



Aficio™

3228C/3235C/3245C

Operating Instructions Copy Reference



-
- 1** Placing Originals
 - 2** Copying
 - 3** Colour Adjustment/Program
 - 4** Troubleshooting
 - 5** User Tools (Copier / Document Server Features)
 - 6** Specifications

Introduction

This manual contains detailed instructions and notes on the operation and use of this machine. For your safety and benefit, read this manual carefully before using the machine. Keep this manual in a handy place for quick reference.

Important

Contents of this manual are subject to change without prior notice. In no event will the company be liable for direct, indirect, special, incidental, or consequential damages as a result of handling or operating the machine.



Notes

Some illustrations in this manual might be slightly different from the machine.

Certain options might not be available in some countries. For details, please contact your local dealer.



Caution:

Use of controls or adjustments or performance of procedures other than those specified in this manual might result in hazardous radiation exposure.

Notes:

The model names of the machines do not appear in the following pages. Check the type of your machine before reading this manual. (For details, see P.3 “*Machine Types*”.)

- Type 1: Aficio 3228C
- Type 2: Aficio 3235C
- Type 3: Aficio 3245C

Certain types might not be available in some countries. For details, please contact your local dealer.

Two kinds of size notation are employed in this manual. With this machine refer to the metric version.

For good copy quality, Ricoh recommends that you use genuine Ricoh toner.

Ricoh shall not be responsible for any damage or expense that might result from the use of parts other than genuine Ricoh parts with your Ricoh office products.

Power Source

220–240V, 50/60Hz, 7A or more

Please be sure to connect the power cord to a power source as shown above. For details about power source, see “Power Connection” in the General Settings Guide.

Manuals for This Machine

The following manuals describe the operational procedures of this machine. For particular functions, see the relevant parts of the manual.

Note

- Manuals provided are specific to machine type.
- Adobe Acrobat Reader/Adobe Reader is necessary to view the manuals as a PDF file.
- Two CD-ROMs are provided:
 - CD-ROM 1 “Operating Instructions”
 - CD-ROM 2 “Scanner Driver and Document Management Utility”

◆ **General Settings Guide**

Provides an overview of the machine and describes System Settings (such as Tray Paper Settings), Document Server functions, and troubleshooting. Refer to this manual for Address Book procedures such as registering fax numbers, e-mail addresses, and user codes.

◆ **Security Reference**

This manual is for administrators of this machine. It describes security functions that the administrators can use to protect data from being tampered, or prevent the machine from unauthorized use. Also refer to this manual for the procedures for registering administrators, as well as setting user and administrator authentication.

◆ **Network Guide (PDF file - CD-ROM1)**

Provides information about configuring and operating the printer in a network environment or using software. This manual covers all models, and therefore contains functions and settings that may not be available for your model. Images, illustrations, functions, and supported operating systems may differ from those of your model.

◆ **Copy Reference (this manual)**

Describes operations, functions, and troubleshooting for the machine's copier function.

◆ **Facsimile Reference <Basic Features>**

Describes operations, functions, and troubleshooting for the machine's facsimile function.

◆ **Facsimile Reference <Advanced Features>**

Describes advanced facsimile functions such as line settings and procedures for registering IDs.

◆ **Printer Reference**

Describes system settings, operations, functions, and troubleshooting for the machine's printer function.

❖ **Scanner Reference (PDF file - CD-ROM1)**

Describes operations, functions, and troubleshooting for the machine's scanner function.

❖ **Manuals for DeskTopBinder Lite**

DeskTopBinder Lite is a utility included on the CD-ROM labeled "Scanner Driver and Document Management Utility".

- DeskTopBinder Lite Setup Guide (PDF file - CD-ROM2)
Describes installation of, and the operating environment for DeskTopBinder Lite in detail. This guide can be displayed from the **[Setup]** display when DeskTopBinder Lite is installed.
- DeskTopBinder Introduction Guide (PDF file - CD-ROM2)
Describes operations of DeskTopBinder Lite and provides an overview of its functions. This guide is added to the **[Start]** menu when DeskTopBinder Lite is installed.
- Auto Document Link Guide (PDF file - CD-ROM2)
Describes operations and functions of Auto Document Link installed with DeskTopBinder Lite. This guide is added to the **[Start]** menu when DeskTopBinder Lite is installed.

❖ **Other manuals**

- PS3 Supplement (PDF file - CD-ROM1)
- Unix Supplement (Available from an authorized dealer, or as a PDF file on our Web site.)

What You Can Do with This Machine

<Colour Functions/Colour Adjustments>

Colour Copying (see p.28)

You can switch the colour copy mode depending on the type of originals used and the desired finish.

Full Colour Copy (see p.28)

Copies using four colours: yellow, magenta, cyan and black.



Black/White Copy (see p.28)

Copies in black and white, even when the original is in colour.



Single Colour Copy (see p.28)

Copies in the designated colour.

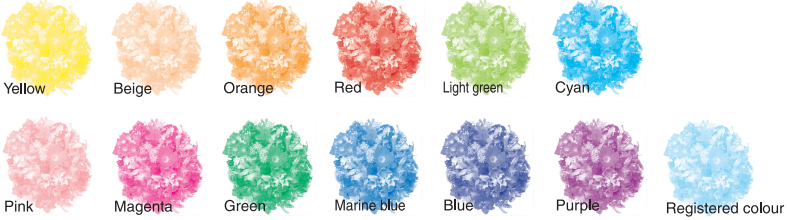

2-Colour Copy (see p.28)

Colour: Copies using 2 registered colours.

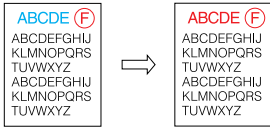

Black/Red: Copies the red part of the original in red, and copies all other areas in black and white.

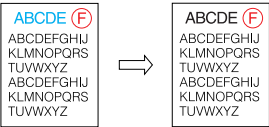

GCM0022e

Colour Copying (see p.28)

Convert Colours (see p.29)

Copies by changing a specific colour in the original to another colour.

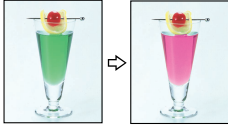

Erase Specified Colour (see p.30)

Copies by deleting a specific colour in the original.

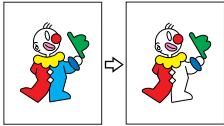

Colour Background (see p.31)

Copies by adding a colour to the whole page.

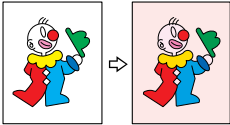

Stamping on Copies (see p.69)

Copies with the date, page numbers, etc. The stamp colour can be yellow, red, cyan, magenta, green, blue, and black.

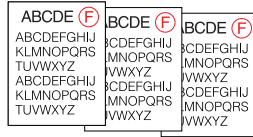
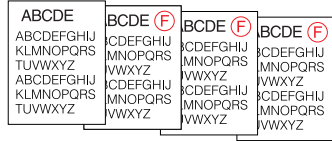

Printed inserts types:

- Background Numbering (p.69)
- Preset Stamp (p.70)
- User Stamp (p.71)
- Date Stamp (p.74)
- Page Numbering (p.75)

Adjusting Colours (see p.87)

Primary Colours

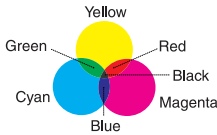

Colours can be created by combining the 3 primary colours: yellow, magenta and cyan. Black can be made by combining yellow, magenta and cyan, however, as there might be some slight differences, "black" will be expressed using a black toner.

Adjust Colour (see p.87)

Adjusts the specific colours (yellow, red, magenta, blue, cyan and green) by mixing them with adjacent colours in the colour circle.

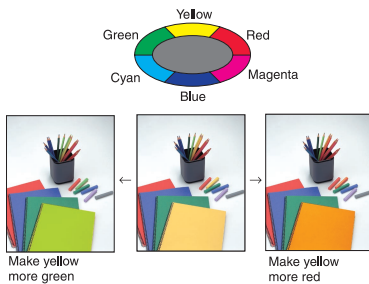

Colour Balance (see p.88)

Adjusts the overall colour tone of copies.

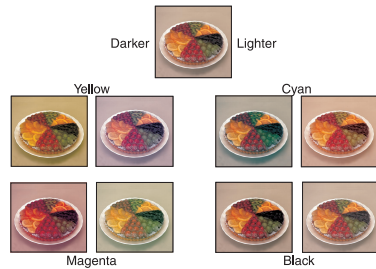

Adjusting Images (see p.90)

Sharp/Soft (see p.90)

Adjusts the outline of the image.

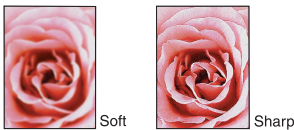

Background Density (see p.91)

Adjusts the background density of the image.



Contrast (see p.90)

Adjusts the shades of the image.



Other Adjustments (see p.91)

- ◆ Adjust U.C.R (see p.91)
- ◆ Text/Photo Sensitivity (see p.91)
- ◆ A.C.S. Sensitivity (see p.123)
- ◆ Colour Sensitivity (see p.123)

What You Can Do with This Machine

Functions differ depending on machine type and options. See p.4 “Functions Requiring Optional Configurations”.

Types of Duplex Copies

● 1-sided 2 Pages → 2-sided 1 Page (see p.53)
 " ❖ 1 Sided → 2 Sided"

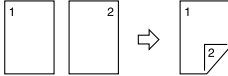

● 2-sided 1 Page → 2-sided 1 Page (see p.53)
 " ❖ 2 Sided → 2 Sided"

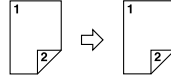

● 1-sided 4 Pages → 2-sided 1 Page (see p.56)
 " ❖ 1 Sided 4 Pages → Combine 2 Side"

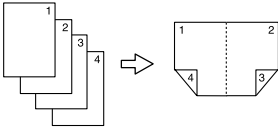

● 2-sided 2 Pages → 2-sided 1 Page (see p.57)
 " ❖ 2 Sided 4 Pages → Combine 2 Side"

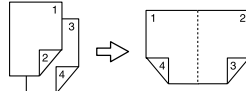

● 1-sided 8 Pages → 2-sided 1 Page (see p.56)
 " ❖ 1 Sided 8 Pages → Combine 2 Side"

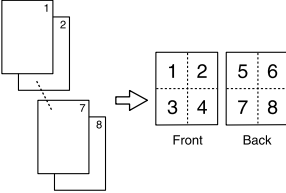

● 2-sided 4 Pages → 2-sided 1 Page (see p.57)
 " ❖ 2 Sided 8 Pages → Combine 2 Side"

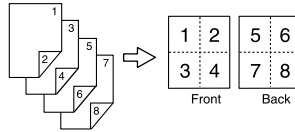

● 1-sided 16 Pages → 2-sided 1 Page (see p.57)
 " ❖ 1 Sided 16 Pages → Combine 2 Side"

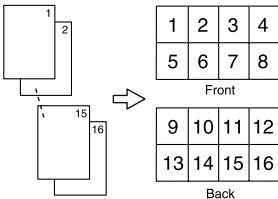

● 2-sided 8 Pages → 2-sided 1 Page (see p.57)
 " ❖ 2 Sided 16 Pages → Combine 2 Side"

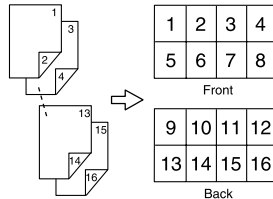

● Bound Originals → 2-sided Pages (see p.58)
 " ❖ Book → 2 Sided"

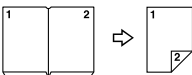

● Front/Back Bound Originals → 2-sided Pages (see p.59)
 " ❖ Front & Back → 2 Sided"

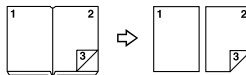

Copying Book Originals

● 1-sided 4 Pages → Booklet (⇒ P.60 " ❖ 1 Sided → Booklet")

Open to Left

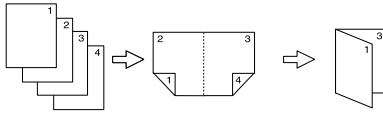

Open to Right

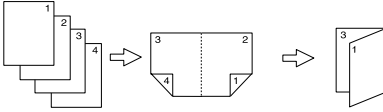

● 2-sided 2 Pages → Booklet (⇒ P.60 " ❖ 2 Sided → Booklet")

Open to Left

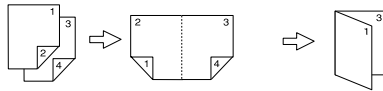

Open to Right

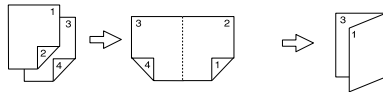

● 1-sided → Magazine (⇒ P.60 " ❖ 1 Sided → Magazine")

Open to Left

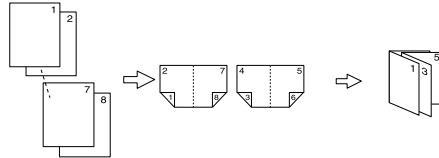

Open to Right

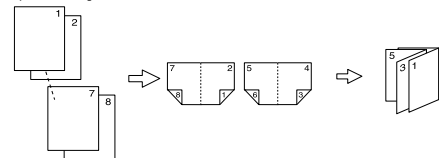

● 2-sided → Magazine (⇒ P.61 " ❖ 2 Sided → Magazine")

Open to Left

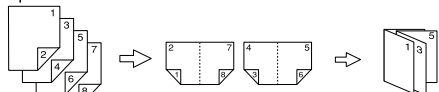

Open to Right

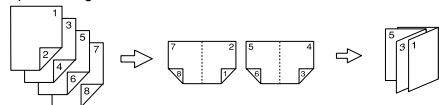

Combining Multiple Pages onto a Single Page (see p.55 "One-Sided Combine")

● 1-sided 2 Pages → 1-sided 1 Page

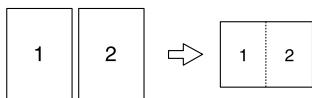

● 2-sided 1 Page → 1-sided 1 Page

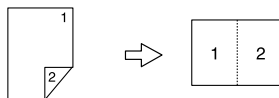

● 1-sided 4 Pages → 1-sided 1 Page

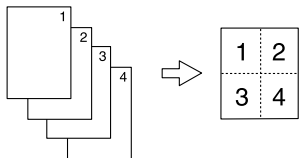

● 2-sided 2 Pages → 1-sided 1 Page

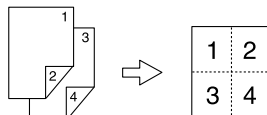

● 1-sided 8 Pages → 1-sided 1 Page

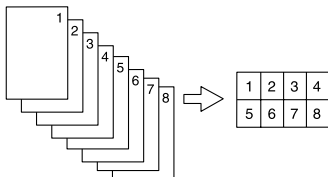

● 2-sided 4 Pages → 1-sided 1 Page

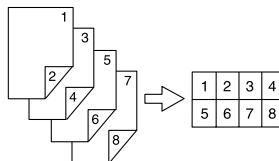

Copying Originals Such as Books (see p.58 "Series Copies")

● Bound Originals → 1-sided Pages

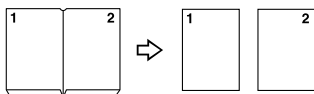

Copying 2-Sided Pages onto 1-Sided Pages (see p.53 "2 Sided → 1 Sided")

● 2-sided 1 Page → 1-sided 2 Pages

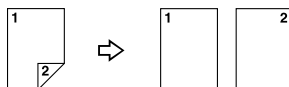

● Bound Originals → 2-sided Pages

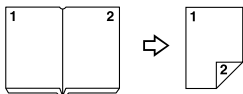

Copying onto Envelopes (see p.26)

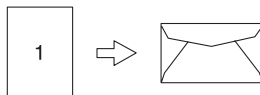

● Front/Back Bound Originals → 2-sided Pages

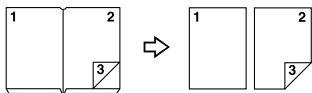

TABLE OF CONTENTS

- Manuals for This Machine i
- What You Can Do with This Machine <Colour Functions/Colour Adjustments>... iii
- What You Can Do with This Machine vi
- Notice 1
- How to Read This Manual 2
- Machine Types 3
- Functions Requiring Optional Configurations 4
- Control Panel 5
 - Display Panel 7

1. Placing Originals

- Originals 9
 - Sizes and Weights of Recommended Originals 9
 - Sizes Detectable by Auto Paper Select 10
 - Missing Image Area 12
- Placing Originals 13
 - Original Orientation 13
 - Placing Originals on the Exposure Glass 14
 - Placing Originals in the Auto Document Feeder 15

2. Copying

- Basic Procedure 19
 - Interrupt Copy 20
 - Left Original Beeper 20
 - Job Preset 21
- Copying from the Bypass Tray 22
 - When copying onto OHP Transparencies or Thick Paper 24
 - When Copying on the Back Side of the Paper 25
 - When Copying onto Envelopes 26
- Making A3, 11" x 17" Full Bleed Copies 27
- Colour Functions 28
 - Selecting a Colour Mode 28
 - Convert Colours 29
 - Erase Colour 30
 - Colour Background 31
- Copier Functions 32
 - Adjusting Copy Image Density 32
 - Selecting the Original Type 33
 - Selecting Copy Paper 34
 - Preset Reduce/Enlarge 37
 - Zoom 38
 - Auto Reduce / Enlarge 38
 - Size Magnification 39
 - Directional Magnification (%) 40
 - Directional Size Magnification (mm) 41
 - Sort 42
 - Stack 44

Staple	45
Punch	49
Duplex	53
1 Sided Combine.....	55
2 Sided Combine.....	56
Series Copies.....	58
Copying Book Originals.....	60
Image Repeat.....	62
Double Copies.....	63
Centring.....	64
Positive / Negative	65
Mirror	65
Erase	66
Margin Adjustment	68
Background Numbering	69
Preset Stamp	70
User Stamp	71
Date Stamp	74
Page Numbering	75
Covers.....	79
Designate	80
Chapter	81
Slip Sheets	82
Storing Data in the Document Server	83
Programs	85
Storing a Program.....	85
Changing a stored program	86
Deleting a Program	86
Recalling a Program.....	86
3. Colour Adjustment/Program	
<hr/>	
Colour Adjustment.....	87
Colour Balance.....	88
Colour Balance Program.....	88
Image Adjustment.....	90
User Colour	92
Adjusting Colours Based on the Selected Colour	92
Mixing Colours Manually with the Number Keys	93
Deleting User Colours	94
Sampling the User Colours	94
4. Troubleshooting	
<hr/>	
If Your Machine Does Not Operate As You Want.....	95
When a Message Is Displayed.....	95
If You Cannot Make Clear Copies.....	97
If You Cannot Make Copies As You Want	98
When Memory Is Full	101

5. User Tools (Copier / Document Server Features)

User Tools Menu (Copier / Document Server Features)	103
Accessing User Tools (Copier / Document Server Features)	110
Changing Default Settings	110
Exiting User Tools	110
Settings You Can Change with User Tools	111
General Features P. ¹ / ₅	111
General Features P. ² / ₅	112
General Features P. ³ / ₅	113
General Features P. ⁴ / ₅	113
General Features P. ⁵ / ₅	113
Reproduction Ratio P. ¹ / ₂	114
Reproduction Ratio P. ² / ₂	114
Edit P. ¹ / ₃	115
Edit P. ² / ₃	116
Edit P. ³ / ₃	117
Stamp	119
Input/Output	122
Adjust Colour Image.....	123
Administrator Tools	124

6. Specifications

Combination Chart	125
Supplementary Specifications	127
INDEX	139

Notice

Do not copy or print any item for which reproduction is prohibited by law.

Copying or printing the following items is generally prohibited by local law:

bank notes, revenue stamps, bonds, stock certificates, bank drafts, checks, passports, driver's licenses.

The preceding list is meant as a guide only and is not inclusive. We assume no responsibility for its completeness or accuracy. If you have any questions concerning the legality of copying or printing certain items, consult with your legal advisor.

The colour samples in this manual may differ slightly from the colours of actual copies.

Colours on colour keys or the colour circle may differ slightly from the colours of actual copies.

This machine is equipped with a function that prevents making counterfeit bank bills. Due to this function the original images similar to bank bills may not be copied properly.

How to Read This Manual

Symbols

This manual uses the following symbols:

WARNING:

This symbol indicates a potentially hazardous situation that might result in death or serious injury if you misuse the machine by not following the instructions under this symbol. Be sure to read the instructions, all of which are included in the Safety Information section in the General Settings Guide.

CAUTION:

This symbol indicates a potentially hazardous situation that might result in minor or moderate injury or property damage that does not involve personal injury when you misuse the machine without following the instructions under this symbol. Be sure to read the instructions, all of which are included in the Safety Information section in the General Settings Guide.

- WARNINGS and CAUTIONS are notes for your safety.

Important

If these instructions are not followed, paper might misfeed, originals might be damaged, or data might be lost. Be sure to read these instructions.

Preparation

This symbol indicates prior knowledge or preparations are required before operation.

Note

This symbol indicates precautions for operation, or actions to be taken following user error.

Limitation

This symbol indicates numerical limits, functions that cannot be used together, or conditions in which a particular function cannot be used.

Reference

This symbol indicates where further relevant information can be found.

[]

Keys that appear on the machine's display panel.

[]

Keys built into the machine's control panel.

Machine Types

This machine comes in three models which vary by copy speed. To confirm which model you have, see the inside front cover of this manual.

	Type 1	Type 2	Type 3
Copy speed/B&W	28 copies/minute (A4 \square , 8 $\frac{1}{2}$ " \times 11" \square)	35 copies/minute (A4 \square , 8 $\frac{1}{2}$ " \times 11" \square)	45 copies/minute (A4 \square , 8 $\frac{1}{2}$ " \times 11" \square)
Copy speed/Full Colour	24 copies/minute (A4 \square , 8 $\frac{1}{2}$ " \times 11" \square)	28 copies/minute (A4 \square , 8 $\frac{1}{2}$ " \times 11" \square)	35 copies/minute (A4 \square , 8 $\frac{1}{2}$ " \times 11" \square)

Functions Requiring Optional Configurations

Certain functions require special machine configuration and extra options. See the table below.

○ Required options

Function	Batch	SADF	Mixed Size	Shift Sort	Stack	Staple	Staple (Saddle Stitch)	Punch
Auto Document Feeder (ADF)	○	○	○					
2 tray finisher *1				○	○	○		○
Booklet finisher *1				○	○	○	○	○

*1 The paper tray unit is required in order to install the finisher.

Control Panel

This illustration shows the control panel of a machine with options fully installed.

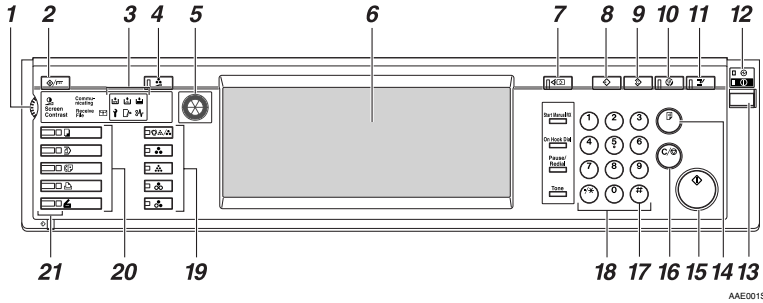

1. Screen Contrast knob

Adjusts display panel brightness.

2. [User Tools/Counter] key

- User Tools
Press to change the defaults and conditions to meet your requirements. See p.103 "User Tools (Copier / Document Server Features)".
- Counter
Press to check or print the counter value. See "Counter", *General Settings Guide*.
- Inquiry
Press to find out where to order expendable supplies and where to call when a malfunction occurs. You can also print these details. See "Inquiry", *General Settings Guide*.

3. Indicators

Display the status of the machine or indicate errors.

- : Add Staple indicator
- : Add Toner indicator
- : Load Paper indicator
- : Service Call indicator
- : Open Cover indicator
- : Misfeed indicator

See "Control Panel", *General Settings Guide*.

4. [Adjust/Program Colour] key

Use this key to adjust and register colours. See p.87 "Colour Adjustment/Program", p.92 "User Colour".

Note

- When image quality is adjusted, the lamp in the **[Adjust/Program Colour]** key is lit.

5. Colour Circle

Refer to this when adjusting colours. See p.87 "Colour Adjustment".

6. Display panel

Displays operation status, error messages, and function menus. See "Display Panel", *General Settings Guide*.

7. [Check Modes] key

Press to check the entered copy job settings.

8. [Program] key

Press to register frequently used settings, or recall registered settings. See p.85 "Programs".

9. [Clear Modes] key

Press to clear the previous copy job settings.

10. **[Energy Saver] key**

Press to switch into and out of Energy Saver mode. See "Saving Energy", *General Settings Guide*.

11. **[Interrupt] key**

Press interrupt a long copy job to make copies during copying or scanning. See p.20 "Interrupt Copy".

12. **Main power indicator and On indicator**

The main power indicator turns on when you turn on the main power. The **On** indicator lights when the power is on.

Important

Do not turn off the main power switch while the **On** indicator is turning on or is flashing. The hard disk may malfunction.

13. **Operation switch**

Press to turn the power on (the **On** indicator turns on). To turn the power off, press again (the **On** indicator turns off).

See "Turning On the Power", *General Settings Guide*.

14. **[Sample Copy] key**

Press to make a single set of copies or prints to check print quality before making multiple sets. See p.43 "Sample copy".

15. **[Start] key**

Press to start copying. Press to start scanning or printing documents stored using the Document Server function.

16. **[Clear/Stop] key**

- Clear
Press to delete a number entered.
- Stop
Press to stop a job in progress.

17. **[#] key**

Press to enter a numerical value.

18. **Number keys**

Press to enter the number of copies and data for a selected function.

19. **Colour Selection Key (Copy mode)**

Switch keys depending on the type of original, or the copying purpose:

[Auto Colour Selection] : 

[Full Colour] : 

[Black & White] : 

[Single Colour] : 

[Two-colour] : 

See p.28 "Colour Functions"

20. **Function keys**

Press to select one of the following functions:

- Copy: 
- Document Server: 
- Facsimile: 
- Printer: 
- Scanner: 



21. **Function status indicators**

Display the status of the above functions:

- Green: active
- Red: interrupted

Display Panel

The function items displayed serve as selector keys. You can select or specify an item by lightly pressing them.

When you select or specify an item on the display panel, it is highlighted like this: . Keys appearing as  cannot be used.

Note

- The following illustration is an example of the panel display when the booklet finisher and 2 tray paper unit installed.

◆ Initial copy display

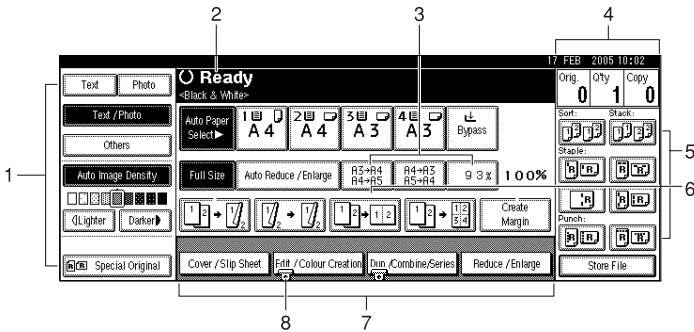

AFZ022S

1. Original function, Image Density and Special Original function.

2. Operational status and messages.

3. You can register up to three frequently used reduce/enlarge ratios other than the fixed reduce/enlarge ratios. See p.114 "Shortcut R/E".

4. Numbers of originals scanned into memory, copies set, and copies made.

5. Sort, Stack, Staple, Punch functions.

6. Displays contents of the Shortcut keys. You can register frequently used functions in these keys. See p.113 "Copy Function Key: F1-F5".

7. Displays available functions. Press a function name to display its menu. For example, press [Reduce / Enlarge] to bring up the Reduce / Enlarge menu.

8. A clip mark indicates the currently selected function.

1. Placing Originals







Originals

Note







- ❑ Highlighter pen colours are difficult to reproduce. Depending on the colour used, they may not come out on copies, or may come out as a different colour.

Sizes and Weights of Recommended Originals

◆ Metric version

Where original is placed	Original size	Original weight
Exposure glass	Up to A3	--
ADF	One-sided originals: A3  - B6 JIS (Japanese Industrial Standard)  	40-128 g/m ²
	Two-sided originals: A3  - A5  	52-105 g/m ²

◆ Inch version

Where original is placed	Original size	Original weight
Exposure glass	Up to 11" × 17"	--
ADF	One-sided originals: 11" × 17"  - 5 ¹ / ₂ " × 8 ¹ / ₂ "  	11-34 lb.
	Two-sided originals: 11" × 17"  - 5 ¹ / ₂ " × 8 ¹ / ₂ "  	14-28 lb.

Note

- ❑ The maximum number of originals that can be placed in the ADF is about 80.
- ❑ The weight range for originals when using the Mixed Size function is 52-81 g/m², 13.8-21.5 lb.

Originals not recommended for the Auto Document Feeder (ADF)

Placing the following types of originals in the ADF can cause paper misfeeds or result in damage to the originals. Place these originals on the exposure glass instead.

- Originals other than those specified on p.9 "Sizes and Weights of Recommended Originals".
- Stapled or clipped originals

1

- Perforated or torn originals
- Curled, folded, or creased originals
- Pasted originals
- Originals with any kind of coating, such as thermal fax paper, art paper, aluminum foil, carbon paper, or conductive paper
- Originals with perforated lines
- Originals with indexes, tags, or other projecting parts
- Sticky originals such as translucent paper
- Thin originals that have low stiffness
- Thick originals such as postcards
- Originals of inappropriate weight
- Bound originals such as books
- Transparent originals such as OHP transparencies or translucent paper











 **Note**

- The original might become dirty if it is written on with a pencil or a similar instrument.

Sizes Detectable by Auto Paper Select

○ : Detectable size × : Undetectable size











◆ Metric version

Size	A3 	B4 JIS 	A4 	B5 JIS 	A5 	B6 JIS 	11" × 17" 	8 ¹ / ₂ " × 14" 	8 ¹ / ₂ " × 11" 	5 ¹ / ₂ " × 8 ¹ / ₂ " 	8 ¹ / ₂ " × 13" 
Location of the original											
Exposure glass	○	○	○	○	×	×	×	×	×	×	○
ADF	○	○	○	○	○	○ ^{*2}	○	×	○	×	○

*1 You can select from 8¹/₂" × 13", 8¹/₄" × 13", 8" × 13" with User Tools (System Settings).

*2 The machine cannot detect two-sided originals of B6 JIS size.

◆ Inch version

Size	A3 	B4 JIS 	A4 	B5 JIS 	A5 	11" × 17" 	8 ¹ / ₂ " × 14" 	8 ¹ / ₂ " × 11" 	5 ¹ / ₂ " × 8 ¹ / ₂ " 	8 ¹ / ₂ " × 13" 	10" × 14" 
Location of the original											
Exposure glass	×	×	×	×	×	○	○	○	×	×	×
ADF	○	×	○	×	×	○	○	○	○	×	○

◆ Exposure glass

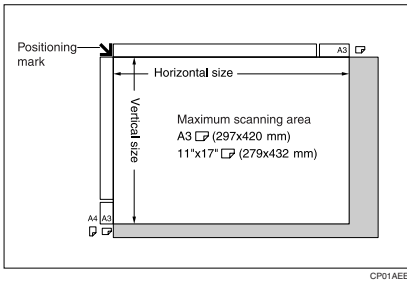

◆ ADF

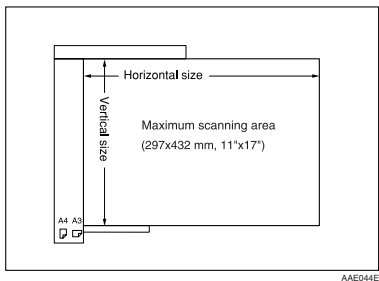

Note

- ❑ When copying custom size originals, make sure you specify the size of the originals. If not, the image may not be copied properly. See p.17 "Placing custom size originals".

Sizes difficult to detect

It is difficult for the machine to automatically detect the sizes of the following types of originals, so select the paper size manually.

- Originals with indexes, tags, or other protrusions
- Transparent originals such as OHP transparencies or translucent paper
- Text or picture dense original
- Originals containing solid images
- Originals containing solid images around their edges

Missing Image Area

Even if you correctly place originals in the ADF or on the exposure glass, margins of a few millimeters on all four sides of the original might not be copied.

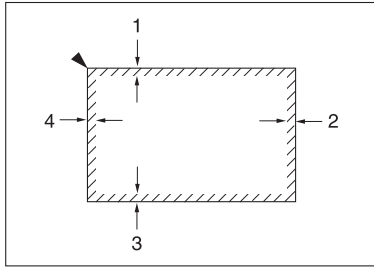

GC GENKZE

1. 0.5 - 4.0 mm, 0"- 0.16"

3. 0.5 - 4.0 mm, 0"- 0.16"

2. 0.5 - 6.0 mm, 0"- 0.24"

4. 1.5 - 5.0 mm, 0.06"- 0.20"

Placing Originals

Note

- Place originals only when all correction fluid and ink has completely dried. Not taking this precaution could dirty the exposure glass, thus resulting in blemished copies.

Reference

For original sizes you can set, see p.9 "Originals".

Original Orientation

This function is useful for copying torn originals or large originals.

You can set the original orientation in the following ways.

◆ Standard orientation

Select this function when original orientation is the same as copy paper orientation.

◆ 90° turn

Use this to copy A3, B4 JIS or 11" x 17" size originals. The machine rotates the copy image by 90°. This is useful for copying large originals using the Staple, Duplex, Combine, or Stamp functions.

For example, to copy A3 or 11" x 17" originals with the Staple function selected:

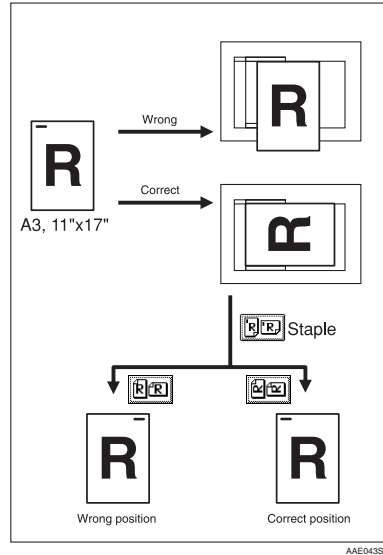

Note

- It is recommended that you use the Original Orientation function with the Auto Paper Select or Preset Reduce/Enlarge function.

1 Press [Special Original].

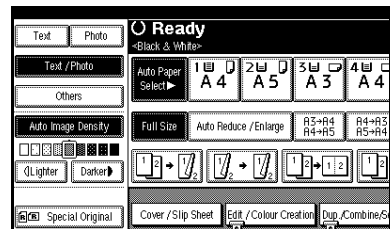

2 Select the original orientation.

Standard orientation

1 Make sure  is selected.

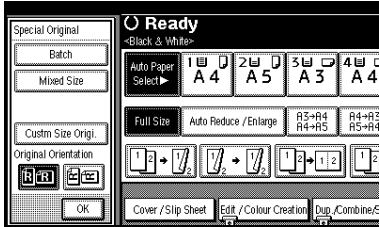

90° turn

1 Place the original in the landscape orientation, and then press .

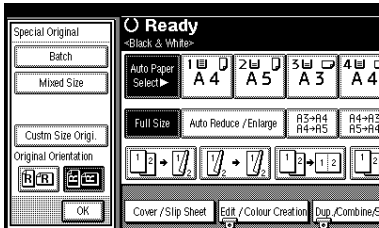

3 Press [OK].

Placing Originals on the Exposure Glass

1 Lift the exposure glass cover or the ADF.

Important

Do not lift the exposure glass cover or the ADF forcefully. Otherwise, the ADF cover might open or be damaged.

Note

Be sure to lift the exposure glass cover or ADF more than 30°. Otherwise, the size of the original might not be detected correctly.

2 Place the original face down on the exposure glass. It should be aligned with the rear left corner.

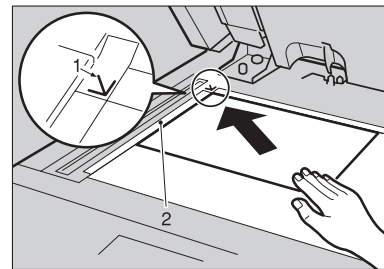

1. Positioning mark

2. Scale

Note

Start with the first page to be copied.

3 Lower the exposure glass cover or ADF.

Placing Originals in the Auto Document Feeder

Settings should be made accordingly in the following situations:

- ❖ **When placing originals consisting of more than 80 pages:**
p.15 "Batch"
- ❖ **When placing originals one by one:**
p.16 "SADF"
- ❖ **When placing originals of the same width but different sizes:**
p.16 "Placing originals of mixed sizes"
- ❖ **When placing custom size originals:**
p.17 "Placing custom size originals"

Note

- Do not stack originals above the limit mark on the side guide of the ADF.
- The last page should be on the bottom.
- Do not place objects on the sensors or cover them with your hands, or the original size may not be detected properly. Also, do not place anything on the exposure glass cover as this could cause a malfunction.

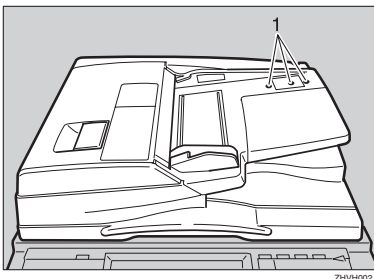

1. Sensors

- 1** Set the document guide to the original size.
- 2** Place the aligned originals face up into the ADF.

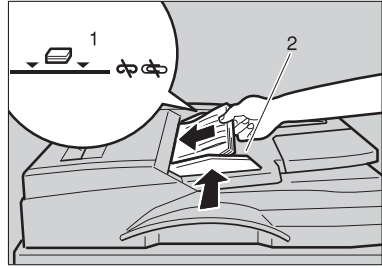

1. Limit mark

2. Document guide

Note

- Straighten any curls in the originals before placing them in the ADF.
- To prevent multiple sheets from being fed at once, fan the originals before placing them in the ADF.
- Place the originals squarely.

Batch

The Batch mode enables you to copy originals of more than 80 pages as a single document, even if you place the originals into the ADF in instalments.

Important

- Place special originals, such as translucent paper, one by one.

1 Press **[Special Original]**.

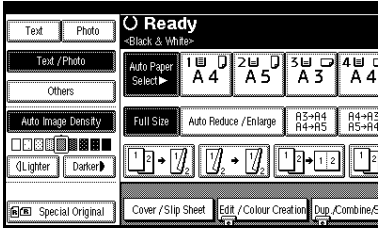

2 Press **[Batch]**, and then press **[OK]**.

Note

- If **[SADF]** is displayed, change the settings. See p.122 “Switch to Batch (SADF)”.

3 Place the first instalment of the originals, and then press the **[Start]** key.

4 After the originals has been fed, place the next instalments.

5 When the Sort, Combine, or Duplex function is set, press the **[#]** key after all originals have been scanned.

6 Press the **[Start]** key.

SADF

In SADF mode, even when an original is placed one page at a time into the ADF, each page is automatically fed as it is placed.

Preparation

To use the SADF function, set the User Tools (Copier / Document Server Features) such that **[SADF]** is displayed when you press **[Special Original]**. See p.122 “Switch to Batch (SADF)”.

Reference

For related default settings, see p.114 “Shortcut R/E”.

1 Press **[Special Original]**.

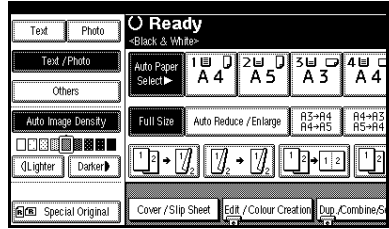

2 Press **[SADF]**, and then press **[OK]**.

3 Place one page of an original, and then press the **[Start]** key.

4 When the machine instructs you to place another original, place the next page.

The second and subsequent pages will feed in automatically without a need to press the **[Start]** key.

Note

- When the Sort, Combine or Duplex function is set, press the **[#]** key after all originals have been scanned.
- You can adjust the time the machine waits before becoming ready for the next original. See p.122 “SADF Auto Reset”.

Placing originals of mixed sizes

When placing different size originals of the same width in the ADF together, the machine automatically checks the sizes of the originals and makes copies.

Note

- When placing same width originals of different sizes in the ADF and making copies without using the Mixed size function, parts of the original image might not be copied, or the paper might jam.

- Copy speed and scanning speed may slow down.
- You can place originals of two different sizes at once.
- Sizes of originals that can be placed together using this function are as follows:

Metric version	A3 <input type="checkbox"/> , B4 JIS <input type="checkbox"/> , A4 <input type="checkbox"/> , B5 JIS <input type="checkbox"/>
Inch version	11" × 17" <input type="checkbox"/> , 8 ¹ / ₂ " × 14" <input type="checkbox"/> , 8 ¹ / ₂ " × 11" <input type="checkbox"/>

1 Press [Special Original].

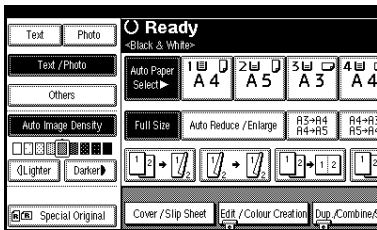

2 Press [Mixed Sizes], and then press [OK].

3 Align the rear and left edges of the originals as shown.

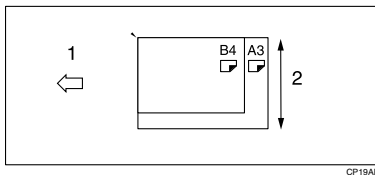

CP19AE

1. Place the originals into the ADF
2. Vertical size
- 4 Adjust the guide to the size of the widest original.
- 5 Place the aligned originals face up in the ADF.
- 6 Press the [Start] key.

Placing custom size originals

When placing custom size originals, specify the size of the originals.

Note

- Paper with a vertical size of 128–297 mm (5.1"–11.6") and a horizontal size of 128–432 mm (5.1"–17") can be placed with this function.

1 Press [Special Original].

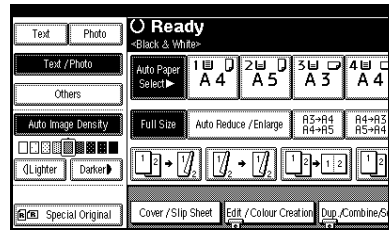

2 Press [Custm Size Ori.].

3 Enter the horizontal size of the original using the number keys, and then press [#].

Note

- If you make a mistake, press [Clear] or the [Clear/Stop] key, and then enter the value again.

4 Enter the vertical size of the original using the number keys, and then press [#].

5 Press [OK].

6 Place the originals, and then press the [Start] key.

2. Copying

Basic Procedure

Preparation

When User Code Authentication is set, the screen for entering a user code will be displayed. Enter your user code using the number keys, and then press the **[#]** key. For user codes, see "Authentication Information", *General Settings Guide*.

When Basic Authentication, Windows Authentication, or LDAP Authentication is set, the authentication screen will be displayed. Enter your login user name and user password, and then press **[Login]**. See "When the Authentication Screen is Displayed", *General Settings Guide*.

1 Make sure "Ready" is shown on the display.

If any other function is displayed, press the **[Copy]** key.

Initial copy display

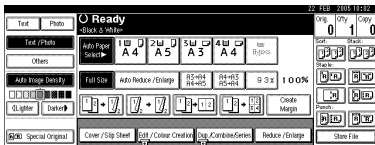

2 Make sure no previous settings remain.

Note

- When there are previous settings remaining, press the **[Clear Modes]** key before entering your settings.

3 Place the originals.

Reference

p.13 "Placing Originals"

4 Make the necessary settings.

5 Enter the required number of copies using the number keys.

Note

- The maximum copy quantity that can be set is 999.

6 Press the **[Start]** key.

Copying starts.

Note

- When placing originals on the exposure glass, press the **[#]** key after all the originals are scanned.
- Copies are delivered face down.

Important

- When Basic Authentication, Windows Authentication, or LDAP Authentication is set, always log off when you have finished using the machine to prevent unauthorized users from using the machine.

How to operate

- ❖ **To stop the machine during a multi-copy run**
Press the **[Clear/Stop]** key.
- ❖ **To return the machine to the initial condition after copying**
Press the **[Clear Modes]** key.
- ❖ **When clearing entered values**
Press the **[Clear/Stop]** key or **[Clear]** on the display.
- ❖ **To check the settings**
Press the **[Check Modes]** key.

Interrupt Copy

Use this function to interrupt a long copy job to make urgently needed copies.

Limitation

- You cannot use Interrupt Copy when fax originals are being scanned.

1 Press the **[Interrupt]** key.

The **Interrupt** indicator lights.

When scanning is interrupted

- 1** **Remove the originals that were being copied, and then place the originals you want to copy.**
- 2** **Press the **[Start]** key.**
Copying starts.
- 3** **When copying is complete, remove the originals and copies.**
- 4** **Press the **[Interrupt]** key again.**
The **Interrupt** indicator turns off.

5 When the display prompts you to do so, place the former set of originals again.

6 Press the **[Start]** key.

Note

- The previous copy job's settings are restored and the machine continues copying from where it left off.

When the machine continues copying

1 Place the originals you want to copy.

2 Press the **[Start]** key.

The machine stops the previous job and starts copying the new originals.

3 When copying is complete, remove originals and copies.

4 Press the **[Interrupt]** key again.

The **Interrupt** indicator goes out.

The previous copy job's settings are restored and the machine continues copying from where it left off.

Left Original Beeper

The beeper sounds and an error message is displayed if you leave originals on the exposure glass after copying.

Note

- See p.112 "Tone: Original remains".

Job Preset

You can make settings for the next copy job while copying is in progress.

If a long copy job is in progress and you do not want to wait for it to finish, you can use this function to make settings for the next copy job in advance. When the current copy job finishes, the next job begins automatically.

- 1 Press **[NextJob]** when "Copying..." is displayed.

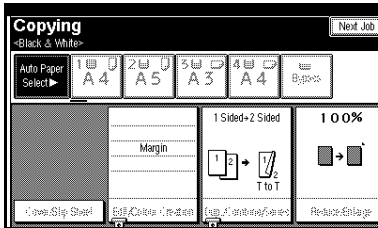

- 2 Make settings for the next copy job.

- 3 Place the originals in the ADF, and then press the **[Start]** key.

All originals are scanned.

- 4 Press **[To "Printing"]**.

Returns to the initial copy display.

After the current copy job, the next job starts automatically.

Note

- You can switch the display to the current copy job by pressing **[To "Printing"]**. You can switch the display to the preset job by pressing **[To "Reserving"]**.

Copying from the Bypass Tray

Use the bypass tray to copy onto special paper such as OHP transparencies, thick paper, thin paper, and copy paper that cannot be loaded in the paper trays.

Preparation

When copying from the bypass tray, select **[1 Sided]** for copying in **[Dup./Combine/Series]** (for example **[1 Sided]** → **[1 Sided]**).

Note

- ❑ The machine can automatically detect the following sizes as standard size copy paper:

Metric version	A3, A4, A5, B4 JIS, B5 JIS, B6 JIS
Inch version	11" × 17", 8 1/2" × 11", 5 1/2" × 8 1/2"

- ❑ Select the paper size when making horizontal copies.
- ❑ If you use non-standard size copy paper or special paper, you should input its vertical and horizontal dimensions directly. See p.17 "Placing custom size originals". The sizes you can input are as follows:

Metric version	<ul style="list-style-type: none"> • Vertical: 90.0 – 305.0 mm • Horizontal: 148.0 – 457.2 mm
Inch version	<ul style="list-style-type: none"> • Vertical: 3.55" – 12.00" • Horizontal: 5.83" – 18.00"

- ❑ When copying onto OHP transparencies or paper heavier than 128 g/m² (about 34 lb.), you need to specify the paper type. See p.24 "When copying onto OHP Transparencies or Thick Paper".
- ❑ You must specify the paper size when using paper (tracing paper, etc.) of less than 59g/m² thickness.

- ❑ The maximum number of sheets you can load at one time depends on paper type. The maximum number of sheets should not exceed the upper limit.
- ❑ Some kinds of envelopes might cause misfeed and wrinkle. If this happens, push down the fusing unit's green lever. See p.26 "When Copying onto Envelopes". Also, be sure to place the front face of the envelope downward.
- ❑ Paper of 433 mm in length, or larger, is likely to jam, crease, or not feed in properly.
- ❑ The print speed when copying onto OHP transparencies or thick paper is slower than when copying onto plain paper.

1 Open the bypass tray.

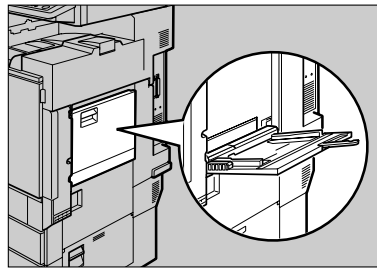

ZKWH120J

- 2 Insert the paper with the side you want to copy facing up until you hear the beep, and align the paper guide to the paper size.

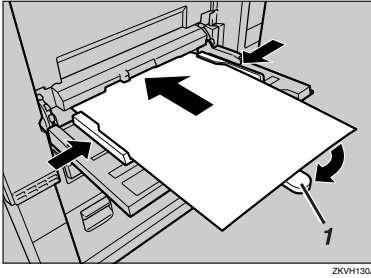

ZKVH130J

1: Extender

Important

- If the guides are not flush against the copy paper, image skewing or misfeeds might occur.

Note

- Do not stack paper over the limit mark, if you do image skewing or misfeeds might occur.
- Swing out the extender to support paper sizes larger than A4 , $8\frac{1}{2}'' \times 11''$.
- Fan paper to get air between the sheets and avoid multi-sheet feeds.

- 3 Select the paper type and size.

Note

- When copying onto OHP transparencies or thick paper, see p.24 "When copying onto OHP Transparencies or Thick Paper".
- When copying on the back side of paper, see p.25 "When Copying on the Back Side of the Paper".

When copying onto standard size paper

- 1 Press the [#] key.

The "Bypass Tray Paper" screen is displayed.

- 2 Press [Select Size].

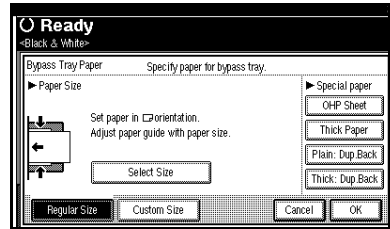

- 3 Select the paper size.

- 4 Press [OK] twice.

When copying onto custom size paper

- 1 Press the [#] key.

- 2 Press [Custom Size].

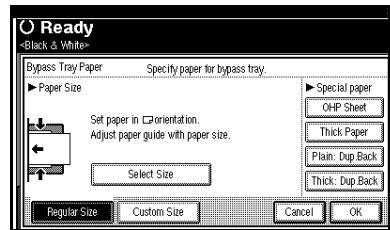

- 3 Enter the vertical size of the paper using the number keys, and then press [#].

- 4 Enter the horizontal size of the paper using the number keys, and then press [#].

Note

- If [Horiz.] is not highlighted, press [Horiz.].

- To register the custom size entered, press **[Program]**, and then press **[Exit]**.

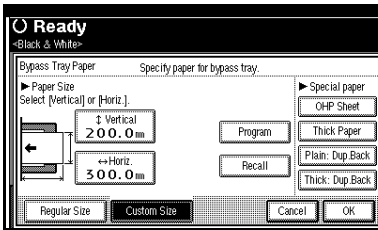

5 Press **[OK]**.

4 Place the originals, and then press the **[Start]** key.

Note

- When the Sort function is set, press the **[#]** key after all originals have been scanned.

5 When your copy job is finished, press the **[Clear Modes]** key to clear the settings.

When copying onto OHP Transparencies or Thick Paper

To make copies onto OHP transparencies or thick paper, you need to specify the paper type and size. See p.23 “When copying onto standard size paper”, p.23 “When copying onto custom size paper”.

Important

- We recommend you use OHP transparencies made by this manufacturer.

Note

- Paper will be delivered to external tray when copying onto OHP transparencies or thick paper from the bypass tray, even if you have specified not to use the external tray as the output tray.

1 Open the bypass tray, and then adjust the guides to the paper size.

2 Gently insert the OHP transparencies or thick paper face up until the beeper sounds.

Important

- When copying onto OHP transparencies, make sure that the cut positions are set properly.
- To avoid paper misfeeds, fan the paper before loading it in the tray.

3 Press the **[#]** key.

4 Select **[OHP Sheet]** or **[Thick Paper]**.

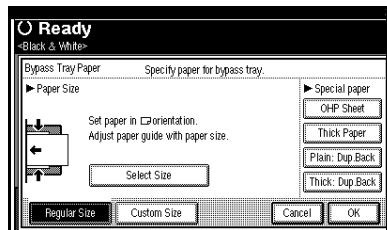

5 Select the paper size.

6 Press **[OK]** twice.

7 Place the originals, and then press the **[Start]** key.

Important

- When copying onto OHP transparencies, remove copied sheets one by one.

8 When your copy job is finished, press the **[Clear Modes]** key to clear the settings.

When Copying on the Back Side of the Paper

Using the bypass tray, you can make copies on the back of paper which has already been copied on the other side.

Note

- Do not use paper that has already been copied onto by other equipment.
- Copies made on the back side of the paper should be originals with very little image area, such as text originals.
- If the paper is curled, straighten it out, and then insert it. If the paper is not straightened out, it can cause paper jams.

Original and paper orientations

Pay attention to the orientation of paper and originals.

Top to top

Orientation of placing originals	Placing originals on the Bypass Tray	Orientation of copying
<p>Exposure glass</p>		
<p>Optional document feeder (ADF)</p>		
<p>Exposure glass</p>		
<p>Optional document feeder (ADF)</p>		

GCMRY03E

Top to bottom

Orientation of placing originals	Placing originals on the Bypass Tray	Orientation of copying
<p>Exposure glass</p>		
<p>Optional document feeder (ADF)</p>		
<p>Exposure glass</p>		
<p>Optional document feeder (ADF)</p>		

GCMRY04E

- 1 Open the bypass tray, and then adjust the guides to the paper size.
- 2 Gently insert the copied paper with the side you want to copy face up until the beeper sounds.
- 3 Press the [#] key.
- 4 Select the paper size.
- 5 Select [Plain: Dup.Back] or [Thick: Dup.Back].

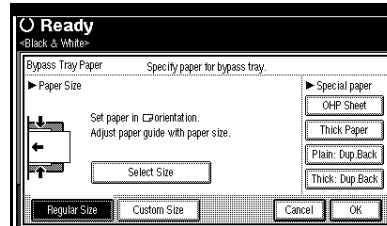

- 6 Press [OK] twice.
- 7 Place the originals, and then press the [Start] key.

When Copying onto Envelopes

Note

- ❑ When placing an original on the exposure glass, place the original with the bottom line aligned to the left scale.
- ❑ When placing originals in the ADF, place the originals with the bottom line inserted in the ADF.
- ❑ When inserting envelopes, be sure to unfold the flaps and position them opposite to the paper feed direction.

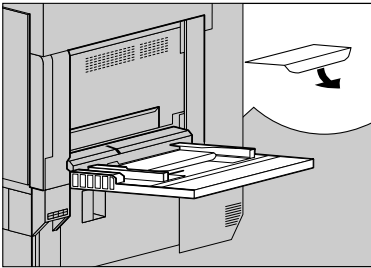

AAE0145

Reference

For more information about supported size of envelope, see “Recommended Paper Sizes and Types”, *General Settings Guide*.

- 1** Open the bypass tray, and then insert the envelopes with the side you want to copy face up until the beeper sounds.
- 2** Align the paper guide to the envelope side.
- 3** Press the [#] key.
- 4** Select the paper size, and then select [Thick Paper] for the paper type.
- 5** Press [OK].

6 Place the originals, and then press the [Start] key.

7 When your copy job is finished, press the [Clear Modes] key to clear the settings.

Making A3, 11" × 17" Full Bleed Copies

You can make A3, 11" × 17" full bleed copies with 12" × 18" paper. This is useful for making A3, 11" × 17" size copies with a coloured background (e.g. catalogues).

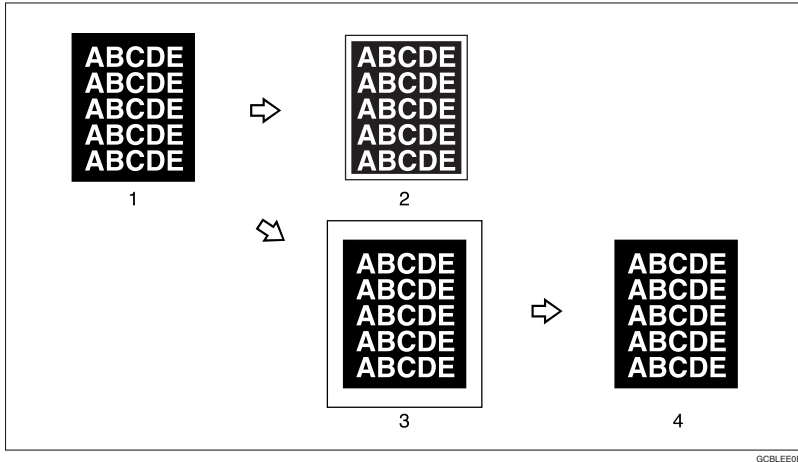

1. A3, 11" × 17" size Original

2. In standard copy mode, margins appear on copies

3. 12" × 18" Full Bleed Copy

4. Cut around the margins to produce a full image

Note

- You can use this function with 12" × 18" paper.
- When A3, 11" × 17" full bleed copying is made, the original image is copied onto the centre.
- You can only use this function with the bypass tray.

Colour Functions

Selecting a Colour Mode

Select a Colour mode that best suits your originals and copying requirements.

Reference

For colour images, see p.iii “What You Can Do with This Machine <Colour Functions/Colour Adjustments>”

The following basic functions are explained in this section.

◆ Auto Colour Selection

Judges the colour of the original automatically, and copies either in full colour or black/white.

◆ Full Colour Copy

Copies by overlaying yellow, magenta, cyan, and black.

◆ Black/White Copy

Copies in black regardless of the colour of the original.

◆ Single Colour Copy

Copies in one designated colour.

Note

- Yellow, magenta, and cyan will be copied with one toner colour, but beige, orange, red, light green, pink, green, marine blue, blue and purple uses 2 toner colours to copy.

◆ Two Colour Copy

- Two Colour Copy (Normal)
Copies black and other parts in two specified colours.

Note

- You can select from basic colours and registered colours.

- Two Colour Copy (Red & Black)
Copies the red part in red, and all the other parts in black or white.

Note

- When the width of the colour is set to “Wider”, colours close to orange and purple will be recognized as red. This adjustment will be valid in “Erase Colour” and “Convert Colours”. See p.123 “Colour Sensitivity”

1 Select the type of colour key.

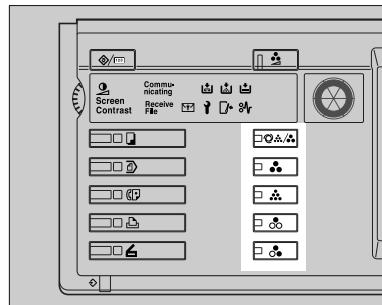

AFZ026S

When the **[Single Colour]** key is selected

1 Select designation method of colour ([Basic Colour], [User Colour]).

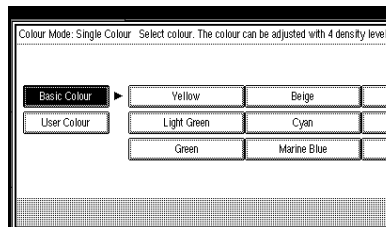

2 Select the colour, and then press [OK].

Note

- When copied using the registered colour, the original will be copied lighter than the registered colour.
- Press [**Lighter**] or [**Darker**], and you can adjust the density in 4 steps.

When the [**Two-colour**] key is selected

- 1** Select either [**Two-colour**] or [**Red & Black**].

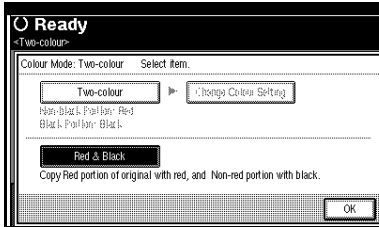

When [**Red & Black**] is pressed

- 1** Press [**OK**].

When [**Two-colour**] is pressed

- 1** Press [**Change Colour Setting**].
- 2** Press [**Black Portion**], and then select the colour to be replaced by black.

Note

- When selecting a colour from the user colours, press [**User Colour**].

- 3** Press [**Non-black Portion**], and then select the colour to replace the black colour of the original.

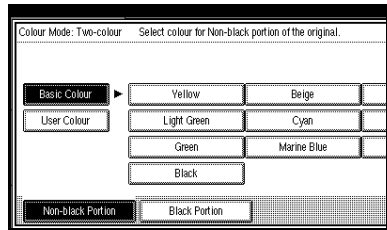

- 4** Press [**OK**] twice.

Convert Colours

Copies by changing the colour in the original to a different colour.

Note

- It is possible to specify up to 4 colours.
- The width of the colour to be converted can be adjusted in 5 levels. If the colour width is set to "Wider" and red has been specified, colours which are close to magenta or orange, will also be converted. The colour width can be adjusted in the "User Tools". See p.123 "Colour Sensitivity"

- 1** Press the [**Full Colour**] key.
- 2** Press [**Edit / Colour Creation**].

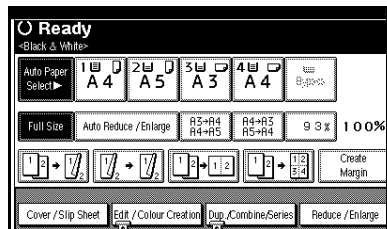

- 3** Press [**Colour Creation**].
- 4** Press [**Convert Colour**].

- 5 Select any one item from [Conversion 1] to [Conversion 4].

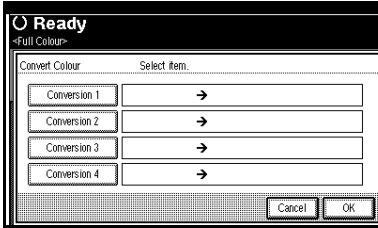

- 6 Select the colour to be converted.

- 7 Select the new colour to be converted.

Note

- You can adjust the density of each colour in 4 levels.
- When you want to change the converted colour, press from [Conversion 1] to [Conversion 4] and make the selection again.
- When changing between more than two colours, repeat steps 5 to 7.

Selecting from [User Colour]

- 1 Press [User Colour].
- 2 Select from the registered colours, then press [OK].
- 8 After selecting all the colours to be converted, press [OK].
- 9 Press [OK] 3 times.
- 10 Place the originals, and then press the [Start] key.

Erase Colour

You can erase a certain colour in the image of the original.

Note

- It is possible to select up to 4 colours.
- The width of the colour to be deleted can be adjusted in 5 levels. If the colour width is set to "Wider" and red has been specified, colours which are close to magenta or orange, will also be deleted. The colour width can be adjusted in the "User Tools". See p.123 "Colour Sensitivity"

- 1 Press [Edit / Colour Creation].

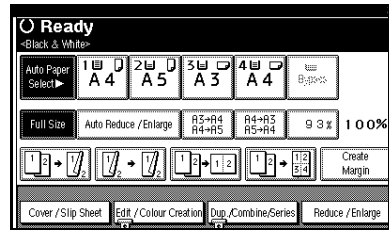

- 2 Press [Colour Creation].
- 3 Press [Erase Colour].
- 4 Select the colour to be erased.

Note

- You can cancel the selection by pressing the selected (highlighted) key.
 - You can erase 4 colours at once.
- 5 Press [OK] after selecting all the colours to be deleted.
 - 6 Press [OK] twice.
 - 7 Place the originals, and then press the [Start] key.

Colour Background

Copies by adding a colour in the whole page.

Note

- Since the Colour Background function overprints the entire original, the colour of the image may change.

1 Press [Edit / Colour Creation].

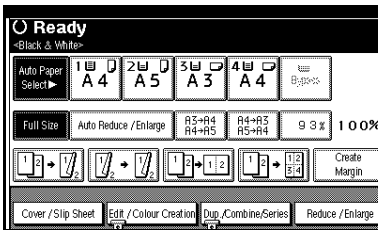

2 Press [Colour Creation].

3 Press [Colour Background].

4 Select the background colour, then press [OK].

Note

- You can adjust the density of each colour in 4 levels.
- You can cancel the selection by pressing the selected (highlighted) key.

Selecting from the [User Colour]

1 Press [User Colour].

2 Select a registered colour, and then press [OK].

5 Press [OK] twice.

6 Place the originals, and then press the [Start] key.

Copier Functions

Adjusting Copy Image Density

There are three types of adjustment available:

- ❖ **Auto Image Density**
The machine automatically adjusts image density.
- ❖ **Manual image density**
You can adjust the general density of the original in nine increments.
- ❖ **Combined auto and manual image density**
Use when copying originals with dirty backgrounds (such as newspapers). You can adjust foreground density while leaving the background unchanged.

Auto image density

- 1 Make sure [Auto Image Density] is selected.

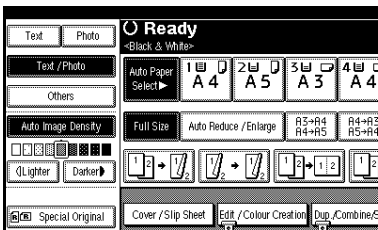

Manual image density

- 1 Press [Auto Image Density] to cancel it.
- 2 Press [Lighter] or [Darker] to adjust image density.

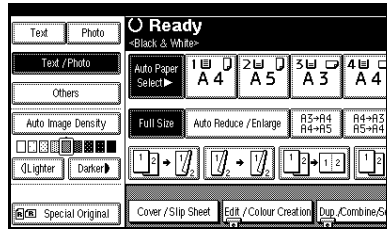

Combined auto and manual image density

- 1 Make sure [Auto Image Density] is selected.
- 2 Press [Lighter] or [Darker] to adjust image density.

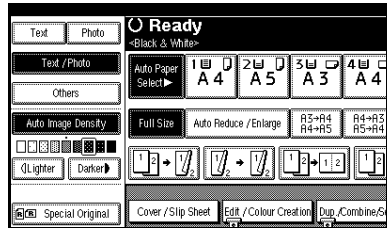

Selecting the Original Type

Select one of the following six types to match originals:

❖ Text

When originals contain only text (no pictures).

❖ Text / Photo

When originals contain photographs or pictures alongside the text.

❖ Photo

When you need to reproduce delicate tones of photographs and pictures.

Note

If you select “Text / Photo” or “Photo” as the original type, select the photo type from among the three options below:

- Glossy Photo
Use when copying developed photographs.
- Printed Photo
Use when copying photographs or pictures that are printed on paper (e.g. magazines).
- Copied Photo
Use when copying copies or originals generated by printers.

❖ Generation Copy

When originals are copies (generation copies), the copy image can be reproduced sharply and clearly.

❖ Pale

When you need to reproduce originals that have lighter lines in pencil, or faintly copied slips. Faint lines are copied with greater clarity.

❖ Map

You can configure the machine to scan Map originals. If “Original Type Display” has been set to “Display” (from Copier / Document Server Features on the User Tools menu), select “Map” from the “Others” menu. If “Original Type Display” has been set to “Hide”, select “Map” from the “Original Type” menu.

Reference

p.111 “Original Type Display”

p.111 “Original Photo Type Priority”

1 Press the appropriate key to select the original type.

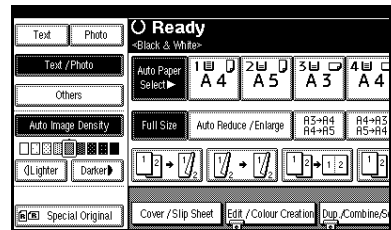

If the original type keys are not displayed

1 Press [Original Type].

2 Select the original type, and then press [OK].

Selecting Copy Paper

There are two ways to select copy paper:

❖ Auto Paper Select

The machine selects a suitable size of copy paper automatically based on original size and reproduction ratio.

❖ Manual Paper Select

Choose the paper you want to copy onto from a paper tray, bypass tray, or Large Capacity Tray (LCT).

Reference

p.11 "Sizes difficult to detect"

p.111 "Paper Display"

Note

- See the following table for copy paper sizes and orientations that can be used with Auto Paper Select (when copying at a ratio of 100%).

❖ Metric version

Where original is placed	Paper size and orientation
Exposure glass	A3☐, B4 JIS☐, A4☐☐, B5 JIS☐☐
ADF	A3☐, B4 JIS☐, A4☐☐, B5 JIS☐☐, A5☐, 11"×17"☐, 8 ¹ / ₂ "×11"☐☐

❖ Inch version

Where original is placed	Paper size and orientation
Exposure glass	11"×17"☐, 8 ¹ / ₂ "×14"☐, 8 ¹ / ₂ "×11"☐☐
ADF	A3☐, A4☐☐, 11"×17"☐, 8 ¹ / ₂ "×14"☐, 8 ¹ / ₂ "×11"☐☐

- Only the paper trays set to **[No Display]** or **[Recycled Paper]** in Paper Type and also set to **[Yes]** in Apply Auto Paper Select can be selected for the Auto Paper Select function. See "Paper Type: Tray 1–4" in "Tray Paper Settings", *General Settings Guide*.
- Auto Paper Select cannot be used if all the paper trays are set to other than **[No Display]** or **[Recycled Paper]**.

Auto Paper Select

- 1 Make sure [Auto Paper Select] is selected.

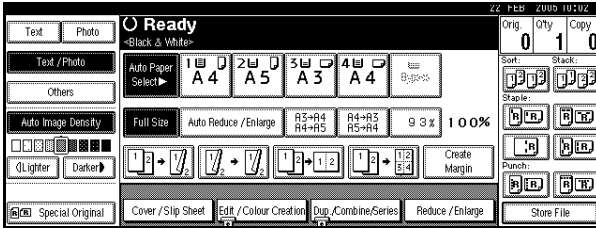

Note

- ❑ Trays with a key mark are not automatically selected. See “Paper Type” in “Tray Paper Settings”, *General Settings Guide*.

Manual Paper Select

- 1 Select the paper tray, bypass tray or LCT.

The selected paper tray is highlighted.

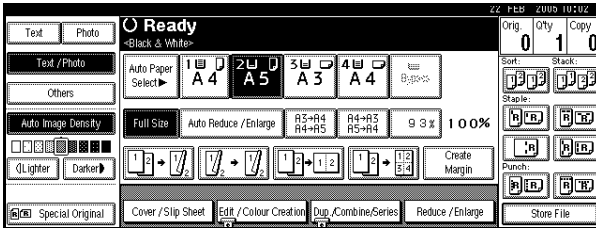

Reference

p.22 “Copying from the Bypass Tray”

If the paper type keys are not displayed

- 1 Press [Auto Paper Select].
- 2 Select the paper type.



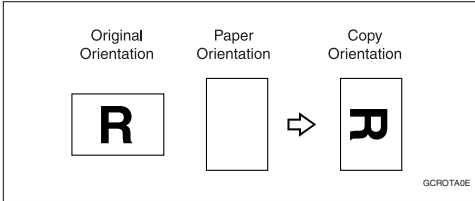

Rotated copy

If the orientation of the original (☐ or ☐) is different to that of the paper you are copying onto, this function rotates the original image by 90°, fitting it onto the copy paper. This function works when [Auto Paper Select] or [Auto Reduce / Enlarge] is selected. See p.34 “Auto Paper Select”, p.38 “Auto Reduce / Enlarge”.



Note

- ☐ The default setting for Auto Tray Switching is [With Image Rotation]. You cannot use the Rotated Copy function if this setting is changed to [Without Image Rotation] or [Off]. See p.111 “Auto Tray Switching”.
- ☐ You cannot use the Rotated Copy function when enlarging onto A3, B4 JIS or 11" × 17", 8¹/₂" × 14" size paper. To do this, place the original in the ☐ orientation.

	Original size and orientation			Copy paper size and orientation	
You cannot rotate:	A4, B5 JIS, or A5 ☐		When enlarging to →	B4 JIS or A3	
However, you can use:	A4, B5 JIS, or A5 ☐		When enlarging to →	B4 JIS or A3	

- ☐ When using the 2 tray finisher, you cannot use the Rotated Copy function when [Left 2], [Top 2] or [Punch] is selected for stapling. See p.45 “Staple”, p.49 “Punch”.
- ☐ When using the booklet finisher, you cannot use the Rotated Copy function when [Left 2], [Top 2] or [Centre] is selected for stapling.

Preset Reduce/Enlarge

You can select a preset ratio for copying.

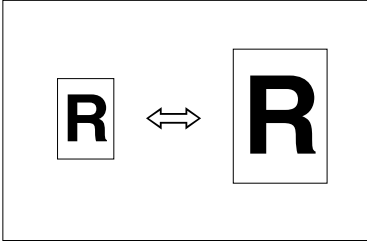

◆ Base Point

The base point of Reduce/Enlarge differs depending on how the original was scanned. When the original is placed on the exposure glass, the upper left corner is the base point. When placed in the ADF, the bottom left corner is the base point.

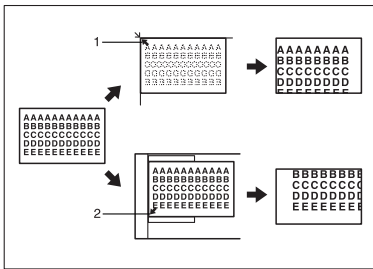

GCKA0316

1. Base point when placed on the exposure glass.

2. Base point when placed in the ADF.

🔍 Reference

- Related default settings:
- p.114 "Shortcut R/E"
- p.115 "R/E Priority"

1 Press [Reduce / Enlarge].

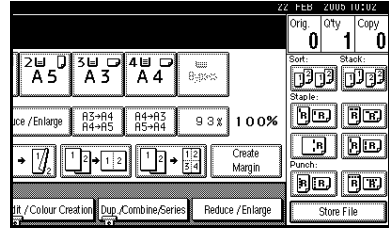

📌 Note

- To select a preset ratio on the initial display, press the shortcut reduce/enlarge key, and then proceed to step **4**.

2 Press [Enlarge] or [Reduce].

3 Select a ratio, and then press [OK].

4 Place originals, and then press the [Start] key.

⚙️ Create margin function

Use Create Margin to reduce the image to 93% of original size using the centre as reference. You can assign this function to a shortcut key on the initial display. By combining it with the Reduce/Enlarge function, you can also provide the Reduce/Enlarge copy with a margin.

🔍 Reference

Related default settings:

- p.113 "Copy Function Key: F1-F5"
- p.115 "Ratio for Create Margin"

- 1 Press **[Create Margin]** on the initial display.

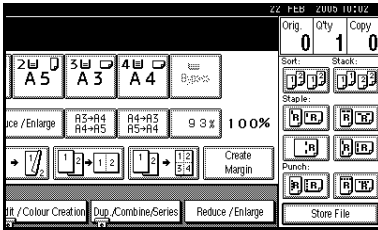

- 2 If you do not want to combine it with the Reduce/Enlarge function, place originals, and then press the **[Start]** key.

Zoom

You can change the reproduction ratio in increments of 1%.

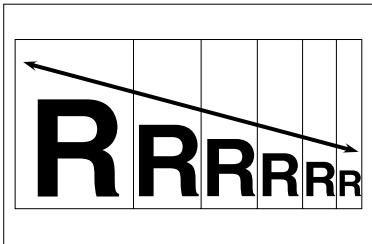

Note

- You can select a preset ratio close to the ratio using **[Reduce]** or **[Enlarge]**, and then adjust it further, using **[+]** or **[-]**.

- 1 Press **[Reduce / Enlarge]**.

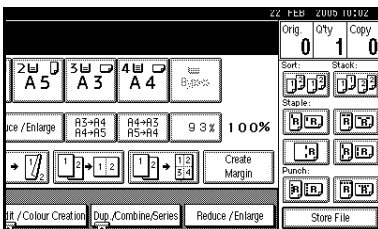

- 2 Enter the ratio.

To select the ratio using **[+]** and **[-]**

- 1 Select a preset ratio close to the ratio using **[Reduce]** or **[Enlarge]**.
- 2 Adjust the ratio further, using **[+]** or **[-]**.

Note

- Pressing **[+]** or **[-]** changes the ratio in increments of 1%. Pressing and holding down **[+]** or **[-]** changes it in increments of 10%.
- If you have incorrectly entered the ratio, readjust it using **[+]** or **[-]**.

To enter the ratio using the number keys

- 1 Press **[Mag. Ratio]**.
 - 2 Enter the ratio using the number keys.
 - 3 Press **[#]**.
 - 4 Press **[OK]**.
- 3 Place the originals, and then press the **[Start]** key.

Auto Reduce / Enlarge

The machine can choose an appropriate reproduction ratio based on the paper and original sizes you select.

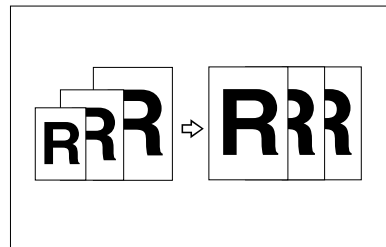

Note

- You cannot use the bypass tray with this function.
- When using Auto Reduce / Enlarge, see the following table for original sizes and orientations you can use:

Metric version

Where original is placed	Original size and orientation
Exposure glass	A3, B4 JIS, A4, A4, B5 JIS
ADF	A3, B4 JIS, A4, B5 JIS, A5, B6 JIS, 11" × 17", 8 1/2" × 11"

Inch version

Where original is placed	Original size and orientation
Exposure glass	11" × 17", 8 1/2" × 14", 8 1/2" × 11"
ADF	A3, A4, 11" × 17", 8 1/2" × 14", 8 1/2" × 11", 5 1/2" × 8 1/2", 10" × 14", 7 1/4" × 10 1/2"

- You cannot use the Rotated Copy function when enlarging to B4 JIS, A3 or 8 1/2" × 14", 11" × 17". When enlarging to B4 JIS, A3 or 8 1/2" × 14", 11" × 17" size copy paper, place the original in the  orientation.

Reference

p.11 "Sizes difficult to detect"

You can place originals of different sizes in the ADF at the same time. See p.16 "Placing originals of mixed sizes".

1 Press [Auto Reduce / Enlarge].

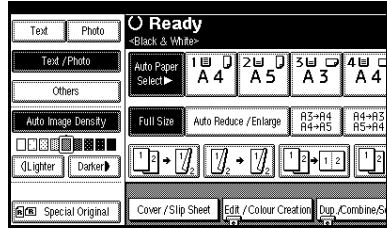

2 Select the paper tray.

3 Place the originals, and then press the [Start] key.

Size Magnification

You can calculate an enlargement or reduction ratio based on the lengths of the original and copy.

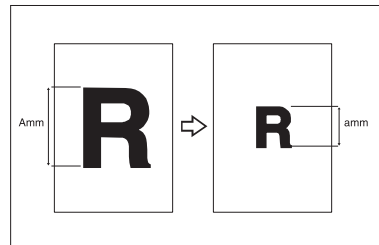

Note

- Measure and specify the lengths of the original and copy by comparing "A" with "a".

1 Press [Reduce / Enlarge].

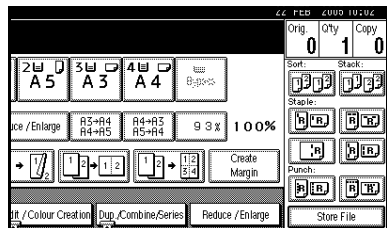

2 Press [Specifd. Ratio].

3 Make sure [Size Magnificatn] is highlighted.

4 Enter the length of the original using the number keys, and then press [#].

Note

You can enter sizes within the following ranges:

Metric version	1–999 mm (increments of 1 mm)
Inch version	0.1"–99.9" (increments of 0.1")

5 Enter the length of the copy using the number keys, and then press [#].

Note

To change the length after pressing [#], select [Original] or [Copy], and then enter the length.

6 Press [OK] twice.

7 Place the originals, and then press the [Start] key.

Directional Magnification (%)

Copies can be reduced or enlarged at different reproduction ratios, horizontally and vertically.

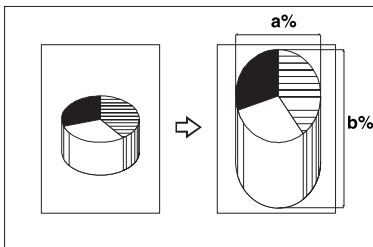

a: Horizontal ratio

b: Vertical ratio

Note

You can also select a preset ratio close to the ratio using [Reduce] or [Enlarge], and then adjust it further, using [+] or [-].

1 Press [Reduce / Enlarge].

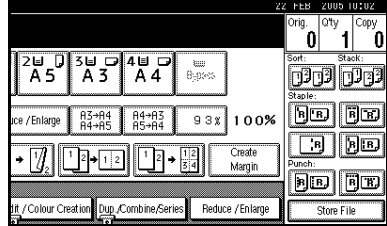

2 Press [Specifd. Ratio].

3 Press [Direct. Mag.%].

To enter the ratio using the number keys

- 1** Press [Horizontal].
- 2** Enter the ratio using the number keys, and then press [#].
- 3** Press [Vertical].
- 4** Enter the ratio using the number keys, and then press [#].
- 5** Press [OK].

To specify a ratio using [+] and [-]

- 1** Press [With + -].
- 2** Press [Horizontal].
- 3** Adjust the ratio using [+] or [-].

Note

Pressing [+] or [-] changes the ratio in increments of 1%. Pressing and holding down [+] or [-] changes it in increments of 10%.

- If you have incorrectly entered the ratio, readjust it using **[+]** or **[-]**.

- 4** Press **[Vertical]**.
- 5** Adjust the ratio using **[+]** or **[-]**.
- 6** Press **[OK]**.

4 Press **[OK]**.

5 Place the originals, and then press the **[Start]** key.

Directional Size Magnification (mm)

A suitable reproduction ratio is automatically selected when you enter the horizontal and vertical lengths of the original and copy image you require.

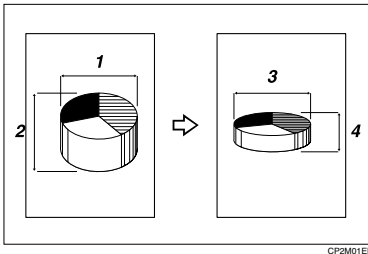

1. Horizontal original size
2. Vertical original size
3. Horizontal copy size
4. Vertical copy size

Preparation

Specify the vertical and horizontal size of the original and that of the copy, as shown.

Note

- You can enter sizes within the following ranges:

Metric version	Vertical: 1–999 mm (increments of 1 mm) Horizontal: 1–999 mm (increments of 1 mm)
Inch version	0.1"–99.9" (increments of 0.1")

1 Press **[Reduce / Enlarge]**.

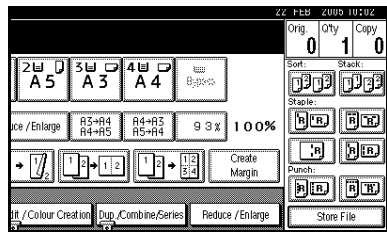

2 Press **[Specifd. Ratio]**.

3 Press **[Dir. Size Mag mm]**.

4 Enter the horizontal size of the original using the number keys, and then press **[#]**.

5 Enter the horizontal size of the copy using the number keys, and then press **[#]**.

6 Enter the vertical size of the original using the number keys, and then press **[#]**.

7 Enter the vertical size of the copy using the number keys, and then press **[#]**.

Note

- To change the length, press the key you want to change, and then enter the new value.

8 Press **[OK]** twice.

9 Place the originals, and then press the **[Start]** key.

Sort

The machine can scan originals into memory and automatically sort copies.

Reference

Related default settings:

p.123 "Select Stack Function"

p.122 "Memory Full Auto Scan Restart"

p.122 "Rotate Sort: Auto Paper Continue"

p.111 "Auto Tray Switching"

Sort

Copies are assembled as sequentially-ordered sets.

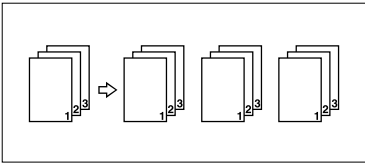

Rotate Sort

Every other copy set is rotated by 90° and delivered to the copy tray.

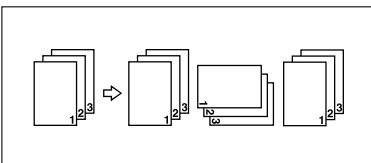

Note

- To use the Rotate Sort function, two paper trays with paper of the same size and type, but different orientation (landscape/portrait), are required. See "Paper Type: Tray1-4", *General Settings Guide*.
- You cannot use the bypass tray with this function.

Shift Sort

- When a finisher is installed: Each time the copies of one set or a job are delivered, the next copy is shifted to separate each set or job.

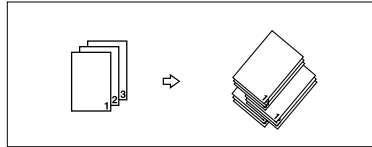

Note

- You cannot use the bypass tray with this function.

1 Press [Sort] or [Rotate Sort].

◆ When a finisher is not installed

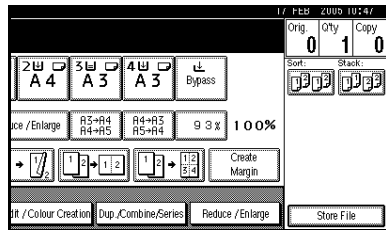

◆ When the 2 tray finisher is installed

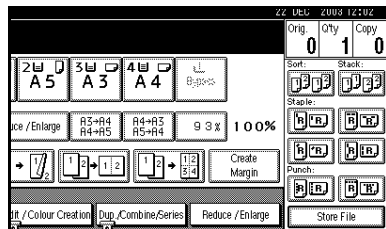

◆ When the booklet finisher is installed

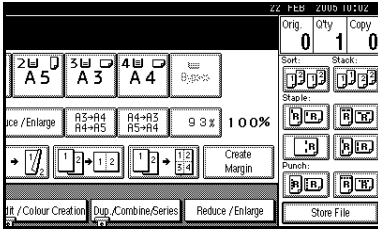

Note

- When the optional finisher is installed, use the User Tools to display **[Rotate Sort]**. See p.123 "Select Stack Function".

2 Enter the number of copy sets using the number keys.

Limitation

- The maximum number of sets is 999.

Note

- To confirm the type of finishing, press the **[Sample Copy]** key. See p.43 "Sample copy".

3 Place the originals.

Note

- When placing originals on the exposure glass, start with the first page to be copied. When placing originals in the ADF, set the first page on top.
- When placing originals on the exposure glass or in the ADF using the Batch function, press the **[#]** key after all the originals have been scanned.

4 Press the **[Start]** key.

Sample copy

You can use this function to check copy settings before making a long copy run.

Note

- This function can be used only when the Sort function is turned on.

1 Select Sort and any other necessary functions, and then place the originals.

2 Press the **[Sample Copy]** key.

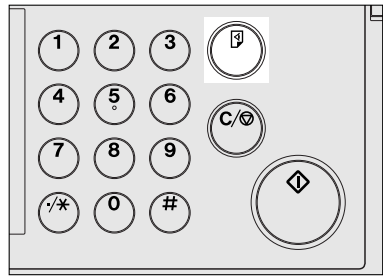

One copy set is delivered as a sample.

3 If the sample is acceptable, press **[Print]**.

The specified number of copies is made, minus one for the proof copy.

Note

- If you press **[Suspend]** after checking the results, return to step 1 to adjust the copy settings as necessary. You can change the settings for Staple, Duplex, Copy Orientation, Stamp, Margin Adjust., and Cover / Slip Sheet. However, depending on the combination of functions, you may not be able to change certain settings.

Changing the number of sets

You can change the number of copy sets during copying.

Note

- This function can only be used when the Sort function is turned on.

1 While "Copying" is displayed, press the **[Clear/Stop]** key.

2 Press **[Change Quantity]**.

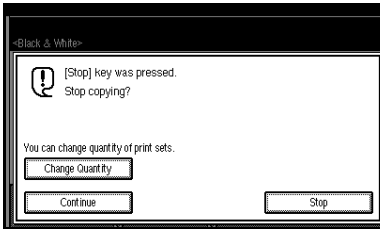

3 Enter the number of copy sets using the number keys, and then press the **[#]** key.

Note

- The number of sets you can enter differs depending on when the **[Clear/Stop]** key is pressed.

4 Press **[Continue]**.

Copying starts again.

Stack

Copies can be assembled with each page shifted.

◆ When a finisher is installed

This function groups together copies of each page in a multi-page original. Every other page stack is shifted for ease of separation.

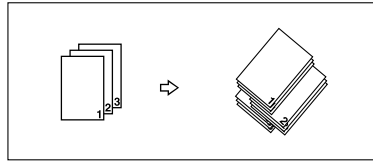

Note

- You cannot use the bypass tray with this function.

1 Press **[Stack]**.

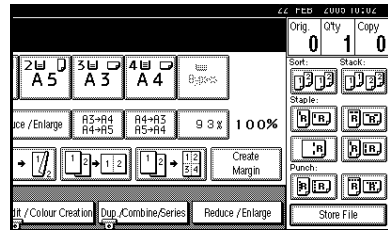

2 Enter the number of copies using the number keys.

3 Place the originals, and then press the **[Start]** key.

Note

- When placing originals on the exposure glass, start with the first page to be copied. When placing originals in the ADF, set the first page on top.
- When placing originals on the exposure glass or in the ADF using the Batch function, press the **[#]** key after all the originals have been scanned.

Staple

Individual copy sets can be stapled.

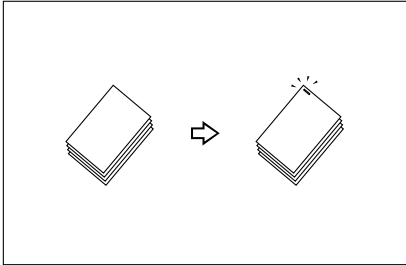

Note

- You cannot use the bypass tray with this function.

Reference

p.123 "Select Stapling Position"



























Stapling position and original setting

Place all the originals in an orientation in which they can be read. They will be automatically rotated for copying. When copy paper is identical in size and orientation to the original, staple positions are as follows:





































◆ 2 tray finisher





		Original location		Stapling position *1
			Exposure glass	
	Top			
	Top Slant			

2

		Original location		Stapling position *1	
			Exposure glass		ADF
	Bottom				
					
	Left 2				
					
	Top 2				
					

◆ Booklet finisher

		Original location		Stapling position *1	
			Exposure glass		ADF
	Top				
					
	Bottom				
					
	Left 2				
					
	Top 2				
					

		Original location		Stapling position *1
		Exposure glass	ADF	
	Saddle Stitch			

*1 This table shows the stapling positions, not the orientation of delivery.

*2 Not available for A3, B4 JIS or 11" x 17", 8 1/2" x 14" size paper.

1 Select one of the stapling positions.

◆ 2 tray finisher

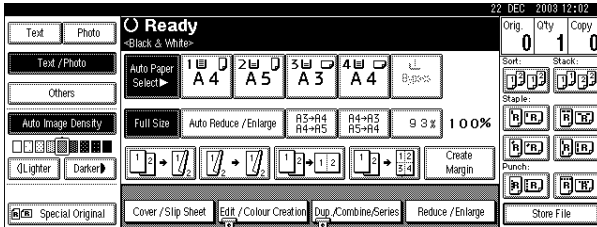

◆ Booklet finisher

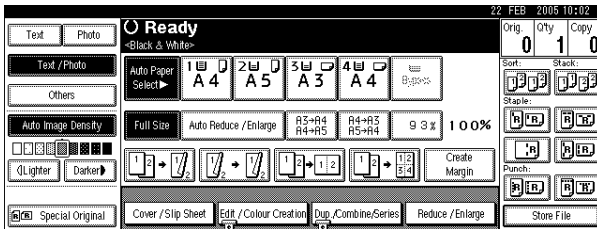

Note

When you select the stapling position, the Sort function is automatically selected.

Reference

- p.45 "Stapling position and original setting"
- p.131 "Staple"

2 Enter the number of copy sets using the number keys.

3 Place the originals, and then press the **[Start]** key.

Note

- ❑ When placing originals on the exposure glass, start with the first page to be copied. When placing originals in the ADF, set the first page on top.
- ❑ When placing originals on the exposure glass or in the ADF using the Batch function, press the **【#】** key after all the originals have been scanned.

Punch

2

You can make punch holes in copies.

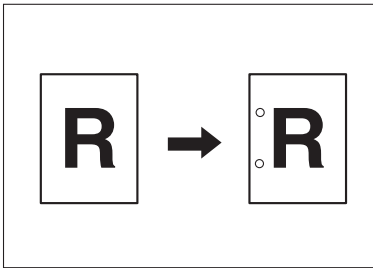
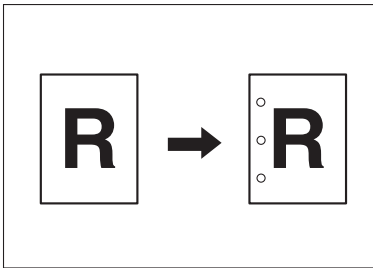
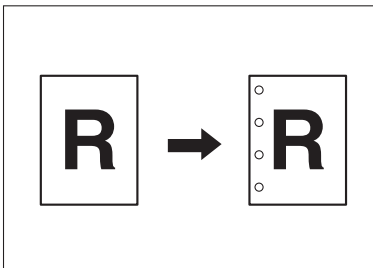
◆ 2 holes**◆ 3 holes****◆ 4 holes**

























 **Note**

























- 3 holes is only available with the 2 tray finisher.
- You cannot use the bypass tray with this function.
- The relationship between the orientation in which you place the original and the punch hole positions is as follows:

2

















Punch hole positions

◆ **2 tray finisher**

		Original location		Punch hole positions *1	
		Exposure glass	ADF		
Standard	2 holes				
					
	3 holes				
					
	4 holes				
					

		Original location		Punch hole positions *1	
		Exposure glass	ADF		
90° Turn	2 holes				
					
	3 holes				
					
	4 holes				
					

◆ Booklet finisher

		Original location		Punch hole positions *1	
		Exposure glass	ADF		
Standard	2 holes				
					
	4 holes				
					

2

		Original location		Punch hole positions *1
		Exposure glass	ADF	
90° Turn	2 holes			
	4 holes			

*1 This table shows the punch hole positions, not the orientation of delivery.

1 Select one of the punch hole positions.

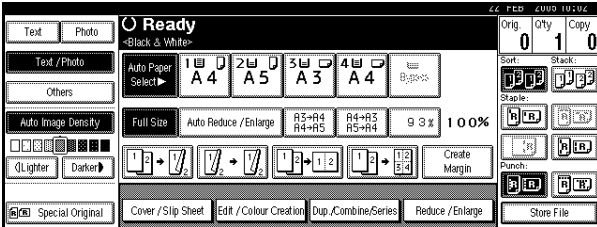

2 Enter the number of copy sets with the number keys.

3 Place the originals, and then press the **[Start]** key.

Duplex

There are three types of duplex copies:

❖ 1 Sided→2 Sided

Copies 2 one-sided pages onto a two-sided page.

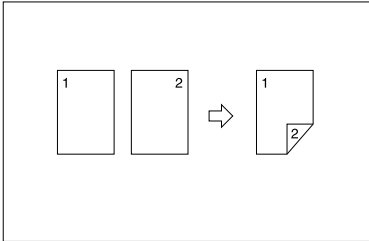

❖ 2 Sided→2 Sided

Copies 1 two-sided page onto a two-sided page.

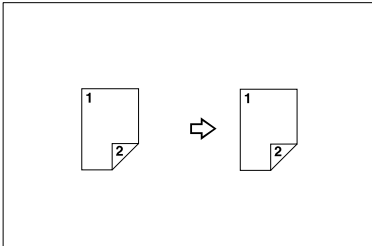





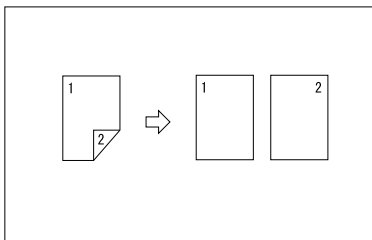



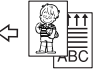

❖ 2 Sided→1 Sided

Copies each side of a two-sided original onto two separate pages.

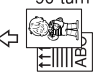

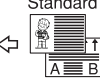
Original orientation and completed copies

Copy images differ according to the orientation in which you place originals (vertical  or horizontal ).

Original	How to place originals	Copy *1
Vertical 	Standard 	Top to Top 
	90° turn 	Top to Bottom 
Horizontal 	Standard 	Top to Top 
	90° turn 	Top to Bottom 

GCIFY01E

*1 This table shows the orientation of images on the front and back of copies, not the orientation of delivered copies.

Note

- You cannot use the bypass tray with this function.
- The maximum paper weight that can be used with duplex copying is 60–105 g/m², 16–28 lb.

Reference

p.68 "Margin Adjustment"

Related default settings:

p.115 "Front Margin: Left/Right"

p.115 "Back Margin: Left/Right"

p.116 "Front Margin: Top/Bottom"

p.116 "Back Margin: Top/Bottom"

1 Press [Dup./Combine/Series].

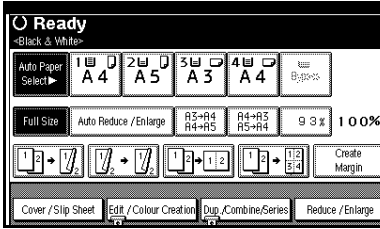

Note

- You can also select "1 Sided to 2 Sided" or "2 Sided to 2 Sided" directly, by pressing the Copy Function Key. If you do this, proceed to step 4.

2 Select [1 Sided] or [2 Sided] for Original, and then select [1 Sided] or [2 Sided] for Copy.

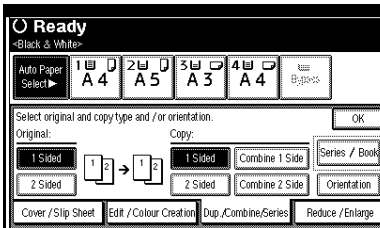

Note

- To change the copy orientation, press [Orientation]. See p.54 "Originals and copy orientation".

3 Press [OK].

4 Place the originals, and then press the [Start] key.

Note

- When placing originals on the exposure glass, start with the first page to be copied. When placing originals in the ADF, start with the first page on top.

- When placing originals on the exposure glass or in the ADF using the Batch function, press the [#] key after all the originals have been scanned.

Originals and copy orientation

You can select the orientation.

- Top to Top

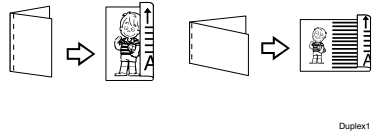

- Top to Bottom

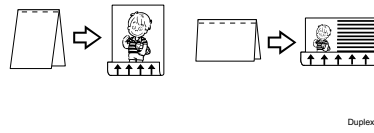

Note

- You can change the default orientation with User Tools. See p.112 "Copy Orientation in Duplex Mode" and p.112 "Original Orientation in Duplex Mode".

1 Press [Dup./Combine/Series].

2 Press [Orientation], select the orientation (Original/Copy), and then press [OK].

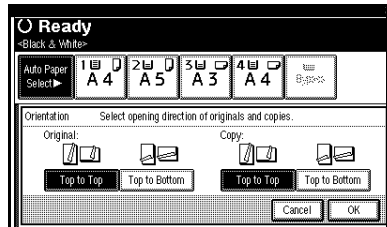

3 Press [OK].

4 Place originals, and then press the [Start] key.

1 Sided Combine

Combine several pages onto one side of a sheet.

❖ 1 Sided 2 Pages → Combine 1 Side

Copies 2 one-sided originals onto one side of a sheet.

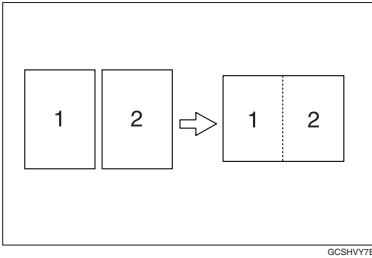

❖ 1 Sided 4 Pages → Combine 1 Side

Copies 4 one-sided originals onto one side of a sheet.

❖ 1 Sided 8 Pages → Combine 1 Side

Copies 8 one-sided originals onto one side of a sheet.

❖ 2 Sided 1 Page → Combine 1 Side

Copies 1 two-sided original onto one side of a sheet.

❖ 2 Sided 2 Pages → Combine 1 Side

Copies 2 two-sided originals onto one side of a sheet.

❖ 2 Sided 4 Pages → Combine 1 Side

Copies 4 two-sided originals onto one side of a sheet.

❖ 2 Sided 8 Pages → Combine 1 Side

Copies 8 two-sided originals onto one side of a sheet.

❖ Orientation of the original and combine image position

- Open to left originals

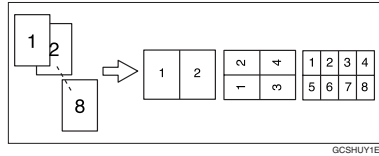

- Open to top originals

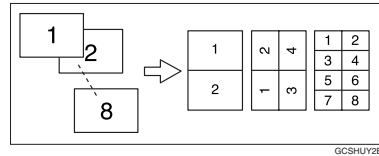

❖ Placing originals (originals placed in the ADF)

- Originals read from left to right

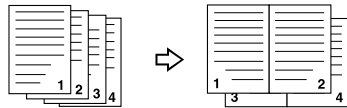

- Originals read from top to bottom

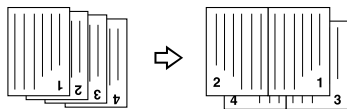

Note

- ❑ You cannot use the bypass tray with this function.

Reference

Related default settings:

p.116 "Erase Original Shadow in Combine"

p.117 "Copy Order in Combine"

p.118 "Separation Line in Combine"

2

1 Press [Dup./Combine/Series].

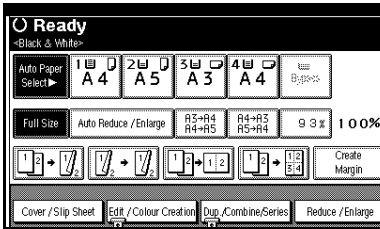

Note

You can select "1 Sided 2 Pages → Combine 1 Side" or "1 Sided 4 Pages → Combine 1 Side" by using Copy Function key. In this case, proceed to step 6.

2 Press [1 Sided] or [2 Sided] for Original, and then press [Combine 1 Side] for Copy.

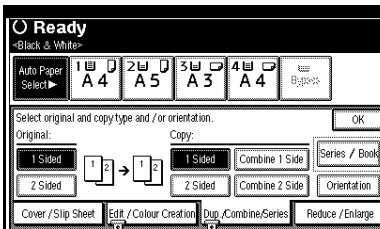

Reference

p.54 "Originals and copy orientation"

3 Select the number of originals to combine, and then press [OK].

4 Select the paper size.

5 Press [OK].

6 Place the originals, and then press the [Start] key.

2 Sided Combine

Combines various pages of originals onto a two-sided sheet.

1 Sided 4 Pages → Combine 2 Side

Copies 4 one-sided originals onto a sheet, two pages per side.

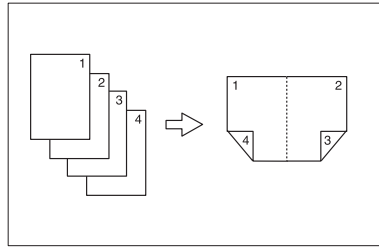

GCSHY9E

1 Sided 8 Pages → Combine 2 Side

Copies 8 one-sided originals onto a sheet, four pages per side.

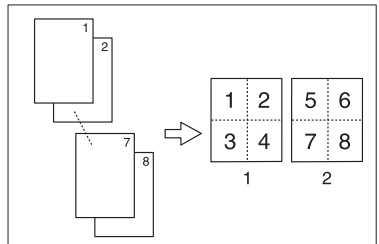

GCSHYAE

1. Front

2. Back

- ◆ **1 Sided 16 Pages → Combine 2 Side**
Copies 16 one-sided originals onto a sheet, eight pages per side.

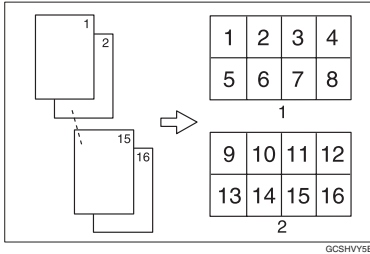

1. Front
2. Back

- ◆ **2 Sided 4 Pages → Combine 2 Side**
Copies 2 two-sided originals onto a sheet, two pages per side.

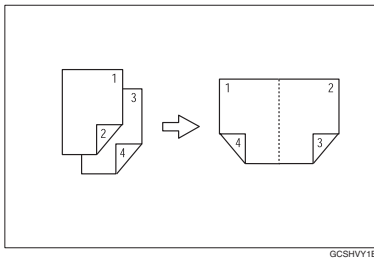

- ◆ **2 Sided 8 Pages → Combine 2 Side**
Copies 4 two-sided originals onto a sheet, four pages per side.

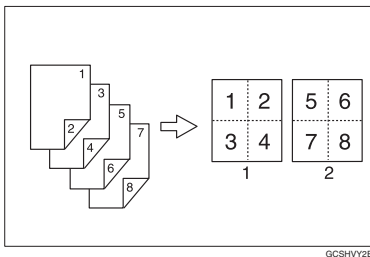

- ◆ **2 Sided 16 Pages → Combine 2 Side**
Copies 8 two-sided originals onto a sheet, eight pages per side.

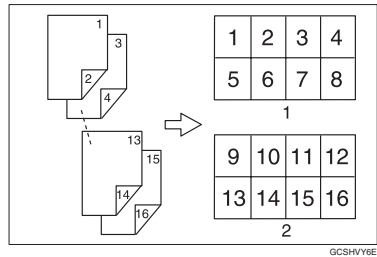

Note

- ☐ You cannot use the bypass tray with this function.

Reference

Related default settings:

p.55 "Orientation of the original and combine image position"

p.116 "Erase Original Shadow in Combine"

p.117 "Copy Order in Combine"

p.118 "Separation Line in Combine"

1 Press [Dup./Combine/Series].

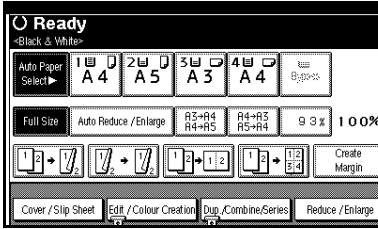

2 Press [1 Sided] or [2 Sided] for Original, and then press [Combine 2 Side] for Copy.

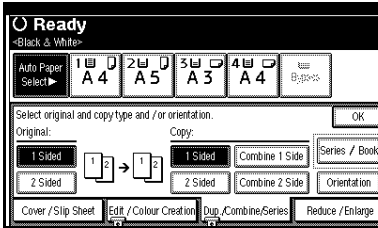

Reference

p.54 "Originals and copy orientation"

3 Select the number of originals to combine, and then press [OK].

4 Select the paper size.

5 Press [OK].

6 Place the originals, and then press the [Start] key.

Series Copies

This function copies the front and back of a two-sided original separately, or two facing pages of a bound original, onto two sheets.

Limitation

You cannot use the Series Copies function with the ADF.

Book→1 Sided

Copies a two-page spread original onto two separate pages.

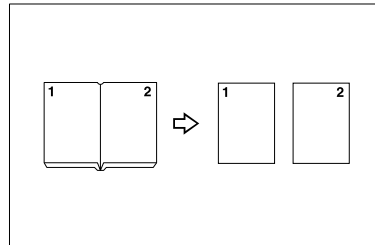

Book→2 Sided

Copies a two-page spread original onto a sheet, one page per side.

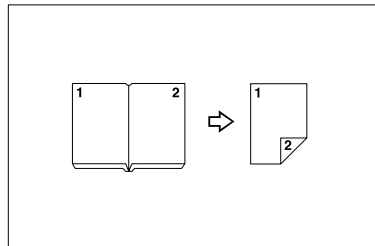

◆ **Front&Back→2 Sided**

Copies both sides of a two-page spread original onto both sides of a sheet.

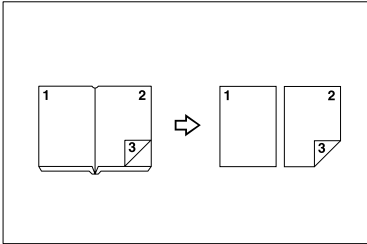

Note

- See the following table for original and copy paper sizes when using a 100% ratio.

◆ **Metric version**

Original	Paper for one-sided copy	Paper for two-sided copy
A3	A4 × 2 sheets	A4 × 1 sheet (two-sided)
B4 JIS	B5 JIS × 2 sheets	B5 JIS × 1 sheet (two-sided)
A4	A5 × 2 sheets	A5 × 1 sheet (two-sided)

◆ **Inch version**

Original	Paper for one-sided copy	Paper for two-sided copy
8 1/2" × 11"	5 1/2" × 8 1/2" × 2 sheets	5 1/2" × 11" × 1 sheet (two-sided)

- You cannot use the bypass tray with Book→2 Sided or Front&Back→2 Sided.

1 Press **[Dup./Combine/Series]**.

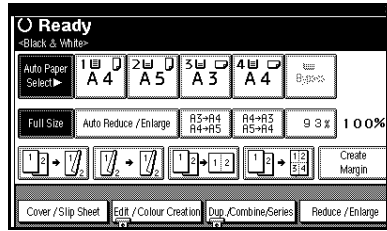

2 Press **[Series / Book]**.

3 Press **[Series]**.

4 Select **[Book→1 Sided]**, **[Book→2 Sided]**, or **[Front&Back→2 Sided]**, and then press **[OK]**.

5 Press **[OK]**.

6 Make sure **[Auto Paper Select]** is selected.

7 Place the original on the exposure glass, and then press the **[Start]** key.

Note

- Press the **[#]** key after all originals have been scanned.

Copying Book Originals

Copies two or more originals in page order.

❖ 1 Sided → Booklet

Makes copies in page order for a folded booklet.

❖ Open to left

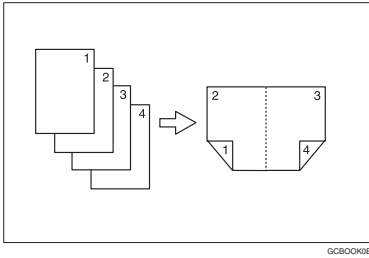

GCB00K0E

❖ Open to right

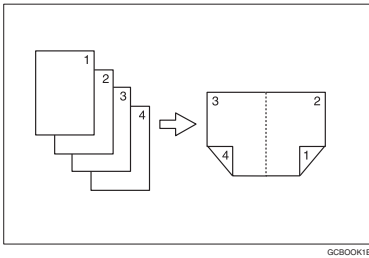

GCB00K1E

❖ 2 Sided → Booklet

Makes 2 sided originals into page ordered copies for a folded booklet.

❖ Open to left

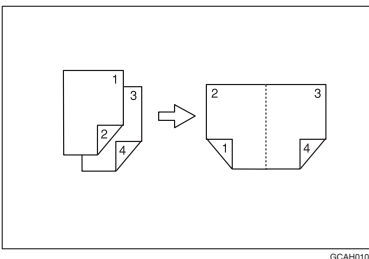

GCAH010E

❖ Open to right

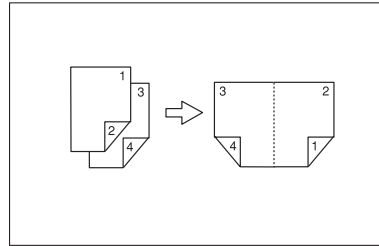

GCAH020E

❖ 1 Sided → Magazine

Copies two or more originals into magazine page order (when folded and stacked).

❖ Open to left

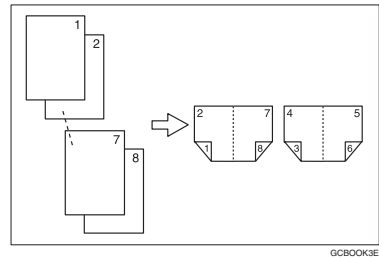

GCB00K3E

❖ Open to right

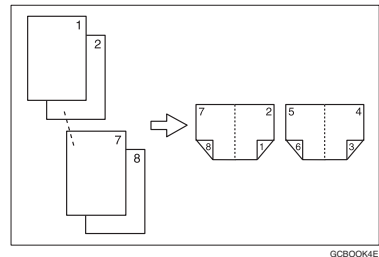

GCB00K4E

◆ **2 Sided→Magazine**

Copies two or more two-sided originals into magazine page order copies (when folded and stacked).

◆ **Open to left**

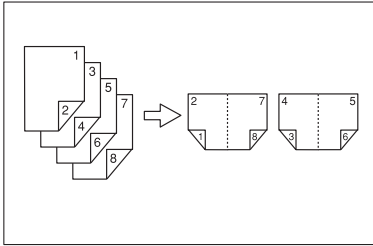

GCAH030E

◆ **Open to right**

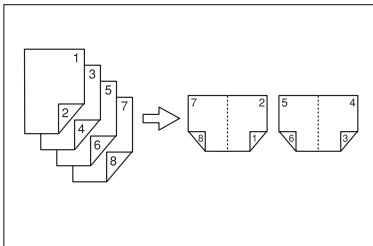

GCAH040E

How to fold and unfold copies to make a magazine

◆ **Open to left**

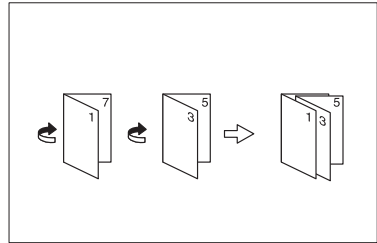

GCBOOK6E

◆ **Open to right**

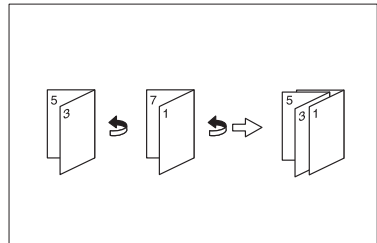

GCBOOK6E

How to fold copies to make a booklet

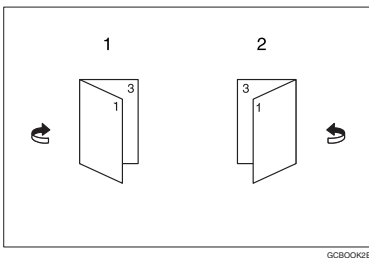

GCBOOK2E

1. Open to Left
2. Open to Right

Note

- You cannot use the bypass tray with this function.
- The machine sets the reproduction ratio automatically to fit the paper size.

Reference

Related default settings:
p.116 "Erase Original Shadow in Combine"

- 1** Select **[Open to Left]** or **[Open to Right]** with User Tools.

Reference

p.117 "Orientation: Booklet, Magazine"

- 2** Press **[Dup./Combine/Series]**.

- 3** Press **[Series / Book]**.

- 4** Press [Book].
- 5** Select [1 Sided→Booklet], [2 Sided→Booklet][1 Sided→Magazine], or [2 Sided→Magazine], and then press [OK].
- 6** Press [OK].
- 7** Select the paper.
- 8** Place the originals, and then press the [Start] key.

Note

- When placing originals on the exposure glass or in the ADF using the Batch function, press the [#] key after all the originals have been scanned.

Image Repeat

The original image is copied repeatedly.

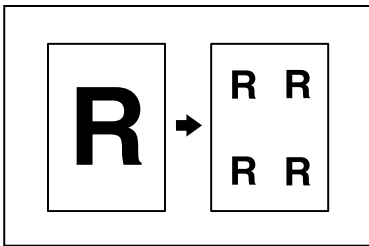

There are two types of designation methods for Image Repeat.

- ◆ **Whole Area Repeat**
Repeatedly copies the entire image.
- ◆ **Specified Area Repeat**
Repeatedly copies a specified portion of the image. Decide the base point of the area, specify the length and the width, and then specify the location of the area.

Reference

Related Initial Settings

See p.117 “Image Repeat Separation Line”

Whole Area Repeat

Note

- The number of repeated images depends on the original size, copy paper size, and reproduction ratio. See the following table.

◆ Original: A5 □/Copy paper: A4 □
or Original: A5 □/Copy paper A4 □

4 repeats (71%)	16 repeats (35%)

◆ Original: A5 □/Copy paper: A4 □
or Original: A5 □/Copy paper A4 □

2 repeats (100%)	8 repeats (50%)	32 repeats (25%)

- 1** Select the size of the copy paper and the reproduction ratio.
- 2** Press [Edit / Colour Creation].

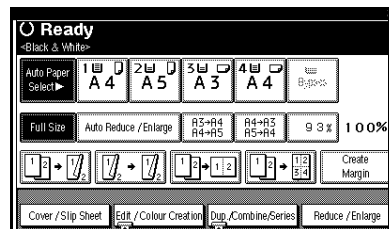

- 3** Press [Edit Image].
- 4** Press [Image Repeat].
- 5** Make sure that [Whole Area] is selected, then press [OK].
- 6** Press [OK] twice.
- 7** Place the original, and then press the [Start] key.

Specified Area Repeat

You can use this function only when you are making a copy from the Exposure Glass.

 **Note**

- The base point X1, Y1, and the length set by point X2, Y2 determines the area of an image repeatedly copied.

 **Limitation**

- You cannot use the specified area repeat from ADF.

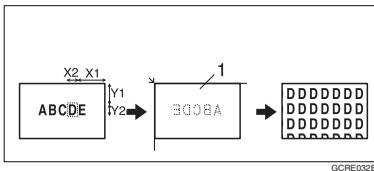

1. Set on the exposure glass

- 1** Specify the location of the area's base point (X1, Y1), and its length and width (X2, Y2).

 **Note**

- You can set any value in the range of X1: 0~412mm (0"~16.2"), X2: 20~432mm (0.8"~17.0"), Y1: 0~277mm (0"~10.8"), and Y2: 20~297mm (0.8"~11.6").

- 2** Select the size of the copy paper and the reproduction ratio.

- 3** Press [Edit / Colour Creation].
- 4** Press [Edit Image].
- 5** Press [Image Repeat].
- 6** Press [Specified Area].
- 7** Enter the length of [X1] with the number keys, then press [#].
- 8** Enter the length of [Y1] with the number keys, then press [#].
- 9** Enter the length of [X2] with the number keys, then press [#].
- 10** Enter the length of the [Y2] by number keys, then press [#].
- 11** Press [OK] three times.
- 12** Place the original on the exposure glass, and then press the [Start] key.

Double Copies

One original image is copied twice onto one sheet, as shown.

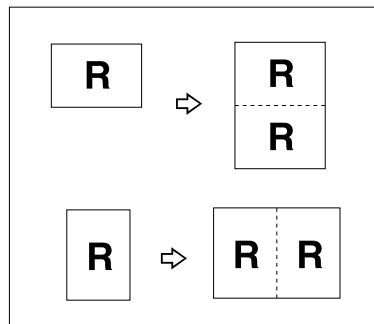

 **Note**

- You cannot use the bypass tray with this function.
- See the following table for original and copy paper sizes and orientations when using a 100% ratio:

◆ Metric version

Original size and orientation	Copy paper size and orientation
A5	A4
B6 JIS	B5 JIS
A4	A3
A5	A4
B5 JIS	B4 JIS
B6 JIS	B5 JIS

◆ Inch version

Original size and orientation	Copy paper size and orientation
5 ¹ / ₂ " × 8 ¹ / ₂ "	8 ¹ / ₂ " × 11"
5 ¹ / ₂ " × 8 ¹ / ₂ "	8 ¹ / ₂ " × 11"
8 ¹ / ₂ " × 11"	11" × 17"

- ❑ Originals with a size of A5, B6 JIS, 5¹/₂" × 8¹/₂" cannot be detected properly on the exposure glass. Be sure to select the copy paper manually or place the originals in the ADF.

🔍 Reference

Related default settings:
p.118 "Double Copies Separation Line"

1 Press [Edit / Colour Creation].

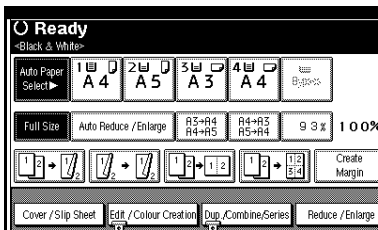

2 Press [Edit Image].

3 Press [Double Copies].

4 Press [OK] twice.

5 Select the paper.

6 Place the originals, and then press the [Start] key.

Centring

You can make copies with the image moved to the centre.

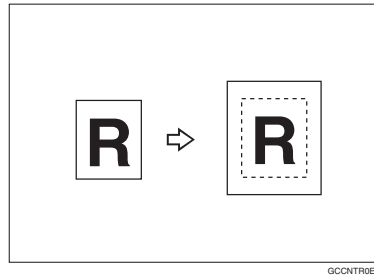

📌 Note

- ❑ You cannot use the bypass tray with this function.
- ❑ Original sizes and orientations for centring are listed below.

◆ Metric version

Original placed on:	Original size and orientation
Exposure glass	A3, B4 JIS, A4, B5 JIS
ADF	A3, B4 JIS, A4, B5 JIS, A5, B6 JIS, 11" × 17", 8 ¹ / ₂ " × 11"

◆ Inch version

Original placed on:	Original size and orientation
Exposure glass	11" × 17", 8 ¹ / ₂ " × 14", 8 ¹ / ₂ " × 11"
ADF	A3, A4, 11" × 17", 8 ¹ / ₂ " × 14", 8 ¹ / ₂ " × 11", 5 ¹ / ₂ " × 8 ¹ / ₂ ", 10" × 14"

- 1 Select the paper.
- 2 Press [Edit / Colour Creation].

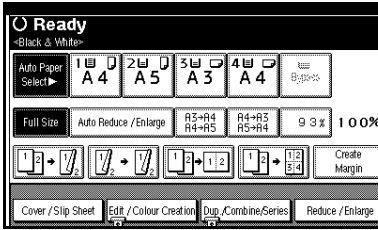

- 3 Press [Edit Image].
- 4 Press [Centring].
- 5 Press [OK] twice.
- 6 Place the originals, and then press the [Start] key.

Positive / Negative

If your original is black and white, copy images are inverted.

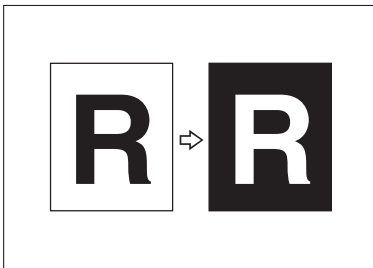

Note

- If your original is black and white, copy images are inverted. If your original is colour, the density, darkness and brightness of each colour will be reversed and inverted to complimentary colours.
- If the **[Single Colour]** key is selected, copy images are copied in white and specified colours.

- If **[Two-colour]** (normal) is selected, the white part of the original becomes black and the black part becomes white, and the coloured part is copied with the specified colour.
- If **[Red & Black]** is selected, the white part of the original becomes black, the black part and the red part becomes white, and the blue part becomes red in colour.

- 1 Press [Edit / Colour Creation].

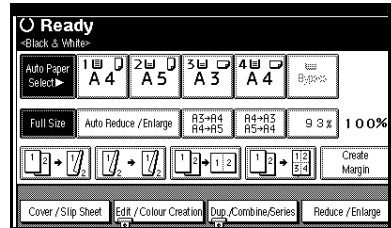

- 2 Press [Edit Image].
- 3 Press [Positive / Negative].
- 4 Press [OK] twice.
- 5 Select the paper.
- 6 Place the originals, and then press the [Start] key.

Mirror

Copies by reversing the image from left to right, as reflected in a mirror.

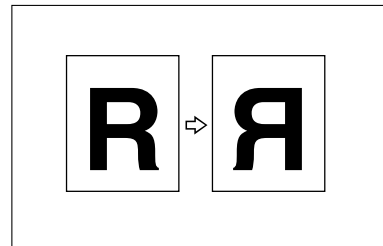

- 1 Press [Edit / Colour Creation].

- 2** Press [Edit Image].
- 3** Press [Mirror Image].
- 4** Press [OK] twice.
- 5** Place the originals, then press the [Start] key.

Erase

You can erase the centre and/or all four sides of the original image.

This function has three modes:

◆ Border

Erases the original's edge margin from the copy.

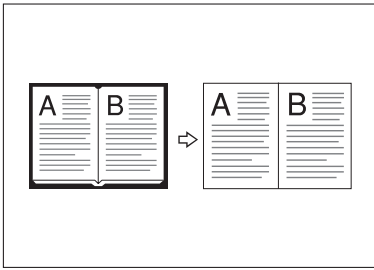

GCCE12E

◆ Centre

Erases the original's centre margin from the copy.

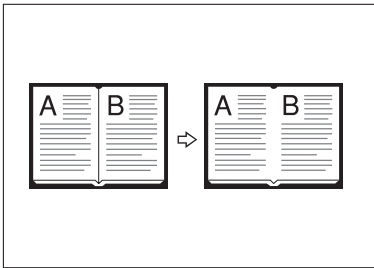

GCCE11E

◆ Centre/Border

Erases both the original's centre and edge margins from the copy.

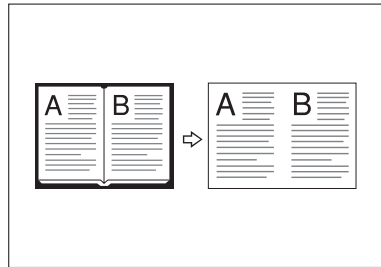

GCCE13E

🔍 Reference

The erase width is set to 10 mm (0.4") as default. You can change this setting with User Tools.

p.116 "Erase Centre Width"

p.116 "Erase Border Width"

📎 Note

- ❑ The relationship between the original orientation and erased area is as follows:

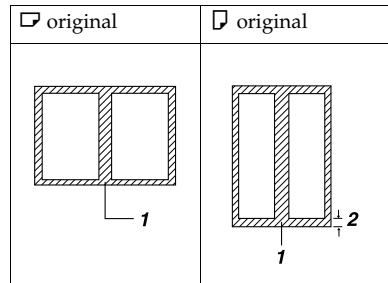

- ❑ 1: Erased part
- ❑ 2: 2-99 mm (0.1"-3.9")

Border Erase

- 1 Press [Edit / Colour Creation].

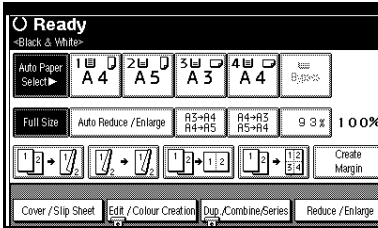

- 2 Press [Erase / Margin Adj.].
- 3 Press [Erase].
- 4 Set the erase border width.

Selecting [Same Width]

- 1 Press [Same Width].
- 2 Set the erase border width using [+] and [-].

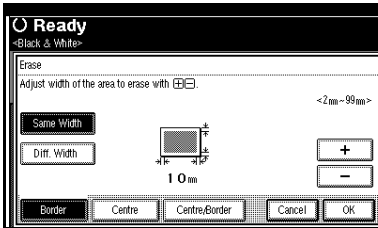

Note

- To change the value entered, press [+] and [-] to set the new value.

- 3 Press [OK].

Selecting [Diff. Width]

- 1 Press [Diff. Width].
- 2 Press the key for the border you want to change, and then set the erase border width using [+] and [-].

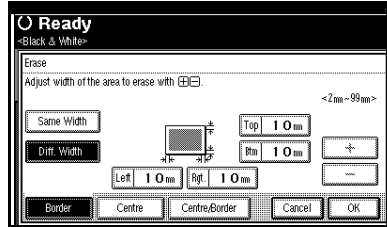

- 3 Press [OK].
- 5 Press [OK] twice.
- 6 Place the originals, and then press the [Start] key.

Centre erase

- 1 Press [Edit / Colour Creation].

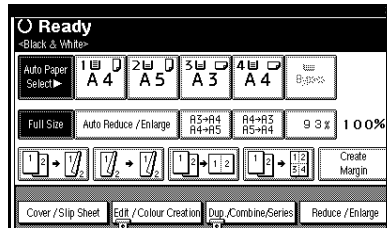

- 2 Press [Erase / Margin Adj.].
- 3 Press [Erase].
- 4 Press [Centre].
- 5 Set the erase centre width using [+] and [-], and then press [OK].
- 6 Press [OK] twice.
- 7 Place the originals, and then press the [Start] key.

Centre/border erase

1 Press [Edit / Colour Creation].

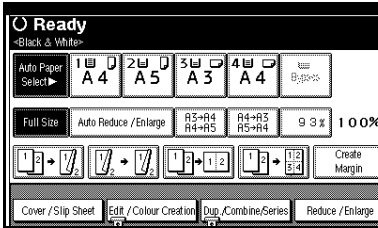

2 Press [Erase / Margin Adj.].

3 Press [Erase].

4 Press [Centre / Border].

5 Set the centre and border to be erased.

Selecting [Same Width]

1 Press [Same Width].

2 Press [Centre], and then set the erase centre width using [+] and [-].

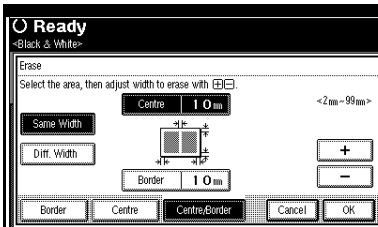

3 Press [Border], and then set the erase border width using [+] and [-].

4 Press [OK].

Selecting [Diff. Width]

1 Press [Diff. Width].

2 Press the key for the part you want to change, and then set the erase margin width using [+] and [-].

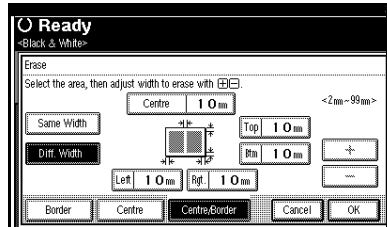

3 Press [OK].

6 Press [OK] twice.

7 Place the originals, and then press the [Start] key.

Margin Adjustment

You can make a binding margin.

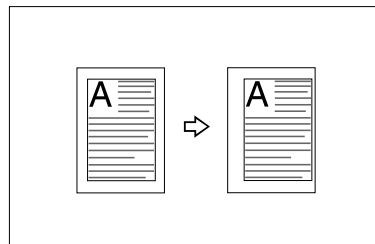

Reference

Related default settings:

p.115 "Front Margin: Left/Right"

p.115 "Back Margin: Left/Right"

p.116 "Front Margin: Top/Bottom"

p.116 "Back Margin: Top/Bottom"

p.116 "1 Sided→2 Sided Auto Margin: TtoT"

Note

- You can change the width of the binding margin as follows:

Metric version	0–30 mm (increments of 1 mm)
Inch version	0"–1.2" (increments of 0.1")

1 Press [Edit / Colour Creation].

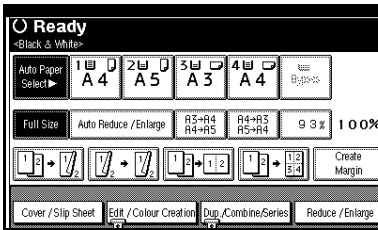

2 Press [Erase / Margin Adj.].

3 Press [Margin Adjustment].

4 Set a binding margin for the front pages. Press [←] and [→] when setting the left and right margins, and [↓] and [↑] when setting the top and bottom margins.

Note

- To change the value entered, press [←], [→], [↓], [↑] to set it.
- If you do not need to specify margins for back side pages, proceed to step **6**.

5 Set a binding margin for back side pages. Press [←] and [→] when setting the left and right margins, and [↓] and [↑] when setting the top and bottom margins.

Note

- Margins on the back side of the page are possible only when [2 Sided] or [Combine 2 Side] is selected.

6 Press [OK] 3 times.

7 Place the originals, and then press the [Start] key.

Background Numbering

Use this function to have numbers printed on the background of copies.

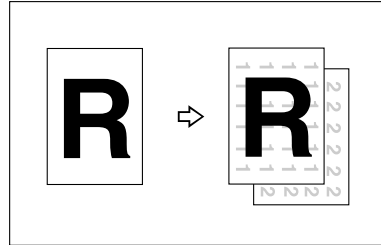

GCSTMP2E

Note

- You cannot use the bypass tray with this function.
- The default stamp colour is black.

Reference

Related Initial Settings p.119
"Background Numbering"

1 Press [Edit / Colour Creation].

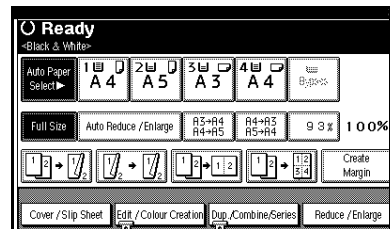

2 Press [Stamp].

3 Press [Background Numbering].

4 Enter the number to start counting from with the number keys.

Note

- To change the entered number, press [Clear] or [Clear/Stop] and enter the new number.

5 Press [OK] 3 times.

6 Place the originals, then press the [Start] key.

Changing the stamp colour

1 Press [Stamp].

2 Select the stamp colour, then press [OK].

Preset Stamp

Frequently used messages can be stored in memory and stamped on copies.

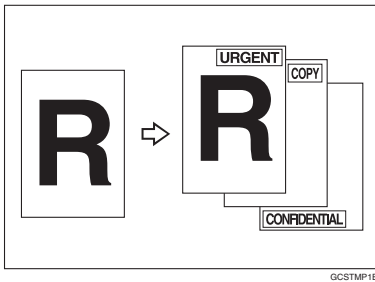

One of the following eight messages can be stamped on copies with a frame around it:

"COPY", "URGENT", "PRIORITY", "For Your Info.", "PRELIMINARY", "For Internal Use Only", "CONFIDENTIAL", "DRAFT".

Stamp position and original orientation

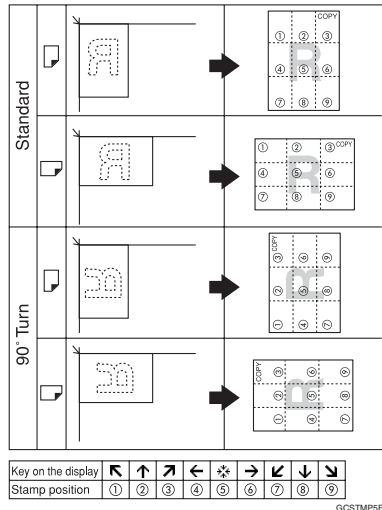

Note

- You cannot use the bypass tray with this function.
- Only one message can be stamped at a time.
- The default stamp colour is black.

Reference

- p.119 "Stamp Priority"
- p.119 "Stamp Language"
- p.119 "Stamp Position"
- p.119 "Stamp Format"
- p.120 "Stamp Colour"

1 Press [Edit / Colour Creation].

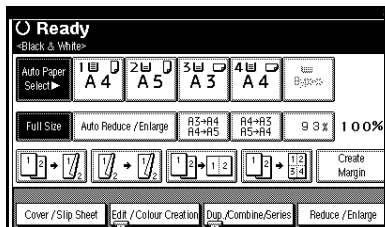

- 2** Press [Stamp].
- 3** Press [Preset Stamp].
- 4** Select the message.
- 5** Press [All Pages] or [1st Page Only] to select the print page.

Note

- You can change the colour, position, size, and density of the stamp. See p.71 "Changing the stamp colour". See p.71 "To change stamp position, size, and density".

- 6** After you have specified all necessary settings, press [OK].
- 7** Press [OK] twice.
- 8** Place the originals, and then press the [Start] key.

Changing the stamp colour

- 1** Press [Stamp Colour].
- 2** Select the stamp colour, then press [OK].

To change stamp position, size, and density

- 1** Press [Change].
- 2** Select the position for print, size, and density, and then press [OK].

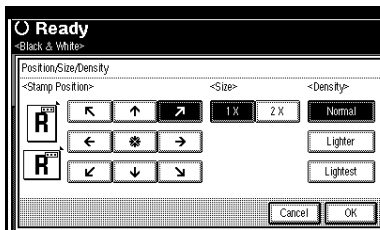

User Stamp

Prints a registered stamp onto copies.

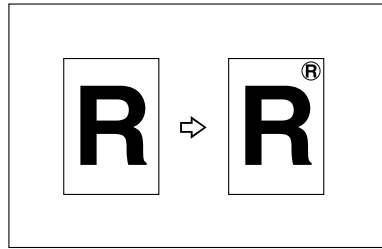

GCSTMP0E

Preparation

You have to register a user stamp before using this function. See p.72 "To program the user stamp".

Stamp position and original orientation

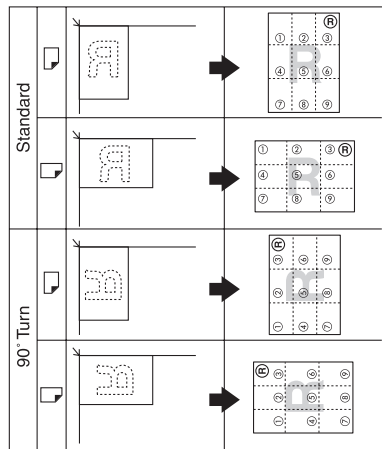

Key on the display: [Left], [Up], [Right], [Home], [Right], [Down], [Down-Right], [Down-Left], [Left], [Right], [Home], [Home].
Stamp position: ① ② ③ ④ ⑤ ⑥ ⑦ ⑧ ⑨

GCSTMP0E

Note

- You cannot use the bypass tray with this function.
- Only one message can be stamped at a time.
- The default stamp colour is black.

Reference

- Related default settings:
- p.120 "Stamp Position 1 - 4"
- p.120 "Stamp Format 1 - 4"
- p.120 "Stamp Colour: 1 - 4"

1 Press [Edit / Colour Creation].

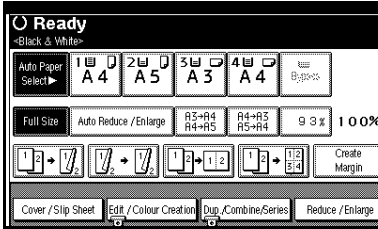

2 Press [Stamp].

3 Press [User Stamp].

4 Select the stamp number.

5 Press [All Pages] or [1st Page Only] to select the print page.

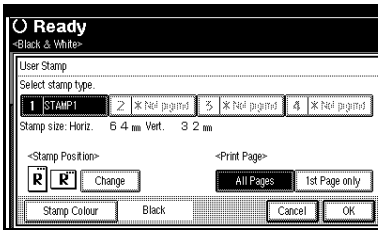

Note

- You can change the stamp colour and position. See p.72 "Changing the stamp colour". See p.72 "To change the stamp position".

6 After all settings are complete, press [OK].

7 Press [OK] twice.

8 Place the originals, and then press the [Start] key.

Changing the stamp colour

1 Press [Stamp Colour].

2 Select the stamp colour, then press [OK].

To change the stamp position

1 Press [Change].

2 Select the position, and then press [OK].

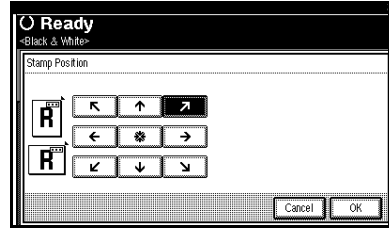

To program the user stamp

Note

- The range of stamp images for readability is 10–297 mm high (0.4"–11.7") and 10–432 mm wide (0.4"–17.0"). However, if the value exceeds the maximum area (5,000 mm², 7.75 inch²), it is automatically adjusted to range.
- Up to four frequently used images can be stored in memory.

1 Make sure the machine's copier function is selected.

2 Press the [User Tools/Counter] key.



ZFLS110E

- 3 Press [Copier / Document Server Features].

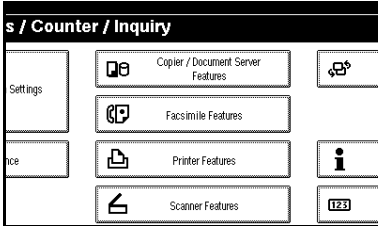

- 4 Press [Stamp].
- 5 Press [User Stamp].
- 6 Press [Program / Delete Stamp].
- 7 Press [Program], and then press the stamp number (1–4) you want to program.

Note

- ❑ Stamp numbers displayed with ↗ next to them already have settings.
- ❑ If the stamp number is already in use, the machine will ask you if you want to overwrite it. Press [Yes] or [No].

- 8 Enter the user stamp name using the letter keys on the display panel. You can register up to 10 characters.
- 9 Press [OK].

Reference

“Entering Text”, *General Settings Guide*

- 10 Enter the horizontal size of the stamp using the number keys, and then press [#].
- 11 Press [Vertical], and then enter the vertical size of the stamp using the number keys, and then press [#].

- 12 Place the original for user stamp on the exposure glass, and then press [Start Scanning].

The original is scanned, and the stamp is registered.

Note

- ❑ Originals cannot be scanned from the ADF when programming the user stamp.

- 13 Press [Exit].
- 14 Press [Exit].
The Copier / Document Server Features main menu is displayed.
- 15 Press [Exit].
Exits settings and gets ready to copy.

To delete the user stamp

Important

- ❑ You cannot restore a deleted stamp.

- 1 Make sure the machine's copier function is selected.
- 2 Press the [User Tools/Counter] key.



ZFLS110E

- 3 Press [Copier / Document Server Features].

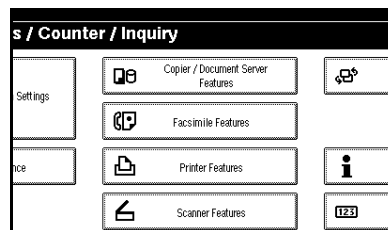

- 4** Press [Stamp].
- 5** Press [User Stamp].
- 6** Press [Program / Delete Stamp].
- 7** Press [Delete], and then press the stamp number you want to delete.
- 8** Select [Delete], and then press [Exit].
- 9** Press [Exit].
The Copier / Document Server Features main menu is displayed.
- 10** Press [Exit].
Exits settings and gets ready to copy.

Date Stamp

You can use this function to print dates onto copies.

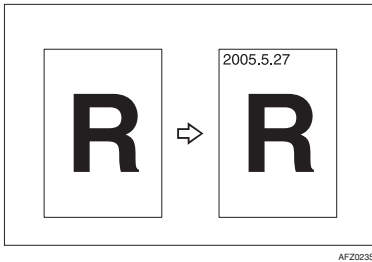

You can select from the following date formats:

- MM/DD/YYYY
- MM.DD.YYYY
- DD/MM/YYYY
- DD.MM.YYYY
- YYYY.MM.DD

Stamp position and original orientation

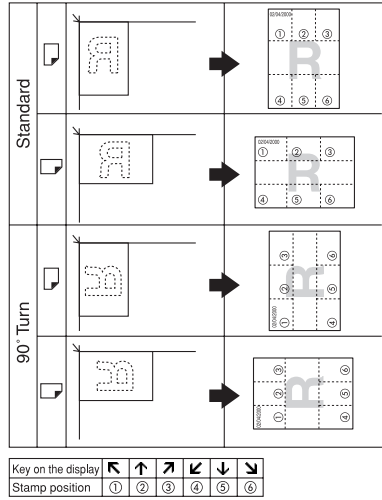

Note

- You cannot use the bypass tray with this function.
- The default stamp colour is black.

Reference

Related default settings:

- p.120 "Format"
 - p.121 "Font"
 - p.121 "Stamp Position"
 - p.121 "Stamp Setting"
 - p.121 "Size"
 - p.121 "Superimpose"
 - p.121 "Stamp Colour"
- "Timer Settings", *General Settings Guide*

- 1 Press [Edit / Colour Creation].

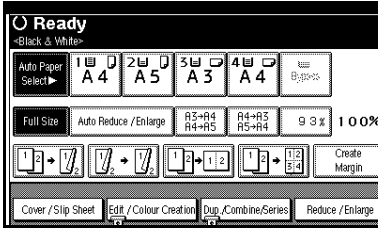

- 2 Press [Stamp].

- 3 Press [Date Stamp].

- 4 Press [All Pages] or [1st Page Only] to select the print page.

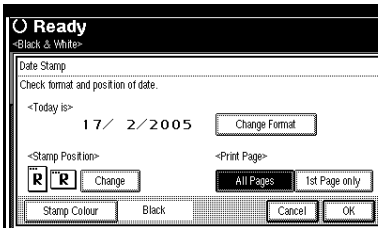

Note

- You can change the colour, format and position of the date stamp. See p.75 "Changing the stamp colour", p.75 "To change the date format".

- 5 After all settings are complete, press [OK].

- 6 Press [OK] twice.

- 7 Place the originals, and then press the [Start] key.

Changing the stamp colour

- 1 Press [Stamp Colour].

- 2 Select the stamp colour, then press [OK].

To change the date format

- 1 Press [Change Format].

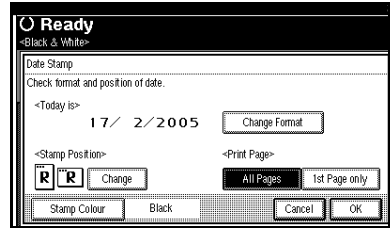

- 2 Select the date format, and then press [OK].

To change the stamp position

- 1 Press [Change].

- 2 Select the date stamp position, and then press [OK].

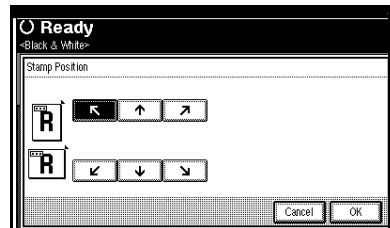

Page Numbering

You can use this function to print page numbers onto copies.

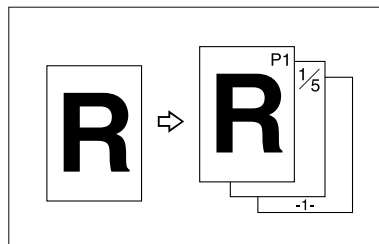

CP200100

There are six types of Page Numbering (“n” is the total number of pages in original):

- P1, P2,...Pn
- 1/n, 2/n,...n/n
- -1-, -2-,...-n-
- P.1, P.2,...P.n
- 1, 2...n
- 1-1, 1-2,...1-n

Stamp position and orientation of originals

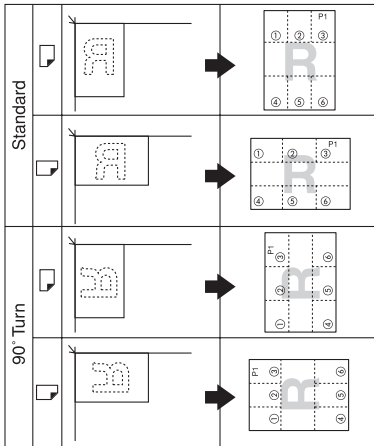

Key on the display	↶	↷	↸	↹	↺
Stamp position	①	②	③	④	⑤

GCSTMP8E

Note

- You cannot use the bypass tray with this function.
- The default stamp colour is black.

Reference

Related default settings:

- p.121 “Stamp Format”
- p.121 “Font”
- p.121 “Size”
- p.121 “Duplex Back Page Stamping Position”

p.121 “Page Numbering in Combine”

p.122 “Stamp Position”

p.122 “Superimpose”

p.122 “Stamp Colour”

1 Press [Edit / Colour Creation].

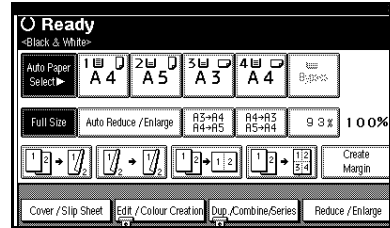

2 Press [Stamp].

3 Press [Page Numbering].

4 Select the format.

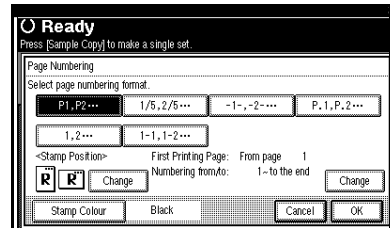

Note

- You can specify the Stamp Colour, position, pages to be stamped, and numbering. See “Changing the stamp colour”, “To change the stamp position”, “Specifying the first printing page and start number”.

5 After all settings are complete, press [OK].

6 Press [OK] twice.

7 Place the originals, and then press the [Start] key.

Changing the stamp colour

- 1 Press [Stamp Colour].
- 2 Select the stamp colour, then press [OK].

To change the stamp position

- 1 Press [Change].
- 2 Select the position, and then press [OK].

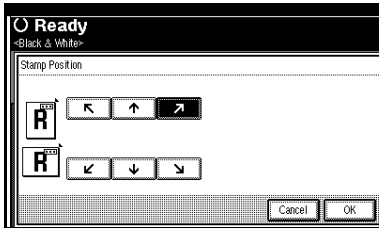

Specifying the first printing page and start number

If you selected (P1, P2..., -1,-2-..., P.1, P.2..., 1, 2...,)

Note

- The following explanation uses P1, P2... as an example. The steps are the same for other selections.

- 1 Press [Change] on the right side.

- 2 Press [First Printing Page], then enter the original page number from which to start printing using the number keys, and then press the [#] key.

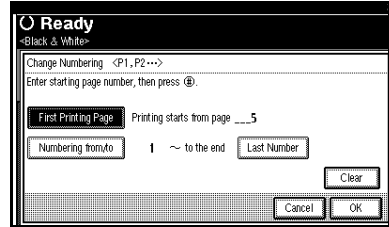

Note

- To change the number entered, press [Clear] or the [Clear/Stop] key, and then enter a new number.

- 3 Press [Numbering from / to], enter the number of the page from which to start numbering using the number keys, and then press the [#] key.

Note

- The example below shows the first printing page as "2" and the start number as "3".

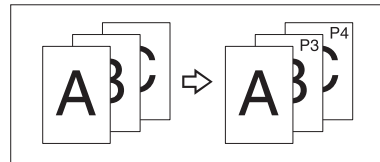

GCANPE2J

- 4 Press [Last Number], enter the number of the page to stop numbering using the number keys, and then press the [#] key.

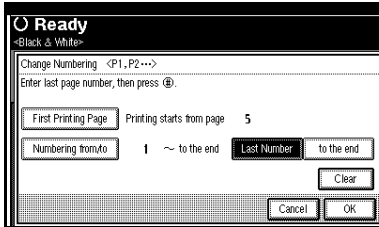

Note

- If you want to number all pages to the end, press [to the End].

- 5 When page designation is complete, press [OK].

- 6 Press [OK] 3 times.

If you selected (1/5, 2/5...)

- 1 Press [Change] on the right hand side of the display.

- 2 Press [First Printing Page], then enter the original page number from which to start printing using the number keys, and then press the [#] key.

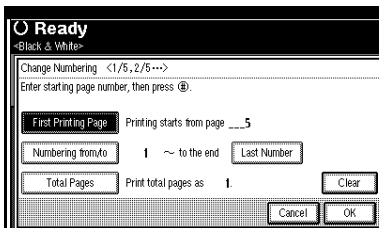

Note

- You can enter between 1 and 9999 for the original page number from which to start printing.

- To change the number entered, press [Clear] or the [Clear/Stop] key, and then enter a new number.

- 3 Press [Numbering from / to], then enter the number of page from which to start numbering using the number keys, and then press the [#] key.

- 4 Press [Last Number], then enter the number of page at which to stop numbering using the number keys, and then press the [#] key.

Proceed to step 5 when not changing.

Note

- To print on the last page, press [to the End].

- The last number is the last page number printed. For example, if [Total Pages] is ten, if you want to print seven pages up to page 7, enter [7] as the [Last Number].

- Normally, you do not need to enter this number.

- 5 Press [Total Pages], enter the total number of original pages using the number keys, and then press the [#] key.

- 6 When page designation is complete, press [OK].

Note

- To change the settings after pressing [OK], press [Change], and then enter the numbers again.

- 7 Press [OK] 3 times.

If you selected (1-1, 1-2,...)

- 1** Press **[Change]** on the right hand side.
- 2** Press **[First Printing Page]**, and then enter the original page number from which to start printing using number keys, and then press the **[#]** key.

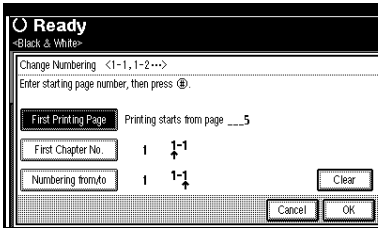

Note

- To change the number entered, press **[Clear]** or the **[Clear/Stop]** key, and then enter a new number.

- 3** Press **[First Chapter No.]**, enter the chapter number from which to start numbering using the number keys, and then press the **[#]** key.

Note

- You can enter between 1 and 9999 for the chapter number from which to start numbering.

- 4** Press **[Numbering from / to]**, and then enter the page number from which to start numbering using the number keys, and then press the **[#]** key.

- 5** When page designation is complete, press **[OK]**.

- 6** Press **[OK]** 3 times.

Covers

You can use this function to create cover sheets by adding additional pages of different paper, or copying existing pages onto different paper.

Preparation

Before selecting this function, set the tray for front cover sheets. See "Cover Sheet Tray" in "Tray Paper Settings", *General Settings Guide*.

Note

- The cover sheet should be the same size and orientation as the copy paper.
- You cannot use the bypass tray with this function.
- When selecting Copy, select whether the front and back covers are copied one-sided or two-sided. See "Cover Sheet Tray" in "Tray Paper Settings", *General Settings Guide*.

Front cover

The first page of originals is copied onto a specified cover sheet paper, or a cover sheet is inserted before the first copy page.

- Copy

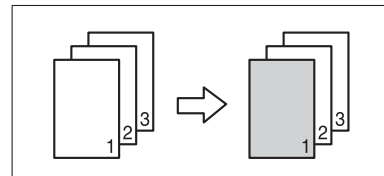

- Blank

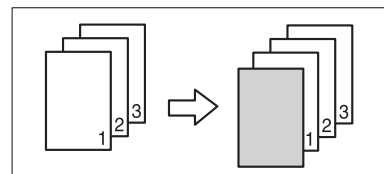

◆ **Front/Back covers**

The first and last page of original is copied onto a specified cover sheet paper.

- Copy

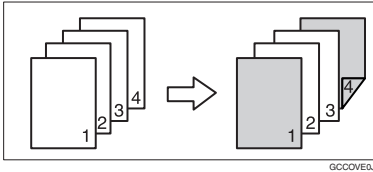

- Blank

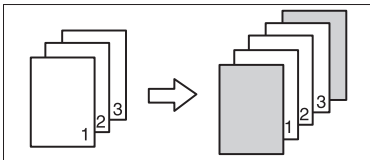

🔍 **Reference**

p.116 "Front Cover Copy in Combine"

1 Press **[Cover / Slip Sheet]**.

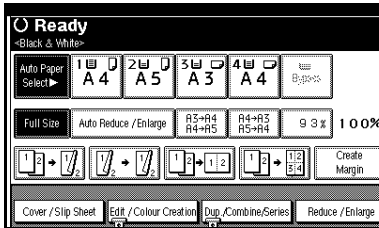

2 Press **[Front Cover]** or **[Front/ Back Cover]**.

3 Select **[Copy]** or **[Blank]** for the cover sheet.

4 Select the paper tray containing the paper to copy the originals onto, and then press **[OK]**.

5 Place the originals in the ADF, and then press the **[Start]** key.

Designate

You can use this function to copy certain pages of your original onto slip sheets.

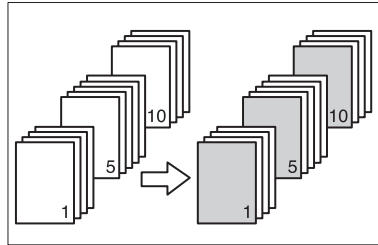

📄 **Preparation**

Before using this function, set the special paper tray for slip sheets. See "Cover Sheet Tray" and "Slip Sheet Tray" in "Tray Paper Settings", *General Settings Guide*.

📝 **Note**

- The paper for slip sheets should be the same size as the copy paper and should be set in the same direction.
- You cannot select the bypass tray for sheet paper to copy the originals.
- You can specify up to 20 pages.

1 Press **[Cover / Slip Sheet]**.

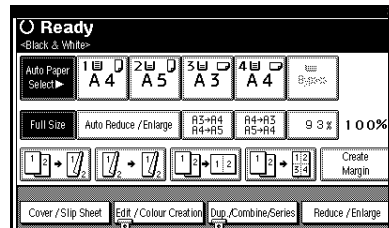

2 Press **[Desig. / Chapter]**.

3 Press the key to select the chapter number.

- 4** Enter the page number of the original's location you want to copy onto a slip sheet with the number keys, and then press the **[#]** key.
- 5** To specify another page, repeat steps **3** to **4**.

 **Note**

- To select chapters 11 to 20, press **[▼11~20]**.

- 6** When page designation is complete, press **[OK]**.

- 7** Press **[OK]**.

- 8** Select the paper tray containing the paper to copy the originals onto.

- 9** Set originals, then press the **[Start]** key.

Chapter

The pages you specify with this function will appear on the front of copy sheets.

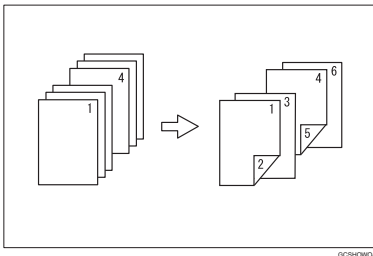

 **Preparation**

Before selecting this function, press the **[Dup./Combine/Series]** key and select Duplex (1 Sided → 2 Sided) mode or Combine mode.

 **Note**

- You can specify up to 20 pages.
- This function can be used only when you select the Duplex (1 Sided→2 Sided) or Combine function.

- 1** Press **[Cover / Slip Sheet]**.

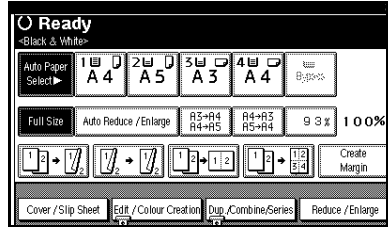

- 2** Press **[Desig. / Chapter]**.

- 3** Press **[Chapter]**.

- 4** Press the key to select the chapter number.

- 5** Enter the number of the first page of the first chapter using the number keys. Then, press the **[#]** key.

- 6** To specify another page, repeat steps **4** to **5**.

 **Note**

- To select chapters 11 to 20, press **[▼11~20]**.

- 7** When page designation is complete, press **[OK]**.

- 8** Press **[OK]**.

- 9** Set originals, and then press the **[Start]** key.

Slip Sheets

Every time the originals' page changes, a slip sheet is inserted. This function can be used to automatically insert a slip sheet between OHP transparencies, or as a stacking function. You can also copy onto slip sheets.

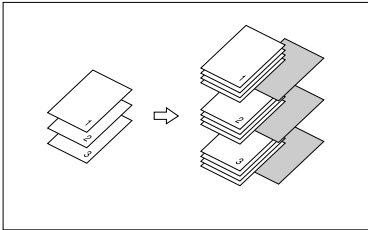

Preparation

Before selecting this function, set the tray for slip sheets. See “Slip Sheet Tray” in “Tray Paper Settings”, *General Settings Guide*.

Note

- ❑ Load slip sheets in the same size and orientation as copy paper or OHP transparencies.

❖ When using OHP transparencies from the bypass tray

- Copy

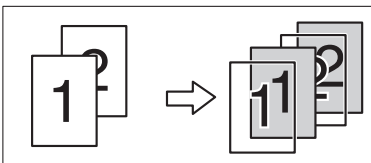

- Blank

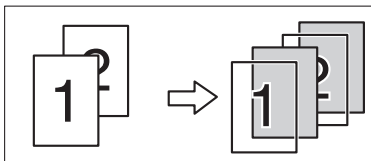

Note

- ❑ Press the **[#]** key and select **[OHP Sheet]** in Special paper. See p.24 “When copying onto OHP Transparencies or Thick Paper”.
- ❑ Paper will be delivered to the external tray when copying onto OHP transparencies or thick paper from the bypass tray, even if you have specified not to use the external tray as the output tray.

1 Press **[Cover / Slip Sheet]**.

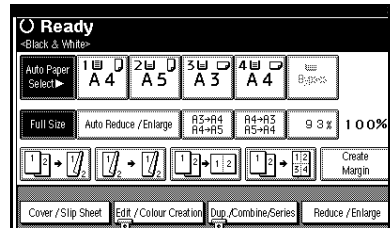

2 Press **[Slip Sheet]**.

3 Select **[Copy]** or **[Blank]**, and then press **[OK]**.

4 Select the paper tray containing the sheet paper to copy the originals.

When using OHP transparencies, open the bypass tray.

5 Place the originals, and then press the **[Start]** key.

Storing Data in the Document Server

The Document Server enables you to store documents in memory and print them as you want.

Important

- Machine failure can result in data loss. Important data stored on the hard disk should be backed up. The manufacturer shall not be responsible for any damage that might result from loss of data.

Note

- Data stored in the Document Server is deleted after three days by setting default. You can specify a period after which stored data is automatically deleted. For more information about settings, see “Auto Delete File” in “Administrator Tools”, *General Settings Guide*.

1 Press [Store File].

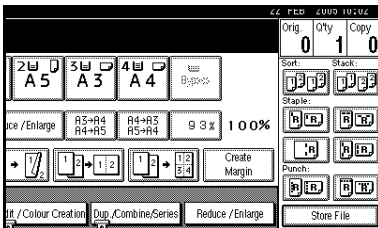

2 Enter a user name, file name, or password if necessary.

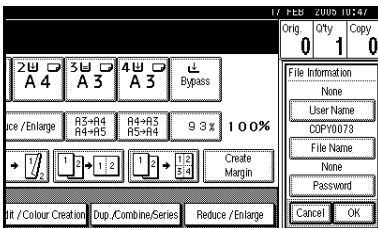

Reference

For details about how to register the user name, file name, or password, see “To register or change a user name”, and “To set or change a password”, *General Settings Guide*.

3 Press [OK].

4 Place the originals.

Reference

For more information about the types of originals that can be placed and how to place them, see p.13 “Placing Originals”.

5 Make the scanning settings for the originals.

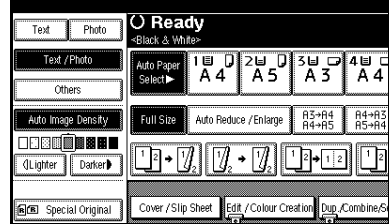

6 Press the [Start] key.

Originals are scanned and stored in memory.

Note

- To stop scanning, press the **[Clear/Stop]** key. To resume a paused scanning job, press **[Continue]** in the confirmation display. To delete saved images and cancel the job, press **[Stop]**.
- When placing an original on the exposure glass, press the **[#]** key after all the originals have been scanned.

- ❑ To check that the document has been stored, press the **【Document Server】** key to display the document selection screen.
- ❑ When the machine is printing a document stored using the copier function, wait until printing has finished before you store another copy document.
- ❑ To print stored documents, see “Printing Stored Documents”, *General Settings Guide*.

Programs

You can store frequently used copy job settings in machine memory and recall them for future use.

Note

- You can store up to 10 programs.
- You can select the standard mode or Program No.10 as the default mode to be set when modes are cleared or reset, or immediately after the operation switch is turned on. See p.112 “Change Initial Mode”.
- Paper settings are stored based on paper size. However, if you have more than one paper tray containing same size paper, the tray prioritized with User Tools (System Settings) is selected first. See “Paper Tray Priority” in “Tray Paper Settings”, *General Settings Guide*.
- Programs are not deleted by turning the power off or pressing the **[Clear Modes]** key. They are canceled only when you delete or overwrite them with another program.

Storing a Program

- 1** Edit the copy settings so all functions you want to store in this program are selected.
- 2** Press the **[Program]** key.

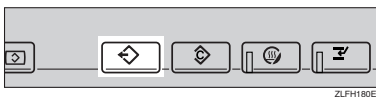

- 3** Press **[Register]**.

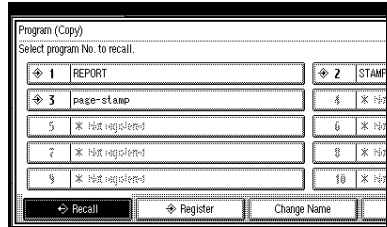

- 4** Press the program number you want to store.

Note

- Program numbers displayed with  next to them already have settings.

Reference

p.86 “Changing a stored program”

- 5** Enter the program name using the letter keys on the display panel.

You can enter up to 40 characters.

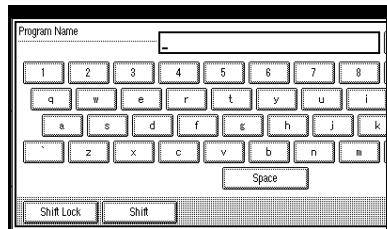

Reference

For details about entering characters, see “Entering Text”, *General Settings Guide*.

Note

- If you do not want to enter a program name, proceed to step **6**.

6 Press [OK].

When the settings are successfully stored, the program name is displayed on the right side of the registered program number. The display returns to the initial copy display for a while.

Changing a stored program**1** Check the program settings. **Note**

- To check the contents of a program, recall it. See p.86 "Recalling a Program".

2 Repeat steps **1** to **4** of "Storing a Program".**3** Press [Register].

Repeat steps **5** and **6** of "Storing a Program".

 **Note**

- When overwritten, the previous program is deleted.

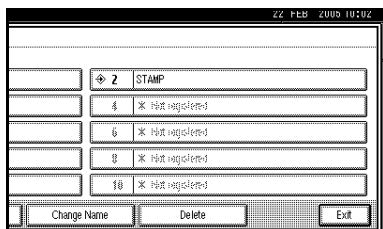
Deleting a Program**1** Press the [Program] key.**2** Press [Delete].**3** Press the number of the program you want to delete.**4** Press [Yes].

The program is deleted, and the display returns to the initial copy display.

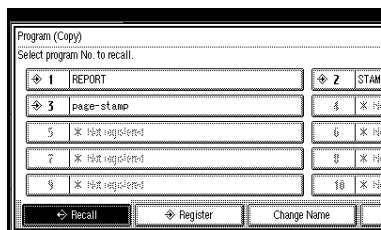
Recalling a Program**1** Press the [Program] key.**2** Press [Recall].**3** Press the number of the program you want to recall.

The stored settings are displayed.

 **Note**

- Program numbers displayed with ⇨ next to them already have settings.

4 Place the originals, and then press the [Start] key.

3. Colour Adjustment/Program

Colour Adjustment

This function lets you alter up to three single colours by mixing them with adjacent colours in the colour circle.

Reference

For types and examples of image adjustment functions, see p.iii “What You Can Do with This Machine <Colour Functions/Colour Adjustments>”.

Note

- You can adjust up to 3 colours from yellow, red, magenta, blue, cyan, or green at the same time.
- This function is only available in Full Colour mode.

1 Press the **[Adjust/Program Colour]** key.

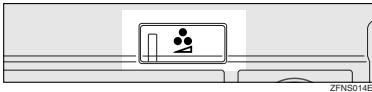

2 Press **[Adjust Colour]**.

The colour circle is displayed.

3 Select the colours you want to adjust.

You can select up to 3 colours.

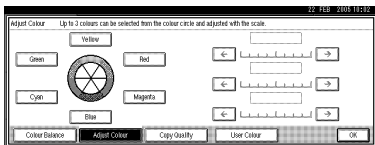

4 Adjust the colour using **[←]** or **[→]**.

Note

- Refer to the colour circle on the control panel.

5 Press **[OK]**.

Note

- The indicator of the **[Adjust/Program Colour]** key will light up when adjusting the colour.
- The adjusted settings will be deleted and the initial values will be reset, when Auto Clear has been performed, when the **[Clear Modes]** key has been pressed or when the power has been turned off.

Colour Balance

You can adjust the overall colour tone when the overall copy is reddish or bluish.

Reference

For types and examples of the image adjustment functions, see p.iii “What You Can Do with This Machine <Colour Functions/Colour Adjustments>”.

- 1 Press the **[Adjust/Program Colour]** key.

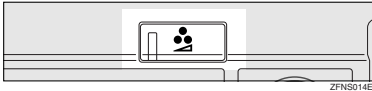

- 2 Make sure that **[Colour Balance]** is selected.

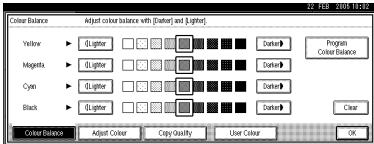

- 3 Adjust by pressing **[Lighter]** or **[Darker]**.

Note

- ❑ You can also register the adjusted settings. See p.88 “Colour Balance Program”.

- 4 Press **[OK]**.

Note

- ❑ The indicator of the **[Adjust/Program Colour]** key will light up when adjusting the colour balance.

- ❑ The adjusted settings will be deleted and the initial values will be reset when either Auto Clear has been performed, when the **[Clear Modes]** key has been pressed or when the power has been turned off.

Colour Balance Program

You can also store the colour balance setting in memory and recall it when you want to use it.

Note

- ❑ You can store up to 3 programs.
- ❑ To change the registered settings, register them again. Previously registered settings will be overwritten.

Storing the adjusted colour balance

- 1 Press the **[Adjust/Program Colour]** Key.

Reference

See p.88 “Colour Balance”.

- 2 Press **[Program Colour Balance]**.

- 3 Press **[Program]**.

- 4 Select a number (1–3) for this setting.

The colour balance setting will be registered in the selected number.

Note

- ❑ If you select the program number key where the  is displayed, the previously registered settings will be overwritten. See p.89 “Changing the registered settings”.

- 5 Press **[OK]**.

Changing the registered settings

- 1** Press the **[Adjust/Program Colour]** key.
- 2** Make sure that **[Colour Balance]** is selected, and then press **[Program Colour Balance]**.

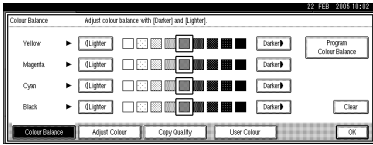

- 3** Select the program number (1–3) whose settings you want to change.
The registered colour balance is displayed.
- 4** Change the registered settings.
- 5** After the registered settings are changed, press **[Program Colour Balance]**.
- 6** Press **[Program]**, and then select the program number to be overwritten.

- 7** Press **[Register]**.

The settings are changed.

- 8** Press **[OK]**.

Copying with the registered settings

- 1** Press the **[Adjust/Program Colour]** key.
- 2** Make sure that **[Colour Balance]** is selected, and then press **[Program Colour Balance]**.
- 3** Make sure that **[Recall]** has been selected, and then select the program that you want to use.

- 4** Press **[OK]**.

- 5** Place the originals, and then press the **[Start]** key.

Note

- The adjusted settings will be deleted and the initial values will be reset when either Auto Clear has been performed, when the **[Clear Modes]** key has been pressed or when the power has been turned off.

Deleting the registered settings

- 1** Press the **[Adjust/Program Colour]** key.
- 2** Make sure that **[Colour Balance]** has been selected, and then press **[Program Colour Balance]**.
- 3** Press **[Delete]**, and then select the program that you want to delete.
- 4** Press **[Yes]**.
- 5** Press **[OK]**.

Image Adjustment

Reference

For types and examples of the image adjustment functions, see p.iii “What You Can Do with This Machine <Colour Functions/Colour Adjustments>”.

You can make the following types of image adjustments.

◆ Sharp / Soft

Adjusts the outline of an image.

◆ Contrast

Adjusts the shades of an image.

◆ Background Density

Adjusts the background density of an image.

◆ Adjust U.C.R.

Adjusts the amount of black toner used in order to vividly express the black areas in an image.

◆ Text / Photo Sensitivity

Adjusts the standard level in judging the image in the text and the photo part, when using “Text / Photo”.

Note

□ “Sharp / Soft”, “Contrast”, “Background Density” can each be adjusted. However, their adjustments can affect the level of other adjustment functions.

□ When adjusting the image quality, the indicator of the **[Adjust/Program Colour]** key will light up.

□ The adjusted settings will be deleted and the initial values will be reset when either Auto Clear has been performed, when the **[Clear Modes]** key has been pressed or when the power has been turned off.

1 Press the **[Adjust/Program Colour]** key.

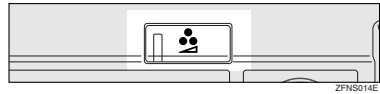

2 Press **[Copy Quality]**.

3 Adjust the settings.

Adjusting the sharpness/softness

1 Adjust by pressing **[Soft]** or **[Sharp]**.

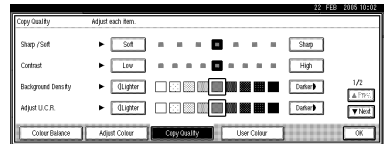

2 Press **[OK]**.

Adjusting the contrast

1 Adjust by pressing **[Low]** or **[High]**.

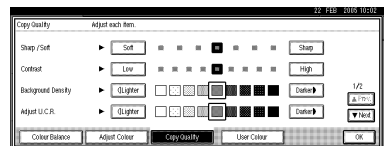

2 Press **[OK]**.

Adjusting the background density

- 1 Adjust by pressing [Lighter] or [Darker].

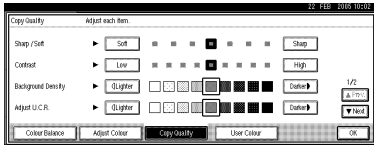

Note

- Adjust to a lighter density when copying dark textured originals, such as newspaper or recycled paper.
- Adjust to a darker density when darkening the colour of markers or highlighters. However, highlighter pen colours are difficult to reproduce. Depending on the colour used, they may not come out on copies, or may come out as a different colour.

- 2 Press [OK].

Adjusting the U.C.R.

- 1 Adjust by pressing [Lighter] or [Darker].

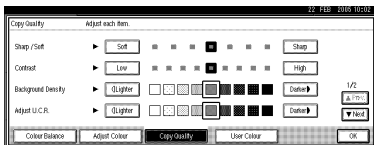

- 2 Press [OK].

Adjusting the text/photo sensitivity

- 1 Press [▼Next].
- 2 Adjust by pressing [Text] or [Photo].

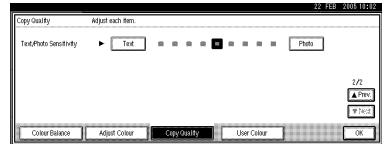

Note

- Adjust toward "Text" if parts of the texts are faded or are not clear. Adjust toward "Photo" if the outline of photos becomes dark.

- 3 Press [OK].

User Colour

You can register colours created by adjusting the density of yellow, magenta, cyan, and black. You can also name the colours that you register, and print out registered colours.

Reference

For types and examples of the image adjustment functions, see p.iii “What You Can Do with This Machine <Colour Functions/Colour Adjustments>”.

The following show you how to create colours:

- Adjust the density of each colour using the density of a chosen basic colour.
- Directly specify the density of each colour using the number keys.

Note

- Adjust the colours to be registered such that the total density of yellow, magenta, cyan, and black is under 255%.
- When the total density of a registered colour is over 256%, it will be corrected to 255%.
- When copying with user colours, the finer shades may vary depending on the condition of the machine.
- In order to correctly reproduce originals, the values entered are corrected by the machine, and copies are made using the optimum values. Therefore, there may be slight colour differences when copying using “Text” and when using “Photo”.
- Up to 15 colours can be registered.

- Sample prints of user colours can also be made on an A4 \square , $8\frac{1}{2}'' \times 11'' \square$ size page or on an A3 \square , $11'' \times 17'' \square$ size page.
- Printing out a user colour sample will be counted under the full colour counter.

Adjusting Colours Based on the Selected Colour

- 1 Press the **[Adjust/Program Colour]** key.

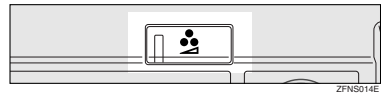

- 2 Press **[User Colour]**.

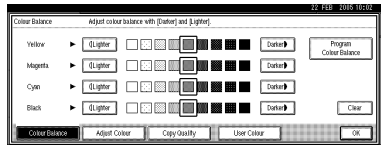

- 3 Select the number (1–15) you want to store the user colour in.

Note

- The settings of the user colour will change when selecting the number already displayed by the colour name.

- 4 Select the colour to be used as a base from **[Basic Colour]**.

The density of each colour for the selected colour is displayed.

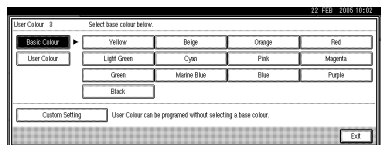

Note

- ❑ Press **[Custom Setting]** to directly specify the density of each colour with the number keys. See p.93 “Mixing Colours Manually with the Number Keys”

Selecting from user colours

- 1 Press **[User Colour]**.
- 2 Select from the registered colours.
- 5 Specify the colour density.

Using **[+]** **[-]**

- 1 Specify the density in percentages (%) using **[+]** or **[-]**.

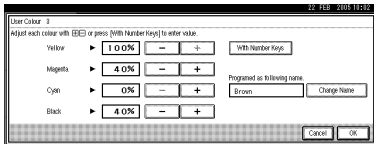
Using **[With Number keys]**

- 1 Press **[With Number keys]**.
- 2 Select the colour that you want to adjust.
- 3 Enter the density in percentages (%) using the number keys, and then press **[#]**.

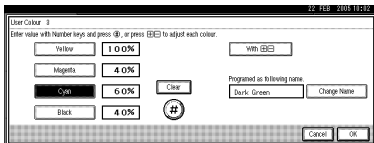
**Note**

- ❑ If you want to use **[+]** or **[-]**, press **[With + -]**.

- ❑ If you enter the wrong density, press **[Clear]** or the **[Clear/Stop]** key, and then re-enter the correct density.
- ❑ Repeat steps 2 and 3 to specify the density of multiple colours.

When renaming a colour

- 1 Press **[Change Name]**.
- 2 Enter the name of the colour (up to 16 characters), and then press **[OK]**.

Reference

“Entering Text”, *General Settings Guide*.

- 6 Check the density and the name of the colour, and then press **[OK]**.

- 7 Press **[Exit]**.

Mixing Colours Manually with the Number Keys

- 1 Press the **[Adjust/Program Colour]** key.
- 2 Press **[User Colour]**.
- 3 Select the number (1–15) that you want to store the user colour in.

Note

- ❑ The settings of the user colour will change when selecting the number already displayed by the colour name.

- 4 Press **[Custom Setting]**.

- 5 Select the colour that you want to adjust.

- 6** Enter the density in percentages (%) with the number keys, and then press [#].

When renaming a colour

- 1** Press [Change Name].
- 2** Enter the name of the colour (up to 16 characters can be used), and then press [OK].



Reference

"Entering Text" General Settings Guide.

- 7** Check the names of each colour, and then press [OK].



Note

- Repeat steps **5** to **7** if you want to specify the density of multiple colours.

- 8** Press [Exit].

Deleting User Colours



Note

- You cannot delete colours registered in the program or registered colours currently in use.

- 1** Press the [Adjust/Program Colour] key.

- 2** Press [User Colour].

- 3** Press [Delete].

- 4** Select the number of the user colour you want to delete.

- 5** Press [Delete].

- 6** Press [Exit].

Sampling the User Colours

- 1** Press the [Adjust/Program Colour] key.





- 2** Press [User Colour].

- 3** Make sure that the paper is of the correct size, and then press [Print Sample of User Colour].

The sample of user colours is output to the standard tray.



Note

- The user colours will be copied on a A4 , 8 1/2" x 11"  sheet or a A3 , 11" x 17"  sheet.

4. Troubleshooting

If Your Machine Does Not Operate As You Want

When a Message Is Displayed

The following chart contains explanations of common messages. If other messages are displayed, then follow the instructions as displayed.



Note

☐ For messages not listed here, see “Troubleshooting”, *General Settings Guide*.

Message	Causes	Solutions
Cannot detect original size.	An irregular original is placed. See p.11 “Sizes difficult to detect”.	Place custom size originals on the exposure glass. See p.14 “Placing Originals on the Exposure Glass”.
		Enter the horizontal and vertical size of the custom size original. See p.14 “Placing Originals on the Exposure Glass”.
		Select paper manually, not with the Auto Paper Select function.
		Do not use the Auto Reduce / Enlarge function.
	Original is not placed.	Place originals.
Check original orientation.	There is no copy paper in the same orientation as the originals.	Place the original in the same orientation as the copy paper.
Check paper size.	An irregular paper size is set.	Press the [Start] key and copying will start on the selected paper.
Rotate Sort is not available with this image size.	A paper size for which Rotate Sort is not available is selected.	Select a proper paper size. See p.129 “Sort, Rotate Sort, Stack”.
Cannot punch paper of this size.	The Punch function cannot be used with paper size selected.	The following paper sizes are available for Punch mode: A3☐, B4 JIS☐, A4☐☐, B5 JIS☐☐, A5☐, 11"×17"☐, 8 ¹ / ₂ "×14"☐, 8 ¹ / ₂ "×11"☐☐. Select one of these sizes.
It is over stapling capacity.	The number of sheets per set is over the staple capacity.	Check the stapler capacity. See p.131 “Staple”.

Message	Causes	Solutions
Cannot staple paper of this size.	The Staple function cannot be used with the paper size selected.	Select a paper size that can be used with the Staple function. See p.131 "Staple".
Duplex is not available with this paper size.	A paper size not available when using the Duplex function has been selected.	Select a proper paper size. See p.134 "Duplex".
Maximum number of sets is *.	The number of copies exceeds maximum copy quantity.	You can change the maximum copy quantity. See p.112 "Max. Copy Quantity".
Cannot copy. Original is being scanned by another function.	The Document Server function is in use.	To cancel a job being processed, press [Exit] , and then press the [Document Server] key. Next, press the [Clear/Stop] key. When the message "[Stop] key was pressed. Stop storing?" is displayed, press [Stop] .
You do not have the privileges to use this function.	The use of this function is restricted to authenticated users only.	Contact the administrator.
Authentication has failed.	The entered login user name or login password is not correct.	Inquire the user administrator for the correct login user name and login password.
	The machine cannot perform authentication.	Contact the administrator.
Selected files contain file(s) that the user does not have access privileges to. Please note that only the files with access privileges will be deleted.	You have tried to delete files without the authority to do so.	Files can be deleted by the person who created the file. To delete a file which you are not authorized to delete, contact the person who created the file.

If You Cannot Make Clear Copies

Problem	Causes	Solutions
Copies appear dirty.	The image density is too dark.	Adjust the image density. See p.32 "Adjusting Copy Image Density".
	Auto Image Density is not selected.	Select Auto Image Density. See p.32 "Adjusting Copy Image Density".
The reverse side of an original image is copied.	The image density is too dark.	Adjust the image density. See p.32 "Adjusting Copy Image Density".
	Auto Image Density is not selected.	Select Auto Image Density. See p.32 "Adjusting Copy Image Density".
A shadow appears on copies if you use pasted originals.	The image density is too dark.	Adjust the image density. See p.32 "Adjusting Copy Image Density". Change the orientation of the original. Put tape over pasted parts.
The same copy area is dirty whenever making copies.	The exposure glass or ADF is dirty.	Clean them. See "Maintaining Your Machine" <i>General Settings Guide</i> .
Copies are too light.	The image density is too light.	Adjust the image density. See p.32 "Adjusting Copy Image Density".
	The paper size is not suitable.	Use a recommended paper size.  Note <input type="checkbox"/> A light copy may result when you use damp or rough grain paper.
	The toner cartridge is almost empty.	Add toner. See "Adding Toner" <i>General Settings Guide</i> .
Parts of the image are not copied.	The original is not set correctly.	Place originals correctly. See p.13 "Placing Originals".
	An irregular paper size is selected.	Select a proper paper size.
Copies are blank.	The original is not placed correctly.	When using the exposure glass, place originals face down. When using the ADF, place them face up. See p.13 "Placing Originals".
A moiré pattern is produced on copies. 	Original has a dot pattern image, or too many lines.	Position the original on the exposure glass at a slight angle.

If You Cannot Make Copies As You Want

This section explains causes of, and remedies for, unexpected copy results.

◆ **Basic**

Problem	Causes	Solutions
Copies are not stapled.	There are jammed staples in the stapler.	Remove jammed staples. See “Removing Jammed Staples” <i>General Settings Guide</i> .  Note □ After removing jammed staples, staples might not eject the first few times you try to use the stapler.
	The number of copies exceeds stapler capacity.	Check the stapler capacity. See p.131 “Staple”.
	Copy paper is curled.	Turn the copy paper over in the tray.
Staples are wrongly positioned.	Originals are not placed correctly.	Check originals are placed in the correct position. See p.45 “Staple”.
You cannot combine several functions.	Selected functions cannot be used together.	Check the combination of functions and make the settings again. See p.125 “Combination Chart”.
When sorting, the pages are divided into two blocks.	The memory became full in the middle of sorting and the pages were delivered in two blocks.	You can interrupt copying when memory becomes full. See p.122 “Memory Full Auto Scan Restart”.
Paper does not output during printing with stapling.	If you stop printing while using the staple function, sheets not stapled during printing may be left in the staple unit.	Press the [Clear Modes] key and cancel copy settings, including stapling.
Colours changed even though they were not selected.	If colour range is set to “Wider” and if red is selected, colours such as magenta and orange may change.	Adjust the colour range by setting the colour width. See p.123 “Adjust Colour Image”.
Colours not selected will be erased when using Erase mode.	If colour range is set to “Wider” and if red is selected, colours such as magenta and orange may change.	Adjust the colour range by setting the colour width. See p.123 “Adjust Colour Image”.

◆ Edit

Problem	Causes	Solutions
When using the Double Copies function, parts of the original image are not copied.	The original and copy paper combination is not correct.	Select A3 <input type="checkbox"/> for A4 <input type="checkbox"/> originals and A4 for A5 originals. See p.63 "Double Copies".
When using the Border, Centre, or Centre/Border function, parts of the original image are not copied.	You set a wide erased margin.	Make the margin width narrower. You can adjust it between 2-99 mm. See "Erase Border Width" and "Erase Centre Width" in p.115 "Edit P. ¹ / ₃ ". Place originals correctly.
	Originals are not scanned correctly.	Place originals correctly.
When using the Margin Adjustment function, parts of the original image are not copied.	You set a wide erased margin.	Set a narrower margin with User Tools. You can set the width between 0-30 mm (0"-1.2"). See p.115 "Front Margin: Left/Right", p.116 "Front Margin: Top/Bottom", p.115 "Back Margin: Left/Right", and p.116 "Back Margin: Top/Bottom".
	There is a lack of margin space on the opposite side of the binding position.	
When using the Image Repeat function, the original image is not copied repeatedly.	You selected copy paper of the same size as the originals, or you did not select a proper reproduction ratio.	Select copy paper of a larger size than the originals.
		Select a proper reproduction ratio.

◆ Stamp

Problem	Causes	Solutions
The stamp position is wrong.	The paper orientation is wrong.	Check the paper orientation and stamp position.

◆ **Combine**

Problem	Causes	Solutions
You cannot fold copies into a book using the Magazine or Booklet function.	Combine Original Magazine Format is not set correctly.	Change the setting. See p.117 "Orientation: Booklet, Magazine"
When using the Combine function, parts of the image are not copied.	You specified a reproduction ratio that does not match the sizes of originals and copy paper.	When you specify a reproduction ratio using the Manual Paper Select function, make sure the ratio matches originals and the copy paper. Note <input type="checkbox"/> Select the correct reproduction ratio before using the Combine function.
Copies are not in correct order.	You placed the originals in incorrect order.	When placing a stack of originals in the ADF, the last page should be on the bottom.
		If you place an original on the exposure glass, start with the first page to be copied.

◆ **Duplex**

Problem	Causes	Solutions
When using Duplex, copy is made Top/Bottom even though Left/Right is selected.	You placed the originals in the wrong orientation.	Place the originals in the correct orientation. See p.13 "Original Orientation".
Copies are not in correct order.	You placed the originals in incorrect order.	When placing a stack of originals in the ADF, the first page should be on top.
		If you place an original on the exposure glass, start with the first page to be copied.

When Memory Is Full

Note

- If you set **[Memory Full Auto Scan Restart]** in User Tools (see p.122 “Memory Full Auto Scan Restart”) to **[Yes]**, even if memory becomes full, the memory overflow message will not be displayed. The machine will make copies of scanned originals first, then automatically scan and copy remaining originals. When this happens, the resulting sorted pages will not be sequential.

Message	Causes	Solutions
<p>Memory is full.* originals have been scanned.</p> <p>Press [Print] to copy scanned originals. Do not remove remaining originals.</p> <p> Note</p> <ul style="list-style-type: none"> <input type="checkbox"/> Copying will stop and this message will be displayed when the memory is full. 	<p>The scanned original exceeds the number of pages that can be stored in memory.</p>	<p>Press [Print] to print out already scanned originals and then delete scan data.</p> <p>Or, press [Clear] to simply delete scan data.</p>
<p>Press [Resume] to scan and copy remaining originals.</p> <p>[Stop] [Resume]</p>	<p>The machine checks if the remaining originals should be copied, after the scanned original is printed.</p>	<p>To continue copying, remove all copies, and then press [Resume]. To stop copying, press [Stop].</p>

5. User Tools (Copier / Document Server Features)

User Tools Menu (Copier / Document Server Features)

User Tools Item Names	Default Settings
General Features P.1/5 See p.111 "General Features P.1/5".	
Auto Paper Select Priority	<i>On</i>
Paper Display	<i>Display</i>
Original Type Display	<i>Display</i>
Original Type Priority	Full Colour / Two-colour: <i>Text / Photo</i>
	B & W/Single Colour: <i>Text / Photo</i>
Original Photo Type Priority	Text / Photo: <i>Printed Photo</i>
	Photo: <i>Printed Photo</i>
Auto Tray Switching	<i>With Image Rotation</i>
General Features P.2/5 See p.112 "General Features P.2/5".	
Duplex Mode Priority	<i>1 Sided→1 Sided (metric) 1 Sided→2 Sided (inch)</i>
Copy Orientation in Duplex Mode	<i>Top to Top</i>
Original Orientation in Duplex Mode	<i>Top to Top</i>
Change Initial Mode	<i>Standard</i>
Max. Copy Quantity	<i>999 Sheet(s)</i>
Tone: Original remains	<i>On</i>
Job End Call	<i>On</i>
General Features P.3/5 See p.113 "General Features P.3/5".	
Copy Function Key: F1~F5	<ul style="list-style-type: none"> • F1: <i>1 Sided→2 Sided: T to T</i> • F2: <i>2 Sided: T to T→2 Sided: T to T</i> • F3: <i>1 Sided→1 Sided Combine</i> • F4: <i>1 Sided→1 Sided Combine: 4 originals</i> • F5: <i>Create Margin</i>

User Tools Item Names	Default Settings
General Features P.4/5 See p.113 "General Features P. ⁴ / ₅ ".	
Document Server Storage Key:F1~F5	<ul style="list-style-type: none"> • F1: 2 Sided Original Top to Top • F2: 1 Sided→1 Sided Combine • F3: 1 Sided→1 Sided Combine: 4 originals • F4: 1 Sided→1 Sided Combine: 8 originals • F5: Create Margin
General Features P.5/5 See p.113 "General Features P. ⁵ / ₅ ".	
Clear Bypass Mode	Clear
Colour Mode Priority	Black & White
Two-colour Mode Priority	Red & Black
Auto Image Density Priority	Full Colour / Two-colour: Off
	B & W / Single Colour: On
Reproduction Ratio P.1/2 See p.114 "Reproduction Ratio P. ¹ / ₂ ".	
Shortcut R/E	Metric version <ul style="list-style-type: none"> •Shortcut R/E 1: 71% •Shortcut R/E 2: 141% •Shortcut R/E 3: 93% Inch version <ul style="list-style-type: none"> •Shortcut R/E 1: 73% •Shortcut R/E 2: 155% •Shortcut R/E 3: 93%
Enlarge 1~5	Metric version <ul style="list-style-type: none"> •Enlarge 1: 115% •Enlarge 2: 122% •Enlarge 3: 141% •Enlarge 4: 200% •Enlarge 5: 400% Inch version <ul style="list-style-type: none"> •Enlarge 1: 121% •Enlarge 2: 129% •Enlarge 3: 155% •Enlarge 4: 200% •Enlarge 5: 400%
Priority Setting: Enlarge	Metric version 141% Inch version 155%

User Tools Item Names	Default Settings
Reproduction Ratio P.2/2 See p.114 "Reproduction Ratio P. ² / ₂ ".	
Reduce1~6	Metric version •Reduce1: 25% •Reduce2: 50% •Reduce3: 65% •Reduce4: 71% •Reduce5: 75% •Reduce6: 82% Inch version •Reduce1: 25% •Reduce2: 50% •Reduce3: 65% •Reduce4: 73% •Reduce5: 78% •Reduce6: 85%
Priority Setting: Reduce	Metric version: 71% Inch version: 73%
Ratio for Create Margin	93%
R/E Priority	<i>Reduce</i>
Edit P.1/2 See p.115 "Edit P. ¹ / ₃ ".	
Front Margin: Left/Right	Metric version: <i>Left 5mm</i> Inch version: <i>Left 0.2"</i>
Back Margin: Left/Right	Metric version: <i>Right 5mm</i> Inch version: <i>Right 0.2"</i>
Front Margin: Top/Bottom	Metric version: <i>T/B 0mm</i> Inch version: <i>T/B 0"</i>
Back Margin: Top/Bottom	Metric version: <i>T/B 0mm</i> Inch version: <i>T/B 0"</i>
1 Sided→2 Sided Auto Margin: TtoT	Metric version: <i>Right 5mm</i> Inch version: <i>Right 0.2"</i>
1 Sided→2 Sided Auto Margin: TtoB	Metric version: <i>T/B 0mm</i> Inch version: <i>T/B 0"</i>
Erase Border Width	Metric version: <i>10mm</i> Inch version: <i>0.4"</i>
Erase Original Shadow in Combine	<i>Yes</i>
Erase Centre Width	Metric version: <i>10mm</i> Inch version: <i>0.4"</i>

User Tools Item Names	Default Settings	
Edit P.2/2 See p.116 "Edit P. ² / ₃ ".		
Front Cover Copy in Combine	<i>Combine</i>	
Copy Order in Combine	<i>From Left to Right</i>	
Copy on Designating Paper	<i>Yes</i>	
Copy on Designating Page in Combine	<i>Combine</i>	
Orientation: Booklet, Magazine	<i>Open to Left</i>	
Edit P. ³ / ₃ See p.117 "Edit P. ³ / ₃ ".		
Image Repeat Separation Line	<i>None</i>	
Double Copies Separation Line	<i>None</i>	
Separation Line in Combine	<i>None</i>	
Stamp See p.119 "Stamp".		
Background Numbering	Size	<i>Normal</i>
	Density	<i>Normal</i>
	Stamp Colour	<i>Black</i>
Preset Stamp	Stamp Priority	<i>Copy</i>
	Stamp Language	<i>English</i>
	Stamp Position	Metric version <ul style="list-style-type: none"> • Position: <i>Top Right</i> • Top Margin: <i>24mm</i> • Right Margin: <i>24mm</i> Inch version <ul style="list-style-type: none"> • Position: <i>Top Right</i> • Top Margin: <i>1.0"</i> • Right Margin: <i>1.0"</i>
	Stamp Format:	Size: <i>1 X</i>
		Density: <i>Normal</i>
		Page to Stamp: <i>All Pages</i>
	Stamp Colour:	<i>Black</i>

User Tools Item Names	Default Settings	
User Stamp	Program / Delete Stamp	
	Stamp Position: 1~4	Metric version <ul style="list-style-type: none"> • Position: <i>Top Right</i> • Top Margin: <i>24mm</i> • Right Margin: <i>24mm</i> Inch version <ul style="list-style-type: none"> • Position: <i>Top Right</i> • Top Margin: <i>1.0"</i> • Right Margin: <i>1.0"</i>
	Stamp Format: 1~4	<i>All Pages</i>
	Stamp Colour: 1~4	<i>Black</i>
Date Stamp	Format	Metric version: <i>DD / MM / YYYY</i> Inch version: <i>MM / DD / YYYY</i>
	Font	<i>Font 1</i>
	Stamp Position	Metric version <ul style="list-style-type: none"> • Position: <i>Top Left</i> • Top Margin: <i>8mm</i> • Right Margin: <i>32mm</i> Inch version <ul style="list-style-type: none"> • Position: <i>Top Left</i> • Top Margin: <i>0.3"</i> • Right Margin: <i>0.8"</i>
	Stamp Setting	<i>All Pages</i>
	Size	<i>Auto</i>
	Superimpose	<i>No</i>
	Stamp Colour	<i>Black</i>

5

User Tools Item Names		Default Settings
Page Numbering	Stamp Format	<i>P1, P2...</i>
	Font	<i>Font 1</i>
	Size	<i>Auto</i>
	Duplex Back Page Stamping Position	<i>Opposite Position</i>
	Page Numbering in Combine	<i>Per Original</i>
	Stamp on Designated Slip Sheet	<i>No</i>
	Stamp Position:	Metric version <ul style="list-style-type: none"> • Position P1, 1/5, P.1, 1: <i>Top Right</i> -1-, 1-1: <i>Bottom Centre</i> • Top/Bottom Margin P1, 1/5, P.1, 1: <i>12mm</i> -1-, 1-1: <i>8mm</i> • Left/Right Margin P1, 1/5, P.1, 1: <i>12mm</i> -1-, 1-1: <i>0mm</i> Inch version <ul style="list-style-type: none"> • Position P1, 1/5, P.1, 1: <i>Top Right</i> -1-, 1-1: <i>Bottom Centre</i> • Top/Bottom Margin P1, 1/5, P.1, 1: <i>0.5"</i> -1-, 1-1: <i>0.3"</i> • Left/Right Margin P1, 1/5, P.1, 1: <i>0.5"</i> -1-, 1-1: <i>0.0"</i>
	Superimpose	<i>No</i>
Stamp Colour	<i>Black</i>	
Input/Output See p.122 "Input/Output".		
Switch to Batch	<i>Batch</i>	
SADF Auto Reset	<i>5 seconds</i>	
Rotate Sort: Auto Paper Continue	<i>No</i>	
Auto Sort	<i>No</i>	
Memory Full Auto Scan Restart	<i>No</i>	
Select Stack Function	<i>Stack</i>	
Select Stapling Position	<i>Top 2</i>	
Letterhead Setting	<i>No</i>	

User Tools Item Names	Default Settings
Adjust Colour Image See p.123 "Adjust Colour Image".	
Background Density of ADS(Full Colour / Two-colour)	Centre of the 5 level adjustment
Colour Sensitivity	Centre of the 5 level adjustment
A.C.S. Sensitivity	Centre of the 5 level adjustment
A.C.S. Priority	<i>Full Colour</i>
Administrator Tools See p.124 "Administrator Tools".	
Menu Protect	<i>Level 2</i>

Accessing User Tools (Copier / Document Server Features)

This section is for key operators in charge of this machine. With User Tools can change the machine's default settings.

 **Note**

- Be sure to exit User Tools and return to the initial copy display after all settings are finished. This section describes system settings you can set for the copier function.
- The selected key is highlighted.
- Any changes you make with User Tools remain in effect even if the main power switch or operation switch is turned off, or the **[Clear Modes]** key is pressed.

 **Reference**

For details, see "Changing Default Settings" in "User Tools (System Settings)", *General Settings Guide*.

Changing Default Settings

- 1** Press the **[User Tools/Counter]** key.

The User Tools main menu appears.

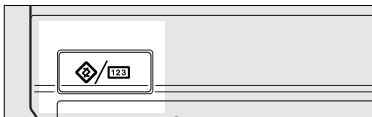

ZFLS110E

- 2** Press **[Copier / Document Server Features]**.

The Copier / Document Server Features menu is displayed.

- 3** Select the menu you want to set.

The setting display for each menu is displayed.

 **Reference**

See p.103 "User Tools Menu (Copier / Document Server Features)".

- 4** Change settings by following the instructions on the display panel, and then press **[OK]**.

Exiting User Tools

- 1** After changing default settings, press **[Exit]** on the User Tools main menu.

Changes to User Tools are complete, and the machine is ready to copy.



 **Note**

- You can also exit User Tools by pressing the **[User Tools/Counter]** key.

Settings You Can Change with User Tools

General Features P.1/5

❖ Auto Paper Select Priority

Auto Paper Select is the default setting. You can cancel this setting. See p.34 “Selecting Copy Paper”.

Note

- Default: *On*

❖ Paper Display

You can choose to have the available paper trays and sizes shown on the initial display.

Note

- Default: *Display*
- If you select [**Hide**], the display is shown as below. Press [**Auto Paper Select**] to display paper sizes.

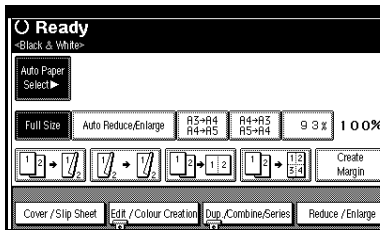

❖ Original Type Display

You can have the original types shown on the initial display.

Note

- Default: *Display*

- If you select [**Hide**], the display is as below.

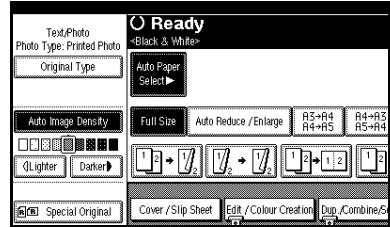

❖ Original Type Priority

You can select the original type effective when the power is turned on, or modes cleared. See p.33 “Selecting the Original Type”.

Note

- Default: Full Colour/Two-Colour: *Text / Photo*, B&W/Single Colour: *Text / Photo*

❖ Original Photo Type Priority

When you select “Text / Photo” or “Photo” in “Original Type Priority”, you can change the settings of the selected original type.

Note

- Default: Text / Photo: *Printed Photo*, Photo: *Printed Photo*

❖ Auto Tray Switching

If you load paper of the same size in two or more trays, the machine automatically shifts to the other when the first tray runs out of paper (when Auto Paper Select is selected.) This function is called “Auto Tray Switching”. This setting specifies whether to use Auto Tray Switching or not.

 **Note**

- Default: *With Image Rotation*
- [With Image Rotation]** Use to copy when using the Auto Tray Switching function.
- [Without Image Rotation]** Only copies with Auto Tray Switching if you load paper of the same size and in the same orientation in two or more trays. If the paper is not the same size or in the same orientation, copying is interrupted and the message "Load paper." is displayed.
- [Off]** When a paper tray runs out of paper, copying is interrupted and the message "Load paper." is displayed.

General Features P.2/5

❖ **Duplex Mode Priority**

You can select the type of the Duplex function effective when the power is turned on, or modes are cleared.

 **Note**

- Default:
 - Metric version: *1 Sided*→*1 Sided*
 - Inch version: *1 Sided*→*2 Sided*

❖ **Copy Orientation in Duplex Mode**

You can set the copy orientation when making two-sided copies.

 **Note**

- Default: *Top to Top*

❖ **Original Orientation in Duplex Mode**

You can set the original orientation when making two-sided copies.

 **Note**

- Default: *Top to Top*

❖ **Change Initial Mode**

You can select standard mode or Program No.10 as the mode effective when power is turned on, or modes are cleared.

 **Note**

- Default: *Standard*

❖ **Max. Copy Quantity**

The maximum copy quantity can be set between 1 and 999.

 **Note**

- Default: *999 Sheet(s)*

❖ **Tone: Original remains**

The beeper (key tone) sounds if you forget to remove originals after copying.

 **Note**

- Default: *On*
- If Panel Tone in User Tools (System Settings) is **[Off]**, the beeper does not sound, whatever the Tone: Original remains setting. See "Panel Tone" in "General Features", *General Settings Guide*.

❖ **Job End Call**

You can choose to have the beeper sound when copying is complete.

 **Note**

- Default: *On*
- If Panel Tone of User Tools (System Settings) settings is **[On]**, the machine beeps to notify you that it did not complete a job for reasons such as: the paper tray ran out of paper, or a paper jam occurred.

General Features P. 3/5

❖ Copy Function Key: F1-F5

You can assign frequently used functions to function keys F1 to F5.

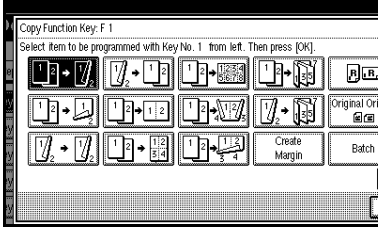

Note

- Default:
 - Copy Function Key: F1: 1 Sided→2 Sided: T to T
 - Copy Function Key: F2: 2 Sided: T to T→2 Sided: T to T
 - Copy Function Key: F3: 1 Sided→1 Sided Combine
 - Copy Function Key: F4: 1 Sided→1 Sided Combine: 4 originals
 - Copy Function Key: F5: Create Margin

General Features P. 4/5

❖ Document Server Storage Key: F1–F5

You can assign frequently used functions to function keys F1 to F5. You can also change assigned functions.

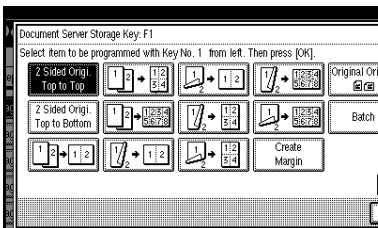

Note

- Default:
 - Document Server Storage Key: F1: 2 Sided Original Top to Top
 - Document Server Storage Key: F2: 1 Sided→1 Sided Combine
 - Document Server Storage Key: F3: 1 Sided→1 Sided Combine: 4 originals
 - Document Server Storage Key: F4: 1 Sided→1 Sided Combine: 8 originals
 - Document Server Storage Key: F5: Create Margin

General Features P. 5/5

5

❖ Clear Bypass Mode

You can set whether to “Clear” or “Do not Clear” bypass tray settings when the machine is turned on, reset, or modes are cleared.

Note

- Default: Clear

❖ Colour Mode Priority

You can select to prioritize “Auto Colour Select”, “Full Colour”, or “Black & White” when the machine is turned on, reset, or modes are cleared.

Note

- Default: Black & White

❖ Two-colour Mode Priority

You can set whether to prioritize “Red & Black” or “Two-colour” in Two-colour mode.

Note

- Default: Red & Black

❖ **Auto Image Density Priority**

You can set whether Auto Image Density is “On” or “Off” when the machine is turned on, reset, or modes are cleared.

 **Note**

- Default: Full Colour/Two-colour: *Off*, B&W/Single Colour: *On*
- When using the Auto Colour Select function, the settings of Full Colour/Two-colour will be effective.

Reproduction Ratio P.1/2

❖ **Shortcut R/E**

You can register up to three frequently used Reduce/Enlarge ratios other than the fixed Reduce/Enlarge ratio and have them shown on the initial display. You can also change registered Reduce/Enlarge ratios.

If no Reduce/Enlarge ratio has been set when selecting [Shortcut R / E 1], [Shortcut R / E 2], or [Shortcut R / E 3], enter the ratio using the number keys.

❖ **Enlarge 1-5**

You can customize available enlargement ratios by pressing [Reduce / Enlarge], followed by [Enlarge].

115% B4→A3	122% F→A3 A4→B4	141% A4→A3 A5→A4	200% A5→A3	400%
Enlarge1	Enlarge2	Enlarge3	Enlarge4	Enlarge5

 **Note**

- Default:
 - Metric version:
 - Enlarge 1: 115%
 - Enlarge 2: 122%
 - Enlarge 3: 141%
 - Enlarge 4: 200%
 - Enlarge 5: 400%
 - Inch version:
 - Enlarge 1: 121%
 - Enlarge 2: 129%
 - Enlarge 3: 155%
 - Enlarge 4: 200%
 - Enlarge 5: 400%
- When selecting [User Enlrg. Ratio], enter a ratio using the number keys (in the range of 101 to 400%).

❖ **Priority Setting: Enlarge**

You can set the ratio with priority when [Reduce / Enlarge] is pressed, followed by [Enlarge].

 **Note**

- Default:
 - Metric version: 141%
 - Inch version: 155%

Reproduction Ratio P.2/2

❖ **Reduce 1-6**

You can customize available reduction ratios by pressing [Reduce / Enlarge], followed by [Reduce].

25% A3→A5	50% A3→A5 F→A5	65% A3→F	71% A3→A4 A4→A5	75% B4→F4 B4→F	82% F→A4 B4→A4
Reduce1	Reduce2	Reduce3	Reduce4	Reduce5	Reduce6

 **Note** Default:

- Metric version:
 - Reduce 1: 25%
 - Reduce 2: 50%
 - Reduce 3: 65%
 - Reduce 4: 71%
 - Reduce 5: 75%
 - Reduce 6: 82%
- Inch version:
 - Reduce 1: 25%
 - Reduce 2: 50%
 - Reduce 3: 65%
 - Reduce 4: 73%
 - Reduce 5: 78%
 - Reduce 6: 85%

- When selecting [**User Redc.Ratio**], enter a ratio using the number keys (in the range of 25 to 99%).

◆ Priority Setting: Reduce

You can set the ratio with priority when [**Reduce / Enlarge**] is pressed, followed by [**Reduce**].

 **Note** Default:

- Metric version: 71%
- Inch version: 73%

◆ Ratio for Create Margin

You can set a Reduce/Enlarge ratio when registering Create Margin in a shortcut key.

 **Note** Default: 93%**◆ R/E Priority**

Specifies which tab has priority on the display panel when [**Reduce / Enlarge**] is pressed.

 **Note** Default: *Reduce*

Edit P.^{1/3}

 **Note**

- Enter the width of the binding margin using the number keys, as follows:

- Metric version: 0–30 mm (1 mm increments)
- Inch version: 0"–1.2" (0.1 in increments)

- Enter the width of the erased margin using the number keys as follows:

- Metric version: 2–99 mm (1 mm increments)
- Inch version: 0.1"–3.9" (0.1 in increments)

◆ Front Margin: Left/Right

You can specify left and right margins on the front side of copies using the Margin Adjustment function.

 **Note** Default:

- Metric version: *Left 5 mm*
- Inch version: *Left 0.2"*

◆ Back Margin: Left/Right

You can specify left and right margins on the back side of copies using the Margin Adjustment function.

 **Note** Default:

- Metric version: *Right 5 mm*
- Inch version: *Right 0.2"*

❖ **Front Margin: Top/Bottom**

You can specify top and bottom margins on the front side of copies using the Margin Adjustment function.

 **Note**

- Default:
 - Metric version: *T/B 0 mm*
 - Inch version: *T/B 0.0"*

❖ **Back Margin: Top/Bottom**

You can specify top and bottom margins on the back side of copies using the Margin Adjustment function.

 **Note**

- Default:
 - Metric version: *T/B 0 mm*
 - Inch version: *T/B 0.0"*

❖ **1 Sided→2 Sided Auto Margin: TtoT**

When using the 1 sided → 2 sided Duplex function, you can specify margins on the back side. The margin is set to the same value as “**Back Margin: Left/Right**”.

 **Note**

- Default:
 - Metric version: *Right 5 mm*
 - Inch version: *Right 0.2"*

❖ **1 Sided→2 Sided Auto Margin: TtoB**

When using the 1 sided → 2 sided Duplex function, you can specify margins on the back side. The margin is set to the same value as “**Back Margin: Top/Bottom**”.

 **Note**

- Default:
 - Metric version: *T/B 0 mm*
 - Inch version: *T/B 0.0"*

❖ **Erase Border Width**

You can specify the width of erased border margins using this function.

 **Note**

- Default:
 - Metric version: *10 mm*
 - Inch version: *0.4"*

❖ **Erase Original Shadow in Combine**

In Combine Copy or Magazine Copy mode, you can specify whether to erase a 3mm, 0.1" bounding margin around all four edges of each original.

 **Note**

- Default: *Yes*

❖ **Erase Centre Width**

You can specify the width of the erased centre margins using this function.

 **Note**

- Default:
 - Metric version: *10 mm*
 - Inch version: *0.4"*

Edit P.²/₃

 **Note**

- An image of approximately 1.5 mm (0.06") will not be displayed as the width of the separation line, when specifying solid or broken lines.

❖ **Front Cover Copy in Combine**

You can make a combined copy on the front cover sheet when you select the Front Cover function.





Combine				Not Combined				
1	2	5	6	1	2	3	6	7
3	4	7	8		4	5	8	

 **Note**

- Default: *Combine*

❖ Copy Order in Combine

You can set the copy order when using the Combine function to Left to Right or Top to Bottom.

From Left to Right	From Top to Bottom
	
	

GCAH090E

 **Note**

- Default: *From Left to Right*

❖ Copy on Designating Paper

You can make a combined copy on a designated paper.

 **Note**

- Default: *Combine*

❖ Copy on Designating Page in Combine

You can make a combined copy on a designated paper.

 **Note**

- Default: *Combine*

❖ Orientation: Booklet, Magazine

You can select the orientation of copies to open when using Magazine or Booklet function.

 **Note**

- Default: *Open to Left*

 **Reference**

p.61 "How to fold and unfold copies to make a magazine"

Edit P.^{3/3}**❖ Image Repeat Separation Line**

You can select a separation line and colour using the Image Repeat function from: None, Solid, Broken A, Broken B, or Crop Marks.

- None



- Solid



- Broken A



- Broken B



- Crop Marks

 **Note**

- Default: *None*
- Line colour (Full Colour): Yellow, Red, Cyan, Magenta, Green, Blue, Black
- Separation lines cannot be specified when using [None].
- In "Black and White", printing will be done in black; in "Single Colour", printing will be done in the specified colour; in "Two-Colour" (standard), printing will be done in the specified colour of the black area; and in "Two-Colour" (Red and Black), printing will be done in black.

- An image of approximately 1.5mm will not be displayed as the width of the separation line, when specifying solid or broken lines.

❖ **Double Copies Separation Line**

You can select a separation line using the Double Copies function from: None, Solid, Broken A, Broken B, or Crop Marks.

- None



- Solid



- Broken A



- Broken B



- Crop Marks



 **Note**

- Default: *None*
- Line colour (Full Colour): Yellow, Red, Cyan, Magenta, Green, Blue, Black
- Separation lines cannot be specified when using **[None]**.

- In "Black and White", printing will be done in black; in "Single Colour", printing will be done in the specified colour; in "Two-Colour" (standard), printing will be done in the specified colour of the black area; and in "Two-Colour" (Red and Black), printing will be done in black.

- Images of approximately 1.5mm will not be displayed as the width of the separation line when solid or broken lines have been specified.

❖ **Separation Line in Combine**

You can select a separation line using the Combine function from: None, Solid, Broken A, Broken B, or Crop Marks. See p.55 "1 Sided Combine" and p.56 "2 Sided Combine".

- None



- Solid



- Broken A



- Broken B



- Crop Marks





 **Note**

- Default: *None*





- Line colour (Full Colour): Yellow, Red, Cyan, Magenta, Green, Blue, Black
- Separation lines cannot be specified when using **[None]**.
- In “Black and White”, printing will be done in black; in “Single Colour”, printing will be done in the specified colour; in “Two-Colour” (standard), printing will be done in the specified colour of the black area; and in “Two-Colour” (Red and Black), printing will be done in black.
- Images of approximately 1.5mm will not be displayed as the width of the separation line when solid or broken lines have been specified.

Stamp

Background Numbering

- ❖ **Stamp Priority**
You can set the size of the numbers.
 -  **Note**
 - Default: *Normal*
- ❖ **Density**
You can set the density of the numbers.
 -  **Note**
 - Default: *Normal*
- ❖ **Stamp Colour**
You can set the colour of the numbers.
 -  **Note**
 - Default: *Black*

Preset Stamp P.1/4-4/4

- ❖ **Stamp Priority**
You can select the stamp type given priority when **[Preset Stamp]** is pressed. See p.70 “Preset Stamp”.
 -  **Note**
 - Default: *Copy*
- ❖ **Stamp Language**
You can select the language of the stamp.
 -  **Note**
 - Default: *English*
- ❖ **Stamp Position**
You can set the position where the stamp is printed.
Press the arrow keys to adjust the position.
 -  **Note**
 - Default:
 - Metric Version:
 - Position: *Top Right*
 - Top Margin: *24 mm*
 - Right Margin: *24 mm*
 - Inch Version:
 - Position: *Top Right*
 - Top Margin: *1.0"*
 - Right Margin: *1.0"*
- ❖ **Stamp Format**
You can adjust the stamp's size, density, and print page.
 - Size
You can set the size of the stamp.
 -  **Note**
 - Default: *1X*
 - Density
You can set the pattern used to print the stamp.

 **Note**

- Default: *Normal*
- Normal: The stamp is printed on the image. You cannot check which parts will overlap.
- Lighter: The image can be seen through the stamp.
- Lightest: The image appears even clearer than in the Lighter setting.
- Page to Stamp
You can have the stamp printed on the first page or all pages.

 **Note**

- Default: *All Pages*

❖ **Stamp Colour**

Sets the stamp print colour.

 **Note**

- Default: *Black*

User Stamp P. 1/2-2/2

❖ **Program / Delete Stamp**

You can register, change, or delete these user stamp designs.

 **Note**

- You can register up to four custom stamps with your favourite designs. See p.72 "To program the user stamp".

 **Reference**

For how to delete the user stamp, see p.73 "To delete the user stamp".

❖ **Stamp Position 1 - 4**

You can set the position where the stamp is printed. Press the arrow keys to adjust the position.

 **Note**

- Default:
 - Metric version:
 - Position: *Top Right*
 - Top Margin: *24 mm*
 - Right Margin: *24 mm*
 - Inch version:
 - Position: *Top Right*
 - Top Margin: *1.0"*
 - Right Margin: *1.0"*

❖ **Stamp Format 1 - 4**

You can adjust the print page for User Stamps 1 to 4 already registered.

- Page to Stamp
Sets whether to print the stamp on all pages or only the first page.

 **Note**

- Default: *All Pages*

❖ **Stamp Colour: 1 - 4**

Sets the colour registered in User Stamp colour (1 to 4).

 **Note**

- Default: *Black*

Date Stamp

❖ **Format**

You can select the date format for the Date Stamp function.

 **Note**

- Default:
 - Metric version: *DD/MM/YYYY*
 - Inch version: *MM/DD/YYYY*

❖ **Font**

You can select the Date Stamp font.

✎ **Note**

- Default: *Font 1*
- This setting is linked to the Page Numbering function.

❖ **Stamp Position**

You can set the position where the stamp is printed. Press the arrow keys to adjust the position.

✎ **Note**

- Default:
 - Metric version:
 - Position: *Top Left*
 - Top Margin: *8 mm*
 - Left Margin: *32 mm*
 - Inch version:
 - Position: *Top Left*
 - Top Margin: *0.3"*
 - Left Margin: *0.8"*

❖ **Stamp Setting**

You can have the date printed on the first page or all pages.

✎ **Note**

- Default: *All Pages*

❖ **Size**

You can set the Date Stamp size.

✎ **Note**

- Default: *Auto*

❖ **Superimpose**

You can have the Date Stamp printed in white where it overlaps black parts of the image.

✎ **Note**

- Default: *No*

❖ **Stamp Colour**

You can set the selected priority colour when printing the date.

✎ **Note**

- Default: *Black*

Page Numbering P. 1/3-2/3

❖ **Stamp Format**

You can select the page number format given priority when [**Page Numbering**] is pressed.

✎ **Note**

- Default: *P1, P2*

❖ **Font**

You can select the page number font.

✎ **Note**

- Default: *Font 1*

❖ **Size**

You can set the size of the page number.

✎ **Note**

- Default: *Auto*

❖ **Duplex Back Page Stamping Position**

You can set the position of the duplex back page number printed using the Duplex function.

✎ **Note**

- Default: *Opposite Position*

❖ **Page Numbering in Combine**

You can set page numbering when using the Combine and Page Numbering function together.

✎ **Note**

- Default: *Per Original*

❖ Stamp on Designated Slip Sheet

You can print the page number on slip sheets when you use the Designate function set to "Copy" and Page Numbering function together.

❖ Stamp Position

P1, P2... Stamp Position: 1/5, 2/5...
Stamp Position: -1-, -2-... Stamp Position: P.1, P.2. Stamp Position: 1, 2... Stamp Position: 1-1, 1-2...
You can set the position where the stamp is printed.
Press the arrow keys to adjust the position.

❖ Superimpose

You can have page numbers printed in white where they overlap black parts of the image.

Note

Default: *No*

❖ Stamp Colour

You can set the selected priority colour when printing the date.

Note

Default: *Black*

Input/Output

❖ Switch to Batch (SADF)

You can select to have the Batch or SADF function displayed when you press [**Special Original**]. See p.15 "Batch".

Note

Default: *Batch*

❖ SADF Auto Reset

In SADF mode, an original must be set within a specific time after the previous original has been fed. You can adjust this time from 3 seconds to 99 in 1 second increments.

Note

Default: *5 seconds*

❖ Rotate Sort: Auto Paper Continue

You can continue copying when paper of the required orientation has run out during rotate-sorting. See p.42 "Rotate Sort".

Note

If you select [**No**] :

- When paper of the required orientation runs out, the machine stops copying and prompts you to supply copy paper. When you load paper, the machine will continue copying.

If you select [**Yes**] :

- Copying continues using copy paper of a different orientation. The copy job will finish even if the machine is left unattended.

Default: *No*

❖ Auto Sort

You can specify whether the Sort function is to be selected when the machine is turned on, or when the functions are cleared.

Note

Default: *No*

❖ Memory Full Auto Scan Restart

If memory becomes full while scanning originals, the machine will copy the scanned originals first, and then automatically proceed scanning remaining originals. You can enable or disable this function.

 **Note**

- If you select **[No]** :
 - When memory becomes full, the machine stops operation, allowing you to remove the copies on the output tray.
- If you select **[Yes]** :
 - You can leave the machine unattended to make copies, but sorted pages will not be sequential.
- Default: *No*

◆ Select Stack Function

Specify whether Stack or Rotate Sort has priority on the initial display.

 **Note**

- Default: *Stack*
- An 2 tray finisher or booklet finisher is required to use this function.

◆ Select Stapling Position

Specify which Top 2 staples or Bottom shown on the initial display with priority.

 **Note**

- Default: *Top 2*
- The 2 tray finisher or booklet finisher is required to use this function.

◆ Letterhead Setting

If you select **[Yes]** for this function, the machine rotates images correctly.

 **Note**

- Default: *No*
- Orientation-fixed (top to bottom) or two-sided paper might not print correctly depending on how the originals and paper are placed.

 **Reference**

When using letterhead paper, pay attention to the paper orientation. See “Orientation–Fixed Paper or Two-Sided Paper” in “Loading Paper”, *General Settings Guide*.

Adjust Colour Image

◆ Background Density of ADS(Full Colour / Two-colour)

The background density is adjusted to skip the texture and copy. You can adjust the background density up to 5 levels when in Full Colour or Two-colour.

 **Note**

- Default: *Centre of the 5 level adjustment*

◆ Colour Sensitivity

You can adjust the tone of red in “Two colour (Red & Black)”, the colour specified to convert in “Colour Convert” and the colour specified for “Erase Colour”, in 5 levels.

 **Note**

- Default: *Centre of the 5 level adjustment*
- When the colour width has been set to “Wider”, and the colour to be deleted, for example is red, all the colours that are close to magenta and orange are deleted. If it's set to “Narrower” the colour red will be deleted.

◆ A.C.S. Sensitivity

This 5-step setting determines the level of the standard used for discriminating between black & white originals and full colour originals when “Auto Colour Select” is selected.

 **Note**

- Default: *Centre of the 5 level adjustment*

◆ **A.C.S. Priority**

This setting determines the copy priority between “Black & White” and “Full Colour” when “Auto Colour Select” is selected.

 **Note**

- Default: *Full Colour*

Administrator Tools

◆ **Menu Protect**

You can prevent unauthenticated users from changing the user tools settings.
For details, consult the administrator.

6. Specifications

Combination Chart

The combination chart below shows which functions can be used together. The following tables explains the symbols used in the chart.

	means that these functions can be used together.
●	means that these functions cannot be used together. The second function selected will be the function you are working in.
×	means that these functions cannot be used together. The first function selected will be the function you are working in.

Functions selected first	Functions	Functions selected after																																			
		Mixed Sizes	Custom Size Originals	Original Orientation (detectable)	Original Orientation (Undetectable)	Auto Image Density	Manual Image Density	Full Colour	Two Colour	Red & Black	Single Colour	Black & White	Auto Colour Select	Auto Paper Select	Manual Paper Select	Bypass Tray	Auto Reduce/Enlarge	Size Magnification	Create Margin	Original: 1 Sided	Original: 2 Sided	Original: Book	1 Sided	2 Sided	1 Sided Combine	2 Sided Combine	Front & Back--2 Sided	Booklet	Magazine	Original: Top to Bottom	Copy: Top to Bottom						
Mixed Sizes																																					
Custom Size Originals		×																																			
Original Orientation (detectable)				●																																	
Original Orientation (Undetectable)				●																																	
Auto Image Density																																					
Manual Image Density																																					
Full Colour																																					
Two Colour																																					
Red & Black																																					
Single Colour																																					
Black & White																																					
Auto Colour Select																																					
Auto Paper Select																																					
Manual Paper Select																																					
Bypass Tray																																					
Auto Reduce/Enlarge																																					
Size Magnification																																					
Create Margin																																					
Original: 1 Sided																																					
Original: 2 Sided																																					
Original: Book																																					
1 Sided																																					
2 Sided																																					
1 Sided Combine																																					
2 Sided Combine																																					
Front & Back--2 Sided																																					
Booklet																																					
Magazine																																					
Original: Top to Bottom																																					
Copy: Top to Bottom																																					
Double Copies																																					
Image Repeat																																					
Specified Area Repeat																																					
Margin Adjustment																																					
Positive/Negative																																					
Centering																																					
Centre Erase																																					
Border Erase																																					
Mirror																																					
Erase Colour																																					
Convert Colour																																					
Colour Background																																					
Background Numbering																																					
Preset Stamp																																					
User Stamp																																					
Date Stamp																																					
Page Numbering																																					
Front Cover																																					
Front/Back Cover																																					
Designate																																					
Slip Sheet																																					
Sort																																					
Rotate Sort																																					
Stack																																					
Staple																																					
Staple Top																																					
Staple Left																																					
Punch																																					
Store File																																					

*1 Combination is not available when the copied content is "2 sided--1 sided".

Specifications

Functions	Functions selected after																												
	Double Copies	Image Repeat	Specified Area Repeat	Margin Adjustment	Positive/Negative	Centering	Centre Erase	Border Erase	Mirror	Erase Colour	Convert Colour	Colour Background	Background Numbering	Preset Stamp	User Stamp	Date Stamp	Page Numbering	Front Cover	Front/Back Cover	Designate	Slip Sheet	Sort	Rotate Sort	Stack	Staple	Staple Top	Staple Left	Punch	Store File
Mixed Sizes																													
Custom Size Originals																													
Original Orientation (detectable)																													
Original Orientation (Undetectable)																													
Auto Image Density																													
Manual Image Density																													
Full Colour																													
Two Colour																													
Red & Black																													
Single Colour																													
Black & White																													
Auto Colour Select																													
Auto Paper Select																													
Manual Paper Select																													
Bypass Tray																													
Auto Reduce/Enlarge																													
Size Magnification																													
Create Margin																													
Original: 1 Sided																													
Original: 2 Sided																													
Original: Book																													
1 Sided																													
2 Sided																													
1 Sided Combine																													
2 Sided Combine																													
Front & Back—2 Sided																													
Booklet																													
Magazine																													
Original: Top to Bottom																													
Copy: Top to Bottom																													
Double Copies																													
Image Repeat																													
Specified Area Repeat																													
Margin Adjustment																													
Positive/Negative																													
Centering																													
Centre Erase																													
Border Erase																													
Mirror																													
Erase Colour																													
Convert Colour																													
Colour Background																													
Background Numbering																													
Preset Stamp																													
User Stamp																													
Date Stamp																													
Page Numbering																													
Front Cover																													
Front/Back Cover																													
Designate																													
Slip Sheet																													
Sort																													
Rotate Sort																													
Stack																													
Staple																													
Staple Top																													
Staple Left																													
Punch																													
Store File																													

*2 Combination with Staple Top 2 is X with Punch left.
 Combination with Staple 1 position is X with punch top.

Supplementary Specifications

◆ Mixed Size mode

- Since small originals may not be correctly aligned with the original guide, the copy image may be slanted.
- Copying speed and scanning speed will be reduced.
- You can place originals of two different sizes at a time.

◆ Bypass Tray Copy

- The following paper sizes can be selected as the standard sizes: A3☐, A4☐☐, A5☐☐☐, A6☐, B4 JIS☐, B5 JIS☐☐, B6 JIS☐, Postcard☐, 11"×17"☐, 8¹/₂"×14"☐, 8¹/₂"×11"☐☐, 5¹/₂"×8¹/₂"☐, 7¹/₄"×10¹/₂"☐☐, 8"×13"☐, 8¹/₂"×13"☐, 8¹/₄"×13"☐, 12"×18"☐
- When the beeper is turned off, it will not sound when you insert paper into the bypass tray. See "Panel Tone" *General Settings Guide*.

◆ Preset Enlarge/Reduce

- You can select one of 12 preset ratios (5 enlargement ratios, 7 reduction ratios).
- You can select a ratio regardless of the size of an original or copy paper. With some ratios, parts of the image might not be copied or margins will be displayed on copies.
- Copies can be reduced or enlarged as follows:

◆ Metric version

Ratio (%)	Original → Copy paper size
400 (enlarge area by 16)	--
200 (enlarge area by 4)	A5→A3
141 (enlarge area by 2)	A4→A3, A5→A4
122	F→A3, A4→B4 JIS
115	B4 JIS→A3
93	--
82	F→A4, B4 JIS→A4
75	B4 JIS→F4, B4 JIS→F
71 (reduce area by 1/2)	A3→A4, A4→A5
65	A3→F
50 (reduce area by 1/4)	A3→A5, F→A5
25	--

◆ **Inch version**

Ratio (%)	Original → Copy paper size
400 (enlarge area by 16)	--
200 (enlarge area by 4)	$5\frac{1}{2}'' \times 8\frac{1}{2}'' \rightarrow 11'' \times 17''$
155 (enlarge area by 2)	$5\frac{1}{2}'' \times 8\frac{1}{2}'' \rightarrow 8\frac{1}{2}'' \times 14''$
129	$8\frac{1}{2}'' \times 11'' \rightarrow 11'' \times 17''$
121	$8\frac{1}{2}'' \times 14'' \rightarrow 11'' \times 17''$
93	--
85	F → $8\frac{1}{2}'' \times 11''$
78	$8\frac{1}{2}'' \times 14'' \rightarrow 8\frac{1}{2}'' \times 11''$
73	$11'' \times 15'' \rightarrow 8\frac{1}{2}'' \times 11''$
65	$11'' \times 17'' \rightarrow 8\frac{1}{2}'' \times 11''$
50 (reduce area by $\frac{1}{4}$)	$11'' \times 17'' \rightarrow 5\frac{1}{2}'' \times 8\frac{1}{2}''$
25	--

6

◆ **Zoom**

- The reproduction ratios you can specify are 25–400%.
- You can select a ratio regardless of the size of an original or copy paper. With some ratios, parts of the image might not be copied or margins will be displayed on copies.

◆ **Size Magnification**

- If the calculated ratio is over the maximum or under the minimum ratio, it is automatically adjusted to within available range. However, with some ratios, parts of the image might not be copied or margins will be displayed on copies.
- The reproduction ratios you can specify are 25–400%.

◆ **Directional Size Magnification**

- The reproduction ratio you can specify are 25–400%.
- When entering a percentage ratio, you can specify any value in the permitted range, regardless of original or copy paper size. However, depending on settings and other conditions, part of the image may not be copied, or margins will be displayed on copies.
- When entering a size in millimeters or inches, and the calculated ratio is over the maximum or under the minimum ratio, it will be automatically adjusted to within available range. However, with some ratios, parts of the image might not be copied or margins will be displayed on copies.









































◆ **Sort, Rotate Sort, Stack**

- Paper sizes and orientations that can be used in the Shift Sort and Stack functions are as follows:

	2 tray finisher	Booklet finisher
Paper size and orientation	A3☐, B4 JIS☐, A4☐☐, B5 JIS☐☐, A5☐, 11" × 17"☐, 8 ¹ / ₂ " × 14"☐, 8 ¹ / ₂ " × 11"☐☐	A3☐, B4 JIS☐, A4☐☐, B5 JIS☐☐, 11" × 17"☐, 8 ¹ / ₂ " × 14"☐, 8 ¹ / ₂ " × 11"☐☐

- Paper sizes and orientations that can be used in the Rotate Sort function are A4☐☐, B5 JIS☐☐, 8¹/₂" × 11"☐☐ and 5¹/₂" × 8¹/₂"☐☐.
- The number of copies that can be placed on the tray is as follows. When the number of copies exceeds capacity, remove copies from the tray.

	Paper size and orientation	Paper capacity and weight
Standard tray	<ul style="list-style-type: none"> • A4☐ or smaller • 8¹/₂" × 11"☐ or smaller 	500 sheets (80 g/m ²) (20 lb.)
	<ul style="list-style-type: none"> • B4 JIS☐ or larger • 8¹/₂" × 14"☐ or larger 	250 sheets (80 g/m ²) (20 lb.)
External tray	A3☐, B4 JIS☐, A4☐☐, B5 JIS☐☐, A5☐, 11" × 17"☐, 8 ¹ / ₂ " × 14"☐, 8 ¹ / ₂ " × 11"☐☐, 5 ¹ / ₂ " × 8 ¹ / ₂ "☐	100 sheets
Left tray	Left tray 1	
	A3☐, B4 JIS☐, A4☐☐, B5 JIS☐☐, 8 ¹ / ₂ " × 14"☐, 8 ¹ / ₂ " × 11"☐☐, 5 ¹ / ₂ " × 8 ¹ / ₂ "☐	100 sheets
Left tray 2	Left tray 2	
	A3☐, B4 JIS☐, A4☐☐, B5 JIS☐☐, 8 ¹ / ₂ " × 14"☐, 8 ¹ / ₂ " × 11"☐☐, 5 ¹ / ₂ " × 8 ¹ / ₂ "☐	250 sheets

	Paper size and orientation	Paper capacity and weight
2 tray finisher	Finisher shift tray 1	
	A4  , B5 JIS  , A5  , 8 1/2" x 11" 	500 sheets (80 g/m ²) (20 lb.)
	A3  , B4 JIS  , 11" x 17"  , 8 1/2" x 14" 	250 sheets (80 g/m ²) (20 lb.)
	Finisher shift tray 2 (No staple)	
	A4  , 8 1/2" x 11" 	2000 sheets (80 g/m ²) (20 lb.)
	A3  , B4 JIS  , A4  , B5 JIS  , 11" x 17"  , 8 1/2" x 14"  , 8 1/2" x 11" 	750 sheets (80 g/m ²) (20 lb.)
	A5 	500 sheets (80 g/m ²) (20 lb.)
	Finisher shift tray 2 (staple)	
	A4  , 8 1/2" x 11" 	1500 sheets (80 g/m ²) (20 lb.)
	A3  , B4 JIS  , A4  , B5 JIS  , 11" x 17"  , 8 1/2" x 14"  , 8 1/2" x 11" 	750 sheets (80 g/m ²) (20 lb.)
Booklet finisher	Finisher shift tray	
	A4  , B5 JIS  , 8 1/2" x 11" 	1000 sheets (80 g/m ²) (20 lb.)
	A3  , B4 JIS  , 11" x 17"  , 8 1/2" x 14" 	500 sheets (80 g/m ²) (20 lb.)
	Finisher booklet tray	
A3  , B4 JIS  , A4  , 11" x 17"  , 8 1/2" x 14"  , 8 1/2" x 11" 	(80 g/m ²) (20 lb.) <ul style="list-style-type: none"> • 2–5 sheets: 20 sets • 6–10 sheets: 10 sets 	

 **Note**

- When using the Rotate Sort or Staple functions, the capacity may be reduced.

◆ Staple

- The following types of paper cannot be stapled:
 - Translucent paper
 - OHP transparencies
 - Label paper (adhesive labels)
 - Thick paper
 - Curled paper
 - Paper of low stiffness
 - Paper of mixed sizes
- In the following cases, copies will be delivered to the shift tray without stapling:
 - When the number of sheets for one set is over stapler capacity
 - When memory reaches 0% during copying
- When using Double Copies, or [1 Sided→1 Sided], [1 Sided→2 Sided], [2 Sided→1 Sided], or [2 Sided→2 Sided] in Combine mode, select paper for original and paper for original.
- When using Double Copies, or [1 Sided 2 Pages→ 1 Sided Combine] and [1 Sided 4 Pages→ 2 Sided Combine] in Combine mode, select paper for original and paper for original.
- When using [Left 2] or [Top 2] with Double Copies, or [1 Sided→1 Sided], [1 Sided→2 Sided], [2 Sided→1 Sided], or [2 Sided→2 Sided] in Combine mode, select paper for original and paper for original.
- When the finisher is installed, even if you place different size originals in the ADF, appropriate size of copy paper can be automatically selected and stapled using the Mixed Size mode and Auto Paper Select function. Load the paper you want to use in the paper trays beforehand. Paper sizes that can be stapled when using the Mixed Size mode are as follows:
 - A3 and A4
 - B4 JIS and B5 JIS
 - 11" × 17" and 8¹/₂" × 11"
- Paper sizes and orientation that can be used in the Staple function and the stapler capacity are as follows:

	Paper size	Stapler capacity
2 tray finisher	A4 <input type="checkbox"/> , B5 JIS <input type="checkbox"/> , 8 ¹ / ₂ " × 11" <input type="checkbox"/>	2–50 sheets
	A3 <input type="checkbox"/> , B4 JIS <input type="checkbox"/> , 11" × 17" <input type="checkbox"/> , 8 ¹ / ₂ " × 14" <input type="checkbox"/>	2–30 sheets
Booklet finisher	A4 <input type="checkbox"/> , B5 JIS <input type="checkbox"/> , 8 ¹ / ₂ " × 11" <input type="checkbox"/>	2–50 sheets
	A3 <input type="checkbox"/> , B4 JIS <input type="checkbox"/> , 11" × 17" <input type="checkbox"/> , 8 ¹ / ₂ " × 14" <input type="checkbox"/>	2–25 sheets
	When Saddle Stitch function is selected: A3 <input type="checkbox"/> , B4 JIS <input type="checkbox"/> , A4 <input type="checkbox"/> , 11" × 17" <input type="checkbox"/> , 8 ¹ / ₂ " × 11" <input type="checkbox"/> , 8 ¹ / ₂ " × 14" <input type="checkbox"/>	2–10 sheets
	mixed size	2–25 sheets

 **Note**

- When stapling B4, A3, 8 1/2" × 14", 11" × 17", pull out the extender of the finisher tray.
- When the number of copies exceeds tray capacity, copying stops. If this happens, remove the copies from the shift tray, and then resume copying.
- The tray capacity for the stapled sheets is as follows: (paper weight: 80 g/m², 20 lb.)

	Paper size and orientation	Tray capacity
2 tray finisher	Finisher shift tray 1	
	A4, B5 JIS, 8 1/2" × 11"	<ul style="list-style-type: none"> • 10–50 sheets: 50–10 sets • 2–9 sheets: 50 sets
	A3, B4 JIS, 11" × 17", 8 1/2" × 14"	<ul style="list-style-type: none"> • 10–30 sheets: 25–8 sets • 2–9 sheets: 25 sets
	mixed size	<ul style="list-style-type: none"> • 2–30 sheets: 8 sets
	Finisher shift tray 2	
	A4, 8 1/2" × 11"	<ul style="list-style-type: none"> • 15–50 sheets: 100–30 sets • 2–14 sheets: 100 sets
	A4, B5 JIS, 8 1/2" × 11"	<ul style="list-style-type: none"> • 15–50 sheets: 50–15 sets • 2–14 sheets: 50 sets
	A3, B4 JIS, 11" × 17", 8 1/2" × 14"	<ul style="list-style-type: none"> • 15–30 sheets: 50–25 sets • 2–14 sheets: 50 sets
	mixed size	<ul style="list-style-type: none"> • 2–30 sheets: 25 sets
	Booklet finisher	Finisher tray
A4, B5 JIS, 8 1/2" × 11"		1000 sheets or 30 sets
A3, B4 JIS, 11" × 17", 8 1/2" × 14"		500 sheets or 30 sets
Finisher booklet tray		
A3, B4 JIS, A4, 11" × 17", 8 1/2" × 11", 8 1/2" × 14"		<ul style="list-style-type: none"> • 2–5 sheets: 20 sets • 6–10 sheets: 10 sets











- You cannot change stapling positions during copying.
- When the original image is rotated, the staple orientation changes by 90°.
- The maximum original image size that can be rotated is as follows:





Metric version	A4
Inch version	8 1/2" × 11"

- When using [Top Slant], [Left 2] or [Top 2] with Combine, Double copies or Auto Reduce / Enlarge function, “Blank part will appear. Check orientation.” message may appear depending on the orientation of originals and paper you placed. In this case, change the paper orientation.
- When [Left 2] or [Top 2] is selected, the following settings are useful to rotate images appropriately:
 - Auto Reduce / Enlarge or Auto Paper Select
 - With image rotation in Auto Tray Switching of User Tools
- If you select Saddle Stitch function with the booklet finisher, the machine staples and folds the paper in the centre, then delivers the paper folded.
- If you select Saddle Stitch function in Magazine or Booklet mode, the machine staples the paper, and folds it like a book, then delivers the paper folded.

◆ **Punch**













- When using Punch and Combine, Double Copies, or Auto Reduce / Enlarge, the message “Blank part will appear. Check orientation.” may appear because of the orientation of the original and the copy paper. If this occurs, change the orientation of the copy paper.
- Since punch holes are made in each copy, the punch hole positions vary slightly.
- Punchable paper sizes are as follows:

2 tray finisher			
Punch kit type			
2 & 4 holes type	2 holes		A3-B5 JIS, 11" × 17"
			A4-A5, 8 ¹ / ₂ " × 11"
	4 holes		A3, B4 JIS, 11" × 17"
			A4, B5 JIS, 8 ¹ / ₂ " × 11"
4 holes type	4 holes		A3-B5 JIS, 11" × 17"
			A4-A5, 8 ¹ / ₂ " × 11"
2 & 3 holes type	2 holes		A3-B5 JIS, 11" × 17"
			A4-A5, 8 ¹ / ₂ " × 11"
	3 holes		A3, B4 JIS, 11" × 17"
			A4, B5 JIS, 8 ¹ / ₂ " × 11"

Booklet finisher			
Punch kit type			
2 holes type	2 holes		A3, A4, B4 JIS, B5 JIS, 11" × 17", 8 ¹ / ₂ " × 14", 8 ¹ / ₂ " × 11"
			A4, B5 JIS, 8 ¹ / ₂ " × 11"
4 holes type	4 holes		A3
			A4

- The punch hole positions change according to the orientation of the paper selected.

❖ Duplex

- You cannot use the following copy paper with this function:
 - Paper smaller than A5, 5¹/₂" × 8¹/₂" (possible on A5 , 5¹/₂" × 8¹/₂" )
 - Paper thicker than 105 g/m², 28 lb.
 - Paper thinner than 60 g/m², 17 lb.
 - Translucent paper
 - OHP transparencies
 - Label paper (adhesive labels)
 - Postcards
- When an odd number of originals is placed in the ADF, the back of the last page of copied paper is blank.
- During copying, the image is shifted to allow for the binding margin.
- The following paper sizes can be duplexed: A3 , B4 JIS , A4  , B5 JIS  , A5 , 11" × 17" , 8¹/₂" × 14" , 8¹/₂" × 11"  

❖ Combine

- In this mode, the machine selects the reproduction ratio automatically. This reproduction ratio depends on copy paper sizes and the number of originals.
- The reproduction ratios you can specify are 25–400%.
- If the calculated ratio is under the minimum ratio, it will be automatically adjusted to within acceptable range. However, with some ratios, parts of the image might not be copied.
- You cannot use custom size paper.
- If the orientation of originals is different from that of the copy paper, the machine will automatically rotate the image by 90° to make copies properly.

- If the number of originals placed is less than the number specified for combining, the last page segment will be left blank as shown.

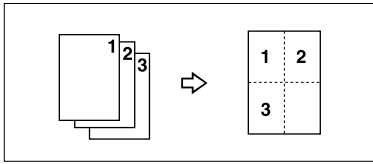

❖ Series Copies

- The machine sets the reproduction ratio automatically to meet the paper size and copies the originals together onto the paper.
- The reproduction ratios you can specify are 25–400%.
- If the calculated ratio is under the minimum ratio, it is automatically adjusted to within acceptable range. However, with some ratios, parts of the image might not be copied.
- If the orientation of originals is different from that of the copy paper, the machine will automatically rotate the image by 90° to make copies properly.
- You cannot copy with originals different in size and orientation.
- If the number of originals scanned is less than a multiple of 4, the last page is copied blank.
- In Magazine or Booklet mode, the copying may take some time after scanning originals.
- When the booklet finisher is installed, if you select Saddle Stitch function in Magazine or Booklet mode, the machine staples and folds the paper in the centre, then delivers the paper folded.

❖ Image Repeat

Depending on the paper size, ratio, and orientation, parts of repeated images may not be copied.

❖ Centring

Though the original is set to a different orientation from the paper loaded, the machine will not rotate the image by 90° (Rotate copy).

◆ **Erase**

The width of the erased margin varies depending on the reproduction ratio. If the size of the original is different from sizes listed in the following chart, the erased margin might be shifted:

- Metric version

Where original is placed	Paper size and orientation
Exposure glass	A3☐, B4 JIS☐, A4☐☐, B5 JIS☐☐
ADF	A3☐, B4 JIS☐, A4☐☐, B5 JIS☐☐, A5☐☐

- Inch version

Where original is placed	Paper size and orientation
Exposure glass	11" × 17"☐, 8 ¹ / ₂ " × 14"☐, 8 ¹ / ₂ " × 11"☐☐
ADF	11" × 17"☐, 8 ¹ / ₂ " × 14"☐, 8 ¹ / ₂ " × 11"☐☐, 10" × 14"☐, 5 ¹ / ₂ " × 8 ¹ / ₂ "☐

◆ **Margin Adjustment**

- If you set a binding margin that is too wide, part of the image may not be copied.
- When making copies in Combine mode, the binding margin is added to the copies after the combination is finished.

◆ **Background Numbering**

If the numbers overlap the copied image, the parts overlapped may look like some pattern.

◆ **Preset Stamp**

- You can change the size and density of the stamp with User Tools. Depending on the setting, density may change.
- Depending on paper size, if you change the stamp size, parts of the stamp might not be printed.

◆ Date Stamp

- When using Combine mode, the date stamp is printed as follows:



- When using Magazine or Booklet function, the date stamp is printed as follows:

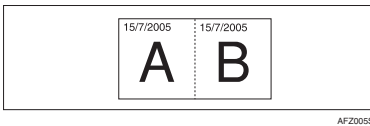

◆ Page Numbering

When page numbering is used with Combine mode, page numbers are printed as follows:

- Page Numbering per original:
Combined with 1 Sided / 2 Sided in the Combine function

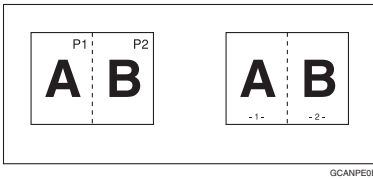

- Page Numbering per copy:
Combined with Magazine or Booklet function
- Page Numbering per copy:
Combined with 1 Sided / 2 Sided in the Combine function

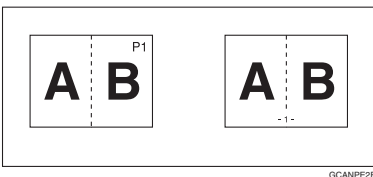

If you combine this function with the Duplex (Top to Top) function and select [P1, P2] or [1/n, 2/n], page numbers on the back are printed as follows:

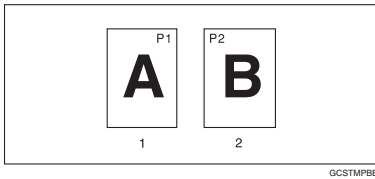

1. Front

2. Back

❖ Front Cover, Front/Back Cover

- If Blank mode is selected, the cover will not be counted as a copy.
 - Front and back covers are two-sided copied depending on the settings made in Display Time in Cover Sheet Tray of User Tools (System Settings).
 - If Display Time is selected to the At Mode Selected, settings made in Cover Sheet Tray will take priority.
 - If Display Time is selected to Full Time, settings made in Paper Type will take priority.
- See “Paper Type” and “Cover Sheet Tray” in “Tray Paper Settings”, *General Settings Guide*.

❖ Slip Sheets

If you do not copy onto slip sheets, they are excluded from the number of copies counted.

INDEX

- 1 sided → 2 sided, 53
- 2 sided → 1 sided, 53
- 2 sided → 2 sided, 53
- 90° turn, 14

A

- Accessing user tools
 - copier/document server features*, 110
- A.C.S.
 - priority*, 124
 - sensitivity*, 123
- Adjust Colour Image, 123
- Adjusting
 - background density*, 91
 - colours based on selected colour*, 92
 - contrast*, 90
 - copy image density*, 32
 - sharpness/softness*, 90
 - text/photo sensitivity*, 91
 - U.C.R.*, 91
- Adjust/Program Colour key, 5
- Auto
 - colour selection*, 28
 - image density*, 32
 - image density priority*, 104
 - paper select*, 34
 - paper select priority*, 103
 - reduce/enlarge*, 38
 - tray switching*, 111
- Auto paper select, 35

B

- Background density of ADS
 - (Full Colour/Two-colour), 123
- Basic procedure, 19
- Batch, 15
- Black/white copy, 28
- Border erase, 67

C

- Centre/border erase, 68
- Centre erase, 67
- Change
 - date format*, 75
 - stamp position*, 72, 75

Changing

- number of sets*, 44
- registered settings*, 89
- stamp position*, 77
- stamp position, size and density*, 71
- stored program*, 86

Check Modes key, 5

Clear Modes key, 5

Clear/Stop key, 6

Colour

- adjustment*, 87
- adjustment/program*, 87
- background*, 31
- balance*, 88
- balance program*, 88
- circle*, 5
- functions*, 28
- mode priority*, 113
- selection key*, 6

Colour Adjustment, 87

Colour functions

- convert colours*, 29
- erase colour*, 30
- selecting a colour mode*, 28

Colour image setting

- colour sensitivity*, 123

Colours

- mixing manually with number keys*, 93

Combination chart, 125

Combined auto and manual image density, 32

Control panel, 5

Copier / Document Server Features, 103

Copier functions, 32

- 1 sided combine*, 55
- 2 sided combine*, 56
- adjusting copy image density*, 32
- auto reduce/enlarge*, 38
- book originals*, 60
- centring*, 64
- covers*, 79
- date stamp*, 74
- designate*, 80
- directional magnification (%)*, 40
- directional size magnification (mm)*, 41
- double copies*, 63
- duplex*, 53
- margin adjustment*, 68
- page numbering*, 75
- preset reduce/enlarge*, 37

- preset stamp, 70
- selecting copy paper, 34
- selecting the original type, 33
- series copies, 58
- size magnification, 39
- slip sheets, 82
- sort, 42
- stack, 44
- staple, 45
- user stamp, 71
- zoom, 38
- Copy functions
 - image repeat, 62
 - mirror, 65
 - positive/negative, 65
 - specified area repeat, 63
- Copying, 19
 - back Side of the Paper, 25
 - interrupt copy, 20
 - job preset, 21
 - left original beeper, 20
 - OHP Transparencies or Thick Paper, 24
 - onto envelopes, 26
 - with registered settings, 89
- Copying from bypass tray
 - onto custom size paper, 23
 - onto standard size paper, 23
- Covers
 - Front, 79
 - front/back, 80
- Create margin function, 37

D

- Date stamp, 74, 120
 - Change colour, 75
 - change format, 75
 - change position, 75
 - font, 121
 - format, 120
 - position, 121
 - position and original orientation, 74
 - size, 121
 - stamp colour, 121
 - stamp setting, 121
 - superimpose, 121
- Deleting
 - program, 86
 - registered settings, 89
 - user colours, 94
 - user stamp, 73
- Display panel, 5
- Document server, 83

E

- Edit, 105, 115
 - 1 sided→2 sided auto margin -T to B, 116
 - 1 sided→2 sided auto margin -T to T, 116
 - back margin - left/right, 115
 - back margin - top/bottom, 116
 - Copy on Designating Page in Combine, 117
 - copy order in combine, 117
 - double copies separation line, 118
 - erase border width, 116
 - erase centre width, 116
 - erase original shadow in combine, 116
 - front cover copy in combine, 116
 - front margin - left/right, 115
 - front margin - top/bottom, 116
 - image repeat separation line, 117
 - Orientation: Booklet, Magazine, 117
 - separation line in combine, 118
- Energy Saver key, 6
- Erase, 66
 - border, 66
 - border width, 116
 - centre, 66
 - centre/border, 66
 - centre width, 116
 - colour, 30
 - original shadow in combine, 116
- Exiting user tools, 110

F

- Font, 121
- Format, 120
- Full colour copy, 28
- Function status indicators, 6

G

- General features, 103, 104, 111, 112, 113
 - auto image density priority, 114
 - auto paper select priority, 111
 - auto tray switching, 111
 - change initial mode, 112
 - clear bypass mode, 113
 - colour mode priority, 113
 - copy function key, 113
 - copy orientation in duplex mode, 112
 - document server storage key, 113
 - duplex mode priority, 112
 - job end call, 112
 - max. copy quantity, 112
 - original orientation in duplex mode, 112
 - original photo type priority, 111
 - original type display, 111

original type priority, 111
paper display, 111
tone – original remains, 112
two-colour mode priority, 113

Generation copy, 33

I

Image adjustment, 90

background density, 90, 91
contrast, 90
sharpness/softness, 90
text/photo sensitivity, 90, 91
U.C.R., 90, 91

Image repeat

specified area repeat, 63
whole area repeat, 62

Indicators, 5

Input/Output, 108, 122

auto sort, 122
letterhead setting, 123
memory full auto scan restart, 122
rotate sort – auto paper continue, 122
SADF auto reset, 122
select stack function, 123
select stapling position, 123
switch to batch (SADF), 122

Interrupt key, 6

K

Key

adjust/program colour, 5
check modes, 5
clear modes, 5
clear/stop, 6
energy saver, 6
interrupt, 6
program, 5
sample copy, 6
(sharp), 6
start, 6
user tools/counter, 5

L

Left original

beeper, 20

M

Main power indicator, 6
Manual image density, 32
Manual paper select, 35
Map, 33

Messages, 95
Missing image area, 12
Mixed size, 16

N

Number keys, 6

O

OHP transparencies, 82

one-sided combine

1 sided 2 pages → combine 1 side, 55
1 sided 4 pages → combine 1 side, 55
1 sided 8 pages → combine 1 side, 55
2 sided 1 page → combine 1 side, 55
2 sided 2 pages → combine 1 side, 55
2 sided 4 pages → combine 1 side, 55
2 sided 8 pages → combine 1 side, 55

Operation switch, 6

Original

combine, 55
copy orientation, 54
orientation, 13
orientation and completed copies, 53
orientation in duplex mode, 112
photo type priority, 111
type display, 111
type priority, 111

Originals, 9

Originals not recommended for

Auto Document Feeder (ADF), 9

P

Page Numbering, 75, 121

Page numbering

colour, 77
duplex back page stamping position, 121
first printing page, 77
font, 121
page numbering in combine, 121
position, 77
position and orientation of originals, 76
size, 121
stamp colour, 122
stamp format, 121
stamp position, 122
start number, 77
superimpose, 122

Pale, 33

Photo, 33

Placing
 custom size originals, 17
 originals, 9, 13, 14, 15, 17
 originals in auto document feeder, 15
 originals on exposure glass, 14
Preset stamp, 119
 changing colour, 71
 changing density, 71
 changing position, 71
 changing size, 71
 colour, 120
 format, 119
 language, 119
 position, 119
 position and original orientation, 70
 priority, 119
Program key, 5
Programs, 85
Punch, 49

R

Recalling a program, 86
Renaming a colour, 93, 94
Reproduction ratio, 104, 105, 114
 enlarge, 114
 priority setting – enlarge, 114
 priority setting – reduce, 115
 ratio for create margin, 115
 reduce, 114
 R/E priority, 115
 shortcut R/E, 114
Rotated copy, 36

S

SADF, 16
Sample copy, 43
Sample copy key, 6
Sampling user colours, 94
Screen contrast knob, 5
Selecting
 colour mode, 28
 copy paper, 34
 original type, 33
Series copies, 58, 135
 book → 1 sided, 58
 book → 2 sided, 58
 front & back → 2 sided, 59
(sharp) key, 6
Single colour copy, 28
Sizes
 detectable by auto paper select, 10
 difficult to detect, 11
 of recommended originals, 9

Sort, 42
 rotate sort, 42
 shift sort, 42
Specifications, 125
Stack, 44
Stamp, 119
 colour, 120, 121, 122
 date stamp, 74
 format, 119, 120, 121
 language, 119
 page numbering, 75
 position, 119, 120, 121, 122
 position and original orientation, 71, 74
 preset stamp, 70
 priority, 119
 setting, 121
 user stamp, 71
Standard orientation, 14
Stapling position and original setting, 45
Start key, 6
Storing
 adjusted colour balance, 88
 data, 83
 program, 85
Superimpose, 121, 122
Supplementary informations
 bypass tray copy, 127
 centring, 135
 combine, 134
 date stamp, 137
 directional size magnification, 128
 duplex, 134
 erase, 136
 front/back cover, 138
 front cover, 138
 image repeat, 135
 margin adjustment, 136
 mixed size mode, 127
 page numbering, 137
 preset enlarge/reduce, 127
 preset stamp, 136
 punch, 133
 rotate sort, 129
 series copies, 135
 size magnification, 128
 slip sheets, 138
 sort, 129
 stack, 129
 staple, 131
 zoom, 128
Supplementary specifications, 127

T

- Text, 33
- Text / Photo, 33
- Tone – original remains, 112
- Troubleshooting, 95
 - memory is full*, 101
 - problems operating the machine*, 95
 - you cannot make clear copies*, 97
 - you cannot make copies as you want*, 98
- Two colour copy, 28
- two-sided combine
 - 1 sided 16 pages → combine 2 side*, 57
 - 1 sided 4 Pages → combine 2 side*, 56
 - 1 sided 8 pages → combine 2 side*, 56
 - 2 sided 16 pages → combine 2 side*, 57
 - 2 sided 4 pages → combine 2 side*, 57
 - 2 sided 8 pages → combine 2 side*, 57
- Types of duplex copies, vi

U

- User colour, 92
- User stamp, 71, 120
 - changing colour*, 72
 - changing position*, 72
 - colours*, 120
 - delete*, 73
 - format*, 120
 - position*, 120
 - position and original orientation*, 71
 - program*, 72
 - program/delete*, 120
- User tools, 103
- User Tools/Counter key, 5

W

- Weights of recommended originals, 9
- What you can do with this machine, iii, vi

MEMO



Declaration of Conformity

“The Product complies with the requirements of the EMC Directive 89/336/EEC and its amending directives and the Low Voltage Directive 73/23/EEC and its amending directives.”

In accordance with IEC 60417, this machine uses the following symbols for the main power switch:

I means **POWER ON.**

O means **POWER OFF.**

⏻ means **STAND BY.**

Trademark

Acrobat® is a registered trademark of Adobe Systems Incorporated.



Overseas Affiliates

U.S.A.

RICOH CORPORATION
5 Dedrick Place
West Caldwell, New Jersey 07006
Phone: +1-973-882-2000

The Netherlands

RICOH EUROPE B.V.
Prof. W.H. Keesomlaan 1,
NL-1183 DJ Amstelveen
P.O. Box 114, NL-1180 AC Amstelveen
Phone: +31-(0)20-5474111

United Kingdom

RICOH UK LTD.
Ricoh House,
1 Plane Tree Crescent, Feltham,
Middlesex, TW13 7HG
Phone: +44-(0)20-8261-4000

Germany

RICOH DEUTSCHLAND GmbH
Wilhelm-Fay-Strasse 51,
D-65936 Frankfurt am Main
Phone: +49-(0)69-7104250

France

RICOH FRANCE S.A.
383, Avenue du Général de Gaulle
BP 307-92143 Clamart Cedex
Phone: +33-(0)-821-01-74-26

Spain

RICOH ESPAÑA S.A.
Avda. Litoral Mar, 12-14,
Blue Building, Marina Village,
08005 Barcelona
Phone: +34-(0)93-295-7600

Italy

RICOH ITALIA SpA
Via della Metallurgia 12,
37139 Verona
Phone: +39-045-8181500

China

RICOH CHINA CO.,LTD.
17/F.,Huamin Empire Plaza,No.728
Yan An West Road,
Shanghai, P.C.:200050
Phone: +86-21-5238-0222

Singapore

RICOH ASIA PACIFIC PTE.LTD.
260 Orchard Road,
#15-01/02 The Heeren,
Singapore 238855
Phone: +65-6830-5888

