

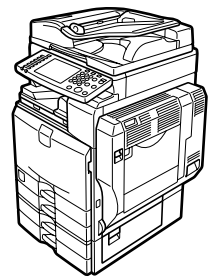

# Operating Instructions

## Troubleshooting



- 
- 1 When the Machine Does Not Operate As wanted
  - 2 Troubleshooting When Using the Copy Function
  - 3 Troubleshooting When Using the Facsimile Function
  - 4 Troubleshooting When Using the Printer Function
  - 5 Troubleshooting When Using the Scanner Function
  - 6 Adding paper, Toner and Staples
  - 7 Clearing Misfeeds
  - 8 Remarks

## Introduction

This manual contains detailed instructions and notes on the operation and use of this machine. For your safety and benefit, read this manual carefully before using the machine. Keep this manual in a handy place for quick reference.

Do not copy or print any item for which reproduction is prohibited by law.

Copying or printing the following items is generally prohibited by local law:

bank notes, revenue stamps, bonds, stock certificates, bank drafts, checks, passports, driver's licenses.

The preceding list is meant as a guide only and is not inclusive. We assume no responsibility for its completeness or accuracy. If you have any questions concerning the legality of copying or printing certain items, consult with your legal advisor.

This machine is equipped with a function that prevents making counterfeit bank bills. Due to this function the original images similar to bank bills may not be copied properly.

Colours on colour keys or the colour circle may differ slightly from the colours of actual copies.

## Important

Contents of this manual are subject to change without prior notice. In no event will the company be liable for direct, indirect, special, incidental, or consequential damages as a result of handling or operating the machine.

### Notes:

Some illustrations in this manual might be slightly different from the machine.

Depending on which country you are in, certain units may be optional. For details, please contact your local dealer.

Two kinds of size notation are employed in this manual. With this machine refer to the metric version.

For good copy quality, the supplier recommends that you use genuine toner from the supplier.

The supplier shall not be responsible for any damage or expense that might result from the use of parts other than genuine parts from the supplier with your office products.

## Power Source

220-240 V, 50/60 Hz, 10 A or more.

Please be sure to connect the power cord to a power source as shown above. For details about power source, see p.120 "Power Connection".

## Trademarks

Microsoft®, Windows® and Windows NT® are registered trademarks of Microsoft Corporation in the United States and/or other countries.

TrueType is registered trademarks of Apple Computer, Inc.

PostScript® and Acrobat® are registered trademarks of Adobe Systems, Incorporated.

PCL is a registered trademark of Hewlett-Packard Company.

Bluetooth is a Trademark of the Bluetooth SIG, Inc. (Special Interest Group) and licensed to Ricoh Company Limited.

PictBridge is a trademark.

Other product names used herein are for identification purposes only and might be trademarks of their respective companies. We disclaim any and all rights to those marks.

The proper names of the Windows operating systems are as follows:

- The product name of Windows® 95 is Microsoft® Windows 95.
- The product name of Windows® 98 is Microsoft® Windows 98.
- The product name of Windows® Me is Microsoft® Windows Millennium Edition (Windows Me).
- The product names of Windows® 2000 are as follows:  
Microsoft® Windows® 2000 Advanced Server  
Microsoft® Windows® 2000 Server  
Microsoft® Windows® 2000 Professional
- The product names of Windows® XP are as follows:  
Microsoft® Windows® XP Professional  
Microsoft® Windows® XP Home Edition
- The product names of Windows Server™ 2003 are as follows:  
Microsoft® Windows Server™ 2003 Standard Edition  
Microsoft® Windows Server™ 2003 Enterprise Edition  
Microsoft® Windows Server™ 2003 Web Edition
- The product names of Windows NT® 4.0 are as follows:  
Microsoft® Windows NT® Server 4.0  
Microsoft® Windows NT® Workstation 4.0

# Manuals for This Machine

Refer to the manuals that are relevant to what you want to do with the machine.

## ❖ **About This Machine**

Be sure to read the Safety Information in this manual before using the machine.

This manual provides an introduction to the functions of the machine. It also explains the control panel, preparation procedures for using the machine, how to enter text, and how to install the CD-ROMs provided.

## ❖ **General Settings Guide**

Explains User Tools settings, and Address Book procedures such as registering fax numbers, e-mail addresses, and user codes. Also refer to this manual for explanations on how to connect the machine.

## ❖ **Troubleshooting**

Provides a guide to solving common problems, and explains how to replace paper, toner, staples, and other consumables.

## ❖ **Security Reference**

This manual is for administrators of the machine. It explains security functions that the administrators can use to protect data from being tampered, or prevent the machine from unauthorized use.

Also refer to this manual for the procedures for registering administrators, as well as setting user and administrator authentication.

## ❖ **Copy/ Document Server Reference**

Explains Copier and Document Server functions and operations. Also refer to this manual for explanations on how to place originals.

## ❖ **Facsimile Reference**

Explains Facsimile functions and operations.

## ❖ **Printer Reference**

Explains Printer functions and operations.

## ❖ **Scanner Reference**

Explains Scanner functions and operations.

## ❖ **Network Guide**

Explains how to configure and operate the machine in a network environment, and use the software provided.

This manual covers all models, and includes descriptions of functions and settings that might not be available on this machine. Images, illustrations, and information about operating systems that are supported might also differ slightly from those of this machine.

## ❖ Other manuals

- Manuals for This Machine
- Safety Information
- Quick Reference Copy Guide
- Quick Reference Fax Guide
- Quick Reference Printer Guide
- Quick Reference Scanner Guide
- PostScript3 Supplement
- UNIX Supplement
- Manuals for DeskTopBinder Lite
  - DeskTopBinder Lite Setup Guide
  - DeskTopBinder Introduction Guide
  - Auto Document Link Guide

## Note

- Manuals provided are specific to machine types.
- Adobe Acrobat Reader/Adobe Reader must be installed in order to view the manuals as PDF files.
- For “UNIX Supplement”, please visit our Web site or consult an authorized dealer.
- “PostScript3 Supplement” and “UNIX Supplement” include descriptions of functions and settings that might not be available on this machine.

# TABLE OF CONTENTS

<b>Manuals for This Machine</b> .....	<b>i</b>
<b>How to Read This Manual</b> .....	<b>1</b>
Symbols .....	1
Names of Major Options .....	2
<b>1. When the Machine Does Not Operate As wanted</b>	
<hr/>	
<b>Indicators</b> .....	<b>3</b>
<b>Panel Tone</b> .....	<b>4</b>
<b>Checking Machine Status and Settings</b> .....	<b>5</b>
<b>When an Indicator to the Right of a Function Key is Lit</b> .....	<b>8</b>
<b>When You Have Problems Operating the Machine</b> .....	<b>9</b>
<b>When a Job is Not Performed</b> .....	<b>14</b>
<b>2. Troubleshooting When Using the Copy Function</b>	
<hr/>	
<b>When a Message Appears</b> .....	<b>19</b>
<b>When You Cannot Make Clear Copies</b> .....	<b>23</b>
<b>When You Cannot Make Copies As Wanted</b> .....	<b>25</b>
When Memory is Full .....	29
<b>3. Troubleshooting When Using the Facsimile Function</b>	
<hr/>	
<b>Adjusting the Volume</b> .....	<b>31</b>
<b>When a Message Appears</b> .....	<b>33</b>
<b>When You Cannot Send or Receive Fax Messages as Wanted</b> .....	<b>40</b>
When Memory is Full .....	43
<b>If an Error Report is Printed</b> .....	<b>44</b>
<b>Turning Off the Main Power / In the Event of Power Failure</b> .....	<b>45</b>
<b>When an Error Occurs Using Internet Fax</b> .....	<b>46</b>
Error Mail Notification .....	46
Error Report (E-Mail) .....	46
Server-Generated Error E-mail .....	46
<b>4. Troubleshooting When Using the Printer Function</b>	
<hr/>	
<b>When a Message Appears during Installation of the Printer Driver</b> .....	<b>47</b>
Windows 95/98/Me .....	47
Windows 2000 .....	48
Windows XP, Windows Server 2003 .....	48
Windows NT 4.0 .....	49
<b>If USB Connection Fails</b> .....	<b>50</b>
<b>When a Message Appears</b> .....	<b>51</b>
Status Messages .....	51
Alert Messages .....	52
Checking the Error Log .....	53

<b>When You Cannot Print</b> .....	<b>54</b>
<b>Other Printing Problems</b> .....	<b>57</b>
<b>When PictBridge Printing Does Not Work</b> .....	<b>63</b>

## **5. Troubleshooting When Using the Scanner Function**

---

<b>When Scanning is Not Done as Expected</b> .....	<b>65</b>
<b>When You Cannot Send Scanned Files</b> .....	<b>66</b>
When Stored Files Cannot be Accessed .....	66
When You Cannot Browse the Network to Send a Scan file .....	66
When the TWAIN Driver Cannot be Started .....	66
When Stored Files Cannot be Edited.....	67
When the Network Delivery Function Cannot be Used.....	67
Operations are not possible when messages appear .....	67
<b>When a Message is Displayed</b> .....	<b>68</b>
When a Message is Displayed on the Control Panel.....	68
When a Message is Displayed on the Client Computer.....	75

## **6. Adding paper, Toner and Staples**

---

<b>Loading paper</b> .....	<b>79</b>
Loading Paper into the Paper Trays .....	80
Loading Paper into the Large Capacity Tray (LCT) .....	81
<b>Changing the Paper Size</b> .....	<b>83</b>
Changing the Paper Size in the Paper Tray.....	84
<b>Adding Toner</b> .....	<b>89</b>
Inserting Toner .....	90
When Toner Remains .....	91
Sending Faxes or Scanned Documents When Toner Has Run Out .....	91
Used Toner .....	91
<b>Maintenance</b> .....	<b>92</b>
Adjusting the Colour Registration.....	92
Auto Colour Calibration .....	94
<b>Adding Staples</b> .....	<b>98</b>
SR790 .....	98
Finisher SR3030 and Booklet Finisher SR3020.....	99
Booklet Finisher SR3020 (Saddle Stitch).....	100
<b>Replacing the Stamp Cartridge</b> .....	<b>101</b>

## **7. Clearing Misfeeds**

---

<b>Removing Jammed Paper</b> .....	<b>103</b>
Locating Jammed Paper .....	104
Removing Jammed Paper.....	105
<b>Removing Jammed Staples</b> .....	<b>111</b>
SR790 .....	111
Finisher SR3030 and Booklet Finisher SR3020.....	112
Booklet Finisher SR3020 (Saddle Stitch).....	113
<b>Removing Punch Waste</b> .....	<b>114</b>
Finisher SR3030 and Booklet Finisher SR3020.....	114

## 8. Remarks

---

<b>Where to Put Your Machine .....</b>	<b>117</b>
Machine Environment .....	117
Moving.....	119
Power Connection.....	120
Access to the Machine .....	121
<b>Maintaining Your Machine .....</b>	<b>122</b>
Cleaning the Exposure Glass.....	122
Cleaning the Exposure Glass Cover .....	123
Cleaning the Auto Document Feeder.....	123
Cleaning the Dustproof Glass .....	124
<b>INDEX.....</b>	<b>125</b>





# How to Read This Manual

---

## Symbols

---

This manual uses the following symbols:

### **WARNING:**

Indicates important safety notes.

Ignoring these notes could result in serious injury or death. Be sure to read these notes. They can be found in the “Safety Information” section of About This Machine.

### **CAUTION:**

Indicates important safety notes.

Ignoring these notes could result in moderate or minor injury, or damage to the machine or to property. Be sure to read these notes. They can be found in the “Safety Information” section of About This Machine.

### **Important**

Indicates points to pay attention to when using the machine, and explanations of likely causes of paper misfeeds, damage to originals, or loss of data. Be sure to read these explanations.

### **Note**

Indicates supplementary explanations of the machine’s functions, and instructions on resolving user errors.

### **Reference**

This symbol is located at the end of sections. It indicates where you can find further relevant information.

### **[ ]**

Indicates the names of keys that appear on the machine’s display panel.

### **[ ]**

Indicates the names of keys on the machine’s control panel.

---

## Names of Major Options

---

Major options of this machine are referred to as follows in this manual:







- Auto Document Feeder → ADF
- Booklet Finisher SR3020 → Booklet Finisher SR3020
- Finisher SR3030 → Finisher SR3030
- Finisher SR790 → SR790

# 1. When the Machine Does Not Operate As wanted

This chapter explains basic troubleshooting procedures that are applicable to all functions of this machine.

## Indicators

This section explains Indicators displayed when the machine requires the user to remove misfed paper, add paper, or other perform other procedures.

 : Misfeed indicator	Appears when a misfeed occurs. See p.103 "Removing Jammed Paper".
 : Add Paper indicator	Appears when paper-out condition occurs. See p.79 "Loading paper".
 : Add Toner indicator	Appears when toner runs out. See p.89 "Adding Toner".
 : Add Staple indicator	Appears when staples run out. See p.98 "Adding Staples".
 : Empty Hole Punch Receptacle indicator	Appears when the hole punch receptacle is full. See p.114 "Removing Punch Waste"
 : Service Call indicator	Appears when the machine is malfunctioning or requires maintenance.
 : Open Cover indicator	Appears when the front cover, etc., is open.

# Panel Tone

The following table explains the meaning of the various beep patterns that the machine produces to alert users about left originals and other machine conditions.

Beep pattern	Meaning	Cause
Two long beeps.	Machine has warmed up.	After cooling or being switched on, the machine has fully warmed up and is ready for use.
Single short beep.	Panel/screen input accepted.	A control panel or screen key was pressed. Single short beeps are produced only when valid keys are pressed.
Single long beep.	Job completed.	A Copier/Document Server Features job has finished.
Four long beeps.	Soft alert.	The initial screen returns when the machine goes into energy-saving mode and when simplified display is cancelled.
Four long beeps repeated five times.	Soft alert.	An original has been left on the exposure glass, paper is empty, or the punch waste box is full.
Five short beeps repeated five time.	Strong alert.	The machine requires user attention because paper has jammed, the toner needs replenishing, or other problems have occurred.

## Note

- Users cannot mute the machine's beep alerts. When the machine beeps to alert users of a paper jam or toner request, if the machine's covers are opened and closed repeatedly within a short space of time, the beep alert might continue, even after normal status has resumed.

## Reference

For details about enabling or disabling beep alerts, see “The System Settings”, General Settings Guide.

# Checking Machine Status and Settings

You can check the machine's system status.

## ❖ Maintenance Info

You can check the following items under **[Maintenance Info]**:

- **[Remaining Toner]**  
Displays the amount of remaining toner.
- **[No Staples]**  
Displays whether there are staples remaining or not.
- **[Punch Receptacle Full]**  
Displays whether the hole punch receptacle is full.
- **[Paper Tray]**  
Displays the paper type and size loaded in the paper tray.
- **[Output Tray Full]**  
Displays whether the output tray is overloaded.
- **[Original Misfeed]**  
Displays state of and solutions for original misfeeds.
- **[Paper Misfeed]**  
Displays state of and solutions for paper jams.
- **[Cover Open]**  
Indicates whether front cover, duplex unit, etc., is open.

## ❖ Data Storage

You can check the following items under **[Data Storage]**:

- **[HDD Remaining Memory]**  
Displays the amount of available hard disk drive memory.
- **[HDD File(s)]**  
Displays the total number of jobs stored in the hard disk drive.
- **[Print Job(s)]**  
Displays the number of jobs for Hold print/Stored print/Locked print/Sample print.
- **[Fax TX / RX File(s)]**  
Displays the number of TX standby files, Print memory lock files, Reception print files, and other files stored in the hard disk drive.
- **[Memory Erase Status]**  
Displays the state of the memory data.

### ❖ **Machine Address Info**

You can check the following items under **[Machine Address Info]**:

- **[Fax No.]**  
Displays the machine's fax number.
- **[H.323 Own Fax No.]**  
Displays the machine's alias telephone number.
- **[SIP User Name]**  
Displays the machine's SIP user name.
- **[Fax E-mail Account]**  
Displays the machine's fax e-mail account.
- **[Machine IPv4 Address]**  
Displays the machine's IPv4 address.
- **[Machine IPv6 Address]**  
Displays the machine's IPv6 address.

### ❖ **Enquiry**

You can check the following items under **[Enquiry]**:

- **[Machine Repairs]**  
Displays the machine number and contact number that are required for service.
- **[Sales Representative]**  
Displays the sales representative's telephone number.
- **[Supply Order]**  
Displays the contact number for placing supply orders.
- **[Supply Details]**  
Displays the name of toner, staples, etc., used on the machine.

**1** On the control panel, press [System Status] on the control panel.

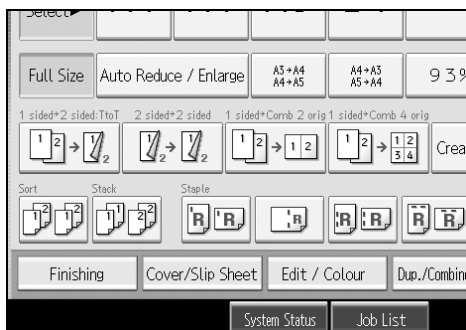

**2** Press each tab and check the contents.

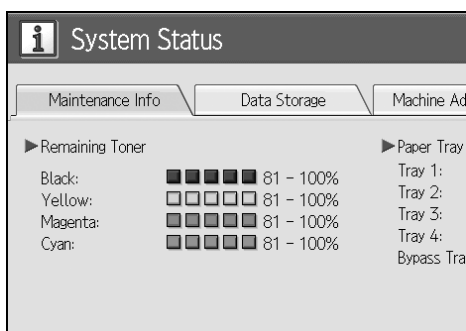

**3** After checking the information, press [Exit]. The previous screen returns.

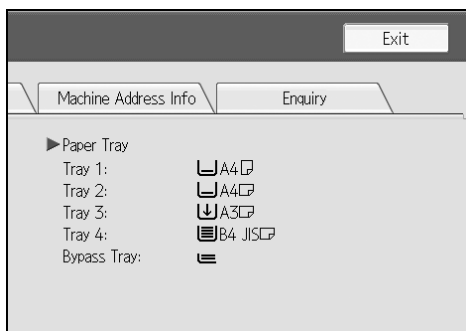

**Note**

- [No Staples], [Punch Receptacle Full], [Output Tray Full], [Original Misfeed], [Paper Misfeed], and [Cover Open] appear only when these errors occur.
- For details about how to locate and remove misfeeds, see “Checking Jammed Paper” or “Removing Jammed Paper”.

**Reference**

- p.104 “Locating Jammed Paper”.
- p.103 “Removing Jammed Paper”.

# When an Indicator to the Right of a Function Key is Lit

1

When an indicator to the right of a function key lights up, press the corresponding function key. Then, follow the instructions displayed on the control panel.

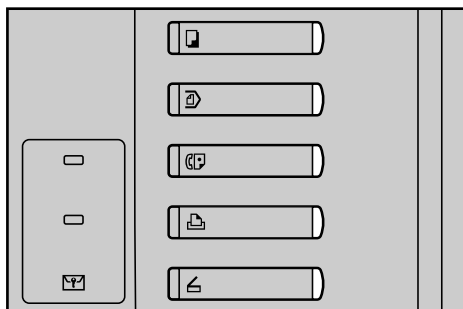

AOE9005

If an error occurs in the function you are using, check the message that appears on the control panel, and then refer to “When a Message is Displayed” for the relevant function.

Following explain the main reasons the function key is lit.

Problem	Cause	Solution
Documents and reports do not print out.	The paper output tray is full.	Remove the paper from the tray.
Documents and reports do not print out.	There is no copy paper left.	Add more paper. See p.79 “Loading paper”.
An error has occurred.	The function whose indicator is lit is defective.	Record the code number shown in the display and contact your service representative. See “When a Message displayed” of each chapter. You can use other functions normally.
The machine is unable to connect to the network.	A network error has occurred.	<ul style="list-style-type: none"> <li>Check the displayed message and take an appropriate action. See “When a Message displayed” of each chapter.</li> <li>Check that the machine is correctly connected to the network, and that the machine is correctly set. See “Network Settings”, General Settings Guide.</li> <li>Contact the administrator.</li> <li>When the function key is still lit, even if you take the measures above, contact your service representative.</li> </ul>

## Reference

- p.19 “Troubleshooting When Using the Copy Function”.
- p.31 “Troubleshooting When Using the Facsimile Function”.
- p.47 “Troubleshooting When Using the Printer Function”.
- p.65 “Troubleshooting When Using the Scanner Function”.



# When You Have Problems Operating the Machine

The following chart gives explanations of common problems and messages. If other messages appear, follow the instructions displayed.

## Important

- Check the contact address and Serial No. of Machine shown in the call service message (📞), and then contact your service representative.

Problem	Cause	Solution
Although the copier screen appears when the machine is turned on using the main power switch, it cannot be switched to another screen by pressing the <b>[Printer]</b> or <b>[Scanner]</b> key.	Functions other than the copier function are not yet ready.	Wait a little longer.
The machine has just been turned on and the User Tools screen is displayed, but the User Tools menu has items missing.	Functions other than the copier function are not yet ready. Time required varies by function. Functions appear in the User Tools menu when they become ready for use.	Wait a little longer.
The main power indicator continues blinking and does not turn off when pressed.	This occurs in the following cases: <ul style="list-style-type: none"> <li>• ADF is open.</li> <li>• The machine is communicating with external equipment.</li> <li>• The hard disk is active.</li> </ul>	Close ADF, and check if the machine is communicating with a computer.
The display is off.	The machine is in Energy Saver mode.	Press the <b>[Energy Saver]</b> key to cancel Energy Saver Mode. mode.
The display is off.	The operation switch is turned off.	Turn on the operation switch.
Nothing happens when the operation switch is turned on.	The main power switch is turned off.	Turn on the main power switch.
"Please wait." appears.	This message appears when you turn on the operation switch.	Wait for the machine to get ready.
"Please wait." appears.	This message appears when you change the toner cartridge.	Wait for the machine to get ready.

Problem	Cause	Solution
"Memory is full. Do you want to store scanned file?" appears.	The scanned originals exceed the number of sheets/pages that can be stored in the hard disk.	<ul style="list-style-type: none"> <li>• Press <b>[Store File]</b> to store pages that have been scanned. Delete unnecessary files with <b>[Delete File]</b>.</li> <li>• Press <b>[No]</b> if you are not storing pages that have been scanned. Delete unnecessary files with <b>[Delete File]</b>.</li> </ul>
"Self checking..." appears.	The machine is performing image adjustment operations.	The machine may perform periodic maintenance during operations. The frequency and duration of maintenance depends on the humidity, temperature, and printing factors such as number of prints, paper size, and paper type. Wait for the machine to get ready.
The user code entry screen is displayed.	Users are restricted by user management.	Enter the user code (up to eight digits), and then press <b>[OK]</b> .
The Authentication screen appears.	Basic Authentication, Windows Authentication, LDAP Authentication or Integration Server Authentication is set.	Enter your login user name and user password. See "When the Authentication Screen is Displayed", About This Machine.
"You do not have the privileges to use this function." is displayed.	The use of the function is restricted to authenticated users only.	Contact the administrator.
"You do not have the privileges to use this function." continues to be displayed even though you have entered a valid user code.	This user code is not allowed to use the function selected.	Press the <b>[Energy Saver]</b> key. Confirm that the display goes off, and then press the <b>[Energy Saver]</b> key again. The display will return to the user code entry display. When printing under the copier or printer function, press the <b>[Energy Saver]</b> key only after printing has finished.
An error message remains, even if misfed paper is removed.	<ul style="list-style-type: none"> <li>• When a misfeed message appears, it remains until you open and close the cover as required.</li> <li>• Paper is still jammed in the tray.</li> </ul>	Clear misfed paper, and then open and close the front cover. see p.103 "Clearing Misfeeds".
Original images are printed on the reverse side of the paper.	You may have loaded the paper incorrectly.	Load paper correctly. Place paper in the paper tray with the print side up. Load paper into the bypass tray with the print side down. See p.82 "Orientation-Fixed Paper or Two-Sided Paper".

Problem	Cause	Solution
Misfeeds occur frequently.	The tray's side fences may not be locked.	<ul style="list-style-type: none"> <li>Remove the paper. See p.103 "Removing Jammed Paper".</li> <li>Check the side fences are locked. See p.83 "Changing the Paper Size".</li> </ul>
Misfeeds occur frequently.	The tray's end fence may not be set properly.	<ul style="list-style-type: none"> <li>Remove the paper. See p.103 "Removing Jammed Paper".</li> <li>Check the end fence is set properly. See p.83 "Changing the Paper Size".</li> </ul>
Misfeeds occur frequently.	Paper of undetectable size has been loaded.	<ul style="list-style-type: none"> <li>Remove the paper. See p.103 "Removing Jammed Paper".</li> <li>When loading the paper of undetectable size, specify the paper size in "Tray Paper Size". See "Paper Size: Tray 1-4", General Settings Guide and "Copy Paper", About This Machine.</li> </ul>
Misfeeds occur frequently.	There is a foreign object on the finisher tray.	<ul style="list-style-type: none"> <li>Remove the paper. See p.103 "Removing Jammed Paper".</li> <li>Do not place anything on the finisher tray. It may cause a paper jam.</li> </ul>
Misfeeds occur frequently.	The staple cartridge is not set correctly.	The Booklet Finisher SR3020 requires the saddle stitch stapler cartridge also. See p.98 "Adding Staples".
Cannot print in duplex mode.	<b>[1 Sided Copy]</b> is selected for Paper Type: Tray 1-4.	Select <b>[2 Sided Copy]</b> for Paper Type: Tray 1-4 See "Paper Size: Tray 1-4", General Settings Guide.
Cannot print in duplex mode.	You cannot select duplex printing if the paper type is set to <b>[OHP]</b> , <b>[Thin Paper]</b> , <b>[Label Paper]</b> , <b>[Thick Paper 2]</b> or <b>[Thick Paper 3]</b> .	Select a paper type that allows duplex printing. See "Paper Size: Tray 1-4", General Settings Guide.
Authentication failed.	The entered login user name or login password is not correct.	Inquire the user administrator for the correct login user name and login password.
Authentication failed.	The machine cannot perform authentication.	Contact the administrator.
The selected file(s) contained file(s) without access privileges. Only file(s) with access privileges will be deleted.	You have tried to delete files without the authority to do so.	Files can be deleted by the person who created the file. To delete a file which you are not authorized to delete, contact the person who created the file.

## ❖ Document Server

Problem	Cause	Solution
"Exceeded max. number of pages per file. Do you want to store the scanned pages as 1 file?" appears.	The number of scanned pages exceeds the capacity per file of the Document Server.	To store scanned pages as a file, press <b>[Store File]</b> . Scanned data is stored as a file in the Document Server. If you do not want to store scanned pages, press <b>[No]</b> . Scanned data is deleted.
You forgot your password.	You cannot access a protected file without entering the password.	Contact the administrator. To delete the files stored in the document server, select <b>[Delete All Files in Document Server]</b> . As this will permanently delete every single file, make sure the document server does not contain any files you want to keep. See "Delete All Files in Document Server", General Settings Guide.
You cannot find out what is stored in a file.	You may not be able to ascertain the contents of a file simply from the file name.	You can switch the Select File screen between <b>[List]</b> and <b>[Thumbnail]</b> display to check the contents of the file. In list display, the file name, date and time of storage, and user name are shown. In thumbnail display, an image of the stored file appears. You can enlarge the image by pressing <b>[Preview]</b> . Use the Select File screen to check information other than the file name. See "Checking the Details of a Stored Document", Copy/Document Server Reference.
Memory frequently becomes full.	The document server memory is full.	Delete unnecessary files. On the file selection display, select unnecessary files, and then press <b>[Delete File]</b> . If this does not increase available memory, do the following. <ul style="list-style-type: none"> <li>• Switch to the scanner screen, and then delete unnecessary files stored under the scanner function.</li> <li>• Switch to the printer screen, and then delete unnecessary files stored under Sample Print, Locked Print, Hold Print, or Stored Print.</li> </ul>

Problem	Cause	Solution
You want to check print quality before making a large print run.	You can print a single copy without specifying the setting again.	Check print quality by printing out only the first set using the <b>[Sample Copy]</b> key.
"Original is being scanned by another function. Please wait." appears.	Copier or Scanner function is in use.	To cancel a job in progress, first press <b>[Exit]</b> , and then press the <b>[Copy]</b> key or <b>[Scanner]</b> key. Next, press the <b>[Clear/Stop]</b> key. When the message "The Stop key was pressed. Stop copying?" press <b>[Stop]</b> .
"Cannot display preview of this page." appears, and you can not check the thumb nail image.	The image data may have been corrupted.	Pressing <b>[Exit]</b> displays the preview screen without a thumbnail.

 **Note**

- ❑ If you cannot make copies as you want because of paper type, paper size, or paper capacity problems, use recommended paper. See "Copy Paper", About This Machine.
- ❑ Using curled paper often causes misfeeds, soiled paper edges, or slipped positions while performing staple or stack printing. When using curled paper, take the stiffness out of the paper with your hands to straighten out the curl, or load the paper up side down. Also, to prevent paper from curling, lay paper on a flat surface, and do not lean it against the wall.

# When a Job is Not Performed

1

If you cannot execute a function, it may be that the machine is being held up by another function.

If you cannot execute a function, terminate any other functions currently active, and then try executing the function again. In certain cases, you can carry out another job (copier, document server, printer, scanner) without canceling the current job being performed. Performing multiple functions simultaneously like this is called “Multi-accessing”.

## Combination Chart

### ❖ **Function Compatibility**

The chart shows Function Compatibility when print priority is set to “Interleave”. See “Print Priority”, General Settings Guide.

△ : Simultaneous operations are possible.

● : Operation is enabled when the relevant function key is pressed and remote switching (of the scanner/external extension) is done.

○ : Operation is enabled when the **[Interrupt]** key is pressed to interrupt the preceding operation.

→ : Operation is performed automatically once the preceding operation ends.

× : The operation must be started once the preceding operation ends. (Simultaneous operations are not possible.)

Mode after you select		Copy			Interrupt Copying		Facsimile				Printer				
		Operations for Copying	Stapling	Sort	Operations for Copying	Copying	Transmission Operation/Manual Reception Operation	Transmission	Reception	Print	Scanner	TWAIN	Document Server	DeskTopBinder	Web Document Server
Mode before you select		Operations for Copying	Stapling	Sort	Operations for Copying	Copying	Transmission Operation/Manual Reception Operation	Transmission	Reception	Print	Scanner	TWAIN	Document Server	DeskTopBinder	Web Document Server
Copy	Operations for Copying	×	×	×	○	○	●	●	△	△	△	△	△	△	△
	Stapling	△	→	→	○	○	●	●	△	△	△	△	△	△	△
	Sort	△	→	→	○	○	●	●	△	△	△	△	△	△	△
Interrupt Copying	Operations for Copying	○	○	○	×	×	×	×	△	△	△	△	△	△	△
	Copying	○	○	○	×	×	×	×	△	△	△	△	△	△	△
Facsimile	Transmission Operation/Manual Reception Operation	●	●	●	○	○	×	×	△	△	△	△	△	△	△
	Transmission	×	×	×	×	×	×	×	△	△	△	△	△	△	△
	Scanning an original for Memory Transmission	×	×	×	×	×	×	×	△	△	△	△	△	△	△
	Memory Transmission	×	×	×	×	×	×	×	△	△	△	△	△	△	△
	Immediate Transmission	×	×	×	×	×	×	×	△	△	△	△	△	△	△
	Memory Reception	×	×	×	×	×	×	×	△	△	△	△	△	△	△
	Printing Received Data	×	×	×	×	×	×	×	△	△	△	△	△	△	△
	Data Reception	×	×	×	×	×	×	×	△	△	△	△	△	△	△
	Printing	×	×	×	×	×	×	×	△	△	△	△	△	△	△
	Stapling	×	×	×	×	×	×	×	△	△	△	△	△	△	△
	Operations for Scanning	×	×	×	×	×	×	×	△	△	△	△	△	△	△
	Scanning	×	×	×	×	×	×	×	△	△	△	△	△	△	△
	Scanning	×	×	×	×	×	×	×	△	△	△	△	△	△	△
	Operations for Document Server	×	×	×	×	×	×	×	△	△	△	△	△	△	△
	Scanning a Document to Store in Document Server	×	×	×	×	×	×	×	△	△	△	△	△	△	△
	Printing from Document Server	×	×	×	×	×	×	×	△	△	△	△	△	△	△
	Printing from Document Server	×	×	×	×	×	×	×	△	△	△	△	△	△	△
	Sending a Facsimile from Document Server	×	×	×	×	×	×	×	△	△	△	△	△	△	△
	Printing	×	×	×	×	×	×	×	△	△	△	△	△	△	△

Mode after you select		Mode before you select		Copy		Interrupt Copying		Facsimile				Printer				Scanner		TWAIN		Document Server		DeskTopBinder		Web Document Server	
				Operations for Copying	Stapling	Sort	Operations for Copying	Copying	Transmission Operation/Manual Reception Operation	Transmission	Reception	Data Reception	Printing	Stapling	Operations for Scanning	Scanning	Scanning	Operations for Document Server	Scanning a Document to Store in Document Server	Printing from Document Server	Printing from Document Server	Sending a Facsimile from Document Server	Printing	Web Document Server	
Facsimile	Transmission	Memory Transmission	△	△	△	△	△	△	△	△	△	△	△	△	△	△	△	△	△	△	△	△	△	△	
		Immediate Transmission	×	×	×	×	×	×	△	×	△	△	△	△	△	×	×	×	×	△	→	△	△	△	
	Reception	Memory Reception	△	△	△	△	△	△	△	△	△	△	△	△	△	△	△	△	△	△	△	△	△	△	△
		Printing Received Data	△	△	△	△	△	△	△	△	△	×	△	△	△	△	△	△	△	△	△	△	△	△	△
Printer	Print	Data Reception	△	△	△	△	△	△	△	△	△	△	△	△	△	△	△	△	△	△	△	△	△	△	△
		Printing	△	△	△	○	○	△	△	△	△	△	△	△	△	△	△	△	△	△	△	△	△	△	△
		Stapling	△	→	△	○	○	△	△	△	△	△	△	△	△	△	△	△	△	△	△	△	△	△	△
Scanner	Operations for scanning	●	●	●	○	○	●	●	●	●	△	△	△	△	△	△	△	△	△	△	△	△	△	△	△
	Scanning	●	●	●	○	○	●	●	△	●	△	△	△	△	△	△	△	△	△	△	△	△	△	△	△



Mode after you select		Copy			Interrupt Copying		Facsimile					Printer			Document Server		DeskTopBinder		Web Document Server				
							Transmission		Reception			Print			Scanner		TWAIN		Document Server		DeskTopBinder		Web Document Server
Mode before you select		Operations for Copying			Operations for Copying		Transmission Operation/Manual Reception Operation					Data Reception			Operations for Document Server		Printing from Document Server		Printing				
		Operations for Copying	Stapling	Sort	Operations for Copying	Copying	Scanning an Original for Memory Transmission	Memory Transmission	Immediate Transmission	Memory Reception	Printing Received Data	Data Reception	Printing	Stapling	Operations for Scanning	Scanning	Scanning	Operations for Document Server	Scanning a Document to Store in Document Server	Printing from Document Server	Printing from Document Server	Sending a Facsimile from Document Server	Printing
TWAIN	Scanning	×	×	×	×	×	×	×	×	△	△	△	△	△	×	×	×	×	△	△	△	△	
Document Server	Operations for Document Server	●	●	●	○	○	●	●	△	●	△	△	△	△	●	●	●	×	×	×	△	△	△
	Scanning a Document to Store in Document Server	●	×	×	○	○	●	×	△	×	△	△	△	△	●	●	×	×	×	×	△	△	△
	Printing from Document Server	●	△	△	○	○	△	△	△	△	△	△	△	△	△	△	△	△	△	△	△	△	△
DeskTopBinder	Printing from Document Server	△	△	△	△	△	△	△	△	△	△	△	△	△	△	△	△	△	△	△	△	△	△
	Sending a Facsimile from Document Server	△	△	△	△	△	△	△	△	△	△	△	△	△	△	△	△	△	△	△	△	→	△
Web Document Server	Printing	△	△	△	△	△	△	△	△	△	△	△	△	△	△	△	△	△	△	△	△	△	△

- \*1 Simultaneous operations are only possible after the preceding job documents are all scanned and **[New Job]** key appears.
- \*2 You can scan a document after the preceding job documents are all scanned.
- \*3 Operation is possible when extra lines are added.
- \*4 During stapling, printing automatically starts after the current job.
- \*5 Stapling is not available.
- \*6 Simultaneous operation become possible after you press **[New Job]** key.
- \*7 During parallel reception, any subsequent job is suspended until the receptions are completed.

 **Note**

- Stapling cannot be used at the same time for multiple functions.
- If the machine is capable of executing multiple functions simultaneously, specify which function should have priority in "Print Priority". This setting is factory-preset to "Display Mode". For setting of Printing Priority Function, see "Print Priority", General Settings Guide.
- When Booklet Finisher SR3020, Finisher SR3030 or SR790 is installed on the machine, you can specify the output tray where documents are delivered. See "Output tray settings", General Settings Guide.
- While printing is in progress, scanning a document using another function may take more time.

# 2. Troubleshooting When Using the Copy Function

This chapter explains likely causes of and possible solutions for copier function problems.

## When a Message Appears

This section explains the machine's main messages. If other messages appear, follow the instructions they contain.

### Important

- ❑ For messages that are not listed here, see p.9 “When You Have Problems Operating the Machine”.

Message	Cause	Solution
Cannot detect original size.	Improper original is placed.	Select paper manually, not in Auto Paper Select mode, and do not use Auto Reduce/Enlarge function. See “Sizes difficult to detect”, Copy/Document Server Reference.
Cannot detect original size.	Improper original is placed.	Place the original on the exposure glass. See “Placing Originals on the Exposure Glass” and “Sizes difficult to detect”, Copy/Document Server Reference.
Cannot detect original size.	Original is not placed.	Place your originals.
Check original orientation.	Original is not placed in a proper orientation.	Change the orientation of the original.
Check paper size.	Improper paper size is set.	If you press the <b>[Start]</b> key, copy will start onto the selected paper.
Rotate Sort is not available with this paper size.	A size of paper for which Rotate Sort is not available is selected.	Select the proper paper size. See “Sort”, Copy/Document Server Reference.
Duplex is not available with this paper size.	A paper size not available in Duplex mode has been selected.	The following paper sizes are available for Duplex mode: A3, B4, A4, B5, A5, 11”×17”, Legal (8 <sup>1</sup> / <sub>2</sub> ”×14”) , 8 <sup>1</sup> / <sub>4</sub> ”×14”, Letter (8 <sup>1</sup> / <sub>2</sub> ”×11”) , Executive (7 <sup>1</sup> / <sub>4</sub> ”×10 <sup>1</sup> / <sub>2</sub> ”) , F/GL (8”×13”) , Foolscap (8”×13”) , Folio (8 <sup>1</sup> / <sub>4</sub> ”×13”) , 11”×15” , 10”×14” , 8”×10” , 8K , 16K . Select one of these sizes.

Message	Cause	Solution
Cannot punch this paper size.	The Punch function cannot be used with paper size selected.	<p>The following paper sizes are available for Punch mode:</p> <ul style="list-style-type: none"> <li>• 2 holes: A3, B4, A4, B5, A5, 11"×17", Legal(8<sup>1</sup>/<sub>2</sub>"×14"), 8<sup>1</sup>/<sub>4</sub>"×14", Letter(8<sup>1</sup>/<sub>2</sub>"×11"), Half Letter (5<sup>1</sup>/<sub>2</sub>"×8<sup>1</sup>/<sub>2</sub>"), Executive (7<sup>1</sup>/<sub>4</sub>"×10<sup>1</sup>/<sub>2</sub>"), F/GL (8"×13"), Foolscap (8<sup>1</sup>/<sub>2</sub>"×13"), Folio (8<sup>1</sup>/<sub>4</sub>"×13"), 11"×15", 10"×14", 8"×10", 8K, 16K. Select one of these sizes.</li> <li>• 3 holes: A3, B4, A4, B5, 11"×17", Letter(8<sup>1</sup>/<sub>2</sub>"×11"), Executive (7<sup>1</sup>/<sub>4</sub>"×10<sup>1</sup>/<sub>2</sub>"), 11"×15", 10"×14", 8K, 16K. Select one of these sizes.</li> <li>• 4 holes: Metric version: A3, B4, A4, B5, 11"×17", Letter(8<sup>1</sup>/<sub>2</sub>"×11"), Executive (7<sup>1</sup>/<sub>4</sub>"×10<sup>1</sup>/<sub>2</sub>"), 11"×15", 8K, 16K. Select one of these sizes.</li> </ul> <p>Narrow 2 × 2 version: A3, B4, A4, B5, A5, 11"×17", Legal(8<sup>1</sup>/<sub>2</sub>"×14"), 8<sup>1</sup>/<sub>4</sub>"×14", Letter(8<sup>1</sup>/<sub>2</sub>"×11"), Half Letter (5<sup>1</sup>/<sub>2</sub>"×8<sup>1</sup>/<sub>2</sub>"), Executive (7<sup>1</sup>/<sub>4</sub>"×10<sup>1</sup>/<sub>2</sub>"), F/GL (8"×13"), Foolscap (8<sup>1</sup>/<sub>2</sub>"×13"), Folio (8<sup>1</sup>/<sub>4</sub>"×13"), 11"×15", 10"×14", 8"×10", 8K, 16K. Select one of these sizes.</p>
Cannot staple paper of this size.	The Staple function cannot be used with paper size selected.	Select a paper size that can be used in Staple mode. See "Supplementary Informations", Copy/Document Server Reference.
Stapling capacity exceeded.	The number of sheets per set is over the staple capacity.	Check the stapler capacity. See "Supplementary Informations", Copy/Document Server Reference.
Maximum number of sets is nn. (A figure is placed at n.)	The number of copies exceeds the maximum copy quantity.	You can change the maximum copy quantity. See "Max. Number of Sets", General Settings Guide.

Message	Cause	Solution
File being stored exceeded max. number of pages per file. Copying will be stopped.	The scanned originals have too many pages to store as one document.	Press <b>[Exit]</b> , and then store again with an appropriate number of pages.
Magazine or Booklet mode is not available due to mixed image mode.	You selected the Magazine or Booklet function for originals scanned using different functions, such as copy and printer.	Make sure originals for the Magazine or Booklet function are scanned using the same function.
You do not have the privileges to use this function.	This user code is not allowed to use the function selected.	Contact the administrator.
You do not have the privileges to use this function.	This user code is not allowed to use the function selected.	If the message continues to be displayed and you cannot switch the screen, press the <b>[Energy Saver]</b> key. Confirm that the display goes off, and then press the <b>[Energy Saver]</b> key again. The display will return to the user code entry display. When printing under the copier or printer function, press the <b>[Energy Saver]</b> key only after printing has finished.
Authentication has failed.	The entered login user name or login password is not correct.	Inquire the user administrator for the correct login user name and login password.
Authentication has failed.	The machine cannot perform authentication.	Contact the administrator.
The selected file(s) contained file(s) without access privileges. Only file(s) with access privileges will be deleted.	You have tried to delete files without the authority to do so.	Files can be deleted by the person who created the file. To delete a file which you are not authorized to delete, contact the person who created the file.
Orig. is being scanned by another function. Please wait.	Document Server or Scanner function is in use.	To cancel the job in process, press <b>[Exit]</b> , and then press the <b>[Document Server]</b> or <b>[Scanner]</b> key. Next, press the <b>[Clear/Stop]</b> key. When the message "The Clear / Stop key was pressed. Are you sure you want to stop scanning?" appears, press <b>[Cancel]</b> .

Message	Cause	Solution
Please wait.	The destination list is being updated from the network using SmartDeviceMonitor for Admin. Depending on the number of destinations to be updated, there may be some delay before you can resume operation. Operations are not possible while this message is displayed.	Wait until the message disappears. Do not switch off the power while this message is displayed.

 **Reference**

p.9 "When You Have Problems Operating the Machine"

# When You Cannot Make Clear Copies

This section explains likely causes of and possible solutions for unclear copies.

Problem	Cause	Solution
Copies appear dirty.	Image density is too high.	Adjust the image density. See "Adjusting Copy Image Density", Copy/Document Server Reference.
Copies appear dirty.	Auto Image Density is not selected.	Adjust the auto density. See "Adjusting Copy Image Density", Copy/Document Server Reference.
The reverse side of an original image is copied.	Image density is too high.	Adjust the image density. See "Adjusting Copy Image Density", Copy/Document Server Reference.
The reverse side of an original image is copied.	Auto Image Density is not selected.	Adjust the auto density. See "Adjusting Copy Image Density", Copy/Document Server Reference.
A shadow appears on copies if you use pasted originals.	Image density is too high.	Adjust the image density. See "Adjusting Copy Image Density", Copy/Document Server Reference. Change the orientation of the original. Put mending tape on the pasted part.
The same copy area is dirty whenever making copies.	The exposure glass, scanning glass, or ADF is dirty.	Clean them. See p.122 "Maintaining Your Machine".
The same copy area is dirty whenever making copies.	The original that has already been printed is scanned.	Select <b>[Generation Copy]</b> , and then begin copying. See "Generation Copy", Copy/Document Server Reference.
Copies are too light.	Image density is too light.	Adjust the image density. See "Adjusting Copy Image Density", Copy/Document Server Reference.
Copies are too light.	A light copy may result when you use damp or rough grain paper.	Use the recommended paper. also, use paper that has been stored in the recommended temperature and humidity condition. See "Copy Paper", About This Machine. Contact your service representative.
Copies are too light.	Toner cartridge is almost empty.	Add toner. See p.89 "Adding Toner".
Parts of images are not copied.	The original is not set correctly.	Set originals correctly. See "Placing Originals", Copy/Document Server Reference.
Parts of images are not copied.	The correct paper size is not selected.	Select the proper paper size.

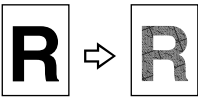
Problem	Cause	Solution
Images appear only partially coloured.	The paper is damp.	Use paper that has been stored in the recommended temperature and humidity condition. See "Copy Paper", About This Machine.
Coloured lines appear.	The exposure glass or scanning glass is dirty.	Clean them. See p.122 "Maintaining Your Machine".
White lines appear.	The exposure glass or scanning glass is dirty.	Clean them. See p.122 "Maintaining Your Machine".
White lines appear.	When  is blinking, toner is beginning to run out.	Add toner. See p.89 "Adding Toner".
Copies are blank.	The original is not set correctly.	When using the exposure glass, face the originals down. When using the ADF, face them up.
<p>A moiré pattern is produced on copies.</p> 	Your original has a dot pattern image or many lines.	Place the original on the exposure glass at a slight angle.
Black spots appear on the copy of a photographic print.	Because of high humidity, the photographic print has stuck to the exposure glass.	<p>Place the print on the exposure glass in either of the following ways:</p> <ul style="list-style-type: none"> <li>• Place an OHP transparency on the exposure glass, and then place the print on top of the OHP transparency.</li> <li>• Place the print on the exposure glass, and then place two or three sheets of white paper on top of it. Leave the auto-document feeder (ADF) open when copying.</li> </ul>



# When You Cannot Make Copies As Wanted

This section explains likely causes of and possible solutions for unclear copies.

## ❖ Basic

Problem	Cause	Solution
Misfeeds occur frequently.	The number of sheets loaded exceeds the capacity of the machine.	Load paper only as high as the upper limit markings on the side fence of the paper tray or bypass tray. See "Copy Paper", About This Machine.
Misfeeds occur frequently.	The paper tray's side fence is set too tightly.	Push the side fence lightly, and then re-set it. Also, we recommend you set at least 20 sheets of thick paper.
Misfeeds occur frequently.	The paper is damp.	Use paper that has been stored in the recommended temperature and humidity condition. See "Copy Paper", About This Machine.
Misfeeds occur frequently.	The paper is too thick or too thin.	Use recommended paper. See "Copy Paper", About This Machine.
Misfeeds occur frequently.	The copy paper is wrinkled or has been folded/creased.	Use recommended paper. Use paper that has been stored in the recommended temperature and humidity condition. See "Copy Paper", About This Machine.
Misfeeds occur frequently.	Printed paper is being used.	Use recommended paper. Do not use paper that has been already copied or printed onto. See "Copy Paper", About This Machine.
Copy paper becomes creased.	The paper is damp.	Use paper that has been stored in the recommended temperature and humidity condition. See "Copy Paper", About This Machine.
Copy paper becomes creased.	The paper is too thin.	Use recommended paper. See "Copy Paper", About This Machine.
Copies are not stapled.	There are jammed staples in the stapler.	Remove jammed staples. See p.111 "Removing Jammed Staples".

Problem	Cause	Solution
Copies are not stapled.	The number of copies exceeds the capacity of the stapler.	Check the stapler capacity. See "Supplementary Informations", Copy/Document Server Reference.
Copies are not stapled.	Copy paper is curled.	Turn the copy paper over in the tray.
Staples are wrongly positioned.	Originals are not set correctly.	Check the correct position to place the originals. See "Staple", Copy/Document Server Reference.
You cannot combine several functions.	Selected functions cannot be used together.	Check the combination of functions and make the settings again. See "Function Compatibility", Copy/Document Server Reference.
When sorting, the pages are divided into two blocks.	The memory became full in the middle of sorting and the pages were delivered in two blocks.	You can interrupt copying when the memory becomes full. See "Memory Full Auto Scan Restart", General Settings Guide.
Paper does not output during printing with stapling.	When you stop printing while using the staple function, paper not stapled during printing may be left in the staple unit.	Press the <b>[Clear Modes]</b> key and cancel copy settings, including stapling.
The copy is grayed out or a text pattern appears in the background of the copy.	You have copied a copy-guarded document protected from unauthorized copying.	Check the document. See "Using [Data Security for Copying]", Printer Reference.
Images are skewed.	The side fences in the paper feed tray is not locked.	Make sure the paper guide is locked. See p.83 "Changing the Paper Size".
Images are skewed.	The paper is feeding in at a slant.	Load the paper correctly. See p.79 "Loading paper".

❖ Edit

Problem	Cause	Solution
In Double Copies mode, parts of the original image are not copied.	Combination of original and copy paper is not correct.	Select A3 <input type="checkbox"/> for A4 <input type="checkbox"/> originals and A4 for A5 originals.
In Border, Centre, or Centre/ Border mode, parts of the original image are not copied.	You set a wide erased margin.	Make the margin width narrower. You can adjust it between 2 - 99 mm (0.1" - 3.9"). See "Erase Border Width" and "Erase Centre Width", General Settings Guide.
In Border, Centre, or Centre/ Border mode, parts of the original image are not copied.	Originals are not scanned correctly.	Place the originals correctly.

Problem	Cause	Solution
In Margin Adjustment mode, parts of the original image are not copied.	You set a wide erased margin.	Set a narrower margin with User Tools. You can set the width between 0 - 30 mm (0" - 1.2"). See "Front Margin: Left/Right", "Back Margin: Left/Right", "Front Margin: Top/Bottom" and "Back Margin: Top/Bottom", General Settings Guide.
In Margin Adjustment mode, parts of the original image are not copied.	There is a lack of margin space on the opposite side of the binding position.	Set a narrower margin with User Tools. You can set the width between 0 - 30 mm (0" - 1.2"). See "Front Margin: Left/Right", "Back Margin: Left/Right", "Front Margin: Top/Bottom" and "Back Margin: Top/Bottom", General Settings Guide.
In Image Repeat mode, the original image is not copied repeatedly.	You selected copy paper the same size as the originals, or you did not select the proper reproduction ratio.	Select copy paper larger than the originals or select the proper reproduction ratio.

## ❖ Stamp

Problem	Cause	Solution
The stamp position is wrong.	The paper orientation is wrong.	Check the paper orientation and stamp position.
The stamp is not printed on the back side of sheets when duplex copying.	The back side stamp position is incorrect for the paper size.	Reset the back side stamp position. See "Back Side Stamp Position in Duplex", General Settings Guide.

## ❖ Combine

Problem	Cause	Solution
You cannot make a book from Booklet or Magazine mode by folding copies.	You selected a setting ("Open to left" or "Open to right") that does not match the orientation of originals.	Change the setting. See "Orientation: Booklet, Magazine", General Settings Guide.
When using Combine, parts of the image are not copied.	You specified a reproduction ratio that does not match the sizes of your originals and copy paper.	When you specify a reproduction ratio using Manual Paper Select mode, make sure that the ratio matches your originals and the copy paper. Select the correct reproduction ratio before using Combine mode.
Copies are not in correct order.	You placed the originals in the incorrect order.	When placing a stack of originals in the ADF, the last page should be on the bottom. If you place an original on the exposure glass, start with the first page to be copied.

❖ Duplex

Problem	Cause	Solution
Cannot print in duplex mode.	You have loaded paper on the bypass tray.	Remove paper loaded on the bypass tray. Load paper in another tray.
Cannot print in duplex mode.	You have loaded paper exceeding 169 g/m <sup>2</sup> .	Change the paper.
Cannot print in duplex mode.	You have selected a tray which is set to <b>[1 Sided Copy]</b> in <b>[Tray Paper Settings]</b> in <b>[System Settings]</b> .	Set the tray to <b>[2 Sided Copy]</b> in <b>[Tray Paper Settings]</b> in <b>[System Settings]</b> . See "System Settings", General Settings Guide.
Copies are not in correct order.	You placed the originals in the incorrect order.	When placing a stack of originals in the ADF, the last page should be on the bottom. If you place an original on the exposure glass, start with the first page to be copied.
When using Duplex, copy is made Top to Bottom even though <b>[Top to Top]</b> is selected.	You placed the originals in the wrong orientation.	Place the original in the correct orientation. See "Original Orientation", Copy/Document Server Reference.

## When Memory is Full

This section explains likely causes of and possible solutions for problems related to full memory.

Message	Cause	Solution
Memory is full. nn originals have been scanned. Press [Print] to copy scanned originals. Do not remove remaining originals. "n" in the message represents a changeable number.	The scanned originals exceeds the number of pages that can be stored in memory.	Press <b>[Print]</b> to copy scanned originals and cancel the scanning data. Press <b>[Stop]</b> to cancel the scanning data and not copy.
Press [Continue] to scan and copy remaining originals.	The machine checked if the remaining originals should be copied, after the scanned originals was printed.	To continue copying, remove all copies, and then press <b>[Resume Printing]</b> . To stop copying, press <b>[Stop]</b> .

### Note

- If you set **[Memory Full Auto Scan Restart]** in User Tools to **[On]**, even if the memory becomes full, the memory overflow message will not be displayed. The machine will make copies of the scanned originals first, then automatically proceed scanning and copying the remaining originals. In this case, the resulting sorted pages will not be sequential. See "Input / Output", General Settings Guide.



# 3. Troubleshooting When Using the Facsimile Function

This chapter explains likely causes of and possible solutions for facsimile function problems.

## Adjusting the Volume

The following describes how to adjust the volume.

You can change the volume of the following sounds that the machine makes.

### ❖ On Hook Mode

Heard when the **[On Hook]** is pressed.

### ❖ At Transmission

Heard when Immediate transmission is performed.

### ❖ At Reception

Heard when the machine receives a document.

### ❖ At Dialing

Heard after pressing the **[Start]** key, until the line connects to the destination.

### ❖ At Printing

Heard when a received document is printed.

**1** Press the **[User Tools / Counter]** key.

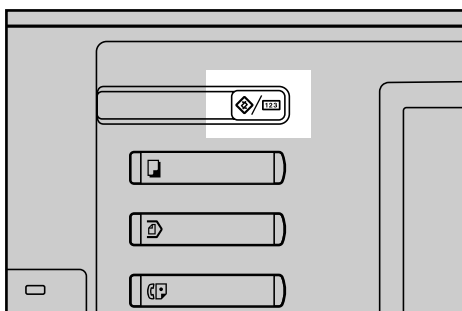

**2** Press **[Facsimile Features]**.

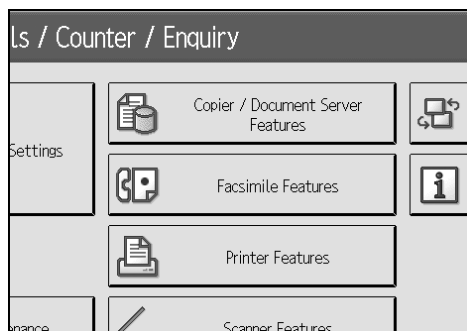

**3** Check that **[General Settings]** screen appears.

**4** Press **[Adjust Sound Volume]**.



**5** Press **[Lower]** or **[Louder]** to adjust the volume, and then press **[OK]**.

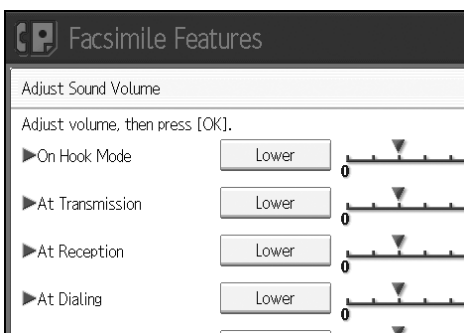

**6** Press the **[User Tools / Counter]** key.

The standby display appears.

**Note**

- You can adjust the On Hook volume when you press the **[On Hook]**. See “On Hook Dial”, Facsimile Reference.
- When you press **[Check]** on the Adjust Sound Volume screen, you will hear a confirmation sound so you can check the volume.
- If you press **[Cancel]**, the volume setting is canceled. The display returns to that of step **4**.
- You can set the volume level to between 0 and 7.



# When a Message Appears

This section explains the machine's main messages. If other messages appear, follow their instructions.

Message	Cause	Solution
Put original back, check it and press the Start key.	Original jammed during Memory Transmission.	Place originals that have not been scanned on the exposure glass or ADF again.
Cannot detect original size. Place original again, then press the Start key.	The machine failed to detect the size of the original.	Place original again, and then press the <b>[Start]</b> key.
Functional problems with facsimile. Data will be initialized.	There is a problem with the fax.	Record the code number shown in the display and contact your service representative. Other functions can be used.
Remove the paper from Internal Tray 1.	The Internal Tray 1 is full.	Remove the paper. If the other tray is also full, the tray name shown in the display changes. Remove paper from the tray indicated in the display.
Original is being scanned by another function. Switch to the following function, then press the Stop key to cancel scanning or press the Start key to continue.	The machine is scanning an original under another function.	Before sending a file by fax, cancel the job in progress. To do this, press <b>[Exit]</b> , and then press the <b>[Copy]</b> or <b>[Document Server]</b> key to display the suspended function. Then, on the copier or document server screen, press the <b>[Clear/Stop]</b> key to display the "The Stop key has been pressed. Are you sure you want to stop copying?" or "The Clear / Stop key was pressed. Are you sure you want to stop scanning?" prompt, and then press <b>[Stop]</b> .

Message	Cause	Solution
Updating the destination list... Please wait. Specified destination(s) or sender's name has been cleared.	The destination list is being updated from the network using SmartDeviceMonitor for Admin or Web Image Monitor. Depending on the number of destinations to be updated, there may be some delay before you can resume operation. Operation is not possible while this message is displayed.	Wait until the message disappears. Do not switch off the power while this message is displayed.
The selected file(s) contained file(s) without access privileges. Only file(s) with access privileges will be deleted.	You tried to delete a document for which you do not have permission to delete.	Only the administrator can delete this document. Contact the administrator if you want to delete a document for which you do not have permission to delete.
Connection with LDAP server has failed. Check the server status.	A network error has occurred and connection has failed.	Try the operation once more. If the message is still shown, the network may be crowded. Check the information of <b>[System Settings]</b> . See "System Settings", General Settings Guide.
LDAP server authentication has failed. Check the settings.	A network error has occurred and connection has failed.	Make settings correctly for the user name and the password for LDAP server authentication.
Exceeded max. No. of display search results. Max.:	The number of search results has exceeded the maximum number of items that can be displayed.	Search again after changing the search conditions.
Exceeded time limit for LDAP server search. Check the server status.	A network error has occurred and connection has failed.	Try the operation once more. If the message is still shown, the network may be crowded. Check the information of <b>[System Settings]</b> . See "System Settings", General Settings Guide.

Message	Cause	Solution
The specified group contains some destination(s) that do not have access privileges. Do you want to select only the privileged destination(s)?	The specified group contains some destinations for sending by e-mail and some destinations for sending by Scan to Folder.	To select destinations for sending by e-mail, press <b>[Select]</b> for the message displayed on the e-mail screen. To select destination for sending by Scan to Folder, press <b>[Select]</b> for the message displayed on the Scan to Folder screen.
Cannot find the specified path. Please check the settings.	The name of the computer or folder entered as the destination is wrong.	Check whether the computer name and the folder name for the destination are correct.
Sender has not been specified.	The sender has not been specified.	A sender's name should be specified before sending e-mail. Send e-mail after specifying the sender's name.
E-mail address entered is not correct. Please re-enter.	The entered e-mail address is wrong.	Make sure the e-mail address is correct, and then enter it again.
You do not have the privileges to use this function.	Use of this function is restricted.	Contact the administrator.
Authentication has failed.	Wrong login user name or password.	Confirm correct login user name or password.
Authentication has failed.	Authentication is not possible from this machine.	Contact the administrator.
Check whether there are any network problems. <b>[13-10]</b>	The alias telephone number you entered is already registered on the gatekeeper by another device.	<ul style="list-style-type: none"> <li>• Check the alias telephone number is correctly programmed using the Web Image Monitor. See the Web Image Monitor's Help.</li> <li>• Consult the administrator.</li> </ul>

Message	Cause	Solution
Check whether there are any network problems. <b>[13-11]</b>	Cannot access gatekeeper.	<ul style="list-style-type: none"> <li>• Use your Web Image Monitor to check the gatekeeper address is correctly programmed. See the Web Image Monitor's Help.</li> <li>• Consult the administrator.</li> </ul>
Check whether there are any network problems. <b>[13-17]</b>	Registering of user name is rejected by SIP server.	<ul style="list-style-type: none"> <li>• Use your Web Image Monitor to check the gatekeeper address is correctly programmed. See the Web Image Monitor's Help.</li> <li>• Consult the administrator.</li> </ul>
Check whether there are any network problems. <b>[13-18]</b>	Cannot access SIP server.	<ul style="list-style-type: none"> <li>• Use your Web Image Monitor to check the SIP server address is correctly programmed. See the Web Image Monitor's Help.</li> <li>• Consult the administrator.</li> </ul>
Check whether there are any network problems. <b>[14-01]</b>	Cannot find the DNS server, SMTP Server or folder for forwarding.	<ul style="list-style-type: none"> <li>• Check that the DNS server IPv4 address is correctly programmed using Web Image Monitor. See the Web Image Monitor's Help.</li> <li>• Check that the host name and IPv4 address of SMTP Server are correctly programmed using Web Image Monitor. See the Web Image Monitor's Help.</li> <li>• Check that the host name or IPv4 address of the SMTP server is correctly programmed using Web Image Monitor. See the Web Image Monitor's Help.</li> <li>• Check that the SMTP server is correctly programmed using Web Image Monitor. See the Web Image Monitor's Help.</li> <li>• Check that the folder for forwarding is correctly specified.</li> <li>• Check that the computer in which the folder for forwarding is specified is correctly operated.</li> <li>• Check that the LAN cable is correctly connected to the machine.</li> <li>• Consult the administrator.</li> </ul>

Message	Cause	Solution
<p>Check whether there are any network problems. <b>[14-09]</b></p>	<p>E-mail transmission was refused by SMTP authentication, POP before SMTP authentication or login authentication of the computer in which the folder for transfer is specified.</p>	<ul style="list-style-type: none"> <li>• Check that the machine e-mail address is correctly programmed from File Transfer under System Settings. See “File Transfer”, General Settings Guide. You can also use the Web Image Monitor for confirmation. See the Web Image Monitor's Help.</li> <li>• Check that the user name and password of the E-mail Account are correctly programmed from File Transfer under System Settings. See “File Transfer”, General Settings Guide. You can also use the Web Image Monitor for confirmation. See the Web Image Monitor's Help.</li> <li>• Check that the user ID and password for the computer in which the folder for forwarding is specified are correctly programmed.</li> <li>• Check that the folder for forwarding is correctly specified.</li> <li>• Check that the computer in which the folder for forwarding is specified is correctly operated.</li> <li>• Consult the administrator.</li> </ul>
<p>Check whether there are any network problems. <b>[14-33]</b></p>	<p>No machine's e-mail address is programmed.</p>	<ul style="list-style-type: none"> <li>• Check that the e-mail address of mail account is correctly programmed using “File Transfer” of “System Settings”. See “File Transfer”, General Settings Guide. You can also use the Web Image Monitor for confirmation. See the Web Image Monitor's Help.</li> <li>• Consult the administrator.</li> </ul>
<p>Check whether there are any network problems. <b>[15-01]</b></p>	<p>No POP3/IMAP4 server address is programmed.</p>	<ul style="list-style-type: none"> <li>• Check that the host name or IPv4 address of the POP3/IMAP4 server is correctly programmed using the Web Image Monitor. See the Web Image Monitor's Help.</li> <li>• Consult the administrator.</li> </ul>
<p>Check whether there are any network problems. <b>[15-02]</b></p>	<p>Cannot log on to the POP3/IMAP4 server.</p>	<ul style="list-style-type: none"> <li>• Check that the user name and password of the E-mail Account are correctly programmed using File Transfer under System Settings. See “File Transfer”, General Settings Guide. You can also use the Web Image Monitor for confirmation. See the Web Image Monitor's Help.</li> <li>• Consult the administrator.</li> </ul>

Message	Cause	Solution
<p>Check whether there are any network problems. <b>[15-03]</b></p>	<p>No machine e-mail address is programmed.</p>	<ul style="list-style-type: none"> <li>• Check that the machine e-mail address is correctly programmed using File Transfer under System Settings. See “File Transfer”, General Settings Guide. You can also use the Web Image Monitor for confirmation. See the Web Image Monitor’s Help.</li> </ul>
<p>Check whether there are any network problems. <b>[15-11]</b></p>	<p>Cannot find the DNS server or POP3/IMAP4 server.</p>	<ul style="list-style-type: none"> <li>• Check that the DNS server IPv4 address is correctly programmed using Web Image Monitor. See the Web Image Monitor’s Help.</li> <li>• Check that the DNS server is correctly programmed using Web Image Monitor. See the Web Image Monitor’s Help.</li> <li>• Check that the host name or IPv4 address of the POP3/IMAP4 server is correctly programmed using Web Image Monitor. See the Web Image Monitor’s Help.</li> <li>• Check that the POP3/IMAP4 server is correctly programmed using Web Image Monitor. See the Web Image Monitor’s Help.</li> <li>• Check that the LAN cable is correctly connected to the machine.</li> <li>• Consult the administrator.</li> </ul>
<p>Check whether there are any network problems. <b>[15-12]</b></p>	<p>Cannot log on to the POP3/IMAP4 server.</p>	<ul style="list-style-type: none"> <li>• Check that the user name and password of the E-mail Account are correctly programmed from File Transfer under System Settings. See “File Transfer Settings”, General Settings Guide. You can also use the Web Image Monitor for confirmation. See the Web Image Monitor’s Help.</li> <li>• Check that the user name and password for POP before SMTP authentication are correctly programmed from File Transfer under System Settings. See “File Transfer Settings”, General Settings Guide. You can also use the Web Image Monitor for confirmation. See the Web Image Monitor’s Help.</li> <li>• Consult the administrator.</li> </ul>

 **Note**

- ❑ If the “Check whether there are any network problems.” message appears, the machine is not correctly connected to the network or the settings of the machine are not correct. If you do not need to connect to a network, you can specify the setting so this message is not displayed, and then the **[Facsimile]** key no longer lights. See “Parameter Settings”, General Settings Guide. If you reconnect the machine to the network, be sure to set “Display” with User Parameters.
- ❑ If the paper tray runs out of paper, “Add paper.” appears on the display, asking you to add more paper. If there is paper left in the other trays, you can receive documents as usual, even if the message appears on the display. You can turn this function on or off with “Parameter Setting”. See “Parameter Settings”, General Settings Guide.

# When You Cannot Send or Receive Fax Messages as Wanted

This section explains likely causes of and possible solutions for transmission and reception-related problems.

## ❖ Transmission/Reception

Problem	Cause	Solution
Both transmission and receiving are impossible.	The modular cord may be disconnected.	Make sure that the modular cord is correctly connected. See “Connecting the Machine to a Telephone Line and Telephone”, General Settings Guide.

## ❖ Transmission

Problem	Cause	Solution
Document appears blank at the other end.	The original was placed upside down.	Place it correctly. See “Placing Originals”, Copy/Document Server Reference.
Transmission failed due to “maximum e-mail size” error.	If the e-mail size specified on the machine is too large, the Internet Fax document cannot be sent.	Set Max. E-mail Size to <b>[Off]</b> , or set the maximum e-mail size to a larger value. Then, re-send the document. See “Maximum E-mail Size”, General Settings Guide.
When using On Hook Dial or Manual Dial, “Receiving data...” appears and transmission is not allowed.	If the machine fails to detect the size of the original when <b>[Start]</b> key is pressed, it performs a receiving operation.	Press <b>[Scan Size]</b> , select the scan area, and then resend the document. If you use On Hook Dial or Manual Dial frequently, it is recommended that you set “Receive documents by pressing the <b>[Start]</b> key when originals are not set.” to “Off” in User Parameters. If this is set to “Off”, when using Manual Dial you cannot receive by pressing the <b>[Start]</b> key. See “Parameter Settings”, General Settings Guide.
LAN-Fax Driver does not work.	The entered login user name, login password, or driver encryption key is incorrect.	Check your login user name, login password, or driver encryption key, and enter them correctly. Contact the administrator.
LAN-Fax Driver does not work.	A high security level is set by the extended security function.	Contact the administrator.
To cancel a Memory Transmission.	-	Press the <b>[Clear/Stop]</b> key or <b>[Stop]</b> to cancel the job during scanning. See “Canceling a Transmission”, Facsimile Reference.



Problem	Cause	Solution
To cancel a Memory Transmission.	-	If the original is being sent or if it is in standby, press the <b>[Clear/Stop]</b> key or <b>[Check / Stop Transmission File]</b> . See "Canceling a Transmission", Facsimile Reference.
To cancel an Immediate Transmission.	-	Press the <b>[Clear/Stop]</b> key. See "Canceling a Transmission", Facsimile Reference.
Although a group specification was set for the following, reception was not possible. Receiving Station of Information Box, Forwarding, Forwarding of Special Sender, Reception Report e-mail, Email TX Results, routing e-mail received via SMTP.	The number of specified destinations exceeds the maximum number that can be specified as a group.	A maximum of 500 parties can be specified for a group. Check if there are over the specified numbers registered in the address book. If a group was registered in another group or designated in 1-5 of Transfer Box, transmission is canceled but an error message does not appear. See "Registering a Names to a Group", General Settings Guide.

### ❖ Reception

Problem	Cause	Solution
The machine failed to print received fax documents.	If this happened when the Receive File indicator was lit, low paper may have caused printing to stop.	<ul style="list-style-type: none"> <li>• Load paper into the tray.</li> <li>• Add toner.</li> </ul> See "Substitute Reception", Facsimile Reference.
The machine failed to print received fax documents.	Store has been selected for Reception File Setting.	Print the fax documents using a Web browser or the Print Stored RX File function. See "Printing Received and Stored Documents" and "Printing fax information using a Web browser", Facsimile Reference.
The machine failed to print received fax documents.	Add Paper indicator is lit.	Load paper into the tray. See p.79 "Loading paper".

### ❖ Printing

Problem	Cause	Solution
Print is slanted.	The tray's side fences might not be locked.	Check the side fences are locked. See p.83 "Changing the Paper Size".
Print is slanted.	The paper is fed at a slant.	Load the paper correctly. See p.79 "Loading paper".
Misfeeds occur frequently.	The number of feeding in exceeds the capacity of the machine.	Load paper only as high as the upper limit markings on the side fences of the paper tray or bypass tray. See "Copy Paper", About This Machine.

Problem	Cause	Solution
Misfeeds occur frequently.	The paper is damp.	Use paper that has been stored in the recommended temperature and humidity condition. See "Copy Paper", About This Machine.
Misfeeds occur frequently.	The paper is too thick or too thin.	Use recommended paper. See "Copy Paper", About This Machine.
Misfeeds occur frequently.	The copy paper is wrinkled or has been folded/creased.	Use recommended paper. Use paper that has been stored in the recommended temperature and humidity condition. See "Copy Paper", About This Machine.
Copy paper becomes creased.	Printed paper is being used.	Use recommended paper. See "Copy Paper", About This Machine.
Copy paper becomes creased.	The paper is damp.	Use paper that has been stored in the recommended temperature and humidity condition. See "Copy Paper", About This Machine.
Copy paper becomes creased.	The paper is too thin.	Use recommended paper. See "Copy Paper", About This Machine.
Images are only partially printed.	The paper is damp.	Use paper that has been stored in the recommended temperature and humidity condition. See "Copy Paper", About This Machine.
Black lines appear on the print produced at the destination.	The exposure glass or scanning glass is dirty.	Clean them. See p.122 "Maintaining Your Machine".
Background of received images appears dirty. Images from the back of the page appear.	Image density is too high.	Adjust scan density. See "Image Density (Contrast)", Facsimile Reference.
Printed or sent images are spotty.	The ADF, exposure glass or scanning glass is dirty.	Clean them. See p.122 "Maintaining Your Machine". Make sure that ink or correction fluid is dry before placing originals.
Received image is too light.	When using moist, rough, or processed paper, areas of print may not be fully reproduced.	Only use recommended paper. See "Copy Paper", About This Machine.
Received image is too light.	When  is blinking, toner is beginning to run out.	Add toner. See p.89 "Adding Toner".
Received image is too light.	<ul style="list-style-type: none"> <li>The image density has been set too low.</li> <li>The original of the transmitted fax was printed on paper that is too thin.</li> </ul>	<ul style="list-style-type: none"> <li>Increase the scanning density. See "Image Density (Contrast)", Facsimile Reference.</li> <li>Ask the sender to reprint the original on thicker paper and fax it again.</li> </ul>

## ❖ Others

Problem	Cause	Solution
All fax documents stored in memory have been lost. Those documents include ones stored through Memory Transmission/Reception, Memory Lock, Substitute Reception, or Auto Document.	When about one hour passes after power to the machine is turned off, all fax documents stored in memory are lost.	If any documents have been lost for this reason, a Power Failure Report is automatically printed when the machine is turned on. If fax documents stored for Memory Transmission have been lost, check the destinations and resend the documents. If fax documents received through Memory, Memory Lock or Substitute Reception have been lost, ask the senders to resend the documents. If Auto Documents have been lost, reprogram them. See p.45 "Turning Off the Main Power / In the Event of Power Failure".
When a correct password is entered, you cannot print documents that appear in the confidential box or bulletin board box, or transmit / print out stored documents.	Documents are locked by a security function if incorrect passwords are entered a certain number of times.	Contact the administrator.
[Prg. Dest.] or [Manual Entry] does not appear.	This function is made unavailable by the enhanced security function.	Contact the administrator.
The following functions are not available: Forwarding, Store File in the Information Box, routing e-mail received via SMTP.	This function is made unavailable by the enhanced security function.	Contact the administrator.

## When Memory is Full

This section explains likely causes of and possible solutions for problems related to full memory.

Problem	Cause	Solution
Memory is full. Cannot scan any more. Transmitting scanned pages only.	The memory is full.	If you press <b>[Exit]</b> , the machine returns to standby mode and starts transmitting the stored pages.

## If an Error Report is Printed

An Error Report is printed if a document cannot be successfully sent or received. Possible causes include a problem with the machine or noise on the telephone line. If an error occurs during transmission, resend the original. If an error occurs during reception, ask the sender to resend the document.

### **Note**

- If an error happens frequently, contact your service representative.
- The “Page” column gives the total number of pages. The “Page not sent” or “Page not received” column gives the number of pages not sent or received successfully.
- You can display a destination with the User Parameters. See “Parameter Settings”, General Settings Guide.
- You can display a sender name with the User Parameters. See “Parameter Settings”, General Settings Guide.

# Turning Off the Main Power / In the Event of Power Failure

This section explains the machine status when the power is turned off or if the power fails.

## **CAUTION:**

- *When you disconnect the power plug from the wall outlet, always pull the plug (not the cable).*

## **Important**

- Do not turn off the main power switch while the power indicator is lit or blinking. If you do, the hard disk and memory may be damaged and failure could result.
- Turn off the main power switch before pulling out the plug. If you pull out the plug with the switch on, the hard disk and memory may be damaged and failure could result.
- Make sure that 100% is shown on the display before you unplug the machine. If a lower value is shown, some data is currently present in memory.
- Right after a power failure, the internal battery needs to be sufficiently recharged to guard against future data loss. Keep the machine plugged in and the main power switch on for about 24 hours after the power loss.

Even if the main power switch is turned off, the contents of the machine memory (for example, programmed numbers) will not be lost. However, if power is lost for about one hour because the main power switch is turned off, there is a power cut, or the power cable is removed, contents of the Fax memory are lost. Lost items will include any fax documents stored in memory using Memory Transmission/Reception, Auto Document, Confidential Reception, Memory Lock, or Substitute Reception.

If a file was deleted from memory, a Power Failure Report is automatically printed as soon as the power is restored.

This report can be used to identify lost files. If a memory stored for Memory Transmission was lost, resend it. If a document received by Memory Reception or Substitute Reception was lost, ask the sender to resend it.

## When an Error Occurs Using Internet Fax

This section explains reports that the machine sends if an Internet Fax error occurs.

---

### Error Mail Notification

---

The machine sends the Error Mail Notification to the sender when it is unable to successfully receive a particular e-mail message. A “cc” of this notification is also sent to the administrator's e-mail address when one is specified.

3

#### Note

- You can select to send Error Mail Notification with User Parameters. See “Parameter Settings”, General Settings Guide.
- If Error Mail Notification cannot be sent, the Error Report (E-Mail) is printed by the machine.
- If an error occurs when an e-mail is received via SMTP, the SMTP server sends an error e-mail to the originator of the document.

---

### Error Report (E-Mail)

---

The Error Report (E-Mail) is printed by the machine when it is unable to send an Error Mail Notification.

---

### Server-Generated Error E-mail

---

The transmitting server sends this error e-mail to the originator of e-mail that cannot be transmitted successfully (due to reasons such as specifying an incorrect e-mail address).

#### Note

- After a server-generated error e-mail is printed, the first page of the sent document is printed.

# 4. Troubleshooting When Using the Printer Function

This chapter explains likely causes of and possible solutions for printer function problems.

## When a Message Appears during Installation of the Printer Driver

This section explains what to do if a message appears when installing the printer driver.

The following describes operations when a message appears during installation of the printer driver. Message number 58 or 34 indicates that the printer driver cannot be installed using Auto Run. Install the printer driver using **[Add Printer]** or **[Install Printer]**.

Message number 58 appears if there is a newer version of the printer driver already installed.

---

### Windows 95/98/Me

---

This section explains the procedure under Windows 95/98/Me.

**1** On the **[Start]** menu, point to **[Settings]**, and then click **[Printers]**.

**2** Double-click the Add Printer icon.

**3** Follow the instructions in Add Printer Wizard.

If the CD-ROM drive is D, the source files of the printer driver are stored in the following location:

- RPCS ("Printer Drivers and Utilities" CD-ROM)  
D:\DRIVERS\RPCS\WIN9X\_ME\ (Language)\DISK1
- PCL 5c ("Printer Drivers and Utilities" CD-ROM)  
D:\DRIVERS\PCL5C\WIN9X\_ME\ (Language)\DISK1
- PCL 6 ("Printer Drivers and Utilities" CD-ROM)  
D:\DRIVERS\PCL6\WIN9X\_ME\ (Language)\DISK1
- PostScript 3 ("Scanner/PostScript Drivers and Utilities" CD-ROM)  
D:\DRIVERS\PS\WIN9X\_ME\ (Language)\DISK1

If the installer starts, click **[Cancel]** to quit.

---

## Windows 2000

---

This section explains the procedure under Windows 2000.

- 1** On the [Start] menu, point to [Settings], and then click [Printers].
- 2** Double-click the Add Printer icon.
- 3** Follow the instructions in Add Printer Wizard.

If the CD-ROM drive is D, the source files of the printer driver are stored in the following location:

- RPCS (“Printer Drivers and Utilities” CD-ROM)  
D:\DRIVERS\RPCS\WIN2K\_XP\ (Language)\DISK1
- PCL 5c (“Printer Drivers and Utilities” CD-ROM)  
D:\DRIVERS\PCL5C\WIN2K\_XP\ (Language)\DISK1
- PCL 6 (“Printer Drivers and Utilities” CD-ROM)  
D:\DRIVERS\PCL6\WIN2K\_XP\ (Language)\DISK1
- PostScript 3 (“Scanner/PostScript Drivers and Utilities” CD-ROM)  
D:\DRIVERS\PS\WIN2K\_XP\ (Language)\DISK1

If the installer starts, click [Cancel] to quit.

---

## Windows XP, Windows Server 2003

---

This section explains the procedure under Windows XP or Windows Server 2003.

- 1** On the [Start] menu, click [Printers and Faxes].
- 2** Click [Add a printer].
- 3** Follow the instructions in Add Printer Wizard.

If the CD-ROM drive is D, the source files of the printer driver are stored in the following location:

- RPCS (“Printer Drivers and Utilities” CD-ROM)  
D:\DRIVERS\RPCS\WIN2K\_XP\ (Language)\DISK1
- PCL 5c (“Printer Drivers and Utilities” CD-ROM)  
D:\DRIVERS\PCL5C\WIN2K\_XP\ (Language)\DISK1
- PCL 6 (“Printer Drivers and Utilities” CD-ROM)  
D:\DRIVERS\PCL6\WIN2K\_XP\ (Language)\DISK1
- PostScript 3 (“Scanner/PostScript Drivers and Utilities” CD-ROM)  
D:\DRIVERS\PS\WIN2K\_XP\ (Language)\DISK1

If the installer starts, click [Cancel] to quit.



---

## Windows NT 4.0

---

This section explains the procedure under Windows NT 4.0.

- 1** On the [Start] menu, point to [Settings], and then click [Printers].
- 2** Double-click the Add Printer icon.
- 3** Follow the instructions in Add Printer Wizard.

If the CD-ROM drive is D, the source files of the printer driver are stored in the following location:

- RPCS (“Printer Drivers and Utilities” CD-ROM)  
D:\DRIVERS\RPCS\NT4\Language\DISK1
- PCL 5c (“Printer Drivers and Utilities” CD-ROM)  
D:\DRIVERS\PCL5C\NT4\Language\DISK1
- PCL 6 (“Printer Drivers and Utilities” CD-ROM)  
D:\DRIVERS\PCL6\NT4\Language\DISK1
- PostScript 3 (“Scanner/PostScript Drivers and Utilities” CD-ROM)  
D:\DRIVERS\PS\NT4\Language\DISK1

If the installer starts, click **[Cancel]** to quit.

## If USB Connection Fails

This section explains how to troubleshoot a problem related to USB connection.

Problem	Cause	Solution
The machine is not automatically recognized.	The USB cable is not connected properly.	Turn off the power of the machine, reconnect the USB cable, and then turn it on again.
Windows has already configured the USB settings.	Check whether the computer has identified the machine as an unsupported device.	<p>Open Windows' Device Manager, and then, under <b>[Universal Serial Bus controllers]</b>, remove any conflicting devices. Conflicting devices have a <b>[!]</b> or <b>[?]</b> icon by them. Take care not to accidentally remove required devices. For details, see Windows Help.</p> <p>When using Windows 2000 / XP or Windows Server 2003, an erroneous device is displayed under <b>[USB Controller]</b> in the <b>[Device Manager]</b> dialog box.</p>
Windows Me and the machine cannot be connected.	You need to download USB Printing Support for Windows Me.	<p>Download USB Printing Support from the supplier's website.</p> <p>Search the model name you use on the supplier's website, and download USB Printing Support.</p>

# When a Message Appears

This section describes the principal messages that appear on the panel display. If a message not described here appears, act according to the message.

## Reference

Before turning the main power off, see “Turning On/Off the Power”, About This Machine.

---

## Status Messages

---

This section describes the machine status messages.

Message	Problem
Ready	This is the default ready message. The machine is ready for use. No action is required.
Printing...	The machine is printing. Wait a while.
Waiting...	The machine is waiting for the next data to print. Wait a while.
Offline	The machine is offline. To start printing, switch the machine online by pressing <b>[Online]</b> key.
Please wait.	The machine is preparing the development unit. Wait a while.
Resetting job...	The machine is resetting the print job. Wait until “Ready” appears on the display panel.
Setting change...	The machine is setting changing. Wait a while.
Hex Dump Mode	In the Hex Dump mode, the machine receives data in hexadecimal format. Turn off the machine after printing, and then turn back on.

## Alert Messages

This section describes the machine Alert messages.

Message	Cause	Solution
Cannot connect with the wireless card. Turn the main power switch off, then check the card. /Problems with the wireless card. /Problems with the wireless board.	<ul style="list-style-type: none"> <li>• IEEE 802.11b interface unit was not inserted when the machine was turned on, or it was pulled out after the machine turned on.</li> <li>• The settings are not updated although the unit is detected, or errors are found while accessing the unit.</li> </ul>	Turn off the machine and check the IEEE 802.11b interface unit is inserted correctly. Then, turn the machine on again. If the message appears again, call your service representative.
Problems with IEEE 1394 Board.	An error may have occurred in the IEEE 1394 board.	Turn off the main power switch, and back on again. If the message appears again, contact your service representative.
Problem with Hard Disk.	An error has occurred in the hard disk drive.	Turn off the main power switch, and back on again. If the message appears again, contact your service representative.
The entered password is incorrect.	The password of the encrypted PDF file has been entered incorrectly.	Enter the correct password.
USB has a problem.	An error has occurred in the USB interface.	Turn off the main power switch, and back on again. If the message appears again, contact your service representative.
Hardware Problem: Ethernet	An error has occurred in the Ethernet board.	Turn off the main power switch, and back on again. If the message appears again, contact your service representative.
You do not have the privileges to use this function.	Use of this function is restricted.	Contact the administrator.
Authentication has failed.	<ul style="list-style-type: none"> <li>• The login user name or password entered is incorrect.</li> <li>• The machine currently cannot perform authentication.</li> </ul>	<ul style="list-style-type: none"> <li>• Check your login user name and password.</li> <li>• Contact the administrator.</li> </ul>
Parallel I/F board has a problem.	An error has occurred in the parallel interface board.	Turn off the main power switch, and back on again. If the message appears again, contact your service representative.
Printer font error.	An error has occurred in the font settings.	Contact your service representative.

Message	Cause	Solution
Memory Overflow	Maximum capacity of PCL 5c/6 or PostScript 3 list display has been exceeded.	Reduce the value of <b>[Resolution]</b> in the printer driver. Alternatively, select <b>[Frame Priority]</b> from <b>[Memory Usage]</b> in <b>[System]</b> . If this message continues to appear after taking these steps, decrease the number of files sent to the machine.

## Checking the Error Log

If files could not be stored due to printing errors, identify the cause of the errors by checking the error log on the control panel.

- 1 Press the **[Printer]** key to display the printer screen.

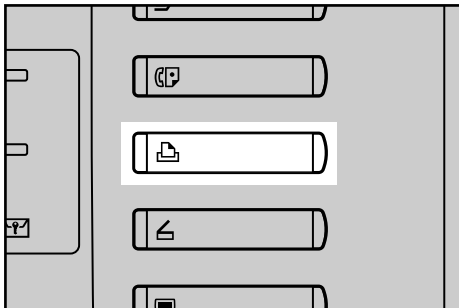

AOE902S

- 2 Press **[Error Log]**.

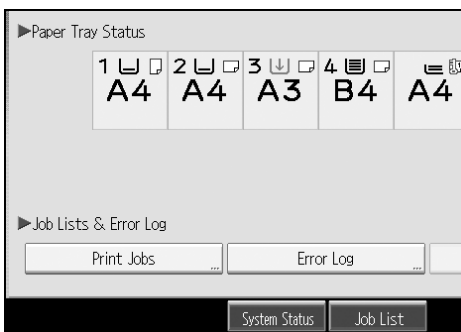

An error log list appears.

### Note

- The most recent 30 errors are stored in the error log. If a new error is added when there are 30 errors already stored, the oldest error is deleted. However, if the earliest error is a Sample Print, Locked Print, Hold Print, or Stored print error, it is not deleted. The error is stored separately until the number of errors reaches 30.
- If the main power switch is turned off, the log is deleted.
- You cannot view the **[Error Log]** on the simplified display.

# When You Cannot Print

Use the following procedures if printing does not start even after performing **[Print]**.

4

Problem	Cause	Solution
Printing does not start.	The power is off.	Check the cable is securely plugged into the power outlet and the machine. Turn on the main power switch.
Printing does not start.	The machine is set to "Offline".	Press the <b>[Online]</b> key.
Printing does not start.	The cause is displayed on the display of the control panel.	Check the error message or warning status on the display panel and take the required action.
Printing does not start.	The interface cable is not connected correctly.	Connect the interface cable securely. If it has a fastener, fasten that securely as well. See "Connecting to the Interfaces", General Settings Guide.
Printing does not start.	The correct interface cable is not being used.	The type of interface cable you should use depends on the computer. Be sure to use the correct one. If the cable is damaged or worn, replace it. See "Connecting to the Interfaces", General Settings Guide.
Printing does not start.	The interface cable was connected after the machine was switched on.	Connect the interface cable before turning on the machine.
Printing does not start.	If the machine is operating in an extended wireless LAN, failure to print might result from a weak wireless signal.	To check signal status, press the <b>[User Tools / Counter]</b> key, and then press <b>[System Settings]</b> on the display panel. On the <b>[Interface Settings]</b> tab, select <b>[IEEE 802.11b]</b> , and then press <b>[Wireless LAN Signal]</b> . If signal quality is poor, move the machine to a location where radio waves can pass or remove objects that might cause interference.  (You can check signal status only when using wireless LAN in the infrastructure mode.)
Printing does not start.	If the machine is operating in an extended wireless LAN, SSID settings are incorrect.	Check using the machine's display panel that the SSID is correctly set. See "Network Settings", General Settings Guide.

Problem	Cause	Solution
Printing does not start.	If the machine is operating in an extended wireless LAN, the receiver's MAC address may be preventing communication with the access point.	Check access point settings when in the infrastructure mode. Depending on the access point, client access may be limited by MAC address. Also, check there are no problems in transmission between access point and wired clients, and between access point and wireless clients.
Printing does not start.	The extended wireless LAN has not started.	Confirm the orange LED is lit, and the green LED is lit or blinks during transmission.
Printing does not start.	The login user name, login password, or driver encryption key is invalid.	Check the login user name, login password, or driver encryption key.
Printing does not start.	Advanced encryption has been set using the Extended Security function.	Check the settings of the Extended Security function with the administrator.
Data-in lamp does not blink or light up.	If the data-in lamp is unlit or not flashing even after performing <b>[Print]</b> , the machine has not received the data.	<ul style="list-style-type: none"> <li>When the machine is connected to a computer via a cable, check the computer print port settings are correct. See "Confirming the Connection Method", Printer Reference.</li> <li>When it is networked with a computer, Contact the administrator.</li> </ul>
The status indicator of the printer is lit.	The cause is displayed on the display of the control panel.	Check the error message on the display panel and take required action. See p.51 "When a Message Appears".
"Updating the destination list... Please wait. Specified destination(s) or sender's name has been cleared." appears.	The destination list is being updated from the network using SmartDeviceMonitor for Admin.	Wait until the message disappears. Do not switch off the power while this message is displayed. Depending on the number of destinations to be updated, there may be some delay before you can resume operation. Operations are not possible while this message is displayed.
<b>[List / Test Print]</b> is disabled.	A mechanical error might have occurred.	Contact your service representative. See "List/Test Print", General Settings Guide.
Printing does not start when using the extended wireless LAN in Ad-hoc mode.	The correct Communication mode is not set.	Turn the main power off and back on. See "Turning On/Off the Power", About This Machine.  Or, change the settings for <b>[System Settings]</b> , <b>[Interface Settings]</b> , and <b>[Network]</b> . See "Network Settings", General Settings Guide.

If the printing does not start, consult your service representative.

❖ **When the machine is connected to the computer using the interface cable**

The following shows how to check the print port when the data-in lamp does not light up or blink.

Check if the print port setting is correct. When it is connected using a parallel interface, connect it to LPT1 or LPT2.

For Windows 95/98/Me

- ① Click the **[Start]** button, point to **[Settings]**, and then click **[Printers]**.
- ② Click the icon of the machine. On the **[File]** menu, click **[Properties]**.
- ③ Click the **[Details]** tab.
- ④ In the **[Print to the following port:]** list, confirm the correct port is selected.

For Windows 2000 or Windows NT 4.0

- ① Click the **[Start]** button, point to **[Settings]**, and then click **[Printers]**.
- ② Click the icon of the machine. On the **[File]** menu, click **[Properties]**.
- ③ Click the **[Ports]** tab.
- ④ In the **[Print to the following port(s)]** list, confirm the correct port is selected.

Windows XP

- ① Click the **[Start]** button, and then click **[Printers and Faxes]**.
- ② Click the icon of the machine. On the **[File]** menu, click **[Properties]**.
- ③ Click the **[Ports]** tab.
- ④ In the **[Print to the following port(s)]** list, confirm the correct port is selected.

Windows Server 2003

- ① Click the **[Start]** button, point to **[Settings]**, and then click **[Printers and Faxes]**.
- ② Click the icon of the machine. On the **[File]** menu, click **[Properties]**.
- ③ Click the **[Ports]** tab.
- ④ In the **[Print to the following port(s)]** list, confirm the correct port is selected.



# Other Printing Problems

This section explains likely causes of and possible solutions for problems that can occur when printing from a computer.

Problem	Cause	Solution
Print is smudged.	Settings for thick paper have not been made when printing on thick paper in the bypass tray.	<ul style="list-style-type: none"> <li>• PCL 5c/6 and PostScript 3 Select <b>[Thick]</b> in the <b>[Type:]</b> list on the <b>[Paper]</b> tab.</li> <li>• RPCS Select <b>[Thick]</b> in the <b>[Paper type:]</b> list on the <b>[Print Settings]</b> tab.</li> </ul>
The print on the entire page is faded.	When  is blinking, toner is beginning to run out.	Add toner. See p.89 "Adding Toner".
The print on the entire page is faded.	The paper is damp.	Use paper that has been stored in the recommended temperature and humidity condition. See "Copy Paper", About This Machine.
The print on the entire page is faded.	The paper is unsuitable.	Use the recommended paper. (Printing on coarse or treated paper might result in faint print image.) See "Copy Paper", About This Machine.
The print on the entire page is faded.	If the <b>[Toner saving]</b> check box is selected in the printer driver settings, the entire page will be faded when printed.	For the RPCS printer driver, <b>[Toner saving]</b> is located on the <b>[Print Quality]</b> tab. For the PostScript 3 printer driver, see PostScript 3 Supplement. See the printer driver Help.
Image bleeds when rubbed.	If you are using thick paper, <b>[Paper type:]</b> might not be set to <b>[Thick]</b> .	On the printer driver's <b>[Setup]</b> tab, set <b>[Paper type:]</b> to <b>[Thick]</b> . See the printer driver Help.
Paper is not fed from the selected tray.	When you are using a Windows operating system, printer driver settings override those set using the display panel.	Set the desired input tray using the printer driver. See the printer driver Help.
The printed image is different from the image on the computer's display.	With certain functions, such as enlargement and reduction, image layout might be different to that on the computer display.	In the application, change the layout, character size, and character settings.
The printed image is different from the image on the computer's display.	You might have selected to replace True Type fonts with machine fonts in the printing process.	To print an image similar to that of the computer display, make settings to print True Type fonts as an image. See the printer driver Help.

Problem	Cause	Solution
Images are printed at slant.	The tray's side fences might not be locked.	Check the side fences are locked. See p.83 "Changing the Paper Size".
Print is slanted.	The paper is feeding in at a slant.	Load the paper correctly. See p.79 "Loading paper".
Misfeeds occur frequently.	The number of sheets loaded exceeds the capacity of the machine.	Load paper only as high as the upper limit markings on the side fences of the paper tray or bypass tray. See "Copy Paper", About This Machine.
Misfeeds occur frequently.	The paper is damp.	Use paper that has been stored in the recommended temperature and humidity condition. See "Copy Paper", About This Machine.
Misfeeds occur frequently.	The paper is too thick or too thin.	Use recommended paper. See "Copy Paper", About This Machine.
Misfeeds occur frequently.	The copy paper is wrinkled or has been folded/creased.	Use recommended paper. Use paper that has been stored in the recommended temperature and humidity condition. See "Copy Paper", About This Machine.
Misfeeds occur frequently.	Printed paper is being used.	Use recommended paper. See "Copy Paper", About This Machine.
Copy paper becomes creased.	The paper is damp.	Use paper that has been stored in the recommended temperature and humidity condition. See "Copy Paper", About This Machine.
Copy paper becomes creased.	The paper is too thin.	Use recommended paper. See "Copy Paper", About This Machine.
White lines appear.	When  is blinking, toner is beginning to run out.	Add toner. See p.89 "Adding Toner".
When printing graphics, the output and the screen are different.	If the printer driver is configured to use the graphics command, the graphics command from the machine is used to print.	If you want to print accurately, set the printer driver to print without using the graphics command. See the printer driver Help.
Garbled characters are printed.	The correct printer language might have not been selected.	Set the correct printer language.
Images are printed in the wrong orientation.	The feed orientation you selected and the feed orientation selected in the printer driver's option setup might not be the same.	Set the machine's feed orientation and the printer driver's feed orientation accordingly. See the printer driver Help.
There is considerable delay between the print start instruction and actual printing.	"Off mode / Sleep mode" might be set.	The machine requires time to warm up if it has been in "Off mode/Sleep mode". Specify "Off mode/Sleep mode" in <b>[System Settings]</b> , <b>[Auto Off Timer]</b> .

Problem	Cause	Solution
There is considerable delay between the print start instruction and actual printing.	Processing time depends on data volume. High volume data, such as graphics-heavy documents, take longer to process.	<p>If the data-in lamp is blinking, data has been received by the printer. Wait for a moment. Making the following setting on the printer driver may reduce the computer's workload. For how to open the printing preferences dialog box, see "Setting Up the Printer Driver", Printer Reference.</p> <p>❖ <b>PCL 5c/6</b> Select the lower value for the <b>[Resolution]</b> list on the <b>[Print Quality]</b> tab in the printing preferences dialog box.</p> <p>❖ <b>PostScript 3</b> If your operating system is Windows, select <b>[PostScript (optimize for speed)]</b> in the <b>[PostScript Output Option]</b> list. <b>[PostScript Output Option]</b> is located as follows:</p> <ul style="list-style-type: none"> <li>• Windows 95 / 98 / Me <b>[PostScript output format:]</b> on the <b>[PostScript]</b> tab in the printing preferences dialog box.</li> <li>• Windows 2000 / XP, Windows Server 2003 <b>[PostScript Output Option]</b> in the <b>[PostScript Options]</b> on the <b>[Advanced...]</b> on the <b>[Layout]</b> tab in the printing preferences dialog box.</li> <li>• Windows NT 4.0 <b>[PostScript Output Option]</b> in the <b>[PostScript Options]</b> on the <b>[Document Options]</b> on the <b>[Advanced]</b> tab in the printing preferences (document defaults) dialog box.</li> </ul> <p>❖ <b>RPCS</b> Select <b>[Speed]</b> in the <b>[Print priority]</b> on the <b>[Print Quality]</b> tab in the printing preferences dialog box. Also, select the <b>[User settings]</b> check box, and then click <b>[Change User Settings...]</b>. Select the lower value for the <b>[Resolution:]</b> list on the <b>[Image Adjustments]</b> tab in the <b>[Change User Settings]</b> dialog box.</p> <p>See the printer driver Help.</p>
Images are cut off, or excess is printed.	You may be using paper smaller than the size selected in the application.	Use the same size paper as that selected in the application. If you cannot load paper of the correct size, use the reduction function to reduce the image, and then print. See the printer driver Help.

Problem	Cause	Solution
Page layout is not as expected.	Print areas differ depending on machine used. Information that fits on a single page on one machine may not fit on a single page of another machine.	Adjust the <b>[Printable area:]</b> setting in the <b>[Printer Configuration...]</b> dialog box on the <b>[Print Settings]</b> tab in the RPCS printer driver. See the printer driver Help.
Photo images are coarse.	Some applications print at lower resolution.	Use the application's settings to specify a higher resolution.
Solid lines are printed as broken lines.	Dither patterns do not match.	Make the following settings with the printer driver: Change the <b>[Dithering:]</b> setting on the <b>[Image Adjustments]</b> tab in the <b>[Change User Settings...]</b> dialog box, on the <b>[Print Quality]</b> tab in the RPCS printer driver. See the printer driver Help.
Optional components connected to the machine are not recognized when using Windows 95 / 98 / Me, Windows 2000 / XP, Windows Server 2003, and Windows NT 4.0.	Bidirectional communication is not working.	Set up optional devices on the Properties of the printer. See the printer driver Help.
Duplex printing is malfunctioning.	Duplex printing cannot be done with paper set in the bypass tray.	When using duplex printing, make settings to use paper from a tray other than the bypass tray.
Duplex printing is malfunctioning.	The upper tray cannot be used as an output destination in duplex mode.	Specify a another output tray.
Duplex printing is malfunctioning.	You have loaded thick paper heavier than 169 g/m <sup>2</sup> .	Specify another paper type.
Duplex printing is malfunctioning.	Duplex printing cannot be done with a tray for which <b>[1 Sided Copy]</b> has been specified as Paper Type on the System Settings menu.	Change the Paper Type setting for the tray to <b>[2 Sided Copy]</b> on the System Settings menu. See "System Settings", General Settings Guide.

Problem	Cause	Solution
When using Windows 95 / 98 / Me / 2000 / XP, Windows Server 2003, or Windows NT 4.0, combined printing or booklet printing does not come out as expected.	The correct application or printer driver settings are not made.	Make sure the application's paper size and orientation settings match those of the printer driver. If a different paper size and orientation are set, select the same size and orientation.
A print instruction was issued from the computer, but printing did not start.	User Authentication may have been set.	Contact the administrators.
No transmission when using 1394 interface connection.	<ul style="list-style-type: none"> <li>• Interface connection has not been made.</li> <li>• The correct computer settings are not made.</li> </ul>	Check using the following procedure: <ol style="list-style-type: none"> <li>① Confirm the IEEE 1394 interface cable is connected securely.</li> <li>② Restart the computer. If the error occurs even after executing the above operation, proceed to the following steps.</li> <li>③ Unplug the IEEE 1394 interface cable connected to the computer.</li> <li>④ Run the utility tool for the IEEE 1394 interface board, which is stored in the following path on the CD-ROM "Printer Drivers and Utilities":                \UTILITY\1394\                (For more information about using the utility tool for IEEE 1394, see the README file in the same directory on the CD-ROM.)</li> <li>⑤ Restart the computer.</li> </ol>
Changes to printer driver colour settings produce extreme change in print colours.	The correct printer driver settings are not made.	Make only minor adjustments to the <b>[Balance Adjustments]</b> setting on the printer driver's <b>[Change User Settings]</b> tab. The sample displayed on the printer driver gives only an indication of the adjustment, it does not give an accurate indication of the printed colour.  See the printer driver Help.
Images are not printed in the specified colours.	The correct printer driver settings are not made.	If it is only one particular colour that does not print, turn off the machine's power, and then turn it back on.  If the problem persists, contact your service representative.
Colour originals are printed in black and white.	No colour print settings are made on the printer driver.	<ul style="list-style-type: none"> <li>• For the functional window: On the <b>[Setup]</b> tab, for <b>[Color/Black and White:]</b>, select <b>[Color]</b>.</li> <li>• For the custom setting: On the <b>[Print Settings]</b> tab, for <b>[Color/Black and White:]</b>, select <b>[Color]</b>.</li> </ul>

Problem	Cause	Solution
PDF files do not print out/cannot perform <b>[PDF Direct Print]</b> .	PDF files are password-protected.	To print password-protected PDF files, enter the password in the <b>[PDF Menu]</b> or on Web Image Monitor. <ul style="list-style-type: none"> <li>• For details about <b>[PDF Menu]</b>, see “PDF Menu”, General Settings Guide.</li> <li>• For details about Web Image Monitor, see the Web Image Monitor Help.</li> </ul>
PDF files do not print out/cannot perform <b>[PDF Direct Print]</b> .	PDF files cannot be printed if they are print-disabled in PDF file security setting.	Change the PDF file security setting.
PDF files do not print out/cannot perform <b>[PDF Direct Print]</b> .	High compression PDF files created using the machine's scanner function cannot print directly.	Open the application used to create the PDF, and then print the file using the application's driver. Re-save the file in normal (non-compressed) PDF format. Some types of High Compression PDF files are not supported. Consult your sales representative about the supported file types.
<b>[PDF Direct Print]</b> produces strange or malformed characters.	Fonts were not embedded.	Embed fonts in the PDF file you want to print and then print.
Printing by Bluetooth is slow.	The number of jobs exceeds the capacity of the machine.	Reduce the number of jobs.
Printing by Bluetooth is slow.	<ul style="list-style-type: none"> <li>• A communication error might have occurred.</li> <li>• Interference from IEEE 802.11b (wireless LAN) devices can reduce communication speed.</li> <li>• Bluetooth transmission speeds are not high.</li> </ul>	<ul style="list-style-type: none"> <li>• Remove the machine from close proximity with IEEE 802.11b wireless LAN devices.</li> <li>• If there are active IEEE 802.11b wireless LAN devices or other Bluetooth devices nearby, relocate the machine or disable those devices.</li> </ul>

If the problem cannot be solved, contact your service representative.

# When PictBridge Printing Does Not Work

This section explains likely causes and possible solutions for problems that can occur when PictBridge printing.

Problem	Cause	Solution
PictBridge is not available.	There is a problem with the USB connection or the PictBridge settings.	Use the following procedure to check the connection and settings: <ol style="list-style-type: none"> <li>① Disconnect and then reconnect the USB cable.</li> <li>② Check the PictBridge settings are enabled.</li> <li>③ Disconnect the USB cable, and then turn off the machine. Turn the machine back on. When the machine has fully booted up, reconnect the USB cable.</li> </ol>
When two or more digital cameras are connected, the second and subsequent cameras are not recognized.	You have connected multiple digital cameras.	Connect one digital camera only. Do not connect multiple cameras.
Printing is disabled.	The number of originals exceeds the maximum number of pages that can be printed at a time.	The maximum specifiable print quantity at a time is 999. Respecify the quantity to 999 or less, and then retry printing.
Printing is disabled.	There is no paper of the specified size remaining.	There is no paper of the specified size remaining. If you have to use paper that is not of the specified size, perform Form Feed. To cancel printing, perform Job Cancel.





# 5. Troubleshooting When Using the Scanner Function

This chapter explains likely causes of and possible solutions for scanner function problems.

## When Scanning is Not Done as Expected

This section explains causes and remedies when scan results are not as expected.

Problem	Cause	Solution
The scanned image is dirty.	The exposure glass or auto document feeder (ADF) is dirty.	Clean these parts. See p.122 "Maintaining Your Machine".
The image is distorted or out of position.	The original was moved during scanning.	Do not move the original during scanning.
The image is distorted or out of position.	The original was not pressed flat against the exposure glass.	Make sure that the original is pressed flat against the exposure glass.
The scanned image is upside down.	The original was placed upside down.	Place the original in the correct orientation. See "Placing Originals", Copy/Document Server Reference.
No image results from scanning.	The original was placed with the front and back reversed.	When the original is placed directly on the exposure glass, the side to be scanned must face down. When the original is fed via the ADF, the side to be scanned must face up. See "Placing Originals", Copy/Document Server Reference.
Images are scanned in rotated.	If you set the original with its upper edge backward and save full color/grey scale images as a TIFF or JPEG file, they are scanned in rotated.	When placing a stack of originals in the ADF, place their upper edges first. See "Various Scan Settings", Scanner Reference.
The scanned image contains white spaces.	<ul style="list-style-type: none"><li>• If you scan originals using functions other than the network TWAIN scanner function, certain paper size and resolution settings may produce scanned images that are larger than the specified size because of margins being added to the sides.</li><li>• If the File Format Converter (optional) is installed, the margins may become wider.</li></ul>	Scanning at a higher resolution may reduce the margins.

# When You Cannot Send Scanned Files

The following sections explain likely causes of and solutions for Network Delivery and E-mail Sending-related problems.

---

## When Stored Files Cannot be Accessed

---

This section explains likely causes of and possible solutions for job access-related problems.

Problem	Cause	Solution
The stored file is locked and is not accessible.	The file, which is password protected, is locked because the password was incorrectly entered ten times.	Contact the administrator.

5

---

## When You Cannot Browse the Network to Send a Scan file

---

This section explains likely causes of and possible solutions for the Browse Network failing to operate when files are sent.

Problem	Cause	Solution
The network cannot be browsed when specifying the destination folder.	The following machine settings may not be correct: <ul style="list-style-type: none"> <li>• IPv4 address</li> <li>• Subnet Mask</li> </ul>	Check the settings. See “Network Settings”, General Settings Guide.

---

## When the TWAIN Driver Cannot be Started

---

This section explains likely causes of and possible solutions for the TWAIN driver failing to operate.

Problem	Cause	Solution
The Scanner Properties dialog box cannot be displayed.	Advanced encryption has been specified in the extended security setting.	For details about the extended security setting, contact an administrator.

## When Stored Files Cannot be Edited

This section explains likely causes of and possible solutions for the TWAIN driver failing to operate.

Problem	Cause	Solution
Stored files cannot be deleted. File names and passwords cannot be changed. Files cannot be redelivered.	Limits have been imposed using the available extended security function.	Contact the administrator.

## When the Network Delivery Function Cannot be Used

This section explains likely causes of and possible solutions for the Network Delivery function failing to operate.

Problem	Cause	Solution
The network delivery function cannot be used.	The delivery software may be an old version or a security setting may be specified.	Contact the administrator.
The network delivery function cannot be used.	The network delivery function setting is not correct.	Specify it correctly. See “Settings Required to Use the Network Delivery Scanner”, General Settings Guide.

## Operations are not possible when messages appear

This section explains likely causes of and possible solutions for messages that appear and when the machine fails to operate.

Message	Cause	Solution
Destination list / machine settings are updated. Selected destinations or function settings have been cleared. Please re-select the settings.	The destination list is being updated from the network using SmartDeviceMonitor for Admin. Depending on the number of destinations to be updated, there may be some delay before you can resume operation. Operations are not possible while this message is displayed.	Wait until the message disappears. Do not switch off the power while this message is displayed.

# When a Message is Displayed

This section explains likely causes of and possible solutions for error messages that may appear on the machine's control panel.

## When a Message is Displayed on the Control Panel

This section explains causes and remedies if an error message appears on the display of the control panel.

### Important

- If a message not described here appears, act according to the message. For information about how to turn off the main power switch, see About This Machine.

Message	Cause	Solution
Connection with LDAP server has failed. Check the server status.	A network error has occurred and connection has failed. Try the operation once more.	Try the operation once more. If the message is still shown, the network may be crowded. Check the information of System Settings. See "System Settings", General Settings Guide.
LDAP server authentication has failed. Check the settings.	The user name and password differ from those set for LDAP Authentication.	Make settings correctly for the user name and the password for LDAP server authentication.
The destination list has been updated. Specified destination(s) or sender's name has been cleared.	A specified destination or sender's name was cleared when the destination list in the delivery server was updated.	Specify the destination or sender's name again.
Updating the destination list has failed. Try again?	A network error has occurred.	Check whether the server is connected.
The destination list has been updated. Specified destination(s) or sender's name has been cleared.	A network error has occurred.	If a destination or sender's name was already selected, re-select it after this message disappears.

Message	Cause	Solution
Exceeded max. number of files which can be sent at the same time. Reduce the number of the selected files.	The number of files exceeded the maximum number possible.	Reduce the number of files and send them again.
Cannot detect original size. Place original again, then press the Start key.	You have loaded paper of a size not shown on the paper size selector.	<ul style="list-style-type: none"> <li>Place the original correctly.</li> <li>Specify the scan size.</li> <li>When placing an original directly on the exposure glass, the lifting/ lowering action of the ADF triggers the automatic original size detection process. Lift the ADF by more than 30 degrees. See "Placing Originals", Copy/Document Server Reference.</li> </ul>
Exceeded max. No. of results to display. Max.:	Search results have exceeded the max. displayable number.	Search again after changing the search conditions.
You do not have the privileges to use this function.	The machine has not been set to allow you to use the function.	Contact the administrator.
Exceeded max. number of standby files. Try again after the current file is sent.	The maximum number of standby files was exceeded.	There are 100 files waiting in the sending queue for e-mail, Scan to Folder, or delivery functions. Wait until files have been sent.
Exceeded time limit for LDAP server search. Check the server status.	A network error has occurred and connection has failed.	Try the operation once more. If the message is still shown, the network may be crowded. Check the information of System Settings. See "System Settings", General Settings Guide.
The specified group contains some destination(s) that do not have access privileges. Do you want to select only the privileged destination(s)?	The specified group contains some destinations for sending by e-mail and some destinations for sending by Scan to Folder.	To select destinations for sending by e-mail, press <b>[Select]</b> for the message displayed on the e-mail screen. To select destination for sending by Scan to Folder, press <b>[Select]</b> for the message displayed on the Scan to Folder screen.

Message	Cause	Solution
Cannot find the specified path. Please check the settings.	The destination computer name or folder name is invalid.	Check whether the computer name and the folder name for the destination are correct.
Exceeded max. number of alphanumeric characters for the path.	The maximum number of specifiable alphanumeric characters in a path has been exceeded.	The maximum number of characters which can be entered for the path is 128. Check the number of character you entered, and then enter the path again. See "Transmission function", Scanner Reference.
The selected file(s) contained file(s) without access privileges. Only file(s) with access privileges will be deleted.	You have tried to delete files without the authority to do so.	The files can be deleted by the file administrator. To delete a file which you are not authorized to delete, contact the administrator.
Some of selected files are currently in use. They could not be deleted.	You cannot delete a file which is waiting to be transmitted ("Waiting..." status displayed) or whose information is being changed with DeskTopBinder.	Cancel transmission ("Waiting..." status cleared) or the DeskTopBinder setting, and then delete the file.
Cannot cancel sending all selected file(s). Certain file(s) are currently being sent.	You cannot cancel a file currently being sent.	You can only cancel files waiting to be sent. You cannot cancel files already sent or currently being sent, files that were sent but did not reach the destination, or files that have been cancelled.
Selected file is currently in use. Cannot change file name.	You cannot change the name of a file whose status is "Waiting..." or that is being edited with DeskTopBinder.	Change the file name after canceling delivery or completing editing.
Selected file is currently in use. Cannot change password.	You cannot change the password of a file whose status is "Waiting..." or that is being edited with DeskTopBinder.	Delete the password after canceling delivery or completing editing.
Selected file is currently in use. Cannot change user name.	You cannot change the sender's name whose status is "Waiting..." or that is being edited with DeskTopBinder.	A sender's name should be specified before sending e-mail. Send e-mail after specifying the sender's name.

Message	Cause	Solution
Connection with the destination has failed. Check the status and connection. To check the current status, press [Scanned Files Status].	The correct Network settings are not made.	<ul style="list-style-type: none"> <li>• Check the network settings of the client computer.</li> <li>• Check that components such as the LAN cable are connected properly.</li> <li>• Check that the server settings are correct and the server is working properly.</li> </ul>
Authentication with the destination has failed. Check settings. To check the current status, press [Scanned Files Status].	The entered user name or password was invalid.	<ul style="list-style-type: none"> <li>• Check that the user name and password are correct.</li> <li>• Check that the ID and password for the destination folder are correct.</li> <li>• A password of 128 or more characters may not be recognized.</li> </ul>
Sender has not been specified.	The sender's name was not specified.	A sender's name should be specified before sending e-mail. Send e-mail after specifying the sender's name.
Exceeded max. E-mail size. Sending E-mail has been cancelled. Check [Max. E-mail Size] in Scanner Features.	The maximum e-mail size has been exceeded.	<ul style="list-style-type: none"> <li>• Increase the size of [Max. E-mail Size].</li> <li>• Set [Divide &amp; Send E-mail] to [Yes (per Page)] or [Yes (per Max. Size)].</li> </ul> See "Send Settings", General Settings Guide.
Sending the data has failed. The data will be re-sent later.	A network error has occurred and a file was not sent correctly.	Wait until sending is retried automatically after the preset interval. If sending fails again, contact the administrator.
Transmission has failed. To check the current status, press [Scanned Files Status].	While a file was being sent, a network error occurred and the file could not be sent correctly.	Try the operation once more. If the message is still shown, the network may be crowded. Contact the administrator. If multiple files were sent, use the Scanned Files Status screen to check for which file the problem occurred.
Transmission has failed. Insufficient memory in the destination hard disk. To check the current status, press [Scanned Files Status].	Transmission has failed. There was not enough free space on the hard disk of the SMTP server, FTP server, or client computer at the destination.	Allocate sufficient space.

Message	Cause	Solution
Output buffer is full. Sending the data has been cancelled. Please try again later.	Too many jobs are in standby state, and sending was cancelled.	Retry sending after sending jobs in standby state completes.
Exceeded max. number of pages per file. Do you want to store the scanned pages as 1 file?	The file being stored has exceeded the max. number of pages for one file.	Specify whether to use the data or not. Scan the pages that were not scanned and store them as a new file. See "Storing Files Using the Scanner Function", Scanner Reference.
Exceeded maximum number of file to store. Delete all unnecessary files.	Too many files are waiting to be delivered.	Please try again after they have been delivered.
Exceeded max. number of stored files. Cannot send the scanned data as capturing files is unavailable.	Too many files are waiting to be delivered.	Please try again after they have been delivered.
Exceeded max. number of files which can be used in Document Server at the same time.	The maximum number of files that can be stored in the document server has been exceeded.	Check the files stored by the other functions, and then delete unneeded files. See "Document Server", Copy/Document Server Reference.
Entered protection code for destination is incorrect. Please re-enter.	The correct protect destination code was not entered.	Make sure the protection code is correct, and then enter it again. See "Registering a Protection Code", General Settings Guide.
Entered user code is not correct.	You have entered an incorrect user code.	Check the authentication settings, and then enter a correct user code.
Exceeded max. number of alphanumeric characters.	The maximum enterable number of alphanumeric characters has been exceeded.	Make sure the maximum number of characters which can be entered, and then enter it again. See "Values of various set items for transmission/storage/delivery function", Scanner Reference.
Authentication has failed.	The entered login user name or login password is incorrect.	Check the login user name and login password. The machine is unable to authenticate. Contact an administrator.



Message	Cause	Solution
The entered path is not correct. Please re-enter.	The entered path format is incorrect.	Confirm the destination computer and the path, and then enter it again.
Captured file exceeded max. number of pages per file. Cannot send the scanned data.	The maximum number of pages per file has been exceeded.	Reduce the number of pages in the transmitted file, and then resend the file. See "Storage function", Scanner Reference.
Original is being scanned by another function. Please wait. [Copier][Document Server]...	The machine is using another function such as copying.	Retry scanning after the operation with the other function is completed.
E-mail address entered is not correct. Please re-enter.	The entered e-mail address is incorrect.	Make sure the e-mail address is correct, and then enter it again.
Memory is full. Scanning has been cancelled. Press [Send] to send the scanned data, or press [Cancel] to delete.	Because there is not enough free hard disk space in the machine for delivering or sending by e-mail while storing in the Document Server, only some of the pages could be scanned.	Specify whether to use the data or not.
Memory is full. Cannot scan. The scanned data will be deleted.	Because of insufficient hard disk space, the first page could not be scanned.	Try one of the following measures: <ul style="list-style-type: none"> <li>• Wait for a while, and then retry the scan operation.</li> <li>• Reduce the scan area or scanning resolution. See "Setting items for Scan Settings", Scanner Reference.</li> <li>• Delete unneeded stored files. See "Deleting a Stored File", Scanner Reference.</li> </ul>
Memory is full. Do you want to store scanned file?	Because there is not enough free hard disk space in the machine for storing in the Document Server, only some of the pages could be scanned.	Specify whether to use the data or not.
No paper. Load paper of one of the following sizes, then press [Start Printing].	No paper is set in the specified paper tray.	Load paper of the sizes listed in the message.

Message	Cause	Solution
Exceeded max. data capacity. Check the scanning resolution, then reset original(s).	The scanned original exceeded maximum data capacity.	Specify the scan size and resolution again. Note that it may not be possible to scan very large originals at a high resolution. See "Relationship between Resolution and File Size", Scanner Reference.
Exceeded max. data capacity. Check scanning resolution, then press Start key again.	The scanned data exceeded maximum data capacity.	Specify the scan size and resolution again. Note that it may not be possible to scan very large originals at a high resolution. See "Relationship between Resolution and File Size", Scanner Reference.
Exceeded max. page capacity per file. Press [Send] to send the scanned data, or press [Cancel] to delete.	The number of scanned pages exceeded maximum page capacity.	Select whether to send the data so far.

## When a Message is Displayed on the Client Computer

This section explains likely causes of and possible solutions for the main error messages displayed on the client computer when using the TWAIN driver.

### Important

- If a message not described here appears, act according to the message. For information about how to turn off the main power switch, see About This Machine.

Message	Cause	Solution
Clear Misfeed(s) in ADF.	A paper misfeed has occurred inside the ADF.	Remove jammed originals, and place them again. Check whether the originals are suitable to be scanned by the machine.
Invalid Winsock version. Please use version 1.1 or higher.	You are using an invalid version of Winsock.	Install the operating system of the computer or copy Winsock from the operating system CD-ROM.
The name is already in use. Check the registered names.	You tried to register a name that is already in use.	Use another name.
Cannot detect the paper size of the original. Specify the scanning size.	The set original was misaligned.	<ul style="list-style-type: none"> <li>Place the original correctly.</li> <li>Specify the scan size.</li> <li>When placing an original directly on the exposure glass, the lifting/lowering action of the ADF triggers the automatic original size detection process. Lift the ADF by more than 30 degrees.</li> </ul>
Cannot add any more scanning mode.	The maximum number of registerable scan modes has been exceeded.	The maximum number of modes that can be stored is 100. Delete unneeded modes.
Cannot specify any more scanning area.	The maximum number of registerable scan areas has been exceeded.	The maximum number of scanning areas that can be stored is 100. Delete unneeded scanning area.
Call Service Please call your service representative.	An unrecoverable error has occurred in the machine.	Call your service representative.

Message	Cause	Solution
Scanner is not available on the specified device.	The TWAIN scanner function cannot be used on this machine.	Contact your service representative.
Scanner is not available. Check the scanner connection status.	<ul style="list-style-type: none"> <li>• The machine's main power switch is off.</li> <li>• The machine is not connected to the network correctly.</li> </ul>	<ul style="list-style-type: none"> <li>• Set the main power switch to "On".</li> <li>• Check whether the machine is connected to the network correctly.</li> <li>• Deselect the personal firewall function of the client computer.</li> <li>• Use an application such as telnet to make sure SNMPv1 or SNMPv2 is set as the machine's protocol. See "Network Settings", General Settings Guide and "Using telnet", Network Guide.</li> </ul>
No response from the scanner.	The machine or client computer is not connected to the network correctly.	Check whether the machine or client computer is connected to the network correctly.
No response from the scanner.	The network is crowded.	Wait for a while, and then try to reconnect.
Error has occurred in the scanner.	The application-specified scan conditions have exceeded the setting range of the machine.	<ul style="list-style-type: none"> <li>• Check whether the scanning settings made with the application exceed the setting range of the machine.</li> <li>• Disable the client computer's own firewall.</li> </ul>
Fatal error has occurred in the scanner.	An unrecoverable error has occurred on the machine.	An unrecoverable error has occurred in the machine. Call your service representative.
Cannot connect to the scanner. Check the network Access Mask settings in User Tools.	An access mask is set.	Contact the network or scanner administrator.
Scanner is not ready. Check the scanner and the options.	The ADF cover is open.	Check whether the ADF cover is closed.

Message	Cause	Solution
Insufficient memory. Reduce the scanning area.	Scanner memory is insufficient.	<ul style="list-style-type: none"> <li>• Reset the scan size.</li> <li>• Lower the resolution.</li> <li>• Set with no compression. See TWAIN Driver help.</li> </ul> <p>The problem may be due to the following cause:</p> <ul style="list-style-type: none"> <li>• “The Relationship between the Resolution and the Scanning Area” chart in Help for halftone scanning might not always apply. Scanning cannot be performed if large values are set for brightness when using halftone or high resolution.</li> </ul>
Cannot find "XXX" scanner used for the previous scan. "YYY" will be used instead. ("XXX" and "YYY" indicate scanner names.)	<ul style="list-style-type: none"> <li>• The main power switch of the previously used scanner is not set to "On".</li> <li>• The machine is not connected to the network correctly.</li> </ul>	<ul style="list-style-type: none"> <li>• Check whether the main power switch of the scanner used for the previous scan is turned off.</li> <li>• Check the previously used scanner is connected to the network correctly.</li> <li>• Cancel the Personal Firewall of the client computer.</li> <li>• Use an application such as telnet to make sure SNMPv1 or SNMPv2 is set as the machine's protocol. See "Network Settings", General Settings Guide and "Using telnet", Network Guide.</li> <li>• Select the scanner used for the previous scan.</li> </ul>
Error has occurred in the scanner driver.	An error has occurred in the driver.	<ul style="list-style-type: none"> <li>• Check whether the network cable is connected correctly to the client computer.</li> <li>• Check whether the Ethernet board of the client computer is recognized correctly by Windows.</li> <li>• Check whether the client computer can use the TCP/IP protocol.</li> </ul>
Communication error has occurred on the network.	A communication error has occurred on the network.	Check whether the client computer can use the TCP/IP protocol.

Message	Cause	Solution
Scanner is in use for other function. Please wait.	A function of the machine other than the scanner function is being used such as the copier function.	Wait for a while and reconnect.
Insufficient memory. Close all other applications, then restart scanning.	Memory is insufficient.	<ul style="list-style-type: none"> <li>• Close all the unnecessary applications running on the client computer.</li> <li>• Uninstall the TWAIN driver, and then reinstall it after restarting the computer.</li> </ul>
No User Code is registered. Consult your system administrator.	Access is restricted with user codes.	Contact the administrator of the machine.
Any of Login User Name, Login Password or Driver Encryption Key is incorrect.	The entered login user name, password, or driver encryption key was invalid.	<ul style="list-style-type: none"> <li>• Check the login user name, login password, and driver encryption key.</li> <li>• Permission to use this function has not been granted. Contact the administrator.</li> </ul>
Cannot register the user because the scanner's address book is full.	Failed to authenticate the user at the authentication server because the address book is full.	Contact the administrator of the machine.
The user has been already registered in the scanner's address book.	Failed to authenticate the user at the authentication server because same user name has been already registered in the address book.	Contact the administrator of the machine.

# 6. Adding paper, Toner and Staples

This chapter explains troubleshooting procedures that are applicable to all the machine's functions.

## Loading paper

This section explains what to do when paper runs out and needs reloading.

### **CAUTION:**

- *When loading paper, take care not to trap or injure your fingers.*

Tray 1 and LCT use A4  exclusively. Load only A4 paper at all times.



### **Note**

- Fan the paper before loading.
- Straighten curled or warped paper before loading.
- If you want to load Letter- sized paper (8 1/2" × 11" ) paper in Tray 1 or LCT, contact your service representative.
- For paper types and sizes, see "Recommended Paper Sizes and Types", About This Machine.
- To load paper in the bypass tray, see "Using the Bypass Tray", Copy/Document Server Reference.

## Loading Paper into the Paper Trays

The following procedure explains loading paper (in paper tray 2 as an example).

### Important

- Tray 1 uses only A4  paper. If you want to load 8 1/2" × 11" , contact your service representative.
- The position of the side and end fences can be changed in tray 2, 1 tray paper unit, and 2 tray paper unit. Paper of various sizes can then be loaded in them. When changing paper size, see "Changing the Paper Size".
- Do not stack paper over the limit mark.

### **1** Carefully pull out the paper tray until it stops.

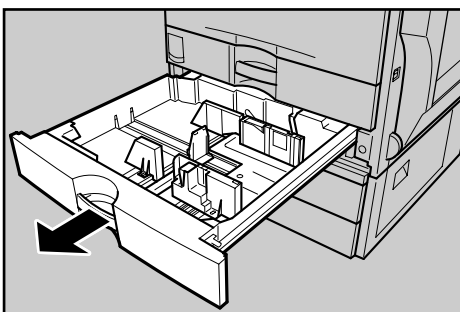

### **2** Square the paper and load it print side up.

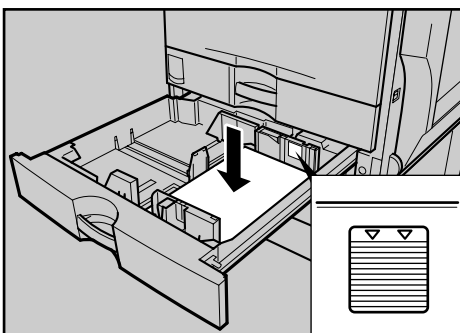

### **3** Carefully push the paper tray fully in.

#### Note

- If you load a paper size that is not selected automatically, you will need to specify the paper size with the control panel.

#### Reference

p.83 "Changing the Paper Size"

p.86 "Changing to a Size That is Not Automatically Detected"



## Loading Paper into the Large Capacity Tray (LCT)

The following procedure explains loading paper into the large capacity tray (LCT).

### **Important**

- ❑ LCT (optional) uses A4 paper exclusively. Only load A4 paper. If you want to load 8<sup>1</sup>/<sub>2</sub>"×11" paper, contact your service representative.
- ❑ Align the paper stacks and load them against the left and right walls, or a paper misfeed might occur.
- ❑ Do not stack paper over the limit mark.

**1** Pull out the LCT, slowly until it stops.

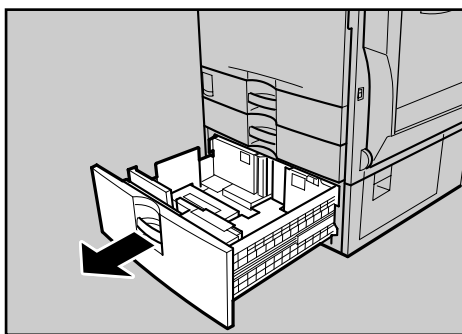

A0D029S

**2** With the print side up, align all four sides of two paper stacks, and then load them next to each other in the tray. Each side has a limit of 1,000 sheets.

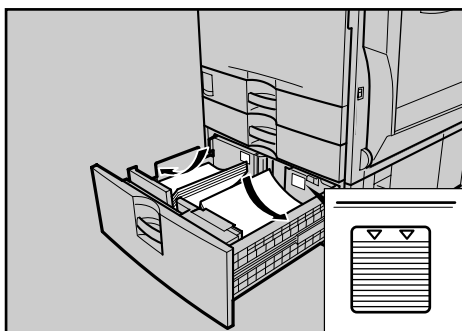

A0D030S

**3** Push the paper tray slowly in until it stops.



## Orientation-Fixed Paper or Two-Sided Paper

The following explains loading paper whose orientation and print side is specified (letterhead paper).





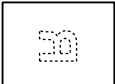

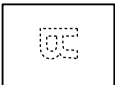



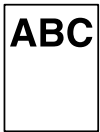

Orientation-fixed (top to bottom) or two-sided paper (for example, letterhead paper, punched paper, or copied paper) might not print correctly, depending on how the originals and paper are placed. Select **[On]** in **[Letterhead Setting]** under **[Copier / Document Server Features]**, and then place the original and paper as shown below. See “Letterhead Setting”, General Settings Guide. When printing with the printer function, placement orientation is the same.

For printing using the printer function, load paper in the same orientation.

### ❖ Original Orientation

Exposure glass		ADF	
	<ul style="list-style-type: none"> <li>copy</li> </ul> 		
	<ul style="list-style-type: none"> <li>scanner</li> </ul> 		

### ❖ Paper Orientation

Paper loading	Paper tray			Bypass tray		
	Copy mode: Place originals on the exposure glass.	Copy mode: Place originals in the ADF.	Printer mode	Copy mode: Place originals on the exposure glass.	Copy mode: Place originals in the ADF.	Printer mode
Paper orientation <input type="checkbox"/>						
Paper orientation <input checked="" type="checkbox"/>						

### Note



- For **[System Settings]**, specify Letterhead as “Paper Type” for the paper tray you want to use. See “Tray Paper Settings”, General Settings Guide.

# Changing the Paper Size

This section explains how to change a paper size.

Procedures for changing the paper size differ depending on the tray (tray 1 or other optional paper tray units). Make sure you are following the appropriate procedure before you begin.

## Note

- Be sure to select the paper size with User Tools. If you do not, misfeeds might occur.
- Tray 1 and LCT (optional) use only A4  paper. To load 8 1/2" × 11" , contact your service representative.
- Fan the paper before loading.
- Straighten curled or warped paper before loading.
- For details about paper sizes and types, see "Copy Paper", About This Machine.

## Changing the Paper Size in the Paper Tray

The following procedure explains how to change a paper size in the paper tray.

### Important

- Do not stack paper over the limit mark.
- Check the top of the paper is aligned to the right side.

**1** Check that paper in the paper tray is not being used for copying, and then pull the tray carefully out until it stops.

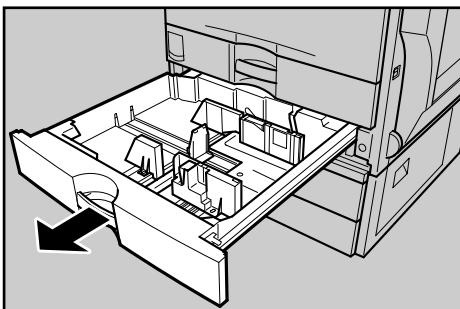

A0D027S

6

**2** Remove papers if loaded.

**3** Release the lock on the side fences.

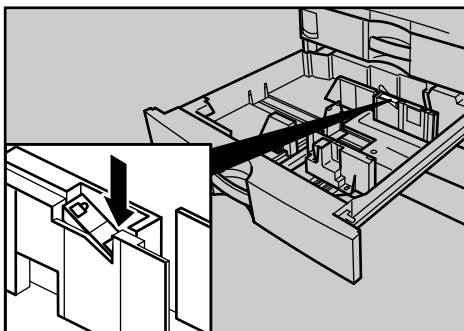

AMJ015S

**4** While pressing down the release lever, slide the side fences until they are aligned the paper size you want to load.

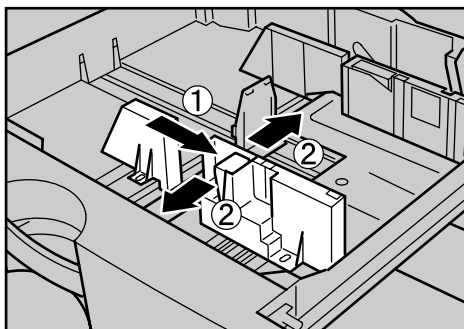

AMJ016S

- 5** Slide the end fence until it is aligned with the size of paper to you want to load.

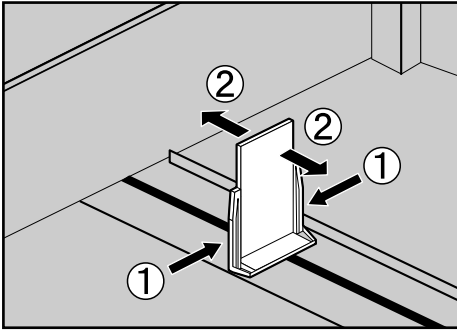

ZH1X1760J

- 6** Square the paper and load it print side up.

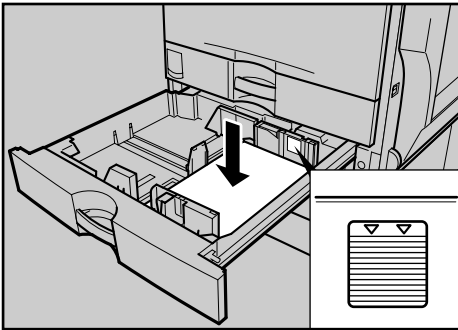

A0D028S

- 7** Re-lock the side fences again.

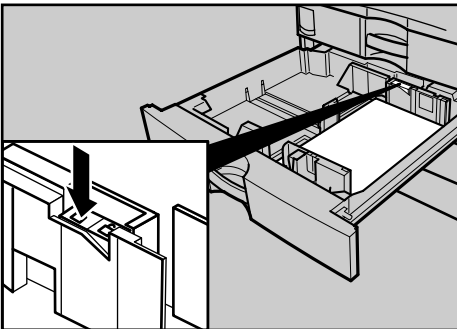

AMJ055S

- 8** Carefully slide the paper tray fully in.

- 9** Check the size on the display.

 **Note**

- If there is space between the side fence and paper, bring the side fence flush against the edge of the paper.

## Changing to a Size That is Not Automatically Detected

If you load a paper size that is not selected automatically, you need to specify the paper size with the control panel.

### **Important**

- Following paper sizes that are not selected automatically.
  - Tray 2, Optional paper feed unit (Tray 3, 4):  
 11" × 17" □, 8<sup>1</sup>/<sub>2</sub>" × 14" □, 8<sup>1</sup>/<sub>4</sub>" × 14" □, 8<sup>1</sup>/<sub>2</sub>" × 11" □, 7<sup>1</sup>/<sub>4</sub>" × 10<sup>1</sup>/<sub>2</sub>" □ □, 8" × 13" □, 8<sup>1</sup>/<sub>2</sub>" × 13" □, 8<sup>1</sup>/<sub>4</sub>" × 13" □, 8K □, 16K □ □
  - Bypass Tray:  
 B4 □, A4 □, B5 □ □, A5 □, B6 □, 12" × 18" □, 11" × 17" □, 8<sup>1</sup>/<sub>2</sub>" × 14" □, 8<sup>1</sup>/<sub>4</sub>" × 14" □, 8<sup>1</sup>/<sub>2</sub>" × 11" □ □, 5<sup>1</sup>/<sub>2</sub>" × 8<sup>1</sup>/<sub>2</sub>" □, 7<sup>1</sup>/<sub>4</sub>" × 10<sup>1</sup>/<sub>2</sub>" □ □, 8" × 13" □, 8<sup>1</sup>/<sub>2</sub>" × 13" □, 8<sup>1</sup>/<sub>4</sub>" × 13" □, 8K □, 16K □ □

**1** Press the **[User Tools / Counter]** key.

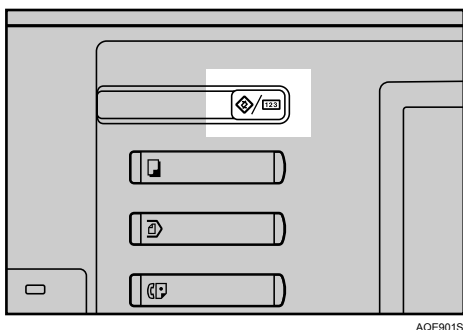

AQE901S

**2** Press **[System Settings]**.



**3** Press [Tray Paper Settings] tab.

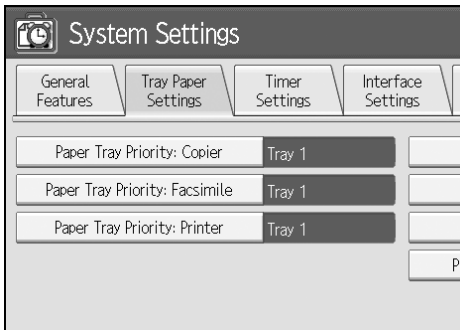

**4** Select the tray for which you want to change the paper settings.  
 Press either of [Tray Paper Size: Tray 2] to [Tray Paper Size: Tray 4].

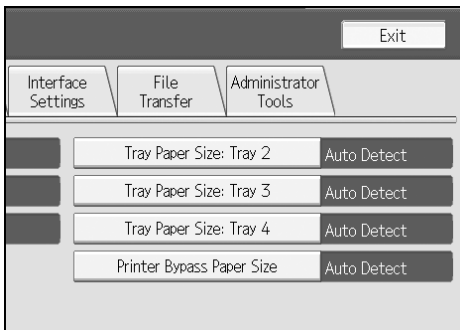

**5** Select the loaded paper size and feed direction, and then press [OK].

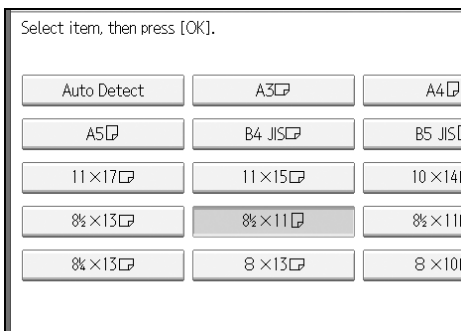

The set paper size and feed direction is displayed.

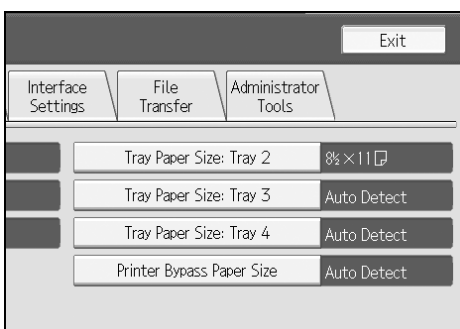

**6** Press the **[User Tools / Counter]** key.

The initial display is shown.

 **Note**

- If you want to print on paper that is selected automatically after printing on a paper size that is not selected automatically, you must return the setting to “Auto Detect”. Reload the paper, select “Auto Detect” in step **5**. The setting is returned to “Auto Detect”.



# Adding Toner

This section explains adding and storing toner.

**⚠ WARNING:**

- *Do not incinerate used toner or toner containers. Toner dust might ignite when exposed to an open flame. Dispose of used toner containers in accordance with local regulations.*

**⚠ CAUTION:**

- *Keep toner (used or unused) and toner containers out of reach of children.*

**⚠ CAUTION:**

- *If toner or used toner is inhaled, gargle with plenty of water and move into a fresh air environment. Consult a doctor if necessary.*

**⚠ CAUTION:**

- *If toner or used toner gets into your eyes, flush immediately with large amounts of water. Consult a doctor if necessary.*

**⚠ CAUTION:**

- *If toner or used toner is swallowed, dilute by drinking a large amount of water. Consult a doctor if necessary.*

**⚠ CAUTION:**

- *Avoid getting toner on your clothes or skin when removing a paper jam or replacing toner. If your skin comes into contact with toner, wash the affected area thoroughly with soap and water.*
- *If toner gets on your clothing, wash with cold water. Hot water will set the toner into the fabric and may make removing the stain impossible.*

**⚠ CAUTION:**

- *Our products are engineered to meet high standards of quality and functionality, and we recommend that you use only the expendable supplies available at an authorized dealer.*

**⚠ CAUTION:**

- *Do not open toner cartridges forcefully. Toner can spill, dirtying your clothes or hands, and possibly resulting in accidental ingestion.*

### **Important**

- Fault may occur if you use toner other than the recommended type.
- When adding toner, do not turn off the operation switch. If you do, settings will be lost.
- Always add toner when the machine instructs you.
- When a message “Add Toner” is shown on the display, replace the applicable colour-toner.
- Store toner containers in a cool, dry place free from direct sunlight.
- Store on a flat surface.

### **Note**

- You can check name of the required toner name and the replacement procedure using the “Add Toner” screen.
- Press **[System Status]** to check contact number where you can order supplies. See p.5 “Checking Machine Status and Settings”.
- You can add all four color toners in the same way.

## 6 Inserting Toner

The following describes how to replace toner.

### **Important**

- Do not shake the removed toner cartridge. The remaining toner might scatter.

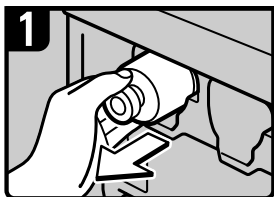

- Open the front cover of the machine.
- Pull out the toner cartridge slowly.

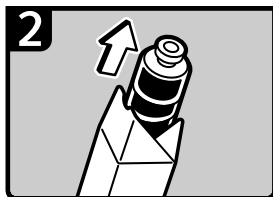

- Take out the new toner cartridge from the box.

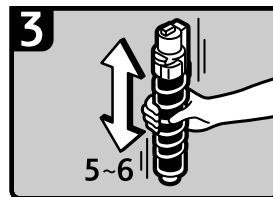

- Hold the toner cartridge and shake it five or six times.

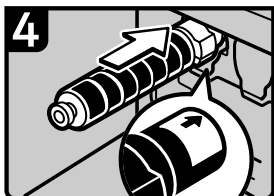

- Check the orientation of the toner cartridge and insert it carefully.
- Close the front cover of the machine.

---

## When Toner Remains

---

Toner can remain inside the toner cartridge in certain environments. If this happens, set the toner cartridge again. Toner will be supplied automatically, and you can then continue to use it.

---

## Sending Faxes or Scanned Documents When Toner Has Run Out

---

When the machine has run out of toner, the indicator on the display lights. Note that even if there is no toner left, you can still send faxes or scanned documents.

### Important

- If number of communications executed after the toner has run out and not listed in the automatically output Journal exceeds 200, communication is not possible.

**1** Make sure that the machine is in facsimile or scanner mode.

**2** Press [Exit], and then perform transmission operation.

The error message disappears.

### Note

- The report that can be printed for transmitted files cannot be printed for files transmitted with Memory Transmission.
- If the fax or scanner screen does not appear in step **1**, press the **[Facsimile]** key or **[Scanner]** key.

---

## Used Toner

---

Toner cannot be re-used.

Bring the stored used container to your sales representative or service representative for recycling through our recycling system. If you discard it on your own, treat it as general plastic waste material.

# Maintenance

This section explains how to adjust the colour registration and gradation by specifying the settings in **[Maintenance]**.

---

## Adjusting the Colour Registration

---

When the machine is moved, the Fusing Unit is replaced, or after printing repeatedly for some time, registration shifting might occur. By performing colour registration adjustment, you can maintain optimum print results.

---

### Colour Registration

---

If the colour documents show registration shifting, perform automatic colour registration.

- 1** Press the **[User Tools / Counter]** key.

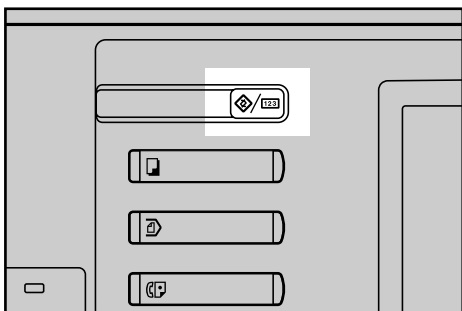

- 2** Press **[Maintenance]**.

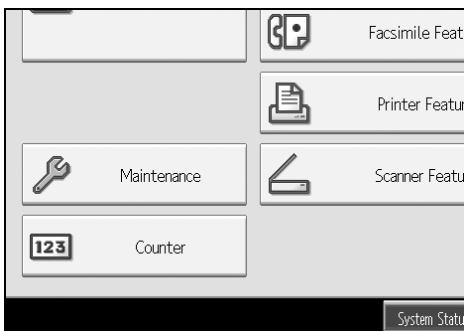

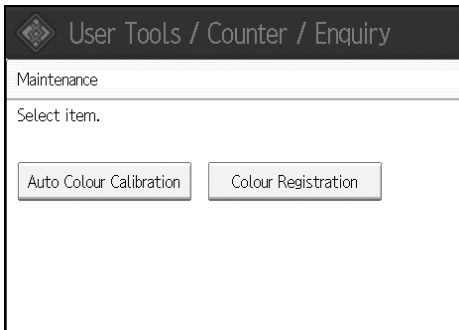
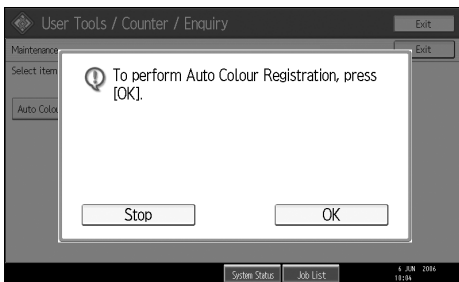
**3** Press [Colour Registration].**4** Press [OK].

Auto colour registration takes about fifty seconds. When it is completed, the display returns to the colour registration menu.

**5** When you have made all the settings, press the [User Tools / Counter] key.  
The initial display is shown.

## Auto Colour Calibration

If a certain colour is strong or the colour of the copy differs from the original, adjust the yellow, magenta, cyan and black balance.

 **Note**

- If “ Add Toner” is shown on the display panel, the test pattern cannot be printed.

**1** Press the [User Tools / Counter] key.

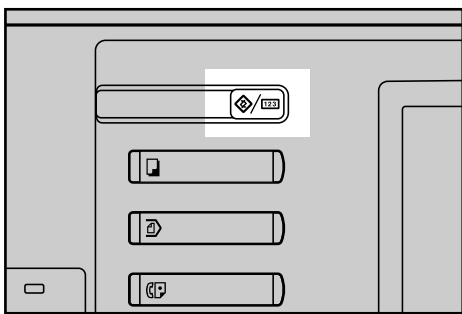

6

**2** Press [Maintenance].

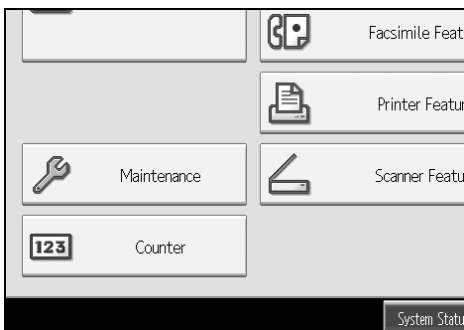

**3** Press [Auto Colour Calibration].

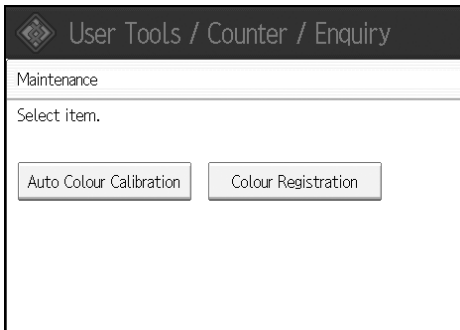

**4** Press [Start].

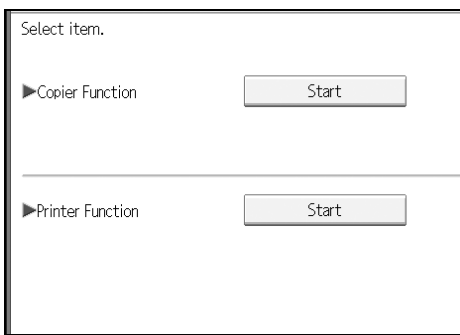



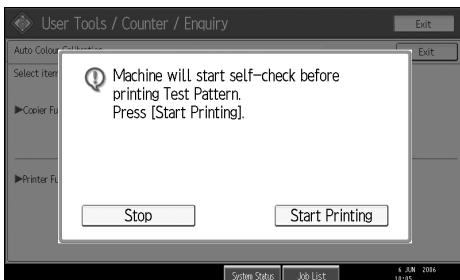

**5** Press [Start Printing] and a test pattern will be printed.



**6** Place the test pattern on the exposure glass and press [Start Scanning].

The image will be corrected after "Scanning...Please wait" disappears.

 **Note**

- When performing the auto colour calibration from the copy function, press **[Start]** under Copier Function. When performing from the printer function, press **[Start]** under Printer Function.
- The test pattern will not be read if it is set in the ADF.
- When performing the auto colour calibration from the printer function, select test patterns from **[600 × 600 dpi]**, **[1800 × 600 dpi]** and **[2400 × 600 dpi]** and then press **[Start Printing]**.
- The test pattern will be printed on an A4 , 8<sup>1</sup>/<sub>2</sub>" × 11"  size page (If A4  is not available then A3 , B4 JIS  will be used.). Make sure to check the paper set in the paper tray.
- Set the test pattern in the following way:

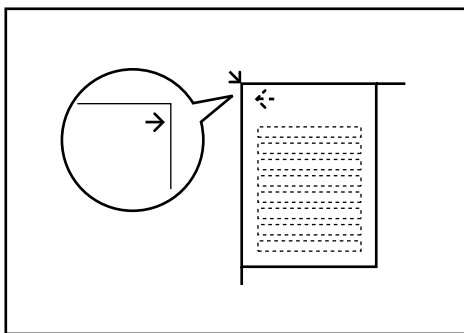

GCCL0PIE

- When the ADF is installed, make sure to set the test pattern on the exposure glass, and then 2 or 3 white sheets, same size as the test pattern, above the test pattern.



## Returning to the Previous Setting

“Previous Setting” means to return to the previous status before any changes.

**1** Press **[Previous Setting]**.



**2** Press **[Yes]**.

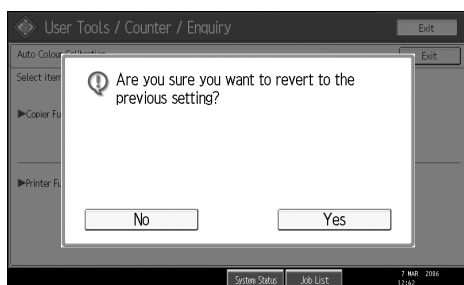

The settings return to the previous contents.

### Note

- When returning the auto colour calibration of the copy function, press **[Previous Setting]** of the Copier Function. If returning the auto colour calibration of the printer function, press **[Previous Setting]** of the Printer Function.
- When returning the auto colour calibration from the printer function, select test patterns from **[600 × 600 dpi]**, **[1800 × 600 dpi]** and **[2400 × 600 dpi]** and then press **[Yes]**.

# Adding Staples

This section explains what to do when staples need replacing.

**⚠ CAUTION:**

- *Keep your hands clear of the booklet finisher tray when pulling out or pushing in the finisher's staple unit. You can trap your fingers if you do not.*

**🔧 Important**

- ❑ Stapling failures or jams may occur if you use a staple cartridge other than that recommended.

Refill the stapler according to the finisher type. (Check the type if you are unsure.) For details about type of finisher, see "Options", About This Machine.

## SR790

The following procedure explains how to add staples to the SR790.

6

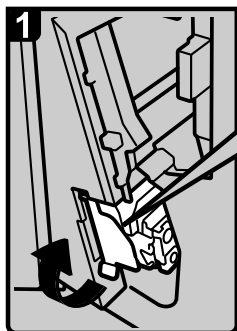

- Open the front cover of the finisher, and then pull out staple unit.

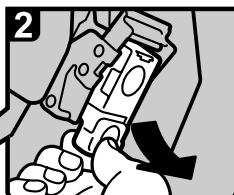

- Hold the green levers while gently pulling out the cartridge.

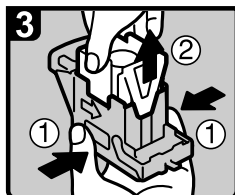

- Hold both sides of the cartridge.
- Pull up the upper unit of the cartridge.

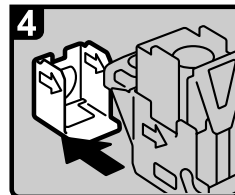

- Take out the empty refill in the arrow direction.

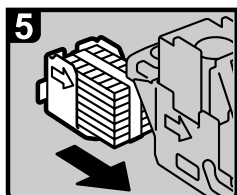

- Align the arrows on the new refill with those on the cartridge, and then push in the refill until clicks.

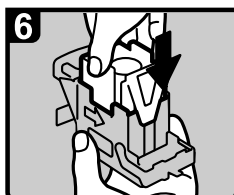

- Gently push down the upper unit into the cartridge.

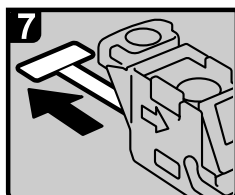

- Pull out the ribbon.

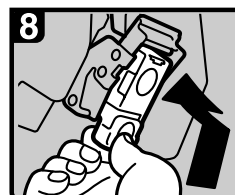

- Hold the green levers while pushing in the cartridge until clicks.
- Push back the staple unit, and then close the front cover of the finisher.

AQE904S

**📌 Note**

- ❑ If you cannot pull out the upper unit, there are staples remaining inside the cartridge. Use all the staples, do not add more.

## Finisher SR3030 and Booklet Finisher SR3020

The following procedure explains how to add staples to the Finisher SR3030 and Booklet Finisher SR3020.

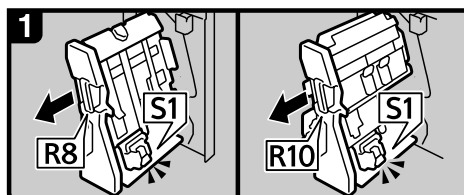

- Finisher SR3030:      Booklet Finisher SR3020:
- Open the finisher front cover.
  - Pull out the staple unit.

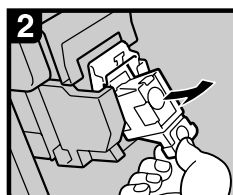

- Pull out the cartridge gently.

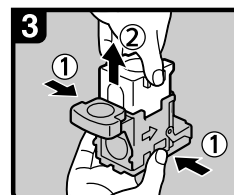

- Holding both sides of the cartridge, pull up the upper unit.

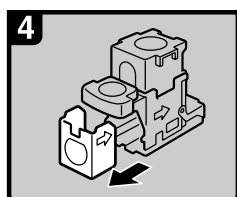

- Remove the empty refill in the direction of the arrow.

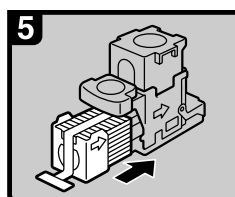

- Push the new refill into the cartridge until it clicks.

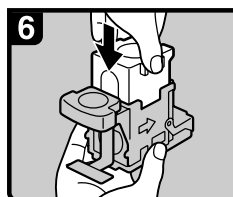

- Push the upper unit gently into the cartridge.

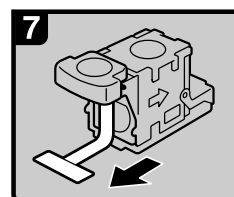

- Pull out the ribbon.

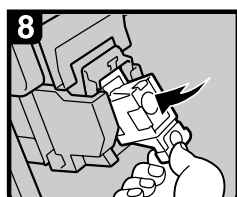

- Push the cartridge down until it clicks.

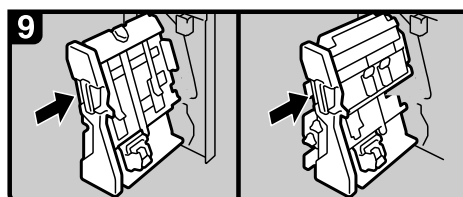

- Finisher SR3030:      Booklet Finisher SR3020:
- Return the staple unit to its original position.
  - Close the finisher front cover.

AQE003S

### Note

- If you cannot pull out the upper unit, there are staples remaining inside the cartridge. Use all the staples, do not add more.

## Booklet Finisher SR3020 (Saddle Stitch)

The following procedure explains how to add staples to the Booklet Finisher SR3020.

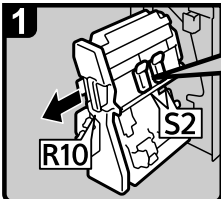
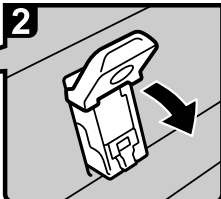
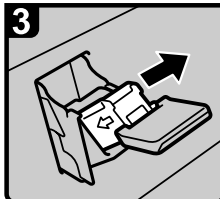
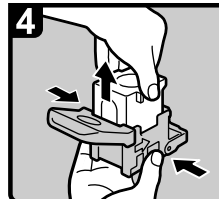
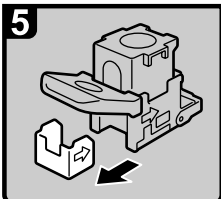
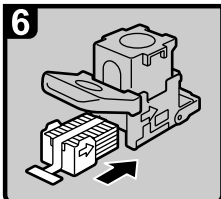
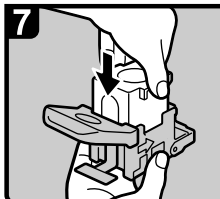
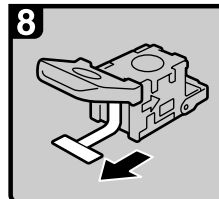
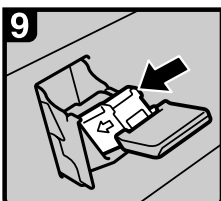
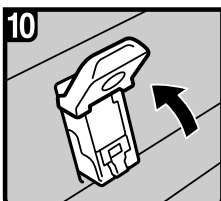
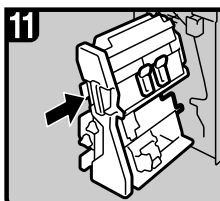
- 
  - Open the finisher front cover.
  - Pull out the staple unit.
- 
  - Pull lever S2.
- 
  - Pull out the cartridge gently.
- 
  - Holding both sides of the cartridge, pull up the upper unit.
- 
  - Remove the empty refill in the direction of the arrow.
- 
  - Push the new refill into the cartridge until it clicks.
- 
  - Push the upper unit gently into the cartridge.
- 
  - Pull out the ribbon.
- 
  - Push the cartridge down until it clicks.
- 
  - Return lever S2 to its original position.
- 
  - Return the staple unit to its original position.
  - Close the finisher front cover.

AQE004S

### Note

- ❑ If you cannot pull out the upper unit, there are staples remaining inside the cartridge. Use all the staples, do not add more.

# Replacing the Stamp Cartridge

If the transmission stamp becomes faint, replace the cartridge.

## Important

- This stamp cartridge is used for facsimile and scanner functions.
- Do not add ink to the cartridge by yourself. Neglecting this can cause ink leakage.
- Be sure not to dirty your fingers with ink from the cartridge.
- Use the cartridge specified for this machine.

### **1** Open the ADF cover.

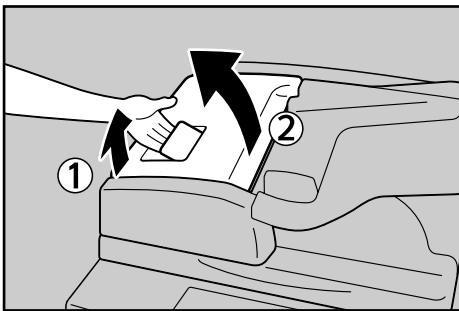

AQD032S

### **2** Raise lever P2, and then pull open cover P2.

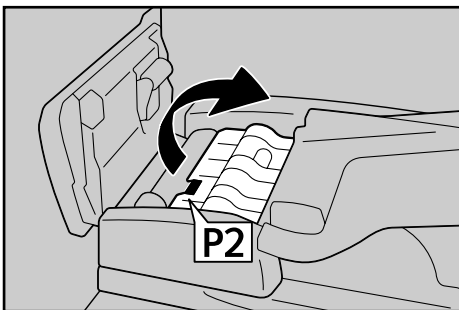

AQD033S

### **3** Push on the area of cover P3 marked "PUSH", and then open the cover P3.

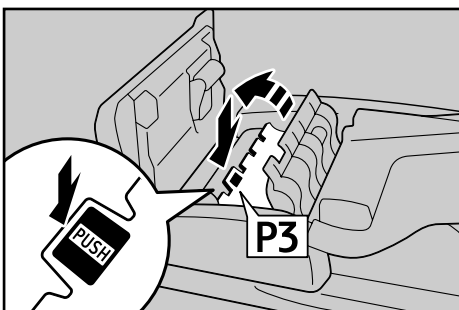

AQD034S

**4** Pull out the old stamp cartridge.

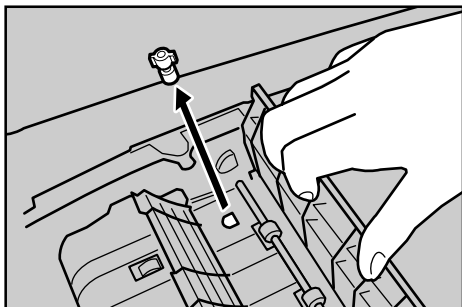

AQD035S

**5** Insert the new stamp cartridge.

Push in the cartridge until the metal parts are no longer visible.

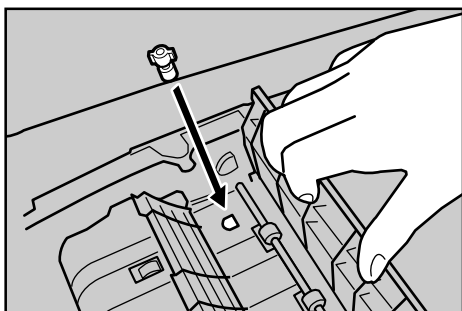

AQD036S

**6** Close cover P3, P2, and the ADF cover.

6

# 7. Clearing Misfeeds

This chapter explains what to do when paper or originals misfeed (become jammed inside the machine).

## Removing Jammed Paper

### **CAUTION:**

- *The fusing section of this machine might be very hot. Caution should be taken when removing misfed paper.*

### **CAUTION:**

- *Keep your hands clear of the booklet finisher tray when pulling out or pushing in the finisher's staple unit. You can trap your fingers if you do not.*

### **Important**

- When clearing misfeeds, do not turn off the operation switch. If you do, your copy settings will be lost.
- To prevent misfeeds, do not leave any torn scraps of paper inside the machine.
- Contact your service representative if misfeeds occur frequently.

### **Note**

- For details about how to locate and remove misfeeds, see “Checking Jammed Paper” or “Removing Jammed Paper”.

### **Reference**

- p.104 “Locating Jammed Paper”.
- p.105 “Removing Jammed Paper”.

## Locating Jammed Paper

If a misfeed happens, remove the misfed paper or original following the procedures stated on the sticker on the rear of main unit front cover.

A misfeed has occurred in the place corresponding to the letter displayed on the control panel.

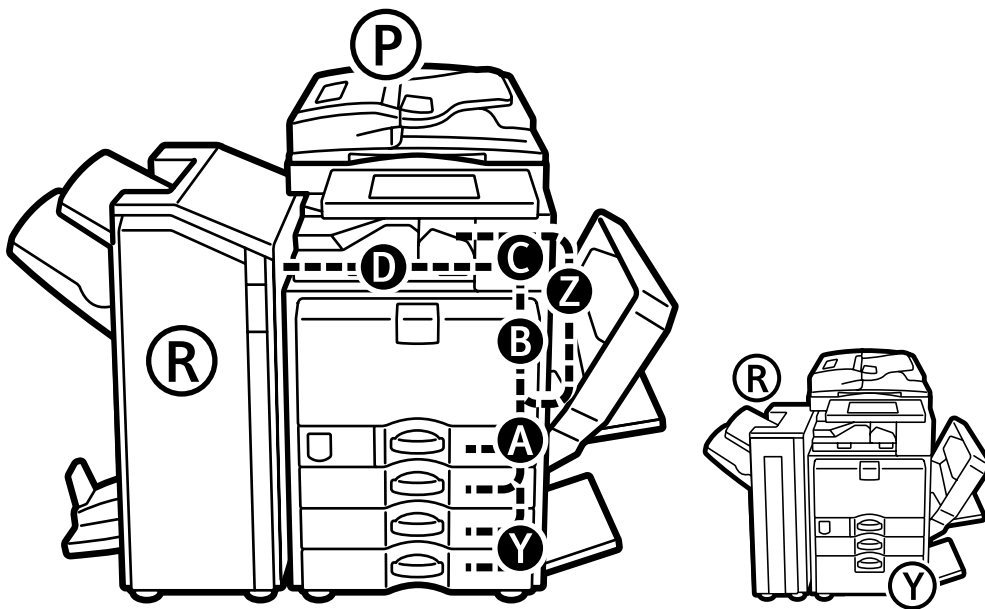

AQD024S

**1** Press the key of the section from where you want to remove the jammed paper.

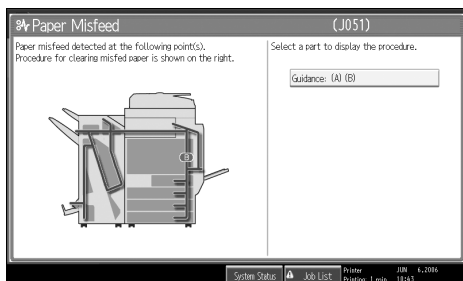

**2** After each step is complete, press [Next]. To go back to the previous step, press [Previous].

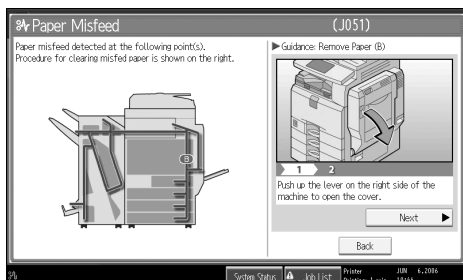



**3** When all jammed paper are removed, restore the machine to the original state.

**Note**

- More than one misfeed may be indicated. When this happens, check all the areas indicated.

## Removing Jammed Paper

The following procedure explains how to remove jammed paper.

**Important**

- The internal parts of the machine may be hot. Wait for the duplex unit to cool down before clearing a jam in the unit.

- When A is lit

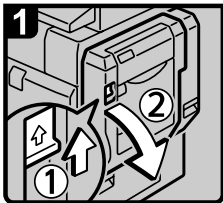

• Open the duplex unit.

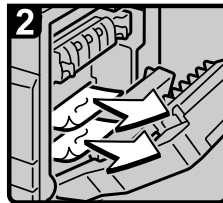

• Remove misfed paper.

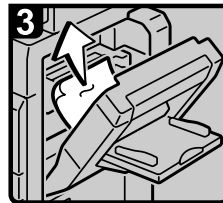

• If you cannot remove misfed paper, open the bypass tray and remove it.

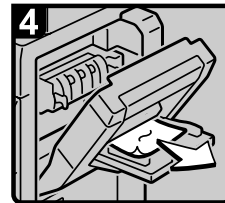

• Remove misfed paper from the bypass tray.  
• Close the duplex unit.  
• Close the bypass tray.

AGE009S

- When B is lit

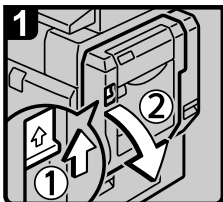

• Open the duplex unit.

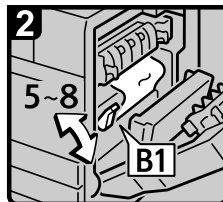

• Move lever B1 up and down.

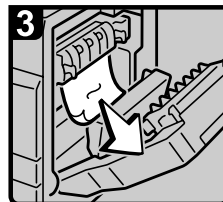

• Remove misfed paper.  
• Close the duplex unit.

AQE010S

• When C is lit

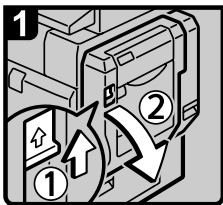

• Open the duplex unit.

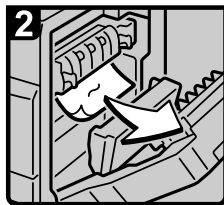

• Remove misfed paper.

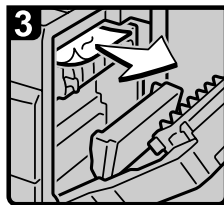

• Remove misfed paper.

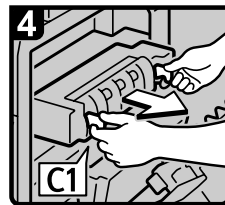

• Pull lever C1 and pull out the fusing unit.

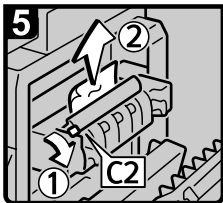

• Lift lever C2 and remove misfed paper.  
• Return the fusing unit to its original position.



• Remove misfed paper from any internal tray.  
• Close the duplex unit.

AQE011S

• When D is lit

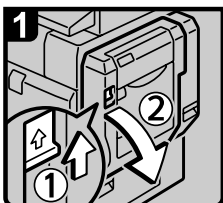

• Open the duplex unit.

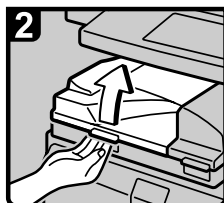

• Open the bridge unit left cover.



• Remove misfed paper.

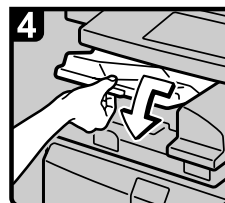

• Close the bridge unit left cover.

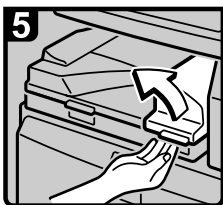

• If you cannot remove misfed paper, open the bridge unit right cover.

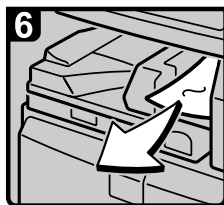

• Remove misfed paper.  
• Close the bridge unit right cover.  
• Close the duplex unit.

AQE012S

• When P is lit (when ADF is installed)

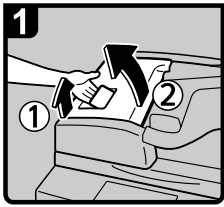

• Open the upper cover of the ADF

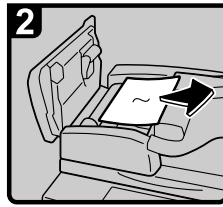

• Remove the misfed original.

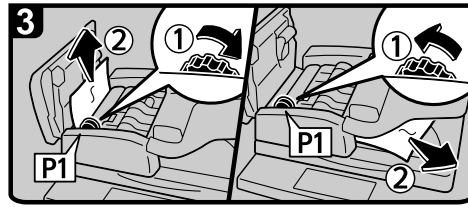

• Turn knob P1, and then remove the misfed original.

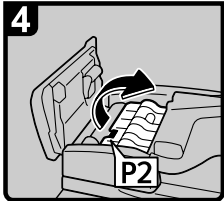

• If you cannot remove the misfed original, lift lever P2 and open the cover P2.

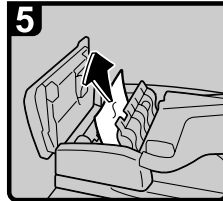

• Remove the misfed original.

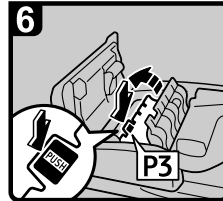

• If you cannot remove the misfed original, open the cover P3.

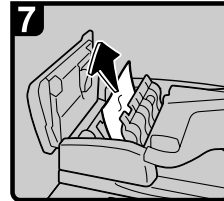

• Remove the misfed original.  
• Closes the cover P3, P2, and the upper cover of the ADF.  
• Lift and lower the ADF.

AQE013S

• When R is lit (when SR790 is installed)

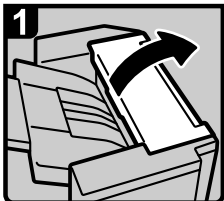

• Open the finisher front cover and upper cover.

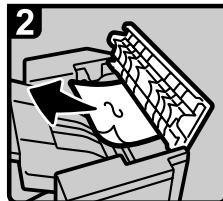

• Remove misfed paper.  
• Close the finisher front cover and upper cover.

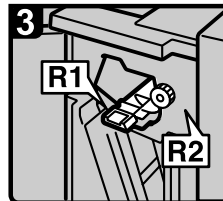

• If you cannot remove misfed paper, open the finisher front cover.

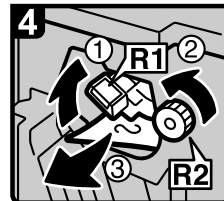

• Raise lever R1 and turn knob R2, and then remove misfed paper.

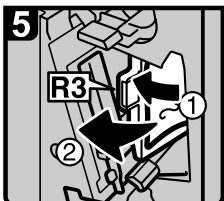

• Pull lever R3 to the left and remove misfed paper.

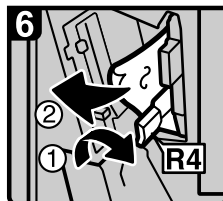

• Lower lever R4 and remove misfed paper.

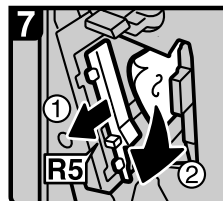

• Pull lever R5 and remove misfed paper.  
• Return levers R1, R3, R4, and R5 to their original positions.  
• Close the finisher front cover.

AQE014S

- When R1 - R8 is lit (when Finisher SR3030 is installed)

**When R1 - R4 is lit**

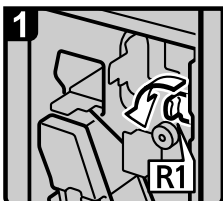

- Open the finisher front cover.
- Turn lever R1.

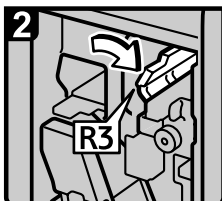

- Pull lever R3.

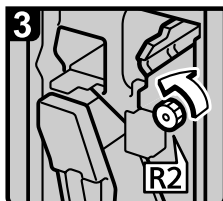

- Turn knob R2.

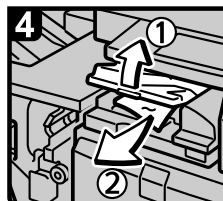

- Open the bridge unit left cover and remove misfed paper.
- Close the bridge unit left cover.

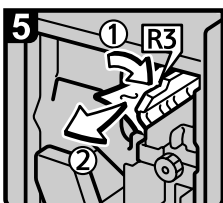

- Pull lever R3 and remove misfed paper.

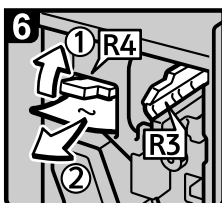

- Raise lever R4 and remove misfed paper.
- Return levers R3 and R4 to their original positions.
- Close the finisher front cover.

**When R5 - R8 is lit**

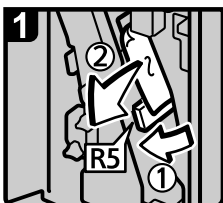

- Open the finisher front cover.
- Lower lever R5 and remove misfed paper.
- Return lever R5 to its original position.

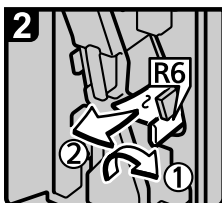

- If you cannot remove misfed paper, raise lever R6 and remove it.
- Return lever R6 to its original position.

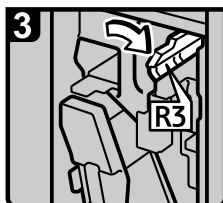

- Pull lever R3.

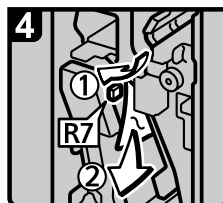

- Lower lever R7 and remove misfed paper.
- Return levers R3 and R6 to their original positions.

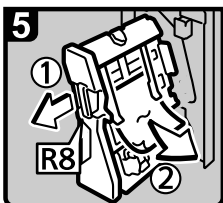

- Pull handle R8 and pull out the staple unit, then remove misfed paper.
- Close the finisher front cover.

- When R1 - R12 is lit (when Booklet Finisher SR3020 is installed)

**When R1 - R4 is lit**

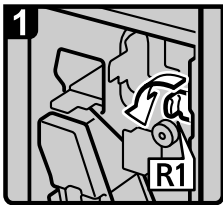

- Open the finisher front cover.
- Turn lever R1.

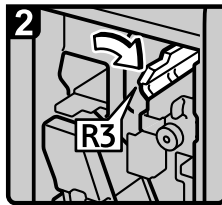

- Pull lever R3.

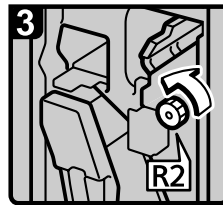

- Turn knob R2.

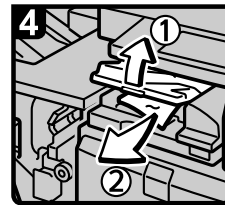

- Open the bridge unit left cover and remove misfed paper.
- Close the bridge unit left cover.

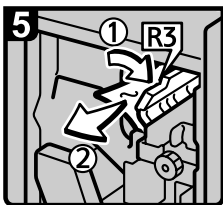

- Pull lever R3 and remove misfed paper.

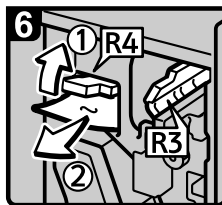

- Raise lever R4 and remove misfed paper.
- Return levers R3 and R4 to their original positions.
- Close the finisher front cover.

**When R5 - R7 is lit**

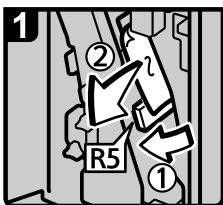

- Open the finisher front cover.
- Lower lever R5 and remove misfed paper.
- Return lever R5 to its original position.

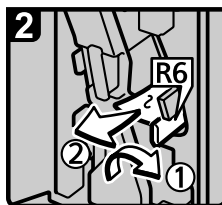

- If you cannot remove misfed paper, raise lever R6 and remove it.
- Return lever R6 to its original position.

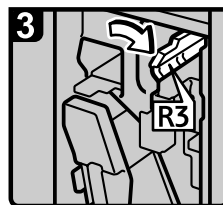

- Pull lever R3.

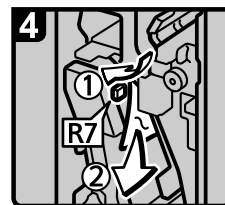

- Lower lever R7 and remove misfed paper.
- Return levers R3 and R4 to their original positions.
- Close the finisher front cover.

AQE016S

**When R8 - R12 is lit**

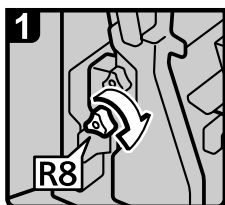

- Open the finisher front cover.
- Turn knob R8.

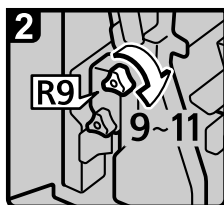

- Turn knob R9 nine to eleven times.

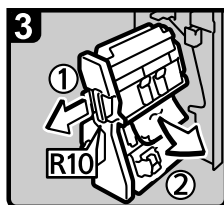

- Pull handle R10 and pull out the staple unit, and then remove misfed paper.

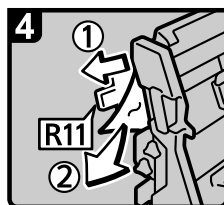

- If you cannot remove misfed paper, raise lever R11 and remove it.

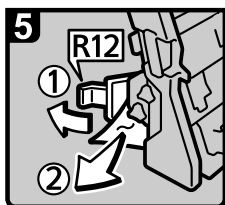

- If you cannot remove misfed paper, raise lever R12 and remove it.
- Return levers R11 and R12 their original positions.
- Push the staple unit back in.
- Close the finisher front cover.

AGE017S

• **When Y is lit (when Wide Large Capacity Tray is installed)**

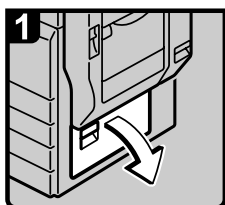

- Open the lower right cover.

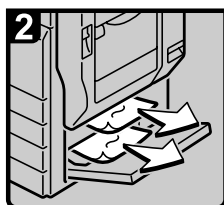

- Remove misfed paper.
- Close the lower right cover.

AGE018S

• **When Z1 is lit**

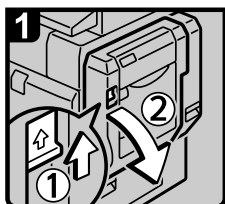

- Open the duplex unit.

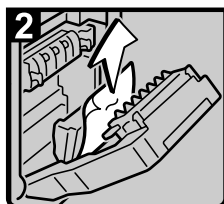

- Remove misfed paper.

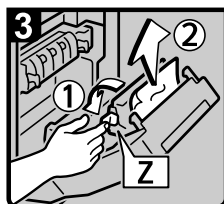

- Hold knob Z and open the paper feed cover, and then remove misfed paper.
- Close the paper feed cover.

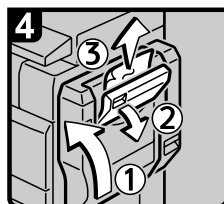

- Close the duplex unit.
- Open the upper right cover and remove misfed paper.
- Close the upper right cover.

AGE020S

**Note**

- ❑ Inside the finisher, or inside the front cover, there is a sticker explaining how to remove misfed paper.
- ❑ If a detailed removal instruction appears on the right of the screen, follow it.
- ❑ You can also use the procedure indicated in **[System Status]** to remove jammed paper.

# Removing Jammed Staples

This section explains how to remove jammed staples.

## ⚠ CAUTION:

- *Keep your hands clear of the booklet finisher tray when pulling out or pushing in the finisher's staple unit. You can trap your fingers if you do not.*

## 🔊 Important

- ❑ Curled paper may cause staples to jam. To avoid this, turn copy paper over in the tray.
- ❑ When the finisher is installed, after removing jammed staples, staples will not be ejected the first few times you try to use the stapler.

Remove the jammed staples according to the finisher type. (Check the type if you are unsure.) For details about type of finisher, see “Options”, About This Machine.

## SR790

The following procedure explains how to remove jammed staples from the SR790.

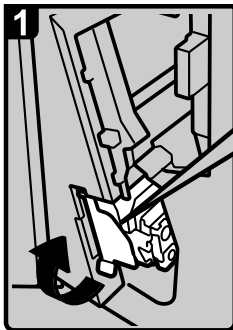

- Open the front cover of the finisher, and then pull out the staple unit.

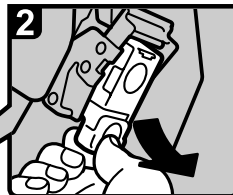

- Hold the green lever while gently pulling out the cartridge.

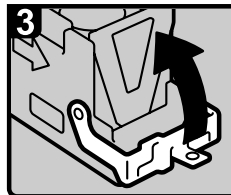

- Open the cartridge's face plate.

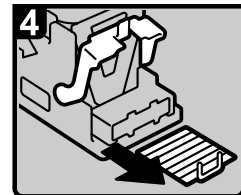

- Remove any jammed staples.

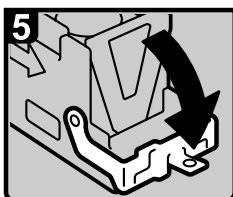

- Pull down the cartridge's face plate until it clicks.

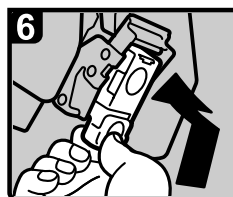

- Hold the green lever while pushing in the cartridge until clicks.
- Push back the staple unit, and then close the front cover of the finisher.

AQE903S

## Finisher SR3030 and Booklet Finisher SR3020

The following procedure explains how to remove jammed staples from the Finisher SR3030 and Booklet Finisher SR3020.

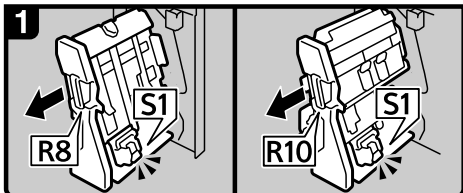

- Finisher SR3030:      Booklet Finisher SR3020:
- Open the finisher front cover.
  - Pull out the staple unit.

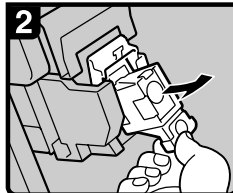

- Pull out the cartridge gently.

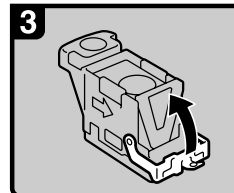

- Open the face plate.

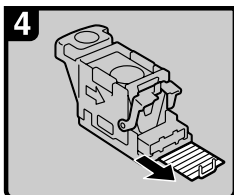

- Remove the jammed staples.

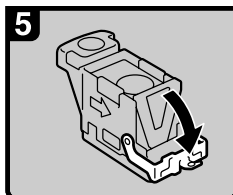

- Pull down the face plate until it clicks.

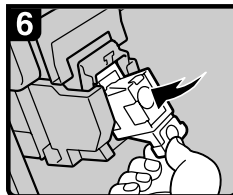

- Pull down the cartridge until it clicks.

7

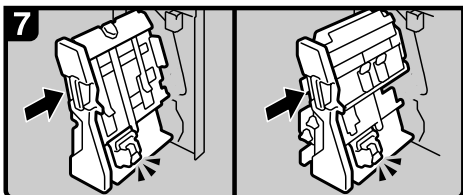

- Finisher SR3030:      Booklet Finisher SR3020:
- Return the staple unit to its original position.
  - Close the finisher front cover.



## Booklet Finisher SR3020 (Saddle Stitch)

The following procedure explains how to remove jammed staples from the Booklet Finisher SR3020.

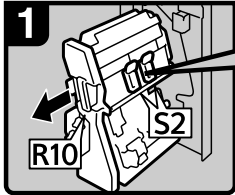

- Open the finisher front cover.
- Pull out the staple unit.

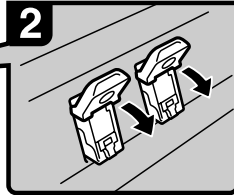

- Pull lever S2.

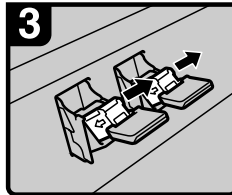

- Pull out the cartridge gently.

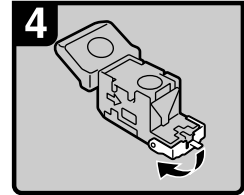

- Open the face plate of the cartridge.

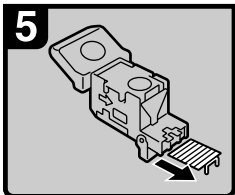

- Remove the jammed staples.

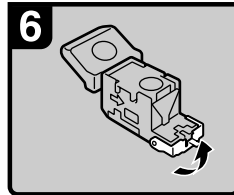

- Pull the face plate down until it clicks.

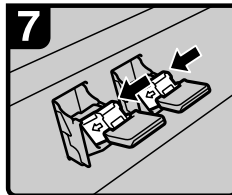

- Push the cartridge down until it clicks.

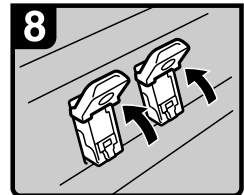

- Return lever S2 to its original position.

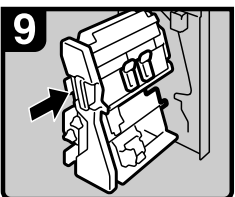

- Return the staple unit to its original position.
- Close the finisher front cover.

# Removing Punch Waste

This section explains how to remove punch waste.

 **Note**

- While “Hole Punch Receptacle is full.” is displayed, you cannot use the Punch function.

---

## Finisher SR3030 and Booklet Finisher SR3020

---

The following procedure explains how to remove punch wastes from the Finisher SR3030 and Booklet Finisher SR3020.

- 1** Open the finisher front cover.

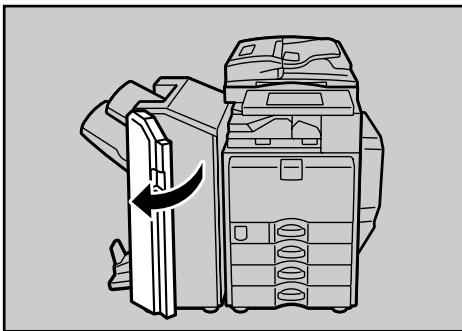

AQ0021S

- 2** Pull out the punch waste box carefully, and then remove punch waste.

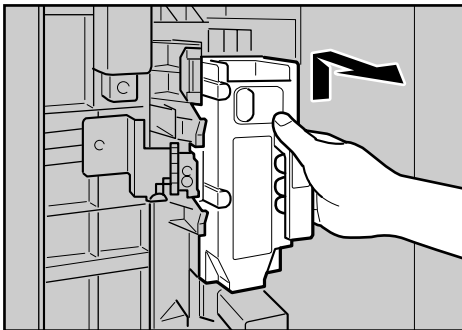

ADB033S

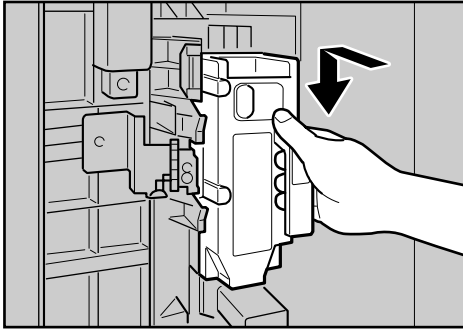
**3** Reinstall the punch waste box.

ADB034S

**4** Close the finisher front cover.

“Hole Punch Receptacle is full.” disappears.

**Note**

- If you do not reinstall the punch waste box in Step **3**, the “Hole Punch Receptacle is full.” message continues to be displayed.
- If the message is still displayed, reinstall the punch waste box.



# 8. Remarks

This chapter describes how to maintain and operate the machine.

## Where to Put Your Machine

This section provides precautions for installation, movement and disposal.

---

### Machine Environment

---

Choose your machine's location carefully.

Environmental conditions greatly affect its performance.

---

#### Optimum environmental conditions

---

The following describes precautions when moving the machine.

**⚠ CAUTION:**

- *Keep the machine away from humidity and dust. Otherwise a fire or an electric shock might occur.*
- *Do not place the machine on an unstable or tilted surface. If it topples over, an injury might occur.*

**⚠ CAUTION:**

- *After you move the machine, use the caster fixture to fix it in place. Otherwise the machine might move or come down to cause an injury.*

**⚠ CAUTION:**

- *Make sure the room where you are using the machine is well ventilated and spacious. Good ventilation is especially important when the machine is used heavily.*

- Temperature: 10-32 °C (50-89.6 °F) (humidity to be 54% at 32 °C, 89.6 °F)
- Humidity: 15-80% (temperature to be 27 °C, 80.6 °F at 80%)
- A strong and level base.
- The machine must be level within 5 mm, 0.2 inches: both front to rear and left to right.
- To avoid possible buildup of ozone, make sure to locate this machine in a large well ventilated room that has an air turnover of more than 30 m<sup>3</sup>/hr/person.

---

### **Environments to avoid**

---

- Locations exposed to direct sunlight or other sources of strong light (more than 1,500 lux).
- Locations directly exposed to cool air from an air conditioner or heated air from a heater. (Sudden temperature changes can cause condensation to form inside the machine.)
- Locations close to machines generating ammonia, such as a diazo copy machine.
- Places where the machine will be subject to frequent strong vibration.
- Dusty areas.
- Areas with corrosive gases.

## Moving

The following describes precautions when moving the machine.

### **CAUTION:**

- *Contact your service representative if you need to lift the machine (such as when relocating it to another floor). Do not attempt to lift the machine without the assistance of your service representative. The machine will be damaged if it topples or is dropped, resulting in malfunction and risk of injury to users. The machine's various handling areas are for service engineer use only. Do not touch these areas.*

### **CAUTION:**

- *Before moving the machine, be sure to disconnect all external connections, especially the power cord from the wall outlet. Damaged power cords are a fire and electric shock hazard.*

### **CAUTION:**

- *Unplug the power cord from the wall outlet before you move the machine. While moving the machine, you should take care that the power cord will not be damaged under the machine.*

### **Important**

- Be careful when moving the machine. Take the following precautions:
  - Turn off the main power.
  - Unplug the power cord from the wall outlet. When you pull out the plug from the socket, grip the plug to avoid damaging the cord, thereby reducing the risk of fire or electric shock.
  - Close all covers and trays, including the front cover and bypass tray.
- Keep the machine level and carry it carefully, taking care not to jolt or tip it. Rough handling may cause a malfunction or damage the hard disk or memory, resulting in loss of stored files.
- Do not take off the holding stand.
- Protect the machine from strong shocks. Impact can damage the hard disk and cause stored files to be lost. As a precautionary measure, files should be copied to another computer.

---

## Power Connection

---

The following explains power supply.

**⚠ WARNING:**

- ***The supplied power cord is for use with this equipment only. Do not use with other appliances. Doing so may result in fire, electric shock, or injury.***

**⚠ WARNING:**

- ***Connect the machine only to the power source described on the inside front cover of this manual. Connect the power cord directly into a wall outlet and do not use an extension cord.***
- ***Do not damage, break or make any modifications to the power cord. Do not place heavy objects on it. Do not pull it hard nor bend it more than necessary. These actions could cause an electric shock or fire.***

**⚠ WARNING:**

- ***If the power cord is damaged (exposure of the core, disconnection, etc.), contact your service representative to change a new one. Operating the machine with a damaged power cord may cause an electric shock or fire.***

**⚠ CAUTION:**

- ***When you disconnect the power plug from the wall outlet, always pull the plug (not the cable).***

**⚠ CAUTION:**

- ***To disconnect the power code, pull it out by plug. Do not drag the code itself. Doing so may result in damage to the code, leading to fire or electric shock.***
- Make sure the plug is inserted firmly in the wall outlet.
- Voltage must not fluctuate by more than 10%.
- The wall outlet shall be installed near the machine and shall be easily accessible.



---

## Access to the Machine

---

Place the machine near the power source, providing the clearance areas shown.

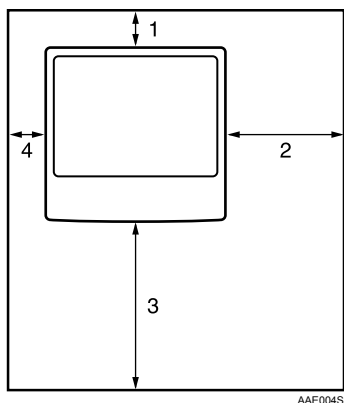

1. Rear: 10 cm (4") or more
2. Right: 55 cm (22") or more
3. Front: 75 cm (29.6") or more
4. Left: 10 cm (4") or more

 **Note**

- For the required space when options are installed, contact your service representative.

# Maintaining Your Machine

If the exposure glass, exposure glass cover, or ADF belt is dirty, copy clarity may be reduced. Clean these parts if they are dirty.

## Important

- Do not use chemical cleaners or organic solvents, such as thinner or benzene. If such substances get inside the machine or melt plastic parts, a failure might occur.
- Do not clean parts other than those explicitly specified in this manual. Other parts should only be cleaned by your service representative.

## ❖ How to maintain

Cleaning the machine: Wipe the machine with a soft, damp cloth, and then wipe it with a dry cloth to remove the water.

---

## Cleaning the Exposure Glass

---

The following procedure explains how to clean the exposure glass and the scanning glass.



Clean 1 and 2.

---

## Cleaning the Exposure Glass Cover

---

The following procedure explains how to clean the exposure glass cover.

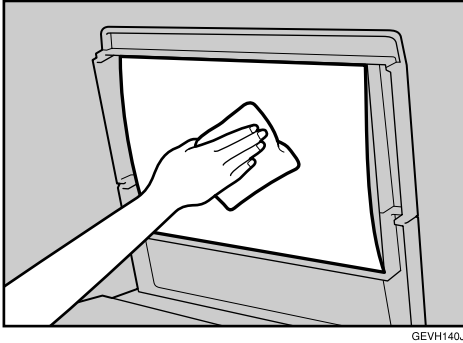

---

## Cleaning the Auto Document Feeder

---

The following procedure explains how to clean the ADF.

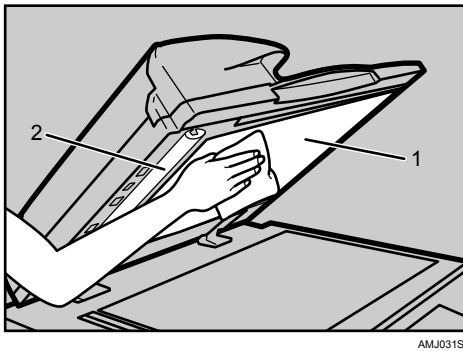

Clean 1 and 2.

## Cleaning the Dustproof Glass

The dustproof glass may require cleaning if white lines appear on the print side of the document.

### Important

- Do not insert the brush forcefully, or the machine might be damaged.

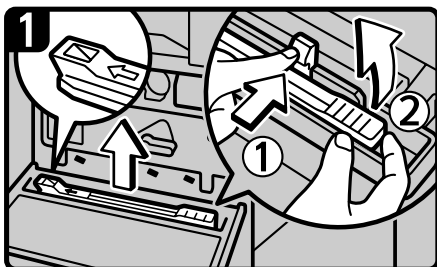

- Turn off the power switch, and then unplug the power cable.
- Open the front cover and remove the cleaning brush. Release the catch at the center of the cleaning brush (1), hold the catch to prevent it re-engaging, and then raise the cleaning brush grip (2).

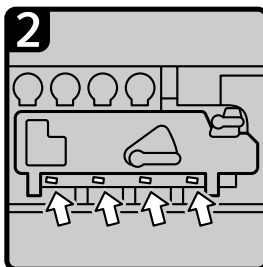

- There are four holes for cleaning the dustproof glass.

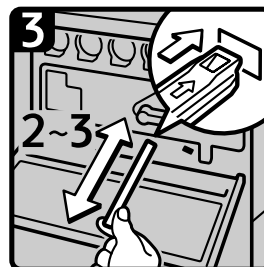

- Slide the cleaning brush in and out slowly 2 to 3 times to clean all four areas.

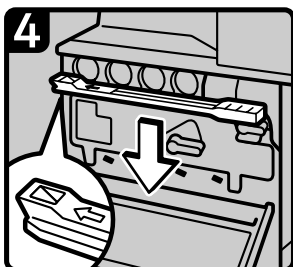

- Return the cleaning brush to its original position, and then close the front cover.
- Plug in the power cable, and then turn on the power switch.

8

### Note

- Insert the cleaning stick so that its rubber surface is pointing down.

AQE031S

# INDEX

## A

---

- Access to the Machine, 121
- Adding
  - Paper*, 79
  - Staples*, 98
  - Toner*, 89
- Adding Staples
  - Booklet Finisher SR3020*, 99, 100
  - Finisher SR3030*, 99
  - Finisher SR790*, 98
- Adjusting the Colour Registration, 92
- Adjusting the Volume, 31
- Alert Messages, 52
- Auto Colour Calibration, 94
- Auto Document Feeder (ADF), 123

## B

---

- Booklet Finisher SR3020, 99, 100, 112, 113, 114

## C

---

- Cannot Browse
  - the Network to Send a Scan File, 66
- Cannot Make Clear Copies, 23
- Cannot Make Copies As Wanted, 25
- Cannot Print, 54
- Cannot Send or
  - Receive Fax Messages as Wanted, 40
- Cannot Send Scanned Files, 66
- Changing the Paper Size, 83
- Changing the Paper Size
  - in the Paper Tray, 84
- Changing to a Size That is Not
  - Automatically Detected, 86
- Checking Machine Status and Settings, 5
- Checking the Error Log, 53
- Cleaning
  - Auto Document Feeder*, 123
  - Dustproof Glass*, 124
  - Exposure Glass*, 122
  - Exposure Glass Cover*, 123
  - Scanning Glass*, 122
- Clearing Misfeeds, 103
- Colour Registration, 92
- Combine, 25
- Copy Function, 19

## D

---

- Data Storage, 5
- Document Server, 9
- Duplex, 25
- Dustproof Glass, 124

## E

---

- Edit, 25
- End fence, 84
- Enquiry, 5
- Environment, 117
- Environments to avoid, 118
- Error Log, 53
- Error Mail Notification, 46
- Error Occurs Using Internet Fax, 46
- Error Report (E-Mail), 46
- Exposure Glass, 122
- Exposure Glass Cover, 123

## F

---

- Facsimile Function, 31
- Finisher, 114
- Finisher SR3030, 99, 112, 114
- Finisher SR790, 98, 111

## H

---

- How to Read This Manual, 1

## I

---

- If an Error Report is Printed, 44
- If USB Connection Fails, 50
- Indicators, 3
- Inserting Toner, 90

## J

---

- Job is Not Performed, 14

## L

---

- LCT, 81
- Letterhead, 82
- Loading Paper, 79
- Loading Paper
  - into the Large Capacity Tray, 81
- Loading Paper into the Paper Trays, 80
- Locating Jammed Paper, 104

## M

---

Machine Address Info, 5  
Machine environment, 117  
Maintaining Your Machine, 122  
Maintenance, 92  
Maintenance Info, 5  
Manuals for This Machine, i  
Memory is Full, 29  
Moving, 119  
Multi-accessing, 14

## N

---

Names of Major Options, 2  
Network Delivery  
Function Cannot be Used, 67

## O

---

Operations are Not Possible  
When Messages Appear, 67  
Optimum environmental conditions, 117  
Orientation-Fixed Paper  
or Two-Sided Paper, 82  
Other Printing Problems, 57

## P

---

Panel Tone, 4  
PictBridge, 63  
PictBridge Printing Does Not Work, 63  
Power connection, 120  
Printer Function, 47  
Printing, 40  
Problems Operating the Machine, 9  
Punch, 114  
Punch waste, 114

## R

---

Reception, 40  
Removing Jammed Paper, 103, 105  
Removing Jammed Staples, 111  
*Booklet Finisher SR3020*, 112, 113  
*Finisher SR3030*, 112  
*Finisher SR790*, 111  
Removing Punch Waste  
*Booklet Finisher SR3020*, 114  
*Finisher SR3030*, 114  
Replacing the Stamp Cartridge, 101  
Returning to the Previous Setting, 97

## S

---

Scanner Function, 65  
Scanning Glass, 122  
Scanning is Not Done as Expected, 65  
Sending Faxes or Scanned Documents  
When Toner Has Run Out, 91  
Server-Generated Error E-mail, 46  
Side fences, 84  
Stamp, 25  
Stamp Cartridge, 101  
Status Messages, 51  
Stored Files Cannot Be Accessed, 66  
Stored Files Cannot be Edited, 67

## T

---

Toner, 89  
Transmission, 40  
Transmission/Reception, 40  
Troubleshooting  
*Copy Function*, 19  
*Facsimile Function*, 31  
*Printer Function*, 47  
*Scanner Function*, 65  
Turning Off the Main Power  
/ In the Event of Power Failure, 45  
TWAIN, 66, 75  
TWAIN Driver Cannot be Started, 66

## U

---

Used Toner, 91

## W

---

When a Message Appears  
*Copy Function*, 19  
*Facsimile Function*, 33  
*Printer Function*, 51  
*Scanner Function*, 68  
*Scanner Function (Client Computer)*, 75  
When a Message Appears during  
Installation of the Printer Driver, 47  
When an Indicator  
to the Right of a Function Key is Lit, 8  
When Memory is Full, 43  
When the Machine  
Does Not Operate As wanted, 3  
When Toner Remains, 91  
Windows 2000, 48  
Windows 95/98/Me, 47  
Windows NT 4.0, 49  
Windows Server 2003, 48  
Windows XP, 48

In accordance with IEC 60417, this machine uses the following symbols for the main power switch:

**I** means **POWER ON.**

**○** means **POWER OFF.**

**⏻** means **STAND BY.**

