

**816/816f/816mf**  
DSm416/DSm416f/DSm416pf  
LD016/LD016f/LD016spf

**Aficio™** MP 161/161F/161SPF

# Operating Instructions General Settings Guide



- 
- 1** Connecting the Machine
  - 2** System Settings
  - 3** Copier Features
  - 4** Fax Features
  - 5** Printer Features
  - 6** Scanner Features
  - 7** Registering Addresses and Users for Facsimile/Scanner Functions
  - 8** Other User Tools
  - 9** Appendix

---

Read this manual carefully before you use this machine and keep it handy for future reference. For safe and correct use, be sure to read the Safety Information in "About This Machine" before using the machine.

## **Introduction**

This manual contains detailed instructions and notes on the operation and use of this machine. For your safety and benefit, read this manual carefully before using the machine. Keep this manual in a handy place for quick reference.

## **Important**

Contents of this manual are subject to change without prior notice. In no event will the company be liable for direct, indirect, special, incidental, or consequential damages as a result of handling or operating the machine.

## **Notes:**

Some illustrations in this manual might be slightly different from the machine.

Certain options might not be available in some countries. For details, please contact your local dealer.

Depending on which country you are in, certain units may be optional. For details, please contact your local dealer.

## **Caution:**

Use of controls or adjustments or performance of procedures other than those specified in this manual might result in hazardous radiation exposure.

Two kinds of size notation are employed in this manual. With this machine refer to the inch version.

# Manuals for This Machine

Refer to the manuals that are relevant to what you want to do with the machine. Manuals for machines with copier function only or with the DDST Unit are different. See "Manuals for Machines with Copier Function Only or with the DDST Unit".

## Important

- Media differ according to manual.
- The printed and electronic versions of a manual have the same contents.
- Adobe Acrobat Reader/Adobe Reader must be installed in order to view the manuals as PDF files.
- Depending on which country you are in, there may also be html manuals. To view these manuals, a Web browser must be installed.

## ❖ About This Machine

Be sure to read the Safety Information in this manual before using the machine.

This manual provides an introduction to the functions of the machine. It also explains the control panel, preparation procedures for using the machine, how to enter text, and how to install the CD-ROMs provided.

## ❖ General Settings Guide

Explains User Tools settings, and Address Book procedures such as registering fax numbers, e-mail addresses, and user codes. Also refer to this manual for explanations on how to connect the machine.

## ❖ Troubleshooting

Provides a guide to solving common problems, and explains how to replace paper, toner, and other consumables.

## ❖ Security Reference

This manual is for administrators of the machine. It explains security functions that the administrators can use to protect data from being tampered with, or prevent the machine from unauthorized use.

Also refer to this manual for the procedures for registering administrators, as well as setting user and administrator authentication.

## ❖ Copy Reference

Explains Copier functions and operations. Also refer to this manual for explanations on how to place originals.

## ❖ Facsimile Reference

Explains Facsimile functions and operations.

## ❖ Printer Reference

Explains Printer functions and operations.

## ❖ Scanner Reference

Explains Scanner functions and operations.

## ❖ Network Guide

Explains how to configure and operate the machine in a network environment, and use the software provided.

This manual covers all models, and includes descriptions of functions and settings that might not be available on this machine. Images, illustrations, and information about operating systems that are supported might also differ slightly from those of this machine.

## ❖ Other manuals

- PostScript3 Supplement
- UNIX Supplement
- Manuals for DeskTopBinder Lite:  
DeskTopBinder Lite Setup Guide  
DeskTopBinder Introduction Guide  
Auto Document Link Guide

## Note

- ❑ Manuals provided are specific to machine types.
- ❑ For "UNIX Supplement", please visit our Web site or consult an authorized dealer.
- ❑ "PostScript3 Supplement" and "UNIX Supplement" include descriptions of functions and settings that might not be available on this machine.

The following software products are referred to using general names:

Product name	General name
DeskTopBinder Lite and DeskTopBinder Professional <sup>*1</sup>	DeskTopBinder
ScanRouter EX Professional <sup>*1</sup> and ScanRouter EX Enterprise <sup>*1</sup>	the ScanRouter delivery software

<sup>\*1</sup>Optional

## Reference

p.iii "Manuals for Machines with Copier Function Only or with the DDST Unit"

---

## Manuals for Machines with Copier Function Only or with the DDST Unit

---

This section describes the manuals for machines with copier function only or with the DDST Unit.

### ❖ **About This Machine**

Be sure to read the Safety Information in this manual before using the machine.

This manual provides an introduction to the functions of the machine. It also explains the control panel, preparation procedures for using the machine, and how to install the CD-ROMs provided.

### ❖ **General Settings Guide**

Explains User Tools settings. Also refer to this manual for explanations on how to register user codes.

### ❖ **Troubleshooting**

Provides a guide to solving common problems, and explains how to replace paper, toner, and other consumables.

### ❖ **Copy Reference**

Explains Copier functions and operations. Also refer to this manual for explanations on how to place originals.

### ❖ **Printer/Scanner Reference**

Explains system settings, functions and operations for the machine's printer/scanner unit. Also refer to this manual for explanations on how to connect the machine.

### ❖ **Network Guide**

Explains how to configure and operate the machine in a network environment, and use the software provided.

### **Note**

- ❑ Some manuals include descriptions of functions and settings that are not available on machines with copier function only or with the DDST Unit.

# TABLE OF CONTENTS

<b>Manuals for This Machine</b> .....	<b>i</b>
Manuals for Machines with Copier Function Only or with the DDST Unit .....	iii
<b>How to Read This Manual</b> .....	<b>1</b>
Symbols .....	1
<b>Display Panel</b> .....	<b>2</b>
Reading the Display and Using Keys.....	3
<b>Accessing User Tools</b> .....	<b>4</b>
Changing Default Settings .....	4
Exiting User Tools .....	5
Menu Protect.....	5
Changing Default Settings Using Web Image Monitor.....	6

## 1. Connecting the Machine

---

<b>Connecting to the Interfaces</b> .....	<b>7</b>
Connecting to the Ethernet Interface .....	8
Connecting to the USB Interface.....	10
Connecting to the IEEE 1284 Interface.....	11
Connecting to the IEEE 802.11b (Wireless LAN) Interface.....	12
<b>Network Settings</b> .....	<b>15</b>
Settings Required to Use the Printer/LAN-Fax .....	15
Settings Required to Use Internet Fax .....	18
Settings Required to Use E-mail Function .....	21
Settings Required to Use Scan to Folder Function .....	23
Settings Required to Use the Network Delivery Scanner.....	25
Settings Required to Use Network TWAIN Scanner .....	27
Using Utilities to Make Network Settings .....	29
<b>Connecting the Machine to a Telephone Line and Telephone</b> .....	<b>37</b>
Connecting the Telephone Line .....	37
Selecting the Line Type.....	38
Connecting the Optional Handset or an External Telephone.....	38

## 2. System Settings

---

<b>General Features</b> .....	<b>41</b>
<b>Tray Paper Settings</b> .....	<b>44</b>
<b>Timer Settings</b> .....	<b>46</b>
<b>Interface Settings</b> .....	<b>48</b>
Network.....	48
Parallel Interface .....	52
IEEE 802.11b .....	53
Print I/F Settings List .....	54
<b>File Transfer</b> .....	<b>55</b>
<b>Administrator Tools</b> .....	<b>59</b>
Program/Change/Delete LDAP Server .....	64
Programming the LDAP Server.....	66
<b>Key Operator Tools</b> <b>(For machines with copier function only or with the DDST Unit)</b> .....	<b>72</b>

<b>User Code</b>	
<b>(For machines with copier function only or with the DDST Unit)</b> .....	<b>74</b>
Registering a User Code.....	74
Changing a User Code.....	75
Deleting a User Code.....	76
Displaying the Counter for Each User Code .....	78
Printing the Counter for Each User Code.....	79
Clearing the Number of Prints.....	80

### 3. Copier Features

---

<b>Copier Features</b> .....	<b>81</b>
------------------------------	-----------

### 4. Fax Features

---

<b>General Settings/Adjust</b> .....	<b>85</b>
<b>Reception Settings</b> .....	<b>87</b>
<b>E-mail Settings</b> .....	<b>88</b>
<b>IP-Fax Settings</b> .....	<b>90</b>
<b>Administrator Tools</b> .....	<b>93</b>
<b>Registering Fax Information</b> .....	<b>97</b>
Registering Fax Information .....	98
Deleting Fax Information .....	101
<b>Forwarding</b> .....	<b>103</b>
Programming an End Receiver .....	104
Canceling Receiver Settings .....	105
Printing a Forwarding Mark .....	106
<b>Parameter Setting</b> .....	<b>107</b>
Changing the User Parameters.....	110
Printing the Parameter Settings List.....	112
<b>Home Position</b> .....	<b>113</b>
Changing the Home Position .....	115
<b>Program Special Sender</b> .....	<b>117</b>
Authorized Reception.....	118
Forwarding .....	119
Memory Lock.....	119
Programming/Changing Special Senders .....	120
Authorized RX (Authorized Reception) .....	122
Forwarding .....	122
Memory Lock.....	124
Programming Initial Set Up of a Special Sender .....	124
Deleting a Special Sender.....	125
Printing Special Sender List .....	127

### 5. Printer Features

---

<b>List/Test Print</b> .....	<b>129</b>
Printing the List/Test page .....	130
<b>Maintenance</b> .....	<b>131</b>
<b>System</b> .....	<b>132</b>
<b>Host Interface</b> .....	<b>135</b>
<b>PCL Menu</b> .....	<b>136</b>

<b>PS Menu</b> .....	<b>138</b>
<b>PDF Menu</b> .....	<b>139</b>

## **6. Scanner Features**

---

<b>Scan Settings</b> .....	<b>141</b>
<b>Destination List Settings</b> .....	<b>143</b>
<b>Send Settings</b> .....	<b>144</b>

## **7. Registering Addresses and Users for Facsimile/Scanner Functions**

---

<b>Address Book</b> .....	<b>147</b>
Managing names in the Address Book .....	150
Sending fax by Quick Dial .....	150
Sending e-mail by Quick Dial .....	150
Sending scanned files to a shared folder directly.....	150
Preventing unauthorized user access to shared folders from the machine .....	151
Managing users and machine usage .....	151
<b>Registering Names</b> .....	<b>152</b>
Registering Names.....	152
Changing a Registered Name.....	154
Deleting a Registered Name .....	156
<b>Authentication Information</b> .....	<b>158</b>
Registering a User Code .....	158
Changing a User Code.....	161
Deleting a User Code.....	164
Displaying the Counter for Each User.....	166
Printing the Counter for Each User .....	168
Printing the Counter for All User .....	170
Clearing the Number of Prints.....	171
<b>Fax Destination</b> .....	<b>174</b>
Fax Destination .....	176
IP-Fax Destination.....	188
<b>E-mail Destination</b> .....	<b>196</b>
Registering E-mail Destination.....	196
Changing a Registered E-mail Destination .....	199
Deleting a Registered E-mail Destination .....	202
<b>Registering Folders</b> .....	<b>205</b>
Using SMB to Connect.....	205
Using FTP to Connect.....	219
Using NCP to Connect.....	230
<b>Registering Names to a Group</b> .....	<b>244</b>
Registering a New Group.....	244
Registering Names to a Group.....	246
Adding a Group to Another Group .....	248
Displaying Names Registered in Groups .....	250
Removing a Name from a Group .....	252
Deleting a Group within Another Group .....	254
Changing a Group Name .....	256
Deleting a Group.....	258



<b>Registering a Protection Code .....</b>	<b>260</b>
Registering a Protection Code to a Single User.....	260
Registering a Protection Code to a Group User.....	264
<b>Registering SMTP and LDAP Authentication.....</b>	<b>267</b>
SMTP Authentication .....	267
LDAP authentication .....	271
<b>Searching.....</b>	<b>275</b>
Searching by Name.....	275
Searching from the List .....	276
Searching by Registration Number .....	277
Searching by User Code .....	278
Searching by Fax Number .....	279
Searching by E-mail Address.....	280
Searching by Destination Folder Name .....	281
<b>Using Web Image Monitor.....</b>	<b>282</b>
<b>8. Other User Tools</b>	
<hr/>	
<b>Changing the Display Language .....</b>	<b>283</b>
<b>Counter .....</b>	<b>284</b>
Displaying the Total Counter.....	284
<b>9. Appendix</b>	
<hr/>	
<b>Copyright Information about Installed Software.....</b>	<b>285</b>
expat .....	285
NetBSD .....	286
Sablotron.....	288
JPEG LIBRARY .....	288
SASL.....	289
MD4.....	290
MD5.....	290
Samba(Ver 3.0.4).....	291
RSA BSAFE® .....	291
Open SSL.....	292
Open SSH.....	294
Open LDAP.....	299
<b>INDEX.....</b>	<b>301</b>



# How to Read This Manual

---

## Symbols

---

This manual uses the following symbols:

 **WARNING:**

Indicates important safety notes.

Ignoring these notes could result in serious injury or death. Be sure to read these notes. They can be found in the "Safety Information" section of About This Machine.

 **CAUTION:**

Indicates important safety notes.

Ignoring these notes could result in moderate or minor injury, or damage to the machine or to property. Be sure to read these notes. They can be found in the "Safety Information" section of About This Machine.

 **Important**

Indicates points to pay attention to when using the machine, and explanations of likely causes of paper misfeeds, damage to originals, or loss of data. Be sure to read these explanations.

This symbol indicates information or preparations required prior to operating.

 **Note**

Indicates supplementary explanations of the machine's functions, and instructions on resolving user errors.

 **Reference**

This symbol is located at the end of sections. It indicates where you can find further relevant information.

**[ ]**

Indicates the names of keys that appear on the machine's display panel.

**[ ]**

Indicates the names of keys on the machine's control panel.

# Display Panel

The display panel shows machine status, error messages, and function menus.

## Important

- ❑ A force or impact of more than 30 N (about 3 kgf) will damage the display panel.

Using the System Settings menu screen as an example, this section explains how to use the machine's display panel.

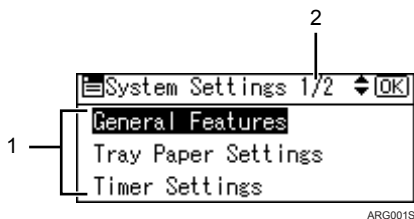

**1.** The settings menu appears. Press the [▲] or [▼] key to scroll to the setting you want to specify or change, and then press the [OK] key to display the screen for specifying that setting.

**2.** The number of pages in the displayed settings menu appears. If you cannot see the entire menu, press the [▲] or [▼] key to scroll the screen.

---

## Reading the Display and Using Keys

---

This section explains how to read the display and use the Selection keys.

Using the Machine IPv4 Address setting screen as an example, this section explains how to use the machine's control panel.

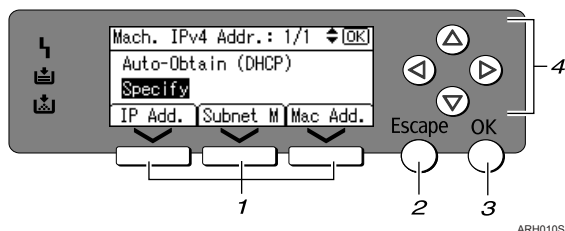

### 1. Selection keys

Correspond to items at the bottom line on the display.

- When the instruction "press **[IP Add.]**" appears in this manual, press the left selection key.
- When the instruction "press **[Subnet M]**" appears in this manual, press the center selection key.
- When the instruction "press **[Mac Add.]**" appears in this manual, press the right selection key.

### 2. [Escape] key

Press to cancel an operation or return to the previous display.

### 3. [OK] key

Press to set a selected item or an entered numeric value.

### 4. Scroll keys

Press to move the cursor in each direction, step by step.

When the **[▲]**, **[▼]**, **[▶]** or **[◀]** key appears in this manual, press the scroll key of the same direction.

# Accessing User Tools

User Tools allow you to change or set defaults.

## Note

- ❑ Operations for system settings differ from normal operations. Always quit User Tools when you have finished.
- ❑ Any changes you make with User Tools remain in effect even if the main power switch or operation switch is turned off, or **[Clear Modes]** key is pressed.

## Reference

p.4 “Changing Default Settings”

---

## Changing Default Settings

---

This section describes how to change the settings of User Tools.

## Important

- ❑ If Administrator Authentication Management is specified, contact your administrator.

**1** Press the **[User Tools/Counter]** key.

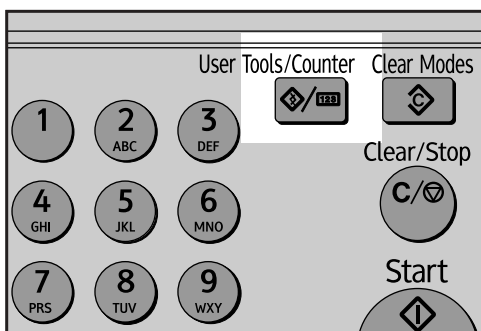

**2** Select the menu using **[▲]** or **[▼]**, and then press the **[OK]** key.

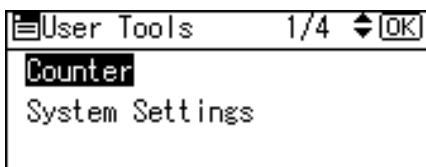

To change the System Settings, select **[System Settings]**.

To change the Copier Features, select **[Copier Features]**.

To change the Fax Features, select **[Fax Features]**.

To change the Printer Features, select **[Printer Features]**.

To change the Scanner Features, select **[Scanner Features]**.

To change the language used on the display, select **[Language]**.

To check the counter, select **[Counter]**.

- 3** Select the item using [▲] or [▼], and then press the [OK] key.

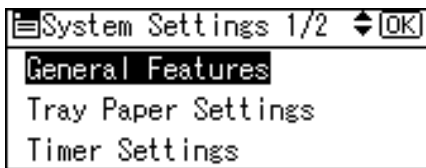

- 4** Change settings by following instructions on the display, and then press the [OK] key.

 **Note**

- Press the [Escape] key to return to the previous display.
- To discontinue the operation and return to the initial display, press the [User Tools/Counter] key.

---

## Exiting User Tools

---

This section describes how to end User Tools.

- 1** Press the [User Tools/Counter] key.

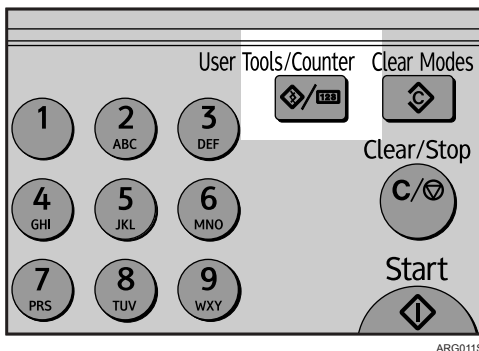

---

## Menu Protect

---

Using Menu Protect, you can prevent unauthenticated users from changing the user tools. Menu Protect can be specified for each of the following user tools menus.

- Copier Features
- Fax Features
- Printer Features
- Scanner Features

For details, consult your administrator.

---

## Changing Default Settings Using Web Image Monitor

---

This section describes how to access the Web Image Monitor.

You can also change the settings of this machine using Web Image Monitor.

**1** Start your Web browser.

**2** Enter "http://(machine's address)/" in the address bar of a Web browser.

Top page of Web Image Monitor appears.

If the machine's host name has been registered on the DNS or WINS server, you can enter it.

When setting SSL, a protocol for encrypted communication, under environment which server authentication is issued, enter "https://(machine's address)/".

**3** Click [Login].

**4** Enter a login user name and password, and then click [Login].

For details about the login user name and password, consult your network administrator.

**5** Click [Configuration].

**6** Click the menu.

**7** Change settings.

For details about how to use Web Image Monitor, see "Using Web Image Monitor", Network Guide and Web Image Monitor Help.



# 1. Connecting the Machine

This chapter describes how to connect the machine to the network and specify the network settings.

## Connecting to the Interfaces

This section explains how to identify the machine's interface and connect the machine according to the network environment.

For machines with the DDST Unit, see "Confirming Connection", Network Guide, and "Connecting the machine", Printer/Scanner Reference.

When the IEEE 1284 interface board (optional) is installed.

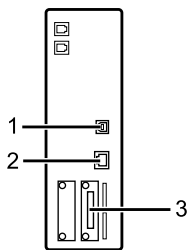

When the wireless LAN board (optional) is installed.

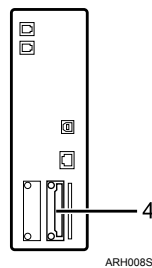

### 1. USB port

Port for connecting the USB 2.0 cable

### 2. 10BASE-T/100BASE-TX port

Port for connecting the 10BASE-T or 100BASE-TX cable

### 3. IEEE 1284 port (optional)

Port for connecting the IEEE 1284 interface cable

### 4. IEEE 802.11b (Wireless LAN) port (optional)

Port for using the wireless LAN

### Note

- ❑ You cannot install two or more of the following options: IEEE 802.11b (wireless LAN) board, IEEE 1284 interface board.

### Reference

"Confirming Connection", Network Guide

"Connecting the machine", Printer/Scanner Reference

## Connecting to the Ethernet Interface

This section describes how to connect 10BASE-T or 100BASE-TX cable to the Ethernet interface.

1

### Important

If the main power switch is on, turn it off.

**1** A ferrite core for the Ethernet cable is supplied with this machine. Make a loop in the cable about 3 cm (1.2 inch) (1) from the machine end of the cable. Attach the ferrite core.

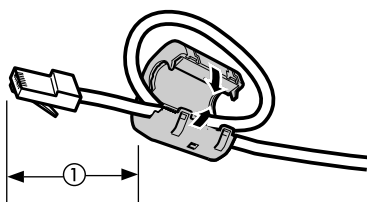

ARH009S

**2** Make sure the main power switch of the machine is off.

**3** Connect the Ethernet interface cable to the 10BASE-T/100BASE-TX port.

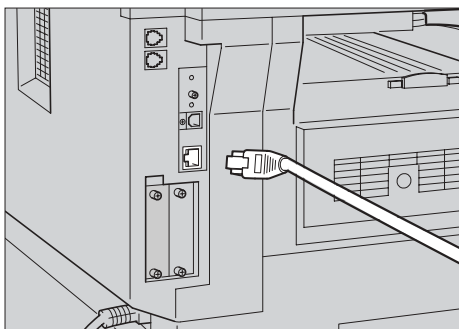

ARH005S

**4** Connect the other end of the Ethernet cable to a network connection device such as a hub.

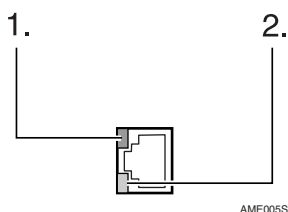
**5** Turn on the main power switch of the machine.

- ① Indicator (green)  
Lights up green when the machine is connected correctly to the network.
- ② Indicator (yellow)  
Lights up yellow when 100 BASE-TX is in operation. Goes off when 10 BASE-T is in operation.

**Note**

- For details about installing the printer driver, see "Preparing the Machine", Printer Reference.

**Reference**

- "Turning On the Power" About This Machine
- "Preparing the Machine", Printer Reference

## Connecting to the USB Interface

This section describes how to connect the USB2.0 interface cable to the USB2.0 port.

1

### 1 Connect the USB 2.0 interface cable to the USB 2.0 port.

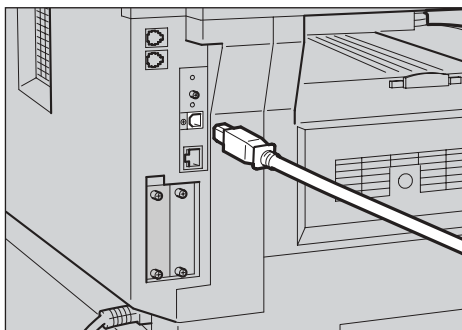

ARH004S

### 2 Connect the other end to the USB port on the host computer.

#### Note

- This machine does not come with a USB interface cable. Make sure you purchase the appropriate cable for the machine and your computer.
- The USB 2.0 interface board is supported by Windows Me / 2000 / XP, Windows Server 2003, Mac OS X10.3.3 or higher.
  - For Windows Me:  
Make sure to install "USB Printing Support". When used with Windows Me, only a speed equal to that of USB 1.1 is possible.
  - For Mac OS:  
To use Macintosh, the machine must be equipped with the optional PostScript 3 unit. When used with Mac OS X10.3.3 or higher, a transfer speed of USB 2.0 is supported.
- For details about installing the printer driver, see "Preparing the Machine", Printer Reference.

#### Reference

"Preparing the Machine", Printer Reference

---

## Connecting to the IEEE 1284 Interface

---

This section describes how to connect the IEEE 1284 interface cable to the IEEE 1284 interface board.

- 1** Make sure the main power switch on the machine is off.  
If the main power switch is on, turn it off.
- 2** Turn off the main power switch of the host computer.
- 3** Connect the IEEE 1284 interface cable to the IEEE 1284 port.

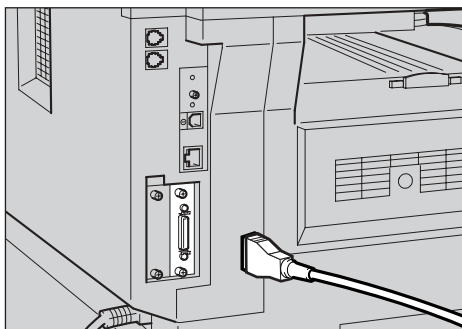

- 4** Connect the other end of the cable into the interface connector on the host computer.  
Check the shape of the connector to the computer. Connect the cable firmly.
- 5** Turn on the main power switch of the machine.
- 6** Turn on the host computer.

When using Windows 95/98/Me/2000/XP and Windows Server 2003, a printer driver installation screen might appear when the computer is turned on. If this happens, click **[Cancel]** on the screen.

 **Note**

- For details about installing the printer driver, see "Preparing the Machine", Printer Reference.

 **Reference**

- "Turning On the Power" About This Machine
- "Preparing the Machine", Printer Reference

## Connecting to the IEEE 802.11b (Wireless LAN) Interface

This section describes how to connect to the IEEE 802.11b (wireless LAN) interface.

### Note

- ❑ Check the settings of the IPv4 address and subnet mask of this machine.
- ❑ For details about how to set the IPv4 address and subnet mask from the control panel of the machine, see "Interface Settings".
- ❑ Before using this machine with an IEEE 802.11b (Wireless LAN) connection, you must select **[IEEE 802.11b]** in **[LAN Type]**.

### Reference

p.48 "Network"

## Setup Procedure

This section describes how to setup IEEE 802.11b (wireless LAN) interface. Set up IEEE 802.11b (wireless LAN) according to the following procedure:

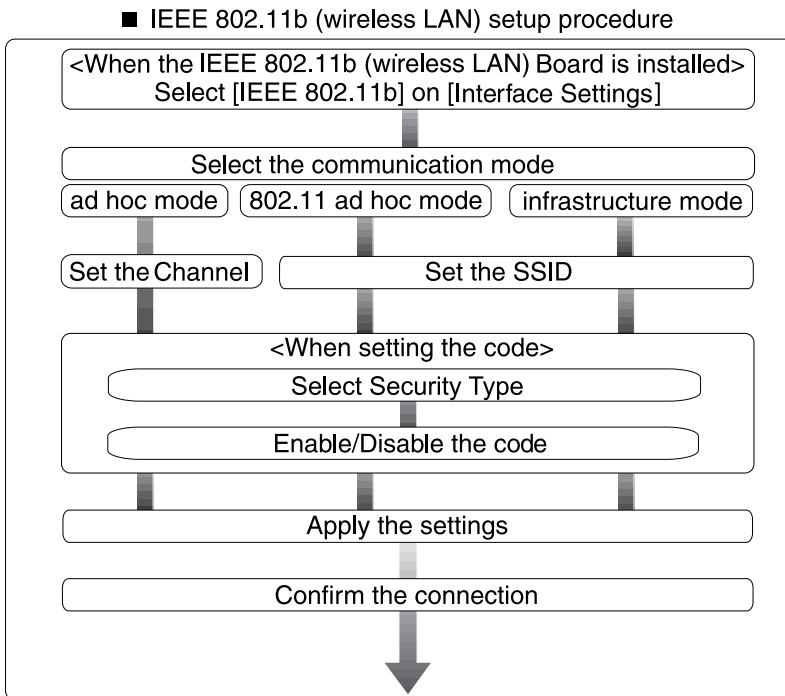

ARH007S

**Note**

- Select **[802.11 Ad hoc]** mode when connecting Windows XP as a wireless LAN client using Windows XP standard driver or utilities, or when not using the infrastructure mode.
- For details about how to specify wireless LAN settings from the control panel on the machine, see "IEEE 802.11b".
- For details about how to specify wireless LAN settings from other than the control panel on the machine, see "Using Utilities to Make Network Settings".
- For details about the setting items, see "IEEE 802.11b".

**Reference**

p.53 "IEEE 802.11b"

p.29 "Using Utilities to Make Network Settings"

**Checking the Connection**

Check the wireless LAN connection.

Make sure the LED of the IEEE 802.11b interface unit is lit.

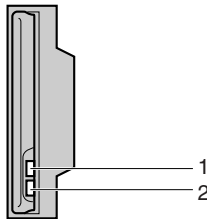
**❖ When using in infrastructure mode**

ZGDH600J

1. If **[LAN Type]** on the **[Interface Settings]** / **[Network]** screen is not set to **[IEEE 802.11b]**, it does not light, even if the main power is on.
2. If it is connected properly to the network, the LED is green when in infrastructure mode. If the LED is blinking, the machine is searching for devices.

❖ When using in ad hoc mode / 802.11 ad hoc mode

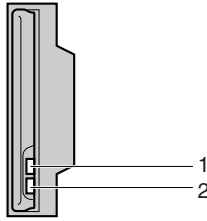

ZGDH600J

- 1. If the IEEE 802.11b interface unit is functioning, the LED lights up in orange.
- 2. If it is connected properly to the network, the LED is green when in ad hoc mode or 802.11 ad hoc mode. If the LED is blinking, the machine is searching for devices. The LED will light after a few seconds.

Print the configuration page to verify settings.

 **Note**

- For details about printing a configuration page, see "Print I/F Settings".

 **Reference**

p.54 "Print I/F Settings List"

---

## Checking the Signal

---

This section describes how to check the machine's radio wave status.

When using in infrastructure mode, you can check the machine's radio wave status using the control panel.

- ① Select **[System Settings]** using **[▲]** or **[▼]**, and then press the **[OK]** key.
- ② Select **[Interface Settings]** using **[▲]** or **[▼]**, and then press the **[OK]** key.
- ③ Select **[IEEE 802.11b]** using **[▲]** or **[▼]**, and then press the **[OK]** key.
- ④ Select **[Wireless LAN Signal]** using **[▲]** or **[▼]**, and then press the **[OK]** key. The machine's radio wave status appears.
- ⑤ After checking radio wave status, press the **[OK]** key.
- ⑥ Press the **[User Tools/Counter]** key to return to the User Tools/Counter menu.

 **Note**

- For the procedure of entering the System Settings, see "Accessing User Tools".

 **Reference**

p.4 "Accessing User Tools"  
p.29 "Using Utilities to Make Network Settings"  
p.53 "IEEE 802.11b"



# Network Settings

This section describes the network settings you can change with User Tools (System Settings). Make settings according to functions you want to use and the interface to be connected.

For machines with the DDST Unit, see "User Tools Menu (Interface Settings)", Network Guide.

## Important

- These settings should be made by the system administrator, or with the advice the system administrator.

## Reference

"User Tools Menu (Interface Settings)", Network Guide.

---

## Settings Required to Use the Printer/LAN-Fax

---

This section lists the settings required for using the printer or LAN-Fax function.

---

### Ethernet

---

This section lists the settings required for using the printer or LAN-Fax function with an Ethernet connection.

For details about how to specify the settings, see "Interface Settings".

Menu	User Tool	Setting Requirements
Interface Settings/Network	Machine IPv4 Address	Necessary
Interface Settings/Network	IPv4 Gateway Address	As required
Interface Settings/Network	Machine IPv6 Address	As required
Interface Settings/Network	IPv6 Gateway Address	As required
Interface Settings/Network	IPv6 Stateless Setting	As required
Interface Settings/Network	DNS Configuration	As required
Interface Settings/Network	DDNS Configuration	As required
Interface Settings/Network	Domain Name	As required
Interface Settings/Network	WINS Configuration	As required
Interface Settings/Network	Effective Protocol	Necessary
Interface Settings/Network	NCP Delivery Protocol	As required
Interface Settings/Network	NW Frame Type	As required
Interface Settings/Network	SMB Computer Name	As required
Interface Settings/Network	SMB Work Group	As required
Interface Settings/Network	Ethernet Speed	As required
Interface Settings/Network	LAN Type	Necessary

Menu	User Tool	Setting Requirements
Interface Settings/Network	Permit SNMPv3 Communicatn.	As required
Interface Settings/Network	Permit SSL/TLS Comm.	As required
Interface Settings/Network	Host Name	As required
Interface Settings/Network	Machine Name	As required

### Note

- IPv6 can be used only for the printer function.
- For the Effective Protocol setting, check that the protocol you want to use is set to **[Active]**.
- [LAN Type]** is displayed when the wireless LAN board is installed. If Ethernet and IEEE 802.11b (wireless LAN) are both connected, the selected interface has priority.

### Reference

p.48 "Interface Settings"

---

## IEEE 802.11b (wireless LAN)

---

This section lists the settings required for using the printer or LAN-Fax function with IEEE 802.11b (wireless LAN).

For details about how to specify the settings, see "Interface Settings".

Menu	User Tool	Setting Requirements
Interface Settings/Network	Machine IPv4 Address	Necessary
Interface Settings/Network	IPv4 Gateway Address	As required
Interface Settings/Network	Machine IPv6 Address	As required
Interface Settings/Network	IPv6 Gateway Address	As required
Interface Settings/Network	IPv6 Stateless Setting	As required
Interface Settings/Network	DNS Configuration	As required
Interface Settings/Network	DDNS Configuration	As required
Interface Settings/Network	Domain Name	As required
Interface Settings/Network	WINS Configuration	As required
Interface Settings/Network	Effective Protocol	Necessary
Interface Settings/Network	NCP Delivery Protocol	As required
Interface Settings/Network	NW Frame Type	As required
Interface Settings/Network	SMB Computer Name	As required
Interface Settings/Network	SMB Work Group	As required
Interface Settings/Network	LAN Type	Necessary
Interface Settings/Network	Permit SNMPv3 Communicatn.	As required
Interface Settings/Network	Permit SSL/TLS Comm.	As required

Menu	User Tool	Setting Requirements
Interface Settings/Network	Host Name	As required
Interface Settings/Network	Machine Name	As required
Interface Settings/ IEEE 802.11b	Communication Mode	Necessary
Interface Settings/ IEEE 802.11b	SSID Setting	As required
Interface Settings/ IEEE 802.11b	Channel	As required
Interface Settings/ IEEE 802.11b	Security Type	As required
Interface Settings/ IEEE 802.11b	Communication Speed	As required

### Note

- For the Effective Protocol setting, check that the protocol you want to use is set to **[Active]**.
- [IEEE 802.11b]** and **[LAN Type]** are displayed when the wireless LAN interface board is installed. If both Ethernet and wireless LAN (IEEE 802.11b) are connected, the selected interface takes precedence.

### Reference

p.48 “Interface Settings”

## Settings Required to Use Internet Fax

This section lists the settings required for using Internet Fax.

### Ethernet

This section lists the settings required for using Internet FAX.

For details about how to specify the settings, see "Interface Settings" and "File Transfer".

Menu	User Tool	Setting Requirements
Interface Settings/Network	Machine IPv4 Address	Necessary
Interface Settings/Network	IPv4 Gateway Address	Necessary
Interface Settings/Network	DNS Configuration	As required
Interface Settings/Network	DDNS Configuration	As required
Interface Settings/Network	Domain Name	As required
Interface Settings/Network	WINS Configuration	As required
Interface Settings/Network	Effective Protocol	Necessary
Interface Settings/Network	Ethernet Speed	As required
Interface Settings/Network	LAN Type	Necessary
Interface Settings/Network	Permit SNMPv3 Communicatn.	As required
Interface Settings/Network	Permit SSL/TLS Comm.	As required
Interface Settings/Network	Host Name	As required
File Transfer	SMTP Server	Necessary
File Transfer	SMTP Authentication	As required
File Transfer	POP before SMTP	As required
File Transfer	Reception Protocol	As required
File Transfer	POP3/IMAP4 Settings	As required
File Transfer	Admin. E-mail Address	As required
File Transfer	E-mail Communication Port	Necessary
File Transfer	E-mail Recept. Interval	As required
File Transfer	Max. Recept. E-mail Size	As required
File Transfer	E-mail Storage in Server	As required
File Transfer	Fax E-mail Account	Necessary

 **Note**

- For the Effective Protocol setting, check that the protocol you want to use is set to **[Active]**.
- [LAN Type]** is displayed when the wireless LAN interface board is installed. If both Ethernet and wireless LAN (IEEE 802.11b) are connected, the selected interface takes precedence.
- SMTP Server and Fax E-mail Account must be specified in order to use the send function.
- When POP before SMTP is set to **[On]**, also make setting for Reception Protocol and POP3/IMAP4 Settings.
- When SMTP Authentication is set to **[On]**, also make setting for Admin. E-mail Address.
- E-mail Communication Port and Fax E-mail Account must be specified in order to use the reception function.
- When setting POP before SMTP to **[On]**, check POP3 port number in E-mail Communication Port.

 **Reference**

p.48 "Interface Settings"

p.55 "File Transfer"

---

**IEEE 802.11b (wireless LAN)**

---

This section lists the settings required for using Internet FAX with IEEE 802.11b (wireless LAN).

For details about how to specify the settings, see "Interface Settings" and "File Transfer".

Menu	User Tool	Setting Requirements
Interface Settings/Network	Machine IPv4 Address	Necessary
Interface Settings/Network	IPv4 Gateway Address	Necessary
Interface Settings/Network	DNS Configuration	As required
Interface Settings/Network	DDNS Configuration	As required
Interface Settings/Network	Domain Name	As required
Interface Settings/Network	WINS Configuration	As required
Interface Settings/Network	Effective Protocol	Necessary
Interface Settings/Network	LAN Type	Necessary
Interface Settings/Network	Permit SNMPv3 Communictn.	As required
Interface Settings/Network	Permit SSL/TLS Comm.	As required
Interface Settings/Network	Host Name	As required
Interface Settings/ IEEE 802.11b	Communication Mode	Necessary

Menu	User Tool	Setting Requirements
Interface Settings/ IEEE 802.11b	SSID Setting	As required
Interface Settings/ IEEE 802.11b	Channel	As required
Interface Settings/ IEEE 802.11b	Security Type	As required
Interface Settings/ IEEE 802.11b	Communication Speed	As required
File Transfer	SMTP Server	Necessary
File Transfer	SMTP Authentication	As required
File Transfer	POP before SMTP	As required
File Transfer	Reception Protocol	As required
File Transfer	POP3/IMAP4 settings	As required
File Transfer	Admin. E-mail Address	As required
File Transfer	E-mail Communication Port	Necessary
File Transfer	E-mail Recept. Interval	As required
File Transfer	Max. Recept. E-mail Size	As required
File Transfer	E-mail Storage in Server	As required
File Transfer	Fax E-mail Account	Necessary

### Note

- For the Effective Protocol setting, check that the protocol you want to use is set to **[Active]**.
- [IEEE 802.11b]** and **[LAN Type]** are displayed when the wireless LAN interface board is installed. If both Ethernet and wireless LAN (IEEE 802.11b) are connected, the selected interface takes precedence.
- SMTP Server and Fax E-mail Account must be specified in order to use the send function.
- When POP before SMTP is set to **[On]**, also make setting for Reception Protocol and POP3/IMAP4 Settings.
- When SMTP Authentication is set to **[On]**, also make setting for Admin. E-mail Address.
- E-mail Communication Port and Fax E-mail Account must be specified in order to use the reception function.
- When setting POP before SMTP to **[On]**, check POP3 port number in E-mail Communication Port.

### Reference

p.48 "Interface Settings"

p.55 "File Transfer"

## Settings Required to Use E-mail Function

This section lists the settings required for sending e-mail.

### Ethernet

This section lists the settings required for sending e-mail with Ethernet cable. For details about how to specify the settings, see "Interface Settings" and "File Transfer".

Menu	User Tool	Setting Requirements
Interface Settings/Network	Machine IPv4 Address	Necessary
Interface Settings/Network	IPv4 Gateway Address	Necessary
Interface Settings/Network	DNS Configuration	As required
Interface Settings/Network	DDNS Configuration	As required
Interface Settings/Network	Domain Name	As required
Interface Settings/Network	WINS Configuration	As required
Interface Settings/Network	Effective Protocol	Necessary
Interface Settings/Network	Ethernet Speed	As required
Interface Settings/Network	LAN Type	Necessary
Interface Settings/Network	Permit SNMPv3 Communicatn.	As required
Interface Settings/Network	Host Name	As required
File Transfer	SMTP Server	Necessary
File Transfer	SMTP Authentication	As required
File Transfer	POP before SMTP	As required
File Transfer	Reception Protocol	As required
File Transfer	POP3/IMAP4 Settings	As required
File Transfer	Admin. E-mail Address	As required
File Transfer	E-mail Communication Port	As required

#### Note

- For the Effective Protocol setting, check that the protocol you want to use is set to **[Active]**.
- [LAN Type]** is displayed when the wireless LAN interface board is installed. If both Ethernet and wireless LAN (IEEE 802.11b) are connected, the selected interface takes precedence.
- When POP before SMTP is set to **[On]**, also make setting for Reception Protocol and POP3/IMAP4 Settings.
- When setting POP before SMTP to **[On]**, check POP3 port number in E-mail Communication Port.

## Reference

p.48 "Interface Settings"

p.55 "File Transfer"

1

### IEEE 802.11b (wireless LAN)

This section lists the settings required for sending e-mail with IEEE 802.11b (wireless LAN).

For details about how to specify the settings, see "Interface Settings" and "File Transfer".

Menu	User Tool	Setting Requirements
Interface Settings/Network	Machine IPv4 Address	Necessary
Interface Settings/Network	IPv4 Gateway Address	Necessary
Interface Settings/Network	DNS Configuration	As required
Interface Settings/Network	DDNS Configuration	As required
Interface Settings/Network	Domain Name	As required
Interface Settings/Network	WINS Configuration	As required
Interface Settings/Network	Effective Protocol	Necessary
Interface Settings/Network	LAN Type	Necessary
Interface Settings/Network	Permit SNMPv3 Communicatn.	As required
Interface Settings/Network	Permit SSL/TLS Comm.	As required
Interface Settings/Network	Host Name	As required
Interface Settings/ IEEE 802.11b	Communication Mode	Necessary
Interface Settings/ IEEE 802.11b	SSID Setting	As required
Interface Settings/ IEEE 802.11b	Channel	As required
Interface Settings/ IEEE 802.11b	Security Type	As required
Interface Settings/ IEEE 802.11b	Communication Speed	As required
File Transfer	SMTP Server	Necessary
File Transfer	SMTP Authentication	As required
File Transfer	POP before SMTP	As required
File Transfer	Reception Protocol	As required
File Transfer	POP3/IMAP4 Settings	As required
File Transfer	Admin. E-mail Address	As required
File Transfer	E-mail Communication Port	As required



 **Note**

- For the Effective Protocol setting, check that the protocol you want to use is set to **[Active]**.
- [LAN Type]** is displayed when the wireless LAN interface board is installed. If both Ethernet and wireless LAN (IEEE 802.11b) are connected, the selected interface takes precedence.
- When POP before SMTP is set to **[On]**, also make setting for Reception Protocol and POP3/IMAP4 Settings.
- When setting POP before SMTP to **[On]**, check POP3 port number in E-mail Communication Port.

 **Reference**

p.48 "Interface Settings"

p.55 "File Transfer"

---

## Settings Required to Use Scan to Folder Function

---

This section lists the settings required for sending file.

---

### Ethernet

---

This section lists the settings required for sending file with Ethernet cable.

For details about how to specify the settings, see "Interface Settings" and "File Transfer".

Menu	User Tool	Setting Requirements
Interface Settings/Network	Machine IPv4 Address	Necessary
Interface Settings/Network	IPv4 Gateway Address	Necessary
Interface Settings/Network	DNS Configuration	As required
Interface Settings/Network	DDNS Configuration	As required
Interface Settings/Network	Domain Name	As required
Interface Settings/Network	WINS Configuration	As required
Interface Settings/Network	Effective Protocol	Necessary
Interface Settings/Network	LAN Type	Necessary
Interface Settings/Network	Permit SNMPv3 Communicatn.	As required
Interface Settings/Network	Permit SSL/TLS Comm.	As required
Interface Settings/Network	Host Name	As required
File Transfer	Default User Name/PW(Send)	As required

 **Note**

- For the Effective Protocol setting, check that the protocol you want to use is set to **[Active]**.
- [LAN Type]** is displayed when the wireless LAN interface board is installed. If both Ethernet and wireless LAN (IEEE 802.11b) are connected, the selected interface takes precedence.

 **Reference**

p.48 "Interface Settings"

p.55 "File Transfer"

---

**IEEE 802.11b (wireless LAN)**

---

This section lists the settings required for sending file with IEEE 802.11b (wireless LAN).

For details about how to specify the settings, see "Interface Settings" and "File Transfer".

Menu	User Tool	Setting Requirements
Interface Settings/Network	Machine IPv4 Address	Necessary
Interface Settings/Network	IPv4 Gateway Address	Necessary
Interface Settings/Network	DNS Configuration	As required
Interface Settings/Network	DDNS Configuration	As required
Interface Settings/Network	Domain Name	As required
Interface Settings/Network	WINS Configuration	As required
Interface Settings/Network	Effective Protocol	Necessary
Interface Settings/Network	LAN Type	Necessary
Interface Settings/Network	Permit SNMPv3 Communicatn.	As required
Interface Settings/Network	Permit SSL/TLS Comm.	As required
Interface Settings/Network	Host Name	As required
Interface Settings/ IEEE 802.11b	Communication Mode	Necessary
Interface Settings/ IEEE 802.11b	SSID Setting	As required
Interface Settings/ IEEE 802.11b	Channel	As required
Interface Settings/ IEEE 802.11b	Security Type	As required
Interface Settings/ IEEE 802.11b	Communication Speed	As required
File Transfer	Default User Name/PW(Send)	As required

 **Note**

- For the Effective Protocol setting, check that the protocol you want to use is set to **[Active]**.
- [IEEE 802.11b]** and **[LAN Type]** are displayed when the wireless LAN interface board is installed. If both Ethernet and wireless LAN (IEEE 802.11b) are connected, the selected interface takes precedence.

 **Reference**

p.48 "Interface Settings"

p.55 "File Transfer"

---

## Settings Required to Use the Network Delivery Scanner

---

This section lists the settings required for delivering data to network.

---

### Ethernet

---

This section lists the settings required for delivering data to network with Ethernet cable.

For details about how to specify the settings, see "Interface Settings" and "File Transfer".

Menu	User Tool	Setting Requirements
Interface Settings/Network	Machine IPv4 Address	Necessary
Interface Settings/Network	IPv4 Gateway Address	As required
Interface Settings/Network	DNS Configuration	As required
Interface Settings/Network	DDNS Configuration	As required
Interface Settings/Network	Domain Name	As required
Interface Settings/Network	WINS Configuration	As required
Interface Settings/Network	Effective Protocol	Necessary
Interface Settings/Network	Ethernet Speed	As required
Interface Settings/Network	LAN Type	Necessary
Interface Settings/Network	Permit SNMPv3 Communicatn.	As required
Interface Settings/Network	Permit SSL/TLS Comm.	As required
Interface Settings/Network	Host Name	As required
File Transfer	Delivery Option	As required

 **Note**

- For the Effective Protocol setting, check that the protocol you want to use is set to **[Active]**.
- [LAN Type]** is displayed when the wireless LAN interface board is installed. When both Ethernet and wireless LAN (IEEE 802.11b) are connected, the selected interface takes precedence.
- If Delivery Option is set to **[On]**, check that IPv4 Address is set.

 **Reference**

p.48 "Interface Settings"

p.55 "File Transfer"

---

**IEEE 802.11b (wireless LAN)**

---

This section lists the settings required for delivering data to network with IEEE 802.11b (wireless LAN).

For details about how to specify the settings, see "Interface Settings" and "File Transfer".

Menu	User Tool	Setting Requirements
Interface Settings/Network	Machine IPv4 Address	Necessary
Interface Settings/Network	IPv4 Gateway Address	As required
Interface Settings/Network	DNS Configuration	As required
Interface Settings/Network	DDNS Configuration	As required
Interface Settings/Network	Domain Name	As required
Interface Settings/Network	WINS Configuration	As required
Interface Settings/Network	Effective Protocol	Necessary
Interface Settings/Network	LAN Type	Necessary
Interface Settings/Network	Permit SNMPv3 Communicatn.	As required
Interface Settings/Network	Permit SSL/TLS Comm.	As required
Interface Settings/Network	Host Name	As required
Interface Settings/ IEEE 802.11b	Communication Mode	Necessary
Interface Settings/ IEEE 802.11b	SSID Setting	As required
Interface Settings/ IEEE 802.11b	Channel	As required
Interface Settings/ IEEE 802.11b	Security Type	As required
Interface Settings/ IEEE 802.11b	Communication Speed	As required
File Transfer	Delivery Option	As required

 **Note**

- For the Effective Protocol setting, check that the protocol you want to use is set to **[Active]**.
- [IEEE 802.11b]** and **[LAN Type]** are displayed when the wireless LAN interface board is installed. When both Ethernet and wireless LAN (IEEE 802.11b) are connected, the selected interface takes precedence.
- If Delivery Option is set to **[On]**, check that IPv4 Address is set.

 **Reference**

p.48 "Interface Settings"

p.55 "File Transfer"

---

## Settings Required to Use Network TWAIN Scanner

---

This section lists the settings required for using TWAIN Scanner under the network environment.

---

### Ethernet

---

This section lists the settings required for using network TWAIN Scanner with Ethernet cable.

For details about how to specify the settings, see "Interface Settings".

Menu	User Tool	Setting Requirements
Interface Settings/Network	Machine IPv4 Address	Necessary
Interface Settings/Network	IPv4 Gateway Address	As required
Interface Settings/Network	DNS Configuration	As required
Interface Settings/Network	DDNS Configuration	As required
Interface Settings/Network	Domain Name	As required
Interface Settings/Network	WINS Configuration	As required
Interface Settings/Network	Effective Protocol	Necessary
Interface Settings/Network	LAN Type	Necessary
Interface Settings/Network	Ethernet Speed	As required
Interface Settings/Network	Permit SNMPv3 Communicatn.	As required
Interface Settings/Network	Permit SSL/TLS Comm.	As required
Interface Settings/Network	Host Name	As required

 **Note**

- For the Effective Protocol setting, check that the protocol you want to use is set to **[Active]**.
- [LAN Type]** is displayed when the wireless LAN interface board is installed. When both Ethernet and wireless LAN (IEEE 802.11b) are connected, the selected interface takes precedence.

## Reference

p.48 "Interface Settings"

### IEEE 802.11b (wireless LAN)

This section lists the settings required for using network TWAIN Scanner with IEEE 802.11b (wireless LAN).

For details about how to specify the settings, see "Interface Settings".

Menu	User Tool	Setting Requirements
Interface Settings/Network	Machine IPv4 Address	Necessary
Interface Settings/Network	IPv4 Gateway Address	As required
Interface Settings/Network	DNS Configuration	As required
Interface Settings/Network	DDNS Configuration	As required
Interface Settings/Network	Domain Name	As required
Interface Settings/Network	WINS Configuration	As required
Interface Settings/Network	Effective Protocol	Necessary
Interface Settings/Network	LAN Type	Necessary
Interface Settings/Network	Permit SNMPv3 Communicatn.	As required
Interface Settings/Network	Permit SSL/TLS Comm.	As required
Interface Settings/Network	Host Name	As required
Interface Settings/ IEEE 802.11b	Communication Mode	Necessary
Interface Settings/ IEEE 802.11b	SSID Setting	As required
Interface Settings/ IEEE 802.11b	Channel	As required
Interface Settings/ IEEE 802.11b	Security Type	As required
Interface Settings/ IEEE 802.11b	Communication Speed	As required

### Note

- For the Effective Protocol setting, check that the protocol you want to use is set to **[Active]**.
- [IEEE 802.11b]** and **[LAN Type]** are displayed when the wireless LAN interface board is installed. When both Ethernet and wireless LAN (IEEE 802.11b) are connected, the selected interface takes precedence.

## Reference

p.48 "Interface Settings"

---

## Using Utilities to Make Network Settings

---

You can also specify network settings using utilities such as Web Image Monitor, SmartDeviceMonitor for Admin, and telnet.

### Note

- For details about using Web Image Monitor, see "Using Web Image Monitor", Network Guide.
- For details about using SmartDeviceMonitor for Admin, see "Using SmartDeviceMonitor for Admin", Network Guide.
- For Details about using telnet, see "Remote Maintenance by telnet", Network Guide.

### Reference

"Using Web Image Monitor" Network Guide

"Using SmartDeviceMonitor for Admin" Network Guide

"Remote Maintenance by telnet", Network Guide

---

## Interface Settings

---

Change settings by using Web Image Monitor, SmartDeviceMonitor for Admin, and telnet.

- ❖ **[Network] → [Machine IPv4 Address] → [Auto-Obtain (DHCP)]**
  - Web Image Monitor: Can be used for specifying the setting.
  - SmartDeviceMonitor for Admin: Can be used for specifying the setting.
  - telnet: Can be used for specifying the setting.
- ❖ **[Network] → [Machine IPv4 Address] → [Specify] → [IP Add.]**
  - Web Image Monitor: Can be used for specifying the setting.
  - SmartDeviceMonitor for Admin: Can be used for specifying the setting.
  - telnet: Can be used for specifying the setting.
- ❖ **[Network] → [Machine IPv4 Address] → [Specify] → [Subnet M]**
  - Web Image Monitor: Can be used for specifying the setting.
  - SmartDeviceMonitor for Admin: Can be used for specifying the setting.
  - telnet: Can be used for specifying the setting.
- ❖ **[Network] → [IPv4 Gateway Address]**
  - Web Image Monitor: Can be used for specifying the setting.
  - SmartDeviceMonitor for Admin: Can be used for specifying the setting.
  - telnet: Can be used for specifying the setting.

- ❖ **[Network] → [Machine IPv6 Address] → [Manual Config. Address]**
  - Web Image Monitor: Can be used for specifying the setting.
  - SmartDeviceMonitor for Admin: Cannot be used for specifying the setting.
  - telnet: Can be used for specifying the setting.
- ❖ **[Network] → [IPv6 Stateless Setting]**
  - Web Image Monitor: Can be used for specifying the setting.
  - SmartDeviceMonitor for Admin: Cannot be used for specifying the setting.
  - telnet: Can be used for specifying the setting.
- ❖ **[Network] → [DNS Configuration] → [Auto-Obtain (DHCP)]**
  - Web Image Monitor: Can be used for specifying the setting.
  - SmartDeviceMonitor for Admin: Cannot be used for specifying the setting.
  - telnet: Can be used for specifying the setting.
- ❖ **[Network] → [DNS Configuration] → [Specify] → [Server 1-3]**
  - Web Image Monitor: Can be used for specifying the setting.
  - SmartDeviceMonitor for Admin: Cannot be used for specifying the setting.
  - telnet: Can be used for specifying the setting.
- ❖ **[Network] → [DDNS Configuration]**
  - Web Image Monitor: Can be used for specifying the setting.
  - SmartDeviceMonitor for Admin: Cannot be used for specifying the setting.
  - telnet: Can be used for specifying the setting.
- ❖ **[Network] → [Domain Name] → [Auto-Obtain (DHCP)]**
  - Web Image Monitor: Can be used for specifying the setting.
  - SmartDeviceMonitor for Admin: Cannot be used for specifying the setting.
  - telnet: Can be used for specifying the setting.
- ❖ **[Network] → [Domain Name] → [Specify] → [Domain Name]**
  - Web Image Monitor: Can be used for specifying the setting.
  - SmartDeviceMonitor for Admin: Cannot be used for specifying the setting.
  - telnet: Can be used for specifying the setting.
- ❖ **[Network] → [WINS Configuration] → [On] → [Server 1-2]**
  - Web Image Monitor: Can be used for specifying the setting.
  - SmartDeviceMonitor for Admin: Cannot be used for specifying the setting.
  - telnet: Can be used for specifying the setting.



- ❖ **[Network] → [WINS Configuration] → [On] → [Scope ID]**
  - Web Image Monitor: Can be used for specifying the setting.
  - SmartDeviceMonitor for Admin: Cannot be used for specifying the setting.
  - telnet: Can be used for specifying the setting.
- ❖ **[Network] → [Effective Protocol] → [IPv4]**
  - Web Image Monitor: Can be used for specifying the setting.
  - SmartDeviceMonitor for Admin: When in communication with this machine with IPX/SPX, TCP/IP setting is enabled.
  - telnet: Can be used for specifying the setting.
- ❖ **[Network] → [Effective Protocol] → [IPv6]**
  - Web Image Monitor: Can be used for specifying the setting.
  - SmartDeviceMonitor for Admin: Can be used for specifying the setting.
  - telnet: Can be used for specifying the setting.
- ❖ **[Network] → [Effective Protocol] → [NetWare]**
  - Web Image Monitor: Can be used for specifying the setting.
  - SmartDeviceMonitor for Admin: When in communication with this machine with TCP/IP, NetWare (IPX/SPX) setting is enabled.
  - telnet: Can be used for specifying the setting.
- ❖ **[Network] → [Effective Protocol] → [SMB]**
  - Web Image Monitor: Can be used for specifying the setting.
  - SmartDeviceMonitor for Admin: Can be used for specifying the setting.
  - telnet: Can be used for specifying the setting.
- ❖ **[Network] → [Effective Protocol] → [AppleTalk]**
  - Web Image Monitor: Can be used for specifying the setting.
  - SmartDeviceMonitor for Admin: Can be used for specifying the setting.
  - telnet: Can be used for specifying the setting.
- ❖ **[Network] → [NCP Delivery Protocol]**
  - Web Image Monitor: Can be used for specifying the setting.
  - SmartDeviceMonitor for Admin: Can be used for specifying the setting.
  - telnet: Cannot be used for specifying the setting.
- ❖ **[Network] → [NW Frame Type] → [Auto Select]**
  - Web Image Monitor: Can be used for specifying the setting.
  - SmartDeviceMonitor for Admin: Cannot be used for specifying the setting.
  - telnet: Can be used for specifying the setting.

❖ **[Network] → [NW Frame Type] → [Ethernet II]**

- Web Image Monitor: Can be used for specifying the setting.
- SmartDeviceMonitor for Admin: Cannot be used for specifying the setting.
- telnet: Can be used for specifying the setting.

❖ **[Network] → [NW Frame Type] → [Ethernet 802.2]**

- Web Image Monitor: Can be used for specifying the setting.
- SmartDeviceMonitor for Admin: Cannot be used for specifying the setting.
- telnet: Can be used for specifying the setting.

❖ **[Network] → [NW Frame Type] → [Ethernet 802.3]**

- Web Image Monitor: Can be used for specifying the setting.
- SmartDeviceMonitor for Admin: Cannot be used for specifying the setting.
- telnet: Can be used for specifying the setting.

❖ **[Network] → [NW Frame Type] → [Ethernet SNAP]**

- Web Image Monitor: Can be used for specifying the setting.
- SmartDeviceMonitor for Admin: Cannot be used for specifying the setting.
- telnet: Can be used for specifying the setting.

❖ **[Network] → [SMB Computer Name]**

- Web Image Monitor: Can be used for specifying the setting.
- SmartDeviceMonitor for Admin: Cannot be used for specifying the setting.
- telnet: Can be used for specifying the setting.

❖ **[Network] → [SMB Work Group]**

- Web Image Monitor: Can be used for specifying the setting.
- SmartDeviceMonitor for Admin: Cannot be used for specifying the setting.
- telnet: Can be used for specifying the setting.

❖ **[Network] → [Ethernet Speed]**

- Web Image Monitor: Cannot be used for specifying the setting.
- SmartDeviceMonitor for Admin: Cannot be used for specifying the setting.
- telnet: Can be used for specifying the setting.

❖ **[Network] → [LAN Type] → [Ethernet]**

- Web Image Monitor: Can be used for specifying the setting.
- SmartDeviceMonitor for Admin: Cannot be used for specifying the setting.
- telnet: Can be used for specifying the setting.

- ❖ **[Network] → [LAN Type] → [IEEE 802.11b]**
  - Web Image Monitor: Can be used for specifying the setting.
  - SmartDeviceMonitor for Admin: Cannot be used for specifying the setting.
  - telnet: Can be used for specifying the setting.
- ❖ **[Network] → [Ping Command]**
  - Web Image Monitor: Cannot be used for specifying the setting.
  - SmartDeviceMonitor for Admin: Cannot be used for specifying the setting.
  - telnet: Cannot be used for specifying the setting.
- ❖ **[Network] → [Permit SNMPv3 Communictn.] → [Encryption Only]**
  - Web Image Monitor: Can be used for specifying the setting.
  - SmartDeviceMonitor for Admin: Cannot be used for specifying the setting.
  - telnet: Can be used for specifying the setting.
- ❖ **[Network] → [Permit SNMPv3 Communictn.] → [Encryption/Clear Text]**
  - Web Image Monitor: Can be used for specifying the setting.
  - SmartDeviceMonitor for Admin: Cannot be used for specifying the setting.
  - telnet: Can be used for specifying the setting.
- ❖ **[Network] → [Permit SSL/TLS Comm.] → [Ciphertext Only]**
  - Web Image Monitor: Cannot be used for specifying the setting.
  - SmartDeviceMonitor for Admin: Cannot be used for specifying the setting.
  - telnet: Cannot be used for specifying the setting.
- ❖ **[Network] → [Permit SSL/TLS Comm.] → [Ciphertext Priority]**
  - Web Image Monitor: Cannot be used for specifying the setting.
  - SmartDeviceMonitor for Admin: Cannot be used for specifying the setting.
  - telnet: Cannot be used for specifying the setting.
- ❖ **[Network] → [Host Name]**
  - Web Image Monitor: Can be used for specifying the setting.
  - SmartDeviceMonitor for Admin: Can be used for specifying the setting.
  - telnet: Can be used for specifying the setting.
- ❖ **[Network] → [Machine Name]**
  - Web Image Monitor: Can be used for specifying the setting.
  - SmartDeviceMonitor for Admin: Cannot be used for specifying the setting.
  - telnet: Can be used for specifying the setting.

❖ **[IEEE 802.11b] → [Communication Mode]**

- Web Image Monitor: Can be used for specifying the setting.
- SmartDeviceMonitor for Admin: Cannot be used for specifying the setting.
- telnet: Can be used for specifying the setting.

❖ **[IEEE 802.11b] → [SSID Setting]**

- Web Image Monitor: Can be used for specifying the setting.
- SmartDeviceMonitor for Admin: Cannot be used for specifying the setting.
- telnet: Can be used for specifying the setting.

❖ **[IEEE 802.11b] → [Channel]**

- Web Image Monitor: Can be used for specifying the setting.
- SmartDeviceMonitor for Admin: Cannot be used for specifying the setting.
- telnet: Can be used for specifying the setting.

❖ **[IEEE 802.11b] → [Security Type]**

- Web Image Monitor: Can be used for specifying the setting.
- SmartDeviceMonitor for Admin: Cannot be used for specifying the setting.
- telnet: Can be used for specifying the setting.

❖ **[IEEE 802.11b] → [Communication Speed]**

- Web Image Monitor: Cannot be used for specifying the setting.
- SmartDeviceMonitor for Admin: Cannot be used for specifying the setting.
- telnet: Can be used for specifying the setting.

---

**File Transfer**

---

Change settings by using Web Image Monitor, SmartDeviceMonitor for Admin, and telnet.

❖ **[File Transfer] → [SMTP Server]**

- Web Image Monitor: Can be used for specifying the setting.
- SmartDeviceMonitor for Admin: Cannot be used for specifying the setting.
- telnet: Cannot be used for specifying the setting.

❖ **[File Transfer] → [SMTP Authentication]**

- Web Image Monitor: Can be used for specifying the setting.
- SmartDeviceMonitor for Admin: Cannot be used for specifying the setting.
- telnet: Cannot be used for specifying the setting.

**❖ [File Transfer] → [POP before SMTP]**

- Web Image Monitor: Can be used for specifying the setting.
- SmartDeviceMonitor for Admin: Cannot be used for specifying the setting.
- telnet: Cannot be used for specifying the setting.

**❖ [File Transfer] → [Reception Protocol]**

- Web Image Monitor: Can be used for specifying the setting.
- SmartDeviceMonitor for Admin: Cannot be used for specifying the setting.
- telnet: Cannot be used for specifying the setting.

**❖ [File Transfer] → [POP3/IMAP4 Settings]**

- Web Image Monitor: Can be used for specifying the setting.
- SmartDeviceMonitor for Admin: Cannot be used for specifying the setting.
- telnet: Cannot be used for specifying the setting.

**❖ [File Transfer] → [Admin. E-mail Address]**

- Web Image Monitor: Can be used for specifying the setting.
- SmartDeviceMonitor for Admin: Cannot be used for specifying the setting.
- telnet: Cannot be used for specifying the setting.

**❖ [File Transfer] → [E-mail Communication Port]**

- Web Image Monitor: Can be used for specifying the setting.
- SmartDeviceMonitor for Admin: Cannot be used for specifying the setting.
- telnet: Cannot be used for specifying the setting.

**❖ [File Transfer] → [E-mail Recept. Interval]**

- Web Image Monitor: Can be used for specifying the setting.
- SmartDeviceMonitor for Admin: Cannot be used for specifying the setting.
- telnet: Cannot be used for specifying the setting.

**❖ [File Transfer] → [Max. Recept. E-mail Size]**

- Web Image Monitor: Can be used for specifying the setting.
- SmartDeviceMonitor for Admin: Cannot be used for specifying the setting.
- telnet: Cannot be used for specifying the setting.

**❖ [File Transfer] → [E-mail Storage in Server]**

- Web Image Monitor: Can be used for specifying the setting.
- SmartDeviceMonitor for Admin: Cannot be used for specifying the setting.
- telnet: Cannot be used for specifying the setting.

❖ **[File Transfer] → [Default User Name/PW(Send)]**

- Web Image Monitor: Can be used for specifying the setting.
- SmartDeviceMonitor for Admin: Cannot be used for specifying the setting.
- telnet: Cannot be used for specifying the setting.

❖ **[File Transfer] → [Fax E-mail Account]**

- Web Image Monitor: Can be used for specifying the setting.
- SmartDeviceMonitor for Admin: Cannot be used for specifying the setting.
- telnet: Cannot be used for specifying the setting.

# Connecting the Machine to a Telephone Line and Telephone

This section describes how to connect the machine to the telephone lines and select the line type.

1

## Connecting the Telephone Line

To connect the machine to a telephone line, use a snap-in modular type connector.

### ⚠ CAUTION:

- To reduce the risk of fire, use only No. 26 AWG or larger telecommunication line cord.

### ⚠ ATTENTION:

- Pour réduire le risque d'incendie, utiliser uniquement des conducteurs de télécommunications 26 AWG ou de section supérieure.

### ⚠ Important

- By law in the United States, you must program your phone number identification (your fax number) into your machine before you can connect the public phone system. See "Registering Fax Information".
- Make sure the connector is the correct type before you start.

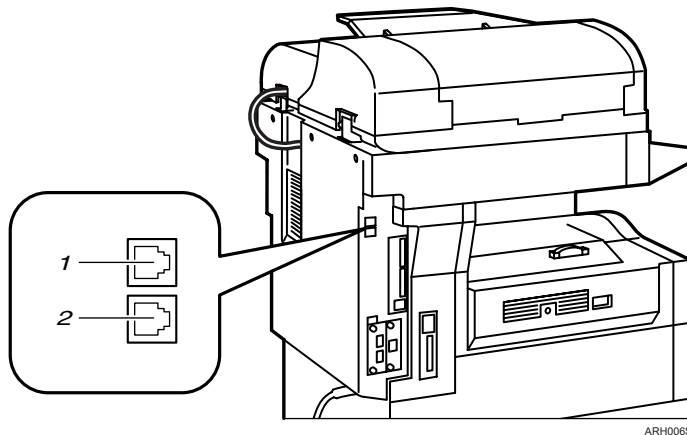

ARH006S

**1. G3 (analog) line interface connector**

**2. External telephone connector**

## Selecting the Line Type

Select the line type to which the machine is connected. There are two types: tone and pulse dial.

Select the line type using "Administrator Tools".

### Note

- This function is not available in some regions.

### Reference

p.85 "Fax Features"

## Connecting the Optional Handset or an External Telephone

You can connect the optional handset or an external telephone to the machine. You can use it for telephone calls.

### Limitation

- When you use the optional handset or an external telephone with the **【On Hook Dial】** key for telephone calls, you can not talk with the other party without pressing the **【On Hook Dial】** key after taking off the receiver.

### ❖ Specifying the handset line type

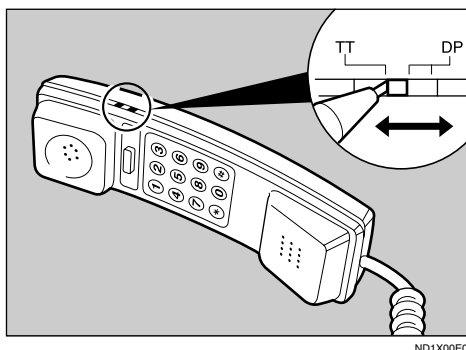

The switch on the handset should be in the appropriate position-TT (Tone Dialing) or DP (Pulse Dialing).



❖ **Adjusting the handset bell volume**

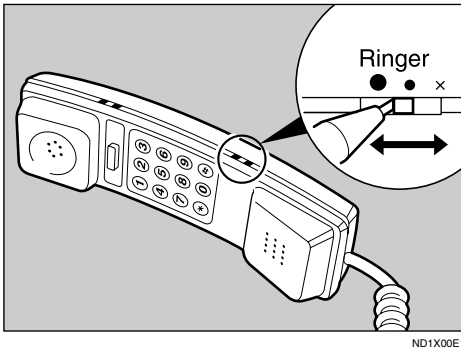

ND1X00E1

Adjust the handset ringer volume using the volume switch.

 **Note**

- Some external telephones may not be connected or may suffer reduced functionality.



# 2. System Settings

This chapter describes user tools in the System Settings menu. For details on how to access System Settings, see "Accessing User Tools".

## General Features

This section describes the user tools in the General Features menu under System Settings.

Default settings are shown in **bold type**.

### ❖ Prog/Change/Del User Text

You can register text phrases you often use when specifying settings, such as ".com" and "Regards".

You can register up to 40 entries.

Program/Change:

- ① Select [**System Settings**] using [**▲**] or [**▼**], and then press the [**OK**] key.
- ② Select [**General Features**] using [**▲**] or [**▼**], and then press the [**OK**] key.
- ③ Select [**Prog/Change/Del User Text**] using [**▲**] or [**▼**], and then press the [**OK**] key.
- ④ Select [**Program/Change**] to program/change text phrases using [**▲**] or [**▼**], and then press the [**OK**] key.
- ⑤ Select [**\*Not Programmed**] using [**▲**] or [**▼**], and then press the [**OK**] key.  
To change programmed text phrases, select the text phrases you want to change/delete.
- ⑥ Enter the text phrases you want to program, and then press the [**OK**] key.
- ⑦ Press the [**User Tools/Counter**] key.

Delete:

- ① Select [**System Settings**] using [**▲**] or [**▼**], and then press the [**OK**] key.
- ② Select [**General Features**] using [**▲**] or [**▼**], and then press the [**OK**] key.
- ③ Select [**Prog/Change/Del User Text**] using [**▲**] or [**▼**], and then press the [**OK**] key.
- ④ Select [**Delete**] using [**▲**] or [**▼**], and then press the [**OK**] key.
- ⑤ Select the text phrases you want to delete using [**▲**] or [**▼**], and then press the [**OK**] key.
- ⑥ Press [**Yes**].  
To cancel deleting a text phrase, press [**No**].
- ⑦ Press the [**User Tools/Counter**] key.

**❖ Panel Key Sound**

The beeper (key tone) sounds when a key is pressed.  
The default setting is **On**.

**❖ Warm-up Beeper (copier)**

You can have the beeper sound when the machine becomes ready to copy after leaving Energy Saver mode, or when the power is turned on.  
The default setting is **On**.

**❖ Copy Count Display**

The copy counter can be set to show the number of copies made (count up) or the number of copies yet to be made (count down).  
The default setting is **Up**.

**❖ Function Priority**

Specify the mode to be displayed immediately after the operation switch is turned on, or when System Reset mode is turned on.  
The default setting is **Copier**.

**❖ Print Priority**

Gives print priority to the mode displayed.  
The default setting is **Display mode**.  
When **[Interleave]** is selected, the current print job will be interrupted after a maximum of five sheets.

**❖ Function Reset Timer**

You can set the length of time the machine waits before changing modes when using the multi-access function.  
This is useful if you are making many copies and have to change settings for each copy. If you set a longer reset period, you can prevent interruption from other functions.  
The Function Reset Timer setting is ignored if **[Interleave]** is set for Print Priority.  
The default setting is **Set Time**.  
When you select **[Set Time]**, enter the time (3–30 seconds, in 1 second increments) using the number keys.  
The default setting for Set Time is **3 seconds**.

**❖ Screen Contrast**

You can adjust the brightness of the display.  
The default setting is "4" (the halfway/medium setting).

**❖ Key Repeat**

Set whether or not to repeat the functions of the **[▲]**, **[▼]**, **[Lighter]**, and **[Darker]** keys when those keys are pressed and held down.  
The default setting is **Normal / On**.

**❖ Measurement Unit**

You can switch the measurement between "mm" and "inch".  
The default setting is **inch**.

** Note**

- If the Panel Key Sound setting is "Off", the beeper does not sound, whatever the Warm-up Beeper setting.

** Reference**

p.4 "Accessing User Tools"

## Tray Paper Settings

This section describes the user tools in the Tray Paper Settings menu under System Settings.

















Default settings are shown in **bold type**.

### Important

- ❑ If the specified paper size differs from the actual size of the paper loaded in the paper tray, a misfeed might occur because the correct paper size was not detected.





















### ❖ Paper Size: Tray 1 -2

Select the size of the paper loaded in the paper tray.

- The paper sizes you can set for Tray 1 are as follows:  
A4 , A5 , B5 JIS , 8<sup>1</sup>/<sub>2</sub>"×11" , 5<sup>1</sup>/<sub>2</sub>"×8<sup>1</sup>/<sub>2</sub>" , 16K   
The default setting is **A4  / 8<sup>1</sup>/<sub>2</sub>"×11" **.
- The paper sizes you can set for Tray 2 are as follows:  
A4 , 8<sup>1</sup>/<sub>2</sub>"×14" , 8<sup>1</sup>/<sub>2</sub>"×13" , 8<sup>1</sup>/<sub>2</sub>"×11" , 8<sup>1</sup>/<sub>4</sub>"×14" , 8<sup>1</sup>/<sub>4</sub>"×13"   
The default setting is **A4  / 8<sup>1</sup>/<sub>2</sub>"×11" **.

### ❖ Printer Bypass Paper Size

Specify the size of the paper in the bypass tray when using the printer function. You can select paper size from Custom size or Regular size.

- The paper sizes you can set for bypass tray are as follows:  
A4 , A5 , A5 , B5 JIS , C6 Env , C5 Env , DL Env , 8<sup>1</sup>/<sub>2</sub>"×14" , 8<sup>1</sup>/<sub>2</sub>"×13" , 8<sup>1</sup>/<sub>2</sub>"×11" , 8<sup>1</sup>/<sub>4</sub>"×13" , 8"×13" , 7<sup>1</sup>/<sub>4</sub>"×10<sup>1</sup>/<sub>2</sub>" , 5<sup>1</sup>/<sub>2</sub>"×8<sup>1</sup>/<sub>2</sub>" , 5<sup>1</sup>/<sub>2</sub>"×8<sup>1</sup>/<sub>2</sub>" , 4<sup>1</sup>/<sub>8</sub>"×9<sup>1</sup>/<sub>2</sub>" , 3<sup>7</sup>/<sub>8</sub>"×7<sup>1</sup>/<sub>2</sub>" , 16K , Custom Size  
You can specify a custom size as follows:  
90.0 to 216.0 mm (3.55 to 8.50 inch) vertically, and 139.0 to 600.0 mm (5.48 to 23.62 inch) horizontally.  
The default setting is **A4  / 8<sup>1</sup>/<sub>2</sub>"×11" **.

### ❖ Paper Type: Bypass Tray

Sets the display so you can see what type of paper is loaded in the bypass tray.

- The paper types you can set for the bypass tray are as follows:  
No Display (Plain Paper), Recycled Paper, Special Paper, Color Paper, Letterhead, Label Paper, Thick Paper, OHP (Transparency), Preprinted Paper, Prepunched Paper, Bond Paper, Cardstock.

The default setting is **Thick Paper**.

Paper types you can set in the bypass tray for machines with the copy function only are plain paper, thick paper and OHP.

**❖ Paper Type: Paper Tray 1-2**

Sets the display so you can see what type of paper is loaded in each paper tray. The print function uses this information to automatically select the paper tray.

- The paper types you can set are as follows:

No Display (Plain Paper), Recycled Paper, Special Paper, Color Paper, Letterhead, Preprinted Paper, Prepunched Paper, Bond Paper, Cardstock

The default setting for "Paper Type" is **No Display (Plain Paper)**.

The default setting for "APS" is **On**.

The default setting for "Duplex" is **On**.

To enable the Auto Tray Switching function, make sure [**On**] is selected in APS.

**❖ Ppr Tray Priority:Copier (copier)**

Specify the tray to supply paper for output.

The default setting is **Tray 1**.

**❖ Ppr Tray Priority:Fax (facsimile)**

Specify the tray to supply paper for output.

The default setting is **Tray 1**.

**❖ Ppr Tray Priority:Printer (printer)**

Specify the tray to supply paper for output.

The default setting is **Tray 1**.

**🔍 Reference**

p.4 "Accessing User Tools"

p.81 "Auto Tray Switching"

## Timer Settings

This section describes the user tools in the Timer Settings menu under System Settings.

Default settings are shown in **bold type**.

**2**

### ❖ Auto Off Timer

After a specified period has passed, following job completion, the machine automatically turns off, in order to conserve energy. This function is called "Auto Off".

The machine status after the Auto Off operation is referred to as "Off mode" or "Sleep mode". Use this setting to specify how long the machine remains idle before switching to "Off mode" or "Sleep mode".

This function can only be specified if AOF is specified to **[On]**.

The time can be set from 1 min. to 240 min, using the number keys.

The default setting is **1 min.**.

From "Off mode" or "Sleep mode", the machine is ready to use within 10 seconds.

Auto Off might not work if an error message is being displayed at the time scheduled for the switch.

### ❖ Energy Saver Timer

The machine automatically enters Low Power mode automatically after a job is finished, and the selected time elapsed.

The time can be set from 1 to 240 minutes, using the number key.

The default setting is **15 min. / 1 min.**.

Energy Saver may not work when error messages appear.

The machine automatically prints any fax or printer data received while in Energy Saver mode.

### ❖ System Auto Reset Timer

The System Reset setting automatically switches the screen to that of the function set in Function Priority, when no operations are in progress, or when an interrupted job is cleared. This setting determines the system reset interval.

The default setting is **On**.

The time can be set from 10 to 999 seconds in 1 second increments, using the number keys.

The default setting time is **60 sec.**.

### ❖ Copier Auto Reset Timer (copier)

Specifies the time to elapse before copier mode resets.

The default setting is **On**.

If **[Off]** is selected, the machine does not automatically switch to the user code entry screen.

The time can be set from 10 to 999 seconds, using the number keys.

The default setting time is **60 sec.**.



**❖ Facsimile Auto Reset Timer (facsimile)**

Specifies the time to elapse before the facsimile mode resets.

The time can be set from 30 to 999 seconds, using the number keys.

The default setting is **30 sec.**

**❖ Printer Auto Reset Timer (printer)**

Specifies the time to elapse before the printer function resets.

The default setting is **On**.

The time can be set from 10 to 999 seconds, using the number keys.

The default setting time is **60 sec.**

**❖ Scanner Auto Reset Timer (scanner)**

Specifies the time to elapse before the scanner function resets.

The default setting is **On**.

If **[Off]** is selected, the machine will not automatically switch to the user code entry screen.

The time can be set from 10 to 999 seconds, using the number keys.

The default setting time is **60 sec.**

**❖ Set Date**

Set the date for the machine's internal clock.

To change between year, month, and day, press **[◀]** and **[▶]** key.

Enter the year, month, and day using the number keys.

**❖ Set Time**

Set the time for the machine's internal clock using the number keys.

Enter time in the 24-hour format (in 1 second increments).

To change between hours, minutes and seconds, press **[◀]** and **[▶]** key.

When the summer time function is set, you cannot make the time setting if the current time falls inside the transition zone. Set the time again later, or contact your service representative.

**❖ Auto Logout Timer**

Specify whether or not to automatically log out a user when the user does not operate the machine for a specified period of time after logging in.

The default setting is **Off**.

When **[On]** is selected, the time can be set from 60 to 999 seconds, in one second increments, using the number keys.

The default setting is **180 sec.**

**🔍 Reference**

p.4 "Accessing User Tools"

# Interface Settings

This section describes the user tools in the Interface Settings menu under System Settings.

Default settings are shown in **bold type**.

## 2

---

### Network

---

This section describes the user tools in the Network menu under Interface Settings.

For machines with the DDST Unit, see "Settings You Can Change With User Tools", Network Guide.

#### ❖ Machine IPv4 Address

Before using this machine in the network environment, you must specify the IPv4 address and subnet mask.

When you select **[Specify]**, enter the **[IP Add.]** and **[Subnet M]** as "xxx.xxx.xxx.xxx" ("x" indicates a number).

- Auto-Obtain (DHCP)
- Specify  
IPv4 Address: 011.022.033.044  
Sub-net Mask: 000.000.000.000

The default setting is **Specify**.

The default setting for IPv4 Address is **011.022.033.044**.

When you select **[Specify]**, make sure that **[IP Add.]** is different from that of another machines on the network.

The physical address (MAC address) also appears.

#### ❖ IPv4 Gateway Address

A gateway is a connection or interchange point between two networks.

Specify the gateway address for the router or host computer used as a gateway.

The default setting is **000.000.000.000**.

#### ❖ Machine IPv6 Address

Specify the machine's IPv6 network address.

- Link-local Address  
The machine's specified link-local address appears.
- Manual Config. Address  
The machine's manually configuration address appears.
- Stateless address: 1-5  
The specified stateless address appears.

#### ❖ IPv6 Gateway Address

Displays the machine's IPv6 gateway address appears.

### ❖ IPv6 Stateless Setting

Specify IPv6 Stateless Setting.  
The default setting is **Active**.

### ❖ DNS Configuration

Make settings for the DNS server.

The default setting is **Specify**.

When you select **[Specify]**, enter the DNS server IPv4 address as "xxx.xxx.xxx.xxx" ("x" indicates a number).

The default settings of DNS server 1-3 are **000.000.000.000**.

### ❖ DDNS Configuration

Specify the DDNS settings.

The default setting is **Active**.

### ❖ Domain Name

Specify the domain name.

The default setting is **Specify**.

### ❖ WINS Configuration

Specify the WINS server settings.

The default setting is **On**.

If **[On]** is selected, enter WINS server IPv4 address as "xxx.xxx.xxx.xxx." ("x" indicates a number)"

The default settings of WINS server 1-2 are **000.000.000.000**.

If DHCP is in use, specify the **[Scope ID]**.

Enter a **[Scope ID]** using up to 31 characters.

### ❖ Effective Protocol

Selects the protocol to use in the network.

The default setting for IPv4 is **Active**.

The default setting for IPv6 is **Inactive**.

The default setting for NetWare is **Active**.

The default setting for SMB is **Active**.

The default setting for AppleTalk is **Active**.

### ❖ NCP Delivery Protocol

Select the protocol for NCP delivery.

The default setting is **TCP/IP Priority**.

If you select "IPX Only" or "TCP/IP Only", you cannot switch the protocol even if you cannot connect with it.

If "NetWare" in **[Effective Protocol]** is set to "Inactive", you can only use TCP/IP.

### ❖ NW Frame Type

Select the frame type when you use NetWare.

The default setting is **Auto Select**.

❖ **SMB Computer Name**

Specify the SMB computer name.  
 Enter the computer name using up to 15 characters.  
 "\*" + , / ; < > = ? [ \ ] | . and spaces cannot be entered.  
 Do not set a computer name starting with RNP and rnp.  
 Use uppercase letters for alphabets.

❖ **SMB Work Group**

Specify the SMB work group.  
 Enter the group name using up to 15 characters.  
 "\*" + , / ; < > = ? [ \ ] | . and spaces cannot be entered.  
 Use uppercase letters for alphabet.

❖ **Ethernet Speed**

Set the access speed for networks.  
 Select a speed that matches your network environment. **[Auto Select]** should usually be selected.

The default setting is **Auto Select**.

- **Setting the Ethernet Speed**  
 Confirm your network environment, and then select a speed that matches it using the following table.

Router/ HUB	Machine				
	10Mbps Half Duplex	10Mbps Full Duplex	100Mbps Half Duplex	100Mbps Full Duplex	Auto Select
10Mbps Half Duplex	○	-	-	-	○
10Mbps Full Duplex	-	○	-	-	-
100Mbps Half Duplex	-	-	○	-	○
100Mbps Full Duplex	-	-	-	○	-
Auto Select	○	-	○	-	○

❖ **LAN Type**

When you have installed the optional IEEE 802.11b interface unit, select the method of connection.

The default setting is **Ethernet**.

**[LAN Type]** is displayed when wireless LAN board is installed. If Ethernet and IEEE 802.11b (wireless LAN) are both connected, the selected interface has priority.

### ❖ Ping Command

Check the network connection with ping command using given IPv4 address. If you fail to connect to the network, check the following, and then retry the ping command.

- Make sure that "IPv4" in **[Effective Protocol]** is set to "Active".
- Check that the machine with assigned IPv4 address is connected to the network.
- Check if the same IPv4 address is used for the specified equipment.

### ❖ Permit SNMPv3 Communicatn.

Set the encrypted communication of SNMPv3.

The default setting is **Encryption/Clear Text**.

If you select to **[Encryption Only]**, you need to set an encryption password for the machine.

### ❖ Permit SSL/TLS Comm.

Set the encrypted communication of SSL/TLS.

The default setting is **Ciphertext/Clear Text**.

If you set to **[Ciphertext Only]**, you need to install the SSL certificate for the machine.

### ❖ Host Name

Specify the host name.

Enter the host name using up to 63 characters.

### ❖ Machine Name

Specify the machine name.

Enter the machine name using up to 31 characters.

### 🔍 Reference

p.4 "Accessing User Tools"

"Settings You Can Change With User Tools", Network Guide

---

## Parallel Interface

---

This section describes the user tools in the Parallel Interface menu under Interface Settings. **[Parallel Interface]** is displayed when this machine is installed with the IEEE 1284 interface board.

❖ **Parallel Timing**

Sets the timing for the control signal of the parallel interface.  
The default setting is **ACK outside**.

❖ **Parallel Comm. Speed**

Sets the communication speed for the parallel interface.  
The default setting is **High Speed**.

❖ **Selection Signal Status**

Sets the level for the select signal of the parallel interface.  
The default setting is **High**.

❖ **Input Prime**

Sets whether to validate or invalidate the input prime signal upon reception.  
The default setting is **Inactive**.

❖ **Bidirectional Comm.**

Sets the printer's response mode to a status acquisition request when using a parallel interface.  
The default setting is **On**.  
When set to **[Off]**, bidirectional communication function will be disabled, and the printer driver will not be installed under Windows Auto Detect function.

❖ **Signal Control**

Specify how error during printing or sending facsimile from the computer is to be dealt with.  
The default setting is **Job Acceptance Priority**.

 **Reference**

p.4 "Accessing User Tools"

---

## IEEE 802.11b

---

This section describes various items of **[IEEE 802.11b]** under **[Interface Settings]**. This section describes the user tools in the IEEE 802.11b menu under Interface Settings. **[IEEE 802.11b]** is displayed when this machine is installed with the wireless LAN interface board.

Be sure to make all settings simultaneously.

### ❖ Communication Mode

Specifies the communication mode of the wireless LAN.  
The default setting is **802.11 Ad hoc**.

### ❖ SSID Setting

Specifies SSID to distinguish the access point in infrastructure mode or 802.11 ad hoc mode.

The characters that can be used are ASCII 0x20-0x7e (32 bytes). If blank is specified in 802.11b ad hoc mode or ad hoc mode, "ASSID" appears.

### ❖ Channel

The default setting is **11**.

The following channels are available:

**1-14** (Metric version) / **1-11** (Inch version)

### ❖ Security Type

Specifies the encryption of the IEEE 802.11b (wireless LAN).

If you select **[WEP]**, always enter WEP key. If you select **[WPA]**, specify the encryption and authentication methods.

Specify "WPA", when **[Communication Mode]** is set to **[Infrastructure]**.

The default setting is **Off**.

- Off
- WEP
- WPA
  - Encryption Method  
Select either "TKIP" or "COMP(AES)".
  - Authentication Method  
Select either "WPA-PSK" or "WPA(802.1X)".  
If you select "WPA-PSK", enter the pre-shared key (PSK) using 8-63 ASCII characters.

### ❖ Wireless LAN Signal

When using in infrastructure mode, you can check the machine's radio wave status using the control panel.

Radio wave status is displayed when you press **[Wireless LAN Signal]**.

### ❖ Communication Speed

Specifies the communication speed of the IEEE 802.11b (wireless LAN).

The default setting is **Auto**.

❖ **Restore Defaults**

You can return the IEEE 802.11b (wireless LAN) settings to their defaults.

🔍 **Reference**

p.4 “Accessing User Tools”

---

## **Print I/F Settings List**

---

You can check items related to the network environment.

The configuration page shows the current network settings and network information.

- ① Select [**System Settings**] using [**▲**] or [**▼**], and then press the [**OK**] key.
- ② Select [**Interface Settings**] using [**▲**] or [**▼**], and then press the [**OK**] key.
- ③ Select [**Print I/F Settings List**] using [**▲**] or [**▼**], and then press the [**OK**] key.
- ④ Press the [**Start**] key.  
The configuration page is printed.
- ⑤ Press the [**User Tools/Counter**] key.

🔍 **Reference**

p.4 “Accessing User Tools”



# File Transfer

This section describes the user tools in the File Transfer menu under System Settings.

Default settings are shown in **bold type**.

## ❖ Delivery Option

Enables or disables sending stored or scanned documents via the ScanRouter delivery server.

The default setting is **Off**.

Specify this option when selecting whether or not to use the ScanRouter delivery software. If you do, you will have to preregister I/O devices in the ScanRouter delivery software.

## ❖ SMTP Server

Specify the SMTP server name.

Enter server name using up to 127 characters. Spaces cannot be entered.

When using DNS, enter the host name.

When not using DNS, enter the SMTP server IPv4 address.

Enter port number between 1 and 65535 using the number keys, and then press the **[OK]** key.

The default setting for "Port No." is **25**.

## ❖ SMTP Authentication

Specify SMTP authentication (PLAIN, LOGIN, CRAMMD5, DIGEST-MD5).

When sending e-mail via an SMTP server, you can enhance the level of SMTP server security using authentication that requires a user name and password to be entered.

If the SMTP server requires authentication, set **[SMTP Authentication]** to **[On]**, and then specify **[User Name]**, **[Password]**, and **[Encrypt]**.

Enter the user name and password to be set for **[Admin. E-mail Address]** when using Internet Fax.

- User Name

Enter **[User Name]** using up to 191 characters. Spaces cannot be entered. Depending on the SMTP server type, "realm" must be specified. Add "@" after the user name, as in "user name@realm".

- E-mail Address

- Password

Enter **[Password]** using up to 63 characters. Spaces cannot be entered.

- Encrypt: Auto/On/Off

**[Encrypt]-[Auto]**: Use if the authentication method is PLAIN, LOGIN, CRAM-MD5, or DIGEST-MD5.

**[Encrypt]-[On]**: Use if the authentication method is CRAM-MD5 or DIGEST-MD5.

**[Encrypt]-[Off]**: Use if the authentication method is PLAIN or LOGIN.

The default setting is **Off**.

**❖ POP before SMTP**

Specify POP authentication (POP before SMTP).

When sending e-mail via an SMTP server, you can enhance the level of SMTP server security by connecting to the POP server for authentication.

To enable POP server authentication before sending e-mail via the SMTP server, set **[POP before SMTP]** to **[On]**. E-mail is sent to the SMTP server after the time specified for **[Wait Time after Auth.]** has elapsed.

If you select **[On]**, enter server name in **[Reception Protocol]**. Also, check the port number for **[POP3]** in **[E-mail Communication Port]**.

- **Wait Time after Auth.: 300 msec.**  
Specify **[Wait Time after Auth.]** from zero to 10,000 milliseconds, in increments of one millisecond.
- **User Name**  
Enter the user name using up to 63 characters. Spaces cannot be entered.
- **E-mail Address**
- **Password**  
Enter the password using up to 63 characters. Spaces cannot be entered.  
The default setting is **Off**.

**❖ Reception Protocol**

Specify Reception Protocol for receiving Internet Fax.

The default setting is **POP3**.

**❖ POP3/IMAP4 Settings**

Specify the POP3/IMAP4 server name for receiving Internet Faxes.

The specified POP3/IMAP4 server name is used for **[POP before SMTP]**.

- **Server Name**  
If DNS is in use, enter the host name.  
If DNS is not in use, enter the POP3/IMAP4 or server IPv4 address.  
Enter POP3/IMAP4 server name using up to 127 alphanumeric characters.  
Spaces cannot be entered.
- **Encrypt**
  - **Auto**  
Password encryption is set automatically based on the POP server settings.
  - **On**  
Encrypt password.
  - **Off**  
Do not encrypt password.

The default setting for "Encrypt" is **Auto**.

### ❖ Admin. E-mail Address

Specify the Administrator's E-mail Address.

If a failure occurs in the machine or consumables need to be replaced, e-mail messages are sent to the Administrator's E-mail Address by E-mail Notification function.

On e-mailed scanned documents, if the sender is not specified, this appears as the sender's address.

When sending e-mail using the Internet Fax function, the administrator's e-mail address appears as the sender's address under the following conditions:

- The sender was not specified and the machine's e-mail address is not registered.
- The specified sender is not registered in the machine's address book and the machine's e-mail address has not been registered.

When conducting SMTP authentication for files transmitted under the Internet Fax function, the Admin. E-mail Address will appear in the "From:" box. If you have specified the user name and e-mail address in **[SMTP Authentication]**, be sure to specify Admin. E-mail Address.

Enter within up to 128 characters.

On e-mailed scanned documents, if **[Auto Specify Sender Name]** is **[Off]**, specify the sender.

### ❖ E-mail Communication Port

Specify the port numbers for receiving Internet Faxes. The specified POP3 port number is used for **[POP before SMTP]**.

Enter a port number between 1 and 65535 using the number keys, and then press the **[OK]** key.

The default setting for "POP3" is **110**.

The default setting for "IMAP4" is **143**.

The default setting for "SMTP" is **25**.

### ❖ E-mail Recept. Interval

Specify, in minutes, the time interval for receiving Internet Faxes via POP3 or IMAP4 server.

The default setting is **On**.

If **[On]** is selected, the time interval can be specified from 2 to 1440 in increments of one minute.

The default setting time is **15 min.**

### ❖ Max. Recept. E-mail Size

Specify the maximum reception e-mail size for receiving Internet Faxes.

Enter a size from 1 to 4 MB in increments of one megabyte.

The default setting is **2MB**.

### ❖ E-mail Storage in Server

Specify whether or not to store received Internet Fax e-mail on the POP3 or IMAP4 server.

The default setting is **Off**.

**❖ Default User Name/PW(Send)**

To send a scan image directly to a Windows shared folder, an FTP server, or a NetWare server, specify the user name and password. The user name and password specified in this setting will be shared by all users.

- SMB User Name
- SMB Password
- FTP User Name
- FTP Password
- NCP User Name
- NCP Password

Enter in up to 64 characters.

**❖ Auto Specify Sender Name**

Set whether or not to specify the name of the e-mail sender.

- On

If you select **[On]**, the specified e-mail address appears in the "From:" box. If you do not specify an address, the administrator's e-mail address appears in the "From:" box instead.

If you do not specify the sender when sending a file by e-mail under the fax function, or if the specified e-mail address is not registered in the machine's address book, the machine's e-mail address will appear in the "From:" box. If the machine does not have an e-mail address, the administrator's e-mail address will appear in the "From:" box.

- Off

If you select **[Off]**, the specified e-mail address appears in the "From:" box and you will not be able to send e-mail without specifying the address. When using the fax function, you cannot send e-mail if the specified e-mail address is not registered in the machine's address book.

The default setting is **Off**.

**❖ Fax E-mail Account**

Specify e-mail address, user name and password for receiving Internet Faxes.

- E-mail Address  
Enter an e-mail address using up to 128 characters.
- User Name  
Enter a user name using up to 191 characters.
- Password  
Enter a password using up to 128 characters.

The default setting is **Do not Receive**.

** Reference**

p.4 "Accessing User Tools"

# Administrator Tools

This section describes the user tools in the Administrator Tools menu under System Settings.

Default settings are shown in **bold type**.

Administrator Tools are used by the administrator. To change these settings, contact the administrator.

We recommend specifying Administrator Authentication before making Administrator Tools settings.

## ❖ Address Book Management

You can add, change or delete information registered in the Address Book. For details, see "Address Book".

- Program/Change

You can register and change names as well as user codes.

- Name
- Reg. No.
- Auth. Info

You can register a user code, and specify the functions available to each user code. You can also register user names and passwords to be used when sending e-mail, sending files to folders, or accessing an LDAP server.

- Auth. Protect

You can register a protection code.

- Fax Settings

You can register a fax number, international TX mode, label insertion, IP-Fax destination, and protocol.

- E-mail Settings

You can register e-mail address.

- Folder Info

You can register the protocol, path, port number, and server name.

- Register Group to

You can put names registered in the Address Book into a group.

- Delete

You can delete a name from the Address Book.

You can register up to 150 names.

You can register up to 50 user codes.

You can also register and manage data in the Address Book using Web Image Monitor or SmartDeviceMonitor for Admin.

### ❖ **Prgrm./Change/Delete Group**

Names registered in the Address Book can be added into a group. You can then easily manage the names registered in each group.

- Program/Change

You can register and change groups.

The following items can be registered or changed:

- Group Name

- Regist.

- Programd. User/Group

- Auth. Protect

You can register a protection code.

- Register Group to

You can put groups registered in the Address Book into a group.

- Delete

You can delete a group from the Address Book.

You can register up to 10 groups.

You can also register and manage groups in the Address Book using Web Image Monitor or SmartDeviceMonitor for Admin.

### ❖ **Address Book:Print List**

You can print the destination list registered in the Address Book.

- Destination List

Prints the list of names in the Address Book.

- Group Destination List

Prints the list of groups in the Address Book.

- Quick Dial Label

Prints the quick dial label.

① Select [**System Settings**] using [**▲**] or [**▼**], and then press the [**OK**] key.

② Select [**Administrator Tools**] using [**▲**] or [**▼**], and then press the [**OK**] key.

③ Select [**Address Book:Print List**] using [**▲**] or [**▼**], and then press the [**OK**] key.

④ Select a desired list to print using [**▲**] or [**▼**], and then press the [**OK**] key.

⑤ Press the [**Start**] key.

The list is printed.

### ❖ **Display/Print Counter**

Allows you to view and print the number of prints.

- Counter

Display the number of prints for each function (Total, Copier, Printer, Fax Prints, Send Total: Clr, Send Total: B&W, Fax TX, Scan Send: Clr, Scan Send: B&W, Duplex ).

- Print

Prints out a list of the number of prints made under each function.

### ❖ **Disp./Print User Counter**

Allows you to view and print the numbers of prints accessed with user codes, and to set those values to 0.

The number of prints may differ from the counter value shown in **[Display/Print Counter]**.

- **Display**  
Press **[▲]** or **[▼]** to show all the numbers of prints.
  - Copier Counter
  - Printer Counter
  - Facsimile Print
  - Fax TX Page Counter
  - Scanner Send Counter: F.Clr
  - Scanner Send Counter: B&W
- **Print**
  - All Users  
Prints the counter values for all the users.
  - Per User  
Prints the counter values for each user.
- **Clear**
  - All Users  
Sets the counter value for all the users.
  - Per User  
Sets the counter value for each user.

### ❖ **User Auth. Management**

- **Off**
- **User Code Auth.**  
Using User Code Authentication, you can limit the available functions (Copier / Printer / Others: Fax/Scanner) and supervise their use.  
When using User Code Authentication, register the user code.  
Using the Printer PC Control function, you can obtain a log of prints corresponding to the codes entered using the printer driver.  
For details about Basic Authentication, Windows Authentication, LDAP Authentication, and Integration Server Authentication, consult your administrator.
- **Basic Auth.**
- **Windows Auth.**
- **LDAP Auth.**
- **Integration Svr. Auth.**

### ❖ **Admin. Auth. Management**

For details about this function, consult your administrator.

❖ **Program/Change Admin.**

For details about this function, consult your administrator.

❖ **Key Counter Management**

Specify that functions that you want to manage with the key counter.

- Copier
- Facsimile
- Printer
- Scanner

❖ **Extended Security**

Specify whether or not to use the extended security functions. For details about this function, consult your administrator.

❖ **Prog/Chnge/Del LDAP Server**

By registering the LDAP server, you can search the LDAP server's address book for an recipient's e-mail address when sending files by e-mail using the scanner or fax functions.

- Name
- Server Name
- Search Base
- Port No.
- SSL
- Authentication
- User Name
- Password
- Search Conditions
- Search Options

To start an LDAP search, make sure that the items listed below are set. For other items, check your environment and make any necessary changes.

- Server name
- Search Base
- Port No.
- Search Conditions
- Authentication

To use the LDAP server in Administrator Tools, select **[On]** under **[LDAP Search]**.

This function supports LDAP Version 2.0 and 3.0. Version 2.0 does not support High Security authentication.

For details about programming, changing, or deleting the LDAP server, see "Program/Change/Delete LDAP Server".



**❖ LDAP Search**

Specify whether or not to use the LDAP server for searching.  
The default setting is **On**.

If you select **[Off]**, **[Search LDAP]** does not appear on the searching display.

**❖ AOF (Always On)**

Specify whether or not to use Auto Off.  
The default setting is **On**.

**❖ Firmware Version**

You can check the version of the software installed in this machine.

**❖ Network Security Level**

For details about this function, consult your administrator.

**❖ Delete All Logs**

For details about this function, consult your administrator.

**❖ Transfer Log Setting**

For details about this function, consult your administrator.

**🔍 Reference**

p.4 "Accessing User Tools"

p.64 "Program/Change/Delete LDAP Server"

p.284 "Counter"

p.168 "Printing the Counter for Each User"

p.147 "Address Book"

---

## Program/Change/Delete LDAP Server

---

This section explains how to program the LDAP server settings.

---

### Programing / Changing the LDAP server

---

2

**1** Select [System Settings] using [▲] or [▼], and then press the [OK] key.

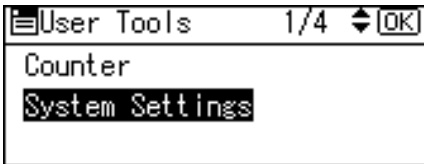

**2** Select [Administrator Tools] using [▲] or [▼], and then press the [OK] key.



**3** Select [Prog/Chnge/Del LDAP Server] using [▲] or [▼], and then press the [OK] key.

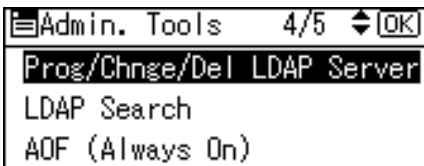

**4** Select [Program/Change] using [▲] or [▼], and then press the [OK] key.

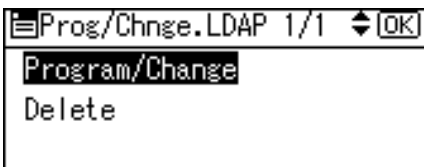

**5** Select the LDAP server you want to program or change using [▲] or [▼], and then press the [OK] key.

When programming the server, select [\*Not Programmed].

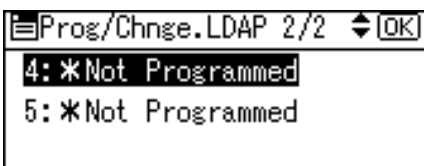

**6** Set each item as necessary.

**7** Press the [OK] after setting each item.

For details about specifying the settings, see "Programming the LDAP Server".

**8** Press [Exit].

**9** Press the [User Tools/Counter] key.

 **Reference**

p.66 "Programming the LDAP Server"

2

---

## Deleting the programmed LDAP server

---

**1** Select [System Settings] using [▲] or [▼], and then press the [OK] key.

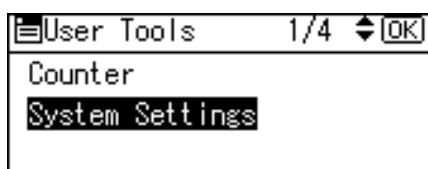

**2** Select [Administrator Tools] using [▲] or [▼], and then press the [OK] key.



**3** Select [Prog/Chnge/Del LDAP Server] using [▲] or [▼], and then press the [OK] key.

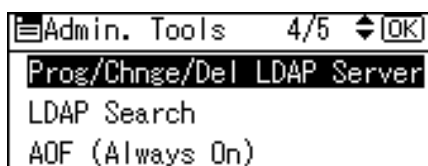

**4** Select [Delete] using [▲] or [▼], and then press the [OK] key.

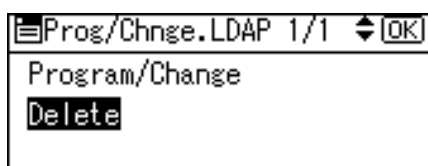

**5** Select the LDAP server you want to delete using [▲] or [▼], and then press the [OK] key.

**6** Press [Yes].

---

## Programming the LDAP Server

---

This section explains how to specify the LDAP server settings.

---

### Entering an identification name

---

2

**1** Select [Name] using [▲] or [▼], and then press the [OK] key.

Register a name for the LDAP server to appear on the server selection screen of the LDAP search operation.



**2** Enter the name and then press the [OK] key.

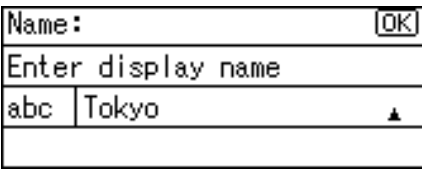

---

### Entering a server name

---

**1** Select [Server Name] using [▲] or [▼], and then press the [OK] key.

Register LDAP Server host name or IPv4 address.

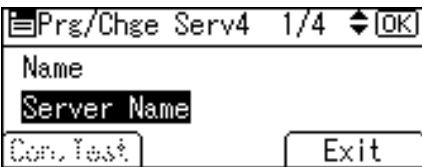

**2** Enter the server name, and then press the [OK] key.

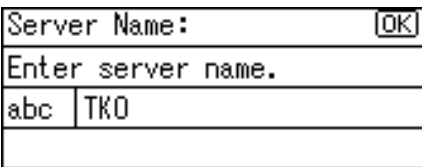

---

## Entering the search base

---

- 1 Select [Search Base] using [▲] or [▼], and then press the [OK] key.

Select a route folder to start the search. E-mail addresses registered in the selected folder are search targets.

A screenshot of a menu interface. At the top, it says 'Prg/Chge Serv4 2/4' with a left arrow, a right arrow, and an 'OK' button. Below this, 'Search Base' is highlighted with a black background. Underneath are the labels 'Port No.', 'Con. Test.', and 'Exit'.

- 2 Enter the Search Base, and then press the [OK] key.

For example, if the search target is the sales department of ABC company, enter "dc=sales department, o=ABC". (In this example, the description is for an active directory. "dc" is for the organization unit, and "o" is for the company.)

Search base registration may be required depending on your server environment. When registration is required, unspecified searches will result in error. Check your server environment and enter any required specifications.

A screenshot of a dialog box titled 'Search Conditions:'. It has an 'OK' button in the top right corner. Below the title is a text input field labeled 'Search base' containing the text 'abc'.

---

## Entering a port number

---

- 1 Select [Port No.] using [▲] or [▼], and then press the [OK] key.

Specify the port number for communicating with the LDAP server. Specify a port that matches your environment.

A screenshot of a menu interface. At the top, it says 'Prg/Chge Serv4 2/4' with a left arrow, a right arrow, and an 'OK' button. Below this, 'Port No.' is highlighted with a black background. Underneath are the labels 'Con. Test.' and 'Exit'.

- 2 Enter Port No. using the number keys and then press the [OK] key.

When SSL is set to [On], the port number automatically changes to "636".

A screenshot of a dialog box titled 'Port No. :'. It has an 'OK' button in the top right corner. Below the title is the text 'Enter with Number keys.' followed by a text input field containing the number '389'. Below the input field is the text '<Default:389>'.

---

## Starting SSL communication

---

- 1** Select [SSL] using [▲] or [▼], and then press the [OK] key.



- 2** Select [On] using [▲] or [▼], and then press the [OK] key.

Use SSL to communicate with the LDAP server.  
To use SSL, the LDAP server must support SSL.

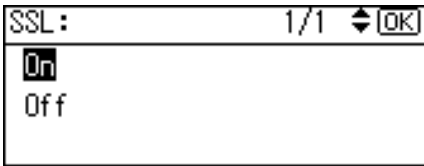

When SSL is set to [On], the port number automatically changes to "636".

SSL setting must be enabled on this machine. For details, consult your network administrator.

---

## Setting authentication

---

- 1** Select [Authentication] using [▲] or [▼], and then press the [OK] key.

To make a search request to the LDAP server, use the administrator account for authentication.



- 2** Select [On] or [High Security] using [▲] or [▼], and then press the [OK] key.

Authentication settings must comply with your server's authentication settings. Check your server settings before setting this machine.

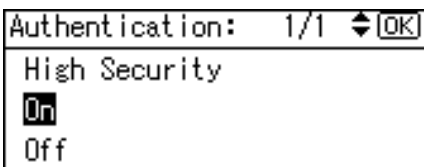

[High Security] can be specified on Version 3.0 LDAP servers only. When [High Security] is selected, the administrator password is encrypted before it is sent to the network. When [On] is selected, the password is sent without encryption.

---

## Entering the user name and password

---

### 1 Enter the user name, and then press the [OK] key.

When [On] or [High Security] is selected for the authentication setting, use the administrator account name and password. Do not enter the administrator account name and password when using authentication for individual users or each search.

Procedures for setting the user name differ depending on server environment. Check your server environment before making the setting.

Example: Domain Name\User Name, User Name@Domain Name  
CN=Name, OU=Department Name, DC=Server Name

User Name:	[OK]
Enter user name.	
abc	tokyo

### 2 Enter the password, and then press the [OK] key.

The user name and password are required for administrator authentication to access the LDAP server.

You can also specify the user name and password in this machine's Address Book to allow individual authentication access to the LDAP server. Use Administrator Tools to select the user name and password you want to use.

Password:	[OK]
Enter password.	
abc	****

---

## Testing the connection

---

**1** Press [Con.Test].

Access the LDAP server to check the proper connection is established. Check authentication works according to the authentication settings.



**2** Press [Exit].

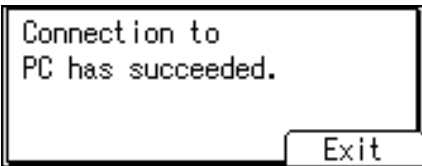

---

## Setting search conditions

---

**1** Select [Search Conditions] using [▲] or [▼], and then press the [OK] key.

If the connection test failed, check the settings, and try again.

This function does not check Search Conditions or Search Base.



**2** Select necessary search items such as [Name], [E-mail Address], [Fax Number], [Company Name], and [Department Name] using [▲] or [▼], and then press the [OK] key.

You can enter an attribute as a typical search keyword. Using the entered attribute, the function searches the LDAP server's Address Book.

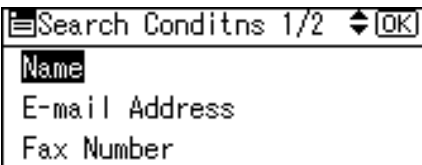



**3** Enter attribute, and then press the [OK] key.

The attribute value may change depending on the server environment. Check the attribute value complies with your server environment before setting it.

You can leave items blank, but you cannot leave attributes blank when searching for e-mail addresses from the LDAP server Address Book.

Name:		[OK]
Enter characters to search		
abc	cn	

2

**Setting search options****1** Select [Search Options] using [▲] or [▼], and then press the [OK] key.

Prg/Chge Servl 4/4		[OK]
Search Conditions		
Search Options		
Con.Test	Exit	

**2** Enter attribute, and then press the [OK] key.

To search the LDAP server data using a keyword other than prepared keywords such as Name, E-mail Address, FAX Number, Company Name, and Department Name, specify the attribute for the keyword registered in your LDAP server, and the name to be displayed on the control panel during the search. For example, to search e-mail addresses by employee number, enter "employee No." in the Attribute field, and "Employee No." in the key display field.

The attribute value may change depending on the server environment. Check the attribute complies with your server environment before setting it.

Search Opt.Attributes:		[OK]
Enter attributes		
abc	employee no.	

**3** Enter key display, and then press the [OK] key.

The registered "key display" appears as a keyword for searching LDAP.

Key Display:		[OK]
Enter display name		
abc	Employee No.	▲

# Key Operator Tools (For machines with copier function only or with the DDST Unit)

This section describes the user tools in the Key Operator Tools menu under System Settings.

Default settings are shown in **bold type**.

Key Operator Tools are used by the administrator. To change these settings, contact the administrator.

We recommend specifying key operator code before making Key Operator Tools settings.

## ❖ **User Code Man. :Copier**

Allows you to control who uses the machine by setting codes for users. User codes must be registered for user code management. The default setting is **Off**.

## ❖ **Key Counter Management**

Use the key counter to specify whether users are restricted or not. The default setting is **Copier**. **[Key Counter Management]** appears when the key counter is set.

## ❖ **Key Operator Code**

Specify whether or not to use passwords (max. eight digits) to control Key Operator Tools settings for key operator code. The default setting is **Off**.

If you select **[On]**, enter the key operator code using the number keys, and then select **[On: Partial]** or **[On: All]** to set the access limit.

- If you selected **[On: Partial]**

A key operator code is only required for the Timer Settings, and Key Operator Tools for System Settings. **[Menu Protect]** can be set for **[Maintenance]** in Printer Features. If you set **[Menu Protect]**, you can set the key operator code for some Printer Features. See “Printer Features Parameters”, Printer/Scanner Reference.

- If you selected **[On: All]**

A key operator code is required to access all items in System Settings, Copier Features, Printer Features.

If you select **[On: All]**, you must enter a key operator code to access the Key Operator Code display.

### ❖ **Display / Print Counter**

Allows you to view and print the number of prints.

- **Display / Print Counter**  
Displays the number of prints for each function (Total, Copier, Printer, Duplex).
  - **Print Counter List**  
Prints out a list of the number of prints made under each function.
- ① Select **[System Settings]** using **[▲]** or **[▼]**, and then press the **[OK]** key.
  - ② Select **[Key Operator Tools]** using **[▲]** or **[▼]**, and then press the **[OK]** key.
  - ③ Select **[Display / Print Counter]** using **[▲]** or **[▼]**, and then press the **[OK]** key.
  - ④ Press **[Print]**.
  - ⑤ Press the **[Start]** key.  
The Print Counter List is printed.

### ❖ **Counter per User Code**

Allows you to view and print the numbers of prints accessed with user codes, and to set those values to 0.

Press **[▲]** or **[▼]** to show all the numbers of prints.

The number of prints may differ from the counter value shown in Display / Print Counter.

- **Print counter per user code**  
Prints the number of prints made under each user code.
- **Clear counter per user code**  
Sets the number of prints made under each user code to 0.  
Print list for each user code, see "Printing the Counter for Each User Code".
- **Print counter for all user codes**  
Prints the number of prints made under all user codes.
- **Clear counter for all user codes**  
Sets the number of prints made under all user codes to 0.

### ❖ **Program / Change User Code**

You can register, change, and delete user codes. For details about these operations, see "User Code".

You can register up to 50 user codes.

### ❖ **AOF (Always On)**

Specify whether or not to use Auto Off.

The default setting is **On**.

# User Code (For machines with copier function only or with the DDST Unit)

Following describes the procedure for authenticating a user code.

Register user codes to restrict copier functions to certain users, and check on their use of copier functions:

2

## Registering a User Code

- 1 Select [System Settings] using [▲] or [▼], and then press the [OK] key.

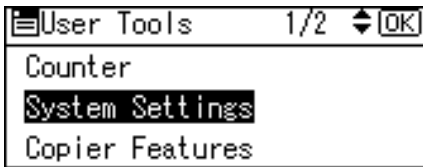

- 2 Select [Key Operator Tools] using [▲] or [▼], and then press the [OK] key.

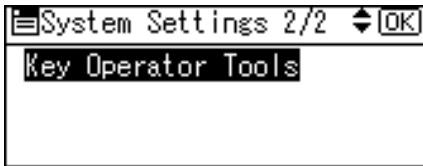

- 3 Select [Program / Change User Code] using [▲] or [▼], and then press the [OK] key.

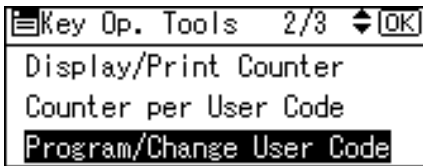

- 4 Select [Program] using [▲] or [▼], and then press the [OK] key.

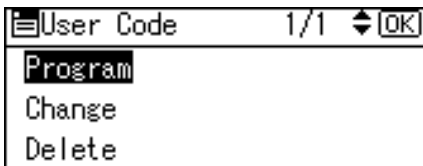

- 5 Enter the user code using the number keys, and then press the [OK] key.

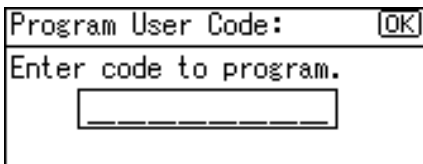

- 6 Press the [User Tools/Counter] key.

## Changing a User Code

Even if you change a user code, the counter value will not be cleared.

- 1 Select **[System Settings]** using **[▲]** or **[▼]**, and then press the **[OK]** key.



- 2 Select **[Key Operator Tools]** using **[▲]** or **[▼]**, and then press the **[OK]** key.



- 3 Select **[Program / Change User Code]** using **[▲]** or **[▼]**, and then press the **[OK]** key.

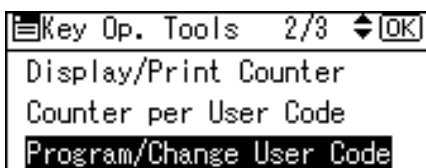

- 4 Select **[Change]** using **[▲]** or **[▼]**, and then press the **[OK]** key.

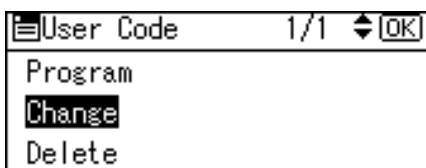

- 5 Enter the registered user code you want to change using the number keys, and then press the **[OK]** key.

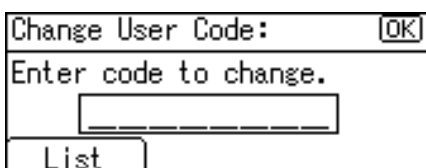

When you select the user code from the User Code List, press **[List]**. Select the user code you want to change using **[▲]** or **[▼]**, and then press the **[OK]** key twice.

2

- 6 Enter the new user code using the number keys, and then press the [OK] key.

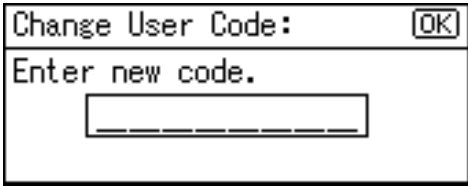

- 7 Press the [User Tools/Counter] key.

---

## Deleting a User Code

---

This operation also deletes user codes registered to multiple functions. User control via the deleted user code is no longer possible.

- 1 Select [System Settings] using [▲] or [▼], and then press the [OK] key.

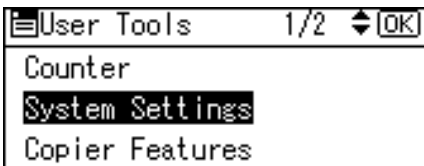

- 2 Select [Key Operator Tools] using [▲] or [▼], and then press the [OK] key.



- 3 Select [Program / Change User Code] using [▲] or [▼], and then press the [OK] key.

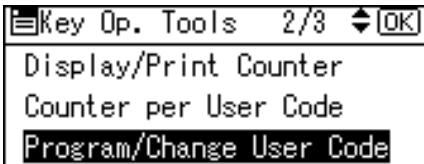

- 4 Select [Delete] using [▲] or [▼], and then press the [OK] key.

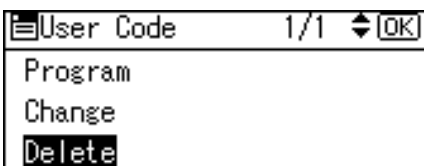

- 5** Select **[Per User Code]** or **[All User Code]** using **[▲]** or **[▼]**, and then press the **[OK]** key.

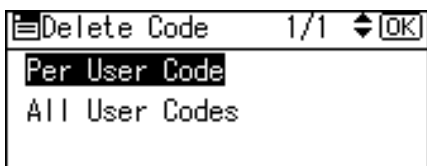

When selecting **[All User Code]**, a confirmation message appears. Press **[Yes]**.

- 6** Enter the registered user code you want to delete using the number keys, and then press the **[OK]** key.

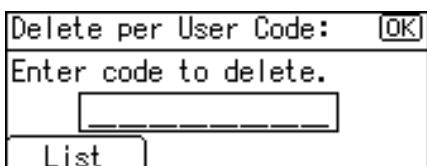

When you select the user code from the User Code List, press **[List]**. Select the user codes you want to delete using **[▲]** or **[▼]**, then confirm it by pressing **[▶]**, and then press the **[OK]** key.

- 7** Press **[Yes]**.

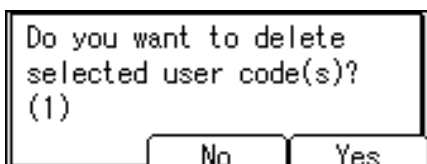

The "Deleted." message appears, and then the "User Code" display returns.

- 8** Press the **[User Tools/Counter]** key.

---

## Displaying the Counter for Each User Code

---

You can check the counter for each user code.

- 1** Select [System Settings] using [▲] or [▼], and then press the [OK] key.



- 2** Select [Key Operator Tools] using [▲] or [▼], and then press the [OK] key.



- 3** Select [Counter per User Code] using [▲] or [▼], and then press the [OK] key.

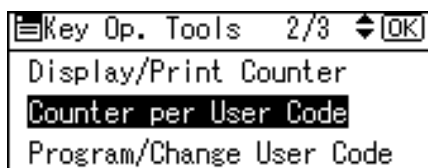

- 4** Select [Display] using [▲] or [▼], and then press the [OK] key.

The counter for each user code will be displayed.

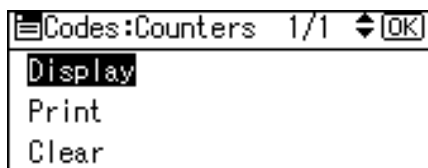

- 5** Press the [User Tools/Counter] key.



## Printing the Counter for Each User Code

You can print out the counter for each user code.

- 1 Select [System Settings] using [▲] or [▼], and then press the [OK] key.



- 2 Select [Key Operator Tools] using [▲] or [▼], and then press the [OK] key.



- 3 Select [Counter per User Code] using [▲] or [▼], and then press the [OK] key.

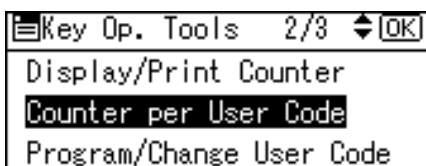

- 4 Select [Print] using [▲] or [▼], and then press the [OK] key.

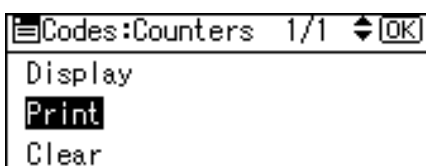

- 5 Press the [Start] key.

The counter list prints out.

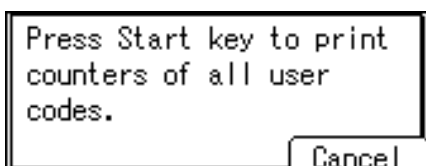

- 6 Press the [User Tools/Counter] key.

---

## Clearing the Number of Prints

---

**1** Select [System Settings] using [▲] or [▼], and then press the [OK] key.

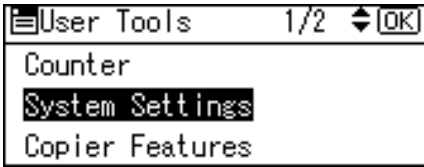

**2** Select [Key Operator Tools] using [▲] or [▼], and then press the [OK] key.



**3** Select [Counter per User Code] using [▲] or [▼], and then press the [OK] key.

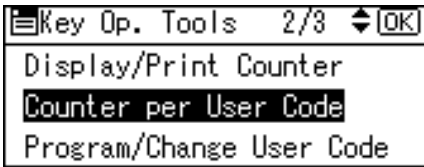

**4** Select [Clear] using [▲] or [▼], and then press the [OK] key.

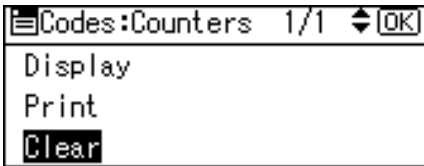

**5** Press [Yes].

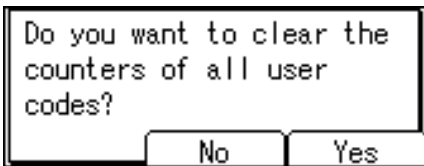

The "Counter has been cleared." message appears, and then the "Codes:Counters" display returns.

**6** Press the [User Tools/Counter] key.

# 3. Copier Features

This chapter describes user tools in the Copier Features menu. For details on how to access Copier Features, see "Accessing User Tools".

## Copier Features

This section describes the user tools in Copier Features.

Default settings are shown in **bold type**.

### ❖ **Auto Tray Switching**

If you load paper of the same size and in the same orientation in two trays, the machine automatically shifts to the other tray when the first tray runs out of paper (if **[On]** is selected.) This function is called "Auto Tray Switching".

This setting specifies whether to use Auto Tray Switching or not.

The default setting is **On**.

**[Off]**: When a paper tray runs out of paper, copying is interrupted and the "Load paper" message appears.

### ❖ Original Type Setting

You can adjust copy finish quality level according to original type. You can choose these functions after selecting **[Original Type 1 (Text)]** or **[Original Type 2 (Photo)]**.

- Text Mode 1  
normal text originals
- Text Mode 2  
newspapers, semi-transparent originals (reverse side print faintly visible)
- Photo Mode 1  
text / photo images containing mostly photo areas
- Photo Mode 2  
text / photo images containing mostly text areas
- Photo Mode 3  
actual photographic paper
- Special Mode 1  
highly transparent originals (reverse side clearly visible), or light text on a colored background. Also for originals with very grainy backgrounds (some newspapers) and light text.
- Special Mode 2  
originals with colored text and lines
- Special Mode 3  
photo images created by dithering (visible dots), such as newspaper photos - normal resolution
- Special Mode 4  
photo images created by dithering (visible dots), such as newspaper photos - coarse resolution
- Special mode 5  
normal text originals (reproducing the background)

The default setting for Original Type 1 (Text) is **Text Mode 1**.

The default setting for Original Type 2 (Photo) is **Photo Mode 1**.

### ❖ Duplex Mode Priority

You can select the type of Duplex function effective when the machine is turned on, reset, or modes are cleared.

The default setting is **1 Sided→1 Sided**.

### ❖ Orientation

You can select the original orientation when using the Combine/Series, or Duplex function.

The default setting is **Do not Specify**.

### ❖ Max. Number of Sets

The maximum copy quantity can be set between 1 and 99 using number keys.

The default setting is **99 sheets**.

### ❖ Original Count Display

You can set to display the count of originals and copying pages on the display when **[On]** is selected.

The default setting is **Off**.

### ❖ Reproduction Ratio

You can select which reduce, enlarge, or input ratio is shown on the display with priority when **[Reduce]** or **[Enlarge]** is selected.

Reduce or Enlarge ratios for setting are as follows:

The default setting for "Ratio 1" is **50%** (Metric version) / **65%** (Inch version).

The default setting for "Ratio 2" is **71%** (Metric version) / **78%** (Inch version).

The default setting for "Ratio 3" is **93%** (Metric version) / **93%** (Inch version).

The default setting for "Ratio 4" is **141%** (Metric version) / **129%** (Inch version).

The default setting for "Ratio 5" is **200%** (Metric version) / **155%** (Inch version).

You can set a ratio other than the above.

① Select **[Reproduction Ratio]** using **[▲]** or **[▼]**, and then press the **[OK]** key.

② Select the ratio you want change using **[▲]** or **[▼]**, and then press the **[OK]** key.

③ Select **[User R/E Ratio]** using **[▲]** or **[▼]**, and then press the **[OK]** key.

④ Enter a ratio using the number keys from "50-200", and then press the **[OK]** key.

The "programmed" message appears.

### ❖ Preset R/E Priority

You can set the ratio with priority when **[R/E]** is selected.

Using the number keys, enter the ratio from "50-200" in units of 1%.

The default setting is **71%** (Metric version) / **65%** (Inch version).

### ❖ Duplex Margin

Specify left margin on the back side of copies, and top margin on the front side. Select **[Top Margin]** or **[Left Margin]**, and then set the required value.

- Top Margin: 0-50mm, 0"-2.0"

- Left Margin: 0-50mm, 0"-2.0"

The default setting is **5 mm** (Metric version) / **0.2 inch** (Inch version).

❖ **Letterhead Setting**

If you select **[On]** for this function, the machine rotates the image correctly. The default setting is **Off**.

Orientation-fixed (top to bottom) or two-sided paper might not print correctly, depending on how the originals and paper are placed.

🔍 **Reference**

p.4 "Accessing User Tools"

"Original Type Setting", Copy Reference

"Selecting Copy Paper", Copy Reference

"Orientation-Fixed Paper or Two-Sided paper", Copy Reference

# 4. Fax Features

This chapter describes user tools in the Fax Features menu. For details on how to access Fax Features, see "Accessing User Tools".

## General Settings/Adjust

This section describes the user tools in the General Settings/Adjust menu under Fax Features.

Default settings are shown in **bold type**.

### ❖ **Adjust Sound Volume**

Adjust the sound volume during On Hook Mode and Immediate Transmission. The volume is factory-preset to the second lowest level. For details about Adjust Sound Volume, see "Adjusting the Volume", Troubleshooting.

### ❖ **Program Fax Information**

Register the sender details that appear on the recipient's fax machine and faxed document.

For details about Program Fax Information, see "Registering Fax Information".

### ❖ **On Hook Release Time**

Use this function to specify a time to cancel On Hook mode after you transmit using On Hook dialing. This is useful when On Hook dialing is cancelled in fax information service.

The default setting is **3 minutes**.

### ❖ Set User Function Key1-3

Frequently used functions programmed as User Function keys are shown on the menu immediately after the power is turned on.

The User Function keys can be programmed with the following items:

- Print Journal
- TX File Status (Transmission File Status)
- RX File Status (Reception File Status)
- 2 Sided TX (Two-sided transmission)
- Print Fax Header
- Forwarding
- Switch Reception Mode
- Start Manual Reception
- Sender Settings
- E-mail Options
- Print TX Status Report (Print Transmission Status Report)
- Manual E-mail Reception
- Use SMTP Server
- SUB/SEP Code
- Not programmed

Up to three functions can be programmed to User Function keys.

The default setting for "User Function Key 1" is **Start Manual Reception**.

The default setting for "User Function Key 2" is **Switch Reception Mode**.

The default setting for "User Function Key 3" is **Print Journal**.

Functions that appear dimmed have already been set.

- ① Select [**Fax Features**] using [**▲**] or [**▼**], and then press the [**OK**] key.
- ② Select [**General Settings/Adjust**] using [**▲**] or [**▼**], and then press the [**OK**] key.
- ③ Select [**Set User Function Key**] using [**▲**] or [**▼**], and then press the [**OK**] key.
- ④ Select User Function key you want to program.
- ⑤ Select the function you want to program in the User Function key using [**▲**] or [**▼**], and then press the [**OK**] key.

### Reference

p.4 "Accessing User Tools"

p.97 "Registering Fax Information"

"Adjusting the Volume", Troubleshooting

"Reading the Display Panel and Using Keys", Facsimile Reference



# Reception Settings

This section describes the user tools in the Reception Settings menu under Fax Features.

Default settings are shown in **bold type**.

## ❖ **Switch Reception Mode**

Specify the method for receiving fax messages.  
The default setting is **Auto Reception**.

## ❖ **RX Mode Auto Switch Time**

Specify the number of rings with the Auto Switch Time.  
In Auto Select Mode, the machine rings a number of times to give you the chance to pick up the handset before taking the call automatically.  
The default setting is **8 Times**.

- ① Select [**Fax Features**] using [**▲**] or [**▼**], and then press the [**OK**] key.
- ② Select [**Reception Settings**] using [**▲**] or [**▼**], and then press the [**OK**] key.
- ③ Select [**RX Mode Auto Switch Time**] using [**▲**] or [**▼**], and then press the [**OK**] key.
- ④ Enter the number of rings from 1 to 29 using the number keys, and then press the [**OK**] key.
- ⑤ Press the [**User Tools/Counter**] key.

## ❖ **Authorized Reception**

Specify whether or not unwanted fax messages are to be screened out.  
The default setting is **Off**.

## ❖ **Checkered Mark**

Specify whether or not a checkered mark is to be printed on the first page of received fax documents.  
The default setting is **On**.

## ❖ **Center Mark**

Specify whether or not a center mark is to be printed halfway down the left side and at the top center of each page received.  
The default setting is **Off**.

## ❖ **Print Reception Time**

Specify whether or not received date and time are to be printed at the bottom of received fax messages.  
The default setting is **Off**.

## **Reference**

p.4 “Accessing User Tools”

# E-mail Settings

This section describes the user tools in the E-mail Settings menu under Fax Features.

Default settings are shown in **bold type**.

## ❖ Internet Fax Settings

You can select to display  or not. When you want to send an Internet Fax, set On to display the icon. The default setting is **Off**.

## ❖ Maximum E-mail Size

Use this setting to limit the size of sent e-mail, so that destinations that refuse e-mail over a certain size can still receive your e-mail. When this function is set to on, you cannot send e-mail that is larger than the specified limit. The default setting is **Off**.

When e-mail exceeds the maximum file size, an Error Report is output, and the e-mail is deleted.

Even when e-mail does not exceed the size limit, it may be rejected if it does not meet the requirements of the server settings.

- ① Select [**Fax Features**] using [**▲**] or [**▼**], and then press the [**OK**] key.
- ② Select [**E-mail Settings**] using [**▲**] or [**▼**], and then press the [**OK**] key.
- ③ Select [**Maximum E-mail Size**] using [**▲**] or [**▼**], and then press the [**OK**] key.
- ④ Select [**On**] using [**▲**] or [**▼**], and then press the [**OK**] key.
- ⑤ Enter an upper limit on the size of outgoing e-mail using the number key, and then press the [**OK**] key.  
Specify a size limit of 128 - 102,400 KB.  
If you make a mistake, press the [**Clear/Stop**] key, and then reenter the number.

### ❖ SMTP RX File Delivery

This function is available on systems that allow routing of e-mail received via SMTP.

The default setting is **Off**.

When an authorized e-mail is set, e-mail received from addresses that do not match the authorized address is discarded and an error message is returned to the SMTP server.

The authorized e-mail address is compared with the addresses of e-mail originators, as illustrated by the following examples.

- When the authorized e-mail address is set to "@aaa.abcd.com":  
abc@aaa.abcd.com - accepted  
def@aaa.xyz.com - not accepted  
abc@abcd.com - not accepted

No Error Report is output even when e-mail is discarded.

- ① Select **[Fax Features]** using **[▲]** or **[▼]**, and then press the **[OK]** key.
- ② Select **[E-mail Settings]** using **[▲]** or **[▼]**, and then press the **[OK]** key.
- ③ Select **[SMTP RX File Delivery]** using **[▲]** or **[▼]**, and then press the **[OK]** key.
- ④ Select **[On]** using **[▲]** or **[▼]**, and then press the **[OK]** key.
- ⑤ Enter the authorized e-mail address and then press the **[OK]** key.  
You can enter up to 128 characters for the e-mail address.  
If you make a mistake, press the **[Clear/Stop]** key, and then enter again.

### Reference

p.4 "Accessing User Tools"

"Reading the Display Panel and Using Keys", Facsimile Reference

# IP-Fax Settings

This section describes the user tools in the IP-Fax Settings menu under Fax Features.

Default settings are shown in **bold type**.

Make settings to use IP-Fax.

Set H.323 for the gatekeeper, SIP for SIP server, and the gateway to G3 fax if necessary. Check the settings of the network to which this machine is connected before making settings.

Make sure you enter these characters correctly:

- Numbers
- Symbols (# and \*)  
The following characters can be used for registration of the SIP User Name in SIP Settings. Make sure you enter these characters correctly:
- Alphanumeric symbols (lower and upper cases)
- Symbols (;?:&=+\$,-\_!.~\*#'@()%/)

Use numbers and periods (".") to enter the correct IPv4 addresses for the gatekeeper, SIP server, and gateway. To obtain the correct IP addresses, consult administrator.

## ❖ Enable H.323

Specify whether or not H.323 is used for IP-Fax transmission.  
The default setting is **Off**.

## ❖ Enable SIP

Specify whether or not SIP is used for IP-Fax transmission.  
The default setting is **Off**.

## ❖ H.323 Settings

Set the IP address or host name of gate keeper, and alias telephone number. To use the gatekeeper, set the parameter setting list (switch 34, bit 0) to "On".

- ① Select **[Fax Features]** using **[▲]** or **[▼]**, and then press the **[OK]** key.
- ② Select **[IP-Fax Settings]** using **[▲]** or **[▼]**, and then press the **[OK]** key.
- ③ Select **[H.323 Settings]** using **[▲]** or **[▼]**, and then press the **[OK]** key.
- ④ Select **[Gatekeeper Address (Main)]** using **[▲]** or **[▼]**, and then press the **[OK]** key.
- ⑤ Enter the IPv4 address or host name of the gatekeeper, and then press the **[OK]** key.
- ⑥ Select **[Own Fax No.]** using **[▲]** or **[▼]**, and then press the **[OK]** key.
- ⑦ Enter Own Fax No and then press the **[OK]** key.
- ⑧ Press the **[User Tools/Counter]** key.

## ❖ SIP Settings

Set the SIP server's IPv4 address and SIP user name.

To use the SIP server, set the parameter setting list (switch 34, bit 1) to "On". The default is "Off".

- ① Select **[Fax Features]** using **[▲]** or **[▼]**, and then press the **[OK]** key.
- ② Select **[IP-Fax Settings]** using **[▲]** or **[▼]**, and then press the **[OK]** key.
- ③ Select **[SIP Settings]** using **[▲]** or **[▼]**, and then press the **[OK]** key.
- ④ Select **[Proxy Server Addr. (Main)]** using **[▲]** or **[▼]**, and then press the **[OK]** key.  
A proxy server relays call requests and responses.
- ⑤ Enter the IPv4 address of the proxy server, and then press the **[OK]** key.
- ⑥ Select **[Redirect Svr. Addr. (Main)]** using **[▲]** or **[▼]**, and then press the **[OK]** key.  
A redirect server processes request destination inquiries.
- ⑦ Enter the IPv4 address of the redirect server, and then press the **[OK]** key.
- ⑧ Select **[Registrar Address (Main)]** using **[▲]** or **[▼]**, and then press the **[OK]** key.  
A register server registers location information of user agents (which correspond to telephones or facsimiles on public telephone lines) on an IP network.
- ⑨ Enter the IPv4 address of the register server, and then press the **[OK]** key.
- ⑩ Select **[SIP User Name]** using **[▲]** or **[▼]**, and then press the **[OK]** key.
- ⑪ Enter SIP User Name, and then press the **[OK]** key.

## ❖ Gateway Settings

Register, change, or delete the gateway used for transmission to IP-Fax. Register to use the gateway without using the gatekeeper/SIP server.

Program/Change:

- ① Select [**Fax Features**] using [**▲**] or [**▼**], and then press the [**OK**] key.
- ② Select [**IP-Fax Settings**] using [**▲**] or [**▼**], and then press the [**OK**] key.
- ③ Select [**Gateway Settings**] using [**▲**] or [**▼**], and then press the [**OK**] key.
- ④ Select [**Program/Change**] using [**▲**] or [**▼**], and then press the [**OK**] key.
- ⑤ Select [**\*Not Programmed**] using [**▲**] or [**▼**], and then press the [**OK**] key.

- ⑥ Enter the Prefix using the number key, and then press the [**OK**] key.

For documents sent using a gateway to G3 Fax, prefixes can be used. If the first several digits of IP-Fax number and the gateway-specific prefix are identical, documents can be transmitted using the registered digits of the gateway. For example, if both 03 and 04 have been registered as gateway number while 0312345678 is also specified, documents can be transmitted via a gateway for which 03 is used as a prefix.

When you wish to use the gateways regardless of the IP-Fax destination numbers, register only the gateway addresses without registering the prefix.

- ⑦ Enter Gateway Address and then press the [**OK**] key.
- ⑧ Select [**H.323**] or [**SIP**] using [**▲**] or [**▼**], and then press the [**OK**] key.

Delete:

- ① Select [**Fax Features**] using [**▲**] or [**▼**], and then press the [**OK**] key.
- ② Select [**IP-Fax Settings**] using [**▲**] or [**▼**], and then press the [**OK**] key.
- ③ Select [**Gateway Settings**] using [**▲**] or [**▼**], and then press the [**OK**] key.
- ④ Select [**Delete**] using [**▲**] or [**▼**], and then press the [**OK**] key.
- ⑤ Select the gateway you want to delete using [**▲**] or [**▼**], and then press the [**OK**] key.
- ⑥ Press [**Yes**].

## 🔍 Reference

p.4 "Accessing User Tools"

p.107 "Parameter Settings List"

# Administrator Tools

This section describes the user tools in the Administrator Tools Settings menu under Fax Features.

Default settings are shown in **bold type**.

## ❖ **Print Journal**

Prints a Journal. Up to 50 of the latest results of transmission/delivery results can be checked on this machine.

You can also print the journal using the **[Job Information]** key.

## ❖ **Print TX Standby File List**

Use this function to print the transmission standby file list.

You can also print the transmission standby file list using the **[Job Information]** key.

## ❖ **Communication Page Count**

Checks the transmission and reception, and totals on the display.

## ❖ **Memory Lock**

When you switch Memory Lock on, received documents are stored in memory and not printed automatically. When a document is received in the Memory Lock mode, the Confidential File indicator blinks. To print this document, enter the Memory Lock ID. A user without the ID cannot print the document. This prevents unauthorized users from accessing the document.

The default setting is **Off**.

To use Memory Lock, program the Memory Lock ID, and then switch Memory Lock on.

To store incoming documents from Special Senders only in Memory Lock, program each sender. with "Program Special Sender".

This function is not available with Internet Fax.

① Select **[Fax Features]** using **[▲]** or **[▼]**, and then press the **[OK]** key.

② Select **[Administrator Tools]** using **[▲]** or **[▼]**, and then press the **[OK]** key.

③ Select **[Memory Lock]** using **[▲]** or **[▼]**, and then press the **[OK]** key.

④ Select **[On]** using **[▲]** or **[▼]**, and then press the **[OK]** key.

## ❖ **Forwarding**

Specify whether or not received fax messages are to be forwarded to a programmed receiver.

The default setting is **Off**.

### ❖ Folder TX Result Report

When a folder is included in the forwarding destination or the forwarding destination by special sender, the specified destination will be notified of the results of forwarding.

To forward to two or more destinations, specify group destination. For information about how to specify group destination, see "Registering a Names to a Group".

The default setting is **Do not E-mail**.

Even when an e-mail to notify the results of forwarding a folder cannot be sent, no report is out from this machine.

- ① Select [**Fax Features**] using [**▲**] or [**▼**], and then press the [**OK**] key.
- ② Select [**Administrator Tools**] using [**▲**] or [**▼**], and then press the [**OK**] key.
- ③ Select [**Folder TX Result Report**] using [**▲**] or [**▼**], and then press the [**OK**] key.
- ④ Select [**E-mail**] using [**▲**] or [**▼**], and then press the [**OK**] key.
- ⑤ Search and select a receiver using the Quick Dial keys or the [**Search Destination**] key, and then press the [**OK**] key.
- ⑥ Press the [**User Tools/Counter**] key.

### ❖ Parameter Setting

Parameter Setting allow you to customize various settings to suit your needs. To change function settings, set the Parameter Switches. For details, see "Parameter Setting".

### ❖ Program Special Sender

Program/Change/Delete Special Senders, perform initial setup, and print the Special Sender List. You can set functions for each sender if Special Senders are preprogrammed. For details, see "Program Special Sender".

### ❖ Program Memory Lock ID

Program a Memory Lock ID to be entered before printing documents when the Memory Lock function is activated.

Preprogram the ID when you set "Memory Lock" and "Memory Lock" in Special Senders function.

- ① Select [**Fax Features**] using [**▲**] or [**▼**], and then press the [**OK**] key.
- ② Select [**Administrator Tools**] using [**▲**] or [**▼**], and then press the [**OK**] key.
- ③ Select [**Program Memory Lock ID**] using [**▲**] or [**▼**], and then press the [**OK**] key.
- ④ Enter the ID using the number key, and then press the [**OK**] key.  
A Memory Lock ID can be any four-digit number, except 0000.  
If you make a mistake, press the [**Clear/Stop**] key before pressing the [**OK**] key, and then enter again.



### ❖ Select Dial/Push Phone

Use this function to select a line type.

Dial and Push lines are available for selection.

The default setting is **Push Phone**.

This function is not available in some areas.

- ① Select **[Fax Features]** using **[▲]** or **[▼]**, and then press the **[OK]** key.
- ② Select **[Administrator Tools]** using **[▲]** or **[▼]**, and then press the **[OK]** key.
- ③ Select **[Select Dial/Push Phone]** using **[▲]** or **[▼]**, and then press the **[OK]** key.
- ④ Select **[Push Phone]** or **[Dial Phone (10PPS)]** using **[▲]** or **[▼]**, and then press the **[OK]** key.

### ❖ G3 Analog Line

You need to make the following settings for the G3 Analog Line before you connect the machine to a standard G3 analog line.

- When your machine is connected through a PABX, set to Extension. If it is connected directly to the telephone network, set to Outside.
- Outside Access No.

Use this setting if your machine is connected to a PABX that requires you to dial a certain number such as "0" followed by a pause to connect to the outside line. By programming "0" as the PSTN Access Number, a pause will be inserted automatically after the "0" when dialing.

- ① Select **[Fax Features]** using **[▲]** or **[▼]**, and then press the **[OK]** key.
- ② Select **[Administrator Tools]** using **[▲]** or **[▼]**, and then press the **[OK]** key.
- ③ Select **[G3 Analog Line]** using **[▲]** or **[▼]**, and then press the **[OK]** key.
- ④ Select **[Extension/Outside]** using **[▲]** or **[▼]**, and then press the **[OK]** key.
- ⑤ Select **[Extension]** or **[Outside]** using **[▲]** or **[▼]**, and then press the **[OK]** key.
- ⑥ Select **[Outside Access No.]** using **[▲]** or **[▼]**, and then press the **[OK]** key.
- ⑦ Enter the Outside Access No. using the number key, and then press the **[OK]** key.  
You can program the number up to two digits.  
If you make a mistake, press the **[Clear/Stop]** key, and then enter again.
- ⑧ Press the **[User Tools/Counter]** key.

❖ **RDS On/Off (Remote Diagnostic System)**

If your machine has a problem, a service representative can perform various diagnostic tasks over the telephone line from the service station to try to find out what is wrong with your machine. The service representative can also use RDS to change some of your machine's settings if you request it. When the machine is shipped, this feature is turned on.

 **Reference**

p.4 "Accessing User Tools"

p.244 "Registering Names to a Group"

p.107 "Parameter Setting"

p.117 "Program Special Sender"

# Registering Fax Information

You can send information to the other party when transmitting or receiving a fax document. This information is shown on the display of the other machine and printed as a report. The following information can be sent.

## Important

- You can confirm programmed settings from the Parameter Settings List. It is recommended to print and keep the Parameter Settings List when you program or change settings. For information about how to print the Parameter Settings List, see "Printing the Parameter Settings List".
- In the USA, the Fax Header must contain the telephone number of the line your machine is connected to. It will be printed on the header of every page you send. Required in the USA.

## ❖ Fax Header

The Fax Header is printed as the header of every fax you send. You should include your name in the Fax Header.

You can register "Fax Header" using up to 32 alphanumeric characters, numbers, and spaces.

You can set whether or not to print the Fax Header (for printing) in **[Print Fax Header]** under **[TX Mode]**. For details about how to set, see "Fax Header Print", Facsimile Reference.

## ❖ Own Name

The Own Name is sent to the other party when you send or receive a fax. This name should include your name. The Own Name is shown on the display of the other machine and printed in a report.

Own Name works only if the other machine is of the same manufacturer and has the Own Name function.

You can register "Own Name" using up to 20 alphanumeric characters and symbols.

## ❖ Own Fax Number (facsimile number of sender)

The sender's Own Fax Number is sent to the other party when sending a fax. The received facsimile number is shown on the display of the other machine and printed in a report.

This function is available regardless of the manufacturer of the other party's machine.

You can register "Own Fax Number" using up to 20 numbers, spaces, and the "+" symbol.

## Reference

p.112 "Printing the Parameter Settings List"

"Fax Header Print", Facsimile Reference

---

## Registering Fax Information

---

- 1** Select [Fax Features] using [▲] or [▼], and then press the [OK] key.

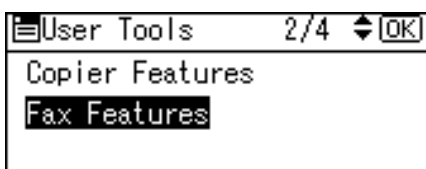

- 2** Select [General Settings/Adjust] using [▲] or [▼], and then press the [OK] key.

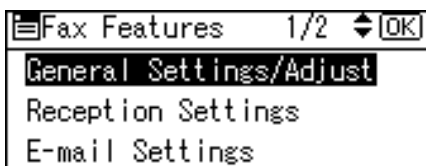

- 3** Select [Program Fax Information] using [▲] or [▼], and then press the [OK] key.

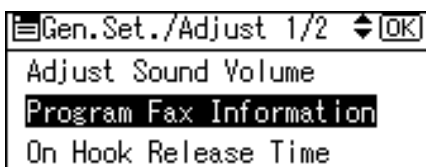

- 4** Select fax information you want to program/change using [▲] or [▼], and then press the [OK] key.

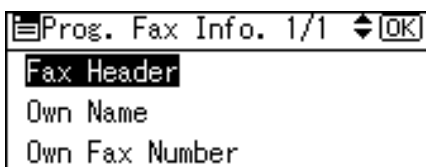

- 5** Program/change the selected fax information, and then press the [OK] key.

- 6** Press the [User Tools/Counter] key.

---

## Programming/Changing Fax Header

---

- 1** Select [Fax Header] using [▲] or [▼], and then press the [OK] key.

Prog. Fax Info. 1/1		[OK]
Fax Header		
Own Name		
Own Fax Number		

- 2** Enter a fax header including your Own Name and Fax Number, and then press the [OK] key.

Fax Header:		[OK]
Enter Name.		
abc	Important	

To change the programmed Fax Header, press the **[Clear/Stop]** key, and then enter again.

 **Note**

- You can register up to 32 characters in the Fax Header.
- You can use characters, symbols, numbers, and spaces.

 **Reference**

"Entering Text", About This Machine

---

## Programming/Changing Own Name

---

- 1** Select [Own Name] using [▲] or [▼], and then press the [OK] key.

Prog. Fax Info. 1/1		[OK]
Fax Header		
Own Name		
Own Fax Number		

- 2** Enter the own name, and then press the [OK] key.

Own Name:		[OK]
Enter Name.		
abc	ABA.COMPANY	▲

To change the programmed Own Name, press the **[Clear/Stop]** key, and then enter again.

 **Note**

- You can register "Own Name" using up to 20 alphanumeric characters and symbols.

 **Reference**

"Entering Text", About This Machine

---

### Programming/Changing Own Fax Number

---

- 1** Select [Own Fax Number] using [**▲**] or [**▼**], and then press the [**OK**] key.

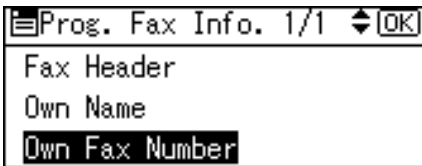

- 2** Enter the source fax number using the number key, and then press the [**OK**] key.



To change the programmed source fax header, press the [**Clear/Stop**] key, and then enter again.

When you enter "+" and space, press [**+**], [**Space**] for each.

If you make a mistake, press the [**Clear/Stop**] key, and then enter again.

 **Note**

- You can register "Own Fax Number" using up to 20 numbers, space, and "+" symbol.

## Deleting Fax Information

- 1 Select [Fax Features] using [▲] or [▼], and then press the [OK] key.

☰	User Tools	2/4	◆	[OK]
	Copier Features			
	<b>Fax Features</b>			

- 2 Select [General Settings/Adjust] using [▲] or [▼], and then press the [OK] key.

☰	Fax Features	1/2	◆	[OK]
	<b>General Settings/Adjust</b>			
	Reception Settings			
	E-mail Settings			

- 3 Select [Program Fax Information] using [▲] or [▼], and then press the [OK] key.

☰	Gen.Set./Adjust	1/2	◆	[OK]
	Adjust Sound Volume			
	<b>Program Fax Information</b>			
	On Hook Release Time			

- 4 Select fax information you want to delete using [▲] or [▼], and then press the [OK] key.

☰	Prog. Fax Info.	1/1	◆	[OK]
	<b>Fax Header</b>			
	Own Name			
	Own Fax Number			

- 5 Press the [Clear/Stop] key.

Fax Header:	[OK]
Enter Name.	
abc   Important	

The programmed information is deleted.

**6** Press the [OK] key.

Fax Header:	[OK]
Enter Name.	
abc	_

**7** Press the [User Tools/Counter] key.



# Forwarding

Print documents received and forward to a specified End Receiver. This is useful if, for example, you are visiting another office and would like a copy of your documents to be sent to that office.

You can also specify a "folder" as the forwarding destination.

## Important

- To use this function, set **[Forwarding]** under **[Administrator Tools]** to **[On]**.
- The Forwarding function does not forward documents received with Memory Lock.
- You can select end receivers only from among destinations programmed in the Address Book. You cannot specify programmed transfer stations as end receivers.

A fax number, e-mail address, IP-Fax destination, and folder can be set as the forwarding destination.

When you wish to change the end receivers depending on the senders, specify the end receivers by the senders, at "Program Special Sender". Documents not received from specified senders are sent to the destination specified in this function.

You can set whether or not to print the forwarded documents on this machine in "Parameter Setting"(switch 11, bit 6). The default is "On".

Deleting a destination specified as a forward destination from the destination list causes the settings of the forward destination to be deleted, so they must be registered again. When a destination is changed, a document is transmitted to the new destination. If there is no destination of the specified type, you can set which destination to be used as an alternative destination. See "Parameter Setting" (switch 32, bit 0).

You can program one of the User Function keys with operations for this function.

If you have specified a folder for forwarding, you can specify the file format used for forwarding. See "Parameter Setting" (switch 21, bit 3).

## Reference

- p.85 "General Settings/Adjust"
- p.107 "Parameter Setting" (switch 11, bit 6)
- p.107 "Parameter Setting" (switch 32, bit 0)
- p.107 "Parameter Setting" (switch 21, bit 3)
- p.87 "Reception Settings"
- p.117 "Program Special Sender"

## Programming an End Receiver

### Important

- ❑ One end receiver can be registered for each special sender. To register two or more end receivers, use group destination. However maximum of 100 destinations can be specified in a group.

**1** Select **[Fax Features]** using **[▲]** or **[▼]**, and then press the **[OK]** key.

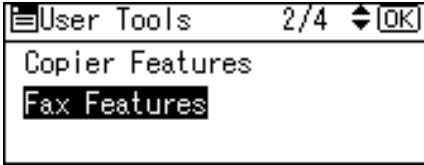

**2** Select **[Administrator Tools]** using **[▲]** or **[▼]**, and then press the **[OK]** key.



**3** Select **[Forwarding]** using **[▲]** or **[▼]**, and then press the **[OK]** key.

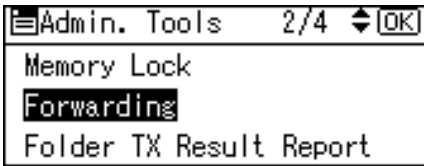

**4** Select **[On]** using **[▲]** or **[▼]**, and then press the **[OK]** key.

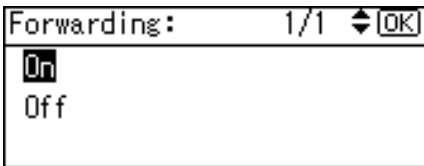

To cancel forwarding, press **[Off]** and proceed to step **6**.

**5** Search and select a receiver using the Quick Dial keys or the , and then press the **[OK]** key.

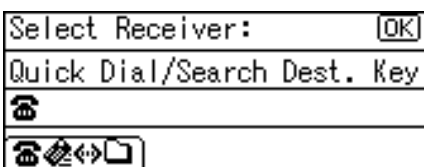

If you make a mistake, press the **[Clear/Stop]** key, and then enter again.

- 6** Press the [User Tools/Counter] key.

 **Reference**

p.107 "Parameter Setting" (switch 21, bit 3)  
p.205 "Registering Folders"

---

## Canceling Receiver Settings

---

- 1** Select [Fax Features] using [▲] or [▼], and then press the [OK] key.

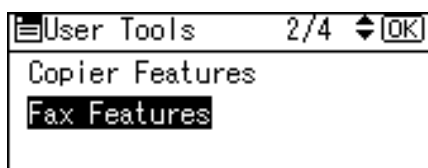

- 2** Select [Administrator Tools] using [▲] or [▼], and then press the [OK] key.

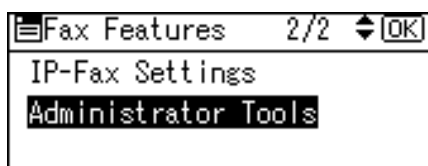

- 3** Select [Forwarding] using [▲] or [▼], and then press the [OK] key.

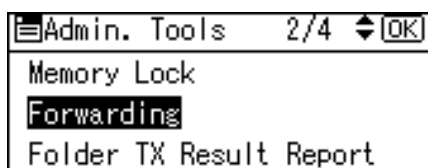

- 4** Select [Off] using [▲] or [▼], and then press the [OK] key.

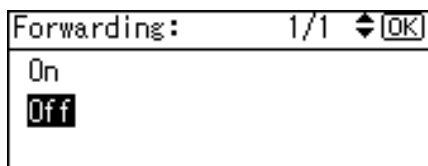

The set receiver name is deleted.

- 5** Press the [User Tools/Counter] key.

## Printing a Forwarding Mark

You can print a Forwarding Mark on receiver's documents that have been forwarded.

The receiver can distinguish between forwarded and normally received documents.

Specify whether or not to print a Forwarding Mark in the "Parameter Setting" (switch 02, bit 0). The default is "ON".

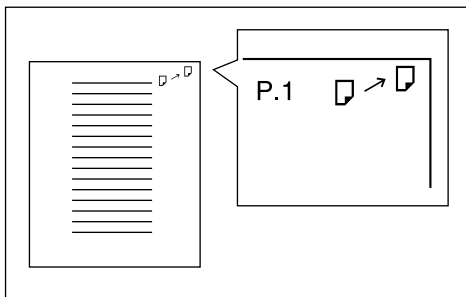

GFMTENOE

This function is not available when forwarding is performed to a folder destination.

### Reference

p.107 "Parameter Setting" (switch 02, bit 0)

# Parameter Setting

Parameter Setting allow you to customize various settings to suit your needs. To change function settings, set the Parameter Switches.

## ❖ Switches and Bits

Each parameter setting has a set of switches, and each of the switches consist of eight bits, whose values are "0" or "1". The right most bit is bit 0 and the left most is bit 7. You can adjust the settings to match your needs by switching the value of bits between "0" and "1".

Switch 02:

0	0	1	1	1	0	1	1
↓	↓	↓	↓	↓	↓	↓	↓
7	6	5	4	3	2	1	0

## ❖ Parameter Settings List

Parameter Settings are outlined below.

Switch	Bit	Item	0	1
02	0	Forwarding Mark	Off	On
02	3	TSI Print	Off	On
03	0	Automatic printing of the Memory Transmission Result Report	Off	On
03	2	Automatic Printing of the Memory Storage Report	Off	On
03	3	Whether or not to print the SEP Code RX Reserve Report automatically.	Off	On
03	4	Whether or not to print the SEP Code RX Result Report automatically.	Off	On
03	5	Automatic printing of the Immediate Transmission Result Report	Off	On
03	7	Automatic printing of the Journal	Off	On
04	1	Whether or not to print the Communication Failure Report and Transfer Result Report automatically.	Off	On
04	4	Indicates the parties	Off	On
04	5	Include sender's name on reports	Off	On
04	7	Include a portion of the image on reports	Off	On
05	0	Receive Service Call (SC) Condition (Substitute Reception during service call)	Possible (Substitute RX)	Not possible (Reception Off)

Switch	Bit	Item	0	1
05	2,1	Substitute the reception when the machine cannot print (because all paper trays have run out of paper, toner is empty, or all paper trays are out of order)	00: Enabled unconditionally (Free) 01: Enabled when Own Name / Own Fax Number is received 11: Disabled (Reception off)	
05	5	Print sheet is limited to that which has highest priority.	Off	On
05	7	Empty tray alert (Paper Empty Warning) even when one paper tray is empty	Off	On
07	2	Parallel Memory Transmission	Off	On
08	2	Authorized Reception Type Authorized RX is "ON"	Receiving from only specified senders	Receiving all messages except those from specified senders
10	6	Use both e-mail notification and printed reports to confirm the transmission results	Off	On
11	2	Detection of Blank Sheet Transmission	Off	On
11	6	Local print when forwarding	Off	On
14	0	Print documents received with Auto Power-On Reception (Night Printing mode)	Immediate printing (On)	When turning on the operation switch (Off)
14	1	Long Document Transmission (Well Log)	Off	On
14	3	Reset when function changed	Off	On
15	0, 1, 2	Select an available paper feed tray	001: Tray 1 010: Tray 2	
15	5	Fix the specified paper feed tray	On	Off
17	2	Whether you need to press <b>[Add Dest]</b> after entering a Quick Dial/Group Dial when broadcasting	Not necessary	Necessary
18	0	Print date with Fax Header	Off	On
18	1	Print transmitter origin with Fax Header	Off	On
18	2	Print file number with Fax Header	Off	On
18	3	Print page number with Fax Header	Off	On

Switch	Bit	Item	0	1
19	1	Sort Journal by line type	Off	On
20	0	Reprint documents that could not be printed using LAN-Fax Driver	Off	On
20	5,4,3,2	Reprinting time of stored documents in memory that could not be printed using LAN-Fax Driver when document reprint (switch 20, bit 1) has been set to on.	0000: 0 minute 0001: 1 minute 0010: 2 minutes 0011: 3 minutes 0100: 4 minutes 0101: 5 minutes 0110: 6 minutes 0111: 7 minutes 1000: 8 minutes 1001: 9 minutes 1010: 10 minutes 1011: 11 minutes 1100: 12 minutes 1101: 13 minutes 1110: 14 minutes 1111: 15 minutes	
21	0	Print results of sending Return Receipt Request message	Off	On
21	1	Respond to e-mail reception acknowledgment request	Off	On
21	3	File format for files forwarded to folder destinations	TIFF	PDF
21	4	Transmit Journal by E-mail	Off	On
21	6	Not displaying Network Errors	Off	On
21	7	Transmit Error Mail Notification	On	Off
22	0	Detect a dial tone before sending faxes when using the telephone line	Not detect (Off)	Detect (On)
32	0	Select priority order for alternative destinations if there is no destination of the specified type.	Paper Output Priority <Priority Order> 1. IP-Fax destination 2. Fax number 3. E-mail address 4. Folder	Electronic Output Priority <Priority Order> 1. E-mail address 2. Folder 3. IP-Fax 4. Fax number
34	0	Use gatekeeper with IP-Fax	Off	On
34	1	Use SIP server with IP-Fax	Off	On

## Changing the User Parameters

This section describes how to set parameters.

### Important

- ❑ Access to some User Parameter Setting may require options, or other settings may need to be made beforehand.
- ❑ It is recommended that you print and store the "Parameter Settings List" when you program or change parameter settings.
- ❑ Do not change any bit switches other than those shown on the previous pages.

**1** Select [Fax Features] using [▲] or [▼], and then press the [OK] key.

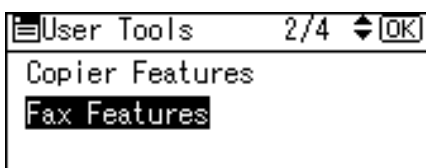

**2** Select [Administrator Tools] using [▲] or [▼], and then press the [OK] key.

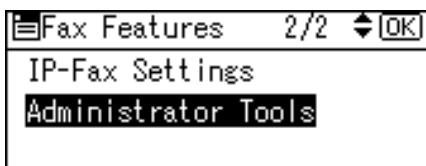

**3** Select [Parameter Setting] using [▲] or [▼], and then press the [OK] key.

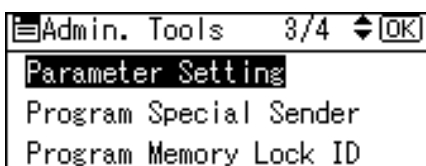

**4** Select [Parameter Setting] using [▲] or [▼], and then press the [OK] key.

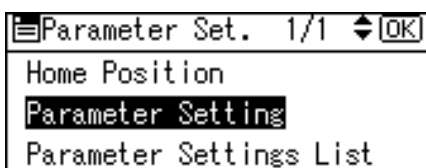

**5** Select the switch number you want to change using the scroll keys, and then press the [OK] key.

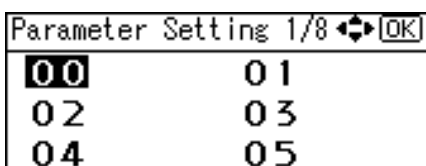



- 6** Select the bit number you want to change.

Switch No. 00:	[OK]
▶Default	0 0 0 0 0 0 0 0
▶Current	0 0 0 0 0 0 1 0

When the bit number is pressed, the current value switches between 1 and 0.  
Repeat step **6** to change another bit number for the same switch.

- 7** Press the [OK] key.

Parameter Setting 1/8 ◀▶ [OK]	
<b>00</b>	01
02	03
04	05

- 8** Repeat steps **5** and **6** to change the switch settings.  
**9** After all the settings are finished, press the [User Tools/Counter] key.

 **Reference**

p.112 “Printing the Parameter Settings List”

## Printing the Parameter Settings List

Print this list to see the current Parameter Settings. However, only items of importance or often-used items are included in the list.

- 1 Select **[Fax Features]** using **[▲]** or **[▼]**, and then press the **[OK]** key.

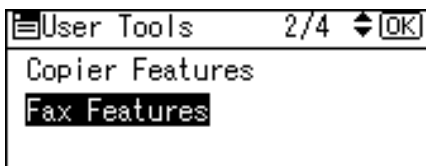

- 2 Select **[Administrator Tools]** using **[▲]** or **[▼]**, and then press the **[OK]** key.

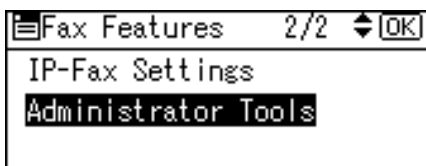

- 3 Select **[Parameter Setting]** using **[▲]** or **[▼]**, and then press the **[OK]** key.

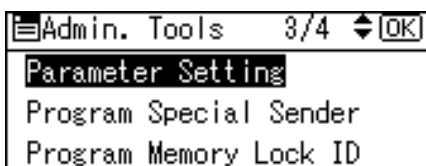

- 4 Select **[Parameter Settings List]** using **[▲]** or **[▼]**, and then press the **[OK]** key.

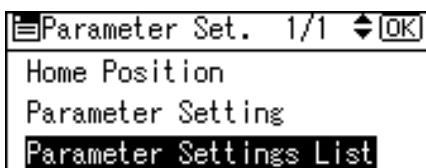

- 5 Press the **[Start]** key.

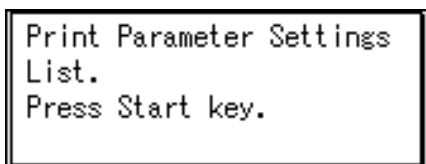

To cancel printing a list, press the **[Escape]** key. The display returns to that of step 3.

- 6 Press the **[User Tools/Counter]** key.

# Home Position

Specify the type of original immediately after the power is turned on and when the **[Clear Modes]** key is pressed.

## ❖ Home Position

- **Image Density**  
Allows one of five image density steps to be set as the home position. For details, see "Image Density (Contrast)", Facsimile Reference.
- **Resolution**  
Allows either Standard, Details, or Fine to be set as the home position. For details, see "Resolution", Facsimile Reference.
- **Original Type**  
Allows either Text or Photo to be set as the home position. For details, see "Original Type", Facsimile Reference.
- **Home Position**  
Enables or disables the home position settings. When Home Position is set to on, the home position settings are enabled and items return to their home positions when scanning and transmission are completed.
- **Transmission Mode**  
Allows either Immediate Transmission or Memory Transmission to be set as the home position. For details, see "Transmission Modes", Facsimile Reference.
- **Label Insertion**  
Allows the label insertion as the home position to be set to on or off. For details, see "Label Insertion", Facsimile Reference.
- **Auto Reduce**  
Allows the auto reduce as the home position to be set to on or off. When set to on, if the receiver's paper is smaller than the paper you are sending on, the message is automatically reduced to fit onto the paper available at the other end.  
If you turn this function off, the scale of the original is maintained and some parts of the image may be lost at the other end.
- **Fax Header**  
Allows the fax header as the home position to be set to on or off. For details, see "Fax Header Print", Facsimile Reference.

❖ **Home Position Parameter List**

For details about setting parameters, see "Parameter Setting".  
Do not change switches other than those listed.

Switch	Bit	Item	0	1
00	3,2,1	Image density	000: Normal density 001: The lightest density 010: The darkest density 101: Lighter density 110: Darker density	
00	5,4	Resolution	00: Standard 01: Detail 10: Fine	
01	1,0	Original Type	00: Text 01: Photo	
01	7	Home Position	Off	On
02	1	Transmission mode	Memory transmission	Immediate transmission
02	2	Label insertion	Off	On
02	4	Auto Reduce	Off	On
02	6,5	Fax Header	00: Off 01: On	

🔍 **Reference**

p.107 "Parameter Setting"

"Image Density (Contrast)", Facsimile Reference

"Resolution", Facsimile Reference

"Original Type", Facsimile Reference

"Transmission Modes", Facsimile Reference

"Label Insertion", Facsimile Reference

"Fax Header Print", Facsimile Reference

## Changing the Home Position

- 1 Select [Fax Features] using [▲] or [▼], and then press the [OK] key.

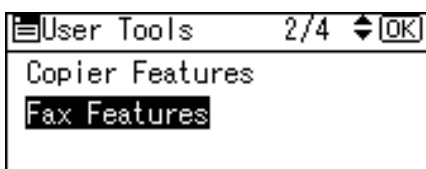

- 2 Select [Administrator Tools] using [▲] or [▼], and then press the [OK] key.

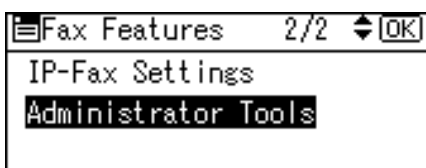

- 3 Select [Parameter Setting] using [▲] or [▼], and then press the [OK] key.

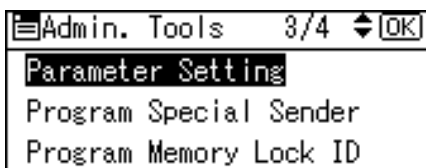

- 4 Select [Home Position] using [▲] or [▼], and then press the [OK] key.

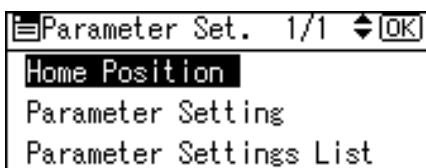

- 5 Select the switch number you want to change using the scroll keys, and then press the [OK] key.

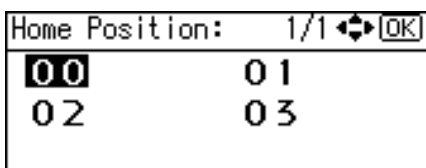

- 6 Select the bit number you want to change.

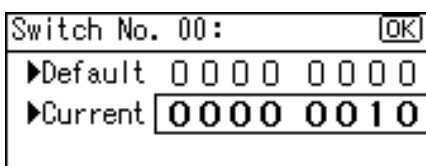

**7** Press the [OK] key.

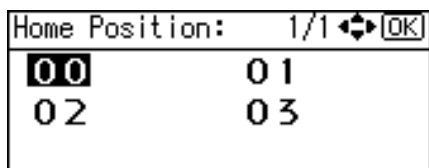

# Program Special Sender

By programming particular senders in advance, you can set the following function for each sender:

- Authorized RX
- Forwarding
- Memory Lock

Use Own Name or Own Fax Number to program your senders. If the sender has a machine of the same manufacturer, program an Own Name that has already been programmed as a sender. If the machine is not from the same manufacturer, Own Fax Number is used. You can apply the same settings to all programmed numbers. You can then customize the settings for individual numbers as necessary using the Special Sender Registration function.

The following items can be programmed.

## ❖ Special Senders

Up to 30 Special Senders can be registered. A maximum of 20 characters can be used for each name when using G3.

## ❖ Full/ Partial agreement

When you program own names and facsimile names for multiple destinations, you can program a common sequence of characters to identify destinations.

Using a Full agreement:

Destination to be programmed (Own Name)	Number of programmed identifications
NEW YORK BRANCH HONG KONG BRANCH SYDNEY BRANCH	3

Using a Partial agreement:

Destination to be programmed (Own Name)	Number of programmed identifications
BRANCH	1

You can program up to 30 wild cards.

Spaces are ignored when identifications are compared.

You can use wild cards for the following functions:

- Forwarding
- Authorized RX (Authorized Reception)

 **Note**

- You cannot program senders as Special Senders if they do not have Own Name or Own Fax Number programmed.
- The machine cannot differentiate between Polling Reception and Free Polling documents from Special Senders.
- You cannot use the following functions with Internet Fax receptions.
  - Authorized RX
  - Memory Lock
- You can program up to 24 characters for the sender.
- To use Forwarding, with Internet Fax reception, program the sender's e-mail address.
- You can check Own Name and Own Fax Number using the Journal. You can check programmed Special Senders using the specified sender list.

 **Reference**

p.127 "Printing Special Sender List"

---

## Authorized Reception

---

Use this function to limit incoming senders. The machine only receives faxes from programmed Special Senders, and therefore, it helps you screen out unwanted documents, such as junk mail, and saves wasting fax paper.

 **Note**

- To use this function, program the Special Senders function, and then select "On" in "Authorized Reception" with "Reception Settings".
- Without programming Special Senders, the Authorized RX function will not work, even if you select "On".
- If you select "Off" for "Authorized RX" in "Initial Set Up", settings are the same as the Reception Settings.
- You can change Special Senders in the same way as you program them.

 **Reference**

p.107 "Parameter Setting" (switch 08, bit 2)



---

## Forwarding

---

Print received documents, and then transfer them to those receivers programmed beforehand.

Folder destination can be registered.

It is also possible to forward faxes sent only by senders programmed as Special Senders.

### Note

- To use this function, program your Special Senders, and then select "On" for "Forwarding" in "Reception Settings".
- If you specify "On" in "Forwarding" and select [**Same as Basic Settings**], the fax document is forwarded to the receivers programmed in "Specify End Receiver".
- If you do not program any Special Senders, the machine transfers all incoming documents to the other end receivers specified in "Specify End Receiver".
- You can set the fax destination, Internet Fax destination, IP-Fax destination, and folder destination, as a forward destination.
- Set folder destinations using the Address Book Management function under System Settings. See "Registering Folders".
- If you have specified a folder for forwarding, you can specify the file format you want to use for forwarding.

### Reference

p.103 "Forwarding"

p.107 "Parameter Setting" (switch 21, bit 3)

---

## Memory Lock

---

Store incoming documents from programmed senders (Special Senders) in memory without printing them. People without the Memory Lock ID cannot print the documents, and therefore this function is useful for receiving confidential documents. If you do not program any senders, the machine receives fax document from all senders using Memory Lock reception.

### Important

- You must register Memory Lock ID in advance.
- If you program the same sender in Memory Lock and Forwarding, Forwarding is disabled.

---

## Programming/Changing Special Senders

---

Program and change Special Senders.

- 1 Select [Fax Features] using [▲] or [▼], and then press the [OK] key.

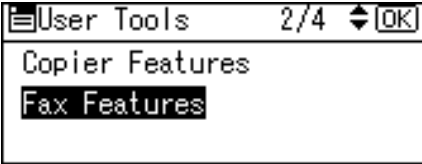

- 2 Select [Administrator Tools] using [▲] or [▼], and then press the [OK] key.



- 3 Select [Program Special Sender] using [▲] or [▼], and then press the [OK] key.

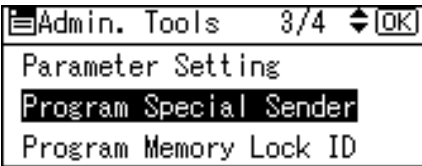

- 4 Select [Program/Change] using [▲] or [▼], and then press the [OK] key.

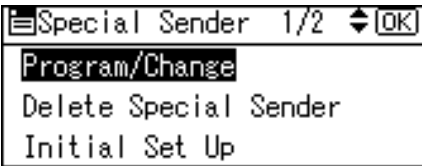

- 5 Select senders using [▲] or [▼], and then press the [OK] key.

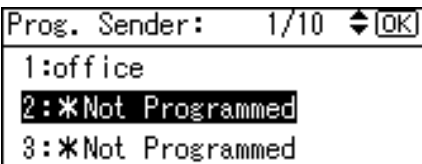

4

- 6** Enter the sender name, and then press the **[OK]** key.

Sender:		[OK]
Enter Sender Information.		
abc	tokyo	

Enter a destination name using Own Name or Own Fax Number.

- 7** Select **[Full Agreement]** or **[Partial Agreement]** using **[▲]** or **[▼]**, and then press the **[OK]** key.

Conditions:	1/1	◆ [OK]
Full Agreement		
Partial Agreement		

- 8** Select items using **[▲]** or **[▼]**, and then press the **[OK]** key.

Program Setting	1/2	◆ [OK]
Memory Lock		
Authorized RX		
		Exit

You must select only the item you want to program.

To cancel these settings, press the **[Escape]** key. The display returns to that of step **5**.

- 9** Press **[Exit]**.

Program Setting	1/2	◆ [OK]
Memory Lock		
Authorized RX		
		Exit

- 10** Press the **[User Tools/Counter]** key.

#### Reference

- p.122 "Authorized RX (Authorized Reception)"
- p.122 "Forwarding"
- p.124 "Memory Lock"

---

## Authorized RX (Authorized Reception)

---

Specify when programming a Special Sender.

**1** Select [Authorized RX] using [▲] or [▼], and then press the [OK] key.

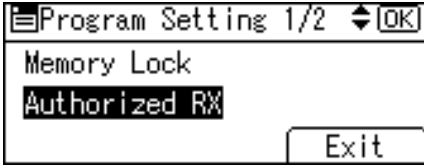

**2** Select [On] or [Off] using [▲] or [▼], and then press the [OK] key.

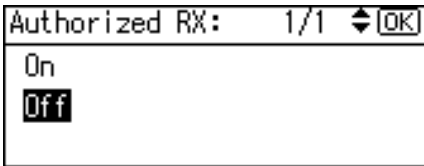

4

---

## Forwarding

---

Specify when programming a Special Sender.

**Important**

One forward destination can be registered for each Special Sender. To register two or more forward destinations, use group destinations. However a maximum of 100 destinations can be specified in a group.

**1** Select [Forwarding] using [▲] or [▼], and then press the [OK] key.

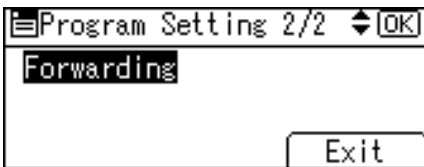

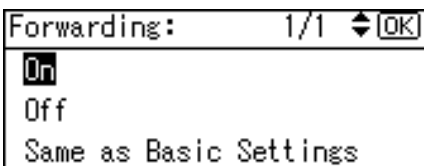

**2** Select [On] or [Off] using [▲] or [▼], and then press the [OK] key.

If you select [Off], proceed to step **4**.



- 3** Specify an End Receiver using the Quick Dial keys or , and then press the [OK] key.

Select Receiver:	[OK]
Quick Dial/Search Dest. Key	
	
	

- 4** Press the [OK] key.

Select Receiver:	[OK]
OK to set/Clear to deselect	
 004 ABC COMPANY	

4

#### Note

- Selecting [**Same as Basic Settings**] will result in the same setting made for [**Forwarding**] under [**Administrator Tools**].
- Press the button on the right of the display to switch the destination between fax number, e-mail address, IP-Fax destination, and folder.
- Set folder destinations using [**Address Book Management**] under [**System Settings**]. For details about registering folder destinations, see "Registering Folders".
- When a folder is specified as the forward destination, you can set a file format for forwarding. See "Parameter Setting" (switch 21, bit 3).
- Deleting a destination specified as a forward destination from the destination list causes the settings of the forward destination to be deleted, so they must be registered again. When a destination is changed, a document is transmitted to the new destination. If there is no destination of the specified type, you can set which destination to be used as an alternative destination. See "Parameter Setting" (switch 32, bit 0).

#### Reference

p.107 "Parameter Setting"

p.205 "Registering Folders"

## Memory Lock

Specify when programming a Special Sender.

- 1 Select **[Memory Lock]** using **[▲]** or **[▼]**, and then press the **[OK]** key.

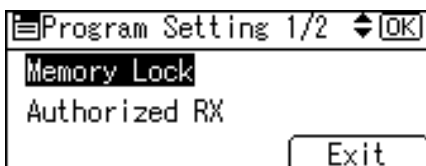

- 2 Select **[On]** or **[Off]** using **[▲]** or **[▼]**, and then press the **[OK]** key.

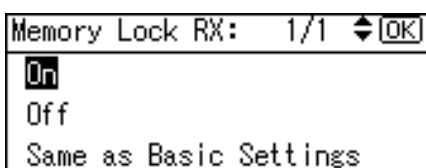

### Note

- Selecting **[Same as Basic Settings]** will result in the same setting made for **[Program Memory Lock ID]** under **[Administrator Tools]**.

## Programming Initial Set Up of a Special Sender

Program the "Initial Set Up" of a Special Sender.

- 1 Select **[Fax Features]** using **[▲]** or **[▼]**, and then press the **[OK]** key.

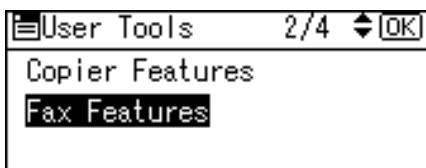

- 2 Select **[Administrator Tools]** using **[▲]** or **[▼]**, and then press the **[OK]** key.



- 3 Select **[Program Special Sender]** using **[▲]** or **[▼]**, and then press the **[OK]** key.



- 4** Select [Initial Set Up] using [▲] or [▼], and then press the [OK] key.



- 5** Select [Authorized Reception] or [Special RX Function] using [▲] or [▼], and then press the [OK] key.

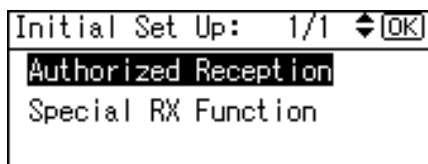

- 6** Select [On] or [Off] using [▲] or [▼], and then press the [OK] key.

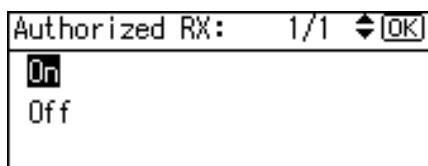

- 7** Press the [User Tools/Counter] key.

---

## Deleting a Special Sender

---

Use this function to delete "Initial Set Up" of a Special Sender.

- 1** Select [Fax Features] using [▲] or [▼], and then press the [OK] key.

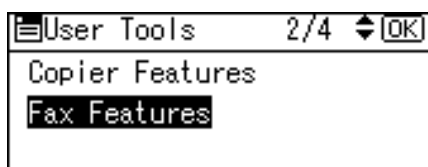

- 2** Select [Administrator Tools] using [▲] or [▼], and then press the [OK] key.

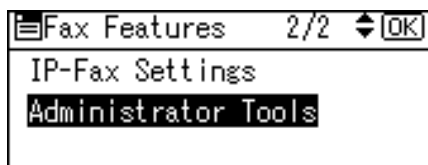

- 3** Select [Program Special Sender] using [▲] or [▼], and then press the [OK] key.

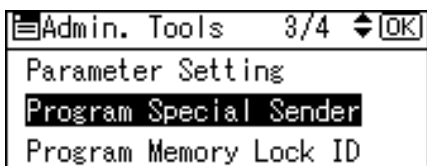

- 4** Select [Delete Special Sender] using [▲] or [▼], and then press the [OK] key.

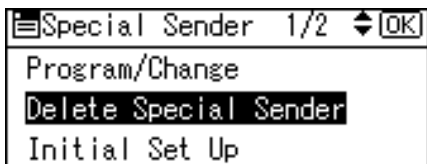

- 5** Select the sender you want to delete using [▲] or [▼], and then press the [OK] key.

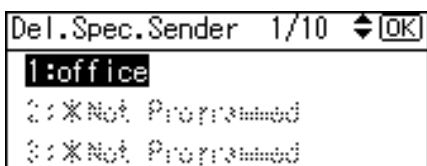

- 6** Press [Yes].

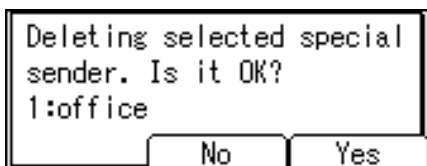

To cancel deleting a special sender, press [No]. The display returns to that of step **4**.

- 7** Press the [User Tools/Counter] key.



## Printing Special Sender List

You can display programmed Special Senders.

- 1 Select [Fax Features] using [▲] or [▼], and then press the [OK] key.

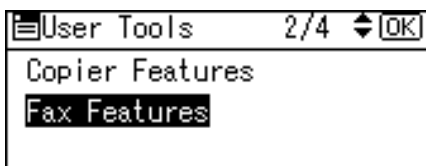

- 2 Select [Administrator Tools] using [▲] or [▼], and then press the [OK] key.

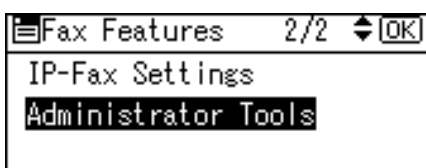

- 3 Select [Program Special Sender] using [▲] or [▼], and then press the [OK] key.

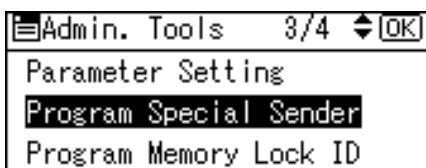

- 4 Select [Print Special Sender List] using [▲] or [▼], and then press the [OK] key.

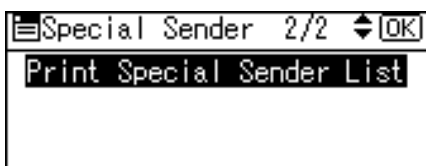

- 5 Press the [Start] key.

The screen returns to step 3 after completion of printing.

To cancel printing, press the [Escape] key. The screen returns to step 3.

- 6 Press the [User Tools/Counter] key.



# 5. Printer Features

This chapter describes user tools in the Printer Features menu. For details on how to access Printer Features, see "Accessing User Tools".

## List/Test Print

This section describes the user tools in the Test Print menu under Printer Features.

For machines with the DDST Unit, see "Printer Features Parameters", Printer/Scanner Reference.

These items are related to test print, including printing the Config. Page.

If changes are made to the machine's environment or its print-related settings, or a new program is registered, we recommend you print the list of settings, so they can be checked.

For viewing purposes, it is also possible to print out every printable character and entire character sets (fonts).

### ❖ Multiple Lists

You can print the configuration page and error log.

### ❖ Config. Page

You can print the machine's current configuration values.

### ❖ Error Log

You can print error logs listing all errors that occurred during printing. The records of Auto Job Cancel and jobs canceled manually from the control panel can be printed.

The most recent 30 errors are stored in the error log. If a new error is added when there are 30 errors already stored, the oldest error is deleted.

### ❖ Menu List

You can print a Menu List showing the Print Features.

### ❖ PCL Config./Font Page

You can print the current configuration and installed PCL font list.

### ❖ PS Config./Font Page

You can print the current configuration and installed PostScript font list.

This menu can be selected only when the optional PostScript 3 unit is installed.

### ❖ PDF Config./Font Page

You can print the current configuration and installed PDF font list.

This menu can be selected only when the optional PostScript 3 unit is installed.

❖ **Hex Dump**

You can print in the Hex Dump mode.

📌 **Note**

- ❑ The layout of the list produced by the test print is fixed to A4 (letter size). We recommend you load A4 or letter size paper (plain or recycled) in one of the paper trays.
- ❑ The tray that contains A4 (letter) size paper is automatically selected. If A4 (letter) size paper is not loaded in any of the paper trays, Paper Tray Priority is selected. If the paper size loaded in the Paper Tray Priority is smaller than A4 (letter) size, the edges may be lost. If the paper size placed in the Paper Tray Priority is larger than A4 (letter) size, margins may become too large.

🔍 **Reference**

p.4 "Accessing User Tools"

"Printer Features Parameters", Printer/Scanner Features

## 5

---

## Printing the List/Test page

---

- 1** Select [Printer Features] using [▲] or [▼], and then press the [OK] key.

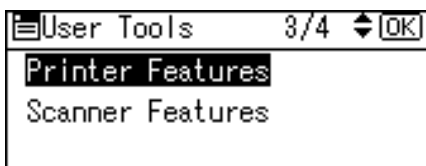

- 2** Select [List/Test Print] using [▲] or [▼], and then press the [OK] key.

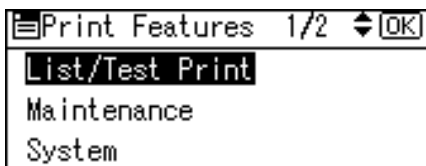

- 3** Select desired list to print using [▲] or [▼], and then press the [OK] key.



- 4** Press the [User Tools/Counter] key.

---

# Maintenance

This section describes the user tools in the Maintenance menu under Printer Features.

For machines with the DDST Unit, see "Printer Features Parameters", Printer/Scanner Reference.

Default settings are shown in **bold type**.

## ❖ List/Test Print Lock

You can Lock the [**List/Test Print**] menu.

The default setting is **Off**.

## 🔍 Reference

p.4 "Accessing User Tools"

p.41 "System Settings"

"Printer Features Parameters", Printer/Scanner Features

# System

This section describes the user tools in the System menu under Printer Features. For machines with the DDST Unit, see "Printer Features Parameters", Printer/Scanner Reference.

Default settings are shown in **bold type**.

## ❖ Print Error Report

Select this to have an error report printed when a printer or memory error occurs.

The default setting is **Off**.

## ❖ Auto Continue

You can select this to enable Auto Continue. When it is On, printing continues after a system error occurs.

The default setting is **Off**.

## ❖ Memory Overflow

Select this to have a memory overflow error report printed.

The default setting is **Do not Print**.

Select "Do not Print" to not print on pages where errors occur. The cancelled page and subsequent pages are not printed.

If you select "Error Report", pages where errors occur are printed up to where the error occurred. Subsequent pages are printed normally, and an Error Report is printed at the end. However, sort instruction is cancelled.

## ❖ Memory Usage

You can select the amount of memory used in Font Priority or Frame Priority, according to paper size or resolution.

Font Priority setting uses memory for registering fonts.

Frame Priority setting uses frame memory for high speed printing.

The default setting is **Frame Priority**.

## ❖ Duplex

You can select to have print on both sides of each page.

The default setting is **Off**.

## ❖ Copies

You can set the number of copies.

The default setting is **1**.

- 1 to 999 by 1

## ❖ Blank Page Print

Specify whether or not to eject the paper if there is no data to be printed and blank sheets are left when the ejection command is received.

The default setting is **On**.

### ❖ Edge Smoothing

You can set to smoothen the edges of printed characters.

The default setting is **On**.

If Toner Saving is set to On, Edge Smoothing is ignored even if it is set to On.

### ❖ Toner Saving

You can save toner.

The default setting is **Off**.

### ❖ Printer Language

Specify the printer language.

The default setting is **Auto**.

### ❖ Sub Paper Size

You can enable the Auto Substitute Paper Size (A4 and LT) feature.

The default setting is **Off**.

### ❖ Page Size

You can select the default paper size.

- The paper size you can select:

$8\frac{1}{2} \times 14$ ,  $8\frac{1}{2} \times 13$ ,  $8\frac{1}{2} \times 11$ ,  $8\frac{1}{4} \times 13$ ,  $8 \times 13$ ,  $7\frac{1}{4} \times 10\frac{1}{2}$ ,  $5\frac{1}{2} \times 8\frac{1}{2}$ ,  
 $4\frac{1}{8} \times 9\frac{1}{2}$ ,  $3\frac{7}{8} \times 7\frac{1}{2}$ , A4, A5, B5JIS, C5 Env, C6 Env, DL Env, 16K,  
Custom Size

The default setting is **A4** (Metric version) / **8 $\frac{1}{2}$  × 11** (Inch version).

### ❖ Letterhead Setting

You can rotate original images when printing.

When printing, original images are always rotated by 180 degrees. Therefore, output might not be as expected when printing onto letterhead or preprinted paper requiring orientation. Using this function, you can specify image rotation.

The default setting is **Off**.

When set to Off, original images are rotated by 180 degrees.

When set to Auto Detect, the machine detects a letterhead or preprinted paper automatically, and does not rotate the image.

When set to On (Always), the machine does not rotate them.

This function reduces printing speed.

### ❖ Bypass Tray Priority

Specify whether (Printer) Driver / Command or Machine Settings, has priority for determining the paper size for the bypass tray.

The default setting is **Driver/Command**.

### ❖ Edge to Edge Print

Specify whether to print on the paper as fully as possible.

The default setting is **Off**.

❖ **Default Printer Lang.**

You can set the default printer language if the machine cannot find the printer language automatically.  
The default setting is **PCL**.

❖ **Tray Switching**

You can set to switch the paper tray.  
The default setting is **Off**.

❖ **RAM Disk**

You can specify how much data the RAM disk can hold. If you do not want to use the RAM disk, select **[0 MB]**. This setting does not appear if the function upgrade option is installed.  
The default setting is **4 MB**.

 **Note**

Setting of **[Bypass Tray Priority]** is for bypass tray only.

 **Reference**

p.4 "Accessing User Tools"

"Loading Paper", Troubleshooting

"Printer Features Parameters", Printer/Scanner Features



# Host Interface

This section describes the user tools in the Host Interface menu under Printer Features.

For machines with the DDST Unit, see "Printer Features Parameters", Printer/Scanner Reference.

Default settings are shown in **bold type**.

## ❖ I/O Buffer

You can set the size of the I/O Buffer. Normally it is not necessary to change this setting.

The default setting is **128 KB**.

## ❖ I/O Timeout

You can set how many seconds the machine should wait before ending a print job. If data from another port usually arrives in the middle of a print job, you should increase this timeout period.

The default setting is **15 seconds**.

## 🔍 Reference

p.4 "Accessing User Tools"

"Printer Features Parameters", Printer/Scanner Features

# PCL Menu

This section describes the user tools in the PCL Menu under Printer Features.

Default settings are shown in **bold type**.

## ❖ Orientation

You can set the page orientation.  
The default setting is **Portrait**.

## ❖ Form Lines

You can set the number of lines per page.  
The default setting is **64 (Metric version) / 60 (Inch version)**.

- 5 to 128 by 1

## ❖ Font Source

You can set the storage location of the default font.  
The default setting is **Resident**.

RAM, SD and SD Font Download can be selected only when fonts have been downloaded to the machine.

## ❖ Font Number

You can set the ID of the default font you want to use.  
The default setting is **0**.

- 0 to 63 by 1

## ❖ Point Size

You can set the point size you want to use for the selected font.  
This setting is effective only with variable-space fonts.  
The default setting is **12.00**.

- 4.00 to 999.75 by 0.25

## ❖ Font Pitch

You can set the number of characters per inch for the selected font.  
This setting is effective only with fixed-space fonts.  
The default setting is **10.00 pitch**.

- 0.44 to 99.99 by 0.01

## ❖ Symbol Set

Specify the set of print characters for the selected font.  
The available options are as follows:

Roman-8, ISO L1, ISO L2, ISO L5, PC-8, PC-8 D/N, PC-850, PC-852, PC8-TK, Win L1, Win L2, Win L5, Desktop, PS Text, VN Intl, VN US, MS Publ, Math-8, PS Math, VN Math, Pifont, Legal, ISO 4, ISO 6, ISO 11, ISO 15, ISO 17, ISO 21, ISO 60, ISO 69, Win 3.0

The default setting is **PC-8**.

---

**❖ Courier Font**

You can select a courier font type.  
The default setting is **Regular**.

**❖ Ext. A4 Width**

You can extend the printing area width (when printing on A4 sheet with PCL).

The default setting is **Off**.

When the setting is On, the width will be 8<sup>1</sup>/<sub>2</sub> inches.

**❖ Append CR to LF**

When set to On, a carriage return will follow each line feed: CR=CR, LF=CR-LF, FF=CR-FF.

The default setting is **Off**.

**❖ Resolution**

You can set the print resolution in dots per inch.

The default setting is **600 dpi**.

**🔍 Reference**

p.4 "Accessing User Tools"

# PS Menu

This section describes the user tools in the PS Menu under Printer Features.

Default settings are shown in **bold type**.

This menu appears only when the optional PostScript 3 unit is installed.

## ❖ Data Format

You can select a data format.

The default setting is **TBCP**.

This setting is not effective when operating the machine with a parallel or EtherTalk connection.

When operating the machine with a parallel connection, and also if the binary data is sent from the printer driver, the print job is canceled.

When operating the machine with an Ethernet connection, the print job is canceled under the following conditions;

- The printer driver data format is TBCP, and the data format selected on the display panel is Binary Data.
- The printer driver data format is binary, and the data format selected on the display panel is TBCP.

## ❖ Resolution

You can set the print resolution in dots per inch.

The default setting is **600 dpi**.

## 🔍 Reference

p.4 “Accessing User Tools”

# PDF Menu

This section describes the user tools in the PDF Menu under Printer Features. Default settings are shown in **bold type**.

## ❖ **Change PDF Password**

Set the password for the PDF file executing PDF Direct Print.

- Current Password
- New Password
- Confirm New Password

A password can be set using on the Web Image Monitor, but in this case the password information is sent through the network. If security is a priority, set the password using this menu from the control panel.

## ❖ **PDF Group Password**

Set the group password already specified with DeskTopBinder.

- Current Password
- New Password
- Confirm New Password

A password can be set using on the Web Image Monitor, but in this case the password information is sent through the network. If security is a priority, set the password using this menu from the Control Panel.

## ❖ **Resolution**

You can set the print resolution in dots per inch. The default setting is **600 dpi**.

## 🔍 **Reference**

p.4 "Accessing User Tools"



# 6. Scanner Features

This chapter describes user tools in the Scanner Features menu. For details on how to access Scanner Features, see "Accessing User Tools".

## Scan Settings

This section describes the user tools in the Scan Settings menu under Scanner Features.

For machines with the DDST Unit, see "Setting Originals", Printer/Scanner Reference.

Default settings are shown in **bold type**.

### ❖ Default Scan Settings

Various basic settings (resolution and scan size) can be set. You can register the scan settings in the same way as specifying them. For details, see "Specifying Send Options", Scanner Reference.

The default setting for "Resolution" is **200 dpi**.

- Paper size for setting  
A4☐, A5☐, A5☐, B5 JIS☐, 8<sup>1</sup>/<sub>2</sub>×14☐, 8<sup>1</sup>/<sub>2</sub>×13☐, 8<sup>1</sup>/<sub>2</sub>×11☐,  
5<sup>1</sup>/<sub>2</sub>×8<sup>1</sup>/<sub>2</sub>☐, 5<sup>1</sup>/<sub>2</sub>×8<sup>1</sup>/<sub>2</sub>☐, Custom Size

The default setting for "Scan Size" is **A4☐ / 8<sup>1</sup>/<sub>2</sub>×11☐**.

You can specify a custom size as follows:

139.0 to 216.0 mm (5.5 to 8.5 inch) vertically, and 139.0 to 356.0 mm (5.5 to 14.0 inch) horizontally.

### ❖ Original Setting

This setting is available only when you have installed the optional ARDF (Auto Document Feeder capable of scanning both sides of a sheet).

Set the default for whether originals are one-sided or two-sided and if two-sided, the relationship between those sides. When the originals are always the same, set this for the default to make operation easier.

The default setting is **1 Sided Original**.

### ❖ Orig. Orientation Priority

Select the default for Original Orientation. When originals are always placed in the same way, select that orientation as the default to make operation easier.

### ❖ Original Type Setting

Make these settings according to the paper type of the original.

Settings made here are assigned to the **[Color Scan]** and **[Original]** keys of the scanner function.

The default setting for Type 1 (Color: Text) is **Full Color: Text / Photo**.

The default setting for Type 2 (Color: Photo) is **Full Color: Glossy Photo**.

The default setting for Type 3 (B&W Text) is **Text/Line Art**.

The default setting for Type 4 (B&W: Photo) is **Photo**.

❖ **Color Mode Priority**

Specify whether to scan originals in Full Color or Black & White mode. The default setting is **Black & White**.

🔍 **Reference**

p.4 "Accessing User Tools"

"Specifying Send Options", Scanner Reference



# Destination List Settings

This section describes the user tools in the Destination List Settings menu under Scanner Features.

For machines with the DDST Unit, see "Setting Originals", Printer/Scanner Reference.

Default settings are shown in **bold type**.

Select the defaults for the display priority and the titles for the destination list of e-mail and delivery server.

## ❖ **Dest. List Priority 1**

Select a destination list to be displayed when the machine is in the initial state. The default setting is **Delivery Server**.

## ❖ **Update Server Dest. List**

Normally, the delivery server destination list is automatically updated. This function allows manual updating at any time.

To update the delivery server destination list, press **[Update Server Dest. List]**.

## ❖ **Dest. List Priority 2**

In the machine's address book, select which address book appears by default. This function is enabled when **[E-mail]** is selected in **[Dest. List Priority 1]**.

The default setting is **E-mail Address**.

## **Reference**

p.4 "Accessing User Tools"

"Specifying Send Options", Scanner Reference

# Send Settings

This section describes the user tools in the Send Settings menu under Scanner Features.

For machines with the DDST Unit, see "Setting Originals", Printer/Scanner Reference.

Default settings are shown in **bold type**.

This section explains how to set the defaults for settings such as the compression level for the scan file and switching to and from the network TWAIN scanner function.

Details of items of Send Settings are as follows:

## ❖ TWAIN Standby Time

When the machine is being used to send e-mail or a file, or functioning as Document Server or a network delivery scanner, a scanning request to the machine as a TWAIN scanner will switch the machine to the network TWAIN scanner function. This setting determines the delay until the machine switches to the network TWAIN scanner function.

The default setting is **On, 10 sec.**

When [**On**] is selected, you can enter the number of seconds to switch with the number keys (3-30 seconds). The machine will switch to the TWAIN scanner mode only when the time set here has elapsed after the last key operation.

When [**Off**] is selected, the machine will switch to the network TWAIN scanner mode immediately.

## ❖ File Type Priority

Select whether to send the scanned originals as single-page files or a multiple-page file.

For single-page files, select either TIFF/JPEG or PDF. For multi-page files, select either TIFF or PDF.

The default setting is **Multi-page:TIFF**.

## ❖ Compression (B&W)

Select whether or not to compress black and white scan files.

The default setting is **On**.

The actual time required for file transfer will vary depending on the file size and network load.

Compression reduces the time required for transferring the scan file.

## ❖ Compress. (Gray/FullClr)

Specify whether or not to compress multi-level (grayscale) scan files.

The default setting is **On**.

If you select [**On**], you can specify the compression level between one and five. The image quality is better for lower compression, but the time required for file transfer increases accordingly.

The actual time required for file transfer will vary depending on the file size and network load.

### ❖ **Print&Del. Scanner Journal**

Up to 100 transmission/delivery results can be checked on this machine. If the stored transmission/delivery results reach 100, select whether to print the delivery journal.

Depending on security settings, the journal might not be printed.

The default setting is **Print and Delete All**.

- **Print and Delete All**  
The transmission/delivery journal is printed automatically. The printed journal is deleted.
- **Do not Print: Delete Oldest**  
Transmission/delivery results are deleted one by one as new results are stored.
- **Do not Print: Disable Send**  
Transmission/delivery cannot be performed when the journal is full.

When printed, all records are deleted after printing. When not printed, records over the limit are automatically deleted in succession from the oldest record.

While the journal is being printed, files with the status waiting cannot be sent.

### ❖ **Print Scanner Journal**

The scanner journal is printed and deleted.

### ❖ **Delete Scanner Journal**

The scanner journal is deleted without being printed.

### ❖ **Max. E-mail Size**

Select whether or not to limit the size of an e-mail to which an image is attached.

The default setting is **On, 2048 KB**.

When **[On]** is selected, enter the size limit (128-45,389 KB) with the number keys.

When the SMTP limits the size, match that setting.

### ❖ **Divide & Send E-mail**

Select whether or not an image exceeding the size specified in **[Max. E-mail Size]** should be divided and sent using more than one e-mail. This function is enabled only when **[On]** is selected for **[Max. E-mail Size]**.

The default setting is **On (per max. size), 5** (Maximum Number of Divisions).

When **[On (per max. size)]** is selected, enter the Max. Number of Divisions (2-355) with the number keys.

When **[Multi-page:TIFF]** or **[Multi-page:PDF]** is selected, the image will not be divided.

When **[On (per max. size)]** is selected, some received files may not be able to be restored, depending on the type of e-mail software.

When **[Off]** is selected, the e-mail is not sent if its size exceeds the limit, and an error message appears. The scan file is discarded.

Set the maximum e-mail size within the capacity of the SMTP server.

❖ **E-mail Informatn. Language**

Select the language in which e-mail information such as title, date, administrator mail address is sent.

Select one of the following 20 languages:

British English, American English, German, French, Italian, Spanish, Dutch, Portuguese, Polish, Czech, Swedish, Finnish, Hungarian, Norwegian, Danish, Japanese, Simplified Chinese, Traditional Chinese, Russian, and Hangul.

The default setting is **American English**.

The e-mail text which is a template cannot be changed.

🔍 **Reference**

p.4 "Accessing User Tools"

"Specifying Send Options", Scanner Reference

# 7. Registering Addresses and Users for Facsimile/Scanner Functions

This chapter describes how to register destinations and users in the Address Book. For details on how to access System Settings see "Accessing User Tools".

## Address Book

Registering information such as the names of users and their e-mail addresses in the Address Book allows you to manage them easily.

You can also use Web Image Monitor to register names in the Address Book. For details about Web Image Monitor, see the Web Image Monitor Help.

For details on how to access Web Image Monitor, see "Using Web Image Monitor".

### Important

- Address Book data is stored in memory. It can be lost if there is some kind of memory failure. The manufacturer shall not be responsible for any damages resulting data loss.

You can register and manage the following items in the Address Book:

#### ❖ Name

You can register the name of the user. This is the basic information required for managing user of the machine.

To register a fax number or e-mail address in the address book, you must first register your user name and destination.

Name:	[OK]
Enter name.	
abc	ABC COMPANY ▲

#### ❖ Authentication Information

You can register user codes in order to restrict particular functions to certain users, and to check their use of each function. You can also register login user names and login passwords to be used when sending e-mail, sending to folders, or accessing an LDAP server.

User Code:	[OK]
Enter user code.	
1 2 3 4 5 6 7 8	

❖ **Protection**

You can set protection codes to stop sender's name from being used or folders from being accessed without authorization.

Auth.Protect	1/1	[OK]
Register as		
Dest.Protect Code		
Dest.Protect Obj.		

❖ **Fax Settings**

You can register fax numbers, line, fax header and select label insertion. When using IP-Fax, you can register the IP-Fax destination and select the protocol.

Fax Settings:		[OK]
Enter Fax Dest.		
☎11111111		
Option	Tone	IP

❖ **E-mail Settings**

You can register e-mail destinations in the Address Book.

E-mail Settings:		[OK]
Enter E-mail address.		
abc	_london@abcdcompany.com	

❖ **Folder Information**

You can register the protocol, path name and server name.

- SMB

Path:	[OK]
Enter path.	
abc	BCD-SERVER\files\Work

- FTP

Server Name:	[OK]
Enter server name.	
abc	ABC-NET

- NCP

Path:	[OK]
Enter path.	
abc	\\Abcd-server\files\wo

❖ **Register Group to**

You can put registered e-mail and folder destinations into a group for easier management.

Groups:	1/1	↕	↔	☐	[OK]
<input checked="" type="checkbox"/>	007	🌐	branch		
<input type="checkbox"/>	015	🌐	group		

📝 **Note**

- ☐ Using **[Address Management Tool]** in SmartDeviceMonitor for Admin, you can backup Address Book data. We recommend backing up data when using the Address Book.
- ☐ For operating instructions, see SmartDeviceMonitor for Admin Help.

🔍 **Reference**

- p.267 "SMTP Authentication"
- p.205 "Registering Folders"
- p.271 "LDAP authentication"

---

## Managing names in the Address Book

---

By registering a name beforehand, you can specify e-mail and folder destinations simply by selecting the Quick Dial keys.

 **Reference**

p.152 "Registering Names"

---

---

## Sending fax by Quick Dial

---

Register a fax number in the Address Book so you can specify a destination simply by selecting it from destination search or selecting the Quick Dial keys when sending a fax. When label insertion is set to "ON", the receiver's name and standard messages are printed on the fax message when it is received at the other end.

Registered IP-Fax numbers can be used and printed as sender's IP-Fax numbers.

 **Reference**

p.174 "Fax Destination"

---

---

## Sending e-mail by Quick Dial

---

By registering e-mail addresses in the Address Book, you can specify e-mail destinations simply by selecting it from destination search or selecting the Quick Dial keys when sending a document by Internet Fax.

A registered e-mail address can be used as the sender's address, and the sender's address are automatically entered in the "From" field of an e-mail header.

 **Reference**

p.196 "E-mail Destination"

---

---

## Sending scanned files to a shared folder directly

---

After registering the path name, user name and password, you can connect to a shared folder simply by selecting it from destination search or selecting the Quick Dial keys whenever sending files using the scanner function to a shared folder.

To share the folder using Windows, select the SMB protocol.

To register the folder to the FTP server, select the FTP protocol.

To register the folder to the NetWare server, select the NCP protocol.

 **Reference**

p.205 "Registering Folders"

---



---

## Preventing unauthorized user access to shared folders from the machine

---

After registering a protection code, you can specify the object of protection to prevent an e-mail destination from being used without permission.

You can prevent unauthorized access to registered folders.

### **Reference**

p.260 "Registering a Protection Code"

---

## Managing users and machine usage

---

Register user codes to limit users to the following functions and check their use of each function:

- Copier
- Facsimile
- Scanner
- Printer

### **Reference**

p.158 "Authentication Information"

p.282 "Using Web Image Monitor"

# Registering Names

Register user information including their names.

The user name is useful for selecting a destination when sending faxes or e-mail. You can also use it as a folder destination.

You can register up to 150 names.

---

## Registering Names

---

This section describes how to register names.

- 1** Select [System Settings] using [▲] or [▼], and then press the [OK] key.

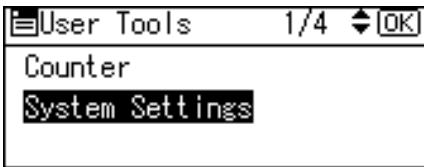

- 2** Select [Administrator Tools] using [▲] or [▼], and then press the [OK] key.



- 3** Select [Address Book Management] using [▲] or [▼], and then press the [OK] key.

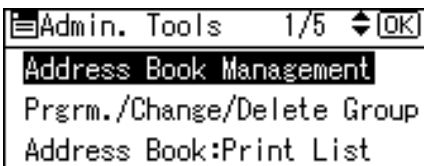

- 4** Select [Program/Change] using [▲] or [▼], and then press the [OK] key.

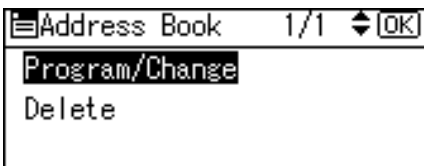

- 5** Enter the registration number you want to program using the number keys or the Quick Dial keys, and then press the [OK] key.

Program/Change:	[OK]
Enter No. to program/change	
001	Quick Dial:001-016
Search	

When you register a new Reg. No., currently available numbers are automatically displayed.

You can automatically specify registration numbers 001-016 by pressing the Quick Dial keys.

- 6** Enter the name and then press the [OK] key.

For the user name, up to 20 characters are usable.

Name:	[OK]
Enter name.	
abc	ABC COMPANY ▲

- 7** Press the [OK] key.

Program/Change:	[OK]
[001] ABC COMPANY	
Press OK key after setting	
Details	Reg. No.

- 8** Press the [User Tools/Counter] key.

### Reference

"Entering Text", About This Machine

## Changing a Registered Name

This section describes how to change a name.

- 1 Select **[System Settings]** using **[▲]** or **[▼]**, and then press the **[OK]** key.

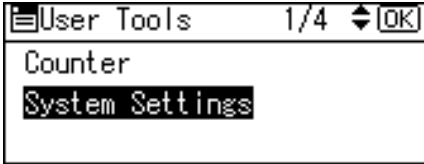

- 2 Select **[Administrator Tools]** using **[▲]** or **[▼]**, and then press the **[OK]** key.



- 3 Select **[Address Book Management]** using **[▲]** or **[▼]**, and then press the **[OK]** key.

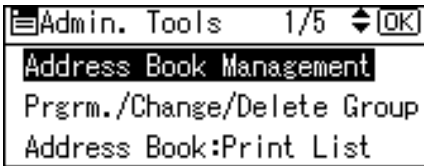

- 4 Select **[Program/Change]** using **[▲]** or **[▼]**, and then press the **[OK]** key.

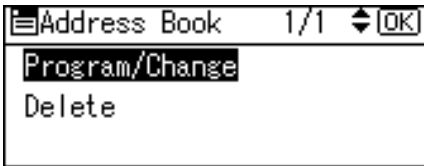

- 5 Enter the registration number you want to change using the number keys or the Quick Dial keys, and then press the **[OK]** key.

If you do not wish to change the registration number, proceed to the next step.

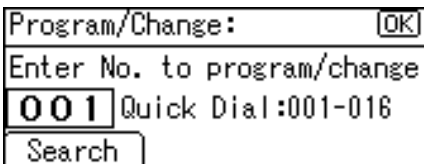

You can automatically specify registration numbers 001-016 by pressing the Quick Dial keys.

Press **[Search]** to search by name, destination list, registration number, user code, fax number, e-mail address, or folder destination.

- 6** Enter the new name, and then press the [OK] key.

Name:		[OK]
Enter name.		
abc	ABC COMPANY	▲

- 7** To change a registration number, press [Reg. No.]. Using the number keys or a Quick Dial key, enter a new number, and then press the [OK] key.

Program/Change:		[OK]
[001]	ABC COMPANY	
Press OK key after setting		
Details	Reg. No.	

- 8** Press the [OK] key.

Program/Change:		[OK]
[001]	ABC COMPANY	
Press OK key after setting		
Details	Reg. No.	

- 9** Press the [User Tools/Counter] key.

### Reference

"Entering Text", About This Machine

## Deleting a Registered Name

This section describes how to delete a name.

- 1 Select **[System Settings]** using **[▲]** or **[▼]**, and then press the **[OK]** key.

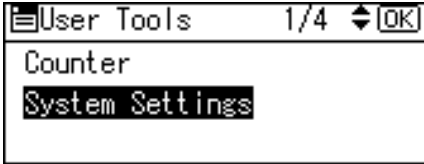

- 2 Select **[Administrator Tools]** using **[▲]** or **[▼]**, and then press the **[OK]** key.



- 3 Select **[Address Book Management]** using **[▲]** or **[▼]**, and then press the **[OK]** key.

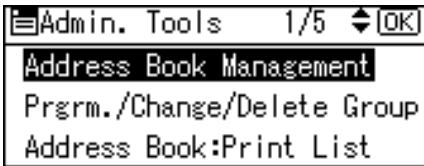

- 4 Select **[Delete]** using **[▲]** or **[▼]**, and then press the **[OK]** key.

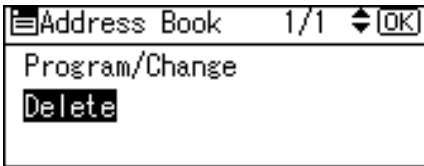

- 5 Enter the registration number you want to delete using the number keys or the Quick Dial keys, and then press the **[OK]** key.

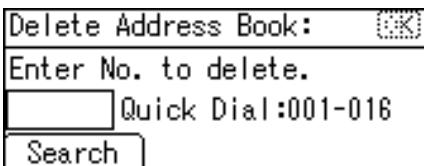

You can automatically specify registration numbers 001-016 by pressing the Quick Dial keys.

Press **[Search]** to search by name, destination list, registration number, user code, fax number, e-mail address, or folder destination.

**6** Press [Yes].

Do you want to delete this user (destination)?	
001 ABC COMPANY	
No	Yes

**7** Press the [User Tools/Counter] key.

# Authentication Information

Following describes the procedure for authenticating a user code.

## Important

- The functions associated with each user code are the same. If you change or delete user codes, management data and limits associated with that code become invalid.

Register user codes to limit users to the following functions and check their use of each function:

- Copier
- Facsimile
- Scanner
- Printer

## Note

- The number of copies scanned using the scanner function is counted for each user code. This allows you to check each user's usage.
- To automatically register the printer driver user code, select **[Auto Program]** for the printer in User Code Authentication. To use the user code set in User Tools, set the user codes registered in User Tools for the printer driver.
- For details about setting user codes for the printer driver, see Printer Driver Help.

## Reference

p.61 "User Auth. Management"

7

---

## Registering a User Code

---

This section describes how to register a user code.

- 1** Select **[System Settings]** using **[▲]** or **[▼]**, and then press the **[OK]** key.

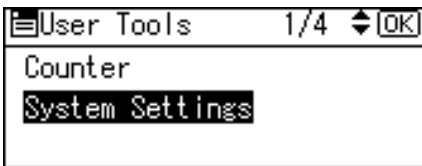

- 2** Select **[Administrator Tools]** using **[▲]** or **[▼]**, and then press the **[OK]** key.





- 3** Select [Address Book Management] using [▲] or [▼], and then press the [OK] key.

Admin. Tools	1/5	◆	[OK]
Address Book Management			
Prgrm./Change/Delete Group			
Address Book:Print List			

- 4** Select [Program/Change] using [▲] or [▼], and then press the [OK] key.

Address Book	1/1	◆	[OK]
Program/Change			
Delete			

- 5** Enter the registration number you want to change using the number keys or the Quick Dial keys, and then press the [OK] key.

Program/Change:	[OK]
Enter No. to program/change	
001	Quick Dial:001-016
Search	

You can automatically specify registration numbers 001-016 by pressing the Quick Dial keys.

Press [Search] to search by name, destination list, registration number, user code, fax number, e-mail address, or folder destination.

- 6** Press the [OK] key.

Name:	[OK]
Enter name.	
abc	ABC COMPANY ▲

- 7** Press [Details].

Program/Change:	[OK]
001 ABC COMPANY	
Press OK key after setting	
Details	Reg. No.

**8** Select [Auth. Info] using [▲] or [▼], and then press the [OK] key.

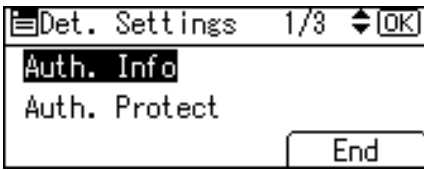

**9** Select [User Code] using [▲] or [▼], and then press the [OK] key.

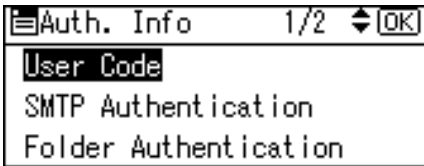

**10** Enter the user code using the number keys, and then press the [OK] key.

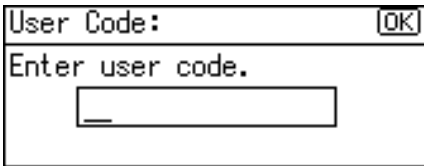

If you have entered a wrong code, press the [Clear/Stop] key and then enter the correct code again.

You can use up to eight digits for specifying the user code.

**11** Select [Function Permissions] using [▲] or [▼], and then press the [OK] key.

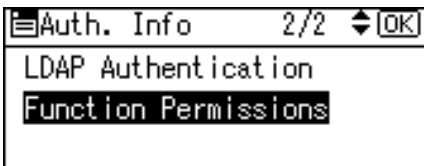

**12** Select the function you want to set the user code for using [▶], and then press the [OK] key.

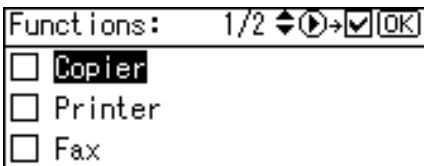

**13** Press the [Escape] key.

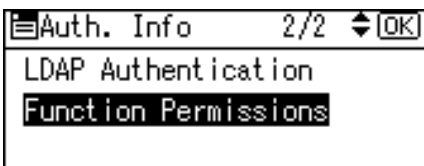

**14** Press [End].

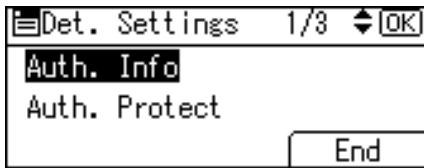

**15** Press the [OK] key.

**16** Press the [User Tools/Counter] key.

**Note**

- You can enter a one-to eight-digit user code.
- For registration of a name, see "Registering Names".

**Reference**

p.152 "Registering Names"

## Changing a User Code

This section describes how to change a user code.

**Important**

- Even if you change a user code, the counter value will not be cleared.

**1** Select [System Settings] using [▲] or [▼], and then press the [OK] key.

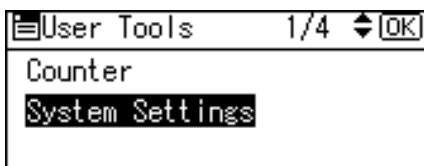

**2** Select [Administrator Tools] using [▲] or [▼], and then press the [OK] key.



**3** Select [Address Book Management] using [▲] or [▼], and then press the [OK] key.

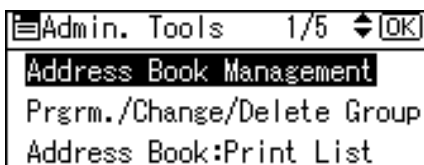

**4** Select [Program/Change] using [▲] or [▼], and then press the [OK] key.

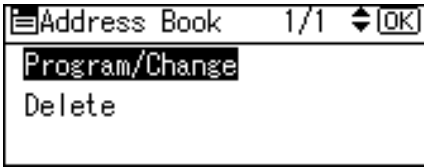

**5** Enter the registration number you want to change using the number keys or the Quick Dial keys, and then press the [OK] key.

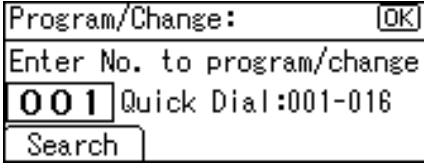

You can automatically specify registration numbers 001-016 by pressing the Quick Dial keys.

Press [Search] to search by name, destination list, registration number, user code, fax number, e-mail address, or folder destination.

**6** Press the [OK] key.

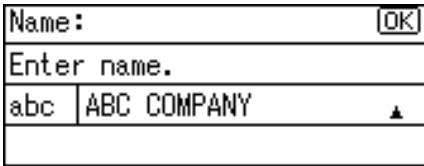

**7** Press [Details].

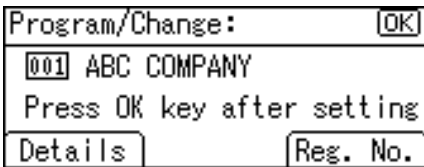

**8** Select [Auth. Info] using [▲] or [▼], and then press the [OK] key.

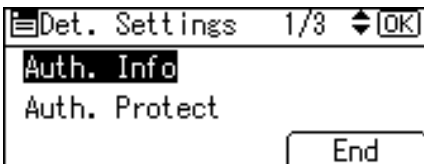

**9** Select [User Code] using [▲] or [▼], and then press the [OK] key.

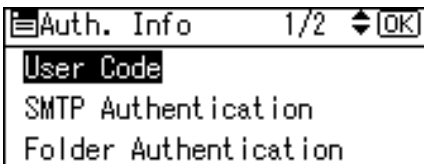

- 10** Enter the new user code using the number keys, and then press the [OK] key.

- 11** Select [Function Permissions] using [▲] or [▼], and then press the [OK] key.

- 12** Select the function you want to change the user code for using [▲] or [▼], then confirm it by pressing [▶], and then press the [OK] key.

- 13** Press the [Escape] key.

- 14** Press [End].

- 15** Press the [OK] key.

- 16** Press the [User Tools/Counter] key.

**Note**

- To change the name, see "Changing a Name".

**Reference**

p.154 "Changing a Registered Name"

---

## Deleting a User Code

---

This section describes how to delete a user code.

### Important

- After clearing the user code, the counter is automatically cleared.

**1** Select [System Settings] using [▲] or [▼], and then press the [OK] key.

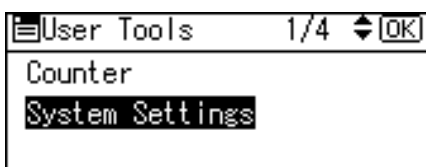

**2** Select [Administrator Tools] using [▲] or [▼], and then press the [OK] key.



**3** Select [Address Book Management] using [▲] or [▼], and then press the [OK] key.

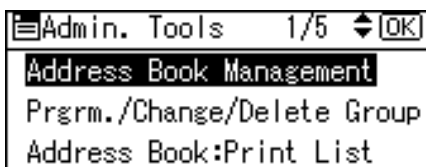

**4** Select [Program/Change] using [▲] or [▼], and then press the [OK] key.

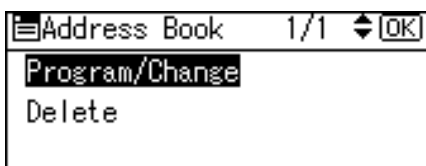

- 5** Enter the registration number you want to delete using the number keys, and then press the [OK] key.

Program/Change:	[OK]
Enter No. to program/change	
001	Quick Dial:001-016
Search	

You can automatically specify registration numbers 001-016 by pressing the Quick Dial keys.

Press [Search] to search by name, destination list, registration number, user code, fax number, e-mail address, or folder destination.

- 6** Press the [OK] key.

Name:	[OK]
Enter name.	
abc	ABC COMPANY ▲

- 7** Press [Details].

Program/Change:	[OK]
001 ABC COMPANY	
Press OK key after setting	
Details	Reg. No.

- 8** Select [Auth. Info] using [▲] or [▼], and then press the [OK] key.

☰ Det. Settings 1/3	◆ [OK]
Auth. Info	
Auth. Protect	
End	

- 9** Select [User Code] using [▲] or [▼], and then press the [OK] key.

☰ Auth. Info 1/2	◆ [OK]
User Code	
SMTP Authentication	
Folder Authentication	

- 10** Press the [Clear/Stop] to delete the user code, and then press the [OK] key.

User Code:	[OK]
Enter user code.	
12345678	

**11** Press the [Escape] key.

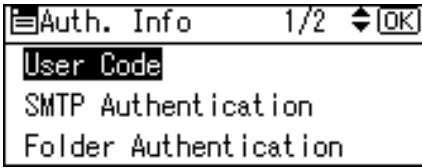

**12** Press [End].

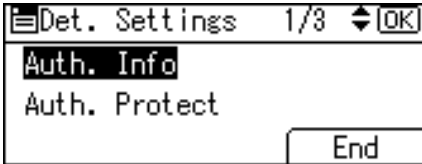

**13** Press the [OK] key.

**14** Press the [User Tools/Counter] key.

**Note**

- To delete a name entirely, see "Deleting a Registered Name".

**Reference**

p.156 "Deleting a Registered Name"

---

## Displaying the Counter for Each User

---

This section describes how to display the counter for each user.

**1** Select [System Settings] using [▲] or [▼], and then press the [OK] key.

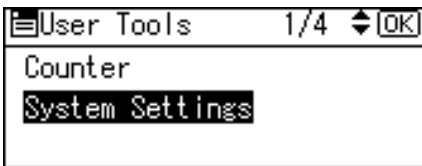

**2** Select [Administrator Tools] using [▲] or [▼], and then press the [OK] key.





- 3** Select [Disp./Print User Counter] using [▲] or [▼], and then press the [OK] key.

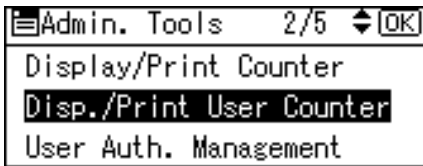

- 4** Select [Display] using [▲] or [▼], and then press the [OK] key.

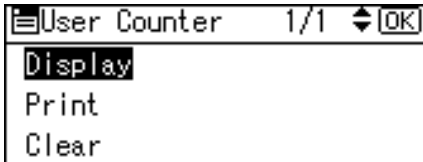

- 5** Select the function you want to display the counter for using [▲] or [▼], and then press the [OK] key.

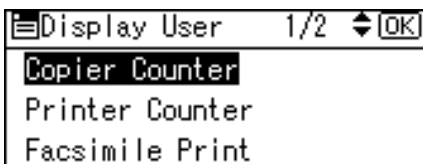

Counters for individual function usage under each user code appear.

- 6** Press the [OK] key.

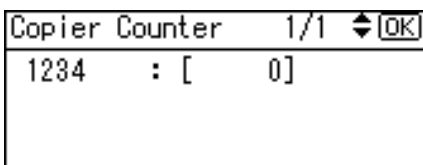

- 7** Press the [User Tools/Counter] key.

## Printing the Counter for Each User

This section describes how to print the counter for each user.

- 1 Select [System Settings] using [▲] or [▼], and then press the [OK] key.

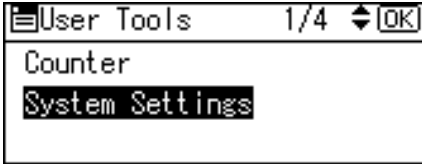

- 2 Select [Administrator Tools] using [▲] or [▼], and then press the [OK] key.



- 3 Select [Disp./Print User Counter] using [▲] or [▼], and then press the [OK] key.

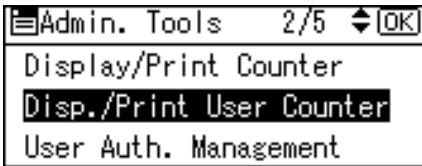

- 4 Select [Print] using [▲] or [▼], and then press the [OK] key.

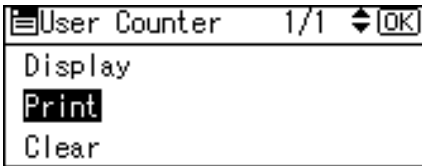

- 5 Select [Per User] using [▲] or [▼], and then press the [OK] key.

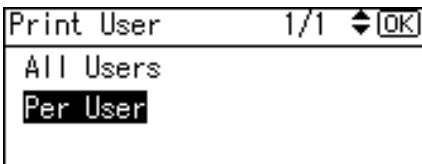

- 6 Select the path destination procedure using [▲] or [▼], and then press the [OK] key.

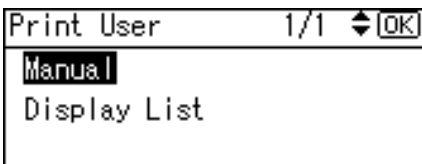

**7** Select the user to print.

If you select **[Manual]** in step **6**, enter the user code and then press the **[OK]** key.

User Counter:Print		[OK]
Enter user to print.		
abc	_	

If you select **[Display List]** in step **6**, confirm the user code using **[▶]** and then press the **[OK]** key.

User List:	1/3	⬆	⬇	⬆	⬇	⬆	⬇	⬆	⬇	[OK]
<input type="checkbox"/>	012345									
<input type="checkbox"/>	11111									
<input type="checkbox"/>	11223344									

**8** Select the function you want to print the counter for using **[▲]** or **[▼]**, then confirm it by pressing **[▶]**, and then press the **[OK]** key.

Select:	1/2	⬆	⬇	⬆	⬇	⬆	⬇	⬆	⬇	[OK]
<input type="checkbox"/>	Copier Counter									
<input type="checkbox"/>	Printer Counter									
<input type="checkbox"/>	Fax Counter									

**9** Press the **[Start]** key.

Press Start to print user counter list.	Cancel
---	--------

**10** Press the **[User Tools/Counter]** key.

## Printing the Counter for All User

This section describes how to print the counter for all user.

- 1 Select [System Settings] using [▲] or [▼], and then press the [OK] key.

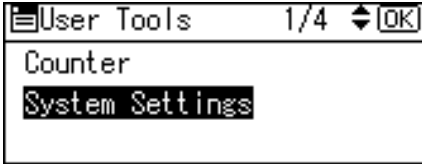

- 2 Select [Administrator Tools] using [▲] or [▼], and then press the [OK] key.



- 3 Select [Disp./Print User Counter] using [▲] or [▼], and then press the [OK] key.

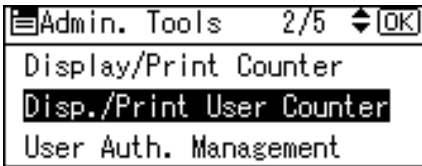

- 4 Select [Print] using [▲] or [▼], and then press the [OK] key.

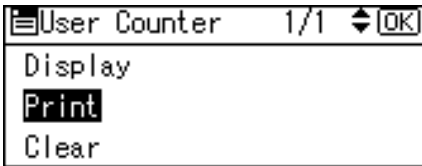

- 5 Select [All Users] using [▲] or [▼], and then press the [OK] key.

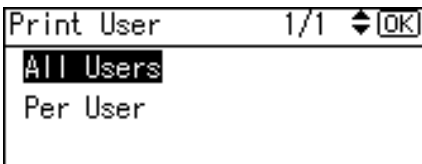

- 6 Select the function you want to print the counter for using [▲] or [▼], then confirm it by pressing [▶], and then press the [OK] key.

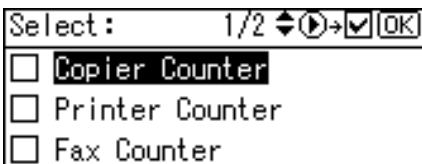

- 7** Press the [Start] key.

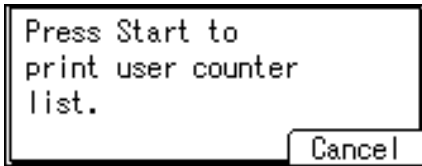

- 8** Press the [User Tools/Counter] key.

---

## Clearing the Number of Prints

---

This section describes how to clear the counter.

- 1** Select [System Settings] using [▲] or [▼], and then press the [OK] key.

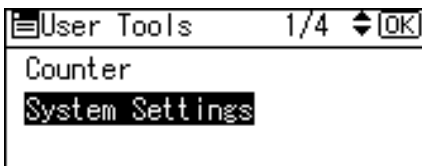

- 2** Select [Administrator Tools] using [▲] or [▼], and then press the [OK] key.



- 3** Select [Disp./Print User Counter] using [▲] or [▼], and then press the [OK] key.

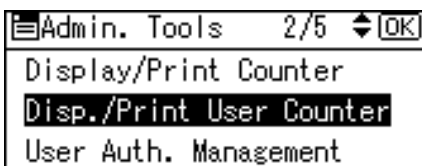

- 4** Select [Clear] using [▲] or [▼], and then press the [OK] key.

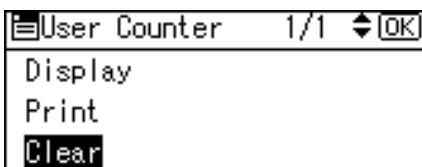

**5** Select [Per User] using [▲] or [▼], and then press the [OK] key.

Clear User	1/1	◆	OK
All Users			
Per User			

**6** Select the path destination procedure using [▲] or [▼], and then press the [OK] key.

Clear User	1/1	◆	OK
Manual			
Display List			

**7** Select the user to clear

If you select [Manual] in step 6, enter the user code and then press the [OK] key.

User Counter:Clear	OK
Enter user to clear.	
abc	_

If you select [Display List] in step 6, confirm the user code using [▶] and then press the [OK] key.

User List:	1/3	◆	▶	→	✓	OK
<input type="checkbox"/>	012345					
<input type="checkbox"/>	11111					
<input type="checkbox"/>	11223344					

**8** Select the function you want to clear the counter for using [▲] or [▼], then confirm it by pressing [▶], and then press the [OK] key.

Select:	1/2	◆	▶	→	✓	OK
<input type="checkbox"/>	Copier Counter					
<input type="checkbox"/>	Printer Counter					
<input type="checkbox"/>	Fax Counter					

**9** Press [Yes].

Are you sure you want to clear the user counter(s)?	
No	Yes

7

- 10** If you want to clear the counter for all users, select [All Users] using [▲] or [▼], and then press the [OK] key.

Clear User	1/1	◆	[OK]
All Users			
Per User			

- 11** Select the function you want to clear the counter for using [▲] or [▼], then confirm it by pressing [▶], and then press the [OK] key.

Select:	1/2	◆	▶	→	✓	[OK]
<input type="checkbox"/>	Copier Counter					
<input type="checkbox"/>	Printer Counter					
<input type="checkbox"/>	Fax Counter					

- 12** Press [Yes].

Are you sure you want to clear the user counter(s)?	
No	Yes

- 13** Press the [User Tools/Counter] key.

# Fax Destination

Register a fax destination so you do not need to enter fax numbers each time, and can send documents that have been scanned in using the fax function.

- It is easy to select the fax destination if you register "Name" for the fax destination.
- You can register fax destinations by selecting them from redial function.
- Registered Fax numbers can be used as sender's Fax numbers.

There are two types of fax destination, as shown below:

- **Fax Number**  
Select this to send the fax over the telephone network.
- **IP-Fax Destination**  
Select this to send the fax to a machine on a TCP/IP network. You cannot send the fax to a machine on another network if that network is behind a firewall.

You can program the following items in a fax destination:

## ❖ **Fax number**

Registers the destination's fax number. You can enter a fax number using up to 128 digits. You must include every digit in the number.

## ❖ **SUB Code**

Registering a SUB Code allows you to use Confidential Transmission to send messages to the other fax machines which support a similar function called "SUB Code". See "Setting SUB Codes for Transmission", Facsimile Reference.

## ❖ **SEP Code**

Registering a SEP Code allows you to use Polling Reception to receive faxes from the other fax machines which support Polling Reception. See "Setting SEP Codes for Reception", Facsimile Reference.

## ❖ **International TX Mode**

When setting the International TX mode to **[On]**, the machine transmits more carefully by lowering transmission speed. However, communication times increase.



### ❖ Label insertion

Use label insertion to print information such as the destination name on the sheet printed out at the destination.

Data is printed as follows:

- **Destination Name**  
The destination name specified in **[Fax Destination]** is printed with "To" before it at the top of the sheet.
- **Standard Message**  
A registered two-line sentence is printed under "Destination Name". To use this function, set Label Insertion to **[On]** when programming fax destinations and also select **[Programmed Name]** when sending fax documents. Fax header and label insertion are also printed when sending by e-mail using the fax function.  
You can program a standard message other than those registered in the machine. See "Specifying Options", Facsimile Reference.

You can program the following items in an IP-Fax Destination:

### ❖ IP-Fax

Register the IP-Fax destination. You can register the name using up to 128 characters. You must make this setting when using IP-Fax.

This setting only works if the IP-Fax function has been selected.

### ❖ SUB Code

Registering a SUB Code allows you to use Confidential Transmission to send messages to the other fax machines which support a similar function called "SUB Code". See "Setting SUB Codes for Transmission", Facsimile Reference.

### ❖ SEP Code

Registering a SEP Code allows you to use Polling Reception to receive faxes from the other fax machines which support Polling Reception. See "Setting SEP Codes for Reception", Facsimile Reference.

### ❖ Select Protocol

Select the protocol for the IP-Fax transmission.

This setting only works if the IP-Fax function has been selected.

### 🔍 Reference

p.244 "Registering Names to a Group"

p.260 "Registering a Protection Code"

---

## Fax Destination

---

This section describes how to register a fax number.

---

### Registering a Fax Destination

---

**1** Select [System Settings] using [▲] or [▼], and then press the [OK] key.

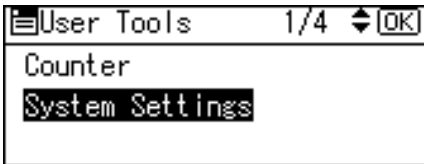

**2** Select [Administrator Tools] using [▲] or [▼], and then press the [OK] key.



**3** Select [Address Book Management] using [▲] or [▼], and then press the [OK] key.

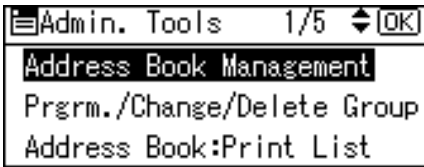

**4** Select [Program/Change] using [▲] or [▼], and then press the [OK] key.

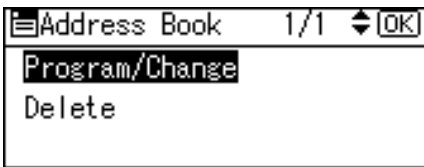

**5** Enter the registration number you want to program using the number keys or the Quick Dial keys, and then press the [OK] key.

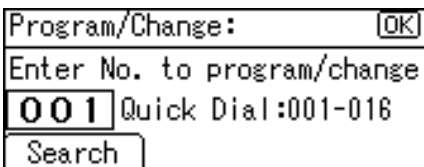

You can automatically specify registration numbers 001-016 by pressing the Quick Dial keys.

Press [Search] to search by name, destination list, registration number, user code, fax number, e-mail address, or folder destination.

- 6** Press the [OK] key.

Name:	[OK]
Enter name.	
abc	ABC COMPANY ▲

- 7** Press [Details].

Program/Change:	[OK]
[001] ABC COMPANY	
Press OK key after setting	
Details	Reg. No.

- 8** Select [Fax Settings] using [▲] or [▼], and then press the [OK] key.

☰ Det. Settings 2/3	◆ [OK]
Fax Settings	
E-mail Settings	
End	

- 9** Enter the fax number using the number keys, and then press the [OK] key.

Fax Settings:	[OK]
Enter Fax Dest.	
☎ 11111111	
Option	Tone IP

- 10** Specify optional settings such as "SUB Code", "SEP Code", "International TX Mode", and "Label Insertion".

- 11** Press [End].

☰ Det. Settings 2/3	◆ [OK]
Fax Settings	
E-mail Settings	
End	

- 12** Press the [OK] key.

**13** Press the **[User Tools/Counter]** key.

**Note**

- After entering a fax number, be sure to press the **[OK]** key. If you press the **[Escape]** key without pressing the **[OK]** key, the entered number is not registered.
- When a group is registered, you can also add this fax destination to the group. For details about registering group, see "Registering Names to a Group".
- For registration of a name, see "Registering Names".

**Reference**

- p.152 "Registering Names"
- p.180 "Using a Fax Destination as a sender"
- p.182 "Programming the SUB Code"
- p.183 "Programming the SEP Code"
- p.184 "Setting the International TX Mode"
- p.185 "Setting label insertion"
- p.246 "Registering Names to a Group"

---

## Changing a Fax Destination

---

**1** Select **[System Settings]** using **[▲]** or **[▼]**, and then press the **[OK]** key.

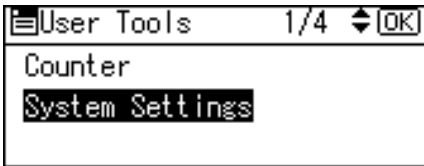

**2** Select **[Administrator Tools]** using **[▲]** or **[▼]**, and then press the **[OK]** key.



**3** Select **[Address Book Management]** using **[▲]** or **[▼]**, and then press the **[OK]** key.

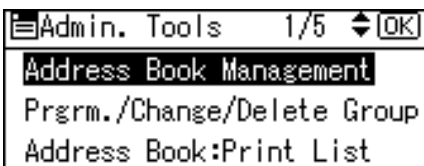

- 4** Select [Program/Change] using [▲] or [▼], and then press the [OK] key.

Address Book	1/1	◆	[OK]
Program/Change			
Delete			

- 5** Enter the registration number you want to change using the number keys or the Quick Dial keys, and then press the [OK] key.

Program/Change:	[OK]
Enter No. to program/change	
001	Quick Dial:001-016
Search	

You can automatically specify registration numbers 001-016 by pressing the Quick Dial keys.

Press [Search] to search by name, destination list, registration number, user code, fax number, e-mail address, or folder destination.

- 6** Press the [OK] key.

Name:	[OK]
Enter name.	
abc	ABC COMPANY ▲

- 7** Press [Details].

Program/Change:	[OK]
[001] ABC COMPANY	
Press OK key after setting	
Details	Reg. No.

- 8** Select [Fax Settings] using [▲] or [▼], and then press the [OK] key.

Det. Settings	2/3	◆	[OK]
Fax Settings			
E-mail Settings			
End			

- 9** Enter again the item to be changed.

**10** Press [End].

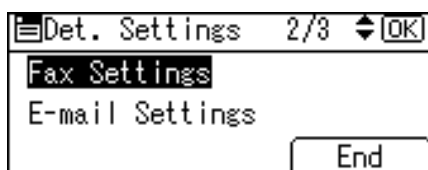

**11** Press the [OK] key.

**12** Press the [User Tools/Counter] key.

 **Note**

To change the name, see "Changing a Name".

 **Reference**

- p.181 "Changing a fax number"
- p.182 "Programming the SUB Code"
- p.183 "Programming the SEP Code"
- p.184 "Setting the International TX Mode"
- p.185 "Setting label insertion"
- p.154 "Changing a Registered Name"

## 7

### Using a Fax Destination as a sender

---

Following describes the procedure for using a fax number as the sender (sending number).

**1** Press [Details].

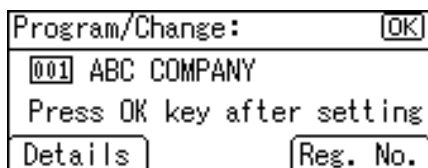

**2** Select [Auth. Protect] using [▲] or [▼], and then press the [OK] key.

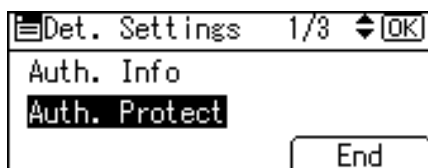

- 3** Select [Register as] using [▲] or [▼], and then press the [OK] key.

Auth.Protect	1/1	◆ [OK]
Register as		
Dest.Protect Obj.		

- 4** Select [Sender Only] using [▲] or [▼], and then press the [OK] key.

Register as:	1/2	◆ [OK]
None		
Destination Only		
Sender Only		

- 5** Press the [Escape] key.

Auth.Protect	1/1	◆ [OK]
Register as		
Dest.Protect Obj.		

- 6** Press [End].

Det. Settings	1/3	◆ [OK]
Auth. Info		
Auth. Protect		
		End

- 7** Press the [OK] key.

 **Reference**

p.158 "Registering a User Code"

---

## Changing a fax number

---

- 1** Enter the new fax number using the number keys, and then press the [OK] key.

Fax Settings:	[OK]
Enter Fax Dest.	
☎11111111	
Option	Tone
	IP

## Programming the SUB Code

**1** Press [Option].

Fax Settings: [OK]		
Enter Fax Dest.		
☎11111111		
Option	Tone	IP

**2** Select [SUB Code] using [▲] or [▼], and then press the [OK] key.

Option:	1/2	[OK]
SUB Code		
SEP Code		
		Exit

**3** Enter the SUB Code using the number keys and then press the [OK] key.

SUB Code:	[OK]
Use No. keys, Space, *, #.	
<input type="text" value=""/>	
Space	

**4** Enter the password using the number keys and then press the [OK] key.

Password (SID)	[OK]
Use No. keys, Space, *, #.	
<input type="text" value=""/>	
Space	

**5** Press [Exit].

Option:	1/2	[OK]
SUB Code		
SEP Code		
		Exit



---

**Programming the SEP Code**

---

- 1** Press [Option].

Fax Settings: [OK]		
Enter Fax Dest.		
☎11111111		
Option	Tone	IP

- 2** Select [SEP Code] using [▲] or [▼], and then press the [OK] key.

Option:	1/2	[OK]
SUB Code		
SEP Code		
		Exit

- 3** Enter the SEP Code using the number keys and then press the [OK] key.

SEP Code:	[OK]
Use No. keys, Space, *, #.	
<input type="text"/>	
Space	

- 4** Enter the password using the number keys and then press the [OK] key.

Password(PWD)	[OK]
Use No. keys, Space, *, #.	
<input type="text"/>	
Space	

- 5** Press [Exit].

Option:	1/2	[OK]
SUB Code		
SEP Code		
		Exit

## Setting the International TX Mode

- 1 Press [Option].

Fax Settings: [OK]		
Enter Fax Dest.		
☎11111111		
Option	Tone	IP

- 2 Select [International TX Mode] using [▲] or [▼], and then press the [OK] key.

Option:	2/2	[OK]
International TX Mode		
Label Insertion		
		Exit

- 3 Select [On] or [Off] using [▲] or [▼], and then press the [OK] key.

Internl. TX Mode:	1/1	[OK]
On		
Off		

- 4 Press [Exit].

Option:	2/2	[OK]
International TX Mode		
Label Insertion		
		Exit

---

## Setting label insertion

---

When Label Insertion is set to ON, the receiver's name and standard messages are printed on the fax message when it is received at the other end.

- 1 Press [Option].

Fax Settings: [OK]		
Enter Fax Dest.		
☎11111111		
Option	Tone	IP

- 2 Select [Label Insertion] using [▲] or [▼], and then press the [OK] key.

Option:	2/2	[OK]
International TX Mode		
Label Insertion		
Exit		

- 3 Select [On] or [Off] using [▲] or [▼], and then press the [OK] key.

Label Insertion:	1/1	[OK]
On		
Off		

- 4 Press [Exit].

Option:	2/2	[OK]
International TX Mode		
Label Insertion		
Exit		

---

## Using the tone

---

This function allows the machine to send tonal signals when it is connected to a pulse dialing line (for example: to use a special service on a tone dialing line).

- 1 Press [Tone].

Fax Settings: [OK]		
Enter Fax Dest.		
☎11111111		
Option	Tone	IP

A tone is shown as a "T" on the display.

## Deleting a registered Fax Destination

### Important

- ❑ If you delete a destination that is a specified delivery destination, messages to its registered personal Box, for example, cannot be delivered. Be sure to check the settings in the fax function before deleting any destinations.

**1** Select [System Settings] using [▲] or [▼], and then press the [OK] key.

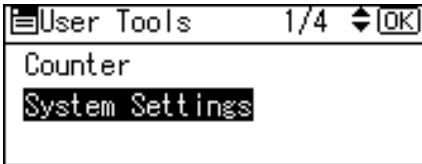

**2** Select [Administrator Tools] using [▲] or [▼], and then press the [OK] key.



**3** Select [Address Book Management] using [▲] or [▼], and then press the [OK] key.

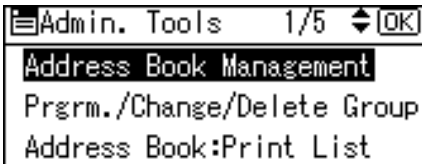

**4** Select [Program/Change] using [▲] or [▼], and then press the [OK] key.

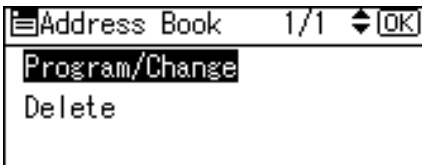

**5** Enter the registration number you want to delete using the number keys or the Quick Dial keys, and then press the [OK] key.

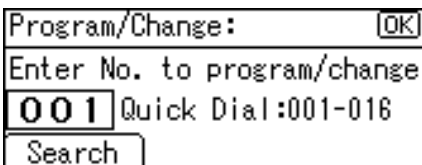

You can automatically specify registration numbers 001-016 by pressing the Quick Dial keys.

Press [Search] to search by name, destination list, registration number, user code, fax number, e-mail address, or folder destination.

- 6** Press the [OK] key.

Name:	[OK]
Enter name.	
abc	ABC COMPANY ▲

- 7** Press [Details].

Program/Change:	[OK]
[001] ABC COMPANY	
Press OK key after setting	
Details	Reg. No.

- 8** Select [Fax Settings] using [▲] or [▼], and then press the [OK] key.

☰ Det. Settings 2/3	◆ [OK]
Fax Settings	
E-mail Settings	
End	

- 9** Press the [Clear/Stop] key to delete the fax number, then press the [OK] key.

Fax Settings:	[OK]
Enter Fax Dest.	
☎ _	
Option	Tone IP

- 10** Press [End].

☰ Det. Settings 2/3	◆ [OK]
Fax Settings	
E-mail Settings	
End	

- 11** Press the [OK] key.

Program/Change:	[OK]
[001] ABC COMPANY	
Press OK key after setting	
Details	Reg. No.

**12** Press the **[User Tools/Counter]** key.

 **Note**

- When you want to delete a user code along with the user itself, see "Deleting a User".

 **Reference**

p.156 "Deleting a Registered Name"

---

## IP-Fax Destination

---

This section describes how to register a IP-Fax destination.

 **Reference**

For details about sending an IP-Fax, see "Sending by IP-Fax", Facsimile Reference.

---

## Registering an IP-Fax Destination

---

 **Important**

- To use an IP-Fax destination as the sender (transmission number), you must first register the user code.

**1** Select **[System Settings]** using **[▲]** or **[▼]**, and then press the **[OK]** key.

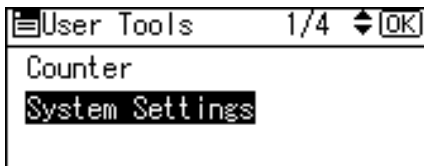

**2** Select **[Administrator Tools]** using **[▲]** or **[▼]**, and then press the **[OK]** key.



**3** Select **[Address Book Management]** using **[▲]** or **[▼]**, and then press the **[OK]** key.

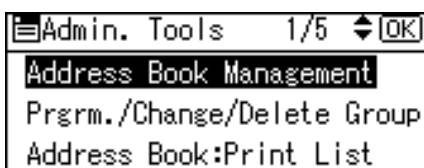

- 4** Select [Program/Change] using [▲] or [▼], and then press the [OK] key.

Address Book	1/1	◆	[OK]
Program/Change			
Delete			

- 5** Enter the registration number you want to register using the number keys or the Quick Dial keys, and then press the [OK] key.

Program/Change:	[OK]
Enter No. to program/change	
001	Quick Dial:001-016
Search	

You can automatically specify registration numbers 001-016 by pressing the Quick Dial keys.

Press [Search] to search by name, destination list, registration number, user code, fax number, e-mail address, or folder destination.

- 6** Press the [OK] key.

Name:	[OK]
Enter name.	
abc	ABC COMPANY ▲

- 7** Press [Details].

Program/Change:	[OK]
001 ABC COMPANY	
Press OK key after setting	
Details	Reg. No.

- 8** Select [Fax Settings] using [▲] or [▼], and then press the [OK] key.

Det. Settings	2/3	◆	[OK]
Fax Settings			
E-mail Settings			
End			

- 9** Press [IP].

Fax Settings:	[OK]	
Enter Fax Dest.		
☎_		
Option	Tone	IP

**10** Select the protocol using [▲] or [▼], and then press the [OK] key.

Select Protocol	1/1	◆	[OK]
H.323			
SIP			

**11** Enter the IP-Fax destination and then press the [OK] key.

IP-Fax Destination:	[OK]
Enter IP-Fax Dest.	
abc	

**12** Press [Option] to select the items to be set.

Fax Settings:	[OK]	
Enter Fax Dest.		
192.168.0.10		
Option	Tone	IP

**13** Press the [OK] key.

Fax Settings:	[OK]	
Enter Fax Dest.		
192.168.0.10		
Option	Tone	IP

**14** Press [End].

Det. Settings	2/3	◆	[OK]
Fax Settings			
E-mail Settings			
			End

**15** Press the [OK] key.

**16** Press the [User Tools/Counter] key.

 **Note**

For registration of a name, see "Registering Names".

 **Reference**

- p.152 "Registering Names"
- p.158 "Registering a User Code"
- p.244 "Registering Names to a Group"
- "Entering Text", About This Machine



## Changing a Registered IP-Fax Destination

- 1 Select [System Settings] using [▲] or [▼], and then press the [OK] key.

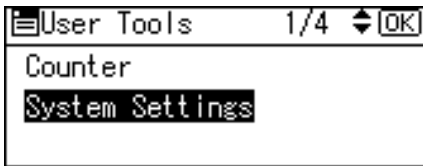

- 2 Select [Administrator Tools] using [▲] or [▼], and then press the [OK] key.



- 3 Select [Address Book Management] using [▲] or [▼], and then press the [OK] key.

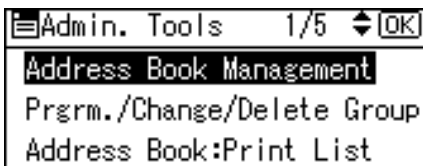

- 4 Select [Program/Change] using [▲] or [▼], and then press the [OK] key.

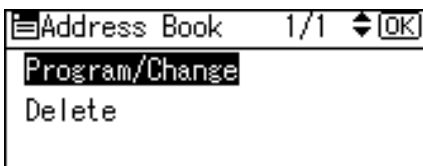

- 5 Enter the registration number you want to change destination using the number keys or the Quick Dial keys, and then press the [OK] key.

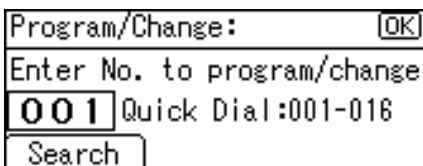

You can automatically specify registration numbers 001-016 by pressing the Quick Dial keys.

Press [Search] to search by name, destination list, registration number, user code, fax number, e-mail address, or folder destination.

**6** Press the [OK] key.

Name:		[OK]
Enter name.		
abc	ABC COMPANY	▲

**7** Press [Details].

Program/Change:		[OK]
[001]	ABC COMPANY	
Press OK key after setting		
Details	Reg. No.	

**8** Select [Fax Settings] using [▲] or [▼], and then press the [OK] key.

Det. Settings 2/3		[OK]
Fax Settings		
E-mail Settings		
		End

**9** Enter again the item to be changed.

**10** Press [End].

Det. Settings 2/3		[OK]
Fax Settings		
E-mail Settings		
		End

**11** Press the [OK] key.

**12** Press the [User Tools/Counter] key.

 **Note**

- To change the name, see "Changing a Name".

 **Reference**

- p.180 "Using a Fax Destination as a sender"
- p.193 "Changing a Registered IP-Fax Destination"
- p.154 "Changing a Registered Name"
- "Entering Text", About This Machine

---

## Changing a Registered IP-Fax Destination

---

- 1 Press [IP].

Fax Settings: [OK]		
Enter Fax Dest.		
[H]192.168.0.10		
Option	Tone	IP

- 2 Select the new protocol using [▲] or [▼], and then press the [OK] key.

Select Protocol	1/1	[OK]
[H.323]		
SIP		

- 3 Enter the new IP-Fax destination and then press the [OK] key.

IP-Fax Destination: [OK]	
Enter IP-Fax Dest.	
abc	192.168.0.10

---

## Deleting a Registered IP-Fax Destination

---

If you delete a destination that is a specified delivery destination, messages to its registered personal Box, for example, cannot be delivered. Be sure to check the settings in the fax function before deleting any destinations.

- 1 Select [System Settings] using [▲] or [▼], and then press the [OK] key.

User Tools	1/4	[OK]
Counter		
[System Settings]		

- 2 Select [Administrator Tools] using [▲] or [▼], and then press the [OK] key.

System Settings	2/2	[OK]
Interface Settings		
File Transfer		
[Administrator Tools]		

**3** Select [Address Book Management] using [▲] or [▼], and then press the [OK] key.

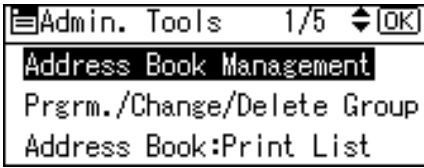

**4** Select [Program/Change] using [▲] or [▼], and then press the [OK] key.

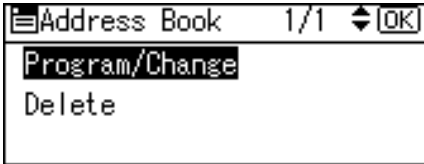

**5** Enter the registration number you want to delete using the number keys or the Quick Dial keys, and then press the [OK] key.

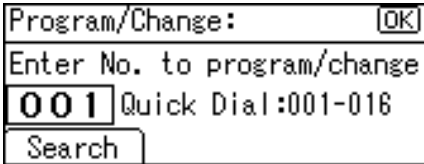

You can automatically specify registration numbers 001-016 by pressing the Quick Dial keys.

Press [Search] to search by name, destination list, registration number, user code, fax number, e-mail address, or folder destination.

**6** Press the [OK] key.

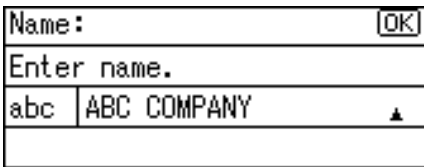

**7** Press [Details].



**8** Select [Fax Settings] using [▲] or [▼], and then press the [OK] key.

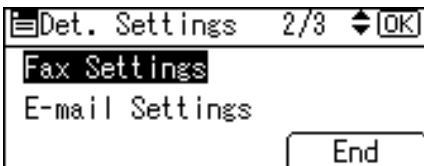

- 9 Press [IP] and then press the [OK] key.

Fax Settings:		[OK]
Enter Fax Dest.		
192.168.0.10		
Option	Tone	IP

- 10 Press the [Clear/Stop] key to delete the IP-Fax destination, then press the [OK] key twice.

IP-Fax Destination:		[OK]
Enter IP-Fax Dest.		
abc		

- 11 Press [End].

Det. Settings 2/3		[OK]
Fax Settings		
E-mail Settings		
		End

- 12 Press the [OK] key.

Program/Change:		[OK]
001 ABC COMPANY		
Press OK key after setting		
Details		Reg. No.

- 13 Press the [User Tools/Counter] key.

 **Note**

- To change the name, see "Changing a Name".
- When you want to delete a user code along with the user itself, see "Deleting a User".

 **Reference**

- p.154 "Changing a Registered Name"
- p.156 "Deleting a Registered Name"

# E-mail Destination

Register e-mail destinations so you do not need to enter an e-mail address every time, and can send scan files from scanner or fax function by e-mail.

- It is easy to select the e-mail destination if you register "User (Destination) Name" for the e-mail destination.
- You can register e-mail destinations as a group.
- You can use the e-mail address as the sender's address when sending scan files in scanner mode. If you want to do this, set a protection code on the sender address to prevent unauthorized access.

 **Note**

- You can select an e-mail address from an LDAP server, and then register it in the Address Book. See "Sending Scan Files by E-mail", Scanner Reference.
- You can set the machine to send a Transmission Result Report by e-mail whenever a transmission is sent. See Facsimile Reference.

 **Reference**

p.260 "Registering a Protection Code"

---

## Registering E-mail Destination

---

 **Important**

- When using a e-mail destination as the sender, you must register the user code previously.

**1** Select [System Settings] using [▲] or [▼], and then press the [OK] key.

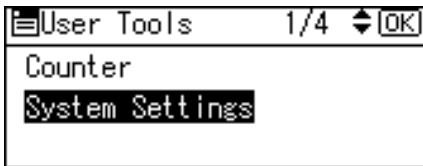

**2** Select [Administrator Tools] using [▲] or [▼], and then press the [OK] key.



- 3** Select [Address Book Management] using [▲] or [▼], and then press the [OK] key.

Admin. Tools	1/5	◆	[OK]
Address Book Management			
Prgrm./Change/Delete Group			
Address Book:Print List			

- 4** Select [Program/Change] using [▲] or [▼], and then press the [OK] key.

Address Book	1/1	◆	[OK]
Program/Change			
Delete			

- 5** Enter the registration number you want to program using the number keys or the Quick Dial keys, and then press the [OK] key.

Program/Change:	[OK]
Enter No. to program/change	
001	Quick Dial:001-016
Search	

You can automatically specify registration numbers 001-016 by pressing the Quick Dial keys.

Press [Search] to search by name, destination list, registration number, user code, fax number, e-mail address, or folder destination.

- 6** Press the [OK] key.

Name:	[OK]
Enter name.	
abc	ABC COMPANY ▲

- 7** Press [Details].

Program/Change:	[OK]
[001] ABC COMPANY	
Press OK key after setting	
Details	Reg. No.

- 8** Select [E-mail Settings] using [▲] or [▼], and then press the [OK] key.

Det. Settings	2/3	◆	[OK]
Fax Settings			
E-mail Settings			
End			

- 9** Enter the e-mail address using the number keys and the Quick Dial keys, and then press the [OK] key.

E-mail Settings: [OK]	
Enter E-mail address.	
abc	

- 10** Select [E-mail/Internet Fax Dest.] or [Internet Fax Dest. only] using [▲] or [▼], and then press the [OK] key.

Email Address Use 1/1 ◆ [OK] <b>E-mail/Internet Fax Dest.</b> Internet Fax Dest. only
---

- 11** Select [Send] or [Do not send] to specify whether or not SMTP server is to be used using [▲] or [▼], and then press the [OK] key.

Send via SMTP: 1/1 ◆ [OK] <b>Send</b> Do not send
---

7

- 12** Press [End].

Det. Settings 2/3 ◆ [OK] Fax Settings <b>E-mail Settings</b>	End
--	-----

- 13** Press the [OK] key.

Program/Change: [OK] [001] ABC COMPANY Press OK key after setting Details                      Reg. No.
--



**14** Press the **[User Tools/Counter]** key.

When a group is registered, other e-mail destinations can be added to the group. For the registration procedure, see "Registering a Name to Group".

**Note**

- Up to 128 alphanumerical characters are usable for the mail address.
- For registration of a name, see "Registering Names".

**Reference**

- p.152 "Registering Names"
- p.158 "Registering a User Code"
- p.246 "Registering Names to a Group"
- "Entering Text", About This Machine

---

## Changing a Registered E-mail Destination

---

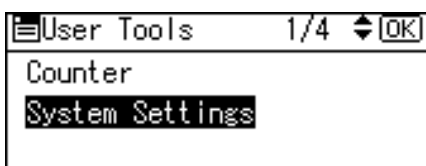
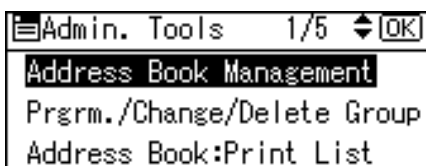
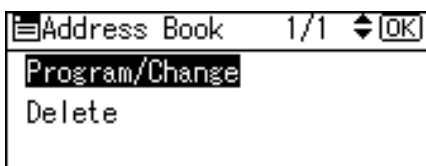
**1** Select **[System Settings]** using **[▲]** or **[▼]**, and then press the **[OK]** key.**2** Select **[Administrator Tools]** using **[▲]** or **[▼]**, and then press the **[OK]** key.**3** Select **[Address Book Management]** using **[▲]** or **[▼]**, and then press the **[OK]** key.**4** Select **[Program/Change]** using **[▲]** or **[▼]**, and then press the **[OK]** key.

**5** Enter the registration number you want to change using the number keys or the Quick Dial keys, and then press the [OK] key.

Program/Change:	[OK]
Enter No. to program/change	
001	Quick Dial:001-016
Search	

You can automatically specify registration numbers 001-016 by pressing the Quick Dial keys.

Press [Search] to search by name, destination list, registration number, user code, fax number, e-mail address, or folder destination.

**6** Press the [OK] key.

Name:	[OK]
Enter name.	
abc	ABC COMPANY ▲

**7** Press [Details].

Program/Change:	[OK]
001	ABC COMPANY
Press OK key after setting	
Details	Reg. No.

**8** Select [E-mail Settings] using [▲] or [▼], and then press the [OK] key.

☰ Det. Settings 2/3	◆ [OK]
Fax Settings	
E-mail Settings	
End	

**9** Enter the new e-mail address using the number keys and the Quick Dial keys, and then press the [OK] key.

E-mail Settings:	[OK]
Enter E-mail address.	
abc	ondon@abcdcompany.com

7

- 10 Select [E-mail/Internet Fax Dest.] or [Internet Fax Dest. only] using [▲] or [▼], and then press the [OK] key.

Email Address Use 1/1	◆ [OK]
E-mail/Internet Fax Dest.	
Internet Fax Dest. only	

- 11 Select [Send] or [Do not send] to specify whether or not SMTP server is to be used using [▲] or [▼], and then press the [OK] key.

Send via SMTP:	1/1	◆ [OK]
Send		
Do not send		

- 12 Press [End].

Det. Settings	2/3	◆ [OK]
Fax Settings		
E-mail Settings		
		End

- 13 Press the [OK] key.

Program/Change:	[OK]
[001] ABC COMPANY	
Press OK key after setting	
Details	Reg. No.

- 14 Press the [User Tools/Counter] key.

 **Note**

- To change the name, see "Changing a Name".

 **Reference**

- p.154 "Changing a Registered Name"  
"Entering Text", About This Machine

## Deleting a Registered E-mail Destination

- 1 Select [System Settings] using [▲] or [▼], and then press the [OK] key.

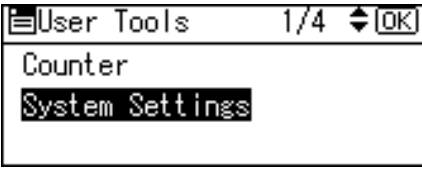

- 2 Select [Administrator Tools] using [▲] or [▼], and then press the [OK] key.



- 3 Select [Address Book Management] using [▲] or [▼], and then press the [OK] key.

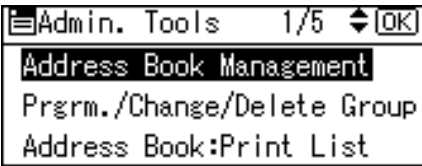

- 4 Select [Program/Change] using [▲] or [▼], and then press the [OK] key.

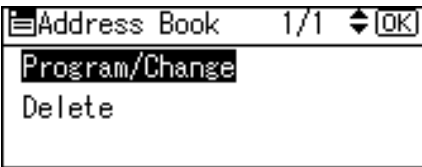

- 5 Enter the registration number you want to delete using the number keys or the Quick Dial keys, and then press the [OK] key.

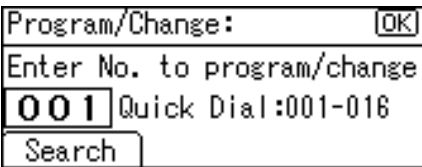

You can automatically specify registration numbers 001-016 by pressing the Quick Dial keys.

Press [Search] to search by name, destination list, registration number, user code, fax number, e-mail address, or folder destination.

- 6** Press the [OK] key.

Name:		[OK]
Enter name.		
abc	ABC COMPANY	▲

- 7** Press [Details].

Program/Change:		[OK]
[001] ABC COMPANY		
Press OK key after setting		
Details	Reg. No.	

- 8** Select [E-mail Settings] using [▲] or [▼], and then press the [OK] key.

Det. Settings 2/3		◆ [OK]
Fax Settings		
E-mail Settings		
End		

- 9** Press the [Clear/Stop] key to delete the mail address, then press the [OK] key.

E-mail Settings:		[OK]
Enter E-mail address.		
abc	ondon@abcdcompany.com	

- 10** Press [End].

Det. Settings 2/3		◆ [OK]
Fax Settings		
E-mail Settings		
End		

- 11** Press the [OK] key.

Program/Change:		[OK]
[001] ABC COMPANY		
Press OK key after setting		
Details	Reg. No.	

 Press the **[User Tools/Counter]** key.

 **Note**

To delete a name entirely, see "Deleting a Registered Name".

 **Reference**

p.156 "Deleting a Registered Name"

# Registering Folders

By registering a shared folder, you can send scan files to it directly.

There are three types of protocol you can use:

- SMB  
For sending files to shared Windows folders.
- FTP  
Use when sending files to an FTP server.
- NCP  
Use when sending files to an Net- Ware server.

## Note

- For details about protocols, server names, and folder levels, consult your network administrator.
- You can prevent unauthorized users from accessing folders from the machine. See "Registering a Protection Code".
- You can only select either SMB, FTP, or NCP. If you change protocol after finishing your settings, all previous entries are cleared.

## Reference

p.260 "Registering a Protection Code"

---

## Using SMB to Connect

---

### Note

- To register a folder in an FTP server, see "Using FTP to Connect".
- To register a folder in an NetWare server, see "Using NCP to Connect".

### Reference

p.219 "Using FTP to Connect"

p.230 "Using NCP to Connect"

---

## Registering an SMB folder

---

- 1** Select [System Settings] using [▲] or [▼], and then press the [OK] key.

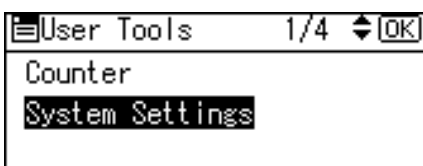

**2** Select **[Administrator Tools]** using **[▲]** or **[▼]**, and then press the **[OK]** key.



**3** Select **[Address Book Management]** using **[▲]** or **[▼]**, and then press the **[OK]** key.

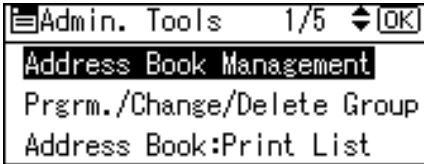

**4** Select **[Program/Change]** using **[▲]** or **[▼]**, and then press the **[OK]** key.

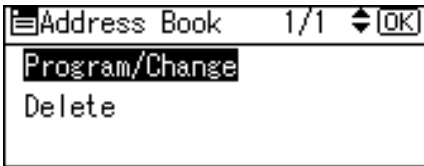

**5** Enter the registration number you want to program using the number keys or the Quick Dial keys, and then press the **[OK]** key.

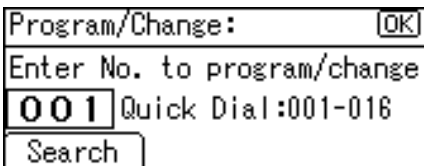

You can automatically specify registration numbers 001-016 by pressing the Quick Dial keys.

Press **[Search]** to search by name, destination list, registration number, user code, fax number, e-mail address, or folder destination.

**6** Press the **[OK]** key.

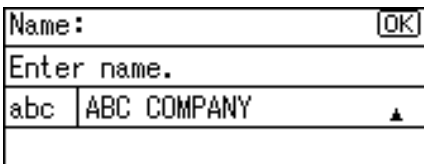

**7** Press **[Details]**.

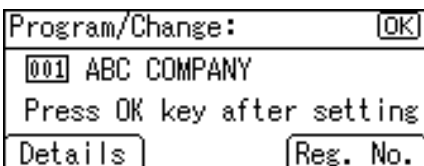



- 8 Select [Auth. Info] using [▲] or [▼], and then press the [OK] key.

Det. Settings 1/3		[OK]
Auth. Info		
Auth. Protect		
		End

- 9 Select [Folder Authentication] using [▲] or [▼], and then press the [OK] key.

Auth. Info 1/2		[OK]
User Code		
SMTP Authentication		
Folder Authentication		

- 10 Select [Specify Other Auth. Info] using [▲] or [▼], and then press [User].

Folder Authent.: 1/1		[OK]
Do not Specify		
Specify Other Auth. Info		
User	Password	

- 11 Enter the login user name, and then press the [OK] key.

Login User Name:	[OK]
Enter user name.	
abc	_

- 12 Press [Password].

Folder Authent.: 1/1		[OK]
Do not Specify		
Specify Other Auth. Info		
User	Password	

- 13 Enter the password, and then press the [OK] key.

Login Password:	[OK]
Enter password.	
abc	

**14** Enter the password again to confirm, and then press the [OK] key.

Confirm Password:	[OK]
Please re-enter password.	
abc	_

**15** Press the [OK] key.

Folder Authent.:	1/1	◆	[OK]
Do not Specify			
Specify Other Auth. Info			
User		Password	

**16** Press the [Escape] key.

Auth. Info	1/2	◆	[OK]
User Code			
SMTP Authentication			
Folder Authentication			

**17** Select [Folder Info] using [▲] or [▼], and then press the [OK] key.

Det. Settings	3/3	◆	[OK]
Folder Info			
Register Group to			
			End

**18** Select [SMB] using [▲] or [▼], and then press the [OK] key.

Select Protocol	1/1	◆	[OK]
SMB			
FTP			
NCP			

**19** Select [Manual Entry] or [Browse Network] to specify the path entry method using [▲] or [▼], and then press the [OK] key.

Path Entry Meth.:	1/1	◆	[OK]
Manual Entry			
Browse Network			

To specify a folder, you can either enter the path manually or locate the folder by browsing the network. See "Locating the folder manually" and "Locating the folder using Browse Network".

- 20 Press [Com.Test] to check the path is set correctly.

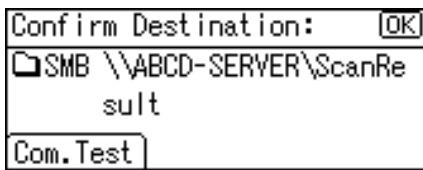

- 21 Press [Exit].

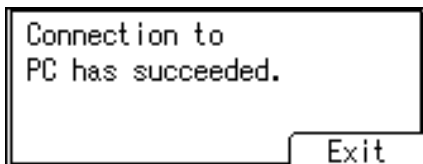

- 22 Press the [Escape] key.

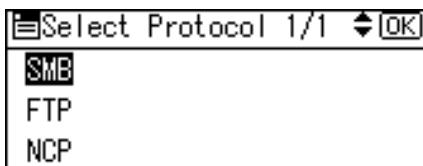

- 23 Press [End].

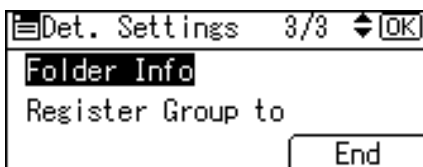

- 24 Press the [OK] key.

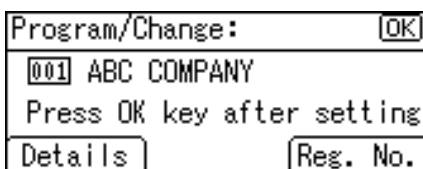

**2** Press the **[User Tools/Counter]** key.

**Note**

- For registration of a name, see "Registering Names".
- You can enter up to 64 characters for the user name.
- You can enter up to 64 characters for the password.
- If the connection test fails, check the settings, and then try again.
- When **[Do not Specify]** is selected in step 1, the SMB User Name and SMB Password that you have specified in Default User Name / Password (Send) of File Transfer settings applies.
- If User Authentication is specified, contact your administrator.

**Reference**

- p.152 "Registering Names"
- p.210 "Locating the SMB folder manually"
- p.211 "Locating the SMB folder using Browse Network"
- p.55 "File Transfer"
- "Entering Text", About This Machine

---

**Locating the SMB folder manually**

---

**1** Select **[Manual Entry]** using **[▲]** or **[▼]**, and then press the **[OK]** key.

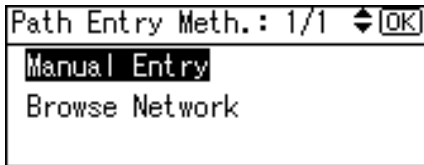

**2** Enter the path and then press the **[OK]** key.

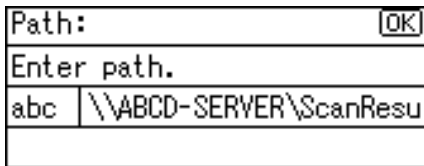

If the format of the entered path is not correct, a message appears. Press **[Exit]**, and then enter the path again.

**Note**

- Enter the path using this format: "\\ServerName\ShareName\PathName".
- You can also enter an IPv4 address.
- You can enter a path using up to 128 characters.

**Reference**

- "Entering Text", About This Machine

---

## Locating the SMB folder using Browse Network

---

- 1 Select **[Browse Network]** using **[▲]** or **[▼]**, and then press the **[OK]** key.

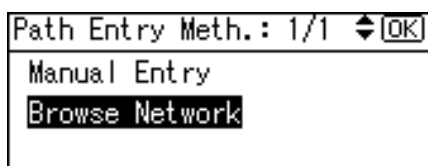

- 2 Select a work group using the scroll keys, and then press the **[OK]** key.

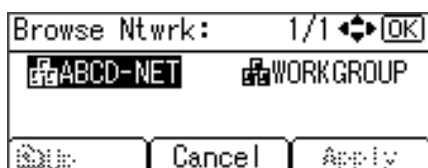

The client computers sharing the same network as the machine appear. Network display only lists client computers you are authorized to access.

- 3 Select a client computer using the scroll keys, and then press the **[OK]** key. Shared folders under it appear.



You can press **[Up]** to switch between levels.

- 4 Select the folder you want to register using the scroll keys, and then press **[Apply]**.

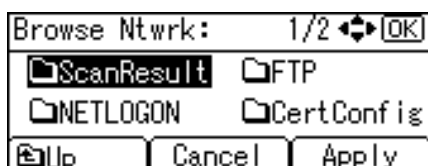

- 5 Press the **[OK]** key.

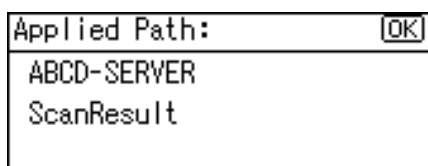

---

## If a Login Screen Appears

---

This section explains how to log in to the machine if a login screen appears when you try to access a folder by browsing the network. The login screen appears if you have not specified folder authentication, or if an incorrect user name or password has been entered for folder authentication.

- 1** Enter the login user name, and then press the [OK] key.

Enter the login user name specified for folder authentication.

Login:	[OK]
Enter a login user name.	
abc	_

- 2** Enter the password, and then press the [OK] key.

Login:	[OK]
Enter login password.	
abc	_

The path to the selected folder appears.

If a message appears, press [Exit], and then enter the login user name and password again.

 **Reference**

"Entering Text", About This Machine

---

## Changing a registered SMB folder

---

- 1** Select [System Settings] using [▲] or [▼], and then press the [OK] key.

User Tools	1/4	◆ [OK]
Counter		
System Settings		

- 2** Select [Administrator Tools] using [▲] or [▼], and then press the [OK] key.

System Settings	2/2	◆ [OK]
Interface Settings		
File Transfer		
Administrator Tools		

- 3** Select [Address Book Management] using [▲] or [▼], and then press the [OK] key.

Admin. Tools	1/5	◆ [OK]
Address Book Management		
Prgrm./Change/Delete Group		
Address Book:Print List		

- 4** Select [Program/Change] using [▲] or [▼], and then press the [OK] key.

Address Book	1/1	◆ [OK]
Program/Change		
Delete		

- 5** Enter the registration number you want to change using the number keys or the Quick Dial keys, and then press the [OK] key.

Program/Change:	[OK]
Enter No. to program/change	
001	Quick Dial:001-016
Search	

You can automatically specify registration numbers 001-016 by pressing the Quick Dial keys.

Press [Search] to search by name, destination list, registration number, user code, fax number, e-mail address, or folder destination.

- 6** Press the [OK] key.

Name:	[OK]
Enter name.	
abc	ABC COMPANY ▲

- 7** Press [Details].

Program/Change:	[OK]
001 ABC COMPANY	
Press OK key after setting	
Details	Reg. No.

- 8** Select [Folder Info] using [▲] or [▼], and then press the [OK] key.

Det. Settings	3/3	◆ [OK]
Folder Info		
Register Group to		
End		

**9** Select [SMB] using [▲] or [▼], and then press the [OK] key.

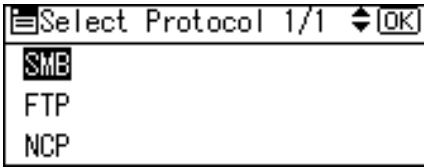

**10** Select [Manual Entry] or [Browse Network] to specify the path entry method using [▲] or [▼], and then press the [OK] key.

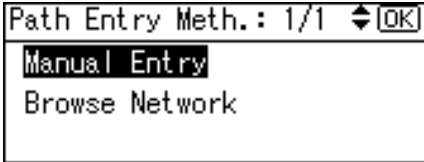

To specify a folder, you can either enter the path manually or locate the folder by browsing the network. See "Locating the folder manually" and "Locating the folder using Browse Network".

**11** Specify the folder.

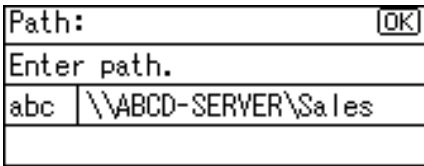

**12** Press [Com.Test] to check the path is set correctly.

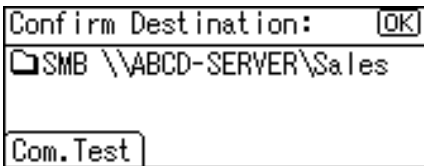

**13** Press [Exit].

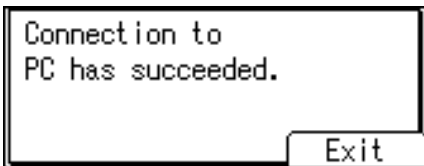

**14** Press the [Escape] key.

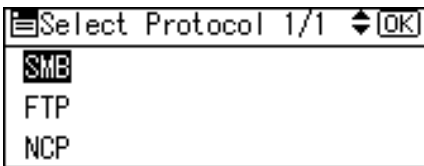



- 15 Press [End].

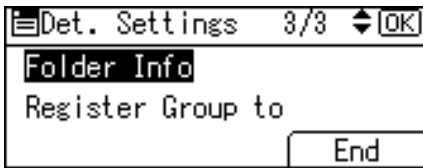

- 16 Press the [OK] key.

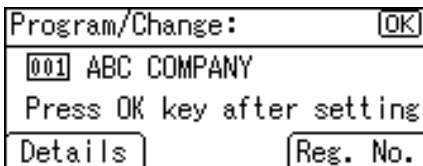

- 17 Press the [User Tools/Counter] key.

**Note**

- To change the name, see "Changing a Registered Name".

**Reference**

- p.210 "Locating the SMB folder manually"
- p.211 "Locating the SMB folder using Browse Network"
- p.154 "Changing a Registered Name"
- "Entering Text", About This Machine

---

## Changing the protocol

---

- 1 Select [FTP] or [NCP] using [▲] or [▼], and then press the [OK] key.

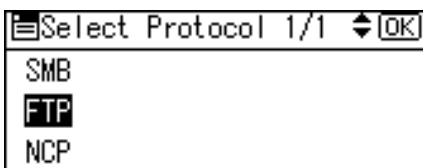

A confirmation message appears.

- 2 Press [Yes].

Changing the protocol will clear all settings made under the previous protocol.

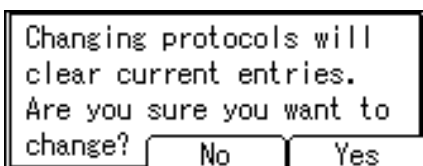

**3** Enter each item again.

**Reference**

p.219 "Registering an FTP Folder"

p.230 "Registering an NCP folder"

---

**Deleting the SMB registered folder**

---

**1** Select [System Settings] using [▲] or [▼], and then press the [OK] key.

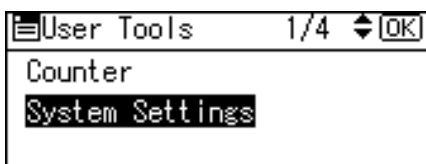

**2** Select [Administrator Tools] using [▲] or [▼], and then press the [OK] key.



7

**3** Select [Address Book Management] using [▲] or [▼], and then press the [OK] key.

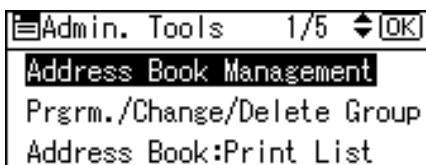

**4** Select [Program/Change] using [▲] or [▼], and then press the [OK] key.

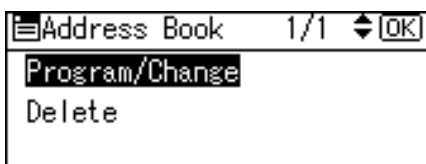

- 5** Enter the registration number you want to delete using the number keys or the Quick Dial keys, and then press the [OK] key.

Program/Change:	[OK]
Enter No. to program/change	
001	Quick Dial:001-016
Search	

You can automatically specify registration numbers 001-016 by pressing the Quick Dial keys.

Press [Search] to search by name, destination list, registration number, user code, fax number, e-mail address, or folder destination.

- 6** Press the [OK] key.

Name:	[OK]
Enter name.	
abc	ABC COMPANY ▲

- 7** Press [Details].

Program/Change:	[OK]
001 ABC COMPANY	
Press OK key after setting	
Details	Reg. No.

- 8** Select [Folder Info] using [▲] or [▼], and then press the [OK] key.

Det. Settings	3/3	◆ [OK]
Folder Info		
Register Group to		
		End

- 9** Select the protocol which is not currently selected using [▲] or [▼], and then press the [OK] key.

Select Protocol	1/1	◆ [OK]
SMB		
FTP		
NCP		

A confirmation message appears.

**10** Press [Yes].

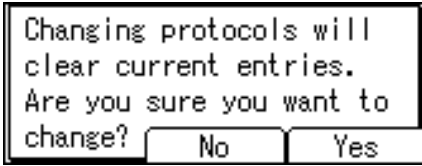

**11** Press the [Escape] key twice.

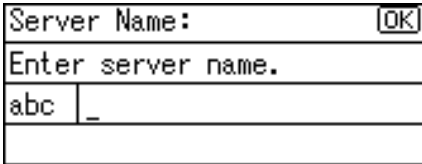

**12** Press [End].

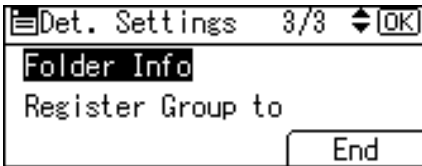

**13** Press the [OK] key.

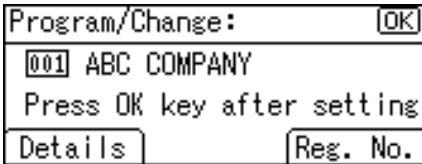

**14** Press the [User Tools/Counter] key.

 **Note**

To delete a name entirely, see "Deleting a Registered Name".

 **Reference**

p.156 "Deleting a Registered Name"

---

## Using FTP to Connect

---

### Note

- To register a shared folder configured in Windows, see "Using SMB to Connect".
- To register a folder in a NetWare server, see "Using NCP to Connect".

### Reference

- p.205 "Using SMB to Connect"
  - p.230 "Using NCP to Connect"
- 

## Registering an FTP Folder

---

- 1** Select [System Settings] using [▲] or [▼], and then press the [OK] key.

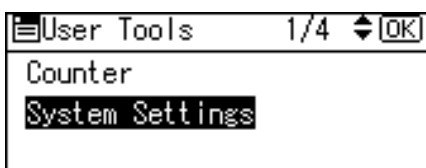

- 2** Select [Administrator Tools] using [▲] or [▼], and then press the [OK] key.



- 3** Select [Address Book Management] using [▲] or [▼], and then press the [OK] key.

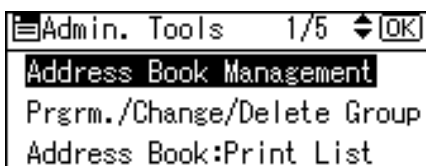

- 4** Select [Program/Change] using [▲] or [▼], and then press the [OK] key.

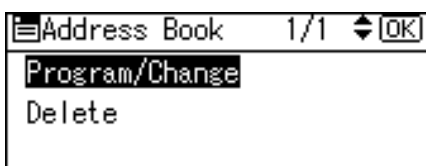

**5** Enter the registration number you want to program using the number keys or the Quick Dial keys, and then press the [OK] key.

Program/Change:	[OK]
Enter No. to program/change	
001	Quick Dial:001-016
Search	

You can automatically specify registration numbers 001-016 by pressing the Quick Dial keys.

Press [Search] to search by name, destination list, registration number, user code, fax number, e-mail address, or folder destination.

**6** Press the [OK] key.

Name:	[OK]
Enter name.	
abc	ABC COMPANY ▲

**7** Press [Details].

Program/Change:	[OK]
001 ABC COMPANY	
Press OK key after setting	
Details	Reg. No.

**8** Select [Auth. Info] using [▲] or [▼], and then press the [OK] key.

☰ Det. Settings 1/3	◆ [OK]
Auth. Info	
Auth. Protect	
End	

**9** Select [Folder Authentication] using [▲] or [▼], and then press the [OK] key.

☰ Auth. Info 1/2	◆ [OK]
User Code	
SMTP Authentication	
Folder Authentication	

**10** Select [Specify Other Auth. Info] using [▲] or [▼], and then press [User].

Folder Authent.: 1/1	◆ [OK]
Do not Specify	
Specify Other Auth. Info	
User	Password

7

- 11** Enter the login user name, and then press the [OK] key.

Login User Name:	[OK]
Enter user name.	
abc	_

- 12** Press [Password].

Folder Authent.:	1/1	◆	[OK]
Do not Specify			
Specify Other Auth. Info			
User		Password	

- 13** Enter the password, and then press the [OK] key.

Login Password:	[OK]
Enter password.	
abc	_

- 14** Enter the password again to confirm, and then press the [OK] key.

Confirm Password:	[OK]
Please re-enter password.	
abc	_

- 15** Press the [OK] key.

Folder Authent.:	1/1	◆	[OK]
Do not Specify			
Specify Other Auth. Info			
User		Password	

- 16** Press the [Escape] key.

Auth. Info	1/2	◆	[OK]
User Code			
SMTP Authentication			
Folder Authentication			

- 17** Select [Folder Info] using [▲] or [▼], and then press the [OK] key.

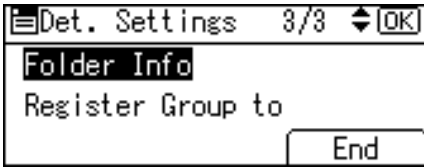

- 18** Select [FTP] using [▲] or [▼], and then press the [OK] key.

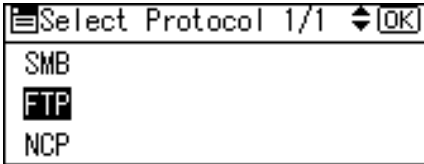

- 19** Enter the server name, and then press the [OK] key.

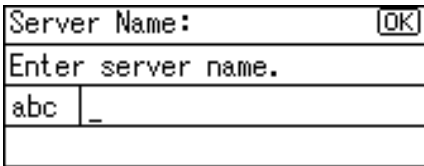

- 20** If you want to change the port number, enter the new port number, and then press the [OK] key.

Otherwise, just press the [OK] key.

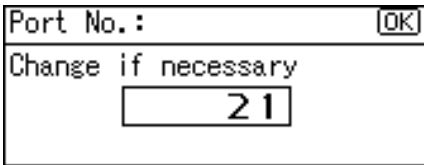

You can enter 1 to 65535.

- 21** Enter the path, and then press the [OK] key.

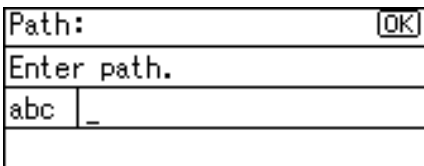

You can also enter an IPv4 address.

- 22** Press [Com.Test] to check the path is set correctly.

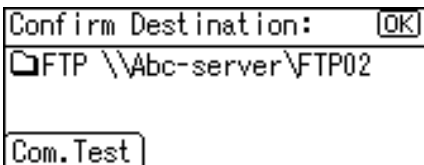



- 23 Press [Exit].

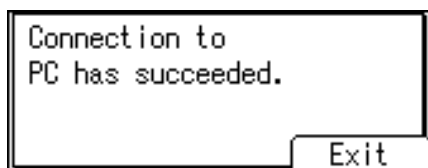

- 24 Press the [Escape] key.

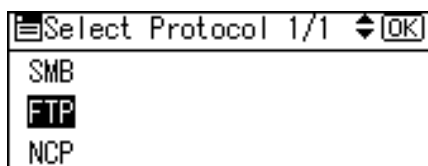

- 25 Press [End], and then press the [OK] key.

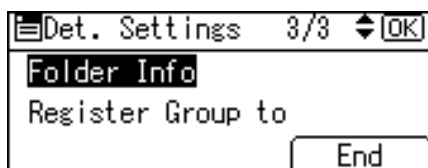

- 26 Press the [User Tools/Counter] key.

 **Note**

- For registration of a name, see "Registering Names".
- You can enter up to 64 characters for the user name.
- You can enter up to 64 characters for the password.
- You can enter a server name using up to 64 characters.
- You can enter an absolute path, using this format: "/user/ home/user-name"; or a relative path, using this format: directory/sub-directory".
- If you leave the path blank, the login directory is assumed to be the current working directory.
- You can enter a path using up to 128 characters.
- If the connection test fails, check the settings, and then try again.
- When **[Do not Specify]** is selected in step 20, the FTP User Name and FTP Password that you have specified in Default User Name / Password (Send) of File Transfer settings applies. For details, see "File Transfer".
- If User Authentication is specified, contact your administrator.

 **Reference**

- p.152 "Registering Names"
- p.210 "Locating the SMB folder manually"
- p.211 "Locating the SMB folder using Browse Network"
- "Entering Text", About This Machine

## Changing the FTP registered folder

- 1 Select [System Settings] using [▲] or [▼], and then press the [OK] key.

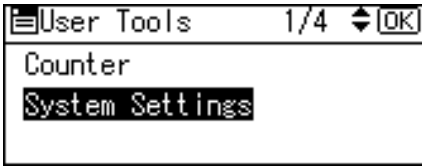

- 2 Select [Administrator Tools] using [▲] or [▼], and then press the [OK] key.



- 3 Select [Address Book Management] using [▲] or [▼], and then press the [OK] key.

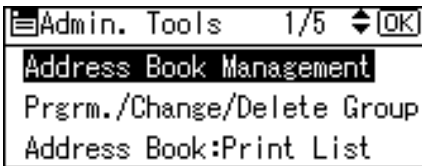

- 4 Select [Program/Change] using [▲] or [▼], and then press the [OK] key.

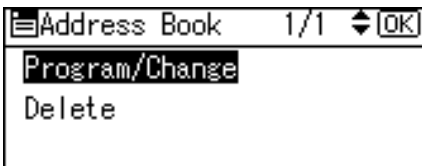

- 5 Enter the registration number you want to change using the number keys or the Quick Dial keys, and then press the [OK] key.

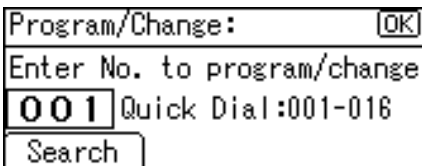

You can automatically specify registration numbers 001-016 by pressing the Quick Dial keys.

Press [Search] to search by name, destination list, registration number, user code, fax number, e-mail address, or folder destination.

- 6** Press the [OK] key.

Name:		[OK]
Enter name.		
abc	ABC COMPANY	▲

- 7** Press [Details].

Program/Change:		[OK]
[001] ABC COMPANY		
Press OK key after setting		
Details	Reg. No.	

- 8** Select [Folder Info] using [▲] or [▼], and then press the [OK] key.

☰ Det. Settings	3/3	◆ [OK]
Folder Info		
Register Group to		
		End

- 9** Select [FTP] using [▲] or [▼], and then press the [OK] key.

☰ Select Protocol	1/1	◆ [OK]
SMB		
FTP		
NCP		

- 10** To change the server name, enter the new server name, and then press the [OK] key.

Otherwise, just press the [OK] key.

Server Name:		[OK]
Enter server name.		
abc	ABC-NET	

- 11** To change the port number, enter the new port number, and then press the [OK] key.

Otherwise, just press the [OK] key.

Port No.:		[OK]
Change if necessary		
21		

- 12** To change the path, enter the new path, and then press the **[OK]** key.  
 Otherwise, just press the **[OK]** key.

Path:	[OK]
Enter path.	
abc	\\Abcd-server\FTP

- 13** Press **[Com.Test]** to check the path is set correctly.

Confirm Destination:	[OK]
<input type="checkbox"/> FTP \\Abc-server\FTP02	
Com. Test	

- 14** Press **[Exit]**.

Connection to PC has succeeded.	
Exit	

7

- 15** Press the **[Escape]** key.

Select Protocol 1/1	[OK]
SMB <input checked="" type="checkbox"/> FTP NCP	

- 16** When you have finished making changes, press **[End]**.

Det. Settings 3/3	[OK]
Folder Info Register Group to	
End	

- 17** Press the **[OK]** key.

Program/Change:	[OK]
[001] ABC COMPANY Press OK key after setting	
Details	Reg. No.

**18** Press the **[User Tools/Counter]** key.

 **Note**

To change the name, see "Changing a Registered Name".

 **Reference**

p.154 "Changing a Registered Name"  
"Entering Text", About This Machine

---

## Changing the protocol

---

**1** Select **[SMB]** or **[NCP]** using **[▲]** or **[▼]**, and then press the **[OK]** key.

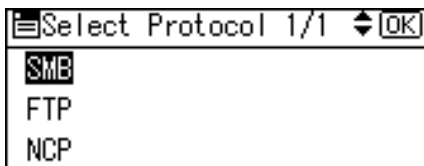

A confirmation message appears.

**2** Press **[Yes]**.

Changing the protocol will clear all settings made under the previous protocol.

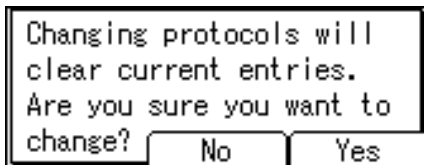

**3** Enter each item again.

 **Reference**

p.205 "Registering an SMB folder"

## Deleting the FTP registered folder

**1** Select [System Settings] using [▲] or [▼], and then press the [OK] key.

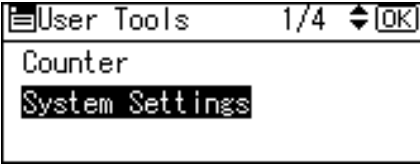

**2** Select [Administrator Tools] using [▲] or [▼], and then press the [OK] key.



**3** Select [Address Book Management] using [▲] or [▼], and then press the [OK] key.

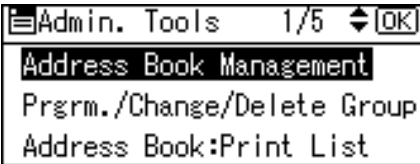

**4** Select [Program/Change] using [▲] or [▼], and then press the [OK] key.

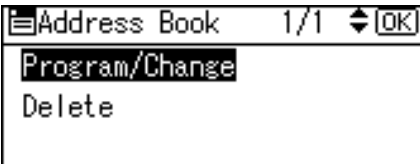

**5** Enter the registration number you want to delete using the number keys or the Quick Dial keys, and then press the [OK] key.

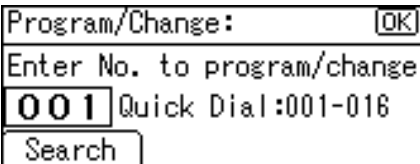

You can automatically specify registration numbers 001-016 by pressing the Quick Dial keys.

Press [Search] to search by name, destination list, registration number, user code, fax number, e-mail address, or folder destination.

- 6** Press the [OK] key.

Name:		[OK]
Enter name.		
abc	ABC COMPANY	▲

- 7** Press [Details].

Program/Change:		[OK]
[001] ABC COMPANY		
Press OK key after setting		
Details	Reg. No.	

- 8** Select [Folder Info] using [▲] or [▼], and then press the [OK] key.

Det. Settings 3/3		◆ [OK]
Folder Info		
Register Group to		
		End

- 9** Select the protocol which is not currently selected using [▲] or [▼], and then press the [OK] key.

Select Protocol 1/1		◆ [OK]
SMB		
FTP		
NCP		

A confirmation message appears.

- 10** Press [Yes].

Changing protocols will clear current entries. Are you sure you want to change?		
No	Yes	

- 11** Press the [Escape] key twice.

Path Entry Meth.: 1/1		◆ [OK]
Manual Entry		
Browse Network		

**12** Press [End].

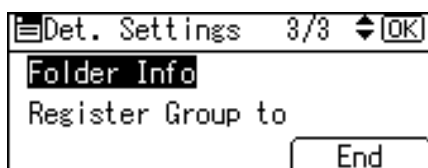

**13** Press the [OK] key.

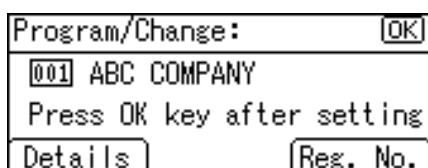

**14** Press the [User Tools/Counter] key.

**Note**

- To delete a name entirely, see "Deleting a Registered Name".

**Reference**

p.156 "Deleting a Registered Name"

---

## Using NCP to Connect

---

**Note**

- To register a shared folder configured in Windows, see "Using SMB to Connect".
- To register a folder in an FTP server, see "Using FTP to Connect".

**Reference**

p.205 "Using SMB to Connect"  
 p.219 "Using FTP to Connect"

---

### Registering an NCP folder

---

**1** Select [System Settings] using [▲] or [▼], and then press the [OK] key.

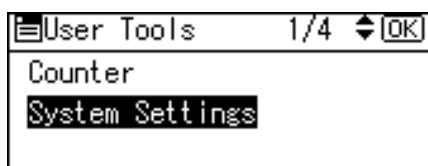



- 2** Select [Administrator Tools] using [▲] or [▼], and then press the [OK] key.

System Settings 2/2		[OK]
Interface Settings		
File Transfer		
Administrator Tools		

- 3** Select [Address Book Management] using [▲] or [▼], and then press the [OK] key.

Admin. Tools 1/5		[OK]
Address Book Management		
Prgrm./Change/Delete Group		
Address Book:Print List		

- 4** Select [Program/Change] using [▲] or [▼], and then press the [OK] key.

Address Book 1/1		[OK]
Program/Change		
Delete		

- 5** Enter the registration number you want to program using the number keys or the Quick Dial keys, and then press the [OK] key.

Program/Change:		[OK]
Enter No. to program/change		
001	Quick Dial:001-016	
Search		

You can automatically specify registration numbers 001-016 by pressing the Quick Dial keys.

Press [Search] to search by name, destination list, registration number, user code, fax number, e-mail address, or folder destination.

- 6** Press the [OK] key.

Name:		[OK]
Enter name.		
abc	ABC COMPANY	▲

**7** Press [Details].

Program/Change:	[OK]
[001] ABC COMPANY	
Press OK key after setting	
Details	Reg. No.

**8** Select [Auth. Info] using [▲] or [▼], and then press the [OK] key.

Det. Settings	1/3	[OK]
Auth. Info		
Auth. Protect		
		End

**9** Select [Folder Authentication] using [▲] or [▼], and then press the [OK] key.

Auth. Info	1/2	[OK]
User Code		
SMTP Authentication		
Folder Authentication		

**10** Select [Specify Other Auth. Info] using [▲] or [▼], and then press [User].

Folder Authent.:	1/1	[OK]
Do not Specify		
Specify Other Auth. Info		
User	Password	

**11** Enter the login user name, and then press the [OK] key.

Login User Name:	[OK]
Enter user name.	
abc	_

**12** Press [Password].

Folder Authent.:	1/1	[OK]
Do not Specify		
Specify Other Auth. Info		
User	Password	

- 13 Enter the password, and then press the [OK] key.

Login Password:	[OK]
Enter password.	
abc	

- 14 Enter the password again to confirm, and then press the [OK] key.

Confirm Password:	[OK]
Please re-enter password.	
abc	_

- 15 Press the [OK] key.

Folder Authent.: 1/1	◆ [OK]
Do not Specify	
Specify Other Auth. Info	
User	Password

- 16 Press the [Escape] key.

Auth. Info 1/2	◆ [OK]
User Code	
SMTP Authentication	
Folder Authentication	

- 17 Select [Folder Info] using [▲] or [▼], and then press the [OK] key.

Det. Settings 3/3	◆ [OK]
Folder Info	
Register Group to	
End	

- 18 Select [NCP] using [▲] or [▼], and then press the [OK] key.

Select Protocol 1/1	◆ [OK]
SMB	
FTP	
NCP	

**19** Select the connection type using **[▲]** or **[▼]**, and then press the **[OK]** key.

If you want to specify a folder in an NDS tree, press **[NDS]**. If you want to specify a folder on a NetWare server, press **[Bindery]**.

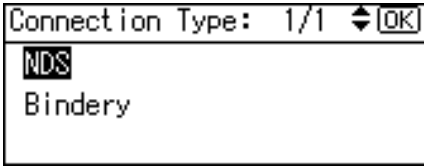

**20** Select **[Manual Entry]** or **[Browse Network]** to specify the path entry method using **[▲]** or **[▼]**, and then press the **[OK]** key.

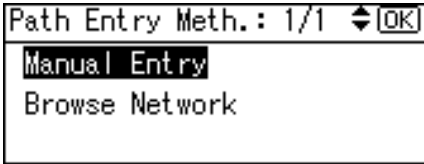

To specify a folder, you can either enter the path manually or locate the folder by browsing the network. See "Locating the folder manually" and "Locating the folder using Browse Network".

**21** Press **[Com.Test]** to confirm whether or not the paths have been correctly set.

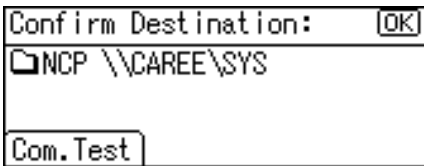

**22** Press **[Exit]**.

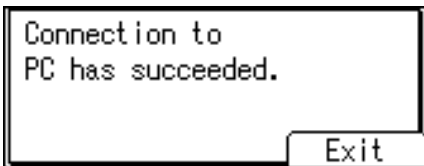

**23** Press the **[Escape]** key.

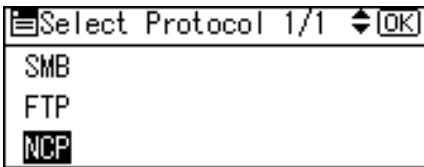

24 Press [End].

25 Press the [OK] key.

26 Press the [User Tools/Counter] key.

#### Note

- To register the name, see "Registering Names".
- You can enter up to 64 characters for the user name.
- If you select [NDS] for the connection type, after the user name, enter the context name where the user object resides. If the user name is "user" and the context name is "context", the user name you would enter is "user.context".
- You can enter up to 64 characters for the password.
- To specify a folder, you can either enter the path manually or locate the folder by browsing the network.
- When [Do not Specify] is selected, the NCP User Name and NCP Password that you have specified in Default User Name / Password (Send) of File Transfer settings applies.
- If User Authentication is specified, contact your administrator.

#### Reference

- p.152 "Registering Names"
- p.236 "Locating the NCP folder manually"
- p.236 "Locating the NCP folder using Browse Network"
- "Entering Text", About This Machine

---

## Locating the NCP folder manually

---

**1** Select [Manual Entry] using [▲] or [▼], and then press the [OK] key.

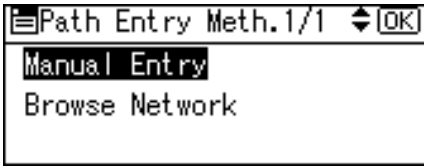

**2** Enter the path name, and then press the [OK] key.

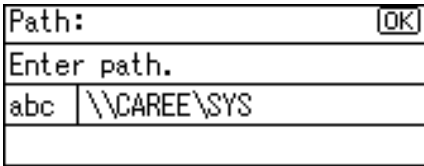

**Note**

- If you set "Connection Type" to [NDS], and if the NDS tree name is "tree", the name of the context including the volume is "context", the volume name is "volume" and the folder name is "folder", then the path will be "\\tree\volume.context\folder".
- If you set "Connection Type" to [Bindery], and if the NetWare server name is "server", the volume name is "volume" and the folder name is "folder", then the path will be "\\server\volume\folder".
- You can enter a path using up to 128 characters.
- If the connection test fails, check the settings, and then try again.

---

## Locating the NCP folder using Browse Network

---

**1** Select [Browse Network] using [▲] or [▼], and then press the [OK] key.

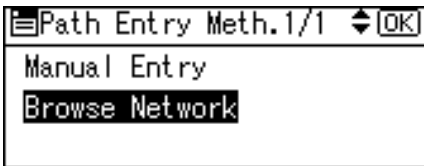

**2** If you have set "Connection Type" to [NDS], a list of items in the NDS tree appears. If you have set "Connection Type" to [Bindery], a list of items on the NetWare server appears.

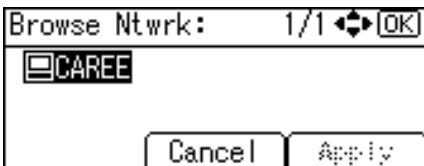

- 3** Search for the destination folder in the NDS tree or NetWare server, and then press [Apply].

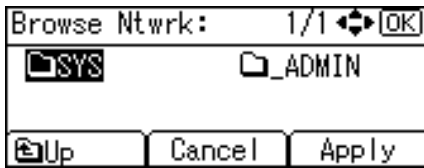

You can press [Up] to switch between levels.

- 4** Press the [OK] key.

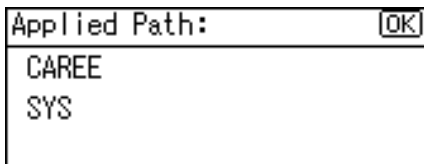

**Note**

- Only the folders you are allowed to access appear in [Browse Network].
- If the languages used on the machine and the destination you want to view differ, the items in the list may not appear correctly.
- Up to 100 items can be displayed in the list.

---

## Changing the NCP registered folder

---

7

- 1** Select [System Settings] using [▲] or [▼], and then press the [OK] key.

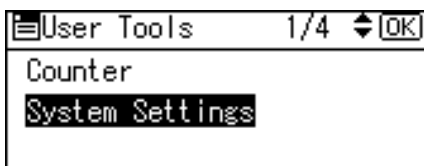

- 2** Select [Administrator Tools] using [▲] or [▼], and then press the [OK] key.



- 3** Select [Address Book Management] using [▲] or [▼], and then press the [OK] key.

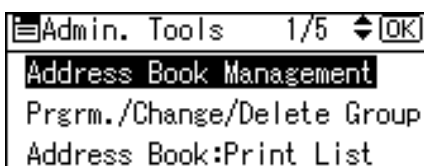

**4** Select [Program/Change] using [▲] or [▼], and then press the [OK] key.

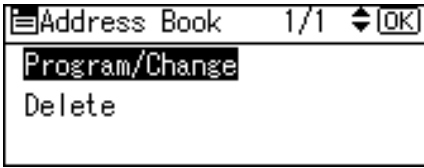

**5** Enter the registration number you want to change using the number keys or the Quick Dial keys, and then press the [OK] key.

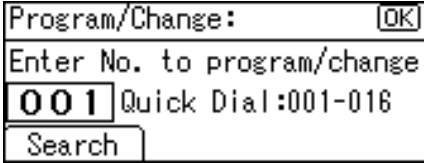

You can automatically specify registration numbers 001-016 by pressing the Quick Dial keys.

Press [Search] to search by name, destination list, registration number, user code, fax number, e-mail address, or folder destination.

**6** Press the [OK] key.

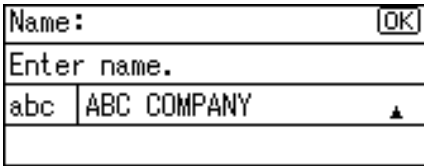

7

**7** Press [Details].

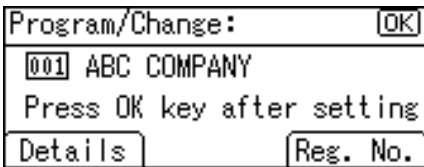

**8** Select [Folder Info] using [▲] or [▼], and then press the [OK] key.

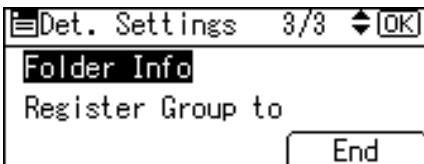

**9** Select [NCP] using [▲] or [▼], and then press the [OK] key.

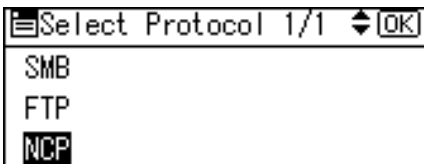



- 10** Select the connection type using [▲] or [▼], and then press the [OK] key.

If you want to specify a folder in an NDS tree, press [NDS]. If you want to specify a folder on a NetWare server, press [Bindery].

- 11** Select [Manual Entry] or [Browse Network] to specify the path entry method using [▲] or [▼], and then press the [OK] key.

To specify a folder, you can either enter the path manually or locate the folder by browsing the network. See "Locating the folder manually" and "Locating the folder using Browse Network".

- 12** Specify the folder.

- 13** Press [Com.Test] to check the path is set correctly.

- 14** Press [Exit].

**15** Press the **[Escape]** key.

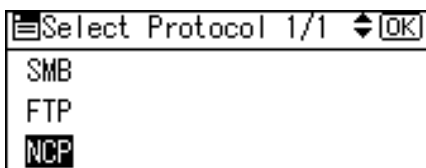

**16** Press **[End]**.

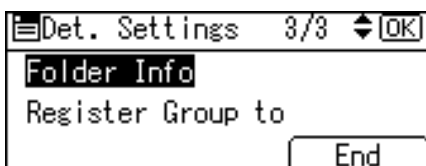

**17** Press the **[OK]** key.

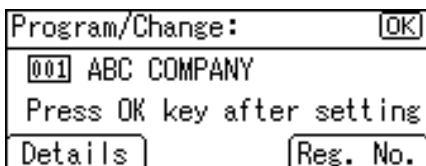

**18** Press the **[User Tools/Counter]** key.

**Note**

To change the name, see "Changing a Registered Name".

**Reference**

p.154 "Changing a Registered Name"

---

## Changing the protocol

---

- 1 Select [SMB] or [FTP] using [▲] or [▼], and then press the [OK] key.

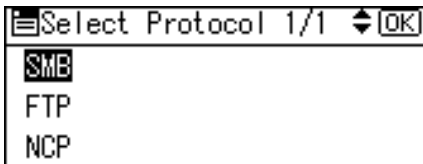

A confirmation message appears.

- 2 Press [Yes].

Changing the protocol will clear all settings made under the previous protocol.

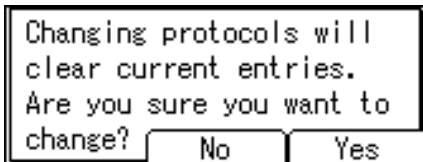

### Reference

p.205 "Registering an SMB folder"

p.219 "Registering an FTP Folder"

---

## Deleting the NCP registered folder

---

- 1 Select [System Settings] using [▲] or [▼], and then press the [OK] key.

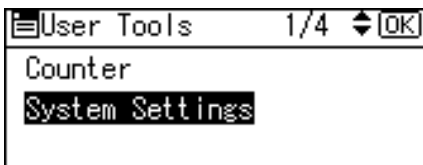

- 2 Select [Administrator Tools] using [▲] or [▼], and then press the [OK] key.



- 3 Select [Address Book Management] using [▲] or [▼], and then press the [OK] key.

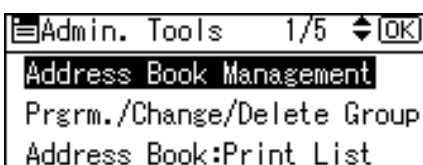

**4** Select [Program/Change] using [▲] or [▼], and then press the [OK] key.

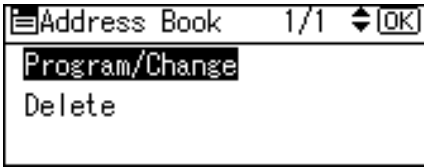

**5** Enter the registration number you want to delete using the number keys or the Quick Dial keys, and then press the [OK] key.

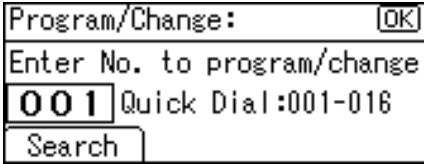

You can automatically specify registration numbers 001-016 by pressing the Quick Dial keys.

Press [Search] to search by name, destination list, registration number, user code, fax number, e-mail address, or folder destination.

**6** Press the [OK] key.

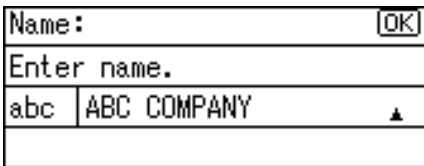

**7** Press [Details].

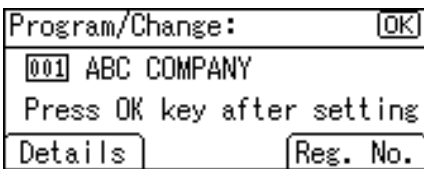

**8** Select [Folder Info] using [▲] or [▼], and then press the [OK] key.

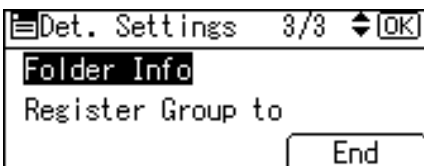

7

- 9 Select the protocol which is not currently selected using [▲] or [▼], and then press the [OK] key.

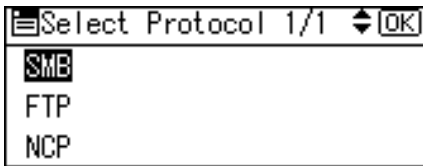

A confirmation message appears.

- 10 Press [Yes].

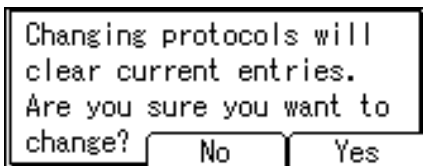

- 11 Press the [Escape] key twice.

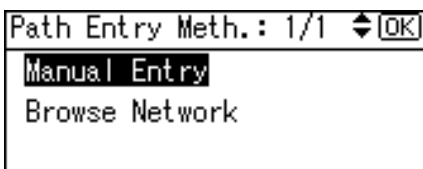

- 12 Press [End].

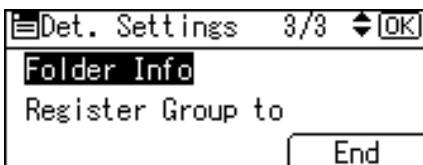

- 13 Press the [OK] key.



- 14 Press the [User Tools/Counter] key.

**Note**

- To delete a name entirely, see "Deleting a Registered Name".

**Reference**

p.156 "Deleting a Registered Name"

# Registering Names to a Group

You can register names to a group to enable easy management of e-mail addresses and folders for each group. To add names to a group, the groups must be registered beforehand.

**Important**

- When using Scan to Folder function, you cannot send scan files to a group with over 50 folders registered.
- The maximum number of group is 10.
- The maximum number of destinations registrable to a group is 100.

**Note**

- You can set a protection code to prevent unauthorized access to the folders registered in a group. For details, see "Registering a Protection Code".

**Reference**

p.260 "Registering a Protection Code"

## Registering a New Group

- 1** Select [System Settings] using [▲] or [▼], and then press the [OK] key.

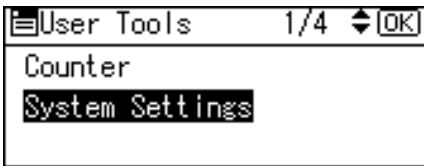

- 2** Select [Administrator Tools] using [▲] or [▼], and then press the [OK] key.



- 3** Select [Prgrm./Change/Delete Group] using [▲] or [▼], and then press the [OK] key.

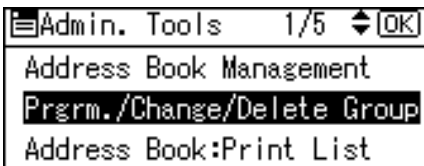

- 4** Select [Program/Change] using [▲] or [▼], and then press the [OK] key.

Group	1/1	[OK]
Program/Change		
Delete		

- 5** Enter the registration number you want to program using the number keys or the Quick Dial keys, and then press the [OK] key.

Program/Change Group:	[OK]
Enter No. to program/change	
001 Quick Dial:001-016	
Search	

You can automatically specify registration numbers 001-016 by pressing the Quick Dial keys.

- 6** Enter the group name, and then press the [OK] key.

Group Name:	[OK]
Enter name.	
abc	▲

- 7** Press the [OK] key.

Program/Change Group:	[OK]
026 0001	
Details	Regist.

- 8** Press the [User Tools/Counter] key.

### Reference

"Entering Text", About This Machine

## Registering Names to a Group

You can put names that have been registered in the Address Book into a group. When registering new names, you can also register groups at the same time.

- 1 Select [System Settings] using [▲] or [▼], and then press the [OK] key.

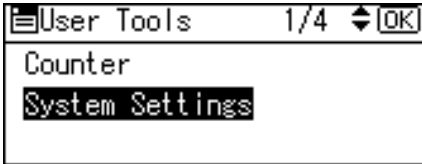

- 2 Select [Administrator Tools] using [▲] or [▼], and then press the [OK] key.



- 3 Select [Address Book Management] using [▲] or [▼], and then press the [OK] key.

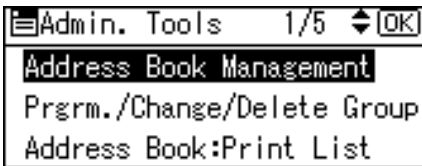

- 4 Select [Program/Change] using [▲] or [▼], and then press the [OK] key.

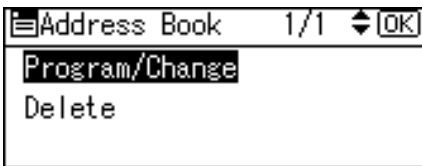

- 5 Enter the registration number you want to change using the number keys or the Quick Dial keys, and then press the [OK] key.

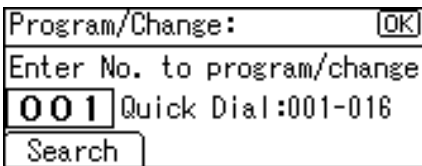

You can automatically specify registration numbers 001-016 by pressing the Quick Dial keys.

Press [Search] to search by name, destination list, registration number, user code, fax number, e-mail address, or folder destination.



- 6** Press the [OK] key.

Name:		[OK]
Enter name.		
abc	ABC COMPANY	▲

- 7** Press [Details].

Program/Change:		[OK]
[001] ABC COMPANY		
Press OK key after setting		
Details	Reg. No.	

- 8** Select [Register Group to] using [▲] or [▼], and then press the [OK] key.

Det. Settings 3/3		[OK]
Folder Info		
Register Group to		
		End

- 9** Select the group name to which you want to register using [▶], and then press the [OK] key.

Groups: 1/1		[OK]
<input checked="" type="checkbox"/>	[007] branch	
<input type="checkbox"/>	[015] group	

- 10** Press [End].

Det. Settings 3/3		[OK]
Folder Info		
Register Group to		
		End

- 11** Press the [OK] key.

Program/Change:		[OK]
[001] ABC COMPANY		
Press OK key after setting		
Details	Reg. No.	

- 12** Press the [User Tools/Counter] key.

## Adding a Group to Another Group

You can add a group to another group.

- 1 Select [System Settings] using [▲] or [▼], and then press the [OK] key.

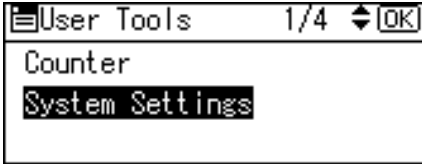

- 2 Select [Administrator Tools] using [▲] or [▼], and then press the [OK] key.



- 3 Select [Prgrm./Change/Delete Group] using [▲] or [▼], and then press the [OK] key.

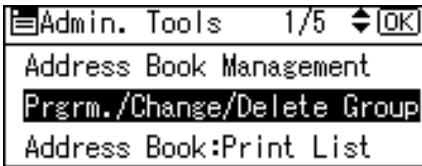

- 4 Select [Program/Change] using [▲] or [▼], and then press the [OK] key.

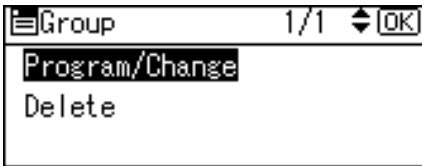

- 5 Enter the registration number of the group that you want to put into another group using the number keys or the Quick Dial keys, and then press the [OK] key.

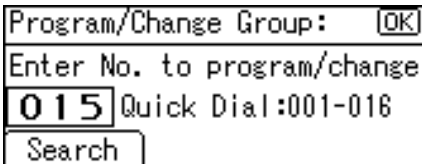

You can automatically specify registration numbers 001-016 by pressing the Quick Dial keys.

Press [Search] to search by name, destination list, or registration number.

- 6** Press the [OK] key.

Group Name:		[OK]
Enter name.		
abc	FACTORY	▲

- 7** Press [Details].

Program/Change Group:		[OK]
[015] 🌿 FACTORY		
Details		Regist.

- 8** Select [Register Group to] using [▲] or [▼], and then press the [OK] key.

Details	2/2	◆ [OK]
Register Group to		
		End

- 9** Select the group name to which you want to register using [▶], and then press the [OK] key.

Groups:	1/1	◆ [OK]
<input type="checkbox"/>	[007] 🌿 branch	
<input type="checkbox"/>	[014] 🌿 0001	
<input checked="" type="checkbox"/>	[015] 🌿 FACTORY	

- 10** Press [End].

Details	2/2	◆ [OK]
Register Group to		
		End

- 11** Press the [OK] key.

Program/Change Group:		[OK]
[015] 🌿 FACTORY		
Details		Regist.

- 12** Press the [User Tools/Counter] key.

## Displaying Names Registered in Groups

You can check the names or groups registered in each group.

- 1 Select **[System Settings]** using **[▲]** or **[▼]**, and then press the **[OK]** key.

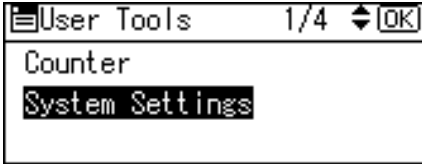

- 2 Select **[Administrator Tools]** using **[▲]** or **[▼]**, and then press the **[OK]** key.



- 3 Select **[Prgrm./Change/Delete Group]** using **[▲]** or **[▼]**, and then press the **[OK]** key.

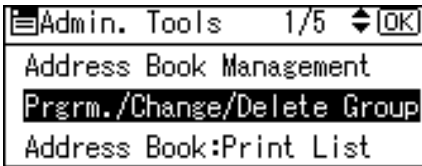

- 4 Select **[Program/Change]** using **[▲]** or **[▼]**, and then press the **[OK]** key.

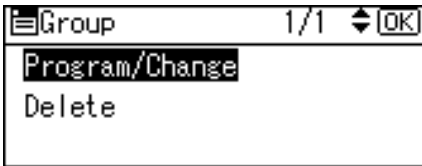

- 5 Enter the registration number you want to display using the number keys or the Quick Dial keys, and then press the **[OK]** key.

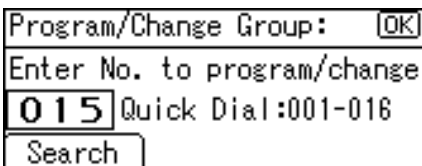

You can automatically specify registration numbers 001-016 by pressing the Quick Dial keys.

Press **[Search]** to search by name, destination list, or registration number.

**6** Press the [OK] key.

Group Name:		[OK]
Enter name.		
abc	FACTORY	▲

**7** Press [Details].

Program/Change Group:		[OK]
@13	FACTORY	
Details		Regist.

**8** Select [Programd. User/Group] using [▲] or [▼], and then press the [OK] key.

Details	1/2	◆	[OK]
Programd. User/Group			
Auth. Protect			
			End

All the user (destination) names in the specified group appear.

**9** Press the [User Tools/Counter] key.

## Removing a Name from a Group

- 1 Select [System Settings] using [▲] or [▼], and then press the [OK] key.

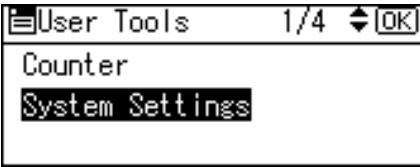

- 2 Select [Administrator Tools] using [▲] or [▼], and then press the [OK] key.



- 3 Select [Address Book Management] using [▲] or [▼], and then press the [OK] key.

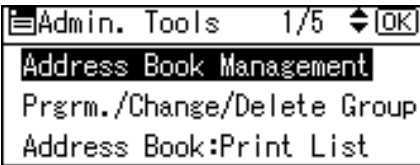

- 4 Select [Program/Change] using [▲] or [▼], and then press the [OK] key.

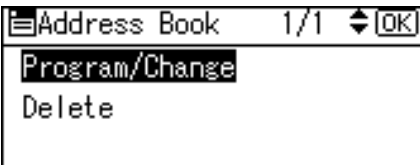

- 5 Enter the registration number you want to delete using the number keys or the Quick Dial keys, and then press the [OK] key.

Press the key of the user to be deleted or enter the registration number from the number keys.

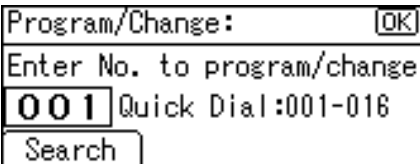

You can automatically specify registration numbers 001-016 by pressing the Quick Dial keys.

Press [Search] to search by name, destination list, registration number, user code, fax number, e-mail address, or folder destination.

- 6** Press the [OK] key.

Name:		[OK]
Enter name.		
abc	ABC COMPANY	▲

- 7** Press [Details].

Program/Change:		[OK]
[001] ABC COMPANY		
Press OK key after setting		
Details	Reg. No.	

- 8** Select [Register Group to] using [▲] or [▼], and then press the [OK] key.

Det. Settings 3/3		[OK]
Folder Info		
Register Group to		
		End

- 9** Select the group name from which you want to delete using [◀], and then press the [OK] key.

Groups: 1/1		[OK]
<input checked="" type="checkbox"/>	[007] branch	
<input type="checkbox"/>	[015] group	

- 10** Press [End].

Det. Settings 3/3		[OK]
Folder Info		
Register Group to		
		End

- 11** Press the [OK] key.

Program/Change:		[OK]
[001] ABC COMPANY		
Press OK key after setting		
Details	Reg. No.	

- 12** Press the [User Tools/Counter] key.

## Deleting a Group within Another Group

- 1 Select [System Settings] using [▲] or [▼], and then press the [OK] key.

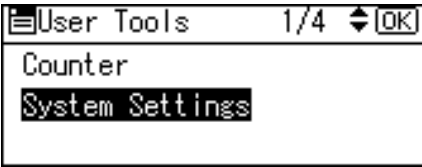

- 2 Select [Administrator Tools] using [▲] or [▼], and then press the [OK] key.



- 3 Select [Prgrm./Change/Delete Group] using [▲] or [▼], and then press the [OK] key.

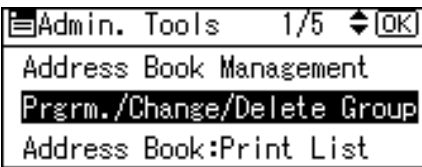

- 4 Select [Program/Change] using [▲] or [▼], and then press the [OK] key.

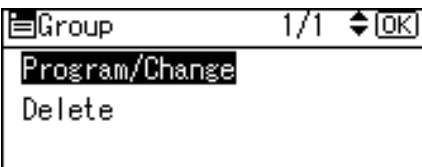

- 5 Enter the registration number of the group that you want to delete from using the number keys or the Quick Dial keys, and then press the [OK] key.

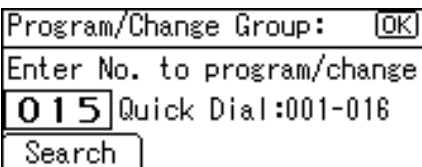

You can automatically specify registration numbers 001-016 by pressing the Quick Dial keys.

Press [Search] to search by name, destination list, or registration number.



**6** Press the [OK] key.

Group Name:		[OK]
Enter name.		
abc	FACTORY	▲

**7** Press [Details].

Program/Change Group:		[OK]
⑩ FACTORY		
Details		Regist.

**8** Select [Register Group to] using [▲] or [▼], and then press the [OK] key.

Details	2/2	◆ [OK]
Register Group to		
		End

**9** Select the group you want to delete using [▲] or [▼], then confirm it by pressing [◀], and then press the [OK] key.

Groups:	1/1	◆ [OK]
<input type="checkbox"/>	⑦	branch
<input type="checkbox"/>	⑭	0001
<input checked="" type="checkbox"/>	⑩	FACTORY

**10** Press [End].

Details	2/2	◆ [OK]
Register Group to		
		End

**11** Press the [OK] key.

Program/Change Group:		[OK]
⑩ FACTORY		
Details		Regist.

**12** Press the [User Tools/Counter] key.

## Changing a Group Name

- 1 Select [System Settings] using [▲] or [▼], and then press the [OK] key.

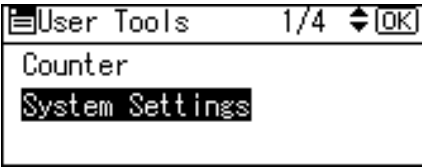

- 2 Select [Administrator Tools] using [▲] or [▼], and then press the [OK] key.



- 3 Select [Prgrm./Change/Delete Group] using [▲] or [▼], and then press the [OK] key.

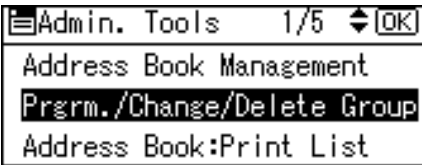

- 4 Select [Program/Change] using [▲] or [▼], and then press the [OK] key.

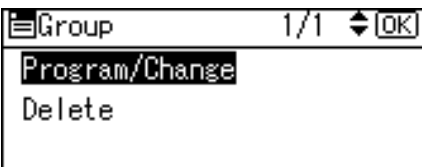

- 5 Enter the registration number you want to change using the number keys and the Quick Dial keys, and then press the [OK] key.

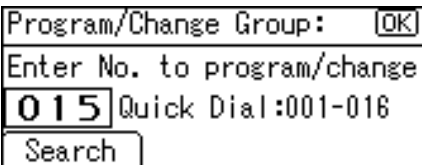

You can automatically specify registration numbers 001-016 by pressing the Quick Dial keys.

Press [Search] to search by name, destination list, or registration number.

- 6** Enter the new group name using the number keys and the Quick Dial keys, and then press the [OK] key.

Group Name:		[OK]
Enter name.		
abc	FACTORY03	▲

- 7** To change the registration number, press [Regist.].

Program/Change Group:		[OK]
[015]	▲	FACTORY03
Details		Regist.

- 8** Enter the new registration number using the number keys or the Quick Dial keys, and then press the [OK] key.

Change Regist. Number:		[OK]
Enter new No. to program.		
[026]	Quick Dial:	001-016

- 9** Press the [OK] key.

Program/Change Group:		[OK]
[026]	▲	FACTORY03
Details		Regist.

- 10** Press the [User Tools/Counter] key.

## Deleting a Group

- 1 Select [System Settings] using [▲] or [▼], and then press the [OK] key.

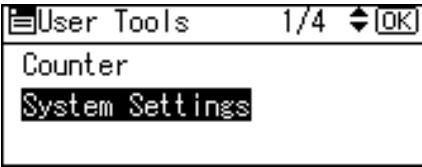

- 2 Select [Administrator Tools] using [▲] or [▼], and then press the [OK] key.



- 3 Select [Prgrm./Change/Delete Group] using [▲] or [▼], and then press the [OK] key.

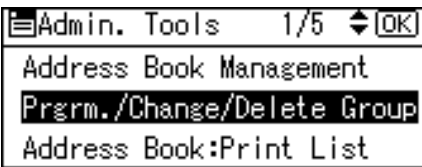

- 4 Select [Delete] using [▲] or [▼], and then press the [OK] key.

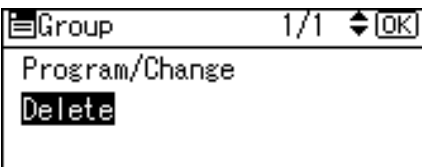

- 5 Enter the registration number you want to delete using the number keys or the Quick Dial keys, and then press the [OK] key.

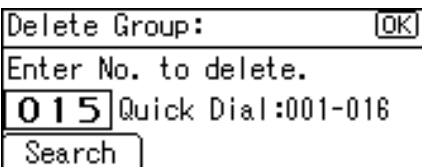

You can automatically specify registration numbers 001-016 by pressing the Quick Dial keys.

Press [Search] to search by name, destination list, or registration number.

**6** Press [Yes].

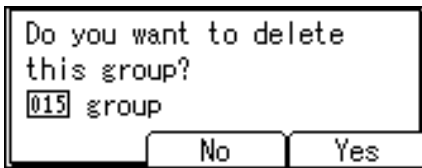

**7** Press the [User Tools/Counter] key.

# Registering a Protection Code

You can stop sender's names or folders being accessed by setting a protection code.

You can use this function to protect the following:

- Folders  
You can prevent unauthorized access to folders.
- Sender's names  
You can prevent misuse of sender's names.

## Reference

p.158 "Registering a User Code"

## Registering a Protection Code to a Single User

- 1** Select [System Settings] using [▲] or [▼], and then press the [OK] key.

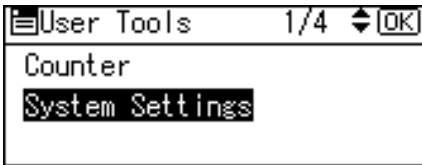

- 2** Select [Administrator Tools] using [▲] or [▼], and then press the [OK] key.



- 3** Select [Address Book Management] using [▲] or [▼], and then press the [OK] key.

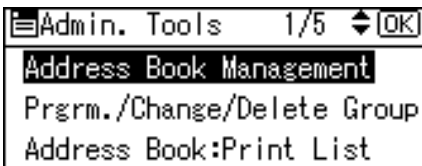

- 4** Select [Program/Change] using [▲] or [▼], and then press the [OK] key.

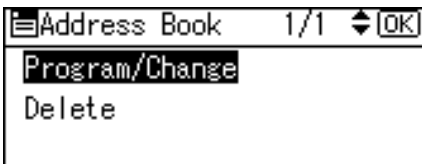

- 5** Enter the registration number you want to protect using the number keys or the Quick Dial keys, and then press the [OK] key.

Program/Change:	[OK]
Enter No. to program/change	
001	Quick Dial:001-016
Search	

You can automatically specify registration numbers 001-016 by pressing the Quick Dial keys.

Press [Search] to search by name, destination list, registration number, user code, fax number, e-mail address, or folder destination.

- 6** Press the [OK] key.

Name:	[OK]
Enter name.	
abc	ABC COMPANY ▲

- 7** Press [Details].

Program/Change:	[OK]
001 ABC COMPANY	
Press OK key after setting	
Details	Reg. No.

- 8** Select [Auth. Protect] using [▲] or [▼], and then press the [OK] key.

☰ Det. Settings 1/3	◆ [OK]
Auth. Info	
Auth. Protect	
End	

- 9** Select [Register as] using [▲] or [▼], and then press the [OK] key.

☰ Auth.Protect 1/1	◆ [OK]
Register as	
Dest.Protect Obj.	

- 10 Select [None], [Destination Only ], [Sender Only] or [Dest. & Sender] using [▲] or [▼], and then press the [OK] key.

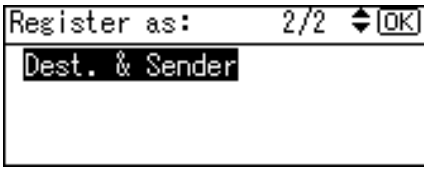

- 11 Select [Dest.Protect Obj.] using [▲] or [▼], and then press the [OK] key.

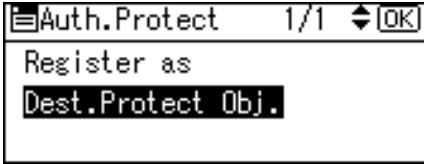

- 12 Select [Folder] or [Sender] using [▲] or [▼], and then press the [OK] key.

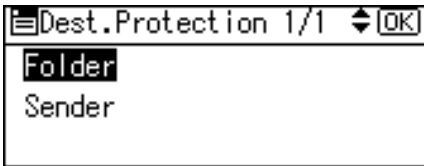

If you select [Destination Only ] in [Register as], only [Folder] can be selected.

If you select [Sender Only] in [Register as], only [Sender] can be selected.

- 13 Select [Protect] or [Do not protect] using [▲] or [▼], and then press the [OK] key.

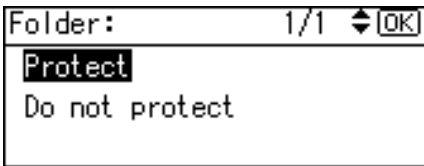

[Protect] or [Do not protect] can be selected for both [Folder] and [Sender] at the same time.

- 14 Select [Dest.Protect Code] using [▲] or [▼], and then press the [OK] key.

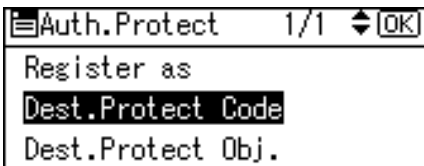



- 15** Enter a protection code using the number keys, and then press the **[OK]** key.

Dest.Protect:	[OK]
Enter code with No. keys.	
<input type="text"/>	

- 16** Press the **[Escape]** key.

Auth.Protect	1/1	◆	[OK]
Register as			
Dest.Protect Code			
Dest.Protect Obj.			

- 17** Press **[End]**.

Det. Settings	1/3	◆	[OK]
Auth. Info			
Auth. Protect			
			End

- 18** Press the **[OK]** key.

Program/Change:	[OK]
[001] ABC COMPANY	
Press OK key after setting	
Details	Reg. No.

- 19** Press the **[User Tools/Counter]** key.

**Note**

- Specify a protection code of up to eight digits. You can also specify "Protection" without specifying a protection code.

## Registering a Protection Code to a Group User

- 1 Select [System Settings] using [▲] or [▼], and then press the [OK] key.

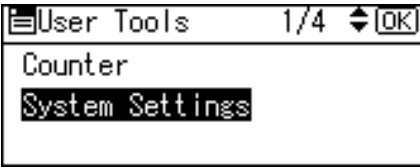

- 2 Select [Administrator Tools] using [▲] or [▼], and then press the [OK] key.



- 3 Select [Prgrm./Change/Delete Group] using [▲] or [▼], and then press the [OK] key.

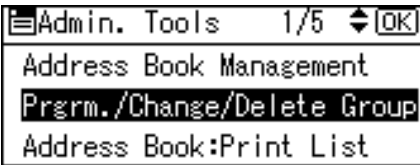

- 4 Select [Program/Change] using [▲] or [▼], and then press the [OK] key.

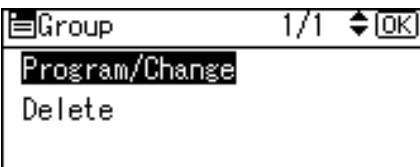

- 5 Enter the registration number of group you want to protect using the number keys or the Quick Dial keys, and then press the [OK] key.

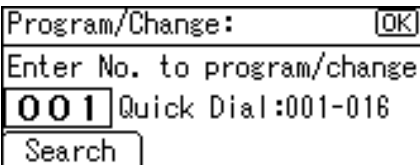

You can automatically specify registration numbers 001-016 by pressing the Quick Dial keys.

Press [Search] to search by name, destination list, or registration number.

- 6** Press the [OK] key.

Group Name:		[OK]
Enter name.		
abc	FACTORY	▲

- 7** Press [Details].

Program/Change Group:		[OK]
⑩ FACTORY		
Details		Regist.

- 8** Select [Auth. Protect] using [▲] or [▼], and then press the [OK] key.

Details	1/2	◆ [OK]
Programd. User/Group		
Auth. Protect		
		End

- 9** Select [Folder Protect] using [▲] or [▼], and then press the [OK] key.

Protection	1/1	◆ [OK]
Folder Protect		
Perms.:Users/Grps>Delete		
		Exit

- 10** Select [On] using [▲] or [▼], and then press the [OK] key.

Folder Protect:	1/1	◆ [OK]
On		
Off		

- 11** Select [Destination Protect] using [▲] or [▼], and then press the [OK] key.

Protection	1/2	◆ [OK]
Destination Protect		
Folder Protect		
		Exit

- 12 Enter a protection code using the number keys, and then press the [OK] key.

- 13 Press [Exit], and then press [End].

- 14 Press the [OK] key.

- 15 Press the [User Tools/Counter].

**Note**

- Specify a protection code of up to eight digits. You can also specify "Protection" without specifying a protection code.

# Registering SMTP and LDAP Authentication

## SMTP Authentication

For each user registered in the Address Book, you can register a login user name and login password to be used when accessing an SMTP server.

To use an SMTP server, you need to program it beforehand.

### Important

- When **[Do not Specify]** is selected for SMTP Authentication, the User Name and Password that you have specified in SMTP Authentication of File Transfer settings applies. For details, see "File Transfer".

- 1** Select **[System Settings]** using **[▲]** or **[▼]**, and then press the **[OK]** key.

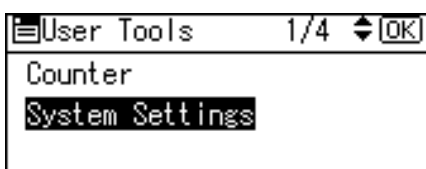

- 2** Select **[Administrator Tools]** using **[▲]** or **[▼]**, and then press the **[OK]** key.



- 3** Select **[Address Book Management]** using **[▲]** or **[▼]**, and then press the **[OK]** key.

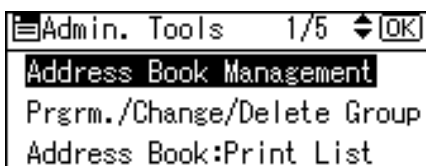

- 4** Select **[Program/Change]** using **[▲]** or **[▼]**, and then press the **[OK]** key.

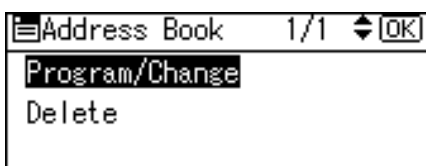

- 5** Enter the registration number you want to register using the number keys or the Quick Dial keys, and then press the [OK] key.

Program/Change:	[OK]
Enter No. to program/change	
001	Quick Dial:001-016
Search	

You can automatically specify registration numbers 001-016 by pressing the Quick Dial keys.

Press [Search] to search by name, destination list, registration number, user code, fax number, e-mail address, or folder destination.

- 6** Press the [OK] key.

Name:	[OK]
Enter name.	
abc	ABC COMPANY ▲

- 7** Press [Details].

Program/Change:	[OK]
001 ABC COMPANY	
Press OK key after setting	
Details	Reg. No.

- 8** Select [Auth. Info] using [▲] or [▼], and then press the [OK] key.

☰ Det. Settings 1/3	◆ [OK]
Auth. Info	
Auth. Protect	
End	

- 9** Select [SMTP Authentication] using [▲] or [▼], and then press the [OK] key.

☰ Auth. Info 1/2	◆ [OK]
User Code	
SMTP Authentication	
Folder Authentication	

- 10** Select [Specify Other Auth. Info] using [▲] or [▼], and then press [User].

SMTP Authent.: 1/1	◆ [OK]
Do not Specify	
Specify Other Auth. Info	
User	Password

- 11** Enter the login user name, and then press the [OK] key.

Login User Name:	[OK]
Enter user name.	
abc	_

- 12** Press the [Password].

SMTP Authent.:	1/1	◆	[OK]
Do not Specify			
Specify Other Auth. Info			
User		Password	

- 13** Enter the password, and then press the [OK] key.

Login Password:	[OK]
Enter password.	
abc	_

- 14** Enter the password again to confirm, and then press the [OK] key.

Confirm Password:	[OK]
Please re-enter password.	
abc	_

- 15** Press the [Escape] key twice.

SMTP Authent.:	1/1	◆	[OK]
Do not Specify			
Specify Other Auth. Info			
User		Password	

- 16** Press [End].

Det. Settings	1/3	◆	[OK]
Auth. Info			
Auth. Protect			
			End

**17** Press the [OK] key.

Program/Change:	[OK]
[001] ABC COMPANY	
Press OK key after setting	
Details	Reg. No.

**18** Press the [User Tools/Counter] key.

 **Note**

- To register the name, see "Registering Names".
- You can enter up to 191 characters for the user name.
- When using POP before SMTP Authentication, you can enter up to 63 alphanumeric characters.
- You can enter up to 128 characters for the password.
- To change the SMTP Authentication settings, repeat step **2** to **16**.

 **Reference**

- p.152 "Registering Names"
- p.15 "Network Settings"
- "Entering Text", About This Machine



## LDAP authentication

For each user registered in the Address Book, you can register a login user name and login password to be used when accessing an LDAP server.

To use an LDAP server, you need to program it beforehand.

### Important

- When **[Do not Specify]** is selected for LDAP Authentication, the User Name and Password that you have specified in Program/Change LDAP Server of Administrator Tools settings applies. For details about LDAP authentication, consult your administrator.

- 1 Select **[System Settings]** using **[▲]** or **[▼]**, and then press the **[OK]** key.

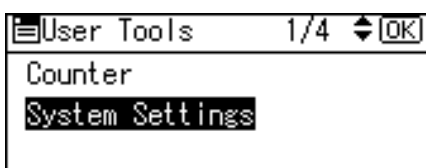

- 2 Select **[Administrator Tools]** using **[▲]** or **[▼]**, and then press the **[OK]** key.



- 3 Select **[Address Book Management]** using **[▲]** or **[▼]**, and then press the **[OK]** key.

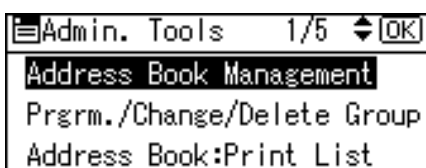

- 4 Select **[Program/Change]** using **[▲]** or **[▼]**, and then press the **[OK]** key.

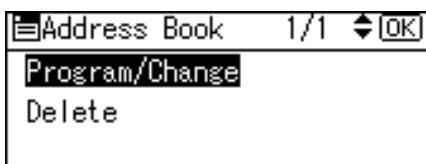

**5** Enter the registration number you want to register using the number keys or the Quick Dial keys, and then press the [OK] key.

Program/Change:	[OK]
Enter No. to program/change	
001	Quick Dial:001-016
Search	

You can automatically specify registration numbers 001-016 by pressing the Quick Dial keys.

Press [Search] to search by name, destination list, registration number, user code, fax number, e-mail address, or folder destination.

**6** Press the [OK] key.

Name:	[OK]
Enter name.	
abc	ABC COMPANY ▲

**7** Press [Details].

Program/Change:	[OK]
001 ABC COMPANY	
Press OK key after setting	
Details	Reg. No.

**8** Select [Auth. Info] using [▲] or [▼], and then press the [OK] key.

☰ Det. Settings 1/3	◆ [OK]
Auth. Info	
Auth. Protect	
End	

**9** Select [LDAP Authentication] using [▲] or [▼], and then press the [OK] key.

☰ Auth. Info 2/2	◆ [OK]
LDAP Authentication	
Function Permissions	

**10** Select [Specify Other Auth. Info] using [▲] or [▼], and then press [User].

LDAP Authent.: 1/1	◆ [OK]
Do not Specify	
Specify Other Auth. Info	
User	Password

7

- 11** Enter the login user name, and then press the [OK] key.

Login User Name:	[OK]
Enter user name.	
abc	_

- 12** Press [Password].

LDAP Authent.:	1/1	◆	[OK]
Do not Specify			
Specify Other Auth. Info			
User		Password	

- 13** Enter the password, and then press the [OK] key.

Login Password:	[OK]
Enter password.	
abc	_

- 14** Enter the password again to confirm, and then press the [OK] key.

Confirm Password:	[OK]
Please re-enter password.	
abc	_

- 15** Press the [Escape] key twice.

LDAP Authent.:	1/1	◆	[OK]
Do not Specify			
Specify Other Auth. Info			
User		Password	

- 16** Press [End].

Det. Settings	1/3	◆	[OK]
Auth. Info			
Auth. Protect			
			End

**17** Press the **[OK]** key.

Program/Change:		[OK]
[001]	ABC COMPANY	
Press OK key after setting		
Details		Reg. No.

**18** Press the **[User Tools/Counter]}** key.

 **Note**

- To register the name, see "Registering Names".
- When **[Do not Specify]** is selected for LDAP Authentication, the User Name and Password that you have specified in Program/Change LDAP Server of Administrator Tools settings applies.
- You can enter up to 128 characters for the user name.
- To change the LDAP Authentication settings, repeat step **2** to **16**.

 **Reference**

- p.152 "Registering Names"
- p.64 "Program/Change/Delete LDAP Server"
- "Entering Text", About This Machine

# Searching

You can search for the user information stored in **[Address Book Management]** under **[Administrator Tools]** in **[System Settings]** by displaying a list. Alternatively, you can search by name, registration number, user code, fax number, e-mail address, or destination folder name.

This section explains how to search for a user name or destination registered in the address book.

For details about accessing **[Address Book Management]**, see "Registering Names".

## Reference

p.152 "Registering Names"

---

## Searching by Name

---

Search the address book using a destination or user name.

- 1 Press **[Search]**.

Program/Change:	[OK]
Enter No. to program/change	
001 Quick Dial:001-016	
Search	

- 2 Select **[Search by Name]** using **[▲]** or **[▼]**, and then press the **[OK]** key.

Address Book	1/1	[OK]
Search by Name		
Display List		
Search by Registration No.		

- 3 Enter the name you want to search for, and then press the **[OK]** key. You can also search by entering part of the name.

Search by Name:	[OK]
Enter characters to search.	
abc   ABC	▲

- 4 Press the **[OK]** key.

Search by Name:	[OK]
Press OK to search.	
abc   ABC	▲

The search results appear.

- 5** Select the name using [▲] or [▼], then confirm it by pressing [▶], and then press the [OK] key.

Results: 1/1 [▲][▶][▼][OK]

001 ABC COMPANY

**Reference**

"Entering Text", About This Machine

## Searching from the List

Search the address book by displaying a list of registered user names and destinations.

- 1** Press [Search].

Program/Change: [OK]

Enter No. to program/change

001 Quick Dial:001-016

Search

- 2** Select [Display List] using [▲] or [▼], and then press the [OK] key.

Address Book 1/1 [▲][▶][▼][OK]

Search by Name

Display List

Search by Registration No.

The list of registered user names or destination names appears.

- 3** Select the destination using [▲] or [▼], then confirm it by pressing [▶], and then press the [OK] key.

Dest. List 2/10 [▲][▶][▼][OK]

004 ABC COMPANY

005 TORONTO OFFICE

006 XYZ CO.,LTD

**Reference**

"Entering Text", About This Machine

## Searching by Registration Number

Search the address book using the registration number of a user or destination.

- 1 Press [Search].

Program/Change:	[OK]
Enter No. to program/change	
<b>001</b> Quick Dial:001-016	
Search	

- 2 Select [Search by Registration No.] using [▲] or [▼], and then press the [OK] key.

Address Book	1/3	◆	[OK]
Search by Name			
Display List			
<b>Search by Registration No.</b>			

- 3 Enter the registration number you want to search for using the number keys, and then press the [OK] key.

Search by No.:	[OK]
Enter No. to search	
<b>004</b>	

- 4 Select the name using [▲] or [▼], then confirm it by pressing [▶], and then press the [OK] key.

Results:	1/1	◆	▶	▶	✓	[OK]
<input type="checkbox"/>	<b>004</b>	ABC COMPANY				

## Searching by User Code

Search the address book using registered user codes.

**1** Press [Search].

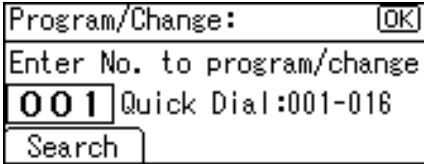

**2** Select [Search by User Code] using [▲] or [▼], and then press the [OK] key.

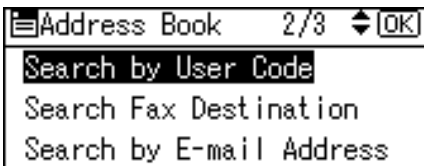

**3** Enter the user code you want to search for using the number keys, and then press the [OK] key.

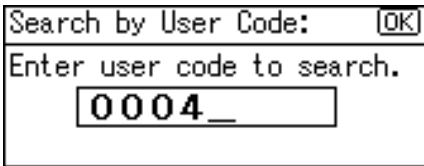

**4** Press the [OK] key.

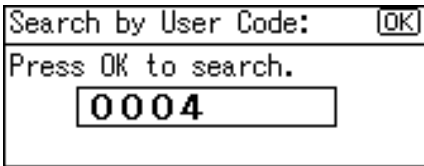

The search results appear.

**5** Select the name using [▲] or [▼], then confirm it by pressing [▶], and then press the [OK] key.





## Searching by Fax Number

Search the address book using registered fax numbers.

- 1 Press [Search].

Program/Change:	[OK]
Enter No. to program/change	
<b>001</b> Quick Dial:001-016	
Search	

- 2 Select [Search Fax Destination] using [▲] or [▼], and then press the [OK] key.

Address Book 2/3	◆ [OK]
Search by User Code	
<b>Search Fax Destination</b>	
Search by E-mail Address	

- 3 Enter the fax number you want to search for using the number keys, and then press the [OK] key.

To search by IP-Fax number, press [IP], enter the IP-Fax number, and then press the [OK] key.

Search Fax Destination:	[OK]
Enter No./chara. to search.	
<b>☎192_</b>	
	Tone IP

- 4 Press the [OK] key.

Search Fax Destination:	[OK]
Press OK to search.	
<b>☎192</b>	

The search results appear.

- 5 Select the name using [▲] or [▼], then confirm it by pressing [▶], and then press the [OK] key.

Results:	1/1	◆▶	☑ [OK]
<input type="checkbox"/>	<b>001NEWYORK BRANCH</b>		
<input type="checkbox"/>	003group3		

### Reference

"Entering Text", About This Machine

## Searching by E-mail Address

Search the address book using registered e-mail addresses.

- 1 Press [Search].

Program/Change:	[OK]
Enter No. to program/change	
001	Quick Dial:001-016
Search	

- 2 Select [Search by E-mail Address] using [▲] or [▼], and then press the [OK] key.

Address Book	2/3	[OK]
Search by User Code		
Search Fax Destination		
Search by E-mail Address		

- 3 Enter the e-mail address you want to search for, and then press the [OK] key.

You can also search by entering part of the e-mail address.

Search by E-mail Add.:	[OK]
Enter characters to search.	
abc	abc

- 4 Press the [OK] key.

Search by E-mail Add.:	[OK]
Press OK to search.	
abc	abc

The search results appear.

- 5 Select the name using [▲] or [▼], then confirm it by pressing [▶], and then press the [OK] key.

Results:	1/1	[▶]	[▶]	[OK]
<input type="checkbox"/>	001	ABC COMPANY		

### Reference

"Entering Text", About This Machine

## Searching by Destination Folder Name

You can search for a destination folder name registered in the address book.

- 1 Press [Search].

Program/Change:	[OK]
Enter No. to program/change	
001 Quick Dial:001-016	
Search	

- 2 Select [Search by Folder Name] using [▲] or [▼], and then press the [OK] key.

Address Book 3/3	↕ [OK]
Search by Folder Name	

- 3 Enter the destination folder name, and then press the [OK] key.

You can also search by entering part of the destination folder name.

Search by Folder Name:	[OK]
Enter characters to search.	
abc   abc	

- 4 Press the [OK] key.

Search by Folder Name:	[OK]
Press OK to search.	
abc   abc	

The search results appear.

- 5 Select the name using [▲] or [▼], then confirm it by pressing [▶], and then press the [OK] key.

Results:	1/1	↕▶✓ [OK]
<input type="checkbox"/> [001]ABC COMPANY		

### Reference

"Entering Text", About This Machine



# 8. Other User Tools

Initial settings allow you switch the language as well as checking the number of printed paper by displaying the counter. For the details on how to access respective settings, see "Accessing User Tools".

## Changing the Display Language

Following describes [Language] provided for the machine.

You can change the language used on the display. English is set as default.

- 1 Select [Language] using [▲] or [▼], and then press the [OK] key.

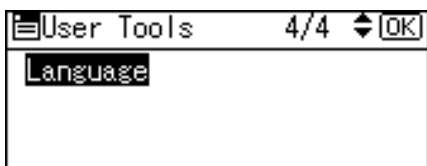

- 2 Select the language using [▲] or [▼], and then press the [OK] key.

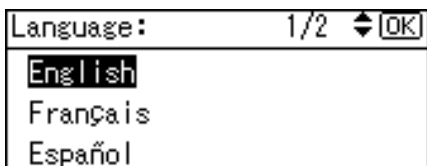

- 3 Press the [User Tools/Counter] key.

### Reference

p.4 "Accessing User Tools"

# Counter

## Displaying the Total Counter

You can display the total counter value used for all functions.

- 1 Select [Counter] using [▲] or [▼], and then press the [OK] key.

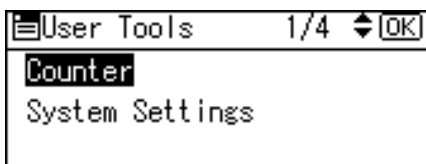

- 2 To print the counter list, press [Print].

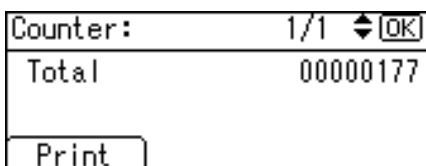

- 3 Press the [Start] key.

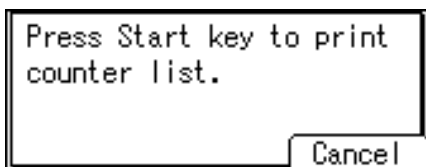

A counter list prints out.

### Reference

p.4 "Accessing User Tools"

## Copyright Information about Installed Software

---

### expat

---

- The software including controller, etc. (hereinafter "software") installed on this product uses the expat under the conditions mentioned below.
- The product manufacturer provides warranty and support to the software of the product including the expat, and the product manufacturer makes the initial developer and copyright holder of the expat, free from these obligations.
- Information relating to the expat is available at:  
<http://expat.sourceforge.net/>

Copyright (c) 1998, 1999, 2000 Thai Open Source Software Center, Ltd. and Clark Cooper.

Copyright © 2001, 2002 Expat maintainers.

Permission is hereby granted, free of charge, to any person obtaining a copy of this software and associated documentation files (the "Software"), to deal in the Software without restriction, including without limitation the rights to use, copy, modify, merge, publish, distribute, sublicense, and/or sell copies of the Software, and to permit persons to whom the Software is furnished to do so, subject to the following conditions:

The above copyright notice and this permission notice shall be included in all copies or substantial portions of the Software.

THE SOFTWARE IS PROVIDED "AS IS", WITHOUT WARRANTY OF ANY KIND, EXPRESS OR IMPLIED, INCLUDING BUT NOT LIMITED TO THE WARRANTIES OF MERCHANTABILITY, FITNESS FOR A PARTICULAR PURPOSE AND NONINFRINGEMENT. IN NO EVENT SHALL THE AUTHORS OR COPYRIGHT HOLDERS BE LIABLE FOR ANY CLAIM, DAMAGES OR OTHER LIABILITY, WHETHER IN AN ACTION OF CONTRACT, TORT OR OTHERWISE, ARISING FROM, OUT OF OR IN CONNECTION WITH THE SOFTWARE OR THE USE OR OTHER DEALINGS IN THE SOFTWARE.

---

## NetBSD

---

### 1. Copyright Notice of NetBSD

For all users to use this product:

This product contains NetBSD operating system:

For the most part, the software constituting the NetBSD operating system is not in the public domain; its authors retain their copyright.

The following text shows the copyright notice used for many of the NetBSD source code. For exact copyright notice applicable for each of the files/binaries, the source code tree must be consulted.

A full source code can be found at <http://www.netbsd.org/>.

Copyright © 1999, 2000 The NetBSD Foundation, Inc.

All rights reserved.

Redistribution and use in source and binary forms, with or without modification, are permitted provided that the following conditions are met:

- ① Redistributions of source code must retain the above copyright notice, this list of conditions and the following disclaimer.
- ② Redistributions in binary form must reproduce the above copyright notice, this list of conditions and the following disclaimer in the documentation and/or other materials provided with the distribution.
- ③ All advertising materials mentioning features or use of this software must display the following acknowledgment:  
This product includes software developed by The NetBSD Foundation, Inc. and its contributors.
- ④ Neither the name of The NetBSD Foundation nor the names of its contributors may be used to endorse or promote products derived from this software without specific prior written permission.

THIS SOFTWARE IS PROVIDED BY THE NETBSD FOUNDATION, INC. AND CONTRIBUTORS "AS IS" AND ANY EXPRESS OR IMPLIED WARRANTIES, INCLUDING, BUT NOT LIMITED TO, THE IMPLIED WARRANTIES OF MERCHANTABILITY AND FITNESS FOR A PARTICULAR PURPOSE ARE DISCLAIMED. IN NO EVENT SHALL THE FOUNDATION OR CONTRIBUTORS BE LIABLE FOR ANY DIRECT, INDIRECT, INCIDENTAL, SPECIAL, EXEMPLARY, OR CONSEQUENTIAL DAMAGES (INCLUDING, BUT NOT LIMITED TO, PROCUREMENT OF SUBSTITUTE GOODS OR SERVICES; LOSS OF USE, DATA, OR PROFITS; OR BUSINESS INTERRUPTION) HOWEVER CAUSED AND ON ANY THEORY OF LIABILITY, WHETHER IN CONTRACT, STRICT LIABILITY, OR TORT (INCLUDING NEGLIGENCE OR OTHERWISE) ARISING IN ANY WAY OUT OF THE USE OF THIS SOFTWARE, EVEN IF ADVISED OF THE POSSIBILITY OF SUCH DAMAGE.

### 2. Authors Name List

All product names mentioned herein are trademarks of their respective owners.

The following notices are required to satisfy the license terms of the software that we have mentioned in this document:



- This product includes software developed by the University of California, Berkeley and its contributors.
- This product includes software developed by Jonathan R. Stone for the NetBSD Project.
- This product includes software developed by the NetBSD Foundation, Inc. and its contributors.
- This product includes software developed by Manuel Bouyer.
- This product includes software developed by Charles Hannum.
- This product includes software developed by Charles M. Hannum.
- This product includes software developed by Christopher G. Demetriou.
- This product includes software developed by Tools GmbH.
- This product includes software developed by Terrence R. Lambert.
- This product includes software developed by Adam Glass and Charles Hannum.
- This product includes software developed by Theo de Raadt.
- This product includes software developed by Jonathan Stone and Jason R. Thorpe for the NetBSD Project.
- This product includes software developed by the University of California, Lawrence Berkeley Laboratory and its contributors.
- This product includes software developed by Christos Zoulas.
- This product includes software developed by Christopher G. Demetriou for the NetBSD Project.
- This product includes software developed by Paul Kranenburg.
- This product includes software developed by Adam Glass.
- This product includes software developed by Jonathan Stone.
- This product includes software developed by Jonathan Stone for the NetBSD Project.
- This product includes software developed by Winning Strategies, Inc.
- This product includes software developed by Frank van der Linden for the NetBSD Project.
- This product includes software developed for the NetBSD Project by Frank van der Linden
- This product includes software developed for the NetBSD Project by Jason R. Thorpe.
- The software was developed by the University of California, Berkeley.
- This product includes software developed by Chris Provenzano, the University of California, Berkeley, and contributors.

---

## Sablotron

---

Sablotron (Version 0.82) Copyright © 2000 Ginger Alliance Ltd. All Rights Reserved

a) The application software installed on this product includes the Sablotron software Version 0.82 (hereinafter, "Sablotron 0.82"), with modifications made by the product manufacturer. The original code of the Sablotron 0.82 is provided by Ginger Alliance Ltd., the initial developer, and the modified code of the Sablotron 0.82 has been derived from such original code provided by Ginger Alliance Ltd.

b) The product manufacturer provides warranty and support to the application software of this product including the Sablotron 0.82 as modified, and the product manufacturer makes Ginger Alliance Ltd., the initial developer of the Sablotron 0.82, free from these obligations.

c) The Sablotron 0.82 and the modifications thereof are made available under the terms of Mozilla Public License Version 1.1 (hereinafter, "MPL 1.1"), and the application software of this product constitutes the "Larger Work" as defined in MPL 1.1. The application software of this product except for the Sablotron 0.82 as modified is licensed by the product manufacturer under separate agreement(s).

d) The source code of the modified code of the Sablotron 0.82 is available at: <http://support-download.com/services/device/sablot/notice082.html>

e) The source code of the Sablotron software is available at: <http://www.ginger-all.com>

f) MPL 1.1 is available at: <http://www.mozilla.org/MPL/MPL-1.1.html>

---

## JPEG LIBRARY

---

- The software installed on this product is based in part on the work of the Independent JPEG Group.

---

## SASL

---

CMU libsasl

Tim Martin

Rob Earhart

Rob Siemborski

Copyright (c) 2001 Carnegie Mellon University. All rights reserved.

Redistribution and use in source and binary forms, with or without modification, are permitted provided that the following conditions are met:

- ① Redistributions of source code must retain the above copyright notice, this list of conditions and the following disclaimer.
- ② Redistributions in binary form must reproduce the above copyright notice, this list of conditions and the following disclaimer in the documentation and/or other materials provided with the distribution.
- ③ The name "Carnegie Mellon University" must not be used to endorse or promote products derived from this software without prior written permission. For permission or any other legal details, please contact:

Office of Technology Transfer  
Carnegie Mellon University  
5000 Forbes Avenue  
Pittsburgh, PA 15213-3890  
(412) 268-4387, fax: (412) 268-7395  
tech-transfer@andrew.cmu.edu

- ④ Redistributions of any form whatsoever must retain the following acknowledgment:  
"This product includes software developed by Computing Services at Carnegie Mellon University (<http://www.cmu.edu/computing/>)."

CARNEGIE MELLON UNIVERSITY DISCLAIMS ALL WARRANTIES WITH REGARD TO THIS SOFTWARE, INCLUDING ALL IMPLIED WARRANTIES OF MERCHANTABILITY AND FITNESS, IN NO EVENT SHALL CARNEGIE MELLON UNIVERSITY BE LIABLE FOR ANY SPECIAL, INDIRECT OR CONSEQUENTIAL DAMAGES OR ANY DAMAGES WHATSOEVER RESULTING FROM LOSS OF USE, DATA OR PROFITS, WHETHER IN AN ACTION OF CONTRACT, NEGLIGENCE OR OTHER TORTIOUS ACTION, ARISING OUT OF OR IN CONNECTION WITH THE USE OR PERFORMANCE OF THIS SOFTWARE.

---

## MD4

---

Copyright (C) 1990-2, RSA Data Security, Inc. All rights reserved.

License to copy and use this software is granted provided that it is identified as the "RSA Data Security, Inc. MD4 Message-Digest Algorithm" in all material mentioning or referencing this software or this function.

License is also granted to make and use derivative works provided that such works are identified as "derived from the RSA Data Security, Inc. MD4 Message-Digest Algorithm" in all material mentioning or referencing the derived work.

RSA Data Security, Inc. makes no representations concerning either the merchantability of this software or the suitability of this software for any particular purpose. It is provided "as is" without express or implied warranty of any kind.

These notices must be retained in any copies of any part of this documentation and/or software.

---

## MD5

---

Copyright (C) 1991-2, RSA Data Security, Inc. Created 1991. All rights reserved.

License to copy and use this software is granted provided that it is identified as the "RSA Data Security, Inc. MD5 Message-Digest Algorithm" in all material mentioning or referencing this software or this function.

License is also granted to make and use derivative works provided that such works are identified as "derived from the RSA Data Security, Inc. MD5 Message-Digest Algorithm" in all material mentioning or referencing the derived work.

RSA Data Security, Inc. makes no representations concerning either the merchantability of this software or the suitability of this software for any particular purpose. It is provided "as is" without express or implied warranty of any kind.

These notices must be retained in any copies of any part of this documentation and/or software.

---

## Samba(Ver 3.0.4)

---

For SMB transmission, this machine uses Samba ver 3.0.4 (hereinafter referred to as Samba 3.0.4).

Copyright © Andrew Tridgell 1994-1998

This program is free software; you can redistribute it and/or modify it under the terms of the GNU General Public License as published by the Free Software Foundation; either version 2 of the License, or (at your option) any later version.

This program is distributed in the hope that it will be useful, but WITHOUT ANY WARRANTY; without even the implied warranty of MERCHANTABILITY or FITNESS FOR A PARTICULAR PURPOSE. See the GNU General Public License along with this program; if not, write to the Free Software Foundation, Inc., 675 Mass Ave, Cambridge, MA 02139, USA.

 **Note**

The source code for SMB transmission by this machine can be downloaded from the following website:

<http://support-download.com/services/scbs>

---

## RSA BSAFE®

---



- This product includes RSA BSAFE® cryptographic or security protocol software from RSA Security Inc.
- RSA and BSAFE are registered trademarks of RSA Security Inc. in the United States and/or other countries.
- RSA Security Inc. All rights reserved.

---

## Open SSL

---

Copyright (c) 1998-2004 The OpenSSL Project. All rights reserved.

Redistribution and use in source and binary forms, with or without modification, are permitted provided that the following conditions are met:

1. Redistributions of source code must retain the above copyright notice, this list of conditions and the following disclaimer.
2. Redistributions in binary form must reproduce the above copyright notice, this list of conditions and the following disclaimer in the documentation and/or other materials provided with the distribution.
3. All advertising materials mentioning features or use of this software must display the following acknowledgment: "This product includes software developed by the OpenSSL Project for use in the OpenSSL Toolkit. (<http://www.openssl.org/>)"
4. The names "OpenSSL Toolkit" and "OpenSSL Project" must not be used to endorse or promote products derived from this software without prior written permission. For written permission, please contact [openssl-core@openssl.org](mailto:openssl-core@openssl.org).
5. Products derived from this software may not be called "OpenSSL" nor may "OpenSSL" appear in their names without prior written permission of the OpenSSL Project.
6. Redistributions of any form whatsoever must retain the following acknowledgment: "This product includes software developed by the OpenSSL Project for use in the OpenSSL Toolkit (<http://www.openssl.org/>)"

THIS SOFTWARE IS PROVIDED BY THE OpenSSL PROJECT "AS IS" AND ANY EXPRESSED OR IMPLIED WARRANTIES, INCLUDING, BUT NOT LIMITED TO, THE IMPLIED WARRANTIES OF MERCHANTABILITY AND FITNESS FOR A PARTICULAR PURPOSE ARE DISCLAIMED. IN NO EVENT SHALL THE OpenSSL PROJECT OR ITS CONTRIBUTORS BE LIABLE FOR ANY DIRECT, INDIRECT, INCIDENTAL, SPECIAL, EXEMPLARY, OR CONSEQUENTIAL DAMAGES (INCLUDING, BUT NOT LIMITED TO, PROCUREMENT OF SUBSTITUTE GOODS OR SERVICES; LOSS OF USE, DATA, OR PROFITS; OR BUSINESS INTERRUPTION) HOWEVER CAUSED AND ON ANY THEORY OF LIABILITY, WHETHER IN CONTRACT, STRICT LIABILITY, OR TORT (INCLUDING NEGLIGENCE OR OTHERWISE) ARISING IN ANY WAY OUT OF THE USE OF THIS SOFTWARE, EVEN IF ADVISED OF THE POSSIBILITY OF SUCH DAMAGE.

This product includes cryptographic software written by Eric Young (eay@cryptsoft.com). This product includes software written by Tim Hudson (tjh@cryptsoft.com).

Original SSLeay License

Copyright (C) 1995-1998 Eric Young (eay@cryptsoft.com) All rights reserved.

This package is an SSL implementation written by Eric Young (eay@cryptsoft.com).

The implementation was written so as to conform with Netscapes SSL.

This library is free for commercial and non-commercial use as long as the following conditions are aheared to. The following conditions apply to all code found in this distribution, be it the RC4, RSA, lhash, DES, etc., code; not just the SSL code. The SSL documentation included with this distribution is covered by the same copyright terms except that the holder is Tim Hudson (tjh@cryptsoft.com).

Copyright remains Eric Young's, and as such any Copyright notices in the code are not to be removed. If this package is used in a product, Eric Young should be given attribution as the author of the parts of the library used. This can be in the form of a textual message at program startup or in documentation (online or textual) provided with the package.

Redistribution and use in source and binary forms, with or without modification, are permitted provided that the following conditions are met:

1. Redistributions of source code must retain the copyright notice, this list of conditions and the following disclaimer.
2. Redistributions in binary form must reproduce the above copyright notice, this list of conditions and the following disclaimer in the documentation and/or other materials provided with the distribution.
3. All advertising materials mentioning features or use of this software must display the following acknowledgement: "This product includes cryptographic software written by Eric Young (eay@cryptsoft.com)" The word 'cryptographic' can be left out if the rouines from the library being used are not cryptographic related :-).
4. If you include any Windows specific code (or a derivative thereof) from the apps directory (application code) you must include an acknowledgement: "This product includes software written by Tim Hudson (tjh@cryptsoft.com)"

THIS SOFTWARE IS PROVIDED BY ERIC YOUNG ``AS IS" AND ANY EXPRESS OR IMPLIED WARRANTIES, INCLUDING, BUT NOT LIMITED TO, THE IMPLIED WARRANTIES OF MERCHANTABILITY AND FITNESS FOR A PARTICULAR PURPOSE ARE DISCLAIMED. IN NO EVENT SHALL THE AUTHOR OR CONTRIBUTORS BE LIABLE FOR ANY DIRECT, INDIRECT, INCIDENTAL, SPECIAL, EXEMPLARY, OR CONSEQUENTIAL DAMAGES (INCLUDING, BUT NOT LIMITED TO, PROCUREMENT OF SUBSTITUTE GOODS OR SERVICES; LOSS OF USE, DATA, OR PROFITS; OR BUSINESS INTERRUPTION) HOWEVER CAUSED AND ON ANY THEORY OF LIABILITY, WHETHER IN CONTRACT, STRICT LIABILITY, OR TORT (INCLUDING NEGLIGENCE OR OTHERWISE) ARISING IN ANY WAY OUT OF THE USE OF THIS SOFTWARE, EVEN IF ADVISED OF THE POSSIBILITY OF SUCH DAMAGE.

The licence and distribution terms for any publically available version or derivative of this code cannot be changed. i.e this code cannot simply be copied and put under another distribution licence [including the GNU Public Licence.]

---

## Open SSH

---

The licences which components of this software fall under are as follows. First, we will summarize and say that all components are under a BSD licence, or a licence more free than that.

OpenSSH contains no GPL code.

1)

Copyright (c) 1995 Tatu Ylonen <ylo@cs.hut.fi>, Espoo, Finland All rights reserved

As far as I am concerned, the code I have written for this software can be used freely for any purpose. Any derived versions of this software must be clearly marked as such, and if the derived work is incompatible with the protocol description in the RFC file, it must be called by a name other than "ssh" or "Secure Shell".

[Tatu continues]

However, I am not implying to give any licenses to any patents or copyrights held by third parties, and the software includes parts that are not under my direct control. As far as I know, all included source code is used in accordance with the relevant license agreements and can be used freely for any purpose (the GNU license being the most restrictive); see below for details.

[However, none of that term is relevant at this point in time. All of these restrictively licenced software components which he talks about have been removed from OpenSSH, i.e.,



- RSA is no longer included, found in the OpenSSL library
- IDEA is no longer included, its use is deprecated
- DES is now external, in the OpenSSL library
- GMP is no longer used, and instead we call BN code from OpenSSL
- Zlib is now external, in a library
- The make-ssh-known-hosts script is no longer included
- TSS has been removed
- MD5 is now external, in the OpenSSL library
- RC4 support has been replaced with ARC4 support from OpenSSL
- Blowfish is now external, in the OpenSSL library

[The licence continues]

Note that any information and cryptographic algorithms used in this software are publicly available on the Internet and at any major bookstore, scientific library, and patent office worldwide. More information can be found e.g. at "<http://www.cs.hut.fi/crypto>".

The legal status of this program is some combination of all these permissions and restrictions. Use only at your own responsibility. You will be responsible for any legal consequences yourself; I am not making any claims whether possessing or using this is legal or not in your country, and I am not taking any responsibility on your behalf.

## NO WARRANTY

BECAUSE THE PROGRAM IS LICENSED FREE OF CHARGE, THERE IS NO WARRANTY FOR THE PROGRAM, TO THE EXTENT PERMITTED BY APPLICABLE LAW. EXCEPT WHEN OTHERWISE STATED IN WRITING THE COPYRIGHT HOLDERS AND/OR OTHER PARTIES PROVIDE THE PROGRAM "AS IS" WITHOUT WARRANTY OF ANY KIND, EITHER EXPRESSED OR IMPLIED, INCLUDING, BUT NOT LIMITED TO, THE IMPLIED WARRANTIES OF MERCHANTABILITY AND FITNESS FOR A PARTICULAR PURPOSE. THE ENTIRE RISK AS TO THE QUALITY AND PERFORMANCE OF THE PROGRAM IS WITH YOU. SHOULD THE PROGRAM PROVE DEFECTIVE, YOU ASSUME THE COST OF ALL NECESSARY SERVICING, REPAIR OR CORRECTION.

IN NO EVENT UNLESS REQUIRED BY APPLICABLE LAW OR AGREED TO IN WRITING WILL ANY COPYRIGHT HOLDER, OR ANY OTHER PARTY WHO MAY MODIFY AND/OR REDISTRIBUTE THE PROGRAM AS PERMITTED ABOVE, BE LIABLE TO YOU FOR DAMAGES, INCLUDING ANY GENERAL, SPECIAL, INCIDENTAL OR CONSEQUENTIAL DAMAGES ARISING OUT OF THE USE OR INABILITY TO USE THE PROGRAM (INCLUDING BUT NOT LIMITED TO LOSS OF DATA OR DATA BEING RENDERED INACCURATE OR LOSSES SUSTAINED BY YOU OR THIRD PARTIES OR A FAILURE OF THE PROGRAM TO OPERATE WITH ANY OTHER PROGRAMS), EVEN IF SUCH HOLDER OR OTHER PARTY HAS BEEN ADVISED OF THE POSSIBILITY OF SUCH DAMAGES.

2)

The 32-bit CRC compensation attack detector in deattack.c was contributed by CORE SDI S.A. under a BSD-style license.

Cryptographic attack detector for ssh - source code

Copyright (c) 1998 CORE SDI S.A., Buenos Aires, Argentina.

All rights reserved. Redistribution and use in source and binary forms, with or without modification, are permitted provided that this copyright notice is retained.

THIS SOFTWARE IS PROVIDED "AS IS" AND ANY EXPRESS OR IMPLIED WARRANTIES ARE DISCLAIMED. IN NO EVENT SHALL CORE SDI S.A. BE LIABLE FOR ANY DIRECT, INDIRECT, INCIDENTAL, SPECIAL, EXEMPLARY OR CONSEQUENTIAL DAMAGES RESULTING FROM THE USE OR MISUSE OF THIS SOFTWARE.

Ariel Futoransky <futo@core-sdi.com>

<<http://www.core-sdi.com>>

3)

One component of the ssh source code is under a 3-clause BSD license, held by the University of California, since we pulled these parts from original Berkeley code.

Copyright (c) 1983, 1990, 1992, 1993, 1995

The Regents of the University of California. All rights reserved.

Redistribution and use in source and binary forms, with or without modification, are permitted provided that the following conditions are met:

1. Redistributions of source code must retain the above copyright notice, this list of conditions and the following disclaimer.
2. Redistributions in binary form must reproduce the above copyright notice, this list of conditions and the following disclaimer in the documentation and/or other materials provided with the distribution.

3. Neither the name of the University nor the names of its contributors may be used to endorse or promote products derived from this software without specific prior written permission.

THIS SOFTWARE IS PROVIDED BY THE REGENTS AND CONTRIBUTORS ``AS IS'' AND ANY EXPRESS OR IMPLIED WARRANTIES, INCLUDING, BUT NOT LIMITED TO, THE IMPLIED WARRANTIES OF MERCHANTABILITY AND FITNESS FOR A PARTICULAR PURPOSE ARE DISCLAIMED. IN NO EVENT SHALL THE REGENTS OR CONTRIBUTORS BE LIABLE FOR ANY DIRECT, INDIRECT, INCIDENTAL, SPECIAL, EXEMPLARY, OR CONSEQUENTIAL DAMAGES (INCLUDING, BUT NOT LIMITED TO, PROCUREMENT OF SUBSTITUTE GOODS OR SERVICES; LOSS OF USE, DATA, OR PROFITS; OR BUSINESS INTERRUPTION) HOWEVER CAUSED AND ON ANY THEORY OF LIABILITY, WHETHER IN CONTRACT, STRICT LIABILITY, OR TORT (INCLUDING NEGLIGENCE OR OTHERWISE) ARISING IN ANY WAY OUT OF THE USE OF THIS SOFTWARE, EVEN IF ADVISED OF THE POSSIBILITY OF SUCH DAMAGE.

4)

Remaining components of the software are provided under a standard 2-term BSD licence with the following names as copyright holders:

Markus Friedl

Theo de Raadt

Niels Provos

Dug Song

Kevin Steves

Daniel Kouril

Wesley Griffin

Per Allansson

Jason Downs

Solar Designer

Todd C. Miller

Redistribution and use in source and binary forms, with or without modification, are permitted provided that the following conditions are met:

1. Redistributions of source code must retain the above copyright notice, this list of conditions and the following disclaimer.
2. Redistributions in binary form must reproduce the above copyright notice, this list of conditions and the following disclaimer in the documentation and/or other materials provided with the distribution.

THIS SOFTWARE IS PROVIDED BY THE AUTHOR "AS IS" AND ANY EXPRESS OR IMPLIED WARRANTIES, INCLUDING, BUT NOT LIMITED TO, THE IMPLIED WARRANTIES OF MERCHANTABILITY AND FITNESS FOR A PARTICULAR PURPOSE ARE DISCLAIMED. IN NO EVENT SHALL THE AUTHOR BE LIABLE FOR ANY DIRECT, INDIRECT, INCIDENTAL, SPECIAL, EXEMPLARY, OR CONSEQUENTIAL DAMAGES (INCLUDING, BUT NOT LIMITED TO, PROCUREMENT OF SUBSTITUTE GOODS OR SERVICES; LOSS OF USE, DATA, OR PROFITS; OR BUSINESS INTERRUPTION) HOWEVER CAUSED AND ON ANY THEORY OF LIABILITY, WHETHER IN CONTRACT, STRICT LIABILITY, OR TORT (INCLUDING NEGLIGENCE OR OTHERWISE) ARISING IN ANY WAY OUT OF THE USE OF THIS SOFTWARE, EVEN IF ADVISED OF THE POSSIBILITY OF SUCH DAMAGE.

5)

Portable OpenSSH contains the following additional licenses:

c) Compatibility code (openbsd-compat)

Apart from the previously mentioned licenses, various pieces of code in the openbsd-compat/ subdirectory are licensed as follows:

Some code is licensed under a 3-term BSD license, to the following copyright holders:

Todd C. Miller

Theo de Raadt

Damien Miller

Eric P. Allman

The Regents of the University of California

Redistribution and use in source and binary forms, with or without modification, are permitted provided that the following conditions are met:

1. Redistributions of source code must retain the above copyright notice, this list of conditions and the following disclaimer.
2. Redistributions in binary form must reproduce the above copyright notice, this list of conditions and the following disclaimer in the documentation and/or other materials provided with the distribution.
3. Neither the name of the University nor the names of its contributors may be used to endorse or promote products derived from this software without specific prior written permission.

THIS SOFTWARE IS PROVIDED BY THE REGENTS AND CONTRIBUTORS ``AS IS" AND ANY EXPRESS OR IMPLIED WARRANTIES, INCLUDING, BUT NOT LIMITED TO, THE IMPLIED WARRANTIES OF MERCHANTABILITY AND FITNESS FOR A PARTICULAR PURPOSE ARE DISCLAIMED. IN NO EVENT SHALL THE REGENTS OR CONTRIBUTORS BE LIABLE FOR ANY DIRECT, INDIRECT, INCIDENTAL, SPECIAL, EXEMPLARY, OR CONSEQUENTIAL DAMAGES (INCLUDING, BUT NOT LIMITED TO, PROCUREMENT OF SUBSTITUTE GOODS OR SERVICES; LOSS OF USE, DATA, OR PROFITS; OR BUSINESS INTERRUPTION) HOWEVER CAUSED AND ON ANY THEORY OF LIABILITY, WHETHER IN CONTRACT, STRICT LIABILITY, OR TORT (INCLUDING NEGLIGENCE OR OTHERWISE) ARISING IN ANY WAY OUT OF THE USE OF THIS SOFTWARE, EVEN IF ADVISED OF THE POSSIBILITY OF SUCH DAMAGE.

---

## Open LDAP

---

The OpenLDAP Public License Version 2.8, 17 August 2003

Redistribution and use of this software and associated documentation ("Software"), with or without modification, are permitted provided that the following conditions are met:

1. Redistributions in source form must retain copyright statements and notices,
2. Redistributions in binary form must reproduce applicable copyright statements and notices, this list of conditions, and the following disclaimer in the documentation and/or other materials provided with the distribution, and
3. Redistributions must contain a verbatim copy of this document.

The OpenLDAP Foundation may revise this license from time to time. Each revision is distinguished by a version number. You may use this Software under terms of this license revision or under the terms of any subsequent revision of the license.

THIS SOFTWARE IS PROVIDED BY THE OPENLDAP FOUNDATION AND ITS CONTRIBUTORS ``AS IS" AND ANY EXPRESSED OR IMPLIED WARRANTIES, INCLUDING, BUT NOT LIMITED TO, THE IMPLIED WARRANTIES OF MERCHANTABILITY AND FITNESS FOR A PARTICULAR PURPOSE ARE DISCLAIMED. IN NO EVENT SHALL THE OPENLDAP FOUNDATION, ITS CONTRIBUTORS, OR THE AUTHOR(S) OR OWNER(S) OF THE SOFTWARE BE LIABLE FOR ANY DIRECT, INDIRECT, INCIDENTAL, SPECIAL, EXEMPLARY, OR CONSEQUENTIAL DAMAGES (INCLUDING, BUT NOT LIMITED TO, PROCUREMENT OF SUBSTITUTE GOODS OR SERVICES; LOSS OF USE, DATA, OR PROFITS; OR BUSINESS INTERRUPTION) HOWEVER CAUSED AND ON ANY THEORY OF LIABILITY, WHETHER IN CONTRACT, STRICT LIABILITY, OR TORT (INCLUDING NEGLIGENCE OR OTHERWISE) ARISING IN ANY WAY OUT OF THE USE OF THIS SOFTWARE, EVEN IF ADVISED OF THE POSSIBILITY OF SUCH DAMAGE.

The names of the authors and copyright holders must not be used in advertising or otherwise to promote the sale, use or other dealing in this Software without specific, written prior permission. Title to copyright in this Software shall at all times remain with copyright holders.

OpenLDAP is a registered trademark of the OpenLDAP Foundation.

Copyright 1999-2003 The OpenLDAP Foundation, Redwood City, California, USA. All Rights Reserved. Permission to copy and distribute verbatim copies of this document is granted.

# INDEX

## A

---

Address Book: Print List, 59  
Address Book Management, 59  
Adjust Sound Volume, 85  
Admin. Auth. Management, 59  
Admin. E-mail Address, 55  
Administrator Tools (Fax Features), 93  
Administrator Tools (System Settings), 59  
AOF (Always On), 59, 72  
Append CR to LF (PCL Menu), 136  
Authorized Reception, 87  
Authorized RX, 122  
Auto Continue, 132  
Auto Erase Memory Setting, 59  
Auto Logout Timer, 46  
Auto Off Timer, 46  
Auto Specify Sender Name, 55  
Auto Tray Switching, 81

## B

---

Bidirectional Comm., 52  
Blank Page Print, 132  
Bypass Tray Priority, 132

## C

---

Center Mark, 87  
Change PDF Password, 139  
Checkered Mark, 87  
Communication Mode, 53  
Communication Page Count, 93  
Communication Speed, 53  
Compression, 144  
Config. Page, 129  
Copier Auto Reset Timer (copier), 46  
Copier Features, 81  
Copies, 132  
Copy Count Display, 41  
Counter per User Code, 72  
Courier Font (PCL Menu), 136

## D

---

Data Format (PS Menu), 138  
DDNS Configuration, 48  
Default Printer Lang., 132  
Default Scan Settings, 141  
Default User Name/PW(Send), 55  
Delete All Logs, 59  
Delete Scanner Journal, 144  
Delivery Option, 55

Destination List Settings (Scanner Features), 143  
Dest. List Priority 1, 143  
Dest. List Priority 2, 143  
Display / Print Counter, 72  
Display/Print Counter, 59  
Disp./Print User Counter, 59  
Divide & Send E-mail, 144  
DNS Configuration, 48  
Domain Name, 48  
Duplex, 132  
Duplex Margin, 81  
Duplex Mode Priority, 81

## E

---

Edge to Edge Print, 132  
Effective Protocol, 48  
E-mail Communication Port, 55  
E-mail Informatn. Language, 144  
E-mail Recept. Interval, 55  
E-mail Settings (Fax Features), 88  
E-mail Storage in Server, 55  
Enable H.323, 90  
Enable SIP, 90  
Energy Saver Timer, 46  
Erase All Memory, 59  
Error Log, 129  
Ethernet Speed, 48  
Ext. A4 Width (PCL Menu), 136  
Extended Security, 59

## F

---

Facsimile Auto Reset Timer (facsimile), 46  
Fax E-mail Account, 55  
Fax Features (Administrator Tools), 93  
Fax Features (E-mail Settings), 88  
Fax Features (General Settings/Adjust), 85  
Fax Features (IP-Fax Settings), 90  
Fax Features (Reception Settings), 87  
File Transfer (System Settings), 55  
File Type Priority, 144  
Firmware Version, 59  
Folder TX Result Report, 93  
Font Number (PCL Menu), 136  
Font Pitch (PCL Menu), 136  
Font Source (PCL Menu), 136  
Form Lines (PCL Menu), 136  
Forwarding, 93, 119, 122  
Function Priority, 41

## G

---

G3 Analog Line, 93  
Gateway Settings, 90  
General Features (System Settings), 41  
General Settings/Adjust (Fax Features), 85

## H

---

H.323 Settings, 90  
Hex Dump, 129  
Host Interface (Printer Features), 135  
Host Name, 48

## I

---

IEEE 802.11b (Network), 53  
I/F Settings List, 54  
Input Prime, 52  
Interface Setting (Network), 48  
Interface Settings (System Settings), 48  
Internet Fax Settings, 88  
I/O Buffer, 135  
I/O Timeout, 135  
IP-Fax Settings (Fax Features), 90  
IPv4 Gateway Address, 48  
IPv6 Gateway Address, 48  
IPv6 Stateless Setting, 48

## K

---

Key Counter Management, 59, 72  
key Operator Code, 72  
Key Operator Tools (For machines with copier function only or with the DDST Unit) (System Settings), 72  
Key Repeat, 41

## L

---

LAN Type, 48  
LDAP Search, 59  
Letterhead Setting, 81, 132  
List/Test Print Lock, 131  
List/Test Print (Printer Features), 129

## M

---

Machine IPv4 Address, 48  
Machine IPv6 Address, 48  
Machine Name, 48  
Maintenance (Printer Features), 131  
Max. E-mail Size, 144  
Maximum E-mail Size, 88  
Max. Number of Sets, 81  
Max. Recept. E-mail Size, 55

Measurement Unit, 41  
Memory Lock, 93  
Memory Overflow, 132  
Memory Usage, 132  
Menu List, 129  
Mixed Orig. Sizes Priority, 141  
Multiple Lists, 129

## N

---

NCP Delivery Protocol, 48  
Network (IEEE 802.11b), 53  
Network (Interface Settings), 48  
Network (Parallel Interface), 52  
Network Security Level, 59  
NW Frame Type, 48

## O

---

On Hook Release Time, 85  
Orientation (PCL Menu), 136  
Original Count Display, 81  
Original Setting, 141  
Original Type Setting, 81, 141  
Orig. Orientation Priority, 141

## P

---

Page Size, 132  
Panel Key Sound, 41  
Paper Size: Tray 1-2, 44  
Paper Type: Bypass Tray, 44  
Paper Type: Paper Tray1-2, 44  
Parallel Comm. Speed, 52  
Parallel Interface (Network), 52  
Parallel Timing, 52  
Parameter Setting, 93  
PCL Config./Font Page, 129  
PCL Menu (Printer Features), 136  
PDF Config./Font Page, 129  
PDF Group Password, 139  
PDF Menu (Printer Features), 139  
Permit SNMPv3 Communictn., 48  
Permit SSL/TLS Comm., 48  
Ping Command, 48  
Point Size (PCL Menu), 136  
POP3/IMAP4 Settings, 55  
POP before SMTP, 55  
Ppr Tray Priority: Copier (copier), 44  
Ppr Tray Priority: Fax (facsimile), 44  
Ppr Tray Priority: Printer (printer), 44  
Preset R/E Priority, 81  
Prgrm./Change/Delete Group, 59  
Print&Del. Scanner Journal, 144  
Printer Auto Reset Timer (printer), 46



Printer Bypass Paper Size, 44  
Printer Features (Host Interface), 135  
Printer Features (List/Test Print), 129  
Printer Features (Maintenance), 131  
Printer Features (PCL Menu), 136  
Printer Features (PDF Menu), 139  
Printer Features (PS Menu), 138  
Printer Features (System), 132  
Printer Language, 132  
Print Error Report, 132  
Print Journal, 93  
Print Priority, 41  
Print Reception Time, 87  
Print Scanner Journal, 144  
Print TX Standby File List, 93  
Prog/Change/Del User Text, 41  
Prog/Chnge/Del LDAP Server, 59  
Program/Change Admin., 59  
Program / Change User Code, 72  
Program Fax Information, 85  
Program Memory Lock ID, 93  
Program Special Sender, 93  
PS Config./Font Page, 129  
PS Menu (Printer Features), 138

## R

---

RAM Disk, 132  
Reception Protocol, 55  
Reception Settings (Fax Features), 87  
Reproduction Ratio, 81  
Resolution (PCL Menu), 136  
Resolution (PDF Menu), 139  
Resolution (PS Menu), 138  
Restore Defaults, 53

## S

---

Scanner Auto Reset Timer (scanner), 46  
Scanner Features (Destination List Settings), 143  
Scanner Features (Scan Settings), 141  
Scanner Features (Send Settings), 144  
Scan Settings (Scanner Features), 141  
Screen Contrast, 41  
Security Type, 53  
Select Dial/Push Phone, 93  
Selection Signal Status, 52  
Send Settings (Scanner Features), 144  
Set Date, 46  
Set Time, 46  
Set User Function Key, 85  
Signal Control, 52  
SIP Settings, 90  
SMB Computer Name, 48

SMB Work Group, 48  
SMTP Authentication, 55  
SMTP RX File Delivery, 88  
SMTP Server, 55  
SSID Setting, 53  
Sub Paper Size, 132  
Switch Reception Mode, 87  
Symbol Set (PCL Menu), 136  
System Auto Reset Timer, 46  
System (Printer Features), 132  
System Settings (Administrator Tools), 59  
System Settings (File Transfer), 55  
System Settings (General Features), 41  
System Settings (Interface Settings), 48  
System Settings (Key Operator Tools)  
(For machines with copier function only  
or with the DDST Unit), 72  
System Settings (Timer Settings), 46  
System Settings (Tray Paper Settings), 44

## T

---

Timer Settings (System Settings), 46  
Transfer Log Setting, 59  
Tray Paper Settings (System Settings), 44  
Tray Switching, 132  
TWAIN Standby Time, 144

## U

---

Update Server Dest. List, 143  
User Auth. Management, 59  
User Code Man.  
*Copier*, 72  
User Name, 150

## W

---

Warm-up Beeper (copier), 41  
WINS Configuration, 48  
Wireless LAN Signal, 53



In accordance with IEC 60417, this machine uses the following symbols for the main power switch:

**I means POWER ON.**

**⏻ means STAND BY.**

### **Trademarks**

Microsoft®, Windows® and Windows NT® are registered trademarks of Microsoft Corporation in the United States and/or other countries.

Acrobat® is a registered trademark of Adobe Systems Incorporated.

NetWare is a registered trademark of Novell, Inc.

Other product names used herein are for identification purposes only and might be trademarks of their respective companies. We disclaim any and all rights to those marks.

The proper names of the Windows operating systems are as follows:

The product name of Windows® 95 is Microsoft® Windows® 95

The product name of Windows® 98 is Microsoft® Windows® 98

The product name of Windows® Me is Microsoft® Windows® Millennium Edition (Windows Me)

The product names of Windows® 2000 are as follows:

Microsoft® Windows® 2000 Advanced Server

Microsoft® Windows® 2000 Server

Microsoft® Windows® 2000 Professional

The product names of Windows® XP are as follows:

Microsoft® Windows® XP Professional

Microsoft® Windows® XP Home Edition

The product names of Windows Server™ 2003 are as follows:

Microsoft® Windows Server™ 2003 Standard Edition

Microsoft® Windows Server™ 2003 Enterprise Edition

Microsoft® Windows Server™ 2003 Web Edition

The product names of Windows® NT are as follows:

Microsoft® Windows NT® Server 4.0

Microsoft® Windows NT® Workstation 4.0

