

KENWOOD

HYUNDAI

00271-84000

CD/MP3 AM/FM RECEIVER
INSTRUCTION MANUAL

KENWOOD CORPORATION



Take the time to read through this instruction manual.

Familiarity with installation and operation procedures will help you obtain the best performance from your new CD-receiver.

For your records

Record the serial number, found on the back of the unit, in the spaces designated on the warranty card, and in the space provided below. Refer to the model and serial numbers whenever you call upon your KENWOOD dealer for information or service on the product.

Model 00271-84000 Serial number _____

© B64-2649-00/00 (KW)

Contents

Warning	3	CD/MP3/External disc control features	17	Basic Operations of remote.....	26
Safety precautions.....	4	Playing CD & MP3		Connecting Wires to Terminals	28
Notes on playing MP3	6	Playing External Disc		Troubleshooting Guide	29
About CDs.....	8	Fast Forwarding and Reversing		Specifications	32
General features	9	Track/File Search			
Power		Disc/ Folder Search			
Selecting the Source		Direct Track/File Search			
Volume		Direct Disc Search			
System Q		Track/File/Disc/Folder Repeat			
Audio Control		Scan Play			
Speaker Setting		Random Play			
Non-fading (Sub woofer) Output		Magazine Random Play			
Switching Display		Folder Select			
Station/Disc Naming (SNPS/DNPS)		Text/Title Scroll			
Auxiliary Input Display Setting		DNPP (Disc Name Preset Play)			
Theft Deterrent Faceplate					
Tuner features.....	15	Menu system.....	22		
Tuning Mode		Menu System			
Tuning		Security Code			
Direct Access Tuning		Touch Sensor Tone			
Station Preset Memory		Manual Clock Adjustment			
Auto Memory Entry		DSI (Disabled System Indicator)			
Preset Tuning		Selectable Illumination			
		Switching Display Type			
		Illumination Color Setting			
		Contrast Adjustment			
		Dimmer			
		Switching preout			
		CRSC (Clean Reception System Circuit)			
		Text Scroll			
		CD Read Setting			

▲ Warning

▲ CAUTION

Use of controls or adjustments or performance of procedures other than those specified herein may result in hazardous radiation exposure.

In compliance with Federal Regulations, following are reproductions of labels on, or inside the product relating to laser product safety.

KENWOOD CORPORATION
2967-3, ISHIKAWA-CHO,
HACHIOJI-SHI
TOKYO, JAPAN

KENWOOD CORP. CERTIFIES THIS EQUIPMENT
CONFORMS TO DHHS REGULATIONS NO.21 CFR
1040. 10, CHAPTER 1, SUBCHAPTER J.

Location : Bottom Panel

FCC WARNING

This equipment may generate or use radio frequency energy. Changes or modifications to this equipment may cause harmful interference unless the modifications are expressly approved in the instruction manual. The user could lose the authority to operate this equipment if an unauthorized change or modification is made.

NOTE

This equipment has been tested and found to comply with the limits for a Class B digital device, pursuant to Part 15 of the FCC Rules. These limits are designed to provide reasonable protection against harmful interference in a residential installation. This equipment may cause harmful interference to radio communications, if it is not installed and used in accordance with the instructions.

However, there is no guarantee that interference will not occur in a particular installation. If this equipment does cause harmful interference to radio or television reception, which can be determined by turning the equipment off and on, the user is encouraged to try to correct the interference by one or more of the following measures:

- Reorient or relocate the receiving antenna.
- Increase the separation between the equipment and receiver.
- Connect the equipment into an outlet on a circuit different from that to which the receiver is connected.
- Consult the dealer or an experienced radio/TV technician for help.

NOTE

This Class B digital apparatus complies with Canadian ICES-003.

Safety precautions

▲WARNING

To prevent injury or fire, take the following precautions:

- Insert the unit all the way in until it is fully locked in place. Otherwise it may fall out of place when jolted.
- When extending the ignition, battery, or ground wires, make sure to use automotive-grade wires or other wires with a 0.75mm² (AWG18) or more to prevent wire deterioration and damage to the wire coating.
- To prevent a short circuit, never put or leave any metallic objects (such as coins or metal tools) inside the unit.
- If the unit starts to emit smoke or strange smells, turn off the power immediately and consult your Kenwood dealer.
- Make sure not to get your fingers caught between the faceplate and the unit.
- Be careful not to drop the unit or subject it to strong shock.
The unit may break or crack because it contains glass parts.
- Do not touch the liquid crystal fluid if the LCD is damaged or broken due to shock. The liquid crystal fluid may be dangerous to your health or even fatal.
If the liquid crystal fluid from the LCD contacts your body or clothing, wash it off with soap immediately.

▲CAUTION

To prevent damage to the machine, take the following precautions:

- Make sure to ground the unit to a negative 12V DC power supply.
- Do not open the top or bottom covers of the unit.
- Do not install the unit in a spot exposed to direct sunlight or excessive heat or humidity. Also avoid places with too much dust or the possibility of water splashing.
- Do not set the removed faceplate or the faceplate case in areas exposed to direct sunlight, excessive heat or humidity. Also avoid places with too much dust or the possibility of water splashing.
- To prevent deterioration, do not touch the terminals of the unit or faceplate with your fingers.
- Do not subject the faceplate to excessive shock, as it is a piece of precision equipment.
- When replacing a fuse, only use a new one with the prescribed rating. Using a fuse with the wrong rating may cause your unit to malfunction.
- To prevent a short circuit when replacing a fuse, first disconnect the wiring harness.
- Do not place any object between the faceplate and the unit.
- Do not use your own screws. Use only the screws provided. If you use the wrong screws, you could damage the unit.

IMPORTANT INFORMATION

About CD players/disc changers connected to this unit

KENWOOD disc changers/ CD players released in 1998 or later can be connected to this unit.

Refer to the catalog or consult your Kenwood dealer for connectable models of disc changers/ CD players.

Note that any KENWOOD disc changers/ CD players released in 1997 or earlier and disc changers made by other makers cannot be connected to this unit.

Unsupported connection may result in damage.

Setting the "O-N" Switch to the "N" position for the applicable KENWOOD disc changers/ CD players.

The functions that can be used and the information that can be displayed will differ depending on the models being connected.



You can damage both your unit and the CD changer if you connect them incorrectly.

Do Not Load 3-in. CDs in the CD slot

If you try to load a 3 in. CD with its adapter into the unit, the adapter might separate from the CD and damage the unit.

NOTE

- If the unit does not seem to be working right, try pressing the reset button first. If that does not solve the problem, consult your Kenwood dealer.
- Press the reset button if the Disc auto changer fails to operate correctly. Normal operation should be restored.

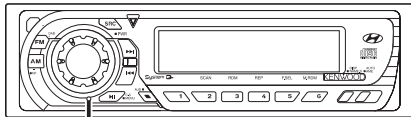

Reset button

- Characters in the LCD may become difficult to read in temperatures below 41 °F (5 °C).
- The illustrations of the display and the panel appearing in this manual are examples used to explain more clearly how the controls are used. Therefore, what appears on the display in the illustrations may differ from what appears on the display on the actual equipment, and some of the illustrations on the display may represent something impossible in actual operation.

Cleaning the Faceplate Terminals

If the terminals on the unit or faceplate get dirty, wipe them with a dry, soft cloth.

Cleaning the Unit

If the faceplate of this unit is stained, wipe it with a dry soft cloth such as a silicon cloth. If the faceplate is stained badly, wipe the stain off with a cloth moistened with neutral cleaner, then wipe neutral detergent off.



Applying spray cleaner directly to the unit may affect its mechanical parts. Wiping the faceplate with a hard cloth or using a volatile liquid such as thinner or alcohol may scratch the surface or erase characters.

Cleaning the CD Slot

As dust tends to accumulate in the CD slot, clean it every once in a while. Your CDs can get scratched if you put them in a dusty CD slot.

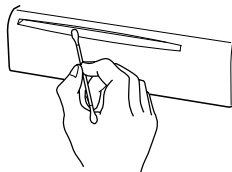

Lens Fogging

Right after you turn on the car heater in cold weather, dew or condensation may form on the lens in the CD player of the unit. Called lens fogging, CDs may be impossible to play. In such a situation, remove the disc and wait for the condensation to evaporate. If the unit still does not operate normally after a while, consult your Kenwood dealer.

Notes on playing MP3

This unit can play MP3(MPEG1, 2, 2.5 Audio Layer 3). Note, however, that the MP3 recording media and formats acceptable are limited. When writing MP3, pay attention to the following restrictions.

Acceptable media

The MP3 recording media acceptable to this unit are CD-ROM, CD-R, and CD-RW.

When using CD-RW, do full format not quick format to prevent malfunction.

Acceptable medium formats

The following formats are available for the media used in this unit. The maximum number of characters used for file name including the delimiter (".") and three-character extension are indicated in parentheses.

- ISO 9660 Level 1 (12 characters)
- ISO 9660 Level 2 (31 characters)
- Joliet (64 characters)
- Romeo (128 characters)

Up to 200 characters can be displayed in the long file name format. For a list of available characters, see the instruction manual of the writing software and the section Entering file and folder names below. The media reproducible on this unit has the following limitations:

- Maximum number of directory levels: 8
- Maximum number of files per folder: 255
- Maximum number of characters for folder name: 64
- Maximum number of folders: 50

MP3 written in the formats other than the above may not be successfully played and their file names or folder names are not properly displayed.

Settings for your MP3 encoder and CD writer

Do the following setting when compressing audio data in MP3 data with the MP3 encoder.

- Transfer bit rate: 8 —320 kbps
- Sampling frequency: 8, 11.025, 12, 16, 22.05, 24, 32, 44.1, 48 kHz

When you use your CD writer to record MP3 up to the maximum disc capacity, disable additional writing. For recording on an empty disc up to the maximum capacity at once, check Disc at Once.

Entering ID3 tag

The Displayable ID3 tag is ID3 version 1.x.

For the character code, refer to the List of Codes.

Entering file and folder names

The code list characters are the only file names and folder names that can be entered and displayed.

If you use any other character for entry, the file and folder names are not displayed correctly. They may neither be displayed correctly depending on the CD writer used. The unit recognizes and plays only those MP3 which have the MP3 extension (.MP3).



A file with a name entered with characters not on the code list may not play correctly.

Writing files into a medium

When a medium containing MP3 data is loaded, the unit checks all the data on the medium. If the medium contains a lot of folders or non-MP3 files, therefore, it takes a long time until the unit starts playing MP3.

In addition, it may take time for the unit to move to the next MP3 file or a File Search or Folder Search may not be performed smoothly.



- Loading such a medium may produce loud noise to damage the speakers.
- Do not attempt to play a medium containing a non-MP3 file with the MP3 extension.
The unit mistakes non-MP3 files for MP3 data as long as they have the MP3 extension.
- Do not attempt to play a medium containing non MP3.

	0	1	2	3	4	5	6	7	8	9	A	B	C	D	E	F
0				0	@	P	q				!	"	#	\$	%	&
1				1	A	O	a	q			!	+	"	#	\$	%
2				"	2	B	R	b	r	t	c	^	~	A	O	a
3				#	3	C	S	c	s		^	~	A	O	a	
4				\$	4	D	T	d	t		^	~	A	O	a	
5				%	5	E	U	e	u		^	~	A	O	a	
6				&	6	F	V	f	v		^	~	A	O	a	
7				'	7	G	W	g	w		^	~	A	O	a	
8				(8	H	X	h	x		^	~	A	O	a	
9)	9	I	Y	i	y		^	~	A	O	a	
A				.	:	J	Z	j	z		^	~	A	O	a	
B				+	,	K	[k	{		^	~	A	O	a	
C				-	<	L	\	l			^	~	A	O	a	
D				=	=	M]	m	}		^	~	A	O	a	
E				>	>	N	^	n	~		^	~	A	O	a	
F				/	?	_	o	_	o	■			^	~	A	O

MP3 playing order

When selected for play, Folder Search, File Search, or for Folder Select, files and folders are accessed in the order in which they were written by the CD writer.

Because of this, the order in which they are expected to be played may not match the order in which they are actually played. You may be able to set the order in which MP3 are to be played by writing them onto a medium such as a CD-R with their file names beginning with play sequence numbers such as "01" to "99", depending on your CD writer.

For example, a medium with the following folder/ file hierarchy is subject to Folder Search, File Search, or Folder Select as shown below.

Example of a medium's folder/file hierarchy

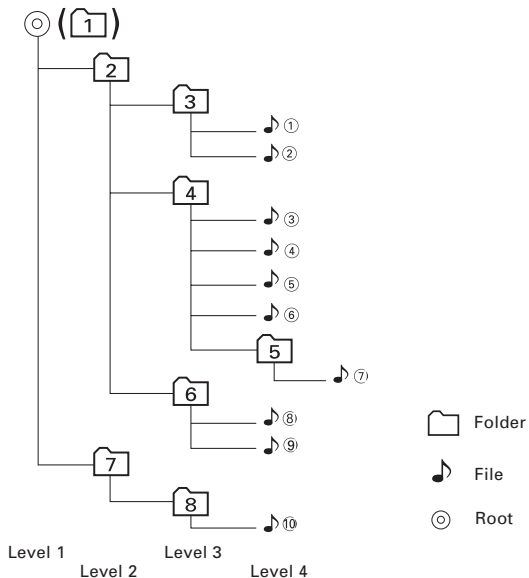

When a File Search is executed with file ④ being played ...

Current file number	Operation of the button	
	⏪ Button	⏩ Button
④	Beginning of file ④ ▶ ③	⑤ ▶ ⑥

When a Folder Search is executed with file ④ being played ...

Current folder number	Operation of the button	
	AM Button	FM Button
④	③ ▶ ② ▶ ① ▶ ⑧ ...	⑤ ▶ ⑥ ▶ ⑦ ▶ ⑧ ▶ ① ...

When Folder Select is selected with file ④ being played to move from folder to folder ...

Current folder number	Operation of the button			
	⏪ Button	⏩ Button	AM Button	FM Button
④	③	⑥	②	⑤

About CDs

Handling CDs

- Don't touch the recording surface of the CD.

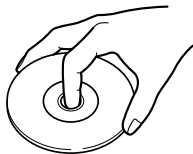

- CD-R and CD-RW are easier to damage than a normal music CD. Use a CD-R or a CD-RW after reading the caution items on the package etc.
- Don't stick tape etc. on the CD. Also, don't use a CD with tape stuck on it.

When using a new CD

If the CD center hole or outside rim has burrs, use it after removing them with a ball pen etc.

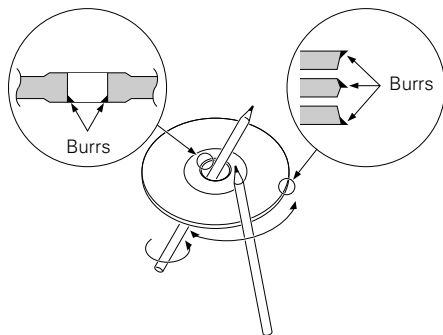

CD accessories

Don't use disc type accessories.

CD cleaning

Clean from the center of the disc and move outward.

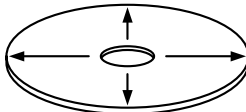

Removing CDs

When removing CDs from this unit pull them out horizontally.

CDs that can't be used

- CDs that aren't round can't be used.

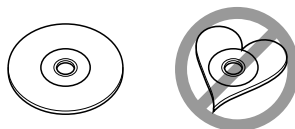

- CDs with coloring on the recording surface or that are dirty can't be used.
- This unit can only play the CDs with



It may not correctly play disks which do not have the mark.

- A CD-R or CD-RW that hasn't been finalized can't be played. (For the finalization process refer to your CD-R/CD-RW writing software, and your CD-R/CD-RW recorder instruction manual.)

CD storage

- Don't place them in direct sunlight (On the seat or dashboard etc.) and where the temperature is high.
- Store CDs in their cases.

General features

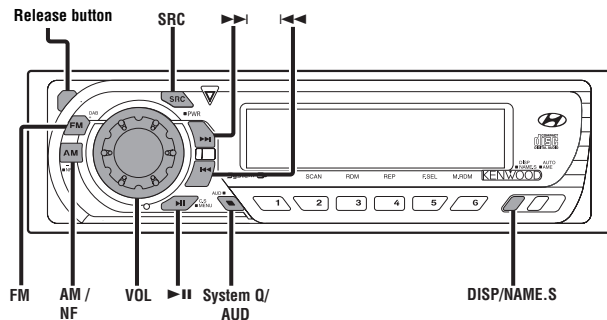

Power

Turning ON the Power

Press the [SRC] button.



When the power is ON, the <Security Code> (page 22) is displayed as "CODE ON" or "CODE OFF".

Turning OFF the Power

Press the [SRC] button for at least 1 second.

Selecting the Source

Press the [SRC] button.

Source required	Display
Tuner	"TUNER"
CD	"CD"
External disc (Optional accessory)	"DISC CH"/ "CD2"
Auxiliary input (Optional accessory)	"AUX1"
Standby (Illumination only mode)	"ALL OFF"

Volume

Increasing Volume

Turn the [VOL] knob clockwise.

Decreasing Volume

Turn the [VOL] knob counterclockwise.

General features

System Q

You can recall the best sound setting preset for different types of music.

1 Select the source to set

Press the [SRC] button.

2 Select the Sound type

Press the [System Q] button.

Each time the button is pressed the sound setting switches.

Sound setting	Display
Flat	"Flat"
User memory	"User"
Rock	"Rock"
Pops	"Pops"
Easy	"Easy"
Top 40	"Top40"
Jazz	"Jazz"



- User memory: The values set on the <Audio control> (page 10).
- Each setting value is changed with the <Speaker setting> (page 11).
First, select the speaker type with the Speaker setting.

Audio Control

1 Select the source for adjustment

Press the [SRC] button.

2 Enter Audio Control mode

Press the [AUD] button for at least 1 second.

3 Select the Audio item for adjustment

Press the [FM] or [AM] button.

Each time the button is pressed the items that can be adjusted

switch as shown below.

4 Adjust the Audio item

Press the [◀◀] or [▶▶] button.

Adjustment Item	Display	Range
Bass level	"Bass"	-8 — +8
Middle level	"Middle"	-8 — +8
Treble level	"Treble"	-8 — +8
Balance	"Balance"	Left 15 — Right 15
Fader	"Fader"	Rear 15 — Front 15
Non-Fading level*	"NF Level"	-15 — +15
Front/Rear High Pass Filter	"HPF"	Through/100/125/170 Hz
Non-Fading Low Pass Filter*	"LPF NF"	50/80/120/Through Hz
Volume offset	"V-Offset"	-8 — ±0
Loudness	"LOUD"	ON/OFF



- Volume offset: Each source's volume can be set as a difference from the basic volume.
- Loudness: Compensating for low and high tones during low volume.
- * When the <Switching preout> (page 25) is "SWPRE Rear", this function is not available.

5 Exit Audio Control mode

Press the [AUD] button.

Speaker Setting

Fine-tuning so that the System Q value is optimal when setting the speaker type.

1 Enter Standby

Press the [SRC] button.
Select the "ALL OFF" display.

2 Enter Speaker Setting mode

Press the [System Q] button.

3 Select the Speaker type

Press the [◀◀] or [▶▶] button.
Each time the button is pressed the setting switches as shown below.

Speaker type	Display
OFF	"SP OFF"
For 5 & 4 in. speaker	"SP 5/4Inch"
For 6 & 6x9 in. speaker	"SP 6*9/6Inch"
For the OEM speaker	"SP O.E.M."

4 Exit Speaker Setting mode

Press the [System Q] button.

Non-fading (Sub woofer) Output

Turning the Non-fading (Sub woofer) output ON or OFF.

Press the [NF] button for at least 1 second.

Each time the button is pressed Non-fading (Sub woofer) output switches ON or OFF.

When it's ON, "NF ON" is displayed.



When the <Switching preout> (page 25) is "SWPRE Rear", this function is not available.

General features

Switching Display

Switching the information displayed.

Press the [DISP] button.

Each time the button is pressed the display switches as shown below.

In Tuner source

Information	Display
Station name	"SNPS"
Frequency	"BAND+FREQ"
Clock	

In CD & External disc source

Information	Display
Disc title	"D-TITLE"
Track title	"T-TITLE"
Track number & Play time	"P-Time"
Disc name	"DNPS"
Clock	

In MP3 source

Information	Display
Song title & Artist name	"TITLE"
Album name & Artist name	"ALBUM"
Folder name	"FOLDER NAME"
File name	"FILE NAME"
Track number & Play time	"P-Time"
Disc name	"DNPS"
Clock	

In Auxiliary input source

Information

Auxiliary input name

Clock



If the Disc title, Track title, Song title & Artist name, or Album name & Artist name is selected when the disc which does not have Disc title, Track title, Song title, Album name, or Artist name is played, track number and play time are displayed.

Station/Disc Naming (SNPS/DNPS)

Attaching a title to a Station or CD.

1 Receive/play the station/disc you want to attach a title to



- A title can't be attached to a MD.
- Refer to the <Switching Display> (page 12) and select either "DNPS" or "SNPS".

2 Enter name set mode

Press the [NAME.S] button for at least 2 seconds.
"NAME SET" is displayed.

3 Move the cursor to the enter character position

Press the [◀] or [▶] button.

4 Select the character type

Press the [▶II] button.

Each time the button is pressed the character type switches as shown below.

Character type

Alphabet upper case

Alphabet lower case

Numbers and symbols

Special characters (Accent characters)

5 Select the characters

Press the [FM] or [AM] button.



Characters can be entered by using a remote with a number buttons.

Example: If "DANCE" is entered.

Character	Button	Times pressed
"D"	[3]	1
"A"	[2]	1
"N"	[6]	2
"C"	[2]	3
"E"	[3]	2

6 Repeat steps 3 through 5 and enter the name.

7 Exit name set mode

Press the [NAME.S] button.



- When operation stops for 10 seconds the name at that time is registered, and Name Set mode closes.
- Memory numbers
 - External CD changer/ player: Varies according to the CD changer/ player. Refer to the CD changer/ player manual.
 - FM: 32stations
 - AM: 16 stations
 - Internal CD player: 30 discs
- The title of station/CD can be changed by the same operation used to name it.

Auxiliary Input Display Setting

Selecting the display when this device is switched to Auxiliary input source.

1 Select Auxiliary input source

Press the [SRC] button.

Select the "AUX1" display.

2 Enter Auxiliary input display setting mode

Press the [DISP] button for at least 2 seconds.

The presently selected AUX Name is blinks.

3 Select the Auxiliary input display

Press the [◀◀] or [▶▶] button.

Each time the button is pressed it switches through the below displays.

- "AUX1"
- "TV"
- "VIDEO"
- "GAME"
- "PORTABLE"
- "DVD"

4 Exit Auxiliary input display setting mode

Press the [DISP] button.



When operation stops for 10 seconds, the name at that time is selected, and Auxiliary input display setting mode closes.

General features

Theft Deterrent Faceplate

The faceplate of the unit can be detached and taken with you, helping to deter theft.

Removing the Faceplate

- 1 Press the Release button.
Drop open the faceplate.
- 2 Drawing the faceplate to left side pull it to the front and remove it.

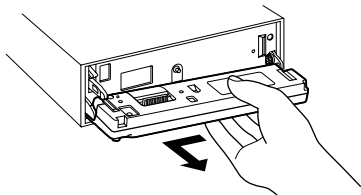

- The faceplate is a precision piece of equipment and can be damaged by shocks or jolts. For that reason, keep the faceplate in its special storage case while detached.
- Do not expose the faceplate or its storage case to direct sunlight or excessive heat or humidity. Also avoid places with too much dust or the possibility of water splashing.

Reattaching the Faceplate

- 1 Align the shaft on the unit with the depression on the faceplate.

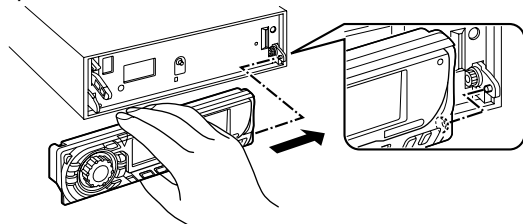

- 2 Push the faceplate in until it clicks.

The faceplate is locked in place, allowing you to use the unit.

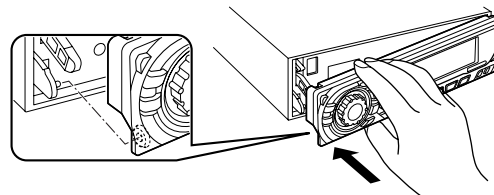

Tuner features

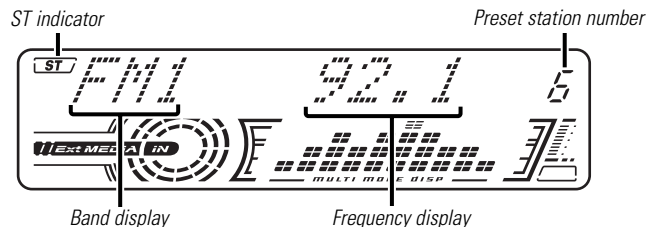
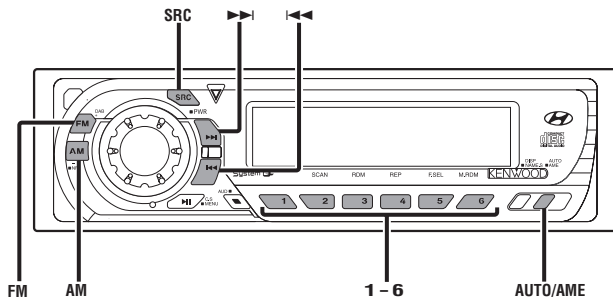

Tuning Mode

Choose the tuning mode.

Press the [AUTO] button.

Each time the button is pressed the Tuning mode switches as shown below.

Tuning mode	Display	Operation
Auto seek	"Auto 1"	Automatic search for a station.
Preset station seek	"Auto 2"	Search in order of the stations in the Preset memory.
Manual	"Manual"	Normal manual tuning control.

Tuning

Selecting the station.

1 Select tuner source

Press the [SRC] button.

Select the "TUNER" display.

2 Select the band

Press the [FM] or [AM] button.

Each time the [FM] button is pressed it switches between the FM1, FM2, and FM3 bands.

3 Tune up or down band

Press the [◀] or [▶] button.



During reception of stereo stations the "ST" indicator is ON.

Tuner features

Direct Access Tuning (Function of remote)

Entering the frequency and tuning.

1 Select the band

Press the [FM] or [AM] button.

2 Enter Direct Access Tuning mode

Press the [DIRECT] button on the remote.
"---" is displayed.

3 Enter the frequency

Press the number buttons on the remote.

Example:

<u>Desired frequency</u>	<u>Press button</u>
92.1 MHz (FM)	[0], [9], [2], [1]
810 kHz (AM)	[0], [8], [1], [0]

Canceling Direct Access Tuning

Press the [DIRECT] button on the remote.

Station Preset Memory

Putting the station in the memory.

1 Select the band

Press the [FM] or [AM] button.

2 Select the frequency to put in the memory

Press the [◀◀] or [▶▶] button.

3 Put the frequency in the memory

Press the desired [1] — [6] button for at least 2 seconds.

The preset number display blinks 1 time.

On each band, 1 station can be put in the memory on each [1] — [6] button.

Auto Memory Entry

Putting stations with good reception in the memory automatically.

1 Select the band for Auto Memory Entry

Press the [FM] or [AM] button.

2 Open Auto Memory Entry

Press the [AME] button for at least 2 seconds.

When 6 stations that can be received are put in the memory Auto Memory Entry closes.

Preset Tuning

Calling up the stations in the memory.

1 Select the band

Press the [FM] or [AM] button.

2 Call up the station

Press the desired [1] — [6] button.

CD/MP3/External disc control features

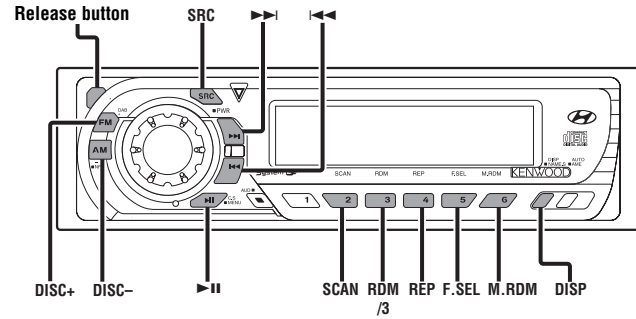

CD/MP3/External disc control features

Playing CD & MP3

When there is no disc inserted

1 Drop open the faceplate

Press the Release button.

2 Insert a disc.

3 Press the faceplate on the left side, and return it to its former position.



- When the faceplate has been dropped open, it might interfere with the shift lever or something else. If this happens, pay attention to safety and move the shift lever or take an appropriate action, then operate the unit.
- Do not use the unit with the faceplate in the open condition. If it's used in the open position dust can enter the inside part and cause damage.



When a disc is inserted, the "IN" indicator is ON.

When a disc is inserted

Press the [SRC] button.

Select the "CD" display.

Pause and play

Press the [▶||] button.

Each time the button is pressed it pauses and plays.

Eject the disc

1 Drop open the faceplate

Press the Release button.

2 Eject the disc

Press the [▲] button.

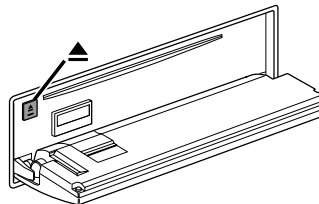

3 Press the faceplate on the left side, and return it to its former position.



3 in. (8cm) disc can't be played. Using an adapter and inserting them into this unit can cause damage.



The MP3 media that this unit can play are CD-ROM, CD-R, and CD-RW.

The medium formats must be ISO 9660 Level 1, Level 2, Joliet, or Romeo. The methods and precautions to be followed for writing MP3 data are covered in <Notes on playing MP3> (page 6). Check that section before creating your MP3 media.

Playing External Disc

Playing discs set in the optional accessory disc player connected to this unit.

Press the [SRC] button.

Select the display for the disc player you want.

Display examples:

Display	Disc player
"CD2"	CD player
"DISC CH"	CD changer/ MD changer

Pause and play

Press the [▶||] button.

Each time the button is pressed it pauses and plays.



- Disc 10 is displayed as "0".
- The functions that can be used and the information that can be displayed will differ depending on the external disc players being connected.

Fast Forwarding and Reversing

Fast Forwarding

Hold down on the [▶▶] button.

Release your finger to play the disc at that point.

Reversing

Hold down on the [◀◀] button.

Release your finger to play the disc at that point.

Track/File Search

Searching for a song on the disc or in the MP3 folder.

Press the [◀◀] or [▶▶] button.

Disc/ Folder Search

Disc Search (Function of disc changer) Folder Search (Function of MP3)

Selecting the disc set in the Disc changer or the folder recorded on the MP3 media.

Press the [DISC-] or [DISC+] button.

Direct Track/File Search (Function of remote) (Direct File Search: Function of MP3)

Doing Track/File Search by entering the track/file number.

1 Enter the track/file number

Press the number buttons on the remote.

2 Do Track/File Search

Press the [◀◀] or [▶▶] button.

Canceling Direct Track/File Search

Press the [▶||] button.

Direct Disc Search (Function of disc changers with remote)

Doing Disc Search by entering the disc number.

1 Enter the disc number

Press the number buttons on the remote.

2 Do Disc Search

Press the [DISC+] or [DISC-] button.

Canceling Direct Disc Search

Press the [▶||] button.



Input "0" to select disc 10.

CD/MP3/External disc control features

Track/File/Disc/Folder Repeat

Replaying the song, disc in the Disc changer or MP3 folder you're listening to.

Press the [REP] button.

Each time the button is pressed the Repeat Play switches as shown below.

In CD & External disc source

Repeat play	Display
Track Repeat	"(T-)Repeat ON"
Disc Repeat (In Disc Changer)	"D-Repeat ON"
OFF	"Repeat OFF"

In MP3 source

Repeat play	Display
File Repeat	"File REP ON"
Folder Repeat	"FOLD REP ON"
OFF	"Repeat OFF"

Scan Play

Playing the first part of each song on the disc or MP3 folder you are listening to and searching for the song you want to listen to.

1 Start Scan Play

Press the [SCAN] button.

"Scan ON" is displayed.

2 Release it when the song you want to listen to is played

Press the [SCAN] button.

Random Play

Play all the songs on the disc or MP3 folder in random order.

Press the [RDM] button.

Each time the button is pressed Random Play turns ON or OFF. When it's ON, "Random ON" is displayed.

 When the [▶|▶] button is pressed, the next song select starts.

Magazine Random Play (Function of disc changer)

Play the songs on all the discs in the disc changer in random order.

Press the [M.RDM] button.

Each time the button is pressed the Magazine Random Play turns ON or OFF.

When it's ON, "M-Random ON" is displayed.

 When the [▶|▶] button is pressed, the next song select starts.

Folder Select (Function of MP3)

Quickly selecting the folder you want to listen to.

1 Enter Folder Select mode

Press the [F.SEL] button.

"Select Mode" is displayed.

During Select mode the folder information is displayed as shown below.

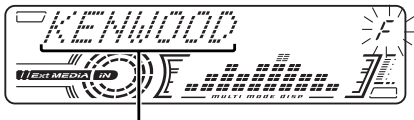

<Folder name display>
Displays the current folder name.

2 Select the folder level

Press the [FM] or [AM] button.
With the [FM] button you move 1 level down and with the [AM] button 1 level up.

Selecting a folder in the same level

Press the [◀◀] or [▶▶] button.
With the [◀◀] button you move to the previous folder, and with the [▶▶] button to the next folder.

Returning to the top level

Press the [3] button.

3 Decide the folder to play

Press the [▶II] button.
The Folder Select mode releases, and the MP3 in the folder displayed is played.



The methods for moving to other folders in the folder select mode are different from those in the folder search mode.
See <Notes on playing MP3> (page 6) for details.

Canceling the Folder Select mode

Press the [F.SEL] button.

Text/Title Scroll

Scrolling the displayed CD text, MP3 text, or MD title.

Press the [DISP] button for at least 1 second.

DNPP (Disc Name Preset Play) (Function of disc changers with remote)

Selecting the CD displayed in the DNPS of the CDs set in the Disc changer.

1 Enter DNPP mode

Press the [DNPP] button on the remote.
When "DNPP" is displayed the DNPS display in order.

Forward / Reverse display

Press the [DISC-] or [DISC+] button.

2 When the disc you want is displayed

Press the [OK] button on the remote.
The disc being displayed is played.

Canceling the DNPP mode

Press the [DNPP] button on the remote.

Menu system

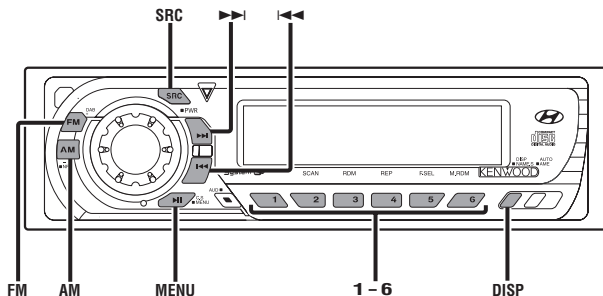

Menu display

Menu System

Setting during operation beep sound etc. functions. The Menu system basic operation method is explained here. The reference for the Menu items and their setting content is after this operation explanation.

1 Enter Menu mode

Press the [MENU] button for at least 1 second.

"MENU" is displayed.

2 Select the menu item

Press the [FM] or [AM] button.

Example: When you want to set the beep sound select the "Beep" display.

3 Set the menu item

Press the [◀◀] or [▶▶] button.

Example: When "Beep" is selected, each time the button is pressed it switches "Beep ON" or "Beep OFF". Select 1 of them as the setting.

You can continue by returning to step 2 and setting other items.

4 Exit Menu mode

Press the [MENU] button.



When other items that are applicable to the basic operation method above are displayed afterwards their setting content chart is entered. (Normally the uppermost setting in the chart is the original setting.)

Also, the explanation for items that aren't applicable (<Manual Clock Adjustment>etc.) are entered step by step.

Security Code

<In Standby mode>

Because authorization by the Security Code is required when it's removed from the vehicle, personalizing this unit is by using the Security Code is a help in preventing theft.



When the Security Code function is activated, the code can't be changed and the function can't be released.
Note, the Security Code can be set as the 4 digit number of your choice.

1 Enter Standby

Press the [SRC] button.
Select the "ALL OFF" display.

2 Enter Menu mode

Press the [MENU] button for at least 1 second.
When "MENU" is displayed, "Security" is displayed.

3 Enter Security Code mode

Press the [◀◀] or [▶▶] button for at least 1 second.
When "ENTER" is displayed, "CODE" is displayed.

4 Select the digits to enter

Press the [◀◀] or [▶▶] button.

5 Select the Security Code numbers

Press the [FM] or [AM] button.

6 Repeat steps 4 and 5, and complete the Security Code.

7 Confirm the Security Code

Press the [▶▶] button for at least 3 seconds.
When "RE-ENTER" is displayed, "CODE" is displayed.

8 Do the step 4 through 7 operation, and reenter the Security Code.

"APPROVED" is displayed.
The Security Code function activates.



When the wrong Code is entered in steps 4 through 6, repeat from step 4.

Press the Reset button and when it's removed from the battery power source

- 1 Turn the power ON.
- 2 Do the step 4 through 7 operation, and enter the Security

Code.
"APPROVED" is displayed.
The unit can be used.

Touch Sensor Tone

Setting the operation check sound (beep sound) ON/OFF.

Display	Setting
"Beep ON"	Beep is heard.
"Beep OFF"	Beep canceled.

Manual Clock Adjustment

1 Select Clock Adjustment mode

Press the [FM] or [AM] button.
Select the "Clock Adjust" display.

2 Enter Clock Adjust mode

Press the [◀◀] or [▶▶] button for at least 1 second.
The clock display blinks.

3 Adjust the hours

Press the [FM] or [AM] button.

Adjust the minutes

Press the [◀◀] or [▶▶] button.

4 Exit Clock adjustment mode

Press the [MENU] button.

Menu system

DSI (Disabled System Indicator)

A red indicator will blink on the unit after the faceplate is removed, warning potential thieves.

Display	Setting
"DSI ON"	LED flashes.
"DSI OFF"	LED OFF.

Selectable Illumination

Selecting the button illumination color as green or red.

Display	Setting
"Button Red"	The illumination color is red.
"Button Green"	The illumination color is green.

Switching Display Type

Setting the Display type.

Display	Setting
"Display C"	Demonstration.
"Display A"	Normal display type.
"Display B"	Silent display type.

Illumination Color Setting

You can set the display to a desired color.

1 Select Illumination Color Setting Mode

Press the [FM] or [AM] button.

Select the "COL" display.

2 The color continues to change gradually

Hold down on the [◀◀] or [▶▶] button.

Release your finger at the color you want.



Colors adjusted using either [◀◀] or [▶▶] will be stored automatically, and they can be called by pressing [5] button.

Quick call up the preset color

Press the desired [1] — [4] button.

Button	Color
[1]	Silky White
[2]	Red
[3]	Blue
[4]	Blue Green

Selecting the Color mode

Press the [6] button.

Each time the button is pressed the Color mode switches as shown below.

Display	Color mode
"Scan"	The color changes in sequence.
"SRC"	The color changes according to the selected source.
"Time"	The color changes every 6 hours.
	Keeps the presently set color.

Blue fine adjustment

1 Press the [3] button for at least 2 seconds.

2 Press the [◀◀] or [▶▶] button.

When the blue fine adjustment is completed, press the [3] button.

Contrast Adjustment

Adjusting the display contrast.

Display and Setting

"Contrast 0"

:

"Contrast 10"

Dimmer

Dimming this unit's display automatically when the vehicle light switch is turned ON.

Display	Setting
"Dimmer ON"	The display dims.
"Dimmer OFF"	The display doesn't dim.

Switching preout <In Standby mode>

Switching the preout between the rear and Non-fading (Sub woofer). (In Non-fading (Sub woofer) it outputs without effect from the fader control.)

Display	Setting
"SWPRE Rear"	Rear preout.
"SWPRE N-Fad"	Non-fading preout.

CRSC (Clean Reception System Circuit) <In FM reception>

Temporarily have reception switched from stereo to mono to

reduce multi-path noise when listening to the FM station.

Display	Setting
"CRSC ON"	The CRSC is ON.
"CRSC OFF"	The CRSC is OFF.



Strong electrical fields (such as from power lines) may cause unstable sound quality when CRSC is turned ON. In such a situation, turn it OFF.

Text Scroll

Setting the displayed text scroll.

Display	Setting
"Scroll Auto"	Repeats scroll.
"Scroll MANU"	Scrolls when the display changes.



The text scrolled is shown below.

- CD text
- Folder name/ File name/ Song title/ Artist name/ Album name
- MD title

CD Read Setting <In Standby mode>

When there is a problem on playing a CD with special format, this setting play the CD by force.

Display	Setting
"CD READ 1"	Play CD and MP3.
"CD READ 2"	Play CD by force.



Setting "CD READ 2" cannot play MP3.

Some music CDs may not be played back even in the "CD READ 2" mode.

Basic Operations of remote

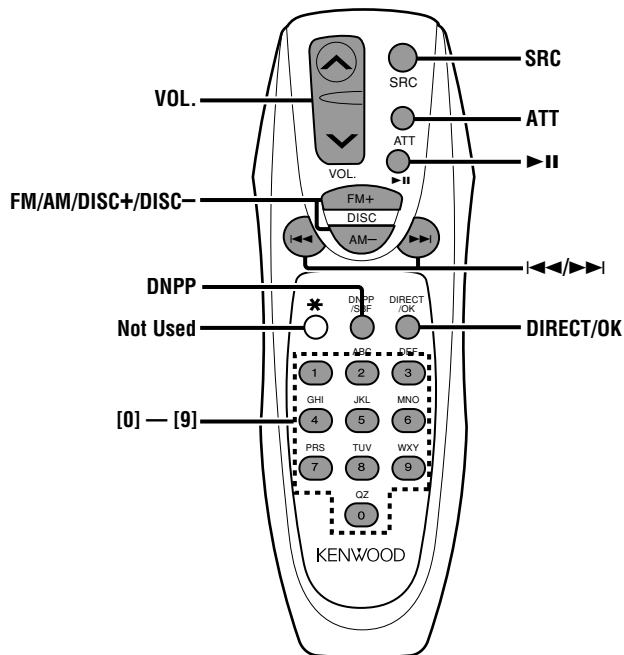

Loading and Replacing the battery

Use two "AA"-size batteries.

Slide the cover while pressing downwards to remove it as illustrated.

Insert the batteries with the + and - poles aligned properly, following the illustration inside the case.

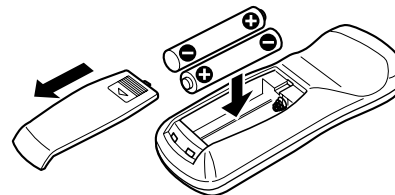

⚠ WARNING

Store unused batteries out of the reach of children. Contact a doctor immediately if the battery is accidentally swallowed.



Do not set the remote on hot places such as above the dashboard.

Basic operations

[VOL.] buttons

Adjusting the volume.

[SRC] button

Each time the button is pressed the source switches.

For the source switching order refer to <Selecting the Source> (page 9).

[ATT] button

Turning the volume down quickly.

When it is pressed again it returns to the previous level.

In Tuner source

[FM]/ [AM] buttons

Select the band.

Each time the [FM] button is pressed it switches between the FM1, FM2, and FM3 bands.

[◀◀]/ [▶▶] buttons

Tune up or down band.

[0] — [9] buttons

Press buttons [1] — [6] to recall preset stations.

[DIRECT] button

Enters and cancels the <Direct Access Tuning> (page 16) mode.

In Disc source

[◀◀]/ [▶▶] buttons

Doing track/file forward and backward.

[DISC+]/ [DISC-] buttons

Doing disc/folder forward and backward.

[▶||] button

Each time the button is pressed the song pauses and plays.

[DNPP]/ [OK] button

Enters and cancels the <DNPP (Disc Name Preset Play)> (page 21) mode.

[0] — [9] buttons

When in <Direct Track/File Search> (page 19) and <Direct Disc Search> (page 19), enter the track/file/disc number.

Connecting Wires to Terminals

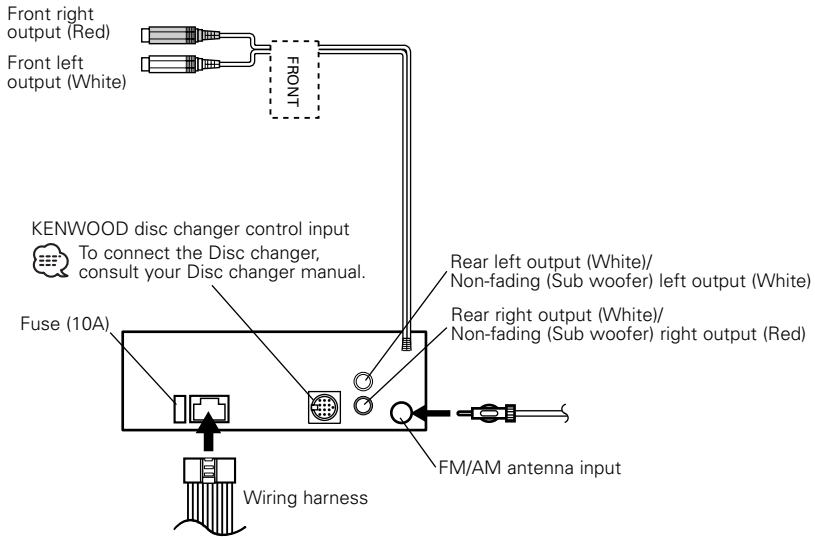

Troubleshooting Guide

What might seem to be a malfunction in your unit may just be the result of slight misoperation or miswiring. Before calling service, first check the following table for possible problems.

General

? The power does not turn ON.

- ✓ The fuse has blown.
 - ☞ After checking for short circuits in the wires, replace the fuse with one with the same rating.
-

? There's a source you can't switch.

- ✓ There's no media inserted.
 - ☞ Set the media you want to listen to. If there's no media in this unit, you can't switch to each source.
 - ✓ The Disc changer isn't connected.
 - ☞ Connect the Disc changer. If the Disc changer isn't connected to its input terminal, You can't switch to an external disc source.
-

? The memory is erased when the ignition is turned OFF.

- ✓ The wire is incorrectly connected.
 - ☞ Check the wire connection.
-

? There's no loudness effect.

- ✓ You're using Non-fading preout.
 - ☞ Loudness has no effect in Non-fading preout.
-

? The Non-fading (Sub woofer) output can't be turned ON or OFF.

- ✓ The <Switching Preout> (page 25) is set is set on Rear preout.
 - ☞ Change it to Non-fading preout.
-

? Even if Loudness is turned ON, high-pitched tone isn't compensated for.

- ✓ Tuner source is selected.
 - ☞ High-pitched tone isn't compensated for when in Tuner source.
-

? No sound can be heard, or the volume is low.

- ✓ The fader or balance settings are set all the way to one side.
 - ☞ Center the fader and balance settings.
-

- ✓ The values of Volume offset are low.
 - ☞ Turn up the Volume offset, referring to the section on <Audio control> (page 10).
-

? Non-fading (Sub woofer) output, Non-fading Low Pass Filter and Non-fading setting can't be done.

- ✓ The <Switching preout> (page 25) is set on Rear preout.
 - ☞ Set it on Non-fading preout.
-

- ✓ The <Non-fading (Sub woofer) output> (page 11) is OFF.
 - ☞ Turn it ON.
-

? There's no Front High Pass Filter and Rear High Pass Filter effect.

- ✓ The Non-fading preout is being used.
 - ☞ There's no effect in Non-fading preout.
-

? The Touch Sensor Tone doesn't sound.

- ✓ The preout jack is being used.
 - ☞ The Touch Sensor Tone can't be output from the preout jack.
-

? The Dimmer function doesn't work.

- ✓ The wire isn't connected correctly.
 - ☞ Check the wire connection.
-

? The display color changes subtly.

- ✓ This is because the temperature is different than the temperature when the setting was done.
 - ☞ The display color condition changes subtly according to the ambient temperature.
-

Troubleshooting Guide

Tuner source

? Radio reception is poor.

- ✓ The car antenna is not extended.
- ☞ Pull the antenna out all the way.

? The desired frequency can't be entered with the Direct Access Tuning.

- ✓ A station that can't be received is being entered.
- ☞ Enter a station that can be received.
- ✓ You're trying to enter a frequency with a 0.01 MHz unit.
- ☞ What can be designated in the FM band is to 0.1 MHz.

Disc source

? "AUX1" is displayed without achieving External disc control mode.

- ✓ Unsupported disc changer is connected.
- ☞ Use the disc changer mentioned in the IMPORTANT INFORMATION of the section on <Safety precautions> (page 4).

? The specified disc does not play, but another one plays instead.

- ✓ The specified CD is quite dirty.
- ☞ Clean the CD.
- ✓ The disc is loaded in a different slot from that specified.
- ☞ Eject the disc magazine and check the number for the specified disc.
- ✓ The disc is severely scratched.
- ☞ Try another disc instead.

? A CD ejects as soon as it is loaded.

- ✓ The CD is quite dirty.
- ☞ Clean the CD, referring to the CD cleaning of the section on <About CDs> (page 8).

? Can't remove disc.

- ✓ The cause is that more than 10 minutes has elapsed since the vehicle ACC switch was turned OFF.
- ☞ The disc can only be removed within 10 minutes of the ACC switch being turned OFF. If more than 10 minutes has elapsed, turn the ACC switch ON again and press the Eject button.

? The disc won't insert.

- ✓ There's already another disc inserted.
- ☞ Press the [▲] button and remove the disc.

? Direct Search can't be done.

- ✓ Another function is ON.
- ☞ Turn Random Play or other functions OFF.

? Track Search can't be done.

- ✓ For the discs/folders first or last song.
- ☞ For each disc/folder, Track Search can't be done in the backward direction for the first song or in the forward direction for the last song.

MP3 source

? Cannot play an MP3.

- ✓ The media is scratched or dirty.
- ☞ Clean the media, referring to the CD cleaning of the section on <About CDs> (page 8).

? The sound skips when an MP3 is being played.

- ✓ The media is scratched or dirty.
- ☞ Clean the media, referring to the CD cleaning of the section on <About CDs> (page 8).
- ✓ The recording condition is bad.
- ☞ Record the media again or use another media.

? The MP3 track time isn't displayed correctly.

- ✓ ---
- ☞ There are times when it isn't displayed correctly according to the MP3 recording conditions.

If the following situations, consult your nearest service center:

Even though the disc changer is connected, the Disc Changer source is not ON, with "AUX1" showing in the display during the Changer Mode.

Troubleshooting Guide

The messages shown below display your systems condition.

Eject:	No disc magazine has been loaded in the changer. The disc magazine is not completely loaded. ⇨ Load the disc magazine properly. No CD in the unit. ⇨ Insert the CD.	Hold Error:	The protective circuit in the unit activates when the temperature inside the automatic disc changer exceeds 60°C (140°F), stopping all operation. ⇨ Cool down the unit by opening the windows or turning on the air conditioner. As the temperature falls below 60°C (140°F), the disc will start playing again.
No Disc:	No disc has been loaded in the disc magazine. ⇨ Load a disc into the disc magazine.	NO NAME:	Attempted to display DNPS during the CD play having no disc names preset.
TOC Error:	No disc has been loaded in the disc magazine. ⇨ Load a disc into the disc magazine. The CD is quite dirty. The CD is upside-down. The CD is scratched a lot. ⇨ Clean the CD and load it correctly.	Load:	Discs are being exchanged in the Disc changer.
E-05:	The CD is upside-down. ⇨ Load the CD correctly.	Reading:	The unit is reading the data on the disc.
Blank Disc:	Nothing has been recorded on the MD.	NO ACCESS:	After setting it in the Disc Changer, DNPP was done without having it been played at least 1 time.
No Track:	No tracks are recorded on the MD, although it has a title.	IN (Blink):	The CD player section is not operating properly. ⇨ Reinsert the CD. If the CD cannot be ejected or the display continues to flash even when the CD has been properly reinserted, please switch off the power and consult your nearest KENWOOD dealer.
E-15:	Media was played that doesn't have data recorded that the unit can play. ⇨ Use media that has data recorded that the unit can play.		
No Panel:	The faceplate of the slave unit being connected to this unit has been removed. ⇨ Replace it.		
E-77:	The unit is malfunctioning for some reason. ⇨ Press the reset button on the unit. If the "E-77" code does not disappear, consult your nearest service center.		
Mecha Error:	Something is wrong with the disc magazine. Or the unit is malfunctioning for some reason. ⇨ Check the disc magazine. And then press the reset button on the unit. If the "Mecha Error" code does not disappear, consult your nearest KENWOOD dealer.		

Specifications

Specifications subject to change without notice.

FM tuner section

Frequency range (200 kHz space)87.9 MHz – 107.9 MHz
Usable sensitivity (S/N = 30dB)9.3dBf (0.8 μ V /75 Ω)
Quieting Sensitivity (S/N = 50dB)15.2dBf (1.6 μ V /75 Ω)
Frequency response (\pm 3.0 dB)30 Hz – 15 kHz
Signal to Noise ratio (MONO)70 dB
Selectivity (\pm 400 kHz) \geq 80 dB
Stereo separation (1 kHz)40 dB

AM tuner section

Frequency range (10 kHz space)530 kHz – 1700 kHz
Usable sensitivity (S/N = 20dB)28 dB μ (25 μ V)

CD player section

Laser diodeGaAlAs (λ =780 nm)
Digital filter (D/A)8 Times Over Sampling
D/A Converter1 Bit
Spindle speed1000 – 400 rpm (CLV 2times)
Wow & FlutterBelow Measurable Limit
Frequency response (\pm 1 dB)10 Hz – 20 kHz
Total harmonic distortion (1 kHz)0.01 %
Signal to Noise ratio (1 kHz)105 dB
Dynamic range93 dB
Channel separation96 dB
MP3 decodeCompliant with MPEG-1.0/2.0/2.5 Audio Layer-3

Audio section

Maximum output power50 W x 4
Full Bandwidth Power (at less than 1% THD)22 W x 4
Tone action	
Bass :100 Hz \pm 10 dB
Middle :1 kHz \pm 10 dB
Treble :10 kHz \pm 10 dB
Preout level / Load (during disc play)2000 mV/10 k Ω
Preout impedance \leq 600 Ω

General

Operating voltage (11 – 16V allowable)14.4 V
Current consumption10 A
Installation Size (W x H x D)182 x 53 x 155 mm 7-3/16 x 2-1/16 x 6-1/10 inch
Weight2.64 lbs (1.2 kg)