

KENWOOD

CD-RECEIVER

KDC-MP6533
KDC-MP5033

INSTRUCTION MANUAL

Kenwood Corporation



Contents

Safety precautions	3	Menu system	19
Notes	4	Menu System	
About CDs	5	Security Code	
About AAC, MP3 and WMA	6	Touch Sensor Tone	
General features	7	Manual Clock Adjustment	
Power		DSI (Disabled System Indicator)	
Selecting the Source		Selectable Illumination	
Volume		Display Illumination Control	
Attenuator		Dimmer	
System Q		Built-in Amp Setting	
Audio Control		Supreme Setting	
Audio Setup		AMP Control	
Speaker Setting		CRSC (Clean Reception System Circuit)	
Switching Display		Auxiliary Input Display Setting	
Subwoofer Output		Text Scroll	
Dimmer Control		CD Read Setting	
Theft Deterrent Faceplate			
TEL Mute			
Tuner/TV control features	12	Basic Operations of remote control	24
Tuning		Accessories/ Installation Procedure	26
Tuning Mode		Connecting Wires to Terminals	27
Direct Access Tuning		Installation	29
Station Preset Memory		Removing the Unit	31
Auto Memory Entry		Troubleshooting Guide	32
Preset Tuning		Specifications	35
Frequency Step Setting			
TV Tuning			
TV channel Preset Memory			
Preset TV Tuning			
Direct TV Tuning			
CD/Audio file/External disc control features	15		
Playing CD & Audio file			
Playing External Disc			
Fast Forwarding and Reversing			
Track/File Search			
Disc Search/Folder Search			
Direct Track/File Search			
Direct Disc Search			
Track/File/Disc/Folder Repeat			
Scan Play			
Random Play			
Magazine Random Play			
Folder Select			
Text/Title Scroll			

Safety precautions

⚠ WARNING

To prevent injury or fire, take the following precautions:

- To prevent a short circuit, never put or leave any metallic objects (such as coins or metal tools) inside the unit.
- Mounting and wiring this product requires skills and experience. For safety's sake, leave the mounting and wiring work to professionals.

Attach the panel while you are on the vehicle

The panel lock arm appears when the panel is removed. Therefore, the panel must be attached while the electrical system of the car is operating.

⚠ CAUTION

To prevent damage to the machine, take the following precautions:

- Make sure to ground the unit to a negative 12V DC power supply.
- Do not install the unit in a spot exposed to direct sunlight or excessive heat or humidity. Also avoid places with too much dust or the possibility of water splashing.
- Do not place the faceplate (and the faceplate case) in areas exposed to direct sunlight, excessive heat or humidity. Also avoid places with too much dust or the possibility of water splashing.
- To prevent deterioration, do not touch the terminals of the unit or faceplate with your fingers.
- Do not subject the faceplate to excessive shock, as it is a piece of precision equipment.
- When replacing a fuse, only use a new fuse with the prescribed rating. Using a fuse with the wrong rating may cause your unit to malfunction.
- Do not apply excessive force to the open faceplate or place objects on it. Doing so will cause damage or breakdown.
- Do not use your own screws. Use only the screws provided. If you use the wrong screws, you could damage the unit.

Do Not Load 8 cm (3 in.) CDs in the CD slot

If you try to load a 8 cm (3 in.) CD with its adapter into the unit, the adapter might separate from the CD and damage the unit.

About CD players/disc changers connected to this unit

Kenwood disc changers/ CD players released in 1998 or later can be connected to this unit.

Refer to the catalog or consult your Kenwood dealer for connectable models of disc changers/ CD players.

Note that any Kenwood disc changers/ CD players released in 1997 or earlier and disc changers made by other makers cannot be connected to this unit. Connecting unsupported disc changers/CD players to this unit may result in damage.

Set the "O-N" Switch to the "N" position for the applicable Kenwood disc changers/ CD players.

The functions you can use and the information that can be displayed may differ depending on the models being connected.



- You can damage both your unit and the CD changer if you connect them incorrectly.

Lens Fogging

When you turn on the car heater in cold weather, dew or condensation may form on the lens in the CD player of the unit. Called lens fogging, this condensation on the lens may not allow CDs to play. In such a situation, remove the disc and wait for the condensation to evaporate. If the unit still does not operate normally after a while, consult your Kenwood dealer.

The "AAC" logo is trademark of Dolby Laboratories.

Notes

- If you experience problems during installation, consult your Kenwood dealer.
- When you purchase optional accessories, check with your Kenwood dealer to make sure that they work with your model and in your area.
- If the unit fails to operate properly, press the Reset button. The unit returns to factory settings when the Reset button is pressed.
- Press the reset button if the disc auto changer fails to operate correctly. Normal operation should be restored.

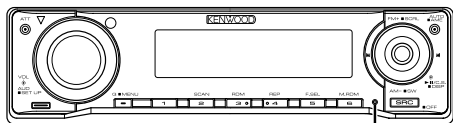

Reset button

- The characters which can be displayed by this unit are A-Z 0-9 @ " ' ` % & * + = , . / \ < > [] () ; : ^ - { } | ~ .
- The illustrations of the display and the panel appearing in this manual are examples used to explain more clearly how the controls are used. Therefore, what appears on the display in the illustrations may differ from what appears on the display on the actual equipment, and some of the illustrations on the display may be inapplicable.

Cleaning the Unit

If the faceplate of this unit is stained, wipe it with a dry soft cloth such as a silicon cloth.

If the faceplate is stained badly, wipe the stain off with a cloth moistened with neutral cleaner, then wipe it again with a clean soft dry cloth.



- Applying spray cleaner directly to the unit may affect its mechanical parts. Wiping the faceplate with a hard cloth or using a volatile liquid such as thinner or alcohol may scratch the surface or erase characters.

Cleaning the Faceplate Terminals

If the terminals on the unit or faceplate get dirty, wipe them with a dry, soft cloth.

About DAB Tuner control

Refer to [A] group on the Instruction manual of DAB Tuner KTC-9090DAB (optional accessory) for the control method of DAB Tuner function.

However, the following control methods of the function for this unit may be differed from the Instruction manual; therefore, refer to the following supplemental instruction.

<Auto Ensemble Memory Entry>

1. Select the preset band for Auto Ensemble Memory Entry.
2. Press the [AME] button for at least 2 seconds. Open Auto Ensemble Memory Entry. After memory storage is finished, the number of the pre-set buttons and the ensemble label are displayed.

<Searching by programme type and language> and <Languages to be displayed> in <Programme Type (PTY) Function>

At the operation to press [DISP] button, use [AUTO] button instead.

<Automatic Switching DAB priority>

This function cannot be used.

The marking of products using lasers (Except for some areas)

**CLASS 1
LASER PRODUCT**

The label is attached to the chassis/case and says that the component uses laser beams that have been classified as Class 1. This means that the unit is utilizing laser beams that are of a weaker class. There is no danger of hazardous radiation outside the unit.

About CDs

Handling CDs

- Do not touch the recording surface of the CD.

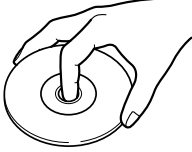

- CD-R and CD-RW are easier to damage than a normal music CD. Use a CD-R or a CD-RW after reading the caution items on the package etc.
- Do not stick tape etc. on the CD, or use a CD with tape stuck on it.

When using a new CD

If the CD center hole or outside rim has burrs, use the CD only after removing the burrs with a ballpoint pen, etc.

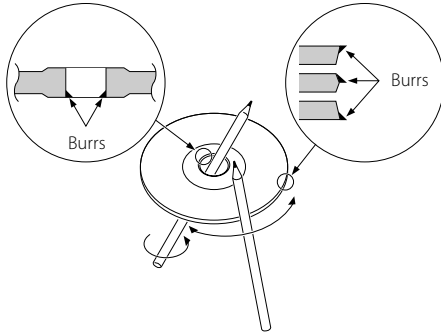

CD accessories

Do not use disc type accessories.

CD cleaning

Clean from the center of the disc and move outward.

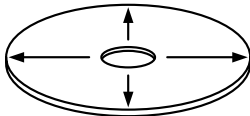

Removing CDs

When removing CDs from this unit pull them out horizontally.

CDs that cannot be used

- CDs that are not round cannot be used.

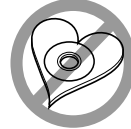
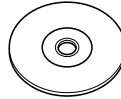

- CDs with coloring on the recording surface or CDs that are dirty cannot be used.
- This unit can only play the CDs with



This unit may not correctly play discs which do not have the mark.

- You cannot play a CD-R or CD-RW that has not been finalized. (For the finalization process refer to your CD-R/CD-RW writing software, and your CD-R/CD-RW recorder instruction manual.)

CD storage

- Do not place CDs in direct sunlight (On the seat or dashboard etc.) or where the temperature is high.
- Store CDs in their cases.

About AAC, MP3 and WMA

The playable AAC/MP3/WMA file (hereafter called Audio file) and the media format has the following limitation. The Audio file, which is not conforming to the specification, may not play normally, or the file and folder names may not display correctly.

Playable Audio file

- AAC, MP3, WMA



- Attach the correct extension for the Audio file (AAC: ".M4A", MP3: ".MP3", WMA: ".WMA")
- Do not attach the extensions to files other than the Audio file. If the extension is attached, the file, which is not the Audio file, will play and outputs a loud noise, causing damage to the speaker.
- The files with copy protection cannot be played.
- The settings of your encoding software and the environment in which it is used may now allow you to play or view specific audio files.
- The unit may not be compatible with upgrade of compression format standard and additional specifications.

Playable AAC file

- ".m4a" file encoded by AAC-LC format.
Refer to <http://www.kenwood.mediamanager.jp> for the details.

Playable MP3 file

- MPEG 1/2 Audio Layer 3 file
- Transfer bit rate: 8-320 kbps
- Sampling frequency
: 8, 11.025, 12, 16, 22.05, 24, 32, 44.1, 48 kHz

Playable WMA file

- The file in accordance with Windows Media Audio (Except for the file for Windows Media Player 9 or after which applies the new functions)
- Transfer bit rate: 48-192 kbps
- Sampling frequency: 32, 44.1, 48 kHz

Playable media

- CD-ROM, CD-R, CD-RW



- CD-RW discs which are quick formatted by the writing software cannot be used.
- When recording to the maximum media capacity at once, the writing software is set to "Disc at once".

Playable disc format

- ISO 9660 Level 1/2
- Joliet
- Romeo
- Long file name.

The maximum number of characters for display

File/Folder name: 64 characters

MP3 ID3 Tag/ WMA Contents property/ AAC song information: 30 characters



- File/Folder name is the number of the characters including the extensions
- MP3 ID3 Tag can only display the tag of Ver1.0/ 1.1.
- AAC ID3 Tag cannot be displayed.

Limitation of structure for the file and the folder

- Maximum number of directory levels: 8
- Maximum number of folders: 100
- Maximum number of files per folder: 255

Playing order of the Audio file

The Audio file plays in the order which is written by writing software. You may be able to set the playing order by writing the play sequence numbers such as "01" to "99" at the beginning of the file name.

Example

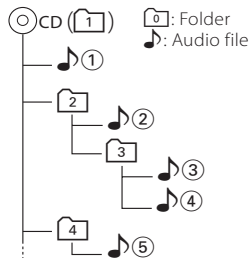

• Playing order

Playing order after 1 play.

➡ 2, 3, 4, 5...

• File search

Forward file search during 3 play.

Push the Control knob towards ➡ 4

• Folder search

Forward folder search during 2 play.

Push the Control knob towards [FM] ➡ 3, 4...

• Folder select

When the selection is set to directory 1, and you want to skip to the folder 2 at the same level.

Push the Control knob towards ➡ 2

When the selection is set to directory 3, moves the level up by folder select.

Push the Control knob towards [AM] ➡ 2

General features

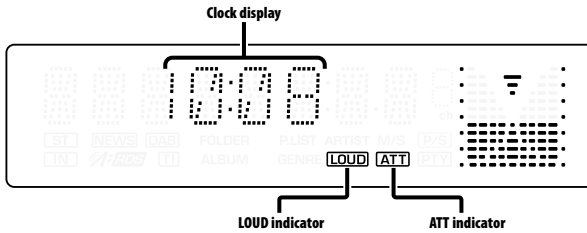
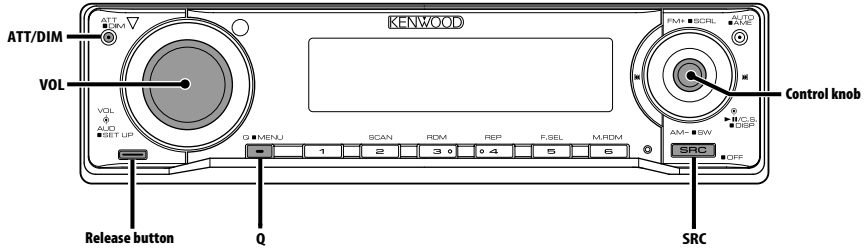

Power

Turning ON the Power

Press the [SRC] button.



- When the power is ON, the <Security Code> (page 20) is displayed as "CODE ON" or "CODE OFF".

Turning OFF the Power

Press the [SRC] button for at least 1 second.

Selecting the Source

Press the [SRC] button.

Source required	Display
Tuner	"TUNER"
CD	"CD"
External disc (Optional accessory)	"CD CH"
TV* (Optional accessory)	"TV"
Auxiliary input (Optional accessory)	"AUX EXT"
Standby (Illumination only mode)	"STANDBY"



- * Function of the KDC-MP6533.

Volume

Increasing Volume

Turn the [VOL] knob clockwise.

Decreasing Volume

Turn the [VOL] knob counterclockwise.

General features

Attenuator

Turning the volume down quickly.

Press the [ATT] button.

Each time you press the button, the Attenuator turns ON and OFF.

When the Attenuator is ON, the "ATT" indicator blinks.

System Q

Selecting the best sound setting preset for different types of music.

1 Select the source to set

Press the [SRC] button.

2 Select the Sound type

Press the [Q] button.

When you press the button once, the current sound setting is displayed.

Each time you press the button, the sound setting alternates.

Sound setting	Display
Natural	"NATURAL"
User memory*	"USER"
Rock	"ROCK"
Pops	"POPS"
Easy	"EASY"
Top 40	"TOP40"
Jazz	"JAZZ"



- * User memory: The values set on the <Audio Control> (page 8).
KDC-MP5033 does not have the User memory function so the values of Bass, Middle, and Treble set in audio control are replaced to the System Q values and "USER" is not displayed when the System Q setting is changed.
- Change each setting value with the <Speaker Setting> (page 9).
First, select the speaker type with the Speaker setting.

Audio Control

1 Select the source to adjust

Press the [SRC] button.

2 Enter Audio Control mode

Press the [VOL] knob.

3 Select the Basic Audio item to adjust

Press the [VOL] knob.

Each time you press the knob, the item to be adjusted alternates between the items shown in the table below.

4 Adjust the Basic Audio item

Turn the [VOL] knob.

Adjustment Item	Display	Range
Subwoofer level ^{*1,2}	"SW L"	-15 — +15
Bass level	"BAS L"	-8 — +8
Middle level	"MID L"	-8 — +8
Treble level	"TRE L"	-8 — +8
Balance	"BAL"	Left 15 — Right 15
Fader	"FAD"	Rear 15 — Front 15

Exit Audio Control mode (Volume control mode)



- *¹ You can control this item when <Subwoofer Output> (page 10) is set to "SW ON".
- *² Function of the KDC-MP6533.

5 Exit Audio Control mode

Press any button.

Press a button other than the [VOL] knob and [ATT] button.

Audio Setup

Setting the Sound system, such as Cross over Network.

1 Select the source to adjust

Press the [SRC] button.

2 Enter Audio Setup mode

Press the [VOL] knob for at least 1 second.

3 Select the Audio Setup item to adjust

Press the [VOL] knob.

Each time you press the knob, the item to be adjusted alternates between the items shown in the table below.

4 Setup the Audio item

Turn the [VOL] knob.

Adjustment Item	Display	Range
Front High Pass Filter*2 "HPF"		Through/80/100/120/150/ 180 Hz
Rear High Pass Filter*2 "HPR"		Through/80/100/120/150/ 180 Hz
Low Pass Filter*1,2 "LPF"		60/80/120/Through Hz
Subwoofer Phase*1,2,3 "PHAS"		Reverse (180°) / Normal (0°)
Volume offset	"V-OFF"	-8 — ±0
Loudness	"LOUD"	OFF/ON



- Volume offset: Sets each source's volume as a difference from the basic volume.
- Loudness: Compensates for low and high tones during low volume.
- *1 You can control this item when <Subwoofer Output> (page 10) is set to "SW ON".
- *2 Function of the KDC-MP6533.
- *3 You can control this item when Low Pass Filter is not set to Through.

5 Exit Audio Setup mode

Press the [VOL] knob for at least 1 second.

Speaker Setting

Fine-tuning so that the System Q value is optimal when setting the speaker type.

1 Enter Standby

Press the [SRC] button.

Select the "STANDBY" display.

2 Enter Speaker Setting mode

Press the [VOL] knob.

3 Select the Speaker type

Turn the [VOL] knob.

Each time you turn the knob, the setting alternates between the settings shown in the table below.

Speaker type	Display
OFF	"SP OFF"
For 5 & 4 in. speaker	"SP 5/4"
For 6 & 6x9 in. speaker	"SP 6*9/6"
For the OEM speaker	"SP OEM"

4 Exit Speaker Setting mode

Press the [VOL] knob.

General features

Switching Display

Changing the information displayed.

1 Enter Switching Display mode

Press the Control knob for at least 1 second.

"DISP SEL" is displayed.

2 Select the Display item

Push the Control knob towards [◀◀] or [▶▶].

In Tuner source

Information	Display
Frequency	"FREQ"
Clock	"CLOCK"

In CD & External disc source

Information	Display
Disc title	"D-TITLE"*
Track title	"T-TITLE"*
Track number & Play time	"P-TIME"
Clock	"CLOCK"

In Audio file source

Information	Display
Song title & Artist name	"TITLE"*
Album name & Artist name	"ALBUM"*
Folder name	"FOLDER"
File name	"FILE"
Track number & Play time	"P-TIME"
Clock	"CLOCK"

In Standby/ Auxiliary input source

Information	Display
Source name	"SRC NAME"
Clock	"CLOCK"

3 Exit Switching Display mode

Press the Control knob.



- When LX-AMP is connected, the item setup by the Display mode of LX-AMP is displayed.
- * If the contents of the information cannot be displayed, Play time is displayed.
- When you select the clock display, the display setting of each source will be changed to the clock display.
- Album name cannot be displayed in WMA file.

Function of the KDC-MP6533

Subwoofer Output

Turning the Subwoofer output ON or OFF.

Push the Control knob toward [AM] for at least 2 seconds.

Each time you press the button, Subwoofer output switches ON and OFF.

When it is ON, "SW ON" is displayed.

Function of the KDC-MP5033

Dimmer Control

You can lower the brightness of the display by using the dimmer function.

Press the [DIM] button for at least 1 second.

Each time you press the button for 1 second, the Dimmer control turns ON or OFF.

When the Dimmer control is ON, "DIM ON" is displayed.

Theft Deterrent Faceplate

The faceplate of the unit can be detached and taken with you, helping to deter theft.

Removing the Faceplate

1 Press the Release button.

Drop open the faceplate.

2 Drawing the faceplate to left side pull it to forward and remove it.

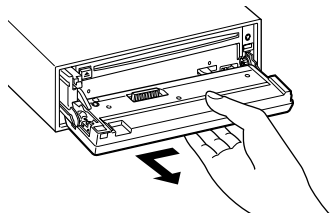

- The faceplate is a precision piece of equipment and can be damaged by shocks or jolts.
- Keep the faceplate in its faceplate case while detached.
- Do not expose the faceplate (and the faceplate case) to direct sunlight or excessive heat or humidity. Also avoid places with too much dust or the possibility of water splashing.

Reattaching the Faceplate

1 Align the shaft on the unit with the depression on the faceplate.

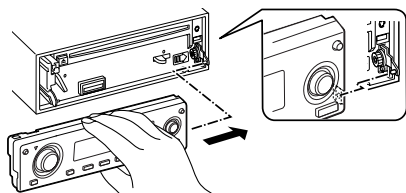

2 Push the faceplate in until it clicks.

The faceplate is locked in place, allowing you to use the unit.

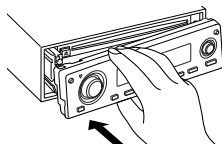

TEL Mute

The audio system automatically mutes when a call comes in.

When a call comes in

"CALL" is displayed.

The audio system pauses.

Listening to the audio during a call

Press the [SRC] button.

The "CALL" display disappears and the audio system comes back ON.

When the call ends

Hang up the phone.

The "CALL" display disappears and the audio system comes back ON.



- To use the TEL Mute feature, you need to hook up the MUTE wire to your telephone using a commercial telephone accessory. Refer to <Connecting Wires to Terminals> (page 27, 28).

Tuner/TV control features

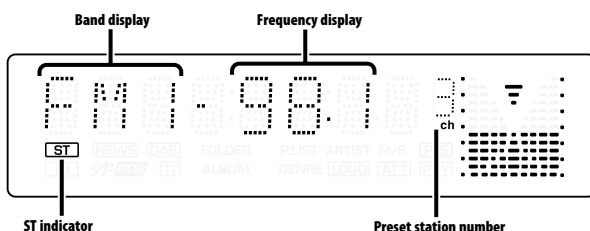
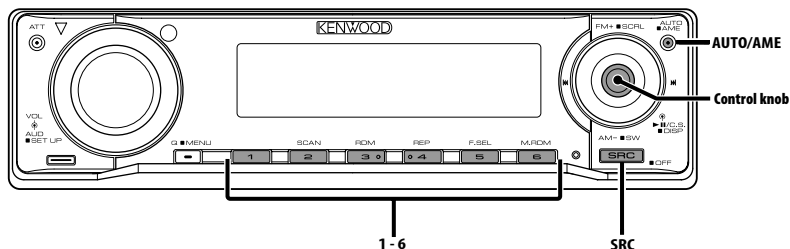

Tuning

Selecting the station.

1 Select tuner source

Press the [SRC] button.

Select the "TUNER" display.

2 Select the band

Push the Control knob towards [FM] or [AM].

Each time you push the knob toward [FM], it switches between the FM1, FM2, and FM3 bands.

3 Tune up or down band

Push the Control knob towards [◀◀] or [▶▶].



- During reception of stereo stations the "ST" indicator is ON.

Tuning Mode

Choose the tuning mode.

Press the [AUTO] button.

Each time you press the button, the Tuning mode alternates between the modes shown in the table below.

Tuning mode	Display	Operation
Auto seek	"AUTO 1"	Automatic search for a station.
Preset station seek	"AUTO 2"	Search in order of the stations in the Preset memory.
Manual	"MANUAL"	Normal manual tuning control.

Function of the KDC-MP6533
Function of remote control

Direct Access Tuning

Entering the frequency and tuning.

1 Select the band

Press the [FM] or [AM] button.

2 Enter Direct Access Tuning mode

Press the [DIRECT] button on the remote control.

"- - - -" is displayed.

3 Enter the frequency

Press the number buttons on the remote control.

Example:

Desired frequency	Press button
92.1 MHz (FM)	[0], [9], [2], [1]
810 kHz (AM)	[0], [8], [1], [0]

Cancelling Direct Access Tuning

Press the [DIRECT] button on the remote control.

Station Preset Memory

Putting a station in the memory.

1 Select the band

Push the Control knob towards [FM] or [AM].

2 Select the frequency to put in the memory

Push the Control knob towards [◀◀] or [▶▶].

3 Put the frequency in the memory

Press the desired [1] — [6] button for at least 2 seconds.

The preset number display blinks 1 time. On each band, 1 station can be put in the memory on each [1] — [6] button.

Auto Memory Entry

Putting stations with good reception in the memory automatically.

1 Select the band for Auto Memory Entry

Push the Control knob towards [FM] or [AM].

2 Open Auto Memory Entry

Press the Control knob for at least 2 seconds.

"A-MEMORY" is displayed.

When 6 stations that can be received are put in the memory Auto Memory Entry closes.

Preset Tuning

Recalling the stations in the memory.

1 Select the band

Push the Control knob towards [FM] or [AM].

2 Recall the station

Press the desired [1] — [6] button.

Frequency Step Setting

Changing the tuning frequency step.

The original setting is FM band 50 kHz, and AM band 9 kHz.

1 Turn the power OFF

Press the [SRC] button for at least 1 second.

2 Switch the frequency step

While pressing the [1] and [5] buttons, press the [SRC] button.

Release the [SRC] button first. After the display appears, release your fingers from the [1] and [5] buttons.

The frequency step changes to FM band 200 kHz, and AM band 10 kHz.



- When the same operation is repeated, the frequency step returns to the original setting.
- When the frequency step is changed, the frequencies in the memory are deleted.

Tuner/TV control features

Function of the KDC-MP6533
Function of LX BUS Television

TV Tuning

Selecting the TV channel of a connected LX BUS Television (optional accessory).

The action depends on the setting of the connected LX BUS Television. Refer to the user instruction of the LX BUS Television for details.

1 Select TV source

Press the [SRC] button.

Select the "TV" display.

2 Select the TV band and Video input

Push the Control knob toward [FM].

Each time you push the knob to [FM], TV bands and Video input alternate.

3 Select the TV channel

Push the Control knob towards [◀◀] or [▶▶].

Function of the KDC-MP6533
Function of LX BUS Television

TV channel Preset Memory

Putting the TV channels in the memory.

1 Select the TV band

Push the Control knob toward [FM].

2 Select the TV channel to put in the memory

Push the Control knob towards [◀◀] or [▶▶].

3 Put the TV channel in the memory

Press the desired [1] — [6] button for at least 2 seconds.

The preset number display blinks 1 time.

On each band, 1 TV channel can be put in the memory on each [1] — [6] button.

Function of the KDC-MP6533
Function of LX BUS Television

Preset TV Tuning

Recalling the TV channels in the memory.

1 Select the TV band

Push the Control knob toward [FM].

2 Recall the TV channel

Press the desired [1] — [6] button.

Function of the KDC-MP6533
Function of remote control

Direct TV Tuning

Entering the TV channel and tuning.

1 Select the TV band

Press the [FM] button.

2 Enter Direct TV Tuning mode

Press the [DIRECT] button on the remote control.

"—" is displayed.

3 Enter the TV channel

Press the number buttons on the remote control.

Example:

Desired channel	Press button
8 ch	[0], [8]

Canceling Direct TV Tuning

Press the [DIRECT] button on the remote control.

CD/Audio file/External disc control features

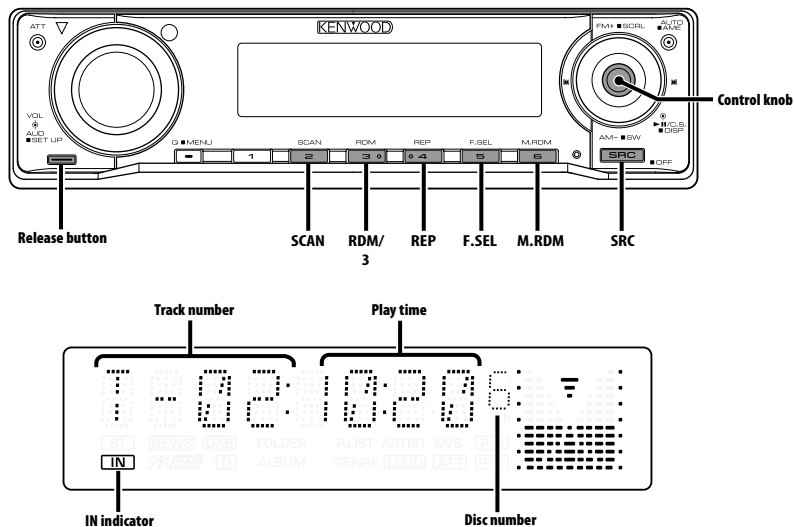

Playing CD & Audio file

When there is no disc inserted

- 1 Drop open the faceplate**
Press the Release button.
- 2 Insert a disc.**
- 3 Push the faceplate on the left side, and return it to its former position.**



- When the faceplate has been dropped open, it might interfere with the shift lever or other vehicle function. If this happens, pay attention to safety and move the shift lever or take an appropriate action to remove the obstacle, then operate the unit.
- Do not use the unit with the faceplate in the open condition. If it's used in the open position dust can enter the inside part and cause damage.



- When a disc is inserted, the "IN" indicator is ON.

When a disc is inserted

- 1 Press the [SRC] button.**
Select the "CD" display.

Pause and play

- 1 Press the Control knob.**
Each time you press the knob, the audio pauses or plays.

Eject the disc

- 1 Drop open the faceplate**
Press the Release button.
- 2 Eject the disc**
Press the [▲] button.

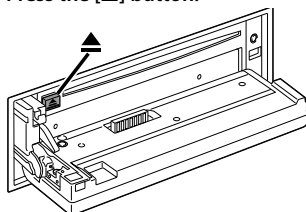

- 3 Press the faceplate on the left side, and return it to its former position.**

CD/Audio file/External disc control features

Playing External Disc

Playing discs set in the optional accessory disc player connected to this unit.

Press the [SRC] button.

Select the display for the disc player you want.

Display examples:

Display	Disc player
"CD CH"	CD changer
"MD CH"	MD changer

Pause and play

Press the Control knob.

Each time you press the knob, the audio pauses or plays.



- Disc 10 is displayed as "0".
- The functions that can be used and the information that can be displayed will differ depending on the external disc players being connected.

Fast Forwarding and Reversing

Fast Forwarding

Hold down toward [▶▶] with the Control knob.

Release your finger to play the disc at that point.

Reversing

Hold down toward [◀◀] with the Control knob.

Release your finger to play the disc at that point.



- There is no sound while the Audio file is being searched.
- You cannot fast Forwarding and Reversing while AAC file is being played.

Track/File Search

Searching for a song on the disc or in the Audio file folder.

Push the Control knob towards [◀◀] or [▶▶].

Function of disc changer/ Audio file

Disc Search/Folder Search

Selecting the disc set in the Disc changer or the folder recorded on the Audio file media.

Push the Control knob towards [FM] or [AM].

Function of remote control

Direct Track/File Search

Doing Track/File Search by entering the track/file number.

1 Enter the track/file number

Press the number buttons on the remote control.

2 Do Track/File Search

Press the [◀◀] or [▶▶] button.

Canceling Direct Track/File Search

Press the [▶II] button.

Function of disc changers with remote control

Direct Disc Search

Doing Disc Search by entering the disc number.

1 Enter the disc number

Press the number buttons on the remote control.

2 Do Disc Search

Press the [+] or [-] button.

Canceling Direct Disc Search

Press the [▶II] button.



- Input "0" to select disc 10.

Track/File/Disc/Folder Repeat

Replaying the song, disc in the Disc changer or Audio file folder you are listening to.

Press the [REP] button.

Each time you press the button, the Repeat Play alternates between the modes shown in the tables below.

In CD & External disc source

Repeat play	Display
Track Repeat	"TRAC REP"
Disc Repeat (In Disc Changer)	"DISC REP"
OFF	"REP OFF"

In Audio file source

Repeat play	Display
File Repeat	"FILE REP"
Folder Repeat	"FOLD REP"
OFF	"REP OFF"

Scan Play

Playing the first part of each song on the disc or Audio file folder you are listening to and searching for the song you want to hear.

1 Start Scan Play

Press the [SCAN] button.

"TRAC SCN"/"FILE SCN"/"SCAN ON" is displayed.

2 Release it when the song you want to listen to is played

Press the [SCAN] button.

Random Play

Play all the songs on the disc or Audio file folder in random order.

Press the [RDM] button.

Each time you press the button, Random Play turns ON or OFF.

When the Random mode is ON, "DISC RDM"/"FOLD RDM"/"RDM ON" is displayed.



- When you push the Control knob toward [▶▶], the next random song starts.

Function of disc changer

Magazine Random Play

Play the songs on all the discs in the disc changer in random order.

Press the [M.RDM] button.

Each time you press the button, the Magazine Random Play turns ON or OFF.

When the Magazine Random mode is ON, "MGZN RDM" is displayed.



- When you push the Control knob toward [▶▶], the next random song starts.

CD/Audio file/External disc control features

Function of Audio file

Folder Select

Quickly selecting the folder you want to hear.

1 Enter Folder Select mode

Press the [F.SEL] button.

"FOLD SEL" is displayed.

During Select mode the folder information is displayed as shown below.

Folder name display

Displays the current folder name.

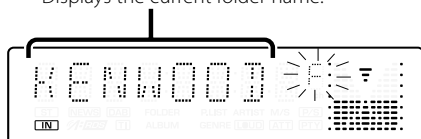

2 Select the folder level

Push the Control knob towards [FM] or [AM].

With the [FM] of the Control knob, you move 1 level down and with the [AM] of the Control knob, 1 level up.

Selecting a folder in the same level

Push the Control knob towards [◀◀] or [▶▶].

With the [◀◀] of the Control knob, you move to the previous folder, and with the [▶▶] of the Control knob, to the next folder.

Returning to the top level

Press the [3] button.

Scrolling the folder name display

Push the Control knob toward [FM] for at least 2 seconds.

3 Decide the folder to play

Press the Control knob.

The Folder Select mode releases, and the Audio file in the folder being displayed plays.

Cancelling the Folder Select mode

Press the [F.SEL] button.

Text/Title Scroll

Scrolling the displayed CD text, Audio file text, or MD title.

Push the Control knob toward [FM] for at least 2 seconds.



- When the <Display Illumination Control> (page 21) is set to OFF, the display may black out while scrolling.

Menu system

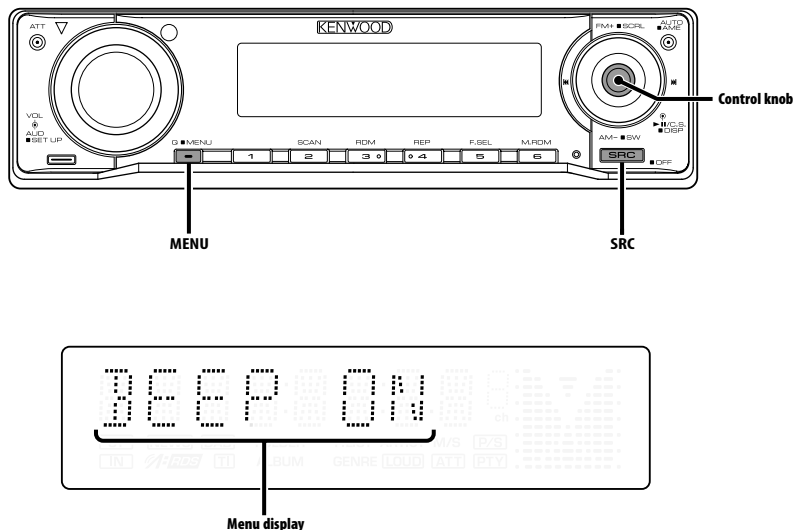

Menu System

Setting beep sound during operation, etc. functions.

The Menu system basic operation method is explained here. The reference for the Menu items and their setting content is after this operation explanation.

1 Enter Menu mode

Press the [MENU] button for at least 1 second.
"MENU" is displayed.

2 Select the menu item

Push the Control knob towards [FM] or [AM].
Example: When you want to set the beep sound select the "BEEP" display.

3 Set the menu item

Push the Control knob towards [◀◀] or [▶▶].

Example: When you select "BEEP", each time you push the knob it alternates between "BEEP ON" or "BEEP OFF". Select 1 of them as the setting.

You can continue by returning to step 2 and setting other items.

4 Exit Menu mode

Press the [MENU] button.



- When other items those applicable to the basic operation method above are displayed, their setting content chart is entered. (Normally the setting listed at the top of the chart is the original setting.) Also, the explanation for items that are not applicable (<Manual Clock Adjustment> etc.) are entered step by step.

Menu system

In Standby mode

Security Code

Activating the Security Code disables the usage of audio unit by someone else. Once the Security Code is activated, the entry of authorized Security Code is required to turn on the audio unit when it is removed from the vehicle. Indication of this Security Code activation prevents your precious audio unit from stealing.



- When you activate the Security Code function, it cannot be released.
Note, your Security Code is the 4 digit number entered in your "Car Audio Passport" in this package.

1 Enter Standby

Press the [SRC] button.

Select the "STANDBY" display.

2 Enter Menu mode

Press the [MENU] button for at least 1 second.

When "MENU" is displayed, "CODE SET" is also displayed.

3 Enter Security Code mode

Press the Control knob for at least 1 second.

When "ENTER" is displayed, "CODE" is also displayed.

4 Select the digits to enter

Push the Control knob towards [◀◀] or [▶▶].

5 Select the Security Code numbers

Push the Control knob towards [FM] or [AM].

6 Repeat steps 4 and 5, and complete the Security Code.

7 Confirm the Security Code

Press the Control knob for at least 3 seconds.

When "RE-ENTER" is displayed, "CODE" is also displayed.

8 Do the step 4 through 7 step operation, and reenter the security code.

"APPROVED" is displayed.

The Security Code function activates.



- If you enter a Code different from your Security Code, you have to start over from step 4.

Resetting the Security Code function when the audio unit is first used after removed from the battery power source or the Reset button is pressed

1 Turn the power ON.

2 Do the step 4 through 7 step operation, and reenter the security code.

"APPROVED" is displayed.

Now, you can use the unit.



- If an incorrect code is entered, "WAITING" is displayed, and the input prohibition periods shown in the table below is generated.
After the input prohibition time lapses, "CODE" is displayed, and you can reenter the code.

Number of times the incorrect code was input	Input prohibited time
1	—
2	5 minutes
3	1 hour
4	24 hours

In Standby mode

Touch Sensor Tone

Setting the operation check sound (beep sound) ON/OFF.

Display	Setting
"BEEP ON"	Beep is heard.
"BEEP OFF"	Beep canceled.

In Standby mode

Manual Clock Adjustment

1 Select Clock Adjustment mode

Push the Control knob towards [FM] or [AM].

Select the "CLK ADJ" display.

2 Enter Clock Adjust mode

Press the Control knob for at least 1 second.

The clock display blinks.

3 Adjust the hours

Push the Control knob towards [FM] or [AM].

Adjust the minutes

Push the Control knob towards [◀◀] or

[▶▶].

4 Exit Clock adjustment mode

Press the [MENU] button.

DSI (Disabled System Indicator)

A red indicator will blink on the unit after the faceplate is removed, warning potential thieves.

Display	Setting
"DSI ON"	LED flashes.
"DSI OFF"	LED OFF.

Function of the KDC-MP6533

In Standby mode

Selectable Illumination

Selecting the button illumination color as green or red.

Display	Setting
"KEY GRN"	The illumination color is green.
"KEY RED"	The illumination color is red.

Display Illumination Control

This function turns off the display when you perform no operation for 5 seconds. This function is effective when you are driving at night.

Display	Setting
"DISP ON"	Keeps the display on.
"DISP OFF"	Turns off the display when you perform no operation for 5 seconds.



- When the display is off, pressing any key will turn on the display.
- When the display is off, you cannot perform any operation except for the following:
 - Volume
 - Attenuator
 - Selecting the source
 - Ejecting the disc
 - Turning off the power
 - Dimmer Control (KDC-MP5033)
- During function control, such as the Menu System, the display stays on.

Function of the KDC-MP6533

In Standby mode

Dimmer

Dimming this unit's display automatically when the vehicle light switch is turned ON.

Display	Setting
"DIM ON"	The display dims.
"DIM OFF"	The display doesn't dim.

Menu system

Function of the KDC-MP6533
In Standby mode

Built-in Amp Setting

Controlling the built-in amplifier.
Turning OFF this control enhances the preout quality.

Display	Setting
"AMP ON"	The built-in amplifier activates.
"AMP OFF"	The built-in amplifier deactivates.

In Audio file source

Supreme Setting

When AAC, MP3 or WMA files encoded at a low bit rate (less than 96kbps (fs=32k, 44.1k, 48kHz)) are played, this function restores their high frequency region to approach the sound quality of equivalents of these files encoded at a high bit rate. Processing is optimized for the compression format used (AAC, MP3, or WMA), and adjustment is made for the bit rate used.

Display	Setting
"SPRM ON"	Plays sound using the Supreme function.
"SPRM OFF"	Plays the original sound stored in the audio file.



- The sound effect may be imperceptible depending on the relationship between the audio file format and setting.

Function of the KDC-MP6533
When LX AMP unit connecting

AMP Control

You can control the LX AMP connected to the unit.

1 Select AMP Control mode
Push the Control knob towards [FM] or [AM].
Select the "AMP CTRL" display.

2 Enter AMP Control mode
Press the Control knob for at least 1 second.

3 Select the AMP Control item for adjustment
Push the Control knob towards [FM] or [AM].



- For the details on the AMP Control item, see the instruction manual attached to the LX AMP.

4 Adjust the AMP Control item
Push the Control knob towards [◀◀] or [▶▶].

5 Exit AMP Control mode
Press the [MENU] button.



- You cannot use the LX AMP operation during standby mode.

In FM reception

CRSC (Clean Reception System Circuit)

Temporarily have reception alternate from stereo to mono to reduce multi-path noise when listening to the FM station.

Display	Setting
"CRSC ON"	The CRSC is ON.
"CRSC OFF"	The CRSC is OFF.



- Strong electrical fields (such as from power lines) may cause unstable sound quality when CRSC is turned ON. In such a situation, turn it OFF.

Auxiliary Input Display Setting

Selecting the display when alternating to Auxiliary input source.

1 Select Auxiliary input source

Press the [SRC] button.

Select the "AUX EXT" display.

2 Enter Menu mode

Press the [MENU] button for at least 1 second.

"MENU" is displayed.

3 Select Auxiliary input display setting mode

Push the Control knob towards [FM] or [AM].

Select the "NAME SET" display.

4 Enter Auxiliary input display setting mode

Press the Control knob for at least 1 second.

The selected Auxiliary input display is displayed.

5 Select the Auxiliary input display

Push the Control knob towards [◀◀] or [▶▶].

Each time you push the knob, the display alternates as listed below.

- "AUX EXT"
- "DVD"
- "PORTABLE"
- "GAME"
- "VIDEO"
- "TV"

6 Exit Auxiliary input display setting mode

Press the [MENU] button.



- When operation stops for 10 seconds, the name at that time is registered, and the Auxiliary input display setting mode closes.
- You can only set the Auxiliary input display when the auxiliary input of optional KCA-S210A is used.

Text Scroll

Setting the displayed text scroll.

Display	Setting
"SCL AUTO"	Repeats scroll.
"SCL MANU"	Scrolls when the display changes.



- The text scrolled is listed below.
 - CD text
 - Folder name/ File name/ Song title/ Artist name/ Album name
 - MD title

In Standby mode

CD Read Setting

When there is a problem with playing a CD with special format, this setting plays the CD by force.

Display	Setting
"CD READ1"	Play CD and Audio file.
"CD READ2"	Play CD by force.



- Setting "CD READ2" cannot play Audio file.
Some music CDs may not play even in the "CD READ2" mode.

Basic Operations of remote control

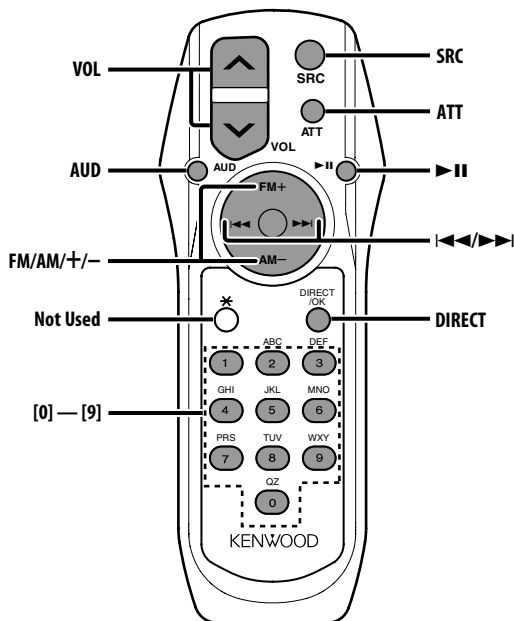

Loading and Replacing the battery

Use two "AA"/ "R6"-size batteries.

Slide the cover while pressing downwards to remove it as illustrated.

Insert the batteries with the + and - poles aligned properly, following the illustration inside the case.

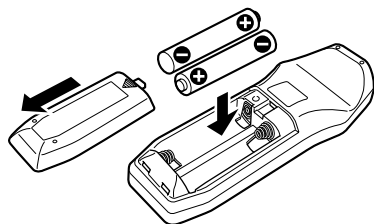

▲WARNING

- Store unused batteries out of the reach of children. Contact a doctor immediately if the battery is accidentally swallowed.



- Do not set the remote control in hot places such as above the dashboard.

Basic operations

[VOL] buttons

Adjusts the volume.

[SRC] button

Each time you press the button, the source alternates.

For the source alternating order refer to <Selecting the Source> (page 7).

[ATT] button

Turns the volume down quickly.

When the button is pressed again, the volume returns to the previous level.

Audio Control

[AUD] button

Selects the Audio item to be adjusted.

[VOL] buttons

Adjusts the Audio item.



- Refer to <Audio Control> (page 8) for the operation method, such as the procedures for Audio control and others operations.

In Tuner source

[FM]/ [AM] buttons

Selects the band.

Each time you press the [FM] button, the band alternates between the FM1, FM2, and FM3 bands.

[◀◀]/ [▶▶] buttons

Tune up or down band.

[0] — [9] buttons

Press buttons [1] — [6] to recall preset stations.

[DIRECT] button

Enters and cancels the <Direct Access Tuning> (page 13) mode.

In Disc source

[◀◀]/ [▶▶] buttons

Going forwards and backwards between track/ files.

[+]/ [-] buttons

Going forwards and backwards between disc/ folders.

[▶ II] button

Each time you press the button, the song pauses or plays.

[0] — [9] buttons

When in <Direct Track/File Search> (page 16) and <Direct Disc Search> (page 16), enters the track/ file/disc number.

Function of the KDC-MP6533

In TV source

[FM] button

Selects the TV band and Video input.

Each time you press the [FM] button, TV bands and Video input alternates.

[◀◀]/ [▶▶] buttons

Selects the TV channel.

[0] — [9] buttons

Press buttons [1] — [6] to recall preset TV channels.

[DIRECT] button

Enters and cancels the <Direct TV Tuning> (page 14) mode.

Accessories/ Installation Procedure

Accessories

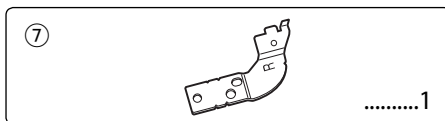
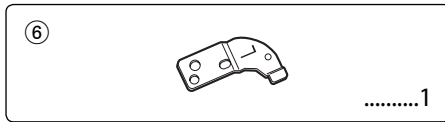
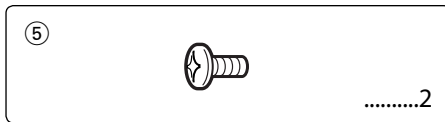
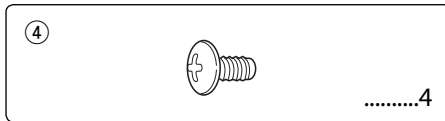
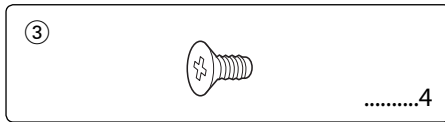
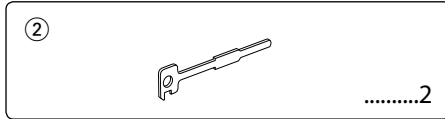
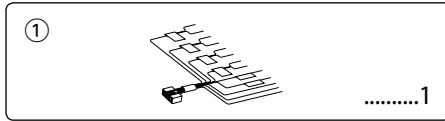

Installation Procedure

1. To prevent a short circuit, remove the key from the ignition and disconnect the ⊖ battery.
2. Make the proper input and output wire connections for each unit.
3. Connect the speaker wires of the wiring harness.
4. Connect the wiring harness wires in the following order: ground, battery, ignition.

5. Connect the wiring harness connector to the unit.
6. Install the unit in your car.
7. Reconnect the ⊖ battery.
8. Press the reset button.

▲WARNING

If you connect the ignition wire (red) and the battery wire (yellow) to the car chassis (ground), you may cause a short circuit, that in turn may start a fire. Always connect those wires to the power source running through the fuse box.



- If the power is not turned ON (or it is ON, but will be OFF immediately), the speaker wire may have a short-circuit or touched the chassis of the vehicle and the protection function may have been activated. Therefore, the speaker wire should be checked.
- If your car's ignition does not have an ACC position, connect the ignition wires to a power source that can be turned on and off with the ignition key. If you connect the ignition wire to a power source with a constant voltage supply, as with battery wires, the battery may die.
- If the console has a lid, make sure to install the unit so that the faceplate will not hit the lid when closing and opening.
- If the fuse blows, first make sure the wires aren't touching to cause a short circuit, then replace the old fuse with one with the same rating.
- Insulate unconnected wires with vinyl tape or other similar material. To prevent a short circuit, do not remove the caps on the ends of the unconnected wires or the terminals.
- Connect the speaker wires correctly to the terminals to which they correspond. The unit may be damaged or fail to work if you share the ⊖ wires or ground them to any metal part in the car.
- When only two speakers are being connected to the system, connect the connectors either to both the front output terminals or to both the rear output terminals (do not mix front and rear). For example, if you connect the ⊕ connector of the left speaker to a front output terminal, do not connect the ⊖ connector to a rear output terminal.
- After the unit is installed, check whether the brake lamps, blinkers, wipers, etc. on the car are working properly.
- Mount the unit so that the mounting angle is 30° or less.

Connecting Wires to Terminals (KDC-MP6533)

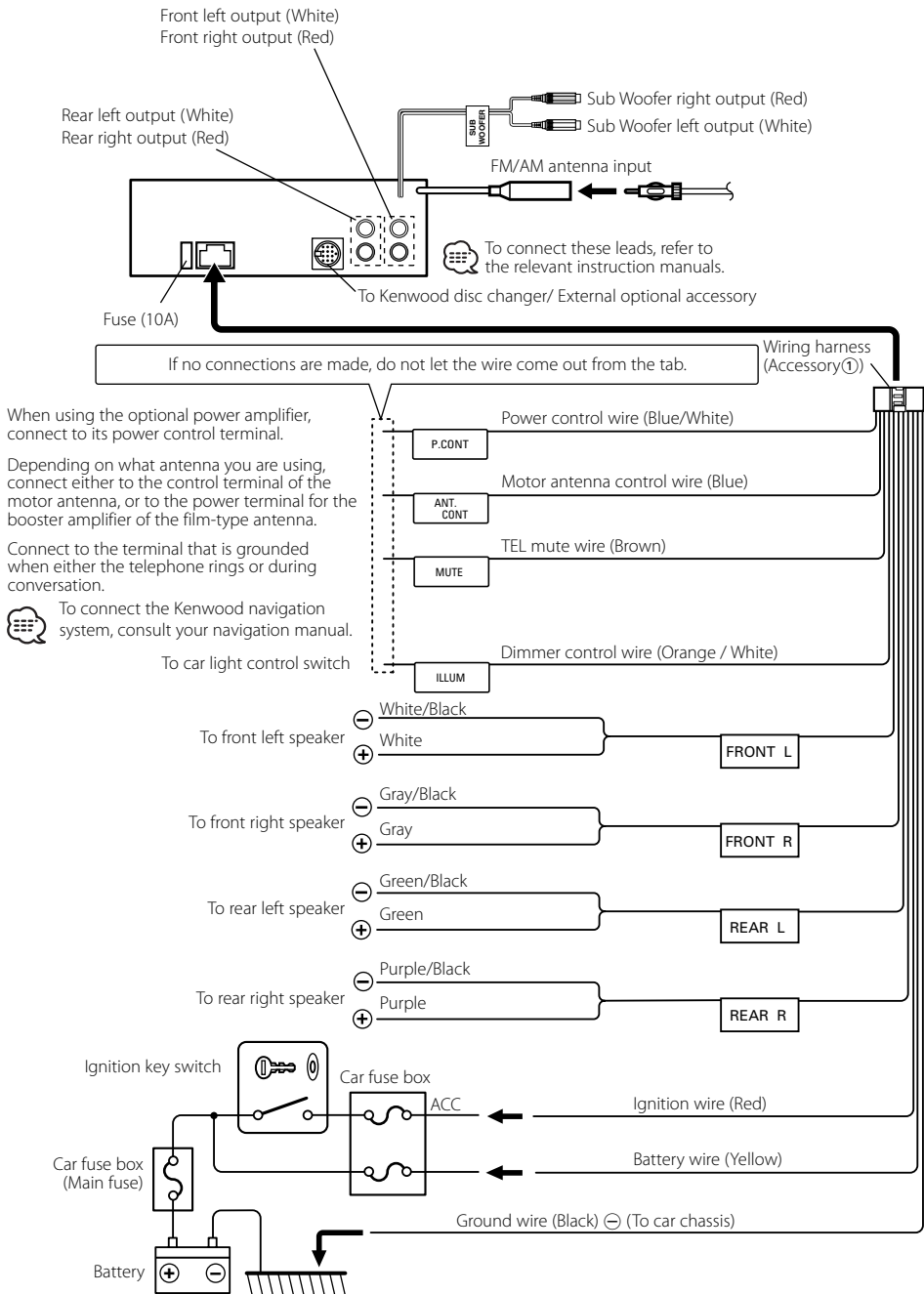

Connecting Wires to Terminals (KDC-MP5033)

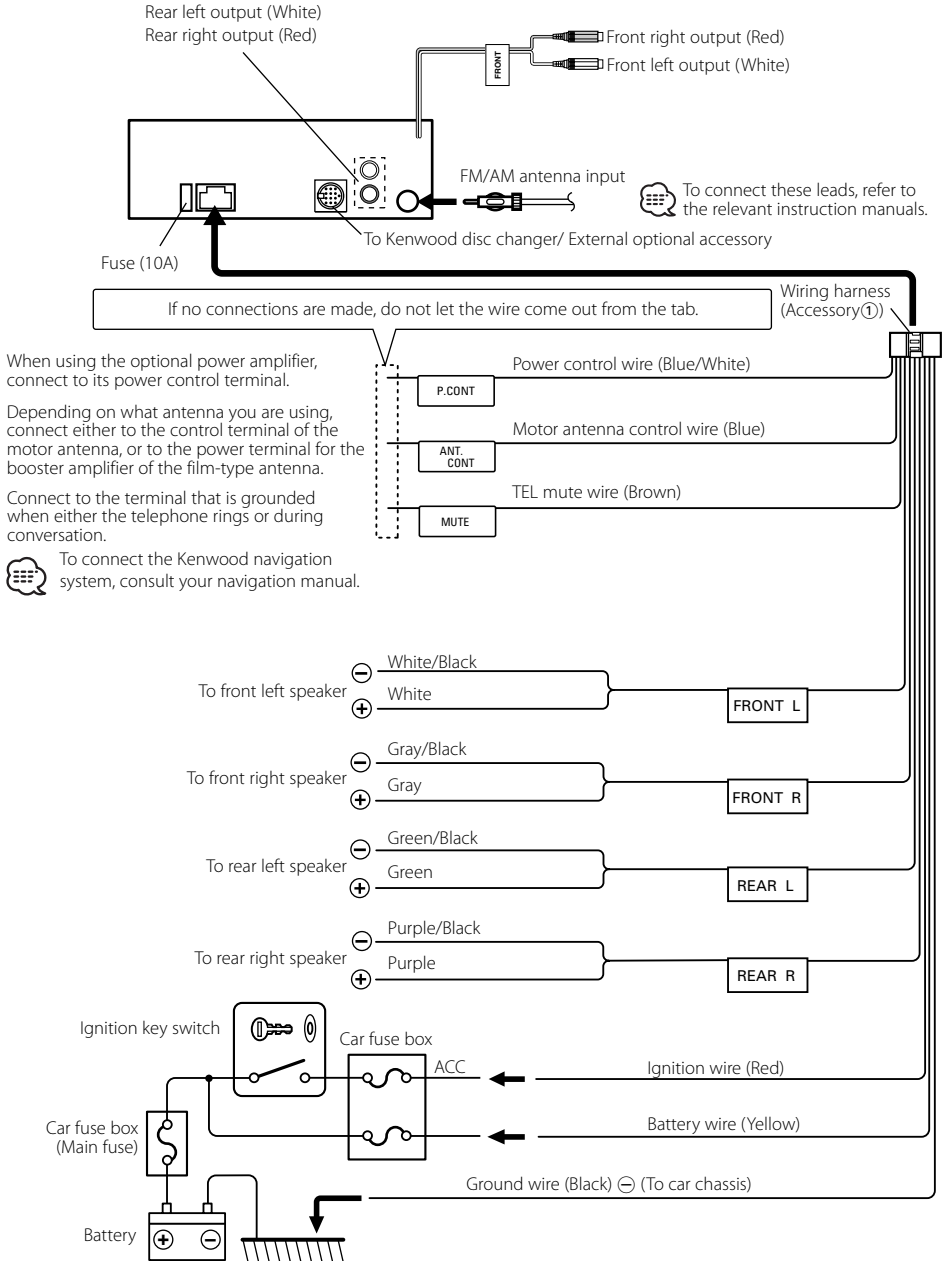

Installation

non-Japanese cars

Metal mounting strap
(commercially available)

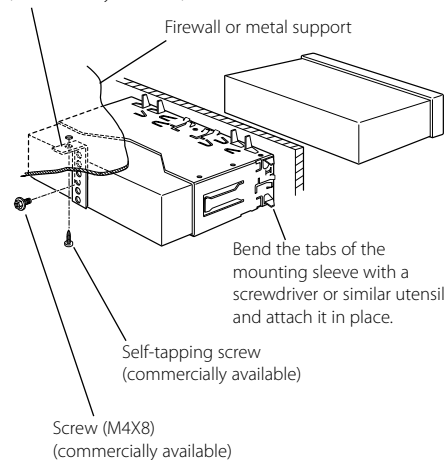

- Make sure that the unit is installed securely in place. If the unit is unstable, it may malfunction (for example, the sound may skip).

Japanese cars

- 1 Refer to the section <Removing the hard rubber frame> (page 31) and then remove the hard rubber frame.
- 2 Align the holes in the unit (two locations on each side) with the vehicle mounting bracket and secure the unit with the accessory screws.

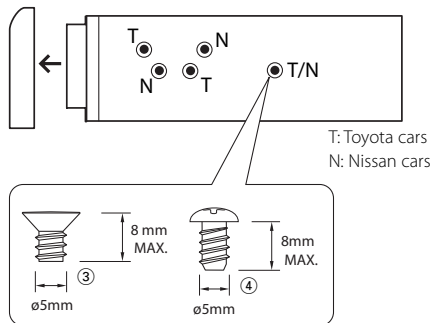

Accessory③...for Nissan car

Accessory④...for Toyota car



- During installation, do not use any screws except for those provided. The use of different screws might result in damage to the main unit.
- Damage may occur if a screwdriver or similar tool is used with excessive force during the installations.

Installation

Screwing the Faceplate on the Unit

If you want to fasten the faceplate to the main unit so that it does not fall off.

- 1 Refer to the section <Removing the hard rubber frame> (page 31) and then remove the hard rubber frame.
- 2 Drop open the faceplate by pressing the Release button.

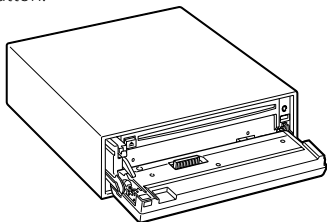

- 3 Tighten the screw ($\varnothing 2 \times 5$ mm) (Accessory⑤) and bracket (Accessory⑥) in the hole shown on the diagram.

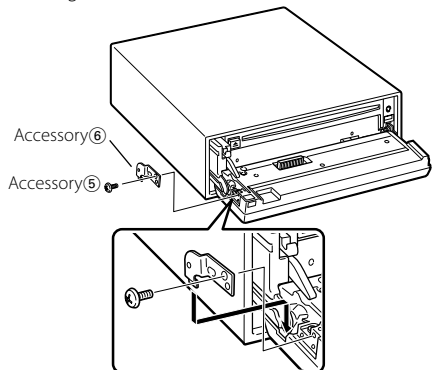

- 4 Tighten the screw ($\varnothing 2 \times 5$ mm) (Accessory⑤) and bracket (Accessory⑦) in the hole shown on the diagram.

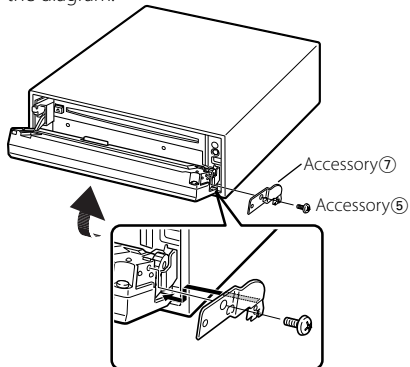

- Never insert the screws in any other screw hole than the one specified. If you screw them in another hole, it will contact and may cause damage to the mechanical parts inside the unit.

Removing the Unit

Removing the hard rubber frame

- 1 Engage the catch pins on the removal tool and remove the two locks on the upper level. Upper the frame and pull it forward as shown in the figure.

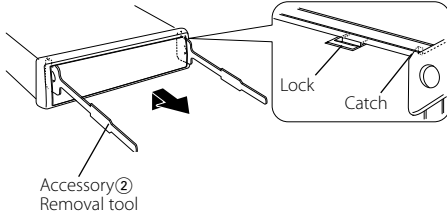

- 2 When the upper level is removed, remove the lower two locations.

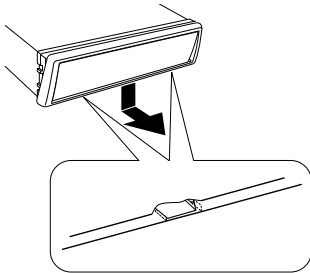

- The frame can be removed from the bottom side in the same manner.

Removing the Unit

- 1 Refer to the section <Removing the hard rubber frame> (page 31) and then remove the hard rubber frame.
- 2 Remove the screw (M4 × 8) on the back panel.
- 3 Insert the two removal tools deeply into the slots on each side, as shown.

Screw (M4X8)
(commercially available)

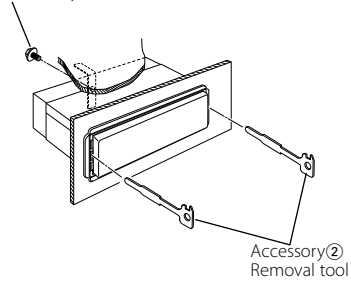

- 4 Lower the removal tool toward the bottom, and pull out the unit halfway while pressing towards the inside.

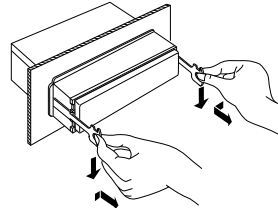

- Be careful to avoid injury from the catch pins on the removal tool.

- 5 Pull the unit all the way out with your hands, being careful not to drop it.

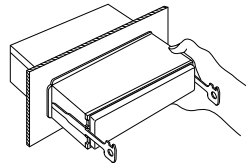

Troubleshooting Guide

What might seem to be a malfunction in your unit may just be the result of slight misoperation or miswiring. Before calling service, first check the following table for possible problems.

General

? The power does not turn ON.

- ✓ The fuse has blown.
 - ☞ Set the media you want to listen to. If there's no media in this unit, you can't switch to each source.

? There's a source you can't switch.

- ✓ There's no media inserted.
 - ☞ Connect the Disc changer. If the Disc changer isn't connected to its input terminal, You can't switch to an external disc source.

? The memory is erased when the ignition is turned OFF.

- ✓ The ignition and battery wire are incorrectly connected.
 - ☞ Connect the wire correctly, referring to the section on <Connecting Wires to Terminals> (page 27, 28).

? The TEL mute function does not work.

- ✓ The TEL mute wire is not connected properly.
 - ☞ Connect the wire correctly, referring to the section on <Connecting Wires to Terminals> (page 27, 28).

? The TEL mute function turns ON even though the TEL mute wire is not connected.

- ✓ The TEL mute wire is touching a metal part of the car.
 - ☞ Pull the TEL mute wire away from the metal part of the car.

? Even if Loudness is turned ON, high-pitched tone isn't compensated for.

- ✓ Tuner source is selected.
 - ☞ High-pitched tone isn't compensated for when in Tuner source.

? No sound can be heard, or the volume is low.

- ✓ The fader or balance settings are set all the way to one side.
 - ☞ Center the fader and balance settings.
- ✓ The input/output wires or wiring harness are connected incorrectly.
 - ☞ Reconnect the input/output wires or the wiring harness correctly. See the section on <Connecting Wires to Terminals> (page 27, 28).
- ✓ The values of Volume offset are low.
 - ☞ Turn up the Volume offset, referring to the section on <Audio Setup> (page 9).
- ✓ The <Built-in Amp Setting> (page 22) is OFF.
 - ☞ Turn it ON.

? The sound quality is poor or distorted.

- ✓ One of the speaker wires is being pinched by a screw in the car.
 - ☞ Check the speaker wiring.
- ✓ The speakers are not wired correctly.
 - ☞ Reconnect the speaker wires so that each output terminal is connected to a different speaker.

? The Touch Sensor Tone doesn't sound.

- ✓ The preout jack is being used.
 - ☞ The Touch Sensor Tone can't be output from the preout jack.

? The Dimmer function doesn't work.

- ✓ The Dimmer wire isn't connected correctly.
 - ☞ Check the Dimmer wire connection.
- ✓ The <Dimmer> (page 21) is OFF.
 - ☞ Turn it ON.

? The display blacks out while scrolling.

- ✓ <Display Illumination Control> is set to OFF.
 - ☞ Refer to <Display Illumination Control> (page 21).

Tuner source

? Radio reception is poor.

- ✓ The car antenna is not extended.
 - ☞ Pull the antenna out all the way.
- ✓ The antenna control wire is not connected.
 - ☞ Connect the wire correctly, referring to the section on <Connecting Wires to Terminals> (page 27, 28).

? The desired frequency can't be entered with the Direct Access Tuning.

- ✓ A station that can't be received is being entered.
 - ☞ Enter a station that can be received.
- ✓ You're trying to enter a frequency with a 0.01 MHz unit.
 - ☞ What can be designated in the FM band is to 0.1 MHz.

Disc source

? "AUX EXT" is displayed without achieving External disc control mode.

- ✓ Unsupported disc changer is connected.
 - ℹ️ Use the disc changer mentioned in the <About CD players/disc changers connected to this unit> (page 3) of the section on <Safety precautions>.

? The specified disc does not play, but another one plays instead.

- ✓ The specified CD is quite dirty.
 - ℹ️ Clean the CD.
- ✓ The disc is loaded in a different slot from that specified.
 - ℹ️ Eject the disc magazine and check the number for the specified disc.
- ✓ The disc is severely scratched.
 - ℹ️ Try another disc instead.

? Can't remove disc.

- ✓ The cause is that more than 10 minutes has elapsed since the vehicle ACC switch was turned OFF.
 - ℹ️ The disc can only be removed within 10 minutes of the ACC switch being turned OFF. If more than 10 minutes has elapsed, turn the ACC switch ON again and press the Eject button.

? The disc won't insert.

- ✓ There's already another disc inserted.
 - ℹ️ Press the [▲] button and remove the disc.

? Direct Search can't be done.

- ✓ Another function is ON.
 - ℹ️ Turn Random Play or other functions OFF.

? Track Search can't be done.

- ✓ For the discs/folders first or last song.
 - ℹ️ For each disc/folder, Track Search can't be done in the backward direction for the first song or in the forward direction for the last song.

Audio file source

? Cannot play an Audio file.

- ✓ The media is scratched or dirty.
 - ℹ️ Clean the media, referring to the CD cleaning of the section on <About CDs> (page 5).

? The sound skips when an Audio file is being played.

- ✓ The media is scratched or dirty.
 - ℹ️ Clean the media, referring to the CD cleaning of the section on <About CDs> (page 5).
- ✓ The recording condition is bad.
 - ℹ️ Record the media again or use another media.

? The Audio file track time isn't displayed correctly.

- ✓ ---
 - ℹ️ There are times when it isn't displayed correctly according to the Audio file recording conditions.

? Supreme does not take effect when it is turned ON.

- ✓ Little high-frequency component.
 - ℹ️ Supreme would not take effect with songs with little high-frequency component.
- ✓ Songs that have not been encoded at bit rates at 96 kbps or less (fs = 32k, 44.1 k, 48 kHz) or those that have been encoded at a variable bit rate cannot be decoded to reproduce their high-frequency components.

ℹ️ ---

Troubleshooting Guide

The messages shown below display your systems condition.

EJECT:	No disc magazine has been loaded in the changer. The disc magazine is not completely loaded. ⇨ Load the disc magazine properly. No CD in the unit. ⇨ Insert the CD.	HOLD:	The protective circuit in the unit activates when the temperature inside the automatic disc changer exceeds 60°C (140°F), stopping all operation. ⇨ Cool down the unit by opening the windows or turning on the air conditioner. As the temperature falls below 60°C (140°F), the disc will start playing again.
NO DISC:	No disc has been loaded in the disc magazine. ⇨ Load a disc into the disc magazine.	LOAD:	Discs are being exchanged in the Disc changer.
TOC ERR:	No disc has been loaded in the disc magazine. ⇨ Load a disc into the disc magazine. The CD is quite dirty. The CD is upside-down. The CD is scratched a lot. ⇨ Clean the CD and load it correctly.	READING:	The unit is reading the data on the disc.
E-05:	The CD is upside-down. ⇨ Load the CD correctly.	IN (Blink):	The CD player section is not operating properly. ⇨ Reinsert the CD. If the CD cannot be ejected or the display continues to flash even when the CD has been properly reinserted, please switch off the power and consult your nearest service center.
BLANK:	Nothing has been recorded on the MD.	PROTECT:	The speaker wire has a short-circuit or touches the chassis of the vehicle, and then the protection function is activated. ⇨ Wire or insulate the speaker cable properly and press the reset button.
NO TRACK:	No tracks are recorded on the MD, although it has a title.	NA FILE:	An Audio file is played with a format that this unit can't support. ⇨ ----
E-15:	Media was played that doesn't have data recorded that the unit can play. ⇨ Use media that has data recorded that the unit can play.	COPY PRO:	A copy-protected file is played. ⇨ ----
NO PANEL:	The faceplate of the slave unit being connected to this unit has been removed. ⇨ Replace it.		
E-77:	The unit is malfunctioning for some reason. ⇨ Press the reset button on the unit. If the "E-77" code does not disappear, consult your nearest service center.		
E-99:	Something is wrong with the disc magazine. Or the unit is malfunctioning for some reason. ⇨ Check the disc magazine. And then press the reset button on the unit. If the "E-99" code does not disappear, consult your nearest service center.		

Specifications

Specifications subject to change without notice.

FM tuner section

- Frequency range (50 kHz space)
 - : 87.5 MHz – 108.0 MHz
- Frequency range (200 kHz space)
 - : 87.9 MHz – 107.9 MHz
- Usable sensitivity (S/N = 30dB)
 - : 9.3dBf (0.8 μ V /75 Ω)
- Quieting Sensitivity (S/N = 50dB)
 - : 15.2dBf (1.6 μ V /75 Ω)
- Frequency response (\pm 3.0 dB)
 - : 30 Hz – 15 kHz
- Signal to Noise ratio (MONO)
 - : 70 dB
- Selectivity (\pm 400 kHz)
 - : \geq 80 dB
- Stereo separation (1 kHz)
 - : 40 dB

AM tuner section

- Frequency range (9 kHz space)
 - : 531 kHz – 1611 kHz
- Frequency range (10 kHz space)
 - : 530 kHz – 1700 kHz
- Usable sensitivity (S/N = 20dB)
 - : 28 dB μ (25 μ V)

CD player section

- Laser diode
 - : GaAlAs
- Digital filter (D/A)
 - : 8 Times Over Sampling
- D/A Converter
 - : 1 Bit
- Spindle speed
 - : 1000 – 400 rpm (CLV 2times)
- Wow & Flutter
 - : Below Measurable Limit
- Frequency response (\pm 1 dB)
 - : 10 Hz – 20 kHz
- Total harmonic distortion (1 kHz)
 - : 0.008 % (KDC-MP6533)
 - : 0.01 % (KDC-MP5033)
- Signal to Noise ratio (1 kHz)
 - : 110 dB (KDC-MP6533)
 - : 105 dB (KDC-MP5033)
- Dynamic range
 - : 93 dB
- MP3 decode
 - : Compliant with MPEG-1/2 Audio Layer-3
- WMA decode
 - : Compliant with Windows Media Audio
- AAC decode
 - : AAC-LC ".m4a" files

Audio section

- Maximum output power
 - : 50 W x 4
- Full Bandwidth Power (at less than 1% THD)
 - : 22 W x 4
- Speaker impedance
 - : 4 - 8 Ω
- Tone action
 - Bass : 100 Hz \pm 8 dB
 - Middle : 1 kHz \pm 8 dB
 - Treble : 10 kHz \pm 8 dB
- Preout level / Load (during disc play)
 - : 4000 mV/10 k Ω (KDC-MP6533)
 - : 2000 mV/10 k Ω (KDC-MP5033)
- Preout impedance
 - : \leq 600 Ω

General

- Operating voltage (11 – 16V allowable)
 - : 14.4 V
- Current consumption
 - : 10 A
- Installation Size (W x H x D)
 - : 182 x 53 x 155 mm
- Weight
 - : 1.40 kg

KENWOOD