

# OMRON®

## INSTRUCTION MANUAL

# Blood Pressure Monitor

Model BP710NVA



ENGLISH

# TABLE OF CONTENTS

## Before using the monitor

INTRODUCTION .....	3
IMPORTANT SAFETY INFORMATION.....	4

## Operating Instructions

1. KNOW YOUR DEVICE .....	7
1.1 Display symbols.....	9
1.2 Before Taking a Measurement.....	10
2. PREPARATION .....	11
2.1 Battery Installation .....	11
3. USING THE DEVICE .....	12
3.1 Applying the Arm Cuff.....	12
3.2 How to Sit Correctly.....	14
3.3 Taking a Measurement .....	15
3.4 Using the Memory Function.....	18

## Care and Maintenance

4. ERROR MESSAGES AND TROUBLESHOOTING .....	20
4.1 Error Messages .....	20
4.2 Troubleshooting.....	22
5. MAINTENANCE AND STORAGE .....	23
5.1 Maintenance .....	23
5.2 Storage .....	24
5.3 Optional Medical Accessories .....	25
6. SPECIFICATIONS.....	26
7. FCC STATEMENT.....	27
8. LIMITED WARRANTY.....	28
9. GUIDANCE AND MANUFACTURER'S DECLARATION .....	30

# INTRODUCTION

Thank you for purchasing the OMRON BP710NVA Blood Pressure Monitor.

Your new blood pressure monitor uses the oscillometric method of blood pressure measurement. This means the monitor detects your blood movement through your brachial artery and converts the movements into a digital reading. An oscillometric monitor does not need a stethoscope so the monitor is simple to use.

## **Intended Use**

This device is a digital monitor intended for use in measuring blood pressure and pulse rate in adult patient population. The device detects the appearance of irregular heartbeats during measurement and gives a warning signal with the measurement result.

 Please read this instruction manual thoroughly before using the device. Please keep for future reference. For specific information about your own blood pressure, CONSULT YOUR PHYSICIAN.

# IMPORTANT SAFETY INFORMATION

**⚠ Warning:** Indicates a potentially hazardous situation which, if not avoided, could result in death or serious injury.

## **(General Usage)**

- ⚠ DO NOT adjust medication based on measurement results from this blood pressure monitor. Take medication as prescribed by your physician. Only a physician is qualified to diagnose and treat High Blood Pressure.
- ⚠ The monitor is not intended to be a diagnostic device.
- ⚠ Consult your physician before using the device for any of the following conditions: common arrhythmias such as atrial or ventricular premature beats or atrial fibrillation, arterial sclerosis, poor perfusion, diabetes, age, pregnancy, pre-eclampsia, renal diseases.  
Note that PATIENT motion, trembling, shivering may affect the measurement reading.
- ⚠ Do not use the device on the injured arm or the arm under medical treatment.
- ⚠ Do not apply the arm cuff on the arm while being on an intravenous drip or blood transfusion.
- ⚠ Consult your physician before using the device on the arm with an arterio-venous (A-V) shunt.
- ⚠ Do not use the device with other medical electrical (ME) equipment simultaneously.
- ⚠ Do not use the device in the area the HF surgical equipment, MRI, or CT scanner exists, or in the oxygen rich environment.
- ⚠ The air tube may cause accidental strangulation in children, toddlers or infants.
- ⚠ Contains small parts that may cause a choking hazard if swallowed by children, toddlers or infants.

## **(Battery Usage)**

- ⚠ Keep the battery out of reach of children, toddlers or infants.

# IMPORTANT SAFETY INFORMATION

**⚠ Caution:** Indicates a potentially hazardous situation which, if not avoided, may result in minor or moderate injury to the user or patient or damage to the equipment or other property.

## (General Usage)

- ⚠ Always consult your physician. Self-diagnosis of measurement results and self-treatment are dangerous.
- ⚠ Consult your physician before using the device if you have had a mastectomy.
- ⚠ Consult your physician before using the device if you have severe blood flow problems or blood disorders as cuff inflation can cause bruising.
- ⚠ Do not take measurements more often than necessary. It may cause bruising due to blood flow interference.
- ⚠ Remove the arm cuff if it does not start deflating during the measurement.
- ⚠ Do not use this device on infants or persons who cannot express their intentions.
- ⚠ Do not use the device for any purpose other than measuring blood pressure.
- ⚠ Use only the approved arm cuff for this device. Use of other arm cuffs may result in incorrect measurement results.
- ⚠ Do not use a mobile phone or other devices that emit electromagnetic fields, near the device. This may result in incorrect operation of the device.
- ⚠ Do not disassemble the monitor or arm cuff. This may cause an inaccurate reading.
- ⚠ Do not use in a location with moisture, or a location where water may splash on the device. This may damage the device.
- ⚠ Do not use the device in a moving vehicle (car, airplane).
- ⚠ Read "If your systolic pressure is more than 210 mmHg" of this instruction manual, if your systolic pressure is known to be more than 210 mmHg. Inflating to a higher pressure than necessary may result in bruising where the arm cuff is applied.

# IMPORTANT SAFETY INFORMATION

## **(Battery Usage)**

- ⚠ Do not insert the batteries with their polarities incorrectly aligned.
- ⚠ Use only 4 “AA” alkaline or manganese batteries with this device. Do not use other types of batteries. Do not use new and used batteries together.
- ⚠ Remove the batteries if the device will not be used for three months or more.

## **General Precautions**

- Do not forcibly crease the arm cuff or the air tube excessively.
- Do not press the air tube while taking a measurement.
- To unplug the air plug, pull on the air plug at the connection with the monitor, not the tube itself.
- Do not drop the monitor or subject device to strong shocks or vibrations.
- Do not inflate the arm cuff when it is not wrapped around your arm.
- Do not use the device outside the specified environment. It may cause an inaccurate reading.
- Dispose of the device, components and optional accessories according to applicable local regulations. Unlawful disposal may cause environmental pollution.

# 1. KNOW YOUR DEVICE

## Contents:

Monitor, arm cuff, battery set, instruction manual, quick start guide

## Monitor:

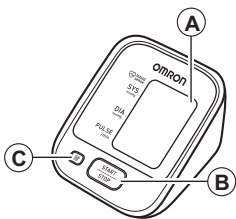

- A. Display
- B. START/STOP button
- C. Memory button

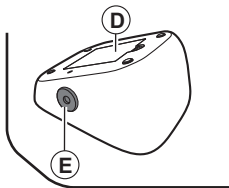

- D. Battery compartment
- E. Air jack

## Arm cuff:

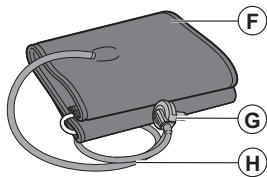

- F. Arm cuff  
(Arm circumference 9" - 17" (22 - 42 cm))
- G. Air plug
- H. Air tube

# 1. KNOW YOUR DEVICE

## Display:

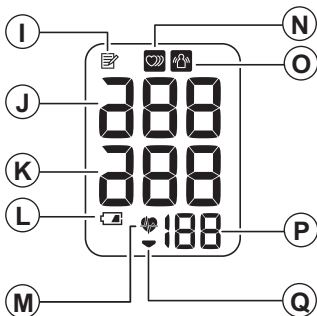

- |  |                                  |
|--|----------------------------------|
| I. Memory symbol                                     | N. Irregular heartbeat symbol    |
| J. Systolic blood pressure                           | O. Movement error symbol         |
| K. Diastolic blood pressure                          | P. Pulse display / Memory number |
| L. Low battery symbol                                | Q. Deflation symbol              |
| M. Heartbeat symbol<br>(Flashes during measurement.) |                                  |



# 1. KNOW YOUR DEVICE

## 1.1 Display symbols

### Irregular Heartbeat Symbol (🫀)

When the monitor detects an irregular rhythm two or more times during the measurement, the irregular heartbeat symbol will appear on the display with the measurement values.

An irregular heartbeat rhythm is defined as a rhythm that is 25% less or 25% more than the average rhythm detected while the monitor is measuring the systolic and diastolic blood pressure.

If the irregular heartbeat symbol displays with your measurement results, we recommend you consult your physician. Follow the directions of your physician.

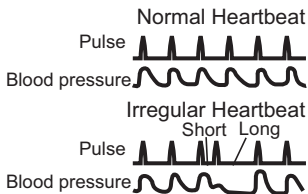

### Movement Error Symbol (🚫)

The movement error symbol is displayed if you move your body during the measurement. Please remove the arm cuff, and wait 2 - 3 minutes.

Take another measurement, remain still during measurement.

## 2013 ESH/ESC Guidelines for the management of arterial hypertension

Definitions of hypertension by office and home blood pressure levels

	Office	Home
Systolic Blood Pressure	≥ 140 mmHg	≥ 135 mmHg
Diastolic Blood Pressure	≥ 90 mmHg	≥ 85 mmHg

These are from statistical values for blood pressure.

# 1. KNOW YOUR DEVICE

## 1.2 Before Taking a Measurement

To help ensure an accurate reading, follow these directions:

1. Avoid bathing, drinking alcohol or caffeine, smoking, exercising and eating for 30 minutes before taking a measurement. Rest for at least 15 minutes before taking the measurement.
2. Stress raises blood pressure. Avoid taking measurements during stressful times.
3. Measurements should be taken in a quiet place.
4. Remove tight-fitting clothing from your arm.
5. Sit on a chair with your feet flat on the floor. Rest your arm on a table so that the arm cuff is at the same level as your heart.
6. Remain still and do not talk during the measurement.
7. Keep a record of your blood pressure and pulse readings for your physician.

A single measurement does not provide an accurate indication of your true blood pressure. You need to take and record several readings over a period of time.

Try to measure your blood pressure at the same time each day for consistency.

## 2. PREPARATION

### 2.1 Battery Installation

1. Remove the battery cover.

2. Insert 4 “AA” batteries as indicated in the battery compartment.

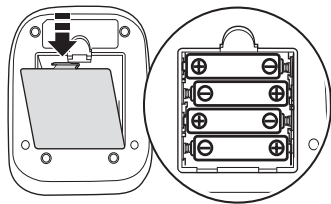

3. Replace the battery cover.

Notes:

- When the low battery symbol (  ) appears on the display, turn the monitor off, then replace all batteries at the same time. Long life alkaline batteries are recommended.
- The measurement values continue to be stored in memory even after the batteries are replaced.
- Dispose of the device, components and optional accessories according to applicable local regulations. Unlawful disposal may cause environmental pollution.

## 3. USING THE DEVICE

### 3.1 Applying the Arm Cuff

Remove tight-fitting clothing or tight rolled up sleeve from your left upper arm. Do not place the arm cuff over thick clothes.

1. Insert the air plug into the air jack securely.



2. Wrap the arm cuff firmly in place around your left upper arm.



The bottom edge of the arm cuff should be 1/2 inch (1 to 2 cm) above the elbow. Air tube is on the inside of your arm and aligned with your middle finger.

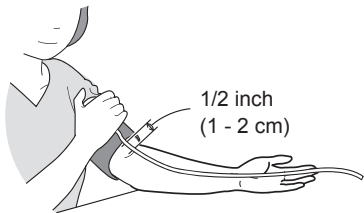

### 3. USING THE DEVICE

3. Secure closed with the fabric fastener.

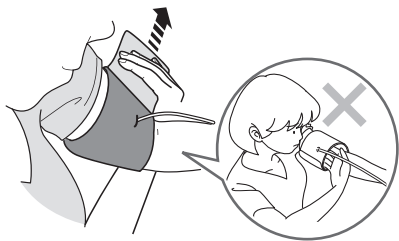

Notes:

- When you take a measurement on the right arm, the air tube will be at the side of your elbow. Be careful not to rest your arm on the air tube.
- The blood pressure can differ between the right arm and the left arm, and the measured blood pressure values can be different. OMRON recommends to always use the same arm for measurement. If the values between both arms differ substantially, please check with your physician which arm to use for your measurements.



## 3. USING THE DEVICE

### 3.2 How to Sit Correctly

To take a measurement, you need to be relaxed and comfortably seated, under comfortable room temperature. Avoid bathing, drinking alcohol or caffeine, smoking, exercising or eating 30 minutes before taking a measurement.

- Sit on a chair with your feet flat on the floor.
- Sit upright with your back straight.
- Sit with your back and arm being supported.
- The arm cuff should be placed on your arm at the same level as your heart.

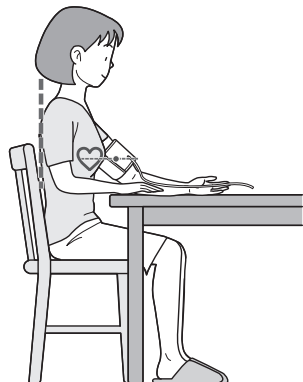

## 3. USING THE DEVICE

### 3.3 Taking a Measurement

Notes:

- To stop the measurement, press the START/STOP button once to deflate the arm cuff.
- Remain still and quiet while taking a measurement.

### 3. USING THE DEVICE

#### 1. Press the START/STOP button.

The arm cuff will start to inflate automatically.

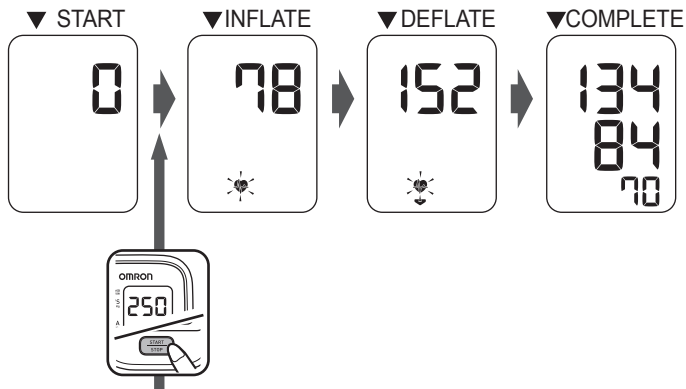

#### ***If your systolic pressure is more than 210 mmHg***

After the arm cuff starts to inflate, press and hold the START/STOP button until the monitor inflates 30 to 40 mmHg higher than your expected systolic pressure.

#### **Notes:**

- The monitor will not inflate above 299 mmHg.

⚠ Inflating to a higher pressure than necessary may result in bruising where the arm cuff is applied.



## 3. USING THE DEVICE

---

2. Remove the arm cuff.

---

3. Press the START/STOP button to turn the monitor off.

The monitor automatically stores the measurement result in its memory. It will automatically turn off after 2 minutes.

Note: Wait 2-3 minutes before taking another measurement. Waiting between measurements allows the arteries to return to the condition prior to taking a measurement.

⚠ DO NOT adjust medication based on measurement results from this blood pressure monitor. Take medication as prescribed by your physician. Only a physician is qualified to diagnose and treat High Blood Pressure.

⚠ This device is not intended to be a diagnostic device.

⚠ Always consult your physician. Self-diagnosis of measurement results and self-treatment are dangerous.

⚠ Inflating to a higher pressure than necessary may result in bruising where the arm cuff is applied.

## 3. USING THE DEVICE

### 3.4 Using the Memory Function

The monitor automatically stores the results up to 14 sets.

Note: If the memory is full, the monitor will delete the oldest value.

#### *To View the Measurement Values Stored in Memory*

---

1. Press the  button.

The Memory number appears for a second before the pulse rate is displayed.

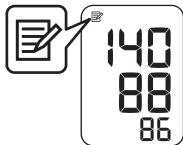

The newest set is numbered "1".



2. Press the  button repeatedly to view the values stored in memory.
-

### 3. USING THE DEVICE

#### *To Delete All the Values Stored in Memory*



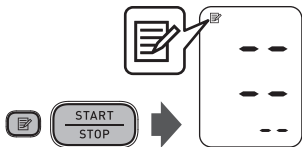

1. Press the  button, while the memory symbol appears.
2. While holding the  button down, press the START/STOP button for more than 3 seconds.



Note: You cannot partially delete the values stored in the memory.

## 4. ERROR MESSAGES AND TROUBLESHOOTING

### 4.1 Error Messages

Error Display	Cause	Solution
	Irregular heartbeats are detected.	Remove the arm cuff. Wait 2 - 3 minutes and then take another measurement. Repeat the steps in section 3.3. If this error continues to appear, contact your physician.
	Movement during measurement.	Carefully read and repeat the steps in section 3.3.
	The batteries are low.	You should replace the batteries with new ones ahead of time. Refer to section 2.1.
	The batteries are exhausted.	You should replace the batteries with new ones at once. Refer to section 2.1.
<b>E 1</b>	Air plug disconnected.	Insert the plug securely. Refer to section 3.1.
	Arm cuff is applied too loosely.	Apply the arm cuff tighter. Refer to section 3.1.
	Air is leaking from the arm cuff.	Replace the arm cuff with a new one. Refer to section 5.3.

## 4. ERROR MESSAGES AND TROUBLESHOOTING

Error Display	Cause	Solution
E2	Movement during measurement and the arm cuff has not been inflated sufficiently.	Repeat measurement. Remain still and do not talk during measurement. Refer to section 3.3.
		If “E2” appears repeatedly, inflate the arm cuff manually until it is 30 to 40 mmHg above your previous measurement result. Refer to section 3.3.
E3	The arm cuff was inflated exceeding the maximum allowable pressure, and then deflated automatically when inflating the arm cuff manually.	Do not touch the arm cuff and/or bend the air tube while taking a measurement. Do not inflate the arm cuff more than necessary. Refer to section 3.3.
E4	Movement during measurement.	Repeat measurement. Remain still and do not talk during measurement. Refer to section 3.3.
E5	Clothing is interfering with the arm cuff.	Remove any clothing interfering with the arm cuff. Refer to section 3.1.
Er	Device error.	Contact Customer Service.

## 4. ERROR MESSAGES AND TROUBLESHOOTING

### 4.2 Troubleshooting

Problem	Cause and Solution
No power. No display appears on the monitor.	Replace all batteries with new ones. Check the battery installation for proper placement of the battery polarities. Refer to section 2.1.
Measurement values appear too high or too low.	Blood pressure varies constantly. Many factors including stress, time of day, and how you wrap the cuff, may affect your blood pressure. Review the section 1.2 and section 3.3.

## 5. MAINTENANCE AND STORAGE

### 5.1 Maintenance

To protect your device from damage, please observe the following:

- Store the device and the components in a clean, safe location.
- Do not use any abrasive or volatile cleaners.
- Do not wash the device and any components or immerse them in water.
- Do not use gasoline, thinners or similar solvents to clean the device.

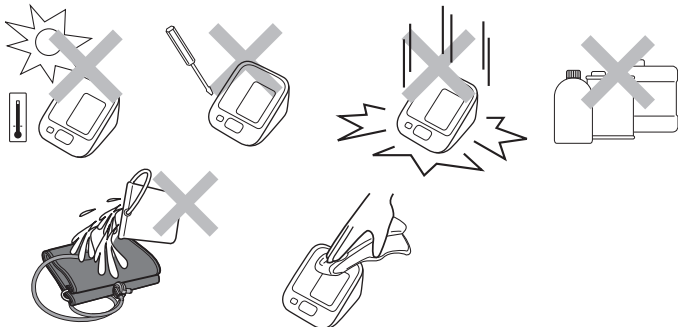

- Use a soft and dry cloth, or a soft and moistened cloth and neutral soap to clean on the monitor and the arm cuff.
- Changes or modification not approved by the manufacturer will void the user warranty. Do not disassemble or attempt to repair the device or components. Consult Customer Service.

## 5. MAINTENANCE AND STORAGE

### 5.2 Storage

1. Unplug the air plug from the air jack.
2. Gently fold the air tube into the arm cuff.

Note: Do not bend or crease the air tube excessively.

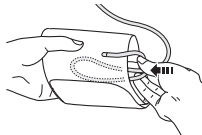

Do not store the device in the following situations:

- If the device is wet.
- Locations exposed to extreme temperatures, humidity, direct sunlight, dust or corrosive vapors such as bleach.
- Locations exposed to vibrations, shocks or where it will be at an angle.



## 5. MAINTENANCE AND STORAGE

### 5.3 Optional Medical Accessories

Arm circumference  
7" - 9" (17 - 22 cm)



CD-CS9  
(Model: HEM-CS24)

#### Arm cuff

Arm circumference  
9" - 17" (22 - 42 cm)



CD-WR17  
(Model: HEM-RML31)

## 6. SPECIFICATIONS

<b>Model</b>	BP710NVA <b>REF</b> HEM-7121-ZVA
<b>Display</b>	LCD digital display
<b>Measurement range</b>	Pressure: 0 to 299 mmHg Pulse: 40 to 180 beats / min.
<b>Accuracy</b>	Pressure: $\pm 3$ mmHg or 2% of reading Pulse: $\pm 5\%$ of display reading
<b>Inflation</b>	Fuzzy-logic controlled by electric pump
<b>Deflation</b>	Automatic pressure release valve
<b>Measurement method</b>	Oscillometric method
<b>IP classification</b>	IP 20
<b>Power source</b>	4 "AA" batteries 1.5V
<b>Battery life</b>	Approximately 1000 measurements (using new alkaline batteries)
<b>Operating temperature / humidity / air pressure</b>	50°F to 104°F (10°C to 40°C) / 15 to 90% RH / 700 to 1060 hPa
<b>Storage temperature / humidity / air pressure</b>	-4°F to 140°F (-20°C to 60°C) / 10 to 95% RH / 700 to 1060 hPa
<b>Weight</b>	Monitor : Approximately 8 7/8 oz. (250 g) not including batteries Arm cuff : Approximately 6 oz. (170 g)
<b>Dimensions</b>	Monitor : Approximately 4" (w) $\times$ 3 1/8" (h) $\times$ 5 1/8" (l) (103 mm $\times$ 80 mm $\times$ 129 mm) Arm cuff : Approximately 5 3/4" $\times$ 23 1/2" (air tube: 29 1/2") (145 mm $\times$ 594 mm (air tube: 750 mm))
<b>Cuff circumference</b>	9" to 17" (22 to 42 cm)
<b>Memory</b>	Up to 14
<b>Contents</b>	Monitor, arm cuff, battery set, instruction manual, quick start guide
<b>Applied part</b>	 = Type BF
<b>Protection against electric shock</b>	Internally powered ME equipment

### Notes:

- These specifications are subject to change without notice.
- In the clinical validation study, the 5th phase was used on 85 subjects for determination of diastolic blood pressure.
- This device has not been validated for use on pregnant patients.

## 7. FCC STATEMENT

### FCC CAUTION

Changes or modifications not expressly approved by the party responsible for compliance could void the user's authority to operate the equipment.

#### Note:

This equipment has been tested and found to comply with the limits for a Class B digital device, pursuant to part 15 of the FCC Rules. These limits are designed to provide reasonable protection against harmful interference in a residential installation. This equipment generates, uses and can radiate radio frequency energy and, if not installed and used in accordance with the instructions, may cause harmful interference to radio communications. However, there is no guarantee that interference will not occur in a particular installation. If this equipment does cause harmful interference to radio or television reception, which can be determined by turning the equipment off and on, the user is encouraged to try to correct the interference by one or more of the following measures:

- Reorient or relocate the receiving antenna.
- Increase the separation between the equipment and receiver.
- Connect the equipment into an outlet on a circuit different from that to which the receiver is connected.
- Consult the dealer or an experienced radio/TV technician for help.

## 8. LIMITED WARRANTY

Your BP710NVA Blood Pressure Monitor, excluding the arm cuff and batteries, is warranted to be free from defects in materials and workmanship appearing within 2 years from the date of purchase, when used in accordance with the instructions provided with the monitor. The arm cuff is warranted to be free from defects in materials and workmanship appearing within 1 year from the date of purchase when the monitor is used in accordance with the instructions provided with the monitor. The above warranty extends only to the original retail purchaser.

We will, at our option, replace without charge any monitor or arm cuff covered by the above warranty. Replacement is our only responsibility and your only remedy under the above warranty.

To obtain warranty service contact Customer Service by calling **1-800-634-4350** for the address of the inspection center and the return shipping and handling fee.

Enclose the original printed receipt. Include a letter, with your name, address, phone number, and description of the specific problem. Pack the product carefully to prevent damage in transit. Because of possible loss in transit, we recommend insuring the product with return receipt requested.

THE FOREGOING IS THE SOLE WARRANTY PROVIDED BY OMRON IN CONNECTION WITH THIS PRODUCT, AND OMRON HEREBY DISCLAIMS ANY OTHER WARRANTIES, EXPRESS OR IMPLIED, INCLUDING IMPLIED WARRANTIES OF MERCHANTABILITY AND FITNESS FOR A PARTICULAR PURPOSE. IMPLIED WARRANTIES AND OTHER TERMS THAT MAY BE IMPOSED BY LAW, IF ANY, ARE LIMITED IN DURATION TO THE PERIOD OF THE ABOVE EXPRESS WARRANTY.

OMRON SHALL NOT BE LIABLE FOR LOSS OF USE OR ANY OTHER SPECIAL, INCIDENTAL, CONSEQUENTIAL OR INDIRECT COSTS, EXPENSES OR DAMAGES.

## 8. LIMITED WARRANTY

This warranty provides you with specific legal rights, and you may have other rights that vary by jurisdiction. Because of special local requirements, some of the above limitations and exclusions may not apply to you.

### FOR CUSTOMER SERVICE

Visit our web site at:

[www.OmronHealthcare.com](http://www.OmronHealthcare.com)

Call toll free:

1-800-634-4350

## 9. GUIDANCE AND MANUFACTURER'S DECLARATION

### OMRON Blood Pressure Monitor (BPM)

Information for accompanying documents in the scope of IEC60601-1-2:2007

#### **Important information regarding Electro Magnetic Compatibility (EMC)**

With the increased number of electronic devices such as PC's and mobile (cellular) telephones, medical devices in use may be susceptible to electromagnetic interference from other devices. Electromagnetic interference may result in incorrect operation of the medical device and create a potentially unsafe situation. Medical devices should also not interfere with other devices.

In order to regulate the requirements for EMC (Electro Magnetic Compatibility) with the aim to prevent unsafe product situations, the IEC60601-1-2 standard has been implemented. This standard defines the levels of immunity to electromagnetic interferences as well as maximum levels of electromagnetic emissions for medical devices.

Medical devices manufactured by OMRON Healthcare conform to this IEC60601-1-2:2007 standard for both immunity and emissions.

Nevertheless, special precautions need to be observed:

- The use of accessories and cables other than those specified by OMRON, with the exception of cables sold by OMRON as replacement parts for internal components, may result in increased emission or decreased immunity of the device.
- The medical devices should not be used adjacent to or stacked with other equipment. In case adjacent or stacked use is necessary, the medical device should be observed to verify normal operation in the configuration in which it will be used.
- Refer to further guidance below regarding the EMC environment in which the device should be used.
- The MEDICAL ELECTRICAL EQUIPMENT BPM needs special precautions regarding EMC and needs to be installed and put into service according to the EMC information provided in this documentations.
- The Essential Performance of the BPM is to measure a blood pressure and a pulse rate and using the memory function.

The BPM may be interfered with by other equipment, even if that other equipment complies with CISPR EMISSION requirements.

## 9. GUIDANCE AND MANUFACTURER'S DECLARATION

### Guidance and manufacturer's declaration - electromagnetic emissions

OMRON BPM is intended for use in the electromagnetic environment specified below. The customer or the user of this OMRON BPM should assure that it is used in such environment.

Emissions test	Compliance	Electromagnetic environment - guidance
RF emissions CISPR 11	Group 1	The OMRON BPM uses RF energy only for its internal function. Therefore, its RF emissions are very low and are not likely to cause any interference in nearby electronic equipment.
RF emissions CISPR 11	Class B	The OMRON BPM is suitable for use in all establishments, including domestic establishments and those directly connected to the public low-voltage power supply network that supplies buildings used for domestic purposes.
Harmonic emissions IEC 61000-3-2	Not Applicable.	
Voltage fluctuations/ flicker emissions IEC61000-3-3	Not Applicable.	

## 9. GUIDANCE AND MANUFACTURER'S DECLARATION

### Guidance and manufacturer's declaration - electromagnetic immunity

OMRON BPM is intended for use in the electromagnetic environment specified below. The customer or the user of this OMRON BPM should assure that it is used in such environment.

Immunity test	IEC 60601 test level	Compliance level	Electromagnetic environment - guidance
Electrostatic discharge (ESD) IEC 61000-4-2	±6 kV contact ±8 kV air	±6 kV contact ±8 kV air	Floor should be wood, concrete, or ceramic tile. If floors are covered with synthetic material, the relative humidity should be at least 30 %.
Electrical fast transient/burst IEC 61000-4-4	±2 kV for power supply lines ±1 kV for input/output lines	Not Applicable.	Not Applicable.
Surge IEC 61000-4-5	±1 kV line(s) to line(s) ±2 kV line(s) to earth	Not Applicable.	Not Applicable.
Voltage dips, short interruptions and voltage variations on power supply inputlines IEC 61000-4-11	<5 % $U_T$ (>95 % dip in $U_T$ ) for 0.5 cycle	Not Applicable.	Not Applicable.
	40 % $U_T$ (60 % dip in $U_T$ ) for 5 cycles		
	70 % $U_T$ (30 % dip in $U_T$ ) for 25 cycles		
	<5 % $U_T$ (>95 % dip in $U_T$ ) for 5 sec.		
Power frequency (50/60 Hz) magnetic field IEC 61000-4-8	3 A/m	3 A/m	Power frequency magnetic fields should be at levels characteristic of a typical location in a typical commercial or hospital environment.

Note:  $U_T$  is the A.C. mains voltage prior to application of the test level.



## 9. GUIDANCE AND MANUFACTURER'S DECLARATION

### Guidance and manufacturer's declaration - electromagnetic immunity

OMRON BPM is intended for use in the electromagnetic environment specified below. The customer or the user of this OMRON BPM should assure that it is used in such environment.

Immunity test	IEC 60601 test level	Compliance level	Electromagnetic environment - guidance
Conducted RF IEC 61000-4-6	3 V rms 150 kHz to 80 MHz	Not Applicable.	<p>Portable and mobile RF communications equipment should be used no closer to any part of the OMRON BPM including cables, than the recommended separation distance calculated from the equation appropriate to the frequency of the transmitter.</p> <p><b>Recommend separation distance</b></p> <p>Not Applicable.</p>
Radiated RF IEC 61000-4-3	3 V/m 80 MHz to 2.5 GHz	3 V/m	<p><math>d = 1.2 \sqrt{P}</math> 80 MHz to 800 MHz</p> <p><math>d = 2.3 \sqrt{P}</math> 800 MHz to 2.5 GHz</p> <p>where <math>P</math> is the maximum output power rating of the transmitter in watts (W) according to the transmitter manufacturer and <math>d</math> is the recommended separation distance in meters (m).</p> <p>Field strengths from fixed RF transmitters as determined by an electromagnetic site survey,<sup>a</sup> should be less than the compliance level in each frequency range.<sup>b</sup></p> <p>Interference may occur in the vicinity of equipment marked with the following symbol:</p> 

## 9. GUIDANCE AND MANUFACTURER'S DECLARATION

Note1: At 80 MHz and 800 MHz, the higher frequency range applies.

Note2: These guidelines may not apply in all situations. Electromagnetic propagation is affected by absorption and reflection from structures, objects, and people.

<sup>a</sup> Field strengths from fixed transmitters, such as base stations for radio (cellular/ cordless) telephones and land mobile radio, AM and FM radio broadcast, and TV broadcast cannot be predicted theoretically with accuracy. To assess the electromagnetic environment due to fixed RF transmitters, an electromagnetic site survey should be considered. If the measured field strength in the location in which the OMRON BPM is used exceeds the applicable RF compliance level above, the OMRON BPM should be observed to verify normal operation. If abnormal performance is observed, additional measures may be necessary, such as reorienting or relocating the OMRON BPM.

<sup>b</sup> Over the frequency range 150 kHz to 80 MHz, field strengths should be less than 3 V/m.

## 9. GUIDANCE AND MANUFACTURER'S DECLARATION

### Recommended separation distance between portable and mobile RF communications equipment and the OMRON BPM

OMRON BPM is intended for use in an electromagnetic environment in which radiated RF disturbances are controlled. The customer or the user of this OMRON BPM can help prevent electromagnetic interference by maintaining a minimum distance between portable and mobile RF communications equipment (transmitters) and the OMRON BPM as recommended below, according to the maximum output power of the communications equipment.

Output Power of Transmitter in Watt	Separation distance according to frequency of transmitter in meter		
	150 kHz to 80 MHz Not Applicable.	80 MHz to 800 MHz $d = 1.2 \sqrt{P}$	800 MHz to 2.5GHz $d = 2.3 \sqrt{P}$
0.01	Not Applicable.	0.12	0.23
0.1		0.38	0.73
1		1.2	2.3
10		3.8	7.3
100		12	23

For transmitters rated at a maximum output power not listed above, the recommended separation distance  $d$  in meters (m) can be estimated using the equation applicable to the frequency of the transmitter, where  $P$  is the maximum output power rating of the transmitter in watts (W) according to the transmitter manufacturer.

Note: At 80 MHz and 800 MHz, the separation distance for the higher frequency range applies.

Note: These guidelines may not apply in all situations. Electromagnetic propagation is affected by absorption and reflection from structures, objects, and people.

Manufactured by:  
OMRON HEALTHCARE Co., Ltd.  
53, Kunotsubo, Terado-cho, Muko, Kyoto, 617-0002 JAPAN

Distributed by:  
OMRON HEALTHCARE, INC.  
1925 West Field Court, Lake Forest, IL 60045 U.S.A.

[www.OmronHealthcare.com](http://www.OmronHealthcare.com)

© 2016 OMRON HEALTHCARE, INC.

Made in Japan

9545432-6A