



BSWA 308/309

Sound Level Meter

User Manual



GB/T 3785.1

GB/T 3785.2

JJG 188-2002

IEC 60651

IEC 60804

IEC 61672-1

BSWA 308/309 Sound Level Meter User Manual

BSWA-III-C021-04-P0274

v3.3

Copyright © 2016 BSWA Technology Co., Ltd

The specification of product is subject to changes without notice

www.bswa.com.cn

Apr. 2016

Change History

Version	Date	Changes	Handle by
1.00	2010.9.17	Original version.	Zhao Dawei, Qiao Jie
1.04	2011.3.11	Add new features.	Zhao Dawei, Qiao Jie, Huang Shan
2.00	2011.9.19	Add RS-232 protocol.	Huang Shan, Qiao Jie
2.05	2013.8.14	Update the storage module, add current save and GPS module.	Huang Shan, Wang Linzhang, Zhao Qingyun
3.0	2015.3.25	Update new version 308/309 features. Add firmware update introduction.	Qiao Jie, Huang Shan
3.1	2015.6.30	Add corrections and other data required by IEC standard.	Qiao Jie, Huang Shan
3.2	2015.10.29	Add application note in RS-232 hardware connecting.	Qiao Jie, Huang Shan
3.3	2016.04.26	Modify 1/1 octave and add 1/3 octave.	Qiao Jie, Huang Shan

THIS MATERIAL, INCLUDING DOCUMENTATION AND ANY RELATED COMPUTER PROGRAMS, IS PROTECTED BY COPYRIGHT CONTROLLED BY BSWA. ALL RIGHTS ARE RESERVED. COPYING, INCLUDING REPRODUCING, STORING, ADAPTING OR TRANSLATING, ANY OR ALL OF THIS MATERIAL REQUIRES THE PRIOR WRITTEN CONSENT OF BSWA. THIS MATERIAL ALSO CONTAINS CONFIDENTIAL INFORMATION, WHICH MAY NOT BE DISCLOSED TO OTHERS WITHOUT THE PRIOR WRITTEN CONSENT OF BSWA.

Contents

Change History	1
Contents	2
Appearance	6
Buttons of Operation	7
1. Introduction	8
1.1 General Description.....	8
1.2 Applications.....	8
1.3 Features.....	8
1.4 Function Upgrades	9
1.5 Spectification.....	9
1.6 Information for Periodic Tests	12
1.7 Key Component	13
1.8 Packing List.....	13
1.9 Packing Drawing	14
1.10 China Certification of Pattern Approval (CPA)	15
1.11 China Metrology Certification (CMC).....	16
1.12 CE Certification	17
2. The Appearance and Operation.....	18
2.1 Keypad.....	18
2.2 Microphone Connector	19
2.3 Windscreen	20
2.4 Data and Power Supply Connector.....	21
2.5 Battery	22
2.6 GPS	23
3. Measurement Screen.....	25
3.1 Icons and Meaning of Screen Display.....	25
3.2 Screen of Level Meter Mode.....	27
3.3 Screen of 1/1 Octave Mode.....	29
3.4 Screen of 1/3 Octave Mode	29

4. Operation and Setting of the Menu	31
4.1 Function	31
4.2 Calibration	32
4.2.1 Calibration by Measurement	32
4.2.2 Calibration by Cal.Factor	32
4.2.3 Conversion of Cal.Factor and Sensitivity	32
4.2.4 Process of Calibration by Measurement	33
4.3 Measurement	35
4.3.1 MEAS.Setup	35
4.3.2 MEAS.Range	37
4.3.3 ICCP Power	38
4.3.4 Profile 1~3	38
4.3.5 Alarm Threshold	39
4.3.6 Extended Function	39
4.3.7 Statistical	39
4.3.8 Time History	40
4.3.9 Octave	40
4.3.10 Custom Measure	40
4.3.11 Timer	41
4.3.12 24h Measurement by Timer	42
4.4 Setup	43
4.4.1 Contrast	43
4.4.2 Backlight	43
4.4.3 Battery	43
4.4.4 Trigger	44
4.4.5 Date & Time	44
4.4.6 Auto PWR Off	46
4.4.7 RS-232	46
4.4.8 File Manager	47
4.4.9 Boot Mode	48

4.4.10 USB Mode	49
4.4.11 GPS.....	50
4.4.12 Setup Template.....	50
4.4.13 About.....	51
4.5 Language.....	51
4.6 Output.....	51
4.6.1 AC OUT.....	51
4.6.2 DC OUT	52
4.6.3 Printer	52
4.7 Factory Settings	53
5. RS-232 Communication Protocol	54
5.1 Hardware Configuration and Settings of Interface	54
5.2 Transfer Protocol.....	54
5.2.1 Start/Stop of the Block Transfer	55
5.2.2 Device ID.....	55
5.2.3 ATTR Attribute Character	55
5.2.4 BCC (Block Check Character).....	56
5.2.5 Block Transfer Format.....	56
5.2.6 Recovery from Transmission Errors	57
5.2.7 Flow Control	58
5.2.8 Multi-Machine Operation.....	58
5.2.9 Rated Parameters	59
5.3 Instruction	59
5.3.1 Instruction List	61
5.3.2 Instruction Format.....	64
5.3.3 Instruction Describe	65
6. Operation Notes.....	99
6.1 Operation.....	99
6.2 Common Issue And Solutions.....	99
6.3 Calibration.....	100

6.4 Firmware Update.....	100
6.4.1 Install USB Driver	100
6.4.2 Firmware Update Procedure	101
6.5 Warranty	102
6.6 Customer Service Phone Number	103
Annex 1 Glossary	104
Annex 2 Adjustments at the Calibration Check Frequency	106
Annex 3 Corrections for the Typical Effects of Reflections from the Case of Sound Level Meter and Diffraction of Sound around the Microphone	107
Annex 4 Corrections of Windscreen in Free Field.....	108
Annex 5 Corrections of Electrostatic Actuator	109
Annex 6 Typical Frequency Response and Corresponding Upper Limit	110
Annex 7 Specification of 1/1 Octave Band Filter	111
Annex 8 Specification of 1/3 Octave Band Filter	112
Annex 9 Mid-band Frequencies for 1/1 Octave Band and 1/3 Octave Band Filters.....	115

Appearance



Buttons of Operation

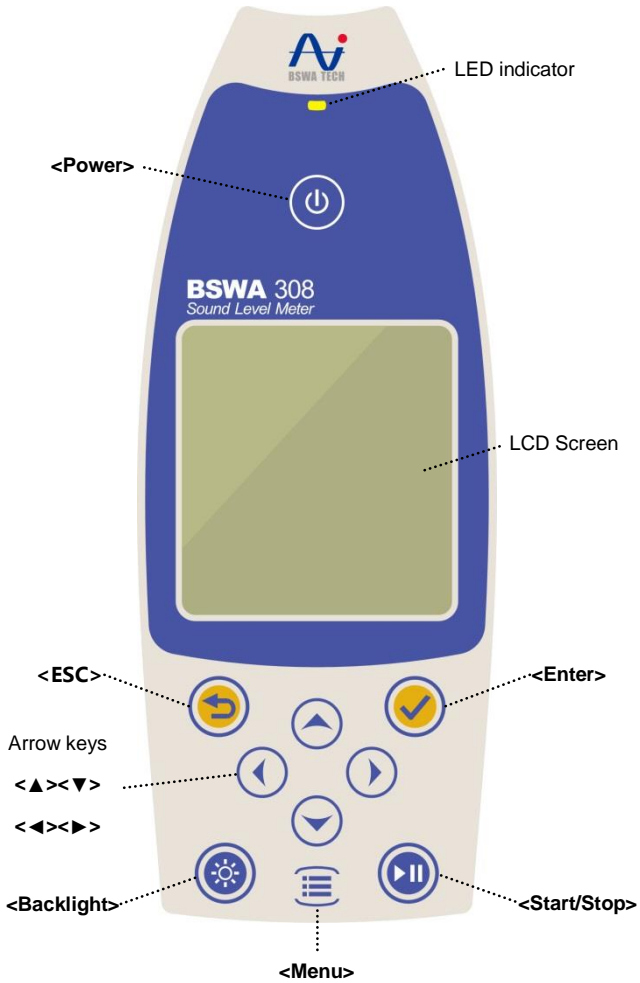

1. Introduction

1.1 General Description

The new **BSWA 308/309** are new generation octave sound level meter upgrade from base BSWA 308/309 to meet the market demand. It fulfill the 1/1 octave requirement of IEC standard and China GB/T standard.

The **BSWA 308/309** is a digital sound level meter which design and manufacture by BSWA. The use of high precision 24 Bits AD converter makes the instruments to be an ideal choice for performing many kinds of measurement, for example, environmental noise, vehicle noise and industrial application.

The new types upgrade the dual-core (DSP+ARM) architecture to single chip ARM with float point unit, and update all fix-point calculation to float-point which significantly improves the accuracy and stability. Re-design analog front end circuit also lower the noise floor and linear range of product. The new developed algorithm brings a single measurement range which can cover more than 120dB dynamic range while still meets the standard.

BSWA 308 is Class 1 and **BSWA 309** is Class 2. Both instruments have certificated by the China CPA (Certification of Pattern Approval) and CMC (China Metrology Certification).

1.2 Applications

- Basic noise measurement
- Environmental noise assessment
- Product quality check
- Evaluation of noise reduction engineering

1.3 Features

- Class 1 (**BSWA 308**) and Class 2 (**BSWA 309**) sound level meter
- Comply with IEC 61672-1:2013, ANSI S1.4-1983 and ANSI S1.43-1997
- Real-time 1/1 and 1/3 Octave in accordance with IEC 61260-1:2014 and ANSI S1.11-2004
- Linearity range: 22dBA~136dBA (**BSWA 308**), 25dBA~136dBA (**BSWA 309**)
- Single range to cover 123dB (**BSWA 308**) / 122dB (**BSWA 309**) dynamic range
- Frequency weighting: A/B/C/Z. Time weighting: Fast/Slow/Impulse
- 3-Profile and 14 custom define measurement are calculate in parallel with different



frequency/time weighting

- Calculate SPL, LEQ, Max, Min, Peak, SD, SEL, E
- LN statistical and time history curve display
- User define integral period measurement, integral period up to 24h
- High speed ARM core with FPU (Float Point Unit) to achieve wide frequency response, large dynamic range and low noise floor
- 4G MicroSD card (TF card) mass storage
- RS-232 remote control port
- Mini thermal printer for measurement data print
- Internal GPS module (option), support GPS timing

1.4 Function Upgrades

➤ Single chip high speed ARM with FPU	➤ USB port function implemented
➤ White backlight LCD	➤ Update firmware via USB (also power supply)
➤ Integral period from 1s~24h	➤ Timer feature support auto measurement
➤ 0.1s, 0.2s, 0.5s logger step added	➤ Internal GPS (option) with GPS timing
➤ 5 templates to save user setting	➤ Single range to cover 123dB dynamic range
➤ B-weighting added to for ANSI standard	➤ Reduce the noise floor (only for Class 1)
➤ Automatic power on with external supply, ease of integration	➤ Upper limit of measurement: 136dBrms/139dBpeak (40mV/Pa)

1.5 Spectification

Specifications		
Type	BSWA 308	BSWA 309
Accuracy	Class 1 (Group X)	Class 2 (Group X)
Standard	GB/T 3785.1-2010, IEC 60651:1979, IEC 60804:2000 IEC 61672-1:2013, ANSI S1.4-1983, ANSI S1.43-1997	
Octave ¹	Real-time 1/1 Octave: 8Hz~16kHz Real-time 1/3 Octave (Option): 6.3Hz~20kHz GB/T 3241-2010, IEC 61260-1:2014 ANSI S1.11-2004. Base 10 system.	Real-time 1/1 Octave: 20Hz~8kHz Real-time 1/3 Octave (Option): 20Hz~12.5kHz GB/T 3241-2010, IEC 61260-1:2014 ANSI S1.11-2004. Base 10 system.

Supplied Microphone	MPA231T: 1/2" prepolarized measurement microphone, Class 1. Sensitivity: 40mV/Pa. Frequency Range: 3Hz~20kHz.	MPA309T: 1/2" prepolarized measurement microphone, Class 2. Sensitivity: 40mV/Pa. Frequency Range: 20Hz~12.5kHz.
Mic Interface	TNC connecter with ICCP power supply (4mA)	
Detector / Filter	Fully float-point digital signal processing (digital detector and filter)	
Integral Period	Infinite or 1s~24h user define integral period. Repeat time: Infinite or 1~9999	
Logger Step	0.1s, 0.2s, 0.5s, 1s~24h	
Measurement Functions	$L_{XY(SPL)}$, L_{Xeq} , L_{XYSD} , L_{XSEL} , L_{XE} , L_{XYmax} , L_{XYmin} , L_{XPeak} , L_{XN} . Where X is the frequency weighting: A, B, C, Z; Y is time weighting: F, S, I; N is the statistical percentage: 1~99. 3-Profile and 14 custom define measurement are calculate in parallel with different frequency/time weighting	
24h Measurement	Automatic measurement based on user define date/time and save the history data	
Frequency Weighting	Parallel A, B, C, Z (It can also be applied to 1/1 and 1/3 Octave)	
Time Weighting	Parallel F, S, I and Peak detection	
Self-Noise ²	Sound: 19dB(A), 25dB(C), 31dB(Z) Electrical: 13dB(A), 17dB(C), 24dB(Z)	Sound: 20dB(A), 26dB(C), 31dB(Z) Electrical: 14dB(A), 19dB(C), 24dB(Z)
Upper Limit ²	136dB(A) Increase to 154dB(A) with 5mV/Pa Microphone	136dB(A) Increase to 154dB(A) with 5mV/Pa Microphone
Frequency Response ¹	10Hz~20kHz	20Hz~12.5kHz
Level Linearity Range ^{2, 3, 4}	22dB(A)~136dB(A) Octave: 30dB~136dB	25dB(A)~136dB(A) Octave: 33dB~136dB
Dynamic Range ²	123dB (13dB(A)~136dB(A))	122dB (14dB(A)~136dB(A))

Peak C Range ^{2, 3}	47dB~139dB	50dB~139dB
Electrical Input	Maximum input voltage: 5Vrms (7.07Vpeak). Input impedance of preamplifier: >6GΩ	
Range Setting	Single range to cover whole dynamic range	
Resolution	24Bits	
Sampling Rate	48kHz	
Time History	Time domain noise curve display. Duration time: 1min, 2min, 10min	
LCD Display	160x160 LCD with white backlight, 14 step contrast level, 1s display update rate	
Mass Storage	4G MicroSD card (TF card)	
Post-Processing	Post-processing software VA-SLM can read, analyze and generate reports of store data.	
Export Data	Directly connect to the computer to read the memory card (USB disk)	
Output	AC Output (max 5V _{RMS} , ±15mA), DC Output (10mV/dB, max 15mA), RS-232 serial interface and USB (USB disk mode or modem mode)	
Alarm	User define alarm threshold. LED indicate the alarm status	
Setup Template	5 templates to save user setup for different application, template can be save in MicroSD card	
Auto Power On	Automatic power on and start measurement when power supply available, ease of integration	
Power Supply	4x1.5V alkaline batteries (LR6/AA/AM3), sustainable use of approx.10 hours (depends on battery). It also can be supply by external DC power (7V~14V 500mA) and USB power (5V 1A)	
RTC	Built-in backup battery has been calibrated at factory to the error <26s in 30days (<10ppm, (25±16) °C). It can keep RTC running when replacing the main batteries. GPS timing function available (option with GPS module)	
Language	English, Chinese, Portuguese, Spanish, German, French	
Firmware Update	Update firmware via USB port	

Conditions	Temperature: -10°C~50°C. Humidity: 20%~90%RH
RT Temperature	Real-time temperature display on the main screen
Size (mm)	W70 x H300 x D36
Weight	Approx. 620g, including 4 alkaline batteries
Option	
GPS	Receiver Type: 50 Channels; Time-To-First-Fix: Cold Start 27s, Warm Start 27s, Hot Start 1s; Sensitivity: Tracking -161dBm, Reacquisition -160dBm, Cold Start -147dBm, Hot Start -156dBm; Horizontal position accuracy: 2.5m, Timing accuracy: 30ns, Velocity accuracy: 0.1m/s; Update Rate: 1Hz, Operation Limits: Dynamic≤4g, Altitude<50000m, Velocity<500m/s
Calibrator	CA111, Class 1, 94dB/114dB, 1kHz
Printer	Mini thermal or dot-matrix printer, RS-232 port

Note 1: Ignore the result outside 20Hz~12.5kHz for type BSWA 309 alone due to microphone frequency response of Class 2.

Note 2: The data was measured with 40mV/Pa microphone for BSWA 308 and BSWA 309.

Note 3: Measurement according to GB/T 3785 and IEC 61672.

Note 4: Measurement according to GB/T 3241 and IEC 61260.

1.6 Information for Periodic Tests

- Reference sound level: 94.0dB.
- Reference incidence direction: parallel to the incident direction of the microphone.
- Reference point of microphone: the central point of microphone diaphragm.
- Reference incidence direction: direction perpendicular to the microphone diaphragm.
- Reference attenuation of octave spectra: 0dB.
- Reference input signal level of octave spectra: 40mV (94dB for sensitivity of 40mV/Pa).

1.7 Key Component

Component Name	Manufacturer	Type	Description
Microphone	BSWA Technology Co., Ltd.	MP231	Class 1 microphone
		MP309	Class 2 microphone

1.8 Packing List

No.	Type	Description
Standard		
1	BSWA 308/309	Sound level meter without microphone
2	CC308 Case	Carrying case
3	MA231T	ICCP preamplifier with TNC connector
4	MP231/MP309	Class 1 (308) or class 2 (309) microphone
5	WS002-9 Windscreen	90mm diameter windscreen for 1/2" microphone
6	MicroSD Card	4G memory card to store data
7	Battery	Alkaline battery (LR6 / AA / AM3) x 4
8	Power Adapter	Power adapter with 9V/500mA
9	MiniUSB Cable	Use to connect computer
10	Quick Start Guide	Quick start guide
11	Certificate of Calibration	Certificate of factory calibration
12	CD	Include post-process software, user manual (pdf), driver, firmware and other utility
13	Certificate of Conformity	Certificate of conformity
Option		
14	GPS	GPS module and antenna
15	Sound Calibrator	CA111: class 1 calibrator, 94dB/114dB CA114: class 2 calibrator, 94dB CA115: class 2 calibrator, 114dB
16	Thermal Printer	Mini thermal printer without ribbons, RS232 connector
17	Tripod	Stand for sound level meter
18	Printed User Manual	Printed user manual
19	Test Report	Test report from metrology institute

1.9 Packing Drawing

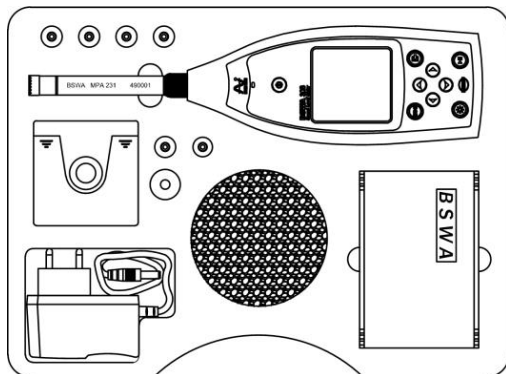

★**Note:** The detail of packing items may vary to follow orders.

1.10 China Certification of Pattern Approval (CPA)

CPA of BSWA 308



2014S226-11

 中华人民共和国 计量器具型式批准证书 北京声望声电技术有限公司		
经批准的计量器具新产品(名称、型号): 名称: 声级计 类别: S		
型号	规格	准确度
BSWA 308	236(A)-131(A)	1级
根据中华人民共和国计量法第十三条和中华人民共和国计量法实施细则有关规定, 对你单位申请型式批准的计量器具新产品经审查合格, 准予批准, 并可使用以下标志和编号:  2014S226-11		
批准人:	姚琦	发证日期: 二〇一四年八月十七日
		发证机关(盖章): 

CPA of BSWA 309



2012S233-11

 中华人民共和国 计量器具型式批准证书 北京声望声电技术有限公司		
经批准的计量器具新产品(名称、型号): 名称: 声级计(注: 不包括滤波器部分) 类别: S		
型号	规格	准确度
BSWA309	236B-131(B)(测量范围)	2级
根据中华人民共和国计量法第十三条和中华人民共和国计量法实施细则有关规定, 对你单位申请型式批准的计量器具新产品经审查合格, 准予批准, 并可使用以下标志和编号:  2012S233-11		
批准人:	姚琦	发证日期: 二〇一二年九月十三日
		发证机关(盖章): 

1.11 China Metrology Certification (CMC)



京制 01020122 号

CMC of BSWA 308



CMC of BSWA 309



京制 01020122 号



1.12 CE Certification



588 West Jindu Road, Songjiang District, Shanghai, China
 Telephone: +86 (0) 21 6191 5666
 Fax: +86 (0) 21 6191 5678
 ee.shanghai@sgs.com

VERIFICATION OF COMPLIANCE

Verification No.: SHEM140200034301TXC
 Applicant: BSWA Technology Co., Ltd.
 Address of Applicant: 1002-1003, North Ring Center, #18 Yumin Road, Xicheng District, Beijing
 100029, China
 Product Description: Sound level meter
 Model No.: BSWA308, BSWA309
 Sufficient samples of the product have been tested and found to be in conformity with
 Test Standard: EN 61326-1:2013
 EN 61326-2-2:2013
 as shown in the
 Test Report Number(s): SHEM140200034301

This verification of EMC Compliance has been granted to the applicant based on the results of the tests, performed by laboratory of SGS-CSTC Standards Technical Services Co., Ltd. on the sample of the above-mentioned product in accordance with the provisions of the relevant specific standards and Directive 2004/108/EC. The CE mark as shown below can be used, under the responsibility of the manufacturer, after completion of an EC Declaration of Conformity and compliance with all relevant EC Directives.



Tony Wu
 E&E Section Manager
 SGS-CSTC (Shanghai) Co., Ltd.

Copyright of this verification is owned by SGS-CSTC Standards Technical Services (Shanghai) Co., Ltd. and may not be reproduced other than in full and with the prior approval of the General Manager. This verification is subjected to the governance of the General Conditions of Services, printed overleaf.

Member of SGS Group (Société Générale de Surveillance)

Note: You may contact us to validate this document by email address: ee.shanghai@sgs.com

2. The Appearance and Operation

BSWA 308/309 uses the same body and the keypad layout. LCD screen, keypad and LED indicators lay on the front of instrument.

2.1 Keypad

Sound level meter has 10 keys, namely:

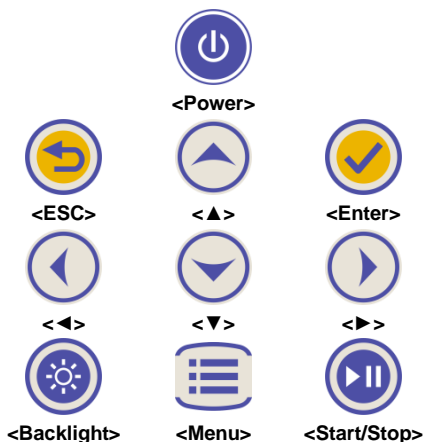

<Power>:

Long press 2 seconds of this key will power on the sound level meter. When sound level meter keep in stop state, long press 2 seconds will trigger the shut-down-dialog-box, and then press <Enter> to power off sound level meter.

☆Note: <Enter> is invalid when the sound level meter is running measurement.

<ESC>:

Exit the menu or return to previous menu. Press <ESC> also can clear the history curve at the time history screen.

<Enter>:

Enter the menu of next level, or confirm the changes of the parameters, or save current data as CSD format in stop state.

<Backlight>:

Press to open or close the LCD backlights. Backlight delay can be set in the menu. Refer to [4.4.2 Backlight](#) to earn more details.

<Start/Stop>:

Start or stop the measurement.

<▲>:

Up arrow used to select the menu item or adjust the parameters.

<▼>:

Down arrow used to select the menu item or adjust the parameters.

<◀>:

Left arrow used to select the menu item, or adjust the parameters, or switch measure screens.

<▶>:

Right arrow used to select the menu item, or adjust the parameters, or switch measure screens.

<Menu>:

Press to enter the main menu list.

2.2 Microphone Connector

The TNC connector on the top of the sound level meter is used to connect to microphone and preamplifier (microphone and preamplifier are usually mounted together). The TNC is threaded coaxial connector.

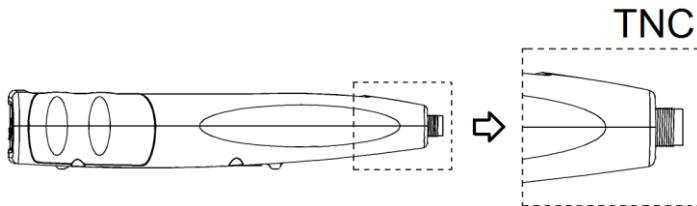

BSWA 308 is equipped with Class 1 microphone, while **BSWA 309** is equipped with Class 2:

MPA231T:

1/2" pre-polarized measurement microphone, class 1. Sensitivity: 40mV/Pa. Frequency range: 3Hz~20kHz. Mounted with ICCP preamplifier and powered by 4mA/24V.

MPA309T:

1/2" pre-polarized measurement microphone, class 2. Sensitivity: 40mV/Pa. Frequency range: 20Hz~12.5kHz. Mounted with ICCP preamplifier and powered by 4mA/24V.

Microphone and preamplifier are mounted together by thread. Unless special situation, please do not separate each other. The microphone is a precision measurement sensor, long-term exposure to high humidity or dust environment would impact microphone. Microphone that is not in use should be placed in a attached box.

The microphone is ICCP power supply. The supply current specifications are 4mA, voltage 24V. It will damage the microphone if voltage over 30V. **BSWA 308/309** sound level meter has internal ICCP power which can connect to microphone directly.

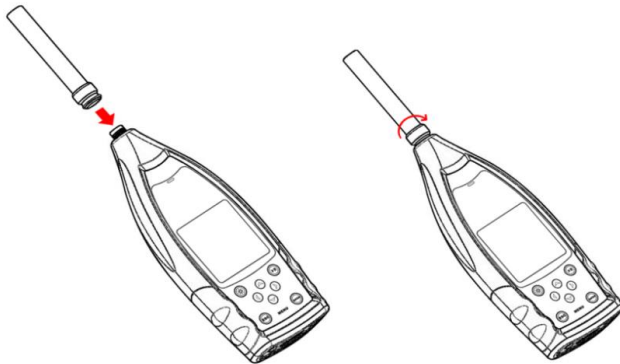

Insert microphone to TNC connector. Then rotate the thread until the connection is tight.

2.3 Windscreen

Sound level meter equipped with WS002-9 windscreen for use in windy outdoor environments. No need to use windscreen when used in a windless environment (such as indoor measurement).

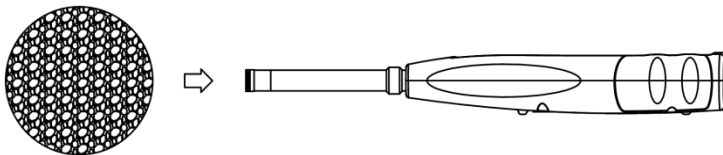

Insert the windscreen onto the microphone until stop according to above diagram. Refer to [Annex 4 Corrections of Windscreen in Free Filed](#) to earn more detail.

2.4 Data and Power Supply Connector

There are 7 interfaces at the bottom of the sound level meter. Open the rubber cover to see these interfaces.

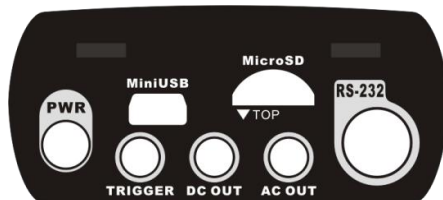

PWR:

Power connector, using the standard DC socket (2.1mm core diameter), can connect to the 7~14V 500mA external power supply.

★Note: Exceed 14V could damage the sound level meter!

MiniUSB:

MiniUSB port which connects to a computer can be select as **USB Disk Mode** or **Modem Mode**, refer to [4.4.10 USB Mode](#) to earn more detail. Additional, MiniUSB can be used as another external power, but the power supply must meet the requirement of 5V/1A.

USB Disk Mode: The files inside the MicroSD card can be access directly at this mode, no need to install driver.

Computer can recognize the MiniUSB as serial port (virtual serial port, need to install driver) and communicate with sound level meter by RS-232 protocol, refer to [5. RS-232 Communication Protocol](#) to earn more detail.

★Note: At least 1A power current capacity must be meet for power supply and cable (cable with ferrite core is not recommend for power supply). Please select the working mode in time after connected to the computer. Otherwise, the computer can't recognize the USB. The MiniUSB and RS-232 port cannot working at the same time when select **Modem Mode**.

MicroSD:

MicroSD socket, standard MicroSD card can be used to store SWN, OCT and CSD files. Recommend to use card-reader to format the MicroSD card, rather than format it at the U

Disk Mode. Note that the MicroSD card provides with the sound level meter has already formatted before sale.

Note: Keep front side (with silk screen) of MicroSD card down to insert without hot-plug.

RS-232:

It can be use as standard RS-232 port at **Remote** mode, and also can be used to connect thermal printer as **Printer** mode. Refer to [4.6.3 Printer](#) and [5. RS-232 Communication Protocol](#) to earn more detail.

TRIGGER:

Trigger input interface using a standard 3.5mm headphone jack. Refer to [4.4.4 Trigger](#) to earn more detail.

DC OUT:

DC output interface using a standard 3.5mm headphone jack. Refer to [4.6.2 DC OUT](#) to earn more detail.

AC OUT:

AC output interface using a standard 3.5mm headphone jack. Refer to [4.6.1 AC OUT](#) to earn more detail.

2.5 Battery

Recommend to use 4 cell of alkaline battery (LR6/AA/AM3), paying attention to the battery polarity (+/-) marked in the battery compartment. Do not mix using of old and new batteries at the same time. Remove batteries when the device is not in use. The total voltage of 4 cell battery cannot exceed 14V, otherwise it will damage the sound level meter.

The real test shows that the 4 cell of alkaline battery can support sustainable use of approx.10 hours (depends on battery) for sound level meter. When use rechargeable battery Eneloop BK-3HCCA/4BC (Rated capacity 2450mAh), sound level meter can work about 12 hours continuously. When the battery voltage is lower than the minimum voltage requirement of the sound level meter, it will shut down automatically.

We recommend using external power supply or USB-power-bank rather than batteries for long time running.

Follow the figure below to install or replace the battery:

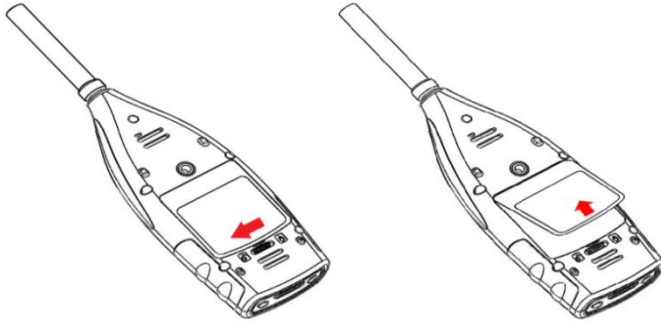

Turn the button to the left side to unlock the battery compartment cover. Then lift the cover to open it.

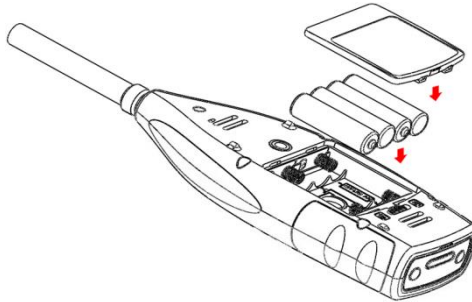

Close and lock the battery compartment after change the battery.

2.6 GPS

GPS antenna cover located on the top surface of sound level meter which select GPS function as option module.

Note: GPS function must be select before delivery to user due to install GPS module should return the sound level meter to factory.

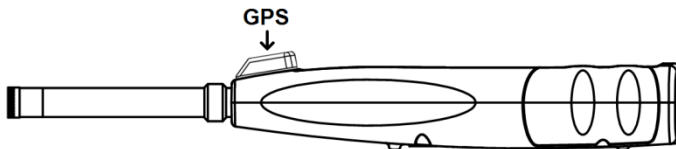

GPS performance is mainly affected by two factors: the satellite ephemeris and the satellite signal noise ratio.

- **Satellite Ephemeris:** GPS satellites orbit information. According to ephemeris, satellite positioning signal and time, the current location can be determined. Ephemeris need to download from the GPS satellites, but the download speed is very low (approx. 50bps), and vulnerable to the impact of satellite signal strength. The high bit error rate may lead to a longer time of download ephemeris, and even download fail. The sound level meter can keep the ephemeris data in memory for approx. 30 minute after turn off GPS module. The ephemeris data is only is valid within 2 hours.
- **Satellite Signal Noise Ratio:** Satellite positioning signal intensity. In rainy days or indoor, signal strength will be affected.

GPS have 3 boot modes: Cold start, warm start and hot start

- **Cold Start:** First location, need to download the latest ephemeris and longer time.
- **Warm Start:** GPS module has the last saved location information, but need to re-download the ephemeris due to expired. Warm start needs almost same time as cold start.
- **Hot Start:** GPS module has valid ephemeris and can reposition in a very short time.

3. Measurement Screen

Sound level meter has two measurement modes: **Level Meter** and **1/1 Octave**. User can select it in the menu of **Function**.

Level Meter has 8 screens which can be switch through <◀>, <▶>. The 8 screens are: Main, 3-Profiles, LN Statistical, Time History, Custom Measurement Page 1, Custom Measurement Page 2, GPS Page 1 and GPS Page 2.

1/1 Octave has 4 screens: Octave Histogram, Octave Table Page 1~3.

3.1 Icons and Meaning of Screen Display

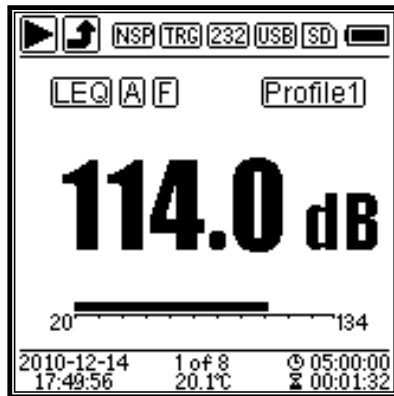

All icons of Main screen is enable, the meaning of each icons are describe as following:



Start/Stop. Describe the measurement state.

Overload indicator and under-range indicator. Solid arrow

indicates that the current state is overload / under-range. Hollow



arrow indicates that overload / under-range event have occurred

within the integral period. At the beginning of the new integral

period, overload and under-range indicator icon will be clear.



ICCP power state. Displayed when ICCP is turn off.









Trigger state. Displayed when trigger is enable.

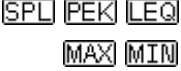
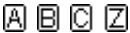

RS-232 state. Icon  will be displayed at the **Remote** mode,

and icon  will be displayed at **Printer** mode.

	Timer state. Icon  means the timer is enabled and only run once. Icon  means the timer is enabled and run in loop.
	MicroSD state. Displayed when enable the MicroSD storage.
	Power state. The icons form left to right: external power supply, battery supply (with voltage display) and USB power supply.
	Calculation mode of measurement.
	Filter state.
	Detector state.
	Icon of Profile. Indicate the profile number of current display.

114.0 dB

Measurement value.



Visualize and dynamic bar graph display of measurement values within the current range.

2010-12-14
17:49:56



Date and time.

1 of 8

Current page number and total page number.

20.1°C

Internal temperature display.

⌚ 05:00:00
⌚ 00:01:32Icon  means the integral period, icon  means the elapsed time. The measurement stop when elapsed time equal to total measurement time (Itg.Period * Repeat).

Icons in the same row will display one at the same time. All icons can be display on each screen and keep the same meaning.

3.2 Screen of Level Meter Mode

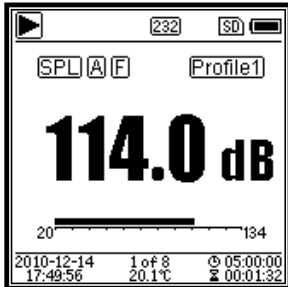

Main screen. Display the measurement data, filter, detector, mode and Profile number. Main screen only display one group data of 3-Profile. Press <▲>, <▼> to switch within 3-Profile.

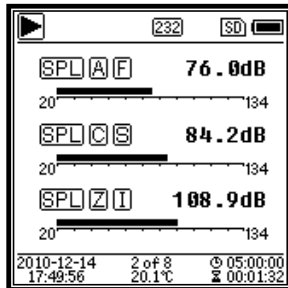

3-Profile. Display the data and corresponding mode, filter and detector of 3-Profile measurement at the same time. 3-Profile data can be saved into SWN file.

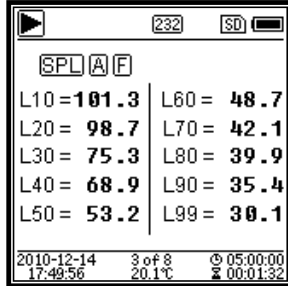

LN Statistical. Display 10 groups of statistical results. Each group of data sources (fix mode to SPL, filter and detector can be customize) and the percentage value can be set through the menu.

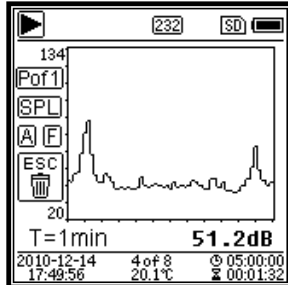

Time History. Display the current noise value and time domain curve. The data sources (one of 3-Profile) and the time-line length (1min, 2min and 10min) can be customize.

Press <ESC> to clear the screen and re-display the curve.

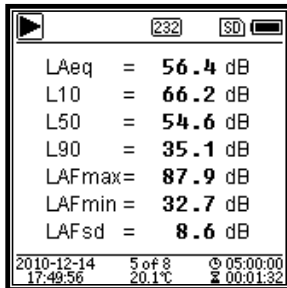

Custom Measurement Page 1. User can set the parameters of the 14 sets of measurement. This screen can display the first 7 sets.

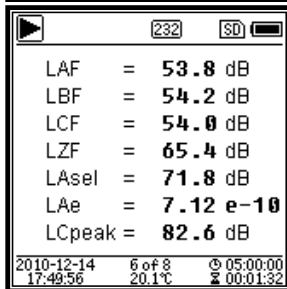

Custom Measurement Page 2. User can set the parameters of the 14 sets of measurement. This screen can display the last 7 sets.



GPS Page 1. Display GPS information: GPS state, GPS date, GPS time, latitude, longitude, altitude and speed.

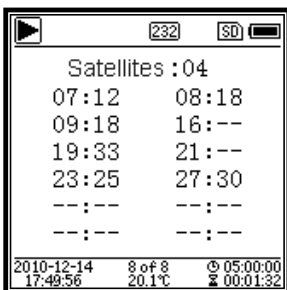

GPS Page 2. Display number of satellite which contribute to positioning, and signal noise ratio of all visible satellites (0dB~99dB).

☆ Note: Number of visible satellites may be greater than the number of positioning satellites due to some satellites is unavailable for positioning.

3.3 Screen of 1/1 Octave Mode

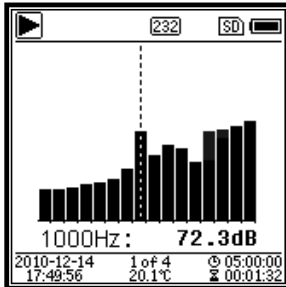

1/1 Octave Spectra. Display 12 bands of 8Hz~16kHz and L_{Aeq} , L_{Beq} , L_{Ceq} , L_{Zeq} as bar graph. Press \blacktriangleleft , \blacktriangleright to display the detail value of each band. A threshold can be set for each band. The LED indicator will turn red when the data exceed the threshold.

Hz	dBZ	Hz	dBZ
8	78.4	16	78.4
31.5	78.4	63	45.6
125	64.2	250	43.1
500	38.6	1k	23.8
2k	42.5	4k	18.9
8k	69.1	16k	11.5

Octave Table Page 1. Display the measurement data of 8Hz~16kHz. The LED indicator will turn red and dB value will display as invert color when the data exceed the threshold.

Leq	dB	Lim.
LeqA	48.6	80.0
LeqB	50.1	80.0
LeqC	68.4	80.0
LeqZ	81.4	80.0

Octave Table Page 2. Display the measurement data of L_{Aeq} , L_{Beq} , L_{Ceq} , L_{Zeq} . The LED indicator will turn red and \triangle will be display when the data exceed the threshold.

3.4 Screen of 1/3 Octave Mode

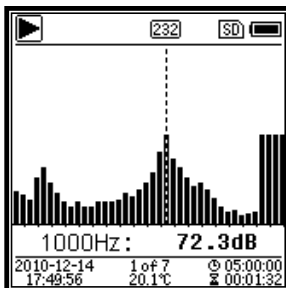

1/3 Octave Spectra. Display 36 bands of 6.3Hz~20kHz and L_{Aeq} , L_{Beq} , L_{Ceq} , L_{Zeq} as bar graph. Press \blacktriangleleft , \blacktriangleright to display the detail value of each band. A threshold can be set for each band. The LED indicator will turn red when the data exceed the threshold.

Hz	dBZ	Hz	dBZ
6.3	78.4	8	78.4
10	78.4	12.5	45.6
16	64.2	20	43.1
25	38.6	31.5	23.8
40	42.5	50	18.9
63	69.1	80	11.5

2010-12-14 17:49:56 2 of 7 20.1°C 05:00:00 00:01:32

Octave Table Page 1. Display the measurement data of 6.3Hz~80Hz. The LED indicator will turn red and dB value will display as invert color when the data exceed the threshold.

Hz	dBZ	Hz	dBZ
100	78.4	125	78.4
160	78.4	200	45.6
250	64.2	315	43.1
400	38.6	500	23.8
630	42.5	800	18.9
1k	69.1	1.25k	11.5

2010-12-14 17:49:56 3 of 7 20.1°C 05:00:00 00:01:32

Octave Table Page 2. Display the measurement data of 100Hz~1.25kHz. The LED indicator will turn red and dB value will display as invert color when the data exceed the threshold.

Hz	dBZ	Hz	dBZ
1.6k	78.4	2k	78.4
2.5k	78.4	3.15k	45.6
4k	64.2	5k	43.1
6.3k	38.6	8k	23.8
10k	42.5	12.5k	18.9
16k	69.1	20k	11.5

2010-12-14 17:49:56 4 of 7 20.1°C 05:00:00 00:01:32

Octave Table Page 3. Display the measurement data of 1.6kHz~20kHz. The LED indicator will turn red and dB value will display as invert color when the data exceed the threshold.

Leq	dB	Lim.
LeqA	48.6	80.0
LeqB	50.1	80.0
LeqC	68.4	80.0
LeqZ	81.4	80.0

2010-12-14 17:49:56 5 of 7 20.1°C 05:00:00 00:01:32

Octave Table Page 4. Display the measurement data of L_{Aeq} 、 L_{Beq} 、 L_{Ceq} 、 L_{Zeq} . The LED indicator will turn red and  will be display when the data exceed the threshold.

4. Operation and Setting of the Menu



Press **<Menu>** to access the next level menu. All parameters related to measurement can be set in the menu.

Menu Tree

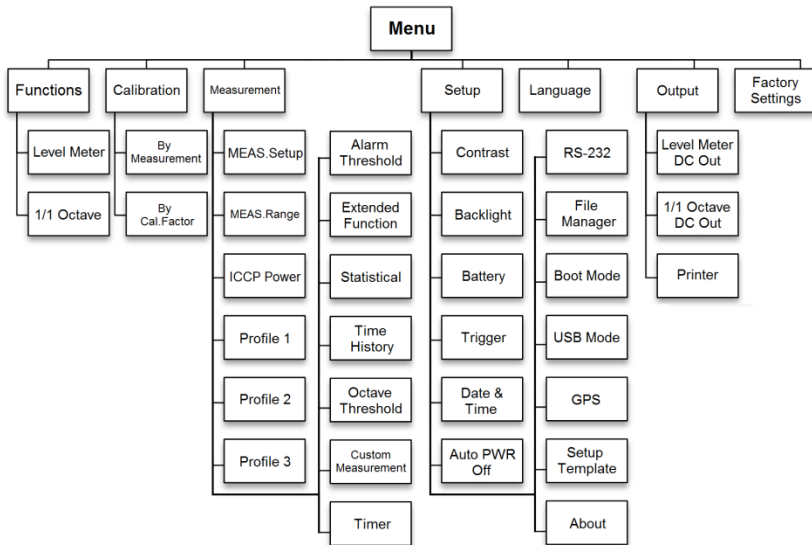

4.1 Function

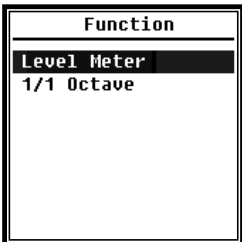

Select **Function** and press **<Enter>** to enter this menu. 2 kind of measurement can be select: **Level Meter** and **1/1 Octave**.

Press **<▲>**, **<▼>** can select mode of measurement. Press **<Enter>** to save setting and return to previous menu. Press **<ESC>** to return to previous menu.

4.2 Calibration



Select **Calibration** and press <Enter> to enter this menu.

Many factors include temperature, humidity and air pressure will impact the microphone's sensitivity. Therefore, user must run calibration at least once before measurement.

There are two calibration methods: **By Measurement** and **By Cal.Factor**. Method of **By Measurement** is recommend for calibration with sound calibrator. Method of **By Cal.Factor** can manually adjust the calibration factor by user.

4.2.1 Calibration by Measurement

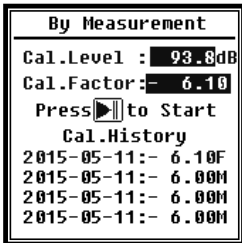

Select **By Measurement** and press <Enter> to enter this menu. Refer to [Annex 2 Adjustments at the Calibration Check Frequency](#) to earn more detail of the stated calibrator and corresponding adjustment value.

Cal.Level can be adjusted between 0dB~199.9dB. Press <Left>, <Right> and <Up>, <Down> can change the Cal.Level and press <Start> to start calibration. After calibration finished, the new Cal.Factor will be update as the result and user can press <Enter> or <ESC> to save or ignore this result. This menu also displays the calibration history. Ending with symbol **M** indicate the record was calibrate by the method of **By Measurement**.

4.2.2 Calibration by Cal.Factor

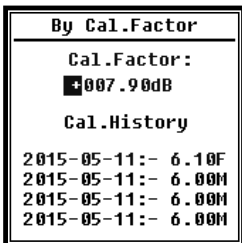

Select **By Cal.Factor** and press <Enter> to enter this menu.

Users can adjust the calibration factor manually. Press <Left>, <Right> can select the digit of factor, press <Up>, <Down> can adjust the value, press <Enter> to save and press <ESC> to return to previous menu. Ending with symbol **F** indicate the record was calibrate by the method of **By Cal.Factor**.

4.2.3 Conversion of Cal.Factor and Sensitivity

The sensitivity can be calculated by the following formulas, and the calibration factor also can be calculated from sensitivity and type into sound level meter directly.

$$Cal.F = 20 * \log (Sens / 40) + offset$$

$$Sens = 40 * 10^{((Cal.F - offset) / 20)}$$

Where:

Cal.F is the calibration factor, expressed in decibels (dB);

Sens is sensitivity of microphone, expressed in mV/Pa;

offset is the calibration factor, expressed in decibels (dB). This value is the calibration result by the method of **By Measurement** with 40mV signal. This offset is inherent deviation which is different for each sound level meter.

4.2.4 Process of Calibration by Measurement

Calibration by measurement is the recommend method of calibration with sound calibrator. BSWA can provide class 1 and class 2 sound calibrator comply with the GB/T 15173-2010, IEC60942: 2003 standard.

The process of calibration by measurement is shown as following:

- (1) Insert the microphone into the cavity of the calibrator until stop without loosening.

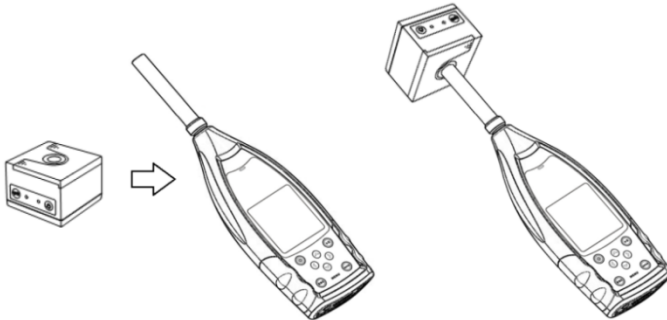

- (2) Then open the power of the calibrator and set to a constant sound pressure level (for example 94dB).

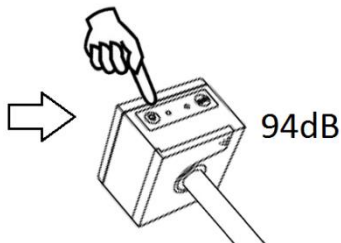

- (3) Select **Calibration** in the menu and then press **<Enter>** to enter **By Measurement**.

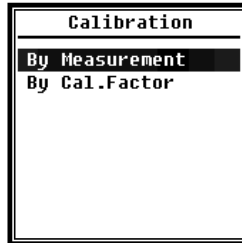

- (4) Adjust **Cal.Level** in the menu, for example adjust to 93.8dB. There is 5s delay after press **<Start>** to run calibration.

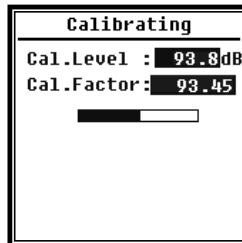
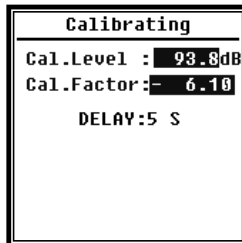

- (5) After the end of calibration, sound level meter will update the calibration factor. Press **<Enter>** to apply the results.

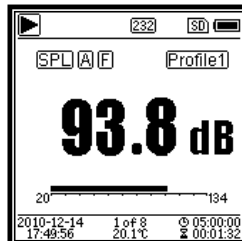
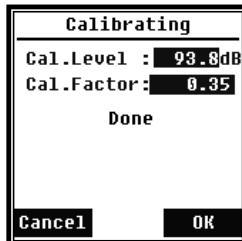

- (6) Return to **Main screen** and press **<Start/Stop>** to start the measurement. The current measurement result will be 93.8dB in this example if calibrator is still working.

4.3 Measurement

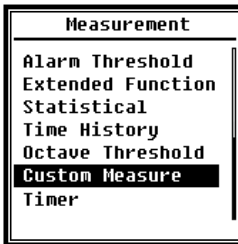
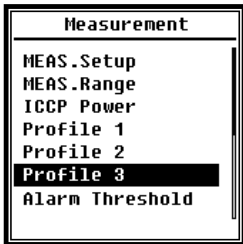

There are 13 items in the menu of **Measurement**. Press <▲>, <▼> can choose and select, press <Enter> to access next level of menu.

4.3.1 MEAS.Setup

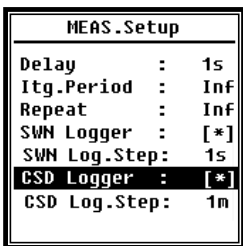

Menu of **MEAS.Setup** is the most important menu related to measurement. It can set the parameter of **Delay**, **Itg.Period**, **Repeat**, **SWN Logger**, **SWN Log.Step**, **CSD Logger** and **CSD Log.Step**. Press <▲>, <▼> can choose and select.

▷Delay:

Delay time between press <Start> and the beginning of the measurement. Press <◀>, <▶> can select the delay time: Sync 1m, Sync 15m, Sync 30m, Sync 1h, 1s~60s.

The delay time can skip the impact come from the key pressing or vibration before the measurement.

▷Itg.Period:

Itg.Period is the integral period of each single measurement. At the beginning of each integral period, all of the integral data and time-hold data will be reset, and the overload and under-range indicator will be clear. Integral data and time-hold data include LEQ, Max, Min, Peak, SD, SEL, E and LN. Press <◀>, <▶> can select the option: Inf, 1s~59s, 1m~59m, 1h~24h.

▷Repeat:

Repeat is the number of repeat time of measurement. Total measurement period = **Itg.Period** x **Repeat**. Press <◀>, <▶> can select the option: Inf, 1~9999.

▷SWN Logger:

Press <◀>, <▶> to switch. If selected, sound level meter will save the SWN/OCT files.

SWN/OCT saves the time history data into file. The data source in **Level Meter** mode is Profile 1~3 (select in **SWN Save** of Profile 1~3 menu) and store as SWN file; in 1/1 Octave mode save all bands of octave and LAeq, LBeq, LCEq, LZeq, store as OCT file.

▷SWN Log.Step:

SWN Log.Step is the logger step (interval time) to save data as SWN/OCT file. Press <◀>, <▶> can select the option: 0.1s, 0.2s, 0.5s, 1s~59s, 1m~59m, 1h~24h.

★**Note**: The **SWN Log.Step** of 1/3 Octave starts from 0.5s (0.1s and 0.2s are disable).

▷CSD Logger:

Press <◀>, <▶> to switch. If selected, sound level meter will save the CSD files.

CSD save the instantaneous data into file. The data source in **Level Meter** mode is 14 group results of **Custom Measure** and store as CSD file; in 1/1 Octave mode save all bands of octave and LAeq, LBeq, LCEq, LZeq, store as CSD file.

★**Note**: If selected, press <Enter> at the main screen can save the data into CSD file manually when measurement is stop.

▷CSD Log.Step:

CSD Log.Step is the logger step (interval time) to save data as CSD file. Press <◀>, <▶> can select the option: 1s~59s, 1m~59m, 1h~24h.

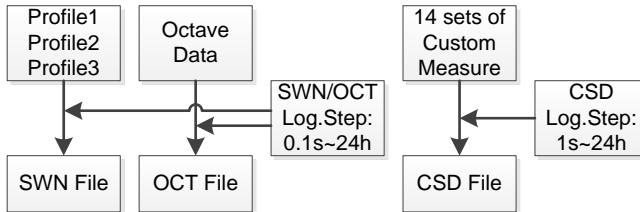

★**Note**: SWN/OCT file only store integral data. The logger step can be considered as the integral period. All the data within logger step (integral period) will be store as one line into SWN/OCT file. CSD file only store instantaneous data without integration. Once the CSD logger step is reached, 14 group data of custom measure will be store as one line into CSD file, just as a screenshot.

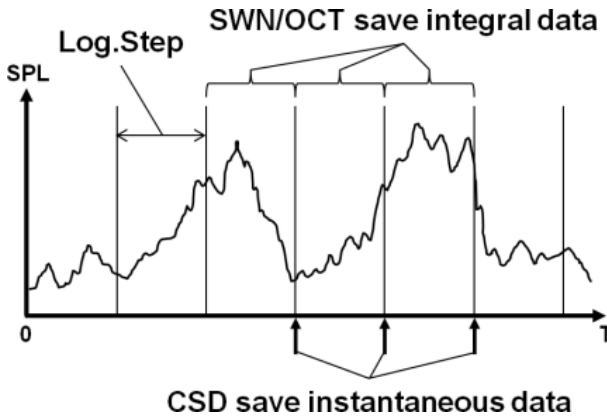

4.3.2 MEAS.Range

MEAS.Range
Linearity Range: 20.00dBa - 134.00dBa
Dynamic Range: 11.00dBa - 134.00dBa
Peak C Range: 45.00dBa - 137.00dBa

Menu of **MEAS.Range** display the **Linearity Range**, **Dynamic Range** and **Peak C Range**.

The new developed algorithm brings a single measurement range that no needs to change the range anymore. The algorithm can meet the requirement of toneburst response down to 0.25ms with only 0.1dB error at 4kHz. And the error is 0.4dB for 0.125ms toneburst test at 4kHz.

▷**Linearity Range**: The measurement result can be considered to be correct only when the result located in the linearity range. Otherwise, the error of measurement result is over the acceptance limits. Sometimes linearity range also can be called measurement range.

▷**Dynamic Range**: Dynamic range is the range between the self-generated noise level and the maximum input signal level. Dynamic range is the maximum range which can be display on the sound level meter. Note the measurement result near the self-generated noise level can be considered is non-linear.

▷**Peak C Range**: Peak C range is the linearity range of Peak C measurement. The Peak C measurement result located in this range can be considered to be correct.

4.3.3 ICCP Power



Menu of ICCP power control the 4mA/24V constant current source which can supply all kind of ICCP sensor. Please disable ICCP power before connect to other kind of sensor or directly connect to signal source. Press <◀>, <▶> can choose and select.

4.3.4 Profile 1~3



Menu of **Profile 1~3** can set the **Filter**, **Detector**, **Mode** and **SWN Save**. Press <▲>, <▼> can choose and select.

▷Filter:

Set the filter of Profile 1~3. Press <◀>, <▶> can select the option: **A**, **B**, **C** and **Z** (Z-weighting means no weighting and sometimes it is called Flat or Linear).

▷Detector:

Set the detector of Profile 1~3. Press <◀>, <▶> can select the option: **Fast**, **Slow**, and **Imp.**.

▷Mode:

Set the integral mode of Profile 1~3. Press <◀>, <▶> can select the option: **SPL**, **PEAK**, **LEQ**, **MAX** and **MIN**.

▷SWN Save:

This option is used to set which data should be store in the SWN file, since the data source of SWN file is Profile 1~3. So this option is no relationship with screen display.

Press <◀>, <▶> can select the option: **LEQ**, **PEAK**, **MAX** or **MIN**.

4.3.5 Alarm Threshold



If measurement result of Profile 1~3 exceeds the **Alarm Threshold**, the LED indicator above <Power> will turn red. Alarm threshold can be set to 20dB~200dB. Press <▲>, <▼> can increase and reduce 1dB. Press <◀>, <▶> can add and reduce 10dB.

4.3.6 Extended Function

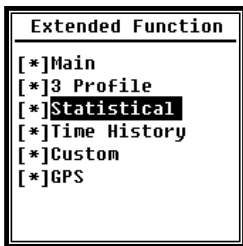

Extended Function can set which screen can be display. If the screen is not selected, it will not be display. Note that **Main** screen is designed to be displayed all the time.

4.3.7 Statistical

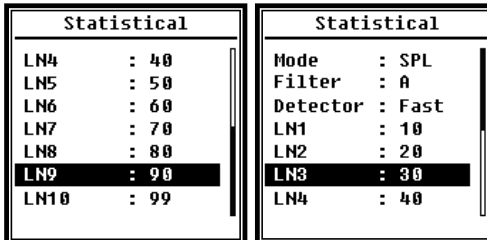

The data source of statistical is SPL which is fixed. User can't change it. But user can set the filter and detector of SPL and the statistical percentage value through this menu.

▷Mode:

It's fixed to SPL and cannot be changed.

▷Filter:

Press <◀>, <▶> can set the filter of statistical analysis: **A, B, C** and **Z** (Flat).

▷Detector:

Press <◀>, <▶> can set the detector of statistical analysis: **Fast, Slow** and **Imp.**.

▷LN1~LN10:

Press <◀>, <▶> can set the percentage of 10 group of LN to 1%~99%.

For example: **LN1:10=80dB** means that in integral period, 10% of measurement data is

greater than 80dB. The LN result related to integral period. It will be reset when a new integral period start.

4.3.8 Time History



Press <▲>, <▼> can set the data source and duration time of **Time History**.

▷Profile:

Press <◀>, <▶> can set the data source of time history: **Profile1, Profile 2, Profile 3**.

▷Duration:

Press <◀>, <▶> can set the timeline of time history: **1min, 2min, 10min**.

4.3.9 Octave

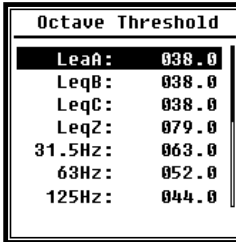

Menu of **Octave** can set filter before octave calculation and the alarm threshold of each octave band, LAeq, LBeq, LReq, LZeq. If the measurement result exceeds the threshold, the LED indicator

will turn red. Press <◀>, <▶> can set the option to 0.1dB~199.9dB.

4.3.10 Custom Measure

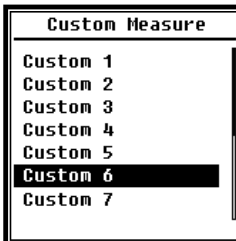
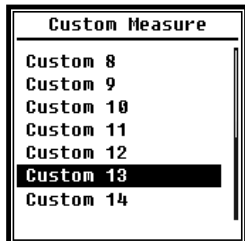

There are 14 items in menu of **Custom Measure** which can set the parameters of group 1~14 custom measurement. Press <▲>, <▼> can choose and select, press <Enter> to access next

level of menu.

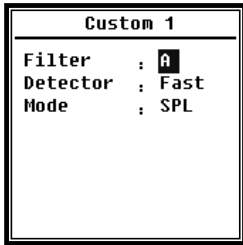

Press <▲>, <▼> can set the option of each group of custom measurement: **Filter**, **Detector** and **Mode**.

▷Filter:

Press <◀>, <▶> can set the filter of custom measurement: **A**, **B**, **C** and **Z** (Flat).

▷Detector:

Press <◀>, <▶> can set the detector of custom measurement: **Fast**, **Slow** and **Imp.**.

▷Mode:

Press <◀>, <▶> can set the integral mode of custom measurement: **SPL**, **SD**, **SEL**, **E**, **Max**, **Min**, **Peak**, **LEQ**, **LN1~LN10**.

4.3.11 Timer



Menu of **Timer** can set the **Timer**, **Start Day**, **Start Time** and **Repeat Interval**. Press <▲>, <▼> can choose and select.

A new function named **Timer** was introduced to start measurement by program. User can set the measurement start from 00:00 of next day, measure several minutes and repeat each hour, in order to achieve 24h auto measurement.

▷Timer:

Press <▲>, <▼> can set **Timer** working mode: **OFF**, **Once** and **Loop**.

▷Start Day:

Press <▲>, <▼> can set **Timer** trigger date: **Ignore** and the certain day in the future 30 days. If select **Ignore**, the **Timer** will ignore the date and only use **Start Time** to trigger.

▷Start Time:

Press <▲>, <▼> can set **Timer** trigger time: **00:00~23:59**.

▷Repeat Period:

If **Timer** is triggered, it will be trigger all the time by the **Repeat Period**. Press <◀>, <▶> can set the option: **1m~59m**, **1h~24h**.

☆**Note:** **Repeat Period** must greater than total integral time (**Itg.Period** x **Repeat**) +5s, since there is fixed 3s delay for **Timer** triggered measurement and another 2s is needed before the delay. It is forbidden to change the settings when the **Timer** is working. Otherwise, there will be something wrong with the **Timer**.

4.3.12 24h Measurement by Timer

User can use the **Timer** to implement 24-hour-measurement. Following description show an example of how to implement the 24-hour -measurement.

MEAS.Setup	
Delay	: 1s
Itg.Period	: 5m
Repeat	: 1
SWN Logger	: [*]
SWN Log.Step	: 1s
CSD Logger	: [*]
CSD Log.Step	: 5m

Purpose: The measurement will be first start at 2015/3/14 00:00, measure first 5m of each hour. It will store CSD file when the stop measurement and store SWN file every second. Delay setting in the MEAS.Setup will be ignored if the measurement is triggered by Timer. Set **Itg.Period** as **5m** and set **Repeat** as **1**. Enable the SWN Logger and CSD Logger.

Set the SWN Log.Step to 1s and set the CSD Log.Step to 5min.

Timer	
Timer	: Loop

Start Day	
Start Day	: 2015-3-14

Set the **Timer** work at **Loop** mode, so that the measurement will be triggering all the time.

Set the **Start Day** as the wanted date.

Start Time	
Start Time	: 00:00

Repeat Interval	
Repeat Interval	: 1h

Set the **Start Time** to **00:00** which means the first time of measurement to be triggered.

Set the **Repeat Interval** to **1h**, so that the measurement will be triggering each hour.

4.4 Setup



Menu of **Setup** include the basic function setup and condition display. Press <▲>, <▼> can choose and select, press <Enter> to access next level menu.

4.4.1 Contrast

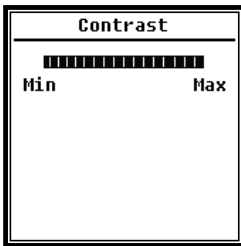

Menu of **Contrast** can set the contrast of LCD display for 14 levels adjustable. Press <▲>, <▼> can choose and select.

4.4.2 Backlight

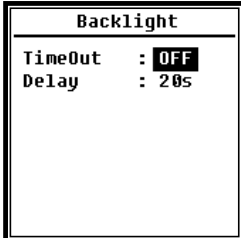

Sound level meter provide the auto turn off function of backlight to reduce the power consume and extend battery life. Menu of **Backlight** can set the backlight timeout on-off and delay time. Press <▲>, <▼> can choose and select.

4.4.3 Battery

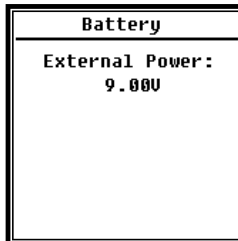
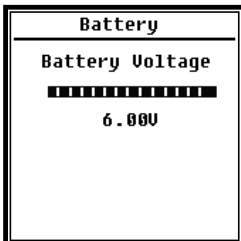

Menu of **Battery** display the power state and power voltage. The discharge cut-off voltage of single cell LR6/AA/AM3 alkaline battery is approx. 0.9V, therefore sound level meter will power off

automatically when the total voltage of 4 cell alkaline battery falls below 3.6V.

4.4.4 Trigger

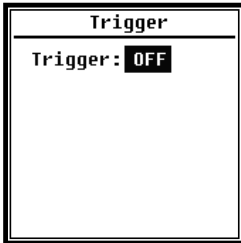

Menu of **Trigger** can set the function of trigger on-off. **Trigger** is an analog input which remote control the sound level meter to start or stop the measurement. The trigger input located on the bottom of sound level meter as a 3.5mm connector.

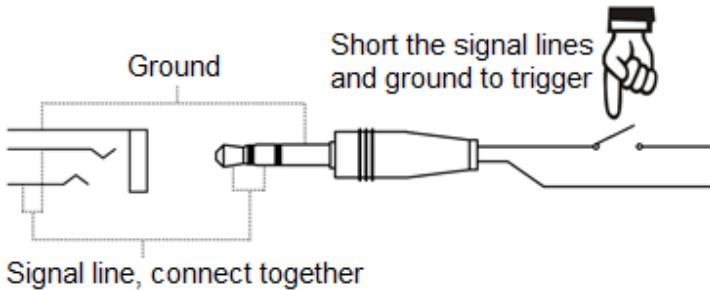

Short the signal lines and ground to trigger measurement to start, otherwise to stop the measurement. Notice that when enable the **Trigger** function, the **<Start/Stop>** button is unavailable.

4.4.5 Date & Time



Menu of **Date & Time** can set the RTC time of sound level meter. Press **<▲>**, **<▼>** can choose and select.

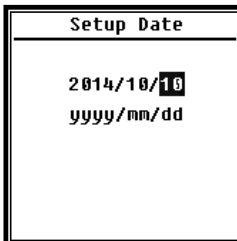
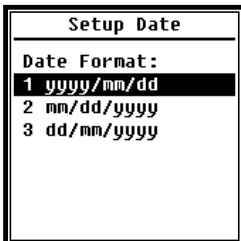

Press **<▲>**, **<▼>** can select date format and turn to date setting. Press **<◀>**, **<▶>** can choose year, month and day, press **<▲>**, **<▼>** can modify the value. Press **<Enter>** to save the setting.

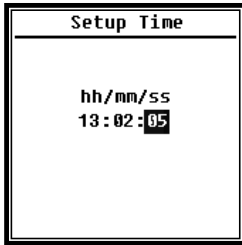

The operation of time setting is almost the same. Press <<<>, <>> can select hour, minute and second, press <▲>, <▼> can modify the value. Press <Enter> to save the setting.

The power supply for RTC comes from an internal battery. Please replace the RTC battery when sound level meter cannot keep the date and time due to voltage of RTC battery is

too low. How to replace RTC battery: remove the 5 screws on the backside of sound level meter to open the cover. The RTC battery is located on the surface of PCB as the following figure. The model of battery is CR-1220.

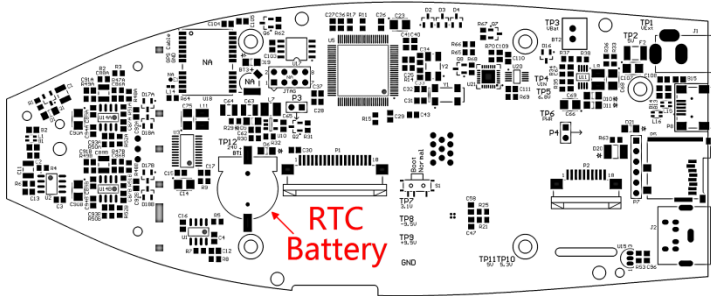

☆**Note:** The RTC of sound level meter has calibrated to a reference clock with average error 2ppm (maximum error 3ppm). The time accuracy keep <10ppm (<26s within 30 days) at room temperature. The maximum time error is approx. 5s~8s at 25°C in internal test.

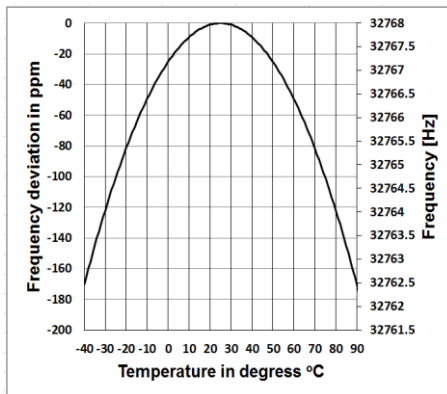

The RTC accuracy may vary by the temperature due to no temperature compensation. As the figure show the typical temperature curve, the RTC keep its basic frequency. When the temperature increase or decrease, RTC frequency change according to $-0.04\text{ppm}/^{\circ}\text{C}^2$. Therefore, when the temperature is 0°C, the change value of RTC is $-0.04 \times (0-25)^2 = -25\text{ppm}$,

equal to slow 2.16s daily. when the temperature is 40°C, the change value of RTC is $-0.04 \times (40-25)^2 = -9\text{ppm}$, equal to slow 0.78s daily.

The maximum error (<10ppm) given by user manual can be calculated as approx. 16°C difference to reference temperature (25°C). Therefore, the RTC can keep every 30 day the error <26s at 9°C~41°C which can be recognized as room temperature. Notice that the real RTC error may beyond the value shown in user manual if exceed the temperature range.

4.4.6 Auto PWR Off

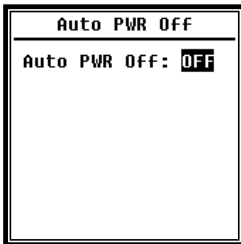

Sound level meter provide the auto power off function to reduce the power consume. When sound level meter keep stop state and no key press for a while, it will power off base on the setting. The Auto PWR Off option: **1min, 5min, 10min, 30min, Off**. Press <◀>, <▶> can choose and select, press <Enter> to save the setting.

4.4.7 RS-232



Menu of RS-232 can set the option of serial port, refer to [5. RS-232 Communication Protocol](#) to earn more detail.

▷RS-232 Mode:

RS-232 Mode option: **Remote, Printer**. Press <◀>, <▶> can choose. Sound level meter can be control and send out data via RS-232 port at **Remote** mode. And RS-232 can be used to connect thermal printer (option) at **Printer** mode.

▷ID Setup:

ID Setup (refer to [5.2.2 Device ID](#) to earn more detail) can set the ID number which is used to distinguish among a network of more than one sound level meter. The ID can be set as: 1~255. Press <◀>, <▶> can choose and select.

▷Baud Rate:

Baud Rate (refer to [5.1 Hardware Configuration and Settings of Interface](#) to earn more

detail) can set the communication baud rate of RS-232, the option is: **4800bps**, **9600bps**, **19200bps**. Press <◀>, <▶> can choose and select.

▷Flow Control:

Flow Control (refer to [5.2.7 Flow Control](#) to earn more detail) can set the flow control mode under remote control, the option is: **Software**, **Hardware**. Press <◀>, <▶> can choose and select.

▷Response:

Response (refer to [5.3 Instruction](#) to earn more detail) can enable or disable the response signal (ACK/NAK), the option is: **ON**, **OFF**. Press <◀>, <▶> can choose and select.

4.4.8 File Manager



File Manager can manage the stored SWN, OCT and CSD file.

The numbers display at the right side of each line is the file count for each kind of file type. Press <▲>, <▼> can choose and select, press <Enter> to access next level of menu.



Menu of SWN File can delete SWN files, press <▲>, <▼> to select the file number which want to be delete. The whole file name will be display on the bottom of the screen. Select 0000 as the file

number can delete the entire existing SWN file.



Menu of **OCT File** can delete the OCT file. The operation is same to menu of **SWN File**.

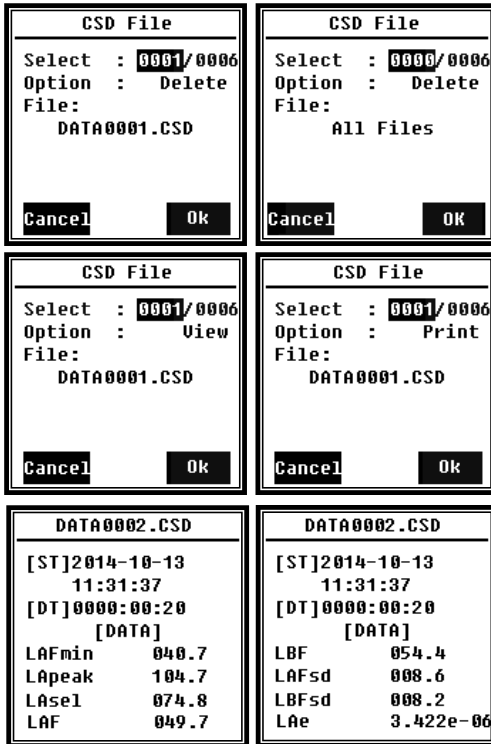

Menu of **CSD File** can view, print and delete the CSD file. Press <▲>, <▼> can change the cursor between **Select** and **Option**.

Delete operation is same to menu of **SWN File**.

Select **Option** in menu of **CSD File**, and then press <◀>, <▶> can **View** or **Print** the CSD file.

After select file number and action, press <Enter> to view or print the content of file.

Press <▲>, <▼>, <◀>, <▶> can brown file contents at **View** mode.

The **Print** mode is almost same to **View** mode. Press <Enter> can print the current displayed content of CSD file.

4.4.9 Boot Mode

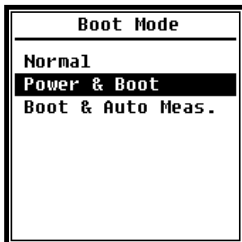

In menu of **Boot Mode**, press<▲>, <▼> can select **Normal**, **Power & Boot**, **Boot & Auto Meas.** mode.

★**Note**: The hardware mode switch located in the battery compartment need to be set to fit to different boot mode.

▷Normal:

Need to change hardware mode switch to **Normal**. This is the normal working mode of sound level meter.

▷Power & Boot:

Need to change hardware mode switch to **Boot**. After select this mode, sound level

meter will power on when proper power supply available. It's suitable for integrate into other system, especially in those cases where power failure, sound level meter can power on automatically from power shutdown.

▷Boot & Auto Meas.:

Need to change hardware mode switch to **Boot**. After select this mode, sound level meter will not only power on when proper power supply available, but also start measurement. When sound level meter was integrated into other system, it will power on and start measurement automatically from power failure.

▷Hardware Mode Switch:

The hardware mode switch located in the battery compartment. It's easily to be found after remove the batteries. Please select the switch to Boot or Normal by nib or tweezers.

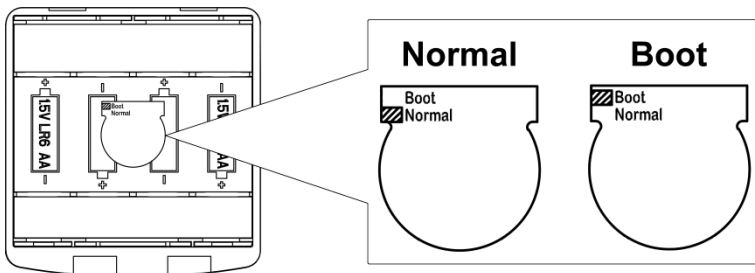



★Note: Static electricity sensitive area. Eliminate static electricity before operation.

4.4.10 USB Mode



Menu of **USB Mode** can set the working mode when connect sound level meter to computer by USB cable. **Always Ask**, **USB Disk Mode** and **Modem Mode** can be select.

▷Always Ask:

It always ask which mode should apply when connect to computer by USB. Please make choose in time, otherwise computer could not recognize the sound level meter due to

timeout.

▷USB Disk Mode:

It always working at **USB Disk Mode** without ask when connect to computer by USB. Sound level meter can be recognized as removable USB disk by computer without driver install, and the files stored in MicroSD card can be access by explorer directly.

▷Modem Mode:

It always working at **Modem Mode** without ask when connect to computer by USB. Sound level meter can be recognized as serial port (virtual serial port) by computer and follow the same protocol as RS-232 (refer to [5. RS-232 Communication Protocol](#) to earn more detail of protocol).

4.4.11 GPS



Menu of **GPS** can set the **GPS** and **Auto Time Sync** on-off. When **GPS** is turn off, the internal GPS module is shutdown. If enable **Auto Time Sync**, the RTC of sound level meter will be synchronized when get GPS time and then keep synchronization once per hour.

4.4.12 Setup Template

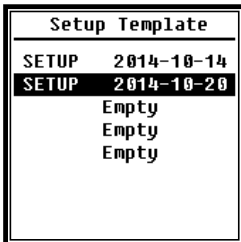

The Setup Template is used to store 5 group user setting parameter of sound level meter for different application.

☆**Note**: Template will not touch the Cal.Factor. Please do not try to load the old version template in new version firmware due to some modification could be apply in template format.

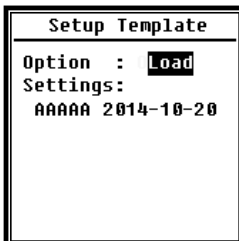

Press **<Enter>** on blank template can save 1 group setting which user can define the name by 5 letter or number.

Press **<Enter>** on one existing template can load or delete it.

4.4.13 About



About menu shows the Type, Class, S/N (serial number), Ver., and HWID (hardware ID) of sound level meter.

4.5 Language



Sound level meter support 6 language: **English, Chinese, Portuguese, Spanish, German** and **French**. Press **<▲>**, **<▼>** can select appropriate language and press **<Enter>** to save the setting.

4.6 Output

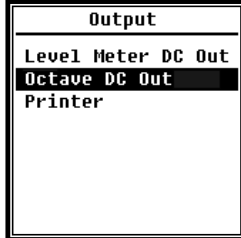

Menu of **Output** can select which measurement data should be output at **DC OUT**. There are **Level Meter DC Out** and **Octave DC Out** option for level meter mode and 1/1 octave mode. The **Printer** option also be include in this menu. Press **<▲>**, **<▼>** can choose and select.

4.6.1 AC OUT

There are two analog output ports on sound level meter: **DC OUT** and **AC OUT**. Please use coaxial cable to connect **DC OUT**, **AC OUT** to other device or system. Recommend input resistance of terminal device or system should above 5kΩ.

AC OUT port is located on the bottom of sound level meter. It output the signal of microphone directly without and setting can be apply. The maximum output voltage is 5Vrms ($\pm 7V_{peak}$), and maximum output current is $\pm 15mA$.

☆Note: Please add impedance transformation circuit when input resistance of terminal device or system is not so high enough. **AC OUT** is only can be used for noise recording or

monitor due to noise floor is higher than the lower limit of linear range of sound level meter.

4.6.2 DC OUT

DC OUT is used to output the analog DC signal which is proportional to measurement result with 10mV/dB ratio. For example, it output 938mV for 93.8dB. Recommend to filter or average the output signal to remove noise.

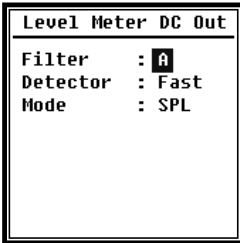

Level Meter DC Out can set the signal output of level meter mode. Press <▲>, <▼>, <◀>, <▶> can choose and select.

Filter: A, B, C, Z (Flat)

Detector: Fast, Slow, Imp.

Mode: SPL, LEQ, Peak



Octave DC Out can set the signal output of octave mode. The option is: LAeq, LBeq, LCeq, LZeq and 6.3Hz~20kHz. Press <◀>, <▶> can choose and select. If select unavailable band for current function, it will display "Invalid Octave Band!".

4.6.3 Printer

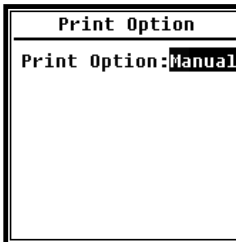

Print Option can set the printer option to Auto or Manual. Select **Auto** will print measurement result automatically after stopped measurement.

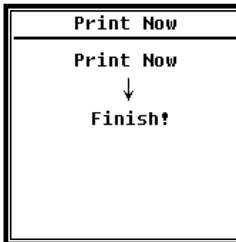

If user selects **Manual** option, select **Print Now** and press <Enter> to print measurement data.

☆**Note**: Please set to **Printer** mode in **RS-232** menu before print operation.

4.7 Factory Settings



Factory Settings provides the function for reset all the parameters which has been modify by users. The parameters will be initialized to the default value. Press <◀>, <▶> can select **Y** (Yes) or **N** (No). Choose **Y** and pressing <Enter> will initialize the parameter. Choose **N** or press <ESC> will cancel the reset.

5. RS-232 Communication Protocol

The Sound Level Meter **BSWA 308/309** has an RS-232 serial interface. User can modify the configuration of the sound level meter via a serial interface and control the sound level meter to run and to stop, and get the current measurement parameters and results for further processing. Operation via serial interface does not affect keyboard operation.

5.1 Hardware Configuration and Settings of Interface

BSWA 308/309 uses three-wire serial interface, the physical socket is PS/2-6 pins. Below is the definition of RS-232 interface:

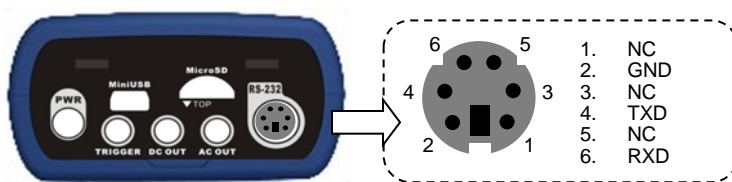

RS-232 transfer settings:

Transfer Mode	Full-duplex
Synchronous / Asynchronous Mode	Asynchronous transfer
Baudrate	4800 bps, 9600 bps, 19200 bps
Data Bits	8 bit
Stop Bits	1 bit
Parity	None
Flow Control	Follow the time data in the rated parameters table

★**Note**: RS-232 connector housing should be grounded and recommended to use ground shield wire. Please be sure to use quality and reliable RS-232 to RS-485 adaptor.

5.2 Transfer Protocol

BSWA 308/309 RS-232 interface protocol is based on a block transfer, as shown below:

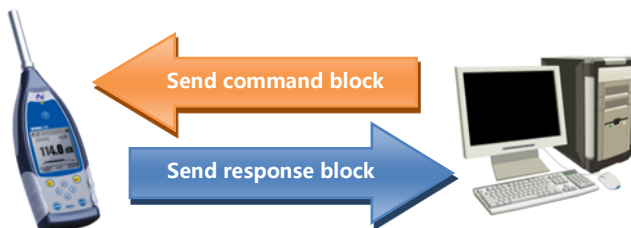

A typical command block or response block consists of “starting character, ID, attribute character, command or data, end character, block check character, carriage returns, line feeds”, as shown below:

<STX>	ID	ATTR	Command or Data	<ETX>	BCC	<CR>	<LF>
-------	----	------	-----------------	-------	-----	------	------

5.2.1 Start/Stop of the Block Transfer

A command block or response block contains start characters, end characters and other control character as shown below:

Name	Hex	Meaning
<STX>	02H	Start Character
<ETX>	03H	Stop Character
<CR>	0DH	Carriage Returns
<LF>	0AH	Line Feeds

5.2.2 Device ID

Each command block contains an ID. It is used to distinguish among a network of more than one sound level meter. When the sound level meter receives a command block, it will match the ID contained in the command block and its own ID. If matched, the corresponding operation will be performed. If not, then ignore this command. The response block returned from the sound level meter also contains the ID which is used to indicate that the block is sent by which one.

☆Note: Please ensure that the ID of sound level meter in the same network are different from each other, otherwise the error will occur during operation!

ID is one byte of binary. It ranges from 1~255. The corresponding hex value is 01H~FFH.

It means that the command is a broadcast command if the ID contained in command block is 00H. The sound level meter will execute the instruction without any return data, regardless of its own ID when the command is a broadcast command.

Name	Hex	Meaning
ID	01H~FFH	Device ID
	00H	Broadcast Command

5.2.3 ATTR Attribute Character

ATTR attribute characters indicate the type of command or response.

Name	Hex	Meaning
'C'	43H	Command Block
'A'	41H	Response Block
<ACK>	06H	Normal Response
<NAK>	15H	Error Response

5.2.4 BCC (Block Check Character)

BCC check bit which include in block is calculated by the sender. The receiver can calculate the block's BCC value and will compare with the BCC value contained in the send block. If same, it indicates that the received block is correct. BCC value is calculated by using bytes between <STX> and <ETX> with XOR operation. Sound level meter will not verify operation and directly authorized instruction if BCC is 00H. This way you can simplify the sending of the instruction block, but do not recommend this way for long-distance applications, because the BCC is the only way to guarantee reliability of data transmission.

Name	Hex	Meaning
BCC	01H~FFH	XOR Checksum
	00H	Ignore the Checksum

5.2.5 Block Transfer Format

Block transfer of data have four types: command block, response block, normal response block and error response block. The following were to describe the four types of instruction format.

(1) Command Block: sent by the computer.

<STX>	ID	ATTR	Instruction	Parameter	<ETX>	BCC	<CR>	<LF>	Byte
1	1	1	3	N	1	1	1	1	

Where: ATTR='C'.

All instructions occupy 3 bytes. If more than one parameter included, all parameters should be separated by spaces.

(2) Response Block: sent by the sound level meter.

<STX>	ID	ATTR	Response	<ETX>	BCC	<CR>	<LF>	Byte
1	1	1	N	1	1	1	1	

Where: ATTR='A'.

If more than one response data, each data should be separated by a comma ','.

(3) Normal Response: sent by the sound level meter.

<STX>	ID	ATTR	<ETX>	BCC	<CR>	<LF>	
1	1	1	1	1	1	1	1 Byte

Where: ATTR=<ACK>.

(4) Error Response: sent by the sound level meter

<STX>	ID	ATTR	Error code	<ETX>	BCC	<CR>	<LF>	
1	1	1	4	1	1	1	1	1 Byte

Where: ATTR=<NAK>.

The error code occupies 4 bytes. All possible error code is listed in the following table. The meaning of error code is described in section [5.2.6](#).

Error Code	Meaning
0001H	Instruction Error
0002H	Parameter Error
0003H	Unavailable on the Current State

5.2.6 Recovery from Transmission Errors

Various errors may occur when transfer the command block or response block. The following describe how the sound level meter will deal with and restore to the initial state when an error occurs.

(1) Block Transfer Not Complete

Section [5.2.5](#) describes the 4 kinds of block transmission format. When the sound level meter receives the beginning of a block of characters <STX>, it will continue to receive the remaining data until the end of the block <CR>, <LF>. When the data reception is complete and correct parity, the sound level meter will conduct follow-up actions. If received the character <STX> again before <CR>, <LF>, the sound level meter will ignore all the information previously received and re-start the reception of a block.

(2) Validation Failure

After receiving the data block, sound level meter will verify it (except when BCC=00H). When validation fails, the sound level meter will ignore this instruction.

(3) Instruction Error

The sound level meter may not recognize the instruction received due to the computer sends an undefined instruction, or unexpected error has occurred during transmission. When the above errors occur, the sound level meter will return a NAK block, which contains the error code 0001H.

(4) Parameter Error

Parameters include in command block also could be wrong due to the parameters not separate by a space, over the available range, or an incorrect number of arguments. When the above error occurs, the sound level meter will return NAK block, which contains the error-code 0002H.

(5) Unavailable on the Current State

The current state cannot make the appropriate operating when the following happens:

1	Be request to return octave data in level meter mode, or be request to return level meter data in octave mode.
2	Be request to perform the calibration operation when running the measurement.
3	Be request to change the measurement parameters or system parameters when running the measurement.

When the above error occurs, the sound level meter will return NAK block, which contains the error-code 0003H.

5.2.7 Flow Control

The sound level meter uses three-wire serial interface by P/S2-6 pin socket, which doesn't contain the hardware flow control pins. Sound level meter doesn't support software flow control. Operation along to the requirements of the rated section [5.2.9 Rated Parameters](#) can guarantee the correctness of the send data and receive data.

5.2.8 Multi-Machine Operation

More than one sound level meter can be connected to the RS-232 bus, to form a measurement network. Users can change the setting of all sound level meter in same network through broadcast instruction, or access to data and parameters of an each sound level meter by ordinary instruction.

Need to pay attention:

- (1) Ensure that no same ID of sound level meter in each network.
- (2) User cannot broadcast command which can return any data.

5.2.9 Rated Parameters

Name	Min.	Rated	Max.	Description
Response time of sound level meter	—	—	2s	Time-out processing should be operating when the value exceeds.
Time interval of instruction sending to sound level meter	—	100ms	—	—
Waiting time after received <STX> for sound level meter	—	Unlimited	—	Means that the sound level meter will waiting for the remaining data forever.
Time interval between each byte for sound level meter to receive	—	Unlimited	—	Means that the sending speed of the computer could be very slow.

5.3 Instruction

The instruction has two types: set instructions and query instructions.

Set Instructions: Set the measurement parameters and system parameters of sound level meter.

Query Instructions: Query the parameters and data of the sound level meter.

There are 3 kind of situation for sending instruction to sound level meter: set instruction (no response), set instructions (with response), query instructions.

(1) Set Instruction (no response):

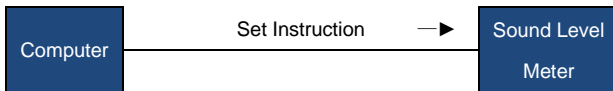

(2) Set instructions (with response):

Normal response:

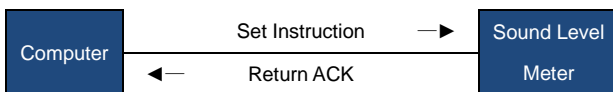

Error response:

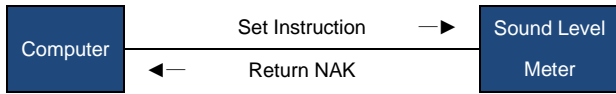

(3) Query command:

Normal response:

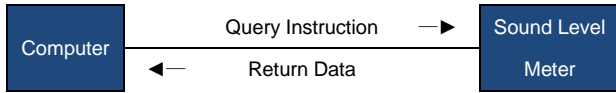

Error response:

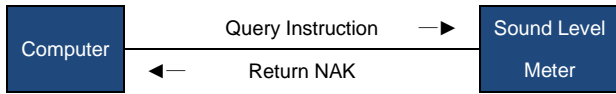

5.3.1 Instruction List

IDXp1: Setup ID.....	65
IDX?: Query ID	65
BRTp1: Set the RS-232 Baud Rate	66
BRT?: Query The RS-232 Baud Rate Setting.....	66
XONp1: Set the Flow Control	67
XON?: Query Flow Control Setting.....	67
RETp1: Set Response Mode.....	67
RET?: Query Response Mode Setting.....	68
MEMp1: Set the Measurement Mode	68
MEM?: Query Measurement Mode Setting.....	69
CALp1: Set Calibration Level and Calibrate by Measurement.....	69
CAL?: Query Calibration Level and Calibration Factor.....	70
CAFP1: Calibrate by Calibration Factor	70
CAF?: Query Calibration History	70
BSEp1_p2_p3_p4_p5_p6_p7: Measurement Setup	71
BSE?: Query Measurement Setup	72
RNS?: Query Measurement Range.....	72
ICPp1: Set ICCP Power	73
ICP?: Query ICCP Power State.....	73
PR1p1_p2_p3_p4: Set Profile1	73
PR1?: Query Profile1 Setting	74
PR2p1_p2_p3_p4: Set Profile2.....	74
PR2?: Query Profile2 Setting	74
PR3p1_p2_p3_p4: Set Profile3.....	74
PR3?: Query Profile3 Setting	74
ALMp1: Set Alarm Threshold	75
ALM?: Query the Alarm Threshold Setting.....	75
ETFP1_p2_p3_p4_p5: Set Extended Function	75
ETF?: Query Extended Function Setting	76

STSp1_p2_p3.....p11_p12: Set Statistical	76
STS?: Query Statistical.....	77
HISp1_p2: Set Time History.....	77
HIS?: Query Time History Setting.....	78
OCSp1_p2.....p13_p14: Set Octave Threshold.....	78
OCS?: Query Octave Threshold Setting.....	79
CUSp1_p2_p3_p4: Set Custom Measure.....	80
CUSp1_?: Query Custom Measure Setting.....	81
TISp1_p2_p3_p4_p5: Set Timer.....	81
TIS?: Query Timer Setting.....	82
CONp1: Set Contrast	82
CON?: Query Contrast Setting.....	82
BLTp1_p2: Set Backlight	83
BLT?: Query Backlight Setting.....	83
BAT?: Query Battery State	83
TRGp1: Set Trigger	84
TRG?: Query Trigger Setting.....	84
DATp1_p2_p3_p4: Set Date.....	85
DAT?: Query Date Setting	85
HORp1_p2_p3: Set Time	85
HOR?: Query Time Setting.....	86
PWOp1: Set Auto Power Off.....	86
PWO?: Query Auto Power Off Setting.....	86
OPMp1: Set Boot Mode.....	87
OPM?: Query Boot Mode Setting.....	87
UMDp1: Set USB Mode.....	88
UMD?: Query USB Mode Setting.....	88
GPDp1_p2: Set GPS	88
GPD?: Query GPS Setting	89
VER?: Query About Information.....	89

LNGp1: Set Language.....	89
LNG?: Query Language Setting.....	90
OUTp1_p2_p3_p4: Set Output	90
OUT?: Query Output Setting	91
RES: Apply Factory Settings	91
STAp1: Start / Stop Measurement	91
STA?: Query Measurement State	92
DMAp1_?: Query the Main Screen Data	92
TPRp1_?: Query 3-Profile Screen Data	93
DLNp1_?: Query Statistical Analysis Data (LN).....	93
DCU?: Query Custom Measure Data.....	94
DSLp1_p2_?: Query All the Data of the Sound Level Meter	95
DOT?: Query Octave Data	96
CSD: Save Custom Data into MicroSD	97

5.3.2 Instruction Format

In this section, “□□□” on behalf of the 3 characters of the instruction, “p1, p2 ……” on behalf of the parameter “d1, d2 …” means the data, “_” means a space.

(1) Separate The Parameters By Space For Multiple Parameters In One Instruction:

□□□	Instruction without parameters
□□□p1	Instruction with 1 parameter
□□□p1_p2	Instruction with 2 parameters
□□□?	Instruction with query parameter
□□□p1_?	Instruction with 1 parameter and a query parameter
□□□p1_p2_?	Instruction with 2 parameters and a query parameter

The parameters can be a wide range, for example from 1 to 255. These parameters are sending by the format of ASCII. Therefore, you may need to send 1~3 bytes.

□□□93	Parameter is 93
□□□124	Parameter is 124

Note that both of 93 and 124 are single parameter. So the individual numbers don't need to be separated by spaces.

□□□1_64	2 individual parameters, 1 and 64
---------	-----------------------------------

Note that 1 and 64 are two parameters in one instruction. So those parameters need to be separated by space.

The parameter is possible to be decimal or integer type. However, if the actual value is integer type, decimal point and decimal bits can be omitted.

(2) Separate The Data By Comma For Multiple Data In One Response

d1,d2,d3	Return 3 data
----------	---------------

Response block, the data bits actually returned is less than its maximum possible number of digits, leading zeros. For example, return 2 data with the maximum possible value 255 (3 digits), and the actually data is 76 and 9, the response is:

076,009	Return data 76 and 9
---------	----------------------

If the returned data contains date and time, use the slash “/” to separate data and use the colon “:” to separate the time:

2011/08/05, 12:13:55

5.3.3 Instruction Describe

Note in This Section:

- In the following description, the value, range and default value of parameter are show as ASCII code.
 - The default value means the sound level meter just delivery to user or restore to the factory settings.

IDXp1: Setup ID

ID of sound level meters in one network must be different. Otherwise, there will be a communication error.

☆Note: When the IDX instruction is correctly received by sound level meter, ACK signal will be returned with the new ID.

	Instruction			Parameters
Explanation	IDX			p1: ID number; Range: 1~255; Default: 1
ASCII	I	D	X	1
Hex	49H	44H	58H	31H
Byte	1	1	1	1~3
Return	ACK / NAK			

Example 1: set the ID as 3.

```
02 01 43 49 44 58 33 03 25 0D 0A
```

Return: ACK. Note where ID has been changed to 3 (03H).

```
02 03 06 03 040D 0A
```

Example 2: set the ID as 255.

```
02 01 43 49 44 58 32 35 35 03 24 0D 0A
```

Return: ACK. Note where ID has been changed to 255 (FFH).

```
02 FF 06 03 F8 0D 0A
```

IDX?: Query ID

	Instruction			Parameters
Explanation	IDX			Query parameter: ?
ASCII	I	D	X	?
Hex	49H	44H	58H	3FH
Byte	1	1	1	1
Return	Return the current ID number			

Example: query ID.

02 01 43 **49 44 58 3F** 03 29 0D 0A

Return: the current ID 001.

02 01 41 **30 30 31** 03 70 0D 0A

BRTp1: Set the RS-232 Baud Rate

★**Note**: When the BRT instruction is correctly received by the sound level meter, it will return the ACK by previous baud rate, and then update the baud rate.

	Instruction			Parameters
Explanation	BRT			p1: RS-232 baud rate; 2=4800bps; 3=9600bps; 4=19200bps; Default: 3
ASCII	B	R	T	3
Hex	42H	52H	54H	33H
Byte	1	1	1	1
Return	ACK / NAK			

Example: set the baud rate to 9600bps.

02 01 43 **42 52 54 33** 03 34 0D 0A

Return: ACK.

02 01 06 03 06 0D 0A

BRT?: Query The RS-232 Baud Rate Setting

	Instruction			Parameters
Explanation	BRT			Query parameter: ?
ASCII	B	R	T	?
Hex	42H	52H	54H	3FH
Byte	1	1	1	1
Return	Return the current baud rate			

Example: query the current baud rate.

02 01 43 **42 52 54 3F** 03 38 0D 0A

Return: the current baud rate is 9600bps.

02 01 41 **33** 03 72 0D 0A

XONp1: Set the Flow Control

	Instruction			Parameters
Explanation	XON			p1: Flow control mode; 0=Hardware flow control; 1=Software flow control; Default: 1
ASCII	X	O	N	1
Hex	58H	4FH	4EH	31H
Byte	1	1	1	1
Return	ACK / NAK			

Example: set to software flow control mode.

```
02 01 43 58 4F 4E 31 03 2B 0D 0A
```

Return: ACK.

```
02 01 06 03 06 0D 0A
```

XON?: Query Flow Control Setting

	Instruction			Parameters
Explanation	XON			Query parameter: ?
ASCII	X	O	N	?
Hex	58H	4FH	4EH	3FH
Byte	1	1	1	1
Return	Return flow control mode			

Example: query flow control mode.

```
02 01 43 58 4F 4E 3F 03 25 0D 0A
```

Return: the current flow control mode is software flow control.

```
02 01 41 31 03 70 0D 0A
```

RETP1: Set Response Mode

Response means the ACK / NAK signal returned from the sound level meter (HIS and OCS instruction returns MicroSD card state or NAK). User can enable or disable such a response.

☆**Note:** RET instruction itself is not affected by response mode. When the sound level meter receive the RET instruction, it will return ACK/NAK whether the current state is enabled or disabled. RET? Query command is also not subject to the influence of response mode.

	Instruction			Parameters
Explanation	RET			p1: Response mode; 0=Disabled; 1=Enabled;

				Default: 1
ASCII	R	E	T	1
Hex	52H	45H	54H	31H
Byte	1	1	1	1
Return	ACK / NAK			

Example: set to enable response.

02 01 43 **52 45 54 31** 03 31 0D 0A

Return: ACK.

02 01 06 03 06 0D 0A

RET?: Query Response Mode Setting

	Instruction			Parameters
Explanation	RET			Query parameter: ?
ASCII	R	E	T	?
Hex	52H	45H	54H	3FH
Byte	1	1	1	1
Return	Return response mode			

Example: query response mode.

02 01 43 **52 45 54 3F** 03 3F 0D 0A

Return: the current response mode is to enable the response.

02 01 41 **31** 03 70 0D 0A

MEMp1: Set the Measurement Mode

When MEM instruction is correctly received by the sound level meter, it will switch to the main screen of the octave mode or the main screen of level meter mode according to the corresponding parameter in instruction.

★**Note:** The 1/3 octave band is optional function.

	Instruction			Parameters
Explanation	MEM			p1: Measurement mode; 0=1/1 Octave; 1=Level meter mode; 2=1/3 Octave (Optional); Default: 1
ASCII	M	E	M	1
Hex	4DH	45H	4DH	31H
Byte	1	1	1	1
Return	ACK / NAK			

Example: set the sound level meter mode.

02 01 43 **4D 45 4D 31** 03 37 0D 0A

Return: ACK.

02 01 06 03 06 0D 0A

MEM?: Query Measurement Mode Setting

	Instruction			Parameters
Explanation	MEM			Query parameter: ?
ASCII	M	E	M	?
Hex	4DH	45H	4DH	3FH
Byte	1	1	1	1
Return	Return the measurement mode			

Example: query the measurement mode.

02 01 43 **4D 45 4D 3F** 03 39 0D 0A

Returns: the current measurement mode is level meter mode.

02 01 41 **31** 03 70 0D 0A

CALp1: Set Calibration Level and Calibrate by Measurement

★Note: When CAL instruction is correctly received by the sound level meter, two ACK will be returned at the beginning and the end of the calibration (several seconds will be spent by the calibration). In the calibration history, ending with symbol **M** indicate the record was calibrate by the method of by Measurement.

	Instruction			Parameters
Explanation	CAL			p1: Calibration level; Range: 0~199.9; Default: 93.8
ASCII	C	A	L	93.8
Hex	43H	41H	4CH	39H, 33H, 2EH, 38H
Byte	1	1	1	1~5
Return	ACK / NAK			

Example 1: set the calibration level as 94dB and calibrate by measurement.

02 01 43 **43 41 4C 39 34** 03 00 0D 0A

Return: ACK.

02 01 06 03 06 0D 0A

Return again after calibration finished: ACK

02 01 06 03 06 0D 0A

Example 2: set the calibration level as 113.8dB and calibrate by measurement.

```
02 01 43 43 41 4C 31 31 33 2E 38 03 28 0D 0A
```

Return: ACK.

```
02 01 06 03 06 0D 0A
```

Return again after calibration finished: ACK

```
02 01 06 03 06 0D 0A
```

CAL?: Query Calibration Level and Calibration Factor

	Instruction			Parameters
Explanation	MEM			Query parameter: ?
ASCII	C	A	L	?
Hex	43H	41H	4CH	3FH
Byte	1	1	1	1
Return	Return the value of the calibration level and calibration factor			

Example: query the calibration level and calibration factor.

```
02 01 43 43 41 4C 3F 03 32 0D 0A
```

Return: the current calibration level is 094.0dB, the calibration factor is 000.00dB.

```
02 01 41 30 39 34 2E 30 2C 2B 30 30 30 2E 30 30 03 7B 0D 0A
```

CAFP1: Calibrate by Calibration Factor

This instruction can modify the calibration factor. In the calibration history, code “F” at the end of each line means by calibration factor.

	Instruction			Parameters
Explanation	CAF			p1: Calibration factor; Range: -199.99~+199.99 (“+” sign can be omitted); Default: 0
ASCII	C	A	F	0
Hex	43H	41H	46H	30H
Byte	1	1	1	1~7
Return	ACK / NAK			

Example: set the calibration factor value as 0.74dB (“+” sign is omitted).

```
02 01 43 43 41 46 30 2E 37 34 03 1A 0D 0A
```

Return: ACK.

```
02 01 06 03 06 0D 0A
```

CAF?: Query Calibration History

Query the most recent 4 group history of calibration.

	Instruction			Parameters
Explanation	CAF			Query parameter: ?
ASCII	C	A	F	?
Hex	43H	41H	46H	3FH
Byte	1	1	1	1
Return	Returns the most recent 4 group history of calibration. Format "Year/Month/day, hour:minute:second, calibration factor, code". Code: M=By Measurement, F=By Calibration Factor.			

Example: query the calibration history.

```
02 01 43 43 41 46 3F 03 38 0D 0A
```

Return: the data returned by this instruction use a slash "/" split date, use a colon ":" split time. Calibration history is 2011/08/04, 17:03:28, +001.29, F, 2011/08/04, 17:03:02, +001.25, F, 2011/08/04, 17:02:20, +000.71, F, 2011/08/04, 17:02:00, +001.27, M.

```
02 01 41 32 30 31 31 2F 30 38 2F 30 34 2C 31 37 3A 30 33 3A 32 38 2C 2B
30 30 31 2E 32 39 2C 46 2C 32 30 31 31 2F 30 38 2F 30 34 2C 31 37 3A 30
33 3A 30 32 2C 2B 30 30 31 2E 32 35 2C 46 2C 32 30 31 31 2F 30 38 2F 30
34 2C 31 37 3A 30 32 3A 32 30 2C 2B 30 30 30 2E 37 31 2C 46 2C 32 30 31
31 2F 30 38 2F 30 34 2C 31 37 3A 30 32 3A 30 30 2C 2B 30 30 31 2E 32 37
2C 4D 03 62 0D 0A
```

BSEp1_p2_p3_p4_p5_p6_p7: Measurement Setup

Set the delay, integral period, repeat, and logger setup.

	Instruction	P1	P2	P3	P4	P5	P6	P7
Explanation	BSE	p1: delay; 1~60=1~60s; 61=Sync. 1m; 62=Sync. 15m; 63=Sync. 30m; 64=Sync. 1h; Default: 1	p2: integral period; 0=Inf; 1~59=1~59s; 60~118=1~59m; 119~142=1h~24h; Default: 0	p3: repeat; 0=Inf; 1~9999=1~9999 times; Default: 0	p4: SWN logger; 0=disable; 1=enable; Default: 0	p5:SWN logger ;st ep 0=0.1s; 1=0.2s; 2=0.5s; 3~61=1~59s; 62~120=1~59m; 121~144=1h~24h; Default: 3	p6:CSD logger; 0=disable; 1=enable; Default: 0	p7:CSD logger step; 0~58=1~59s; 59~117=1~59m; 118~141=1~24h; Default: 59
ASCII	B S E	1	0	0	0	3	0	59

Hex	42 H	53 H	45 H	31H	30H	30H	30H	33H	30H	35H, 39H
Byte	1	1	1	1~2	1~3	1~4	1	1~3	1	1~2
Return	Returns: 0=setting succeed, MicroSD card is OK; 1=setting succeed, but the MicroSD card is abnormal; 2=setting succeed, but no MicroSD card detected.									

Example: set delay as 2s, integral period as 5m, repeat as infinite, SWN logger enable, SWN logger step as 0.2s, CSD logger disable, CSD logger step as 2s.

```
02 01 43 42 53 45 32 20 36 34 20 30 20 31 20 31 20 31 20 31 03 17 0D 0A
```

Returns: setting succeeds, MicroSD card is OK.

```
02 01 41 30 03 71 0D 0A
```

BSE?: Query Measurement Setup

	Instruction			Parameters
Explanation	BSE			Query parameter: ?
ASCII	B	S	E	?
Hex	42H	53H	45H	3FH
Byte	1	1	1	1
Return	Return parameter of measurement setup: delay, integral period, repeat, SWN logger, SWN logger step, CSD Logger, CSD Logger step.			

Example: query the measurement setup.

```
02 01 43 42 53 45 3F 03 28 0D 0A
```

Returns: the current measurement setup: delay=2s, integral period=5min, repeat=infinite, SWN logger=enable, SWN logger step= 0.2s, CSD logger=enable, CSD logger step=2s.

```
02 01 41 30 32 2C 30 36 34 2C 30 30 30 30 2C 31 2C 30 30 31 2C 31 2C 30 30 31 03 71 0D 0A
```

RNS?: Query Measurement Range

	Instruction			Parameters
Explanation	RNG			Query parameter: ?
ASCII	R	N	S	?
Hex	52H	4EH	53H	3FH
Byte	1	1	1	1
Return	Return measurement range			

Example: query measurement range.

```
02 01 43 52 4E 53 3F 03 33 0D 0A
```

Return: linearity, dynamic and peak C range is 22.8-133.8, 12.8-133.8, 44.8-136.8.

```
02 01 41 30 32 32 2E 38 7E 31 33 33 2E 38 2C 30 31 32 2E 38 7E 31 33 33
2E 38 2C 30 34 34 2E 38 7E 31 33 36 2E 38 03 38 0D 0A
```

ICPp1: Set ICP Power

	Instruction			Parameters
Explanation	ICP			p1: ICP power state; 0=Enable; 1=Disable; Default: 0
ASCII	I	C	P	0
Hex	49H	43H	50H	30H
Byte	1	1	1	1
Return	ACK / NAK			

Example: enable ICCP power:

```
02 01 43 49 43 50 30 03 29 0D 0A
```

Return: ACK.

```
02 01 06 03 06 0D 0A
```

ICP?: Query ICP Power State

	Instruction			Parameters
Explanation	ICP			Query parameter: ?
ASCII	I	C	P	?
Hex	49H	43H	50H	3FH
Byte	1	1	1	1
Return	Return ICP power state			

Example: query ICCP power state

```
02 01 43 49 43 50 3F 03 26 0D 0A
```

Return: ICP power is enable

```
02 01 41 30 03 71 0D 0A
```

PR1p1_p2_p3_p4: Set Profile1

	Instruction	P1	P2	P3	P4
Explanation	PR1	p1: Filter; 0=A; 1=B; 2=C;	p2: Detector; 0=Fast; 1=Slow; 2=Imp;	p3: Integration mode; 0=SPL; 1=PEAK;	p4: SWN Logger; 0=LEQ; 1=PEAK;

				3=Z; Default: 0	Default: 0	2=LEQ; 3=MAX; 4=MIN; Default: 0	2=MAX; 3=MIN; Default: 0
ASCII	P	R	1	0	0	0	0
Hex	50H	52H	31H	30H	30H	30H	30H
Byte	1	1	1	1	1	1	1
Return	ACK / NAK						

Example: set Profile1 as A, Fast, SPL and save LEQ.

```
02 01 43 50 52 31 30 20 30 20 30 03 50 0D 0A
```

Return: ACK.

```
02 01 06 03 06 0D 0A
```

PR1?: Query Profile1 Setting

	Instruction			Parameters
Explanation	PR1			Query parameter: ?
ASCII	P	R	1	?
Hex	50H	52H	31H	3FH
Byte	1	1	1	1
Return	Return Profile1 setting			

Example: query Profile1 setting.

```
02 01 43 50 52 31 3F 03 4F 0D 0A
```

Return: current Profile1 setting is A, Fast, SPL, save LEQ.

```
02 01 41 30 2C 30 2C 30 2C 30 03 6D 0D 0A
```

PR2p1_p2_p3_p4: Set Profile2

Except the instruction is "PR2" and the default filter is 2 (C-weighting), all others are same to the "PR1".

PR2?: Query Profile2 Setting

Except the instruction is "PR2", all others are same to the "PR1?".

PR3p1_p2_p3_p4: Set Profile3

Except the instruction is "PR3" and the default filter is 3 (Z-weighting), all others are same to the "PR1".

PR3?: Query Profile3 Setting

Except the instruction is "PR3", all others are same to the "PR1?".

ALMp1: Set Alarm Threshold

	Instruction			Parameters
Explanation	ALM			p1: Alarm threshold; Range: 20~200; Default: 100
ASCII	A	L	M	100
Hex	41H	4CH	4DH	31H, 30H, 30H
Byte	1	1	1	1~3
Return	ACK / NAK			

Example: setting alarm threshold as 100dB.

```
02 01 43 41 4C 4D 31 30 30 03 32 0D 0A
```

Return: ACK.

```
02 01 06 03 06 0D 0A
```

ALM?: Query the Alarm Threshold Setting

	Instruction			Parameters
Explanation	ALM			Query parameter: ?
ASCII	A	L	M	?
Hex	41H	4CH	4DH	3FH
Byte	1	1	1	1
Return	Return alarm threshold			

Example: query alarm threshold.

```
02 01 43 41 4C 4D 3F 03 3C 0D 0A
```

Return: the current alarm threshold is 100dB.

```
02 01 41 31 30 30 03 70 0D 0A
```

ETFP1_p2_p3_p4_p5: Set Extended Function

	Instruction			P1	P2	P3	P4	P5
Explanation	ETF			p1: 3Profile Screen; 0=Disable; 1=Enable	p2: Statistical Screen; 0=Disable; 1=Enable	p3: Time History Screen; 0=Disable; 1=Enable	p4: Custom Screen; 0=Disable; 1=Enable	p5: GPS Screen; 0=Disable; 1=Enable
ASCII	E	T	F	1	1	1	1	1
Hex	45H	54H	46H	31H	31H	31H	31H	31H

Byte	1	1	1	1	1	1	1	1
Return	ACK / NAK							

Example: enable 3Profile, statistical, time history, custom, GPS.

02 01 43 45 54 46 31 20 31 20 31 20 31 20 31 03 25 0D 0A
--

Return: ACK

02 01 06 03 06 0D 0A

ETF?: Query Extended Function Setting

	Instruction			Parameters
Explanation	ETF			Query parameter: ?
ASCII	E	T	F	?
Hex	45H	54H	46H	3FH
Byte	1	1	1	1
Return	Return the extended function setting			

Example: query the extended function setting

02 01 43 45 54 46 3F 03 2B 0D 0A

Return: 3Profile, statistical, time history, custom and GPS are all enable

02 01 41 31 2C 31 2C 31 2C 31 03 70 0D 0A

STSp1_p2_p3.....p11_p12: Set Statistical

	Instruction			P1	P2	P3~P12
Explanation	STS			p1: Filter 0=A; 1=B; 2=C; 3=Z; Default: 0	p2: Detector 0=F; 1=S; 2=I; Default: 0	p3~p12: statistical percentage; Range: 1~99; Default: 10, 20, 30, 40, 50, 60, 70, 80, 90, 99
ASCII	S	T	S	0	0	10_20_30_40_50_ 60_70_80_90_99
Hex	53H	54H	53H	30H	30H	31H, 30H, 20H, 32H, 30H, 20H, 33H, 30H, 20H, 34H, 30H, 20H, 35H, 30H, 20H, 35H, 30H, 20H, 36H, 30H, 20H, 37H, 30H, 20H, 38H, 30H, 20H, 39H, 30H, 20H, 39H, 39H
Byte	1	1	1	1	1	10~20+9 (spaces)
Return	ACK / NAK					

Example: set filter as B, detector as I, percentage as 10, 20, 30, 40, 50, 60, 70, 80, 90 and 99.

```
02 01 43 53 54 53 31 20 32 20 31 30 20 32 30 20 33 30 20 34 30 20 35 30 20 36 30
20 37 30 20 38 30 20 39 30 20 39 39 03 35 0D 0A
```

Return: ACK.

```
02 01 06 03 06 0D 0A
```

STS?: Query Statistical

	Instruction			Parameters
Explanation	STS			Query parameter: ?
ASCII	S	T	S	?
Hex	53H	54H	53H	3FH
Byte	1	1	1	1
Return	Return filter, detector and 10 percentage of statistical			

Example: query statistical

```
02 01 43 53 54 53 3F 03 28 0D 0A
```

Return: filter=B, detector=I, percentage=10, 20, 30, 40, 50, 60, 70, 80, 90, 99.

```
02 01 41 31 2C 32 2C 31 30 2C 32 30 2C 33 30 2C 34 30 2C 35 30 2C 36 30
2C 37 30 2C 38 30 2C 39 30 2C 39 39 03 6F 0D 0A
```

HISp1_p2: Set Time History

	Instruction			Parameters 1	Parameters 2
Explanation	HIS			p1: Profile; 0=Profile1; 1=Profile2; 2=Profile3; Default: 1	p2: Duration; 0=1min; 1=2min; 2=10min; Default: 1
ASCII	H	I	S	1	1
Hex	48H	49H	53H	31H	31H
Byte	1	1	1	1	1
Return	ACK / NAK				

Example: set Profile2 as data sources and duration as 2min.

```
02 01 43 48 49 53 31 20 31 03 31 0D 0A
```

Return: ACK.

```
02 01 06 03 06 0D 0A
```



```

33 38 2E 32 2C 30 33 38 2E 33 2C 30 33 38 2E 34 2C 30 33 38 2E 35 2C 30
33 38 2E 36 2C 30 33 38 2E 37 2C 30 33 38 2E 38 2C 30 33 38 2E 39 2C 30
33 38 2E 31 2C 30 33 38 2E 32 2C 30 33 38 2E 33 2C 30 33 38 2E 34 2C 30
33 38 2E 35 2C 30 33 38 2E 36 2C 30 33 38 2E 37 2C 30 33 38 2E 38 2C 30
33 38 2E 39 03 7D 0D 0A

```

CUSp1_p2_p3_p4: Set Custom Measure

	Instruction			P1	P2	P3	P4
Explanation	CUS			p1: Group; Range: 1~14	p2: Filter; 0=A; 1=B; 2=C; 3=Z	p3: Detector; 0=Fast; 1=Slow; 2=Imp.	p4: Mode; 0=SPL; 1=SD; 2=SEL; 3=E; 4=Max; 5=Min; 6=Peak; 7=LEQ; 8=LN1; 17=LN10
ASCII	C	U	S	1	0	0	0
Hex	43H	55H	53H	31H	30H	30H	30H
Byte	1	1	1	1~2	1	1	1~2
Return	ACK / NAK						

Example: set custom measurement of group 1 to B-weighting, Fast, Peak.

```
02 01 43 43 55 53 31 20 31 20 30 20 36 03 20 0D 0A
```

Return: ACK

```
02 01 06 03 06 0D 0A
```

Default value of each group in custom measurement (parameter with * is actually useless):

	Filter	Detector	Mode	Meaning
Custom 1	0	0	7	A, Fast*, LEQ
Custom 2	0	0	8	A*, Fast*, LN1
Custom 3	0	0	12	A*, Fast*, LN5
Custom 4	0	0	16	A*, Fast*, LN 9
Custom 5	0	0	4	A, Fast, Max
Custom 6	0	0	5	A, Fast, Min

Custom 7	0	0	1	A, Fast, SD
Custom 8	0	0	0	A, Fast, SPL
Custom 9	1	0	0	B, Fast, SPL
Custom 10	2	0	0	C, Fast, SPL
Custom 11	3	0	0	Z, Fast, SPL
Custom 12	0	0	2	A, Fast*, SEL
Custom 13	0	0	3	A, Fast*, E
Custom 14	2	0	6	C, Fast*, Peak

CUSp1_?: Query Custom Measure Setting

	Instruction			P1	P2
Explanation	CUS			p1: Group 1~14	Query parameter: ?
ASCII	C	U	S	1	?
Hex	43H	55H	53H	31H	3FH
Byte	1	1	1	1~2	1
Return	Return custom measure setting				

Example: query custom measure settings of group 12.

```
02 01 43 43 55 53 31 32 20 3F 03 1A 0D 0A
```

Return: the setting of group 12 is A-weighting, Fast, E.

```
02 01 41 31 32 2C 30 2C 30 2C 30 33 03 6D 0D 0A
```

TISp1_p2_p3_p4_p5: Set Timer

	Instruction			P1	P2	P3	P4	P5
Explanation	TIS			P1: Switch; 0=OFF; 1=ON; Default: 0	p2: Start Day; 0=Ignore; 1~31= 1~31 day form today; Default: 0	p3: Start hour; 0~23= 0~23h; Default: 12	p4: Start minute; 0~59= 0~59m; Default: 0	P5: Repeat period; 1~59= 1~59m; 60~83= 1~24h; Default: 1
ASCII	T	I	S	0	0	12	0	1
Hex	54H	49H	53H	30H	30H	31H, 32H	30H	31H
Byte	1	1	1	1	1	1~2	1~2	1~2
Return	ACK / NAK							

Example: set the Timer as switch: ON, start day: Ignore, start hour: 12:00, repeat period: 1m.

```
02 01 43 54 49 53 31 20 30 20 31 32 20 30 20 31 03 0E 0D 0A
```

Return: ACK

```
02 01 06 03 06 0D 0A
```

TIS?: Query Timer Setting

	Instruction			Parameters
Explanation	TIS			Query parameter: ?
ASCII	54H	49H	53H	?
Hex	1	1	1	3FH
Byte	54H	49H	53H	1
Return	Return Timer setting			

Example: query Timer setting.

```
02 01 43 54 49 53 3F 03 32 0D 0A
```

Return: Timer setting is switch=OFF, start day=Ignore, Start Time=12:00, Repeat period=1m.

```
02 01 41 30 2C 30 30 2C 31 32 3A 30 30 2C 30 31 03 65 0D 0A
```

CONp1: Set Contrast

	Instruction			Parameters
Explanation	CON			p1: Contrast; Range:0~14; Default: 7
ASCII	C	O	N	7
Hex	43H	4FH	4EH	37H
Byte	1	1	1	1
Return	ACK / NAK			

Example: set the contrast as 9.

```
02 01 43 43 4F 4E 39 03 38 0D 0A
```

Return: ACK

```
02 01 06 03 06 0D 0A
```

CON?: Query Contrast Setting

	Instruction			Parameters
Explanation	CON			Query parameter: ?
ASCII	C	O	N	?
Hex	43H	4FH	4EH	3FH
Byte	1	1	1	1
Return	Return contrast setting			

Example: query contrast setting

02 01 43 **43 4F 4E 3F** 03 3E 0D 0A

Returns: the current contrast is 7

02 01 41 **30 37** 03 46 0D 0A

BLTp1_p2: Set Backlight

	Instruction			Parameter 1	Parameter 2
Explanation	BLT			p1: TimeOut; 0=ON, Auto shut down; 1=OFF, Never turn off; Default: 0	p2: Delay; 0=10s; 1=20s; 2=30s; 3=40s; 4=50s; 5=60s; Default: 0
ASCII	B	L	T	0	0
Hex	42H	4CH	54H	30H	30H
Byte	1	1	1	1	1
Return	ACK / NAK				

Example: set backlight as timeout: ON, delay: 20s

02 01 43 **42 4C 54 30 20 31** 03 38 0D 0A

Return: ACK

02 01 06 03 06 0D 0A

BLT?: Query Backlight Setting

	Instruction			Parameters
Explanation	BLT			Query parameter: ?
ASCII	B	L	T	?
Hex	42H	4CH	54H	3FH
Byte	1	1	1	1
Return	Return backlight settings			

Example: query the backlight settings

02 01 43 **42 4C 54 3F** 03 26 0D 0A

Return: the current backlight setting is timeout=OFF, delay=20s (delay is useless when backlight timeout is OFF)

02 01 41 **31 2C 31** 03 6D 0D 0A

BAT?: Query Battery State

	Instruction			Parameters
Explanation	BAT			Query parameter: ?
ASCII	B	A	T	?

Hex	42H	41H	54H	3FH
Byte	1	1	1	1
Return	Returns the power state and supply voltage Power state: 0=Battery; 1=External power; 2=USB power Supply voltage: xx.xx V			

Example: query battery state

```
02 01 43 42 41 54 3F 03 2B 0D 0A
```

Returns: the current battery state is external power supply, supply voltage is 9.24V

```
02 01 41 31 2C 30 39 2E 32 34 03 7D 0D 0A
```

TRGp1: Set Trigger

	Instruction			Parameters
Explanation	TRG			p1: Trigger switch; 0=OFF; 1=ON; Default: 0
ASCII	T	R	G	0
Hex	54H	52H	47H	30H
Byte	1	1	1	1
Return	ACK / NAK			

Example: set trigger as OFF

```
02 01 43 54 52 47 30 03 32 0D 0A
```

Return: ACK

```
02 01 06 03 06 0D 0A
```

TRG?: Query Trigger Setting

	Instruction			Parameters
Explanation	TRG			Query parameter: ?
ASCII	T	R	G	?
Hex	54H	52H	47H	3FH
Byte	1	1	1	1
Return	Return Trigger settings			

Example: query trigger setting

```
02 01 43 54 52 47 3F 03 3D 0D 0A
```

Returns: the current trigger setting is OFF

```
02 01 41 30 03 71 0D 0A
```

DATp1_p2_p3_p4: Set Date

	Instruction			P1	P2	P3	P4
Explanation	DAT			p1: Date format; 0=Year/Month/Day; 1=Month/Day/Year; 2=Day/Year/Month; Default: 0	p2: Year; Range: 2000~2999	p3: Month; Range: 1~12	p4: Day; Range: 1~31
ASCII	D	A	T	0	2011	1	1
Hex	44H	41H	54H	30H	32H, 30H 31H, 31H	31H	31H
Byte	1	1	1	1	4	1~2	1~2
Return	ACK / NAK						

Example: set the date format as year/month/day, date: 5th August 2011

02 01 43 **44 41 54 30 20 32 30 31 31 20 38 20 35** 03 0D 0D 0A

Return: ACK

02 01 06 03 06 0D 0A

DAT?: Query Date Setting

	Instruction			Parameters
Explanation	DAT			Query parameter: ?
ASCII	D	A	T	?
Hex	44H	41H	54H	3FH
Byte	1	1	1	1
Return	Return date setting			

Example: query date

02 01 43 **44 41 54 3F** 03 2D 0D 0A

Return: the current date format=year/month/day, date=5th August 2011

02 01 41 **30 2C 32 30 31 31 2F 30 38 2F 30 35** 03 52 0D 0A

HORp1_p2_p3: Set Time

	Instruction			P1	P2	P3
Explanation	HOR			p1: Hour; Range: 0~23h	p2: Minute; Range: 0~59m	p3: Second; Range: 0~59s
ASCII	H	O	R	1	1	1
Hex	48H	4FH	52H	31H	31H	31H

Byte	1	1	1	1~2	1~2	1~2
Return	ACK / NAK					

Example: set the time as 18:37:30

02 01 43 48 4F 52 31 38 20 33 37 20 33 30 03 18 0D 0A
--

Return: ACK

02 01 06 03 06 0D 0A

HOR?: Query Time Setting

	Instruction			Parameters
Explanation	HOR			Query parameter: ?
ASCII	H	O	R	?
Hex	48H	4FH	52H	3FH
Byte	1	1	1	1
Return	Return time settings			

Example: query time setting

02 01 43 48 4F 52 3F 03 29 0D 0A

Returns: the current time is 18:37:48

02 01 41 31 38 3A 33 37 3A 34 38 03 40 0D 0A

PWOp1: Set Auto Power Off

	Instruction			Parameters
Explanation	PWO			p1: Auto power off time; 0=1min; 1=5min; 2=10min; 3=30min; 4=OFF; Default: 4
ASCII	P	W	O	4
Hex	50H	57H	4FH	34H
Byte	1	1	1	1
Return	ACK / NAK			

Example: set auto power off as OFF

02 01 43 50 57 4F 34 03 3F 0D 0A

Return: ACK

02 01 06 03 06 0D 0A

PWO?: Query Auto Power Off Setting

	Instruction	Parameters
Explanation	PWO	Query parameter: ?

ASCII	P	W	O	?
Hex	50H	57H	4FH	3FH
Byte	1	1	1	1
Return	Return auto power off settings			

Example: query auto power off settings

```
02 01 43 50 57 4F 3F 03 34 0D 0A
```

Returns: the current auto power off setting is OFF

```
02 01 41 34 03 75 0D 0A
```

OPMp1: Set Boot Mode

	Instruction			Parameters
Explanation	OPM			p1: Boot mode; 0=Normal; 1=Power & Boot; 2=Boot & Auto Measure; Default: 0
ASCII	O	P	M	0
Hex	4FH	50H	4DH	30H
Byte	1	1	1	1
Return	ACK / NAK			

Example: set bott mode as normal

```
02 01 43 4F 50 4D 30 03 21 0D 0A
```

Return: ACK

```
02 01 06 03 06 0D 0A
```

OPM?: Query Boot Mode Setting

	Instruction			Parameters
Explanation	OPM			Query parameter: ?
ASCII	O	P	M	?
Hex	4FH	50H	4DH	3FH
Byte	1	1	1	1
Return	Return boot mode setting			

Example: query boot mode

```
02 01 43 4F 50 4D 3F 03 2E 0D 0A
```

Return: the current boot mode is normal

```
02 01 41 30 03 71 0D 0A
```

UMDp1: Set USB Mode

	Instruction			Parameters
Explanation	UMD			p1: USB Mode; 0=Always Ask; 1=U Disk Mode; 2=Modem Mode; Default: 0
ASCII	U	M	D	0
Hex	55H	4DH	44H	30H
Byte	1	1	1	1
Return	ACK / NAK			

Example: set to modem mode

```
02 01 43 55 4D 44 32 03 2D 0D 0A
```

Return: ACK

```
02 01 06 03 06 0D 0A
```

UMD?: Query USB Mode Setting

	Instruction			Parameters
Explanation	UMD			Query parameter: ?
ASCII	U	M	D	?
Hex	55H	4DH	44H	3FH
Byte	1	1	1	1
Return	Return USB mode setting			

Example: query USB mode setting

```
02 01 43 55 4D 44 3F 03 20 0D 0A
```

Return: the current USB mode is modem mode

```
02 01 41 32 03 73 0D 0A
```

GPDp1_p2: Set GPS

	Instruction			P1	P2
Explanation	GPD			p1: GPS switch; 0=OFF; 1=ON; Default: 0	p2: Auto time sync; 0=OFF; 1=ON; Default: 0
ASCII	G	P	D	0	0

Hex	47H	50H	44H	30H	30H
Byte	1	1	1	1	1
Return	ACK / NAK				

Example: set GPS as switch: ON, auto time sync: ON

```
02 01 43 47 50 44 31 20 31 03 30 0D 0A
```

Return: ACK

```
02 01 06 03 06 0D 0A
```

GPD?: Query GPS Setting

	Instruction			Parameters
Explanation	GPD			Query parameter: ?
ASCII	G	P	D	?
Hex	47H	50H	44H	3FH
Byte	1	1	1	1
Return	Return GPS setting			

Example: query GPS setting

```
02 01 43 47 50 44 3F 03 2D 0D 0A
```

Returns: the current GPS setting is switch=ON, auto time sync=ON

```
02 01 41 31 2C 31 03 6F 0D 0A
```

VER?: Query About Information

	Instruction			Parameters
Explanation	VER			Query parameter: ?
ASCII	V	E	R	?
Hex	56H	45H	52H	3FH
Byte	1	1	1	1
Return	Return the about information			

Example: query about information

```
02 01 43 56 45 52 3F 03 3D 0D 0A
```

Returns: type=309S, class=2, S/N=490001, version=3.00.141020, HWID=P0274.03.B11

```
02 01 41 33 30 39 53 2C 32 2C 34 39 30 30 30 31 2C 33 2E 30 30 2E 31 34
31 30 32 30 2C 50 30 32 37 34 2E 30 33 2E 42 31 31 03 33 0D 0A 03 70 0D
0A
```

LNGp1: Set Language

	Instruction	Parameters
Explanation	LNG	p1: Language selection;

				0=English; 1=Chinese; 2=Portuguese; 3=Spanish; 4=German; 5=French; Default: 0
ASCII	L	N	G	0
Hex	4CH	4EH	47H	30H
Byte	1	1	1	1
Return	ACK / NAK			

Example: set the language as Chinese

02 01 43 **4C 4E 47 31** 03 37 0D 0A

Return: ACK

02 01 06 03 06 0D 0A

LNG?: Query Language Setting

	Instruction			Parameters
Explanation	LNG			Query parameter: ?
ASCII	L	N	G	?
Hex	4CH	4EH	47H	3FH
Byte	1	1	1	1
Return	Return the language setting			

Example: query language setting

02 01 43 **4C 4E 47 3F** 03 39 0D 0A

Returns: the current language is Chinese

02 01 41 **31** 03 70 0D 0A

OUTp1_p2_p3_p4: Set Output

	Instruction			P1	P2	P3	P4
Explanation	OUT			p1: Filter of SLM; 0=A; 1=B; 2=C; 3=Z; Default: 0	p2: Detector of SLM; 0=Fast; 1=Slow; 2=Imp.; Default: 0	p3: Mode of SLM; 0=SPL; 1=LEQ; 2=Peak; Default: 0	p4: Output of Octave; 0=LAeq; 1=LBeq; 2=LCEq; 3=LZeq; 4~39=6.3Hz~20kHz; Default: 0
ASCII	O	U	T	0	0	0	0
Hex	4FH	55H	54H	30H	30H	30H	30H

Byte	1	1	1	1	1	1	1~2
Return	ACK / NAK						

Example: set the output to A-weighting, Fast, SPL for SLM. Set the output to LAeq for Octave

02 01 43 **4F 55 54 30 20 30 20 30 20** 30 03 2D 0D 0A

Return: ACK

02 01 06 03 06 0D 0A

OUT?: Query Output Setting

	Instruction			Parameters
Explanation	OUT			Query parameter: ?
ASCII	O	U	T	?
Hex	4FH	55H	54H	3FH
Byte	1	1	1	1
Return	Return output setting			

Example: query output setting

02 01 43 **4F 55 54 3F** 03 32 0D 0A

Return: the output for SLM=A-weighting, Fast, SPL. For Octave=LAeq

02 01 41 **30 2C 30 2C 30 2C 30** 03 6D 0D 0A

RES: Apply Factory Settings

☆**Note:** After receipt of the ACK, user must wait at least 6 seconds to finish the operation.

	Instruction			Parameters
Explanation	RES			None
ASCII	R	E	S	None
Hex	52H	45H	53H	None
Byte	1	1	1	None
Return	ACK / NAK			

Example: apply the factory settings

02 01 43 **52 45 53** 03 07 0D 0A

Return: ACK. Wait at least 6 seconds after receipt of ACK

02 01 06 03 06 0D 0A

STAp1: Start / Stop Measurement

	Instruction	Parameters
Explanation	STA	p1: Start / Stop measurement; 0=Stop; 1=Start

ASCII	S	T	A	1
Hex	53H	54H	41H	31H
Byte	1	1	1	1
Return	ACK / NAK			

Example: start measurement

```
02 01 43 53 54 41 31 03 34 0D 0A
```

Return: ACK

```
02 01 06 03 06 0D 0A
```

STA?: Query Measurement State

	Instruction			Parameters
Explanation	STA			Query parameter: ?
ASCII	S	T	A	?
Hex	53H	54H	41H	3FH
Byte	1	1	1	1
Return	Return measurement state			

Example: query the measurement state

```
02 01 43 53 54 41 3F 03 3A 0D 0A
```

Returns: the measurement state is start (running)

```
02 01 41 31 03 70 0D 0A
```

☆Note: The following instructions are to query the sound level meter measurements data.

They contain the "return manner" parameter, it means:

Stop return: The sound level meter no longer to return measurements data every second after received this instruction.

Single return: The sound level meter will return the measurements data on time after received the instruction.

Continuous return: Automatically return the measurements data every second after received the instruction.

Therefore, the "return manner" parameter in the instruction can be set to 2 and send to the sound level meter, sound level meter will return the latest measurements data every second.

DMAp1_?: Query the Main Screen Data

	Instruction	P1	P2
Explanation	DMA	p1:Return manner 0=Stop return 1=Single return 2=Continuous return	Query parameter: ?

ASCII	D	M	A	1	?
Hex	44H	4DH	41H	31H	3FH
Byte	1	1	1	1	1
Return	Return the main screen data Filter: 0=A, 1=B, 2=C, 3=Z Detector: 0=Fast, 1=Slow, 2=Imp. Mode: 0=SPL, 1=PEAK, 2=LEQ, 3=MAX, 4=MIN Measurement data: The value of the main screen				

Example: query the data of the main screen, and return only once

```
02 01 43 44 4D 41 31 20 3F 03 25 0D 0A
```

Returns: the current main screen is: B-weighting, Slow, measurement data 066.1dB

```
02 01 41 31 2C 31 2C 32 2C 30 36 36 2E 31 03 70 0D 0A
```

TPRp1_?: Query 3-Profile Screen Data

	Instruction			P1	P2
Explanation	TPR			p1: Return manner; 0=Stop return; 1=Single return; 2=Continuous return	Query parameter: ?
ASCII	T	P	R	1	?
Hex	54H	50H	52H	31H	3FH
Byte	1	1	1	1	1
Return	Return 3-Profile screen data Profile 1: Filter, Detector, Mode, Data Profile 2: Filter, Detector, Mode, Data Profile 3: Filter, Detector, Mode, Data				

Example: query 3-Profile screen data

```
02 01 43 54 50 52 31 20 3F 03 3B 0D 0A
```

Returns: the current 3-Profile screen data: profile 1: B-weighting, LEQ, 066.1dB; profile 2: C-weighting, Fast, SPL, 067.1dB; profile 3: Z-weighting, Fast, SPL, 067.4dB

```
02 01 41 31 2C 31 2C 32 2C 30 36 36 2E 31 2C 32 2C 30 2C 30 2C 30 36 37 2E 34 03 74 0D 0A
```

DLNp1_?: Query Statistical Analysis Data (LN)

	Instruction	P1	P2
Explanation	DLN	p1: Return manner; 0=Stop return;	Query parameter: ?

				1=Single return; 2=Continuous return	
ASCII	D	L	N	1	?
Hex	44H	4CH	4EH	31H	3FH
Byte	1	1	1	1	1
Return	Return statistical analysis (LN) data Filter: 0=A, 1=B, 2=C, 3=Z Detector: 0=Fast, 1=Slow, 2=Imp. Mode: 0=SPL Group 1 LN percentages and LN statistics Group 10 LN percentages and LN statistics				

Example: query statistical analysis (LN) data

```
02 01 43 44 4C 4E 31 20 3F 03 2B 0D 0A
```

Returns: the current statistical analysis data is: A-weighting, Fast, SPL, LN10=065.4dB, LN20=065.4dB, LN30=065.4dB, LN40=065.3dB, LN50=065.3dB, LN60=065.3dB, LN70=035.2dB, LN80=065.2dB, LN 90=065.2dB, LN99=065.1dB

```
02 01 41 30 2C 30 2C 30 2C 31 30 2C 30 36 35 2E 34 2C 32 30 2C 30 36 35
2E 34 2C 33 30 2C 30 36 35 2E 34 2C 34 30 2C 30 36 35 2E 33 2C 35 30 2C
30 36 35 2E 33 2C 36 30 2C 30 36 35 2E 33 2C 37 30 2C 30 36 35 2E 32 2C
38 30 2C 30 36 35 2E 32 2C 39 30 2C 30 36 35 2E 32 2C 39 39 2C 30 36 35
2E 31 2C 03 58 0D 0A
```

DCU?: Query Custom Measure Data

	Instruction			P1	P2
Explanation	DCU			p1: Return manner; 0=Stop return; 1=Single return; 2=Continuous return	Query parameter: ?
ASCII	D	C	U	1	?
Hex	44H	43H	55H	31H	3FH
Byte	1	1	1	1	1
Return	Return custom measure data: Group 1 Filter, Detector, Mode, Data Group 14 Filter, Detector, Mode, Data				

Example: query custom measure data

```
02 01 43 44 43 55 31 20 3F 03 3F 0D 0A
```

Returns: the current custom measure data: Group 0: A-weighting, Fast*, L10, 065.4dB; Group 1: A-weighting, Fast*, L20, 065.4dB; Group 2: A-weighting, Fast*, L60, 065.3dB; Group 3: A-weighting, Fast*, L99, 065.1dB; Group 4: A-weighting, Fast, Min, 064.4dB; Group 5: A-weighting, Fast*, Peak, 081.9dB; Group 6: A-weighting, Fast, Sel, 083.8dB; Group7: A-weighting, Fast, SPL, 065.3dB; Group 8: B-weighting, Fast, SPL, 066.4dB; Group 9: A-weighting, Fast, SD, 005.6dB; Group10: B-weighting, Fast, SD, 007.2dB; Group 11: A-weighting, Fast*, E, 2.696E-05dB; Group 12: A-weighting, Fast, Max, 65.5dB; Group 13: B-weighting, Fast*, Leq, 066.2dB. **★Note:** Parameters with * are useless

```
02 01 41 30 2C 30 2C 30 38 2C 30 36 35 2E 34 2C 30 2C 30 2C 30 2C 30 39 2C 30
36 35 2E 34 2C 30 2C 30 2C 31 33 2C 30 36 35 2E 33 2C 30 2C 30 2C 31 37
2C 30 36 35 2E 31 2C 30 2C 30 2C 30 35 2C 30 36 34 2E 34 2C 30 2C 30 2C
30 36 2C 30 38 31 2E 39 2C 30 2C 30 2C 30 32 2C 30 38 33 2E 38 2C 30 2C
30 2C 30 30 2C 30 36 35 2E 33 2C 31 2C 30 2C 30 30 2C 30 36 36 2E 34 2C
30 2C 30 2C 30 31 2C 30 30 35 2E 36 2C 31 2C 30 2C 30 31 2C 30 30 37 2E
32 2C 30 2C 30 2C 30 33 2C 32 2E 36 39 36 65 2D 30 35 2C 30 2C 30 2C 30
34 2C 30 36 35 2E 35 2C 31 2C 30 2C 30 37 2C 30 36 36 2E 32 03 2F 0D 0A
```

DSLp1_p2_?: Query All the Data of the Sound Level Meter

	Instruction			P1	P2	P3
Explanation	DSL			p1: Data group; 0=SPL; 1=SD; 2=SEL; 3=E; 4=Max; 5=Min; 6=Peak; 7=Leq; 8=LN	p2: Return manner; 0=Stop return; 1=Single return; 2=Continuous return	Query parameter: ?
ASCII	D	S	L	0	1	?
Hex	44H	53H	4CH	30H	31H	3FH
Byte	1	1	1	1	1	1
Return	Return the corresponding group data: Group 0: LAF, LAS, LAI, LBF, LBS, LBI, LCF, LCS, LCI, LZf, LZs, LZI Group 1: LAFsd, LASsd, LAIsd, LBFsd, LBSsd, LBIsd, LCFsd, LCSsd, LCIsd, LZfsd, LZssd, LZIsd Group 2: LASeI, LBSeI, LCSeI, LZSeI					

	Group 3: LAe, LBe, LCe, LZe Group4: LAFmax, LASmax, LAImax, LBFmax, LBSmax, LBImax, LCFmax, LCSmax, LCImax, LZFmax, LZSmax, LZImax Group 5: LAFmin, LASmin, LAImin, LBFmin, LBSmin, LBImin, LCFmin, LCSmin, LCImin, LZFmin, LZSmin, LZImin Group 6: LApeak, LBpeak, LCpeak, LZpeak Group 7: LAeq, LBeq, LReq, LZeq Group 8: Percentage values and statistics of ten LN
--	---

Example: query group 7 (LEQ)

```
02 01 43 44 53 4C 37 20 31 20 3F 03 21 0D 0A
```

Returns: the LEQ data: LAeq=065.0dB, LBeq=066.2dB; LReq=067.0dB; LZeq=067.2dB

```
02 01 41 30 36 35 2E 30 2C 30 36 36 2E 32 2C 30 36 37 2E 30 2C 30 36 37
2E 32 03 6E 0D 0A
```

DOT?: Query 1/1 Octave Band Data

	Instruction			P1	P2
Explanation	DOT			p1: Return manner; 0=Stop return; 1=Single return; 2=Continuous return;	Query parameter: ?
ASCII	D	O	T	1	?
Hex	44H	4FH	54H	31H	3FH
Byte	1	1	1	1	1
Return	Return 1/1 octave band data: Filter, LAeq, LBeq, LReq, LZeq, 8Hz, 16Hz, 31.5Hz, 63Hz, 125Hz, 250Hz, 500Hz, 1kHz, 2kHz, 4kHz, 8kHz, 16kHz				

Example: query 1/1 octave data

```
02 01 43 44 4F 54 31 20 3F 03 32 0D 0A
```

Returns: the current 1/1 octave band filter is C-weighting, and data are: LAeq=064.7dB, LBeq=066.0dB, LReq=066.8dB, LZeq=067.1dB, 8Hz=030.7dB, 16Hz=041.6dB, 31.5Hz=048.4dB, 63Hz=053.9dB, 125Hz=056.8dB, 250Hz=059.5dB, 500Hz=060.8dB, 1kHz=060.3dB, 2kHz=057.8dB, 4kHz=053.6dB, 8kHz=047.0dB, 16kHz=035.4dB

```
02 01 41 31 2C 30 36 34 2E 37 2C 30 36 36 2E 30 2C 30 36 36 2E 38 2C 30
36 37 2E 31 2C 30 33 30 2E 37 2C 30 34 31 2E 36 2C 30 34 38 2E 34 2C 30
35 33 2E 39 2C 30 35 36 2E 38 2C 30 35 39 2E 35 2C 30 36 30 2E 38 2C 30
36 30 2E 33 2C 30 35 37 2E 38 2C 30 35 33 2E 36 2C 30 34 37 2E 30 2C 30
33 35 2E 34 03 7F 0D 0A
```

DTT?: Query 1/3 Octave Band Data

	Instruction			P1	P2
Explanation	DTT			p1: Return manner; 0=Stop return; 1=Single return; 2=Continuous return;	Query parameter: ?
ASCII	D	T	T	1	?
Hex	44H	54H	54H	31H	3FH
Byte	1	1	1	1	1
Return	Return 1/3 octave band data: Filter, LAeq, LBeq, LCEq, LZeq, 6.3Hz, 8Hz, 10Hz, 12.5Hz, 16Hz, 20Hz, 25Hz, 31.5Hz, 40Hz, 50Hz, 63Hz, 80Hz, 100Hz, 125Hz, 160Hz, 200Hz, 250Hz, 315Hz, 400Hz, 500Hz, 630Hz, 800Hz, 1kHz, 1.25kHz, 1.6kHz, 2kHz, 2.5kHz, 3.15kHz, 4kHz, 5kHz, 6.3kHz, 8kHz, 10kHz, 12.5kHz, 16kHz, 20kHz				

Example: query 1/3 octave band data.

```
02 01 43 44 54 54 31 20 3F 03 00 0D 0A
```

Return: current Filter is C-weighting, LAeq=064.8dB, LBeq=066.0dB, LCEq=066.9dB, LZeq=067.1dB, 6.3Hz=017.8dB, 8Hz=023.5dB, 10Hz=028.0dB, 12.5Hz=032.2dB, 16Hz=035.4dB, 20Hz=038.4dB, 25Hz=041.0dB, 31.5Hz=043.6dB, 40Hz=045.9dB, 0Hz=047.0dB, 63Hz=048.5dB, 80Hz=049.8dB, 100Hz=050.9dB, 125Hz=052.1dB, 160Hz=053.0dB, 200Hz=054.1dB, 250Hz=054.7dB, 315Hz=055.5dB, 400Hz=055.9dB, 500Hz=056.2dB, 630Hz=056.3dB, 800Hz=056.1dB, 1kHz=055.6dB, 1.25kHz=054.9dB, 1.6kHz=054.2dB, 2kHz=053.0dB, 2.5kHz=051.8dB, 3.15kHz=050.4dB, 4kHz=048.8dB, 5kHz=046.9dB, 6.3kHz=044.6dB, 8kHz=041.8dB, 10kHz=038.1dB, 12.5kHz=033.3dB, 16kHz=026.2dB, 20kHz=015.0dB

```
02 01 41 31 2C 30 36 34 2E 38 2C 30 36 36 2E 30 2C 30 36 36 2E 39 2C 30
36 37 2E 31 2C 30 31 37 2E 38 2C 30 32 33 2E 35 2C 30 32 38 2E 30 2C 30
33 32 2E 32 2C 30 33 35 2E 34 2C 30 33 38 2E 34 2C 30 34 31 2E 30 2C 30
34 33 2E 36 2C 30 34 35 2E 39 2C 30 34 37 2E 30 2C 30 34 38 2E 35 2C 30
34 39 2E 38 2C 30 35 30 2E 39 2C 30 35 32 2E 31 2C 30 35 33 2E 30 2C 30
35 34 2E 31 2C 30 35 34 2E 37 2C 30 35 35 2E 35 2C 30 35 35 2E 39 2C 30
35 36 2E 32 2C 30 35 36 2E 33 2C 30 35 36 2E 31 2C 30 35 35 2E 36 2C 30
35 34 2E 39 2C 30 35 34 2E 32 2C 30 35 33 2E 30 2C 30 35 31 2E 38 2C 30
35 30 2E 34 2C 30 34 38 2E 38 2C 30 34 36 2E 39 2C 30 34 34 2E 36 2C 30
34 31 2E 38 2C 30 33 38 2E 31 2C 30 33 33 2E 33 2C 30 32 36 2E 32 2C 30
31 35 2E 30 03 72 0D 0A
```

CSD: Save Custom Data into MicroSD

	Instruction			Parameters
Explanation	CSD			None
ASCII	C	S	D	None
Hex	43H	53H	44H	None
Byte	1	1	1	None
Return	Return state: 0= Stored successfully, MicroSD OK; 1= Failure to store, MicroSD error; 2=No MicroSD.			

Example: Save CSD

02 01 43 43 53 44 03 17 0D 0A

Return: save successfully, MicroSD OK

02 01 41 30 03 71 0D 0A

6. Operation Notes

6.1 Operation

- Please minimize the influence of vibration when using sound level meter, mechanical vibration could affect indicated levels at the lower boundary of the measurement range at frequencies within the range of the sound level meter (10Hz~20kHz).
- Sound level meter need at least 6 hours to reach equilibrium with the ambient environment before switching on the power. After the equilibrium process and switching on the power, no initial time need before sound level meter measure the level of sound.
- The measurement microphone is a sensitive component, please use it careful. Store the microphone in the attached box which can protect it against damage from outside.
- Please follow the introduction and using step in the user manual. Do not drop, knock or shake the product. Any operation over the limit could damage the product.
- Keep out the water and any other liquid due to no waterproof design on this product.
- Using qualified alkaline battery can extend your operation time and bring benefit to device. Do not mix using of old and new batteries at the same time. Remove batteries when the device is not in use. Long-term place the battery inside the product could cause battery leakage and damage to the product.

6.2 Common Issue And Solutions

Issue	Possible Root Cause And Solution
Boot up failure.	<ul style="list-style-type: none"> ● Low battery: replace battery; ● Power adapter failure: replace power adapter; ● Power button failure: please return to factory.
Inaccurate measurements.	Please try to calibrate again.
Measurement data don't have observable changes when sound source changed a lot.	<ul style="list-style-type: none"> ● Damaged microphone: return microphone to factory. ● Bad contact between microphone and main body: please return the main body to factory.
Button failure.	Button was damaged: please return to factory.
Slow response when operation.	Too much files in the MicroSD card: please delete the trashy files.

Can't save the measurement data.	<ul style="list-style-type: none"> ● Check logger settings. ● Format SD to FAT32. ● Replace new MicroSD card with maximum capacity 4G.
The Printer can't print the measurement data.	<ul style="list-style-type: none"> ● Check the settings related to printer. ● Make sure the print-paper is installed correctly.

6.3 Calibration

Sound level meter has been calibrated before sales. Keep regular calibration can ensure the accuracy of the measurement. BSWA provide the calibration service for acoustic products.

6.4 Firmware Update

BSWA 308/309 can update firmware via USB port. Following items need to be prepared:

- BSWA 308/309 sound level meter (HWID is P0274 and above) and keep off;
- MiniUSB cable (include in sales package);
- External power supply (include in sales package);
- Firmware for update (can be download from BSWA website);
- USB driver (Silicon Labs CP210x driver), can be find in CD-ROM or BSWA website;
- Firmware update tool: FlashTool Wizard, can be find in CD-ROM or BSWA website.

6.4.1 Install USB Driver

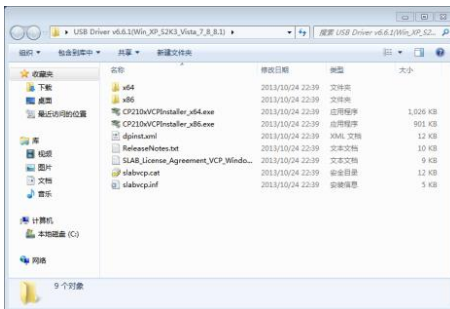

Unzip and install driver step by step. Note that select X86 for 32-bit OS and select X64 for 64-bit OS.

Note: Do not connect sound level meter to computer when install driver. Follow the prompt to install, accept the license agreement and then click next until the driver installation is complete.



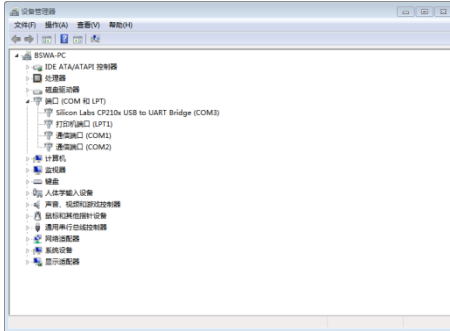

After driver installation, connect sound level meter to computer via USB cable, a new device named **Silicon Labs CP210x USB to UART Bridge (COMx)** could be found in Device Manager.

Note: Power sound level meter by external supply when connect to computer.

6.4.2 Firmware Update Procedure



The firmware update software FlashTool Wizard is very easy to use. Please just follow the prompt step by step.

Run FlashTool Wizard and select language.

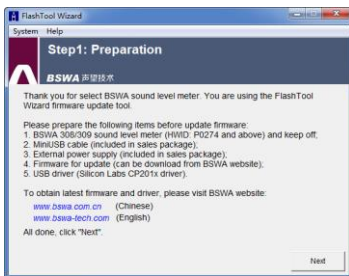

Step 1: prepare the list items for update firmware.



Step 2: Install the driver. Please skip if you already install deriver before.

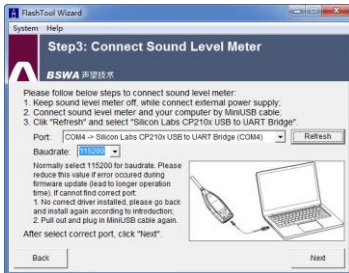

Step 3: Connect sound level meter and computer according to the prompt. Note that sound level meter needs external power supply. If driver is working properly, it will automatically select **Port** of CP210x. The default value of **Baudrate** is 115200, which relate to the computer. Higher **Baudrate** can fast the update procedure.

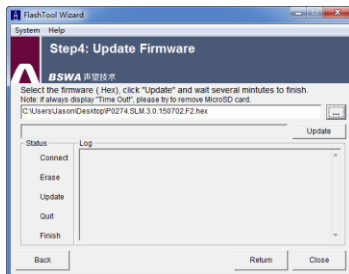

Step 4: first press the button located on the top right corner  to select firmware, and then press **Update** button to start. The whole procedure need 3–4 minutes.

☆ Note: Reset to factory settings and run calibration at least one time after firmware update, otherwise sound level meter may not work

properly. If always display "Time Out!", remove MicroSD card and try again.

There is no limitation for firmware to upgrade or downgrade, so user can update to any version. Hence, we advise to keep the latest version of firmware. Please no hesitate to contact us by phone call or e-mail to request support for any issue or bugs of firmware.

☆ Note: Firmware update is a feature only available for new sound level meter with HWID: P0274 and above. The old type of HWID: P0115 cannot update firmware by user. Following list the difference of old and new type:

- In **About** page, P0115 displays type 308/309, while P0274 displays type 308S/309S.
- RS-232 port of P0115 using Lemo 3-pin socket, while P0274 using PS/2 6-pin socket.
- P0115 USB port is unavailable in function, while P0274 USB function is available.
- P0115 has two measurement ranges: High and Low, some early product also has Auto range, while P0274 has only one range.

6.5 Warranty

BSWA can provide warranty service during the warranty period. The component could be replaced according to the determination of BSWA to solve the issue caused by materials, design or manufacture.

Please refer to the product warranty promise in sales contract. Do not try to open or repair the device by customer. Any unauthorized behavior will result in loss warranty of this product

6.6 Customer Service Phone Number

Please do not hesitate to contact us for any issue:

Customer Service	+86-10-51285118-ext.222	(workday 9:00~17:00)
Phone Number:	+86-13671375687	(24h)
Sales Service	Please visit BSWA website www.bswa-tech.com to find the sales	
Phone Number:	number of your region.	

Annex 1 Glossary

- **Frequency Weighting¹**: Difference, as a specified function of frequency, between the level of the frequency weighted signal indicated on the display device and the corresponding level of a constant amplitude sinusoidal input signal. Level difference is expressed in decibels (dB). Frequency weighting usually have A, B, C and D-weighting, which can simulate the response of human hearing. The A and C-weighting are more commonly used and defined in IEC and GB/T standard. B-weighting is only defined in ANSI standard. D-weighting related international standard is already withdrawn. Only some old type instrument has D-weighting. No frequency weighting or to say flat response always named as Z-weighting, Flat or Linear.
- **Time Weighting¹**: Exponential function of time, of a specified time constant, that weights the square of a sound pressure signal. The weighting of sound pressure is more higher if it closer to the current time, and vice versa. Time weighting Fast and Slow are more commonly used, while Impulse is not recommended to use and was reserved only for historical reasons.
- **SPL**: Sound pressure level, SPL calculated in sound level meter is the greatest time weighted sound level within 1 second.
- **LEQ¹**: Time averaged sound level or equivalent continuous sound level. Ten times the logarithm to the base 10 of the ratio of the time average of the square of a frequency weighted sound pressure signal during a stated time interval to the square of the reference value. The LEQ is actually integral value of sound level within stated duration. The longer the integration period, the slower LEQ changes. LEQ is widely used in the noise overall evaluation.
- **Peak¹**: Peak sound level. Ten times the logarithm to the base 10 of the ratio of the square of a frequency weighted peak sound pressure signal to the square of the reference value. It's usually used to evaluate the very short pulse of noise.
- **E¹**: Sound exposure. Time integral of the square of a frequency weighted sound pressure signal over a stated time interval or event of stated duration. It's always used to evaluate the impact of noise to human being.

- **SEL**¹: Sound exposure level. Ten times the logarithm to the base 10 of the ratio of a sound exposure to the reference value. It sometime called single event level.
- **LN**: Statistical analysis result. The noise level exceeded for N% of the measurement period.
- **Max**¹: Maximum time weighted sound level within stated duration.
- **Min**: Minimum time weighted sound level within stated duration.
- **SD**: Time weighted sound level of standard deviation within stated duration. SD is used to describe the degree of dispersion changes of sound level.

Note 1: Refer to the definition of IEC 61672.1:2013 to earn more details.

Annex 2 Adjustments at the Calibration Check Frequency

Recommend to use CA111/CA114/CA115 sound calibrator for sensitivity calibration before the measurement. The manual of sound calibrator provide the equivalent free field sound level for 1/2" microphone as shown in the following table:

Type of Sound Calibrator	Frequency	Calibration Sound Level for BSWA 308/309	
		Nominal 94dB	Nominal 114dB
CA111	1000Hz	93.8dB	113.8dB
CA114	1000Hz	93.8dB	N/A
CA115	1000Hz	N/A	113.8dB

Annex 3 Corrections for the Typical Effects of Reflections from the Case of Sound Level Meter and Diffraction of Sound around the Microphone

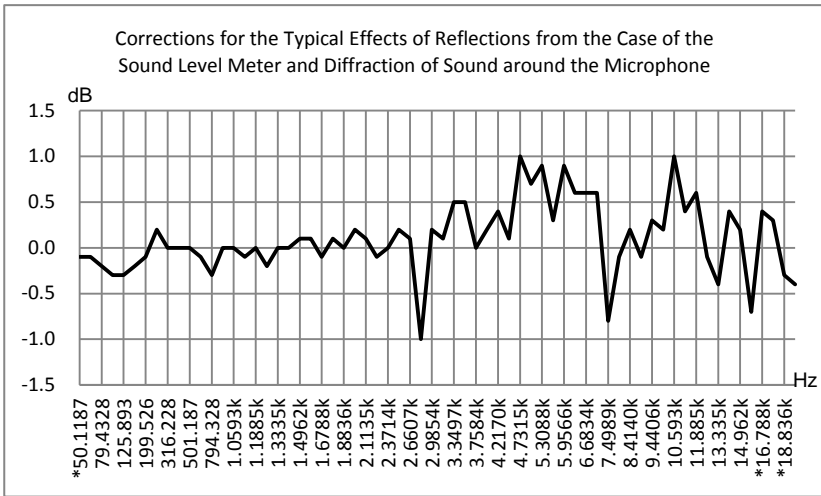

Freq. [Hz]	value [dB]	Freq. [Hz]	value [dB]	Freq. [Hz]	value [dB]	Freq. [Hz]	value [dB]	Freq. [Hz]	value [dB]	Freq. [Hz]	value [dB]
*50.119	-0.1	630.96	-0.1	1678.8	-0.1	3162.3	0.1	5956.6	0.9	11220	0.4
63.096	-0.1	794.33	-0.3	1778.3	0.1	3349.7	0.5	6309.6	0.6	11885	0.6
79.433	-0.2	1000.0	0.0	1883.6	0.0	3548.1	0.5	6683.4	0.6	12589	-0.1
100.00	-0.3	1059.3	0.0	1995.3	0.2	3758.4	0.0	7079.5	0.6	13335	-0.4
125.89	-0.3	1122.0	-0.1	2113.5	0.1	3981.1	0.2	7498.9	-0.8	14125	0.4
158.49	-0.2	1188.5	0.0	2238.7	-0.1	4217.0	0.4	7943.3	-0.1	14962	0.2
199.53	-0.1	1258.9	-0.2	2371.4	0.0	4466.8	0.1	8414.0	0.2	15849	-0.7
251.19	0.2	1333.5	0.0	2511.9	0.2	4731.5	1.0	8912.5	-0.1	*16788	0.4
316.23	0.0	1412.5	0.0	2660.7	0.1	5011.9	0.7	9440.6	0.3	*17783	0.3
398.11	0.0	1496.2	0.1	2818.4	-1.0	5308.8	0.9	10000	0.2	*18836	-0.3
501.19	0.0	1584.9	0.1	2985.4	0.2	5623.4	0.3	10593	1.0	*19953	-0.4

Expanded Uncertainties: U=0.17 (k=2) @ <=4kHz, U=0.29 (k=2) @ >4kHz

Note: the frequency with * is not requirement of standard, refer to IEC 61672-1 for exact frequency.

Annex 4 Corrections of Windscreen in Free Field

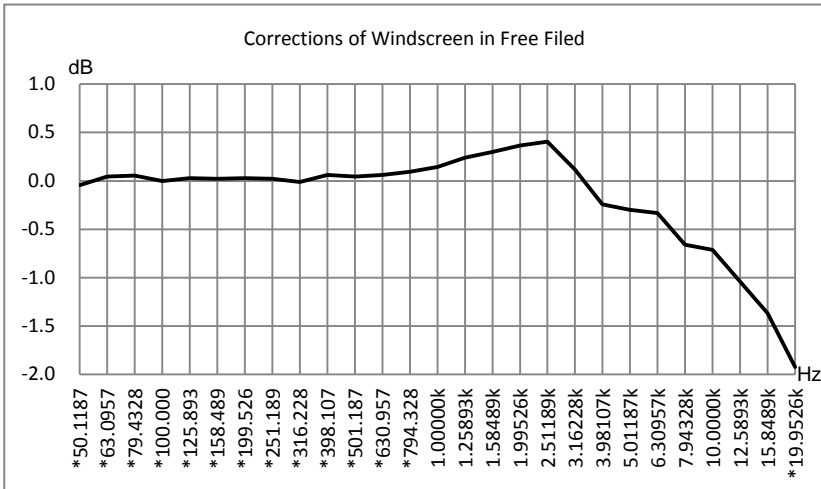

Freq. [Hz]	Value [dB]	Freq. [Hz]	Value [dB]	Freq. [Hz]	Value [dB]
*50.119	-0.04	*398.11	0.06	3162.3	0.12
*63.096	0.04	*501.19	0.04	3981.1	-0.24
*79.433	0.06	*630.96	0.06	5011.9	-0.30
*100.00	0.00	*794.33	0.09	6309.6	-0.33
*125.89	0.03	1000.0	0.14	7943.3	-0.66
*158.49	0.02	1258.9	0.24	10000	-0.71
*199.53	0.03	1584.9	0.30	12589	-1.04
*251.19	0.02	1995.3	0.37	15849	-1.37
*316.23	-0.01	2511.9	0.41	*19953	-1.92

Expanded Uncertainties: U=0.15 (k=2) @ ≤4kHz, U=0.21 (k=2) @ >4kHz.

Note: the frequency with * is not requirement of standard, refer to IEC 61672-1 for exact frequency.

Annex 5 Corrections of Electrostatic Actuator

The following corrections are measured by BSWA EA002 electrostatic actuator and AS001 power supply.

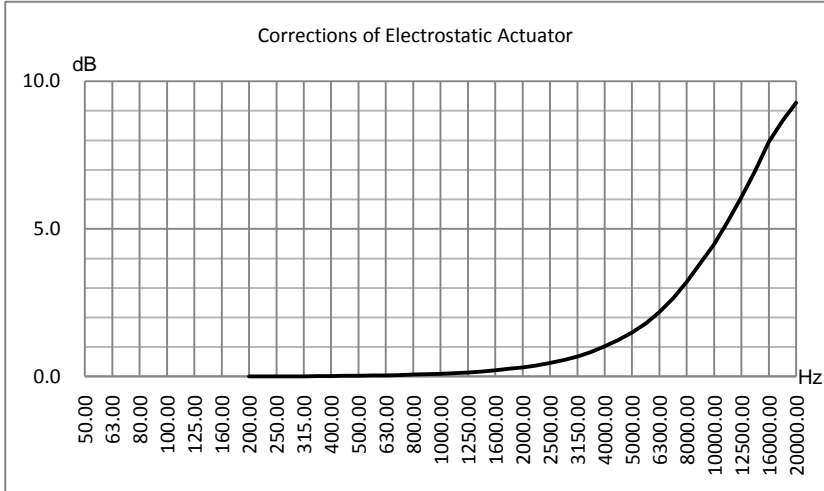

Freq. [Hz]	Value [dB]	Freq. [Hz]	Value [dB]	Freq. [Hz]	Value [dB]	Freq. [Hz]	Value [dB]
200	0.000	630	0.043	2000	0.312	6300	2.184
224	0.002	710	0.053	2240	0.378	7100	2.651
250	0.004	800	0.065	2500	0.456	8000	3.204
280	0.006	900	0.080	2800	0.554	9000	3.840
315	0.009	1000	0.096	3150	0.678	10000	4.488
355	0.013	1120	0.116	3550	0.832	11200	5.264
400	0.017	1250	0.140	4000	1.020	12500	6.081
450	0.022	1400	0.170	4500	1.245	14000	6.960
500	0.027	1600	0.213	5000	1.488	16000	7.956
560	0.034	1800	0.260	5600	1.798	18000	8.664
						20000	9.272

Expanded Uncertainties: $U=0.19$ ($k=2$) @ $\leq 4\text{kHz}$, $U=0.34$ ($k=2$) @ $4\text{kHz}\sim 10\text{kHz}$, $U=0.39$ ($k=2$) @ $\geq 10\text{kHz}$.

Annex 6 Typical Frequency Response and Corresponding Upper Limit

Each microphone was test carefully before go out of factory, the calibration chart in the attached box describe the real response of electrostatic actuator and free filed.

The typical response of frequency weighting of sound level meter as shown in the following figure. The typical response plus free field response of microphone can be considered as the totally response of sound level meter in free field. The certificate of calibration also include the real test result of response of A, C and Z-weighting.

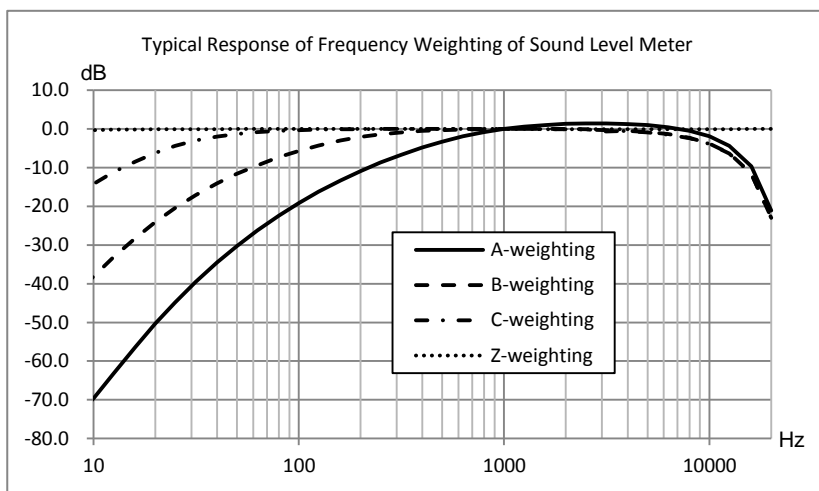

Base on the typical response of above figure, the impact to upper limit of measurement range for A, B and C-weighting as shown in the following table:

Freq. [Hz]	8*	16*	31.5	63	125	250	500	1k	2k	4k	8k	16k*
A-weighting [dB]	-74.8	-56.3	-39.5	-26.2	-16.2	-8.7	-3.3	0.0	+1.3	+1.2	-0.5	-9.7
B-weighting [dB]	-43.2	-28.2	-17.1	-9.4	-4.3	-1.4	-0.3	0.0	0.0	-0.5	-2.3	-11.6
C-weighting [dB]	-17.4	-8.4	-3.0	-0.8	-0.2	0.0	0.0	0.0	-0.1	-0.6	-2.4	-11.7

Note *: only available for BSWA 308.

Annex 7 Specification of 1/1 Octave Band Filter

1/1 octave filter was designed by the Butterworth filter and base 10 system. The specification of each filter as the shown in the following figure:

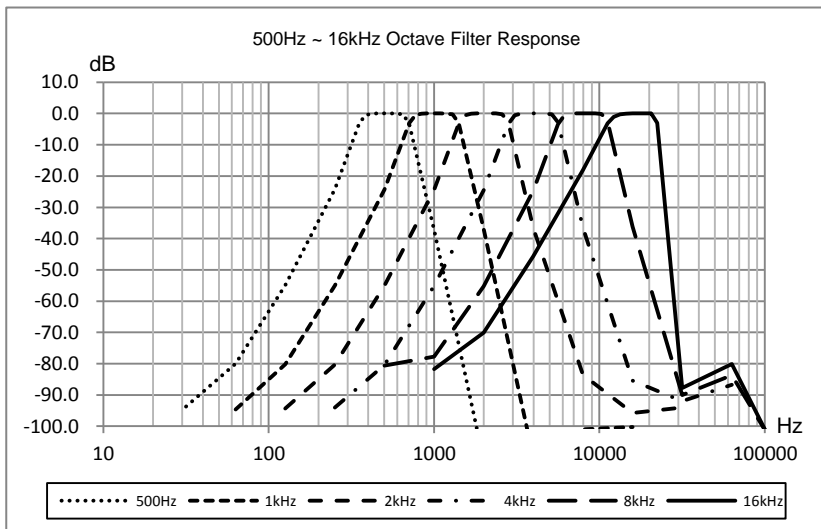
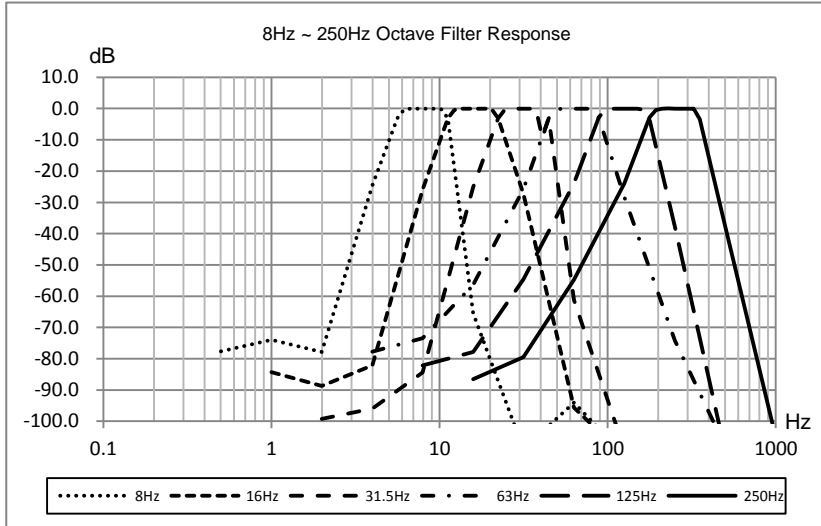

Annex 8 Specification of 1/3 Octave Band Filter

1/3 octave filter was designed by the Butterworth filter and base 10 system. The specification of each filter as the shown in the following figure:

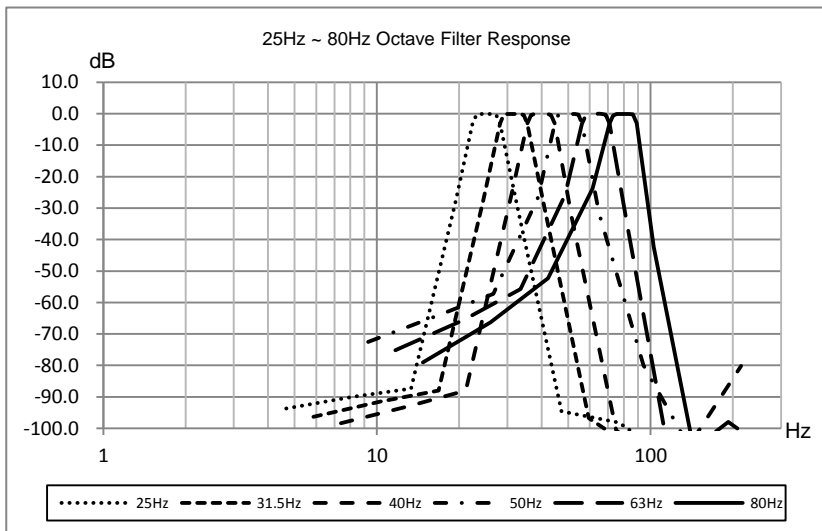
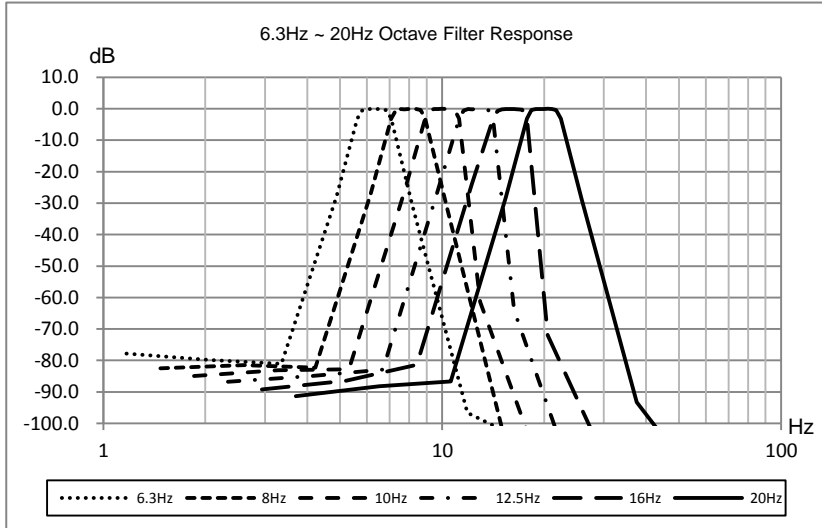

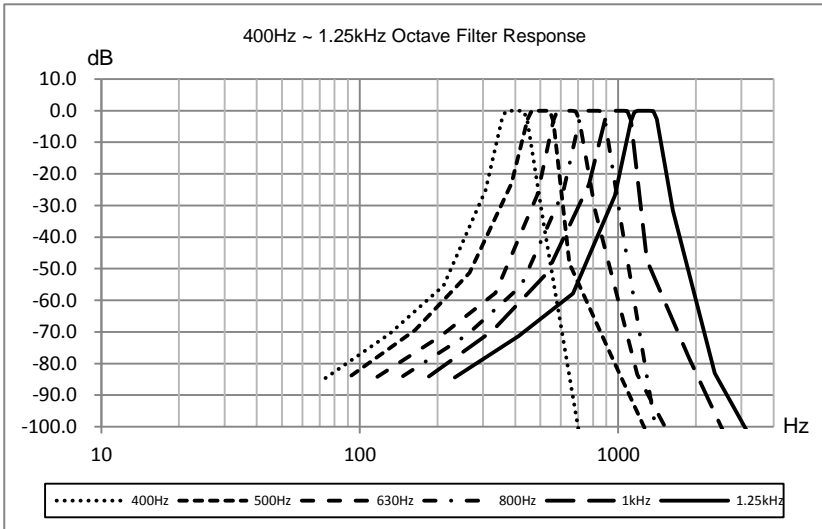
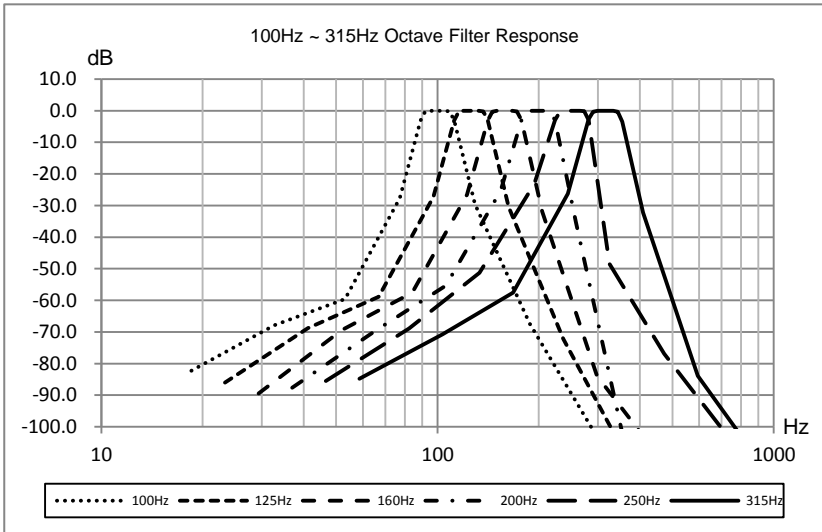

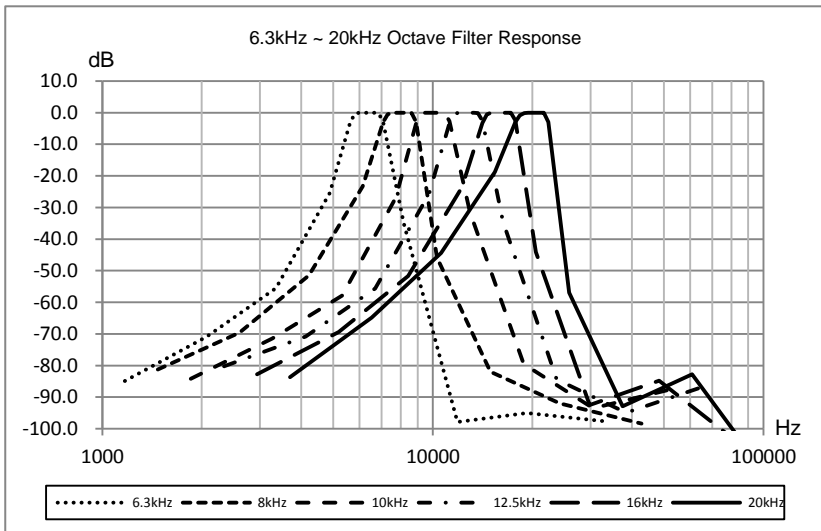
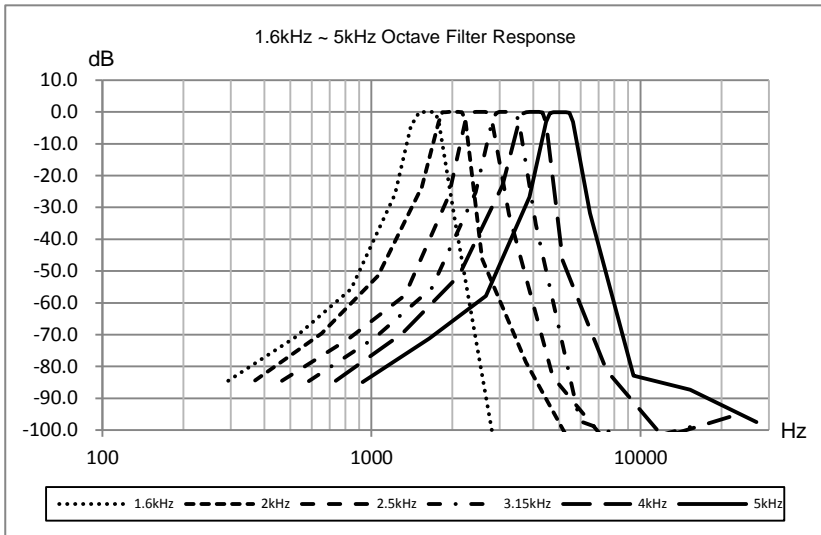

Annex 9 Mid-band Frequencies for 1/1 Octave Band and 1/3 Octave Band Filters

Base 10 Exact f_m [Hz]	Nominal Midband Frequency [Hz]	1/1 Octave Band	1/3 Octave Band
6.3096	6.3		X
7.9433	8	X	X
10.000	10		X
12.589	12.5		X
15.849	16	X	X
19.953	20		X
25.119	25		X
31.623	31.5	X	X
39.811	40		X
50.119	50		X
63.096	63	X	X
79.433	80		X
100.00	100		X
125.89	125	X	X
158.49	160		X
199.53	200		X
251.19	250	X	X
316.23	315		X
398.11	400		X
501.19	500	X	X
630.96	630		X
794.33	800		X
1000.0	1000	X	X
1258.9	1250		X
1584.9	1600		X
1995.3	2000	X	X
2511.9	2500		X
3162.3	3150		X
3981.1	4000	X	X
5011.9	5000		X
6309.6	6300		X
7943.3	8000	X	X
10000	10000		X
12589	12500		X
15849	16000	X	X
19953	20000		X

Note: Exact mid-band frequencies were calculated to five significant digits.

BSWA Technology Co., Ltd



Room 1003, North Ring Center, No.18 Yumin Road,

Xicheng District, Beijing 100029, China

Tel: 86-10-5128 5118

Fax: 86-10-8225 1626

E-mail: info@bswa-tech.com

URL: www.bswa-tech.com

2016 BSWA