

VIDEO DOOR ENTRY AND HOME VIDEO SURVEILLANCE SYSTEM

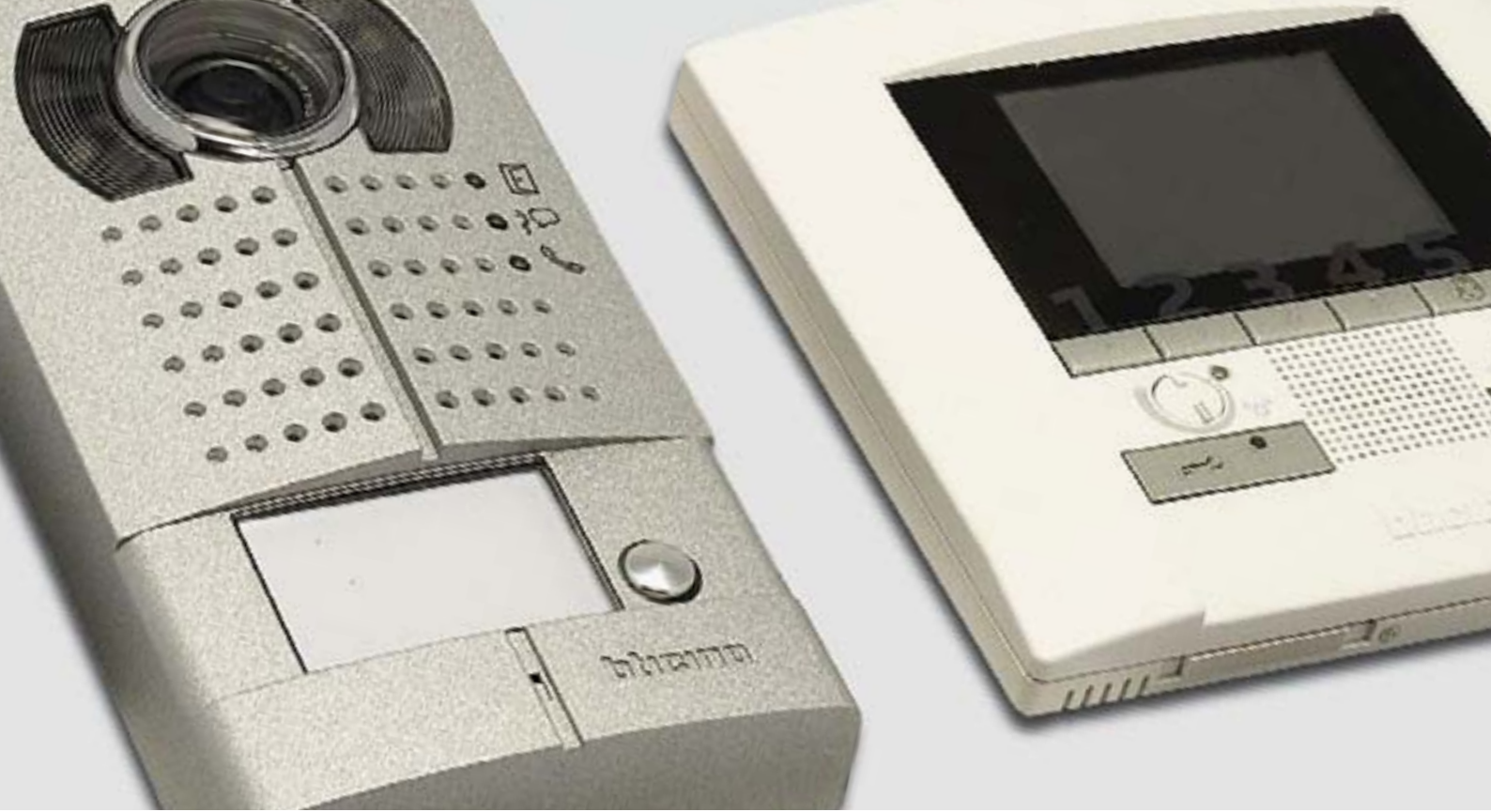

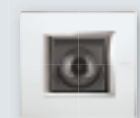

CONTENTS**2 WIRE SYSTEM**

General features	4
Entrance panel range	6
Handset range	8
Catalogue (entrance panels)	11
Composition tables (entrance panels)	24
Catalogue (handsets)	31
Catalogue (system accessories)	41

AUDIO AND VIDEO KIT	48
----------------------------	----

OTHER SYSTEMS

DIGITAL SYSTEM - Catalogue	58
ANALOGUE SYSTEM - Catalogue	67
TERSYSTEM - Catalogue	75

DIMENSIONAL DATA	79
-------------------------	----

NUMERIC INDEX	91
----------------------	----

2 WIRE SYSTEM

General features

■ YOUR JOB IS EASIER

The 2-WIRE system is easy to use. Thanks to the NON POLARIZED 2-wire wiring used in each part of the system, connection is simple, quick, and error-proof. There will be no more mistakes, and therefore no need to waste time in subsequent adjustments.



■ HIGH PERFORMANCES

Thanks to the 2-WIRE technology, it is possible to install with the same ease any type of systems, from those in single villas, to those for whole groups of apartment blocks. Also, thanks to the possibility of using the existing cables, it represents the ideal solution when refurbishment existing systems.

THE SYSTEM MAY INCLUDE:

3900 Apartments

3900 Apartment video entrance panels

5 Handsets per apartment

39 Risers with independent sound mode

96 Video entrance panels

Entrance panel



Farthest handset



600 metres



The villa

The apartment

The group of apartment blocks

The group of houses

MAXIMUM VERSATILITY

The 2-WIRE system has been conceived to ensure a high level of versatility, to meet the needs of each and every customer.

The 2-WIRE technology enables installing a door entry system

already preset for future conversion into a video system, and is ideal when a mixed audio/video system is required, to meet the needs of individual residents. The system also offers a wide range of entrance panels and handsets, to meet all

the needs of the customer: from the basic door entry system functions, to the more advanced ones, to the integration with MY HOME home automation applications, or look integration with BTicino residential series.

**INTEGRATION WITH IP TECHNOLOGY**

IP and 2-WIRE technologies may be integrated, for the realisation of large projects. Thanks to the dedicated LAN network, IP technology offers high

system performances: long distances, multichannel operation, switchboard software and centralised alarm notification.



Switchboard software



IP to 2 WIRE interface

2 WIRE SYSTEM

Entrance panel range

VERSATILITY

SFERA MODULAR

The solution for every installation need: from the single villa, to the large residential complex.



STRENGTH

VANDAL-RESISTANT MONOBLOC

Minimalist design enhanced by the aluminium or stainless steel finish, it's the solution with call pushbuttons for where a high degree of protection against mechanical impact is required.



SFERA VANDAL-RESISTANT

It's the entrance panel with a rigorous shape, emphasized by the vandal-resistant stainless steel front cover. Equipped with digital call, it's ideal for large groups of apartment blocks.



EXCLUSIVITY AND LUXURY

AXOLUTE OUTDOOR

The luxury and refinement of AXOLUTE, also outside the building. It's the ideal solution for large prestigious complexes.

SFERA MONOBLOC

The versatility of SFERA combined with the steel or brass monolithic front cover, for prestigious small and medium size solutions.

THE SOLUTION FOR THE VILLA

LINEA 2000 METAL

Elegant and strong, enhanced by the zamak finish, it's the ideal solution for the villa.

LINEA 2000

The basic solution in a smaller size, for one-family or two-family homes.

THE SOLUTION FOR SMALL SPACES

MINISFERA

The compact solution for small buildings, ideal in refurbishments and in those cases where space is limited.



2 WIRE SYSTEM

Handset range

TECHNOLOGY AND INTEGRATION

AXOLUTE MULTIMEDIA TOUCH SCREEN

Large 10" touch display for control and display of video door entry system and MY HOME functions.



PERFECT INTEGRATION WITH RESIDENTIAL LINES AND THE MY HOME FUNCTIONS

The video handset has been conceived as an integral part of the residential series and home control terminal. Available in two versions: VIDEO DISPLAY and VIDEO STATION.

VIDEO DISPLAY

The VIDEO DISPLAY terminal is characterised by its compact size. With handsfree technology, it's flush mounted using the same procedure used for a light point. Available in the AXOLUTE and AXOLUTE ETERIS versions.



VIDEO STATION

The wall mounted handsfree solution featuring a large display. Available in two versions.

VIDEO STATION Nighter & White feature an exclusive and elegant design, where glass is the main element.

AXOLUTE VIDEO STATION has instead been conceived for integration with the AXOLUTE residential series.



TECHNOLOGY AND COMFORT

POLYX RANGE

Handsfree range with a modern and minimalist design, well suited to every style of home: the range extends from the basic audio and video versions to the advanced version, which offers the management of video door entry system memory and of the MY HOME functions.

POLYX is the first video door entry system range designed following

the “for all” design criteria:

multi-sensor notifications and accurate ergonomic design are the distinguishing traits of POLYX.



TRADITION

PIVOT

The traditional range with a receiver for every installation requirement: wall mounted, flush mounted, and table-top versions.

SWING

A range characterised by a classic and elegant design. The B/W basic video version has been conceived as the perfect standard specification solution.

The range is completed by the audio and colour video version.

SPRINT AUDIO

The audio receiver meeting the standard specifications.





CONTENTS**2 WIRE CATALOGUE - ENTRANCE PANELS**

AXOLUTE Outdoor _____	12
SFERA _____	13
Monobloc vandal-resistant pushbutton panels _____	20
MINISFERA _____	21
LINEA 2000 METAL _____	22
LINEA 2000 _____	23



2 WIRE SYSTEM

AXOLUTE Outdoor entrance panels

Flush mounted digital call video entrance panel available in STEEL and BRASS finish. Protection index: IP54. Protection index against mechanical impact: IK07



339313



349140



FLUSH MOUNTED BOX WITH TEARING PROTECTION

Item	Description
339313	3 module flush mounted steel box with tearing protection. The SFERA 3 module flush mounted box, item 331130, may also be used in alternative

ELECTRONIC MODULE

Item	Description
349140	outdoor AXOLUTE electronic module. Device also suitable for use in IP systems. It's fitted with capacitive soft touch control backlit keypad, motorised colour camera (which swivelling operation can be controlled from the preset handsets), colour display with home page that can be fully customised by the installer, and transponder reader for the release of the door lock, which may also be activated using a numeric code for residents. Module to be finished with flush mounted box, item 339313, and surround plate, item 339213 (steel), or 339223 (brass). TiAxoluteOutdoor and TiContacts programming software, residents' address book creation, and configuration supplied. By locally installing a permanent cable with RJ45 socket (T568B type cross connection), it is possible to update the residents address book and the configuration, without removing the pushbutton panel. The device meets the following characteristics: Protection index IP54, protection index against mechanical impact IK07



339213

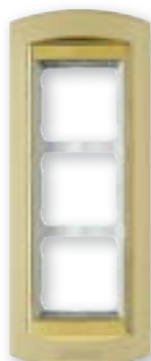

339223

SURROUND PLATE + FRAME

Item	Description
339213	3-module surround plate + frame in steel finish. Anti-tamper assembly/disassembly safety key supplied
339223	brass finish 3 module plate+frame. Anti-tamper assembly/disassembly safety key supplied



348200



348201



348202



348203



348204



348205



348206



348402

TRANSPONDER KEYS AND PROGRAMMER

Item	Description
348200	black transponder key
348201	red transponder key
348202	green transponder key
348203	blue transponder key
348204	orange transponder key
348205	grey transponder key
348206	yellow transponder key
348402	table-top transponder key programmer

SFERA entrance panels - mechanics and function modules

Digital call or pushbutton audio and video entrance panels, for flush mounted or wall mounted installation, available in zamak monobloc and modular version. Guaranteed protection from rain and water sprays



331130

FLUSH MOUNTED BOX + FRAME

Item	Modules	Dimensions (mm)		
		A	B	C
331110	1	117	123	45
331120	2	117	214	45
331130	3	117	306	45



331331

WALL MOUNTED ENCLOSURE WITH RAINSHIELD

Item	Modules	No. of columns	Dimensions (mm)		
			A	B	C
331311	1	1	155	160	92
331321	2	1	155	255	92
331331	3	1	155	360	92
331341	4	2	290	255	92
331361	6	2	290	360	92
331391	9	3	430	360	92

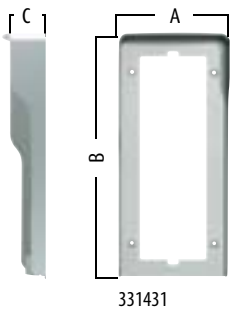

331431

RAINSHIELD (OPTIONAL)

Item	Modules	No. of columns	Dimensions (mm)		
			A	B	C
331411	1	1	151	151	50
331421	2	1	151	242	50
331431	3	1	151	334	50
331441	4	2	290	242	50
331461	6	2	290	334	50
331491	9	3	430	334	50



342150
speaker module + 2 keys
for audio systems
(max. 26 handsets)



342170
speaker module + 2 keys
for audio/video systems



342350
speaker module + 4 keys
for audio/video systems



342560
speaker module + 2 keys
with colour camera for
A/V system



342630
speaker module with
graphic display for
A/V systems



342600
alphanumeric call
module



342240
4 key module
342480
8 key module



342510
B/W camera module
342550
colour camera module



342640
additional alphanumeric
keypad module for speaker
module 342630



342610
numeric keypad module
for direct call



332650
code lock module
(it controls 2 relays with
numeric code)



































342200
nameplate module

2 WIRE SYSTEM

SFERA entrance panels - Modular front covers and surround plates - pushbutton call

Modular surround plates and audio and video front covers, available in ALLMETAL, WHITE and ALUGRAY finish

PUSHBUTTON CALL

						
33210... speaker module	33211... speaker module + 1 key	33212... speaker module + 2 keys	33234... speaker module + 4 keys	34246.. speaker module with A/V camera	34247.. speaker module with A/V camera + 1 key	34248.. speaker module with A/V camera + 2 keys
 	 	 				
342150 342170	342150 342170	342150 342170	342350	342560	342560	342560
						
33223... 3 keys	33224... 4 keys	33246... 6 keys	33248.. 8 keys	33220.. nameplate	33251... camera	
					 	
342240	342240	342280	342280	342200	342510 342550	
						
33295... blank to cover unused electronic modules	33291... blanking module for covering holes (presetting)					

AVAILABLE FINISHES



1 Allmetal **2 White** **3 Alugray**

Replace the dots in the code with the corresponding finish number

MODULAR SURROUND PLATES



33121...
1 module

33122...
2 modules (vertical)

33123...
3 modules (vertical)

Code lock



33265..
alphanumeric call

To open the entrance door by entering previously saved numeric codes.



332650

SFERA entrance panels - digital call

In case of high number of apartments (normally more than 20-30 apartments) the traditional entrance panel may pose space problems.

In this case, it will be possible to replace the traditional pushbutton call system with a digital call system operating in two different ways:

- with a **direct code**: the apartment is called by simply entering the number of the desired resident on a numeric keypad.
- using an **address book**: the visitor calls the apartment by selecting the resident's name from an address book displayed, as for mobile phones

The SFERA modular range is equipped with modules allowing one or both types of digital calls.

SPEAKER MODULE WITH GRAPHIC DISPLAY - 342630

(Optional)



33251...
camera



342510



342550

+



33266...
speaker module with graphic display



342630

It can be used to make the call by selecting the resident's name **from the address book**.

SPEAKER MODULE WITH GRAPHIC DISPLAY AND ADDITIONAL KEYPAD 342630 + 342640

(Optional)



33251...
camera



342510



342550

+



33266...
speaker module with graphic display



342630

+



33267..
additional alphanumeric call



342640

The direct code call function is possible by combining the speaker module item 342630 with the additional alphanumeric keypad, item 342640.

It is recommended that the module is installed side by side with one or more nameplate modules (342200+33220.) to obtain the correspondence between the numbers and the names of the residents.

2 WIRE SYSTEM

SFERA entrance panels - Modular front covers and surround plates - digital call

ALPHANUMERIC CALL MODULE - 342600

(Optional)



33251...
camera

+



33210...
speaker module

+



33260..
alphanumeric call

It can be used to call from the address book, using a direct code. It enables the user to release the door lock (entrance) using a code. It is recommended that the module is installed side by side with one or more nameplate modules (342200+3322..) to obtain the correspondence between the numbers and the names of the residents.



342510



342550



342170



342600

NUMERIC CALL MODULE - 342610

(Optional)



33251...
camera

+



33210...
speaker module

+



33265..
numeric call

It can be used to call by using a direct code. It enables the user to release the door lock (entrance) using a code.



342510



342550



342150



342610

Monobloc front covers - pushbutton call

Monobloc zamak audio and video front covers available in ALLSTEEL and ALLBRASS finish

ALPHANUMERIC CALL



33312...
2 keys speaker module
or speaker module with
grafic display



33311...
1 key speaker module



33361...
code lock



33314...
speaker module +
4 keys



33316...
speaker module +
6 keys

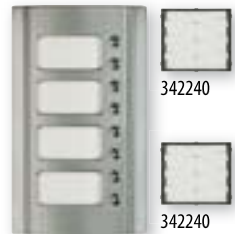

33328...
8 keys



33381...
speaker module +
camera + 1 key



33382...
speaker module +
camera + 2 keys

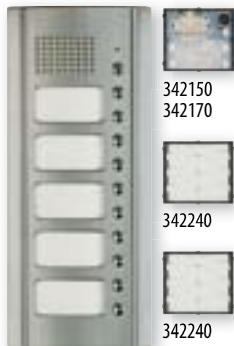

33310...
speaker module+10 keys

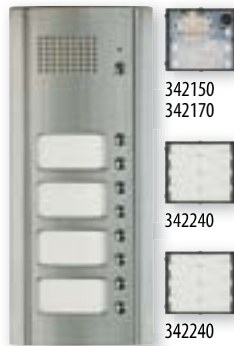

33318...
speaker module+ 8 keys

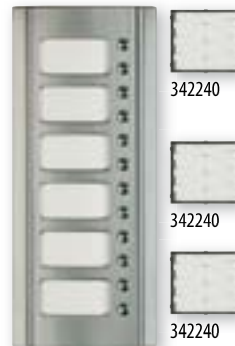

33320...
12 keys



33384...
speaker module+ camera +
4 keys



33386...
speaker module+ camera +
6 keys

Code lock



33361..



332650

To open the entrance door by entering previously saved numeric codes.



4 Allsteel



5 Allbrass

Replace the dots in the code with the corresponding finish number

2 WIRE SYSTEM

SFERA entrance panels - Monobloc front covers - digital call

In case of high number of apartments (normally more than 20-30 apartments) the traditional entrance panel may pose space problems.

Also SFERA monobloc can be used to make digital calls, in alternative to the traditional pushbutton calls.

SPEAKER MODULE WITH GRAFIC DISPLAY - 342630



Using the speaker module with display, it is possible to make calls by selecting the name of the desired resident from the address book displayed.

ALPHANUMERIC CALL MODULE - 342600



It enables making the call by selecting the desired resident from an address book that can be displayed on the display, and/or by entering the direct code. It enables the user to release the door lock (entrance) using a code.

SFERA vandal-resistant

Vandal-resistant entrance panel consisting of a vandal-resistant stainless steel front cover and flush mounted box with tearing protection.



NOTE: the vandal-resistant front covers must only be used with the following modules :



EXAMPLE OF MODULARITY

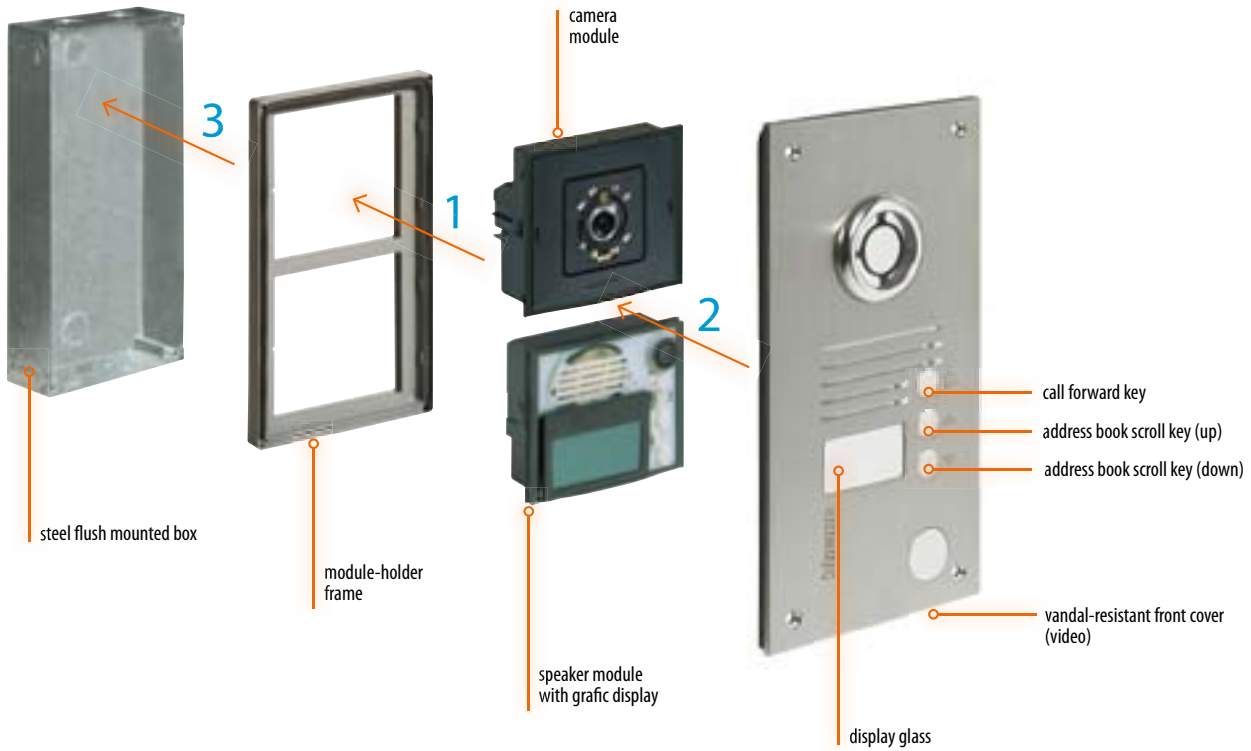

2 WIRE SYSTEM

Monobloc vandal-resistant pushbutton panels

Video pushbutton entrance panels for flush mounted or wall mounted installation, available in ALUMINIUM and STAINLESS STEEL finish. Protection index: IP44. Protection index against mechanical impact: IK07.

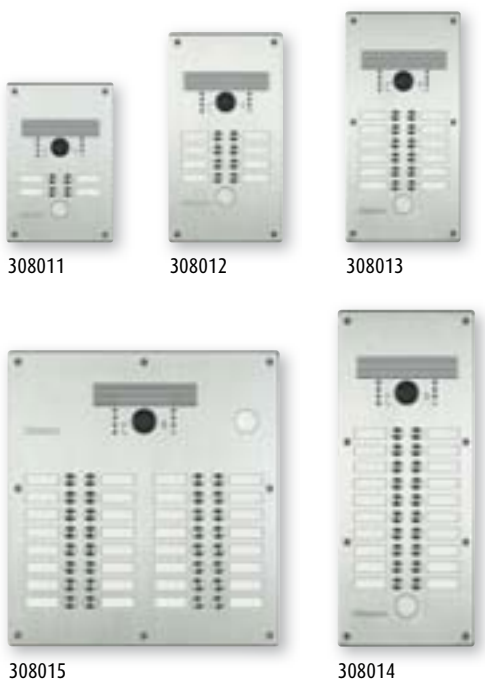
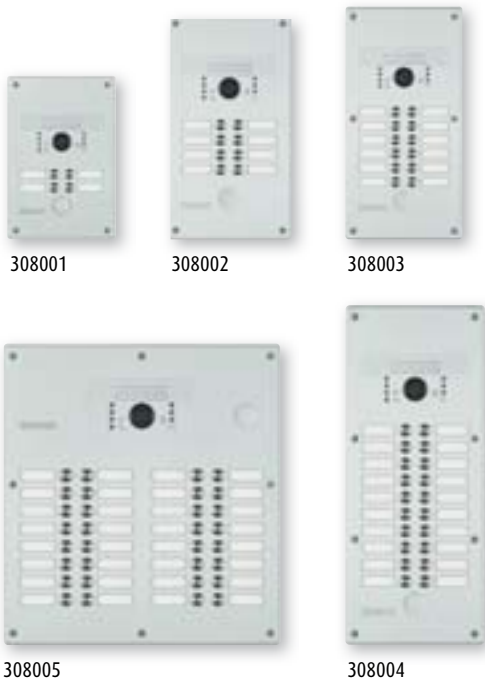

Compatibility with SFERA 2 and 3 modules flush mounted box 331120 and 331130 in case of building renovation.

ALUMINIUM FINISH PUSHBUTTON PANEL

Item	Description
308001	Monobloc vandal-resistant 2-WIRE video pushbutton panel for 2 and 4 calls with aluminium finish. The item code includes: flush mounted box, frame, colour video and audio electronic module, prewired pushbutton module/s. Presetting for the mounting of transponder reader or key switch. Backlit call keys. Visual and sound notifications of the communication status for: call active, system busy, door lock status
308002	same as item 308001 but for up to 8 calls
308003	same as item 308001 but for up to 12 calls
308004	same as item 308001 but for up to 20 calls
308005	same as item 308001 but for up to 32 calls

STAINLESS STEEL FINISH PUSHBUTTON PANEL

Item	Description
308011	Monobloc vandal-resistant 2-WIRE video pushbutton panel for 2 and 4 calls with stainless steel finish. The item code includes: flush mounted box, frame, colour video and audio electronic module, prewired pushbutton module/s. Presetting for the mounting of transponder reader or key switch. Backlit call keys. Visual and sound notifications of the communication status for: call active, system busy, door lock status
308012	same as item 308011 but for up to 8 calls
308013	same as item 308011 but for up to 12 calls
308014	same as item 308011 but for up to 20 calls
308015	same as item 308011 but for up to 32 calls

WALL MOUNTED BOXES

Item	Description
308021	Wall mounted box for pushbutton panels 308001-308011
308022	Wall mounted box for pushbutton panels 308002-308012
308023	Wall mounted box for pushbutton panels 308003-308013
308024	Wall mounted box for pushbutton panels 308004-308014
308025	Wall mounted box for pushbutton panels 308005-308015

MINISFERA entrance panels



332710



332711

FLUSH MOUNTED AND WALL MOUNTED BOXES

Item	Description
332710	plastic box for flush mounted installation
332711	plastic box for wall mounted installation



342702



342708



342704

ELECTRONIC MODULES

Item	Description
342702	speaker module with six call keys, microphone sensitivity and speaker volume adjustment. The system is directly connected to the speaker module terminal board. The nameplates are lit by 6 green LEDs
342708	video speaker module with black and white camera and four call keys, IR LED for night viewing included. The viewing angle may be adjusted by +/-15° both horizontally and vertically. The system is directly connected to the speaker module terminal board. the nameplates are lit by 4 green LEDs
342704	pushbutton module with ten call pushbuttons. The connections to the speaker module are performed using the multicable supplied. The nameplates are lit by ten green LEDs



332721



332712



332713



332714

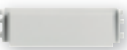

332715

SURROUND PLATE AND KEYS

Item	Description
332721	aluminium surround plate
332712	narrow key 1 module with name label
332713	wide key 2 modules with name label
332714	2 modules nameplate with label
332715	blanking key (1 module) - blank

2 WIRE SYSTEM

LINEA 2000 METAL entrance panels

Audio and video entrance panels for one-family and two family systems for wall mounted, gate post, or flush mounted installation.

Protection index against mechanical impact: IK10 (audio EP) – IK07 (video EP)



342971



342972

WALL MOUNTED AUDIO ENTRANCE PANELS

Item	Description
342971	2-WIRE audio pushbutton panel with one call pushbutton for wall mounted installation. Zamak front cover. Nameplate lit by blue LED. Protection index against mechanical impact: IK10
342972	same as item 342971, but with 2 call pushbuttons



342981
342991



342982
342992

WALL MOUNTED VIDEO ENTRANCE PANELS

Item	Description
342981	2-WIRE video pushbutton panel with black and white camera and one call pushbutton. With white LEDs for illumination of the viewing field in low light conditions. Communication status audible - light signals for: call active, system busy, door lock release. Wall mounted installation. Zamak front cover. Nameplate lit by blue LED. Protection index against mechanical impact: IK07
342982	same as item 342981, but with 2 call pushbuttons
342991	2-WIRE video pushbutton panel with colour camera and one call pushbutton. With white LEDs for illumination of the viewing field in low light conditions. Communication status audible - light signals for: call active, system busy, door lock release. Wall mounted installation. Zamak front cover. Nameplate lit by blue LED. Protection index against mechanical impact: IK07
342992	same as item 342991, but with 2 call pushbuttons



343001



343002

FLUSH MOUNTED VIDEO ENTRANCE PANELS

Item	Description
343001	2-WIRE video pushbutton panel with colour camera and one call pushbutton. With white LEDs for illumination of the viewing field in low light conditions. Communication status audible - light signals for: call active, system busy, door lock release. Wall mounted installation. Zamak front cover. Nameplate lit by blue LED. Flush mounted box, frame, and speaker module supplied.
343002	same as item 343001, but with 2 call pushbuttons

LINEA 2000 entrance panels

Audio and video entrance panels for one-family and two family systems for wall mounted or gate post installation.



342911



342921

LINEA 2000 AUDIO ENTRANCE PANELS

Item	Description
342911	2-WIRE audio pushbutton panel with one call pushbutton for wall mounted installation. Aluminium front cover. Nameplate lit by green LED
342921	same as item 342911, but with 2 call pushbuttons



342951



342961

LINEA 2000 VIDEO ENTRANCE PANELS

Item	Description
342951	2-WIRE video pushbutton panel with black and white camera and one call pushbutton. Wall mounted installation. Aluminium front cover. Nameplate lit by green LED
342961	same as item 342951, but with 2 call pushbuttons

2 WIRE ENTRANCE PANELS - AUDIO SFERA MODULAR

Composition table with speaker module 342170 or 342150

2 WIRE SYSTEM

System composition table

No. of calls	BOX + FRAME				SURROUND PLATES			SPEAKER MODULE 342170 (p. supp. 346000) 342150 (p. supp. 346010)	PUSHBUTTON MODULE 342240	MODULAR FRONT COVERS						
	331110	331120	331130	33121.	33122.	33123.	33210.			33211.	33212.	33223.	33224.	33291.		
1	1			1			1									
2	1			1			1					1				
3		1			1			1					1			
4		1			1			1						1		
5		1			1			1						1		
6		1			1			1						1		
7			1			1		1					1			
8			1			1		1					1			
9			1			1		1					1			
10			1			1		1					1			
11		2*				2		1					1			
12		2*				2		1					1			
13		2*				2		1					1			
14		2*				2		1					1			
15			2*			2		1					1		1	1
16			2*			2		1					1		4	1

* Allow for item 346902 for the connection of the modules in different frames.

KEYPAD COLOUR RANGE

Replace the dots in the code with the number corresponding to the desired colour

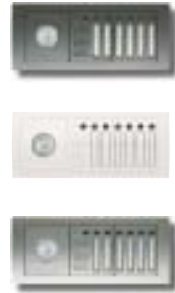

1. Allmetal 2. White 3. Alugray



WARNING

- Add to the system composition any configurators needed
- For pushbutton panels with more than 26 calls see the "2-WIRE TECHNICAL GUIDE"

2 WIRE ENTRANCE PANELS - VIDEO SFERA MODULAR

Composition table with speaker module 342170 and camera module 342550 colour or 342510 B/W

No. of calls	BOX + FRAME		SURROUND PLATES		VIDEO MODULE	SPEAKER MODULE	KEYPAD MODULE	MODULAR FRONT COVERS							
	331120	331130	33122.	33123.				342550 (colori) 342510 (b/n)	342170	342240	33251.	33270.	33271.	33272.	33273.
1	1		1		1	1		1							
2	1		1		1	1		1			1				
3		1		1	1	1	1						1		
4		1		1	1	1	1							1	
5		1		1	1	1	1							1	
6		1		1	1	1	1							1	
7	2*		2		1	1	2							1	
8	2*		2		1	1	2							2	
9	2*		2		1	1	2							2	
10	2*		2		1	1	2							2	
11		2*		2	1	1	3							1	1
12		2*		2	1	1	3							2	1
13		2*		2	1	1	3							3	1
14		2*		2	1	1	3							3	1
15		2*		3	1	1	4							3	1
16		2*		3	1	1	4							3	4

* Allow for item 346902 for the connection of the modules in different frames.

KEYPAD COLOUR RANGE

Replace the dots in the code with the number corresponding to the desired colour

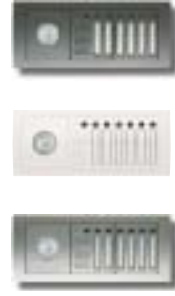

1. Allmetal 2. White 3. Alugray



WARNING

- Add to the system composition any configurator's needed
- For pushbutton panels with more than 26 calls see the "2-WIRE TECHNICAL GUIDE"

2 WIRE ENTRANCE PANELS - VIDEO SFERA MODULAR

Composition table with audio/video module 342560

2 WIRE SYSTEM

System composition table

No. of calls	BOX + FRAME			SURROUND PLATES			AUDIO/ VIDEO MODULE	KEYS MODULE	MODULAR FRONT COVERS							
	331110	331120	331130	33121.	33122.	33123.	342560	342240	342480	34246.	34247.	34248.	33223.	33224.	33246.	33248.
1	1			1			1				1					
2	1			1			1					1				
3		1			1		1	1					1			
4		1			1		1	1						1		
5		1			1		1	1			1					
6		1			1		1	1							1	
7		1			1		1	1								1
8		1			1		1	1								1
9		1			1		1	1				1				1
10		1			1		1	1				1				1
11			1			1	1	2								1
12		1			1		1	2								1
13		1			1		1	2								1
14		1			1		1	2								1
15		1			1		1	2								2
16		1			1		1	2								2
17		1			1		1	2				1				2
18		1			1		1	2				1				2
19		2			2		1	3								2
20		2			2		1	3								2
21		2			2		1	3								2
22		2			2		1	3								2
23		2			2		1	3								3
24		2			2		1	3								3
25		2			2		1	3				1				3
26		2			2		1	3				1				3



WARNING

Add to the system composition any configurators needed

For pushbutton panels with more than 26 calls see the "2-WIRE TECHNICAL GUIDE"

KEYPAD COLOUR RANGE

Replace the dots in the code with the number corresponding to the desired colour



1. Allmetal



2. White



3. Alugray

2 WIRE ENTRANCE PANELS - AUDIO SFERA MONOBLOC

Composition table with speaker module 342170 or 342150

No. of calls	BOX + FRAME		SPEAKER MODULE		PUSHBUTTON MODULE		MONOBLOC FRONT COVERS						
	331110	331120	331130	342170 (supply 346000) 342150 (supply 346010)	342240	33311.	33312.	33314.	33316.	33318.	33310.	33328.	33320.
1	1			1		1							
2	1			1			1						
3		1		1	1			1					
4		1		1	1			1					
5		1		1	1				1				
6		1		1	1				1				
7			1	1	2					1			
8			1	1	2					1			
9			1	1	2						1		
10			1	1	2						1		
11		2*		1	3							1	
12		2*		1	3							1	
13		2*		1	3				1			1	
14		2*		1	3				1			1	
15			2*	1	5							1	1
16			2*	1	5							1	1

* Allow for item 346902 for the connection of the modules in different frames.

KEYPAD COLOUR RANGE

Replace the dots in the code with the number corresponding to the desired colour



4. Allsteel 5. Allbrass



WARNING

- Add to the system composition any configurators needed
- For pushbutton panels with more than 26 calls see the "2-WIRE TECHNICAL GUIDE"

2 WIRE ENTRANCE PANELS - VIDEO SFERA MONOBLOC

2 WIRE SYSTEM

System composition table

Composition table with speaker module 342170 and camera module 342550 colour or 342510 B/W

No. of calls	BOX + FRAME		CAMERA MODULE	SPEAKER MODULE	PUSHBUTTON MODULE	MONOBLOC FRONT COVERS								
	331120	331130				342550 (colour) 342510 (b/w)	342170	342240	33381.	33382.	33384.	33386.	33328.	33320.
1	1		1	1		1								
2	1		1	1		1			1					
3		1	1	1	1					1				
4		1	1	1	1					1				
5		1	1	1	1						1			
6		1	1	1	1						1			
7	2*		1	1	2	1						1		
8	2*		1	1	2	1							1	
9	2*		1	1	2	1							1	
10	2*		1	1	2	1			1					
11		2*	1	1	4	1				1				1
12		2*	1	1	4	1				1				1
13		2*	1	1	4	1				1				1
14		2*	1	1	4	1				1				1
15		2*	1	1	4	1				1				1
16		2*	1	1	4	1				1				1

* Allow for item 346902 for the connection of the modules in different frames.

KEYPAD COLOUR RANGE

Replace the dots in the code with the number corresponding to the desired colour



4. Allsteel

5. Allbrass



WARNING

■ Add to the system composition any configurators needed

■ For pushbutton panels with more than 26 calls see the "2-WIRE TECHNICAL GUIDE"

2 WIRE ENTRANCE PANELS - AUDIO MINISFERA

Composition table

No. of calls	FLUSH MOUNTED OR SURFACE MOUNTED BOX		SURROUND PLATE	SPEAKER MODULE	EXPANSION MODULE	KEYS			
	332710 or 332711	332721				332712	332713	332715	332714*
1	1	1	1	1	1	1	1	4	2
2	1	1	1	1	1	2	2	2	1
3	1	1	1	1	1	3	3		
4	1	1	1	1	1	4	4	2	1
5	1	1	1	1	1	5	5	1	
6	1	1	1	1	1	6	6		
7	2	2	2	2	1	7	7	2	1
8	2	2	2	2	1	8	8		
9	2	2	2	2	1	4	5	2	1
10	2	2	2	2	1	5	5	1	
11	2	2	2	2	1	6	5		
12	2	2	2	2	1	12	4	4	2
13	2	2	2	2	1	13	3	3	1
14	2	2	2	2	1	14	2	2	1
15	2	2	2	2	1	1	15	1	1
16	2	2	2	2	1	1	16		



WARNING

- Add to the system composition any configurators needed
- For pushbutton panels with more than 16 calls see the "2-WIRE TECHNICAL GUIDE"
- * 2-module nameplate with label to be used instead of 2 items 332715

2 WIRE ENTRANCE PANELS - VIDEO MINISFERA

Composition table

2 WIRE SYSTEM

System composition table

No. of calls	FLUSH MOUNTED BOX OR SURFACE MOUNTED BOX	SURROUND PLATE	SPEAKER MODULE	EXPANSION MODULE	332712	332713	332715	332714*
1	332710 o 332711	332721	342708	342704	332712	332713	332715	332714*
2	1	1	1	1	1	1	2	1
3	1	1	1			2		
4	1	1	1		3		1	
5	2	2	1	1	4			
6	2	2	1	1		5	4	2
7	2	2	1	1		6	2	1
8	2	2	1	1		7		
9	2	2	1	1	2	6		
10	2	2	1	1	4	5		
11	2	2	1	1	10		4	2
12	2	2	1	1	11		3	1
13	2	2	1	1	12		2	1
14	2	2	1	1	13		1	
					14			



WARNING
 Add to the system composition any configurators needed
 For pushbutton panels with more than 14 calls see the "2-WIRE TECHNICAL GUIDE"
 * 2 module nameplate with label to be used instead of 2 items 332715

CONTENTS**2 WIRE CATALOGUE - HANDSETS**

AXOLUTE Multimedia Touch Screen _____	32
AXOLUTE Nighter & Whice Video Station _____	33
AXOLUTE Video Station _____	33
AXOLUTE Video Display _____	34
AXOLUTE Etèris Video Display _____	35
POLYX audio and video _____	36
PIVOT audio and video _____	37
SWING audio and video _____	39
SPRINT audio _____	40
Video Switchboard _____	40



2 WIRE SYSTEM

AXOLUTE Multimedia Touch Screen handset



HD4690

HC4690



HS4690

SURROUND PLATE RANGE



HA4690VBB



HA4690VSW



HA4690XC



HA4690VNB



HA4690LTK

MULTIMEDIA TOUCH SCREEN

Item	Description
HD4690	advanced touch screen handset with 10" 16/9 LCD display for wall mounted installation. Axolute white finish. In addition to the video door entry system and video monitoring systems functions, it also becomes - when integrated with a MY HOME home automation system - the actual control terminal for the whole house. Thanks to the OSD icon menu, customisable using the PC, it is possible to control and monitor all the MY HOME home automation functions. It gives the possibility of displaying videos and photos through the USB ports and SD CARD included. When connected to a LAN network, it provides access to RSS services. To be completed with the appropriate surround plate
HC4690	same as item HD4690 - Tech AXOLUTE
HS4690	same as item HD4690 - Anthracite AXOLUTE

SURROUND PLATES FOR MULTIMEDIA TOUCH SCREEN

Item	Description
HA4690XC	surround plate in satin-finished aluminium
HA4690VBB	white surround plate
HA4690LTK	Teak surround plate
HA4690VNB	Nighter surround plate
HA4690VSW	Whice surround plate

Multimedia Touch Screen assembly

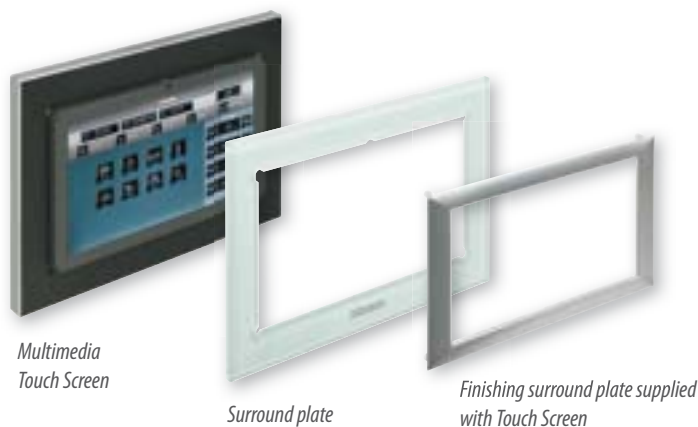

Multimedia Touch Screen

Surround plate

Finishing surround plate supplied with Touch Screen

AXOLUTE VIDEO STATION handsets



349320



349321



349310

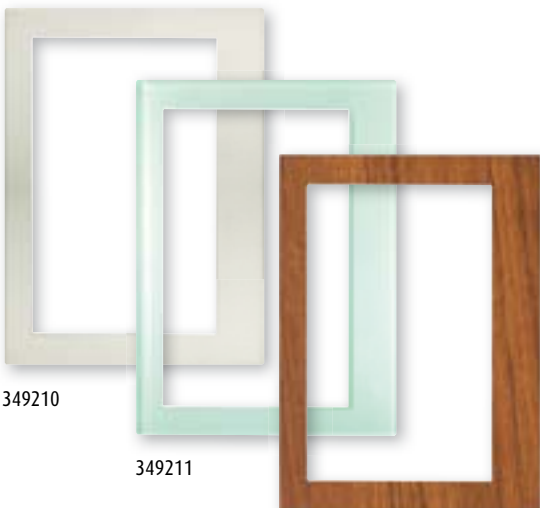

349210

349211

349212

NIGHTER AND WHICE AXOLUTE VIDEO STATION

Item	Description
349320	2-WIRE handsfree video handset for wall mounted installation in Nighter finish. With 8" colour LCD display, backlit capacitive keypad with soft touch controls and PC customisable OSD navigation icon menu for the management of the following MY HOME applications: video door entry system, temperature control, sound system, automation (scenarios) and anti-intrusion and multimediality. In systems integrated with the sound system, the VIDEO STATION behaves as an amplifier, enabling playback of all audio/video sources connected to the system. Keys available: navigation, auto-switch on, door lock release, staircase lights, mute, handsfree/pager connection, and call exclusion. LED signalling for: call exclusion, door status, and connection. Firmware update/programming USB port. It can be integrated with MY HOME, also in combination with the Multimedia interface, item 3465 - (in this case, allow for a local video door entry system power supply). Suitable for wall mounted installation using the special bracket (supplied as standard). It can be configured using physical configurators or the TiNighterandWhiceStation programming and configuration software (supplied as standard)
349321	same as item 349320 - white

VIDEO STATION

Item	Description
349310	2-WIRE handsfree video handset for wall mounted installation. With 5.6" colour LCD display with PC customisable OSD navigation icon menu for the management of the following MY HOME applications: video door entry system, temperature control, sound system, automation (scenarios) and anti-intrusion. In systems integrated with the sound system, the VIDEO STATION behaves as an amplifier, enabling playback of all audio/video sources connected to the system. Keys included: navigation, auto-switch on, door lock release, mute function, handsfree/pager connection, and call exclusion. LED signalling for: call exclusion, door status, and connection. Firmware update/programming USB port. Suitable for wall mounted installation using the special bracket (supplied as standard). It can be configured using physical configurators or the TiAxoluteStation programming and configuration software (supplied as standard). To be completed with surround plate
349210	surround plate in satin-finished aluminium
349211	Kristall glass surround plate
349212	Teak surround plate

2 WIRE SYSTEM

AXOLUTE VIDEO DISPLAY handsets



349313



349311



349312

VIDEO DISPLAY

Item	Description
349313	2-WIRE handsfree video handset for flush mounted installation - white Axolute. With 2.5" colour LCD display with PC customisable OSD navigation icon menu for the management of the following MY HOME applications: video door entry system, temperature control, sound system, automation (scenarios) and anti-intrusion. Keys included: navigation, auto-switch on, door lock release, handsfree connection. LED signalling for: call exclusion, door status, and connection. Firmware update/programming USB port. Suitable for flush mounted installation using item 506 boxes. To be completed with finishing plate (all those suitable for item 506E of the AXOLUTE series). It can be configured using physical configurators or the TiAxoluteDisplay programming and configuration software (supplied as standard).
349311	same as item 349313 - Tech AXOLUTE
349312	same as item 349313 - Anthracite AXOLUTE



349319

VIDEO DISPLAY TABLE-TOP BASE

Item	Description
349319	AXOLUTE VIDEO DISPLAY video handset table-top base. It can be connected to the system using the cable item 336813 and an 8 pole socket (item 349413, item 349414, item 349415). To be completed with the rectangular front cover plates for item 506E of the AXOLUTE civil series



349413



349414



349415

TABLE-TOP INSTALLATION 8 POLE PLUG

Item	Description
349413	Axolute 8 pole plug for table-top connection of the AXOLUTE VIDEO DISPLAY video handsets. White
349414	Axolute 8 pole plug for table-top connection of the AXOLUTE VIDEO DISPLAY video handsets. Tech
349415	Axolute 8 pole plug for table-top connection of the AXOLUTE VIDEO DISPLAY video handsets. Anthracite

AXOLUTE ETÈRIS VIDEO DISPLAY handsets



349340



349243



349241



349242

VIDEO DISPLAY ETÈRIS

Item	Description
349340	2-WIRE handsfree video handset for flush mounted installation. With 2.5" colour LCD display with PC customisable OSD navigation icon menu for the management of the following MY HOME applications: video door entry system, temperature control, sound system, automation (scenarios) and anti-intrusion. Keys included: navigation, auto-switch on, door lock release, handsfree connection. LED signalling for: call exclusion, bells, door status, and connection. Firmware update/programming USB port. Flush mounted installation using the specific boxes, item 528W (masonry) and item PB528W (plasterboard). To be completed using the front covers and the finishing cover plates, items HW4826HC, HW4826HS, HW4826HD. It can be configured using physical configurators or the TiAxoluteDisplay programming and configuration software (supplied as standard)
349243	white finish front cover plate
349241	Tech finish front cover plate
349242	Anthracite finish front cover plate

INSTALLATION DIAGRAM

Flush mounted box (wall)



Plasterboard box

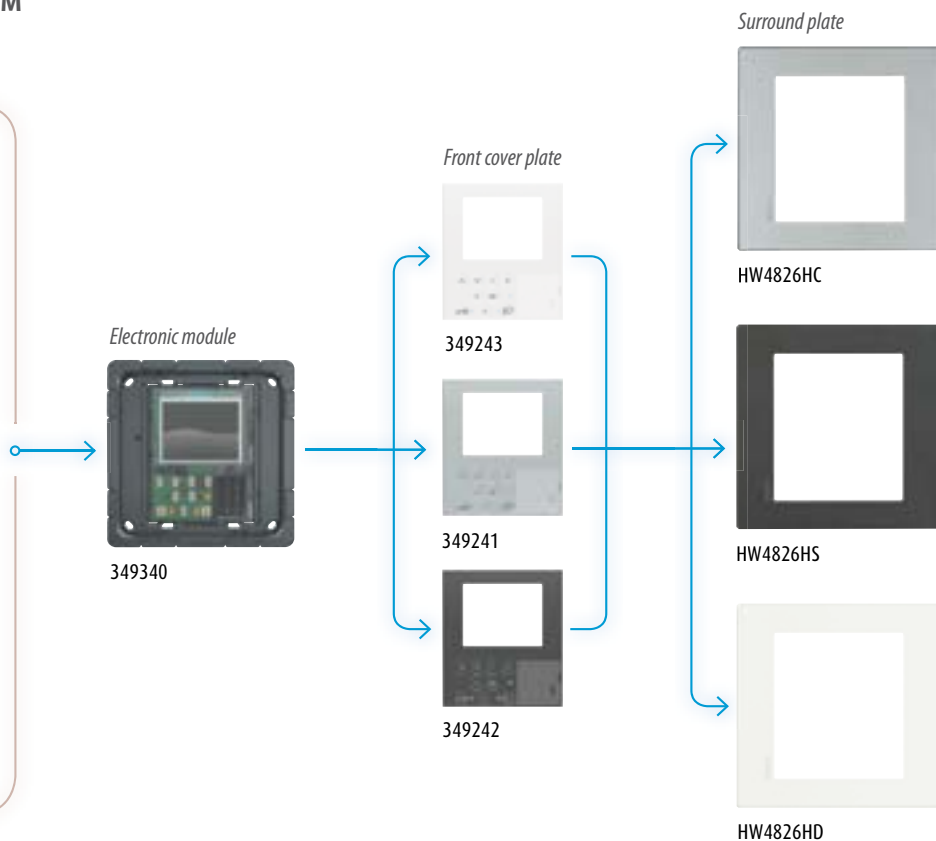

2 WIRE SYSTEM

POLYX audio and video handsets



344082

POLYX AUDIO

Item	Description
344082	wall mounted 2-WIRE handsfree audio handset. Performs all the traditional door entry system functions. Keys available: entrance panel/cycling activation, door lock release, staircase light switching on, and 4 programmable keys, which operation is defined during the configuration procedure. Configuration through physical connection of the configurators. Wall fixing bracket supplied. Specific audible and visual signals mean that it is also suitable for use by disabled people



344192
344182

POLYX VIDEO

Item	Description
344192	wall mounted 2-WIRE handsfree video handset with 3.5" colour LCD display. Performs all the traditional video door entry system functions. Keys available: entrance panel/cycling activation, door lock release, staircase light switching on, and 4 programmable keys, which operation is defined during the configuration procedure. Configuration through physical connection of the configurators. Wall fixing bracket supplied. Specific audible and visual signals mean that it is also suitable for use by disabled people
344182	same as item 344192 but with integrated inductive teleloop module



344163



344165

POLYX MEMORY DISPLAY AND TELELOOP MODULE

Item	Description
344163	wall mounted installation 2-WIRE handsfree video handset with audio and video memory. With 3.5" colour LCD display with PC customisable OSD navigation icon menu for the management of the following MY HOME applications: video door entry system, temperature control, sound system, scenarios and anti-intrusion. With video door entry system answering machine with call memory function. LED signalling for: call exclusion, door status, connection with entrance panel, and answering machine status. Suitable for wall mounted installation using the special bracket (supplied as standard). Configuration using the physical configurators or the TiPolyxMemoryDisplay software supplied as standard with the product
344165	2-WIRE inductive TELELOOP module to be used with the Polyx Memory Display video handset, to enable use by people wearing hearing aids (fitted with T selector). The module must be configured using the same address (N) of the associated handset. Wall mounted installation without the need of accessories

PIVOT audio and video handsets



344032

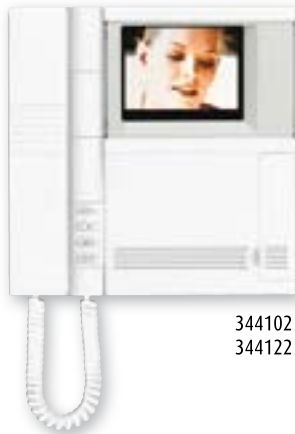

344102
344122

PIVOT AUDIO AND VIDEO HANDSET

Item	Description
344032	2-WIRE audio handset for wall, table-top and flush mounted installation (using the appropriate MULTIBOX accessories). Keys available: door lock release, staircase light switching on, and generic actuation. Bell volume adjustable on 3 levels: high, medium and disabled (this condition is signalled by a flashing red LED). With conversation secrecy function. White. Wall fixing bracket supplied. It can be fitted with a 4 key module, item 346812
344102	2-WIRE video handset with black and white 4" flat monitor. Wall, table-top, and flush mounted installation (using the appropriate MULTIBOX accessories). Keys available: entrance panel/cycling activation, door lock release, staircase light switching on, and generic actuation. Bell volume adjustable on 3 levels: high, medium and disabled (this condition is signalled by a flashing red LED). With conversation secrecy function. White. Wall fixing bracket supplied. It can be fitted with a 4 key module, item 346812
344122	2-WIRE video handset with colour 4" TFT monitor. all, table-top, and flush mounted installation (using the appropriate MULTIBOX accessories). Keys available: entrance panel/cycling activation, door lock release, staircase light switching on, and generic actuation. Bell volume adjustable on 3 levels: high, medium and disabled (this condition is signalled by a flashing red LED). With conversation secrecy function. White. Wall fixing bracket supplied. It can be fitted with a 4 key module, item 346812



346812



337102



337122



336982

PIVOT HANDSET ACCESSORIES

Item	Description
346812	additional 4 key module (optional) for PIVOT audio and video handsets. It gives the possibility of controlling and performing additional functions, such as: activation of lights, door locks, and scenarios, intercom calls, direct activation of the entrance panels. It requires configuration using physical configurators. White
337102	PIVOT handset table-top installation support. It can also be used for tilted wall mounted installation. White
337122	PIVOT video handset table-top installation support. It can also be used for tilted wall mounted installation. White
336982	LIGHT series 8-pole socket for table-top installation of PIVOT handsets. White

2 WIRE SYSTEM

MULTIBOX accessories for PIVOT handsets

Audio handset

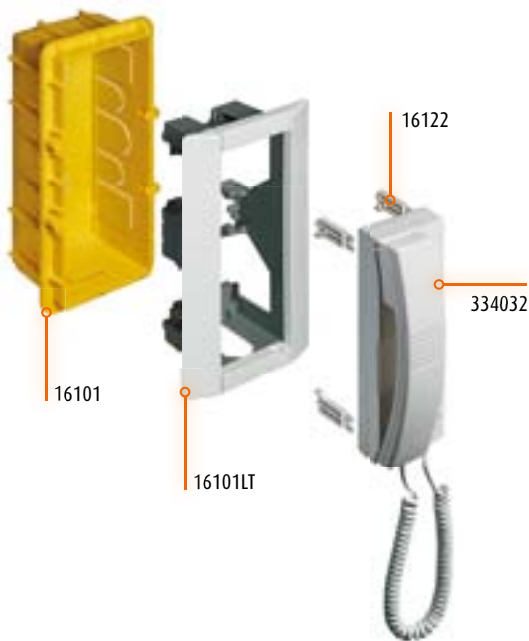

MULTIBOX INSTALLATION OF THE AUDIO HANDSET

Item	Description
16101	flush mounted box
16101LT	installation kit with white lateral surround plates
16122	no. 4 white fixing supports
344032	PIVOT audio handset

Video handset

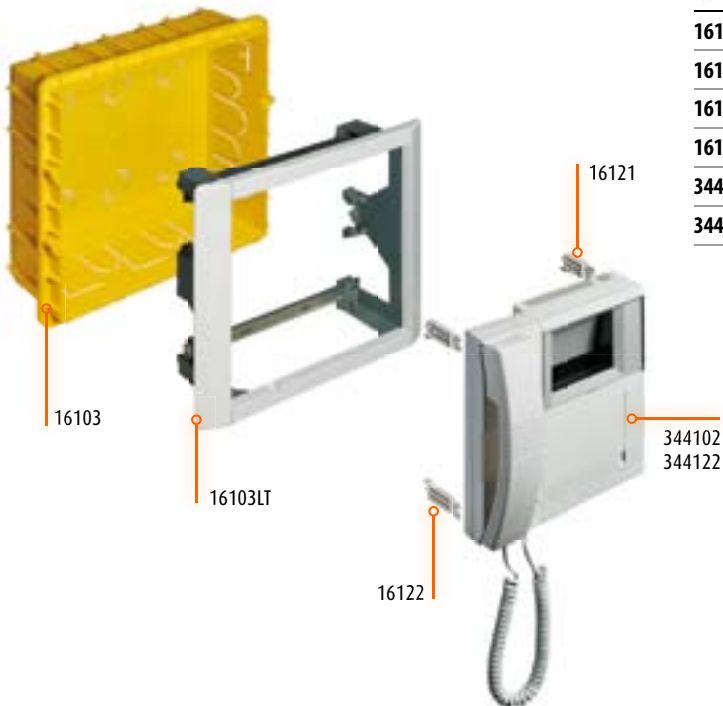

MULTIBOX INSTALLATION OF THE VIDEO HANDSET

Item	Description
16103	flush mounted box
16103LT	installation kit with white lateral surround plates
16121	no. 4 white fixing supports
16122	no. 4 white fixing supports
344102	b/w PIVOT video handset
344122	colour PIVOT video handset

SWING audio and video handsets



344704



344832
(BASIC B/W monitor)



344824
(colour monitor)

SWING AUDIO AND VIDEO HANDSETS

Item	Description
344704	2-WIRE audio handset for wall mounted installation. With door lock release key and 4 programmable keys (0-1-2-3), which operating mode is set through appropriate configuration procedure. The volume of the bell can be adjusted, or the bell may be disabled. Conversation secrecy function, office function, and door lock release (signalling through appropriate LED). White. Wall fixing bracket supplied
344832	2-WIRE basic video handset with black and white 4" monitor. Wall mounted installation. With the following keys for the video door entry system functions: door lock release, entrance panel/ camera cycling activation, staircase light switching on, and intercom. The volume of the bell can be adjusted, or the bell may be disabled. Call secrecy function and door status function also available. Wall fixing bracket supplied
344824	2-WIRE video handset with colour 4" TFT monitor. With door lock release key and 4 programmable keys (0-1-2-3), which operating mode is set through appropriate configuration procedure. The volume of the bell can be adjusted, or the bell may be disabled. Conversation secrecy function, office function, and door lock release (signalling through appropriate LED). White. Wall fixing bracket supplied

2 WIRE SYSTEM

SPRINT audio handsets



344202



344212

SPRINT HANDSETS

Item	Description
344202	2-WIRE audio handset (WITHOUT the possibility of fitting with accessories) for audio systems. Wall mounted installation. With door lock release key. White
344212	2-WIRE audio handset (WITH the possibility of fitting with accessories) for audio systems and mixed audio/video systems. Wall mounted or table-top installation (using the 337242 support). With door lock release key and auxiliary functions key. Preset for call to the floor function. It can be accessorised with additional keys and call exclusion card 346800. Bell volume adjustable on 3 levels. White

Colour video switchboard



346310

SWITCHBOARD

Item	Description
346310	switchboard for 2-WIRE audio and video systems. Access to various services (video door entry system functions, door lock and/or stair light management, and monitoring of apartment alarms) directly from the keyboard, or using the intuitive menu icons. The switchboard is supplied with built-in table top support and has a 7" colour LCD display, receiver and handsfree, dedicated keys for the main functions, and configurable keys. Programming can be performed directly from the device, or using a PC with the software (supplied as standard)
336982	8-way socket for switchboard table top installation – LIGHT finish
336813	AMP – RJ cable for switchboard table top installation

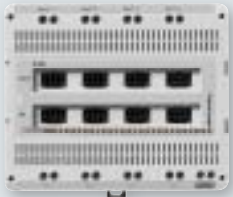
CONTENTS**2 WIRE CATALOGUE - SYSTEM ACCESSORIES**

Power supplies	42
Video mixers	42
System interfaces	43
Interfaces with other BTicino systems	43
DIN actuators	43
BASIC housing devices	44
Wiring accessories	44
Cable	45
Configurators	45
Melodic bells and extra bells	46
2-WIRE outdoor and indoor cameras	46
Software switchboard	47

2 WIRE SYSTEM

DIN auxiliary devices



346000 □ SELV



346010 □ SELV



346030 □ SELV



346020 □ SELV

POWER SUPPLIES

Item	Description
346000	2-WIRE audio and video system power supply with 8 DIN modular housing. Power supply 230 Vac @ 50-60 Hz. On the output it supplies 27 Vdc continuous low voltage, with a maximum current of 1.2 A. It's electronically protected (without fuses) against short circuit and overload. It's a SELV double insulation safety device
346010	2-WIRE audio system power supply with 6 DIN modular housing. Power supply 230 Vac @ 50-60 Hz. On the output it supplies 27 Vdc continuous low voltage, with a maximum current of 250 mA. It's electronically protected (without fuses) against short circuit and overload. It's a SELV double insulation safety device
346030	mini power supply with integrated video adapter for small 2-WIRE video systems (intercom). 2 DIN modular housing. Power supply 230 Vac @ 50-60 Hz. On the output it supplies 27 Vdc continuous low voltage, with a maximum current of 600 mA. It's protected on the PRI side (with fuses) against short circuit and overload. It's a SELV double insulation safety device
346020	additional power supply used for the local power supply of preset handsets and entrance panels. 2 DIN modular housing. Power supply 230 Vac @ 50-60 Hz. On the output it supplies 27 Vdc continuous low voltage, with a maximum current of 600 mA. It's protected on the PRI side (with fuses) against short circuit and overload. It's a SELV double insulation safety device



346830



F441

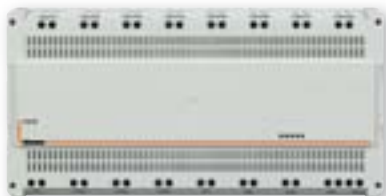

F441M

VIDEO MIXERS

Item	Description
346830	video adapter with 2 DIN modular housing. For connecting 3 BUS to the system. It is therefore possible to install systems with 2 video entrance panels and 1 riser, as well as systems with one video entrance panel and 2 risers. The device must be used with system power supply, item 346000
F441	audio/video node with 2 DIN modular housing preset with 4 input clamps and 4 output clamps. It can be used for connecting up to 4 source device posts (entrance panels or cameras) on the input and up to 4 2-wire video risers on the output. The device must be used with system power supply item 346000. It must be used in alternative to the audio/video adapter, item 346830
F441M	multichannel matrix with 10 DIN modular housing. Preset for the connection of video door entry system entrance panels, cameras and sound system sources on the input, and entrance panels and amplifiers on the output. Four inputs are for entrance panels/cameras, and 4 for sound system sources. It enables to create multichannel sound system. The device must be used with system power supply item 346000. Within the systems, it replaces the video adapter, item 346830, and the audio/video node, item F441



346850



346851

SYSTEM INTERFACES

Item	Description
346850	apartment interface in 4 DIN modular housing. It can be used to interface to a 2-wire riser a dedicated apartment video door entry system with local video monitoring system, sound system, and MY HOME applications control. The device must be configured using physical configurators
346851	system expansion interface with modular 4 DIN housing. It enables doubling of the length of the entrance panel - handset line, to create independent audio risers, and to expand the range or functions of the apartment system. The device must be configured using physical configurators



346890



346810

INTERFACES WITH OTHER BTICINO SYSTEMS

Item	Description
346890	2-WIRE - IP interface with 10 DIN modular housing. Thanks to the creation of an IP backbone with 2-wire risers, it gives the possibility of installing very large mixed 2-wire/IP systems with a high number of devices. The device must be configured using physical configurators, or the software supplied
346810	2-WIRE - PABX interface with 3 DIN modular housing. For interfacing the 2-wire audio system with PABX 335818 and 335828 telephone switchboards
346150	8/2-WIRE interface with 6 DIN modular housing. For installing mixed video door entry systems (digital 8-wire backbone/2-WIRE risers). The device must be configured using physical configurators
349410	analogue/2-WIRE interface with 4 DIN modular housing. For interfacing an analogue riser, 8-wire digital, audio TERSYSTEM, VIDEOPORTER 2000 to a dedicated apartment 2-wire video door entry system, with cameras and MY HOME applications control



346150



349410

DIN ACTUATORS

Item	Description
346200	relay actuator with 4 DIN modular housing. it can be used for switching the lights on, opening the gates, repeating calls on bells (MOD=SLA), or for controlling other devices using the video handsets. The device must be configured using physical configurators
346230	door lock relay actuator with 2 DIN modular housing. For the power supply and activation of an electrical door lock. The device must be configured using physical configurators
346260	timed door lock relay actuator with 4 DIN modular housing. It can be used for switching the lights on, opening gates, or manage electromagnetic door locks, timed door opening, and door lock status (with NC contact). The device must be configured using physical configurators



346200



346230



346260

2 WIRE SYSTEM

System accessories



346841



346833



347400

BASIC HOUSING DEVICES

Item	Description
346841	4-output floor shunt. For installing 2-wire video door entry systems with star wiring distribution. The device automatically adapts the video signal. Thanks to its compact sizes, it can also be fitted inside a flush mounted box
346833	call to the floor interface. By connecting traditional pushbuttons, the following functions will be possible: general call to the floor, addressed call to the floor, staircase lights on, and door lock release (specific actuator needed), and association of the video image to the call to the floor. The device must be configured using physical configurators
347400	interface for the conversion of the coaxial signal into a 2-WIRE BUS signal. It can be used to connect to the BUS of the 2-wire video door entry system a camera with coaxial video output powered at 12 Vdc, with maximum absorption 150 mA and 1 Vpp video output (75 Ω). The device must be configured using physical configurators



346870



346903



346902

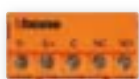

346250



F442



3499

WIRING ACCESSORIES

Item	Description
346870	2-WIRE video amplifier. In video systems wired using non-twisted wires, where the distance between the entrance panels and the handset exceeds 50 metres, it enables increasing such distance to up to 100 metres
346903	accessory for the connection of SFERA pushbutton panels with more than 26 calls. To be fitted on the back of the SFERA speaker module, in the appropriate socket
346902	cable for the connection of SFERA pushbutton modules arranged on several columns
346250	gate opening relay module to be used with LINEA 2000, LINEA 2000 METAL, MINISFERA AND SFERA pushbutton panels (only audio/video module 342560). It can be used to release door locks (NOT managed through the BUS) from the entrance panel
346907	adaptor cable for AUDIO/VIDEO SFERA module, length 40 cm
336813	cable (RJ45/8 poles) for table top connection of video handsets
F442	TV SCS modulator with 6 DIN modular housing. For displaying on the home television set the images from the 2-WIRE video door entry system. 22 selectable S band channels
3499	line terminator. To be used to terminate the riser or apartment line, when the last installed device is not fitted with line closing micro switch



346991



346992

UNIVERSAL SPEAKER UNIT AND EXPANSION MODULE

Item	Description
346991	The universal speaker unit can be used to install the 2-WIRE audio system in new or refurbished systems, where pushbutton panels of other manufacturers are present or required (mail boxes, patterned brass, compact sheet metal units, etc.), preset for a traditional speaker module (e.g. 2659N). The universal speaker unit has a contact base for the connection of 8 call keys; for systems with a higher number of keys (up to 56 when using the 346000 power supply and up to 24 when using the 346010 power supply) one or more key expansion modules must be used (1 every 8 keys)
346992	expansion module for connecting more than 8 call keys to item 346991 - max. 6 modules (56 calls max.) with power supply 346000. Max 2 modules (24 calls max.) with power supply 346010



336904

SYSTEM CABLE

Item	Description
336904	specific cable for video door system applications with 2 twisted conductors. It can be installed in underground piping, in accordance with CEI 20-13 and CEI 20-14 standards. It ensures the best performance in video systems (higher distance between EP and Handset when compared with other cables). 200 m coil



3501K

CONFIGURATORS (10 PIECE PACK)

Item	Description
3501/0	configurator 0
3501/1	configurator 1
3501/2	configurator 2
3501/3	configurator 3
3501/4	configurator 4
3501/5	configurator 5
3501/6	configurator 6
3501/7	configurator 7
3501/8	configurator 8
3501/9	configurator 9

CONFIGURATOR KIT

Item	Description
3501K	configurator kit consisting of: - 10 pieces for each type of configurator from 0 to 9 - 2 blue removable 8-clamp connectors - 2 green removable 2-clamp connectors - 1 configurator connection tool - 1 plastic screwdriver

2 WIRE SYSTEM

System accessories



346982



346983



346984



349412



349413



336992



336993



336994



336910



391658
391668



391659
391669



391657
391667



391663



391661



391662



391670

MELODIC BELLS

Item	Description
346982	2-WIRE melodic bell with LIGHT look (white). It's used to repeat the video door entry system call in several rooms. Wall mounted installation using the accessories and front cover plates of the LIGHT residential series
346983	same as item 346982 - LIVING
346984	same as item 346982 - LIGHT TECH
349412	same as item 346982 - tech AXOLUTE
349413	same as item 346982 - anthracite AXOLUTE

EXTRA BELLS

Item	Description
336992	LIGHT extra bell (white). It's used to repeat the video door entry system call in several rooms. Wall mounted installation using the accessories and front cover plates of the LIGHT residential series
336993	same as item 336992 - LIVING
336994	same as item 336992 - LIGHT TECH
336910	extra bell with neutral look. It's used to repeat the video door entry system call in several rooms. Wall mounted installation or installation inside round box (with fixing clips)

2 WIRE INDOOR CAMERAS

Item	Description
391658	flush mounted colour camera in LIGHT finish. 3.7 mm fixed optics, 1/3" CCD, 380 horizontal lines resolution. With microphone. The device must be configured using physical configurators
391659	same as item 391658 - LIGHT TECH
391657	same as item 391658 - LIVING
391668	flush mounted b/w camera in LIGHT finish. 3.7 mm fixed optics, 1/3" CCD, 380 horizontal lines resolution. With microphone. The device must be configured using physical configurators
391669	same as item 391668 - LIGHT TECH
391667	same as item 391668 - LIVING
391663	same as item 391658 - White AXOLUTE
391661	same as item 391658 - AXOLUTE TECH
391662	same as item 391658 - Anthracite AXOLUTE

2 WIRE OUTDOOR CAMERA

Item	Description
391670	compact colour camera with IP 65 housing, fixed 6 mm optics, 1/3" CMOS, 330 horizontal lines resolution. The device must be configured using physical configurators

Software switchboard



346300

SOFTWARE SWITCHBOARD

Item	Description
346300	<p>switchboard software for the management of audio and video door entry system calls. The software (Windows operating system compatible) can be installed on any desktop or laptop PC, and gives the possibility of receiving, managing and transferring the calls from the entrance panel and the handset. It implements home video monitoring, with cyclical display of the cameras, night and day functions, and the possibility of displaying the alarms in the various apartments.</p> <ul style="list-style-type: none">- Supported operating systems: Microsoft Windows XP Service Pack 2 and Windows Vista.- Software required: NET Framework 2.0 or higher

2 WIRE SYSTEM

Audio and video kit

The kit is the most economical and practical solution for creating one-family and two-family 2-wire or analog audio and video door entry systems for the residential and small service sector.

With a single reference code, the kit includes all the items required for the creation of a system: power supply, entrance panel, handset, and any wiring accessories.

The kit includes a manual with all the technical information required for the installation, the connection, the putting into operation of the system, as well as an explanation of all the system features, and expansion possibilities.

The combinations between entrance panels and handsets and the type of installation (surface or flush mounted), meet all installation requirements.



The 2-WIRE kits are fully expandable and are suitable for all installation requirements. They are fully compatible with the 2-WIRE range of devices (outdoor pushbutton panels,

audio handsets, video handsets, system accessories, and indoor or outdoor cameras), ensuring the possibility of expansion without limitations.

CONTENTS**2 WIRE CATALOGUE - AUDIO AND VIDEO KIT**

SWING audio kit - LINEA 2000 METAL	50
SWING audio kit - modular SFERA	50
SWING BASE B/W video kit - LINEA 2000	51
SWING colour video kit - LINEA 2000 METAL	51
POLYX VIDEO handsfree colour video kit - LINEA 2000 METAL ..	52
POLYX MEMORY DISPLAY handsfree colour video kit with memory - LINEA 2000 METAL	53
SWING BASE - SFERA A/V system basic B/W video kit	54
SWING - SFERA system basic colour video kit	54

ANALOGUE KIT

Audio and b/w video kits	55
Colour video kits	56

2 WIRE SYSTEM

Audio kit



SWING AUDIO KIT - LINEA 2000 METAL

Item	Description		
368111	one-family kit with SWING handset and LINEA 2000 METAL pushbutton panel. 2-WIRE technology. Devices suitable for wall mounted installation. The pushbutton panel has an IK10 protection index against mechanical impact		
368121	two-family kit with SWING handsets and LINEA 2000 METAL pushbutton panel. 2-WIRE technology. The pushbutton panel has an IK10 protection index against mechanical impact		
Composition	Item	368111	368121
LINEA 2000 METAL pushbutton panel 1 call pushbutton	342971	1	-
LINEA 2000 METAL pushbutton panel 2 call pushbuttons	342972	-	1
SWING handset	344704	1	2
Power supply	346000	1	1



SWING AUDIO KIT - MODULAR SFERA

Item	Description		
367211	one-family kit with SWING handset and SFERA modular pushbutton panel in Allmetal finish. 2-WIRE technology. Handset suitable for wall mounted installation. Pushbutton panel suitable for flush mounted installation		
367221	two-family kit with SWING handsets and SFERA modular pushbutton panel in Allmetal finish. 2-WIRE technology. Handsets suitable for wall mounted installation. Pushbutton panel suitable for flush mounted installation		
Composition	Item	367211	367221
Box + frame, 1 module	331110	1	1
speaker module front cover 1 Allmetal pushbutton	332111	1	-
speaker module front cover 2 Allmetal pushbuttons	332121	-	1
Surround plate 1 Allmetal module	331211	1	1
2-WIRE speaker module	342170	1	1
SWING handset	344704	1	2
Power supply	346000	1	1

B/W and colour video kit



(4" B/W display)

SWING BASE VIDEO KIT - LINEA 2000

Item	Description
365411	one-family video (black & white) kit with SWING BASE video handset and LINEA 2000 pushbutton panel. 2-WIRE technology. Devices suitable for wall mounted installation.
365421	two-family video (black & white) kit with SWING BASE video handsets and LINEA 2000 pushbutton panel. 2-WIRE technology. Devices suitable for wall mounted installation.

Composition	Item	365411	365421
LINEA 2000 pushbutton panel 1 call pushbutton	342951	1	-
LINEA 2000 pushbutton panel 2 call pushbuttons	342961	-	1
BASE SWING video handset	344832	1	2
Power supply	346000	1	1
Video adapter	346830	1	1
Door lock relay accessory	346250	1	1



(4" colour display)

SWING VIDEO KIT - LINEA 2000 METAL

Item	Description
367511	one-family video (colour) kit with SWING BASE video handset and LINEA 2000 pushbutton panel. 2-WIRE technology. Devices suitable for wall mounted installation. The pushbutton panel has an IK10 protection index against mechanical impact
367521	two-family video (colour) kit with SWING BASE video handsets and LINEA 2000 pushbutton panel. 2-WIRE technology. Devices suitable for wall mounted installation. The pushbutton panel has an IK10 protection index against mechanical impact

Composition	Item	367511	367521
LINEA 2000 METAL pushbutton panel 1 call pushbutton	342991	1	-
LINEA 2000 METAL pushbutton panel 2 call pushbuttons	342992	-	1
SWING colour video handset	344824	1	2
Power supply	346000	1	1
Video adapter	346830	1	1
Door lock relay accessory	346250	1	1

2 WIRE SYSTEM

Handsfree colour video kit



(3.5" colour display)

POLYX VIDEO HANDSFREE KIT - LINEA 2000 METAL WALL MOUNTED INSTALLATION

Item	Description		
368911	one-family handsfree video (colour) kit with POLYX VIDEO handset and LINEA 2000 pushbutton panel. 2-WIRE technology. Devices suitable for wall mounted installation. The pushbutton panel has an IK10 protection index against mechanical impact		
368921	two-family handsfree video (colour) kit with POLYX VIDEO handsets and LINEA 2000 METAL pushbutton panel. 2-WIRE technology. Devices suitable for wall mounted installation. The pushbutton panel has an IK10 protection index against mechanical impact		
Composition	Item	368911	368921
LINEA 2000 METAL pushbutton panel 1 call pushbutton	342991	1	-
LINEA 2000 METAL pushbutton panel 2 call pushbuttons	342992	-	1
POLYX VIDEO video handset	344192	1	2
Power supply	346000	1	1
Video adapter	346830	1	1
Door lock relay accessory	346250	1	1



(3.5" colour display)

POLYX VIDEO HANDSFREE KIT - LINEA 2000 METAL FLUSH MOUNTED INSTALLATION

Item	Description		
368811	one-family handsfree video (colour) kit with POLYX VIDEO handset and LINEA 2000 pushbutton panel for flush mounted installation. 2-WIRE technology. Handset suitable for wall mounted installation. Pushbutton panel suitable for flush mounted installation. The pushbutton panel has an IK10 protection index against mechanical impact		
368821	two-family handsfree video (colour) kit with POLYX VIDEO handsets and LINEA 2000 pushbutton panel for flush mounted installation. 2-WIRE technology. Handset suitable for wall mounted installation. Pushbutton panel suitable for flush mounted installation. The pushbutton panel has an IK10 protection index against mechanical impact		
Composition	Item	368811	368821
LINEA 2000 METAL pushbutton panel 1 call pushbutton	343001	1	-
LINEA 2000 METAL pushbutton panel 2 call pushbuttons	343002	-	1
POLYX VIDEO video handset	344192	1	2
Power supply	346000	1	1
Video adapter	346830	1	1
Door lock relay accessory	346250	1	1

Handsfree colour video kit with memory



(3.5" colour display)

POLYX MEMORY DISPLAY HANDSFREE KIT WITH MEMORY - LINEA 2000 METAL WALL MOUNTED INSTALLATION

Item	Description
369411	one-family handsfree kit with call memory and colour video display consisting of POLYX MEMORY DISPLAY video handset and LINEA 2000 METAL pushbutton panel. The video handset has an icon menu for the control of video door entry functions and MY HOME automation functions. 2-WIRE technology. Devices suitable for wall mounted installation. The pushbutton panel has an IK10 protection index against mechanical impact
369421	Two-family handsfree kit with call memory and colour video display consisting of POLYX MEMORY DISPLAY video handset and LINEA 2000 METAL pushbutton panel. The video handsets have icon menus for the control of video door entry functions and MY HOME automation functions. 2-WIRE technology. Devices suitable for wall mounted installation. The pushbutton panel has an IK10 protection index against mechanical impact

Composition	Item	369411	369421
LINEA 2000 METAL pushbutton panel 1 call pushbutton	342991	1	-
LINEA 2000 METAL pushbutton panel 2 call pushbuttons	342992	-	1
POLYX MEMORY DISPLAY video handset	344163	1	2
Power supply	346000	1	1
Video adapter	346830	1	1
Door lock relay accessory	346250	1	1



(3.5" colour display)

POLYX MEMORY DISPLAY HANDSFREE KIT WITH MEMORY - LINEA 2000 METAL FLUSH MOUNTED INSTALLATION

Item	Description
369511	one-family handsfree kit with call memory and colour video display consisting of POLYX MEMORY DISPLAY video handset and LINEA 2000 METAL pushbutton panel for flush mounted installation. The video handset has an icon menu for the control of video door entry functions and MY HOME automation functions. 2-WIRE technology. Devices suitable for wall mounted installation. Pushbutton panel suitable for flush mounted installation. The pushbutton panel has an IK10 protection index against mechanical impact
369521	two-family handsfree kit with call memory and colour video display consisting of POLYX MEMORY DISPLAY video handset and LINEA 2000 METAL pushbutton panel for flush mounted installation. The video handsets have icon menus for the control of video door entry functions and MY HOME automation functions. 2-WIRE technology. Devices suitable for wall mounted installation. Pushbutton panel suitable for flush mounted installation. The pushbutton panel has an IK10 protection index against mechanical impact

Composition	Item	369511	369521
LINEA 2000 METAL pushbutton panel 1 call pushbutton	343001	1	-
LINEA 2000 METAL pushbutton panel 2 call pushbuttons	343002	-	1
POLYX MEMORY DISPLAY video handset	344163	1	2
Power supply	346000	1	1
Video adapter	346830	1	1
Door lock relay accessory	346250	1	1

2 WIRE SYSTEM

BASE SYSTEM video kit

The 2-WIRE BASE SYSTEM video kits are the basis for the creation of black&white or colour video systems in small residential units.



(4" B/W display)

The kit contains all the necessary materials for the installation which can then be easily expanded using the products in the 2-WIRE BTicino range (entrance panels, handsets, video handsets, and system accessories).

SWING BASE - SFERA AUDIO/VIDEO EXPANDABLE VIDEO KIT

Item	Description
366311	expandable video kit with SWING BASE video handset and SFERA A/V pushbutton panel. The video handset is suitable for wall mounted installation. The pushbutton panel is suitable for flush mounted installation. 2-WIRE technology

Composition	Item	Quantity
SFERA flush mounted box, 1 module	331110	1
SFERA audio/video module with colour camera	342560	1
Allmetal front cover, 1 key	342471	1
Allmetal SFERA surround plate	331211	1
SWING BASE video handset with b/w monitor	344832	1
Video adapter	346830	1
Power supply	346000	1



(4" colour display)

SWING – SFERA MODULAR EXPANDABLE VIDEO KIT

Item	Description
369111	one-family expandable video kit with SWING colour video handset and SFERA A/V pushbutton panel. The video handset is suitable for wall mounted installation. The pushbutton panel is suitable for flush mounted installation. 2-WIRE technology
369121	two-family expandable video kit with SWING colour video handsets and SFERA A/V pushbutton panel. The video handsets are suitable for wall mounted installation. The pushbutton panel is suitable for flush mounted installation. 2-WIRE technology

Composition	Item	369111	369121
SFERA flush mounted box , 2 modules	331120	1	1
SFERA speaker module	342170	1	1
Colour SFERA camera module	342550	1	1
Allmetal speaker module front cover, 1 pb.	332111	1	-
Allmetal speaker module front cover, 2 pb.	332121	-	1
Allmetal camera front cover	332511	1	1
Allmetal 2 modules surround plate	331221	1	1
SWING colour video handset	344824	1	2
Power supply	346000	1	1
Video adapter	346830	1	1

ANALOGUE SYSTEM KIT

Audio and b/w video kits

The analogue audio and video kits can be installed very easily. The audio and video handsets have a power supply socket (Standard Euro Plug - EEC 7/16), or a PLUG IN (15 Vdc) power supply unit.

They have a door lock release key, and INTERCOM function (expansion to up to a maximum of 3 handsets).



ANALOGUE ONE FAMILY AUDIO KIT

Item	Description
316113	one-family analogue audio kit with wall mounted dedicated entrance panel and handset. PLUG IN system power supply included. It can be expanded with up to 3 dedicated handsets.



ANALOGUE B/W ONE FAMILY VIDEO KIT

Item	Description
316213	one-family analogue B/W video kit with wall mounted dedicated entrance panel and handset. Entrance panel with pin-hole camera. Video handset with 4" B/W monitor. It can be expanded with up to 3 video handsets



ANALOGUE B/W HANDSFREE ONE FAMILY VIDEO KIT

Item	Description
316313	one-family analogue B/W video handsfree kit with wall mounted dedicated entrance panel and video handset. Entrance panel with pin-hole camera. Handset with 4" B/W monitor. It can be expanded with up to 3 video handsets

ANALOGUE SYSTEM KIT

Colour video kits



(3.5" colour display)

ANALOGUE COLOUR ONE FAMILY VIDEO KIT

Item	Description
316413	one-family analogue colour video handsfree kit with wall mounted dedicated entrance panel and video handset. Metal entrance panel with colour camera and LED for the illumination of the field of view. Handset with 3.5" colour monitor. It can be expanded with up to 3 video handsets



(7" colour display)

ANALOGUE COLOUR HANDSFREE ONE FAMILY VIDEO KIT

Item	Description
316513	one-family analogue colour video handsfree kit with wall mounted dedicated entrance panel and video handset. Metal entrance panel with colour camera and LED for the illumination of the field of view. Handset with 7" colour monitor. It can be expanded with up to 3 video handsets

OTHER SYSTEMS

General considerations

The 2-WIRE SYSTEM is for BTicino the state of the art system, due to the complete range of functions, and installation flexibility.

This section shows **the other systems that complete the offer range, recommended for the maintenance of existing systems.**

For the installation of new systems, refer to the 2-WIRE SYSTEM section.

DIGITAL SYSTEM



audio and video



- B/w and colour video door entry systems
- 6 audio wires or 8 video wires with no need to use coaxial cable
- by integrating it with the 2 WIRE system, it allows to realize large and very extended combined systems

AUDIO ANALOGUE SYSTEM



audio



- 4 audio wires +n return calls

AUDIO TERSYSTEM



DIGITAL SYSTEM

SFERA function modules



342160

SPEAKER MODULE

Item	Description
342160	digital speaker module with two call pushbuttons and a pushbutton to control the staircase light relay actuator. The connections to the system are made by wiring the removable clamp supplied; also the nameplates are lit up by 8 green LED. A closing card is supplied to be inserted in the last pushbutton module. This item, used in combination with floor distribution block Item 346190, makes the home CCTV functions available



342620

DIGITAL CALL SPEAKER MODULE WITH GRAPHIC DISPLAY

Item	Description
342620	digital alphanumeric call + speaker module. Can send the call to an handset by scrolling the residents' names or codes on a display using the dedicated keys. Combines the functions of digital speaker module and alphanumeric keypad in one single device. The module can save up to 2000 residents' names and surnames associating them to the apartment SCS address. 500 names can be saved when the option of coupling a message with them is selected. If only the residents' codes are saved, the capacity extends to 5000 codes

NOTE: for the programming use a PC with TICALL software installed (can be downloaded free from the www.bticino.it site) and the interfaces item 335919 (RS-232) – item 3559 (USB), or the infrared remote control item 392123



342640

ADDITIONAL ALPHANUMERIC KEYPAD MODULE

Item	Description
342640	extra alphanumeric keypad to be used together with module Item 342630. It can call the resident directly (by typing the programmed code) and access the door lock release function (by typing the secret code). It is supplied with multi-cable and connector for connection to the speaker module



342200

NAMEPLATE MODULE

Item	Description
342200	digital nameplate module which can be used to enter the street number or any other information. Can be used to enter a caption in entrance panels with numeric call module item 342610



342240

PUSHBUTTON MODULE

Item	Description
342240	digital pushbutton module with 4 call pushbuttons. The connections to the system are made using the multi-cable supplied; also the nameplates are illuminated by 12 green LED

WARNING: assembly note: flush mounted boxes, wall mounted enclosures, rainshield, front cover, and surround plates are the same as for 2-WIRE SFERA entrance panels (refer to the specific section in the catalogue)



342610

NUMERIC DIGITAL CALL MODULE

Item	Description
342610	the numeric call module can make calls from the entrance panel to handsets by just keying in the number corresponding to the handset required. In practice it works like making a telephone call on a normal telephone. The correspondence between the numbers and the user names is found from a phone book by the side of the module and made up of nameplate modules Item 342200. From one to four numbers may be keyed in to make the call, as programmed by the installer. The module can also activate the electric door lock by means of a secret code number. The module is supplied with a multicable for the connection to the speaker module



342600

ALPHANUMERIC DIGITAL CALL MODULE

Item	Description
342600	module which can send the call choosing the name of the audio handset in a list which is shown on a display. It can also release the door locks by typing a code. The module is supplied with a multicable for the connection to the phone module



332650

CODE-LOCK MODULE

Item	Description
332650	code-lock module that can be used both in analogue and digital systems. This module opens and closes two relays by keying in two code numbers



332510



332550

SWIVEL B/W CAMERA MODULE

Item	Description
332510	camera module with IR lighting for night views. The lens viewing angle can be adjusted horizontally and vertically by $\pm 20^\circ$ in the installation phase

SWIVEL COLOUR CAMERA MODULE

Item	Description
332550	camera module with lighting with white LED for night views. The lens viewing angle can be adjusted horizontally ($\pm 20^\circ$) and vertically ($\pm 15^\circ$) during installation



346220

ACCESSORY FOR CAMERA MODULES

Item	Description
346220	accessory which can be installed in the camera module when there are several video entrance panels in series



332540

SEPARATE CAMERA MODULE

Item	Description
332540	optoinsulated separate camera module. It allows to position the camera of the video door entry system in a different place from the speaker module, and can thus view the entrance at an angle set by the user. The product has a relay which can be used to drive a spotlight for the camera field of view. The product has a relay which can be used to drive a spotlight for the camera field of view

DIGITAL SYSTEM

SFERA vandal-resistant front covers



333714



342620

AUDIO PUSHBUTTON PANEL

Item	Description
333714	pushbutton panel consisting of galvanized sheet metal flush mounted box, module holder, and front cover in 316L stainless steel with bright finish. It must be fitted with digital call speaker module with graphic display, item 342620 . The display screen is made of scratch-resistant polycarbonate glass (5 mm thick) The three pushbuttons (diam. 16 mm) are made of 316L stainless steel



333914



332510 b/w
332550 colour



342620

VIDEO PUSHBUTTON PANEL

Item	Description
333914	pushbutton panel consisting of galvanized sheet metal flush mounted box, module holder, and front cover in 316L stainless steel with bright finish. It must be fitted with digital call speaker module with graphic display + camera module, (items 342620 + 332510/332550). The display screen is made of scratch-resistant polycarbonate glass (5 mm thick) The three pushbuttons (diam. 16 mm) are made of 316L stainless steel

EXAMPLE OF VIDEO MODULARITY - SFERA VANDAL-RESISTANT

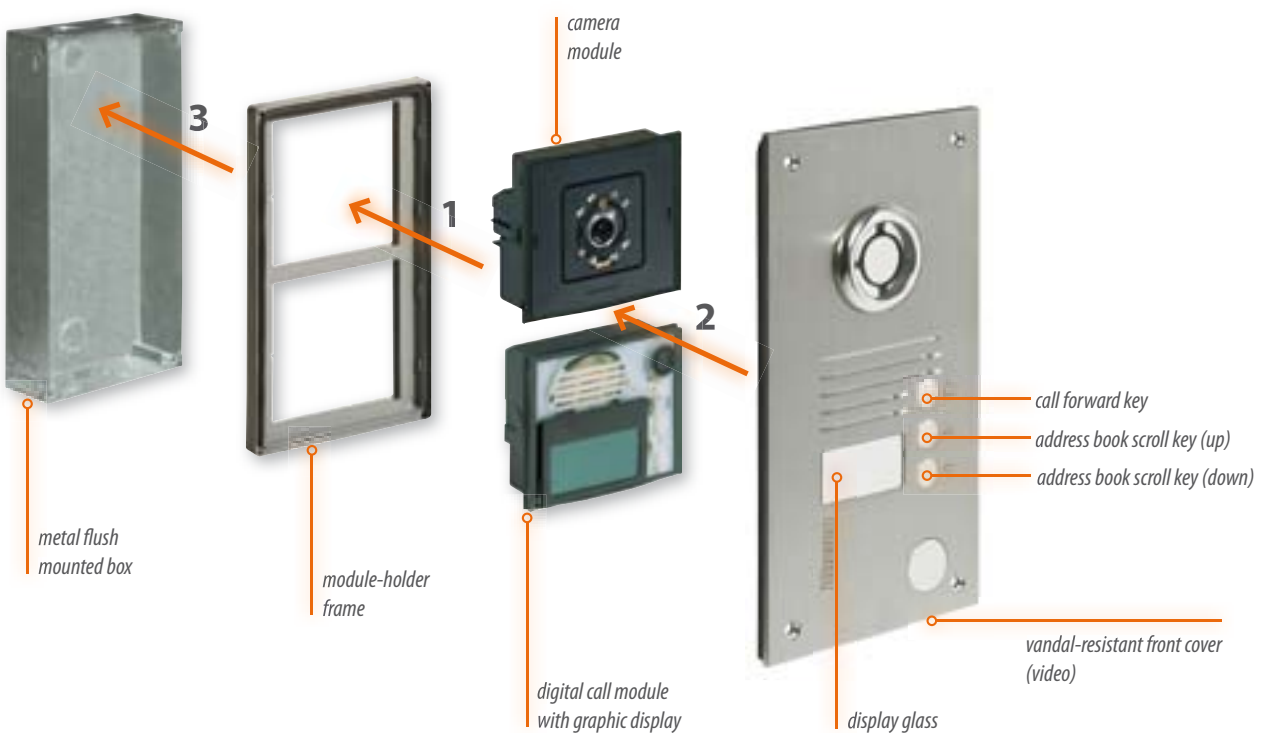

PIVOT handsets



334002



PIVOT HANDSET

Item	Description
334002	white PIVOT handset which can be installed in analogue and digital systems. It has a door lock release pushbutton, staircase light control and self-switching on key to monitor the entrance panel or any cameras (or call to the switchboard). The call volume can be set on three levels. It also has a call secrecy function. It is connected to the system using the removable clamp supplied. Suitable for wall mounted installation, using the bracket supplied, table-top installation, or flush mounted installation, with the right accessories

PIVOT BLACK AND WHITE VIDEO HANDSET

Item	Description
334102	PIVOT video handset which can be installed in analogue systems. It has a door lock release pushbutton, staircase light control and self-switching on key to monitor the entrance panel or any cameras (or call to the switchboard). The call volume can be set on three levels. It also has a call secrecy function. It is connected to the system using the removable clamp supplied. Black and white 4 inch monitor with brightness and contrast adjustment. Suitable for wall mounted installation, using the bracket supplied, table-top installation, or flush mounted installation, with the right accessories



344002

SWITCHBOARD

Item	Description
344002	switchboard for audio and video digital systems. For video systems the specific video section b/w item 334402 or colour item 335122 can be fitted by the side. Access to the various services from keypad or via programmable phone books. Calls can be received from the entrance panel or sent to an extension, calls can be received and sent from the handsets and a call queue can be created in which they are saved. The device comes with an slanting base for table-top installation with cable and a cord for use in the wall mounted installation or with the MULTIBOX boxes



334402



335122

VIDEO SECTION FOR SWITCHBOARD

Item	Description
334402	video section to be fitted by the side of the switchboard. Black and white 4 inch monitor with brightness and contrast adjustment
335122	as above but with colour flat LCD 4" monitor in TFT technology



336982



337102



337122

ACCESSORIES FOR AUDIO AND VIDEO HANDSETS

Item	Description
337102	support for table for handset. It can be used also for slanting wall mounted installation. White
337122	support for table for video handset. It can be used also for slanting wall mounted installation. White
336982	LIGHT 8-way socket for table-top installation of PIVOT audio and video handset
337140	wall metal bracket for handset
337160	wall metal bracket for video handset

DIGITAL SYSTEM

SWING - SPRINT and BASIC handsets



334804



334704

SWING VIDEO HANDSET

Item	Description
334804	white SWING handset which can be installed in digital systems. It has a door lock release pushbutton, activation of the entrance panel or any cameras and three pushbuttons for auxiliary functions referred to three clean contacts (NO-max. output 24 Vac/dc – 1A). The ring volume can be adjusted or the ring muted. It also has a conversation secrecy function. It is connected to the system using the removable clamps supplied. Black and white 4 inch monitor with brightness and contrast adjustment. Suitable for wall mounted installation using the special bracket (supplied as standard)

SWING HANDSET

Item	Description
334704	ash-coloured SWING audio handset which can be installed in analogue and digital systems. It has a door lock release pushbutton, activation of the entrance panel and three pushbuttons for auxiliary functions referred to three clean contacts (NO-output max. 24 Vac/dc -1A). The ring volume can be adjusted and excluded. It also has a call secrecy function. It is connected to the system using the removable clamps supplied. Suitable for wall mounted installation



334202

SPRINT HANDSET

Item	Description
334202	SPRINT handset which can be installed in analogue and digital systems. It has a door lock release pushbutton. The call volume can be set on three levels. It does not need any accessory for wall installation. The cord can be extended with RJ plugs. Conversation secrecy not available

ACCESSORIES FOR SPRINT HANDSET

Item	Description
336982	LIGHT 8-way socket for table-top installation of SPRINT handset
337242	support for table-top with 2 m cable and plug for handset
337400	call exclusion changeover switch and signal LED; can exclude the call from the entrance panel, signalled by a red LED lighting up
337411	intercom card for handset; must have pushbuttons item 337430 to send the calls to the other handsets
337430	extra pushbutton to be used for various commands or for intercom together with card item 337411
337440	signalling LED



334602

BASIC HANDSET

Item	Description
334602	BASIC handset which can be installed in analogue and digital systems. (6 wires). It has a door lock release pushbutton. It does not need any accessory for wall installation. It can not be fitted with accessories.

Installation accessories



336010

AUDIO AND VIDEO POWER SUPPLY

Item	Description
🔌 336010	power supply for digital audio-video and analogue video systems, with removable clamps. Power supply: 230 Vac @ 50/60 Hz - 10 DIN modules. SELV device



346100



346120



346190



346140



346180



346960



346980



349410



346200



346230

INSTALLATION ACCESSORIES

Item	Description
346100	video riser distribution block for digital systems with an input and two outputs (generated riser columns). Several riser distribution blocks can be connected in cascade. 6 DIN modules
346120	audio floor distribution block with 4 outputs to be connected to the audio handsets. 6 DIN modules
346190	video floor distribution block with 4 outputs to be connected to the audio or video handsets. If used with speaker unit Item 342160, this accessory provides the home CCTV functions from the handsets. 6 DIN modules
346140	audio riser distribution block for digital systems with an input and 5 outputs (generated riser columns). Several riser distribution blocks can be connected in cascade. This device can also be used as mixer for several star-cabled entrance panels. 6 DIN modules
346180	repeater distribution block for very large installations with more than 40 risers or for risers with more than 100 apartments. As well as the functions available with Item 346980, it allows independence of the speaker system and guarantees total independence of the riser from the main stretch even if there is a fault. 6 DIN modules
346960	video mixer for several digital entrance panels connected with star wiring. 6 DIN modules
346860	video device for digital systems with two-directional video input and output - allows video communication between switchboard - main EP and secondary EP and the audio and video activation from the telephone switchboard of all the main and secondary EP. 6 DIN modules
346980	audio and video riser distribution block for digital systems. This device can insulate the riser from the system when a conversation is in progress between the riser entrance panel and an handset. This allows another conversation on other sections of the system. 6 DIN modules
346200	relay actuator for digital systems which can switch on lights, open gates or command any device using the handset pushbuttons. 4 DIN modules
346230	door lock relay actuator for digital systems. Can control an electric door lock using the dedicated handset pushbuttons. 2 DIN modules
349410	it enables to establish an interface between an analogue, 8 wire digital, Tersystem and Videoparter 2000 riser, a 2 wire dedicated apartment video door entry system with local CCTV, sound system and control of MY HOME applications - 4 DIN modules

DIGITAL SYSTEM

Installation accessories



346150



346000



391469



346820



337320



336000



336200



391612



391613



391614

INSTALLATION ACCESSORIES

Item	Description
346150	interface used to realize combined video door entry systems (digital backbone/2 wire risers). Ideal for very large systems due to the fact that all the performance advantages of the digital system (switchboard, CCTV, independent risers) can be combined with the installation advantages of the 2 wire system (simple wiring, intercommunication, no need for local power supply of monitors). The device must be used together with the power supply item 346000
346000	power supply to be used with interface item 346150. With removable clamps - 8 DIN modules. Power supply: 230 Vac @ 50/60 Hz. SELV device
336820	video distribution block for intercom systems or with telephone switchboard. All the connections are made with the removable clamps supplied - 6 DIN modules
336850	video distribution block for the simultaneous switching on of several video handsets in the same apartment
391469	interface which displays the pictures from the video door entry system on the television following a call from the entrance panel. It connects to the system like a normal video handset and to the TV by means of a common Scart socket. Different modes of connection means that the TV can be used as an extra monitor for a fixed or cordless telephone (in systems with PABX switchboard and video distribution block), or CCTV systems can automatically switch between the monitoring cameras. The device has a potentiometer to adjust the video signal amplitude
346820	interface to connect a camera (internal or external) on the digital riser. The images of the camera connected to this interface will be visible from all the system handsets - 6 DIN modules
337320	optoisolated video signal converter for indoor/outdoor and minidome cameras. It converts the video signal from coaxial into balanced - 2 DIN modules

POWER SUPPLY AND RELAY FOR INTERCOM SYSTEMS

Item	Description
336000	power supply to be installed in each home in multi-family intercom systems - 6 DIN modules. Power supply: 230 Vac @ 50/60 Hz. SELV device
336200	relay to be installed inside the home to give the intercom service. In multi-family installations it must be supplied locally. All the connections are made with the removable clamps supplied - 6 DIN modules

B/W INDOOR CAMERAS TO BE USED WITH THE BTICINO HOME SERIES

With video signal output in balanced

Item	Description
391612	b/w camera - LIGHT
391613	b/w camera - LIVING INTERNATIONAL
391614	b/w camera - LIGHT TECH



336910

EXTRA BELL

Item	Description
336910	extra bell to broadcast the electronic call in several rooms; it can be installed on the wall or on a round box with clips



336992

LIVING, LIGHT AND LIGHT TECH EXTRA BELLS

Item	Description
336992	extra bell to broadcast the electronic call in several rooms. There is a potentiometer on the front to adjust the volume. It can be installed flush mounted using a 2-module box with chassis and LIGHT surround plates
336993	extra bell as above - LIVING
336994	extra bell as above - LIGHT TECH



336993

VIDEO MONITORING ACCESSORIES

Item	Description
391468	camera switcher with 2 inputs to connect indoor or outdoor cameras or SFERA entrance panels. The images of the cameras connected or of the entrance panels, will only be visible from the video handset the camera switcher is connected to - 6 DIN modules
391470	white 4-pushbutton block for PIVOT video handsets. This accessory enables to individually switch on the 4 cameras of the system, or to control 4 actuators, item 346200



336994

WIRING TESTER

Item	Description
336950	tester to check the wiring of analogue and digital systems. It is made up of three units: a transmitter, a receiver and a distributor. The tester gives information on: broken connections, inverted connections and short circuits



336950

DIGITAL SYSTEM

Installation accessories

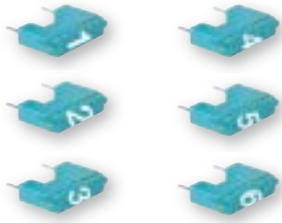

CONFIGURATORS (10 PIECE PACK)

Item	Description
3501/0	configurator 0
3501/1	configurator 1
3501/2	configurator 2
3501/3	configurator 3
3501/4	configurator 4
3501/5	configurator 5
3501/6	configurator 6
3501/7	configurator 7
3501/8	configurator 8
3501/9	configurator 9
3501K	configurator kit consisting of: - 10 pieces for each type of configurator from 0 to 9 - 2 blue removable 8-clamp connectors - 2 green removable 2-clamp connectors - 1 configurator connection tool - 1 plastic screwdriver

WIRING ACCESSORIES

Item	Description
336900	non-fire propagating 8-conductor cable which can be buried in piping, conforms to standards (CEI 20-22 II), (CEI 20-13) and (CEI 20-14) – 100-metre skein
336903	non-fire propagating 8-conductor cable which can be buried in piping, conforms to standards (CEI 20-22 II), (CEI 20-13) and (CEI 20-14) – 500-metre skein



336810



336964



336968

INSTALLATION ACCESSORIES

Item	Description
336810	video signal distribution block for box Ø 60 mm. It has an output for the video handset and another pass-through
336964	removable connector, 4 clamps not numbered
336968	removable connector, 8 clamps not numbered

ANALOGUE SYSTEM

SFERA function modules



332120

SPEAKER MODULE

Item	Description
332120	analogue speaker module with two call pushbuttons and a pushbutton to control the staircase light relay actuator. The connections to the system are made by wiring the removable clamp supplied; also the nameplates are lit up by a lamp fitted on a removable drawer. The module is supplied with all the connection wires



332200

NAMEPLATE MODULE

Item	Description
332200	analogue nameplate module which can be used to enter the street number or any other information. It can be used for the "wait" signal, in systems with 2 entrance panels. The module is supplied with all the connection wires



332240



332650

PUSHBUTTON MODULE

Item	Description
332240	analogue pushbutton module with 4 call pushbuttons. The connections to the system are made by cabling the removable clamp supplied; also the nameplates are lit up by a lamp fitted on a removable drawer. The module is supplied with all the necessary wires for connection to other modules

CODE-LOCK MODULE

Item	Description
332650	code-lock module that can be used both in analogue and digital systems. This module opens and closes two relays by keying in two code numbers

ACCESSORIES

Can be installed in the analogue speaker module

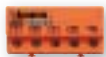

336300

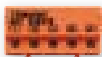

336310



332930

Item	Description
336300	card to be installed on the analogue speaker module to have the conversation secrecy in all the system. The handsets must be PIVOT or SWING (only item 334702/03/04)
336310	card to be installed on the analogue speaker module, to have the control relay of the electric door lock nearby the door lock itself. This solution enables a consistent reduction of the conductor sections in the line between the entrance panel and the power supply.
332930	differentiated note generator to be installed on the analogue speaker module to diversify the call note in systems with 2 entrance panels

WARNING: assembly note: flush mounted boxes, wall mounted enclosures, rainshield, front cover, and surround plates are the same as for 2-WIRE SFERA entrance panels (refer to the specific section in the catalogue)

ANALOGUE SYSTEM

MINISFERA pushbutton panels



332700



332704



332710



332711

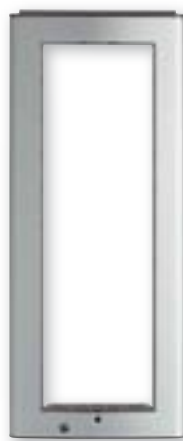

332721



332713



332714



332712



332715



332718

SPEAKER MODULE

Item	Description
332700	analogue speaker module preset for max. 6 calls. It must be fitted with contact small block item 332718, surround plate item 332721 and keys item 332712, item 332713, item 332714, item 332715. With microphone sensitivity and loudspeaker volume adjustment. The connections to the system are made directly on the speaker module terminal board. The nameplates are illuminated by 6 green LEDs

EXPANSION MODULE

Item	Description
332704	analogue pushbutton module preset for max. 10 calls. It must be fitted with contact small block item 332718, surround plate item 332721 and keys item 332712, item 332713, item 332714, item 332715. The nameplates are illuminated by 10 green LEDs

COMMON ACCESSORIES

Item	Description
332710	flush mounted box
332711	surface mounted box
332721	aluminium surround plate

COMMON ACCESSORIES

Item	Description
332712	narrow key 1 module with name label
332713	wide key 2 modules with name label
332714	2 modules nameplate with label
332715	1 module false key - standard grey
332718	pushbutton contact to be associated to the call keys

MINISFERA BASIC pushbutton panel



332801

SPEAKER MODULE - BASIC

Item	Description
332801	analogue speaker module preset for max. 4 calls. It must be fitted with contact block item 332718 and keys item 332712, item 332713, item 332714, item 332715. With microphone sensitivity and loudspeaker volume adjustment. The connections to the system are made directly on the speaker module terminal board. The nameplates are illuminated by 4 green LEDs



332713



332714



332712

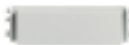

332715



332718

ACCESSORIES FOR BASIC MINISFERA

Item	Description
332712	narrow key 1 module with name label
332713	wide key 2 modules with name label
332714	2 module nameplate with label
332715	1 module false key - standard grey
332718	pushbutton contact to be associated to the call keys

ANALOGUE SYSTEM

PIVOT handset



334002



337102



336982

PIVOT AUDIO HANDSET

Item	Description
334002	Pivot handset which can be installed in analogue and digital systems. It has a door lock release pushbutton, staircase light control and self-switching on key to monitor the entrance panel or any cameras (or call to the switchboard). The call volume can be set on three levels. It also has a call secrecy function used with item 336300. It is connected to the system using the removable clamp supplied. Suitable for wall mounted installation, using the bracket supplied, table-top installation, or flush mounted using the correct accessories. White

ACCESSORIES FOR PIVOT HANDSETS

Item	Description
337102	support for table for handset. It can be used also for slanting surface mounted installation. White
336982	LIGHT 8-way socket for table-top installation of PIVOT audio and video handset

SWING handset



334704

SWING HANDSET

Item	Description
334704	white SWING audio handset which can be installed in analogue and digital systems. It has a door lock release pushbutton, activation of the entrance panel and three pushbuttons for auxiliary functions referred to three clean contacts (NO-output max. 24 Vac/dc 1A). The ring volume can be adjusted and excluded. It also has a call secrecy function. It is connected to the system using the removable clamps supplied. Suitable for wall mounted installation

SPRINT handset and accessories



334202



337242

SPRINT HANDSET

Item	Description
334202	SPRINT handset which can be installed in analogue and digital systems. It has a door lock release pushbutton. The call volume can be set on three levels. It does not need any accessory for wall installation. The cord can be extended with RJ plugs. Conversation secrecy not available

ACCESSORIES FOR SPRINT HANDSET

Item	Description
336803	black cable with plug, length 2 m
336982	LIGHT 8-way socket for table-top installation of SPRINT handset
337242	support for table with 2 m cable and plug for handset
337400	call exclusion changeover switch and signal LED; can exclude the call from the entrance panel, signalled by a red LED lighting up
337411	intercom card for handset; must have pushbuttons item 337430 to send the calls to the other handsets
337430	extra pushbutton to be used for various commands or for intercom together with card item 337411
337440	signalling LED

BASIC handset



334602

BASIC HANDSET

Item	Description
334602	BASIC handset which can be installed in analogue and digital systems. It has a door lock release pushbutton. It does not need any accessory for wall installation

ANALOGUE SYSTEM

Installation accessories



336200



336210



336220



336230



336802



349410

INSTALLATION ACCESSORIES

Item	Description
336200	relay to be installed inside the home to give the intercom service. In multi-family installations it must be supplied locally. All the connections are made with the removable clamps supplied - 6 DIN modules
336210	switching relay to be installed on systems with 2 entrance panels. All the connections are made with the removable clamps supplied - 6 DIN modules
336220	auxiliary relay for the control of an extra bell or any other device. Contacts 5A 230 Vac - 3 DIN modules
336230	staircase lights timer relay (from 15 seconds to 10 minutes) It can be controlled either from the 230 V mains or from the 12 - 30 Vac-dc door entry system. Contacts 10 A 230 Vac - 3 DIN modules
336802	noise reduction filter, to be used with systems installed in electrically noisy environments - 2 DIN modules
336860	audio floor distribution block for 4 handsets. All the connections are made with the removable clamps supplied - 6 DIN modules
349410	it enables to establish an interface between an analogue riser, 8 wire digital, Tersystem and Videoporter 2000, a 2 wire dedicated apartment video handset with local video surveillance, sound system and MY HOME application control - 4 DIN modules



336920



Tersystem



T500



POSTAL BOX



UNIVERSAL SPEAKER UNIT

Item	Description
336920	universal speaker unit to be installed in the Tersystem and Postal box pushbutton panels, in order to use them also with the new analogue system



336910

EXTRA BELL

Item	Description
336910	extra bell to broadcast the electronic call in several rooms; it can be installed on the wall or on a round box with clips



336992



336993



336994

LIVING, LIGHT AND LIGHT TECH EXTRA BELLS

Item	Description
336992	extra bell to broadcast the electronic call in several rooms. There is a potentiometer on the front to adjust the volume. Suitable for flush mounted installation using a 2-module box with chassis and LIGHT surround plates
336993	extra bell as above - LIVING
336994	extra bell as above - LIGHT TECH



336968



336964

ACCESSORIES AND CONNECTORS

Item	Description
336964	removable connector, 4 clamps not numbered
336968	removable connector, 8 clamps not numbered

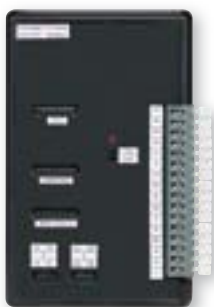

WIRING TESTER

Item	Description
336950	tester to check the wiring of analogue and digital systems. It is made up of three units: a transmitter, a receiver and a distributor. The tester gives information on: broken connections, inverted connections and short circuits



336950

ANALOGUE SYSTEM

Power supplies and transformer



336000

AUDIO POWER SUPPLY

Item	Description
 336000	power supply for audio analogue systems. Power supply: 230 Vac @ 50/60 Hz - 6 DIN modules. SELV device <input type="checkbox"/>

AUDIO POWER SUPPLY FOR BACK-UP BATTERY

Item	Description
 336020	power supply for audio analogue systems, with removable clamps, preset for back-up battery (not supplied). Power supply: 230 Vac @ 50/60 Hz - 8 DIN modules. SELV device <input type="checkbox"/>



336842

TRANSFORMER

Item	Description
336842	transformer 230 V – 12 V, 18 VA - 3 DIN modules



2251

2252

2253

MODULE-HOLDER COVER PLATES

Supplied with flush mounted box – colour aluminium. With opening hinge to make wiring easier, and accessories for coupling several boxes together. Flush mounting depth 45 mm

Item	Modules
2251	1
2252	2
2253	3



2701

RAINSHIELDS

For flush mounted module-holder cover plates - colour aluminium

Item	Modules
2701	1
2702	2
2703	3
2704	4
2706	6
2709	9



2301

MODULE-HOLDER COVER PLATES

For wall mounted installation – colour aluminium. With opening hinge to make wiring easier, and rain protection. Maximum protrusion 78 mm

Item	Modules
2301	1
2302	2
2303	3
2304	4
2306	6
2309	9



2304

TERSYSTEM

Speaker units and front covers



2130

2131

2132



2659N

336920



2140

2141

2142



2143

2144

2149



40.71



2659N

336920

346991

MODULES FOR SPEAKER UNIT - ALUMINIUM

For the installation of the "Porter" 2659N speaker module, with backlit call pushbuttons and staircase light key

Item	Call pushbuttons
------	------------------

2130	none
------	------

2131	1
------	---

2132	2
------	---

UNIVERSAL SPEAKER UNITS

Item	Description
------	-------------

 2659N	universal speaker unit to be installed in the Tersystem and Postalbox pushbutton panels, in order to use them with the 4 wire system + n
---	--

336920	universal analogue speaker unit to be installed in the Tersystem and Postal box pushbutton panels, in order to use them with the analogue system
--------	--

CALL MODULES AND SIGNALLING - ALUMINIUM

Supplied with lighting

Item	Call pushbuttons
------	------------------

2140	none
------	------

2141	1
------	---

2142	2
------	---

2143	3
------	---

2144	4
------	---

2149	signalling module
------	-------------------

MAIL BOXES FOR VIDEO DOOR ENTRY SYSTEMS

Fully made of anodized aluminium, they can be installed on the wall or the gate. The mailbox door is fitted with door lock

Item	Description
------	-------------

40.71	with pushbutton and speaker module grid - front opening
-------	---

40.72	with 2 pushbuttons and speaker module grid - front opening
-------	--

UNIVERSAL SPEAKER UNITS

Item	Description
------	-------------

 2659N	universal speaker unit to be installed in the Tersystem and Postalbox pushbutton panels, in order to use them with the 4 wire system + n
---	--

336920	universal analogue speaker unit to be installed in the Tersystem and Postalbox pushbutton panels, in order to use them with the analogue system
--------	---

346991	universal speaker unit to be installed in the Tersystem and Postalbox pushbutton panels, in order to use them with the 2 wire system
--------	--

Handsets and accessories



603R



600



600WS

HANDSETS, POWER SUPPLIES AND ACCESSORIES

The 603 and 600 series handsets with power supply 672 and switching groups 607 and 608N can be connected to the pushbutton stations, Tersystem and Postalbox

SERIES 603 HANDSET

Item	Description
 603R	white, with pushbutton for opening door lock

SERIES 600 HANDSET

With these models it is possible to expand the range of functions by adding pushbuttons (up to six maximum)

Item	Description
600	beige, with 2 pushbuttons
600WS	white, with 2 pushbuttons

ACCESSORIES AND SPARE PARTS FOR SERIES 600 HANDSET

Item	Description
UE611	electronic unit to be fitted inside the handset for conversation secrecy function, and for auto-exclusion, if the receiver is off for more than 1 second
600ETE	additional pushbutton for the creation of intercommunicating systems
600D	red LED diode for luminous signalling
600S	call exclusion switch
600G1A	extra monotone bell; for installation inside the handsets
602UZ	kit for 600 handset used in parallel with video handsets

TERSYSTEM

Installation accessories



336920

UNIVERSAL ANALOGUE SPEAKER UNIT

Item	Description
336920	universal analogue speaker unit to be installed in the Tersystem and Postalbox pushbutton panels, in order to use them with the analogue system



672



607

POWER SUPPLY

Item	Description
 672	modular housing, 6 DIN modules; power supply 230 Vac



608N

SWITCHING UNITS

Item	Description
607	for intercommunicating systems. Modular housing, 3 DIN modules
608N	for systems with 2, 3 or 4 entrance panels. Modular housing, 10 DIN modules



349410

ANALOGUE/2 WIRE COMMUNICATION INTERFACE

Item	Description
349410	it enables to establish an interface between an analogue riser, 8 wire digital, Tersystem and Videoporter 2000, a 2 wire dedicated apartment video handset with local video surveillance, sound system and MY HOME application control - 4 DIN modules

CONTENTS**2 WIRE CATALOGUE - DIMENSIONAL DATA**

Entrance panels _____	80
Handsets _____	85
Video Switchboard _____	88
Accessory devices in BASIC housing _____	88
Accessory devices in DIN housing _____	89
Melodic and extra bells _____	90
Indoor cameras (flush mounted) _____	90
Outdoor camera _____	90

DIMENSIONAL DATA

AXOLUTE OUTDOOR entrance panels

FLUSH MOUNTED BOX

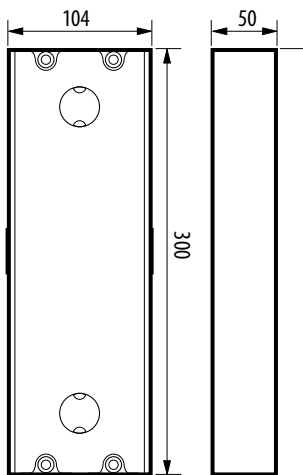

339313

ELECTRONIC MODULE

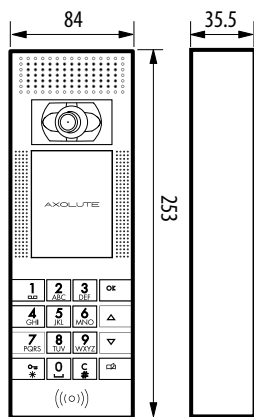

349140

SURROUND PLATES + FRAME

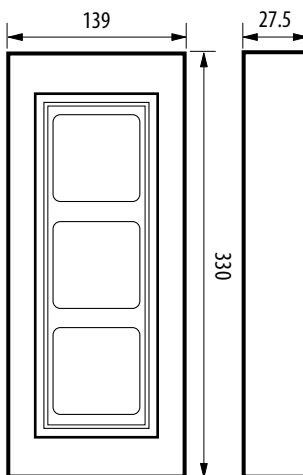

339213

Steel surround plate.

Protrusion from the wall: 11 mm

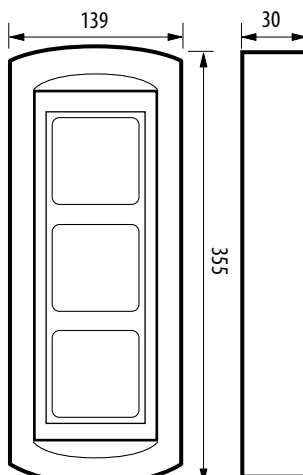

339223

Brass surround plate.

Protrusion from the wall: 13.5 mm

NOTE: dimensions in mm

SFERA entrance panels

FLUSH MOUNTED BOXES

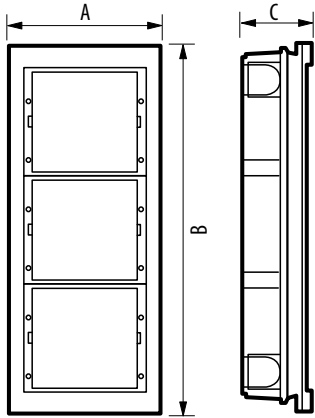

DIMENSIONS IN mm

Item	A	B	C
331110	117	123	45
331120	117	214	45
331130	117	306	45

SFERA MODULAR RAINSHIELDS

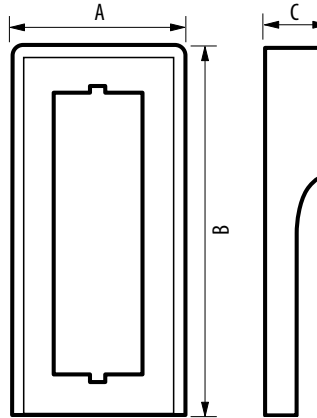

DIMENSIONS IN mm

Item	A	B	C
331411	151	151	50
331421	151	242	50
331431	151	334	50
331441	290	242	50
331461	290	334	50
331491	430	334	50

MODULAR SFERA WALL MOUNTED ENCLOSURES

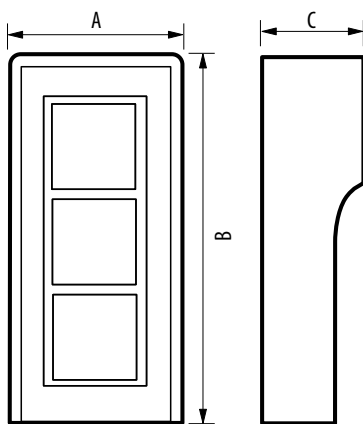

DIMENSIONS IN mm

Item	A	B	C
331311	150	154	92
331321	150	245	92
331331	150	337	92
331341	289	245	92
331361	289	337	92
331391	428	337	92

SFERA MODULAR SURROUND PLATES

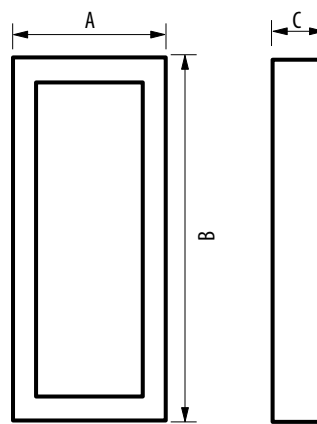

DIMENSIONS IN mm

Item	A	B
331211	140	142
331221	140	233
331231	140	325
331821	125	233
331831	125	325

SFERA ALL FUNCTION MODULES

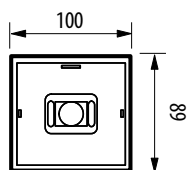

NOTE: dimensions in mm

DIMENSIONAL DATA

SFERA entrance panels

MONOBLOC SFERA FRONT COVERS

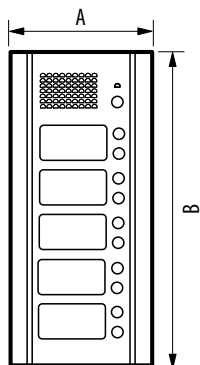

DIMENSIONS IN mm

No. of modules	A	B
1	140	142
2	140	233
3	140	325

VANDAL-RESISTANT SFERA

Video pushbutton panels

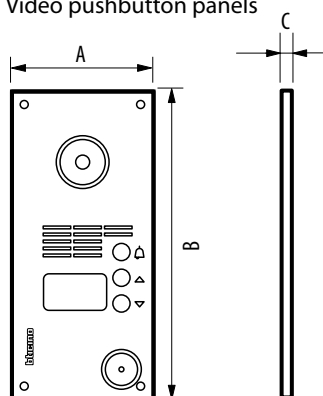

DIMENSIONS IN mm

Item	A	B	C
333914	150	284	4

Audio pushbutton panels

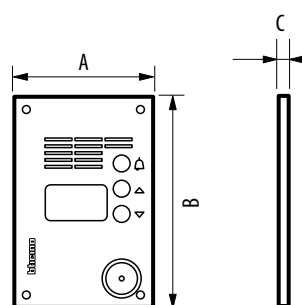

DIMENSIONS IN mm

Item	A	B	C
333714	150	198	4

NOTE: dimensions in mm

Monobloc vandal-resistant entrance panels

MONOBLOC PUSHBUTTON PANELS

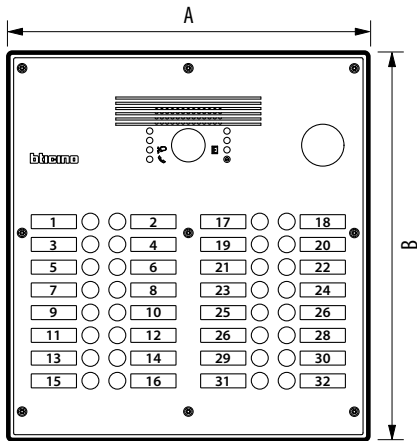

DIMENSIONS IN mm

Item	A	B
308001 - 308011	180	270
308002 - 308012	180	330
308003 - 308013	180	360
308004 - 308014	180	440
308005 - 308015	340	370

WALL MOUNTED BOXES FOR MONOBLOC PUSHBUTTON PANELS

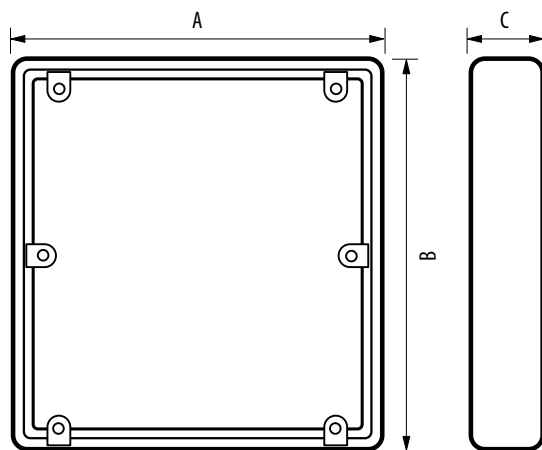

DIMENSIONS IN mm

Item	A	B	C
308021	178	267	40
308022	178	327	40
308023	178	357	40
308024	178	437	40
308025	338	367	40

NOTE: dimensions in mm

DIMENSIONAL DATA

MINISFERA entrance panels

MINISFERA FLUSH MOUNTED BOX

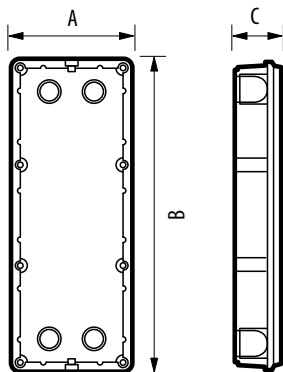

DIMENSIONS IN mm

Item	A	B	C
332710	95	235	45

MINISFERA WALL MOUNTED BOX

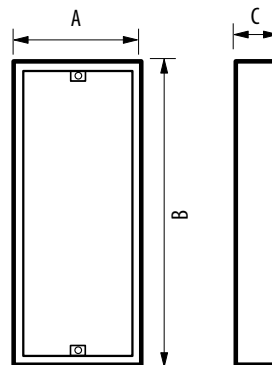

DIMENSIONS IN mm

Item	A	B	C
332711	99	245	16

MINISFERA FUNCTION MODULES

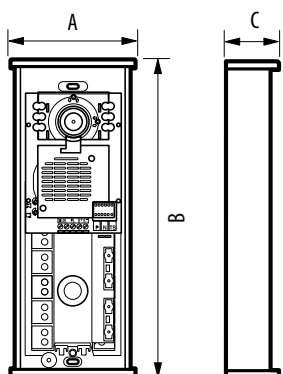

DIMENSIONS IN mm

Item	A	B	C
342702	100	245	21
342704	100	245	21
342708	100	245	21

MINISFERA SURROUND PLATE

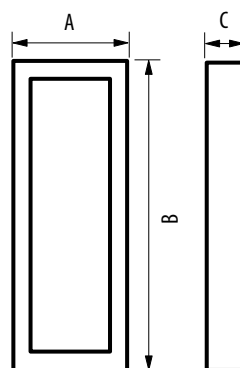

DIMENSIONS IN mm

Item	A	B	C
332721	100	237	18

LINEA 2000 entrance panels

AUDIO AND VIDEO PUSHBUTTON PANELS

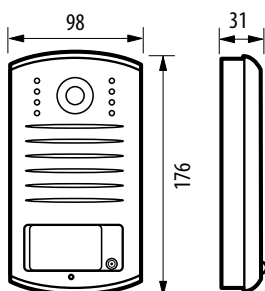

342951 342911
342961 342921

NOTE: dimensions in mm

LINEA 2000 METAL entrance panels

WALL AUDIO AND VIDEO PUSHBUTTON PANELS

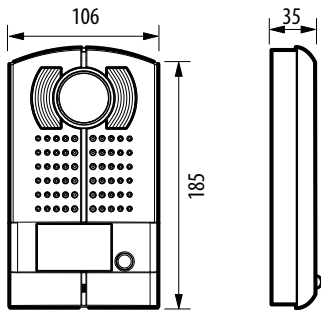

342991 342981 342971
342992 342982 342972

FLUSH MOUNTED VIDEO PUSHBUTTON PANELS

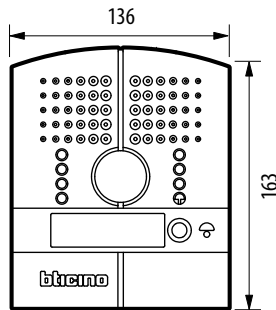

343001
343002

AXOLUTE handsets

MULTIMEDIA TOUCH SCREEN

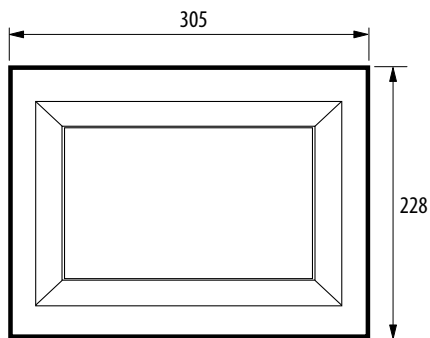

HD4690 - HC4690 - HS4690

NIGHTER AND WHICE VIDEO STATION

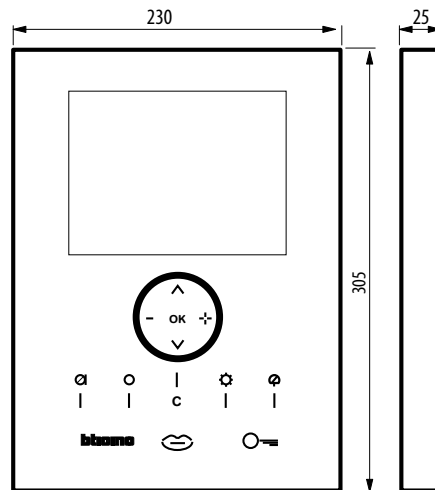

349320
349321

VIDEO STATION

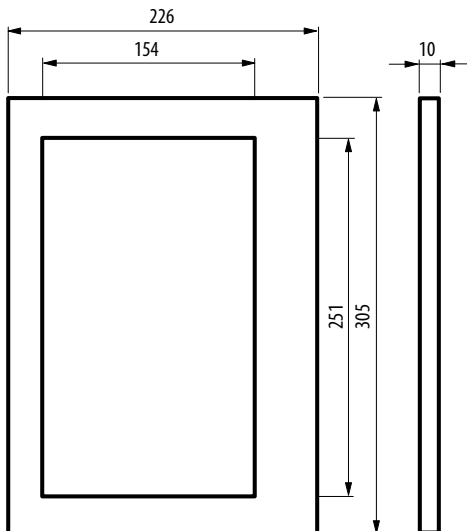

349210 - 349211 - 349212

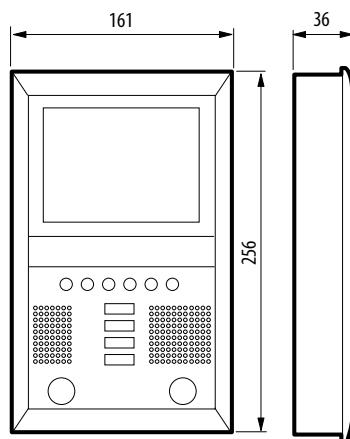

349310

NOTE: dimensions in mm

DIMENSIONAL DATA

AXOLUTE handsets

AXOLUTE VIDEO DISPLAY

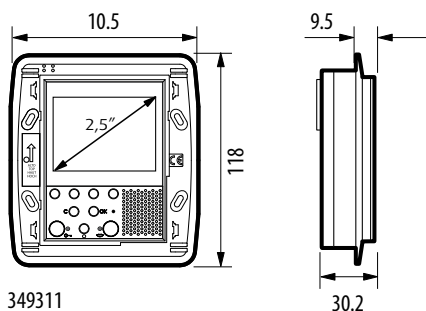

349311
349312
349313

TABLE-TOP BASE

For AXOLUTE VIDEO DISPLAY

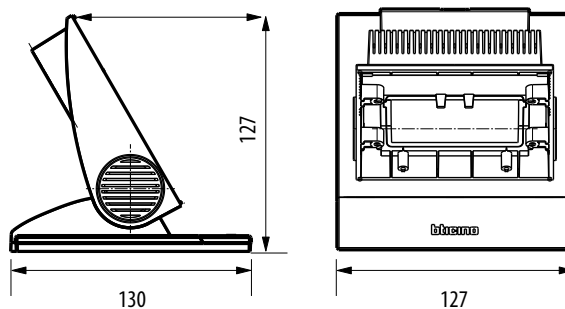

349319

AXOLUTE ETÉRIS VIDEO DISPLAY

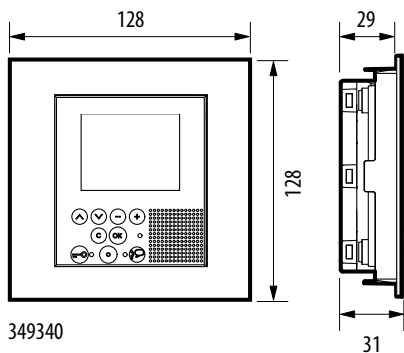

349340

POLYX handsets

POLYX AUDIO

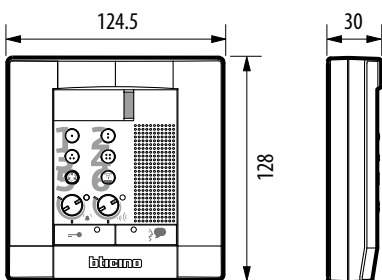

344082

POLYX VIDEO - POLYX MEMORY DISPLAY

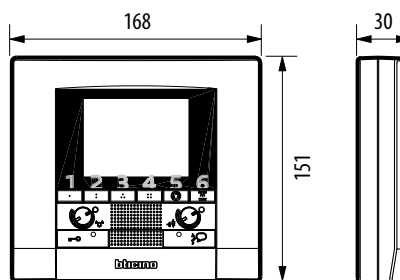

344192
344163
344182

NOTE: dimensions in mm

TELELOOP inductive module

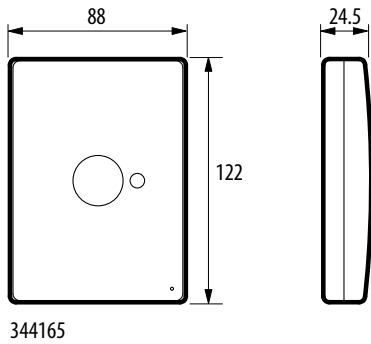

344165

PIVOT handsets

PIVOT AUDIO AND VIDEO HANDSET

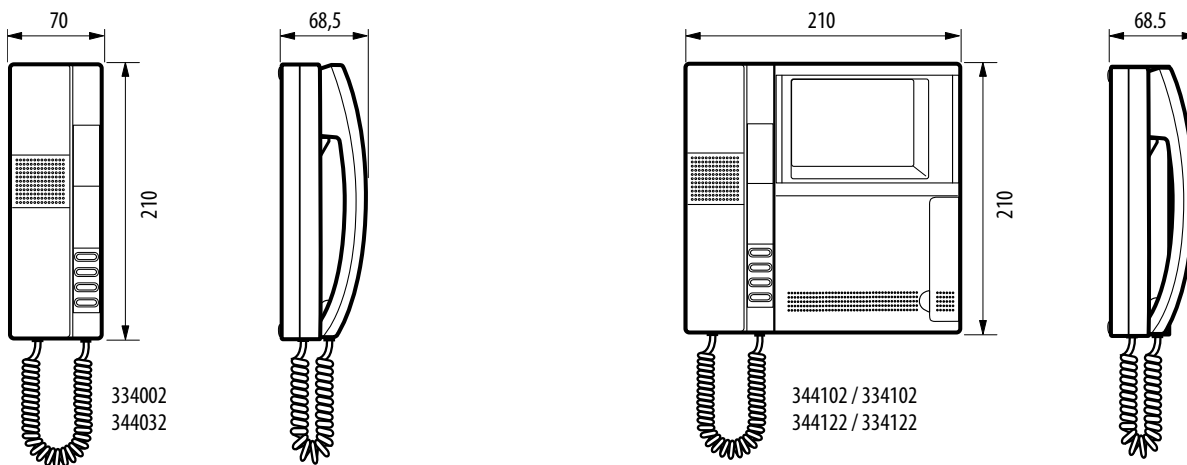

334002
344032

344102 / 334102
344122 / 334122

MULTIBOX FLUSH MOUNTED BOXES

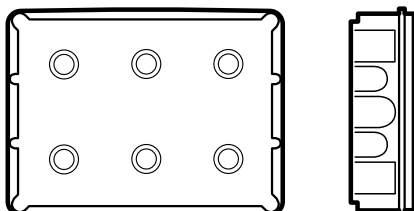

Item	Internal dimensions (mm)	External dimensions (mm)
16101	84x218x69	110x243x70
16103	224x218x69	250x243x70

NOTE: dimensions in mm

DIMENSIONAL DATA

SWING handsets

SWING AUDIO AND VIDEO HANDSETS

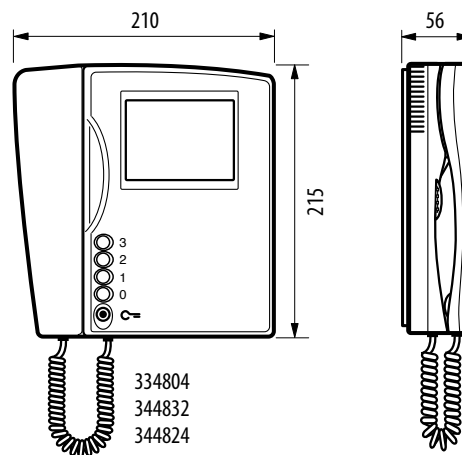
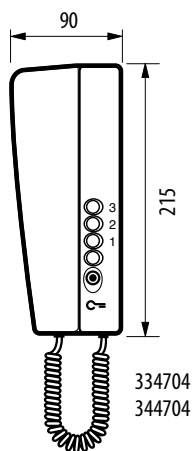

SPRINT handsets

SPRINT AUDIO HANDSETS

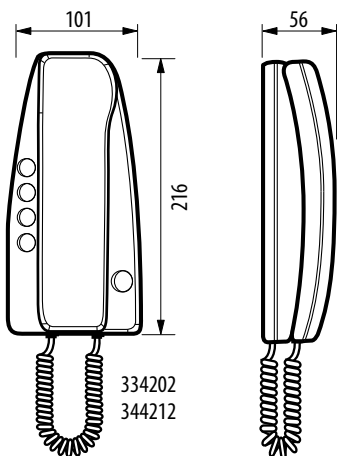

Switchboard

COLOUR VIDEO SWITCHBOARD

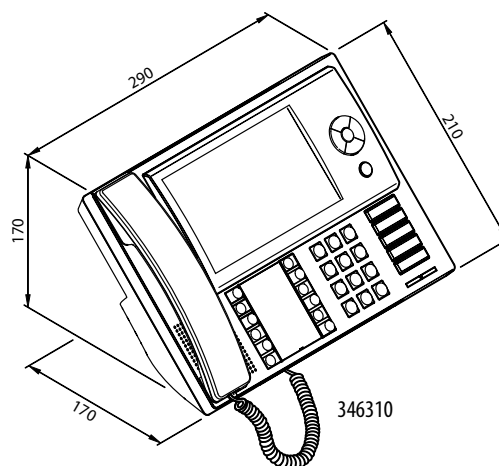

Devices in BASIC housing

COAX INTERFACE - 2 WIRES

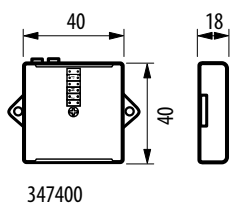

VIDEO SHUNT - 2 WIRES

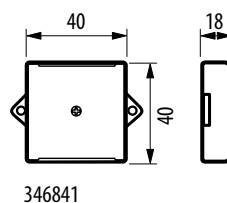

FLOOR CALL INTERFACE

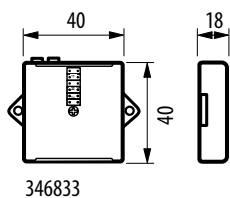

UNIVERSAL SPEAKER MODULE

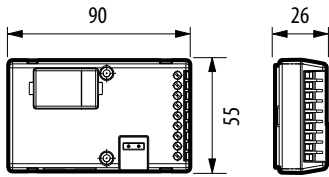

346991

LINE AMPLIFIER

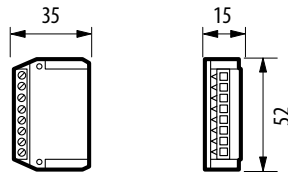

346870

DIN RAIL DEVICES

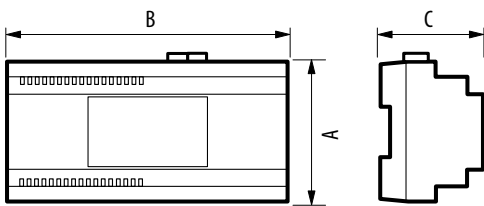

Item	Dimensions (mm)			No. of DIN modules
	A	B	C	
346000	90	140	61	8
346010	90	105	61	6
346020	105	35	30	2
346030	105	35	30	2
346150	90	105	61	6
346200	90	72	61	4
346230	105	35	30	2
346260	105	70	30	4
346810	90	52.5	37	3
346830	105	35	30	2
346850	90	72	30	4
346851	90	72	30	4
346890	90	175	60	10
349410	90	105	37	6
F441	90	105	30	6
F441M	90	175	30	10
F442	90	105	30	6

DIMENSIONAL DATA

Bells and cameras

MELODIC BELLS

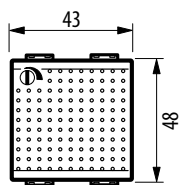

346982 349412
346983 349413
346984

EXTRA BELLS

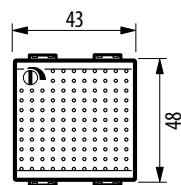

336992
336993
336994

FLUSH MOUNTED INDOOR CAMERAS

LIVING, LIGHT, LIGHT TECH and AXOLUTE cameras

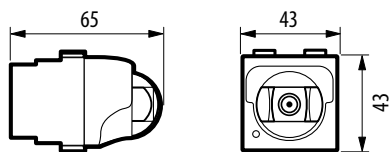

391657 391667 391661
391658 391668 391662
391659 391669 391663

OUTDOOR CAMERA

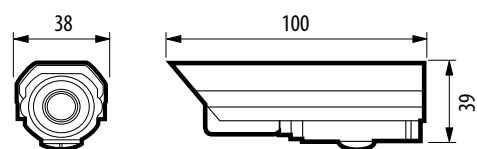

391670

NUMERIC INDEX

Item	Catalogue page	Dimensional data page
600	77	-
607	78	-
672	78	-
2130	76	-
2131	76	-
2132	76	-
2140	76	-
2141	76	-
2142	76	-
2143	76	-
2144	76	-
2149	76	-
2251	75	-
2252	75	-
2253	77	-
2301	75	-
2302	75	-
2303	75	-
2304	75	-
2306	75	-
2309	75	-
2701	75	-
2702	75	-
2703	75	-
2704	75	-
2706	75	-
2709	75	-
3499	44	-
16101	38	87
16103	38	87
16121	38	-
16122	38	-
308001	20	83
308002	20	83
308003	20	83
308004	20	83
308005	20	83
308011	20	83
308012	20	83
308013	20	83
308014	20	83

Item	Catalogue page	Dimensional data page
308015	20	83
308021	20	83
308022	20	83
308023	20	83
308024	20	83
308025	20	83
316113	55	-
316213	55	-
316313	55	-
316413	56	-
316513	56	-
331110	13	81
331120	13	81
331130	13	81
331311	13	81
331321	13	81
331331	13	81
331341	13	81
331361	13	81
331391	13	81
331411	13	81
331421	13	81
331431	13	81
331441	13	81
331461	13	81
331491	13	81
332120	67	81
332200	67	81
332240	67	81
332510	59	81
332540	59	81
332550	59	81
332650	13-59-67	81
332700	68	81
332704	68	81
332710	21-68	84
332711	21-68	84
332712	21-68-69	-
332713	21-68-69	-
332714	21-68-69	-
332715	21-68-69	-

NUMERIC INDEX

Item	Catalogue page	Dimensional data page	Item	Catalogue page	Dimensional data page
332718	68-69	-	337242	40-71	-
332721	21-68	84	337320	64	-
332801	69	-	337400	71	-
332930	67	-	337411	71	-
333714	19-60	82	337430	71	-
333914	19-60	82	337440	71	-
334002	61-70	87	339213	12	80
334102	61	87	339223	12	80
334202	62-71	88	339313	12	80
334402	61	-	342150	13	-
334602	62-71	-	342160	58	81
334704	62-70	88	342170	13	81
334804	62	88	342200	13-58	81
335122	61	-	342240	13-58	81
336000	64-74	-	342350	13	81
336010	63	-	342480	13	81
336200	64-72	-	342510	13	81
336210	72	-	342550	13	81
336220	72	-	342560	13	81
336230	72	-	342600	13-59	81
336300	67	-	342610	13-59	81
336310	67	-	342620	58	81
336802	72	-	342630	13	81
336810	66	-	342640	13-58	81
336820	64	-	342702	21	84
336842	74	-	342704	21	84
336850	64	-	342708	21	84
336900	66	-	342911	23	84
336903	66	-	342921	23	84
336904	45	-	342951	23	84
336910	46-65-73	-	342961	23	84
336920	71-72-77	-	342971	22	85
336950	64-72	-	342972	22	85
336964	65	-	342981	22	85
336968	65	-	342982	22	85
336982	37-40-60	-	342991	22	85
336992	46-65	90	342992	22	85
336993	46-65	90	343001	22	85
336994	46-65	90	343002	22	85
337102	37-61-70	-	344002	61	-
337122	37-61	-	344032	37	87

Item	Catalogue page	Dimensional data page
344082	36	86
344102	37	87
344122	37	87
344163	36	86
344165	36	87
344182	36	86
344192	36	86
344202	40	88
344212	40	88
344704	39	88
344824	39	88
344832	39	88
346000	42	89
346010	42	89
346020	42	89
346030	42	89
346100	63	-
346120	63	-
346140	63	-
346150	43-64	89
346180	63	-
346190	63	-
346200	43-63	89
346220	59	-
346230	43-63	89
346250	44	-
346260	43	89
346300	47	-
346310	40	88
346810	43	89
346812	37	-
346820	64	-
346830	42	89
346833	44	88
346841	44	88
346850	43	89
346851	43	89
346860	63	-
346870	44	88
346890	43	89
346902	44	-

Item	Catalogue page	Dimensional data page
346903	44	-
346907	44	-
346960	64	-
346980	64	-
346982	46	90
346983	46	90
346984	46	90
346991	45	89
346992	45	89
347400	44	88
348200	12	-
348201	12	-
348202	12	-
348203	12	-
348204	12	-
348205	12	-
348206	12	-
348402	12	-
349140	12	80
349210	33	85
349211	33	85
349212	33	85
349241	35	-
349242	35	-
349243	35	-
349310	33	85
349311	34	86
349312	34	86
349313	34	86
349319	34	86
349320	33	85
349321	33	85
349340	35	86
349410	43-63-72	89
349412	46	90
349413	46	90
349414	34	-
349415	34	-
365411	51	-
365421	51	-
366311	54	-

NUMERIC INDEX

Item	Catalogue page	Dimensional data page	Item	Catalogue page	Dimensional data page
367211	50	-	3501/8	45-66	-
367221	50	-	3501/9	45-66	-
367511	51	-	3501K	45-66	-
367521	51	-	40.71	76	-
368111	50	-	40.72	76	-
368121	50	-	40.91	78	-
368811	52	-	40.92	78	-
368821	52	-	600D	77	-
368911	52	-	600ETE	77	-
368921	52	-	600G1A	77	-
369111	54	-	600S	77	-
369411	53	-	600WS	77	-
369421	53	-	602UZ	77	-
369511	53	-	603R	77	-
369521	53	-	608N	78	-
391469	64	-	F441	42	89
391612	64	-	F441M	42	89
391613	64	-	F442	44	89
391614	64	-	HA4690LTK	32	-
391657	46	90	HA4690VBB	32	-
391658	46	90	HA4690VNB	32	-
391659	46	90	HA4690VSW	32	-
391661	46	90	HA4690XC	32	-
391662	46	90	HC4690	32	85
391663	46	90	HD4690	32	85
391667	46	90	HS4690	32	85
391668	46	90	UE611	76	-
391669	46	90			
391670	46	90			
16101LT	38	-			
16103LT	38	-			
2659N	76	-			
3501/0	45-66	-			
3501/1	45-66	-			
3501/2	45-66	-			
3501/3	45-66	-			
3501/4	45-66	-			
3501/5	45-66	-			
3501/6	45-66	-			
3501/7	45-66	-			

BTicino SpA
Via Messina, 38
20154 Milano - Italy
www.bticino.com

BTicino SpA reserves at any time the right to modify the contents of this booklet and to communicate, in any form and modality, the changes brought to the same.

AD-EXGM11C/UK- Version 03/2011