



# Official Cert Guide

Learn, prepare, and practice for exam success



170 Practice  
Exam Questions  
in Two Highly  
Realistic  
Sample Exams

# CCNA

## Wireless 640-722

[ciscopress.com](http://ciscopress.com)

DAVID HUCABY, CCIE® No. 4594

# CCNA Wireless 640-722 Official Cert Guide

---

David Hucaby

**Cisco Press**

800 East 96th Street

Indianapolis, IN 46240

# CCNA Wireless 640-722 Official Cert Guide

David Hucaby

Copyright© 2014 Cisco Systems, Inc.

Published by:

Cisco Press

800 East 96th Street

Indianapolis, IN 46240 USA

All rights reserved. No part of this book may be reproduced or transmitted in any form or by any means, electronic or mechanical, including photocopying, recording, or by any information storage and retrieval system, without written permission from the publisher, except for the inclusion of brief quotations in a review.

Printed in the United States of America

First Printing February 2014

Library of Congress Control Number: 2014931706

ISBN-13: 978-1-58720-562-0

ISBN-10: 1-58720-562-9

## Warning and Disclaimer

This book is designed to provide information about preparing for the CCNA Wireless 640-722 exam. Every effort has been made to make this book as complete and as accurate as possible, but no warranty or fitness is implied.

The information is provided on an “as is” basis. The author, Cisco Press, and Cisco Systems, Inc., shall have neither liability nor responsibility to any person or entity with respect to any loss or damages arising from the information contained in this book or from the use of the discs or programs that may accompany it.

The opinions expressed in this book belong to the author and are not necessarily those of Cisco Systems, Inc.

## Trademark Acknowledgments

All terms mentioned in this book that are known to be trademarks or service marks have been appropriately capitalized. Cisco Press or Cisco Systems, Inc. cannot attest to the accuracy of this information. Use of a term in this book should not be regarded as affecting the validity of any trademark or service mark.

## Special Sales

For information about buying this title in bulk quantities, or for special sales opportunities (which may include electronic versions; custom cover designs; and content particular to your business, training goals, marketing focus, or branding interests), please contact our corporate sales department at [corpsales@pearsoned.com](mailto:corpsales@pearsoned.com) or (800) 382-3419.

For government sales inquiries, please contact [governmentsales@pearsoned.com](mailto:governmentsales@pearsoned.com).

For questions about sales outside the U.S., please contact [international@pearsoned.com](mailto:international@pearsoned.com).

## Feedback Information

At Cisco Press, our goal is to create in-depth technical books of the highest quality and value. Each book is crafted with care and precision, undergoing rigorous development that involves the unique expertise of members from the professional technical community.

Readers' feedback is a natural continuation of this process. If you have any comments regarding how we could improve the quality of this book, or otherwise alter it to better suit your needs, you can contact us through e-mail at [feedback@ciscopress.com](mailto:feedback@ciscopress.com). Please make sure to include the book title and ISBN in your message.

We greatly appreciate your assistance.

**Publisher:** Paul Boger

**Associate Publisher:** Dave Dusthimer

**Executive Editor:** Mary Beth Ray

**Managing Editor:** Sandra Schroeder

**Project Editor:** Seth Kerney

**Editorial Assistant:** Vanessa Evans

**Cover Designer:** Mark Shirar

**Composition:** Jake McFarland

**Business Operation Manager, Cisco Press:** Jan Cornelssen

**Manager Global Certification:** Sean Donovan

**Senior Development Editor:** Christopher Cleveland

**Copy Editor:** Keith Cline

**Technical Editor:** Jerome Henry

**Proofreader:** Jess DeGabriele

**Indexer:** Tim Wright



## About the Author

**David Hucaby**, CCIE No. 4594, is a network architect for the University of Kentucky, where he works with academic and healthcare networks based on the Cisco Unified Wireless Network products. David has bachelor's and master's degrees in electrical engineering from the University of Kentucky. He is the author of several Cisco Press titles, including *CCNP SWITCH Exam Certification Guide*; *Cisco LAN Switching Video Mentor*; *CCNP Security FIREWALL Exam Certification Guide*; *Cisco ASA, PIX, and FWSM Firewall Handbook*, Second Edition; and *Cisco Firewall Video Mentor*.

David lives in Kentucky with his wife, Marci, and two daughters.

## About the Technical Reviewer

**Jerome Henry, CCIE Wireless No. 24750**, is technical marketing engineer in the Wireless Enterprise Networking Group at Cisco systems. Jerome has close to 15 years experience teaching technical Cisco courses in more than 15 different countries and 4 different languages, to audiences ranging from bachelor degree students to networking professionals and Cisco internal system engineers.

Focusing on his wireless experience, Jerome joined Cisco in 2012. Before that time, he was consulting and teaching Heterogeneous Networks and Wireless Integration with the European Airespace team, which was later acquired by Cisco to become their main wireless solution. He then spent several years with a Cisco Learning partner, developing wireless courses, and working on training material for new wireless technologies. In addition to his CCIE Wireless certification, Jerome is a certified wireless networking expert (CWNE #45) and has developed several Cisco courses focusing on wireless topics (IUWNE, IUWMS, IUWVN, CUWSS, IAUWS, LBS, CWMN lab guide, and so on) and authored several Wireless books (IUWMS, CUWSS Quick Reference, and so on). Jerome is also an IEEE 802.11 group member and participant of Wi-Fi Alliance working groups. With more than 10000 hours in the classroom, Jerome was awarded the IT Training Award best Instructor silver medal in 2009. He is based in the Research Triangle Park in North Carolina.

## Dedications

As always, this book is dedicated to the most important people in my life: my wife, Marci, and my two daughters, Lauren and Kara. Their love, encouragement, and support carry me along. I'm so grateful to God, who gives endurance and encouragement (Romans 15:5), and who has allowed me to enjoy networking and work on projects like this.

I would also like to dedicate this book to the memory of my father-in-law, Ermel Wilson. He helped me appreciate the simpler things in life—the outdoors, hikes in the woods, and snow.

## Acknowledgments

It has been my great pleasure to work on another Cisco Press project. I enjoy the networking field very much, and technical writing even more. And more than that, I'm thankful for the joy and inner peace that Jesus Christ gives, making everything more abundant and worthwhile. As much as I enjoy learning about wireless networking (there's no end to it!), I realize that God created the original wireless connection that has no distance limits, unlimited capacity for clients (there's always room for one more), is trustworthy, always available everywhere, and connects directly to the Source: prayer!

I've now been writing Cisco Press titles continuously for what will soon be 15 years. I have physically worn out several laptop keyboards and probably several Cisco Press editors in the process. It has been a great pleasure to work with Chris Cleveland and Mary Beth Ray. I should have a certification in schedule slipping by now. Keith Cline and Seth Kerney have been great to work with and have made the whole review process smooth and efficient. One important part of the book I never get to see is the index. I'm grateful that Tim Wright worked on this one.

I am very grateful for the insight, knowledge, and helpful comments that Jerome Henry has provided. He is a great resource for wireless networking expertise and training. Jerome's input has made this a more well-rounded book and me a more educated author.

Finally, I have enjoyed the good discussions with my dad, Reid Hucaby, a fellow EE and a seasoned RF engineer, that this book has prompted about all things wireless.

## Contents at a Glance

	Introduction	xix
Chapter 1	RF Signals and Modulation	3
Chapter 2	RF Standards	37
Chapter 3	RF Signals in the Real World	67
Chapter 4	Understanding Antennas	85
Chapter 5	Wireless LAN Topologies	105
Chapter 6	Understanding 802.11 Frame Types	123
Chapter 7	Planning Coverage with Wireless APs	147
Chapter 8	Using Autonomous APs	163
Chapter 9	Understanding the CUWN Architecture	181
Chapter 10	Initial Controller Configuration	201
Chapter 11	Understanding Controller Discovery	221
Chapter 12	Understanding Roaming	239
Chapter 13	Understanding RRM	259
Chapter 14	Wireless Security Fundamentals	281
Chapter 15	Configuring a WLAN	307
Chapter 16	Implementing a Wireless Guest Network	323
Chapter 17	Understanding Wireless Clients	335
Chapter 18	Managing Wireless Networks with WCS	359
Chapter 19	Dealing with Wireless Interference	383
Chapter 20	Troubleshooting WLAN Connectivity	401
Chapter 21	Maintaining Controllers	427
Chapter 22	Final Review	447
Appendix A	Answers to “Do I Know This Already?” Quizzes	457
Appendix B	Modulation and Coding Schemes	473
	Key Terms Glossary	481
	Index	494

# Contents

## Introduction xix

### Chapter 1 RF Signals and Modulation 3

- “Do I Know This Already?” Quiz 3
- Foundation Topics 7
- Comparing Wired and Wireless Networks 7
- Understanding Basic Wireless Theory 8
  - Understanding Frequency 10
  - Understanding Phase 14
  - Measuring Wavelength 14
  - Understanding RF Power and dB 15
  - Important dB Facts to Remember* 17
  - Comparing Power Against a Reference: dBm* 19
  - Measuring Power Changes Along the Signal Path* 20
  - Understanding Power Levels at the Receiver* 23
- Carrying Data Over an RF Signal 24
  - FHSS 26
  - DSSS 27
  - 1-Mbps Data Rate* 28
  - 2-Mbps Data Rate* 29
  - 5.5-Mbps Data Rate* 30
  - 11-Mbps Data Rate* 30
  - OFDM 31
  - Modulation Summary 32
- Exam Preparation Tasks 34
  - Review All Key Topics 34
  - Key Terms 34

### Chapter 2 RF Standards 37

- “Do I Know This Already?” Quiz 37
- Foundation Topics 41
- Regulatory Bodies 41
  - ITU-R 41
  - FCC 42
  - ETSI 44
  - Other Regulatory Bodies 45
- IEEE Standards Body 45
- 802.11 Channel Use 47
  - Channels in the 2.4-GHz ISM Band 47
  - Channels in the 5-GHz U-NII Bands 49

	IEEE 802.11 Standards	51
	802.11-1997	52
	802.11b	52
	802.11g	52
	802.11a	54
	802.11n	55
	<i>Channel Aggregation</i>	57
	<i>Spatial Multiplexing</i>	58
	<i>MAC Layer Efficiency</i>	59
	<i>Transmit Beam Forming (TxBF)</i>	60
	<i>Maximal-Ratio Combining</i>	61
	<i>802.11n Modulation and Coding Schemes</i>	61
	Beyond 802.11n	62
	Wi-Fi Alliance	63
	Exam Preparation Tasks	64
	Review All Key Topics	64
	Define Key Terms	64
<b>Chapter 3</b>	<b>RF Signals in the Real World</b>	<b>67</b>
	“Do I Know This Already?” Quiz	67
	Foundation Topics	70
	Interference	70
	Co-Channel Interference	70
	Neighboring Channel Interference	71
	Non-802.11 Interference	72
	Free Space Path Loss	72
	Mitigating the Effects of Free Space Path Loss	74
	Effects of Physical Objects	76
	Reflection	76
	Absorption	78
	Scattering	78
	Refraction	79
	Diffraction	80
	Fresnel Zones	80
	Exam Preparation Tasks	83
	Review All Key Topics	83
	Define Key Terms	83
<b>Chapter 4</b>	<b>Understanding Antennas</b>	<b>85</b>
	“Do I Know This Already?” Quiz	85
	Foundation Topics	88

Antenna Characteristics	88
Radiation Patterns	88
Gain	91
Beamwidth	92
Polarization	92
Antenna Types	93
Omnidirectional Antennas	94
Directional Antennas	97
Antenna Summary	101
Adding Antenna Accessories	101
Exam Preparation Tasks	103
Review All Key Topics	103
Define Key Terms	103
<b>Chapter 5 Wireless LAN Topologies</b>	<b>105</b>
“Do I Know This Already?” Quiz	105
Foundation Topics	108
Types of Wireless Networks	108
Wireless LAN Topologies	109
Basic Service Set	110
Distribution System	112
Extended Service Set	114
Independent Basic Service Set	115
Other Wireless Topologies	116
Repeater	116
Workgroup Bridge	117
Outdoor Bridge	118
Mesh Network	119
Exam Preparation Tasks	120
Review All Key Topics	120
Define Key Terms	120
<b>Chapter 6 Understanding 802.11 Frame Types</b>	<b>123</b>
“Do I Know This Already?” Quiz	123
802.11 Frame Format	126
802.11 Frame Addressing	128
Accessing the Wireless Medium	130
Carrier Sense	131
Collision Avoidance	132
802.11 Frame Types	134
Management Frames	134



	Control Frames	135
	Data Frames	136
	Client Housekeeping	136
	A Client Scans for APs	137
	A Client Joins a BSS	138
	A Client Leaves a BSS	139
	A Client Moves Between BSSs	140
	A Client Saves Power	142
	Exam Preparation Tasks	145
	Review All Key Topics	145
	Define Key Terms	145
<b>Chapter 7</b>	<b>Planning Coverage with Wireless APs</b>	<b>147</b>
	“Do I Know This Already?” Quiz	147
	AP Cell Size	150
	Tuning Cell Size with Transmit Power	150
	Tuning Cell Size with Data Rates	152
	Adding APs to an ESS	153
	The Roaming Process	155
	WLAN Channel Layout	157
	Exam Preparation Tasks	161
	Review All Key Topics	161
	Define Key Terms	161
<b>Chapter 8</b>	<b>Using Autonomous APs</b>	<b>163</b>
	“Do I Know This Already?” Quiz	163
	Foundation Topics	166
	Autonomous Architecture	166
	Configuring an Autonomous AP	167
	Connecting the AP	167
	Configuring the AP	170
	Converting an Autonomous AP	174
	Using the Autonomous to Lightweight Mode Upgrade Tool	174
	Converting an Autonomous AP Manually	176
	Exam Preparation Tasks	178
	Review All Key Topics	178
	Define Key Terms	178
<b>Chapter 9</b>	<b>Understanding the CUWN Architecture</b>	<b>181</b>
	“Do I Know This Already?” Quiz	181
	Foundation Topics	184
	A Distributed Architecture	184

	A Centralized Architecture	186
	Split-MAC Architecture	188
	Traffic Patterns in a CUWN	190
	CUWN Building Blocks	192
	Cisco Wireless LAN Controllers	192
	Cisco Lightweight APs	194
	CUWN Management	197
	Exam Preparation Tasks	198
	Review All Key Topics	198
<b>Chapter 10</b>	<b>Initial Controller Configuration</b>	<b>201</b>
	“Do I Know This Already?” Quiz	201
	Foundation Topics	204
	Connecting the Controller	204
	Using Controller Ports	204
	Using Controller Interfaces	206
	Running the Initial Setup Wizard	208
	Initial Setup with the Web Interface	208
	Initial Setup with the CLI	216
	Exam Preparation Tasks	218
	Review All Key Topics	218
	Define Key Terms	218
<b>Chapter 11</b>	<b>Understanding Controller Discovery</b>	<b>221</b>
	“Do I Know This Already?” Quiz	221
	Foundation Topics	224
	Discovering a Controller	224
	AP States	224
	Discovering a WLC	226
	Selecting a WLC	227
	Designing High Availability	228
	Detecting a Controller Failure	230
	Building Redundancy	231
	<i>N+1 Redundancy</i>	231
	<i>N+N Redundancy</i>	232
	<i>N+N+1 Redundancy</i>	232
	<i>AP SSO Redundancy</i>	233
	Exam Preparation Tasks	235
	Review All Key Topics	235
	Define Key Terms	236

**Chapter 12 Understanding Roaming 239**

- “Do I Know This Already?” Quiz 239
- Foundation Topics 242
- Roaming with Autonomous APs 242
- Intracontroller Roaming 244
- Intercontroller Roaming 246
  - Layer 2 Roaming 247
  - Layer 3 Roaming 248
  - Using Mobility Groups 252
- Exam Preparation Tasks 256
  - Review All Key Topics 256
  - Define Key Terms 256

**Chapter 13 Understanding RRM 259**

- “Do I Know This Already?” Quiz 259
- Foundation Topics 262
- Configuring 802.11 Support 262
  - Configuring Data Rates 263
  - Configuring 802.11n Support 264
- Understanding RRM 265
  - RF Groups 267
  - TPC 269
  - DCA 272
  - Coverage Hole Detection 274
  - Manual RF Configuration 276
  - Verifying RRM Results 278
- Exam Preparation Tasks 279
  - Review All Key Topics 279
  - Define Key Terms 279

**Chapter 14 Wireless Security Fundamentals 281**

- “Do I Know This Already?” Quiz 282
- Foundation Topics 285
- Anatomy of a Secure Connection 285
  - Authentication 286
  - Message Privacy 287
  - Message Integrity 288
  - Intrusion Protection 289
- Wireless Client Authentication Methods 290
  - Open Authentication 290
  - WEP 291

	802.1x/EAP	292
	<i>LEAP</i>	294
	<i>EAP-FAST</i>	294
	<i>PEAP</i>	294
	<i>EAP-TLS</i>	295
	Wireless Privacy and Integrity Methods	295
	TKIP	295
	CCMP	296
	WPA and WPA2	297
	Securing Management Frames with MFP	298
	Configuring Wireless Security	298
	Configuring WPA or WPA2 Personal	299
	Configuring WPA2 Enterprise Mode	300
	Configuring WPA2 Enterprise with Local EAP	302
	Exam Preparation Tasks	305
	Review All Key Topics	305
	Define Key Terms	305
<b>Chapter 15</b>	<b>Configuring a WLAN</b>	<b>307</b>
	“Do I Know This Already?” Quiz	307
	Foundation Topics	309
	WLAN Overview	309
	Configuring a WLAN	310
	Configuring a RADIUS Server	310
	Creating a Dynamic Interface	312
	Creating a New WLAN	313
	Configuring WLAN Security	315
	Configuring WLAN QoS	317
	Configuring Advanced WLAN Settings	318
	Finalizing WLAN Configuration	319
	Exam Preparation Tasks	320
	Review All Key Topics	320
<b>Chapter 16</b>	<b>Implementing a Wireless Guest Network</b>	<b>323</b>
	“Do I Know This Already?” Quiz	323
	Foundation Topics	325
	Guest Network Overview	325
	Configuring a Guest Network	326
	Scaling the Guest Network	329
	Exam Preparation Tasks	332
	Review All Key Topics	332
	Define Key Terms	332

**Chapter 17 Understanding Wireless Clients 335**

- “Do I Know This Already?” Quiz 335
- Foundation Topics 338
- Configuring Common Wireless Clients 338
  - Windows 7 and 8 338
  - Intel PROSet 341
  - Android 345
  - Apple OS X 346
  - Cisco AnyConnect 348
- Cisco Compatible Extensions 352
- Exam Preparation Tasks 356
  - Review All Key Topics 356
  - Define Key Terms 356

**Chapter 18 Managing Wireless Networks with WCS 359**

- “Do I Know This Already?” Quiz 359
- Foundation Topics 362
- WCS Overview 362
  - Alarm Summary Dashboard 364
  - Main Navigation Area 366
  - WCS Home Area 366
- Using WCS to Configure Devices 368
- Using WCS Maps 370
  - Displaying Maps 370
  - Manipulating APs on Maps 373
  - Viewing Information on Maps 375
- Generating Reports 377
- Exam Preparation Tasks 381
  - Review All Key Topics 381

**Chapter 19 Dealing with Wireless Interference 383**

- “Do I Know This Already?” Quiz 383
- Understanding Types of Interference 386
- Bluetooth 386
  - ZigBee 387
  - Cordless Phones 388
  - Microwave Ovens 388
  - WiMAX 388
  - Other Devices 389

Using Cisco CleanAir to Manage Interference	390
Enabling CleanAir	392
Air-Quality Index	394
Using Event-Driven RRM	396
Exam Preparation Tasks	397
Review All Key Topics	397
Define Key Terms	398
<b>Chapter 20 Troubleshooting WLAN Connectivity</b>	<b>401</b>
“Do I Know This Already?” Quiz	401
Foundation Topics	405
Troubleshooting Client Connectivity	405
Troubleshooting Clients from the Controller	406
Performing a Link Test	411
Debugging a Client	412
Troubleshooting Clients from WCS/NCS	415
Troubleshooting AP Connectivity	420
Verifying AP-to-WLC Connectivity	420
Verifying AP-to-Network Connectivity	422
Exam Preparation Tasks	425
Review All Key Topics	425
<b>Chapter 21 Maintaining Controllers</b>	<b>427</b>
“Do I Know This Already?” Quiz	427
Accessing WLC and AP Management Interfaces	430
Accessing APs	432
Maintaining WLC Code Images	434
Maintaining WLC Configurations	437
Working with WLC Logs	439
Exam Preparation Tasks	444
Review All Key Topics	444
<b>Chapter 22 Final Review</b>	<b>447</b>
Advice About the Exam Event	447
Learn the Question Types Using the Cisco Certification Exam Tutorial	447
Think About Your Time Budget	452
Other Pre-Exam Suggestions	453
Final Thoughts	455

**Appendix A Answers to “Do I Know This Already?” Quizzes 457**

Chapter 1 457

Chapter 2 458

Chapter 3 459

Chapter 4 459

Chapter 5 460

Chapter 6 461

Chapter 7 461

Chapter 8 462

Chapter 9 463

Chapter 10 464

Chapter 11 464

Chapter 12 465

Chapter 13 466

Chapter 14 467

Chapter 15 467

Chapter 16 468

Chapter 17 468

Chapter 18 469

Chapter 19 469

Chapter 20 470

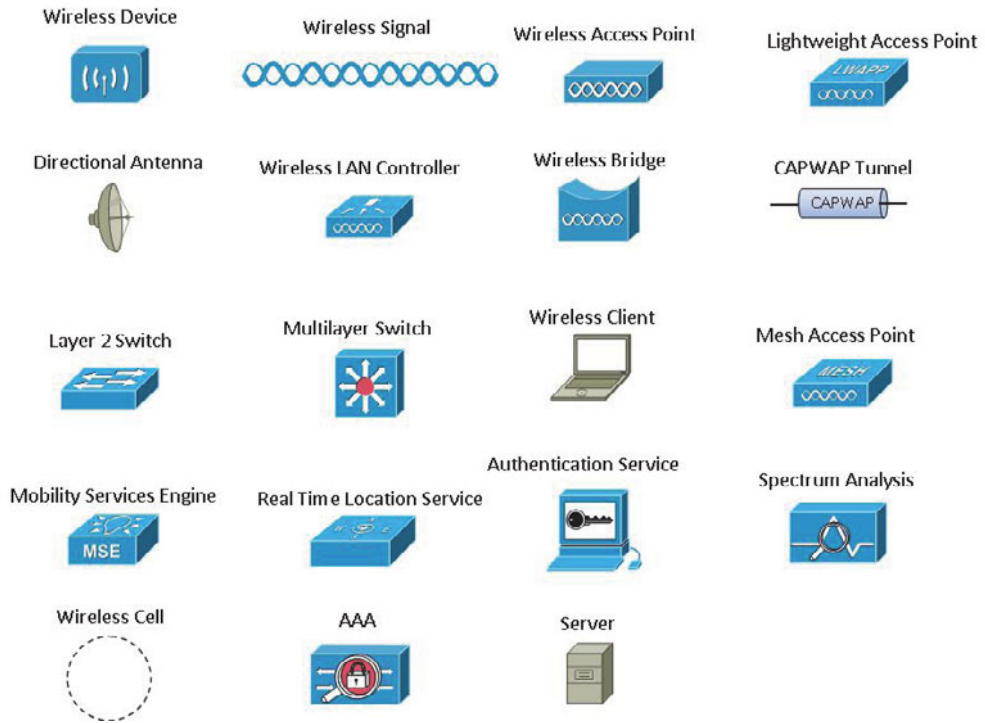
Chapter 21 471

**Appendix B Modulation and Coding Schemes 473**

**Key Terms Glossary 481**

**Index 494**

## Icons Used in This Book



## Command Syntax Conventions

The conventions used to present command syntax in this book are the same conventions used in the IOS Command Reference. The Command Reference describes these conventions as follows:

- **Boldface** indicates commands and keywords that are entered literally as shown. In actual configuration examples and output (not general command syntax), boldface indicates commands that are manually input by the user (such as a **show** command).
- *Italic* indicates arguments for which you supply actual values.
- Vertical bars (|) separate alternative, mutually exclusive elements.
- Square brackets ([ ]) indicate an optional element.
- Braces ({ }) indicate a required choice.
- Braces within brackets ({ [ ]}) indicate a required choice within an optional element.



## Introduction

Welcome to the world of Cisco Certified Network Associate (CCNA) Wireless! As technology continues to evolve, wireless technologies are finding their way to the forefront. This clearly indicates the progression from a fixed wired type of connectivity to a more fluid, mobile workforce that can work when, where, and how they want. Regardless of your background, one of the primary goals of the CCNA Wireless certification is to introduce you to the Cisco Unified Wireless Network (CUWN).

This book is designed to help you prepare for the Cisco CCNA Wireless 640-722 IUWNE (Implementing Cisco Unified Wireless Networking Essentials) certification exam. To achieve the CCNA Wireless specialization, you must first pass the ICND1, ICND2, or the CCNA Composite exam.

## Who Should Read This Book

Wireless networking is a complex business. The CCNA Wireless specialization was developed to introduce wireless LANs, the CUWN, and Cisco's wireless product line. The certification tests for proficiency in designing, installing, configuring, monitoring, and troubleshooting wireless networks in an enterprise setting.

## How to Use This Book

The book consists of 22 chapters. Each chapter tends to build upon the chapter that precedes it. The chapters of the book cover the following topics:

- **Chapter 1, “RF Signals and Modulation”:** This chapter covers the basic theory behind radio frequency (RF) signals and the methods used to carry data wirelessly.
- **Chapter 2, “RF Standards”:** This chapter covers the agencies that regulate, standardize, and validate the correct use of wireless LAN devices.
- **Chapter 3, “RF Signals in the Real World”:** This chapter explores many of the conditions that can affect wireless signal propagation.
- **Chapter 4, “Understanding Antennas”:** This chapter explains some basic antenna theory, in addition to various types of antennas and their application.
- **Chapter 5, “Wireless LAN Topologies”:** This chapter explains the topologies that can be used to control access to the wireless medium and provide data exchange between devices.
- **Chapter 6, “Understanding 802.11 Frame Types”:** This chapter covers the frame format and frame types that APs and clients must use to communicate successfully. It also discusses the choreography that occurs between an AP and its clients.
- **Chapter 7, “Planning Coverage with Wireless APs”:** This chapter explains how wireless coverage can be adjusted to meet a need and how it can be grown to scale over a greater area and a greater number of clients.
- **Chapter 8, “Using Autonomous APs”:** This chapter discusses basic operation of an autonomous AP and how you can connect to it and convert it to lightweight mode, to become a part of a larger, more integrated wireless network.
- **Chapter 9, “Understanding the CUWN Architecture”:** This chapter describes the centralized or unified wireless architecture and how you can leverage its strengths to solve some fundamental problems.
- **Chapter 10, “Initial Controller Configuration”:** This chapter covers the wireless controller's role in linking wired and wireless networks. It also covers the minimal initial configuration needed to get a controller up on the network where you can manage it more fully.
- **Chapter 11, “Understanding Controller Discovery”:** This chapter explains the process that each lightweight AP must go through to discover and bind itself with a controller before wireless clients can be supported.

- **Chapter 12, “Understanding Roaming”:** This chapter discusses client mobility from the AP and controller perspectives so that you can design and configure your wireless network properly as it grows over time.
- **Chapter 13, “Understanding RRM”:** This chapter covers Radio Resource Management (RRM), a flexible and automatic mechanism that Cisco wireless LAN controllers can use to make wireless network operation more efficient.
- **Chapter 14, “Wireless Security Fundamentals”:** This chapter covers many of the methods you can use to secure a wireless network.
- **Chapter 15, “Configuring a WLAN”:** This chapter explains how to define and tune a wireless LAN to support wireless clients and connectivity with a wired infrastructure.
- **Chapter 16, “Implementing a Wireless Guest Network”:** This chapter discusses the steps you can take to configure a guest network as an extension to your wireless infrastructure.
- **Chapter 17, “Understanding Wireless Clients”:** This chapter introduces some of the most common types of wireless clients and how to configure them to join a wireless LAN.
- **Chapter 18, “Managing Wireless Networks with WCS”:** This chapter provides a brief overview of WCS, how you can configure controllers and APs with it, and how you can use it to monitor a variety of things in your network.
- **Chapter 19, “Dealing with Wireless Interference”:** This chapter covers some common types of devices that can cause interference and the Cisco CleanAir features that can detect and react to the interference sources.
- **Chapter 20, “Troubleshooting WLANs”:** This chapter helps you get some perspective about wireless problems, develop a troubleshooting strategy, and become comfortable using the tools at your disposal.
- **Chapter 21, “Maintaining Controllers”:** This chapter explains how you can interface with controllers and APs so that you can upload and download files needed for their operation.
- **Chapter 22, “Final Review”:** This short chapter lists the exam preparation tools useful at this point in the study process. It also provides a suggested study plan now that you have completed all of the earlier chapters in this book.
- **Appendix A, “Answers to the ‘Do I Know This Already?’ Quizzes”:** This appendix provides the correct answers to the “Do I Know This Already?” quizzes that you will find at the beginning of each chapter. Brief explanations for the correct answers will also help you complete your understanding of topics covered.
- **Appendix B, “Modulation and Coding Schemes”:** This appendix outlines the direct sequence spread spectrum (DSSS) and orthogonal frequency-division multiplexing (OFDM) data rates used for 802.11b/g and 802.11a; the modulation and coding schemes and data rates used for 802.11n; and the modulation, coding schemes, and data rates used for 802.11ac.

- **Key Terms Glossary:** The glossary defines all WLAN-related terms that you were asked to define at the end of each chapter.

Each chapter follows the same format and incorporates the following tools to assist you by assessing your current knowledge and emphasizing specific areas of interest within the chapter:

- **Do I Already Know This Quiz?:** Each chapter begins with a quiz to help you assess your current knowledge of the subject. The quiz is divided into specific areas of emphasis that enable you to best determine where to focus your efforts when working through the chapter.
- **Foundation Topics:** The foundation topics are the core sections of each chapter. They focus on the specific protocols, concepts, or skills that you must master to successfully prepare for the examination.
- **Exam Preparation:** Near the end of each chapter, this section highlights the key topics from the chapter and the pages where you can find them for quick review. This section also provides a list of key terms that you should be able to define in preparation for the exam. It is unlikely that you will be able to successfully complete the certification exam by just studying the key topics and key terms, although they are a good tool for last-minute preparation just before taking the exam.
- **CD-ROM-based practice exam:** This book includes a CD-ROM containing several interactive practice exams. It is recommended that you continue to test your knowledge and test-taking skills by using these exams. You will find that your test-taking skills will improve by continued exposure to the test format. Remember that the potential range of exam questions is limitless. Therefore, your goal should not be to “know” every possible answer but to have a sufficient understanding of the subject matter so that you can figure out the correct answer with the information provided.

## **Pearson IT Certification Practice Test Engine and Questions on the CD-ROM**

The CD-ROM in the back of the book includes the Pearson IT Certification Practice Test engine—software that displays and grades a set of exam-realistic multiple-choice questions. Using the Pearson IT Certification Practice Test engine, you can either study by going through the questions in Study Mode, or take a simulated exam that mimics real exam conditions. You can also serve up questions in a Flash Card Mode, which will display just the question and no answers, challenging you to state the answer in your own words before checking the actual answers to verify your work.

The installation process requires two major steps: installing the software and then activating the exam. The CD in the back of this book has a recent copy of the Pearson IT Certification Practice Test engine. The practice exam (the database of exam questions) is not on the CD.

**Note** The cardboard CD case in the back of this book includes the CD and a piece of paper. The paper lists the activation code for the practice exam associated with this book. Do not lose the activation code. On the opposite side of the paper from the activation code is a unique, one-time-use coupon code for the purchase of the Premium Edition eBook and Practice Test.

## Install the Software from the CD

The Pearson IT Certification Practice Test is a Windows-only desktop application. You can run it on a Mac using a Windows virtual machine, but it was built specifically for the PC platform. The minimum system requirements are as follows:

- Windows XP (SP3), Windows Vista (SP2), Windows 7, or Windows 8
- Microsoft .NET Framework 4.0 Client
- Pentium-class 1GHz processor (or equivalent)
- 512MB RAM
- 650MB disk space plus 50MB for each downloaded practice exam
- Access to the Internet to register and download exam databases

The software installation process is routine as compared with other software installation processes. If you have already installed the Pearson IT Certification Practice Test software from another Pearson product, there is no need for you to reinstall the software. Simply launch the software on your desktop and proceed to activate the practice exam from this book by using the activation code included in the CD sleeve.

The following steps outline the installation process:

1. Insert the CD into your PC.
2. The media interface that automatically runs allows you to access and use all CD-based features, including the exam engine and sample content from other Cisco self-study products. From the main menu, click the **Install the Exam Engine** option.
3. Respond to windows prompts as with any typical software installation process.

The installation process will give you the option to activate your exam with the activation code supplied on the paper in the CD sleeve. This process requires that you establish a Pearson website login. You need this login to activate the exam, so please do register when prompted. If you already have a Pearson website login, there is no need to register again. Just use your existing login.

## Activate and Download the Practice Exam

Once the exam engine is installed, you should then activate the exam associated with this book (if you did not do so during the installation process) as follows:

1. Start the Pearson IT Certification Practice Test software from the Windows Start menu or from your desktop shortcut icon.
2. To activate and download the exam associated with this book, from the My Products or Tools tab, click the **Activate Exam** button.
3. At the next screen, enter the activation key from paper inside the cardboard CD holder in the back of the book. Once entered, click the **Activate** button.
4. The activation process will download the practice exam. Click **Next**, and then click **Finish**.

When the activation process completes, the My Products tab should list your new exam. If you do not see the exam, make sure that you have selected the **My Products** tab on the menu. At this point, the software and practice exam are ready to use. Simply select the exam and click the **Open Exam** button.

To update a particular exam you have already activated and downloaded, display the **Tools** tab and click the **Update Products** button. Updating your exams will ensure that you have the latest changes and updates to the exam data.

If you want to check for updates to the Pearson Cert Practice Test exam engine software, display the **Tools** tab and click the **Update Application** button. You can then ensure that you are running the latest version of the software engine.

## Activating Other Exams

The exam software installation process, and the registration process, only has to happen once. Then, for each new exam, only a few steps are required. For instance, if you buy another Pearson IT Certification Cert Guide, extract the activation code from the CD sleeve in the back of that book; you do not even need the CD at this point. From there, all you have to do is start the exam engine (if not still up and running) and perform Steps 2 through 4 from the previous list.

## Certification Exam Topics and This Book

The questions for each certification exam are a closely guarded secret. However, we do know which topics you must know to successfully complete this exam. Cisco publishes them as an exam blueprint for Implementing Cisco Unified Wireless Networking Essentials (IUWNE), exam 640-722. Table I-1 lists each exam topic listed in the blueprint along with a reference to the book chapter that covers the topic. These are the same topics you should be proficient in when working with Cisco wireless LANs in the real world.

**Table I-1** *IUWNE Exam 640-722 Topics and Chapter References*

<b>Exam Topic</b>	<b>Chapter Where Topic is Covered</b>
<b>Describe WLAN Fundamentals</b>	
Describe basics of spread spectrum technology	Chapter 1
Describe the impact of various wireless technologies (Bluetooth, WiMAX, ZigBee, and cordless phone)	Chapter 19
Describe wireless regulatory bodies, standards and certifications (FCC, ETSI, 802.11a/b/g/n, and WiFi Alliance)	Chapter 2
Describe Wireless LAN (WLAN) RF principles (antenna types, RF gain/loss, Effective Isotropic Radiated Power (EIRP), refraction, reflection, and so on)	Chapters 3-4
Describe networking technologies used in wireless (SSID to WLAN_ID to Interface to VLAN, 802.1q trunking)	Chapter 5
Describe wireless topologies, such as Independent Basic Service Set (IBSS), Basic Service Set (BSS), Extended Service Set (ESS), Point-to-Point, Point-to-Multipoint, Mesh, and bridging)	Chapter 5
Describe 802.11 authentication and encryption methods (Open, Shared, 802.1X, EAP, TKIP, and AES)	Chapter 14
Describe frame types (associated and unassociated, management, control, and data)	Chapter 6
Describe basic RF deployment considerations related to site survey design of data or VoWLAN applications, common RF interference sources such as devices, building material, AP location, and basic RF site survey design related to channel reuse, signal strength, and cell overlap	Chapter 7
<b>Install a Basic Cisco Wireless LAN</b>	
Identify the components of the Cisco Unified Wireless Network architecture (Split MAC, LWAPP, stand-alone AP vs controller-based AP, specific hardware examples)	Chapter 9
Install and configure autonomous access points in the small business environment	Chapter 8
Describe the modes of controller-based AP deployment (local, monitor, HREAP, sniffer, rogue detector, bridge, OEAP, and SE-Connect)	Chapter 9
Describe controller-based AP discovery and association (DHCP, DNS, Master-Controller, Primary-Secondary-Tertiary, and n+1 redundancy)	Chapter 11
Describe roaming (Layer 2 and Layer 3, intra-controller and inter-controller, and mobility list)	Chapter 12

<b>Exam Topic</b>	<b>Chapter Where Topic is Covered</b>
Configure a WLAN controller and access points WLC: ports, interfaces, WLANs, NTP, CLI and Web UI, CLI wizard, and link aggregation group (LAG) AP: Channel and Power	Chapter 10, 15
Describe Radio Resource Management (RRM) fundamentals including ED-RRM.	Chapter 13
Verify basic wireless network operation	Chapter 20
<b>Install Wireless Clients</b>	
Describe client WLAN configuration requirements, such as Service Set Identifier (SSID), security selection, and authentication	Chapter 17
Identify basic configuration of common wireless supplicants (Macintosh, Intel Wireless Pro, Windows, iOS, and Android)	Chapter 17
Describe basic AnyConnect 3.0 or above wireless configuration parameters	Chapter 17
Identify capabilities available in CCX versions 1 through 5	Chapter 17
<b>Implement Basic WLAN Security</b>	
Describe the general framework of wireless security and security components (authentication, encryption, MFP, IPS)	Chapter 14
Describe and configure authentication methods (Guest, PSK, 802.1X, WPA/WPA2 with EAP- TLS, EAP-FAST, PEAP, LEAP)	Chapters 14, 16
Describe and configure encryption methods (WPA/WPA2 with TKIP, AES)	Chapter 14
Describe and configure the different sources of authentication (PSK, EAP-local or -external, Radius)	Chapter 14
<b>Operate Basic WCS</b>	
Identify key functions of Cisco Wireless Control System (WCS) and Navigator (versions and licensing)	Chapter 18
Navigate WCS interface	Chapter 18
Configure controllers and access points (APs) (using the Configuration tab not templates)	Chapter 18
Use preconfigured maps in the WCS (adding/relocating/removing access points, turn on/off heat maps, view client location, and view CleanAir zones of influence)	Chapter 18
Use the WCS monitor tab and alarm summary to verify the WLAN operations	Chapter 18
Generate standard WCS reports (inventory, CleanAir, client-related, AP-related, and utilization)	Chapter 18



<b>Exam Topic</b>	<b>Chapter Where Topic is Covered</b>
<b>Conduct Basic WLAN Maintenance and Troubleshooting</b>	
Identify and use basic WLAN troubleshooting tools (WLC show debug and logging) for client to AP connectivity, AP to controller connectivity	Chapter 20
Use the WCS client troubleshooting tool	Chapter 20
Transfer logs, configuration files, and O/S images to and from the WLC via the GUI	Chapter 21
Differentiate and use WLC and AP (autonomous and LAP) management access methods (console port, CLI, telnet, ssh, http, https, and wired vs wireless management)	Chapter 21

Notice that not all the chapters map to a specific exam topic. Each version of the exam can have topics that emphasize different functions or features, and some topics can be rather broad and generalized. The goal of this book is to provide the most comprehensive coverage to ensure that you are well prepared for the exam. Although some chapters might not address specific exam topics, they provide a foundation that is necessary for a clear understanding of important topics. Your short-term goal might be to pass this exam, but your long-term goal should be to become a qualified wireless networking professional.

It is also important to understand that this book is a “static” reference, whereas the exam topics are dynamic. Cisco can and does change the topics covered on certification exams often.

This exam guide should not be your only reference when preparing for the certification exam. You can find a wealth of information available at Cisco.com that covers each topic in great detail. If you think that you need more detailed information on a specific topic, read the Cisco documentation that focuses on that topic.

Note that as wireless technologies continue to develop, Cisco reserves the right to change the exam topics without notice. Although you can refer to the list of exam topics in Table I-1, always check Cisco.com to verify the actual list of topics to ensure that you are prepared before taking the exam. You can view the current exam topics on any current Cisco certification exam by visiting the Cisco.com website, hovering over Training & Events, and selecting from the Certifications list. Note also that, if needed, Cisco Press might post additional preparatory content on the web page associated with this book at <http://www.ciscopress.com/title/9781587205620>. It’s a good idea to check the website a couple of weeks before taking your exam to be sure that you have up-to-date content.

## Taking the CCNA Wireless Certification Exam

As with any Cisco certification exam, you should strive to be thoroughly prepared before taking the exam. There is no way to determine exactly what questions are on the exam, so the best way to prepare is to have a good working knowledge of all subjects covered on the exam. Schedule yourself for the exam and be sure to be rested and ready to focus when taking the exam.

The best place to find out the latest available Cisco training and certifications is under the Training & Events section at Cisco.com.

## Tracking Your Status

You can track your certification progress by checking <http://www.cisco.com/go/certifications/login>. You must create an account the first time you log in to the site.

## How to Prepare for an Exam

The best way to prepare for any certification exam is to use a combination of the preparation resources, labs, and practice tests. This guide has integrated some practice questions and example scenarios to help you better prepare. If possible, get some hands-on experience with CUWN equipment. There is no substitute for real-world experience; it is much easier to understand the designs, configurations, and concepts when you can actually work with a live wireless network.

Cisco.com provides a wealth of information about wireless LAN controllers, access points (APs), and wireless management products, and wireless LAN technologies and features.

## Assessing Exam Readiness

Exam candidates never really know whether they are adequately prepared for the exam until they have completed about 30 percent of the questions. At that point, if you are not prepared, it is too late. The best way to determine your readiness is to work through the “Do I Know This Already?” quizzes at the beginning of each chapter and review the foundation and key topics presented in each chapter. It is best to work your way through the entire book unless you can complete each subject without having to do any research or look up any answers.

## Cisco Wireless Certifications in the Real World

Cisco has one of the most recognized names on the Internet. Cisco Certified wireless specialists can bring quite a bit of knowledge to the table because of their deep understanding of wireless technologies, standards, and networking devices. This is why the

Cisco certification carries such high respect in the marketplace. Cisco certifications demonstrate to potential employers and contract holders a certain professionalism, expertise, and dedication required to complete a difficult goal. If Cisco certifications were easy to obtain, everyone would have them.

## Exam Registration

The CCNA Wireless IUWNE 640-722 exam is a computer-based exam, with around 75 to 85 multiple-choice, fill-in-the-blank, list-in-order, and simulation-based questions. You can take the exam at any Pearson VUE (<http://www.pearsonvue.com>) testing center. According to Cisco, the exam should last about 90 minutes. Be aware that when you register for the exam, you might be told to allow a certain amount of time to take the exam that is longer than the testing time indicated by the testing software when you begin. This discrepancy is because the testing center will want you to allow for some time to get settled and take the tutorial about the test engine.

## Book Content Updates

Because Cisco occasionally updates exam topics without notice, Cisco Press might post additional preparatory content on the web page associated with this book at <http://www.ciscopress.com/title/9781587205620>. It is a good idea to check the website a couple of weeks before taking your exam, to review any updated content that might be posted online. We also recommend that you periodically check back to this page on the Cisco Press website to view any errata or supporting book files that may be available.

*This page intentionally left blank*



---

This chapter covers the following topics:

- **Comparing Wired and Wireless Networks**—This section provides a brief overview of how a wireless network differs from a wired network.
- **Understanding Basic Wireless Theory**—This section discusses radio frequency signals and their properties, such as frequency, bandwidth, phase, wavelength, and power level.
- **Carrying Data over an RF Signal**—This section covers the encoding and modulation methods that are used in wireless LANs.

This chapter covers the following exam topics:

- Describe basics of spread spectrum technology

# RF Signals and Modulation

Wireless LANs must transmit a signal over radio frequencies (RF) to move data from one device to another. Transmitters and receivers can be fixed in consistent locations or they can be free to move around. This chapter covers the basic theory behind RF signals and the methods used to carry data wirelessly.

## “Do I Know This Already?” Quiz

The “Do I Know This Already?” quiz allows you to assess whether you should read this entire chapter thoroughly or jump to the “Exam Preparation Tasks” section. If you are in doubt about your answers to these questions or your own assessment of your knowledge of the topics, read the entire chapter. Table 1-1 lists the major headings in this chapter and their corresponding “Do I Know This Already?” quiz questions. You can find the answers in Appendix A, “Answers to the ‘Do I Know This Already?’ Quizzes.”

**Table 1-1** “Do I Know This Already?” Section-to-Question Mapping

Foundation Topics Section	Questions
Comparing Wired and Wireless Networks	1
Understanding Basic Wireless Theory	2–8
Carrying Data Over an RF Signal	9–12

**Caution** The goal of self-assessment is to gauge your mastery of the topics in this chapter. If you do not know the answer to a question or are only partially sure of the answer, you should mark that question as wrong for purposes of the self-assessment. Giving yourself credit for an answer you correctly guess skews your self-assessment results and might provide you with a false sense of security.

1. Which one of the following is the common standard that defines wireless LAN operation?
  - a. IEEE 802.1
  - b. IEEE 802.1x
  - c. IEEE 802.11
  - d. IEEE 802.3
2. Which of the following represent the frequency bands commonly used for wireless LANs? (Choose two.)
  - a. 2.4 MHz
  - b. 2.4 GHz
  - c. 5.5 MHz
  - d. 11 MHz
  - e. 5 GHz
3. Two transmitters are each operating with a transmit power level of 100 mW. When you compare the two absolute power levels, what is the result in dB?
  - a. 0 dB
  - b. 20 dB
  - c. 100 dB
  - d. You can't compare power levels in dB.
4. A transmitter is configured to use a power level of 17 mW. One day it is reconfigured to transmit at a new power level of 34 mW. How much has the power level increased in dB?
  - a. 0 dB
  - b. 2 dB
  - c. 3 dB
  - d. 17 dB
  - e. None of these answers are correct; you need a calculator to figure this out.
5. Transmitter A has a power level of 1 mW, and transmitter B is 100 mW. Compare transmitter B to A using dB, and then identify the correct answer from the following choices.
  - a. 0 dB
  - b. 1 dB

- c. 10 dB
  - d. 20 dB
  - e. 100 dB
6. A transmitter normally uses an absolute power level of 100 mW. Through the course of needed changes, its power level is reduced to 40 mW. What is the power-level change in dB?
- a. 2.5 dB
  - b. 4 dB
  - c. -4 dB
  - d. -40 dB
  - e. None of these answers are correct; where is that calculator?
7. Consider a scenario with a transmitter and a receiver that are separated by some distance. The transmitter uses an absolute power level of 20 dBm. A cable connects the transmitter to its antenna. The receiver also has a cable connecting it to its antenna. Each cable has a loss of 2 dB. The transmitting and receiving antennas each have a gain of 5 dBi. What is the resulting EIRP?
- a. +20 dBm
  - b. +23 dBm
  - c. +26 dBm
  - d. +34 dBm
  - e. None of these answers are correct.
8. A receiver picks up an RF signal from a distant transmitter. Which one of the following represents the best signal quality received? Example values are given in parentheses.
- a. Low SNR (10 dBm), Low RSSI (-75)
  - b. High SNR (30 dBm), Low RSSI (-75)
  - c. Low SNR (10 dBm), High RSSI (-30)
  - d. High SNR (30 dBm), High RSSI (-30)
9. The typical data rates of 1, 2, 5.5, and 11 Mbps can be supported by which one of the following modulation types?
- a. OFDM
  - b. FHSS
  - c. DSSS
  - d. QAM



- 10.** Put the following modulation schemes in order of the number of possible changes that can be made to the carrier signal, from lowest to highest.
  - a.** 16-QAM
  - b.** DQPSK
  - c.** DBPSK
  - d.** 64-QAM
  
- 11.** 64-QAM modulation alters which two of the following aspects of an RF signal?
  - a.** Frequency
  - b.** Amplitude
  - c.** Phase
  - d.** Quadrature
  
- 12.** OFDM offers data rates up to 54 Mbps, but DSSS supports much lower limits. Compared with DSSS, which one of the following does OFDM leverage to achieve its superior data rates?
  - a.** Higher-frequency band
  - b.** Wider 20-MHz channel width
  - c.** 48 subcarriers in a channel
  - d.** Faster chipping rates
  - e.** Greater number of channels in a band

---

## Foundation Topics

---

### Comparing Wired and Wireless Networks

In a wired network, any two devices that need to communicate with each other must be connected by a wire. (That was obvious!) The “wire” might contain strands of metal or fiber-optic material that run continuously from one end to the other. Data that passes over the wire is bounded by the physical properties of the wire. In fact, the IEEE 802.3 set of standards defines strict guidelines for the Ethernet wire itself, in addition to how devices may connect, send, and receive data over the wire.

Wired connections have been engineered with tight constraints and have few variables that might prevent successful communication. Even the type and size of the wire strands, the number of twists the strands must make around each other over a distance, and the maximum length of the wire must adhere to the standard.

Therefore, a wired network is essentially a bounded medium; data must travel over whatever path the wire or cable takes between two devices. If the cable goes around a corner or lies in a coil, the electrical signals used to carry the data must also go around a corner or around a coil. Because only two devices may connect to a wire, only those two devices may send or transmit data. Even better: The two devices may transmit data to each other simultaneously because they each have a private, direct path to each other.

Wired networks also have some shortcomings. When a device is connected by a wire, it cannot move around very easily or very far. Before a device can connect to a wired network, it must have a connector that is compatible with the one on the end of the wire. As devices get smaller and more mobile, it just is not practical to connect them to a wire.

As its name implies, a wireless network removes the need to be tethered to a wire or cable. Convenience and mobility become paramount, enabling users to move around at will while staying connected to the network. A user can (and often does) bring along many different wireless devices that can all connect to the network easily and seamlessly.

Wireless data must travel through free space, without the constraints and protection of a wire. In the free space environment, many variables can affect the data and its delivery. To minimize the variables, wireless engineering efforts must focus on two things:

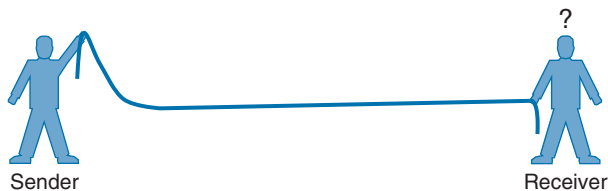
- Wireless devices must adhere to a common standard.
- Wireless coverage must exist in the area where devices are expected.

Wireless LANs are based on the IEEE 802.11 standard, which is covered in more detail in Chapter 2, “RF Standards.”

## Understanding Basic Wireless Theory

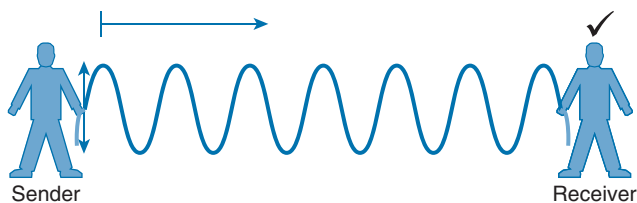
To send data across a wired link, an electrical signal is applied at one end and is carried to the other end. The wire itself is continuous and conductive, so the signal can propagate rather easily. A wireless link has no physical strands of anything to carry the signal along.

How then can an electrical signal be sent across the air, or free space? Consider a simple analogy of two people standing far apart, and one person wants to signal something to other. They are connected by a long and somewhat-loose rope; the rope represents free space. The sender at one end decides to lift his end of the rope high and hold it there so that the other end of the rope will also raise and notify the partner. After all, if the rope were a wire, he knows that he could apply a steady voltage at one end of the wire and it would appear at the other end. Figure 1-1 shows the end result; the rope falls back down after a tiny distance, and the receiver never notices a change.



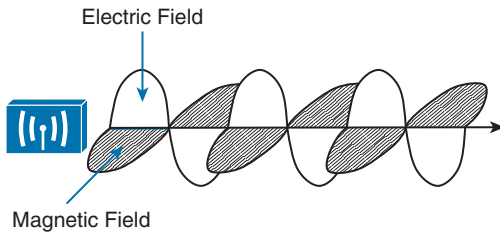
**Figure 1-1** *Failed Attempt to Pass a Message Down a Rope.*

The sender tries a different strategy. He cannot push the rope, but when he begins to wave it up and down in a steady, regular motion, a curious thing happens. A continuous wave pattern appears along the entire length of the rope, as shown in Figure 1-2. In fact, the waves (each representing one up and down cycle of the sender's arm) actually travel from the sender to the receiver.



**Figure 1-2** *Sending a Continuous Wave Down a Rope.*

In free space, a similar principle occurs. The sender (a transmitter) can send an alternating current into a section of wire (an antenna), which sets up moving electric and magnetic fields that propagate out and away as traveling waves. The electric and magnetic fields travel along together and are always at right angles to each other, as shown in Figure 1-3. The signal must keep changing, or alternating, by cycling up and down, to keep the electric and magnetic fields cycling and pushing ever outward.

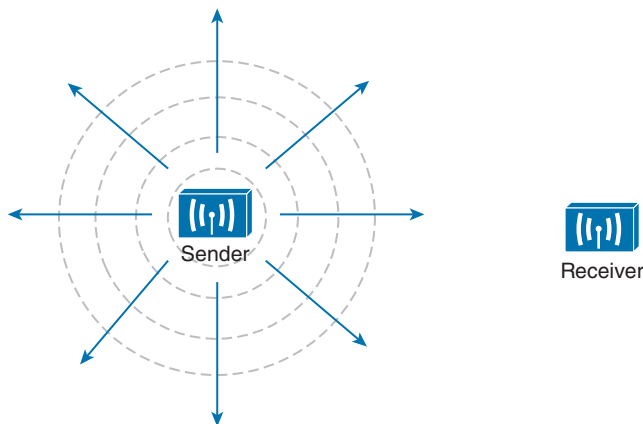


**Figure 1-3** *Traveling Electric and Magnetic Waves.*

Electromagnetic waves do not travel in a straight line. Instead, they travel by expanding in *all* directions away from the antenna. To get a visual image, think of dropping a pebble into a pond when the surface is still. Where it drops in, the pebble sets the water's surface into a cyclic motion. The waves that result begin small and expand outward, only to be replaced by new waves. In free space, the electromagnetic waves expand outward in all three dimensions.

Figure 1-4 shows a simple idealistic antenna that is a single point at the end of a wire. The waves produced expand outward in a spherical shape. The waves will eventually reach the receiver, in addition to many other locations in other directions.

**Tip** The idealistic antenna does not really exist, but serves as a reference point to understand wave propagation. In the real world, antennas can be made in various shapes and forms that can limit the direction that the waves are sent. Chapter 4, “Understanding Antennas,” covers antennas in more detail.

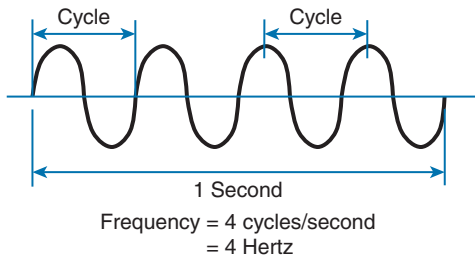


**Figure 1-4** *Wave Propagation with an Idealistic Antenna.*

At the receiving end of a wireless link, the process is reversed. As the electromagnetic waves reach the receiver's antenna, they induce an electrical signal. If everything works right, the received signal will be a reasonable copy of the original transmitted signal.

## Understanding Frequency

The waves involved in a wireless link can be measured and described in several ways. One fundamental property is the *frequency* of the wave, or the number of times the signal makes one complete up and down *cycle* in 1 second. Figure 1-5 shows how a cycle of a wave can be identified. A cycle can begin as the signal rises from the center line, falls through the center line, and rises again to meet the center line. A cycle can also be measured from the center of one peak to the center of the next peak. No matter where you start measuring a cycle, the signal must make a complete sequence back to its starting position where it is ready to repeat the same cyclic pattern again.



**Figure 1-5** *Cycles Within a Wave.*

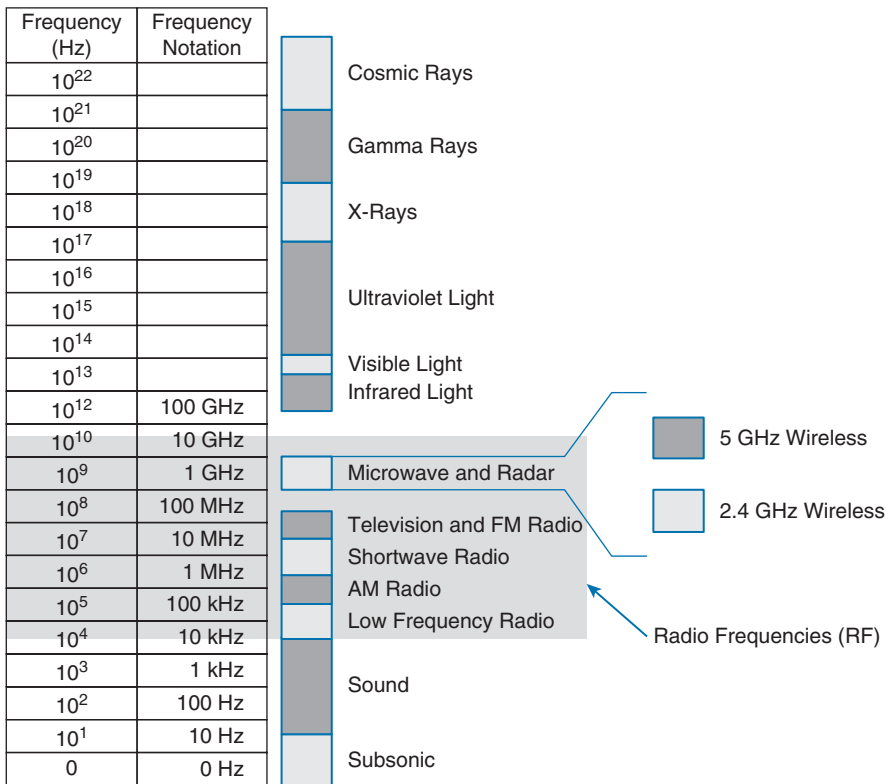
In Figure 1-5, suppose that 1 second has elapsed, as shown. During that 1 second, the signal progressed through four complete cycles. Therefore, its frequency is 4 cycles/second or 4 hertz. A *hertz* (Hz) is the most commonly used frequency unit and is nothing other than one cycle per second.

Frequency can vary over a very wide range. As frequency increases by orders of magnitude, the numbers can become quite large. To keep things simple, the frequency unit name can be modified to denote an increasing number of zeros, as listed in Table 1-2.

**Table 1-2** *Frequency Unit Names*

Unit	Abbreviation	Meaning
Hertz	Hz	Cycles per second
Kilohertz	kHz	1000 Hz
Megahertz	MHz	1,000,000 Hz
Gigahertz	GHz	1,000,000,000 Hz

Figure 1-6 shows a simple representation of the continuous frequency spectrum ranging from 0 Hz to 10<sup>22</sup> (or 1 followed by 22 zeros) Hz. At the low end of the spectrum are frequencies that are too low to be heard by the human ear, followed by audible sounds. The highest range of frequencies contains light, followed by X, gamma, and cosmic rays.



**Figure 1-6** Continuous Frequency Spectrum.

The frequency range from around 3 kHz to 300 GHz is commonly called *radio frequency* (RF). It includes many different types of radio communication, including low-frequency radio, AM radio, shortwave radio, television, FM radio, microwave, and radar. The microwave category also contains the two frequency ranges that are used for wireless LAN communication: 2.4 and 5 GHz.

Because a range of frequencies might be used for the same purpose, it is customary to refer to the range as a *band* of frequencies. For example, the range from 530 kHz to around 1710 kHz is used by AM radio stations; therefore it is commonly called the AM band or the AM broadcast band.

One of the two frequency ranges used for wireless LAN communication lies between 2.400 and 2.4835 GHz. This is usually called the *2.4-GHz band*, even though it does not encompass the entire range between 2.4 and 2.5 GHz. It is much more convenient to refer to the band name instead of the specific range of frequencies included.

The other wireless LAN range is usually called the *5-GHz band* because it lies between 5.150 and 5.825 GHz. The 5-GHz band actually contains the following four separate and distinct bands:

5.150 to 5.250 GHz

5.250 to 5.350 GHz

5.470 to 5.725 GHz

5.725 to 5.825 GHz

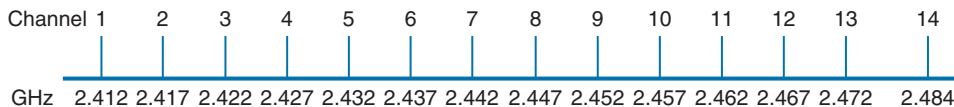
**Tip** You might have noticed that most of the 5-GHz bands are contiguous except for a gap between 5.350 and 5.470. At the time of this writing, this gap exists and cannot be used for wireless LANs (although it might become a useful band at some point.)

It is interesting that the 5-GHz band can contain several smaller bands. Remember that the term *band* is simply a relative term that is used for convenience. At this point, do not worry about memorizing the band names or exact frequency ranges; Chapter 2 covers this in more detail.

A frequency band contains a continuous range of frequencies. If two devices require a single frequency for a wireless link between them, which frequency can they use? Beyond that, how many unique frequencies can be used within a band?

To keep everything orderly and compatible, bands are usually divided up into a number of distinct *channels*. Each channel is known by a channel number and is assigned to a specific frequency. As long as the channels are defined by a national or international standards body, they can be used consistently in all locations.

For example, Figure 1-7 shows the channel assignment for the 2.4-GHz band that is used for wireless LAN communication. The band contains 14 channels numbered 1 through 14, each assigned a specific frequency. First, notice how much easier it is to refer to channel numbers than the frequencies. Second, notice that the channels are spaced at regular intervals that are 0.005 GHz (or 5 MHz) apart. The channel spacing is known as the channel separation or channel width.



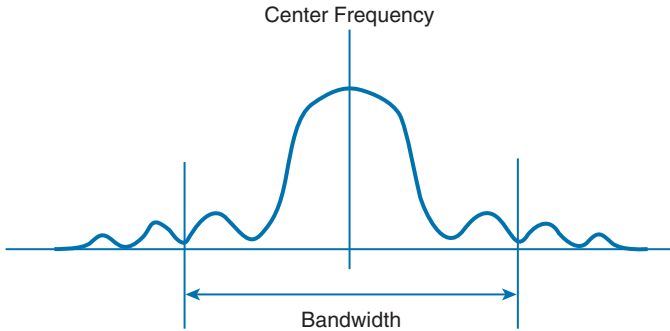
**Figure 1-7** An Example of Channel Spacing in the 2.4-GHz Band.

If devices use a specific frequency for a wireless link, why do the channels need to be spaced apart at all? The reason lies with the practical limitations of RF signals, the electronics involved in transmitting and receiving the signals, and the overhead needed to add data to the signal effectively.

In practice, an RF signal is not infinitely narrow; instead, it spills above and below a center frequency to some extent, occupying neighboring frequencies, too. It is the center frequency that defines the channel location within the band. The actual frequency range needed for the transmitted signal is known as the signal *bandwidth*, as shown in Figure 1-8. As its name implies, bandwidth refers to the width of frequency space required within the band. For example, a signal with a 22-MHz bandwidth is bounded at 11 MHz above and below the center frequency. In wireless LANs, the signal bandwidth is defined as part of a standard. Even though the signal might extend farther above and below the

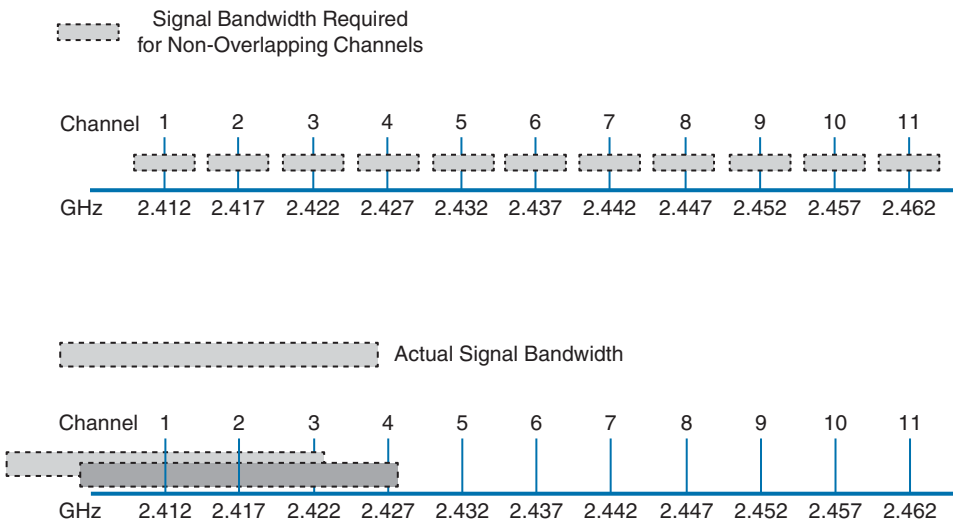
center frequency than the bandwidth allows, wireless devices will use something called a spectral mask to ignore parts of the signal that fall outside the bandwidth boundaries.

Ideally, the signal bandwidth should be less than the channel width so that a different signal could be transmitted on every possible channel with no chance that two signals could overlap and interfere with each other.



**Figure 1-8** *Signal Bandwidth.*

You should not assume that signals centered on the standardized channel assignments will not overlap with each other. The upper portion of Figure 1-9 shows most of the 2.4-GHz band, along with a signal bandwidth that is narrower than the channel spacing. A signal can exist on every possible channel without overlapping with others. The bottom portion of the figure shows the real world signal bandwidth, which is slightly wider than four channels! Signals centered on adjacent channels cannot possibly coexist without overlapping and interfering. Instead, the signals must be placed on more distant channels to prevent overlapping, thus limiting the number of channels that can be used in the band.



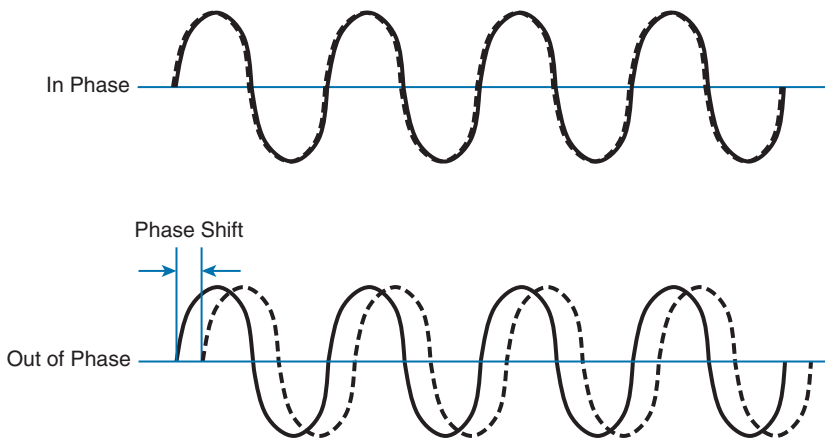
**Figure 1-9** *Examples of Channel Spacing and Overlap.*



## Understanding Phase

RF signals are very dependent upon timing because they are always in motion. By their very nature, the signals are made up of electric and magnetic forces that vary over time. The *phase* of a signal is a measure of shift in time relative to the start of a cycle. Phase is normally measured in degrees, where 0 degrees is at the start of a cycle, and one complete cycle equals 360 degrees. A point that is halfway along the cycle is at the 180-degree mark. Because an oscillating signal is cyclic, you can think of the phase traveling around a circle again and again.

When two identical signals are produced at exactly the same time, their cycles match up and they are said to be *in phase* with each other. If one signal is delayed from the other, the two signals are said to be *out of phase*. Figure 1-10 shows examples of both scenarios.



**Figure 1-10** *Signals In and Out of Phase.*

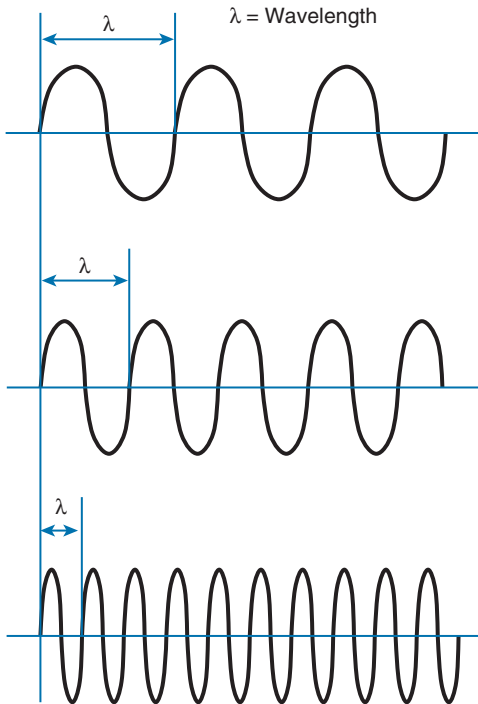
Phase becomes important as RF signals are received. Signals that are in phase tend to add together, whereas signals that are 180 degrees out of phase tend to cancel each other out. Chapter 3, “RF Signals in the Real World,” explores signal phase in greater detail.

## Measuring Wavelength

RF signals are usually described by their frequency; however, it is difficult to get a feel for their physical size as they move through free space. The *wavelength* is a measure of the physical distance that a wave travels over one complete cycle. Wavelength is usually designated by the Greek symbol lambda ( $\lambda$ ). To get a feel for the dimensions of a wireless LAN signal, assuming you could see it as it travels in front of you, a 2.4-GHz signal would have a wavelength of 4.92 inches, while a 5-GHz signal would be 2.36 inches.

Figure 1-11 shows the wavelength of three different waves. The waves are arranged in order of increasing frequency, from top to bottom. Regardless of the frequency, RF waves travel at a constant speed. In a vacuum, radio waves travel at exactly the speed of light; in air, the velocity is slightly less than the speed of light. Notice that the wave-

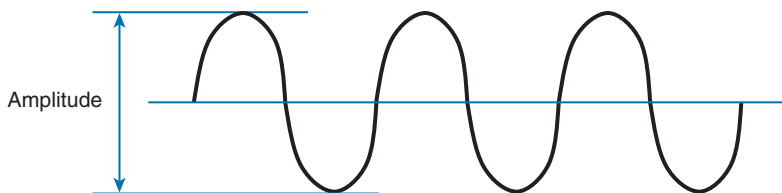
length decreases as the frequency increases. As the wave cycles get smaller, they cover less distance. Wavelength becomes useful in the design and placement of antennas.



**Figure 1-11** Examples of Increasing Frequency and Decreasing Wavelength.

## Understanding RF Power and dB

For an RF signal to be transmitted, propagated through free space, received, and understood with any certainty, it must be sent with enough strength or energy to make the journey. This strength can be measured as the *amplitude*, or the height from the top peak to the bottom peak of the signal's waveform, as shown in Figure 1-12.

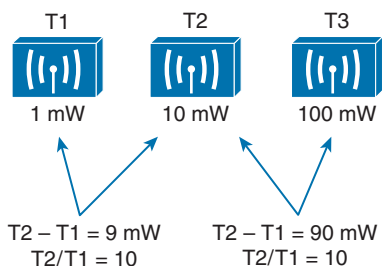


**Figure 1-12** Signal Amplitude.

The strength of an RF signal is usually measured by its power, in watts (W). For example, a typical AM radio station broadcasts at a power of 50,000 W; an FM radio station might use 16,000 W. In comparison, a wireless LAN transmitter usually has a signal strength between 0.1 W (100 mW) and 0.001 W (1 mW).

When power is measured in watts or milliwatts, it is considered to be an absolute power measurement. In other words, something has to measure exactly how much energy is present in the RF signal. This is fairly straightforward when the measurement is taken at the output of a transmitter because the transmit power level is usually known ahead of time.

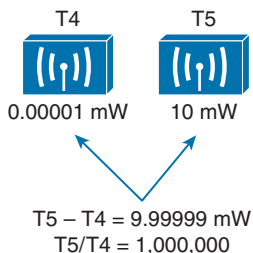
Sometimes you might need to compare the power level between two different transmitters. For example, suppose that device T1 is transmitting at 1 mW, while T2 is transmitting at 10 mW, as shown in Figure 1-13. Simple subtraction tells you that T2 is 9 mW stronger than T1. You might also notice that T2 is 10 times stronger than T1.



**Figure 1-13** Comparing Power Levels Between Transmitters.

Now compare transmitters T2 and T3, which use 10 mW and 100 mW, respectively. Using subtraction, T2 and T3 differ by 90 mW, but T3 is again 10 times stronger than T2. In each instance, subtraction yields a different result than division. Which method should you use?

Quantities like absolute power values can differ by orders of magnitude. A more surprising example is shown in Figure 1-14, where T4 is 0.00001 mW and T5 is 10 mW. Subtracting the two values gives their difference as 9.99999 mW. However, T5 is 1,000,000 times stronger than T4!



**Figure 1-14** Comparing Power Levels That Differ By Orders of Magnitude.

Because absolute power values can fall anywhere within a huge range, from a tiny decimal number to hundreds, thousands, or greater values, we need a way to transform the exponential range into a linear one. The logarithm function can be leveraged to do just that. In a nutshell, a logarithm takes values that are orders of magnitude apart (0.001, 0.01, 0.1, 1, 10, 100, and 1000, for example) and spaces them evenly within a reasonable range.

**Tip** The base-10 logarithm function, denoted by  $\log_{10}$ , computes how many times 10 can be multiplied by itself to equal a number. For example,  $\log_{10}(10)$  equals 1 because 10 multiplied by itself exactly once equals 10. The  $\log_{10}(100)$  equals 2 because  $10 \times 10$ , or 10 multiplied by itself twice, equals 100. Computing other  $\log_{10}$  values is difficult, requiring the use of a calculator. The good news is that you will not need a calculator or a logarithm on the CCNA Wireless exam. Even so, try to suffer through the few equations in this chapter so that you get a better understanding power comparisons and measurements.

The *decibel* (dB) is a handy function that uses logarithms to compare one absolute measurement to another. It was originally developed to compare sound intensity levels, but it applies directly to power levels, too. After each power value has been converted to the same logarithmic scale, the two values can be subtracted to find the difference. The following equation is used to calculate a dB value, where P1 and P2 are the absolute power levels of two sources:

$$dB = 10(\log_{10}P2 - \log_{10}P1)$$

P2 represents the source of interest, and P1 is usually called the *reference* value or the source of comparison.

The difference between the two logarithmic functions can be rewritten as a single logarithm of P2 divided by P1, as follows:

$$dB = 10 \cdot \log_{10}\left(\frac{P2}{P1}\right)$$

Here, the *ratio* of the two absolute power values is computed first; then the result is converted onto a logarithmic scale.

Oddly enough, we end up with the same two methods to compare power levels with dB: a subtraction and a division. Thanks to the logarithm, both methods arrive at identical dB values. Be aware that the ratio or division form of the equation is the most commonly used in the wireless engineering world.

### Important dB Facts to Remember

There are three cases where you can use mental math to make power-level comparisons using dB. You should memorize the following three facts; you will be tested on them in the CCNA Wireless exam. All other dB cases require a calculator, so you will not be tested on those:

- **Fact 1**—A value of 0 dB means that the two absolute power values are equal.

If the two power values are equal, the ratio inside the logarithm is 1, and the  $\log_{10}(1)$  is 0. This fact is intuitive; if two power levels are the same, one is 0 dB more than the other.

- **Fact 2**—A value of 3 dB means that the power value of interest is double the reference value; a value of -3 dB means the power value of interest is half the reference.



When P2 is twice P1, the ratio is always 2. Therefore,  $10\log_{10}(2) = 3$  dB.

When the ratio is 1/2,  $10\log_{10}(1/2) = -3$  dB.

The 3 dB fact is not very intuitive, but is still easy to learn. Whenever a power level doubles, it increases by 3 dB. Whenever it is cut in half, it decreases by -3 dB.

- **Fact 3**—A value of 10 dB means that the power value of interest is 10 times the reference value; a value of -10 dB means the power value of interest is 1/10 of the reference.

When P2 is 10 times P1, the ratio is always 10. Therefore,  $10\log_{10}(10) = 10$  dB.

When P2 is one tenth of P1, then the ratio is 1/10 and  $10\log_{10}(1/10) = -10$  dB.

The 10 dB fact is intuitive because multiplying or dividing by 10 adds or subtracts 10 dB, respectively.

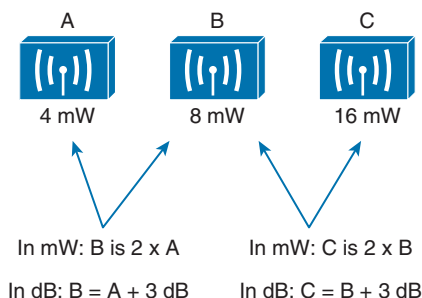
Notice another handy rule of thumb: When absolute power values multiply, the dB value is positive and can be added. When the power values divide, the dB value is negative and can be subtracted. Table 1-3 summarizes the useful dB comparisons.



**Table 1-3** Power Changes and Their Corresponding dB Values

Power Change	dB Value
=	0 dB
$\times 2$	+3 dB
$/ 2$	-3 dB
$\times 10$	+10 dB
$/ 10$	-10 dB

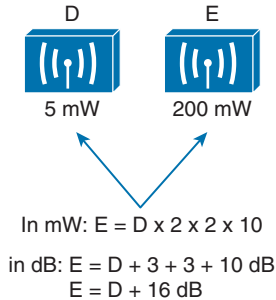
Try a few example problems to see whether you understand how to compare two power values using dB. In Figure 1-15, sources A, B, and C transmit at 4, 8, and 16 mW, respectively. Source B is double the value of A, so it must be 3 dB greater than A. Likewise, source C is double the value of B, so it must be 3 dB greater than B.



**Figure 1-15** Comparing Power Levels Using dB.

You can also compare sources A and C. To get from A to C, you have to double A, and then double it again. Each time you double a value, just add 3 dB. Therefore, C is 3 dB + 3 dB = 6 dB greater than A.

Next, try the more complicated example shown in Figure 1-16. Keep in mind that dB values can be added and subtracted in succession (in case several multiplication and division operations involving 2 and 10 are needed).



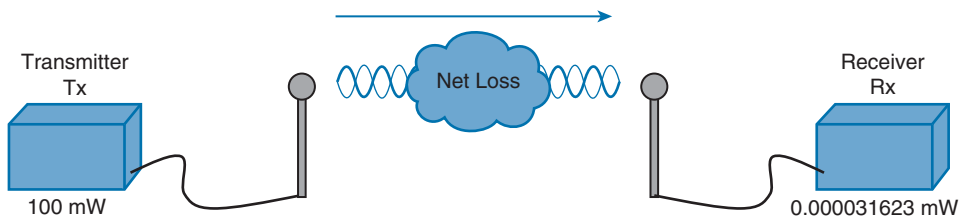
**Figure 1-16** An Example of Computing dB with Simple Rules.

Sources D and E have power levels 5 and 200 mW. Try to figure out a way to go from 5 to 200 using only  $\times 2$  or  $\times 10$  operations. You can double 5 to get 10, then double 10 to get 20, and then multiply by 10 to reach 200 mW. Next, use the dB facts to replace the doubling and  $\times 10$  with the dB equivalents. The result is  $E = D + 3 + 3 + 10$  or  $E = D + 16$  dB.

### Comparing Power Against a Reference: dBm

Beyond comparing two transmitting sources, a wireless LAN engineer must be concerned about the RF signal propagating from a transmitter to a receiver. After all, transmitting a signal is meaningless unless someone is there to receive it and make use of it.

Figure 1-17 shows a simple scenario with a transmitter and a receiver. Nothing in the real world is ideal, so assume that something along the path of the signal will induce a net loss. At the receiver, the signal strength will be degraded by some amount. Suppose that you are able to measure the power level leaving the transmitter, which is 100 mW. At the receiver, you measure the power level of the arriving signal. It is an incredibly low 0.000031623 mW.



**Figure 1-17** An Example of RF Signal Power Loss.

Wouldn't it be nice to quantify the net loss over the signal's path? After all, you might want to try several other transmit power levels or change something about the path between the transmitter and receiver. To design the signal path properly, you would like to make sure that the signal strength arriving at the receiver is at an optimum level.

You could leverage the handy dB formula to compare the received signal strength to the transmitted signal strength, as long as you can remember the formula and have a calculator nearby:

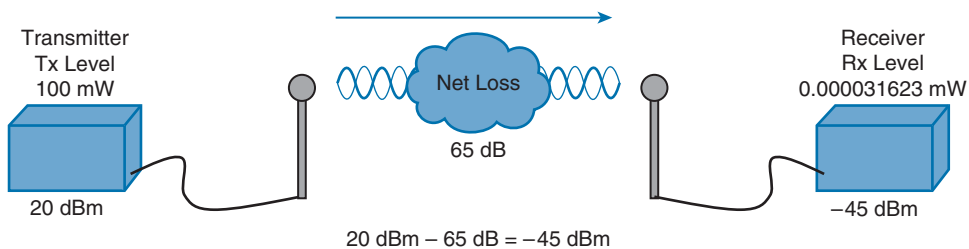
$$dB = 10 \cdot \log_{10}\left(\frac{0.000031623 \text{ mW}}{100 \text{ mW}}\right) = -65 \text{ dB}$$

The net loss over the signal path turns out to be a decrease of 65 dB. Knowing that, you decide to try a different transmit power level to see what would happen at the receiver. It does not seem very straightforward to use the new transmit power to find the new signal strength at the receiver. That might require more formulas and more time at the calculator.

A better approach is to compare each absolute power along the signal path to one common reference value. Then, regardless of the absolute power values, you could just focus on the changes to the power values that are occurring at various stages along the signal path. In other words, convert every power level to a dB value and simply add them up along the path.

Recall that the dB formula puts the power level of interest on the top of the ratio, with a reference power level on the bottom. In wireless networks, the reference power level is usually 1 mW, so the units are designated by *dBm* (dB-milliwatt).

Returning to the scenario from Figure 1-17, the absolute power values at the transmitter and receiver can be converted to dBm, the results from which are shown in Figure 1-18. Notice that the dBm values can be added along the path: The transmitter dBm plus the net loss in dB equals the received signal in dBm.



**Figure 1-18** Subtracting dB to Represent a Loss in Signal Strength.

### Measuring Power Changes Along the Signal Path

Up to this point, this chapter has considered a transmitter and its antenna to be a single unit. That might seem like a logical assumption because many wireless access points have built-in antennas. In reality, a transmitter, its antenna, and the cable that connects them are all discrete components that not only propagate an RF signal but also affect its absolute power level.

When an antenna is connected to a transmitter, it provides some amount of gain to the resulting RF signal. This effectively increases the dB value of the signal above that of the transmitter alone. Chapter 4 explains this in greater detail; for now, just be aware that antennas provide positive gain.

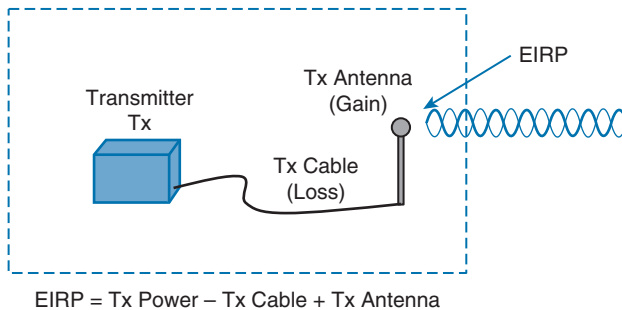
By itself, an antenna does not generate any amount of absolute power. In other words, when an antenna is disconnected, no milliwatts of power are being pushed out of it. That makes it impossible to measure the antenna's gain in dBm. Instead, an antenna's gain is measured by comparing its performance with that of a reference antenna, then computing a value in dB.

Usually, the reference antenna is an *isotropic antenna*, so the gain is measured in *dBi* (dB-isotropic). An isotropic antenna does not actually exist, because it is ideal in every way. Its size is a tiny point, and it radiates RF equally in every direction. No physical antenna can do that. The isotropic antenna's performance can be calculated according to RF formulas, making it a universal reference for any antenna.

Because the physical qualities of the cable that connects an antenna to a transmitter, some signal loss always occurs. Cable vendors supply the loss in dB per foot or meter of cable length for each type of cable manufactured.

Once you know the complete combination of transmitter power level, the length of cable, and the antenna gain, you can figure out the actual power level that will be radiated from the antenna. This is known as the *effective isotropic radiated power* (EIRP), measured in dBm.

EIRP is a very important parameter because it is regulated by governmental agencies in most countries. In those cases, a system cannot radiate signals higher than a maximum allowable EIRP. To find the EIRP of a system, simply add the transmitter power level to the antenna gain and subtract the cable loss, as illustrated in Figure 1-19.



**Figure 1-19** Calculating EIRP.

Suppose a transmitter is configured for a power level of 10 dBm (10 mW). A cable with 5-dB loss connects the transmitter to an antenna with an 8-dBi gain. The resulting EIRP of the system is 10 dBm – 5 dB + 8 dBi, or 13 dBm.

You might notice that the EIRP is made up of decibel-milliwatt (dBm), dB relative to an isotropic antenna (dBi), and decibel (dB) values. Even though the units appear to be dif-

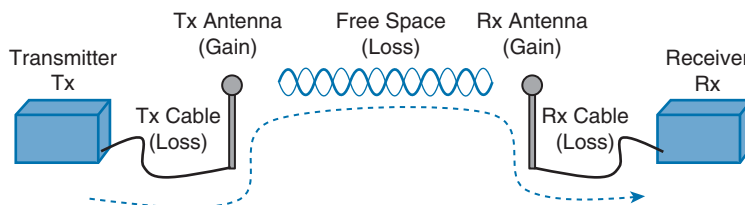




ferent, you can safely combine them because they are all in the dB “domain.” The only exception to this is when an antenna’s gain is measured in *dBd* (dB-dipole). In that case, a dipole antenna has been used as the reference antenna, rather than an isotropic antenna. A dipole is a simple actual antenna, which has a gain of 2.14 dBi. If an antenna has its gain shown as dBi, you can add 2.14 dBi to that value to get its gain in dBi units instead.

Power-level considerations do not have to stop with the EIRP. You should also be concerned with the complete path of a signal, to make sure that the transmitted signal has sufficient power so that it can effectively reach and be understood by a receiver. This is known as the *link budget*.

The dB values of gains and losses can be combined over any number of stages along a signal’s path. Consider Figure 1-20, which shows every component of signal gain or loss along the path from transmitter to receiver.

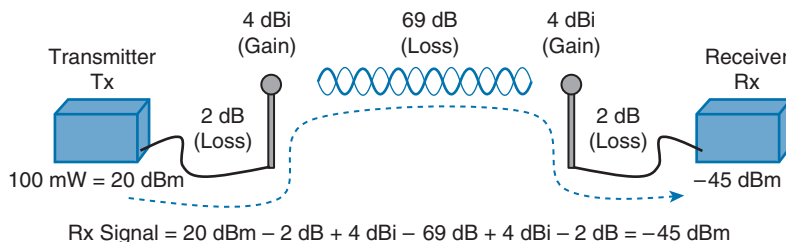


$$\text{Rx Signal} = \text{Tx Power} - \text{Tx Cable} + \text{Tx Antenna} - \text{Free Space} + \text{Rx Antenna} - \text{Rx Cable}$$

**Figure 1-20** Calculating Received Signal Strength Over the Path of an RF Signal.

At the receiving end, an antenna provides gain to increase the received signal power level. A cable connecting the antenna to the receiver also introduces some loss.

Figure 1-21 shows some example dB values, as well as the resulting sum of the component parts across the entire signal path. The signal begins at 20 dBm at the transmitter, has an EIRP value of 22 dBm at the transmitting antenna (20 dBm – 2 dB + 4 dBi), and arrives at the receiver with a level of –45 dBm.



$$\text{Rx Signal} = 20 \text{ dBm} - 2 \text{ dB} + 4 \text{ dBi} - 69 \text{ dB} + 4 \text{ dBi} - 2 \text{ dB} = -45 \text{ dBm}$$

**Figure 1-21** An Example of Calculating Received Signal Strength.

If you always begin with the transmitter power expressed in dBm, it is a simple matter to add or subtract the dB components along the signal path to find the signal strength that arrives at the receiver.

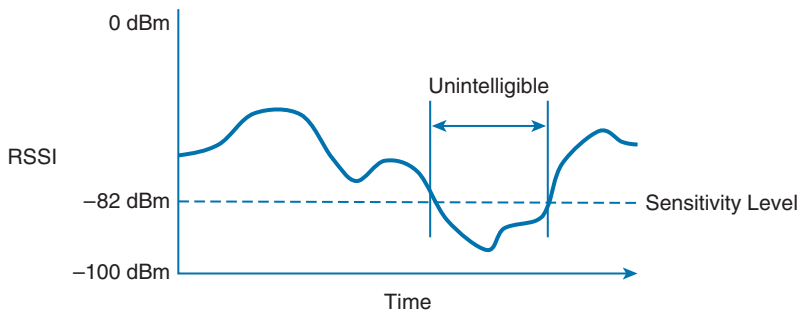
## Understanding Power Levels at the Receiver

At the receiving end of the signal path, a receiver expects to find a signal on a predetermined frequency, with enough power to contain useful data. Receivers measure a signal's power in dBm according to the *received signal strength indicator* (RSSI) scale.

When you work with wireless LAN devices, the EIRP levels leaving the transmitter's antenna normally range from 100 mW down to 1 mW. This corresponds to the range +20 dBm down to 0 dBm. At the receiver, the power levels are much, much less, ranging from 1 mW all the way down to tiny fractions of a milliwatt, approaching 0 mW. The corresponding range of received signal levels is from 0 dBm down to -100 dBm or less.

Therefore, the RSSI of a received signal can range from 0 to -100, where 0 is the strongest and -100 is the weakest. The range of RSSI values can vary between one hardware manufacturer and another. RSSI values are supposed to represent dBm values, but the results are not standardized across all receiver manufacturers. An RSSI value can vary from one receiver hardware to another.

Assuming a transmitter is sending an RF signal with enough power to reach a receiver, what RSSI value is good enough? Every receiver has a *sensitivity level* or a threshold that divides intelligible, useful signals from unintelligible ones. As long as a signal is received with a power level that is greater than the sensitivity level, chances are that the data from the signal can be understood correctly. Figure 1-22 shows an example of how the signal strength at a receiver might change over time. The receiver's sensitivity level is -82 dBm.



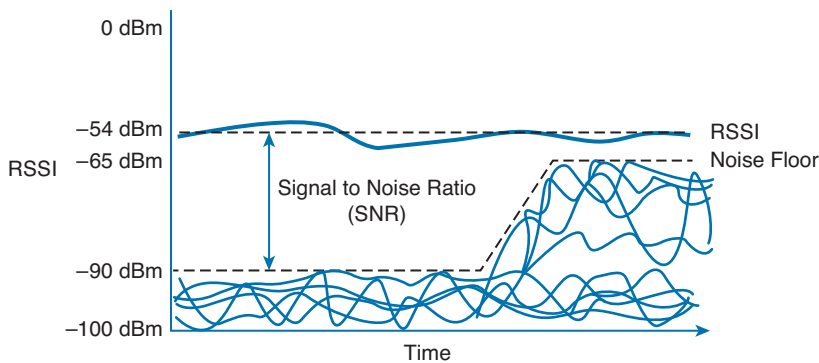
**Figure 1-22** An Example of Receiver Sensitivity Level.

The RSSI value focuses on the expected signal alone, without regard to any other signals that may be received, too. All other signals that are received on the same frequency as the one you are trying to receive are simply viewed as *noise*. The noise level, or the average signal strength of the noise, is called the *noise floor*.

It is easy to ignore noise as long as the noise floor is well below what you are trying to hear. For example, two people can whisper in a library effectively because there is very little competing noise. Those same two people would become very frustrated if they tried to whisper to each other in a crowded sports arena.

Receiving an RF signal is no different; its signal strength must be greater than the noise floor by a decent amount so that it can be received and understood correctly. The difference between the signal and the noise is called the *signal-to-noise ratio* (SNR), measured in dB. A higher SNR value is preferred.

Figure 1-23 shows the RSSI of a signal compared with the noise floor that is received. The RSSI averages around  $-54$  dBm. On the left side of the graph, the noise floor is  $-90$  dBm. The resulting SNR is  $-54$  dBm  $- (-90)$  dBm or 36 dB. Toward the right side of the graph, the noise floor gradually increases to  $-65$  dBm, reducing the SNR to 11 dB. The signal is so close to the noise that it probably will not be usable.



**Figure 1-23** An Example of a Changing Noise Floor and SNR.

## Carrying Data Over an RF Signal

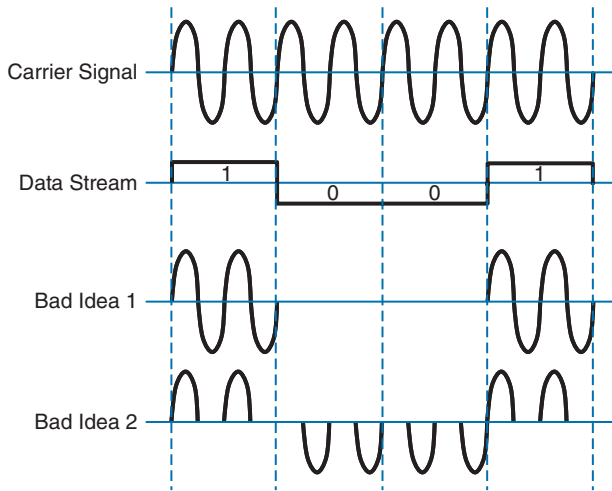
Up to this point in the chapter, only the RF characteristics of wireless signals have been discussed. The RF signals presented have existed only as simple oscillations in the form of a sine wave. The frequency, amplitude, and phase have all been constant. The steady, predictable frequency is important because a receiver needs to tune to a known frequency to find the signal in the first place.

This basic RF signal is called a *carrier signal* because it is used to carry other useful information. With AM and FM radio signals, the carrier signal also transports audio signals. TV carrier signals have to carry both audio and video. Wireless LAN carrier signals must carry data.

To add data onto the RF signal, the frequency of the original carrier signal must be preserved. Therefore, there must be some scheme of altering some characteristic of the carrier signal to distinguish a 0 bit from a 1 bit. Whatever scheme is used by the transmitter must also be used by the receiver so that the data bits can be correctly interpreted.

Figure 1-24 shows a carrier signal with a constant frequency. The data bits 1001 are to be sent over the carrier signal, but how? One idea might be to simply use the value of each data bit to turn the carrier signal off or on. The Bad Idea 1 plot shows the resulting RF signal. A receiver might be able to notice when the signal is present and has an amplitude and correctly interpret 1 bits, but there is no signal to receive during 0 bits. If the signal

becomes weak or is not available for some reason, the receiver will incorrectly think that a long string of 0 bits have been transmitted. A different twist might be to transmit only the upper half of the carrier signal during a 1 bit and the lower half during a 0 bit, as shown in the Bad Idea 2 plot. This time, a portion of the signal is always available for the receiver, but the signal becomes impractical to receive because important pieces of each cycle are missing. In addition, it is very difficult to transmit RF with disjointed alternating cycles.



**Figure 1-24** *Poor Attempts at Sending Data Over an RF Signal.*

Such naive approaches might not be successful, but they do have the right idea: to alter the carrier signal in a way that indicates the information to be carried. This is known as *modulation*, where the carrier signal is modulated or changed according to some other source. At the receiver, the process is reversed; *demodulation* interprets the added information based on changes in the carrier signal.

RF modulation schemes generally have the following goals:

- Carry data at a predefined rate
- Be reasonably immune to interference and noise
- Be practical to transmit and receive

Due to the physical properties of an RF signal, a modulation scheme can alter only the following attributes:

- Frequency, but only by varying slightly above or below the carrier frequency
- Phase
- Amplitude

The modulation techniques require some amount of bandwidth centered on the carrier frequency. This additional bandwidth is partly due to the rate of the data being carried and partly due to the overhead from encoding the data and manipulating the carrier signal. If the data has a relatively low bit rate, such as an audio signal carried over AM or FM radio, the modulation can be straightforward and requires little extra bandwidth. Such signals are called *narrowband* transmissions.

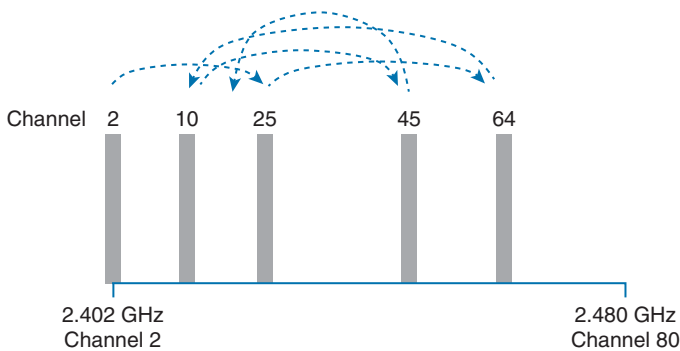
In contrast, wireless LANs must carry data at high bit rates, requiring more bandwidth for modulation. The end result is that the data being sent is spread out across a range of frequencies. This is known as *spread spectrum*. At the physical layer, wireless LANs can be broken down into the following three spread-spectrum categories, which are discussed in subsequent sections:

- Frequency-hopping spread spectrum (FHSS)
- Direct-sequence spread spectrum (DSSS)
- Orthogonal frequency-division multiplexing (OFDM)

## FHSS

Early wireless LAN technology took a novel approach as a compromise between avoiding RF interference and needing complex modulation. The wireless band was divided into 79 channels or fewer, with each channel being 1 MHz wide. To avoid narrowband interference, where an interfering signal would affect only a few channels at a time, transmissions would need to continuously “hop” between frequencies all across the band. This is known as *frequency-hopping spread spectrum*.

Figure 1-25 shows an example of how the FHSS technique works, where the sequence begins on channel 2, then moves to channels 25, 64, 10, 45, and so on, through an entire predetermined sequence before repeating again. Hopping between channels has to occur at regular intervals so that the transmitter and receiver can stay synchronized. In addition, the hopping order must be worked out in advance so that the receiver can always tune to the correct frequency in use at any given time.



**Figure 1-25** An Example FHSS Channel-Hopping Sequence.

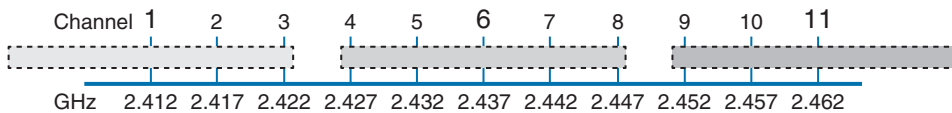
Whatever advantage FHSS gained avoiding interference was lost because of the following limitations:

- Narrow 1-MHz channel bandwidth, limiting the data rate to 1 or 2 Mbps.
- Multiple transmitters in an area could eventually collide and interfere with each other on the same channels.

As a result, FHSS fell out of favor and was replaced by another, more robust and scalable spread-spectrum approach: DSSS. Even though FHSS is rarely used now, you should be familiar with it and its place in the evolution of wireless LAN technologies.

## DSSS

Direct-sequence spread spectrum uses a small number of fixed, wide channels that can support complex modulation schemes and somewhat scalable data rates. Each channel is 22 MHz wide—a much wider bandwidth compared with the maximum supported 11-Mbps data rate, but wide enough to augment the data by spreading it out and making it more resilient to disruption. In the 2.4-GHz band where DSSS is used, there are 14 possible channels, but only 3 of them that do not overlap. Figure 1-26 shows how channels 1, 6, and 11 are normally used.



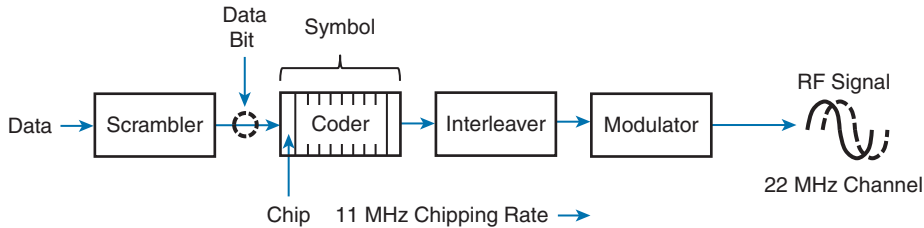
**Figure 1-26** Example Nonoverlapping Channels Used for DSSS.

DSSS transmits data in a serial stream, where each data bit is prepared for transmission one at a time. It might seem like a simple matter to transmit the data bits in the order that they are stored or presented to the wireless transmitter; however, RF signals are often affected by external factors like noise or interference that can garble the data at the receiver. For that reason, a wireless transmitter performs several functions to make the data stream less susceptible to being degraded along the transmission path:

- **Scrambler**—The data waiting to be sent is first scrambled in a predetermined manner so that it becomes a randomized string of 0 and 1 bits rather than long sequences of 0 or 1 bits.
- **Coder**—Each data bit is converted into multiple bits of information that contain carefully crafted patterns that can be used to protect against errors due to noise or interference. Each of the new coded bits is called a *chip*. The complete group of chips representing a data bit is called a *symbol*. DSSS uses two encoding techniques: Barker codes and Complementary Code Keying (CCK).
- **Interleaver**—The coded data stream of symbols is spread out into separate blocks so that bursts of interference might affect one block, but not many.

- **Modulator**—The bits contained in each symbol are used to alter or modulate the phase of the carrier signal. This enables the RF signal to carry the binary data bit values.

Figure 1-27 shows the entire data preparation process. At the receiver, the entire process is reversed. The DSSS techniques discussed in this chapter focus only on the coder and modulator functions.



**Figure 1-27** Functional Blocks Used in a DSSS Transmitter.

DSSS has evolved over time to increase the data rate that is modulated onto the RF signal. This section describes each DSSS method and data rate, in progression. Regardless of the data rate, DSSS always uses a chipping rate of 11 million chips per second.

### 1-Mbps Data Rate

To minimize the effect of a low SNR and data loss in cases of narrowband interference, each bit of data is encoded as a sequence of 11 bits called a *Barker 11 code*. The goal is to add enough additional information to each bit of data that its integrity will be preserved when it is sent in a noisy environment.

It might seem ridiculous to turn 1 bit into 11 bits. As an analogy, voice transmissions over an RF signal can be subject to noise and interference, too. Spelling words letter by letter can help, but even single letters can become garbled and ambiguous. For example, the letters *B, C, D, E, G, P, T, V,* and *Z* can all sound similar when noise is present. Phonetic alphabets have been developed to remove the ambiguity. Instead of saying the letter *B*, the word *Bravo* is spoken; *C* becomes *Charlie*, *D* becomes *Delta*, and so on. Replacing single letters with longer, unique words makes the listener's job much easier and more accurate.

There are only two possible values for the Barker chips—one corresponding to a 0 data bit (10110111000) and one for a 1 data bit (01001000111). The receiver must also expect the Barker chips and convert them back into single bits of data. The number and sequence of the Barker chip bits have been defined to allow data bits to be recovered if some of the chip bits are lost. In fact, up to 9 of the 11 bits in a single chip can be lost before the original data bit cannot be restored.

Each bit in a Barker chip can be transmitted by using the *differential binary phase shift keying* (DBPSK) modulation scheme. The phase of the carrier signal is shifted or rotated according to the data bit being transmitted, as follows:

**0:** The phase is not changed.

**1:** The phase is “rotated” or shifted 180 degrees, such that the signal is suddenly inverted.

DBPSK can modulate 1 bit of data at a time onto the RF signal. With a steady chipping rate of 11 million chips per second, where each symbol (1 original bit) contains 11 chips, the transmitted data rate is 1 Mbps.

## 2-Mbps Data Rate

It is possible to couple the 1-Mbps strategy with a different modulation scheme to double the data rate. As before, each data bit is coded into an 11-bit Barker code with an 11-MHz chipping rate. This time, chips are taken two at a time and modulated onto the carrier signal by using *differential quadrature phase shift keying* (DQPSK). The two chips are used to affect the carrier signal’s phase in four possible ways, each one 90 degrees apart (hence, the name quadrature). The bit patterns produce the following phase shifts:

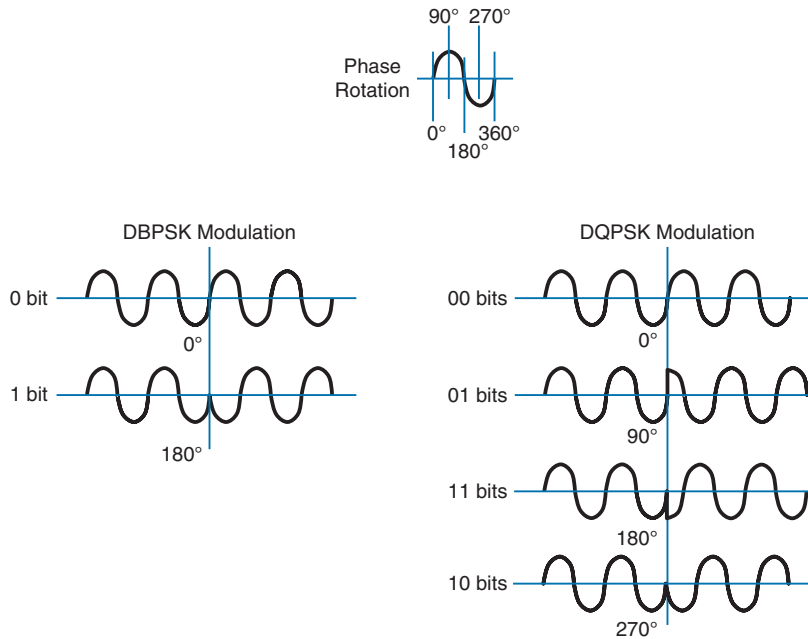
- **00:** The phase is not changed.
- **01:** Rotate the phase 90 degrees.
- **11:** Rotate the phase 180 degrees.
- **10:** Rotate the phase 270 degrees.

Because DQPSK can modulate data bits in pairs, it is able to transmit twice the data rate of DBPSK, or 2 Mbps.

Figure 1-28 shows examples of DBPSK and DQPSK modulation. Each input data bit combination is shown along with the carrier signal phase rotation that occurs. Phase rotations can occur at several points along a cycle; for simplicity, only rotations at the beginning of the cycle (0 degrees) are shown. Notice how abrupt the phase can change, according to the bits being modulated. The receiver must detect these phase changes when it demodulates the signal so that the original data bits can be recovered.

**Tip** As you read about wireless modulation techniques, you will often see DBPSK and BPSK mentioned. The two forms reference the same type of modulation (BPSK, in this case), but differ in the reference signal that the receiver uses to detect the phase changes. The nondifferential form (without the initial *D*) means the receiver must compare with the original premodulated signal to find phase changes. The differential form (with the *D*) means the receiver must figure out phase changes by comparing with previous phases already seen in received signal.





**Figure 1-28** Example Phase Changes During DBPSK and DQPSK Modulation.

### 5.5-Mbps Data Rate

To gain more efficiency, *Complementary Code Keying* (CCK) can replace the Barker code. CCK can take 4 bits of data at a time and build out redundant information to create a unique 6-chip symbol. Two more bits are added to indicate the modulated phase orientation for the symbol, resulting in 8 chips total. CCK is naturally coupled with DQPSK modulation; the two-phase orientation bits determine four possible carrier signal phase rotation values.

The chipping rate remains steady at 11 MHz, but each symbol contains 8 chips. This results in a symbol rate of 1.375 MHz. Each symbol is based on 4 original data bits, so the effective data rate is 5.5 Mbps.

### 11-Mbps Data Rate

The 5.5-Mbps CCK data rate can be doubled by making an adjustment to the coder. Instead of taking 4 data bits at a time to make each coder symbol, data can be taken 8 bits at a time to create a unique 8-chip symbol. The CCK symbol rate is still 1.375 MHz, so 8 data bits per symbol results in a data rate of 11 Mbps.

The smaller 8-chip CCK symbol is more efficient than the 11-bit Barker code because more data bits can be sent with each new symbol. At the same time, CCK loses some of the extra bits used by the Barker code to recover information received in a noisy or low SNR environment. In other words, CCK achieves faster data rates at the expense of requiring a stronger, less-noisy signal.

## OFDM

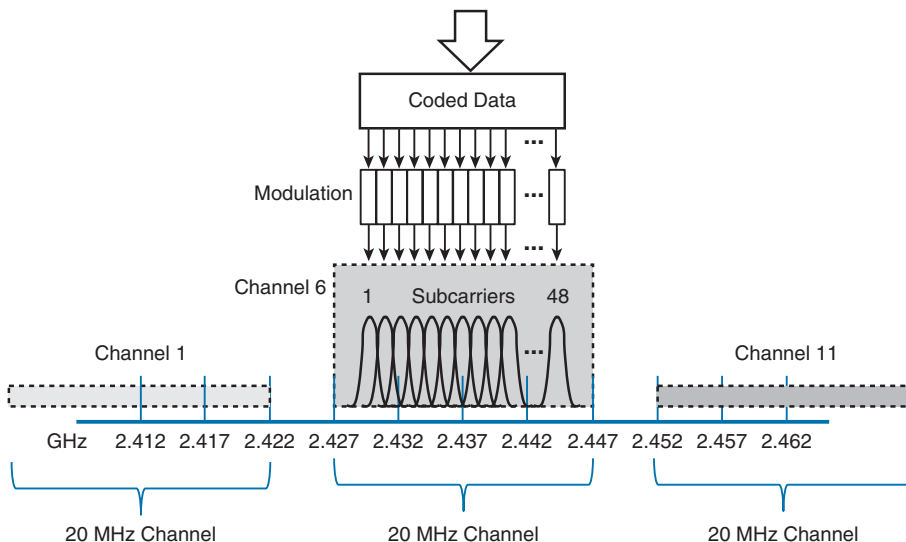
DSSS spreads the chips of a single data stream into one wide 22 MHz channel. It is inherently limited to an 11 Mbps data rate because of the consistent 11-MHz chipping rate that feeds into the RF modulation. To scale beyond that limit, a vastly different approach is needed.

In contrast, orthogonal frequency division multiplexing (OFDM) sends data bits in *parallel* over multiple frequencies, all contained in a single 20 MHz channel. Each channel is divided into 64 subcarriers (also called subchannels or tones) that are spaced 312.5 kHz apart. The subcarriers are broken down into the following types:

- **Guard**—12 subcarriers are used to help set one channel apart from another.
- **Pilot**—4 subcarriers are equally spaced to help receivers lock onto the channel.
- **Data**—48 subcarriers are devoted to carrying data.

**Tip** Sometimes you might see OFDM described as having 52 subcarriers (48 for data and 4 for pilot). This is because the 12 guard frequencies are not actually transmitted, but stay silent as channel spacing.

Figure 1-29 shows an example of OFDM, where channel 6 in the 2.4-GHz band is 20 MHz wide with 48 data subcarriers. OFDM is named for the way it takes one channel and divides it into a set of distinct frequencies for its subcarriers. Notice that the subcarriers appear to be spaced too close together, causing them to overlap. In fact, that is the case, but instead of interfering with each other, the overlapped portions are aligned so that they cancel most of the potential interference.



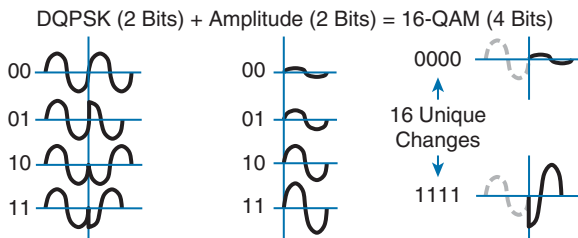
**Figure 1-29** OFDM Operation with 48 Parallel Subcarriers.

OFDM has the usual scrambling, coding, interleaving, and modulating functions, but it gains its scalability by leveraging so many data subcarriers in parallel. Even though the data rates through each subcarrier are relatively low, the sum of all subcarriers results in a high aggregate data rate.

OFDM offers many different data rates through several different modulation schemes. Because OFDM is concerned with moving data in parallel at higher rates, the amount of information that is repeated for resilience can be varied. The coders used with OFDM are named according to the fraction of symbols that are new or unique, and not repeated. For example, BPSK 1/2 designates that one half of the bits are new and one half are repeated. BPSK 3/4 uses a coder that presents three-fourths new data and repeats only one fourth. As a rule of thumb, a greater fraction means a greater data rate, but a lower tolerance for errors.

At the low end of the range, the familiar BPSK modulation can be used along with two different coder ratios. In this case, OFDM still uses 48 subchannels or tones, with a reduced tone rate of 250 Kbps. OFDM with BPSK 1/2 results in a 6-Mbps data rate, whereas BPSK 3/4 gives 9 Mbps. QPSK 1/2 and 3/4 can be used to increase the data rate to 12 and 18 Mbps, respectively.

Recall that QPSK uses 2 data bits to modulate the RF signal, resulting in four possible phase shifts. To achieve data rates greater than 18 Mbps, more bits must be used to modulate the signal. Quadrature amplitude modulation (QAM) combines QPSK phase shifting (*quadrature*) with multiple amplitude levels to get a greater number of unique alterations to the signal. For example, 16-QAM uses 2 bits to select the QPSK phase rotation and 2 bits to select the amplitude level, giving 4 bits or 16 unique modulation changes. Figure 1-30 illustrates a 16-QAM operation.



**Figure 1-30** Examples of Phase and Amplitude Changes with 16-QAM.

The number of possible outcomes is always given as a prefix to the QAM name, followed by the coder ratio of new data. In other words, 16-QAM is available in 1/2 and 3/4, providing data rates of 24 and 36 Mbps, respectively. Beyond that, 64-QAM 2/3 and 64-QAM 3/4 offer 48 and 54 Mbps, respectively.

## Modulation Summary

Table 1-4 lists all the modulation techniques used in wireless LANs. There are quite a few, and you will have to know them all for the CCNA Wireless exam. The modulation types are broken down by DSSS and OFDM. This will become important as wireless

standards are introduced in Chapter 2.

Try to get a feel for the relative data rates, working from the lowest to the highest. Remember that

- *B* in DBPSK stands for binary (two outcomes).
- *Q* in DQPSK stands for quadrature (four outcomes).
- CCK is coupled with QPSK and replaces Barker 11 to go a bit faster.
- OFDM generally wins out, except at the two slowest BPSK methods, which sit between the two CCK methods.
- QAM leverages both phase and amplitude changes to move the greatest amount of data.
- Higher fractions mean higher data rates.

**Table 1-4** *Wireless LAN Modulation Techniques*

<b>Modulation</b>	<b>DSSS Data Rate (Mbps)</b>	<b>OFDM Data Rate (Mbps)</b>
DBPSK	1	
DQPSK	2	
CCK 4	5.5	
OFDM BPSK 1/2		6
OFDM BPSK 3/4		9
CCK 8	11	
OFDM QPSK 1/2		12
OFDM QPSK 3/4		18
OFDM 16-QAM 1/2		24
OFDM 16-QAM 3/4		36
OFDM 64-QAM 2/3		48
OFDM 64-QAM 3/4		54



To pass data over an RF signal successfully, both a transmitter and receiver have to use the same modulation method. In addition, the pair should use the best data rate possible, given their current environment. If they are located in a noisy environment, where a low SNR or a low RSSI might result, a lower data rate might be preferable. If not, a higher data rate is better.

With so many possible modulation methods available, how do the transmitter and receiver select a common method? To complicate things, the transmitter, the receiver,

or both might be mobile. As they move around, the SNR and RSSI conditions will likely change. The most effective approach is to have the transmitter and receiver negotiate a modulation method (and the resulting data rate) dynamically, based on current RF conditions.

Chapter 2 explains the industry standards that are used in wireless LANs and how they influence the modulation techniques that are used.

---

## Exam Preparation Tasks

---

As mentioned in the section “How to Use This Book” in the Introduction, you have a couple of choices for exam preparation: the exercises here, Chapter 22, “Final Review,” and the exam simulation questions on the CD-ROM.

## Review All Key Topics

Review the most important topics in this chapter, noted with the Key Topic icon in the outer margin of the page. Table 1-5 lists a reference of these key topics and the page numbers on which each is found.



**Table 1-5** *Key Topics for Chapter 1*

Key Topic Element	Description	Page Number
Paragraph	dB definition	17
List	Important dB facts to remember	17
Table 1-3	Power changes and corresponding dB values	18
Paragraph	EIRP calculation	21
Figure 1-22	Receiver sensitivity and noise floor	23
Table 1-4	Modulation technique summary	33

## Key Terms

Define the following key terms from this chapter and check your answers in the glossary:

amplitude, band, bandwidth, Barker code, carrier signal, channel, chip, coder, Complementary Code Keying (CCK), decibel (dB), dBd, dBi, dBm, demodulation, differential binary phase shift keying (DBPSK), differential quadrature phase shift keying (DQPSK), direct-sequence spread spectrum (DSSS), effective isotropic radiated power (EIRP), frequency, frequency-hopping spread spectrum (FHSS), hertz

(Hz), in phase, isotropic antenna, link budget, modulation, narrowband, noise floor, orthogonal frequency division multiplexing (OFDM), out of phase, phase, quadrature amplitude modulation (QAM), radio frequency (RF), received signal strength indicator (RSSI), sensitivity level, signal-to-noise ratio (SNR), spread spectrum, symbol, wavelength



---

This chapter covers the following topics:

- **Regulatory Bodies**—This section describes the organizations that regulate radio frequency spectrum and its uses.
- **IEEE Standards Body**—This section discusses the IEEE and the 802.11 standards that define wireless LAN operation.
- **802.11 Channel Use**—This section covers each of the frequency bands used for 802.11 wireless LANs and the encoding and modulation methods that are used in wireless LANs.
- **IEEE 802.11 Standards**—This section describes the standards that define the progressive generations of 802.11 wireless LANs.
- **Wi-Fi Alliance**—This section introduces the global industry association that promotes and certifies wireless LAN products to ensure interoperability.

This chapter covers the following exam topics:

- Describe wireless regulatory bodies, standards and certifications (FCC, ETSI, 802.11a/b/g/n, and WiFi Alliance)

# RF Standards

To communicate successfully, wireless devices must first find each other in the radio frequency (RF) spectrum and then use compatible methods to generate RF signals, modulate and encode data, negotiate communication parameters and features, and so on—all without interfering with the operation of other wireless devices. This chapter covers the agencies that regulate, standardize, and validate the correct use of wireless LAN devices.

## “Do I Know This Already?” Quiz

The “Do I Know This Already?” quiz allows you to assess whether you should read this entire chapter thoroughly or jump to the “Exam Preparation Tasks” section. If you are in doubt about your answers to these questions or your own assessment of your knowledge of the topics, read the entire chapter. Table 2-1 lists the major headings in this chapter and their corresponding “Do I Know This Already?” quiz questions. You can find the answers in Appendix A, “Answers to the ‘Do I Know This Already?’ Quizzes.”

**Table 2-1** “Do I Know This Already?” Section-to-Question Mapping

Foundation Topics Section	Questions
Regulatory Bodies	1–3
IEEE Standards Body	4
802.11 Channel Use	5–6
IEEE 802.11 Standards	7–12
Wi-Fi Alliance	13

**Caution** The goal of self-assessment is to gauge your mastery of the topics in this chapter. If you do not know the answer to a question or are only partially sure of the answer, you should mark that question as wrong for purposes of the self-assessment. Giving yourself credit for an answer you correctly guess skews your self-assessment results and might provide you with a false sense of security.



- 1.** Which regulatory body allocated the 2.4-2.5 GHz band for industrial, scientific, and medical use?
  - a.** IEEE
  - b.** ETSI
  - c.** ITU-R
  - d.** FCC
- 2.** The U-NII-1 band is used for which one of the following purposes?
  - a.** 2.4-GHz wireless LANs
  - b.** 5-GHz wireless LANs
  - c.** Medical applications
  - d.** Point-to-point links
- 3.** In the 2.4-GHz band, the FCC limits the EIRP of a point-to-multipoint link to which one of the following maximum values?
  - a.** 100 mW
  - b.** 20 dBm
  - c.** 50 mW
  - d.** 36 dBm
- 4.** Wireless LAN operation is defined in which one of the following standards?
  - a.** 802.1
  - b.** 802.2
  - c.** 802.3
  - d.** 802.11
  - e.** 802.15
- 5.** Which one of the following specifies the correct list of non-overlapping channels for DSSS use in the 2.4-GHz band?
  - a.** 1, 2, 3
  - b.** 1, 5, 10
  - c.** 1, 6, 11
  - d.** 1, 7, 14
  - e.** All of channels 1–14

6. The U-NII-1 band begins at which one of the following channel numbers?
  - a. 0
  - b. 1
  - c. 24
  - d. 36
  
7. Which of the following standards apply to wireless LAN operation in the 5-GHz band? (Choose multiple correct answers.)
  - a. IEEE 802.1
  - b. IEEE 802.11g
  - c. IEEE 802.11a
  - d. IEEE 802.11n
  - e. IEEE 802.11b
  - f. IEEE 802.11-2012
  
8. Which of the following wireless LAN standards use OFDM for transmissions? (Choose all that apply.)
  - a. 802.11-1997
  - b. 802.11b
  - c. 802.11g
  - d. 802.11a
  
9. Which one of the following correctly specifies the maximum theoretical data rate of the 802.11b, 802.11a, and 802.11n standards, respectively?
  - a. 11 Mbps, 54 Mbps, 600 Mbps
  - b. 54 Mbps, 54 Mbps, 150 Mbps
  - c. 1 Mbps, 11 Mbps, 54 Mbps
  - d. 11 Mbps, 20 Mbps, 40 Mbps
  
10. A  $2 \times 3$  MIMO device correctly describes which one of the following?
  - a. A device with two radios and three antennas
  - b. A device with two transmitters and three receivers
  - c. A device with two bonded channels and three spatial streams
  - d. A device with two receivers and three transmitters

- 11.** An 802.11n device can aggregate channels to which one of the following maximum widths?
- a.** 5 MHz
  - b.** 20 MHz
  - c.** 40 MHz
  - d.** 80 MHz
- 12.** Which one of the following standards can make use of multiple spatial streams on a transmitter and a receiver?
- a.** 802.11n
  - b.** 802.11b
  - c.** 802.11g
  - d.** 802.11a
  - e.** All of these answers are correct.
- 13.** Which one of the following organizations certifies 802.11 interoperability?
- a.** ITU-R
  - b.** FCC
  - c.** IEEE
  - d.** Wi-Fi Alliance
  - e.** Cisco

---

## Foundation Topics

---

### Regulatory Bodies

The RF portion of the frequency spectrum ranges from about 3 kHz to 300 GHz. Frequencies within the RF spectrum are available because they exist everywhere, but it would not be wise to use any frequency at will. For example, suppose someone decides to set up a radio transmitter to broadcast a signal on 123.45 MHz. Unless other people know about the transmitter's frequency and have radio receivers that can tune to that frequency, no one will be able to receive the signal. Even further, a frequency might be used by one entity for a specific purpose, while another entity might try to use the same frequency for a different purpose. To keep the RF spectrum organized and open for fair use, regulatory bodies were formed.

### ITU-R

A telecommunications regulatory body regulates or decides which part of the RF spectrum can be used for a particular purpose, in addition to how it can be used. A country might have its own regulatory body that controls RF spectrum use within its borders, but RF signals can be more far-reaching than that. For example, one purpose for shortwave radio stations is to broadcast from one country around the earth to reach other countries. In a similar manner, one radio manufacturer might sell its equipment internationally, where a transmitter or receiver might be used in any global location.

To provide a hierarchy to manage the RF spectrum globally, the United Nations set up the International Telecommunication Union Radiocommunication Sector (ITU-R; <http://www.itu.int>). The ITU-R maintains spectrum and frequency assignments in three distinct regions:

- **Region 1:** Europe, Africa, and Northern Asia
- **Region 2:** North and South America
- **Region 3:** Southern Asia and Australasia

While the ITU-R strives to make the RF spectrum usable by all countries, it also tries to make sure that the RF signals from one country do not interfere with the signals of another country. The ITU-R even keeps track of geostationary satellite orbits and frequencies so that signals for one country's satellites do not harmfully interfere with those of another country.

Most bands in the RF spectrum are tightly regulated, requiring you to apply for a license from a regulatory body before using a specific frequency. Licensed bands might seem restrictive, for a good reason: "Harmful" or disruptive interference is kept to a minimum because frequencies are reserved for approved transmitters, purposes, and locations. To use a frequency in a licensed band, someone has to submit an application to a regulatory

body that governs frequency use in a given country, wait for approval, and then abide by any restrictions that are imposed.



In contrast, the ITU-R allocated the following two frequency ranges specifically for industrial, scientific, and medical (ISM) applications. Although there are other ISM bands, too, these are the only two that apply to wireless LANs:

2.400 to 2.500 GHz

5.725 to 5.825 GHz

The purposes for these bands are broad and access is open to anyone who wants to use them. In other words, the ISM bands are unlicensed and no registration or approval is needed to transmit on one of the frequencies.

While unlicensed bands are more accessible and convenient to use, they are much more vulnerable to interference and misuse. For example, suppose that you decide to set up a transmitter in your office to use one frequency. The next day, someone in a neighboring office sets up his own transmitter to broadcast on the same or an overlapping frequency. Because the band is unlicensed, you can do little to relieve the interference other than move your transmitter to a different frequency or use diplomacy to convince your neighbor to move his transmitter instead.

Fortunately, all the frequency bands used for wireless LANs are unlicensed. You can purchase a wireless LAN device and begin to use it immediately—provided you abide by the rules set up by the regulatory agency that governs RF use in your country. Usually, unlicensed transmitters must stay within an approved frequency range and transmit within an approved maximum power level. Several national regulatory agencies are discussed in the following sections.

## FCC

In the United States and several other countries in the Americas, the Federal Communications Commission (FCC; <http://www.fcc.gov>) regulates RF frequencies, channels, and transmission power. In addition to the 2.4–2.5-GHz ISM band allocated by the ITU-R, the FCC has allocated the Unlicensed National Information Infrastructure (U-NII) frequency space in the 5-GHz band for wireless LAN use. U-NII is actually four separate sub-bands, as follows:



U-NII-1 (Band 1): 5.15 to 5.25 GHz

U-NII-2 (Band 2): 5.25 to 5.35 GHz

U-NII-2 Extended (Band 3): 5.47 to 5.725 GHz

U-NII-3 (Band 4): 5.725 to 5.825 GHz (also allocated as ISM)

**Tip** As you read and work with the 5-GHz bands, be aware that you may see various forms of the band names. For example, the 5.15- to 5.25-GHz band is often referenced by names like U-NII-1, UNII-1, U-NII Low, and so on.

All transmitting equipment must be approved by the FCC before it can be sold to users. For the 2.4- and 5-GHz unlicensed bands, the FCC requires strict limits on the effective isotropic radiated power (EIRP). Recall from Chapter 1, “RF Signals and Modulation,” that the EIRP is the net power level that is being transmitted from an antenna that is connected to a transmitter.

You must be aware of the EIRP limits and make sure that your wireless LAN equipment does not exceed the limits. If the FCC has to approve wireless transmitters, it might seem logical that the maximum EIRP of the equipment would have to be approved, too. Why would you, as a wireless user, have to worry about staying within the limits? Some transmitters are sold without antennas, so you are free to buy and install your own. Without considering the EIRP limit, you might choose an antenna that has too much gain, which would raise the EIRP too high.

In an effort to prevent users from exceeding the EIRP limits, the FCC requires all removable antennas to have a unique, nonstandard connector, based on the transmitter manufacturer. The original idea was to require both transmitter and antenna to be purchased from the same manufacturer, preventing the end user from mixing and matching parts from different vendors.

Cisco uses a variant of the threaded Neill-Concelman (TNC) connector on its equipment. The reverse polarity TNC (RP-TNC) connector is identical to the TNC, but has key male and female parts reversed so that antennas with TNC connectors cannot be connected. Figure 2-1 shows the male version of the regular TNC and RP-TNC connector side by side.



**Figure 2-1** A Comparison Between TNC (left) and Cisco RP-TNC Connector (right).

In practice, you can find all sorts of antennas from a wide variety of manufacturers that all have RP-TNC connectors. In other words, you cannot depend on the FCC and the

RP-TNC connector to limit the EIRP of your wireless equipment; you have to do that yourself.

Transmitters in the 2.4-GHz band can be used indoors or outdoors. The power emitted at the transmitter must be limited to 30 dBm and the EIRP limited to 36 dBm. An antenna gain of +6 dBi is assumed. However, there is some flexibility according to the following two rules, based on the intended spread of the signal:



- **Point-to-multipoint links**—Where the transmitted signal propagates in all directions, you can make adjustments according to a 1:1 rule. For each dBm you remove from the transmitter, one dBi can be added to the antenna gain, as long as the EIRP is no greater than 36 dBm.
- **Point-to-point links**—Where the transmitted signal propagates in one general direction, you can make adjustments according to a 3:1 rule. For each dBm you remove from the transmitter, 3 dBi can be added to the antenna gain. The resulting EIRP can exceed 36 dBm, but cannot be greater than 56 dBm.

Transmitters in the 5-GHz bands must follow the FCC limits listed in Table 2-2. In each of the U-NII bands, you can make power adjustments according to the 1:1 rule. Notice that the U-NII-1 band is the only one restricted to indoor use.

**Table 2-2** *FCC Requirements in the 5-GHz U-NII Bands*

Band	Allowed Use	Transmitter Max	EIRP Max
U-NII-1	Indoor only	17 dBm (50 mW)	23 dBm
U-NII-2	Indoor or outdoor	24 dBm (250 mW)	30 dBm
U-NII-2 Extended	Indoor or outdoor	24 dBm (250 mW)	30 dBm
U-NII-3	Indoor or outdoor	30 dBm (1 W)	36 dBm

Normally, transmitters operating in any of the 2.4- and 5-GHz unlicensed bands must endure any interference caused by other transmitters. The FCC requires one exception in the U-NII-2 and U-NII-2 Extended bands: When a signal from an approved device, such as a military or weather radar, is detected on a frequency, all other transmitters must move out of the way to a different frequency. This is known as *dynamic frequency selection* (DFS).

## ETSI

In Europe and several other countries, the European Telecommunication Standards Institute (ETSI; <http://www.etsi.org>) regulates radio transmitter use. Like the FCC, the ETSI allows wireless LANs to be used in the 2.4-GHz ISM and most of the same 5-GHz U-NII bands; however, the U-NII-3 band is a licensed band and cannot be used.

Table 2-3 lists the transmitter requirements for each of the bands. The ETSI allows adjustments to the transmit power and antenna gain, as long as the maximum EIRP is not exceeded.

**Table 2-3** *ETSI Requirements in the 2.4- and 5-GHz Bands*

<b>Band</b>	<b>Allowed Use</b>	<b>EIRP Max</b>
2.4 GHz ISM	Indoor or outdoor	20 dBm
U-NII-1	Indoor only	23 dBm
U-NII-2	Indoor only	23 dBm
U-NII-2 Extended	Indoor or outdoor	30 dBm
U-NII-3	Licensed	N/A

The ETSI regulations also include DFS, which requires wireless LAN transmitters to move to a random frequency after a radar signal is detected.

## Other Regulatory Bodies

Wireless LAN equipment use is regulated outside the Americas and Europe, too. Does each country have its own set of regulations? Not necessarily; a country might have its own or it can adhere to all or parts of the regulations of a larger, more established regulatory body. Countries that use a common set of RF regulations are known as a regulatory domain.

For example, a Cisco wireless device that is compatible with the American regulatory domain can also be used in Canada, many Latin and South American countries, and in the Philippines.

Cisco manufactures wireless devices for use in at least 13 different regulatory domains. The basic wireless LAN operation is identical in all domains, but the frequency ranges, channels, and maximum transmit powers can differ.

## IEEE Standards Body

To pass data over a wireless link, many parameters have to be defined and standardized. Wireless LANs rarely involve just one transmitter and receiver; normally, many devices must contend for use of airtime on a frequency. The Institute of Electric and Electronic Engineers (IEEE; <http://ieee.org>) maintains the industry standards that are used for wireless LANs, among many others.

The IEEE is a professional organization made up of engineers from around the world. It is organized as a collection of “societies” that are focused on particular engineering areas. For example, the IEEE Computer Society develops and maintains standards on a variety of topics related to computing, including Ethernet and wireless LANs.



The IEEE 802 standards all deal with local-area networks and metropolitan-area networks (LANs and MANs, respectively). The standards mainly deal with the physical and data link layers of the OSI model, and with transporting variable-size data packets across a network media. As you explore the portion of the 802 standards that are dedicated to wireless LANs, you will find that they focus on accessing the shared RF media (physical layer or Layer 1) and on sending and receiving data frames (data link layer or Layer 2).

**Tip** What is the significance of the number 802? The Local Network Standards Committee of the IEEE Computer Society first met in February 1980, to begin work on “Project 802,” the first LAN standard. The number 802 was the next sequential project number, but also fit the odd coincidence of the date—year 80, second month.

To develop networking standards, the IEEE is organized into working groups, which have an open membership. Each working group is assigned an index number that is appended to the 802 standards family number. For example, 802.1 refers to the first working group, which developed standards for network bridging. Table 2-4 lists a few familiar 802 working groups. Notice that the eleventh working group, 802.11, is responsible for the wireless LAN standards that are used by Cisco, many other wireless vendors, and users like yourself. For the remainder of this chapter, the focus will be on 802.11.

**Table 2-4** *Example IEEE 802 Working Groups*

<b>Name</b>	<b>Description</b>
802.1	Network bridging (includes Spanning Tree Protocol)
802.2	Link-layer control
802.3	Ethernet
802.4	Token Bus
802.5	Token Ring MAC layer
...	
802.11	Wireless LANs
...	
802.15	Wireless PANs (personal-area networks such as Bluetooth, ZigBee, and so on)

As a new improvement is needed or the technology advances, a study group (SG) researches the topic to see whether an amendment to the 802.11 standard is needed. Each time a new amendment is necessary, a new task group (TG) is formed to collaborate and develop it. Task groups are assigned a suffix letter in alphabetic order. For example, as amendments are introduced, their names become 802.11a, 802.11b, 802.11c, and so on. If there are enough amendments to reach letter *z*, any subsequent amendments are

given a two-letter suffix, beginning with the letter *a* followed by letters *a* through *z*. At the time of this writing, the 802.11 working group had assigned amendments 802.11aa through 802.11aq.

Once a draft amendment is completed, it must be voted on and ratified. At that point, manufacturers can then begin to build products that operate according to all or a part of the standard. For example, when the 802.11n amendment was finalized and published, the new features of 802.11n were then added to many wireless LAN devices.

Sometimes an amendment takes a very long time to get through the development, voting, and final approval processes, so many manufacturers will decide to move ahead and implement the draft amendment into their products early. Usually a manufacturer has to decide if the draft amendment is stable enough to implement into device hardware or whether it is likely to receive drastic changes before it is ratified. This scenario occurred with the 802.11n amendment. Many manufacturers offered early implementations as “Draft N-compliant” products, which may or may not have been compatible with similar products from other manufacturers.

The 802.11 standards usually have the year they were ratified added to their names. For example, the original 802.11 standard was issued in 1997, so it is now known as 802.11-1997. Likewise, the name 802.11a-1999 means that the 802.11a amendment was ratified in 1999.

Periodically, the IEEE 802 working group chooses to revise the 802.11 standard as a whole. When this occurs, every amendment that has been ratified since the last 802.11 revision is “rolled up” and absorbed into the new updated standard. The idea is to maintain one document that defines the entire standard, as of a certain date, so that wireless developers can find all of the technical details in one place.

Even though the amendments become part of the larger standard, their names are still commonly used to reference the specific functions they introduced. Since its introduction in 1997, the 802.11 standard has been revised in 1999, 2007, and 2012. The current 802.11-2012 standard is over 2700 pages long.

## 802.11 Channel Use

Chapter 1 introduced RF frequency, bands, and channels in a generic fashion. Wireless devices built around the 802.11 standard must also have a standardized concept of the same RF parameters. As wireless devices move around, they should be able to detect and participate in wireless LANs as they become available, regardless of geographic location.

The following sections describe the 802.11 channel definitions in the 2.4- and 5-GHz bands.

### Channels in the 2.4-GHz ISM Band

In the 2.4-GHz ISM band, the frequency space is divided up into 14 channels, numbered 1 through 14. With the exception of channel 14, the channels are spaced 5 MHz apart, as listed in Table 2-5.

**Table 2-5** *IEEE 802.11 Channel Layout in the 2.4-GHz Band*

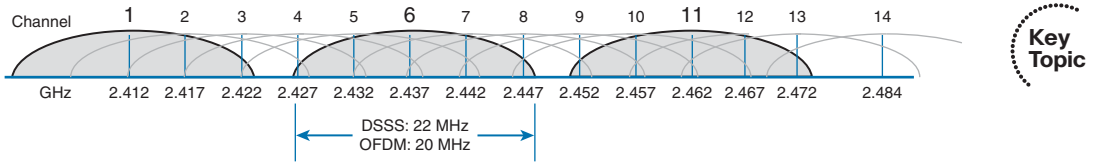
Channel	Frequency (GHz)
1	2.412
2	2.417
3	2.422
4	2.427
5	2.432
6	2.437
7	2.442
8	2.447
9	2.452
10	2.457
11	2.462
12	2.467
13	2.472
14	2.484

The 802.11 standard allows either direct-sequence spread spectrum (DSSS) or Orthogonal frequency-division multiplexing (OFDM) modulation and coding schemes to be used in the 2.4-GHz band. DSSS radios require each channel to be 22 MHz wide, and OFDM requires 20 MHz. Either way, with only 5 MHz between channels, transmissions on neighboring channels are bound to overlap and interfere with each other. (This condition is covered in Chapter 3, “RF Signals in the Real World.”)

Even though the band is made up of 14 channels, not all of them may be used in all countries. For example, the FCC limits the band to channels 1 through 11 only. The ETSI permits channels 1 through 13. Japan permits all 14 channels to be used, but channel 14 has some restrictions.

Figure 2-2 shows how 802.11 signals can overlap on neighboring 2.4-GHz channels. The only way to prevent transmitters on nearby channels from interfering with each other is to keep them on channels that are spaced farther apart. The most common arrangement is to use only channels 1, 6, and 11, which do not overlap with each other at all.

**Tip** One scheme uses channels 1, 5, 9, and 13 to gain an extra channel, but it is not commonly used. With DSSS, the channels end up overlapping, which violates the 802.11 definition for adjacent channels and also raises the noise floor. Only the OFDM 20-MHz-wide channels can avoid overlapping each other. Channel 13 presents an interesting case because it is not supported on all wireless clients in all areas of the world.



**Figure 2-2** *Channel Layout in the 2.4-GHz Band.*

Why should you be concerned about non-overlapping channels? After all, having three non-overlapping channels might seem like plenty. Problems can arise when you need to set up several wireless LAN transmitters in the same general area. You could set the first three transmitters to each use a different channel, but the fourth or fifth ones would have to reuse one of the three non-overlapping channels.

Reusing channels becomes a puzzle that you have to solve when you administer a growing wireless LAN. Chapter 7, “Planning Coverage with Wireless APs,” covers channel reuse in greater detail. Be aware that the three-channel limitation also applies to every transmitter located in an area—regardless of whether you administer them. Because the 2.4-GHz band is unlicensed, anyone is free to bring up a transmitter on any of the three non-overlapping channels without consulting you or anybody else. In fact, they might decide to set their transmitter to use any of the 14 available channels, thinking that none of them overlap.

## Channels in the 5-GHz U-NII Bands

Recall that the 5-GHz band is organized as four separate, smaller bands: U-NII-1, U-NII-2, U-NII-2 Extended, and U-NII-3. The bands are all divided into channels that are 20 MHz apart, as listed in Table 2-6.

**Table 2-6** *IEEE 802.11 Channel Layout in the 5-GHz Bands*

Band	Channel	Frequency (GHz)
U-NII-1	36	5.180
	40	5.200
	44	5.220
	48	5.240
U-NII-2	52	5.260
	56	5.380
	60	5.300
	64	5.320

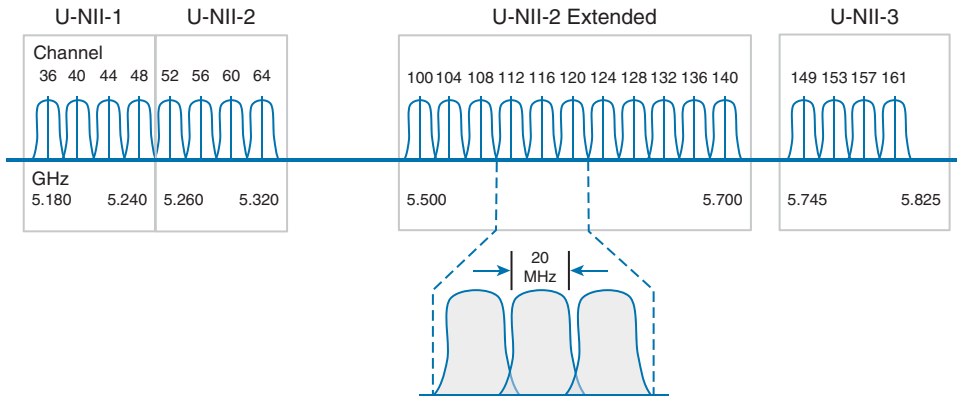
<b>Band</b>	<b>Channel</b>	<b>Frequency (GHz)</b>
U-NII-2Extended	100	5.500
	104	5.520
	108	5.540
	112	5.560
	116	5.580
	120	5.600
	124	5.620
	128	5.640
	132	5.660
	136	5.680
	140	5.700
U-NII-3	149	5.745
	153	5.765
	157	5.785
	161	5.805

The fact that the 5-GHz space is divided into four different bands might seem confusing. Even worse is the channel numbering. For instance, why is the first channel in the U-NII-1 band called channel 36 instead of channel 1? And why are neighboring channels actually four channel numbers apart?

The answers lie in the 802.11 standard itself: The entire 5-GHz frequency space is defined as a sequence of channels spaced 5 MHz apart, beginning with channel 0 at 5.000 GHz. Therefore, the first U-NII-1 channel is located at 5.180 GHz, which corresponds to channel number 36. Each U-NII channel is 20 MHz wide, so an adjacent channel is located four 5-MHz channel widths, or four channel numbers, away.

The FCC originally allocated three separate bands as U-NII-1, U-NII-2, and U-NII-3, each having four 20-MHz channels. In 2004, the FCC added the U-NII-2 Extended band, which offered 11 additional 20-MHz channels. Figure 2-3 shows the complete frequency layout of the four bands. Notice that the U-NII-1 and U-NII-2 bands are contiguous, but that the U-NII-2 Extended and U-NII-3 bands are separated by a range of frequencies that are unusable at the time of this writing but that might become available in the future.

**Tip** The U-NII-1, -2, and -3 bands each have four channels. Sometimes you may find 802.11 devices that support a fifth channel in the U-NII-3 band as channel 165.



**Figure 2-3** Channel Layout in the 5-GHz U-NII Bands.

Because the FCC allocated the U-NII bands, no global consensus controls their use. Some countries allow all four bands to be used, others allow only a few bands, and still others permit none of the bands to be used.

The 802.11 standard allows only OFDM modulation and coding schemes to be used in the U-NII bands. OFDM requires a 20-MHz channel width, which fits perfectly with the 20-MHz spacing in the U-NII bands. In other words, neighboring channels can be used in the same area without overlap or interference.

With all four U-NII bands set aside for wireless LANs, a total of 23 non-overlapping channels are available. This is quite a contrast to the three non-overlapping channels in the 2.4-GHz band. Having 23 channels at your disposal gives you much more flexibility in a crowded environment. The additional channels can also be leveraged to scale wireless LAN performance, as explained in the 802.11n and 802.11ac sections later in this chapter.

## IEEE 802.11 Standards

The 802.11 standard defines the mechanisms that devices can use to communicate wirelessly with each other. Through 802.11, RF signals, modulation, coding, bands, channels, and data rates all come together to provide a robust communication medium.

Since the original IEEE 802.11 standard was published in 1997, there have been many amendments added to it. The amendments cover almost every conceivable aspect of wireless LAN communication, including things like quality of service (QoS), security, RF measurements, wireless management, more efficient mobility, and ever-increasing throughput.

By now, most of the amendments have been rolled up into the overall 802.11 standard and no longer stand alone. Even so, the amendments may live on and be recognized in the industry by their original task group names. For example, the 802.11b amendment was approved in 1999, was rolled up into 802.11 in 2007, but is still recognized by its name today. When you shop for wireless LAN devices, you will often find the 802.11a,

b, g, and n amendments listed in the specifications.

The following sections discuss the progression of 802.11 amendments that have allowed wireless LANs to steadily increase in performance over time. The original amendment names are used to distinguish each one. At the CCNA level, you should become familiar with these amendments. As you read through the remainder of this chapter, notice how the transmission types, modulation types, and data rates presented in Chapter 1 fit into the 802.11 standard.

## 802.11-1997

The original 802.11 standard was ratified in 1997. It included the only transmission types that were available at the time: FHSS and DSSS, for use only in the 2.4-GHz band. The theoretical data rates included 1 and 2 Mbps, as listed in Table 2-7.



**Table 2-7** IEEE 802.11-1997 Data Rates

Band	Transmission Type	Modulation	Data Rate
2.4 GHz	FHSS	—	1, 2 Mbps
	DSSS	DBPSK	1 Mbps
		DQPSK	2 Mbps

## 802.11b

To increase throughput over the original 802.11-1997 standard, 802.11b was introduced in 1999. It offered data rates of 5.5 and 11 Mbps through the use of Complementary Code Keying (CCK). Because 802.11b was based on DSSS and was used in the 2.4-GHz band, it was backward compatible with the original standard. Devices could select either 1, 2, 5.5, or 11 Mbps by simply changing the modulation and coding schemes. Table 2-8 lists the new data rates introduced in 802.11b.



**Table 2-8** IEEE 802.11b Data Rates

Band	Transmission Type	Modulation	Data Rate
2.4 GHz	DSSS	CCK	5.5 Mbps
			11 Mbps

## 802.11g

With 802.11b, the DSSS maximum data rate was limited to 11 Mbps. To increase data rates further, a different transmission type was needed. The 802.11g amendment was based on OFDM and was introduced in 2003. It is commonly called Extended Rate PHY (ERP) or ERP-OFDM. Whenever you see *ERP*, think of 802.11g in the 2.4-GHz band.

Table 2-9 lists the data rates available with 802.11g.



**Table 2-9** IEEE 802.11g Data Rates

Band	Transmission Type	Modulation	Data Rate
2.4 GHz	ERP-OFDM	BPSK 1/2	6 Mbps
		BPSK 3/4	9 Mbps
		QPSK 1/2	12 Mbps
		QPSK 3/4	18 Mbps
		16-QAM 1/2	24 Mbps
		16-QAM 3/4	36 Mbps
		64-QAM 2/3	48 Mbps
		64-QAM 3/4	54 Mbps

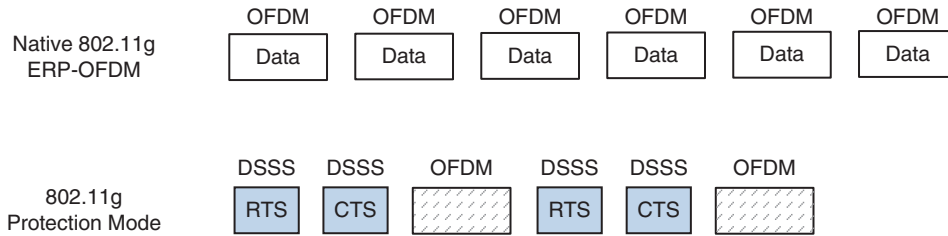
By selecting one of eight different modulation schemes, wireless devices can choose data rates of 6, 9, 12, 18, 24, 36, 48, or 54 Mbps. The higher data rates can be used when the signal strength and signal-to-noise ratio (SNR) are optimal.

Clearly, 802.11g offers far superior throughput than 802.11b. It might seem logical to simply use 802.11g and its higher data rates everywhere. Sometimes that is not possible because 802.11b-only devices are still being used on a wireless LAN. Notice that 802.11g and 802.11b use completely different transmission types—OFDM versus DSSS. This means that 802.11g and 802.11b devices cannot communicate directly because they cannot understand each other's RF signals.

Oddly enough, 802.11g was designed to be backward compatible with legacy 802.11b devices. Devices using 802.11g and OFDM are able to downgrade and understand 802.11b DSSS messages. However, the reverse is not true; 802.11b devices are limited to DSSS, so they are not able to understand any OFDM data. When two 802.11g devices are communicating with OFDM, 802.11b devices cannot understand any of the transmissions, so they might interrupt with transmissions of their own.

To allow both OFDM and DSSS devices to coexist on a wireless LAN, 802.11g offers a *protection mechanism*. The idea is to precede each 802.11g OFDM transmission with DSSS flags that 802.11b devices can understand. Figure 2-4 compares the basic sequence of events as data is transmitted in a native 802.11g OFDM network and when the 802.11g protection mechanism is enabled. When an 802.11g device is ready to transmit data in protection mode, it first sends a Request to Send (RTS) and a Clear to Send (CTS) message using DSSS (and a low data rate) that informs all 802.11b devices that an OFDM transmission will follow. Any 802.11b devices that are listening must wait a predefined time until the transmission is complete because the OFDM transmission is unintelligible.





**Figure 2-4** A Comparison of 802.11g Native and Protected Mode Transmissions.

Protection mode is enforced if an 802.11b device is detected on a wireless LAN. If the 802.11b device leaves the local network, protection mode is lifted. While the protection mechanism enables 802.11b and 802.11g devices to share the wireless medium, it also reduces throughput significantly—often by one third to one half or more. To get the most performance out of an 802.11g network, you should make sure that there are no 802.11b-only devices in use.

Be aware that 802.11g has the following limitations:

- It is used in the 2.4-GHz band, which offers only three non-overlapping channels.
- OFDM devices are limited to a maximum transmit power of 15 dBm, rather than the 20-dBm limit for DSSS.

## 802.11a

Both 802.11b and 802.11g share one problem: They live in the 2.4-GHz ISM band. Having only three non-overlapping channels can limit wireless LAN growth in an area—assuming that all 802.11 devices stay within those three channels and do not cause unnecessary interference. Even worse, the ISM band is not limited to 802.11 devices. A wide variety of transmitters—even microwave ovens—can use the 2.4-GHz band without any regard for channels at all.

With too few channels and the potential for interference, the 802.11a amendment was introduced to utilize the 5-GHz U-NII bands for wireless LANs. Only one of the four U-NII bands is designated as ISM, so the chance for non-802.11 interference is very low. In addition, many more channels are available for use.

The 802.11a amendment restricts devices to use OFDM only. The end result is a set of modulation schemes and data rates that are identical to those used for 802.11g, but with less chance for interference and more room for growth. Table 2-10 lists the data rates available with 802.11a.

**Table 2-10** IEEE 802.11a Data Rates

Band	Transmission Type	Modulation	Data Rate
5 GHz	OFDM	BPSK 1/2	6 Mbps
		BPSK 3/4	9 Mbps
		QPSK 1/2	12 Mbps
		QPSK 3/4	18 Mbps
		16-QAM 1/2	24 Mbps
		16-QAM 3/4	36 Mbps
		64-QAM 2/3	48 Mbps
		64-QAM 3/4	54 Mbps



802.11a was not designed to be backward compatible with anything else, so there is no need to support data rates below 6 Mbps or to support DSSS at all. Wireless devices can select one of the eight modulation schemes to support data rates of 6, 9, 12, 18, 24, 36, 48, or 54 Mbps.

802.11a is based on OFDM channels that are 20 MHz wide. Even though the U-NII bands have channels that are spaced 20 MHz apart (a perfect fit), signals on adjacent channels might still have a small amount of overlap. Therefore, 802.11a recommends that transmitters in the same geographic space stay separated by one channel. In other words, one transmitter might use channel 36, but another should use channel 44 rather than the adjacent channel 40.

**Tip** If the 802.11 amendment letters come in chronological order, how could the higher-performance 802.11a come before the lower-performance 802.11b? Actually, interference on the 2.4-GHz ISM band was so prevalent that a move to the 5-GHz bands was proposed right away. The 802.11a amendment was introduced in 1999—earlier in the same year as 802.11b. OFDM did come to the 2.4-GHz band, too, with 802.11g in 2003, mainly because migrating to 802.11a and 5 GHz required an investment in new hardware.

## 802.11n

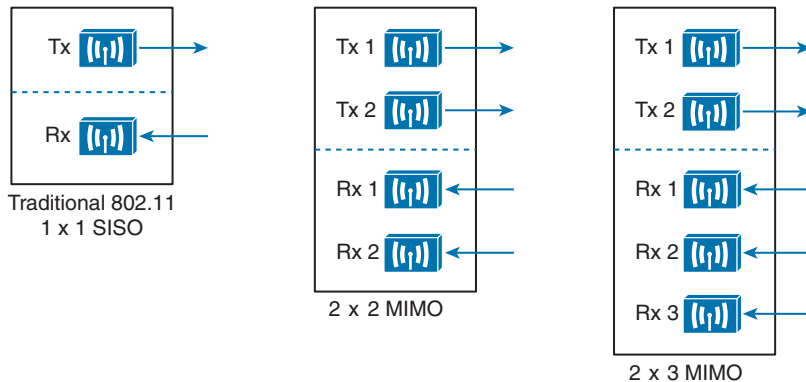
Under the best conditions, both 802.11g and 802.11a are capable of offering a 54-Mbps data rate. Each amendment was introduced in the days when wired Ethernet devices used 10- or 100-Mbps connections. As the speed of Ethernet connections has progressed, 802.11 amendments have been introduced to keep in step.

The 802.11n amendment was published in 2009 in an effort to scale wireless LAN performance to a theoretical maximum of 600 Mbps. The amendment defines a number

of techniques known as *high throughput* (HT) that can be applied to either the 2.4- or 5-GHz band. 802.11n was designed to be backward compatible with 802.11b, 802.11g, and 802.11a.

Before 802.11n, wireless devices used a single transmitter and a single receiver. In other words, the components formed one radio, resulting in a single *radio chain*. This is also known as a single-in, single-out (SISO) system. The secret to 802.11n's better performance is its use of multiple radio components, forming multiple radio chains. For example, an 802.11n device can have multiple antennas, multiple transmitters, and multiple receivers at its disposal. This is known as a multiple-input, multiple-output (MIMO) system.

802.11n devices are characterized according to the number of radio chains available. This is described in the form  $T \times R$ , where  $T$  is the number of transmitters and  $R$  is the number of receivers. A  $2 \times 2$  MIMO device has two transmitters and two receivers, and a  $2 \times 3$  device has two transmitters and three receivers. The 802.11n amendment requires at least two radio chains ( $2 \times 2$ ), up to a maximum of four ( $4 \times 4$ ). Figure 2-5 compares the traditional  $1 \times 1$  SISO device with  $2 \times 2$  and  $2 \times 3$  MIMO devices.



**Figure 2-5** Example SISO and MIMO Devices.

The multiple radio chains can be leveraged in a variety of ways. In fact, 802.11n has a rich set of features that can make many aspects of wireless communication more efficient. You should be familiar with the following features that improve throughput:

- Channel aggregation
- Spatial multiplexing (SM)
- MAC layer efficiency

You should also become familiar with the following features that improve the reliability of the 802.11n RF signals:

- Transmit beam forming (TxBF)
- Maximal-ratio combining (MRC)

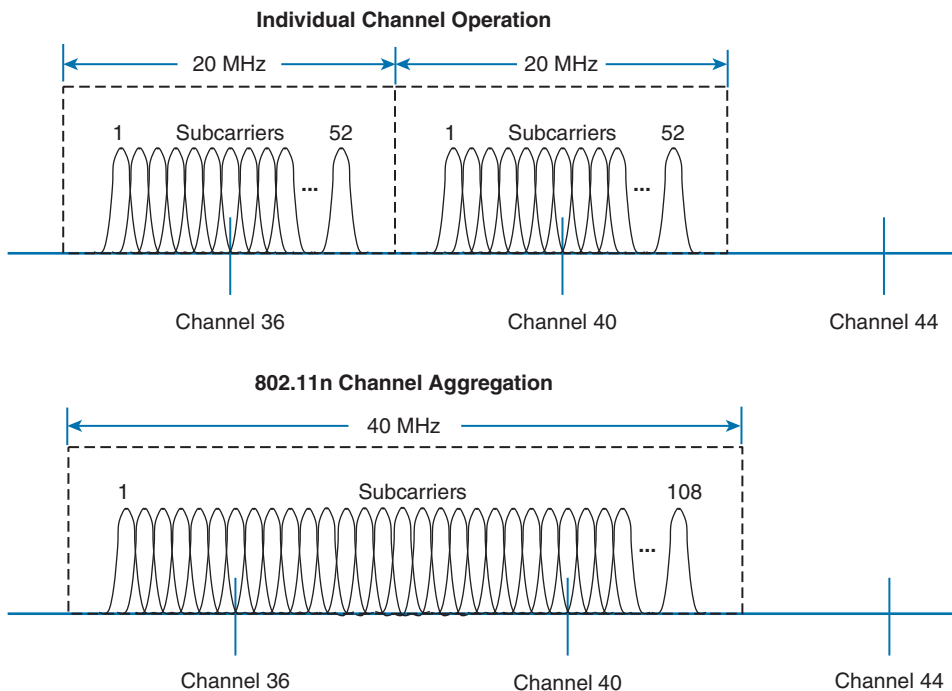
Each of these features is described in the sections that follow.

## Channel Aggregation

Normally, an 802.11a or 802.11g wireless LAN device has one transmitter and one receiver that operate on one 20-MHz channel only. The transmitter and receiver can be configured or tuned to operate on different channels in a band, but only one channel at a time. Each 20-MHz OFDM channel has 48 subcarriers to carry data in parallel.

The 802.11n amendment increased the 20-MHz channel throughput by increasing the number of data subcarriers to 52. In addition, it introduced radios that could operate on either a single 20-MHz channel or a single 40-MHz channel. By doubling the channel width to 40 MHz, the throughput is also doubled.

Aggregated channels must always bond two adjacent 20-MHz channels. Figure 2-6 shows a comparison between two 20-MHz channels and one 40-MHz channel, formed from channels 36 and 40 in the 5-GHz band. Notice that the 20-MHz channels have a quiet space below and above, providing some separation between channels. When two 20-MHz channels are aggregated or bonded, the quiet space below and above remain, separating 40-MHz channels from each other. However, the quiet space that used to sit between the two 20-MHz channels can be used for additional subcarriers in the 40-MHz channel, for a total of 108. As more subcarriers are utilized, more data can be carried over time.



Key  
Topic

**Figure 2-6** Comparing 20-MHz Channels to a 802.11n 40-MHz Channel.

When channels are aggregated, the total number of available channels in a band decreases. For example, the 5-GHz band is made up of 23 non-overlapping 20-MHz channels. If

aggregated 40-MHz channels are used instead, only 11 non-overlapping channels would be possible. That still gives plenty of channels to work with.

Now consider the 2.4-GHz band, which has only three non-overlapping channels. It just is not practical to try to aggregate any of them into 40-MHz channels. Therefore channel aggregation is not recommended and not normally attempted on any 2.4-GHz channels.

## Spatial Multiplexing

Channel aggregation can double the throughput by doubling the channel width—all with a single radio chain. An 802.11n device can have multiple radio chains waiting to be used. To increase data throughput even more, data can be multiplexed or distributed across two or more radio chains—all operating on the same channel, but separated through spatial diversity. This is known as *spatial multiplexing*.

How can several radios transmit on the same channel without interfering with each other? The key is to try to keep each signal isolated or easily distinguished from the others. Each radio chain has its own antenna; if each antenna is spaced some distance apart, the signals arriving at the receiver's antennas (also appropriately spaced) will likely be out of phase with each other or at different amplitudes. This is especially true if the signals bounce off some objects along the way, making each antenna's signal travel over a slightly different path to reach the receiver.

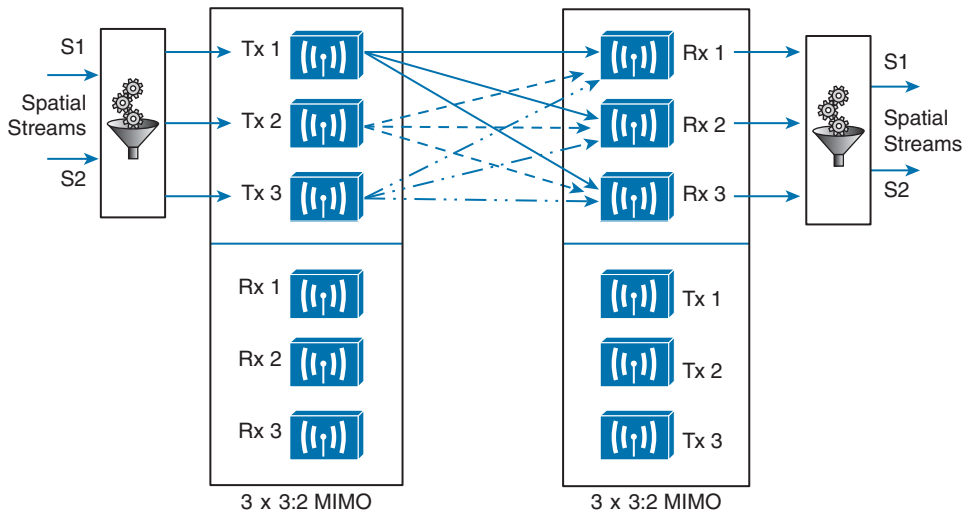
In addition, data can be distributed across the transmitter's radio chains in a known fashion. In fact, several independent streams of data can be processed as *spatial streams* that are multiplexed over the radio chains. The receiver must be able to interpret the arriving signals and rebuild the original data streams by reversing the transmitter's multiplexing function.

Spatial multiplexing requires a good deal of digital signal processing on both the transmitting and receiving end. This pays off by increasing the throughput over the channel—the more spatial streams that are available, the more data that can be sent over the channel.

The number of spatial streams that a device can support is usually designated by adding a colon and a number to the MIMO radio specification. For example, a 3×3:2 MIMO device would have three transmitters, three receivers, and would support two unique spatial streams. Figure 2-7 shows spatial multiplexing between two 3×3:2 MIMO devices. A 3×3:3 device would be similar, but would support three spatial streams.



**Tip** Notice that a MIMO device can support a different number of unique spatial streams than it has transmitters or receivers. It might seem logical that each spatial stream is assigned to a transmitter/receiver, but that is not true. Spatial streams are processed so that they are distributed across multiple radio chains. The number of possible spatial streams depends on the processing capacity of the 802.11n device—not on the number of its radios.



**Figure 2-7** Spatial Multiplexing Between Two 3x3:2 MIMO Devices.

802.11n devices come with a variety of MIMO capabilities. Ideally, two devices should support an identical number of spatial streams to multiplex and demultiplex the data streams correctly. That is not always possible or even likely because more spatial streams usually translates to a greater cost. What happens when two devices have mismatched spatial stream support? They negotiate the wireless connection by informing each other of their capabilities. Then they can use the lowest number of spatial streams that they have in common, but a transmitting device can leverage an additional spatial stream to repeat some information for increased redundancy.

### MAC Layer Efficiency

Even without multiple radio chains, 802.11n offers some important methods to make data communication more efficient. Two of the methods are as follows:

- **Block acknowledgment**—Normally, 802.11 requires that each frame of data transmitted must be acknowledged by the recipient. If a frame goes unacknowledged, the transmitter can assume that the frame was lost and needs to be resent. The overhead of having acknowledgment messages interleaved with every transmitted frame is inefficient; it uses up airtime on the shared media.

With 802.11n, data frames can be transmitted in one burst. Only one acknowledgment is expected from the recipient after the burst is complete. More airtime can be spent sending data, increasing the overall throughput.

- **Guard interval**—As OFDM symbols are transmitted, they can take different paths to reach the receiver. If two symbols somehow arrive too close together, they can interfere with each other and corrupt the received data. This is known as *intersymbol interference* (ISI). The 802.11 standard requires a *guard interval* (GI), a period of 800 nanoseconds, between each OFDM symbol that is transmitted to protect against ISI.

As an option, you can configure 802.11n devices to use a much shorter 400-nanosecond guard interval. This allows OFDM symbols to be transmitted more often, increasing throughput by about 10 percent, at the expense of making data corruption more likely.

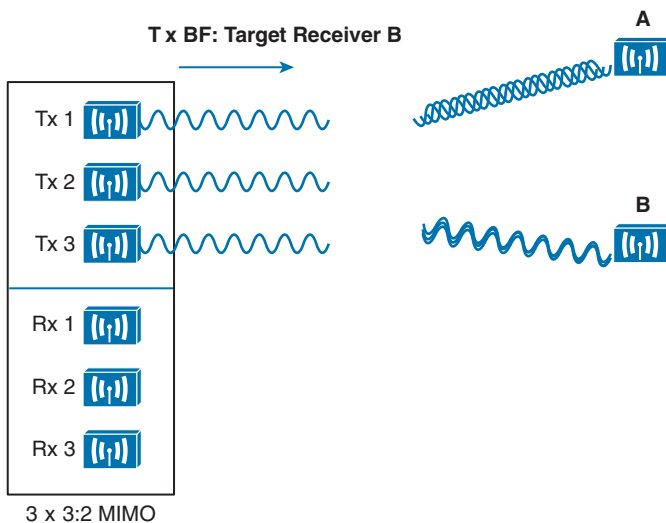
### Transmit Beam Forming (TxBF)

When a transmitter with a single radio chain sends an RF signal, any receivers that are present have an equal opportunity to receive and interpret the signal. In other words, the transmitter does nothing to prefer one receiver over another; each is at the mercy of its environment and surrounding conditions to receive at a decent SNR.

The 802.11n amendment offers a method to customize the transmitted signal to prefer one receiver over others. By leveraging MIMO, the same signal can be transmitted over multiple antennas to reach specific client locations more efficiently.

Usually multiple signals travel over slightly different paths to reach a receiver, so they can arrive delayed and out of phase with each other. This is normally destructive, resulting in a lower SNR and a corrupted signal. With *transmit beamforming* (TxBF), the phase of the signal is altered as it is fed into each transmitting antenna so that the resulting signals will all arrive in phase at a specific receiver. This has a constructive effect, improving the signal quality and SNR.

Figure 2-8 shows an 802.11n device using transmit beamforming to target device B. The phase of each copy of the transmitted signal is adjusted so that all three signals arrive at device B more or less in phase with each other. The same three signal copies also arrive at device A, which is not targeted by TxBF. As a result, the signals arrive as is and are out of phase.



**Figure 2-8** Using Transmit Beamforming to Target a Specific Receiving Device.

The location and RF conditions can be unique for each receiver in an area. Therefore, transmit beamforming can use explicit feedback from an 802.11n device at the far end, enabling the transmitter to make the appropriate adjustments to the transmitted signal phase. As TxBF information is collected about each far end device, a transmitter can keep a table of the devices and phase adjustments so that it can send focused transmissions to each one dynamically. Although the feedback process sounds straightforward, it is complex to implement. To date, no vendor has implemented a feedback mechanism that makes TxBF practical and usable.

Cisco also offers ClientLink, which performs a similar transmit beamforming function; however, ClientLink does not require explicit feedback from an 802.11n device at all. Based on data that is received from a far end device, the phase values can be calculated and performed on data transmissions that are returned to it. In this case, the far end device can be 802.11n or legacy 802.11a/b/g.

### Maximal-Ratio Combining

When an RF signal is received on a device, it may look very little like the original transmitted signal. The signal may be degraded or distorted due to a variety of conditions. If that same signal can be transmitted over multiple antennas, as in the case of a MIMO device, then 802.11n can attempt to restore it to its original state.

An 802.11n device can use multiple antennas and radio chains to receive the multiple transmitted copies of the signal. One copy might be better than the others, or one copy might be better for a time, and then become worse than the others. In any event, 802.11n offers *maximal-ratio combining* (MRC), a feature that can combine the copies to produce one signal that represents the best version at any given time. The end result is a reconstructed signal with an improved SNR and receiver sensitivity.

### 802.11n Modulation and Coding Schemes

Recall that 802.11g and 802.11a are both based on OFDM and can use binary phase shift keying (BPSK), quadrature phase shift keying (QPSK), 16-QAM (quadrature amplitude modulation), and 64-QAM modulation schemes. Depending on conditions affecting the RF signal, wireless devices can choose one of the eight possible modulation and coding schemes. The 802.11n amendment is backward compatible with 802.11a and 802.11g, so it supports the same eight schemes. However, as the schemes are applied to an increasing number of spatial streams, the number of combinations multiplies.

802.11n supports a total of 32 possible schemes (8 per spatial stream)—so many that they are known by a modulation coding scheme (MCS) index number. Beyond that, channel aggregation and guard interval selection add even more variables to the mix. In all, 802.11n has 128 possible data rates. For your reference, Appendix B lists all of the MCS and data rates.



## Beyond 802.11n

The many features and high throughput of 802.11n might make it seem like the end-all wireless LAN technology. As with most any aspect of computing, the current state of the art is never good enough. Two 802.11 draft amendments are being developed that will take wireless performance to much greater heights. These amendments are not covered on the CCNA Wireless exam (yet), but are introduced here so that you can get a feel for the continuing evolution of 802.11 capabilities.

The 802.11ac amendment takes the best of 802.11n and offers a new generation that is much faster and more scalable. The goal is to bring wireless on a par with Gigabit Ethernet. Some of the most notable improvements are as follows:

- **Better channel aggregation**—40-MHz bonded channels can be bonded again into channels that are 80 or 160 MHz wide.
- **More dense modulation**—256-QAM will be used to modulate the RF signal in 256 different ways, taking more data at one time and boosting throughput. The 802.11n modulation schemes (BPSK, QPSK, 16-QAM, and 64-QAM) will still be supported.
- **Scalable MIMO**—Up to eight spatial streams will be used.
- **Multi-user MIMO (MU-MIMO)**—An 802.11ac device will be able to send multiple frames to multiple receiving devices simultaneously.

Because of the extensive use of channels, 802.11ac will be used only in the 5-GHz band. Devices using 2.4 GHz will have to continue using 802.11n instead. With 802.11ac, devices should have a selection of 40 modulation coding schemes, based on the number of spatial streams. When channel aggregation and guard interval variables are figured in, there should be a total of 320 possible data rates.

802.11ac hardware is expected to develop somewhat slowly, in phases or waves. Products in the first wave will be able to reach a throughput of 1 to 2.4 Gbps. When the second wave of product development peaks, those devices could reach a theoretical maximum throughput of 6.93 Gbps.

In 2009, the Wireless Gigabit Alliance (WiGig) introduced a wireless specification that would offer throughput of up to 7 Gbps over the unlicensed 60-GHz frequency space. That specification became the 802.11ad amendment.

802.11ad is designed for very high throughput at shorter distances, making it a good fit for wireless offices. Devices will be able to communicate directly with each other, with support for interfaces like HDMI, DisplayPort, USB, and PCIe.

The 802.11ad amendment is meant to be backward compatible with 802.11 (including 802.11a, b, g, n, and ac), but will require new hardware because it operates in a completely different frequency band.

## Wi-Fi Alliance

All wireless LAN products must adhere to the IEEE 802.11 set of standards to be compatible with each other. Even though the 802.11 standards are very thorough and lengthy, it is still possible for one manufacturer to build a product based on one interpretation of a standard feature, while another manufacturer works with a different interpretation. This is especially true when products are developed while an 802.11 amendment is still in draft form. In addition, manufacturers are not obligated to implement every function described in a standard; they may pick and choose certain parts or implement the entire standard, and may even add in some proprietary features.

The Wi-Fi Alliance (<http://wi-fi.org>) is a nonprofit industry association made up of wireless manufacturers around the world, all devoted to promoting wireless use. To address the problem of incompatible wireless products, the Wi-Fi Alliance introduced the Wi-Fi CERTIFIED program in 2000. Wireless products are tested in authorized testing labs against stringent criteria that represent correct implementation of a standard. If a product passes the tests, then it is certified and receives a Wi-Fi CERTIFIED stamp of approval, using the logo shown in Figure 2-9.



**Figure 2-9** *Wi-Fi Alliance Certification Logo.*

For example, a Wi-Fi CERTIFIED 802.11n product must correctly implement the following features, among many others:

- At least two spatial streams
- Block acknowledgment
- 2.4- and 5-GHz operation
- Channel aggregation

**Tip** Remember that the IEEE develops and maintains the 802.11 set of standards and the Wi-Fi Alliance tests and certifies product interoperability according to the standards.

## Exam Preparation Tasks

As mentioned in the section, “How to Use This Book,” in the Introduction, you have a couple of choices for exam preparation: the exercises here, Chapter 22, “Final Review,” and the exam simulation questions on the CD-ROM.

## Review All Key Topics

Review the most important topics in this chapter, noted with the Key Topic icon in the outer margin of the page. Table 2-11 lists a reference of these key topics and the page numbers on which each is found.



**Table 2-11** *Key Topics for Chapter 2*

Key Topic Element	Description	Page Number
List	ISM band allocation	42
List	U-NII band allocation	42
List, Table 2-2	2.4-GHz and 5-GHz EIRP rules	44
Figure 2-2	Channel layout in the 2.4-GHz band	49
Table 2-7	802.11-1997 data rates	52
Table 2-8	802.11b data rates	52
Table 2-9	802.11g data rates	53
Table 2-10	802.11a data rates	55
Figure 2-6	802.11n channel aggregation	57
Paragraph	802.11n spatial stream notation	58

## Define Key Terms

Define the following key terms from this chapter and check your answers in the glossary:

block acknowledgment, channel aggregations, guard interval (GI), high throughput (HT), intersymbol interference (ISI), maximal-ratio combining (MRC), protection mechanism, spatial multiplexing, spatial stream, transmit beamforming (TxBF)

*This page intentionally left blank*



---

This chapter covers the following topics:

- **Interference**—This section describes several types of external interference that can adversely affect a wireless signal.
- **Free Space Path Loss**—This section explains why a radio frequency signal degrades as it travels through free space.
- **Effects of Physical Objects**—This section explores what happens when an RF signal meets various physical objects, resulting in effects such as reflection, absorption, refraction, and diffraction.

This chapter covers the following exam topics:

- Describe Wireless LAN (WLAN) RF principles (antenna types, RF gain/loss, Effective Isotropic Radiated Power (EIRP), refraction, reflection, and so on)

# RF Signals in the Real World

Radio frequency (RF) signals travel through the air as electromagnetic waves. In an ideal setting, a signal would arrive at the receiver exactly as the transmitter sent it. In the real world, this is not always the case. Many things affect RF signals as they travel from a transmitter to a receiver. This chapter explores many of the conditions that can affect wireless signal propagation.

## “Do I Know This Already?” Quiz

The “Do I Know This Already?” quiz allows you to assess whether you should read this entire chapter thoroughly or jump to the “Exam Preparation Tasks” section. If you are in doubt about your answers to these questions or your own assessment of your knowledge of the topics, read the entire chapter. Table 3-1 lists the major headings in this chapter and their corresponding “Do I Know This Already?” quiz questions. You can find the answers in Appendix A, “Answers to the ‘Do I Know This Already?’ Quizzes.”

**Table 3-1** “Do I Know This Already?” Section-to-Question Mapping

Foundation Topics Section	Questions
Interference	1–4
Free Space Path Loss	5–7
Effects of Physical Objects	8–10

**Caution** The goal of self-assessment is to gauge your mastery of the topics in this chapter. If you do not know the answer to a question or are only partially sure of the answer, you should mark that question as wrong for purposes of the self-assessment. Giving yourself credit for an answer you correctly guess skews your self-assessment results and might provide you with a false sense of security.

1. An 802.11 transmitter is configured to send a signal on channel 11. Someone reports a problem receiving the signal, so you investigate and find a second transmitter broadcasting on channel 11. Which one of the following best describes the problem?
  - a. Path interference
  - b. Adjacent channel interference
  - c. Co-channel interference
  - d. Cross-channel interference
2. Suppose that you place a new 802.11 transmitter in a building, but notice that there are other signals already coming from transmitters in the same general area. To avoid interference problems, how much greater should your transmitter's signal be above all of the others?
  - a. 0 dBm
  - b. +3 dBm
  - c. +5 dBm
  - d. +10 dBm
  - e. +20 dBm
3. An existing transmitter in your office sends its signal on 2.4-GHz channel 1. Suppose that someone in a neighboring office sets up a new wireless router. He notices your signal on channel 1, so he chooses channel 2 instead. Which one of the following might adversely affect the wireless operation?
  - a. Co-channel interference
  - b. Neighboring channel interference
  - c. Wideband interference
  - d. Excessive SNR
4. Which one of the following is the best strategy for avoiding interference between neighboring channels in the 2.4-GHz band?
  - a. Use any channel number that seems to be available
  - b. Leverage 802.11n for 40-MHz aggregated channels
  - c. Use only channels that are spaced four numbers apart, beginning with channel 1
  - d. Use only channels that are spaced five numbers apart, beginning with channel 1
5. Which one of the following is the primary cause of free space path loss?
  - a. Spreading
  - b. Absorption

- c. Humidity levels
  - d. Magnetic field decay
6. Which one of the following has the shortest effective range in free space, assuming that the same transmit power level is used for each?
- a. An 802.11g device
  - b. An 802.11a device
  - c. An 802.11b device
  - d. None of these answers
7. Suppose that an 802.11a device moves away from a transmitter. As the signal strength decreases, which one of the following might the device or the transmitter change to improve the signal quality along the way?
- a. Aggregate more channels
  - b. Use more radio chains
  - c. Switch to a more complex modulation scheme
  - d. Switch to a less-complex modulation scheme
8. When RF signals are reflected by objects in a building, which one of the following best describes the result that might be experienced at a receiver?
- a. Fresnel loss
  - b. Multipath
  - c. Cross-channel fading
  - d. Free space path loss
9. Which one of the following best describes the effect that a building material has as an RF signal passes through a wall?
- a. Reflection
  - b. Refraction
  - c. Diffraction
  - d. Absorption
  - e. Multipath
10. Which one of the following best describes the purpose of the first Fresnel zone?
- a. The area covered by one transmitter on a channel
  - b. The area around a signal path that should be kept clear of any obstructions
  - c. The area around a signal path that is blocked by the earth's curvature
  - d. The area around a transmitter that represents the range of a signal



---

## Foundation Topics

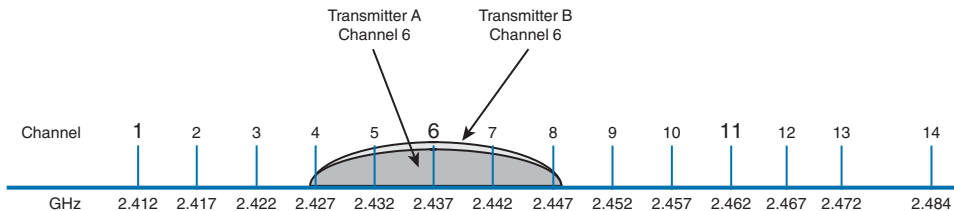
---

### Interference

The idea behind WLAN modulation is to pack as much data as possible into the wireless signal, and to minimize the amount of data that might be lost due to interference or noise. When data is lost, it must be retransmitted, using more of the wireless resources. Therefore, it is always best if a transmitter is configured to use a channel that is open and is clear from any other transmitter.

### Co-Channel Interference

Whenever one transmitter's signal overlaps another on a frequency or channel, the signals interfere with each other. Interference can be described by the way the signals overlap. For example, *co-channel interference* occurs when two or more transmitters use the same channel. In Figure 3-1, Transmitters A and B are both transmitting an RF signal on channel 6 in the 2.4-GHz band.



**Figure 3-1** *Co-Channel Interference.*

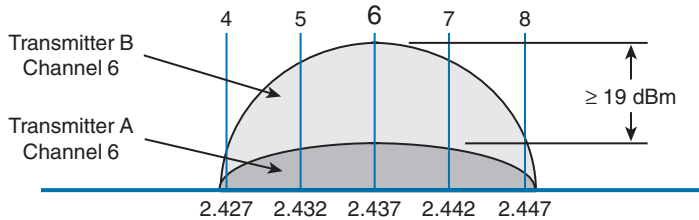
Because the two 802.11 transmitters are using the same channel, their signals completely overlap and the whole 22-MHz channel bandwidth is affected. This might not be a problem if the transmitters are not sending data at the same time. After all, wireless LAN devices must contend for use of the airtime; if nobody is transmitting at a given time, someone may use the channel.

When both transmitters are busy sending data, the channel can become very congested. The two signals begin to interfere and cause data corruption, which causes devices to retransmit lost data, which uses more airtime, and so on.

In the real world, co-channel interference is often a necessary evil. The 2.4-GHz band offers only three non-overlapping channels. If you have many transmitters in a building or area, you are bound to have some of them transmitting on the same channel as others. The best solution is to use careful planning when you select the channel for each transmitter. For instance, two nearby transmitters should never be placed on the same channel because their strong signals would be more likely to interfere.

Instead, a transmitter should only share a channel with other distant transmitters whose received signals are much weaker. A best practice is to place a transmitter on a channel

only if its signal will be at least 19 dBm above any other received signal, as shown in Figure 3-2. Having at least 19 dBm separation helps maintain a healthy SNR in the area surrounding the transmitter. Channel assignment is covered in more detail in Chapter 7, “Planning Coverage with Wireless APs.”

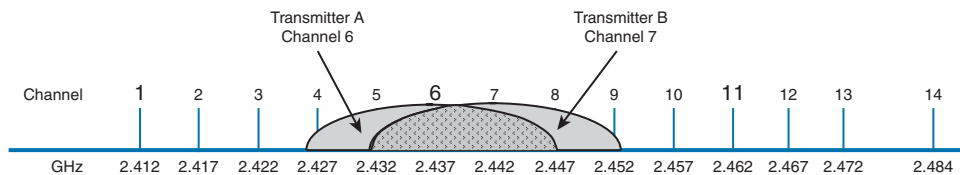


**Figure 3-2** Maintaining Signal Separation to Minimize Co-Channel Interference.

## Neighboring Channel Interference

Suppose that two transmitters are placed on two different channels. However, the channels are spaced too closely together such that they overlap each other. Perhaps someone decided to use neighboring channels, rather than reuse the same channel, to avoid co-channel interference. More likely, two different people have transmitters located in the same general area and decided to use slightly different channel numbers—not realizing that neighboring channels in the 2.4-GHz band overlap.

The end result is *interference on both channels* because a portion of one signal overlaps a portion of another signal. In Figure 3-3, transmitter A is using channel 6, while transmitter B is using channel 7. The two signals do not completely overlap, but the interference between them is enough to be detrimental to both.



**Figure 3-3** Adjacent Channel Interference.

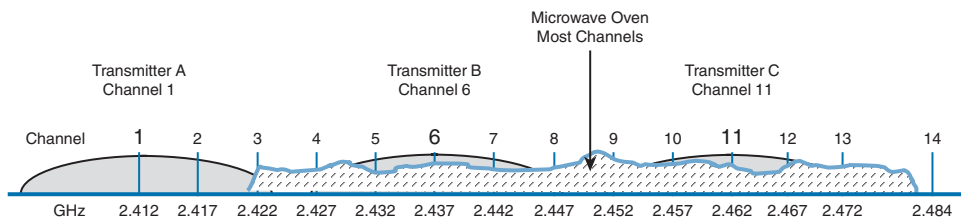
**Tip** Do you think of neighboring channels as having adjacent channel numbers? You are not alone; after all, channel numbers 1 and 2 are adjacent. Interference between neighboring channels is commonly called *adjacent channel interference*. Technically, this term is incorrect and is often misused. The 802.11 standard defines adjacent channels as non-overlapping channels. Therefore, by definition, it is impossible for adjacent channels to overlap and interfere. Be aware that the CCNA Wireless exam strictly uses the terminology found in the 802.11 standard. *Adjacent* channels cannot overlap, but *neighboring* channels can.

To remedy the situation, all transmitters in an area should be configured to use the three non-overlapping 2.4-GHz channels: 1, 6, and 11. In the 5-GHz band, adjacent channel interference is not a problem because the channels do not significantly overlap; the channels are 20 MHz wide, whereas the orthogonal frequency-division multiplexing (OFDM) signals have a bandwidth of 20 MHz. As a best practice, you should still avoid placing neighboring APs on neighboring 5 GHz channels, just to avoid the possibility of raising the noise floor.

## Non-802.11 Interference

Recall that the 2.4-GHz band is an ISM band. This means that your 802.11 wireless LAN devices might share the same frequency space as non-802.11 devices. That might not sound like a bad situation because the devices could simply be configured to use different, non-overlapping channels.

In practice, such an elegant solution might not be possible. Many non-802.11 devices do not sit on any one channel; they use frequency-hopping spread spectrum (FHSS) to hop around on a variety of channels at any given time. Even worse, some devices do not adhere to any channel scheme at all. Figure 3-4 shows transmitters A, B, and C using channels 1, 6, and 11—a perfect world—until someone decides to warm up her lunch. A nearby microwave oven also uses RF energy in the 2.4-GHz ISM band to radiate the food. Because it is poorly shielded, the RF energy escapes and interferes with most of the 802.11b/g channels. The microwave’s transmission is also constant, rendering the wireless LAN channels mostly useless.



**Figure 3-4** *Non-802.11 Interference From a Microwave Oven.*

To mitigate interference from non-802.11 devices, you have to eliminate the source. Leaky microwave ovens should be replaced with better models that have proper RF shielding. Devices like 2.4-GHz FHSS cordless phones or wireless video cameras should be replaced with models that operate in a non-802.11 band.

## Free Space Path Loss

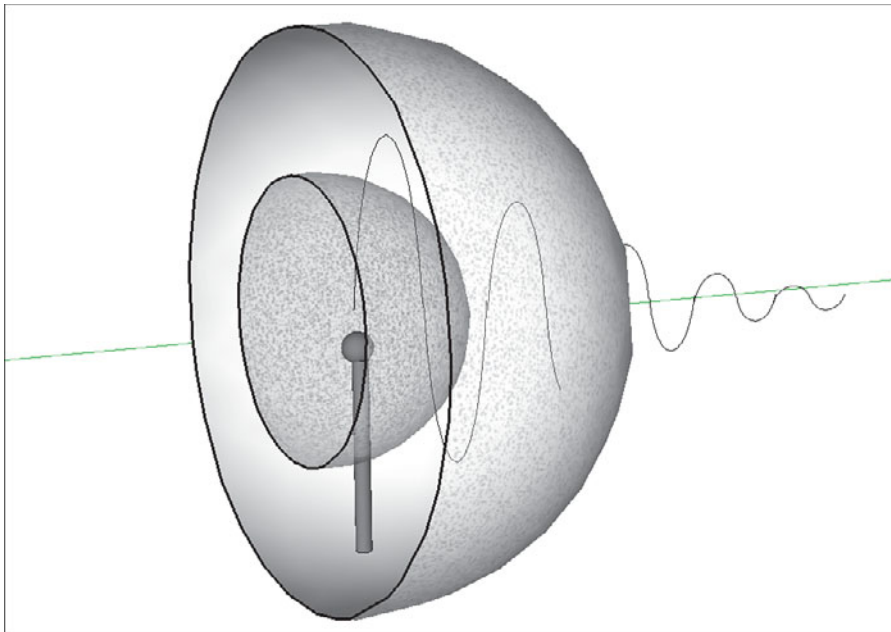
Whenever an RF signal is transmitted from an antenna, its amplitude decreases as it travels through free space. Even if there are no obstacles in the path between the transmitter and receiver, the signal strength will weaken. This is known as *free space path loss*.

What is it about free space that causes an RF signal to be degraded? Is it the air or maybe the earth’s magnetic field? No, even signals sent to and from spacecraft in the

vacuum of outer space are degraded.

Recall that an RF signal propagates through free space as a wave, not as a ray or straight line. The wave has a three-dimensional curved shape that expands as it travels. It is this expansion or spreading that causes the signal strength to weaken.

Figure 3-5 shows a cutaway view of the free space loss principle. Suppose the antenna is a tiny point, such that the transmitted RF energy travels in every direction. The wave that is produced would take the form of a sphere; as the wave travels outward, the sphere increases in size. Therefore, the same amount of energy coming out of the tiny point is soon spread over an ever expanding sphere in free space. The concentration of that energy gets weaker as the distance from the antenna increases.



**Figure 3-5** *Free Space Loss Due to Wave Spreading.*

Even if you could devise an antenna that could focus the transmitted energy into a tight beam, the energy would still travel as a wave and would spread out over a distance. Regardless of the antenna used, the amount of signal strength loss is consistent.

The free space path loss in dB can be calculated according to the following equation:

$$\text{FSPL (dB)} = 20\log_{10}(d) + 20\log_{10}(f) + 32.44$$

where  $d$  is the distance from the transmitter in kilometers and  $f$  is the frequency in megahertz. Do not worry, though: you will not have to know this equation for the CCNA Wireless exam. It is presented here to show two interesting facts:

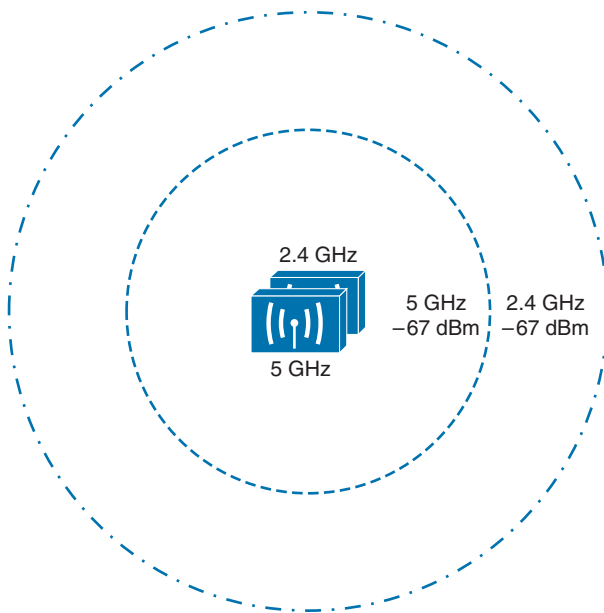
- Free space path loss is an exponential function; the signal strength falls off quickly near the transmitter, but more slowly farther away.

- The loss is a function of distance and frequency only.

With the formula, you can calculate the free space path loss for any given scenario, but you will not have to for the exam. Just be aware that the free space path loss is always an important component of the link budget, along with antenna gain and cable loss.

You should also be aware that the free space path loss is greater in the 5-GHz band than it is in the 2.4-GHz band. In the equation, as the frequency increases, so does the loss in dB. This means that 802.11b/g/n devices (2.4 GHz) have a greater effective range than 802.11a/n (5 GHz) devices, assuming an equal transmitted signal strength. Figure 3-6 shows the range difference, where both transmitters have an effective isotropic radiated power (EIRP) of 14 dBm and the effective range ends where a receiver's received signal strength indicator (RSSI) equals  $-67$  dBm.

Key  
Topic



**Figure 3-6** *The Effective Range of 2.4-GHz and 5-GHz Transmitters.*

**Tip** To get a feel for the actual range difference between 2.4 and 5 GHz, a receiver was carried away from the two transmitters until the RSSI reached  $-67$  dBm. On a 2.4-GHz channel, the range was measured to be 140 feet, whereas at 5 GHz it was reduced to 80 feet.

## Mitigating the Effects of Free Space Path Loss

One simple solution to overcome free space path loss is to increase the transmitter's output power. Increasing the antenna gain can also boost the EIRP. Having a greater signal

strength before the free space loss occurs translates to a greater RSSI value at a distant receiver after the loss. This approach might work fine for an isolated transmitter, but can cause interference problems when several transmitters are located in an area.

A more robust solution is to just cope with the effects of free space path loss. Wireless devices are usually mobile and can move closer to or farther away from a transmitter at will. As a receiver gets closer to a transmitter, the RSSI increases. This, in turn, translates to an increased signal-to-noise ratio (SNR). Recall from Chapter 1, “RF Signals and Modulation,” that more complex modulation and coding schemes can be used to transport more data when the SNR is high. As a receiver gets farther away from a transmitter, the RSSI (and SNR) decreases. More basic modulation and coding schemes are needed there because of the increase in noise and the need to repeat more data.

802.11 devices have a clever way to adjust their modulation and coding schemes based on the current RSSI and SNR conditions. If the conditions are favorable for good signal quality and higher data rates, a complex modulation and coding scheme is used. As the conditions deteriorate, less-complex schemes can be selected, resulting in a greater range but lower data rates. The scheme selection is commonly known as *dynamic rate shifting* (DRS). As its name implies, it can be performed dynamically with no manual intervention.

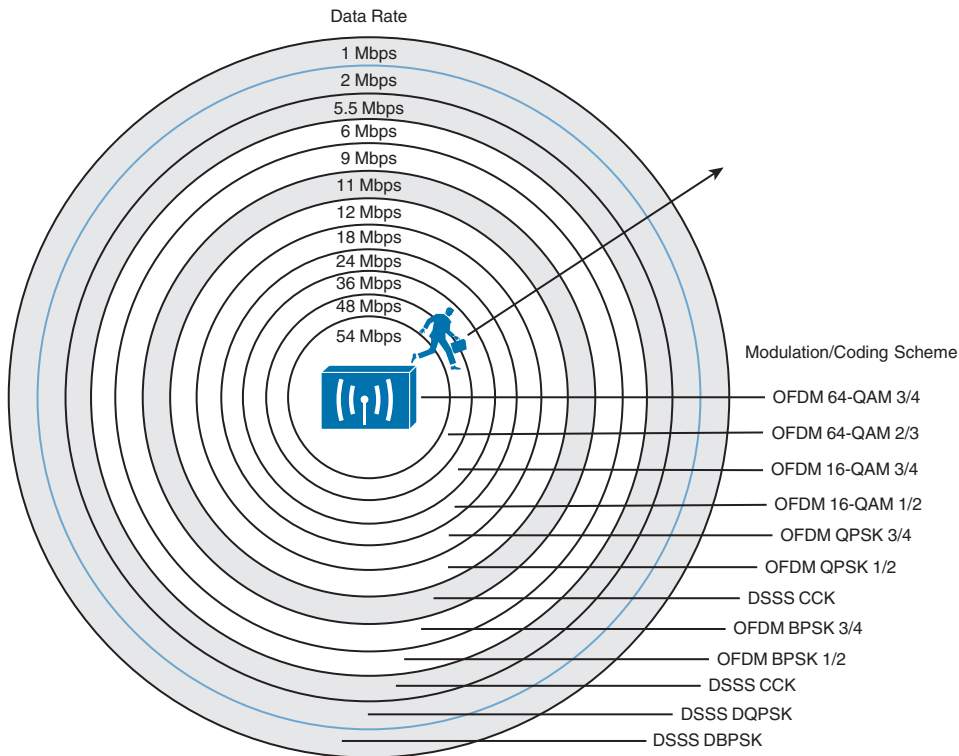
**Tip** Although DRS is inherently used in 802.11 devices, it is not defined in the 802.11 standard. Each manufacturer can have its own approach to DRS; so all devices don't necessarily select the same scheme at the same location. DRS is also known by many alternative names, such as *link adaptation*, *adaptive modulation and coding* (AMC), *rate adaptation*, and so on.

Figure 3-7 illustrates DRS operation on the 2.4-GHz band. Each concentric circle represents the range supported by a particular modulation and coding scheme. The figure is somewhat simplistic because it assumes a consistent power level across all modulation types. Notice that the white circles denote OFDM modulation (802.11g) and that the shaded circles contain DSSS modulation (802.11b). The data rates are arranged in order of increasing circle size or range from the transmitter.

Suppose that a mobile user starts out near the transmitter, within the innermost circle, where the received signal is strong and SNR is high. Most likely, wireless transmissions will use the OFDM 64-QAM 3/4 modulation and coding scheme to achieve a data rate of 54 Mbps. As the user walks away from the transmitter, the RSSI and SNR fall by some amount. The new RF conditions will likely trigger a shift to a different modulation and coding scheme, resulting in a lower data rate.

In a nutshell, each move into a larger concentric circle causes a dynamic shift to a reduced data rate, in an effort to maintain the data integrity to the outer reaches of the transmitter's range.

The 5-GHz band looks very similar to Figure 3-7, except that every circle uses an OFDM modulation scheme corresponding to 802.11a.



**Figure 3-7** *Dynamic Rate Shifting as a Function of Range.*

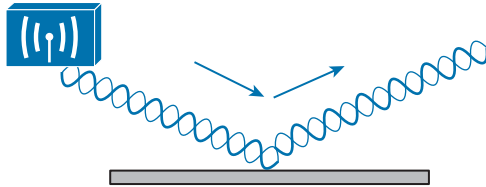
## Effects of Physical Objects

As an RF signal propagates through free space, it might encounter physical objects in its path. Objects and materials can affect an RF signal in a variety of ways, mostly in a degrading or destructive fashion. The following sections cover the most common scenarios.

### Reflection

If an RF signal traveling as a wave meets a dense reflective material, the signal can be reflected. Think of the light emitted from a light bulb; while most of the light is traveling in all directions away from the bulb, some might be reflected from objects in a room. The reflected light might travel back toward the bulb or toward another area of the room, making that area even brighter.

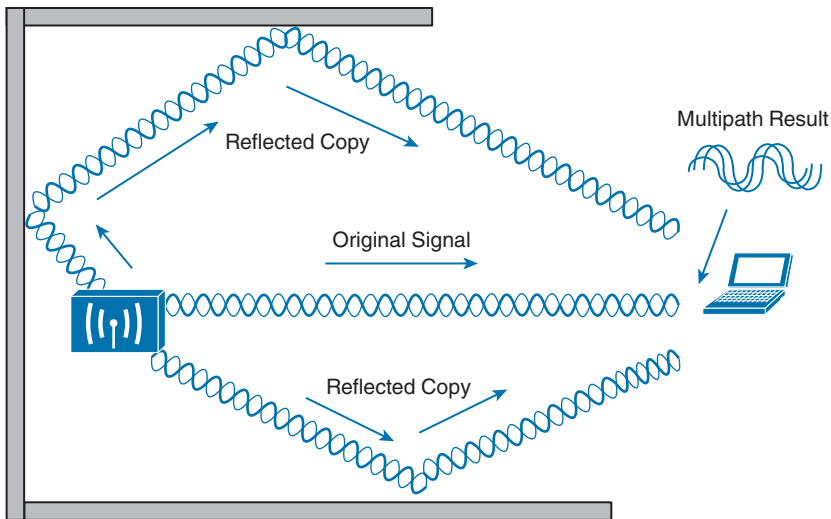
Figure 3-8 depicts a reflected RF signal. Indoor objects such as metal furniture, filing cabinets, and metal doors can cause reflection. An outdoor wireless signal can be reflected by objects such as a body of water, reflective glass on a building, or the surface of the earth.



**Figure 3-8** Reflection of an RF Signal.

A reflection is not necessarily bad because it is just a copy of the original signal. However, if both the copy and the original reach a receiver, they can arrive out of phase with each other. This is because the reflection takes a different path than the original, causing it to arrive slightly later. This is known as *multipath*. When the receiver combines the two signals, the result is a poor representation of the original signal. The combined signal can be weak and distorted, causing the data to be corrupted.

In Figure 3-9, the original signal, along with two different reflections, arrive at the receiver embedded in a laptop computer. The two reflections each take a different path and arrive at different times.



**Figure 3-9** Multipath Transmissions.

When multipath transmissions occur, there can be two outcomes:

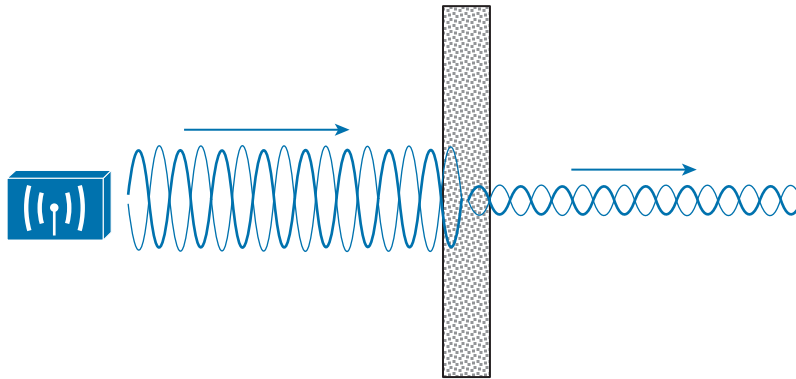
- If the receiver has a single radio chain, then all of the arriving signals (original and reflected) are combined into one poor, error prone composite signal.
- If the receiver has multiple radio chains and supports multiple-input, multiple-output (MIMO), each arriving signal might be received on a different antenna or radio. Further processing can improve the signal quality or extract multiple data streams—making something good out of a bad situation.



## Absorption

If an RF signal passes into a material that can absorb some of its energy, the signal will be attenuated. The more dense the material, the more the signal will be attenuated.

Figure 3-10 shows how a signal is affected by absorption and how a receiver might be affected by the lower signal strength.



**Figure 3-10** *Absorption of an RF Signal.*

One common example of absorption is when a wireless signal passes through a wall in a building. Different wall materials absorb different amounts of energy. For example, a wall constructed from gypsum or drywall might attenuate a signal by  $-4$  dBm. A solid concrete wall might attenuate it by  $-12$  dBm. The thicker the wall or the more dense the material, the greater the attenuation will be.

In outdoor wireless scenarios, RF signals frequently have to travel through water. The water might be contained in tree leaves positioned along the wireless path. Even in unobstructed space, the signal might encounter water in the form of rain, snow, hail, or fog. As the air is filled with heavier rain or snow, the signal will be attenuated more.

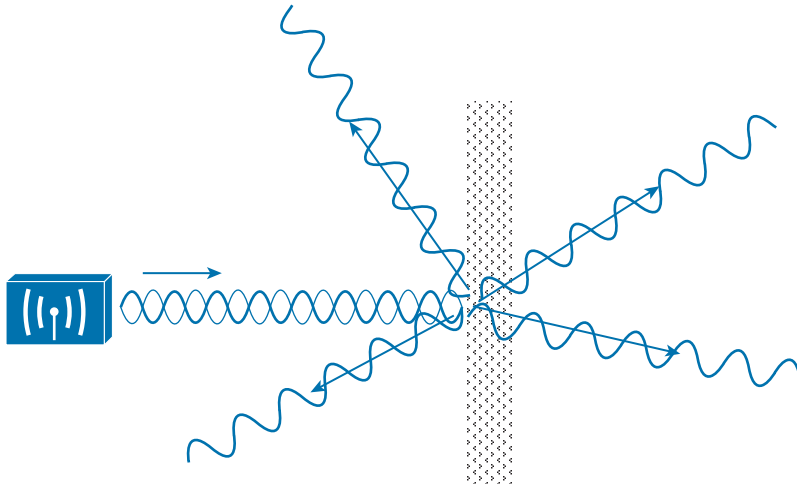
Another less-obvious example of absorption is the human body, which is made up mostly of water. A person will usually hold a laptop computer, tablet PC, or a smartphone close to his or her body. Depending on how the person is oriented with respect to the transmitter, his body could sit between the transmitter and the receiver, attenuating the signal. Likewise, a classroom or auditorium might be filled with human bodies, each with the potential to attenuate the signal from a transmitter.

**Tip** To gain perspective, a quick experiment revealed that a human body attenuated a 2.4-GHz signal by  $-5$  dBm.

## Scattering

When an RF signal passes into a medium that is rough, uneven, or made up of very small particles, the signal can be scattered into many different directions. This is because the

tiny irregular surfaces of the medium can reflect the signal, as shown in Figure 3-11. Scattering can occur when a wireless signal passes through a dusty or sandy environment.

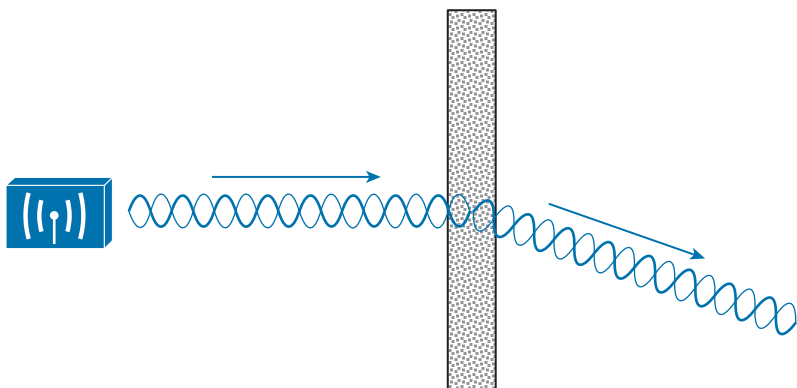


**Figure 3-11** *Scattering an RF Signal.*

## Refraction

When an RF signal meets the boundary between media of two different densities, it can also be refracted. Think of reflection as bouncing off a surface and refraction as being bent while passing through a surface.

A refracted signal will have a different angle from the original, as illustrated in Figure 3-12. The speed of the wave can also be affected as it passes through the different materials. A signal can be refracted when it passes through layers of air having different densities or through building walls with different densities, for example.

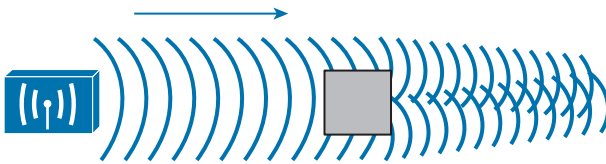


**Figure 3-12** *Refraction of an RF Signal.*

## Diffraction

Suppose an RF signal approaches an opaque object, or one that is able to absorb the energy that strikes it. You might think that the object would produce a shadow in place of the signal that is absorbed, much like an object might make a shadow as light shines on it. If a shadow formed, it might make a dead or silent zone in the RF signal behind the object.

With RF propagation, however, the signal tends to bend around the object and eventually rejoin to complete the wave. Figure 3-13 shows how a radio opaque object can cause diffraction of an RF signal. Diffraction is best viewed as concentric waves, rather than an oscillating signal, so that its effect on the actual waves can be seen. In the figure, diffraction has caused the signal to “heal” itself around an absorbing object. This makes reception possible even when a building stands between the transmitter and receiver. However, the signal is never quite like the original again, as it has been distorted by the diffraction.

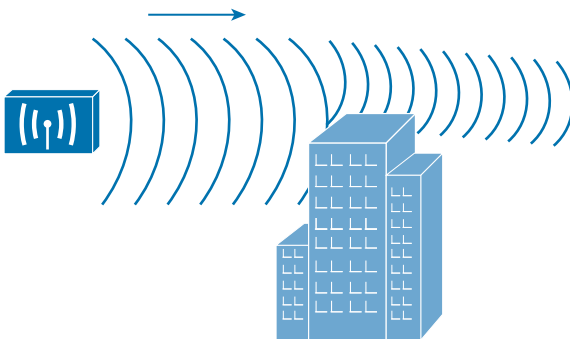


**Figure 3-13** *Diffraction of an RF Signal.*

## Fresnel Zones

If an object is standing free, so that an RF signal traveling parallel with the ground is diffracted around it on both sides, the signal will often fill in the object’s “shadow” as it continues to propagate. However, if a standing object such as a building or a mountain obstructs the signal, the signal can be adversely affected in the vertical direction.

In Figure 3-14, a building partially obstructs the path of the signal. Because of diffraction along the front and top of the building, the signal is bent and also attenuated. This causes the signal to be masked behind most of the height of the building.



**Figure 3-14** *A Standing Obstacle Diffracts a Signal.*

This is especially important in narrow line-of-sight wireless transmission, which is suited for very long distances. These signals do not propagate in all directions; rather, they are focused into a tight cone-shaped pattern, as shown in Figure 3-15. For a line-of-sight path, the signal must be clear of any obstructions between the transmitter's antenna and the receiver's antenna. Paths between buildings or between cities commonly have other buildings, trees, or other objects that might block the signal. In those cases, the antennas must be raised higher than the obstructions to get a clear path.

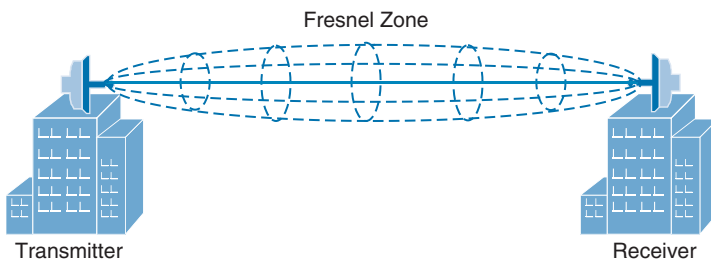


**Figure 3-15** *A Line-of-Sight Wireless Signal.*

Over a very long distance, the curvature of the earth actually becomes an obstacle that can affect the signal. Beyond a distance of about two miles, the far end cannot be seen because it lies slightly below the horizon. Nevertheless, a wireless signal tends to propagate along the same curve, following the atmosphere around the earth's curvature.

Even narrow line-of-sight signals can be affected by diffraction, even if an object does not directly block the signal. There is an elliptical-shaped volume around the line of sight that must also remain free of obstructions. This is called the *Fresnel zone*, as shown in Figure 3-16. If an object penetrates the Fresnel zone anywhere along the path, some portion of the RF signal can be diffracted by it. That portion of the signal gets bent, causing it to be delayed or altered so that it affects the overall signal arriving at the receiver.

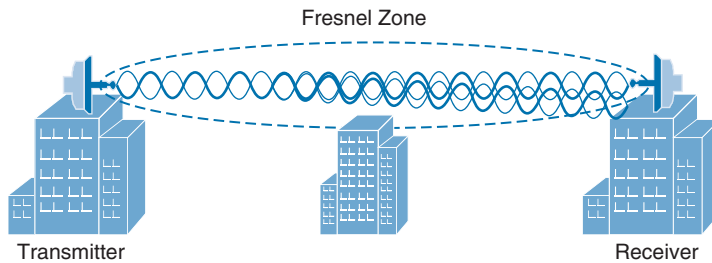
**Tip** Actually, there are many concentric Fresnel zones surrounding the line of sight path. Only the innermost, or first, Fresnel zone is described in this section and taken into account because it affects the transmitted signal the most. Fresnel zones are numbered incrementally as their size increases. Oddly enough, the odd-numbered Fresnel zones have a destructive effect on signals, whereas the even-numbered zones can have a constructive effect and add to the signal's power.



**Figure 3-16** *The Fresnel Zone.*

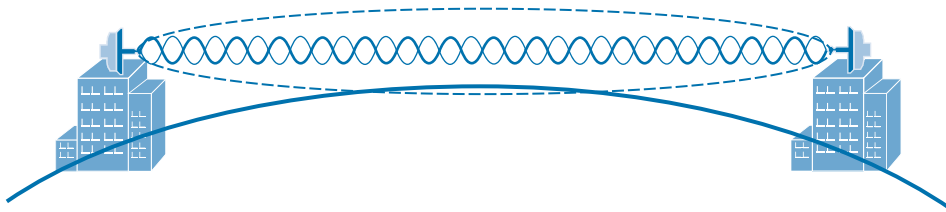


In Figure 3-17, a building lies along the signal's path, but does not obstruct the beam of the signal; however, it does penetrate the Fresnel zone, so the received signal will be negatively affected.



**Figure 3-17** *Signal Degradation Due to a Fresnel Zone Obstruction.*

As a rule, you should raise the antennas of a line-of-sight system so that even the bottom of the Fresnel zone is higher than any obstruction. Remember that as the path gets very long, even the curvature of the earth can enter the Fresnel zone and cause problems, as Figure 3-18 shows.



**Figure 3-18** *The Earth's Curvature Enters the Fresnel Zone.*

The radius of the Fresnel zone can be calculated according to a complex formula. However, you should only be concerned with the idea that the Fresnel zone exists and should remain clear. Table 3-2 gives some example values of the Fresnel zone radius at the midpoint of some line-of-sight path lengths for wireless frequencies in the 2.4GHz band.

**Table 3-2** *Fresnel Zone Radius Values*

Path Length	Fresnel Zone Radius at Path Midpoint
0.5 miles	16 feet
1.0 miles	23 feet
2.0 miles	33 feet
5.0 miles	52 feet
10.0 miles	72 feet

## Exam Preparation Tasks

As mentioned in the section, “How to Use This Book,” in the Introduction, you have a couple of choices for exam preparation: the exercises here, Chapter 22, “Final Review,” and the exam simulation questions on the CD-ROM.

## Review All Key Topics

Review the most important topics in this chapter, noted with the Key Topic icon in the outer margin of the page. Table 3-3 lists a reference of these key topics and the page numbers on which each is found.

**Table 3-3** *Key Topics for Chapter 3*

Key Topic Element	Description	Page Number
Figure 3-2	Co-channel interference	71
Figure 3-6	Free space path loss affecting signal range	74
Figure 3-7	Changing modulation and coding schemes with DRS	76
Figure 3-8	Reflection	77
Figure 3-10	Absorption	78
Figure 3-16	Fresnel zone	81



## Define Key Terms

Define the following key terms from this chapter and check your answers in the glossary:

absorption, adjacent channel interference, co-channel interference, diffraction, dynamic rate shifting, free space path loss, Fresnel zone, multipath, reflection, refraction, scattering



---

This chapter covers the following topics:

- **Antenna Characteristics**—This section describes the radiation pattern, gain, beamwidth, and polarization of an antenna.
- **Antenna Types**—This section covers the two basic types of antennas and their applications.
- **Adding Antenna Accessories**—This section explains several devices that can be added to an antenna to increase or reduce signal strength and to protect connected equipment from lightning damage.

This chapter covers the following exam topics:

- Describe Wireless LAN (WLAN) RF principles (antenna types, RF gain/loss, Effective Isotropic Radiated Power (EIRP), refraction, reflection, and so on)

# Understanding Antennas

Chapters 1 through 3 covered radio frequency (RF) signals, as used by 802.11 devices, and their propagation from the perspective of a transmitter and a receiver. By considering the link budget, or the net signal strength gain between a transmitter and receiver, you can make sure that a signal will arrive in good condition at its destination. The antenna gain is an important piece of the equation, but it does not completely describe an antenna's construction or performance. This chapter explains some basic antenna theory, in addition to various types of antennas and their application.

## “Do I Know This Already?” Quiz

The “Do I Know This Already?” quiz allows you to assess whether you should read this entire chapter thoroughly or jump to the “Exam Preparation Tasks” section. If you are in doubt about your answers to these questions or your own assessment of your knowledge of the topics, read the entire chapter. Table 4-1 lists the major headings in this chapter and their corresponding “Do I Know This Already?” quiz questions. You can find the answers in Appendix A, “Answers to the ‘Do I Know This Already?’ Quizzes.”

**Table 4-1** “Do I Know This Already?” Section-to-Question Mapping

Foundation Topics Section	Questions
Antenna Characteristics	1–5
Antenna Types	6–9
Adding Antenna Accessories	10

**Caution** The goal of self-assessment is to gauge your mastery of the topics in this chapter. If you do not know the answer to a question or are only partially sure of the answer, you should mark that question as wrong for purposes of the self-assessment. Giving yourself credit for an answer you correctly guess skews your self-assessment results and might provide you with a false sense of security.



1. Which two of the following plots are used to show the radiation pattern of an antenna?
  - a. A plane
  - b. E plane
  - c. XY plane
  - d. H plane
  - e. YZ-plane
2. Which one of the following is another name for the H plane radiation pattern?
  - a. Horizon plane
  - b. Azimuth plane
  - c. Heat map
  - d. Lateral plane
3. Which one of the following answers correctly identifies the antenna parameter that is measured at 3 dB below the strongest point on a radiation pattern plot?
  - a. Half life
  - b. Decay point
  - c. Cut off point
  - d. Beamwidth
  - e. Sensitivity
4. The orientation of an electromagnetic wave is best described by which one of the following?
  - a. Phase
  - b. Amplitude
  - c. Modulation
  - d. Polarization
  - e. Azimuth
5. A Cisco dipole antenna is mounted so that it points straight upward and has a radiation pattern that extends far outward horizontally. Which one of the following best describes the antenna's polarization?
  - a. Horizontal polarization
  - b. Vertical polarization
  - c. Dual polarization
  - d. Elliptical polarization

6. Which one of the following antennas would probably have the greatest gain?
  - a. Patch
  - b. Dish
  - c. Yagi
  - d. Dipole
  - e. Integrated
7. An omnidirectional antenna usually has which of the following characteristics? (Choose two.)
  - a. Low gain
  - b. Small beamwidth
  - c. High gain
  - d. Zero gain
  - e. Large beamwidth
8. A certain Cisco wireless access point model has antennas that are hidden inside the case. Which one of the following describes the antennas?
  - a. Patch antennas
  - b. Monopole antennas
  - c. Omnidirectional antennas
  - d. Isotropic antennas
9. A dipole antenna is connected to a transmitter. You would like to leverage the directional quality of the antenna. Based on the radiation pattern of the antenna, what would happen if you orient the antenna such that its cylindrical shape points directly at a distant receiver?
  - a. The receiver would pick up a stronger signal.
  - b. The receiver would pick up a weaker signal.
  - c. The antenna is omnidirectional, so the orientation would not matter.
  - d. This is pointless unless the receiver's dipole is also aimed directly at the transmitter.
10. Which one of the following is *not* true about a lightning arrestor?
  - a. It is connected inline between a transmitter and an antenna.
  - b. It protects against large transient spikes of energy.
  - c. It protects against lightning strikes on an antenna.
  - d. It directs energy to the ground, rather than the transmitter equipment.
  - e. Every outdoor antenna needs one.

---

## Foundation Topics

---

### Antenna Characteristics

The world of wireless LANs would be rather simple if all antennas were created equal—too simple, in fact. To provide good wireless LAN coverage in a building, an outdoor area, or between two locations, you might be faced with a number of variables. For example, an office space might be arranged as a group of open cubicles or as a strip of closed offices down a long hallway. You might have to cover a large open lobby, a large open classroom, a section of a crowded sports arena, an oblong portion of a hospital roof where helicopters land, a large expanse of an outdoor park, city streets where public safety vehicles travel, and so on.

In other words, one type of antenna cannot fit every application. Instead, antennas come in many sizes and shapes, each with its own gain value and intended purpose. The following sections describe antenna characteristics in more detail.

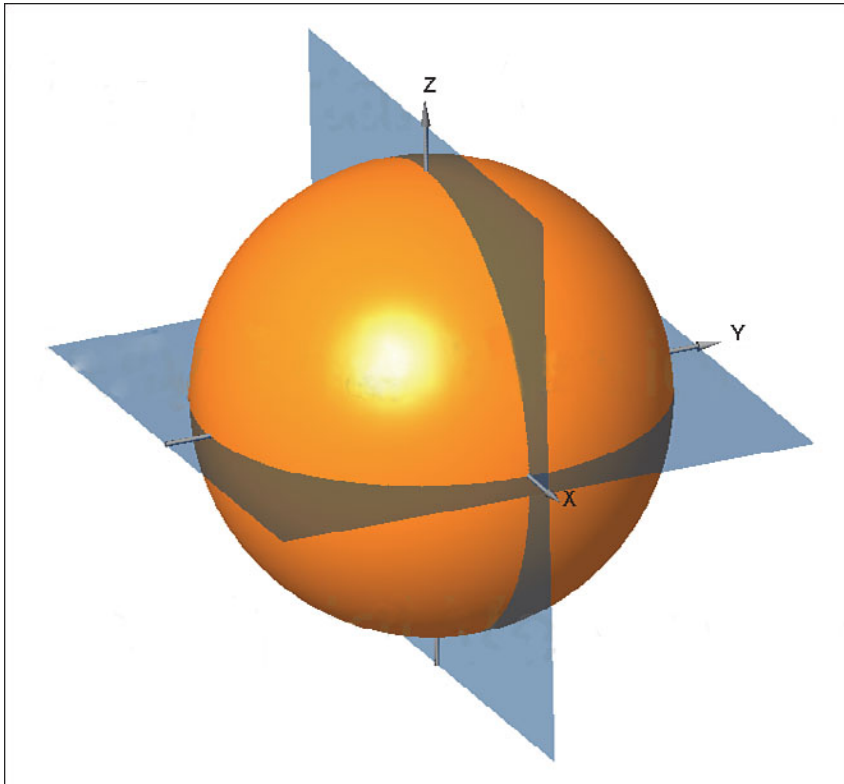
### Radiation Patterns

Recall from Chapter 1, “RF Signals and Modulation,” that antenna gain is normally a comparison of one antenna against an isotropic antenna, and is measured in dBi (decibel-isotropic). An isotropic antenna does not actually exist because it is ideal, perfect, and impossible to construct. It is also the simplest, most basic antenna possible, which makes it a good starting place for antenna theory.

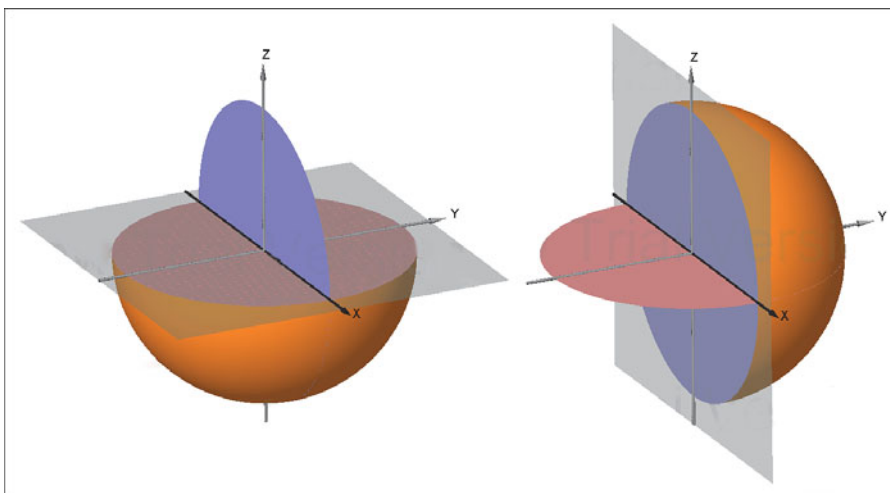
An isotropic antenna is shaped like a tiny round point. When an alternating current is applied, an RF signal is produced and the electromagnetic waves are radiated equally in all directions. The energy produced by the antenna takes the form of an ever-expanding sphere. If you were to move all around an isotropic antenna at a fixed distance, you would find that the signal strength is the same.

To describe the antenna’s performance, you might draw a sphere with a diameter that is proportional to the signal strength, as shown in Figure 4-1. Most likely, you would draw the sphere on a logarithmic scale so that very large and very small numbers could be shown on the same linear plot. A plot that shows the relative signal strength around an antenna is known as the *radiation pattern*.

It is rather difficult to show a three-dimensional plot or shape on a two-dimensional document—especially if the shape is complex or unusual. After all, most physical antennas are not ideal, so their radiation pattern is not a simple sphere. Instead, you could slice through the three-dimensional plot with two orthogonal planes and show the two outlines that are formed from the plot. In Figure 4-1, the sphere is cut by the XY plane, which lies flat along the horizon, and by the XZ plane, which lies vertically along the elevation of the sphere. Figure 4-2 shows the resulting cuts.



**Figure 4-1** *Plotting the Radiation Pattern of an Isotropic Antenna.*

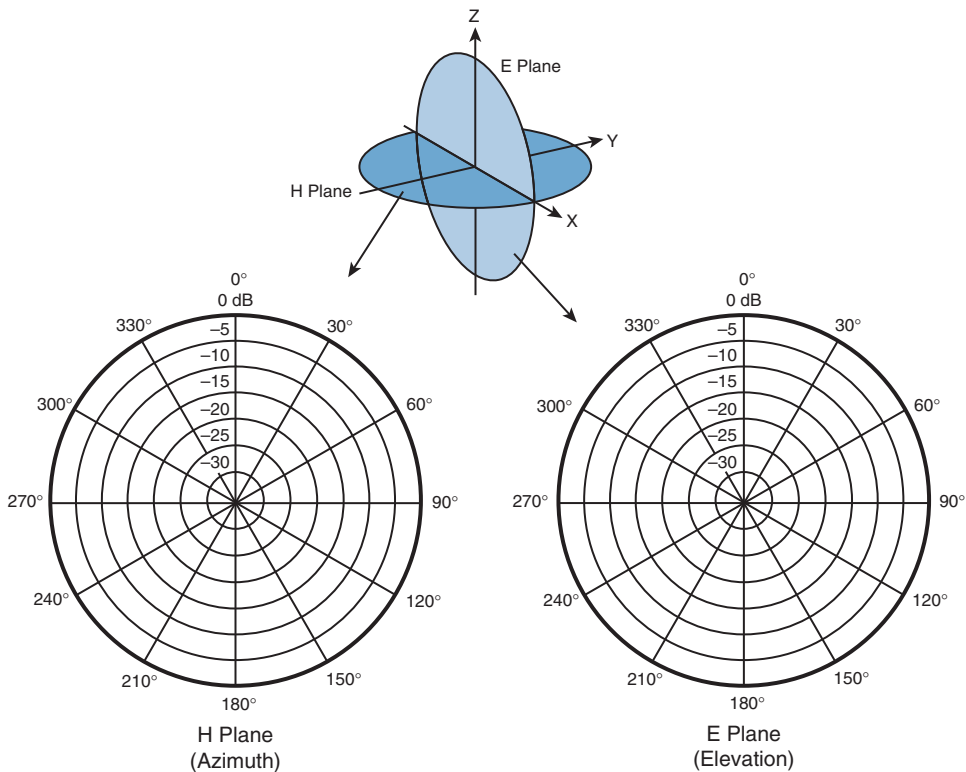


**Figure 4-2** *Cutting the Radiation Pattern with Two Planes.*



The plane at the left is known as the *H plane* or the *azimuth plane*, and usually shows a top down view of the radiation pattern through the center of the antenna. The plane at the right is known as the *E plane* or *elevation plane*, and shows a side view of the same radiation pattern.

The outline of each plot can be recorded on a polar plot, as shown by the heavy dark lines in Figure 4-3. A polar plot contains concentric circles that represent relative changes in the signal strength as measured at a constant distance from the antenna. The outermost circle usually represents the strongest signal strength, and the inner circles represent weaker signal strength. Although the circles are labeled with numbers like 0, -5, -10, -15, and so on, they do not necessarily represent any absolute dB values. Instead, they are measurements that are relative to the maximum value at the outside circle. If the maximum is shown at the outer ring, everything else will be less than the maximum and will lie further inward.



**Figure 4-3** Recording an Isotropic Antenna Pattern on E and H Polar Plots.

The circles are also divided into sectors so that a full sweep of 360 degrees can be plotted. This allows measurements to be taken at every angle around the antenna in the plane shown.

Are you confused? You aren't alone. The E and H polar plots of the radiation pattern are presented here because most antenna manufacturers include them in their product literature. The antenna is always placed at the center of the polar plots, but you will not always be able to figure out how the antenna is oriented with respect to the E and H planes. Cisco usually includes a small picture of the antenna at the center of the plots as a handy reference.

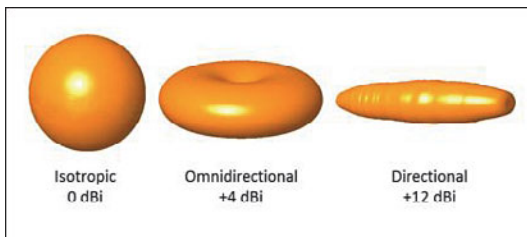
As a wireless engineer, you will have to look at various antenna patterns and try to figure out whether the antenna is a good match for the environment you are trying to cover with an RF signal. You will need a good bit of imagination to merge the two plots into a 3D picture in your mind. As various antennas are described in this chapter, the plots, planes, and a 3D rendering are presented to help you get a feel for the thinking process.

## Gain

Antennas are passive devices; they do not amplify a transmitter's signal with any circuitry or external power. Instead, they amplify or add gain to the signal by shaping the RF energy as it is propagated into free space. In other words, the *gain* of an antenna is a measure of how effectively it can focus RF energy in a certain direction.

Because an isotropic antenna radiates RF energy in all directions equally, it cannot focus the energy in any certain direction. Recall from Chapter 1 that the gain of an antenna in dBi is measured relative to an isotropic antenna. When an isotropic antenna is compared with itself, the result is a gain of  $10\log(1)$  or 0 dBi.

Think of a zero gain antenna producing a perfect sphere. If the sphere is made of rubber, you could press on it in various locations and change its shape. As the sphere is deformed, it expands in other directions. Figure 4-4 shows some simple examples, along with some example gain values. As you work through this chapter and examine antennas on your own, notice how the gain is lower for omnidirectional antennas, which are made to cover a widespread area, and higher for directional antennas, which are built to cover more focused areas.



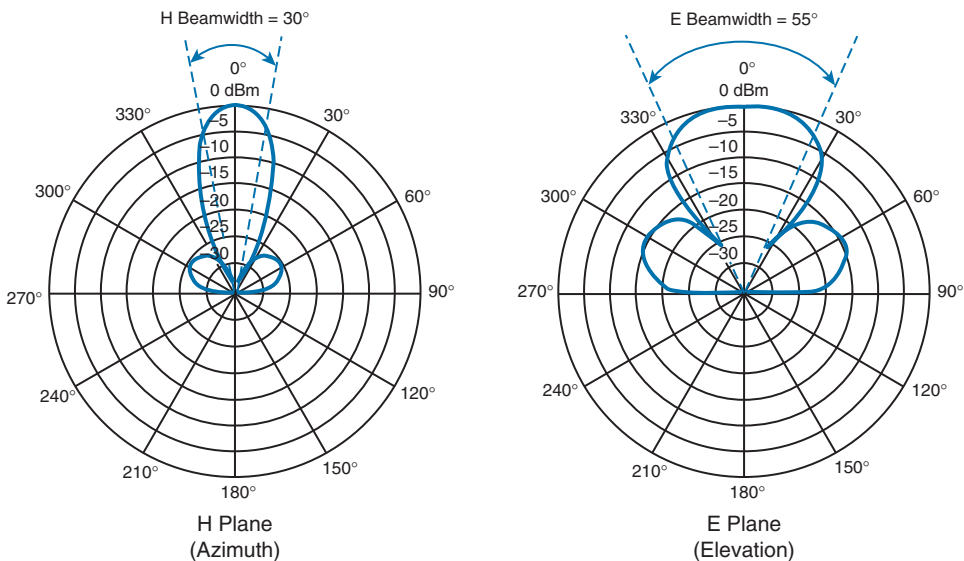
**Figure 4-4** *Radiation Patterns for the Three Basic Antenna Types.*

**Tip** The gain itself is not indicated on either E or H plane radiation pattern plots. The only way to find an antenna's gain is to look at the manufacturer's specifications.

## Beamwidth

The antenna gain can be an indicator of how focused an antenna's pattern might be, but it is really more suited for link budget calculations. Instead, many manufacturers list the *beamwidth* of an antenna as a measure of the antenna's focus. Beamwidth is normally listed in degrees for both the H and E planes.

The beamwidth is determined by finding the strongest point on the plot, which is usually somewhere on the outer circle. Next, the plot is followed in either direction until the value decreases by 3 dB, indicating the point where the signal is one-half the strongest power. A line is drawn from the center of the plot to intersect each 3 dB point, and then the angle between the two lines is measured. Figure 4-5 shows a simple example. The H plane has a beamwidth of 30 degrees, and the E plane has a beamwidth of 55 degrees.



**Figure 4-5** An Example of Antenna Beamwidth Measurement.

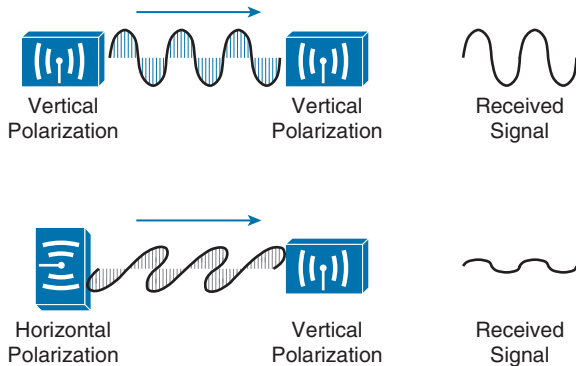
## Polarization

When an alternating current is applied to an antenna, an electromagnetic wave is produced. From Chapter 1, you learned that the wave has two components: an electrical field wave and a magnetic field wave. The electrical portion of the wave will always leave the antenna in a certain orientation. For example, most Cisco antennas produce a wave that oscillates up and down in a vertical direction as it travels through free space. Other antennas might be designed to produce waves that oscillate back and forth horizontally. Still others might produce waves that actually twist in a three-dimensional spiral motion.

The wave's orientation is called the antenna *polarization*. Antennas that produce vertical oscillation are vertically polarized; ones that produce horizontal oscillation are horizontally polarized. By itself, the antenna polarization is not of critical importance. However, the antenna polarization at the transmitter must be matched to the polarization at the

receiver. If the polarization is mismatched, the received signal can be severely degraded.

Figure 4-6 illustrates antenna polarization. The transmitter and receiver along the top both use vertical polarization, so the received signal is optimized. The pair along the bottom is mismatched, causing the signal to be poorly received.



**Figure 4-6** Matching the Antenna Polarization Between Transmitter and Receiver.

**Tip** Even though Cisco antennas are designed to use vertical polarization, someone might mount an antenna in an unexpected orientation. For example, suppose you mount a transmitter with its antennas pointing upward. After you leave, someone knocks the antennas so that they are turned sideways. Not only does that change the radiation pattern you were expecting, it also changes the polarization.

## Antenna Types

Wireless LAN antennas are available in a variety of styles, shapes, and radiation patterns. In addition, antennas are normally rated for indoor or outdoor use, depending on weather resistance and mounting options. Antennas are usually designed for a specific frequency range and are approved by the local regulatory body, such as the FCC in the US. There are two basic types of antennas, omnidirectional and directional, which are discussed in the following sections.

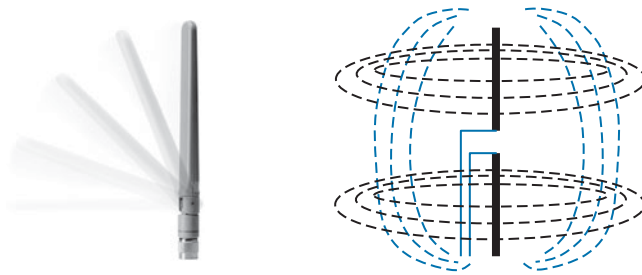
**Tip** You can learn more about the full line of Cisco antennas in the *Cisco Aironet Antennas and Accessories Reference Guide*, at [http://www.cisco.com/en/US/prod/collateral/wireless/ps7183/ps469/at\\_a\\_glance\\_c45-513837.pdf](http://www.cisco.com/en/US/prod/collateral/wireless/ps7183/ps469/at_a_glance_c45-513837.pdf).



## Omnidirectional Antennas

An omnidirectional antenna is usually made in the shape of a thin cylinder. It tends to propagate a signal equally in all directions away from the cylinder, but not along the cylinder's length. The result is a donut-shaped pattern that extends further in the H plane than the E plane. This type of antenna is well suited for broad coverage of a large room or floor area where the antenna is located in the center. Because an omnidirectional antenna distributes the RF energy throughout a broad area, it has a relatively low gain.

A common type of omnidirectional antenna is the *dipole*, shown in the left portion of Figure 4-7. Some dipole models are articulated such that they can be folded up or down, depending on the mounting orientation, whereas others are rigid and fixed. As its name implies, the dipole has two separate wires that radiate an RF signal when an alternating current is applied across them, as shown in the right portion of Figure 4-7. Dipoles usually have a gain of around +2 to +5 dBi.

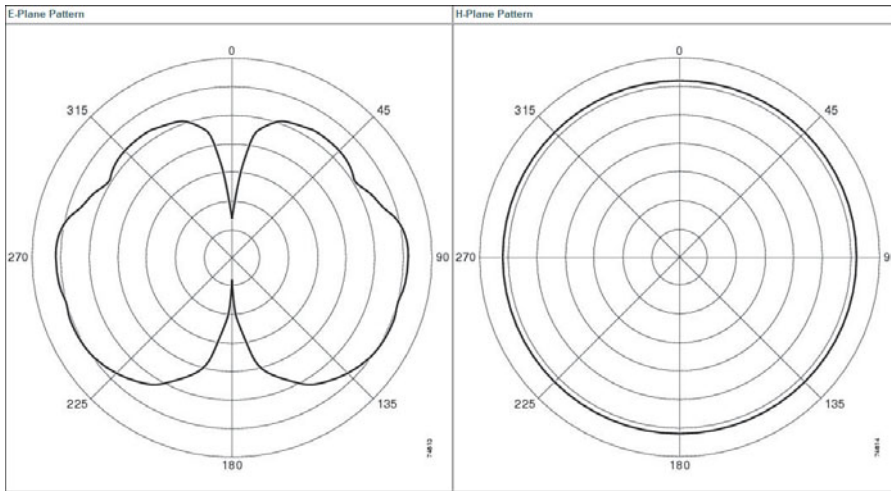


**Figure 4-7** A Cisco Dipole Antenna.

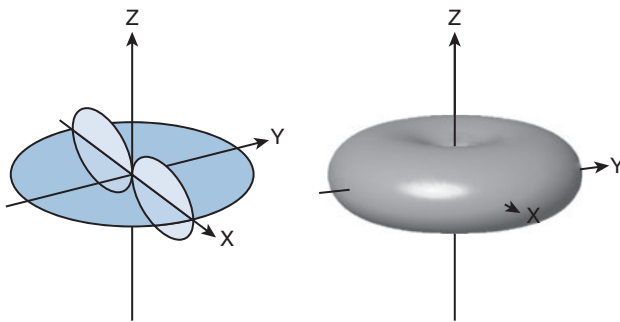
The E and H plane radiation patterns for a typical dipole antenna are shown in Figure 4-8. In the E plane, think of the dipole lying on its side in the center of the plot; the H plane is looking down on the top of the dipole. Figure 4-9 takes the patterns a step further, showing how the two planes are superimposed and merged to reveal the three-dimensional radiation pattern.

Dipoles are often connected to wireless LAN devices that mount on the ceilings of rooms and hallways. Most dipole antennas are between 3.5 and 5.5 inches long, so they are not always aesthetically pleasing when they stick down from a ceiling. For this reason, Cisco offers several monopole antennas as an alternative.

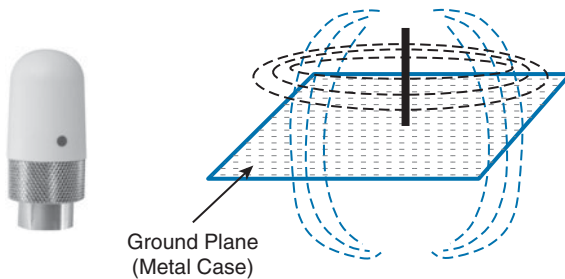
Monopole antennas are very short—less than 2 inches in length, as shown in Figure 4-10. To achieve such a small size, they contain only one short length of wire. You can think of this as a compromised dipole antenna, where one of the antenna segments stands out away from the wireless device. The other segment is moved down into the device, in the form of a metal ground plane. Therefore, monopole antennas can be used only on devices that have a large, flat metal casing. The radiation pattern is similar to that of a dipole, but not quite as symmetrical. Monopole antennas have a typical gain of 2.2 dBi in the 2.4- and 5-GHz bands.



**Figure 4-8** *E and H Radiation Patterns for a Typical Dipole Antenna.*



**Figure 4-9** *Dipole Radiation Pattern in Three Dimensions.*



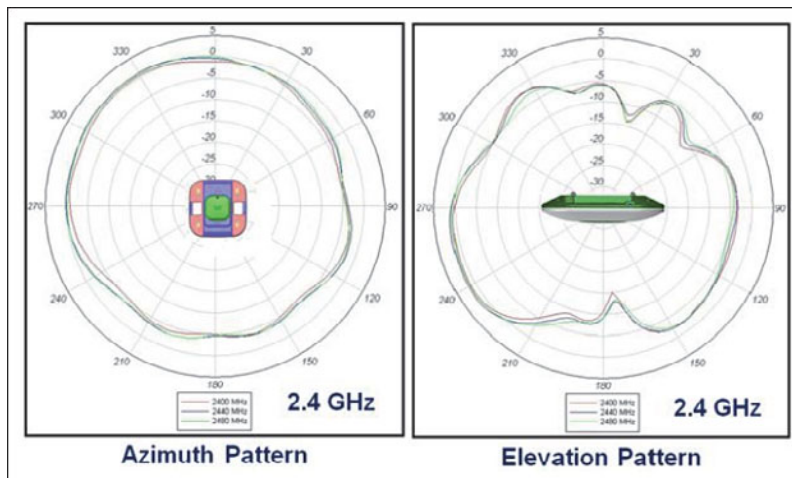
**Figure 4-10** *A Cisco Monopole Antenna.*

To reduce the size of an omnidirectional antenna even further, many Cisco wireless access points (APs) have integrated antennas that are hidden inside the device's smooth case. For example, the AP shown in Figure 4-11 has six tiny antennas hidden inside it.



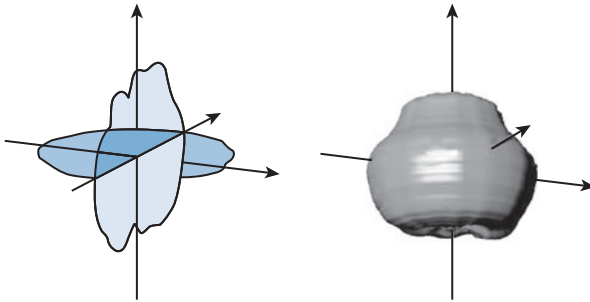
**Figure 4-11** A Cisco Wireless Access Point with Integrated Omnidirectional Antennas.

Integrated omnidirectional antennas typically have a gain of 2 dBi in the 2.4-GHz band and 5 dBi in the 5-GHz band. The E and H plane radiation patterns are shown in Figure 4-12. When the two planes are merged, the three-dimensional pattern shown in Figure 4-13 is revealed.



**Figure 4-12** E and H Radiation Patterns for a Typical Integrated Omnidirectional

*Antenna.*



**Figure 4-13** *Integrated Omnidirectional Antenna Radiation Pattern in 3D.*

**Tip** What about wireless LAN adapters that are used in mobile devices like laptops and smartphones? Because the adapters are so small, their antennas must also be tiny. As a result, USB wireless adapters often have a gain of 0 dBi, while some smartphones even have a negative gain!

## Directional Antennas

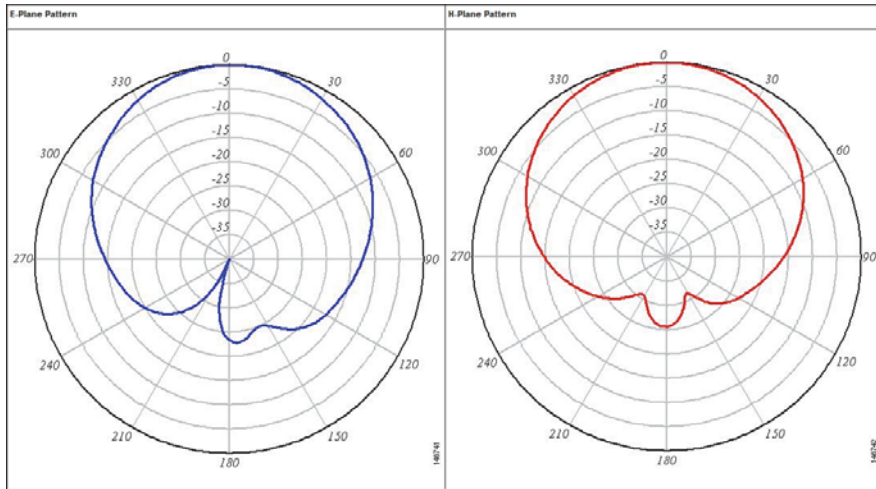
Directional antennas have a higher gain than omnidirectional antennas because they focus the RF energy in one general direction. Typical applications include elongated indoor areas, such as the rooms along a long hallway or the aisles in a warehouse. They can also be used to cover outdoor areas out away from a building or long distances between buildings.

Patch antennas have a flat rectangular shape, as shown in Figure 4-14, so that they can be mounted on a wall.

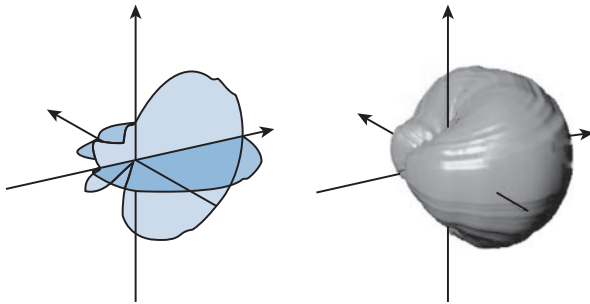


**Figure 4-14** *A Typical Cisco Patch Antenna.*

Patch antennas produce a broad egg-shaped pattern that extends out away from the flat patch surface. The E and H radiation pattern plots are shown in Figure 4-15. When the planes are merged as shown in Figure 4-16, you can see the somewhat broad directional pattern that results. Patch antennas have a gain of about 6 to 8 dBi in the 2.4-GHz band and 7 to 10 dBi at 5 GHz.



**Figure 4-15** E and H Radiation Patterns for a Typical Patch Antenna.



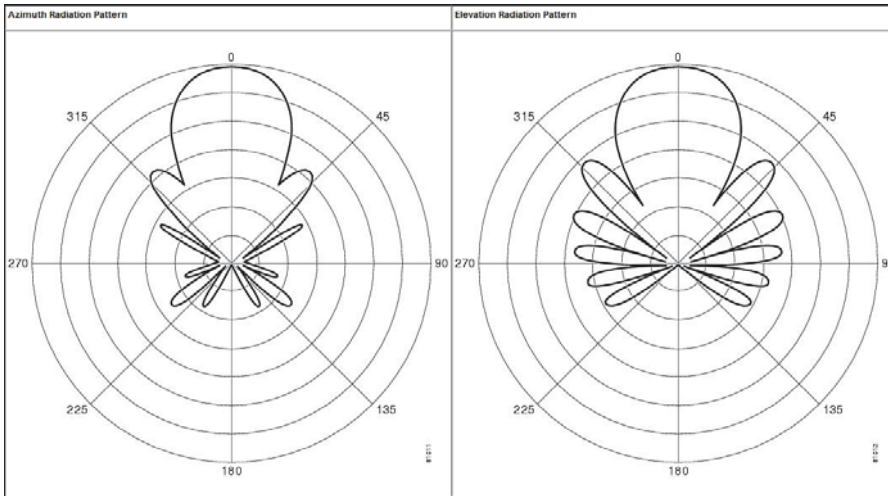
**Figure 4-16** A Patch Antenna Radiation Pattern in Three Dimensions.

Figure 4-17 shows the Yagi-Uda antenna, named after its inventors, and more commonly known as the Yagi. Although its outer case is shaped like a thick cylinder, the antenna is actually made up of several parallel elements of increasing length.

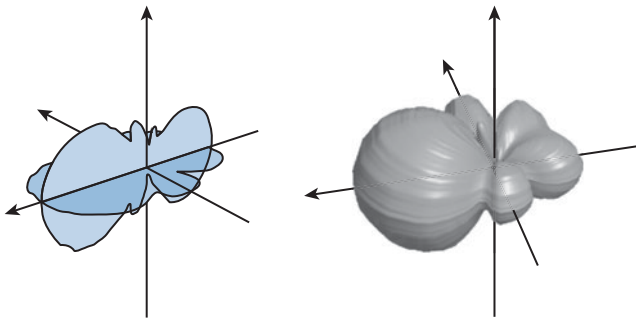


**Figure 4-17** A Cisco Yagi Antenna.

Figure 4-18 shows the E and H radiation pattern plots. A Yagi produces a more focused egg-shaped pattern that extends out along the antenna's length, as shown in Figure 4-19. Yagi antennas have a gain of about 10-14 dBi in the 2.4-GHz band. Cisco does not offer a 5-GHz Yagi.



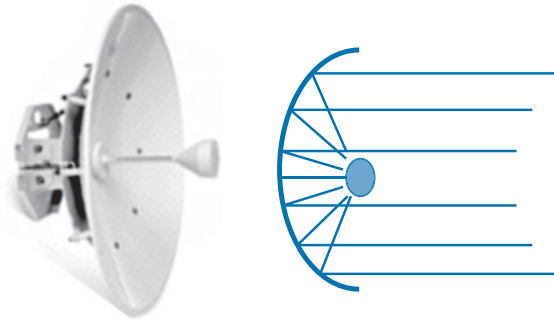
**Figure 4-18** *E and H Radiation Patterns for a Typical Yagi Antenna.*



**Figure 4-19** *A Yagi Antenna Radiation Pattern in Three Dimensions.*

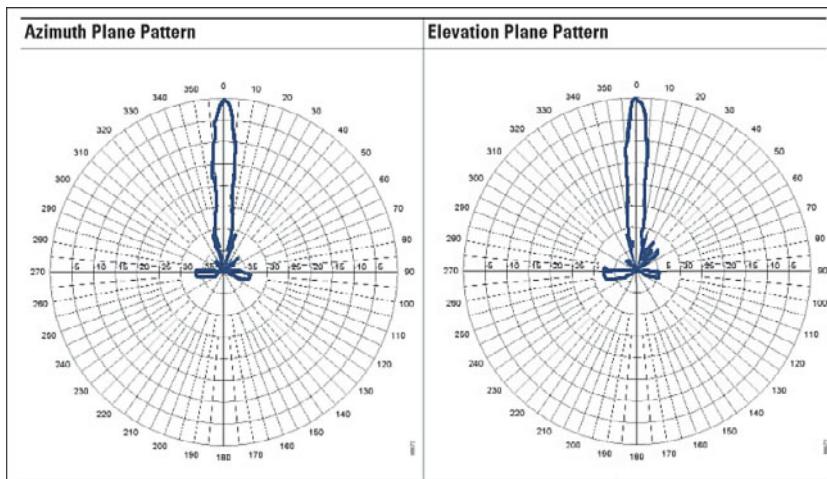
In a line-of-sight wireless path, an RF signal must be propagated a long distance using a narrow beam. Highly directional antennas are tailored for that use, but focus the RF energy along one narrow elliptical pattern. Because the target is only one receiver location, the antenna does not have to cover any area outside of the line of sight.

Dish antennas, such as the one shown in Figure 4-20, use a parabolic dish to focus received signals onto an antenna mounted at the center. The parabolic shape is important because any waves arriving from the line of sight will be reflected onto the center antenna element that faces the dish. Transmitted waves are just the reverse; they are aimed at the dish and reflected such that they are propagated away from the dish along the line of sight.

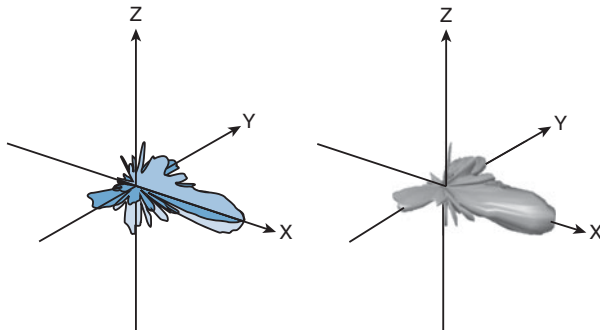


**Figure 4-20** *A Cisco Parabolic Dish Antenna.*

Figure 4-21 shows the radiation patterns in the E and H planes, which are merged into three dimensions in Figure 4-22. Notice how the antenna’s coverage pattern is long and narrow, extending out away from the dish. The focused pattern gives the antenna a gain of between 20 and 30 dBi—the highest gain of all the wireless LAN antennas.



**Figure 4-21** *E and H Radiation Patterns for a Parabolic Dish Antenna.*



**Figure 4-22** *A Parabolic Dish Antenna Radiation Pattern in Three Dimensions.*

## Antenna Summary

Table 4-2 lists each antenna type and style, along with typical beamwidth and gain values. You can use this table as a summary to help compare the antennas side by side. Notice that the beamwidth is the largest for omnidirectional antennas, and then begins to narrow through the progression of directional antennas. The opposite is true of the gain—omnidirectional antennas have the lowest gain, whereas directional antennas increase gain as their beamwidth narrows.

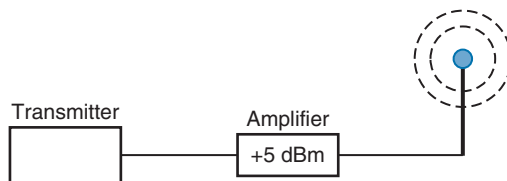
**Table 4-2** A Summary of Antenna Characteristics

Type	Style	Beamwidth		Gain (dBi)	
		H Plane	E Plane	2.4 GHz	5 GHz
Omnidirectional	Dipole	360°	65°	2.2	3.5
	Monopole	360°	50°	2.2	2.2
	Integrated	360°	150°	2	5
Directional	Patch	50°	50°	6–8	7–10
	Yagi	30°	25°	10–14	—
	Parabolic dish	5°	5°	20–30	20–30

Key  
Topic

## Adding Antenna Accessories

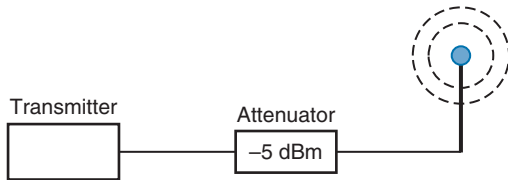
Occasionally, you may find that you are simply not able to meet the path link budget between a transmitter and a receiver. This might be because the distance, and therefore the free space path loss, is too great. Perhaps the transmitter does not offer enough output power, or the cable connecting the transmitter to the antenna is too long or introduces too much loss. You can add an *amplifier* to provide additional gain, provided the EIRP does not exceed the maximum value allowed. An amplifier is an active, powered device that is connected inline between a transmitter and an antenna, as shown in Figure 4-23.



**Figure 4-23** Using an Amplifier to Add 5-dBm Gain.

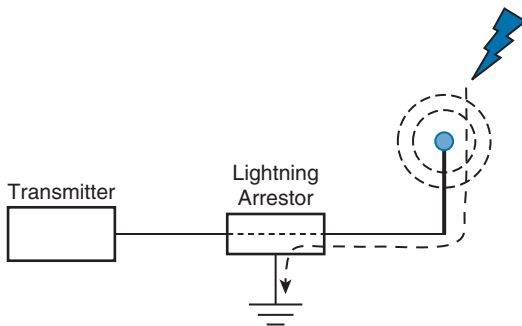


At other times, you may need to reduce the signal strength of a transmitter beyond what is possible with the transmitter settings. For example, the transmitter may already be configured for its lowest possible transmit power level, but the signal strength is still too great for nearby receivers. You can position an *attenuator*, a passive device that absorbs part of the energy, inline between a transmitter and an antenna, as shown in Figure 4-24.



**Figure 4-24** Using an Attenuator to Add 5-dBm Loss.

When a transmitter or receiver is connected to an outdoor antenna, there is always the possibility that lightning will induce a tremendous amount of energy through the antenna—enough to damage the wireless LAN equipment and portions of the network. To protect against such damage, you should always connect a *lightning arrester* inline between an outdoor antenna and a wireless LAN device, as shown in Figure 4-25.



**Figure 4-25** Using a Lightning Arrester to Protect Sensitive Wireless LAN Equipment.

The lightning arrester has two connectors that attach to the two ends of coaxial cable, in addition to a grounding lug, which should connect to the nearest building or electrical ground. The RF signal is allowed to pass on through the lightning arrester, but sudden spikes of electricity will be bypassed to ground. Contrary to its name, a lightning arrester can never prevent the damage from a direct lightning strike. In can, however, prevent damage that might occur due to static electricity discharges or transient voltage spikes during thunderstorms.

## Exam Preparation Tasks

As mentioned in the section, “How to Use This Book,” in the Introduction, you have a couple of choices for exam preparation: the exercises here, Chapter 22, “Final Review,” and the exam simulation questions on the CD-ROM.

### Review All Key Topics

Review the most important topics in this chapter, noted with the Key Topic icon in the outer margin of the page. Table 4-3 lists a reference of these key topics and the page numbers on which each is found.

**Table 4-3** *Key Topics for Chapter 4*

Key Topic Element	Description	Page Number
Figure 4-2	Cutting a radiation pattern into the E and H planes	89
Figure 4-5	Determining the beamwidth of an antenna	92
Figure 4-6	Antenna polarization	93
Table 4-2	A summary of antenna characteristics	101



### Define Key Terms

Define the following key terms from this chapter and check your answers in the glossary:

amplifier, attenuator, beamwidth, dipole, directional antenna, E plane, gain, H plane, integrated antenna, lightning arrestor, monopole, omnidirectional antenna, parabolic dish antenna, patch antenna, polar plot, polarization, radiation pattern, Yagi antenna



---

This chapter covers the following topics:

- **Types of Wireless Networks**—This section gives a brief overview of several major network types and their scales.
- **Wireless LAN Topologies**—This section discusses the basic building blocks of 802.11 wireless LANs and how they work together.
- **Other Wireless Topologies**—This section describes some network topologies that can be used to solve unique problems.

This chapter covers the following exam topics:

- Describe networking technologies used in wireless (SSID to WLAN\_ID to Interface to VLAN, 802.1q trunking)
- Describe wireless topologies, such as independent basic service set (IBSS), basic service set (BSS), extended service set (ESS), point-to-point, point-to-multipoint, mesh, and bridging)

# Wireless LAN Topologies

Wireless communication usually involves a data exchange between two devices. A wireless LAN goes even further; many devices can participate in sharing the medium for data exchanges. This chapter explains the topologies that can be used to control access to the wireless medium and provide data exchange between devices.

## “Do I Know This Already?” Quiz

The “Do I Know This Already?” quiz allows you to assess whether you should read this entire chapter thoroughly or jump to the “Exam Preparation Tasks” section. If you are in doubt about your answers to these questions or your own assessment of your knowledge of the topics, read the entire chapter. Table 5-1 lists the major headings in this chapter and their corresponding “Do I Know This Already?” quiz questions. You can find the answers in Appendix A, “Answers to the ‘Do I Know This Already?’ Quizzes.”

**Table 5-1** “Do I Know This Already?” Section-to-Question Mapping

Foundation Topics Section	Questions
Types of Wireless Networks	1
Wireless LAN Topologies	2–8
Other Wireless Topologies	9–10

**Caution** The goal of self-assessment is to gauge your mastery of the topics in this chapter. If you do not know the answer to a question or are only partially sure of the answer, you should mark that question as wrong for purposes of the self-assessment. Giving yourself credit for an answer you correctly guess skews your self-assessment results and might provide you with a false sense of security.

- 1.** Which two of the following types of wireless networks use the same frequency band?
  - a.** WPAN
  - b.** WLAN
  - c.** WMAN
  - d.** WWAN
  
- 2.** Devices using a wireless LAN must operate in which one of the following modes?
  - a.** Round-robin access
  - b.** Half duplex
  - c.** Full duplex
  - d.** None of these answers
  
- 3.** An access point is set up to offer wireless coverage in an office. Which one of the following is the correct 802.11 term for the resulting standalone network?
  - a.** BSA
  - b.** BSD
  - c.** BSS
  - d.** IBSS
  
- 4.** Which one of the following is used to uniquely identify an AP and the basic service set it maintains with its associated wireless clients?
  - a.** SSID
  - b.** BSSID
  - c.** Ethernet MAC address
  - d.** Radio MAC address
  
- 5.** Which one of the following statements is true about a wireless BSS?
  - a.** A wireless client can send frames directly to any another client at any time.
  - b.** Once two clients are associated to the BSS, they may communicate directly with each other with no further intervention.
  - c.** A client must send frames through the AP only when the destination client is associated to a different AP.
  - d.** A client must send all frames through the AP to reach any other client or coordinate with the AP to reach another client directly.

- 6.** In a Cisco wireless network, which of the following statements full of acronyms are correct? (Choose two.)
  - a.** The DS connects two BSSs to form an ESS.
  - b.** The BSA of a BSS looks like a MAC address.
  - c.** The SSID of a STA must be unique within the ESS.
  - d.** The BSSID is unique for each SSID in a BSS.
  
- 7.** A wireless client is configured to associate with the wireless network called BeMyGuest. For the client to roam successfully everywhere within a building, which one of the following correctly identifies the WLAN topology that must be in place?
  - a.** A basic service set
  - b.** A distribution system
  - c.** An extended service set
  - d.** The SSID BeMyGuest defined on every AP
  - e.** All of these answers are correct.
  
- 8.** Which one of the following is also known as an ad hoc wireless network?
  - a.** DS
  - b.** ESS
  - c.** BSA
  - d.** IBSS
  - e.** BSS
  
- 9.** Which one of the following can be used to provide wireless connectivity to a non-wireless device?
  - a.** Wireless repeater
  - b.** Workgroup bridge
  - c.** Transparent bridge
  - d.** Adaptive bridge
  
- 10.** Which one of the following is not needed in a Cisco outdoor mesh network?
  - a.** A BSS function
  - b.** Ethernet cabling to each AP
  - c.** A wireless LAN controller
  - d.** A backhaul network

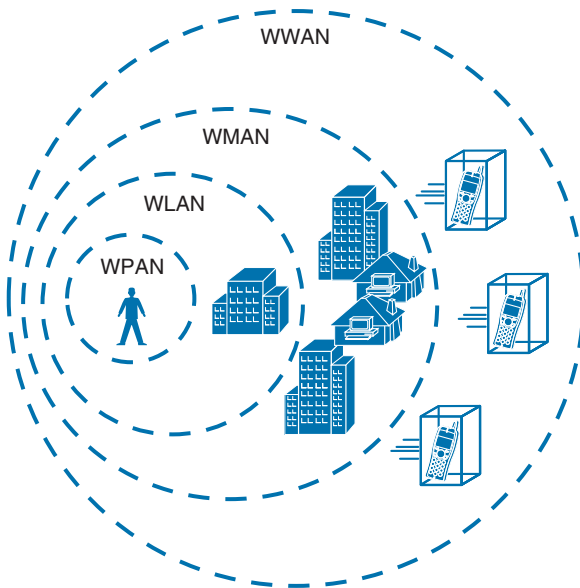
---

## Foundation Topics

---

### Types of Wireless Networks

The term *wireless LAN* is used quite freely in this book. After all, it is the central theme of the CCNA Wireless exam, but it is only one type of wireless network that you might encounter. Wireless networks can be classified into four main types according to the geographic scope where a signal and service is available. Figure 5-1 gives a general idea of the network types and their scopes.



**Figure 5-1** *Wireless Network Types and Scopes.*

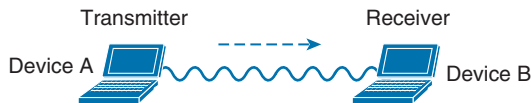
- **Wireless personal-area network (WPAN)**—As its name implies, a WPAN uses low-powered transmitters to create a network with a very short range, usually 20 to 30 feet (7 to 10 meters). WPANs are based on the IEEE 802.15 standard and include technologies like Bluetooth and ZigBee, although ZigBee can have a greater range. Unlicensed ISM frequencies are used, including the 2.4-GHz band.
- **Wireless local-area network (WLAN)**—A wireless service that connects multiple devices using the IEEE 802.11 standard over a medium-sized range, usually up to 300 feet (100 meters). Unlicensed frequencies in the 2.4- and 5-GHz band are used.
- **Wireless metropolitan-area network (WMAN)**—A wireless service over a large geographic area, such as all or a portion of a city. One common example, WiMAX, is based on the IEEE 802.16 standard. Licensed frequencies are commonly used.

- **Wireless wide-area network (WWAN)**—A wireless data service for mobile phones that is offered over a very large geographic area (regional, national, and even global) by telecommunications carriers. Licensed frequencies are used.

The remainder of this chapter focuses on WLANs and how they are constructed.

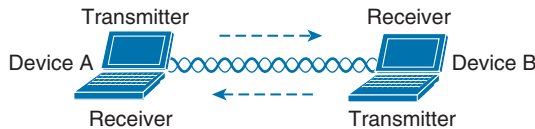
## Wireless LAN Topologies

Up to this point, this book has discussed radio frequency (RF) signals as they travel from a transmitter to a receiver. As Figure 5-2 shows, the transmitter can contact the receiver at any and all times, as long as both devices are tuned to the same frequency (or channel) and use the same modulation and coding scheme. That all sounds simple, except that it is not really practical.



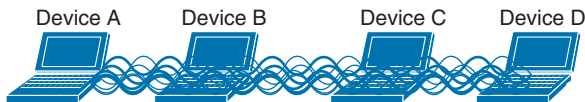
**Figure 5-2** *Unidirectional Communication.*

To fully leverage wireless communication, data should travel in *both* directions, as shown in Figure 5-3. Sometimes Device A needs to send data to Device B, while Device B would like to take a turn to send at other times.



**Figure 5-3** *Bidirectional Communication.*

Because the two devices are using the same channel, two phrases in the preceding sentence become vitally important: *Take a turn* and *send at other times*. As you learned in previous chapters, if multiple signals are received at the same time, they interfere with each other. The likelihood of interference increases as the number of wireless devices grows. For example, Figure 5-4 shows four devices tuned to the same channel and what might happen if some or all of them transmit at the same time.



**Figure 5-4** *Interference from Simultaneous Transmissions.*

All this talk about waiting turns and avoiding interference should remind you of an Ethernet LAN, where multiple hosts can share common bandwidth and a collision domain. To use the media effectively, all the hosts must operate in half-duplex mode so that they avoid colliding with other transmissions. The side effect is that no host can transmit and receive at the same time on a given frequency.



**Tip** IEEE 802.11 WLANs are always half duplex because transmitting and receiving stations use the same frequency. Only one station can transmit at any time; otherwise, collisions occur. To achieve full-duplex mode, all transmitting would have to occur on one frequency and all receiving would occur over a different frequency—much like full-duplex Ethernet links work. Although this is certainly possible and practical, the 802.11-2012 standard does not permit full-duplex operation. The 802.11ac amendment will ease that restriction in its “wave 2” implementation.

A wireless LAN is very similar. Because multiple hosts can share the same channel, they also share the “airtime” or access to that channel at any given time. Therefore, to keep everything clean, only one device should transmit at any given time. To contend for use of the channel, devices based on the 802.11 standard have to determine whether the channel is clear and available before transmitting anything. This process is described in more detail in Chapter 6, “Understanding 802.11 Frame Types.”

At the most basic level, there is no inherent organization to a wireless medium or any inherent control over the number of devices that can transmit and receive frames. Any device that has a wireless network adapter can power up at any time and try to communicate. At a minimum, a wireless network should have a way to make sure that every device using a channel can support a common set of parameters, including data rates, 802.11 modulation types, channel width, and so on. Beyond that, there should be a way to control which devices (and users) are allowed to use the wireless medium, and the methods that are used to secure the wireless transmissions.

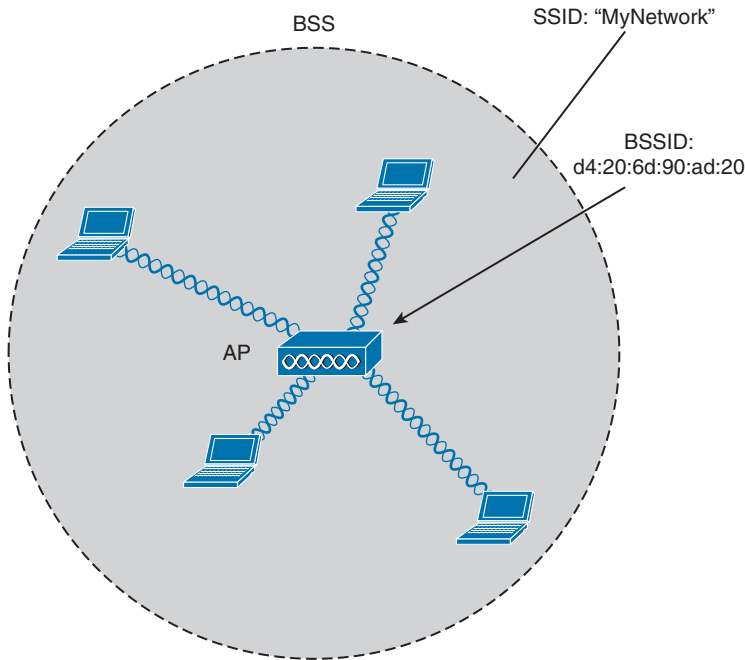
## Basic Service Set

The solution is to make every wireless service area a closed group—before a device can participate, it must advertise its capabilities and then be granted permission to join. The 802.11 standard calls this a *basic service set* (BSS). At the heart of every BSS is a wireless *access point* (AP), as shown in Figure 5-5. The AP operates in *infrastructure mode*, which means it offers the services that are necessary to form the infrastructure of a wireless network.

Because the operation of a BSS hinges on the AP, the BSS is bounded by the area where the AP’s signal is usable. This is known as the *basic service area* (BSA) or *cell*. In Figure 5-5, the cell is shown as a simple circular area that might result from the radiation pattern of an omnidirectional antenna. Cells can have other shapes too, depending on the antenna that is connected to the AP and on the physical surroundings.

The AP serves as a single point of contact for every device that wants to use the BSS. It advertises the existence of the BSS so that devices can find it and try to join. To do that, the AP uses a unique BSS identifier (BSSID) that is based on the AP’s own radio MAC address.

In addition, the AP advertises the wireless network with a service set identifier (SSID), which is a text string containing a logical name. Think of the BSSID as a machine-readable name tag that identifies the unique BSS ambassador (the AP), and the SSID as a human readable name tag that identifies the wireless service.

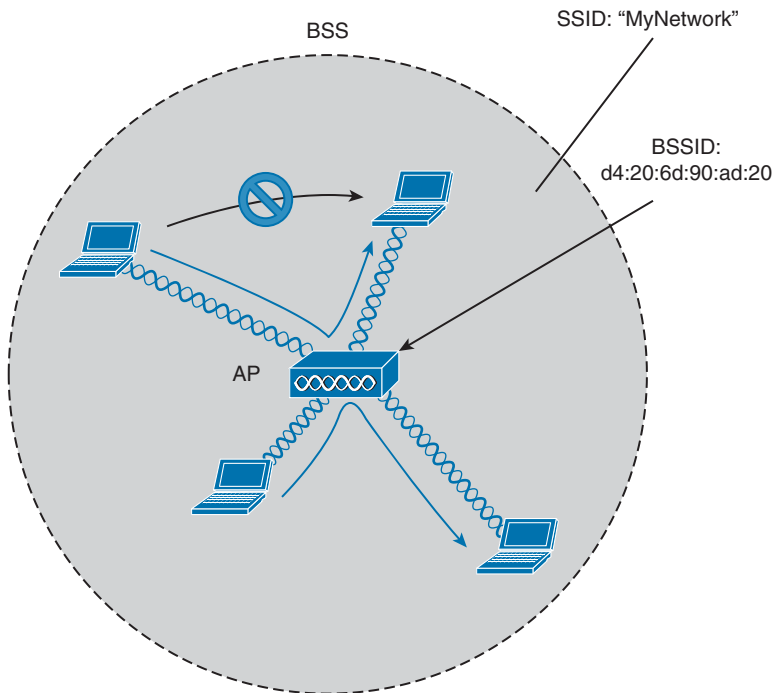


**Figure 5-5** An 802.11 Basic Service Set.

Membership with the BSS is called an *association*. A device must send an association request and the AP must either grant or deny the request. Once associated, a device becomes a client, or an 802.11 *station* (STA), of the BSS. What then? As long as a wireless client remains associated with a BSS, most communications to and from the client must pass *through* the AP, as indicated in Figure 5-6. By using the BSSID as a source or destination address, data frames can be relayed to or from the AP.

You might be wondering why all client traffic has to traverse the AP at all. Why cannot two clients simply transmit data frames directly to each other and bypass the middleman? If clients are allowed to communicate directly, then the whole idea of organizing and managing a BSS is moot. By sending data through the AP first, the BSS remains stable and under control. The 802.11z amendment provides an exception to the rule, which permits two clients to communicate directly without passing through an AP—only if the communication is mediated by an AP.

**Tip** Even though data frames are meant to pass through an AP, keep in mind that other devices in the same general area that are listening on the same channel can overhear the transmissions. After all, frames are freely available over the air to anyone that is within range to receive them. Only the BSSID value contained within the frames indicates that the intended sender or recipient is the AP.



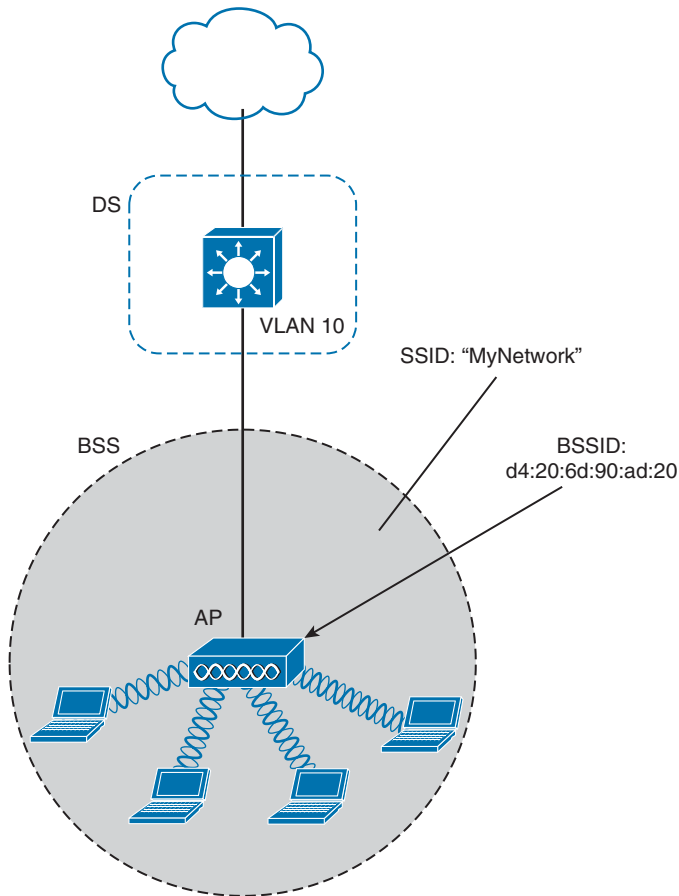
**Figure 5-6** *Traffic Flows Within a BSS.*

## Distribution System

Notice that a BSS involves a single AP and no explicit connection into a regular Ethernet network. In that setting, the AP and its associated clients make up a standalone network. But the AP's role at the center of the BSS does not just stop with managing the BSS—sooner or later, wireless clients will need to communicate with other devices that are not members of the BSS. Fortunately, an AP can also uplink into an Ethernet network because it has both wireless and wired capabilities. The 802.11 standard refers to the upstream wired Ethernet as the *distribution system* (DS) for the wireless BSS, as shown in Figure 5-7.

You can think of an AP as a translational bridge, where frames from two dissimilar media (wireless and wired) are translated and then bridged at Layer 2. In simple terms, the AP is in charge of mapping a virtual local-area network (VLAN) to an SSID. In Figure 5-7, the AP maps VLAN 10 to the wireless LAN using SSID “MyNetwork.” Clients associated with the “MyNetwork” SSID will appear to be connected to VLAN 10.

This concept can be extended so that multiple VLANs are mapped to multiple SSIDs. To do this, the AP must be connected to the switch by a trunk link that carries the VLANs. In the Figure 5-8, VLANs 10, 20, and 30 are trunked to the AP over the DS. The AP uses the 802.1Q tag to map the VLAN numbers to the appropriate SSIDs. For

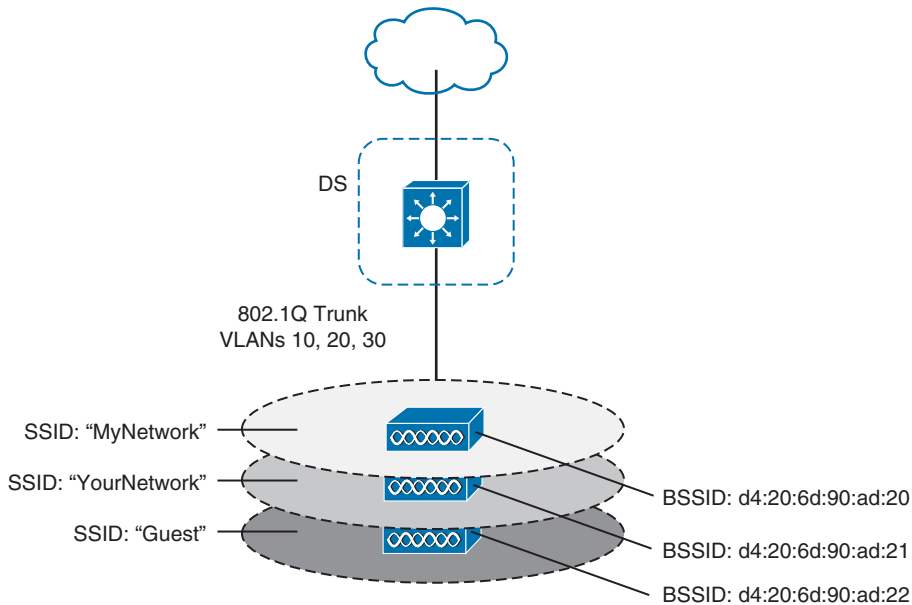


**Figure 5-7** *The Distribution System Supporting a BSS.*

example, VLAN 10 is mapped to SSID “MyNetwork,” VLAN 20 is mapped to SSID “YourNetwork,” and VLAN 30 to SSID “Guest.”

In effect, when an AP uses multiple SSIDs, it is trunking VLANs over the air to wireless clients. The clients must use the appropriate SSID that has been mapped to the respective VLAN when the AP was configured. The AP then appears as multiple logical APs—one per BSS—with a unique BSSID for each. With Cisco APs, this is usually accomplished by incrementing the last digit of the radio’s MAC address for each SSID.

Even though an AP can advertise and support multiple logical wireless networks, each of the SSIDs covers the same geographic area. That is because the AP uses the same transmitter, receiver, antennas, and channel for every SSID that it supports. Beware of one misconception though: Multiple SSIDs can give an illusion of scale. Even though wireless clients can be distributed across many SSIDs, all of those clients must share the same AP’s hardware and must contend for airtime on the same channel.



**Figure 5-8** Supporting Multiple SSIDs on One AP.

## Extended Service Set

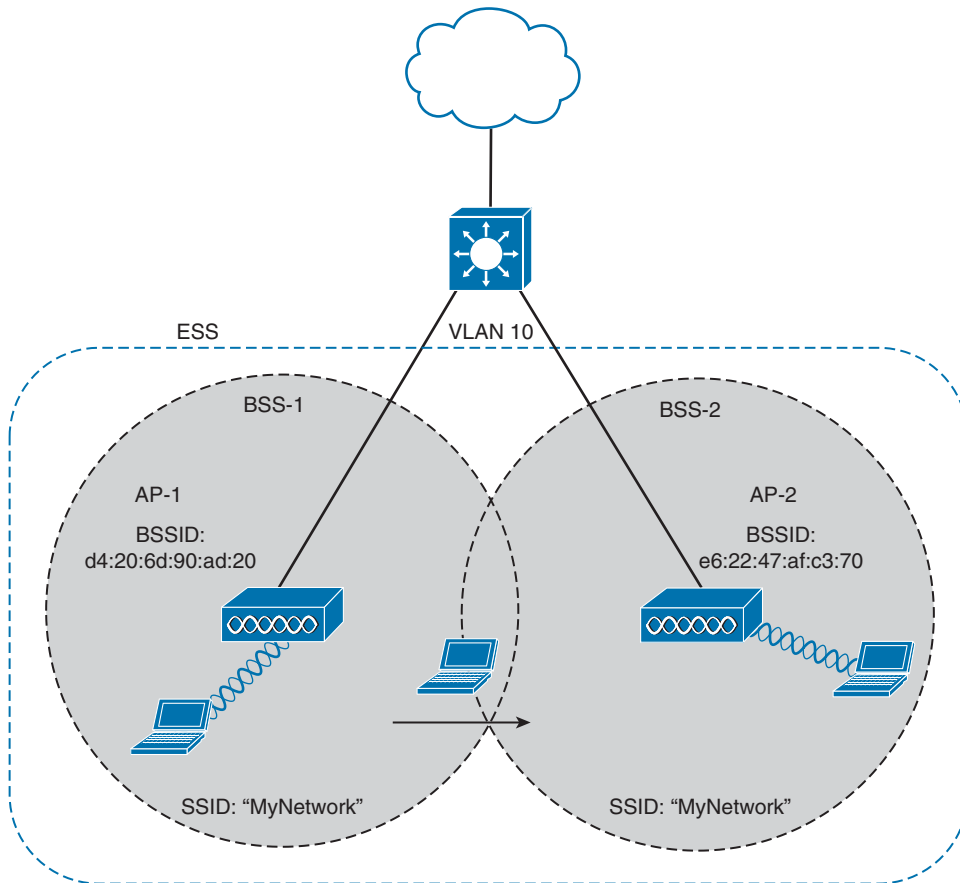
Normally, one AP cannot cover the entire area where clients might be located. For example, you might need wireless coverage throughout an entire floor of a business, hotel, hospital, or other large building. To cover more area than a single AP's cell, you simply need to add more APs and spread them out geographically.

When APs are placed at different geographic locations, they can all be interconnected by a switched infrastructure. The 802.11 standard calls this an extended service set (ESS), as shown in Figure 5-9.

**Tip** Chapter 7, "Planning Coverage with Wireless APs," discusses AP and cell placement in greater detail.

The idea is to make multiple APs cooperate so that the wireless service is consistent and seamless from the client's perspective. Ideally, any SSIDs that are defined on one AP should be defined on all the APs in an ESS; otherwise, it would be very cumbersome and inconvenient for a client to be reconfigured each time it moves into a different AP's cell.

Notice that each cell in Figure 5-9 has a unique BSSID, but both cells share one common SSID. Regardless of a client's location within the ESS, the SSID will remain the same but the client can always distinguish one AP from another.



**Figure 5-9** *Scaling Wireless Coverage with an 802.11 Extended Service Set.*

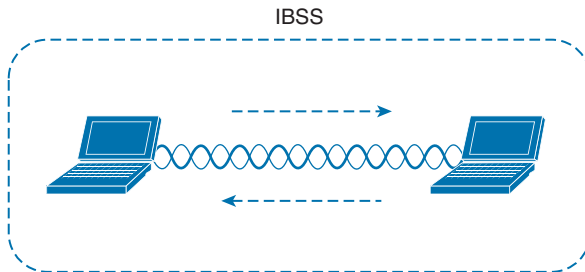
In an ESS, a wireless client can associate with one AP while it is physically located near that AP. If the client later moves to a different location, it can associate with a different nearby AP automatically. Passing from one AP to another is called *roaming* and is covered in Chapter 6.

## Independent Basic Service Set

Usually a wireless network leverages APs for organization, control, and scalability. Sometimes that is not possible or convenient in an impromptu situation. For example, two people might want to exchange electronic documents at a meeting, but they are unable to find a BSS available. In addition, many personal printers have the capability to print documents wirelessly, without relying on a regular BSS or AP.

The 802.11 standard allows two or more wireless clients to communicate directly with each other, with no other means of network connectivity. This is known as an *ad hoc* wireless network, or an *independent basic service set* (IBSS), as shown in Figure 5-10.

For this to work, one of the devices must take the lead and begin advertising a network name and the necessary radio parameters. Any other device can then join as needed.



**Figure 5-10** An 802.11 Independent Basic Service Set.

Regardless of their convenience, ad hoc networks are seldom recommended and used because of their limitations. The 802.11 standard intended for IBSSs to be organized in an impromptu, distributed fashion. Therefore, they do not scale well beyond eight to ten devices.

## Other Wireless Topologies

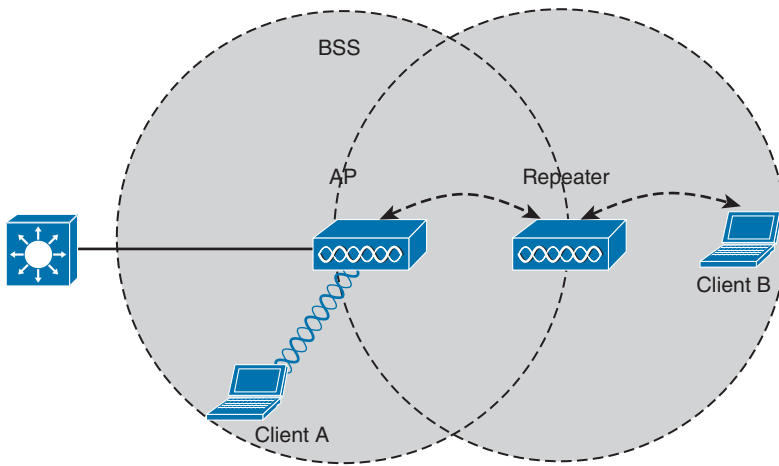
Wireless APs can be configured to operate in noninfrastructure modes when a normal BSS cannot provide the functionality that is needed. The following sections cover the most common modes.

### Repeater

Normally, each AP in a wireless network has a wired connection back to the DS or switched infrastructure. To extend wireless coverage, additional APs and their wired connections are added. In some scenarios, it is not possible to run a wired connection to a new AP because the cable distance is too great to support Ethernet communication.

In that case, you can add an additional AP that is configured for *repeater mode*. A wireless repeater takes the signal it receives and repeats or retransmits it. The idea is to move the repeater out away from the AP so that it is still within range of both the AP and the distant client, as shown in Figure 5-11.

If the repeater has a single radio, there is a possibility that the AP's signal will be received and retransmitted by the repeater, only to be received again by the AP—halving the effective throughput. As a remedy, some repeaters can use two radios to keep the original and repeated signals isolated. One radio is dedicated to signals in the AP's cell, while the other radio is dedicated to signals in the repeater's own cell.

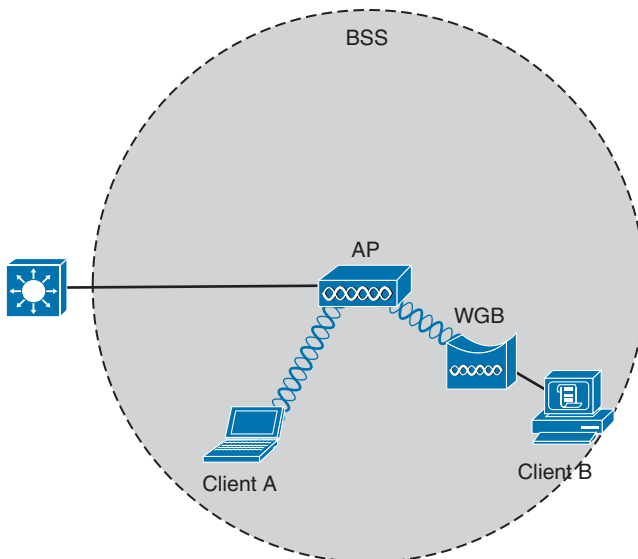


**Figure 5-11** *Extending the Range of an AP with a Wireless Repeater.*

## Workgroup Bridge

Suppose you have a device that supports a wired Ethernet link but is not capable of having a wireless connection. You can use a workgroup bridge (WGB) to connect the device's wired network adapter to a wireless network.

Rather than providing a BSS for wireless service, a WGB becomes a wireless client of a BSS. In effect, the WGB acts as an external wireless network adapter for a device that has none. In Figure 5-12, an AP provides a BSS; Client A is a regular wireless client, while Client B is associated with the AP through a WGB.



**Key  
Topic**

**Figure 5-12** *A Nonwireless Device Connects Through a Workgroup Bridge.*



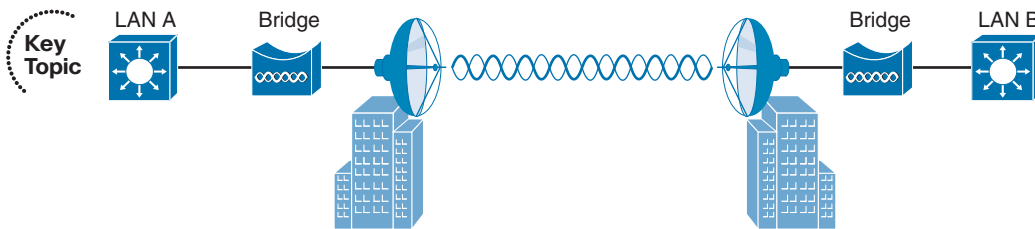
You might encounter two types of workgroup bridges:

- **Universal workgroup bridge (uWGB)**—A single wired device can be bridged to a wireless network.
- **Workgroup bridge (WGB)**—A Cisco-proprietary implementation that allows multiple wired devices to be bridged to a wireless network.

## Outdoor Bridge

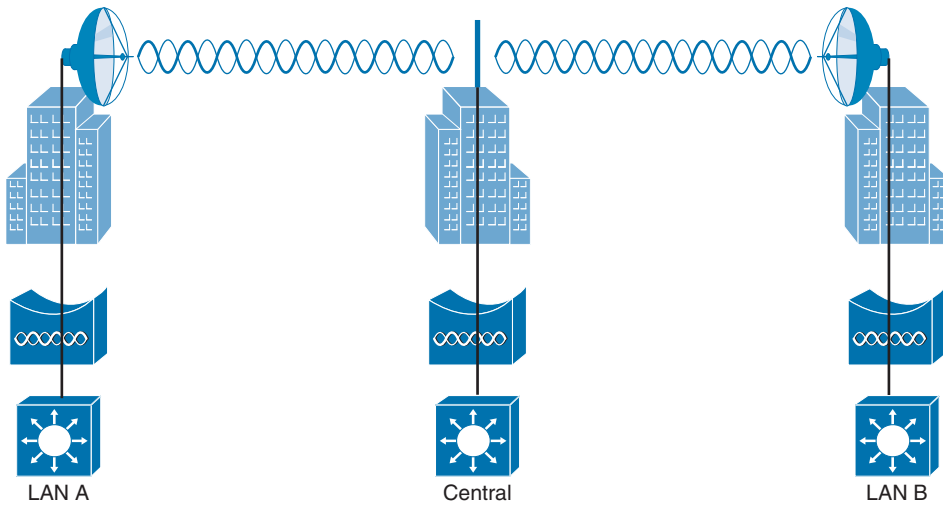
An AP can be configured to act as a bridge to form a single wireless link from one LAN to another over a long distance. Outdoor bridged links are commonly used for connectivity between buildings or between cities.

If the LANs at two locations need to be bridged, a point-to-point bridged link can be used. One bridge mode AP is needed on each end of the wireless link. Directional antennas are normally used with the bridges to maximize the link distance, as shown in Figure 5-13.



**Figure 5-13** A Point-to-Point Outdoor Bridge.

Sometimes the LANs at multiple sites need to be bridged. A point-to-multipoint bridged link allows a central site to be bridged to several other sites. The central site bridge is connected to an omnidirectional antenna so that its signal can reach the other sites simultaneously. The bridges at each of the other sites can be connected to a directional antenna aimed at the central site. Figure 5-14 shows the point-to-multipoint scenario.

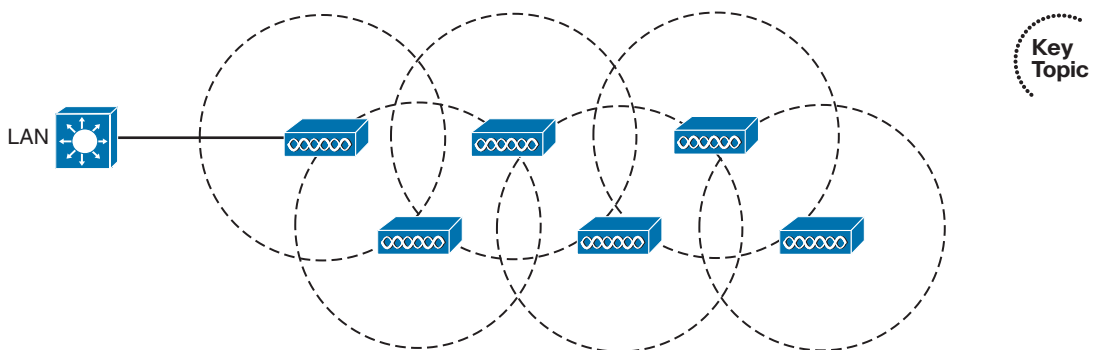


**Figure 5-14** *A Point-to-Multipoint Outdoor Bridge.*

## Mesh Network

To provide wireless coverage over a large area, it is not always practical to run Ethernet cabling to every AP that is needed. Instead, you could use multiple APs configured in mesh mode. In a mesh topology, traffic is bridged from AP to AP, in a daisy-chain fashion.

Mesh APs can leverage dual radios—one in the 2.4-GHz band and one in the 5-GHz band. Each mesh AP usually maintains a BSS on a 2.4-GHz channel, with which wireless clients can associate. Client traffic is then usually bridged from AP to AP over 5-GHz channels as a backhaul network. At the edge of the mesh network, the backhaul traffic is bridged to the wired LAN infrastructure. Figure 5-15 shows a typical mesh network. With Cisco APs, you can build a mesh network indoors or outdoors. The mesh network runs its own dynamic routing protocol to work out the best path for backhaul traffic to take across the mesh APs.



**Figure 5-15** *A Typical Wireless Mesh Network.*

## Exam Preparation Tasks

As mentioned in the section, “How to Use This Book,” in the Introduction, you have a couple of choices for exam preparation: the exercises here, Chapter 22, “Final Review,” and the exam simulation questions on the CD-ROM.

## Review All Key Topics

Review the most important topics in this chapter, noted with the Key Topic icon in the outer margin of the page. Table 5-2 lists a reference of these key topics and the page numbers on which each is found.



**Table 5-2** *Key Topics for Chapter 5*

Key Topic Element	Description	Page Number
Figure 5-5	Basic service set	111
Figure 5-8	Multiple SSIDs	114
Figure 5-9	Extended service set	115
Figure 5-12	Workgroup bridge	117
Figure 5-13	Point-to-point bridge	118
Figure 5-15	Mesh network	119

## Define Key Terms

Define the following key terms from this chapter and check your answers in the glossary:

access point (AP), ad hoc network, basic service set (BSS), basic service set identifier (BSSID), cell, distribution system (DS), extended service set (ESS), independent basic service set (IBSS), infrastructure mode, mesh network, point-to-point bridge, repeater, roaming, service set identifier (SSID), station (STA), workgroup bridge (WGB)

*This page intentionally left blank*



---

This chapter covers the following topics:

- **802.11 Frame Format**—This section describes the basic format of wireless LAN frames and the addressing fields they contain.
- **Accessing the Wireless Medium**—This section explains the mechanisms that wireless devices must use to contend for use of a channel when transmitting.
- **802.11 Frame Types**—This section discusses the three basic types of 802.11 frames and their use.
- **Client Housekeeping**—This section discusses many common operations between a wireless client and an access point, based on 802.11 management frames.

This chapter covers the following exam topics:

- Describe frame types (associated and unassociated, management, control, and data)

# Understanding 802.11 Frame Types

Wireless networks based on the 802.11 standard operate in a very organized and controlled fashion. The standard defines the frame format and frame types that access points (APs) and clients must use to communicate successfully. Before a device transmits on a channel, it must cooperate with all other devices and contend for use of the channel. This chapter covers these topics and the choreography that occurs between an access point (AP) and its clients.

## “Do I Know This Already?” Quiz

The “Do I Know This Already?” quiz allows you to assess whether you should read this entire chapter thoroughly or jump to the “Exam Preparation Tasks” section. If you are in doubt about your answers to these questions or your own assessment of your knowledge of the topics, read the entire chapter. Table 6-1 lists the major headings in this chapter and their corresponding “Do I Know This Already?” quiz questions. You can find the answers in Appendix A, “Answers to the ‘Do I Know This Already?’ Quizzes.”

**Table 6-1** “Do I Know This Already?” Section-to-Question Mapping

Foundation Topics Section	Questions
802.11 Frame Format	1–3
Accessing the Wireless Medium	4–6
802.11 Frame Types	7–8
Client Housekeeping	9–12

**Caution** The goal of self-assessment is to gauge your mastery of the topics in this chapter. If you do not know the answer to a question or are only partially sure of the answer, you should mark that question as wrong for purposes of the self-assessment. Giving yourself credit for an answer you correctly guess skews your self-assessment results and might provide you with a false sense of security.

1. Which one of the following is the correct number of address fields defined in an 802.11 frame header?
  - a. 1
  - b. 2
  - c. 3
  - d. 4
2. Every 802.11 frame contains 2 flag bits that designate whether the frame is headed to or from which one of the following?
  - a. The AP
  - b. The DS
  - c. The BSS
  - d. The ESS
3. The Address1 field in an 802.11 frame always contains which one of the following?
  - a. The transmitter address (TA)
  - b. The BSSID
  - c. The AP's base radio MAC address
  - d. The receiver address (RA)
4. To access a wireless channel, 802.11 devices participate in which one of the following?
  - a. DCF
  - b. GCF
  - c. LCM
  - d. BSD
5. A wireless client maintains a NAV value that is used for which one of the following purposes?
  - a. To navigate the frame through the ESS
  - b. To identify the MAC address of the next client to transmit
  - c. To predict when the channel might become free
  - d. To set the priority of the client's ability to transmit
6. Which one of the following specifies the default amount of time between successive 802.11 data frames?
  - a. CCA
  - b. IBSS
  - c. SIFS
  - d. DIFS

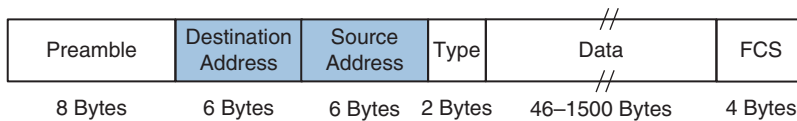
7. Which one of the following is the frame type sent to discover APs within the signal range of a wireless client?
  - a. Scan
  - b. Probe
  - c. Beacon
  - d. Discovery
8. An ACK frame is an example of which one of the following 802.11 frame types?
  - a. Management
  - b. Control
  - c. Administration
  - d. Data
9. A wireless AP advertises mandatory data rates of 1, 2, 5.5, and 11 Mbps. Which of the following represent client data rates that can successfully join the BSS? (Choose all that apply.)
  - a. Mandatory: 1 Mbps, Supported: 2, 5.5, 11 Mbps
  - b. Mandatory: 2 Mbps, Supported: 1, 5.5, 11 Mbps
  - c. Mandatory: 1 Mbps, Supported: None
  - d. Mandatory: 5, 11 Mbps; Supported: None
10. In a passive scan, a wireless client uses which one of the following methods to discover nearby APs?
  - a. Beacons
  - b. Probe requests
  - c. ACKs
  - d. Discovers
11. When a client attempts to join a BSS, which one of the following frame types is sent first?
  - a. Beacon
  - b. Rate request
  - c. Association request
  - d. Authentication request
12. Which one of the following frame types does a client use to roam seamlessly from one BSS to another, within the same ESS and the same SSID?
  - a. Association request
  - b. Disassociation
  - c. Reassociation
  - d. Roam request



## 802.11 Frame Format

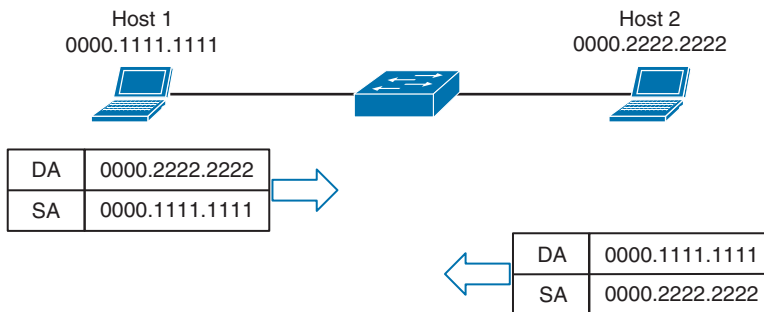
To understand more about 802.11 frames and how they are transported, it might be useful to compare them with the familiar 802.3 frames.

Ethernet devices based on IEEE 802.3 send and receive frames in the format shown in Figure 6-1. The sender and the intended recipient of a frame are identified by two MAC addresses—a source and a destination. The source address is not used to deliver the frame; rather, it is used for any return traffic that is sent back to the source. When the recipient receives a frame that has its own MAC address as the destination, the frame is then accepted and processed.



**Figure 6-1** IEEE 802.3 Ethernet Frame Format.

Suppose that the source and destination hosts are connected by a switched network, as shown in Figure 6-2. The switch that connects the two hosts forwards frames between them as needed, but it does not intervene or actively participate in the exchange. In other words, neither host has to be aware of the switch's existence at all. Frames enter and exit a switch simply because hosts are connected to it through wires or cables. The switch silently forwards the frames based on the destination MAC addresses and the device locations it has learned from the source MAC addresses.



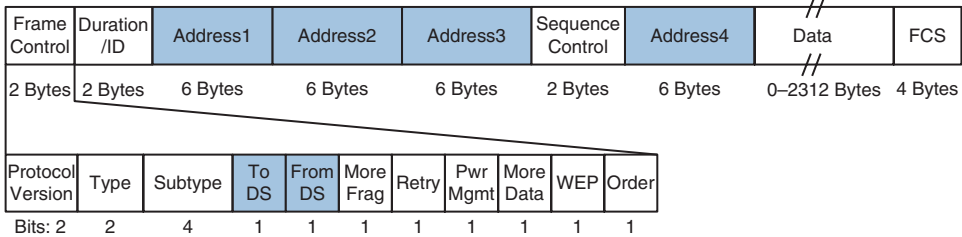
**Figure 6-2** Forwarding 802.3 Frames in a Switched Network.

In contrast, the APs in an 802.11 network are active participants. Recall from Chapter 5, “Wireless LAN Topologies,” that an AP acts as the central “hub” or manager of a basic service set (BSS). With the absence of wired connections, a client must join or associate with a specific wireless network by first getting permission from the AP. Then the client must send and receive every frame through the AP or coordinate with the AP for direct client-to-client communication to use 802.11z - Direct Link Setup (DLS).

IEEE 802.11 networks are based on traditional MAC addresses. Each client's radio interface must have a unique MAC address so that frames can be sent from and received to

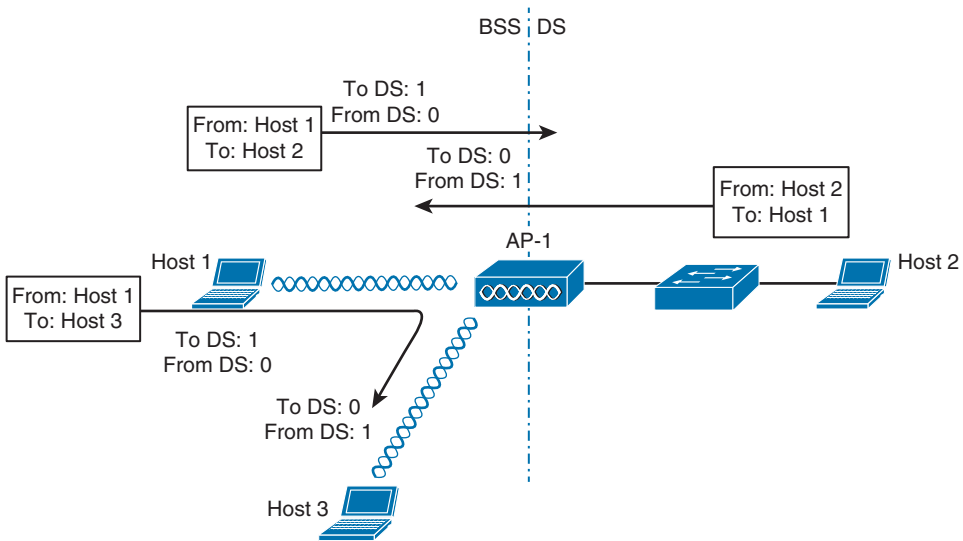
that address. To direct frames through an AP, the AP must also have a MAC address of its own. Wireless clients know the AP's address as the BSS identifier (BSSID), which must be included in each frame.

Figure 6-3 shows the basic format of 802.11 frames, which can be a maximum of 2346 bytes in length. The frame begins with a 2-byte Frame Control field, which identifies such things as the frame type and the direction in which the frame is traveling as it moves from one wireless device to another.



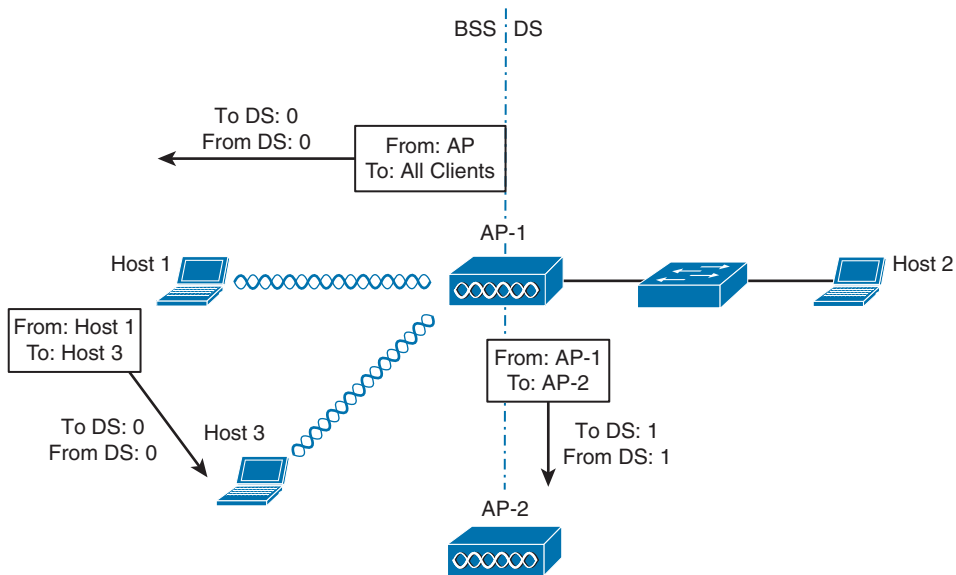
**Figure 6-3** IEEE 802.11 Frame Format.

Consider a common scenario where several wireless clients are associated with an AP. This is not a standalone BSS—the AP also connects to an upstream DS. Most of the time, wireless frames pass through the AP, either coming from clients toward the DS or coming from the DS toward the clients. Frame motion is indicated by 2 bits, *To DS* and *From DS*, contained in the 802.11 frame header. On the surface, it seems that frames travel in only one of two directions, relative to the DS, as shown in the simple examples of Figure 6-4.



**Figure 6-4** Some Example 802.11 Frames Moving to and from the DS.

With just two frame directions to indicate, a single bit would suffice. Why are there two different direction bits in the frame header? There are two other special cases where frames are destined for something other than a specific wireless client or somewhere in the distribution system (DS), as shown in Figure 6-5. This gives a total of four possible destinations, or 2 bits worth of direction values.



**Figure 6-5** Examples of 802.11 Frames That Are Not Moving to and from the DS.

One special case commonly occurs when a frame is sourced or destined from a location that cannot be clearly defined in relation to the DS. In the following examples, both the To DS and From DS bits are set to 0:

- An AP sends a management or control frame, which is broadcast to all wireless clients in the BSS. The AP, and not the DS, is the source of the frame.
- A client sends a management frame to an AP, such that the AP itself is the destination.
- One client sends a frame directly to another client via DLS. The frame is not destined for the AP or the DS.

The other special case is related to mesh AP networks, where frames are relayed from AP to AP over wireless backhaul links. A backhaul link is neither in the BSS nor in the DS, so both direction bits are set to 1.

## 802.11 Frame Addressing

From an addressing viewpoint, an 802.11 frame header can contain up to four different address fields. In Figure 6-3, you can see them listed with the rather generic names

Address1 through Address4. Wireless frames are always sent from a transmitting device to a receiving device. Therefore, each frame header must contain a transmitter address (TA) and a receiver address (RA). The Address1 field always contains the RA, though its exact contents may vary depending on where the frame is headed. Likewise, Address2 always contains the TA.

Address3 contains the final destination address when the RA is not the final recipient. For example, when a wireless client sends a frame to a destination on the DS, the frame is transmitted from the client's wireless adapter, is received by the AP, but still needs to be forwarded on to the final destination on the DS. Likewise, Address3 can contain the original source address when the TA is not the originator. Consider a frame sent from a device on the DS to a wireless client. When the frame is sent over the wireless medium, the AP's radio is the transmitter address, but the AP did not originate the frame—a device on the DS did.

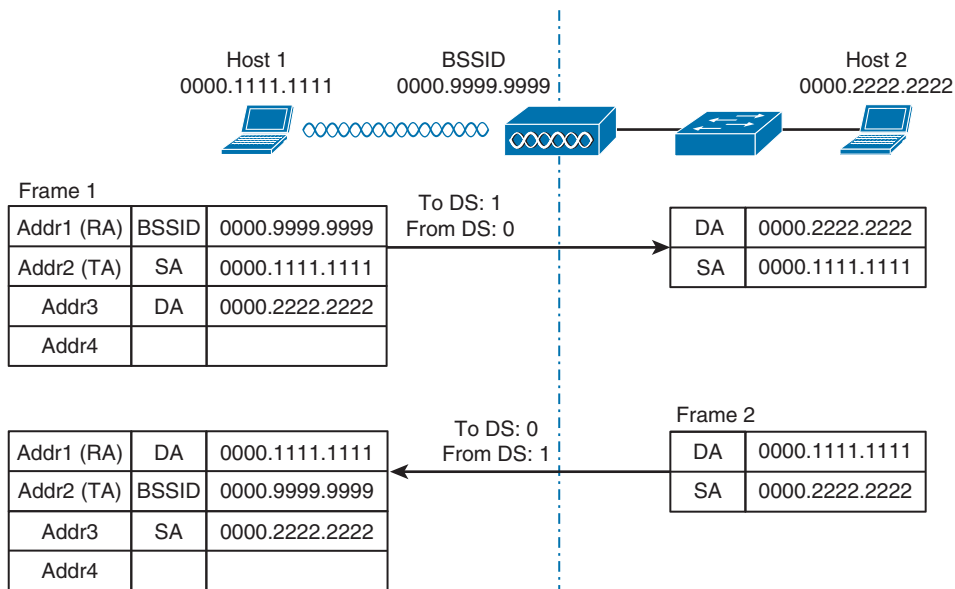
Address4 does not come into play unless a frame is being transported from one AP to another AP across a wireless link. In that case, the frame has to carry the original sender and recipient addresses, in addition to the MAC addresses of a receiver and transmitter—the APs relaying the frame over the air.

Table 6-2 lists the possible combinations of frame direction bits, along with the four address field contents. You should become familiar with frame addressing, as the CCNA Wireless exam may cover it. Try to break the table down into parts. First, get comfortable with the To/From DS bits and the reasons behind the frame directions. Next, think about what happens to a frame each step along the way as it travels from its source to its destination. Does it stop at the AP? Does the AP relay it to or from a more distant location? Remember that Address1 and Address2 are always the receiver and transmitter MAC addresses, respectively. Address3 will contain the address of an additional hop, if one is needed.

**Table 6-2** 802.11 Frame Header Direction and Addressing

	To DS	From DS	Address1 (RA)	Address2 (TA)	Address3	Address4
Management, control, or DLS	0	0	Dest Addr	Src Addr	BSSID	
DS to client	0	1	Dest Addr	BSSID	Src Addr	
Client to DS	1	0	BSSID	Src Addr	Dest Addr	
Wireless bridge or mesh	1	1	Dest Radio	Src Radio	Dest Addr	Src Addr

Figure 6-6 shows two example frames and their address fields. Frame1 at the top is being sent from Host1 to Host2, while Frame2 at the bottom is coming from Host2 to Host1. Fictitious MAC addresses are used for clarity.



**Figure 6-6** Examples of 802.11 Frame Addressing.

Host1 is sending the frame through the AP to the DS, so the Address1 (RA) contains the BSSID 0000.9999.9999. Frame1 is sourced or transmitted by Host1, so the Address2 (TA) field contains Host1's MAC address, 0000.1111.1111. The frame must pass through the AP, so Host1 populates Address3 with the destination address of Host2, 0000.2222.2222. Once the AP receives Frame1, it finds that Host2 is located on the DS, so the wireless frame is converted into an 802.3 wired frame. The original source and destination addresses are copied into the new frame so that it can be forwarded on to Host2.

On the return trip, Host2 fills in the source and destination addresses of Frame2 in 802.3 format. The switch forwards the frame to the AP, which knows that the destination (Host1) is located within the wireless BSS. The AP populates Address1 (RA) with the destination address of Host1. The AP is transmitting the frame, so Address2 (TA) contains the BSSID. The address of the original source, Host2, is copied into the Address3 field.

## Accessing the Wireless Medium

Once a wireless device has data to send, it must access the network medium and try to send it. Remember that a wireless channel is a shared medium and that every device trying to use it must share the airtime and contend for its use. There is no centralized function that coordinates the use of a wireless channel. Instead, this effort is distributed to each device that uses a channel. This is known as a *distributed coordination function (DCF)*.

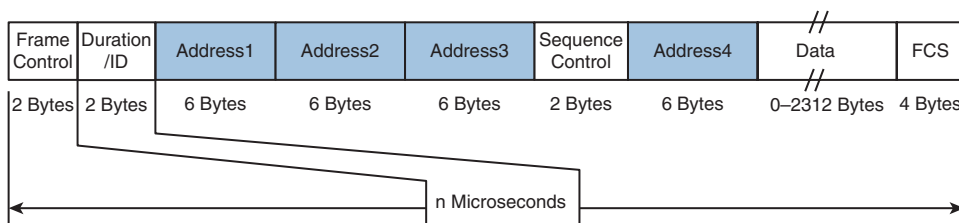
With a shared medium, such as wired Ethernet or wireless, two or more stations transmitting at the same time can cause collisions. A collision ruins the transmitted data,

wastes time on the medium, and causes the data to be retransmitted—wasting even more time. When full-duplex operation isn't possible, some collisions are inevitable; therefore, every device should make its best attempt to mitigate and/or hopefully prevent collisions in the first place.

## Carrier Sense

Devices based on the 802.3 and 802.11 standards must use the carrier sense multiple access (CSMA) technique to determine if the media is available before transmitting. Wired devices are able to sense an electrical signal on the wire to detect a transmission already in progress. Wireless devices can use a two-fold process to detect a channel in use:

- **Physical Carrier Sense**—When a wireless client is not transmitting, it can listen to the channel to overhear any other transmissions that might be occurring. If it overhears a frame that is destined for its own MAC address, then it receives the frame for processing. Otherwise, if a transmission is detected but the client cannot read the transmitter's MAC address in the header, the client decides that the channel is busy. This process is also known as *clear channel assessment (CCA)*. While CCA is effective, it isn't a proactive approach and must be used in conjunction with other methods.
- **Virtual Carrier Sense**—When a wireless client transmits a frame, it must include a duration field in the Duration/ID frame header field. The duration indicates how many microseconds are required for the whole frame to be sent over the channel, and effectively reserves the channel for that length of time. As long as other wireless clients can overhear a frame and its header, they can predict how long they should wait for the frame to complete. Figure 6-7 depicts the frame duration field and its relationship to the frame length in time,



**Figure 6-7** The 802.11 Frame Duration Field.

Each wireless client must maintain a *network allocation vector (NAV)* timer that is used to predict when the channel will become free. Each time a frame is overheard on the channel, its Duration value is loaded into the NAV. The NAV timer then counts down while the client waits to transmit.

The NAV timer must be at zero before a client can contend for use of the channel. That sounds simple, but the contention process is still a bit more complex. Sensing the carrier alone can alert a client when the medium is quiet and available—except that every cli-

ent on the channel will come to the same conclusion at the same time! If multiple clients have frames to transmit and all decide that the channel is free at the same time, collisions are still likely.

## Collision Avoidance

The 802.3 and 802.11 standards differ when it comes to dealing with collisions. Wired devices can *detect* collisions in real time so that they can back off and wait a random time to try again. This is known as CSMA/CD (collision detection).

Wireless devices always operate in half-duplex mode, which prevents a client from receiving signals on a channel while it is transmitting. This means that a transmitting wireless client can't detect when a collision occurs at all. Therefore, 802.11 devices must try to *avoid* collisions in the first place, resulting in the CSMA/CA (collision avoidance) scheme.

Wireless clients avoid collisions by backing off and waiting a random time *before* transmitting. If a client has a frame to transmit, it must then choose a random number (0 to 31) of timeslots to use as a *backoff timer*. If there are multiple clients with frames ready to transmit, their random backoff timer values will lessen the likelihood that they will contend to use a channel at the same time.

If the channel becomes busy before the backoff timer reaches zero, the timer is paused and the overheard frame duration value is added to the NAV. The waiting client can transmit only when every timer mechanism has expired and the channel is available. The total time a client spends waiting to transmit is called the *contention window*.

Believe it or not, there is one more timing scheme that controls frame transmission. The 802.11 standard defines a few different *interframe space* periods that provide a safety cushion between frames. These periods of silence give the channel enough time for signals to dampen out—especially when multipath is involved and some reflected copies take longer to propagate than others.

Several different interframe space periods are used, according to the type and priority of the frame being transmitted:

- **Reduced interframe space (RIFS)**—The shortest period of time, used before each data frame during a burst of 802.11n frames
- **Short Interframe Space (SIFS)**—Used between data frames and frame acknowledgements or, CTS 802.11g protection mode control frames
- **Distributed Interframe Space (DIFS)**—The default period used after most standard priority frame types
- **Extended interframe space (EIFS)**—The longest period of time, used after collisions and before retransmitted frames

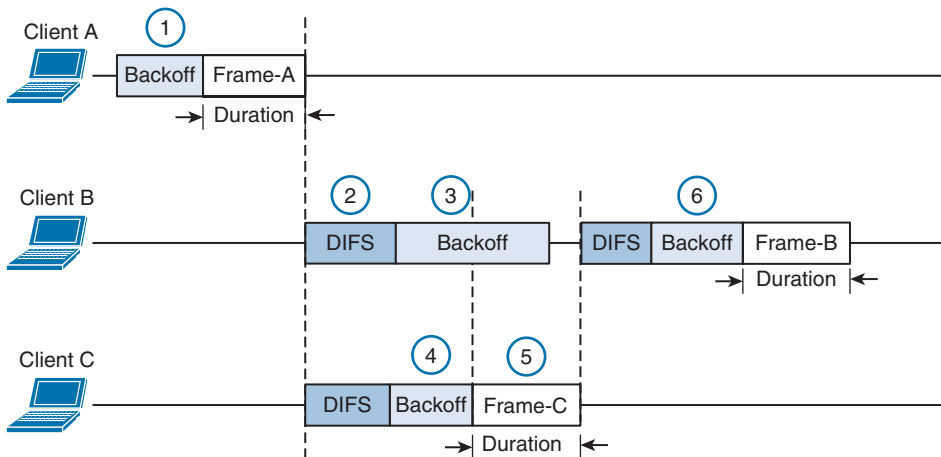
**Tip** If you feel confused over all of the timer mechanisms, try to remember this simple rule. Before a device can transmit on a channel, it must do the following:

1. Wait for DIFS.
2. Wait for its own backoff timer.
3. Listen.
4. Wait for contention window (backoff timer + NAV). If the channel is clear afterward, the client may transmit.

Assuming all of the carrier sense and collision avoidance methods have worked, how does a transmitting client know that the frame it just sent arrived in good condition? During transmission, the receiver must be off, so there is no way to listen to the channel. Instead, every client must rely on a very rudimentary feedback mechanism. Each time a client receives a unicast frame, it must send a unicast acknowledgement frame back to the sender. The 802.11 standard requires this one-to-one response for every frame received, except in the case of 802.11n and 802.11e (WMM) bursts of frames, which require one acknowledgement for a whole block of frames.

If a transmitted frame fails and is not acknowledged, the sending client must try again by retransmitting the frame. The client chooses a new backoff timer value that is double the previous choice. In effect, this relaxes the conditions on the channel to give the retransmitted frame a better chance of surviving. With every failed attempt, the backoff timer is doubled, up to a maximum of 1023 timeslots.

Figure 6-8 shows an example of the DCF operation within a wireless cell.



**Figure 6-8** *Avoiding Collisions with the DCF Process.*



The following sequence of events occurs:

1. Client A listens and determines that no other devices are transmitting. Client A waits a random backoff timer period before transmitting Frame-A. The frame's duration is advertised in the header's Duration field.
2. Client B has a frame to transmit. It must wait until Client A's frame is completed and then wait until a DIFS period has expired.
3. Client B waits a random backoff time before attempting to transmit.
4. While Client B is waiting, Client C has a frame to transmit. Like Client B, Client C must wait until the DIFS period has elapsed. Client C then listens and detects that no one else is transmitting. It then waits a random backoff time that is shorter than Client B's backoff timer.
5. Client C transmits a frame and advertises the frame duration in the Duration field.
6. Client B must now wait the duration of Client C's frame plus a DIFS period plus the remainder of its own backoff timer before attempting to transmit again.

## 802.11 Frame Types

The 802.11 standard defines three different frame types that can be used:



- Management frames
- Control frames
- Data frames

The frame type is identified by a 2-bit Type field and a 4-bit SubType field in the Frame Control portion of the header. This implies that each of the three frame types can have several different subtypes that perform various functions. The frame types and their most common subtypes are discussed in the following sections.

### Management Frames

Management frames are used to advertise a BSS and to manage clients as they join or leave the BSS. A client must first locate a candidate BSS to join, authenticate itself to an AP, and associate itself with the BSS. Although there are 14 different management frame subtypes available, you should become familiar with just the following for the CCNA Wireless exam:

- **Beacon**—A frame that is broadcast by the AP to advertise the BSS, the data rates necessary and allowed in the BSS, an optional security set identifier (SSID) string, and vendor-specific information when necessary. Beacons are sent to any and all devices in the BSA about ten times per second (100 ms intervals). If the AP supports multiple SSIDs, a different beacon is broadcast for each SSID.

A wireless device can learn about BSSs within range by listening to the beacons that are received. This is known as *passive scanning*.

- **Probe**—A wireless device can send probe request frames to ask any APs within range or a specific AP to provide information about their BSSs. An AP answers by sending a probe response that contains most of the beacon information. Probing for BSS information is known as *active scanning*.
- **Authentication and deauthentication**—To join a BSS, a wireless device must first send an authentication request frame to an AP. The AP can support either *Open System authentication*, where any device is authenticated without any sort of verification, or *shared key authentication*, where a device must exchange a Wired Equivalent Privacy (WEP) key that matches the key used by the AP. The AP sends the result of the authentication in an authentication response frame.

If a device wants to leave the authenticated state, it can send a deauthentication frame to the AP. However, the AP can force a device out of the authenticated state by sending it a deauthentication frame.

**Tip** It might seem odd that Open System and WEP are the only two authentication methods offered in authentication request frames, because both methods are known to be very weak. Wireless networks can offer robust authentication methods through a different method of frame exchanges. Those methods are covered in Part III, “Implementing Wireless LANs.”

- **Association, disassociation, and reassociation**—Once a device is authenticated, it can send an association request frame to the AP to ask permission to join the BSS. If the device supports compatible parameters and is allowed to join, then the AP will reply with an association response frame, along with a unique association identifier (AID) for that client.

If a device wants to gracefully leave a BSS, it can send a disassociation frame to the AP. An AP can also decide to drop a client by sending it a disassociation frame.

When a client wants to leave one BSS for another, while staying within the same SSID, it can send a reassociation request frame to the new AP. In effect, the client is attempting to reassociate with the SSID, not an AP. The new AP responds with a reassociation response frame. (Moving from one BSS to another is covered in greater detail in Chapter 12, “Understanding Roaming.”)

## Control Frames

Control frames are used to gain control of and to help deliver data over a channel. Control frames contain only frame header information and no data payload. There are nine different control frames possible. Be familiar with the following four:

- **ACK**—A short frame that is sent as an acknowledgment of a unicast frame that has been received.
- **Block ACK**—A short frame that is sent as an acknowledgment of a burst of frames send as a single block of data.
- **PS-Poll**—The Power Save Poll frame is sent from a client to an AP to request the next frame that was buffered while the client’s radio was powered down.
- **RTS/CTS**—Frames that are used to reserve a channel during 802.11g protected mode, while a legacy 802.11b client is transmitting. RTS/CTS frames carry a Duration value that reserves the channel airtime for the frame they are protecting. RTS/CTS may also be used to help avoid collisions between clients that cannot hear each other because of the distance between them. When clients cannot hear each other, they also cannot hear the Duration values or detect a carrier to know when to cease transmitting. As long as the clients can hear the AP when it sends RTS/CTS frames, they can remain silent while others are transmitting.

## Data Frames

Data is sent to and from clients in data frames. A data frame contains up to four address fields that identify the sender and recipient and identify the BSSID and any wireless link involved with forwarding the frame. The 802.11 standard defines 15 different data frame subtypes, but you should just be aware of a generic data frame and its addressing mechanism.

## Client Housekeeping

Recall from Chapter 1, “RF Signals and Modulation,” that a client and an AP have to use the same modulation and coding scheme (MCS) to successfully communicate. The scheme can be changed dynamically, if needed, as long as both ends agree on the choice. The MCS directly affects the data rate between the client and the AP.

An AP is configured with a set of data rates that it can use. Each data rate can be set to one of the following states:

- **Disabled**—The AP will not use the data rate for any client communication.
- **Supported**—The AP can use the data rate if a client also supports its use, but the client is not required to support it.
- **Mandatory**—The AP can use the data rate and expects every client to support it. This is also known as an 802.11 *BSS basic rate*.

At least one data rate must be mandatory to provide a common rate that can be used for management and control frames. In fact, the AP will always send broadcast management frames using the lowest mandatory rate. The idea is to leverage a lower data rate to get better signal-to-noise ratio (SNR) and greater signal range to reliably manage client devices within the BSS.

Other data rates can be configured as supported. Normal data frames and unicast management frames will be sent at whatever supported rate is most optimal between the client and the AP. Acknowledgment frames are sent at the first mandatory rate that is below the current optimal data rate.

APs advertise their mandatory and supported data rates in each beacon frame so that potential clients can know what is available. By default, 802.11b/g/n radios are configured with 1-, 2-, 5.5-, and 11-Mbps data rates as mandatory; 802.11a/n radios consider 6, 12, and 24 Mbps to be mandatory.

Before a wireless device can join a BSS, it must announce its own set of mandatory and supported data rates in an association request frame. The AP compares the client's list of data rates with its own. If the client can support all of the AP's mandatory rates, the client can take the next step to be associated with the BSS.

Wireless clients can be mobile and transient. The following sections describe how a wireless client and a BSS interact using management frames in a variety of common scenarios.

## A Client Scans for APs

To join a BSS, a wireless device first has to scan its surroundings to look for any live APs that might offer network service. Beyond that, the device might need to build a list of SSIDs that are available. A device can scan the wireless horizon in two ways:

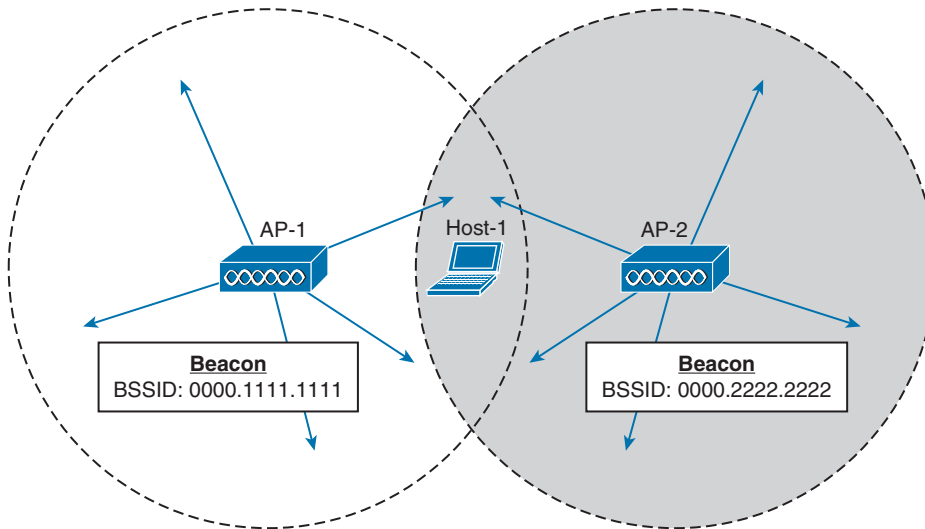
- **Passive scan**—The device simply listens for any beacon frames broadcast from nearby APs. Passive scanning has a couple of drawbacks—a device must wait until beacons are broadcast at the next interval, which might not be soon enough in a time critical situation; beacons don't always contain specific SSID names, so a device cannot always depend on learning that a desired SSID exists on an AP.



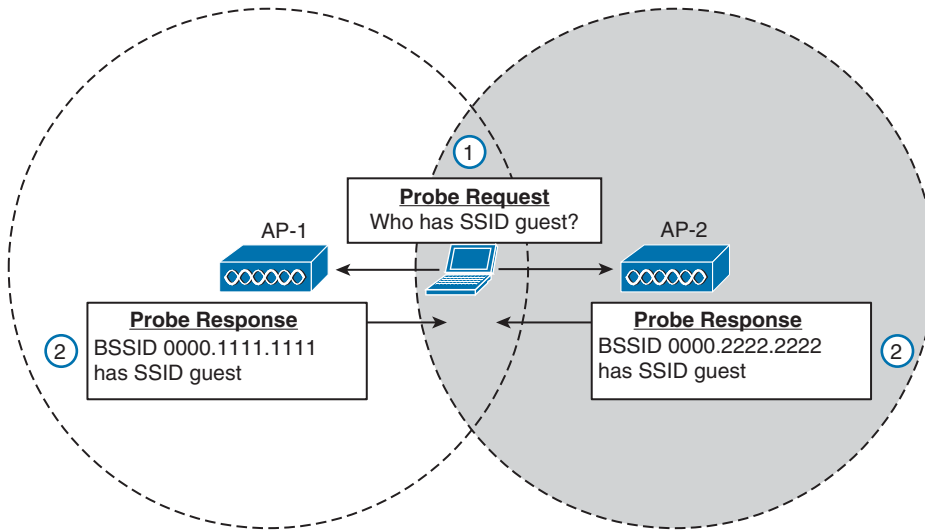
In Figure 6-9, Host-1 is able to receive beacons from AP-1 and AP-2. The beacon frames specify the BSSIDs and SSIDs that are offered, as well as supported data rates and other information about their BSSs.

- **Active scan**—The device must take an active role and broadcast a probe request frame to ask any APs within range to identify themselves. The device can include a specific SSID name in the request. Any APs that receive the probe request must send a unicast probe response frame back to the device.

In Figure 6-10, a device broadcasts a probe request to look for any APs that can offer the “guest” SSID. Both AP-1 and AP-2 receive the request and send probe responses containing their BSSIDs and other information about the BSS and SSID.



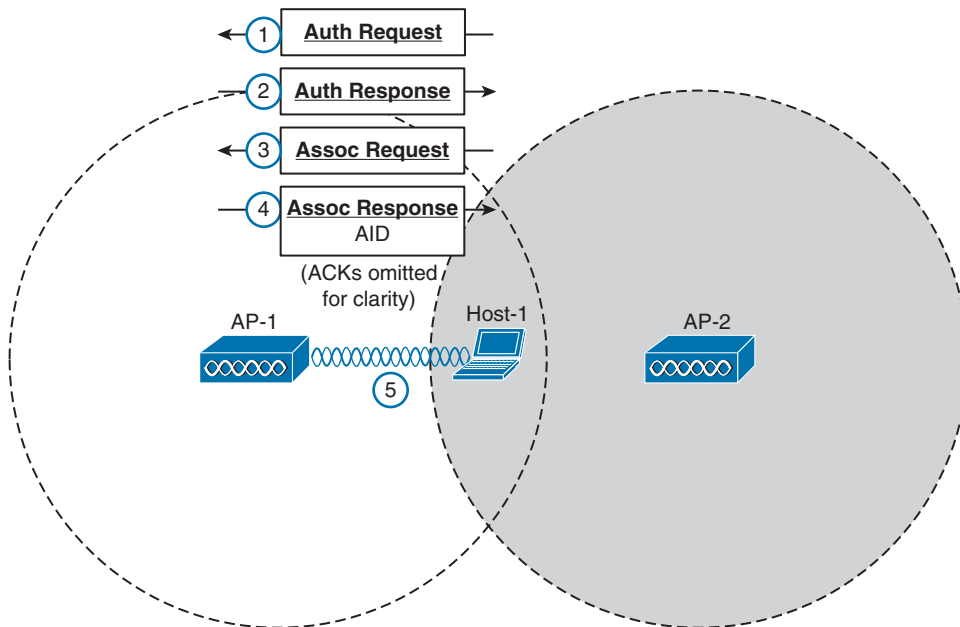
**Figure 6-9** Using a Passive Scan to Discover BSSs.



**Figure 6-10** Using an Active Scan to Discover BSSs.

## A Client Joins a BSS

Suppose a wireless device is not currently joined to a wireless network. The device comes within range of two different APs that form a single ESS and offer a common SSID. The device performs an active scan and discovers the two APs. Through some algorithm, it decides that AP-1 is more preferable than AP-2. Figure 6-11 shows the steps that the device takes to join the network offered by AP-1.



**Figure 6-11** *A Wireless Client Joins a BSS.*

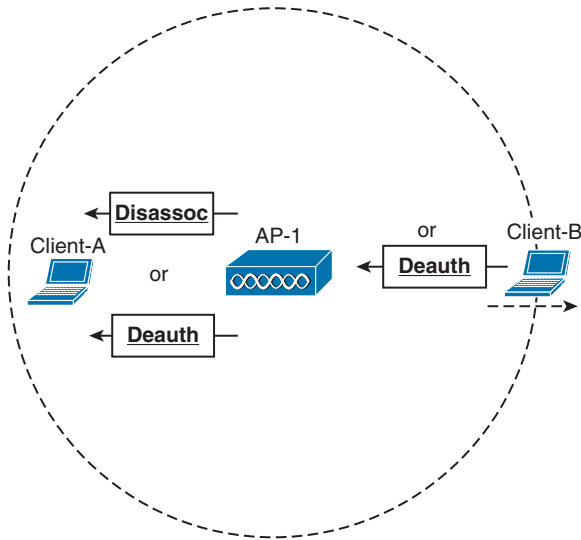
- Step 1.** Host-1 sends an authentication request frame to AP-1's BSSID address.
- Step 2.** If AP-1 is satisfied with the host's identity, it sends an authentication response frame back to Host-1.
- Step 3.** Now that Host-1 is known to the AP, it must ask for BSS membership by sending an association request frame to AP-1. Host-1 includes a list of its 802.11 capabilities, the SSID it wants to join, a list of data rates and channels it supports, and any parameters that are needed to secure the wireless link to the AP.
- Step 4.** If the AP is satisfied with the request, it sends an association response frame back to Host-1.
- Step 5.** The response also contains the AID that uniquely identifies Host-1 as an associated client. In effect, the AID is Host-1's membership card while it remains a part of the BSS.

## A Client Leaves a BSS

Once a wireless device successfully becomes a client of a BSS, it keeps that relationship with the AP until something happens to remove it. For example, a wireless client might be removed if it violates a security policy, is recognized as a rogue device, has a session that stays idle for too long, and so on.

A client can be removed from a BSS if the AP sends it a disassociation or a deauthentication frame. Once that happens, the device must start the whole association process over again. In Figure 6-12, Client-A has been forced to leave the BSS through either disassociation or deauthentication.

A client can gracefully remove itself from a BSS, when needed. To do this, the client simply notifies the AP by sending it a deauthentication frame. In Figure 6-12, Client-B has sent a deauthentication for itself to AP-1.



**Figure 6-12** *Disassociating and Deauthenticating—Two Ways to Leave a BSS.*

What happens if a client physically leaves a BSS without informing the AP? For example, suppose Client-B in Figure 6-12 reaches the edge of AP-1's cell, but does not send a deauthentication frame? Once it goes outside the cell range, the AP might not even notice. Even before it leaves the cell, the client might just go into sleep mode and stop communicating with the AP altogether. In this case, the AP maintains the AID entry for the device, in case it returns to the cell or wakes up, but only for a certain amount of time. Cisco APs age out unresponsive clients after 5 minutes. In case the client is still listening, the AP also sends a deauthentication frame to it.

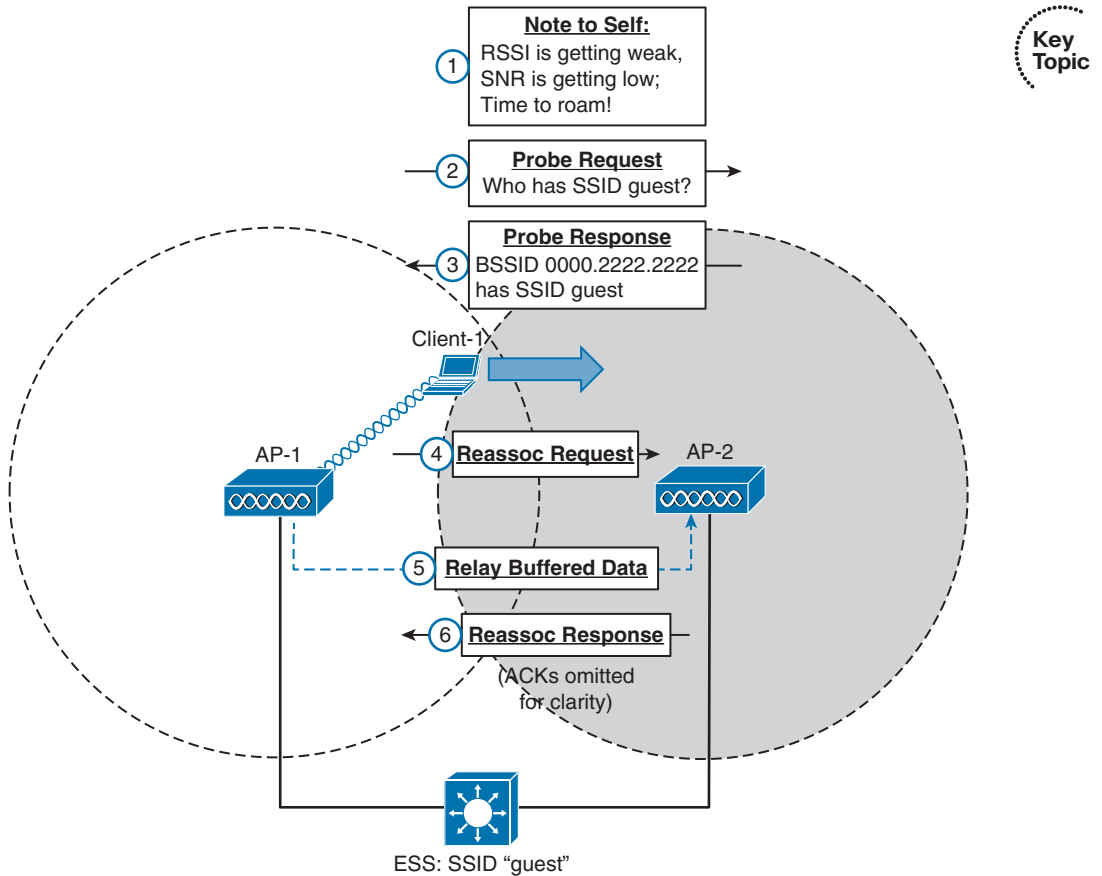
## A Client Moves Between BSSs

When a wireless client is within range of several APs, it must choose to associate with only one of them. A client can join only one BSS at any given time. If the client changes its location, it might stay within its original BSS or it might move out of range and into the cell of an adjacent BSS. Moving seamlessly from one BSS to another is called *roaming*.

The basic roaming process is not much different than finding and associating with a BSS, except that the client does this while it is actively associated with another BSS. To switch

BSSs seamlessly, the client must recognize that it is nearing the cell boundary and that it needs to find other potential cells to move into before losing the signal completely.

Figure 6-13 illustrates the basic steps of the roaming process.



**Figure 6-13** *Roaming Between Two BSSs.*

The wireless client begins with an active association with AP-1 using SSID "guest":

- Step 1.** Client-1 notices that the signal from AP-1 is degrading. Based on various conditions like the received signal strength indicator (RSSI) and SNR, the client will decide that it needs to roam.
- Step 2.** Client-1 begins to search for a successor BSS to move into. It broadcasts a probe request frame to look for nearby APs that can offer the same "guest" SSID.
- Step 3.** AP-2 receives the probe request and returns a probe response, advertising its BSSID and the "guest" SSID. Other APs may also hear the request and send probe responses of their own.



- Step 4.** Client-1 must decide which AP is the best candidate out of all probe responses that are received. It then sends a reassociation request frame to the new AP, asking to transfer its ESS membership from AP-1's BSS to AP-2.
- Step 5.** AP-2 communicates with AP-1 over the wired DS network to begin the client handoff. Client-1's association will be moved from AP-1 to AP-2. Any frames that are destined for the client during the handoff will be buffered on AP-1, then relayed to AP-2 and transmitted to the client.
- Step 6.** If the reassociation is accepted, AP-2 will inform the client with a reassociation response frame.

## A Client Saves Power

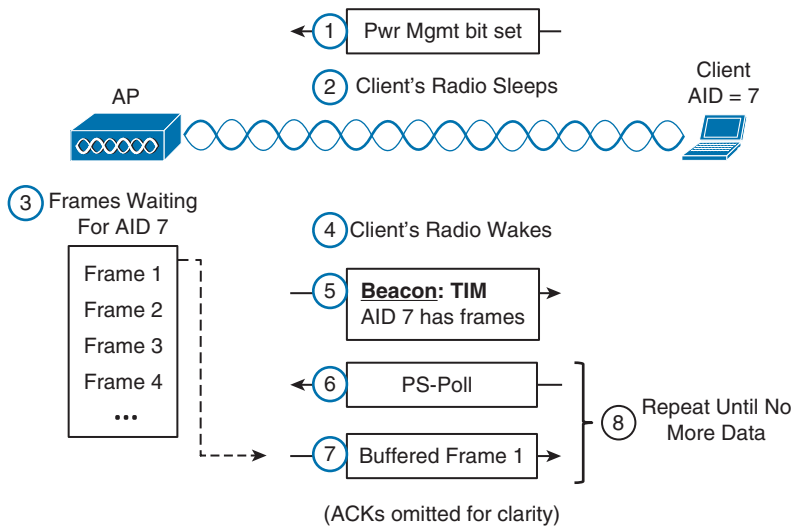
Wireless devices are commonly small in size and powered by batteries. Because the devices are mobile and carried around, it is not very practical to stop and charge the batteries. To maximize the battery life, the device should conserve as much power as possible.

By default, the radio (both transmitter and receiver) is powered on all the time, so that the device is always ready to send and receive data. That might be good for performance, but applies a constant drain on the battery. Fortunately, the 802.11 standard defines some methods to save power by putting the radio to sleep when it is not needed.

**Tip** Be aware that a device's radio sleeping is different than the whole device sleeping, as when you close the lid on a laptop. While a radio is sleeping, its transmitter and receiver are powered down for a short amount of time and cannot send or receive wireless frames. In contrast, when a laptop is sleeping, most of its functions are paused for a long period of time. While asleep, a laptop can become disassociated from the AP; when it wakes, it must probe and associate again. The "legacy" method was defined in the original 802.11 standard and is described by Figure 6-14 and the following sequence of steps. (For simplicity, the ACK frames that acknowledge each frame have been omitted.)

In a nutshell, the method works by letting the client's radio power down and go to sleep while the AP stores up any frames that are destined for the client. The client's radio must periodically wake up and fetch any buffered frames from the AP:

- Step 1.** The client informs the AP that it is entering power save mode by setting the Power Management bit in the Frame Control field of the frame header (refer to Figure 6-3).
- Step 2.** The client shifts its wireless radio into a very low power or "sleep" mode.
- Step 3.** The AP begins to buffer any unicast frames that are destined for the client while it is in power save mode.
- Step 4.** To check for any potentially buffered frames, the client's radio must wake up in time to receive a beacon frame.



**Figure 6-14** Using the Legacy Power Save Delivery Method.

- Step 5.** The beacon can contain a *traffic indication map* (TIM), or a list of AID entries for clients that have buffered frames. The client, known as AID 7, has frames available and is listed in the TIM.
- Step 6.** The client can begin to retrieve its buffered frames one by one. To do so, it must send a PS-Poll management frame to the AP.
- Step 7.** The AP sends the next buffered frame to the client, along with a flag that indicates more buffered frames are available.
- Step 8.** The client and AP continue the exchange in Steps 6 and 7 until no more frames are available in the buffer.

Broadcast and multicast frames become special cases for clients that have radios in power save mode. Such frames are not destined for any specific client; rather, they are destined for mass delivery. Sleeping radios will miss the frames unless the AP somehow intervenes.

An AP can also buffer broadcast and multicast frames and deliver them at regular intervals. The *delivery traffic indication message* (DTIM) is a beacon that is sent at some multiple of regular beacon periods. The DTIM period is advertised in every beacon so that all clients know to wake up their radios in time to receive the next DTIM. At that time, the DTIM is sent, followed by any buffered broadcast and multicast frames.

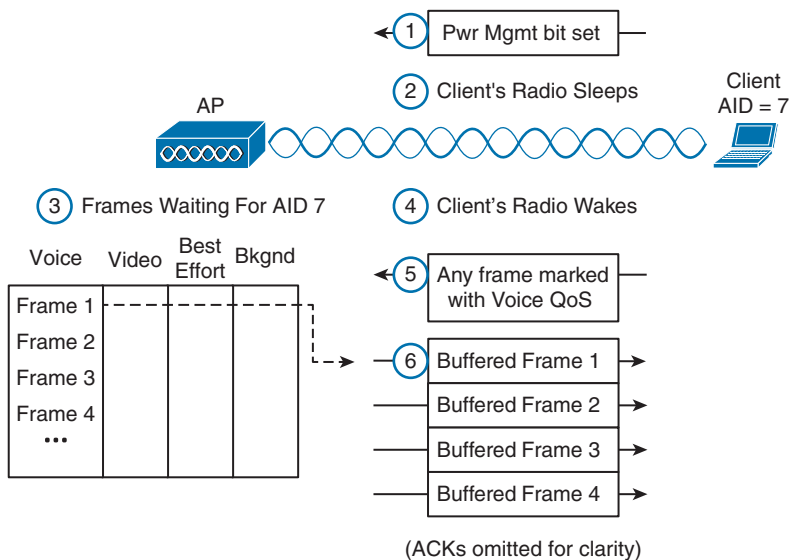
The legacy TIM and DTIM schemes have one drawback—they are AP-centric. Even though a client needs to conserve its battery power, it is the AP that dictates when and how often the client's radio should wake up and consume more power.

Ideally, a client should have more control over its own power consumption. The 802.11e amendment, certified by the Wi-Fi Alliance and known as *Wireless Multimedia*

(WMM), introduced a new quality of service (QoS) mechanism along with a new and improved power save mode that is more client-centric.

Traffic to and from a wireless client can be handled according to four different categories, in order of decreasing time critical delivery: voice, video, best effort, and background. While a client is in a power save mode, the AP buffers its frames in four queues that correspond to the QoS categories. When the client is ready to wake its radio up, it sends a frame marked for one of the queues. The AP responds by sending the buffered frames in that queue to the client in a burst.

This method is known as *unscheduled automatic power save delivery* (U-APSD), and must be supported on both the client and the AP. The client does not have to request each frame, and the client does not have to wake its radio up until it is ready to do so. Figure 6-15 illustrates the sequence of steps involved in U-APSD, which are detailed in the list that follows.



**Figure 6-15** Using the U-APSD Power Save Delivery Method.

- Step 1.** The client informs the AP that it is entering power save mode by setting the Power Management bit in a frame.
- Step 2.** The client puts its radio into power down or sleep mode.
- Step 3.** The AP buffers any frames destined for the client in the appropriate QoS queues.
- Step 4.** The client decides to wake its radio.
- Step 5.** The client is ready to receive any buffered frames from the “voice” queue, so it marks a frame as voice and signals the AP that it is awake.
- Step 6.** The AP sends the frames it has buffered in the voice queue in a burst.

## Exam Preparation Tasks

As mentioned in the section, “How to Use This Book,” in the Introduction, you have a couple of choices for exam preparation: the exercises here, Chapter 22, “Final Review,” and the exam simulation questions on the CD-ROM.

## Review All Key Topics

Review the most important topics in this chapter, noted with the Key Topic icon in the outer margin of the page. Table 6-3 lists a reference of these key topics and the page numbers on which each is found.

**Table 6-3** *Key Topics for Chapter 6*

Key Topic Element	Description	Page Number
Figure 6-3	802.11 frame format	127
Figure 6-7	802.11 Frame Duration (NAV) field	131
Figure 6-8	Avoiding collisions with DCF	133
List	802.11 frame types	134
List	Client scanning methods	137
Figure 6-11	Joining a BSS	139
Figure 6-13	Roaming between BSSs	141
Figure 6-14	Legacy power save mode	143



## Define Key Terms

Define the following key terms from this chapter and check your answers in the glossary:

active scanning, association, backoff timer, BSS basic rate, clear channel assessment (CCA), collision avoidance, contention window, delivery traffic indication message (DTIM), distributed coordination function (DCF), interframe space, network allocation vector (NAV), open system authentication, passive scanning, physical carrier sense, reassociation, shared key authentication, traffic indication map (TIM), unscheduled automatic power save deliver (U-APSD), virtual carrier sense, Wireless Multimedia (WMM)



---

This chapter covers the following topics:

- **AP Cell Size**—This section discusses how the size of a wireless cell affects things like coverage area, performance, and efficiency.
- **Adding APs to an ESS**—This section covers the process of growing an extended service set, with an emphasis on client roaming and proper layout of wireless channels over an area.

This chapter covers the following exam topics:

- Describe basic RF deployment considerations related to site survey design of data or VoWLAN applications; common RF interference sources such as devices, building material, AP location; and basic RF site survey design related to channel reuse, signal strength, and cell overlap

# Planning Coverage with Wireless APs

Chapters 1 through 6 covered wireless communication with a focus on a single access point (AP) exchanging data with one or more clients. A single AP may be sufficient for home or small office use, but most wireless LANs involve a greater geographic area and require more APs. This chapter explains how wireless coverage can be adjusted to meet a need and how it can be grown to scale over a greater area and a greater number of clients. As you work through this chapter, remember that two things are important: the size of the BSA or AP cell and the location of cells in relation to each other.

## “Do I Know This Already?” Quiz

The “Do I Know This Already?” quiz allows you to assess whether you should read this entire chapter thoroughly or jump to the “Exam Preparation Tasks” section. If you are in doubt about your answers to these questions or your own assessment of your knowledge of the topics, read the entire chapter. Table 7-1 lists the major headings in this chapter and their corresponding “Do I Know This Already?” quiz questions. You can find the answers in Appendix A, “Answers to the ‘Do I Know This Already?’ Quizzes.”

**Table 7-1** “Do I Know This Already?” Section-to-Question Mapping

Foundation Topics Section	Questions
AP Cell Size	1–4
Adding APs to an ESS	5–10

**Caution** The goal of self-assessment is to gauge your mastery of the topics in this chapter. If you do not know the answer to a question or are only partially sure of the answer, you should mark that question as wrong for purposes of the self-assessment. Giving yourself credit for an answer you correctly guess skews your self-assessment results and might provide you with a false sense of security.

1. Which of the following parameters can be adjusted on an AP to change the size of its cell or BSA? (Choose all that apply.)
  - a. Channel number within a band
  - b. Transmit power
  - c. Supported modulation and coding schemes
  - d. Supported data rates
2. An AP has been configured to use channel 1 with a transmit power of 20 dBm. With the AP located in the center of the lobby, you have determined that its signal will reach all locations in the lobby area. However, some users with small battery-operated devices report connectivity problems when they move toward the outer walls of the lobby. Which one of the following approaches will probably fix the problem?
  - a. Increase the AP's transmit power to increase its range
  - b. Increase the client device's transmit power
  - c. Adjust the client device's roaming algorithm
  - d. Enable some lower data rates on the AP
3. Suppose that an AP is configured to offer the following data rates: 2-, 5.5-, 6-, 9-, 11-, 12-, 18-, 24-, 36-, and 48-Mbps data rates to its clients. Which one of the following strategies should be used to reduce the AP's cell size?
  - a. Enable the 1-Mbps data rate
  - b. Enable the 54-Mbps data rate
  - c. Disable the 36- and 48-Mbps data rates
  - d. Disable the 2-Mbps data rate
4. All the APs on the second floor of a building are part of a single ESS. Each AP has been configured with a transmit power level of 14 dBm. In addition, each AP has been configured to use a non-overlapping channel that is different from its adjacent neighbors. All APs have been configured to offer only the 24-, 36-, 48-, and 54-Mbps data rates; all other rates are disabled. One day, one of the APs fails and someone replaces it. Afterward, users begin to call and complain about poor performance and roaming. You discover that the problems are not occurring in the area covered by the failed AP; instead, they are occurring about two APs away from it. Which one of the following could be causing the problem?
  - a. The replacement AP has its radios disabled.
  - b. The replacement AP is using a transmit level of 1 dBm.
  - c. The replacement AP is using the 1- and 2-Mbps data rates.
  - d. The replacement AP is new and cannot be causing the problem.
5. Which one of the following determines when a wireless client will roam from one AP to another?
  - a. The current AP detects a weak signal coming from the client and forces the client to roam.

- b.** The next AP overhears the client's signal and asks it to roam.
  - c.** The client's roaming algorithm reaches a threshold in signal quality.
  - d.** The client loses its IP address.
- 6.** Which one of the following 802.11 frames is used to trigger a roam from one AP to another?
  - a.** Association request
  - b.** Disassociation request
  - c.** Probe
  - d.** Reassociation request
- 7.** Which one of the following statements is true about roaming?
  - a.** All wireless clients use the same algorithms to trigger a roaming condition.
  - b.** Wireless clients can scan available channels to look for a new AP when roaming.
  - c.** Wireless clients must roam from one AP to another on the same channel.
  - d.** The 802.11 standard defines a set of roaming algorithms for clients.
- 8.** Which one of the following statements is true about a good wireless LAN design?
  - a.** Neighboring APs should use the same channel to promote good roaming.
  - b.** APs should be positioned so that their cells overlap.
  - c.** APs should be positioned so that their cells do not overlap at all.
  - d.** APs should use channels that overlap each other.
- 9.** When you are designing the AP channel layout for an area, which one of the following is the most important consideration?
  - a.** The number of channels is conserved.
  - b.** APs in different areas use different channels.
  - c.** Adjacent APs use non-overlapping channels.
  - d.** Clients are grouped into common channels.
- 10.** An AP is located in the main office on the third floor of a building. The AP is configured to use channel 6 in the 2.4-GHz band. Which of the following conditions might hinder clients as they move around on the third floor and need to roam? (Choose all that apply.)
  - a.** Two other APs in the third floor main office area use channel 6.
  - b.** None of the fourth floor APs directly above the main office use channel 6.
  - c.** One of the second floor APs directly below the main office use channel 6.
  - d.** All of these answers are correct.



## AP Cell Size

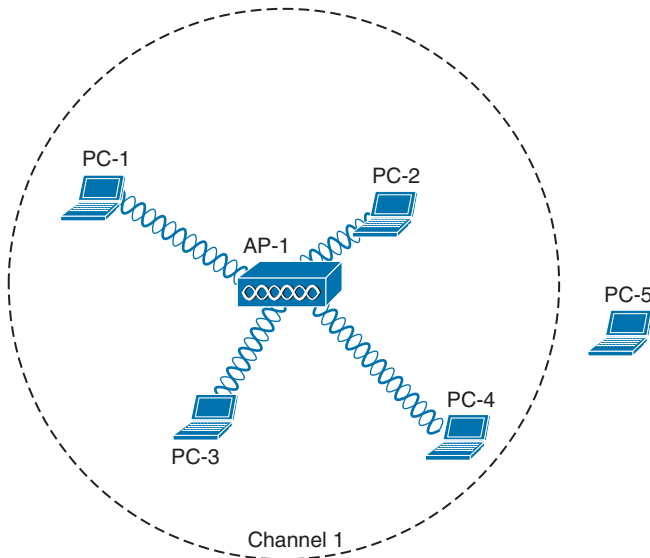
The basic service area (BSA) or cell that is provided by an AP can vary, depending on several factors. Obviously, the cell size determines the geographic area where wireless service will be offered. AP cell size can also affect the performance of the APs as clients move around or gather in one place.

Remember that a wireless LAN is a shared medium. Within a single AP cell, all of the clients associated with that AP must share the bandwidth and contend for access. If the cell is large, a large number of clients could potentially gather and use that AP. If the cell size is reduced, the number of simultaneous clients can also be reduced.

The signal from an AP does not simply stop at the boundary of its cell. Instead, the signal continues to expand ad infinitum, growing exponentially weaker. Devices inside the cell boundary can communicate with the AP. Devices outside the boundary cannot because the signal strength of either the client or the AP is too weak for the pair to find any usable modulation that can be used to exchange information. You can control the size of a cell by changing the parameters that are described in the following sections.

## Tuning Cell Size with Transmit Power

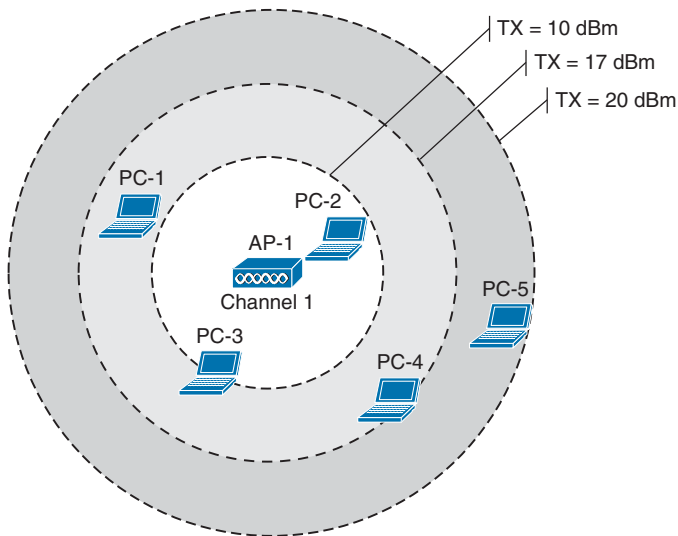
To use a wireless LAN, devices must be located within the range of an AP's signal and have an active association with the AP. This area is known as the BSA or cell. Consider the scenario shown in Figure 7-1. PCs 1 through 4 are within the cell's perimeter and are associated with the AP. PC-5, however, is outside the cell and cannot form an association or participate in the basic service set (BSS).



**Figure 7-1** *An Example Cell That Includes All but One Client.*

If the area outside a cell is a legitimate location where wireless devices might be present, the coverage area should probably be extended there. How can that be accomplished? The most straightforward approach is to increase the transmit power or signal strength leaving the AP's antenna. A greater signal strength will overcome some of the free space path loss so that the usable signal reaches farther away from the AP.

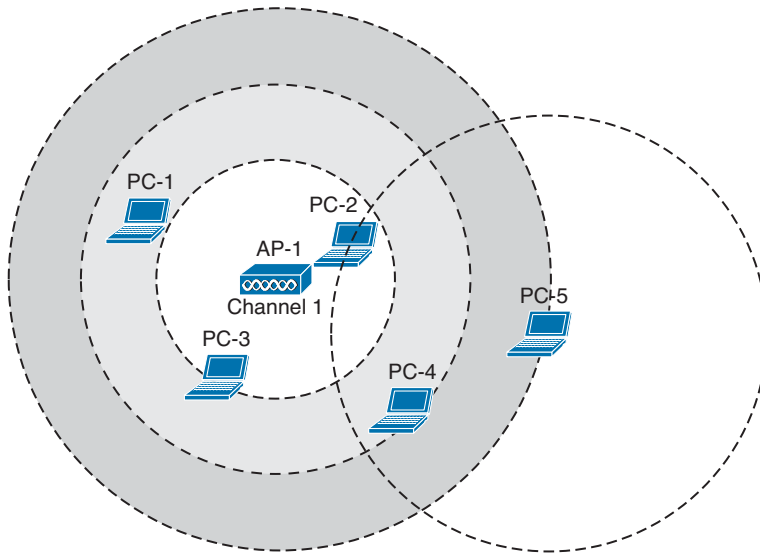
Figure 7-2 shows the effect of changing the AP's transmit power level. The original cell from Figure 7-1 is shown as the second concentric circle, where the transmit power level was set to 17 dBm. If the level is increased to 20 dBm, the cell grows into the area shown by the outermost circle. Notice that PC-5 now falls within the cell boundary. If the transmit power level is decreased to 10 dBm, the cell shrinks and includes only clients PC-2 and PC-3. Why would you ever want to decrease a cell's size? That question will be answered later in this section.



**Figure 7-2** *The Effects of the Transmit Power Level on Cell Size.*

How should you decide on a transmit power level value? Cisco APs offer eight different values for their 2.4-GHz radios and seven values for their 5-GHz radios. Most 802.11 scenarios fall within government regulations which limit the effective isotropic radiated power (EIRP) to a maximum transmit power level of 20 dBm (100 mW). You could just configure an AP to run wide open at maximum power, but that is not always appropriate or beneficial.

One thing to consider is the two-way nature of wireless communications. By increasing the AP's transmit power, the AP might reach a distant client, but can the client's own signal reach the AP? Notice client PC-5 in Figure 7-3. If the AP transmit power level is increased to 20 dBm (the outermost circle), PC-5 is included in the cell. However, PC-5's wireless transmitter has a lesser power level; in its current location, PC-5 has a coverage area that falls short of including the AP. This scenario is known as the *asymmetric power* problem, where the two communicating devices have differing transmit power levels that might not reach each other.



**Figure 7-3** *The Asymmetric Power Problem.*

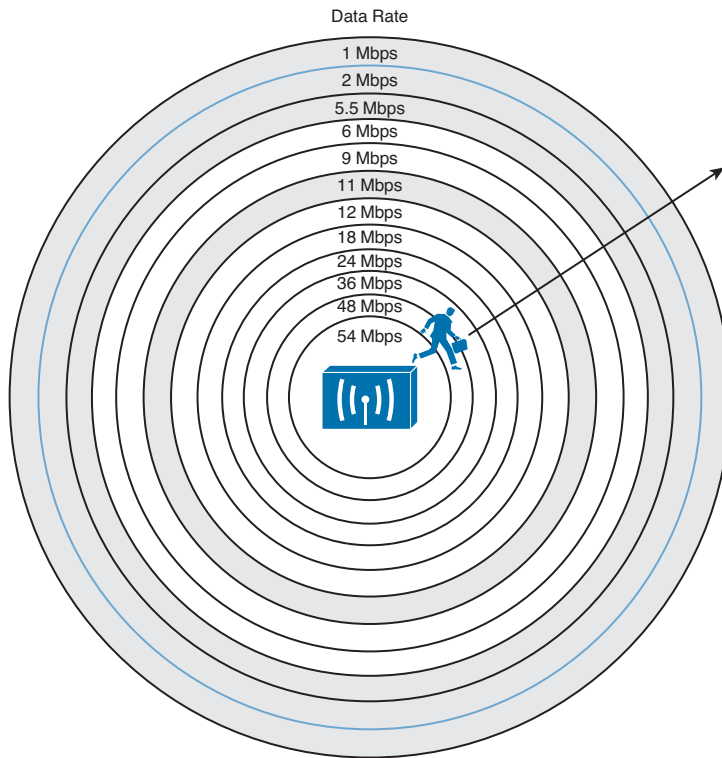
## Tuning Cell Size with Data Rates

Setting the transmit power level is a simplistic approach to defining the cell size, but that is not the only variable involved. The cell size of an AP is actually a compromise between its transmit power and the data rates that it offers.

Recall from Chapters 1 and 3 that the higher data rates or more complex modulation and coding schemes (MCS) offer the greatest throughput but require the best signal conditions—usually closer to the AP. The less complex schemes can work further away from an AP, but offer slower data rates. Therefore, at the perimeter of a cell, a client is likely to be using the least complex MCS and the lowest data rate. Figure 7-4 shows a simplified representation of the range of each data rate with concentric circles. At the outer edge of the cell, a client will probably resort to a 1-Mbps data rate.

To design a wireless LAN for best performance, you would most likely need to disable some of the lower data rates. For example, you could disable the 1-, 2-, and 5.5-Mbps rates to force clients to use higher rates and better modulation and coding schemes. That would improve throughput for individual clients and would also benefit the BSS as a whole by eliminating the slower rates that use more time on a channel.

As you disable lower data rates, the respective concentric circles in Figure 7-4 become irrelevant. This effectively *reduces* the usable size of the AP's cell, even though the radio frequency (RF) footprint remains the same. After all, you haven't reduced the transmit power level which would reduce the extent of the RF energy. Be aware that as smaller usable cells are placed closer together, their available data rates are higher. At the same time, their RF footprints can remain large and overlap each other, resulting in a higher noise floor.



**Figure 7-4** *The Relationship of Data Rates and Cell Range.*

To provide robust wireless coverage to an ever-increasing area, you should use the following two-pronged approach:

- Tune the cell size based on data rates and performance.
- Add additional APs to build an ESS that covers more area.

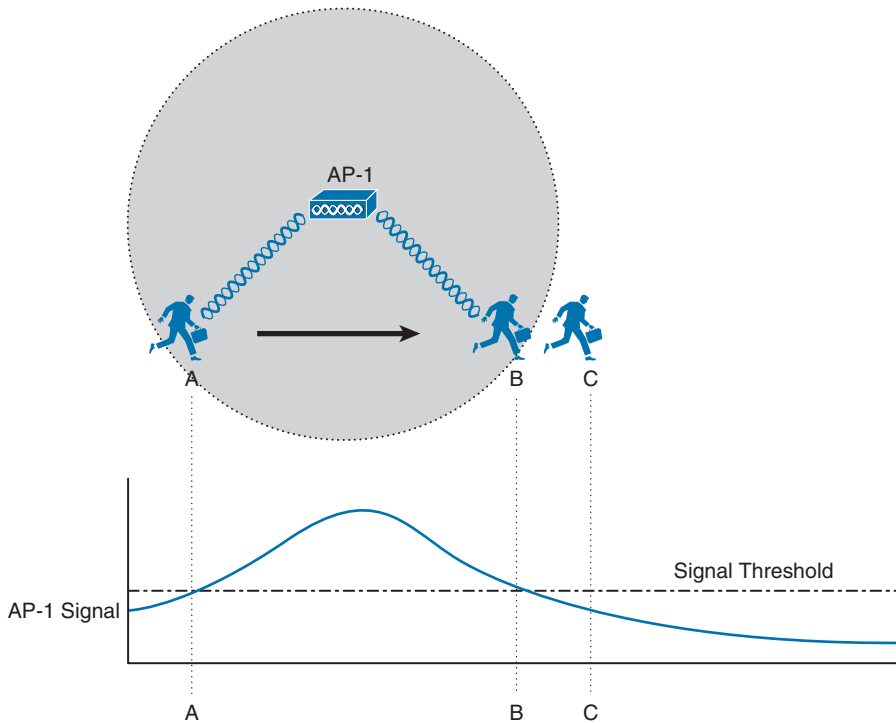
Adding APs requires careful consideration for client mobility and the use of wireless channels. These topics are covered in the next section.

## Adding APs to an ESS

If a client is associated with an AP, it can maintain the association as long as it stays within range of the AP. Consider the cell shown in Figure 7-5. As long as the client stays within points A and B, three conditions are met:

- The client is able to receive the AP's signal at an acceptable level.
- The AP is able to receive the client's signal.
- One of the acceptable modulations can be successfully used between the client and the AP.

As soon as the client goes outside the cell range at point C, one or more of the conditions fails and the client loses the association. In the figure, the AP's signal has fallen below an acceptable threshold.

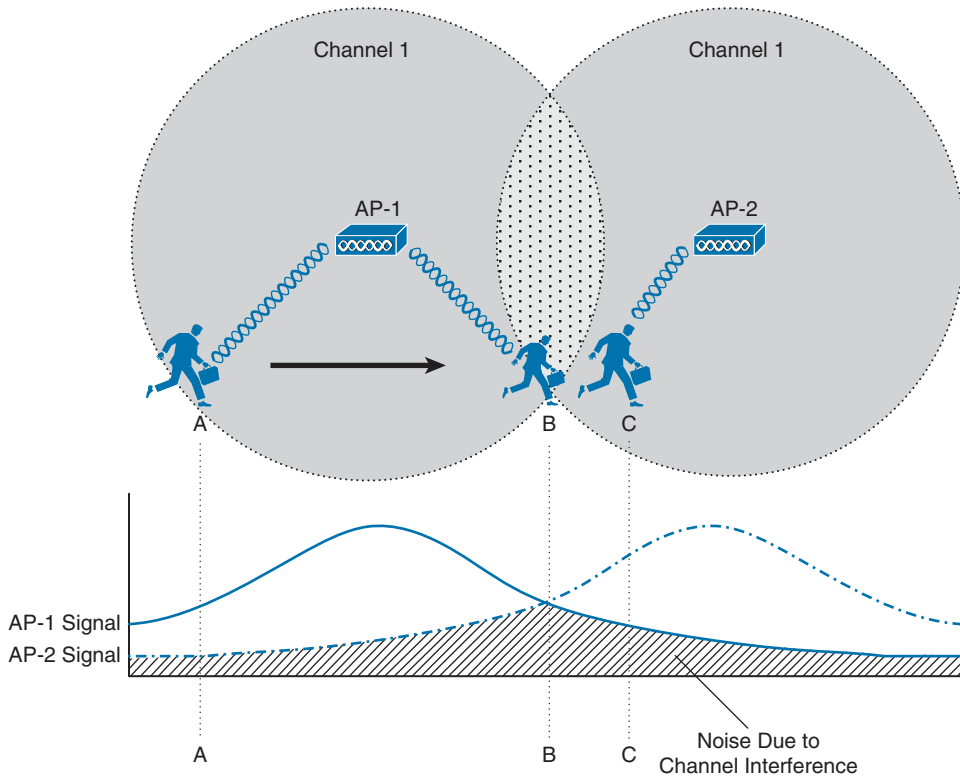


**Figure 7-5** A Mobile Client Moves Within an AP Cell.

Other APs can be added so that the client can move within a larger area; however, the APs must be carefully deployed to allow the client to roam from AP to AP. *Roaming* is the process of moving an association from one AP to the next, so that the wireless connection is maintained as the client moves.

In Figure 7-6, a new AP has been added alongside AP-1, each using the same channel. It might seem intuitive to build a larger coverage area by using a single channel. Usually this turns out to be a bad idea because the client may experience an excessive amount of frame collisions in the area between the two cells.

Remember that the signal from an AP does not actually stop at the edge of the cell; rather, it continues to propagate as it eventually dies off. This is shown by the signal strength graph of each AP. The client is able to form an association with AP-1 at point A. Even at that location, some portion of AP-2's signal can be received, albeit at a lower level. Because AP-2 is using the same channel as AP-1, the two APs (and any clients within range) can essentially interfere with each other through co-channel interference.



**Figure 7-6** *Pitfalls of Reusing Channels in Adjacent Aps.*

Ideally, when the client in Figure 7-6 moves to location B, it should begin to anticipate the need to roam or transfer its association from AP-1 to AP-2. Notice that AP-1 and AP-2 are spaced appropriately for roaming, where their cells have some overlap. The two APs are out of range of each other, so they are not aware of each other's transmissions on the same channel. Each AP will coordinate the use of the channel with devices that are inside its own cell, but not with the other AP and devices in the other cell. As a result, the client around location B will probably experience so many collisions that it may never be able to roam cleanly.

## The Roaming Process

What enables a client to roam in the first place? First, adjacent APs *should* be configured to use different non-overlapping channels. For example, an AP using channel 1 must not be adjacent to other APs also using channel 1. Instead, a neighboring AP should use channel 6 or higher to avoid any frequency overlap with channel 1. This ensures that clients will be able to receive signals from a nearby AP without interference from other APs. As you learned in Chapter 2, "RF Standards," the 5-GHz band is much more flexible in this regard because it has many more non-overlapping channels available.

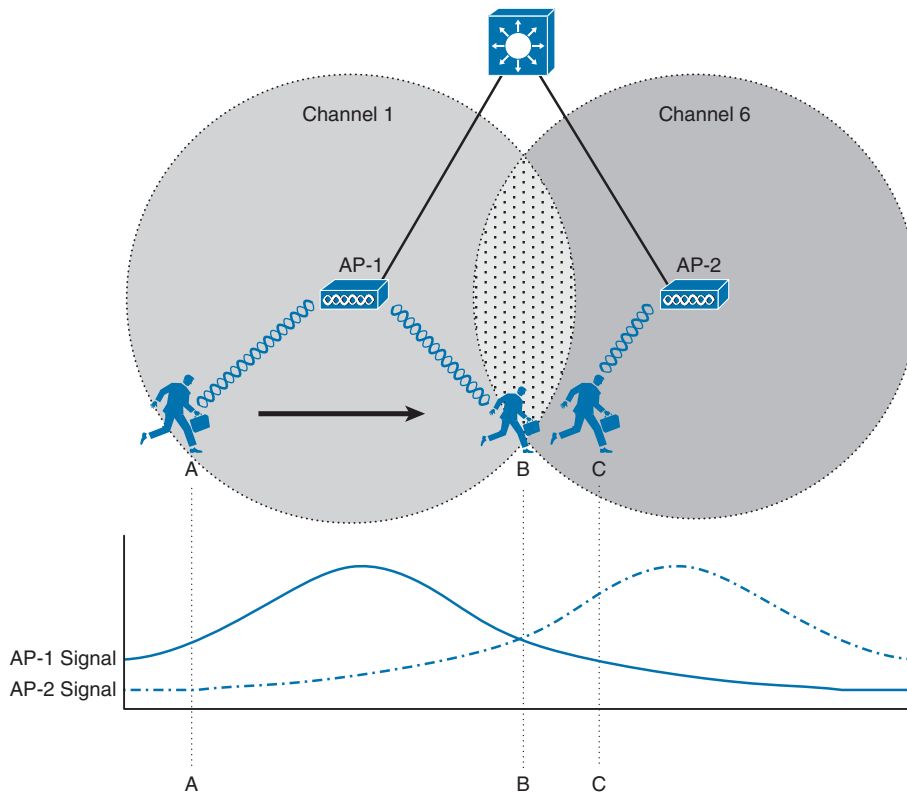
The roaming process is driven entirely by the wireless client driver—not by the AP. Wireless clients decide that it is time to roam based on a variety of conditions. The 802.11 standard does not address this at all, so roaming algorithms are vendor specific. In addition, the roaming algorithms are usually “secret recipes,” so the exact thresholds and conditions are hidden from view.

Some of the ingredients in the roaming algorithm are the received signal strength indicator (RSSI), signal-to-noise ratio (SNR), a count of missed AP beacons, errors due to collisions or interference, and so on. These are usually logical choices because they indicate an inferior connection.

Because different clients use different thresholds, some will try to roam earlier than others at a given location within a cell. Some clients will tend to “latch on” to an existing association until the AP can hardly be heard, whereas others will attempt to roam whenever a better AP is discovered.

Figure 7-7 depicts a clean roam between two APs that have been correctly configured with non-overlapping channels 1 and 6. The two AP signal strengths are also shown as a graph corresponding to the client’s location. At location A, the client has a clear signal from AP-1, so it maintains an association with that AP.

**Key  
Topic**



**Figure 7-7** A Client Roaming Correctly Between Two APs.

As the client moves toward location B, it decides that AP-1's signal is no longer optimal. Somewhere along the way, the client begins to gather more information about any neighboring AP cells. The client can passively scan by tuning its radio to another channel and listening for beacons transmitted from other APs. During the time that the radio is tuned away from the associated channel, the client might lose packets that have been sent to it. A client might use active scanning instead, where it sends probe requests to seek out a better AP where it can move its association. The client does not know what channel is used on the next AP it encounters, so it must send the probes over every possible channel. Again, the client must take time to tune its radio away from the current AP's channel so it can scan other channels and send probes.

You might think of this as someone watching television. As the current program gets boring or nears its end, the viewer begins to "channel surf" and scans other channels for a better program. One thing to keep in mind: While the viewer is scanning channels, he cannot keep watching the original program. Some of that program will be missed. This is also true of wireless clients. While a radio is scanning other channels, packets arriving on the original channel will be dropped because they cannot be received. Therefore, there is a trade-off between staying available on a single channel and attempting to roam to other APs.

After the client is satisfied with all of the beacons or probe responses it receives, it evaluates them to see which AP offers the most potential for a new association. Returning to Figure 7-7, when the client nears location B, it receives a probe response from AP-2 on channel 6. At location C, the client sends a reassociation frame to AP-2 and moves its association to that BSS.

How much should cells overlap each other to promote good roaming? Cisco recommends 15 percent to 20 percent overlap for most applications. The idea is to give a client device some continued coverage even after the RSSI of its associated AP falls below a threshold and a roam might be triggered. The client can probe and reassociate with the next AP before it completely loses contact with the previous AP. Seamless roaming is especially important for time critical applications like voice traffic.

## WLAN Channel Layout

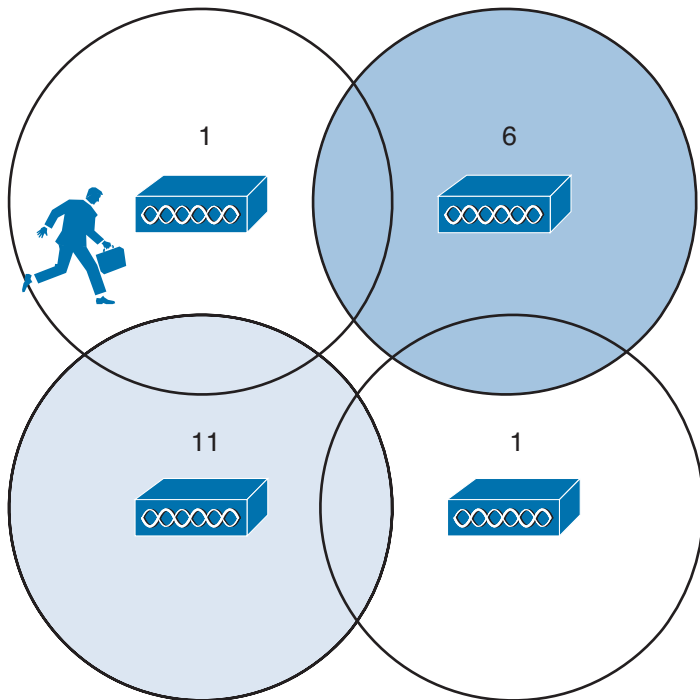
The previous section laid the foundation for roaming by describing movement between two AP cells. Most scenarios require more than two APs to cover the appropriate area within a building. Therefore, you need to consider the layout and configuration of more and more APs to scale the design to fit your wireless environment.

For example, to cover the entire area of a warehouse or one floor of a building, APs must be placed at regular intervals throughout that space. A site survey is a vital step toward deciding on AP placement, as actual live measurements are taken with an AP staged at various points in the actual space. This method also takes any factors like free space loss and absorption into account, as the signal strength is measured within the actual environment where clients are located.

To minimize channel overlap and interference, APs cells should be designed so that adjacent APs use different channels. For simplicity and a convenient design constraint, the



examples in this section use the three non-overlapping 2.4-GHz channels. The cells could be laid out in a regular, alternating pattern, as shown in Figure 7-8.



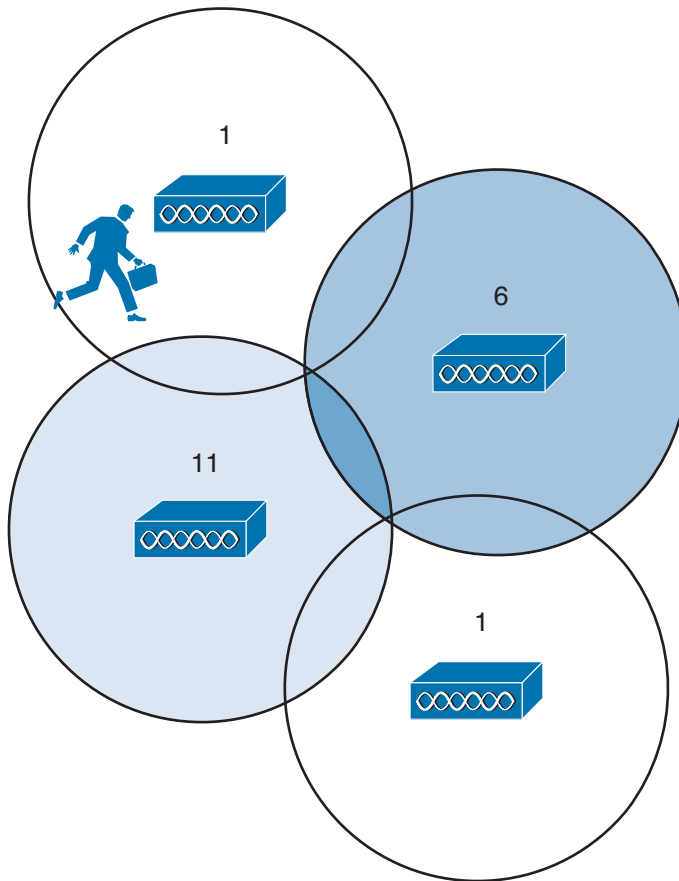
**Figure 7-8** *Holes in an Alternating Channel Pattern.*

However, notice what is happening in the center where the cells meet; there is a small hole in RF coverage. If a client roams through that hole, his wireless signal could drop completely. In addition, if the cells were brought closer together to close this hole, the two cells using channel 1 would overlap and begin interfering with each other.

Instead, you should lay the cells out in a “honeycomb” fashion, as shown in Figure 7-9. This pattern is seamless, leaving no holes in coverage. In addition, notice how the two cells using channel 1 are well separated, providing isolation from interference. As far as ordering channels in the pattern, there are several different variations using combinations of the three channels, but the result is basically the same.

Notice that as the client shown in the channel 1 cell moves around, it will roam into adjacent cells on different channels. For roaming to work properly, a client must be able to move from one channel into a completely different channel.

Alternating channels to avoid overlap is commonly called *channel reuse*. The basic pattern shown in Figure 7-9 can be repeated to expand over a larger area, as shown in Figure 7-10. Naturally, this ideal layout uses perfect circles that are positioned regularly across the building. In practice, cells can take on different shapes and the AP locations may end up being irregularly spaced.

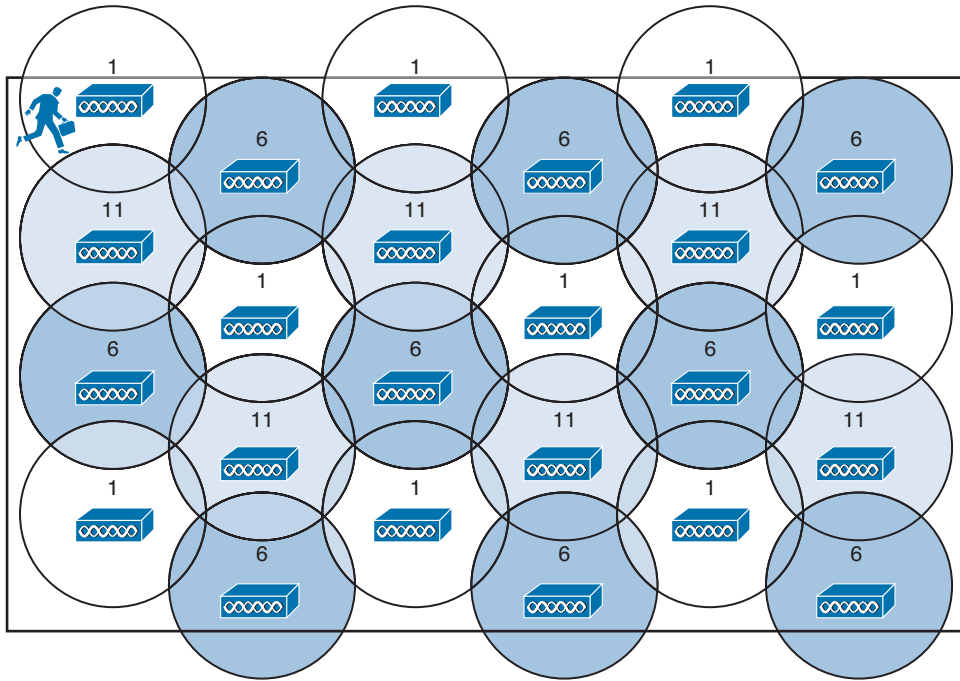


**Figure 7-9** *A Better Alternating Channel Pattern.*

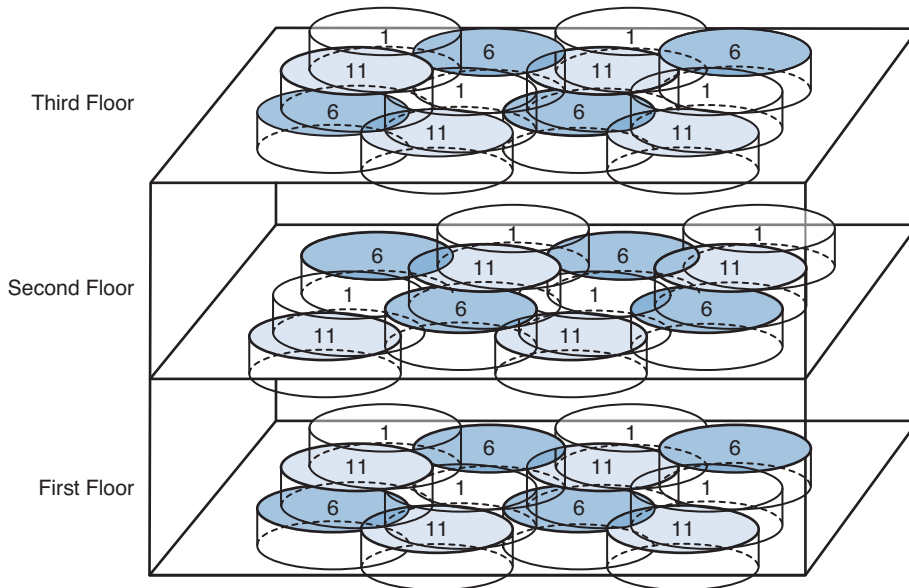
So far, only the channel layout of a two-dimensional area has been discussed. For example, Figure 7-10 might represent only one floor of a building. What happens when you need to design a wireless LAN for multiple floors in the same building?

Recall that an RF signal propagating from an antenna actually takes on a three-dimensional shape. With an omnidirectional antenna, the pattern is somewhat like a donut shape with the antenna at the center. The signal extends outward, giving the cell a circular shape along the floor. The signal also extends upward and downward to a lesser extent—affecting AP cells on adjacent floors as well.

Consider the building with three floors shown in Figure 7-11. The same two-dimensional channel layout from Figure 7-10 is being used on the first floor. The floors in the figure are shown greatly separated, so that you can see the channel patterns and numbers. In reality, the cells on adjacent floors would touch or overlap, just as adjacent cells on the same floor do.



**Figure 7-10** Channel Reuse Over a Large Area.



**Figure 7-11** Channel Layout in Three Dimensions.

The pattern of alternating channels exists within the plane of a floor and between floors. Channel 1 on the first floor should not overlap with channel 1 directly above it on the second floor or below it in the basement.

When you consider each of the tasks involved in designing and maintaining a wireless LAN, it can really become a puzzle to solve. The cell size, transmit power, and channel assignment all have to be coordinated for each and every AP. Roaming also becomes an issue on a large scale, if mobile clients can move throughout an entire campus wireless network.

The good news is that Chapter 13, “Understanding RRM,” explains how to solve many of these puzzles automatically.

---

## Exam Preparation Tasks

---

As mentioned in the section, “How to Use This Book,” in the Introduction, you have a couple of choices for exam preparation: the exercises here, Chapter 22, “Final Review,” and the exam simulation questions on the CD-ROM.

## Review All Key Topics

Review the most important topics in this chapter, noted with the Key Topic icon in the outer margin of the page. Table 7-2 lists a reference of these key topics and the page numbers on which each is found.

**Table 7-2** *Key Topics for Chapter 7*

Key Topic Element	Description	Page Number
Figure 7-2	The effects of transmit power on cell size	151
Figure 7-4	The effects of data rate on cell size	153
Figure 7-7	Roaming between BSSs	156
Figure 7-9	Optimizing channel layout for roaming	159



## Define Key Terms

Define the following key terms from this chapter and check your answers in the glossary:

asymmetric power problem, channel reuse



---

This chapter covers the following topics:

- **Autonomous Architecture**—This section describes an autonomous access point and how it is used to connect wireless clients to a wired network infrastructure.
- **Configuring an Autonomous AP**—This section explains how to connect and configure an access point to form a functional basic service set.
- **Converting an Autonomous AP**—This section covers the steps needed to convert an access point from autonomous mode to lightweight mode.

This chapter covers the following exam topics:

- Install and configure autonomous access points in the small business environment

# Using Autonomous APs

An autonomous wireless access point (AP) is self-contained and standalone, offering a fully functional BSS. At the CCNA Wireless level, you are expected to be able to install an autonomous AP, find its IP address, connect to it, and configure it. In addition, you should know how to convert an autonomous AP to lightweight mode, to become a part of a larger, more integrated wireless network. This chapter covers the skills you will need to develop.

## “Do I Know This Already?” Quiz

The “Do I Know This Already?” quiz allows you to assess whether you should read this entire chapter thoroughly or jump to the “Exam Preparation Tasks” section. If you are in doubt about your answers to these questions or your own assessment of your knowledge of the topics, read the entire chapter. Table 8-1 lists the major headings in this chapter and their corresponding “Do I Know This Already?” quiz questions. You can find the answers in Appendix A, “Answers to the ‘Do I Know This Already?’ Quizzes.”

**Table 8-1** “Do I Know This Already?” Section-to-Question Mapping

Foundation Topics Section	Questions
Autonomous Architecture	1–2
Configuring an Autonomous AP	3–8
Converting an Autonomous AP	9–10

**Caution** The goal of self-assessment is to gauge your mastery of the topics in this chapter. If you do not know the answer to a question or are only partially sure of the answer, you should mark that question as wrong for purposes of the self-assessment. Giving yourself credit for an answer you correctly guess skews your self-assessment results and might provide you with a false sense of security.

1. Suppose that you need to set up an autonomous AP so that it will offer three different SSIDs to clients. The AP will be connected to a wired network infrastructure. Which one of the following is a true statement about the AP?
  - a. It can support only one SSID, which must be carried over an access link.
  - b. It can support multiple SSIDs over an access link.
  - c. It can support multiple SSIDs over an 802.1Q trunk link.
  - d. An autonomous AP needs a centralized controller to support SSIDs.
2. Which one of the following is a true statement?
  - a. An autonomous AP cannot connect to a DS.
  - b. An autonomous AP connects through a centralized controller.
  - c. An autonomous AP operates in a standalone fashion.
  - d. None of these answers are correct.
3. An autonomous AP has a console port. True or false?
  - a. True
  - b. False
4. After looking at a sticker on the back of an autonomous AP, you see MAC C4:7D:4F:12:34:56 listed. Which one of the following is a safe assumption?
  - a. The string of numbers is the AP's serial number.
  - b. The string of numbers is the 2.4-GHz radio MAC address.
  - c. The string of numbers is the 5-GHz radio MAC address.
  - d. The string of numbers is the Ethernet port MAC address.
5. Which methods can be used to assign an IP address to an autonomous AP? (Choose all that apply.)
  - a. DHCP
  - b. Static through the CLI
  - c. TFTP
  - d. DNS

6. Which of the following methods can be used to obtain the IP address of an autonomous AP? (Choose all that apply.)
  - a. DHCP server logs
  - b. CDP
  - c. AP console CLI
  - d. IP Setup Utility
7. In its default configuration, which of the following is true of an autonomous AP? (Choose all that apply.)
  - a. Both radios are enabled.
  - b. Both radios are disabled.
  - c. No SSIDs are configured.
  - d. One SSID (“Cisco”) is configured.
8. You can apply a separate SSID to different radios. True or false?
  - a. True
  - b. False
9. If you are using the Autonomous to Lightweight Mode Upgrade tool, what else must you obtain from Cisco?
  - a. A TFTP server
  - b. Cisco Prime Infrastructure
  - c. An appropriate lightweight code image
  - d. An appropriate autonomous upgrade image
10. To upgrade an autonomous AP to lightweight mode, which one of the following initial command keywords should be used from the CLI?
  - a. `upgrade download-sw`
  - b. `copy flash: tftp:`
  - c. `archive download-sw`
  - d. `download upgrade-sw`



---

## Foundation Topics

---

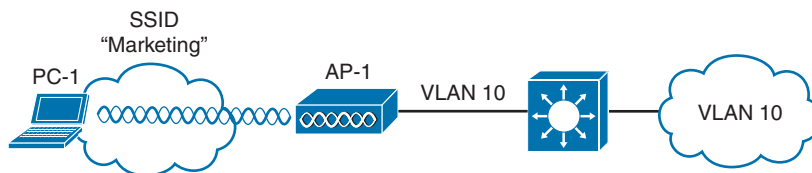
### Autonomous Architecture

An AP's primary function is to bridge wireless data from the air to a normal wired network. An AP can accept “connections” from a number of wireless clients so that they become members of the LAN, as if the same clients were using wired connections.

APs act as the central point of access (hence the AP name), controlling client access to the wireless LAN. An *autonomous AP* is self-contained; it is equipped with both wired and wireless hardware so that the wireless client associations can be terminated onto a wired connection locally at the AP.

Autonomous APs are commonly used in small networks, such as a small office or a remote site. Because the APs are self-contained and self-sufficient, they are fairly easy to set up and configure. The end result is a decentralized, distributed architecture, where each wireless AP touches the wired network independently. Each AP is configured and managed independently too, which can lead to a management nightmare as the number of APs grows.

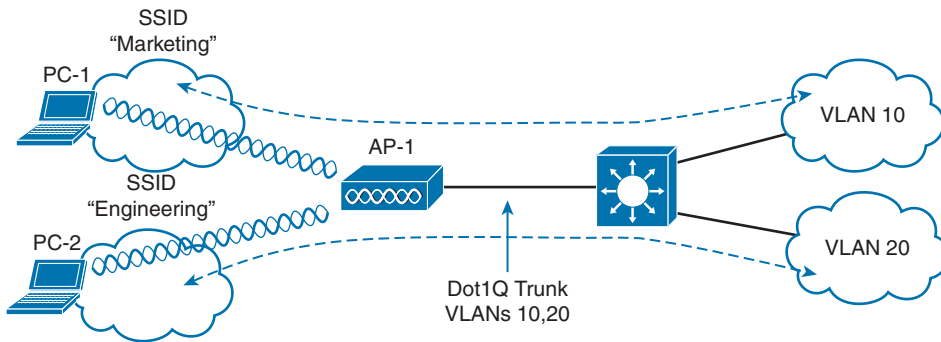
You can think of an AP as a translational bridge, where frames from two dissimilar media are translated and then bridged at Layer 2. In simple terms, the AP is in charge of mapping a service set identifier (SSID) to a VLAN, or in 802.11 terms, mapping a basic service set (BSS) to a distribution system (DS). This is shown in Figure 8-1, where the AP connects a client that is associated to the SSID “Marketing” with the wired network on VLAN 10. On the wired side, the AP's Ethernet port is connected to a switch port configured for access mode and mapped to VLAN 10.



**Figure 8-1** Bridging an SSID to a VLAN.

This concept can be extended so that multiple VLANs are mapped to multiple SSIDs. To do this, the AP must be connected to the switch by a trunk link that carries the VLANs. In Figure 8-2, VLAN 10 and VLAN 20 are both trunked to the AP. The AP uses the 802.1Q tag to map the VLAN numbers to SSIDs. For example, VLAN 10 is mapped to SSID “Marketing,” while VLAN 20 is mapped to SSID “Engineering.”

In effect, when an AP uses multiple SSIDs, it is trunking VLANs over the air to wireless clients. In the 802.11 space, the VLAN tag is replaced by the SSID. The autonomous AP then becomes an extension of an access layer switch because it bridges SSIDs and VLANs right at the access layer.



**Figure 8-2** Bridging Multiple SSIDs to VLANs.

## Configuring an Autonomous AP

As a wireless engineer, you will likely have to install and configure an autonomous AP. Many Cisco APs can operate in autonomous mode by running an IOS image—much like many other Cisco products. You can configure an AP through any of the following methods:

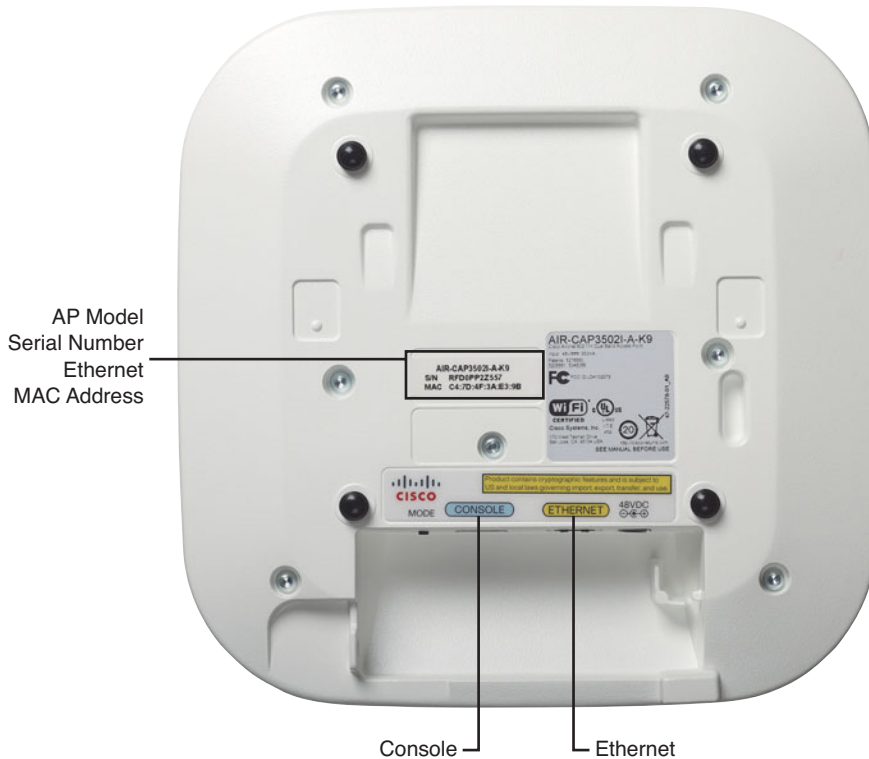
- A terminal emulator connected to the AP's console port
- Telnet or Secure Shell (SSH) to the AP's IP address
- Use a web browser to access a graphical user interface (GUI) at the AP's IP address

As you read through this chapter, think about the different parameters you might have to configure on an autonomous AP. At a minimum, you would have to configure one or more SSIDs and some wireless security settings. In addition, you would have to set the transmit power level and channel number for each of the AP's radios. Now think about your wireless network as it grows—manually configuring a handful of autonomous APs might not be difficult, but working out the channel reuse layout for 50 or 100 APs in the same building might become a nightmare. Fortunately, you can leverage a centralized architecture to automate many configuration functions. Such architecture is covered in more detail in Chapters 9 through 13.

## Connecting the AP

Figure 8-3 shows the ports that are available on a typical access point. You should connect the Ethernet port to a switch port where the DS is located. The console port can remain disconnected unless you need to use it. A sticker on the AP provides the model and serial numbers, as well as the Ethernet port's MAC address.

By default, an AP will try to use Dynamic Host Configuration Protocol (DHCP) to request an IP address for itself. If it is successful, you can connect to it and interact with its GUI or command-line interface (CLI). If not, the AP will use the static IP address 10.0.0.1/26. You can also use the console port to configure a static IP address on the BV11 interface of the AP, but it is usually more flexible and convenient to let it request an address on its own.



**Figure 8-3** The Ports Available on an Autonomous AP.

The AP's IP address will not be readily visible because the AP has no way to display it, other than through its user interface and configuration. To find the IP address, you can query the DHCP server that assigned it and look for the AP's MAC address.

Suppose that an AP has MAC address 00:22:bd:19:28:dd. From the output listed in Example 8-1, the MAC address is bound to IP address 192.168.199.44.

**Example 8-1** Finding an Autonomous AP's IP address

```
Branch_Office# show ip dhcp binding
Bindings from all pools not associated with VRF:
IP address           Client-ID/
                    Hardware address/
                    User name
192.168.199.7        0020.6b77.9549      Infinite           Manual
192.168.199.8        000e.3b00.b1a3      Infinite           Manual
192.168.199.9        0004.00d0.378d      Infinite           Manual
192.168.199.14      0100.24f3.da9b.95   May 10 2013 01:09 AM Auto-
matic
192.168.199.20      0170.f1a1.131c.48   May 09 2013 09:25 PM Auto-
matic
```

```

192.168.199.23      0194.39e5.826c.38      May 09 2013 08:51 PM      Auto-
matic
192.168.199.24      0100.216a.0ac3.a0      May 09 2013 11:21 PM      Auto-
matic
192.168.199.34      0100.166f.6614.6d      May 09 2013 09:33 PM      Auto-
matic
192.168.199.43      01cc.fe3c.4d66.49      May 09 2013 04:59 PM      Auto-
matic
192.168.199.44      0100.22bd.1928.dd      May 10 2013 11:20 AM      Auto-
matic
Branch_Office#

```

As an alternative, you could also log in to the switch where the AP is connected and display detailed Cisco Discovery Protocol (CDP) neighbor information. Example 8-2 shows the output that reveals the IP address of the AP connected to interface GigabitEthernet1/0/1.

**Example 8-2** *Displaying CDP Neighbor Information to Find an Autonomous AP's IP Address*

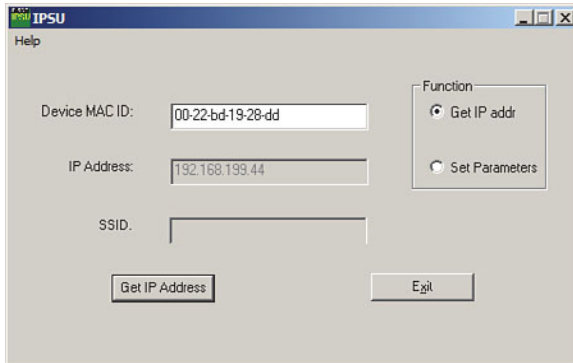
```

Switch# show cdp neighbor gigabitethernet1/0/1 detail
-----
Device ID: ap
Entry address(es):
  IP address: 192.168.199.44
Platform: cisco AIR-AP1142N-A-K9 , Capabilities: Trans-Bridge IGMP
Interface: GigabitEthernet1/0/1, Port ID (outgoing port): GigabitEthernet0
Holdtime : 160 sec
Version :
Cisco IOS Software, C1140 Software (C1140-K9W7-M), Version 12.4(25d)JA1,
RELEASE SOFTWARE (fc1)
Technical Support: http://www.cisco.com/techsupport
Copyright (c) 1986-2011 by Cisco Systems, Inc.
Compiled Thu 11-Aug-11 02:58 by prod_rel_team
advertisement version: 2
Duplex: full
Power drawn: 15.400 Watts
Switch#

```

You can also use the IP Setup Utility (IPSU), a Cisco tool that is available on Cisco.com. The tool has a simple interface, as shown in Figure 8-4—you provide the Ethernet MAC address of an AP, click the **Get Address** button, and the tool returns the AP's IP address.

An autonomous AP binds the IP address to its bridged-virtual interface (BVI), which is a logical interface used to bridge the physical wired and wireless interfaces. If you are connected to the AP's console port, you can display the IP address with the **show interface bvi1** command, as shown in Example 8-3.



**Figure 8-4** Using the IP Setup Utility to Discover the IP Address of an AP.

### Example 8-3 Displaying the BVI IP Address

```
ap# show interface bvi1
BVI1 is up, line protocol is up
  Hardware is BVI, address is 0022.bd19.28dd (bia 0023.eb81.eb70)
  Internet address is 192.168.199.44/24
  MTU 1500 bytes, BW 54000 Kbit/sec, DLY 5000 usec,
    reliability 255/255, txload 1/255, rxload 1/255
  Encapsulation ARPA, loopback not set
  ARP type: ARPA, ARP Timeout 04:00:00
[output truncated]
```

## Configuring the AP

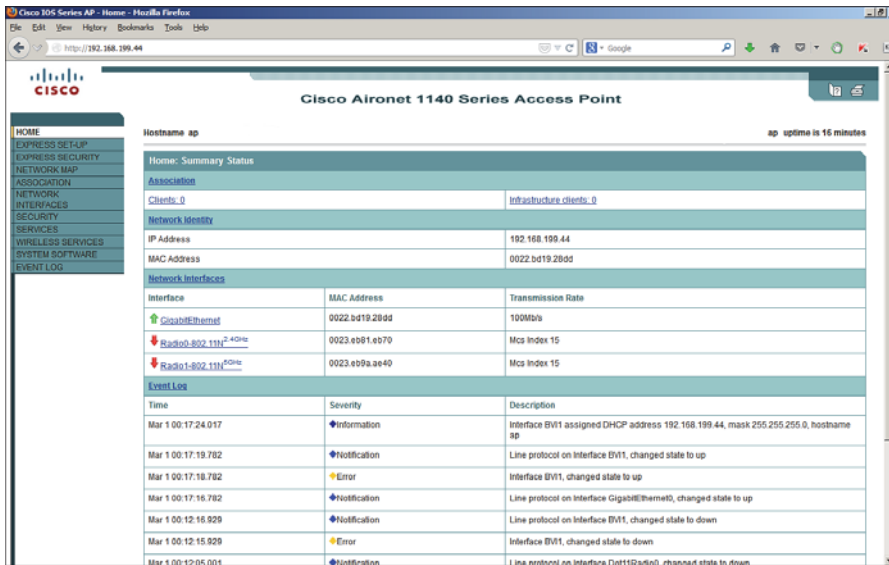
By default, any autonomous AP running IOS Release 12.3(4)JA or later has its radios disabled and does not have any SSIDs configured. This is done to prevent the new AP from interfering with any existing signals before you have a chance to configure it. This also prevents anyone from inadvertently discovering a wireless signal coming from the AP before you can secure it.

Perhaps the easiest method you can use to configure an autonomous AP is to use its web interface. Once you know the AP's IP address, you can open a web browser to it. By default, you can leave the username blank and enter the password as Cisco. The home page, as shown in Figure 8-5, displays a summary of associated clients, the AP's Ethernet and radio interfaces, and an event log.

At the CCNA Wireless level, Cisco expects candidates to be able to perform basic configuration tasks on autonomous APs. Therefore, you should be familiar with only the Express Setup and Express Security tabs at the upper-left corner of the web page.

To use the Express Setup tab, as shown in Figure 8-6, you need to enter the following information about the AP:

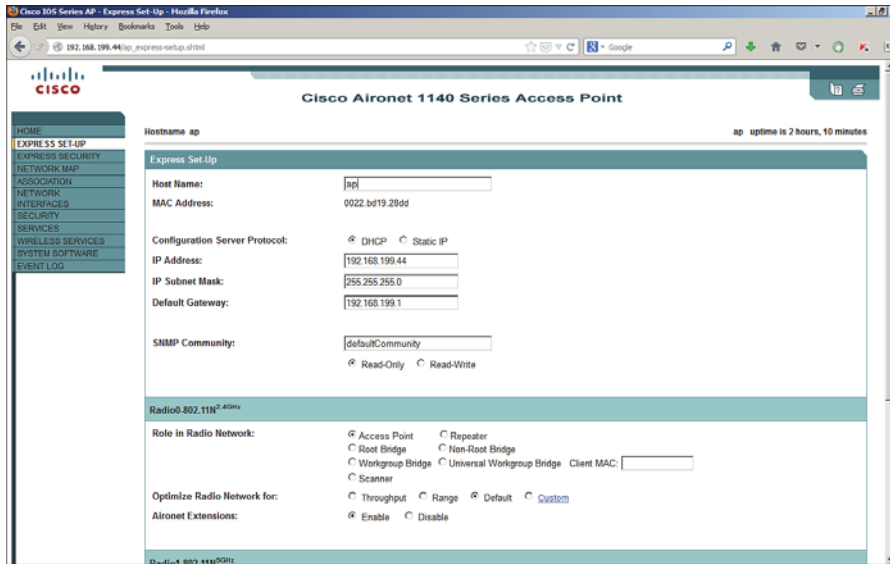
- Hostname
- Method of IP address assignment
- For a static address: IP address, subnet mask, default gateway
- SNMP community



**Figure 8-5** Autonomous AP Summary Page.

You will also need to set some parameters for the 2.4- and 5-GHz radios. By default, each radio is configured to operate in the access point mode, so that the AP maintains an active BSS. You can select one of the following roles instead:

- **Repeater**—The AP will associate with another nearby AP automatically, to repeat or extend that AP's cell coverage. The Ethernet port will be disabled.
- **Root Bridge**—The AP uses its Ethernet port to connect to bridge the wired network to a remote wireless bridge over a point-to-point or point-to-multipoint link. No wireless clients will be allowed to associate.
- **Non-Root Bridge**—The AP will act as a remote wireless bridge and will connect to a root bridge AP over a wireless link.
- **Workgroup Bridge**—The AP will use one radio to associate with a nearby Cisco access point, as if it is a wireless client. The other radio interface is disabled. The AP bridges between its radio and its Ethernet port. You can use an AP in workgroup bridge (WGB) mode to provide wireless client capability to wired-only devices.
- **Universal Workgroup Bridge**—The AP will act as a workgroup bridge to associate with Cisco and non-Cisco access points.
- **Scanner**—The AP will use its radio to scan channels and collect data



**Figure 8-6** Express Setup Configuration Page.

Click **Apply** for the settings to take effect

In the Optimize Radio Network For section, you can select how the AP will optimize its cell for wireless clients. By default, the AP will offer data rates that can provide good range and throughput. You can select **Throughput** to leverage higher data rates at the expense of cell range, **Range** to require the lowest data rate for maximum cell range, or **Custom** to set your own radio parameters.

Aironet Extensions are Cisco proprietary information elements that Cisco APs can use to interact with Cisco-compatible wireless clients. For example, an AP can provide information about its current client load so that potential clients can choose the least busy AP. Aironet extensions are enabled by default.

You can use the Express Security tab to define an initial SSID. Be aware that the SSID will be available on both 2.4- and 5-GHz radios. If the AP is connected to a switch with an 802.1Q trunk link, you can bind the SSID to a VLAN number. You can also define a wireless security method for the SSID. Figure 8-7 shows the Express Security page. If you intend to define multiple SSIDs and VLANs, you will have to drill down into some of the other tabs on the web page.

**Tip** Although the CCNA Wireless exam is limited to the “express” configuration tabs on an autonomous AP, you will need to be proficient with many more complex features on lightweight APs as part of a larger, unified wireless network. Don’t worry; lightweight APs (LAPs) and unified networks are covered in detail throughout the remainder of the book.

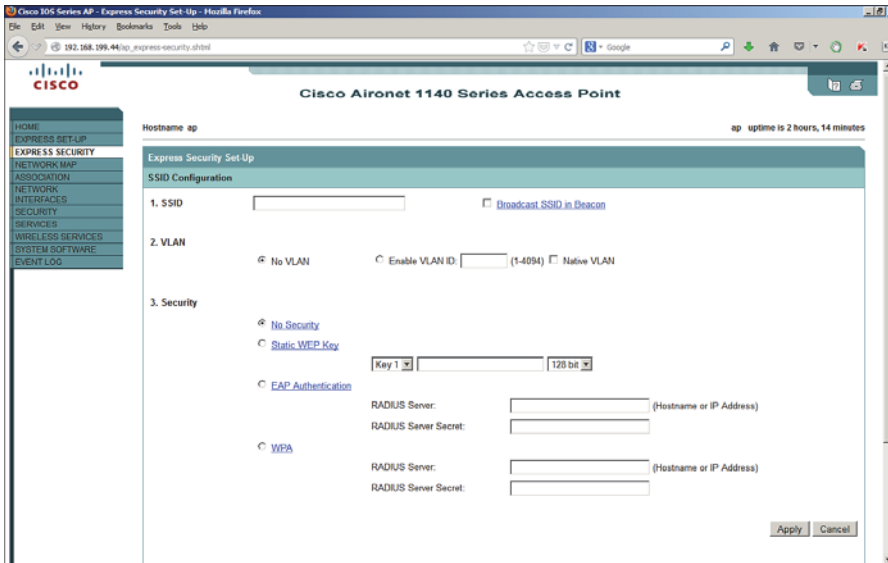


Figure 8-7 Express Security Configuration Page.

At this point of the configuration, you do not necessarily have a functional AP because the radios are still disabled. To enable a radio, navigate to the AP's home page and select **Radio0-802.11N2.4GHz** or **Radio1-802.11N5GHz** in the Network Interfaces section. Click the **Settings** tab to open it, and then for Enable Radio click the **Enable** button, as shown in Figure 8-8.

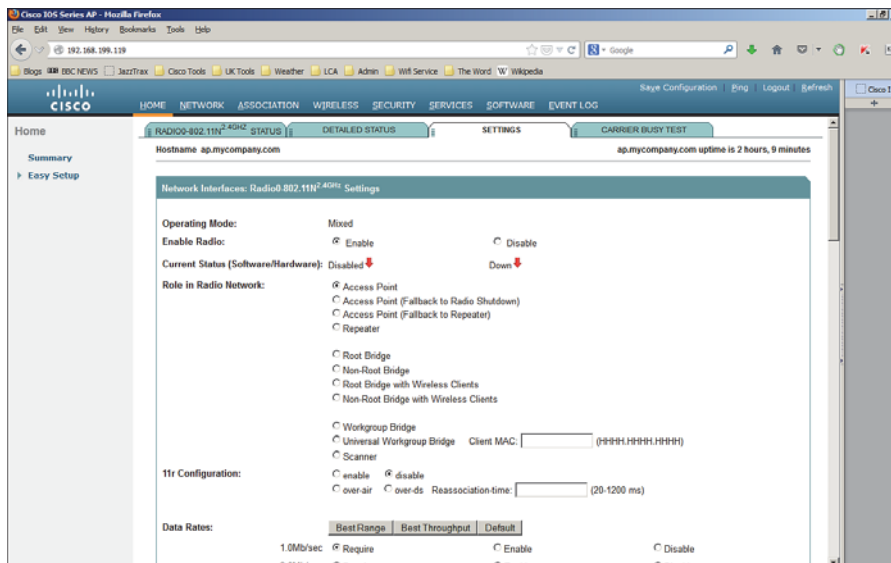


Figure 8-8 Enabling an Autonomous AP Radio.



## Converting an Autonomous AP

Autonomous APs can be useful in remote sites, small offices, or homes where centralized management is not necessary or practical. In larger environments, a centralized or unified approach is more common. Sometimes you might face a hybrid scenario, where some legacy autonomous APs still exist in a centrally managed network. In that case, you might need to either replace the AP hardware or convert its software image so that it can join the wireless controllers that manage the network. In fact, Cisco expects a CCNA Wireless engineer to know how to convert an autonomous AP to a “lightweight” version that can join a controller.

To convert an AP, you can use one of the following methods, which are described in the subsequent sections:

- Use the Cisco Prime Infrastructure application; all wireless controllers and lightweight APs can be monitored and managed from this one application. The autonomous AP must first be managed, then it can be converted. Cisco Prime Infrastructure is covered in Part V, “Managing Wireless LANs with WCS,” but using it to convert autonomous APs is not covered on the CCNA Wireless exam.
- Use the Autonomous to Lightweight Mode Upgrade tool, which you can download from Cisco.com.
- Use the `archive` command from the autonomous AP’s CLI.

### Using the Autonomous to Lightweight Mode Upgrade Tool

You can use the Autonomous to Lightweight Mode Upgrade tool to upgrade the IOS image so that an AP is converted from autonomous to lightweight mode. The tool only works with Cisco Aironet 1100, 1130, 1200, 1240, and 1310 models; all other models require a manual upgrade using the `archive` command.

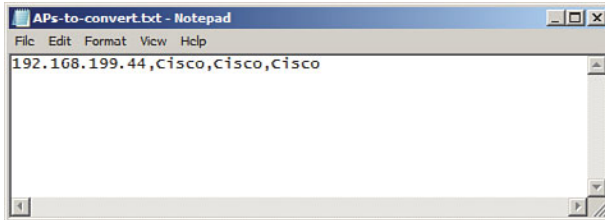
First, download the upgrade tool from Cisco.com. Be aware that the upgrade tool is known by several different names. You might also see it called the Cisco Aironet AP to LWAPP Upgrade tool. To find the software, navigate to **Support > Download > Wireless Software > Access Points**, and then select a specific AP model. Once the upgrade tool is downloaded, install it on a Windows PC.

You will also need to download a lightweight recovery software image for the AP model. After downloading the upgrade tool, click the **Lightweight AP IOS Software** link. The recovery image filename usually includes `rcv` (as in the word *recover*) in the filename, as in `c1140-rcvk9w8-tar.152-2.JB.tar`. The recovery image is a small bootstrap version of lightweight code that allows the AP to boot up and find a wireless controller. From there, the AP will automatically download a full version of lightweight code from the controller that it will use long term.

The upgrade tool looks in a text file to find a list of autonomous APs to upgrade. Therefore, you must prepare the text file ahead of time. Use a text editor such as Notepad to make a list of APs, one per line, with the following format:

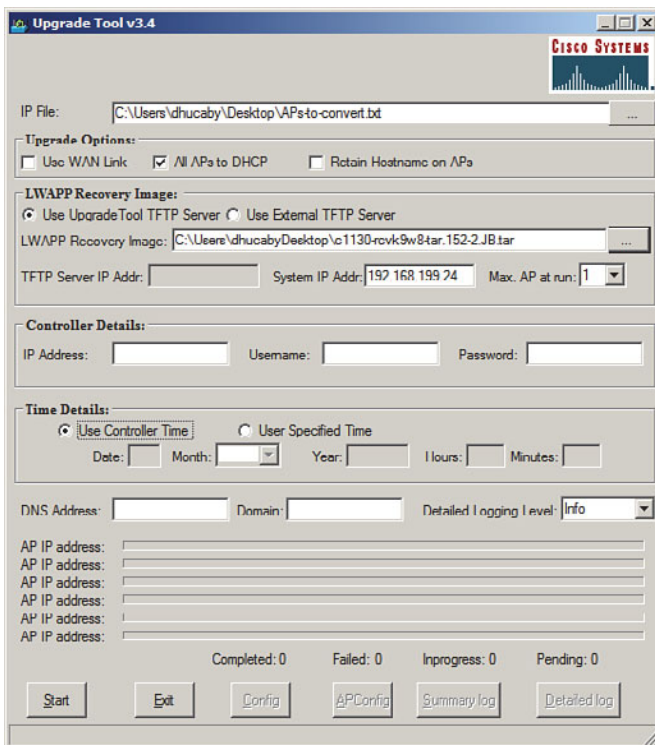
*ap-ip-address, telnet-username, telnet-Password, enable-password*

Figure 8-9 shows a text file created in Notepad with a single entry for an autonomous AP with the default settings.



**Figure 8-9** Text File Containing One Autonomous AP for Upgrade.

Figure 8-10 shows the upgrade tool.



**Figure 8-10** The Cisco Autonomous to Lightweight Mode AP Upgrade Tool.

Use the following steps to upgrade an autonomous AP to lightweight mode:

- Step 1.** Open the Upgrade tool. If the tool complains that it is unable to start the Cisco TFTP server, exit the application. Right-click over the Upgrade tool's icon and select **Run as Administrator**. This will enable the tool to run its own TFTP server for downloading an image file to the AP.

- Step 2.** In the IP File field, click the ... button and browse to find the file containing the list of AP IP addresses. Click **Open**.
- Step 3.** Select the appropriate functions under Upgrade Options. Are the APs being upgraded over a slow WAN link? Should the AP be converted to use DHCP after the upgrade? Should the APs keep their existing hostname after the upgrade?
- Step 4.** In the LWAPP Recovery Image section, choose whether the TFTP server is internal (integrated into the Upgrade tool) or external. Then select the LWAPP recovery image that will be downloaded to the AP. Choose how many APs can upgrade at once in the Max AP at Run field.
- Step 5.** The Controller Details section is optional; fill in a controller's IP address, username, and password, if you want to preconfigure the AP with a specific controller to use. Otherwise, the AP will go through a discovery process to find a controller.
- Step 6.** In the Time Details section, select the method the AP will use to set its clock. The AP can set its clock according to the controller or a date and time that you specify.
- Step 7.** If resolving by DNS, enter the DNS address and domain name. Optionally, change the logging level if you want to see more verbose information.
- Step 8.** Click the **Start** button to begin the process.

The upgrade process verifies each parameter you have entered and errors out if inconsistencies are noted. After the conversion, the AP reboots. After the reboot, the AP behaves like any lightweight AP and tries to find a controller.

**Note** During the upgrade process on an older AP, a self-signed certificate is generated if the AP doesn't have a Cisco signed certificate. If you specify a controller in the Upgrade tool, the certificate will be imported into the controller. Otherwise, the Upgrade tool generates a text file that contains the certificate information. You can import that file into the controller manually.

## Converting an Autonomous AP Manually

You can use the CLI to upgrade the IOS image on an autonomous AP and convert it to lightweight mode. You will also need a TFTP server along with the appropriate lightweight code image. The process is simple—save the AP's configuration, then use the following command:

```
archive download-sw /overwrite /force-reload {tftp:|ftp:} //location/
image-name
```

The lightweight image will be downloaded such that it overwrites the current autonomous IOS image, then the AP will reload and run the new image. Example 8-4 demonstrates the conversion process. The TFTP server is located at 192.168.199.24, and the new lightweight image is named c1140-k9w8-tar.152-2.JB.tar.

**Tip** Cisco AP image filenames can be difficult to identify. If a filename contains k9w8, as in Example 8-4, it is a lightweight image. If it contains k9w7, it is an autonomous image.

#### Example 8-4 Manually Converting an Autonomous AP

```
ap# archive download-sw /overwrite /reload tftp://192.168.199.24/c1140-
k9w8-tar.152-2.JB.tar
examining image...
Loading c1140-k9w8-tar.152-2.JB.tar from 192.168.199.24 (via BVI1): !
extracting info (282 bytes)
Image info:
  Version Suffix: k9w8-.152-2.JB
  Image Name: c1140-k9w8-mx.152-2.JB
  Version Directory: c1140-k9w8-mx.152-2.JB
  Ios Image Size: 9421312
  Total Image Size: 9615872
  Image Feature: WIRELESS LAN|LWAPP
  Image Family: C1140
  Wireless Switch Management Version: 7.4.1.37
Extracting files...
c1140-k9w8-mx.152-2.JB/ (directory) 0 (bytes)O
c1140-k9w8-mx.152-2.JB/html/ (directory) 0 (bytes)
[output omitted for clarity]
extracting info.ver (282 bytes)
[OK - 9615360 bytes]

Deleting current version: flash:/c1140-k9w7-mx.124-25d.JA1...done.
New software image installed in flash:/c1140-k9w8-mx.152-2.JB
Configuring system to use new image...done.
Requested system reload
archive download: takes 107 seconds
```

Key  
Topic

---

## Exam Preparation Tasks

---

As mentioned in the section, “How to Use This Book,” in the Introduction, you have a couple of choices for exam preparation: the exercises here, Chapter 22, “Final Review,” and the exam simulation questions on the CD-ROM.

### Review All Key Topics

Review the most important topics in this chapter, noted with the Key Topic icon in the outer margin of the page. Table 8-2 lists a reference of these key topics and the page numbers on which each is found.



**Table 8-2** *Key Topics for Chapter 8*

Key Topic Element	Description	Page Number
Figure 8-2	Bridging multiple SSIDs to VLANs	167
Figure 8-5	Autonomous AP web interface	171
Figure 8-10	Autonomous AP Upgrade tool	175
Example 8-3	Manually converting an autonomous AP	177

### Define Key Terms

Define the following key terms from this chapter and check your answers in the glossary:

autonomous AP, IP Setup Utility (IPSU), Autonomous to Lightweight Mode Upgrade tool

*This page intentionally left blank*



---

This chapter covers the following topics:

- **A Distributed Architecture**—This section discusses a wireless network formed by autonomous access points.
- **A Centralized Architecture**—This section describes a wireless network built from lightweight access points and a centralized wireless LAN controller.
- **CUWN Building Blocks**—This section covers the devices that are necessary to build a Cisco Unified Wireless Network.

This chapter covers the following exam topics:

- Identify the components of the Cisco Unified Wireless Network architecture (Split MAC, LWAPP, stand-alone AP vs controller-based AP, specific hardware examples)
- Describe the modes of controller-based AP deployment (local, monitor, HREAP, sniffer, rogue detector, bridge, OEAP, and SE-Connect)

# Understanding the CUWN Architecture

---

In Chapter 8, “Using Autonomous APs,” you learned about autonomous access points (APs) and their distributed nature. The Cisco Unified Wireless Network (CUWN) takes the opposite approach by keeping the radios distributed but collapsing wireless services into the core of the switched network. In this chapter, you will learn more about the centralized or unified wireless architecture and how you can leverage its strengths to solve some fundamental problems.

## “Do I Know This Already?” Quiz

The “Do I Know This Already?” quiz allows you to assess whether you should read this entire chapter thoroughly or jump to the “Exam Preparation Tasks” section. If you are in doubt about your answers to these questions or your own assessment of your knowledge of the topics, read the entire chapter. Table 9-1 lists the major headings in this chapter and their corresponding “Do I Know This Already?” quiz questions. You can find the answers in Appendix A, “Answers to the ‘Do I Know This Already?’ Quizzes.”

**Table 9-1** “Do I Know This Already?” Section-to-Question Mapping

Foundation Topics Section	Questions
A Distributed Architecture	1–2
A Centralized Architecture	3–8
CUWN Building Blocks	9–10

**Caution** The goal of self-assessment is to gauge your mastery of the topics in this chapter. If you do not know the answer to a question or are only partially sure of the answer, you should mark that question as wrong for purposes of the self-assessment. Giving yourself credit for an answer you correctly guess skews your self-assessment results and might provide you with a false sense of security.



1. Which one of the following term best describes a Cisco wireless access point that operates in a standalone, independent manner?
  - a. Autonomous AP
  - b. Independent AP
  - c. Lightweight AP
  - d. Embedded AP
2. Suppose that an autonomous AP is used to support wireless clients. Which one of the following paths would traffic usually take when passing from one wireless client to another?
  - a. Through the AP only
  - b. Through the AP and its controller
  - c. Through the controller only
  - d. None of these answers (Traffic can go directly over the air.)
3. Suppose that a lightweight AP in default local mode is used to support wireless clients. Which one of the following paths would traffic usually take when passing from one wireless client to another?
  - a. Through the AP only
  - b. Through the AP and its controller
  - c. Through the controller only
  - d. None of these answers (Traffic must go directly over the air.)
4. A lightweight access point is said to participate in which one of the following architectures?
  - a. Light-MAC
  - b. Tunnel-MAC
  - c. Split-MAC
  - d. Big-MAC
5. How does a lightweight access point communicate with a wireless LAN controller?
  - a. Through an IPsec tunnel
  - b. Through an CAPWAP tunnel
  - c. Through a GRE tunnel
  - d. Directly over Layer 2
6. Which one of the following types of traffic is sent securely over a CAPWAP tunnel by default?

- a. Control messages
  - b. Client data
  - c. DHCP requests
  - d. 802.11 beacons
7. Which one of the following is not needed for a lightweight AP in default local mode to be able to support three SSIDs that are bound to three VLANs?
- a. A trunk link carrying three VLANs
  - b. An access link bound to a single VLAN
  - c. A WLC connected to three VLANs
  - d. A CAPWAP tunnel to a WLC
8. A CUWN is built with one WLC and 32 lightweight APs. Which one of the following best describes the resulting architecture?
- a. A direct Layer 2 path from the WLC to each of the 32 LAPs, all using the same IP subnet
  - b. A direct Layer 3 path from the WLC to each of the 32 LAPs, all using the same IP subnet
  - c. 32 CAPWAP tunnels daisy-chained between the LAPs, one CAPWAP tunnel to the WLC
  - d. 32 CAPWAP tunnels—one tunnel from the WLC to each LAP, with no IP subnet restrictions
9. A CUWN network is built with 300 lightweight APs and a 5508 WLC. Suppose wireless coverage needs to be offered in several more floors within a building, which will double the number of APs in use. Which of the following strategies would work? (Choose all that apply.)
- a. Add another 5508 WLC.
  - b. Replace the 5508 with a WLC that offers a greater AP capacity.
  - c. The 5508 will become full, so replace the APs with models that can cover twice the area.
  - d. Do nothing; you can have only one WLC in a network and no other model offers more APs than the 5508.
10. Which one of the following AP models should you choose if you expect to see 802.11ac clients in the near future?
- a. 1140
  - b. 1602i
  - c. 2602i
  - d. 3602i

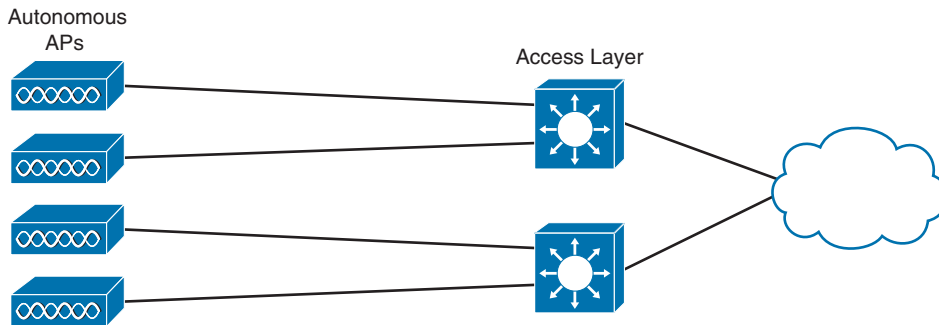
---

## Foundation Topics

---

### A Distributed Architecture

Autonomous APs are self-contained, each offering one or more fully functional, stand-alone basic service sets (BSSs). They are also a natural extension of a switched network, connecting wireless SSIDs to wired VLANs at the access layer. Figure 9-1 shows the basic architecture; even though only four APs are shown, a typical enterprise network could consist of hundreds or thousands of APs.

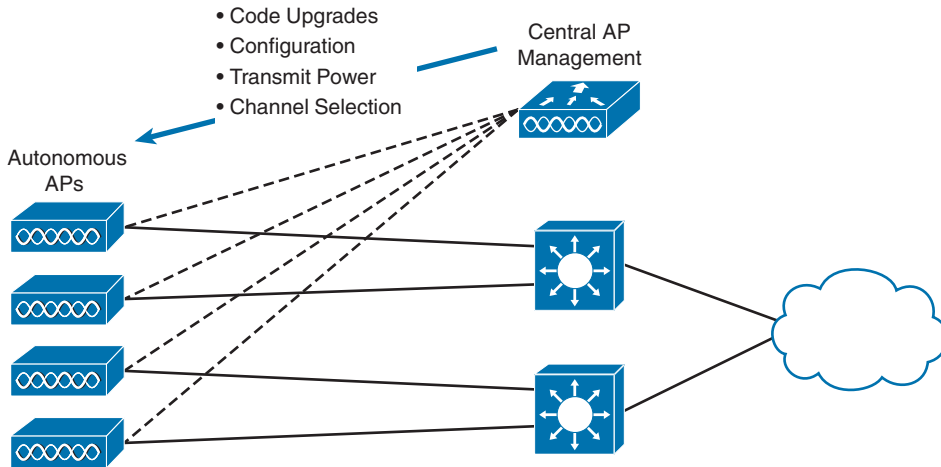


**Figure 9-1** *Wireless Network Architecture with Autonomous APs.*

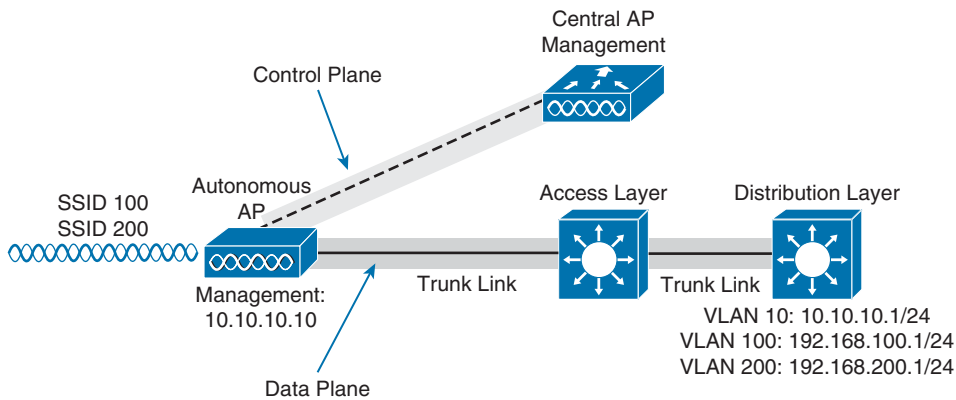
Recall that an autonomous AP needs quite a bit of configuration and management. To help manage more and more autonomous APs as the wireless network grows, you could place an AP management device in a central location, as illustrated in Figure 9-2. The device could push out code upgrades and configuration changes to the APs in a bulk fashion, to streamline AP management. With added intelligence, the device could instruct each AP on which channel and transmit power level to use. It could also collect information from all of the APs about things such as RF interference, rogue or unexpected wireless devices that were overheard, and wireless usage statistics.

**Note** At one time, Cisco offered a central AP management appliance called the Wireless LAN Solution Engine (WLSE). Its usefulness ended with the dawn of the CUWN architecture.

What exactly does an autonomous AP need to become a part of the network? Refer to Figure 9-3, which focuses on just one AP and its connections. The wireless network consists of two SSIDs: 100 and 200. These correspond to wired VLANs 100 and 200, respectively. The VLANs must be trunked from the distribution layer switch to the access layer, where they are extended further over a trunk link to the AP.



**Figure 9-2** Centrally Managing a Network of Autonomous APs.



Key  
Topic

**Figure 9-3** The Network Architecture of a Single Autonomous AP.

The AP must be configured with a management IP address (10.10.10.10) so that you and your central AP management device can remotely manage it. The management address is not normally part of any of the data VLANs, so a dedicated management VLAN (VLAN 10 in the figure) must be added to the trunk links to reach the AP.

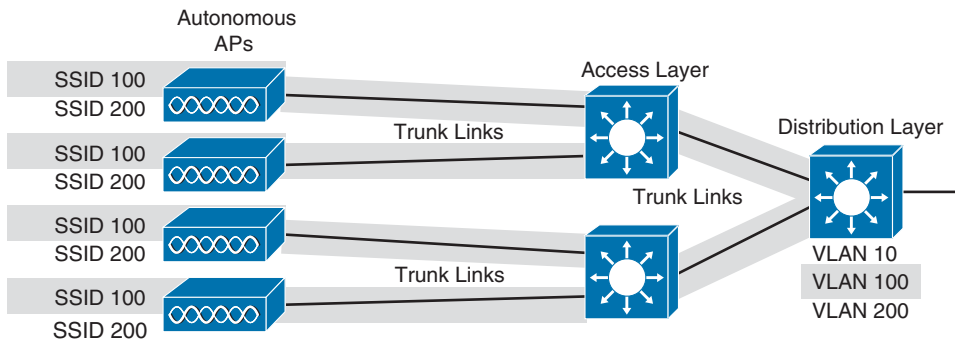
With the central AP management device controlling the AP, notice what happens to the traffic going to and from the AP. The traffic is divided into two functions:

- **A control plane**—Traffic used to control, configure, manage, and monitor the AP itself
- **A data plane**—End-user traffic passing through the AP

Because the control and data plane traffic must reach every autonomous AP, the network configuration and efficiency can become cumbersome as the network scales. For

example, you will likely want to offer the same SSID on many APs so that wireless clients can associate with that SSID in most any location or while roaming between two APs. You might also want to extend the corresponding VLAN to each and every AP so that clients do not have to request a new IP address for each new association.

Because SSIDs and their VLANs must be extended at Layer 2, you should consider how they are extended throughout the switched network. Figure 9-4 shows an example of a single VLAN's extent in the data plane. Working right to left, follow VLAN 100 as it reaches through the network. VLAN 100 is routed within the distribution layer and must be carried over trunk links to the access layer switches and then to each autonomous AP. In effect, VLAN 100 must extend end to end across the whole infrastructure—something that is considered a bad practice.



**Figure 9-4** *The Extent of VLAN 100 in a Network of Autonomous APs.*

That might not sound cumbersome until you have to add a new VLAN and configure every switch in your network. Even worse, suppose your network has redundant links between each layer of switches. The Spanning Tree Protocol (STP) running on each switch becomes a vital ingredient to prevent bridging loops from forming and corrupting the network. As the wireless network expands, the infrastructure becomes more difficult to configure correctly and becomes less efficient.

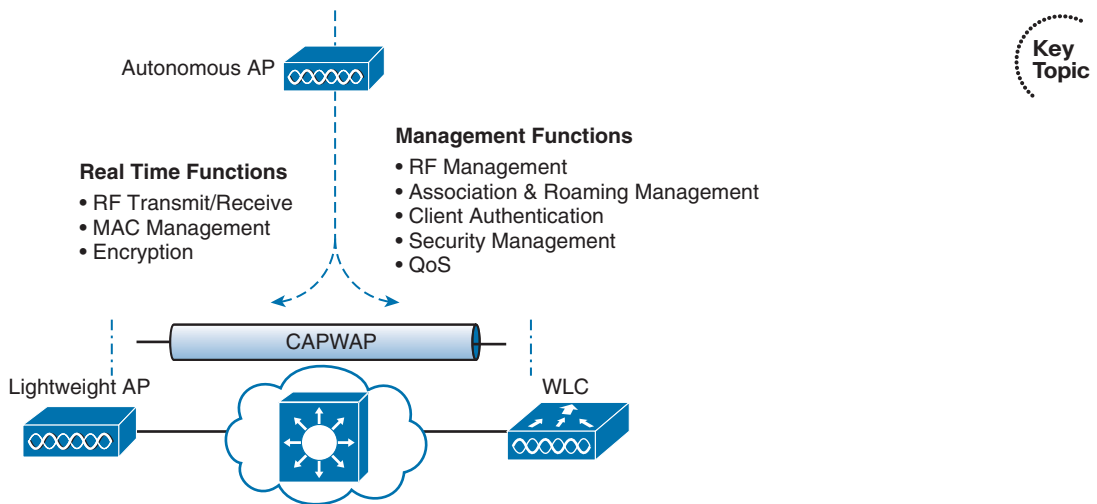
## A Centralized Architecture

Because autonomous APs are... well, autonomous, managing their RF operation can be quite difficult. As a network administrator, you are in charge of selecting and configuring the channel used by each AP and detecting and dealing with any rogue APs that might be interfering. You must also manage things such as the transmit power level to make sure that the wireless coverage is sufficient, does not overlap too much, and there aren't any coverage holes—even when an AP's radio fails.

Managing wireless network security can also be difficult. Each autonomous AP handles its own security policies, with no central point of entry between the wireless and wired networks. That means there is no convenient place to monitor traffic for things such as intrusion detection and prevention, quality of service, bandwidth policing, and so on.

The Cisco Unified Wireless Network (CUWN) is a centralized, unified approach that

overcomes the shortcomings of distributed autonomous APs. To build such an architecture, many of the functions found within autonomous APs have to be shifted toward some central location. In Figure 9-5, most of the activities performed by an autonomous AP are broken up into two groups—real-time processes on the left and management processes on the right.



**Figure 9-5** *Autonomous Versus Lightweight Access Point.*

The real-time processes involve sending and receiving 802.11 frames, beacons, and probe messages. 802.11 data encryption is also handled in real-time, on a per-packet basis. The AP must interact with wireless clients on some low level, known as the *media access control* (MAC) layer. These functions must stay with the AP, closest to the clients.

The management functions are not integral to handling frames over the RF channels, but are things that should be centrally administered. Therefore, those functions are moved to a centrally located platform away from the AP.

In the CUWN, a *lightweight access point* (LAP) performs only the real-time 802.11 operation. The LAP gets its name because the code image and the local intelligence are stripped down or lightweight, compared to the traditional autonomous AP.

The management functions are usually performed on a *wireless LAN controller* (WLC), which is common to many LAPs. This is shown in the bottom portion of Figure 9-5. Notice that the LAP is left with duties in Layers 1 and 2, where frames are moved into and out of the RF domain. The LAP becomes totally dependent on the WLC for every other WLAN function, such as authenticating users, managing security policies, and even selecting RF channels and output power.

**Tip** Remember that a lightweight AP cannot normally operate on its own—it is very dependent upon a WLC somewhere in the network.

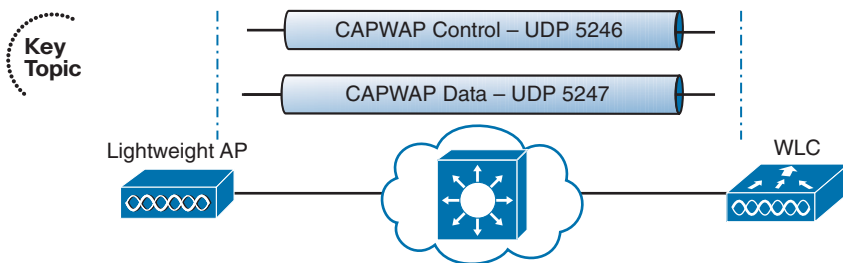
## Split-MAC Architecture

The LAP-WLC division of labor is known as a *split-MAC architecture*, where the normal MAC operations are pulled apart into two distinct locations. This occurs for every LAP in the network; each one must boot and bind itself to a WLC to support wireless clients. The WLC becomes the central hub that supports a number of LAPs scattered about in the network.

How does an LAP bind with a WLC to form a complete working access point? The two devices must use a tunneling protocol between them, to carry 802.11-related messages and also client data. Remember that the LAP and WLC can be located on the same VLAN or IP subnet, but they do not have to be. Instead, they can be located on two entirely different IP subnets in two entirely different locations.

The Control and Provisioning of Wireless Access Points (CAPWAP) tunneling protocol makes this all possible by encapsulating the data between the LAP and WLC within new IP packets. The tunneled data can then be switched or routed across the campus network. As Figure 9-6 shows, the CAPWAP relationship actually consists of the following two tunnels:

- **CAPWAP control messages**—Used for exchanges that are used to configure the LAP and manage its operation. The control messages are authenticated and encrypted, so that the LAP is securely controlled by only the WLC, then transported using UDP port 5246 at the controller.
- **CAPWAP data**—Used for packets traveling to and from wireless clients that are associated with the LAP. Data packets are transported using UDP port 5247 at the controller, but are not encrypted by default. When data encryption is enabled for an LAP, packets are protected with Datagram Transport Layer Security (DTLS).

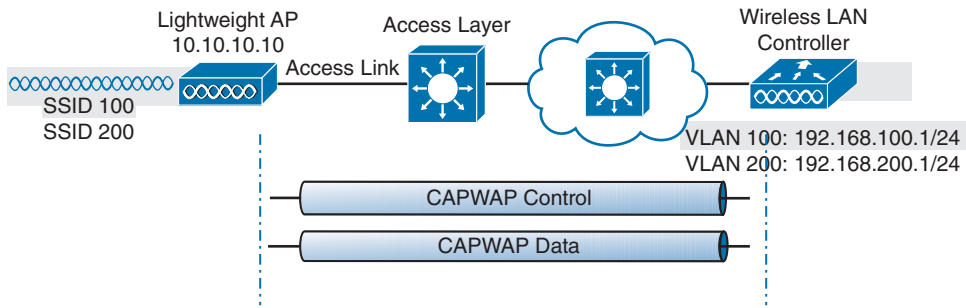


**Figure 9-6** Linking an LAP and WLC with CAPWAP.

**Tip** CAPWAP is defined in RFCs 5415, 5416, 5417, and 5418. CAPWAP is based on the Lightweight Access Point Protocol (LWAPP), which was a legacy Cisco proprietary solution.

Every LAP and WLC must also authenticate each other with digital certificates. An X.509 certificate is preinstalled in each device when it is purchased. By using certificates behind the scenes, every device is properly authenticated before becoming part of the CUWN. This process helps assure that no rogue LAP or WLC (or devices posing as an LAP or WLC) can be introduced into the network. The LAP-WLC association is covered in greater detail in Chapter 11, “Understanding Controller Discovery.”

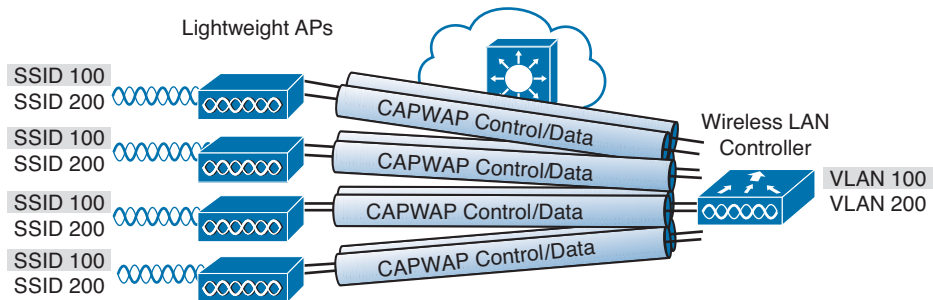
The CAPWAP tunneling allows the LAP and WLC to be separated geographically and logically. It also breaks the dependence on Layer 2 connectivity between them. For example, Figure 9-7 uses shaded areas to show the extent of VLAN 100. Notice how VLAN 100 exists at the WLC and in the air as SSID 100, near the wireless clients—but not in between the LAP and the WLC. Instead, traffic to and from clients associated with SSID 100 is transported across the network infrastructure encapsulated inside the CAPWAP data tunnel.



**Figure 9-7** The Extent of VLAN 100 in a CUWN.

Also, notice how the LAP is known by only a single IP address 10.10.10.10. Because the LAP sits on the access layer where its CAPWAP tunnels terminate, it can use one IP address for management and tunneling. No trunk link is needed because all of the VLANs it supports are encapsulated and tunneled.

As the wireless network grows, the WLC simply builds more CAPWAP tunnels to reach more APs. Figure 9-8 depicts a network with four LAPs. Each LAP has a control and a data tunnel back to the centralized WLC. SSID 100 can exist on every AP, and VLAN 100 can reach every AP through the network of tunnels.



**Figure 9-8** Using CAPWAP Tunnels to Connect LAPs to One Central WLC.



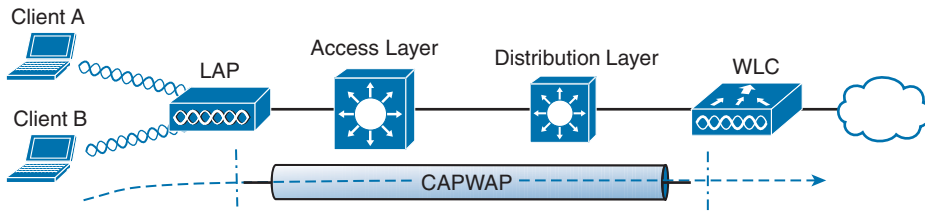
Once CAPWAP tunnels are built from a WLC to one or more lightweight APs, the WLC can begin offering a variety of additional functions. Think of all the puzzles and shortcomings that were discussed for the traditional autonomous WLAN architecture as you read over the following list of WLC activities:

- **Dynamic channel assignment**—The WLC can automatically choose and configure the RF channel used by each LAP, based on other active access points in the area.
- **Transmit power optimization**—The WLC can automatically set the transmit power of each LAP based on the coverage area needed.
- **Self-healing wireless coverage**—If an LAP radio dies, the coverage hole can be “healed” by turning up the transmit power of surrounding LAPs automatically.
- **Flexible client roaming**—Clients can roam between LAPs at either Layer 2 or Layer 3 with very fast roaming times.
- **Dynamic client load balancing**—If two or more LAPs are positioned to cover the same geographic area, the WLC can associate clients with the least used LAP. This distributes the client load across the LAPs.
- **RF Monitoring**—The WLC manages each LAP so that it scans channels to monitor the RF usage. By listening to a channel, the WLC can remotely gather information about RF interference, noise, signals from neighboring LAPs, and signals from rogue APs or ad hoc clients.
- **Security management**—The WLC can authenticate clients from a central service and can require wireless clients to obtain an IP address from a trusted DHCP server before allowing them to associate and access the WLAN.
- **Wireless intrusion protection system**—Leveraging its central location, the WLC can monitor client data to detect and prevent malicious activity.

## Traffic Patterns in a CUWN

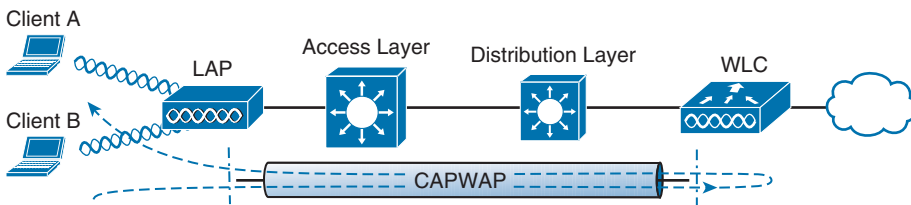
Recall that autonomous APs bridge traffic between a wireless BSS and a wired VLAN. To get to and from the wired network, the AP relies on its connection to the distribution system (DS). LAPs work in a similar fashion, except that the BSS and DS are separated by some expanse of the network infrastructure; that expanse is connected by the CAPWAP tunnel.

Consider the network shown in Figure 9-9. Two wireless clients are associated with the WLAN that is formed by the LAP and WLC combination. Traffic from Client B to a host somewhere on the wired network travels through the LAP, through the CAPWAP data tunnel to the WLC, and then out onto the switched campus network.



**Figure 9-9** CUWN Traffic Patterns Between Wireless and Wired Networks.

Traffic between the two wireless clients, however, takes an interesting path. With an autonomous AP, the traffic from one client usually passes through the AP to reach the other client. The CUWN architecture is similar, as shown in Figure 9-10. The client traffic usually travels through the CAPWAP tunnel and passes through the WLC before making a return trip back through the tunnel to the other client. There are exceptions, however. Clients may use DLS to communicate directly, without passing through the AP and controller; LAPs can also be configured in FlexConnect mode, so that traffic can be forwarded locally at the AP if needed.



**Key  
Topic**

**Figure 9-10** CUWN Traffic Pattern Between Wireless Clients.

In a switched campus infrastructure, the CUWN traffic pattern is not a big problem because the WLC is centrally located and bandwidth is plentiful. Suppose that the network grows to include some remote sites. LAPs are placed at the remote sites, but the only WLC is located back at the main campus. This scenario forces wireless traffic to traverse the CAPWAP tunnel between remote and main sites, then perhaps back through the tunnel to the remote site again. Such a path might not be efficient at all, especially when the bandwidth to the remote site is limited.

To address the inefficiency, you can leverage the FlexConnect mode on the remote site LAPs. Remote-site traffic that needs to traverse the CAPWAP data tunnel to reach the WLC will be transported as usual. However, wireless traffic that is destined for remote site networks can stay within the remote site; the remote site LAPs are able to locally switch the traffic without traversing the CAPWAP tunnel. Even if the remote site link goes down, severing the CAPWAP tunnel completely, FlexConnect allows the LAP to keep switching traffic locally to maintain wireless connectivity available inside the remote site.

**Tip** FlexConnect was previously known as the Hybrid Remote Edge Access Point (H-REAP) feature.

## CUWN Building Blocks




A successful CUWN design involves LAPs, WLCs, and a platform to manage them all. The following sections describe the Cisco hardware you can use to build a CUWN.

### Cisco Wireless LAN Controllers

Cisco WLCs are available in many platforms, differing mainly in the form factor and the number of managed LAPs. The WLC platforms are listed in Table 9-2, arranged in ascending order by the maximum number of LAPs supported.

**Table 9-2** *Cisco WLC Platforms and Capabilities*

Model	Form Factor	Data Uplink	LAPs Supported	Application
 2100 Series	Appliance*	8x10/100	6, 12, or 25	Small
 WLCM	Module (ISR)*	Internal	Up to 25	Small
 SRE ISM	Module (ISR)	Internal	Up to 10 (ISM-300) Up to 50 (ISM-710, ISM-910)	Small
 Catalyst 3850	Integrated	4x10GigE	Up to 50 per switch	Small branch stack
4400 Series (image not available)	Appliance*	2x1GigE (4402) 4x1GigE (4404)	Up to 50 (4402) Up to 100 (4404)	Small to mid
 2504	Appliance	4x1GigE	Up to 75	Small
Virtual WLC (image not available)	VM	Internal	Up to 200	Small, multisite
WiSM (image not available)	Module (Catalyst 6500)*	4x1GigE per WLC	Up to 300 (150 per WLC)	Mid
 5508	Appliance	8x1GigE	Up to 500	Mid to large
 WiSM2	Module (Catalyst 6500)	2x10GigE	Up to 1000	Mid to large

Model	Form Factor	Data Uplink	LAPs Supported	Application
 5760	Appliance	6x1/10GigE	Up to 1000 Up to 6000 per cluster	Large
 Flex 7500	Appliance	2x10GigE	Up to 6000 FlexConnect	Very large, multi-site
 8500 Series	Appliance	2x10GigE	Up to 6000	Very large, multi-site

\*- Denotes legacy product that is currently end-of-sale or end-of-life

Table 9-2 lists both legacy and current state-of-the-art products, at the time of this writing. You might see any of these products mentioned on the CCNA Wireless exam. Because new products are usually introduced before exams are updated, you might have exam questions that pertain to some of the legacy products. A star in the form factor column designates a legacy product, or one that has been given end-of-sale (EOS) or end-of-life (EOL) status.

Use Table 9-2 to become familiar with the entire spectrum of Cisco WLCs—not to memorize their specifications. Be aware of the relative AP capacity based on the model. Generally, the number of supported LAPs rises as the model number increases. Products that support a low number of LAPs are usually meant for small campus sites, while products that support 1000 or 6000 LAPs are flagship models that are meant for very large enterprises.

Many WLCs are standalone appliances, while a few are special purpose modules that can be installed in routers (ISR) or Catalyst 6500 chassis. The Wireless Service Module 2 (WiSM2) is unique because it can be integrated into an existing Catalyst 6500 switch. Up to seven WiSM2 modules can live in a single switch chassis.

You might be surprised to see the Catalyst 3850 switch listed as a WLC. Cisco has added the WLC functionality to it as an additional software license. The integrated WLC function can be managed through the CLI or its own web interface. From a wireless LAN perspective, the Catalyst 3850 is best suited for a small single-site enterprise or at remote sites. Even though each switch can support up to 50 APs, the limit does not increase when switches are stacked. That is not really a problem because it is very unlikely you would ever encounter more than 50 APs in a single site each limited to a 100-meter twisted-pair cable.

The virtual WLC (vWLC) is an interesting product because it consists of software only, running under a VMware Hypervisor. You might use it in a small enterprise or in a lab scenario. Because of its virtual nature, vWLC can coexist with other Cisco wireless management software on a single VMware platform. The vWLC cannot support any APs in local mode; all APs must be configured for FlexConnect instead.







Be aware that you can deploy several WLCs in a network, to handle a growing number of LAPs. In addition, multiple WLCs offer some redundancy so that LAPs can recover from a WLC failure. High availability and redundancy are covered in Chapter 11.





## Cisco Lightweight APs

Cisco offers a complete line of LAPs that are designed to connect to a WLC to offer fully functional wireless service. Table 9-3 lists many of the LAP models, along with their intended application, antenna gain, and 802.11 radio support. The list of APs might seem staggering at first, especially when you are studying for the exam.

Try to break the table down into sections and then compare the capabilities between models. For example, the top portion of the table consists of the 1040, 1140, 1250, and 1260—all legacy models that might be mentioned on the exam, but are not considered to be forward-looking models. The bottom portion of the table consists of the 1602, 2602, 3602, and 3607—forward-looking models for the small/midsize, small/midsize/large, and midsize/large enterprise environments, respectively.

**Table 9-3** *Cisco Lightweight Access Points and Their Capabilities*

	<b>Model</b>	<b>Application</b>	<b>CleanAir</b>	<b>Antenna Gain 2.4/5 GHz</b>	<b>802.11</b>	<b>Radios</b>
	1040*	Indoor	No	4 dBi / 3 dBi	a/g/n	2x2:2
	1140*	Indoor	No	4 dBi / 3 dBi	a/g/n	2x3:2
	1250*	Rugged	No	External	a/g/n	2x3:2
	1260*	Rugged	No	External	a/g/n	2x3:2
	3502i 3502e	Indoor Rugged	Yes Yes	4 dBi / 3 dBi External	a/g/n a/g/n	2x3:2 2x3:2
	600 OfficeExtend	Indoor	No	3.5 dBi / 4 dBi	a/g/n	2x3:2

	<b>Model</b>	<b>Application</b>	<b>CleanAir</b>	<b>Antenna Gain 2.4/5 GHz</b>	<b>802.11</b>	<b>Radios</b>
	1602i	Indoor	Express	4 dBi /	a/g/n	3×3:2
	1602e	Rugged	Express	4 dBi External	a/g/n	3×3:2
	2602i	Indoor	Yes	4 dBi /	a/g/n	3×4:3
	2602e	Rugged	Yes	4 dBi External	a/g/n	3×4:3
	3602i	Indoor	Yes	2 dBi /	a/g/n/ac	4×4:3
	3602e	Rugged	Yes	5 dBi External	a/g/n/ac	4×4:3
	3702i	Indoor	Yes	4 dBi /	a/g/n/ac	4×4:3
	3702e	Rugged	Yes	6 dBi External	a/g/n/ac	4×4:3

\*-Denotes legacy product that is currently end-of-sale or end-of-life

The 3602 is unique because it is modular and can provide “future-proof” upgrades. It can accept an 802.11ac module or a Wireless Security and Spectrum Intelligence (WSSI) module for added functionality. With the WSSI module, an AP can perform channel scanning and intrusion protection with dedicated radios, rather than borrowing idle time from the AP’s own radios between transmissions. The 3702 integrates 802.11ac Wave 1 and provides space for a Wave 2 module.

The 600 OfficeExtend AP is a unique model that is targeted for the remote worker located in a home office. It can connect directly to a broadband network service and provide a BSS, while building CAPWAP tunnels back to a centrally located WLC. The 600 encrypts the CAPWAP control tunnel, like other LAP models, but can also encrypt the CAPWAP data tunnel using DTLS.

CleanAir is a Cisco feature that allows an AP to perform spectrum analysis on the wireless channels to detect non-802.11 interference. In cooperation with a WLC, CleanAir APs can detect and identify sources of interference and make adjustments to avoid the interference. When the AP and WLC are used in conjunction with Cisco Mobility Services Engine (MSE) and a CUWN management platform, interferers can even be located on a map! This enables the CUWN to be self-healing, able to pinpoint and recover from external problems dynamically. CleanAir is discussed further in Chapter 19, “Dealing with Wireless Interference.”

Each of the APs listed in Table 9-3 offers 802.11a/b/g/n support. The main difference between models pertains to multiple-input, multiple-output (MIMO) operation, with a differing number of radios and spatial streams. Recall from Chapter 2, “RF Standards,” that a radio described as 2×3:2 has two transmitters, three receivers, and two spatial streams. As the number of radios and spatial streams increases, the AP is able to provide

a greater throughput for its clients. Notice how the number of radios and spatial streams increase as you move down the table toward higher end models.

**Note** Table 9-3 lists only the lightweight APs that are used to provide a straightforward BSS. Cisco also offers the 1500 family of LAPs, which are used to build an outdoor wireless mesh network. Mesh networks are outside the scope of this book and the CCNA Wireless exam.

As you learned in Chapter 8 many Cisco APs can operate in either autonomous or lightweight mode, depending on which code image is loaded and run. From the WLC, you can also configure a lightweight AP to operate in one of the following special purpose modes:

- **Local mode**—The default lightweight mode that offers one or more functioning BSSs on a specific channel. During times that it is not transmitting, the LAP will scan the other channels to measure the noise floor, measure interference, discover rogue devices, and match against intrusion detection system (IDS) events.
- **Monitor mode**—The LAP does not transmit at all, but its receiver is enabled to act as a dedicated sensor. The LAP checks for IDS events, detects rogue access points, and determines the position of stations through location-based services (LBS).
- **HREAP mode**—Also known as FlexConnect mode, an LAP at a remote site can locally switch traffic between an SSID and a VLAN if its CAPWAP tunnel to the WLC is down and if it is configured to do so.
- **Sniffer mode**—An LAP dedicates its radios to receiving 802.11 traffic from other sources, much like a sniffer or packet capture device. The captured traffic is then forwarded to a PC running network analyzer software such as Wildpackets OmniPeek or WireShark, where it can be analyzed further.
- **Rogue detector mode**—An LAP dedicates its radios to listening for other neighboring APs and clients to determine whether they are rogue devices. Device MAC addresses heard on the LAP's wired interface are compared with those heard over the air. Rogue devices are those that appear on both networks.
- **Bridge**—An LAP becomes a dedicated bridge (point to point or point to multipoint) between two networks. Two LAPs in bridge mode can be used to link two locations separated by a distance. Multiple LAPs in bridge mode can form an indoor or outdoor mesh network.
- **OEAP**—The LAP operates as an OfficeExtend AP, intended for teleworkers in remote home offices. The LAP connects to the local broadband service and builds a CAPWAP tunnel to the central WLC. User data can be encrypted over the CAPWAP data tunnel using DTLS.
- **SE-Connect**—The LAP dedicates its radios to spectrum analysis on all wireless channels. You can remotely connect a PC running software such as the Cisco Spectrum Expert to the LAP to collect and analyze the spectrum analysis data to discover sources of interference.

## CUWN Management

Managing several WLCs can require a significant effort, due to the number of controllers, LAPs, and clients involved. In addition, it is difficult to monitor all of the alarms and events generated by all of the related equipment present in the network. Fortunately, Cisco offers a central management platform that is up to the task.

The CUWN management platform began as the Wireless Control System (WCS), then evolved to become Cisco Prime Network Control System (NCS), and is now known as Cisco Prime Infrastructure (PI). Unfortunately, the CCNA Wireless Exam 640-722 covers only WCS and something called Navigator. Do not worry, though: Even though the product names have changed and many new functions have been added since the WCS days, the basic CUWN management functions are very much the same. In other words, if you know something about Cisco PI, you will know something about WCS. The remainder of this section presents a running history of the management products, so that you can put them all into perspective.

WCS was a dedicated appliance that offered a single web-based front end to manage and monitor all CUWN devices and client activity. From the WCS, you could perform any WLAN management or configuration task, without having to connect to individual WLCs or LAPs. You could even streamline configuration tasks by using templates that could be applied to multiple devices in one pass. WCS also offered RF planning, and wireless user tracking, troubleshooting, and monitoring.

WCS used building floor plans to display predictive “heatmap” representations of wireless coverage. It could also be fed information about the building construction to improve its concept of RF signal propagation. Once this was done, WCS could locate a wireless client to within a few meters by triangulating the client’s signal as received by multiple LAPs.

WCS could be teamed with the legacy Cisco Wireless Location Appliance to track the location of thousands of wireless clients. You could even deploy active 802.11 RFID tags to track objects as they move around in the wireless coverage area.

As a network scaled to become very large, multiple WCS servers might have been needed. The WCS Navigator product provided a single portal to manage up to 20 instances of WCS and up to 30,000 APs.

When WCS evolved to become NCS, it could be run on a dedicated appliance or as a VMware image. In addition to wireless device management, NCS added some switch management functions. It also provided dynamic RF coverage heatmaps, depicting current conditions on building floor plans. Wireless client location and tracking was improved by teaming NCS with the Cisco Mobility Services Engine (MSE).

The final evolution from Cisco Prime NCS to Cisco PI streamlined many management processes and added much more functionality. For example, PI offers converged management of both wireless and wired network devices, and more integration with wireless intrusion prevention services, spectrum analysis, and tracking of users, interferers, and rogue devices.

You can learn more about the management functions that are necessary for the CCNA Wireless exam in Chapter 18, “Managing Wireless Networks with WCS.”



---

## Exam Preparation Tasks

---

As mentioned in the section, “How to Use This Book,” in the Introduction, you have a couple of choices for exam preparation: the exercises here, Chapter 22, “Final Review,” and the exam simulation questions on the CD-ROM.

### Review All Key Topics

Review the most important topics in this chapter, noted with the Key Topic icon in the outer margin of the page. Table 9-4 lists a reference of these key topics and the page numbers on which each is found.



**Table 9-4** *Key Topics for Chapter 9*

Key Topic Element	Description	Page Number
Figure 9-3	Autonomous AP architecture	185
Figure 9-5	Split-MAC architecture	187
Figure 9-6	CAPWAP operation	188
Figure 9-10	CUWN traffic pattern	191

*This page intentionally left blank*



---

This chapter covers the following topics:

- **Connecting the Controller**—This section describes the controller ports and interfaces and explains how the controller is connected to the network.
- **Running the Initial Setup Wizard**—This section covers how to provide a bootstrap configuration to a new controller. Both web-based and command-line interface versions of the initial setup wizard are explored.

This chapter covers the following exam topics:

- Configure a WLAN controller and access points  
WLC: ports, interfaces, WLANs, NTP, CLI and Web UI, CLI wizard, and link aggregation group (LAG) AP: Channel and Power

# Initial Controller Configuration

---

Before you can use a Cisco wireless LAN controller, you must connect it to the switched network. The controller must also link wired networks with wireless ones. You need to understand how to make the necessary connections, both physical and logical, to build a functioning Cisco Unified Wireless Network (CUWN). This chapter covers these concepts, in addition to how to enter a minimal initial configuration to get a controller up on the network where you can manage it more fully.

## “Do I Know This Already?” Quiz

The “Do I Know This Already?” quiz allows you to assess whether you should read this entire chapter thoroughly or jump to the “Exam Preparation Tasks” section. If you are in doubt about your answers to these questions or your own assessment of your knowledge of the topics, read the entire chapter. Table 10-1 lists the major headings in this chapter and their corresponding “Do I Know This Already?” quiz questions. You can find the answers in Appendix A, “Answers to the ‘Do I Know This Already?’ Quizzes.”

**Table 10-1** “Do I Know This Already?” Section-to-Question Mapping

Foundation Topics Section	Questions
Connecting the Controller	1–7
Running the Initial Setup Wizard	8–10

**Caution** The goal of self-assessment is to gauge your mastery of the topics in this chapter. If you do not know the answer to a question or are only partially sure of the answer, you should mark that question as wrong for purposes of the self-assessment. Giving yourself credit for an answer you correctly guess skews your self-assessment results and might provide you with a false sense of security.

- 1.** A wireless controller port is used for which one of the following purposes?
  - a.** Construct CAPWAP tunnel packets
  - b.** Provide a physical connection to a switch port
  - c.** Create a logical connection to a WLAN
  - d.** Provide a physical connection to an AP
- 2.** Which one of the following is used for remote out-of-band management of a controller and the initial controller setup?
  - a.** Distribution system port
  - b.** Virtual interface
  - c.** Service port
  - d.** AP-manager interface
- 3.** A distribution system port is usually configured in which one of the following modes?
  - a.** 802.1Q trunk
  - b.** Access mode
  - c.** LACP trunk negotiation
  - d.** Recovery mode
- 4.** Which one of the following correctly describes the single logical link formed by bundling all of a controller's distribution system ports together?
  - a.** PHY
  - b.** DSP
  - c.** LAG
  - d.** GEC
- 5.** A CAPWAP tunnel terminates on which one of the following controller interfaces?
  - a.** Virtual interface
  - b.** Dynamic interface
  - c.** Service port interface
  - d.** AP-manager interface

- 6.** If an AP-manager interface is not explicitly configured on a port, APs will build CAPWAP tunnels to which one of the following controller interfaces?
  - a.** Management interface
  - b.** Dynamic interface
  - c.** Virtual interface
  - d.** Service port interface
- 7.** Which one of the following controller interfaces maps a WLAN to a VLAN?
  - a.** Bridge interface
  - b.** Virtual interface
  - c.** WLAN interface
  - d.** Dynamic interface
- 8.** Suppose that you have just powered up a new controller. If you connect to the controller's console port, in which one of the following modes will you find the controller?
  - a.** Initial setup mode
  - b.** ROMMON mode
  - c.** Discovery mode
  - d.** Promiscuous mode
- 9.** You can perform the initial setup of a wireless LAN controller from a web browser. True or false?
  - a.** True
  - b.** False
- 10.** To access a controller for its initial setup wizard, to which one of the following interface addresses should you connect with your web browser?
  - a.** Virtual interface
  - b.** Console port
  - c.** Dynamic interface
  - d.** Service-port interface

## Foundation Topics

### Connecting the Controller

Cisco wireless LAN controllers partner with lightweight access points (LAPs) to provide connectivity between a switched network and mobile wireless clients. The switched network infrastructure also transports the packets that make up the Control and Provisioning of Wireless Access Points (CAPWAP) tunnels between the controllers and the access points (APs). Your first task to begin using a controller is to connect it to the network.

From your work with Cisco routers and switches, you probably know that the terms *interface* and *port* are usually interchangeable. For example, switches can come in 24- or 48-port models, and you apply configuration changes to the corresponding interfaces. Cisco wireless controllers differ a bit; ports and interfaces refer to different concepts.

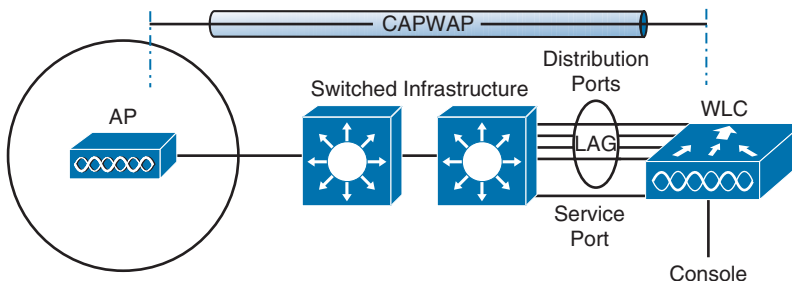
Controller ports are physical connections made to an external switched network, whereas interfaces are logical connections made internally within the controller. The following sections explain each connection type in more detail.

### Using Controller Ports

You can connect several different types of controller ports to your network, as shown in Figure 10-1 and discussed in the following list:



- **Service port**—Used for out-of-band management, system recovery, and initial boot functions; always connects to a switch port in access mode
- **Distribution system port**—Used for all normal AP and management traffic; usually connects to a switch port in 802.1Q trunk mode
- **Console port**—Used for out-of-band management, system recovery, and initial boot functions; asynchronous connection to a terminal emulator (9600 baud, 8 data bits, 1 stop bit, by default)
- **Redundancy port**—Used to connect to a peer controller for redundant operation



**Figure 10-1** Cisco Wireless LAN Controller Ports.

Controllers have a single service port that must be connected to a switched network. Usually the service port is assigned to a management VLAN so that you can access the controller with Secure Shell (SSH) or a web browser to perform initial configuration or for maintenance. Notice that the service port supports only a single VLAN, so the corresponding switch port must be configured for access mode only.

Controllers also have multiple distribution system ports that you must connect to the network. These ports carry most of the data coming to and going from the controller. For example, the CAPWAP tunnels (control and data) that connect to each of a controller's APs pass across the distribution system ports. Client data also passes from wireless LANs to wired VLANs over the ports. In addition, any management traffic using a web browser, SSH, SNMP, or TFTP normally reaches the controller through the ports.

Because the distribution system ports must carry data that is associated with many different VLANs, VLAN tags and numbers become very important. For that reason, the distribution system ports always operate in 802.1Q trunking mode. When you connect the ports to a switch, you should also configure the switch ports for unconditional 802.1Q trunk mode.

The distribution system ports can operate independently, each one transporting multiple VLANs to a unique group of internal controller interfaces. For resiliency, you can configure distribution system ports in redundant pairs. One port is primarily used; if it fails, a backup port is used instead.

To get the most use out of each distribution system port, you can configure all of them to operate as a single logical group, much like an EtherChannel on a switch. Controller distribution system ports can be configured as a link aggregation group (LAG) such that they are bundled together to act as one larger link. In Figure 10-1, the four distribution system ports are configured as a LAG. With a LAG configuration, traffic can be load balanced across the individual ports that make up the LAG. In addition, LAG offers resiliency; if one individual port fails, traffic will be redirected to the remaining working ports instead.

Table 10-2 lists common Cisco controller models along with the distribution system and service ports available. As you might expect, the more APs a controller platform supports, the greater distribution system port throughput it needs. In contrast, almost every model uses a 1-Gbps service port because the out-of-band management traffic requirements are fairly small.

**Table 10-2** *Controller Models and Supported Distribution and Service Ports*

<b>Controller Model</b>	<b>Distribution Ports</b>	<b>Service Port</b>
2500	(4) 1 Gbps	
5500	(8) 1 Gbps	(1) 1 Gbps
5760	(6) 1 or 10 Gbps	(1) 1 Gbps
Flex 7500	(2) 10 Gbps	(1) 1 Gbps



<b>Controller Model</b>	<b>Distribution Ports</b>	<b>Service Port</b>
8500	(2) 10 Gbps	(1) 1 Gbps
WiSM2	(2) 10 Gbps (internal)	(1) 1 Gbps (internal)

## Using Controller Interfaces

Through its distribution system ports, a controller connects to multiple VLANs on the switched network. Internally, the controller must somehow map those wired VLANs to equivalent logical wireless networks. For example, suppose that VLAN 10 is set aside for wireless users in the Engineering division of a company. That VLAN must be connected to a unique wireless LAN that exists on a controller and its associated APs. The wireless LAN must then be connected to every client that associates with service set identifier (SSID) “Engineering”.

Cisco wireless controllers provide the necessary connectivity through internal interfaces. A controller interface is logical and must be configured with an IP address, subnet mask, default gateway, and a Dynamic Host Configuration Protocol (DHCP) server. Each interface is then assigned to a physical port and a VLAN ID. You can think of an interface as a Layer 3 termination on a VLAN.

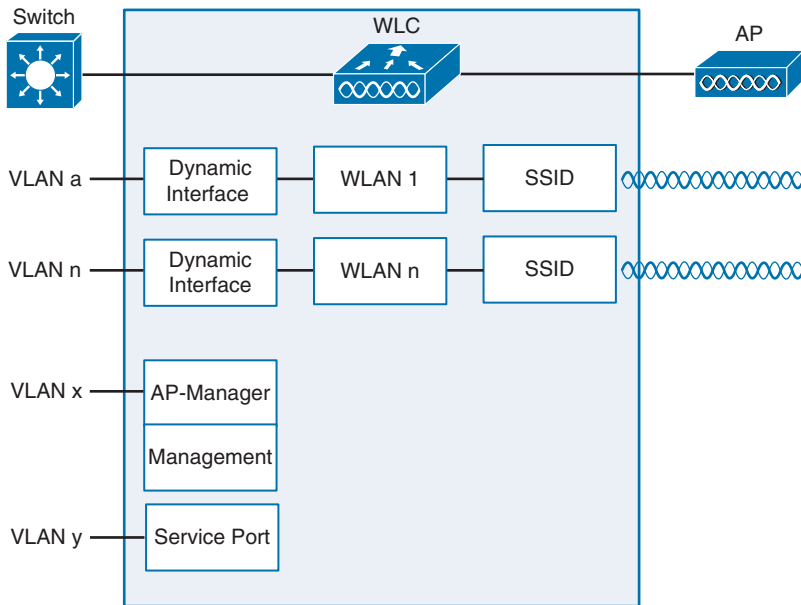
Cisco controllers support the following interface types, also shown in Figure 10-2:



- **Management interface**—Used for normal management traffic, such as RADIUS user authentication, wireless LAN controller (WLC)-to-WLC communication, web-based and SSH sessions, SNMP, NTP, syslog, and so on
- **AP-manager interface**—Used to terminate CAPWAP tunnels between the controller and its APs
- **Virtual interface**—Used to relay client DHCP requests, client web authentication, and to support client mobility
- **Service port interface**—Bound to the service port and used for out-of-band management
- **Dynamic interface**—Used to connect a VLAN to a WLAN

The management and AP-manager interfaces both face the switched network, where management users and APs are located. Management traffic will usually consist of protocols like HTTPS, SSH, SNMP, NTP, TFTP, and so on. AP-manager traffic always consists of CAPWAP packets that carry control and data tunnels to and from the APs.

The two interfaces are listed separately, but the AP-manager interface is optional. By default, the AP-manager interface is not available for use until it is explicitly configured, so CAPWAP tunnels will be terminated on the Management interface instead. You can create an AP-manager interface if you would like to keep the management and CAPWAP traffic separate. However, the two interfaces should always reside on the same VLAN.



**Figure 10-2** Cisco Wireless LAN Controller Interfaces.

The virtual interface is used only for certain client facing operations. For example, when a wireless client issues a DHCP request to obtain an IP address, the controller can relay the request on to a normal DHCP server. From the client’s perspective, the DHCP server appears to be the controller’s virtual interface’s address, but that address is never used when the controller communicates with other devices on the switched network.

Because the virtual interface is used only for some client management functions, you should configure it with a unique, nonroutable address. For example, you might use 10.1.1.1 because it is within a private address space defined in RFC 1918.

**Tip** Traditionally, many people have assigned IP address 1.1.1.1 to the virtual interface. Although it is a unique address, it is routable and already in use elsewhere on the Internet. A better practice is to use an IP address from a private address space that is unused or reserved, such as 192.0.2.1.

The virtual interface address is also used to support client mobility. For that reason, every controller that exists in the same mobility group should be configured with a virtual address that is identical to the others. By using one common virtual address, all the controllers will appear to operate as a cluster as clients roam from controller to controller.

Dynamic interfaces map WLANs to VLANs, making the logical connections between wireless and wired networks. You will configure one dynamic interface for each wireless LAN that is offered by the controller’s APs, and then map the interface to the WLAN.

Each dynamic interface must also be configured with its own IP address and can act as a DHCP relay for wireless clients. To filter traffic passing through a dynamic interface, you can configure an optional access list. Dynamic interface and WLAN configuration are covered in more detail in Chapter 15, “Configuring a WLAN.”

## Running the Initial Setup Wizard

When you power up a wireless controller for the first time, it comes up with a minimal default configuration. The distribution system ports are not yet usable, but you can connect to the controller through its console port or through its service port—provided you have connected the service port to a switch or an Ethernet crossover cable. The service port can use a default IP address of 192.168.1.1, or it can request an address through DHCP.

The default configuration has no interfaces or WLANs defined. APs cannot connect to it until you provide some initial setup information and then configure it further after the controller reboots into normal operation.

You can use either a web browser or the command-line interface (CLI) to set up a controller for the first time. Both methods are covered in the following sections. Through the initial setup, you define the minimum parameters for the controller to become operational—the service port, management interface, virtual interface, WLAN, authentication server, clock, and so on.

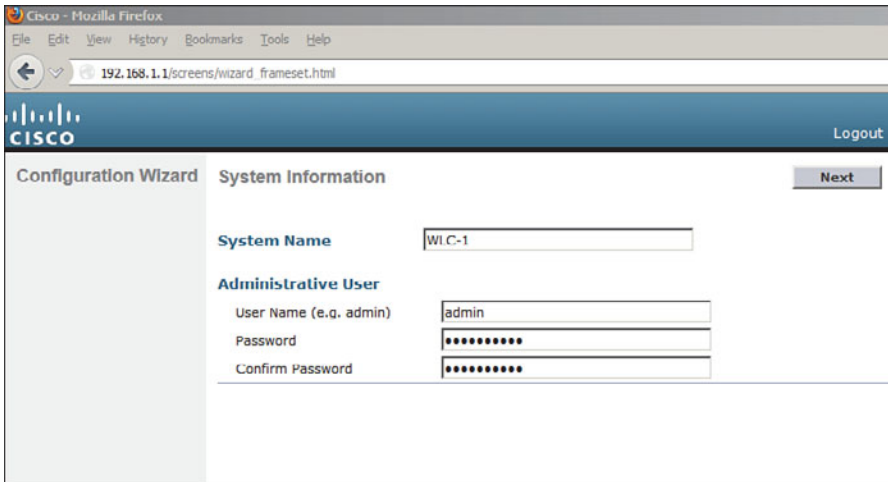
### Initial Setup with the Web Interface

After you have connected a controller to the network and have powered it up, you can use a web browser to enter a basic configuration. The controller prompts you through the following sequence of steps to configure various parameters as part of an initial setup wizard:

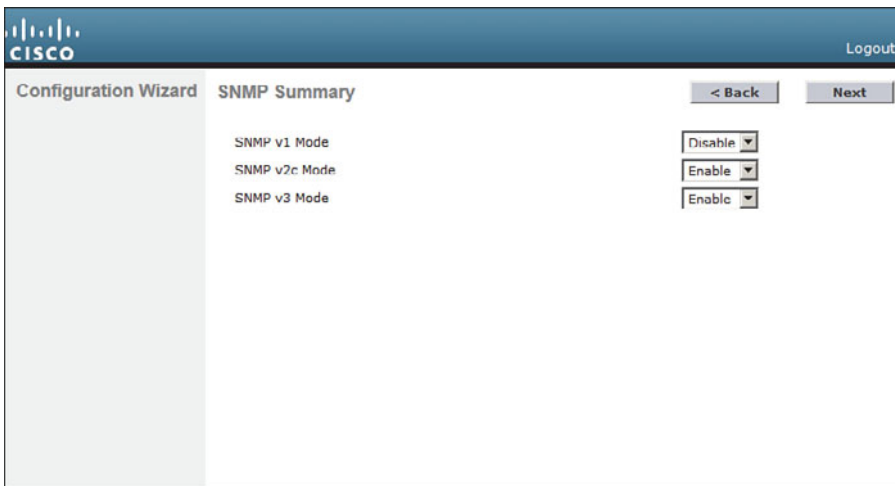
**Step 1.** Configure system access. Connect your PC to the same VLAN and subnet that the controller’s service port uses, and then open a web browser to the controller’s service port IP address. In Figure 10-3, the service port uses 192.168.1.1 and the initial setup wizard asks for a system name for the controller, along with an administrative user’s ID and password. By default, the username is **admin** and the password is **admin**. The system name is somewhat like a hostname and is used to identify the controller to APs and other controllers. Click the **Next** button to continue.

**Step 2.** Configure SNMP access.

By default, SNMP Versions 2c and 3 are enabled. Version 3 provides the most secure access and is recommended, whereas Version 2c is not. Version 1 is disabled because it is not considered to be secure. You can enable or disable each version as shown in Figure 10-4. If SNMPv3 is enabled, the controller will remind you to configure an SNMPv3 user once the initial configuration is complete and the controller reboots. Click **Next** to continue.



**Figure 10-3** Starting the Initial Setup Wizard.



**Figure 10-4** Configuring SNMP Access.

**Step 3.** Configure the service port.

Although the controller's service port has a default initial IP address (the one you're using to run the initial configuration), you can configure it to use something else in the future. Check the **DHCP Protocol** box to have the controller request an address through DHCP. Otherwise, you can leave the box unchecked and enter a static IP address instead. In Figure 10-5, the service port is configured to use DHCP. The address and netmask shown will be disregarded. Click **Next** to continue.

The screenshot shows the 'Service Interface Configuration' page in the Cisco Configuration Wizard. The page is divided into two main sections: 'General Information' and 'Interface Address'. In the 'General Information' section, the 'Interface Name' is set to 'service-port' and the 'MAC Address' is '30:e4:db:38:b4:21'. In the 'Interface Address' section, the 'DHCP Protocol' is checked and labeled 'Enabled'. The 'IP Address' is '192.168.1.1' and the 'Netmask' is '255.255.255.0'. There are '< Back' and 'Next' buttons at the top right of the configuration area.

**Figure 10-5** *Configuring the Service Port.*

**Step 4.** Configure LAG mode.

By default, all the distribution system ports will be bundled together as a single LAG link, as shown in Figure 10-6. You can disable LAG mode through the drop-down menu. Click **Next** to continue.

The screenshot shows the 'LAG Configuration' page in the Cisco Configuration Wizard. The page features a single configuration option: 'Link Aggregation (LAG) Mode', which is set to 'Enabled' via a dropdown menu. There are '< Back' and 'Next' buttons at the top right of the configuration area.

**Figure 10-6** *Configuring LAG Mode.*

**Step 5.** Configure the management interface.

By default, a controller uses a single management interface for both management and CAPWAP traffic. The interface is configured for VLAN 0 (the 802.1Q trunk native VLAN), with no valid IP address. You can set the VLAN number, IP address, subnet mask, and gateway as shown in Figure 10-7. In this example, the management interface resides on VLAN 50 at

192.168.50.10. You can also configure the primary and secondary DHCP server addresses that the controller will use if it has to relay any DHCP requests from wireless clients. Because the management interface does not touch wireless clients directly, the DHCP server addresses are not necessary. Click **Next** to continue.

**Tip** You might have noticed that the controller's native VLAN is VLAN 0, whereas Cisco switches use native VLAN 1 as a default. A controller and a switch may communicate over the native VLAN because traffic is *untagged*. Even though the native VLAN numbers differ, it does not matter because no tag is added at all.

The screenshot shows the Cisco Configuration Wizard interface for 'Management Interface Configuration'. The page is divided into several sections:

- General Information:** Interface Name is 'management' and MAC Address is '30:e4:db:30:b4:2f'.
- Interface Address:** VLAN Identifier is '50', IP Address is '192.168.50.10', Netmask is '255.255.255.0', and Gateway is '192.168.50.1'.
- Physical Information:** The interface is attached to a LAG.
- DHCP Information:** Primary DHCP Server is '192.160.3.17' and Secondary DHCP Server is '192.168.3.18'.

Navigation buttons for '< Back' and 'Next >' are visible at the top right of the configuration area.

**Figure 10-7** Configuring the Management Interface.

**Step 6.** Configure the RF mobility domain and country code.

A controller must be configured to use the RF parameters that are defined by the local regulatory body. It also uses a RF mobility domain name to group like controllers together so that things like AP channel numbers and transmit power can be centrally managed. By default, the RF mobility domain is set to default. You can override that value as shown in Figure 10-8. Although the selected country code is not shown in the figure, it has defaulted to US. Click **Next** to continue.

The screenshot shows the 'Miscellaneous Configuration' page in the Cisco Configuration Wizard. The 'RF Mobility Domain Name' is 'MyRF' and the 'Configured Country Code(s)' is 'US'. The 'Regulatory Domain' section shows '802.11a: -A' and '802.11bg: -A'. Below this is a table of country codes and names with checkboxes for selection.

Select	Country Code	Name
<input type="checkbox"/>	AE	United Arab Emirates
<input type="checkbox"/>	AR	Argentina
<input type="checkbox"/>	AT	Austria
<input type="checkbox"/>	AU	Australia
<input type="checkbox"/>	BA	Bosnia
<input type="checkbox"/>	BE	Belgium
<input type="checkbox"/>	BG	Bulgaria
<input type="checkbox"/>	BH	Bahrain
<input type="checkbox"/>	DO	Dominica
<input type="checkbox"/>	BR	Brazil
<input type="checkbox"/>	BY	Belarus
<input type="checkbox"/>	CA	Canada

**Figure 10-8** *Configuring the RF Regulatory Domain.*

**Step 7.** Configure the virtual interface.

By default, the virtual interface is configured with address 1.1.1.1. You should enter a different address, such as the one shown in Figure 10-9. You should have an entry for the virtual interface in your DNS server, to streamline client web authentication. You can also configure a DNS hostname on the controller, but that same name should also exist on the DNS server. Click **Next** to continue.

**Step 8.** Configure a WLAN.

During the initial setup, you must define one wireless LAN, as shown in Figure 10-10. The profile name is the name of the WLAN within the controller. The WLAN SSID is the SSID string that will be advertised by any APs that offer the WLAN. You might find it convenient to configure both strings with the same name, as shown in the figure.

Notice that you only need to enter the name of the WLAN—not a VLAN number or an interface name. The initial setup process creates a placeholder for the WLAN. You will complete the WLAN configuration later, when the controller reboots and becomes fully functional.

After you click **Next** to continue, you will see a reminder window noting that the WLAN has been created with the following default wireless security settings: WPA2, AES, and 802.1x authentication. Chapter 14, “Wireless Security Fundamentals,” covers these terms in greater detail.

The screenshot shows the Cisco Configuration Wizard interface for 'Virtual Interface Configuration'. The top left has the Cisco logo and 'Configuration Wizard'. The top right has a 'Logout' link. Below the title bar are '< Back' and 'Next >' buttons. The main content area is divided into two sections: 'General Information' and 'Interface Address'. Under 'General Information', the 'Interface Name' field contains the text 'virtual'. Under 'Interface Address', the 'IP Address' field contains '10.1.1.1' and the 'DNS Host Name' field is empty.

**Figure 10-9** *Configuring the Virtual Interface.*

**Tip** The WLAN Configuration screen also shows a WLAN ID number. As you create new WLANs, the ID number increments. The WLAN ID is an internal index that is mainly used when configuration templates are applied to a controller from an Cisco Prime Network Control System (NCS) or Cisco Prime Infrastructure (PI) management station.

The screenshot shows the Cisco Configuration Wizard interface for 'WLAN Configuration'. The top left has the Cisco logo and 'Configuration Wizard'. The top right has a 'Logout' link. Below the title bar are '< Back' and 'Next >' buttons. The main content area shows three fields: 'WLAN ID' with the value '1', 'Profile Name' with the value 'Staff', and 'WLAN SSID' with the value 'Staff'.

**Figure 10-10** *Configuring a WLAN.*

**Step 9.** Configure a RADIUS server.

As an optional step, you can define a RADIUS server that will be used for client authentication. You can always click the **Skip** button to skip this step and define the server at a later time.



If you choose to define the server now, enter the RADIUS server's IP address, shared secret key, port number, and the server status. Figure 10-11 shows these fields. You use the Server Status field when multiple servers are defined; the controller will send a request to the next server that is in the Enabled state in the list. Click **Apply** to apply the settings and continue to the next step.

The screenshot shows the Cisco Configuration Wizard interface for RADIUS Server Configuration. The fields are as follows:

Field	Value
Server IP Address	192.168.200.20
Shared Secret Format	ASCII
Shared Secret	.....
Confirm Shared Secret	.....
Port Number	1812
Server Status	Disabled

Navigation buttons: < Back, Apply, Skip. A Logout link is visible in the top right corner.

**Figure 10-11** *Configuring a RADIUS Server.*

**Step 10.** Configure 802.11 support.

By default, a controller enables 802.11a, 802.11b, and 802.11g support globally for all APs that associate with it. You can override the support settings by changing the check boxes shown in Figure 10-12. When the initial setup is complete and the controller has rebooted into full functionality, you can fine-tune the 802.11 support settings further.

Also by default, the controller enables Auto-RF, which will automatically determine the channel and transmit power level for each AP's radio. You can always fine-tune the Auto-RF settings globally or on a per-AP basis at a later time. Click **Next** to continue.

The Auto-RF functions are also known as Radio Resource Management (RRM), which is covered in greater detail in Chapter 13, "Understanding RRM."

**Step 11.** Configure the system clock.

The controller maintains an internal clock. You can set the date, time, and time zone, as shown in Figure 10-13. Click **Next** to continue. After the controller has rebooted and is fully functional, you can configure it to use an NTP server to synchronize its clock.

The screenshot shows the Cisco Configuration Wizard interface for 802.11 Configuration. The page title is "802.11 Configuration" and it includes "Back" and "Next" navigation buttons. The configuration options are as follows:

Option	Status
802.11a Network Status	<input checked="" type="checkbox"/> Enabled
802.11b Network Status	<input checked="" type="checkbox"/> Enabled
802.11g Network Status	<input checked="" type="checkbox"/> Enabled
Auto RF	<input checked="" type="checkbox"/> Enabled

**Figure 10-12** *Configuring 802.11 Support.*

The screenshot shows the Cisco Configuration Wizard interface for Set Time. The page title is "Set Time" and it includes "Back" and "Next" navigation buttons. The configuration options are as follows:

**Current Time** Thu Jul 11 09:03:10 2013

**Date**

Field	Value
Month	July
Day	11
Year	2013

**Time**

Field	Value
Hour	9
Minutes	3
Seconds	10

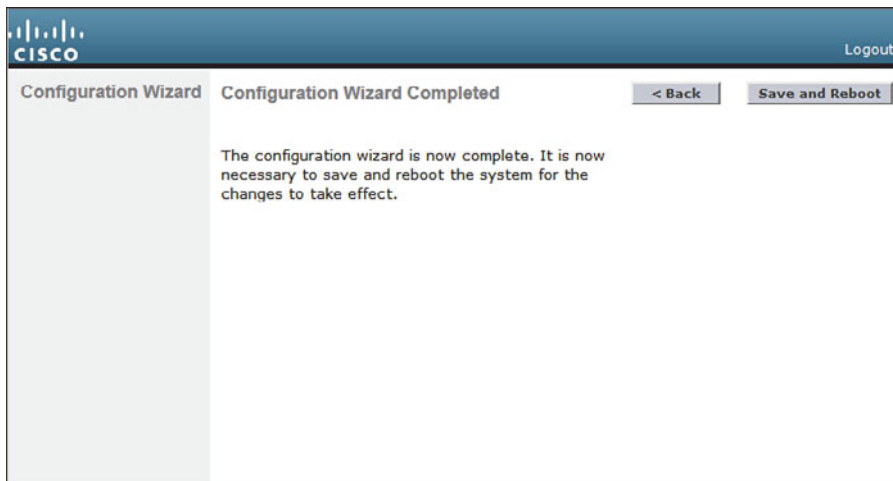
**Timezone**

Field	Value
Delta	hours 0 mins 0

**Figure 10-13** *Configuring the System Clock.*

**Step 12.** Reboot the controller.

As a last step, to save the initial configuration and reboot the controller, click the **Save and Reboot** button (see Figure 10-14).



**Figure 10-14** *Save and Reboot After Completing the Configuration Wizard.*

After the controller has rebooted, it will be fully functional. At that time, you can reposition your PC on the regular wired network and point your web browser toward the controller's management interface IP address. You will have to log in using the administrative user ID and password that you configured in Step 1.

## Initial Setup with the CLI

As an alternative to using a web browser for the initial setup, you can connect your PC to the controller's asynchronous console port and use the CLI. Your terminal emulator will need to be configured for 9600 baud, 8 data bits, and 1 stop bit—the same settings you use to access the console ports on most Cisco routers and switches.

For comparison, the same parameters used in the web-based initial setup are used to demonstrate the CLI initial setup in Example 10-1. Notice that some CLI prompts end with things like [yes][NO]. You can enter either string option shown (yes or NO) or you can press **Enter** to use the capitalized default value.

### Example 10-1 *Using the Controller CLI for Initial Setup*

```
Welcome to the Cisco Wizard Configuration Tool
Use the '-' character to backup
Would you like to terminate autoinstall? [yes]:
AUTO-INSTALL: starting now...

System Name [Cisco_38:b4:2f] (31 characters max): WLC-1
Enter Administrative User Name (24 characters max): admin
Enter Administrative Password (3 to 24 characters): *****
Re-enter Administrative Password                : *****

Service Interface IP Address Configuration [static] [DHCP]: DHCP
```

```
Management Interface IP Address: 192.168.50.10
Management Interface Netmask: 255.255.255.0
Management Interface Default Router: 192.168.50.1
Management Interface VLAN Identifier (0 = untagged): 50
Management Interface DHCP Server IP Address: 192.168.3.17

Virtual Gateway IP Address: 10.1.1.1

Mobility/RF Group Name: MyRF

Network Name (SSID): Staff

Configure DHCP Bridging Mode [yes] [NO]:

Allow Static IP Addresses [YES] [no]:

Configure a RADIUS Server now? [YES] [no]:
Enter the RADIUS Server's Address: 192.168.200.20
Enter the RADIUS Server's Port [1812]:
Enter the RADIUS Server's Secret: thisismysharedsecret

Enter Country Code list (enter 'help' for a list of countries) [US]:

Enable 802.11b Network [YES] [no]:
Enable 802.11a Network [YES] [no]:
Enable 802.11g Network [YES] [no]:
Enable Auto-RF [YES] [no]:

Configure a NTP server now? [YES] [no]:
Enter the NTP server's IP address: 192.168.200.30
Enter a polling interval between 3600 and 604800 secs: 3600

Configuration correct? If yes, system will save it and reset. [yes] [NO]:
yes
```

---

## Exam Preparation Tasks

---

As mentioned in the section, “How to Use This Book,” in the Introduction, you have a couple of choices for exam preparation: the exercises here, Chapter 22, “Final Review,” and the exam simulation questions on the CD-ROM.

### Review All Key Topics

Review the most important topics in this chapter, noted with the Key Topic icon in the outer margin of the page. Table 10-3 lists a reference of these key topics and the page numbers on which each is found.



**Table 10-3** *Key Topics for Chapter 10*

Key Topic Element	Description	Page Number
List	Controller ports	204
List	Controller interfaces	206

### Define Key Terms

Define the following key terms from this chapter and check your answers in the glossary:

AP-manager interface, controller interface, controller port, distribution system port, dynamic interface, link aggregation group (LAG), management interface, service port, virtual interface

*This page intentionally left blank*



---

This chapter covers the following topics:

- **Discovering a Controller**—This section explains how a lightweight access point discovers and joins a wireless LAN controller.
- **Designing High Availability**—This section discusses what happens when a wireless LAN controller fails and APs need to find a new home. It also covers several common approaches to building networks with redundant controllers.

This chapter covers the following exam topics:

- Describe controller-based AP discovery and association (DHCP, DNS, Master-Controller, Primary-Secondary-Tertiary, and n+1 redundancy)

# Understanding Controller Discovery

Cisco lightweight wireless access points need to be paired with a wireless LAN controller (WLC) to function. Each lightweight access point (LAP) must discover and bind itself with a controller before wireless clients can be supported. This chapter covers the discovery process in detail.

## “Do I Know This Already?” Quiz

The “Do I Know This Already?” quiz allows you to assess whether you should read this entire chapter thoroughly or jump to the “Exam Preparation Tasks” section. If you are in doubt about your answers to these questions or your own assessment of your knowledge of the topics, read the entire chapter. Table 11-1 lists the major headings in this chapter and their corresponding “Do I Know This Already?” quiz questions. You can find the answers in Appendix A, “Answers to the ‘Do I Know This Already?’ Quizzes.”

**Table 11-1** “Do I Know This Already?” Section-to-Question Mapping

Foundation Topics Section	Questions
Discovering a Controller	1–6
Designing High Availability	7–10

**Caution** The goal of self-assessment is to gauge your mastery of the topics in this chapter. If you do not know the answer to a question or are only partially sure of the answer, you should mark that question as wrong for purposes of the self-assessment. Giving yourself credit for an answer you correctly guess skews your self-assessment results and might provide you with a false sense of security.



- 1.** Which one of the following comes first in a LAP's state machine, after it boots?
  - a.** Build a CAPWAP tunnel
  - b.** Discover WLCs
  - c.** Download a configuration
  - d.** Join a WLC
- 2.** If a LAP needs to download a new software image, how does it get the image?
  - a.** From a TFTP server
  - b.** From an FTP server
  - c.** From a WLC
  - d.** You must preconfigure it.
- 3.** Which of the following are ways that an AP can learn of WLCs that it might join? (Choose all that apply.)
  - a.** Primed entries
  - b.** List from a previously joined controller
  - c.** DHCP
  - d.** Subnet broadcast
  - e.** DNS
  - f.** All of these
- 4.** Which one of the following will an AP try first in order to select a controller to join?
  - a.** Master controller
  - b.** Least-loaded controller
  - c.** Primed address
  - d.** DHCP option 43
  - e.** Wait for a controller to send a Join Request
- 5.** If an AP tries every available method to discover a controller, but fails to do so, what happens next?
  - a.** It broadcasts on every possible subnet.
  - b.** It tries to contact the default controller at 10.0.0.1.
  - c.** It reboots and starts discovering again.
  - d.** It uses IP redirect on the local router.

6. You can configure the priority value on an AP to accomplish which one of the following?
  - a. To set the controller it will try to join first
  - b. To define which APs will be preferred when joining a controller
  - c. To set the SSID that will be advertised first
  - d. To identify the least loaded controller to join
7. Which of the following is the most deterministic strategy you can use to push a specific AP to join a specific controller?
  - a. Select the least-loaded controller
  - b. Use DHCP option 43
  - c. Configure the master controller
  - d. Configure the primary controller
8. By default, which one of the following methods and intervals does an AP use to detect a failed controller?
  - a. ICMP, 60 seconds
  - b. ICMP, 30 seconds
  - c. CAPWAP keepalive, 60 seconds
  - d. CAPWAP keepalive, 30 seconds
  - e. CAPWAP discovery, 30 seconds
9. Suppose that an AP is joined to the WLC that is configured as the primary controller. At a later time, that controller fails and the AP joins its secondary controller. Once the primary controller is restored to service, which feature would allow the AP to rejoin it again?
  - a. CAPWAP Rejoin
  - b. AP Failover
  - c. AP Priority
  - d. AP Fallback
10. A CUWN architecture consists of two controllers and a number of APs. The APs are distributed equally across the two controllers. Each AP is configured with one controller as primary and the other controller as secondary. Based on this information, which one of the following redundancy models is being used?
  - a. No redundancy
  - b. N+1 redundancy
  - c. N+N redundancy
  - d. N+N+1 redundancy

---

## Foundation Topics

---

### Discovering a Controller

Cisco LAPs are designed to be “touch free,” so that you can simply unbox a new one and connect it to the wired network, without any need to configure it first. Naturally, you have to configure the switch port, where the AP connects, with the correct access VLAN, access mode, and inline power settings. From that point on, the AP can power up and use a variety of methods to find a viable WLC to join.

### AP States

From the time it powers up until it offers a fully functional basic service set (BSS), a LAP operates in a variety of states. Each of the possible states are well defined in the Control and Provisioning of Wireless Access Points (CAPWAP) RFC, but are simplified here for clarity. The AP enters each state in a specific order; the sequence of states is called a *state machine*. You should become familiar with the AP state machine so that you can understand how an AP forms a working relationship with a WLC. If an AP cannot form that relationship for some reason, your knowledge of the state machine can help you troubleshoot the problem.

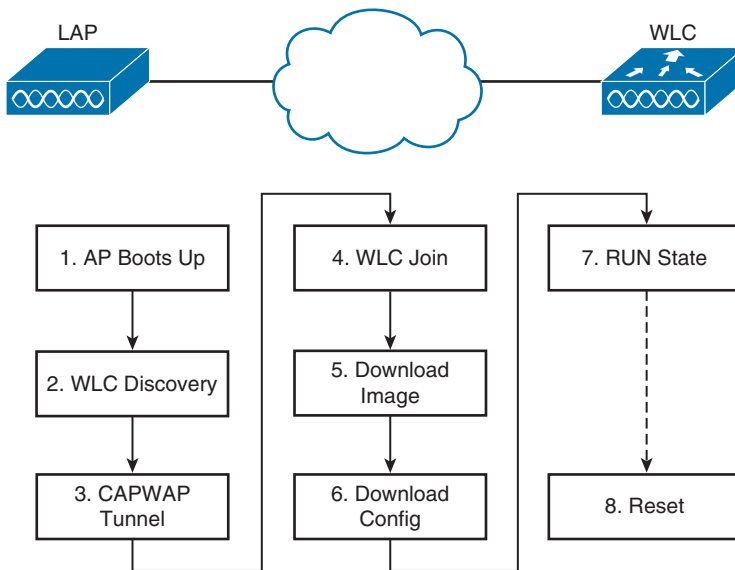
**Tip** CAPWAP is defined in RFC 5415, and in a few other RFCs. The terms used in the RFC differ somewhat from the ones used in CUWN and this book. For example, access controller (AC) refers to a WLC, whereas wireless termination point (WTP) refers to an AP.



The sequence of the most common states, as shown in Figure 11-1, is as follows:

1. **AP boots:** Once an AP receives power, it boots on a small IOS image so that it can work through the remaining states and communicate over its network connection. The AP must also receive an IP address from a Dynamic Host Configuration Protocol (DHCP) server so that it can communicate over the network.
2. **WLC discovery:** The AP goes through a series of steps to find one or more controllers that it might join. The steps are explained further in the next section.
3. **CAPWAP tunnel:** The AP attempts to build a CAPWAP tunnel with one or more controllers. The tunnel will provide a secure Datagram Transport Layer Security (DTLS) channel for subsequent AP-WLC control messages. The AP and WLC authenticate each other through an exchange of digital certificates.
4. **WLC join:** The AP selects a WLC from a list of candidates, and then sends a CAPWAP Join Request message to it. The WLC replies with a CAPWAP Join Response message. The next section explains how an AP selects a WLC to join.

5. **Download image:** The WLC informs the AP of its software release. If the AP's own software is a different release, the AP will download a matching image from the controller and then reboot. If the two are running identical releases, no download is needed.
6. **Download config:** The AP pulls configuration parameters down from the WLC and can update existing values with those sent from the controller. Settings include RF, service set identifier (SSID), security, and quality of service (QoS) parameters.
7. **Run state:** Once the AP is fully initialized, the WLC places it in the "run" state. The AP and WLC then begin providing a BSS and begin accepting wireless clients.
8. **Reset:** If an AP is reset by the WLC, it tears down existing client associations and any CAPWAP tunnels to WLCs. The AP then reboots and starts through the entire state machine again.



**Figure 11-1** *The State Machine of a LAP.*

Be aware that you cannot control which software image release a LAP runs. Rather, the WLC that the AP joins determines the release, based on its own software version. Downloading a new image can take a considerable amount of time, especially if there are a large number of APs waiting for the same download from one WLC. That might not matter when a newly installed AP is booting and downloading code, because it does not yet have any wireless clients to support.

However, if an existing, live AP happens to reboot or join a different controller, clients can be left hanging with no AP while the image downloads. Some careful planning with your controllers and their software releases will pay off later by minimizing downtime. Consider the following scenarios when an AP might need to download a different release:

- The AP joins a WLC, but has a version mismatch.
- A code upgrade is performed on the WLC itself, requiring all associated APs to upgrade too.
- The WLC fails, causing all associated APs to be dropped and join elsewhere.

If there is a chance that an AP could rehome from one WLC to another, you should make sure that both controllers are running the same code release. Otherwise, the AP move should happen under controlled circumstances, such as during a maintenance window. Fortunately, if you have downloaded a new code release to a controller, but not yet rebooted it to run the new code, you can predownload the new release to the controller's APs. The APs will download the new image, but will keep running the previous release. When it comes time to reboot the controller on the new image, the APs will already have the new image staged without having to take time to download it. The APs can reboot on their new image and join the controller after it has booted and become stable.

## Discovering a WLC

A LAP must be very diligent to discover any controllers that it can join—all without any preconfiguration on your part. To accomplish this feat, several methods of discovery are used. The goal of discovery is just to build a list of live candidate controllers that are available, using the following methods:

- Prior knowledge of WLCs
- DHCP and DNS information to suggest some controllers
- Broadcast on the local subnet to solicit controllers

To discover a WLC, an AP sends a unicast CAPWAP Discovery Request to a controller's IP address or a broadcast to the local subnet. If the controller exists and is working, it returns a CAPWAP Discovery Response to the AP. The exact sequence of discovery steps used in Controller Software Release 7.0 is as follows:

- Step 1. Broadcast on the local subnet**—The AP will broadcast a CAPWAP Discovery Request on its local wired subnet. Any WLCs that also exist on the subnet will answer with a CAPWAP Discovery Response.



**Tip** If the AP and controllers lie on different subnets, you can configure the local router to relay any broadcast requests on UDP port 5246 to specific controller addresses. Use the following configuration commands:

```
router(config)# ip forward-protocol udp 5246
router(config)# interface vlan n
router(config-int)# ip helper-address WLC1-MGMT-ADDR
router(config-int)# ip helper-address WLC2-MGMT-ADDR
```

- Step 2.** Use locally stored WLCs—An AP can be “primed” with up to three controllers—a primary, a secondary, and a tertiary. These are stored in nonvolatile memory so that the AP can remember them after a reboot or power failure. Otherwise, if an AP has previously joined with a controller, it should have stored up to 8 out of a list of 32 WLC addresses that it received from the last controller it joined. The AP will attempt to contact as many controllers as possible to build a list of candidates.
- Step 3.** Use DHCP—The DHCP server that supplies the AP with an IP address can also send DHCP option 43 to suggest a list of WLC addresses.
- Step 4.** Use DNS—The AP will attempt to resolve the name CISCO-CAPWAP-CONTROLLER.*localdomain* with a DNS request. The *localdomain* string is the domain name learned from DHCP. If the name resolves to an IP address, the controller attempts to contact a WLC at that address.
- Step 5.** Reset and try again—If none of the steps has been successful, the AP resets itself and starts the discovery process all over again.

## Selecting a WLC

Once an AP has finished the discovery process, it should have built a list of live candidate controllers. Now it must begin a separate process to select one WLC and attempt to join it. Joining a WLC involves sending it a CAPWAP Join Request and waiting for it to return a CAPWAP Join Response. From that point on, the AP and WLC build a DTLS tunnel to secure their CAPWAP control messages.

The WLC selection process consists of the following three steps:

- Step 1.** Try primed addresses—If the AP has previously joined a controller and has been configured or “primed” with a primary, secondary, and tertiary controller, it will try to join those controllers in succession.
- Step 2.** Try the master controller—If the AP does not know of any candidate controller, it can try to discover one by broadcasting on the local subnet. If a controller has been configured as a master controller, it can respond to the AP’s broadcast.
- Step 3.** Try the least loaded controller—The AP will attempt to join the least loaded WLC, in an effort to load balance APs across a set of controllers. During the discovery phase, each controller reports its load—the ratio of the number of currently joined APs to the total AP capacity. The least loaded WLC is the one with the lowest ratio. For example, suppose that a 5508 controller has 20 out of a possible 100 APs joined to it, while a 2504 controller has 20 out of a possible 25 APs. The 5508 would be the least loaded with a ratio of 20/100; the 2504 is more loaded with 20/25.

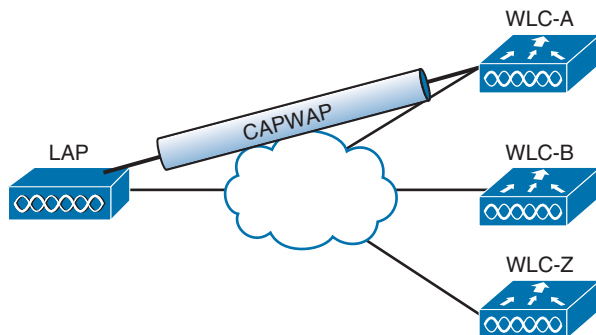
If an AP discovers a controller, but gets rejected when it tries to join it, what might be the reason? Every controller has a set maximum number of APs that it can support. This is defined by platform or by license. If the controller already has the maximum number of APs joined to it, it will reject any additional APs.

To provide some flexibility in supporting APs on an oversubscribed controller, where more APs are trying to join than a license allows, you can configure the APs with a priority value. All APs begin with a default priority of low. You can change the value to low, medium, high, or critical. A controller will try to accommodate as many higher-priority APs as possible. Once a controller is full of APs, it will reject an AP with the lowest priority to make room for a new one that has a higher priority.

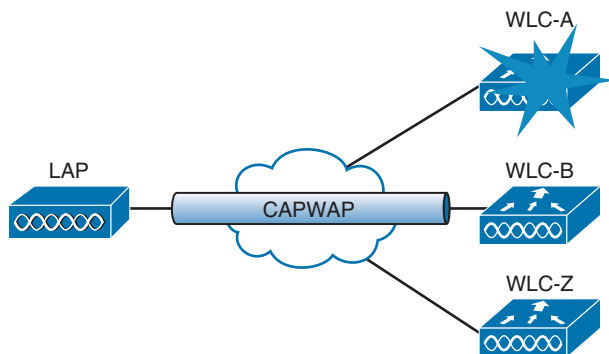
## Designing High Availability

Once an AP has discovered, selected, and joined a controller, it must stay joined to that controller to remain functional. Now consider that a single controller might support as many as 1000 or even 6000 APs—enough to cover a very large building or an entire enterprise. If something ever causes the controller to fail, a large number of APs would also fail. In the worst case, where a single controller carries the enterprise, the entire wireless network would become unavailable. That might be catastrophic.

Fortunately, Cisco APs can discover multiple controllers—not just the one that it chooses to join. Figure 11-2 shows this scenario. If the joined controller becomes unavailable, the AP can simply select the next least-loaded controller and request to join it, as Figure 11-3 depicts. That sounds simple, but it is not very deterministic.



**Figure 11-2** An AP Joins One of Several Discovered Controllers.



**Figure 11-3** An AP Joins a Different Controller After a Failure.

For example, if a controller full of 1000 APs fails, all 1000 APs must detect the failure, discover other candidate controllers, and then select the least loaded one to join. During that time, wireless clients can be left stranded with no connectivity. You might envision the controller failure as a commercial airline flight that has just been canceled; everyone that purchased a ticket suddenly joins a mad rush to find another flight out.

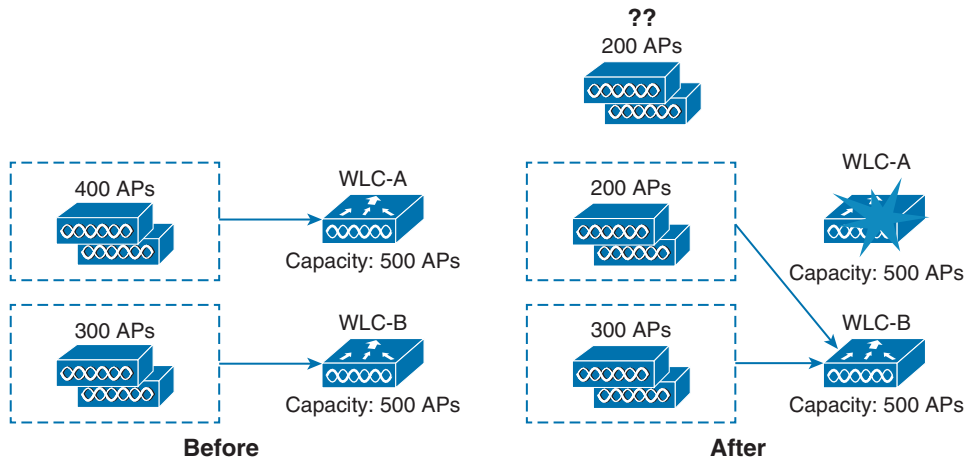
The most deterministic approach is to leverage the primary, secondary, and tertiary controller fields that every AP stores. If any of these fields are configured with a controller name or address, the AP knows which three controllers to try in sequence before resorting to a more generic search.

**Tip** When an AP boots and builds a list of potential controllers, it can use CAPWAP to build a tunnel to more than one controller. The AP will join only one controller, which it uses as the primary unit. By building a tunnel with a second controller ahead of time, before the primary controller fails, the AP will not have to spend time building a tunnel to the backup controller before joining it.

As a wireless network grows, you might have several controllers implemented just to support the number of APs that are required. A good network design should also take failures and high availability (HA) into consideration. It is not enough just to have multiple controllers in a network. What if they are all in use and full of APs? There would not be enough room to spare for a large group of additional, displaced APs to join in their time of need. In the commercial flight analogy, there might be other flights departing the airport soon after the cancellation. If those flights are already mostly full of passengers, many people will be left waiting at the gate.

Figure 11-4 illustrates an example network that does not offer enough capacity to fully survive a controller failure. In the “before” diagram, a group of 400 APs has joined controller WLC-A, and a group of 300 APs has joined WLC-B. Each controller has a maximum capacity of 500 APs. As long as both controllers stay up and functional, the wireless network should work fine. In the “after” diagram, WLC-A has failed. All 400 APs that were previously joined to WLC-A will discover that WLC-B is alive, so they will all try to join it. WLC-B already has 300 APs, so it has room for only 200 more. That means 200 APs will be able to join WLC-B and 200 more will be left out in the cold with no controller to join at all.





**Figure 11-4** *The Result of Undersized Controllers During a Failure.*

## Detecting a Controller Failure

When HA is required, make sure that you design your wireless network to support it properly. Fortunately, Cisco APs and controllers are built with HA in mind, so you have several strategies at your disposal. First, it is important to understand how APs detect a controller failure and what action they take to recover from it.

Once an AP joins a controller, it sends keepalive (also called heartbeat) messages to the controller over the wired network at regular intervals. By default, keepalives are sent every 30 seconds. The controller is expected to answer each keepalive as evidence that it is still alive and working. If a keepalive is not answered, an AP running Software Release 7.0 will escalate the test by sending up to five more keepalive messages at 1-second intervals. In Release 7.2, four more keepalives are sent at 3-second intervals. If the controller answers, all is well; if it does not answer, the AP presumes that the controller has failed. The AP then moves quickly to find a successor to join.

Using the default values, an AP can detect a controller failure in as little as 35 seconds. You can adjust the regular keepalive timer between 1 and 30 seconds and the escalated or “fast” heartbeat timer between 1 and 10 seconds. By using the minimum values, a failure can be detected after only 6 seconds.

Normally, an AP will stay joined to a controller until it fails. If the AP has been configured with primary and secondary controller information, it will join the primary controller first. If the primary fails, the AP will try to join the secondary until it fails. Even if the primary controller is put back into service, the AP will stay with the secondary. You can change that behavior by enabling the AP Fallback feature—a global controller configuration parameter. If AP Fallback is enabled (the default), an AP can try to rejoin its primary controller at any time, whether its current controller has failed or not.

## Building Redundancy

Building a wireless network with one controller and some APs is straightforward, but it does not address what would happen if the controller fails for some reason. Adding another controller or two could provide some redundancy, as long as the APs know how to move from one controller to another when the time comes.

Redundancy is best configured in the most deterministic way possible. The following sections explain how you can configure APs with primary, secondary, and tertiary controller fields to implement various forms of redundancy. As you read through the sections, keep in mind that redundant controllers should be configured similarly so that APs can move from one controller to another without having to undergo any major configuration changes.

**Key  
Topic**

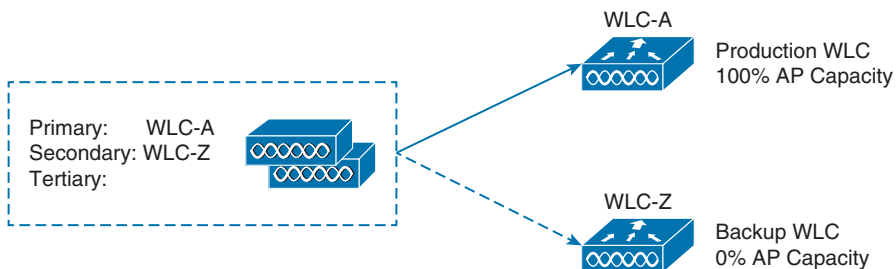
### N+1 Redundancy

The simplest way to introduce HA into a Cisco unified wireless network is to provide an extra backup controller. This is commonly called N+1 or N:1 redundancy, where *N* represents some number of active controllers and 1 denotes the one backup controller.

By having one backup controller, N+1 redundancy can withstand a failure of only one active controller. As long as the backup controller is sized appropriately, it can accept all of a failed controller's APs. However, once an active controller fails and all its APs rehome to the backup controller, there will be no space to accept any other APs if a second controller fails.

Figure 11-5 illustrates N+1 redundancy with a two-controller network for simplicity. The network could have any number of active controllers, but only one backup controller. WLC-A is the active controller and carries 100 percent of the network's APs. WLC-Z is the backup controller, which normally carries no APs at all. The backup controller sits idle until an active controller fails.

To configure N+1 redundancy, you configure the primary controller field on all APs with the name of an active controller (WLC-A, for example). The secondary controller field is set to the name of the backup controller (WLC-Z).



**Figure 11-5** *Configuring N+1 Controller Redundancy.*

## N+N Redundancy

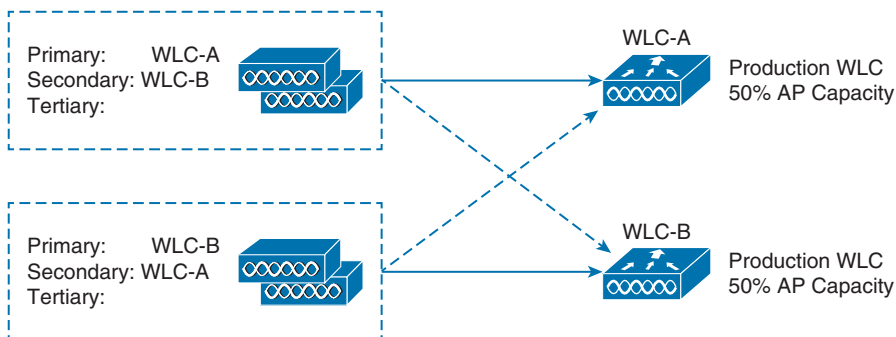
N+1 design is simple, but it has a couple of shortcomings. First, the backup controller must sit idle and empty of APs until another controller fails. That might not sound like a problem, except that the backup unit must be purchased with the same AP capacity as the active controller it supports. That means the active and backup controllers must be purchased at the same price. Having a full-price device sit empty and idle might seem like a poor use of funds.

Second, the backup controller must be configured identically to every other active controller it has to support. The idea is to make a controller failure as seamless as possible so the APs should not have any noticeable configuration differences when they move from one controller to another.

The N+N redundancy strategy tries to make better use of the available controllers. N+N gets its name from grouping controllers in pairs. If you have one active controller, you would pair it with one other controller; two controllers would be paired with two others, and so on. You might also see the same strategy called N:N or 1+1.

By grouping controllers in pairs, you can divide the active role across two separate devices. This makes better use of the AP capacity on each controller. As well, the APs and clients loads will be distributed across separate hardware, while still supporting redundancy during a failure. N+N redundancy can support failures of more than one controller, but only if the active controllers are configured in pairs.

Figure 11-6 illustrates the N+N scenario consisting of two controllers, WLC-A and WLC-B. The APs are divided into two groups—one that joins WLC-A as primary controller and another that joins WLC-B as primary. Notice that the primary and secondary controllers are reversed between the two groups of APs. To support the full set of APs during a failure, each controller must not be loaded with more than 50 percent of its AP capacity.



**Figure 11-6** *Configuring N+N Controller Redundancy.*

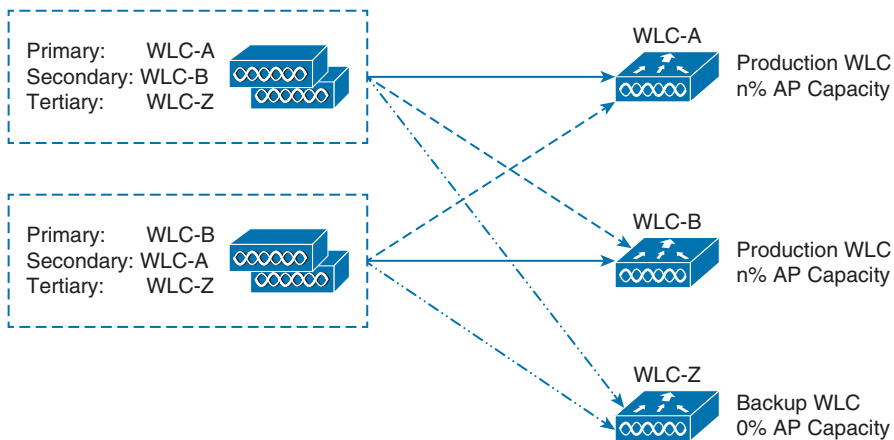
## N+N+1 Redundancy

What if a scenario calls for more resiliency than the N+N plan can provide? You can simply add one more controller to the mix, as a backup unit. As you might expect, this is

commonly called N+N+1 redundancy and combines the advantages of the N+N and N+1 strategies.

Two or more active controllers are configured to share the AP and client load, while reserving some AP capacity for use during a failure. One additional backup controller is set aside as an additional safety net. Figure 11-7 shows a simple example using three controllers—two active (WLC-A and WLC-B) and one backup (WLC-Z). Like N+N redundancy, the two groups of APs are configured with primary and secondary controllers that are the reverse of each other. Each group of APs is also configured with a tertiary controller that points to the backup unit.

If one active controller fails, APs that were joined to it will move to the secondary controller. As long as the two active controllers are not loaded with over 50 percent of their AP capacity, either one may accept the full number of APs. N+N+1 goes one step further; if the other active controller happens to fail, the backup controller is available to carry the load.



**Figure 11-7** *Configuring N+N+1 Controller Redundancy.*

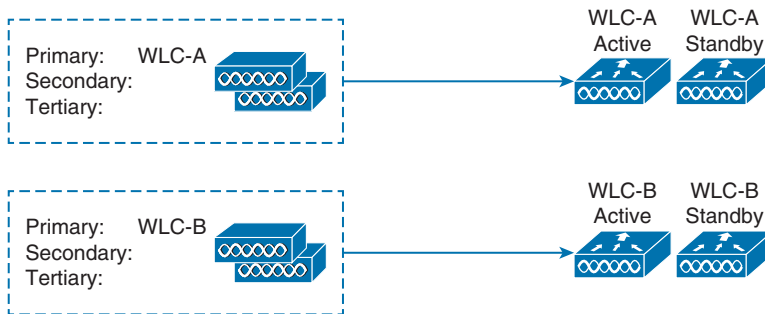
### AP SSO Redundancy

The N+1, N+N, and N+N+1 strategies all address redundancy and fault tolerance, but each still relies on the basic controller discovery and join processes. In other words, APs require a certain amount of time to seek out a new controller when they detect that one has failed.

With Controller Software Release 7.3 or later, Cisco offers AP stateful switchover (SSO) redundancy, in addition to the other methods. AP SSO groups controllers into HA pairs, where one controller takes on the active role while the other is in a hot standby mode. Only the active unit must be purchased with the appropriate license to support the AP count; the standby unit is purchased with an HA license. The standby unit can be paired with an active unit of any license size, as its AP licenses are not really used until it takes on the active role.

**Tip** The 640-722 CCNA Wireless exam covers features found in Controller Software Release 7.0. AP SSO and client SSO are presented here to provide an overview of more advanced redundancy mechanisms that are available.

Figure 11-8 depicts AP SSO redundancy. The APs can be configured with only a primary controller name that references the active unit. Because each active controller has its own standby controller, there really is no need to configure a secondary or tertiary controller on the APs unless you need an additional layer of redundancy.



**Figure 11-8** *Configuring AP SSO Redundancy.*

Each AP learns of the HA pair during a CAPWAP discovery phase, then builds a CAPWAP tunnel to the active controller. The active unit keeps CAPWAP tunnels, AP states, configurations, and image files all in sync with the hot standby unit. If the active unit fails, the hot standby unit quickly takes over the active role. The APs do not have to discover another controller to join; the controllers simply swap roles so the APs can stay joined to the active controller in the HA pair.

The APs do not even have to rebuild their CAPWAP tunnels after a failure. The tunnels are synchronized between active and standby, so they are always maintained. The AP SSO switchover occurs at the controllers—not at the APs.

**Tip** The active and standby controllers must always run an identical software image. When one controller is upgraded, its standby peer is also upgraded. That also means when the active unit is rebooted, the standby unit follows suit. At the time of this writing, “hitless” in-service software upgrades are not possible.

The hot standby controller monitors the active unit through keepalives that are sent every 100 ms. If a keepalive is not answered, the standby unit begins to send ICMP echo requests to the active unit to determine what sort of failure has occurred. For example, the active unit could have crashed, lost power, or had its network connectivity severed.

Once standby unit has declared the active unit as failed, it assumes the active role. The failover may take up to 500 ms, in the case of a crash or power failure, or up to 4 seconds if a network failure has occurred.

AP SSO is designed to keep the failover process transparent from the AP's perspective. In fact, the APs know only of the active unit; they are not even aware that the hot standby unit exists. The two controllers share a “mobility” MAC address that initially comes from the first active unit's MAC address. From then on, that address is maintained by whichever unit has the active role at any given time. The controllers also share a virtual IP address. Keeping both MAC and IP addresses virtual and consistent allows the APs to stay in contact with the active controller—regardless of which controller currently has that role.

Even though redundant controllers maintain the state of each AP to minimize any disruption during a failover, AP SSO does not maintain the state of any clients. If a primary controller fails, any associated clients will be dropped and will have to reassociate with their APs (and the secondary controller).

Controller Release 7.5 introduced client SSO to make controller failover seamless to wireless clients. A primary controller synchronizes the state of each associated client that is in the RUN state with a secondary controller. If the primary fails, the secondary will already have the current state information for each client, making the failover process transparent.

---

## Exam Preparation Tasks

---

As mentioned in the section, “How to Use This Book,” in the Introduction, you have a couple of choices for exam preparation: the exercises here, Chapter 22, “Final Review,” and the exam simulation questions on the CD-ROM.

## Review All Key Topics

Review the most important topics in this chapter, noted with the Key Topic icon in the outer margin of the page. Table 11-2 lists a reference of these key topics and the page numbers on which each is found.

**Table 11-2** *Key Topics for Chapter 11*

Key Topic Element	Description	Page Number
List	AP states	224
List	Controller discovery methods	226
List	Controller selection process	227
Paragraph	Controller redundancy methods	231



## Define Key Terms

Define the following key terms from this chapter and check your answers in the glossary:

AP SSO, CAPWAP Discovery Request, CAPWAP Join Request, client SSO, N+1 redundancy, N+N redundancy, N+N+1 redundancy, primed controller address

*This page intentionally left blank*





---

This chapter covers the following topics:

- **Roaming with Autonomous APs**—This section reviews the fundamentals of wireless client mobility between autonomous access points, without the benefit of a controller.
- **Intracontroller Roaming**—This section discusses wireless client mobility between access points that are bound to the same controller.
- **Intercontroller Roaming**—This section covers wireless client mobility between access points that are bound to different controllers. It also explains how client mobility can be scaled as a network grows.

This chapter covers the following exam topics:

- Describe roaming (Layer 2 and Layer 3, intra-controller and inter-controller, and mobility list)

# Understanding Roaming

Wireless client devices are inherently mobile, so you should expect them to move around. This chapter discusses client mobility from the AP and controller perspectives. You should have a good understanding of client roaming so that you can design and configure your wireless network properly as it grows over time.

## “Do I Know This Already?” Quiz

The “Do I Know This Already?” quiz allows you to assess whether you should read this entire chapter thoroughly or jump to the “Exam Preparation Tasks” section. If you are in doubt about your answers to these questions or your own assessment of your knowledge of the topics, read the entire chapter. Table 12-1 lists the major headings in this chapter and their corresponding “Do I Know This Already?” quiz questions. You can find the answers in Appendix A, “Answers to the ‘Do I Know This Already?’ Quizzes.”

**Table 12-1** “Do I Know This Already?” Section-to-Question Mapping

Foundation Topics Section	Questions
Roaming with Autonomous APs	1–2
Intracontroller Roaming	3–5
Intercontroller Roaming	6–10

**Caution** The goal of self-assessment is to gauge your mastery of the topics in this chapter. If you do not know the answer to a question or are only partially sure of the answer, you should mark that question as wrong for purposes of the self-assessment. Giving yourself credit for an answer you correctly guess skews your self-assessment results and might provide you with a false sense of security.

1. When a client moves its association from one autonomous AP to another, it is actually leaving and joining which one of the following?
  - a. SSID
  - b. BSS
  - c. ESS
  - d. DS
2. Which one of the following makes the decision for a device to roam from one AP to another?
  - a. The client device
  - b. The original AP
  - c. The candidate AP
  - d. The wireless LAN controller
3. Ten lightweight APs are joined to a wireless LAN controller. If a client roams from one of the APs to another, which one of the following correctly describes the roam?
  - a. Autonomous roaming
  - b. Intercontroller roaming
  - c. Intracontroller roaming
  - d. Indirect roaming
4. Which one of the following provides the most efficient means for roaming, as measured by the time to complete the roam?
  - a. Layer 2 intercontroller roaming
  - b. Layer 3 intercontroller roaming
  - c. Intracontroller roaming
  - d. All of these answers because each takes an equal amount of time
5. Which one of the following is used to cache authentication key information to make roaming more efficient?
  - a. PGP
  - b. CCNA
  - c. CCKM
  - d. EoIP
6. The term *Layer 3 roaming* refers to which one of the following types of client roam in a CUWN?

- a. Autonomous AP roaming
  - b. Intracontroller roaming
  - c. Intercontroller roaming
  - d. RRM roaming
7. In a Layer 2 roam, what mechanism is used to tunnel client data between the two controllers?
- a. GRE tunnel
  - b. EoIP tunnel
  - c. CAPWAP tunnel
  - d. None of these answers
8. When a client roams from one controller to another, it must obtain a new IP address from a DHCP server. True or false?
- a. True
  - b. False
9. A client roams from controller A to controller B. If it undergoes a Layer 3 roam, which one of the following best describes the role of controller A?
- a. Foreign controller
  - b. Host controller
  - c. Master controller
  - d. Anchor controller
10. A network consists of three controllers: A, B, and C. The mobility group lists of controllers A and B are shown here. Which one of the following answers describes what will happen when a client tries to roam between controllers A and B?

**Controller A**

00:00:00:11:11:11	192.168.1.1	group1
00:00:00:22:22:22	192.168.1.2	group2
00:00:00:33:33:33	192.168.1.3	group3

**Controller B**

00:00:00:22:22:22	192.168.1.2	group2
00:00:00:11:11:11	192.168.1.1	group1
00:00:00:33:33:33	192.168.1.3	group3

- a. Roaming is seamless and efficient.
- b. Roaming is not possible.
- c. Roaming is possible, but CCKM and PKC will not work.
- d. Only Layer 3 roaming is possible.

When a wireless client moves about, the expectations are simple—good, seamless coverage wherever the client goes. Clients know how to roam between access points (APs), but they are ignorant about the wireless network infrastructure. Even in a large network, roaming should be easy, quick, and not disrupt the client’s service.

Cisco Unified Wireless Networks offer several roaming strategies. From your perspective as a wireless engineer, roaming configuration is straightforward. The inner workings can be complex, depending on the size of the wireless network as measured by the number of APs and controllers. As you work through the sections in this chapter, you will review roaming fundamentals, then learn more about how the Cisco Unified Wireless Network (CUWN) handles client roaming and how to configure your controllers to support it properly.

---

## Foundation Topics

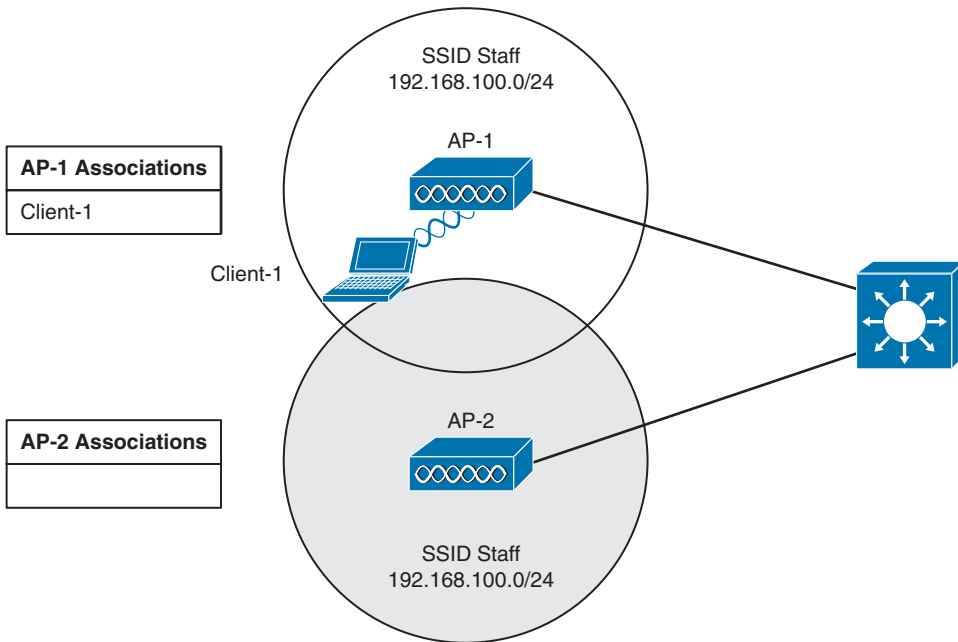
---

### Roaming with Autonomous APs

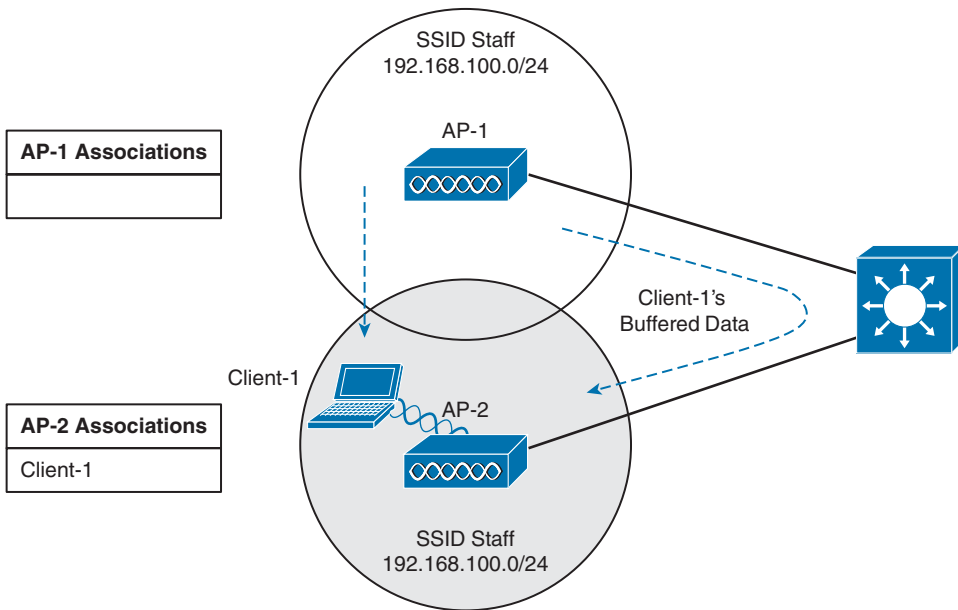
In Chapter 6, “Understanding 802.11 Frame Types,” you learned that a wireless client can move from one basic service set (BSS) to another by roaming between APs. A client continuously evaluates the quality of its wireless connection. If the signal quality degrades, the client begins looking for an AP with a better signal. The process is usually quick and simple; active scanning reveals candidate APs, and then the client selects one and tries to reassociate with it.

Figure 12-1 shows a simple scenario with two APs and one client. The client begins with an association to AP-1. Because the APs are running in autonomous mode, each one maintains a table of its associated clients. AP-1 has one client; AP-2 has none.

Suppose that the client then begins to move into AP-2’s cell. Somewhere near the cell boundary, the client decides to roam and reassociate with AP-2. Figure 12-2 shows the new scenario after the roam occurs. Notice that both APs have updated their list of associated clients to reflect Client-1’s move from AP-1 to AP-2. If AP-1 still has any leftover wireless frames destined for the client after the roam, it forwards them to AP-2 over the wired infrastructure—simply because that is where the client’s MAC address now resides.

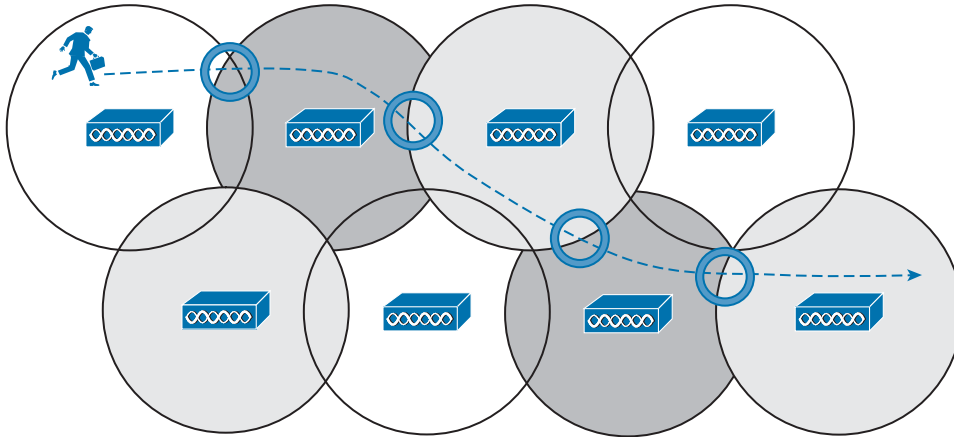


**Figure 12-1** Before Roaming Between Autonomous APs.



**Figure 12-2** After Roaming Between Autonomous APs.

Naturally, roaming is not limited to only two APs; instead, it occurs between two APs at any given time. To cover a large area, you will probably install many APs in a pattern such that their cells overlap. Figure 12-3 shows a typical pattern. When a wireless client begins to move, it might move along an arbitrary path. Each time the client decides that the signal from one AP has degraded enough, it attempts to roam to a new, better signal from a different AP and cell. The exact location of each roam depends on the client's roaming algorithm. To illustrate typical roaming activity, each roam in Figure 12-3 is marked with a dark ring.



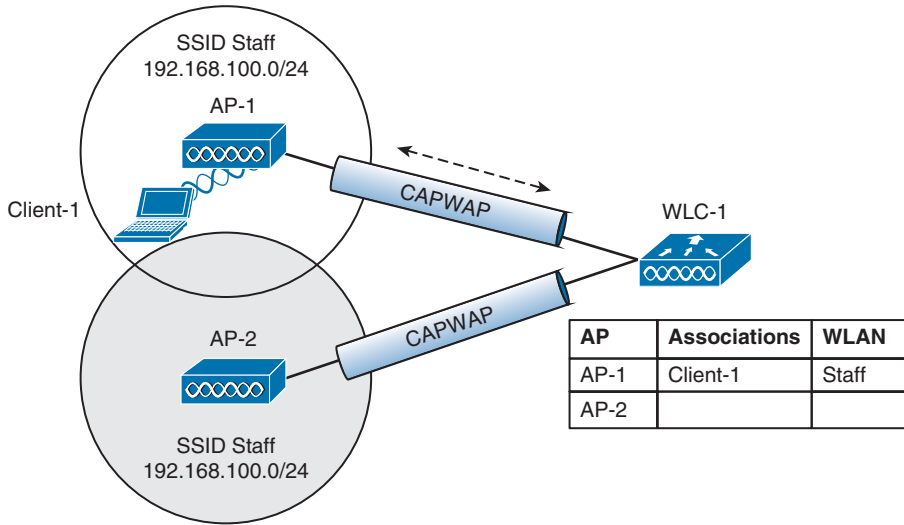
**Figure 12-3** *Successive Roams of a Mobile Client.*

## Intracontroller Roaming

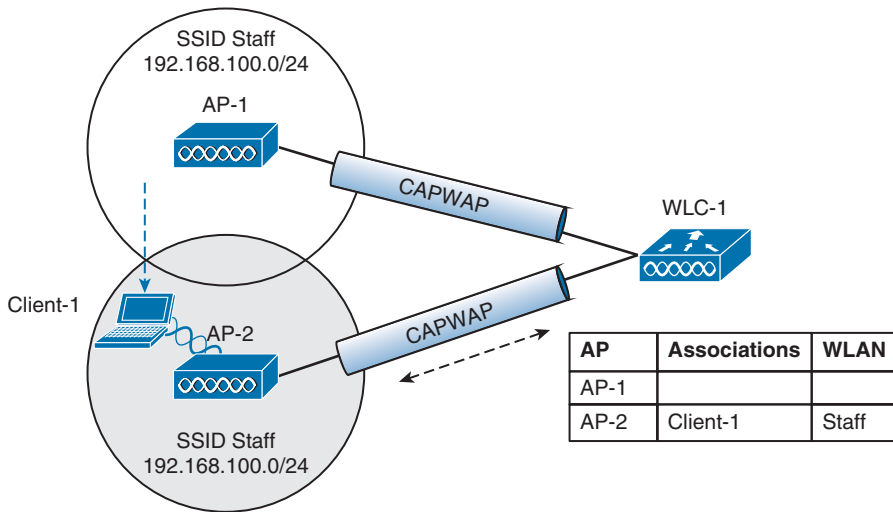
In a CUWN, lightweight APs are bound to a wireless LAN controller through CAPWAP tunnels. The roaming process is similar to that of autonomous APs; clients must still reassociate to new APs as they move about. The only real difference is that the controller handles the roaming process because of the split-MAC architecture.

Figure 12-4 shows a two-AP scenario where both APs connect to a single controller. Client-1 is associated to AP-1, which has a Control and Provisioning of Wireless Access Points (CAPWAP) tunnel to controller WLC-1. The controller maintains a client database that contains detailed information about how to reach and support each client. For simplicity, Figure 12-4 shows the database as a list of its APs, associated clients, and the wireless LAN (WLAN) being used. The actual database also contains client MAC and IP addresses, quality of service (QoS) parameters, and other information.

When Client-1 starts moving, it eventually roams to AP-2, as shown in Figure 12-5. Not much has changed except that the controller has updated the client association from AP-1 to AP-2. Because both APs are bound to the same controller, the roam occurs entirely within the controller. This is known as *intracontroller* roaming.



**Figure 12-4** A CUWN Before an Intracontroller Roam.



**Figure 12-5** A CUWN After an Intracontroller Roam.

If both APs involved in a client roam are bound to the same controller, the roaming process is simple and efficient. The controller has to update its client association table so that it knows which CAPWAP tunnel to use to reach the client. Thanks to the simplicity, an intracontroller roam takes less than 10 ms to complete—the amount of processing time needed for the controller to switch the client entry from AP-1 to AP-2. From the client’s perspective, an intracontroller roam is no different than any other roam. The client has no knowledge that the two APs are communicating with a controller over CAPWAP tunnels; it simply decides to roam between two APs based on its own signal analysis.



Efficient roaming is especially important when time-critical applications are being used over the wireless network. For example, wireless phones need a consistent connection so that the audio stream is not garbled or interrupted. When a roam occurs, there could be a brief time when the client is not fully associated with either AP. So long as that time is held to a minimum, the end user probably will not even notice that the roam occurred.

Along with the client reassociation, a couple of other processes can occur:

- **DHCP**—The client may be programmed to renew the DHCP lease on its IP address or to request a new address.
- **Client authentication**—The controller might be configured to use an 802.1x method to authenticate each client on a WLAN.

To achieve efficient roaming, both of these processes should be streamlined as much as possible. For instance, if a client roams and tries to renew its IP address, it is essentially cut off from the network until the Dynamic Host Controller Protocol (DHCP) server responds.

The client authentication process presents the biggest challenge because the dialog between a controller and a RADIUS server, in addition to the cryptographic keys that need to be generated and exchanged between the client and an AP or controller, can take a considerable amount of time to accomplish. Cisco controllers offer three techniques to minimize the time and effort spent on key exchanges during roams:

- **Cisco Centralized Key Management (CCKM)**—One controller maintains a database of clients and keys on behalf of its APs and provides them to other controllers and their APs as needed during client roams. CCKM requires Cisco Compatibility Extensions (CCX) support from clients.
- **Proactive key caching (PKC)**—Each client maintains a list of keys used with prior AP associations and presents them as it roams. The destination AP must be present in this list, which is limited to eight AP-key entries. PKC is also known as sticky pairwise master key ID caching (SKC).
- **802.11r**—An 802.11 amendment that addresses fast roaming or fast BSS transition; a client can cache a portion of the authentication server's key and present that to future APs as it roams. The client can also maintain its QoS parameters as it roams.

Each of the fast roaming strategies requires help on the part of the wireless client. That means the client must have a supplicant or driver software that is compatible with fast roaming and can cache the necessary pieces of the authentication credentials.

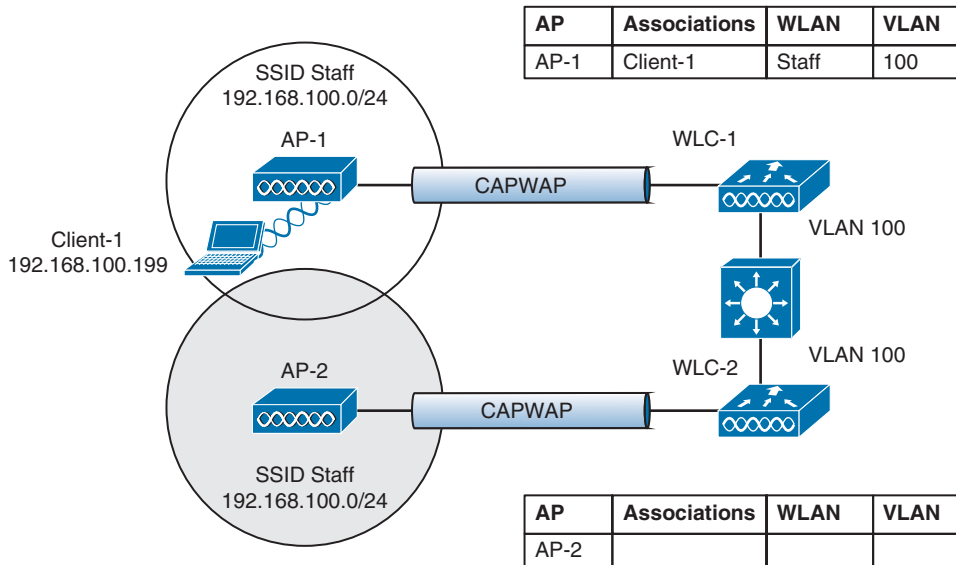
## Intercontroller Roaming

As a wireless network grows, one controller might not suffice. When two or more controllers support the APs in an enterprise, the APs are distributed across them. As always, when clients become mobile, they roam from one AP to another—except they could also be roaming from one controller to another, depending on how neighboring APs are

assigned to the controllers. The following sections cover the two types of intercontroller roaming that are possible.

## Layer 2 Roaming

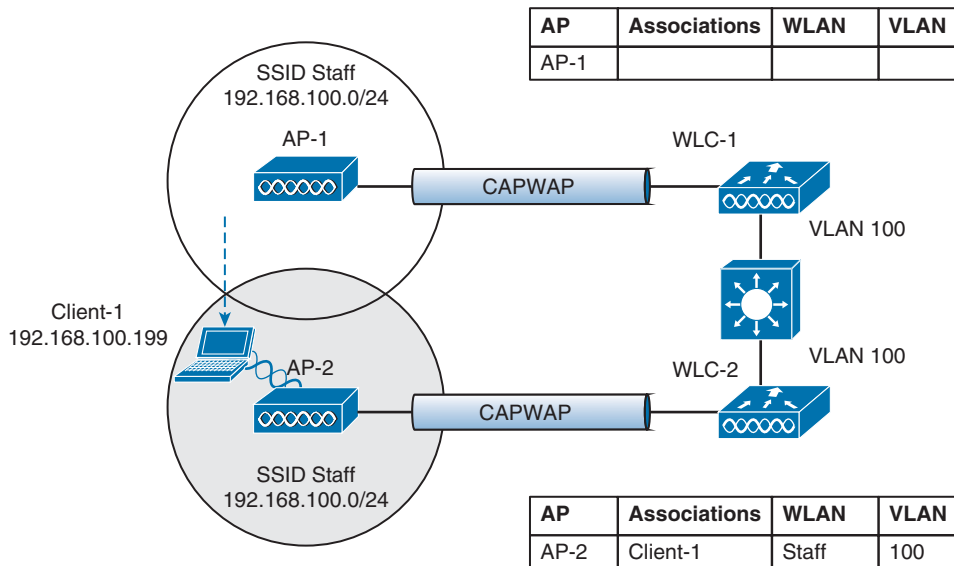
When a client roams from one AP to another and those APs lie on two different controllers, the client makes an intercontroller roam. Figure 12-6 shows a simple scenario prior to a roam. Controller WLC-1 has one association in its database—that of Client-1 on AP-1. Figure 12-7 shows the result of the client roaming to AP-2.



**Figure 12-6** Before an Intercontroller Roam.

The roam itself is fairly straightforward. When the client decides to roam and reassociate itself with AP-2, the two controllers must coordinate the move. One subtle detail involves the client's IP address. Before the roam, Client-1 is associated with AP-1 and takes an IP address from the VLAN and subnet that are configured on the WLAN supplied by controller WLC-1. In Figure 12-6, WLAN Staff is bound to VLAN 100, so the client uses an address from the 192.168.100.0/24 subnet.

When the client roams to a different AP, it can try to continue using its existing IP address or work with a DHCP server to either renew or request an address. Figure 12-7 shows the client roaming to AP-2, where WLAN Staff is also bound to the same VLAN 100 and 192.168.100.0/24 subnet. Because the client has roamed between APs but stayed on the same VLAN and subnet, it has made a Layer 2 intercontroller roam. Layer 2 roams (commonly called local-to-local roams) are nice for two reasons: The client can keep its same IP address, and the roam is fast (usually less than 20 ms).



**Figure 12-7** After an Intercontroller Roam.

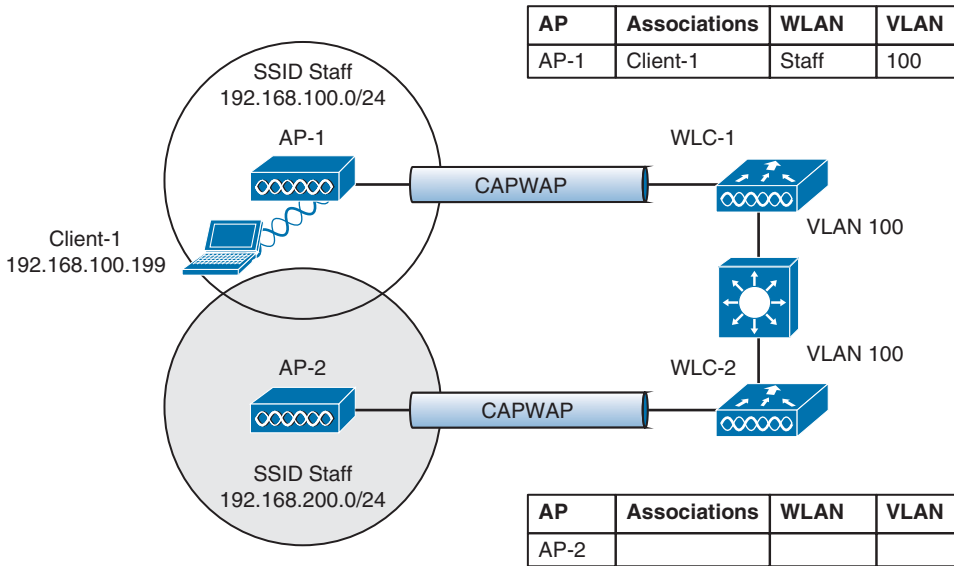
### Layer 3 Roaming

What if a wireless network grows even more, such that the WLAN interfaces on each controller are assigned to different VLANs and subnets? Breaking a very large WLAN up into individual subnets seems like a good idea from a scalability viewpoint. However, when a wireless client roams from one controller to another, it could easily end up on a different subnet than it started with.

Clients will not usually be able to detect that they have changed subnets. They will be aware of the AP roam but little else. Only clients that aggressively contact a DHCP server after each and every roam will continue to work properly. But to make roaming seamless and efficient, time-consuming processes such as DHCP should be avoided.

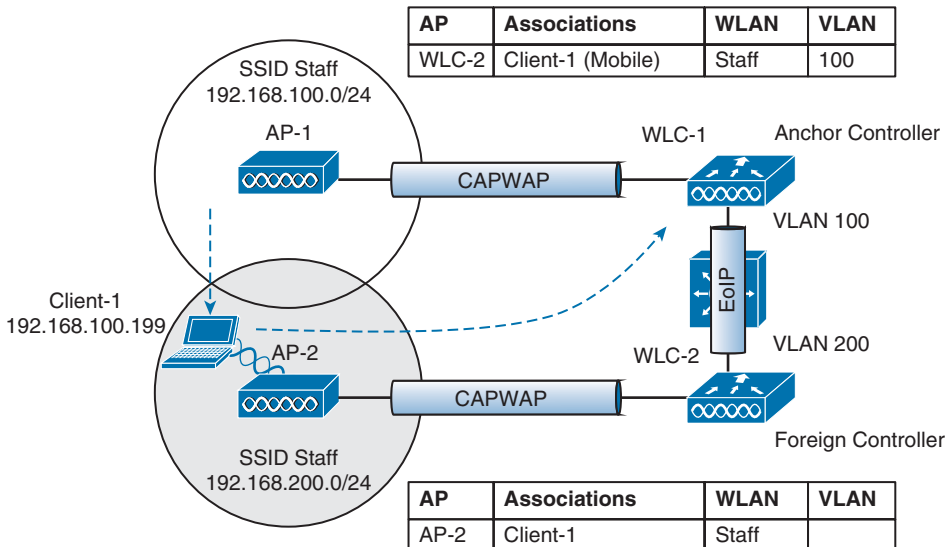
No worries—the CUWN has a clever trick up its sleeve. When a client initiates an intercontroller roam, the two controllers involved can compare the VLAN numbers that are assigned to their respective WLAN interfaces. If the VLAN IDs are the same, nothing special needs to happen; the client undergoes a Layer 2 intercontroller roam and can continue to use its original IP address on the new controller. If the two VLAN IDs differ, the controllers arrange a *Layer 3 roam* (also known as a local-to-foreign roam) that will allow the client to keep using its IP address.

Figure 12-8 illustrates a simple wireless network containing two APs and two controllers. Notice that the two APs offer different IP subnets in their BSSs: 192.168.100.0/24 and 192.168.200.0/24. The client is associated with AP-1 and is using IP address 192.168.100.199. On the surface, it looks like the client will roam into subnet 192.168.200.0/24 if it wanders into AP-2's cell, and will lose connectivity if it tries to keep using its same IP address.



**Figure 12-8** Before a Layer 3 Intercontroller Roam.

A Layer 3 intercontroller roam consists of an extra tunnel that is built between the client’s original controller and the controller it has roamed to. The tunnel carries data to and from the client as if it is still associated with the original controller and IP subnet. Figure 12-9 shows the results of a Layer 3 roam. The original controller (WLC-1) is called the *anchor controller*, and the controller with the roamed client is called the *foreign controller*. Think of the client being anchored to the original controller no matter where it roams later. When the client roams away from its anchor, it moves into foreign territory.



**Key Topic**

**Figure 12-9** After a Layer 3 Intercontroller Roam.

You can see clients that have undergone a Layer 3 roam by selecting **Monitor > Clients** from the controller graphical user interface (GUI). The client from Figures 12-8 and 12-9 is shown in the WLC-1 client list displayed in Figure 12-10. Notice that the client's protocol is shown as 802.11(Mobile); other clients would be listed as 802.11 only.

Client MAC Addr	AP Name	WLAN Profile	WLAN SSID	Protocol
<a href="#">00:09:ef:06:87:bd</a>	172.22.253.20	Staff	Staff	802.11(Mobile)

**Figure 12-10** *Displaying Clients with a Layer 3 Intercontroller Roam.*

You can click the client's MAC address to see more details about its state. In Figure 12-11, you can see that the controller has mobility role Anchor and that the Layer 3 mobility peer is 172.22.253.20, or WLC-2.

Client Properties		AP Properties	
MAC Address	00:09:ef:06:87:bd	AP Address	Unknown
IP Address	192.168.100.199	AP Name	172.22.253.20
Client Type	Regular	AP Type	Mobile
User Name		WLAN Profile	Staff
Port Number	29	Status	Associated
Interface	Staff	Association ID	0
VLAN ID	3602	802.11 Authentication	Open System
CCX Version	Not Supported	Reason Code	1
F2F Version	Not Supported	Status Code	0
Mobility Role	Anchor	CF Pollable	Not Implemented
Mobility Peer IP Address	172.22.253.20	CF Poll Request	Not Implemented
Policy Manager State	RUN	Short Preamble	Implemented
Management Frame Protection	No	PBCC	Not Implemented
Uptime (Sec)	2719	Channel Agility	Not Implemented
Power Save Mode	OFF	Timeout	0
Current TxRateSet		WEP State	WEP Enable
Data RateSet	5.5,11.0,6.0,9.0,12.0,18.0,24.0,36.0,48.0,54.0		

**Figure 12-11** *Displaying Client Details on the Anchor Controller.*

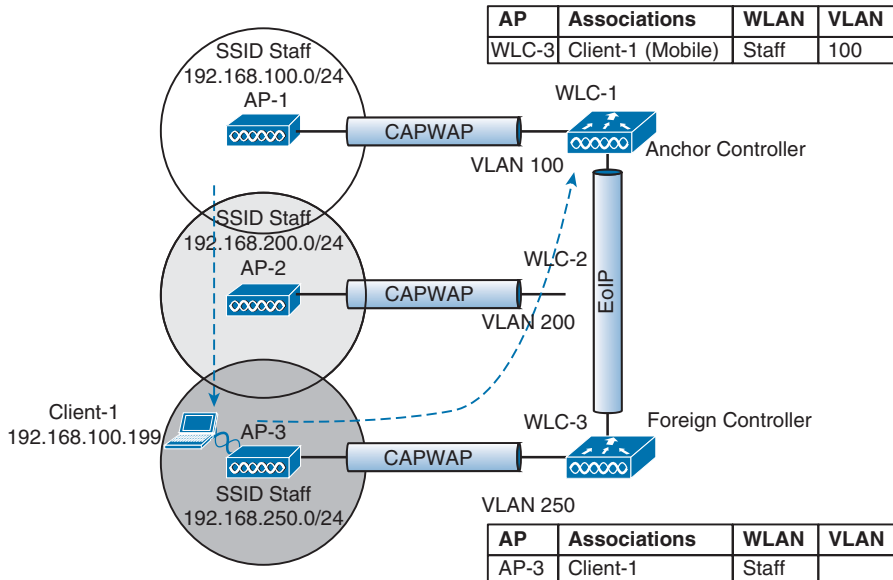
Due to the Layer 3 roam, the client should have an active association with both the anchor and foreign controllers. On the foreign controller, you can view the client details from a different perspective. In Figure 12-12, the client is shown associated with a foreign controller with IP address 172.22.253.9, or WLC-1. On the foreign controller, the client is associated to an actual AP (AP-2) with a normal AP type.

Clients > Detail		AP Properties	
MAC Address	00:09:ef:06:87:bd	AP Address	00:1a:30:30:52:f0
IP Address	192.168.100.199	AP Name	AP-2
Client Type	Regular	AP Type	002.11g
User Name		WLAN Profile	Staff
Port Number	29	Status	Associated
Interface	Staff	Association ID	3
VLAN ID	570	802.11 Authentication	Open System
CCX Version	Not Supported	Reason Code	1
E2E Version	Not Supported	Status Code	0
Mobility Role	Foreign	CF Pollable	Not Implemented
Mobility Peer IP Address	172.22.253.9	CF Poll Request	Not Implemented
Policy Manager State	RUN	Short Preamble	Not Implemented
Management Frame Protection	No	PBCC	Not Implemented
UpTime (Sec)	2397	Channel Agility	Not Implemented
Power Save Mode	ON	Timeout	0
Current TxRateSet	48.0	WEP State	WEP Enable
Data RateSet	5.5,11.0,6.0,9.0,12.0,18.0,24.0,36.0,48.0,54.0		

**Figure 12-12** Displaying Client Details on the Foreign Controller.

Cisco controllers have traditionally used Ethernet over IP (EoIP) tunnels between controllers for Layer 3 roaming. Beginning with controller software releases 7.3.112.0, Layer 3 roaming uses a “new mobility” strategy, with CAPWAP tunnels rather than EoIP. Regardless of the tunnel type, be aware that the controller-to-controller tunnel makes each Layer 3 roam possible.

You should also know that the tunnel tethers the client to its original anchor controller (and original IP subnet), regardless of its location or how many controllers it roams through. For example, in Figure 12-13, the client has roamed from AP-1 to AP-2 to AP-3, and from WLC-1 to WLC-2 to WLC-3, respectively. Although each controller offers a different IP subnet for the client to use, the client can keep using its original 192.168.100.199 address. While the client is on AP-2 and WLC-2, a Layer 3 roam tunnel is built from WLC-2 to anchor controller WLC-1. Then when the client finally lands on AP-3 and WLC-3, WLC-3 builds a Layer 3 roam tunnel back to anchor controller WLC-1.



**Figure 12-13** Layer 3 Roaming Across Multiple Controllers.

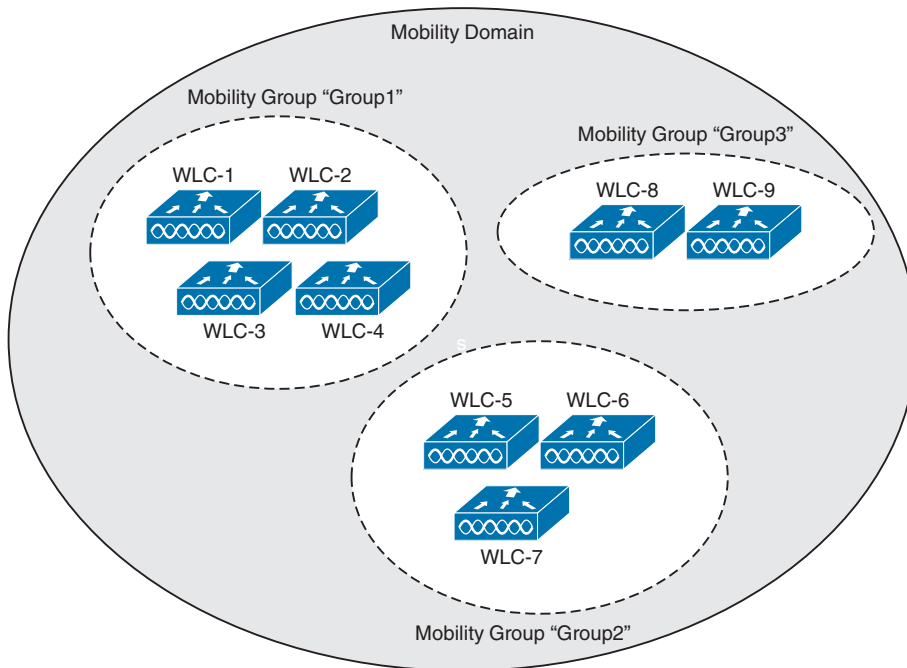
Anchor and foreign controllers are normally determined automatically. When a client first associates with an AP and controller, that controller becomes its anchor controller. When the client roams to a different controller, that controller can take on the foreign role. Sometimes you might not want a client's first controller to be its anchor. For example, guest users should not be allowed to associate with just any controller in your network. Instead, you might want guests to be forced onto a specific controller that is situated behind a firewall or contained in a protected environment. You can configure one controller to be a static anchor for a WLAN so that other controllers will direct clients toward it through Layer 3 roaming tunnels. Static anchor controllers are covered in more detail in Chapter 16, "Implementing a Wireless Guest Network."

## Using Mobility Groups

Cisco controllers can be organized into mobility groups to facilitate intercontroller roaming. Mobility groups become important as a wireless network scales and there are more controllers cooperating to provide coverage over a large area.

If two controllers are configured to belong to the same mobility group, clients can roam quickly between them. Layer 2 and Layer 3 roaming are both supported, along with CCKM, PKC, and 802.11r credential caching. If two controllers are assigned to different mobility groups, clients can still roam between them, but the roam is not very efficient. Credentials are not cached and shared, so clients must go through a full authentication during the roam.

Mobility groups have an implied hierarchy as shown in Figure 12-14. Each controller maintains a mobility list that contains its own MAC address and the MAC addresses of other controllers. Each controller in the list is also assigned a mobility group name. In effect, the mobility list gives a controller its view of the outside world; it knows of and trusts only the other controllers configured in the list. If two controllers are not listed in each other's mobility list, they are unknown to each other and clients will not be able to roam between them. Clients will have to associate and authenticate from scratch.



**Figure 12-14** *Mobility Group Hierarchy.*

You can think of this list as a mobility domain. The list can contain up to 72 controllers, with up to 24 controllers in each mobility group.

You must configure each controller with a mobility group name. Go to **Controller > General** and enter the group name in the Default Mobility Domain Name field. In Figure 12-15, the controller has been assigned to Group1.

Next, populate the controller's mobility list with other controllers and their mobility group names. You can see the current list by selecting **Controller > Mobility Management > Mobility Groups**, as shown in Figure 12-16.



The screenshot shows the configuration page for a Wireless LAN Controller (WLC) in the CONTROLLER tab. The 'General' section is expanded, showing various settings. The 'Default Mobility Domain Name' field is highlighted with a red oval and contains the value 'Group1'. Other settings include Name (WLC-1), 802.3x Flow Control Mode (Disabled), LAG Mode on next reboot (Enabled), Broadcast Forwarding (Disabled), AP Multicast Mode (Unicast), AP Fallback (Enabled), Fast SSID change (Enabled), RF Group Name (RFGroup1), User Idle Timeout (300), ARP Timeout (300), Web Radius Authentication (PAP), Operating Environment (Commercial), Internal Temp Alarm Limits (N/A), WebAuth Proxy Redirection Mode (Disabled), and WebAuth Proxy Redirection Port (0).

**Figure 12-15** Configuring the Default Mobility Group Name.

The screenshot shows the 'Static Mobility Group Members' page in the CONTROLLER tab. The page displays a table of mobility group members. The table has columns for MAC Address, IP Address, Group Name, Multicast IP, and Status. There are two entries in the table, both for Group1.

MAC Address	IP Address	Group Name	Multicast IP	Status
30:c4:db:38:b4:a0	172.22.253.9	Group1		Up
00:1b:53:47:46:60	172.22.253.20	Group1		Up

**Figure 12-16** Displaying a Controller's Mobility Group Member List.

To add a new controller to the list, you can click the **New** button, and then enter the controller's IP address, MAC address, and mobility group name, as shown in Figure 12-17. Click the **Apply** button when you finish.

If you have several controllers to add or if you need to make changes to the list, you can click the **Edit All** button. This will bring up a page that allows you to edit the list as one complete text box. You can make simple edits or copy and paste an entire list from your

computer. Figure 12-18 shows a list of controllers that has been input corresponding to the mobility grouping from Figure 12-14. Notice that the first controller in the list does not have an explicit mobility group name. That is because the first controller is the one that is hosting the list and the web interface. Its mobility group is configured elsewhere as part of the general controller settings.

The screenshot shows the Cisco Controller web interface. The top navigation bar includes 'MONITOR', 'WLANS', 'CONTROLLER', 'WIRELESS', 'SECURITY', 'MANAGEMENT', and 'COMMANDS'. The 'CONTROLLER' tab is selected. On the left, a sidebar lists various configuration categories: General, Inventory, Interfaces, Interface Groups, Multicast, Network Routes, Internal DHCP Server, Mobility Management (with sub-items: Mobility Groups, Mobility Anchor Config, Multicast Messaging), Ports, NTP, CDP, IPv6, and Advanced. The main content area is titled 'Mobility Group Member > New' and contains three input fields: 'Member IP Address' with the value '172.22.253.20', 'Member MAC Address' with the value '00:1b:53:47:46:60', and 'Group Name' with the value 'Group1'. There are '< Back' and 'Apply' buttons at the top right of the form.

Figure 12-17 Adding a New Mobility Group List Entry.

The screenshot shows the Cisco Controller web interface. The top navigation bar is the same as in Figure 12-17. The main content area is titled 'Mobility Group Members > Edit All' and contains a text box with instructions: 'This page allows you to edit all mobility group members at once. Mobility group members are listed below, one per line. Each mobility group member is represented as a MAC address, IP address and group name(optional) separated by one or more spaces.' Below the text box is a table with the following data:

00:e4:db:00:b4:a0	172.22.253.9	
00:1b:53:47:46:60	172.22.253.20	Group1
00:16:46:4b:6a:80	172.22.253.10	Group1
00:16:46:4b:6a:e0	172.22.253.11	Group1
00:16:46:4b:92:60	172.22.253.12	Group2
00:16:46:4b:92:c0	172.22.253.13	Group2
00:17:a0:a6:5b:40	172.22.253.14	Group2
00:17:a0:a6:78:60	172.22.253.15	Group3
00:1b:53:47:48:40	172.22.253.16	Group3

There are '< Back' and 'Apply' buttons at the top right of the page.

Figure 12-18 Editing the Mobility Group List.

---

## Exam Preparation Tasks

---

As mentioned in the section, “How to Use This Book,” in the Introduction, you have a couple of choices for exam preparation: the exercises here, Chapter 22, “Final Review,” and the exam simulation questions on the CD-ROM.

### Review All Key Topics

Review the most important topics in this chapter, noted with the Key Topic icon in the outer margin of the page. Table 12-2 lists a reference of these key topics and the page numbers on which each is found.



**Table 12-2** *Key Topics for Chapter 12*

Key Topic Element	Description	Page Number
Figures 12-4 and 12-5	Intracontroller roaming	245
Figure 12-9	Intercontroller roaming	249
Figure 12-13	Intercontroller roaming across a network	252
Figure 12-14	Mobility group hierarchy	253

### Define Key Terms

Define the following key terms from this chapter and check your answers in the glossary:

anchor controller, foreign controller, intercontroller roaming, intracontroller roaming, Layer 2 roam, Layer 3 roam, mobility group

*This page intentionally left blank*



---

This chapter covers the following topics:

- **Configuring 802.11 Support**—This section explains how to configure the data rates in the 2.4- and 5-GHz bands and support for 802.11n high-throughput functionality.
- **Understanding RRM**—This section describes the algorithms that can monitor and adjust radio frequency parameters automatically in a wireless network.

This chapter covers the following exam topics:

- Describe Radio Resource Management (RRM) fundamentals including ED-RRM

# Understanding RRM

In Chapter 7, “Planning Coverage with Wireless APs,” you learned how to size access point (AP) cells appropriately by disabling data rates and changing the transmit power levels. You also learned how important a proper channel layout is to promote efficient roaming and minimize co-channel interference. You probably also realized how difficult these tasks are when you have to tune the radio frequency (RF) parameters manually across a large number of APs.

In this chapter, you learn about Radio Resource Management (RRM), a flexible and automatic mechanism that Cisco Wireless LAN controllers can use to make your life much easier.

## “Do I Know This Already?” Quiz

The “Do I Know This Already?” quiz allows you to assess whether you should read this entire chapter thoroughly or jump to the “Exam Preparation Tasks” section. If you are in doubt about your answers to these questions or your own assessment of your knowledge of the topics, read the entire chapter. Table 13-1 lists the major headings in this chapter and their corresponding “Do I Know This Already?” quiz questions. You can find the answers in Appendix A, “Answers to the ‘Do I Know This Already?’ Quizzes.”

**Table 13-1** “Do I Know This Already?” Section-to-Question Mapping

Foundation Topics Section	Questions
Configuring 802.11 Support	1–4
Understanding RRM	5–10

**Caution** The goal of self-assessment is to gauge your mastery of the topics in this chapter. If you do not know the answer to a question or are only partially sure of the answer, you should mark that question as wrong for purposes of the self-assessment. Giving yourself credit for an answer you correctly guess skews your self-assessment results and might provide you with a false sense of security.

1. Which one of the following correctly describes a mandatory data rate?
  - a. The data rate must be used by wireless clients all the time.
  - b. The highest data rate used by an AP and its clients.
  - c. A data rate that must be supported by a client before it can associate with an AP.
  - d. A data rate required by the IEEE 802.11 standards body.
2. You can configure only one data rate as mandatory on an AP. True or false?
  - a. True
  - b. False
3. An AP sends 802.11 broadcast management frames at which one of the following data rates?
  - a. The highest mandatory data rate
  - b. The lowest mandatory data rate
  - c. The lowest supported data rate
  - d. All supported data rates
4. Which one of the following is the default state of 802.11n support and the default channel width on a Cisco wireless LAN controller?
  - a. Disabled; 20-MHz channels
  - b. Enabled; 20-MHz channels
  - c. Enabled; 40-MHz channels
  - d. Disabled; 40-MHz channels
5. Which one of the following correctly identifies the scope of the RRM algorithms?
  - a. All APs joined to one controller
  - b. All APs joined to all controllers
  - c. All APs joined to controllers in an RF group
  - d. All APs of a specific model

- 6.** An RF group is automatically formed by which one of the following?
  - a.** All APs that share the same channel
  - b.** All clients that share the same SSID
  - c.** Any controllers that can overhear neighbor messages with identical RF group names sent between their APs
  - d.** All controllers that can overhear neighbor messages with identical mobility group names sent between their APs
- 7.** The TPC algorithm is used for which one of the following purposes?
  - a.** To adjust the transmission control protocol rate
  - b.** To detect problems in transmission perimeter coverage
  - c.** To adjust the transmitting primary channel
  - d.** To adjust the transmit power level
- 8.** If the DCA algorithm detects that an AP is experiencing interference or excessive noise, what might it do to mitigate the problem?
  - a.** Increase the AP's transmit power level
  - b.** Decrease the AP's transmit power level
  - c.** Change the AP's channel number
  - d.** Direct the client to a different band
- 9.** Which one of the following runs the DCA algorithm?
  - a.** RF group leader
  - b.** Master controller
  - c.** Each controller
  - d.** NCS or Cisco Prime Infrastructure
- 10.** The 2.4-GHz radio in one of several APs in a building has failed. Which one of the following algorithms should be able to detect the failure?
  - a.** CCA
  - b.** DCA
  - c.** Dead radio detection
  - d.** Coverage hole detection



## Foundation Topics

### Configuring 802.11 Support

Cisco controllers and most APs can support wireless LANs in both the 2.4- and 5-GHz bands. By default, both bands are enabled; however, you can view or change a number of parameters by browsing to the Wireless tab in the controller, shown in Figure 13-1.

The screenshot shows the Cisco Controller GUI with the 'Wireless' tab selected. The left sidebar contains a navigation tree with 'Access Points' expanded, showing 'All APs', 'Radios', '802.11a/n', '802.11b/g/n', and 'Global Configuration'. The '802.11a/n' and '802.11b/g/n' items are highlighted with a blue bar. The main content area displays 'All APs' with a 'Current Filter' of 'None' and a 'Number of APs' of 70. A table lists the following APs:

AP Name	AP Model	AP MAC
<a href="#">mn507-ap2</a>	AIR-CAP3602I-A-K9	7c:ad:74:84:fa:ad
<a href="#">ms517-ap7</a>	AIR-CAP3602I-A-K9	bc:16:65:6d:04:fe
<a href="#">ms51-ap20</a>	AIR-CAP3602I-A-K9	7c:ad:74:28:4c:a6
<a href="#">ms513-ap5</a>	AIR-CAP3602I-A-K9	bc:16:65:16:7b:28
<a href="#">ms570-ap17</a>	AIR-CAP3602I-A-K9	bc:16:65:6d:04:a9
<a href="#">ms571-ap15</a>	AIR-CAP3602I-A-K9	bc:16:65:bd:99:3f
<a href="#">mn576-ap16</a>	AIR-CAP3602I-A-K9	7c:ad:74:50:1f:10
<a href="#">mn517-ap4</a>	AIR-CAP3602I-A-K9	7c:ad:74:fb:d4:56
<a href="#">mn563-ap10</a>	AIR-CAP3602I-A-K9	7c:ad:74:84:fa:36
<a href="#">mn580-ap18</a>	AIR-CAP3602I-A-K9	7c:ad:74:28:4b:e0
<a href="#">ms529-ap9</a>	AIR-CAP3602I-A-K9	bc:16:65:6d:05:3a
<a href="#">ms585-ap19</a>	AIR-CAP3602I-A-K9	7c:ad:74:fb:d4:16
<a href="#">mn682-ap20</a>	AIR-CAP3602I-A-K9	7c:ad:74:18:c3:29
<a href="#">mn670-ap16</a>	AIR-CAP3602I-A-K9	7c:ad:74:20:4b:f3
<a href="#">ms603-ap1</a>	AIR-CAP3602I-A-K9	7c:ad:74:28:46:97
<a href="#">ms666-ap15</a>	AIR-CAP3602I-A-K9	7c:ad:74:50:1d:32

**Figure 13-1** The Wireless Tab on a Cisco Controller GUI.

The wireless parameters are organized under a list of links that are found on the left side of the web page. At the CCNA level, you should be familiar with the following links:

- **Access Points**—Used to verify and configure RF things like transmit power level and channel number on individual APs
- **802.11a/n**—Used to configure global parameters for the 5-GHz band
- **802.11b/g/n**—Used to configure global parameters for the 2.4-GHz band

The initial web page displays a list of all APs that are currently joined to the controller, as if you had selected **Wireless > Access Points > All APs**. The remaining configuration is covered in the sections that follow.

## Configuring Data Rates

You can enable or disable the 2.4- or 5-GHz bands by selecting **802.11b/g/n** or **802.11a/n**, respectively, and then clicking the **Network** link. Figures 13-2 and 13-3 show the two network configuration pages. Make sure that the **802.11b/g** or **802.11a Network Status** check box is checked to enable the 2.4- or 5-GHz radios on all APs.

802.11b/g Global Parameters	
Save Configuration   Ping	
MONITOR WLANs CONTROLLER WIRELESS SECURITY MANAGEMENT COMMANDS HELP FEEDBACK	
Apply	
<b>General</b>	
802.11b/g Network Status	<input checked="" type="checkbox"/> Enabled
802.11g Support	<input checked="" type="checkbox"/> Enabled
Beacon Period (milliseconds)	<input type="text" value="100"/>
Short Preamble	<input checked="" type="checkbox"/> Enabled
Fragmentation Threshold (bytes)	<input type="text" value="2346"/>
DTPC Support	<input checked="" type="checkbox"/> Enabled
Maximum Allowed Clients	<input type="text" value="200"/>
<b>CCX Location Measurement</b>	
Mode	<input type="checkbox"/> Enabled
<b>Data Rates**</b>	
1 Mbps	Mandatory
2 Mbps	Mandatory
5.5 Mbps	Mandatory
6 Mbps	Supported
9 Mbps	Supported
11 Mbps	Mandatory
12 Mbps	Supported
18 Mbps	Supported
24 Mbps	Supported
36 Mbps	Supported
48 Mbps	Supported
54 Mbps	Supported
<p>** Data Rate 'Mandatory' implies that clients who do not support that specific rate will not be able to associate. Data Rate 'Supported' implies that any associated client that also supports that same rate may communicate with the AP using that rate. But it is not required that a client be able to use the rates marked supported in order to associate. The actual data rates that are supported depend on the channel selected as different channels may have different bandwidths. The reason is that we show data rates and allow the user to select the data rates. But in reality, the AP will pick the next lower</p>	

**Figure 13-2** Configuring 2.4-GHz Radios.

On the right side of the network web pages, as shown in Figures 13-2 and 13-3, you can configure the individual data rates (and the corresponding modulation and coding schemes) that are supported on each band. Each data rate can have one of the following states:

- **Mandatory**—A client must be able to use the data rate and Modulation Coding Scheme (MCS) to associate with an AP.
- **Supported**—A client can associate with an AP even if it cannot use the data rate.
- **Disabled**—An AP will not use the data rate with any clients.



By default, all data rates are enabled and supported. In the 2.4-GHz band, the 1-, 2-, 5.5-, and 11-Mbps rates are all marked as mandatory, based on the initial IEEE requirement that all clients be able to support each possible modulation type defined in 802.1b. In the 5-GHz band, the 6-, 12-, and 24-Mbps rates are marked as mandatory.

Save Configuration | Ping

MONITOR WLANs CONTROLLER WIRELESS SECURITY MANAGEMENT COMMANDS HELP FEEDBACK

### 802.11a Global Parameters

Apply

**General**

802.11a Network Status	<input checked="" type="checkbox"/> Enabled
Beacon Period (milliseconds)	100
Fragmentation Threshold (bytes)	2346
DTPC Support	<input checked="" type="checkbox"/> Enabled
Maximum Allowed Clients	200

**802.11a Band Status**

Low Band	Enabled
Mid Band	Enabled
High Band	Enabled

**Data Rates\*\***

6 Mbps	Mandatory
9 Mbps	Supported
12 Mbps	Mandatory
18 Mbps	Supported
24 Mbps	Mandatory
36 Mbps	Supported
48 Mbps	Supported
54 Mbps	Supported

**CCX Location Measurement**

Mode  Enabled

\*\* Data Rate 'Mandatory' implies that clients who do not support that specific rate will not be able to associate. Data Rate 'Supported' implies that any associated client that also supports that same rate may communicate with the AP using that rate. But it is not required that a client be able to use the rates marked supported in order to associate. The actual data rates that are supported depend on the channel selected as different channels may have different bandwidths. The reason is that we show data rates and allow the user to select the data rates. But in reality, the AP will pick the next lower data rate allowed for that channel if the chosen data rate is not supported.

**Figure 13-3** Configuring 5-GHz Radios.

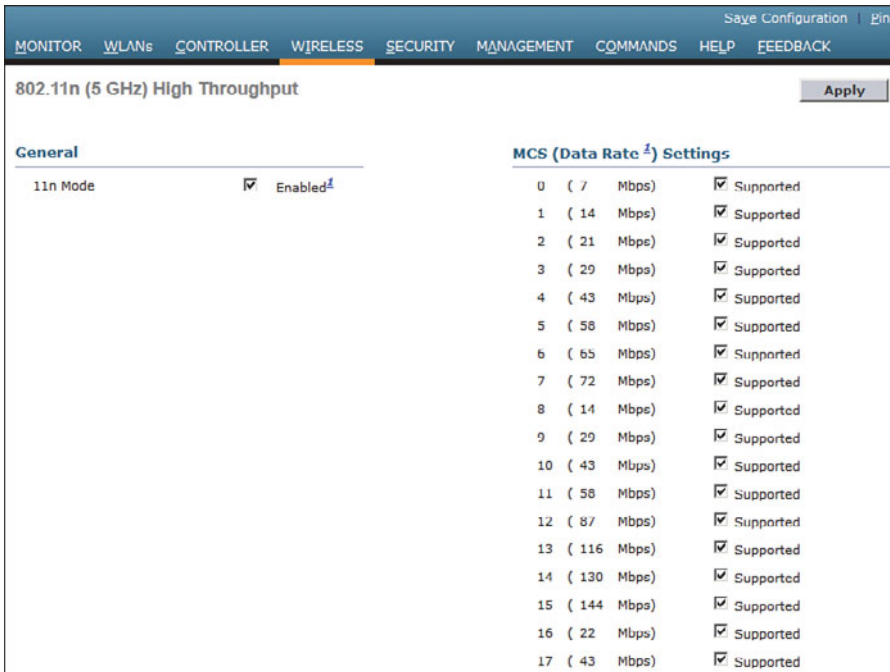
You can change the state of any data rate by selecting a new state from the drop-down menu. Remember that you can disable lower data rates to decrease the AP cell size and make channel use more efficient. Just make sure that your actions do not shrink the cells too much, leaving holes or gaps in the coverage between APs. Also be sure that all of your wireless clients can use the same set of mandatory and supported data rates.

Be sure to click the **Apply** button to make any configuration changes active. Any wireless networks that are already in production on the controller might be disrupted while the new configuration takes effect.

## Configuring 802.11n Support

You might have noticed that you can configure plenty of data rates, but 802.11n is never mentioned on the wireless network configuration pages. That is because 802.11n is considered to be a rich set of high-throughput enhancements to both 802.11g and 802.11a and must be configured separately.

By default, 802.11n is enabled. To check or change its state, go to **Wireless > 802.11a/n or 802.11b/g/n > High Throughput (802.11n)**. Figure 13-4 shows the 5-GHz 802.11n configuration page. 802.11n is enabled when the **11n Mode** check box is checked. By default, every possible MCS is enabled and supported.

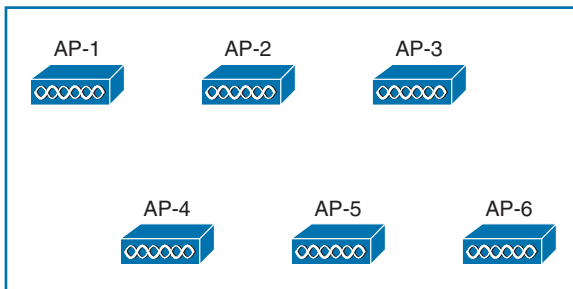


**Figure 13-4** *Configuring 802.11n Support.*

Recall that 802.11n can bond one 20-MHz to an adjacent 20-MHz channel to effectively double the channel width. By default, the controller will use only a single 20-MHz channel. You can configure channel bonding as a part of the dynamic channel allocation (DCA) configuration for the 5-GHz band only, as covered in the following section.

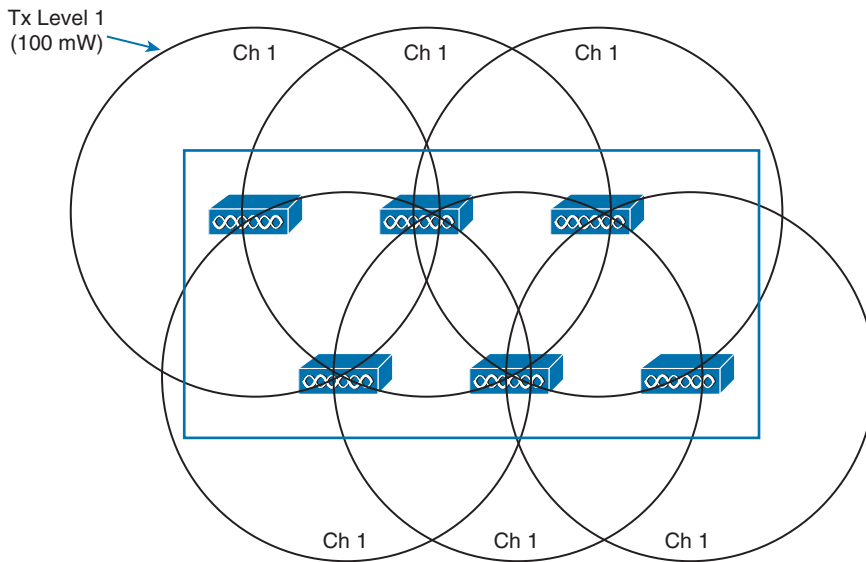
## Understanding RRM

Suppose that you need to provide wireless coverage in a rectangular-shaped building. Using the information you have learned from this book, you decide to use six APs and locate them such that they form a staggered, regular pattern. The pattern shown in Figure 13-5 should create optimum conditions for roaming and channel use. (The building dimensions have not been mentioned, just to keep things simple.)



**Figure 13-5** *A Hypothetical AP Layout.*

So far, you have considered the layout pattern and an average cell size, but you still have to tackle the puzzle of selecting the transmit power level and channel number for each AP. The transmit power level will affect the final cell size, and the channel assignment will affect co-channel interference and roaming handoff. At this point, if all the APs are powered up, they might all end up transmitting at maximum power on the same channel. Figure 13-6 shows one possible scenario; each of the AP cells overlaps its neighbors by about 50 percent, and all the APs are fighting to use channel 1!



**Figure 13-6** *Poorly Configured RF Coverage.*

Where do you begin to prevent such mayhem? Because the AP locations are already nailed down, you can figure out the transmit power level that will give the proper cell overlap. Then you can work your way through the AP layout choosing an alternating pattern of channel numbers. With six APs, that might not be a daunting task.

Do not forget to repeat the task for both 2.4- and 5-GHz bands.

Also, if you plan on using 802.11n and 40-MHz channel width, do not forget to reserve the extra channels needed for that. Be aware that only the 5-GHz band is capable of supporting wide channels.

If you happen to notice that an AP fails one day, you could always reconfigure its neighboring APs to increase their transmit power level to expand their cells and cover the hole.

If you introduce another AP or two in the future, do not forget to revisit the entire configuration again to make room for cells and channels.

Did your life as the wireless LAN administrator just become depressing and tedious? Cisco Radio Resource Management (RRM) can handle all these tasks regularly and automatically. RRM consists of several algorithms that can look at a large portion of a

wireless network and work out an optimum transmit power level and channel number for each AP. If conditions that affect the RF coverage change over time, RRM can detect that and make the appropriate adjustments.

## RF Groups

RRM works by monitoring a number of APs and working out optimal RF settings for each one. The APs that are included in the RRM algorithms are contained in a single RF group. An RF group is formed for each band that is supported—one group for 2.4-GHz AP radios and another for 5-GHz AP radios. By default, an RF group contains all the APs that are joined to a single controller.

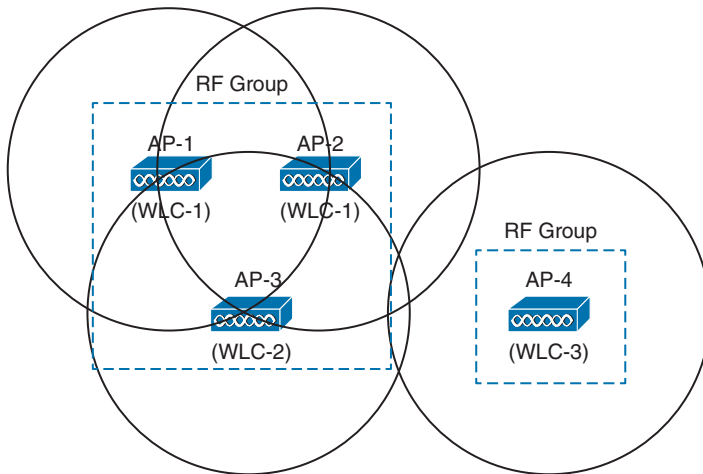
You can also configure a controller to automatically populate its RF group. In that case, the RF group can expand to include APs from multiple controllers, provided the following two conditions are met:

- The controllers share a common RF group name.
- At least one AP from one controller can be overheard by an AP on another controller.

When an RF group touches more than one controller, the controllers form a type of cluster so that they all participate in any RF adjustments that are needed. Every AP sends a Neighbor Discovery Packet (NDP) at maximum transmit power and at 60-second intervals, by default. If two controllers are close enough in proximity for an AP on one to hear an AP on the other at a received signal strength indicator (RSSI) of  $-80$  dBm or greater, they are close enough to belong to the same RF group. Up to 20 controllers and 1000 APs can join to form a single RF group.

Figure 13-7 shows a simple scenario with four controllers and four APs, resulting in two separate RF groups. AP-1 and AP-2 are both joined to controller WLC-1, so they are members of one RF group by default. AP-3, joined to WLC-2, is located near enough to AP-1 and AP-2 that neighbor advertisements are overheard. As a result, controller WLC-2 joins the RF group with WLC-1. However, AP-4, joined to controller WLC-3, is not close enough to pass the neighbor test. Even though AP-4's cell intersects the cells of AP-2 and AP-3, the APs themselves are not within range. Therefore, controller WLC-3 resides in a different RF group by itself.

One controller in each group is elected as an RF group leader, although you can override that by configuring one controller as a static leader. The leader collects and analyzes information from all APs in the group about their RF conditions in real time. You can access the RF group leader configuration information by selecting **Wireless > 802.11a/n or 802.11b/g/n > RRM > RF Grouping**. In Figure 13-8, the controller is in automatic RF group mode and is a member of an RF group along with two other controllers. The RF group leader is controller WLC-1.



**Figure 13-7** Automatic RF Group Discovery and Formation.

**802.11a > RRM > RF Grouping**

**RF Grouping Algorithm**

Group Mode:

Group Role: Auto-Member

Group Update Interval: 600 secs

Group Leader: WLC-1 : 192.168.200.6

**RF Group Members**

\*If the member has not joined the group, the reason of failure will be shown in brackets

Controller Name	IP Address
WLC-2	192.168.200.15
WLC-3	192.168.200.16
WLC-1	192.168.200.6

**Figure 13-8** Displaying RF Group Information.

Radio resource monitoring is used to gather and report information from the APs. Each AP is assigned to transmit and receive on a single channel, so it can easily detect noise and interference on that channel, as well as the channel utilization. The AP can also keep a list of clients and other APs that it hears transmitting on that channel.

Each AP can also spend a short bit of time (less than 60 ms) tuning its receiver to all of the other channels that are available. By scanning channels other than the one normally used, an AP can measure noise and interference all across the band from its own vantage point. The AP can also detect unexpected transmissions coming from rogue clients and APs, or devices that are not formally joined to the Cisco Unified Wireless Network (CUWN).

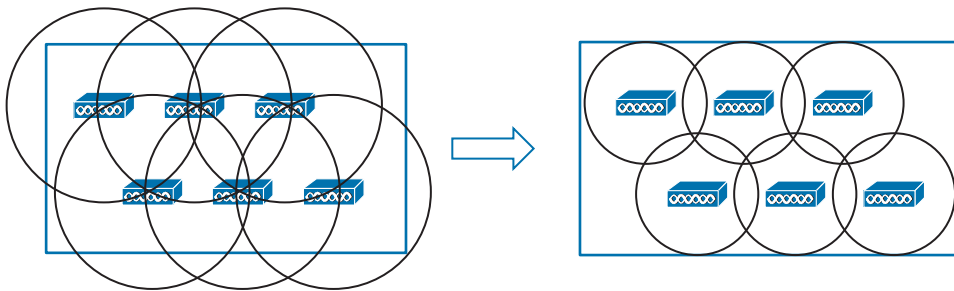
Based on the radio resource monitoring data, RRM can make the following decisions about APs in an RF group:

- **Transmit power control (TPC)**—RRM can set the transmit power level of each AP.
- **Dynamic channel allocation (DCA)**—RRM can select the channel number for each AP.
- **Coverage hole detection mechanism (CHDM)**—Based on information gathered from client associations, RRM can detect an area with weak RF coverage and increase an AP's transmit power level to compensate.

The RRM algorithms are designed to keep the entire wireless network as stable and efficient as possible. The TPC and DCA algorithms run independently because they perform very different functions. By default, the algorithms are run every 600 seconds (10 minutes). If conditions in the RF environment change, such as interference or the addition or failure of an AP, RRM can discover and react to the changes at the next interval. The RRM algorithms are discussed in more detail in the following sections.

## TPC

The TPC algorithm focuses on one goal: setting each AP's transmit power level to an appropriate value so that it offers good coverage for clients while avoiding interference with neighboring APs that are using the same channel. Figure 13-9 illustrates this process. APs that were once transmitting too strongly and overlapping each other's cells are adjusted for proper coverage, reducing the cell size more appropriately to support clients.



**Figure 13-9** Basic Concept of the TPC Algorithm.

Controllers have no knowledge of the physical location of each AP. By looking at Figure 13-9, you can see that the APs are arranged in a nice evenly spaced pattern, but the con-



troller cannot see that. When an AP joins a controller, only the AP's MAC address, IP address, and some basic information are advertised to the controller. If the locations of neighboring APs cannot be known, each AP must resort to using the RSSI of its neighbors as a measure of how closely their cells touch or overlap its own.

During the time each AP scans the channels to listen for RF conditions and other APs, it forms a list of its neighbors and their RSSI values. Each of those lists is sent to the local controller and on to the RF group leader where they are used by the TPC algorithm.

TPC works on one AP at a time, one band at a time. If an AP has been heard with an RSSI above a threshold (−70 dBm by default) by at least three of its neighbors, TPC considers the AP's cell to be overlapping the cells of its three neighbors too much. The AP's transmit power level will be decreased by 3 dB, and then its RSSI will be evaluated again. This process is repeated at regular intervals until the neighbor that is measuring the third-strongest RSSI value for the AP no longer measures the RSSI greater than the threshold

Although you probably will not have to make any configuration changes for the TPC algorithm, it is still useful to understand its settings. TPC runs on the 2.4- and 5-GHz bands independently. You can see the settings by selecting **Wireless > 802.11a/n or 802.11b/g/n > RRM > TPC**. Figure 13-10 shows the TPC configuration for the 5-GHz 802.11a band.

The screenshot shows the configuration page for TPC (Tx Power Control) on the 802.11a band. The page is titled "802.11a > RRM > Tx Power Control(TPC)" and includes an "Apply" button. The configuration is as follows:

TPC Version	
<input type="radio"/>	Interference Optimal Mode (TPCv2)
<input checked="" type="radio"/>	Coverage Optimal Mode (TPCv1)
Tx Power Level Assignment Algorithm	
Power Level Assignment Method	<input checked="" type="radio"/> Automatic Every 600 secs <input type="radio"/> On Demand Invoke Power Update Once <input type="radio"/> Fixed 1
Maximum Power Level Assignment (-10 to 30 dBm)	30
Minimum Power Level Assignment (-10 to 30 dBm)	-10
Power Assignment Leader	WLC-1 (192.168.200.6)
Last Power Level Assignment	N.A
Power Threshold (-80 to -50 dBm)	-70
Power Neighbor Count	3

**Figure 13-10** *Adjusting the RRM TPC Algorithm Parameters.*

By default, TPC runs automatically every 10 minutes. This is the recommended mode because any changes in the RF environment can be detected and compensated for without any intervention. As an alternative, you can select **On Demand** to run the algorithm once at the next 10-minute interval, and then the resulting transmit power levels will be frozen until TPC is manually triggered again. If you would rather have the controller set the transmit power level on all APs to one fixed value, you can select **Fixed** and choose the power level from the drop-down menu.

Cisco controllers determine the transmit power level according to an index from 1 to 8, rather than discrete dBm or mW values. A value of 1 corresponds to the maximum power level that is allowed in the AP's regulatory domain. You can use Table 13-2 to correlate the power levels used in the 2.4-GHz band in the Americas or European domains to more familiar real-world values.

**Table 13-2** AP Transmit Power Level Numbers, dBm, and mW Values in the 2.4-GHz Band

Power Level	dBm	mW
1	20	100
2	17	50
3	14	25
4	11	12.5
5	8	6.25
6	5	3.13
7	2	1.56
8	-1	0.78



With every iteration, the TPC algorithm can continue adjusting the transmit power levels until no further changes are needed. As a result, some APs might end up higher or lower than you might want. For example, it is usually best to match the AP transmit power level with that of the clients. Suppose that some of the clients have a fixed power level of 25 mW; if TPC ends up reducing some APs to 10 mW, the AP and client power levels will be mismatched.

To prevent such a condition, you can set minimum and maximum power level boundaries for the TPC algorithm. By default, the minimum level is set to -10 dBm and the maximum to 30 dBm, as shown in Figure 13-10.

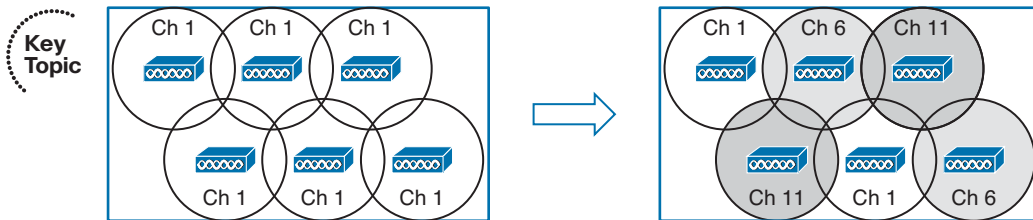
Whenever you change the TPC parameters in a controller configuration, remember to make the same changes to all controllers that might be members of the same RF group. No matter which controller might become the RF group leader, the parameters will be identical.

**Tip** What transmit power level does an AP use when it first powers up? A new AP right out of the box will power up at its maximum power level. After the TPC algorithm has run and adjusted an AP's power level, that level is remembered the next time the AP is power cycled.

## DCA

Recall from Chapter 7, “Planning Coverage with Wireless APs,” and Chapter 12, “Understanding Roaming,” that a proper channel assignment is vital for efficient use of air time and for client mobility. When neighboring APs use the same channel, they can interfere with each other. Ideally, adjacent APs should use different, non-overlapping channels. Working out a channel layout for many APs can be a difficult puzzle, but the DCA algorithm can work out optimum solutions automatically for all APs in an RF group.

When a new AP first powers up, it uses the first non-overlapping channel in each band—channel 1 for 2.4 GHz and channel 36 for 5 GHz. Consider a simplistic scenario where all APs are new and powered up for the first time. You would end up with a building full of overlapping cells competing for the use of 2.4-GHz channel 1, as shown in simplified form in Figure 13-11. The DCA algorithm works to correct this situation by finding a channel that each AP in the RF group can use without overlapping or interfering with other APs. Like TPC, DCA works out one channel layout in the 2.4-GHz band and another layout in the 5-GHz band.



**Figure 13-11** Basic Concept of the DCA Algorithm.

DCA does not just solve the channel layout puzzle once for all APs. The algorithm runs every 10 minutes by default, so that it can detect any conditions that might require an AP’s channel to change. APs in the RF group are monitored for the metrics listed in Table 13-3 that can influence the channel reassignment decision.

**Table 13-3** Metrics Affecting DCA Decisions

Metric	Default State	Description
RSSI of neighboring APs	Always enabled	If DCA detects co-channel interference, it may move an AP to a different channel.
802.11 interference	Enabled	If transmissions from APs and devices that are not part of the wireless network are detected, DCA may choose to move an AP to a different channel.
Non-802.11 noise	Enabled	If excessive noise is present on a channel, DCA may choose to avoid using it.

<b>Metric</b>	<b>Default State</b>	<b>Description</b>
AP traffic load	Disabled	If an AP is heavily used, DCA may not change its channel to keep client disruption to a minimum.
Persistent interference	Disabled	If an interference source with a high duty cycle is detected on a channel, DCA may choose to avoid using it.

The DCA algorithm tends to look at each AP individually to find the ones with the worst RF conditions. Changing the channel of even one AP can affect many other APs if there are not other alternative channels available. Channel layout is a puzzle that may require several iterations to solve. For this reason, the controller that is the RF group leader will undergo an RRM startup mode after it is elected. The startup mode consists of ten DCA iterations at 10-minute intervals, or a total of 100 minutes before the channel layout reaches a steady state.

The end result of DCA is a channel layout that takes a variety of conditions into account. The channel layout is not just limited to the two dimensions of a single floor space in a building; it also extends to three-dimensional space because the RF signals from one floor can bleed through to another. As long as the APs on different floors belong to the same RF group, co-channel interference between them should be minimized.

You can display and configure the DCA parameters of either the 2.4- or 5-GHz band by selecting **Wireless > 802.11a/n or 802.11b/g/n > RRM > DCA**. Figure 13-12 shows the 802.11a configuration.

By default, the DCA algorithm runs automatically at 10-minute intervals. You can change the interval time, select **Freeze** to run DCA manually on demand, or turn it **Off** completely. You can also select the conditions to avoid, which will trigger a channel change on an AP.

The DCA parameters also include the 802.11n channel width. By default, 20-MHz channels will be used. If you have enabled 802.11n in the 5-GHz band and want to enable 40-MHz channels, be sure to select **40 MHz** as the channel width.

The bottom portion of the web page contains a list of channels that DCA can use as it assigns channels to APs in the respective band. This list is populated with channel numbers by default, but you can edit the list as needed. You can also enable or disable individual channel use by using the list of **Select** check boxes.

The DCA algorithm normally runs on an automatic schedule or manually on demand. Event-Driven RRM (ED-RRM) takes this a step further; DCA can be triggered based on RF events that occur in real time. The CleanAir feature, covered in more detail in Chapter 19, “Dealing with Wireless Interference,” provides the triggers for ED-RRM. By default, ED-RRM is disabled. You can enable it with the **EDRRM** check box at the very bottom of the web page.

The screenshot shows the configuration page for Dynamic Channel Assignment (DCA) on a Cisco Wireless LAN Controller (WLC). The page is titled "802.11a > RRM > Dynamic Channel Assignment (DCA)" and includes an "Apply" button. The configuration is organized into two main sections: "Dynamic Channel Assignment Algorithm" and "DCA Channel List".

**Dynamic Channel Assignment Algorithm**

- Channel Assignment Method:**  Automatic,  Freeze,  OFF. Interval: 10 minutes, AnchorTime: 0. A button "Invoke Channel Update Once" is visible.
- Avoid Foreign AP interference:**  Enabled
- Avoid Cisco AP load:**  Enabled
- Avoid non-802.11a noise:**  Enabled
- Avoid Persistent Non-WiFi Interference:**  Enabled
- Channel Assignment Leader:** WLC-1 (192.168.200.6)
- Last Auto Channel Assignment:** N.A
- DCA Channel Sensitivity:** Medium (15 dB)
- Channel Width:**  20 Mhz,  40 Mhz
- Avoid check for non-DFS channel:**  Enabled

**DCA Channel List**

DCA Channels: 36, 40, 44, 48, 52, 56, 60, 64, 149, 153, 157, 161

**Figure 13-12** *Adjusting the RRM DCA Algorithm Parameters.*

## Coverage Hole Detection

The TPC algorithm normally reduces AP transmit power levels to make cell sizes appropriate. Sometimes you might find that your best intentions at providing RF coverage with a good AP layout still come up short. For example, you might discover that signals are weak in some small area of a building due to the building construction or surrounding obstacles. You might also have an AP radio that happens to fail, causing a larger coverage hole. How would you discover such a condition? You could make a habit of surveying the RF coverage often. More likely, your wireless users will discover a weakness or hole in the coverage and complain to you about it.

The Cisco CUWN offers an additional RRM algorithm that can detect coverage holes and take action to address them. Coverage hole detection mechanism (CHDM) can alert you to a hole that it has discovered and it can increase an AP's transmit power level to compensate for the hole.

Coverage hole detection is useful in two cases:

- Extending coverage in a weak area
- Healing a coverage hole caused by an AP or radio failure

The algorithm does not run at regular intervals like TPC and DCA do. Instead, it monitors the RF conditions of wireless clients and decides when to take action. In effect, the algorithm leverages your wireless users who are out in the field and tries to notice a problem before they do.

Every controller maintains a database of associated clients and their RSSI and signal-to-noise ratio (SNR) values. It might seem logical to think that a low RSSI or SNR would mean a client is experiencing a hole in coverage. Assuming the client and its AP are using the same transmit power levels, if the AP is receiving the client at a low level, the client must also be receiving the AP at a low level. This might not be true at all; the client might just be exiting the building and getting too far away from the AP. The client might also have a “sticky” roaming behavior, where it maintains an association with one AP until the RSSI falls to a very low level before reassociating elsewhere.

Coverage hole detection tries to rule out conditions that are experienced by small numbers of clients and signal conditions due to client roaming behavior. A valid coverage hole is detected when some number of clients, all associated to the same AP, have RSSI values that fall below a threshold. In addition, the coverage hole condition must exist longer than a threshold of time without the client roaming to a different AP.

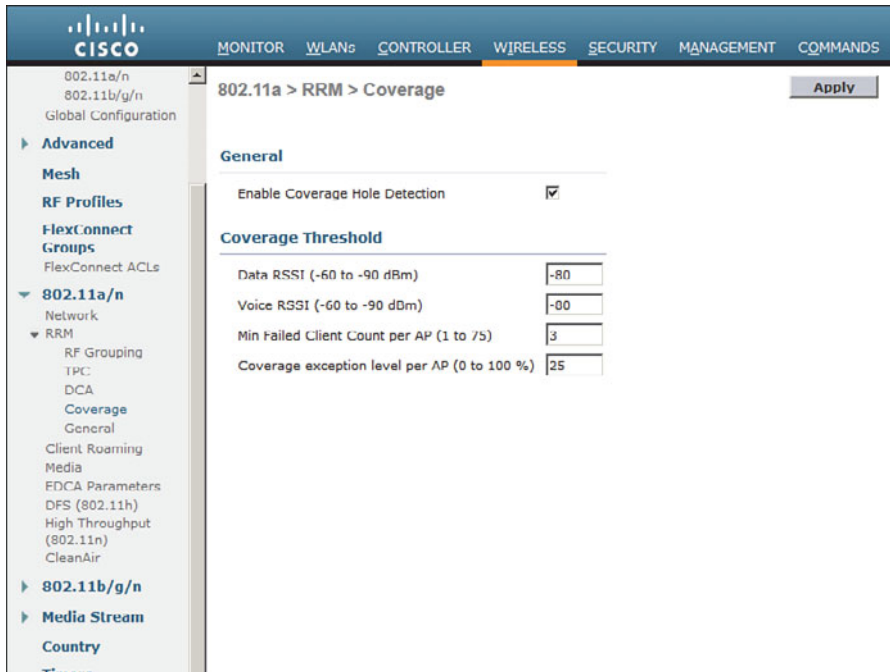
By default, the following conditions must all be met for a coverage hole to be detected:

- Client RSSI at the AP is at or below  $-80$  dBm.
- The low RSSI condition must last at least 60 seconds over the past 180 seconds.
- The condition must affect at least three clients or more than 25 percent of the clients on a single AP.

Be aware that the coverage hole detection runs on a per-band basis. Unlike TPC and DCA, which operate on the entire RF group of controllers, coverage hole detection runs on each controller independently.

You can display and configure the coverage hole detection thresholds by selecting **Wireless > 802.11a/n or 802.11b/g/n > RRM > Coverage**. Figure 13-13 shows the threshold parameters for the 5-GHz 802.11a band.





**Figure 13-13** *Displaying Coverage Threshold Parameters for the 5-GHz 802.11a Band.*

## Manual RF Configuration

You might sometimes want to keep RRM from changing the RF conditions in parts of your wireless network. For instance, you might have client devices that operate at a fixed transmit power level. Ideally, the AP and client power levels should be identical or matched. If RRM raises or lowers AP power levels at a later time, then asymmetric power levels would result.

You can override RRM on a per-AP basis by selecting **Wireless > Access Points > Radios > 802.11a/n** or **802.11b/g/n**. From the list of APs displayed, choose a specific AP and select the drop-down menu at the far-right side of the list. From this menu, select **Configure**, as shown in Figure 13-14.

On the AP configuration page, as shown in Figure 13-15, you can set the channel under RF Channel Assignment or the transmit power under Tx Power Level Assignment. By default, the **Global** radio button is selected for each, which allows the value to be determined globally within the RF group. You can set a specific channel or power level by selecting the **Custom** radio button and then choosing a value from the drop-down list. In the figure, the AP's transmit power level has been manually set to 3.

Entries 1 - 75 of 846  
 [Change Filter] [Clear Filter]

Radio Slot#	Base Radio MAC	Admin Status	Operational Status	Channel	CleanAir Admin Status	CleanAir Oper Status	Power Level	Antenna
0	64:a0:e7:db:87:50	Enable	UP	11 *	Enable	UP	3	Internal
0	6c:9c:ed:87:a4:d0	Enable	UP	6 *	Enable	UP	8 *	Internal
0	64:a0:e7:db:8d:70	Enable	UP	6 *	Enable	UP	7 *	Internal
0	00:d0:9f:bf:d5:b0	Enable	UP	1 *	Enable	UP	2 *	Internal
0	58:bfea:ba:b1:e0	Enable	UP	6 *	Enable	UP	8 *	Internal
0	a4:18:75:c2:55:10	Enable	UP	11 *	Enable	UP	1 *	Internal
0	1c:17:d3:32:27:00	Enable	UP	11 *	NA	NA	7 *	Internal
0	64:a0:e7:b0:78:30	Enable	UP	1 *	Enable	UP	3	External
0	3c:ce:73:70:0a:50	Enable	UP	11 *	Enable	UP	8 *	External
0	18:33:9d:ff:b1:60	Enable	UP	11 *	Enable	UP	5 *	Internal
0	64:a0:e7:dd:68:40	Enable	UP	11 *	Enable	UP	2 *	Internal
0	2c:36:f8:0f:9c:e0	Enable	UP	11 *	Enable	UP	2 *	External
0	64:a0:e7:db:87:20	Enable	UP	1 *	Enable	UP	3	Internal
0	9c:4c:20:73:88:10	Enable	UP	6 *	NA	NA	6 *	Internal
0	00:1d:a1:75:b8:80	Enable	UP	1 *	NA	NA	5 *	Internal
0	64:a0:e7:91:3c:20	Enable	UP	11 *	Enable	UP	3	Internal
0	3c:ce:73:6c:51:70	Enable	UP	1 *	Enable	UP	8 *	External

Figure 13-14 Selecting an AP for Manual Configuration.

802.11b/g/n Cisco APs > Configure

< back Apply

**General**

AP Name: ap-1  
 Admin Status: enable  
 Operational Status: UP  
 Slot #: 0

**RF Channel Assignment**

Current Channel: 1  
 Channel Width: 20 MHz  
 Assignment Method: Global  
 Note: Only Channels 1,6 and 11 are nonoverlapping

**11n Parameters**

11n Supported: Yes

**CleanAir**

CleanAir Capable: Yes  
 CleanAir Admin Status: Enable  
 \* CleanAir enable will take effect only if it is enabled on this band.  
 Number of Spectrum Expert connections: 0

**Antenna Parameters**

Antenna Type: Internal

**Tx Power Level Assignment**

Current Tx Power Level: 3  
 Assignment Method: Custom  
 Tx Power Level: 3

**Performance Profile**

View and edit Performance Profile for this AP  
 Performance Profile

Note: Changing any of the parameters causes the Radio to be taken down and thus may result in loss of connectivity for some clients.

Figure 13-15 Manually Setting the Transmit Power Level of an AP.

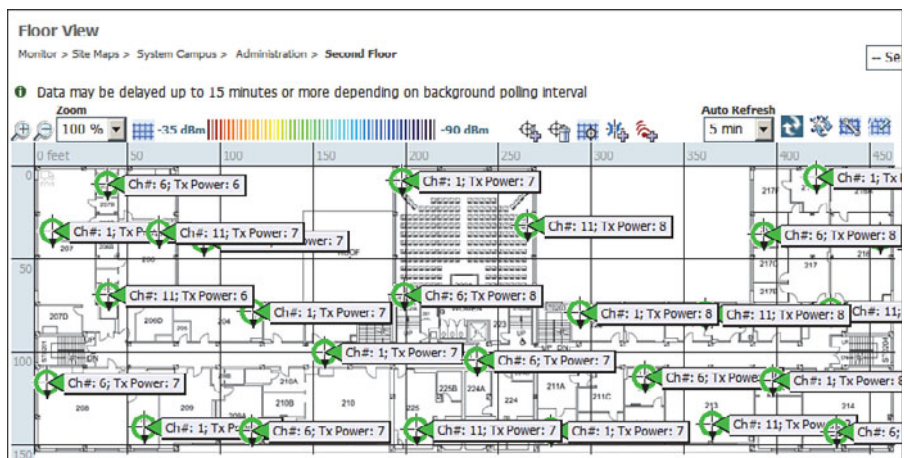


**Tip** You should let RRM automatically adjust both channels and transmit power levels whenever possible.

## Verifying RRM Results

The RRM algorithms can either run at regular intervals or on demand. You can display the channel number and transmit power level that are being used on every AP by selecting **Wireless > Access Points > Radios > 802.11a/n** or **802.11b/g/n**, as shown in Figure 13-15. The controller displays an asterisk next to values that have been set through RRM. Otherwise, if no asterisk appears, the value has been set manually.

To get a much better feel for the RRM results, you can use the CUWN management system (Cisco Network Control System [NCS] or Prime Infrastructure [PI], as covered in Chapters 18 through 20) to view APs on a graphical representation of an area. The NCS map in Figure 13-16 displays each AP's location on a building floor plan, along with its channel number and transmit power level. Seeing the physical arrangement of APs and their cells can help you get a much better idea how the channels are assigned and reused.



**Figure 13-16** Displaying RRM Results in Cisco NCS Maps.

## Exam Preparation Tasks

As mentioned in the section, “How to Use This Book,” in the Introduction, you have a couple of choices for exam preparation: the exercises here, Chapter 22, “Final Review,” and the exam simulation questions on the CD-ROM.

### Review All Key Topics

Review the most important topics in this chapter, noted with the Key Topic icon in the outer margin of the page. Table 13-4 lists a reference of these key topics and the page numbers on which each is found.

**Table 13-4** *Key Topics for Chapter 13*

Key Topic Element	Description	Page Number
List	Data rate states	263
Figure 13-7	RF group formation	268
Figure 13-9	TPC operation	269
Table 13-2	AP transmit power level numbers	271
Figure 13-11	DCA operation	272
List	Coverage hole detection criteria	275



### Define Key Terms

Define the following key terms from this chapter and check your answers in the glossary:

coverage hole, DCA, mandatory data rate, RRM, RF group, RF group leader, supported data rate, TPC



---

This chapter covers the following topics:

- **Anatomy of a Secure Connection**—This section provides an overview of the types of information that should be protected over a wireless connection and the functions that you can use to provide protection.
- **Wireless Client Authentication Methods**—This section describes many of the common methods that you can use to authenticate clients on a wireless network.
- **Wireless Privacy and Integrity Methods**—This section discusses two methods that you can leverage to keep data obscured from eavesdroppers and to discover when data has been tampered with over a wireless connection.
- **WPA and WPA2**—This section explains two important industry standards that specify a suite of security methods for wireless security.
- **Securing Management Frames with MFP**—This section discusses a method that you can use to prevent attacks that use management frames to disrupt a wireless network.
- **Configuring Wireless Security**—This section covers the configuration steps needed to implement WPA and WPA2 security on a wireless LAN.

This chapter covers the following exam topics:

- Describe 802.11 authentication and encryption methods (Open, Shared, 802.1X, EAP, TKIP, and AES)
- Describe the general framework of wireless security and security components (authentication, encryption, MFP, and IPS)

## Wireless Security Fundamentals

---

- Describe and configure authentication methods (Guest, PSK, 802.1X, WPA/WPA2 with EAP-TLS, EAP-FAST, PEAP, and LEAP)
- Describe and configure encryption methods (WPA/WPA2 with TKIP, and AES)
- Describe and configure the different sources of authentication (PSK, EAP-local or -external, and Radius)

As you know by now, wireless networks are complex. Many technologies and protocols work behind the scenes to give end users a stable, yet mobile, connection to a wired network infrastructure. From the user's perspective, a wireless connection should seem no different than a wired connection. A wired connection can give users a sense of security; data traveling over a wire is probably not going to be overheard by others. A wireless connection is inherently different; data traveling over the air can be overheard by anyone within range.

Therefore, securing a wireless network becomes just as important as any other aspect. A comprehensive approach to wireless security focuses on the following areas:

- Identifying the endpoints of a wireless connection
- Identifying the end user
- Protecting the wireless data from eavesdroppers
- Protecting the wireless data from tampering

The identification process is performed through various authentication schemes. Protecting wireless data involves security functions like encryption and frame authentication.

This chapter covers many of the methods you can use to secure a wireless network. Be warned—wireless security can be a confusing topic because it is filled with many acronyms. Some of the acronyms rhyme like words from a children's book. In fact, this chapter is a story about WEP, PSK, TKIP, MIC, AES, EAP, EAP-FAST, EAP-TLS, LEAP, PEAP, WPA, WPA2, CCMP, and on and on it goes. When you finish with this chapter, though, you will come away with a clear view of what these terms mean and how they all fit together.

As a CCNA Wireless engineer, you will need to have a basic understanding of the wireless security framework and the common methods you can use to build it. You will also need to know how to configure the most robust methods in a wireless network.

## “Do I Know This Already?” Quiz

The “Do I Know This Already?” quiz allows you to assess whether you should read this entire chapter thoroughly or jump to the “Exam Preparation Tasks” section. If you are in doubt about your answers to these questions or your own assessment of your knowledge of the topics, read the entire chapter. Table 14-1 lists the major headings in this chapter and their corresponding “Do I Know This Already?” quiz questions. You can find the answers in Appendix A, “Answers to the ‘Do I Know This Already?’ Quizzes.”

**Table 14-1** “Do I Know This Already?” Section-to-Question Mapping

Foundation Topics Section	Questions
Anatomy of a Secure Connection	1–2
Wireless Client Authentication Methods	3–7
Wireless Privacy and Integrity Methods	8
WPA and WPA2	9–10
Securing Management Frames with MFP	11
Configuring Wireless Security	12

**Caution** The goal of self-assessment is to gauge your mastery of the topics in this chapter. If you do not know the answer to a question or are only partially sure of the answer, you should mark that question as wrong for purposes of the self-assessment. Giving yourself credit for an answer you correctly guess skews your self-assessment results and might provide you with a false sense of security.

1. Which of the following are necessary components of a secure wireless connection? (Choose all that apply.)
  - a. Encryption
  - b. MIC
  - c. Authentication
  - d. WIPS
  - e. All of these answers
2. Which one of the following is used to protect the integrity of data in a wireless frame?
  - a. WIPS
  - b. WEP

- c. MIC
  - d. EAP
- 3. Which one of the following is a wireless encryption method that has been found to be vulnerable and is not recommended for use?
  - a. AES
  - b. WPA
  - c. EAP
  - d. WEP
- 4. Which one of the following is used as the 802.11 authentication method when 802.1x is used on a WLAN?
  - a. Open authentication
  - b. WEP
  - c. EAP
  - d. WPA
- 5. A Cisco WLC is configured for 802.1x authentication, using an external RADIUS server. The controller takes on which one of the following roles?
  - a. Authentication server
  - b. Supplicant
  - c. Authenticator
  - d. Adjudicator
- 6. Which one of the following authentication methods uses a certificate to authenticate the AS but not the client?
  - a. LEAP
  - b. PEAP
  - c. EAP-FAST
  - d. EAP-TLS
- 7. Which one of the following authentication methods requires digital certificates on both the AS and the supplicants?
  - a. TKIP
  - b. PEAP
  - c. WEP
  - d. EAP-TLS

- 8.** Which one of the following is currently the most secure data encryption and integrity method for wireless data?
  - a.** WEP
  - b.** TKIP
  - c.** CCMP
  - d.** WPA
  
- 9.** WPA2 differs from WPA in which one of the following ways?
  - a.** Allows TKIP
  - b.** Allows CCMP
  - c.** Allows WEP
  - d.** Allows TLS
  
- 10.** A pre-shared key is used in which of the following wireless security configurations?
  - a.** WPA personal mode
  - b.** WPA enterprise mode
  - c.** WPA2 personal mode
  - d.** WPA2 enterprise mode
  
- 11.** Which of the following is required to implement MFP on a WLAN to protect both the wireless infrastructure and the client? (Select all that apply.)
  - a.** WPA
  - b.** WPA2
  - c.** CCXv4 or v5
  - d.** CCXv5
  - e.** WEP
  
- 12.** Which one of the following options should you select to configure WPA2 personal on a WLAN?
  - a.** 802.1x
  - b.** PSK
  - c.** TKIP
  - d.** CCMP

---

## Foundation Topics

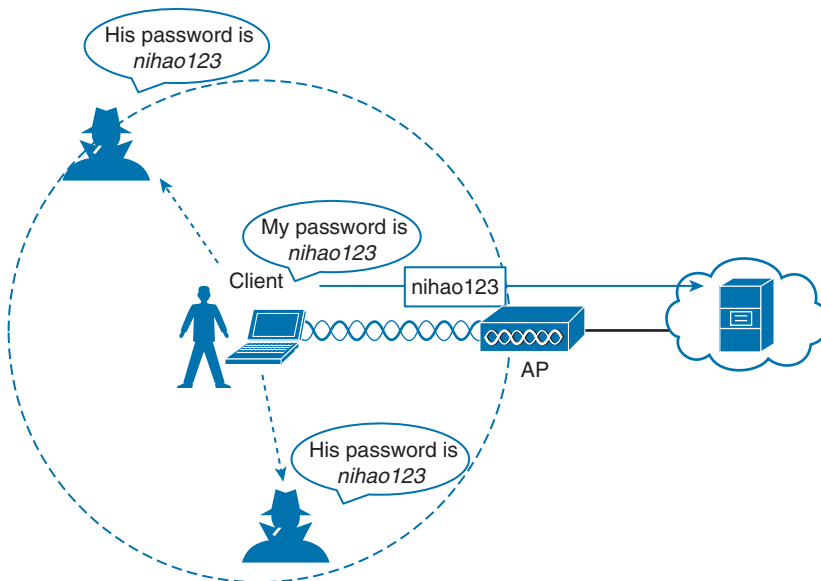
---

### Anatomy of a Secure Connection

In the previous chapters of this book, you have learned about wireless clients forming associations with wireless access points (APs) and passing data back and forth across the air. The main focus has been on the radio frequency (RF) conditions, the modulation schemes, and the management of airtime that are all necessary to send data from one place to another successfully.

As long as all clients and APs conform to the 802.11 standard, they can all coexist—even on the same channel. Not every 802.11 device is friendly and trustworthy, however. Sometimes it is easy to forget that transmitted frames do not just go directly from the sender to the receiver, as in a wired or switched connection. Instead, they travel according to the transmitter's antenna pattern, potentially reaching any receiver that is within range.

Consider the scenario in Figure 14-1. The wireless client opens a session with some remote entity and shares a confidential password. Because two untrusted users are also located within range of the client's signal, they may also learn the password by capturing frames that have been sent on the channel. The convenience of wireless communication also makes it easy for transmissions to be overheard and exploited by malicious users.



**Figure 14-1** *Wireless Transmissions Reaching Unintended Recipients.*

If data is sent through open space, how can it be secured so that it stays private and intact? The 802.11 standard offers a framework of wireless security mechanisms that



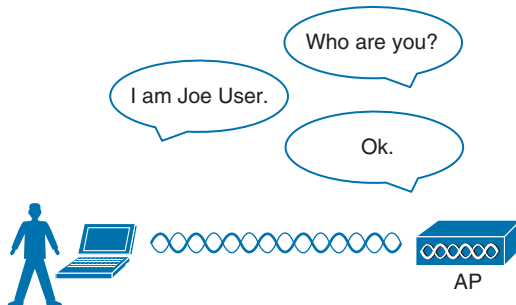
can be used to add trust, privacy, and integrity to a wireless network. A Cisco Unified Wireless Network (CUWN) can go even further by detecting and preventing malicious activity. The following sections give an overview of the wireless security framework. Each element is described in more detail later in the chapter.

## Authentication

In Chapter 6, “Understanding 802.11 Frame Types,” you learned that wireless clients must discover a basic service set (BSS) and then request permission to associate with it. Clients should be authenticated by some means before they can become functioning members of the wireless LAN. Why?

Suppose that your wireless network connects to corporate resources where confidential information can be accessed. In that case, only devices known to be trusted and expected should be given access. Guest users, if they are permitted at all, should be allowed to join a different guest WLAN where they can access nonconfidential or public resources. Rogue clients, which are not expected or welcomed, should not be permitted to associate at all. After all, they are not affiliated with the corporate network and are likely to be unknown devices that happen to be within range of your network.

To control access, wireless networks can authenticate the client devices before they are allowed to associate. Potential clients must identify themselves by presenting some form of credentials to the APs. Figure 14-2 shows the basic client authentication process.



**Figure 14-2** *Authenticating a Wireless Client.*

Wireless authentication can take many forms. Some methods require only a static text string that is common across all trusted clients and APs. The text string is stored on the client device and presented directly to the AP when needed. What might happen if the device was stolen or lost? Most likely, any user who possessed the device could still authenticate to the network. Other more stringent authentication methods require interaction with a corporate user database. In those cases, the end user must enter a valid username and password—something that would not be known to a thief or an imposter.

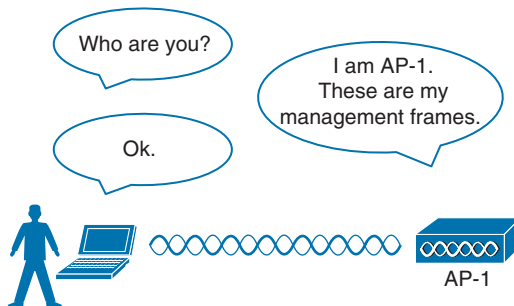
If you have ever joined a wireless network, you might have focused on authenticating your device or yourself, while implicitly trusting the nearest AP. For example, if you turn on your wireless device and find a wireless network that is available at your workplace, you probably join it without hesitating. The same is true for wireless networks in

an airport, a hotel, a hot spot, or in your home—you expect the AP that is advertising the SSID to be owned and operated by the entity where you are located. But how can you be sure?

Normally, the only piece of information you have is the SSID being broadcast or advertised by an AP. If the SSID looks familiar, you will likely choose to join it. Perhaps your computer is configured to automatically connect to a known SSID so that it associates without your intervention. Either way, you might unwittingly join the same SSID even if it was being advertised by an imposter.

Some common attacks focus on a malicious user pretending to be an AP. The fake AP can send beacons, answer probes, and associate clients just like the real AP it is impersonating. Once a client associates with the fake AP, the attacker can easily intercept all communication to and from the client from its central position. A fake AP could also send spoofed management frames to disassociate or deauthenticate legitimate and active clients, just to disrupt normal network operation.

To prevent this type of man-in-the-middle attack, the client should authenticate the AP before it associates. Figure 14-3 shows a simple scenario. Even further, any management frames received by a client should be authenticated too, as proof that they were sent by a legitimate and expected AP.



**Figure 14-3** *Authenticating a Wireless AP.*

## Message Privacy

Suppose that the client in Figure 14-3 must authenticate before joining the wireless network. It might also authenticate the AP and its management frames. The client's relationship with the AP might become much more trusted, but data passing to and from the client is still available to eavesdroppers on the same channel.

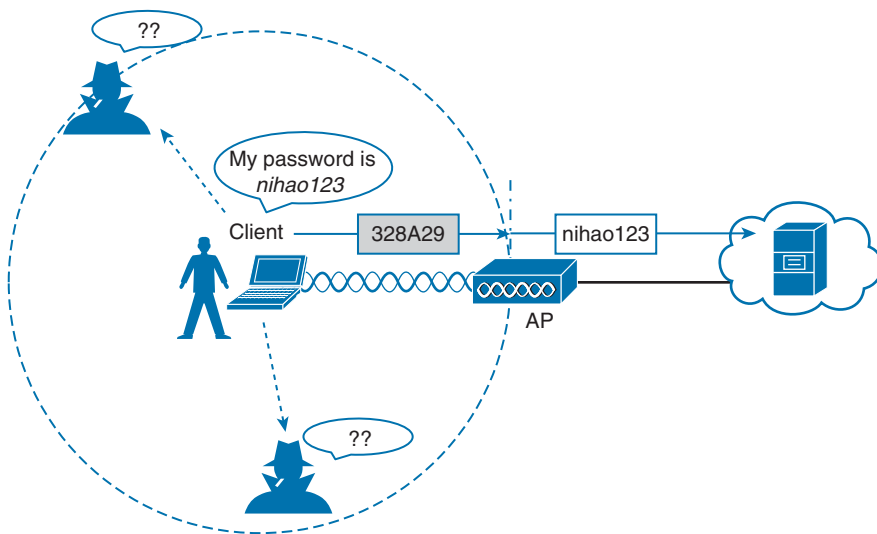
To protect data privacy on a wireless network, the data should be encrypted for its journey through free space. This is accomplished by encrypting the data payload in each wireless frame just prior to being transmitted, then decrypting it as it is received. The idea is to use an encryption method that the transmitter and receiver share, so the data can be encrypted and decrypted successfully.

In wireless networks, each WLAN supports only one authentication and encryption scheme, so all clients must use the same encryption method when they associate. You

might think that having one encryption method in common would allow every client to eavesdrop on every other client. That is not necessarily the case because the AP should securely negotiate an encryption key to use for each associated client.

Ideally, the AP and a client are the only two devices that have the encryption keys in common so that they can understand each other's data. No other device should know about or be able to use the same keys to eavesdrop and decrypt the data. In Figure 14-4, the client's confidential password information has been encrypted before being transmitted. The AP can decrypt it successfully before forwarding it onto the wired network, but other wireless devices cannot.

The AP also maintains a “group key” that it uses when it needs to send encrypted data to all clients in its cell at one time. Each of the associated clients uses the same group key to decrypt the data.



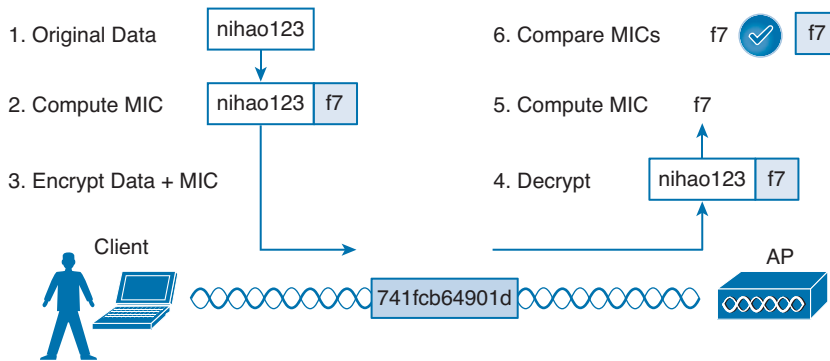
**Figure 14-4** *Encrypting Wireless Data to Protect Data Privacy.*

## Message Integrity

Encrypting data obscures it from view while it is traveling over a public or untrusted network. The intended recipient should be able to decrypt the message and recover the original contents, but what if someone managed to alter the contents along the way? The recipient would have a very difficult time discovering that the original data had been modified.

A message integrity check (MIC) is a security tool that can protect against data tampering. You can think of MIC as a way for the sender to add a secret stamp inside the encrypted data frame. The stamp is based on the contents of the data bits to be transmitted. Once the recipient decrypts the frame, it can compare the secret stamp to its own idea of what the stamp should be, based on the data bits that were received. If the two

stamps are identical, the recipient can safely assume that the data has not been tampered with. Figure 14-5 shows the MIC process.



**Figure 14-5** Checking Message Integrity over a Wireless Network.

## Intrusion Protection

Many of the tools in the wireless security framework operate as choreographed steps between a client and an AP. Because both the client and the AP are active participants in securing the connection between them, the data they are exchanging can be protected. In other words, much of the security framework focuses on keeping attackers from joining the wireless network and from tampering with existing associations.

Wireless attacks do not stop there; they can involve malicious activity from a variety of angles or vectors. A wireless intrusion protection system (wIPS) can monitor wireless activity and compare that against a database of known signatures or patterns. Cisco APs can recognize some signatures and inform their controllers. Controllers also have a set of signatures that can match against data coming from many APs. The Cisco Wireless Control System (WCS), Cisco Prime Network Control System (NCS), and Cisco Prime Infrastructure (PI) are wireless management systems that can go even further by recognizing a rich set of signatures, implementing customizable wIPS policies, and integrating with Cisco Mobility Services Engine (MSE) for granular analysis. Chapter 18, “Managing Wireless Networks with WCS,” discusses these management platforms in greater detail.

For the CCNA Wireless exam, you should understand the basics of wireless IPS. Know that wireless security threats can be grouped into the following categories:

- Rogue devices
- Ad hoc networks
- Client association issues
- Passive or active attacks

Despite your best efforts to configure and secure every piece of your wireless network, someone could always bring in his own AP or wireless router and connect it to the wired network. A rogue AP is one that is not part of your wireless infrastructure but that is

close enough to be overheard or to cause interference. Any clients that associate with a rogue AP are known as *rogue clients*. Cisco controllers can discover both.

Controllers can collect beacon information that is overheard by legitimate APs. Rogue detection algorithms running on the controllers and WCS/NCS can classify APs as rogue if they do not appear in the database of APs known to your network. As a wireless network administrator, you can override the classification and declare an AP as either friendly or rogue.

When coupled with an MSE, the wIPS can locate rogue APs so that you can go and find them. The wIPS process can even transmit special probe frames to determine if a rogue AP is connected to your wired network. This happens if the probe frames are received by the rogue over the air and then delivered back to the controller through the wired network.

The wIPS can go one step further and attempt to contain the rogue so that it does not become a security risk to your own network. Over-the-air rogue containment works by listening for any wireless clients that associate with a rogue AP. The controller then sends spoofed deauthentication frames to those clients so that they think the rogue AP has dropped them.

Based on information gathered by the controllers, wIPS can detect many types of wireless network attacks. Attacks can range from completely passive, such as an eavesdropper silently capturing wireless frames, to active ones that attempt to disrupt wireless service. For example, an attacker might send a flood of association requests to an AP to overwhelm it with fake potential clients—to the point where the AP can no longer service real clients. Another type of attack is similar to Cisco's rogue containment, where the attacker sends spoofed deauthentication frames to legitimate clients to continually knock them off the network.

**Tip** Although you should not need to know the specifics about wIPS and attack signatures, you can investigate further on your own by navigating to **Security > Wireless Protection Policies** on a controller and **Configure > wIPS Profiles** on WCS/NCS.

## Wireless Client Authentication Methods

You can use many different methods to authenticate wireless clients as they try to associate with the network. The methods have been introduced over time, and have evolved as security weaknesses have been exposed and wireless hardware has advanced. This section covers the most common authentication methods you might encounter.

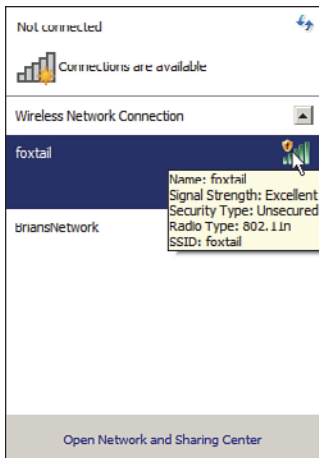
### Open Authentication

In Chapter 6, you learned about the frames that are used when a client asks to join a wireless network. The original 802.11 standard offered only two choices to authenticate a client: open authentication and WEP.

Open authentication is true to its name; it offers open access to a WLAN. The only requirement is that a client must use an 802.11 authentication request before it attempts to associate with an AP. No other credentials are needed.

When would you want to use open authentication? After all, it does not sound very secure, because it is not. With no challenge, any client may authenticate to access the network. This strategy is most often used in public places that offer wireless hot spots. If any client screening is used at all, it comes in the form of web authentication. A client can associate right away, but must open a web browser to see and accept the terms for use and enter basic credentials. From that point, network access is opened up for the client.

You have probably seen a WLAN with open authentication when you have visited a public location. Most client operating systems flag such networks to warn you that your wireless data will not be secured in any way if you join. Figure 14-6 shows an open WLAN discovered on a Windows-based client. Notice the shield-shaped caution icon and the security type Unsecured.



**Figure 14-6** *Discovering a WLAN with Open Authentication.*

## WEP

As you might expect, open authentication offers nothing that can obscure or encrypt the data being sent between a client and an AP. As an alternative, the 802.11 standard has traditionally defined the Wireless Equivalent Privacy (WEP) as a method to make a wireless link more like or equivalent to a wired connection.

WEP uses the RC4 cipher algorithm to make every wireless data frame private and hidden from eavesdroppers. The same algorithm encrypts data at the sender and decrypts it at the receiver. The algorithm uses a string of bits as a key, commonly called a WEP key, to derive other encryption keys—one per wireless frame. As long as the sender and receiver have an identical key, one can decrypt what the other encrypts.

You can configure up to four WEP keys to be used on a WLAN, although only one of them can be active. The key number is included in the wireless frame so that the sender and receiver can know which one of the four to use.

WEP is known as a shared-key security method. The same key must be shared between the sender and receiver ahead of time, so that each can derive other mutually agreeable encryption keys. In fact, every potential client and AP must share the same key ahead of time so that any client can associate with the AP.

The WEP key can also be used as an optional authentication method as well as an encryption tool. Unless a client can use the correct WEP key, it cannot associate with an AP. The AP tests the client's knowledge of the WEP key by sending it a random challenge phrase. The client encrypts the challenge phrase with WEP and returns the result to the AP. The AP can compare the client's encryption with its own to see whether the two WEP keys yield identical results.

WEP keys can be either 40 or 104 bits long, represented by a string of 10 or 26 hex digits. As a rule of thumb, longer keys offer more unique bits for the algorithm, resulting in more robust encryption. Except in WEP's case, that is. Because WEP was defined in the original 802.11 standard in 1999, every wireless adapter was built with encryption hardware specific to WEP. In 2001, a number of weaknesses were discovered and revealed, so work began to find better wireless security methods. By 2004, the 802.11i amendment was ratified and WEP was officially deprecated. Both WEP encryption and WEP shared-key authentication are widely considered to be weak methods to secure a wireless LAN.

You might think such a clear call to move away from a weak or flawed security method would be easy and quick to achieve. In practice, it has taken many years to move away from WEP. Why?

Because WEP was implemented in wireless adapter hardware, any better security schemes had to leverage variations of WEP without the benefit of new cryptographic hardware. Wireless hardware manufacturers are usually reluctant to commit to build products until the technology is firmly established in the IEEE 802.11 standard. Therefore, WEP was an underlying theme for a very long time. In fact, for backward compatibility, you will still find it supported by clients, APs, and controllers even today. As you work through the rest of this chapter, notice how wireless security schemes have evolved and improved, and notice how many of them leverage WEP to some extent.

## **802.1x/EAP**

With only open authentication and WEP available in the original 802.11 standard, a more secure authentication method was needed. Client authentication generally involves some sort of challenge, a response, and then a decision to grant access. Behind the scenes, it can also involve an exchange of session or encryption keys, in addition to other parameters needed for client access. Each authentication method might have unique requirements as a unique way to pass information between the client and the AP.

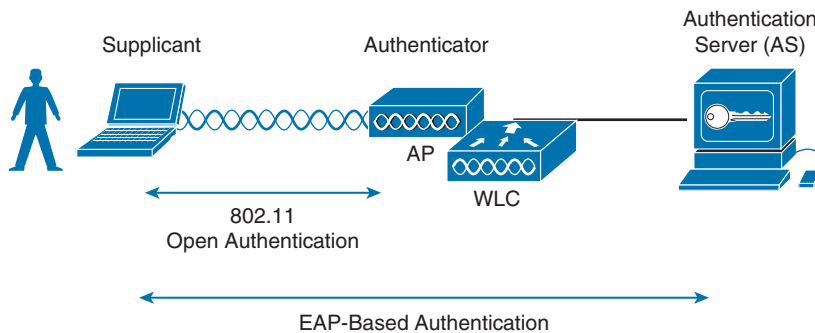
Rather than build additional authentication methods into the 802.11 standard, a more

flexible and scalable authentication framework, the Extensible Authentication Protocol (EAP), was chosen. As its name implies, EAP is extensible and does not consist of any one authentication method. Instead, EAP defines a set of common functions that actual authentication methods can use to authenticate users. As you read through this section, notice how many authentication methods have *EAP* in their names. Each method is unique and different, but each one follows the EAP framework.

EAP has another interesting quality: It can integrate with the IEEE 802.1x port-based access control standard. When 802.1x is enabled, it limits access to a network media until a client authenticates through an EAP method. This means that a wireless client might be able to associate with an AP, but will not be able to pass data to any other part of the network until it successfully authenticates.

With open and WEP authentication, wireless clients are authenticated locally at the AP without further intervention. The scenario changes with 802.1x; the client uses open authentication to associate with the AP, and then the actual client authentication process occurs at a dedicated authentication server. Figure 14-7 shows the three-party 802.1x arrangement that consists of the following entities:

- **Supplicant**—The client device that is requesting access
- **Authenticator**—The network device that provides access to the network (usually a wireless LAN controller [WLC])
- **Authentication Server (AS)**—The device that takes user or client credentials and permits or denies network access based on a user database and policies (usually a RADIUS server)



**Figure 14-7** 802.1x Client Authentication Roles.

The controller becomes a middleman in the client authentication process, controlling user access with 802.1x and communicating with the authentication server using the EAP framework.

The following sections provide an overview of several common EAP-based authentication methods.



## LEAP

As an early attempt to address the weaknesses in WEP, Cisco developed a proprietary wireless authentication method called Lightweight EAP (LEAP). To authenticate, the client must supply username and password credentials. Both the authentication server and the client exchange challenge messages that are then encrypted and returned. This provides mutual authentication; as long as the messages can be decrypted successfully, the client and the AS have essentially authenticated each other.

At the time, WEP-based hardware was still widely used. Therefore, LEAP attempted to overcome WEP weaknesses by using dynamic WEP keys that changed frequently. Nevertheless, the method used to encrypt the challenge messages was found to be vulnerable, so LEAP has since been deprecated. Even though wireless clients and controllers still offer LEAP, you should not use it.

## EAP-FAST

Cisco developed a more secure method called EAP Flexible Authentication by Secure Tunneling (EAP-FAST). Authentication credentials are protected by passing a protected access credential (PAC) between the AS and the supplicant. The PAC is a form of shared secret that is generated by the AS and used for mutual authentication.

After the supplicant and AS have authenticated each other, they negotiate a Transport Layer Security (TLS) tunnel. The end user can then be authenticated through the TLS tunnel for additional security.

Notice that two separate authentication processes occur in EAP-FAST—one between the AS and the supplicant and another with the end user. These occur in a nested fashion, as an outer authentication (outside the TLS tunnel) and an inner authentication (inside the TLS tunnel).

Like other EAP-based methods, a RADIUS server is required. However, the RADIUS server must also operate as an EAP-FAST server to be able to generate PACs, one per user. EAP-FAST has a known vulnerability, but is still considered to be secure provided that rogue APs and supplicants are managed well.

## PEAP

Like EAP-FAST, the Protected EAP (PEAP) method uses an inner and outer authentication; however, the AS presents a digital certificate to authenticate itself with the supplicant in the outer authentication. If the supplicant is satisfied with the identity of the AS, the two will build a TLS tunnel to be used for the inner client authentication and encryption key exchange.

The digital certificate of the AS consists of data in a standard format that identifies the owner and is “signed” or validated by a third party. The third party is known as a certificate authority (CA) and is known and trusted by both the AS and the supplicants. The supplicant must also possess the CA certificate just so that it can validate the one it receives from the AS. The certificate is also used to pass a public key, in plain view, which can be used to help decrypt messages from the AS.

Notice that only the AS has a certificate for PEAP. That means the supplicant can readily authenticate the AS. The client does not have or use a certificate of its own, so it must be authenticated within the TLS tunnel using one of the following two methods:

- **MSCHAPv2**—Microsoft Challenge Authentication Protocol
- **GTC**—Generic Token Card; a hardware device that generates one-time passwords for the user or a manually generated password

## EAP-TLS

PEAP leverages a digital certificate on the AS as a robust method to authenticate the RADIUS server. It is easy to obtain and install a certificate on a single server, but the clients are left to identify themselves through other means. EAP Transport Layer Security (EAP-TLS) goes one step further by requiring certificates on the AS and on every client device.

With EAP-TLS, the AS and the supplicant exchange certificates and can authenticate each other. A TLS tunnel is built afterward so that the client can be authenticated and encryption key material can be securely exchanged.

EAP-TLS is considered to be the most secure wireless authentication method available; however, implementing it can sometimes be complex. Along with the AS, each wireless client must obtain and install a certificate. Manually installing certificates on hundreds or thousands of clients can be impractical. Instead, you would need to implement a Public Key Infrastructure (PKI) that could supply certificates securely and efficiently and revoke them when a client or user should no longer have access to the network. This usually involves setting up your own CA or building a trust relationship with a third-party CA that can supply certificates to your clients.

**Tip** EAP-TLS is practical only if the wireless clients can accept and use digital certificates. Many wireless devices, such as communicators, medical devices, and RFID tags, have an underlying operating system that cannot interface with a CA or use certificates.

## Wireless Privacy and Integrity Methods

The original 802.11 standard supported only one method to secure wireless data from eavesdroppers: WEP. As you have learned in this chapter, WEP has been compromised, deprecated, and can no longer be recommended. What other options are available to encrypt data and protect its integrity as it travels through free space?

### TKIP

During the time when WEP was embedded in wireless client and AP hardware, yet was known to be vulnerable, the Temporal Key Integrity Protocol (TKIP) was developed.

TKIP is the product of the 802.11i working group and the Wi-Fi Alliance.

TKIP adds the following security features using legacy hardware and the underlying WEP encryption:

- **MIC**—An efficient algorithm to add a hash value to each frame as a message integrity check to prevent tampering; commonly called “Michael” as an informal reference to MIC.
- **Time stamp**—A time stamp is added into the MIC to prevent replay attacks that attempt to reuse or replay frames that have already been sent
- **Sender’s MAC address**—The MIC also includes the sender’s MAC address as evidence of the frame source.
- **TKIP sequence counter**—Provides a record of frames sent by a unique MAC address, to prevent frames from being replayed as an attack.
- **Key mixing algorithm**—Computes a unique 128-bit WEP key for each frame.
- **Longer Initialization Vector (IV)**—The IV size is doubled from 24 to 48 bits, making it virtually impossible to exhaust all WEP keys by brute force calculation.

TKIP became a reasonably secure stopgap security method, buying time until the 802.11i standard could be ratified. Some attacks have been created against TKIP, so it, too, should be avoided if a better method is available. In fact, TKIP was deprecated in the 802.11-2012 standard.

## CCMP

The Counter/CBC-MAC Protocol (CCMP) is that better method. CCMP consists of two algorithms:

- AES counter mode encryption
- Cipher Block Chaining Message Authentication Code (CBC-MAC) used as a message integrity check

The Advanced Encryption Standard (AES) is the current encryption algorithm adopted by U.S. National Institutes of Standards and Technology (NIST) and the U.S. government, and widely used around the world. In other words, AES is open, publicly accessible, and represents the most secure encryption method available today.

Before CCMP can be used to secure a wireless network, the client devices and APs must support the AES counter mode and CBC-MAC in hardware. CCMP cannot be used on legacy devices that support only WEP or TKIP. How can you know if a device supports CCMP? Look for the WPA2 designation, which is described in the following section.

## WPA and WPA2

This chapter covers a variety of authentication methods and encryption and message integrity algorithms. When it comes time to configure a WLAN with wireless security, should you try to select some combination of schemes based on which one is best or which one is not deprecated? Which authentication methods are compatible with which encryption algorithms?

The Wi-Fi Alliance has worked out a couple of ways to do that. The IEEE 802.11i standard defines best practice wireless security methods. While that standard was still being developed, the Wi-Fi Alliance introduced its Wi-Fi Protected Access (WPA) industry standard. WPA was based on parts of 802.11i and included 802.1x authentication, TKIP, and a method for dynamic encryption key management.

Once 802.11i was ratified and published, the Wi-Fi Alliance included it in full in its WPA Version 2 (WPA2) standard. WPA2 offers the capabilities of WPA, to be backward compatible, while adding the superior CCMP algorithms. Table 14-2 summarizes the simple differences between WPA and WPA2.

**Table 14-2** *Comparing WPA and WPA2*

	WPA	WPA2
Authentication	Pre-shared key or 802.1x	Pre-shared key or 802.1x
Encryption and MIC	TKIP	TKIP or CCMP
Key management	Dynamic key management	Dynamic key management



Notice that WPA and WPA2 specify 802.1x, which implies EAP-based authentication, but they do not require any specific EAP method. Instead, the Wi-Fi Alliance certifies interoperability with methods like EAP-TLS, PEAP, EAP-TTLS, and EAP-SIM.

The WPA and WPA2 standards also support two authentication modes, based on the scale of the deployment:

- **Personal mode**—A pre-shared key is used to authenticate clients on a WLAN.
- **Enterprise mode**—An 802.1x EAP-based authentication method must be used to authenticate clients.

**Tip** Personal mode is usually easier to deploy in a small environment or with clients that are embedded in certain devices. Be aware that every device using the WLAN must be configured with an identical pre-shared key. If you ever need to update or change the key, you must touch every device.

## Securing Management Frames with MFP

Normally, APs send 802.11 management frames on a BSS with no effort to secure the contents. When clients receive management frames, they assume that the frames were sent by legitimate APs that control their own BSSs. Malicious users can exploit this implicit trust by crafting their own spoofed management frames that appear to come from actual APs.

To mitigate attacks that leverage AP management frames, Cisco developed Management Frame Protection (MFP), which is available in the following two forms:

- **Infrastructure MFP**—To protect the integrity of management frames, APs add a MIC toward the end of each frame; other neighboring APs also participating in infrastructure MFP can determine whether overheard management frames have been tampered with and can alert their controllers.
- **Client MFP**—Protects the integrity of management frames through a MIC and encryption that only associated clients and neighboring APs can understand.

Notice that infrastructure MFP is based on a coordinated effort of APs only. Participating APs compute and tag management frames with a MIC value and then listen to detect any evidence of tampering. Wireless clients cannot participate.

Client MFP, in contrast, uses a MIC to protect management frame integrity and adds end-to-end encryption to protect the privacy of management frame contents. Clients must be capable of participating too, to decrypt the management frames and validate the MIC value. Clients using MFP can safely ignore any disassociation, deauthentication, and WMM quality of service action frames that are broadcast and any unicast frames that are not signed.

Clients must support CCXv5 and must use WPA2 with either TKIP or CCMP. This implies that the clients already have a secure relationship with the AP. This same secure link is used to send trusted management frames. The frames are encrypted in a way that only the MFP-capable client can understand.

## Configuring Wireless Security

Wireless security is fairly straightforward to configure. Each WLAN has its own security policies. You can configure the security settings when you create a new WLAN or you can edit the parameters of an existing one. Keep in mind that you should use WPA2 and CCMP as a best practice. You can select personal or enterprise mode based on your environment and its security policies.

According to the CCNA Wireless exam blueprint, you should know how to configure WPA and WPA2 with pre-shared keys and 802.1x. You should also know how to configure EAP and RADIUS support on Cisco wireless LAN controllers. These topics are covered in the following sections.

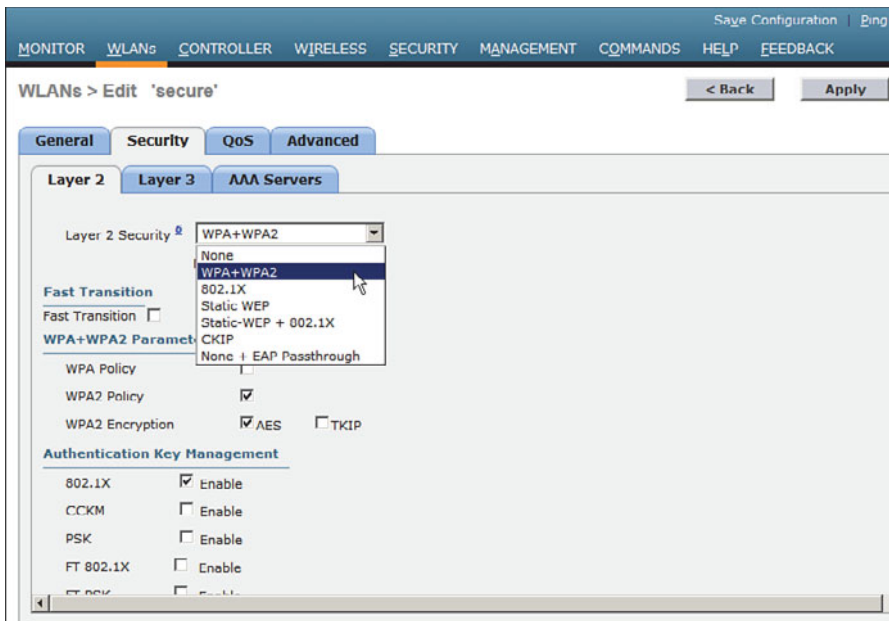
**Tip** Wireless security methods are configured on a per-WLAN basis. The configuration steps you learn in this chapter will be applied in Chapter 15, “Configuring a WLAN.”

## Configuring WPA or WPA2 Personal

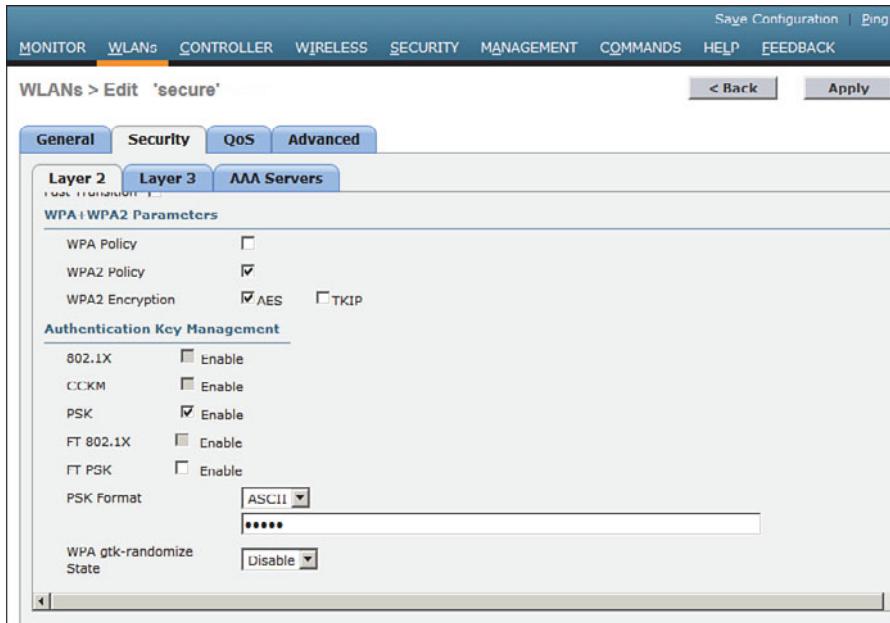
You can configure WPA or WPA2 personal mode and the pre-shared key in one step. Navigate to **WLANs** and select **Create New** or select the WLAN ID of an existing WLAN to edit. Make sure that the parameters on the **General** tab are set appropriately.

Next, select the **Security > Layer 2** tab. In the **Layer 2 Security** drop-down menu, select **WPA+WPA2**, as shown in Figure 14-8 for the WLAN named **secure**. In the **WPA+WPA2 Parameters** section of the **Layer 2** page, you can enable WPA or WPA2 with the **WPA Policy** and **WPA2 Policy** check boxes. In Figure 14-9, WPA2 has been selected. Be sure to select **AES** or **TKIP** as the WPA2 encryption type.

**Tip** The controller will allow you to enable both WPA and WPA2 check boxes. You should do that only if you have legacy clients that require WPA support and are mixed in with newer WPA2 clients. Be aware that the WLAN will only be as secure as the weakest security suite you configure on it. Ideally, you should use WPA2 with AES/CCMP and try to avoid any other hybrid mode. Hybrid modes such as WPA with AES and WPA2 with TKIP can cause compatibility issues; in addition, they will likely be deprecated soon.



**Figure 14-8** Selecting the WPA+WPA2 Security Suite for a WLAN.



**Figure 14-9** *Selecting WPA or WPA2, Encryption, and Authentication.*

For WPA or WPA2 personal mode, select **PSK** under the Authentication Key Management settings section. This will use a pre-shared key to authenticate clients on the WLAN. Be sure to click the **Apply** button to apply the WLAN changes you have made.

## Configuring WPA2 Enterprise Mode

You can use WPA2 enterprise mode to authenticate wireless clients with 802.1x and EAP through an external RADIUS server located somewhere on the wired network. You should begin by configuring one or more RADIUS servers on the controller. Navigate to **Security > AAA > RADIUS > Authentication**. Click the **New** button to define a new server or select the Server Index number to edit an existing server definition.

In Figure 14-10, a new RADIUS server is being defined. Enter the server's IP address and the shared secret key that the controller will use to communicate with the server. Make sure that the RADIUS port number is correct; if not, you can enter a different port number. The server status should be **Enabled**, as selected from the drop-down menu. You can disable a server to take it out of service if needed. To authenticate wireless clients, check the box next to **Network User**. Click the **Apply** button to apply the new settings.

Next, you will need to enable 802.1x authentication on the WLAN. Navigate to **WLANs** and select a new or existing WLAN to edit. Under the **Security > Layer 2** tab, select **WPA+WPA2** and make sure that the **WPA2 Policy** box is checked. Select **AES** as the encryption method, and then select **802.1x** under the Authentication Key Management section. Figure 14-11 illustrates the settings that are needed on the WLAN named MoreSecure.

The screenshot shows the 'RADIUS Authentication Servers > New' configuration page. The fields are as follows:

- Server Index (Priority): 1
- Server IP Address: 172.21.10.199
- Shared Secret Format: ASCII
- Shared Secret: [Redacted]
- Confirm Shared Secret: [Redacted]
- Key Wrap:  (Designed for FIPS customers and requires a key wrap compliant RADIUS server)
- Port Number: 1012
- Server Status: Enabled
- Support for RFC 3576: Enabled
- Server Timeout: 2 seconds
- Network User:  Enable
- Management:  Enable
- IPSec:  Enable

**Figure 14-10** Defining a RADIUS Server for WPA2 Enterprise Authentication.

**Tip** The default settings for a new WLAN are WPA2 with AES and 802.1x.

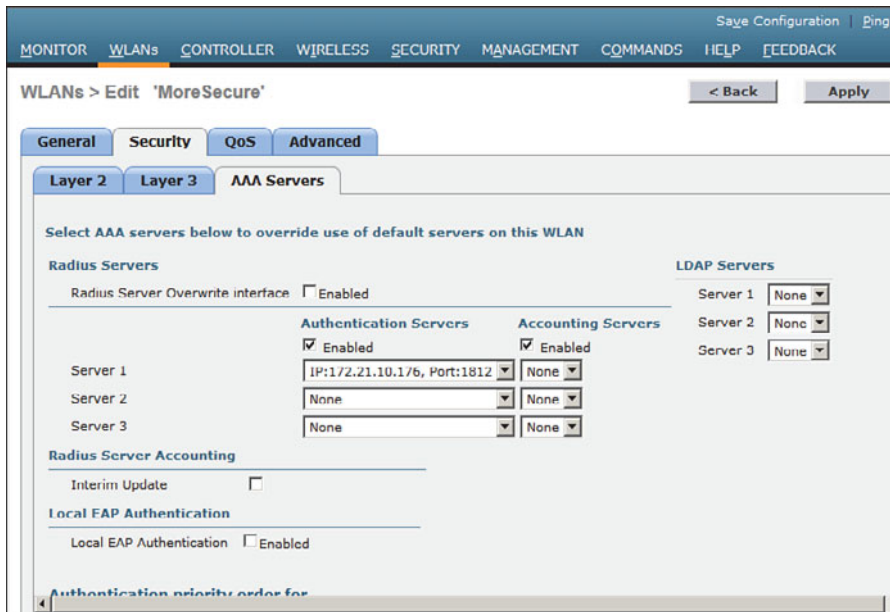
The screenshot shows the 'WLANs > Edit 'MoreSecure'' configuration page. The 'Security' tab is selected, and the 'AAA Servers' sub-tab is active. The configuration is as follows:

- Layer 2 Security: WPA+WPA2
- MAC Filtering:
- Fast Transition:
- WPA+WPA2 Parameters:
  - WPA Policy:
  - WPA2 Policy:
  - WPA2 Encryption:  AES  TKIP
- Authentication Key Management:
  - 802.1X:  Enable
  - CCKM:  Enable
  - PSK:  Enable
  - FT 802.1X:  Enable
  - FT PSK:  Enable
  - WPA gtk-randomize State: Disable

**Figure 14-11** Enabling WPA2 Enterprise Mode with 802.1x Authentication.



By default, a controller will use the global list of RADIUS servers in the order you have defined under Security > AAA > RADIUS > Authentication. You can override that list on the AAA Servers tab, where you can define which RADIUS servers will be used for 802.1x authentication. You can define up to three RADIUS servers that will be tried in sequential order, designated as Server 1, Server 2, and Server 3. Choose a predefined server by clicking the drop-down menu next to one of the server entries. In Figure 14-12, the RADIUS server at 172.21.10.176 will be used as Server 1. After you finish selecting servers, you can edit other WLAN parameters or click the **Apply** button to make your configuration changes operational.



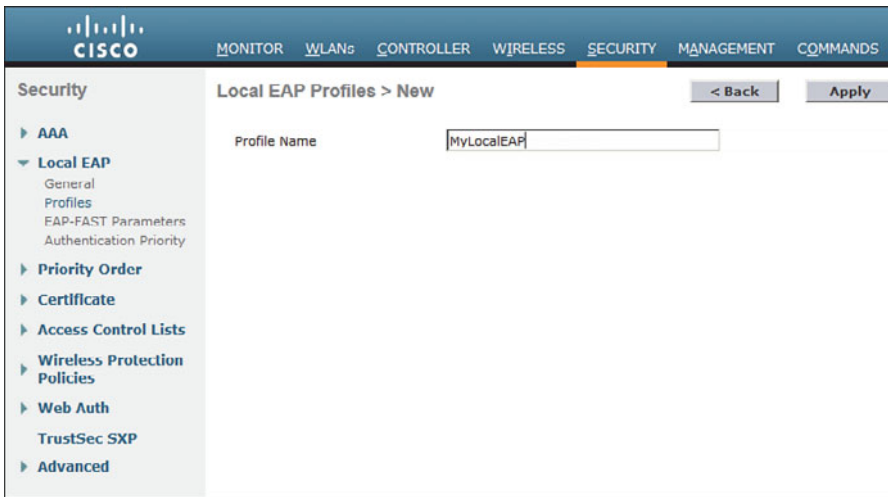
**Figure 14-12** *Selecting RADIUS Servers to Authenticate Clients in the WLAN.*

**Tip** As you worked through the WPA2 enterprise configuration, did you notice that you never saw an option to use a specific authentication method like PEAP or EAP-TLS? The controller only has to know that 802.1x will be in use. The actual authentication methods are configured on the RADIUS server. The client's supplicant must also be configured to match what the server is using.

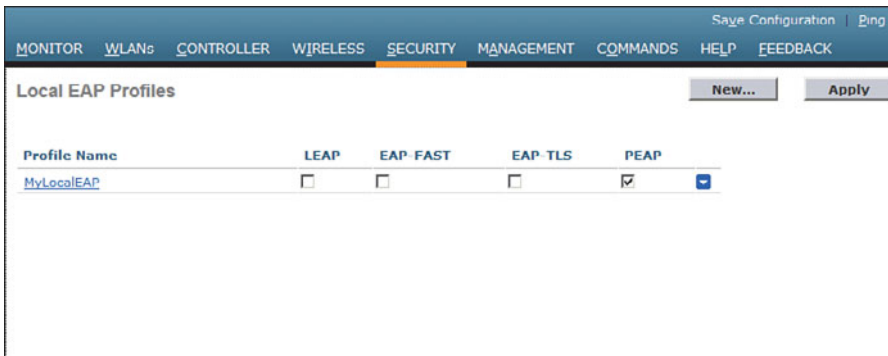
## Configuring WPA2 Enterprise with Local EAP

If your environment is relatively small or you do not have a RADIUS server in production, you can use an authentication server that is built in to the WLC. This is called local EAP, which supports LEAP, EAP-FAST, PEAP, and EAP-TLS.

First, you will need to define and enable the local EAP service on the controller. Navigate to **Security > Local EAP > Profiles** and click the **New** button. Enter a name for the local EAP profile, which will be used to define the authentication server methods. In Figure 14-13, a new profile called MyLocalEAP has been defined. Click the **Apply** button to create the profile. Now you should see the new profile listed, along with the authentication methods it supports, as shown in Figure 14-14. From this list, you can check or uncheck the boxes to enable or disable each method.



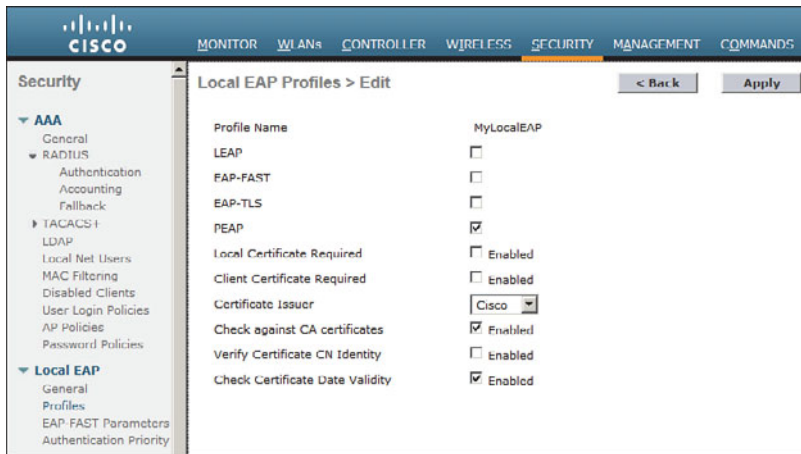
**Figure 14-13** Defining a Local EAP Profile on a Controller.



**Figure 14-14** Displaying Configured Local EAP Profiles.

Select the profile name to edit its parameters. In Figure 14-15, the profile named MyLocalEAP has been configured to use PEAP. Click the **Apply** button to activate your changes.

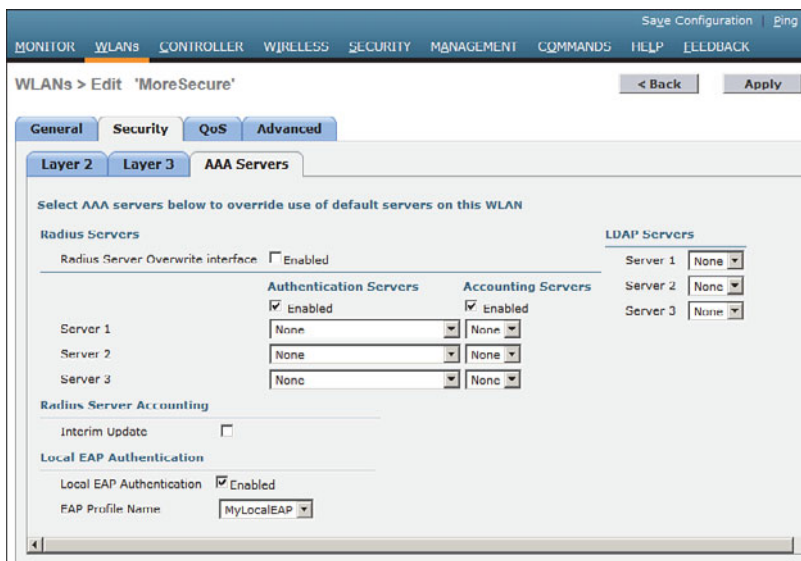
Next, you need to configure the WLAN to use the Local EAP server rather than a regular external RADIUS server. Navigate to WLANs, select the WLAN ID, and then select the **Security > Layer 2** tab and enable WPA2, AES, and 802.1x as before.



**Figure 14-15** Configuring a Local EAP Profile to Use PEAP.

If you have defined any RADIUS servers in the global list under Security > AAA > RADIUS > Authentication or any specific RADIUS servers in the WLAN configuration, the controller will use those first. Local EAP will then be used as a backup method.

To make Local EAP the primary authentication method, you must make sure that no RADIUS servers are defined on the controller. Select the AAA Servers tab and make sure that all three RADIUS servers use **None** from the drop-down menu. In the Local EAP Authentication section, check the **Enabled** box to begin using the Local EAP server. Select the EAP profile name that you have previously configured. In Figure 14-16, the Local EAP authentication server is enabled and will use the MyLocalEAP profile, which was configured for PEAP.



**Figure 14-16** Enabling Local EAP Authentication for a WLAN.

Because the Local EAP server is local to the controller, you will have to maintain a local database of users there too. You can create users by navigating to **Security > AAA > Local Net Users**.

---

## Exam Preparation Tasks

---

As mentioned in the section, “How to Use This Book,” in the Introduction, you have a couple of choices for exam preparation: the exercises here, Chapter 22, “Final Review,” and the exam simulation questions on the CD-ROM.

## Review All Key Topics

Review the most important topics in this chapter, noted with the Key Topic icon in the outer margin of the page. Table 14-3 lists a reference of these key topics and the page numbers on which each is found.

**Table 14-3** *Key Topics for Chapter 14*

Key Topic Element	Description	Page Number
List	802.1x entities	293
Table 14-2	WPA and WPA2 comparison	297



## Define Key Terms

Define the following key terms from this chapter and check your answers in the glossary:

802.1x, authentication server (AS), authenticator, certificate authority (CA), Counter/CBC-MAC Protocol (CCMP), EAP Flexible Authentication by Secure Tunneling (EAP-FAST), EAP-TLS, enterprise mode, Extensible Authentication Protocol (EAP), Lightweight EAP (LEAP), management frame protection (MFP), message integrity check (MIC), open authentication, personal mode, protected access credential (PAC), Protected EAP (PEAP), Public Key Infrastructure (PKI), RADIUS server, supplicant, Temporal Key Integrity Protocol (TKIP), Wireless Equivalent Privacy (WEP), wireless intrusion protection system (wIPS), Wi-Fi Protected Access (WPA), WPA Version 2 (WPA2)



---

This chapter covers the following topics:

**WLAN Overview**—This section provides a review of WLAN concepts and rules of thumb for their use.

**Configuring a WLAN**—This section covers the steps necessary to create a WLAN on a Cisco wireless LAN controller.

This chapter covers the following exam topics:

- Configure a WLAN controller and access points  
WLC: ports, interfaces, WLANs, NTP, CLI and Web UI, CLI wizard, and link aggregation group (LAG) AP: Channel and Power

# Configuring a WLAN

A WLC sits somewhere between wireless APs and a wired network. In this chapter, you learn how to define and tune a wireless LAN to reach devices on each of those networks. In addition, based on the concepts you learned in Chapter 14, “Wireless Security Fundamentals,” you will be able to configure basic security parameters for the WLAN.

## “Do I Know This Already?” Quiz

The “Do I Know This Already?” quiz allows you to assess whether you should read this entire chapter thoroughly or jump to the “Exam Preparation Tasks” section. If you are in doubt about your answers to these questions or your own assessment of your knowledge of the topics, read the entire chapter. Table 15-1 lists the major headings in this chapter and their corresponding “Do I Know This Already?” quiz questions. You can find the answers in Appendix A, “Answers to the ‘Do I Know This Already?’ Quizzes.”

**Table 15-1** “Do I Know This Already?” Section-to-Question Mapping

Foundation Topics Section	Questions
WLAN Overview	1–4
Configuring a WLAN	5–6

**Caution** The goal of self-assessment is to gauge your mastery of the topics in this chapter. If you do not know the answer to a question or are only partially sure of the answer, you should mark that question as wrong for purposes of the self-assessment. Giving yourself credit for an answer you correctly guess skews your self-assessment results and might provide you with a false sense of security.

1. Which two of the following things are bound together when a new WLAN is created?
  - a. VLAN
  - b. AP
  - c. Controller interface
  - d. SSID
2. What is the maximum number of WLANs you can configure on a Cisco wireless controller?
  - a. 8
  - b. 16
  - c. 512
  - d. 1024
3. What is the maximum number of WLANs that can be enabled on a Cisco light-weight AP?
  - a. 8
  - b. 16
  - c. 512
  - d. 1024
4. Which one of the following is a limiting factor when multiple WLANs are offered on an AP and its radio channel?
  - a. The speed of the controller interface
  - b. The airtime used for each WLAN's beacons
  - c. Co-channel interference between WLANs
  - d. The number of APs joined to the controller
5. Which of the following parameters are necessary when creating a new WLAN with the controller GUI? (Choose all that apply.)
  - a. SSID
  - b. VLAN number
  - c. Interface
  - d. BSSID
  - e. IP subnet
6. The WLAN ID number is advertised to wireless clients. True or false?
  - a. True
  - b. False

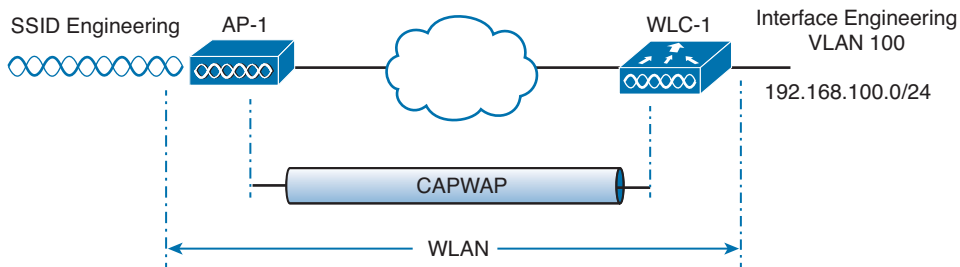
---

## Foundation Topics

---

### WLAN Overview

Recall from Chapter 9, “Understanding the CUWN Architecture,” that a wireless LAN controller and an access point (AP) work in concert to provide network connectivity to wireless clients. From a wireless perspective, the AP advertises a service set identification (SSID) for the client to join. From a wired perspective, the controller connects to a VLAN through one of its dynamic interfaces. To complete the path between the SSID and the VLAN, as illustrated in Figure 15-1, you must first define a WLAN on the controller.



**Figure 15-1** *Connecting Wired and Wireless Networks with a WLAN.*

The controller will bind the WLAN to one of its interfaces and then push the WLAN configuration out to all of its APs by default. From that point on, wireless clients will be able to learn about the new WLAN and will be able to probe and join the new basic service set (BSS).

Like VLANs, you can use WLANs to segregate wireless users and their traffic into logical networks. Users associated with one WLAN cannot cross over into another one unless their traffic is bridged or routed from one VLAN to another through the wired network infrastructure.

Before you begin to create new WLANs, it is usually wise to plan your wireless network first. In a large enterprise, you might have to support a wide variety of wireless devices, user communities, security policies, and so on. You might be tempted to create a new WLAN for every occasion, just to keep groups of users isolated from each other or to support different types of devices. Although that is an appealing strategy, you should be aware of two limitations:

- A controller supports a maximum of 512 WLANs, but only 16 of them can be actively configured on an AP.
- Advertising each WLAN uses up valuable airtime.

Every AP must broadcast beacon management frames at regular intervals to advertise the existence of a BSS. Because each WLAN is bound to a BSS, each WLAN must be adver-



tised with its own beacons. Beacons are normally sent 100 times per second at the lowest mandatory data rate. The more WLANs you have created, the more beacons you will need to announce them.

Even further, the lower the mandatory data rate, the more time each beacon will take to be transmitted. The end result is this: If you create too many WLANs, a channel can be starved of any usable airtime. Clients will have a hard time transmitting their own data because the channel is overly busy with beacon transmissions. As a rule of thumb, always limit the number of WLANs to five or fewer.

## Configuring a WLAN

By default, a controller has no configuration and therefore no WLANs. Before you create a new WLAN, think about the following parameters it will need to have:

- SSID
- Controller interface and VLAN number
- Type of wireless security needed

Make sure that you have already created the appropriate controller interface to support the new WLAN. Then you will enter the parameters as you work through the following sections.

## Configuring a RADIUS Server

If your new WLAN will use a security scheme that requires a RADIUS server, you need to define the server first. Select **Security > AAA > RADIUS > Authentication** to see a list of servers that have already been configured, as shown in Figure 15-2. If multiple servers are defined, the controller will try them in sequential order. Click **New** to create a new server.

Next, enter the server's IP address, shared secret key, and port number, as shown in Figure 15-3. Because the controller already had two other RADIUS servers configured, the server at 192.168.200.30 will be index number 3. Be sure to set the server status to **Enabled** so that the controller can begin using it. At the bottom of the page, you can select the type of user that will be authenticated with the server. Check **Network User** to authenticate wireless clients or **Management** to authenticate wireless administrators that will access the controller's management functions. Click **Apply** to complete the server configuration.

The screenshot shows the Cisco Security configuration interface. The left sidebar contains a navigation menu with categories like AAA, Local EAP, Priority Order, Certificate, Access Control Lists, Wireless Protection Policies, Web Auth, TrustSec SXP, and Advanced. The main content area is titled "RADIUS Authentication Servers" and includes a table of configured servers.

**RADIUS Authentication Servers**

Call Station ID Type: IP Address

Use AES Key Wrap:  (Designed for FIPS customers and requires a key wrap compliant RADIUS)

MAC Delimiter: Hyphen

Network User	Management	Server Index	Server Address	Port	IPSec
<input checked="" type="checkbox"/>	<input type="checkbox"/>	1	192.168.200.28	1812	Disabled
<input checked="" type="checkbox"/>	<input type="checkbox"/>	2	192.168.200.29	1812	Disabled

1. Call Station ID Type will be applicable only for non 802.1x authentication only.

**Figure 15-2** *Displaying the List of RADIUS Authentication Servers.*

The screenshot shows the "RADIUS Authentication Servers > New" configuration page. It contains various fields for defining a new RADIUS server, including server index, IP address, shared secret, port number, and status options.

**RADIUS Authentication Servers > New**

Server Index (Priority): 3

Server IP Address: 192.168.200.30

Shared Secret Format: ASCII

Shared Secret: [Redacted]

Confirm Shared Secret: [Redacted]

Key Wrap:  (Designed for FIPS customers and requires a key wrap compliant RADIUS server)

Port Number: 1812

Server Status: Enabled

Support for RFC 3576: Enabled

Server Timeout: 2 seconds

Network User:  Enable

Management:  Enable

IPSec:  Enable

**Figure 15-3** *Configuring a New RADIUS Server.*

## Creating a Dynamic Interface

In Chapter 10, “Initial Controller Configuration,” you learned about the different types of controller interfaces. A dynamic interface is used to connect the controller to a VLAN on the wired network. When you create a WLAN, you will bind the dynamic interface (and VLAN) to a wireless network.

To create a new dynamic interface, navigate to **Controller > Interfaces**. You should see a list of all the controller interfaces that are currently configured. Click the **New** button to define a new interface. Enter a name for the interface and the VLAN number it will be bound to. In Figure 15-4, the interface named Engineering is mapped to wired VLAN 100. Click the **Apply** button.



**Figure 15-4** Defining a Dynamic Interface Name and VLAN ID.

Next, enter the IP address, subnet mask, and gateway address for the interface. You should also define a primary and secondary DHCP server addresses that the controller will use when it relays DHCP requests from clients that are bound to the interface. Figure 15-5 shows how interface Engineering has been configured with IP address 192.168.100.10. Click the **Apply** button to complete the interface configuration and return to the list of interfaces.



The screenshot shows the Cisco Controller configuration page for editing dynamic interface parameters. The page is titled "Interfaces > Edit" and has a "Back" button and an "Apply" button. The left sidebar shows the navigation menu with "Internal DHCP Server" selected. The main content area is divided into several sections:

- General Information:** Interface Name: Engineering, MAC Address: 30:e4:db:30:b4:2f
- Configuration:** Guest Lan (checkbox), Quarantine (checkbox), Quarantine Vlan Id: 0
- Physical Information:** The interface is attached to a LAG. Enable Dynamic AP Management (checkbox)
- Interface Address:** VLAN Identifier: 100, IP Address: 192.168.100.10, Netmask: 255.255.255.0, Gateway: 192.168.100.1
- DHCP Information:** Primary DHCP Server: 192.168.200.17

Figure 15-5 Editing the Dynamic Interface Parameters.

## Creating a New WLAN

You can display a list of the currently defined WLANs by selecting **WLANs** from the top menu bar. In Figure 15-6, the controller has one WLAN called **guest** already defined. You can create a new WLAN by selecting **Create New** from the drop-down menu and then clicking the **Go** button.

The screenshot shows the Cisco Controller configuration page for displaying a list of WLANs. The page is titled "WLANs" and has a "Create New" dropdown menu and a "Go" button. The left sidebar shows the navigation menu with "WLANs" selected. The main content area shows the following information:

- Current Filter:** None, [Change Filter], [Clear Filter]
- WLAN List:**

WLAN ID	Type	Profile Name	WLAN SSID
1	WLAN	guest	guest

Figure 15-6 Displaying a List of WLANs.

Next, enter a descriptive name as the profile name and the SSID text string. In Figure 15-7, the profile name and SSID are identical, just to keep things straightforward. The ID number is used as an index into the list of WLANs that are defined on the controller. The ID number becomes useful when you use templates on Cisco Network Control System (NCS) or Prime Infrastructure (PI) to configure WLANs on multiple controllers at the same time.

**Tip** WLAN templates are applied to specific WLAN ID numbers on controllers. As a rule, you should keep the sequence of WLAN names and IDs consistent across multiple controllers so that any configuration templates you use in the future will be applied to the correct WLANs.



The screenshot shows the Cisco configuration interface for creating a new WLAN. The top navigation bar includes tabs for MONITOR, WLANs (selected), CONTROLLER, WIRELESS, SECURITY, MANAGEMENT, and COMMANDS. The left sidebar shows 'WLANs' with a sub-menu 'Advanced'. The main content area is titled 'WLANs > New' and contains the following form fields:

Type	WLAN
Profile Name	engineering
SSID	engineering
ID	2

Buttons for '< Back' and 'Apply' are visible at the top right of the form.

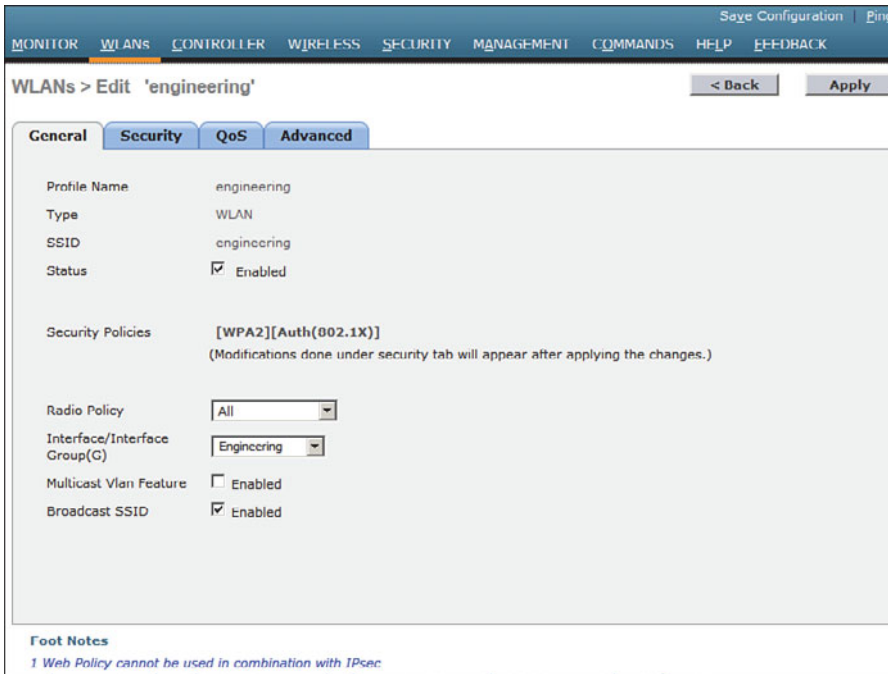
**Figure 15-7** Creating a New WLAN.

Click the **Apply** button to create the new WLAN. The next page will allow you to edit four categories of parameters, corresponding to the tabs across the top as shown in Figure 15-8. By default, the General tab is selected.

You can control whether the WLAN is enabled or disabled with the Status check box. Even though the General page shows a specific security policy for the WLAN (the default WPA2 with 802.1x), you can make changes in a later step through the Security tab.

Under Radio Policy, select the type of radios that will offer the WLAN. By default, the WLAN will be offered on all radios that are joined with the controller. You can select a more specific policy with 802.11a only, 802.11a/g only, 802.11g only, or 802.11b/g only. For example, if you are creating a new WLAN for devices that have only a 2.4-GHz radio, it probably does not make sense to advertise the WLAN on both 2.4- and 5-GHz AP radios.

Next, select the controller interface that will be bound to the WLAN. The drop-down list contains all the interface names that are available. In Figure 15-8, the new engineering WLAN will be bound to the Engineering interface.



**Figure 15-8** *Configuring the General WLAN Parameters.*

Finally, use the **Broadcast SSID** check box to select whether the APs should broadcast the SSID name in the beacons. Broadcasting SSIDs is usually more convenient for users, because their devices can learn and display the SSID names automatically. Hiding the SSID name, by not broadcasting it, does not really provide any worthwhile security. Instead, it just prevents user devices from discovering an SSID and trying to use it as a default network.

## Configuring WLAN Security

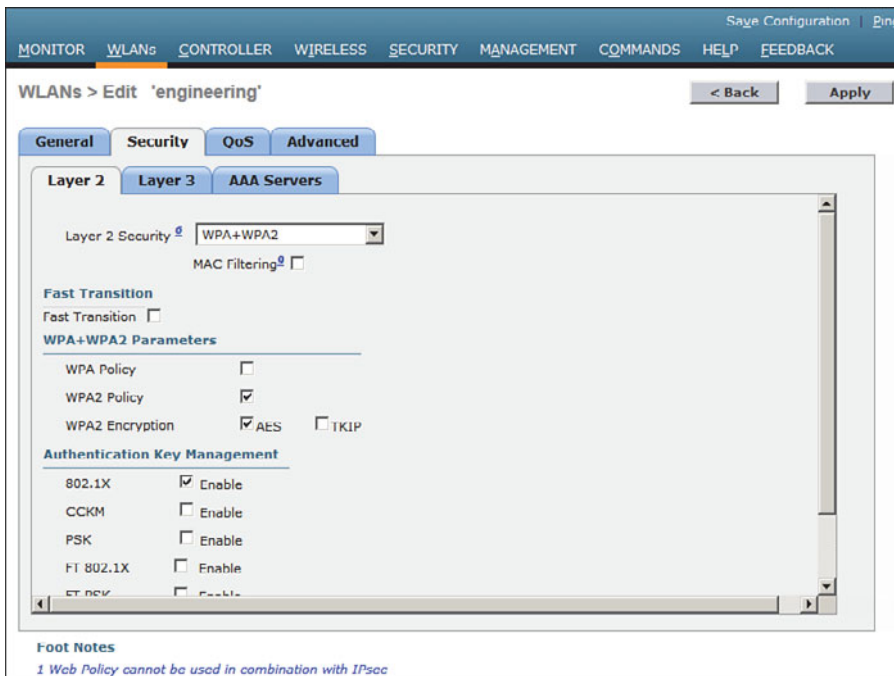
Select the **Security** tab to configure the security settings. By default, the Layer 2 security tab is selected. From the Layer 2 Security drop-down menu, select the appropriate security scheme to use. Table 15-2 lists the types that are available. You can also check the **MAC Filtering** check box to use client MAC addresses as authentication credentials.

**Table 15-2** *Layer 2 WLAN Security Types*

Option	Description
None	Open authentication
WPA+WPA2	Wi-Fi protected access WPA or WPA2
802.1x	EAP authentication with dynamic WEP

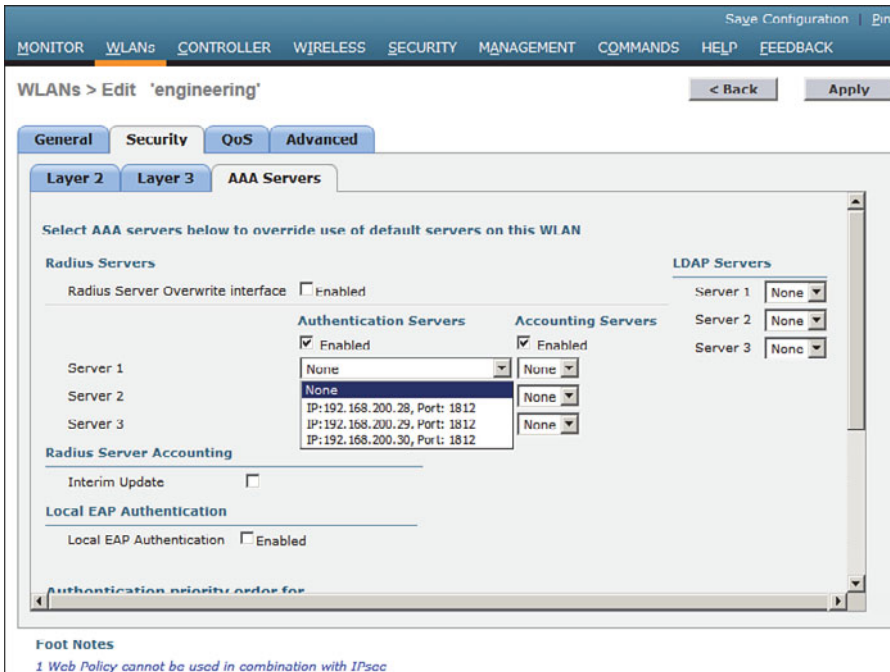
Option	Description
Static WEP	WEP key security
Static WEP + 802.1x	EAP authentication or static WEP
CKIP	Cisco Key Integrity Protocol
None + EAP Passthrough	Open authentication with remote EAP authentication

In Figure 15-9, WPA+WPA2 security is selected. In the remainder of the page, you can set parameters that are specific to the security scheme. For example, WPA2 with AES is used, but WPA and TKIP are not.



**Figure 15-9** Configuring Layer 2 WLAN Security.

If you choose a Layer 2 security scheme that requires a RADIUS server, the controller will use the global list of servers you have defined under **Security > AAA > RADIUS > Authentication**. You can override that list by identifying up to three specific RADIUS servers in the WLAN configuration. Display the **AAA Servers** tab, then under each server, you can select a specific server IP address from the drop-down menu of globally defined servers. Servers 1, 2, and 3 are tried in sequential order until one of them responds. In Figure 15-10, Server 1 is being set from a list of servers at 192.168.200.28, 192.168.200.29, and 192.168.200.30.



**Figure 15-10** *Selecting RADIUS Servers for WLAN Authentication.*

By default, a controller will contact a RADIUS server from its management interface. You can override this behavior by checking the box next to **RADIUS Server Overwrite Interface**, so that the controller sources RADIUS requests from the dynamic interface that is associated with the WLAN.

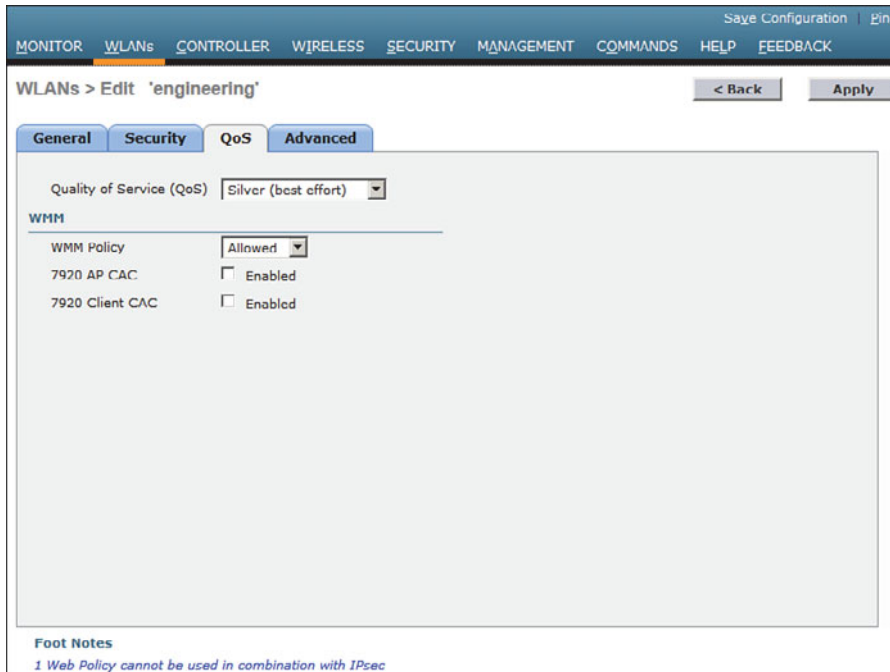
## Configuring WLAN QoS

Display the QoS tab to configure quality of service settings for the WLAN, as shown in Figure 15-11. By default, the controller will consider all frames in the WLAN to be normal data, to be handled in a “best effort” manner. You can set the Quality of Service (QoS) drop-down menu to classify all frames in one of the following ways:

- Platinum (voice)
- Gold (video)
- Silver (best effort)
- Bronze (background)

You can also set the Wi-Fi Multimedia (WMM) policy and call admission control (CAC) policies on the QoS page.





**Figure 15-11** *Configuring QoS Settings.*

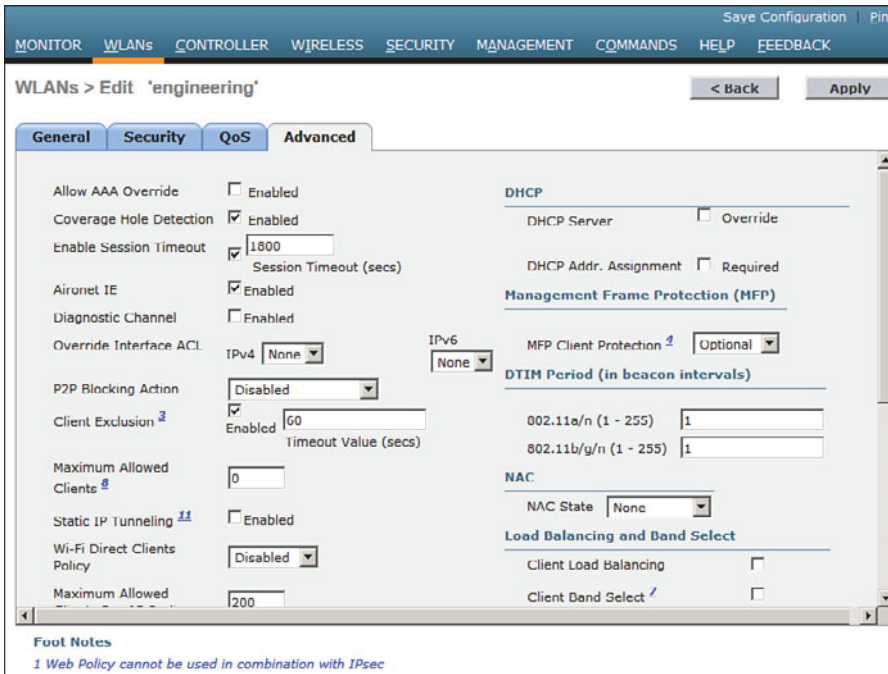
## Configuring Advanced WLAN Settings

Finally, display the **Advanced** tab to configure a variety of advanced WLAN settings. From the page shown in Figure 15-12, you can enable functions such as coverage hole detection, peer-to-peer blocking, client exclusion, client load limits, and so on.

Although most of the advanced settings are beyond the scope of the CCNA Wireless level, you should be aware of a few defaults that might affect your wireless clients.

By default, client sessions with the WLAN are limited to 1800 seconds (30 minutes). Once that session time expires, a client will be required to reauthenticate. This setting is controlled by the **Enable Session Timeout** check box and the **Timeout** field.

A controller maintains a set of security policies that are used to detect potentially malicious wireless clients. If a client exhibits a certain behavior, the controller can exclude it from the WLAN for a period of time. By default, all clients are subject to the policies configured under **Security > Wireless Protection Policies > Client Exclusion Policies**. These policies include excessive 802.11 association failures, 802.11 authentication failures, 802.1x authentication failures, web authentication failures, and IP address theft or reuse. Offending clients will be automatically excluded or blocked for 60 seconds, as a deterrent to attacks on the wireless network.



**Figure 15-12** *Configuring Advanced WLAN Settings.*

**Tip** Is 60 seconds really enough time to deter an attack coming from a wireless client? In the case of a brute-force attack, where passwords are guessed from a dictionary of possibilities, 60 seconds is enough to disrupt and delay an attacker's progress. What might have taken 2 minutes to find a matching password without an exclusion policy would take 15 years with one.

## Finalizing WLAN Configuration

When you are satisfied with the settings in each of the WLAN configuration tabs, click the **Apply** button. The WLAN will be created and added to the controller configuration. In Figure 15-13, the engineering WLAN has been added as WLAN ID 2 and is enabled for use.

The screenshot shows the 'WLANs' configuration page. At the top, there are navigation tabs: MONITOR, WLANs (selected), CONTROLLER, WIRELESS, SECURITY, MANAGEMENT, COMMANDS, HELP, and FEEDBACK. Below the tabs, the page title is 'WLANs' and it indicates 'Entries 1 - 8 of 8'. There is a 'Current Filter: None' section with links for '[Change Filter]' and '[Clear Filter]', and a 'Create New' button with a dropdown menu and a 'Go' button. The main content is a table with the following data:

<input type="checkbox"/>	WLAN ID	Type	Profile Name	WLAN SSID	Admin Status	Security Policies
<input type="checkbox"/>	1	WLAN	guest	guest	Enabled	None
<input type="checkbox"/>	2	WLAN	engineering	engineering	Enabled	[WPA2][Auth(802.1X)]

**Figure 15-13** *Displaying WLANs Configured on a Controller.*

## Exam Preparation Tasks

As mentioned in the section, “How to Use This Book,” in the Introduction, you have a couple of choices for exam preparation: the exercises here, Chapter 22, “Final Review,” and the exam simulation questions on the CD-ROM.

## Review All Key Topics

Review the most important topics in this chapter, noted with the Key Topic icon in the outer margin of the page. Table 15-3 lists a reference of these key topics and the page numbers on which each is found.



**Table 15-3** *Key Topics for Chapter 15*

Key Topic Element	Description	Page Number
Figure 15-5	Creating a dynamic interface	313
Figure 15-7	Creating a WLAN	314
Figure 15-9	Configuring WLAN security	316

*This page intentionally left blank*



---

This chapter covers the following topics:

- **Guest Network Overview**—This section describes a guest wireless network and how it can be used to segregate guests from other users on a network.
- **Configuring a Guest Network**—This section covers the process needed to implement a guest wireless LAN.
- **Scaling the Guest Network**—This section explains how the guest WLANs on multiple controllers can be merged and aimed toward a common anchor point. As a result, guest users can be isolated and contained with one set of policies.

This chapter covers the following exam topics:

- Describe and configure authentication methods (Guest, PSK, 802.1X, WPA/WPA2 with EAP- TLS, EAP-FAST, PEAP, and LEAP)

# Implementing a Wireless Guest Network

In Chapter 15, “Configuring a WLAN,” you learned how to define and configure a new wireless LAN to support a community of clients that have something in common. You can even configure multiple WLANs to support multiple user communities. In most cases, the WLAN users are trusted at some level because they are a necessary part of your enterprise.

What about guest users, who might not be trusted or integral to your business? Guest users commonly need to access the wireless network as a convenience. This chapter discusses the steps you can take to configure a guest network as an extension to your wireless infrastructure.

## “Do I Know This Already?” Quiz

The “Do I Know This Already?” quiz allows you to assess whether you should read this entire chapter thoroughly or jump to the “Exam Preparation Tasks” section. If you are in doubt about your answers to these questions or your own assessment of your knowledge of the topics, read the entire chapter. Table 16-1 lists the major headings in this chapter and their corresponding “Do I Know This Already?” quiz questions. You can find the answers in Appendix A, “Answers to the ‘Do I Know This Already?’ Quizzes.”

**Table 16-1** “Do I Know This Already?” Section-to-Question Mapping

Foundation Topics Section	Questions
Guest Network Overview	1–2
Configuring a Guest Network	3
Scaling the Guest Network	4–6

**Caution** The goal of self-assessment is to gauge your mastery of the topics in this chapter. If you do not know the answer to a question or are only partially sure of the answer, you should mark that question as wrong for purposes of the self-assessment. Giving yourself credit for an answer you correctly guess skews your self-assessment results and might provide you with a false sense of security.

- 1.** Which one of the following should be used to contain visitors and transient users of a wireless network?
  - a.** WPA2 enterprise
  - b.** Guest WLAN
  - c.** One-time WEP
  - d.** Broadcast SSID
- 2.** Once a data WLAN and a guest WLAN are configured on a controller and mapped to two VLANs, the controller can provide connectivity between the two. True or false?
  - a.** True
  - b.** False
- 3.** To create a guest WLAN, which one of the following must be configured on a wireless controller?
  - a.** A private WLAN
  - b.** A guest mobility group
  - c.** A guest BSS
  - d.** A regular WLAN
- 4.** By default, all guest WLANs defined on controllers in an enterprise are merged into one VLAN and subnet. True or false?
  - a.** True
  - b.** False
- 5.** Which one of the following is necessary to merge guest WLANs from multiple controllers onto a common guest WLAN on a controller?
  - a.** RF group
  - b.** Global WLAN
  - c.** Mobility anchor
  - d.** Master controller
  - e.** NCS templates
- 6.** You can configure only one controller as a mobility anchor for a guest WLAN. True or false?
  - a.** True
  - b.** False

---

## Foundation Topics

---

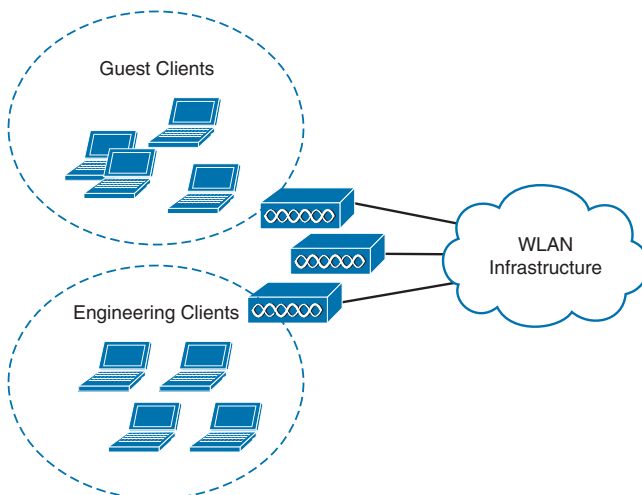
### Guest Network Overview

Wireless LANs are usually configured to support specific groups of clients or client devices. For example, one WLAN might support wireless users in the Engineering department, even if that department is scattered in several buildings or locations. Other WLANs might support a sales staff, teachers, students, and so on. These examples segment wireless users by function or the need to access certain enterprise resources. Each WLAN might have a different set of security policies from the others.

You might also decide to create WLANs to support different types of wireless devices. For example, one WLAN could be configured to support all medical devices in a hospital that can use only Wi-Fi Protected Access Version 2 (WPA2) with a pre-shared key. A separate WLAN could be created for users with medical devices that support WPA2 Enterprise, with digital certificates. In these cases, WLANs are created according to the wireless device capabilities.

As a wireless network administrator, you might be asked to provide connectivity for users who do not fall into any convenient category. Guest users are normally temporary visitors who need to access a wireless network to make their work and their time onsite more convenient. Because guests are not regular, trusted employees, you should always try to offer some basic network access while containing and isolating them from the trusted portion of your network.

In Figure 16-1, both guests and engineering staff are able to use the same wireless infrastructure, while the two user groups are kept isolated from each other. The engineering users can communicate directly with the company resources. However, the guest users are commonly placed within a demilitarized zone (DMZ) that has limited access and is secured by a firewall.



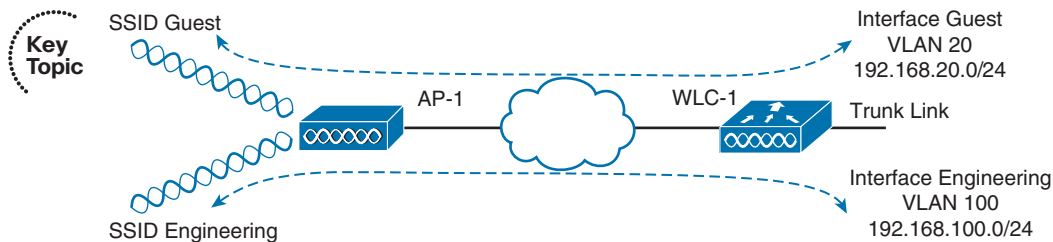
**Figure 16-1** *Isolating Guest Wireless Users from Other User Groups.*



## Configuring a Guest Network

Building a guest wireless network might seem like a complex task; however, it is really no different from building any other WLAN that is tailored for a user community. The trick is to provide the appropriate degree of isolation from the rest of the enterprise network.

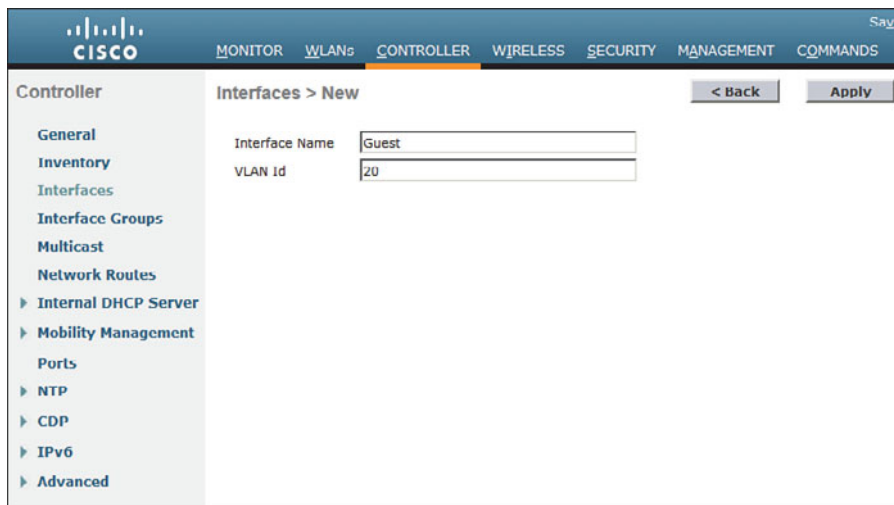
The guest WLAN can be bound to a guest VLAN that is isolated from other VLANs, as shown in Figure 16-2. Before guest users can access any other WLAN or VLAN, a router or firewall must permit and provide the access. The Guest WLAN advertises service set identifier (SSID) Guest and is bound to the controller's Guest interface on VLAN 20. The same access point (AP) and controller infrastructure has an Engineering WLAN that is bound to the controller's Engineering interface on VLAN 100.



**Figure 16-2** Isolation Between a Guest and Other WLANs.

To create a guest WLAN, follow these steps:

- Step 1.** Create a dynamic interface for the guest WLAN. Under **Controller > Interfaces > New**, define the dynamic interface, the VLAN ID, and the IP addressing information. Figures 16-3 and 16-4 show an interface named Guest configured for VLAN 20 and the 192.168.20.0/24 subnet.



**Figure 16-3** Creating a Controller Interface for a Guest WLAN.

The screenshot shows the configuration page for the 'Guest' interface. The page is titled 'Interfaces > Edit' and has a navigation bar with tabs: MONITOR, WLANs, CONTROLLER (selected), WIRELESS, SECURITY, MANAGEMENT, COMMANDS, HELP, and FEEDBACK. The interface is configured with the following details:

- General Information:** Interface Name: Guest, MAC Address: 30:e4:db:38:b4:2f
- Configuration:** Guest Lan: , Quarantine: , Quarantine Vlan Id: 0
- Physical Information:** The interface is attached to a LAG. Enable Dynamic AP Management:
- Interface Address:** VLAN Identifier: 20, IP Address: 192.168.20.3, Netmask: 255.255.255.0, Gateway: 192.168.20.1
- DHCP Information:** (Section header visible)

**Figure 16-4** *Configuring IP Address Information on the Guest Interface.*

**Step 2.** Create the guest WLAN.

Select **WLAN > New** to define a new WLAN, and then enter the profile name and SSID. In Figure 16-5, the controller has been configured with a second WLAN (ID 2) that uses SSID Guest.

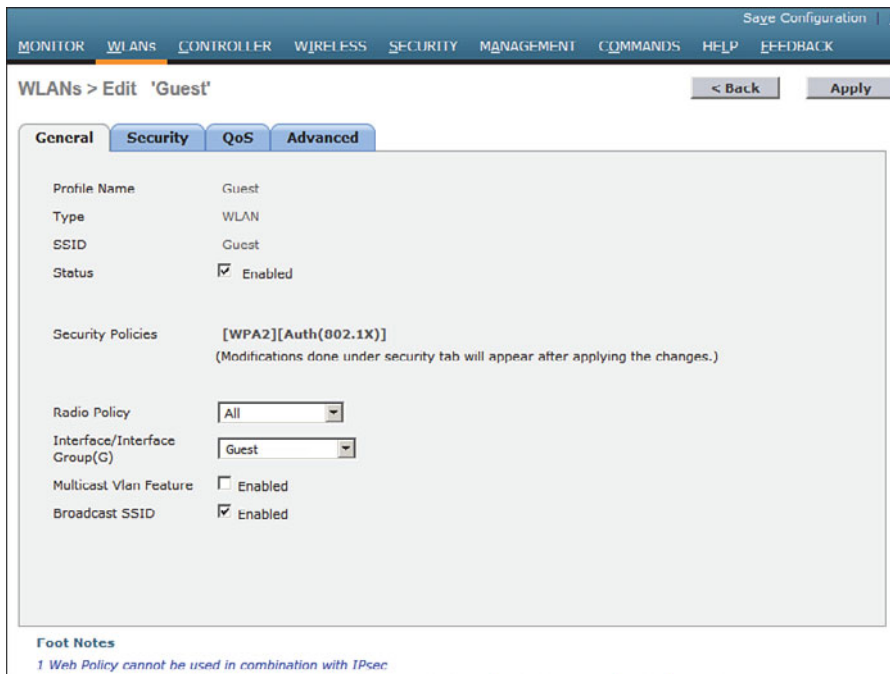
The screenshot shows the 'WLANs > New' configuration page. The navigation bar is the same as in Figure 16-4. The configuration details are as follows:

- Type:** WLAN (dropdown menu)
- Profile Name:** Guest (text input field)
- SSID:** Guest (text input field)
- ID:** 2 (dropdown menu)

**Figure 16-5** *Creating a Guest WLAN.*

**Step 3.** Bind the guest WLAN to the guest WLAN interface.

On the **General** tab of the WLAN, select the guest controller interface to be used. In Figure 16-6, the Guest WLAN is configured to use the Guest dynamic interface.



**Figure 16-6** Assigning a Dynamic Interface to the Guest WLAN.

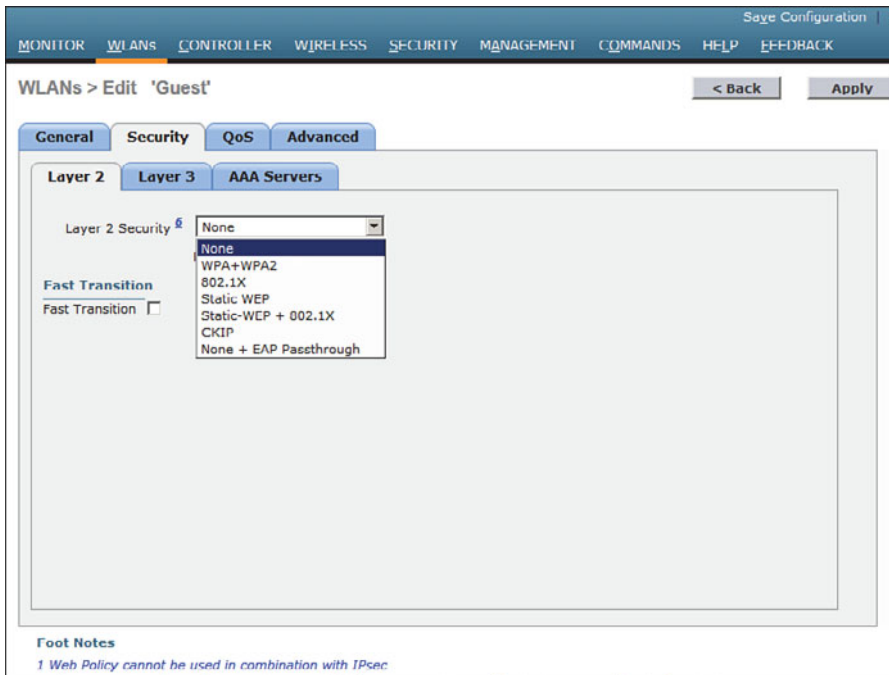
**Step 4.** Configure wireless security. Guest users are commonly kept isolated from an enterprise network. Even so, you will have to decide how to secure the guest WLAN for its users. For example, your security policies might dictate that guest users must be authenticated before they are granted any access at all. You might also want to configure a wireless security mechanism to encrypt and protect each guest user's traffic from eavesdropping and tampering. On the Security tab, you can select a Layer 2 security scheme as shown in Figure 16-7. You can also select the **Layer 3** tab to enable web authentication, where guest users are presented with a login web page before being allowed to connect to the guest network.

To authenticate guest users, you can use one of the following methods:

- Create guest users on a RADIUS server, which will be authenticated with 802.1x
- Create local usernames and passwords on the controller; either a lobby ambassador or an administrative user on the controller can log into the controller and create temporary guest user credentials

At the CCNA level, you should know how to configure and implement a guest wireless network. Guest user authentication is not specified on the exam blueprint.

Be sure to visit the QoS and Advanced tabs to complete the guest WLAN configuration.



**Figure 16-7** *Configuring Guest WLAN Security.*

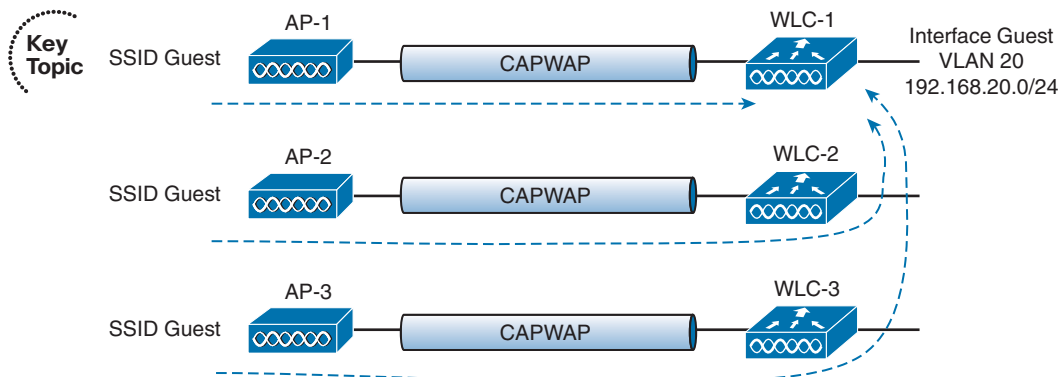
## Scaling the Guest Network

Configuring a guest WLAN on a single controller is straightforward. The guest WLAN is just like any other WLAN defined on the controller. In larger installations, you might have more than one controller. In that case, each guest WLAN terminates on its own controller, making it difficult to isolate all guest clients in a single DMZ or behind a single firewall.

Recall from Chapter 12, “Understanding Roaming,” that Cisco WLCs can support Layer 3 roaming by automatically building a tunnel between the first controller a client associates with and the controller where the client is currently located. In effect, the client is tunneled from a foreign controller back to the original anchor controller. This same tunneling strategy can be leveraged to funnel guest clients from any controller into a mobility anchor controller where guests share a common IP subnet and security policies.

Where Layer 3 roaming builds controller-to-controller tunnels to follow clients as they move, mobility anchors are configured ahead of time so that guest clients will be tunneled to a predetermined anchor. Figure 16-8 illustrates the concept with three WLCs. Each WLC is configured with its own guest WLAN, but only WLC-1 is identified as a mobility anchor. Regardless of which controller a guest user joins, the user will be tunneled to the anchor and connected into the guest VLAN. You can also identify several mobility anchors so that guest users can be distributed across them to balance the load.

**Tip** In many implementations, the controller used as a mobility anchor for a guest network does not even have any APs joined to it. Instead, it acts as the final destination for the guest WLANs across an entire enterprise network. Without APs to support, the anchor controller can devote more resources toward handling guest users.

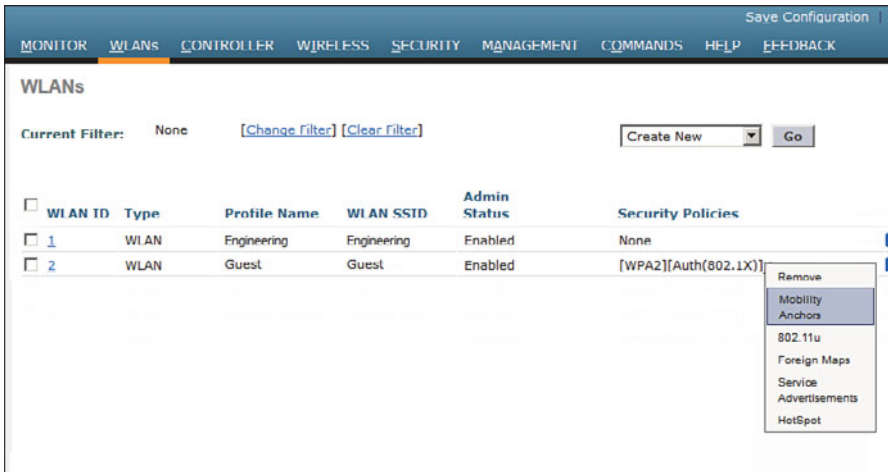


**Figure 16-8** Using Mobility Anchors to Consolidate Guest Wireless Clients.

Configuring mobility anchors is straightforward, provided you configure every controller involved in the guest WLAN consistently and use the following steps:

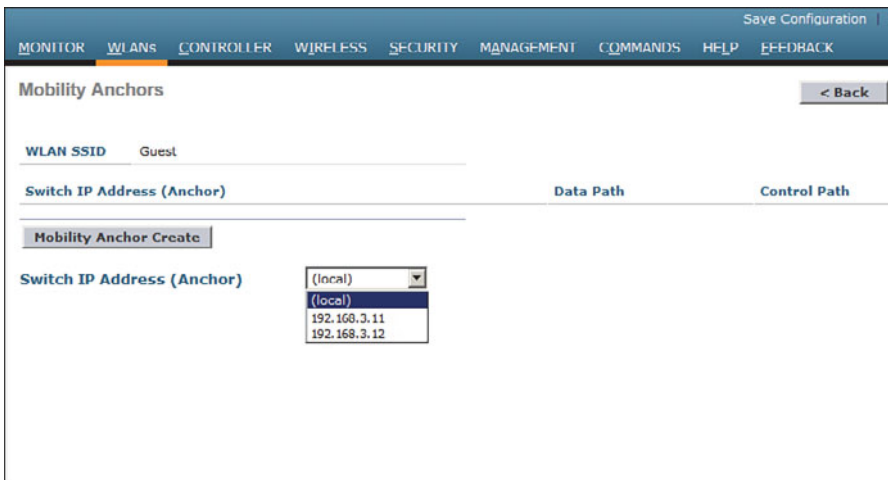
- Step 1.** Create a guest WLAN on each controller. The guest WLAN should be configured identically across all of the controllers so that each one can build a tunnel to the anchor. The foreign and anchor controller guest WLANs can have different outgoing interfaces, RADIUS servers, and pre-shared keys. Because the guest WLAN on each controller is tunneled to the anchor controller, the outgoing interface does not really matter. For this reason, the management interface is commonly used. The guest WLAN on the anchor controller, however, must use the actual dynamic interface name for the guest DMZ network.
- Step 2.** Form a mobility group relationship.
 

All the controllers involved must be configured to use the same mobility group before the anchor relationships can be built. Each of the controllers must be listed in the anchor controller's mobility group list, and vice versa.
- Step 3.** Identify the anchor on each controller. Be aware that even the anchor controller must be configured with an anchor controller (itself) so that it will accept tunnels from other controllers. Configure the anchor controller first by selecting the **WLANs** tab to display the list of WLANs. At the far-right end of the guest WLAN entry, right-click the blue triangle, and then select **Mobility Anchors** from the drop-down menu, as shown in Figure 16-9.



**Figure 16-9** Configuring a Mobility Anchor on a Guest WLAN.

From the Switch IP Address (Anchor) drop-down menu, select the anchor controller from the list of controllers that are members of the mobility group. The local entry that is displayed in the list of switch IP addresses represents the controller you are configuring. Select the **local** entry and click the **Mobility Anchor Create** button. In Figure 16-10, the local switch that is being configured will serve as the mobility anchor for the guest WLAN.



**Figure 16-10** Enabling a Controller as the Mobility Anchor.

Next, move to a different controller and repeat the process. On that controller, you will select the IP address of the anchor controller and click the **Mobility Anchor Create** button. In Figure 16-11, the controller at 192.168.3.10 has been identified as the mobility anchor. Once the two controllers know about their new relationship, they will display the status of their EoIP tunnel. The figure shows the control and data paths as Up.



**Figure 16-11** *Identifying the Mobility Anchor on Another Controller.*

## Exam Preparation Tasks

As mentioned in the section, “How to Use This Book,” in the Introduction, you have a couple of choices for exam preparation: the exercises here, Chapter 22, “Final Review,” and the exam simulation questions on the CD-ROM.

## Review All Key Topics

Review the most important topics in this chapter, noted with the Key Topic icon in the outer margin of the page. Table 16-2 lists a reference of these key topics and the page numbers on which each is found.



**Table 16-2** *Key Topics for Chapter 16*

Key Topic Element	Description	Page Number
Figure 16-2	WLAN isolation	326
Figure 16-8	Scaling the guest WLAN	330

## Define Key Terms

Define the following key terms from this chapter and check your answers in the glossary:

guest WLAN, mobility anchor

*This page intentionally left blank*





---

This chapter covers the following topics:

- **Configuring Common Wireless Clients**—This section provides an overview of several common clients and how they are configured.
- **Cisco Compatible Extensions (CCX)**—This section describes the CCX program and how it is used to certify compatibility with sets of Cisco features and extensions.

This chapter covers the following exam topics:

- Describe client WLAN configuration requirements, such as Service Set Identifier (SSID), security selection, and authentication
- Identify basic configuration of common wireless supplicants (Macintosh, Intel Wireless Pro, Windows, iOS, and Android)
- Describe basic AnyConnect 3.0 or above wireless configuration parameters
- Identify capabilities available in CCX versions 1 through 5

# Understanding Wireless Clients

A Cisco Unified Wireless Network (CUWN) consists of wireless LAN controllers, light-weight access points, and wireless client devices. Even though the majority of this book is devoted to the controllers and access points (APs), the CCNA Wireless exam also includes client configuration. Why? When you build and support a wireless network, you often need to help your users configure and troubleshoot their devices so that they can use your network.

Wireless networks suffer from the bring-your-own-devices (BYOD) syndrome, where users often carry all sorts of wireless devices with them. Each device might use a different operating system, different wireless adapter hardware, and have different capabilities. This chapter covers the most common types of wireless clients.

## “Do I Know This Already?” Quiz

The “Do I Know This Already?” quiz allows you to assess whether you should read this entire chapter thoroughly or jump to the “Exam Preparation Tasks” section. If you are in doubt about your answers to these questions or your own assessment of your knowledge of the topics, read the entire chapter. Table 17-1 lists the major headings in this chapter and their corresponding “Do I Know This Already?” quiz questions. You can find the answers in Appendix A, “Answers to the ‘Do I Know This Already?’ Quizzes.”

**Table 17-1** “Do I Know This Already?” Section-to-Question Mapping

Foundation Topics Section	Questions
Configuring Common Wireless Clients	1–3
Cisco Compatible Extensions (CCX)	4–10

**Caution** The goal of self-assessment is to gauge your mastery of the topics in this chapter. If you do not know the answer to a question or are only partially sure of the answer, you should mark that question as wrong for purposes of the self-assessment. Giving yourself credit for an answer you correctly guess skews your self-assessment results and might provide you with a false sense of security.

- 1.** On a Windows machine that has an Intel wireless adapter, wireless connections can be managed from both Windows Network and Sharing Center and the Intel PROSet Utility application. True or false?

  - a.** True
  - b.** False
- 2.** Which one of the following modules must be installed with the Cisco AnyConnect client?

  - a.** VPN
  - b.** DART
  - c.** Posture
  - d.** Web Security
- 3.** Which one of the following is used to configure and push policies to AnyConnect clients?

  - a.** Cisco WLC
  - b.** Web browser
  - c.** RADIUS server
  - d.** ASDM
- 4.** CCX is used to certify which one of the following?

  - a.** Interoperability between wireless hardware manufacturers
  - b.** Compatibility with Cisco wireless features
  - c.** RF coverage
  - d.** Wireless networking professionals
- 5.** To date, how many versions of CCX have been defined?

  - a.** 1
  - b.** 4
  - c.** 5
  - d.** 10
- 6.** Someone has purchased a new 802.11 wireless device to use in an enterprise that has a Cisco Unified Wireless Network. After reading through the device specifications, you realize that it is not certified for any CCX version at all. Which one of the following most correctly describes the outcome?

- a. The device will not work on the network.
  - b. The device will likely work fine.
  - c. The device must support at least one CCX version to associate with the network.
  - d. The device is compatible with all CCX versions because CCX is part of the 802.11 standard.
7. A wireless device is certified for CCXv1. Which one of the following is a correct statement?
- a. The device is compatible with all Cisco features.
  - b. The device is compatible with WPA.
  - c. The device can support MFP.
  - d. The device is compatible with 802.11.
8. WPA2 with 802.1x and AES is supported in which one of the following CCX versions?
- a. CCXv1
  - b. CCXv2
  - c. CCXv3
  - d. CCXv4
  - e. CCXv5
9. Which one of the following is a CCX Lite module?
- a. CCXv1
  - b. Voice
  - c. Crypto
  - d. Video
10. A device is certified as CCX Lite. Which one of the following modules is mandatory for that certification?
- a. CCXv5
  - b. Foundation
  - c. Mobility
  - d. Survey

---

## Foundation Topics

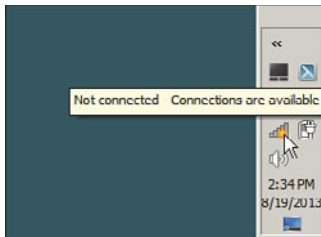
---

### Configuring Common Wireless Clients

As you work through this chapter, keep in mind that the CCNA Wireless exam blueprint uses words like *describe* and *identify* in exam topics that involve client capabilities and configuration. Therefore, you will find an overview of several common clients in the sections that follow.

#### Windows 7 and 8

Microsoft Windows 7 and 8 include a stock wireless client that offers basic connectivity options. To access the wireless client, display the taskbar and look for the wireless icon that shows a sequence of bars indicating signal strength. The current network status displays when you hover the cursor over the icon, as shown in Figure 17-1.



**Figure 17-1** *Displaying Windows Network Status.*

You can click the wireless network icon to see a list of service set identifiers (SSIDs), as shown in Figure 17-2. By default, a Windows PC does not have a prepopulated list of SSIDs to use. To scan for available SSIDs, it will transmit probe requests with a null or empty SSID name, expecting nearby APs to respond. You can manually initiate a scan by clicking on the circulating arrows symbol in the upper-right corner of the wireless network status window. To connect to one of the listed networks, click its name and then click the **Connect** button that appears.

You can manually populate a list of wireless networks or edit their properties by clicking the **Open Network and Sharing Center** link and then selecting the **Manage Wireless Networks**. Figure 17-3 shows an example list of wireless networks. Windows will try to find and connect to a network using the ordered sequence in the list. You can change the order by selecting a network and using the **Move Up** and **Move Down** links to move it to a new position in the list.

To add a new network to the list, click the **Add** link. As shown in Figure 17-4, you can enter the network name (SSID) and security and encryption types. You can also specify whether the PC should automatically connect to the network each time the SSID is detected, even if the SSID is not broadcast in any beacon frames.

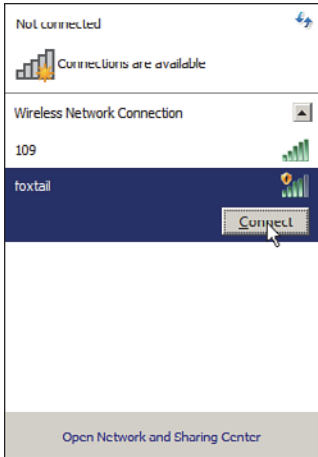


Figure 17-2 Selecting a Wireless Network to Use.

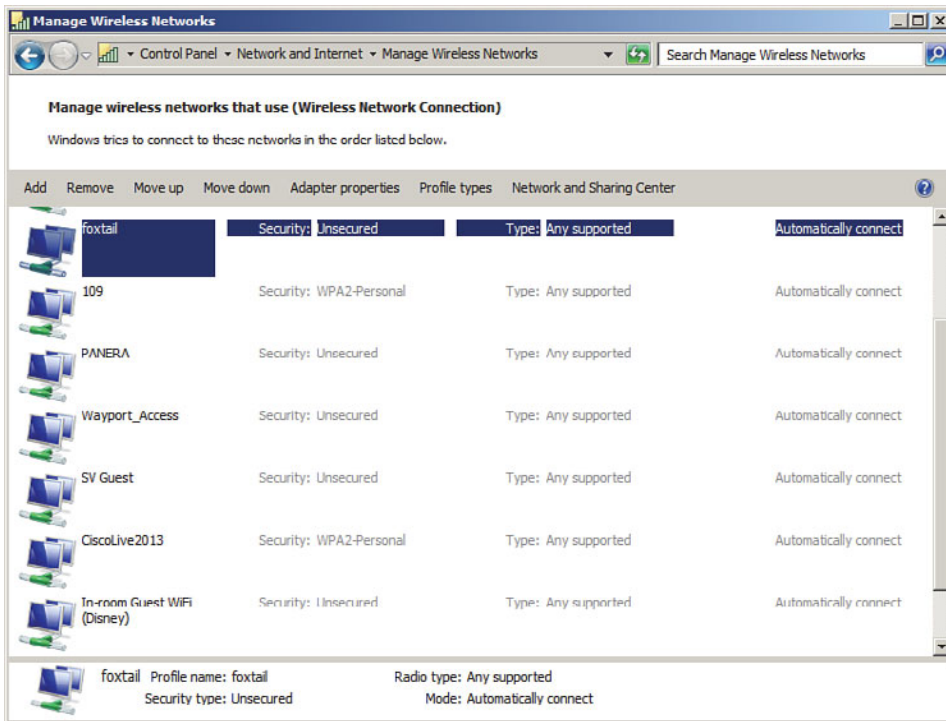
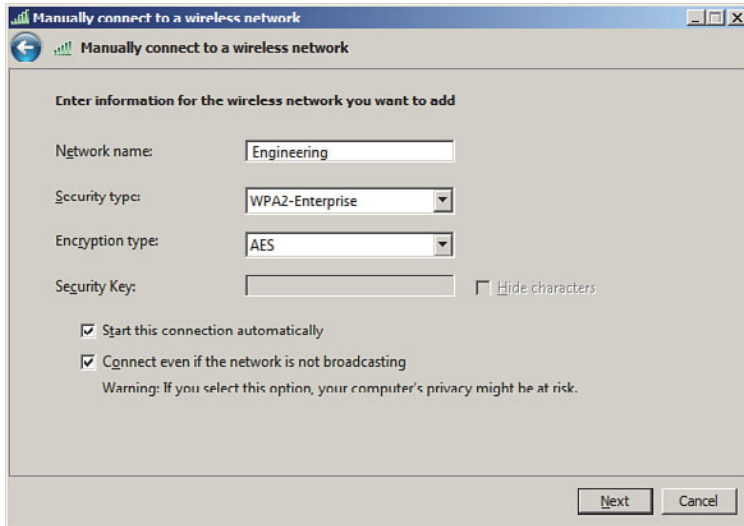
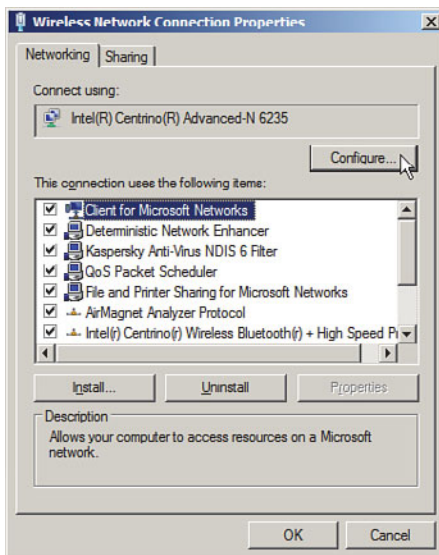


Figure 17-3 Displaying a List of Wireless Networks.

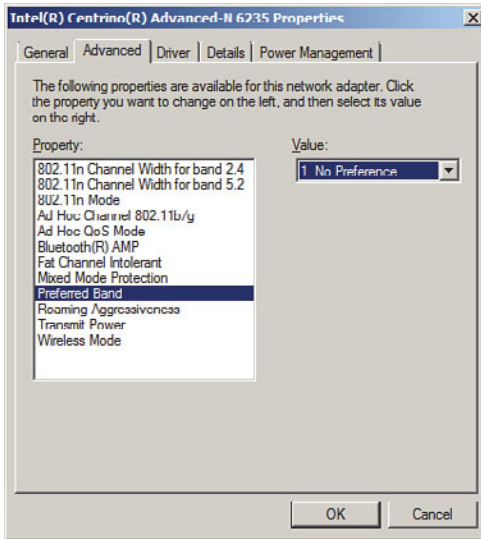


**Figure 17-4** *Manually Configuring a New Wireless Network.*

The built-in Windows wireless client does not offer many specific configuration options; however, you might find more options by configuring the wireless adapter. From the Network and Sharing Center, select **Change Adapter Settings** to display a list of installed adapters. Right-click a wireless adapter and select **Properties** to display the adapter properties and a list of installed protocols, as shown in Figure 17-5. Click the **Configure** button to bring up a window of adapter driver properties. Finally, display the **Advanced** tab to display a list of parameters and values, as shown in Figure 17-6. The list of parameters varies from one adapter to another, depending on what settings the manufacturer offers.



**Figure 17-5** *Configuring Wireless Adapter Properties.*



**Figure 17-6** *Configuring Advanced Wireless Adapter Settings.*

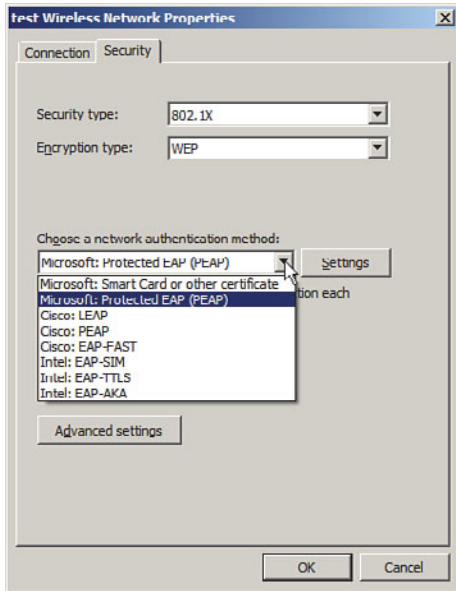
## Intel PROSet

If you have an Intel wireless adapter installed, you can download and install the Intel PROSet driver to access additional features that are not offered by the native Windows driver. For example, the Windows driver does not support Lightweight Extensible Authentication Protocol (LEAP), EAP Flexible Authentication by Secure Tunneling (EAP-FAST), or Cisco Compatible Extensions (CCX), but the Intel PROSet driver does. The Intel PROSet driver integrates Intel-specific features directly into the wireless network and wireless adapter configurations that you can access through the Windows Network and Sharing Center.

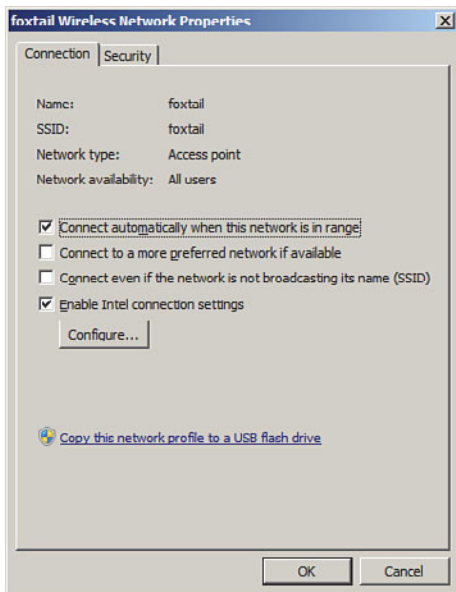
You can configure additional wireless security features by navigating to Manage Wireless Networks and then editing the properties of a wireless network. On the Security tab, you can select the security type, encryption type, and authentication method. In Figure 17-7, 802.1x security has been selected. Notice that the Intel PROSet driver has added authentication methods Cisco:LEAP, Cisco:PEAP, and Cisco:EAP-FAST.

To enable the CCX on the Intel adapter, display the **Connection** tab and check the box next to **Enable Intel Connection Settings**, as shown in Figure 17-8. Then click the **Configure** button, select **Cisco Options**, and then check the box next to **Enable Radio Measurement**.





**Figure 17-7** *Configuring Intel PROSet Wireless Security Settings.*



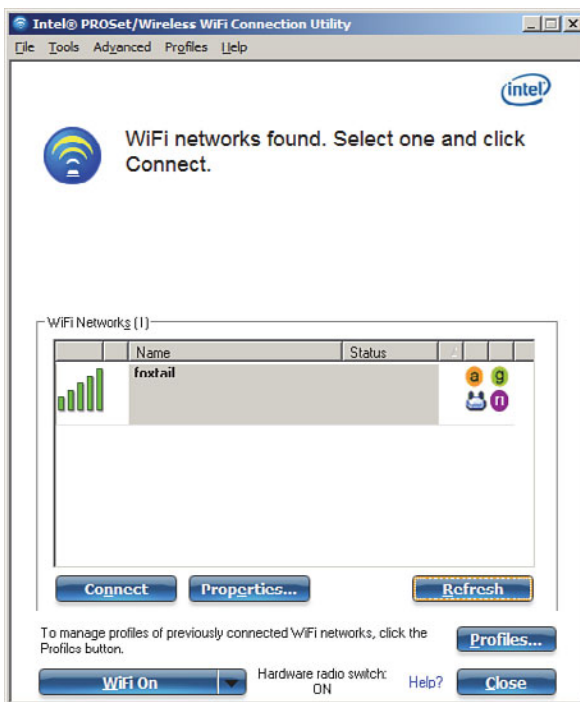
**Figure 17-8** *Enabling Intel PROSet Wireless Adapter Connection Settings.*

Intel also offers a PROSet utility application that you can download along with the PROSet driver. The PROSet utility is an alternate way to manage wireless networks and configure the adapter settings. An Intel wireless adapter can be managed by only one method—either by Windows or by the Intel PROSet utility.

**Tip** Even though you can choose to manage an Intel adapter through one of two methods, it is better to install the PROSet driver and manage the adapter through the native Windows network configuration tools. In contrast, the Intel PROSet utility application uses a third-party configuration utility and is not available for all Windows versions.

If you do choose to install the PROSet utility, you can access it through its taskbar icon, which looks like a radio frequency (RF) wave. If Windows is currently managing the adapter, you can click the **Enable WiFi Control** button to switch to PROSet management.

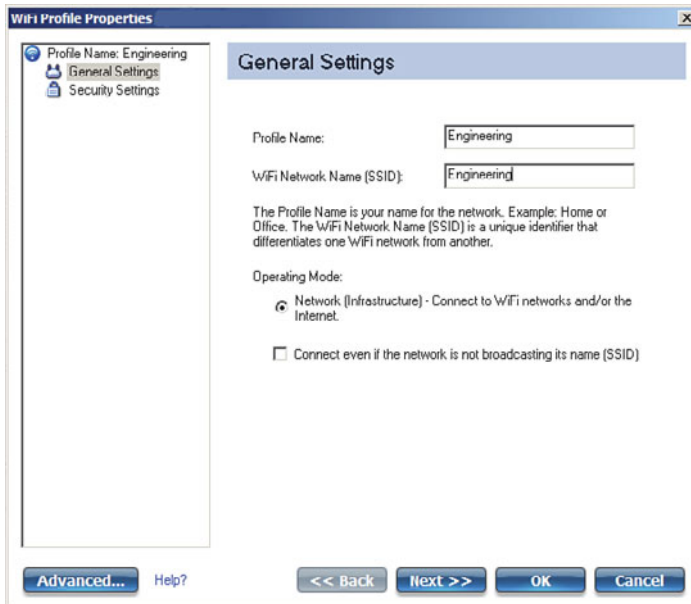
Like the native Windows driver, the PROSet utility tries to use any preconfigured wireless profiles in sequential order. If no profiles have been defined, it scans for available networks. In Figure 17-9, PROSet has discovered one SSID and is waiting for confirmation to connect to it. To do that, you can select the network name and click the **Connect** button.



**Figure 17-9** *Discovering a Network in the Intel PROSet Utility.*

You can also configure a list of network profiles by clicking the **Profiles** button. As you build a list, you can change the order that the profiles are tried by selecting one and using the up and down arrows on the right side of the window to raise or lower the profile in the list.

To add a new profile, click the **Add** button. You can configure general settings and security parameters as shown in Figures 17-10 and 17-11, respectively. Click the **OK** button to save the profile.



**Figure 17-10** *Configuring General Parameters for a New PROSet Profile.*

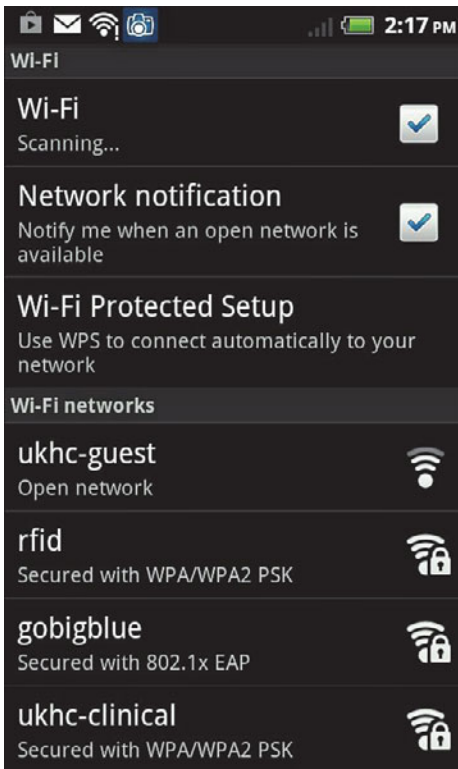


**Figure 17-11** *Configuring Security Parameters for a New PROSet Profile.*

## Android

Devices based on the Android operating system use a built-in driver and utility to manage connections to wireless networks. Android devices can discover a list of available networks and can manage manually configured networks too.

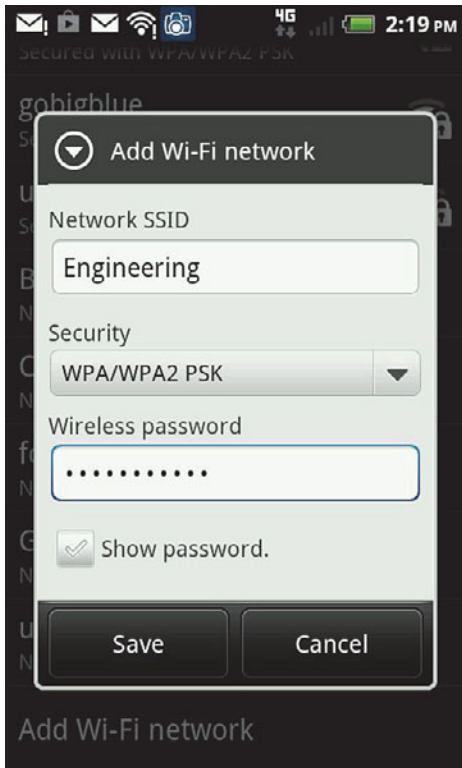
First, you should enable the wireless adapter by selecting **Settings > Wireless & Networks** and then checking the **Wi-Fi** check box. Select **Wi-Fi Settings** to manage individual wireless connections from the list, as shown in Figure 17-12. The list shows the SSIDs of networks that have been discovered, in addition to those that are locally configured. After a network has been learned and connected at least once, the device will automatically try to use it again in the future.



**Figure 17-12** *Displaying a List of Wireless Networks on an Android Device.*

You can manually add a new network by clicking the **Add Wi-Fi Network** link at the bottom of the network list. Enter the SSID and security parameters as shown in Figure 17-13, and then click the **Save** button.

**Tip** After a network has been learned, you cannot edit its properties. Instead, you can select the network name and click the **Forget** button to remove the network from the list. From there, the network can be rediscovered or reconfigured manually.



**Figure 17-13** Adding a Wireless Network on an Android Device.

## Apple OS X

Apple devices use a built-in wireless adapter and a configuration utility to manage networks that are discovered and manually defined. To access the configuration utility, select **System Preferences**, and then select **Network**. Figure 17-14 shows an example, with all available network types listed down the left side. From this window, you can enable or disable the wireless adapter. You can also select **Wi-Fi** and then click the **Advanced** button to display and edit the network connection configurations.

The advanced settings window, as shown in Figure 17-15, has seven tabs across the top. The **Wi-Fi** tab contains a list of preferred networks—SSIDs that have already been configured. The network will be tried in sequential order; you can change the order by dragging networks up or down in the list.

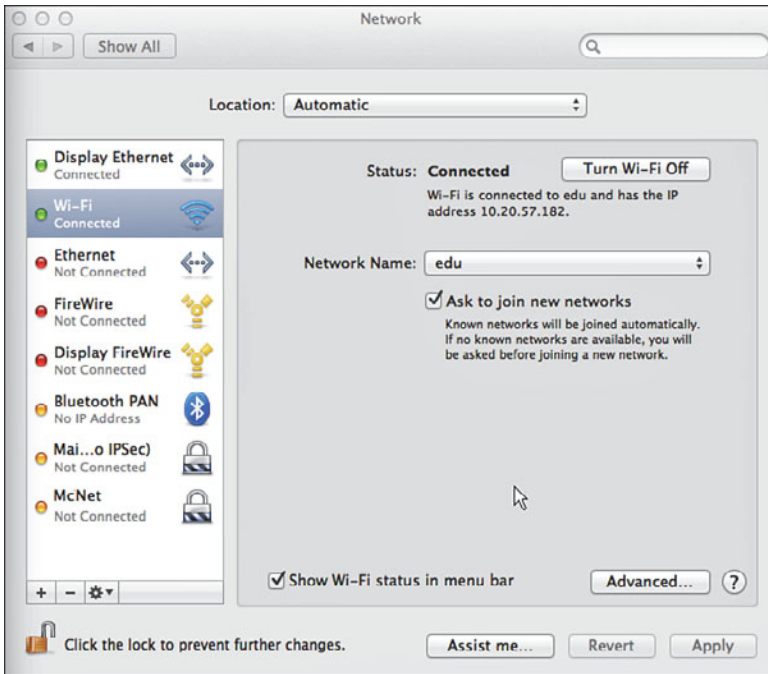


Figure 17-14 Accessing Apple Network Properties.

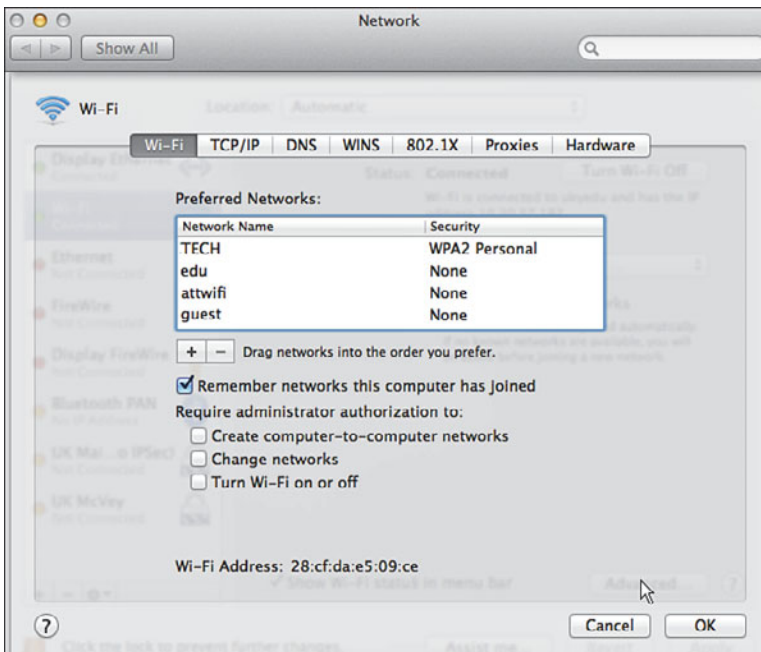
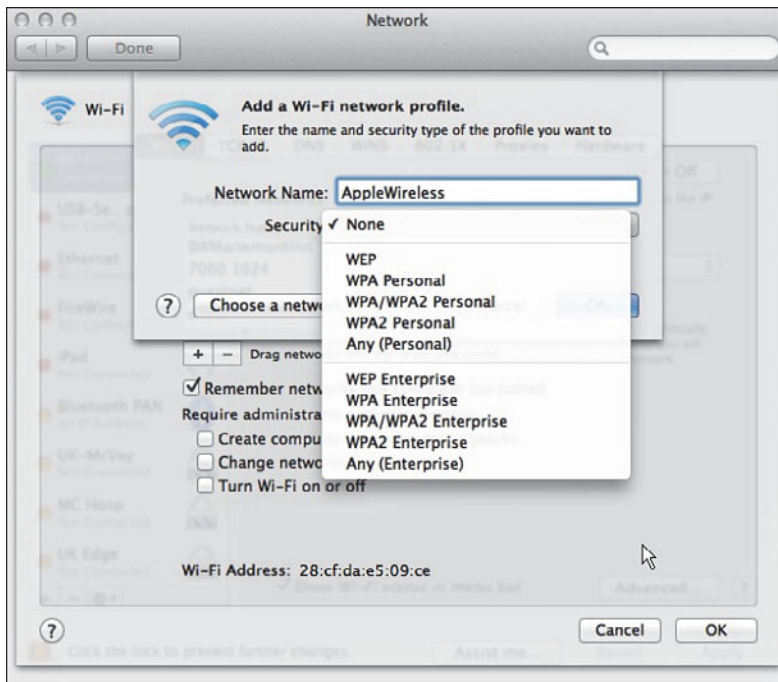


Figure 17-15 Displaying a List of Preferred Wireless Networks.

You can create a new wireless network by clicking the + (plus sign) button. As shown in Figure 17-16, you can enter an SSID and security parameters for the new network profile.



**Figure 17-16** *Creating a New Wireless Network Profile.*

## Cisco AnyConnect

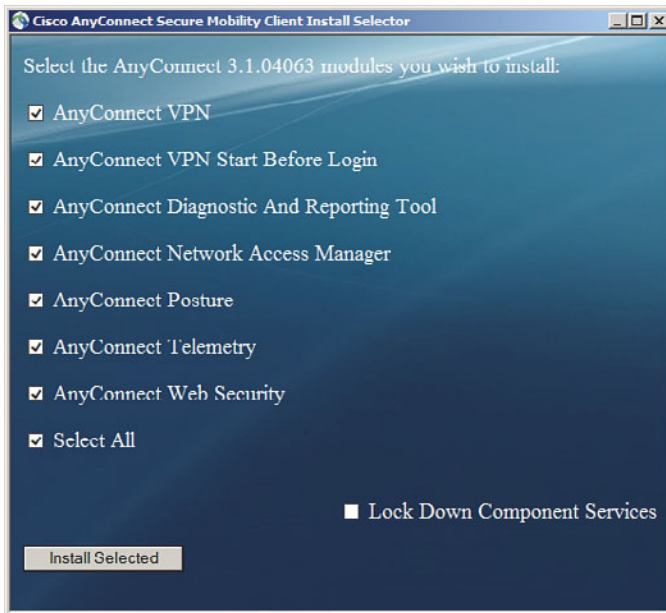
The Cisco AnyConnect Secure Mobility Client is a robust, modular security client that integrates a variety of functions into a single software application. The AnyConnect client runs on Windows, OS X, Linux, Apple iOS, and Google Android devices. AnyConnect can be installed in a modular fashion too, as shown in Figure 17-17.

The modules include the following:

- **VPN**—Virtual private network connections to a security gateway
- **Diagnostic and Reporting Tool (DART)**—Connection status and troubleshooting information
- **Network Access Manager (NAM)**—Control over secure connection methods and user authentication
- **Posture Assessment**—Verifies that antivirus, personal firewall, and service pack software are installed prior to building a connection
- **Telemetry**—Feeds information back into a web filtering infrastructure



- **Web Security**—Security policies enforced according to Cisco Web Security policies



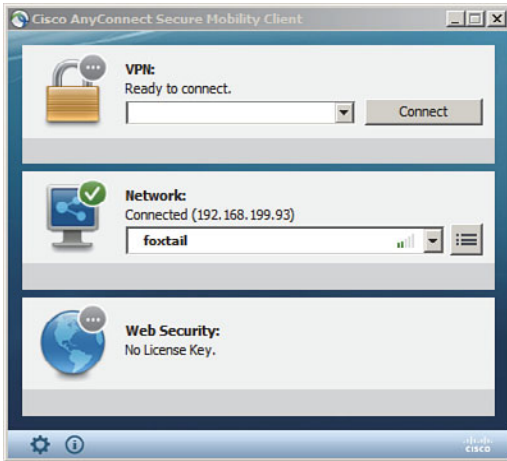
**Figure 17-17** *Installing Cisco AnyConnect Secure Mobility Client Modules.*

Notice that wireless was not mentioned in any of the AnyConnect module descriptions. That is because AnyConnect collects a suite of security functions into a single client software, regardless of the connection type. AnyConnect does provide integrated management of wireless connections, overriding that of any wireless client software that is installed on the client device. By controlling wireless connections, AnyConnect can also enforce any security policies that might affect the wireless security parameters an end user might try to use.

**Tip** To use AnyConnect to manage wireless connections, you must install the VPN and NAM modules.

AnyConnect policies can be created on a Cisco Adaptive Security Appliance (ASA) through its Adaptive Security Device Manager (ASDM) management front end and then pushed out to AnyConnect clients. The main AnyConnect client interface consists of VPN, network, and web security functions, as shown in Figure 17-18. The network function is the only one relevant to the CCNA Wireless exam.





**Figure 17-18** *Controlling the Cisco AnyConnect Secure Mobility Client.*

You can create and edit network profiles by selecting the properties button to the right of the Network Status section. Under the Networks > Configuration tab shown in Figure 17-19, the list of wireless networks is displayed. You can change the order of the networks by selecting one and using the up and down arrows to change its position in the list.

**Tip** Be aware that your ability to create and edit parameters is limited by the policies that are used to push the AnyConnect client and its profile to your local machine. For example, the AnyConnect administrator may have restricted your ability to create new connections only to wireless networks that use open authentication and pre-shared keys.

To create a new wireless network profile, click the **Add** button. Enter the SSID, wireless security parameters, and the 802.1x mode, as shown in Figure 17-20.

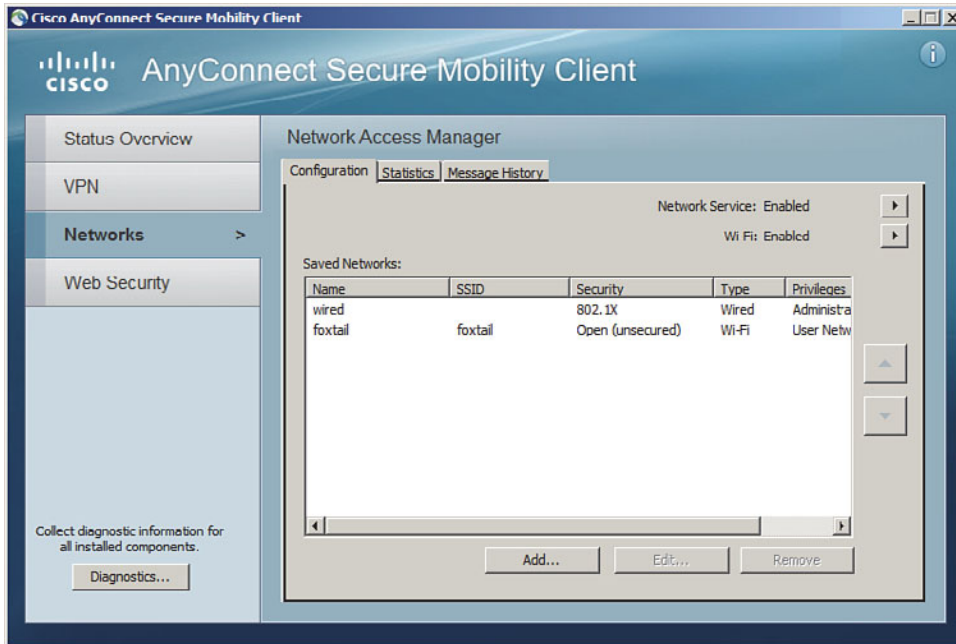


Figure 17-19 Managing Wireless Network Connections in AnyConnect.

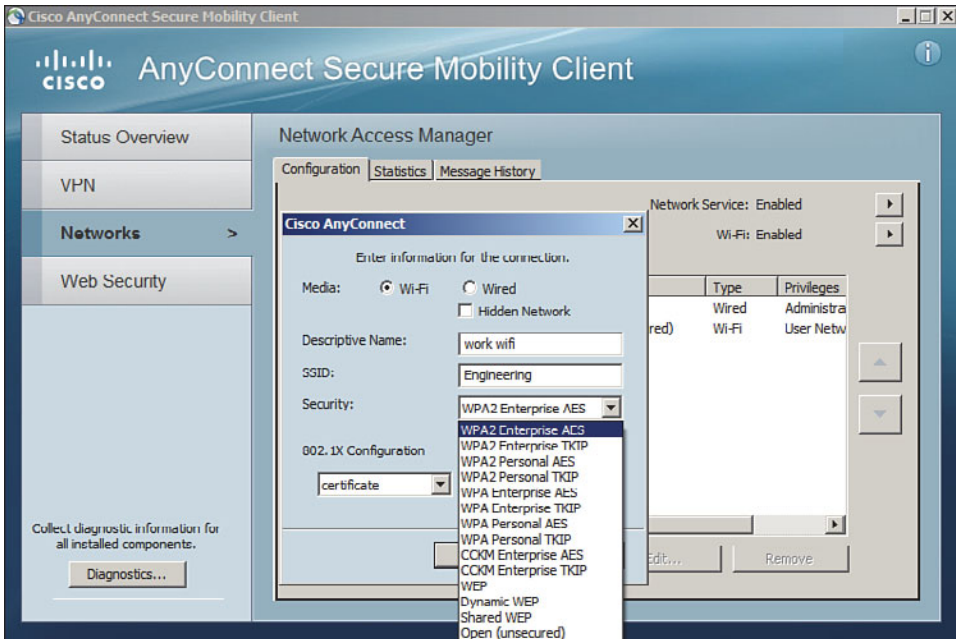


Figure 17-20 Configuring a New Wireless Network in AnyConnect.

## Cisco Compatible Extensions

The wireless clients described in the previous sections are fairly straightforward; the client has a wireless network adapter and controls the SSID and wireless security that are used to associate with an AP. Beyond that, the AP can make a safe assumption that the client complies with the 802.11 standard and supports certain data rates, but it knows little else about the client and its capabilities.

For example, without thorough testing, how do you know whether a wireless client and its driver software release support Wi-Fi Protected Access Version 2 (WPA2) with EAP Transport Layer Security (EAP-TLS) or some other security scheme? How do you know whether a client can optimally transport audio and video over wireless? Suppose that your enterprise just purchased several hundred wireless communication or medical devices. How can you be certain which wireless functions and security features the devices support?

To remove some of the unknowns, Cisco created the Cisco Compatible Extensions (CCX) program. Cisco defines a set of features as part of a specific CCX version. Wireless device manufacturers can implement the features in their devices and then submit their devices for testing and validation. If a device passes the interoperability tests, it receives a “Cisco Certified Compatibility” designation.

The CCX program really has two goals:

- Take advantage of Cisco enhancements and innovations above what is defined in the 802.11 standard
- Verify that a client supports each enhancement correctly

Over time, Cisco has developed CCX in phases or versions. To date, there are five versions, each building on its predecessor with an increasing set of features. Table 17-2 lists some of the 70 features, along with the CCX versions that support them. Notice how the more traditional and general features such as 802.11 are supported in all versions, essentially over a long period of time as WLAN technology has evolved. Features available only in v4 and v5 tend to be interactive, where the client works with the wireless infrastructure to report information about itself.

For example, management frame protection (MFP) addresses an inherent weakness in the management frames that an AP transmits. When a client receives a management frame, it implicitly trusts that the frame came from an AP and that the frame contents have not been tampered with. To secure management frames, both the AP and the client must participate to encrypt and authenticate each frame. Only CCXv5 clients are equipped to use frames protected with MFP.

**Table 17-2** *Feature Support in CCX Versions 1–5*

Feature	v1	v2	v3	v4	v5
IEEE 802.11 (general support for the standard as a whole)	X	X	X	X	X
Wi-Fi compliance	X	X	X	X	X
IEEE 802.1s	X	X	X	X	X
Windows Hardware Quality Labs (WHQL)	X	X	X	X	X
WPA		X	X	X	X
AP-assisted client roaming		X	X	X	X
RF scanning and reporting		X	X	X	X
AP-specified client maximum transmit power		X	X	X	X
Wi-Fi Multimedia (WMM)			X	X	X
Call admission control (CAC)				X	X
Client keepalive				X	X
Client link test				X	X
Unscheduled automatic power save delivery (U-APSD)				X	X
Client location reporting				X	X
Performance reporting					X
Diagnostic channel					X
Roaming and real-time diagnostics					X
Management frame protection (MFP)					X


 Key Topic

**Tip** What if a device is not certified for any CCX version? Chances are that it will work just fine on a Cisco wireless infrastructure. CCX certifies extended features that are specific to Cisco networks—not features that are needed for basic wireless operation.

Each CCX version contains more complex and interactive features than the version before it, but the features are organized more by the version number than by function. Some devices that are designed for a specific application, such as a wireless phone or a locator tag, do not have a need to support the entire list of features in a CCX version. To simplify the compatibility process for these devices, Cisco introduced the CCX Lite designation.

CCX Lite is organized into four basic categories or modules, according to device function:



- **Foundation**—The core set of features that are common to most general purpose devices
- **Voice**—Features specific to voice communication devices, such as WMM, CAC, expedited bandwidth request, and voice metrics
- **Location**—Features specific to near real-time location reporting, usually used with RFID tags
- **Management**—Features specific to client management, such as link test, diagnostic channel, client reporting, and roaming and real-time diagnostics

A device must be compliant with the Foundation module to achieve CCX Lite certification. The other modules are optional for application specific devices.

For the CCNA Wireless exam, be familiar with the CCX basics and know the CCX Lite modules. You should also have a good understanding of wireless security features and which CCX version supports them. For example, Cisco Centralized Key Management (CCKM) is used to make client authentication much more efficient during roaming. You should know which CCX version should be used to support a given authentication method. Study Table 17-3, which lists the wireless security and authentication schemes along with the CCX versions.

**Table 17-3** *Wireless Security Support in CCX Versions 1–5*

<b>Feature</b>	<b>v1</b>	<b>v2</b>	<b>v3</b>	<b>v4</b>	<b>v5</b>
IEEE 802.1x	X	X	X	X	X
LEAP	X	X	X	X	X
PEAP-GTC (PEAP with EAP-GTC)		X	X	X	X
EAP-FAST			X	X	X
PEAP-MSCHAP (PEAP with EAP-MSCHAPv2)				X	X
EAP-TLS				X	X
<b>WPA — 802.1x + WPA TKIP</b>		X	X	X	X
with LEAP		X	X	X	X
with PEAP-GTC		X	X	X	X

<b>Feature</b>	<b>v1</b>	<b>v2</b>	<b>v3</b>	<b>v4</b>	<b>v5</b>
with EAP-FAST			X	X	X
with PEAP-MSCHAP				X	X
with EAP-TLS				X	X
<b>WPA2 — 802.1x + AES (802.11i)</b>			X	X	X
with LEAP			X	X	X
with PEAP-GTC			X	X	X
with EAP-FAST			X	X	X
with PEAP-MSCHAP				X	X
with EAP-TLS				X	X
<b>Management frame protection (MFP)</b>					X

Table 17-3 might seem daunting, especially if you have to remember which CCX versions correspond to one of the many security features listed. Notice that the table can be broken down into four main divisions: 802.1x, WPA, WPA2, and MFP. Within each division, the same set of LEAP, PEAP-GTC, EAP-FAST, PEAP-MSCHAP, and EAP-TLS schemes are repeated. Therefore, you might benefit from memorizing the following rules of thumb:

- 802.1x is covered in all versions.
- WPA and its schemes were all introduced in CCXv2.
- WPA2 and its schemes were all introduced in CCXv3.

Except:

- EAP-FAST introduced in CCXv3
- PEAP-MSCHAP and EAP-TLS introduced in CCXv4
- MFP was introduced in CCXv5.

For example, without looking at the table, which CCX versions support WPA2 with EAP-TLS? From the third rule, you know that WPA2 is supported in Versions 3 and later, except that EAP-TLS is Version 4 and later. Therefore, your answer should be CCXv4 and CCXv5.

---

## Exam Preparation Tasks

---

As mentioned in the section, “How to Use This Book,” in the Introduction, you have a couple of choices for exam preparation: the exercises here, Chapter 22, “Final Review,” and the exam simulation questions on the CD-ROM.

### Review All Key Topics

Review the most important topics in this chapter, noted with the Key Topic icon in the outer margin of the page. Table 17-4 lists a reference of these key topics and the page numbers on which each is found.



**Table 17-4** *Key Topics for Chapter 17*

Key Topic Element	Description	Page Number
List	Cisco AnyConnect modules	348
Table 17-2	CCX versions	353
List	CCX Lite modules	354

### Define Key Terms

Define the following key terms from this chapter and check your answers in the glossary:

Cisco Compatibility Extensions (CCX), CCX Lite

*This page intentionally left blank*





---

This chapter covers the following topics:

- **WCS Overview**—This section provides a summary of Cisco Wireless Control System, its licensing, and its web-based management interface.
- **Using WCS to Configure Devices**—This section explains how you can use the WCS to add and configure wireless LAN controllers.
- **Using WCS Maps**—This section explains WCS maps and how they are used to provide a graphical representation of a wireless network in a physical space.
- **Generating Reports**—This section covers the process of creating and running a report to gather historical data from WCS.

This chapter covers the following exam topics:

- Identify key functions of Cisco Wireless Control System (WCS) and Navigator (versions and licensing)
- Navigate WCS interface
- Configure controllers and access points (APs) (using the Configuration tab, not templates)
- Use preconfigured maps in the WCS (adding/relocating/removing access points, turn on/off heat maps, view client location, and view CleanAir zones of influence)
- Use the WCS monitor tab and alarm summary to verify the WLAN operations
- Generate standard WCS reports (inventory, CleanAir, client-related, AP-related, and utilization)

# Managing Wireless Networks with WCS

A Cisco Unified Wireless Network (CUWN) is based on a centralized architecture. Multiple APs all connect to the same controller for their connectivity. You can configure, monitor, and manage the APs through the controller. As a network scales, management tasks can become tedious because you have to visit more than one controller to apply the same configuration changes or to monitor wireless events. The Wireless Control System (WCS) provides a central platform for managing multiple controllers and their access points (APs).

This chapter is a brief overview of WCS, how you can configure controllers and APs with it, and how you can use it to monitor a variety of things in your network.

## “Do I Know This Already?” Quiz

The “Do I Know This Already?” quiz allows you to assess whether you should read this entire chapter thoroughly or jump to the “Exam Preparation Tasks” section. If you are in doubt about your answers to these questions or your own assessment of your knowledge of the topics, read the entire chapter. Table 18-1 lists the major headings in this chapter and their corresponding “Do I Know This Already?” quiz questions. You can find the answers in Appendix A, “Answers to the ‘Do I Know This Already?’ Quizzes.”

**Table 18-1** “Do I Know This Already?” Section-to-Question Mapping

Foundation Topics Section	Questions
WCS Overview	1–6
Using WCS to Configure Devices	7
Using WCS Maps	8–9
Generating Reports	10

**Caution** The goal of self-assessment is to gauge your mastery of the topics in this chapter. If you do not know the answer to a question or are only partially sure of the answer, you should mark that question as wrong for purposes of the self-assessment. Giving yourself credit for an answer you correctly guess skews your self-assessment results and might provide you with a false sense of security.

- 1.** What are three benefits of using Cisco WCS?
  - a.** Wireless planning
  - b.** Wireless management
  - c.** Wireless troubleshooting
  - d.** Wireless site surveys
- 2.** Which two of the following are benefits of purchasing the WCS Plus license?
  - a.** Closest AP client location on demand
  - b.** High-availability operation
  - c.** Wireless LAN controller management
  - d.** MSE integration for client location
- 3.** What is the maximum number of APs that a single-server WCS license will support?
  - a.** 100
  - b.** 500
  - c.** 1000
  - d.** 50,000
- 4.** WCS Navigator is meant for which one of the following functions?
  - a.** Use location-based information to plot a route through the network
  - b.** A tool to assist with orienting AP antennas
  - c.** Management of multiple WCS instances
  - d.** Management of multiple controllers
- 5.** In the alarm summary dashboard, what is represented by the orange triangle pointing downward?
  - a.** Helpful cautions about RF parameters
  - b.** Minor alarms from controllers
  - c.** Major alarms from controllers
  - d.** A summary of all alarm types

6. If a WCS alarm goes unacknowledged, what will happen to it?
  - a. Nothing; the alarm will be active forever until it is acknowledged.
  - b. After 15 days, the alarm will be automatically acknowledged.
  - c. After 1 hour, the alarm will be automatically acknowledged.
  - d. After 1 day, the AP that is the source of the alarm will be disabled.
7. To add a controller to WCS, which one of the following menus should you use?
  - a. Configure > Add
  - b. Configure > Controllers
  - c. Administration > Controllers > Add
  - d. Management > Controllers
8. Which one of the following WCS menu options enables you to find a list of maps?
  - a. Monitor > Maps
  - b. Configure > Maps
  - c. View > Maps
  - d. Management > Maps
9. WCS maps are organized into which one of the following hierarchies?
  - a. Campus > building > floor
  - b. Enterprise > department > building
  - c. Building > floor > room
  - d. Domain > building > floor
10. Suppose that you want to see information about all the APs on your wireless network. Which one of the following reports should you choose to generate?
  - a. Inventory > APs
  - b. Network Summary > APs
  - c. Device > Inventory
  - d. Device > Controllers

---

## Foundation Topics

---

### WCS Overview

The Cisco WCS is a browser-based software application that offers the capability to manage multiple controller deployments through a single interface. Benefits of WCS include the following:

- Wireless planning tools for access point (AP) placement and radio frequency (RF) parameters
- Controller and AP deployment through configuration templates
- Monitoring of controllers, APs, and wireless client devices
- Troubleshooting through alerts, events, wireless interference analysis, and a built-in client troubleshooting tool
- Extensive set of reports that can be automated or run on-demand

**Note** You might be aware that Cisco WCS is no longer a supported product. Nevertheless, WCS is still covered on the IUWNE 640-722 exam. WCS has undergone an evolution, becoming Cisco Prime Network Control System (NCS) and then becoming Cisco Prime Infrastructure (PI). Prime Infrastructure can manage both wireless and wired networks and has much greater functionality than WCS. It can work with Cisco Mobility Services Engines (MSE) to locate clients, leverage Cisco CleanAir, and provide improved wireless intrusion prevention system (wIPS) functionality.

WCS is a service that is installed on a 32-bit Windows 2003 SP1+ or Red Hat Linux server. It is available in two forms: WCS Base and WCS Plus. Both forms can manage multiple controllers and APs, and can monitor wireless clients, but they differ according to the functions listed in Table 18-2.

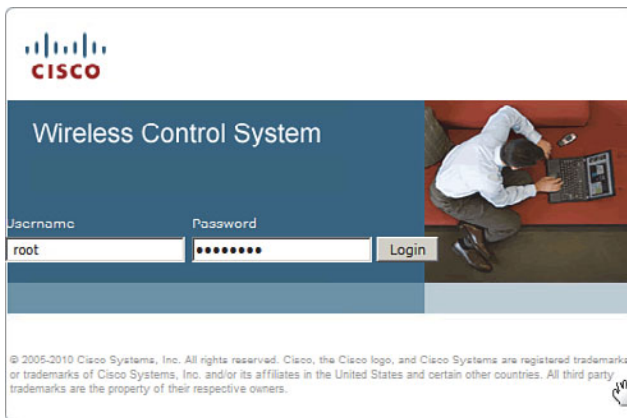
**Table 18-2** *Comparison Between WCS Base and WCS Plus*

WCS Base	WCS Plus
Clients can be coarsely located, in relation to the nearest AP.	Clients can be located in a context-based fashion by triangulating between three nearest APs, for a high degree of accuracy.
	WCS can operate as a high-availability pair.
	WCS can leverage MSE for client tracking, wIPS.

WCS is also licensed according to scale and the number of APs that will be supported. You can purchase WCS as a single-server license for installations that can support up to 50, 100, or 500 APs. For larger networks, WCS is available as an enterprise license that can support one or more server instances and up to 50,000 APs. The enterprise license is available only in the Plus form.

In large enterprise settings, you might need more than one instance of WCS to manage a vast number of controllers and APs. The enterprise license allows you to install multiple WCS servers, but you still have to visit each WCS individually. To scale even further, you could leverage the Cisco WCS Navigator. Navigator provides a single WCS-like interface that can aggregate and manage up to 20 distinct WCS servers. You can purchase Navigator as a separate product or take advantage of one free license that is included in a WCS enterprise license.

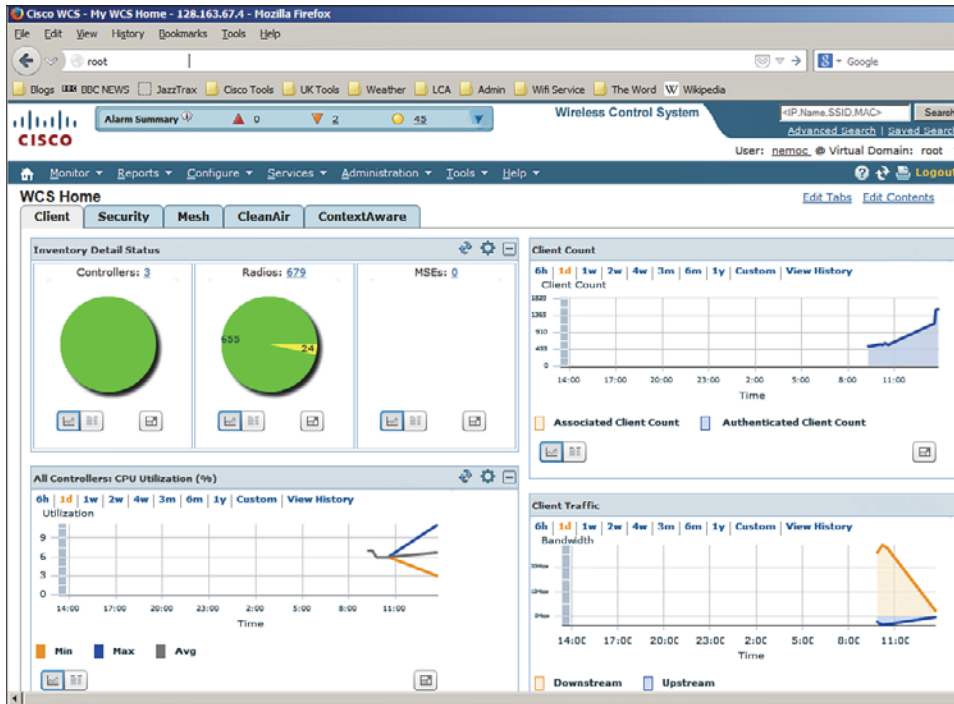
Once WCS is installed, you can connect to it with a secure web browser session pointed to the IP address of the WCS server. Installing and initially configuring WCS is beyond the scope of the CCNA Wireless exam. You can log in with username root and the initial password, as shown in Figure 18-1, or with another username that has been subsequently configured.



**Figure 18-1** WCS Login Screen.

Once you log in to WCS, you see a home page like the one shown in Figure 18-2. The home page is organized into several sections or areas:

- **Alarm Summary dashboard**—A narrow strip of alarm counters across the top left of the page
- **Main navigation menu**—Monitor, Reports, Configure, Services, Administration, Tools, and Help drop-down menus
- **WCS Home area**—Client, Security, Mesh, CleanAir, and ContextAware tabs



**Figure 18-2** WCS Home Page.

Each area is described further in the following sections.

**Tip** You can return to the WCS home page at any time by clicking the small house-shaped icon located in the upper-left corner of the WCS navigation menu.

## Alarm Summary Dashboard

As WCS receives alarms from controllers and other wireless management devices, it categorizes them by severity level and displays a summary count. There are three severity levels, as follows:

- **Critical**—Denoted by a red upward triangular arrow
- **Major**—Denoted by an orange downward triangular arrow
- **Minor**—Denoted by a yellow circle

If the severity level count is nonzero, you can click the number to display a list of the specific alarms. Figure 18-3 shows a typical list of minor severity alarms. Notice that each alarm has a check box in the far-left column. WCS will remember each alarm it receives for a default period of 15 days or until someone takes some action on it. You

can check the box next to one or more alarms and then select the drop-down menu at the upper right of the alarm list to select an action to take. Table 18-3 lists the actions.

<input type="checkbox"/>	Severity	Failure Source	Owner	Date/Time	Message	
<input checked="" type="checkbox"/>	●	<a href="#">AP_d214-ap8, Interface 802.11a</a>		8/26/13 2:39:07 PM	Load threshold violation reported by '802.11b/g' interface of AP 'dsb-d214-ap8', connected to Controller '1'	
<input type="checkbox"/>	●	<a href="#">Controller wism-sw1-m4-c1</a>		8/26/13 2:30:17 PM	Decrypt error occurred for client 'b4:b6:76:2a:bf:ed' using 'WPA2' key on '802.11b/g' interface of AP 'ha629-ap6'.	No
<input type="checkbox"/>	●	<a href="#">Controller wism-sw1-m3-c2</a>		8/26/13 2:30:17 PM	Decrypt error occurred for client '00:15:af:ba:fe:37' using 'WPA2' key on '802.11b/g' interface of AP 'm134-ap3'.	No
<input checked="" type="checkbox"/>	●	<a href="#">AP dsb-d214-ap8, Interface 802.11b/g</a>		8/26/13 2:37:39 PM	Load threshold violation reported by '802.11b/g' interface of AP 'd214-ap8', connected to Controller	No
<input checked="" type="checkbox"/>	●	<a href="#">AP cop-492-ap13, Interface 802.11b/g/n</a>		8/26/13 2:37:26 PM	Load threshold violation reported by '802.11b/g/n' interface of AP '492-ap13', connected to Controller	No
<input checked="" type="checkbox"/>	●	<a href="#">AP mdc-h/5/-hall-ap22, Interface 802.11b/g</a>		8/26/13 2:36:12 PM	Load threshold violation reported by '802.11b/g' interface of AP 'h757-hall ap22', connected to Controller '128.1...	No
<input checked="" type="checkbox"/>	●	<a href="#">AP dsb-d214-ap4, Interface 802.11b/g</a>		8/26/13 2:36:00 PM	Load threshold violation reported by '802.11b/g' interface of AP 'd214-ap4', connected to Controller	No
<input type="checkbox"/>	●	<a href="#">Rogue AP 88:1f:a1:31:64:e0</a>		8/26/13 2:34:39 PM	Rogue AP '88:1f:a1:31:64:e0' with SSID 'Mody' and channel number '1' is detected by AP 'cop-47g-ap2' Radio type '802....	No
<input type="checkbox"/>	●	<a href="#">Rogue AP 2c:e4:12:49:80:2d</a>		8/26/13 2:32:15 PM	Rogue AP '2c:e4:12:49:80:2d' with SSID 'MEDICALVIEW10' and channel number '6' is detected by AP 'd214-ap8' Radio...	No

**Figure 18-3** A Typical List of Alarms.

**Table 18-3** Alarm Actions

Action	Description
Assign to Me	The alarm will remain in your own alarm list.
Unassign	Take the alarm out of your alarm list.
Delete	Make WCS forget about the alarm.
Clear	Remove the alarm from the list, but WCS will keep a record of it.
Acknowledge	The alarm has been checked and can be removed from the list.
Unacknowledge	The alarm should be added back to the list.
Email Notification	Select alarm types to be emailed.

You can also click one of the links that is listed under the Failure Source column in the alarm list. This will display all the information available about the specific alarm, as shown in Figure 18-4. WCS can maintain any annotation text you or other users add about the alarm as an audit trail or history of the problem. To add an annotation, click the **New Annotation** button on the right side of the page.



The screenshot shows the Cisco WCS interface. At the top, there's a navigation bar with 'Monitor', 'Reports', 'Configure', 'Services', 'Administration', 'Tools', and 'Help'. Below this, the main title is 'Alarm Details : AP d214-ap8, Interface 802.11b/g'. The interface is divided into two main sections: 'General' and 'Message'. The 'General' section contains a table with the following data:

Failure Source	AP d214-ap8, Interface 802.11b/g AP
Owner	
Acknowledged	No
Category	Access Points
Created	Aug 26, 2013 2:37:39 PM
Modified	Aug 26, 2013 2:37:39 PM
Generated By	Controller
Severity	Minor
Previous Severity	Clear
Event Details	<a href="#">Event History</a>

The 'Message' section contains a text box with the message: 'Load threshold violation reported by '802.11b/g' interface of AP 'd214-ap8', connected to Controller'. Below the message is an 'Annotations' section with a 'New Annotation' button and a table with columns for 'Date/Time', 'Posted By', and 'Message'.

**Figure 18-4** *Displaying Details About a Specific Alarm.*

## Main Navigation Area

You can use the main navigation area to perform many functions. The area is organized as a bar of the following drop-down menus:



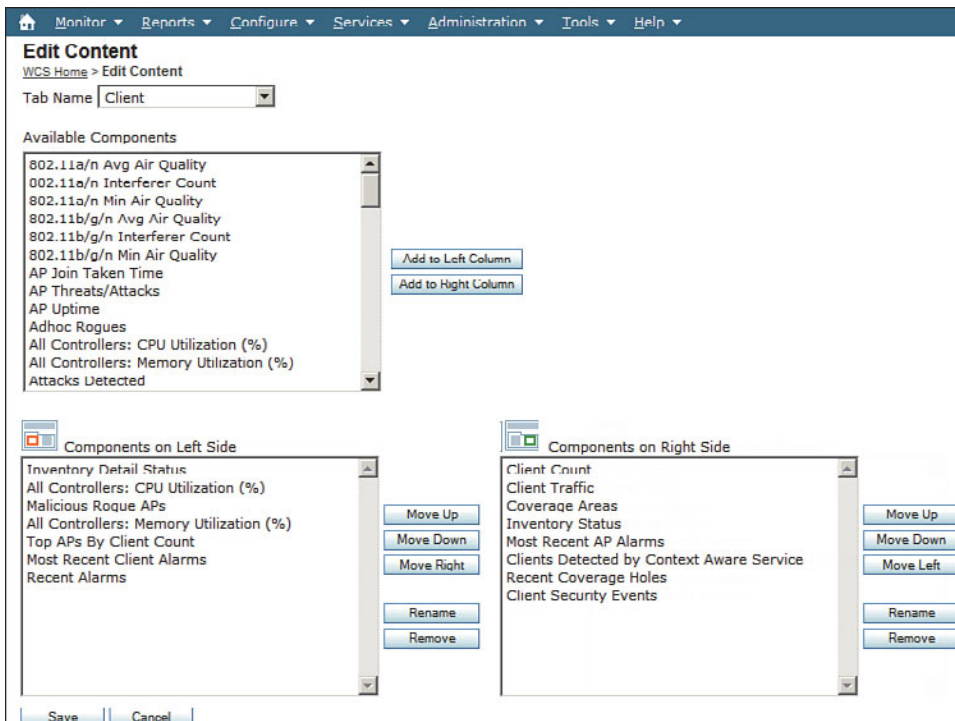
- **Monitor**—Display current information from building maps, controllers, access points, clients, RFID tags, and RF spectrum data. You can also display helpful information about Radio Resource Management (RRM) events, alarms, and other events that have occurred.
- **Reports**—Define, schedule, and display reports on various aspects of the wireless network.
- **Configure**—Make configuration changes to controllers, APs, spectrum expert devices; define and edit configuration templates to be applied to wireless devices.
- **Services**—Integrate WCS with external location-based services and applications.
- **Administration**—Configure administrative aspects of WCS.
- **Tools**—Perform voice and controller configuration audits, attach information to a Cisco TAC service request, and more.
- **Help**—Display helpful information and learn more about WCS topics.

## WCS Home Area

The home area is organized as a set of tabs that you can select to display charts and graphs about categories of wireless activity. By default, the home area consists of the following tabs:

- **Client**—Displays an inventory count of controllers, radios, and MSEs; a client count; and utilization and traffic histories. The Client tab is displayed by default on the home page.
- **Security**—Displays summaries of threats and attacks that have been detected, in addition to alarms about rogue APs and other security events.
- **Mesh**—Displays statistics that might indicate problems with indoor and outdoor wireless mesh networks.
- **CleanAir**—Displays air-quality and interference information gleaned from APs that are capable of measuring RF spectrum use.
- **ContextAware**—Displays information about various elements and devices that have been identified and tracked by MSEs.

The home area can be customized for each WCS user. You can edit the list of tabs by clicking the **Edit Tabs** link at the upper right of the WCS page. You can also tailor the tab contents by clicking the **Edit Content** link. Select the appropriate tab from the **Tab Name** drop-down menu, as shown in Figure 18-5. Then you can select one of the many information components you want to see and click either the **Add to Left Column** or **Add to Right Column** button to choose which side of the tab page should be used. You can change the position of each component by using the two component lists at the bottom of the page.



**Figure 18-5** *Editing the WCS Home Page Area Tabs and Contents.*

## Using WCS to Configure Devices

Before WCS can manage any controllers, you must add them into the WCS configuration. Select **Configure > Controllers** to display a list of currently managed controllers. To add a new one, select **Add Controllers** from the drop-down menu and click the **Go** button, as shown in Figure 18-6.



The screenshot shows the Cisco Wireless Control System (WCS) interface. The top navigation bar includes 'Monitor', 'Reports', 'Configure', 'Services', 'Administration', 'Tools', and 'Help'. The main content area is titled 'Controllers' and contains a table with the following data:

IP Address	Controller Name	Type	Location	Software
<a href="#">192.168.10.10</a>	sw1-m3-c2	WiSM (Slot 19, Port 2)	Main Building Room 101	7.0.116
<a href="#">192.168.10.11</a>	sw1-m2-c2	WiSM (Slot 18, Port 2)	Main Building Room 101	7.0.116
<a href="#">192.168.10.12</a>	sw1-m4-c1	WiSM (Slot 20, Port 1)	Main Building Room 101	7.0.116

A dropdown menu is open over the table, showing the following options: 'Add Controllers', 'Remove Controllers', 'Reboot Controllers', 'Reboot Controllers and APs(Swap AP Images)', 'Reboot Controllers and APs(Do Not Swap AP Images)', 'Download Software(TFTP)...', 'Download Software(FTP)...', 'Download IDS Signatures', 'Download Customized WebAuth', 'Download Vendor Device Certificate', 'Download Vendor CA Certificate', 'Save Config to Hash', 'Refresh Config from Controller', 'Discover Templates from Controller', 'Templates Applied to Controller', and 'Audit Now'. The 'Add Controllers' option is highlighted.

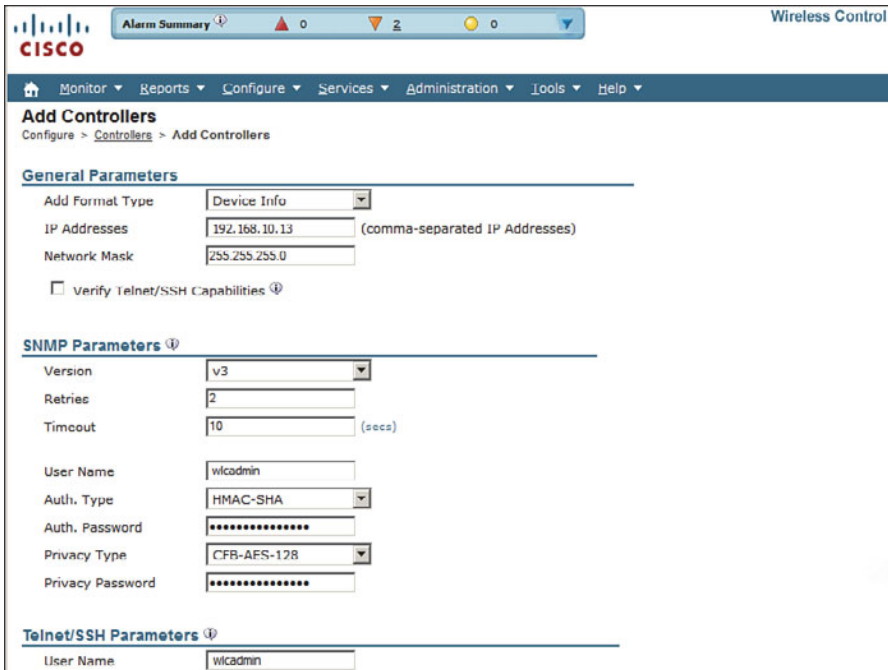
**Footnotes:**

- 'Reachability Status' is updated based on the last execution information of 'Device Status' background task. For updating the current status, use 'Execute Now' command of Administration > Background Tasks.
- 'Audit Status' is updated based on the last execution information of either 'Configuration Sync' background task or 'Audit Now' command option in Controllers page. To get the current status, either use 'execute Now' command of Administration > Background Tasks or 'Audit Now' command option in Controllers page.

**Figure 18-6** Adding a New Controller to WCS.

Next, enter the controller's IP address, along with its Simple Network Management Protocol (SNMP) and Secure Shell (SSH) credentials, and then click **OK**. The SNMP credentials can have read-only access to view the WLC, but must be read-write for WCS to make configuration changes on the WLC. SSH and Telnet are not necessary except for migrating autonomous APs to lightweight mode. Figure 18-7 shows a new controller at 192.168.10.13 being added to the WCS database. If the SNMP credentials are correct, WCS will pull the controller's configuration, along with the full list of APs joined to it, into the WCS database.

After you have populated WCS with a list of controllers, you can use it to configure controller and AP parameters from one central location. To make a configuration change, you can select **Configure > Controllers** and then select the IP address link of the target controller. Next, WCS displays a configuration page that is similar to that of the controller itself. The far-left column represents a list of controller functions. Each entry is actually a drop-down list of parameters. In Figure 18-8, the 802.11b/g/n > RRM > DCA parameters are being configured. The idea is to mimic an actual controller's configuration before pushing the configuration out to it.



**Alarm Summary** 0 2 0

**CISCO** Wireless Control System

Monitor Reports Configure Services Administration Tools Help

### Add Controllers

Configure > Controllers > Add Controllers

#### General Parameters

Add Format Type: Device Info

IP Addresses: 192.168.10.13 (comma-separated IP Addresses)

Network Mask: 255.255.255.0

Verify Telnet/SSH Capabilities

#### SNMP Parameters

Version: v3

Retries: 2

Timeout: 10 (secs)

User Name: wicadmin

Auth. Type: HMAC-SHA

Auth. Password: .....

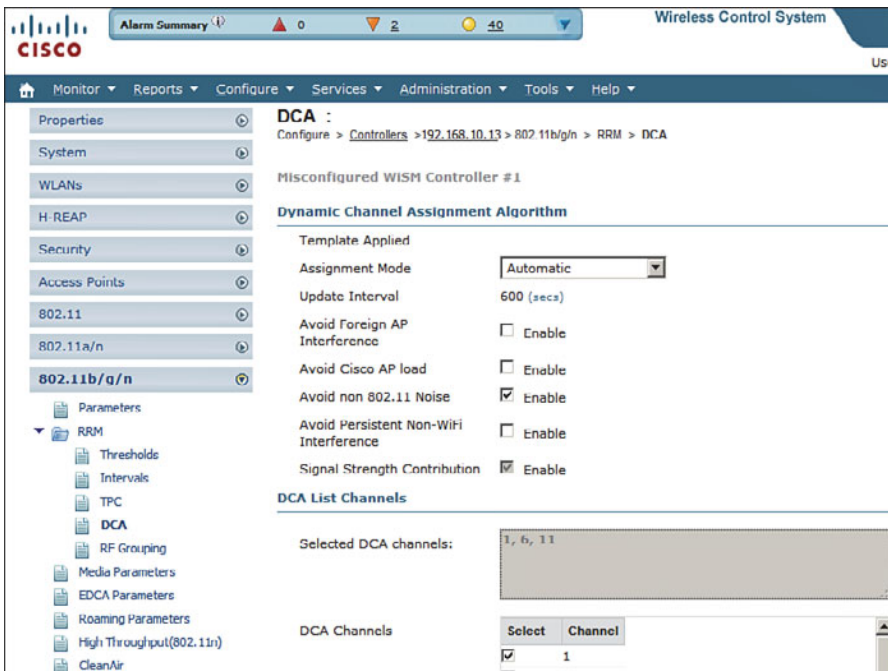
Privacy Type: CFR-AES-128

Privacy Password: .....

#### Telnet/SSH Parameters

User Name: wicadmin

**Figure 18-7** Configuring Controller Access Information.



**Alarm Summary** 0 2 40

**CISCO** Wireless Control System

Monitor Reports Configure Services Administration Tools Help

### DCA

Configure > Controllers > 192.168.10.13 > 802.11b/g/n > RRM > DCA

Misconfigured WISM Controller #1

#### Dynamic Channel Assignment Algorithm

Template Applied

Assignment Mode: Automatic

Update Interval: 600 (secs)

Avoid Foreign AP Interference:  Enable

Avoid Cisco AP load:  Enable

Avoid non 802.11 Noise:  Enable

Avoid Persistent Non-WiFi Interference:  Enable

Signal Strength Contribution:  Enable

#### DCA List Channels

Selected DCA channels: 1, 6, 11

Select	Channel
<input checked="" type="checkbox"/>	1

**Figure 18-8** Configuring Controller Parameters Through WCS.

When you click the **Save** button at the bottom of the configuration page, the configuration changes are pushed out to the controller.

WCS also offers a flexible and scalable solution for configuring multiple controllers and APs. You can define configuration templates that can be applied to specific devices automatically. For example, you can define a template that gets pushed to a newly installed controller so that it gets configured similarly to other controllers already in production. You might also want to change RF settings on a long list of APs. WCS makes a tedious and time-consuming chore into an organized, efficient, and repeatable task.

You can configure WCS templates by selecting **Configure > Controller Template Launch Pad**. WCS templates are not covered on the CCNA Wireless exam.

## Using WCS Maps

As you work with wireless controllers and APs, you might find yourself getting lost in the names and numbers without having a visual concept of things like AP location and RF coverage in an area. Fortunately, WCS can help! WCS can provide a graphical representation of a wireless network, complete with maps, physical locations, predictive RF coverage, and interactive data displays. In other words, WCS will help you see your wireless network as it really is—APs and clients distributed throughout a building or outdoor area.

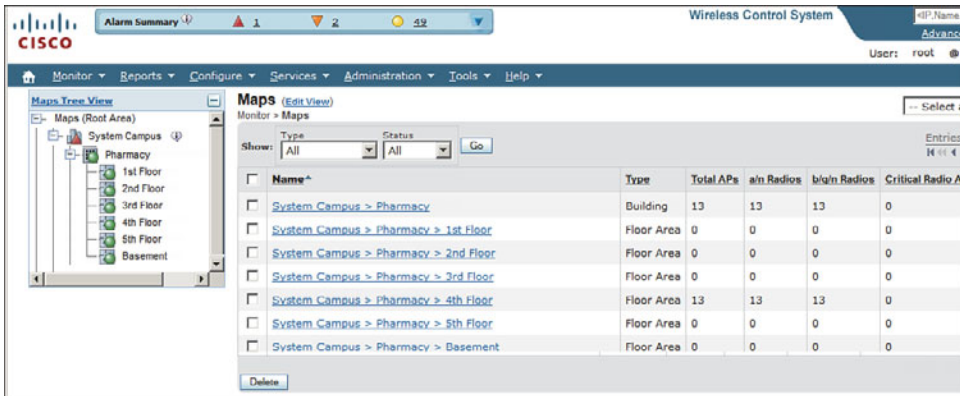
WCS can use an image file (PNG, JPG, or GIF formats) as the background behind objects and data that it displays. For example, you can upload the floor plan of a building into WCS and have the APs and clients that are located on that floor shown in relation to their actual locations.

WCS maps are organized in a tree-like structure. A campus contains one or more buildings or outdoor areas. Each building can contain one or more floor maps. By default, maps are placed into a system campus. You can define your own campuses and your own buildings as you add maps into WCS.

**Tip** The CCNA Wireless exam blueprint focuses on manipulating and using preconfigured maps. You will not have to worry about how to create and organize the maps—just how to work with the APs and the parameters needed to display various wireless data.

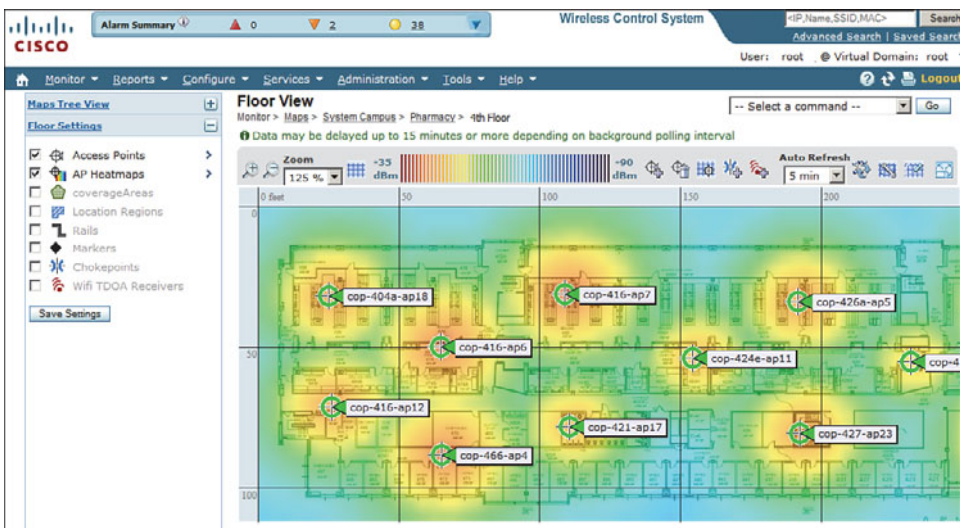
## Displaying Maps

You can access the WCS maps by selecting **Monitor > Maps**. The list in the far-left column contains the map tree structure; the rest of the page contains a single flat list of every campus, building, and floor map. In Figure 18-9, WCS already has one building preconfigured with maps for five floors. You can see from the AP and radio counts that only the fourth-floor map shows APs. The other floors have maps, but no APs have been added or located on them yet.



**Figure 18-9** A Typical List of Maps Displayed in Monitor > Maps.

You can click a map name in the list to display it, as shown in Figure 18-10. The map consists of the background image, usually a building floor plan or a drawing of an outdoor area, overlaid with AP icons and data. For example, the AP icons in the figure are shown in their current locations with labels that display the AP names.



**Figure 18-10** A WCS Map Showing AP Locations.

By default, a map is shown with dynamic information. WCS computes the RF signal strength for each AP and displays the results as a colored heatmap. The colors represent the signal strength that might be received in each location on the map. The color scale is shown above the heatmap. Red represents a strong signal ( $-35$  dBm), progressing through orange, yellow, green, and then blues and purples at the weak end of the scale ( $-90$  dBm).

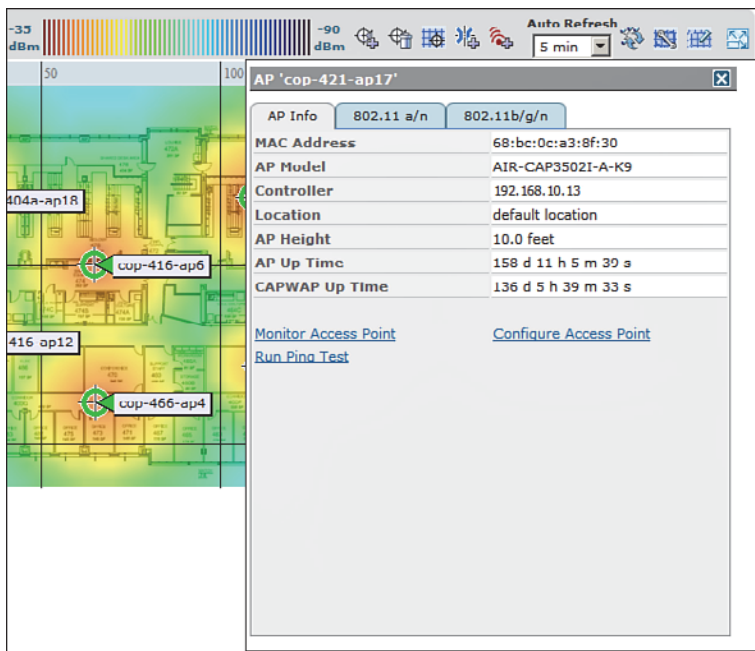
The heatmap that WCS computes is based on many of the RF principles you learned about in Chapter 3, “RF Signals in the Real World.” Based on each map location, WCS



can compute the free-space loss based on the distance from each of the APs. What about things like absorption, where the walls of a building attenuate or reduce RF signal strength? At a minimum, a WCS map contains only the AP icons positioned over a floor plan background image. You might be able to see objects like walls, doors, and elevators on the map, but WCS is not able to interpret the drawing at all. Instead, if you want WCS to know about obstacles and compute their influence, you can use the map editor tool to define the physical objects and their dBm attenuation values. The more information you put into a map, the more accurate WCS can be when it produces the RF heat-map.

WCS also updates the AP icons based on current conditions. A green icon represents an AP radio that is working properly, with no faults or alarms. A yellow icon represents an AP radio with a minor alarm, while a red icon indicates a major alarm. Icons can also blink, indicating that one of the AP's profile thresholds (load, interference, noise, or coverage hole) has been exceeded. By default, WCS updates a map every 5 minutes.

While a map is displayed, you can hover the cursor over an icon to display more information about it. For example, Figure 18-11 shows a small window that popped up to display information about the AP named cop-421-ap17. From this window, you can find the AP's MAC address, model number, and the IP address of the controller it has joined. You can select the 802.11a/n or 802.11b/g/n tab to display information about that specific radio, including channel number and transmit power level.



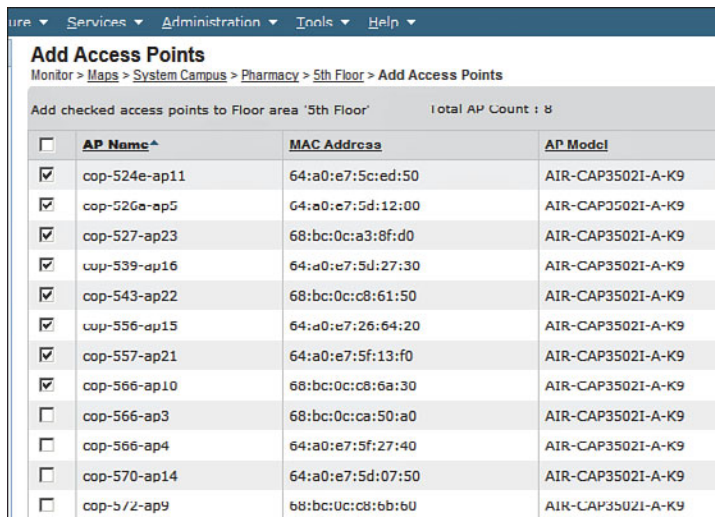
**Figure 18-11** *Displaying Information About an AP on a Map.*

## Manipulating APs on Maps

Once a map has been created for a building floor or outdoor area, you will need to populate it with AP icons. Sometimes you might also need to move AP icons to reflect their location more accurately or delete icons if the corresponding APs have been removed.

To place APs on a map, first display the map. Next, you will need to select the APs that will be placed on the map. The APs must already exist, be joined to a controller, and be known to WCS. From the drop-down menu in the upper-right corner of the map floor view page, select **Add Access Points**, and then click the **Go** button.

On the Add Access Points page, WCS will display a list of all of the APs it knows. You will have to search through the pages of the list to find and select the APs you want to add to the map. You can sort the list by AP name to make the search easier. After you have checked the box next to each AP, as shown in Figure 18-12, click the **OK** button at the bottom of the page.



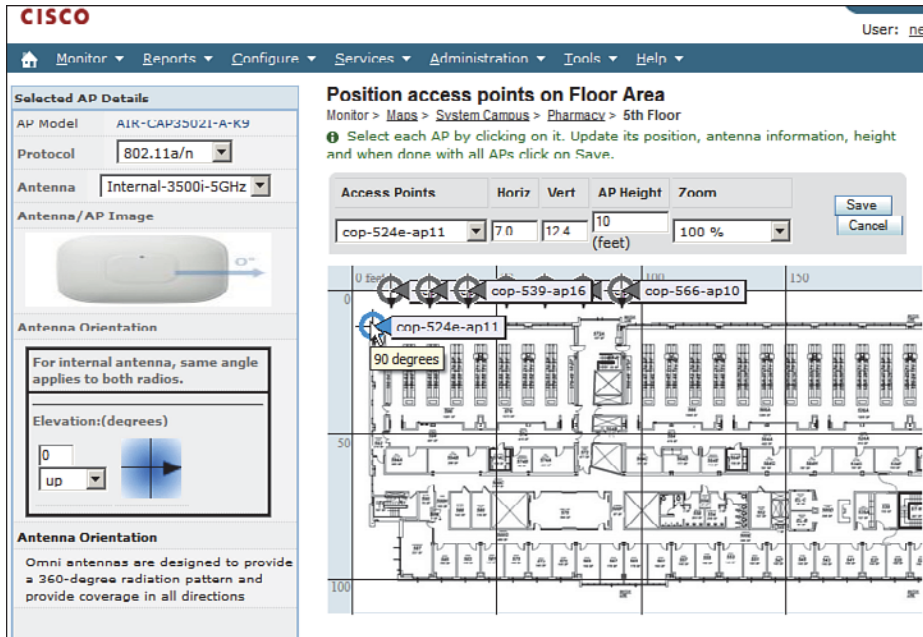
<input type="checkbox"/>	AP Name*	MAC Address	AP Model
<input checked="" type="checkbox"/>	cop-524e-ap11	64:a0:e7:5c:ed:50	AIR-CAP3502I-A-K9
<input checked="" type="checkbox"/>	cop-526a-ap5	64:a0:e7:5d:12:00	AIR-CAP3502I-A-K9
<input checked="" type="checkbox"/>	cop-527-ap23	68:bc:0c:a3:8f:d0	AIR-CAP3502I-A-K9
<input checked="" type="checkbox"/>	cup-539-ap16	64:a0:e7:5d:27:30	AIR-CAP3502I-A-K9
<input checked="" type="checkbox"/>	cop-543-ap22	68:bc:0c:c8:61:50	AIR-CAP3502I-A-K9
<input checked="" type="checkbox"/>	cup-556-ap15	64:a0:e7:26:64:20	AIR-CAP3502I-A-K9
<input checked="" type="checkbox"/>	cop-557-ap21	64:a0:e7:5f:13:f0	AIR-CAP3502I-A-K9
<input checked="" type="checkbox"/>	cop-566-ap10	68:bc:0c:c8:6a:30	AIR-CAP3502I-A-K9
<input type="checkbox"/>	cop-566-ap3	68:bc:0c:ca:50:a0	AIR-CAP3502I-A-K9
<input type="checkbox"/>	cop-566-ap4	64:a0:e7:5f:27:40	AIR-CAP3502I-A-K9
<input type="checkbox"/>	cop-570-ap14	64:a0:e7:5d:07:50	AIR-CAP3502I-A-K9
<input type="checkbox"/>	cop-572-ap9	68:bc:0c:c8:6b:b0	AIR-CAP3502I-A-K9

**Figure 18-12** Selecting APs to Add to a WCS Map.

Next, you will have to position each AP in its appropriate location on the map. WCS displays the map and lines the selected APs up along the top edge. Usually the AP icons start out so close together that their names are obscured. You may have to move them elsewhere on the map just to space them out and see their names.

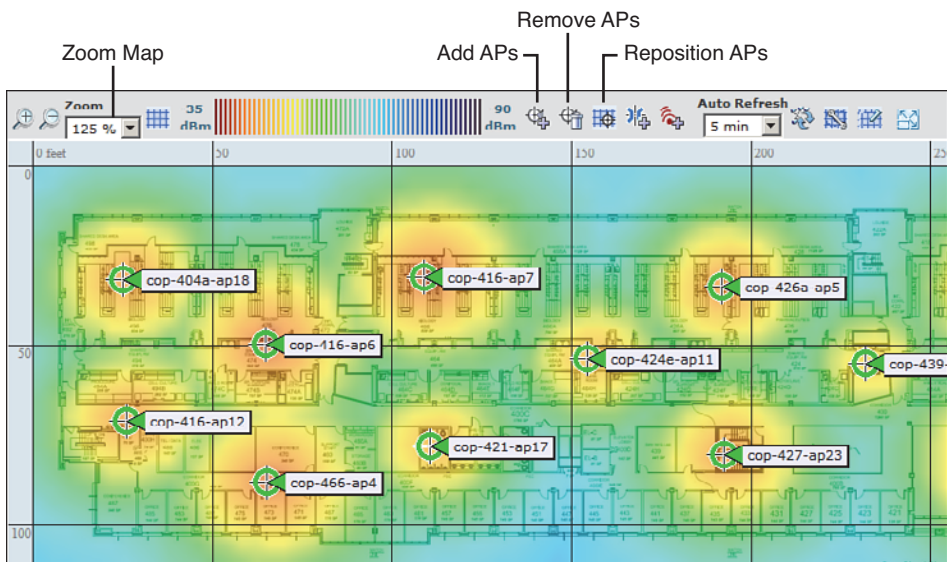
To move an AP icon, just click it and drag it to the desired location. In Figure 18-13, AP cop-524e-ap11 is being moved from its default position at the upper-left corner. All of the AP icons will remain dark while the AP being moved will be blue. When you select an AP to move, WCS will also display the AP's name, position on the map, mounting height, and antenna orientation. During this process, you can always make further adjustments and relocate APs as needed. Click the **Save** button to save the map and AP locations.





**Figure 18-13** Locating APs on a WCS Map.

You can make further changes to a map whenever it is displayed. There are several small editing icons along the top of the map, as shown in Figure 18-14. Use the zoom factor to resize the map so that you can view it at an appropriate size. You can click the respective icon to add, remove, and reposition APs in the map.



**Figure 18-14** Icons Used to Zoom a Map and Edit AP Locations.

## Viewing Information on Maps

After the APs are placed and their locations are saved, WCS recomputes the RF coverage and displays the results as a heatmap. By default, the heatmap is always displayed on the map and updated every 5 minutes. You can control the heatmap display with the AP Heatmaps check box found in the Floor Settings portion of the maps page, to the left of the map display, as shown in Figure 18-15.

You can also control which APs contribute to the heatmap computation. For example, you might want to see what might happen if an AP was removed. Select the right arrow next to AP Heatmaps to display a list of contributing APs that are located on the map. Then select or deselect specific APs and observe the effect on the heatmap. In Figure 18-16, three APs have been deselected, resulting in a white area of no signal in the heatmap.

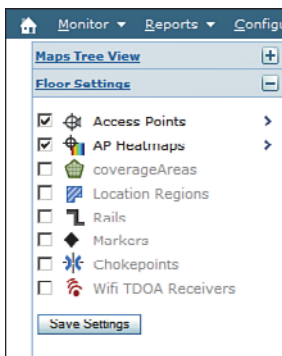


Figure 18-15 Enabling Heatmap Display.

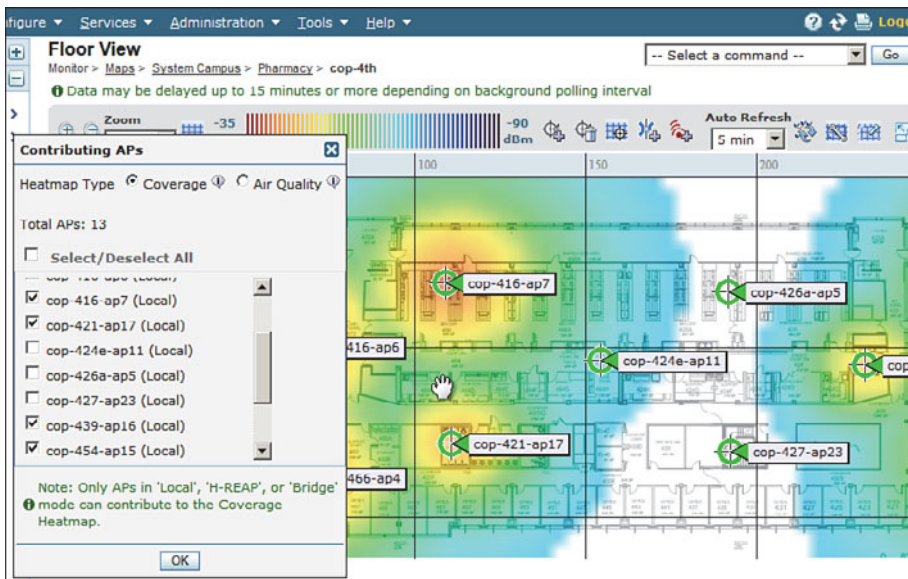
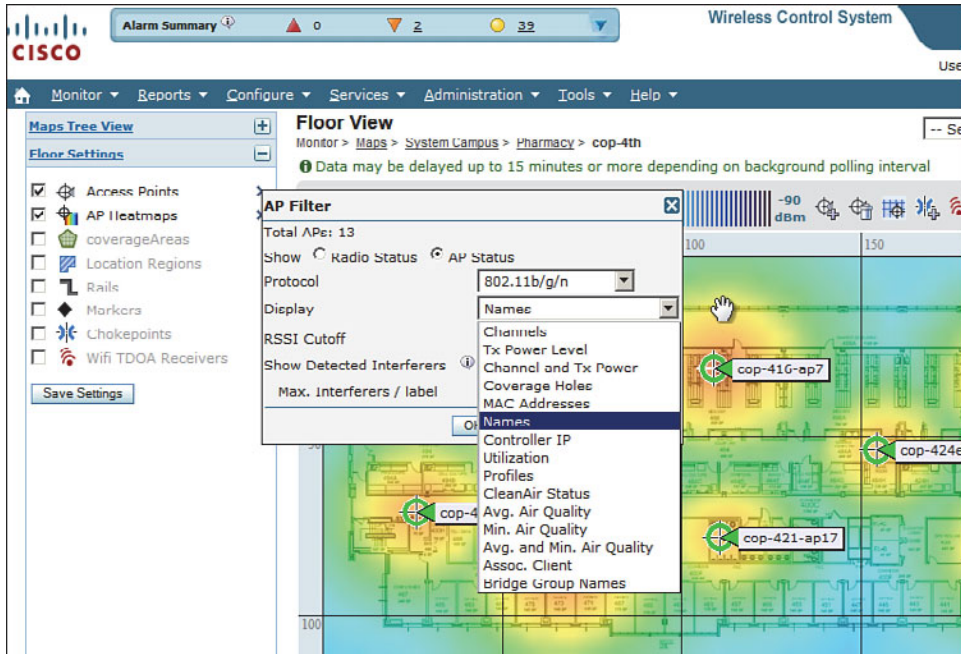


Figure 18-16 Controlling AP Contributions to the Heatmap Display.

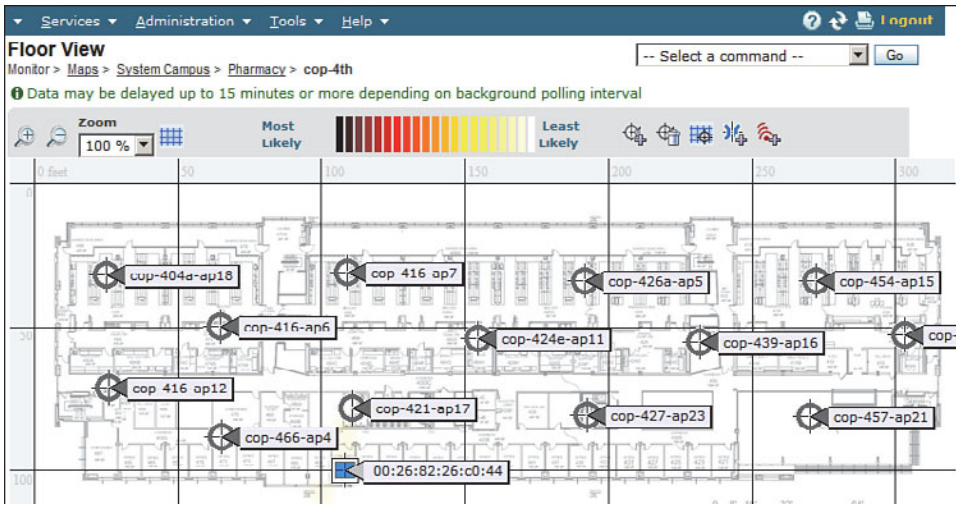
By default, WCS maps display AP icons and their names. You can select many other AP labels instead, including AP MAC addresses, transmit power levels, channel numbers, controller IP address, utilization, associated clients, and so on. Figure 18-17 shows the complete list of AP label choices.



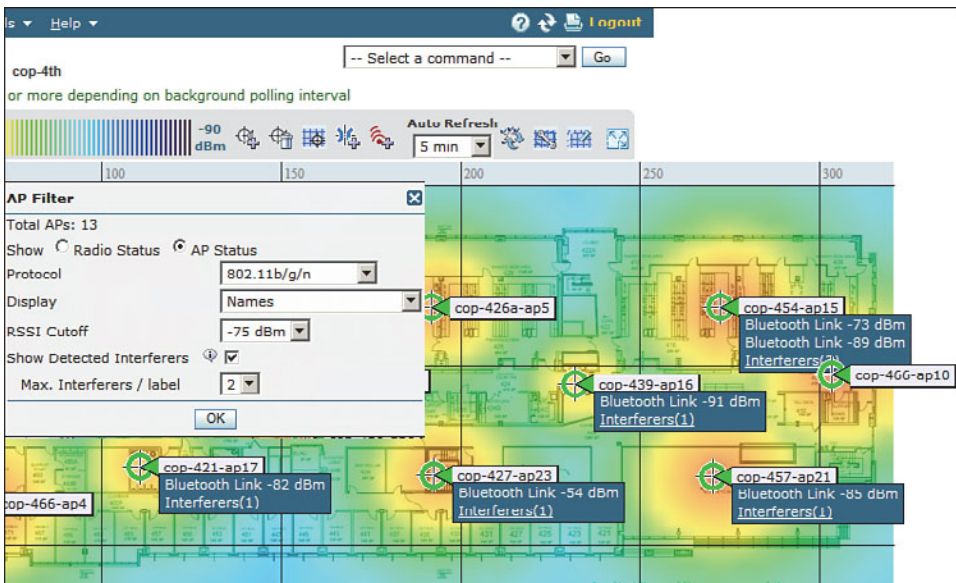
**Figure 18-17** Selecting AP Icon Labels in a WCS Map.

WCS maps can also display client locations. This is a useful function that can help you pinpoint a client's whereabouts within the network. If you have an MSE integrated with WCS, clients will be located and displayed on the maps automatically. You can still display a client's location even without an MSE. Select **Monitor > Clients** and filter for the client's MAC address or other information. Once the list of clients is displayed, click the link that represents the client's name to display detailed information about it. Select **Recent Map** in the drop-down list and click the **Go** button to display the map where the client was last known to be located. WCS will display the floor view map with an icon showing the client's location and MAC address, as demonstrated in Figure 18-18.

WCS can also display interference sources that have been detected by CleanAir capable APs. Select the right arrow to the right of Access Points in the Floor Settings options list, and then check the **Show Detected Interferers** box. By default, up to two interferers will be shown in each AP label. Figure 18-19 shows an example map with some interference sources identified.



**Figure 18-18** Locating a Client with WCS.

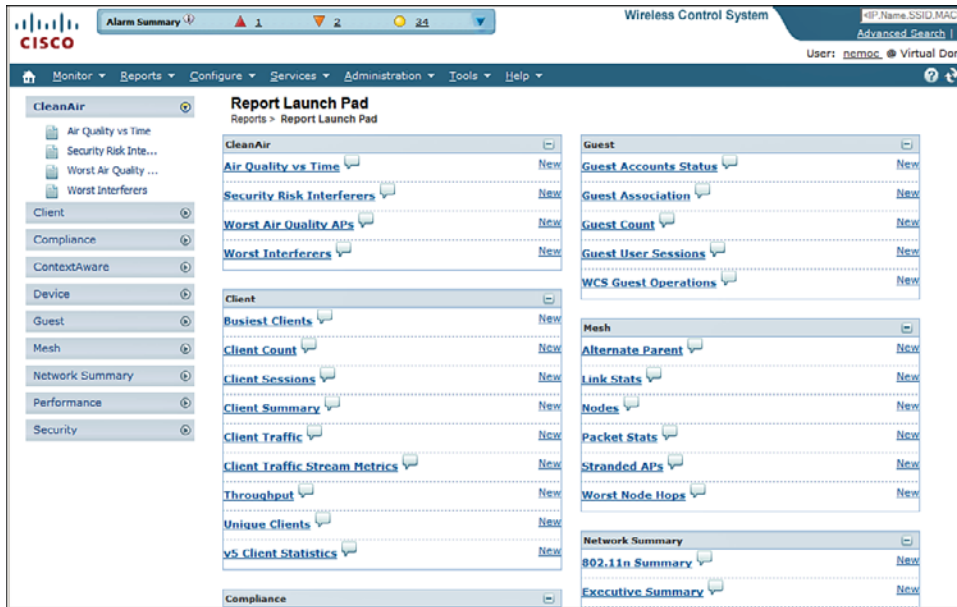


**Figure 18-19** Displaying Interference Sources in a WCS Map.

## Generating Reports

WCS maintains a robust database of all the data it collects about the wireless network. It can also generate a wide variety of reports based on the information in the database. You can access the reporting functions by selecting **Reports > Report Launch Pad**, as shown in Figure 18-20.





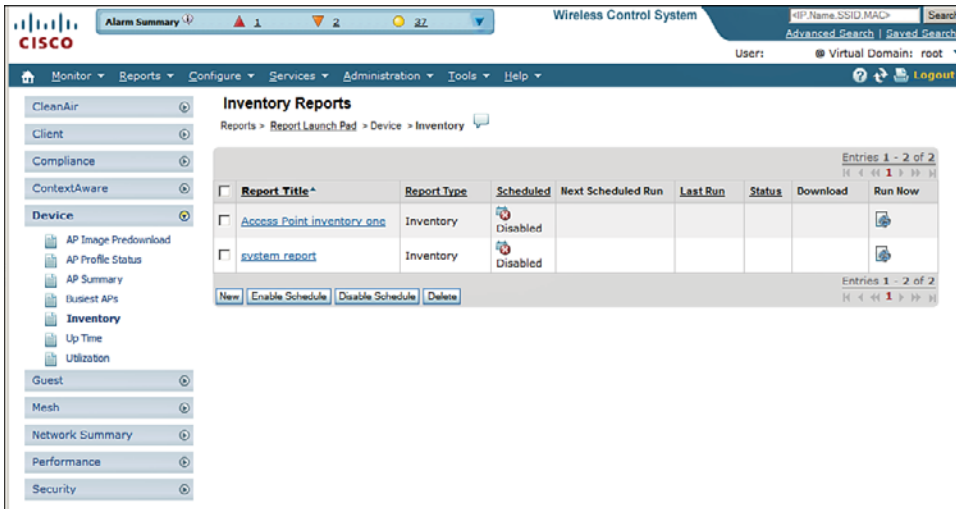
**Figure 18-20** Accessing the WCS Report Launch Pad.

The report launch pad provides a single page that contains every possible report. The reports are organized into the following categories:

- **CleanAir**—Air-quality reports based on CleanAir RF spectrum data
- **Client**—Statistics about client populations, loads, and activity
- **Compliance**—Audit-based information
- **ContextAware**—Client and device location
- **Device**—AP status and usage
- **Guest**—Guest network activity
- **Mesh**—Indoor and outdoor mesh network performance
- **Network Summary**—Executive summary, 802.11n summary
- **Performance**—802.11 statistics, RF coverage, voice activity, and statistics
- **Security**—Wireless intrusion protection system and rogue AP detection

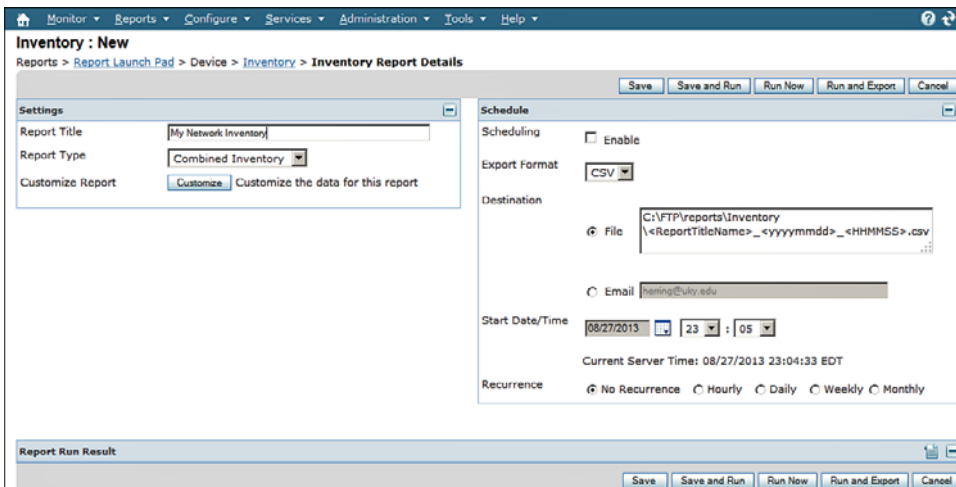
For the CCNA Wireless exam, you should be familiar with generating standard, built-in reports for network inventory, CleanAir, client information, AP information, and network utilization.

From the report launch pad, select the type of report you want. For example, Figure 18-21 shows how a Device > Inventory report has been selected. You might see a list of pre-configured or saved reports. You can select the check box next to one of those or click the **New** button to create a new report.



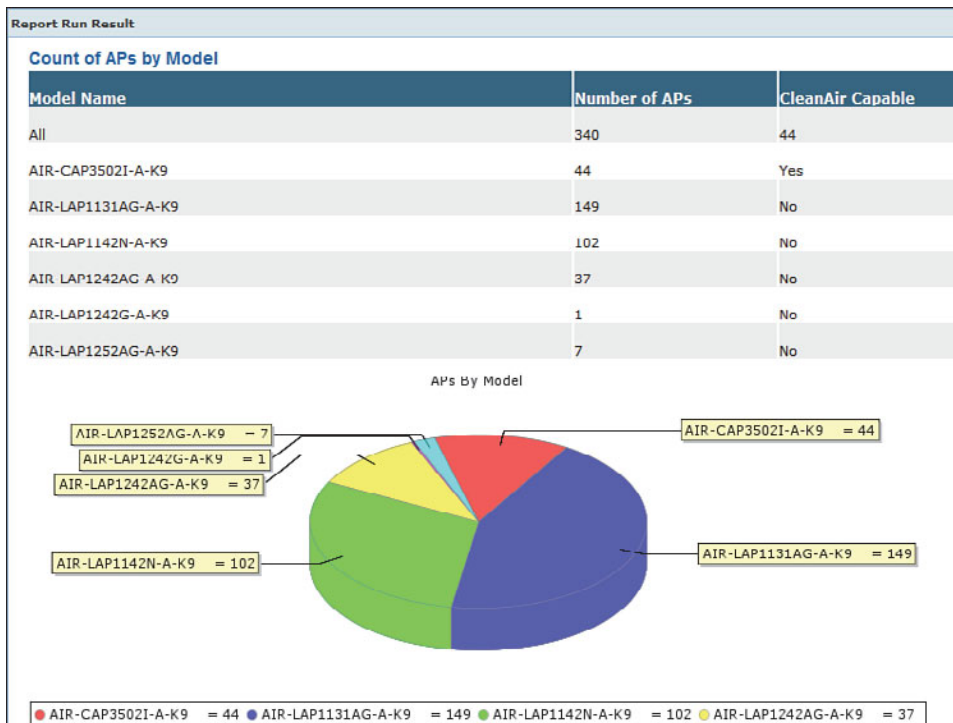
**Figure 18-21** *Selecting a Report to Run.*

When you create a new report, you can give it a title and select a specific type of report from a prepopulated list. In Figure 18-22, an inventory report is being configured as a Combined Inventory type, which will give information about both APs and controllers. You can also specify when the report should be run—either on a scheduled basis or right now. If you click the **Run Now** button, the report will run immediately and be displayed within WCS. If you enable scheduling instead, most likely you will not access WCS to view the report when it is run. Therefore, you can choose to have the report automatically saved in a file on the WCS server or sent in an email.



**Figure 18-22** *Setting the Schedule for a Report to Run.*

Figure 18-23 shows an example of the results of an inventory report. The breakdown of AP model numbers is represented in a table and a pie chart. The actual report is much longer than that shown.



**Figure 18-23** *An Example Inventory Report.*

---

## Exam Preparation Tasks

---

As mentioned in the section, “How to Use This Book,” in the Introduction, you have a couple of choices for exam preparation: the exercises here, Chapter 22, “Final Review,” and the exam simulation questions on the CD-ROM.

## Review All Key Topics

Review the most important topics in this chapter, noted with the Key Topic icon in the outer margin of the page. Table 18-4 lists a reference of these key topics and the page numbers on which each is found.

**Table 18-4** *Key Topics for Chapter 18*

<b>Key Topic Element</b>	<b>Description</b>	<b>Page Number</b>
Figure 18-2	WCS home page organization	364
List	Major functions in the WCS navigation area	366
Figure 18-6	Adding a controller to WCS	368
Figure 18-17	Displaying AP information in maps	376







---

This chapter covers the following topics:

- **Understanding Types of Interference**—This section describes common technologies and devices that can cause wireless interference.
- **Using Cisco CleanAir to Manage Interference**—This section covers CleanAir operation and explains how you can configure it to deal with interference automatically and efficiently.

This chapter covers the following exam topics:

- Describe the impact of various wireless technologies (Bluetooth, WiMAX, ZigBee, and cordless phones)

# Dealing with Wireless Interference

With careful design and planning, 802.11 devices can operate as a fully functional wireless network. However, many readily available products do not use the 802.11 standard. When 802.11 and non-802.11 devices come together, the two can interfere with each other. Wireless interference can make WLAN performance sluggish or completely unusable. This chapter covers some common types of devices that can cause interference and the Cisco CleanAir features that can detect and react to the interference sources.

## “Do I Know This Already?” Quiz

The “Do I Know This Already?” quiz allows you to assess whether you should read this entire chapter thoroughly or jump to the “Exam Preparation Tasks” section. If you are in doubt about your answers to these questions or your own assessment of your knowledge of the topics, read the entire chapter. Table 19-1 lists the major headings in this chapter and their corresponding “Do I Know This Already?” quiz questions. You can find the answers in Appendix A, “Answers to the ‘Do I Know This Already?’ Quizzes.”

**Table 19-1** “Do I Know This Already?” Section-to-Question Mapping

Foundation Topics Section	Questions
Understanding Types of Interference	1–6
Using Cisco CleanAir to Manage Interference	7–10

**Caution** The goal of self-assessment is to gauge your mastery of the topics in this chapter. If you do not know the answer to a question or are only partially sure of the answer, you should mark that question as wrong for purposes of the self-assessment. Giving yourself credit for an answer you correctly guess skews your self-assessment results and might provide you with a false sense of security.

- 1.** DECT cordless phone devices in the United States use which one of the following designations to differentiate from European DECT devices?
  - a.** DECT 1.0
  - b.** DECT 2.4
  - c.** DECT 5.8
  - d.** DECT 6.0
  
- 2.** Bluetooth is designed to cover which one of the following areas?
  - a.** Metropolitan
  - b.** Personal area
  - c.** Wide area
  - d.** Local area
  
- 3.** Bluetooth operates in which one of the following frequency bands?
  - a.** 900 MHz
  - b.** 2.4 GHz
  - c.** 5 GHz
  - d.** 11 GHz
  
- 4.** ZigBee is used for which two of the following common applications?
  - a.** Building automation
  - b.** GPS location
  - c.** Energy management
  - d.** RFID device location
  
- 5.** ZigBee belongs to which one of the following family of standards?
  - a.** IEEE 802.11
  - b.** IEEE 802.3
  - c.** IEEE 802.15.4
  - d.** IEEE 802.16
  
- 6.** The IEEE 802.16 standard defines which one of the following technologies?
  - a.** Token Ring
  - b.** ZigBee

- c. Bluetooth
  - d. WiMAX
7. CleanAir adds which one of the following capabilities to a Cisco lightweight AP?
- a. Wireless mesh
  - b. Rogue filtration
  - c. Spectral multiplexing
  - d. Spectrum analysis
8. Cisco CleanAir analyzes which one of the following types of RF signals?
- a. Non-802.11
  - b. 802.11
  - c. 802.11b
  - d. CAPWAP
9. By default, is Cisco CleanAir enabled or disabled on a controller?
- a. Enabled
  - b. Disabled
10. Suppose that an AP has detected an interference source and reported it with RSSI -58, duty cycle 1 percent, and severity 4. Which one of the following statements is most correct?
- a. The interfering source is very severe.
  - b. The interfering source is constantly transmitting.
  - c. The interfering source is too weak to be detected.
  - d. The interfering source is not severe.
11. When an interference source is detected and classified, the controller assigns which one of the following to uniquely identify the same source across several reporting APs?
- a. BSSID
  - b. Cluster ID
  - c. ISSID
  - d. Actual MAC address

## Understanding Types of Interference

Recall from Chapter 3, “RF Signals in the Real World,” that APs can interfere with each other. If two APs are configured to use the same channel and are in close proximity to each other, co-channel interference results. If the APs are set to use adjacent or overlapping channels, adjacent channel interference occurs.

While those types of interference can certainly be destructive, they involve devices that are based on the 802.11 standard. For example, each access point (AP) transmits on a specific channel (possibly the wrong one!), uses a standardized channel width, and always transmits frames in the 802.11 format. As well, each AP should also follow the 802.11 rules for clear channel assessment (CCA) to maintain some etiquette to share the airtime.

Rogue APs can be a significant and pesky source of interference because they usually belong to someone else. In other words, someone outside your organization is free to bring up their own APs on channels of their choosing. As long as signals from their APs can be received within your own AP cells, you might have to deal with the interference. To mitigate the problem, you must do one of the following:

- Find the rogue AP and its owner, and then convince the owner to remove the AP or change its channel.
- Move your own AP to a different channel, which may cause other nearby APs to be moved too.

When 802.11 devices interfere with each other, the result is usually poor performance due to frame retransmissions, errors, and the lack of available airtime. In other words, the 802.11 data can still be detected but not always correctly received. In contrast, non-802.11 devices do not have to obey any of the familiar 802.11 rules. When a non-802.11 device transmits, the result is completely incompatible with 802.11. APs and 802.11 clients will view the signal as unintelligible and regard it as noise.

The following sections provide an overview of some common non-802.11 devices that can interfere with a WLAN. As you work through this chapter, keep the following two terms in mind:

- **Interference:** 802.11 signals that come from sources other than expected APs
- **Noise:** Signals or radio frequency (RF) energy that do not come from 802.11 sources



## Bluetooth

Bluetooth is a technology used to form a personal-area network (PAN), in an effort to unify telephony and computing devices. Today, Bluetooth can be found integrated into cell phones, PDAs, laptops, desktops, printers, headsets, cameras, and video game consoles. Bluetooth has low power consumption, making it a good choice for mobile, battery-powered devices.

Bluetooth began as Versions 1.0 and 1.0b, developed by the Bluetooth Special Interest Group (SIG). For a time, several Bluetooth versions were incorporated into the IEEE 802.15.1 standard, but that standard is no longer maintained. The Bluetooth SIG continued to develop its own standard, currently published as core Version 4.

**Tip** You can find the Bluetooth SIG at <http://www.bluetooth.org>.

Bluetooth devices are grouped into three classes according to their radiated power. Classes 1 and 2 are the most common and use a maximum transmit power level of 1 and 2.5 mW, respectively. Because Bluetooth operates as a PAN, class 1 and 2 devices use a relatively low transmit power level and have a range of only 35 feet. Less common, “industrial” Bluetooth class 3 devices can operate at up to 100 mW.

Up to eight devices can be paired or linked into a PAN, with one device taking a master role and the others operating as slaves. Devices operate in the 2.4-GHz ISM band, but are not compatible with the 802.11 standard. Bluetooth uses a frequency hopping spread spectrum (FHSS) technique, with devices moving through a predefined sequence of 79 channels with a bandwidth of 1 MHz each.

Bluetooth transmitters could potentially interfere with the majority of the 2.4-GHz band because their channels overlap with the three non-overlapping 802.11 channels. Bluetooth devices can interfere at a close range because of their low transmit power. If there are many Bluetooth devices in an 802.11 cell, they can create a saturation effect that tends to starve wireless LAN devices for airtime. Be aware that people commonly carry Bluetooth phones, headsets, and computer peripherals right into your WLAN. You might have a difficult time finding them and convincing their owners to leave them outside your wireless network.

## ZigBee

ZigBee is wireless LAN technology that is based around relatively low power consumption and low data rates (20 to 250 Kbps). As a result, it offers reliable communication. ZigBee is commonly used for energy management and home and building automation applications.

ZigBee is defined in the IEEE 802.15.4 standard. It allocates the 2.4-GHz ISM band into 16 channels of 5 MHz each. Even though ZigBee uses the same band as 802.11 devices, it has a low duty cycle and does not utilize a channel much of the time. As well, ZigBee devices normally use a low transmit power level, which minimizes interference, but can ramp up to a maximum of 60 mW when necessary.

**Tip** You can find the ZigBee Alliance at <http://www.zigbee.org>.

## Cordless Phones

Cordless phones use several wireless technologies to connect remote handsets to a central base station. Phones that are advertised to use the 2.4- and 5.8-GHz bands do just that—and can cause significant interference with nearby WLANs. Cordless phones can use one channel at a time, but can also change channels dynamically. As well, transmit power levels can rise up to 250 mW, overpowering an AP at maximum power.

The Digital Enhanced Cordless Telecommunications (DECT) standard was developed by ETSI and uses the upper portion of the 1.8 GHz band in Europe, Asia, Australia, and South America. In the United States, cordless phones are based on DECT 6.0, which uses the 1.9-GHz band.

Because DECT and DECT 6.0 phones do not use the 2.4-GHz ISM band, they should not interfere with 802.11 WLANs. However, some similar “DECT-like” phones may operate in the 2.4- and 5.8-GHz bands and interfere.

## Microwave Ovens

You might not think of a microwave oven as a communication device. After all, microwave ovens are designed to cook food—not to transmit data. To heat food, liquids, and make popcorn, a microwave oven transmits RF energy into a sealed cavity. The energy is meant to stay inside the oven where it can penetrate food items.

In practice, the RF shielding around microwave oven doors is not ideal, causing some amount of energy to leak out into the surrounding area. Like many other consumer devices, microwave ovens are free to use the 2.4-GHz ISM band. In fact, most microwaves produce a signal that spreads over a large portion of the band. The signal is simply crudely transmitted energy that does not need to follow any standard or frame format. Microwaves are commonly rated to generate around 700 W of power inside the oven. Leaked energy often interferes with nearby APs and 802.11 devices.

To mitigate interference coming from microwave ovens, you can move the oven farther away from WLAN coverage areas. Even better, suggest that the oven be swapped out for a commercial model that has higher-quality RF shielding around the oven and its door.

## WiMAX

Worldwide Interoperability for Microwave Access (WiMAX) is a wireless technology designed to provide “last mile” broadband access to consumers within a geographic area. WiMAX does not require line of sight with a base station, so it can offer connectivity to many fixed and mobile users within a 3 to 10-km radius.

WiMAX is defined by the WiMAX Forum and published as the IEEE 802.16 standard. Although WiMAX, with its central base station and a shared wireless medium, sounds similar to 802.11 WLANs, the two are incompatible. WiMAX operates in several bands

between 2 and 11 GHz and from 10 to 66 GHz. Depending on the frequency being used, WiMAX can possibly interfere with 802.11 devices, but such interference is highly unlikely. No widely deployed solutions use the ISM bands; the systems that are advertised for ISM are not supported by any major WiMAX players.

**Tip** You can find the WiMAX Forum at <http://www.wimaxforum.org>.

## Other Devices

You may encounter other types of non-802.11 devices in and around a WLAN. The following devices can cause varying degrees of interference:

- **Canopy:** A fixed wireless broadband technology developed by Motorola for Internet service providers; uses the 900-MHz, 2.4-GHz, 5.2-GHz, 5.4-GHz, and 5.7-GHz bands.
- **Continuous transmitter:** A device that transmits a continuous, generic waveform that causes steady interference.
- **Jammer:** A device that is designed to disrupt radio signals so that channels or bands become completely unusable.
- **SuperAG:** A proprietary set of extensions developed by Atheros to make Wi-Fi transmissions more efficient. SuperG (802.11g) and SuperAG (both 802.11a and 802.11g) define schemes to compress frames, send bursts of frames, and bond channels for improved throughput. However, they are incompatible with the 802.11 standard and can cause interference.
- **Video camera:** Wireless security cameras that transmit on the 900-MHz, 2.4-GHz, and 5.8-GHz bands with analog or non-802.11 signals.
- **WiFi invalid channel:** Wireless devices that use a nonstandard channel or one that is slightly offset from the familiar channel numbers and center frequencies in the 2.4- and 5-GHz bands. These devices are proprietary and can be difficult to detect because they sit on unexpected frequencies. They can overlap normal 802.11 channels and cause interference.
- **WiFi inverted:** Devices that invert the components of an RF signal from what is normally expected. The inverted signals appear as noise to 802.11 devices. However, two inverted devices can correctly receive and use each other's signal and operate as an undetectable wireless bridge.
- **Xbox:** A video game console developed by Microsoft. Its wireless controller uses a frequency-hopping technique that can interfere with 802.11 devices in the 2.4-GHz band.



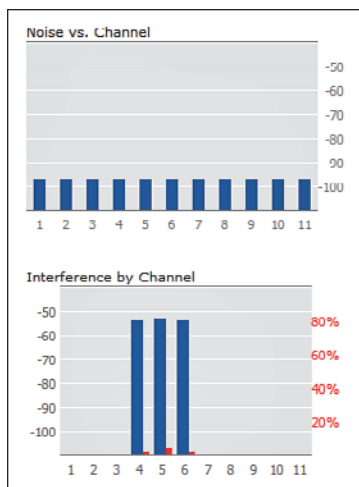
## Using Cisco CleanAir to Manage Interference

As you have learned in this book, WLANs use the same unlicensed bands as many other technologies and devices. If the RF conditions in your environment are superb, such that your 802.11 APs and clients can enjoy clear channels with low noise and no interference, users will be happy and your job will become easier. However, it is all too easy for someone to power up a rogue AP or a non-802.11 device that begins to interfere with your network.

If some portion of your wireless network begins to have degraded performance, wireless interference might be occurring there. How should you approach such a problem? First, you should figure out what type of device is generating the interference. Then you should attempt to locate the device so that you can negotiate with its owner to have it disabled. If that is not possible, you should move your AP onto a different channel that is clear from interference.

Any Cisco lightweight AP can measure both noise and interference as it scans the channels in a band, as part of the RRM process. Figure 19-1 shows an example of the information gathered from the 2.4-GHz radio of an AP. The noise level appears to be very low and acceptable on every channel. The Interference by Channel graph displays the received strength of an interference source in dBm on the left vertical axis (dark blue) and the duty cycle of the interference in percent on the right vertical axis (red). Figure 19-1 shows fairly strong interference on channels 4 through 6, but at a very low duty cycle. Although that is good information to have, can you tell what sort of thing is causing the interference?

**Tip** You can display the results by selecting **Monitor > Access Points > Radios > 802.11a/n or 802.11b/g/n**. Find an AP of interest in the list, and then scroll over to the right side of the page. Click the blue drop-down menu and select **Details**.



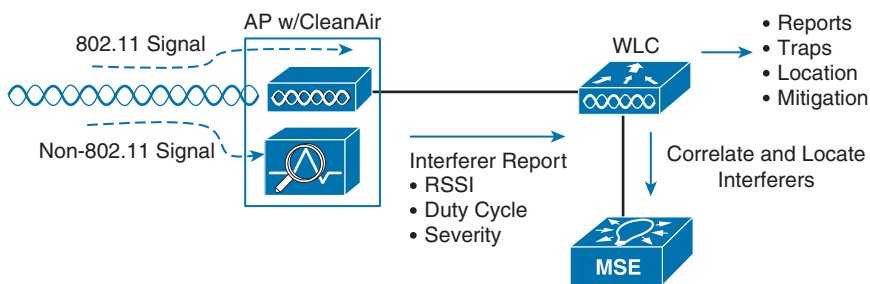
**Figure 19-1** Basic Channel Quality Information Gathered by an AP.

To accurately detect and identify interference, you should use a spectrum analyzer, which sweeps through a range of frequencies and displays the signal strength it receives on each one. Spectrum analyzers can display this information in many forms so that it is easier to see patterns in the RF activity. Rather than rely on your own ability to recognize interference patterns, many spectrum analyzers offer their own intelligence. They can recognize and identify specific types of devices that are causing interference based on patterns and signatures in the spectrum data.

Now imagine carrying a spectrum analyzer throughout an entire WLAN to look for wireless interference. You never know where interference might crop up or how long it will last. What if you could have a spectrum analyzer permanently located at each AP?

Cisco CleanAir does just that; APs, such as the 3500 and 3600 models, have spectrum analysis capability built right in to the radio hardware. While a CleanAir AP is busy operating its normal basic service sets (BSSs) on a channel, it can also monitor RF energy on that channel, analyze the data, and report specific information about any interfering devices—all without interrupting normal WLAN operation.

Anything that the AP receives and recognizes as an 802.11 frame is processed normally by the split MAC architecture. Other signals that cannot be demodulated according to any known modulation and coding scheme must be coming from a non-802.11 source. That signal information is processed by the spectrum analysis hardware in the AP, as shown in Figure 19-2.



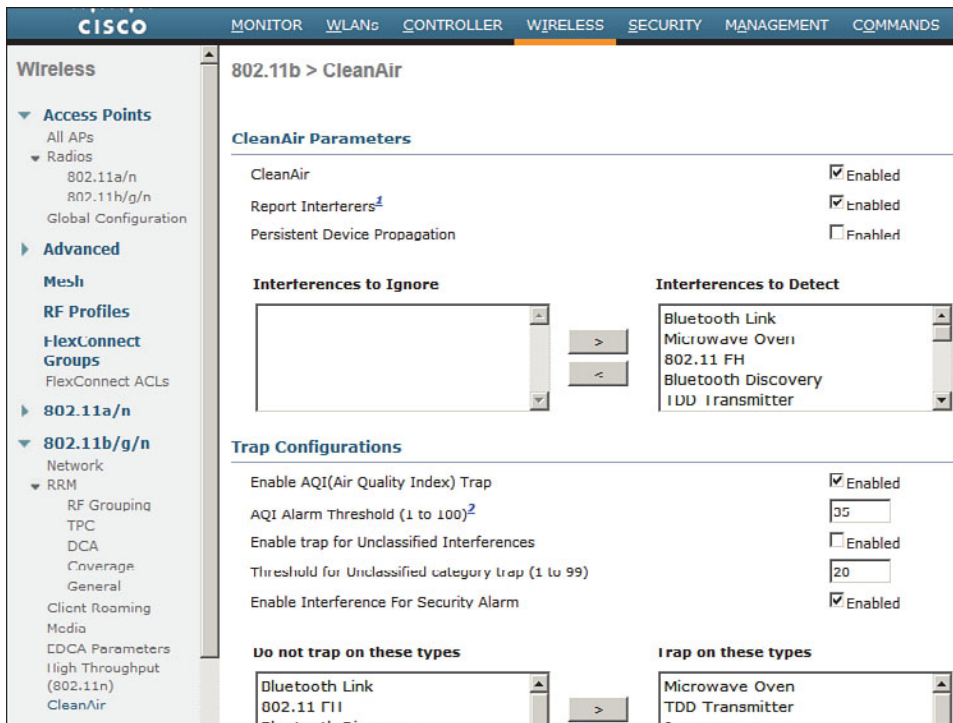
**Figure 19-2** Overview of CleanAir Operation.

The spectrum information from every AP is sent up to the corresponding wireless LAN controller (WLC), where it can be collected and processed. If an interference source is received by more than one AP, the controller can usually correlate the data and realize that a single source is involved and not several different ones. WLCs can also pass interference reports to an MSE to determine an interference source's location and display it on a WCS/NCS map. With CleanAir, interference can be automatically detected, identified, and the source located—which should make your job easier!

Beyond that, a Cisco Unified Wireless Network (CUWN) can even react to wireless interference automatically. Recall that the Radio Resource Management (RRM) process is responsible for working out a channel reuse plan and assigning APs to use specific channels in a band—all on a periodic basis. Event-driven RRM can react to interference immediately, without waiting for the next scheduled RRM iteration, so that an AP can be moved to a different channel to escape the interference.

## Enabling CleanAir

CleanAir operates on each band independently. You can enable or disable it globally for all APs on a controller by selecting **Wireless > 802.11a/n** or **802.11b/g/n > CleanAir** and using the **CleanAir** check box, as shown in Figure 19-3. By default, CleanAir is disabled globally on a controller.



**Figure 19-3** Enabling CleanAir Globally on a Controller.

By default, APs will report the interference types listed in Table 19-2 to their respective controller. You can change this behavior by selecting a type and moving it to the Interferences to Ignore or Interferences to Detect list. You can also select which types will generate an SNMP trap from the controller when they are detected. Otherwise, any types not selected will not be reported.

**Table 19-2** CleanAir Interference Types and Their Default Actions

Interference Type	Report	Trap
802.11 FH (frequency hopping)	X	
802.15.4 (ZigBee)	X	
Bluetooth discovery	X	
Bluetooth link	X	

<b>Interference Type</b>	<b>Report</b>	<b>Trap</b>
Canopy	X	
Continuous Transmitter	X	X
DECT-like phone	X	
Jammer	X	X
Microwave oven	X	X
SuperAG	X	
TDD transmitter	X	X
Video camera	X	X
WiFi invalid channel	X	X
WiFi inverted	X	X
WiMax fixed	X	X
WiMax mobile	X	X
Xbox	X	

**Tip** An AP must be configured for either local or monitor mode before it can generate CleanAir interference reports. Reporting is not possible in the Spectrum Only Monitor Mode (SOMM).

As interference sources are detected and classified according to interference type, the AP also measures the RSSI and the duty cycle of the interferer. The duty cycle is the percentage of time the source is transmitting on the channel, which indicates its persistence or how much of the airtime the interferer is consuming. The AP combines the RSSI and duty cycle into a severity index value. Severity ranges from 0 (not severe) to 100 (very severe). Interference with a high severity rating can render a channel unusable.

Interference detection reports sent to a controller include the AP name, interference type, affected channel, timestamp, severity, duty cycle, and RSSI. The controller then tries to determine whether the same interference source is involved in reports coming from multiple APs. If so, the source is uniquely identified by assigning it a cluster ID. A cluster ID is actually a pseudo-MAC address that represents the non-802.11 device with a familiar wireless identifier.

You can display a list of interference detection reports on a controller by selecting **Monitor > CleanAir > 802.11a/n** or **802.11b/g/n > Interference Devices**. Figure 19-4 shows an example list.

AP Name	Radio Slot#	Interferer Type	Affected Channel	Severity	Duty Cycle(%)	RSSI	DevID	ClusterID
mn348-ap25	0	DECT phone	1	2	1	-79	0x918f	99:b4:a0:19:84:c3
mn348-ap25	0	DECT phone	1	2	1	-78	0x919d	99:b4:a0:19:85:74
mn348-ap25	0	BT Link	1	2	1	-71	0x91b4	99:b4:a0:19:86:9e
mn348-ap25	0	BT Link	1	2	1	-81	0x91b5	99:b4:a0:19:86:9c
mn348-ap25	0	BT Link	1	2	1	-67	0x91b7	99:b4:a0:19:84:06
HG611-AP3	0	DECT phone	6	2	1	-90	0x329c	99:b4:a0:18:58:53
HG611-AP4	0	DECT phone	6	2	1	-90	0x4d1b	99:b4:a0:19:86:9e
HG611-AP2	0	DECT phone	1	2	1	-88	0x6690	99:b4:a0:18:58:53
k531e-ap25	0	BT Link	11	2	1	-77	0x7430	99:b4:a0:16:fc:64
mob-140a-ap7	0	DECT phone	1	2	1	-83	0x4e53	99:b4:a0:14:ca:c1
mob-166-ap9	0	DECT phone	11	2	1	-86	0x5f42	99:b4:a0:14:ca:c1
mob-166-ap9	0	BT Link	11	0	1	-86	0x5f53	99:b4:a0:19:86:ec
mob-140-ap2	0	DECT phone	11	2	1	-81	0x5649	99:b4:a0:14:ca:c1
mob-142-ap6	0	DECT phone	6	2	1	-77	0x6037	99:b4:a0:14:ca:c1
I804-ap24	0	BT Link	1	3	1	-77	0x611d	99:b4:a0:19:84:72
I142-ap3	0	BT Link	11	2	1	-86	0x3ff1	99:b4:a0:19:85:a0
I128-ap5	0	BT Link	unknown	2	1	-84	0x37ef	99:b4:a0:19:85:a0
I128-ap5	0	BT Link	11	2	1	-87	0x37f1	99:b4:a0:19:85:a0
I128-a05	0	BT Link	11	0	1	-86	0x37f6	99:b4:a0:19:7d:bc

Figure 19-4 Example List of Interference Device Reports.

## Air-Quality Index



As APs and controllers work together to generate a list of interference reports, the list can grow quite long. For example, the controller from Figure 19-4 has a list of 263 reports from the 2.4 GHz 802.11b/g/n band alone. To get a feel for the RF conditions on any one channel and AP, you would have to read through the list of reports manually and guess the cumulative effect that various interferers were having.

Cisco WLCs can do a better analysis by calculating an air-quality index (AQI) for each AP and its channels. The AQI indicates WiFi health within an AP's cell, as indicated by a scale from 0 (unusable) to 100 (perfect). You can display the air quality metrics for every AP on a controller by selecting **Monitor > CleanAir > 802.11a/n** or **802.11b/g/n > CleanAir > Air Quality Report**, as shown in Figure 19-5. You can see a summary of the AP with the worst air-quality rating in each band by selecting **Worst Air-Quality Report**.

Air-quality ratings are updated dynamically. Each AP measures RF conditions once a second and then calculates an air quality value every 15 seconds and a summary every 30 seconds. By default, these values are reported to the AP's controller every 15 minutes.

You can also view an AP's CleanAir activity more frequently through the rapid update mode. To access this mode, use **Monitor > Access Points > 802.11a/n** or **802.11b/g/n** to display a list of APs. Choose an AP, and then select **CleanAir** from the blue triangular drop-down menu on the right side of the list. In rapid update mode, the controller automatically refreshes the page every 30 seconds with updated CleanAir data.

MONITOR WLANS CONTROLLER WIRELESS SECURITY MANAGEMENT COMMANDS

Monitor 802.11b/g/n Cisco APs >Air Quality Report Entries 1 - 25 of 443

Current Filter: None [Change Filter] [Clear Filter]

AP Name	Radio Slot#	Channel	Average AQ	Minimum AQ	Interferer	DFS
whc-triage-ap2	0	6	90	01	1	No
whc-exam6-ap1	0	1	98	98	2	No
whc-waiting-ap3	0	11	99	99	0	No
224-ap6	0	1	99	99	0	No
285-ap12	0	6	99	99	0	No
144-ap13	0	11	99	99	0	No
pac-219-ap15	0	11	98	93	3	No
183-ap15	0	1	99	99	0	No
106-ap12	0	11	99	99	0	No
263-ap/	0	6	99	99	0	No
230-ap2	0	6	99	99	0	No
120-ap10	0	11	99	99	0	No
182-ap9	0	6	99	99	0	No
103-ap10	0	1	99	99	0	No
203-ap10	0	1	100	100	0	No
250-ap3	0	11	99	99	0	No
246-ap1	0	6	99	99	0	No
119-ap6	0	1	99	99	0	No
264-ap4	0	1	99	99	0	No

**Figure 19-5** *Displaying Air-Quality Indices for all APs on a Controller.*

Rapid update mode also shows more detailed CleanAir information from an AP. In Figure 19-6, the AP has detected interference from a microwave oven. The air quality is shown as a bar graph. Normally only the one channel used by an AP is shown; if the AP is in monitor mode, all channels are shown. The same page also shows channel utilization and interference power measured by the AP.

Controllers display air quality on a per-AP (and channel) basis, and this information is aggregated further by Wireless Control System/Network Control System/Prime Infrastructure (WCS/NCS/PI). Air quality is summarized for the entire set of controllers that are managed in the enterprise.



**Figure 19-6** *Displaying Detailed CleanAir Data in Rapid Update Mode.*

## Using Event-Driven RRM

By default, APs and controllers work together to detect, classify, and report wireless interference from non-802.11 devices. CleanAir and RRM can work together so that controllers actually take some action on interference events at the regular RRM intervals. By default, RRM runs the DCA algorithm every 10 minutes, but you can increase the interval up to 24 hours. If non-802.11 interference occurs near an AP, the controller must wait until the next dynamic channel allocation (DCA) interval before it can move the AP away from the unusable channel.

When Event-Driven RRM (ED-RRM) is enabled, the normal periodic RRM DCA process is triggered immediately in response to interference reported by an AP. ED-RRM must be enabled and then triggered based on an AQI threshold. You can set the threshold to Low (AQI 35), Medium (AQI 50), or High (AQI 60).

First, enable ED-RRM globally on a controller. ED-RRM uses the DCA function to change an AP's channel and work out any other channel allocation changes that might be needed. Therefore, navigate to the DCA configuration by selecting **Wireless > 802.11a/n or 802.11b/g/n > RRM > DCA**. Scroll to the bottom of the page to the Event Driven RRM section, as shown in Figure 19-7. Once you check the **EDRRM** box, you will be able to select a **Sensitivity Threshold** from the drop-down list. By default, the threshold is set to **Medium**. You can select Low, Medium, High, or Custom.

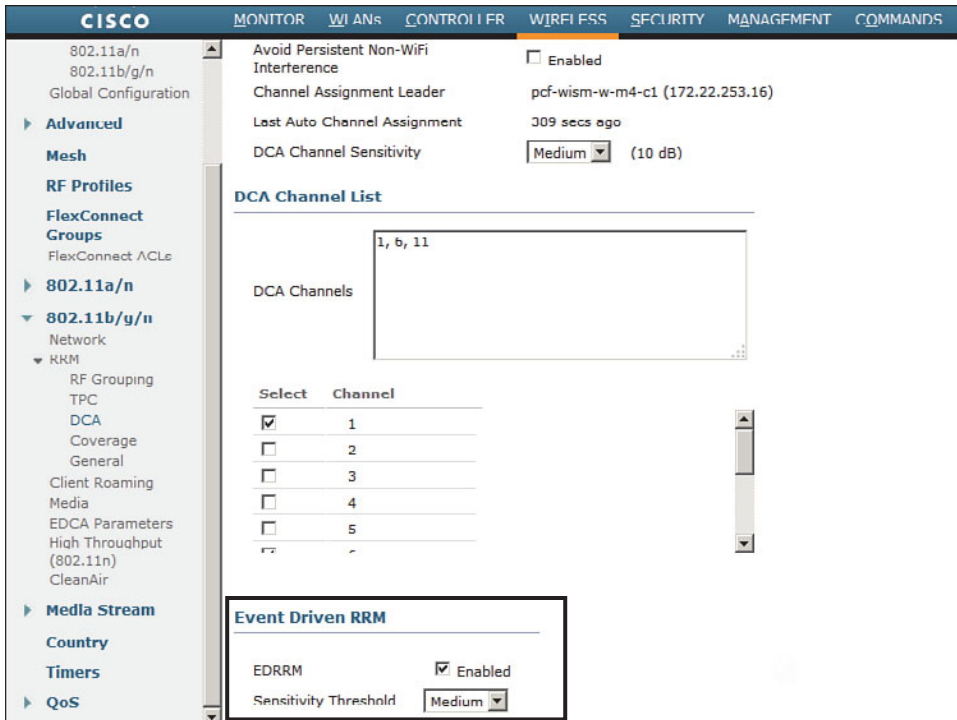


Figure 19-7 Enabling ED-RRM.

## Exam Preparation Tasks

As mentioned in the section “How to Use This Book” in the Introduction, you have a couple of choices for exam preparation: the exercises here, Chapter 22, “Final Review,” and the exam simulation questions on the CD-ROM.

## Review All Key Topics

Review the most important topics in this chapter, noted with the Key Topic icon in the outer margin of the page. Table 19-3 lists a reference of these key topics and the page numbers on which each is found.

Table 19-3 Key Topics for Chapter 19

Key Topic Element	Description	Page Number
List	Interference and noise	386
Paragraph	CleanAir operation	391
Paragraph	Air-quality index	394





## Define Key Terms

Define the following key terms from this chapter and check your answers in the glossary:

air-quality index (AQI), Cisco CleanAir, cluster ID, Event-Driven RRM (ED-RRM), duty cycle, interference, noise, pseudo-MAC address, rogue AP, spectrum analyzer

*This page intentionally left blank*



---

This chapter covers the following topics:

- **Troubleshooting Client Connectivity**—This section covers some strategies and methods you can use when faced with wireless clients that report problems connecting to the network.
- **Troubleshooting AP Connectivity**—This section describes some troubleshooting steps you can use to figure out why an access point is not connecting or operating properly.

This chapter covers the following exam topics:

- Verify basic wireless network operation
- Identify and use basic WLAN troubleshooting tools (WLC show debug and logging) for client to AP connectivity, AP to controller connectivity
- Use the WCS client troubleshooting tool

# Troubleshooting WLAN Connectivity

As a CCNA Wireless engineer, you will be expected to perform some basic troubleshooting work when wireless problems arise. The CCNA Wireless exam blueprint focuses on some troubleshooting tools that are available on Cisco Wireless LAN Controllers (WLCs) and the Cisco Wireless Control System (WCS). This chapter helps you get some perspective on wireless problems, develop a troubleshooting strategy, and become comfortable using the tools at your disposal.

## “Do I Know This Already?” Quiz

The “Do I Know This Already?” quiz allows you to assess whether you should read this entire chapter thoroughly or jump to the “Exam Preparation Tasks” section. If you are in doubt about your answers to these questions or your own assessment of your knowledge of the topics, read the entire chapter. Table 20-1 lists the major headings in this chapter and their corresponding “Do I Know This Already?” quiz questions. You can find the answers in Appendix A, “Answers to the ‘Do I Know This Already?’ Quizzes.”

**Table 20-1** “Do I Know This Already?” Section-to-Question Mapping

Foundation Topics Section	Questions
Troubleshooting Client Connectivity	1–8
Troubleshooting AP Connectivity	9–10

**Caution** The goal of self-assessment is to gauge your mastery of the topics in this chapter. If you do not know the answer to a question or are only partially sure of the answer, you should mark that question as wrong for purposes of the self-assessment. Giving yourself credit for an answer you correctly guess skews your self-assessment results and might provide you with a false sense of security.

1. To get a WLC to display information about a specific wireless client, you go to the Monitor > Clients page. Which one of the following pieces of information should you input to obtain the best troubleshooting data?
  - a. Client's IP address
  - b. SSID
  - c. Client's MAC address
  - d. AP name
2. From the Monitor > Clients page of a controller, you can see the entire list of active clients. Which of the following represent parameters you can use to further filter the client list? (Select all that apply.)
  - a. AP name
  - b. AP address
  - c. WLAN profile name
  - d. SSID
  - e. Client MAC address
  - f. Client state
3. Suppose that you search for a wireless client on a controller and notice that it is associated. Which one of the following parameters would confirm that the client has completed the association process with the controller and is ready to pass data?
  - a. Client's IP address
  - b. AP name and IP address
  - c. Associated AP status
  - d. RUN policy manager state
4. Which two of the following are ways you can force a client off the wireless network temporarily so that it has to reassociate?
  - a. Add the client to the Shunned Clients list
  - b. Add the client to the Disabled Clients list
  - c. Select **Remove** from the client details drop-down menu
  - d. Select **Disassociate** from the client details page
  - e. Select **Deauthenticate** from the client details page

5. If a client is shown to be in the 8021X\_REQD state, even though the end user tried to join the wireless network several minutes ago, which one of the following best describes the client's current condition?
  - a. The client does not support any of the 802.11 amendments.
  - b. The client failed to authenticate itself properly.
  - c. Spanning Tree Protocol is blocking the AP's uplink.
  - d. The client failed to receive an IP address.
6. To troubleshoot a client's connection to the wireless network, you decide to use a Link Test from the controller. The client is a Windows-based machine, uses an adapter that supports 802.11n, is configured to support all possible data rates, and supports CCXv1. Which one of the following link tests will the controller perform with the client?
  - a. CCXv1 test frames
  - b. ICMP echo packets
  - c. Round-trip time (RTT) measurements
  - d. RSSI measurements at client and AP
7. Which of the following are required on the client's wireless adapter before a CCX link test can be performed on a controller? (Select all that apply.)
  - a. CCXv1
  - b. CCXv2
  - c. CCXv4
  - d. CCXv5
  - e. Support for any CCX version
8. To gather detailed troubleshooting information in real time about client MAC address 40:20:30:10:20:30, which one of the following controller CLI commands should you use?
  - a. `show mac-address 40:20:30:10:20:30`
  - b. `test client 40:20:30:10:20:30`
  - c. `trace client 40:20:30:10:20:30`
  - d. `debug client 40:20:30:10:20:30`

9. Suppose that you have a large wireless network with several controllers, many APs, a RADIUS server, a syslog server, and a WCS server. A user has reported connectivity problems in a specific building location, but gave no details about the AP or controller he tried to join. Which one of the following represents the most efficient troubleshooting method you can use to find information about the client?
- a. Go to the client's location and use your own computer to associate with the network, then find out which AP and controller you are using
  - b. Search for the client's MAC address on each controller
  - c. Search for the client's MAC address on WCS
  - d. Search for the client's MAC address on the RADIUS server
10. Suppose that you have just received news that no users can connect with a newly installed lightweight AP. You decide to examine the switch configuration where the AP is connected, knowing that it needs to be bound to VLAN 11. Which one of the following switch interface configurations is correct?
- a. `switchport`  
`switchport mode access`  
`no shutdown`
  - b. `switchport`  
`switchport trunk allowed vlan 1-11`  
`switchport trunk encapsulation dot1q`  
`switchport mode trunk`
  - c. `switchport`  
`switchport access vlan 11`  
`switchport mode access`  
`spanning-tree portfast`  
`shutdown`
  - d. `switchport`  
`switchport access vlan 11`  
`switchport mode access`  
`no shutdown`

## Foundation Topics

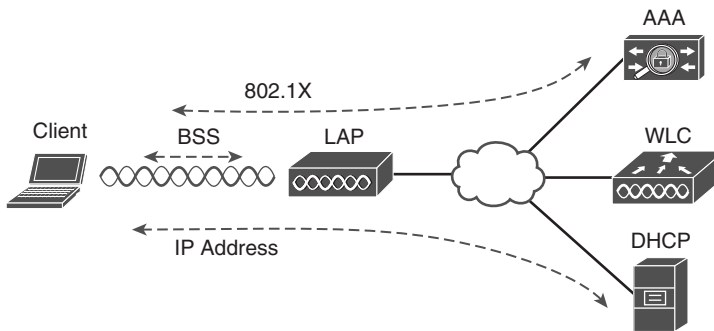
### Troubleshooting Client Connectivity

When one or more network users report that they are having problems, your first course of action should be to gather more information. Begin with a broad perspective and then try to ask pointed questions that will narrow the scope of possible causes. You do not want to panic or waste time chasing irrelevant things. Instead, ask questions and try to notice patterns or similarities in the answers you receive.

For example, if you get reports from many people in the same area, perhaps an access point (AP) is misconfigured or malfunctioning. Reports from many areas or from a single service set identifier (SSID) may indicate problems with a controller. However, if you receive a report of only one wireless user having problems, it might not make sense to spend time troubleshooting a controller, where many users are supported. Instead, you should focus on that one user's client device and its interaction with an AP.

As you prepare to troubleshoot a single wireless client, think about all of the things a client needs to join and use the network. Figure 20-1 illustrates the following conditions that must be met for a successful association:

- Client is within RF range of an AP, asks to associate.
- Client requests and receives an IP address.
- Client authenticates.



**Figure 20-1** Conditions for a Successful Association.

Try to gather information from the end user to see what the client is experiencing. “I cannot connect” or “The WiFi is down” might actually mean that the user's device cannot associate, cannot get an IP address, or cannot authenticate. A closer inspection of the device might reveal more clues.

Can the client associate at all? Most client operating systems display an icon that shows whether a wireless adapter is connected or disconnected. If the client is not associated, compare its wireless profile settings with the WLAN configuration on the controller.



The controller and the client must have identical settings for the following parameters:

- 2.4- or 5-GHz band
- Data rates and Modulation Coding Scheme (MCS)
- SSID string
- Wireless security
- Encryption method

Navigate to WLANs, select the WLAN that the client is trying to use, and then review the settings on the General, Security, QoS, and Advanced tabs. See whether the client is configured appropriately.

If the client still cannot associate, be aware that it may be listed in the controller as a disabled client. A client can be added to the disabled list manually, usually as a result of violating a local security policy, or automatically when the client's activity matches one of the controller's wireless protection policy signatures. Navigate to **Security > Disabled Clients** and look for the client's MAC address in the list. If the list is long, you can also search for the MAC address on that page.

If the client is able to associate, verify that it has an IP address. Does the client have an IP address from a subnet on the correct WLAN? If it does not show an address, check the Dynamic Host Configuration Protocol (DHCP) server to make sure that the respective DHCP scope is not already full. Remember that the controller acts as a DHCP relay, accepting the client's DHCP request and forwarding it on to the server. If an address is offered in return, the controller relays that back to the client.

**Tip** Because the controller relays the DHCP offer, it will substitute its own virtual interface address as the DHCP server's. Do not be surprised to see the controller virtual gateway IP address, such as 1.1.1.1, or an address that differs from the actual server, when you display the DHCP information on the client.

## Troubleshooting Clients from the Controller

As a wireless client probes and attempts to associate with an AP, it is essentially communicating with the controller. You can access a wealth of troubleshooting information from the controller, as long as you know the client's MAC address.



You can view a client's current status by navigating to **Monitor > Clients**. The controller will display every client that is associated to any of its APs. To find a specific client in the long list of clients, click the **Change Filter** link. You can then filter the list based on MAC address, AP name, WLAN profile or SSID, client status, client radio type, or work-group bridge (WGB) mode. In Figure 20-2, the list will be filtered to display only client MAC address 00:01:36:19:12:4a.

The screenshot shows the Cisco WLC Monitor interface. The 'Clients' section is active, displaying a table of client information. A search filter dialog is overlaid on the table, showing a search for MAC Address '00:01:36:19:12:4a'. The table lists several clients, with the first one matching the search criteria.

Client MAC Addr	AP Name	WLAN Profile	WLAN Name
<a href="#">00:01:36:18:f2:5b</a>	ghi-227-ap5	clinical	ukf
<a href="#">00:01:36:18:f2:ca</a>	ghi-321-ap5	clinical	ukf
<a href="#">00:01:36:18:f3:d9</a>	ghii-321-ap5	clinical	ukf
<a href="#">00:01:36:19:12:4a</a>	ghi-321-ap5	clinical	ukf
<a href="#">00:01:36:19:12:4b</a>			ukf
<a href="#">00:01:3e:12:08:4d</a>			voi
<a href="#">00:01:3e:12:38:e8</a>			voi
<a href="#">00:01:3e:12:39:62</a>			voi
<a href="#">00:08:ee:03:3d:49</a>			ukf
<a href="#">00:09:ef:05:6d:31</a>			vo
<a href="#">00:09:ef:05:c4:35</a>			vo
<a href="#">00:09:ef:06:7b:02</a>			vo
<a href="#">00:09:ef:06:7c:d7</a>			vo
<a href="#">00:09:ef:07:a0:73</a>			vo
<a href="#">00:09:ef:07:ab:39</a>			vo
<a href="#">00:09:ef:07:ce:07</a>			vo
<a href="#">00:09:ef:07:cf:7c</a>	172.22.253.20	vucera	vuc
<a href="#">00:09:ef:07:e2:05</a>	172.22.253.24	vocera	vo
<a href="#">00:09:ef:08:98:57</a>	172.22.253.15	vucera	vn

**Figure 20-2** *Displaying and Filtering Client Status Information.*

Click the client MAC address link to display all the known detailed information about the client. The page begins with client properties, as shown in Figure 20-3, which lists useful parameters such as the client's IP address, the AP name and type, and the AP's MAC address.

Scrolling further down, you will find a section of information about the client's current operating state, as demonstrated in Figure 20-4. From this information, you can learn that the client supports CCXv4. The client's mobility role is Local, which means it has a normal association to the local controller. If the mobility role is shown as Anchor, the client has undergone a Layer 3 roam to another controller with the mobility peer IP address listed. Toward the bottom of the page, you can see the list of data rates the client supports, in addition to its current transmit data rate (TxRateSet) of 18 Mbps.

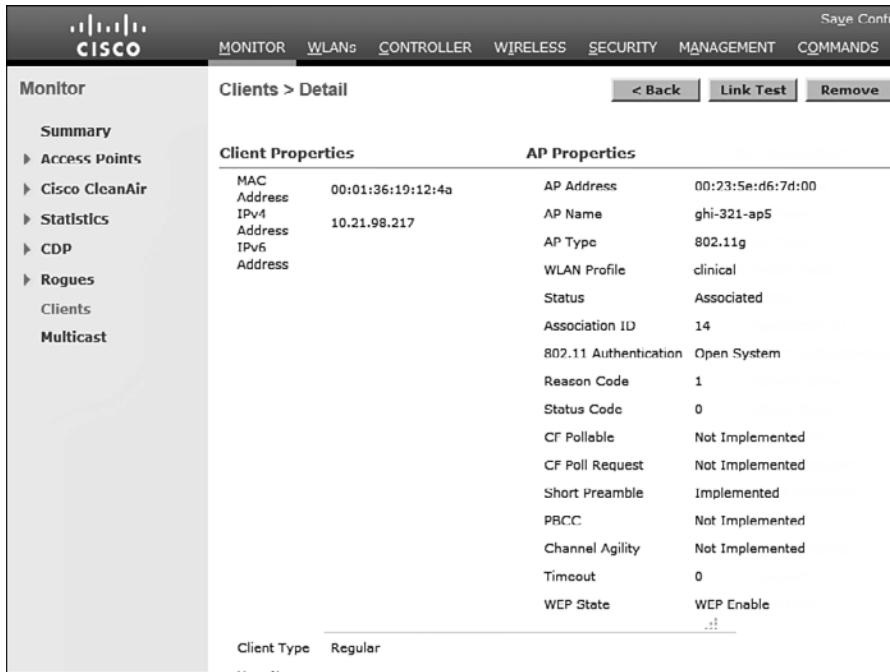


Figure 20-3 Displaying Detailed Information About a Client.

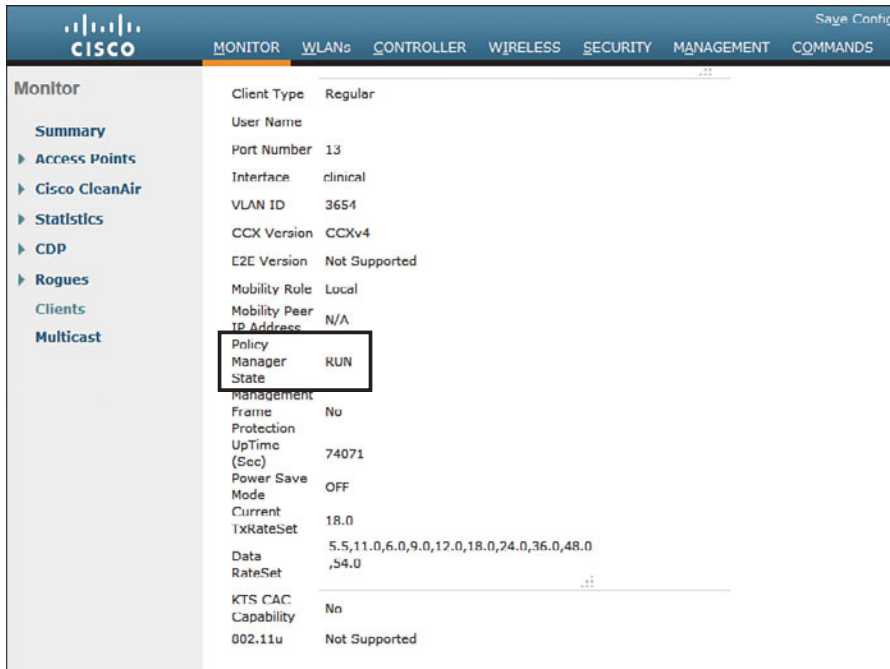


Figure 20-4 Displaying Client Operating State Information.

Perhaps the most important information about the client is listed as the policy manager state, which is highlighted in Figure 20-4. Before a controller will permit a client to fully associate with a basic service set (BSS), the client must progress through a sequence of states. Each state refers to a policy that the client must meet before moving on to the next state. Table 20-2 lists and describes the client policy states.

**Table 20-2** *Possible WLC Client States*

State	Description
START	Client activity has just begun.
AUTHCHECK	Client must pass Layer 2 authentication policy.
8021X_REQD	Client must pass 802.1x authentication.
L2AUTHCOMPLETE	Layer 2 policy is complete; Layer 3 policies can begin.
WEP_REQD	Client must authenticate with Wireless Equivalent Privacy (WEP).
DHCP_REQD	WLC is waiting to learn the client's IP address.
WEBAUTH_REQD	Client must pass web authentication.
RUN	Client has passed Layer 2 and Layer 3 policies, successfully associated, and can pass traffic.

Key  
Topic

A probing client always begins in the START state and then moves into Layer 2 policy states and Layer 3 policy states. For example, if the client is attempting to associate with a WLAN that is configured for some form of 802.1x authentication, the client must pass through the 8021X\_REQD state. If it successfully authenticates, it can move further down the list of states.

Ultimately, each client should end up in the RUN state, where it has fully associated with the BSS and is permitted to pass traffic over the WLAN. If you find a client that is consistently shown in a state other than RUN, the client must be having a problem passing the policy of that state.

For example, a client that is stuck in 8021X\_REQD is likely having trouble authenticating successfully. That could be because the client is sending an incorrect key, has an invalid certificate, or because the RADIUS server is down.

A client stuck in DHCP\_REQD is having trouble obtaining an IP address. The controller monitors the DHCP request of each client, as well as the DHCP offer returned to each client. If an offer is not seen, the client is stuck waiting. (One exception is a client that is using a static IP address, without the need for DHCP. So long as the WLAN is configured to not require DHCP, the controller will move the client on through the DHCP\_REQD state.)

Toward the bottom of the client details page, you will find a list of client statistics, such as those shown in Figure 20-5. The controller maintains counters for the number of bytes and packets sent and received by the client. You can also see the received signal

strength indicator (RSSI) value of the client and the signal-to-noise ratio (SNR) value, as measured by the AP. This can give you a good idea about how well the client's signal is being received. The data retries, request to send (RTS) retries, and duplicates counters help indicate congested conditions on the AP's channel. More congestion generally results in more retries, where frames must be re-sent.

Client Statistics	
Bytes Received	224141975
Bytes Sent	195103236
Packets Received	930070
Packets Sent	1091245
Policy Errors	0
RSSI	-54
SNR	31
Sample Time	Fri Sep 20 02:16:51 2013
Excessive Retries	0
Retries	0
Success Count	0
Fail Count	0
Tx Filtered	0
Data Retries	381383
Rts Retries	273
Duplicates	986
Decrypt Failed	0
Mic Errors	0
Mic Missing Frames	0

**Figure 20-5** *Displaying Client Statistics.*

You can also select the blue drop-down menu at the right end of the client entry to manage the client's association, as shown in Figure 20-6. Selecting **Remove** will deauthenticate the client and force it off the network, so that it will attempt to associate again. Selecting **Disable** will add the client's MAC address to the list of disabled clients and will force the client off the network.

Protocol	Status	Auth	Port	WGB
802.11g	Associated	Yes		

**Figure 20-6** *Managing a Client Association.*

## Performing a Link Test

You can select **Link Test** to perform a short test to gauge the RF conditions between the controller and the client. If the client does not support Cisco Compatible Extensions Version 4 (CCXv4) or CCXv5, the controller will run a ping test consisting of 20 500-byte Internet Control Message Protocol (ICMP) echo packets sent to the client's IP address. The client should reply to each of the ping packets if the wireless link is good and if the client supports ping traffic. The controller also records the RSSI of the client device and the SNR and reports the test results as shown in Figure 20-7.

Ping Test Results	
Client MAC Address	00:01:36:19:12:4a
Packets Length	500
Packets Sent	20
Packets Received	20
Local Signal Strength (dBm)	-55
Local Signal to Noise Ratio (dB)	32

**Figure 20-7** Results of a Ping Test to a Client Device.

Notice that the ping test reports only a single RSSI value. Even though a wireless link is bidirectional and involves two devices, the AP and the client, the controller can report only on the RSSI of the signal it receives from the client. Naturally, the client can (and probably does) measure the RSSI of the AP's signal that it receives, but it cannot share that information with the controller using ping packets.

If you perform a link test on a client that does support CCXv4 or CCXv5, the controller can gather much more information about the conditions at *both* ends of the link. In that case, the link test uses CCX messages rather than pings. A client with the more advanced CCX versions can return its own signal quality data to the controller.

Figure 20-8 shows an example of a link test with a CCXv4 client. The controller displays the round-trip time of the CCX exchange, the RSSI and SNR as measured at the client and the controller, and frame retries. The last two sets of data show the data rate used by the AP and the client (that is, 54 Mbps) and the MCS index and frame count in both directions.



Link Test Results															
Client MAC Address	00:24:c4:54:fa:c4														
AP MAC Address	0c:27:24:92:14:20														
Packets Sent/Received by AP	20/20														
Packets Lost (Total/AP->Client/Client->AP)	0/0/0														
Packets RTT (min/max/avg) (ms)	88/112/103														
RSSI at AP (min/max/avg) (dBm)	-55/-54/-54														
RSSI at Client (min/max/avg) (dBm)	-59/-54/-57														
SNR at AP (min/max/avg) (dB)	35/37/36														
SNR at Client (min/max/avg)(dB)	0/0/0														
Transmit retries at AP (Total/Max)	0/0														
Transmit retries at Client (Total/Max)	0/0														
Packet rate	1M	2M	5.5M	6M	9M	11M	12M	18M	24M	36M	48M	54M			
Sent count	0	0	0	0	0	0	0	0	0	0	0	0	20		
Receive count	0	0	0	0	0	0	0	0	0	0	0	0	20		
Packet rate(mcs)	0	1	2	3	4	5	6	7	8	9	10	11	12	13	
Sent count	0	0	0	0	0	0	0	0	0	0	0	0	0	0	
Receive count	0	0	0	0	0	0	0	0	0	0	0	0	0	0	

**Figure 20-8** Results of a Link Test to a CCXv4 or CCXv5 Client Device.

## Debugging a Client

Sometimes you might encounter a client that is having trouble connecting, but nothing seems to be obviously wrong. For example, a controller might show that the client is stuck in the 8021X\_REQD or DHCP\_REQD state, but you are not able to figure out why. Perhaps the client does not even get that far along in its attempts to associate. If you know which AP and controller the client is attempting to associate with, you can gather useful debugging information.



From the controller command-line interface (CLI), enter the command **debug client client-mac-address**. Be sure to configure your terminal emulator session to log or save all of the output that scrolls by so that you can go back and review it closely. Example 20-1 lists the output produced by the **debug client 60:67:20:9a:9e:fa** command, as the client attempts to join the wireless network. The **debug** command can provide extensive information about processes running in the AP and the WLC while the client authenticates. Much of the command output is cryptic, but you can pick out important events in the life of the client as it interacts with the controller. Only the important lines of output have been extracted and listed in Example 20-1.

### Example 20-1 Output From the debug client 60:67:20:9a:9e:fa Command

```
*apFMsConnTask_4: Sep 21 02:45:11.456: 60:67:20:9a:9e:fa Association
received from mobile on AP
20:3a:07:6f:5e:f0
*apFMsConnTask_4: Sep 21 02:45:11.457: 60:67:20:9a:9e:fa 0.0.0.0 START (0)
Initializing policy
```

```

*apfMsConnTask_4: Sep 21 02:45:11.457: 60:67:20:9a:9e:fa 0.0.0.0 START (0)
Change state to AUTHCHECK
(2) last state AUTHCHECK (2)
*apfMsConnTask_4: Sep 21 02:45:11.457: 60:67:20:9a:9e:fa 0.0.0.0 AUTHCHECK
(2) Change state to
8021X_REQD (3) last state 8021X_REQD (3)
*apfMsConnTask_4: Sep 21 02:45:11.457: 60:67:20:9a:9e:fa 0.0.0.0 8021X_REQD
(3) DHCP required on AP
20:3a:07:6f:5e:f0 vapId 5 apVapId 5for this client
*apfMsConnTask_4: Sep 21 02:45:11.458: 60:67:20:9a:9e:fa apfPemAddUser2
(apf_policy.c:270) Changing
state for mobile 60:67:20:9a:9e:fa on AP
20:3a:07:6f:5e:f0 from Idle to Associated
*apfMsConnTask_4: Sep 21 02:45:11.458: 60:67:20:9a:9e:fa Sending Assoc
Response to station on BSSID
20:3a:07:6f:5e:f0 (status 0) ApVapId 5 Slot 0
*apfMsConnTask_4: Sep 21 02:45:11.458: 60:67:20:9a:9e:fa apfProcessAssocReq
(apf_80211.c:6309)
Changing state for mobile 60:67:20:9a:9e:fa on AP
20:3a:07:6f:5e:f0 from Associated to Associated
*dot1xMsgTask: Sep 21 02:45:11.459: 60:67:20:9a:9e:fa dot1x - moving mobile
60:67:20:9a:9e:fa into
Connecting state
*dot1xMsgTask: Sep 21 02:45:11.459: 60:67:20:9a:9e:fa Sending EAP-Request/
Identity to mobile
60:67:20:9a:9e:fa (EAP Id 1)
*Dot1x_NW_MsgTask_2: Sep 21 02:45:11.469: 60:67:20:9a:9e:fa Received EAPOL
EAPPKT from mobile
60:67:20:9a:9e:fa
*Dot1x_NW_MsgTask_2: Sep 21 02:45:11.469: 60:67:20:9a:9e:fa EAP State
update from Connecting to
Authenticating for mobile 60:67:20:9a:9e:fa
*Dot1x_NW_MsgTask_2: Sep 21 02:45:11.469: 60:67:20:9a:9e:fa dot1x - moving
mobile 60:67:20:9a:9e:fa
into Authenticating state
*Dot1x_NW_MsgTask_2: Sep 21 02:45:11.477: 60:67:20:9a:9e:fa Processing
Access-Challenge for mobile
60:67:20:9a:9e:fa
*Dot1x_NW_MsgTask_2: Sep 21 02:45:11.477: 60:67:20:9a:9e:fa Entering Back-
end Auth Req state (id=2) for
mobile 60:67:20:9a:9e:fa
*Dot1x_NW_MsgTask_2: Sep 21 02:45:11.477: 60:67:20:9a:9e:fa Sending EAP
Request from AAA to mobile
60:67:20:9a:9e:fa (EAP Id 2)
*Dot1x_NW_MsgTask_2: Sep 21 02:45:11.552: 60:67:20:9a:9e:fa Received EAPOL
EAPPKT from mobile
60:67:20:9a:9e:fa
*Dot1x_NW_MsgTask_2: Sep 21 02:45:11.552: 60:67:20:9a:9e:fa Received EAP
Response from mobile
60:67:20:9a:9e:fa (EAP Id 10, EAP Type 13)

```



```

*Dot1x_NW_MsgTask_2: Sep 21 02:45:11.554: 60:67:20:9a:9e:fa Processing
Access-Accept for
mobile 60:67:20:9a:9e:fa
*Dot1x_NW_MsgTask_2: Sep 21 02:45:11.554: 60:67:20:9a:9e:fa Username entry
(host/IMKYCD212L13.mydomain.com) created for mobile, length = 253
*Dot1x_NW_MsgTask_2: Sep 21 02:45:11.554: 60:67:20:9a:9e:fa Username entry
(host/IMKYCD212L13.mydomain.com) created in mscb for mobile, length = 253
*Dot1x_NW_MsgTask_2: Sep 21 02:45:11.556: 60:67:20:9a:9e:fa Sending EAP-
Success to mobile
60:67:20:9a:9e:fa (EAP Id 10)
*Dot1x_NW_MsgTask_2: Sep 21 02:45:11.556: 60:67:20:9a:9e:fa Received Auth
Success while in
Authenticating state for mobile 60:67:20:9a:9e:fa
*Dot1x_NW_MsgTask_2: Sep 21 02:45:11.556: 60:67:20:9a:9e:fa dot1x - moving
mobile 60:67:20:9a:9e:fa
into Authenticated state
*Dot1x_NW_MsgTask_2: Sep 21 02:45:11.565: 60:67:20:9a:9e:fa 0.0.0.0 8021X_
REQD (3) Change state to
L2AUTHCOMPLETE (4) last state L2AUTHCOMPLETE (4)
*Dot1x_NW_MsgTask_2: Sep 21 02:45:11.568: 60:67:20:9a:9e:fa 0.0.0.0 L2AUTH-
COMPLETE (4)
DHCP required on AP 20:3a:07:6f:5e:f0 vapId 5 apVapId 5for this client
*Dot1x_NW_MsgTask_2: Sep 21 02:45:11.568: 60:67:20:9a:9e:fa 0.0.0.0 L2AUTH-
COMPLETE (4)
Change state to DHCP_REQD (7) last state DHCP_REQD (7)
    type = Airespace AP - Learn IP address
    on AP 20:3a:07:6f:5e:f0, slot 0, interface = 13, QOS = 0
    IPv4 ACL ID = 255, IP
*Dot1x_NW_MsgTask_2: Sep 21 02:45:11.568: 60:67:20:9a:9e:fa 0.0.0.0 DHCP_
REQD (7) Fast Path rule
(contd...) 802.1P = 0, DSCP = 0, TokenID = 15206 Local Bridging Vlan =
3606, Local Bridging intf id =
13
*Dot1x_NW_MsgTask_2: Sep 21 02:45:11.568: 60:67:20:9a:9e:fa 0.0.0.0 DHCP_
REQD (7) Successfully plumbed
mobile rule (IPv4 ACL ID 255, IPv6 ACL ID 255)
*apfReceiveTask: Sep 21 02:45:14.484: 60:67:20:9a:9e:fa 0.0.0.0 DHCP_REQD
(7) State Update from
Mobility-Incomplete to Mobility-Complete, mobility role=Local, client
state=APF_MS_STATE_ASSOCIATED
*apfReceiveTask: Sep 21 02:45:14.484: 60:67:20:9a:9e:fa 0.0.0.0 DHCP_REQD
(7) Successfully plumbed
mobile rule (IPv4 ACL ID 255, IPv6 ACL ID 255)
*apfReceiveTask: Sep 21 02:45:14.484: 60:67:20:9a:9e:fa 172.22.121.128
DHCP_REQD (7) Change state to
RUN (20) last state RUN (20)
*apfReceiveTask: Sep 21 02:45:14.484: 60:67:20:9a:9e:fa 172.22.121.128 RUN
(20) Reached PLUMBFASPATH:
from line 5842
*apfReceiveT: Sep 21 02:45:14.484: 60:67:20:9a:9e:fa 172.22.121.128 RUN

```

```

(20) Replacing Fast Path rule
    type = Airespace AP Client
    on AP 20:3a:07:6f:5e:f0, slot 0, interface = 13, QOS = 0
    IPv4 ACL ID = 255, IPv6 ACL
*apfReceiveTask: Sep 21 02:45:14.485: 60:67:20:9a:9e:fa Assigning Address
172.22.121.128 to mobile
*apfReceiveTask: Sep 21 02:45:14.485: 60:67:20:9a:9e:fa Successfully
installed IP address
172.22.121.128 for station
*pemReceiveTask: Sep 21 02:45:14.486: 60:67:20:9a:9e:fa Sending a gratu-
itous ARP for 172.22.121.128,
VLAN Id 3606

```

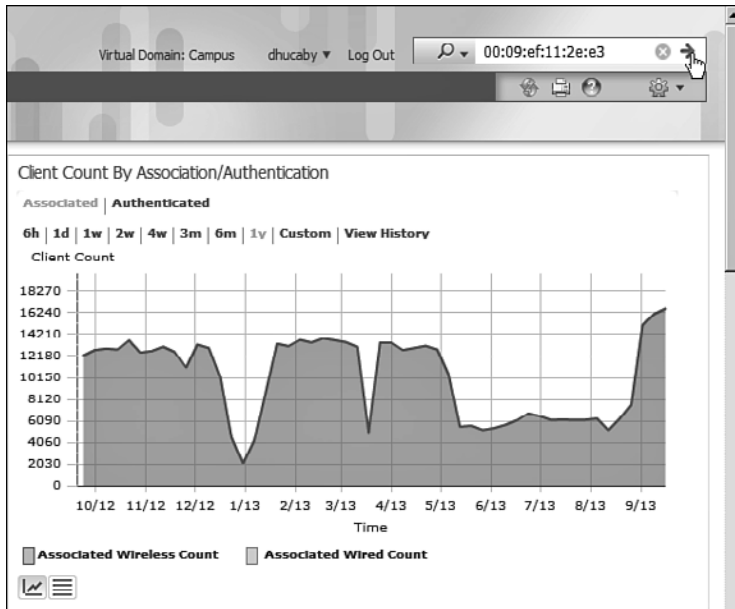
The **debug client** command can also prove useful when you are troubleshooting roaming issues, as a client moves from one AP to another on the same controller or between two controllers. In the latter case, you can use **debug client** on multiple controllers, collect the output from each CLI session, and find the point where the client leaves one AP and reassociates with another.

## Troubleshooting Clients from WCS/NCS

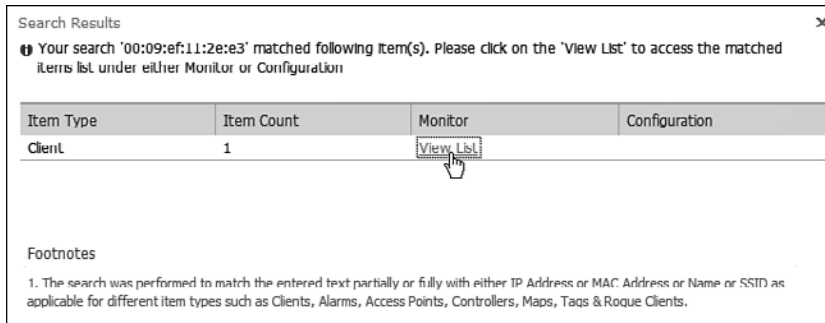
Most of the troubleshooting tools described in this chapter must be used from a controller. What if your network is large and consists of many controllers? You might have a hard time figuring out which controller a client is trying to join so that you can gather information about it. Instead, you can simply move further upstream and troubleshoot the client from the Wireless Control System/Network Control System/Prime Infrastructure (WCS/NCS/PI), at the point where all of the controllers are centrally managed.

You can search for a single wireless client in the entire database of active clients. Enter all or a part of the client's MAC address into the search box in the upper-right corner and click the right arrow to begin the search. In Figure 20-9, MAC address 00:09:ef:11:2e:e3 has been entered. When the search is complete, you are prompted with the results, as shown in Figure 20-10. Select the entry in the Monitor tab that you want to display.

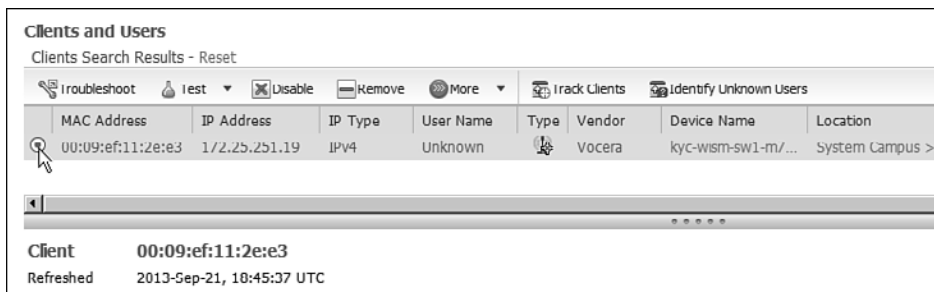
The search results will be displayed in a Clients and Users page, as shown in Figure 20-11. Selecting the radio button of the desired entry will display much more information about it lower on the page, beginning with the client attributes shown in Figure 20-12. From this information, you can verify things such as the client's IP address, vendor, and power save mode, in addition to details about the AP where the client is joined and the security parameters in use.



**Figure 20-9** Searching for a Client MAC Address.



**Figure 20-10** Selecting Results to View.



**Figure 20-11** Selecting a Client to Display in Detail.

**Client** 00:09:ef:11:2e:e3  
**Refreshed** 2013-Sep-21, 18:45:37 UTC

Note: None

▼ Client Attributes

General	Session	Security
User Name <b>Unknown</b>	Controller Name <b>m7-c2</b>	Security Policy Type <b>N/A</b>
IP Address <b>172.25.251.19</b>	AP Name <b>h329-ap10</b>	EAP Type <b>Unknown</b>
MAC Address <b>00:09:ef:11:2e:e3</b>	AP IP Address <b>172.25.1.199</b>	On Network <b>No</b>
Vendor <b>Vocera</b>	AP Type <b>Cisco AP</b>	802.11 Authentication <b>Open System</b>
Endpoint Type <b>Unknown</b>	AP Base Radio MAC <b>00:23:33:c2:29:60</b>	Encryption Cipher <b>WEP (104 bits)</b>
Client Type <b>Regular</b>	Anchor Controller <b>Data Not Available</b>	SNMP NAC State <b>Access</b>
Media Type <b>Lightweight</b>	802.11 State <b>Disassociated</b>	Radius NAC State <b>RUN</b>
Mobility Status <b>Local</b>	Association ID <b>137</b>	AAA Override ACL Name <b>Data Not Available</b>
Hostname <b>Data Not Available</b>	Port <b>29</b>	AAA Override ACL Applied Status <b>N/A</b>
EZE <b>Not Supported</b>	Interface <b>vocera</b>	Redirect URL <b>Data Not Available</b>
Power Save <b>OFF</b>	SSID <b>vocera</b>	ACL Name <b>Data Not Available</b>
CCX <b>Not Supported</b>	Profile Name <b>vocera</b>	ACL Applied Status <b>N/A</b>
	Protocol <b>802.11g</b>	FlexConnect Local Authentication <b>No</b>
	VLAN ID <b>570</b>	Policy Manager State <b>RUN</b>
		Authenticating ISE <b>Data Not Available</b>
		Authorization Profile Name <b>Data Not Available</b>
		Posture Status <b>Unknown</b>
		TrustSec Security Group <b>Data Not Available</b>
		Windows AD Domain <b>Data Not Available</b>

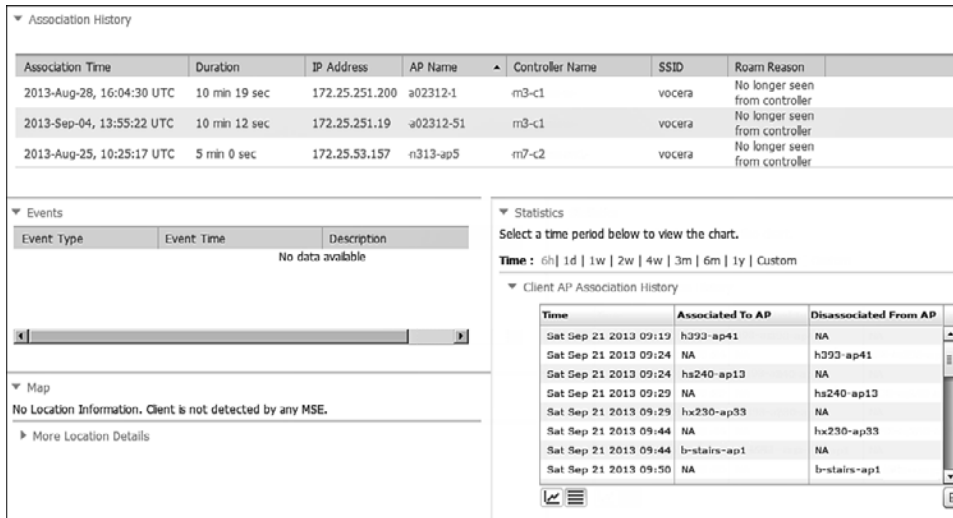
**Figure 20-12** *Displaying Client Attributes (Continued Screen from Figure 20-11).*

You might notice one thing that is missing from all of the client information presented: the client's RSSI value. In the previous section, you learned that a controller can display a current RSSI that it learned from the AP. WCS and NCS are positioned further upstream to collect client statistics from all controllers and all APs. They also maintain a database that contains a history of the client activity.

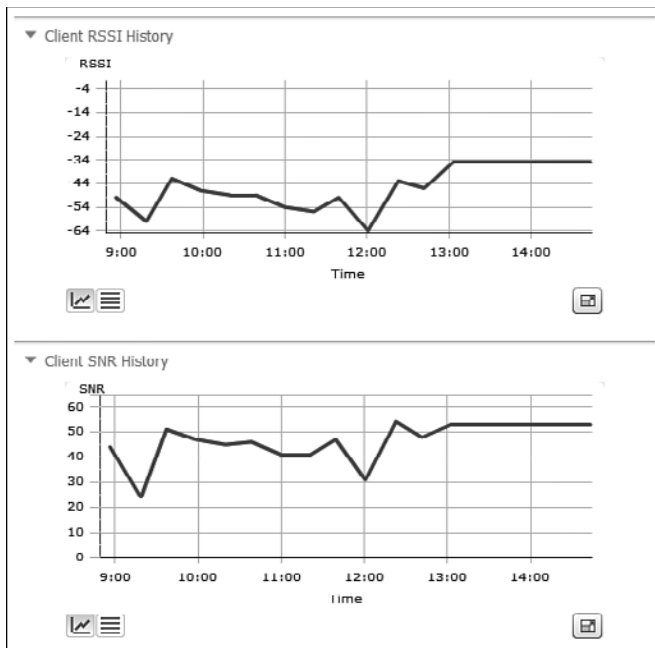
For example, the client details page also contains an association history in two different scrolling lists, as shown in Figure 20-13. The first list contains the APs and controllers the client was associated with most recently, along with a time stamp and the duration of each association. If the controllers were able to determine a reason for the client changing its association, that reason is displayed too.

The second association history list forms a continuous timeline of the client's path through the wireless network. Each time stamp marks an association change or a roam and identifies the APs that the client was associated with before and after the roam. If you piece this information together, you can trace the path that the client took as it moved throughout its journey. Sometimes you can figure out locations where the RF coverage might be lacking. For instance, you might see that the client left the network near a stairwell in the basement, only to reappear somewhere on the fourth floor.

Further down on the client details page, you will find graphs that represent a history of the client's RSSI values and the SNR, as shown in Figure 20-14.



**Figure 20-13** *Displaying a Client's Association History.*



**Figure 20-14** *Displaying a Client's RSSI and SNR History.*

You can also use WCS/NCS to perform some interactive troubleshooting on a client. Select the client's radio button and then click the **Troubleshoot** button at the top of the page (refer to Figure 20-11). WCS/NCS will collect debug client information from the controller and will display the results in a graphical format, breaking the client association process down into the following steps:



- 802.11 association
- 802.1x authentication
- IP address assignment
- Successful association

WCS/NCS will also interpret the results and display suggested actions, all on the client details page. In Figure 20-15, the client d4:20:6d:90:ad:22 has failed to authenticate to the WLAN. Notice that the 802.11 association step has a check mark, whereas 802.1x authentication has a caution triangle. The problem is shown to be “802.1x Authentication Failure,” and you are given a series of parameters to check as part of your troubleshooting efforts.

**Tip** If WCS/NCS does not show any obvious problems after you click the **Troubleshoot** button, you can scroll to the bottom of the page and click the **Check Again** button. The troubleshooting information will refresh with new results.

**Client Troubleshooting** [Go back](#)

▼ Properties

General	Session	Security
User Name <b>Unknown</b>	Controller Name <b>m3-c1</b>	Security Policy Type <b>N/A</b>
IP Address <b>10.20.101.67</b>	AP Name <b>11k001-ap57</b>	EAP Type <b>Unknown</b>
MAC Address <b>d4:20:6d:90:ad:22</b>	AP IP Address <b>172.25.2.229</b>	On Network <b>Yes</b>
Vendor <b>Htc</b>	AP Type <b>Cisco AP</b>	802.11 Authentication <b>Open Sys</b>
Endpoint Type <b>Unknown</b>	AP Base Radio MAC <b>00:23:04:f4:12:b0</b>	Encryption Cipher <b>None</b>
Client Type <b>Regular</b>	Anchor Controller <b>Data Not Available</b>	SNMP NAC State <b>Access</b>
Media Type <b>Lightweight</b>	802.11 State <b>Associated</b>	Radius NAC State <b>RUN</b>
Mobility Status <b>Local</b>	Association ID <b>12</b>	AAA Override ACL Name <b>none</b>
Hostname <b>Data Not Available</b>	Port <b>29</b>	AAA Override ACL Applied Status <b>N/A</b>
E2E <b>Not Supported</b>	Interface <b>guest</b>	Redirect URL <b>none</b>
	SSID <b>guest</b>	ACL Name <b>none</b>
	Profile Name <b>guest</b>	ACL Applied Status <b>N/A</b>
	Protocol <b>802.11g</b>	FlexConnect Local Authentication <b>No</b>
	VLAN ID <b>609</b>	Policy Manager State <b>RUN</b>
	AP Mode <b>local</b>	Authenticating ISE <b>Data Not</b>
		Authorization Profile Name <b>Data Not</b>
		Posture Status <b>Unknown</b>
		TrustSec Security Group <b>Data Not</b>
		Windows AD Domain <b>Data Not</b>

Troubleshoot

802.11 Association   
  802.1X Authentication   
  IP Address Assignment   
  Successful Association

Problem	Recommendation
802.1X Authentication Failure	Check whether Radius server(s) is reachable Check whether client's choice of EAP method is supported by radius server Check Clients username/password/cert is valid Check to see if the certificates used by the Authentication server are accepted by the client.

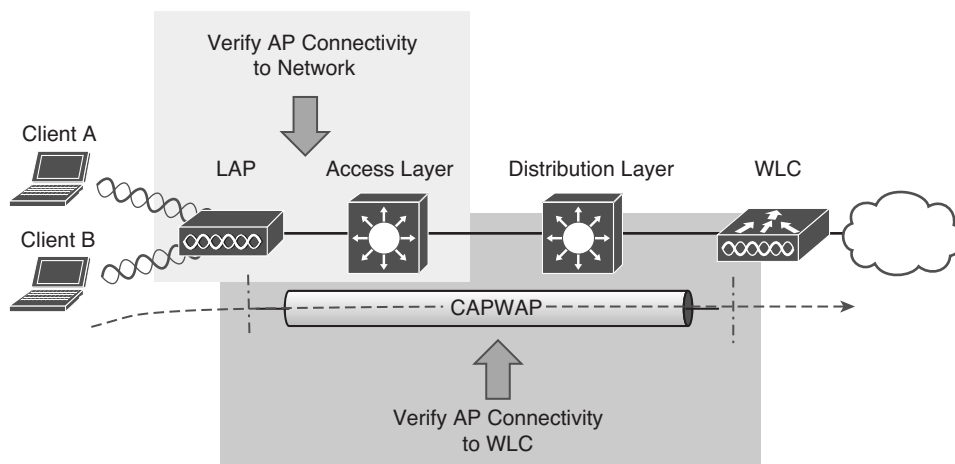
**Figure 20-15** Troubleshooting a Client from WCS/NCS.

## Troubleshooting AP Connectivity

In cases where you get reports from multiple users who are all having problems in the same general area, you might need to focus your efforts on an AP. The problem could be as simple as a defective radio, where no clients are receiving a signal. In that case, you might have to go onsite to confirm that the transmitter is not working correctly.

Otherwise, the split-MAC architecture creates several different points where you can troubleshoot. Recall the Cisco Unified Wireless Network (CUWN) structure illustrated in Figure 20-16. To successfully operate the lightweight AP and provide a working BSS, the following two things must work correctly:

- The LAP must have connectivity to its access layer switch.
- The LAP must have connectivity to its WLC.



**Figure 20-16** Verifying AP Connectivity in a CUWN.

### Verifying AP-to-WLC Connectivity

First, verify the connectivity between an AP and a controller. Usually you will do this when a new AP is installed, to make sure it is able to discover and join a controller before clients arrive and try to use the wireless network. You can also do this at any time as a quick check of the AP's health.

The easiest approach is to simply look for the AP in the list of live APs that have joined the controller. If you know which controller the AP should join, open a management session to it. Navigate to **Wireless > All APs > Change Filter**, and then enter the AP's MAC address or some portion of its name. In Figure 20-17, the controller is being searched for an AP with d208 in its name. Fortunately, the search reveals a live AP that is joined to the controller, as shown in Figure 20-18. You can click the AP name link to display more information about the AP and to configure its parameters. From the details listed on the General tab, as shown in Figure 20-19, you can also verify the IP address that the AP is using.



The screenshot shows the Cisco Wireless Control System (WCS) interface. The 'All APs' page is active, displaying a table of APs. A search dialog box is open, allowing the user to filter APs by various criteria. The 'AP Name' field is filled with 'd208'. The 'Number of APs' is currently 75.

AP Name	AP Model	AP MAC
kyc-d208-ap0	AIR-CAP3602I-A-K9	6c:20:56:a6:46:be
		ac:f2:c5:6b:01:0b
		e0:2f:6d:37:bf:27
		fc:99:47:44:4e:1d
		fc:99:47:d5:3f:82
		fc:99:47:d5:39:48
		fc:99:47:94:86:0f
		/0:81:05:07:40:c0
		fc:99:47:d5:3f:5f
		fc:99:47:2d:1a:04
		6c:20:56:b5:24:76
		fc:99:47:df:9f:ed
		6c:20:56:c6:7b:4c
		e4:d3:f1:c9:10:c2
		e4:d3:f1:ef:7f:4d
		fc:99:47:df:a4:12

**Figure 20-17** Searching a Controller for an AP.

The screenshot shows the Cisco WCS interface after the search. The 'All APs' page now displays only one AP matching the search criteria. The 'Number of APs' is 1.

AP Name	AP Model	AP MAC	AP Up Time
kyc-d208-ap0	AIR-CAP3602I-A-K9	6c:20:56:a6:46:be	240 d, 04 h 20 m 00 s

**Figure 20-18** Reviewing the Search Results.

As long as the controller shows the AP with an appropriate IP address, you can assume that there is a working Control and Provisioning of Wireless Access Points (CAPWAP) tunnel between the two. If clients are reporting problems with one SSID that they have in common, you should review the WLAN configuration on the controller to make sure it is bound to the correct controller interface and to the correct VLAN.

If your network is large and you have many controllers, you might not know which one the AP has joined. You can look from a more broad perspective by searching for the AP on WCS, NCS, or PI.



The screenshot shows the configuration page for AP 'kyc-d208-ap8'. The 'IP Config' section is highlighted with a red box. The IP Address is 172.25.4.76 and the Static IP checkbox is unchecked. Other sections include General, Versions, and Time Statistics.

General		Versions	
AP Name	kyc-d208-ap8	Primary Software Version	7.2.111.3
Location	Default location	Backup Software Version	0.0.0.0
AP MAC Address	6c:20:56:a6:46:be	Predownload Status	None
Base Radio MAC	1c:e6:c7:e0:d3:a0	Predownload Version	None
Admin Status	Enable	Predownload Next Retry Time	NA
AP Mode	local	Predownload Retry Count	NA
AP Sub Mode	None	Boot Version	12.4.23.0
Operational Status	REG	IOS Version	12.4(25e)JA2\$
Port Number	LAG	Mini IOS Version	7.3.1.73
Venue Group	Unspecified	<b>IP Config</b>	
Venue Type	Unspecified	IP Address	172.25.4.76
Venue Name		Static IP	<input type="checkbox"/>
Language		<b>Time Statistics</b>	
Network Spectrum Interface Key	3E6FF7621FBC19D986774C5C053FAFC6	UP Time	248 d, 04 h 20 m 54 s
		Controller Associated Time	248 d, 03 h 53 m 55 s
		Controller Association Latency	0 d, 00 h 00 m 11 s

**Figure 20-19** Verifying the AP's IP Address.

## Verifying AP-to-Network Connectivity

If you do not find the AP joined to a controller, you will have to move your focus further away from the controller and onto the AP and its wired connection.

Does the AP have an IP address? Without the help of a controller, you might have to connect to the AP console and watch the logging information scroll by as the AP tries to boot, get an address, and find a controller to join. You can also query the DHCP server to see whether the AP has an active address lease. If it is not able to get an address from a DHCP server, check the address scope on the server to ensure that the address space is not exhausted.

**Tip** To connect to the CLI of an AP, you need to enter some credentials. By default, log in with username Cisco and password Cisco. The default enable secret password is also Cisco.

If the AP is having trouble joining a controller, verify that the switch port configuration where the AP is connected. A lightweight AP needs only a single VLAN to support the CAPWAP tunnel. All WLANs are transported over the tunnel without the need for separate VLANs. In contrast, an autonomous AP has no CAPWAP tunnel, so it needs a trunk

link that can carry individual WLANs over VLANs. The switch port configuration should look like one of those shown in Table 20-3.

**Table 20-3** *Switch Port Configuration to Support an AP*

<b>Lightweight AP (Access Link)</b>	<b>Autonomous AP (Trunk Link)</b>
<code>interface gigabitethernet1/0/1</code>	<code>interface gigabitethernet1/0/1</code>
<code>switchport</code>	<code>switchport</code>
<code>switchport access vlan 100</code>	<code>switchport trunk allowed vlan 100,101,102,103</code>
<code>switchport mode access</code>	<code>switchport trunk native vlan 100</code>
<code>spanning-tree portfast</code>	<code>switchport trunk encapsulation dot1q</code>
<code>no shutdown</code>	<code>switchport mode trunk</code>
	<code>no shutdown</code>

Finally, recall that a lightweight AP tries a variety of methods to discover viable controllers to join. Most likely, the DHCP server has been configured to send DHCP option 43 with lease offers to APs. Option 43 is a string of hex digits that contain the IP addresses of one or more controllers. The DHCP server might not have option 43 configured at all, or it could have a typo or error in the hex string.

Sometimes you might connect an AP and wait a very long time for it to join a controller, only to find that it does not. First, check the controller licensing to make sure that there are enough available licenses for the AP. If you still cannot figure out what the AP is doing, you can connect directly to its console port and watch the logging information scroll by as the AP attempts to discover controllers.

The console output listed in Example 20-2 shows that the AP is not able to obtain an IP address so it can join the wired network. In Example 20-3, the AP picked up a list of three candidate controller IP addresses (192.168.90.22, 192.168.90.23, and 192.168.90.16) from the DHCP server. However, the AP then tries to initiate a DTLS tunnel (part of CAPWAP) to a controller known as m7-c1 at address 172.22.253.17, and successfully joins it. Perhaps this AP was previously configured with a primary controller address elsewhere before it was installed on the network. Therefore, it used an unexpected controller address.

**Example 20-2** *AP Console Output Showing an IP Address Problem*

```
*Mar 1 00:13:33.515: %CDP_PD-4-POWER_OK: Full power - INJECTOR_DETECTED_PD
inline power source
*Mar 1 00:13:34.537: %LINK-3-UPDOWN: Interface Dot11Radio1, changed state
to up
*Mar 1 00:13:35.537: %LINEPROTO-5-UPDOWN: Line protocol on Interface
Dot11Radio1, changed state to up
```

```
*Mar 1 00:13:35.563: %LINK-3-UPDOWN: Interface Dot11Radio0, changed state
to up
*Mar 1 00:13:36.563: %LINEPROTO-5-UPDOWN: Line protocol on Interface
Dot11Radio0, changed state to up
*Mar 1 00:13:57.962: %CAPWAP-3-ERRORLOG: Not sending discovery request AP
does not have an Ip !!
*Mar 1 00:14:17.962: %CAPWAP-3-ERRORLOG: Not sending discovery request AP
does not have an Ip !!
```

### Example 20-3 Verifying Candidate Controller Addresses from the AP Console

```
*Mar 1 00:16:18.971: %CAPWAP-5-DHCP_OPTION_43: Controller address
192.168.90.22 obtained through DHCP
*Mar 1 00:16:18.971: %CAPWAP-5-DHCP_OPTION_43: Controller address
192.168.90.23 obtained through DHCP
*Mar 1 00:16:18.971: %CAPWAP-5-DHCP_OPTION_43: Controller address
192.168.90.16 obtained through DHCP
*Mar 1 00:16:19.012: %CAPWAP-3-ERRORLOG: Could Not resolve CISCO-CAPWAP-
CONTROLLER
*Mar 1 00:16:29.020: %CAPWAP-3-ERRORLOG: Selected MWAR m7-c1'(index 0).
*Mar 1 00:16:29.020: %CAPWAP-3-ERRORLOG: Go join a capwap controller
*Sep 12 14:16:04.000: %CAPWAP-5-DTLSREQSEND: DTLS connection request sent
peer_ip: 172.22.253.17 peer_port: 5246
*Sep 12 14:16:04.791: %CAPWAP-5-DTLSREQSUCC: DTLS connection created suc-
cessfully peer_ip: 172.22.253.17 peer_port: 5246
*Sep 12 14:16:04.792: %CAPWAP-5-SENDJOIN: sending Join Request to
172.22.253.17
*Sep 12 14:16:05.069: %LINK-3-UPDOWN: Interface Dot11Radio0, changed state
to down
*Sep 12 14:16:05.108: %LINK-5-CHANGED: Interface Dot11Radio0, changed state
to reset
*Sep 12 14:16:05.117: %CAPWAP-5-JOINEDCONTROLLER: AP has joined controller
m7-c1
```

---

## Exam Preparation Tasks

---

As mentioned in the section, “How to Use This Book,” in the Introduction, you have a couple of choices for exam preparation: the exercises here, Chapter 22, “Final Review,” and the exam simulation questions on the CD-ROM.

### Review All Key Topics

Review the most important topics in this chapter, noted with the Key Topic icon in the outer margin of the page. Table 20-4 lists a reference of these key topics and the page numbers on which each is found.

**Table 20-4** *Key Topics for Chapter 20*

<b>Key Topic Element</b>	<b>Description</b>	<b>Page Number</b>
Paragraph	Monitoring a client	406
Table 20-2	Possible WLC client states	409
Figure 20-8	Performing a CCX link test	412
Paragraph	Displaying client debug information	412
Figure 20-9	Searching for a client in WCS/NCS	416
List	WCS/NCS client troubleshooting stages	419
Figure 20-17	Verifying AP operation from WCS/NCS	421





---

This chapter covers the following topics:

- **Accessing WLC and AP Management Interfaces**—This section describes the methods you can use to interact with a controller and its access points for configuration and monitoring.
- **Maintaining WLC Code Images**—This section explains how you can verify a controller's code image and how you can upgrade it.
- **Maintaining WLC Configurations**—This section discusses the controller configuration and how to save it and back it up.
- **Working with WLC Logs**—This section covers controller activity logs and how you can display and record them.

This chapter covers the following exam topics:

- Transfer logs, configuration files, and O/S images to and from the WLC via the GUI
- Differentiate and use WLC and AP (autonomous and LAP) management access methods (console port, CLI, telnet, ssh, http, https, and wired vs wireless management)

# Maintaining Controllers

Like Cisco routers, switches, and other networking devices, wireless LAN controllers maintain configuration files, run operating system images, and generate logs. As a CCNA Wireless engineer, you will likely be involved in maintaining controllers on a network and dealing with the information and files they use. This chapter explains how you can interface with controllers and APs so that you can upload and download their files.

## “Do I Know This Already?” Quiz

The “Do I Know This Already?” quiz allows you to assess whether you should read this entire chapter thoroughly or jump to the “Exam Preparation Tasks” section. If you are in doubt about your answers to these questions or your own assessment of your knowledge of the topics, read the entire chapter. Table 21-1 lists the major headings in this chapter and their corresponding “Do I Know This Already?” quiz questions. You can find the answers in Appendix A, “Answers to the ‘Do I Know This Already?’ Quizzes.”

**Table 21-1** “Do I Know This Already?” Section-to-Question Mapping

Foundation Topics Section	Questions
Accessing WLC and AP Management Interfaces	1–2
Maintaining WLC Code Images	3–6
Maintaining WLC Configurations	7–8
Working with WLC Logs	9–10

**Caution** The goal of self-assessment is to gauge your mastery of the topics in this chapter. If you do not know the answer to a question or are only partially sure of the answer, you should mark that question as wrong for purposes of the self-assessment. Giving yourself credit for an answer you correctly guess skews your self-assessment results and might provide you with a false sense of security.

1. By default, which of the following are methods you can use to access a wireless LAN controller? (Choose all that apply.)
  - a. Telnet
  - b. SSH
  - c. HTTP
  - d. HTTPS
  - e. Console port
2. After a lightweight AP in its default configuration joins a controller, you can use SSH to connect to it. True or false?
  - a. True
  - b. False
3. A controller maintains how many code image files?
  - a. 1
  - b. 2
  - c. 3
  - d. Unlimited
4. Which two of the following file transfer methods can be used to move a controller code image file onto a controller?
  - a. TFTP
  - b. RCP
  - c. SSH
  - d. FTP
  - e. XMODEM
  - f. HTTP
5. Suppose that you need to transfer a code image file from a TFTP server on your PC to a controller. Which of the following file copy directions should you choose?
  - a. Download
  - b. Upload
  - c. None of these answers because a controller automatically gets its image from WCS/NCS/PI
  - d. None of these answers are correct because it is not possible to transfer an image file via TFTP

6. After copying a new code image file to a controller, how should you copy the same code release to the lightweight APs?
  - a. Use **Commands > Download to APs**.
  - b. Connect to each AP and copy the file there.
  - c. Put the address of a TFTP server in the DHCP options field.
  - d. Do nothing; each AP will get the new image as it rejoins the controller.
7. Suppose that you use a web browser to access a controller and make a configuration change. You make sure to click the **Apply** button. A short time later, the controller loses power and then reboots. Which two of the following answers correctly describes the result?
  - a. The Apply button saved the change permanently.
  - b. The Apply button made the change active, but didn't save it across the reboot.
  - c. You would need to click the **Save Configuration** link to save the change permanently.
  - d. To save the change permanently, you would need to use the **copy run start** command from the CLI.
8. To save a copy of a controller's configuration, which of the following methods could you use?
  - a. **Commands > Upload File**
  - b. **Commands > Download File**
  - c. The **copy config tftp** CLI command
  - d. The **show running-config** CLI command
9. Which one of the following controller logs contains information about things that a controller has monitored or detected on the wireless network?
  - a. Message log
  - b. Trap log
  - c. Event log
  - d. CleanAir log
10. Which one of the following protocols is needed to send entries from the trap log to a collection station as they occur?
  - a. TFTP
  - b. CAPWAP
  - c. SNMP
  - d. SMTP
  - e. NTP



## Accessing WLC and AP Management Interfaces

To interact with and manage a wireless controller, you need a way to connect to it. Cisco Wireless LAN Controllers (WLCs) offer the following access methods:



- **Command-line interface CLI**—You can initiate a CLI session by connecting directly to the console port (asynchronous serial) or by opening a Telnet or Secure Shell (SSH) session to the controller’s management interface IP address.
- **Graphical-user interface (GUI)**—You can use a web browser to open a session to the controller’s management interface IP address.

Normally, you will manage a WLC through an HTTPS session with a web browser. HTTP is disabled by default. You can configure these settings from **Management > HTTP-HTTPS**, as shown in Figure 21-1.

The screenshot shows the Cisco WLC Management GUI. The top navigation bar includes: MONITOR, WLANs, CONTROLLER, WIRELESS, SECURITY, MANAGEMENT (highlighted), and COMMANDS. The left sidebar shows a tree view under Management: Summary, SNMP, HTTP-HTTPS (selected), Telnet-SSH, Serial Port, Local Management Users, User Sessions, Logs, Mgmt Via Wireless, Software Activation, and Tech Support. The main content area is titled 'HTTP-HTTPS Configuration' and has buttons for 'Apply', 'Delete Certificate', and 'Regenerate'. The configuration includes:
 

- HTTP Access: Disabled
- HTTPS Access: Enabled
- Web Session Timeout: 30 Minutes

 Below this is the 'Current Certificate' section:
 

- Name: bsnSslWebadminCert
- Type: 3rd Party
- Serial Number: 3677926432
- Valid: From 2012 Nov 21st, 00:00:01 GMT Until 2022 Nov 21st, 00:00:01 GMT
- Subject Name: C=US, O=Cisco Systems Inc., OU=DeviceSSL (WebAdmin), CN=169.254.1.1
- Issuer Name: C=US, O=Cisco Systems Inc., OU=DeviceSSL (WebAdmin), CN=169.254.1.1
- MD5 Fingerprint: aa:88:fb:b0:6c:60:cb:81:02:3c:e2:fa:f7:0c:4b:95
- SHA1 Fingerprint: d1:72:ae:a6:72:88:04:6d:bd:ca:81:20:ee:d0:be:3c:58:3a:96:bf

 At the bottom, there is a 'Download SSL Certificate \*' button with a note '\* Controller must be'.

**Figure 21-1** Configuring GUI Access to a Controller.

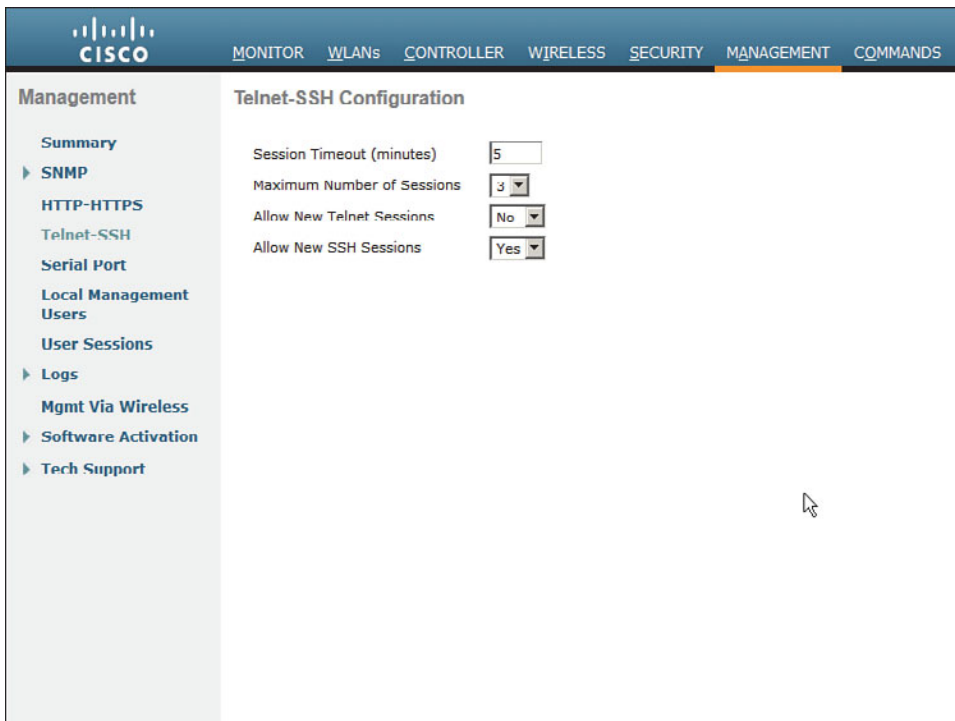
You might need to use the CLI for the initial bootstrap configuration, until a new WLC is configured with a management IP address and you can access the web-based GUI. The CLI is also useful when you are troubleshooting problems with wireless clients or collecting important output for Cisco TAC.

The CLI is based on an operating system called AireOS, which is very different from Cisco IOS. Although the AireOS commands are different from IOS, there are a few

similarities. For example, you can use the **show** and **debug** commands along with a wide variety of keywords to gather specific information. You can type a question mark (?) to see a list of possible keywords you can use to complete a command. The Tab key can be used to complete a keyword you have started to type. Each configuration change must be made with the **config** command followed by keywords.

**Tip** The CCNA Wireless exam covers controllers that are based on AireOS. Cisco has also introduced a line of “converged access” controllers that are based on the familiar IOS. At the time of this writing, converged access controllers include the 5760 WLC and the Catalyst 3850 switch.

The CLI is accessible through the console port, Telnet, and SSH. By default, Telnet access is disabled and SSH access is enabled. You can configure these settings from **Management > Telnet-SSH**, as shown in Figure 21-2. It is usually a best practice to keep Telnet disabled because keystrokes are sent in clear text, without any encryption.

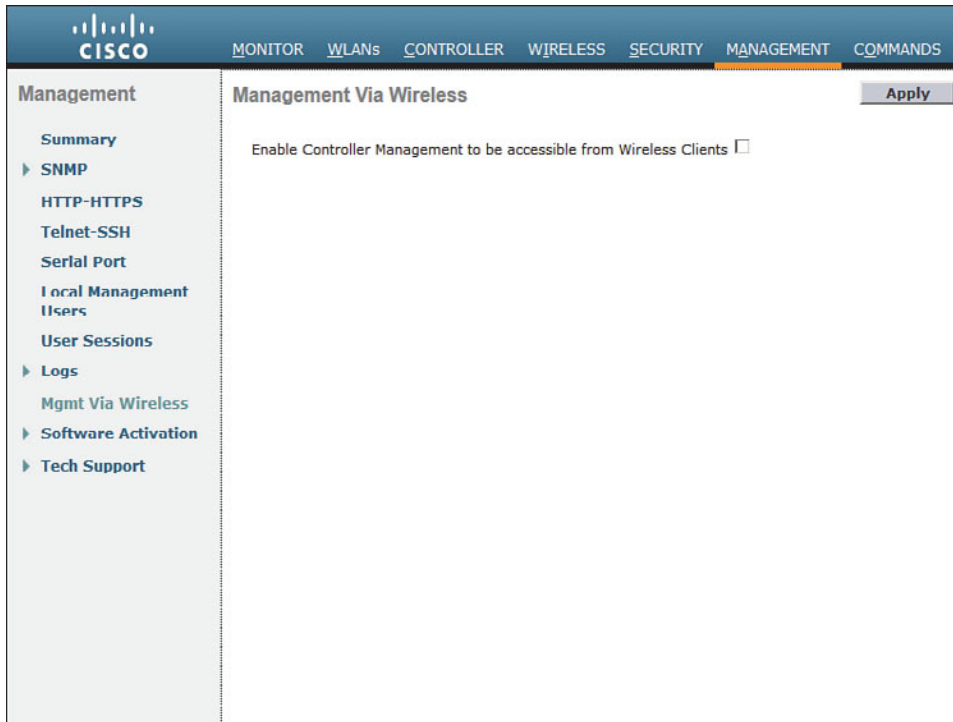


**Figure 21-2** *Configuring Telnet and SSH Access to a Controller.*

You can initiate management sessions to a controller from anywhere on the network, as long as your IP address can be routed to the controller’s management IP address. However, by default, a controller will not permit Telnet, SSH, HTTP, and HTTPS

connections from any of its own wireless network subnets. If you need to connect to the controller from a WLAN, you can enable access through **Management > Mgmt via Wireless**, as shown in Figure 21-3. Be sure to check the box and click **Apply**. Even when management via wireless is enabled, the controller will not allow any type of file uploads or downloads.

**Tip** If you try to access a controller through a web browser from a wireless network, you might find that the web login page is not available. In that case, you should check to see that the management via wireless setting is enabled.



**Figure 21-3** Enabling Management Access from a Wireless LAN.

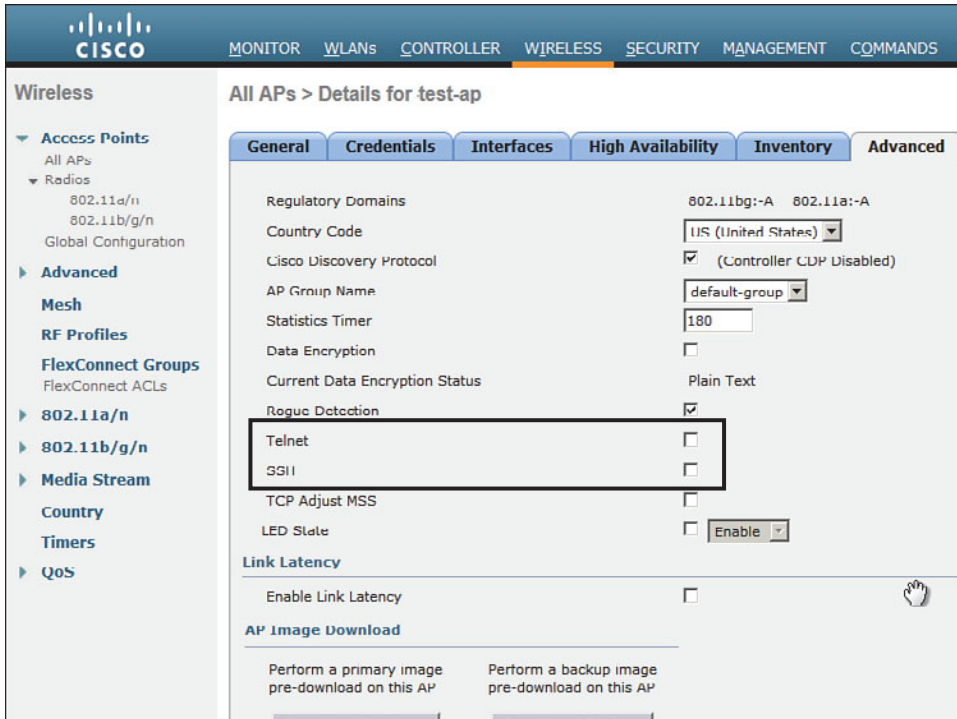
## Accessing APs

You can manage a Cisco autonomous AP's GUI with a web browser or through a CLI session with Telnet, or SSH, if you know the AP's IP address. You can also connect to it through its console port.

Lightweight APs (LAPs) differ somewhat. Once an LAP boots and joins a controller, all of its functions are configured, managed, and monitored by the controller. Each AP runs

a special version of the IOS software, so it is possible to open a CLI management session for troubleshooting purposes.

By default, LAPs do not permit management Telnet or SSH connections. If you need to connect directly to an AP to troubleshoot problems, you can enable Telnet and SSH access from **Wireless > Access Points > All APs**. Select an AP from the list, and then select **Config** from the drop-down menu at the far-right side of the page. On the **Advanced** tab, you can use the **Telnet** and **SSH** check boxes to control management access, as shown in Figure 21-4.



**Figure 21-4** Controlling Telnet and SSH Access on a Lightweight AP.

You can also connect to the AP's console port and use the CLI to troubleshoot connection problems. For example, you can watch useful information displayed as the AP boots and attempts to discover controllers and enable its radios.

**Tip** To access the CLI on autonomous or LAPs through their console ports, Telnet, or SSH, you can use the default credentials of username Cisco, password Cisco, and enable password Cisco. To help prevent unauthorized access, you should change the default credentials and restrict remote access to your APs.

## Maintaining WLC Code Images

Like any other network device, a controller requires a code image to operate. Periodically, you might want to upgrade the code image to a new release so that you can take advantage of bug fixes and new features. Less often, you might have to downgrade the code image to return to a more stable version.

A controller maintains two separate code images—a primary image and a backup image. When a controller boots, it runs the primary image by default. That means you can download a new image file into the backup position on the controller while it is running, with no interruption of service. To run the new image, you must reboot the controller. You can display the two code image versions by navigating to **Commands > Config Boot**, as shown in Figure 21-5. You can select the image that will be run after the next reboot with the Config Boot Image drop-down menu.



**Figure 21-5** *Displaying Controller Code Images.*

To download a new code image, go to **Commands > Download File**. The controller can download from a TFTP or an FTP server. Select the code file type, then enter the file server's IP address, file path, and code image filename, as shown in Figure 21-6. For an FTP download, enter the credentials required by the FTP server. Then, click the **Download** button to start the file transfer.



 The screenshot shows the Cisco WLC configuration interface. The top navigation bar includes "MONITOR", "WLANs", "CONTROLLER", "WIRELESS", "SECURITY", "MANAGEMENT", and "COMMANDS". The "COMMANDS" tab is active. On the left, a "Commands" sidebar lists options: "Download File", "Upload File", "Reboot", "Config Boot", "Scheduled Reboot" (highlighted), "Reset to Factory Default", "Set Time", and "Login Banner". The main area is titled "Download file to Controller" and contains:
 

- "File Type" dropdown menu set to "Code".
- "Transfer Mode" dropdown menu set to "TFTP".
- "Server Details" section with the following fields:
  - IP Address: 172.21.4.20
  - Maximum retries: 10
  - Timeout (seconds): 6
  - File Path: /
  - File Name: AIR-WISM2-K9-7-2-115-2.aes

 "Clear" and "Download" buttons are located at the top right of the form.

**Figure 21-6** *Preparing to Download a Code Image.*

**Tip** The file transfer terminology might be a bit different from what you are used to seeing. The terms *download* and *upload* refer to the controller's perspective, as if it acts like a client. You always download *to* the controller and upload *from* it.

WLC image files are usually named according to the hardware platform and the release number, and ends with an .aes suffix, as in AIR-WISM2-K9-7-2-115-2.aes. During the download, the WLC periodically updates the web page to display the following sequence of status messages. (This process can take several minutes.)

1. TFTP code transfer starting.
2. TFTP receive complete...extracting components.
3. Executing backup script.
4. Writing new RTOS to flash disk.
5. Writing new FP to flash disk.
6. Writing new APIB to flash disk.
7. Executing install\_apib script.

8. Executing fini script.
9. TFTP File transfer is successful.

At this point, the new image is ready to be used. You must reboot the controller to run the new image, according to the status message shown in Figure 21-7. Be aware that rebooting the controller will interrupt wireless service. All the APs joined to the controller will lose contact with it and will rehome to a secondary controller (if one is configured) or begin the controller discovery process to find a new home.

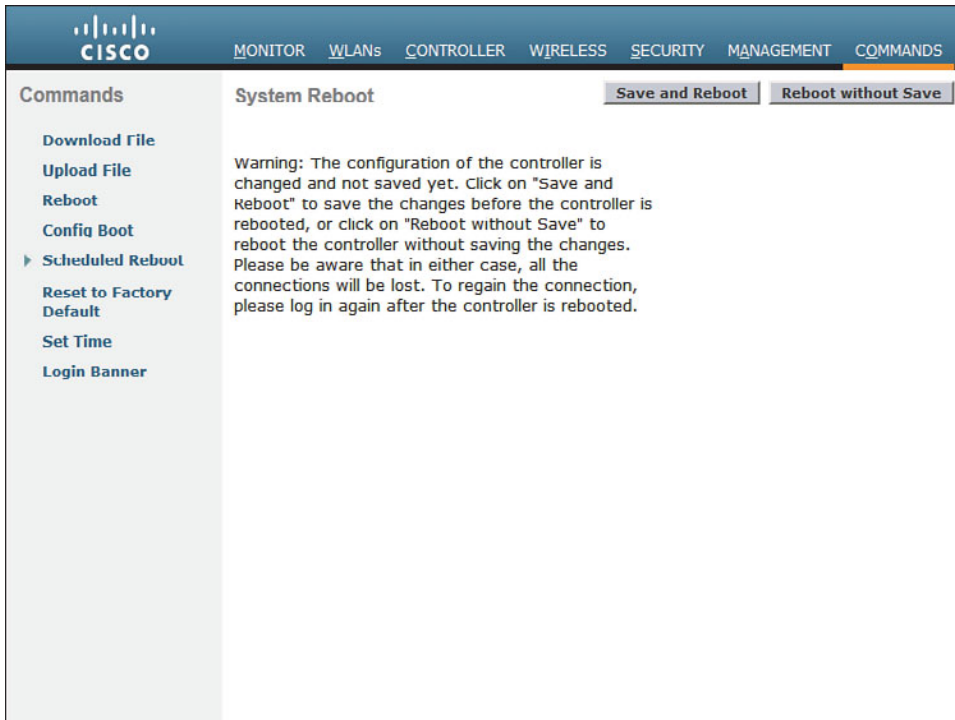
You can get ready to reboot the controller by selecting the **Click Here** link at the bottom of the download status or by navigating to **Commands > Reboot**, as shown in Figure 21-8. You can save the current controller configuration and reboot immediately by clicking the **Save and Reboot** button.

The screenshot shows the Cisco WLC web interface with the following details:

- Navigation:** MONITOR, WLANs, CONTROLLER, WIRELESS, SECURITY, MANAGEMENT, COMMANDS
- Left Menu:** Commands, Download File, Upload File, Reboot, Config Boot, Scheduled Reboot, Reset to Factory Default, Set Time, Login Banner
- Page Title:** Download file to Controller
- Buttons:** Clear, Download
- Form Fields:**
  - File Type: Code
  - Transfer Mode: TFTP
  - Server Details:
    - IP Address: 172.21.4.20
    - Maximum retries: 10
    - Timeout (seconds): 6
    - File Path: /
    - File Name: AIR-WISM2-K9-7-2-115-2.aes
- Status Message:** TFTP File transfer is successful. Reboot the controller for update to complete. Optionally, pre-download the image to APs before rebooting to reduce network downtime. [Click Here](#) to get redirected to reboot page.

**Figure 21-7** After an Image Download, the Controller Is Ready to Reboot.

After you install a new controller image file, should you install the same code release on the lightweight APs? Recall that the controller manages all aspects of the APs, including their code images. When a LAP joins a controller, it compares its own code release with that of the controller. If the images differ, the AP will download a matching image from the controller automatically. Therefore, after the controller reboots and begins to run a new image, each AP will download the same release as it rejoins the controller.



**Figure 21-8** *Triggering a Controller Reboot.*

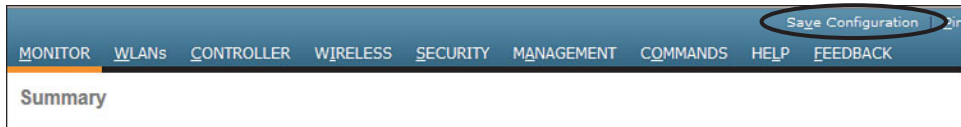
As you might imagine, the code upgrade process can impose an extensive outage on a wireless network. The controller must be rebooted so that it can begin running the new image. After that, each AP must go offline to download the new image, reboot, and begin running the new image. To lessen the impact to wireless users, controller releases 7.2 and later can push a new code image to the APs *before* the controller or the APs need to reboot. This prepares the APs ahead of time so that they can reboot in parallel with the controller and can begin running the new code image much sooner.

## Maintaining WLC Configurations

As you use the web-based controller GUI to make configuration changes, you need to click the **Apply** button to make the changes active. This is similar to configuring a router or switch, where changes take effect immediately and are updated in the running configuration, but are not saved to the startup configuration. As long as the controller stays up, your changes will stay active. If the controller reboots or loses power, your changes will be lost.

A controller also has nonvolatile storage for its configuration, much like flash memory. You can save the configuration by clicking the **Save Configuration** link at the upper right of any controller web page, as shown in Figure 21-9.

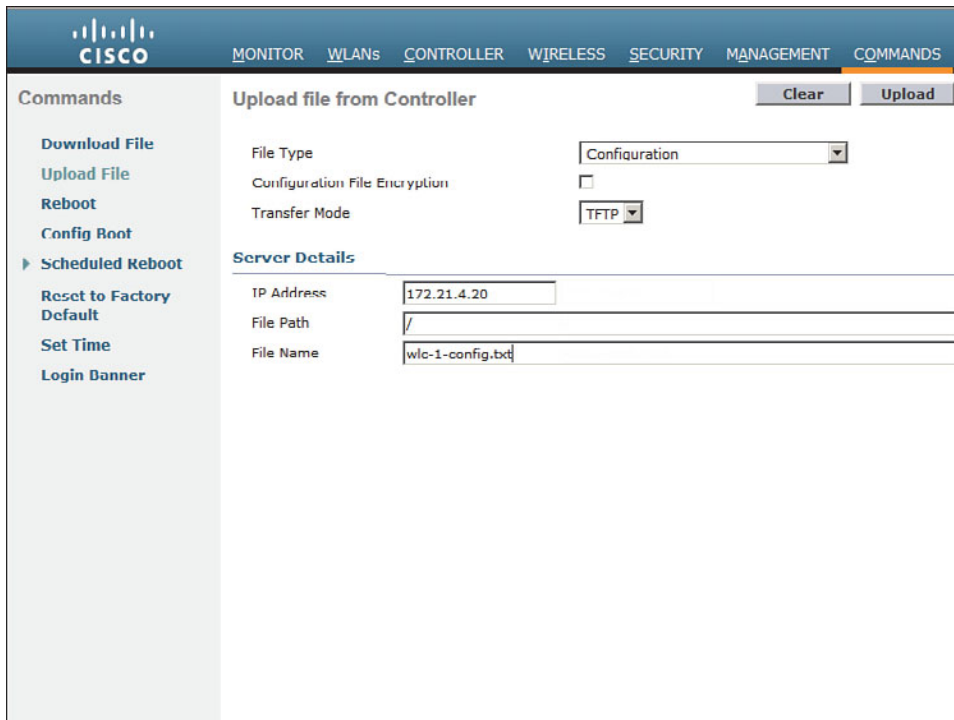




**Figure 21-9** *Saving the Controller Configuration.*

It is important to save the controller configuration to flash memory so that any configuration changes are retained. Beyond that, you should think about saving the configuration to a location away from the controller itself. If the controller hardware ever fails and you receive a replacement, you will need a way to access the configuration so you can import it into the new unit.

From the controller GUI, navigate to **Commands > Upload File** and select **Configuration** from the file type drop-down menu. Select either **TFTP** or **FTP** and enter the IP address, file path, and the target filename, as shown in Figure 21-10. The controller configuration will be transferred and saved in clear text, showing the CLI commands that are used to build the entire configuration. You can check the **Configuration File Encryption** check box and enter an encryption key string to encrypt the configuration file so that it cannot be read easily. The file contents will be decrypted when they are transferred back onto a WLC.



**Figure 21-10** *Uploading the Controller Configuration to a PC.*

You can display the configuration file from a CLI session by entering the command **show run-config** commands. Before you enter the command, configure your terminal emulator application to save the session output to a file. When you display the configuration file contents, the output will automatically be saved on your PC.

**Tip** By default, a CLI session will pause the output after every 22 lines of text and prompt you for a keystroke to continue. You can disable the paging action by entering the **config paging disable** command before displaying large amounts of output.

After you have an offline copy of the configuration file, you can download the contents to a controller. This process is just the opposite of uploading the configuration to your PC, select **Commands > Download File**, select file type **Configuration**, and enter the TFTP or FTP server parameters and filename.

**Tip** The **show run-config** command, with no additional keywords, displays the entire controller configuration, complete with all RF and AP configuration parameters. The output can be enormous if the controller has a large number of APs associated with it. The **show run-config** output is normally collected for Cisco TAC or for input into the Cisco WLC Config Analyzer tool.

## Working with WLC Logs

While a controller is busy managing connections with APs, handling client traffic, and monitoring wireless activity, it also keeps a record of events that occur. You can view the controller logs to see more information about important events or share the contents with Cisco TAC when you have a service request open.

A controller maintains three types of logs, as listed in Table 21-2. You can display the log contents in a CLI session with the command shown.

**Table 21-2** *Controller Logs*

Log Name	CLI Command	Description
Message log	<b>show msglog</b>	System messages and errors
Trap log	<b>show traplog</b>	Alarms generated by the controller
Event log	<b>show eventlog</b>	Internal events from controller activity

The trap log is probably the most useful to wireless network administrators. Traps are messages that are recorded and reported in real time, as events occur. Traps are nor-

mally sent via SNMP to a management station such as Wireless Control System (WCS), Network Control System (NCS), or Prime Infrastructure (PI). Common traps include reports of rogue APs that have been detected; APs with excessive client loads, interference, or noise; coverage holes that have been detected; CleanAir events; and so on.

You can view the trap log from the **Monitor > Summary** page. Look for the **Most Recent Traps** section, as shown in Figure 21-11. You can select the **View All** link to see the 256 most recent log entries that have been buffered.

The screenshot displays the Cisco WLC Monitor > Summary page. The top navigation bar includes links for MONITOR, WLANS, CONTROLLER, WIRELESS, SECURITY, MANAGEMENT, COMMANDS, HELP, and FEEDBACK. The main content area is divided into several sections:

- System Information:** Version 7.0.43.32, System Name wism-w-m4-c1, Up Time 269 days, 4 hours, 43 minutes, System Time Mon Sep 16 03:45:22 2013.
- Top WLANs:** A table showing Profile Name and # of Clients.
 

Profile Name	# of Clients
guest	884
clinical	94
- Most Recent Traps:** A list of detected events, including rogue APs removed from the base radio MAC and a detected rogue AP.
  - Rogue AP : 2c:59:e5:c5:0b:bc removed from Base Radio MAC : 1c:e6:c7
  - Rogue AP : 2c:59:c5:c5:0b:bc removed from Base Radio MAC : 1c:c6:c7
  - Rogue AP : 2c:59:e5:c5:0b:bc removed from Base Radio MAC : 84:78:ac
  - Rogue AP : 28:93:fe:24:82:03 detected on Base Radio MAC : 24:01:c7:15
  - Rogue AP : b0:e7:54:53:ac:41 removed from Base Radio MAC : b4:e9:b0
- Access Point Summary:** A table showing the status of APs.
 

	Total	Up	Down	
802.11a/n Radios	488	488	0	<a href="#">Detail</a>
802.11b/g/n Radios	488	488	0	<a href="#">Detail</a>
All APs	488	488	0	<a href="#">Detail</a>
- Client Summary:** Shows Current Clients: 1000.

A note at the bottom of the traps section states: "This page refreshes every 30 seconds."

**Figure 21-11** Viewing the Trap Log.

In addition to buffering the log entries, a controller can send each message as an SNMP trap to one or more trap receivers. The trap receivers are usually some type of management platform that collects traps from a variety of devices and keeps a long term record that can be used as an audit trail. From **Management > SNMP > General**, enter text strings that define a name for the controller, its location, and contact information. You can also configure the SNMP version that will be used. In Figure 21-12, the controller will use SNMPv3 and a username and security method to send traps.

Next, define a trap receiver from **Management > SNMP > Trap Receivers**, as shown in Figure 21-13. If the controller has been added into WCS, NCS, or PI, the management station will be added as a trap receiver automatically. You can add a new receiver by clicking on the **New** button, then entering the receiver's name and IP address, and then selecting **Enable** or **Disable** from the drop-down menu.



The screenshot shows the Cisco Management interface for configuring SNMP System Summary. The navigation menu on the left includes Summary, SNMP (General, SNMP V3 Users, Communities, Trap Receivers, Trap Controls, Trap Logs), HTTP-HTTPS, Telnet-SSH, Serial Port, Local Management Users, User Sessions, Logs, Mgmt Via Wireless, Software Activation, and Tech Support. The main configuration area is titled 'SNMP System Summary' and includes an 'Apply' button. The fields are as follows:

Name	wism-w-m4-c1
Location	Building 1
Contact	John Doe
System Description	Cisco Controller
System Object ID	1.3.6.1.4.1.9.1.1293
SNMP Port Number	161
Trap Port Number	162
SNMP v1 Mode	Disable
SNMP v2c Mode	Disable
SNMP v3 Mode	Enable

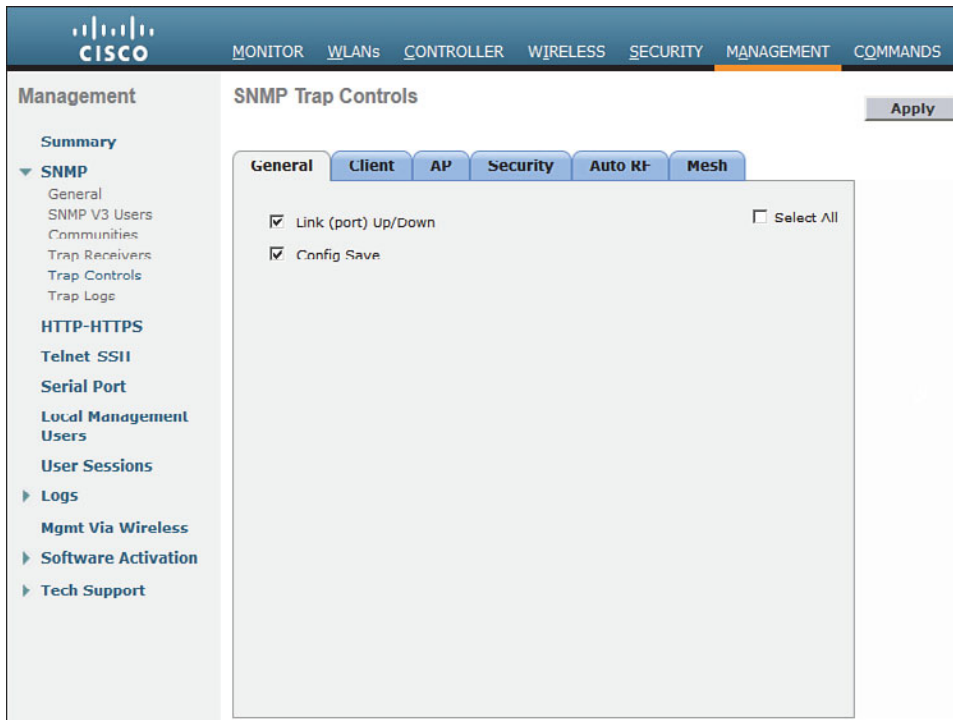
Figure 21-12 Configuring General SNMP Parameters.

The screenshot shows the Cisco Management interface for configuring SNMP Trap Receivers. The navigation menu on the left is identical to the previous figure. The main configuration area is titled 'SNMP Trap Receiver' and includes a 'New...' button. The table below shows the configured trap receiver:

Community Name	IP Address	Status
NOC	10.10.3.4	Enable

Figure 21-13 Configuring SNMP Trap Receivers.

Finally, you can configure the trap types that are forwarded to the trap receivers. From the **Management > SNMP > Trap Controls** page, you can enable or disable individual trap types. The types are organized under a series of tabs, as shown in Figure 21-14. The trap types from each tab are listed in Table 21-3 for your reference.



**Figure 21-14** *IDS and IPS Operational Differences.*

**Table 21-3** *Controller Trap Types*

Tab	Trap Type	Enabled
General	Link (port) Up/Down	X
	Config Save	X
Client	802.11 Association	
	802.11 Disassociation	
	802.11 Deauthentication	
	802.11 Failed Authentication	
	802.11 Failed Association	

<b>Tab</b>	<b>Trap Type</b>	<b>Enabled</b>
AP	AP Register	X
	AP Interface Up/Down	X
	AP Authorization	X
Security	User Authentication	X
	RADIUS Servers Not Responding	X
	WEP/WPA Decrypt Error	X
	IDS Signature Attack	X
	Rogue AP	X
	SNMP Authentication	X
	Multiple Users	X
	Strong Password	X
Auto RF	Load Profile	X
	Noise Profile	X
	Interference Profile	X
	Coverage Profile	X
	Channel Update	X
	Tx Power Update	X
Mesh	Child Excluded Parent	X
	Parent Change	X
	Authfailure Mesh	X
	Child Moved	X
	Excessive Parent Change	X
	Excessive Children	X
	Poor SNR	X
	Console Login	X
	Excessive Association	X
	Default Bridge Group Name	X
	Excessive Hop Count	
Secondary Backhaul Change		

---

## Exam Preparation Tasks

---

As mentioned in the section, “How to Use This Book,” in the Introduction, you have a couple of choices for exam preparation: the exercises here, Chapter 22, “Final Review,” and the exam simulation questions on the CD-ROM.

### Review All Key Topics

Review the most important topics in this chapter, noted with the Key Topic icon in the outer margin of the page. Table 21-4 lists a reference of these key topics and the page numbers on which each is found.



**Table 21-4** *Key Topics for Chapter 21*

Key Topic Element	Description	Page Number
List	WLC management sessions	430
Figure 21-6	Downloading a WLC code image	435
Figure 21-9	Saving the controller configuration	438
Paragraph	Defining a trap receiver	440

*This page intentionally left blank*





---

This chapter covers the following topics:

- **Advice About the Exam Event**—This section provides an overview of the exam structure and the types of questions you will encounter. It also discusses some strategies for managing your time during the exam, reviewing before the exam, and preparing yourself to sit through the exam.
- **Final Thoughts**—This brief section provides some concluding bits of encouragement about your exam results.

## Final Review

---

Congratulations! You made it through the book, and now it is time to finish getting ready for the exam. This chapter helps you get ready to take and pass the exam. You should know the content and topics. Now you need to think about what will happen during the exam and what you need to do prepare your mind for it. At this point, you should be focused on getting yourself ready to pass.

### Advice About the Exam Event

Now that you have finished the bulk of this book, you could just register for your Cisco CCNA Wireless exam, show up, and take the exam. However, if you spend a little time thinking about the exam event itself and learning more about the user interface of the real Cisco exams and the environment at the Vue testing centers, you will be better prepared—particularly if this is your first Cisco exam.

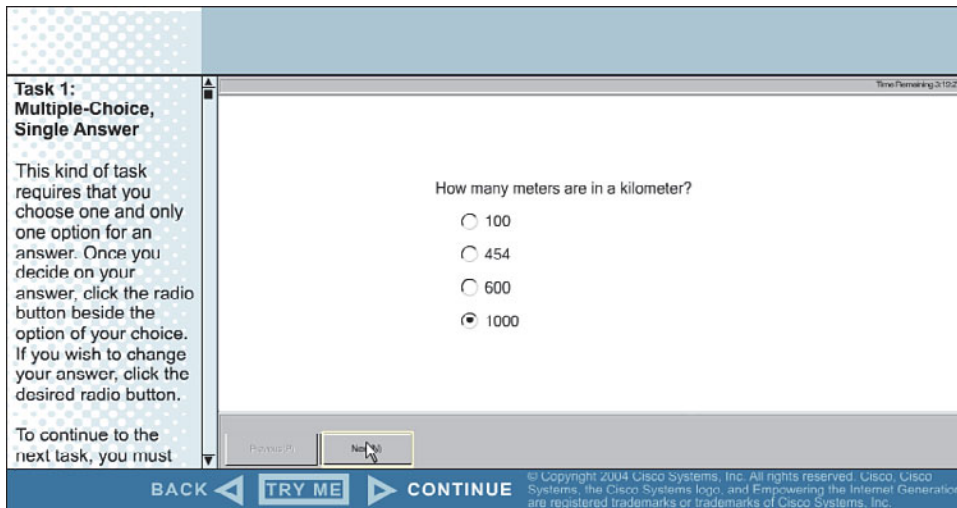
### Learn the Question Types Using the Cisco Certification Exam Tutorial

During the time leading up to your exam, think more about the different types of exam questions and have a plan for how to approach them. One of the best ways to learn about the exam questions is to use the Cisco Certification Exam Tutorial.

To find the Cisco Certification Exam Tutorial, go to <http://www.cisco.com> and search for “exam tutorial.” The tutorial sits inside a web page with a Flash presentation of the exam user interface. Each type of exam question is presented, along with a real-time demonstration of the actions you might take when answering the question. You can also click the **Try Me** button to reset the question and practice interacting and answering the question yourself.

You can expect to find the following types of questions on the exam. (The example questions depicted in Figures 22-1 through 22-7 serve only to demonstrate the exam question formats; they have nothing to do with the actual CCNA Wireless exam content.)

- **Multiple choice, single answer**—The question has several possible answers, but only one correct one. Figure 22-1 shows an example.
- **Multiple choice, multiple answer**—The question has several possible answers, with a given number of correct ones. Figure 22-2 shows an example.
- **Drag and drop**—The question has a series of items that you must drag and drop into boxes that represent the correct category, correct sequence, and so on. Figure 22-3 shows an example.
- **Fill in the blank**—The question has one or more blank answers that you must fill in. Figure 22-4 shows an example.
- **Simulation**—The question includes a description and a network diagram. You can click a network device and interact with it through a simulated command-line interface (CLI) session. Figure 22-5 shows an example.
- **Testlet**—The question includes a detailed scenario and a set of questions that you must select and answer. Figure 22-6 shows an example.
- **Simlet**—The question includes a scenario and a set of questions that you must answer based on your interaction with a simulated network device. Figure 22-7 shows an example.



**Figure 22-1** An Example Multiple-Choice, Single-Answer Exam Question.

**Task 2:  
Multiple-Choice,  
Multiple-Answer**

This kind of task requires that you choose more than one answer. The question itself will tell you how many answers you must select.

To choose an option, click the mouse in the small square next to the option. The square will then show a check mark. To change your answer, simply click

Time Remaining: 0:19:27

Which items are the names of specific computer operating systems? (Choose three.)

- Apple
- Linux
- Google
- Windows XP
- Windows 98
- Microsoft

Previous Question Next Question

BACK TRY ME CONTINUE

© Copyright 2004 Cisco Systems, Inc. All rights reserved. Cisco, Cisco Systems, the Cisco Systems logo, and Empowering the Internet Generation are registered trademarks or trademarks of Cisco Systems, Inc.

**Figure 22-2** An Example Multiple-Choice, Multiple-Answer Exam Question.

**Task 3:  
Drag and Drop**

**Some preliminary definitions:**

**Drag:** to move the mouse pointer while holding down the mouse button.

**Drag and drop:** to drag and release an object to move text.

This kind of task requires that you select an option and match it to its

Time Remaining: 0:19:27

Drag each item listed on the left to its proper category on the right.  
Not all items will fit the categories.

IP  
RIP  
NetBEUI  
AppleTalk

Layer 3 Routed Protocols  
IGMP  
DECnet

Layer 3 Routing Protocols  
BGP

Previous Question Next Question

BACK TRY ME CONTINUE

© Copyright 2004 Cisco Systems, Inc. All rights reserved. Cisco, Cisco Systems, the Cisco Systems logo, and Empowering the Internet Generation are registered trademarks or trademarks of Cisco Systems, Inc.

**Figure 22-3** An Example Drag-and-Drop Exam Question.

**Task 4:  
Fill-in-the-Blank**

This kind of task requires that you type an answer into a text box.

With your mouse, click inside the box and then type your answer. Some tasks require more than one text box, so please be sure to click in each of the boxes.

Sometimes a cursor will be blinking inside one of the text boxes.

Time Remaining: 3:19:27

What are the respective Celsius values for 32 degrees Fahrenheit and 68 degrees Fahrenheit?

32 F  C  
68 F  C

Previous (P) Next (N)

BACK TRY ME CONTINUE

© Copyright 2004 Cisco Systems, Inc. All rights reserved. Cisco, Cisco Systems, the Cisco Systems logo, and Empowering the Internet Generation are registered trademarks or trademarks of Cisco Systems, Inc.

**Figure 22-4** An Example Fill-in-the-Blank Exam Question.

**Task 5:  
Router Simulation**

This kind of task involves router simulations. The functionality of these simulations may not match the functionality of actual routers, but you will be able to complete all the tasks with the available commands.

All necessary commands are available from privileged mode. The Tab key and most of

Time Remaining: 3:19:27

You have been assigned the task of changing the name of the first router.

Change the hostname of "Lab\_A" to "Router\_A".

00:00:00

You will need to scroll this window and the problem statement window to view the entire problem.

To configure the router, click the picture of the host that is connected to the router via a

Hide Topology

Previous (P) Next (N)

BACK TRY ME CONTINUE

© Copyright 2004 Cisco Systems, Inc. All rights reserved. Cisco, Cisco Systems, the Cisco Systems logo, and Empowering the Internet Generation are registered trademarks or trademarks of Cisco Systems, Inc.

**Figure 22-5** An Example Simulation Exam Question.

**Task 6: Testlet Question**

This kind of task involves a scenario-based testlet. The testlet consists of the description of the scenario and multiple-choice questions based on information contained in the scenario.

The main window is divided into two panes: the upper pane and the lower pane. Both panes have a vertical scroll bar on the left side.

**Scenario**

This is a "Testlet" - it contains 4 questions that relate to the scenario below.

Approximate total time in minutes: Minimum = 0ms, Maximum = 0ms, Average = 0ms

The support person tells the employee that the employee is on and that the 192.168.0.1 port of the network support office. The support person then suggests to the employee that on the basis of the evidence the inability of the laptop to establish a connection to the network has two possible causes.

**Questions #1**

How many packets were sent and received in the ping of 192.168.0.1, and what is the loss percentage? (Choose three.)

0 Sent

0 Received

4 Sent

100% Loss

100% Received

BACK TRY ME CONTINUE

© Copyright 2004 Cisco Systems, Inc. All rights reserved. Cisco, Cisco Systems, the Cisco Systems logo, and Empowering the Internet Generation are registered trademarks or trademarks of Cisco Systems, Inc.

**Figure 22-6** An Example Testlet Exam Question.

**Task 7: Simlet**

This task, like task 5, involves router simulations. The functionality of this simulation may not match the functionality of actual routers, but you will be able to complete all the tasks with the available commands.

All necessary commands are available from privileged mode. The main window, the topology window. Click on one of the workstations showing a serial console cable connection and you will be brought to the router interface.

**Scenario**

What is the IP address for the Ethernet0 interface?

192.168.151.1

192.168.51.1

192.168.22.1

192.168.112.1

**Questions #1**

Building configuration...

```

Current configuration : 3342 bytes
!
version 22.2
no service single-slot-reload-enable
service timestamps debug uptime
service timestamps log uptime
service password-encryption
!
hostname Lab_A
!
logging rate-limit console 10 enable
errors
.....

```

BACK TRY ME CONTINUE

© Copyright 2004 Cisco Systems, Inc. All rights reserved. Cisco, Cisco Systems, the Cisco Systems logo, and Empowering the Internet Generation are registered trademarks or trademarks of Cisco Systems, Inc.

**Figure 22-7** An Example Simlet Exam Question.

You should find the multiple-choice questions fairly straightforward because they have only one correct answer. Read through the possible answers carefully so that you can eliminate the obviously incorrect ones. You might find that some answers appear to be similar or are not easy to dismiss. Look for subtle differences and any key words that relate to concepts you have learned.

Multiple-choice questions that require multiple answers sometimes prove more difficult. Fortunately, the questions always state the number of correct answers you should enter. Pay close attention to that number, and then use the answer check boxes to select and narrow down your final answers.

Drag-and-drop questions present you with a list of objects that you must drag and drop into the correct locations in a blank list. Sometimes you will need to sort the objects into two different lists. Sometimes you will need to select only the objects that match a category and then place them in sequential order. Pay close attention to the stated goals and the order that you should put the answers in. If you need to change any of your answers, just drag them back to their starting positions and try again.

The simulation and simlet question formats usually involve network devices such as routers, switches, and firewalls that have a CLI to interact with. Most likely, you will not find such questions on the CCNA Wireless exam. Even though Cisco Wireless LAN controllers and access points (APs) have a CLI that you can access, you are not really expected to until you move to more advanced certifications.

Testlet questions include a short set of questions to answer. The questions are listed on the right side of the exam, usually numbered in sequence. Read through the scenario description, and then select one of multiple-choice questions to answer. Do not forget to move through the other multiple-choice questions and answer them all before moving on to the next exam question.

You might encounter a testlet question that simulates the Cisco Wireless LAN Controller (WLC) graphical user interface (GUI). Know how to navigate the controller to find important information like the IP address of an interface, which interface is bound to a WLAN, client information based on a MAC address, and so on.

## Think About Your Time Budget

On exam day, keep an eye on your progress as you move through the questions. Budget your time so that you have enough to make your way through all the exam questions. You might find yourself struggling between two feelings:

- **I'm going too slowly!**—If your pace is too slow, you might not have enough time to answer all the questions. You might also find that you are spending what seems like an eternity on one pesky question when you should be moving on to others.
- **I'm going too fast!**—If your pace is too fast, you will get through all the questions, but you might be rushing without being thorough. Remember that you need to read both the questions and the answers completely so that you fully understand them.

During the exam, you need to be able to somehow know whether you are moving quickly enough to answer all the questions, while not rushing. The exam user interface shows some useful information—a countdown timer and a question counter. The question counter shows the question number you are currently answering and the total number of questions on your exam.

Unfortunately, treating each question equally does not give you an accurate time estimate. For example, if your exam allows 90 minutes and your exam has 45 questions, you have an average of 2 minutes per question. Suppose that 40 minutes have elapsed and you have answered 20 questions. At 2 minutes per question, it seems like you would be right on schedule. However, several factors make that kind of estimate difficult to run before the exam.



First, Cisco does not tell us beforehand the exact number of questions for each exam. For example, Cisco.com lists the CCNA Wireless 640-722 exam as having from 75 to 85 questions in 90 minutes. You will not know exactly how many questions are on your exam until you go through the initial screens that lead up to the point where you click **Start Exam** and the exam actually begins. As a worst case, 85 questions in 90 minutes works out to an average of slightly over a minute per question.

Next, some questions clearly take a lot more time to answer than others. These are commonly called “time-burner” questions. Consider the following comparison:

- **Normal-time questions**—Multiple-choice and drag-and-drop questions, approximately 1 minute each
- **Time burners**—Sim, simlet, and testlet questions, approximately 6 to 8 minutes each

Cisco does not tell us why you might get 85 questions and someone else taking the same exam might get 75 questions. It seems reasonable to think that the person with 75 questions might have a few more of the time burners, making the two exams even out.

Even though testlet and simlet questions contain several individual multiple-choice questions (each graded and scored independently), the exam software counts each testlet and simlet question as one question in the question counter. For example, if a testlet question has four embedded multiple-choice questions, the exam software’s question counter will show it counting as one exam question.

During the exam, as you encounter each question, resist the temptation to skim through it. Try to deliberately read it from start to finish so that you do not skip over any important words or information. For example, a question might ask “which one is not; if you skip over the word *not*, you will likely get the answers wrong.

Scenario descriptions can be lengthy, especially when they set the stage for a complex problem. Be aware that the text will be located in a scrolling window that might be hard to read or navigate because of the cramped screen real estate. Network diagrams can be equally cumbersome because they have to show many icons, links, addresses, and other information in a small space.

## Other Pre-Exam Suggestions

Here are just a few more suggestions for things to think about before exam day arrives. First, consider the following strategies for reviewing the exam content:

- Go back through the “Do I Know This Already?” quizzes at the beginning of each chapter.
- Open this book to the table of contents page. Read down through the entries until you find a topic that seems foreign or does not come to mind right away. Spend time reviewing the corresponding chapter or section to refresh your memory.
- Use the practice questions on the accompanying CD. You might not find every type of exam question there, but you should get a thorough sample of the exam content.



If you get a practice question in the multiple-choice, single-answer format, think about what might happen if you see that same question on the real exam in another format.

- Keep a running list of topics, acronyms, or concepts that you feel you do not understand completely or are taking too much time remembering. Go back and review the things on your list.
- Join in the discussions on the Cisco Learning Network. Try to answer questions asked by other learners. The process of answering, even if you keep your answer to yourself, makes you think much harder about the topic. When someone posts an answer with which you disagree, think about why and talk about it online. This is a great way to both learn more and build confidence.

Next, think about the things you might need to do right before your exam time:

- Get some earplugs. Testing centers often have some, but if you do not want to chance it, come prepared. The testing center is usually a room inside the space of a company that does something else as well. There could be people talking in nearby rooms, in addition to other office noises. Earplugs can help. Headphones and electronic devices are not permitted.
- The testing center usually provides a white-erase card and a marker, but does not allow you to bring in any notes. Some people like to spend the first minute of the exam writing down some notes on the white-erase card for reference. For example, you might want to write out a table of mW-to-dBm value conversions. If you plan to do that, practice making those notes ahead of time. Before each practice exam, transcribe those lists, just like you expect to do at the real exam.
- Plan your travel to the testing center with enough time so that you will not be rushing to make it there by your scheduled exam time.
- If you tend to be nervous before exams, practice your favorite relaxation techniques for a few minutes before each practice exam, just to be ready to use them.
- Rest the night before the exam, rather than staying up late to study. Clarity of thought is more important than learning one extra fact, especially because the exam requires so much analysis and thinking.
- You can bring personal effects into the building and testing company's space, but not into the actual room in which you take the exam. So, take as little extra stuff with you as possible. If you have a safe place to leave briefcases, purses, electronics, and so on, leave them there. However, the testing center should have a place to store your things as well. Simply put, the less you bring, the less you have to worry about storing.
- Find a restroom before going into the testing center. If you cannot find one, of course you can use one in the testing center. The testing personnel will direct you and give you time before your exam starts.
- Do not drink a large quantity of liquid before your exam begins. Once the exam has started, the timer will not stop while you go to the restroom.

## Final Thoughts

Congratulations for working your way this far through this book. Nothing about Cisco certification exams is easy, but they are well worth your time and hard work. At the end of the exam, you will receive your final score and news of your passing or failing. If you pass, congratulate yourself and breathe a sigh of relief at not having to study more.

If you fail, remind yourself that you are not a failure. It is never a disgraceful thing to fail a Cisco exam, as long as you decide to try it again. Anybody who has ever taken a Cisco exam knows that to be true; just ask the people who have attempted the CCIE lab exam. As soon as you can after learning that you failed, take a few minutes to write down as many exam questions as you can remember. Note which questions left you uneasy. Next, schedule to take the same exam again. Allow a few days so that you can study the topics that gave you trouble. The exam score should also break down the entire exam into major topics, each with its respective score. Do not be discouraged about starting over with your studies; the majority of it is already behind you. Just spend time brushing up on the “low spots” where you lack knowledge or confidence. Go for it and do your best!



# Answers to “Do I Know This Already?” Quizzes

---

## Chapter 1

1. C. The IEEE 802.11 standard focuses on wireless LAN definitions, methods, and operation. It is made up of many pieces, as described in Chapter 2, “RF Standards.” Sometimes you might see IEEE 802.11x, which refers to the many subparts of 802.11. Be aware of the subtle difference between that and 802.1x, which defines port-based network access control.
2. B, E. Wireless LANs use the 2.4-GHz and 5-GHz bands. Be careful to notice the difference between megahertz (MHz) and gigahertz (GHz). Also remember that 5.5 Mbps and 11 Mbps are some of the common data rates used in wireless LANs, but those are not involved when you need to identify the frequency band.
3. A. When the two power levels are the same, the result is 0 dB. As long as you remember the first handy 0 dB fact, you will find exam questions like this easy. If not, you will need to remember that  $\text{dB} = 10\log_{10}(100 \text{ mW} / 100 \text{ mW}) = 10\log_{10}(1) = 0 \text{ dB}$ .
4. C. At first glance, 17 mW and 34 mW might seem like odd numbers to work with. Notice that if you double 17, you get 34. The second handy dB fact says that doubling a power level will increase the dB value by 3.
5. D. Start with transmitter A’s level of 1 mW and try to figure out some simple operations that can be used to get to transmitter B’s level of 100 mW. Remember the handy dB facts, which use multiplication by 2 and 10. In this case,  $1 \text{ mW} \times 10 = 10 \text{ mW}$ ;  $10 \text{ mW} \times 10 = 100 \text{ mW}$ . Each multiplication by 10 adds 10 dB, so the end result is  $10 + 10 = 20 \text{ dB}$ . Notice that transmitter B is being compared to A (the reference level), which is 1 mW. You could also state the end result in dB-milliwatt (dBm).
6. C. This question involves a *reduction* in the power level, so the dB value must be negative. Try to find a simple way to start with 100 and get to 40 by multiplying or dividing by 2 or 10. In this case,  $100 / 10 = 10$ ;  $10 \times 2 = 20$ ;  $20 \times 2 = 40$ . Dividing by 10 reduced the dB value by 10 dB; then multiplying by 2 increased the total by +3 dB; multiplying again by 2 increased the total by +3 more dB. In other words,  $\text{dB} = -10 + 3 + 3 = -4 \text{ dB}$ .
7. B. Remember that the EIRP involves radiated power, and that is calculated using only the transmitter components. The EIRP is the sum of the transmitter power level (+20 dBm), the cable loss (–2 dB), and the antenna gain (+5 dBi). Therefore, the EIRP is +23 dBm.

8. D. A high SNR is best, where the received signal strength is more elevated above the noise floor. A 30-dBm SNR separates the signal from the noise more than a 10-dBm SNR does. Likewise, a higher RSSI value means that the signal strength alone is higher. The RSSI scale ranges from 0 (highest) to -100 (lowest).
9. C. DSSS supports 1, 2, 5.5, and 11 Mbps data rates through different combinations of coding and modulation schemes. FHSS is locked to 1 or 2 Mbps. With the exception of 6 and 9 Mbps, only OFDM supports the highest data rates of all the modulation types.
10. C, B, A, D. The correct order is C, B, A, D or DBPSK (2 possible phase changes), DQPSK (4 possible phase changes), 16-QAM (16 possible phase/amplitude changes), 64-QAM (64 possible phase/amplitude changes).
11. B, C. Both 16-QAM and 64-QAM alter the amplitude and phase of a signal.
12. C. OFDM uses 48 subcarriers in a single 20-MHz-wide channel, allowing it to transmit data bits in parallel. DSSS uses a single 22-MHz channel with only one main carrier signal.

## Chapter 2

1. C. The ITU-R allocated the ISM bands for global use.
2. B. The U-NII-1 band is the first of four 5-GHz bands set aside for wireless LAN use.
3. D. The EIRP is always limited to +36 dBm in the 2.4-GHz band, except in the case of point-to-point links.
4. D.
5. C. Only channels 1, 6, and 11 are nonoverlapping. The 2.4-GHz channels are spaced 5 MHz apart, whereas the DSSS channel width is 22 MHz.
6. D. The first U-NII-1 channel is labeled channel 36.
7. C, D, F. IEEE 802.11g and 802.11b deal with the 2.4-GHz band. IEEE 802.11a is strictly for 5 GHz, and 802.11n includes both 2.4 and 5 GHz. The IEEE 802.11-2012 standard has all of these amendments rolled up into one document.
8. C, D. Both 802.11g and 802.11a define OFDM use, even though the two standards use different bands.
9. A.
10. B. The device has two transmitters and three receivers. The number of spatial streams supported would be added after the 2x3 designation.
11. C. 802.11n is limited to aggregating two 20 MHz channels for a total width of 40 MHz.
12. A. Devices using 802.11n can use multiple radio chains and multiple spatial streams..
13. D. Only the Wi-Fi Alliance tests and certifies wireless products according to industry standards.

## Chapter 3

1. C. Because both transmitters are using the same channel, the interference is described as co-channel.
2. E. Cisco recommends a separation of *at least* 19 dBm, so +20 dBm is the only correct answer.
3. B. The two channels being used are adjacent, so their signals overlap by some degree. The resulting interference is called adjacent channel interference.
4. D. In the 2.4-GHz band, channels 1, 6, and 11 are the only ones that are spaced far enough apart (five channel numbers) that they do not overlap.
5. A. Energy traveling in an electromagnetic wave spreads in three dimensions, weakening the signal strength over a distance.
6. B. The 802.11b and g devices operate at 2.4 GHz, which is less affected by free space loss than the 802.11a device, at 5 GHz.
7. D. By switching to a less-complex modulation scheme, more of the data stream can be repeated to overcome worsening RF conditions. This can be done automatically through DRS.
8. B. As a signal is reflected, a new copy travels in a different direction. Each copy of the signal takes a different path to reach the receiver; thus, the name *multipath*.
9. D. As a signal passes through a wall, the building material absorbs some of the RF energy, reducing the signal strength by some amount.
10. B. The first Fresnel zone is an elliptical area along the length of a signal path that should be kept free of obstructions. When an object extends into a significant portion of the Fresnel zone, the signal can be diffracted and distorted.

## Chapter 4

1. B, D. The - and H plane plots are used to show a side view and a top-down view, respectively, with the antenna in the center of the plots.
2. B. The H plane is also known as the azimuth plane because measurements are taken at every azimuth angle around the base of the antenna.
3. D. The beamwidth is the angle measured between the two points on a radiation pattern plot that are 3 dB below the maximum.
4. D. A wave’s orientation with respect to the horizon is known as the polarization.
5. B. Cisco antennas are designed to use vertical polarization. Because the dipole antenna is mounted correctly (pointing straight up or down), the wave will be vertically polarized.
6. B. A parabolic dish antenna has the greatest gain because it focuses the RF energy into a tight beam.

7. A, E. An omnidirectional antenna is usually used to cover a large area. Therefore, it has a large beamwidth. Because it covers a large area, its gain is usually small.
8. C. Integrated antennas are omnidirectional.
9. B. Orienting a dipole so that its cylinder points toward a receiver will probably cause the received signal to become weaker. That is because the donut shaped radiation pattern to rotate away from the receiver. The radiation pattern is weakest along the length of the antenna.
10. C. Lightning arrestors cannot protect against direct lightning strikes on an antenna.

## Chapter 5

1. A, B. WPANs and WLANs can both use the unlicensed 2.4-GHz ISM band.
2. B. WLANs require half-duplex operation because all stations must contend for use of a channel to transmit frames.
3. C. An AP offers a basic service set (BSS).
4. B. The AP at the heart of a BSS or cell identifies itself (and the BSS) with a basic service set identifier (BSSID). It also uses an SSID to identify the wireless network, but that is not unique to the AP or BSS. Finally, the radio MAC address is used as the basis for the BSSID value, but the value can be altered to form the BSSID for each SSID that the AP supports.
5. D. In a BSS, the 802.11 standard requires all traffic to pass through an AP. The only exception is the 802.11z amendment, which permits an AP to coordinate direct client-to-client traffic without passing through the AP.

6. A, D.

True: “The DS connects two BSSs to form an ESS”—The distribution system connects two basic service sets (APs) to form an extended service set.

False: “The BSA of a BSS looks like a MAC address”—The basic service area of a BSS is its coverage area or cell, which has nothing to do with a MAC address.

False: “The SSID of a STA must be unique within the ESS”—The service set identifier can be common across one or many BSSs in an ESS.

True: “The BSSID is unique for each SSID in a BSS”—An AP in a BSS uses its radio MAC address as the basis for its BSSIDs, but each SSID has a unique BSSID value.

7. E. Roaming implies that the building has some wireless APs that are interconnected. Therefore, the client must first associate with a BSS. The BSS must connect to a switched infrastructure through a DS. The DS must extend to at least one more AP through an ESS. Finally, the same SSID has to be defined on every AP in the ESS.
8. D. An independent basic service set is also called an ad hoc network.
9. B. A workgroup bridge acts as a wireless client, but bridges traffic to and from a wired device connected to it.

10. B. In a mesh network, each mesh AP builds a standalone BSS. The APs relay client traffic to each other over wireless backhaul links, rather than wired Ethernet. A wireless LAN controller is necessary.

## Chapter 6

1. D. An 802.11 frame contains four different address fields.
2. B. Frames are marked as going to the DS or from the DS.
3. D. The Address1 field always contains the RA.
4. A. 802.11 devices can participate in the distributed coordination function (DCF).
5. C. A wireless client uses the network allocation vector (NAV) to predict the number of timeslots required for the channel to become free so that a frame can be transmitted.
6. D. Frames are separated by the distributed interframe space (DIFS).
7. B. A probe request frame is sent to ask any listening APs to identify themselves.
8. B. A wireless device must send an ACK frame, one of the 802.11 control frames, back to the source of each unicast frame that is received.
9. A, B. A client can join a BSS as long as it has at least one mandatory rate in common with the AP but it must be able to support all of the AP’s mandatory rates.
10. A. In a passive scan, a client simply listens to any beacons that are transmitted by nearby APs. In contrast, probes are sent by the client to discover APs in an active scan.
11. D. A client must first be authenticated to the BSS, then it can request to be associated.
12. C. As long as the client can move from one BSS to another without losing a signal or getting disassociated or deauthenticated, it can probe for a new AP and send a reassociation frame to reassociate itself with the existing SSID.

## Chapter 7

1. B, C, D. The transmit power directly affects the range of the AP’s signal. The supported modulation and coding schemes can affect the range because the simpler schemes can tolerate a lower SNR and a weaker signal, implying a greater range. The more complex schemes offer better data rates, but need a better signal quality within a shorter range. The supported data rates also affect the range because they directly affect the modulation and coding schemes that are used.
2. B. If you have already tested the AP’s signal and determined that it reaches every location in the lobby area, the problem is not that the AP’s transmit power is insufficient. Instead, the problem is occurring because the small client devices must be using a transmit power that is lower than that of the AP. In other words, the client



signals are not strong enough to reach the AP, so the two have asymmetric power levels. The solution is to increase the client's transmit power level to be identical to the AP's.

3. D. The 1-Mbps data rate is already disabled, which limits the cell size to some extent. You can reduce it further by disabling the 2-Mbps data rate.
4. C. If the problem is occurring some distance away from the replacement AP, the replacement AP must be working correctly within its immediate area. If the replacement had a 1-dBm transmit power, it could not be causing any interference at a great distance away. The problem is likely because the lowest data rates have been enabled. The lower rates effectively extend the replacement AP's cell size into the cells of other APs farther away. If the channels are identical, the replacement could be causing co-channel interference in other cells, degrading client performance and roaming.
5. C. Roaming is entirely up to the client. The client runs a roaming algorithm that compares current conditions to a threshold. When the signal quality or other factors drop below the threshold, the client tries to roam.
6. D. Whereas an association request is used to join a BSS, a reassociation request is used to move from one BSS to another within the same ESS.
7. B. Roaming algorithms are not standardized at all. Instead, each manufacturer might have its own interpretation of an algorithm. Wireless clients can scan a set of available channels when they anticipate roaming, to look for a new AP. Cisco APs and controllers can also prime a Cisco compatible client (CCX Versions 3 and later) with a list of viable APs ahead of time, so that the client can save time without having to scan channels.
8. B. To promote clean roaming, neighboring APs should use different, nonoverlapping channels. In addition, APs should be located such that their coverage overlaps each other by some amount, usually 15 percent to 20 percent.
9. C. Adjacent APs should always use different, nonoverlapping channels.
10. A, C. The fourth-floor APs will not interfere with the main office AP on channel 6. However, the other third-floor APs and the second-floor AP all use channel 6. Those signals could penetrate the floor and interfere with the main office AP, causing roaming issues.

## Chapter 8

1. C. A trunk link is needed to carry multiple SSIDs to multiple VLANs.
2. C. An autonomous AP is a standalone AP; it offers a BSS and connects to a DS, all without the need for a centralized controller.
3. A. A console port is available for configuration and management.
4. D. The wired Ethernet port MAC address is always listed on the sticker. To find the radio MAC address, you would have to connect to the AP's console, use Telnet or

SSH to connect to it, or access it through its web interface. Be aware that both 2.4- and 5-GHz radios use one common base MAC address.

5. A, B. An autonomous AP tries to use DHCP by default, but you can configure a static address if necessary.
6. A, B, C, D. You can use all of the given methods to obtain the AP’s IP address.
7. B, C. The radios are disabled and no SSIDs are configured. This prevents the AP from becoming active until you have properly configured it.
8. A. When you configure an SSID, you can decide which radio should support it.
9. C. The upgrade tool downloads a lightweight code image, which you must obtain from Cisco. A TFTP server is necessary, but you can use the one that is integrated into the upgrade tool.
10. C. You should use the `archive download-sw` command, which also specifies the TFTP server address and filename.

## Chapter 9

1. A. An autonomous AP can operate independently, without the need for a centralized wireless LAN controller.
2. A. Client-to-client traffic usually passes through an autonomous AP, although clients can use DLS to communicate directly after coordinating with the AP.
3. B. An LAP transports client traffic through a tunnel back to a wireless LAN controller. Therefore, client-to-client traffic usually passes through both the AP, the controller, and back through the AP. If DLS is used, two wireless clients can communicate directly without passing through the AP and controller, but only after the communication has been coordinated with the AP.
4. C. On a lightweight AP, the MAC function is divided between the AP hardware and the WLC. Therefore, the architecture is known as split-MAC.
5. B. An LAP builds a CAPWAP tunnel with a WLC.
6. A. Only the CAPWAP control tunnel is secured by default. Client data passes over the CAPWAP data tunnel, but is optionally encrypted. DHCP requests are client data and are not encrypted by default. Finally, 802.11 beacons are sent over the air from an LAP, so they are not encrypted or transported by CAPWAP.
7. A. A trunk link carrying three VLANs is not needed at all. A lightweight AP in local mode needs only an access link with a single VLAN; everything else is carried over the CAPWAP tunnel to a WLC. The WLC will need to be connected to three VLANs so that it can work with the LAP to bind them to the three SSIDs.
8. D. Because the network is built with a WLC and LAPs, CAPWAP tunnels are required. One CAPWAP tunnel connects each LAP to the WLC, for a total of 32 tunnels. CAPWAP encapsulates wireless traffic inside an additional IP header, so the tunnel packets are routable across a Layer 3 network. That means the LAPs and

WLC can reside on any IP subnet as long as the subnets are reachable. There are no restrictions for the LAPs and WLC to live on the same Layer 2 VLAN or Layer 3 IP subnet.

9. A, B. You can have multiple WLCs in a CUWN, so you could add a second 5508 or replace the existing one with a more robust model. You should not try to expand the coverage of each AP, rather than expand the capacity of the WLC.
10. D. The 3602 offers future-proof capability to add an 802.11ac module. The 3702 AP has 802.11ac Wave 1 capability integrated; an optional 802.11ac Wave 2 module will become available in the future.

## Chapter 10

1. B. Controller ports are physical connections to the switched network infrastructure.
2. C. The service port is used for out-of-band management.
3. A. The distribution system ports are usually configured as unconditional 802.1Q trunks.
4. C. Controllers use a link aggregation group (LAG) to bundle the ports together.
5. D. CAPWAP tunnels always terminate on the AP-manager interface. All the APs discover the controller by that interface and its IP address.
6. A. The management interface can terminate CAPWAP tunnels if no AP-manager interface exists.
7. D. A dynamic interface makes a logical connection between a WLAN and a VLAN, all internal to the controller.
8. A. The controller will begin its initial setup to build a bootstrap configuration.
9. A. You can connect to either the controller console port or use a web browser to run through the initial setup procedure. The console will use CLI only, while the service port is used for a web interface.
10. D. You should connect to the service-port interface's IP address. You cannot use a web browser with the console port. Neither the virtual interface nor a dynamic interface can be used because it will not be configured until you complete the initial setup wizard.

## Chapter 11

1. B. An AP will discover all possible WLCs before attempting to build a CAPWAP tunnel or join a controller.
2. C. After an AP boots, it compares its own software image to that of the controller it has joined. If the images differ, the AP downloads a new image from the controller.
3. F. An AP can learn controller addresses from all of the listed methods.

4. C. An AP will try the three primed addresses (primary, secondary, and tertiary) first before any other method.
5. C. If an AP cannot find a viable controller, it reboots and tries the discovery process all over again.
6. B. The AP priority determines which APs can join a controller when the controller fills with APs. Higher-priority APs will be allowed to join and displace lower-priority APs.
7. D. If the primary controller responds to an AP's discovery methods, the AP will always try to join it first, ahead of any other controller. Configuring an AP with a primary controller is the most specific method because it points the AP to a pre-determined controller. Other methods are possible, but they can yield ambiguous results that could send an AP to one of several possible controllers.
8. D. APs use CAPWAP keepalive messages that are sent to the controller every 30 seconds.
9. D. The AP Fallback feature allows APs to fall back or revert to a primary controller at any time.
10. C. N+N redundancy is being used because there are two active controllers and no standby or backup controllers.

## Chapter 12

1. B. The client must associate with a BSS offered by an AP.
2. A. The client device is in complete control over the roaming decision, based on its own roaming algorithm. It uses active scanning and probing to discover other candidate APs that it might roam to.
3. C. Because a single controller is involved, the roam occurs in an intracontroller fashion. Even though the client thinks it is associating with APs, the associations actually occur at the controller, thanks to the split-MAC architecture.
4. C. Intracontroller roaming is the most efficient because the reassociation and client authentication occur within a single controller.
5. C. Cisco Centralized Key Management (CCKM) is used to cache key information between a client and an AP. The cached information is then used as a quick check when a client roams to a different AP.
6. C. Intercontroller roaming supports Layer 3 roaming when a client moves from one controller to another and when the client's IP subnet changes between controllers.
7. D. In a Layer 2 roam, the client's IP subnet does not change as it moves between controllers. Therefore, there is no need to tunnel the client data between the controllers; instead, the client simply gets handed off to the new controller.

8. B. A client can always choose to renew or obtain an IP address, but it does not have to. The client can continue to use its same IP address during either Layer 2 or Layer 3 roams.
9. D. The anchor controller, where the client starts, maintains the client's state and builds a tunnel to the foreign controller, where the client has now roamed.
10. C. Controllers A and B are listed in each other's mobility list, so they are known to each other. However, they are configured with different mobility group names. Clients may roam between the two controllers, but CCKM and PKC information will not be exchanged.

## Chapter 13

1. C. A data rate marked as mandatory by an AP must be supported by any client that intends to associate with the AP.
2. B. You can configure one or more data rates as mandatory. In fact, the 1-, 2-, 5.5-, and 11-Mbps data rates in the 2.4-GHz band are set as mandatory by default.
3. B. Broadcast management frames are sent at the lowest mandatory data rate. Unicast management frames can be sent at any optimal supported or mandatory data rate.
4. B. 802.11n support is enabled by default. Only 20-MHz channels will be used until 40 MHz channels are enabled.
5. C. RRM monitors and adjusts all APs in a single RF group. The RF group may contain one or more controllers.
6. C. By default, all APs joined to a controller belong to one common RF group. The group can be extended to any other controller that has APs within range by configuring that controller with the same RF group name. To build an RF group, APs send neighbor messages so that they can be discovered. If one controller's APs hear neighbor messages sent from another controller's APs, and the RF group names match, the RF group is extended to include both controllers.
7. D. The transmit power control (TPC) algorithm adjusts the power level used by each AP in an RF group.
8. C. The goal of DCA is to maintain an efficient channel layout and avoid interference and noise. Therefore, DCA might choose to move the AP to a different channel.
9. A. TPC and DCA are RRM algorithms that run on a per-RF group basis. Therefore, the RF group leader runs the algorithms.
10. D. A failed radio will probably cause a hole or weakness in the RF coverage around the AP. Coverage hole detection can detect the failure based on the weak signal clients in that area are experiencing. The algorithm can also boost the transmit power level in neighboring APs to help heal the coverage hole.

## Chapter 14

1. E. A secure wireless connection between a client and an AP should have all of the listed security components.
2. C. The message integrity check (MIC) is used to protect data against tampering.
3. D. Wireless Equivalent Privacy (WEP) is a wireless encryption method that has been found to be vulnerable and is not recommended for use.
4. A. Open authentication is used so that the client can associate with the AP and can then authenticate through 802.1x and EAP.
5. C. A controller becomes an authenticator in the 802.1x process.
6. B. PEAP uses a server certificate, but clients authenticate using more traditional means without a certificate.
7. D. EAP-TLS requires digital certificates on both the AS and the supplicants.
8. C. CCMP is currently the most secure data encryption and integrity method for wireless data.
9. B. WPA2 requires CCMP, whereas WPA does not.
10. A, C. Pre-shared keys can be used in WPA personal and WPA2 personal modes. Enterprise mode requires 802.1x authentication.
11. B, D. MFP requires a secure connection between an AP and a CCXv5 client. Therefore, WPA2 and CCXv5 are needed.
12. B. WPA2 personal requires a pre-shared key (PSK). The same key must be configured on the WLAN, which gets propagated to all APs that are joined to the controller, in addition to every client that might associate with the WLAN.

## Chapter 15

1. C, D. A WLAN binds an SSID to a controller interface, so that the controller can link the wired and wireless networks. Although the WLAN ultimately reaches a wired VLAN, it does so only through a controller interface. It is the interface that is configured with a VLAN number.
2. C. You can configure a maximum of 512 WLANs on a controller. However, a maximum of only 16 of them can be configured on an AP.
3. B. Each AP supports a maximum of 16 WLANs. Even so, you should always try to limit the number of WLANs to five or fewer.
4. B. The BSS for each WLAN must be advertised, requiring airtime for beacons. A growing number of WLANs results in a growing number of beacons needed, which results in a diminishing amount of airtime left available for data frames.

5. A, C. The SSID and controller interface are the only parameters from the list that are necessary. The VLAN number is not because it is supplied when a controller interface is configured.
6. B. The WLAN ID is used internally as an index into the list of WLANs on a controller. Therefore, it is not made visible to any clients.

## Chapter 16

1. B. A guest WLAN is normally used to provide limited network access to guest clients, while keeping them isolated from the rest of the network.
2. B. By itself, the controller cannot route packets between WLANs; any connectivity must be provided by an external router or firewall.
3. D. A guest WLAN is no different from a data or regular WLAN. The only differences are the type of user authentication and the external means to keep the guest VLAN isolated from the other networks.
4. B. A guest WLAN on one controller is completely separate from the guest WLAN defined on another controller. The guest WLANs can be bound to a common VLAN so that they share a common IP subnet, but the WLANs are not merged or joined by default.
5. C. Guest WLANs can be merged toward a common controller if each of the controllers identifies the same controller as a mobility anchor.
6. B. You can configure more than one mobility anchor for a guest WLAN. Guest clients will be load balanced across the anchor controllers.

## Chapter 17

1. B. Wireless connections can be managed by either Windows or Intel PROSet, but not both.
2. A. The VPN module must be installed.
3. D. You can use a Cisco ASA and its ASDM software to push policies to AnyConnect clients.
4. B. CCX certifies compatibility with a set of Cisco innovations and features.
5. C. CCX has five versions.
6. B. Even though the device has no CCX certification at all, it will most likely work fine on the network. CCX measures compatibility with Cisco features, not with the 802.11 standard.
7. D. CCXv1 is the oldest version and has few compatible features. One of the features is the initial 802.11 standard.
8. C. WPA2 with 802.1x was introduced in CCXv3 and so is supported in it and later versions.

9. B. CCX Lite includes the Foundation, Voice, Location, and Management modules.
10. B. The Foundation module is mandatory because it contains the core set of compatible features.

## Chapter 18

1. A, B, C. WCS can be used to plan, manage, and troubleshoot wireless networks.
2. B, D.
3. B. A single-server license will support up to 500 APs; an enterprise license supports up to 50,000 APs.
4. C. WCS Navigator can manage up to 20 WCS instances in a single management interface.
5. C. Selecting the number beside the orange triangle will display a list of major alarms that have been received from controllers.
6. B. Unacknowledged alarms are automatically acknowledged after 15 days.
7. B. To add a controller to WCS, select **Configure > Controllers**.
8. A. To access the maps, select **Monitor > Maps**. WCS maps are normally used to monitor conditions in the wireless network.
9. A. WCS maps are organized according to campus > building > floor.
10. C. An inventory of controller and AP devices can be found under the Device report type.

## Chapter 19

1. D. DECT 6.0 refers to U.S. devices.
2. B. Bluetooth forms a personal-area network (PAN) and has a short range.
3. B. Bluetooth operates in the 2.4-GHz band and can affect 802.11b/g/n devices.
4. A, C. ZigBee is used for building automation and for energy management.
5. C. ZigBee belongs to the IEEE 802.15.4 family of standards.
6. D. The IEEE 802.16 standard defines WiMAX.
7. D. CleanAir adds spectrum analysis capabilities to a Cisco lightweight AP.
8. A. CleanAir analyzes non-802.11 signals to detect and classify devices that interfere with 802.11 AP cells.
9. B. By default, Cisco CleanAir is disabled on a controller.
10. D. Because CleanAir has assigned a severity value of 4, the interference is likely not severe. The severity scale runs from 0 (not severe) to 100 (very severe).



11. B. A unique cluster ID is assigned to each uniquely identified interferer. The cluster ID is also known as a pseudo-MAC address. Non-802.11 devices do not use regular MAC addresses, so a virtual MAC address is created and used as a label.

## Chapter 20

1. C. By entering the client's MAC address, the controller can display information about it straightaway. The other answers might also lead to useful information, but only after you spend more time sifting through the data.
2. A, C, D, E.
3. D. From the controller's perspective, a client must go through a sequence of state changes before it can be fully associated and joined to the network. Only when a client is in the RUN state is it fully operational.
4. C. Removing a client causes the controller to deauthenticate it so that it is removed from the network temporarily. The client is free to probe, associate, and return to the network again.
5. B. The client must have failed to authenticate with the 802.1x method that is configured on the WLAN. Perhaps a RADIUS server is down, the client is sending an incorrect username or password, or the client's digital certificate is invalid.
6. B. Because the client supports only CCXv1, the controller uses ping tests with ICMP packets. The controller can record RSSI measurements of the client's signal, but the lack of robust CCX support prevents the client from relaying its own RSSI measurements of the AP's signal.
7. C, D. The client must support CCXv4 or CCXv5 before it can accept the CCX link test frames and return information about its own radio to the controller.
8. D.
9. C. You should leverage WCS and its central location in the wireless network. Assuming that every controller is configured to send SNMP traps to WCS, you should be able to find useful information about the client with just a single search through the WCS database.
10. D. Answer A is incorrect because the access VLAN number is left to the default (VLAN 1). Answer B is incorrect, even though a lightweight AP can use a trunk link, as long as the trunk is configured with the AP's VLAN number as the 802.1Q native VLAN. The configuration allows VLAN 11 over the trunk, but will use the default native VLAN 1 because it does not define a specific native VLAN number. Answer C is incorrect because the switch interface is left in the shutdown state. Answer D is correct because it provides VLAN 11 to the AP over an access mode link.

## Chapter 21

1. B, D, E. By default, SSH and HTTPS are permitted. You can always connect to a controller’s console port when necessary.
2. B. Telnet and SSH are not permitted by default.
3. B. A controller can store a primary and a backup code image. One file can be run until the controller is rebooted.
4. A, D. TFTP and FTP are the only two methods supported.
5. A. File transfers are always named from the viewpoint of the controller, as if the controller is a client getting a file from a remote server. In this case, the code image file should be downloaded to the controller.
6. D. Lightweight APs will compare their own code image releases to that of the controller they intend to join. If the controller has a different release, the APs will download the matching release from the controller automatically.
7. B, C. The Apply button made the change active, but didn’t save it across the reboot, and you would need to click the **Save Configuration** link to save the change permanently.
8. A, D. To save a copy of a controller’s configuration, you can use the **show running-config** CLI command.
9. B. The trap log contains wireless events that have been detected.
10. C. Traps are sent via SNMP.



## Modulation and Coding Schemes

Table B-1 lists the possible modulation and coding methods used for direct sequence spread spectrum (DSSS) and orthogonal frequency-division multiplexing (OFDM) for 802.11b/g and 802.11a wireless LANs.

**Table B-1** *DSSS and OFDM Data Rates Used for 802.11b/g and 802.11a*

<b>Modulation and Coding</b>	<b>DSSS Data Rate (Mbps)</b>	<b>OFDM Data Rate (Mbps)</b>
DBPSK	1	
DQPSK	2	
CCK	5.5	
OFDM BPSK 1/2		6
OFDM BPSK 3/4		9
CCK	11	
OFDM QPSK 1/2		12
OFDM QPSK 3/4		18
OFDM 16-QAM 1/2		24
OFDM 16-QAM 3/4		36
OFDM 64-QAM 2/3		48
OFDM 64-QAM 3/4		54

Table B-2 lists the possible modulation coding schemes (MCS) used in 802.11n wireless LANs. The resulting data rates also vary according to the number of spatial streams in use (1 to 4), the guard interval (800 or 400 ns), and the channel width (20 or 40 MHz).

**Table B-2** *Modulation and Coding Schemes and Data Rates Used for 802.11n*

MCS Index	Spatial Streams	Modulation and Coding	Data Rate (Mbps)			
			Guard Interval = 800 ns		Guard Interval = 400 ns	
			20-MHz Channel	40-MHz Channel	20-MHz Channel	40-MHz Channel
0	1	BPSK 1/2	6.5	13.5	7.2	15
1	1	QPSK 1/2	13	27	14.4	30
2	1	QPSK 3/4	19.5	40.5	21.7	45
3	1	16-QAM 1/2	26	54	28.9	60
4	1	16-QAM 3/4	39	81	43.3	90
5	1	64-QAM 2/3	52	108	57.8	120
6	1	64-QAM 3/4	58.5	121.5	65	135
7	1	64-QAM 5/6	65	135	72.2	150
8	1	BPSK 1/2	13	27	14.4	30
9	2	QPSK 1/2	26	54	28.9	60
10	2	QPSK 3/4	39	81	43.3	90
11	2	16-QAM 1/2	52	108	57.8	120
12	2	16-QAM 3/4	78	162	86.7	180
13	2	64-QAM 2/3	104	216	115.6	240
14	2	64-QAM 3/4	117	243	130.3	270
15	2	64-QAM 5/6	130	270	144.4	300
16	3	BPSK 1/2	19.5	40.5	21.7	45
17	3	QPSK 1/2	39	81	43.3	90
18	3	QPSK 3/4	58.5	121.5	65	135
19	3	16-QAM 1/2	78	162	86.7	180
20	3	16-QAM 3/4	117	243	130	270
21	3	64-QAM 2/3	156	324	173.3	360
22	3	64-QAM 3/4	175.5	364.5	195	405
23	3	64-QAM 5/6	195	405	216.7	450
24	4	BPSK 1/2	26	54	28.9	60
25	4	QPSK 1/2	52	108	57.8	120
26	4	QPSK 3/4	78	162	86.7	180

MCS Index	Spatial Streams	Modulation and Coding	Data Rate (Mbps)			
			Guard Interval = 800 ns		Guard Interval = 400 ns	
			20-MHz Channel	40-MHz Channel	20-MHz Channel	40-MHz Channel
27	4	16-QAM 1/2	104	216	115.6	240
28	4	16-QAM 3/4	156	324	173.3	360
29	4	64-QAM 2/3	208	432	231.1	480
30	4	64-QAM 3/4	234	486	260	540
31	4	64-QAM 5/6	260	540	288.9	600

Table B-3 lists the possible MCS used in 802.11ac wireless LANs. The resulting data rates also vary according to the number of spatial streams in use (1 to 4), the guard interval (800 or 400 ns), and the channel width (20, 40, 80, or 160 MHz).

**Table B-3** *Modulation and Coding Schemes and Data Rates Used for 802.11ac*

MCS Index	Spatial Streams	Modulation and Coding	Data Rate (Mbps)							
			Guard Interval = 800 ns				Guard Interval = 400 ns			
			20-MHz Channel	40-MHz Channel	80-MHz Channel	160-MHz Channel	20-MHz Channel	40-MHz Channel	80-MHz Channel	160-MHz Channel
0	1	BPSK 1/2	6.5	13.5	29.3	58.5	7.2	15	32.5	65
1	1	QPSK 1/2	13	27	58.5	117	14.4	30	65	130
2	1	QPSK 3/4	19.5	40.5	87.8	175.5	21.7	45	97.5	195
3	1	16-QAM 1/2	26	54	117	234	28.9	60	130	260
4	1	16-QAM 3/4	39	81	175.5	351	43.3	90	195	390
5	1	64-QAM 2/3	52	108	234	468	57.8	120	260	520

MCS Index	Spatial Streams	Modulation and Coding	Data Rate (Mbps)							
			Guard Interval = 800 ns				Guard Interval = 400 ns			
			20-MHz Channel	40-MHz Channel	80-MHz Channel	160-MHz Channel	20-MHz Channel	40-MHz Channel	80-MHz Channel	160-MHz Channel
6	1	64-QAM 3/4	58.5	121.5	263.3	526.5	65	135	292.5	585
7	1	64-QAM 5/6	65	135	292.5	585	72.2	150	325	650
8	1	256-QAM 3/4	78	162	351	702	86.7	180	390	780
9	1	256-QAM 5/6	—	180	390	780	—	200	433.3	866.7
0	2	BPSK 1/2	13	27	58.6	117	14.4	30	65	130
1	2	QPSK 1/2	26	54	117	234	28.8	60	130	260
2	2	QPSK 3/4	39	81	175.6	351	43.4	90	195	390
3	2	16-QAM 1/2	52	108	234	468	57.8	120	260	520
4	2	16-QAM 3/4	78	162	351	702	86.6	180	390	780
5	2	64-QAM 2/3	104	216	468	936	115.6	240	520	1040
6	2	64-QAM 3/4	117	243	526.6	1053	130	270	585	1170
7	2	64-QAM 5/6	130	270	585	1170	144.4	300	650	1300
8	2	256-QAM 3/4	156	324	702	1404	173.4	360	780	1560

MCS Index	Spatial Streams	Modulation and Coding	Data Rate (Mbps)							
			Guard Interval = 800 ns				Guard Interval = 400 ns			
			20-MHz Channel	40-MHz Channel	80-MHz Channel	160-MHz Channel	20-MHz Channel	40-MHz Channel	80-MHz Channel	160-MHz Channel
9	2	256-QAM 5/6	—	360	780	1560	—	400	866.7	1733.4
0	3	BPSK 1/2	19.5	40.5	87.9	175.5	21.6	45	97.5	195
1	3	QPSK 1/2	39	81	175.5	351	43.2	90	195	390
2	3	QPSK 3/4	58.5	121.5	263.4	526.5	65.1	135	292.5	585
3	3	16-QAM 1/2	78	162	351	702	86.7	180	390	780
4	3	16-QAM 3/4	117	243	526.5	1053	129.9	270	585	1170
5	3	64-QAM 2/3	156	324	702	1404	173.4	360	780	1560
6	3	64-QAM 3/4	175.5	364.5	789.9	1579.5	195	405	877.5	1755
7	3	64-QAM 5/6	195	405	877.5	1755	216.6	450	975	1950
8	3	256-QAM 3/4	234	486	1053	2106	260.1	540	1170	2340
9	3	256-QAM 5/6	—	540	1170	2340	—	600	1299.9	2600.1
0	4	BPSK 1/2	26	54	117.2	234	28.8	60	130	260
1	4	QPSK 1/2	52	108	234	468	57.6	120	260	520



MCS Index	Spatial Streams	Modulation and Coding	Data Rate (Mbps)							
			Guard Interval = 800 ns				Guard Interval = 400 ns			
			20-MHz Channel	40-MHz Channel	80-MHz Channel	160-MHz Channel	20-MHz Channel	40-MHz Channel	80-MHz Channel	160-MHz Channel
2	4	QPSK 3/4	78	162	351.2	702	86.8	180	390	780
3	4	16-QAM 1/2	104	216	468	936	115.6	240	520	1040
4	4	16-QAM 3/4	156	324	702	1404	173.2	360	780	1560
5	4	64-QAM 2/3	208	432	936	1872	231.2	480	1040	2080
6	4	64-QAM 3/4	234	486	1053.2	2106	260	540	1170	2340
7	4	64-QAM 5/6	260	540	1170	2340	288.8	600	1300	2600
8	4	256-QAM 3/4	312	648	1404	2808	346.8	720	1560	3120
9	4	256-QAM 5/6	—	720	1560	3120	—	800	1733.2	3466.8

*This page intentionally left blank*



# Key Terms Glossary

---

**802.1x** An IEEE standard that defines port-based access control for wired and wireless networks

**absorption** The effect of an RF signal meeting a material that absorbs or attenuates the signal strength by some amount

**access point (AP)** A device that provides wireless service for clients within its coverage area or cell

**active scanning** A method used by wireless clients to actively scan for available APs by sending probe request frames

**ad hoc network** See independent basic service set (IBSS)

**air-quality index (AQI)** A scale from 0 to 100 that indicates how usable an 802.11 channel is, based on the number and intensity of interfering sources

**amplifier** An active device that adds gain to an RF signal

**amplitude** The height from the top peak to the bottom peak of a signal's waveform; also known as the peak-to-peak amplitude

**anchor controller** The original controller a client was associated with before a Layer 3 intercontroller roam occurs. An anchor controller can also be used for tunneling clients on a guest WLAN or with a static anchor. Traffic is tunneled from the client's current controller (the foreign controller) back to the anchor.

**AP SSO** High availability offered by controllers running software release 7.3 or later and configured as failover pairs. One controller is active and supports the AP and client load, and the other controller is a hot standby. Stateful information about APs is synchronized between the active and standby units for an efficient failover.

**AP-manager interface** A logical link that can be configured to terminate CAPWAP tunnels from lightweight APs

**association** The process by which a wireless device becomes a functioning member of a BSS

**asymmetric power problem** The scenario where the AP and a client use differing transmit power levels such that the messages sent by device 1 are received and understood by device 2, but the replies from device 2 are too weak to be understood by device 1.

**attenuator** A passive device that introduces additional loss to an RF signal

**authentication server (AS)** An 802.1x entity that authenticates users or clients based on their credentials, as matched against a user database. In a wireless network, a RADIUS server is an AS.

**authenticator** An 802.1x entity that exists as a network device that provides access to the network. In a wireless network, a WLC acts as an authenticator.

**autonomous AP** A wireless AP operating in a standalone mode, such that it can provide a fully functional BSS and connect to the DS

**Autonomous to Lightweight Mode Upgrade Tool** A Cisco software tool that is used to upgrade or convert an autonomous AP to a lightweight AP

**backoff timer** The random amount of time a wireless client must wait before attempting to transmit a frame

**band** A contiguous range of frequencies

**bandwidth** The range of frequencies used by a single channel or a single RF signal

**Barker 11 code** An 11-bit sequence of encoded bits that represent a single data bit

**basic service set (BSS)** Wireless service provided by an AP to one or more associated clients

**basic service set identifier (BSSID)** A unique MAC address that is used to identify the AP that is providing a BSS

**beamwidth** A measure of the angle of a radiation pattern in both the E and H planes, where the signal strength is 3 dB below the maximum value

**block acknowledgment** A feature used in 802.11n that permits a burst of data frames to be followed by a single acknowledgment message, improving throughput

**BSS basic rate** A data rate that is required to be supported between an AP and a wireless client

**CAPWAP Discovery Request** A message sent by a lightweight AP to discover one or more wireless LAN controllers. Any controllers that receive the request should return a CAPWAP Discovery Response message to the AP.

**CAPWAP Join Request** A message sent by a lightweight AP to a specific WLC indicating the AP's desire to join or associate with the controller. If the AP is accepted, the WLC returns a CAPWAP Join Response message.

- carrier signal** The basic, steady RF signal that is used to carry other useful information
- CCX Lite** A CCX certification program that is organized in modules, according to specific applications for wireless devices
- cell** The area of wireless coverage provided by an AP; also known as the basic service area
- certificate authority (CA)** A trusted entity that generates and signs digital certificates
- channel** An arbitrary index that points to a specific frequency within a band
- channel aggregation** An 802.11n feature that allows two 20-MHz OFDM channels to be aggregated or bonded into a single 40-MHz channel
- channel reuse** The pattern of APs and their channels, arranged such that neighboring APs never use the same channels
- chip** A bit produced by a coder
- Cisco CleanAir** Wireless technology used to detect, classify, report, and react to non-802.11 interference
- Cisco Compatibility Extensions (CCX)** A wireless device certification that verifies compatibility with a set of Cisco developed features. CCX is defined in five versions.
- clear channel assessment (CCA)** The process a wireless devices uses to determine whether a channel is clear and available to use
- client SSO** High availability offered by controllers running Software Release 7.5 or later and configured as failover pairs. Stateful information about clients associated with the primary controller is synchronized to the secondary standby unit for a transparent failover.
- cluster ID** A unique identifier that a WLC assigns to a non-802.11 device found to be interfering with an AP. See also pseudo-MAC address.
- co-channel interference** RF signal interference caused by two or more transmitters using the same frequency or channel
- coder** A function that converts data bits into multiple encoded bits before transmission, to provide resilience against noise and interference
- collision avoidance** The technique used by 802.11 devices to proactively avoid collisions on a channel
- Complementary Code Keying (CCK)** An encoding method that takes either 4 or 8 data bits at a time to create a 6-bit or 8-bit symbol, respectively. The symbols are fed into DQPSK to modulate the carrier signal.
- contention window** The total amount of time a wireless client waits before transmitting a frame

**controller interface** A logical connection that a wireless controller uses internally

**controller port** A physical connection to an external switched network

**Counter/CBC-MAC Protocol (CCMP)** A wireless security scheme based on 802.11i that uses AES counter mode for encryption and CBC-MAC for data integrity

**coverage hole** An area that is left without good RF coverage. A coverage hole can be caused by a radio failure or a weak signal in an area.

**dBd** The gain of an antenna, measured in dB, as compared to a simple dipole antenna

**dBi** The gain of an antenna, measured in dB, as compared to an isotropic reference antenna

**dBm** The power level of a signal measured in dB, as compared to a reference signal power of 1 milliwatt

**DCA** Dynamic channel allocation; an RRM algorithm that monitors APs in an RF group and adjusts their channel assignment based on poor RF conditions

**decibel (dB)** A logarithmic function that compares one absolute measurement to another

**delivery traffic indication message (DTIM)** A beacon sent at regular intervals that indicates whether buffered broadcast and multicast frames will be sent for clients that have been in a power save mode

**demodulation** The receiver's process of interpreting changes in the carrier signal to recover the original information being sent

**differential binary phase shift keying (DBPSK)** A modulation method that takes 1 bit of encoded data and changes the phase of the carrier signal in one of two ways

**differential quadrature phase shift keying (DQPSK)** A modulation method that takes 2 bits of encoded data and changes the phase of the carrier signal in one of four ways

**diffraction** The effect of an RF signal approaching an opaque object, causing the electromagnetic waves to bend around the object

**dipole** An omnidirectional antenna composed of two wire segments

**direct sequence spread spectrum (DSSS)** A wireless LAN method where a transmitter uses a single fixed, wide channel to send data

**directional antenna** A type of antenna that propagates an RF signal in a narrow range of directions

**distributed coordination function (DCF)** The method used by each wireless device to coordinate the use of a wireless channel

**distribution system (DS)** The wired Ethernet that connects to an AP and transports traffic between a wired and wireless network

**distribution system port** A physical interface that connects a wireless controller to a switched network and carries both AP and management traffic

**duty cycle** A measure of the percentage of time a device transmits on a given frequency

**dynamic interface** An internal logical link that connects a VLAN to a WLAN. Traffic passing through a dynamic interface also passes through a VLAN on a distribution system port.

**dynamic rate shifting** A mechanism used by an 802.11 device to change the modulation coding scheme (MCS) according to dynamic RF signal conditions

**EAP Flexible Authentication by Secure Tunneling (EAP-FAST)** A Cisco authentication method that is based on EAP and uses a PAC as a credential for outer authentication and a TLS tunnel for inner authentication

**EAP-TLS** An authentication method that uses digital certificates on both the server and the supplicant for mutual authentication. A TLS tunnel is used during client authentication and key exchanges.

**effective isotropic radiated power (EIRP)** The resulting signal power level, measured in dBm, of the combination of a transmitter, cable, and an antenna, as measured at the antenna

**enterprise mode** 802.1x EAP-based authentication requirement for WPA or WPA2

**E plane** The “elevation” plane passing through an antenna that shows a side view of the radiation pattern

**Event-Driven RRM (ED-RRM)** Using Cisco CleanAir to trigger the RRM DCA process automatically, as interference is detected

**extended service set (ESS)** Multiple APs that are connected by a common switched infrastructure

**Extensible Authentication Protocol (EAP)** A standardized authentication framework that is used by a variety of authentication methods

**foreign controller** The current controller a client is associated with after a Layer 3 intercontroller roam occurs. Traffic is tunneled from the foreign controller back to an anchor controller so that the client retains connectivity to its original VLAN and subnet.

**free-space path loss** The degradation of an RF signal’s strength as it travels through free space

**frequency** The number of times a signal makes one complete up and down cycle in 1 second.

**frequency hopping spread spectrum (FHSS)** A wireless LAN method where a transmitter “hops” between frequencies all across a band



**Fresnel zone** The elliptical shaped space between a transmitter and receiver that must be kept clear of objects, else the RF signal will be degraded

**gain** A measure of how effectively an antenna can focus RF energy in a certain direction

**guard interval (GI)** The amount of time required between OFDM symbols to prevent inter-symbol interference. In 802.11n, the guard interval can be reduced from 800 ns to 400 ns.

**guest WLAN** A wireless LAN that is specially created to support guest clients

**hertz (Hz)** A unit of frequency equaling one cycle per second

**high throughput (HT)** The techniques defined in 802.11n and used to scale performance to a maximum of 600 Mbps

**H plane** The “azimuth” plane passing through an antenna that shows a top-down view of the radiation pattern

**in phase** The condition when the cycles of two identical signals are in sync with each other

**independent basic service set (IBSS)** An impromptu wireless network formed between two or more devices without an AP or a BSS; also known as an ad hoc network

**infrastructure mode** The operating mode of an AP that is providing a BSS for wireless clients

**integrated antenna** A very small omnidirectional antenna that is set inside a device’s outer case

**intercontroller roaming** Client roaming that occurs between two APs that are joined to two different controllers

**interference** Signals coming from 802.11 devices other than expected or known APs

**interframe space** The amount of time the 802.11 standard defines to separate adjacent frames on a channel

**intersymbol interference (ISI)** Data corruption caused by OFDM symbols arriving too close together at a receiver, usually caused by signals that take different paths from transmitter to receiver

**intracontroller roaming** Client roaming that occurs between two APs joined to the same controller

**IP Setup Utility (IPSU)** A Cisco software tool that can be used to find an autonomous AP’s IP address or to set its IP address and SSID

**isotropic antenna** An ideal, theoretical antenna that radiates RF equally in every direction

**Layer 2 roam** An intercontroller roam where the WLANs of the two controllers are configured for the same Layer 2 VLAN ID; also known as a local-to-local roam.

**Layer 3 roam** An intercontroller roam where the WLANs of the two controllers are configured for different VLAN IDs; also known as a local-to-foreign roam. To support the roaming client, a tunnel is built between the controllers so that client data can pass between the client's current controller and its original controller.

**lightning arrestor** A device used to protect a transmitter or receiver from large transient voltages that might be induced by lightning around an antenna

**Lightweight EAP (LEAP)** A legacy Cisco proprietary wireless security method

**link aggregation group (LAG)** A grouping or bundling of multiple physical links into a single logical link

**link budget** The cumulative sum of gains and losses measured in dB over the complete RF signal path; a transmitter's power level must overcome the link budget so that the signal can reach a receiver effectively

**management frame protection (MFP)** A method developed by Cisco to protect wireless clients and APs from attacks involving spoofed management frames

**management interface** A logical link that is used for normal management traffic. If an AP-manager interface is not configured, the management interface also terminates CAPWAP tunnels from APs.

**mandatory data rate** An 802.11 data rate that must be supported by a client before it can associate with an AP

**maximal-ratio combining (MRC)** An 802.11n technique that takes multiple copies of a signal, received over multiple antennas, and combines them to reconstruct the original signal.

**mesh network** A network of APs used to cover a large area without the need for wired Ethernet cabling; client traffic is bridged from AP to AP over a backhaul network

**message integrity check (MIC)** A cryptographic value computed from the contents of a data frame and used to detect tampering.

**mobility anchor** A wireless LAN controller that acts as the anchor or home base for remote wireless clients that are joined to a different controller

**mobility group** A logical grouping of controllers that facilitates efficient client roaming and mobility

**modulation** The transmitter's process of altering the carrier signal according to some other information source

**monopole** A very short omnidirectional antenna composed of a single wire segment set over a metal ground plane

**multipath** Reflected copies of an RF signal arrive at a receiver after taking different paths through free space

**N+1 redundancy** High availability offered by N number of active controllers plus one idle standby controller.

**N+N redundancy** High availability offered by N number of active controllers. The AP load is distributed across the active controllers, so no additional backup controller is used.

**N+N+1 redundancy** High availability offered by N number of active controllers plus one idle standby controller.

**narrowband** RF signals that use a very narrow range of frequencies

**neighboring channel interference** RF signal interference caused by two or more transmitters using channels that are different, but do not completely overlap

**network allocation vector (NAV)** An internal timer maintained by each wireless device that measures the number of timeslots before a transmission may be attempted

**noise** Signals or RF energy that do not come from 802.11 sources

**noise floor** The average power level of noise measured at a specific frequency

**omnidirectional antenna** A type of antenna that propagates an RF signal in a broad range of directions in order to cover a large area

**open authentication** An 802.11 authentication method that requires clients to associate with an AP without providing any credentials at all

**open system authentication** A simple method used to verify that a wireless device uses 802.11 before it is permitted to join a BSS

**orthogonal frequency-division multiplexing (OFDM)** A data transmission method that sends data bits in parallel over multiple frequencies within a single 20 MHz wide channel. Each frequency represents a single subcarrier.

**out of phase** The condition when the cycles of one signal are shifted in time in relation to another signal

**parabolic dish antenna** A highly directional antenna that uses a passive dish shaped like a parabola to focus an RF signal into a tight beam

**passive scanning** A method used to scan for available APs by listening to their beacon frames

**patch antenna** A directional antenna that has a planar surface and is usually mounted on a wall or column

**personal mode** Pre-shared key authentication as applied to WPA or WPA2

**phase** A measure of shift in time relative to the start of a cycle; ranges between 0 and 360 degrees

**physical carrier sense** To determine whether a channel is available, a device simply listens to any signals that might be present.

**point-to-point bridge** An AP configured to bridge a wired network to a companion bridge at the far end of a line of sight path

**polar plot** A round graph that is divided into 360 degrees around an antenna and into concentric circles that represent decreasing dB values. The antenna is always placed at the center of the plot.

**polarization** The orientation (horizontal, vertical, circular, and so on) of a propagating wave with respect to the ground

**primed controller address** The name or IP address of a controller that is configured in advance on an AP

**protected access credential (PAC)** Special-purpose data that is used as an authentication credential in EAP-FAST

**Protected EAP (PEAP)** An authentication method that uses a certificate on the AS for outer authentication and a TLS tunnel for inner authentication. Clients can provide their credentials through either MS-CHAPv2 or GTC.

**protection mechanism** A method of supporting backward compatibility between an advanced and a legacy wireless standard, such as 802.11g and 802.11b, respectively. For example, each 802.11g OFDM transmission is flagged with RTS/CTS messages sent in the lower-rate DSSS format.

**pseudo-MAC address** A virtual MAC address that a controller assigns to each uniquely identified non-802.11 interferer so that it can be reported and displayed. See also cluster ID.

**Public Key Infrastructure (PKI)** An enterprise-wide system that generates and revokes digital certificates for client authentication

**quadrature amplitude modulation (QAM)** A modulation method that combines QPSK phase shifting with multiple amplitude levels to produce a greater number of unique changes to the carrier signal. The number preceding the QAM name designates how many carrier signal changes are possible.

**radiation pattern** A plot that shows the relative signal strength in dBm at every angle around an antenna

**radio frequency (RF)** The portion of the frequency spectrum between 3 kHz and 300 GHz

**RADIUS server** An authentication server used with 802.1x to authenticate wireless clients

**reassociation** The process by which a wireless client changes its association from one BSS to another as it moves

**received signal strength indicator (RSSI)** The measure of signal strength (in dBm) as seen by the receiver. RSSI is normally negative (0 to -100) because the received signal is always a degraded form of the original signal that was sent.

**reflection** The effect of an RF signal meeting a dense, reflective material, such that it is sent in a different direction

**refraction** The effect of an RF signal meeting the boundary between two different materials, causing its trajectory to change slightly

**repeater** A device that repeats or retransmits signals it receives, effectively expanding the wireless coverage area

**RF group** A logical grouping of wireless LAN controllers that operates as a single RF domain. RRM algorithms run on a per-RF group basis.

**RF group leader** A controller that is elected to handle all of the RRM algorithms for the entire RF group

**roaming** The process a wireless client uses to move from one AP to another as it changes location

**rogue AP** A wireless AP that operates outside local administrative control

**RRM** Radio Resource Management; a set of algorithms that are used to maintain a stable and optimum wireless network even in a changing RF environment

**scattering** The effect of an RF signal meeting a rough or uneven surface, causing it to be reflected or scattered in many different directions

**sensitivity level** The RSSI threshold (in dBm) that divides unintelligible RF signals from useful ones

**service port** A physical nontrunking interface that connects a wireless controller to a switched network and carries only out-of-band management traffic

**service set identifier (SSID)** A text string that is used to identify a wireless network

**shared key authentication** A method used to authenticate a wireless device with a BSS by using a shared WEP key

**signal-to-noise ratio (SNR)** A measure of received signal quality, calculated as the difference between the signal's RSSI and the noise floor. A higher SNR is preferred.

**spatial multiplexing** Distributing streams of data across multiple radio chains with spatial diversity

**spatial stream** An independent stream of data that is sent over a radio chain through free space. One spatial stream is separate from others due to the unique path it travels through space.

**spectrum analyzer** A device that sweeps through a range of frequencies and displays signals that it receives. The signal data can be processed and displayed in a variety of ways to assist in the analysis.

**spread spectrum** RF signals that spread the information being sent over a wide range of frequencies

**station (STA)** An 802.11 client device that is associated with a BSS

**supplicant** An 802.1x entity that exists as software on a client device and serves to request network access

**supported data rate** An 802.11 data rate that can be supported by a client when it associates with an AP

**symbol** A complete group of encoded chips that represent a data bit

**Temporal Key Integrity Protocol (TKIP)** A wireless security scheme developed before 802.11i that provides a MIC for data integrity, a dynamic method for per-frame WEP encryption keys, and a 48-bit initialization vector. The MIC also includes a time stamp and the sender's MAC address.

**TPC** Transmit power control; an RRM algorithm that adjusts the transmit power level of APs to minimize cell overlap and interference

**traffic indication map (TIM)** A list of the association IDs of wireless clients who are in a power save mode but have frames buffered. The TIM is included in beacon frames sent by an AP.

**transmit beamforming (TxBF)** An 802.11n method to transmit a signal over multiple antennas, each having the signal phase carefully crafted, so that the multiple copies are all in phase at a targeted receiver

**unscheduled automatic power save deliver (U-APSD)** The method defined in 802.11e and WMM that allows a wireless client to enter power save mode and then have buffered frames delivered whenever the client is ready to receive them

**virtual carrier sense** The method by which a wireless device calculates that a channel is available, based on frame duration information that is used to set the NAV

**virtual interface** A logical link used to support wireless clients with things like DHCP relay and web authentication

**wavelength** The physical distance that a wave travels over one complete cycle

**Wi-Fi Protected Access (WPA)** A Wi-Fi Alliance standard that requires pre-shared key or 802.1x authentication, TKIP, and dynamic encryption key management; based on portions of 802.11i before its ratification

**Wireless Equivalent Privacy (WEP)** An 802.11 authentication and encryption method that requires clients and APs to use a common WEP key

**wireless intrusion protection system (wIPS)** A system that monitors wireless activity to detect malicious behavior according to a set of signatures or patterns

**Wireless Multimedia (WMM)** A Wi-Fi Alliance interoperability certification that covers quality of service (QoS) and enhanced power save delivery methods

**workgroup bridge (WGB)** An AP that is configured to bridge between a wired device and a wireless network. The WGB acts as a wireless client.

**WPA Version 2 (WPA2)** A Wi-Fi Alliance standard that requires pre-shared key or 802.1x authentication, TKIP or CCMP, and dynamic encryption key management; based on the complete 802.11i standard after its ratification

**Yagi antenna** A directional antenna made up of several parallel wire segments that tend to amplify an RF signal to each other

*This page intentionally left blank*



# Index

---

## Symbols & Numerics

- $\lambda$  (lambda), 14
- 1-Mbps data rate, 28-29
- 2.4 GHz ISM band, 47-49
- 2-Mbps data rate (DSSS), 29
- 5.5-Mbps data rate (DSSS), 30
- 5-GHz frequency bands, 12
- 5-GHz U-NII bands, 49-51
- 11-Mbps data rate (DSSS), 30
- 802.11-1997 standard, 52
- 802.11a standard, 54-55
- 802.11ac amendment, 62
- 802.11b standard, 52-53
- 802.11g standard, 52-54
- 802.11n standard, 55-56
  - channel aggregation, 57-58
  - Cisco controller support, configuring, 264
  - MAC layer efficiency, 59-60
  - MRC, 61
  - spatial multiplexing, 58-59
  - TxBF, 60-61
- 802.1x standard, 292-293

## A

---

- absolute power measurement, 16
- absorption, 78

- accessing
  - AP management interface, 432-433
  - wireless media, 130-134
  - WLC management interface, 430-432
- accessories, adding to antennas, 101-102
- ACK frames, 136
- active scans, 137
- adding
  - APs to ESS, 153-161
    - roaming process*, 155-157
  - controllers to WCS configuration, 368-369
- addressing, 802.11 frames, 128-130
- advanced settings, configuring on WLANs, 318-319
- AES (Advanced Encryption Standard), 296
- Alarm Summary dashboard (WCS), 364-365
- alternating channel pattern, 159-160
- amendments (IEEE), 47
  - 802.11ac, 62
- amplifiers, 101
- amplitude, 15
- Android wireless clients, configuring, 345
- answers to self-assessment quizzes
  - chapter 1, 456-458
  - chapter 2, 458

chapter 3, 459  
chapter 4, 459-460  
chapter 5, 460-461  
chapter 6, 461  
chapter 7, 461-462  
chapter 8, 462-463  
chapter 9, 463-464  
chapter 10, 464  
chapter 11, 464-465  
chapter 12, 465-466  
chapter 13, 466  
chapter 14, 467  
chapter 15, 467-468  
chapter 16, 468  
chapter 17, 468-469  
chapter 18, 469  
chapter 19, 469-470  
chapter 20, 470  
chapter 21, 471

**antennas, 20-21**  
adding accessories, 101-102  
amplifiers, 101  
attenuators, 102  
beamwidth, 92  
dipole, 22  
directional antennas, 96-100  
    *dish antennas, 99-100*  
    *patch antennas, 96-98*  
    *Yagi-Uda antennas, 98-99*

EIRP, measuring, 21-22  
gain, 91  
lightning arrestors, 102  
omnidirectional antennas, 94-96  
    *dipole antennas, 94*  
    *integrated omnidirectional antennas, 96*  
    *monopole antennas, 94*  
polarization, 92-93  
radiation patterns, 88-91

**AP SSO redundancy, 233-235**

**Apple OS X wireless clients, configuring, 345**

**APs (access points), 110-111**  
adding to an ESS, 153-161  
    *roaming process, 155-157*  
authentication, 287  
autonomous APs  
    *centralized architecture, 186-187*  
    *configuring, 167-173*  
    *converting to lightweight mode, 174-177*  
    *distributed architecture, 184-186*  
    *management functions, 187*  
    *real-time processes, 187*  
    *roaming, 242-244*

BSS, join process, 137-140  
CAPWAP, 188-190

- cell size, tuning, 150-153
  - with data rates, 152-153*
  - with transmit power, 150-151*
- connectivity, troubleshooting, 420-424
  - AP-to-network connectivity, verifying, 422-423*
  - AP-to-WLC connectivity, verifying, 420-421*
- data rates, 136
- IP address, identifying, 168-170
- LAPs, 187
  - image downloads, 225-226*
  - split-MAC architecture, 188-190*
  - state machine, 224*
  - WLC, discovering, 226-227*
  - WLC, selecting, 227-228*
- management interface, accessing, 432-433
- manipulating on maps, 373-374
- multiple SSID support, 113-114
- placement of, 157-161
- ports, 167-168
- repeater mode, 116
- roaming process, intercontroller roaming, 246-255
- rogue APs, 290, 386
- RRM
  - CHDM, 274-275*
  - DCA, 272*
  - ED-RRM, 272*
  - manual RFconfiguration, 276-278*
  - RF groups, 267-269*
  - TPC, 269-271*
- AQI (air quality index), displaying, 394-395
- association request frames, 135
- associations, 111, 405-406
- attenuators, 102
- authentication, 286-287
  - 802.1x, 292-293
  - EAP, 292-293
  - EAP-FAST, 294
  - EAP-TLS, 295
  - enterprise mode authentication (WPA/WPA2), configuring, 300-302
  - LEAP, 294
  - local EAP, configuring, 302-305
  - open authentication, 290-291
  - PEAP, 294-295
  - personal mode authentication (WPA), 297
  - personal mode authentication (WPA), configuring, 299-300
  - supported schemes in CCX versions, 355-354
  - WEP, 291-292
- autonomous APs, 166-167**
  - centralized architecture, 186-187
  - configuring, 167-173, 170-173
  - converting to lightweight mode, 174-177
    - Autonomous to Lightweight Mode Upgrade tool, 174-176*
    - manual conversion, 176-177*
  - distributed architecture, 184-186
  - management functions, 187
  - real-time processes, 187
  - roaming, 242-244
- Autonomous to Lightweight Mode Upgrade tool, 174-176**
- azimuth plane, 90

## B

---

**bands of frequency, 11**

- channels, 12-13
- licensed bands, 42
  - 2.4 GHz ISM band, 47-49*
- U-NII, 42
- unlicensed bands, 42

**bandwidth, 12**

**base-10 logarithm function, 17**

**beacons, 134**

**beamwidth, 92**

**benefits of Cisco WCS, 362**

**bidirectional communication, 109**

**Block ACK frames, 136**

**Bluetooth as source of interference, 386-387**

**BPSK (binary phase shift keying), 32**

**BSA (basic service area), 111**

**BSS (basic service set), 110-111**

- DS, 112-114
  - multiple SSID support on APs, 113-114*
- join process, 137-140
- leaving, 139-140
- moving between, 140-142

**BSSID (basic service set identifier), 111**

**building blocks of CUWN, 192-194**

- Cisco LAPs, 194-196
- Cisco WLC, 192-194

**BVI (bridged-virtual interface), displaying P address, 169-170**

## C

---

**calculating free space path loss, 73-74**

**Canopy as source of interference, 389**

**CAPWAP (Control and Provisioning of Wireless Access Points), 188-190**

- RFC 5415, 224

**carrier sense, 131**

**carrier signals, 24**

**CCA (clear channel assessment), 131**

**CCK (Complementary Code Keying), 27, 30**

**CCKM (Cisco Centralized Key Management), 246**

**CCMP (Counter/CBC-MAC Protocol), 296**

**CCX (Cisco Compatible Extensions), 352-354**

- feature support, 352-353
- goals of, 352
- supported authentication schemes, 355-354

**CCX Lite, 354**

**cells**

- layout, 157-161
- size of, tuning
  - with data rates, 152-153*
  - with transmit power, 150-151*

**centralized architecture, 186-187**

**channel aggregation, 57-58**

**channel separation, 12**

**channels, 12-13**

- in 2.4 GHz ISM band, 47-49
- alternating pattern, 159-160
- AP placement, 157-161
- DCA, 272
- non-overlapping, 49
- subchannels, 31

**CHDM (coverage hole detection mechanism), 269, 274-275**

**Cisco Aironet Antennas and Accessories Reference Guide, 93**

- Cisco AnyConnect Secure Mobility Client, configuring, 348-350
- Cisco Certification Exam Tutorial, 446-452
- Cisco CleanAir, 392-396. *See also*
  - AQI, 394-395
  - ED-RRM, 396
  - enabling, 392
- Cisco LAPs (lightweight access points), 194-196
- Cisco WLC (Wireless LAN Controller), 192-194
- CLI
  - initial WLC configuration, 216-217
  - LAP management interface, accessing, 432-433
  - WLC management interface, accessing, 430-432
- client MFP, 298
- co-channel interference, 70-71
- code images
  - displaying, 434
  - downloading, 434-436
- coding, 27
- collisions, 131, 132-134
  - DCF, 134
  - interframe space periods, 132-133
- commands, show run-config, 439
- comparing
  - 802.3 and 802.11 frames, 126-128
  - power levels, 17-19
  - wired and wireless networks, 7
- configuration files
  - displaying, 439
  - saving, 437-438
  - uploading to PC, 438
- configuring
  - autonomous APs, 167-173, 170-173
    - IP address, identifying, 168-170
  - controllers
    - 802.11n support, 264
    - data rates, 263-264
    - with WCS, 368-370
  - wireless clients
    - Android, 345
    - Apple OS X, 345
    - Cisco AnyConnect Secure Mobility Client, 348-350
    - Intel PROSet, 341-344
    - Windows 7/8, 338-340
- WLANs, 310-312, 315-319
  - advanced settings, 318-319
  - dynamic interface, 312
  - QoS, 317
  - RADIUS server, 310
  - security, 315-317
- WLC
  - with CLI, 216-217
  - with web browser, 208-216
- WPA/WPA2
  - enterprise mode authentication, 300-302
  - personal mode authentication, 299-300
- connecting WLC to switched network
  - using controller interfaces, 205-208
  - using controller ports, 204-206
- connectivity
  - AP connectivity, 420-424
    - AP-to-network connectivity, verifying, 422-423
    - AP-to-WLC connectivity, verifying, 420-421

- wireless clients, troubleshooting, 405-419
  - associations, 405-406*
  - from controller, 41-410*
  - link tests, performing, 411*
  - from WCS/NCS, 44-45*
- conserving power on wireless devices, 142-144
- control plane, 185
- controllers
  - 802.11n support, configuring, 264
  - adding to WCS configuration, 368-369
  - AQI, displaying, 394-395
  - code images
    - displaying, 434*
    - downloading, 434-436*
  - configuration files
    - displaying, 439*
    - saving, 437-438*
    - uploading to PC, 438*
  - configuring
    - with CLI, 216-217*
    - with WCS, 368-370*
    - with web browser, 208-216*
  - connecting WLC to switched network
    - using controller interfaces, 205-208*
    - using controller ports, 204-206*
  - data rates, configuring, 263-264
  - discovering, 228-229
  - failure, detecting, 230
  - high availability
    - AP SSO redundancy, 233-235*
    - N+1 redundancy, 231*
    - N+N redundancy, 232*
    - N+N+1 redundancy, 232-233*
    - redundancy, 231*
  - hot standby controller, 234
  - intercontroller roaming, 246-255
    - Layer 2 roaming, 247*
    - mobility groups, 252-255*
  - intracontroller roaming, 244-246
  - rebooting, 436-437
  - trap logs, 439-443
    - sending to trap receivers, 440-443*
    - viewing, 440*
  - wireless client connectivity, troubleshooting, 41-410
  - WLC, discovering, 226-227
- converting autonomous APs to lightweight mode, 174-177
  - Autonomous to Lightweight Mode Upgrade tool, 174-176
  - manual conversion, 176-177
- cordless phones as source of interference, 388
- creating
  - guest networks, 326-328
  - WCS reports, 377-380
  - WLANs, 313-315
- CSMA (carrier sense multiple access), 131
- CUWN (Cisco Unified Wireless Network), 180
  - building blocks, 192-194
    - Cisco LAPs, 194-196*
    - Cisco WLC, 192-194*
  - LAPs, 187
    - split-MAC architecture, 188-190*
  - managing, 197
  - traffic patterns, 190-191
- cycles, 10

## D

---

**data frames, 136**

**data plane, 185**

**data rates**

802.11-1997 standard, 52

802.11a standard, 54

802.11b standard, 52-53

802.11g standard, 53

for APs, 136

for controllers, configuring, 263-264

effect on AP cell size, 152-153

**dB (decibel), 17-19**

**dBm (decibel-milliwatt), 22**

**DBPSK (differential binary phase shift keying), 28-29**

**DCA (dynamic channel allocation), 269, 272**

**DCF (distributed coordination function), 130, 134**

**debugging wireless clients, 44-415**

**designing**

AP cells, 157-161

high availability, 228-235

*AP SSO redundancy, 233-235*

*controller failure, detecting, 230*

*N+N redundancy, 232*

*N+N+1 redundancy, 232-233*

*redundancy, 231*

**detecting**

controller failure, 230

sources of interference, 390-391

**diffraction, 80**

**DIFS (distributed interframe space), 132**

**dipole antennas, 22, 94**

**directional antennas, 96-100**

dish antennas, 99-100

patch antennas, 96-98

Yagi-Uda antennas, 98-99

**disabled data rates, 136**

**discovering**

controllers, 228-229

WLC, 226-227

**dish antennas, 99-100**

**displaying**

alarm details (WCS), 364-365

AQI, 394-395

configuration files, 439

maps (WCS), 370-372

RRM results in NCS maps, 278

**dissociation frames, 135**

**distributed architecture, 184-186**

**DMZ (demilitarized zone), 325**

**"Do I Know This Already?" quizzes.**

*See self-assessment quizzes*

**downloading controller code images, 434-436**

**DQPSK (differential quadrature phase shift keying), 29**

**DRS (dynamic rate shifting), 75**

**DS (distribution system), 112-114**

multiple SSID support, 113-114

**DSSS (direct-sequence spread spectrum), 26, 27-28**

11-Mbps data rate, 30

1-Mbps data rate, 28-29

2-Mbps data rate, 29

5.5-Mbps data rate, 30

**DTIM (delivery traffic indication message), 143**

**duration field, 802.11 frames, 131**

**dynamic interface, configuring for WLANs, 312**

## E

---

**EAP (Extensible Authentication Protocol)**, 292-293

**EAP-FAST (EAP Flexible Authentication by Secure Tunneling)**, 294

**EAP-TLS (EAP Transport Layer Security)**, 295

**ED-RRM (Event-Driven RRM)**, 272  
using with Cisco CleanAir, 396

**EIFS (extended interframe space)**, 132

**EIRP (effective isotropic radiated power)**  
FCC requirements, 43-44  
measuring, 21-22

electromagnetic waves in wireless networks, 9

elevation plane, 90

enabling Cisco CleanAir, 392

encoding, Barker 11 code, 28

encryption, AES, 296

enterprise mode authentication (WPA/WPA2), configuring, 300-302

**ERP (Extended Rate PHY)**, 53

**ESS (extended service set)**, 114-115  
APs, adding, 153-161

**ETSI (European Telecommunication Standards Institute)**, 44-45

**Express Setup configuration**, autonomous APs, 170-173

## F

---

**FCC (Federal Communications Commission)**, 42-44

EIRP, 43-44

transmitter requirements, 44

U-NII, 5-GHz bands, 49-51

**feature support for CCX program**, 352-353

**FHSS (frequency-hopping spread spectrum)**, 26-27

**finalizing WLAN configuration**, 319

**frames (802.11)**, 126-130  
addressing, 128-130  
collision avoidance, 132-134  
comparing with 802.3 frames, 126-128  
data frames, 136  
duration field, 131  
management frames, 134-135  
*securing with MFP*, 298  
NAV timer, 131-132

**free space path loss**, 72-76  
calculating, 73-74  
mitigating, 74-76

**frequency**, 10-13  
5-GHz frequency bands, 12  
amplitude, 15  
bands, 11  
bands of frequency  
*channels*, 12-13  
*U-NII*, 42  
cycles, 10  
Hz, 10  
microwave frequency, 11  
phase, 14  
RF, 11-13  
*absolute power measurement*, 16  
*signal strength*, 15-17  
signal bandwidth, 12  
watts, 15  
wavelength, measuring, 14-15

**Fresnel zones**, 80-82



## G

---

- gain, 20-21, 91
- generating WCS reports, 377-380
- goals of CCX program, 352
- GTC (Generic Token Card), 295
- guest networks, 325
  - configuring, 326-328
  - scaling, 329-331

## H

---

- H plane, 90
- half-duplex transmission, 110
- heatmaps (WCS), 370-372
- high availability, 228-235
  - AP SSO redundancy, 233-235
  - controller failure, detecting, 230
  - N+1 redundancy, 231
  - N+N redundancy, 232
  - N+N+1 redundancy, 232-233
  - redundancy, 231
- history of CUWN management products, 197
- home area (WCS), 366-367
- home page (WCS), 363
  - Alarm Summary dashboard, 364-365
  - home area, 366-367
  - main navigation area, 366
- hot standby controller, 234
- Hz (hertz), 10

## I

---

- IBSS (independent basic service set), 115-116

## identifying

- IP address of APs, 168-170
- sources of interference, 390-391
- IEEE (Institute of Electric and Electronic Engineers), 45-47
  - amendments, 47
  - study groups, 47
  - task groups, 47
  - working groups, 46
- IEEE 802.11 standard, 47-62
  - 2.4 GHz ISM band, 47-49
  - 5-GHz U-NII bands, 49-51
  - 802.11-1997 standard, 52
  - 802.11a standard, 54-55
  - 802.11ac amendment, 62
  - 802.11b standard, 52-53
  - 802.11g standard, 52-54
  - 802.11n standard, 55-56
    - channel aggregation*, 57-58
    - MAC layer efficiency*, 59-60
    - modulation*, 61
    - MRC*, 61
    - spatial multiplexing*, 58-59
    - TxBF*, 60-61
- CSMA, 131
- frames, 126-130
  - addressing*, 128-130
  - collision avoidance*, 132-134
  - comparing with 802.3 frames*, 126-128
  - data frames*, 136
  - duration field*, 131
  - management frames*, 134-135
  - NAV timer*, 131-132
- interframe space periods, 132-133
- IEEE 802.3 standard, 7
- image downloads for LAP, 225-226

**infrastructure MFP, 298**  
**initial WLC configuration**  
   using CLI, 216-217  
   using web browser, 208-216  
**integrated omnidirectional antennas, 96**  
**integrity**  
   MIC, 288-289  
   TKIP, 295-296  
**Intel PROSet wireless client,**  
   **configuring, 341-344**  
**intercontroller roaming, 246-255**  
   Layer 2 roaming, 247  
   Layer 3 roaming, 248-252  
   mobility groups, 252-255  
**interfaces, connecting WLC to switched**  
   **network, 205-208**  
**interference, 386-389**  
   co-channel interference, 70-71  
   neighboring channel interference,  
     71-72  
   non-802.11 interference, 72  
   rogue APs, 386  
   sources of, 389  
     *Bluetooth, 386-387*  
     *cordless phones, 388*  
     *locating, 390-391*  
     *microwave ovens, 388*  
     *WiMAX, 388-389*  
     *ZigBee, 387*  
**interframe space periods, 132-133**  
**interleaving, 27**  
**intracontroller roaming, 244-246**  
**intrusion protection, 289-290**  
**IP address of APs, identifying,**  
   168-170  
**ISM (industrial, scientific, and medical**  
   **applications), 2.4 GHz band, 47-49**

**isotropic antennas**  
   EIRP, measuring, 21-22  
   radiation patterns, 88-91  
**ITU-R (International**  
   **Telecommunication Union**  
   **Radiocommunication Sector), 41-42**  
**IV (Initialization Vector), 296**

## J-K

---

**jammers as source of interference, 389**  
**join process (BSS), 137-140**  
**keepalives, detecting controller failure,**  
   230  
**key exchanges during roams, 246**

## L

---

**LAPs (lightweight access points), 187**  
   Cisco LAPs, 194-196  
   image downloads, 225-226  
   management interface, accessing, 432-  
     433  
   split-MAC architecture, 188-190  
   state machine, 224  
   WLC  
     *discovering, 226-227*  
     *selecting, 227-228*  
**Layer 2 roaming, 247**  
**Layer 3 roaming, 248-252**  
**leader configuration (RF groups), 268**  
**LEAP (Lightweight EAP), 294**  
**leaving a BSS, 139-140**  
**licensed bands, 42**  
   2.4 GHz ISM band, 47-49  
**licensing, WCS, 363**  
**lightning arrestors, 102**

**lightweight mode**

- conversion from autonomous APs, 174-177

**lightweight mode, conversion from autonomous APs**

- Autonomous to Lightweight Mode Upgrade tool, 174-176
- manual conversion, 176-177

**limitations**

- of 802.11g, 54
- of wired networks, 7

**line-of-sight transmission, Fresnel zones, 80-82****link budget, 22****link tests, performing, 411****local EAP, configuring, 302-305****locating sources of interference, 390-391****log files, 439****logarithms, 16****login screen, WCS, 363****loss in signal strength, measuring, 19-20**

## M

---

**MAC layer efficiency, 59-60****magnetic waves in wireless networks, 8****main navigation area (WCS), 366****management frames (802.11), 134-135**

- securing with MFP, 298

**management functions of autonomous APs, 187****management interface**

- for APs, accessing, 432-433
- for WLC, accessing, 430-432

**managing CUWN, 197****mandatory data rates, 136****manipulating APs on maps, 373-374****manual RF configuration (RRM), 276-278****maps (WCS), 370**

- APs, manipulating, 373-374
- displaying, 370-372
- viewing information, 375-376

**MCS (modulation and coding scheme), 136****measuring**

- EIRP, 21-22

- loss in signal strength, 19-20

- power

- absolute power measurement, 16-17*

- dB, 17-19*

- QAM, 32

- wavelength, 14-15

**media, accessing wireless media, 130-134****mesh networks, 119****message privacy, 287-288****MFP (Management Frame Protection), 298****MIC (message integrity check), 288-289****microwave frequency, 11****microwave ovens as source of interference, 388****MIMO (multiple-input, multiple-output) systems, 56****mitigating free space path loss, 74-76****mobility anchors, creating for guest networks, 330-331****mobility groups, 252-255****modulation, 25-26,**

- 802.11n standard, 61

- DBPSK, 28-29

DQPSK, 29  
 monopole antennas, 94  
 moving between a BSS (clients),  
 140-142  
 MRC (maximal-ratio combining), 61  
 MSCHAPv2 (Microsoft Challenge  
 Authentication Protocol), 295  
 multi-floor buildings, cell layout,  
 159-161

## N

---

N+1 redundancy, 231  
 N+N redundancy, 232  
 N+N+1 redundancy, 232-233  
 narrowband transmissions, 26  
 NAV (network allocation vector) timer,  
 131-132  
 NCS (Cisco Prime Network Control  
 System), 197  
   displaying RRM results, 278  
   wireless client connectivity,  
   troubleshooting, 44-45  
 neighboring channel interference,  
 71-72  
 net loss in signal strength, measuring,  
 19-20  
 noise, 386  
 non-802.11 interference, 72  
 non-overlapping channels, 49  
   DCA, 272

## O

---

OFDM (orthogonal frequency-division  
 multiplexing), 26, 31-32  
 omnidirectional antennas, 94-96  
   dipole antennas, 94  
   integrated omnidirectional antennas, 96

  monopole antennas, 94  
 open authentication, 290-291  
 outdoor bridges, 118  
 overlapping channels, DCA, 272

## P

---

PAC (protected access credential), 294  
 parabolic dish antennas, 99-100  
 passive scans, 137  
 patch antennas, 96-98  
 PEAP (Protected EAP), 294-295  
 performing link tests, 411  
 personal mode authentication (WPA),  
 297  
   configuring, 299-300  
 phase, 14  
 physical carrier sense, 131  
 ping tests, performing, 411  
 PKC (proactive key caching), 246  
 polarization, 92-93  
 ports  
   on APs, 167-168  
   connecting WLC to switched network,  
   204-206  
 power  
   absolute power measurement, 16  
   dB, 17-19  
   link budget, 22  
   at receiving end, 23-24  
   TPC, 269-271  
 power conservation on wireless clients,  
 142-144  
 preparing for exam, 453-454  
   Cisco Certification Exam Tutorial,  
   446-452  
   time management, 452-453

**privacy**

CCMP, 296

message privacy, 287-288

WEP, 291-292

probes, 135

Project 802, 46

protected mode transmission (802.11g),  
53-54

protecting message privacy, 287-288

PS-Poll frames, 136

**Q**QAM (quadrature amplitude  
modulation), 32QoS (Quality of Service), configuring  
on WLANs, 317QPSK (quadrature phase shift keying),  
32**R**

radiation patterns, 88-91

radio chains, 56

RADIUS server, configuring for  
WLANs, 310

RC4 cipher algorithm, 291

real-time processes of autonomous  
APs, 187

reassociation frames, 135

rebooting controllers, 436-437

receivers

loss of signal strength, measuring,  
19-20

power levels, 23-24

redundancy

AP SSO redundancy, 233-235

N+1 redundancy, 231

N+N redundancy, 232

N+N+1 redundancy, 232-233

reflection, 76-77

refraction, 79

regions in ITU-R, 41

regulatory bodies, 41-45

ETSI, 44-45

FCC, 42-44

*EIRP, 43-44**transmitter requirements, 44*

ITU-R, 41-42

repeater mode, 116

reports (WCS), generating, 377-380

RF (radio frequency), 11-13

absolute power measurement, 16

absorption, 78

amplitude, 15

antennas, 20-21

*EIRP, measuring, 21-22*bands of frequency, 2.4 GHz ISM  
band, 47-49

carrier signals, 24

channel aggregation, 57-58

diffraction, 80

free space path loss, 72-76

*calculating, 73-74**mitigating, 74-76*

Fresnel zones, 80-82

interference, 386-389

*Bluetooth as source of, 386-387**cordless phones as source of, 388**microwave ovens as source of,  
388**rogue APs, 386**WiMAX as source of, 388-389**ZigBee as source of, 387*

MAC layer efficiency, 59-60

- modulation, 25-26
    - DBPSK*, 28-29
    - DQPSK*, 29
  - narrowband transmissions, 26
  - non-overlapping channels, 49
  - phase, 14
  - receiver power levels, 23-24
  - reflection, 76-77
  - refraction, 79
  - scattering, 78-79
  - signal strength, 15-17
  - spatial multiplexing, 58-59
  - spread spectrum
    - DSSS*, 27-28
    - FHSS*, 26-27
  - watts, 15
  - RF groups, 267-269**
  - RFC 5415, 224**
  - RIFS (reduced interframe space), 132**
  - roaming process, 155-157**
    - with autonomous APs, 242-244
    - intercontroller roaming, 246-255
      - Layer 2 roaming*, 247
      - Layer 3 roaming*, 248-252
      - mobility groups*, 252-255
    - intracontroller roaming, 244-246
    - key exchanges, 246
  - rogue APs, 290, 386**
  - rogue clients, 290**
  - rope analogy of wireless networks, 8**
  - RP-TNC (reverse-polarity threaded Neill-Concelman) connectors, 43**
  - RRM (Radio Resource Management), 265-278**
    - CHDM, 274-275
    - DCA, 272
    - ED-RRM, 272
    - manual RF configuration, 276-278
    - results, displaying in NCS maps, 278
    - RF groups, 267-269
    - TPC, 269-271
  - RSSI (received signal strength indicator) scale, 23-24**
  - RTS/CTS frames, 136**
- ## S
- 
- saving controller configuration files, 437-438**
  - scanning for APs, 137**
  - scattering, 78-79**
  - scrambling, 27**
  - security**
    - authentication, 286-287
      - 802.1x*, 292-293
      - EAP*, 292-293
      - EAP-FAST*, 294
      - EAP-TLS*, 295
      - LEAP*, 294
      - open authentication*, 290-291
      - PEAP*, 294-295
      - personal mode authentication (WPA)*, 297
      - supported schemes in CCX versions*, 354-355
      - WEP*, 291-292
    - CCMP, 296
    - integrity
      - MIC*, 288-289
      - TKIP*, 295-296
    - intrusion protection, 289-290
    - message privacy, 287-288
    - MFP, 298
    - MIC, 288-289

- shared-key security, 292
- WLAN, configuring, 315-317
- WPA, 297
  - enterprise mode authentication, configuring, 300-302*
  - personal mode authentication, configuring, 299-300*
- WPA2, 297
  - enterprise mode authentication, configuring, 300-302*
  - personal mode authentication, configuring, 299-300*
- selecting WLC, 227-228
- self-assessment quizzes
  - answers
    - chapter 1, 456-458*
    - chapter 2, 458*
    - chapter 3, 459*
    - chapter 4, 459-460*
    - chapter 5, 460-461*
    - chapter 6, 461*
    - chapter 7, 461-462*
    - chapter 8, 462-463*
    - chapter 9, 463-464*
    - chapter 10, 464*
    - chapter 11, 464-465*
    - chapter 12, 465-466*
    - chapter 13, 466*
    - chapter 14, 467*
    - chapter 15, 467-468*
    - chapter 16, 468*
    - chapter 17, 468-469*
    - chapter 18, 469*
    - chapter 19, 469-470*
    - chapter 20, 470*
    - chapter 21, 471*
- chapter 1, 2-6
- chapter 2, 36-40
- chapter 3, 66-69
- chapter 4, 84-87
- chapter 5, 104-107
- chapter 6, 122-125
- chapter 7, 146-149
- chapter 8, 162-165
- chapter 9, 180-183
- chapter 10, 200-203
- chapter 11, 220-223
- chapter 12, 238-242
- chapter 13, 258-261
- chapter 14, 282-284
- chapter 15, 306-308
- chapter 16, 322-324
- chapter 17, 334-337
- chapter 18, 358-361
- chapter 19, 382-385
- chapter 20, 400-404
- chapter 21, 426-429
- sending messages to trap receivers, 440-443
- shared-key security, 292
- show run-config command, 439
- SIFS (short interframe space), 132
- signal bandwidth, 12
- signal strength (RF), 15-17
  - free space path loss, 72-76
    - calculating, 73-74*
    - mitigating, 74-76*
  - link budget, 22
  - loss in, measuring, 19-20
  - RSSI, 23-24
  - watts, 15
- SISO (single-in, single-out) systems, 56

SNMP, sending messages to trap receivers, 440-443

SNR (signal-to-noise ratio), 75

sources of interference, 389

- Bluetooth, 386-387
- cordless phones, 388
- microwave ovens, 388
- WiMAX, 388-389

spatial multiplexing, 58-59

spectral mask, 13

split-MAC architecture, 188-190

spread spectrum, 26

- DSSS, 27-28
  - 11-Mbps data rate, 30*
  - 1-Mbps data rate, 28-29*
  - 2-Mbps data rate, 29*
  - 5.5-Mbps data rate, 30*
- FHSS, 26-27
- OFDM, 31-32

SSID (service set identifier), 111

- bridging to VLANs, 166-167

state machine, 224

STP (Spanning Tree Protocol), 186

study groups, 47

subchannels, 31

SuperAG as source of interference, 389

supplicants, 293

supported data rates (APs), 136

## T

---

task groups, 47

telecommunications regulatory bodies, 41

three-dimensional channel layout, 159-161

TIM (traffic indication map), 143

time management, preparing for exam, 452-453

timing schemes, 132-133

TKIP (Temporal Key Integrity Protocol), 295-296

TLS (Transport Layer Security), 294

- EAP-TLS, 295

TNC (threaded Neill-Concelman) connectors, 43

topologies for wireless networks, 109-119

- BSS, 110-111
  - DS, 112-114*
- ESS, 114-115
- IBSS, 115-116
- mesh network, 119
- outdoor bridge, 118
- repeater mode, 116
- WGB, 117-118

TPC (transmit power control), 269-271

traffic patterns in CUWN, 190-191

translational bridging, 112

transmitters

- absolute power measurement, 16-17
- antennas, 20-21
  - adding accessories, 101-102*
  - amplifiers, 101*
  - attenuators, 102*
  - beamwidth, 92*
  - directional antennas, 96-100*
  - EIRP, measuring, 21-22*
  - gain, 91*
  - lightning arrestors, 102*
  - omnidirectional, 94-96*
  - polarization, 92-93*
  - radiation patterns, 88-91*

ETSI requirements, 45



FCC requirements, 44

interference

- co-channel interference*, 70-71
- neighboring channel interference*, 71-72
- non-802.11 interference*, 72

loss in signal strength, measuring, 19-20

narrowband transmissions, 26

power level, effect on AP cell size, 150-151

**trap logs, 439-443**

- sending to trap receivers, 440-443
- viewing, 440

**troubleshooting**

- AP connectivity, 420-424
  - AP-to-network connectivity, verifying*, 422-423
  - AP-to-WLC connectivity, verifying*, 420-421
- wireless client connectivity, 405-419
  - associations*, 405-406
  - from controller*, 41-410
  - link tests, performing*, 411
  - from WCS/NCS*, 44-45

**tuning cell size of APs, 150-153**

- with data rates, 152-153
- with transmit power, 150-151

**two-dimensional channel layout, 157-160**

**TxBF (transmit beam forming), 60-61**

## U

---

**U-APSD (unscheduled automatic power delivery), 144**

**unidirectional communication, 109**

**U-NII (Unlicensed National Information**

**Infrastructure), 42**

- 5-GHz bands, 49-51

**unlicensed bands, 42**

**uploading configuration files to PC, 438**

**uWGB (universal workgroup bridge), 118**

## V

---

**verifying**

- AP-to-network connectivity, 422-423
- AP-to-WLC connectivity, 420-421

**video cameras as source of interference, 389**

**viewing**

- map information, 375-376
- trap logs, 440

**virtual carrier sense, 131**

**VLANs, bridging to SSIDs, 166-167**

## W

---

**W (watts), 15**

**wave propagation, 8-9**

- cycles, 10
- frequency, 10-13
  - benefits of*, 362

**wavelength, measuring, 14-15**

**WCS (Wireless Control System), 197.**  
*See also* NCS (Cisco Prime Network Control System)

**controllers**

- adding*, 368-369
- configuring*, 368-370

home page, 363

- Alarm Summary dashboard*, 364-365
- home area*, 366-367

- main navigation area, 366*
- licensing, 363
- login screen, 363
- maps, 370
  - APs, manipulating, 373-374*
  - displaying, 370-372*
  - viewing information, 375-376*
- reports, generating, 377-380
- wireless client connectivity,
  - troubleshooting, 44-45
- web browser, initial WLC configuration, 208-216**
- websites**
  - ETSI, 44
  - FCC, 42
  - IEEE, 45
  - ITU-R, 41
  - Wi-Fi Alliance, 63
- WEP (Wired Equivalent Privacy), 135, 291-292**
- WGB (workgroup bridge), 117-118**
- Wi-Fi Alliance, WPA, 297**
- WiGig (Wireless Gigabit Alliance), 62**
- WiMAX as source of interference, 388-389**
- Windows 8, wireless client configuration, 338-340**
- wIPS (wireless intrusion protection system), 289-290**
- wired networks**
  - comparing with wireless, 7
  - DS, 112-114
  - limitations of, 7
- wireless clients**
  - Android, configuring, 345
  - Apple OS X, configuring, 345
  - authentication, 286-287
    - open authentication, 290-291*
    - WEP, 291-292*
- CCX, 352-354
  - feature support, 352-353*
  - goals of, 352*
- CCX Lite, 354
- Cisco AnyConnect Secure Mobility Client, configuring, 348-350
- connectivity
  - associations, 405-406*
  - troubleshooting, 405-419*
- conserving power, 142-144
- debugging, 44-415
- Intel PROSet, configuring, 341-344
- joining a BSS, 139-140
- leaving a BSS, 139-140
- moving between a BSS, 140-142
- rogue clients, 290
- scanning for APs, 137
- Windows 7/8, configuring, 338-340
- wireless networks**
  - APs, repeater mode, 116
  - collision avoidance, 132-134
  - comparing with wired, 7
  - distributed architecture, 184-186
  - electromagnetic waves, 9
  - frequency, 10-13
    - 5-GHz frequency bands, 12*
    - bands of frequency, 11*
    - channels, 12-13*
    - Hz, 10*
    - phase, 14*
    - RF, 11-13*
    - signal bandwidth, 12*
  - rope analogy, 8
  - topologies, 109-119

- BSS, 110-111*
  - ESS, 114-115*
  - IBSS, 115-116*
  - mesh network, 119*
  - outdoor bridge, 118*
  - WGB, 117-118*
  - wave propagation, 8-9
    - cycles, 10*
  - wireless LANs, 108
  - WLANs, 108
  - WMANs, 108
  - WPANs, 108
  - WWANs, 109
  - WiSM2 (Wireless Service Module 2), 192**
  - WLANs (wireless local-area networks), 108, 309-310**
    - advanced settings, configuring, 318-319
    - channel layout, 157-161
    - configuring, 310-312, 315-319
    - creating, 313-315
    - dynamic interface, configuring, 312
    - QoS, configuring, 317
    - RADIUS server, configuring, 310
    - security, configuring, 315-317
  - WLC (wireless LAN controller), 190**
    - configuration files
      - displaying, 439*
      - saving, 437-438*
      - uploading to PC, 438*
    - configuring
      - with CLI, 216-217*
      - with web browser, 208-216*
    - connecting to switched network, 204-217
      - using controller interfaces, 205-208*
      - using controller ports, 204-206*
    - as CUWN building block, 192-194
    - discovering, 226-227
    - management interface, accessing, 430-432
    - selecting, 227-228
    - trap logs, 439-443
  - WMANs (wireless metropolitan-area networks), 108**
  - WMM (Wireless Multimedia), 144**
  - working groups, 46**
  - WPA (Wi-Fi Protected Access), 297**
    - personal mode authentication, configuring, 299-300
  - WPA2 (Wi-Fi Protected Access version 2), 297**
    - local EAP, configuring, 302-305
    - personal mode authentication, configuring, 299-300
  - WPANs (wireless personal-area networks), 108**
  - WWANs (wireless wide-area networks), 109**
- ## X-Y-Z
- 
- Xbox as source of interference, 389
  - Yagi-Uda antennas, 98-99
  - zero gain antennas, 91
  - ZigBee as source of interference, 387