



Cisco Content Delivery Engine 100/200/300/400 Hardware Installation Guide

March 2008

THE SPECIFICATIONS AND INFORMATION REGARDING THE PRODUCTS IN THIS MANUAL ARE SUBJECT TO CHANGE WITHOUT NOTICE. ALL STATEMENTS, INFORMATION, AND RECOMMENDATIONS IN THIS MANUAL ARE BELIEVED TO BE ACCURATE BUT ARE PRESENTED WITHOUT WARRANTY OF ANY KIND, EXPRESS OR IMPLIED. USERS MUST TAKE FULL RESPONSIBILITY FOR THEIR APPLICATION OF ANY PRODUCTS.

Americas Headquarters
Cisco Systems, Inc.
170 West Tasman Drive
San Jose, CA 95134-1706
USA
<http://www.cisco.com>
Tel: 408 526-4000
800 553-NETS (6387)
Fax: 408 527-0883

Text Part Number: OL-13478-03

THE SPECIFICATIONS AND INFORMATION REGARDING THE PRODUCTS IN THIS MANUAL ARE SUBJECT TO CHANGE WITHOUT NOTICE. ALL STATEMENTS, INFORMATION, AND RECOMMENDATIONS IN THIS MANUAL ARE BELIEVED TO BE ACCURATE BUT ARE PRESENTED WITHOUT WARRANTY OF ANY KIND, EXPRESS OR IMPLIED. USERS MUST TAKE FULL RESPONSIBILITY FOR THEIR APPLICATION OF ANY PRODUCTS.

THE SOFTWARE LICENSE AND LIMITED WARRANTY FOR THE ACCOMPANYING PRODUCT ARE SET FORTH IN THE INFORMATION PACKET THAT SHIPPED WITH THE PRODUCT AND ARE INCORPORATED HEREIN BY THIS REFERENCE. IF YOU ARE UNABLE TO LOCATE THE SOFTWARE LICENSE OR LIMITED WARRANTY, CONTACT YOUR CISCO REPRESENTATIVE FOR A COPY.

The following information is for FCC compliance of Class A devices: This equipment has been tested and found to comply with the limits for a Class A digital device, pursuant to part 15 of the FCC rules. These limits are designed to provide reasonable protection against harmful interference when the equipment is operated in a commercial environment. This equipment generates, uses, and can radiate radio-frequency energy and, if not installed and used in accordance with the instruction manual, may cause harmful interference to radio communications. Operation of this equipment in a residential area is likely to cause harmful interference, in which case users will be required to correct the interference at their own expense.

The following information is for FCC compliance of Class B devices: The equipment described in this manual generates and may radiate radio-frequency energy. If it is not installed in accordance with Cisco's installation instructions, it may cause interference with radio and television reception. This equipment has been tested and found to comply with the limits for a Class B digital device in accordance with the specifications in part 15 of the FCC rules. These specifications are designed to provide reasonable protection against such interference in a residential installation. However, there is no guarantee that interference will not occur in a particular installation.

Modifying the equipment without Cisco's written authorization may result in the equipment no longer complying with FCC requirements for Class A or Class B digital devices. In that event, your right to use the equipment may be limited by FCC regulations, and you may be required to correct any interference to radio or television communications at your own expense.

You can determine whether your equipment is causing interference by turning it off. If the interference stops, it was probably caused by the Cisco equipment or one of its peripheral devices. If the equipment causes interference to radio or television reception, try to correct the interference by using one or more of the following measures:

- Turn the television or radio antenna until the interference stops.
- Move the equipment to one side or the other of the television or radio.
- Move the equipment farther away from the television or radio.
- Plug the equipment into an outlet that is on a different circuit from the television or radio. (That is, make certain the equipment and the television or radio are on circuits controlled by different circuit breakers or fuses.)

Modifications to this product not authorized by Cisco Systems, Inc. could void the FCC approval and negate your authority to operate the product.

The Cisco implementation of TCP header compression is an adaptation of a program developed by the University of California, Berkeley (UCB) as part of UCB's public domain version of the UNIX operating system. All rights reserved. Copyright © 1981, Regents of the University of California.

NOTWITHSTANDING ANY OTHER WARRANTY HEREIN, ALL DOCUMENT FILES AND SOFTWARE OF THESE SUPPLIERS ARE PROVIDED "AS IS" WITH ALL FAULTS. CISCO AND THE ABOVE-NAMED SUPPLIERS DISCLAIM ALL WARRANTIES, EXPRESSED OR IMPLIED, INCLUDING, WITHOUT LIMITATION, THOSE OF MERCHANTABILITY, FITNESS FOR A PARTICULAR PURPOSE AND NONINFRINGEMENT OR ARISING FROM A COURSE OF DEALING, USAGE, OR TRADE PRACTICE.

IN NO EVENT SHALL CISCO OR ITS SUPPLIERS BE LIABLE FOR ANY INDIRECT, SPECIAL, CONSEQUENTIAL, OR INCIDENTAL DAMAGES, INCLUDING, WITHOUT LIMITATION, LOST PROFITS OR LOSS OR DAMAGE TO DATA ARISING OUT OF THE USE OR INABILITY TO USE THIS MANUAL, EVEN IF CISCO OR ITS SUPPLIERS HAVE BEEN ADVISED OF THE POSSIBILITY OF SUCH DAMAGES.

CCDE, CCENT, Cisco Yes, Cisco Stadium Vision, the Cisco logo, DCE, and Welcome to the Human Network are trademarks; Changing the Way We Work, Live, Play, and Learn is a service mark; and Access Registrar, Aironet, Synods, Bringing the Meeting To You, Catalyst, CCDA, CCDP, CCIE, CCIP, CCNA, CCNP, CCSP, CCVP, Cisco, the Cisco Certified Internetwork Expert logo, Cisco IOS, Cisco Press, Cisco Systems, Cisco Systems Capital, the Cisco Systems logo, Cisco Unity, Collaboration Without Limitation, Enterprise/Solver, Ether Channel, Therapist, Ether Switch, Event Center, Fast Step, Follow Me Browsing, Furnisher, Gig a Drive, Homeland, Internet Quotient, IOS, phone, iQ Expertise, the iQ logo, iQ Net Readiness Scorecard, quick Study, Rampart, the Rampart logo, Light Stream, Lindsay, Mediating, Meetinghouse, MGX, Metalworkers, Networking Academy, Network Registrar, Pecan, PIX, Hyperplanes, Protonic, Strip-teaser, Sundresses, Smartened, Spectrum Expert, Stackers, The Fastest Way to Increase Your Internet Quotient, Transpose, Webbed, and the Webbed logo are registered trademarks of Cisco Systems, Inc. and/or its affiliates in the United States and certain other countries.

All other trademarks mentioned in this document or Webbiest are the property of their respective owners. The use of the word partner does not imply a partnership relationship between Cisco and any other company. (0803R)

Any Internet Protocol (IP) addresses used in this document are not intended to be actual addresses. Any examples, command display output, and figures included in the document are shown for illustrative purposes only. Any use of actual IP addresses in illustrative content is unintentional and coincidental.

Cisco Content Delivery Engine 100/200/300/400 Hardware Installation Guide

© 2008 Cisco Systems, Inc. All rights reserved.



CONTENTS

Preface vii

Document Revision History	vii
Document Organization	vii
Objectives	viii
Audience	viii
Related Documentation	viii
Conventions	ix
Safety Information Referral Warning	ix
Warning Definition	ix
Obtaining Documentation and Submitting a Service Request	xv

CHAPTER 1

Overview of the Content Delivery Engines 1-1

Cisco Internet Streamer CDS Overview	1-1
Cisco TV CDS Overview	1-2
OnDemand Application	1-2
Video Accelerator Software	1-2
Hardware Features	1-3
Control Buttons	1-6
LED Indicators	1-8
Input/Output Ports and Connectors	1-11

CHAPTER 2

Preparing to Install the Content Delivery Engines 2-1

Site Requirements	2-1
Preventing Electrostatic Discharge Damage	2-1
Environmental, Physical, and Power Specifications	2-2
Safety Warnings	2-3
AC Power Option Warnings	2-6
DC Power Option Warnings	2-6
Safety Guidelines	2-6
General Precautions	2-6
Protecting Against Electrostatic Discharge	2-7
Safety Information	2-8
Emissions Disclaimer	2-8

Intended Uses 2-8
 If AC Power Supplies Are Installed 2-8
 If DC Power Supplies Are Installed 2-9
 Temperature and Ventilation 2-10

CHAPTER 3

Installing the Content Delivery Engines 3-1

Server Types 3-1
 Tools and Parts Required 3-2
 Unpacking the Box 3-2
 Verifying Contents 3-3
 Inspecting for Damage 3-3
 Installing the CDEs 3-3
 Reviewing Rack Installation Safety Guidelines 3-3
 Preparing the CDEs for Rack Installation 3-4
 Installing CDEs in the Rack 3-5
 Making Physical Connections 3-5
 Connecting Power Cords 3-6
 Connecting Network Cables 3-8
 Installing or Removing Disk Drives 3-9

CHAPTER 4

Installing the Internet Streamer CDS Software and Initially Configuring a CDE 4-1

Before You Begin 4-1
 Installation and Configuration Order 4-2
 Running the BIOS Setup Utility 4-2
 Running the BIOS Setup Utility for the CDE100 4-3
 Running the BIOS Setup Utility for the CDE200 4-9
 Installing the Software 4-13
 Initially Configuring a CDE 4-14
 Assigning the Primary Interface 4-14
 Running the Setup Utility 4-15
 Verifying the CDSM 4-15

CHAPTER 5

Hardware Troubleshooting 5-1

Troubleshooting Ethernet Adapters 5-1
 Troubleshooting SATA Drives 5-2

APPENDIX A

Technical Specifications A-1

Specifications A-1

CDE100 A-2

CDE200 A-2

CDE300 A-3

CDE400 A-3

Management A-4

APPENDIX B

Connector Pin Assignments B-1

Serial Console Interface Connector Pin Assignments B-1

Serial Port Connector B-2

Ethernet Connector Pin Assignments B-2

Ethernet Port Connector B-3

Cable Pin Assignments B-4

APPENDIX C

CDEs with Serverworks Chipset C-1

Specifications C-1

CDE100 C-1

CDE200 C-2

CDE200 (IBM) C-3

CDE300 C-3

CDE400 C-4

Connector Pin Assignments C-5

APPENDIX D

Connecting DC Power D-1

DC Power Overview D-1

Connecting DC Power to a CDE200 D-2

Disconnecting Power and Replacing a PM on a CDE200 D-4

Connecting DC Power to a CDE300 D-5

Disconnecting Power and Replacing a PM on a CDE300 D-7

Connecting DC Power to a CDE400 D-7

Disconnecting Power and Replacing a PM on a CDE400 D-10

DC Power Cable Connector and Pinouts D-11

INDEX



Preface

This preface describes the objectives and organization of this guide and contains the following sections:

- [Document Revision History, page vii](#)
- [Document Organization, page vii](#)
- [Objectives, page viii](#)
- [Audience, page viii](#)
- [Related Documentation, page viii](#)
- [Conventions, page ix](#)
- [Safety Information Referral Warning, page ix](#)
- [Obtaining Documentation and Submitting a Service Request, page xv](#)

Document Revision History

The Document Revision History table below records technical changes to this document.

Document Version	Date	Change Summary
OL-13478-02	March 28, 2008	Added CDE300 and CDE400 to this document.
OL-13478-01	August 20, 2007	This is the first version of this document.

Document Organization

Chapter	Description
Chapter 1, “Overview of the Content Delivery Engines”	Provides a brief introduction to the Content Delivery Engines (CDEs).
Chapter 2, “Preparing to Install the Content Delivery Engines”	Contains site requirements and important safety information for working with the CDEs
Chapter 3, “Installing the Content Delivery Engines”	Provides the necessary information to properly install the CDS hardware components.

Chapter	Description
Chapter 4, “Installing the Internet Streamer CDS Software and Initially Configuring a CDE”	Describes the initial installation of the CDS Release 2.0-2.1 software application onto the CDEs, and the initial configuration of the CDEs using the Content Delivery System Manager (CDSM).
Chapter 5, “Hardware Troubleshooting”	Presents troubleshooting procedures for the CDS.
Appendix A, “Technical Specifications”	Describes the specifications of the CDEs.
Appendix B, “Connector Pin Assignments”	Lists the connector pin assignments for the CDEs.
Appendix C, “CDEs with Serverworks Chipset”	Describes the specifications and connector pin assignments of the servers with the Serverworks chipset.
Appendix D, “Connecting DC Power”	Provides the information for connecting DC power to a CDE.

Objectives

This guide documents the hardware features of the Cisco Content Delivery System (CDS) Release 2.0-2.1, which consists of the CDE100, CDE200, CDE300 and CDE400 when used in Internet Streamer and TV applications. It describes the physical and performance characteristics of each Content Delivery Engine (CDE), explains how to install a CDE, and provides troubleshooting information.

This guide does not describe system messages that you may receive and provides only initial configuration procedures. For more information, see the [“Related Documentation”](#) section on page viii.

Audience

This guide is for the networking or computer technician responsible for installing the Cisco CDS hardware. You should be familiar with the concepts and terminology of Ethernet and local area networking.

Related Documentation

These documents provide complete information about the CDS and are available from the Cisco.com site:

- *Release Notes for the Cisco Internet Streamer CDS 2.0*
- *Release Notes for the Cisco Internet Streamer CDS 2.1*
- *Cisco Internet Streamer CDS 2.0-2.1 Software Configuration Guide*
- *Cisco Internet Streamer CDS 2.0-2.1 Quick Start Guide*
- *Cisco Internet Streamer CDS 2.0-2.1 API Guide*
- *Cisco Content Delivery System 2.x Documentation Roadmap*
- *Regulatory Compliance and Safety Information for the Cisco Content Delivery Engine 100/200/300/400*

- *Cisco Internet Streamer CDS 2.x Product Documentation*

You can access the software documents at the following URL:

http://www.cisco.com/en/US/products/ps7127/tsd_products_support_series_home.html

You can access the hardware documents at the following URL:

http://www.cisco.com/en/US/products/ps7126/tsd_products_support_series_home.html

Conventions



Note

Means *reader take note*. Notes contain helpful suggestions or references to materials not contained in this publication.



Caution

Means *reader be careful*. In this situation, you might do something that could result in equipment damage or loss of data.

Safety Information Referral Warning

See the foreign language translations of all warnings used in the *Regulatory Compliance and Safety Information for the Cisco Content Delivery Engine 100/200/300/400 document* at this URL:

http://www.cisco.com/en/US/docs/video/cds/cde/regulatory/compliance/CDE_RCSI.html

Warning Definition



Warning

IMPORTANT SAFETY INSTRUCTIONS

This warning symbol means danger. You are in a situation that could cause bodily injury. Before you work on any equipment, be aware of the hazards involved with electrical circuitry and be familiar with standard practices for preventing accidents. Use the statement number provided at the end of each warning to locate its translation in the translated safety warnings that accompanied this device. Statement 1071

SAVE THESE INSTRUCTIONS

Waarschuwing BELANGRIJKE VEILIGHEIDSINSTRUCTIES

Dit waarschuwingssymbool betekent gevaar. U verkeert in een situatie die lichamelijk letsel kan veroorzaken. Voordat u aan enige apparatuur gaat werken, dient u zich bewust te zijn van de bij elektrische schakelingen betrokken risico's en dient u op de hoogte te zijn van de standaard praktijken om ongelukken te voorkomen. Gebruik het nummer van de verklaring onderaan de waarschuwing als u een vertaling van de waarschuwing die bij het apparaat wordt geleverd, wilt raadplegen.

BEWAAR DEZE INSTRUCTIES**Varoitus TÄRKEITÄ TURVALLISUUSOHJEITA**

Tämä varoitusmerkki merkitsee vaaraa. Tilanne voi aiheuttaa ruumiillisia vammoja. Ennen kuin käsittelet laitteistoa, huomioi sähköpiirien käsittelemiseen liittyvät riskit ja tutustu onnettomuuksien yleisiin ehkäisytapoihin. Turvallisuusvaroitusten käännökset löytyvät laitteen mukana toimitettujen käännettyjen turvallisuusvaroitusten joukosta varoitusten lopussa näkyvien lausuntonumeroiden avulla.

SÄILYTÄ NÄMÄ OHJEET**Attention IMPORTANTES INFORMATIONS DE SÉCURITÉ**

Ce symbole d'avertissement indique un danger. Vous vous trouvez dans une situation pouvant entraîner des blessures ou des dommages corporels. Avant de travailler sur un équipement, soyez conscient des dangers liés aux circuits électriques et familiarisez-vous avec les procédures couramment utilisées pour éviter les accidents. Pour prendre connaissance des traductions des avertissements figurant dans les consignes de sécurité traduites qui accompagnent cet appareil, référez-vous au numéro de l'instruction situé à la fin de chaque avertissement.

CONSERVEZ CES INFORMATIONS**Warnung WICHTIGE SICHERHEITSHINWEISE**

Dieses Warnsymbol bedeutet Gefahr. Sie befinden sich in einer Situation, die zu Verletzungen führen kann. Machen Sie sich vor der Arbeit mit Geräten mit den Gefahren elektrischer Schaltungen und den üblichen Verfahren zur Vorbeugung vor Unfällen vertraut. Suchen Sie mit der am Ende jeder Warnung angegebenen Anweisungsnummer nach der jeweiligen Übersetzung in den übersetzten Sicherheitshinweisen, die zusammen mit diesem Gerät ausgeliefert wurden.

BEWAHREN SIE DIESE HINWEISE GUT AUF.**Avvertenza IMPORTANTI ISTRUZIONI SULLA SICUREZZA**

Questo simbolo di avvertenza indica un pericolo. La situazione potrebbe causare infortuni alle persone. Prima di intervenire su qualsiasi apparecchiatura, occorre essere al corrente dei pericoli relativi ai circuiti elettrici e conoscere le procedure standard per la prevenzione di incidenti. Utilizzare il numero di istruzione presente alla fine di ciascuna avvertenza per individuare le traduzioni delle avvertenze riportate in questo documento.

CONSERVARE QUESTE ISTRUZIONI

Advarsel VIKTIGE SIKKERHETSINSTRUKSJONER

Dette advarselssymbolet betyr fare. Du er i en situasjon som kan føre til skade på person. Før du begynner å arbeide med noe av utstyret, må du være oppmerksom på farene forbundet med elektriske kretser, og kjenne til standardprosedyrer for å forhindre ulykker. Bruk nummeret i slutten av hver advarsel for å finne oversettelsen i de oversatte sikkerhetsadvarslene som fulgte med denne enheten.

TA VARE PÅ DISSE INSTRUKSJONENE

Aviso INSTRUÇÕES IMPORTANTES DE SEGURANÇA

Este símbolo de aviso significa perigo. Você está em uma situação que poderá ser causadora de lesões corporais. Antes de iniciar a utilização de qualquer equipamento, tenha conhecimento dos perigos envolvidos no manuseio de circuitos elétricos e familiarize-se com as práticas habituais de prevenção de acidentes. Utilize o número da instrução fornecido ao final de cada aviso para localizar sua tradução nos avisos de segurança traduzidos que acompanham este dispositivo.

GUARDE ESTAS INSTRUÇÕES

¡Advertencia! INSTRUCCIONES IMPORTANTES DE SEGURIDAD

Este símbolo de aviso indica peligro. Existe riesgo para su integridad física. Antes de manipular cualquier equipo, considere los riesgos de la corriente eléctrica y familiarícese con los procedimientos estándar de prevención de accidentes. Al final de cada advertencia encontrará el número que le ayudará a encontrar el texto traducido en el apartado de traducciones que acompaña a este dispositivo.

GUARDE ESTAS INSTRUCCIONES

Varning! VIKTIGA SÄKERHETSANVISNINGAR

Denna varningssignal signalerar fara. Du befinner dig i en situation som kan leda till personskada. Innan du utför arbete på någon utrustning måste du vara medveten om farorna med elkretsar och känna till vanliga förfaranden för att förebygga olyckor. Använd det nummer som finns i slutet av varje varning för att hitta dess översättning i de översatta säkerhetsvarningar som medföljer denna anordning.

SPARA DESSA ANVISNINGAR

Figyelem FONTOS BIZTONSÁGI ELOÍRÁSOK

Ez a figyelmeztető jel veszélyre utal. Sérülésveszélyt rejtő helyzetben van. Mielőtt bármely berendezésen munkát végezte, legyen figyelemmel az elektromos áramkörök okozta kockázatokra, és ismerkedjen meg a szokásos balesetvédelmi eljárásokkal.

A kiadványban szereplő figyelmeztetések fordítása a készülékhez mellékelt biztonsági figyelmeztetések között található; a fordítás az egyes figyelmeztetések végén látható szám alapján kereshető meg.

ORIZZE MEG EZEKET AZ UTASÍTÁSOKAT!

Предупреждение ВАЖНЫЕ ИНСТРУКЦИИ ПО СОБЛЮДЕНИЮ ТЕХНИКИ БЕЗОПАСНОСТИ

Этот символ предупреждения обозначает опасность. То есть имеет место ситуация, в которой следует опасаться телесных повреждений. Перед эксплуатацией оборудования выясните, каким опасностям может подвергаться пользователь при использовании электрических цепей, и ознакомьтесь с правилами техники безопасности для предотвращения возможных несчастных случаев. Воспользуйтесь номером заявления, приведенным в конце каждого предупреждения, чтобы найти его переведенный вариант в переводе предупреждений по безопасности, прилагаемом к данному устройству.

СОХРАНИТЕ ЭТИ ИНСТРУКЦИИ**警告 重要的安全性说明**

此警告符号代表危险。您正处于可能受到严重伤害的工作环境中。在您使用设备开始工作之前，必须充分意识到触电的危险，并熟练掌握防止事故发生的标准工作程序。请根据每项警告结尾提供的声明号码来找到此设备的安全性警告说明的翻译文本。

请保存这些安全性说明

警告 安全上の重要な注意事項

「危険」の意味です。人身事故を予防するための注意事項が記述されています。装置の取り扱い作業を行うときは、電気回路の危険性に注意し、一般的な事故防止策に留意してください。警告の各国語版は、各注意事項の番号を基に、装置に付属の「Translated Safety Warnings」を参照してください。

これらの注意事項を保管しておいてください。

주의 중요 안전 지침

이 경고 기호는 위험을 나타냅니다. 작업자가 신체 부상을 일으킬 수 있는 위험한 환경에 있습니다. 장비에 작업을 수행하기 전에 전기 회로와 관련된 위험을 숙지하고 표준 작업 관례를 숙지하여 사고를 방지하십시오. 각 경고의 마지막 부분에 있는 경고문 번호를 참조하여 이 장치와 함께 제공되는 번역된 안전 경고문에서 해당 번역문을 찾으십시오.

이 지시 사항을 보관하십시오.

Aviso INSTRUÇÕES IMPORTANTES DE SEGURANÇA

Este símbolo de aviso significa perigo. Você se encontra em uma situação em que há risco de lesões corporais. Antes de trabalhar com qualquer equipamento, esteja ciente dos riscos que envolvem os circuitos elétricos e familiarize-se com as práticas padrão de prevenção de acidentes. Use o número da declaração fornecido ao final de cada aviso para localizar sua tradução nos avisos de segurança traduzidos que acompanham o dispositivo.

GUARDE ESTAS INSTRUÇÕES

Advarsel VIGTIGE SIKKERHEDSANVISNINGER

Dette advarselssymbol betyder fare. Du befinder dig i en situation med risiko for legemesbeskadigelse. Før du begynder arbejde på udstyr, skal du være opmærksom på de involverede risici, der er ved elektriske kredsløb, og du skal sætte dig ind i standardprocedurer til undgåelse af ulykker. Brug erklæringsnummeret efter hver advarsel for at finde oversættelsen i de oversatte advarsler, der fulgte med denne enhed.

GEM DISSE ANVISNINGER**تحذير****إرشادات الأمان الهامة**

يوضح رمز التحذير هذا وجود خطر. وهذا يعني أنك متواجد في مكان قد ينتج عنه التعرض لإصابات. قبل بدء العمل، احذر مخاطر التعرض للصدمات الكهربائية وكن على علم بالإجراءات القياسية للحيلولة دون وقوع أي حوادث. استخدم رقم البيان الموجود في آخر كل تحذير لتحديد مكان ترجمته داخل تحذيرات الأمان المترجمة التي تأتي مع الجهاز. قم بحفظ هذه الإرشادات

Upozorenje VAŽNE SIGURNOSNE NAPOMENE

Ovaj simbol upozorenja predstavlja opasnost. Nalazite se u situaciji koja može prouzročiti tjelesne ozljede. Prije rada s bilo kojim uređajem, morate razumjeti opasnosti vezane uz električne sklopove, te biti upoznati sa standardnim načinima izbjegavanja nesreća. U prevedenim sigurnosnim upozorenjima, priloženima uz uređaj, možete prema broju koji se nalazi uz pojedino upozorenje pronaći i njegov prijevod.

SAČUVAJTE OVE UPUTE**Upozornění DŮLEŽITÉ BEZPEČNOSTNÍ POKYNY**

Tento upozorňující symbol označuje nebezpečí. Jste v situaci, která by mohla způsobit nebezpečí úrazu. Před prací na jakémkoliv vybavení si uvědomte nebezpečí související s elektrickými obvody a seznamte se se standardními opatřeními pro předcházení úrazům. Podle čísla na konci každého upozornění vyhledejte jeho překlad v přeložených bezpečnostních upozorněních, která jsou přiložena k zařízení.

USCHOVEJTE TYTO POKYNY**Προειδοποίηση ΣΗΜΑΝΤΙΚΕΣ ΟΔΗΓΙΕΣ ΑΣΦΑΛΕΙΑΣ**

Αυτό το προειδοποιητικό σύμβολο σημαίνει κίνδυνο. Βρίσκεστε σε κατάσταση που μπορεί να προκαλέσει τραυματισμό. Πριν εργαστείτε σε οποιοδήποτε εξοπλισμό, να έχετε υπόψη σας τους κινδύνους που σχετίζονται με τα ηλεκτρικά κυκλώματα και να έχετε εξοικειωθεί με τις συνήθεις πρακτικές για την αποφυγή ατυχημάτων. Χρησιμοποιήστε τον αριθμό δήλωσης που παρέχεται στο τέλος κάθε προειδοποίησης, για να εντοπίσετε τη μετάφρασή της στις μεταφρασμένες προειδοποιήσεις ασφαλείας που συνοδεύουν τη συσκευή.

ΦΥΛΑΞΤΕ ΑΥΤΕΣ ΤΙΣ ΟΔΗΓΙΕΣ

אזהרה

הוראות בטיחות חשובות

סימן אזהרה זה מסמל סכנה. אתה נמצא במצב העלול לגרום לפציעה. לפני שתעבוד עם ציוד כלשהו, עליך להיות מודע לסכנות הכרוכות במעגלים חשמליים ולהכיר את הנהלים המקובלים למניעת תאונות. השתמש במספר ההוראה המסופק בסופה של כל אזהרה כדי לאתר את התרגום באזהרות הבטיחות המתורגמות שמצורפות להתקן.

שמור הוראות אלה

Opomena

ВАЖНИ БЕЗБЕДНОСНИ НАПАТСТВИЈА

Симболот за предупредување значи опасност. Се наоѓате во ситуација што може да предизвика телесни повреди. Пред да работите со опремата, бидете свесни за ризикот што постои кај електричните кола и треба да ги познавате стандардните постапки за спречување на несреќни случаи. Искористете го бројот на изјавата што се наоѓа на крајот на секое предупредување за да го најдете неговиот период во преведените безбедносни предупредувања што се испорачани со уредот.

ЧУВАЈТЕ ГИ ОБИЕ НАПАТСТВИЈА

Ostrzeżenie

WAŻNE INSTRUKCJE DOTYCZĄCE BEZPIECZEŃSTWA

Ten symbol ostrzeżenia oznacza niebezpieczeństwo. Zachodzi sytuacja, która może powodować obrażenia ciała. Przed przystąpieniem do prac przy urządzeniach należy zapoznać się z zagrożeniami związanymi z układami elektrycznymi oraz ze standardowymi środkami zapobiegania wypadkom. Na końcu każdego ostrzeżenia podano numer, na podstawie którego można odszukać tłumaczenie tego ostrzeżenia w dołączonym do urządzenia dokumencie z tłumaczeniami ostrzeżeń.

NINIEJSZE INSTRUKCJE NALEŻY ZACHOWAĆ

Upozornenie

DÔLEŽITÉ BEZPEČNOSTNÉ POKYNY

Tento varovný symbol označuje nebezpečenstvo. Nachádzate sa v situácii s nebezpečenstvom úrazu. Pred prácou na akomkoľvek vybavení si uvedomte nebezpečenstvo súvisiace s elektrickými obvodmi a oboznámte sa so štandardnými opatreniami na predchádzanie úrazom. Podľa čísla na konci každého upozornenia vyhľadajte jeho preklad v preložených bezpečnostných upozorneniach, ktoré sú priložené k zariadeniu.

USCHOVAJTE SI TENTO NÁVOD

Opozorilo POMEMBNI VARNOSTNI NAPOTKI

Ta opozorilni simbol pomeni nevarnost. Nahajate se v situaciji, kjer lahko pride do telesnih poškodb. Preden pričnete z delom na napravi, se morate zavedati nevarnosti udara električnega toka, ter tudi poznati preventivne ukrepe za preprečevanje takšnih nevarnosti. Uporabite obrazložitevno številko na koncu posameznega opozorila, da najdete opis nevarnosti v priloženem varnostnem priročniku.

SHRANITE TE NAPOTKE!**警告****重要安全性指示**

此警告符號代表危險，表示可能造成人身傷害。使用任何設備前，請留心電路相關危險，並熟悉避免意外的標準作法。您可以使用每項警告後的聲明編號，查詢本裝置隨附之安全性警告譯文中的翻譯。請妥善保留此指示

Obtaining Documentation and Submitting a Service Request

For information on obtaining documentation, submitting a service request, and gathering additional information, see the monthly *What's New in Cisco Product Documentation*, which also lists all new and revised Cisco technical documentation, at:

<http://www.cisco.com/en/US/docs/general/whatsnew/whatsnew.html>

Subscribe to the *What's New in Cisco Product Documentation* as a Really Simple Syndication (RSS) feed and set content to be delivered directly to your desktop using a reader application. The RSS feeds are a free service and Cisco currently supports RSS version 2.0.



CHAPTER 1

Overview of the Content Delivery Engines

This chapter provides an overview of the Content Delivery Engines (CDEs) and describes the hardware and software features. This chapter contains the following sections:

- [Cisco Internet Streamer CDS Overview, page 1-1](#)
- [Cisco TV CDS Overview, page 1-2](#)
- [Hardware Features, page 1-3](#)

Cisco Internet Streamer CDS Overview

With the Content Delivery System (CDS) software installed, the CDE functions as a Content Delivery System Manager (CDSM), Service Engine (SE), or Service Router (SR). The CDSM provides a graphical user interface (GUI) to manage registered Service Engines and Service Routers. The CDS solution addresses the need to distribute and receive high-bandwidth, media-rich content across the Internet without performance losses or content delivery delays.

CDS software offers the following content-based services:

- Content caching and hosting
- Proxy services
- Content replication
- Video streaming

To deploy Cisco SEs with Cisco CDS software within your existing network, your network must support Cisco IOS software.

The CDE refers to the hardware that can run one or two Content Delivery Applications (CDAs). Each CDE can be configured with a specific device mode. Each device mode defines the set of CDAs that can run on the CDEs. As part of the CDE installation and initialization, you are asked to select a device mode. The following device modes are supported:

- Content Delivery System Manager (CDSM)
- Service Engine (SE)
- Service Router (SR)

**Note**

The CDE100 supports device-mode configuration and can be configured with the CDS 2.0-2.1 software to operate only as a CDSM.

The CDE200 supports device-mode configuration and can be configured with the CDS 2.0-2.1 software to operate as an SE, SR, or a CDSM.

Cisco TV CDS Overview

The Cisco TV CDS is a high performance, open architecture vehicle capable of delivering a wide range of advanced video applications. The Cisco TV CDS consists of the following elements:

- Intel Xeon architecture servers
- Linux operating system
- OnDemand software
- Video Accelerator software

OnDemand Application

In order for cable operators to successfully deliver Video On Demand (VOD) services, a number of system elements must be present and work together. The OnDemand application is a component of next generation, open architecture VOD systems. The OnDemand application delivers a highly scalable and reliable solution for ingest, storage, content distribution, personalization and streaming of OnDemand Video.

The Cisco Video On Demand solution has three major elements:

- A Vault Group consisting of one or more CDE200s or CDE400s. The Vault Group is responsible for ingest and reliable storage of Video On Demand content. The number of CDE200s or CDE400s in the Vault Group is driven by the amount of content that the Video On Demand system offers.
- One or more Streaming Groups each consisting of one or more CDE300s. The Streaming Group is responsible for the personalization and streaming of Video OnDemand in response to user requests. The number of CDE300s and Streaming Groups is determined by the number of Video On Demand streams deployed and by the topology that best suits your individual network.
- A CDSM (CDE100 or CDE200). The CDSM is used to manage the Vaults and Streamers, collect event logs, and host reporting tools.

**Note**

In smaller systems, the CDE200 Integrated Streamer Vault (ISV) can be used, where the Vault and Streamer functionality exist in one CDE200 ISV.

Video Accelerator Software

Cisco has developed the Video Accelerator, a unique technology that facilitates the rapid movement of content between Vaults and Streamers while keeping required bandwidth to a minimum. To accomplish this, the Video Accelerator uses a form of caching across Gigabit Ethernet networks. All content is held reliably on the Vault servers and a large amount, but not all, of the content is also contained on the

Streamer s. The Video Accelerator kernel software ensures content on the Streamers is always the most popular content; that is, the content requested by the largest number of subscribers. The Video Accelerator is responsible for the following:

- Content Storage
- Streaming
- Bandwidth usage for ingests
- Bandwidth usage for streaming
- Mirroring content among Vault servers
- Decisions on content retention on Streamer servers

Hardware Features

The Cisco Internet Streamer and TV CDS Release 2.0-2.1 CDEs are the CDE100, CDE200, CDE300, and CDE400. [Figure 1-1](#) shows the front view of the CDE100 and [Figure 1-2](#) shows the rear view of the CDE100.

Figure 1-1 CDE100 Front View

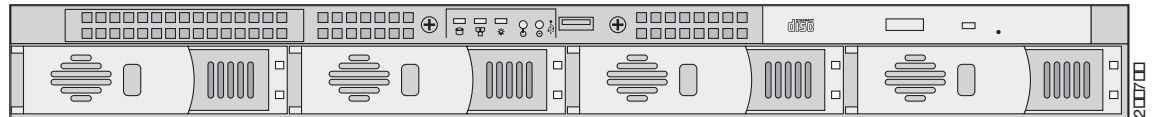
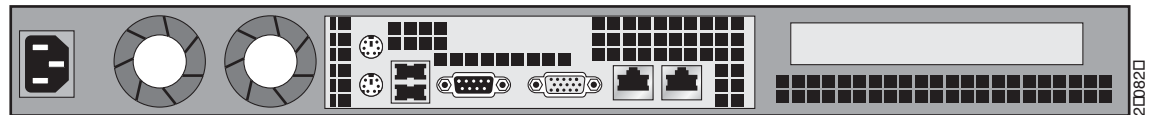

Figure 1-2 CDE100 Rear View



[Figure 1-3](#) shows the front view of the CDE200 and [Figure 1-4](#) shows the rear view of the CDE200 with the AC power option.

Figure 1-3 CDE200 Front View

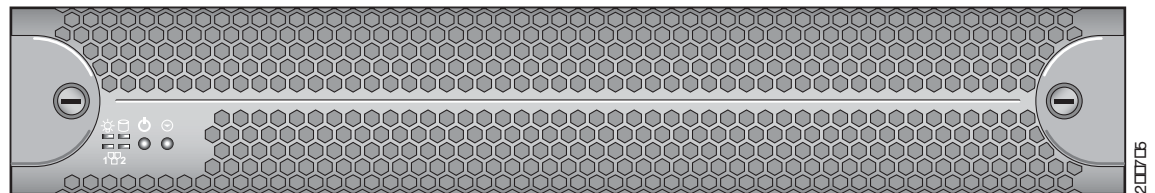

Figure 1-4 CDE200 Rear View

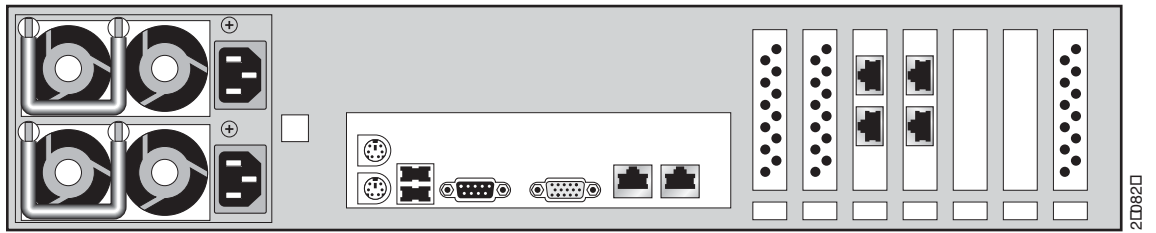

Figure 1-5 shows the front view of the CDE300 and Figure 1-6 shows the rear view of the CDE300 with the AC power option.

Figure 1-5 CDE300 Front View

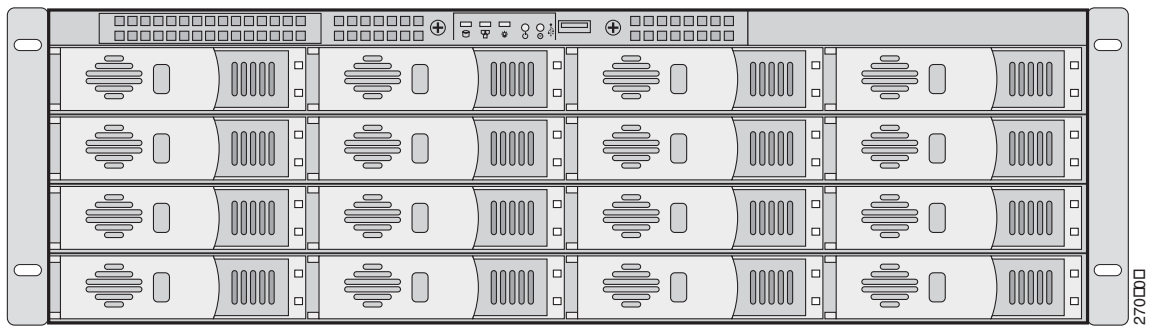

Figure 1-6 CDE300 Rear View

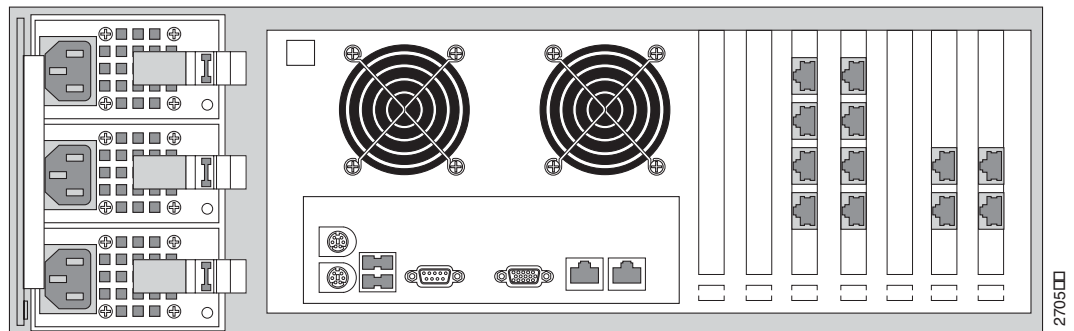

Figure 1-7 shows the front view of the CDE400 and Figure 1-8 shows the rear view of the CDE400 with the AC power option and six cache/streamer interfaces.

Figure 1-7 CDE400 Front View

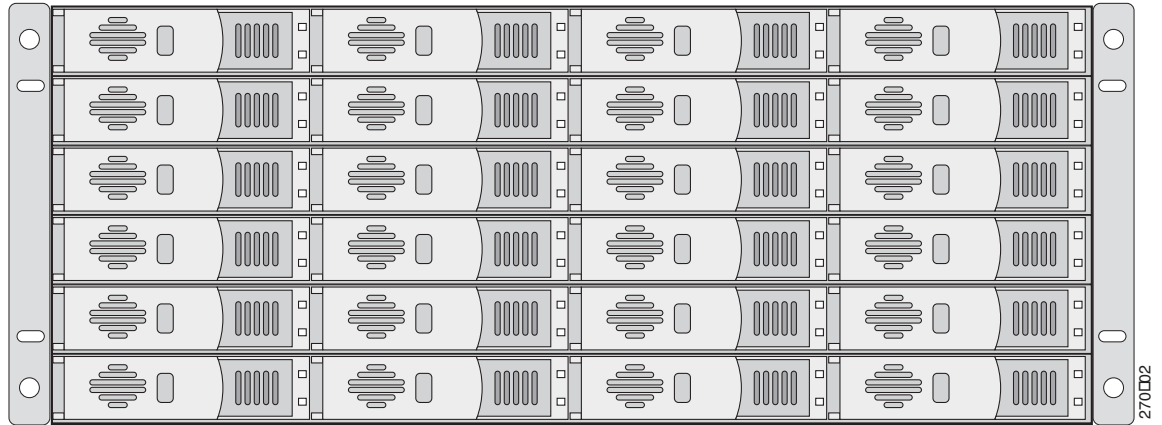
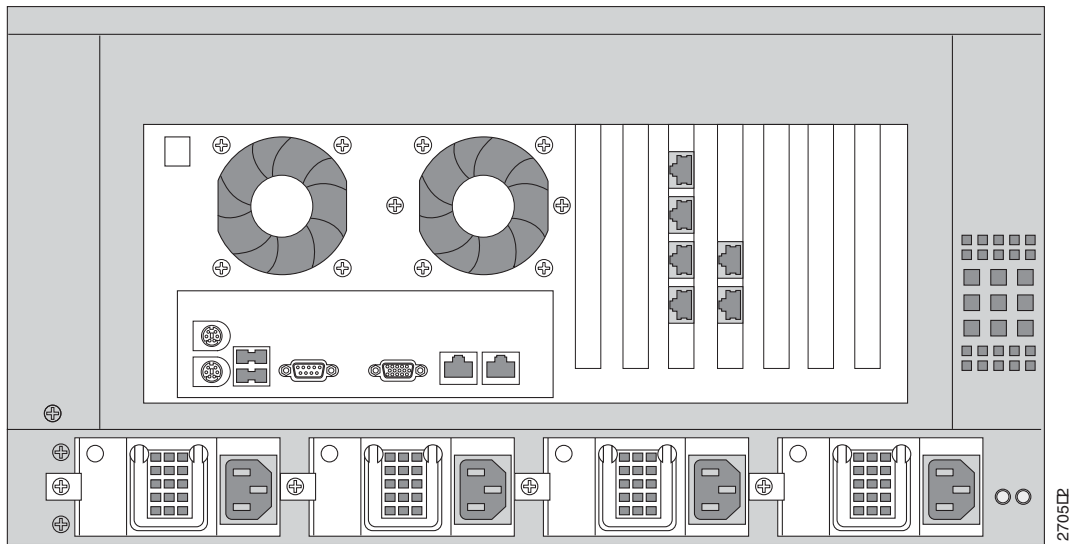

Figure 1-8 CDE400 Rear View



Each CDE is designed to be rack-mounted in a standard 19-inch rack with a depth of 30 inches.

Table 1-1 shows the hardware features of each CDE.

Table 1-1 CDE Hardware Features

CDE	Rack Unit (RU)	Processor	Memory	Drives	GE Ports	Ethernet Interface
CDE100	1	1 dual-core Intel Xeon processor	4 GB	4 150-GB Small Computer System Interface (SCSI) drives	2	—
CDE200	2	2 dual-core Intel Xeon processors	8 GB	12 500-GB Serial ATA (SATA) drives	6	1 ¹

Table 1-1 CDE Hardware Features (continued)

CDE	Rack Unit (RU)	Processor	Memory	Drives	GE Ports	Ethernet Interface
CDE300	3	2 dual-core Intel Xeon processors	Up to 16 GB	Up to 16 SCSI hard drives	12 full-duplex GE interfaces ²	—
CDE400	4	2 dual-core Intel Xeon processors	Up to 16 GB	Up to 24 SATA hard drives ³	—	8 ⁴

1. Provides management communication with the CDSM.
2. Normally configured with 12 full-duplex Gigabit Ethernet (GE) interfaces, each used to deliver up to 250 simultaneous streams and to receive new content from the CDE200 or CDE400.
3. Each drive contains 300 or 400 GB of storage. Each CDE400 can therefore contain up to 2400 hours of standard definition content (3840 hours on a 400-GB drive), including storage of information to support trick play.
4. Six Ethernet interfaces for content movement, an interface for ingest, and an interface for system management.

Control Buttons

Figure 1-9 shows the CDE100 front panel, and describes the front panel control buttons.

Figure 1-9 CDE100 Front Panel Control Buttons

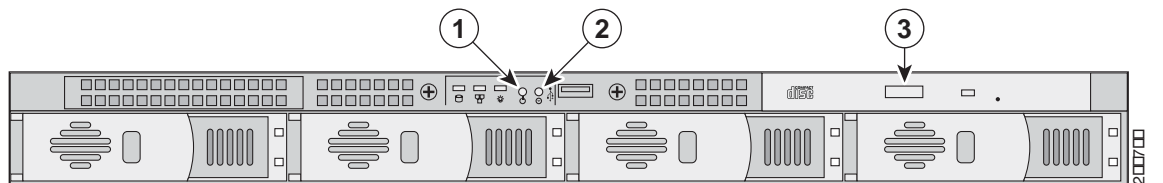

1	Power	Powers up the device.
2	Reset	Resets the device and runs the power-on self-test (POST).
3	CD eject	Opens the CD drive tray.



Note

You may need to use a pen or the end of a straightened paper clip to press the Power and Reset buttons.

The Reset button does not restore the device to the factory default software settings.

Figure 1-10 shows the CDE200 front panel, and describes the front panel control buttons.

Figure 1-10 CDE200 Front Panel Control Buttons

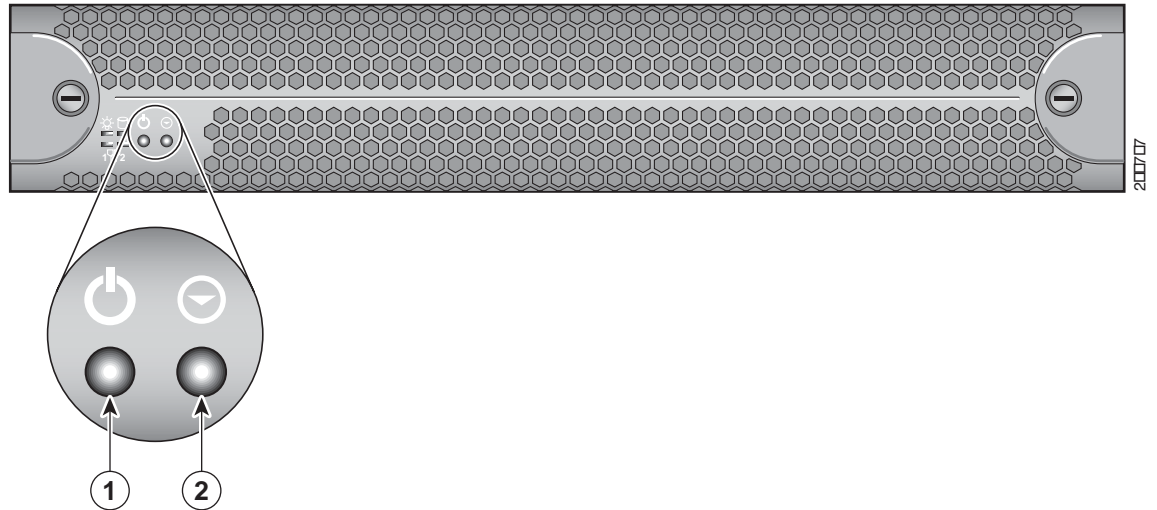

1	Power	Powers up the device.
2	Reset	Resets the device and runs the power-on self-test (POST).

Figure 1-11 shows the CDE300 front panel with the front cover removed, and describes the front panel control buttons.

Figure 1-11 CDE300 Front Panel Control Buttons

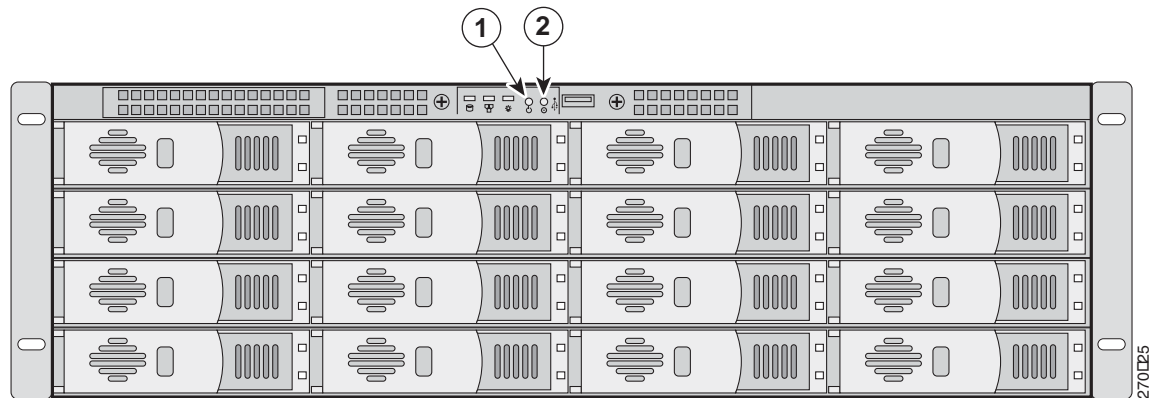

1	Power	Powers up the device.
2	Reset	Resets the device and runs the power-on self-test (POST).

Figure 1-9 shows the CDE400 back panel, and describes the back panel control buttons.

Figure 1-12 CDE400 Back Panel Control Buttons

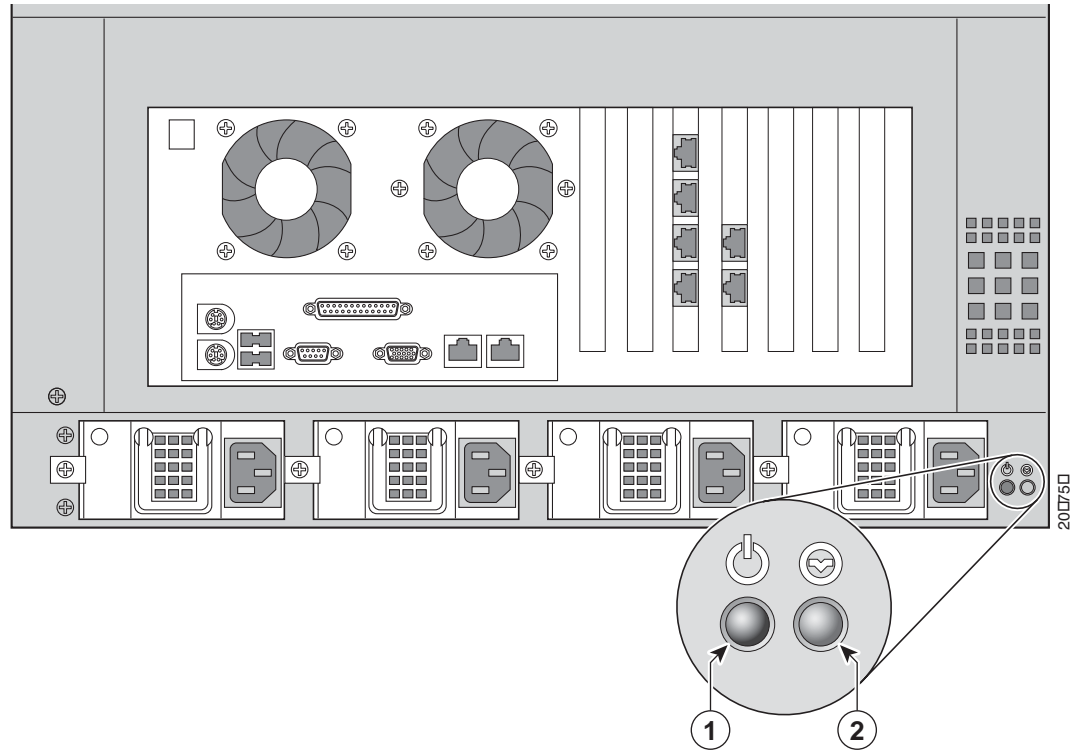

1	Power	Powers up the device.
2	Reset	Resets the device and runs the power-on self-test (POST).

LED Indicators

Figure 1-13 shows the location of the CDE100 front panel LEDs, and describes their functions.

Figure 1-13 CDE100 Front Panel LEDs

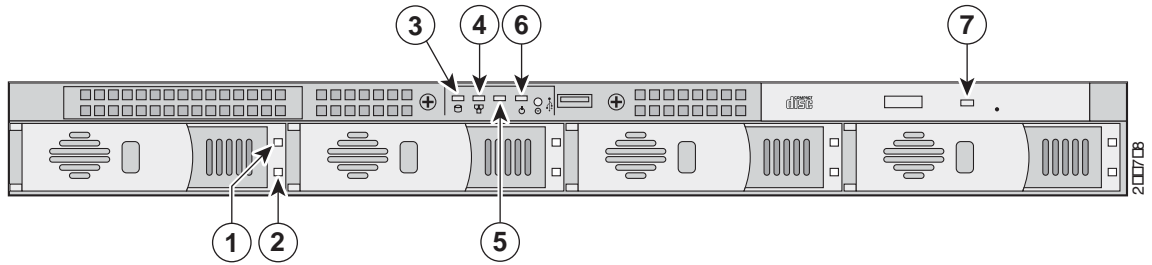

No.	LED	Color	State	Description
1	Hard disk drive power	Blue	On	Power is flowing to the drive.
2	Hard disk drive activity	Blue	On	Associated hard disk drive is in use.
3	Hard disk drive activity	Blue	On	A hard disk drive is in use.
4	Ethernet port 1	Blue	On	Port is connected.
5	Ethernet port 2	Blue	On	Port is connected.
6	Power	Blue	On	Device is powering on.
7	CD-ROM drive activity	Blue	On	CD-ROM drive is in use.

Figure 1-14 shows the location of the CDE200 front panel LEDs with the front cover on, and describes their functions.

Figure 1-14 CDE200 Front Panel LEDs

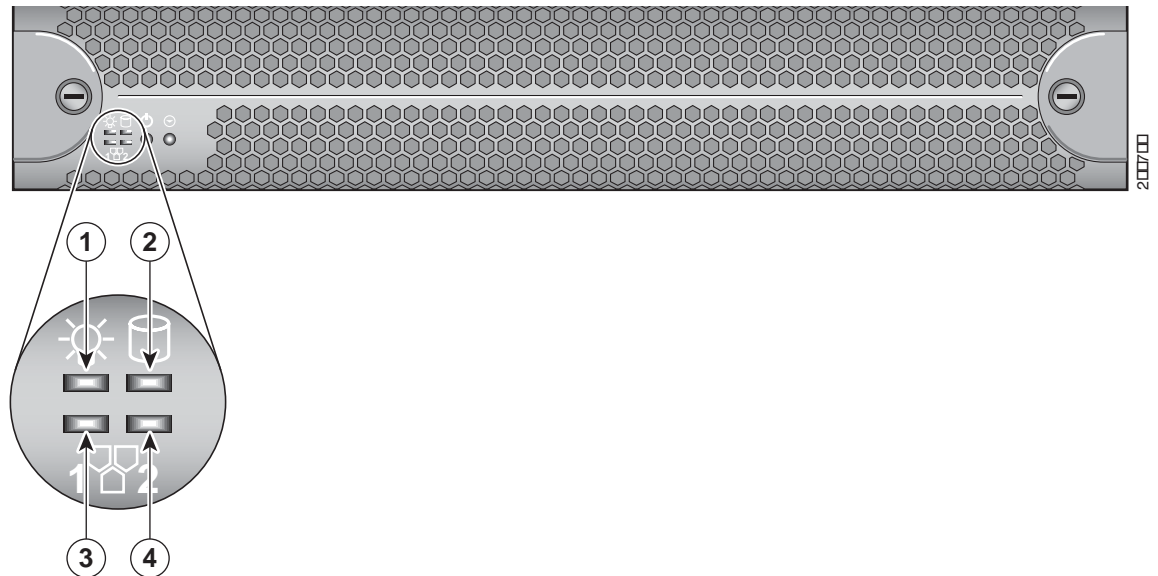

No.	LED	Color	State	Description
1	Power	Blue	On	Device is powering on.
2	Hard disk drive activity	Blue	On	A hard disk drive is in use.
3	Ethernet port 1	Blue	On	Port is connected.
4	Ethernet port 2	Blue	On	Port is connected.

Figure 1-15 shows the location of the CDE300 front panel LEDs, and describes their functions.

Figure 1-15 CDE300 Front Panel LEDs

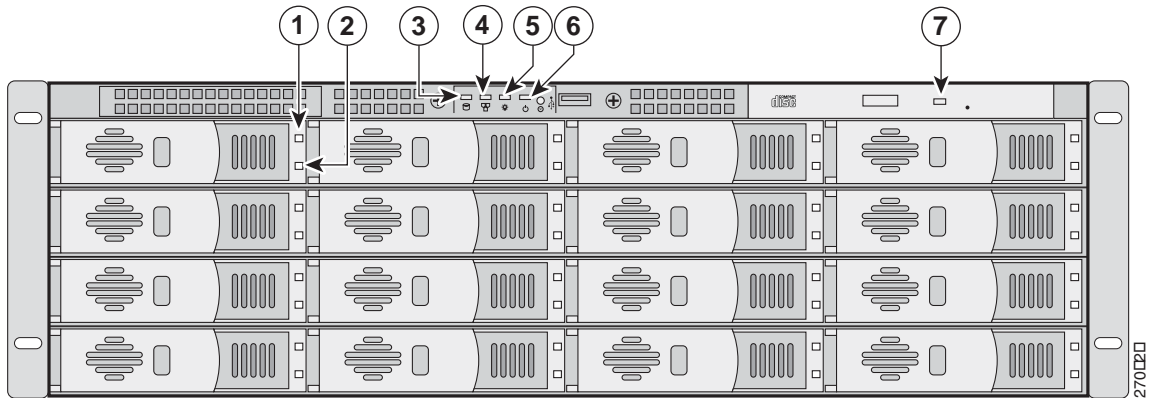

No.	LED	Color	State	Description
1	Hard disk drive power	Blue	On	Power is flowing to the drive.
2	Hard disk drive activity	Blue	On	Associated hard disk drive is in use.
3	Hard disk drive activity	Blue	On	A hard disk drive is in use.
4	Ethernet port 1	Blue	On	Port is connected.
5	Ethernet port 2	Blue	On	Port is connected.
6	Power	Blue	On	Device is powering on.

Figure 1-16 shows the location of the CDE400 front panel LEDs, and describes their functions.

Figure 1-16 CDE400 Front Panel LEDs

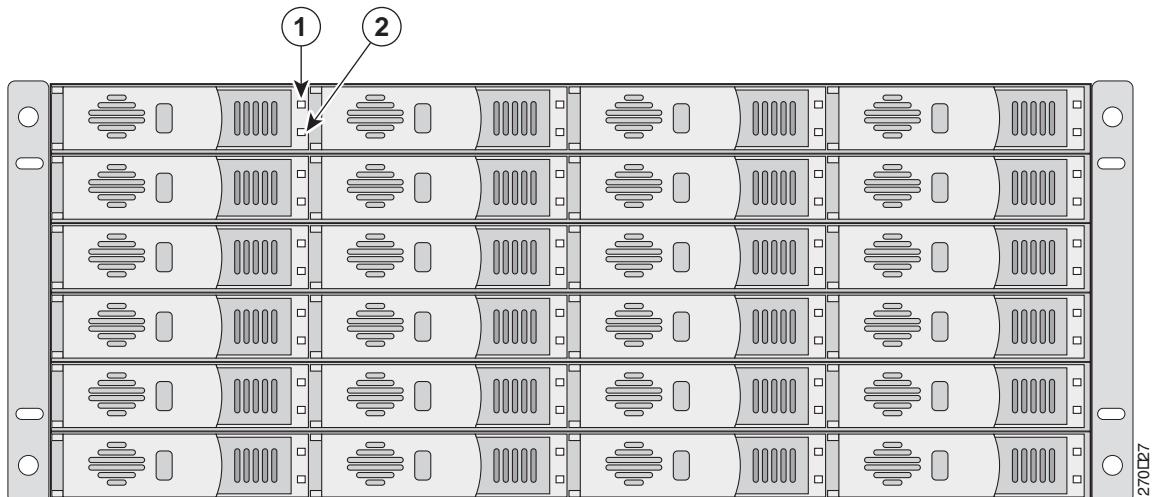

No.	LED	Color	State	Description
1	Hard disk drive power	Blue	On	Power is flowing to the device.
2	Hard disk drive activity	Blue	On	Associated hard disk drive is in use.

Input/Output Ports and Connectors

The CDEs support the following I/O connectors on the rear of the device:

- Ethernet connector
- Serial connector
- Video and audio connectors (on optional adapter)



Caution

Once the product installation is complete, all I/O cables, except those installed in the Ethernet ports, must be disconnected from the CDE to maintain EMC compliance. Any other cable connections are temporary and are only used to initialize the system. All PS/2 keyboard, PS/2 mouse, USB interface, serial console interface, and VGA interface cables must be disconnected from the CDE's front and rear I/O ports.

Figure 1-17 shows the location of the CDE100 back panel ports and connectors.

Figure 1-17 CDE100 Connector Locations

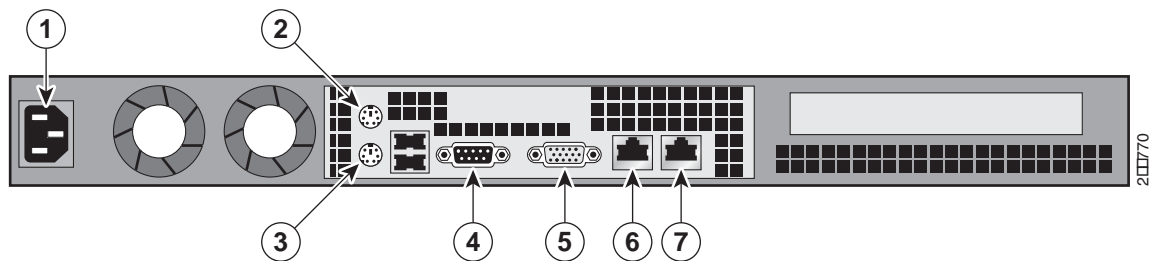

1	Power connector	5	VGA interface
2	Mouse connector	6	Management interface (eth0)
3	Keyboard connector	7	Ingest interface (eth1)
4	Serial console interface		



Note

The system software does not support the use of a keyboard or mouse [Personal System 2 (PS/2) or Universal Serial Bus (USB)]. However, the keyboard and mouse are supported by the BIOS for POST, and the BIOS Setup Utility as described in [Chapter 4, “Installing the Internet Streamer CDS Software and Initially Configuring a CDE.”](#)

Figure 1-18 shows the location of the CDE200 back panel ports and connectors.

Figure 1-18 CDE200 Connector Locations

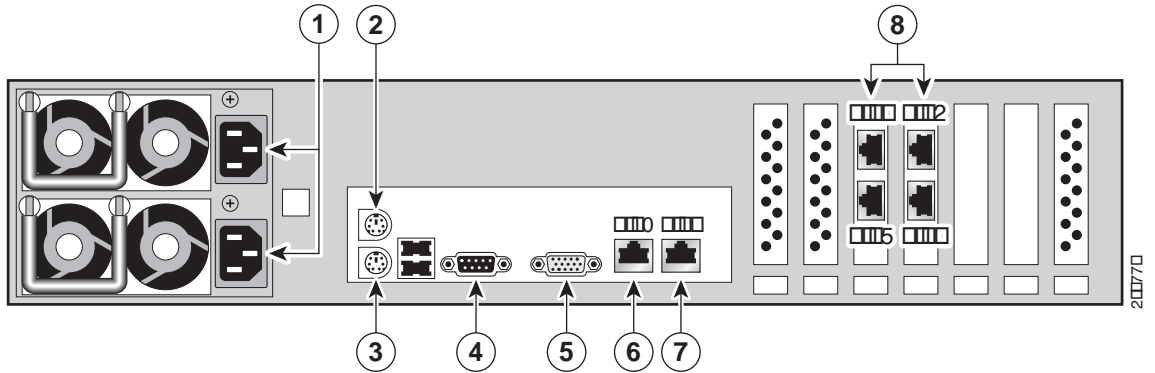

1	Power connectors	5	VGA interface
2	Mouse connector	6	Management interface (eth0)
3	Keyboard connector	7	Ingest interface (eth1)
4	Serial console interface	8	Stream interfaces (eth2 through eth5)

Caution

In some CDE200 chassis, the streaming interface network interface card (NIC) is installed in slots 4 and 5 (counting from the left-most slot). In this hardware configuration, the Gigabit Ethernet interfaces on the motherboard are addressed as interfaces 3/0 and 4/0, and the interfaces on the NICs are detected as 1/0, 2/0, 5/0, and 6/0. The interface numbering must be taken into consideration when configuring IP addresses and port channels.

Figure 1-19 shows the location of the CDE300 back panel ports and connectors.

Figure 1-19 CDE300 Connector Locations

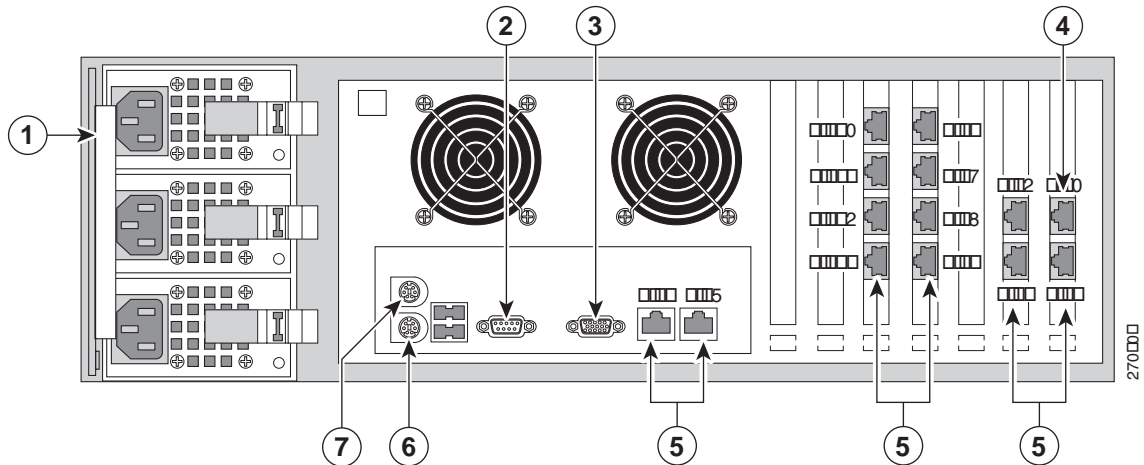

1	Power connectors	5	Cache/stream interfaces
2	Serial console interface	6	Mouse connector
3	VGA interface	7	Keyboard connector
4	Management interface (eth0)		

Figure 1-20 shows the location of the CDE400 back panel ports and connectors.

Figure 1-20 CDE400 Connector Locations

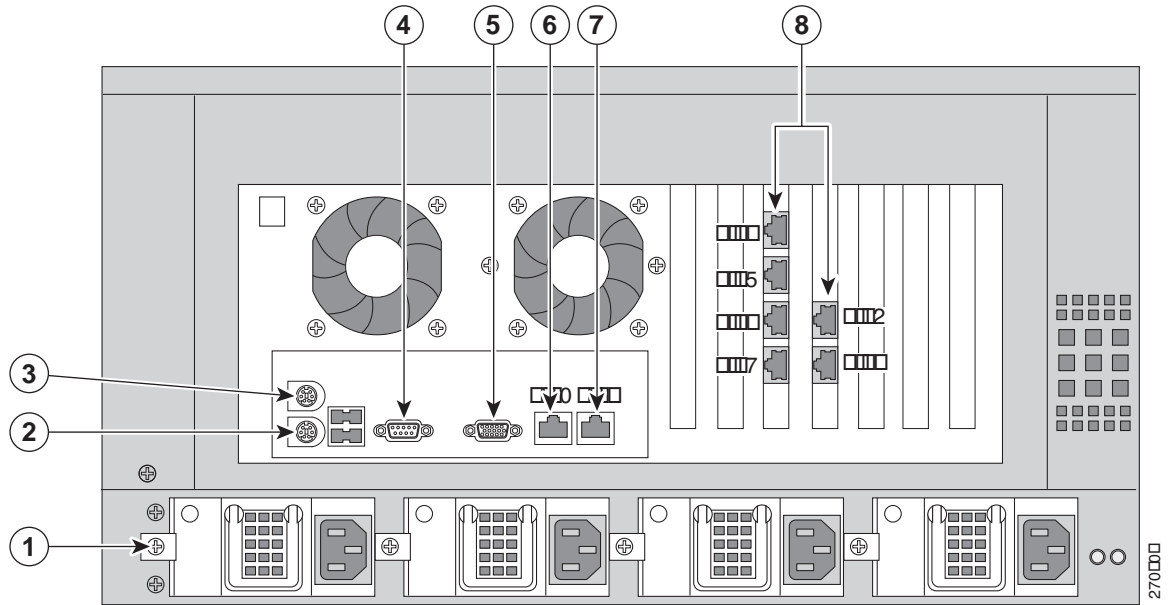

1	Power connectors	5	VGA interface
2	Mouse connector	6	Management Interface (eth0)
3	Keyboard connector	7	Ingest Interface (eth1)
4	Serial console interface	8	Cache/Stream interfaces (eth2 through eth7)



CHAPTER 2

Preparing to Install the Content Delivery Engines

This chapter contains site requirements and important safety information you should know before working with the CDEs. Use the guidelines in this chapter to ensure your own personal safety and to help protect your device from potential damage.

This chapter contains the following sections:

- [Site Requirements, page 2-1](#)
- [Safety Warnings, page 2-3](#)
- [Safety Guidelines, page 2-6](#)
- [Safety Information, page 2-8](#)



Note

Read the *Regulatory Compliance and Safety Information for the Cisco Content Delivery Engine 100/200/300/400* document that came with your device before you begin the installation.

Site Requirements

This section provides site requirements for the CDEs. You should verify the site power prior to installing the CDEs.

Preventing Electrostatic Discharge Damage

The CDEs have no user-serviceable parts inside their chassis. The only field-replaceable units are the AC and DC power supplies and hard disk drives.



Warning

No user-serviceable parts inside. Do not open. Statement 1073

Electrostatic discharge (ESD) damage, which can occur when disk drives, electronic cards or components are improperly handled, results in complete or intermittent failures. The following are guidelines for preventing ESD damage:

- Always use an ESD wrist or ankle strap and ensure that it makes good skin contact.
- Connect the equipment end of the strap to a bare metal, unpainted surface on the rackmount.

- When removing or installing a component, use any available handles, ejector levers, or captive installation screws. These devices prevent accidental removal, provide proper grounding for the system, and help to ensure that bus connectors are properly seated.

**Caution**

For safety, periodically check the resistance value of the antistatic strap. The measurement should be between 1 and 10 megohm (Mohm).

Environmental, Physical, and Power Specifications

The CDEs are tested to the environmental specifications indicated in [Table 2-1](#). All testing is performed per procedures defined in *Bellcore GR-63-CORE NEBS Physical Protection* and the *Bellcore GR-1089-CORE EMC and Electrical Safety — Generic Criteria for Network Telecommunications Equipment*.

Table 2-1 Environmental Specifications Summary

Environment	Specification
Temperature, operating	0 to 50°C (32 to 122° F)
Temperature, non-operating	–40°C to 70°C (–104°F to 158°F)
Altitude	60 to 4000 m
Humidity, non-operating	5 to 95%, noncondensing at temperatures of 23°C (73°F) to 40°C (104°F)

[Table 2-2](#) provides the physical dimensions of the CDEs.

Table 2-2 Physical Dimensions

Height	
CDE100	1.75 inches (4.45 cm)
CDE200	3.50 inches (8.90 cm)
CDE300	4.75 inches (12.1 cm)
CDE400	7.00 inches (17.8 cm)
Width	
CDE100	19.00 inches (48.26 cm)
CDE200	17.50 inches (44.45 cm)
CDE300	17.25 inches (43.8 cm)
CDE400	17.25 inches (43.8 cm)
Depth	
CDE100	27.6 inches (70.10 cm)
CDE200	28.5 inches (72.39 cm)
CDE300	27.5 inches (69.9 cm)
CDE400	26.5 inches (67.3 cm)
Front clearance	2.0 inches (7.6 cm)
Side clearance	1.0 inches (2.5 cm)
Rear clearance	3.6 inches (9.2 cm)

For information on the power requirements of the CDEs, see these sections:

- [If AC Power Supplies Are Installed, page 2-8](#)
- [If DC Power Supplies Are Installed, page 2-9](#)

Safety Warnings



Warning

These warnings are translated into several languages in the *Regulatory Compliance and Safety Information for the Cisco Content Delivery Engine 100/200/300/400* document that ships with the CDEs.



Warning

Read the installation instructions before you connect the system to its power source. Statement 10



Warning

The ports labeled "Ethernet," "10BaseT," "Token Ring," "Console," and "AUX" are safety extra-low voltage (SELV) circuits. SELV circuits should only be connected to other SELV circuits. Because the BRI circuits are treated like telephone-network voltage, avoid connecting the SELV circuit to the telephone network voltage (TNV) circuits. Statement 22



Warning

This unit is intended for installation in restricted access areas. A restricted access area is where access can only be gained by service personnel through the use of a special tool, lock and key, or other means of security, and is controlled by the authority responsible for the location. Statement 37



Warning

Before working on equipment that is connected to power lines, remove jewelry (including rings, necklaces, and watches). Metal objects will heat up when connected to power and ground and can cause serious burns or weld the metal object to the terminals. Statement 43



Warning

Only trained and qualified personnel should be allowed to install or replace this equipment. Statement 49



Warning

During this procedure, wear grounding wrist straps to avoid ESD damage to the card. Do not directly touch the backplane with your hand or any metal tool, or you could shock yourself. Statement 94



Warning

Because invisible radiation may be emitted from the aperture of the port when no fiber cable is connected, avoid exposure to radiation and do not stare into open apertures. Statement 125



Warning

This equipment must be installed and maintained by service personnel as defined by AS/NZS 3260. Incorrectly connecting this equipment to a general purpose outlet could be hazardous. The telecommunications lines must be disconnected 1) before unplugging the main power connector and/or 2) while the housing is open. Statement 185



Warning

Before working on a chassis or working near power supplies, unplug the power cord on AC units.
Statement 246



Warning

For Nordic countries (Norway, Finland, Sweden and Denmark) this system must be installed in a Restricted Access Location, where the voltage of the main ground connection of all equipment is the same (equipotential earth) and the system is connected to a grounded electrical outlet. Statement 328



Warning

Do not work on the system or connect or disconnect cables during periods of lightning activity.
Statement 1001



Warning

Read the installation instructions before connecting the system to the power source. Statement 1004



Warning

Class 1 laser product. Statement 1008



Warning

This unit is intended for installation in restricted access areas. A restricted access area can be accessed only through the use of a special tool, lock and key, or other means of security.
Statement 1017



Warning

Take care when connecting units to the supply circuit so that wiring is not overloaded. Statement 1018



Warning

The plug-socket combination must be accessible at all times, because it serves as the main disconnecting device. Statement 1019



Warning

To avoid electric shock, do not connect safety extra-low voltage (SELV) circuits to telephone-network voltage (TNV) circuits. LAN ports contain SELV circuits, and WAN ports contain TNV circuits. Some LAN and WAN ports both use RJ-45 connectors. Use caution when connecting cables. Statement 1021



Warning

This equipment must be grounded. Never defeat the ground conductor or operate the equipment in the absence of a suitably installed ground conductor. Contact the appropriate electrical inspection authority or an electrician if you are uncertain that suitable grounding is available. Statement 1024



Warning

Class 1 LED product. Statement 1027



Warning

Blank faceplates and cover panels serve three important functions: they prevent exposure to hazardous voltages and currents inside the chassis; they contain electromagnetic interference (EMI) that might disrupt other equipment; and they direct the flow of cooling air through the chassis. Do not operate the system unless all cards, faceplates, front covers, and rear covers are in place. Statement 1029



Warning

Only trained and qualified personnel should be allowed to install, replace, or service this equipment. Statement 1030



Warning

To prevent personal injury or damage to the chassis, never attempt to lift or tilt the chassis using the handles on modules (such as power supplies, fans, or cards); these types of handles are not designed to support the weight of the unit. Statement 1032



Warning

Ultimate disposal of this product should be handled according to all national laws and regulations. Statement 1040



Warning

This product requires short-circuit (overcurrent) protection, to be provided as part of the building installation. Install only in accordance with national and local wiring regulations. Statement 1045



Warning

Installation of the equipment must comply with local and national electrical codes. Statement 1074



Warning

Hazardous voltage or energy may be present on DC power terminals. Always replace cover when terminals are not in service. Be sure uninsulated conductors are not accessible when cover is in place. Statement 1075



Warning

The covers are an integral part of the safety design of the product. Do not operate the unit without the covers installed. Statement 1077



Warning

This product is not intended to be directly connected to the Cable Distribution System. Additional regulatory compliance and legal requirements may apply for direct connection to the Cable Distribution System. This product may connect to the Cable Distribution System ONLY through a device that is approved for direct connection. Statement 1078

AC Power Option Warnings

These warnings apply only to CDEs with the AC power option.



Warning

The device is designed to work with TN power systems. Statement 19



Warning

Connect the device to a grounded power outlet. Statement 25

DC Power Option Warnings

These warnings apply only to CDEs with the DC power option.



Warning

This unit might have more than one power supply connection. All connections must be removed to de-energize the unit. Statement 1028



Warning

This product requires short-circuit (overcurrent) protection, to be provided as part of the building installation. Install only in accordance with national and local wiring regulations. Statement 1045

Safety Guidelines

To reduce the risk of bodily injury, electrical shock, fire, and damage to the equipment, observe the precautions in this section.

General Precautions

Observe the following general precautions for using and working with your system:

- Observe and follow service markings. Do not service any Cisco product except as explained in your system documentation. Opening or removing covers that are marked with the triangular symbol with a lightning bolt may expose you to electrical shock. Components inside these compartments should be serviced only by an authorized service technician.
- If any of the following conditions occur, unplug the product from the electrical outlet and replace the part or contact your authorized service provider:
 - The power cable or plug is damaged.
 - An object has fallen into the product.
 - The product has been exposed to water.
 - The product has been dropped or damaged.
 - The product does not operate correctly when you follow the operating instructions.
- Keep your system components away from radiators and heat sources. Also, do not block cooling vents.

- Do not spill food or liquids on your system components, and never operate the product in a wet environment.
- Do not push any objects into the openings of your system components. Doing so can cause fire or electric shock by shorting out interior components.
- Use the product only with other Cisco-approved equipment.
- Allow the product to cool before removing covers or touching internal components.
- Use the correct external power source. Operate the product only from the type of power source indicated on the electrical ratings label. If you are not sure of the type of power source required, consult your service representative or local power company.
- Use only approved power cables. If you have not been provided with a power cable for your system or for any AC-powered option intended for your system, purchase a power cable that is approved for use in your country. The power cable must be rated for the product and for the voltage and current marked on the product's electrical ratings label. The voltage and current rating of the cable should be greater than the ratings marked on the product.
- To help prevent electric shock, plug the system components and peripheral power cables into properly grounded electrical outlets. These cables are equipped with three-prong plugs to help ensure proper grounding. Do not use adapter plugs or remove the grounding prong from a cable.
- Observe power strip ratings. Make sure that the total ampere rating of all products plugged into the power strip does not exceed 80 percent of the power strip ampere ratings limit.
- Do not use appliance or voltage converters or kits sold for appliances with your product.
- To help protect your system components from sudden, transient increases and decreases in electrical power, use a surge suppressor, line conditioner, or uninterruptible power supply (UPS).
- Position cables and power cords carefully; route cables and the power cord and plug so that they cannot be stepped on or tripped over. Be sure that nothing rests on your system components' cables or power cord.
- Do not modify power cables or plugs. Consult a licensed electrician or your power company for site modifications. Always follow your local or national wiring rules.

Protecting Against Electrostatic Discharge

Static electricity can harm delicate components inside the device. To prevent static damage, discharge static electricity from your body before you touch any of your system's electronic components. You can do so by touching an unpainted metal surface on the chassis.

You can also take the following steps to prevent damage from electrostatic discharge (ESD):

- When unpacking a static-sensitive component from its shipping carton, do not remove the component from the antistatic packing material until you are ready to install the component in your system. Just before unwrapping the antistatic packaging, be sure to discharge static electricity from your body.
- When transporting a sensitive component, first place it in an antistatic container or packaging.
- Handle all sensitive components in a static-safe area. If possible, use antistatic floor pads and workbench pads.

Safety Information

This section contains additional important safety information you should know before working with the CDEs.

Emissions Disclaimer

See *Regulatory Compliance and Safety Information for the Cisco Content Delivery Engine 100/200/300/400* for product safety and EMC regulatory compliance information. This is an FCC (Federal Communications Commission) Class A device.

Intended Uses

This product was evaluated as Information Technology Equipment (ITE), which may be installed in Central Offices, Telecommunication Centers, Network Telecommunication Facilities, offices, schools, computer rooms, and similar commercial type locations where The National Electric Code (NEC) applies. The suitability of this product for other product categories and environments (medical, industrial, telecommunications, residential, alarm systems, test equipment, etc.), other than an ITE application, may require further evaluation.



Warning

To prevent bodily injury when mounting or servicing this unit in a rack, you must take special precautions to ensure that the system remains stable. The following guidelines are provided to ensure your safety:

- This unit should be mounted at the bottom of the rack if it is the only unit in the rack.
 - When mounting this unit in a partially filled rack, load the rack from the bottom to the top with the heaviest component at the bottom of the rack.
 - If the rack is provided with stabilizing devices, install the stabilizers before mounting or servicing the unit in the rack. Statement 1006
-

If AC Power Supplies Are Installed

When installing the CDEs, use the provided AC power cords.

Mains AC power disconnect: The AC power cord(s) is considered the mains disconnect for the server and must be readily accessible when installed. If the individual server power cord(s) will not be readily accessible for disconnection then you must install an AC power disconnect for the entire rack unit. This main disconnect must be readily accessible, and it must be labeled as controlling power to the entire rack, not just to the server(s).

Grounding the rack installation: To avoid the potential for an electrical shock hazard, you must include a third wire safety ground conductor with the rack installation. If the server power cord is plugged into an AC outlet that is part of the rack, then you must provide proper grounding for the rack itself. If the server power cord is plugged into a wall AC outlet, the safety ground conductor in the power cord

provides proper grounding only for the server. You must provide additional, proper grounding for the rack and other devices installed in it. This system is intended for connection to a Common Bonding Network (CBN) as defined by NEBS GR-1089.

Overcurrent protection: The server is designed for an AC line voltage source with up to 20 amperes of overcurrent protection per cord feed. If the power system for the equipment rack is installed on a branch circuit with more than 20 amperes of protection, you must provide supplemental protection for the server. The overall current rating of a configured server is less than 6 amperes.

If DC Power Supplies Are Installed

Connection with a DC (Direct Current) source should only be performed by trained service personnel. The server with DC input is to be installed in a Restricted Access Location in accordance with articles 110-16, 110-17, and 110-18 of the National Electric Code, ANSI/NFPA 70. The DC source must be electrically isolated by double or reinforced insulation from any hazardous AC source. The DC source must be capable of providing up to 300 watts of continuous power per feed pair.

Mains DC power disconnect: You are responsible for installing a properly rated DC power disconnect for the server system. This mains disconnect must be readily accessible, and it must be labeled as controlling power to the server. The circuit breaker of a centralized DC power system may be used as a disconnect device when easily accessible and should be rated no more than 10 amps.

Grounding the server: This server is intended for installation with an isolated DC return (DC-I) and is to be installed in a Common Bonding Network (CBN) per NEBS GR-1089. To avoid the potential for an electrical shock hazard, you must reliably connect an earth grounding conductor to the server. The earth grounding conductor must be #14 to #10 AWG connected to the earth ground stud(s) on the rear of the server. The safety ground conductor should be connected to the chassis stud with a Listed closed two-hole crimp terminal having 5/8-inch pitch. The nuts on the chassis earth ground studs should be installed with a 10 in-lb torque. The safety ground conductor provides proper grounding only for the server. You must provide additional, proper grounding for the rack and other devices installed in it.

Overcurrent protection: Overcurrent protection circuit breakers must be provided as part of each host equipment rack and must be incorporated in the field wiring between the DC source and the server. The branch circuit protection shall be rated minimum 75Vdc, 10 A maximum per feed pair. If the DC power system for the equipment rack is installed with more than 10 amperes of protection, you must provide supplemental protection for the server. The overall current rating of a maximum configured server is 8 amperes.



Warning

This product relies on the building's installation for short-circuit (overcurrent) protection. Ensure that the protective device is rated not greater than: 10 Amps Statement 1005



Warning

When stranded wiring is required, use approved wiring terminations, such as closed-loop or spade-type with upturned lugs. These terminations should be the appropriate size for the wires and should clamp both the insulation and conductor. Statement 1002

Temperature and Ventilation

**Caution**

Temperature: The temperature, in which the server operates when installed in an equipment rack, must be between 0 to 50°C (32 to 122° F). Extreme fluctuations in temperature can cause a variety of problems in your server.

**Caution**

Ventilation: The equipment rack must provide sufficient airflow to the front of the server to maintain proper cooling. The rack must also include ventilation sufficient to exhaust a maximum of 1023 BTUs (British Thermal Units) per hour for the server. The rack selected and the ventilation provided must be suitable to the environment in which the server will be used.



CHAPTER 3

Installing the Content Delivery Engines

This chapter provides the necessary information to properly install the CDEs. This chapter contains the following sections:

- [Server Types, page 3-1](#)
- [Tools and Parts Required, page 3-2](#)
- [Unpacking the Box, page 3-2](#)
- [Verifying Contents, page 3-3](#)
- [Inspecting for Damage, page 3-3](#)
- [Installing the CDEs, page 3-3](#)



Note

This chapter only provides information on CDEs that were shipped after December 1, 2006 and contain the Lindenhurst chipset. For information on CDEs that were shipped before December 1, 2006 and contain the Serverworks chipset, see [Appendix C, “CDEs with Serverworks Chipset.”](#)

Server Types

There are two types of CDS: Internet Streamer (IS) and TV. Both types of CDS consists of servers that are connected through Ethernet switches. The Intel Xeon-based servers are populated with multiple high-capacity hard drives.

There are three distinct server types in the IS Content Delivery System:

- Content Delivery System Manager (CDSM)—CDE100 or CDE200
- Service Engine (SE)—CDE200
- Service Router (SR)—CDE200

Depending on your application, you may have multiple SEs and SRs. A network switch is employed to link multiple servers together within a larger network.

There are four distinct server types in the TV Content Delivery System:

- CDSM—CDE100 or CDE200
- Streamer—CDE300
- Vault—CDE200 or CDE400
- Integrated Streamer Vault (ISV)—CDE200

Depending on your application, you may have multiple streamers and vaults. A network switch is employed to link multiple servers together within a larger network.

Tools and Parts Required

You need the following tools to install the CDEs:

- CDE100, CDE200, CDE300 or CDE400
- Hard disk drives
- Antistatic mat
- Properly grounded ESD-preventive device
- 1/4-inch flat-blade screwdriver
- 3/16-inch flat-blade screwdriver
- Number 2 Phillips screwdriver

Unpacking the Box

Each Cisco CDE is securely packaged in a shipping box. The cards and power supplies ship installed in the CDEs.



Caution

Proper ESD protection is required whenever you handle Cisco equipment. Installation and maintenance personnel should be properly grounded through the use of grounding straps to eliminate the risk of ESD damage to the equipment. Modules are subject to ESD damage whenever they are removed from the chassis.

To unpack the shipping container, follow these steps:

Step 1 Inspect the packing containers.

If any damage or other signs of mishandling are evident, inform both the local freight carrier and Cisco before unpacking. Your freight carrier can provide you with the procedures necessary to file a claim for damages.

Step 2 Carefully open the box.

Step 3 Remove all packing material.

Step 4 Remove the chassis from the box.

Step 5 Carefully open the additional boxes, remove the packing material, and remove the drives and other contents.

Step 6 Open the accessory kits and boxes that contain the cables and so forth. Do not use a knife to open these boxes.



Tip

Save these boxes should you need to return any components to Cisco.

Verifying Contents

To verify that your shipment is complete, make sure that you received everything on your packing list, and then compare your packing list to your order.

If any items are missing or if you need additional information, contact Cisco Technical Support at the following URL:

www.cisco.com/techsupport

Inspecting for Damage

After you verify that all of the equipment is included, carefully examine the CDEs, cards, power supplies, and cables for any damage resulting from shipping. If you suspect any damage from shipping, contact your local freight carrier for procedures on damage claims.

If you observe any physical defects in the items you ordered, obtain standard warranty service by delivering the defective part, accompanied by a copy of the dated proof-of-purchase, to the Cisco Systems Corporate Service Center or an authorized Cisco Systems service center during the applicable warranty period. Contact Cisco Technical Support for the location of your nearest service center.



Note

Before proceeding with the installation, verify that all of the ordered parts are present and in good condition. Keep a record of the parts and serial numbers. If any parts are missing or damaged, contact your sales representative.

Installing the CDEs

Installing the CDS consists of the following tasks:

- [Reviewing Rack Installation Safety Guidelines, page 3-3](#)
- [Preparing the CDEs for Rack Installation, page 3-4](#)
- [Installing CDEs in the Rack, page 3-5](#)
- [Making Physical Connections, page 3-5](#)
- [Installing or Removing Disk Drives, page 3-9](#)

Reviewing Rack Installation Safety Guidelines

Before installing your device in a rack, review the following guidelines:

- The equipment is to be installed by a trained service person.
- The equipment is to be installed in a Restricted Access Location.
- Handles on the equipment are provided for positioning purpose only, not for lifting the chassis.
- The customer should follow their own company guidelines and governing regulations for handling heavy equipment.
- Two or more people are required to install the device in a rack.
- Ensure that the room air temperature is below 95°F (35°C).

- Do not block any air vents; usually 6 inches (15 cm) of space provides proper airflow.
- Plan the device installation starting from the bottom of the rack.
- Install the heaviest device in the bottom of the rack.
- Do not extend more than one device out of the rack at the same time.
- Remove the rack doors and side panels to provide easier access during installation.
- Connect the device to a properly grounded outlet.
- Do not overload the power outlet when installing multiple devices in the rack.
- Do not place any object weighing more than 110 lb (50 kg) on top of rack-mounted devices.

Preparing the CDEs for Rack Installation

Verify correct hardware configuration by performing the following steps:

Step 1 Remove the top cover on the chassis by removing the screws and lifting the cover from the chassis.

Step 2 Configure the applicable chassis as follows:

CDE100

- Set all dip switches at the back of the disk array case to the OFF (down) position.
- Make sure the CD-ROM drive is connected to the primary IDE cable, and the compact flash drive is connected to the secondary IDE cable. There are two IDE connectors on the motherboard. The one parallel to the front panel of the chassis is the primary IDE connector. The one in the upright position is the secondary IDE connector. If necessary, swap the internal CD-ROM drive with the compact flash drive to ensure that the compact flash drive is connected to the secondary IDE cable.

CDE200

- Make sure the 80-GB hard drive is connected to the primary IDE cable, and the compact flash drive is connected to the secondary IDE cable. If necessary, swap the internal CD-ROM drive with the compact flash drive to ensure that the compact flash drive is connected to the secondary IDE cable.
- Disable the onboard SCSI controller by connect pins 2 and 3 (instead of 1 and 2) for the jumper labeled “JPA-1” (located about two inches below the center PCI-X slot—slot 3 of 5). Pin 1 is closest to the rear of the case and pin 3 is closest to the front.

CDE300

- Make sure the 80-GB hard drive is connected to the primary IDE cable.
- Disable the onboard SCSI controller by connect pins 2 and 3 (instead of 1 and 2) for the jumper labeled “JPA-1” (located about two inches below the center PCI-X slot—slot 3 of 5). Pin 1 is closest to the rear of the case and pin 3 is closest to the front.

CDE400

- Make sure the 160-GB hard drive is connected to primary IDE cable.

Step 3 Replace the top cover on the chassis.

Installing CDEs in the Rack

The CDEs are best rail-mounted in a standard 19-inch wide by 30-inch deep rack. For information on installing a CDE in a rack, see the “Installing the Cisco CDE110 in a Rack” section in the *Cisco Content Delivery Engine 110 Hardware Installation Guide* at the following URL:

http://www.cisco.com/en/US/docs/video/cds/cde/cde110/installation/guide/ch3_inst.html#wp1051129



Note

The CDE300 and CDE400 ship with a rack mounting kit and instructions.



Caution

At least two people are required to lift the unit and place it at the desired position in the rack, holding it steady. A third person secures the unit into the rack.



Caution

Be sure that the chassis is securely attached to both sides of the rack to avoid the possibility of chassis flexing.

When installing the CDEs, consider the following:

- Elevated operating ambient temperature—In a closed or multi-unit rack assembly, this is the operating ambient temperature of the rack. Environmental temperature may be greater than the room ambient temperature. Do not exceed the ambient temperature of 32 to 122°F (0 to 50°C).
- Reduced airflow—Install equipment so that the amount of airflow for safe operation of the equipment is not compromised: the recommended amount is a minimum of 1 RU between all servers.
- Mechanical loading—Mount equipment so that a hazardous condition is not achieved because of uneven mechanical loading.

Making Physical Connections

After mounting the servers, continue the hardware setup by making the physical connections for power and network.



Caution

The unit is intended for indoor use. It is provided with numerous standard USB and Ethernet ports. This product is not intended to be directly connected to the Telecommunication Network System. Additional regulatory compliance and legal requirements may apply for direct connection to the Telecommunication Network System. This product may connect to the Telecommunication Network System only through a device that is approved for direct connection.



Caution

Once the product installation is complete, all I/O cables, except those installed in the Ethernet ports, must be disconnected from the CDE to maintain EMC compliance. Any other cable connections are temporary and are only used to initialize the system. All PS/2 keyboard, PS/2 mouse, USB interface, serial console interface, and VGA interface cables must be disconnected from the CDE's front and rear I/O ports.

Connecting Power Cords

Redundant power connectors are located at the rear of the chassis as shown in [Figure 3-2](#) through [Figure 3-5](#). Power connections have the following properties:

- Chassis power inlets accept AC (120V or 220V) or -48 VDC.
- The CDE100 chassis contains one VAC power port; the CDE200 chassis contains two VAC or VDC power ports; the CDE300 chassis contains three VAC or VDC power ports, and the CDE400 chassis contains four VAC or VDC power ports. See [Appendix D](#) for information connecting DC Power.



Note

All unlabeled ports are unused ports. Do not install cables in any unused ports.

Figure 3-1 CDE100 Connector Locations

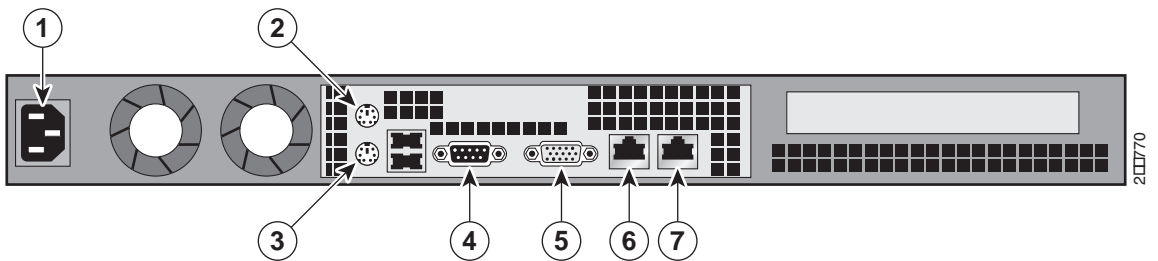

1	Power connector	5	VGA interface
2	Mouse connector	6	Management interface (eth0)
3	Keyboard connector	7	Ingest interface (eth1)
4	Serial console interface		

Figure 3-2 CDE200 or CDE200 ISV Connector Locations

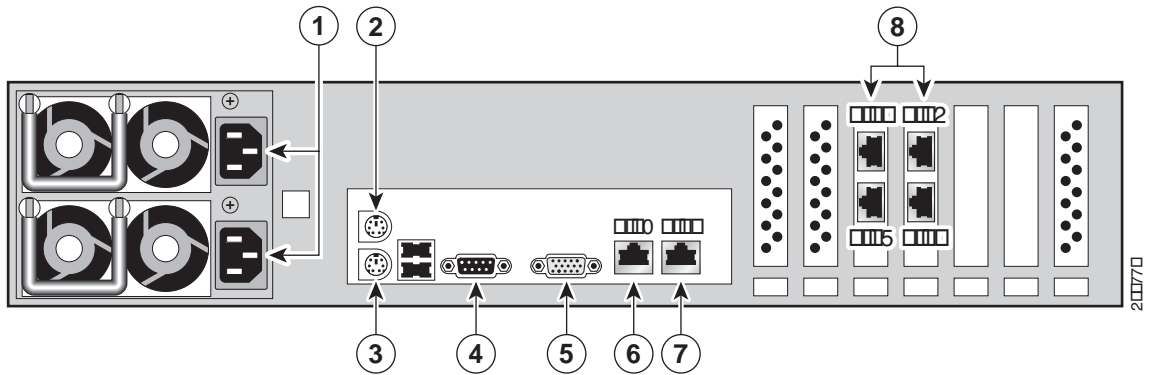

1	Power connectors	5	VGA interface
2	Mouse connector	6	Management interface (eth0)
3	Keyboard connector	7	Ingest interface (eth1)
4	Serial console interface	8	Stream interfaces (eth2 through eth5)

Figure 3-3 CDE300 (SX Version) Connector Locations

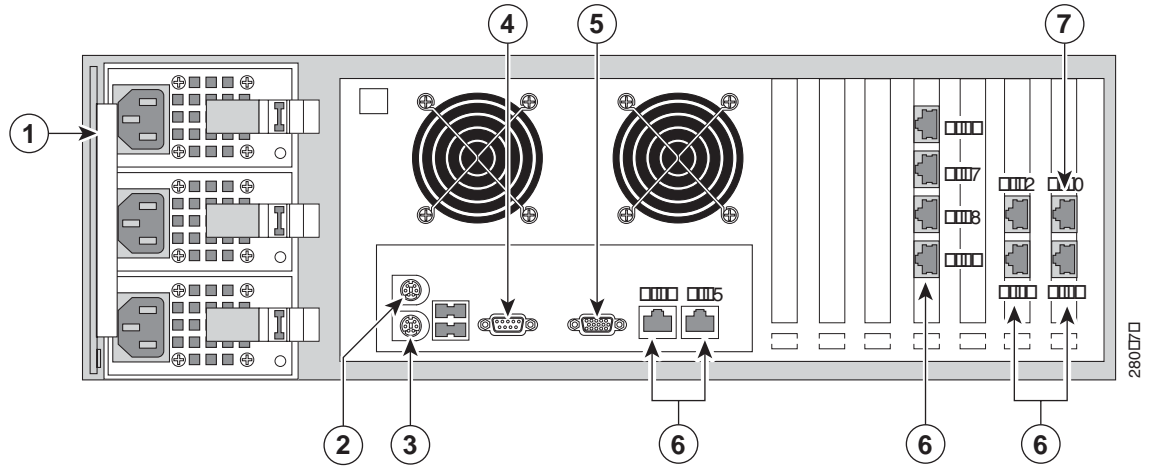

1	Power connectors	5	VGA interface
2	Mouse connector	6	Management interface (eth0)
3	Keyboard connector	7	Stream interfaces (eth2 through eth9)
4	Serial console interface		

Figure 3-4 CDE300 Connector Locations

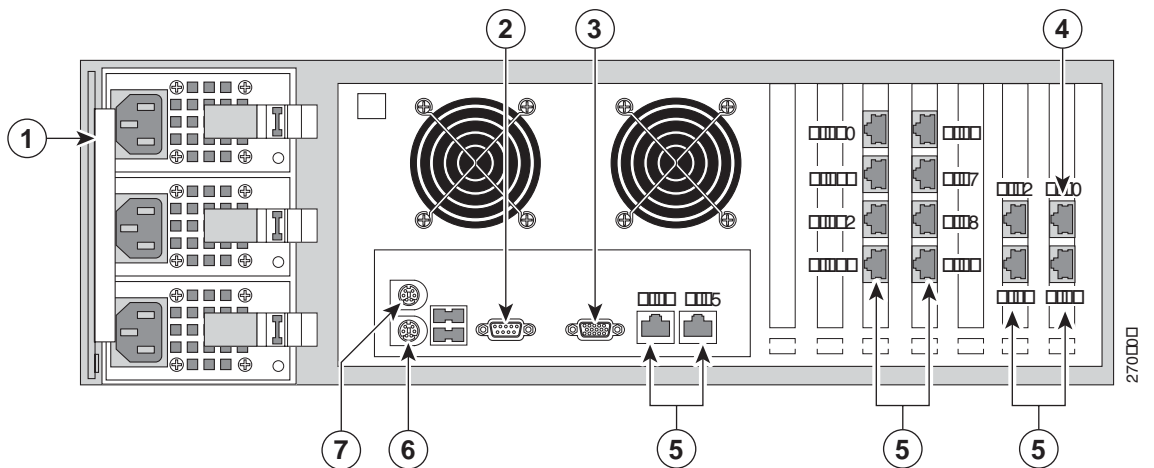

1	Power connectors	5	Cache/stream interfaces
2	Serial console interface	6	Mouse connector
3	VGA interface	7	Keyboard connector
4	Management interface (eth0)		

Figure 3-5 CDE400 or CDE400 ISV Connector Locations

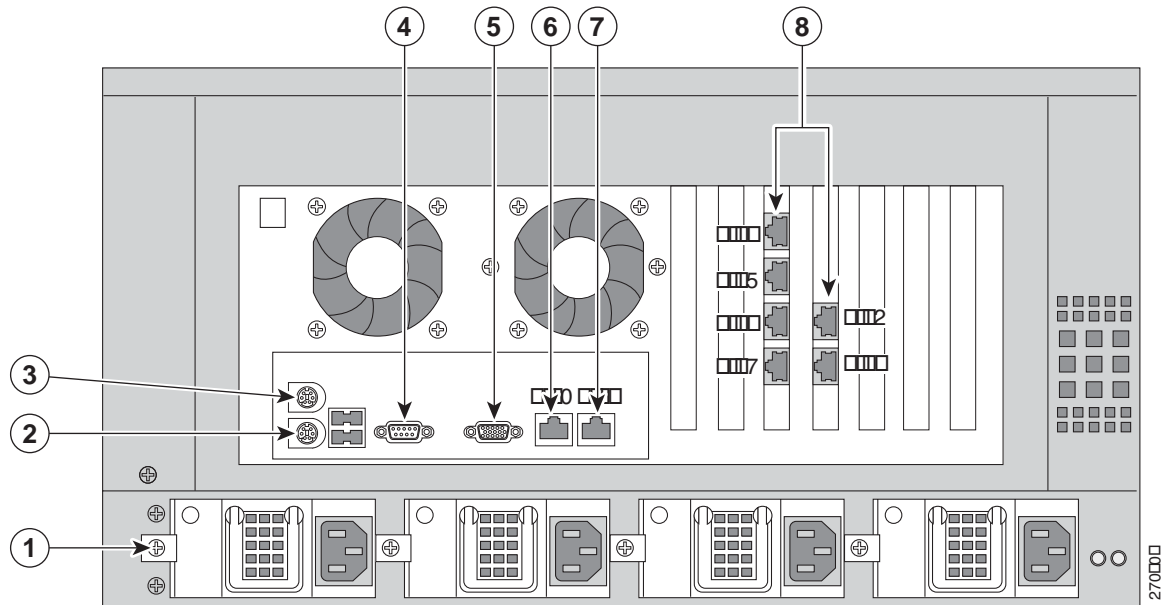

1	Power connectors	5	VGA interface
2	Mouse connector	6	Management Interface (eth0)
3	Keyboard connector	7	Ingest Interface (eth1)
4	Serial console interface	8	Cache/Stream interfaces (eth2 through eth7)

Connecting Network Cables

Using the topology prescribed for the application, attach Ethernet cables to the Ethernet interfaces on the CDEs (see [Figure 3-1](#) through [Figure 3-5](#)).

SE and SR System

In a system that uses SEs and SRs that are collocated, the Ethernet cables are used to make the following physical connections:

- SR to switch
- SE to switch
- CDSM to switch

Vault and Streamer System

In a system that uses Vaults and Streamers that are collocated, the Ethernet cables are used to make the following physical connections:

- Vault to switch
- Streamer to switch
- CDSM to switch

Specifically, the physical connections consist of the following:

Interface	Switch Port Mbps
Vault cache	Must be 1000
Vault ingest	Can be 100/1000, but 1000 is recommended
Vault management	Can be 100/1000
Streamer cache	Must be 1000
Streamer stream	Must be 1000
Streamer management	Can be 100/1000
CDSM management	Can be 100/1000

ISV System

In a system that uses ISVs that are collocated, the Ethernet cables are used to make the following physical connections:

- ISV to switch
- CDSM to switch

Specifically, the physical connections consist of the following:

Interface	Switch Port Mbps
ISV ingest	Can be 100/1000, but 1000 is recommended
ISV management	Can be 100/1000
ISV stream	Must be 1000
CDSM management	Can be 100/1000

Installing or Removing Disk Drives

The disk drives for the CDEs are shipped separately. You must install the disk drives before using the CDEs. A minimum of two disks are required for basic software installation (needed for the RAID-1 set). If the CDE is used to store content (configured as an SE), more than two disks are needed.

For maintenance or other reasons, it may become necessary to remove a disk drive from the chassis. The disk drives on the CDE100 are monitored using Self-Monitoring, Analysis, and Reporting Technology (S.M.A.R.T.) and statistics are displayed through the Administrative Interface, as well as sent to the CDSM. For more information about S.M.A.R.T., see the *Cisco Internet Streamer CDS 2.0-2.1 Software Configuration Guide*.

The CDE100 contains 4 disk drives (see [Figure 3-6](#)), the CDE200 contains 12 disk drives (see [Figure 3-7](#)), the CDE300 contains 16 disk drives (see [Figure 3-8](#)), and the CDE400 contains 24 disk drives (see [Figure 3-9](#)).

Figure 3-6 CDE100 Disk Drive Locations

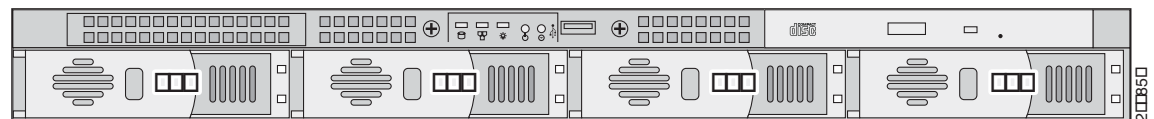
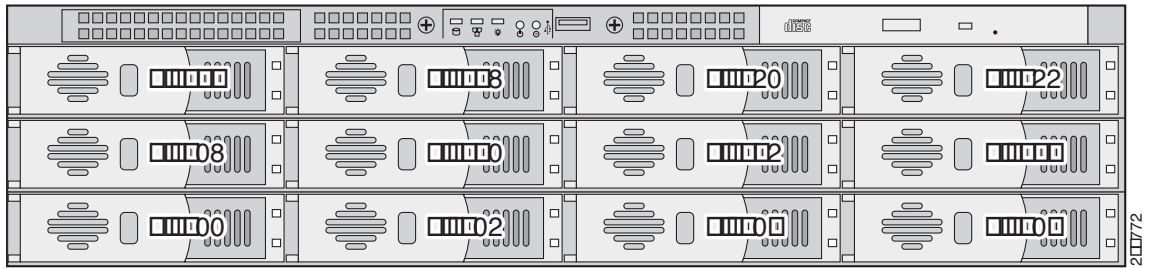

Figure 3-7 CDE200 Disk Drive Locations



The disk drive layout on a CDE300 changes depending on the bios settings. The code dynamically establishes the drive configuration at run time.

Figure 3-8 CDE300 Disk Drive Locations

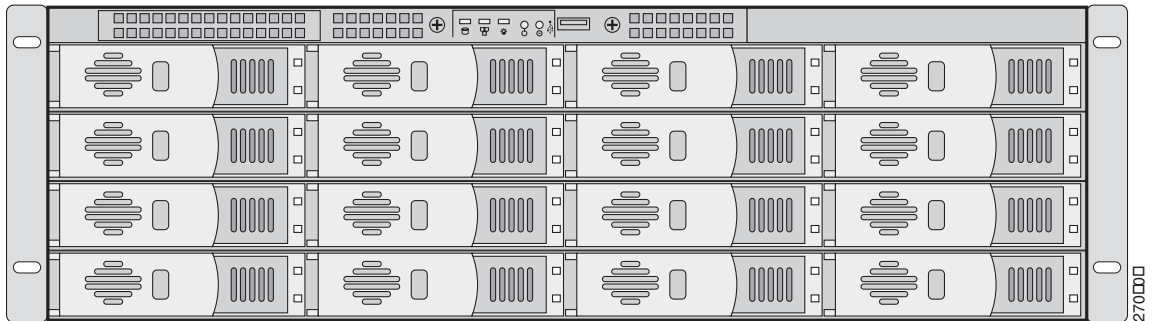
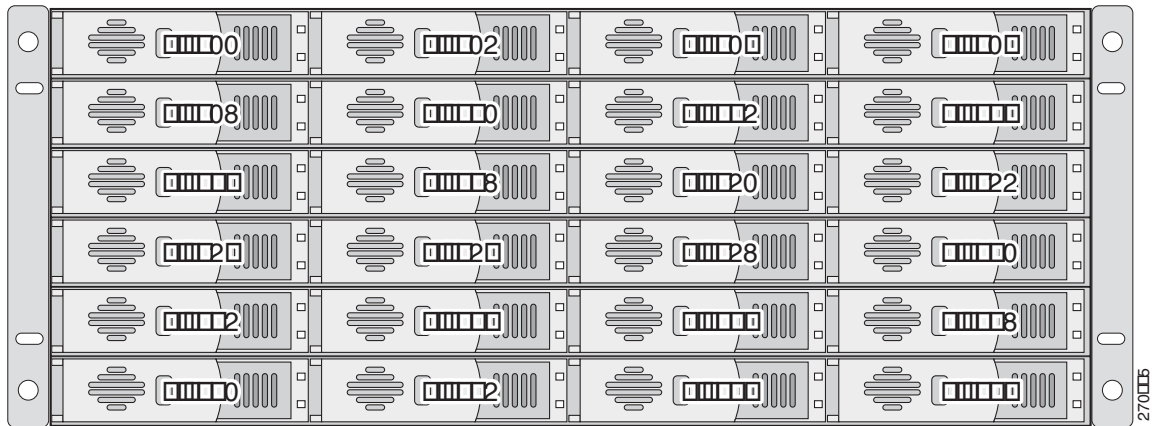

Figure 3-9 CDE400 Disk Drive Locations



Install a disk drive by performing the following steps:



Warning During this procedure, wear grounding wrist straps to avoid ESD damage to the card. Do not directly touch the backplane with your hand or any metal tool, or you could shock yourself.
Statement 94

- Step 1** Power off the CDE before removing or installing a disk drive.
- Step 2** To access the disk drives on a CDE200, CDE300, and CDE400, you must first remove the front cover by turning the keys on the left and right sides of the cover and removing it from the CDE (see 1 and 2 in [Figure 3-10](#)).

Figure 3-10 CDE200 Front Cover

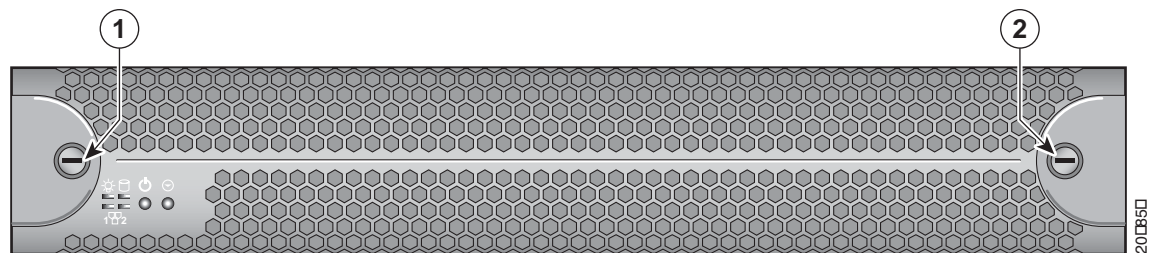

- Step 3** Unlock the latch by pressing the safety lock button on the front of the latch (see [Figure 3-11](#)).
- Step 4** Unlatch the disk drive tray from the locking clip and swing open the main latch (see [Figure 3-11](#)).
- Step 5** Carefully pull the disk drive out of its drive tray slot.
- Step 6** Insert a new disk drive into the drive tray slot and make sure it is properly seated.
- Step 7** Close the latch completely and lock it in place by pressing the safety lock button.

Figure 3-11 Disk Drive Tray Installation and Removal

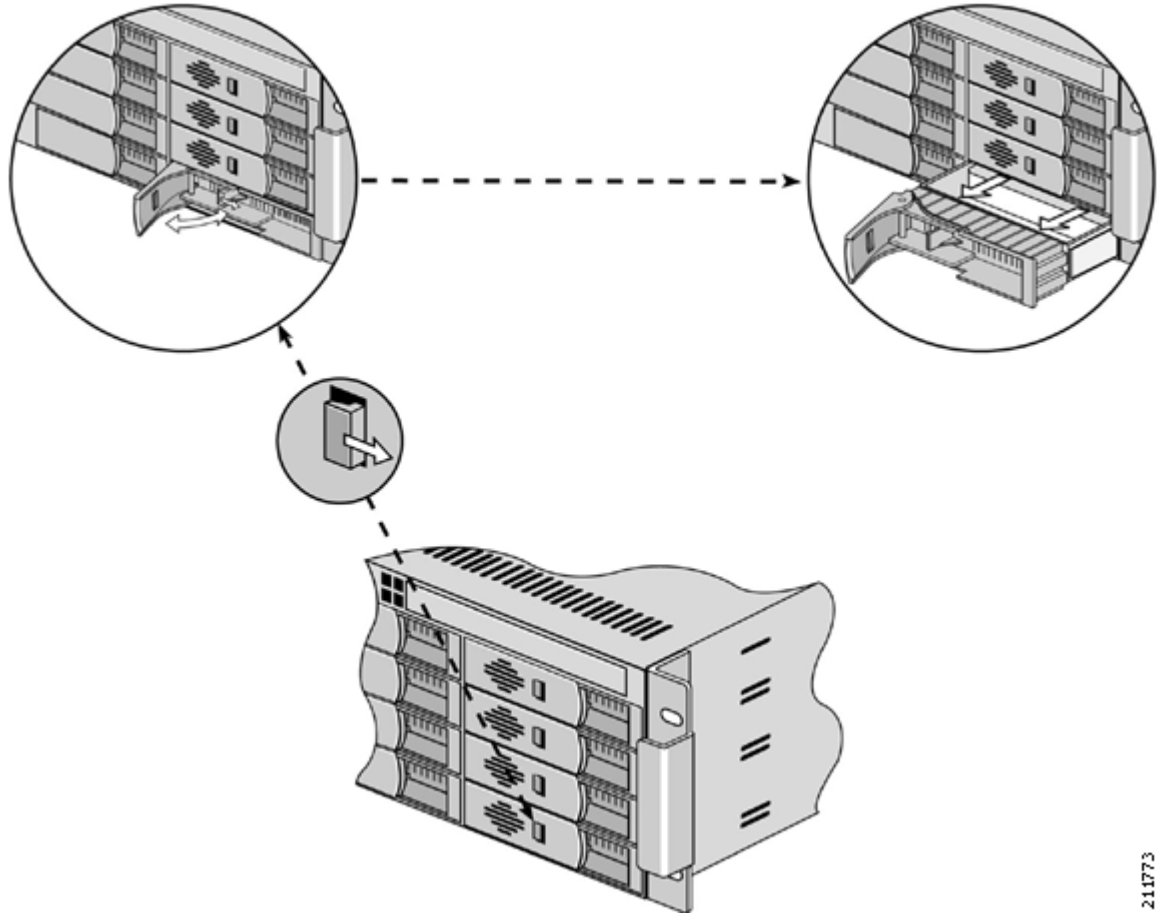

211773

**Note**

Once the servers are powered up, a Cisco technician will initially configure the servers to be able to communicate properly. Further configuration is accomplished through the CDSM. See the *Cisco TV CDS Software Configuration Guide* for more information.



CHAPTER 4

Installing the Internet Streamer CDS Software and Initially Configuring a CDE

This chapter describes the initial installation of the Cisco Internet Streamer CDS Release 2.0-2.1 software application suite, and the initial configuration of the CDE. This chapter contains the following sections:

- [Before You Begin, page 4-1](#)
- [Running the BIOS Setup Utility, page 4-2](#)
- [Installing the Software, page 4-13](#)
- [Initially Configuring a CDE, page 4-14](#)
- [Verifying the CDSM, page 4-15](#)

Before You Begin

You need the following to perform the initial installation and configuration of the CDS:

- CDE100 or CDE200
- USB CD-ROM drive (for CDE200 only [provided])
- Internal IDE compact flash drive (pre-installed)
- Terminal server connection with the following parameters:
 - 9600 baud
 - 8 bits
 - No parity
 - Redirection After BIOS POST is off in CDE BIOS setup
 - Console redirection enabled for COM1
- CDS image CD
- Network connection



Note

On the CDE200, use the USB port to connect the USB CD-ROM drive. After the initial installation, remove the USB CD-ROM drive. The internal IDE compact flash drive becomes the boot drive for subsequent operations.

**Note**

For the CDE100, use the internal CD-ROM drive for recovery or remanufacture procedures.

For the CDE200, do not use the internal CD-ROM drive for recovery or remanufacture procedures. Use the external USB CD-ROM drive for all procedures that require a CD-ROM drive.

You also need to configure the ports on the CDE200 as shown below:

- The two built-in Gigabit Ethernet ports are GigabitEthernet 1/0 and GigabitEthernet 2/0 and are management ports using channel bonding 1 (see [Figure 1-18](#)).

Ethernet Management Ports	Gigabit Ethernet Management Ports
eth0	g1/0
eth1	g2/0

- The four interface ports on the stream interfaces are GigabitEthernet 3/0, GigabitEthernet 4/0, GigabitEthernet 5/0 and GigabitEthernet 6/0 using channel bonding 2 (see [Figure 1-18](#)).

Ethernet Stream Interface Ports	Gigabit Ethernet Stream Interface Ports
eth2	g3/0
eth3	g4/0
eth4	g5/0
eth5	g6/0

Installation and Configuration Order

Perform the initial installation and configuration of your CDS network in the following order:

- Run the BIOS setup utility on each CDE in the CDS network.
- Install the CDS Release 2.0-2.1 software on each CDE in the CDS network.
- Configure the CDSM.

**Caution**

It is very important that the onboard SCSI controller be disabled on the CDE200. Do this by physically opening the CDE200 case (by removing two side screws and a back thumbscrew), and verifying that the jumper labeled “JPA-1” (located about two inches below the center PCI-X slot—slot 3 of 5) has pins 2 and 3 connected (instead of 1 and 2). Pin 1 is closest to the rear of the case and pin 3 is closest to the front.

Running the BIOS Setup Utility

Running the BIOS setup utility is different for the CDE100 and the CDE200; therefore, this section provides a separate BIOS setup procedure for each CDE.

Running the BIOS Setup Utility for the CDE100

Perform the following steps to run the BIOS setup utility for the CDE100:

- Step 1 Power on the CDE100.
- Step 2 Insert the CD with the CDS image into the internal CD-ROM drive.
- Step 3 Reboot the CDE100 and wait for the initial BIOS screen to appear.



Note Step 4 through Step 16 are required only for the initial installation. The BIOS setup does not need to be changed for the second and subsequent installations or recovery.

- Step 4 To enter the BIOS Setup menu, press **Delete** as instructed at the bottom of the BIOS screen. The Main menu appears (see Figure 4-1).

Figure 4-1 Main Menu

```

Main      Advanced  Boot      Security  Exit
* System Overview
* *****
* AMIBIOS
* Version   : 08.00.10
* Build Date: 01/05/06
* ID        : DVAG2007
*
* Processor
* Type      : Intel(R) Xeon(TM) CPU 3.60GHz
* Speed     : 3600MHz
* Count     : 1
*
* System Memory
* Size      : 4096MB
*
* System Time           [19:27:49]
* System Date           [Wed 08/08/2007]
*
* Use [ENTER], [TAB]
* or [SHIFT-TAB] to
* select a field.
*
* Use [+] or [-] to
* configure system Date.
*
* ** Select Screen
* ** Select Item
* +- Change Field
* Tab Select Field
* F1 General Help
* F10 Save and Exit
* ESC Exit
*
* 211844

```



Tip If you are viewing the initial BIOS screen through a remote terminal server, **Ctrl-Backspace** functions the same as the **Delete** key.

- Step 5 From the Main menu, choose **Boot** and press **Enter**. The Boot Settings menu appears (see Figure 4-2).

Figure 4-6 Advanced Settings Menu

```

Main    Advanced    Boot    Security    Exit

* Advanced Settings                               * Configure CPU.          *
* *****                                         *                         *
* WARNING: Setting wrong values in below sections *                         *
*   may cause system to malfunction.              *                         *
* * CPU Configuration                             *                         *
* * IDE Configuration                             *                         *
* * Floppy Configuration                          *                         *
* * PCIPnP Configuration                         *                         *
* * SuperIO Configuration                        *                         *
* * Advanced Chipset Configuration              *                         *
* * ACPI Configuration                           *                         *
* * Power Configuration                          * **   Select Screen    *
* * Event Log Configuration                      * **   Select Item      *
* * MPS Configuration                            * Enter Go to Sub Screen *
* * PCI Express Configuration                   * F1   General Help     *
* * Remote Access Configuration                 * F10  Save and Exit    *
* * USB Configuration                           * ESC  Exit              *
* * System Health Monitor                       *                         *

```

Step 11 Choose **IDE Configuration** and press **Enter**. The IDE Configuration screen appears (see [Figure 4-7](#)).

Figure 4-7 IDE Configuration Screen

```

Advanced

* IDE Configuration                               * Select IDE Mode.      *
* *****                                         *                         *
* IDE Configuration [P-ATA Only]                  *                         *
* S-ATA Running Enhanced Mode [No]                *                         *
* P-ATA Channel Selection [Primary]                *                         *
* * Primary IDE Master : [Hard Disk]               *                         *
* * Primary IDE Slave  : [Not Detected]            *                         *
* * Secondary IDE Master : [Not Detected]          *                         *
* * Secondary IDE Slave : [Not Detected]          *                         *
* * Third IDE Master    : [Not Detected]          *                         *
* * Third IDE Slave     : [Not Detected]          *                         *
* * Fourth IDE Master   : [Not Detected]          * **   Select Screen    *
* * Fourth IDE Slave    : [Not Detected]          * **   Select Item      *
* * Hard Disk Write Protect [Disabled]            * +   Change Option    *
* * IDE Detect Time Out (Sec) [35]                * F1   General Help     *
* * * * *                                         * F10  Save and Exit    *
* * * * *                                         * ESC  Exit              *

```

- a. Set the **IDE Configuration** option to **P-ATA Only**.
- b. Set the **S-ATA Running Enhanced Mode** option to **No**.
- c. Set the **P-ATA Channel Selection** option to **Both**.



Note On the CDE100, the Primary IDE Slave is connected to the internal CD-ROM drive, the Secondary IDE Master is connected to a 128-MB compact flash drive.

Step 12 Press **Esc** to return to the Advanced menu. Choose **Super I/O Configuration** and press **Enter**. The Configure Super I/O Chipset screen appears (see [Figure 4-8](#)).

Figure 4-10 Exit Options Screen

```

Main      Advanced      Boot      Security      Exit
* Exit Options
* *****
* Save Changes and Exit
* Discard Changes and Exit
* Discard Changes
* Load Optimal D*****
* Load Failsafe *
* * Save configuration changes and exit setup? *
* *
* *****
* [Ok] [Cancel] *
* *****
* * * * *lect Screen
* * * * * Select Item
* Enter Go to Sub Screen
* F1 General Help
* F10 Save and Exit
* ESC Exit
*
*

```

- Step 15** Ensure that the CD with the CDS image is in the internal CD-ROM drive and press **Enter** to confirm and reboot the system. Your configuration is saved, you exit the BIOS Setup menu, and the system reboots.

The system boots from the image on the CD. This requires a terminal server to be hooked up to the serial port of the CDE100. All communication is done through the serial port (see the “[Before You Begin](#)” section on page 4-1 for terminal server settings).

Once the CD starts booting, it displays a spinning “|” symbol for approximately five minutes. Allow the booting to proceed and monitor the sequence from a remote terminal provided by the terminal server.

The CD boot menu is displayed at the conclusion of this boot sequence:

Welcome to the installer. The installer enables installation of a new software image onto your system, or recovers a previous image in the event that the hardware was changed.

```

MODEL: CDE100
FLASH: found, directory validated
COOKIE: valid
IMAGE: DEVELOPMENT[jbohach-lnx02:/data/jbohach/ws/ipvideo/refact-dev-1
FLASHDEV: /dev/hdX

```

```

Installer Main Menu:
1. Configure Network
2. Manufacture flash
3. Install flash cookie
4. Install flash image from network
5. Install flash image from cdrom
6. Install flash image from disk
7. Wipe out disks and install.bin image
8. Exit (and reboot)
9. Force manufacturing flash
Choice [0]:

```

- Step 16** Confirm that the FLASHDEV: line near the top of the menu displays something similar to “/dev/hdX”, where “X” can be any letter.

- If no flash device is found, choose **Option 8** to exit and reboot, and enter the BIOS Setup menu again. Confirm that the BIOS detected the flash device.
- If the BIOS detects the CD-ROM drive but the CD installation menu is not displayed, this is an abnormal condition. Contact Cisco Technical Support at the following URL:

www.cisco.com/techsupport

Running the BIOS Setup Utility for the CDE200

Perform the following steps to run the BIOS setup utility for the CDE200:

- Step 1** Ensure that the CDE200 is powered off.
- Step 2** Attach the USB CD-ROM drive to any available USB port at the rear of the CDE200 (see [Figure 1-4](#)).
- Step 3** Power on the USB CD-ROM drive.
- Step 4** Power on the CDE200 and wait for the initial BIOS screen to appear.



Note [Step 5](#) through [Step 12](#) are required only for the initial installation. The BIOS setup does not need to be changed for the second and subsequent installations or recovery.

- Step 5** To enter the BIOS Setup menu, press **Delete** as instructed at the bottom of the BIOS screen. The Main menu appears (see [Figure 4-11](#)).

Figure 4-11 Main Menu

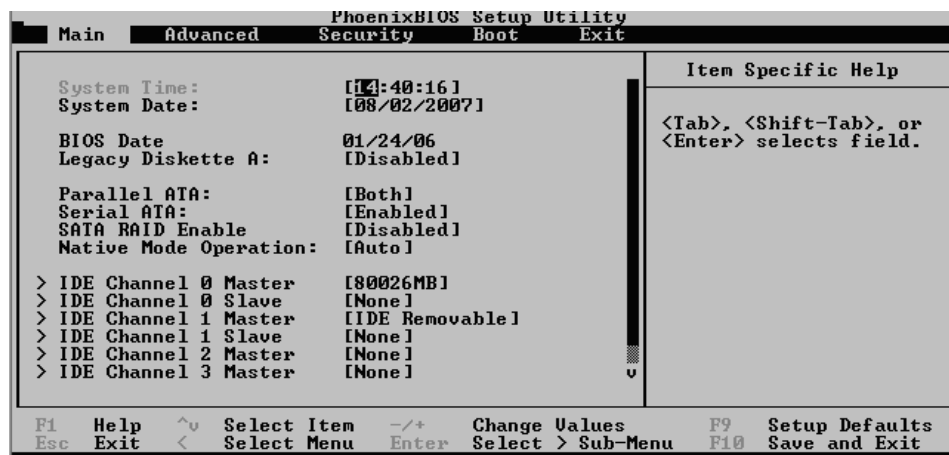

Tip If you are viewing the initial BIOS screen through a remote terminal server, **Ctrl-Backspace** functions the same as the **Delete** key.

- Step 6** Use the arrow keys to navigate to the Advanced menu and press **Enter**. The Advanced menu appears (see [Figure 4-12](#)).

Figure 4-12 Advanced Menu

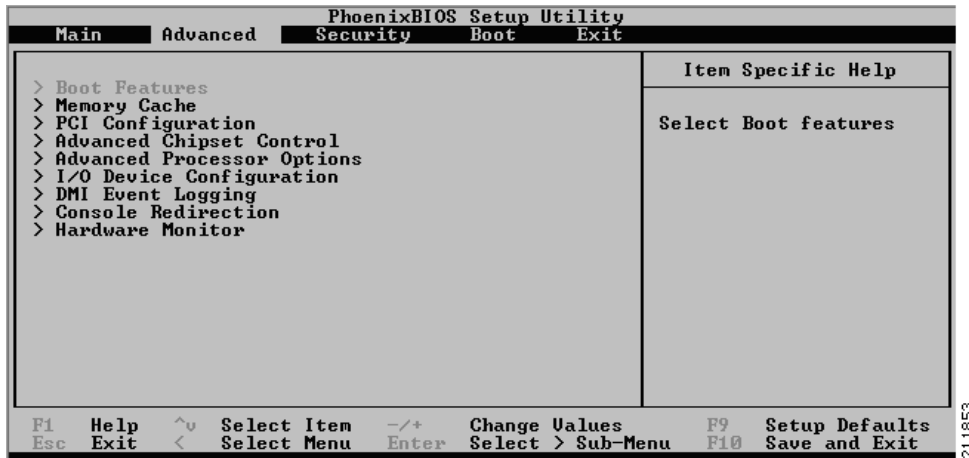

Step 7 Choose **Boot Features** and press **Enter**. The Boot Features screen appears (see [Figure 4-13](#)).

Figure 4-13 Boot Features Screen

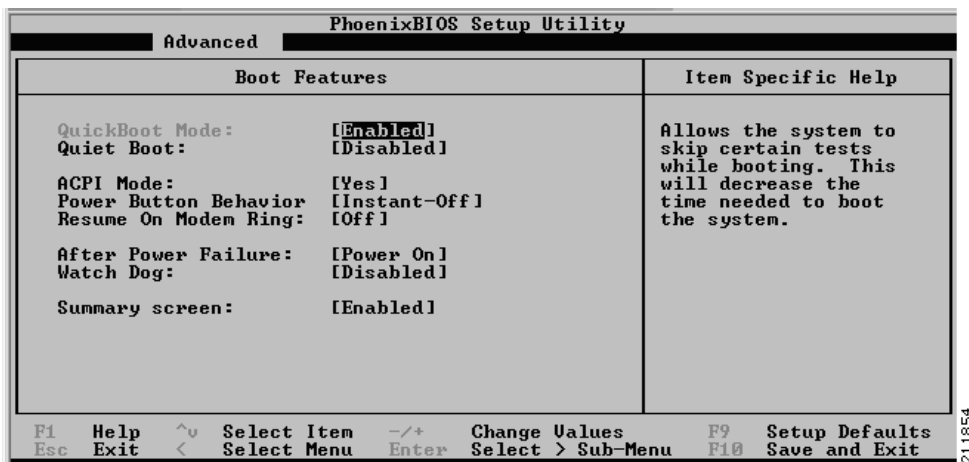

- a. Set the **QuickBoot Mode** option to **Enabled**.
- b. Set the **Quiet Boot** option to **Disabled**.
- c. Set the **After Power Failure** option to **Power On**.

Step 8 Use the **Down Arrow** key to expand **+Hard Drive** and expose its subelements (see [Figure 4-14](#)).

Figure 4-14 Hard Disk Drives Screen

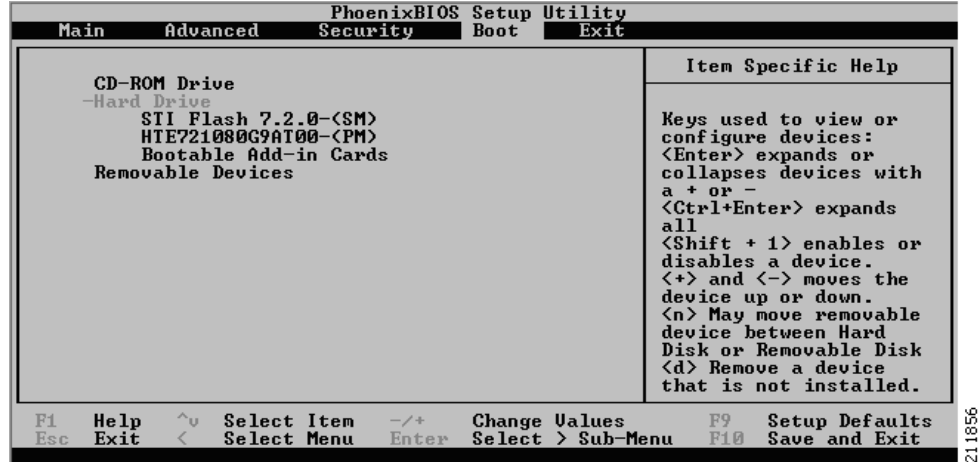

Step 9 Use the on-screen instructions to move the elements into the following order:

1. CD-ROM drive (first boot device)
2. Flash device (first hard drive)
3. Removable devices
4. Network device



Caution

The devices must be in the correct order for the installation to be successful.

Step 10 Press **Esc** to return to the Main menu. To configure IDE, set the **IDE Channel 0 Master** option to **None** and the **IDE Channel 1 Master** option to **128** (this is compact flash card) (see [Figure 4-15](#)).

Figure 4-15 Main Menu

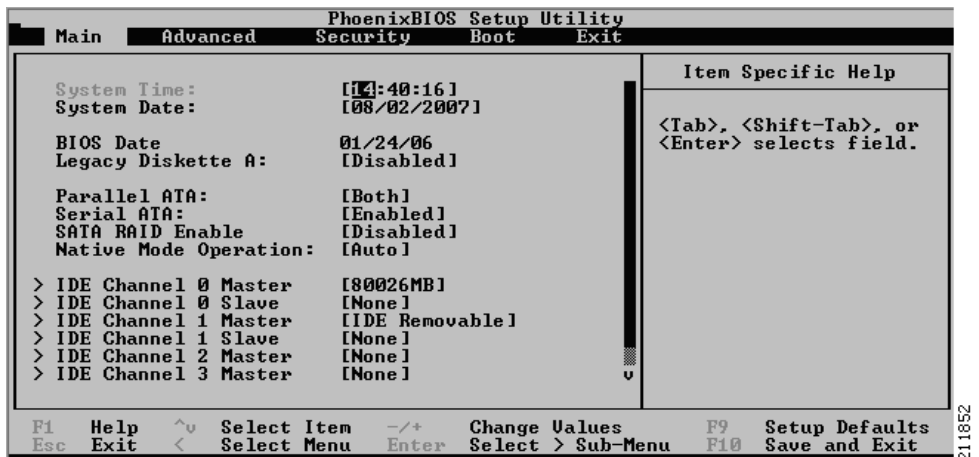

Note

On the CDE200, the Primary IDE Master is connected to the 80-GB hard drive (not used), and the Secondary IDE Master is connected to a 128-MB compact flash drive.

- Step 11 Use the arrow keys to return to the Advanced menu. Choose **Console Redirection** and press **Enter**. The Console Redirection screen appears (see [Figure 4-16](#)).

Figure 4-16 Console Redirection Screen

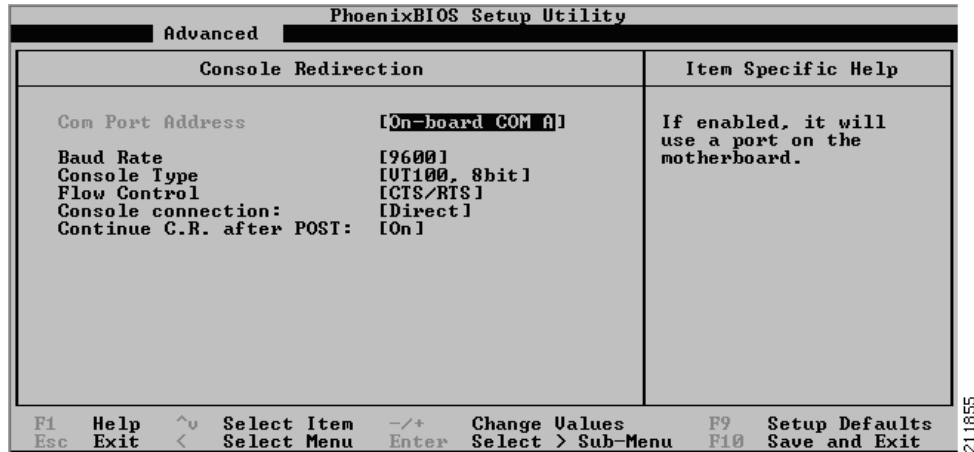

- Set the **Com Port Address** option to **On-board COM A**.
 - Set the **Baud Rate** option to **9600**.
 - Set the **Continue C.R. after POST:** option to **On**.
- Step 12 When you are finished, navigate to the **Exit** submenu and choose **Exit Saving Changes**. Press **Yes** when prompted (see [Figure 4-17](#)).

Figure 4-17 Exit Saving Changes Screen

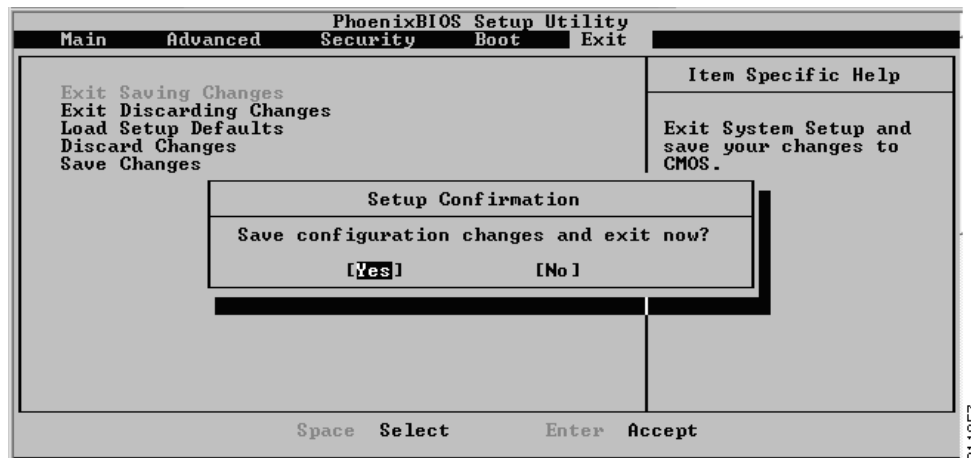

- Step 13 Ensure that the CD with the CDS software image is in the USB CD-ROM drive and press **Enter** to confirm and reboot the system. Your configuration is saved, you exit the BIOS Setup menu, and the system reboots.
- Sometimes the USB CD-ROM drive is not detected by the BIOS after the first power-on. In this case, the CD-ROM drive is not present in the above Hard Drive element list. Press the **Reset** button (not the Power button) and try again. If it still fails, try a different USB CD-ROM drive.

- b. If the USB CD-ROM drive is still not detected (not shown), press the **Reset** button again. If you are still unable to detect the CD-ROM drive at the BIOS level, contact Cisco Technical Support at the following URL:

www.cisco.com/techsupport

The system boots from the image on the CD. This requires a terminal server to be hooked up to the serial port of the CDE200. All communication is done through the serial port (see the “[Before You Begin](#)” section on page 4-1 for terminal server settings).

Once the CD starts booting, it displays a spinning “|” symbol for approximately five minutes. Allow the booting to proceed and monitor the sequence from a remote terminal provided by the terminal server.

The CD boot menu is displayed at the conclusion of this boot sequence:

Welcome to the installer. The installer enables installation of a new software image onto your system, or recovers a previous image in the event that the hardware was changed.

```
MODEL: CDE200
FLASH: found, directory validated
COOKIE: valid
IMAGE: DEVELOPMENT[jbohach-lnx02:/data/jbohach/ws/ipvideo/refact-dev-1
FLASHDEV: /dev/hdX
```

Installer Main Menu:

```
1. Configure Network
2. Manufacture flash
3. Install flash cookie
4. Install flash image from network
5. Install flash image from cdrom
6. Install flash image from disk
7. Wipe out disks and install.bin image
8. Exit (and reboot)
9. Force manufacturing flash
Choice [0]:
```

- Step 14** Confirm that the FLASHDEV: line near the top of the menu displays something similar to “/dev/hdX”, where “X” can be any letter.
- a. If no flash device is found, choose **Option 8** to exit and reboot, and enter the BIOS Setup menu again. Confirm that the BIOS detected the flash device.
 - b. If the BIOS detects the CD-ROM drive but the CD installation menu is not displayed, this is an abnormal condition. You can use a different USB CD-ROM drive and attempt the procedure again, or contact Cisco Technical Support at the following URL:

www.cisco.com/techsupport

Installing the Software

Perform the following steps to install the software:

- Step 1** Manufacture the IDE compact flash drive by selecting **Option 2**. This makes the IDE compact flash drive bootable. Enter **Y** to confirm the process.



Note This step is not necessary if the IDE compact flash drive has been previously manufactured. The system produces an error; ignore the error and proceed.

- Step 2** Choose **Option 3** to install the flash cookie.
- Step 3** Choose **Option 5** to install the flash image from the CD-ROM drive.
- Step 4** Choose **Sub-option 2** and enter **Y** to confirm and proceed with the flash write.
- Step 5** Choose **Option 7** to wipe out the disks and install the .bin image. Enter **Y** to confirm and wipe out all disks. You should see something like this:

```
Successfully installed product image.
MODEL: CDE200
FLASH: found, directory validated
COOKIE: valid
IMAGE: 2.0.0.320
FLASHDEV: /dev/hdc
```

- Step 6** Eject the CD from the CD-ROM drive, disconnect the CD-ROM drive from the CDE, and choose **Option 8** to exit and reboot. Press **Y** and **Enter** to confirm the reboot request.

The system boots from the IDE compact flash drive with the data installed from the CD. All prior data is removed and the original system remains unaffected.



Caution Be sure to disconnect the CD-ROM drive before rebooting the system or the system will not boot with the normal image.

Initially Configuring a CDE

This section provides the steps to perform the initial software configuration after a CDE has been loaded with a CDS software image for the first time. The initial configuration must be done on all CDEs (SEs, SRs, and CDSM) in a network.

Assigning the Primary Interface

The CDE must be configured with a primary interface that acts as the management interface for the CDE. Any interface in the CDE can be configured as the primary interface. Interface GigabitEthernet 1/0 is chosen by default to be the primary interface.

Enter the following commands to assign a primary interface:

```
CDE# configure
CDE(config)# primary-interface GigabitEthernet 1/0
```

Running the Setup Utility

Use the Setup utility to configure the network settings and register the CDEs with the CDSM.

Step 1 Enter the following commands to run the Setup utility:

```
CDE# setup
CDE#
What is the mode of the device (SE/SR/CDSM) [SE]: SE
Is this SE going to be managed by a CDSM (Content Delivery System Manager) (y/n) [y]:y
Please choose an interface to configure from the following list:

1: GigabitEthernet 1/0
2: GigabitEthernet 2/0
3: GigabitEthernet 3/0
4: GigabitEthernet 4/0
5: GigabitEthernet 5/0
6: GigabitEthernet 6/0

Enter choice: 1
Do you want to enable DHCP on this interface (y/n) [n]: n
Please enter the IP address of this interface: 209.165.200.255
Please enter the netmask of this interface: 255.255.255.244
Please enter the default gateway: 10.0.0.0
Please enter the domain name server ip: 172.16.0.0
Please enter the domain name: spcdn.com
Please enter the hostname: CDStr1
Please enter CDSM (Content Delivery System Manager) IP or Host name: 209.165.201.0
Press any key to continue

CDE# configure terminal
CDE# cms enable
```

This process initiates database services on the device that you just configured.



Note Once the IP default gateway has been set, we recommend you ping the outside network to verify it is reachable. Then verify that the CDSM is reachable.

Step 2 After you have run the Setup utility on each SE or SR, they register with the CDSM. Save the configuration by entering the following command:

```
CDE# copy running-config startup-config
```

Verifying the CDSM

Perform the following steps to verify that the CDSM is operational:

Step 1 Launch a web browser and enter the CDSM IP address. The CDSM Login page appears (see [Figure 4-18](#)).

Figure 4-18 CDSM Login Page

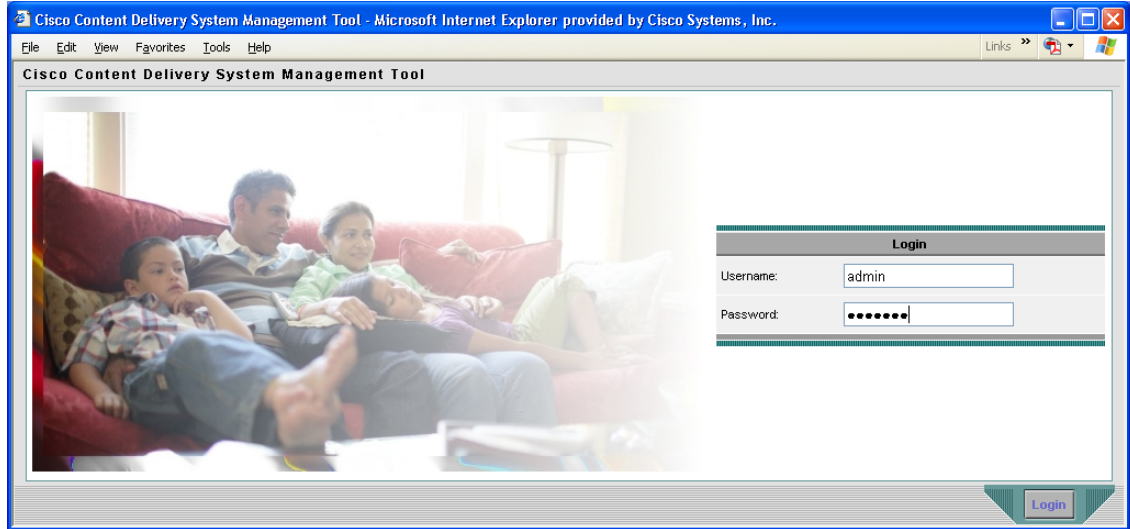

- Step 2 Enter **admin** as the username and **default** as the password and press **Login**.
The CDSM Main menu appears (see Figure 4-19).

Figure 4-19 CDSM Main Menu

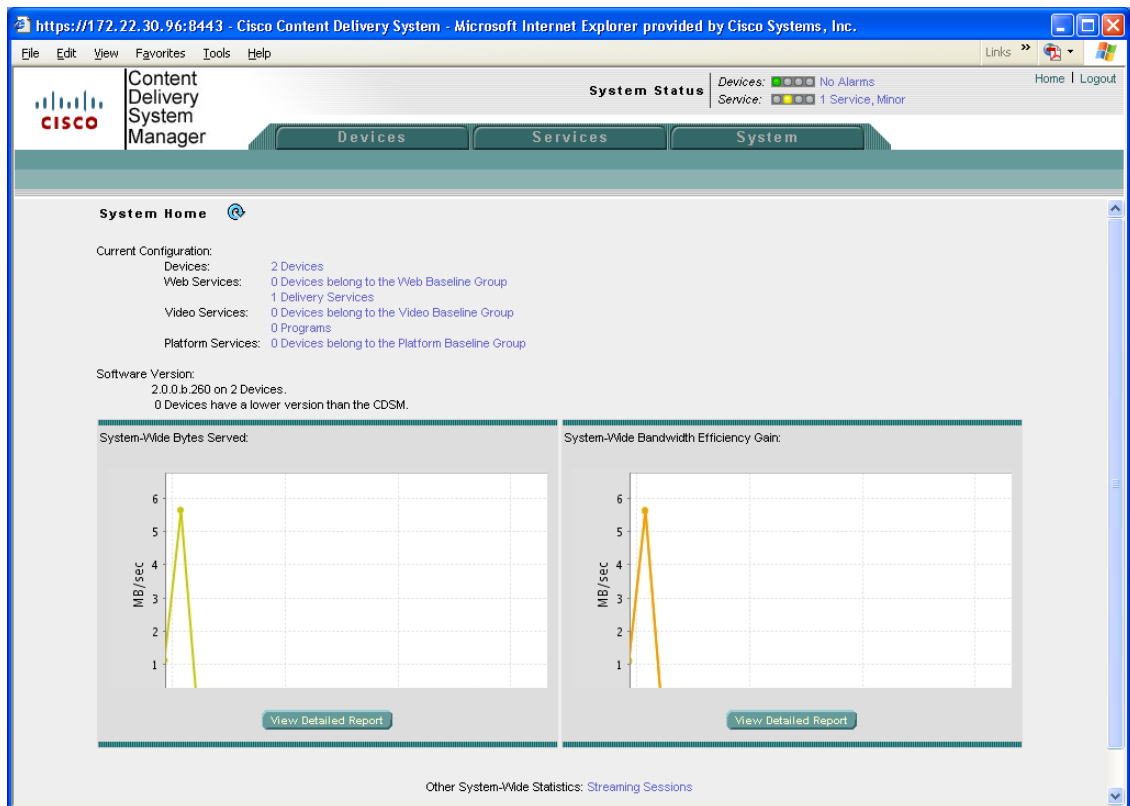

- Step 3** From the CDSM Main menu, select the **Devices** tab. A list of all your registered Service Engines and Service Routers appears (see [Figure 4-20](#)).

Figure 4-20 *Devices Page*

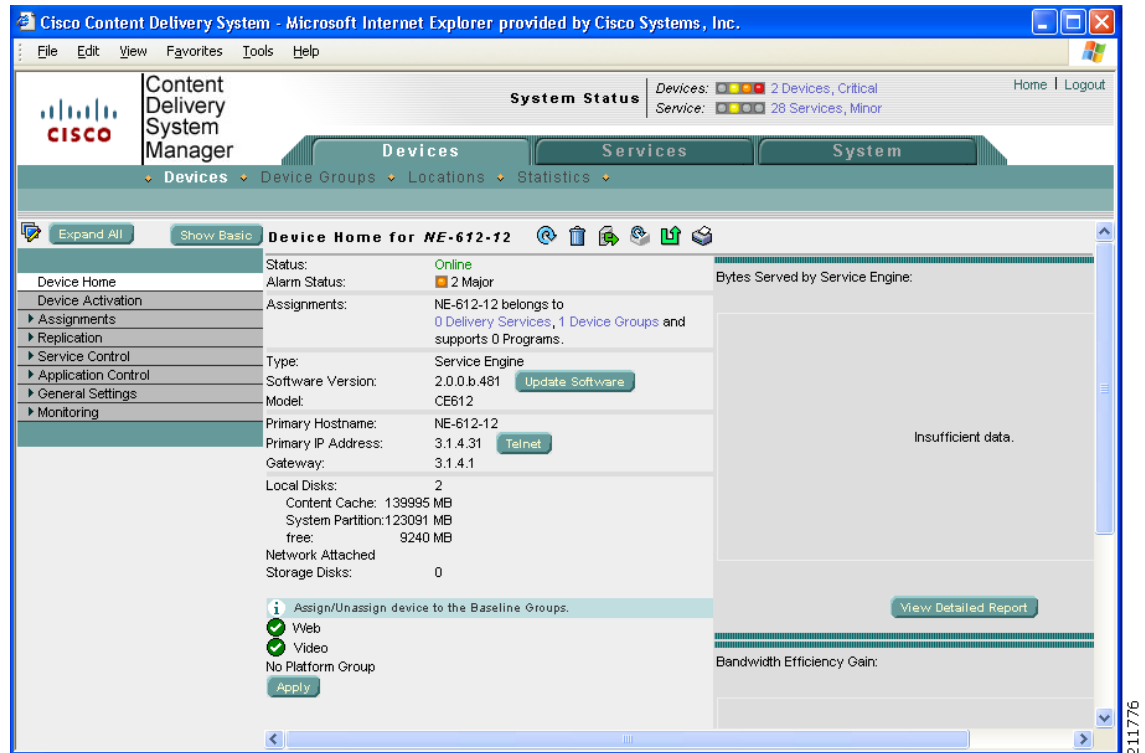

- Step 4** Verify that the devices you configured for your CDS network are listed.
- Step 5** If a device is not listed, restart the CMS for that device by using either the console or Telnet connection and entering the following commands in global configuration mode:

```
CDE(config)# no cms enable
CDE(config)# cms enable
```

The installation is now complete. Refer to the *Cisco Internet Streamer CDS 2.0-2.1 Software Configuration Guide* for information on configuring and using the CDS. See the [“Related Documentation”](#) section on page 2-viii.



CHAPTER 5

Hardware Troubleshooting

This chapter presents troubleshooting procedures for the Cisco CDS Release 2.0-2.1 hardware and recommended actions for a variety of problems. This chapter contains the following sections:

- [Troubleshooting Ethernet Adapters, page 5-1](#)
- [Troubleshooting SATA Drives, page 5-2](#)

Troubleshooting Ethernet Adapters

If you are having problems with any of your Ethernet adapters, perform the following steps to isolate the problem:

-
- Step 1** Make sure the power is applied to the system.
 - Step 2** Verify that the Ethernet cable is of Category 5E quality, or better.
 - Step 3** Try replacing the cable with a known good cable.
 - Step 4** Ensure that the switch at the other end of the Ethernet cable is powered up. Verify that the LED is on for each switch port that is connected to an adapter.

Do not be alarmed if an LED is not lit on an adapter when power is applied to the system. LED illumination at system startup is dependent on the version of the adapter. LEDs on all configured adapters should be lit once the CDS has been started.

- Step 5** Verify that the port configuration on the switch. Most scenarios require that the ports be set to autonegotiate.
- Step 6** As a final troubleshooting technique, it may be necessary to download and run the adapter diagnostics from the appropriate adapter vendor.

The on-board adapter used is a Broadcom component. Vault servers also use a single-port 3Com adapter and dual-port Intel adapters. CDEs use dual-port and quad-port Intel adapters. Driver and diagnostic utilities are available on each vendor's website.

You may also contact Cisco Technical Support at this URL:

www.cisco.com/techsupport

Troubleshooting SATA Drives

The CDE200 and CDE400 contain SATA drives. When working properly, the CDS detects the SATA drives and reports the number of drives in the system.

In the CDE200, there are twelve 500-GB SATA drives. In the CDE400, there are three SATA controller cards. Each controller card controls a total of 8 SATA drives for a total of 24 SATA drives. The SATA controller cards are located in slots 1, 5, and 6 counting from the right as you are facing the rear of the chassis (see [Figure 3-7 on page 3-10](#)).

If the system reports that there is a problem with the SATA drives (such as the drives not being recognized or are being reported as bad), perform the following steps:

-
- Step 1** Reboot the system.
 - Step 2** Reseat the drive in question (see the [“Installing or Removing Disk Drives” section on page 3-9](#)).
 - Step 3** If the problem persists, replace the drive with a known good drive. If the problem still persists, contact Cisco Technical Support at the following URL:
www.cisco.com/techsupport
-



APPENDIX A

Technical Specifications

This appendix provides the technical specifications for the CDEs. It includes the following sections:

- [Specifications, page A-1](#)
- [Management, page A-4](#)



Note

This appendix only provides information on CDEs that were shipped after December 1, 2006 and contain the Lindenhurst chipset. For information on CDEs that were shipped before December 1, 2006 and contain the Serverworks chipset, see [Appendix C, “CDEs with Serverworks Chipset.”](#)

Specifications

This section contains the technical specifications for the CDEs.

CDE100

Rack Units	1
Storage	290-GB SCSI (4x 73-GB SCSI disks)
Memory	4 Gigabytes DRAM
Network interfaces	Two 10/100/1000BASE-T (Copper)
Other interfaces	One serial port for console
Compact Flash	128MB
Optical drive	CD/DVD-ROM
Power	100–240 VAC; single, internal power supply
Power rating	350 W peak
Humidity	5 to 95% noncondensing
Operating temperature	0 to 50°C (32 to 122° F)
Altitude	–60 to 4000 m
Dimensions (H x W x D)	1.75 x 19 x 27.6 in. (4.45 x 48.26 x 70.10 cm)
Weight (fully configured)	35 lb (15.88 kg)
Approvals: Safety	UL 1950, 3rd edition
Approvals: EMC	FCC Part 15 Class A (USA)

CDE200

Rack units	2
Storage	6-TB SATA (12x 500-GB SATA)
Memory	8 Gigabytes DRAM
Network interfaces	Copper: Four 10/100/1000BASE-T Fiber: Four 1000BASE-SX
Other interfaces	Two 10/100/1000BASE-T on motherboard, one for out-of-band management; One serial port for console
Compact Flash	128MB
Optical drive	None
Power	115–240 VAC or –48 VDC; Redundant power supplies included
Power rating	500 W
Humidity	5 to 95% noncondensing
Operating temperature	0 to 50°C (32 to 122° F)
Altitude	–60 to 4000m
Dimensions (H x W x D)	3.50 x 17.50 x 28.50 in. (8.90 x 44.45 x 72.39 cm)
Weight (fully configured)	53.5 lb (24.27 kg)
Approvals: Safety	UL 1950, 3rd edition
Approvals: EMC	FCC Part 15 Class A (USA)

CDE300

Rack units	3
Storage	1.15-TB SCSI (16x 73-GB SCSI disks)
Memory	16 Gigabytes DRAM
Network interfaces	Copper: Twelve 10/100/1000BASE-T; Fiber: Eight 1000BASE-SX
Other interfaces	Two 10/100/1000BASE-T on motherboard of which one used for out-of-band management; One serial port for console
Compact Flash	None
Optical drive	None
Power	100–240 VAC or –48 VDC; Redundant power supplies included
Power rating	650 W peak; 506 W nominal
Humidity	5 to 90% noncondensing
Operating temperature	0 to 50°C (32 to 122° F)
Altitude	–60 to 4000m
Dimensions (H x W x D)	4.75 x 17.25 x 27.50 in. (12.1 x 43.8 x 69.9 cm)
Weight (fully configured)	125 lb (56.7 kg)
Approvals: Safety	UL 1950, 3rd edition
Approvals: EMC	FCC Part 15 Class A (USA)

CDE400

Rack units	4
Storage	12-TB SATA (24x 500-GB SATA disks)
Memory	4 Gigabytes DRAM
Network interfaces	Copper: Six 10/100/1000BASE-T; Fiber: Six 1000BASE-SX
Other interfaces	Two 10/100/1000BASE-T on motherboard, one for out-of-band management and one for Ingest; One serial port for console
Compact Flash	None
Optical drive	None
Power	100–240 VAC or –48 VDC; Redundant power supplies included
Power rating	950 W peak; 627 W nominal
Humidity	5 to 95% noncondensing
Operating temperature	0 to 50°C (32 to 122° F)
Altitude	–60 to 4000m
Dimensions (H x W x D)	7.00 x 17.25 x 26.50 in. (17.8 x 43.8 x 67.3 cm)
Weight (fully configured)	150 lb (68.0 kg)
Approvals: Safety	UL 1950, 3rd edition
Approvals: EMC	FCC Part 15 Class A (USA)

Management

Data Rate	2 Gbps maximum
Ports	Console port: DB-9 RS-232 10/100/1000 Mbps Ethernet interface: RJ-45 (management)
Input Cables	For console port: DB-9 female serial cable For Ethernet interface: RJ-45 Category 5E or higher cable



APPENDIX B

Connector Pin Assignments

This appendix lists the connector pin assignments for the CDEs. This appendix includes the following sections:

- [Serial Console Interface Connector Pin Assignments, page B-1](#)
- [Ethernet Connector Pin Assignments, page B-2](#)
- [Cable Pin Assignments, page B-4](#)



Note

This appendix only provides information on CDEs that were shipped after December 1, 2006 and contain the Lindenhurst chipset. For information on CDEs that were shipped before December 1, 2006 and contain the Serverworks chipset, see [Appendix C, “CDEs with Serverworks Chipset.”](#)

Serial Console Interface Connector Pin Assignments

The serial console interface connector is a 9-pin, RS-232 D-type, DTE connector. A null modem cable is required to connect a workstation running the Linux or Windows operating system. [Table B-1](#) lists the pin assignments for the serial console interface connector.

Table B-1 RS-232 Connector Pin Assignments

Description	Pin	I/O	Signal Name
Data carrier detect; input	1	In	DCD
Receive data; input	2	In	RXD
Transmit data; output	3	Out	TXD
Data terminal ready; output	4	Out	DTR
Interface signal ground	5	–	GND
Data set ready; input	6	In	DSR
Ready to send; output	7	Out	RTS
Clear to send; input	8	In	CTS
Ring indicator; input	9	In	RI

Serial Port Connector

The CDEs have one standard serial port connector located on the back of the device.

[Figure B-1](#) shows the pin number assignments for the 9-pin, male D-shell serial port connector on the back of the device. These pin number assignments conform to the industry standard for RS-232 communications.

Figure B-1 Serial Port Connector

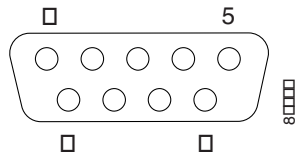

Ethernet Connector Pin Assignments

The Ethernet connector is an 8-pin, modular RJ-45 connector. [Table B-2](#) through [Table B-4](#) list the Ethernet connector pin assignments.

Table B-2 Ethernet Connector Pin Assignments for T568A

RJ-45 Pin	Wire Color (T568A)	Wire Diagram (T568A)	10BASE-T 100BASE-T	1000BASE-T Signal
1	White/Green		Transmit+	BI_DA+
2	Green		Transmit-	BI_DA-
3	White/Orange		Receive+	BI_DB+
4	Blue		Unused	BI_DC+
5	White/Blue		Unused	BI_DC-
6	Orange		Receive-	BI_DB-
7	White/Brown		Unused	BI_DD+
8	Brown		Unused	BI_DD-

Table B-3 Ethernet Connector Pin Assignments for T568B

RJ-45 Pin	Wire Color (T568B)	Wire Diagram (T568B)	10BASE-T 100BASE-T	1000BASE-T Signal
1	White/Orange		Transmit+	BI_DA+
2	Orange		Transmit-	BI_DA-
3	White/Green		Receive+	BI_DB+
4	Blue		Unused	BI_DC+

Table B-3 Ethernet Connector Pin Assignments for T568B (continued)









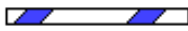

RJ-45 Pin	Wire Color (T568B)	Wire Diagram (T568B)	10BASE-T 100BASE-T	1000BASE-T Signal
5	White/Blue		Unused	BI_DC-
6	Green		Receive-	BI_DB-
7	White/Brown		Unused	BI_DD+
8	Brown		Unused	BI_DD-

Table B-4 RJ-45 Crossover Cable Pin Assignments for T568B

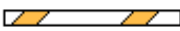
RJ-45 Pin End 1	Wire Color	Diagram End 1	RJ-45 Pin End 2
1	White/Orange		3
2	Orange		6
3	White/Green		1
4	Blue		7
5	White/Blue		8
6	Green		2
7	White/Brown		4
8	Brown		5

Ethernet Port Connector

The CDEs come with an integrated dual-port Ethernet controller. This controller provides an interface for connecting to 10-Mbps, 100-Mbps, or 1000-Mbps networks and provides full-duplex (FDX) capability, which enables simultaneous transmission and reception of data on the Ethernet LAN.

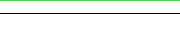
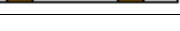
To access the Ethernet port, connect a Category 3, 4, or 5 unshielded twisted-pair (UTP) cable to the RJ-45 connector on the back of the device.



Note

The 100BASE-TX/1000BASE-TX Ethernet standard requires that the cabling in the network be Category 5 or higher.

Figure 2-2 shows the pin number assignments for the Ethernet RJ-45 port.

Figure 2-2 RJ-45 Ethernet Port Connector

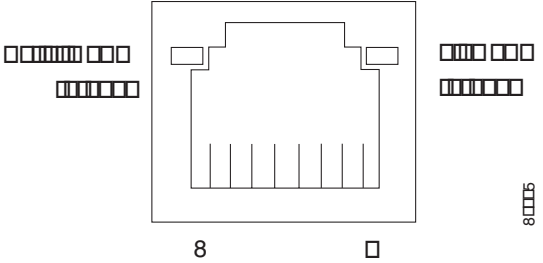

Cable Pin Assignments

Figure B-3- through Figure B-5 show the pin assignments for the cable connection for an RS-232 null modem, RJ45 straight-through, and RJ-45 crossover cable, respectively.

Figure B-3 Pin Assignments for RS-232 Null Modem

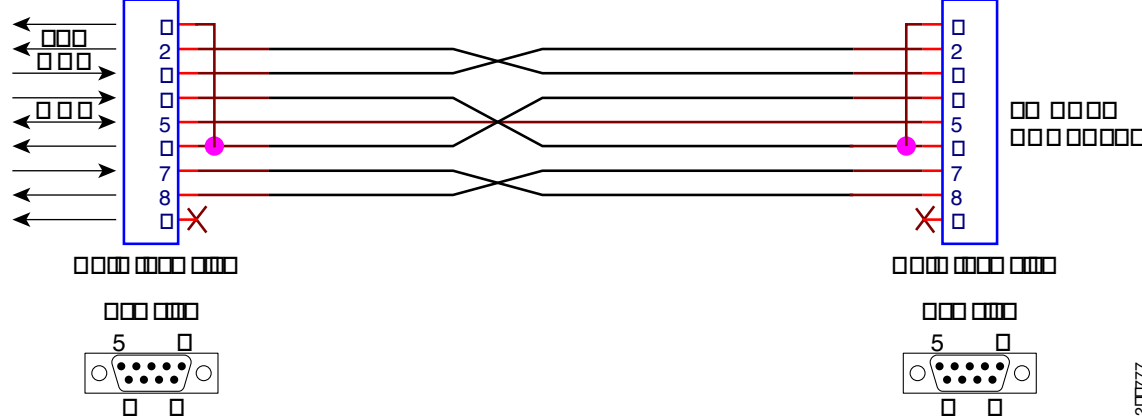
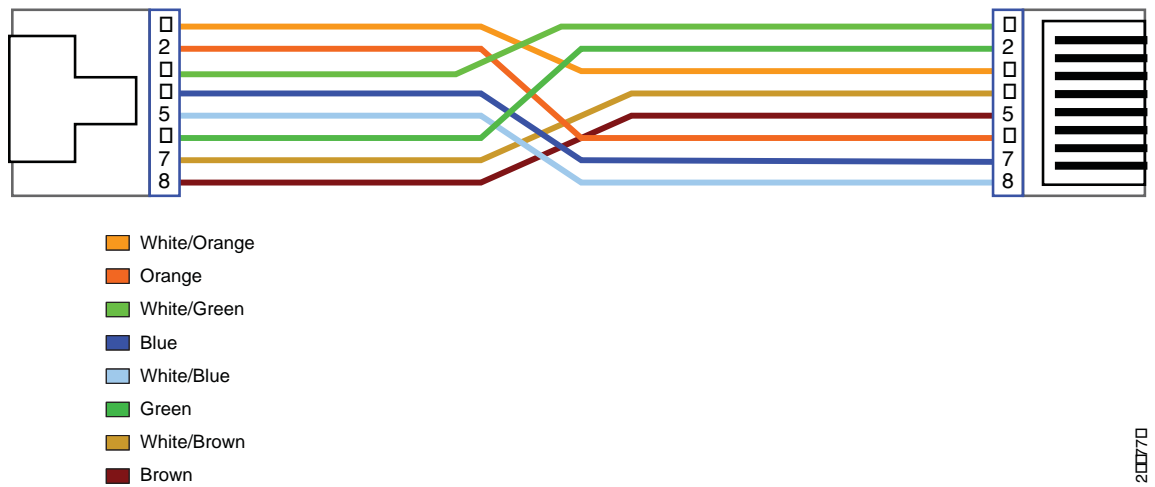

Figure B-4 Pin Assignments and Wiring for an RJ-45 Straight-Through Cable



200778

Figure B-5 Pin Assignments and Wiring for an RJ-45 Crossover Cable



200770



CDEs with Serverworks Chipset

This appendix provides the specifications and connector pin assignments for CDEs with the Serverworks chipset that shipped before December 1, 2006. This appendix includes the following sections:

- [Specifications, page C-1](#)
- [Connector Pin Assignments, page C-5](#)

Specifications

This section contains the technical specifications for the CDEs with the Serverworks chipset.

CDE100

Dimensions (H x W x D)	1.75 (1U) × 19 × 27.6 in. (4.45 × 48.26 × 70.10 cm)
Weight	Chassis fully configured (all slots filled): 35 lb (15.88 kg)
Database Storage Capacity	4 Serial-ATA 74 or 320-GB hard drives
Management Interface	1 Gigabit Ethernet interface
Memory	4 Gigabytes RAM
Processor	Pentium 4 @ 3.6 GHz 800-MHz FSB, 1-MB Cache
Protocols	IP, SNMP, FTP, Gigabit Ethernet, SSH
Operating System	Red Hat 9.0 distribution supporting Linux kernel 2.4.30
Operating System Disk	60 GB small form factor IDE hard drive
Cable length	Maximum length of 330 ft (100 m) using Category 5E or higher
Performance Monitoring	Integrate with both the Tandberg and C-COR back office suite
Power	350 W peak (110 and 220 VAC)
Fan Assembly	Redundant with operation alarm monitored by system
Operating Temperature	32 to 122°F (0 to 50°C)
Humidity	5 to 95% noncondensing
Short Term Humidity	5 to 98% (96 hours)
Altitude	-197 to 13120 ft (-60 to 4000 m)

CDE200

Dimensions (H x W x D)	3.50 (2U) × 17.50 × 28.50 in. (8.90 × 44.45 × 72.39 cm)
Weight	Chassis fully configured (all slots filled): 53.5 lb. (24.27 kg)
Content Storage Capacity	12 Serial-ATA 320, 400, or 500 GB hard drives
Management Interface	1 Gigabit Ethernet interface
Ingest Interface	1 Gigabit Ethernet interface
Stream Interfaces	3 Gigabit Ethernet interfaces
Transport	High Definition MPEG-2 and Advanced Codec; Network PVR is fully supported
Memory	8 Gigabytes RAM
Processor	Two Dual Xeon @ 3.2 GHz (or above)
Protocols	IP, SNMP, FTP, Gigabit Ethernet, SSH, FSI, DSM-CC, LSCP, RTSP
Controllers	Marvell Serial-ATA
Operating System	Red Hat 7.3 distribution supporting Linux kernel 2.4.19
Operating System Disk	Two 60– GB small form-factor IDE hard drives
Cable length	Twisted Pair: Maximum of 330 ft (100 m) using Category 5E or higher, 4 pair Fiber-Optic SX multimode: 1640 ft (500 m) maximum (50/125 mm), 902 ft (275 m) maximum (62.5/125 mm)
Performance Monitoring	Integrate with both the Tandberg and C-COR back office suite
Power	500 W (110 and 220 VAC or –48 VDC) redundant, hot-swappable ¹
Fan Assembly	Redundant with operation alarm monitored by system
Operating Temperature	32 to 122°F (0 to 50°C)
Humidity	5 to 95% noncondensing
Short Term Humidity	5 to 98% (96 hours)
Altitude	–197 to 13120 ft (–60 to 4000 m)

1. The power supplies for the CDE200 ISV server has not been investigated for hot-swapping.

CDE200 (IBM)

Dimensions (H x W x D)	3.50 (2U) × 17.50 × 27.48 in. (8.90 × 44.45 × 69.80 cm)
Weight	Chassis fully configured (all slots filled): 50 lb. (22.68 kg)
Content Storage Capacity	4 SCSI 300-GB hard drives
Management Interface	1 Gigabit Ethernet interface
Ingest Interface	1 Gigabit Ethernet interface
Stream Interfaces	3 Gigabit Ethernet interfaces
Transport	High Definition MPEG-2 and Advanced Codec
Memory	8 Gigabytes RAM
Processor	Two Dual Xeon @ 3.6 GHz (or above)
Protocols	IP, SNMP, FTP, Gigabit Ethernet, SSH, FSI, DSM-CC, LSCP, RTSP
Controllers	Ultra320 SCSI
Operating System	Red Hat 7.3 distribution supporting Linux kernel 2.4.19
Operating System Disk	2 SCSI 73-GB hard drives
Cable length	Twisted Pair: Maximum of 330 ft (100 m) using Category 5E or higher, 4 pair Fiber-Optic SX multimode: 1640 ft (500 m) maximum (50/125 mm), 902 ft (275 m) maximum (62.5/125 mm)
Performance Monitoring	Integrate with both the Tandberg and C-COR back office suite
Power	625 W (110 and 220 VAC or –48 VDC) redundant, hot-swappable ¹
Fan Assembly	Redundant with operation alarm monitored by system
Operating Temperature	50 to 95°F (10 to 35°C) for altitudes from 0 to 3000 ft (914.4 m) decrease system temperature by 33.35°F for every 1000 feet increase in altitude
Humidity	8 to 80% noncondensing

1. The power supplies for the CDE200 ISV server has not been investigated for hot-swapping.

CDE300

Dimensions (H x W x D)	4.75 (3U) × 17.25 × 27.50 in. (12.1 × 43.8 × 69.9 cm)
Weight	Chassis fully configured (all slots filled): 125 lb (56.7 kg)
Cached Content Capacity	16 SCSI 73-GB hard drives
Management Interface	1 Gigabit Ethernet interface
Ethernet Interfaces	12 Gigabit Ethernet interfaces for cache and stream traffic
Transport	High Definition MPEG-2 and Advanced Codec; Pre-encryption and Network PVR is fully supported
Memory	16 Gigabytes RAM
Processor	Two Dual Xeon @ 3.2 GHz (or above)

Protocols	IP, SNMP, FTP, Gigabit Ethernet, SSH, FSI, DSM-CC, LSCP, RTSP
SCSI Controllers	Ultra320 SCSI
Operating System	Enterprise Linux 3 is the supported operating system
Operating System Disk	60-GB small form-factor IDE hard drive
Cable length	Twisted Pair: Maximum of 330 ft (100 m) using Category 5E or higher, 4 pair Fiber-Optic SX multimode: 1640 ft (500 m) maximum (50/125 mm), 902 ft (275 m) maximum (62.5/125 mm)
Performance Monitoring	Integrate with both the Tandberg and C-COR back office suite
Power	650 W peak; 506 W nominal (110 and 220 VAC or –48 VDC) redundant, hot-swappable
Fan Assembly	Redundant with operation alarm monitored by system
Operating Temperature	32 to 122°F (0 to 50°C)
Humidity	5 to 90% noncondensing
Short Term Humidity	5 to 98% (96 hours)
Altitude	–197 to 13120 ft (–60 to 4000 m)

CDE400

Dimensions (H x W x D)	7.00 (4U) × 17.25 × 26.50 in. (17.8 × 43.8 × 67.3 cm)
Weight	Chassis fully configured (all slots filled): 150 lb (68.0 kg)
Content Storage Capacity	24 Serial-ATA 320-, 400-, or 500-GB hard drives
Management Interface	1 Gigabit Ethernet interface
Ingest Interface	1 Gigabit Ethernet interface
Cache or Stream Interfaces	4 or 6 Gigabit Ethernet interfaces (for cache traffic on Vault; for stream traffic on ISV)
Transport	High Definition MPEG-2 and Advanced Codec; Network PVR is fully supported
Memory	8 or 16 Gigabytes RAM
Processor	Two Dual Xeon @ 3.2 GHz (or above)
Protocols	IP, SNMP, FTP, Gigabit Ethernet, SSH, FSI, DSM-CC, LSCP, RTSP
Controllers	Marvell Serial-ATA
Operating System	Red Hat 7.3 distribution supporting Linux kernel 2.4.19
Operating System Disk	Two 120-GB ATA hard drives
Cable length	Twisted Pair: Maximum of 330 ft (100 m) using Category 5E or higher, 4 pair Fiber-Optic SX multimode: 1640 ft (500 m) maximum (50/125 mm), 902 ft (275 m) maximum (62.5/125 mm)
Performance Monitoring	Integrate with both the Tandberg and C-COR back office suite

Power	950 W peak; 627 W nominal (110 and 220 VAC or –48 VDC) redundant, hot-swappable
Fan Assembly	Redundant with operation alarm monitored by system
Operating Temperature	32 to 122°F (0 to 50°C)
Humidity	5 to 95% noncondensing
Short Term Humidity	5 to 98% (96 hours)
Altitude	–197 to 13120 ft (–60 to 4000 m)

Connector Pin Assignments

Figure C-1 shows the location of all connectors for a CDE100.

Figure C-1 CDE100 Connector Locations

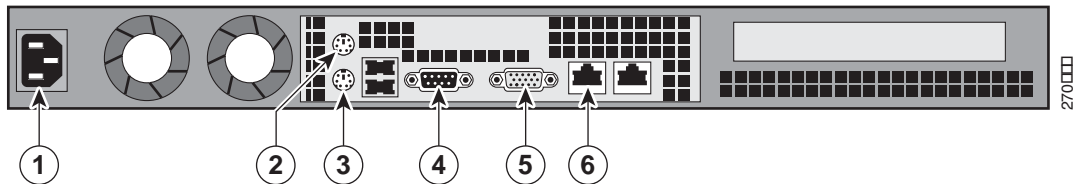

1	Power connectors	4	Serial console interface
2	Mouse connector	5	VGA interface
3	Keyboard connector	6	Management interface (eth0)

Figure C-2 shows the location of all connectors for a CDE200.

Figure C-2 CDE200 Connector Locations

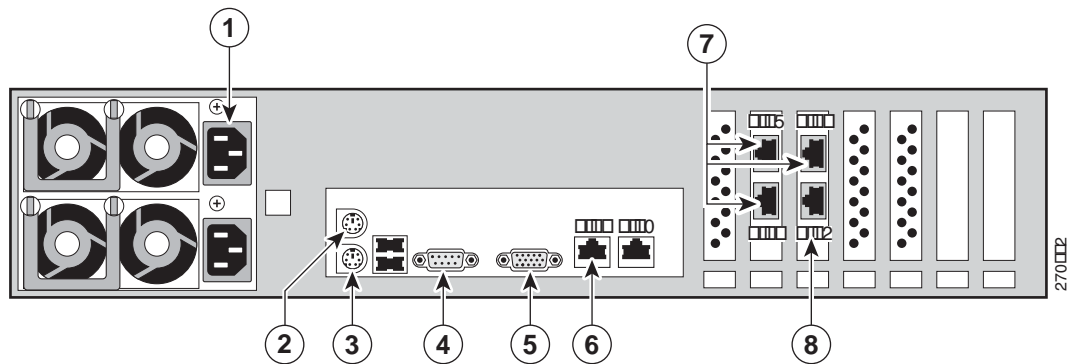

1	Power connectors	5	Serial console interface
2	Mouse connector	6	Management Interface (eth1)
3	Keyboard connector	7	Stream interfaces (eth3, eth4, eth5)
4	VGA interface	8	Ingest Interface (eth2)

Caution

In some CDE200 chassis, the streaming interface NICs are installed in slots 4 and 5 (counting from the left-most slot). In this hardware configuration, the Gigabit Ethernet interfaces on the motherboard are detected as interfaces 3/0 and 4/0, and the interfaces on the NICs are detected as 1/0, 2/0, 5/0, and 6/0. The interface numbering must be taken into consideration when configuring IP addresses and port channels.

Figure C-3 shows the location of all connectors for a CDE200 (IBM).

Figure C-3 CDE200 (IBM) Connector Locations

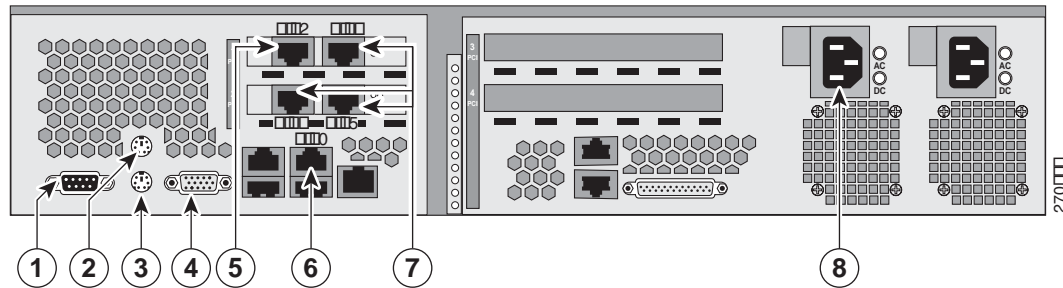

1	Serial console interface	5	Ingest Interface (eth2)
2	Mouse connector	6	Management Interface (eth0)
3	Keyboard connector	7	Stream interfaces (eth3, eth4, eth5)
4	VGA interface	8	Power connector

Figure C-4 shows the location of all the connectors for a CDE300.

Figure C-4 CDE300 Connector Locations

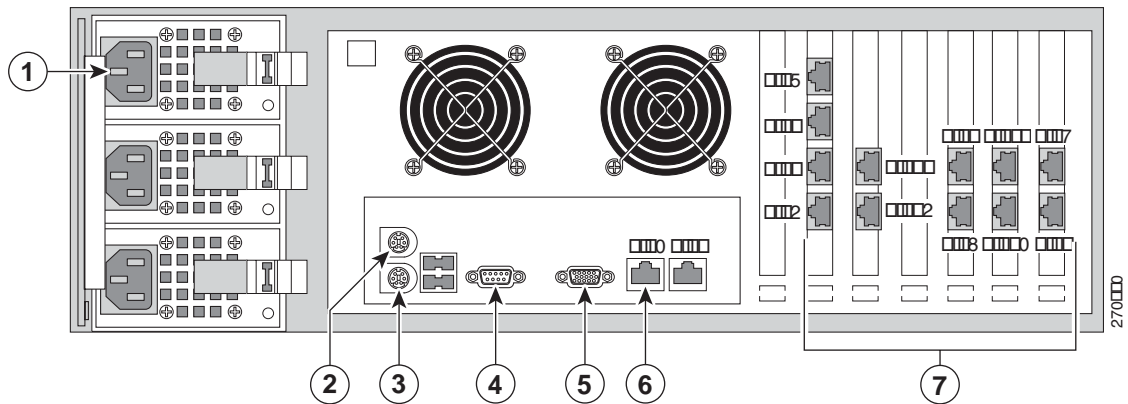

1	Power connectors	5	VGA interface
2	Mouse connector	6	Management interface (eth0)
3	Keyboard connector	7	Cache/Stream interfaces (eth2 through eth13)
4	Serial console interface		

Figure C-5 shows the location of all the connectors for a CDE400 with four cache interfaces.

Figure C-5 CDE400 with Four Cache Interfaces Connector Locations

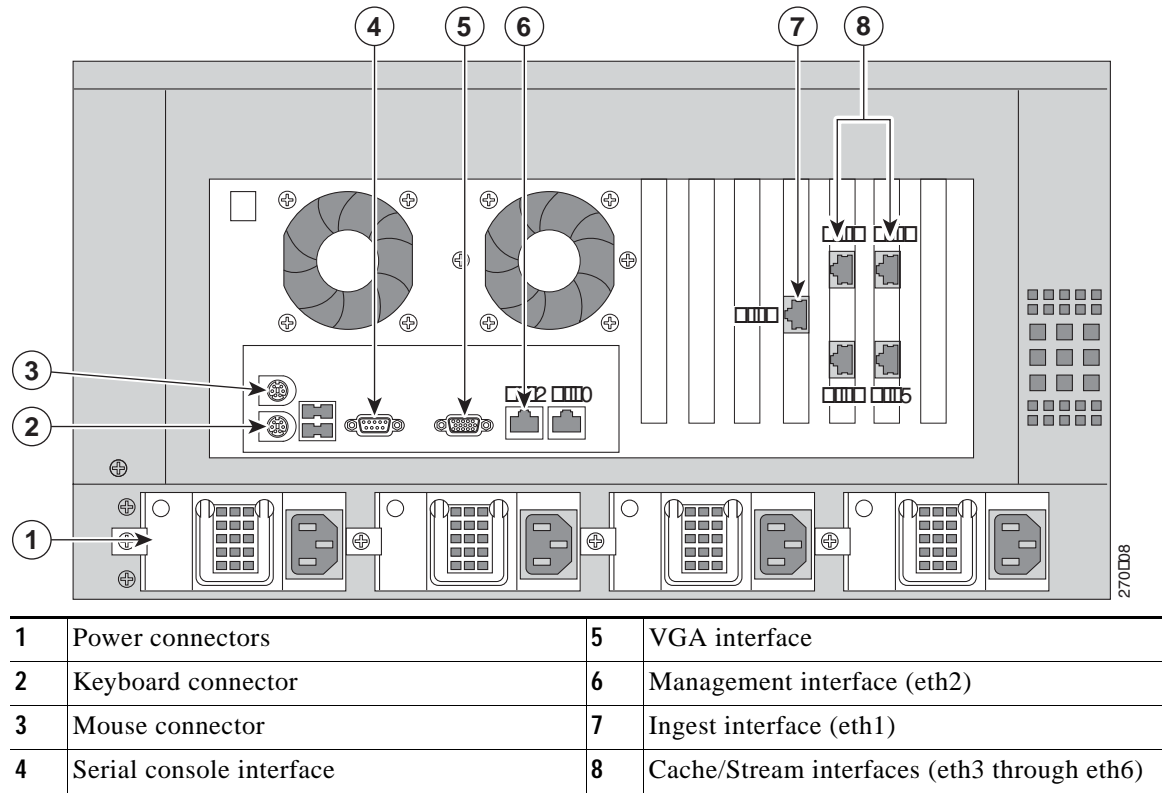
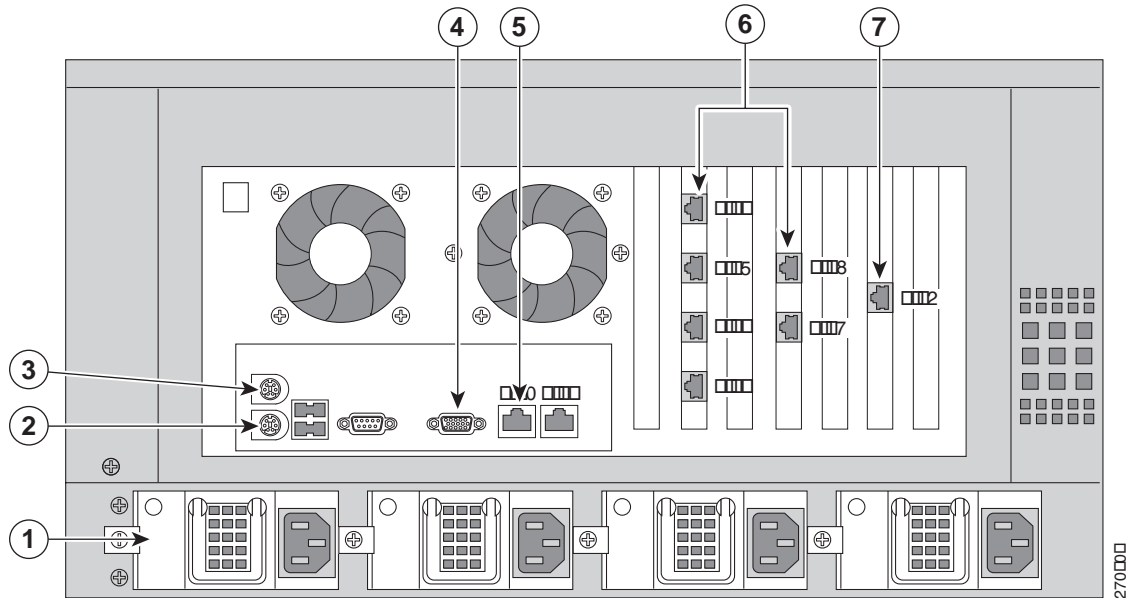

Figure C-6 shows the location of all the connectors for a CDE400 with six cache interfaces.

Figure C-6 CDE400 with Six Cache Interfaces Connector Locations



1	Power connectors	5	VGA interface
2	Keyboard connector	6	Management interface (eth0)
3	Mouse connector	7	Cache/Stream interfaces (eth3 through eth8)
4	Serial console interface	8	Ingest interface (eth2)



APPENDIX D

Connecting DC Power

This appendix provides the information for connecting DC power to a CDE. This appendix includes the following sections:

- [DC Power Overview, page D-1](#)
- [Connecting DC Power to a CDE200, page D-2](#)
- [Connecting DC Power to a CDE300, page D-5](#)
- [Connecting DC Power to a CDE400, page D-7](#)
- [DC Power Cable Connector and Pinouts, page D-11](#)



Note

Prior to connecting DC Power to a CDE, consult the *Regulatory Compliance and Safety Information for the Cisco Content Delivery Engine 100/200/300/400* document for important regulation and safety information.

DC Power Overview

The CDE200, CDE300 and CDE400 can accept DC power (CDE100s do not have a DC power option). The CDEs can accept power from a –48 VDC (–42 to –56 VDC) source that connects to one (primary) or two (secondary/redundant) –48 VDC power modules (PMs). Each DC PM must be connected to a dedicated 60A regulated source. [Figure D-1](#) shows a DC PM for a CDE200.

Figure D-1 DC Power Module for a CDE200

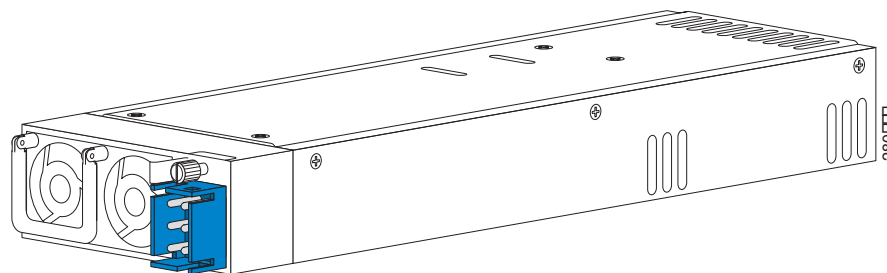

Note

In this chapter, the power supply is referred to as a “power module.”

Connecting DC Power to a CDE200

The CDE200 ships fully populated with two DC PMs installed in the PM slots on the rear of the chassis; two DC power cables are shipped separately. The chassis has one building ground stud and one PM ground stud. The minimum cabling requirement for connecting DC power to a CDE200 is one PM connect, but it is recommended that you use both PM connects. [Figure D-2](#) shows the rear view of a fully-connected CDE200 and provides the location of the ground studs and PMs.

Figure D-2 CDE200 Rear Panel

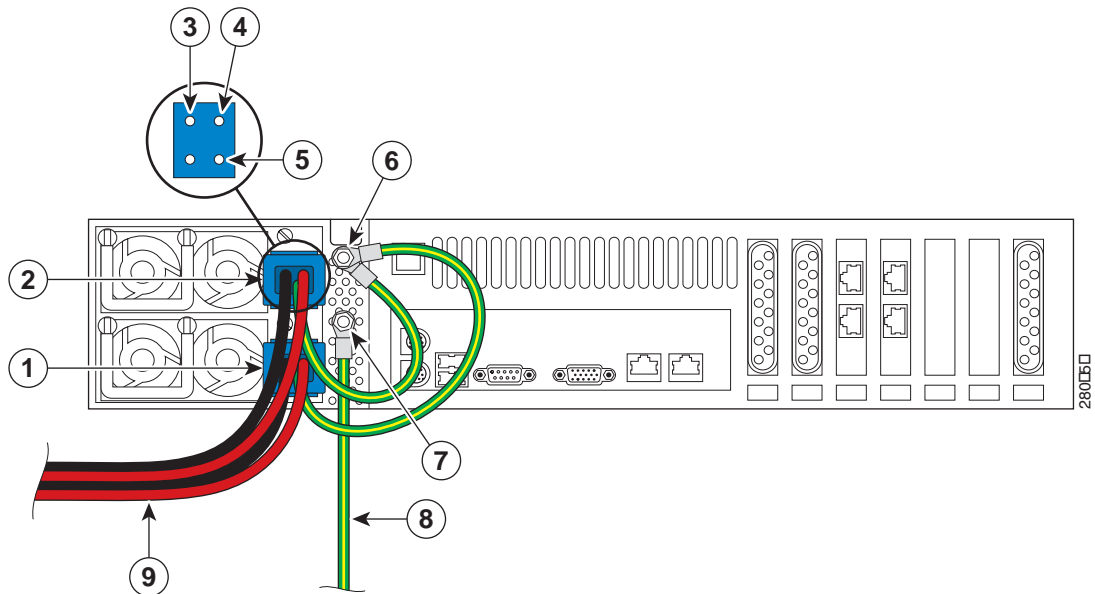

1	PM 1	6	PM ground stud
2	PM 2	7	Building ground stud
3	-48 VDC	8	Building ground wire
4	+Return	9	DC power wires
5	PM ground		

Connect DC power to the CDE200 by performing the following steps:



Caution

Make sure the DC power wires are not attached to the DC power source until all the ground wires are connected on the CDE.

- Step 1** Insert a blue DC power cable connector into the blue port on each PM, making sure it is completely seated.
- Step 2** Attach the ground wires from PM 1 and PM 2 to the PM ground stud:
- Remove the nut and star washers from the PM ground stud.
 - Place the ring lug at the end of the ground wires (green and yellow) attached to the DC power cable connector over the PM ground stud in the following order and secure with the nut (see [Figure D-3](#)):

- Star washer
- PM ground ring lug 1
- PM ground ring lug 2
- Star washer
- Nut



Note Install star washers between the ring lug and chassis ground connection so that the star washers dig into the metalwork finish and make a good ground bond. Use a wrench to tighten the nut and secure the connection.

Figure D-3 CDE200 PM Ground Stud Order

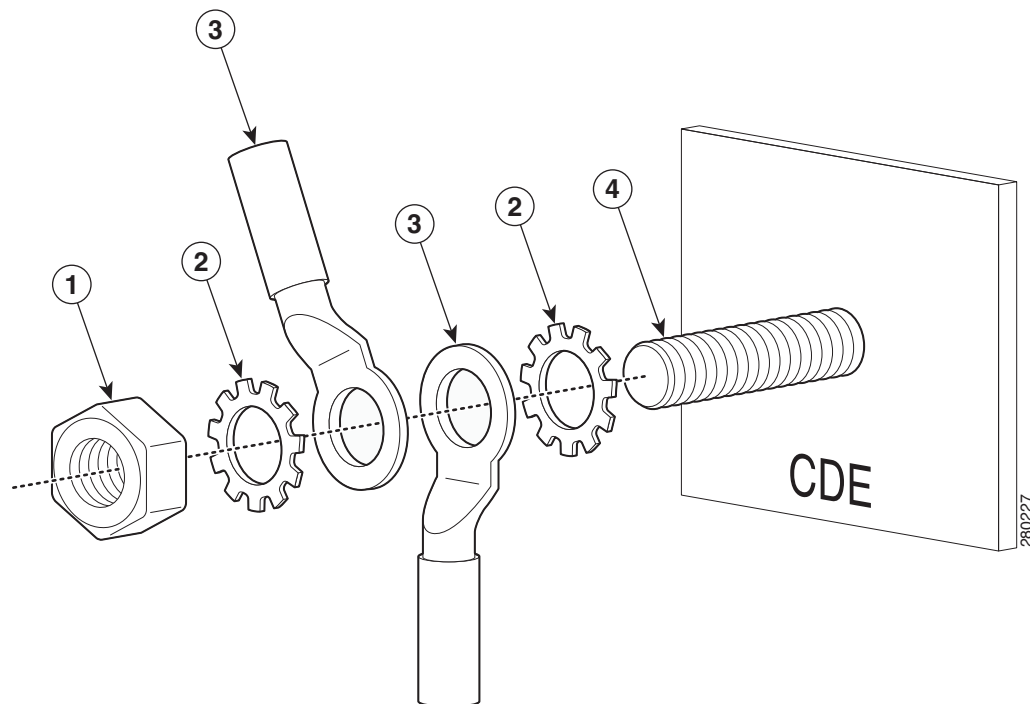

1	Nut	3	PM ground ring lug
2	Star washer	4	PM ground stud

Step 3 Attach the building ground wire to the building ground stud (see [Figure D-4](#)).



Warning

The DC ground connection in the CDE serves as a functional earth point to maintain the full EMI and EMC integrity of the equipment. The purpose is to mitigate the damaging effects of electrostatic discharge. This connection should be installed by a trained service person and the equipment is to be installed per local code or local authority having jurisdiction (AHJ). The building ground wire should not exceed 3 meters in length and be sized similarly to the conductors used for the DC power connections (-48 VDC and +Return).

Figure D-4 CDE200 Building Ground Stud Order

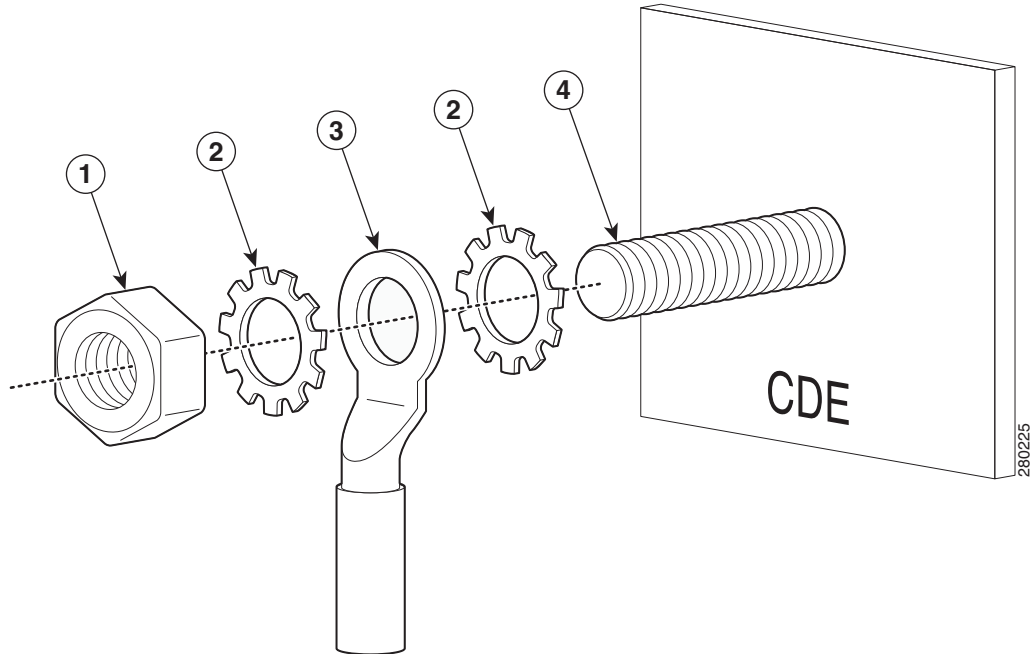

1	Nut	3	Building ground ring lug
2	Star washer	4	Building ground stud

Step 4 Attach the +Return (red) and –48 VDC (black) DC power wires to your power source.

The CDE200 is now ready for use.

Disconnecting Power and Replacing a PM on a CDE200



Warning

The PM connectors and PMs are not hot-swappable. You must disconnect the power source from the building before disconnecting PM wires or removing PMs from a CDE.

Should you need to replace a PM, you must first disconnect DC power and remove the PM from the CDE chassis. Perform the following steps:

- Step 1** Remove the +Return (red) and –48 VDC (black) DC power wires from your power source.
- Step 2** Remove the PM ground wires (green and yellow) from the PM ground stud.
- Step 3** Loosen the screw and press the latch to release the PM from the chassis. Pull the handle and gently slide the PM from the slot.
- Step 4** Insert a new PM in the slot and make sure it is completely seated in the CDE.
- Step 5** Reconnect the PM ground wires (green and yellow) to the PM ground stud as described in [Step 2](#) of the “Connecting DC Power to a CDE200” section on page D-2.

Step 6 Reconnect the +Return (red) and -48 VDC (black) DC power wires to your power source.

Connecting DC Power to a CDE300

The CDE300 ships fully populated with three DC PMs installed in the PM slots on the rear of the chassis; three DC power cables are shipped separately. The chassis has one ground stud that provides building and PM grounding. The minimum cabling requirement for connecting DC power to a CDE300 is two PM connects, but it is recommended that you use all three PM connects. [Figure D-5](#) shows the rear view of a fully-connected CDE300 and provides the location of the studs and PMs.

Figure D-5 CDE300 Rear Panel

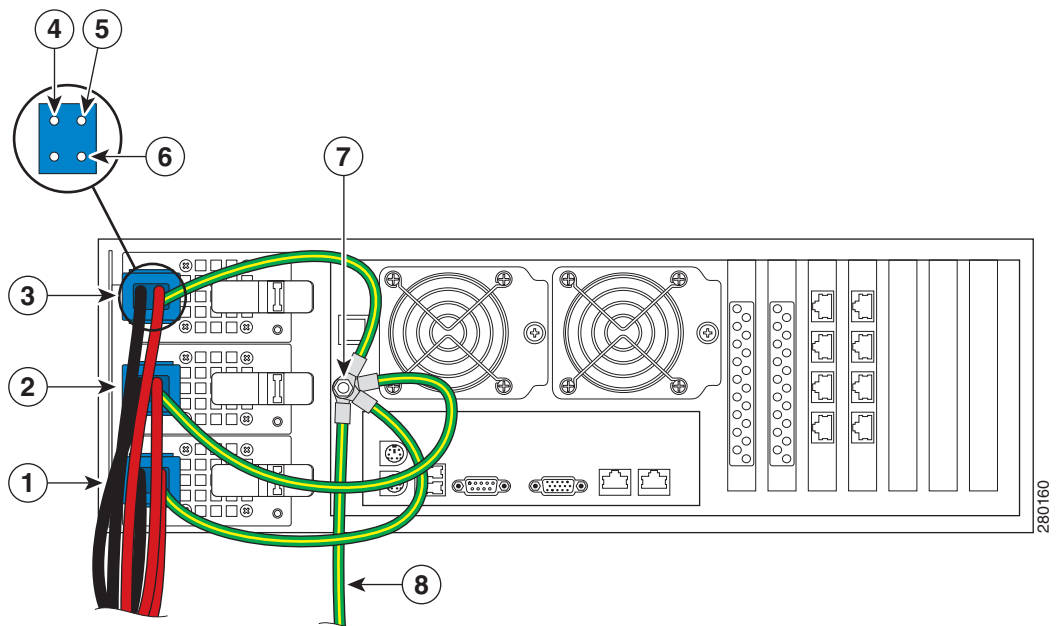

1	PM 1	5	+Return
2	PM 2	6	PM ground
3	PM 3	7	Building/PM ground stud
4	-48 VDC	8	Building ground wire

Connect DC power to the CDE300 by performing the following steps:



Caution

Make sure the DC power wires are not attached to the DC power source until all the ground wires are connected on the CDE.

- Step 1** Insert one blue DC power cable connector into the blue port on each PM, making sure it is completely seated.
- Step 2** Remove the nut and star washers from the Building/PM ground stud.

Step 3 Place the ring lugs at the end of the ground wires (green and yellow) attached to the DC power cable connector over the Building/PM ground stud in the following order and secure with the nut (see [Figure D-6](#)):



Note Fan the ring lugs and barrels so that they fit on the Building/PM ground stud (see [Figure D-6](#)).

- Star washer
- Building ground ring lug
- Star washer
- Nut
- PM 1 ground ring lug
- PM 2 ground ring lug
- PM 3 ground ring lug
- Star washer
- Nut

Figure D-6 CDE300 Building/PM Ground Stud Order

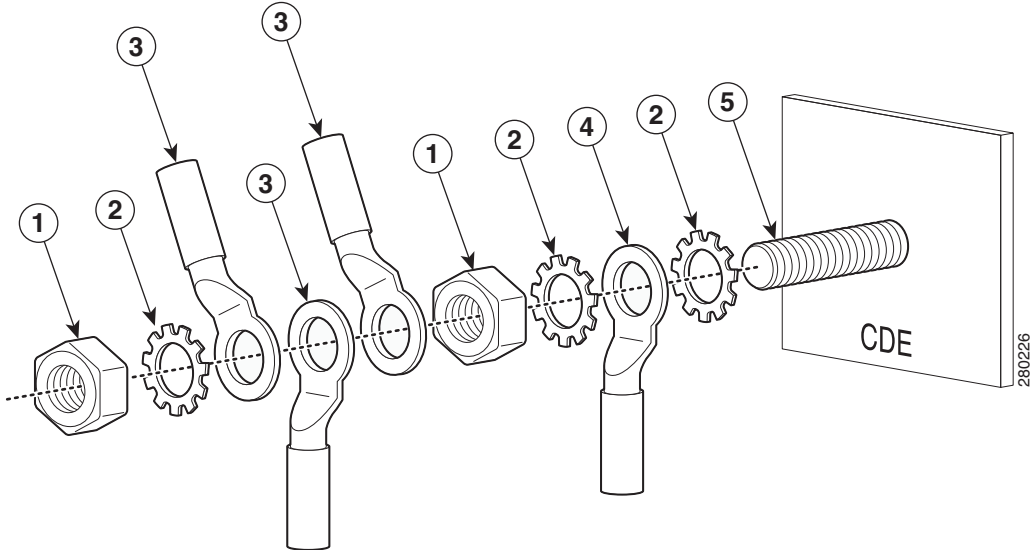

1	Nut	4	Building ground ring lug
2	Star washer	5	Building/PM ground stud
3	PM ground ring lug		



Note Install star washers between the ring lug and chassis ground connection so that the star washers dig into the metalwork finish and make a good ground bond. Use a wrench to tighten the nut and secure the connection.

**Warning**

The DC ground connection in the CDE serves as a functional earth point to maintain the full EMI and EMC integrity of the equipment. The purpose is to mitigate the damaging effects of electrostatic discharge. This connection should be installed by a trained service person and the equipment is to be installed per local code or local authority having jurisdiction (AHJ). The building ground wire should not exceed 3 meters in length and be sized similarly to the conductors used for the DC power connections (–48 VDC and +Return).

Step 4 Attach the +Return (red) and –48 VDC (black) DC power wires to your power source.

The CDE300 is now ready for use.

Disconnecting Power and Replacing a PM on a CDE300

**Warning**

The PM connectors and PMs are not hot-swappable. You must disconnect the power source from the building before disconnecting PM wires or removing PMs from a CDE.

Should you need to replace a PM, you must first disconnect DC power and remove the PM from the CDE chassis. Perform the following steps:

Step 1 Remove the +Return (red) and –48 VDC (black) DC power wires from your power source.

Step 2 Remove the PM ground wires (green and yellow) from the Building/PM ground stud.

Step 3 Press the butterfly lever to release the CDE from the chassis. Pull the handle and gently slide the PM from the slot.

Step 4 Insert a new PM in the slot and make sure it is completely seated in the CDE.

Step 5 Reconnect the PM ground wires (green and yellow) to the PM ground stud as described in [Step 3](#) of the “[Connecting DC Power to a CDE300](#)” section on page D-5.

Step 6 Reconnect the +Return (red) and –48 VDC (black) DC power wires to your power source.

Connecting DC Power to a CDE400

The CDE400 ships fully populated with four DC PMs installed in the PM slots on the rear of the chassis; four DC power cables are shipped separately. The chassis has one building ground stud and two PM ground studs. The minimum cabling requirement for connecting DC power to a CDE400 is three PM connects, but it is recommended that you use all four PM connects. [Figure D-7](#) shows the rear view of a fully-connected CDE400 and provides the location of the studs and PMs.

Figure D-7 CDE400 Rear Panel

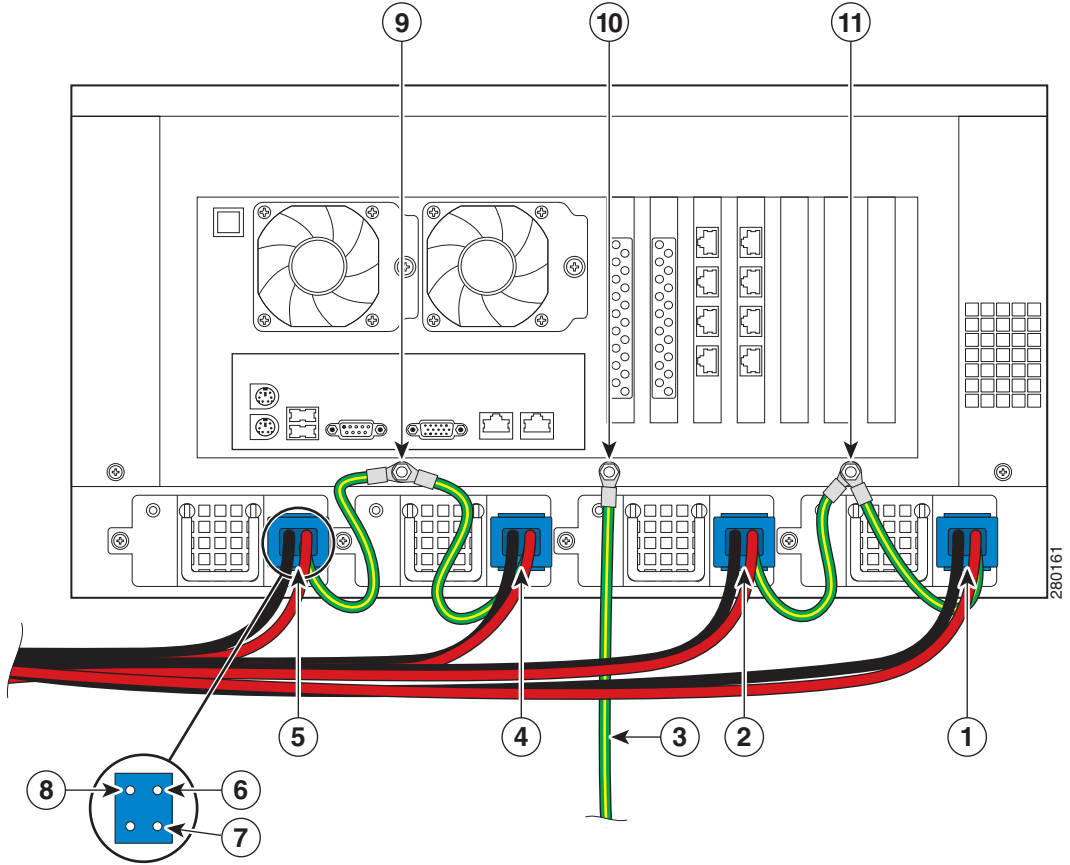

1	PM 4	7	PM ground
2	PM 3	8	-48 VDC
3	Building ground wire	9	PM ground stud 1
4	PM 2	10	Building ground stud
5	PM 1	11	PM ground stud 2
6	+Return		

Connect DC power to the CDE400 by performing the following steps:

Caution

Make sure the DC power wires are not attached to the DC power source until all the ground wires are connected on the CDE.

Step 1

Insert one blue DC power cable connector into the blue port on each PM, making sure it is completely seated.

- Step 2** Attach the ground wires from the PMs to the PM ground studs:
- a. Remove the nut and star washers from the PM 1 ground stud.
 - b. Place the ring lug at the end of the ground wires (green and yellow) attached to the DC power cable connectors in PM 1 and PM 2 over PM ground stud 1 in the following order and secure with the nut (see [Figure D-8](#)):
 - Star washer
 - PM 1 ground ring lug
 - PM 2 ground ring lug
 - Star washer
 - Nut



Note Install star washers between the ring lug and chassis ground connection so that the star washers dig into the metalwork finish and make a good ground bond. Use a wrench to tighten the nut and secure the connection.

Figure D-8 CDE400 PM Ground Stud Order

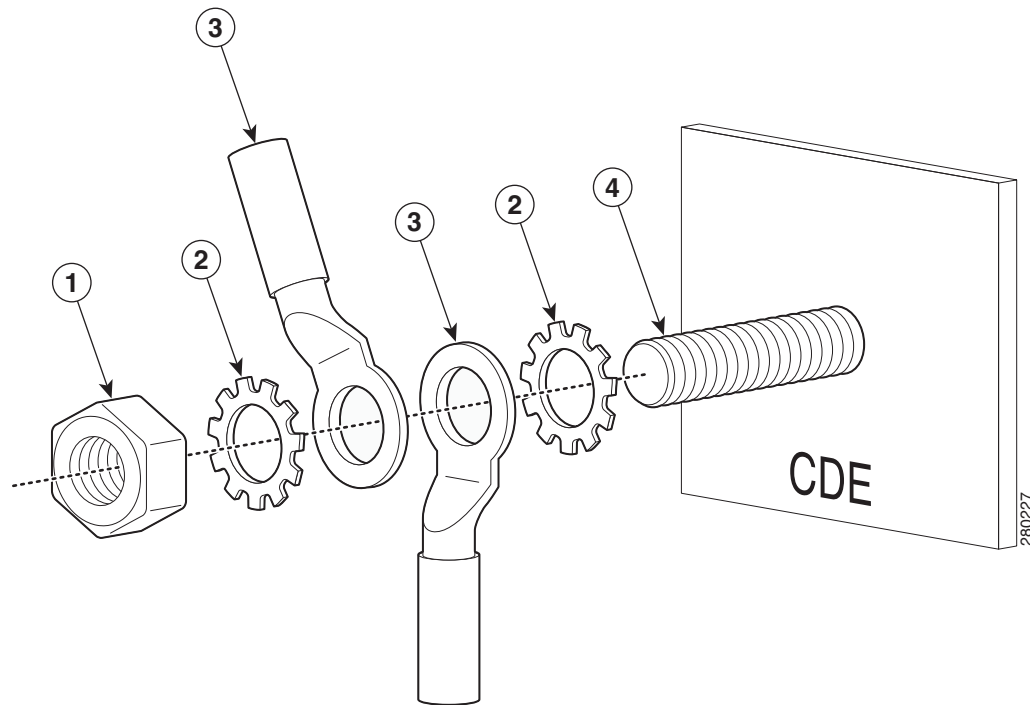

1	Nut	3	PM ground ring lugs
2	Star washer	4	PM ground stud

- c. Remove the nut and star washers from the PM 2 ground stud.
- d. Place the ring lug at the end of the ground wires (green and yellow) attached to the DC power cable connectors in PM 3 and PM 4 over PM ground stud 2 in the following order and secure with the nut (see [Figure D-8](#)):

- Star washer
- PM 3 ground ring lug
- PM 4 ground ring lug
- Star washer
- Nut

Step 3 Attach the building ground wire to the building ground stud (see [Figure D-4 on page D-4](#)).



Warning

The DC ground connection in the CDE serves as a functional earth point to maintain the full EMI and EMC integrity of the equipment. The purpose is to mitigate the damaging effects of electrostatic discharge. This connection should be installed by a trained service person and the equipment is to be installed per local code or local authority having jurisdiction (AHJ). The building ground wire should not exceed 3 meters in length and be sized similarly to the conductors used for the DC power connections (-48 VDC and +Return).

Step 4 Attach the +Return (red) and -48 VDC (black) DC power wires to your power source.

The CDE400 is now ready for use.

Disconnecting Power and Replacing a PM on a CDE400



Warning

The PM connectors and PMs are not hot-swappable. You must disconnect the power source from the building before disconnecting PM wires or removing PMs from a CDE.

Should you need to replace a PM, you must first disconnect DC power and remove the PM from the CDE chassis. Perform the following steps:

- Step 1** Remove the +Return (red) and -48 VDC (black) power wires from your power source.
- Step 2** Remove the PM ground wires (green and yellow) from the PM ground studs.
- Step 3** Loosen the screw on the PM to release it from the chassis. Pull the handle and gently slide the PM from the slot.
- Step 4** Insert a new PM in the slot and make sure it is completely seated in the CDE.
- Step 5** Reconnect the PM ground wires (green and yellow) to the PM ground studs as described in [Step 2](#) of the “[Connecting DC Power to a CDE400](#)” section on page D-7.
- Step 6** Reconnect the +Return (red) and -48 VDC (black) DC power wires to your power source.

DC Power Cable Connector and Pinouts

The DC power cable connector (see [Figure D-9](#)) ships with the CDEs when you order the DC power option. This is the only DC power connector you should use to connect power to the CDEs in your system.

Figure D-9 DC Power Cable and Pinouts

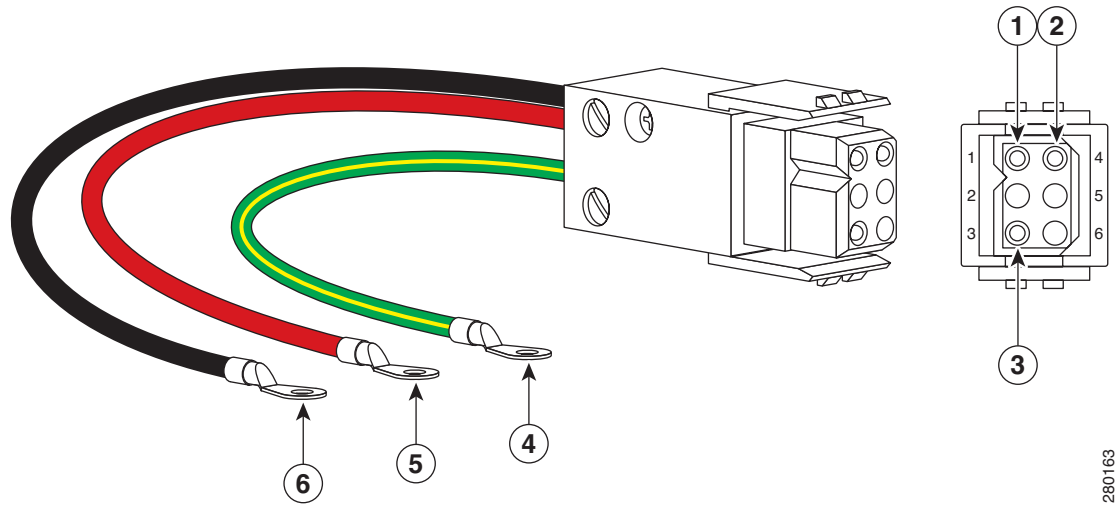

1	+Return	4	PM ground wire and ring lug
2	-48 VDC	5	-48 VDC wire and ring lug
3	PM ground	6	+Return wire and ring lug



INDEX

Numerics

10BASE-T

connector pin assignments [B-2](#)

A

AC power

disconnect [2-8](#)

power supply [2-8](#)

safety warnings [2-6](#)

audio connector [1-11](#)

B

BIOS Setup utility [4-2](#)

CDE100 [4-3](#)

CDE200 [4-9](#)

C

cables

connectors [B-4](#)

network [3-8](#)

pin assignments [B-4](#)

RJ-45 crossover [B-5](#)

RJ-45 straight-through [B-5](#)

RS-232 null modem [B-4](#)

cabling requirements

Ethernet [B-3](#)

CDE [2-viii](#)

CDE100 [1-3](#)

CDE200 [1-3](#)

CDE300 [1-3](#)

CDE400 [1-3](#)

environmental specifications [2-2](#)

initially configuring [4-1, 4-14](#)

intended uses [2-8](#)

overview [1-1](#)

preparing to install [2-1](#)

registering with CDSM [4-15](#)

safety [2-8](#)

server types [3-1](#)

site requirements [2-1](#)

CDE100

BIOS Setup [4-3](#)

connectors [1-11, 3-6](#)

control buttons [1-6](#)

disk drives [3-9](#)

hardware features [1-5](#)

LEDs [1-8](#)

overview [1-3](#)

physical dimensions [2-2](#)

safety [2-6](#)

safety warnings [2-3](#)

specifications [A-2](#)

CDE200

BIOS Setup [4-9](#)

configuring ports [4-2](#)

connecting DC power [D-2](#)

connectors [1-12, 3-6](#)

control buttons [1-7](#)

disk drives [3-9](#)

front cover [1-9, 3-11](#)

hardware features [1-5](#)

LEDs [1-9](#)

- overview 1-3
 - physical dimensions 2-2
 - safety 2-6
 - safety warnings 2-3
 - specifications A-2
- CDE300
- connecting DC power D-5
 - connectors 1-12, 3-7
 - control buttons 1-7
 - disk drives 3-9
 - front cover 3-11
 - hardware features 1-6
 - LEDs 1-10
 - overview 1-3
 - physical dimensions 2-2
 - safety 2-6
 - safety warnings 2-3
 - specifications A-3
- CDE300 SX
- connectors 3-7
- CDE400
- connecting DC power D-7
 - connectors 1-13, 3-8
 - control buttons 1-8
 - disk drives 3-9
 - front cover 3-11
 - hardware features 1-6
 - LEDs 1-10
 - overview 1-3
 - physical dimensions 2-2
 - safety 2-6
 - safety warnings 2-3
 - specifications A-3
- CDS
- image CD 4-1
 - installing the software 4-1, 4-13
 - Release 2.0-2.1 software 4-13
- CDSM 2-viii, 1-1, 3-1
- CDE100 1-2
 - CDE200 1-2
 - connections 3-8
 - registering CDEs 4-15
 - verifying 4-15
 - verifying devices 4-17
- chipset
- Lindenhurst 3-1
 - Serverworks C-1
- circuit breakers for DC power 2-9
- Cisco Technical Assistance 5-2
- Common Bonding Network (CBN) 2-9
- configuration
- assigning a primary interface 4-14
 - CDE 4-14
 - order 4-2
 - running Setup Utility 4-15
- connections
- CDSM 3-8
 - ISV 3-9
 - SE 3-8
 - SR 3-8
 - streamer 3-8
 - vault 3-8
- connector pin assignments
- 10BASE-T B-2
 - Ethernet B-2
 - Lindenhurst chipset B-1
 - Serial console interface B-1
 - Serverworks chipset C-5
- connectors
- CDE100 1-11, 3-6
 - CDE200 1-12, 3-6
 - CDE300 1-12, 3-7
 - CDE300 SX 3-7
 - CDE400 1-13, 3-8
 - description 1-11
 - Ethernet 1-11, B-3
 - Gigabit Ethernet 4-2
 - I/O 1-11

keyboard [1-11](#)

mouse [1-11](#)

power [1-11](#)

serial [1-11](#)

video and audio [1-11](#)

Content Delivery Application, see CDA

Content Delivery Engine, see CDE

Content Delivery System Manager, see CDSM

control buttons

CDE100 [1-6](#)

CDE200 [1-7](#)

CDE300 [1-7](#)

CDE400 [1-8](#)

D

DC power

connecting [2-9, D-1](#)

CDE200 [D-2](#)

CDE300 [D-5](#)

CDE400 [D-7](#)

disconnect [2-9](#)

disconnecting

CDE200 [D-4](#)

CDE300 [D-7](#)

CDE400 [D-10](#)

grounding CDEs [2-9](#)

overview [D-1](#)

PM [D-1](#)

power supply [2-9](#)

replacing

CDE200 PM [D-4](#)

CDE300 PM [D-7](#)

CDE400 PM [D-10](#)

safety warnings [2-6](#)

devices

verifying with the CDSM [4-17](#)

disk drives

CDE100 [3-9](#)

CDE200 [3-9](#)

CDE300 [3-9](#)

CDE400 [3-9](#)

IDE compact flash [4-1, 4-13](#)

installing [3-9](#)

removing [3-9](#)

USB CD-ROM [4-1](#)

E

electrostatic discharge (ESD) damage [2-1, 2-7](#)

EMC regulatory compliance [2-8](#)

environment [3-5](#)

environmental specifications [2-2](#)

Ethernet adapter

troubleshooting [5-1](#)

Ethernet port

cabling requirements [B-3](#)

connector [1-11](#)

connector pin assignments [B-2](#)

connector pinout [B-4](#)

controller [B-3](#)

F

FCC (Federal Communications Commission) Class A device [2-8](#)

field-replaceable units [2-1](#)

front cover

CDE200 [3-11](#)

CDE300 [3-11](#)

CDE400 [3-11](#)

G

Gigabit Ethernet

connectors [4-2](#)

ports [4-2](#)

Gigabit Ethernet Modules [A-4](#)

grounding

- CDEs [2-9](#)
- studs [2-9, D-2, D-5, D-7](#)
- the rack installation [2-8](#)

H

hardware

- CDE100 features [1-5](#)
- CDE200 features [1-5](#)
- CDE300 features [1-6](#)
- CDE400 features [1-6](#)
- overview [1-3](#)

hardware troubleshooting, see troubleshooting

I

IDE compact flash drive [4-1, 4-13](#)

ingest interface [1-11](#)

initially configuring

- CDEs [4-1](#)

installation

- BIOS Setup utility [4-2](#)
- CDE100 [3-3, 3-4](#)
 - boot sequence [4-8](#)
- CDE200 [3-3, 3-4](#)
 - boot sequence [4-13](#)
- CDE300 [3-3, 3-4](#)
- CDE400 [3-3, 3-4](#)
- CDS Release 2.0-2.1 software [4-13](#)
- CDS Release 2.0 software [4-1](#)
- disk drives [3-9](#)
- environment [3-5](#)
- physical connections [3-5](#)
- preparing CDEs for rack [3-4](#)
- rack [3-5](#)
- rack safety guidelines [3-3](#)
- software installation order [4-2](#)

- tools and parts [3-2](#)

Integrated Vault Streamer, see ISV

interfaces

- stream [4-2](#)

Internet Streamer CDS

- overview [1-1](#)
- server types [3-1](#)

ISV [3-1](#)

- CDE200 ISV [1-2](#)
- connections [3-9](#)

L

LEDs

- CDE100 [1-8](#)
- CDE200 [1-9](#)
- CDE300 [1-10](#)
- CDE400 [1-10](#)

Lindhurst chipset [3-1](#)

- connector pin assignments [B-1](#)

M

management

- interface [1-11](#)
- specifications [A-4](#)

N

network cables [3-8](#)

O

overcurrent protection

- AC circuits [2-9](#)
- DC circuits [2-9](#)

P

physical connections

network cables [3-8](#)power cords [3-6](#)physical dimensions [2-2](#)

pin assignments

10BASE-T connector [B-2](#)cable [B-4](#)RJ-45 crossover [B-5](#)RJ-45 straight-through [B-5](#)RS-232 connector [B-1](#)RS-232 null modem [B-4](#)serial console interface [B-1](#)

pin assignments, see also connector pin assignments

PMCDE200 [D-2, D-4](#)CDE300 [D-5, D-7](#)CDE400 [D-7, D-10](#)PM, see also power supply [D-1](#)

ports

description [1-11](#)Gigabit Ethernet [4-2](#)I/O [1-11](#)ingest interface [1-11](#)management interface [1-11](#)serial console interface [1-11](#)USB [4-1](#)VGA interface [1-11](#)

power

AC [2-8](#)connecting DC power [D-1](#)cords [2-8, 3-6](#)DC [2-9](#)

power module see PM

power supply

AC [2-8](#)DC [2-9](#)ESD damage [2-1](#)

R

removing

CDE200 PM [D-4](#)CDE300 PM [D-7](#)CDE400 PM [D-10](#)disk drives [3-9](#)

RJ-45 crossover

pin assignments [B-5](#)

RJ-45 straight-through

pin assignments [B-5](#)

RS-232

connector pin assignments [B-1](#)

RS-232 null modem

connector pin assignments [B-4](#)

S

safety

general precautions [2-6](#)guidelines [2-6](#)information [2-8](#)warnings [2-3](#)AC power [2-6](#)DC power [2-6](#)SE [1-1, 3-1](#)connections [3-8](#)

serial

connector [1-11](#)ports [B-2](#)connector pinout [B-2](#)serial console interface [1-11, B-1](#)

server types

CDSM [1-1, 3-1](#)ISV [3-1](#)SE [1-1, 3-1](#)SR [1-1, 3-1](#)streamer [3-1](#)vault [3-1](#)

Serverworks chipset

- CDE100 [C-1](#)
- CDE200 [C-2](#)
- CDE200 (IBM) [C-3](#)
- CDE300 [C-3](#)
- CDE400 [C-4](#)
- connector pin assignments [C-5](#)
- specifications [C-1](#)

Service Engine, see [SE](#)

Service Router, see [SR](#)

site requirements [2-1](#)

specifications

- CDE100 [A-2](#)
- CDE200 [A-2](#)
- CDE300 [A-3](#)
- CDE400 [A-3](#)

management [A-4](#)

Serverworks chipset

- CDE100 [C-1](#)
- CDE200 [C-2](#)
- CDE200 (IBM) [C-3](#)
- CDE300 [C-3](#)
- CDE400 [C-4](#)

technical [A-1, C-1](#)

SR [1-1, 3-1](#)

connections [3-8](#)

streamer [1-2, 3-1](#)

CDE300 [1-2](#)

connections [3-8](#)

stream interfaces [4-2](#)

SX CDE300 [3-7](#)

T

technical specifications, see [specifications](#)

temperature

- non-operating [2-2](#)
- operating [2-2, 2-10](#)

terminal server parameters [4-1](#)

troubleshooting

Cisco Technical Assistance [5-2](#)

Ethernet adapter [5-1](#)

SATA drives [5-2](#)

TV CDS

OnDemand [1-2](#)

overview [1-2](#)

server types [3-1](#)

Video Accelerator [1-2](#)

U

unpacking [3-2](#)

inspecting for damage [3-3](#)

verifying contents [3-3](#)

USB CD-ROM drive [4-1](#)

user-serviceable parts [2-1](#)

V

vault [1-2, 3-1](#)

CDE200 [1-2](#)

CDE400 [1-2](#)

connections [3-8](#)

group [1-2](#)

ventilation [2-10](#)

verifying the CDSM [4-15](#)

VGA interface [1-11](#)

video connector [1-11](#)