

Service  
Service  
**Service**



# Service Manual



## CONTENTS

Technical specification .....	1-2
Version variation .....	1-2
Service measurement setup.....	1-3
Service aids .....	1-4
Instructions on CD playability .....	2-1..2-2
Block diagram.....	3-1
Wiring diagram.....	4-1
Disassembly diagram.....	5-1
Main board	
Circuit diagram .....	6-1
Layout diagram.....	6-2..6-3
Servo board	
Circuit diagram .....	7-1
Layout diagram.....	7-2
Exploded view diagram .....	8-1



© Copyright 2010 Philips Consumer Electronics B.V. Eindhoven, The Netherlands  
All rights reserved. No part of this publication may be reproduced, stored in a retrieval system or transmitted, in any form or by any means, electronic, mechanical, photocopying, or otherwise without the prior permission of Philips.



# TECHNICAL SPECIFICATION

## Display

- Type: High contrast LCD, 32K color illuminations (11 characters)
- Key illumination: White

## Audio Playback

- Playback Media: CD, CD-R, CD-RW, MP3-CD, WMA, WMA-CD
- Compression format: MP3, WMA
- Disc Playback Modes: Fast Forward/Backward, Introscan, Next/Previous Album Search, Next/Previous Track Search
- MP3 bit rates: 32-320kbps and variable bit rate
- ID3 Tag support: Song title, artist, album
- USB Direct Modes: Fast Backward/Fast Forward, Play/Pause, Previous/Next, Repeat, Shuffle

## Tuner/Reception/Transmission

- Tuner Bands: AM, FM Stereo
- Auto digital tuning
- No. of preset stations: 18(FM), 12(AM)
- Tuner Enhancements: Auto search and store
- RDS: Station Name, Station Information, Radio Text, Program Type, News, News & Traffic, RDS Clock Set

## Dimensions

- Product dimensions (W x H x D): 188 x 58 x 190 mm
- Chassis: 1 Din

## Sound

- Output power (MAX): 50Wx4 channels
- Output power (RMS): 24Wx4 channels (4 ohms, 10% T.H.D.)
- Equalizer: 3-bands
- Equalizer settings: Classic, Jazz, Pop, Rock, Flat, Optimal, Techno, User defined
- Sound Enhancement: Dynamic Bass Boost, MAX Sound

## Connectivity

- USB: USB 2.0 Host
- MP3-Link: For portable MP3 music playback
- Sub-woofer preamp output: With gain control
- Preamp output: 2 pairs RCA(L/R)

## Security/Anti-thief

- Front panel: Detachable
- Display blackout: 10/20 sec selectable

## Accessories

- Remote control: Slim remote with battery
- Quick start guide: English, Traditional Chinese, Brazilian, Portuguese, Spanish
- User Manual: Brazilian Portuguese, Spanish

## Power

- Power supply: 12V DC

# VERSION VARIATION

Type /Versions:		CEM3000									
Board in used:	Service policy	/05	/00		/55	/58	/61				/98
SERVO BOARD			C/M		C/M						C/M
MAIN BOARD			C/M		C/M						C/M
Type /Versions:		CEM3000									
Features	Feature difference	/05	/12		/55	/58	/61				/98
RDS											
VOLTAGE SELECTOR											
ECO STANDBY - DARK											
* TIPS : C -- Component Lever Repair. M -- Module Lever Repair √ -- Used											

# MEASUREMENT SETUP

## Tuner FM

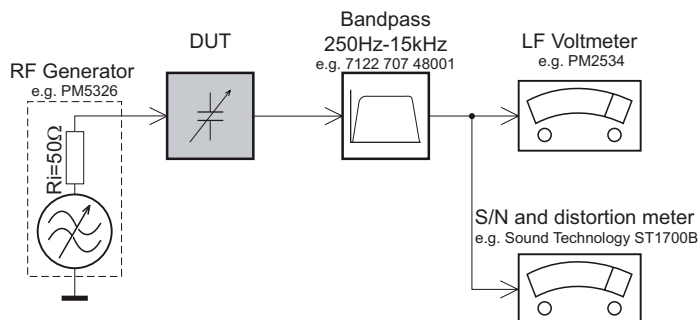

Use a bandpass filter to eliminate hum (50Hz, 100Hz) and disturbance from the pilotone (19kHz, 38kHz).

## Tuner AM (MW,LW)

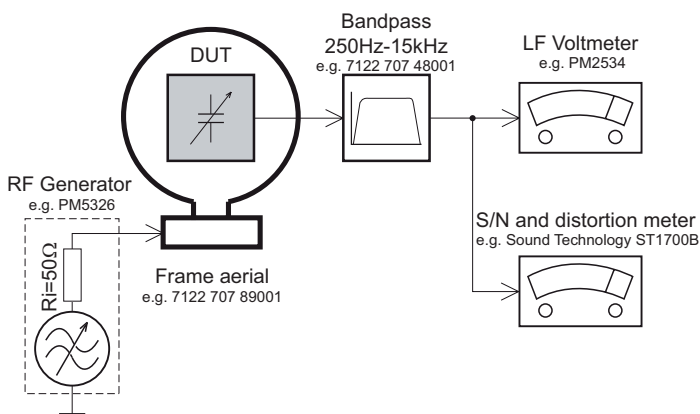

To avoid atmospheric interference all AM-measurements have to be carried out in a Faraday's cage. Use a bandpass filter (or at least a high pass filter with 250Hz) to eliminate hum (50Hz, 100Hz).

## CD

Use Audio Signal Disc SBC429 4822 397 30184  
(replaces test disc 3)

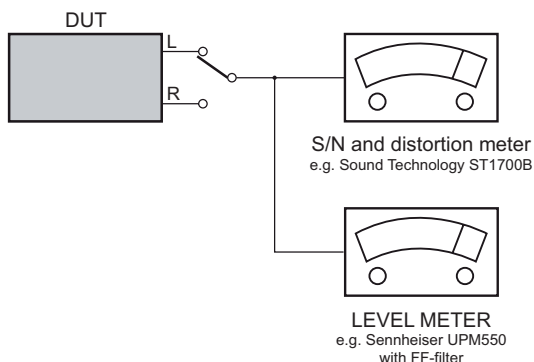

## Recorder

Use Universal Test Cassette **Cr02** SBC419 4822 397 30069  
or Universal Test Cassette **Fe** SBC420 4822 397 30071

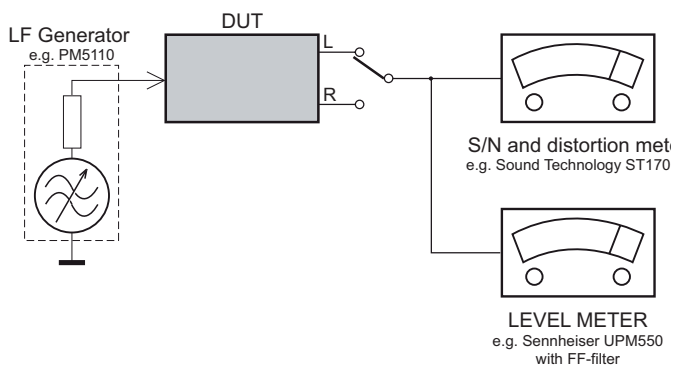

## SERVICE AIDS

### **GB** WARNING

All ICs and many other semi-conductors are susceptible to electrostatic discharges (ESD). Careless handling during repair can reduce life drastically.

When repairing, make sure that you are connected with the same potential as the mass of the set via a wrist wrap with resistance. Keep components and tools also at this potential.

### ESD



### **GB**

Safety regulations require that the set be restored to its original condition and that parts which are identical with those specified, be used

Safety components are marked by the symbol .

**CLASS 1  
LASER PRODUCT**

## INFORMATION ABOUT LEAD-FREE SOLDERING

Philips CE is producing lead-free sets from 1.1.2005 onwards.

### IDENTIFICATION:

Regardless of special logo (not always indicated) one must treat all sets from 1 Jan 2005 onwards, according next rules:



- On our website [www.atyourservice.ce.Philips.com](http://www.atyourservice.ce.Philips.com) you find more information to:
  - \* BGA-de-/soldering (+ baking instructions)
  - \* Heating-profiles of BGAs and other ICs used in Philips-sets
  - \* Lead free

You will find this and more technical information within the "magazine", chapter "workshop news".

For additional questions please contact your local repair-helpdesk.

## SERVICE INSTRUCTION

Safety regulations require that after a repair, the set must be returned in its original condition. Pay in particular attention to the following points:

- Route the wire trees correctly and fix them with the mounted cable clamps.
- Check the insulation of the AC Power lead for external damage.
- Check the strain relief of the AC Power cord for proper function.
- Check the electrical DC resistance between the AC Power Plug and the secondary side (only for sets which have a AC Power isolated power supply):
  1. Unplug the AC Power cord and connect a wire between the two pins of the AC Power plug.
  2. Set the AC Power switch to the "on" position (keep the AC Power cord unplugged!).
  3. Measure the resistance value between the pins of the AC Power plug and the metal shielding of the tuner or the aerial connection on the set. The reading should be larger than 4.5 Mohm (For U.S. it should be between 4.2 Mohm and 12 Mohm).
  4. Switch "off" the set, and remove the wire between the two pins of the AC Power plug.
- Check the cabinet for defects, to avoid touching of any inner parts by the customer.

# INSTRUCTIONS ON CD PLAYABILITY

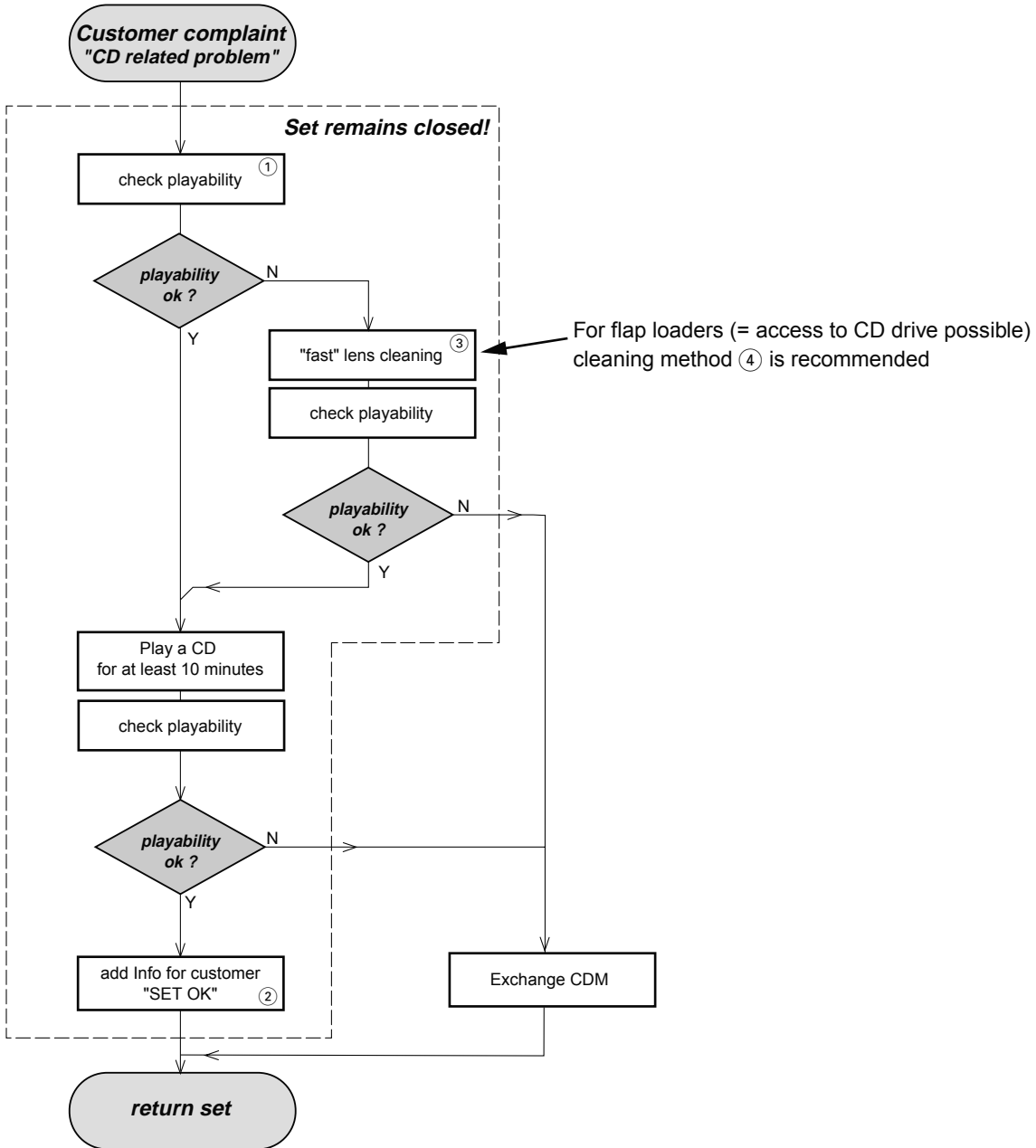

① - ④ For description - see following pages

## INSTRUCTIONS ON CD PLAYABILITY

①

### PLAYABILITY CHECK

For sets which are compatible with **CD-RW** discs  
 use CD-RW Printed Audio Disc .....7104 099 96611  
 TR 3 (Fingerprint)  
 TR 8 (600µ Black dot) **maximum at 01:00**

- playback of these two tracks without audible disturbance  
 playing time for: Fingerprint  $\geq 10$ seconds  
 Black dot from 00:50 to 01:10
- jump forward/backward (search) within a reasonable time

For all other sets  
 use CD-DA SBC 444A .....4822 397 30245  
 TR 14 (600µ Black dot) **maximum at 01:15**  
 TR 19 (Fingerprint)  
 TR 10 (1000µ wedge)

- playback of all these tracks without audible disturbance  
 playing time for: 1000µ wedge  $\geq 10$ seconds  
 Fingerprint  $\geq 10$ seconds  
 Black dot from 01:05 to 01:25
- jump forward/backward (search) within a reasonable time

②

### CUSTOMER INFORMATION

It is proposed to add an addendum sheet to the set which informs the customer that the set has been checked carefully - but no fault was found.

The problem was obviously caused by a scratched, dirty or copy-protected CD. In case problems remain, the customer is requested to contact the workshop directly.

The lens cleaning (method ③) should be mentioned in the addendum sheet.

The final wording in national language as well as the printing is under responsibility of the Regional Service Organizations.

④

### LIQUID LENS CLEANING

**Before touching the lens it is advised to clean the surface of the lens by blowing clean air over it. This to avoid that little particles make scratches on the lens.**

Because the material of the lens is synthetic and coated with a special anti-reflectivity layer, cleaning must be done with a non-aggressive cleaning fluid. It is advised to use "Cleaning Solvent"

The actuator is a very precise mechanical component and may not be damaged in order to guarantee its full function. Clean the lens gently (don't press too hard) with a soft and clean cotton bud moistened with the special lens cleaner.

The direction of cleaning must be in the way as indicated in the picture below.

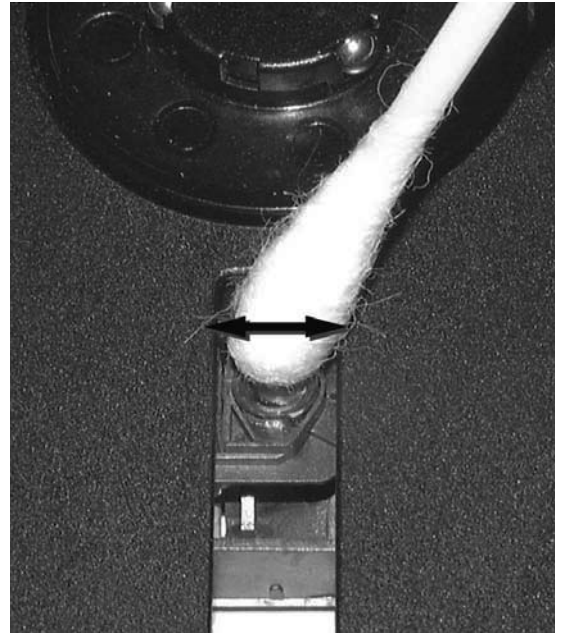

SET BLOCK DIAGRAM

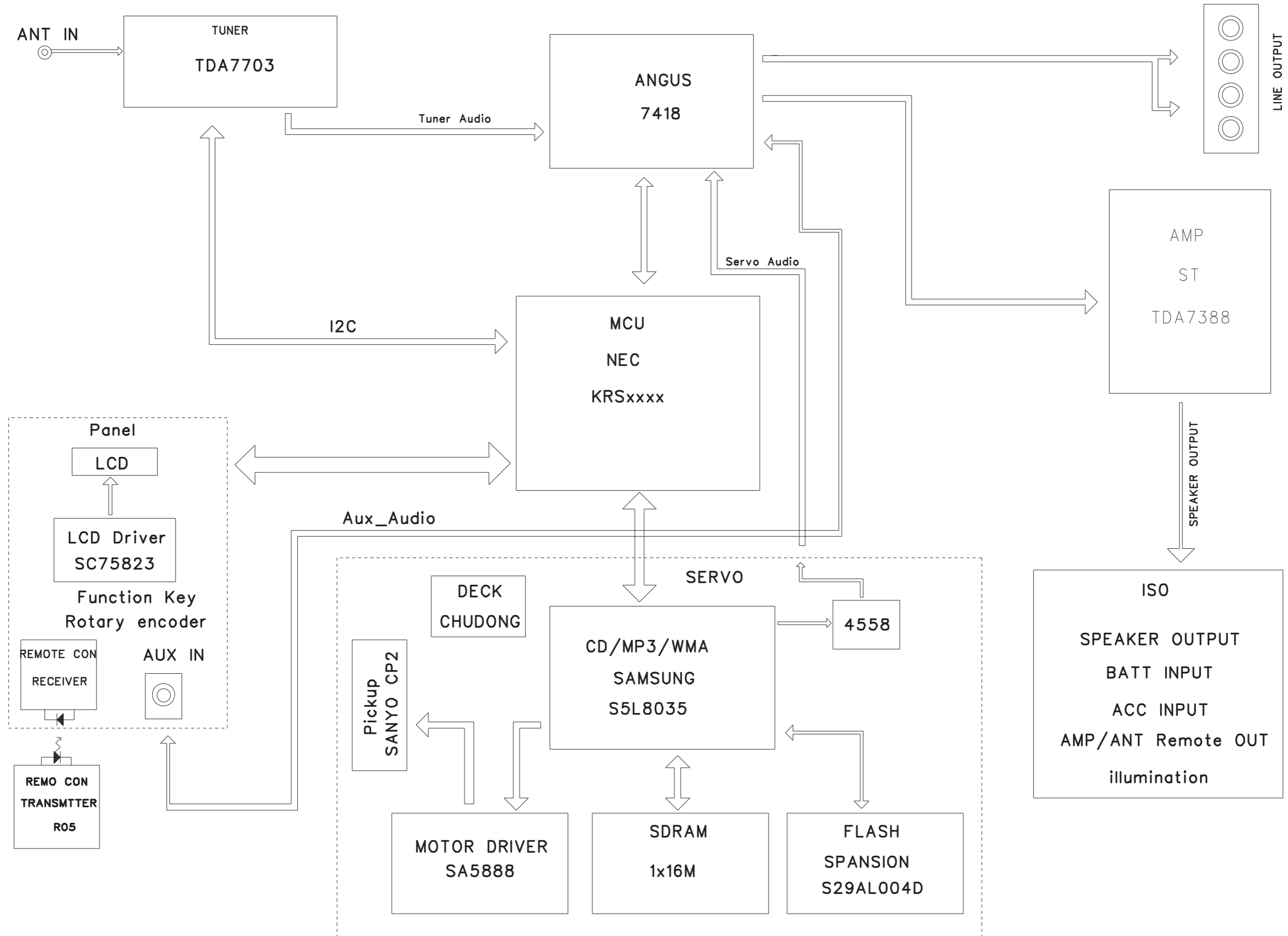

# SET WIRING DIAGRAM

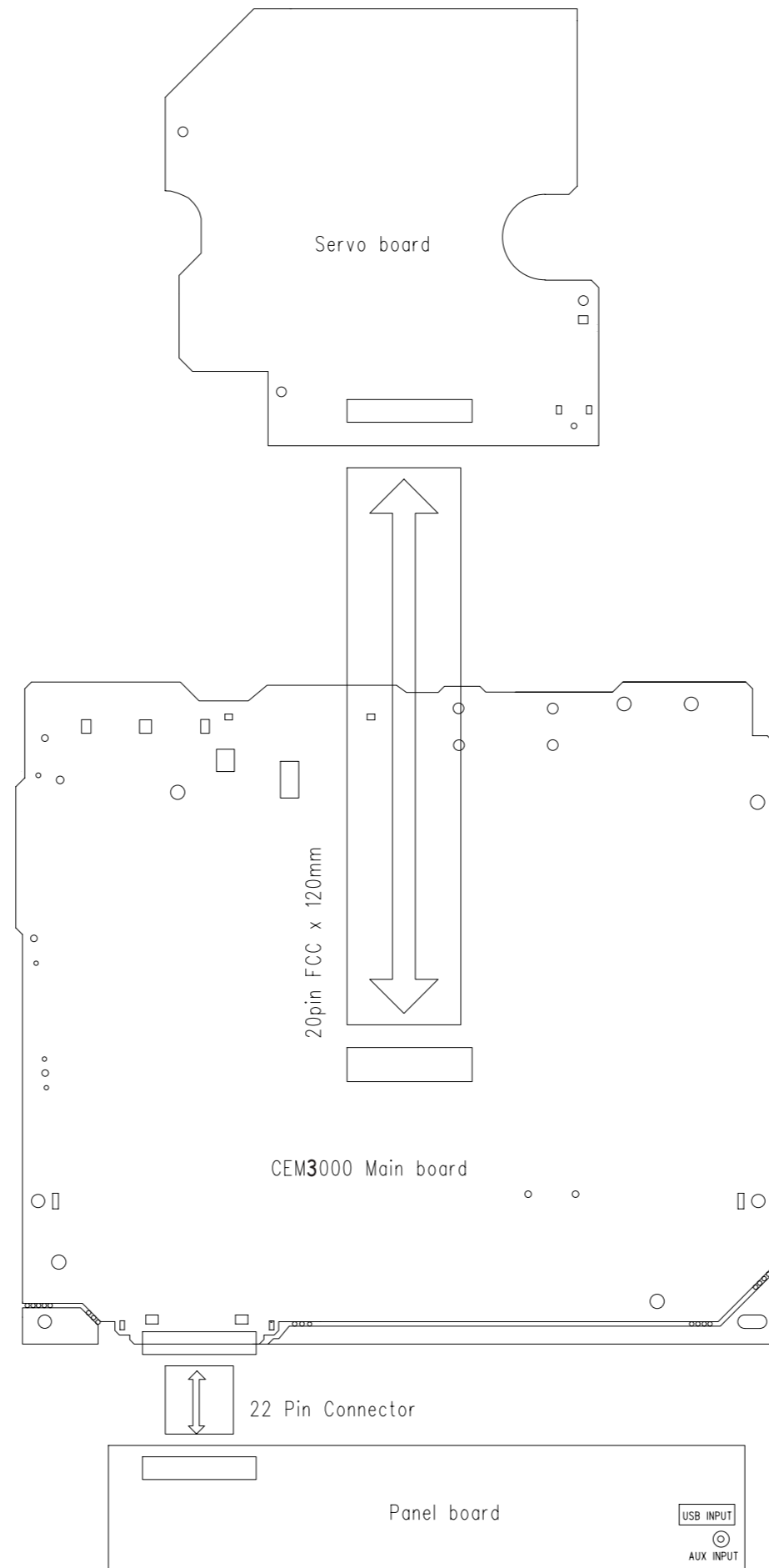



## SET DISASSEMBLY DIAGRAM

- 1) PRESS "▲" TO OPEN THE PANEL, THEN DISENGAGE IT FROM THE CHASSIS
- 2) REMOVE SCREW "A" AS INDICATED TO DISCHARGE THE TOP LID
- 3) REMOVE SCREW "B" & "C" AS INDICATED
- 4) REMOVE SCREW "D" & "E" AS INDICATED
- 5) PUT OUT FLAT CABLE FROM DECK AS "F" INDICATED
- 6) REMOVE 5 SCREWS AS INDICATED TO LOOSEN THE FRONT PANEL

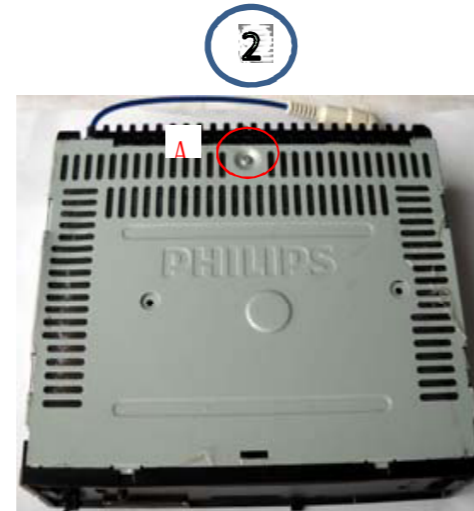

3

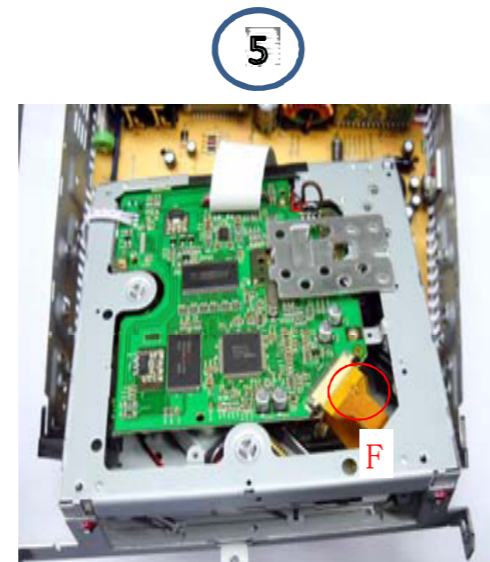
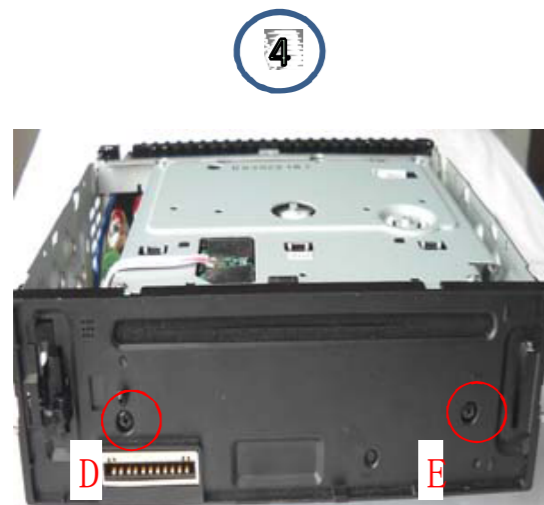

CIRCUIT DIAGRAM - MAIN BOARD

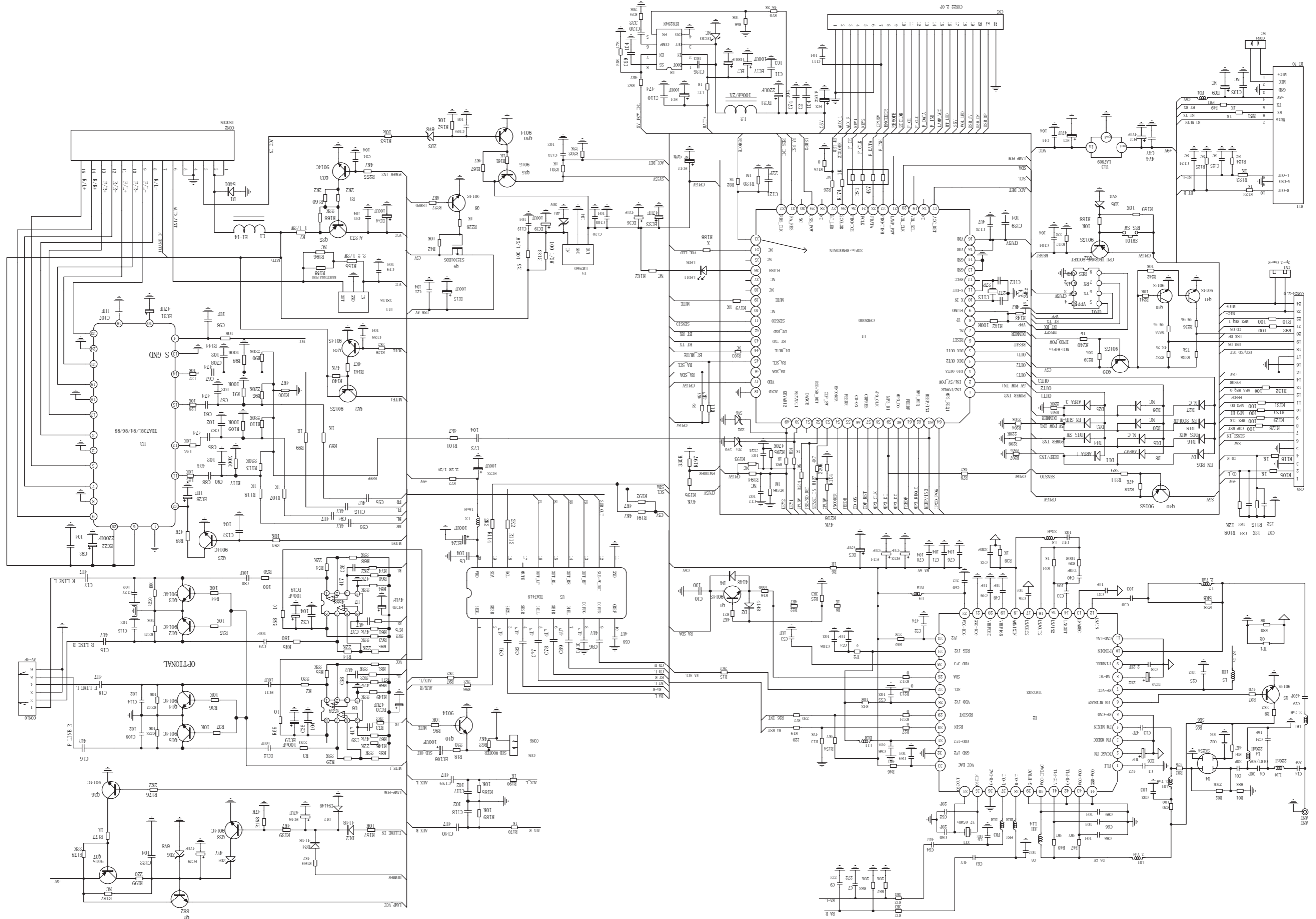

# LAYOUT DIAGRAM - MAIN BOARD COMPONENT SIDE

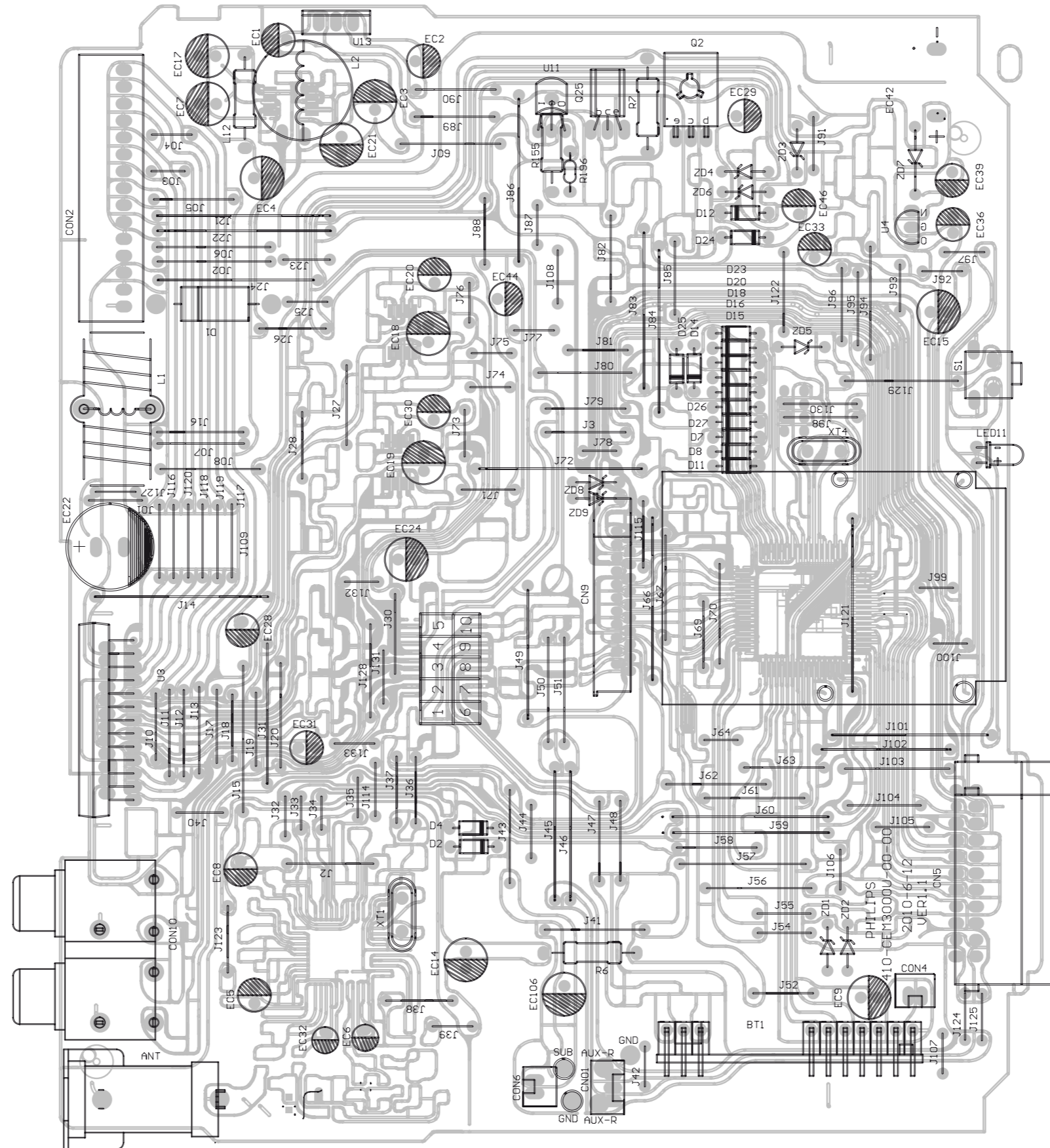

LAYOUT DIAGRAM - MAIN BOARD  
COPPER SIDE

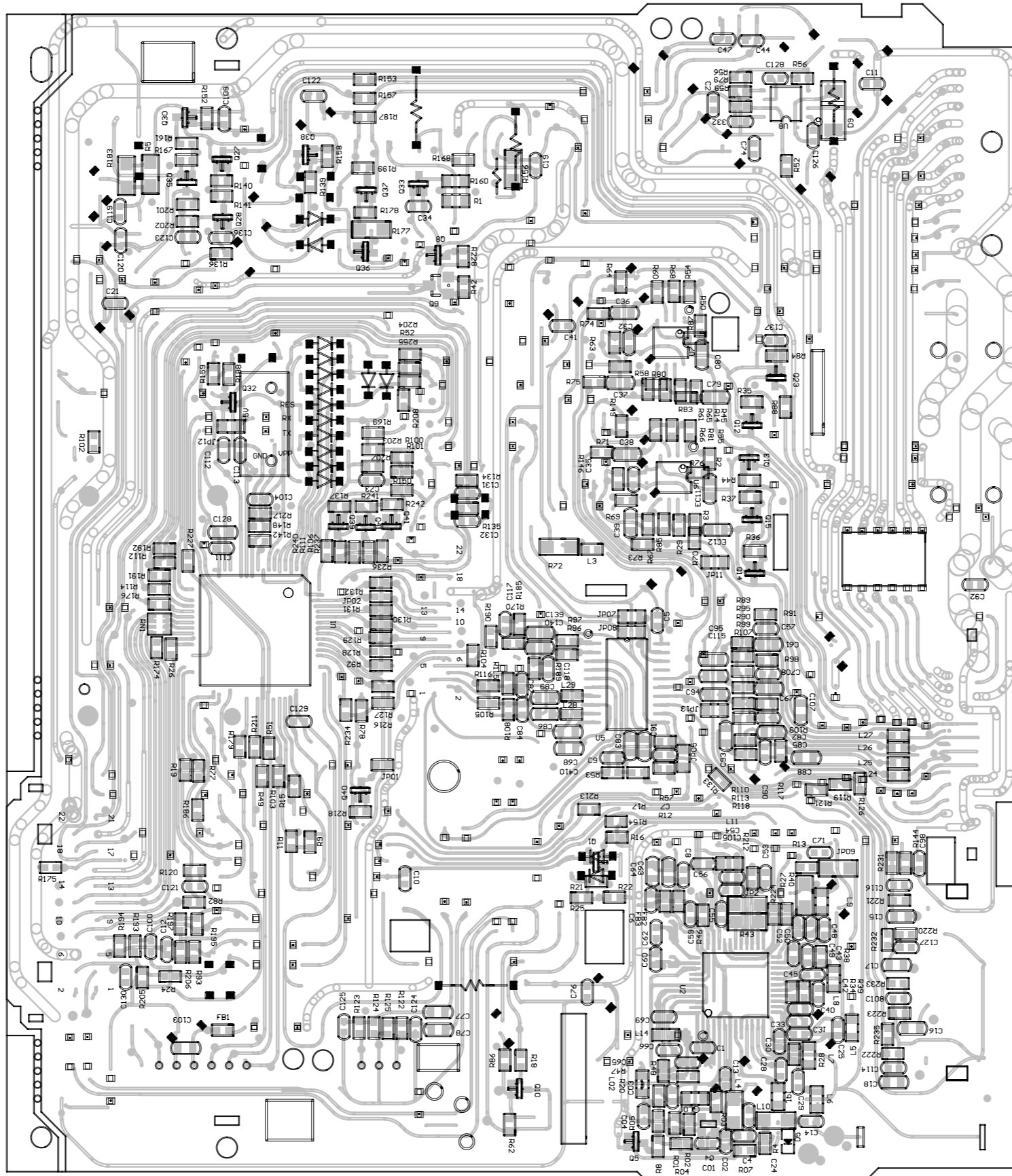

# CIRCUIT DIAGRAM - SERVO BOARD

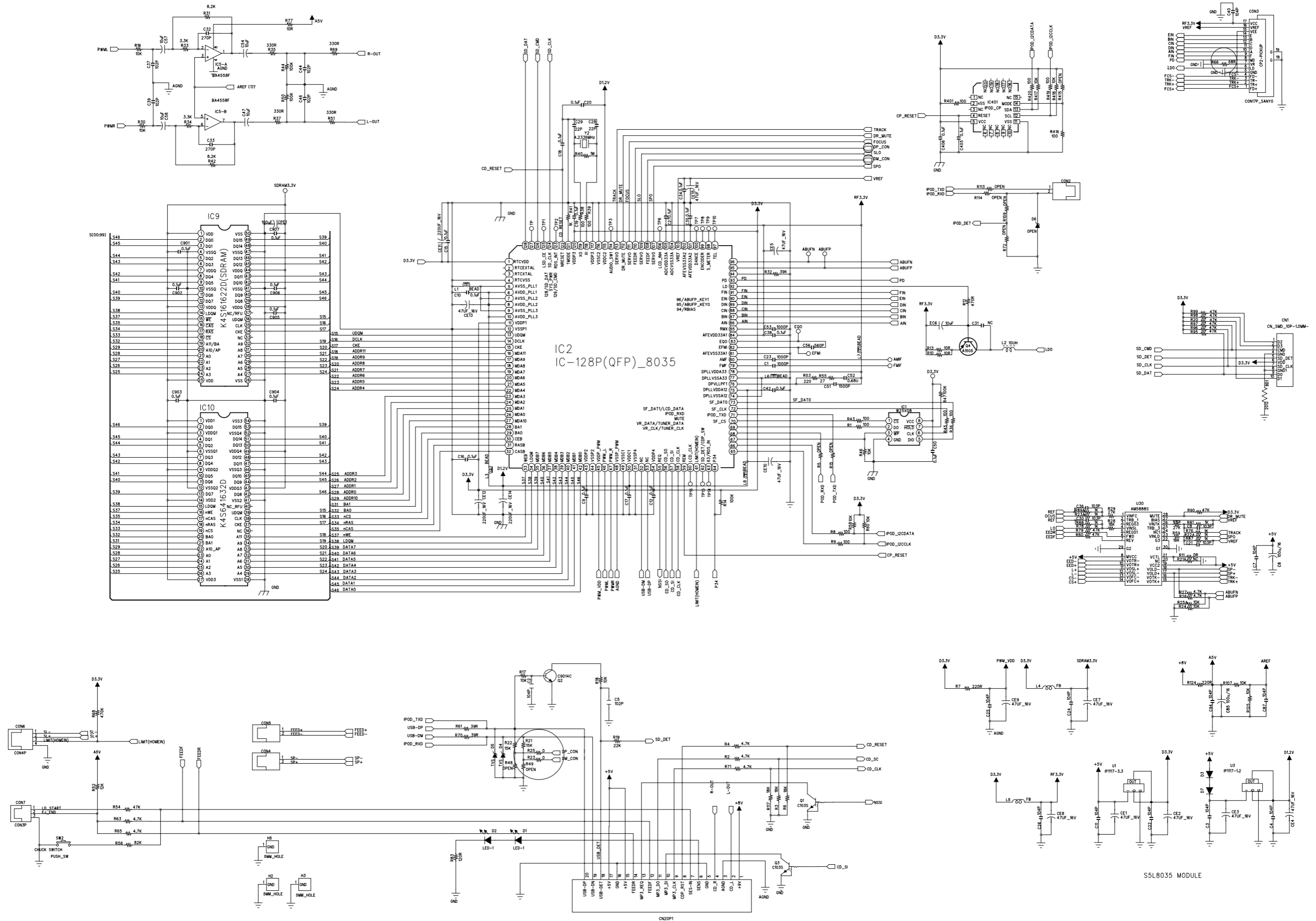

LAYOUT DIAGRAM - SERVO BOARD

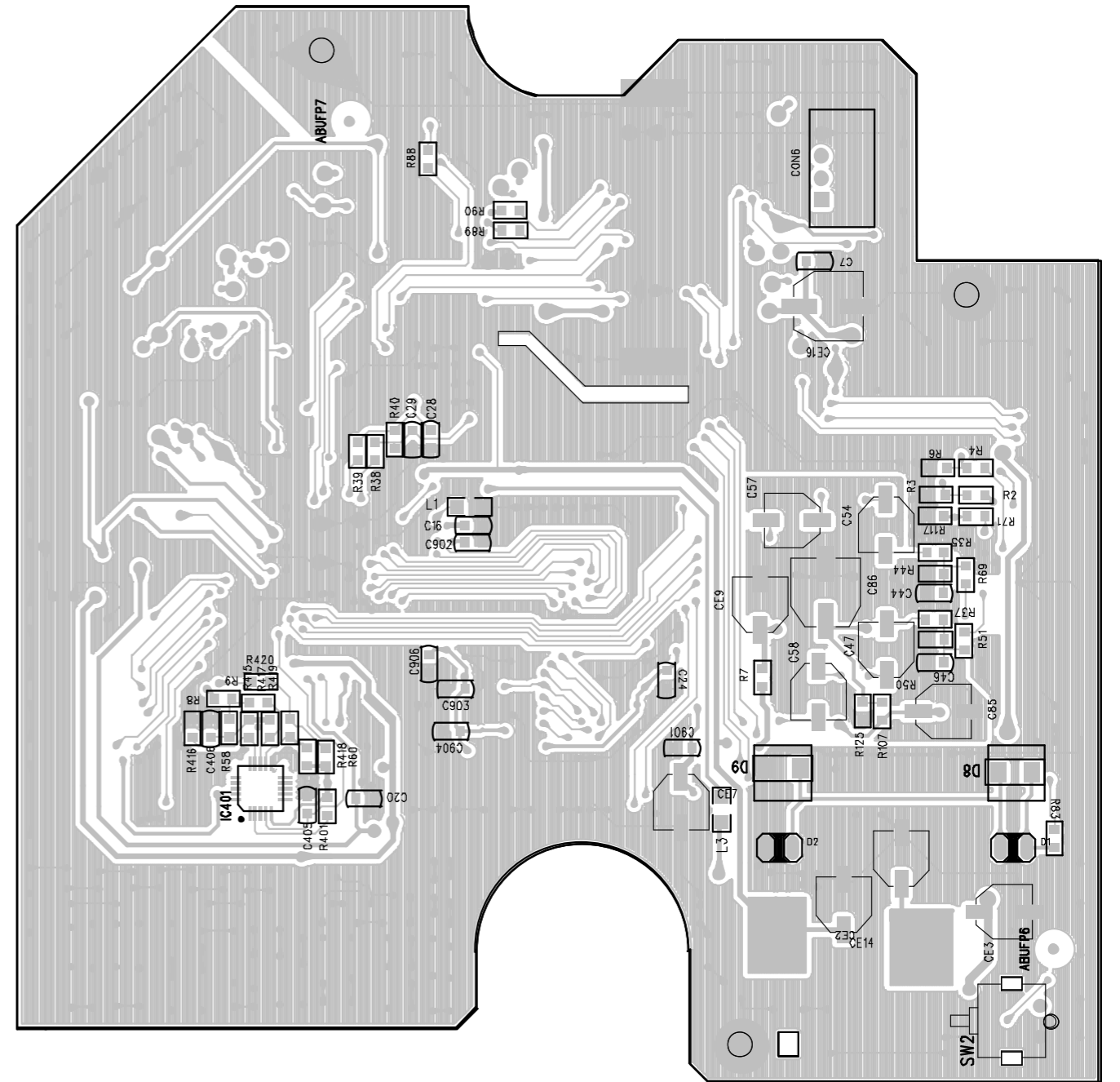
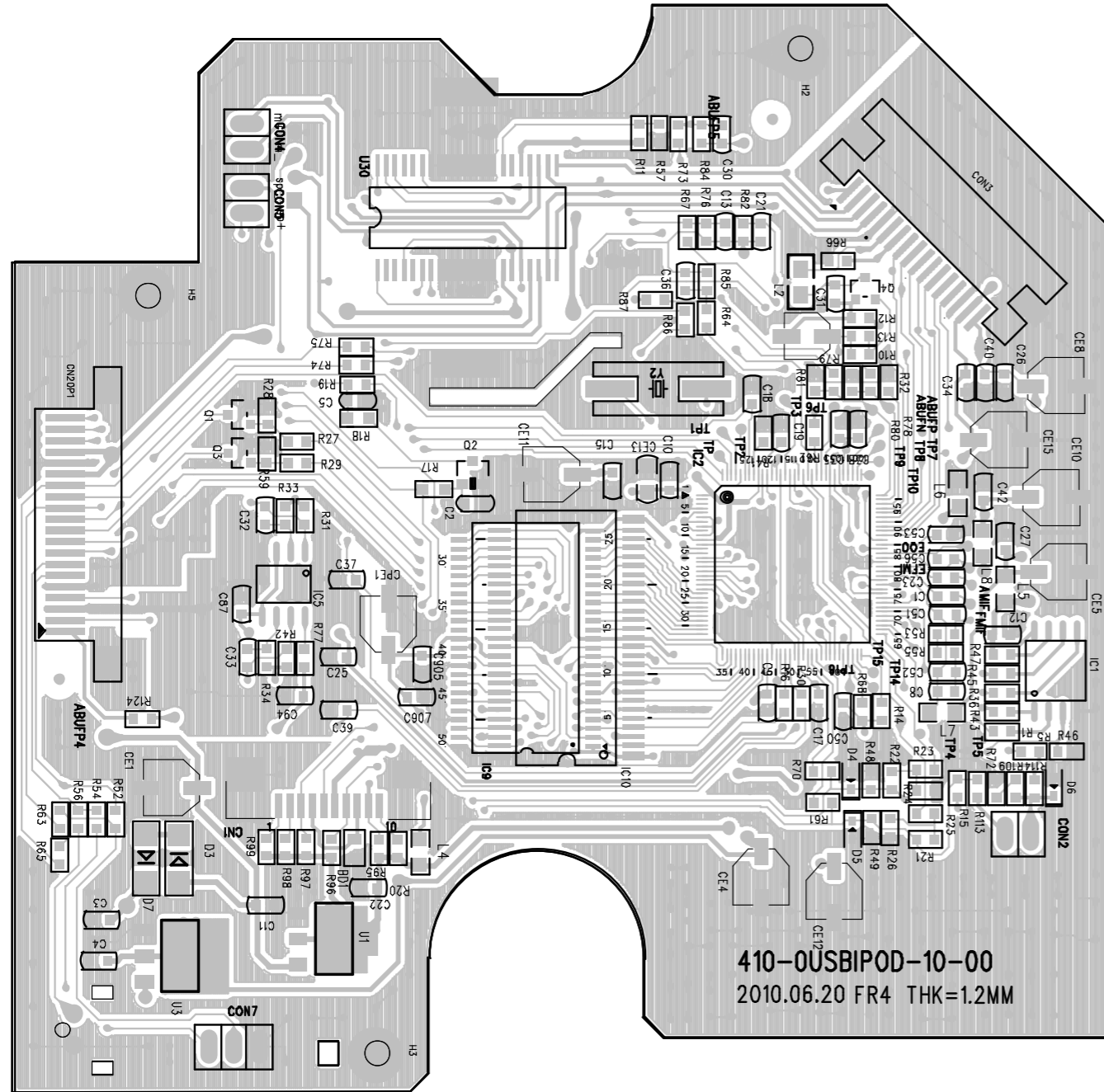

EXPLODED VIEW DIAGRAM

