

# ELECTRONIC SNAP CIRCUITS®

With Computer Interface

Model CI-73

Projects PC1 - PC73

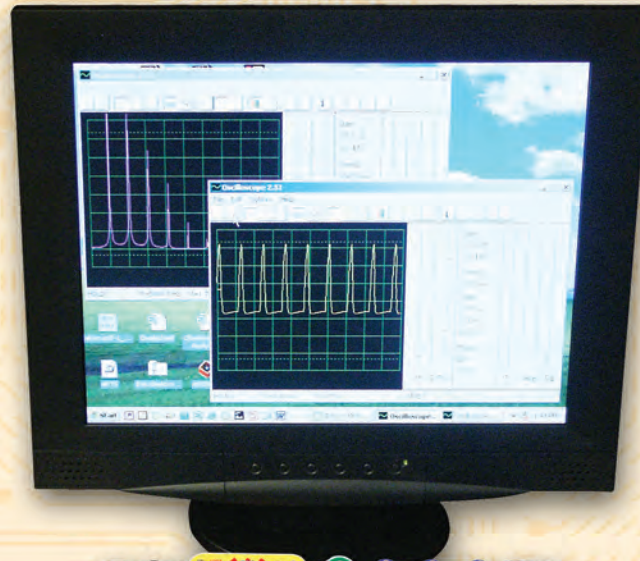

AGES  
8 - 108

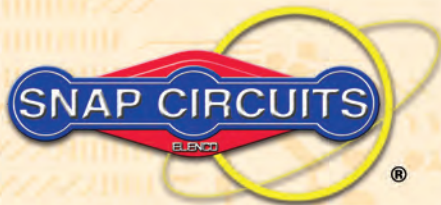

Instruction Manual

ELENCO®

# CI-73 - READ THIS FIRST

The CI-73 is a set of 73 Snap Circuits® with special software that allows you to “see” the electrical signals in the circuits, just like electronics engineers do using oscilloscopes and spectrum analyzers.

Requirements for your computer:

1. Windows® computer with internet connection.
2. A microphone input port.

Complies with CAN ICES-3 (B)/NMB-3 (B). This product should only be connected to equipment of class II.

## INSTRUCTIONS:

1. Download our software from [www.elenco.com/downloads/CI-73.zip](http://www.elenco.com/downloads/CI-73.zip) (Windows® may give you a warning, but our software is safe to download). Go to the download and extract the compressed files. Connect the plug end of our cable to the microphone input (or microphone/USB adapter) on your computer. With our cable connected, open the extracted files folder and run file **Winscope.exe**.
2. Change the default settings for Winscope by selecting <Options>. Then select <Timing> and change Sampling to 44100 and press <OK>. Then select <Options> again, then <Colors> - <Y1 Trace> and pick a bright color like pink. Then select <Options>, then <Save Setup> to save these settings as your default.
3. Follow the instructions through project PC3 before moving on to any other circuits, since the main features of the software are demonstrated.

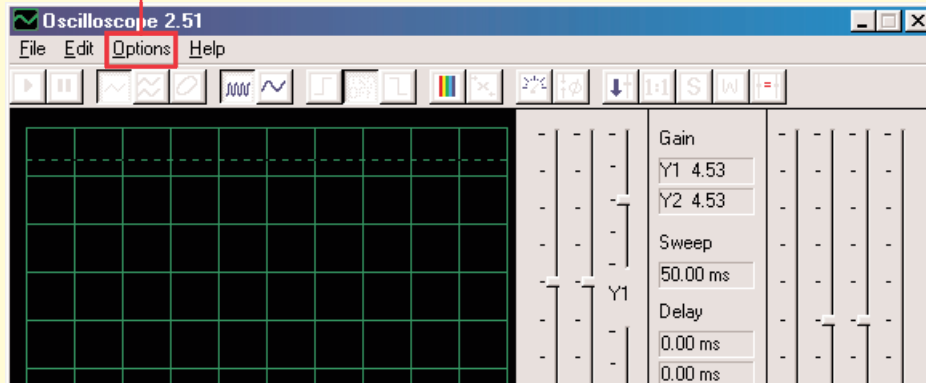

If you have any questions contact:

**ELENCO®**

150 Carpenter Avenue  
Wheeling, IL 60090  
(847) 541-3800

Website: [www.elenco.com](http://www.elenco.com) • e-mail: [elenco@elenco.com](mailto:elenco@elenco.com)



**WARNING:**



SHOCK HAZARD - **NEVER** connect the probe to AC power or a wall electricity outlet for any reason since serious injury or damage may result.

# Looking at Electronic Signals using the WINSCOPE Software

Electronic engineers use specialized test equipment to “see” electronic signals and make performance measurements. They use an oscilloscope to look at the shape of the signal and use a spectrum analyzer to look at its frequency content. This equipment is specialized and usually very expensive.

The Winscope software simulates this equipment using your personal computer. The **PC-interface cable** can be connected across any 2 points in your circuit to look at the signal.

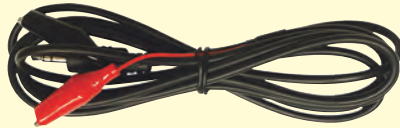

## WARNING:

**SHOCK HAZARD - NEVER** connect the probe to AC power or a wall electricity outlet for any reason since serious injury or damage may result.

It is usually connected to the output of a circuit, as in the circuits shown for the CI-73. **Connect the plug end of the probe to the microphone input on your personal computer.** Run the Winscope application (Winscope.exe). It will come up in Hold mode looking like this:

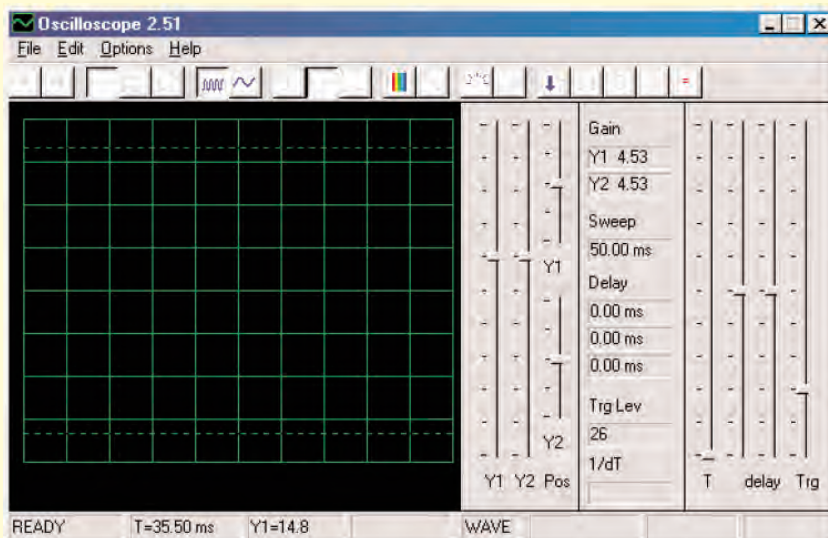

Click on the **On-Line** button to turn it on. You should now get one of the following 2 pictures, depending on whether your microphone input is properly turned on:

**On-Line**  
**button**

**Example**  
**A**

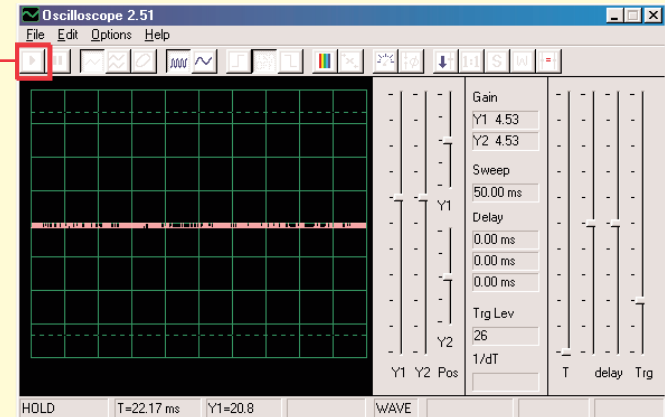

**Example**  
**B**

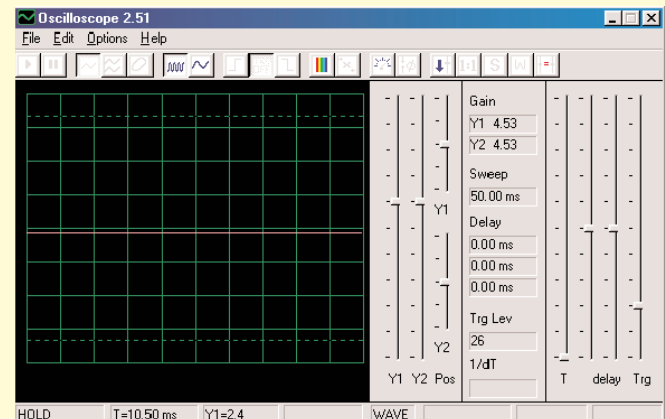

If you get the picture shown in Example B, then your microphone input is not properly turned on. Go to the “Turning On Your Microphone Input” section to turn it on. There may also be other sound card controls on your computer that you need to set. When your input is properly configured, you will get a picture like Example A above. Touch the red and black “alligator” clips on the PC-interface cable to each other and you should see the random pattern on the Winscope screen change as you do so. You are now ready to proceed with the first CI-73 experiment or you may investigate the Winscope software on your own.

## Looking at Electronic Signals using the WINSCOPE Software (continued)

You may freeze a waveform on the screen by clicking on the **Hold mode button** (just to the right of the On-Line button).

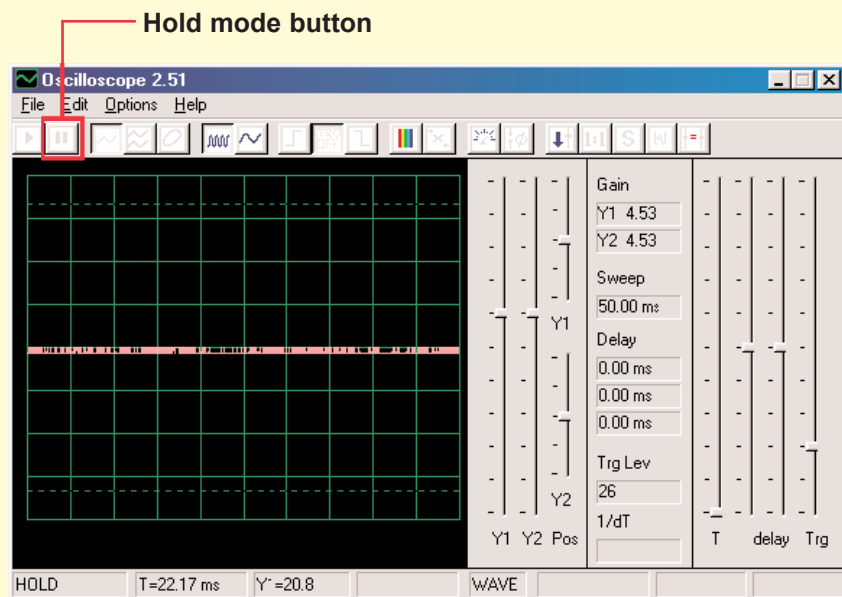

**WARNING:** Do not “save setup” in Winscope. Many of the buttons on Winscope control features that this manual will not be using. If you accidentally place the Winscope software into an unknown mode, you may always close and re-start Winscope. Doing so will reset all settings to those described in this booklet unless you have done a “save setup”.

**PROJECTS PC1-PC3 SHOW HOW TO USE THE MAIN FUNCTIONS OF WINSCOPE SO DO THEM FIRST!**

### NOTES:

1. It is recommended that you disable or turn down the volume to the speakers on your computer. CI-73's use of the microphone input port will also channel the same signal to the speakers, and the result can be distracting.
2. It is recommended that you become familiar with the Snap Circuits® parts and assembly methods before building any of the circuits in this manual.
3. For some Windows® versions, you must plug in the PC-interface cable before you run Winscope, or you will not be able to activate the Winscope on-line button.

### Turning On Your Microphone

(For Windows® 98 or XP, other Windows® versions may be slightly different.)

If you don't get any signal from the PC-interface cable then your microphone may be disabled on your computer. To turn it on, follow these instructions which begin by pressing the <Start> button on the lower-left corner:

1. Select <Start> - <Programs> - <Accessories> - <Entertainment> (or <Multimedia>) - <Volume Control>.
2. Select <Options>.
3. Select <Properties>.
4. Select <Recording> in the “Adjust Volume For” box.
5. In the “Show the Following Controls” box, check <Microphone>.
6. Select <OK>.
7. In the “Microphone - Volume” box, check <Select> and set volume to about 40% of max.

Your microphone should now be turned on.

## Looking at Electronic Signals using the WINSCOPE Software (continued)

**IMPORTANT NOTE:** The designs for the microphone input port vary throughout the computer industry. Hence you may get waveforms different from those shown in your manual even though the circuit is actually performing the same way. Here are some types of differences:

- A. The gain of your microphone input may be significantly different from that indicated on pages 8-10 (and similarly for the other circuits). Page 4 describes how to turn on the microphone input and adjust its volume to about 40% of max, you may want to adjust this volume higher or lower so that your results better match those shown. Note that having the volume set too high may “clip off” the top or bottom portion of a waveform.
- B. The oscilloscope waveforms shown on your display may appear upside down (“inverted”) from those shown throughout this document. For example the waveform shown on the top of page 10 would look like this:

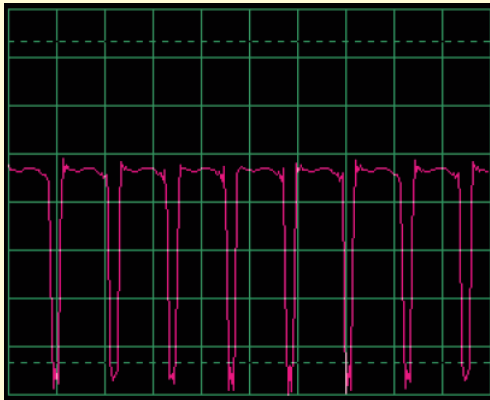

If this is the case then swap the connections of the red and black clips of the Winscope probe in all circuits.

- C. The shape of waveforms may appear distorted for some circuits, due to protection circuitry that acts as a filter. For example:

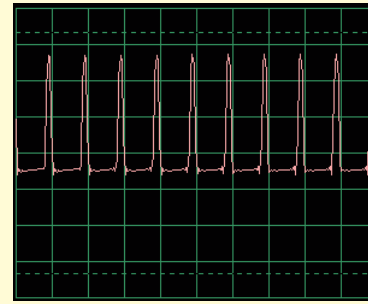

This waveform . . .

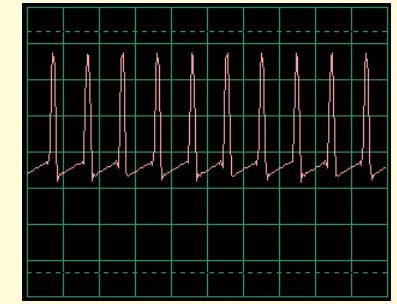

might look like this.

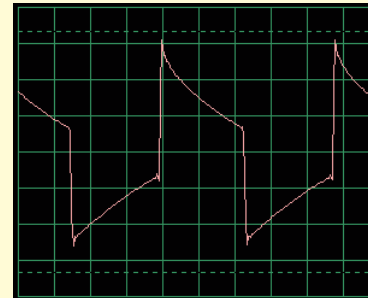

And this waveform . . .

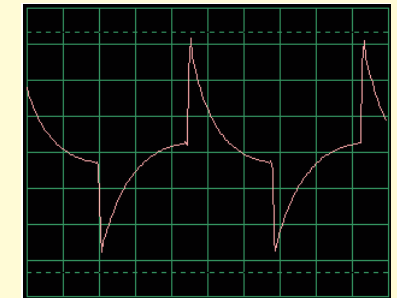

might look like this.

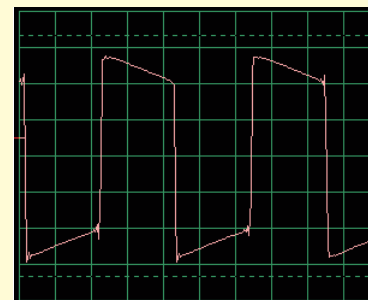

And this waveform . . .

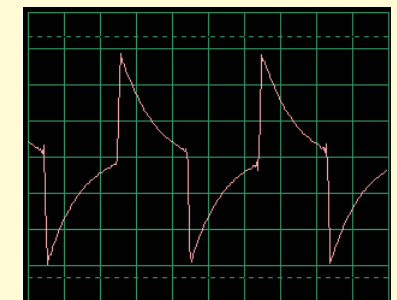

might look like this.

Contact ELENCO® if you have any questions about this.

## Limitations of WINSCOPE and Its Interface

By using the microphone audio input and the flexible processing power of the personal computer, we have created an inexpensive and easy-to-use way of looking at electronic signals. However, no electronic oscilloscope or spectrum analyzer ever made works on all electronic signals, and similarly Winscope has limitations. The projects in this booklet were written to minimize those limitations.

Winscope can only measure changing signals (AC voltages, >20 Hz frequency) and cannot measure fixed voltages (DC voltages, such as a battery), due to the design of the microphone input. Fixed voltages are not very exciting to look at anyway. Slow-changing or transient signals (such as when you first turn on power to a circuit) will be displayed in a distorted form.

Winscope works best on signals up to about 5kHz, since its sampling rate is limited to 44kHz. If you attempt to measure higher frequency signals, then you will get wrong results due to undersampling. This is a narrow range but it covers human voice and most (but not all) music. AM and FM radio frequencies cannot be measured. Every measurement you make will have some amount of random “chatter” superimposed on the signal of interest. This chatter is due to the limited sampling rate and from the PC-interface cable picking up energy from other electronic instruments in the vicinity (including room lights and your computer), hence it cannot be avoided.

## Using WINSCOPE's Full Capabilities

Winscope has 2 input channels that can be displayed at the same time. This is commonly done by electronic engineers using an oscilloscope, to show the relationship of one (or more) signals to another. However, use of this requires a second microphone input, which most computers do not have. If the sound card in your computer has this then you may use all of Winscope

features for 2 channels, which include X-Y and correlate modes. Use of these Winscope capabilities is beyond the introductory level of this product, use the Help menu in Winscope for information about using these features (to make the help file work on Windows Vista, you may need to download and install the program (WinHlp32.exe) from the Microsoft Download Center).



### WARNING:

SHOCK HAZARD - **NEVER** connect the probe to AC power or a wall electricity outlet for any reason since serious injury or damage may result.



## Exporting Graphs from WINSCOPE

To make a copy of the Winscope display screen, hold down the **Alt** button and press the **PrtScn** button on your computer when Winscope is the active window. You can then paste it into word processing programs such as **Microsoft Word**.

# Project Listings

Project #	Description	Page #	Project #	Description	Page #
PC1	Pitch PC .....	7	PC38	Adjustable FM Radio PC.....	44
PC2	Screaming Fan PC.....	11	PC39	Transistor AM Radio PC (II).....	45
PC3	Hissing Foghorn PC.....	14	PC40	Playback & Record PC.....	45
PC4	Light and Sounds PC.....	16	PC41	Power Amplifier Playing Music PC.....	46
PC5	Light and Sounds PC (II).....	18	PC42	Music Meter PC.....	47
PC6	Light and Sounds PC (III).....	18	PC43	Oscillation Sounds PC.....	48
PC7	Light and Sounds PC (IV).....	18	PC44	Oscillation Sounds PC (II).....	48
PC8	Light and Sounds PC (V).....	18	PC45	Oscillation Sounds PC (III).....	48
PC9	Light and Sounds PC (VI).....	19	PC46	Oscillation Sounds PC (IV).....	48
PC10	Modulation .....	19	PC47	Oscillator Sounds PC.....	49
PC11	Filtering .....	21	PC48	Oscillator Sounds PC (II).....	49
PC12	AM Radio PC .....	22	PC49	Whistle Chip Sounds PC.....	49
PC13	Space War PC.....	24	PC50	Whistle Chip Sounds PC (II).....	50
PC14	Microphone .....	25	PC51	Whistle Chip Sounds PC (III).....	50
PC15	Speaker Microphone.....	27	PC52	Whistle Chip Sounds PC (IV).....	50
PC16	Symphony of Sounds PC.....	28	PC53	Bird Sounds PC.....	50
PC17	Doorbell PC.....	29	PC54	Bird Sounds PC (II).....	51
PC18	Periodic Sounds PC.....	30	PC55	Electronic Cat PC.....	51
PC19	Lasting Doorbell PC.....	31	PC56	Electronic Cat PC (II).....	51
PC20	Space War Flicker PC.....	33	PC57	Electronic Cat PC (III).....	51
PC21	Buzzing in the Dark PC.....	34	PC58	Electronic Cat PC (IV).....	51
PC22	Trombone PC.....	35	PC59	Variable Oscillator PC.....	52
PC23	Sound Pulse Oscillator PC.....	37	PC60	Variable Oscillator PC (II).....	52
PC24	High Pitch Bell PC.....	38	PC61	Variable Oscillator PC (III).....	52
PC25	Tone Generator PC.....	39	PC62	Variable Oscillator PC (IV).....	52
PC26	Tone Generator PC (II).....	39	PC63	Electronic Sound PC.....	53
PC27	Tone Generator PC (III).....	39	PC64	Electronic Sound PC (II).....	53
PC28	Old-Style Typewriter PC.....	40	PC65	Siren PC.....	54
PC29	Transistor Fading Siren PC.....	41	PC66	Drawing Resistors PC.....	55
PC30	Fading Doorbell PC.....	41	PC67	Electronic Noisemaker PC.....	55
PC31	Police Siren Amplifier PC.....	42	PC68	Electronic Noisemaker PC (II).....	56
PC32	Music Amplifier PC.....	42	PC69	Bee PC.....	56
PC33	Space War Amplifier PC.....	43	PC70	Bee PC (II).....	57
PC34	Adjustable Tone Generator PC.....	43	PC71	Space War Alarm Combo PC.....	57
PC35	Adjustable Tone Generator PC (II).....	44	PC72	Space War Music Combo PC.....	58
PC36	Adjustable Tone Generator PC (III).....	44	PC73	Sound Mixer PC.....	58
PC37	Adjustable Tone Generator PC (IV).....	44			



# Project #PC1

# Pitch PC

*OBJECTIVE: To look at the output signal from a transistor oscillator while changing the pitch of the sound.*

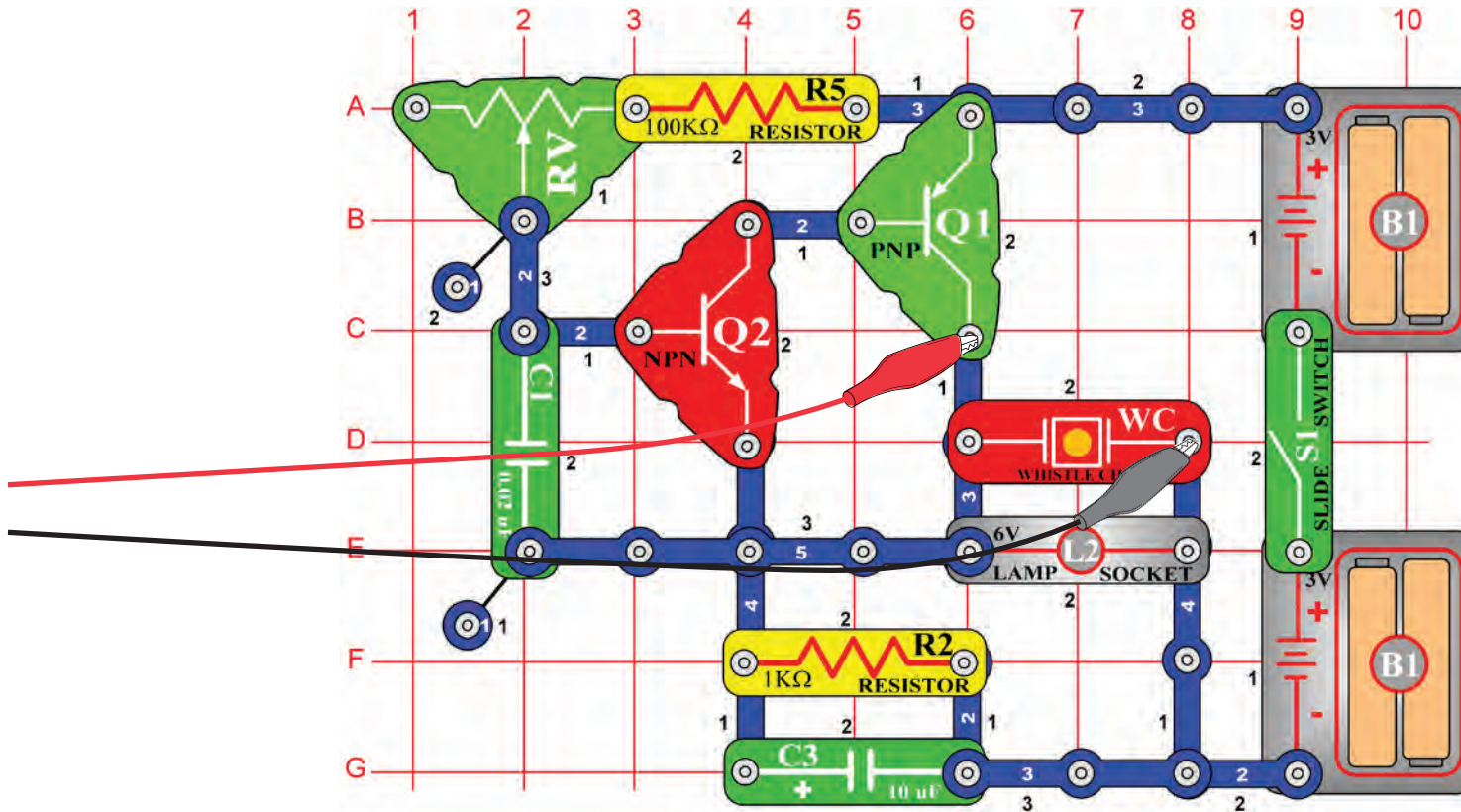

You will now be introduced to the Winscope features, and thereby become familiar with oscilloscopes and spectrum analyzers, and see some of the most important concepts in electronics. It is recommended that you already be familiar with the Snap Circuits® parts and assembly methods from the other manuals.

Build the circuit shown and connect the PC-interface cable to the microphone input on your computer. Turn on the slide switch (S1) and vary the adjustable resistor (RV). The frequency or pitch of the sound is changed. Run the Winscope software and be sure your microphone input is configured properly, as described earlier.



Click on the **On-Line** button if Winscope is currently in Hold mode and you should get a picture similar to this one:

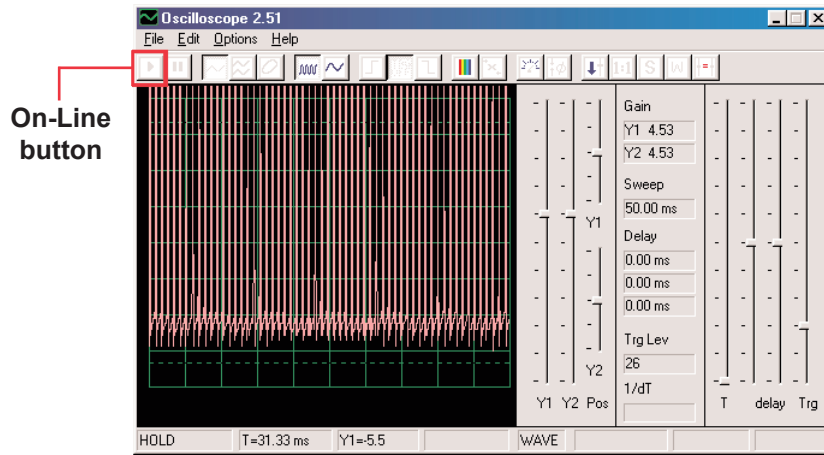

The waveform peak is off the top of the screen because the scope gain (amplification) is set too high. You may adjust this gain by moving the **Y1 gain control** around (try it).

Similarly, you may adjust the position of the waveform on the screen by moving the **Y1 position control** around (try it).

Now click on the **1:1** button to set the gain to x1 and disable the Y1 controls. You should now have a picture similar to this one:

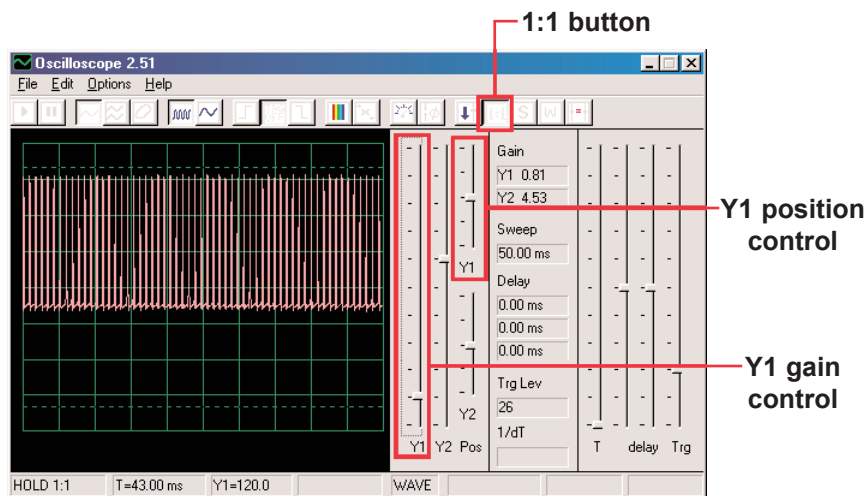

Note that your picture may not exactly match this picture due to variances in the microphone input gain between computers, which is beyond software control. You may want to adjust the volume control of your microphone input to compensate, see note A on page 4 for more details. You may also disable 1:1 mode by clicking on its button again and then adjust the gain using the Y1 control.

The gain and position control features just described enable electronic engineers and technicians to “see” the amplitude (voltage level) of a signal. By adjusting the settings on an oscilloscope, they can look at both very large and very small voltage waveforms.

Move the adjustable resistor control (snap part RV) and watch how it changes the waveform on the computer screen. Now click on the **0.5ms/div** button to change the time scale on the display. (The button to the left of it is for 5ms/div, the default.) Move the adjustable resistor control around again. You may click on the **Hold** button to freeze the waveform on the screen, then click on On-Line to restart.

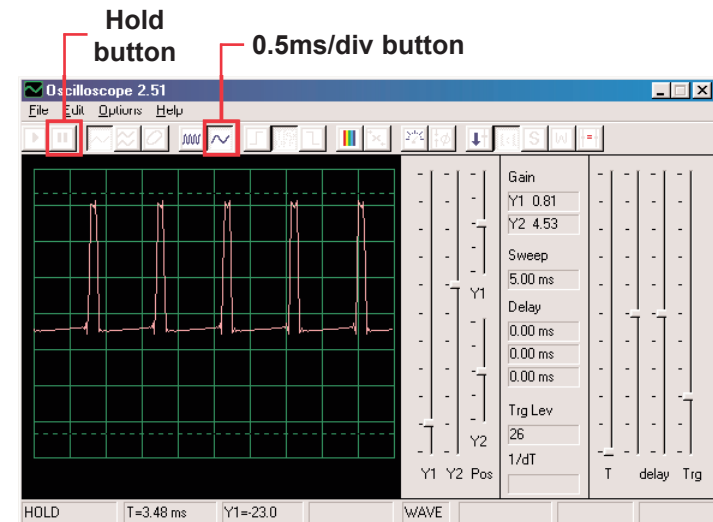

With the time scale at 0.5ms/div and the adjustable resistor set for middle position, you should now have a picture similar to this one.

Your picture may appear different due to variations in the microphone input designs between computers. Although this is beyond software control, in some cases you may be able to compensate externally. See notes B and C on page 4 for details.

Notice that the waveform seems to be randomly dancing across the screen, making it hard to study. We can fix this. Click on the **“trigger positive level”** button and make sure the **trigger bar** is in the position shown here. Notice that a small **“-”** appears on the left of the display as you do so.

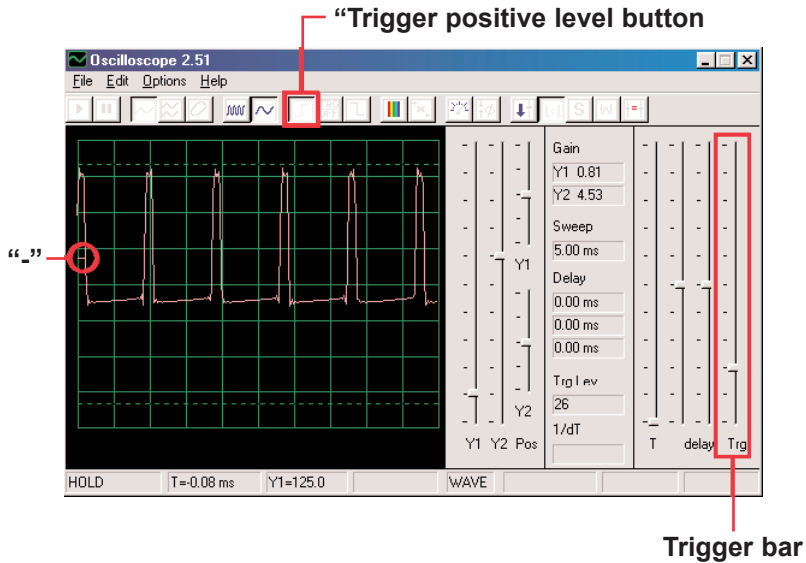

The small slash **“-”** represents the trigger voltage, when the signal reaches this voltage level it activates the display. This makes it easy to observe a stream of pulses like you have now, and also to record a single (non-repeating) pulse.

Move the adjustable resistor control (snap part RV) and watch how it changes the waveform on the computer screen. Now you can see how changing the adjustable resistor changes the time between the pulses, which changes the tone of the sound you hear.

The waveform you see here is the voltage across the speaker, the peaks of the pulses occur when the transistors turn on and provide current to the speaker. Changing the amplitude of the peaks changes the loudness of the sound, changing their separation changes the tone or **“pitch”** of the sound. The time scale and trigger control features just described enable electronic engineers and technicians to see the relationship between parts of a waveform on their oscilloscope.

Now its time to look at your electronic signal in a different way. The oscilloscope features you have been using show you voltage (amplitude) vs. **time**, now you will see voltage vs. **frequency**. Engineers use expensive instruments called spectrum analyzers to do this, but Winscope uses a mathematical transformation called an FFT to do this. Set the Y1 gain control back to its **default position** for now. Click on the **5ms/div** button to display a wider range, then click on the **FFT** button. Your display should be similar to this:

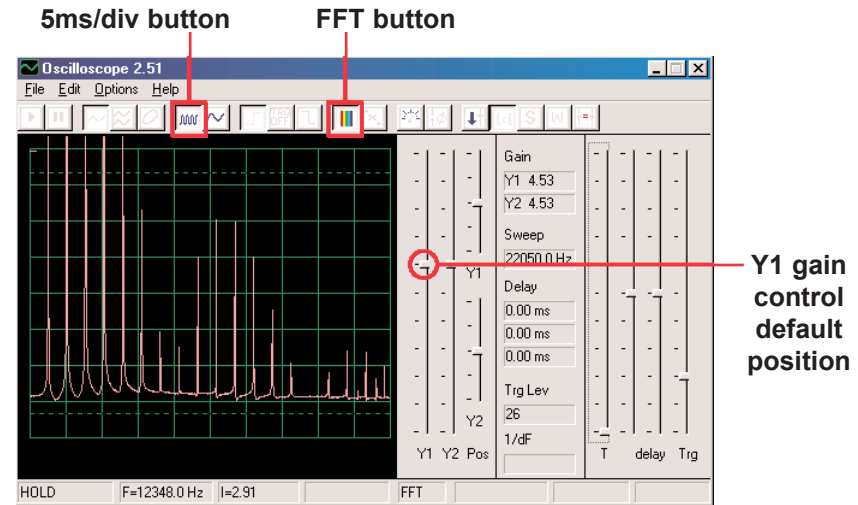

You are seeing the frequency spectrum of your signal, up to 22kHz. Notice that most of the energy is at the low frequencies (below 7kHz), and there is very little as you go higher.

The 1:1 gain mode does not apply to the FFT screen, so move the **Y1 gain control** down to here so you can see the peak energy at the low frequencies.

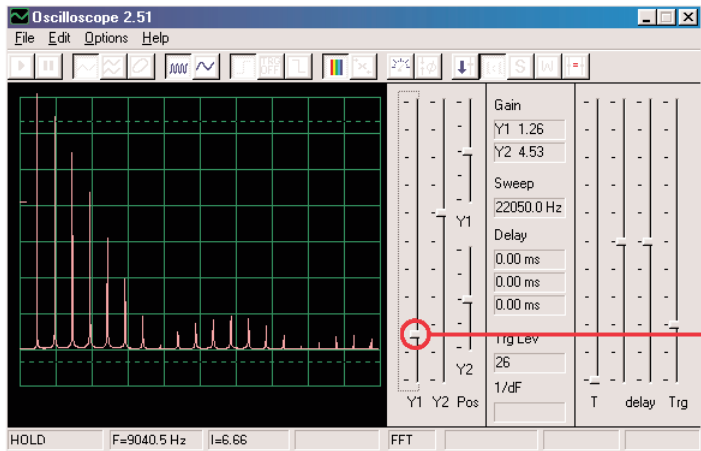

Y1 gain control level

Move the adjustable resistor control (snap part RV) and watch how it changes the frequencies on the display.

Set the adjustable resistor control (snap part RV) to mid-range. In addition to the 5ms/div and 0.5ms/div settings for the horizontal scale, there is also a **variable setting**. See if you can set it so that all the signal peaks line up with the grid lines, as shown.

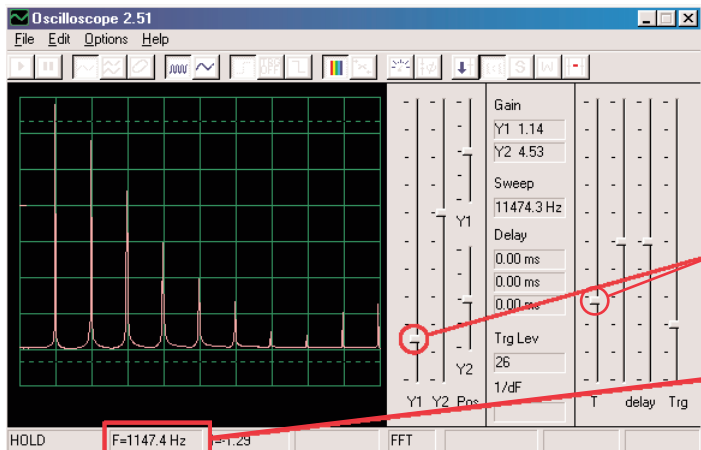

Variable setting

Frequency

As you can see, all the peaks are equally spaced in frequency. Move your computer mouse directly over the first peak, the software displays the **frequency** you are pointing at. Move the mouse to the other peaks and you see they are multiples of the first frequency.

Now you can see that the tone you hear is actually a range of related frequencies combined together. The first peak is considered to be the main signal (and it is usually but not always the highest), the energy at all the other peaks determine the waveform of the signal you see on an oscilloscope.

Now modify your circuit by placing the 0.1 $\mu$ F capacitor (C2) on top of the 0.02 $\mu$ F capacitor (C1).

By increasing circuit capacitance, you lower the oscillation frequency and your display should now look something like this:

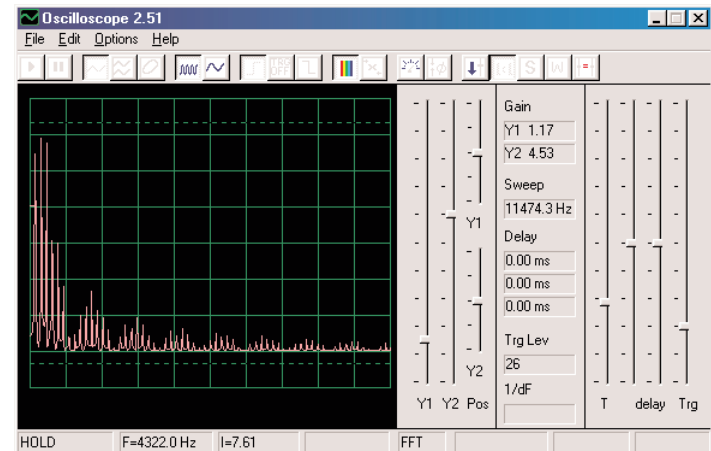

Now adjust the **horizontal scale** so the peaks line up with the gridlines as they did before.

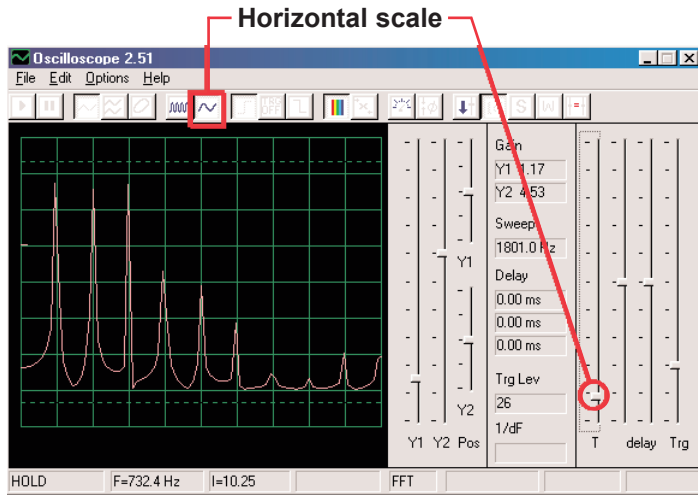

Notice that all the peaks went down in frequency by a corresponding amount and many changed in amplitude, that is why your ears hear a different sound. Notice also that in this case the left-most frequency peak no longer is the highest in voltage (your results may vary).

Now you can click on the FFT box to return to oscilloscope mode and look at the waveform with the  $0.1\mu\text{F}$  capacitor in the circuit. You can observe it with the same settings as before for comparison, but these settings usually work best:

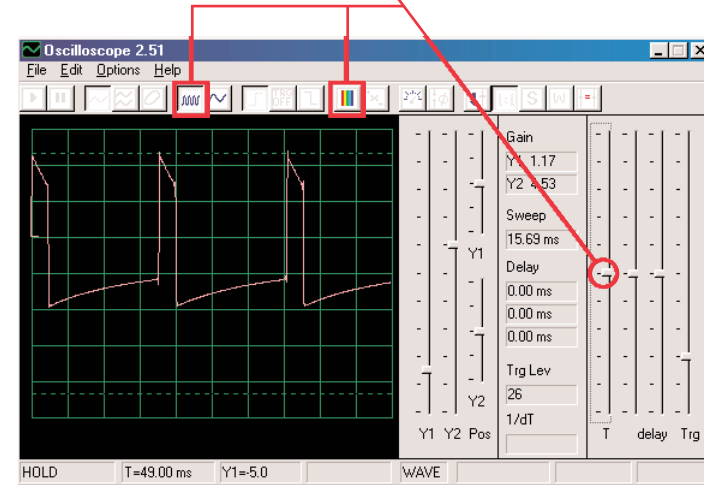

## Project #PC2

**OBJECTIVE:** To demonstrate storage mode.

**WARNING:** Moving parts. Do not touch the fan or motor during operation. Do not lean over the motor.

## Screaming Fan PC

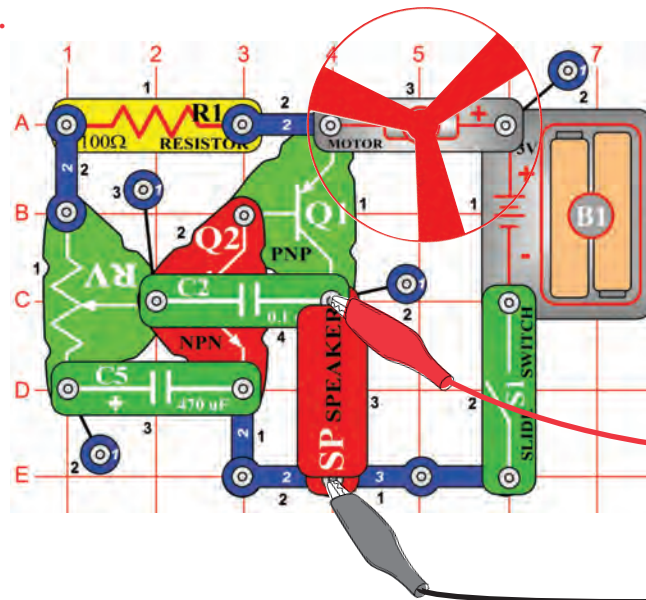

Build the circuit shown. If continuing from the previous experiment then close the Winscope program and run it again, to reset the settings. Click on the **On-Line** button to activate, and turn on the switch (snap part S1). Set Winscope to the settings shown below, and move the lever on the adjustable resistor (snap part RV) around to change **the waveform** and the sound. A sample waveform is shown here, but the pattern and shape of the pulses depends on the adjustable resistor setting.

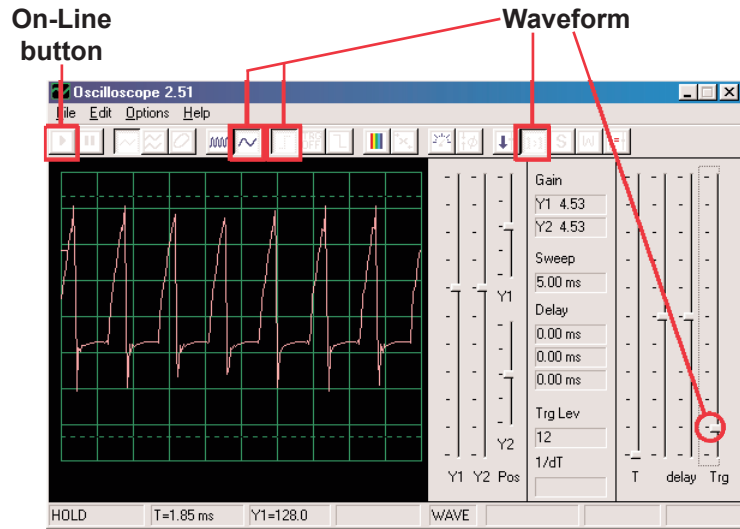

Winscope has a mode that can display multiple scans at the same time, called **Storage mode**. Set the adjustable resistor lever to a low-middle position, place Winscope in this mode, and watch the results.

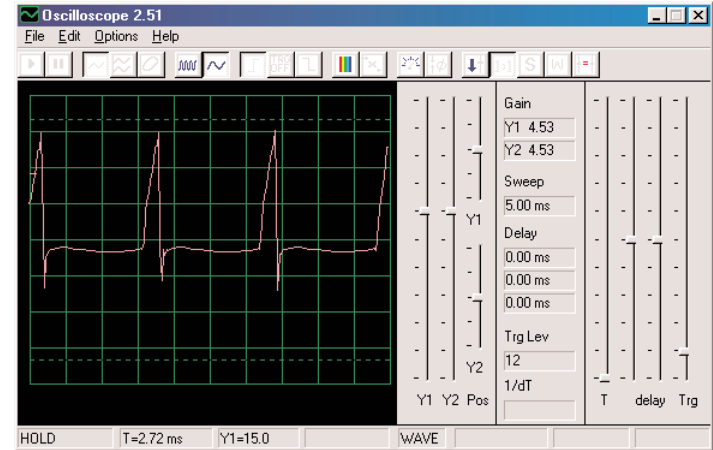

Without Storage Mode

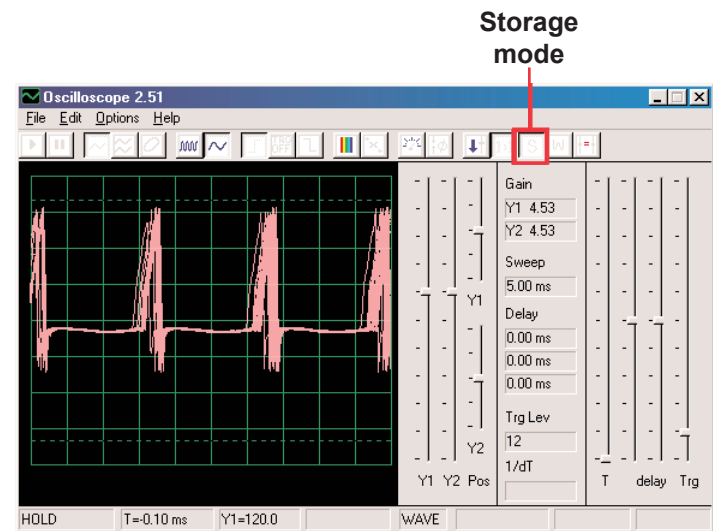

With Storage Mode

What you see here is the effect of timing variations on the trigger used for synchronization. Turn off the **trigger** and you will see how much variation there is without using the trigger:

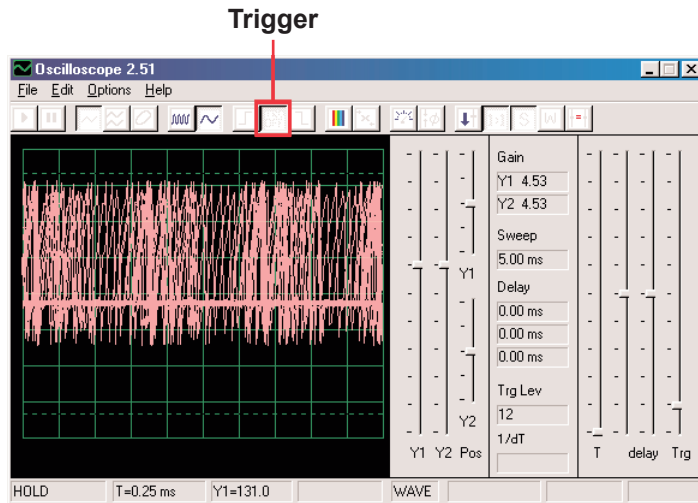

You can use Storage mode on any of the other circuit waveforms if desired.

Now turn off storage mode and turn on FFT mode to look at the frequency spectrum, try the **settings** shown here.

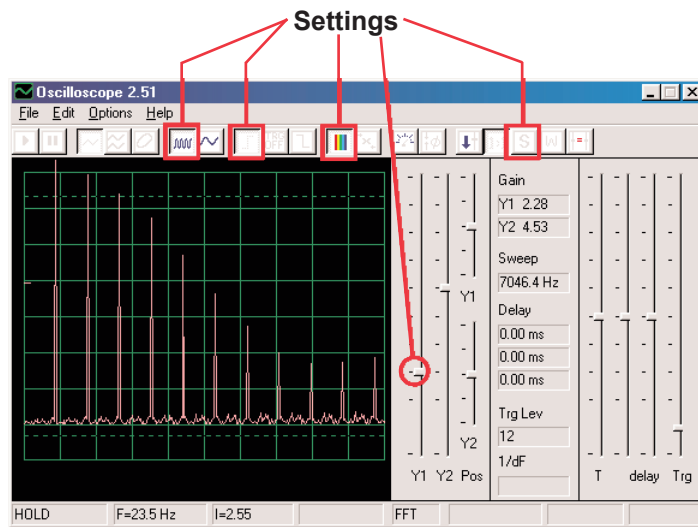

Moving the adjustable resistor lever will change the spectrum shown.

You can also use **storage mode** when in FFT mode, so turn it on now.

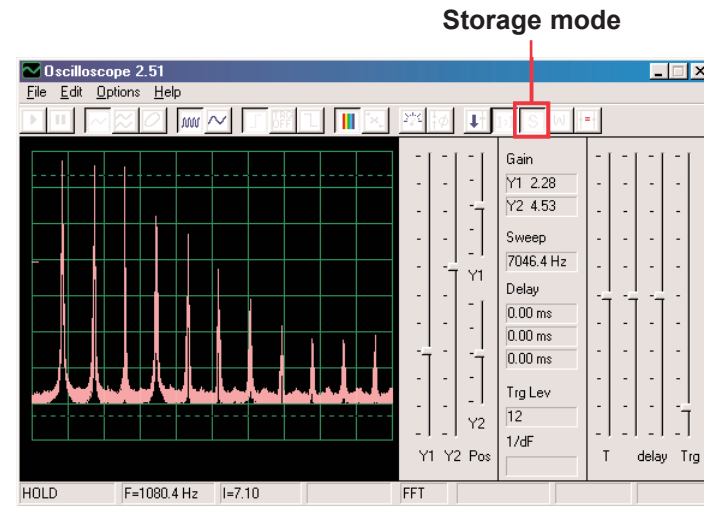

In this way you can show the peak energy achieved at each frequency. But this is only useful on a stable waveform, so if you move the adjustable resistor lever now the signal will fill the screen as the peaks move across the display.

Most oscilloscopes and spectrum analyzers have a storage mode like this of some form.



# Project #PC3

# Hissing Foghorn PC

*OBJECTIVE: To demonstrate wait mode with multiple colors.*

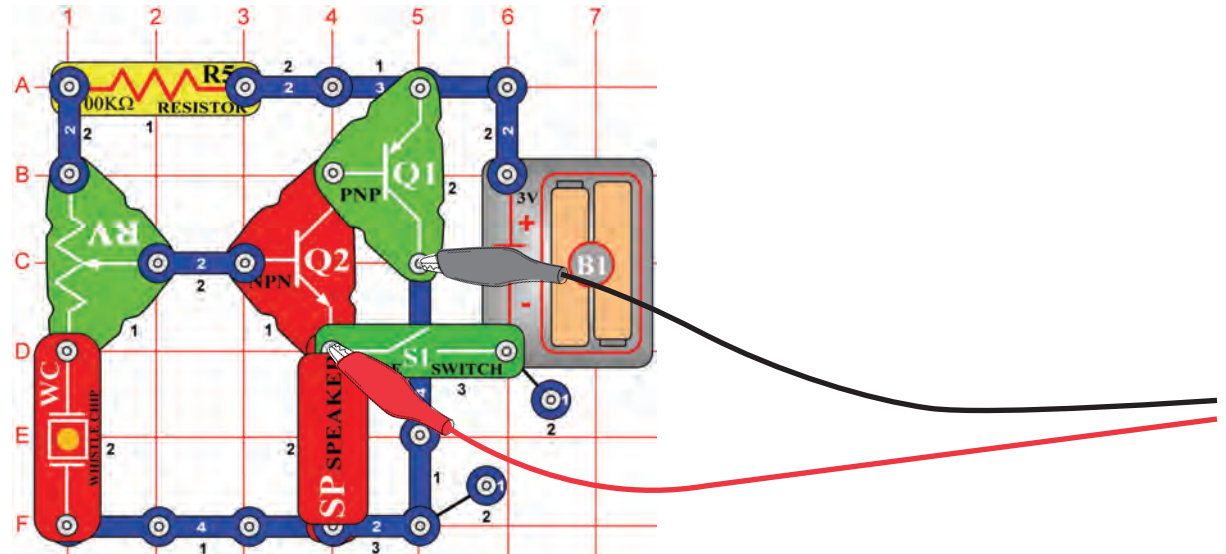

Build the circuit shown. If continuing from the previous experiment then close the Winscope program and run it again, to reset the settings. Click on the **On-Line** button to activate, and turn on the switch (snap part S1). Set Winscope to the **settings** shown on the right, and move the lever on the adjustable resistor (snap part RV) around to change the waveform and the sound. At some positions there may be no sound. A sample waveform is shown here, but the pattern and shape of the pulses depends on the adjustable resistor setting.

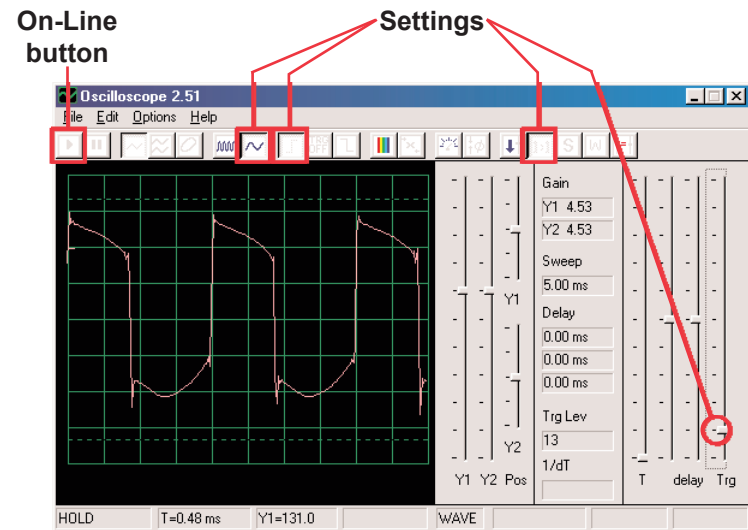

Place Winscope in **Wait mode** by clicking on the button for it, then slowly press the **On-Line button** several times. Now turn off the slide switch (snap part S1) and press On-Line again. Then turn the switch back on. You see that in Wait mode Winscope scans (“waits”) until it sees a waveform that exceeds the trigger level you set, then stops. With a strong signal it will make one scan and then stop, whereas if no signal is present it keeps scanning until it finds one. You could use this to sense when someone has turned on the circuit.

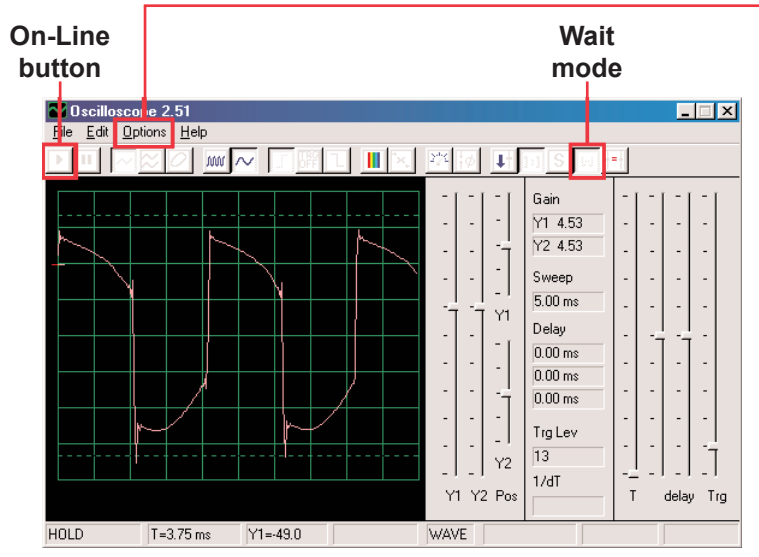

You can change the color of the waveform: select **<Options>**, then select **<Colors>**, then select **<Y1 Trace>**. Now select the color you like and click **<OK>**.

Now we will combine the wait and storage modes to display several waveforms that this circuit can create. You should have the circuit on with the adjustable resistor at mid-range and Winscope in Wait mode. Now turn on **Storage mode**. Now change the color of the Y1 trace. Move the adjustable resistor control lever a little, then press On-Line once to record another waveform. Now change the color of Y1 again. Move the resistance control again and press On-Line once. Change the Y1 color, adjust the resistance and press On-Line. Do this several more times if you like. Note that at some resistance settings there may be no waveform to trigger on, move the resistance control until it does.

Now your display should look something like this:

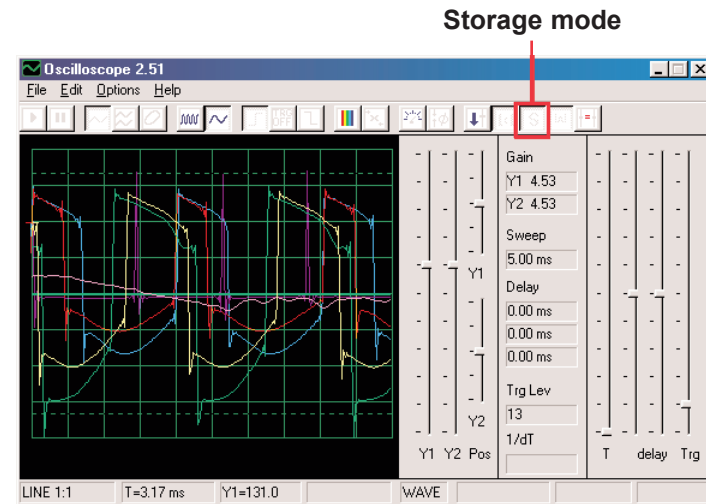

Now you see the range of waveforms this circuit can create, all at the same time. Engineers often do this to compare signals during analysis.

You can use Wait mode and different colors like this on the other circuits if you like.

Now turn off storage mode and turn on FFT mode to look at the frequency spectrum, try the **settings** shown here. Wait mode does not apply in FFT mode, so it has no effect here. Moving the adjustable resistor lever will change the spectrum shown.

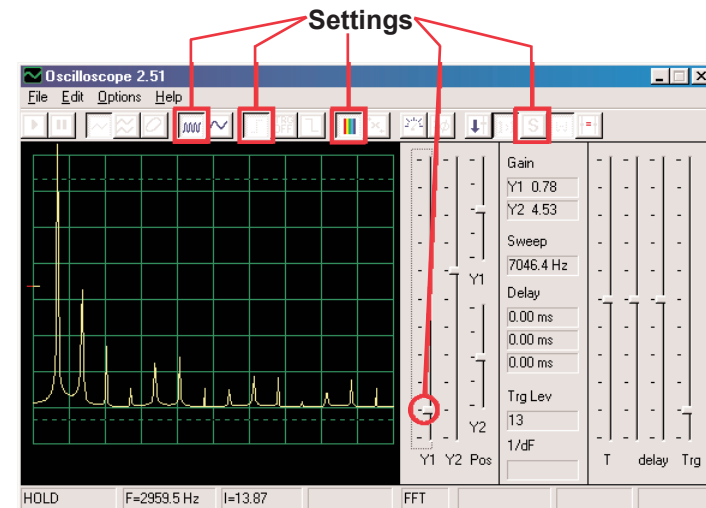





# Project #PC4

# Light & Sounds PC

*OBJECTIVE: To look at the output signal from a circuit that makes alarm sounds.*

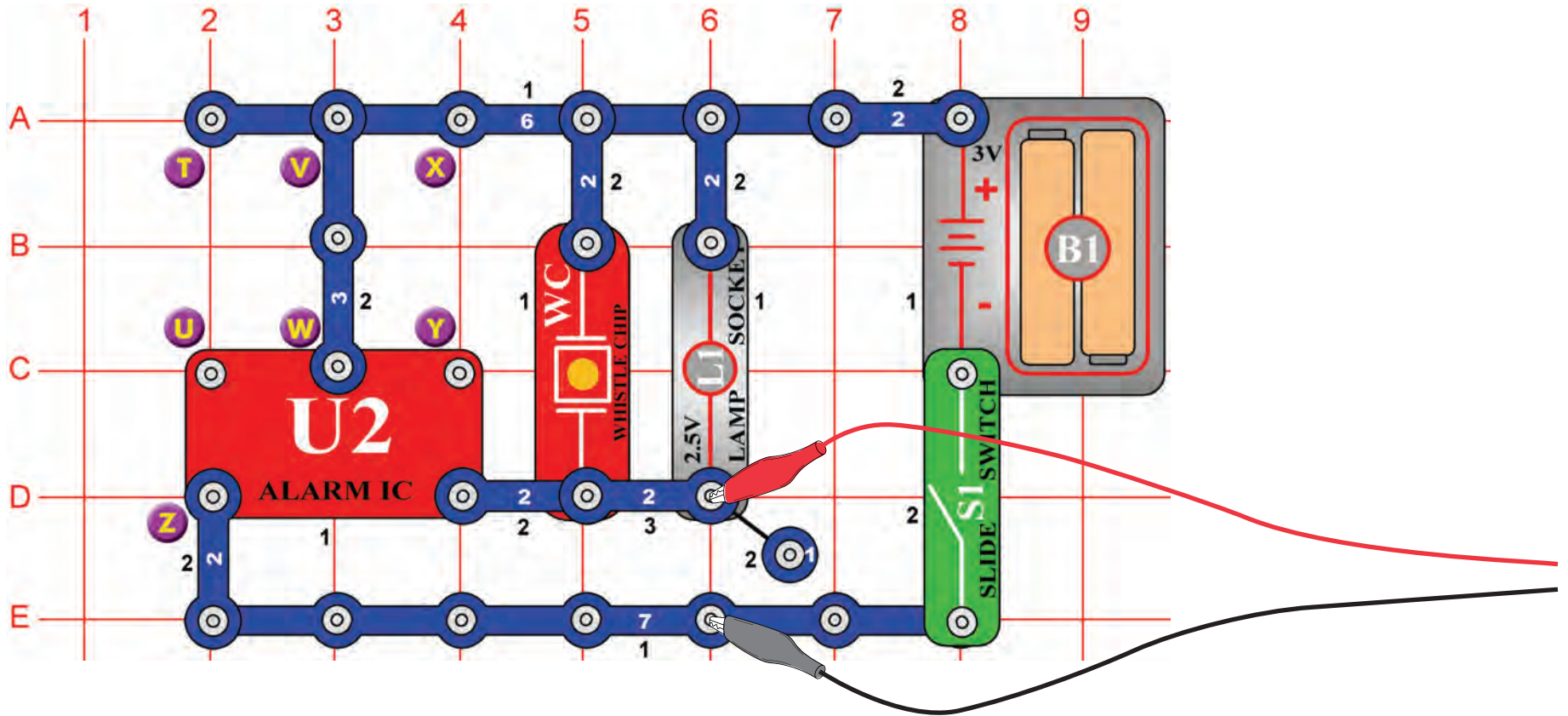

Build the circuit and connect the Winscope PC-interface cable as shown, the cable should still be connected to the microphone input on your computer.

If continuing from the previous experiment then close the Winscope program and run it again, to reset the settings. Then use the mouse to **set it up** as shown here, and turn on the switch (snap part S1). Click on the **On-Line** button to activate.

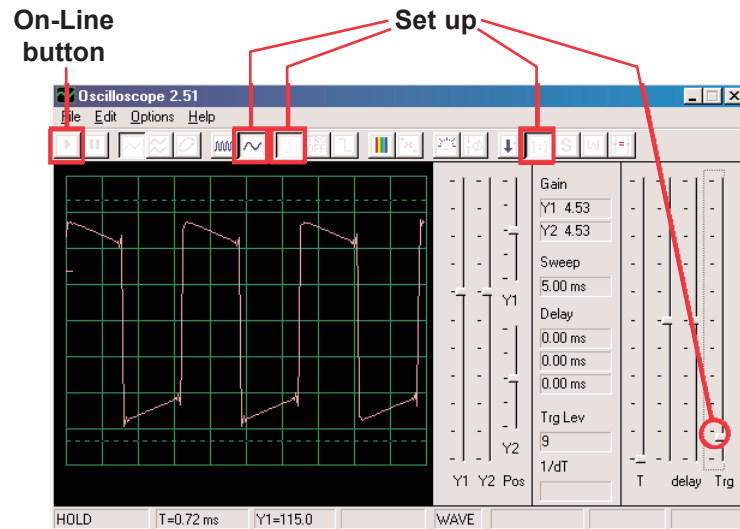

You should see a waveform similar to that shown here, but it will be constantly changing. This is because the siren sound you hear is not a continuous tone but instead is constantly changing. Note the differences in the waveshape for this circuit compared to the circuit in Project PC1.

Your picture may appear different due to variations in the microphone input designs between computers. See the notes on page 4 for details.

Click on the **FFT** button to look at the frequency spectrum. Also set the **amplitude** and **time scales** (really amplitude and frequency scales in FFT mode) to be as shown here.

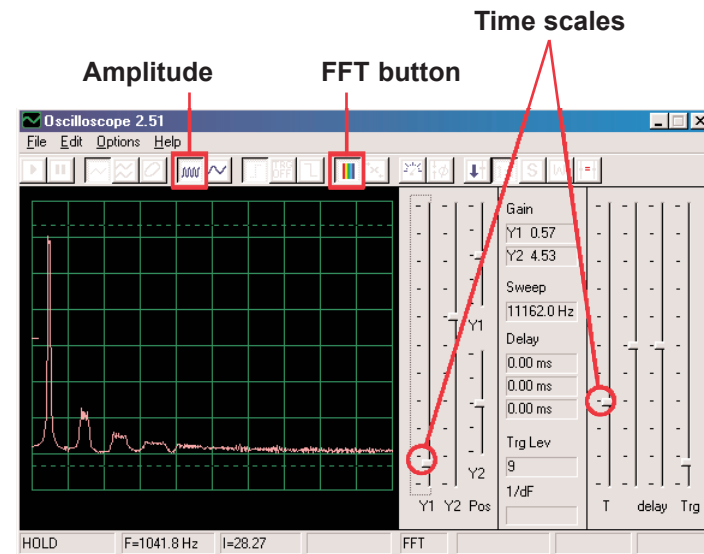

You should see a fuzzy spectrum similar to that shown here, but it will be constantly changing. This is because the siren sound you hear is not a continuous tone but instead is constantly changing frequency, and it spends more time at some frequencies than at others. Note the differences in the spectrum for this circuit compared to the circuit in Project PC1.

## Project #PC5 Light & Sounds PC (II)

Modify the circuit for project PC4 by connecting points X and Y on the snap diagram. Now the sound is a machine gun, it shuts off between bursts.

Look at the waveform and frequency spectrum using the same settings as for project PC4, and compare them to those for the siren.

## Project #PC6 Light & Sounds PC (III)

Modify the circuit by removing the connection between X and Y and then make a connection between T and U. It makes a fire engine sound.

Look at the waveform and frequency spectrum using the same settings as for project PC4. The waveform slowly rises and falls in pitch, and gives a clear spectrum that slowly rises and falls in frequency.

## Project #PC7 Light & Sounds PC (IV)

Remove the connection between T and U and then make a connection between U and Z. It makes an ambulance sound.

Look at the waveform and frequency spectrum using the same settings as for project PC4. It alternates between two frequencies.

Sample Frequency Spectrum

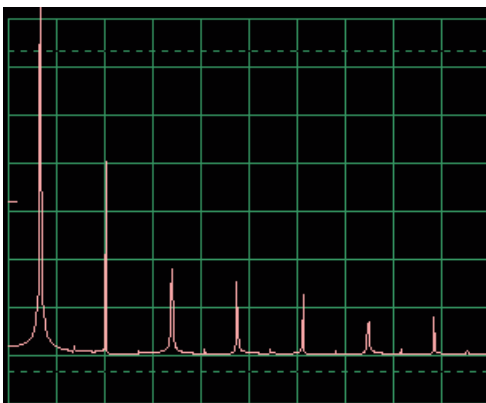

## Project #PC8 Light & Sounds PC (V)

Remove the connections between U and Z and between V and W, then make a connection between T and U. It makes a water faucet sound.

Look at the waveform and frequency spectrum using the same settings as for project PC4. This sound is different from the others and seems to have little or no pattern.

Sample Frequency Spectrum

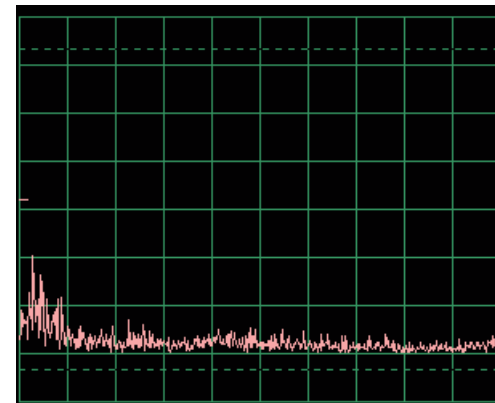

# Project #PC9 Light & Sounds PC (VI)

Look at the waveform in oscilloscope mode using the same settings as earlier in PC4. Replace the whistle chip with the speaker and remove the lamp. Compare the waveform you see now with that from the whistle chip. The amplitude of the waveforms are similar but yet the sound from the speaker is much louder, since the speaker is drawing more current.

# Project #PC10 Modulation

*OBJECTIVE: To demonstrate AM and FM modulation.*

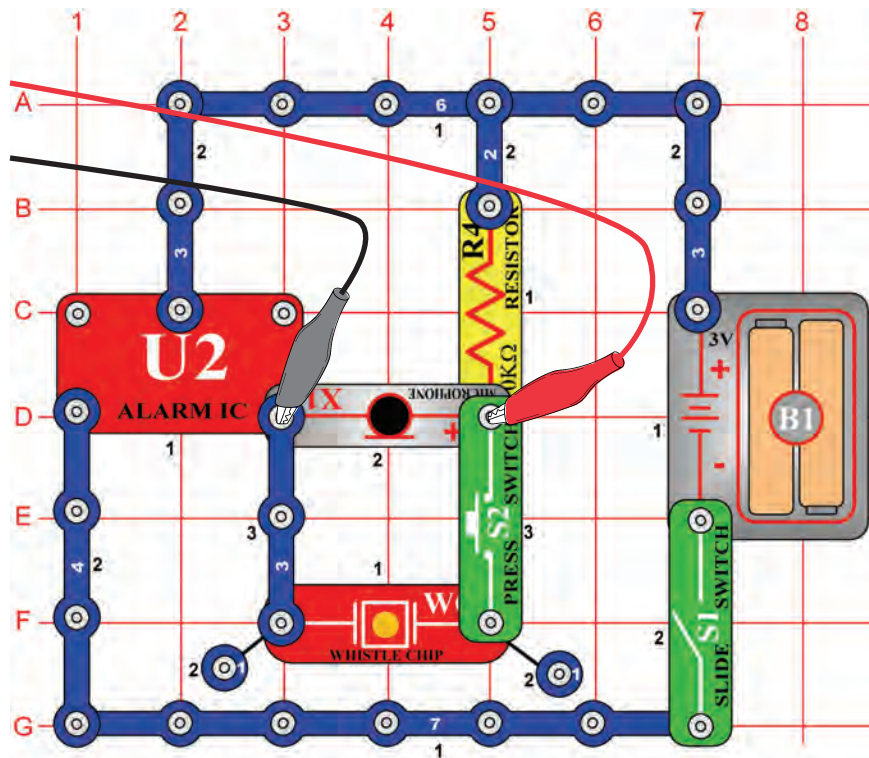

Build the circuit shown. If continuing from the previous experiment then close the Winscope program and run it again, to reset the settings. Click on the On-Line button to activate, and turn on the switch (snap part S1). If you press the key (snap part S2) then you will hear a siren sound, but it will not be very loud. Click on the **1:1** button to set the gain automatically, then talk or hum into the microphone (snap part X1) and observe how the waveform changes. You may freeze the waveform by pressing the **Hold** button if desired.

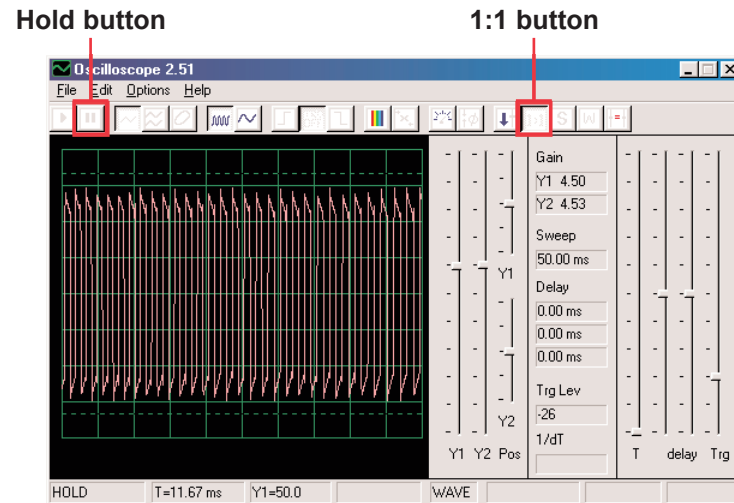

When you are quiet you just get a stream of pulses with roughly equal height and width, as shown at left.

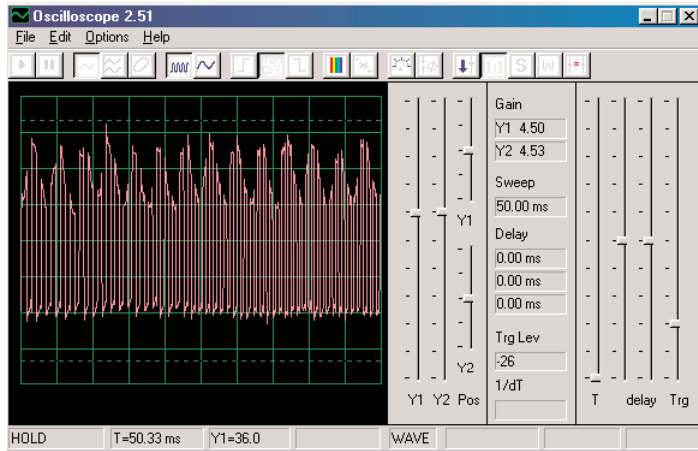

The waveform shown here is from humming into the microphone, notice how the tops of the pulses show a regular pattern of dips now.

Look ahead to the Microphone project PC14 on page 25, and note the waveform shown there for humming into the microphone:

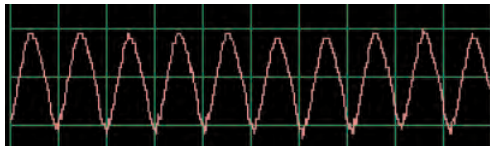

Notice that you can see roughly the same pattern in the peaks of the waveform at left. If you hum at a similar tone and at a similar distance from the microphone, you will get similar results.

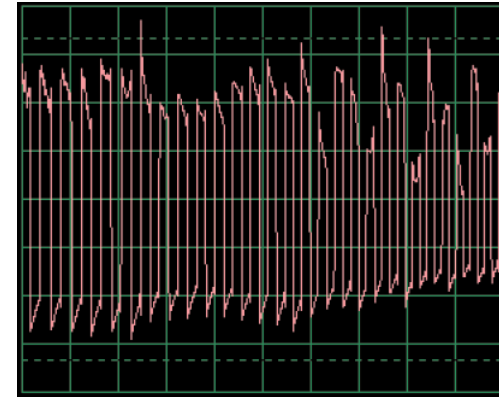

If you talk into the microphone now you will get different patterns depending on what words you say, how loudly you say them, and your distance from the microphone. Words produce a more “random” pattern than humming, but less random than blowing into the microphone. The waveform at left is an example of talking into the microphone. Observe the waveforms you get and compare with what you get in project PC14.

And so you see that your voice is being superimposed onto the peaks of the stream of pulses, this is called **Amplitude Modulation** or **AM**. At AM radio stations music or voice is superimposed on a high frequency waveform (similar to the pulse stream here), filtered, amplified, and transmitted. Doing this allows the music to be transmitted over great distances.

You can place Winscope into FFT mode to view the frequency spectrum if you like, but it will be confusing to look at.

You probably noticed that the width of the pulses in the pulse stream is constantly changing, that is because there is actually a second type of modulation occurring here. Press the key again and you hear a siren. A siren is not a stable tone but rather is constantly changing in frequency. Change the **time scale** to 0.5ms/div and observe the range of waveforms:

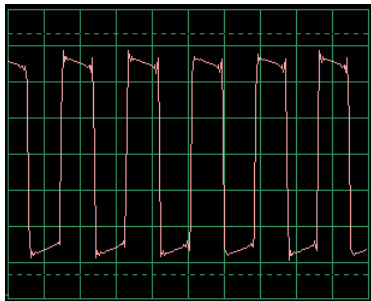
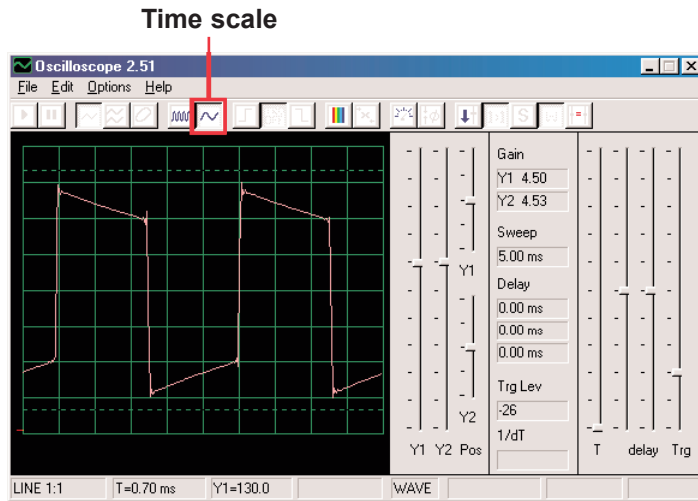

The width of the pulses (or frequency of the signal) is slowly being changed, at a regular and repetitive rate. This is an example of **Frequency Modulation**, or **FM**. In AM you use a controlling signal (voice or music) to vary the amplitude of a second signal, in FM you use the controlling signal to vary the frequency of the other signal. In this circuit the output frequency from the alarm IC is being controlled by a signal created inside the alarm IC, but it could have been controlled by humming like you did for the AM (you don't have the parts needed to do this).

Look back at the Light & Sounds project PC4 on page 16. It shows several different ways of configuring the alarm IC to make different sounds, all of these are examples of frequency modulation using different controlling signals created within the alarm IC. It also shows examples of the frequency spectrum.

## Project #PC11 Filtering

With the same circuit as PC10 and the same settings as shown at the end of PC10, look at the waveform again and then press the key. Notice how the pulses become more "rounded" when the key is pressed. The whistle chip (snap part WC) has capacitance that filters or smoothes the output signal. Now replace the whistle chip with the 0.02 $\mu$ F capacitor (snap part C1) and it should look similar though you won't hear any sound. You can also look at the frequency spectrum in FFT mode like in the other projects.

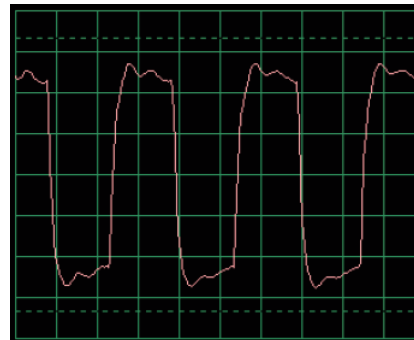

Typical waveform using  
whistle chip

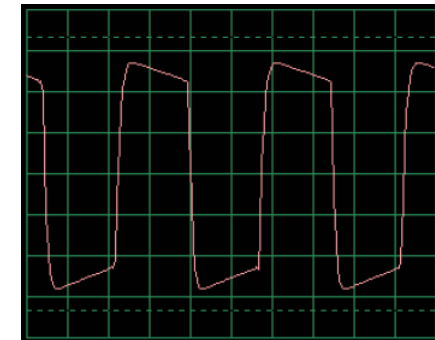

Typical waveform using  
0.02 $\mu$ F capacitor



# Project #PC12 AM Radio PC

*OBJECTIVE: To look at the output signal from an AM radio.*

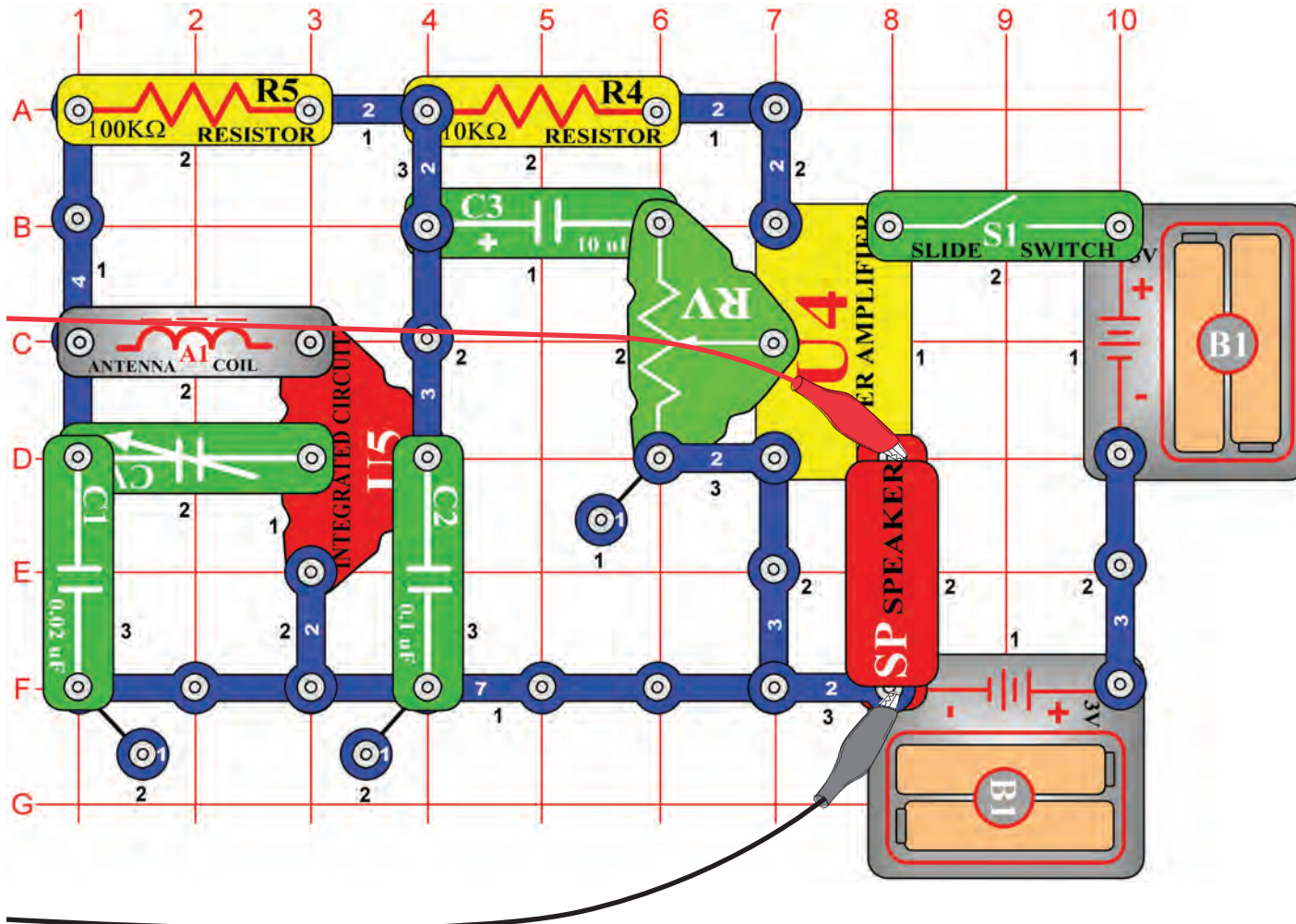

Build the circuit shown and connect the PC-interface cable to the microphone input on your computer. Turn on the slide switch (snap part S1), tune the variable capacitor (snap part CV) to a local radio station that gives good reception, and set the adjustable resistor (snap part RV) to a comfortable volume. The integrated circuit (snap part U5) detects and amplifies the AM radio waves all around you. The power amplifier IC (snap part U4) drives the speaker (snap part SP) to complete the circuit.

In this project you will study the audio signal at the radio's output to the speaker. The actual AM radio transmission is at high frequencies that cannot be viewed using Winscope.

If continuing from the previous experiment then close the Winscope program and run it again, to reset the settings. Then use the mouse to set the scale to **1:1 mode**. Click on the **On-Line button** to activate.

**On-Line button**

**1:1 mode**

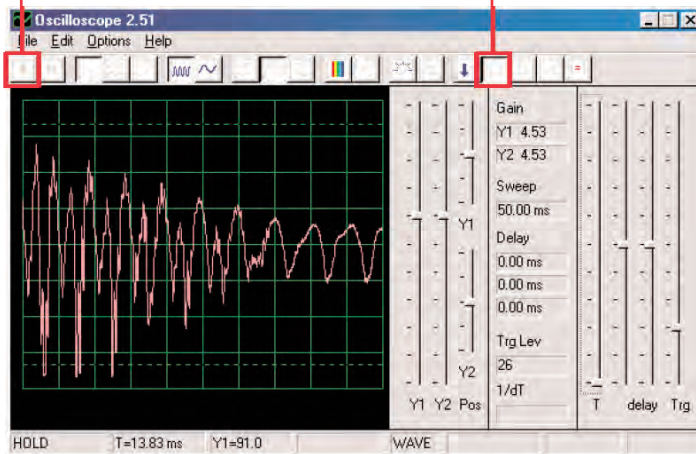

You should see a waveform similar to that shown here, but it will be constantly changing as the music or talking you hear is changing. Try tuning the adjustable capacitor (snap part CV) to different radio stations and compare the waveforms.

This shows you what talking or music look like in electrical form. Every word that every person says looks different, though there are many patterns. The waveform will be fuzzier if there is lots of static on the station. Here are some other examples of talking and music using the same settings above:

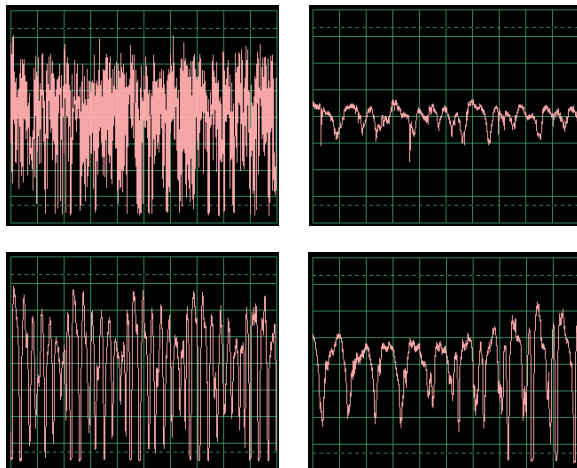

Click on the **FFT button** to look at the frequency spectrum. Set the **time scale** (really frequency scale in FFT mode) and **amplitude scale** to be as shown here.

**FFT button**

**Amplitude scale**

**Time scale**

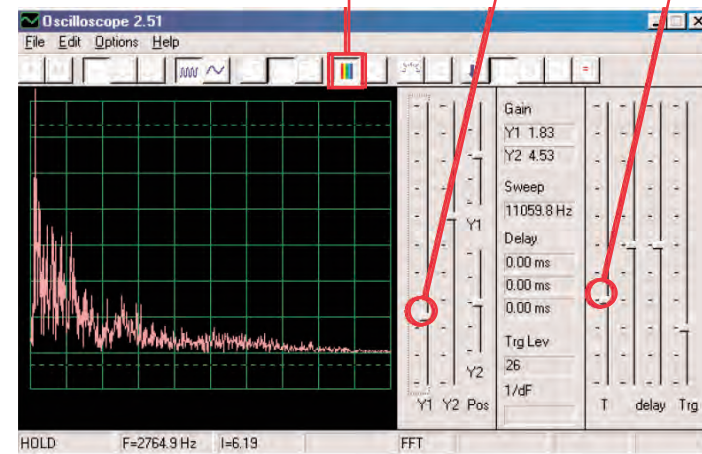

You should see a spectrum similar to that shown here, but it will be constantly changing as the music or talking you hear is changing. Try tuning the adjustable capacitor (snap part CV) to different radio stations and compare the waveforms.

This shows you the frequency spectrum of talking or music. Every word that every person says looks different, though there are many patterns. The spectrum will be fuzzier if there is lots of static on the station. Here are some other examples of talking and music using the same settings above:

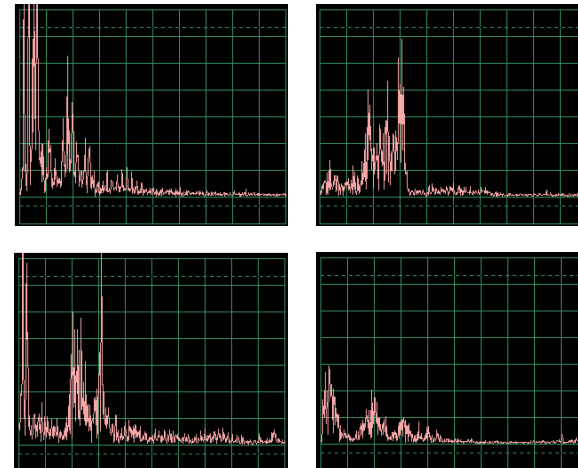



# Project #PC13 Space War PC

**OBJECTIVE:** To look at the output signal from a circuit that makes space war sounds.

Build the circuit shown and connect the PC-interface cable to the microphone input on your computer.

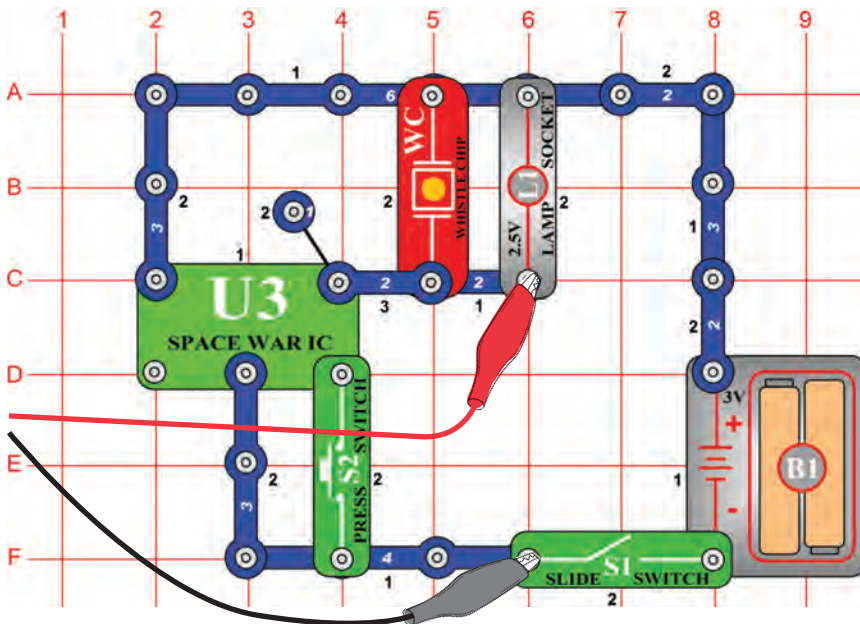

If continuing from the previous experiment then close the Winscope program and run it again, to reset the settings. Then use the mouse to **set it up** as shown here, and turn on the switch (snap part S1). Click on the **On-Line** button to activate.

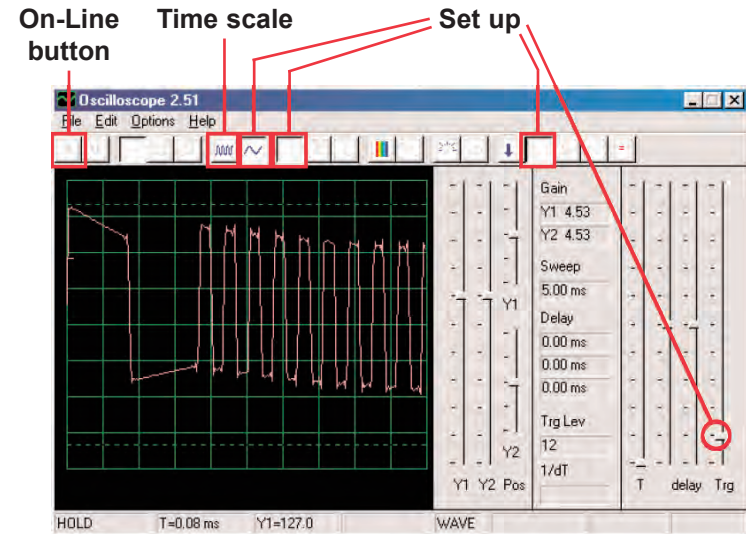

Press the press switch (snap part S2) several times to step through the eight different sounds from the space war integrated circuit. Hold it down for a few seconds each time so you can see the waveform representing the sound you hear.

It is also interesting to switch to the **5ms/div time scale** setting to see more of the waveform at one time. Here are some example waveforms using the same settings as above:

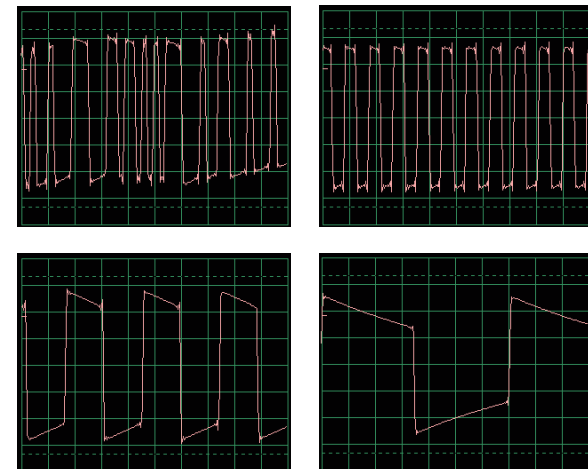

Click on the **FFT button** to look at the frequency spectrum for these signals. For best viewing set the **amplitude** and **time scales** (really amplitude and frequency scales in FFT mode) to be as shown here.

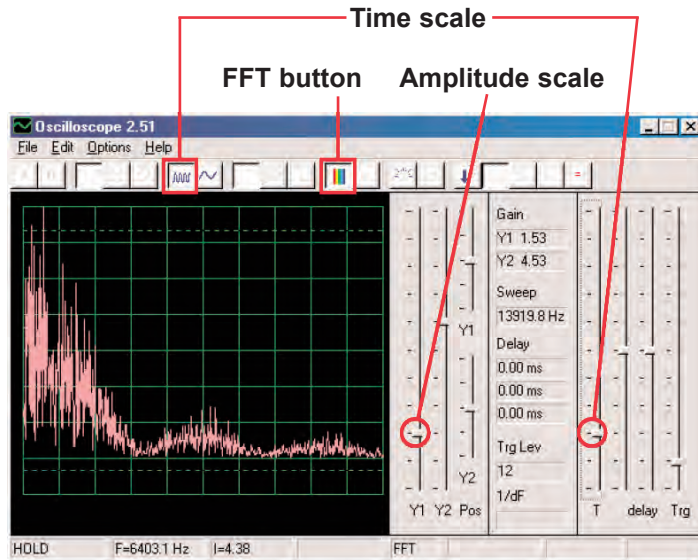

Press the press switch (snap part S2) several times to step through the eight different sounds from the space war integrated circuit. Hold it down for a few seconds each time so you can see the frequency spectrum representing the sound you hear.

Here are sample spectrums from some of the other sounds using the same settings as above:

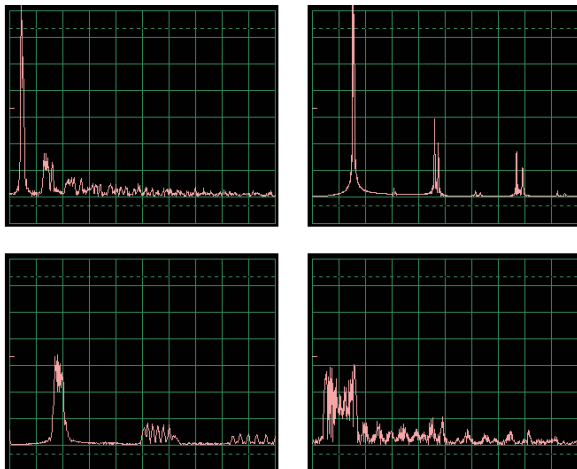

# Project #PC14 Microphone

**OBJECTIVE:** To see what your voice looks like in electrical form.

Build the circuit shown and connect the PC-interface cable to the microphone input on your computer.

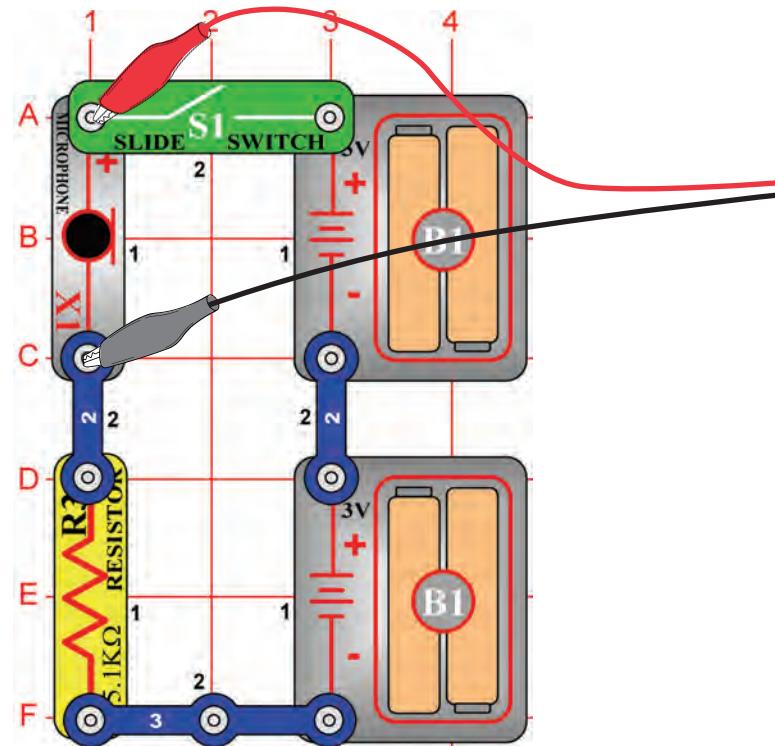

If continuing from the previous experiment then close the Winscope program and run it again, to reset the settings. Click on the **On-Line** button to activate Winscope, and turn on the switch (snap part S1).

**On-Line button**

**Y1 gain control**

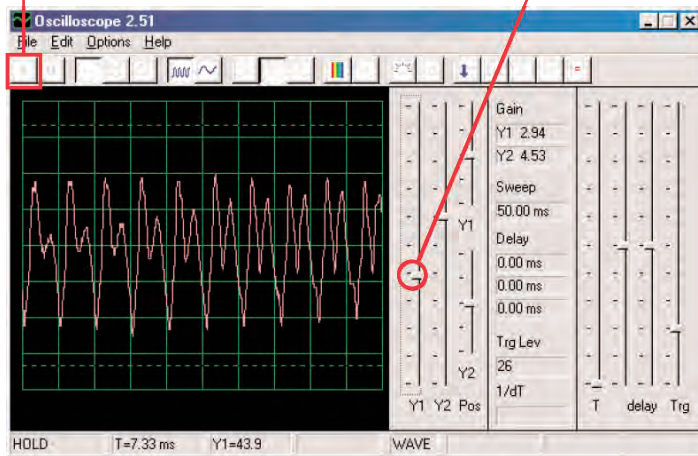

Talk into the microphone (snap part X1) and see what your voice looks like after the microphone converts it to electrical energy. Adjust the **Y1 gain control** to get the best view of it, since the amplitude is greater if you talk louder or are closer to the microphone. Notice how the waveform is different depending on which words or tones you say.

Here are some example waveforms using the same settings as above. Try not to blow on the microphone while you talk into it.

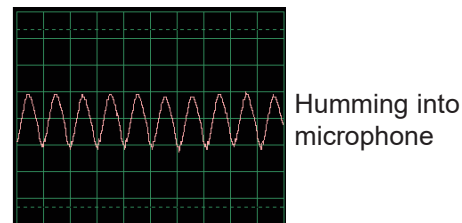
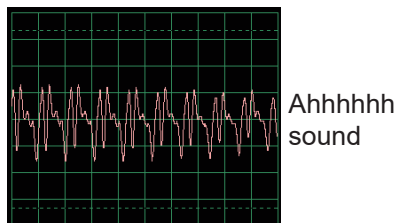
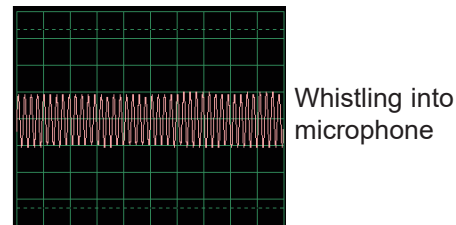
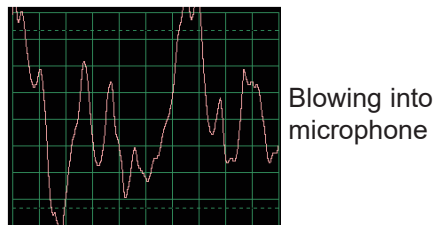

Click on the **FFT** button to look at the frequency spectrum for these signals. Try the **amplitude** and **time scales** shown here to start, but your best settings will depend on what sounds you make, how loud you speak, and how close you are to the microphone.

**On-Line button**

**Amplitude and time scales**

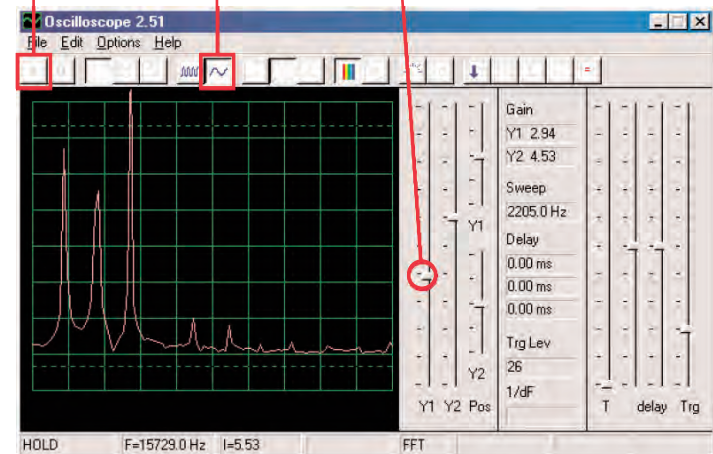

Notice that most women have higher-frequency voices than most men, and so their frequency peaks are further to the right on your display.

Here are some example waveforms using the same settings as above:

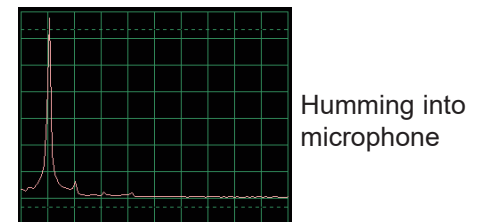
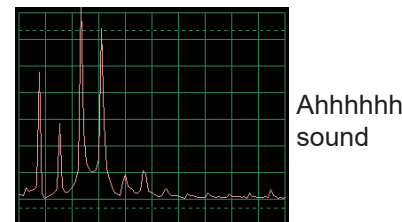
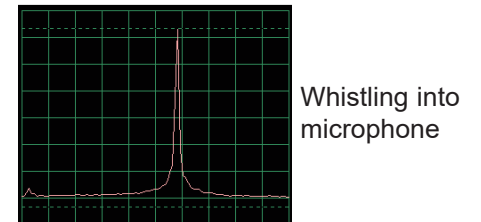
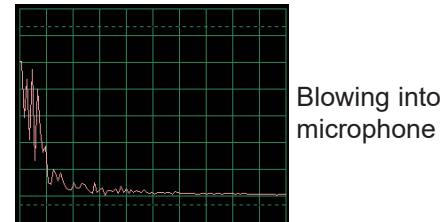

The above frequency spectrum pictures correspond directly to the waveform pictures on the preceding page. Notice that the spectrums for the hum and whistle have only a single big peak. Smooth, well-rounded, and repetitive waveforms (in oscilloscope

mode) have nearly all of their energy at a specific frequency like for the hum. “Square” or “rectangular” looking waveforms (like in Project PC1) and most music have a series of mathematically-related peaks, while “random” waveforms (like from blowing into the microphone or several people talking at the same time) have a frequency “blob” instead of distinct peaks.

## Project #PC15 Speaker Microphone

**OBJECTIVE:** *To see what your voice looks like in electrical form.*

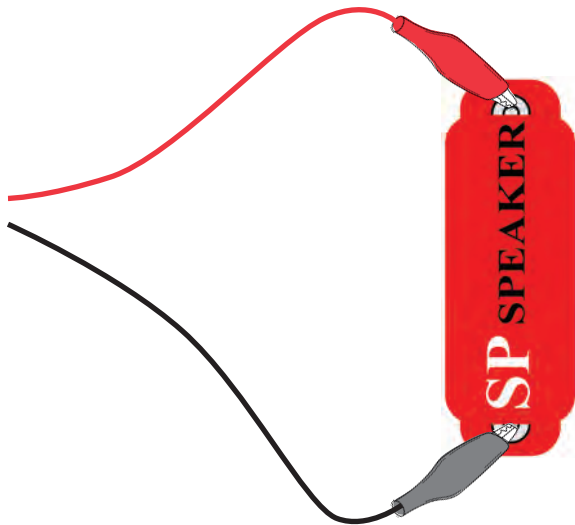

A speaker uses electrical energy to create mechanical vibrations. These vibrations create variations in air pressure, called sound waves, which travel across the room. You “hear” sound when your ears feel these air pressure variations. But if air pressure variations reach the speaker from another source, they will cause it to vibrate too. This, in turn, causes the speaker to create a small electrical signal just like a microphone does (though not very efficiently, since speakers were not designed to be microphones).

Connect the PC-interface cable directly onto the speaker as shown; no other parts are needed here. If continuing from the previous experiment then close the Winscope program and run it again, to reset the settings. Click on the **On-Line** button to activate.

Hold the speaker next to your mouth and talk into it to see what your voice looks like after the speaker converts it to electrical energy. Adjust the **Y1 gain control** to get the best view of it.

On-Line button

Y1 gain control

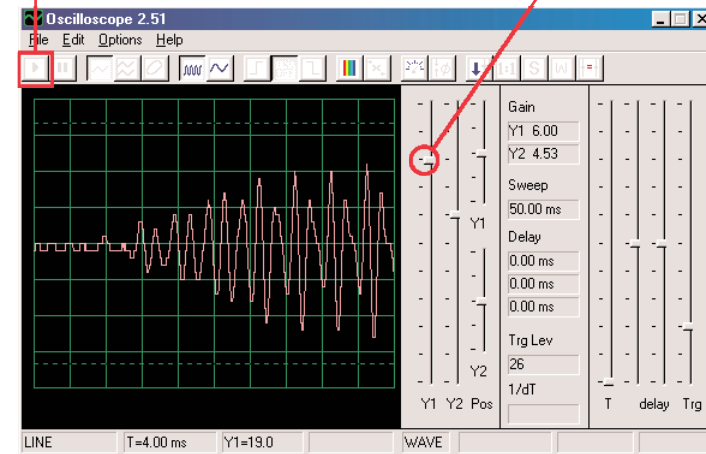

Notice that you need to set the gain control higher here than in the preceding project using the microphone, since speakers were not designed to be used in the same way.

You may switch to FFT mode and view the frequency spectrum in the same manner as for the microphone project PC14.

# Project #PC16 Symphony of Sounds PC

*OBJECTIVE: To see the waveforms for a complex signal.*

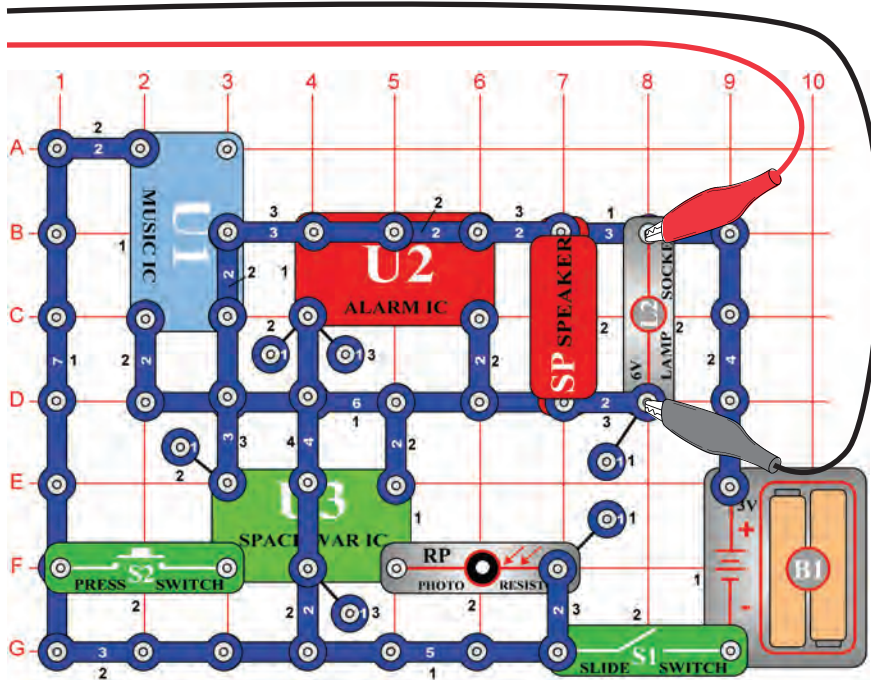

The Symphony of Sounds project combines waveforms from the Music, Alarm, and Space War integrated circuits. Build the circuit shown. If continuing from the previous experiment then close the Winscope program and run it again, to reset the settings. Click on the On-Line button to activate, and turn on the switch (snap part S1). Press the press switch (S2) and wave your hand over the photosensitive resistor (RP).

Due to the combination of sounds, the waveform is complex. Set Winscope to the **settings** shown, or as you prefer.

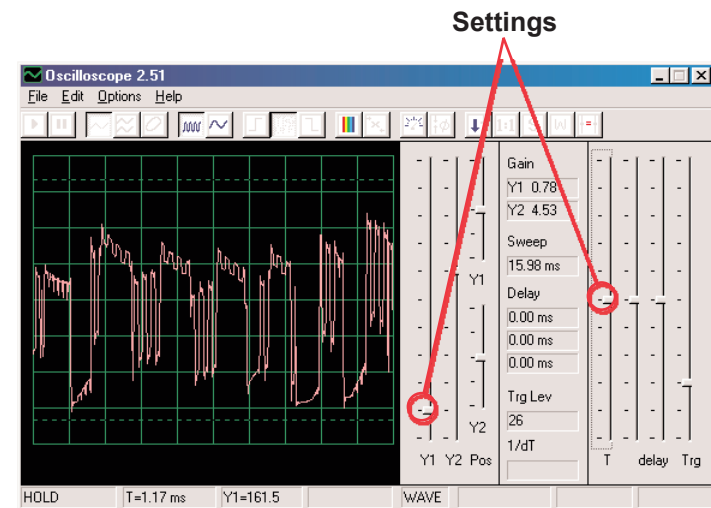

Click on the FFT button to look at the frequency spectrum for the signal. Try the **settings** shown here, or as you prefer.

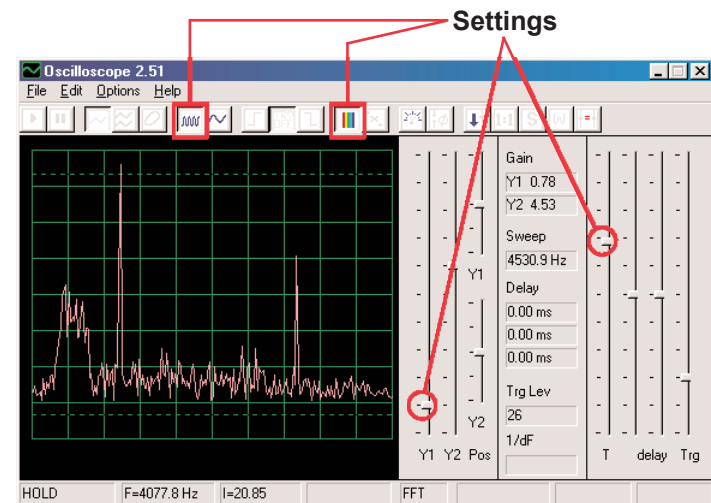

# Project #PC17 Doorbell PC

**OBJECTIVE:** To look at the output of a musical circuit.

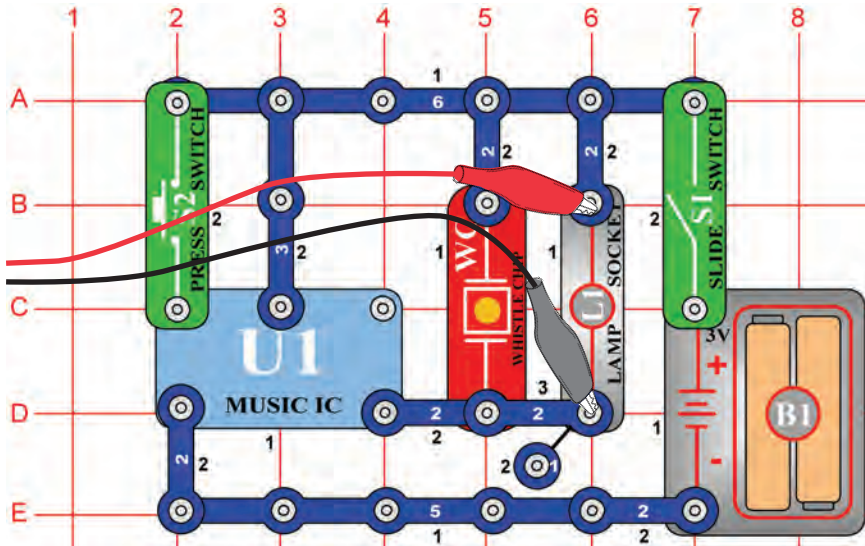

Build the circuit shown. If continuing from the previous experiment then close the Winscope program and run it again, to reset the settings. Click on the On-Line button to activate, and turn on the slide switch (snap part S1). Try the **settings** shown here. When the music stops, press the press switch (part S2) and it will resume.

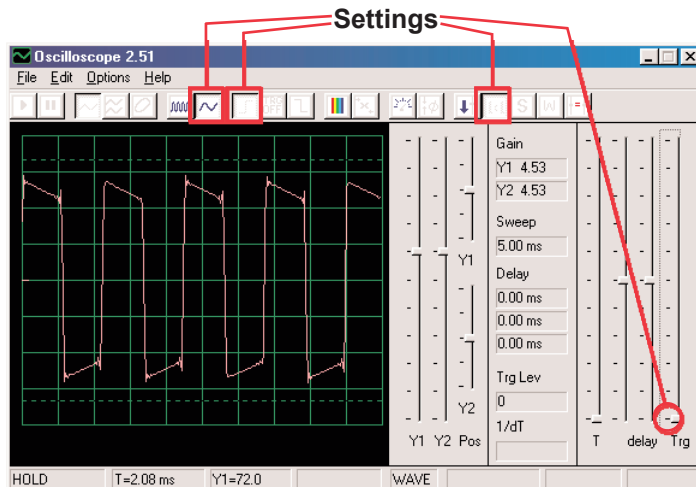

Click on the **5ms/div time scale button** and on the **FFT button** to look at the frequency spectrum for the signal. The Y1 gain control is set for high gain now, so the higher peaks are off the screen but lots of the lower peaks are visible.

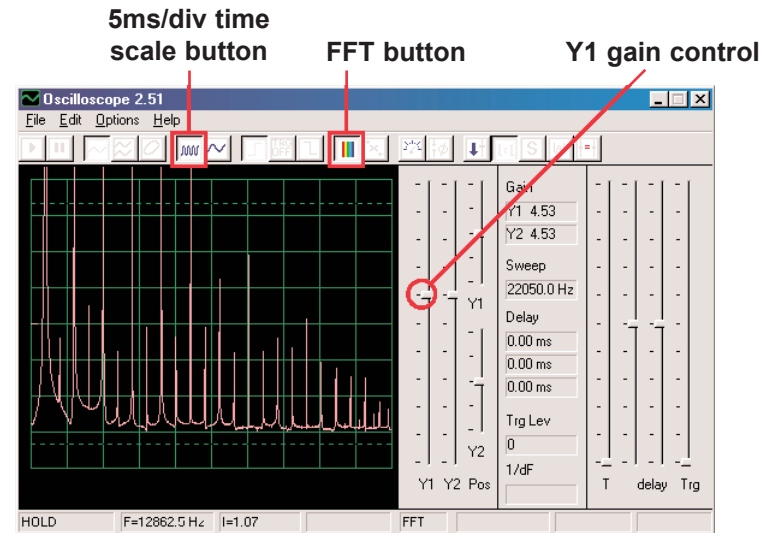

Note that the sound is music and the oscilloscope waveform has a “square” shape, as a result the frequency spectrum has a lot of peaks with equal spacing.

Now adjust the **gain** lower until you see the higher peaks.

# Project #PC18

## Periodic Sounds PC

**OBJECTIVE:** To look at the output of an alternately changing circuit.

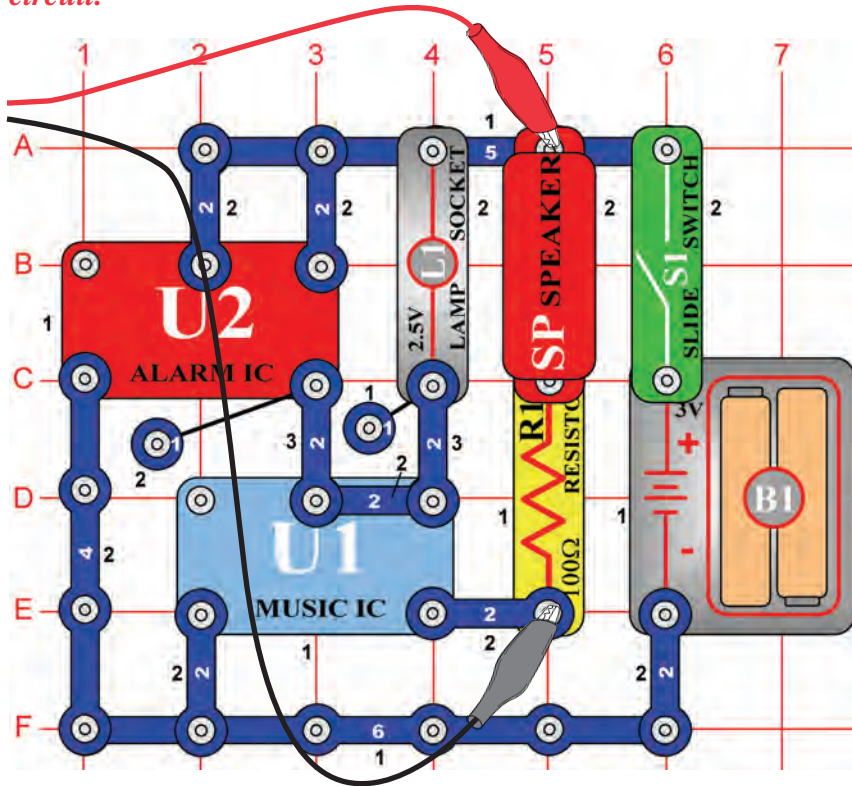

Build the circuit shown. If continuing from the previous experiment then close the Winscope program and run it again, to reset the settings. Click on the On-Line button to activate, and turn on the slide switch (snap part S1). Try the **settings** shown here.

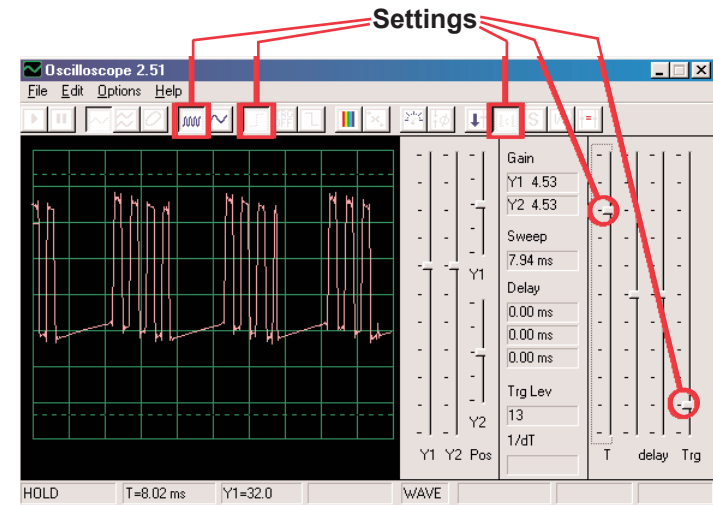

The oscilloscope display alternates between 2 waveforms, the one shown here and the one on the next page. This one shows some pulses followed by a flat signal, then more pulses, then flat, then pulses, then flat . . .

This is the second oscilloscope waveform, using the same settings. It is a continuous series of pulses. You can use the **Hold button** to freeze the display for easier viewing.

**Hold button**

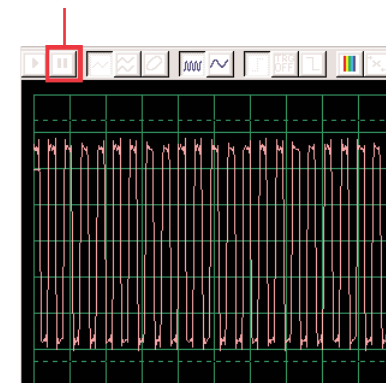

Now change to FFT mode to look at the frequency spectrums corresponding to the 2 waveforms above. Try the **settings** shown here.

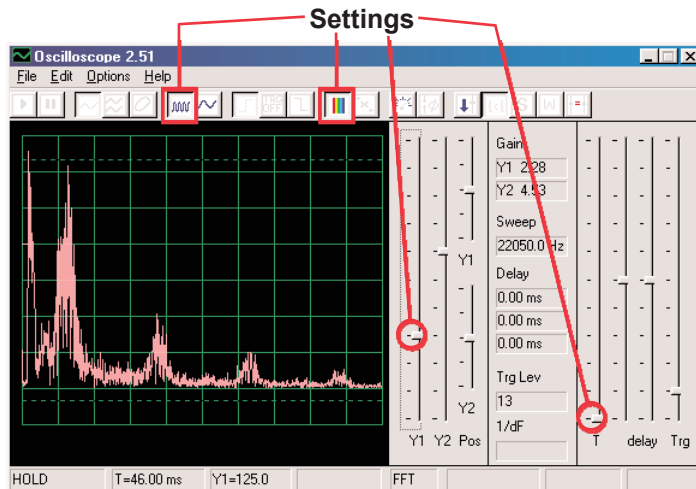

This is the spectrum for the oscilloscope waveform shown on the preceding page, which alternates between pulses and flat. Because of the transition between pulses and flat, the spectrum is the irregular shape shown here.

This is the spectrum for the oscilloscope waveform shown at the top of this page, which has a continuous series of pulses. There are only pulses there, with no transition between pulses and flat. Hence the frequency spectrum is very “clean”, with the energy concentrated at a few tall peaks instead of being spread out like in the other spectrum display.

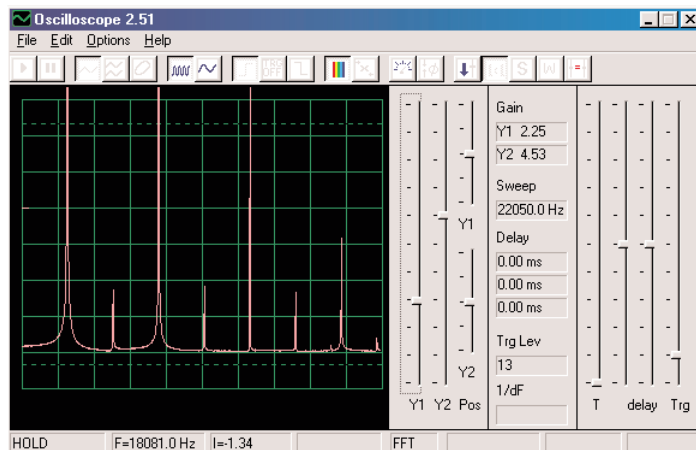

# Project #PC19

## Lasting Doorbell PC

**OBJECTIVE:** To look at the output of an alternately changing circuit.

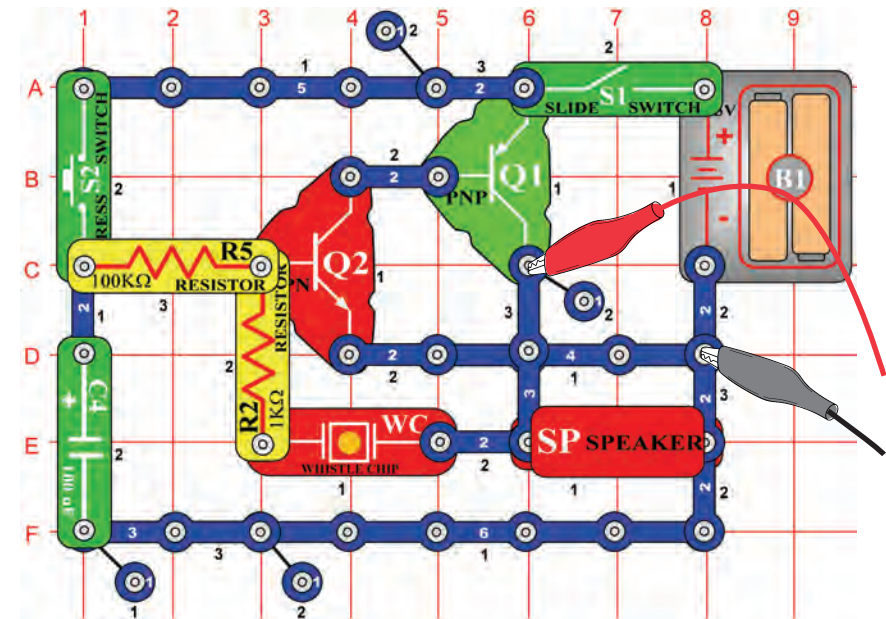



Build the circuit shown. If continuing from the previous experiment then close the Winscope program and run it again, to reset the settings. Click on the On-Line button to activate, turn on the switch (snap part S1), and press the press switch (part S2). Try the **settings** shown here.

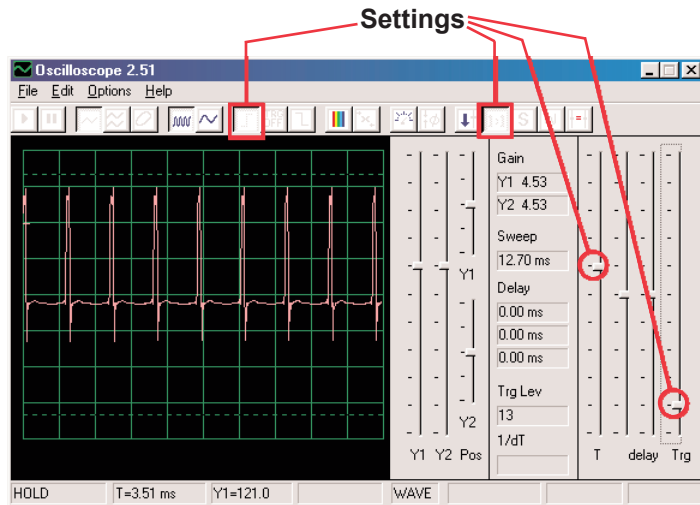

The waveform at left shows the signal just after pressing the press switch, the waveform below uses the same settings and shows the waveform just before the sound stops. You see the pulses slowly spread out as the tone of the sound changes.

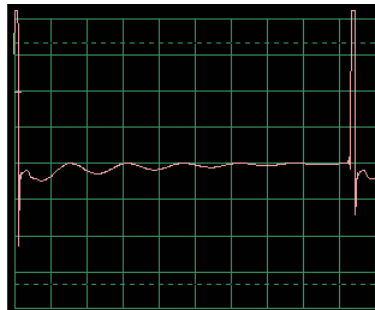

Now change to FFT mode to look at the frequency spectrum as the sound fades away. Try the **settings** shown here.

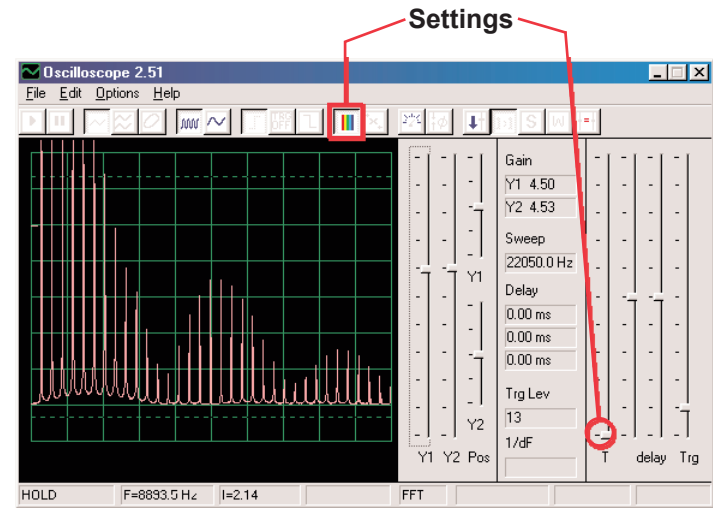

The spectrum at left is for just after pressing the press switch. The spectrum below uses the same settings and shows the spectrum just before the sound stops. The frequencies and amplitude slowly get lower as the sound fades away.

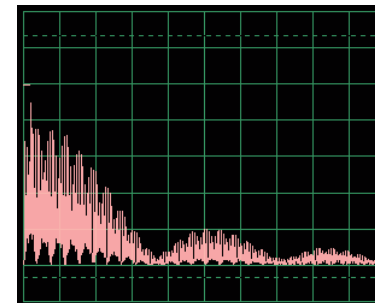

# Project #PC20 Space War Flicker PC

**OBJECTIVE:** To continuously show the patterns created by the space war IC.

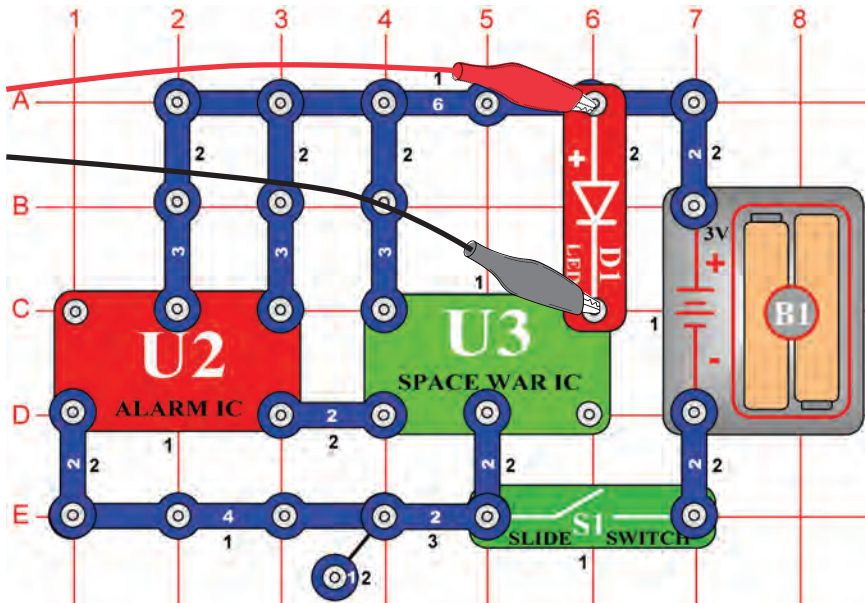

Build the circuit shown. If continuing from the previous experiment then close the Winscope program and run it again, to reset the settings.

Click on the **On-Line** button to activate, and turn on the switch (snap part S1). Set Winscope to the **settings** shown below. The signal from the alarm IC (snap part U2) causes the space war IC (part U3) to step through the 8 different patterns it can create. A sample waveform is shown here.

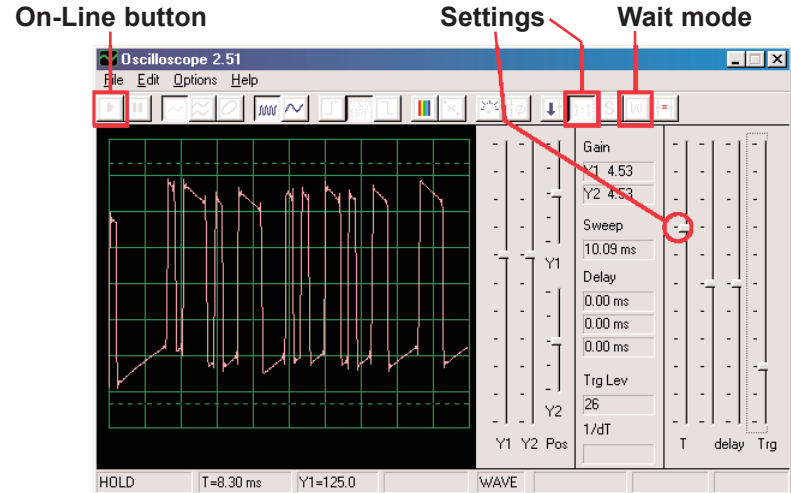

You can also activate **Wait mode** and press the On-Line button several times to view one scan of the signal at a time, instead of seeing continuous scans.

Turn on FFT mode to look at the frequency spectrum, try the **settings** shown here. You can see the spectrums for the different patterns produced by the space war IC, a sample is shown here.

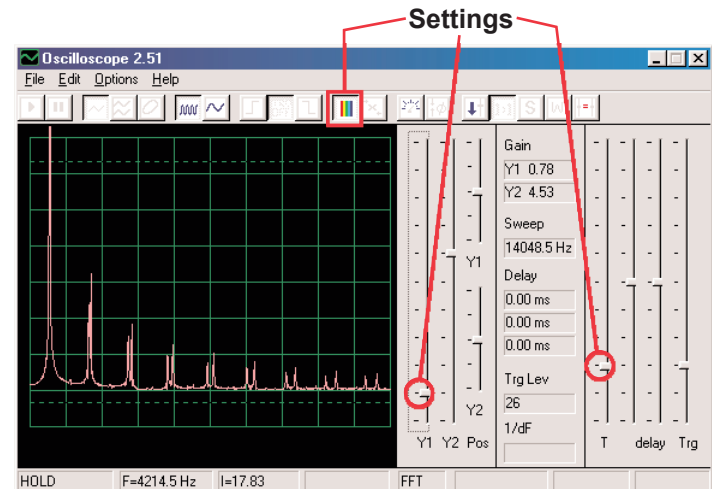

# Project #PC21 Buzzing in the Dark PC

**OBJECTIVE:** To build a circuit that buzzes.

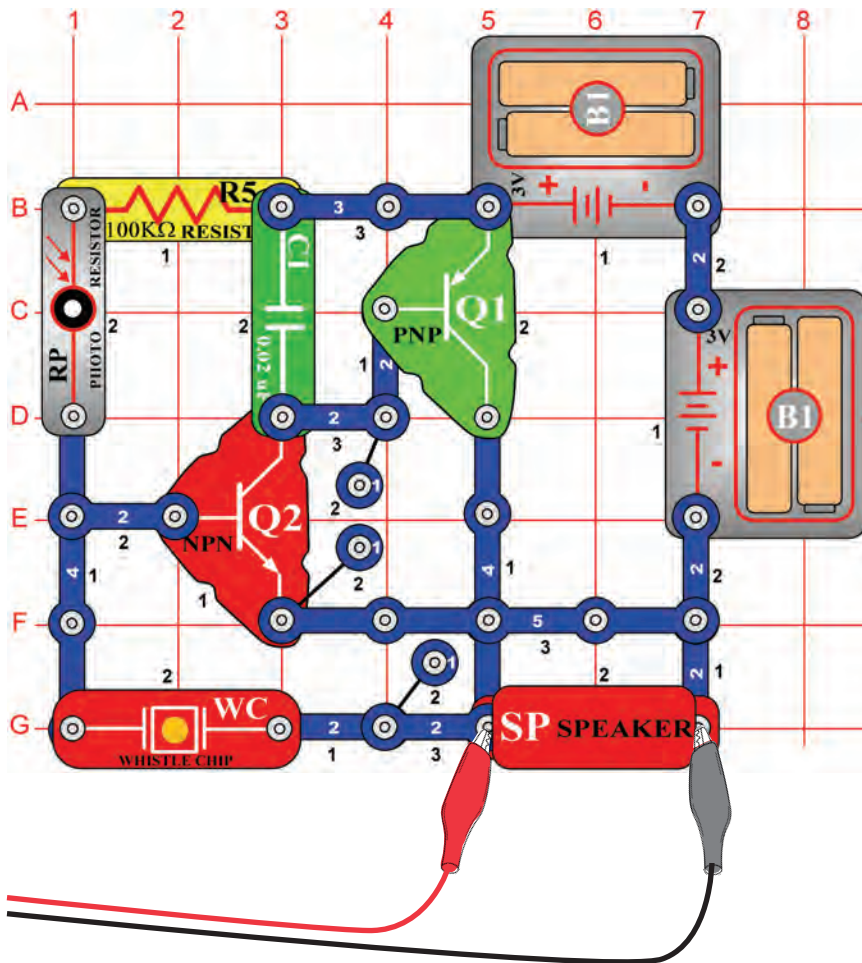

Build the circuit shown. If continuing from the previous experiment then close the Winscope program and run it again, to reset the settings. Set Winscope to the **settings** shown below and click on the On-Line button to activate. A sample waveform is shown here.

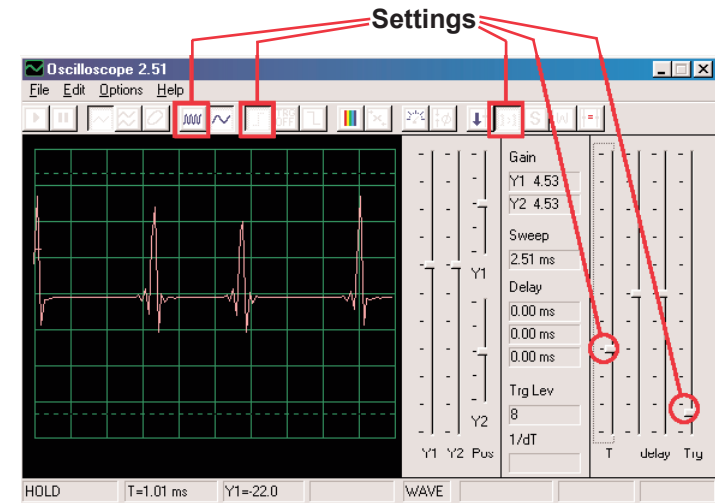

The actual waveform will vary depending on how much light is shining on the photoresistor (snap part RP). If you cover the photoresistor then the circuit shuts off.

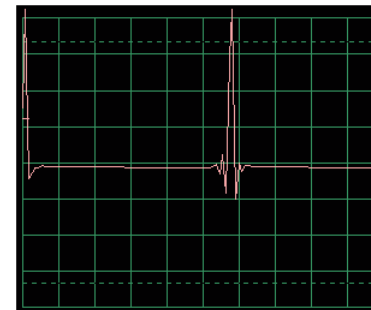

The waveform above is weak and erratic, so replace the 0.02 $\mu$ F capacitor (snap part C1) with the 0.1 $\mu$ F capacitor. A sample of the new waveform is at left, with the same settings. It is lower in frequency but higher in amplitude.

Turn on FFT mode to look at the frequency spectrum, try the **settings** shown here.

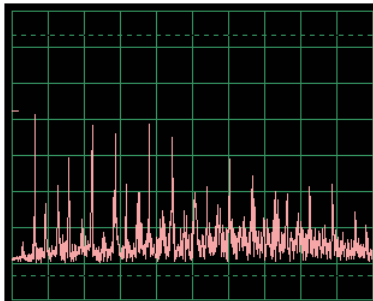
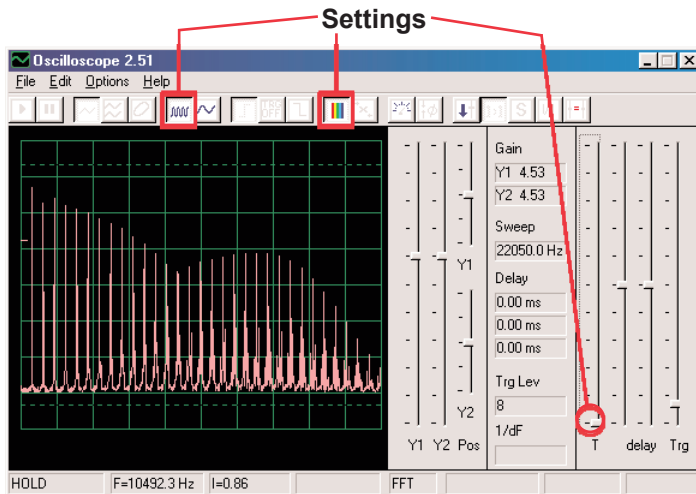

Now put the 0.02µF capacitor back in place of the 0.1µF capacitor to compare its spectrum. A sample is on the left, with the same Winscope settings as above. As with the oscilloscope mode, its spectrum is weaker and more erratic.

# Project #PC22 Trombone PC

*OBJECTIVE: To build a circuit that sounds like a trombone.*

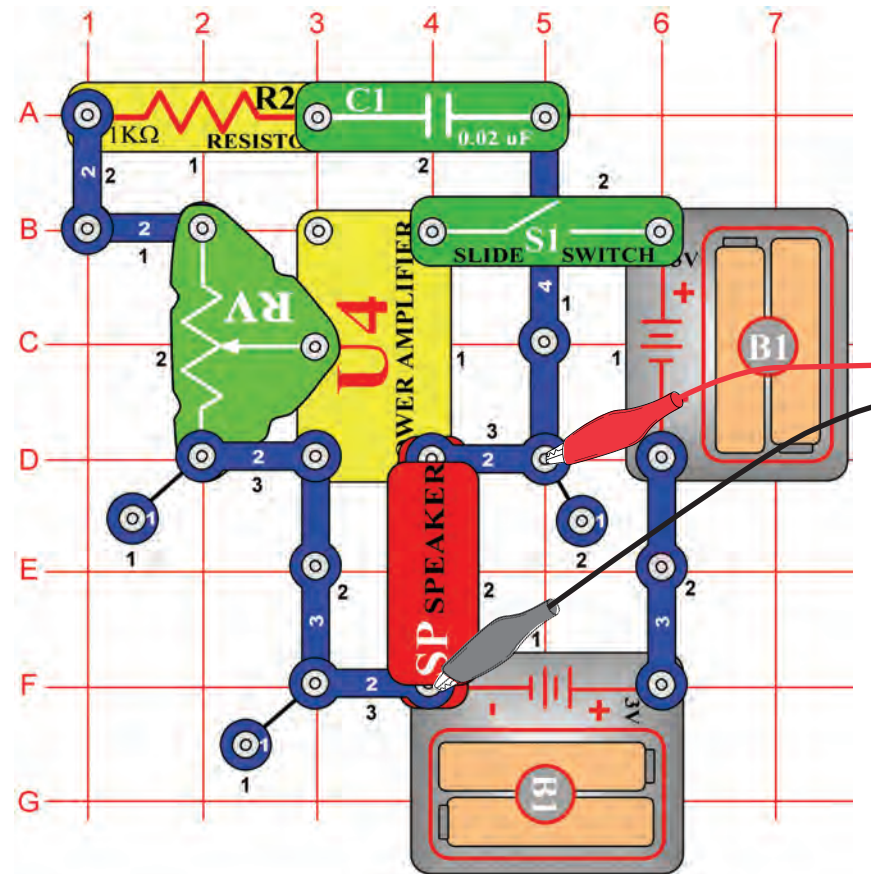

Build the circuit shown. If continuing from the previous experiment then close the Winscope program and run it again, to reset the settings. Click on the On-Line button to activate, and turn on the switch (snap part S1). Set Winscope to the **settings** shown below, and move the lever on the adjustable resistor (snap part RV) around to change the waveform and the sound. At some positions there may be no sound. A sample waveform is shown here.

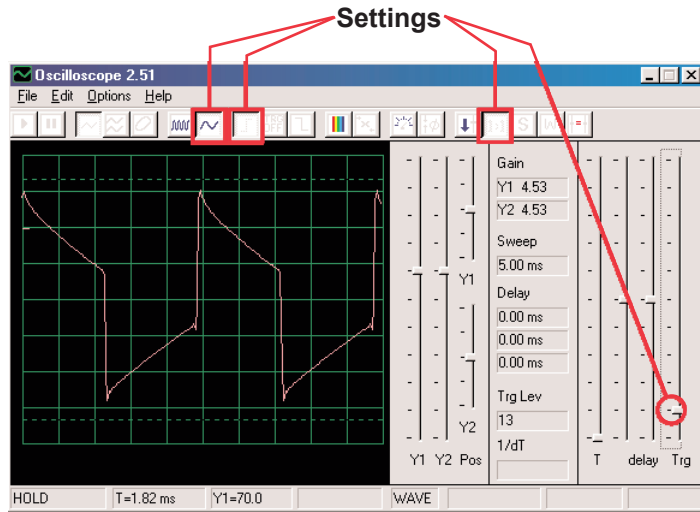

Note that in the above display the Y1 Gain is set high to show the low energy levels of the signal, even though the higher frequency components of the signal, even though the stronger peaks of the lower frequency components are off the top of the display. This can be deceiving. Now change the **Y1 Gain** so that the highest peak can be seen, this is shown on the right. Now you see how the main signal frequency dominates the others.

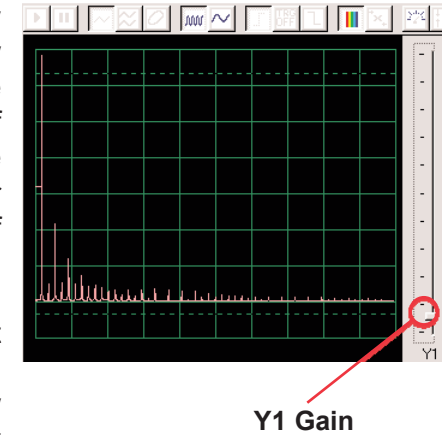

Turn on FFT mode to look at the frequency spectrum, try the **settings** shown here.

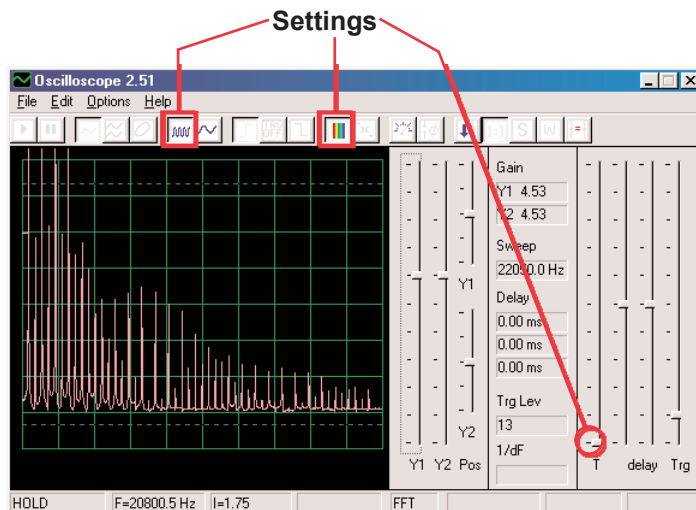

# Project #PC23 Sound Pulse Oscillator PC

**OBJECTIVE:** To build a pulse oscillator.

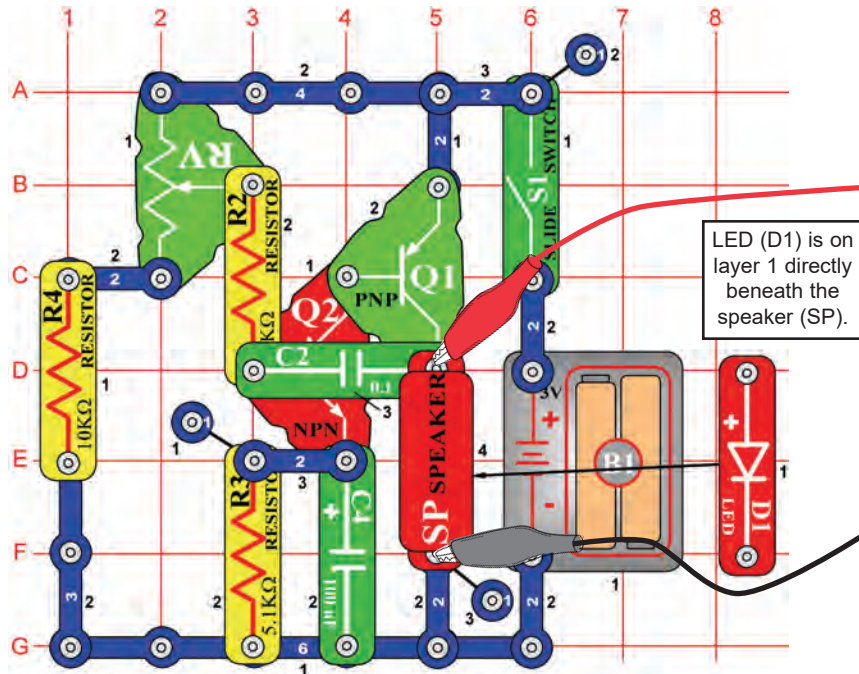

Build the circuit shown. If continuing from the previous experiment then close the Winscope program and run it again, to reset the settings. Click on the On-Line button to activate, and turn on the slide switch (snap part S1). Set Winscope to the **settings** shown on the upper right, and move the lever on the adjustable resistor (snap part RV) around to change the waveform and the sound. At some positions there may be no sound. A sample waveform is shown on the upper right.

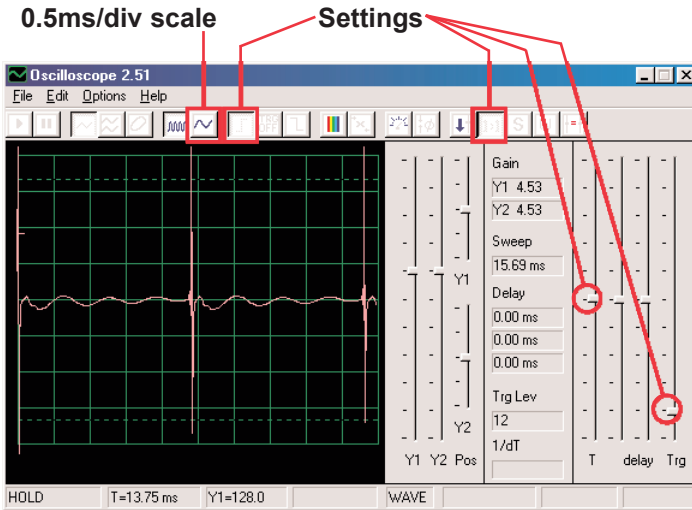

You can also change to the **0.5ms/div scale** to take a closer look at one of the pulses, shown on the right:

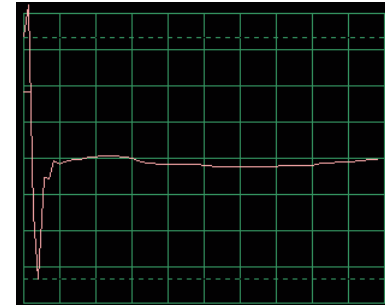

Turn on FFT mode to look at the frequency spectrum, try the **settings** shown here.

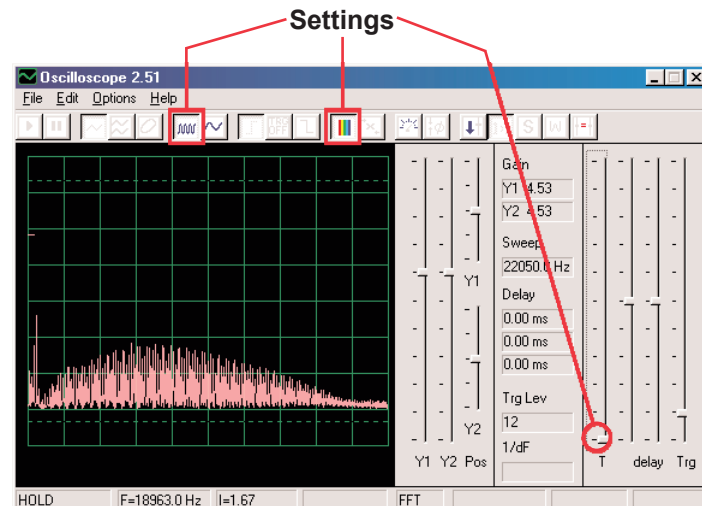

# Project #PC24 High Pitch Bell PC

**OBJECTIVE:** To build a high pitch bell.

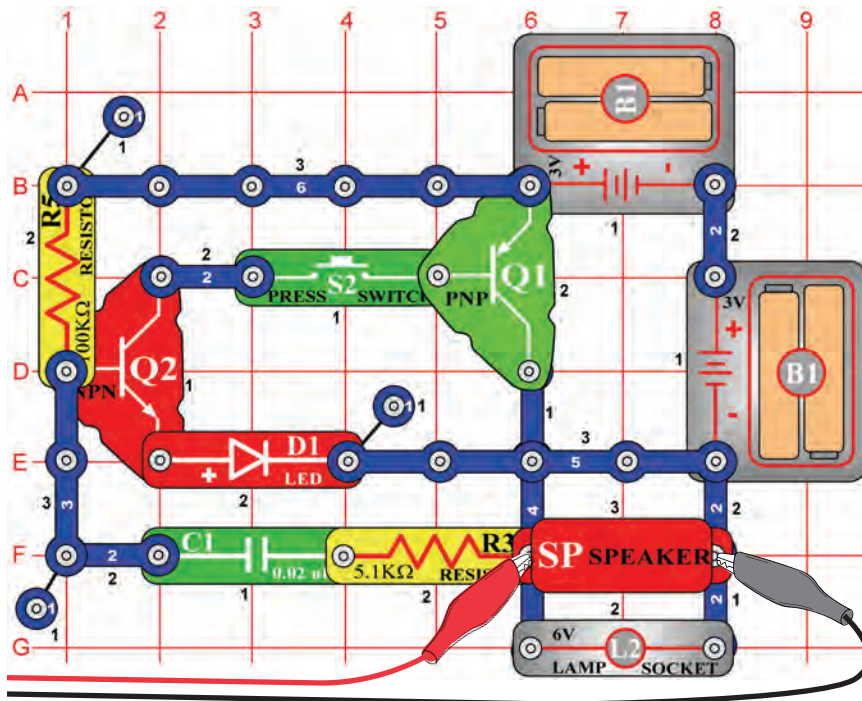

Build the circuit shown. If continuing from the previous experiment then close the Winscope program and run it again, to reset the settings. Click on the On-Line button to activate, and hold down the press switch (snap part S2). Set Winscope to the **settings** shown on the upper right. A sample waveform is shown on the upper right.

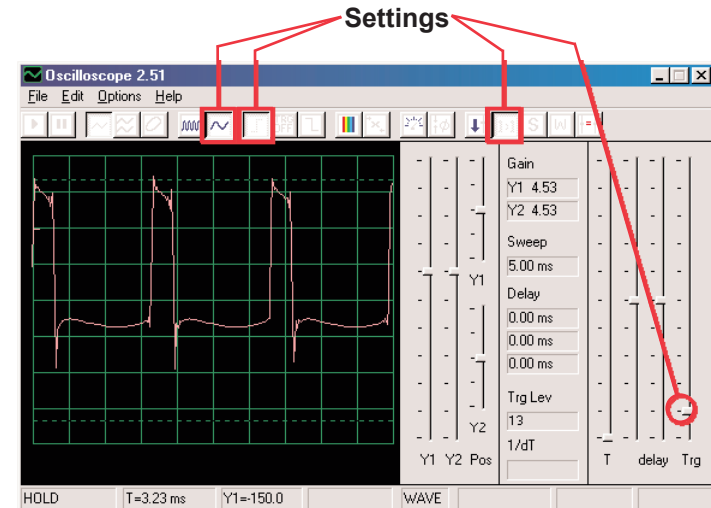

Turn on FFT mode to look at the frequency spectrum, try the **settings** shown here.

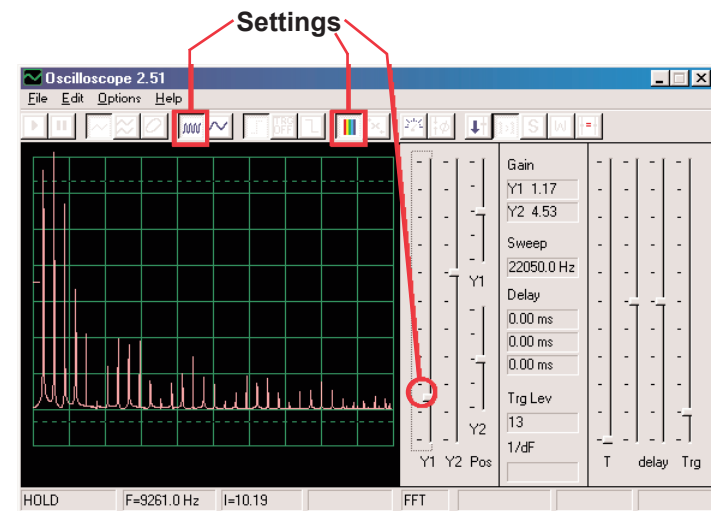

You can change some of the Winscope settings around to view the waveform and spectrum in different ways if desired. You can also place the 0.02μF capacitor on top of the whistle chip to lower the frequency.

# Project #PC25 Tone Generator PC

**OBJECTIVE:** To build a high frequency oscillator.

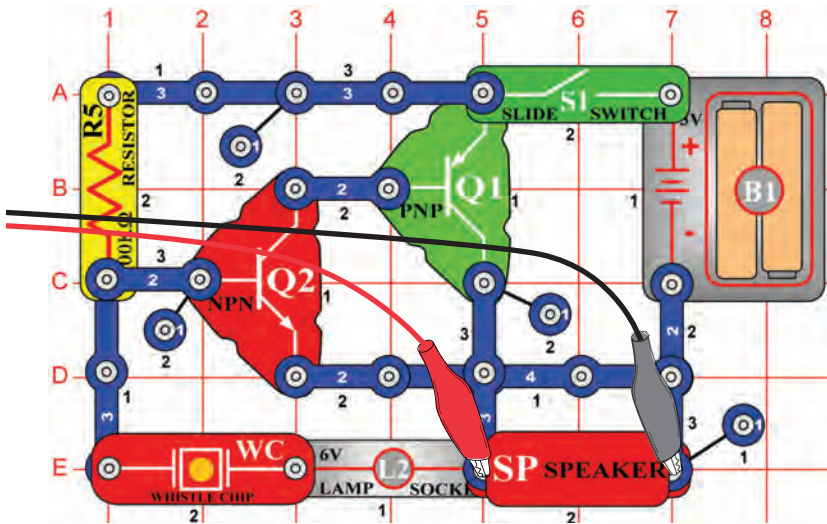

Build the circuit shown. If continuing from the previous experiment then close the Winscope program and run it again, to reset the settings. Click on the On-Line button to activate, and turn on the switch. Set Winscope to the **settings** shown below. A sample waveform is shown here.

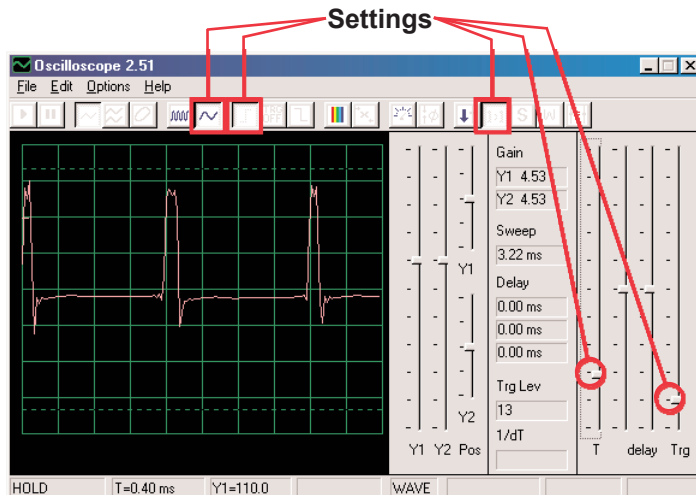

Turn on FFT mode to look at the frequency spectrum, try the **settings** shown here.

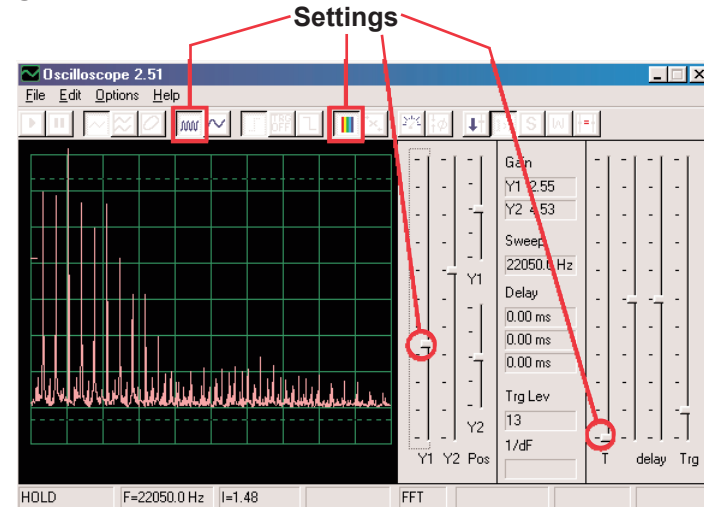

# Project #PC26 Tone Generator PC (II)

Modify the circuit for project PC25 by placing the  $0.02\mu\text{F}$  capacitor (C1) on top of the whistle chip (WC). Look at the waveform and frequency spectrum using the same settings as for project PC19, the frequency is lower now.

# Project #PC27 Tone Generator PC (III)

Modify the circuit for project PC25 by placing the  $0.1\mu\text{F}$  capacitor (C2) on top of the whistle chip (WC). Look at the waveform and frequency spectrum using the same settings as for project PC19, but you may want to change the time scale since the frequency is much lower now.



# Project #PC28 Old-Style Typewriter PC

**OBJECTIVE:** To build a circuit that sounds like a typewriter.

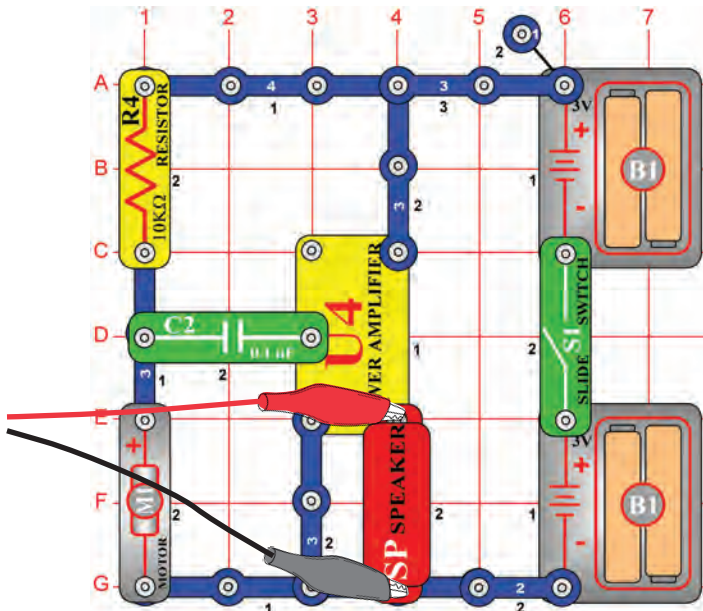

Build the circuit shown. If continuing from the previous experiment then close the Winscope program and run it again, to reset the settings. Click on the On-Line button to activate, and turn on the switch. Set Winscope to the **settings** shown on the upper right. Turn the motor (snap part M1) slowly with your fingers and watch the waveforms generated. They are very erratic and unpredictable. A sample is shown on the upper right.

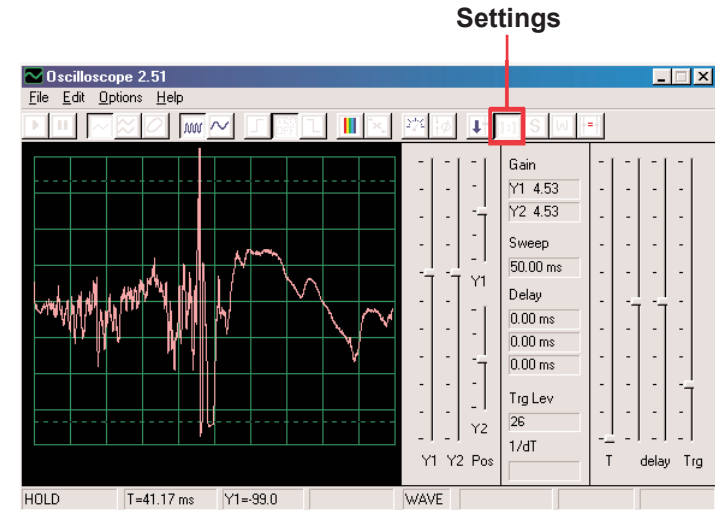

Turn on FFT mode to look at the frequency spectrum, try the **settings** shown here.

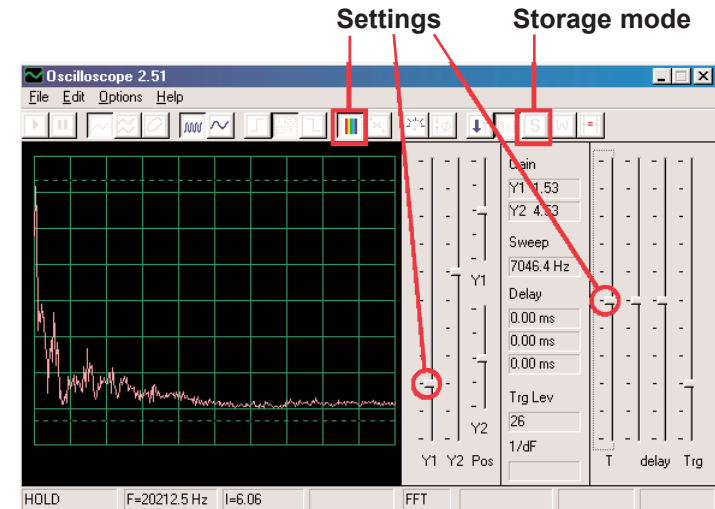

You can also turn on **Storage mode** to see the peaks recorded as you turn the motor, a sample of this is at right.

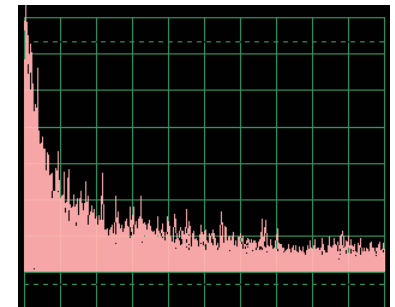

# Project #PC29 Transistor Fading Siren PC

**OBJECTIVE:** To build a siren that slowly fades away.

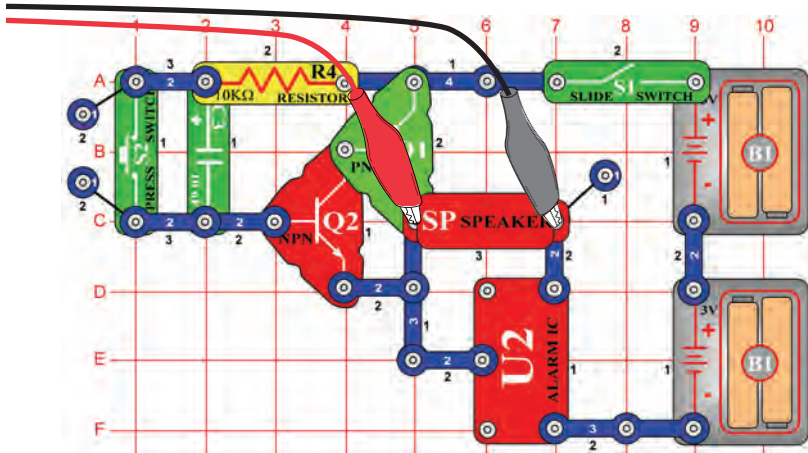

Build the circuit shown. If continuing from the previous experiment then close the Winscope program and run it again, to reset the settings. Set Winscope to the **settings** shown on the right. Click on the On-Line button to activate, turn on the switch, and press the press switch (snap part S2). You hear a siren that slowly fades away.

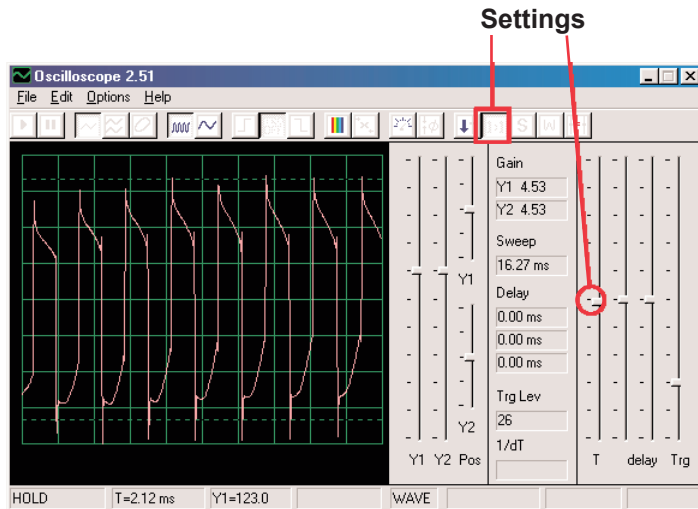

This display shows the siren just after pressing the press switch.

This display (at the same settings) shows the siren when it has almost faded out. The waveform has become weak and sometimes erratic.

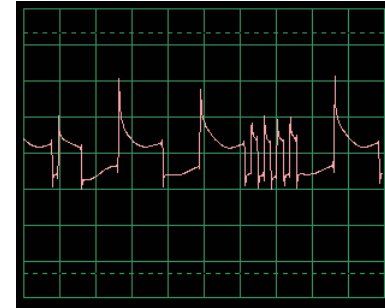

Turn on FFT mode to look at the frequency spectrum, try the **settings** shown here. The display on the left shows the signal just after pressing the press switch and on the right shows it just before it fades out.

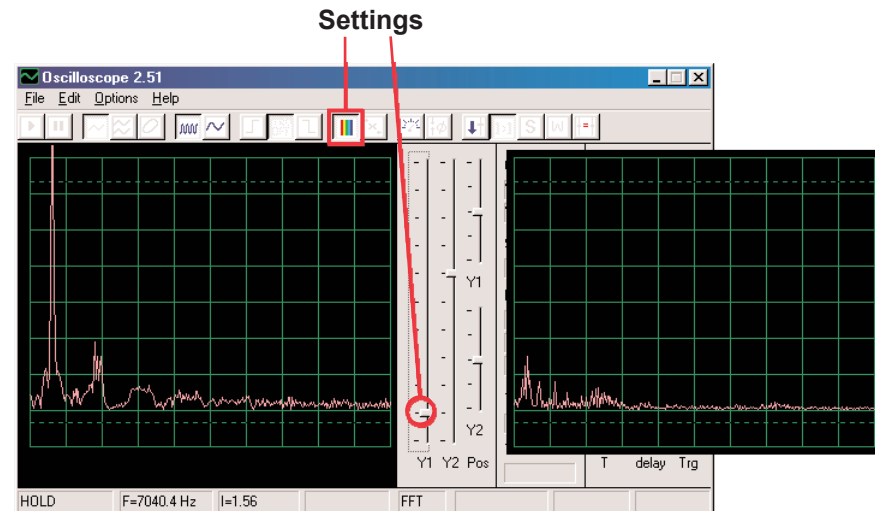

# Project #PC30 Fading Doorbell PC

Modify the circuit in PC29 by replacing the alarm IC (U2) with the music IC (U1), use a 1-snap and a 2-snap to make a connection across D6-E6 on top of the music IC. The music slowly fades away and stops. Use the same settings as in PC29 to view the waveform and frequency spectrum.

# Project #PC31 Police Siren Amplifier PC

**OBJECTIVE:** To show the output of an amplifier.

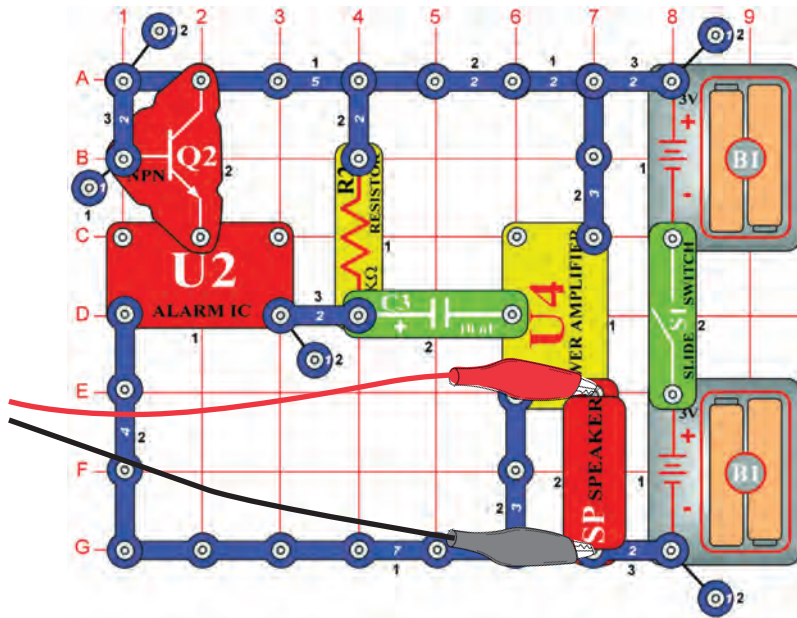

Build the circuit shown and set Winscope to the **settings** shown below. The siren sound is very loud. In most cases the waveform will have **flat edges** on the top and bottom, indicating the voltage is too high for the microphone input stage on your computer and is being distorted. You may sometimes correct for this if you like by reducing the volume control of your microphone input (see p. 3), but it is recommended that you return the volume to the normal level before doing other projects.

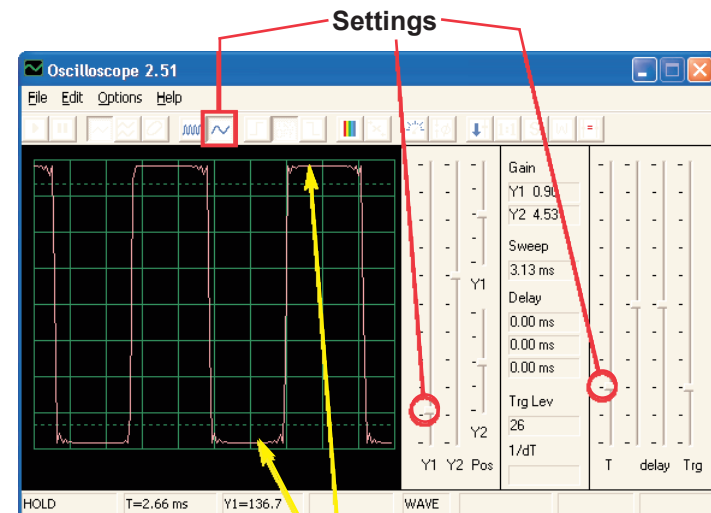

Flat edges

You may also make different alarm sounds by connecting the alarm IC using the configurations shown in projects #23-26.

---

# Project #PC32 Music Amplifier PC

Modify the circuit in PC31 by replacing the alarm IC (U2) with the music IC (U1). Use the same settings as in PC31 to view the waveform, you may also use the FFT button to view the frequency spectrum.

# Project #PC33 Space War Amplifier PC

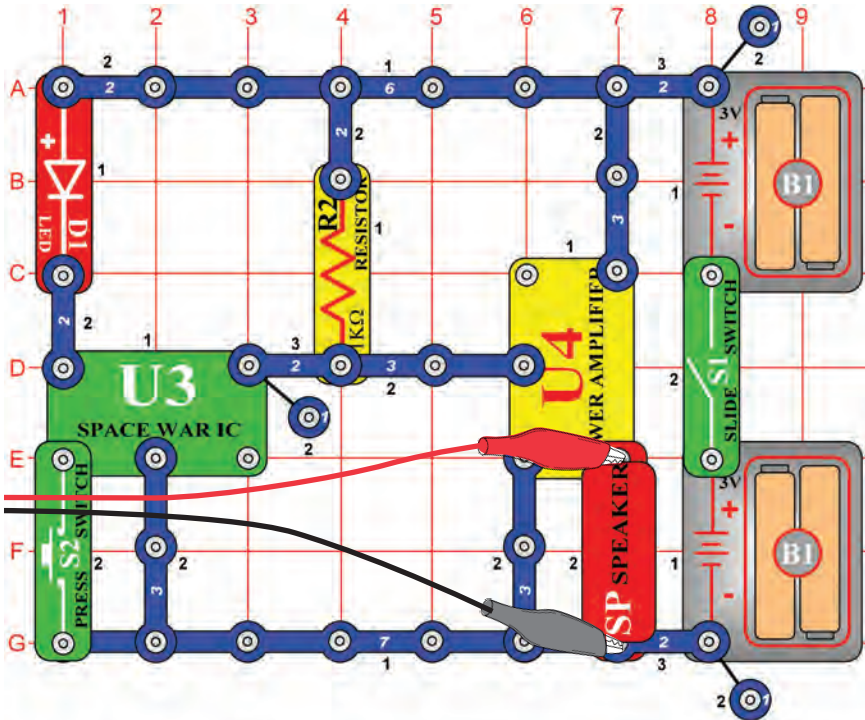

Build the circuit shown and use the same settings as in PC31 to view the waveform. Press the switch (S2) to change the sounds and waveform.

# Project #PC34 Adjustable Tone Generator PC

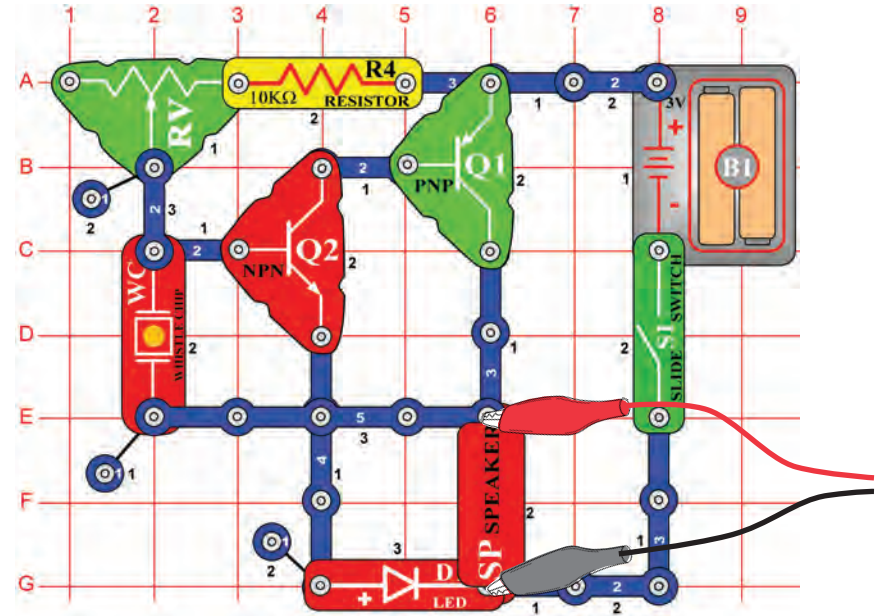

Build the circuit shown, and try the **settings** below. Move the adjustable resistor lever to change the frequency. A sample waveform is shown here.

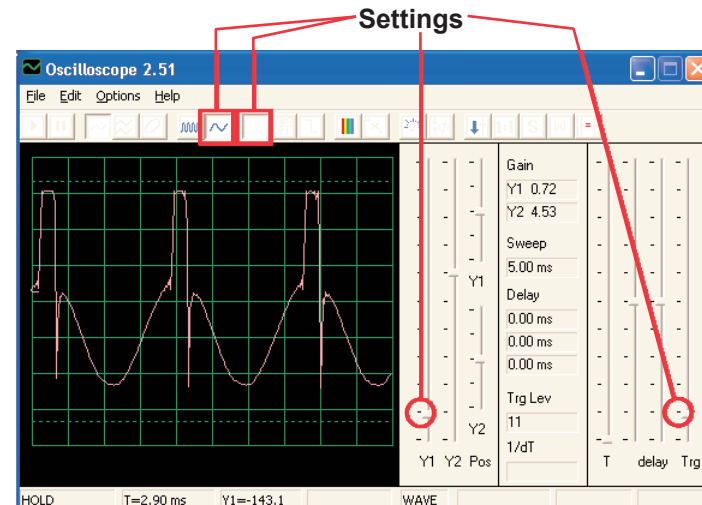

Try these settings to see the spectrum:

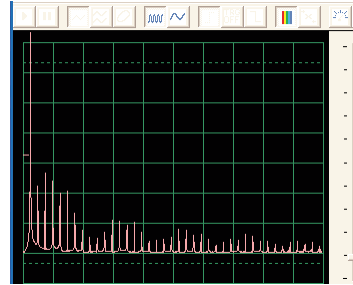

## Project #PC35 Adjustable Tone Generator PC (II)

Modify the circuit for project PC34 by placing the  $0.02\mu\text{F}$  capacitor (C1) on top of the whistle chip (WC). Look at the waveform and frequency spectrum using the same settings as for project PC34, the frequency is lower now.

## Project #PC36 Adjustable Tone Generator PC (III)

Modify the circuit for project PC34 by placing the  $0.1\mu\text{F}$  capacitor (C2) on top of the whistle chip (WC). Look at the waveform and frequency spectrum using the same settings as for project PC34, but you may want to change the time scale since the frequency is much lower now.

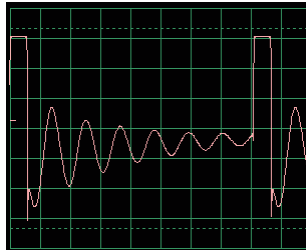

## Project #PC37 Adjustable Tone Generator PC (IV)

Modify the circuit for project PC34 by replacing the  $10\text{K}\Omega$  (R4) resistor with the photoresistor (RP). Look at the waveform and frequency spectrum using the same settings as for project PC34, and wave your hand over the photoresistor to change the sound and pattern. There will not always be sound.

# Project #PC38 Adjustable FM Radio PC

**OBJECTIVE:** To show the output of an FM Radio.

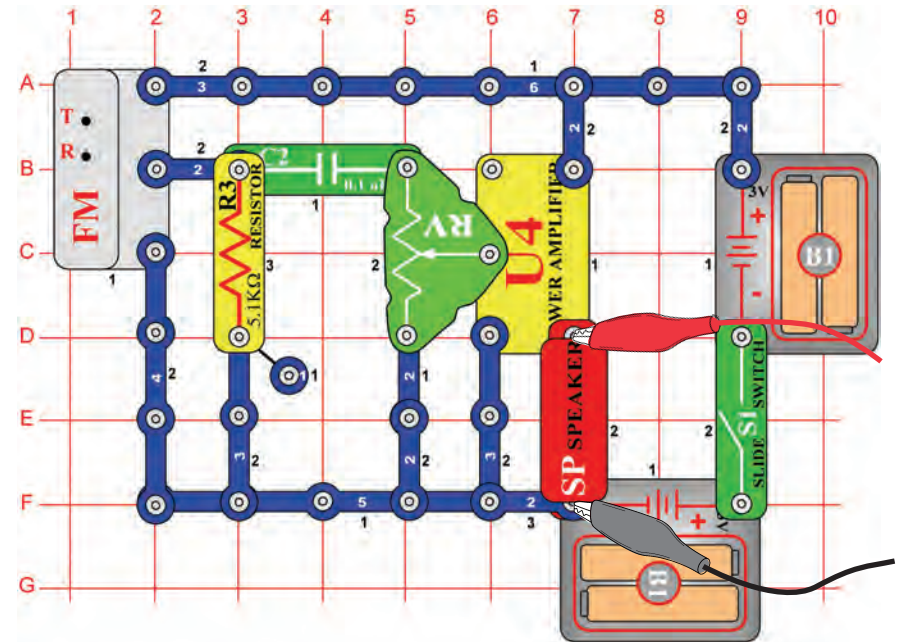

Turn on the slide switch (S1) and press the R button. Now press the T button and the FM module scans for a radio station. When a station is found, it locks on to it and you hear it on the speaker. Press the T button again for the next radio station.

Connect the PC-interface cable as shown. Set up Winscope as desired or use the same Winscope settings to view the waveform and frequency spectrum as for project PC12 (AM radio), since the output signal to the speaker is music or talking just like in PC12. (AM and FM radio transmit the same types of information using different modulation methods.) Adjust the volume using the adjustable resistor (RV) so that all of the waveform is shown on the Winscope screen.

# Project #PC39 Transistor AM Radio PC (II)

*OBJECTIVE: To show the output of an AM Radio.*

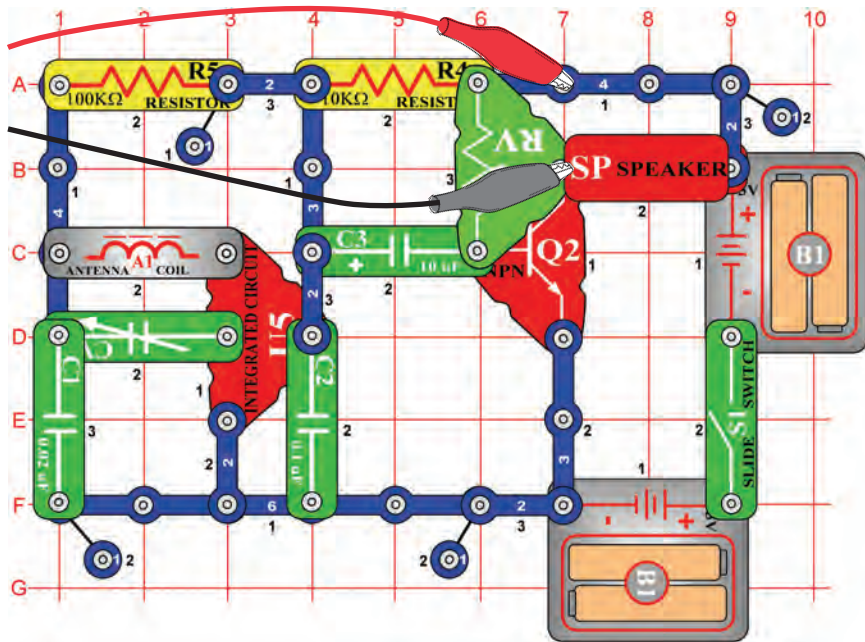

Turn on the switch and adjust the variable capacitor (CV) for a radio station, then adjust the loudness using the adjustable resistor (RV). Use the same Winscope settings as for project PC12 (AM radio) to view the waveform and frequency spectrum. The waveform will be different from that in projects PC12 and PC38, because those circuits use the power amplifier IC (U4) instead of the NPN transistor for amplification.

# Project #PC40 Playback & Record PC

*OBJECTIVE: To show the waveforms for music and your voice.*

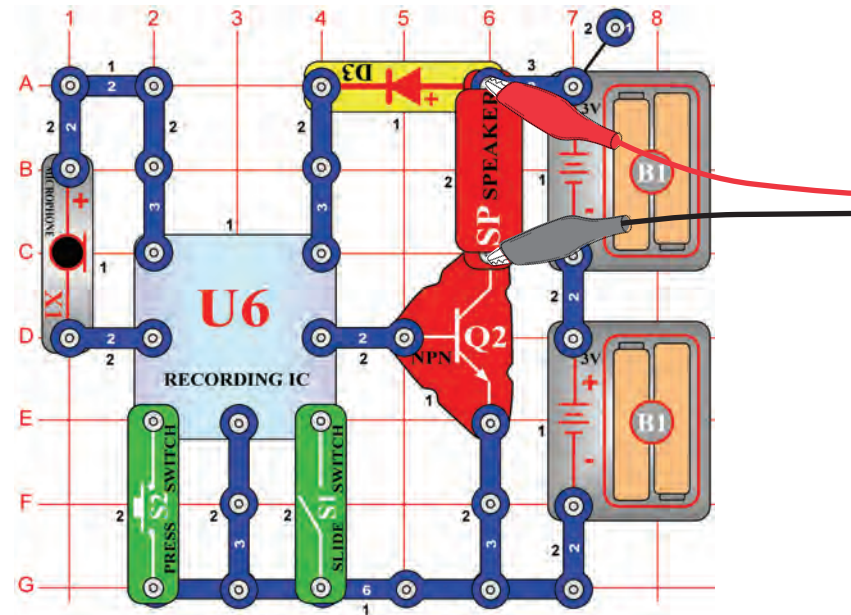

Build the circuit shown. Turn on the slide switch (S1), you hear a beep signaling that you may begin recording. Talk into the microphone (X1) up to 8 seconds, and then turn off the slide switch (it also beeps after the 8 seconds expires).

Press the press switch (S2) for playback. It plays the recording you made followed by one of three songs. If you press the press switch before the song is over, the music will stop. You may press the press switch several times to play all three songs.

Use Winscope to view the waveform and frequency spectrum when playing back your recording and music. A **sample music waveform** is shown here.

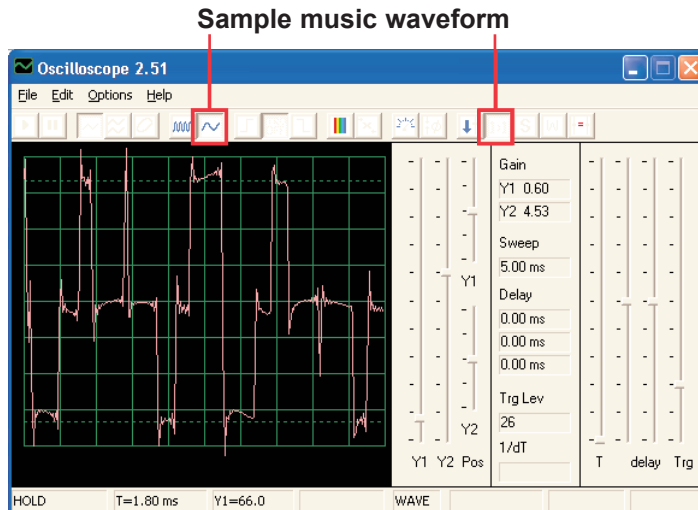

# Project #PC41 Power Amplifier Playing Music IC

*OBJECTIVE: To show how high amplification can distort*

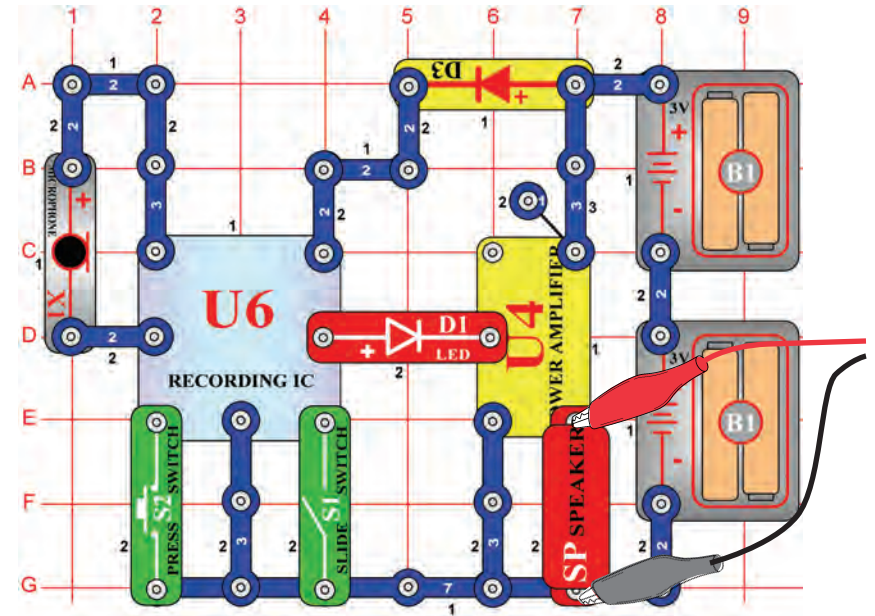

Build the circuit shown. Turn on the slide switch (S1), you hear a beep signaling that you may begin recording. Talk into the microphone (X1) up to 8 seconds, and then turn off the slide switch (it also beeps after the 8 seconds expires).

Press the switch S2 for playback. It plays the recording you made followed by one of three songs. If you press the press switch (S2) before the song is over, the music will stop. You may press the press switch several times to play all three songs.

This recorder IC circuit works the same as in project PC40 except that the power amplifier IC (U4) used here makes the sound much louder than in project PC40. If viewed with the same Winscope settings as in PC40, then the waveform appears as shown below. The output from the recorder IC has not changed, but the **flat edges** at the top and bottom of the waveform indicate that the higher amplification is distorting the sound.

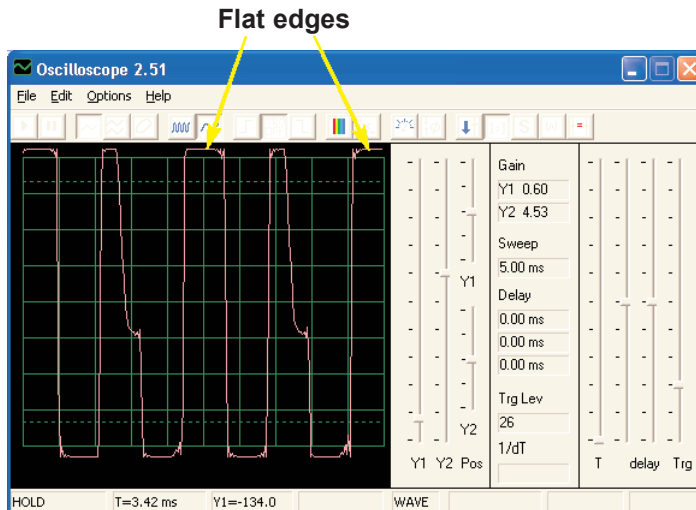

Use the LOW (or 10mA) setting on the meter (M2). Set the adjustable resistor (RV) to the bottom position and turn on the slide switch (S1), you will see a waveform like that shown below. Set the adjustable resistor to the top, and the waveform looks like that shown on the bottom left, due to lower resistance in the circuit. A sample frequency spectrum is also shown on the bottom right.

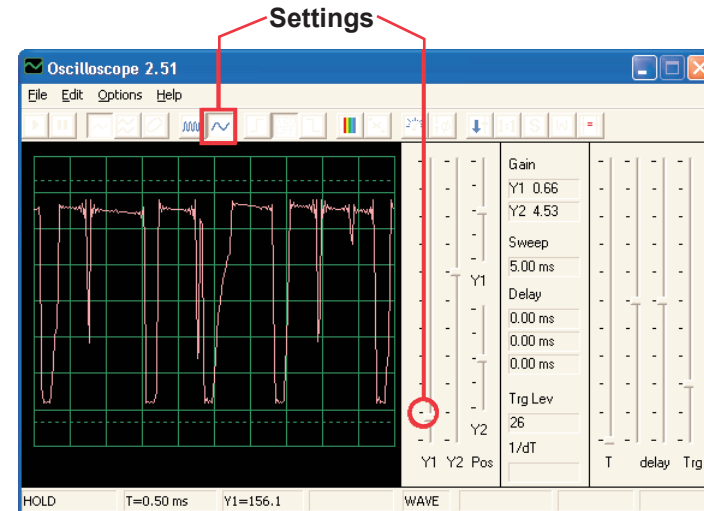

## Project #PC42 Music Meter PC

**OBJECTIVE:** To show how high amplification can distort

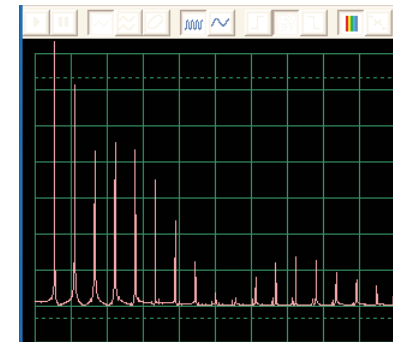
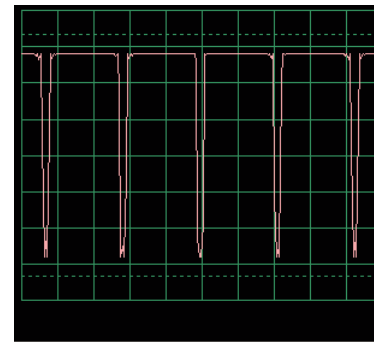
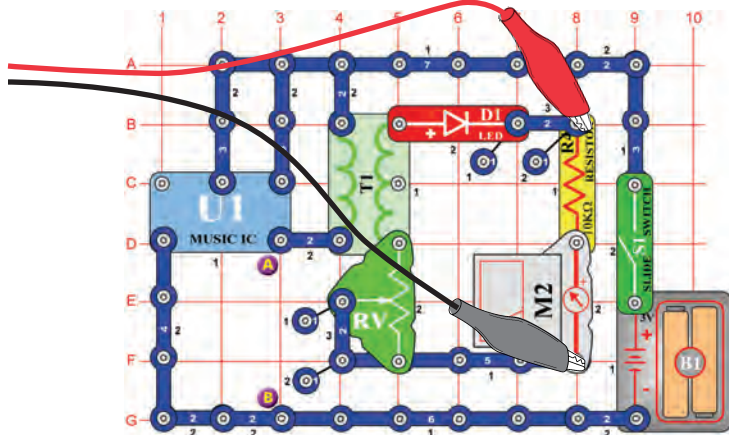



# Project #PC43 Oscillation Sounds PC

**OBJECTIVE:** To view the output of an oscillator circuit.

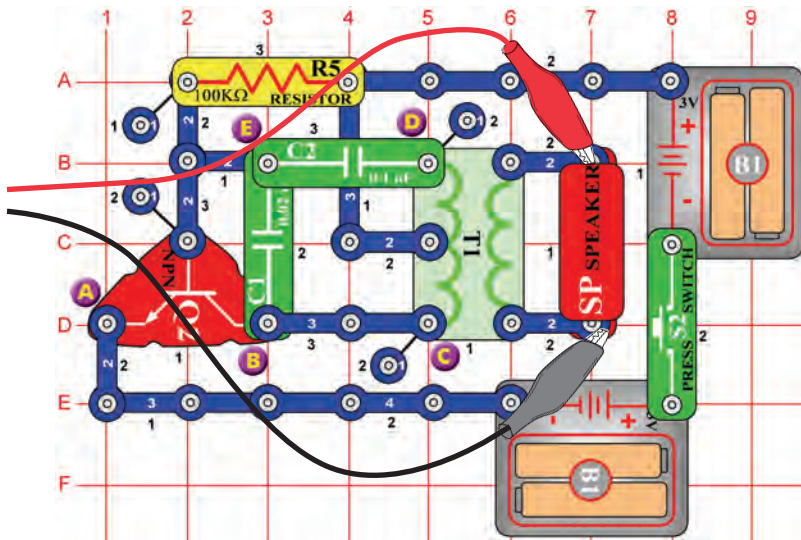

Build the circuit and try the **settings** shown here. This circuit produces a series of pulses (shown below), representing when the transistor is activated.

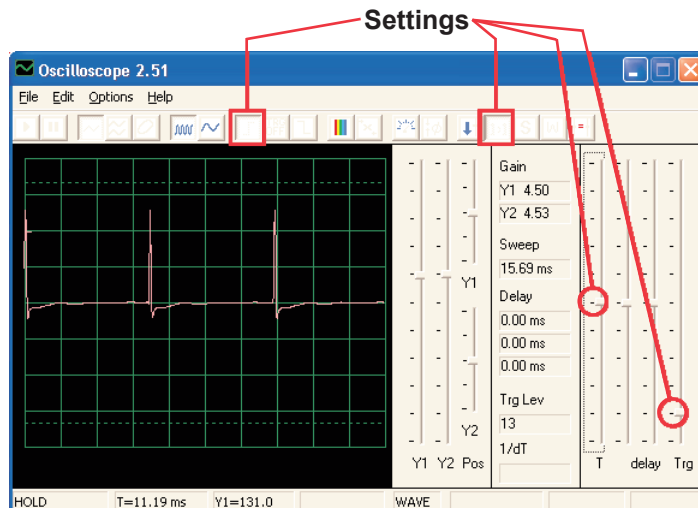

You may look at a pulse close-up by changing the **time scale** and slightly adjusting the **delay**, as shown.

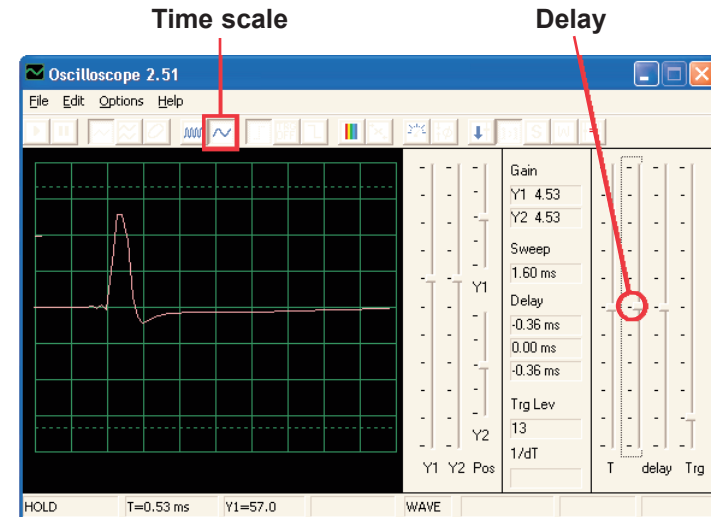

You may look at the frequency spectrum on your own if desired.

## Project #PC44

Using the circuit from PC43, connect the whistle chip across points C & D. Notice how the shape of the pulse has changed from that shown in PC43 (using the same settings):

### Oscillation Sounds PC (II)

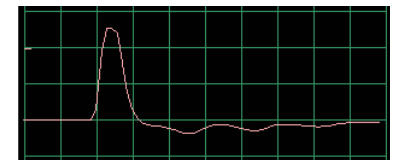

## Project #PC45

Using the circuit from PC43, connect the whistle chip across points B & E. Notice how the shape of the pulse has changed.

### Oscillation Sounds PC (III)

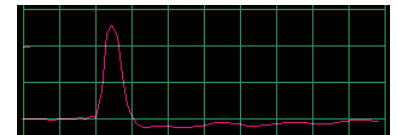

## Project #PC46

Using the circuit from PC43, install the whistle chip under capacitor C2. Notice how the shape of the pulse has changed.

### Oscillation Sounds PC (IV)

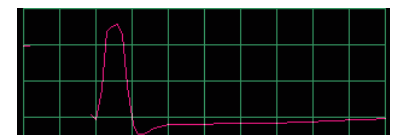

# Project #PC47 Oscillator Sounds PC

**OBJECTIVE:** To view the output of an oscillator circuit.

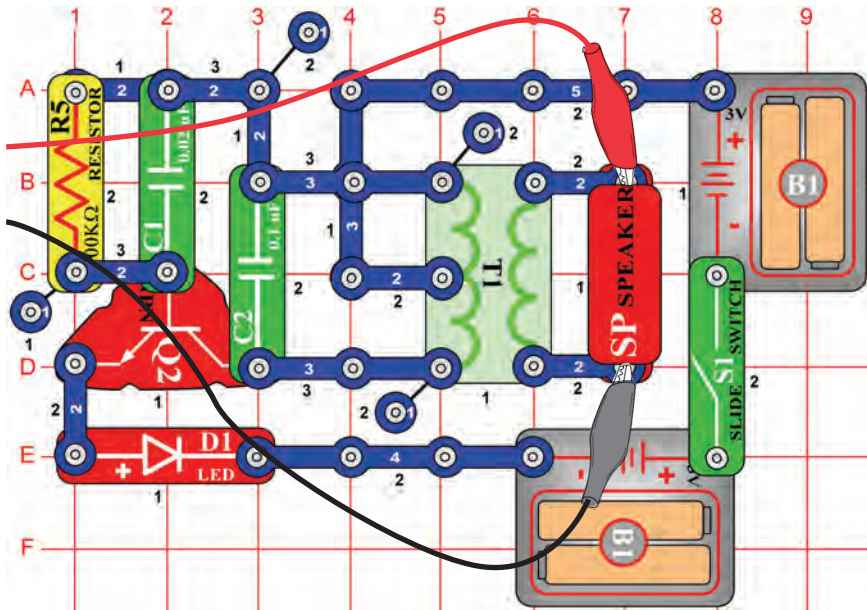

Build the circuit and try the **settings** shown.

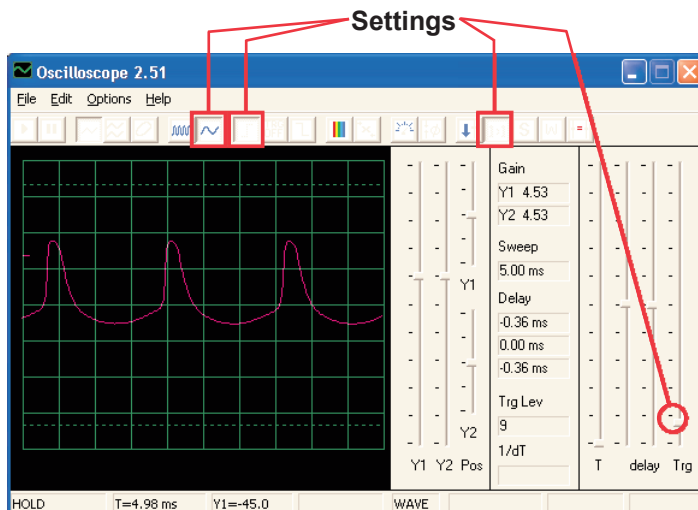

# Project #PC48

## Oscillation Sounds PC (II)

Using the circuit from PC47, install the whistle chip on top of capacitor C1. Notice how the spacing between the pulses has changed.

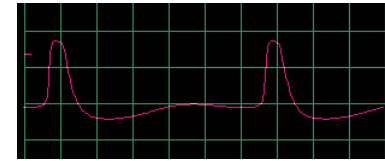

# Project #PC49 Whistle Chip Sounds PC

**OBJECTIVE:** To view the output of an oscillator circuit.

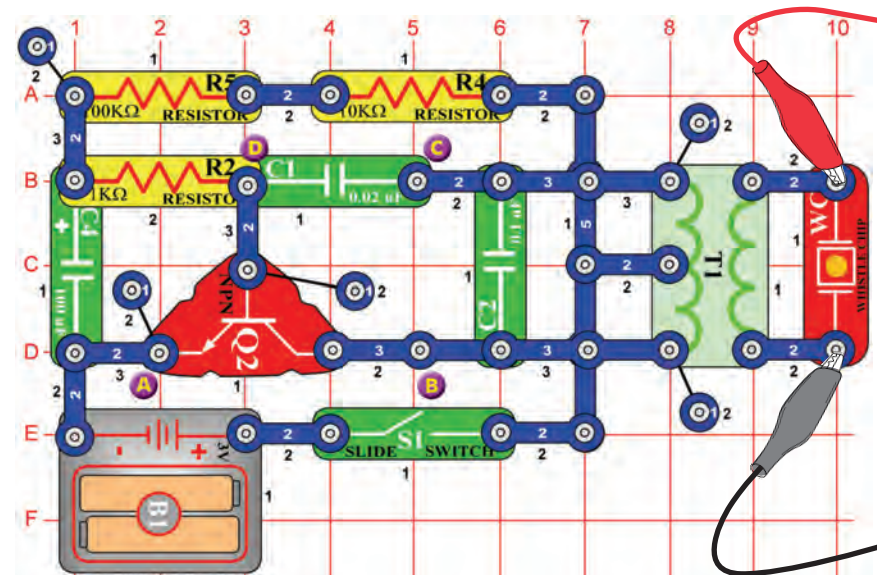

Build the circuit and try the **settings** shown. You may try other settings to zoom in or look at the frequency spectrum.

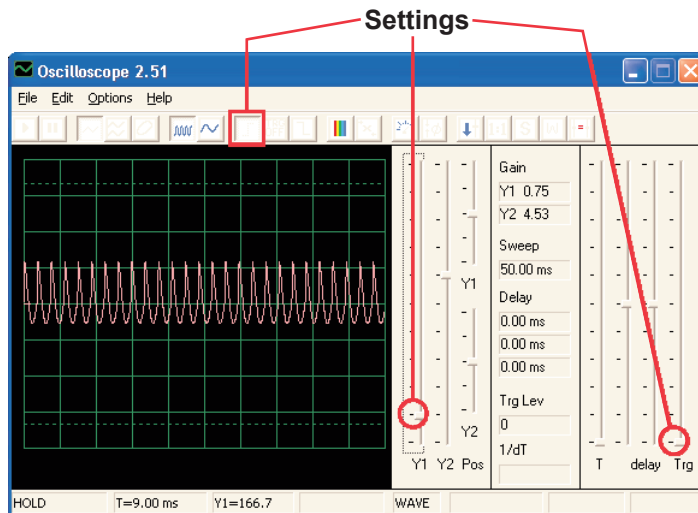

## Project #PC50 Whistle Chip Sounds PC (II)

Connect the whistle chip (with the PC-interface cable still connected across it) across points B & C. The circuit oscillates in short intervals.

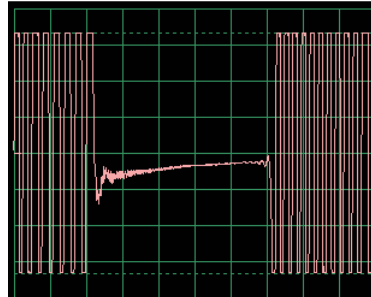

## Project #PC51

### Whistle Chip Sounds PC (III)

Connect the whistle chip (with PC cable) across points C & D using a 1-snap, the sound and waveforms are different.

## Project #PC52 Whistle Chip Sounds PC (IV)

Place the 470 $\mu$ F capacitor C5 on top of the 100 $\mu$ F capacitor C4, and connect the whistle chip across points A & B. The circuit oscillates in 2-second intervals.

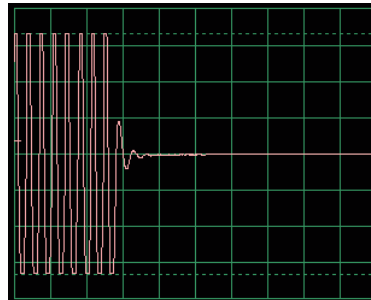

# Project #PC53 Bird Sounds PC

**OBJECTIVE:** To view the output of an oscillator circuit.

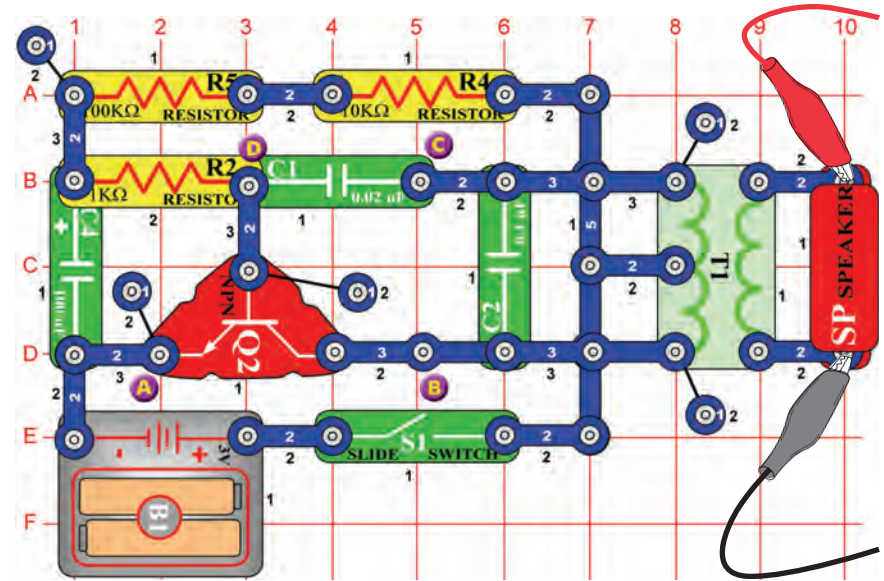

Build the circuit and try the **settings** shown. The oscillator activates about once-a-second, sounding like a bird chirping. You may look at the frequency spectrum if you like.

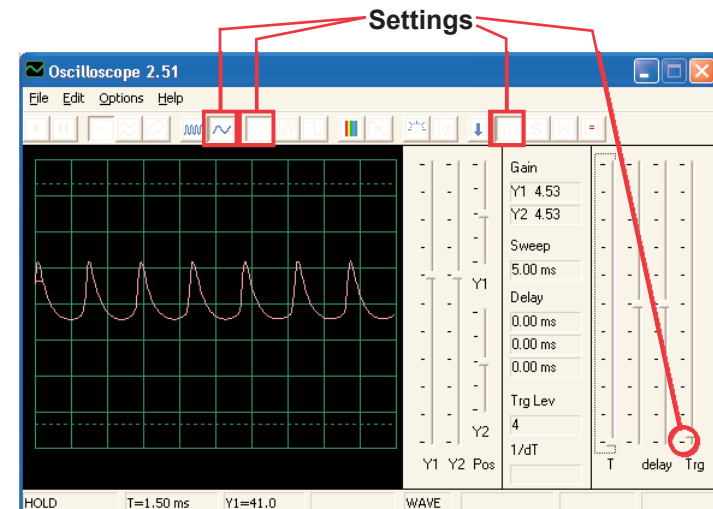

## Project #PC54 Bird Sounds PC (II)

Replace the 100 $\mu$ F capacitor (C4) with the 10 $\mu$ F capacitor (C3). The frequency of the oscillator is the same as before (and so the pulses look the same), but the oscillator activates in shorter intervals (so the bursts of pulses are shorter but closer together). You could use the 470 $\mu$ F capacitor to increase the oscillation interval.

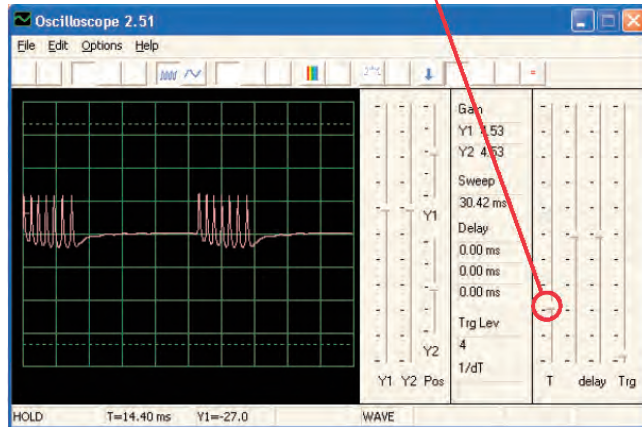

Build the circuit and try the **settings** shown. Start with the adjustable resistor set to the left but then adjust to change the tone. The signal dies out after you release the switch.

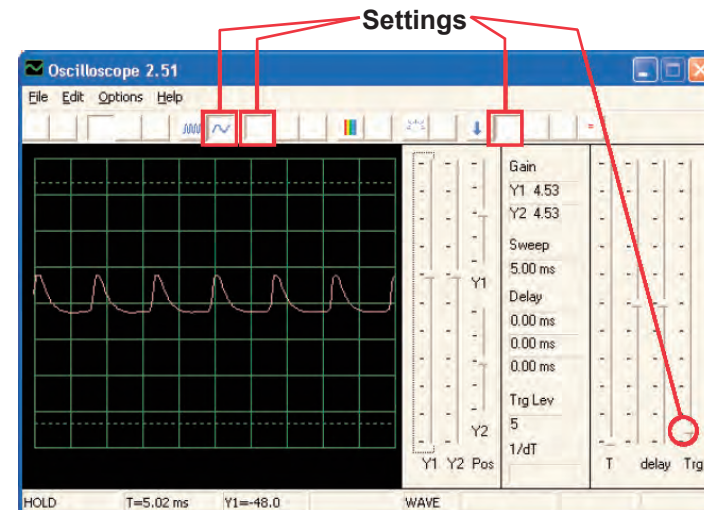

## Project #PC55 Electronic Cat PC

**OBJECTIVE:** To view the output of an oscillator circuit.

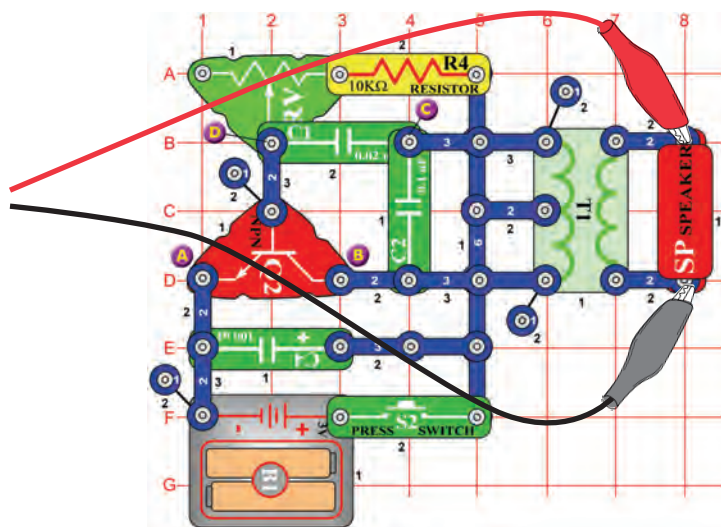

## Project #PC56 Electronic Cat PC (II)

Connect the whistle chip across points A & B, then B & C, then C & D and observe how the waveform changes as the sound changes.

## Project #PC57 Electronic Cat PC (III)

Remove the speaker. Connect the PC interface cable across the whistle chip and install the whistle chip across points A & B, then B & C, then C & D and observe how the waveform changes as the sound changes. Try different settings of the adjustable resistor. The waveform for B & C is shown.

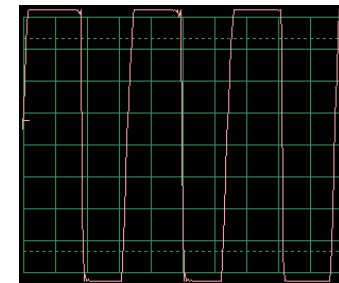

## Project #PC58 Electronic Cat PC (IV)

Replace the 100 $\mu$ F capacitor with the 470 $\mu$ F capacitor and repeat projects PC55-PC57. The signal dies out at a much slower rate now, making it easier to observe. You can also use FFT mode to view the frequency spectrum as desired.

# Project #PC59 Variable Oscillator PC

**OBJECTIVE:** To view the output of an oscillator circuit.

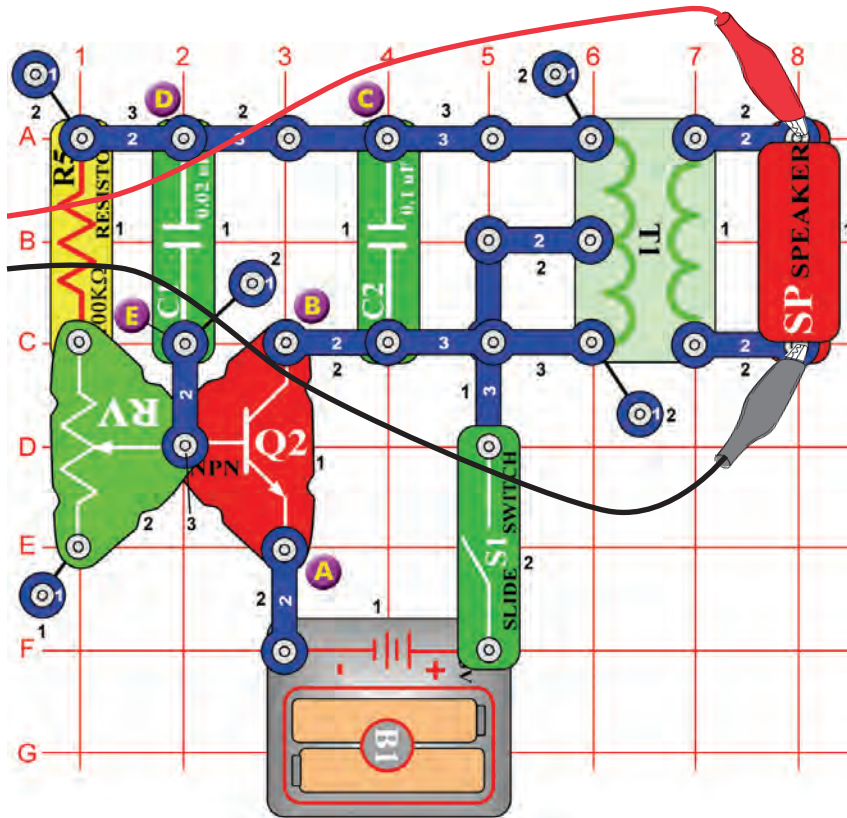

Build the circuit and try the **settings** shown. Move the adjustable resistor lever to change the pitch of the sound and pulse separation in the waveform.

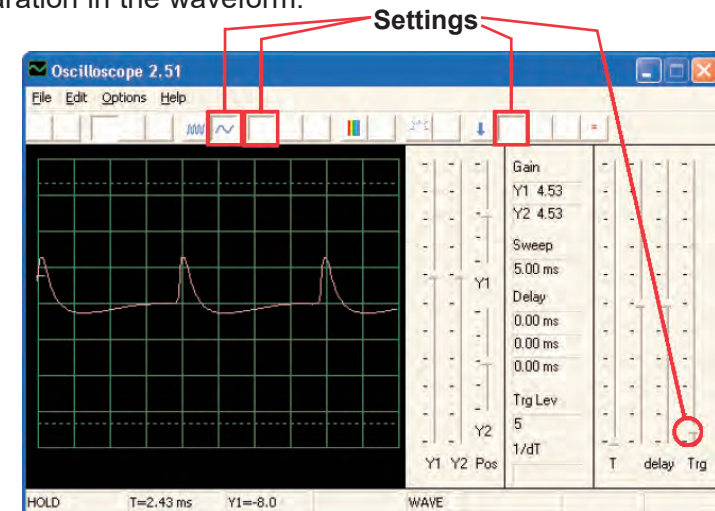

## Project #PC60 Variable Oscillator PC (II)

Connect the whistle chip across points A & B, then B & C, then D & E and observe how the waveform changes as the sound changes. Sometimes the speaker sound and waveform are unchanged, but the whistle chip itself makes new sound.

## Project #PC61 Variable Oscillator PC (III)

Replace the 100KΩ resistor R5 with the photoresistor RP, wave your hand or a piece of paper over it and observe how the sound and waveform change.

## Project #PC62 Variable Oscillator PC (IV)

Remove the speaker. Connect the PC interface cable across the whistle chip and install the whistle chip across points A & B, then B & C, then D & E and observe how the waveform changes as the sound changes. Try different settings of the adjustable resistor. The waveform for A & B is shown.

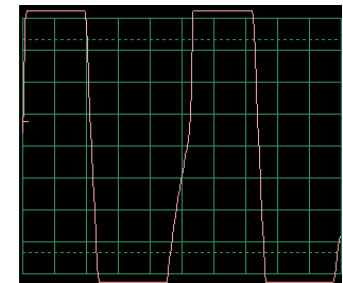

# Project #PC63 Electronic Sound PC

**OBJECTIVE:** To view the output of an oscillator circuit.

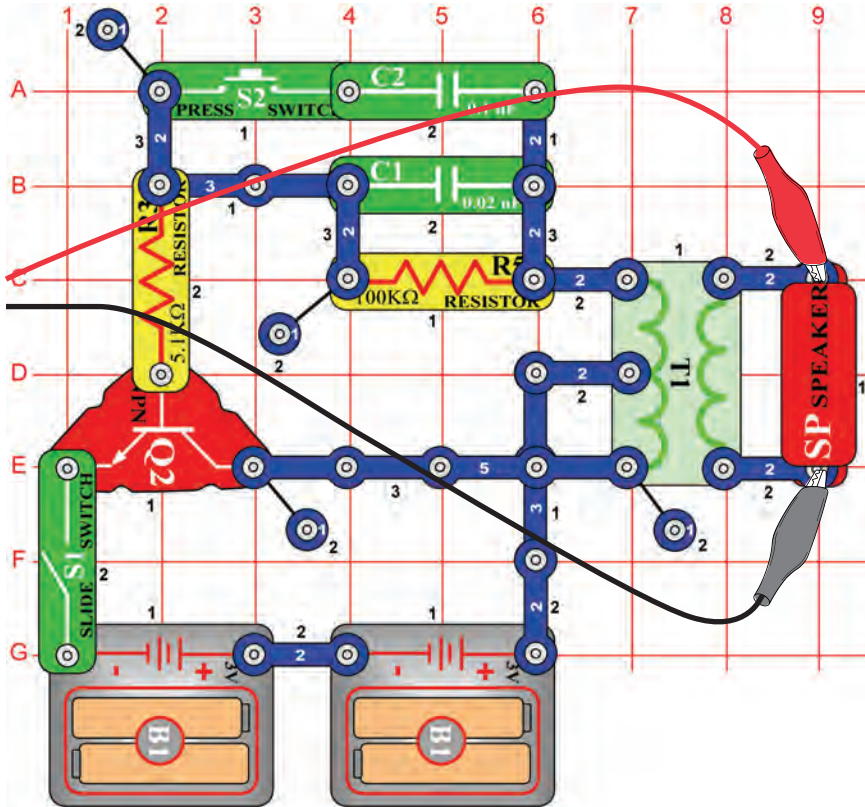

Build the circuit and try the **settings** shown. Press the press switch to lower the frequency of the signal by increasing the capacitance in the oscillator. You can replace the  $0.1\mu\text{F}$  capacitor C2 with the  $10\mu\text{F}$  capacitor C3 (“+” on the right) to further lower the frequency of the tone. You may try other settings to zoom in or look at the frequency spectrum.

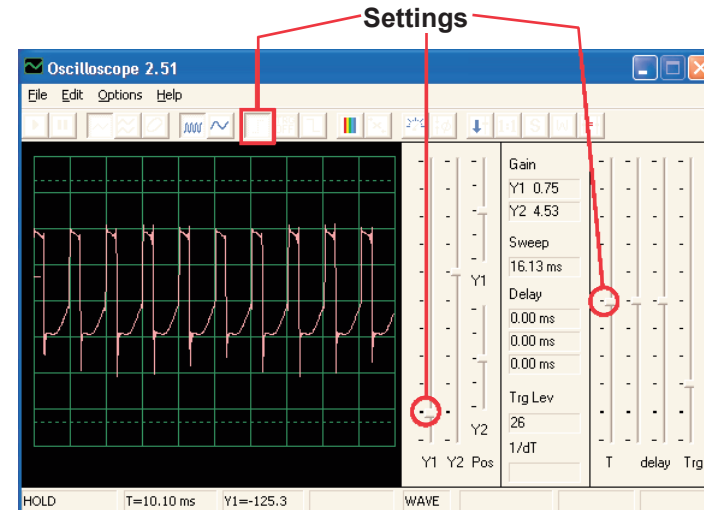

# Project #PC64 Electronic Sound PC (II)

Replace the  $100\text{k}\Omega$  resistor R5 with the  $10\text{k}\Omega$  resistor R4, place the  $0.1\mu\text{F}$  capacitor back in the circuit as before. Now you change the frequency by changing the resistance in the oscillator.

# Project #PC65 Siren PC

**OBJECTIVE:** To view the output of a fading siren circuit.

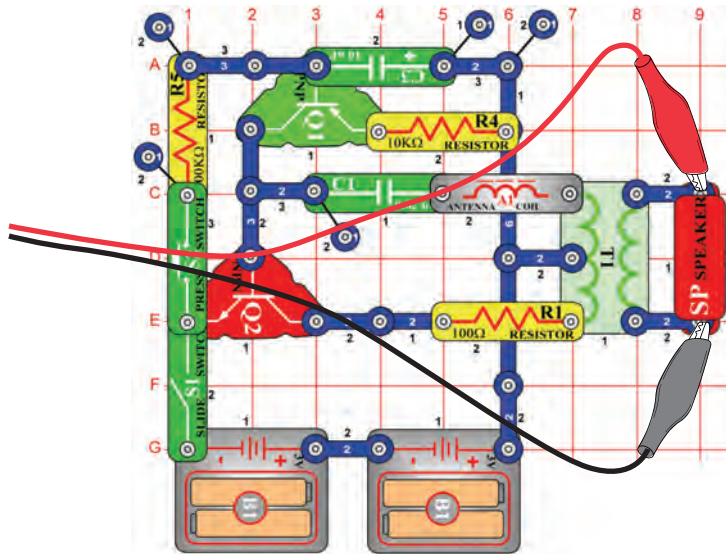

Build the circuit and try the **settings** shown. Flip on the slide switch and press the press switch for a few seconds and release. View the waveform as a siren starts up and then slowly fades away.

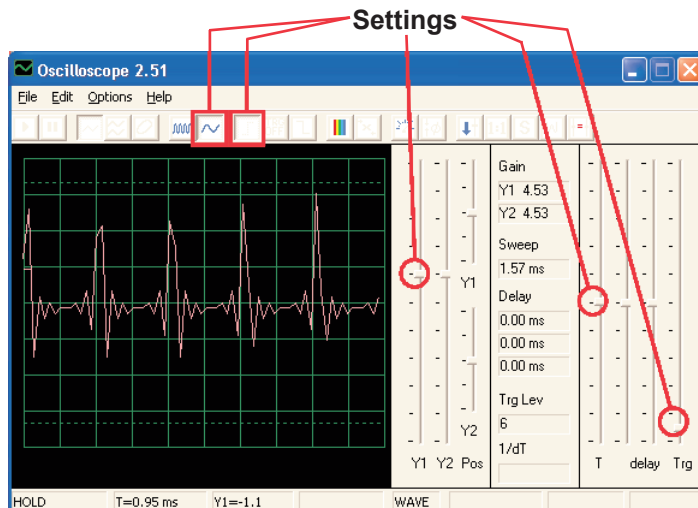

**Note:** Although the amplitude of the pulses appears to be varying across the screen (the wider time scale shown below shows this better), this is an illusion caused by the way Winscope measures the signal. The amplitude of the pulses is not really varying.

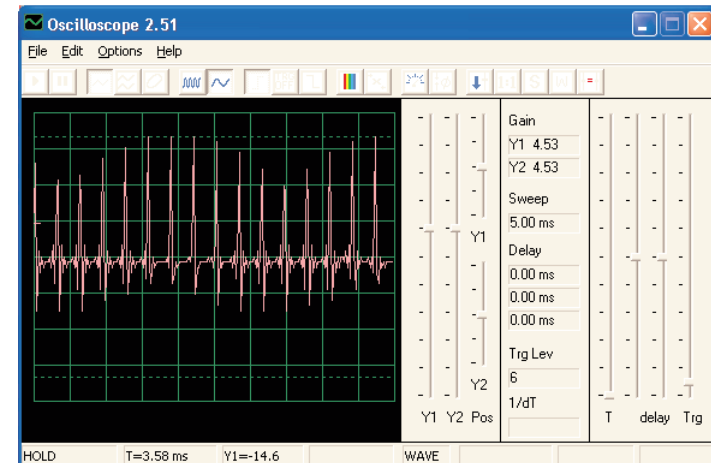

Winscope makes measurements using a 44kHz sampling rate, which is fast enough to measure the frequency of this signal (varying from 1-5kHz). However these pulses have much of their energy spread among higher frequencies that approach the sampling rate (see the sample spectrum plots at right), where the amplitude measurement becomes increasingly inaccurate.

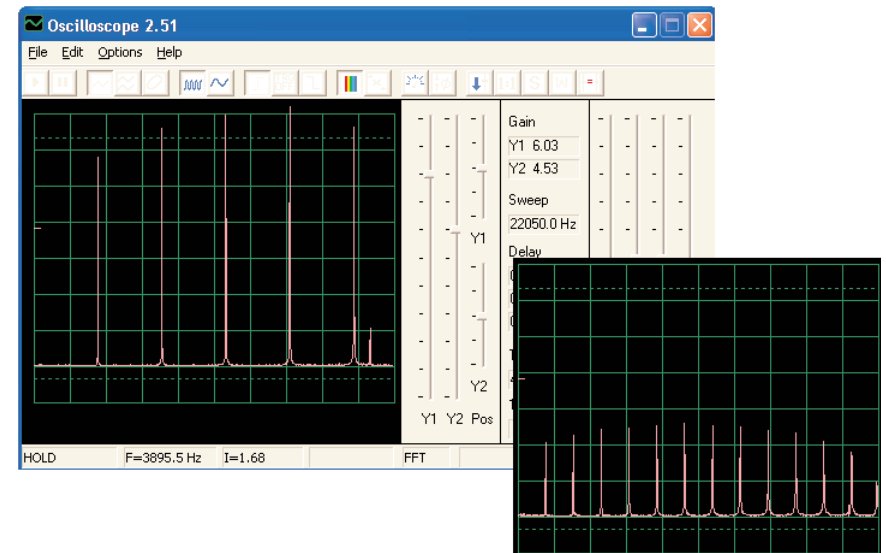

# Project #PC66 Drawing Resistors PC

**OBJECTIVE:** To draw your own resistors.

Use the circuit from the Drawing Resistors project #516, but connect the PC-interface cable across the speaker. Use a pencil to draw the shapes shown in projects #516-518, as per the directions given in those projects. Use Winscope to see how the waveforms and frequency spectrums vary as you move the jumper wires across the shapes to change the sounds. A sample is shown here.

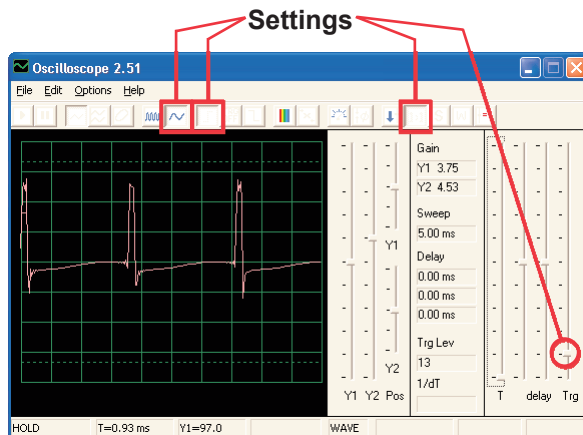

Next, place the loose ends of the jumper wires into a cup of water, as per project #519. The waveforms and frequency spectrum you see will be similar to the resistors you drew, just as the sounds are similar.

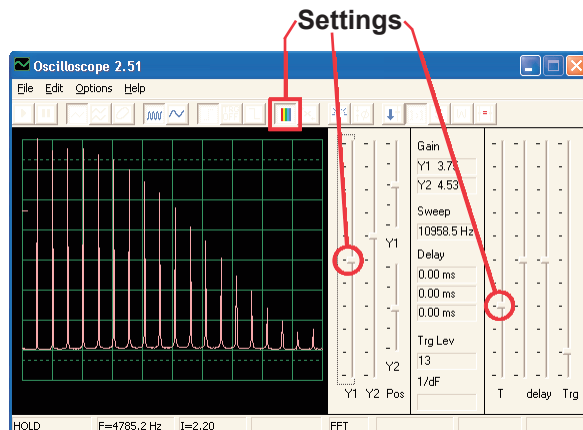

# Project #PC67 Electronic Noisemaker PC

**OBJECTIVE:** To view the output of an oscillator circuit.

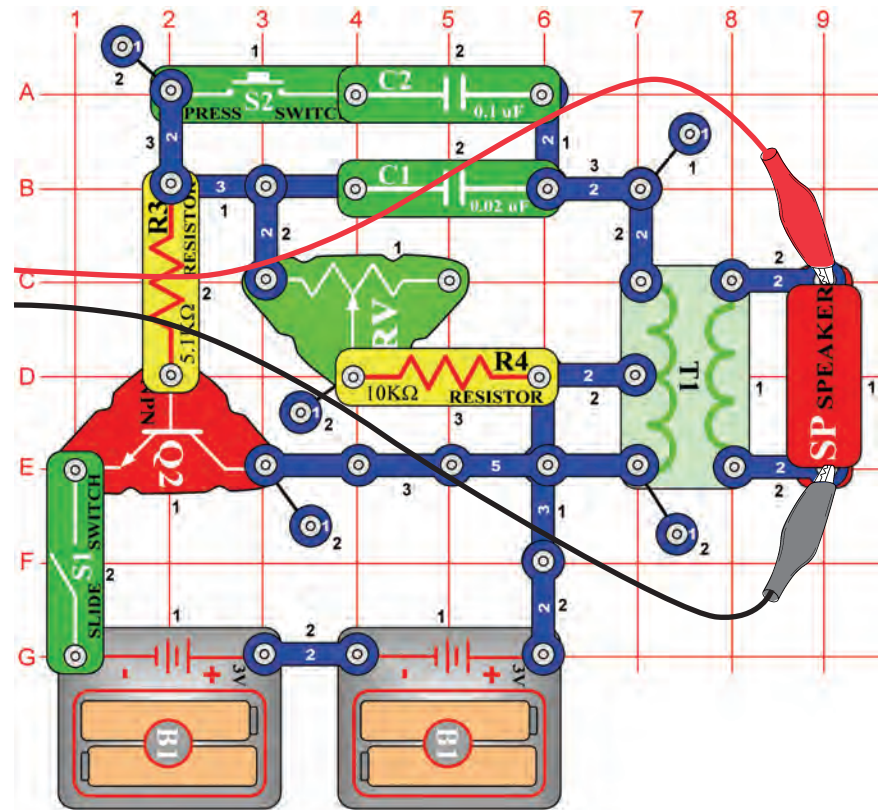

Build the circuit and try the settings shown. Flip on the slide switch and press the press switch a few times while moving the adjustable resistor control around. View the waveform and frequency spectrum.



Sample frequency spectrum:

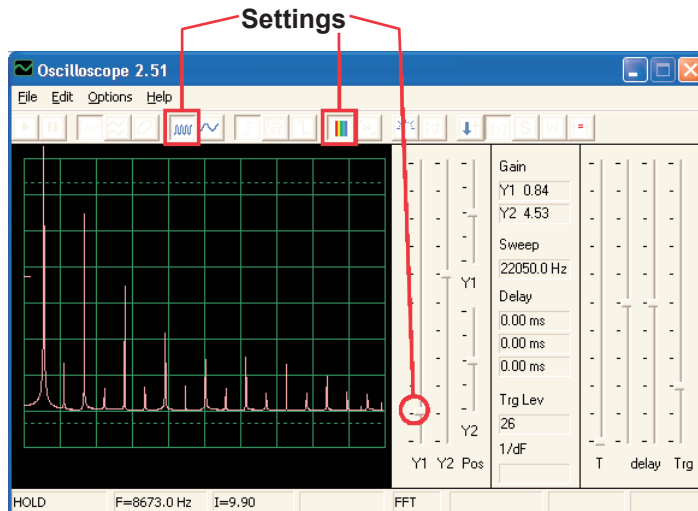

Sample waveform:

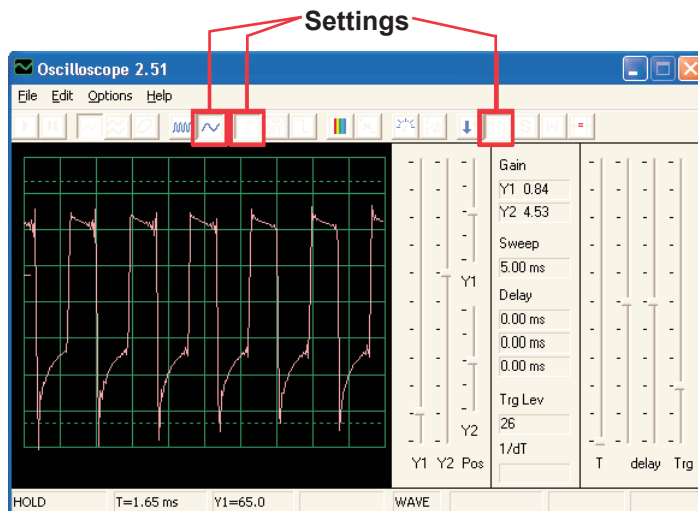

You can replace the  $0.1\mu\text{F}$  capacitor C2 with the  $10\mu\text{F}$  capacitor C3 (“+” on the right) to change the sound.

## Project #PC68 Electronic Noisemaker PC (II)

Replace the  $10\text{K}\Omega$  resistor R4 with the  $100\text{K}\Omega$  resistor R5. Now you change the frequency by changing the resistance in the oscillator.

## Project #PC69 Bee PC

*OBJECTIVE: To view the output of an oscillator circuit.*

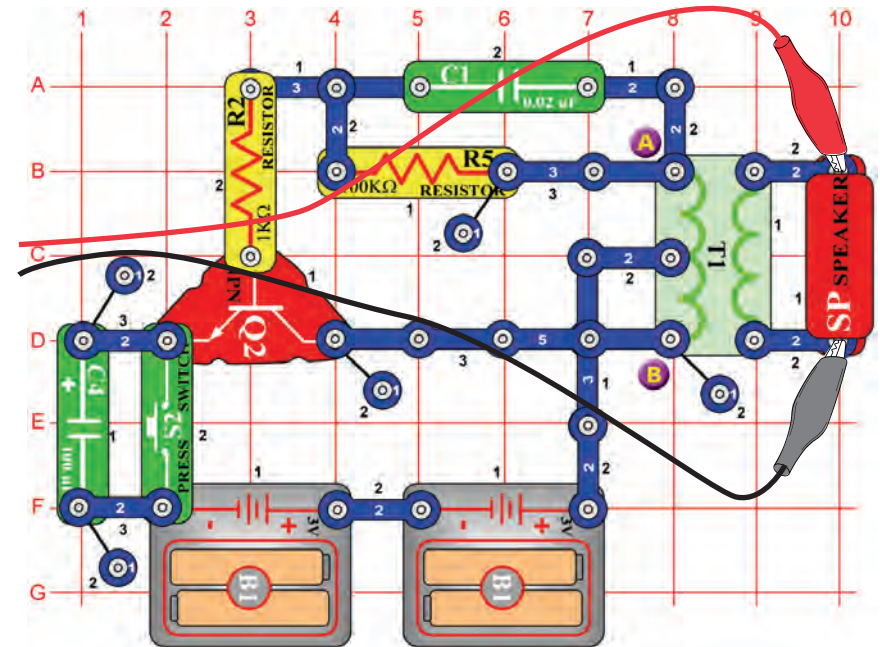

Build the circuit and press the press switch a few times, you hear cute sounds like a bumble bee. Use Winscope to see how the waveform fades away after you release the switch, and try **storage mode** as shown here.

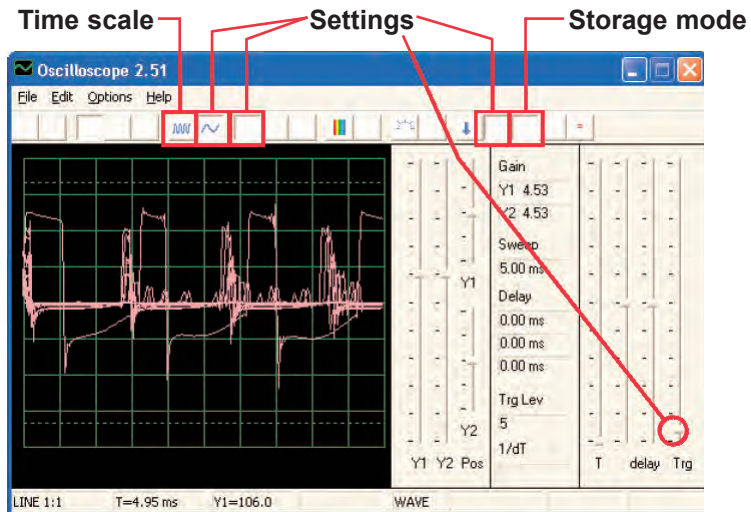

You may replace the  $0.02\mu\text{F}$  capacitor C1 with  $0.1\mu\text{F}$  capacitor C2 or  $10\mu\text{F}$  capacitor C3 (“+” on the right) to change the sound, but you may want to change the **time scale**.

You may also replace the  $100\mu\text{F}$  capacitor C4 with the  $10\mu\text{F}$  capacitor C3 or the  $470\mu\text{F}$  capacitor C5 to change the duration of the sound.

## Project #PC70 Bee PC (II)

Remove the speaker from the circuit and place the whistle chip (WC) across the transformer at points labeled A & B on the circuit layout, connect the PC-interface cable across the whistle chip. Listen to the sounds and view the waveforms as you press the press switch. Replace the  $0.02\mu\text{F}$  capacitor C1 with  $0.1\mu\text{F}$  capacitor C2 or  $10\mu\text{F}$  capacitor C3 (“+” on the right) to change the sound, or replace the  $100\mu\text{F}$  capacitor C4 with the  $10\mu\text{F}$  capacitor C3 (“+” on the right) or the  $470\mu\text{F}$  capacitor C5 to change the duration.

## Project #PC71 Space War Alarm Combo PC

**OBJECTIVE:** To view the output of the combined outputs from the space war and alarm integrated circuits.

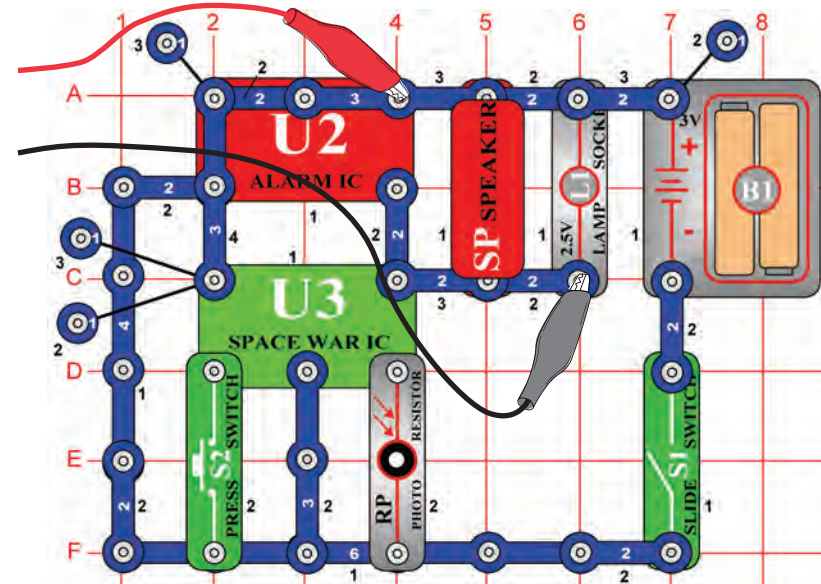

Build the circuit and try the settings shown. Turn it on, press the press switch (S2) several times, and wave your hand over the photoresistor (RP) to view all the sound combinations. You may also use FFT mode to view the frequency spectrum.

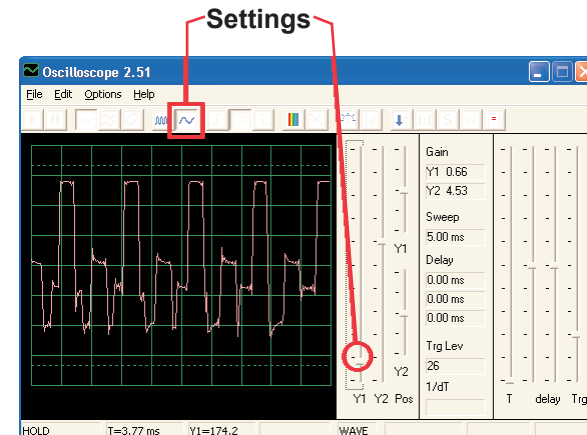

# Project #PC72 Space War Music Combo PC

**OBJECTIVE:** To view the output of the combined outputs from the space war and music integrated circuits.

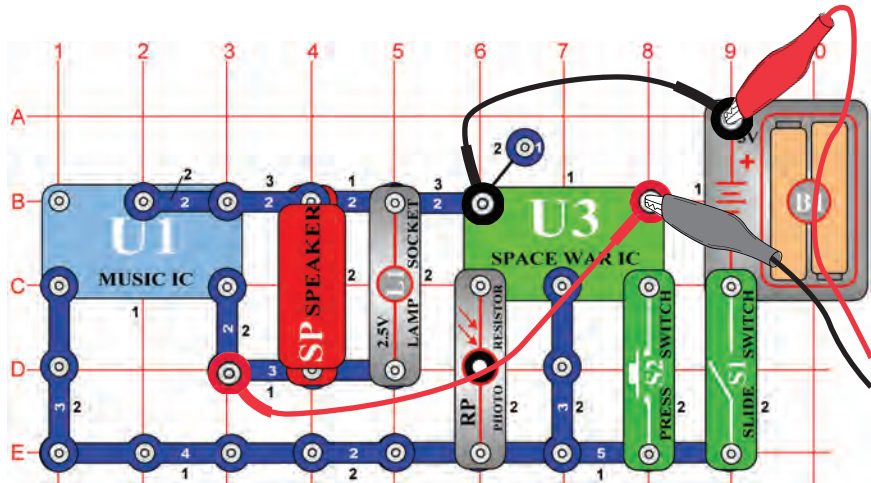

Build the circuit and try the **settings** shown. Turn it on, press the press switch (S2) several times, and wave your hand over the photoresistor (RP) to view all the sound combinations. Compare the waveform and spectrum to the alarm IC combo circuit.

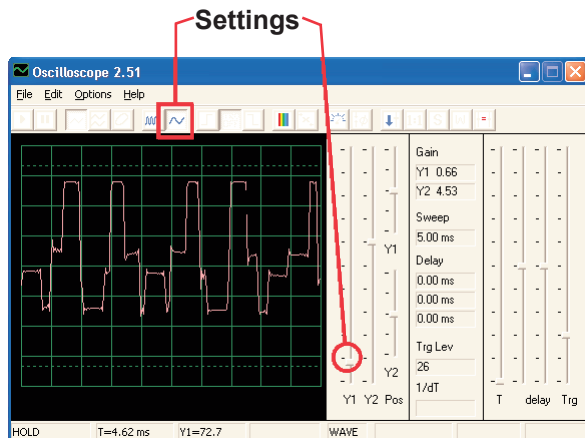

# Project #PC73 Sound Mixer PC

**OBJECTIVE:** To view the output of the music and alarm integrated circuits.

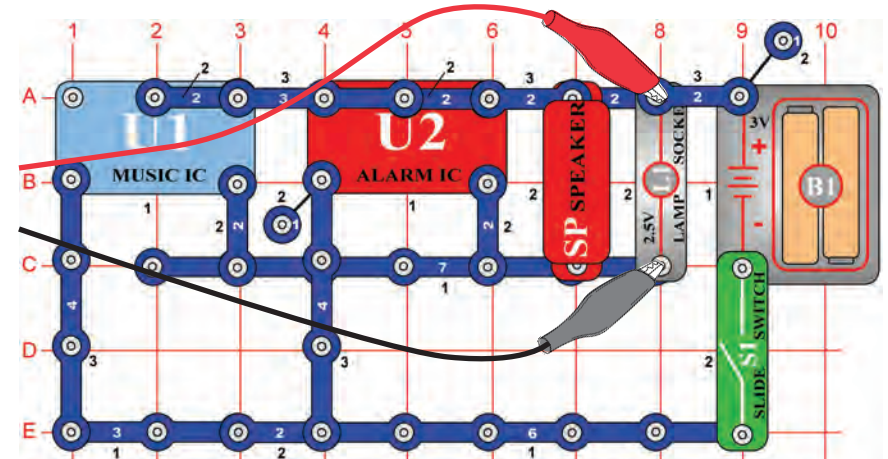

Build the circuit and try the **settings** shown. Turn it on and view the waveforms.

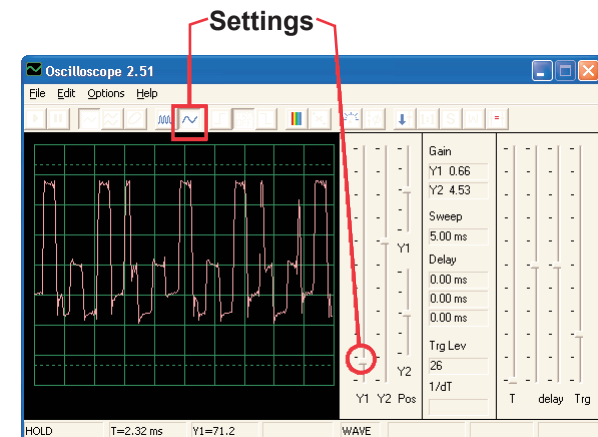

# IMPORTANT NOTICE

## Disclaimer Information

Oscilloscope for Windows95® or newer, version 2.51.

OSCILLOSCOPE IS SUPPLIED TO YOU AS IS, AND IN NO CASE IS THE AUTHOR OF THIS PROGRAM RESPONSIBLE FOR PERSONAL INJURY, HARDWARE AND/OR DATA DAMAGE, PROPERTY DAMAGE OR PROFIT LOSS ARISING FROM USE OR INABILITY TO USE THIS SOFTWARE.

THERE IS NO GUARANTEE IMPLIED OR OTHERWISE TO THE FITNESS OF THIS OSCILLOSCOPE PROGRAM FOR ANY PARTICULAR PURPOSE. THIS SOFTWARE IS NOT INTENDED FOR INDUSTRIAL OR COMMERCIAL USE.

### **ELENCO®**

150 Carpenter Avenue

Wheeling, IL 60090

(847) 541-3800

Website: [www.elenco.com](http://www.elenco.com)

e-mail: [elenco@elenco.com](mailto:elenco@elenco.com)