

LaserDisc™

Operating Instructions

COMPACT DISC/ LASERVISION PLAYER

CLD-900

NTSC

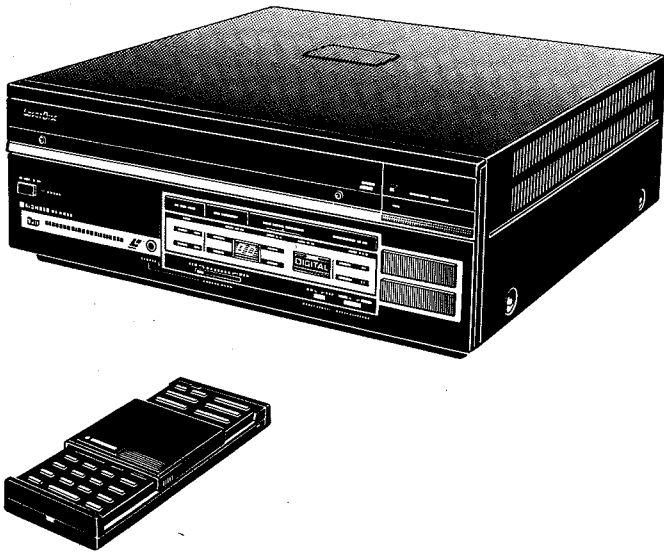

Thank you for buying this Pioneer product. Please read these operating instructions thoroughly, so you will know how to operate your model properly. After you have finished reading the instructions, put them away in a safe place for future reference.

These operating instructions are based on the model KU, and they can be used for the S/G model.

The differences between the models are given below.

KU model: For U.S.A. ("KU" printed on packing case).
Power line voltage is 120 volts.

S/G model: "S/G" printed on packing case.
A 4-point (110V/120V/220V/240V) voltage selector switch is provided.

NOTE FOR S/G MODEL

The voltage selector switch is located on the rear panel of the player. Please check that it is set properly before plugging the power cord into an outlet. If it is not set properly, change the setting of it according to the VOLTAGE SELECTOR on page 10.

The internal mechanisms of this player are secured with the Transit Screws. Before using the player, be sure to loosen the Screws. (See page 8)

IMPORTANT NOTICE (For KU model)

The serial number for this equipment is located on the rear panel. Please write this serial number on your enclosed warranty card and keep in a secure area. This is for your security.

CAUTION: Use of controls or adjustments, or performance of procedures other than those specified herein may result in hazardous radiation exposure.

WARNING: TO PREVENT FIRE OR SHOCK HAZARD, DO NOT EXPOSE THIS APPLIANCE TO RAIN OR MOISTURE.

Use this player with discs bearing the following mark.

(LaserVision Disc)



NOTE:

This player is to be used exclusively with the NTSC color system. Please use NTSC LaserVision Discs. PAL and SECAM system LaserVision Discs cannot be used with this player.

(Compact Disc)

COMPACT
disc
DIGITAL AUDIO

 PIONEER®

SAFETY INSTRUCTIONS (FOR KU MODEL)

READ INSTRUCTIONS — All the safety and operating instructions should be read before the appliance is operated.

RETAIN INSTRUCTIONS — The safety and operating instructions should be retained for future reference.

HEED WARNINGS — All warnings on the appliance and in the operating instructions should be adhered to.

FOLLOW INSTRUCTIONS — All operating and use instructions should be followed.

CLEANING — Unplug this video product from the wall outlet before cleaning. Do not use liquid cleaners or aerosol cleaners. Use a damp cloth for cleaning.

ATTACHMENTS — Do not use attachments not recommended by the video product manufacturer as they may cause hazards.

WATER AND MOISTURE — Do not use this video product near water — for example, near a bathtub, wash bowl, kitchen sink, or laundry tub, in a wet basement, or near a swimming pool, and the like.

ACCESSORIES — Do not place this video product on an unstable cart, stand, tripod, bracket, or table. The video product may fall, causing serious injury to a child or adult, and serious damage to the appliance. Use only with a cart, stand, tripod, bracket, or table recommended by the manufacturer, or sold with the video product. Any mounting of the appliance should follow the manufacturer's instructions, and should use a mounting accessory recommended by the manufacturer.

VENTILATION — Slots and openings in the cabinet are provided for ventilation and to ensure reliable operation of the video product and to protect it from overheating, and these openings must not be blocked or covered. The openings should never be blocked by placing the video product on a bed, sofa, rug, or other similar surface. This video product should never be placed near or over a radiator or heat register. This video product should not be placed in a built-in installation such as a bookcase or rack unless proper ventilation is provided or the manufacturer's instructions have been adhered to.

POWER SOURCES — This video product should be operated only from the type of power source indicated on the marking label. If you are not sure of the type of power supply to your home, consult your appliance dealer or local power company. For video products intended to operate from battery power, or other sources, refer to the operating instructions.

POLARIZATION — This video product is equipped with a polarized alternating current line plug (a plug having one blade wider than the other). This plug will fit into the power outlet only one way. This is a safety feature. If you are unable to insert the plug fully into the outlet, try reversing the plug. If the plug should still fail to fit, contact your electrician to replace your obsolete outlet. Do not defeat the safety purpose of the polarized plug.

POWER-CORD PROTECTION
Power-supply cords should be routed so that they are not likely to be walked on or pinched by items placed upon or against them, paying particular attention to cords at plugs, convenience receptacles, and the point where they exit from the appliance.

LIGHTNING — For added protection for this video product receiver during a lightning storm, or when it is left unattended and unused for long periods of time, unplug it from the wall outlet and disconnect the antenna or cable system. This will prevent damage to the video product due to lightning and power-line surges.

POWER LINES — An outside antenna system should not be located in the vicinity of overhead power lines or other electric light or power circuits, or where it can fall into such power lines or circuits. When installing an outside antenna system, extreme care should be taken to keep from touching such power lines or circuits as contact with them might be fatal.

OVERLOADING — Do not overload wall outlets and extension cords as this can result in the risk of fire or electric shock.

OBJECT AND LIQUID ENTRY — Never push objects of any kind into this video product through openings as they may touch dangerous voltage points or short-out parts that could result in a fire or electric shock. Never spill liquid of any kind on the video product.

SERVICING — Do not attempt to service this video product yourself as opening or removing covers may expose you to dangerous voltage or other hazards. Refer all servicing to qualified service personnel.

DAMAGE REQUIRING SERVICE

Unplug this video product from the wall outlet and refer servicing to qualified service personnel under the following conditions:

- When the power-supply cord or plug is damaged.
- If liquid has been spilled, or objects have fallen into the video product.
- If the video product has been exposed to rain or water.
- If the video product does not operate normally by following the operating instructions. Adjust only those controls that are covered by the operating instructions as an improper adjustment of other controls may result in damage and will often require extensive work by a qualified technician to restore the video product to its normal operation.
- If the video product has been dropped or the cabinet has been damaged.
- When the video product exhibits a distinct change in performance — this indicates a need for service.

REPLACEMENT PARTS — When replacement parts are required, be sure the service technician has used replacement parts specified by the manufacturer or having the same characteristics as the original part. Unauthorized substitutions may result in fire, electric shock or other hazards.

SAFETY CHECK — Upon completion of any service or repairs to this video product, ask the service technician to perform safety checks to determine that the video product is in proper operating condition.

OUTDOOR ANTENNA GROUNDING — If an outside antenna is connected to the antenna terminal, be sure the antenna system is grounded so as to provide some protection against voltage surges and build up static charges.

In the U.S.A. section 810 of the National Electrical Code, ANSI/NEPA No. 70-1984, provides information with respect to proper grounding of the mast and supporting structure, grounding of the lead-in wire to an antenna discharge unit, size of grounding conductors, location of antenna-discharge unit, connection to grounding electrodes, and requirements for the grounding electrode.

See Fig. A.

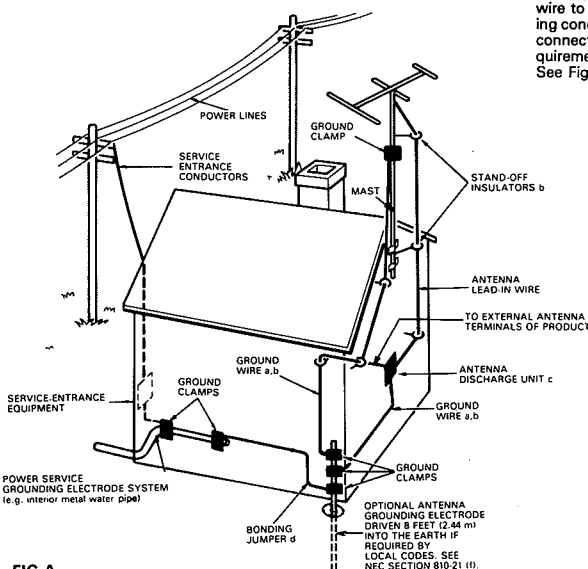

FIG. A

- Use No. 10 AWG (5.3 mm²) copper wire, No. 8 AWG (8.4 mm²) aluminum wire, No. 17 AWG (1.0 mm²) copper-clad steel wire, bronze wire or larger wire as ground wire.
- Secure antenna lead-in and ground wires to house with stand-off insulators spaced from 4 feet (1.22 meters) to 6 feet (1.83 meters) apart.
- Mount antenna discharge unit as closely as possible to where lead-in enters house.
- Use jumper wire not smaller than No. 6 AWG (13.3 mm²) copper or equivalent when separate antenna-grounding electrode is used.

IMPORTANT



The lightning flash with arrowhead, within an equilateral triangle, is intended to alert the user of the presence of uninsulated "dangerous voltage" within the product's enclosure that may be of sufficient magnitude to constitute a risk of electric shock to persons.

CAUTION

RISK OF ELECTRIC SHOCK
DO NOT OPEN

CAUTION:
TO PREVENT THE RISK OF ELECTRIC SHOCK, DO NOT REMOVE COVER (OR BACK). NO USER-SERVICEABLE PARTS INSIDE. REFER SERVICING TO QUALIFIED SERVICE PERSONNEL.



The exclamation point within an equilateral triangle is intended to alert the user of the presence of important operating and maintenance (servicing) instructions in the literature accompanying the appliance.

CONTENTS

Features	4
Disc Handling Precautions	6
Before Operation	7
About the Transit Screws	8
Rear Panel Facilities	10
Connections	12
Panel Facilities	14
Remote Control Unit Facilities	16
Operation	18
Operation with the Remote Control Unit	22
Operation for LaserVision Video Disc	22
Operation for Compact Disc	29
Troubleshooting	32
Specifications	34
Player Handling Precautions	36

FEATURES

Both LaserVision discs and Compact Discs utilize laser technology in playback. The CLD-900 now allows you to play both these discs on a single component.

It is also possible to play back LaserVision with Digital Sound Disc, thus allowing even greater sound fidelity.

In addition, the CLD-900 has the following features:

EQUIPPED WITH LASER DIODE

A laser diode with superb reliability and long service life is built into the pickup, the heart of the player.

FRONT-LOADING MECHANISM

The front-loading mechanism not only increases ease of operation, but also allows a more compact, space-saving design.

AUTOMATIC SETTING OF LASERVISION DISC/COMPACT DISC

Merely load the disc you want to play and close the disc table; the player will discriminate the type of disc and set itself to the appropriate playback mode.

CX NOISE REDUCTION SYSTEM

Combined with CX encoded LaserVision discs, an expanded dynamic range and greatly increased S/N ratio are possible.

FUNCTION SWITCHES WITH SUPERB EASE OF OPERATION

Function buttons use logic-controlled, soft-push switches, thus making operation not just easy, but a positive pleasure.

WIRELESS REMOTE CONTROL

Most functions can be performed from your easy chair by using the accessory remote control unit.

EXCLUSIVE LSI RESULTS IN HIGH-RELIABILITY DESIGN

Concentrating a high level of circuit technology and greatly compacting the circuit parts, the exclusive LSI utilized gives stable reliability and performance.

About LaserVision Discs

There are two kinds of LaserVision discs: standard play disc, and extended play disc. Some discs also use digital technology to record the audio signals (LaserVision with Digital Sound Disc).

Standard Play (CAV) Discs

Standard Play

These discs are called CAV discs since they play at a "Constant Angular Velocity."

These discs allow such special functions as STILL/STEP, FAST, and MULTI-SPEED play. In addition, standard play discs allow random access, chapter stop, and interval repeat playback.

Extended Play (CLV) Discs

Extended Play

Since these discs play at a "Constant Linear Velocity," they are called CLV discs. Compared to standard play (CAV) discs, the CLV disc allows longer playback time.

The special effects playback available with the CAV discs cannot be performed with CLV discs, but random access, chapter stop, and interval repeat playback may be performed.

LaserVision with Digital Sound Discs

These discs have PCM (Pulse Code Modulation) audio signals (the same as on a Compact Disc) recorded together with the normal analog audio signals.

As a result, in addition to the high quality of video image obtainable with the LaserVision disc, you can also enjoy the same kind of digital sound found on the Compact Discs. These audio channels are recorded using separate frequency bands as shown below.

In these Operating Instructions, the two audio channels will be referred to for convenience as the "Analog Sound" and "Digital Sound" signals.

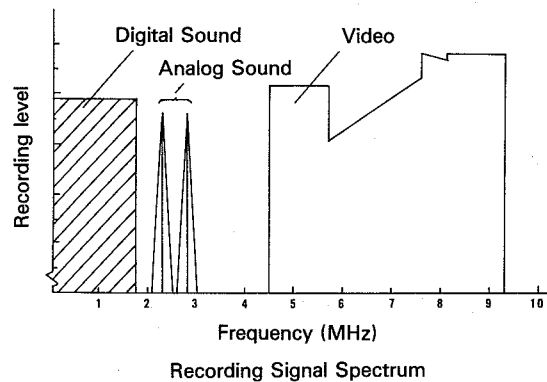

DISC HANDLING PRECAUTIONS

This player may be used with LaserVision Video discs and Compact Discs bearing the following marks:

(LaserVision Disc)



This symbol is the universal indicator for LaserVision video discs.

(Compact Disc)



This player has been designed for use exclusively with the NTSC television system, and it cannot be used with televisions of other systems (PAL, SECAM). In addition, LaserVision discs bearing the PAL or SECAM marks cannot be used with this player. Use only LaserVision discs conforming to the NTSC system.

■ AS MUCH AS POSSIBLE, TRY NOT TO TOUCH THE SURFACE OF THE DISC

When holding discs, handle them as shown in the illustration and try as much as possible not to touch their playing surfaces.

If the surfaces of the discs are scratched, it may cause track skipping if the scratches are severe.

How to hold the LaserVision Disc

Holding with both hands... Hold the disc by its edges with both hands, as shown in Fig. A.

Holding with one hand... As shown in Fig. B, hold the disc by its center hole and one edge.

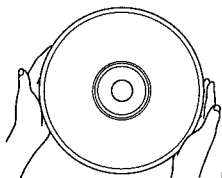

Fig. A

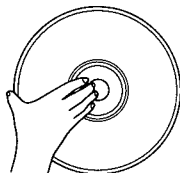

Fig. B

How to hold the Compact Disc

Hold the disc by its edges as shown in Fig. C.

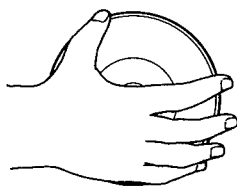

Fig. C

Do not affix tape, paper, or gummed seals to the disc's label surface. Also be careful not to scratch the label surface.

■ BEFORE PLAYING, CLEAN YOUR DISCS

When fingerprints or other dirt are on the disc surface, it will cause a skipping, jumping or sticking problem. Always be sure to clean your discs before playing them. Use a soft clean cloth to wipe off them. If necessary, moisten a soft cloth with diluted neutral detergent to remove heavy dirt or fingerprints.

Record cleaning sprays, static prevention sprays, etc., cannot be used. Also, do not use other types of cleaners, etc., containing benzene, thinner or other solvents.

Using such preparations may cause damage to the surface of discs.

■ DO NOT USE DAMAGED DISCS

Discs rotate inside the player at high speeds. Do not use damaged (warped, cracked, etc.) discs. The player may be damaged as a result.

■ KEEP YOUR PLAYER AWAY FROM HEAT

Do not place the player on top of the amplifier or any other unit that emits heat since heat may adversely affect the player and possibly warp a loaded disc.

If the player is used with other audio equipment in the same rack, place it on the lowest shelf away from heat and keep the area well-ventilated.

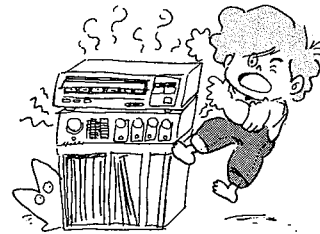

■ KEEP YOUR DISCS AWAY FROM HEAT

Take care not to allow discs to warp.

After playing a disc, always remove it from the player and return it to its jacket or case, then store it vertically in a location not subject to high temperatures or humidity.

Be careful when transporting discs since, for example, the seat of a car may become unbelievably hot when left in the sun.

Take special care to store the LaserVision video disc, if you store the video discs at an angle, or stacked on top of each other, discs may become warped. If the video disc becomes warped, put the disc into the protective envelope, and place it on a flat desk top. Subsequently, place a flat board on the disc, and load it with weights of about 4~5 kg (about 10 lbs.). If it is left in this state for one day, sometimes the warp will be alleviated.

BEFORE OPERATION

DISC HANDLING PRECAUTIONS
BEFORE OPERATION

INSTALLING THE PLAYER

- Choose a stable platform next to the television and stereo system with which you plan to use the player. Avoid placing the player in locations subject to extremely high and low temperatures. Do not use the player in direct sunlight, or on radiators and other heating appliance. Also, protect from high humidity, dust, smoke, steam, oil and possible water spillage.
- When using the player with a stereo system, your speakers should be installed somewhat separated from your television (video TV monitor).
- Do not place heavy items on top of the player. Also, cassette tape decks and other components easily affected by magnetism should be installed separately from the player.
- If the power to the player is turned on while you are receiving FM or AM radio broadcasts, noise may be heard in the radio broadcast. As a result, when not using the player, be sure the power switch is in the OFF position. Also, if you experience noise during radio broadcasts when using an indoor antenna, try readjusting the antenna's position or direction.

NOTICE

Moisture will form in the operating section of the player and the player's performance will be impaired if the player is brought from cool surroundings into a warm room or if the temperature of the room rises suddenly.

To prevent this, let the player stand in its new surroundings for about an hour before switching it on, or ensure that the room temperature rises gradually.

PREPARING THE REMOTE CONTROL UNIT

The player's remote control unit may be found inside the cardboard panel resting on top of the player when you open the packing case. Remove the remote control unit and insert batteries in it.

1. Open the battery compartment cover on the rear of the remote control unit. The cover should open easily if you press on it with your thumb while sliding it to the right.
2. Take out the 2 accessory size "AA" dry batteries and insert them into the battery compartment in accordance with the diagram in the compartment, then replace the cover.
3. Press the buttons on the remote control unit and confirm that the red indicator flashes.

Incorrect use of batteries may lead to leakage or rupture.

Always be sure to follow these guidelines:

- A. Always insert batteries into the battery compartment correctly matching the positive (+) and negative (-) polarities as shown in the display inside the compartment.
- B. Never mix new and used batteries together.
- C. Batteries of the same size may have differing voltages, depending on brand. Do not mix different brands of batteries together.
- D. Both rechargeable and non-rechargeable batteries are available. Be sure to use your batteries in accordance with the caution labels affixed to them.

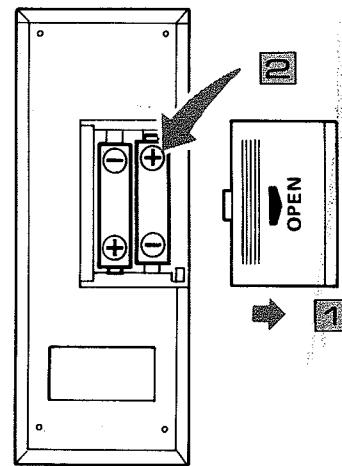

Remote Control Unit CU-900

ABOUT THE TRANSIT SCREWS

The internal mechanisms of this player are fastened in place during shipment with 2 transit screws. These screws must be loosened before the player is used. If you attempt to operate the player without loosening the transit screws, correct operation will not be possible. If you should retransport the player at a future date, be sure to retighten the transit screws before moving the player.

WHEN USING THE PLAYER

Loosen the Transit Screws

1. Spread out a cloth or blanket, etc., and stand the player on its right side down (viewed from the front), taking care not to scratch the finish.
2. While supporting the player with one hand, use a flat blade screwdriver to loosen the two transit screws A and B as shown in the illustration. Even when fully loosened, the screws cannot be removed.

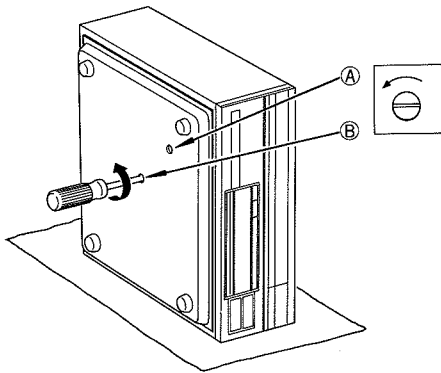

Loosen the screws fully until no further resistance is felt.

When standing the player up, be sure to stand it on its side only. Do not stand the player on its rear panel (with its front panel facing up).

* *The player's pickup moves in a front-back direction. If the player is stood with its front panel facing up when the transit screws are removed, the pickup will naturally fall, possibly causing damage to the player. Be careful.*

WHEN TRANSPORTING THE PLAYER

Tighten the Transit Screws

Before attempting to tighten the transit screws, confirm that no disc is loaded in the player. If a disc is loaded, be sure to remove it before tightening the transit screws.

1. Turn off the power, and stand the player on its side (right side down).
2. While supporting the player with one hand, use a flat blade screw driver to retighten the two transit screws A and B.

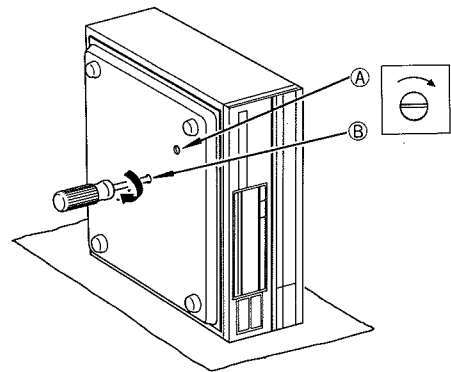

If the last disc played was a Compact Disc, the transit screws may not match their holes, making tightening impossible. In this event, follow the instructions listed under "When the Transit Screws Can't Be Tightened."

When the Transit Screws Can't Be Tightened

When both screws A and B can't be tightened

When screw A only can't be tightened

- ① Return the player to its normal horizontal position.
- ② Use a screwdriver to press the transit switch deep in the hole at the upper right of the rear panel, and while pressing the switch, turn on the power.

After turning on the power, you may stop pressing the transit switch after about 4 seconds.

- ③ Wait an additional 15 to 16 seconds and turn off the power.
- ④ Stand the player on its side (right side down).
- ⑤ While supporting the player with one hand, use a flat blade screwdriver to retighten the two transit screws A and B or A only as required.

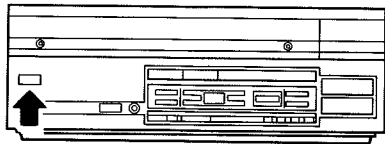
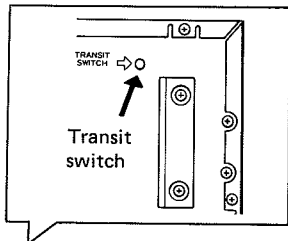

Turn on the power, wait 15 ~ 16 seconds and turn off the power.

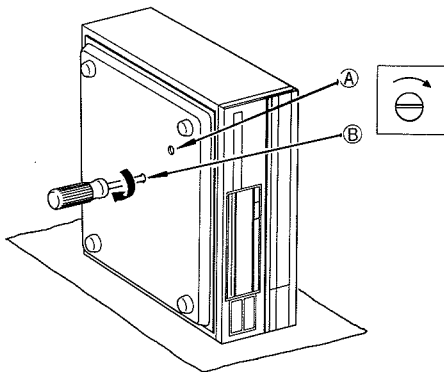

When screw B only can't be tightened

- ① Return the player to its normal horizontal position.
- ② Turn on the power, wait for 5 to 6 seconds and turn the power off.
- ③ Stand the player on its side (right side down).
- ④ While supporting the player with one hand, tighten the transit screw B.

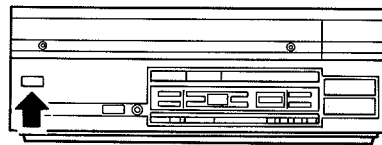

Turn on the power, wait 5 ~ 6 seconds and turn off the power.

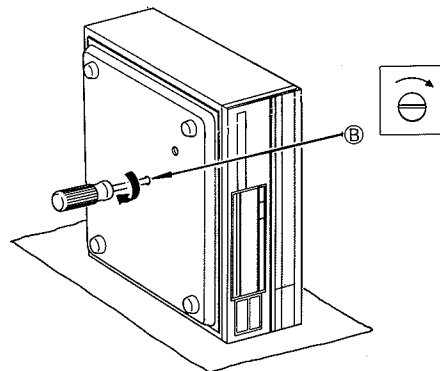

If a LaserVision disc is available, the following procedure can be used to simply align the positions of the transit screws:

- 1) Turn on the power, load the LaserVision disc on the disc table, and push in the disc table.
- 2) Press the EJECT (▲) button and remove the disc.

After this procedure, turn off the power and stand the player on its side to tighten the transit screws.

REAR PANEL FACILITIES

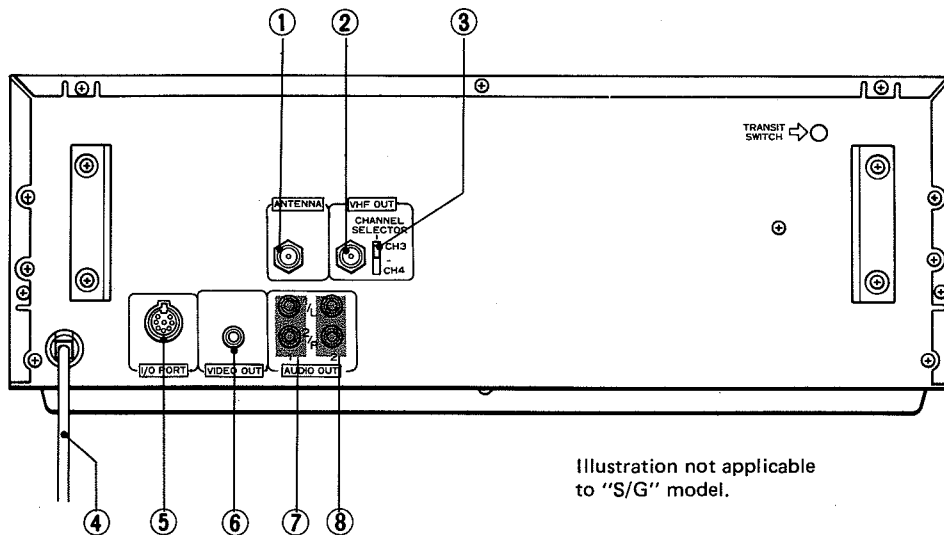

Illustration not applicable to "S/G" model.

① ANTENNA

The coaxial cable (75 ohm) from a VHF television antenna is connected here.

② CH. 3/4 VHF OUT

Connect to a television's VHF antenna input terminal.

③ VHF CHANNEL SELECTOR

This selector is for switching the internal VHF converter. Set to the channel which is not used for TV broadcasts in your area.

④ POWER CORD

Plug this into an electrical outlet.

⑤ I/O PORT

This is the I/O port used when performing external control of the player.

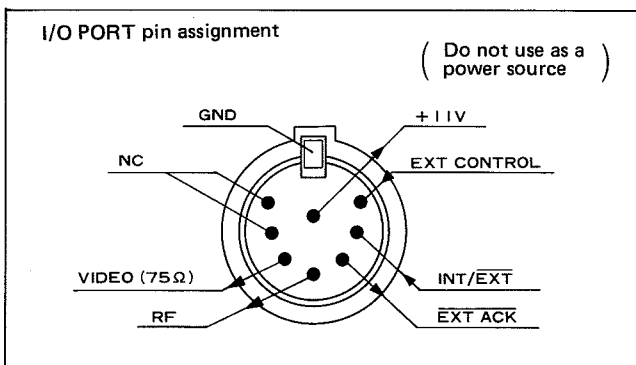

⑥ VIDEO OUTPUT

When using a video TV monitor to play back the video image, connect this terminal to the TV monitor's video input terminal.

⑦ AUDIO OUTPUT 1

Connect to your stereo amplifier's AUX, CD, or TUNER input terminals.

When playing back the LaserVision with Digital Sound Discs, select the front panel's VIDEO DISC AUDIO switch to AUTO DIGITAL (Digital Sound output) or ANALOG ONLY (Analog Sound output).

The audio signals of the Compact Disc are output from these terminals only.

⑧ AUDIO OUTPUT 2

Connect to your stereo amplifier's AUX, CD, or TUNER input terminals.

These terminals output only the LaserVision disc's Analog Sound signals.

[FOR S/G MODEL]

VOLTAGE SELECTOR SWITCH

A 4-point (110V/120V/220V/240V) voltage selector switch is located on the rear panel of the player.

Check that it is set properly before plugging the power cord into the wall socket. If the voltage is not properly set or if you move to an area where the voltage supply differs, adjust the selector switch as follows:

1. Disconnect the power cord.
2. Provide yourself with a medium-sized (flat blade) screwdriver. Insert the tip of the screwdriver into the groove of the selector switch and turn it so that the power voltage marking of your area point to the arrow.

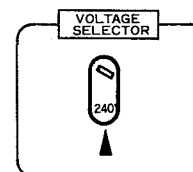

NOTE:

"KU" (For U.S.A.) model is not provided with VOLTAGE SELECTOR switch.

About the AUDIO OUTPUT 1/2 Terminals

This player is equipped with two sets of "AUDIO OUTPUT Terminals".

The "AUDIO OUTPUT 2" terminals output only the Analog Sound signals from LaserVision discs.

The "AUDIO OUTPUT 1" terminals can output the LaserVision disc's Analog Sound, Digital Sound, and Compact Disc's audio signals.

(1) LaserVision Disc (Analog Sound only) playback

- AUDIO OUTPUT 1 Analog Sound
- AUDIO OUTPUT 2 Analog Sound
- VHF OUT Analog Sound

(2) LaserVision with Digital Sound Disc playback (When set the VIDEO DISC AUDIO switch on the front panel to "AUTO DIGITAL")

- AUDIO OUTPUT 1 Digital Sound
- AUDIO OUTPUT 2 Analog Sound
- VHF OUT Analog Sound

In the LaserVision with Digital Sound Disc, both the Digital sound and Analog Sound are recorded.

(3) LaserVision with Digital Sound Disc playback (When set the VIDEO DISC AUDIO switch on the front panel to "ANALOG ONLY")

- AUDIO OUTPUT 1 Analog Sound
- AUDIO OUTPUT 2 Analog Sound
- VHF OUT Analog Sound

(4) Compact Disc playback

- AUDIO OUTPUT 1 Compact Disc
 Digital Sound
- AUDIO OUTPUT 2 no output
- VHF OUT no output

NOTE:

- * 1/L and 2/R audio channels of the AUDIO OUTPUT 1 or AUDIO OUTPUT 2 terminals have been combined here for ease of explanation.
- * This diagram is meant for explanatory purposes and differs from actual signal processing.
- * The audio for VHF output is based on Analog Sound. The Compact Disc's audio, and the Digital Sound of the LaserVision with Digital Sound Disc are not output from the VHF output terminal.

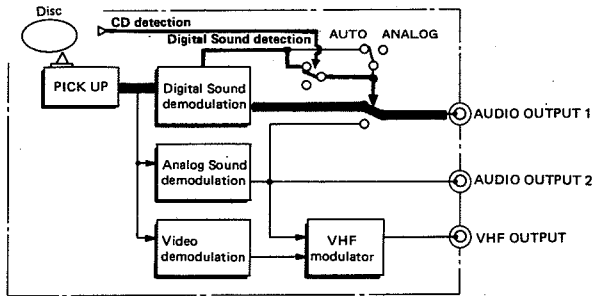
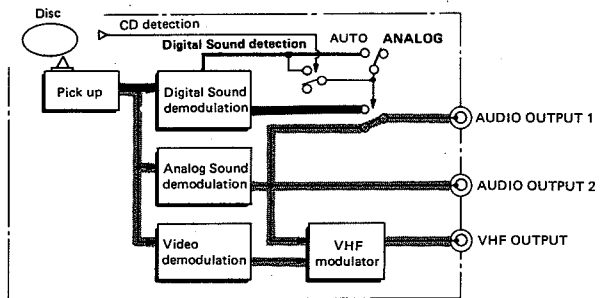
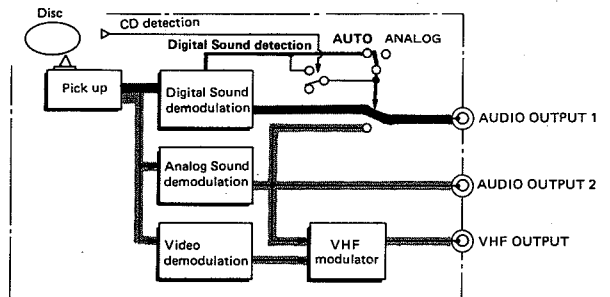
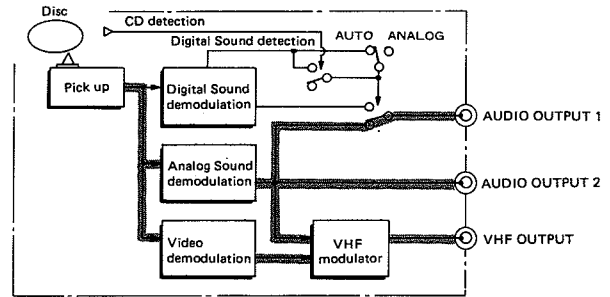

CONNECTIONS

BASIC COMBINATION (CLD-900 + TV set + Stereo system)

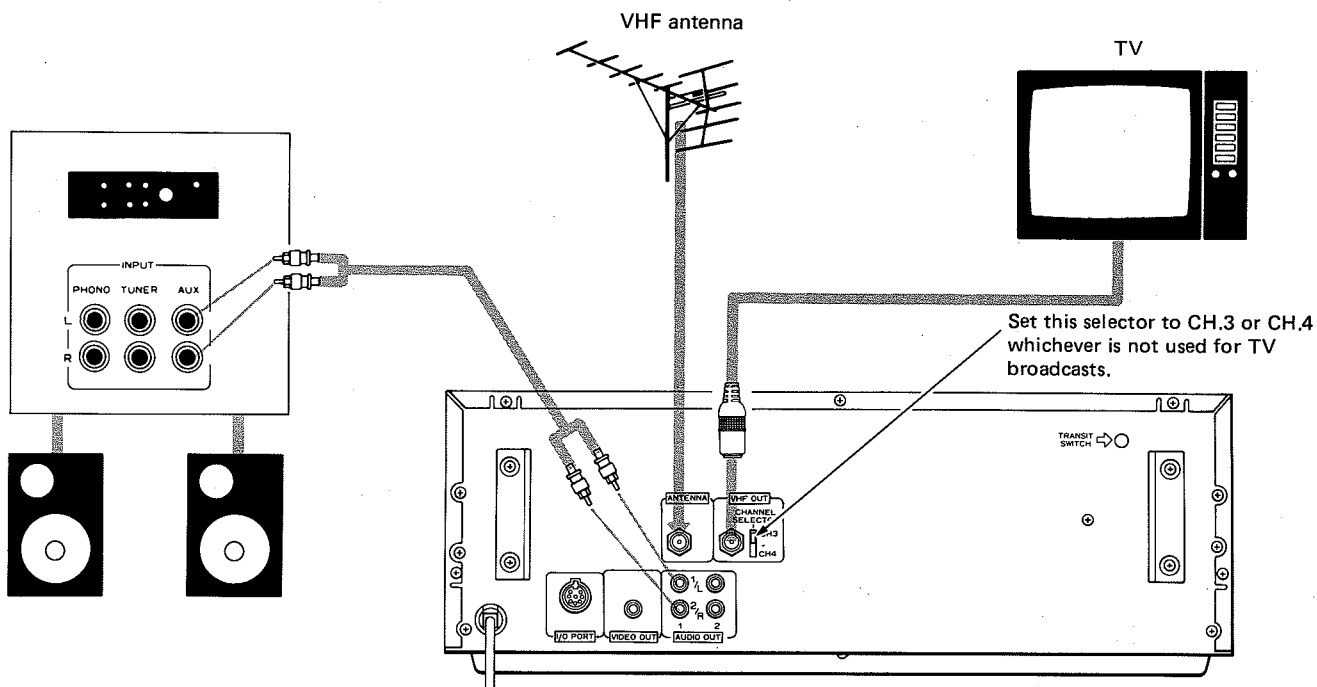

Illustration not applicable to "S/G" models.

NOTE: Leave the player, amplifier and TV set unplugged while connections are being made.

1. Remove the VHF antenna cable from the VHF antenna terminal(s) on your TV set, and connect the cable to the ANTENNA terminal on the player. For coaxial antenna cables (75-ohm), an F-type plug must be fitted to the end of the cable. If the 75-ohm coaxial cable does not have an F-type plug attached to its end, use the accessory 75-ohm F-type plug adapter to connect. For twin-lead feeder antenna cable (300-ohm), first prepare the wire leads, and connect them to the 300-ohm terminals of the furnished 300-ohms to 75-ohms F-type plug adapter. Then connect the adapter (F-type plug) to the ANTENNA terminal on the player.

1

ANTENNA terminal on the player

75-ohm coaxial cable preparation

1. Remove the adapter fitting.
2. Prepare the end of the cable.
3. Attach the fitting to the cable.
4. Return the fitting to the adapter.

Unit: mm

Hold with pliers.

Push through hole.

300-ohm feeder preparation

1. Cut out the center portion.
2. Twist the lead wire.
3. Loosen the adapter screws, connect the antenna wires under the toothed washers and tighten.
4. Tighten the terminal cap.

Antenna adapter

Unit: mm

2. An accessory cable with F-type plugs at both ends is supplied with the player. Connect one end of this cable to the VHF OUT terminal on the player, and connect the other end to the VHF ANT IN (75-ohm, unbal. F-type jack) terminal on your TV set. If your TV has no F-type VHF ANT IN terminal, prepare the end of the cable. If your TV has no 75-ohm antenna terminal, purchase a 75-ohm (F-type jack)-to-300-ohm adapter and connect the cable to the adapter (75-ohm terminal). Then connect the adapter's twin-lead feeder to the TV's VHF IN (300-ohm balanced) antenna terminals.

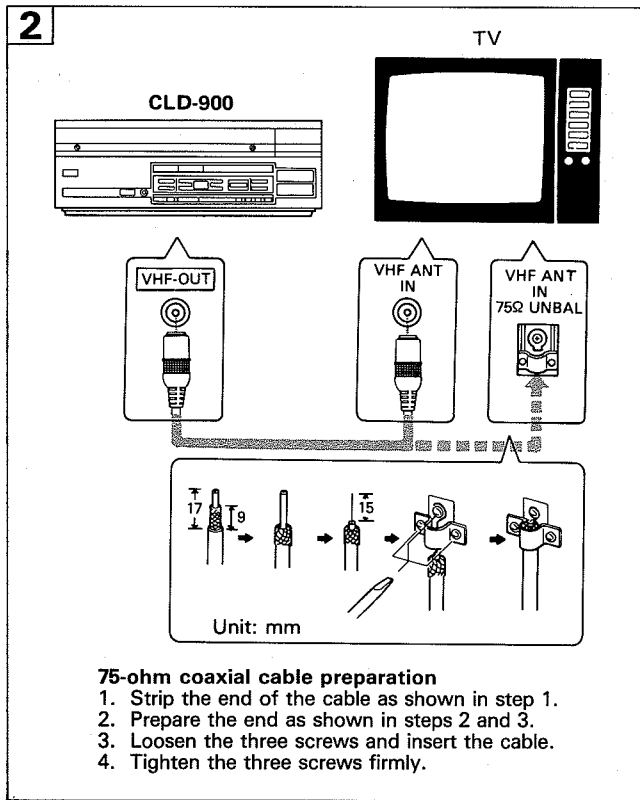

3. Next, set the VHF CHANNEL SELECTOR on the player to channel 3 or 4, whichever is not used for TV broadcasts in your area. Then set your TV to the same channel.

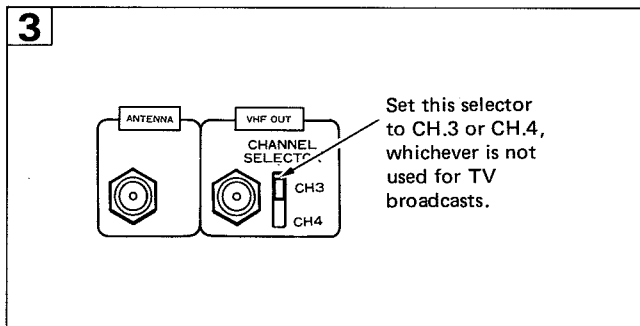

4. Use the two audio connection cords to connect the AUDIO OUTPUT 1 jacks on the player to the left and right channel AUX (or CD, TUNER) input jacks on your stereo amplifier or receiver.

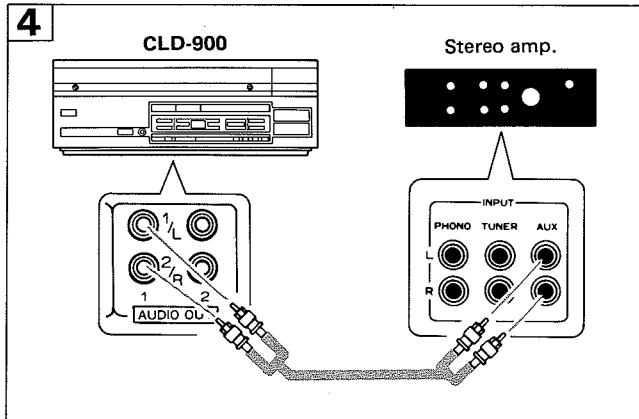

5. Plug the AC power cords of all equipment (player, amplifier and TV set) into an AC outlet.

NOTE FOR S/G MODEL

Please check that the VOLTAGE SELECTOR is set properly (Refer to page 10).

This completes the standard connection procedure for video and audio reproduction through your TV and stereo system.

WHEN USING A TV MONITOR

If you are using a TV monitor (equipped with a video input terminal), use the video connecting cable with RCA-plug to connect the VIDEO OUTPUT terminal on the player to the video input terminal on the TV monitor. Next, connect the AUDIO OUTPUT 1 jacks on the player to the audio input jacks on the TV monitor or AUX (or CD, TUNER) input jacks on your amplifier (or receiver).

PANEL FACILITIES

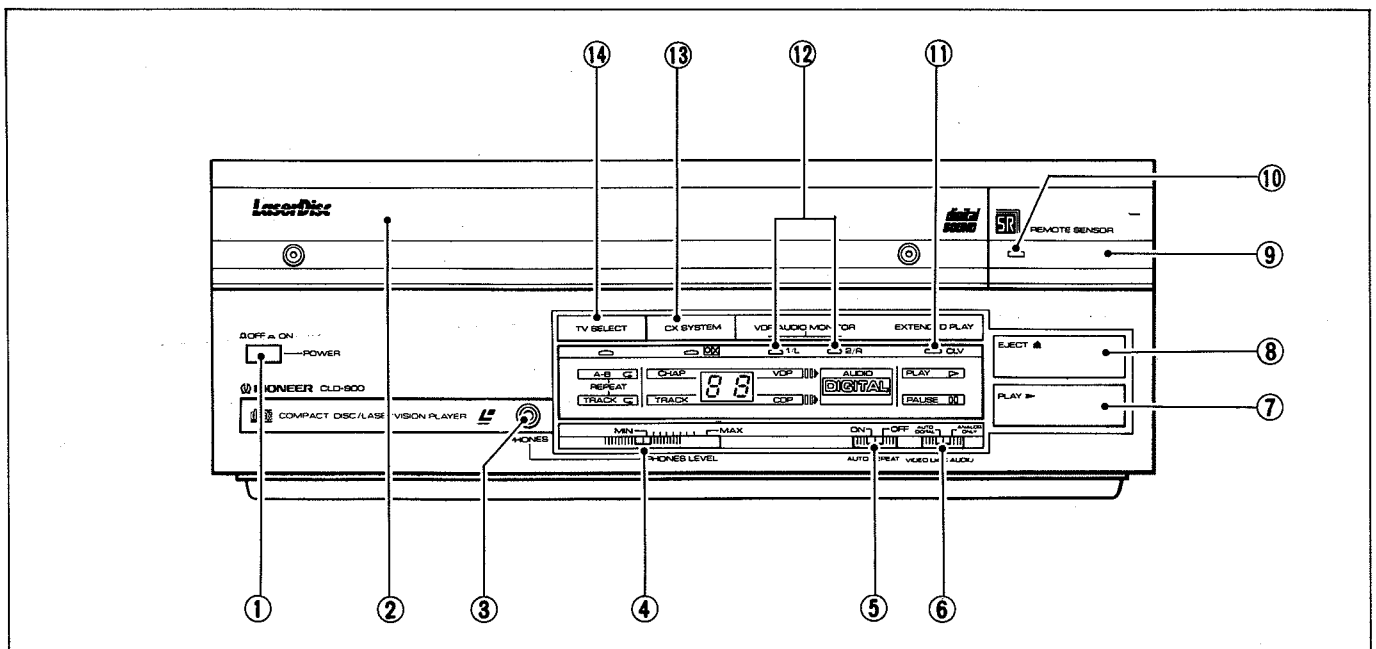
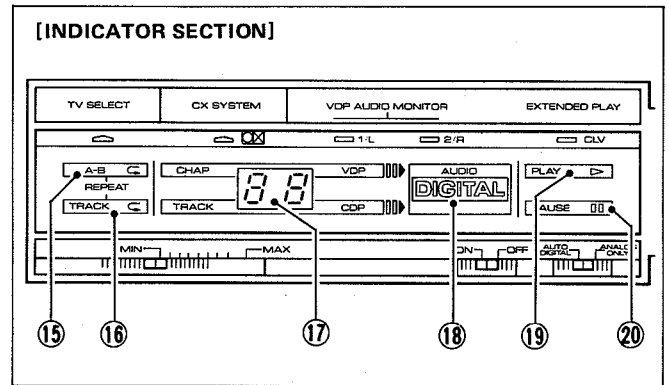

① **POWER**

② **DISC TABLE**

After turning on the POWER switch, press the EJECT button ⑧ and the disc table will open slightly towards the front. Then, pull the disc table out by hand to load discs.

③ **PHONES jack**

Connect stereo headphones here.

④ **PHONES LEVEL**

Use to control the volume level of headphones connected to the PHONES jack.

⑤ **AUTO REPEAT ON/OFF switch**

When set to ON, repeat playback of one side of the disc will be performed. When set to OFF, disc rotation will stop after one side of the disc has been played.

⑥ **VIDEO DISC AUDIO:
AUTO DIGITAL/ANALOG ONLY**

This switch is used to select the audio mode when playing back LaserVision with Digital Sound Discs. By setting this switch appropriately, the audio output from the rear panel "AUDIO OUTPUT 1" terminals can be switched between Digital Sound and Analog Sound.

AUTO DIGITAL

When set to this position, if playing back the LaserVision with Digital Sound Discs, those Digital Sound will be reproduced.

When playing back the LaserVision Discs recorded with Analog Sound only, the Analog Sound will be reproduced.

ANALOG ONLY

No matter what the LaserVision disc (with Digital Sound or not), the Analog Sound signals only will be played back.

This selector switch is unrelated to the rear panel "AUDIO OUTPUT 2" terminals since those terminals constantly output Analog Sound signals only.

⑦ **PLAY ►**

Press to begin playback.

⑧ **EJECT ▲**

Press to stop playback and remove a loaded disc. The disc table will open slightly to the front.

⑨ **REMOTE CONTROL receiver**

The infrared signals from the remote control unit are received here.

⑩ **REMOTE CONTROL indicator**

This indicator lights when the remote control unit's buttons are pressed.

⑪ **EXTENDED PLAY DISC indicator**

This indicator lights automatically when playing extended play (CLV) discs.

⑫ **VDP AUDIO MONITOR indicator**

Indicates the audio output channel (1/L, 2/R) when playing LaserVision discs.

⑬ **CX SYSTEM**

Use for turning the CX noise reduction system ON and OFF (see page 20).

⑭ **TV SELECT**

Use for switching between LaserVision disc or Compact Disc playback and VHF television broadcast reception. When the indicator goes out, LaserVision disc or Compact Disc playback is possible; when lit, TV broadcasts can be watched.

[INDICATOR SECTION]

⑮ **A—B (interval) REPEAT indicator**

Lights when performing repeat play of an interval between two selected points.

⑯ **TRACK REPEAT indicator**

Lights when performing repeat playback of a single track on a Compact Disc.

⑰ **Numeric display (CHAP./TRACK)**

When playing back a LaserVision disc, displays the "chapter" number presently being played back. When playing back a Compact Disc, displays the "track" number presently being played back.

When playing back LaserVision discs without recorded chapter numbers, no chapter numbers are displayed.

⑱ **DIGITAL indicator**

Lights when playing LaserVision with Digital Sound Discs, or when playing Compact Discs.

⑲ **PLAY indicator**

Lights when the player is in the play mode. When time is required between the pressing of the button and actual beginning of playback (for example, when first beginning play, or when performing search), this indicator will flash during that interval.

⑳ **PAUSE indicator**

Lights to indicate player is in the pause mode.

REMOTE CONTROL UNIT FACILITIES

The accessory remote control unit can be used during playback of both LaserVision discs and Compact Discs. Some buttons have different functions when used with LaserVision discs and Compact Discs; these buttons appear in the following colors when used with the two disc modes:

Blue: Function used only with LaserVision discs.

Green: Function used only with Compact Discs.

Buttons appearing in other colors have same functions with both kinds of discs.

[WHEN PLAYING BACK VIDEO DISCS]

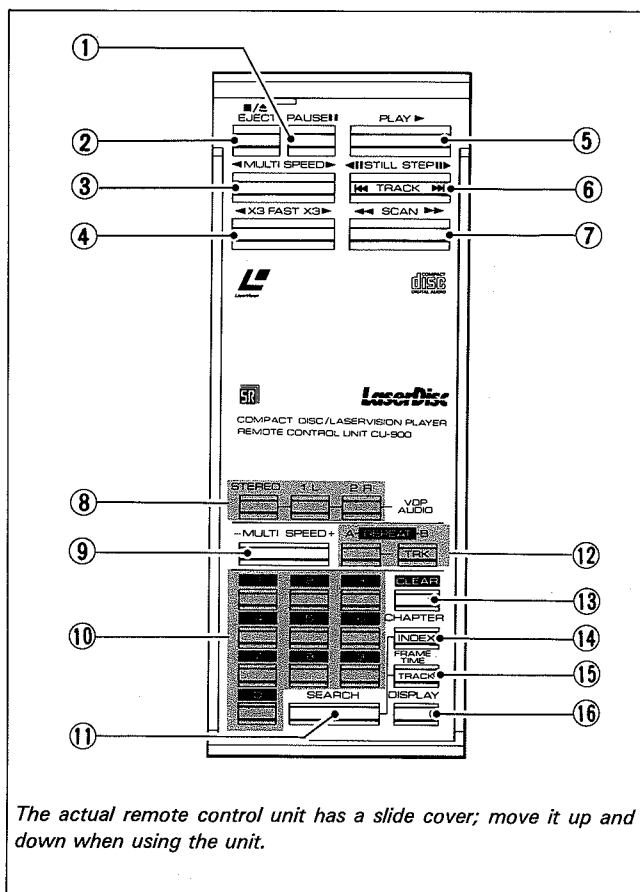

The actual remote control unit has a slide cover; move it up and down when using the unit.

① PAUSE (||)

Press to temporarily halt playback.

To release the player from the pause mode, press once again.

② EJECT (■/▲)

When this button is pressed, playback is stopped, and the disc rotation ceases. When pressed once again, the disc table will open after the disc stops rotating.

③ ◀ MULTI-SPEED ▶ (Standard play discs only)

When the right side (▶) of the button is pressed, the video image will be sent forward at the speed set with the -MULTI-SPEED+ button.

When the left side (◀) of the button is pressed, the video image will be sent backwards (see page 25).

④ ◀x3 FAST x3▶ (Standard play discs only)

During the time the right side (x3▶) of the button is held depressed, the video image will advance at three times normal speed. When the left side (◀x3) is held depressed, the video image will be sent backwards at three times normal speed.

⑤ PLAY ▶

Press to begin playback.

⑥ ◀◀ STILL/STEP ▶▶ (Standard play discs only)

When either the right or left side of the button is pressed, the video image will be shown as a still picture. Then, each time thereafter that the right side (▶▶) is pressed, the image will be advanced by one frame; each time that the left side (◀◀) is pressed, the image will be reversed one frame.

⑦ ◀◀ SCAN ▶▶

While right side of the button (▶▶) is held depressed, the video image will be advanced at high speed.

While left side of the button (◀◀) is held depressed, the video image will be reversed at high speed.

⑧ VDP AUDIO

Use to select the audio channel. When the power is first turned on, the audio will be reset automatically to both 1/L, 2/R.

When one of the buttons 1/L, 2/R is pressed, the audio channel corresponding to that button only will be heard. The other channel will be suppressed, and its indicator on the player's front panel will go out.

When the STEREO button is pressed, both channels will return to their original play condition.

NOTE:

- Audio reproduction is only possible in the normal play mode.
- When only one audio channel is in use, the sound is still fed to both audio output terminals (1/L, 2/R).

⑨ -MULTI-SPEED +

Use to select the playback speed during multi-speed playback (see page 25).

⑩ Numeric buttons

Use when performing search (random access).

⑪ SEARCH

Use when performing search (random access).

12 REPEAT

Use when performing repeat playback between two selected points (see page 26).

13 CLEAR

Use when correcting input numbers during the search procedures, or cancelling the search procedures. Also, use to cancel the repeat play back mode.

14 CHAPTER

Use when performing search by means of chapter numbers.

15 FRAME/TIME

Use when performing search by means of frame numbers (time numbers on extended play discs).

16 DISPLAY

Use to display and erase chapter numbers and frame numbers (time numbers on extended play discs) on the TV screen.

[WHEN PLAYING BACK COMPACT DISCS]

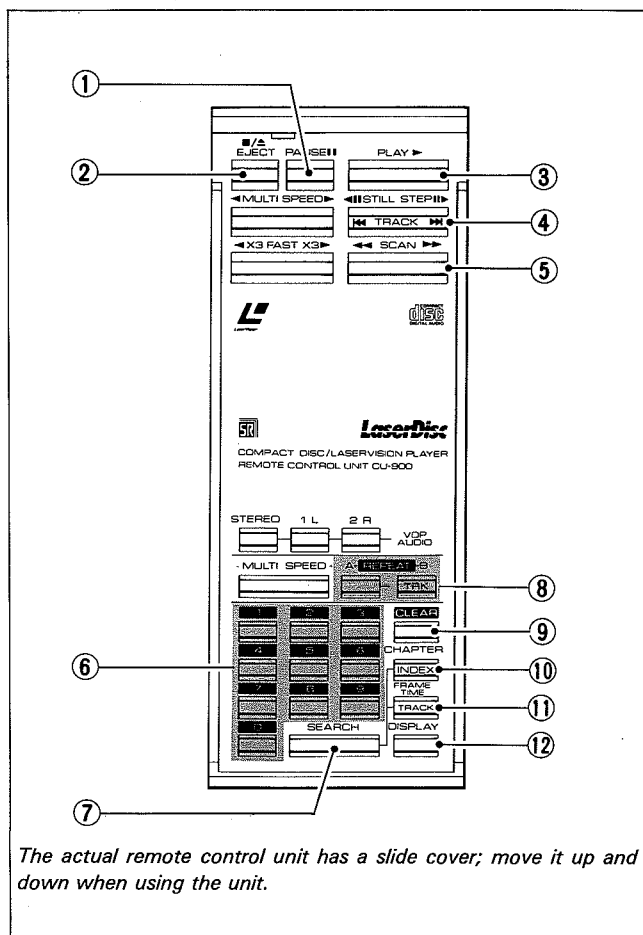

The actual remote control unit has a slide cover; move it up and down when using the unit.

1 PAUSE

Use to temporarily halt playback.

2 EJECT

When this button is pressed, playback is stopped, and the disc rotation ceases. When pressed once again, the disc table opens to the front after the disc has stopped rotating.

3 PLAY ▶

Use to begin playback, and to cancel the pause mode.

4 ◀◀ TRACK ▶▶

Use when skipping tracks search. (Skip search operation: see page 30).

▶▶: Playback moves forward to the beginning of the next track.

◀◀: Playback moves backwards to the beginning of the presently playing track.

By pressing repeatedly, any desired number of tracks can be skipped.

5 ◀◀ SCAN ▶▶

While the ▶▶ side is held depressed, the playback will be advanced at high speed.

While the ◀◀ side is held depressed, the playback will be reversed at high speed.

During the scan operation, the audio will be heard at a reduced level.

6 Numeric buttons

Use to designate specific track numbers, and index numbers within tracks when performing search.

7 SEARCH

This is the command button pressed to execute track and index search (see page 31).

8 TRK. REPEAT, A—B REPEAT

Use when performing single-track repeat playback, or repeat play of the interval between two designated points on the disc (see page 30).

9 CLEAR

Use to cancel single-track or interval repeat playback, to correct numbers used for search, and to cancel the search procedure itself.

10 INDEX

Use when performing search by means of index numbers within the track currently playing.

11 TRACK

Use when performing search by track numbers.

12 DISPLAY

Use for selecting the information to be displayed on the TV screen when playing a Compact Disc.

* INDEX refers to signals which are previously recorded on a disc and which indicate sub-divisions within a track.

OPERATION

DISC TABLE DESIGN

This player has been designed to allow playback of three types of disc: 12-inch LaserVision video discs, 8-inch LaserVision video discs, and Compact Discs.

In order to facilitate loading the respective types of disc, the disc table has been shaped with guides corresponding to the disc sizes.

Be sure to load discs properly so that they fit securely inside the guides, as shown in the illustration.

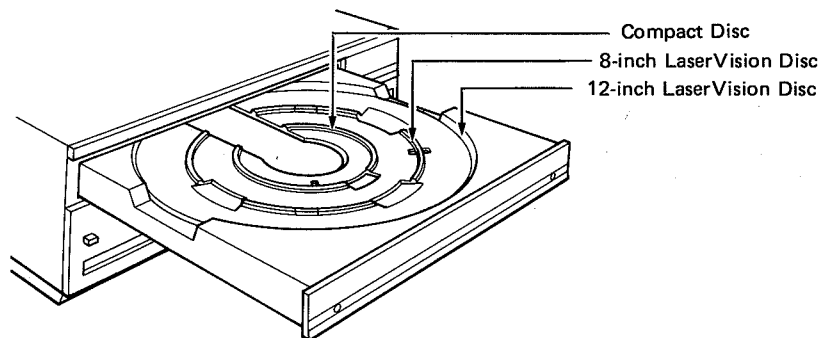

BEFORE BEGINNING PLAYBACK

Compact Discs utilize PCM (pulse code modulation) audio signals. Also, some LaserVision video discs are recorded with digital sound signals (LaserVision with Digital Sound Disc). One of the features of PCM recordings is that their dynamic range is extremely broad. As a result, be extremely careful when playing back these discs and adjust the sound volume properly in order to prevent damage to your speakers from an excessive input.

TO BEGIN PLAYBACK

**Have you loosened the transit screws?
(see page 8).**

1. Turn on your television, and set it to the empty channel in your area.

(When using a color TV monitor and stereo system, turn their power switches ON).

(When playing a Compact Disc and you do not want to display the playback information on the screen of the television (or color TV monitor), turn on the stereo system only).

2. Turn on the power to the player.
The audio indicator (VDP AUDIO MONITOR) will light, and the numeric display will show 0.
3. Press the EJECT button.
The disc table will open slightly to the front.
4. Pull out the disc table.

(To begin playback)

The illustration shows the case when loading a 12-inch LaserVision video disc.

- 1 Turn on the TV set and stereo system.

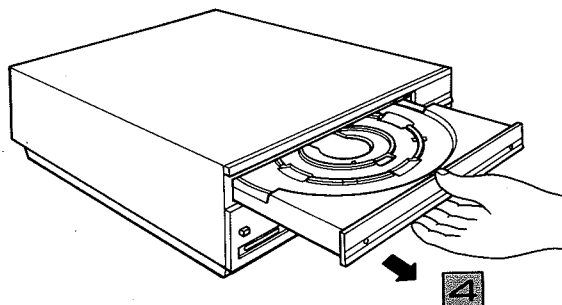
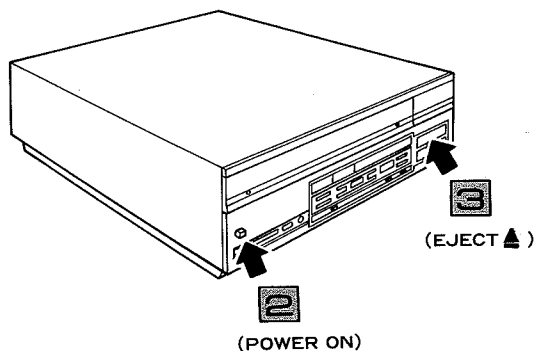

5. Load a disc.

- Whether a LaserVision video disc or Compact Disc, be sure to load the disc so that the label of the side you wish to play is facing up.
- If fingerprints or dirt adheres to the playback surface of the disc, the video and audio quality will be impaired. Before loading a disc, clean the disc's bottom surface (see page 6).

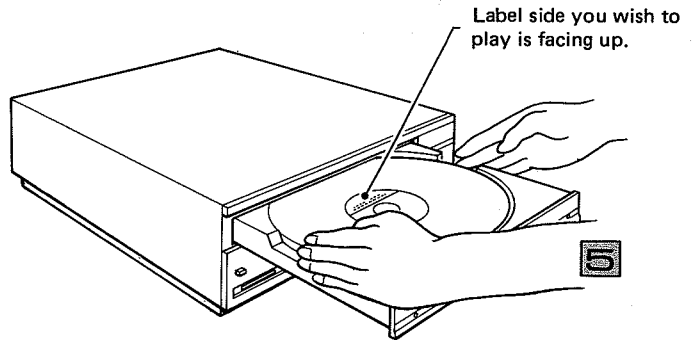

6. Close the disc table.

Slowly push in the disc table until it locks with a click.

7. Press the PLAY (▶) button.

The PLAY indicator will begin flashing. When the disc reaches its designated rotating speed, playback will begin, and the PLAY indicator will light steadily. The front panel numeric display will show the CHAPTER numbers for LaserVision video discs, and TRACK numbers for Compact Discs.

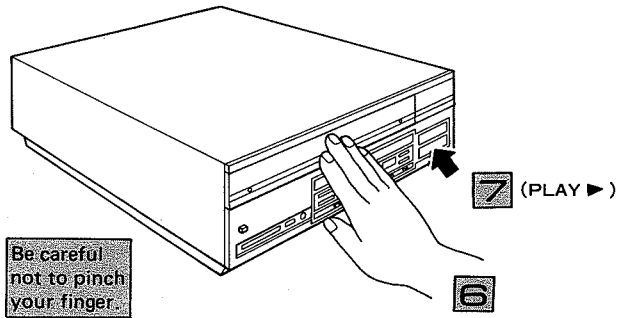

NOTE: HAVE YOU LOOSENED THE TRANSIT SCREWS?

If the transit screws fixing the internal mechanisms have not been loosened, or only loosened partway, the player will not operate properly. If the player fails to operate even though a disc has been loaded properly, check once again to make sure the transit screws have been completely loosened.

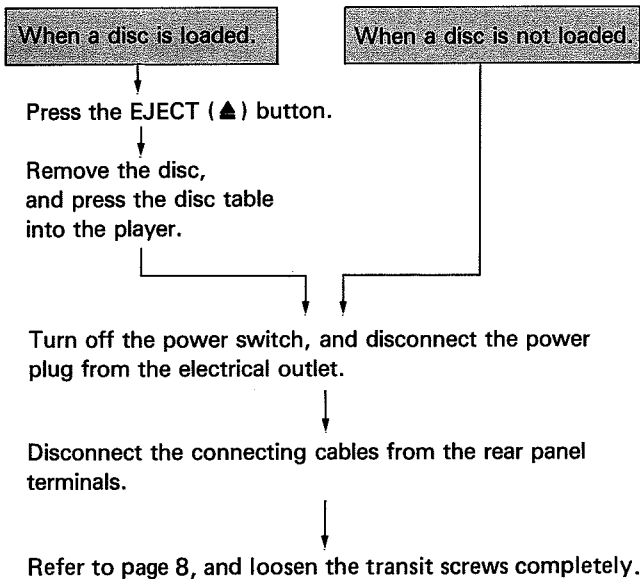

VHF CHANNEL ADJUSTMENT FOR VIDEO DISC PLAYBACK

The video and audio signals picked up from the video disc are passed to the TV set as VHF television signals (CH3 or CH4). Channel tuning should be performed following the procedure listed below.

1. Press one of the channel selector buttons on your TV set not occupied by a broadcasting TV station.
2. Start disc playback.
3. Adjust the tuning knob of your TV set corresponding to the channel selector button pressed in step 1 above until the picture from the disc playback is at its clearest.

NOTE:

Details on tuning may be found in the instruction manual for the TV set in use.

**CX NOISE REDUCTION SYSTEM
(Functions only during playback of video discs)**

The CX noise reduction system is used to reduce noise which may be caused during recording of the disc and thus, it improves signal-to-noise ratio. When a disc marked with the CX symbol is to be played, press the CX button on the front panel. An indicator light will confirm that the CX decoder is operational.

While the CX decoder will significantly improve the dynamic range of a CX disc, the disc can be played quite satisfactorily without decoding. However, discs with no CX symbol should not be played with the CX control on. The function can be disabled by pressing the CX button again, making sure that the indicator lamp goes out.

In addition, the CX system is turned off automatically when playback stops at the end of a disc, when play is stopped manually, or the EJECT button is pressed.

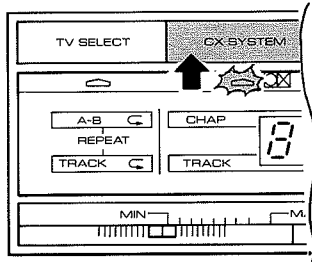

On some CX discs, a special code is recorded which automatically turns the CX system on and off. When such a disc is played, the player reads the code, and the CX system's on/off controls are performed automatically, making it impossible to turn the CX system on and off with the player's CX button. If you find during playback that the CX system does not respond to the CX button, it indicates that the CX switching is being performed automatically; it is not a malfunction.

AUTOMATIC AUDIO DISCRIMINATION FOR THE "LaserVision with Digital Sound Disc"

When playing back the LaserVision with Digital Sound Discs on this player, the player automatically discriminates between Digital Sound and Analog Sound signals. When Digital Sound signals are present, the player can automatically switch the output of the rear panel **AUDIO OUTPUT 1** terminals to Digital Sound.

Select with the front panel VIDEO DISC AUDIO switch.

AUTO DIGITAL — With LaserVision discs recorded only in Analog Sound, the Analog Sound is output from the "AUDIO OUTPUT 1" terminals; With LaserVision with Digital Sound Discs (which include Digital Sound signals and Analog Sound signals), the Digital Sound is output from the "AUDIO OUTPUT 1" terminals.

When Digital Sound is output, the "DIGITAL" indicator on the player's front panel will light.

ANALOG ONLY — Even when Digital Sound signals are recorded, the player will output only the Analog Sound.

The rear panel "AUDIO OUTPUT 2" terminals are capable of Analog Sound signals only (Digital Sound signals cannot be output here). Also, the audio for VHF output is based on Analog Sound signals.

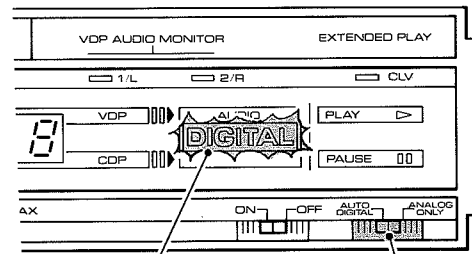

Lights when set to "AUTO DIGITAL" and a LaserVision with Digital Sound Disc is played. **AUTO DIGITAL** ↔ **ANALOG ONLY**

During Compact Disc Playback

When playing back a Compact Disc, the "DIGITAL" indicator lights. The Compact Disc audio is output only from the "AUDIO OUTPUT 1" terminals, and is not output from the "AUDIO OUTPUT 2" or "VHF OUT" terminals.

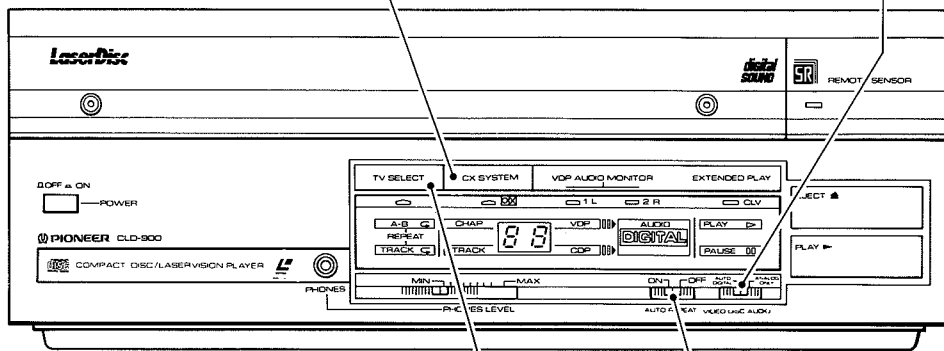

**AUTO REPEAT SELECTION
(both Video Disc and Compact Disc)**

By setting the front panel AUTO REPEAT switch, the player can be set for repeat playback following the end of one side of a disc.

ON: When the play mode comes to an end on one side of a disc, player performs continuous repetitive play.

OFF: When the play mode comes to an end on one side of a disc, playback is stopped, and the disc ceases rotating.

For normal playback, set to the OFF position.

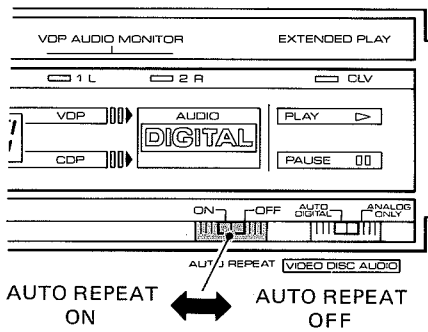

TO STOP PLAYBACK

The player operation following completion of disc playback can be selected in advance by setting the front panel AUTO REPEAT switch (see AUTO REPEAT SELECTION).

To stop a disc midway through playback, perform the following procedures:

1. Press the EJECT button on the player or on the remote control unit.

- When the player's EJECT button is pressed, the disc will stop rotating, and the disc table will open slightly.
- When the remote control's EJECT button is pressed once: Disc will stop rotating.
Pressed twice: Disc will stop rotating, disc table will open.

2. Pull out the disc table.

3. Remove the disc.

Always remove the disc after playing it, and return it to its jacket or case and store in a vertical position.

4. Close the disc table.

Always close the disc table after use in order to prevent dust and dirt from adhering to the pickup lens inside the player.

5. Turn off power.

TO WATCH A TELEVISION BROADCAST

When a VHF television antenna has been connected in accordance with the procedures given in these operating instructions, television broadcasts can be received normally by meeting either of the following conditions:

- **Turn off the player's power switch ...** The VHF television antenna will be connected to the TV through the player.
- **Turn on the TV indicator ...** Press the TV SELECT button on the player's front panel. The indicator will light, and the VHF television antenna will be connected to the TV through the player.

NOTE:

Even when the indicator lights, and a television broadcast is showing on the TV screen, the player will continue in the playback mode if it has been so set.

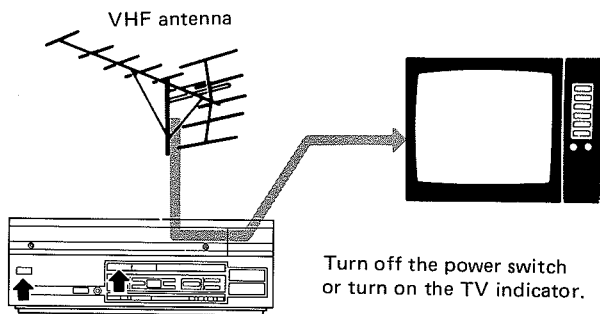

NOTE:

In the area where electric field for TV broadcasting is weak, slanting stripes may appear on the TV screen when TV SELECT button is pressed to receive TV broadcasting. This, however, does not indicate any trouble. This phenomenon will be eliminated when power switch of the player is turned off.

We advise you to turn off the power switch of the player when you enjoy a long-time TV broadcasting.

CAUTION

When the disc table is in its open (pulled out) position, do not press down on it strongly, or place items other than discs (particularly, heavy items) on it. Forcing the disc table up or down when it is in its open position may cause damage to the player. It is also dangerous since, depending on the installation location, it may even cause the player to fall over. When not using the player, always be sure to push the disc table into the player.

OPERATION WITH THE REMOTE CONTROL UNIT

When operating the remote control unit, point the front part of the unit at the remote control receiver on the player. The remote control unit may be used within a range of several meters from the player. When a command from the remote control unit is received by the player, the indicator on the player front panel lights.

NOTE:

- Even if the remote control unit is operated within the effective range, remote control operation may be impossible if there is any obstacle between the player and the remote control unit.
- If the player is operated in the vicinity of other appliances generating infrared rays, or if other remote control devices using infrared rays are used near the player, the player may operate improperly. Or the reverse, if the player's remote control unit is operated in the vicinity of other appliances which use an infrared remote control device, the other appliance may operate improperly.
- When the unit is not to be used for a long period of time (more than one month), remove the batteries to prevent them from leaking inside the compartment. If leakage takes place, wipe up the liquid inside the compartment and replace the batteries with new ones.
- Do not place books or other objects on the remote control unit since they might depress the buttons and run down the batteries.

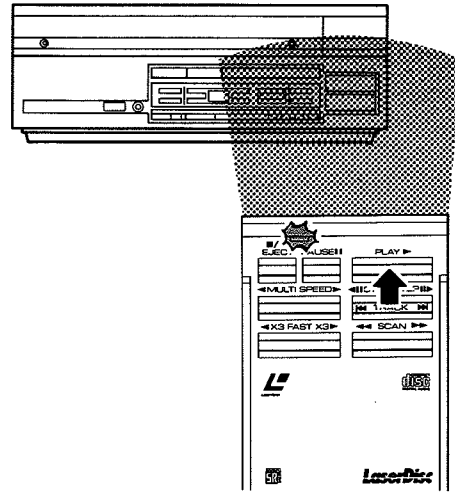

The ◀◀ SCAN ▶▶, ◀x3 FAST x3▶, ◀ MULTI-SPEED ▶, -MULTI-SPEED+, and ◀|| STILL/STEP||▶ (◀◀ TRACK ▶▶) buttons on the remote control unit are rocker type switches, so they will not operate if you press the center of the buttons.

REMOTE CONTROL OPERATION FOR LASERVISION VIDEO DISC

AUDIO REPRODUCTION

Look at the audio indicator on the player's front panel. When playback of a disc is begun, the audio portion is also automatically played. Audio indicators 1/L and 2/R will both light, indicating that both audio channels are being played back.

NOTE:

Audio reproduction is only possible in the normal play mode.

When you wish to listen to only one of the audio channels, for example when playing a disc recorded in two languages, press either the 1/L or 2/R button, corresponding to the audio channel to which you wish to listen. The player will switch to the audio channel corresponding to the button pressed, and the indicator for the other audio channel will go out.

NOTE:

When only one audio channel is in use, the sound is still fed to both audio outputs.

When playing discs recorded with stereo sound, check to make sure that both the 1/L and 2/R audio indicators are lit. If one of the indicators is not lit, press the STEREO button to turn the indicator for the other channel on.

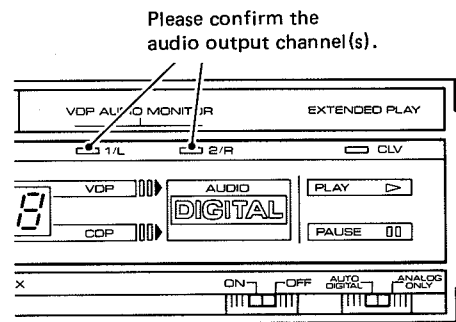

Please confirm the audio output channel(s).

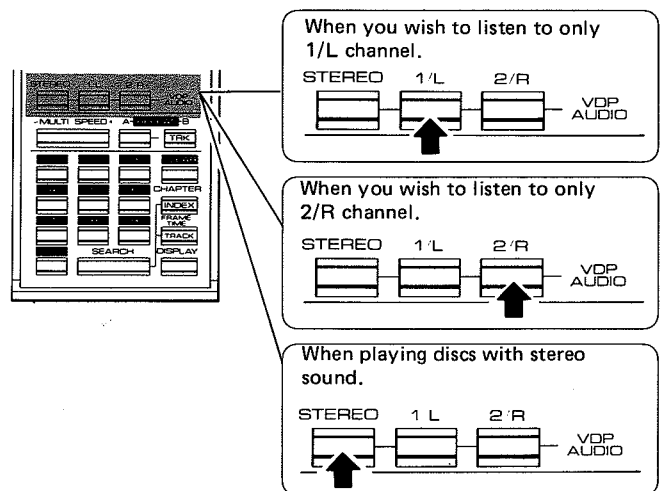

PAUSE

Operation is interrupted at the point where you press the PAUSE button, and the video picture disappears from the TV screen. The pause indicator will light during the pause mode. To resume playback, press either the PAUSE, PLAY, or SCAN button.



◀◀ SCAN ▶▶

This is for quickly finding a particular point in the program from which you wish to play the disc. Scanning continues in the forward direction for as long as you keep the ▶▶ marked end of the SCAN button depressed. Scanning continues in the reverse direction for as long as you keep the ◀◀ marked end of the SCAN button depressed. The player returns to the previous mode when you release the SCAN button.

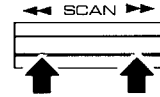

CHAPTER/FRAME (TIME) DISPLAY

Discs have recorded on them CHAPTER numbers—corresponding to the “chapters” of a book, and FRAME numbers—corresponding to a book’s “pages” (extended play discs have TIME numbers [unit: minutes] showing the elapsed playing time from the beginning of the disc’s program, instead of frame numbers). These CHAPTER numbers and FRAME (TIME) numbers are alternately displayed and erased on the screen each time the DISPLAY button is pressed.

NOTE:

When playing a disc which does not have recorded chapter numbers, no chapter numbers will be shown on the screen even if the DISPLAY button is pressed. As a result, the chapter stop and chapter number search operations explained below cannot be performed.

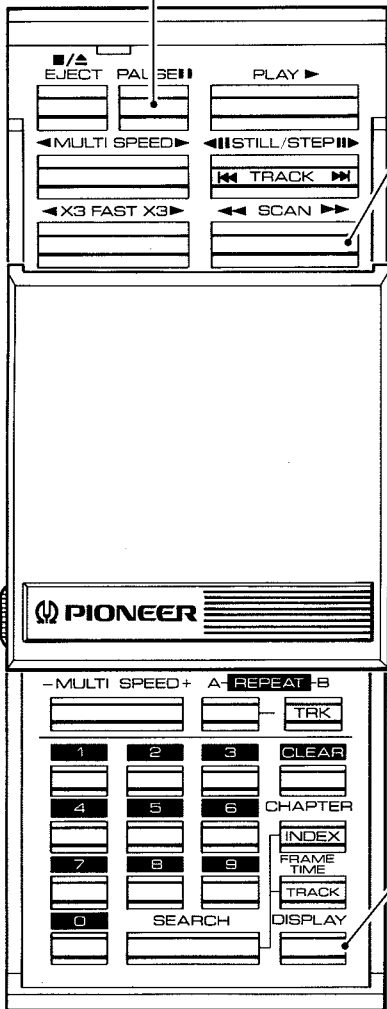
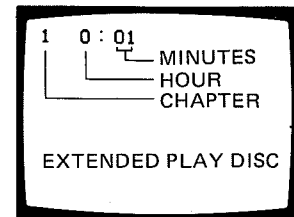
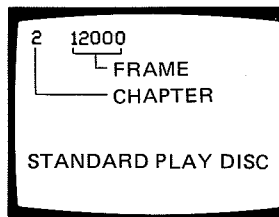

AUTOMATIC PICTURE STOP (only for discs recorded with picture stop code)

The player has a function called “automatic picture stop” which freezes the program at the frame designated by a specially recorded code in the video disc. The freeze frame occurs when the player is in the normal play or NORM * 1, SLOW or STEP of MULTI-SPEED mode. When the automatic picture stop has occurred, simply press the PLAY button to release the freeze frame.

CHAPTER STOP

On discs which have more than one chapter on a side, it is convenient to be able to skip from the middle of one chapter to the beginning of the next chapter. To do this, first press the DISPLAY button so the chapter number is displayed on the TV screen. Then press the ►►-marked end of the SCAN button. Keep pressing the button and the disc will be scanned to the beginning of the next chapter. Scanning stops automatically when the beginning is reached, and the player switches back to the previous function mode with standard play discs; on extended play discs, however, it switches to the normal play mode. Release the SCAN button at this point; scanning will not continue, even if you keep the button depressed. Likewise, if you wish to return to the beginning of the chapter being played, display the chapter number on the TV screen and press the ◀◀-marked end of the SCAN button. Release the SCAN button when the beginning of the chapter is reached.

NOTE:

The chapter stop function cannot be used with some home-study and other special discs. Depending on the disc used, chapter stop operation may not function, but this is not a malfunction.

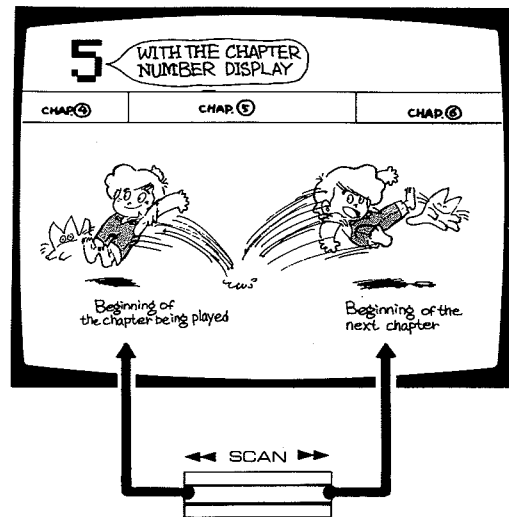

◀|| STILL/STEP ||▶ (standard play disc only)

Press this button for still video reproduction or step-by-step reproduction of a frame. Pressing either end of the button will produce a still video image. Then each time you press the ►► marked end of the button, the image will advance to the next frame, each time you press the ◀◀ marked end of the button, the image will go backwards to the preceding frame.



◀x3 FAST x3▶ (standard play disc only)

Press and hold the x3► marked end of the FAST button to play the disc at three times normal speed in the forward direction. Press and hold the ◀x3 marked end of the FAST button to play the disc at three times normal speed in the reverse direction. Fast play continues for as long as you keep pressing the button, and audio is not reproduced during the fast play. The player returns to the previous mode when you release the FAST button.

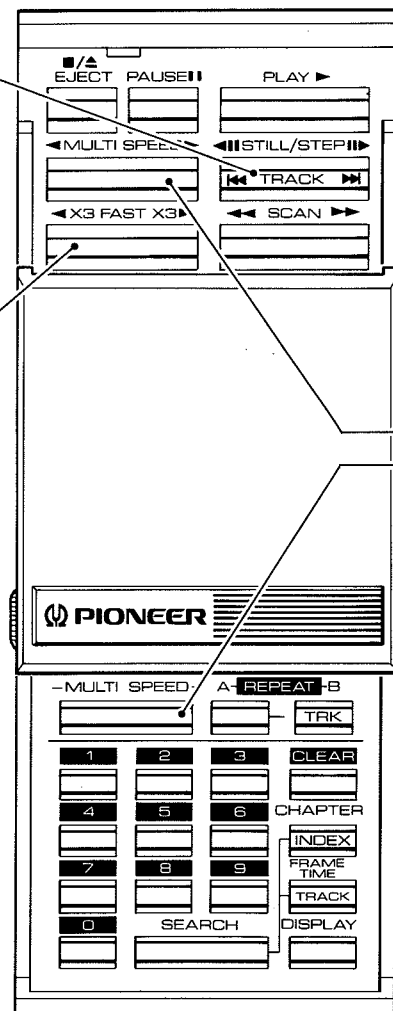
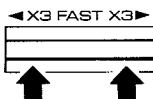

◀ **MULTI-SPEED** ▶
(standard play disc only)

With this function, you can choose from a fast 3-times normal playback speed to an ultra-slow, one frame every 3 seconds, allowing you to enjoy playback at whatever speed you desire.

When the ▶ marked end of the MULTI-SPEED button is pressed, the picture moves forward, and when the ◀ marked end of the MULTI-SPEED button is pressed, it reverses direction. By using the -MULTI-SPEED+ button, you can select from the following 9 speed levels:

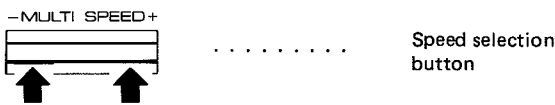
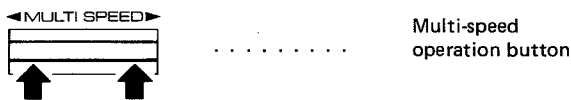

The speed of the multi-speed mode is automatically reset to SLOW /4 whenever the power is switched on.

To change the set speed, use the -MULTI-SPEED+ button. Each time the (+) side is pressed, the multi-speed function is set alternately to SLOW /2 → NORM *1 → FAST *2 → FAST *3.

Each time the (-) side is pressed, the function is set in the slow direction, SLOW /8→SLOW /16→STEP 1→STEP 3.

While the button is held depressed, the newly set speed is displayed on the TV screen.

When a speed is set, it will be memorized even if you switch to another playback mode, but if the REJECT button is pressed to place the player in the stop mode, the speed will automatically be reset to SLOW/4.

The - MULTI-SPEED + button can be used to set the speed for multi-speed playback even when the player is in a playback mode other than the multi-speed mode. In this way, you can set the playback speed before actually switching to the multi speed mode.

NOTE:

- During interval repeat playback (see p. 26), the FAST *2, and FAST *3 speeds cannot be used for playback. Even if the FAST *2 or FAST *3 speeds are displayed on the screen, playback will be at the NORM *1 speed.
- During multi-speed playback, audio signals are not reproduced.

[Speed selection]

FAST *3 (3x normal play mode)
FAST *2
NORM *1 (normal play mode)
SLOW /2
SLOW /4 (1/4 normal play mode: initial setting)
SLOW /8
SLOW /16 (1/16 normal play mode)
STEP 1
STEP 3 (1 frame every 3 seconds)

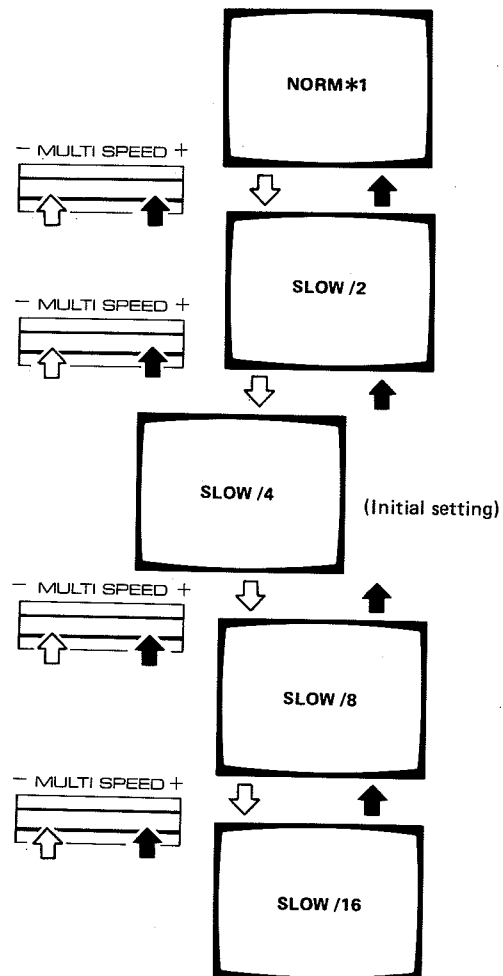

INTERVAL REPEAT PLAYBACK

This function allows you to perform repeat play (256 times) of any interval between frames which you designate.

(Repeat Playback Procedures)

1. At the beginning point of the interval you wish to repeat, press the repeat "A" button.
2. Allow the playback to continue, and when you reach the point at which you wish repeat playback to end, press the repeat "B" button. When the repeat "B" button is pressed, the player will search for the picture (frame) at which you pressed the repeat "A" button, and at that point, it will begin playback in the same mode as that the player was in when the repeat "B" button was pressed. At that time, the repeat indicator (A-B ◀) will light. When the playback reaches the picture (frame) at which you pressed the "B" button, the player will once again search for the frame at which you pressed the "A" button, and begin playback again from that point.

NOTE:

- If you press the "A" button, and then return to a point in the program earlier than that frame and press the "B" button there ("B" < "A"), the player will repeat the interval between the point at which you pressed the "A" button and the end of the program (the outermost circumference of the disc).
- Designation of the interval to be repeated can be made on standard play discs during the play, still and multi-speed playback mode. On extended play discs, it can be designated during playback in the play mode only.
- If you designate a repeat interval during multi-speed playback on a standard play disc, the "A" button will respond to inputs during forward or reverse playback, but the "B" button will respond only when playback is in the forward direction.
- The automatic picture stop function also operates during the repeat playback mode.

With standard play discs, the play, still/step, and multi-speed (▶ only) operation buttons all function during repeat playback, allowing you to change the playback mode as desired. (However, note that with the multi-speed mode, the only normal play speeds available are FAST * 2 and FAST * 3.) During repeat playback, the SCAN (◀▶, ▶▶), FAST (◀x3, x3▶), MULTI-SPEED reverse direction (◀), and PAUSE buttons do not operate.

[To Cancel the Repeat Mode]

- When the designated interval has been played back 256 times, the repeat mode will be cancelled (repeat indicator goes out).
- To cancel the repeat mode during repeat playback, press the CLEAR button.

Press

CLEAR

[EXAMPLE] To repeat the interval between frames numbered 1000 and 5000

1. At frame 1000, press the "A" button.
2. Allow playback to continue, and at frame 5000, press the "B" button.
 - The player will then search for frame 1000, and begin playback in the same mode as that the player was in when the "B" button was pressed.
 - When the playback reaches frame 5000, the player will once again search for frame 1000, and begin playback again. The player will repeat this operation 256 times.

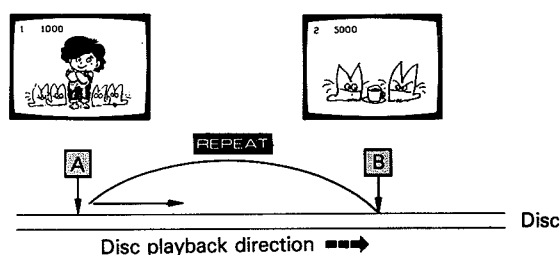

NOTICE

When playing extended play discs, playback is performed by TIME numbers (units: minutes). As a result, the interval set with the A, B buttons may not agree exactly with the actual repeat interval. For example, if the A button is pressed at any point when the display indicates TIME 0:10, and the B button is pressed at any point when the display shows TIME 0:12, the repeat playback will actually start from the beginning of TIME 0:10, and end at the end of TIME 0:12. In other words, there may be up to 59 seconds deviation between the point the buttons are pressed, and the actual start/end points of playback.

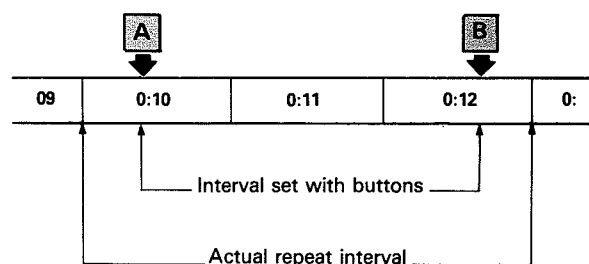

NOTE:

On extended play discs, the minimum repeat interval is 1 minute (if you press REPEAT A, B buttons in the same "TIME" number.)

[To redesignate the repeat interval during repeat playback]

Even if the player is presently in the repeat playback mode, you can change point A (beginning point) and point B (ending point), so long as they fall within the bounds of the presently repeating interval.

To change point A ... During repeat playback, if the "A" button is pressed, the frame (or time) at that point will be memorized as point A, and the former point A will be cancelled. The interval between the new point A and point B will be repeat-played, but the total number of repeat plays will still total 256, including the number of repeat plays before the new point A was designated. When a total of 256 repeat plays has been performed, repeat play will be cancelled.

To change point B ... During repeat playback, if the "B" button is pressed, the frame (or time) at that point will be memorized as point B, and the former point B will be cancelled. Repeat play will be cancelled when the interval between point A and the new point B has been repeat-played 256 times.

[To repeat-play the entire side of a disc]

If you wish to perform repeat play of all programs recorded on one side of a disc, set the AUTO REPEAT ON/OFF switch on the front panel of the player to ON.

For details, see "AUTO REPEAT SELECTION" on page 21.

RANDOM ACCESS

This function uses frame numbers, chapter numbers and time numbers to allow you to quickly display any desired picture. This operation is performed with the remote control unit while a picture is being played back.

Exercise care when performing the search operation, since if you designate a number larger than the highest chapter number, frame number (standard play discs) or time number (extended play discs) recorded on the disc, the player will search for the outermost circumference of the disc (the end of the disc's program).

**FRAME NUMBER SEARCH
(standard play disc only, with remote control unit)**

The player searches for the image at a designated frame number, and plays that image as a still picture.

[EXAMPLE] To search for frame number 12340

1. Press the FRAME/TIME button.
 - The word FRAME will appear on the screen.
2. Press 1 2 3 4 0.
 - FRAME 1 2 3 4 0 will be displayed on the screen.
 - If you press a mistaken number button, press the CLEAR button, and reenter the correct number.

To cancel the search mode, press the CLEAR button, and after FRAME 0 is displayed, press the CLEAR button once again.

3. Press the SEARCH button.
 - The present picture will disappear from the screen, and the PLAY indicator will begin flashing. When the designated frame has been found, it will be played on the screen as a still picture.
 - During the search operation, if the PLAY, or MULTI-SPEED button is pressed, playback will begin in that mode upon completion of the search operation.

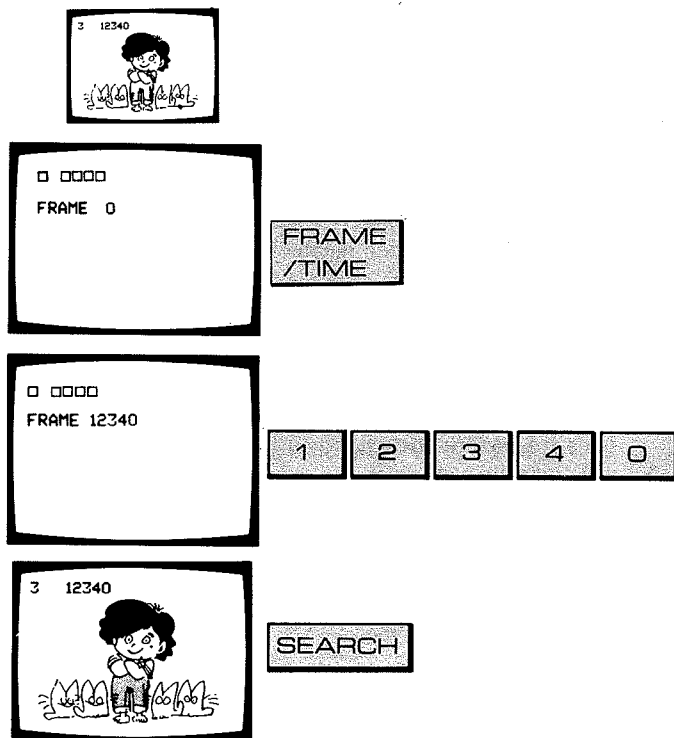

CHAPTER NUMBER SEARCH (with remote control unit)

This function allows you to search for the beginning of a program chapter.

Chapter number search cannot be performed when playing back discs on which chapter numbers are not recorded.

[EXAMPLE] To search for the beginning of chapter 3

1. Press the CHAPTER button.
 - The word CHAP. will be displayed on the screen.
2. Press 3.
 - CHAP. 3 will be displayed on the screen.
 - If you press a mistaken number button, press the CLEAR button, and then reenter the correct number.

To cancel the search mode, press the CLEAR button, and after CHAP. 0 appears on the screen, press the CLEAR button once again.
3. Press the SEARCH button.
 - The picture will disappear from the screen, and the PLAY indicator will begin flashing. When the player finds the beginning of the designated chapter, it will be played in the still picture mode on standard play discs, or the normal play mode on extended play discs.
 - On standard play discs, if the PLAY or MULTI-SPEED button is pressed during the search operation, playback will commence in the selected mode upon completion of the search.

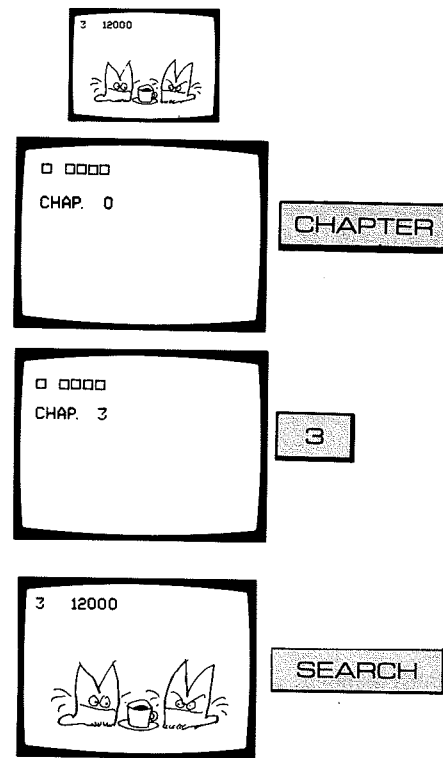

TIME NUMBER SEARCH (extended play disc only, with remote control unit)

This function allows you to search for pictures corresponding to the elapsed playing time from the beginning of a program.

[EXAMPLE] To search for the picture 12 minutes from the beginning of a program.

1. Press the FRAME/TIME button.
 - The word TIME will appear on the screen.
2. Press 1, 2.
 - The display TIME 0:12 will appear on the screen.
 - If you press a mistaken number button, press the CLEAR button and then reenter the correct number.

To cancel the search mode, press the CLEAR button, and after TIME 0:00 is displayed on the screen, press the CLEAR button once again.
3. Press the SEARCH button.
 - The picture will disappear from the screen, and the PLAY indicator will begin flashing. When the player finds the picture corresponding to the time number, it will enter the play mode.

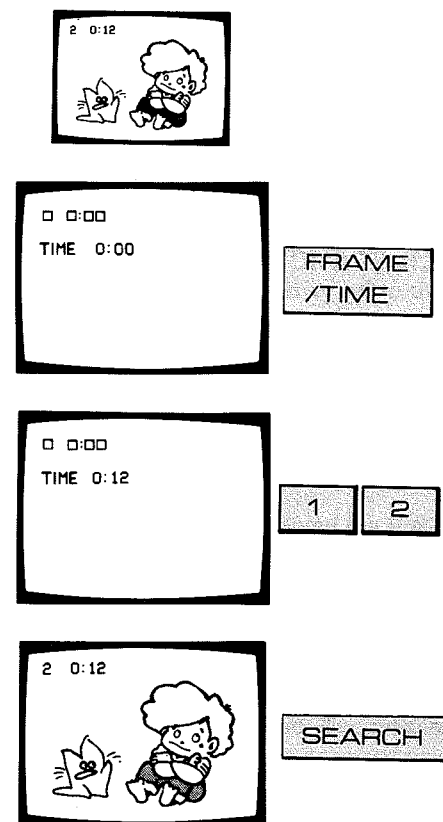

When performing a search, the search program will remain memorized until playback is stopped, the end of the program is reached, or the search designation is changed. As a result, merely by pressing the FRAME/TIME, and SEARCH buttons, or the CHAPTER and SEARCH buttons, you can perform the same search that you performed earlier.

REMOTE CONTROL OPERATION FOR
COMPACT DISC

TELEVISION SCREEN INFORMATION
DISPLAY

Information about the Compact Disc playback (currently playing track number, index number, elapsed time from beginning of current track) can be displayed on the screen of the television or color TV monitor connected to the player.

In addition to the above information, the DISPLAY button can be used to display REMAIN (remaining time from current position to end of disc), or TOTAL (the total number of tracks recorded on the disc and their total playing time).

(At beginning of playback)...Track number, index number, minutes, seconds.

Press DISPLAY

Track number, index number, minutes, seconds,
REMAIN remaining time

Press DISPLAY

Track number, index number, minutes, seconds,
TOTAL total number of tracks, total playing time.

Press DISPLAY

Track number, index number, minutes, seconds

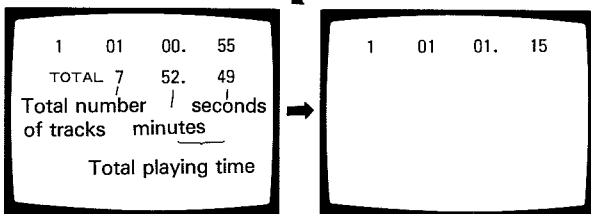
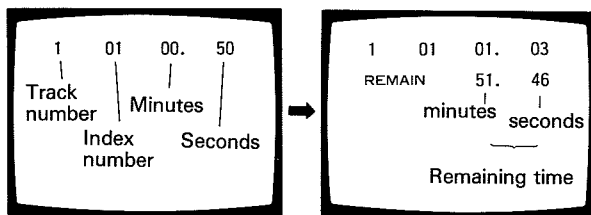

When performing skip search, track search, index search, and repeat playback, during the time that the player is searching for the playback starting point the screen will display the word "SEARCH."

◀◀ SCAN ▶▶

After beginning Compact Disc playback, this button can be pressed to move the pickup forward or back at high speed. This function operates only while the button is held depressed; the playback sound is simultaneously diminished.

- ▶▶ marked end is depressed: Forward direction
- ◀◀ marked end is depressed: Reverse direction

When the button is released, the player returns to normal-speed playback. If the button is pressed when the player is in the pause mode, the pickup can be moved quickly forward or backward without sound being produced, and when the button is released, the player will return to the pause mode.

NOTE:

If scan is performed to the end of a disc, the player will enter the pause mode. If scan is performed in the reverse direction all the way to the beginning of a disc, the player will stop at the beginning of the first track, and enter the pause mode.

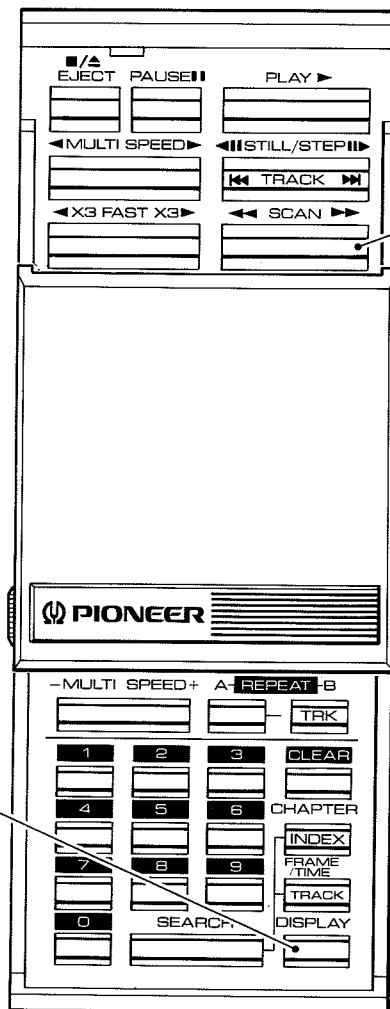

SKIP SEARCH

During normal playback, if the ►►I marked end of the button is pressed, the player will search for the beginning of the next track on the disc, and if the I◄◄ marked end of the button is pressed, the player will search for the beginning of the presently playing track.

If skip search is performed from the pause mode, the player will return to the pause mode after performing the search. The numeric display will indicate the track number of the track being searched.

If the button is pressed repeatedly, you can skip over any number of tracks to find a particular track. Operate the appropriate end of the button until the desired track number appears in the display.

NOTE:

- When performing search in the reverse direction, be sure to note the number of times the button must be pressed. When the I◄◄ button is pressed once, the pickup will return to the start of the presently playing track; when pressed a second time, the pickup will return to the beginning of the previous track.
- If the search operation is performed past the last track on the disc, the pickup will return to the first track on the disc.

When you wish to designate a specific track number for playback, see the section "TRACK SEARCH" on page 31.

SINGLE-TRACK REPEAT PLAY (TRK. REPEAT)

During disc playback press the TRK. button. The track currently playing at the time the button is pressed will be played repeatedly.

When single-track repeat is initiated, the front panel TRACK REPEAT indicator will light.

NOTE:

Be sure to press the TRK. button only after confirming that the desired track has begun playing. When performing single-track playback of the first track on a disc, do not press the TRK. button while the PLAY indicator is flashing, since the desired track will not be detected and the repeat function will not operate properly.

CANCELLING SINGLE-TRACK REPEAT

Press the CLEAR button. The TRACK REPEAT indicator will go out, and when the currently playing track finishes playing, the player will move to the next track.

NOTE:

If you operate such functions as SCAN, SKIP SEARCH, TRACK SEARCH and INDEX SEARCH during repeat playback, the repeat mode will be release.

INTERVAL REPEAT PLAY (A—B REPEAT)

This function allows you to perform repeat playback of an interval between any two desired points within the entire disc program.

[Procedures]

1. At the point at which you wish repeat play to begin, press the REPEAT [A] button.
2. At the point at which you wish repeat play to end, press the REPEAT [B] button.

When button [B] is pressed, the player will begin searching for the point (track number, minutes, seconds) at which button [A] was pressed and begin playback from that point.

When the disc has played to the point (track number, minutes, seconds) at which button [B] was pressed, the player will once again search for point [A] and repeat playback in the same way.

When interval repeat play is begun, the front panel A—B REPEAT indicator will light.

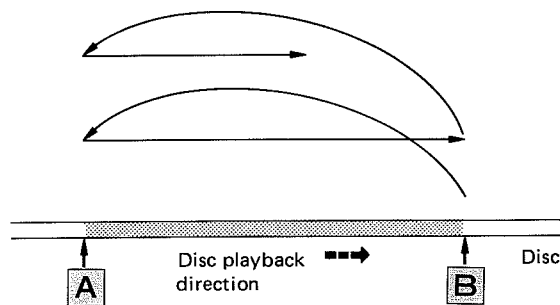

CANCELLING INTERVAL REPEAT PLAY

Press the CLEAR button. The A—B REPEAT indicator will go out, and the player will return to the normal play mode.

NOTE:

If you operate such functions as SCAN, SKIP SEARCH, TRACK SEARCH and INDEX SEARCH during repeat playback, the repeat mode will be release.

TO PERFORM REPEAT PLAY OF ALL TRACKS ON A DISC

To play all tracks on one side of a disc repeatedly, set the front panel AUTO REPEAT switch to ON. For details, see page 21.

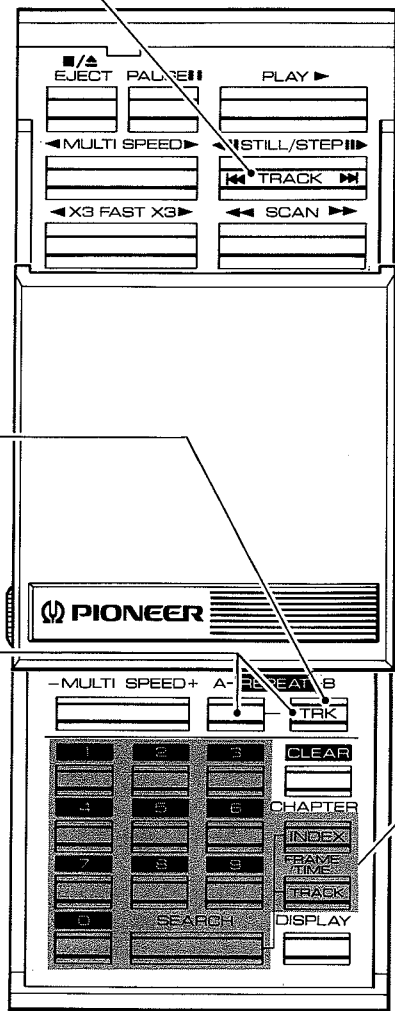

TRACK SEARCH

This function allows you to search for a desired track and begin playback from that point.

[Example] To search for the beginning of 3rd track on a disc and begin playback from that point.

Material enclosed in parentheses () refers to playback data displayed on the television screen.

1. Press the TRACK button.

(INPUT is displayed)

2. Press 3.

(The number 3 is displayed as the track number)

3. Press the SEARCH button.

(SEARCH is displayed)

In this way, the player will search for the beginning of 3rd track on the disc and begin playback from that point.

INDEX SEARCH

This function allows you to search for a desired index number (numbers indicating divisions within tracks) and begin playback from that point.

[Example] During playback of track 3, to search for the beginning of index 2 of the same track, and begin playback from that point.

1. Press the INDEX button.

(INPUT is displayed)

2. Press 2.

(The number 2 is displayed as the index number)

3. Press the SEARCH button.

(SEARCH is displayed)

In this way, the player will search for the beginning of index 2 of track 3, and begin playback from that point.

Depending on the disc, some entire tracks may be recorded as index 1.

By combining track search and index search, you can quickly find any desired index of any track on a disc.

[Example] To begin playback from the beginning of index 2 of track 5.

1. Press TRACK, 5, SEARCH.

- Player search for track 5.

Once track 5 has begun playing,

2. Press INDEX, 2, SEARCH.

- Player search for index 2.

In this way, playback will begin from index 2 of track 5.

When VCR is used

NOTE:

Assume that picture and sound are recorded using the VCR, with the VIDEO INPUT and AUDIO INPUT terminals connected to the CLD-900. If the compact disc sound is recorded with the VIDEO INPUT terminal still connected, the sound may not be recorded properly.

If this occurs, remove the VIDEO INPUT terminal plug for recording.

The compact disc playback information displayed on the TV (or TV monitor) cannot be recorded on the VCR.

Use Caution when Using the Disc

All rights reserved.

Unauthorized public performance, broadcasting or copying is a violation of applicable laws.

TROUBLESHOOTING

Before concluding that the player is out of order, please refer to this troubleshooting guide to make sure that there is not a simple remedy for the problem. The vast majority of performance problems have their source in set up errors, bad connections to other equipment, or malfunctions of other equipment (TV, stereo system). Find the trouble symptom on the chart below, and try the suggested remedies.

SYMPTOM	CAUSE	REMEDY
Disc table does not open when ETECT button is pressed.	<ul style="list-style-type: none"> • Power cord is not properly plugged into AC wall socket. • Power switch is not turned on. 	<ul style="list-style-type: none"> • Plug in power cord. • Turn on power switch.
Disc does not rotate.	<ul style="list-style-type: none"> • Power is not on. • Disc table hasn't been pushed securely into player. • Moisture has condensed on the player. 	<ul style="list-style-type: none"> • Plug in power cord. Turn on power switch. • Push in disc table slowly until it locks with a click. • Turn off the power switch, and leave it as it is for about 1 hour. Use it after the condensation disappears.
Player does not work when the function buttons are pressed.	<ul style="list-style-type: none"> • Disc is not loaded. • Transit screws have not been loosened. 	<ul style="list-style-type: none"> • Load disc correctly. • Loosen transit screws.
VDP indicator flashes and player does not operate.	_____	<ul style="list-style-type: none"> • Turn the power switch off and then on again.
Remote control does not work.	<ul style="list-style-type: none"> • Remote control unit batteries are weak. • An obstacle between the player and the remote control unit. • Remote control unit is not located in a good direction for transmission. 	<ul style="list-style-type: none"> • Replace batteries. • Remove the obstacle or shift the remote control position. • Locate the remote control unit in front of the player.

[During video disc playback]

Disc rotates but there is no picture.	<ul style="list-style-type: none"> • TV is not turned on. • Wrong connections from player to TV. • TV set is not turned to channel 3 or 4. • Player VHF CHANNEL SELECTOR is at the wrong setting. • Player is in the PAUSE mode. • TV SELECT indicator lights up. 	<ul style="list-style-type: none"> • Turn on TV. • Make correct connections. • Set TV to the channel (3 or 4) that is not used for TV broadcasting in your area. • Set selector to same channel as the TV's empty channel. • Press PLAY button. • Press the TV SELECT button and turn out the indicator.
Picture quality is bad.	<ul style="list-style-type: none"> • Bad connections between player and TV set. • Player VHF out channel is different from TV channel. • TV fine tuning has not been adjusted. • Poor disc. • Moisture has condensed on the player. 	<ul style="list-style-type: none"> • Check all connections, particularly F-type plugs. • Both TV and player must be set to the same channel (3 or 4) which is not used for TV broadcasting in your area. • Adjust TV fine tuning knob for optimum picture quality. • Try playing a different disc. If other discs give good quality, the problem is with that particular disc. • Turn off the power switch, and leave it as it is for about 1 hour. Use it after the condensation disappears.
TV no longer receives other channels after it has been connected to the player.	<ul style="list-style-type: none"> • Antenna cable has not been connected. • TV SELECT indicator is not lit. 	<ul style="list-style-type: none"> • Connect VHF antenna cable to antenna terminal on the player. • Press the TV SELECT button to make the indicator light, or turn off the player's power switch.
Special effects play cannot be performed.	<ul style="list-style-type: none"> • Playing back an extended play disc. 	<ul style="list-style-type: none"> • With extended play discs, special effects playback, such as STILL/STEP, MULTI-SPEED, and FAST cannot be performed.

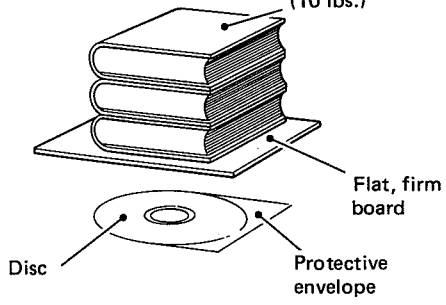
SYMPTON	CAUSE	REMEDY
<p>Particular part of a particular video disc does not playback properly.</p>	<ul style="list-style-type: none"> • The disc is damaged. • The playing surface of the disc is soiled. • The disc is warped. 	<ul style="list-style-type: none"> • Press the SCAN button to skip over the damaged portion. • Use a soft cloth and lightly wipe off the soil from the surface of the disc. If necessary, moisten a cloth with diluted neutral detergent to remove heavy dirt or fingerprints. • Put the disc into the protective envelope, then place it on a flat desk top. Subsequently, place a flat board on the disc, and load it with weights of about 4 ~ 5 kgs (about 10 lbs). If it is left in this state for one day, sometimes the warp will be alleviated. <div style="text-align: right; margin-top: 10px;"> <p>Thick book of about 4 ~ 5 kg (10 lbs.)</p>  <p>Flat, firm board</p> <p>Disc</p> <p>Protective envelope</p> </div>
<p>During STILL playback, one part of the screen does not remain still.</p>	<hr style="width: 50%; margin: 0 auto;"/>	<ul style="list-style-type: none"> • Even if the disc is a standard play disc, there may be some cases in which a fully still image cannot be obtained, but this does not mean that the player or the disc is defective.
<p>No sound output during playback.</p>	<ul style="list-style-type: none"> • MULTI-SPEED playback is being performed. 	<ul style="list-style-type: none"> • Sound is output only during the normal play mode. The audio channels are not output during other playback modes.

[During Compact Disc playback]

<p>When playback is attempted, player immediately stops, and disc table opens.</p>	<ul style="list-style-type: none"> • Disc is inserted upside down. 	<ul style="list-style-type: none"> • Insert disc correctly with label side up.
<p>No sound is produced.</p>	<ul style="list-style-type: none"> • Connecting cords are not connected properly. • Amplifier is not operated properly. • RCA plugs or amplifier input terminals are dirty. • Player is in pause mode. • The player's AUDIO OUTPUT 2 terminals are connected to the amplifier. 	<ul style="list-style-type: none"> • Connect cords securely. • Check amplifier settings and volume control. • Clean plugs and/or terminals. • Press the PLAY button. • Connect the player's AUDIO OUTPUT 1 terminals to the amplifier's AUX or TUNER input terminals. (The Compact Disc's audio playback signals are not output from the AUDIO OUTPUT 2 terminals)
<p>Sound is distorted.</p>	<ul style="list-style-type: none"> • Connections are incorrect. • RCA plugs or amplifier input terminals are dirty. 	<ul style="list-style-type: none"> • Check that the player is connected to the amplifier's AUX or TUNER input terminals. Do not connect to the PHONO input terminals. • Clean plugs and/or terminals.
<p>When playing a particular disc, loud noise is produced, or playback stops.</p>	<ul style="list-style-type: none"> • Disc is severely scratched or warped. • Disc is extremely dirty. 	<ul style="list-style-type: none"> • Use a different disc. • Clean the disc.

SPECIFICATIONS

1. General

System LaserVision video disc system and Compact disc digital audio system

Power requirement
 KU model AC120V, 50/60 Hz
 S/G model AC 110V/120V/220V/240V (switchable), 50/60 Hz

Power consumption 45 watts

Dimensions 420 (W) x 447 (D) x 168 (H) mm.
 16.5 (W) x 17.6 (D) x 6.6 (H) in.

Net weight (without package) 15.6 kg (34.5 lbs.)

Operating temperature +5°C to +35°C

Operating humidity 0 to 95%
 (There should be no moisture condensation)

2. Disc

LaserVision video disc

*Maximum playing time
 12-inch standard play disc 30 min/side
 12-inch extended play disc 60 min/side
 8-inch standard play disc 14 min/side
 8-inch extended play disc 20 min/side

Spindle motor speed
 Standard play disc 1,800 RPM
 Extended play disc 1,800 RPM (inner circumference) to 600 RPM (outer circumference)

Compact disc

Disc Diameter: 120 mm, Thickness: 1.2 mm
 *Maximum playing time over 60 minutes (stereo)
 Linear speed 1.2 ~ 1.4 m/sec

**Actual playback time differs for each disc.*

3. Video characteristics

Format NTSC specifications

Video output
 Level 1 Vp-p nominal, sync. negative, terminated
 Impedance 75 ohms unbalanced
 Terminal RCA jack

VHF output
 Channel Channel 3 or 4 (switchable)
 Impedance 75 ohms unbalanced
 Terminal F-type jack

4. Audio Characteristics

Disc	AUDIO OUTPUT 1	AUDIO OUTPUT 2
LaserVision Disc	YES	YES
LaserVision with Digital Sound Disc	YES*	YES**
Compact Disc	YES	NO

* Digital Sound/Analog Sound switching possible.

** Only Analog Sound output.

Terminal RCA jacks
 Channel

LaserVision disc playback Two channel: stereo or two individual channels

Compact Disc playback Two channel: stereo

Digital sound characteristics (AUDIO OUTPUT 1)
 Frequency response 5 Hz to 20 kHz, ±0.5 dB
 S/N (signal to noise ratio) 96 dB (1 kHz)
 Dynamic range 96 dB (1 kHz)
 Channel separation 94 dB (1 kHz)
 Wow and Flutter Quartz oscillator accuracy
 Total harmonic distortion 0.003% (1 kHz, 0 dB)

Level

AUDIO OUTPUT 1

Analog sound playback 260 mVrms (1 kHz, 40%)
 Digital sound playback 260 mVrms (1 kHz, -20 dB)

AUDIO OUTPUT 2

Analog sound playback only 260 mVrms (1 kHz, 40%)

5. Functions

Functions possible with the Remote Control Unit CU-900:

Functions	LaserVision Disc		Compact Disc
	Standard Play Disc	Extended Play Disc	
PLAY	YES	YES	YES
STOP (EJECT)	YES	YES	YES
PAUSE	YES	YES	YES
SCAN (Forward, Reverse)	YES	YES	YES
INTERVAL REPEAT	YES	YES	YES
FAST (Forward, Reverse)	YES	NO	—
STILL/STEP (Forward, Reverse)	YES	NO	—
MULTI-SPEED PLAY (Forward, Reverse)	YES	NO	—
MULTI-SPEED DISPLAY	YES	NO	—
FRAME NUMBER DISPLAY	YES	NO	—
TIME NUMBER DISPLAY	NO	YES	—
CHAPTER NUMBER DISPLAY	YES*	YES*	—
FRAME NUMBER SEARCH	YES	NO	—
TIME NUMBER SEARCH	NO	YES	—
CHAPTER NUMBER SEARCH	YES*	YES*	—
CHAPTER STOP	YES*	YES*	—
SINGLE-TRACK REPEAT	—	—	YES
ALL-TRACK REPEAT	—	—	YES
SKIP SEARCH	—	—	YES
TRACK SEARCH	—	—	YES
INDEX SEARCH	—	—	YES
PLAYBACK INFORMATION DISPLAY	—	—	YES

Functions possible with the function buttons and switches on the player.

Functions	LaserVision Disc		Compact Disc
	Standard Play Disc	Extended Play Disc	
PLAY	YES	YES	YES
EJECT	YES	YES	YES
AUTO REPEAT ON/OFF	YES	YES	YES
CX NOISE REDUCTION ON/OFF	YES**	YES**	—

* Only for discs recorded with chapter codes.
 ** Effective when using LaserVision discs with the CX mark.

Other functions (LaserVision video disc playback only)
 AUTOMATIC PICTURE STOP Only for discs recorded with picture stop code.
 DIGITAL SOUND/ANALOG SOUND SELECTION Only for LaserVision with Digital Sound Disc playback.

6. Other terminals

I/O port 8-pin, DIN
 PHONES Stereo headphones jack

7. Furnished Accessories

- Remote control unit (CU-900) 1
- Size "AA" dry batteries 2
- VHF connecting cable with F-type plugs 1
- Audio connecting cords with RCA-plugs 1
- Video connecting cable with RCA-plugs 1
- 300-ohms to 75-ohms F-type plug 1
- 75-ohms F-type plug adaptor 1
- Operating instructions 1
- Warranty card 1

NOTE:
 Specifications and design subject to possible modifications without notice, due to improvement.

PLAYER HANDLING PRECAUTIONS

OPERATING TEMPERATURE

The player can be operated in an environment of between 5° and 35°C (41° to 95°F). Do not use the player in an extremely hot or cold environment.

POWER SOURCES

The player is designed to operate on an AC power supply.

KU model: 120V, 50/60 Hz

S/G model: 110V/120V/220V/240V (switchable),
50/60 Hz

Do not use it with a DC power supply or an AC power supply of a different voltage or frequency.

POWER CORD

Handle the power cord by the plug. Do not pull out the plug by tugging on the cord and never touch the power cord when your hands are wet as this could cause a short circuit or electric shock.

Do not place furniture on the power cord or pinch the cord between two pieces of furniture. A damaged power cord can cause fire or give you a strong shock.

WHILE IN OPERATION

Do not move or bump the player while a disc is being played since this could prevent the player from operating properly and may even result in a breakdown.

THE COVER

Do not attempt to inspect or change any of the internal parts. If you open the player and touch any of the parts, you may get a strong electric shock.

CLEANING OUTSIDE OF PLAYER

- Unplug the player from the wall outlet before cleaning.
- Use a soft, clean cloth to wipe off dust and dirt accumulated on the player. If necessary, moisten a soft cloth with diluted neutral detergent to remove heavy dirt.
- Never use paint-thinner, benzene or other solvents. They react with the surface and cause color changes and melting.