

HCR3

Multi Head Embroidery Machine

INSTRUCTION BOOK

Program Ver. *2.11 ~



HappyJapan

IMPORTANT SAFETY INSTRUCTIONS...	1-1	SEWING WITH TUBULAR FRAMES	
WARNING LABELS & THEIR LOCATIONS	1-2	Installing and removing the tubular frame	
SETTING UP THE MACHINE		bracket	6-1
Connection to power source	2-1	How to hoop	6-2
Disposal of a battery	2-1	Mounting the hoop on the machine.....	6-3
Assemble machine unit.....	2-2	Cloth guard	
Machine installation	2-3	(For model HCR3-1512).....	6-3
Assemble of removable table and border frame	2-6	Starting to embroider	6-4
Removing of removable table and border frame.	2-6b	CAP FRAME (option)	
Center support	2-7	Cap frame settings.....	7-1
Assemble bobbin winder (Option).....	2-8	Installing and removing the cap drive frame...	7-2
MAIN PARTS	3-1	Normal cap frames.....	7-5
THE CONTROL BOX	3-3	Wide cap frames	7-8
DRIVE MODE.....	3-4	Starting to embroider	7-B
MENU	3-A	ADJUSTING THE THREAD TENSION	8-1
INSERTING A NEEDLE.....	4-1	ADJUSTING THE LASER POINTER (OPTION) ..	8-2
SELECT NEEDLES AND THREADS	4-2	BORER (Option).....	8-4
BACKING MATERIALS	4-3	SEWING	
BOBBIN WINDING		What to do if the thread breaks while sewing	9-1
Winding the bobbin (Option)	4-4	Stopping and resuming sewing.....	9-1
Removing the bobbin	4-5	Loss of power while embroidering	9-2
Inserting the bobbin	4-5	Moving the hoop while embroidering and then returning to	
Adjusting bobbin thread tension.....	4-5	the correct location (Position)	9-3
Inserting the bobbin case.....	4-5	Moving back to the starting point (Origin)	9-3
THREADING THE MACHINE		Going back to the beginning of the design (Top) ...	9-4
How to thread upper thread	4-6	Placing the design in the center of the selected	
HOW TO READ THESE INSTRUCTIONS, SCROLLBAR ...	4-8	embroidery frame (Center)	9-4
DISPLAYING THE PATTERN IN SETTING MODE...	4-9	Rotating and mirroring designs (Convert)	9-5
TURNING THE MACHINE ON		Starting in the middle of a design (Position)...	9-6
How to turn on the machine	5-1	Mending the faulty part of embroidery	
Calendar and clock setting.....	5-2	(Mending).....	9-7b
MESSAGES	5-3	POSITION ALIGNMENT BY DEFINING 2 POINTS ..	9-8
PREPARATION OF PATTERN DATA		POSITION	9-B
Connecting to a PC.....	5-4	Piece number.....	9-C
Reading embroidery pattern data from the PC .	5-4b	REGISTER	9-D
Reading embroidery pattern data	5-5	Entry.....	9-E
Selection of folders	5-9	Return	9-F
How to select patterns from memory ...	5-A	READING	
Erasing patterns from memory.....	5-B	Join	10-1
NEEDLE BAR SELECTION	5-E	Pattern read settings.....	10-3

PATTERNS IN MEMORY	
Locking pattern data	11-1
Trace type	11-2
Export.....	11-3
Renaming patterns.....	11-5
Copying pattern data.....	11-6
Moving pattern data	11-7
Renaming folders.....	11-9
Sort	11-A
Thread break report	11-B
Retrieve built-in design data	11-C
Searching pattern data.....	11-D
NEEDLE BAR SELECTION	12-1
Auto setting	12-2
Thread color.....	12-4
Color change data registration.....	12-6
Color change data read	12-7
Repetition of color group setting	12-8
FRAME CONFIRMATION	13-1
Frame selection	13-2
Adjusted for embroidery area.....	13-4
User-defined frames (1 ~ 5).....	13-7
User-defined frames (6 ~ 20).....	13-A
How to change center point of frame (1 ~ 5, 6 ~ 20).....	13-H
Non registered frame	13-J
PATTERN SETTINGS	14-1
Scaling	14-2
Width adjustment	14-3
Angle.....	14-4
Repeat sewing	14-5
Auto origin.....	14-7
Offset	14-8
Frame out.....	14-D
MACHINE SETTINGS.....	15-1
LOCK STITCHES.....	15-5
OPTIONAL DEVICE SETTING	15-6
LETTER.....	16-1
QUEUE.....	17-1
How to make design data for continuous embroidery ..	17-1c
Alter and Execution (Standard Mode)...	12-2
Alter and Execution (Continuous Mode) ..	17-3b
Needle bar selection and Pattern settings...	17-4
Registration of QUEUE setting	17-6
Read QUEUE setting	17-7
OTHER SETTINGS	
Create network.....	18-1
Version information and software update	18-3
Language	18-5
Calibrate.....	18-6
User maintenance mode.....	18-8
Report.....	19-1
GUIDE	20-1
SCREEN SAVER.....	21-1
i-CUSTOM.....	22-1
USER MANAGEMENT	
Registration of administrator	22-3
Registration of user.....	22-6
Selection of user (Login).....	22-8
Selection of user (Login) at power ON..	22-9
LAYOUT	22-A
SPECIFICATIONS	23-1
MAINTENANCE	
Oiling, Cleaning the air filter.....	23-1b
Cleaning the rotary hook	
Cleaning the thread cutting knife	23-2
ERRORS AND WHAT TO DO	24-1
INITIALIZING OF MACHINE SETTINGS	
Re-Initialization of machine system	25-1
Initializing of machine speed.....	25-2
HELPFUL HINTS.....	26-1
EMBROIDERY TERMS.....	26-2
BUILT-IN FONT LIST.....	26-3
BUILT-IN PATTERNS LIST.....	26-4

When using an electrical appliance, basic safety precautions should always be followed, including the following.

Read all instructions before using this appliance.



DANGER - To reduce the risk of electric shock:

1. An appliance should never be left unattended when plugged in. Always unplug this appliance from the electric outlet or switch main breaker OFF after using and before cleaning.

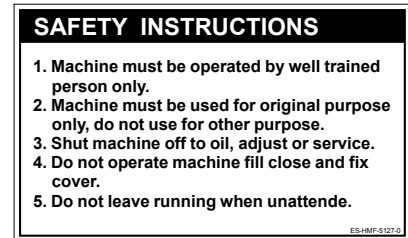


WARNING - To reduce the risk of burns, fire, electric shock, or injury to persons:

1. Do not allow to be used as a toy. Close attention is necessary when this appliance is used by or near children.
2. Use this appliance only for its intended use as described in this manual. Use only attachments recommended by the manufacturer as contained in this manual.
3. Never operate this appliance if it has a damaged cord or plug, if it is not working properly, if it has been dropped or damaged, or dropped into water. Return the appliance to the nearest authorized dealer or service center for examination, repair, electrical or mechanical adjustment.
4. Never operate the appliance with any air openings blocked. Keep ventilation openings of the sewing machine free from the accumulation of lint, dust, and loose cloth.
5. Never drop or insert any object into any opening.
6. Do not use outdoors.
7. Do not operate where aerosol (spray) products are being used or where oxygen is being administered.
8. To disconnect, turn all controls to the off ("0") position, then remove plug from outlet.
9. Do not unplug by pulling on cord. To unplug, grasp the plug, not the cord.
10. Keep fingers away from all moving parts. Special care is required around the sewing machine needle.
11. Always use the proper needle plate. The wrong plate can cause the needle to break.
12. Do not use bent needles.
13. Do not pull or push fabric while stitching. It may deflect the needle causing it to break.
14. Switch the sewing machine off ("0") when making any adjustments in the needle area, such as threading needle, changing needle, threading bobbin, or changing presser foot, etc.
15. Always unplug this appliance from the electric outlet or switch main breaker OFF when removing covers, lubricating, or when making any other user servicing adjustments mentioned in the instruction manual.

SAVE THESE INSTRUCTIONS

Safety Instruction Sticker for servicing, operating and maintaining



Caution Sticker for hot surface

(on all pulse motors, the motors may reach a certain temperature after long time running, which can reach up to 60°C)



Risk of serious finger and hand injury

Please make sure this cover is always closed and fixed via screw, only for necessary action you are allowed to open it, never leave it open while machine is running.

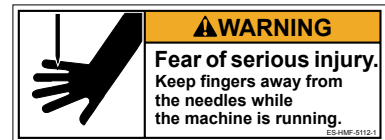


Trapping hazard wherever this label is found



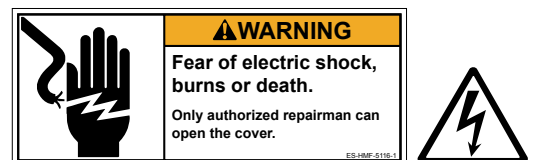
Injury risk warning for all needles

Keep fingers away from the needles while the machine is running.



Shock hazard on all electrical components

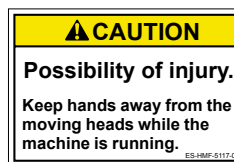
All works on electrical power cabinet must be carried out by authorized and qualified Personnel.



Trapping hazard on all moving heads,

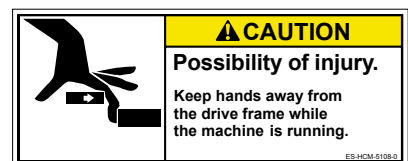
due to avoid additional stress for operator we did not cover this area, because for each time the string is broken it would necessary to remove it;

Please consult our local sales department and we will seek a solution.



CAUTION sticker for trapping hazard EN 292,

Please read carefully the instructions on this sticker (the sticker may vary for production reason)



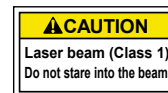
WARNING LABELS & THEIR LOCATIONS

1-3

All grooves are minimized to 8 mm,
so that fingers may not enter, however it depends on various
circumstances, the manufacturer can not foresee.

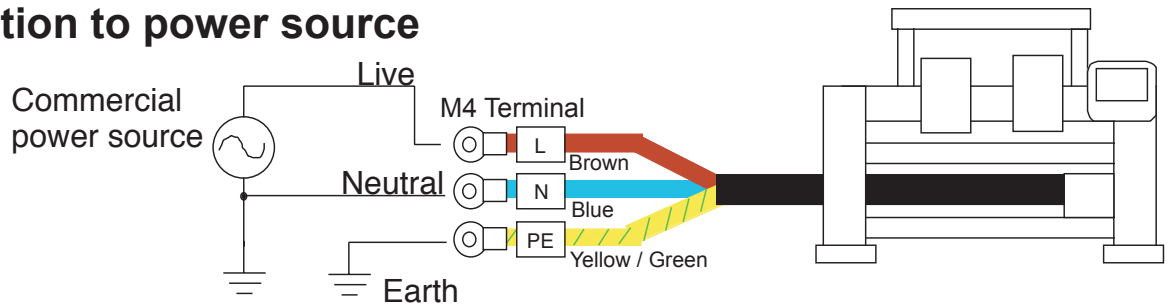


Laser beam (Class 1)
Do not stare into the beam.



SETTING UP THE MACHINE for qualified personnel only **2-1**

● Connection to power source



The power cable from the machine has 3 cords which are L(Live: Brown), N(Neutral: Blue) and PE(Earth:Yellow/Green).

Connect brown cord to Live, blue cord to Neutral and yellow/green cord to Earth.

In case a plug is used for power connection, a plug has to have more capacity than voltage and ampere of the machine (Recommendation: More than AC250V 10A), and which is following safety standard of country.

The power cable from the machine

- Across Section (Wire) 2.5mm² (AWG14) X 3
- Cord diameter (Outer) 9 - 10mm

⚠ CAUTION - Connection to power source, earth and a plug should be done by qualified electric engineer.

If there is question, please contact with service staff of a agent.

⚠ DANGER - Connect to earth tightly.

Looseness of connection to earth causes machine trouble, electric leakage and a fire.

■ In case using a breaker with electric leakage detector, please use a breaker which has detecting function for leakage of high frequency current. If breaker does not have this function, power trip can be happened frequently.

● Disposal of a battery



A battery is had built-in to this embroidery machine.

When you dispose of a battery, according to each country or a method determined in each area, please dispose appropriately.

SETTING UP THE MACHINE for qualified personnel only **2-2**

● Assemble machine unit

1. Turn the Thread guide pillar clockwise with a spanner until tight.
Fix Rear thread guide pillar with a washer and a nut (M8).

2. Install the Thread guide ass'y with supplied screws (pan head screw M4 X 8).

3. Fix Thread guide A (with spiral tube) on Thread guide ass'y with screws (M3x8) from lower side.

4. Please off all shipping blocks.

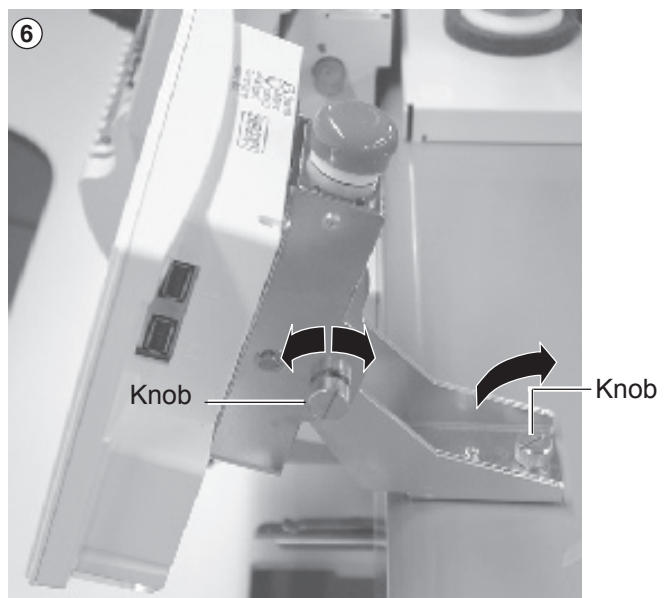
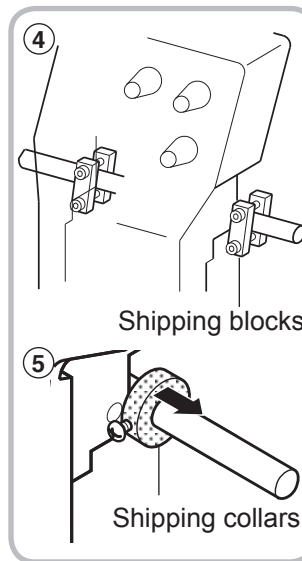
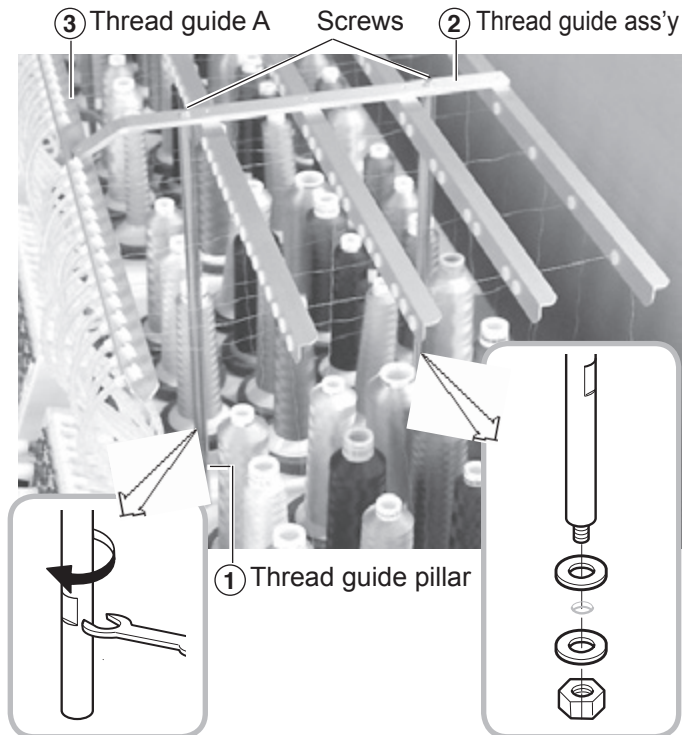
5. Unscrew and remove the Shipping collars (or blocks) that are equipped on the both side of the guide bar. (Keep the shipping collars. It is necessary when packing.)

6. Loose the Knob screw and adjust an angle of Control box, and tight the Knob screw for fixing an angle of Control box.

7. Install the Arm for tubular embroidery. Please refer to (page 6-1) "Installing and removing the frame base".

Or, Install the Cap frame for the cap embroidery. Please refer to (page 7-1) "CAP FRAME".

- When taking the machine apart in case of packing, the process is opposite of assembling the machine. Please do exactly the opposite way of assembling.
- When packing the machine up for transportation, be sure to select the eighth needle and fix it with Shipping collars on the both side of the Guide bar.



SETTING UP THE MACHINE for qualified personnel only **2-3**

● Machine installation

■ Do not run the machine before setting it properly.
Make sure of taking the following steps to set the machine.

1. Please set four Casters to machine for easy movement.

Each machine has the Caster suitable size for the weight of the machine.
Please do not put Caster from different weight machine.

2. Place Block base and Rubber mount under bolts and adjust bolts so that the machine becomes level.

Block bases and Rubber mounts are included in accessories.

At this moment, get Caster slightly risen from the floor.

As shown in Fig. 1, levelers should be placed on both sides of Head bed with Upper cover removed.

In case your machine has the center adjusters, turn the adjuster until to touch the Block base.

Check level of the machine again by Water leveler at both ends of the Head bed.

Fix Pipe covers.
Pipe covers are included in accessories.

3. Remove Needle plates and Bobbin cases from all the heads.
4. Please set main shaft position to C point and pressing down the Needle holder by your finger.

You can turn main shaft using by Six square wrench of 4mm size turns in the direction of the arrow.

5. Turn Main shaft by using the 5mm wrench in direction shown with arrow mark and set the angle of the Adjustment disk as shown in Fig. 4.

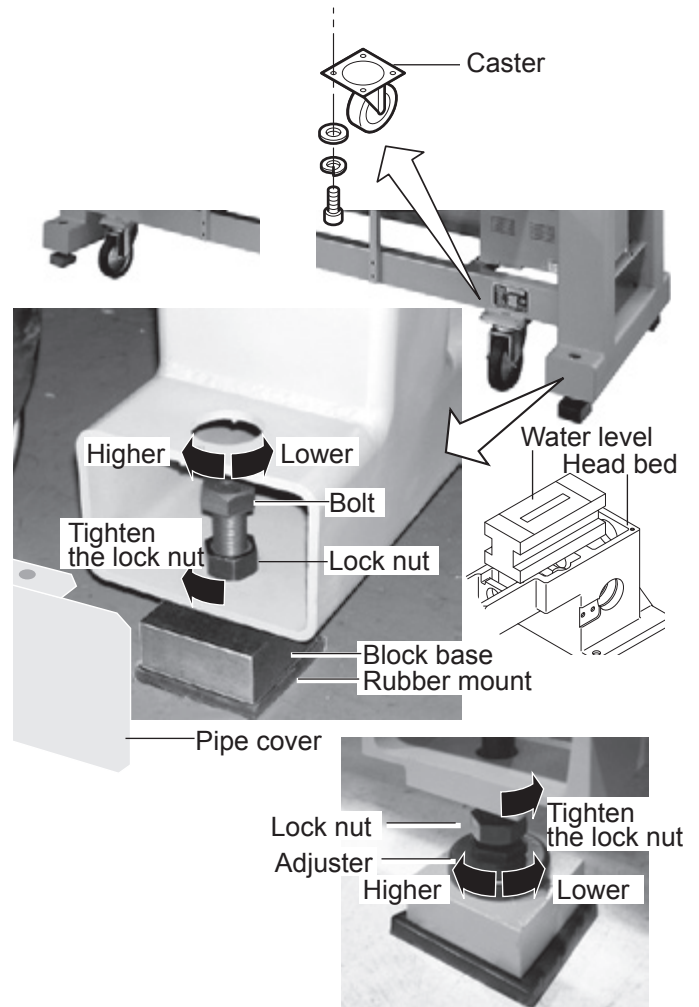


Fig. 1

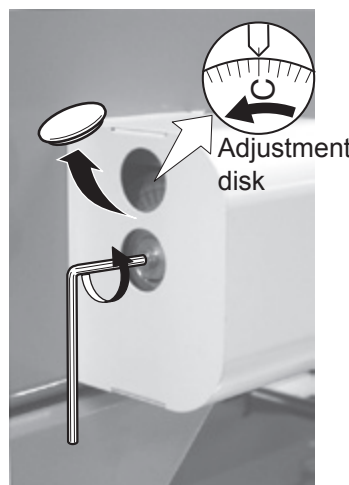


Fig. 2

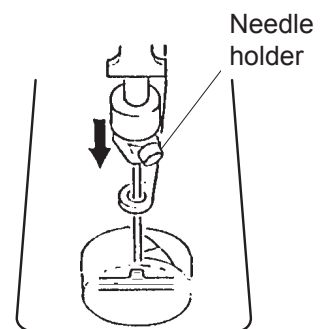
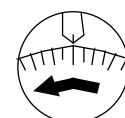


Fig. 3



L+10°

Fig. 4

SETTING UP THE MACHINE for qualified personnel only **2-4**

6. Check the needle depth on all Needles.
Pull white plastic $\phi 17$ measuring gauge in and out of Rotary hook in fig. 7.
If height gauge brushes lightly against tip of Needle, needle height is correct.
If not, loosen Needle bar block screw to adjust, then re-tighten after adjustment.
(Remove the gauge when finished).
Note: Height gauge is contained in tool box.

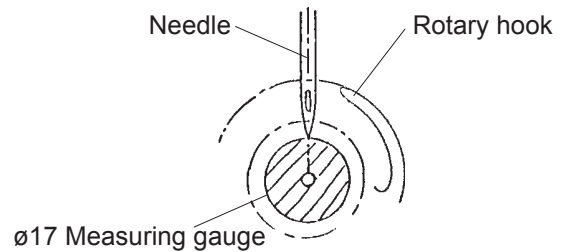
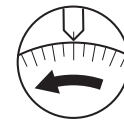


Fig. 5

7. Turn Main shaft slightly in direction shown by the arrow mark.
Then set the angle of Adjustment disc as shown in Fig. 6.
Note the space or timing between needle and tip of Rotary hook as shown Fig. 7, 8.
If the space is too open or too close, loosen 3 screws of shuttle to adjust.
Make sure to tighten 3 screws after adjusted the space.
(The timing is set exactly at the factory. However, in some cases timing is inadvertently thrown off from handling during shipment.)



L+25°

Fig. 6

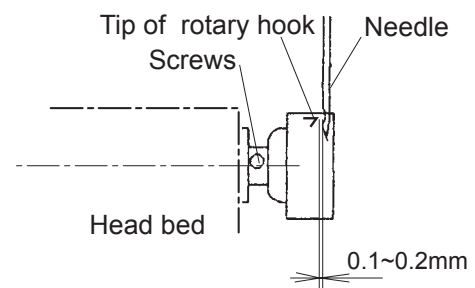


Fig. 7

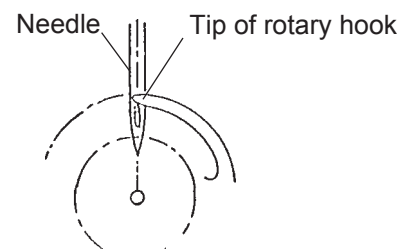


Fig. 8

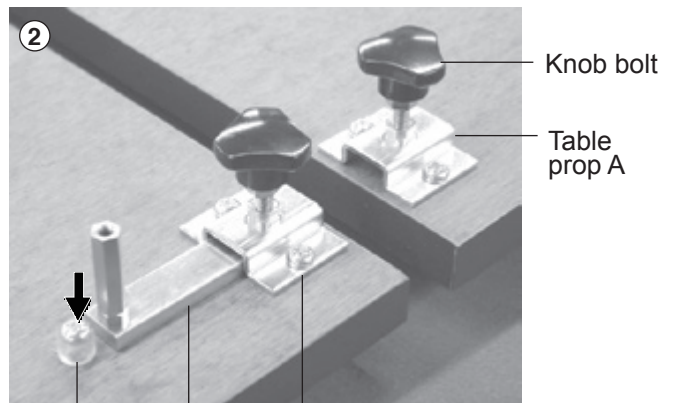
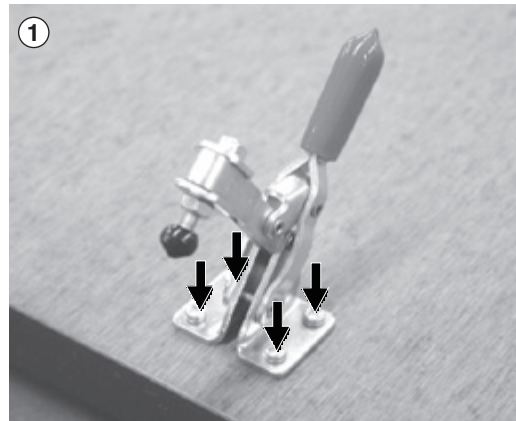
8. Turn Main shaft in direction and set to C point.
Place the Bobbin and Bobbin case in the Hook and replace the Needle plate and tighten.

9. Machine is now ready for sewing.

Installation of parts for Removable table

Table clamping parts are packed separately. Please set all Clamps when you set Removable table to the machine.

1. Please set Clamp as showing picture by 4 set screws (3.5x26mm) to back side of the Table.
2. Insert "Table prop B" to Stopper side "Table prop A".
Please set Stopper to hole for stopper.
(Set screw 3.5X16)
Please set Knob bolt.
(Except model HCR-1502, 1504)

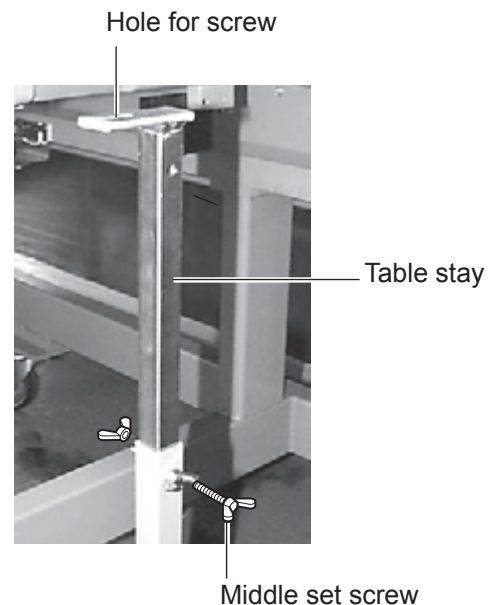


Hole for Stopper Table prop B Stopper side "Table prop A"

Turn Table stay

The Table stay setting flipped side from factory for safety purpose.

1. Please remove the Middle set screw and pulling out the Table stay.
Then insert Table stay front side of Hole for screw and insert the Middle set screw.



● Assemble Removable table and Border frame

1. Make sure that power source of the machine is off.
2. Make sure that all Rotary hook covers are shut.

⚠ If Rotary hook cover is not shut, the Table will hit Rotary hook and damage it.

3. Remove middle set screw on Table stay, extend Table stay as illustrated in Fig. 1 and insert middle set screw.



Middle set screw Fig. 1

Upper set screw

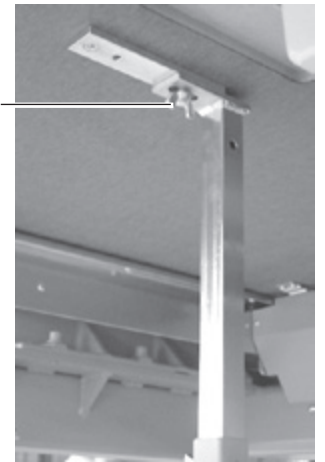
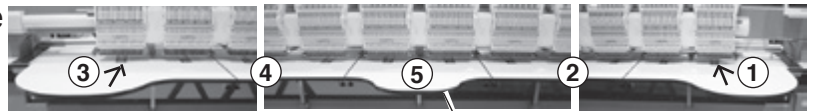


Fig. 2

4. As shown in Fig. 3, insert Removable table in order of left, right and center (last time).

As shown in Fig. 4, check rear edge of the Removable table from bottom and confirm that each table prop plate are inserted and there is no gap between Removable table and Pre-fixed table. As shown in Fig. 2, fix set upper set screw on each Table.



Removable table Fig. 3

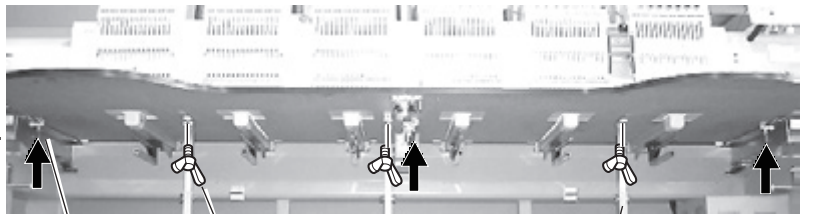


Gap between Removable table and Pre-fixed table
Table prop plate

Fig. 4

⚠ To prevent removable table from falling down, fix screws immediately.

5. As shown in Fig. 5,6, shut all clamps.



Clamp Upper set screw Table stay Fig. 5

6. As shown in Fig. 5, insert Table prop B and tighten Knob bolts. Tighten middle set screws which are inserted as step 3.



Fig. 6

7. Fix the Border frame under the bracket of the X carriage and tighten the Knob screw lightly.

Tighten Knob screw pulling Border frame toward an arrow mark (to your side).

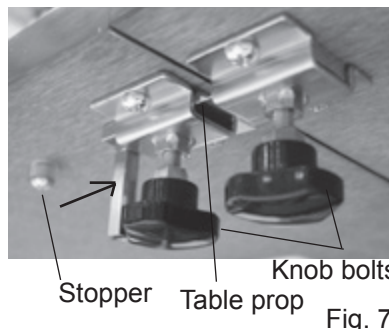
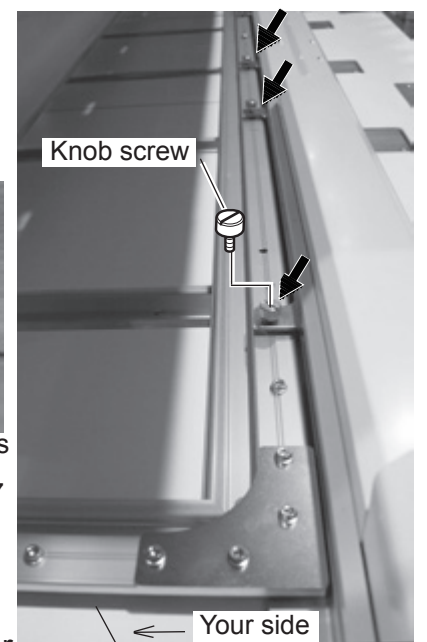


Fig. 7



Your side
Border frame Fig. 8

■ Combination of table type and number of Clamp are depending on model type.

■ Please reverse procedure when remove the Table and the Border frame.

SETTING UP THE MACHINE

2-6b

● Removing of Removable table and Border frame

1. Make sure that power source of the machine is off.

2. Make sure that all Rotary hook covers are shut.

⚠ If Rotary hook cover is not shut, the Table will hit Rotary hook and damage it.

3. Remove all knob screw indicated in arrow mark on back of the Border frame and take out Border frame slowly toward you as shown in Fig. 1.

4. Loosen all of the Knob bolts on the reverse side of the Table slightly, pull the Table prop B till it hits Stopper as shown in Fig. 2.

5. Open all Clumps indicated by an arrow mark as shown in Fig. 4, 5.

6. Unscrew set screws on Table stay in order of center, right and left, then pull out Removable table slowly toward you.

⚠ To prevent the table from falling down, be sure to take off set screws immediately before pulling out the table.

7. Remove middle set screw on Table stay, shrink Table stay as illustrated in Fig. 8 and insert middle set screw.

8. As shown in Fig. 6, 7, insert removable table to Bracket in order of right, left and center (last time) and slide it deep inside. Fix set screws on each Table.

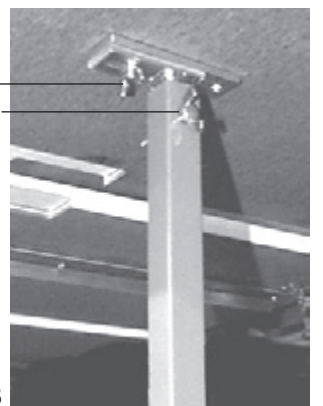
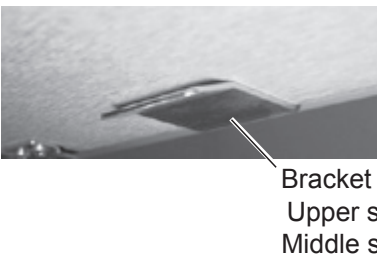
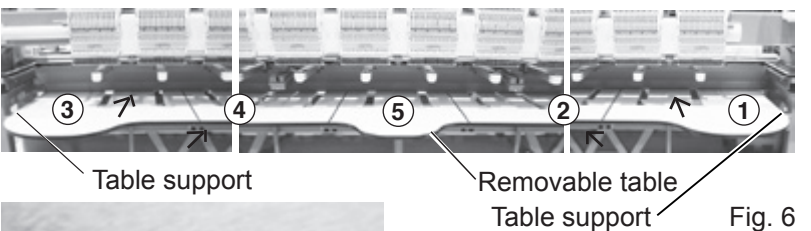
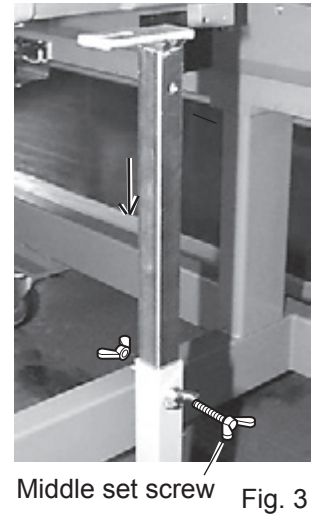
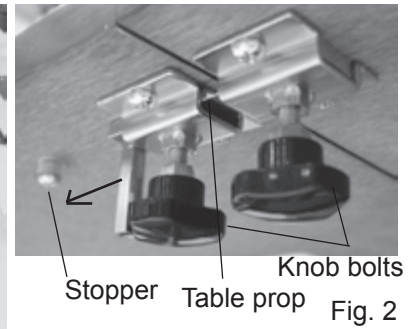
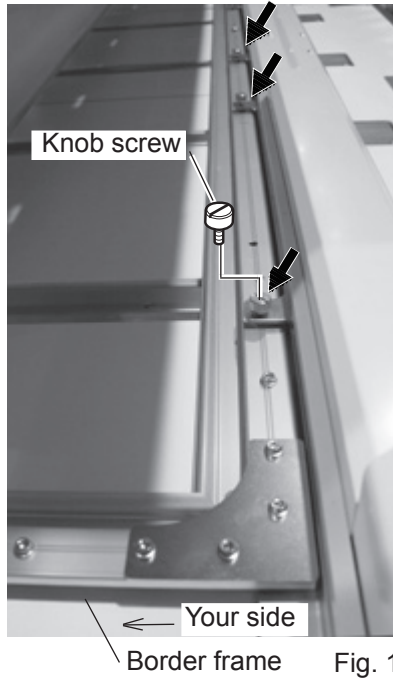
⚠ To prevent removable table from falling down, fix screws immediately.

9. As shown in Fig. 6, tighten middle set screw, shut all clamps, insert Table prop and tighten knob bolts.

■ Combination of Table type and number of Clamp are depending on model type.

■ Please reverse procedure when fix the Table and the Border frame.

Insert set screw lightly as shown in Fig. 1 for mounting Border frame and tighten set screw pulling Border frame toward an arrow mark (to your side).



● Center support

If you embroider patterns dense in stitches like wappen to the brim of border frame, front part of border frame is pulled inside by shrinkage of fabric and there is a chance that front part of border frame bends as shown in Fig.1.

If front part of border frame bends, it causes off registration.

If you embroider under such condition, please fix center support in the center of border frame.

■ Please reverse procedure when remove the table.

* If you fix center support in border frame, neighboring area is reduced by 35mm as shown.

If you misplace pattern, needle and presser foot hit border frame and cause breakage.

Please pay care in this respect.

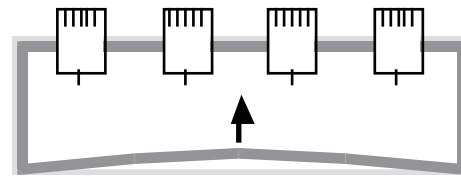


Fig. 1

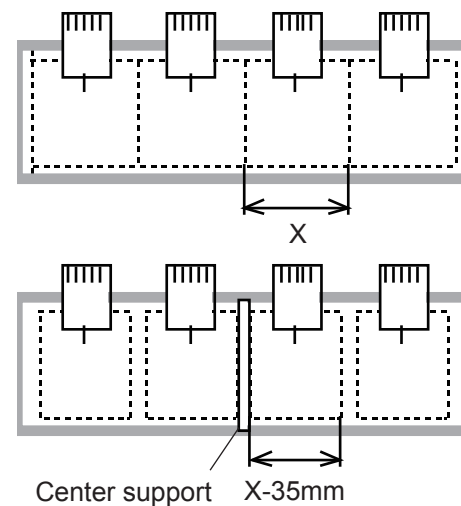


Fig. 2

1. Spread fabric in border frame and hold it with clips.

2. As shown in Fig. 3, fix center support in the center of border frame with set screws.

At this moment, long fixing hole should face toward you.

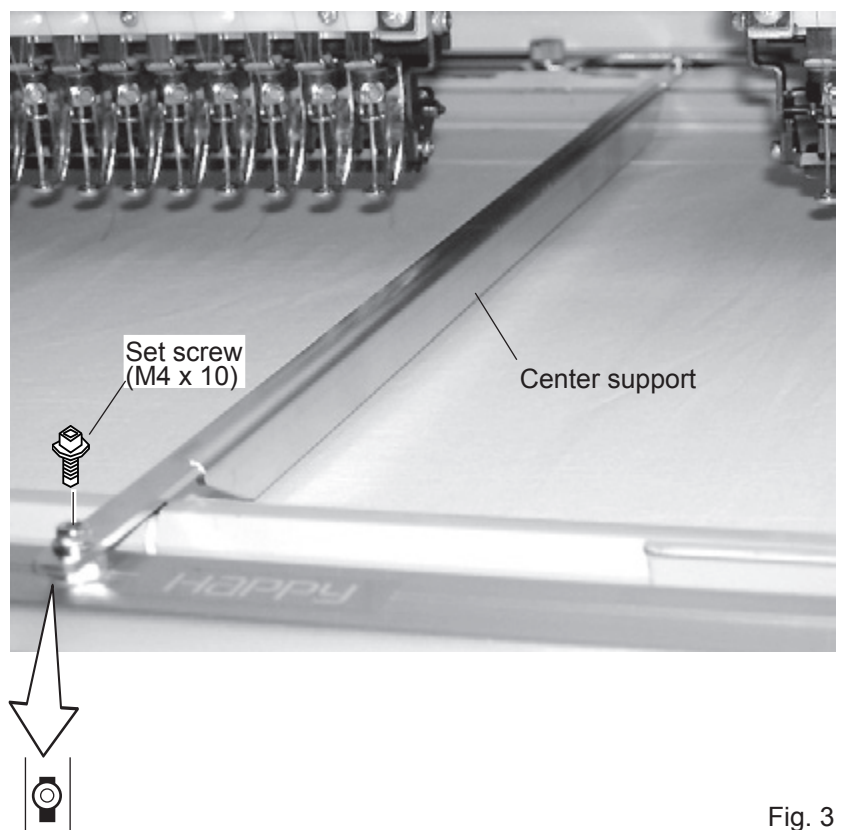
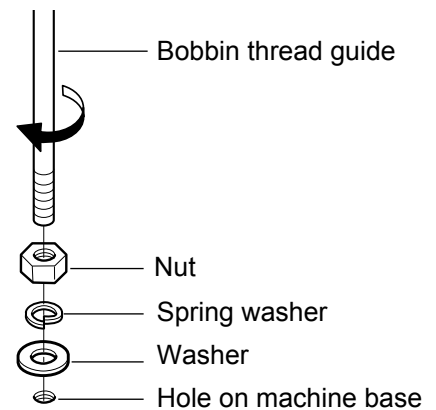


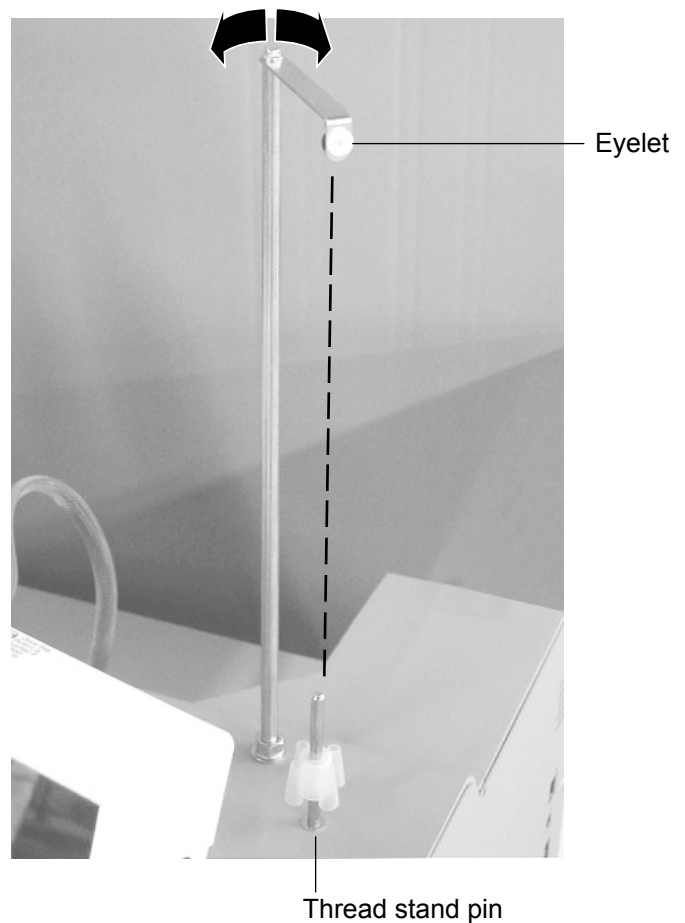
Fig. 3

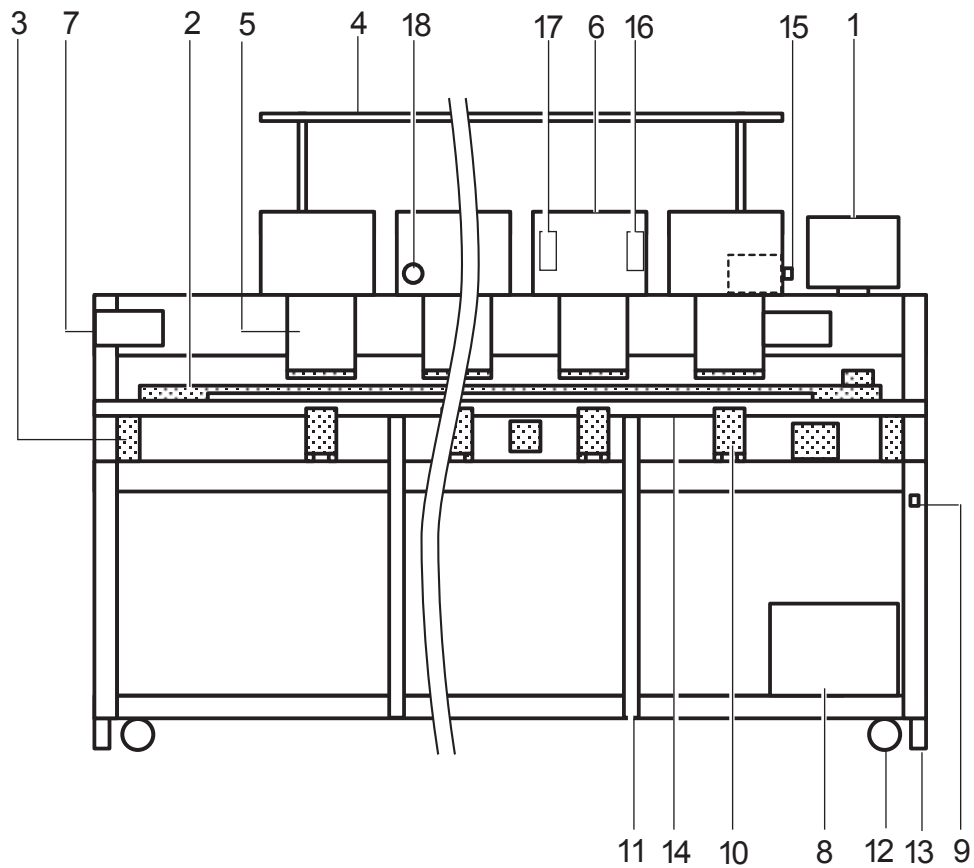
● Assemble bobbin winder (Option)

1. Attach nut, spring washer and washer to the bobbin thread guide, then fix into the hole on machine base, which is located behind of control box.



2. Adjust a position of eyelet on bobbin thread guide to a position above of thread stand pin, and fix nut.



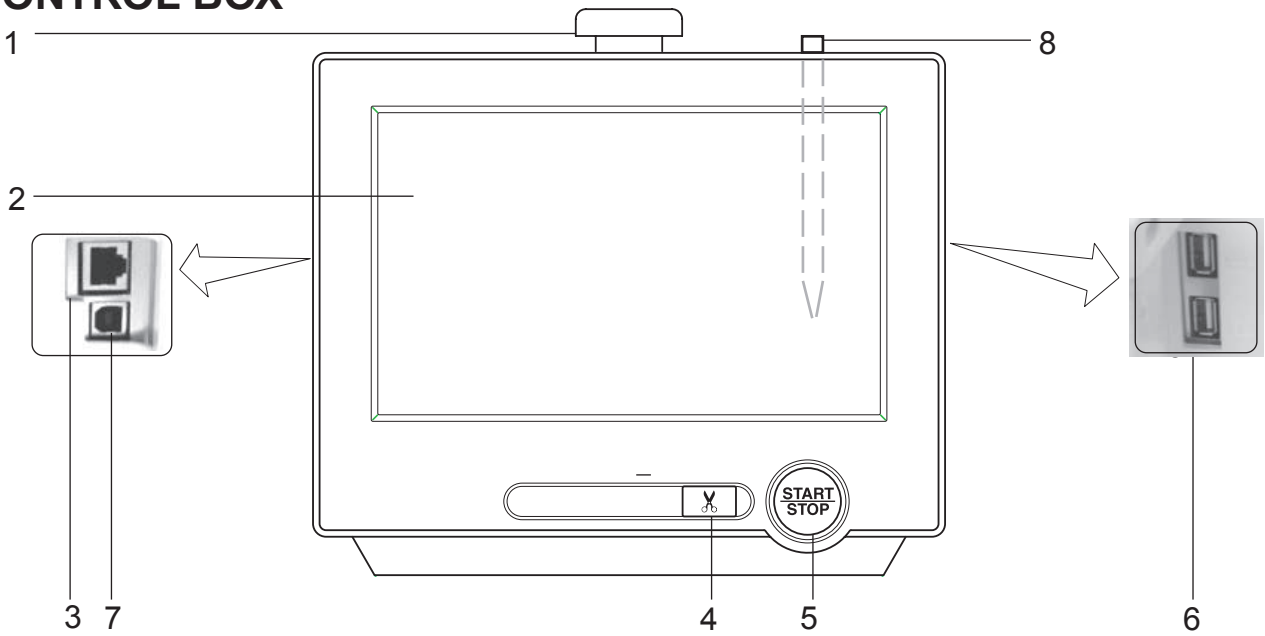


- 1. Control box
- 2. X carriage
- 3. Y carriage
- 4. Thread cone stand
- 5. Head
- 6. Thread tension unit

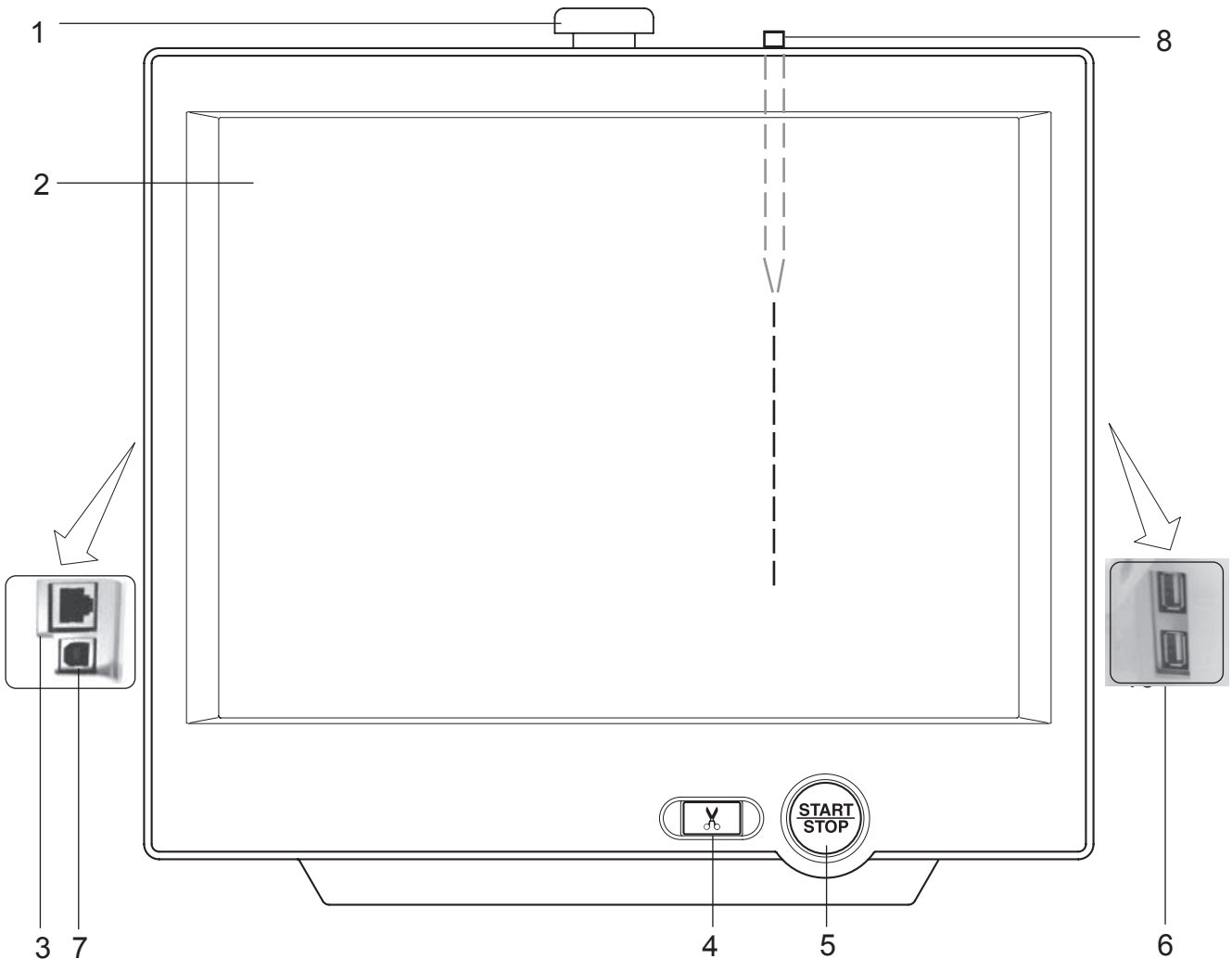
- 7. Adjustment disc
- 8. Main unit
- 9. Power switch
- 10. Head bed
- 11. Table stay
- 12. Caster

- 13. Adjuster
- 14. Removable table
- 15. Needle bar selection knob
- 16. Operation panel
- 17. Thread break detecting unit
- 18. Emergency stop button

CONTROL BOX



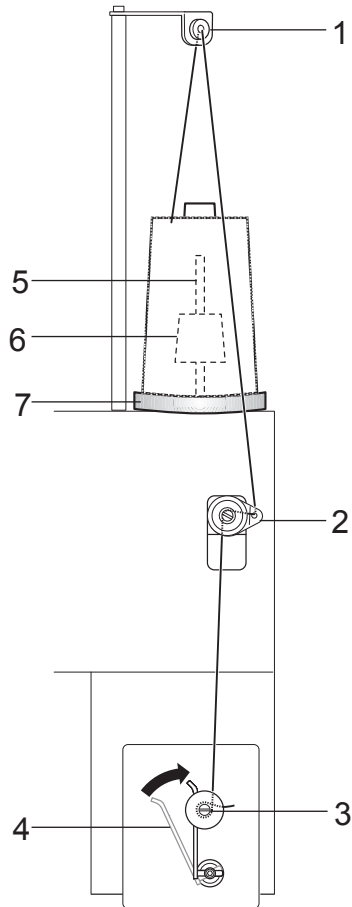
10.4" CONTROL BOX (Option)



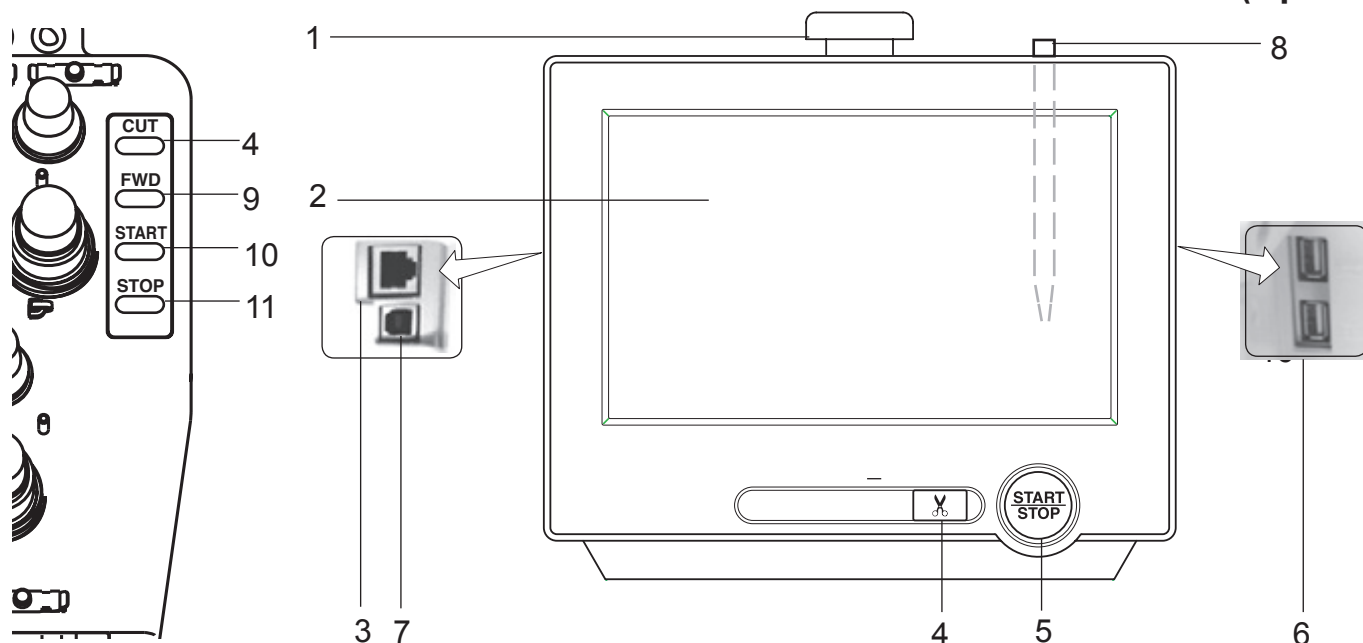
- | | | |
|--------------------------|-------------------------------------|-------------------------------------|
| 1. Emergency stop button | 4. Thread cut button | 7. USB port (Standard-B receptacle) |
| 2. Display (L.C.D.) | 5. Start/Stop button | 8. Stylus |
| 3. LAN port | 6. USB port (Standard-A receptacle) | |

BOBBIN WINDING (Option)

1. Thread guide
2. Thread tension
3. Spindle
4. Lever
5. Thread stand pin
6. Plastic spring
7. Thread stand felt



OPERATION PANEL STANDARD CONTROL BOX / 10.4" CONTROL BOX (Option)



CAUTION

The touch screen can be operated by finger, but in some cases sensitivity of the screen will be affected by condition of the finger. In such cases, please use the fingertip or built-in stylus to hit small touch targets.

1. Emergency stop button

When pressed, the power is switched off and the machine stops immediately. The emergency button locks when pressed.

To unlock, turn the emergency button to the right (Arrow direction) then release. The button will unlock.

Use this button only for emergency.



machine will stop.


- Green Machine ready to sew.
Main menu also accessible by pressing MENU, which causes menu to display.
- Blinking red.. Indicates the upper thread has broken or the Bobbin thread has run out.
- Red..... Machine is running.
- Orange Machine has detected an error.
An error number will be shown on the Display. [P 24-1](#)


2. Display (Touch screen)

Shows the embroidery design name, the number of the current needle and other machine generated messages.

Menu and keys in the display can be operated with a finger or built-in stylus.

6. USB port (Standard-A receptacle)

 USB memory socket.

 USB mouse socket.

Menu and keys in the display can be operated with a commercial USB mouse.

Press right mouse button to show a mouse pointer in the display.

3. LAN port

You can connect PC with a LAN.

4. Thread trim button

The Machine will cut the upper and lower thread when this button is pressed.

In case you press and keep (around 2 sec.), you can cut only bobbin thread.

7. USB port (Standard-B receptacle)

Use this port to connect the machine with PC via USB.



CAUTION: To prevent accidents.

If you Press thread trim button, the needle will penetrate the fabric. Please keep your hands clear for your safety.

8. Stylus

Stylus can be used for pressing menu and keys in place of fingers.

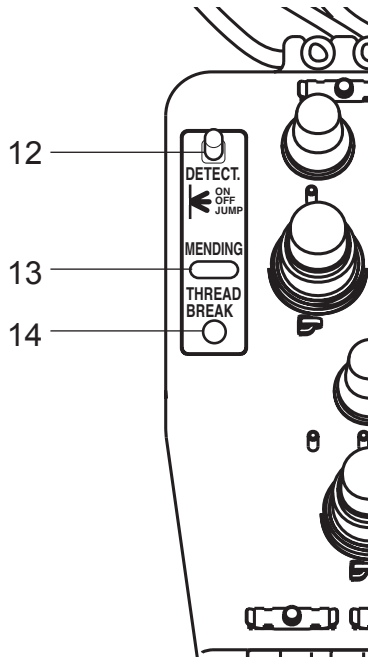
Most operation can be done by fingers. Stylus is required for some operation such as calibration for the touch panel LCD. [P 18-6](#)

Insert a stylus into the holder (slot) of control box when not used to prevent loss of the stylus.

5. Start/Stop button

This button starts the machine.

When pressed, while the machine is running, the



9. Forward button

- Press once The frame moves forward one stitch.
- Press continuously The frame will move forward continuously.
- Keep pressing The “Key lock” is activated and the button’s function is locked.
The frame will move forward by 1 stitch continuously.
When you stop it, push this button again or Push the “STOP” button.
- Pressing longer still The “Fast forward” is activated and the button’s function is locked.
The frame will move forward by 10 stitches continuously.
When you stop it, push this button again or Push the “STOP” button.

■ The “Key lock” function will be activated after setting through “Machine Setting” menu. **P** 15-2

10. Start button

This button starts the machine.
When pressed, while the machine is running, running, the machine will switch to “inching”. (Super slow speed)
The Machine will return to the previous speed when button is released.
If you use the inching function for an extended length of time, the stitch quality may be influenced.

11. Stop button

This stops the machine.
When the STOP button is pressed while the Start/ Stop button is blinking (green color), the following will take place depending on the manner pressed:

- Press once Frame moves back one stitch.
- Press continuously The frame will move backwards continuously.
- Keep pressing. The “Key lock” is activated and the button’s function is locked. The frame goes back by 1 stitch at a time continuously. When you stop it, push this button again or Push the forward button.
- Keep pressing longer still .. The “Fast forward” is activated and the button’s function is locked. The frame goes back by 10 stitches at a time continuously.
When you stop it, push this button again or Push the forward button.

■ The “Key lock” function will be activated after setting through “Machine Setting” menu. **P** 15-2

12. Thread break detecting switch

This switch by its position will make the machine as follows:

- ON This switch is normally at this position. Function of thread break detection works.
When thread break or frayed threads occurs, thread break lamp blinks and the machine stops..
- OFF Function of thread break detection doesn’t work.
- Individual jump Head with its switch lowered becomes jump and the machine doesn’t embroider.

13. Mending switch

When you press this switch with the machine in non-operation (including automatic stop by thread break detection), the machine becomes same state as it stops by thread trouble regardless of actual trouble or not, and thread break lamp lights.
With thread break lamp being lit, return the frame with *trace back to position where you want to mend.
When you press this switch and start the machine, it will mend portion not embroidered. **P** 9-7b

■ When you stop the machine manually, there is a case that thread break lamp doesn’t light even if you press this switch, however mending is conducted.

14. Thread break lamp

- When threads break, lamp blinks.
- Blinking red.. Indicates the upper thread has broken or the Bobbin thread has run out.
- Orange Indicates the machine is under mending process. **P** 9-7b

BRAKE SWITCH



15.Brake switch

This switch will change brake switch on the main shaft motor to ON and OFF.

Normally run the machine with brake switch turned ON.

When the machine is in stop, brake switch on the main shaft motor will turn on, and you can't turn the main shaft by a hand.

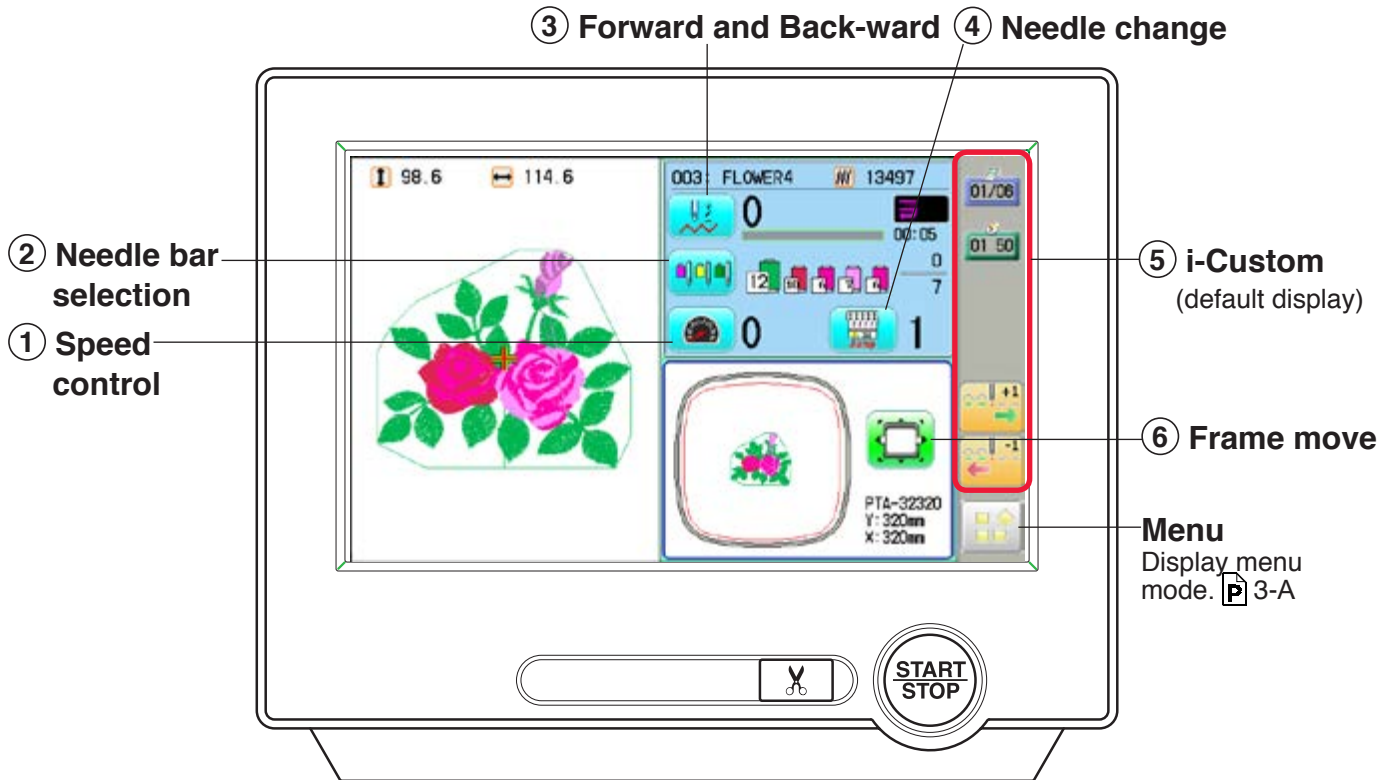
When you need to turn the main shaft by a hand in order to clean thread cut blade etc., turn brake switch OFF.

- You will be able to run the machine with brake switch turned OFF, but error (error code No. 50) may frequently come out because of deteriorating of stop accuracy of the main shaft.

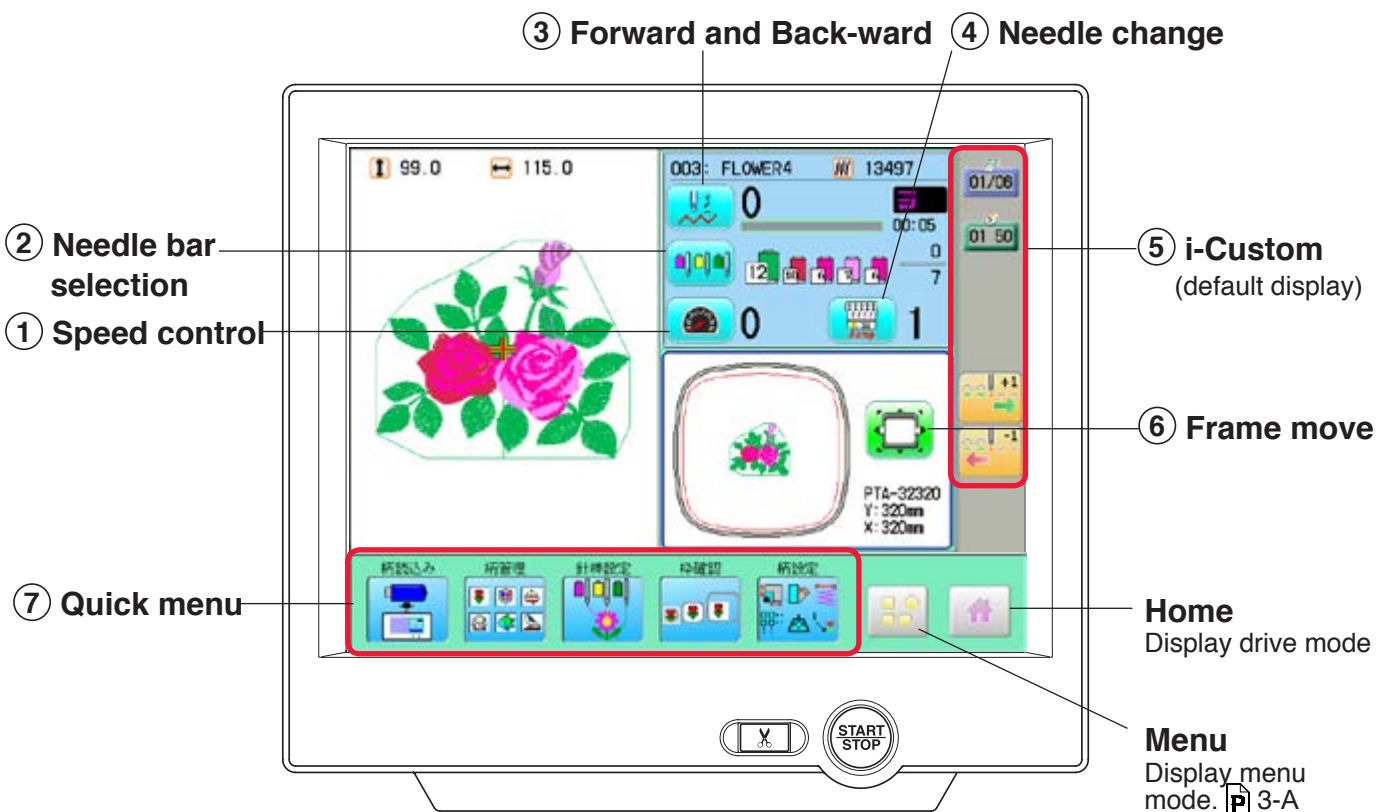
Drive key

The each key menu will be shown.

STANDARD CONTROL BOX



10.4" CONTROL BOX (Option)




① Drive speed


Control embroidery speed.
The speed can be controlled while embroidering.






Speed control

Press the + button to increase the machine sewing speed and the - button to lower the machine speed. is displayed on the LCD display.

 Low speed operation (OFF state)
Press the button to turn "ON" state.

 Low speed operation (ON state)
The drive speed will be reduced to "200 rpm".
Press the button to turn "OFF" state.

 Speed setting by needle (OFF state)
Press the button to turn "ON" state.

 Speed setting by needle (ON state)
Press the button to turn "OFF" state.  3-8

② Needle bar selection 5-E



For each color change in a given pattern, the needle number loaded with the correct color thread is assigned by the operator.

③ Frame forward



This creates direct designations to the position and data to the designated sewing position.

 Piece  9-C


If "Repeat" is set, this allows the frame to move to the beginning of any piece at will.


 Change (Color position)  9-7

This moves the frame to the beginning of any Color change number at will beginning of color.

 Stitch (Number of stitches)  9-6

This moves the frame to any stitch at will.

 Color position forward

 Move the frame to the beginning embroidery position of the previous or later color position number

   Stitch number forward

   Move the frame forward or backward by the stitch number displayed in each button.

④ Needle change



Change the needle bar directly to the indicated needle number on the button.

  Change

Move the sewing head to the adjacent needle in the direction of the arrows.


Although the needle bar setting has been done, needle bar setting is changed and pressed


, following dialogue will be displayed.

Needle bar has been changed.
Reflect on the color change setting?

YES

NO

 Needle bar setting will be changed and the display will return to Drive mode.

 Needle bar setting will not be changed and the display will return to Drive mode.

 Jump (Off)

The machine can embroider.

 Jump (On)

Machine becomes jump and the machine doesn't embroider.

⑤ i-Custom 22-1

The following display and key icons are set as default. You can place other frequently used icons freely on the right side of Drive mode screen.



Calendar

Current year, month date is displayed.



Clock

Current time is displayed.



Stitch number forward


Move the frame forward or backward by the one

When the key is pressed continuously, the “Key

lock” function is activated and the frame will move continuously even the finger is released from the key.

When the key is pressed much longer, the step of “Stitch number forward” will be changed from one stitch to 10 stitches.

When you stop it, press  (Start/Stop button).

■ The “Key lock” and “Fast forward” function will be activated after setting through ÅgMachine SettingÅh menu.  15-2

⑥ **Frame move**

Selection the way of frame movement and Move frame.



Frame change

Change the frame to be used.



Design centering

Move design to the center of frame.




Center

Moves the embroidery frame to the center automatically.



Frame out

Move frame to the front position which was set before

Press  (Position) to return the frame to the

original position before frame out position. It is convenience if hand work is required in the middle of embroider process.



Position

When sewing is interrupted in the middle of a design, this returns the frame to current sewing position regardless of where frame may have been moved with the arrow keys after interrupt. target design.



Original point return

This returns the frame to *pattern origin point. After performing this action once, repeating this again will cause the frame to return to the previous position.



Origin registration

Register the current frame position as origin.



Trace

When pressed while at the beginning of design, the embroidery frame moves following the outer edge of the design. This allows you to compare the design size and position against the frame before sewing.

Indicate target design on LCD panel when non-showing design.

If you press this key and hold, re-display your



Register

Register will restore the position of the frame to the last point before a power failure even if the point of origin or the pattern itself were changed.



Quick move

First press this key and then the arrow key to move the frame toward the edge of the embroidery area in the direction of the arrow.



Quick embroidery design data position

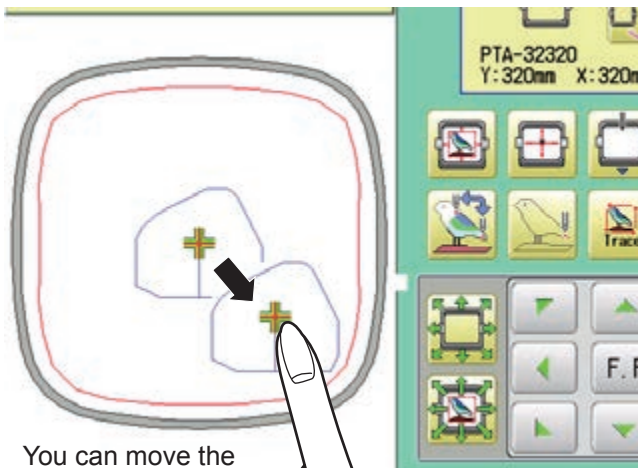
move

First press this key and then the arrow key to move the frame where the design data can be embroidered at the edge in the direction of the arrow.



Frame move key

The frame moves toward direction of the arrow mark.



You can move the embroidery frame by pressing desired position on the screen.

F.F Fast move (OFF state)

Press the button to turn "ON" state.



Fast move (ON state)

Press this key one time to move the frame faster toward the direction of the arrow.
Press the button to turn "OFF" state.



Fast move speed setting (High)



Fast move speed setting (Middle)



Fast move speed setting (Low)

The speed of "Fast move" can be adjusted.



Pointer (Option)

Turn on and off the laser pointer.



X Direction frame move



Y Direction frame move

The frame can be moved with specified distance along X axis or Y axis. (Unit: mm)
The function allows you to move the frame precisely with a pitch of 0.1mm.



Select the number, and press **SET**.

The frame will move specified distance.




Changing is cancelled.

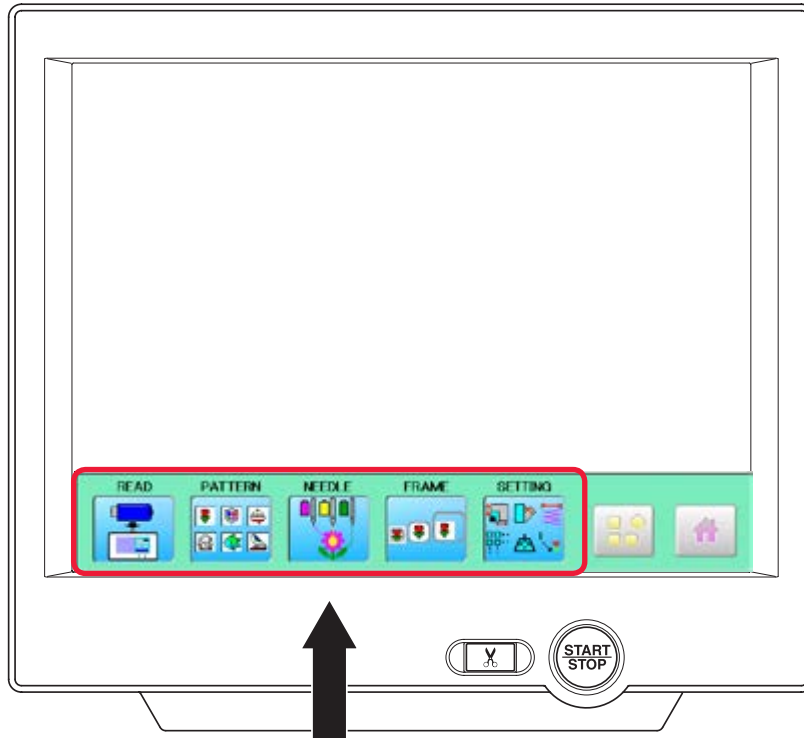


Numbers are deleted.

⑦ Quick menu (10.4' CONTROL BOX)

Display menu icons at lower part of the screen.

You can choose menu icons (top line of the menu screen) directly without pressing .



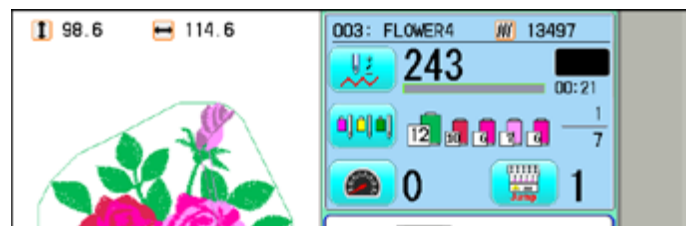
Top line of the menu screen

Speed setting by needle (ON state)

Embroidery speed can be set by needle.

If speed by needle exceeds the speed set at Drive speed setting, the value of speed turns gray and speed by the needle is applied to the speed set at Drive speed setting.



You can be set up taking the following steps.




1. Press .



2. Press .

3. Change the setting on the needle number you would like to change with  .

Press  when returning the setting on all the needle numbers to maximum.

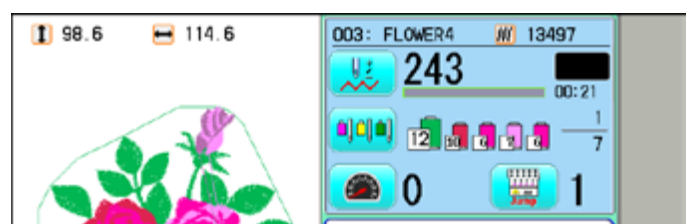
Speed setting by needle

Drive speed setting



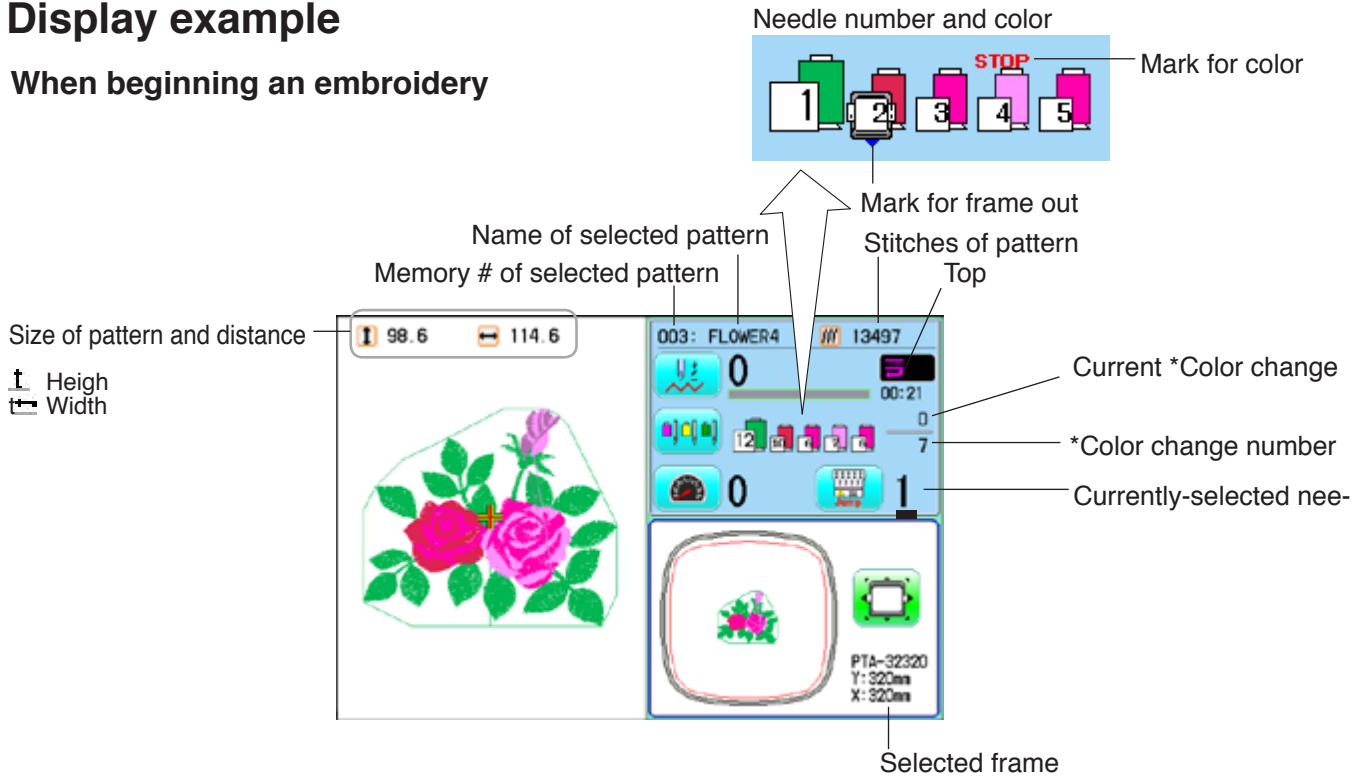
4. Press .

The screen returns to Drive mode.

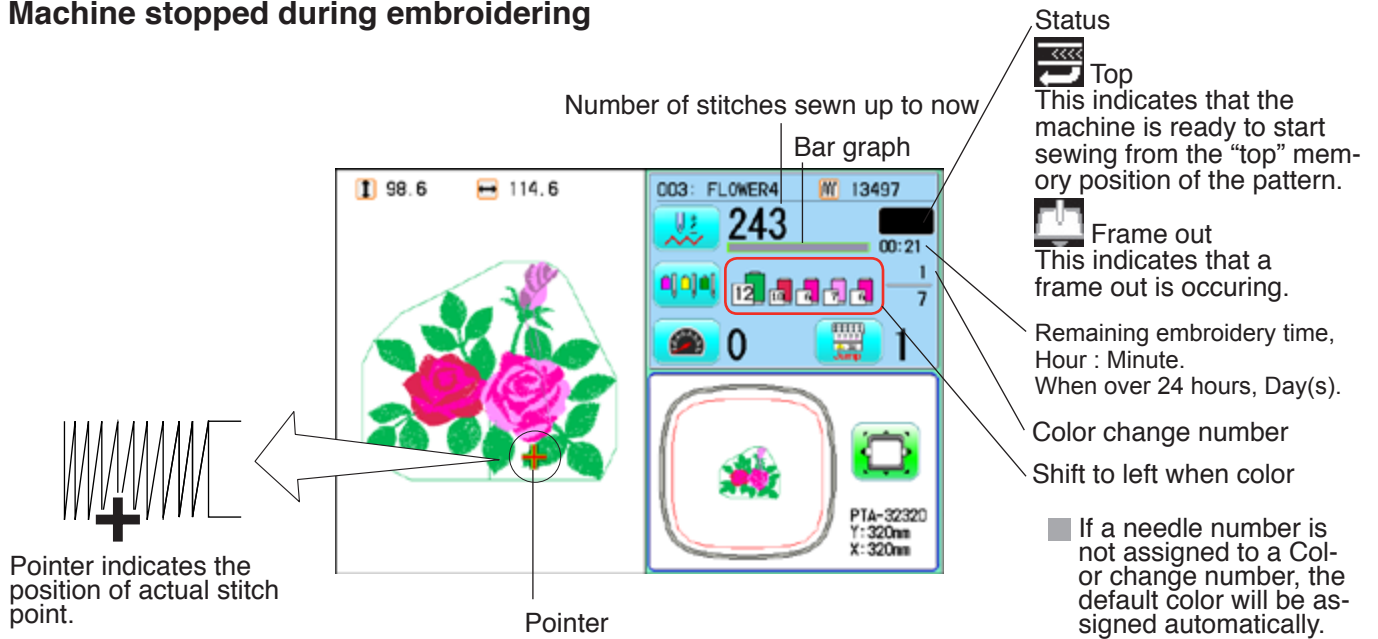


Display example

When beginning an embroidery




Machine stopped during embroidering



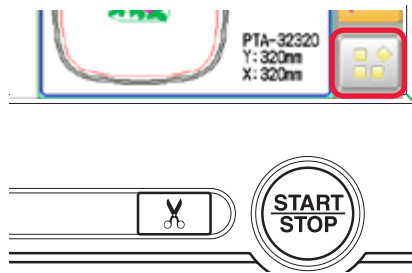
Display if the machine has no design in memory



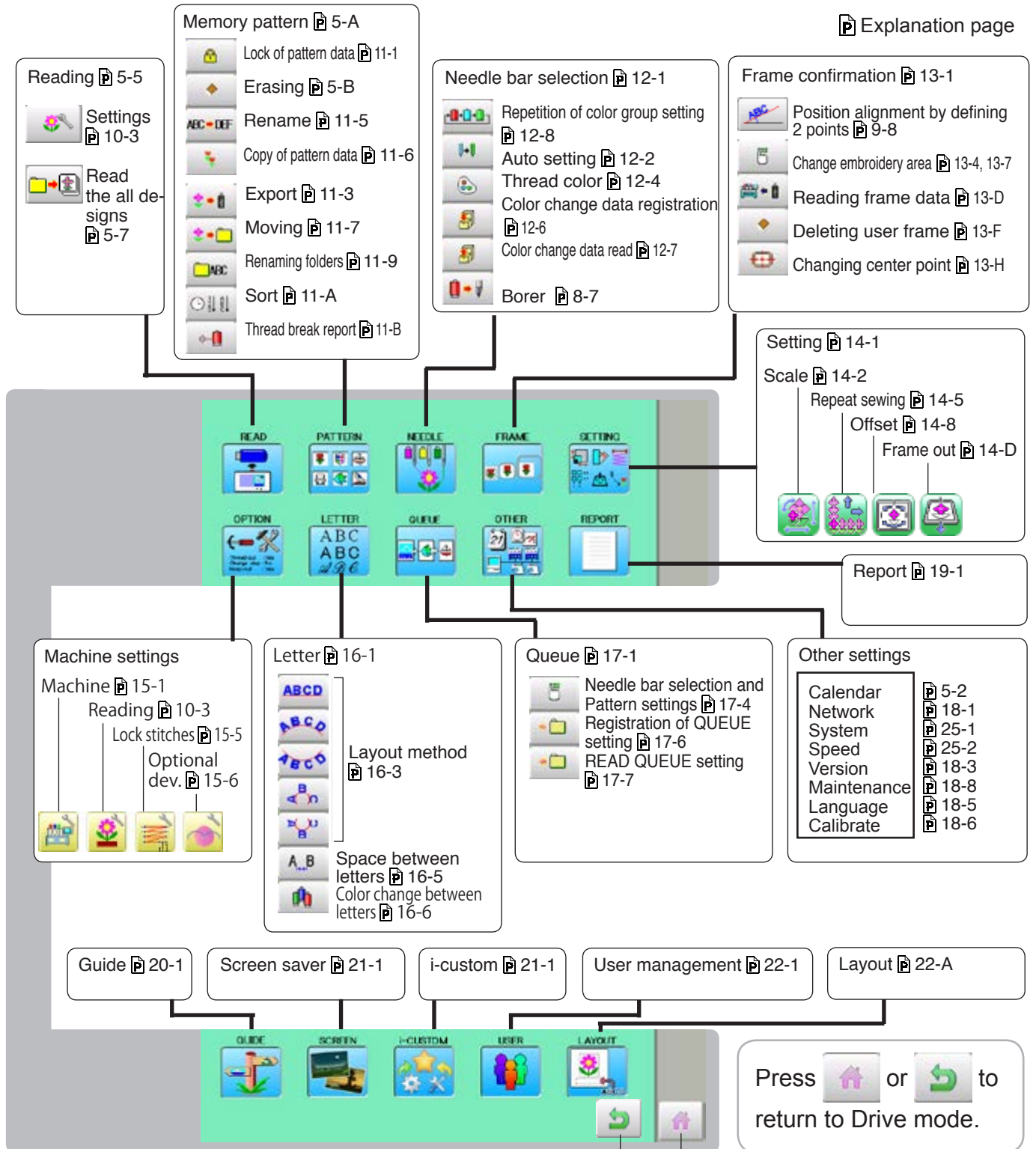
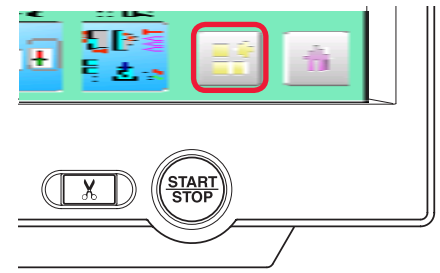
The diagram below describes the layout functions accessed from the main menu.

The main menu is accessed by pressing .

STANDARD CONTROL BOX



10.4" CONTROL BOX (Option)



10.4" CONTROL BOX (Option) STANDARD CONTROL BOX

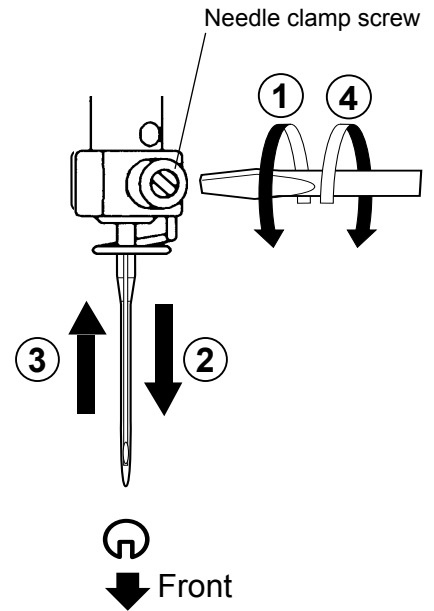
INSERTING A NEEDLE

4-1

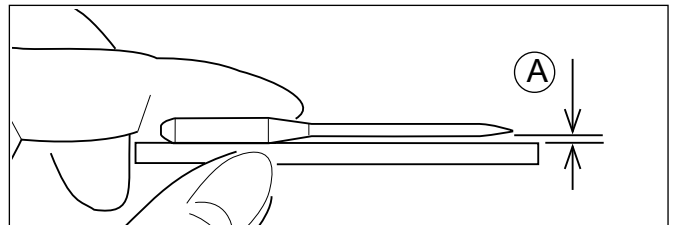
Select a needle of the right type. See the following “SELECT THREADS”.

 **CAUTION: To prevent accidents.**
Turn off the power before removing the needle.

1. Loosen the needle clamp screw slightly with the screwdriver.
2. Remove the needle.
3. Insert a new needle into the needle clamp with push it up as far as it will go keeping the slotted side of the needle in front.
4. Tighten the needle clamp screw with the screwdriver.



- A. Do not use a bent or blunt needle.
Place the needle on a flat surface and check for straightness.



About needle

Please select needles by type of material .

Normally, We supply a DB X K5 needle as in the machine accessory kit.

TYPE	APPLICATION	Needle Size
DB X K5	For normal embroidery	9 ~ 18
DB - K23	For knit	9 ~ 12

Relation of needle and upper thread

Please select type of needle and upper thread by flowing list.

Size		Relation of needle and upper thread			
Organ	German	Cotton #	Silk	Polyester	Rayon
# 8	# 60	100 ~ 130	140 ~ 160	150 ~ 200	50 ~ 70
9	65	70 ~ 80	100 ~ 120	130 ~ 150	70 ~ 100
10	70				
11	75	50 ~ 60	80 ~ 100	100 ~ 130	100 ~ 130
12	80				
13	85	36 ~ 40	60 ~ 70	80 ~ 100	130 ~ 150
14	90				
15	95				
16	100	30 ~ 36	50 ~ 60	60 ~ 80	150 ~ 160
17	105				
18	110	24 ~ 30	40 ~ 50	50 ~ 60	180 ~ 230

Normal embroidery field

► Normal use embroidery needle and upper thread.

Upper thread : Rayon 120 d/2 (120 denier)
Polyester 120 d/2 (120 denier)

Needle : #11 (DB X K5)

► If the relationship of needle size and thread type is incorrect, it is possible to have any of the following problems.

- Thread break
- Skip stitch (Upper thread does not catch bobbin thread)
- Other stitch quality problem

Backing

Generally, Backing is used for hooped embroidery fabric. Knit fabrics particularly require the use of embroidery backings.

Embroidery backings will allow the hoop to move the fabric more accurately, creating a more beautiful embroidery.

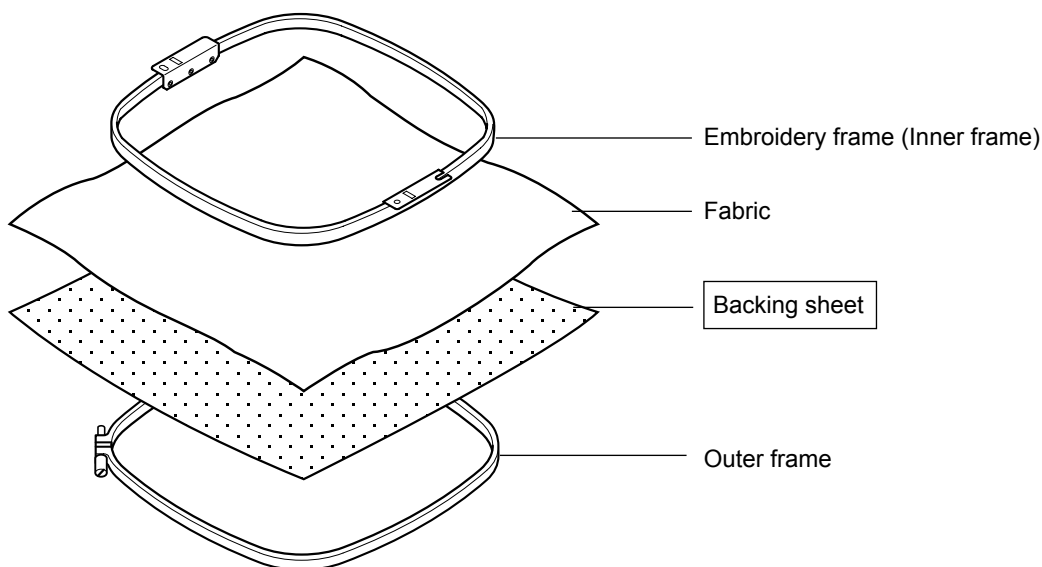
Select backing type

Choose the thickness and number of sheets by the type of material and embroidery condition. Generally, you should consider the following items.

- Embroidery stitch quality
- Contraction or compression of fabric caused by sewing, etc.
- Stiffness of fabric

■ In case, if you sew lace and leather, you may not need backing sheet.

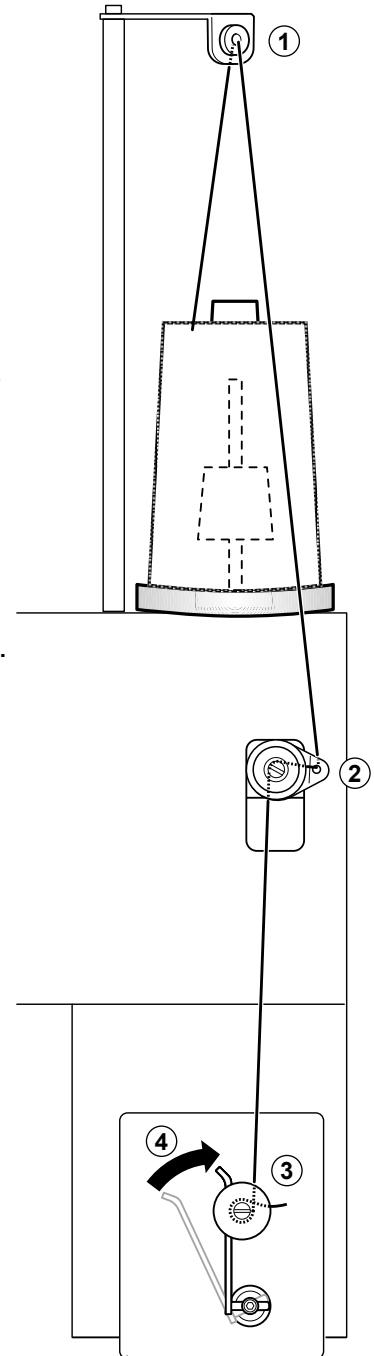
Example of using a backing



● Winding the bobbin (OPTION)

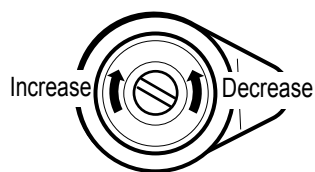
Thread the bobbin winder as shown below:

1. Thread guide
2. Thread tension – Be sure to thread through the small eye before going between the disks.
3. Bobbin (Place the bobbin on the bobbin winder spindle.)
4. Press the limit lever as indicated by the arrow to start the winder. The lever stops the winder automatically after the winding is complete.



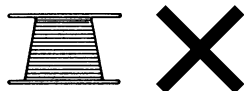
Tension

When adjusting bobbin winder tension:



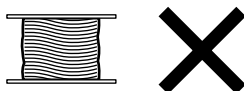
- Ensure thread winds evenly on bobbin as shown.

Confirm that the bobbin is wound properly..



- Keep the tension constant while winding.

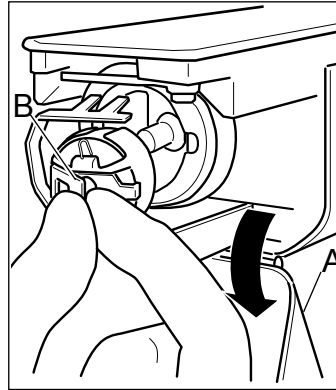
Tighten thread tension if thread winds too loosely.



⚠ CAUTION: To prevent accidents.
Please watch out for the point of the rotary hook when you replace the bobbin.

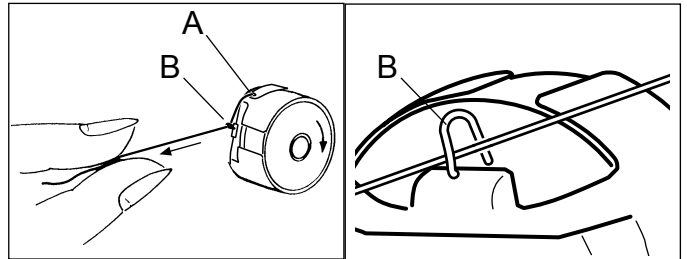
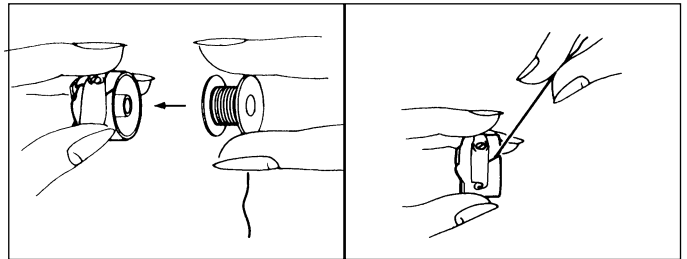
● Removing the bobbin

1. Open hook cover (A) to front.
2. Grasp bobbin case latch (B) and withdraw bobbin case from hook taking care not to damage the thread keeper.



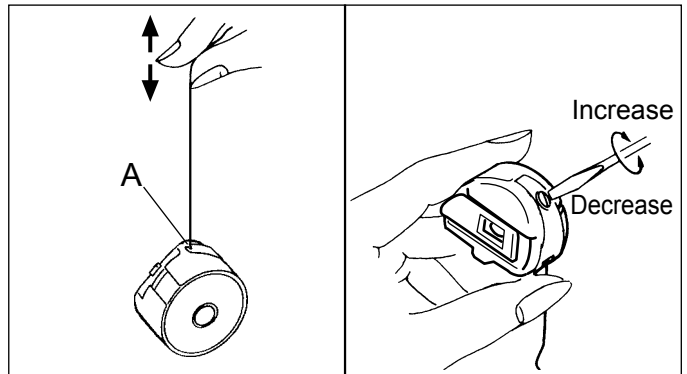
● Inserting the bobbin

1. Hold the bobbin case in left hand. Hold the bobbin in your right hand with thread on top leading from left to right.
2. Insert bobbin in case and draw thread up into slot in case.
3. Draw thread under tension spring (A) and wind into guide coil (B). The bobbin should turn clockwise in the case when the thread is pulled.



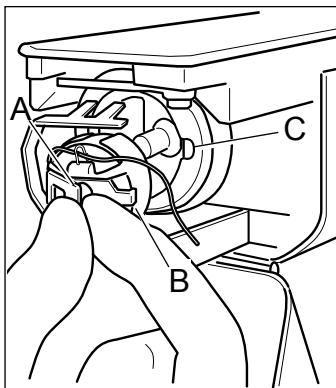
● Adjusting bobbin thread tension

1. Hold bobbin thread and jerk upward approx. an inch. Thread should unspool further approx. the same amount.
2. The screw on the tension spring is for adjusting bobbin tension. This adjustment is very delicate. Please turn the screw only a small amount. Only 1/8 of a turn maximum.

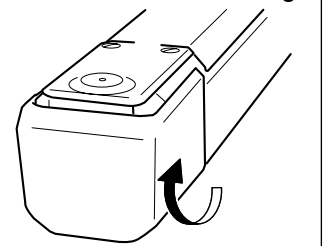


● Inserting the bobbin case

1. After threading bobbin in case, open bobbin case latch (A), grasping it in fingers as shown. Slip bobbin and case on stud of rotary hook body, and press in securely. Release bobbin case latch. Press the bobbin case in to be sure it is fully seated.
2. Close hook cover.



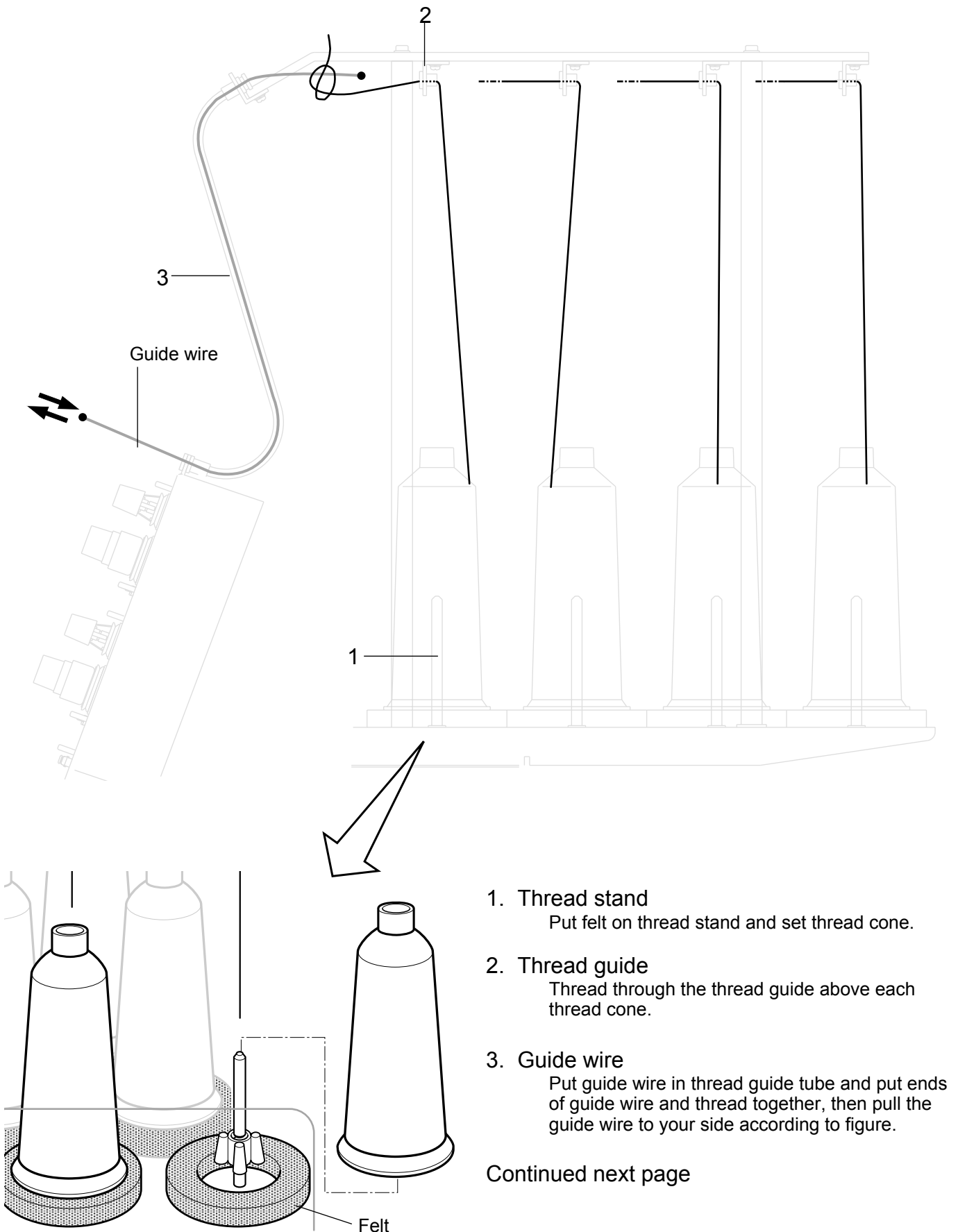
⚠ CAUTION: To prevent accidents.
Keep hook cover close and fingers away while the machine is running.



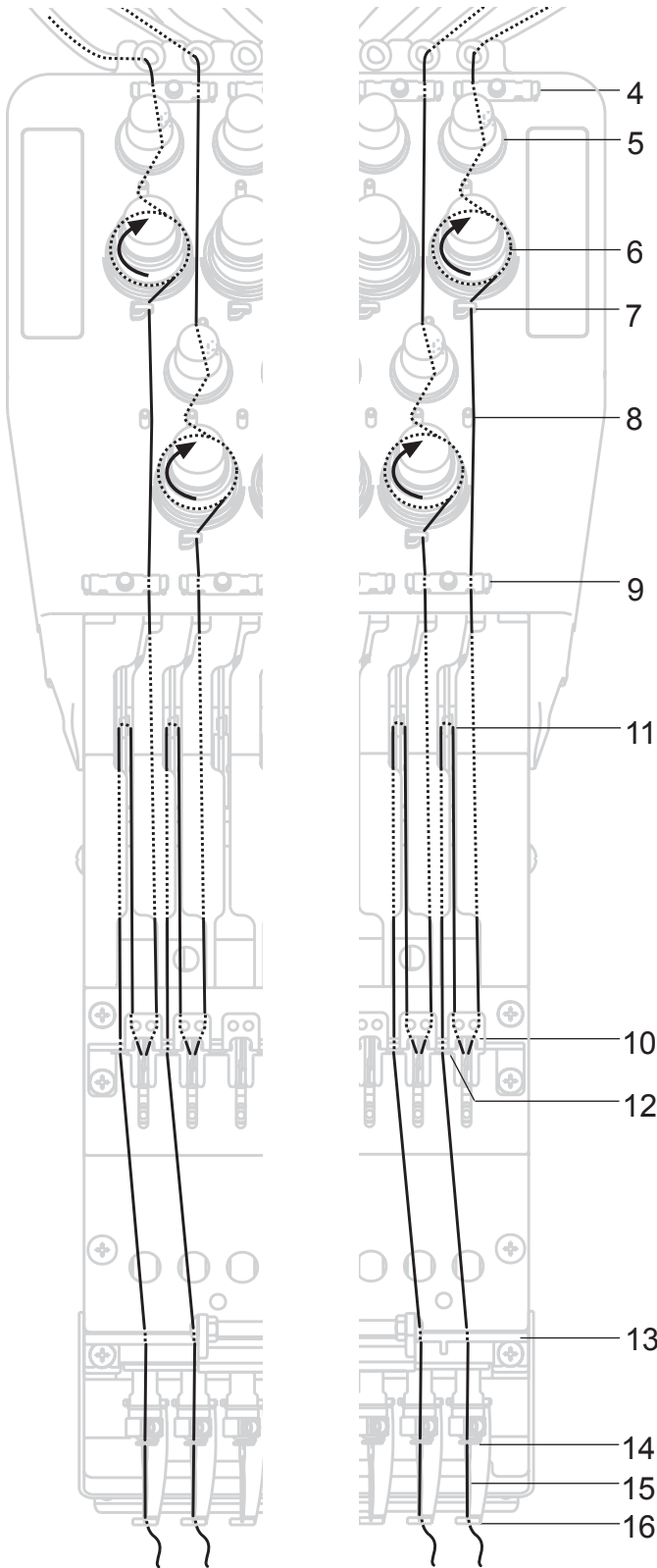
■ The attached bobbin case is available only for this machine. Thread may be caught in thread guide coil if other types are used.

● How to thread upper thread

Pass upper threads in order according to the figure:




Continued next page

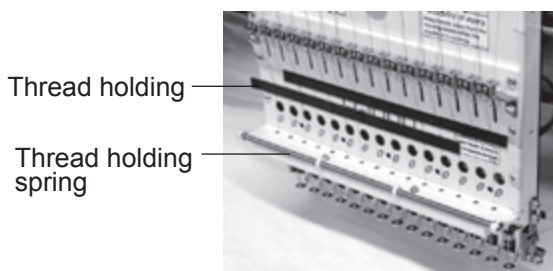


4. Upper rectifier
5. Minor thread tension
6. Thread tension
Wind upper threads one time around rotary tension disc clock-wise.
7. Thread guide
8. Guide pin
9. Lower rectifier
10. Thread adjusting spring
11. Take-up lever
12. Thread guide
13. Lighting bracket
14. Needle bar thread guide
15. Needle
Thread from front side of needle.
Pull upper threads slowly and see that the rotary tension disc moves smoothly by pulling the thread downward as much as possible.
16. Pressure foot

When checking thread, pull upper threads from needle and check if rotary tension disc moves smoothly.

 **CAUTION: To prevent accidents.**
Please be careful of the sharp point of the needles when threading upper threads through the needle.

Thread holding rubber




When you use the machine in QUEUE or run the machine in individual head sewing, thread take up levers for unused heads move and upper threads come off from thread catch holder or thread holding spring. Therefore in order to keep upper threads in place, put thread holding rubber against front panel of unused heads. By doing this way, you will be able to prevent upper threads from coming off.

- When you embroider, please be sure to take out thread holding rubber.
- Stick removed thread holding rubbers to the machine and keep them.


HOW TO READ THESE INSTRUCTIONS and SCROLLBAR 4-8

The instructions in this manual have been formatted as follows:
 Written instructions will be provided on the left side of the page while graphics depicting the necessary steps are provided on the right.
 Graphics on the far right will show the display after performing the steps indicated.

 **CAUTION: To prevent accidents.**
 This will appear for items related to your safety.

 **CAUTION: To avoid problems.**
 This will appear for items related to potential problems.

Order of operation





1. When the machine is stopped, press  .



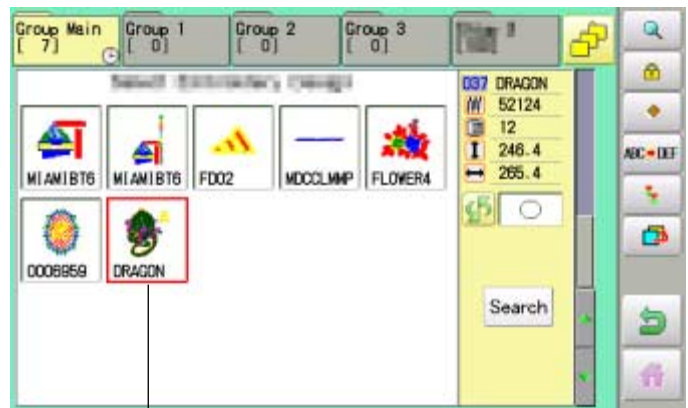
Indicates supplementary explanation regarding a given operation or action.

2. Select "PATTERN".

The display indicates the current pattern. The left side of display shows the number, name and details for the current pattern.


-  Number of stitches
-  Number of Color change number
-  Height
-  Width

AWords marked with a "*" are explained in "EMBROIDERY TERMS" at the end of this instruction manual.



Selected pattern data

3. Select *pattern data.

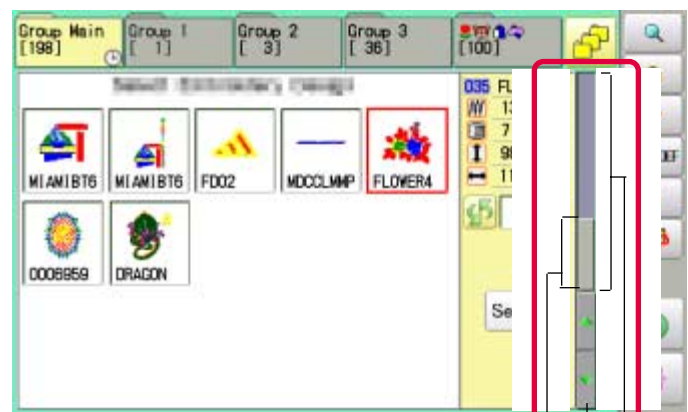
This pattern will be selected.  3-3

Operation key

This indicates an additional explanation on an operation elsewhere in the manual for more detail.

Press  to return to Menu mode.

Press  to return to Drive mode.




Display area
 Arrow key
 Scroll area
 Scrollbar

Scrollbar

If the data are too much to fit into display screen, you can use scrollbar.

- Display area : It shows the area which is displayed.
- Arrow key : You can scroll the display area to arrow marked direction.
- Scroll area : It shows the whole area of the data.
 You can push arbitrary point of Scroll area to display the desired location.


DISPLAYING THE PATTERN IN SETTING MODE 4-9

When there is  shows on the right side menu, the pattern data may be shown on the screen.

1. When the machine is stopped, press .



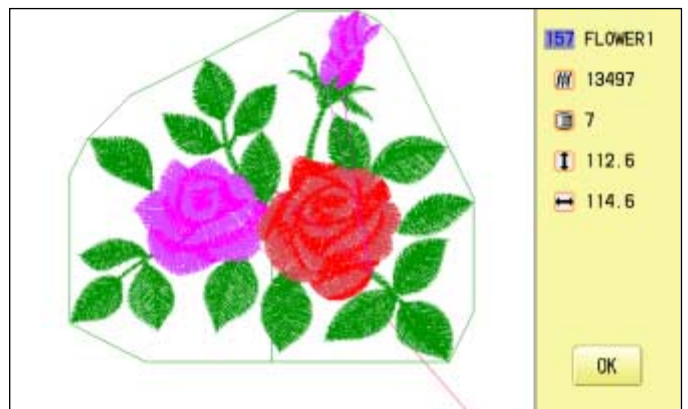
2. Select desired menu.

Icon of  will be shown in sub-menu.



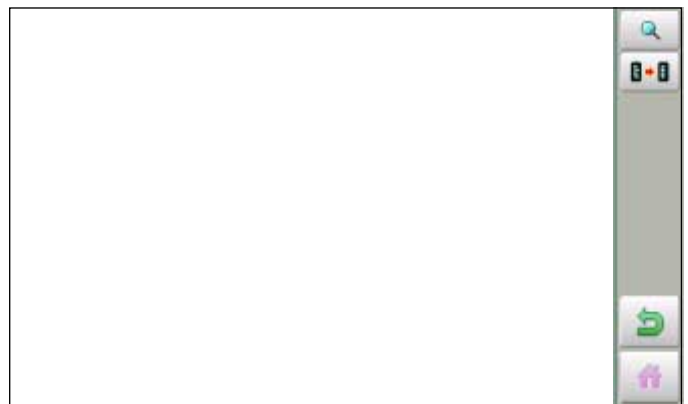
3. Press .

Illustration of the pattern selected will be displayed.
Right side of display shows the detail information of the current pattern data.



4. Press .

The display returns to the view of Step 2.



Press  to return to Menu mode.

Press  to return to Drive mode.

● How to turn on the machine

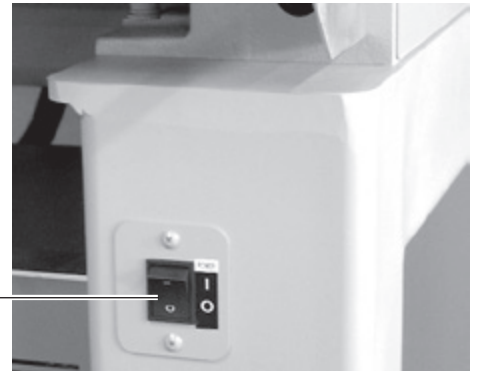
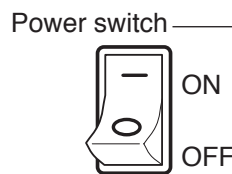
CAUTION

The touch screen can be operated by finger, but in some cases sensitivity of the screen will be affected by condition of the finger.
In such cases, please use the fingertip or built-in stylus to hit small touch targets.

1. Connect the power plug to an electrical outlet.

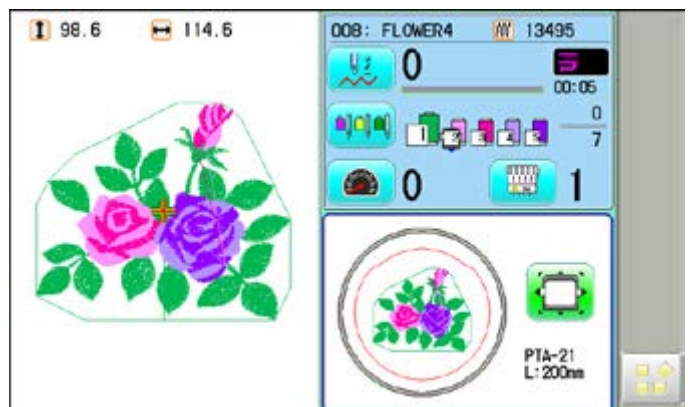
2. Turn on the power switch.
Indicates the select frame.

Please confirm the emergency stop button has been released.
Push the power switch firmly so it will remain on.



3. In case you do not need to change frame type, Press **Next**.

After the carriage and frame move slightly, the embroidery frame will return to the previous position automatically.
Machine becomes ready for operation.



⚠ CAUTION: To prevent accidents.








The embroidery frame and carriage will move.
Please keep hands clear for your safety.

In case you want to change frame type,

Press .



4. Select the desired frame with  .

-  : Tubular round frame
-  : Tubular square frame
-  : Cap and One-point frame.
-  : Border frame
-  : Sock frame
-  : User-defined frame
-  : Non registered



5. Select desired type of frame and Press



The display returns to the view of Step 2.

To disconnect, switch the power switch to the off position, then remove plug from outlet.



DANGER: To reduce the risk of electric shock.

Never leave the machine unattended when plugged in.

Always unplug this machine from the electrical outlet immediately after use and before performing any maintenance on it.




WARNING: To reduce the risk of burns, fire, electric shock, or injury to persons.

Do not unplug by pulling on cord. To unplug, grasp the plug, not the cord.

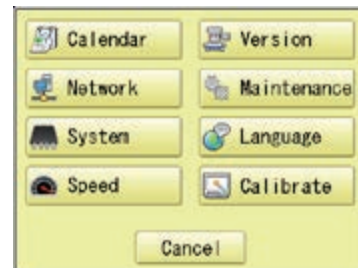
● Calendar and clock setting

Setting the calendar and clock lets the machine advise when oiling and other maintenance is scheduled to occur.

1. When the machine is stopped, press .







2. Press .





3. Press . Current year, month date and time is displayed.




4. Select year/month, time or date.
Press right /left of   to select the setting point, and press up/down of   to select the number of year, month and time.



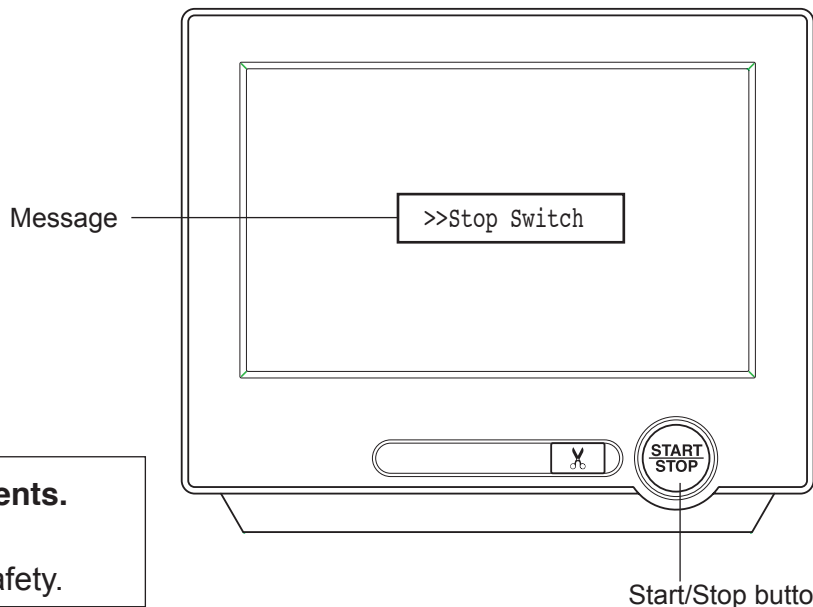
5. Press . The date is fixed.


6. Press  to return to Menu mode.











Below is a list of possible messages that may appear while operating the machine, along with an brief explanation and suggested actions to take as a result.

The message with  mark will be appeared with beep sound.

Press the screen (any location is okay) or button, then message and buzzer will be stopped.



 **CAUTION: To prevent accidents.**
The embroidery frame may move.
Please keep hands clear for your safety.

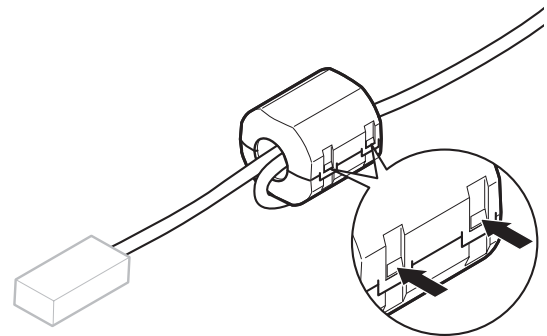
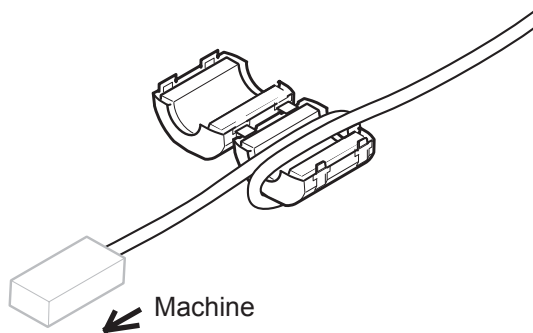
MESSAGE	EXPLANATION	OPERATION	PAGE
 Place to oil	Designated letter on the display is due to be lubricated.	Push [Done] and lubricate indicated location with instruction in the reference page. Push [Leter], if you can not lubricate right away. The message will be disappeared temporary, but it will come up later.	23-1b
 Cleaning of rotary fook  Cleaning of thread cut knife	Clean the rotary hook and the thread cutting knife.	Clean with instruction in the reference page.	23-2
>>Stop Switch	The machine is stopped because the stop button was pressed while embroidering the design.	Press the start/stop button to resume sewing.	
 >>End	The machine is stopped because it has finished the design.	If you wish to sew design again, please newly hooped item on machine & press start/stop button.	
 >>Change Stop	Machine stopped, because you used "Stop at color change point" function.	When you press the start/stop button, the machine will select the next color and resume embroidering automatically.	
 >>Color ?	Machine stopped, because you used "Stop at color change point" function.	Please select next needle number by needle selection button then press the start/stop button.	
  >>Thread Break * (head)	Machine stopped, because upper or bobbin thread is broken at displayed needle number and head.	Please thread upper thread or check bobbin thread then press start/stop button to resume sewing.	
 >>Frame out	The "Frame out" function has been executed.	Press the start/stop button if OK.	14-D
 >>Sequin Empty	Sequin is empty.	Please set the new sequin then press start button to resume sewing.	

●Connecting to a PC

This embroidery machine will allow you to read design data from a connected PC.
A USB cable or a LAN cable can be used for the connection.

Install the clampfilter

In order to avoid unexpected trouble caused by electric noise, install attached clamp filter on the embroidery machine side on USB cable or LAN cable.
Install attached clamp filter when also using other cable than attached cable.



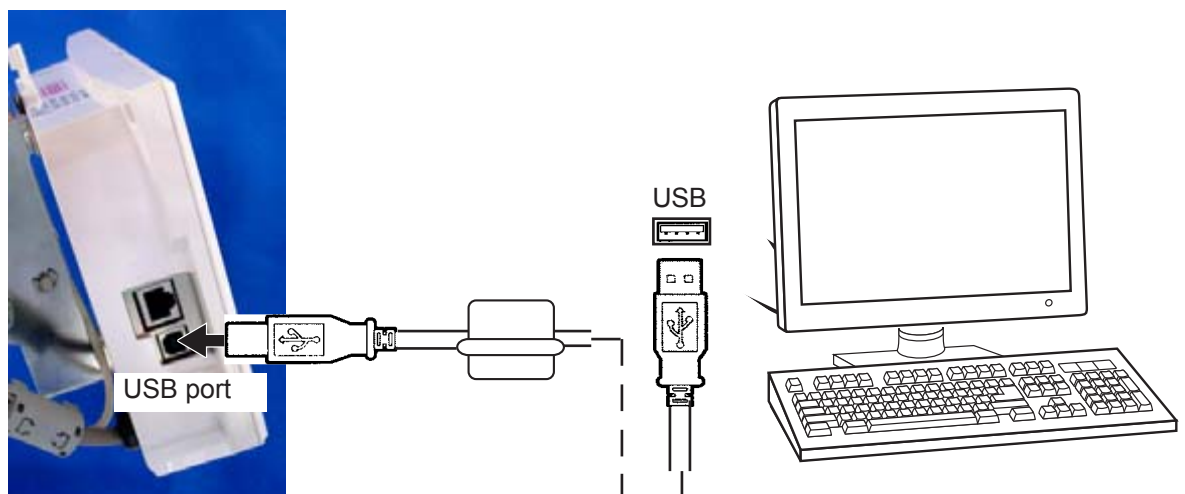
1. Please set clampfilter on new cable as picture.
Clampfilter should be located close to machine.
Cable should be turned around clampfilter as picture.

2. Please confirm filter is closed completely.
When the filter is removed, please press latch (2 positions) on clampfilter by thin rod.
Clampfilter opens and it can be removed from cable..

USB connection (based on the USB 1.1, 2.0)

Connect by USB cable between USB port (Standard-B receptacle) of the machine and USB port of the PC.

When you connect the USB cable, make sure that the machine is powered and set into drive mode, and that the PC is also turned on.
After recognizing USB in your PC, start-up the "Happy Link".
Please refer to instruction book of "Happy Link" for more precise information.

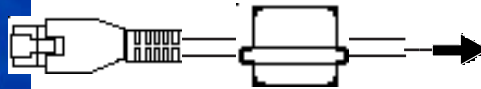
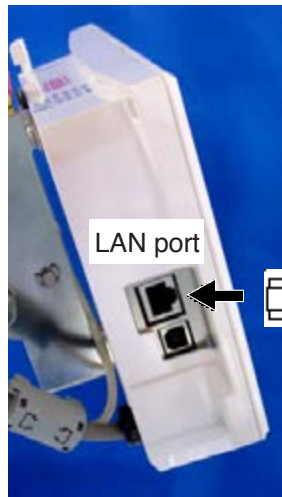


LAN connection

Connect the LAN cable between the LAN port of the machine and the network of the PC.

Multiple and different type of machines can be connected to a PC which has Happy Link LAN software installed.

Please refer to instruction book of "Happy Link LAN" for more precise information.



Connect to the Switching HUB or the Wireless LAN device.
Please refer to instruction book of "Happy Link LAN" for more precise information.

● Reading embroidery pattern data from the PC

Designs can be transferred to the machine along with some functions by using the "Happy Link LAN" software.

Please refer to the "Happy Link" or "Happy Link LAN" software manual for instructions.

The maximum number of registrable pattern will be 999.

Please use following software version which supports the "max. registrable pattern" function.

" Happy Link Ver. Ver. 4.03 or later"

" Happy Link LAN Ver. A2.03 or later"

● Read embroidery pattern data

Read the pattern to be embroidered from the memory media.

These types of memory media can be used.

This machine is able to read different kinds of memory media, which are generally used.

•USB memory

■ If you initialize the memory media with your PC, please proceed with FAT or FAT32 format.



Handling note of memory media.

Do not bend, drop, disassemble, charge or heat the memory media.
Keep away from humidity or direct sunlight.

To insert a USB memory

1. Insert the USB memory all the way into the USB memory port of the machine (right side of controller).
2. Read embroidery design data according to following “Memory card reading” in the next section.



To remove a USB memory

Please handle USB memory carefully.

Reading pattern data

This reads pattern data and writes into memory.



When the HAPPY format pattern data with *various function settings are read in memory, various functions such as needle bar selection, pattern data adjustments and etc. will be set automatically. (It is necessary to set "etc.func read". P 10-3)

In addition to memory media, this machine can read pattern data saved in the PC connected with "Happy Link LAN".

Design folder settings on the "Happy Link LAN" is required before reading pattern data.

Please refer to "Happy Link LAN" System INSTRUCTION MANUAL regarding the settings method.

The pattern data can be read through the designated folder and sub-folders by accessing from the machine.

■ If the Happy or Tajima pattern data has Barudan or ZSK *data. (Tajima file :  DSB [Barudan] or  DSZ [ZSK])

The machine can read HAPPY and Tajima pattern data normally when "Auto" is selected at SETTING RANGE of SETTING ITEM 7 data format of Pattern read settings on page 10-3.

If the machine dose not read pattern data cannot at "Auto", please try with other data format

1. Insert the USB memory into the machine as described in "Inserting USB memory".

2. When the machine is stopped, press .





3. Select "READ".








Un-recognized device will be shown with gray color.

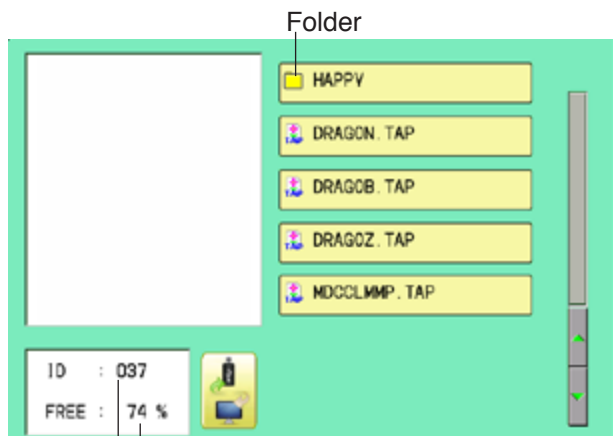
--- Serch pattern ---

4. Select  (USB memory) or  (Pattern data in the PC).

Indicates pattern data.

-  TAP : HAPPY
-  DST : Tajima
-  DSB : Tajima (Barudan)
-  DSZ : Tajima (ZSK)

 Folder : Contents of folder will be displayed when you select this icon.



Free memory

The designs new ID number in the machines memory.


5. Select pattern data.

1 % of free memory is equivalent to about 400,000 stitches.
If there are more stitches than remaining space, you may need to delete some designs to make room for the new patterns.

Once design is read.


Enable to read other pattern data.

If you wish to read another design, continue to read other pattern data.

If you press , the display will return to step 3.

Switch the source you would like to extract pattern data from.


Press  to return to Menu mode.


Press  to return to Drive mode.

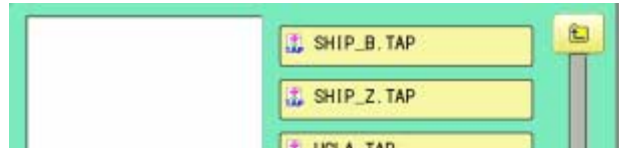
--- Reading ---


--- Check pattern data ---



When the screen displays pattern data in the folder,  is displayed.

When  is pressed, the screen moves off from the current folder.




The icon  allows you to read the all designs at once which are located in the currently opened folder or directory.



● Selection of folders

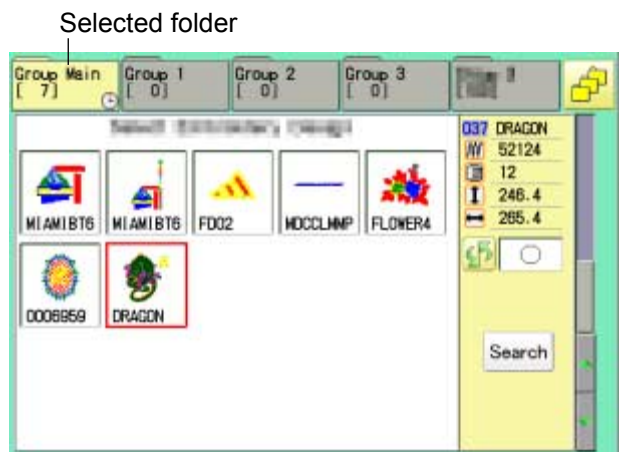
The pattern data memory is consist of 20 individual folders.
Select desired folder to choose or input pattern data.

1. When the machine is stopped, press  .




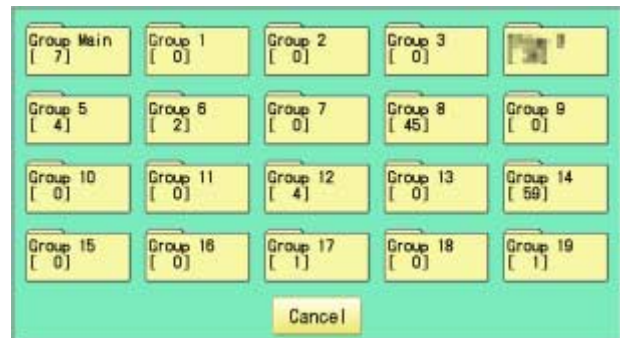
2. Select "PATTERN".

The pattern data of the selected folder will appear on the display.



3. Go on to step 4, if you want to select pattern from displayed folder.

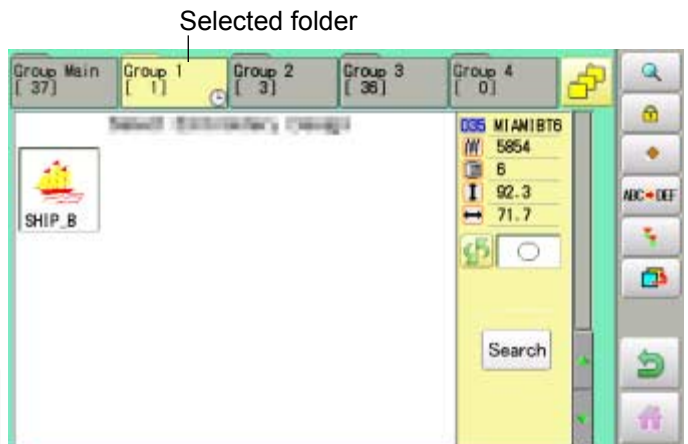
Press  to select from whole folders.



4. Select desired folder.

The selected folder has been switched.

You cannot switch to the folder without pattern data.




Press  to return to Menu mode.

Press  to return to Drive mode.

● How to select patterns from memory





To select an embroidery design previously stored into the machine memory.

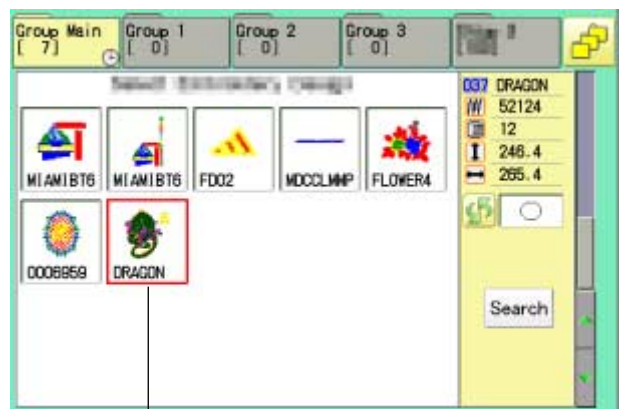
1. When the machine is stopped, press  .



2. Select "PATTERN".

The display indicates the current pattern. The right side of display shows the number, name and details for the current pattern.

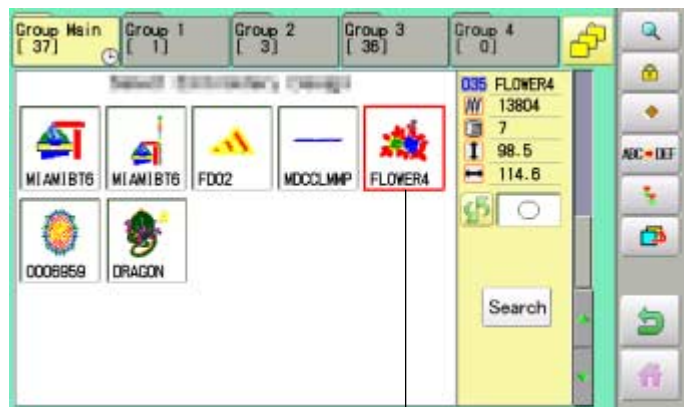
-  Number of stitches
-  Number of Color change number
-  Height
-  Width



Selected pattern data

3. Select pattern data.

This pattern will be selected.




Selected pattern data


Press  to return to Menu mode.

Press  to return to Drive mode.

●Erasing patterns from memory

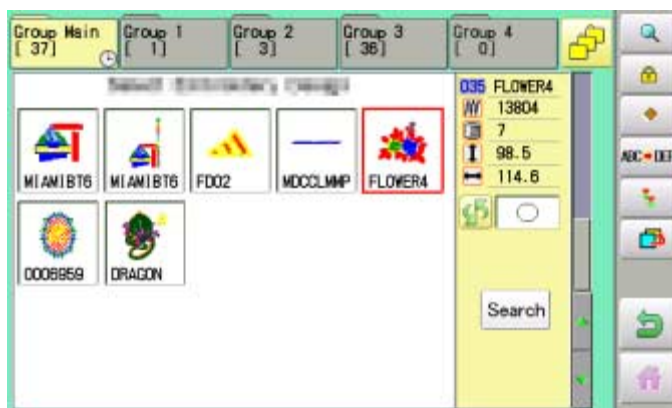
This is to erase an unnecessary design data from the machine memory.

 Pattern data cannot be erased if the lock is set.

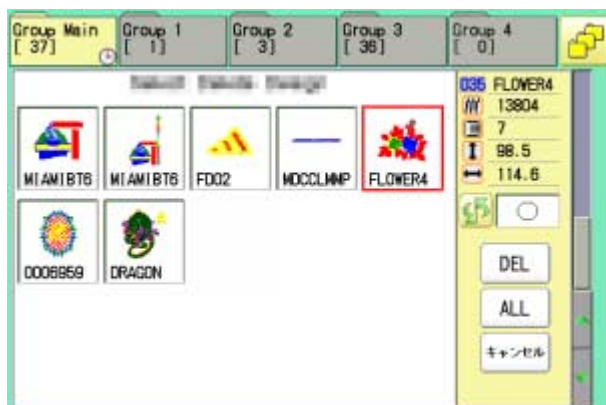
1. When the machine is stopped, press .



2. Select "PATTERN".





3. Press  from right submenu.

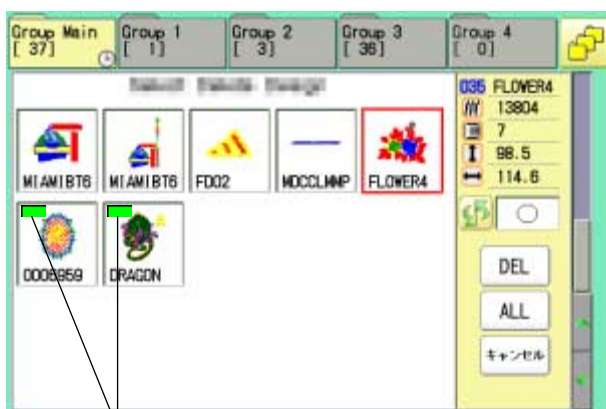


4. Select desired pattern.

Mark will appear left of the pattern.
 Make will be cleared by press it again.
 Multiple pattern data can be selected.

 : Select all the pattern data

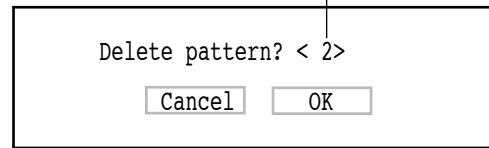
 : Cancel pattern data erasing



Mark

5. Press .

Showing number of delete design(s)



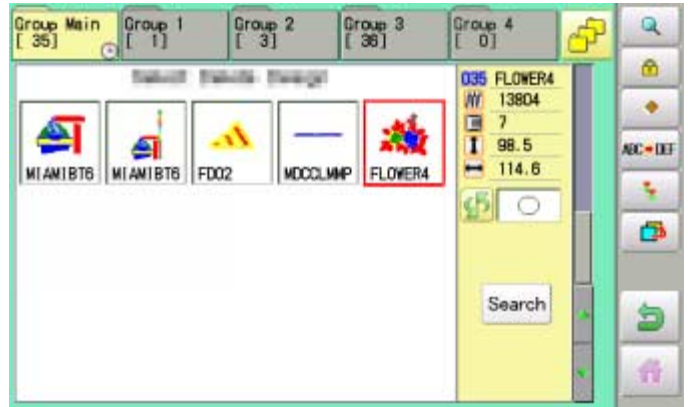
6. Push "OK" to delete.

The item will be deleted.

To delete other patterns, repeat steps 3 to 6.

Press "Cancel" to cancel the delete.

The display will return to step 2.




Press  to return to Menu mode.

Press  to return to Drive mode.

Erasing all patterns from memory

This is to erase alldesign data from the machine memory.


 Pattern data can be erased if the lock is set.

1. When the machine is stopped, press



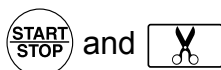
Please note that this function can not be activated through "PATTERN" icon at "Quick menu".


In this case, open normal ÅgMENUÅh by

pressing  and follow the procedure as below.



2. Select "PATTERN" while pressing the




3. Press .


The item will be deleted.

NEEDLE BAR SELECTION

5-E

For each color change in a given pattern, the needle number loaded with the correct color thread is assigned by the operator. When this is set, the machine automatically changes to the programmed needle when the design reaches that point in the course of sewing the design.

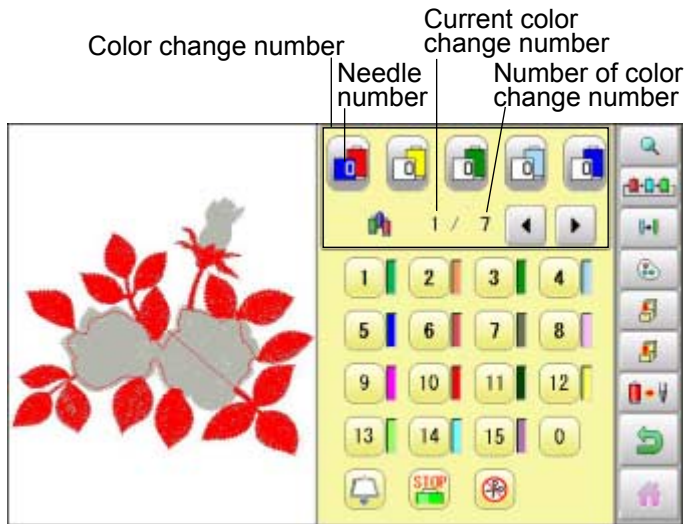
 You can not setting "NEEDLE" for selected "LOCK" design.
Please release "LOCK" from design.  11-1

1. When the machine is stopped, press .





2. Select "NEEDLE".

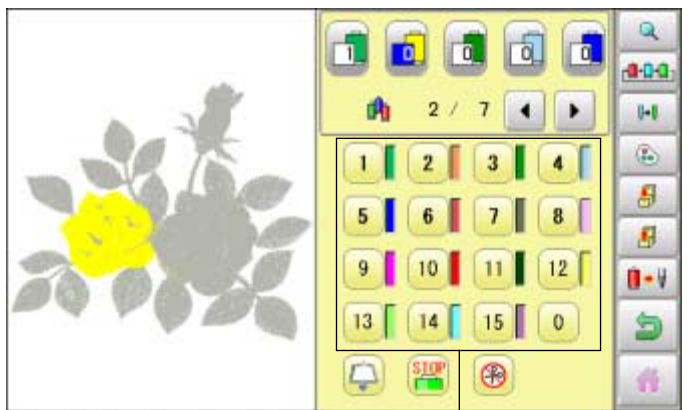
The screen of color number 1 selection is displayed.
The current color number is showed in the pattern data display portion.




3. Select the needle number.

After setting the needle number on color number, the following color number selection is displayed.
You can also select color number directly.
You can switch color change numbers with


  if the color change number has more than 5.



4. Select the needle number on all the color change numbers.

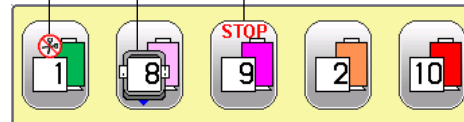
Press  to return to Menu mode.

Needle number

Press  to on the sub menu to check the setting.





No thread cut mark Frame out mark Color change stop mark



Color change stop function

When a color change stop is set to a color change number, the machine will stop after it finishes sewing the marked needle number, then following message will be shown:

When you wish to start again, Press  (Start/Stop button).


1. Select a color change number and press .
The mark is displayed on the color change number.


2. Set it to the same on other color change number if necessary.

Selection of color change number


Set Color change number to execute frameout.

A frame out command can be added to a design. By setting frameout to a *Color change number in a design, you can move the frame to a desired position automatically and stop it after the machine finishes sewing of that color change number.

When you resume operation, the frame has an automatic return to previous position and you can continue sewing.  14-D

1. Select a color change number and press .
The mark is displayed on the color change number.

2. Set it to the same on other color change number if necessary.

■ When you turn frameout "On" without setting the movement distance of frameout, the frame will move automatically to the position which was set already with "20 Frameout position" at "MACHINE SETTINGS".  15-2.

No thread cut after color change

When "no thread cut after color change" is set on a color change number, thread cut is not done after color change at the specified color change number and the machine switches to the next color change number.

"No thread cut after color change" function can be set by combining color change stop or frame out function.

● Installing and removing the tubular frame bracket

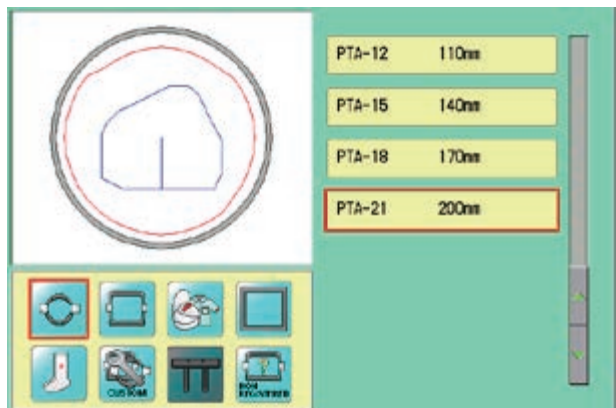
Please attach the frame base to the carriage when you wish to use a tubular embroidering hoop. Please remove it in the reverse order of installation.



1. When the machine is stopped, press





2. Press



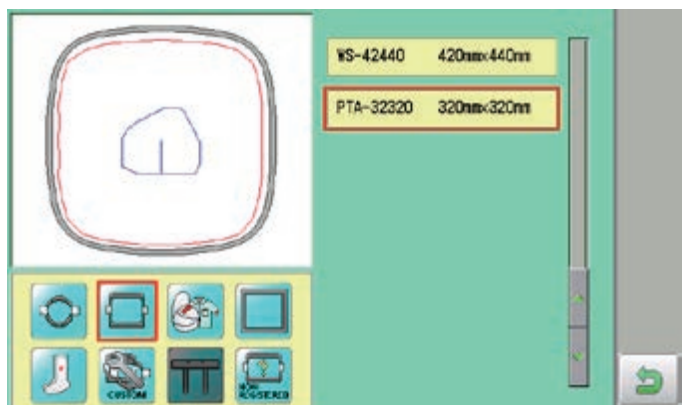
3. Select   or .

 : Tubular round frame

 : Tubular square frame

 : User-defined frame

4. Select desired type of frame.



SEWING WITH TUBULAR FRAMES

6-1b

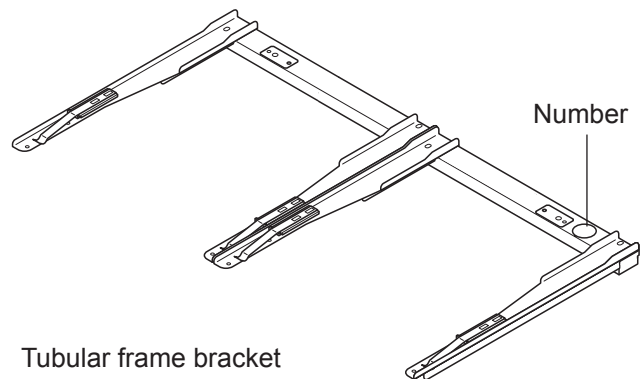
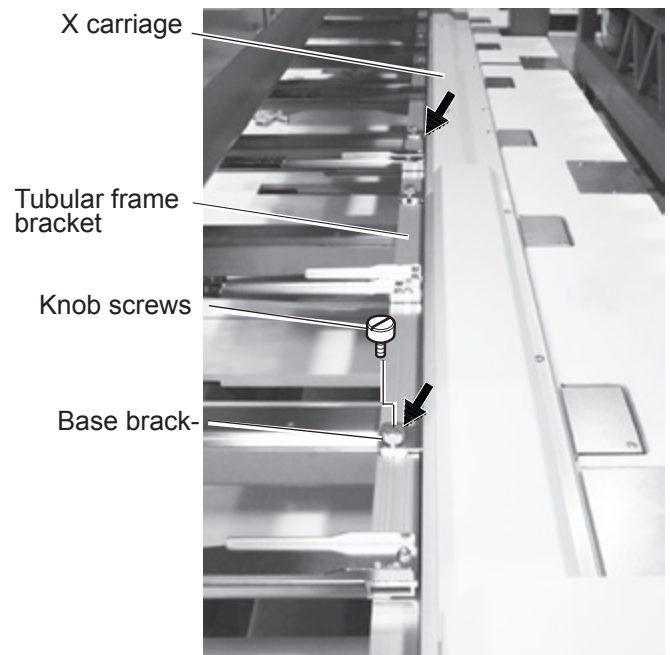
5. Press .




6. Move the carriage to the position shown by

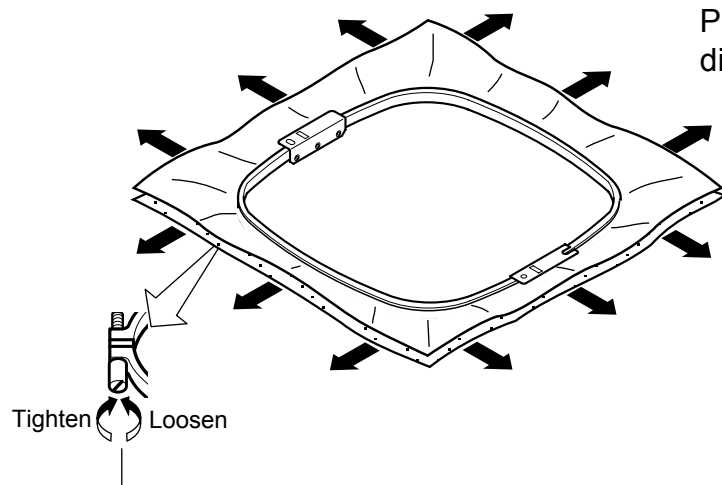
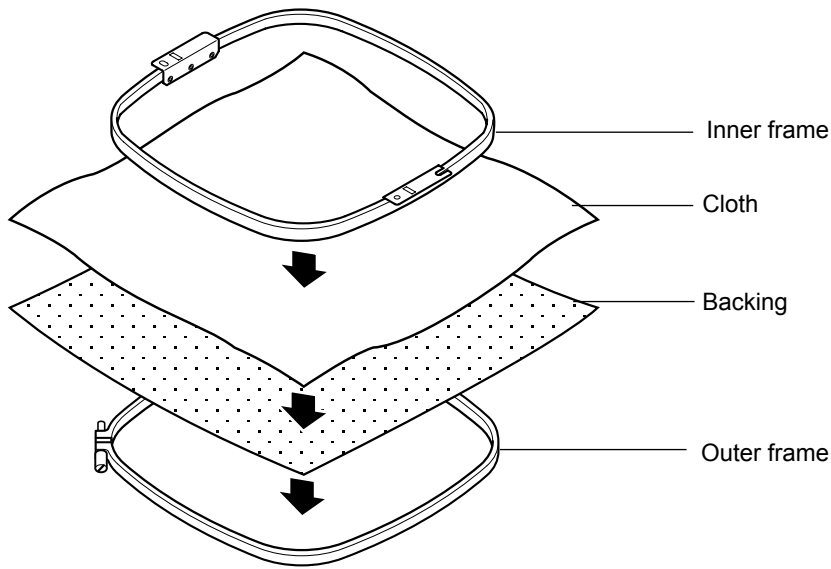


7. Each Tubular frame bracket have number label for fixing location. Please set the Tubular frame bracket in the order right to left. Fix the tubular frame bracket under the base bracket of the X carriage and tighten the screws completely.



Press  to return to Drive mode.

●How to hoop

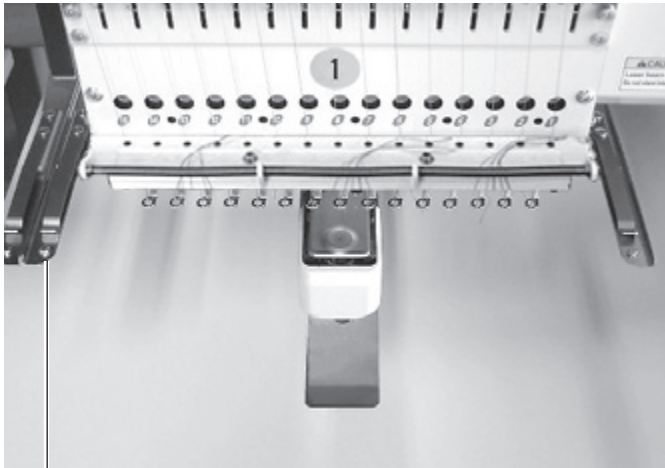


Please stretch the embroidery cloth in the directions of the arrow to smooth the cloth.

Please smooth the embroidery cloth while adjusting tightness of outer frame.

Do not stretch the elastic cloth too much.

● Mounting the hoop on the machine

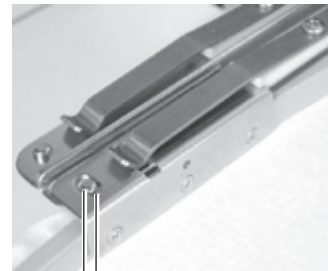
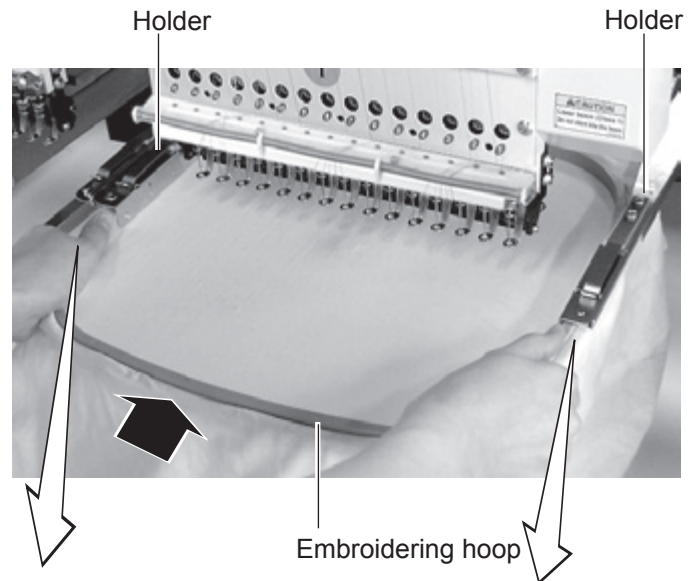


Tubular frame bracket

1. Move the frame base to the approximate center position before inserting the tubular embroidering frame.

2. Insert the embroidery frame.

Make sure that the holder pins are inserted into the positioning holes of the frame base on each side.



Positioning hole
Positioning pin



Positioning hole
Positioning pin

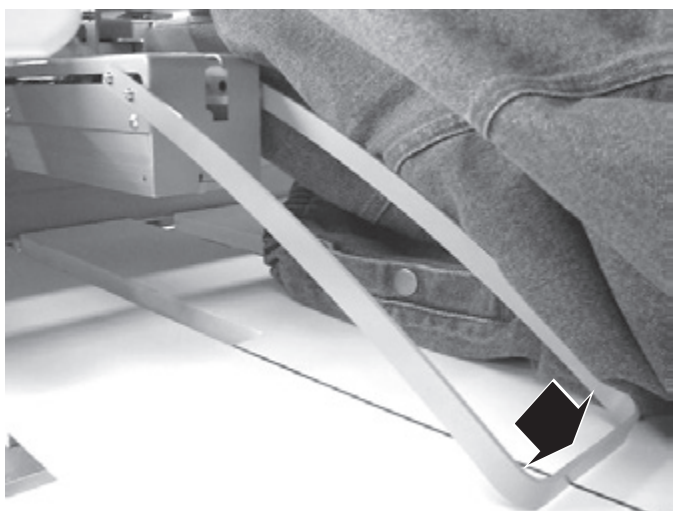
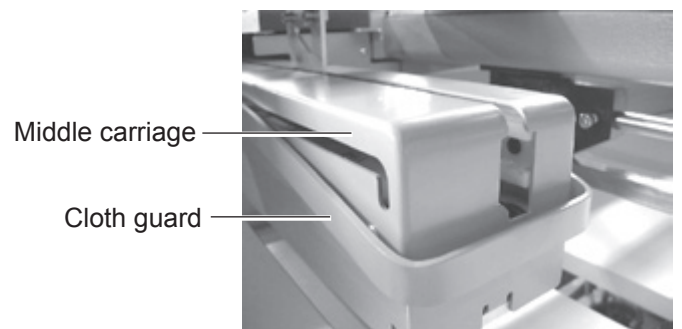
● Cloth guard

(For provided with middle carriage)

When embroidering the finished garment by using the tubular frame, the cloth that is placed out from the frame might be caught to the middle carriage.

In such a case, please fully draw out cloth guard.

Please return it to former position when the cloth guard is not necessary.



Use TAJIMA made tubular frame

You can use TAJIMA made tubular frame which has the same installation width (space between left and right positioning pin) as HAPPY's frame by changing the position of both left and right hold springs and left and right hold spring bases.

Follow the procedure below after removing tubular frame.

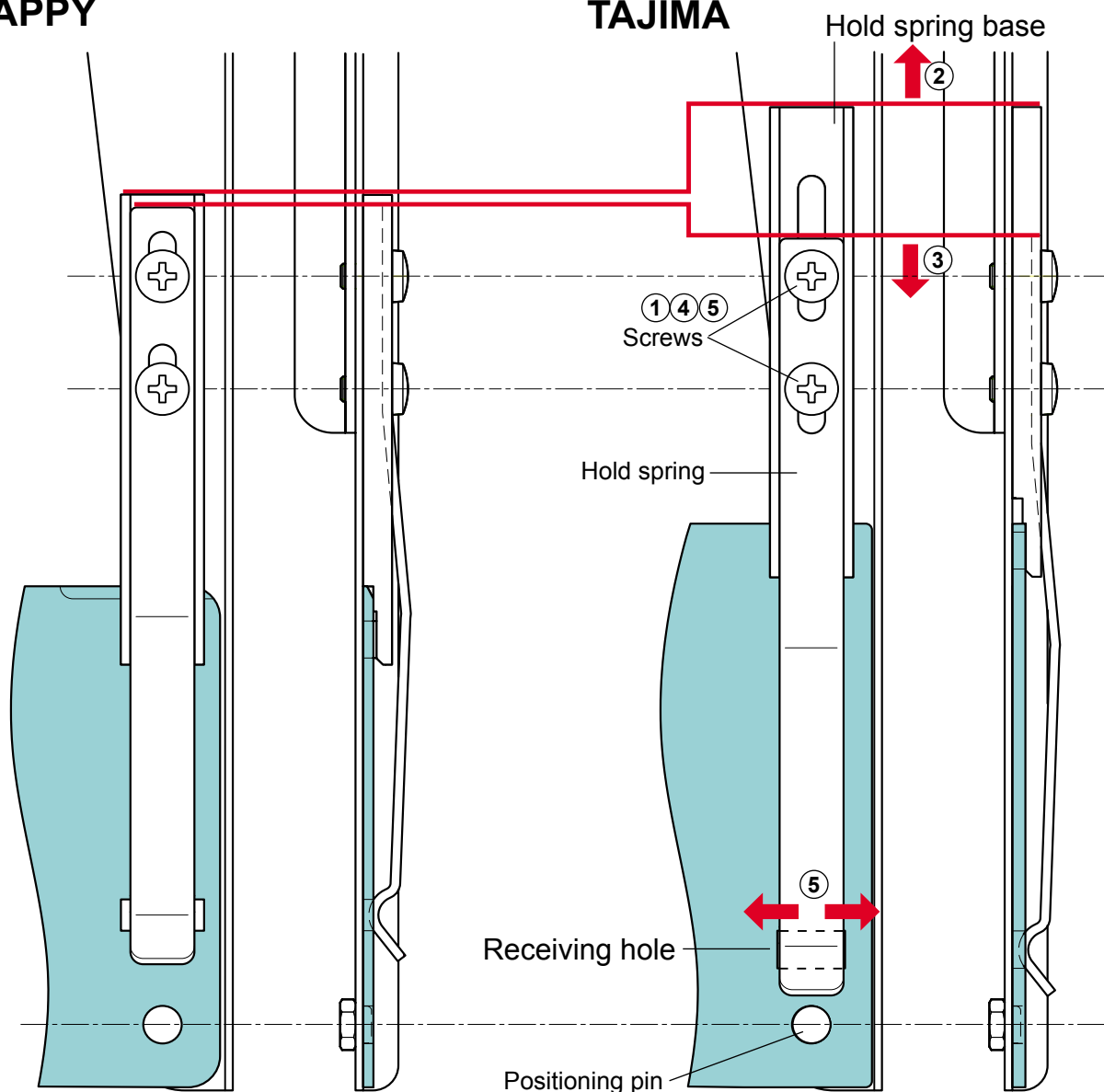
1. Loosen screws (2 each at both left and right).
2. Move both left and right hold spring bases deep into screws.
3. Move both left and right hold springs forward until the spring touches screws and stops moving.
4. Tighten screws (2 each at both left and right).
5. Install tubular frame and check if the tip of both left and right hold springs enters receiving hole on tubular frame.

If the tip dose not enter receiving hole, loosen screw, rotate hold springs left or right so that the tip can enter the hole, and tighten screw.


Please reverse the procedure above when returning to the position of something before change has been made.

HAPPY

TAJIMA



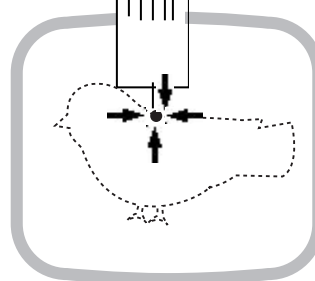
● Starting to embroider





1. Press  and move the frame to the original point with the

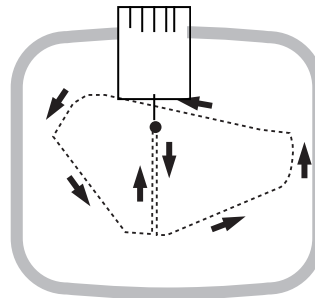


original point with the

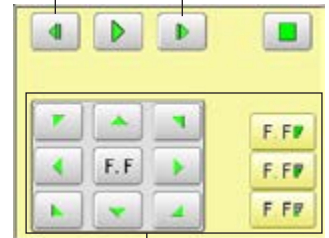
■ : Original point (Start point)



2. Press  .
 Press , and the embroidering frame moves for the design trace.  10-4
 Make sure that the pressure foot and needle do not touch the frame.
 Press , and trace is stopped.




Backward only when pressing
 Forward only when pressing

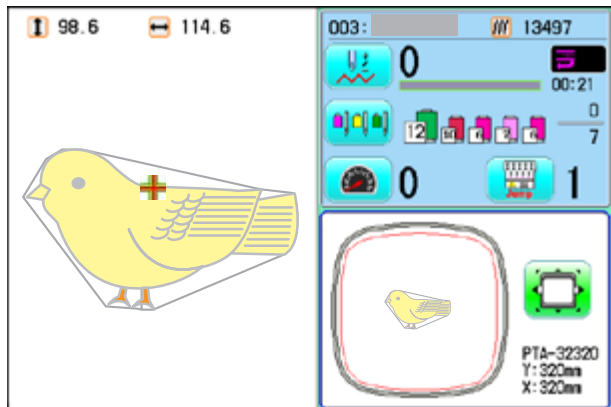


Frame move

Go on to step 4 if you want to start embroidering without tracing.

You can confirm outline trace and the position of the design.

3. Press  after the trace is completed.
 The embroidering frame has moved to the first stitch point of the pattern.

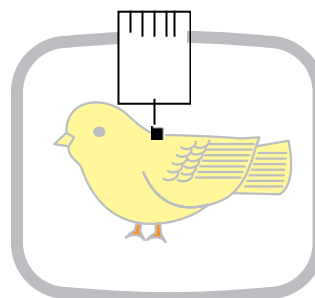


4. Press  .
 The embroidery will start.

5. After embroidering your design is complete, show ">>End" and the machine will stop.

The embroidery frame returns to the original point automatically if the "Auto origin" function has been activated.

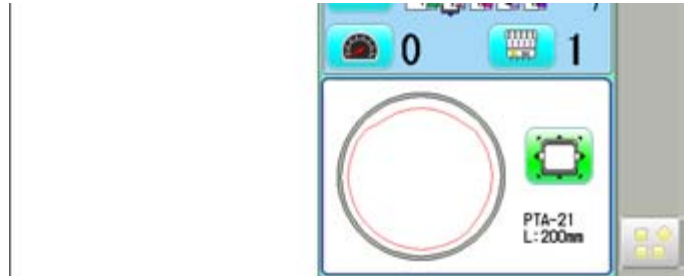
>>End




● Cap frame settings

2 types of cap frames, Normal and Wide, are available with this model. When you embroider by using a cap frame, please ensure that a correct setting is selected according to each.

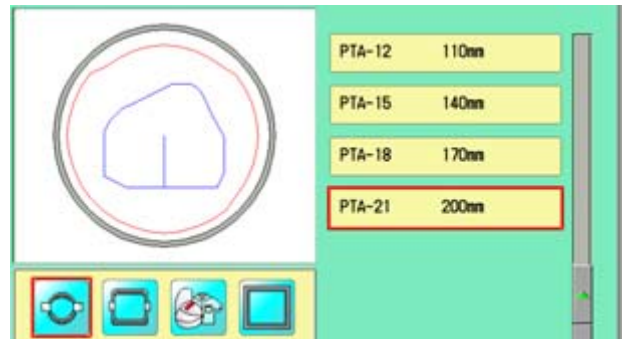
CAUTION: To avoid problems. The machine and/or cap frame may be damaged if the incorrect frame settings are used.




1. When the machine is stopped, press .



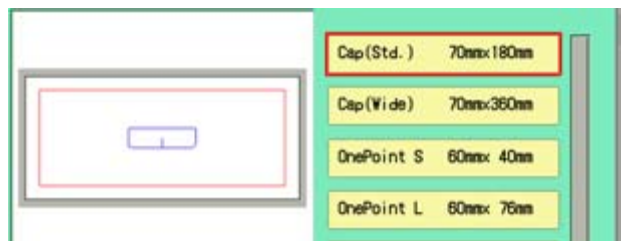
2. Press .



3. Select  "Cap and One-point frame".




4. Select desired type of frame. Then Cap frame will be set.



5. Press  and . The embroidery frame will move to the center.

CAUTION: To prevent accidents. The embroidery frame and carriage will move. Please keep hands clear for your safety.



Press  to return to Drive mode.

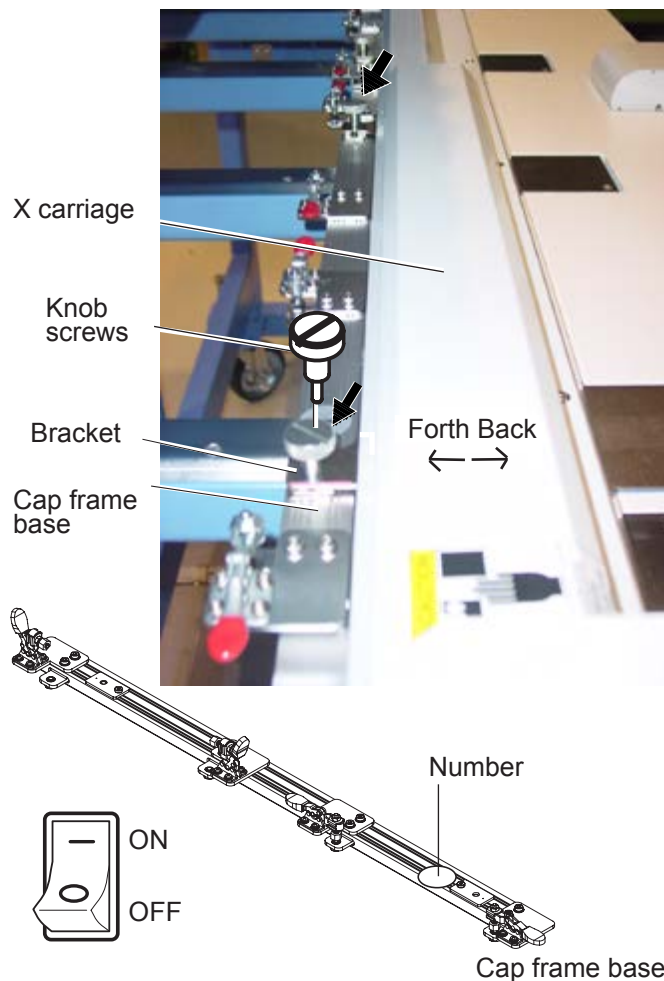
● Installing and removing the cap drive frame

The cap drive frame must be installed onto the X carriage to embroider a cap.
Please remove by reverse order of these step.

1. With machine powered off, move the X carriage back and forth by hand and note the resistance before mounting the cap drive frame.

2. Each Cap frame base have number label for fixing location.
Please set the Tubular frame bracket in the order right to left. Fix the cap frame base under the bracket of the X carriage and tighten the knob screws completely.

3. Turn on the power switch.
Push the power switch firmly so it will remain on.



Confirm that there are “Cap (Std.)” or “Cap (Wide)” in the display.

If these icons are not in the display, please return to “How to turn on the machine” on previous page and change the cap frame.



4. Press **Next**.

The carriage and frame will move slightly and then the embroidery frame will return to the previous position automatically.



CAUTION: To prevent accidents.
The frame moves quickly.
Keep hands away from the frame.

CAP FRAME option

5. Press  and Press  .
The embroidery frame will move to the center .



CAUTION: To prevent accidents.
The frame moves quickly.
Keep hands away from the frame.

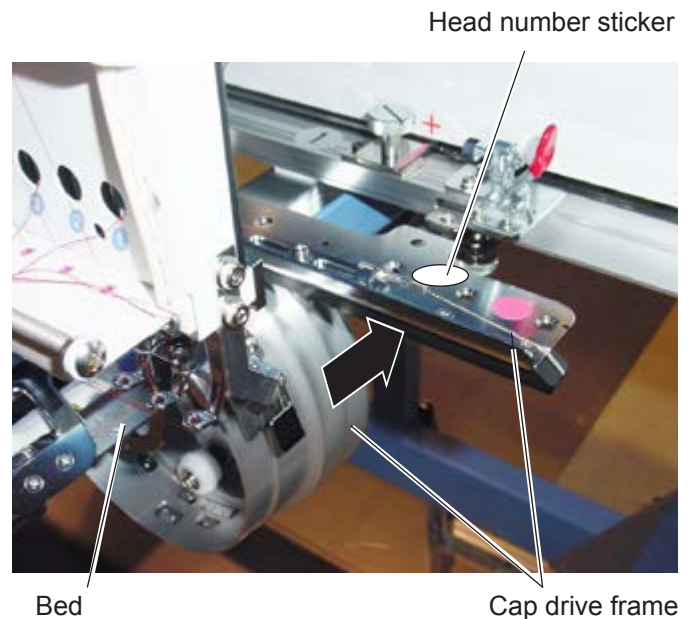
6. Turn off the machine.



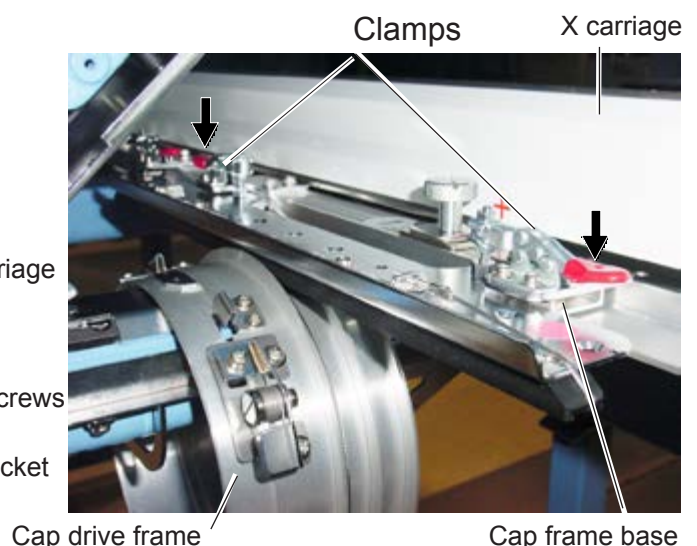
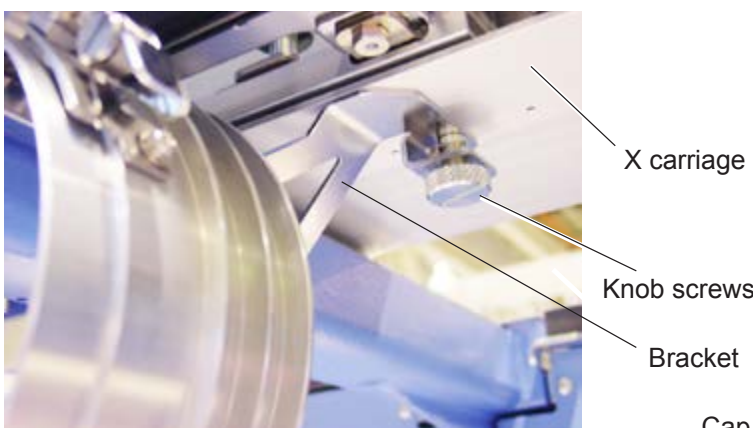
7. Insert cap drive frame with head number sticker labeled for respective head in bed.
This work requires firstly to insert drive frame assembly for even numbered heads and secondly insert cap drive frame assembly for odd numbered heads.

When holding the cap drive frame, be sure to also hold onto the rotary cylinder. If you hold the rail bracket, fingers may be caught between the rail bracket and rotary cylinder or the rail bracket may be knocked out of place.

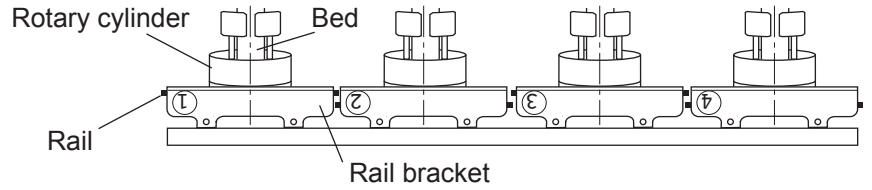
For machines with needle distance of 360mm, if you insert cap drive frame for odd numbered heads firstly, you can't insert cap drive frame for even numbered heads.



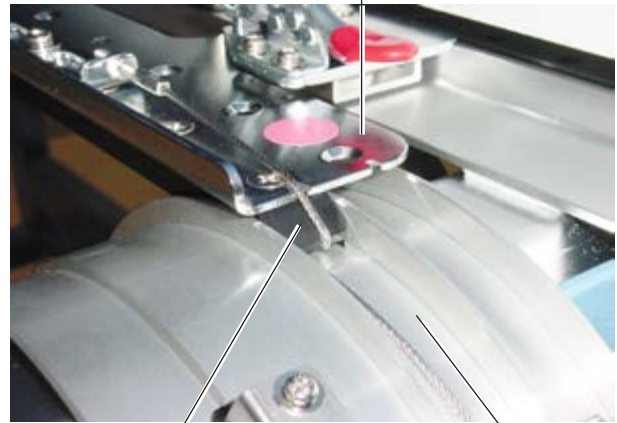
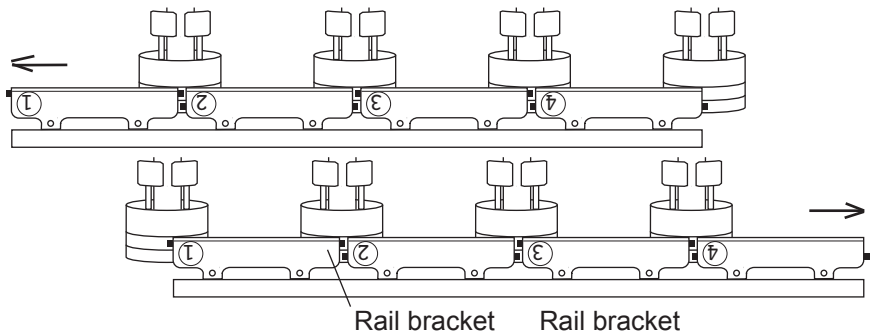
8. Move the cap drive frame towards the X carriage to place it on cap frame base, then shut the clamps.
Temporary fix right and left bracket of the cap drive frame below the X carriage by knob screws.
This work also requires firstly to insert even numbered leads, then go to odd numbered heads.



9. Confirm that rails of rail bracket are in grooves in front and back of rotary cylinder.

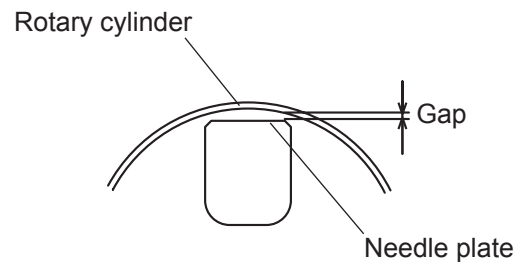


10. Move rail bracket fully to the right side or left side to confirm that all rails are in grooves in front and back of rotary cylinder.

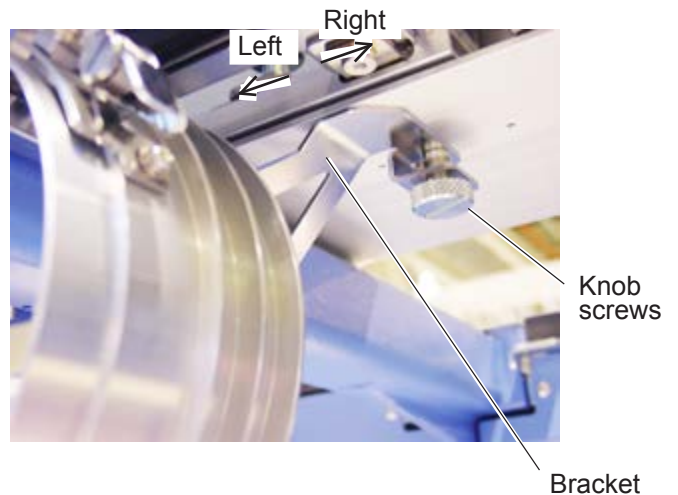


Rail Grooves of rotary cylinder

11. Adjust the Bracket horizontally so that the right and left gap between Rotary cylinder and Needle plate may become the same, then tighten the set screws completely.



12. Manually move the X carriage back and forth to ensure that it moves freely throughout its range of movement without catching. There may be some additional resistance but the frame should not be difficult to move. If you have a problem, start over from the beginning.



● Normal cap frame

Adjustment

When you hoop a cap on the cap frame, please adjust in the following manner:

1. Adjust up and down position of the hook according to the thickness of the cap to adjust clamp tension. At this moment, the hook should open and close without feeling too tight.
(For adjustment, proceed to procedure 5 below).
Use the wing nuts for adjustment. (Fig. 1)

If the hook is extremely tight, it will damage the cap frame permanently.

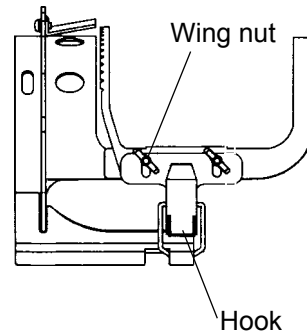


Fig. 1

2. Adjust the guide position to suit the height of the cap.
Remove screws at left and right to adjust.
(Fig. 2)

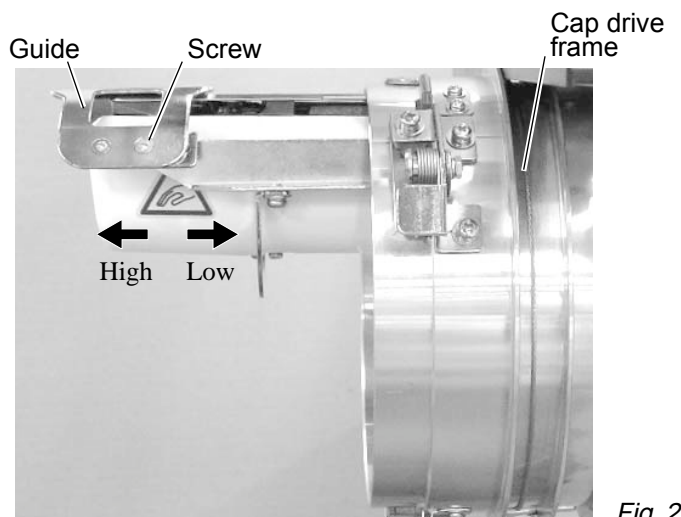


Fig. 2

CAP FRAME (OPTION)

7-6

Hooping caps

1. Place cap stretcher securely on a sturdy work bench.
2. As shown in Fig. 5, hold cap frame with both hands and place on cap stretcher. By pushing locking levers at 2 places with fingers, place cap frame so that center guide of cap stretcher fits in concave area of cap frame.

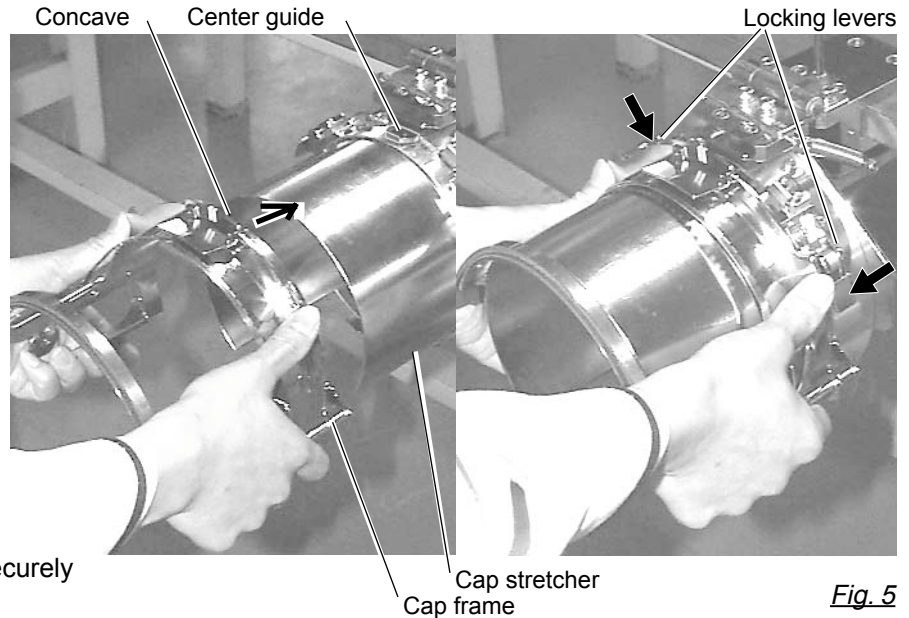


Fig. 5

Confirm that the cap frame is securely placed on cap stretcher.

3. As shown in Fig. 6, open clamp and keep open to the right.
4. Take the front half of the sweatband out of the cap and cover the cap stretcher with the sweatband. Cover the cap stretcher with the sweatband so that the edge of the sweatband contacts the flange of the cap frame.

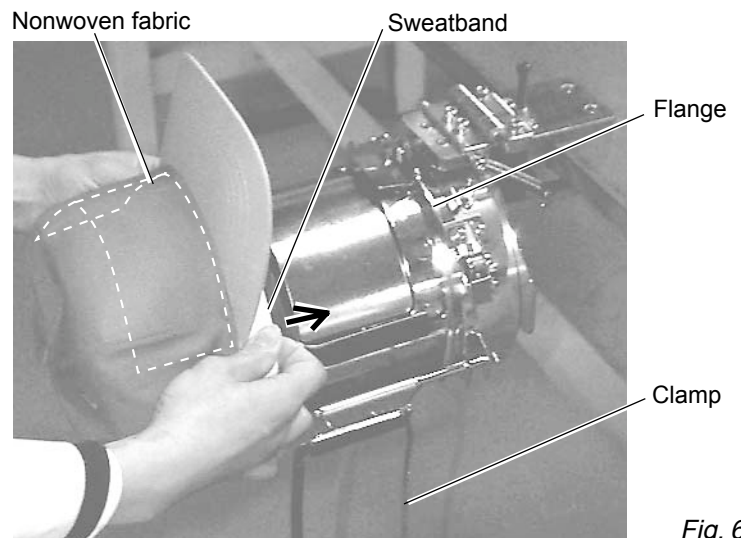


Fig. 6

Please place one or two sheets of nonwoven fabric (backing) of standard thickness under unstructured caps.

5. As shown in Fig. 7, pull back part of cap and hook it temporarily on the hook and smooth out wrinkles on cap. At this time, align the center of the cap to the center mark on the cap frame so that notched portion of the clamp fits into the seam of the visor of the cap.
6. Latch the hook, taking care not to cause wrinkles in the cap.

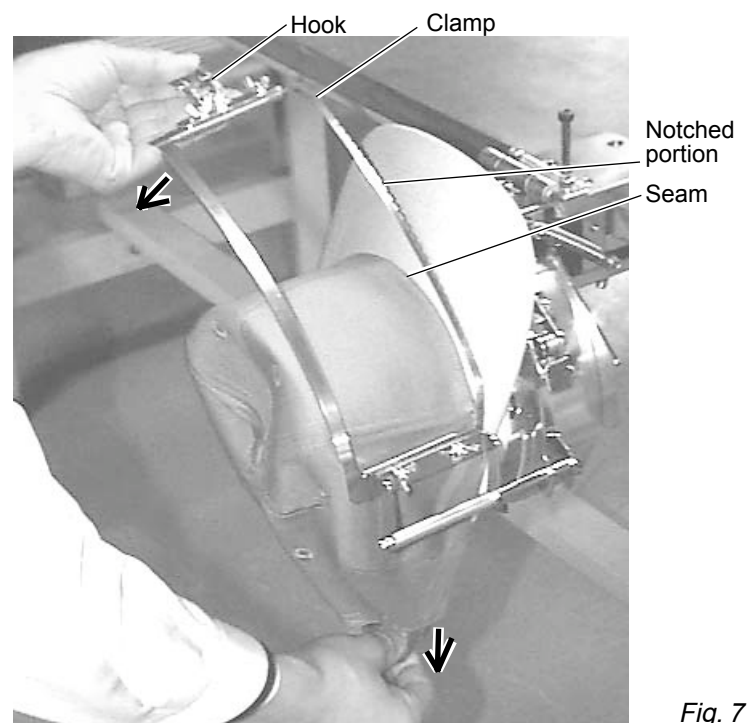


Fig. 7

If you can't get rid of wrinkles on the cap, adjust the cap frame again according to "Adjustment" of the previous page.

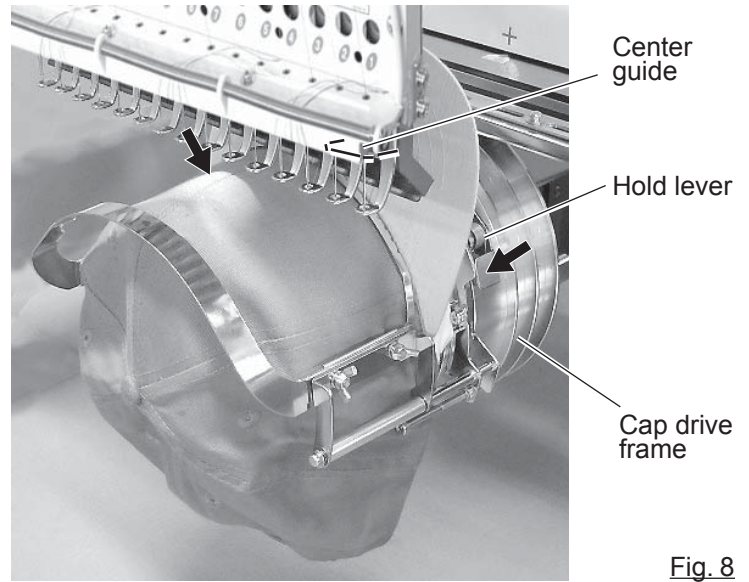
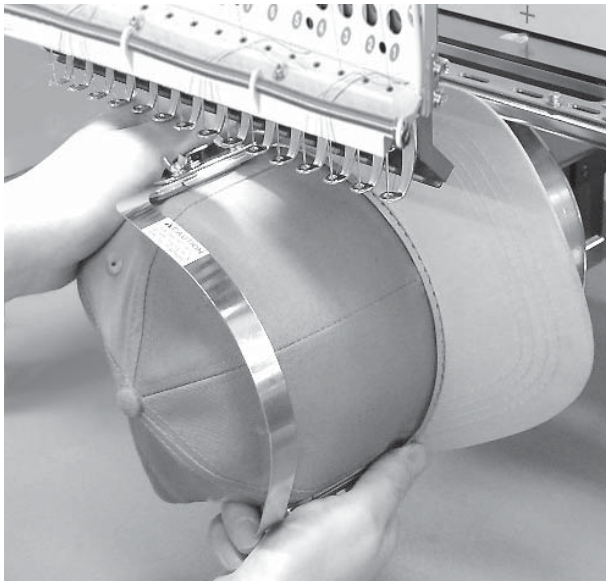


Fig. 8

7. Remove the cap frame from the cap stretcher.
8. As shown in Fig. 8, install the cap frame on cap in the drive frame.
Rotate the cap frame as show in the Fig 8 so that the brim of the cap cannot hit the machine.
Then, push the holder lever in the 2 places shown in the arrow in Fig. 8, and install the cap frame in the cap drive frame so that so that the center guide of the drive frame fits the concave area of the cap frame.

Confirm that the cap frame is firmly installed on the cap drive frame without any gap.
If there is a gap between the cap frame and the cap frame drive or the holder lever does not fit the hole of the cap frame, adjust loosen the set screw on the hold lever to adjust the position.

●Wide cap frame

Adjustment

When you fix cap to cap hold frame, please adjust in the following manner.

Make sure to do the adjustment of the cap hold frame. If it is not adjusted properly, it may cause the deformity, damage of the cap, damage of the cap hold frame and break of the cap grip.

After adjusting the cap hold frame, make sure the cap to be set properly.

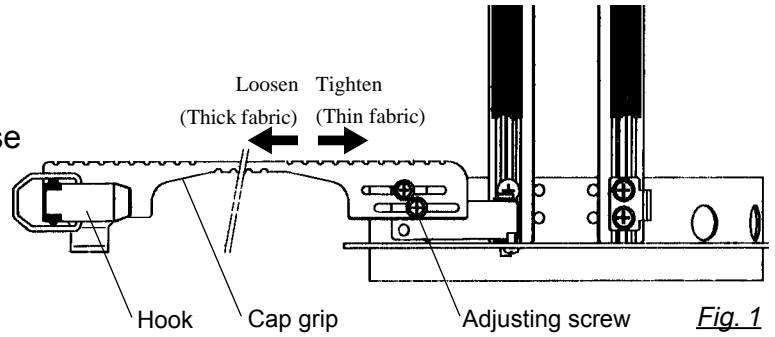


Fig. 1

1. Adjust the length of the cap grip to suit the thickness of the fabric. At this moment, hook should open and close without feeling heavy. (For the adjustment follow the next page "Hooping caps" item 1 to 5.) The adjustment to be done by two adjusting screws. (Fig. 1)

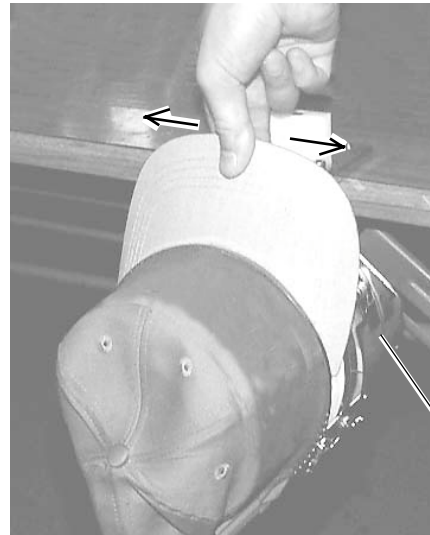


Fig. 2

If the cap grip is loose, even after hooked the cap is not fixed tightly and the cap is moving. (Fig. 2)

If the cap grip is too tight, you feel heavy when it is hooked and the grip bites into the cap too much. (Fig. 3)

If you feel hook extremely heavy in opening and closing, there is a case that cap hold frame will lose its shape or damaged.

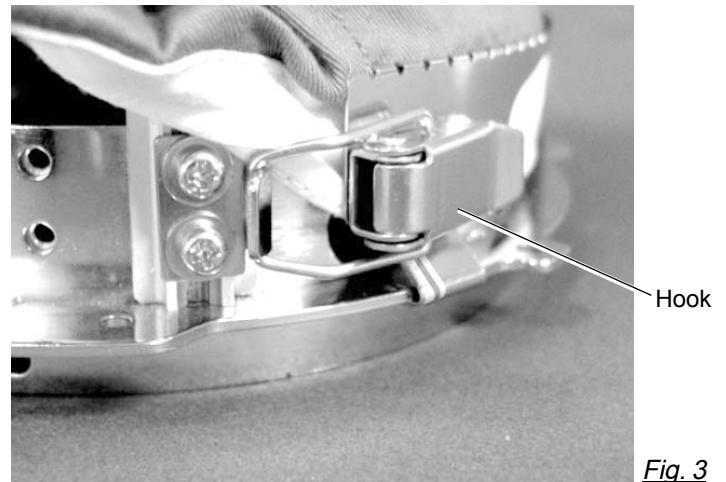


Fig. 3

2. Adjust the guide position to suit the height of the cap. Remove screws at left and right to adjust. (Fig. 4)

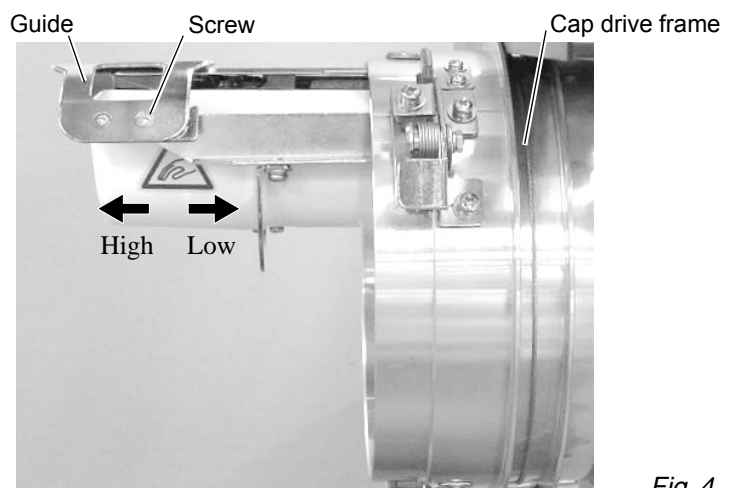


Fig. 4

Hooping caps

1. Place cap stretcher securely on sturdy work bench.
2. As shown in Fig. 1, hold cap hold frame with both hands and place on cap stretcher. By pushing hold lever at 3 places in arrow marks with fingers, place cap hold frame so that center guide of cap stretcher gets in concave of upper cap hold frame.

Confirm that cap holder frame is securely placed on cap stretcher without gap.

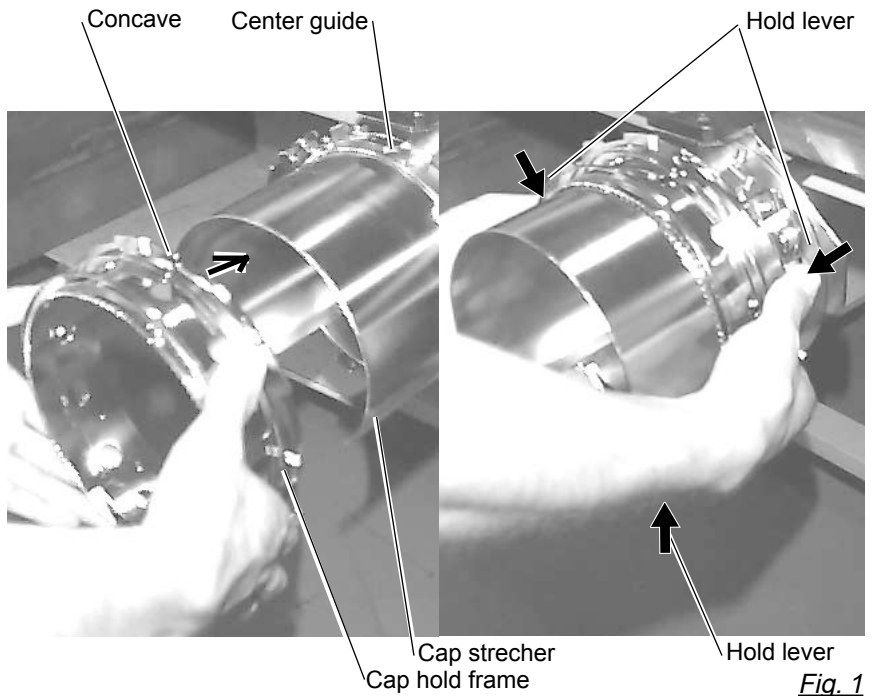


Fig. 1

3. As shown in Fig. 2, remove cap grip and keep open to the left.
4. Take the front half of the sweatband out of the cap and cover the cap stretcher with the sweatband. Cover the cap stretcher with the sweatband so that the edge of the sweatband contacts the flange of the cap frame.

Please place one or two sheets of nonwoven fabric (backing) of standard thickness under unstructured caps. The length of nonwoven fabric should be the same as one of round of cap.

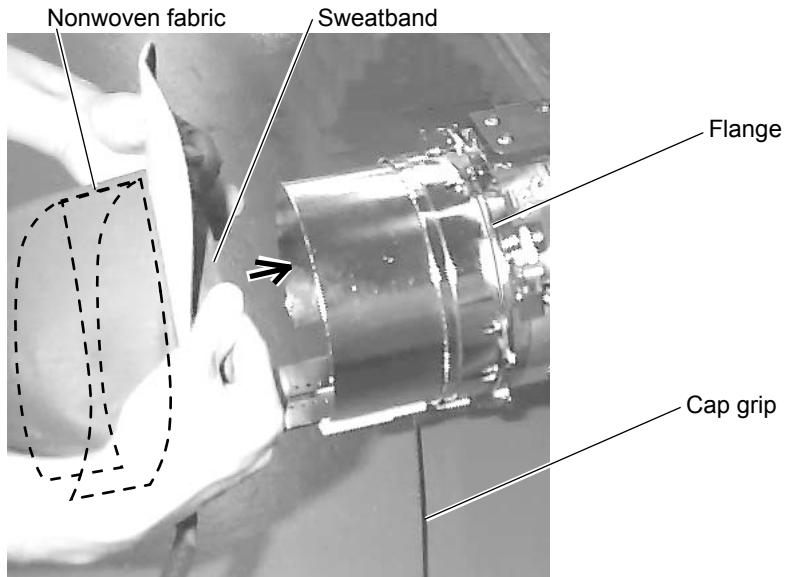


Fig. 2

5. Place hook of the cap grips. At this time, align the center of the cap to the center mark on the cap frame so that notched portion of the clamp fits into the seam of the visor. Close hook.

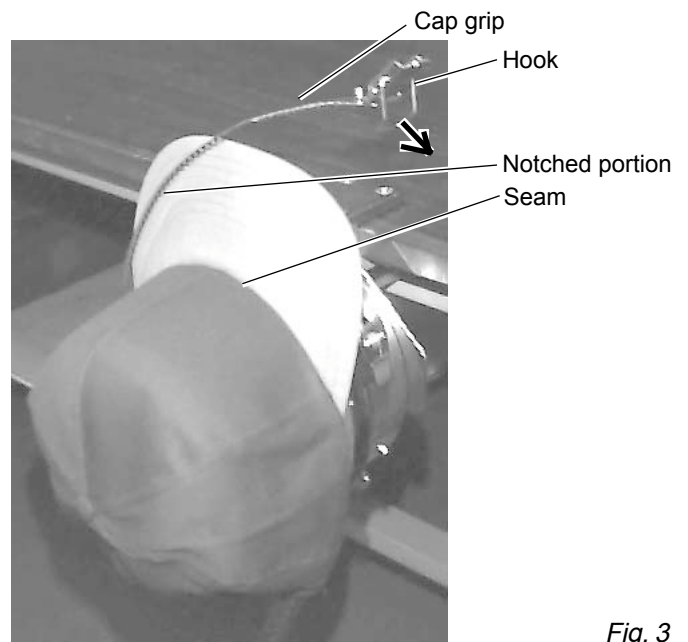


Fig. 3

CAP FRAME option

7-A

6. As shown in Fig. 4, tip the cap stretcher forward. Clip the back of the cap and nonwoven fabric in two places.

Make the clip levers face each other.

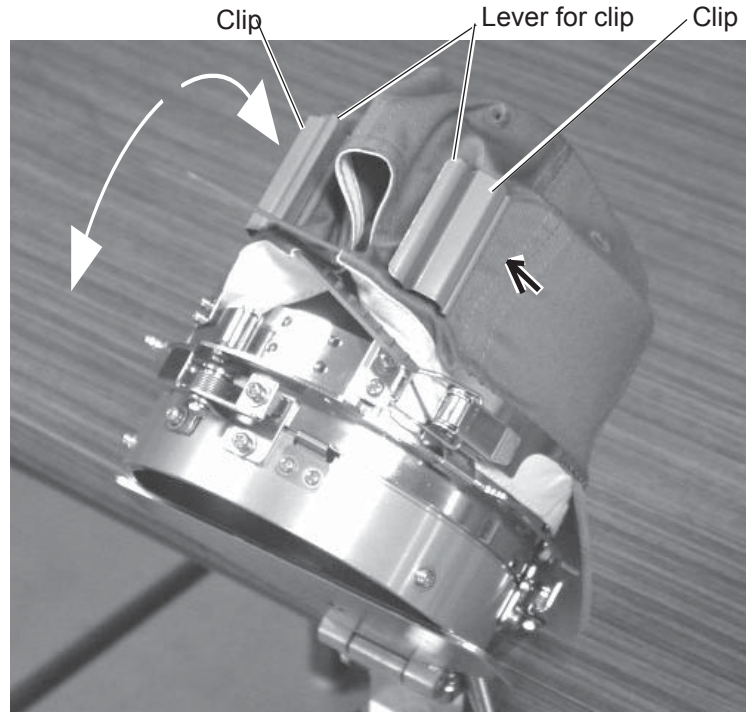


Fig. 4

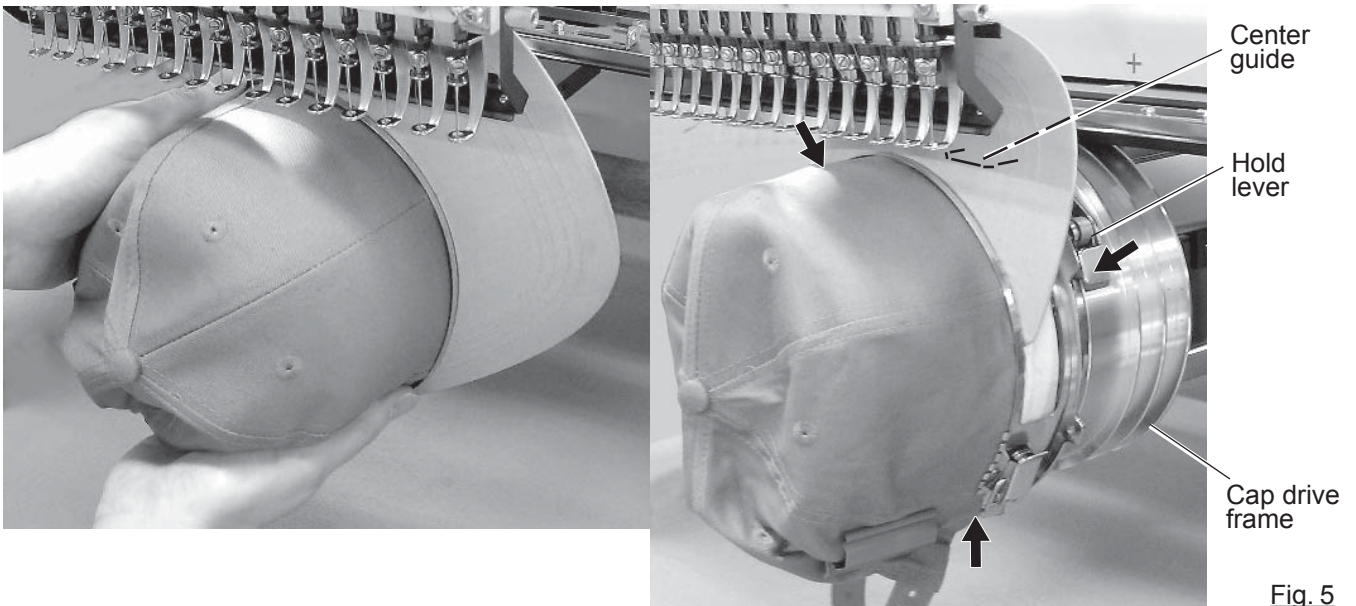


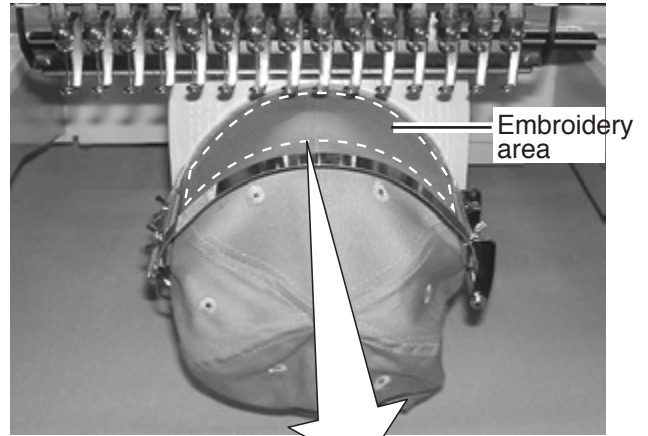
Fig. 5

7. Remove the cap holder frame from the cap stretcher.
8. As shown in Fig. 5, install the cap frame on cap in the drive frame. Rotate the cap frame as show in the Fig 5 so that the brim of the cap cannot hit the machine. Then, push the holder lever in the 3 places shown in the arrow in Fig. 5, and install the cap frame in the cap drive frame so that so that the center guide of the drive frame fits the concave area of the cap frame.

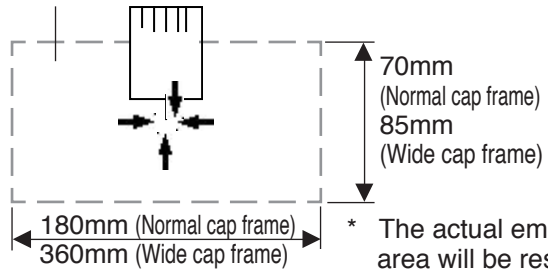
Confirm that the cap frame is firmly installed on the cap drive frame without any gap.

If there is a gap between the cap frame and the cap frame drive or the holder lever does not fit the hole of the cap frame, adjust loosen the set screw on the hold lever to adjust the position.

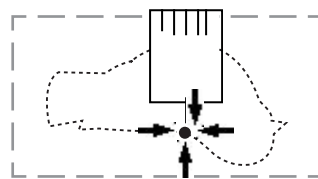
● Starting to embroider





Embroidery area (Max. *1)





■:Original point (Start point)



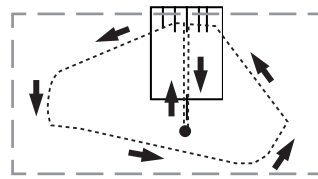
1. Press  and move the frame to the original point of pattern data by .

2. Press .



When you Press , the frame will start moving for the design trace.  10-4
Make sure that the pressure foot and needle does not touch the frame.

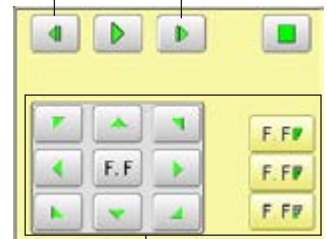
When you Press , the machine will stop.

Go on to step 4 if you want to start embroidering without tracing first.



You can confirm the outline and position of design.

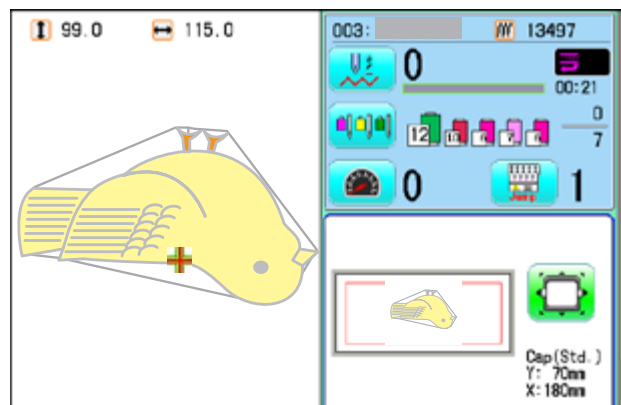
Backward only when pressing  Forward only when pressing 




Frame move

3. Press , the design trace finished.

The cap frame will return to the original point.




4. Press the .

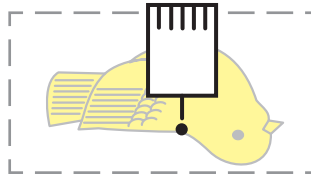
Embroidery will start.

5. After finishing your design, the display will show ">>End" and the machine will stop.

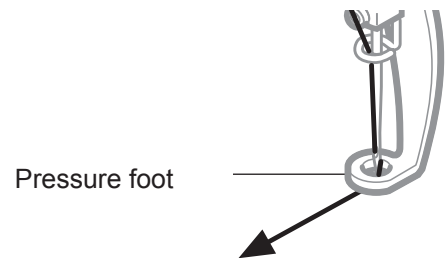
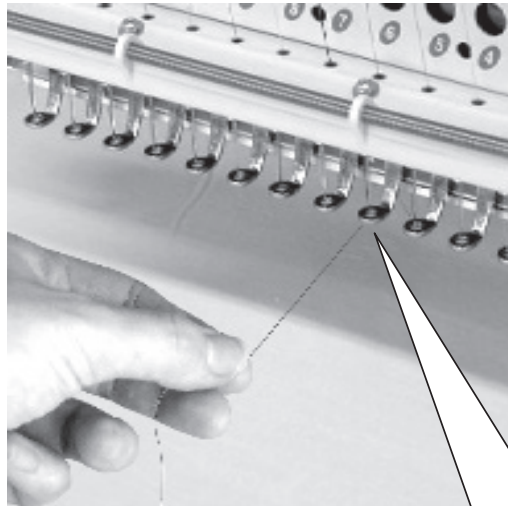


The embroidery frame will return to the original point automatically if the auto origin function has been activated.  12-7

●:Original point (Start point)

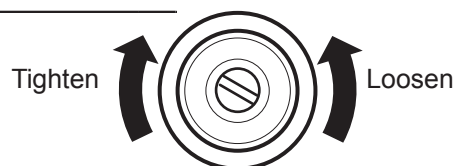
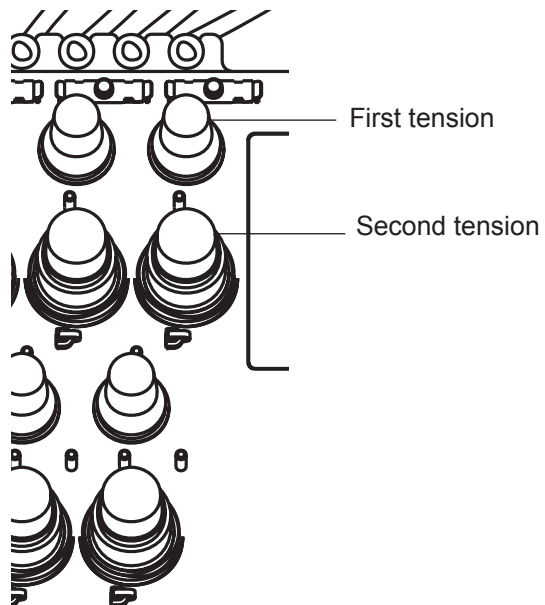


1. With the thread going through the hole of the pressure foot, pull it out slowly toward the front.



2. Adjust the Minor thread tension by the first tension knob and then the second Thread tension knob.

According to the type of upper thread and cloth.






ADJUSTING THE LASER POINTER (OPTION)

8-2

Laser pointer indicates the needle position.



The beam of laser is coming from right upper side, thus the position of laser pointer can be changed depending on the height of surface of fabric.

Please adjust the angle of laser pointer depending on thickness of fabric and type of frame.

- For switch ON laser pointer, Press  and Press  on the submenu.
For switch OFF laser pointer, Press .



CAUTION: Laser beam (Class 1)
Do not stare into the beam.



- Press  to return to Drive mode, and press  and set a position of moving head to needle No. 1.





- Set fabric on the frame, then put white paper to the position of needle and fix by Scotch tape.

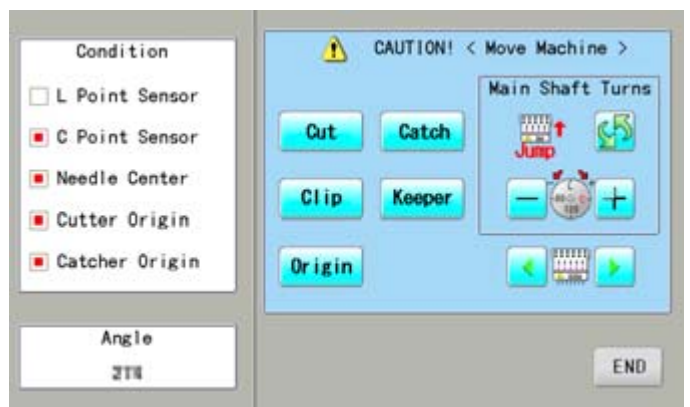
- Press  and Press .



- Press .

- Press  to cancel "Jump".

- Press  and keep until needle reaches to the paper and make hole.



CAUTION: To prevent accidents.
The needle will penetrate the fabric.
Please keep your hands clear for your safety.

ADJUSTING THE LASER POINTER (OPTION)

8-3

8. Unscrew a fixing screw for X direction slightly and change angle of support(X).


9. Unscrew a fixing screw for Y direction slightly and change angle of support(Y).

10. Fix the fixing screw for X and the fixing screw for Y.

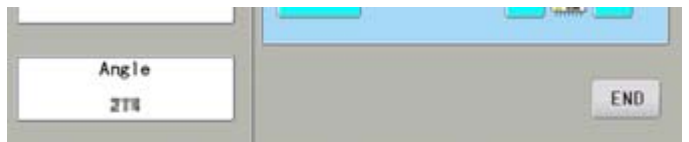
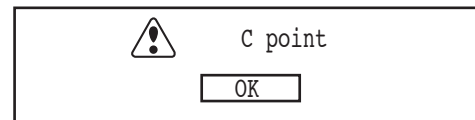
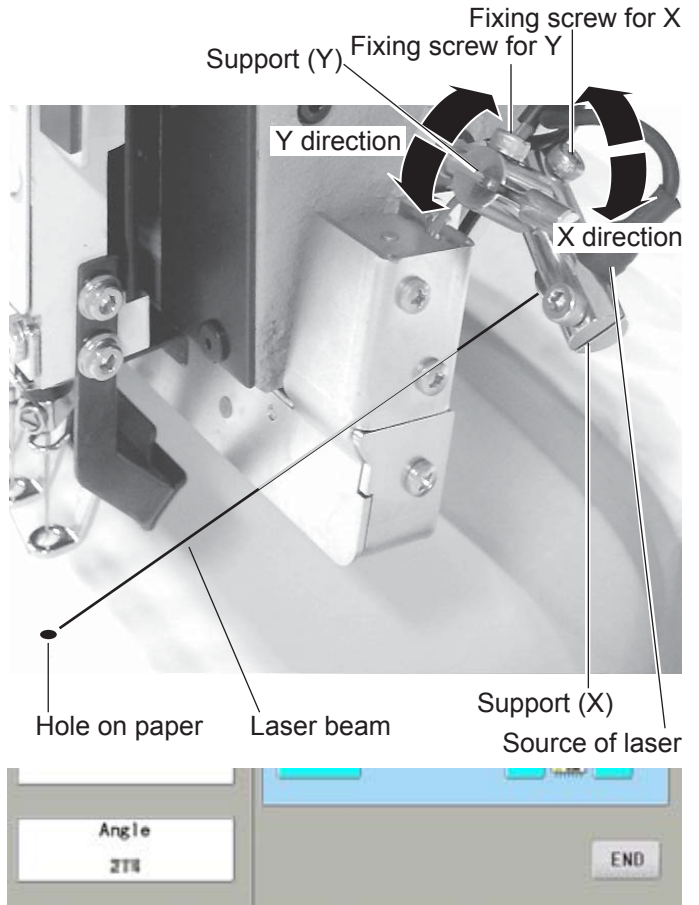
11. Check the hole position on paper and the point of laser beam, and take paper out.


12. Press **END**.

13. Press **OK**.

 **CAUTION: To prevent accidents.**
The needle will penetrate the fabric.
Please keep your hands clear for your safety.

14. Press **END**.



Press  to return to Drive mode.

Important safety instructions

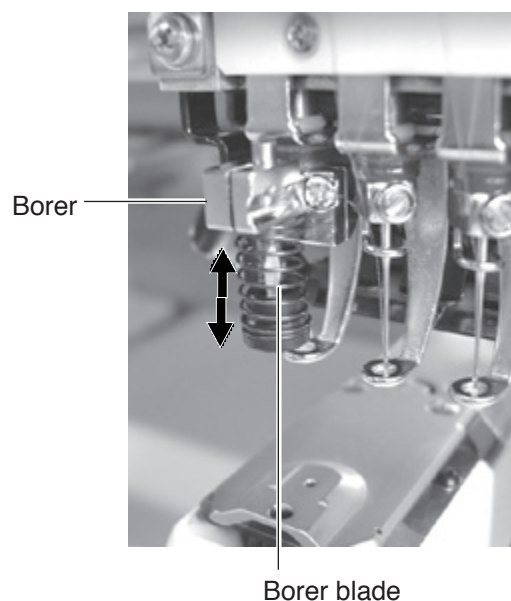
When using an appliance, basic safety precautions should always be followed, including the following.



WARNING - To reduce the risk of injury to persons:

1. An appliance should never be left unattended when plugged in. Always unplug this appliance from the electric outlet or switch main breaker OFF after using and before cleaning.
2. Do not allow to be used as a toy. Close attention is necessary when this appliance is used by or near children.
3. Use this appliance only for its intended use as described in this manual. Use only attachments recommended by the manufacturer as contained in this manual.
4. Keep fingers away from all moving parts. Special care is required around the sewing machine needle and borer blade.
5. Switch the sewing machine off ("0") when making any adjustments in the borer device area, such as changing borer blade, etc.


SAVE THESE INSTRUCTIONS



- For safe use of this device, we highly recommend to use "Safety Sensor" (option) together. "Safety Sensor" will stop machine, when your hand gets closer to needles or knife. Please contact your local distributor to get more detail information.

Select needle number for Borer device

Select needle number which Borer device is installed.

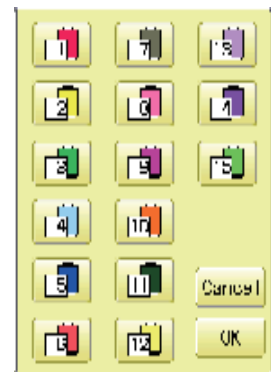
1. When the machine is stopped, press  .




2. Select "NEEDLE".

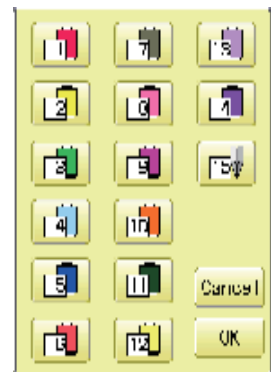


3. Press  from right submenu.



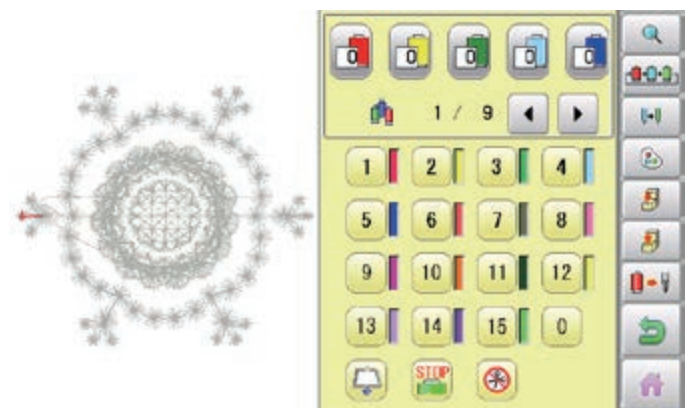
4. Select 15th needle number.



Display  on right side of needle number.
If you press again, cancel the BORER setting.



5. For fix the setting, press  .

If you like to cancel this setting, press  .




Press  to return to Menu mode.
Press  to return to Drive mode.

Borer setting to color change sequence

When you use the borer, you can set the use of the borer blade to any color number of the selected pattern data.

 You can not setting "NEEDLE" for selected "LOCK" design.

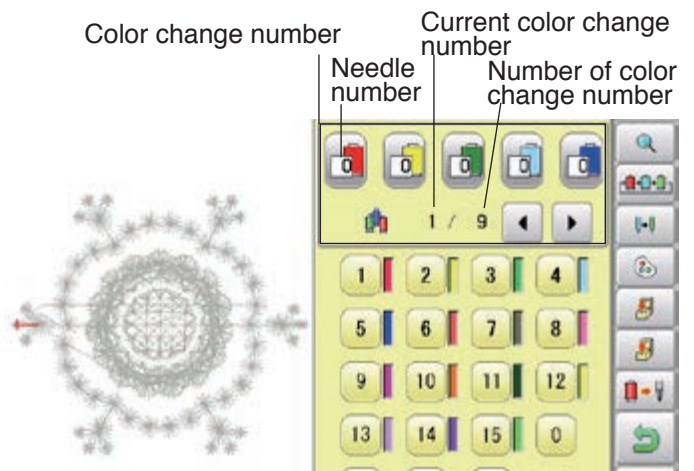
Please release "LOCK" from design.  11-1

1. When the machine is stopped, press .



2. Select "NEEDLE".

The screen of color number 1 selection is displayed.
The current color number is showed in the pattern data display portion.



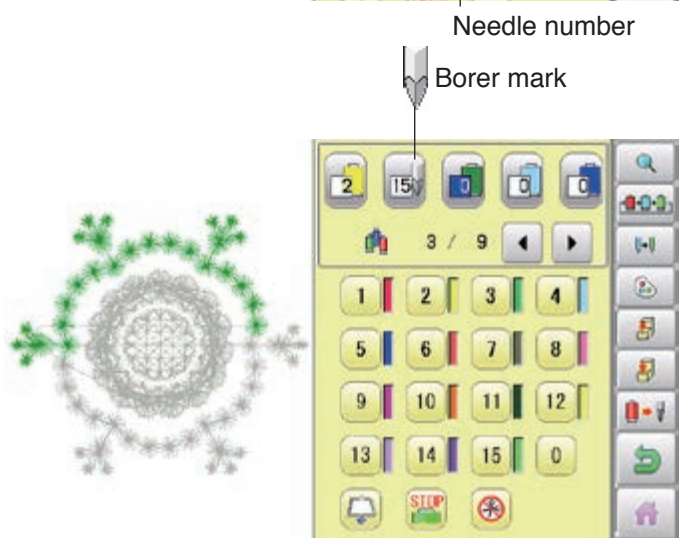
3. Select the color change number.

The current color number is showed in the pattern data display portion.



4. Select Needle number (15th needle).

The setting is completed.
If you like to set borer to another color sequence too, you need to repeat step 3 and 4 again.




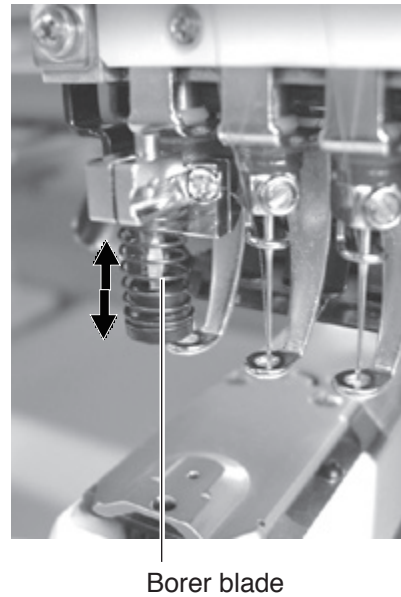
Press  to return to Menu mode.

Press  to return to Drive mode.


● Exchange the borer blade (option)

If the Borer blade become bunt or should chip, exchange the Blade in the following procedures.

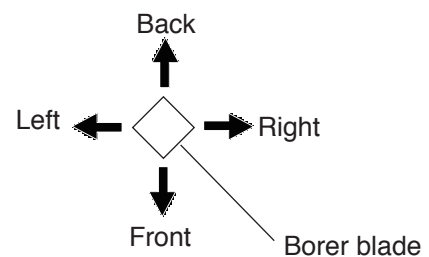
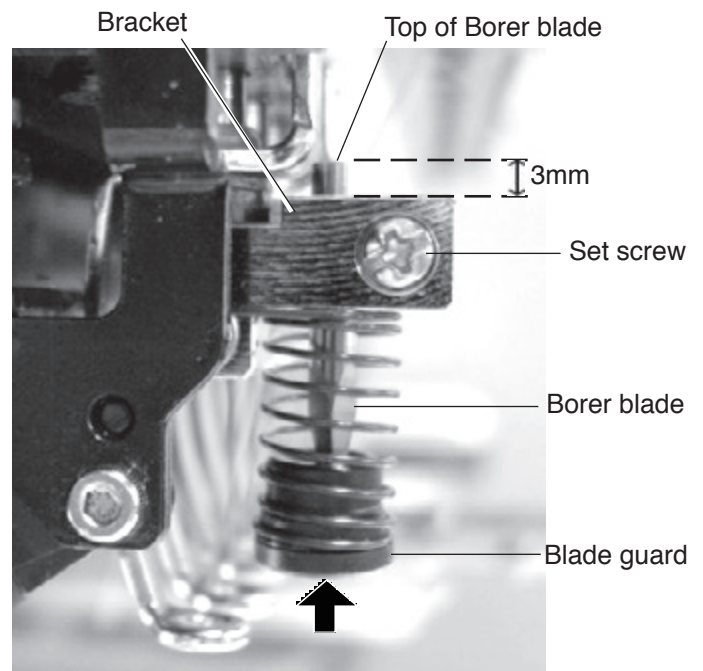
 **CAUTION: To prevent accidents;**
Be sure power switch is "OFF".



1. Loosen the set screw and remove old borer blade from bracket.
2. Please set position of Top of borer blade 3 mm higher than surface of Bracket, and Cutting point of blade should be on front and back, right and left.

 **CAUTION: To prevent accidents;**
Please do not push up Blade guard by finger.

Standard Borer blade position is that position of Top of borer blade is 3mm higher than surface of Bracket.
Depending on cutting result this height can be adjusted between 0mm to 3mm.



● What to do if the thread breaks while sewing

If the thread breaks or runs out while sewing, the machine senses the break, stops, and moves back several stitches from the break point.

(This prevents open sections in the design when sewing is resumed. See the thread break section. P5-1)

If the upper thread breaks

Thread the upper thread again.

(Refer to P4-6)

In case bobbin thread breaks

Thread lower thread again.

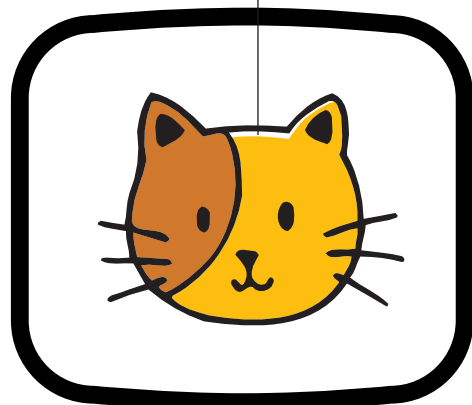
(See bobbin winding P4-5)

● Stopping and resuming sewing


Even if you need to turn off the machine in the middle of embroidering, you will be able to resume sewing from the stop point after turning on the machine back on.

■ If you leave the machine off for too long, the fabric may distort which will create gaps in the embroidery design.

Example: An unsatisfactory gap between lines because the machine stopped at a half point in embroidery and the material shrunk.



To suspend sewing

1. Stop the sewing by pressing the  button.

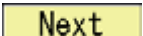
2. Press  button.

The needle will go down and trim the thread.



3. Turn off the power switch.

To resume sewing from the last sewn position:


4. Turn on the power switch.

5. Press  button.

After the carriage and frame move slightly, the embroidery frame will return to the previous position automatically.

6. Press  and back up several stitches from the stop point by pressing the  3-4 times.

7. Press .

8. Start sewing again by pressing the .

>>Stop Switch



CAUTION: To prevent accidents.
When performing a thread trim, be careful of the needle which will pierce the fabric.



CAUTION: To prevent accidents.
The frame moves quickly.
Keep your hands and body clear of the machine.

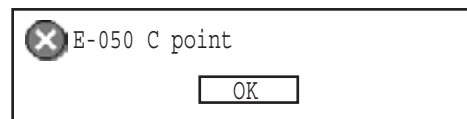
● Loss of power while embroidering

If you have a power failure while embroidering, follow these instructions and you can restore the position of the frame and the pattern data to its state before the failure.

1. Turn on the power switch.



2. Press **Next**.



3. Press **OK**.



4. Press **Auto**.

The main shaft will make one rotation and stop at the "C" point (proper stop position).




5. Press .


The needle will go down and trim the thread.


6. Press **Next**.


After the carriage and frame move slightly, the embroidery frame will return to the previous position automatically.

7. Press  and back up several stitches from the stop point by pressing the **U-1** 3-4 times.


8. Press .

9. Start sewing again by pressing the .


 **CAUTION: To prevent accidents.**
When performing a thread trim, be careful of the needle which will pierce the fabric.

 **CAUTION: To prevent accidents.**
The frame moves quickly.
Keep your hands and body clear of the machine.

● Moving the hoop while embroidering and then returning to the correct location

1. Stop the sewing by pressing the  while embroidering.

>>Stop Switch


2. Press  and move frame with



3. Press .

The frame will automatically return to the current sewing position.






 **CAUTION: To prevent accidents.**
The frame moves quickly.
Keep hands away from the frame.

4. Press .




● Moving back to the starting point (Origin)

The frame returns to the origin point (beginning position of design).

 **CAUTION: To prevent accidents.**
The frame moves quickly.
Keep hands away from the frame.

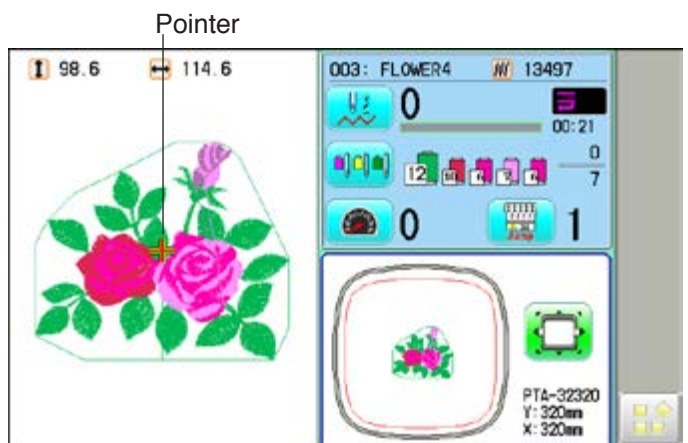
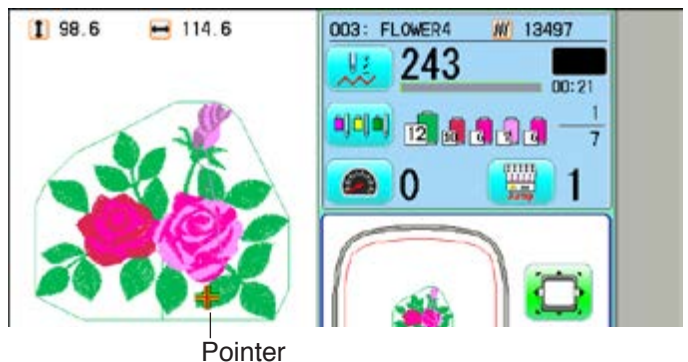
1. Press  and press .

The frame will move to the origin point and the pattern data will return to the start point.

 (Top) will be shown on the display.
If you would like the frame to be restored to the previous state of origin point (before pressing ) , press  again.

 (Top) will be cleared on the display.

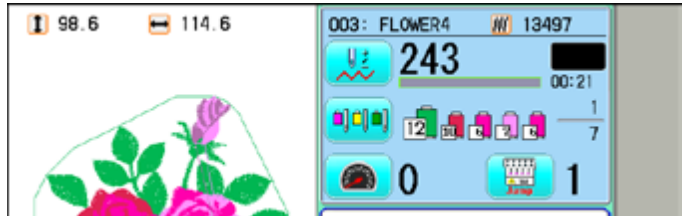
2. Press .





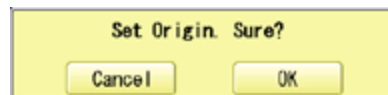
● Going back to the beginning of the design (Top)

Stopping sewing in the middle of a design, changing the design's location in the hoop, and then restarting from the beginning.

If you use "Top", you will return to the start point the frame position left where it is.




1. Press  and Press .

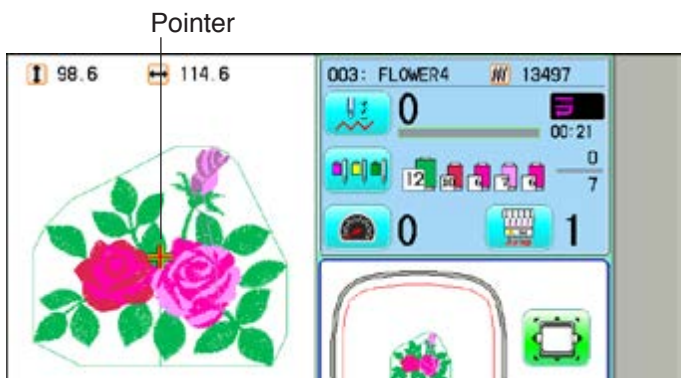


2. Press .

The pattern data will return to the start point.

 (Top) will be shown on the display.

3. Press .





● Placing the design in the center of the selected embroidery frame




CAUTION: To prevent accidents.

The frame moves quickly.
Keep hands away from the frame.

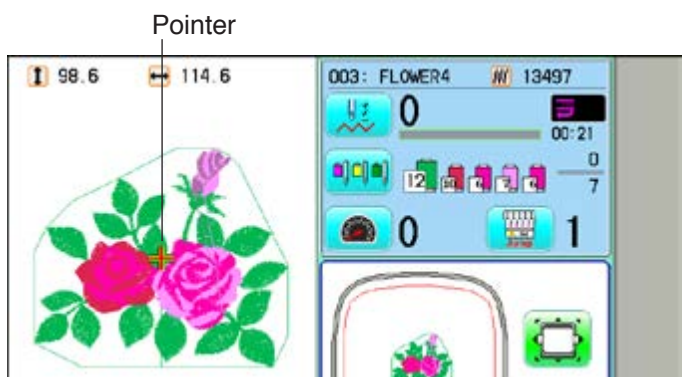
1. Press  and Press .

The embroidery frame will move to the center automatically.

If you want to get back to the previous status from "Center". Do procedure of  "Position".

 9-3

2. Press .




● Rotating and mirroring designs (Convert)


Convert selected pattern data.

Setting example

● : Start point of pattern



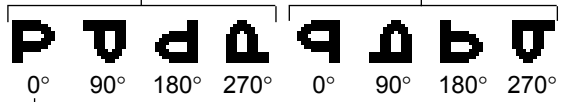
Normal



Mirror reverse + 90°


With the start point of pattern as a pivot, the machine changes the angle in 90 degree increments.

Normal Mirror reverse



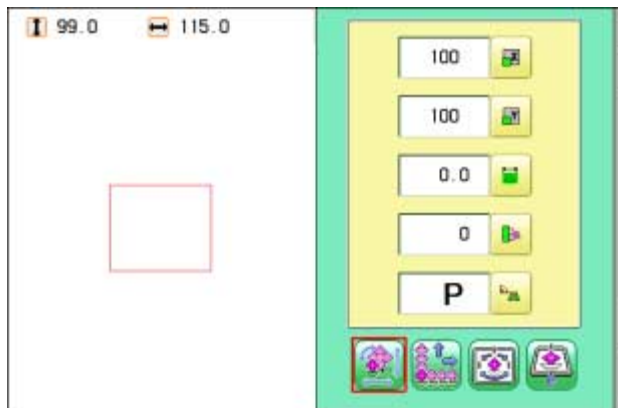
0° 90° 180° 270° 0° 90° 180° 270°

Normal angle

1. When the machine is stopped, Press 




2. Press  "SETTING".

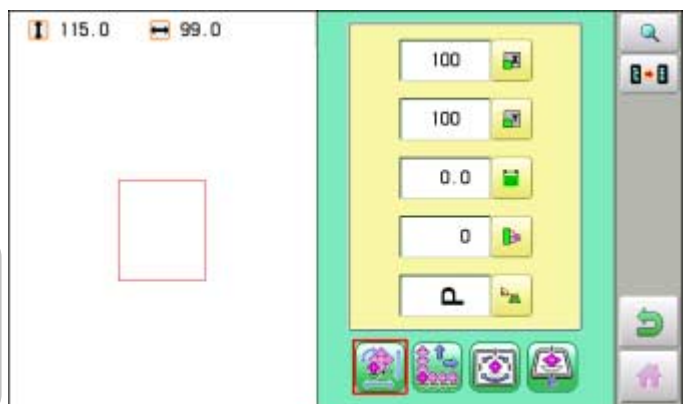



3. Press .



4. Press  to select conversion of position required.

The setting is fixed.



Press  to return to Menu mode.

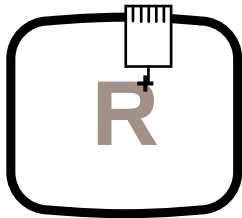
Press  to return to Drive mode.

● Starting in the middle of a design (POSITION)

This function allows you to go directly to a stitch number or a color change and positions the hoop correctly.

Stitch (Number of stitches)

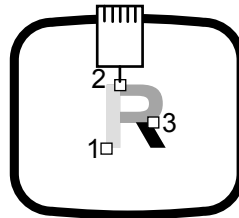
This moves the frame to any stitch number desired.



+ : Any stitches

Change (Color position)

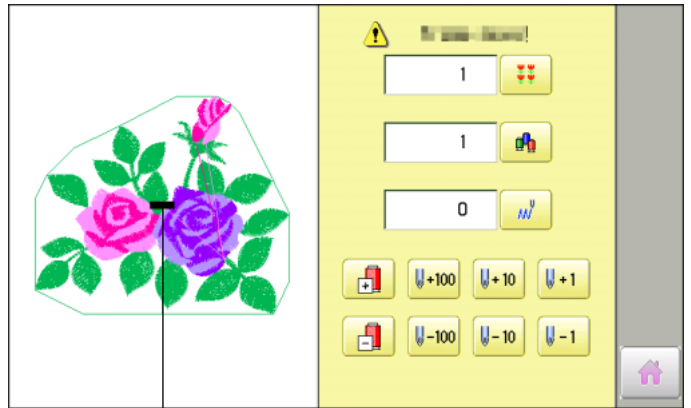
This moves the frame to the beginning of any Color change number.




□ : Beginning of any colour number

Stitch

1. Press the  "Frame forward".




Pointer shows you the current position of the frame.

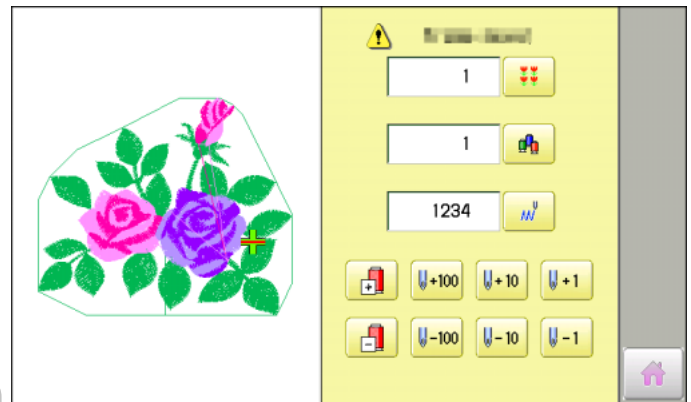
2. Press the .



3. Input the stitch number and press .

The frame will move to the selected stitch number position.

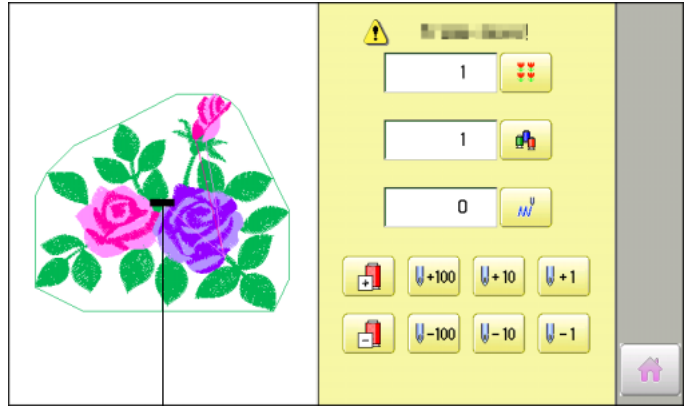
 **CAUTION: To prevent accidents.**
The frame moves quickly.
Keep hands away from the frame.



Press  to return to Drive mode.

Change

1. Press  "Frame forward".



Pointer shows the current position of the frame.


2. Press .

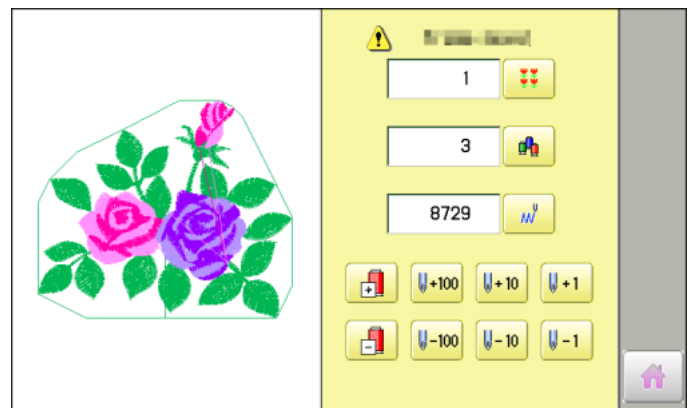


3. Input the color change number and press



The frame moves to the selected color position.

 **CAUTION: To prevent accidents.**
The frame moves quickly.
Keep hands away from the frame.



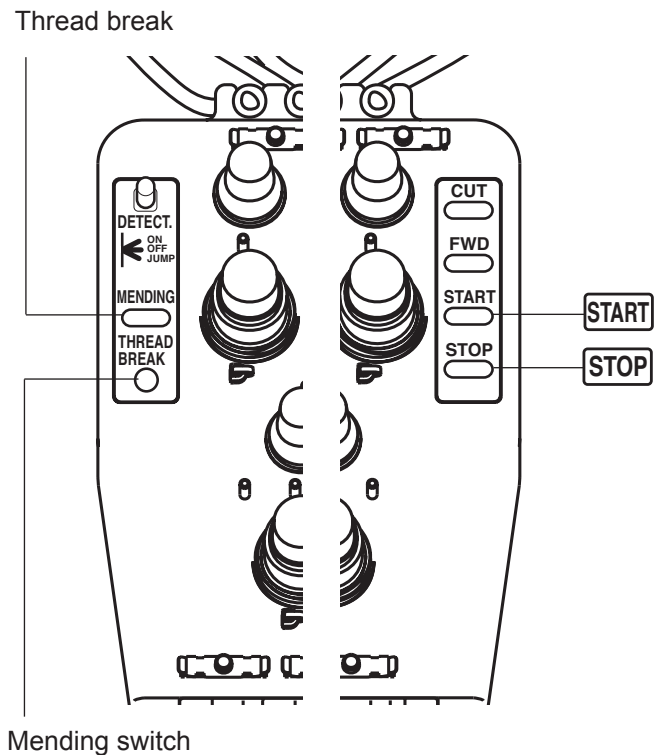
Press  to return to Drive mode.

● Mending the faulty part of embroidery (MENDING)

Mending the parts where have not be embroidered because of any trouble such as thread break.

1. When the machine is stopped, keep press **STOP** (*trace back) until you back to the window you want to work.
2. Press the mending switch for head you want to mend.
3. Press the **START** button.

Start mending.
 The machine will mend head only where thread break jump lights or blinks.
 All heads will start to sew 2 stitches before mending finishes. When mending finishes, the machine will go on normal sewing.



⚠ CAUTION: To prevent accidents.
 After mending all heads start working immediately.
 Keep hands away from the needles.

- In course of mending, when you press this switch for head not conducting mending, the machine will mend from this point.
- In case thread cut takes place by color change etc. while doing mend sewing, head not doing mend sewing doesn't activate thread cut because its needle doesn't come down.

POSITION ALIGNMENT BY DEFINING 2 POINTS 9-8

When embroidery position is aligned, machine automatically sets angle and embroidery only by defining 2 points (P1, P2).

This function is easy to align the position for embroidery on the edge of pocket or over seam of shirt.

*This function cannot be executed when repeat sewing " is set. [P 14-5](#)

*This function is cleared when pattern with "Offset" is set. [P 14-8](#)

Alignment Example

base line

P1 P2

Method : Align pattern on base line
Align pattern at the center of base line

Offset of Y direction : none
Offset of X direction : none

P1

P2

Method : Align pattern at the center of base line
Align base line at the center of width of pattern

Offset of Y direction : yes
Offset of X direction : none

P1 P2

P1

Method : Align pattern under base line
Align pattern left of base line

Offset of Y direction : yes
Offset of X direction : yes

P1

P2

P2

Method : Align pattern bottom of base line
Align pattern at right side of base line

Offset of Y direction : none
Offset of X direction : yes

Alignment Method

Align pattern with horizontal base line

Align pattern under base line			
Align base line at the center of height of pattern			
Align pattern on base line			
Y dir. X dir.	Align pattern left of base line	Align pattern at the center of base line	Align pattern right of base line

Align pattern with vertical base line

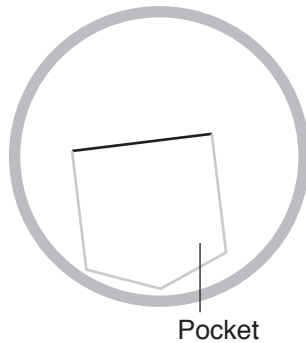
			Align pattern top of base line
			Align pattern at the center of base line
			Align pattern bottom of base line
Align pattern at right side of base line	Align base line at the center of width of pattern	Align pattern at left side of base line	Y dir. X dir.

POSITION ALIGNMENT BY DEFINING 2 POINTS

9-9

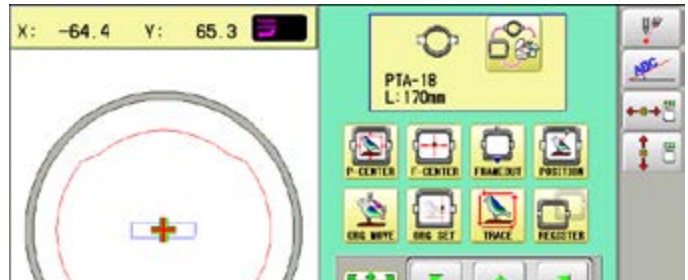
The procedure is explained as an example of embroidering pattern on pocket of shirt.

1. Hoop a shirt on embroidery frame.
(Diagonal position of pocket on frame is okay.)
Set the frame on the machine.

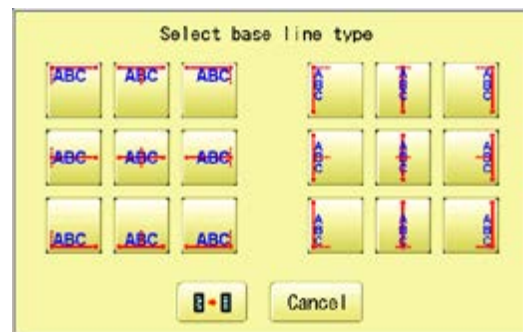


2. Press

Press and to turn the pointer on when laser pointer is installed.

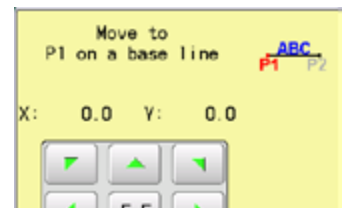


3. Press

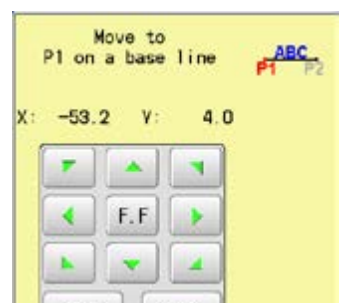
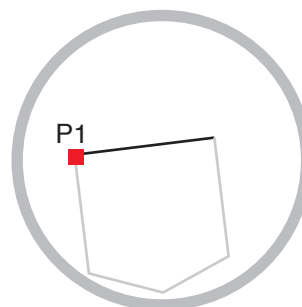


4. Select alignment method

Select in this case.



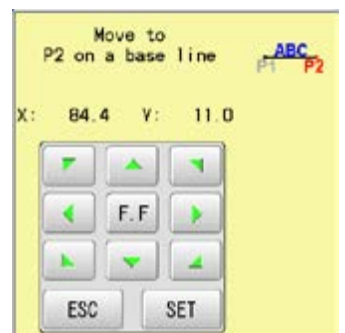
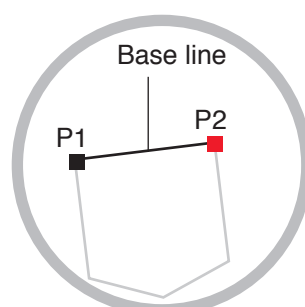
5. Move frame with and align the pointer or pressure foot on the left edge (P1) of pocket.



6. Press and move frame with



, and align the pointer or pressure foot on the right edge (P2) of pocket.



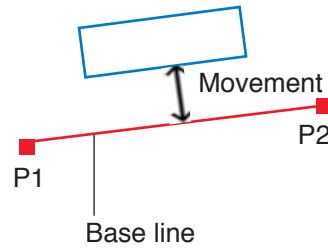
Line connected between P1 and P2 is base line.

POSITION ALIGNMENT BY DEFINING 2 POINTS 9-A

7. Press **SET**.

Enter movement of arrow from base line (edge of pocket) to pattern.

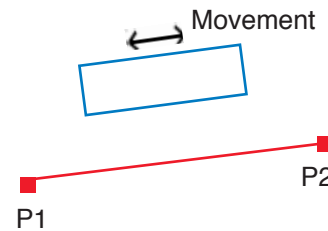
Enter "15.0"(15mm) in this case.



8. Press **SET**.

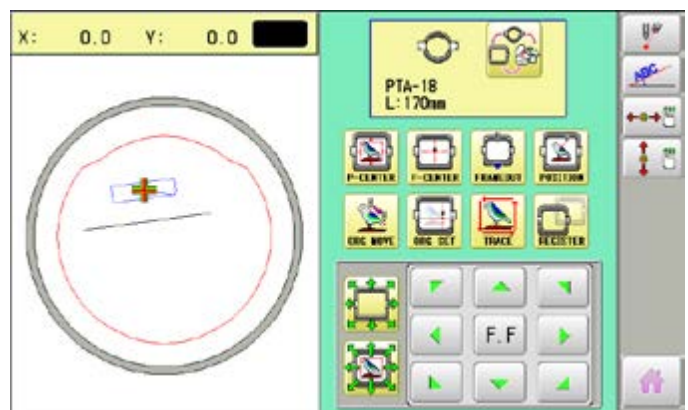
Enter movement of arrow from base line (edge of pocket) to pattern.

Leave "0.0" when pattern is aligned to the center of base line (width of pocket).



9. Press **SET**.

Complete

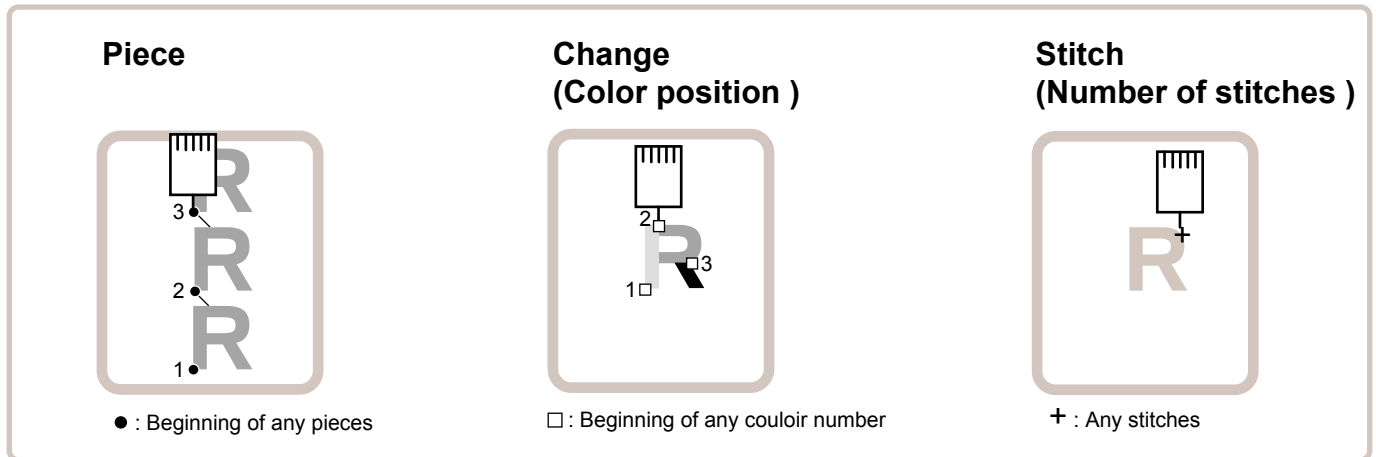


10. Press **HOME**.

Angle and position of embroidery are automatically set.



This creates direct designations to the number of stitches and *color change number, as well as setting the frame and data to the designated sewing position.



Piece

If "Repeat" is set, this allows the frame to move to the beginning of any piece at will.

- You can specify sewing position at specified pattern data number and specified number of stitch or color change number by entering the specified information.

Change (Color position) 9-7

This moves the frame to the beginning of any Color change number at will beginning of color.

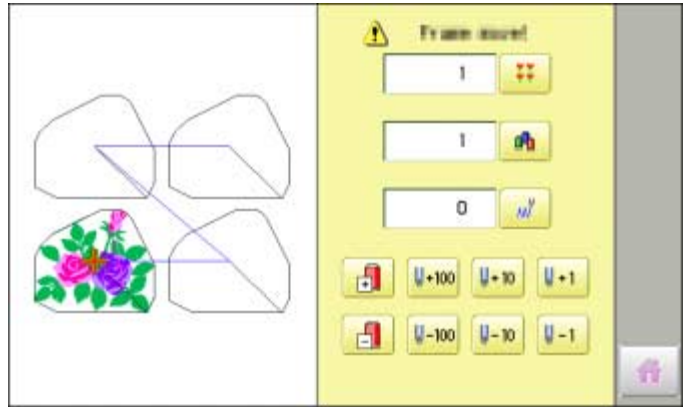
Stitch (Number of stitches) 9-6

This moves the frame to any stitch at will.

Piece number

The frame and pointer can be moved a specified piece number.

1. Press  "Frame forward".




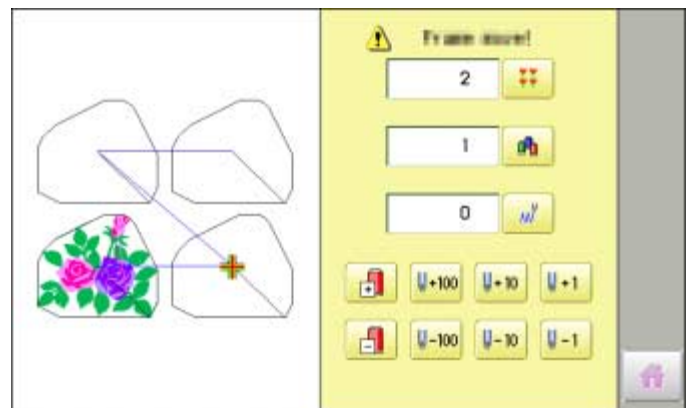
2. Press .



3. Input the number and press .

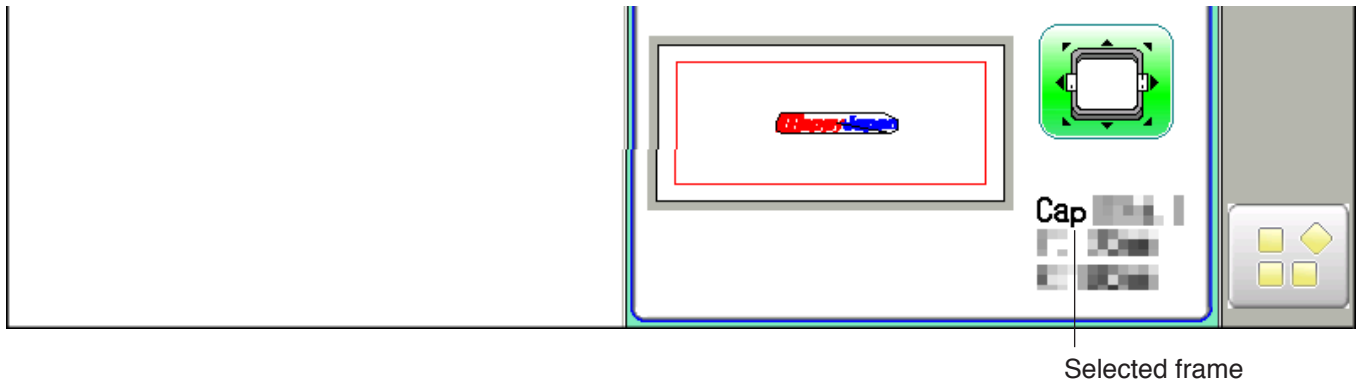
The frame and pointer will move to the specified piece number.

 **CAUTION: To prevent accidents.**
The frame moves quickly.
Keep hands away from the frame.



Press  to return to Drive mode.

Register will restore the position of the frame to the last point before a power failure even if the point of origin or the pattern itself were changed.



- ⚠ If register is used with a cap drive frame, make sure that the machine recognizes it by showing “Cap” (Cap frame) or “OnePoint” (One Point frame) the appropriate frame or the machine could be damaged.
If register is used with indication of frames that do not require cap drive frame, carriage moves and exceeds embroidery area of cap drive frame and damages the machine and cap drive frame.
- ⚠ When you use “REGISTER”, keep clear of the frame and table. It is dangerous as the frame could make sudden movements.
Never use register with the needle bar and presser foot lowered, as they could hit the cap drive frame and break.
- It is not always necessary to set “Entry”, but you can’t set “Return”. Once “Entry” is set, it is retained even if power is turned off.
If you change the position of the original point, set it again.
- Even if you set “Entry”, the frame may not return exactly to the original position in process of time.
Reset this monthly.

Entry

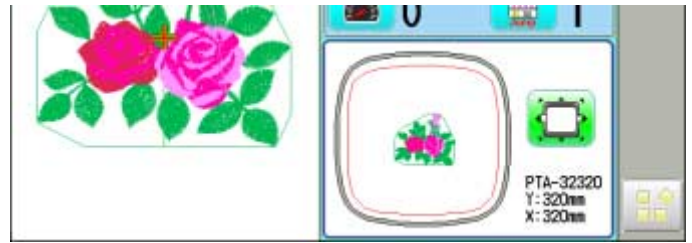
Registering the start point in the selected pattern.



Return (Registered position)


When position of the frame changes because of power loss, this will restore the frame to the registered point.


Entry

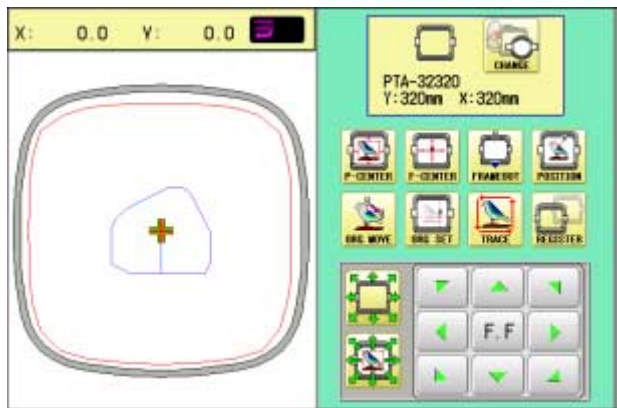
This registers the original point of the selected pattern.



1. Press .
2. Confirm that there is indication of  (Top) in the display and go on to procedure no. 3.

Press  "Top", if there is not a indication.

Upper right indication of  will be shown.



3. Move the frame to the original point with the



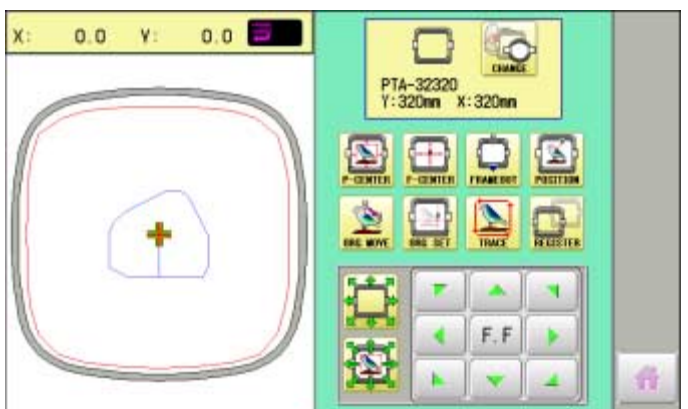
If the frame is located at the origin point, proceed to Step 4.

4. Press .



5. Press .


The origin point is registered.

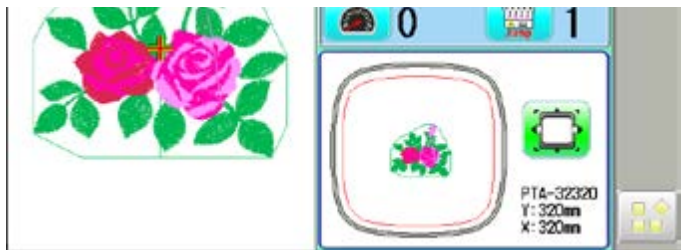






Press  to return to Drive mode.

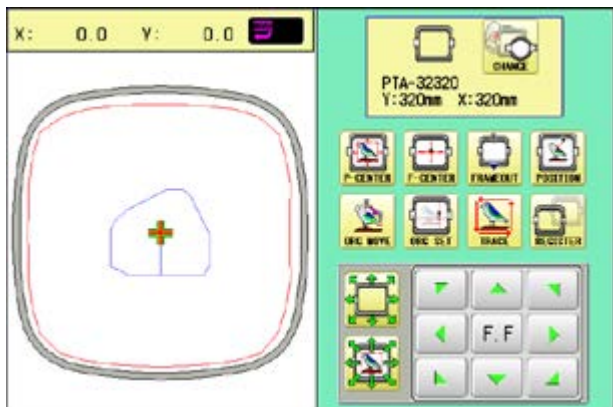
Return

In case of power failure you can return to the original point you registered.

 **CAUTION: To prevent accidents.**
The frame moves quickly.
Keep your hands away from the frame.



1. Press .
2. Confirm that there is indication of  (Top) in the display and go on to procedure no. 3.
Press  "Orig. Sel.", if there is not a indication.
Upper right indication of  will be shown.

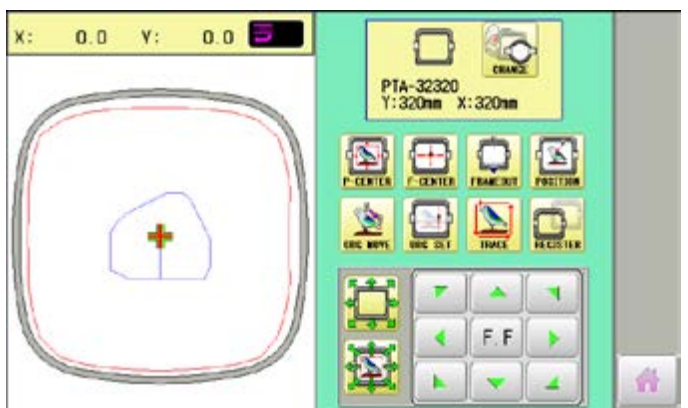



3. Press .



4.  press.

The frame will return to the origin point you registered.



Press  to return to Drive mode.


●Join

Joining 2 patterns into 1 pattern data to be read from a memory media.

Function of joining patterns is not valid for pattern data in PC connected with LAN.

■ In case you would like to use "Join" function, please set "Join design data" to "YES" on "READING" setting in advance.

1. Insert the memory media into the machine as described in "Inserting memory media".

2. When the machine is stopped, press 








3. Select "READ".



4. Select  (USB memory).

Indicates pattern data of the memory media.

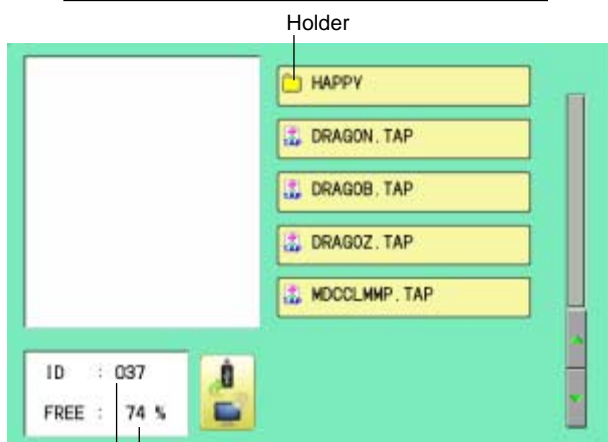
-  TAP : HAPPY
-  DST : Tajima
-  DSB : Tajima (Barudan)
-  DSZ : Tajima (ZSK)

 Folder : Contents of folder will be displayed when you select this icon.

1 % of free memory is equivalent to about 400,000 stitches.

If there are more stitches than remaining space, you may need to delete some designs to make room for the new patterns.

--- Serch pattern ---

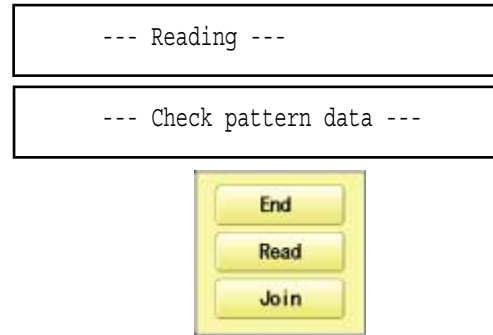


Free memory
The designs new ID number in the machines memory.

5. Select the pattern.

Once design is read.

Enable to read other pattern data.

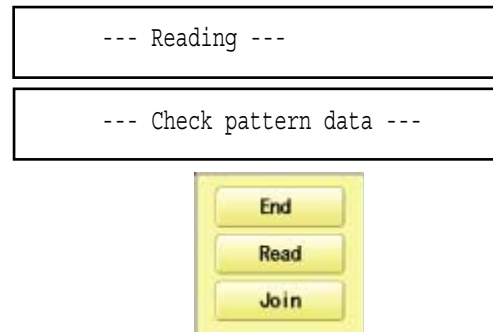


6. Press  .

Shift the Memory media if the pattern data you desire to Join is in the other Memory media.



7. Select the pattern data to be Joined.




8. Press  .


The pattern data selected to be joined is joined next to the pattern data previously read in the machine as one pattern data and the screen returns to Menu screen.


Pattern name is registered as the name of the first pattern data read in the machine in pattern datum joined.

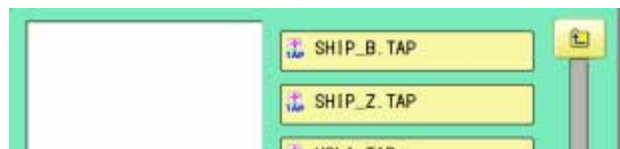


Press  if you desire to join more patterns.

Necessary pattern data can be read by performing step 6 to 8.



When the screen displays pattern data in the folder,  is displayed.

When  is pressed, the screen moves off from the current folder.



● Pattern read settings

Settings related to pattern data reading:

SETTING ITEM	SETTING RANGE (Default is underlined)	
1 Keep null (CHG.)	Yes• <u>No</u>	: This function lets the machine read zero stitches as they are before color change when reading pattern data.
2 Skip null stitch	Yes• <u>No</u>	: This lets you choose to ignore all null stitches when reading pattern data.
3 Combine jump	Yes• <u>No</u>	: Allows you to combine multiple, consecutive jump stitches when reading pattern data, if desired. It combines them into jump stitches of the maximum 12.7mm and reads the pattern with the combined jumps.
4 <u>Stitch sweeper</u>	<u>Yes</u> •No	: This function eliminates extremely short stitch for stitch width when reading pattern data.
5 Sweep length	0 ~ <u>0.4</u> ~ 0.8 (mm)	: This setting controls the length of the stitches eliminated by the Stitch sweeper. Stitches shorter than this setting will be eliminated.
6 DST name display	<u>Yes</u> •No	: When patterns in Tajima format are read in, the display shows the file name.
7 <u>Data format</u>	<u>Auto</u> →Automatic Happy→HAPPY, Tajima Brd →Barudan Zsk →Zsk	: Turn data format for reading patterns. Usually, set it to Automatic.
8 <u>Design information</u>	<u>Yes</u> •No	: This function reads various function setting which are set in pattern data together with pattern data (type TAP).
9 <u>Trace type</u>	 	: Lets you select the type of trace data that is created as a pattern is read in. → Maximum embroidery area of pattern → Out line
10 Join design data	Yes• <u>No</u>	: It is appeared that other pattern data is joined to the data previously read in the machine. You can make one pattern data by joining multiple pattern data read in the machine.
11 Folder select	Yes• <u>No</u>	: When reading pattern data, the list for selection of folders will be displayed.
12 Completion msg.	<u>Yes</u> •No	: Completion msg. will appear after reading pattern data.

Detailed explanation of machine setting

4 Stitch sweeper

This removes stitches that are extremely narrow when reading pattern data and writing to machine memory. If thread breaks occur often at the same point in a pattern, this may be because of narrow stitches.

■ If the thread still breaks in the same place you can use this function again but repeated usage may distort the shape of the stitch.

1. Save the pattern to USB memory.
2. Conduct a stitch sweeping of the pattern and load it into the machine again.

End

7 Data format

This enables you to select a different format and read the pattern again if the machine did not read it correctly the first time.

8 Design information

*Various settings are saved together with a pattern. If some settings are changed in the pattern and you wish to return to the originals, simply reload.

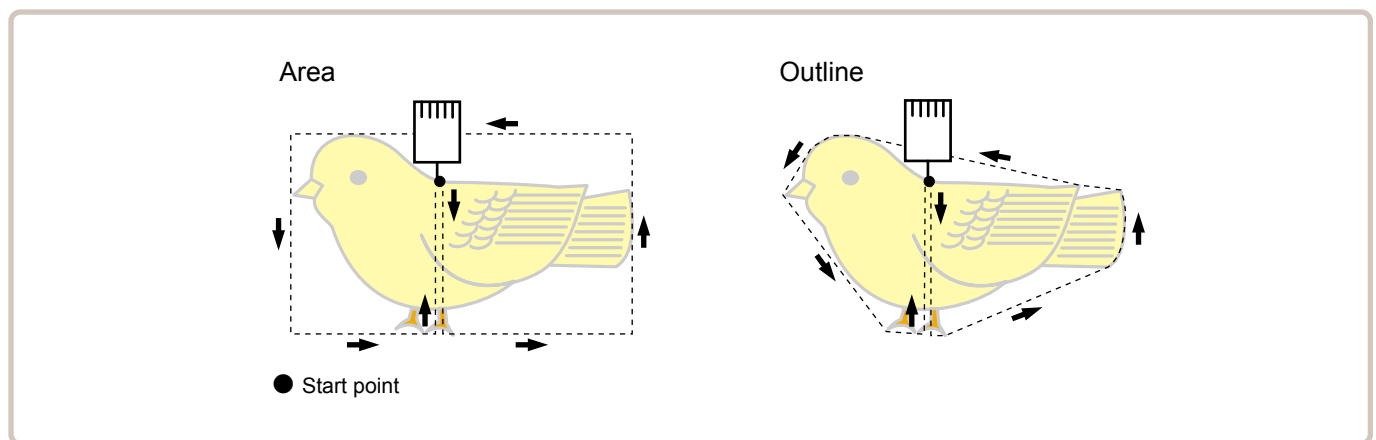
■ The data may only be HAPPY format (TAP).


9 Trace type

You can compare the design size and design position to the embroidery frame before you start sewing.

The embroidery frame will move around the actual design size.

At this time you can choose which type of trace from the two types as seen in the following figure:



1. When the machine is stopped, press .



2. Select "OPTION".




3. Select .



4. Select desired setting item and change the setting.

You can move to next page by pressing .


Press , all settings are returned to the default.

Press  to return to Menu mode.

Press  to return to Drive mode.

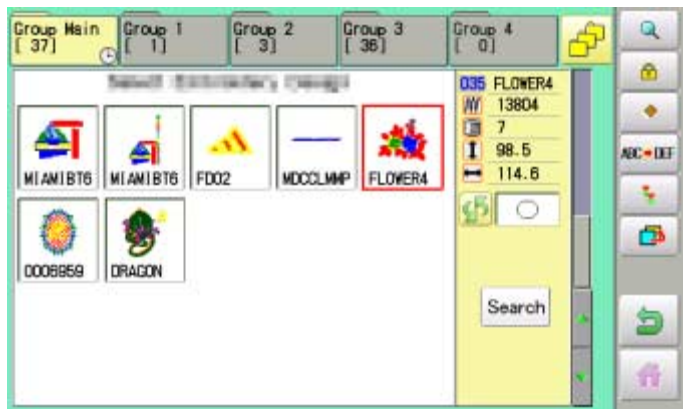
● Locking pattern data

Locking pattern data stored in the machine memory will prevent deletion and changes in settings.

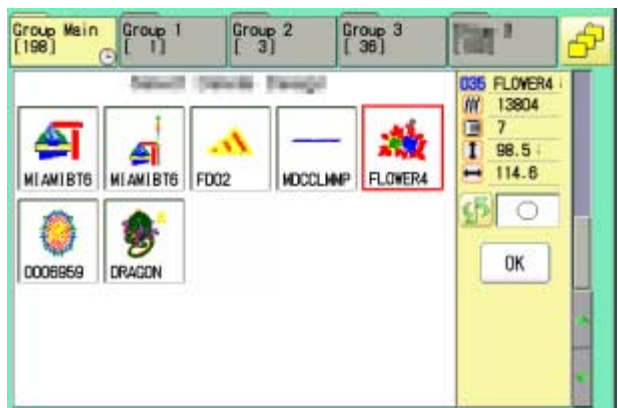
1. When the machine is stopped, press .



2. Select "PATTERN".

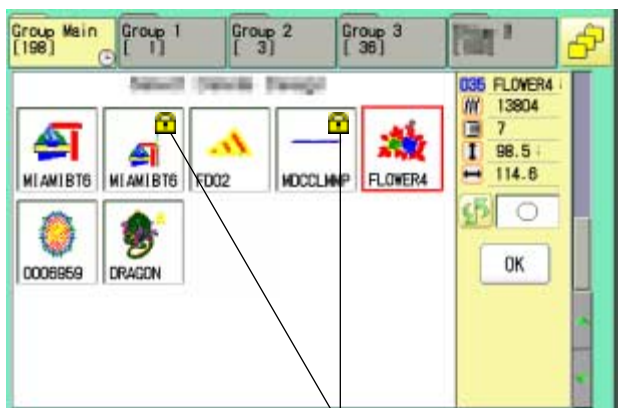


3. Press  from right submenu.




4. Select desired pattern.

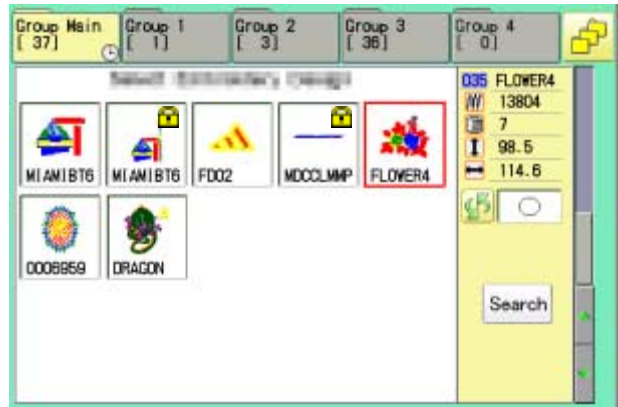
Mark will appear right of the pattern.
 Make will be cleared by press it again.
 Multiple pattern data can be selected.




Mark

5. Press .

Repeat steps 3 and 5 to unlock.



Press  to return to Menu mode.

Press  to return to Drive mode.

● Trace type

Changing the trace type of the pattern data in the machine memory. 10-4

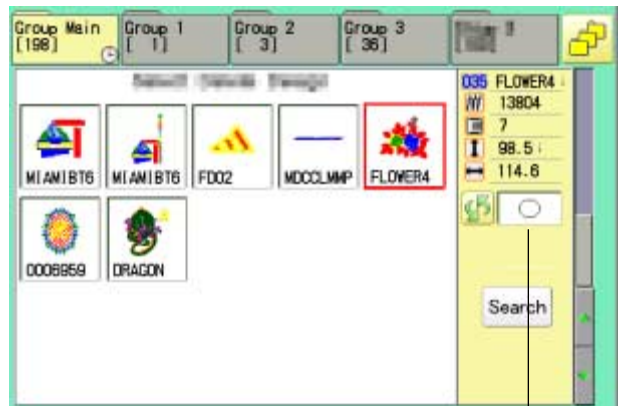
1. When the machine is stopped, press .



2. Select "PATTERN".

3. Select desired pattern.

- Maximum embroidery area of pattern
- Outline of pattern

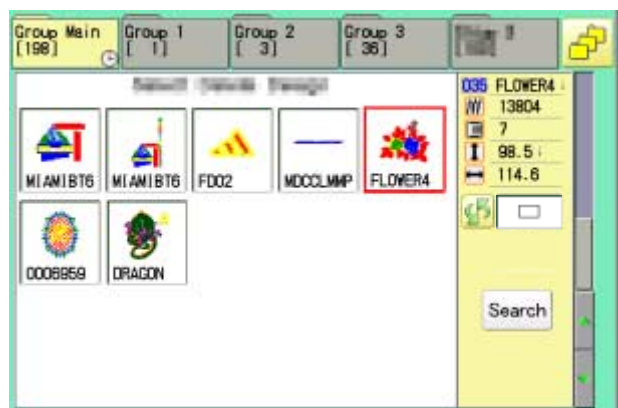


Trace type

4. Press and select or .

Trace type is changed.

--- Calculating ---




Press to return to Menu mode.

Press to return to Drive mode.

●Export

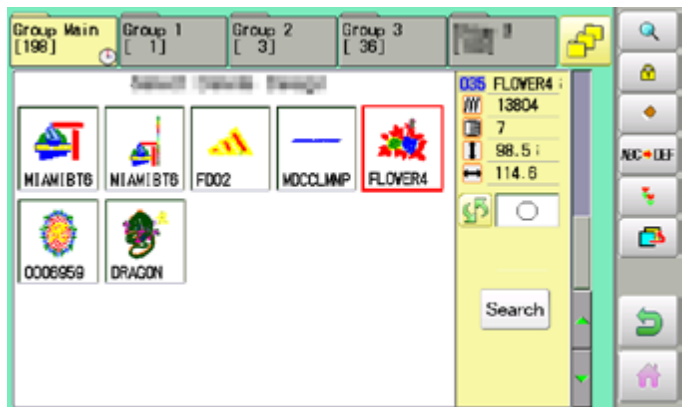
You can write out of machine memory to a memory media.

1. When the machine is stopped, press .

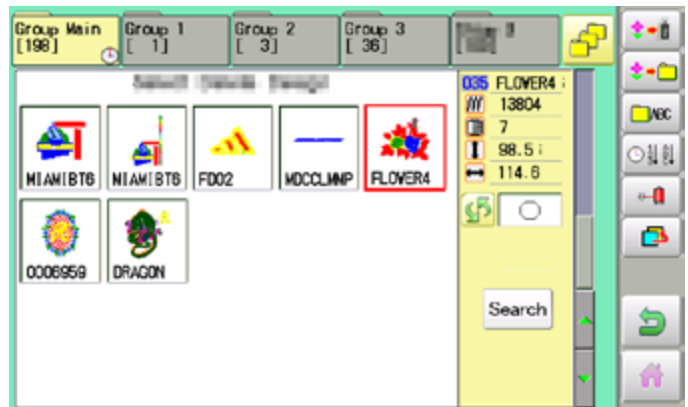


2. Select "PATTERN".

3. Select desired pattern.



4. Press  from right submenu.



5. Press  from right submenu.

The name of the pattern will be shown.



7. Press **SAVE** if the pattern name is not to be changed.

The pattern data will be written.

Choose the column with **◀ ▶**.

Then select each digit in the existing name.

Select word and press **SAVE**.

The pattern data will be written.

The maximum number of characters in a design name is eight letters or numbers.

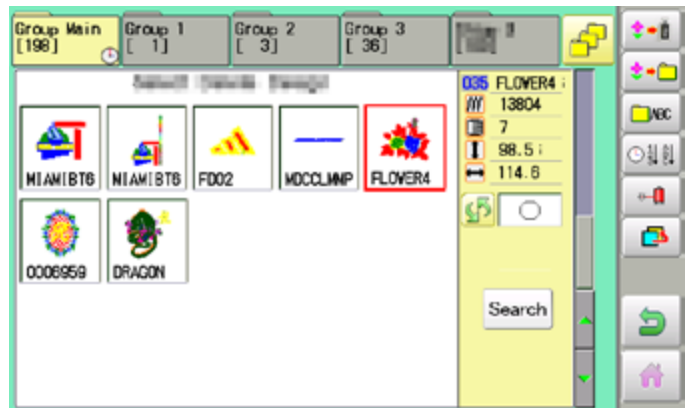
CLEAR All the letters and/or numbers are deleted.

DEL Selected letter or number is deleted.

CANCEL Changing name is cancelled.



The display returns to the view of Step 5.




Press **↶** to return to Menu mode.

Press **🏠** to return to Drive mode.

● Renaming patterns

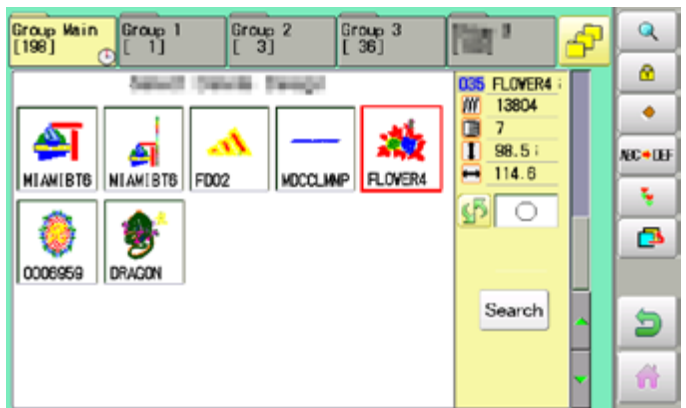
Rename pattern in memory.

1. When the machine is stopped, press  .





2. Select "PATTERN".

3. Select desired pattern.






4. Press  from right submenu.



5. Choose the column with   .
Then select each digit in the existing name.
Select word.

The maximum number of characters in a design name is eight letters or numbers.

-  All the letters and/or numbers are deleted.
-  Selected letter or number is deleted.
-  Renaming is cancelled.

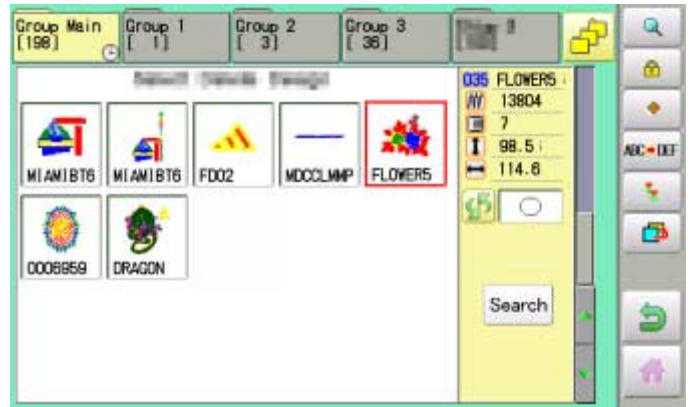



PATTERNS IN MEMORY


11-5b

6. Press  .

The pattern name will be changed.




Press  to return to Menu mode.

Press  to return to Drive mode.

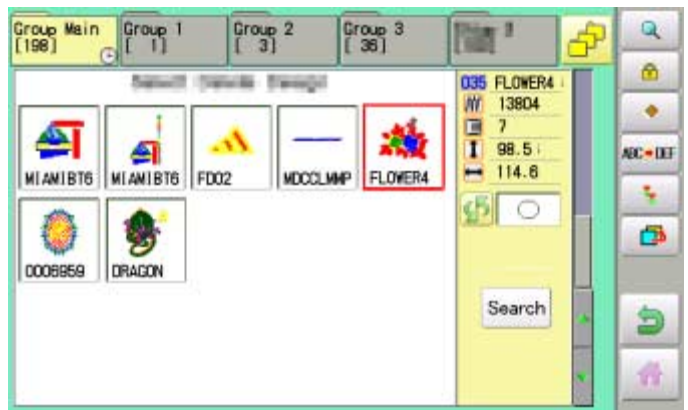
● Copying pattern data

Copying of the pattern data stored in the machine memory is available.

1. When the machine is stopped, press .



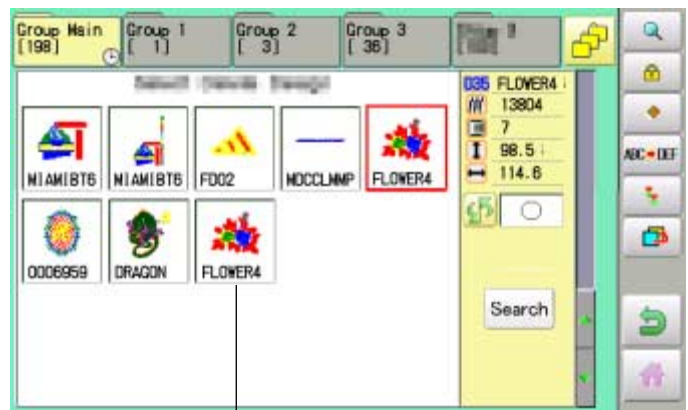
2. Select "PATTERN".



3. Select desired pattern.


4. Press  from right submenu.

Copy of the selected pattern will be made.




Copied pattern data

Press  to return to Menu mode.

Press  to return to Drive mode.

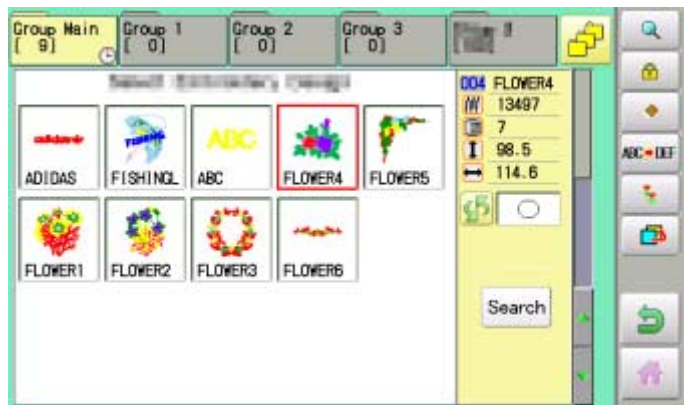
● Moving pattern data

Export pattern data into the other folder.

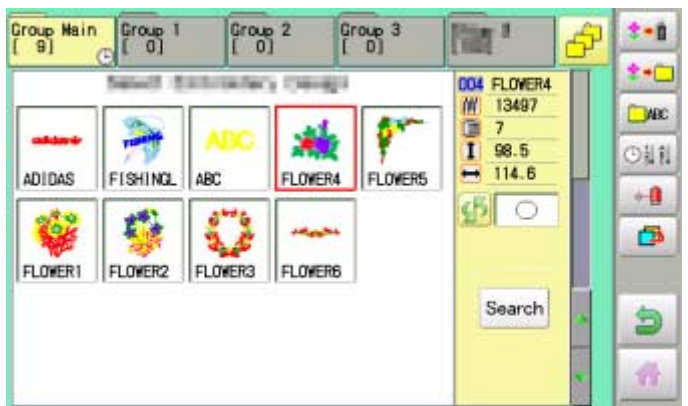
1. When the machine is stopped, press .



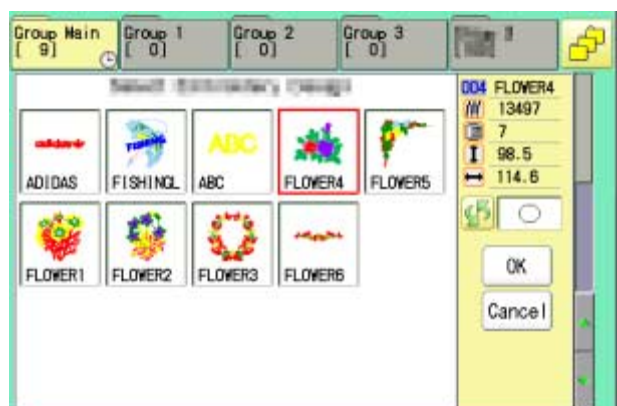
2. Select "PATTERN".



3. Press  from right submenu.



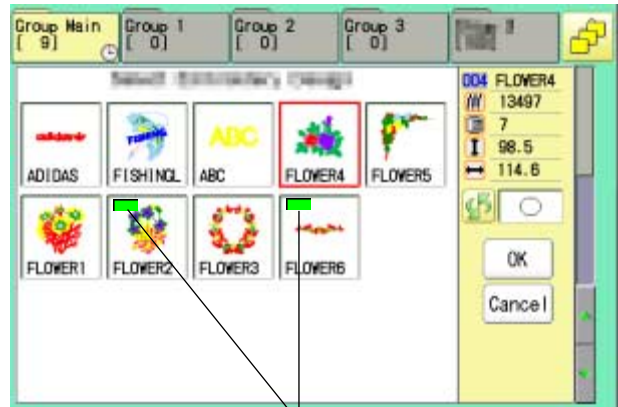
4. Press  from right submenu.



4. Select desired pattern.

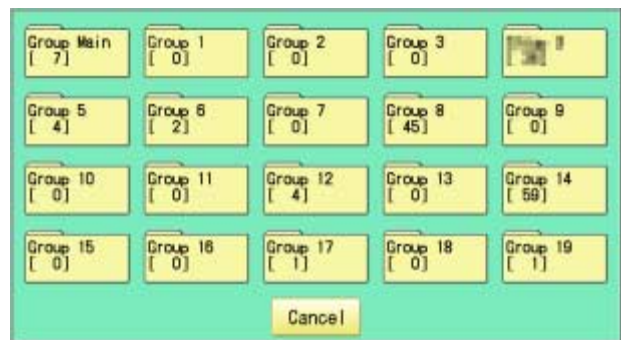
Mark will appear left of the pattern.
 Make will be cleared by press it again.
 Multiple pattern data can be selected.

Cancel : Cancel pattern data moving



Mark

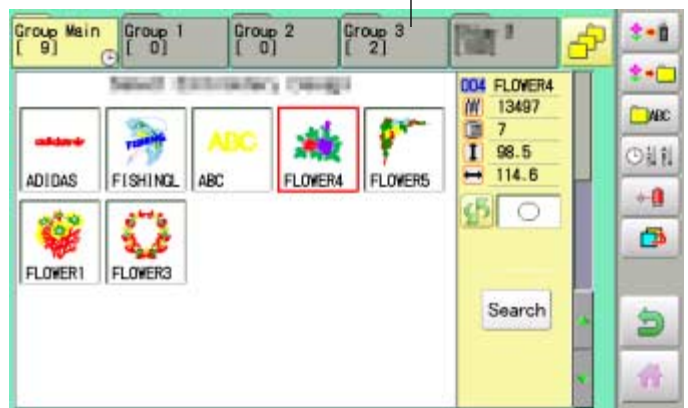
5. Press **OK**.



6. Select the importing folder.

The pattern data will be transferred.

Importing folder




Press  to return to Menu mode.

Press  to return to Drive mode.

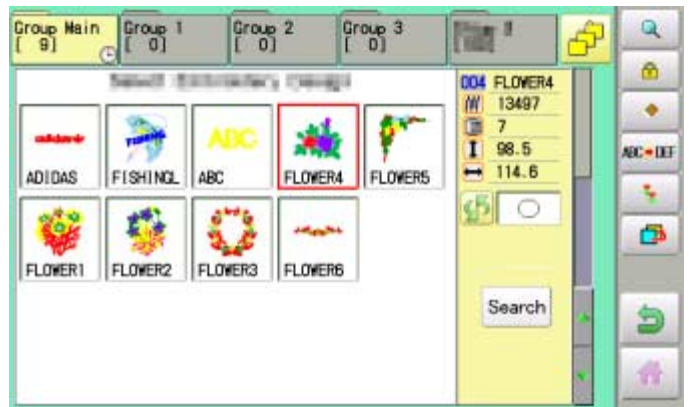
●Renaming folders

Rename folder in memory.

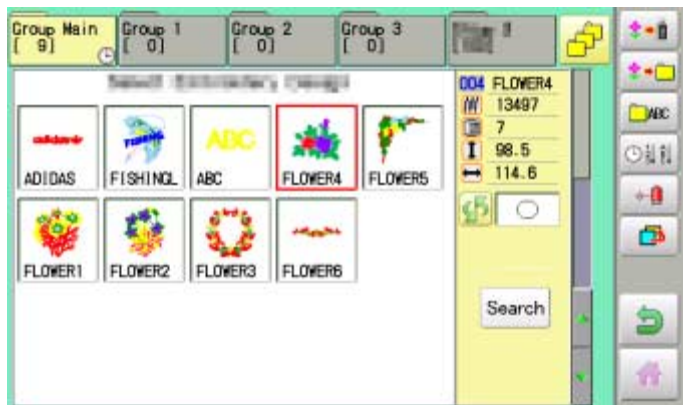
1. When the machine is stopped, press  .



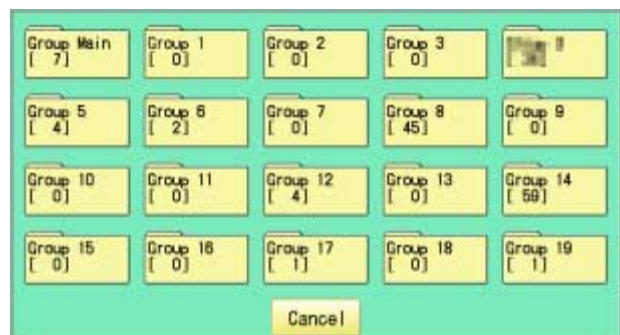
2. Select "PATTERN".



3. Press  from right submenu.





4. Press  from right submenu.




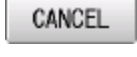


5. Select desired folder.



6. Choose the column with  .
Then select each digit in the existing name.
Select word.

The maximum number of characters in a design name is 12 letters or numbers.

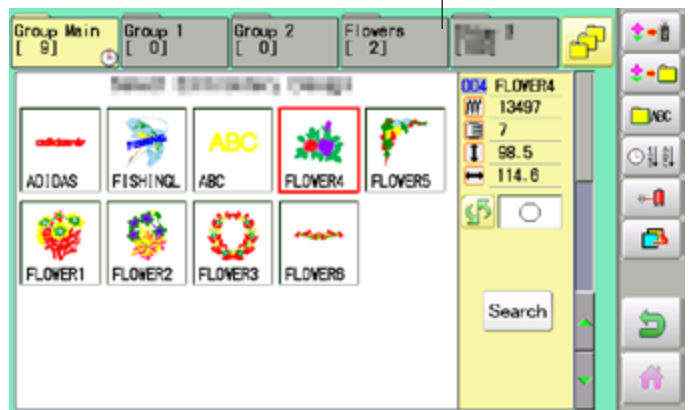
-  Uppercase and lowercase letter are switched.
-  All the letters are deleted.
-  Selected letter or number is deleted.
-  Renaming is cancelled.



7. Press .

The folder name will be changed.

Renamed folder




Press  to return to Menu mode.

Press  to return to Drive mode.

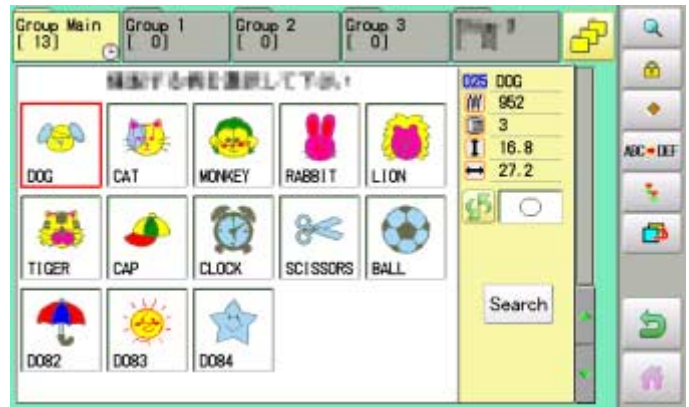
●Sort

Ordinate the pattern data in the displayed folder.

1. When the machine is stopped, press  .



2. Select "PATTERN".



3. Press  from right submenu.



4. Press  from right submenu.



To sort in ascending order of loading



To sort in descending order of loading



To sort in ascending order of pattern number



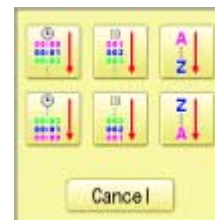
To sort in descending order of pattern number



To sort in ascending order of name of pattern




To sort in descending order of name of pattern



5. Select sorting method.

Sort will be carry out.




Press  to return to Menu mode.

Press  to return to Drive mode.

● Thread break report

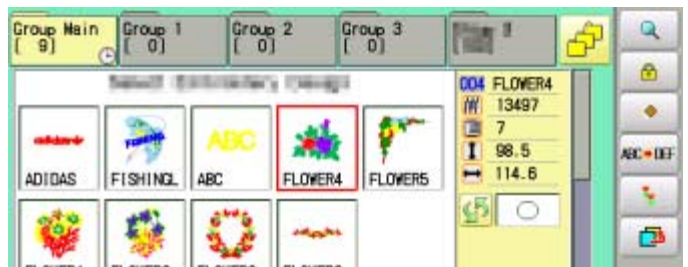
This function will show recorded thread break of pattern data. The machine detects break thread during operation and records by pattern the number of stitches at the stopped position. If thread break is happening at same number of stitches, please check construction of stitch design.

1. When the machine is stopped, press  .

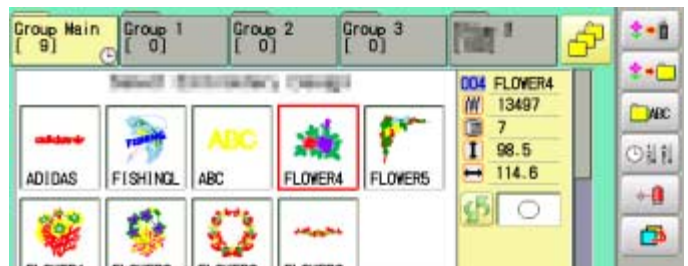


2. Select "PATTERN".

3. Select desired pattern.



4. Press  from right submenu.



5. Press  from right submenu.


Thread break report will appear in the window. The maximum memory is up to No. 30. If the record exceeds No. 30, the new records will be added to the latest 29 records.

 To delete the record

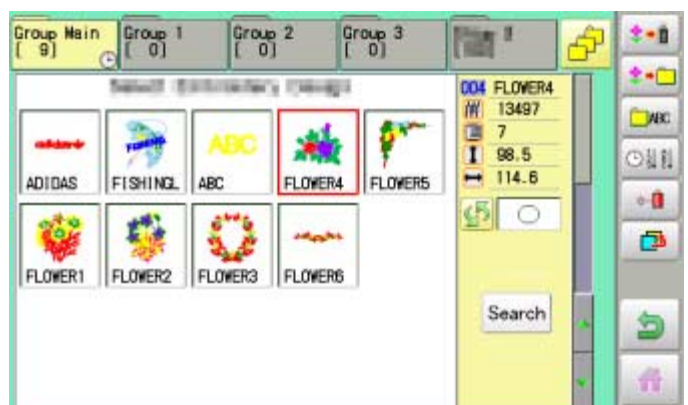
Pattern number
Pattern name
Number of stitches

009: FLOWER4 (13497)			
No	No	No	No
1:	0	11:	0
2:	0	12:	0
3:	0	13:	0
4:	0	14:	0
5:	0	15:	0
6:	0	16:	0
7:	0	17:	0
8:	0	18:	0
9:	0	19:	0
10:	0	20:	0
		21:	0
		22:	0
		23:	0
		24:	0
		25:	0
		26:	0
		27:	0
		28:	0
		29:	0
		30:	0

Number of stitches at the stopped position by thread break

6. Press  .

Exit the mode.




Press  to return to Menu mode.

Press  to return to Drive mode.



●Retrieving built-in design data

100 built-in design data are saved in the folder .

100 built-in data is shown on page  26-4.

Empty the [Group 4] folder before built-in pattern data are retrieved from machine memory.

Built-in pattern data cannot be retrieved if there is any pattern data in the [Group 4] folder.

Built-in pattern data can be moved to other folder and/or deleted like monogramming data made on LETTER screen and other pattern data imported from outside of machine.  11-7,  5-B

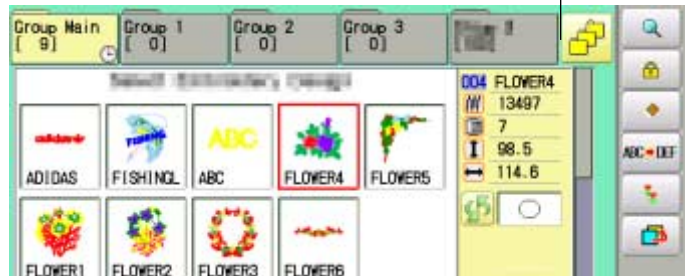
You can retrieve the pattern data from machine memory again after deleting the built-in data.

1. When the machine is stopped press .

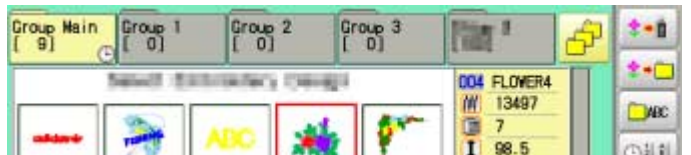


The folder [Group 4] which deleted all data

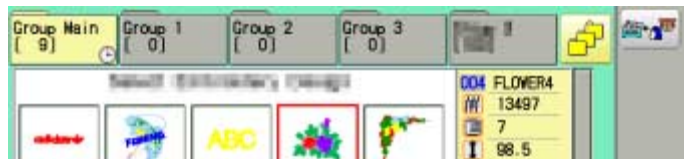
2. Select "PATTERN" .



3. Press  from right submenu.



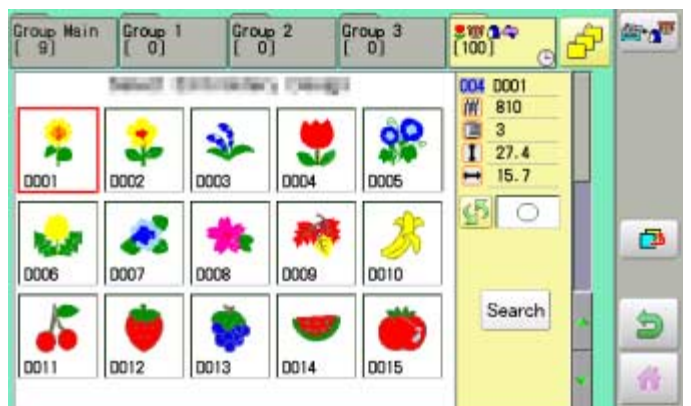
4. Press  from right submenu.



5. Press  from right sub-menu.

Retrieving patter data is started.
It takes several minutes to complete data retriev-
ing.

— Reading —



Press  to return to Menu mode.

Press  to return to Drive mode.

● Searching pattern data

Searching of the pattern data stored in the machine memory is available.

1. When the machine is stopped press .




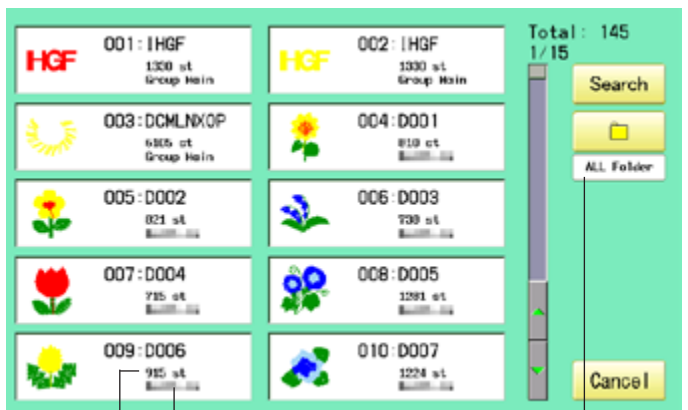
2. Select "PATTERN" .



3. Press .

All pattern data stored in the machine memory will be displayed.

 Search from designated folder.



Stitches

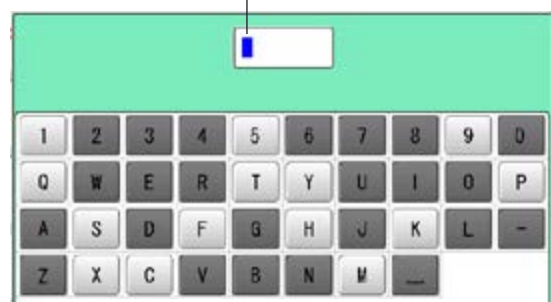
Display the folder name to search

The folder name which the pattern is saved

Cursor

4. Press .

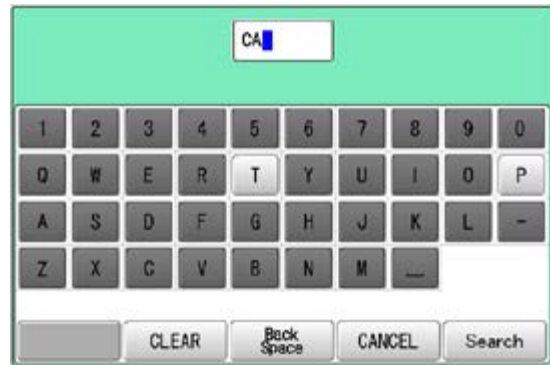
In this keyboard for searching, all design names are checked beforehand and only candidate alphabets will be highlighted along respective digits.



5. Enter the whole or a part of the pattern name.

The maximum number of characters in a design name is eight letters or numbers.

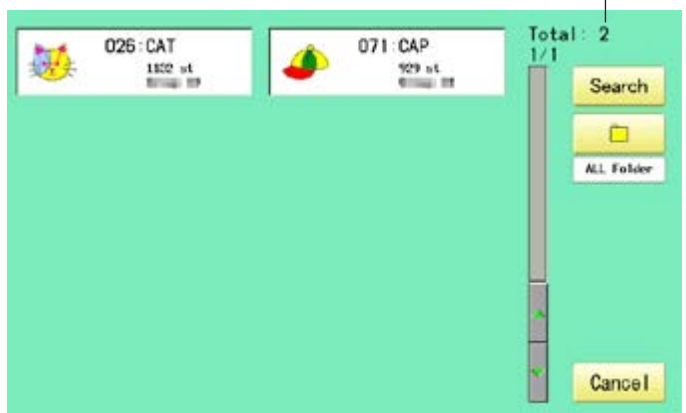
- CLEAR** All the letters and/or numbers are deleted.
- DEL** Selected letter or number is deleted.
- CANCEL** Searching is cancelled.



6. Press **Search**.

In this example, "CA" is entered as first 2 characters of the design name. Then, all design name which start from "CA" is displayed.

Number of searched pattern data



7. Press displayed pattern icon to confirm your selection.

Press **Cancel** to leave from searching menu.

Selected pattern data



Press  to return to Menu mode.

Press  to return to Drive mode.

Needle number settings 5-E

A needle number can be assigned to a *color change number.

When the needle number is assigned, the machine will embroider and automatically switch to the programmed for each color change number.

Color change stop function 5-F

A *color change stop can be assigned to a color change number.

When this is done, the machine embroiders the stitches for that color change number and then stops, displaying the following message:

>>Change Stop

Auto setting

Changes all designated needle numbers at once.

Thread color

This sets the background color or color assigned to each needle bar to be shown in the display.

Color change data registration, Color change data read

You can use the color change data from a saved pattern, register it, and then export the registered data to the selected pattern for use.

Repetition of color group setting

If your design has repetition of the group of the same color sequence, only set first sequence and set other automatically by following steps.


NEEDLE BAR SELECTION

12-2

●Auto setting

This changes all designated needle numbers at once.

For example, if you want to change all needles numbered “3” to “5”, just select one of the color change numbers in which “5” is set, then all color change numbers can be changed into “3”.

1. When the machine is stopped, press .



2. Select “NEEDLE”.



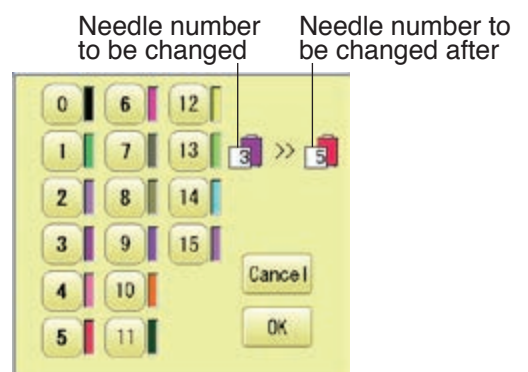
3. Press  from right submenu.



4. Select the current needle number you would like to change.




5. Select the needle number to be changed.




NEEDLE BAR SELECTION

12-3

6. Press .

 Setting is cancelled.

 Preview screen is displayed.





7. Press .

The setting is fixed.

The needle number has been changed from 3 to 5.



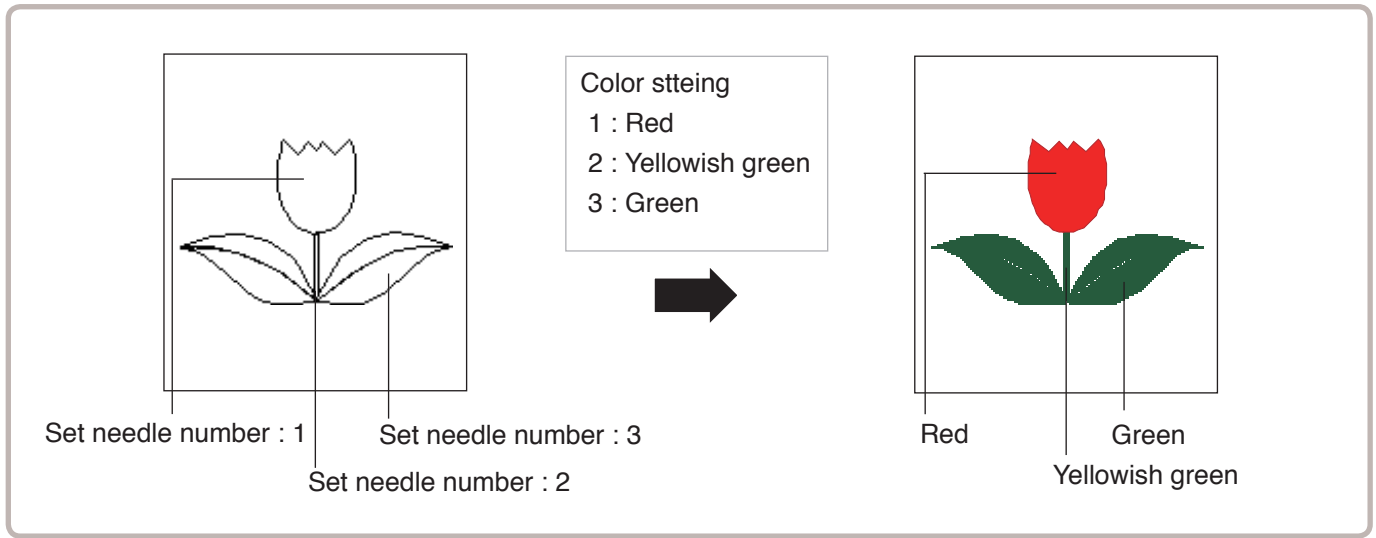
Press  to return to Menu mode.


Press  to return to Drive mode.

● Thread color

This sets the background color or color assigned to each needle bar to be shown in the display. This is useful to help confirm the correct color setup of a pattern.

■ You will find difficulty to see the pattern if you set same color on both pattern and background.



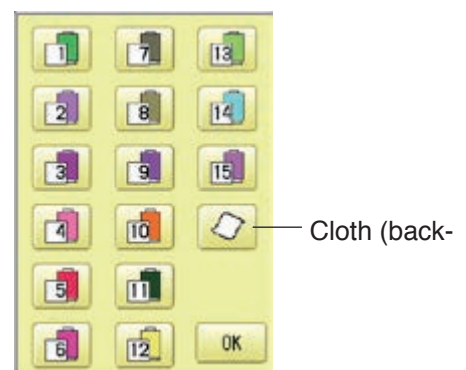
1. When the machine is stopped, press .



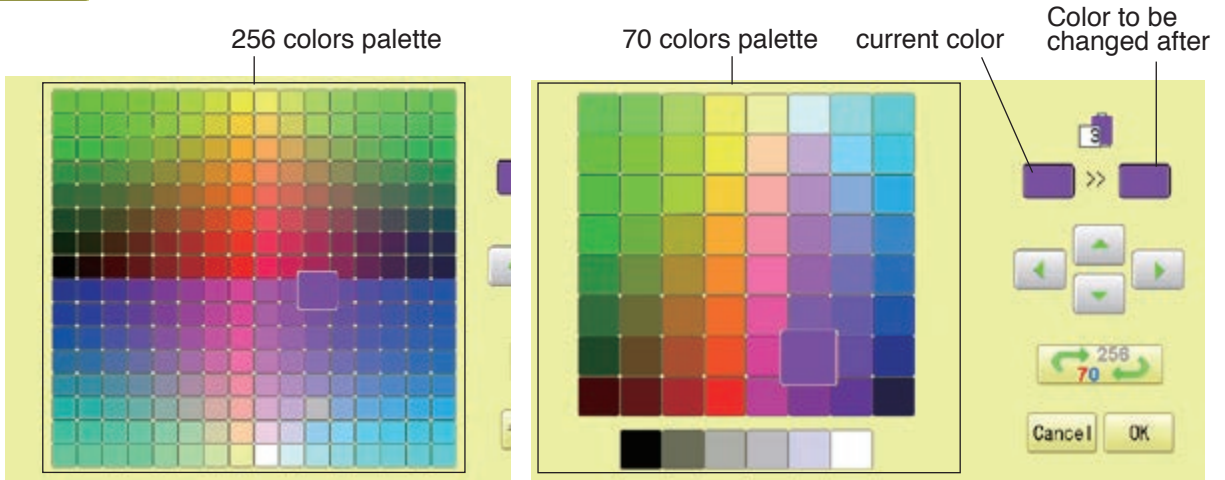
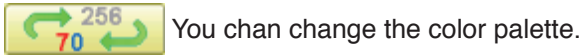
2. Select "NEEDLE".



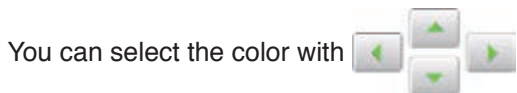
3. Press  from right submenu.



4. Select the needle number or cloth (background color).



5. Select the color to be changed at the palette.



Current color will be shown.

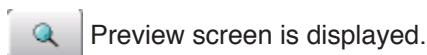



6. Press .



7. Press .

The setting is fixed.



Press  to return to Menu mode.


Press  to return to Drive mode.



● Color change data registration

You can import and apply color change data from saved patterns (Including color change stops) to the current pattern. This function lets you apply the same color change data from other patterns.

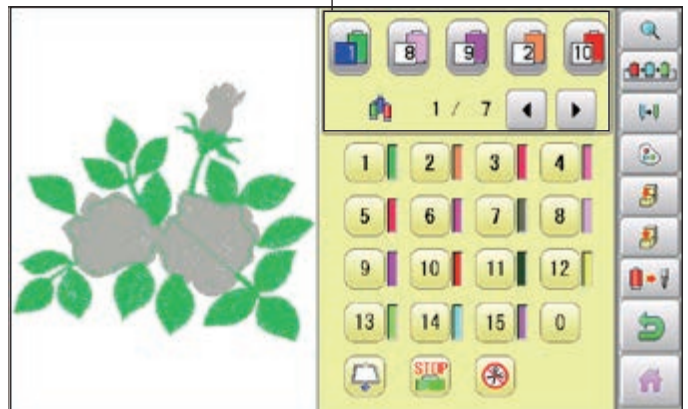
■ The color change data is limited to one and the color change numbers are limited to 250.

1. When the machine is stopped, press .

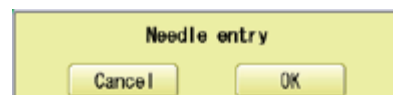


2. Select "NEEDLE".

Color change number



3. Press  from right submenu.



4. Press .

The color change data will be saved into memory.




Press  to return to Menu mode.

Press  to return to Drive mode.

● Color change data read

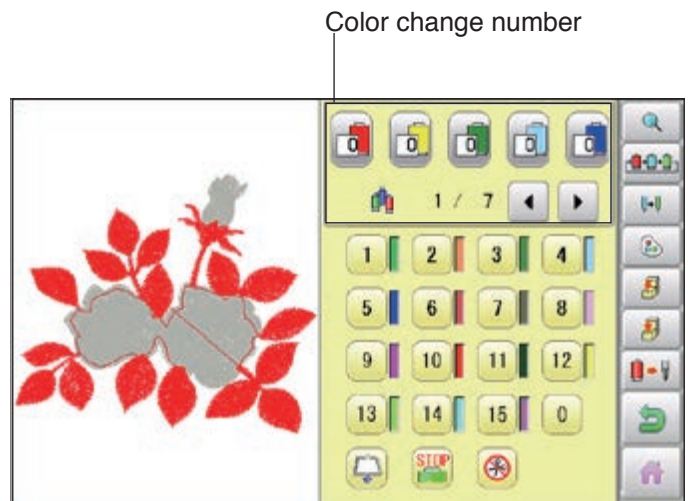
You can export the registered color change data to other patterns.

- If the pattern receiving the imported color change data has more color changes than the imported data, the extra color changes will be set to “0” and will need to be set manually later.

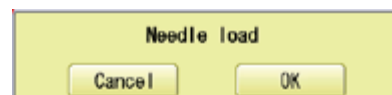
1. When the machine is stopped, press .



2. Select “NEEDLE”.




3. Press  from right submenu.




4. Press .

The needle number set is subject to the color change data exported.

Confirm the color shown in the  preview display.

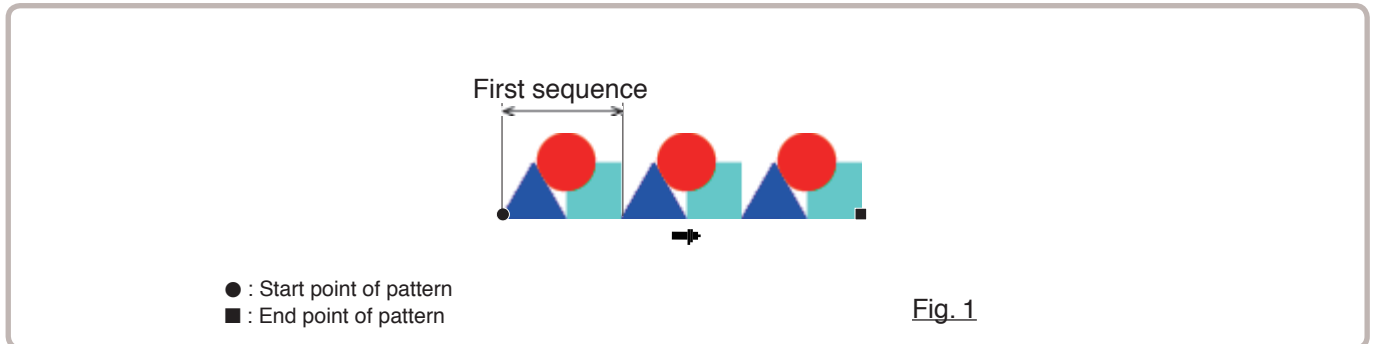



Press  to return to Menu mode.

Press  to return to Drive mode.

● Repetition of color group setting

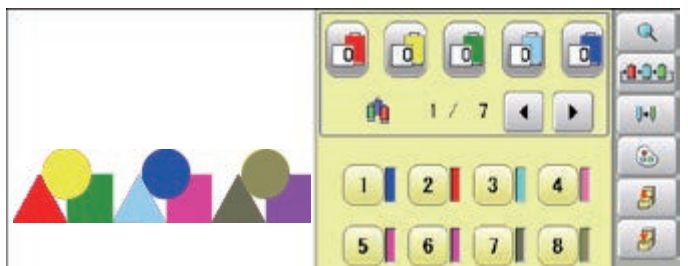
If your design has repetition of the group of the same color sequence, only set first sequence and set other automatically by following steps.
 (If you have some function in the needle “Example: color change stop”, the function also will set)



1. When the machine is stopped, press 

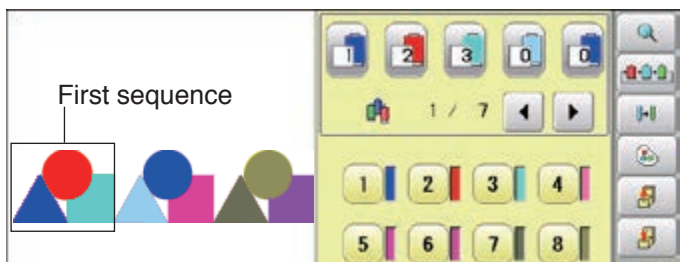


2. Select “NEEDLE”.



3. Set first color sequence group.

Please confirm that the next number of the group is “0”.



4. Press  from right submenu.


Set other color change setting automatically.

If the number of total color change does not become the first number of group multiple number. Machine display warning.



Press  to return to Menu mode.

Press  to return to Drive mode.

 Check repeat setting.

OK

By default the machine checks if the pattern fits the embroidery area.

This helps you to check whether or not the selected pattern fits in the desired hoop.

This helps confirm positioning between the embroidery area and the pattern.

If you change the frame position by the frame move key, the display will be changed and you can check the position onscreen.

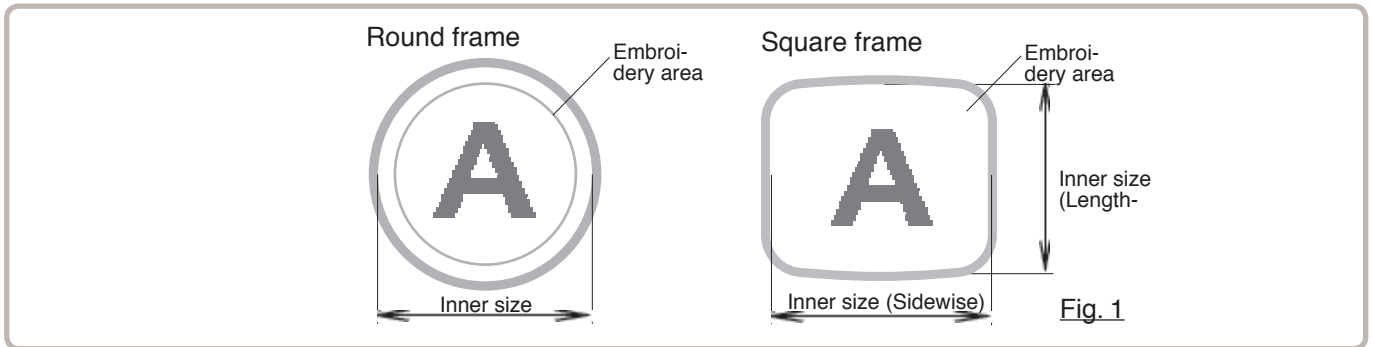
- ⚠ The "monitor display" checks whether or not the pattern fits the embroidery area of the frame you are going to use before starting the operation.
This is not a safety device that will prevent crashes if pattern size is too large for the frame; it is intended for your reference only when judging the fit of a pattern to a given size frame. After using "monitor display", do not move the frame. If you do so the machine may be damaged due to the needle or pressure foot hitting the frame.
- ⚠ Make sure to perform "Registration number selection" when changing hoop size. If not done, the machine may be damaged from the needle or pressure foot hitting the frame.

● Frame selection

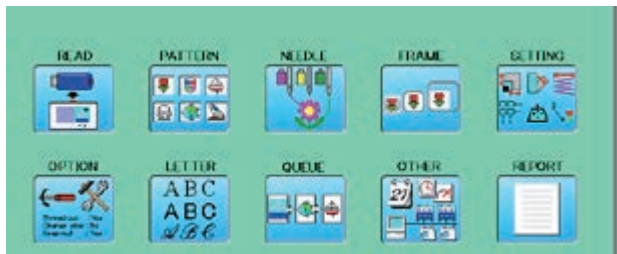
Selecting a frame.

The embroidery area for each registered frame is set to the inside of the frame edge to allow for pressure foot clearance. (Fig. 1)

This allows confirmation of positioning between the embroidery area and the pattern.



1. When the machine is stopped, press



2. Select "FRAME".

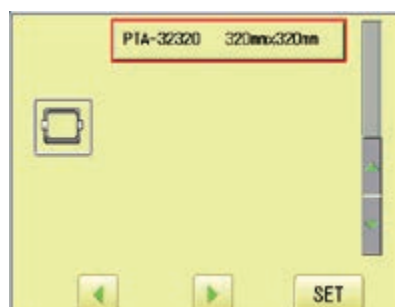
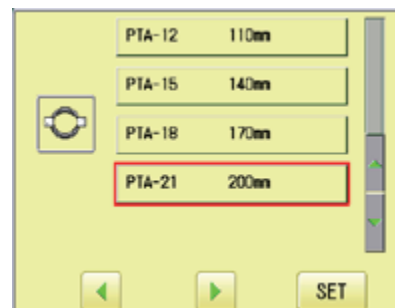
- Tubular round frame
- Tubular square frame
- Cap and One-point frame
- Border frame (for HCD2, HCR3)
- Sock frame
- User-defined frame
- Special frame (Except HCR3)
- Non registered



3. Select type of frame.



Change the type of frame.

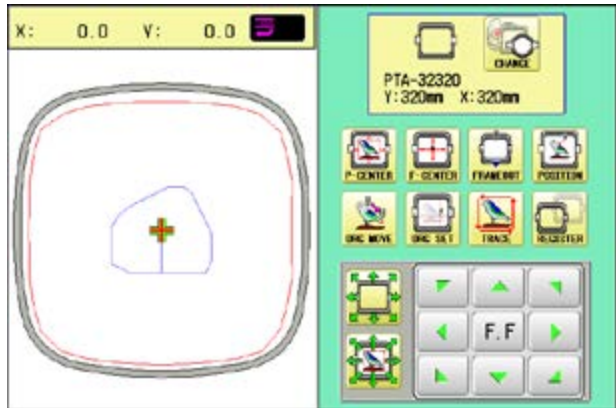


4. Select desired size of frame and press



The embroidery area appear in red.

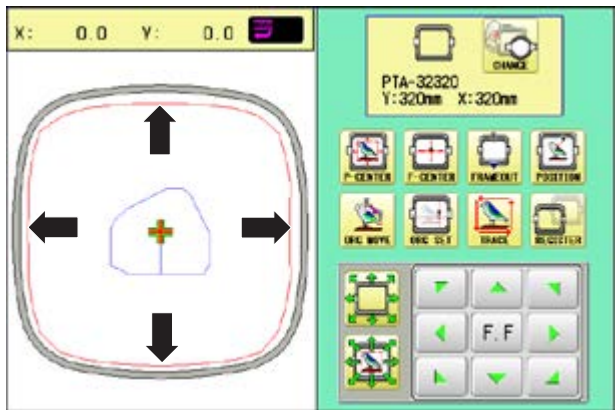
5. Confirm that (Top) appears in the display and go to step 7.
If this does not appear, go to step 6.



6. Press "Top".

Upper right indication of will be shown.

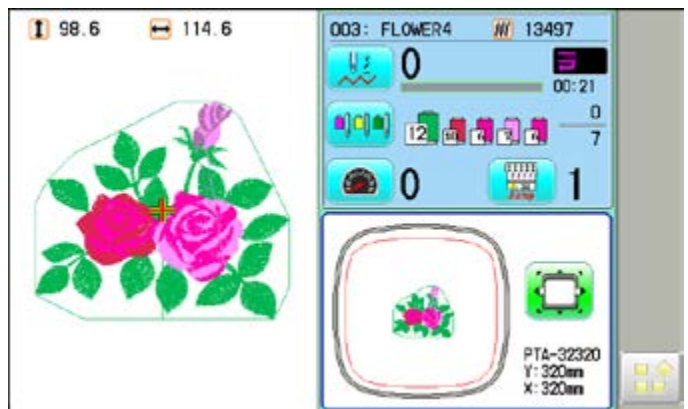
7. By position of design can be moved.



8. Press .

The display returns to Drive mode.

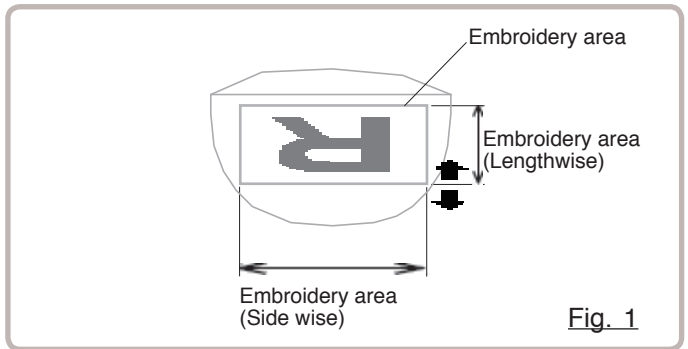
Start sewing by pressing .




● Adjusted for embroidery area

Cap frame

The embroidery area of HAPPY semi-wide and wide cap frames is saved in the machine.
The Y axis of the embroidery area can be adjusted for a variety of caps. (Fig. 1)




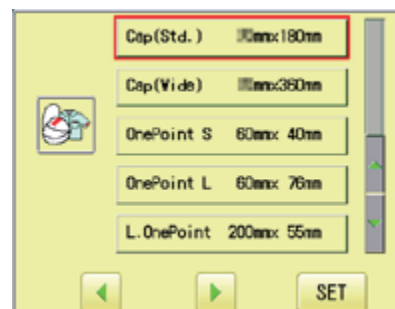
1. When the machine is stopped, press .



2. Select "FRAME".



3. Select  "Cap and One-point frame".



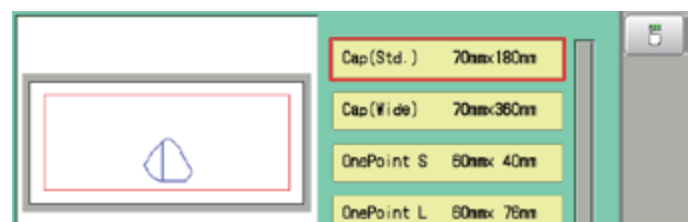
4. Select desired size of frame and press



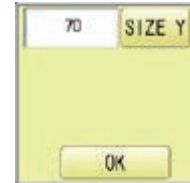
The embroidery area appear in red.



5. Press .



6. Press .



7. Press .



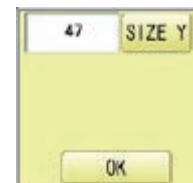
8. Select the number .

Enter the width of the cap.

Standard 40 ~ 70mm
Width 40 ~ 95mm

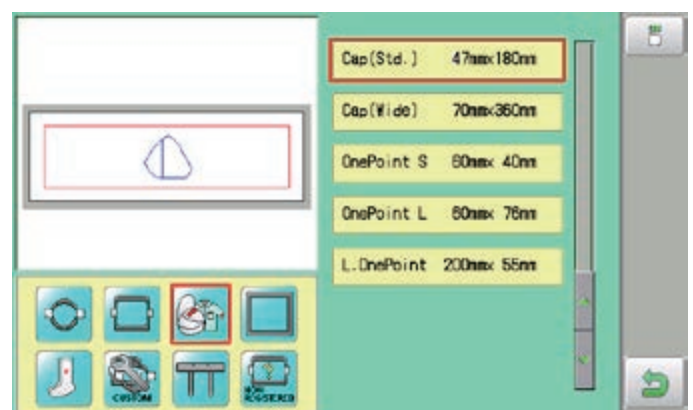


9. Press .

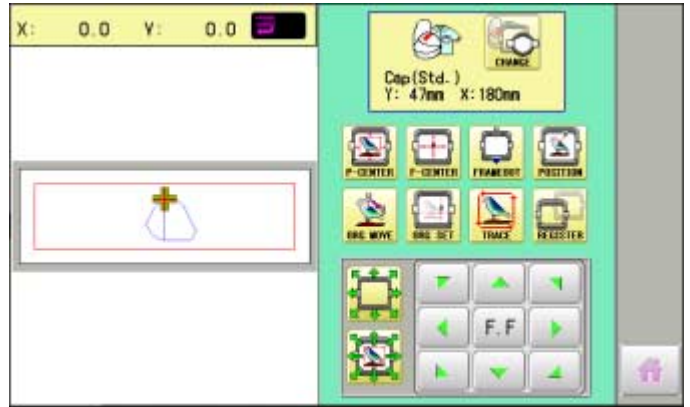


10. Press .

The setting is fixed.



11. Press



Press



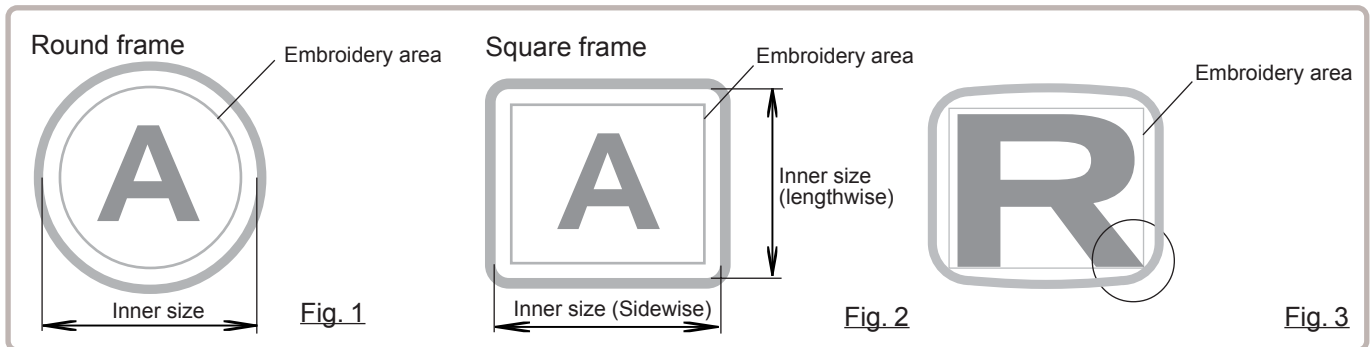
to return to Drive mode.

User-defined frames (1 ~ 5)

The embroidery area of each registered frame is set to the inside of the frame edge for pressure foot clearance. (Fig. 1, 2)

■ The embroidery area of each registered frame is set to the inside of the frame edge for pressure foot clearance. (Fig. 1, 2)

When you use square frame as shown in fig.3, pressure foot may hit the corner of frame. In this case you need to create frame as special shape under the frame No.6 - 20.



1. When the machine is stopped, press



2. Select "FRAME".



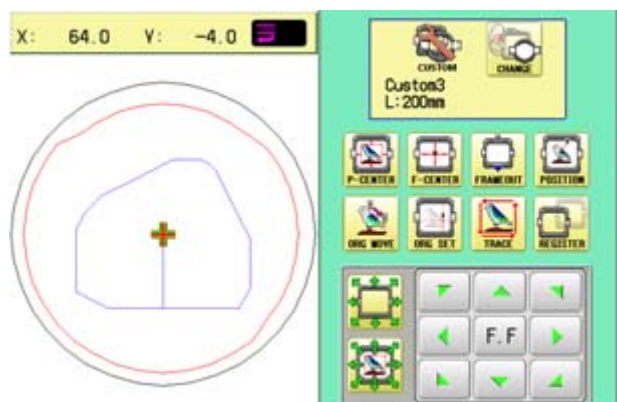
3. Select "User-defined frames".



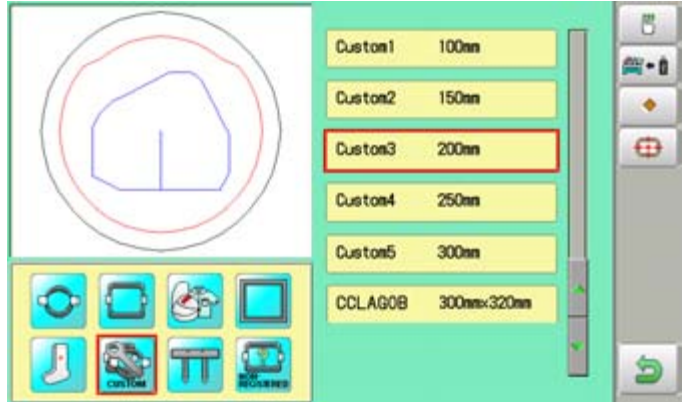
4. Select desired size of frame and press



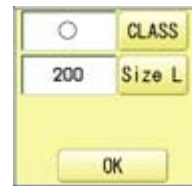
The embroidery area appear in red.



5. Press .



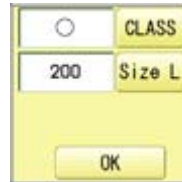
6. Press .



7. Press **CLASS** to select the hoop (Class).

- : Round frame
- : Square frame

Case for selected round frame



Case for selected square frame



8. Press **Size L**.

Select **SIZE Y** or **SIZE X** you wish to change square frame size.

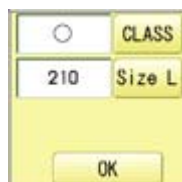


9. Select the number .

Input number for size of embroidery area.



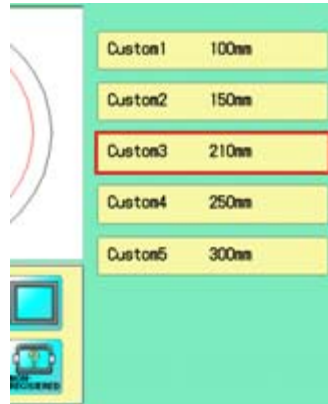
10. Press **SET**.



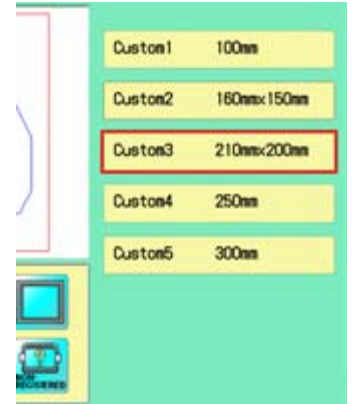
11. Press  .

The date is fixed.

Case for selected round frame




Case for selected square frame



12. Press  .



Press  to return to Drive mode.

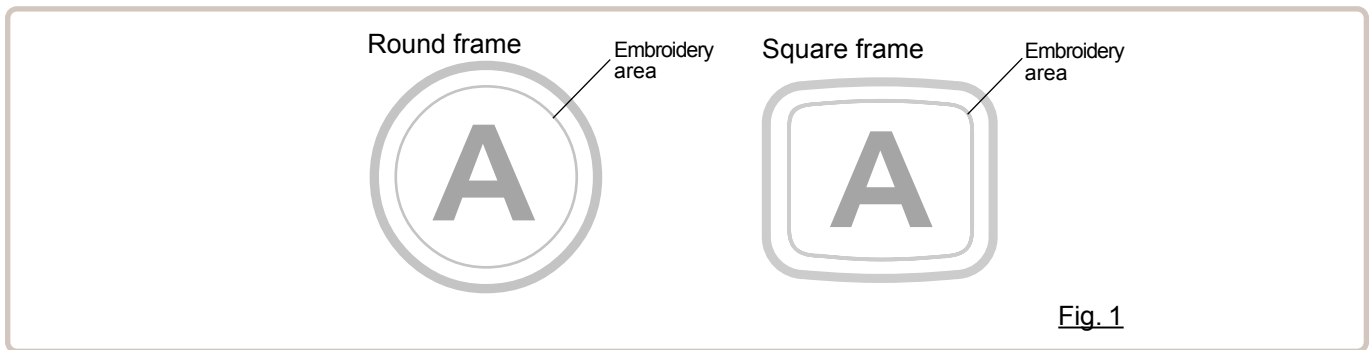
● User-defined frames (6 ~ 20)

You need to prepare for the data which entered the shape of the frame and entry the entered data.

You can entry the data up to 15 different size of custom frames.

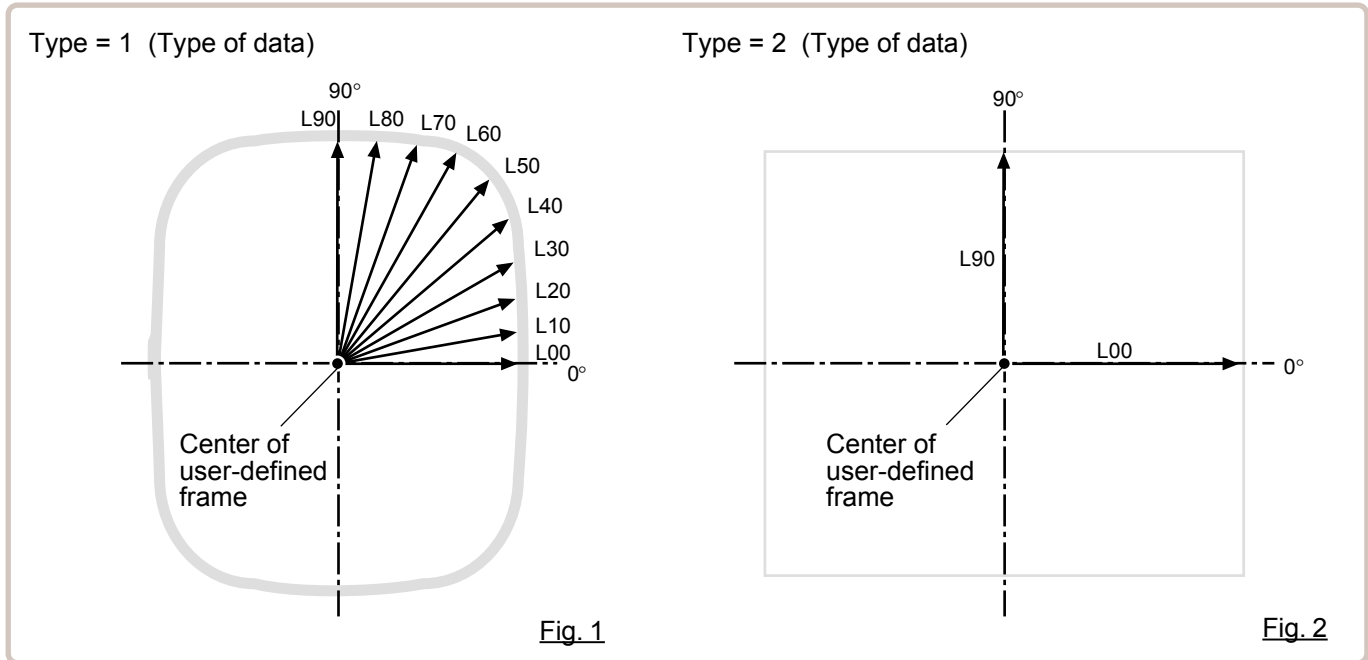
You need to prepare custom frame size data for entry the size to your machine.  13-B

The embroidery area for each registered frame is set to the inside of the frame edge to allow for pressure foot clearance. (Fig. 1)



How to make frame size data of your User-defined frames (6 ~ 20)

We need to use text edit software of PC like "WordPad" and make frame size data with following constitution, then entry the data to your machine.



Frame data constitution

Type = [Type of data]

Name = "[Name of frame]"

Form = [L00],[L10],[L20],[L30],[L40],[L50],[L60],[L70],[L80],[L90] (Frame shape)

Type : Select type of data by following number.

1 : Frame size 2 : Possible embroidery size

Note: If select "1", machine will memory reduced size for Presser foot diameter automatically.

If select "2", machine will memory exactly same size as can embroider it on.

Name : Naming the your User-custom frame. Pick up to 10 letters up with a "mark.

Form : Refer the above figure. Please fill it out every 10 degrees of dimensions to the inside of the frame in a frame heartily. (20 to 500mm)

Fill it out length from point from No. L00 till L90 total 10 points size using ", " between the each size data.

If your frame shape is Round, the every 10 points length frame size data should be same.

If you select Type (Type of data) "2", please put length data of L00 and L90 only.

END : Please fill out the line of the last of data. Please make entry of "END" by all means.

Please use half width character for the length data.


Please cut off the decimal of the length.

Example: 102.3mm -> 102

When you save the frame size data, please save as text document form and file name should be less than 8 characters.

Extension should be ".TXT"

Example: ROUND250.TXT

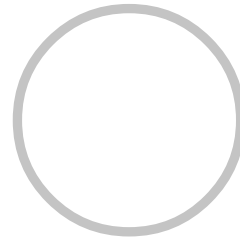
Please save the frame size data to machine usable memory media and read the data by embroidery machine.  13-D

Example of making the frame size data

Sample for each teaching method.

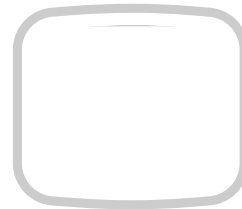
Ex. Round frame

Type = 1
Name = "Round"
Form = 125,125,125,125,125,125,125,125,125,125
END



Ex. Square frame

Type = 1
Name = "PS240"
Form = 120,122,126,130,128,120,106,100,96,94
END




Ex. Possible embroidery size

Type = 2
Name = "T-SC-01"
Form = 90,60
END




Reading frame data

1. When the machine is stopped, press 



2. Select "FRAME".

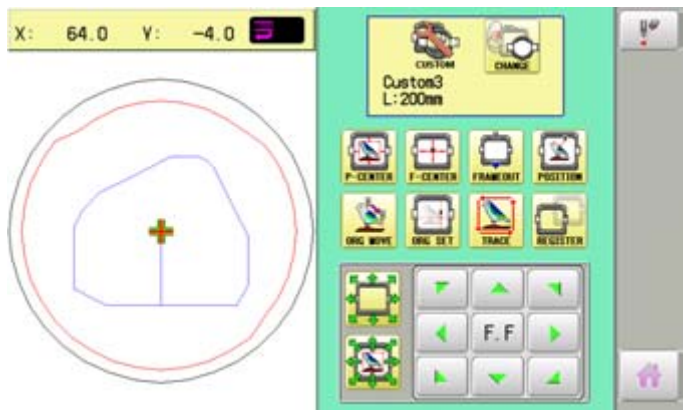


3. Select  "User-defined frames".

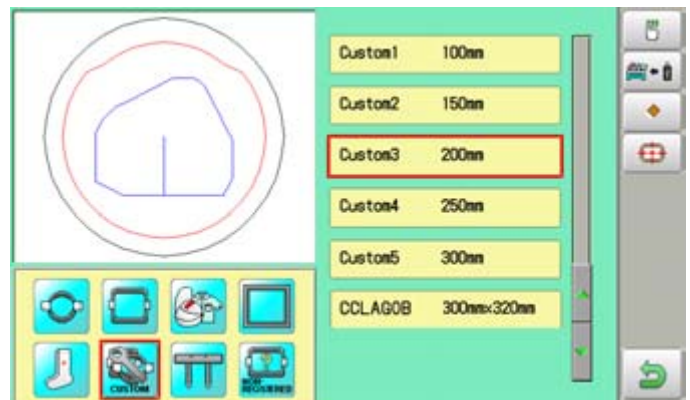


4. Press 

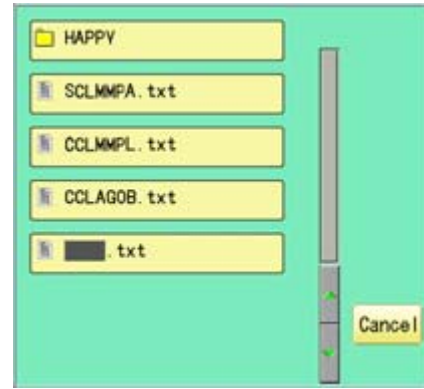
You can choose any frame options.



5. Press 

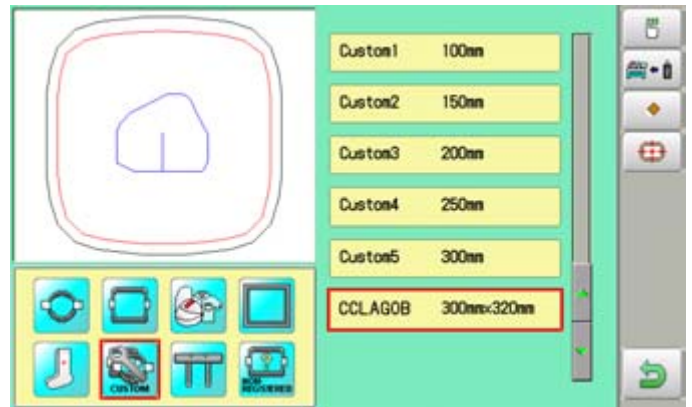


6. Press .



7. Select the frame data "CCLAGOB.txt".

The frame data has been read.



8. Press .



Press  to return to Drive mode.

How to delete the resisted user-defined frames (6 ~ 20)


Delete resisted User-defined frame from memory.

1. When the machine is stopped, press .



2. Select "FRAME".

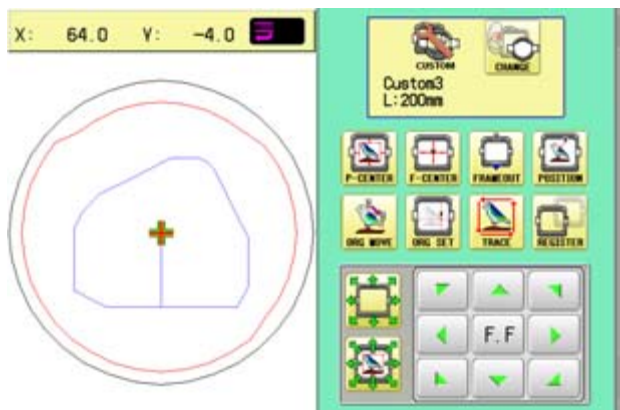


3. Select  "User-defined frames".

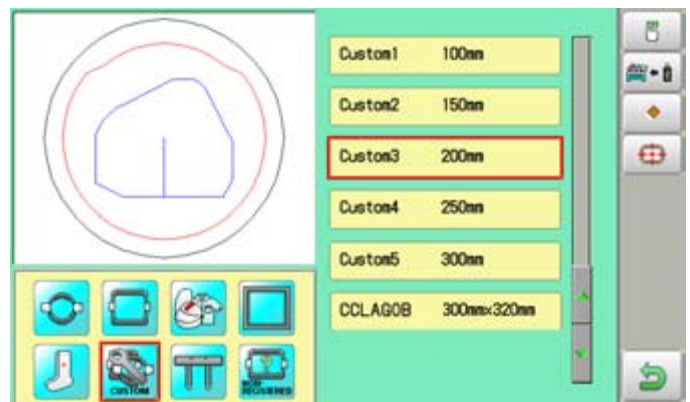


4. Press .

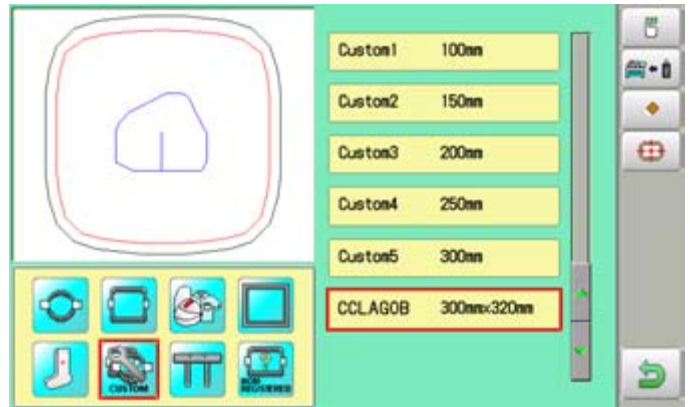
You can choose any frame options.



5. Press .

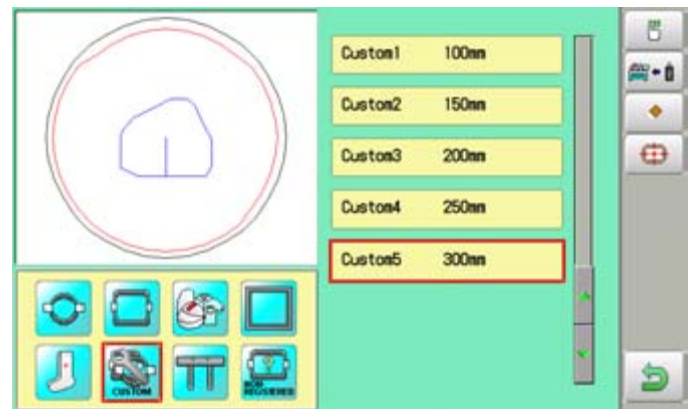


6. Select desired User-defined frames.



7. Press .

The user-defined frames will be deleted.




8. Press .




Press  to return to Drive mode.

● How to change center point of frame (1 ~ 5, 6 ~ 20)

You can change memorized frame center point.

When you set your frame and use machine function of “Frame move” and “Center” ( 3-6), If your frame is not center, please practice following steps for center setting again.

1. When the machine is stopped, press  .



2. Select “FRAME”.

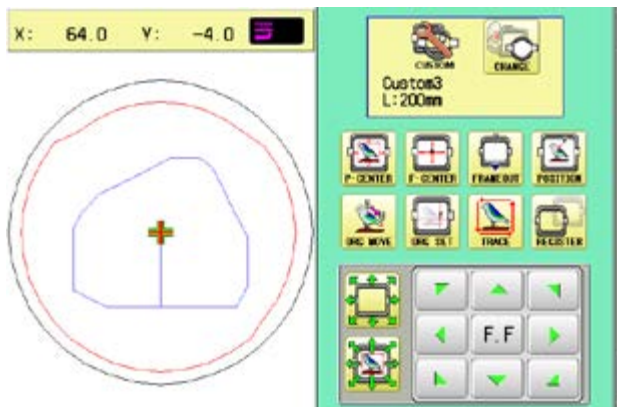



3. Select  “User-defined frames”.

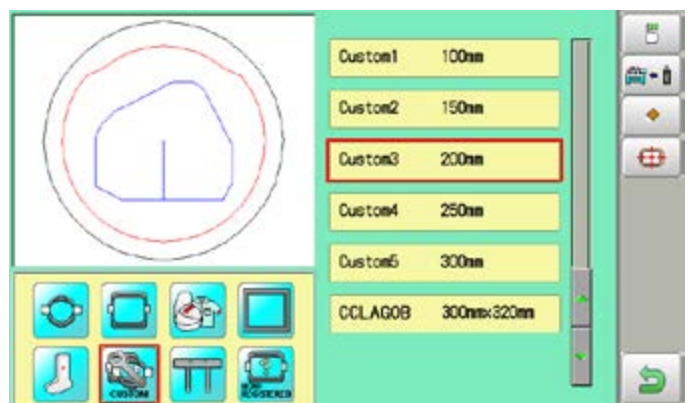


4. Press  .

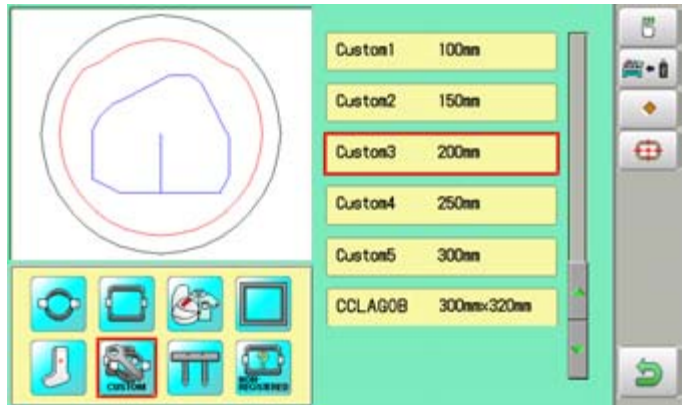
You can choose any frame options.



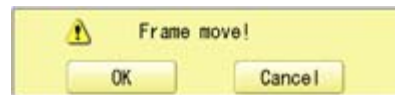
5. Press t  .




6. Select desired User-defined frames.




7. Press .

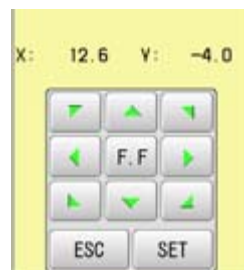


8. Press .



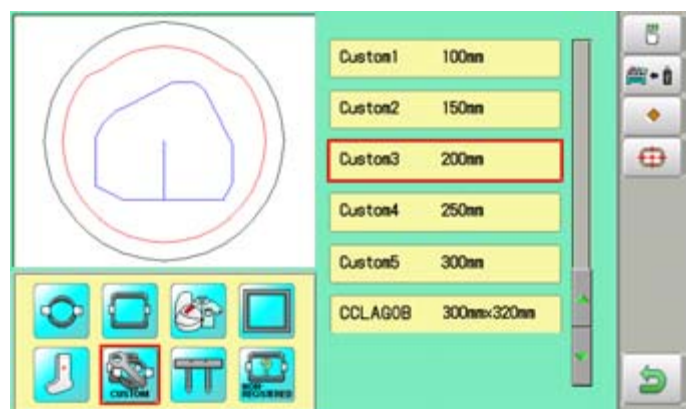
 **CAUTION: To prevent accidents.**
The frame moves quickly.
Keep hands away from the frame.

9. Move embroidery frame to frame center




10. Press .

Memorized frame center point coordinate to the machine.



11. Press .



Press  to return to Drive mode.

● Non registered frame

In case Non Registered Frame is selected, carriage does not have movement for creating the coordinates of frame position at the time of turning machine on.

Please select Non Registered Frame, when you need use special frame which can hit pressure foot or other machine parts by movement of carriage for creating the coordinates of frame position.

The following functions is canceled by selecting Non Registered Frame;

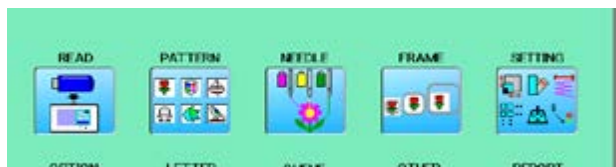
- * Frame confirmation
- * Restore the position at the time of power failure
- * Locate
- * Autostop function when movement exceeds the carriage limit.



Except using special shape frame, please do not select Non Registered Frame.

In case you have operation mistake, needle and/or pressure foot may hit frame and machine and/or frame can be damaged.

1. When the machine is stopped, press



2. Select "FRAME".



3. Select "Non registered".



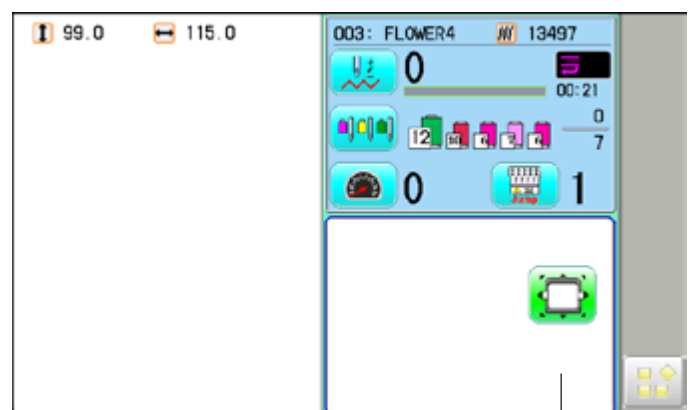
4. Press



Indication of frame type disappears.
It means that "Non Registered" is selected.

- When you need to change from Non Registered frame (Special frame) to other type of frame, please power machine off and start again.

Without re-starting machine, machine will move incorrectly.



Frame indication disappears

Various settings such as the scaling, repeat sewing, offset and frame out can be applied to a pattern.

Adjust

This menu contains settings such as scaling, width adjustment, angle and convert design.

Repeat sewing

The machine repeats the pattern a number of times in the X and Y directions as set by the user.

Offset

Sets the start point of the frame in the selected pattern.

Frame out

Inserts a frame out command in the selected pattern.

■ Various settings are executed in assortment.

● **Adjust**

Scaling

This adjusts the scale of the selected pattern.

Width adjustment

This adjusts the width of the selected pattern.

Angle

This adjusts the angle of the selected pattern.

Convert design **9-5**

This sets the rotation of the selected pattern in increments of 90 degrees, normal or reversed.

Scaling

The pattern's scale can be increased or decreased in 1% increments.

Setting example

R


Normal

Default : X,Y 100%

R

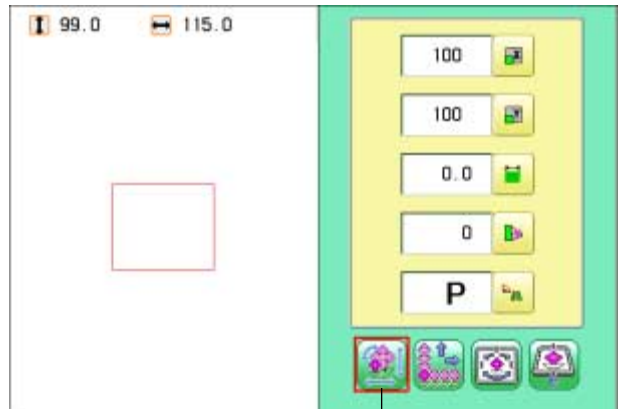
X 100 %, Y 150 %

● : Start point of pattern



1. When the machine is stopped, press .



2. Select "SETTING".



Adjust

3. Select  (Scaling X) or  (Scaling Y).



4. Select the number.



 Changing is cancelled.


 Numbers are deleted.

5. Press .


The setting is fixed.

148.0 115.0



 The pattern data may be shown.

 Setting is returned to the default.

 To return to Menu mode.

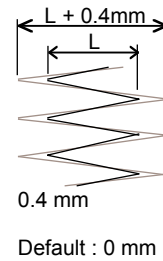
 to return to Drive mode.


Width adjustment

This setting adjusts stitch width (L) in a pattern in a range of -1.0 ~ +1.0mm in increments of 0.1mm.

■ In case "Width" (Width adjustment) is set and embroidery is made, there is a case that error occurs at end point. In such a case, please return setting figure of stitch width to "0.0".

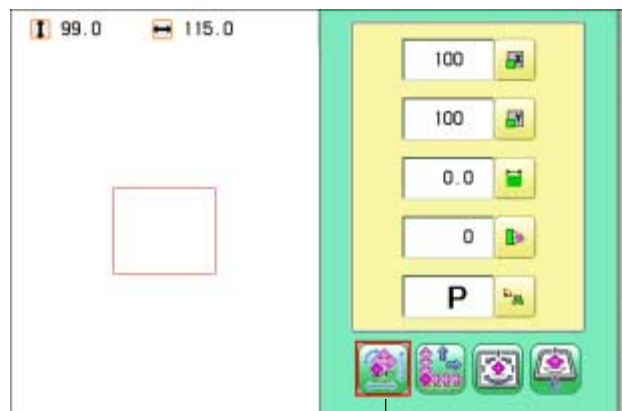
Setting example



1. When the machine is stopped, press .





2. Select "SETTING".




3. Select  (Width adjustment).



4. Select the number.





-  Changing is cancelled.
-  Numbers are deleted.



5. Press .

The setting is fixed.



-  The pattern data may be shown.
-  Setting is returned to the default.
-  To return to Menu mode.
-  to return to Drive mode.

Angle

With the start point of the pattern as a pivot, the machine rotates the angle clockwise.

Setting example




Normal

Default : 0°



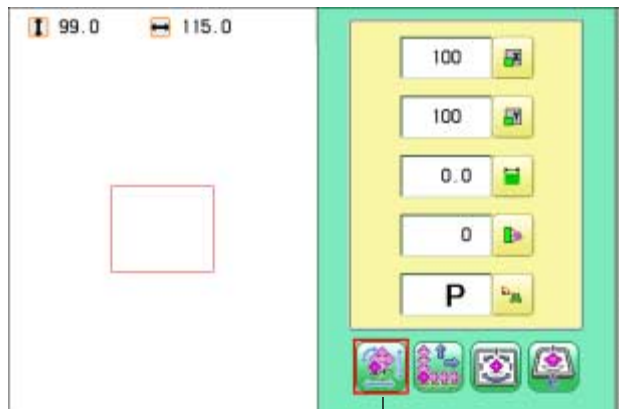
30°


● : Start point of pattern

1. When the machine is stopped, press .



2. Select "SETTING".



3. Select  (Angle).

Adjust



4. Select the number.



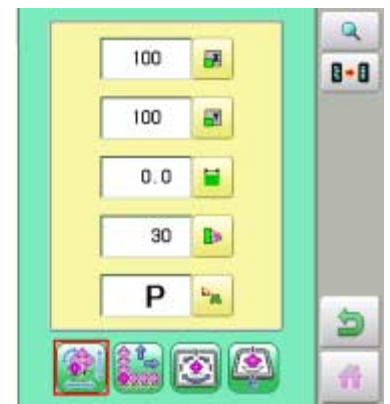
 Changing is cancelled.





 Numbers are deleted.

5. Press .

The setting is fixed.

110.0 120.0

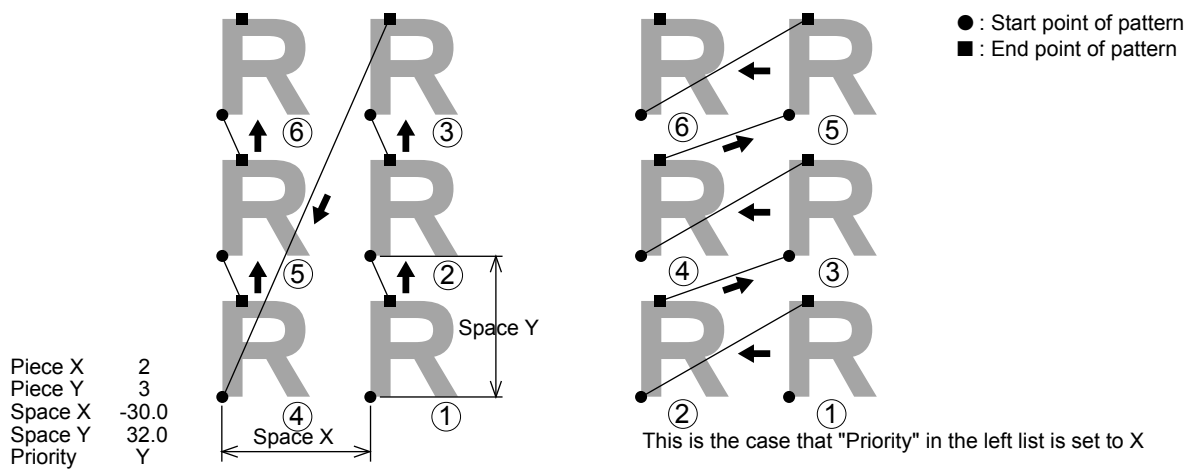


-  The pattern data may be shown.
-  Setting is returned to the default.
-  To return to Menu mode.
-  to return to Drive mode.


● Repeat sewing

The machine embroiders a user-specified number of copies in the X and Y directions.

Setting example



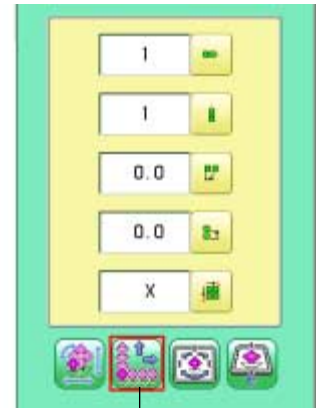
SETTING ITEM	SETTING RANGE	DEFAULT	
Piece X	1 ~ 30	1	This sets number of pieces side wise and length wise when you perform repeat.
Piece Y	1 ~ 30	1	The number of pieces to be embroidered is product obtained by multiplying numbers in X and Y.
Space X	-999.9 ~ 999.9 mm	0	This sets side wise distance between start point of each pattern when you perform repeat. When plus number is input, the machine makes repeat toward right. In case of minus number, toward left.
Space Y	-999.9 ~ 999.9 mm	0	This sets length wise distance between start point of each pattern when you perform repeat. When plus number is input, the machine makes repeat upward. In case of minus number, downward.
Priority	X (Side)• Y (Length)	X	When you set more than 2 pieces for repeat length wise and side wise, this selects direction to embroider 2nd piece.

1. When the machine is stopped, press .





2. Select "SETTING" and select  (Repeat).

99.0 115.0




Repeat

3. Select each setting item and select the number.

-  Changing is cancelled.
-  Numbers are deleted.







4. Press .

The setting is fixed.

339.0 265.0

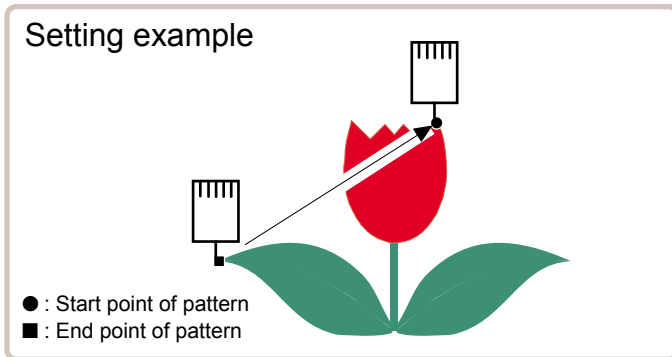



5. Set necessary item by performing procedure no. 3 to no.4.
Set all the necessary items.

-  The pattern data may be shown.
-  Setting is returned to the default.
-  To return to Menu mode.
-  to return to Drive mode.


● Auto origin

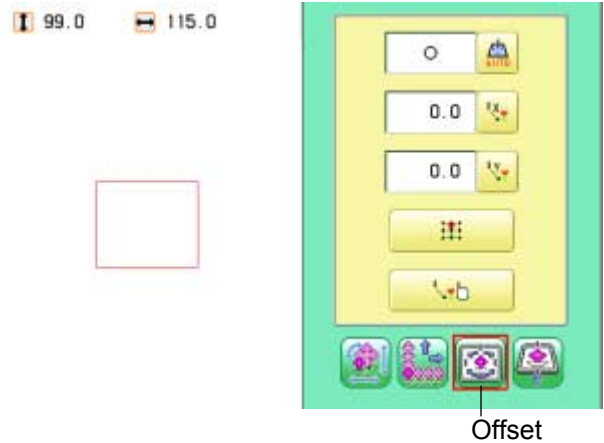
When a pattern has different start and end points, the frame returns to the start point.




1. When the machine is stopped, press .







2. Select "SETTING" and select  (Offset).



3. Press  (Auto origin) and select (ON) or (OFF).

The setting is fixed.



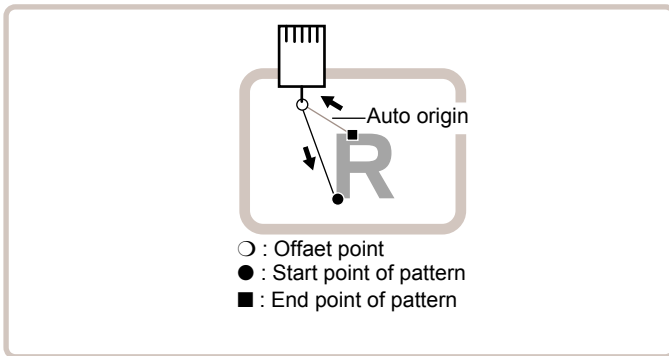
-  The pattern data may be shown.
-  Setting is returned to the default.
-  To return to Menu mode.
-  to return to Drive mode.

● Offset

Setting the offset point designates a place for the frame to rest before moving to the start point of the actual embroidery.

When used together with the "Auto origin" (P 14-7) feature, the machine will return to the offset when it is finished embroidering as well.

This allows you to send the frame to a place where it will be easier to handle, when you will need to change hoops for example.



Direct input


You can move the offset point manually and save the position with "Teaching input".

Preset

There are 9 preset points that can be used for offsets around and in the center of the pattern.

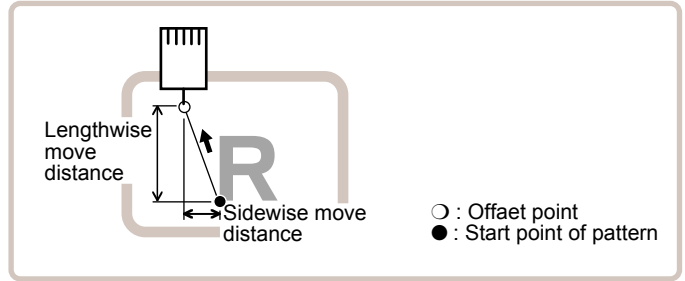
Teaching input

You can set the offset point manually.

- When you Press  (Original point return) or use "Auto origin" (P 14-7) with an offset, the frame will return to the offset point.

Direct input

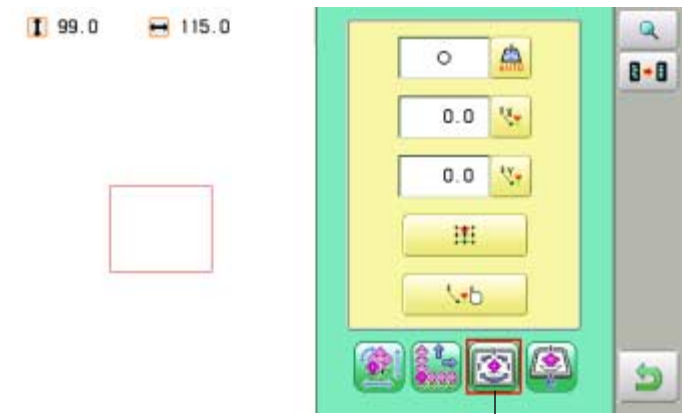
You can move the offset manually and save the position with "teaching input".



1. When the machine is stopped, press



2. Select "SETTING" and select (Offset).



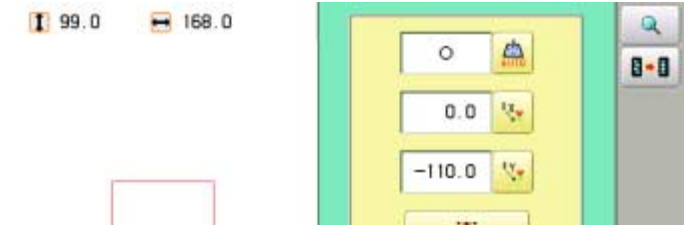
3. Select (X axis distance) or (Y axis distance) and select the number.

- Changing is cancelled.
- Numbers are deleted.

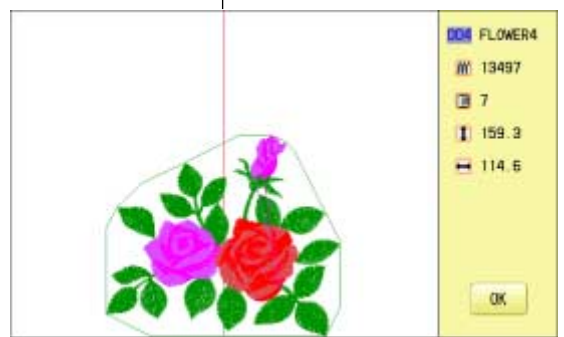


4. Press .

The setting is fixed.




Offset point




- The pattern data may be shown.
- Setting is returned to the default.
- To return to Menu mode.
- to return to Drive mode.

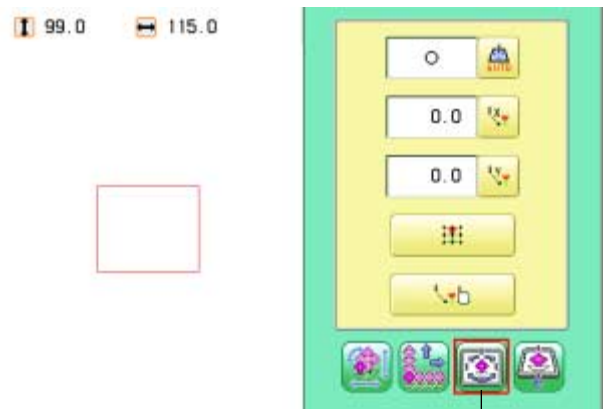
Preset

There are 9 preset points that can be used for offsets around the or in the center of the pattern.

1. When the machine is stopped, press .



2. Select "SETTING" and select  (Offset).



Offset

3. Select .



4. Select the offset point and press .





The setting is fixed.

 Setting is unset.



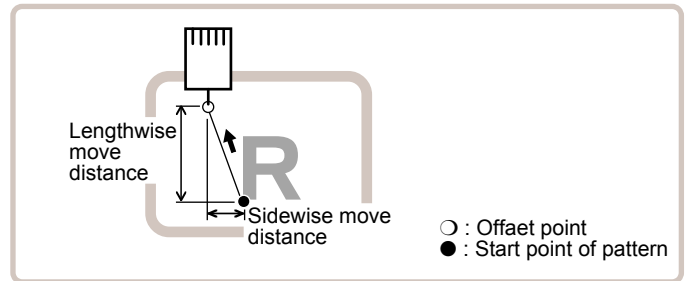
Offset point




-  The pattern data may be shown.
-  Setting is returned to the default.
-  To return to Menu mode.
-  to return to Drive mode.


Teaching input

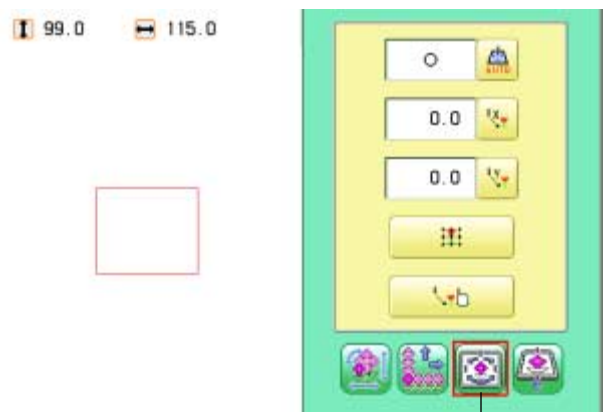
You can set the offset position manually.



1. When the machine is stopped, press .

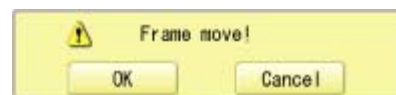


2. Select "SETTING" and select  (Offset).



Offset


3. Select .

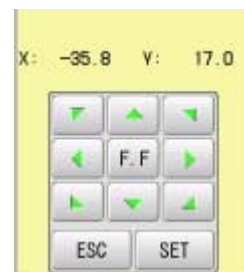


4. Press .



5. Move the frame to the pattern start point.

 Setting is cancelled.



6. Press .

The setting is fixed.

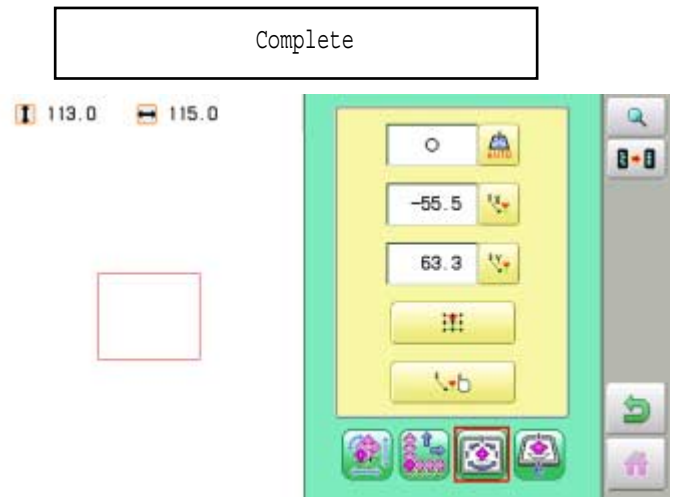






7. Move the frame to the offset point.



8. Press **SET**.

The setting is fixed.



-  The pattern data may be shown.
-  Setting is returned to the default.
-  To return to Menu mode.
-  to return to Drive mode.



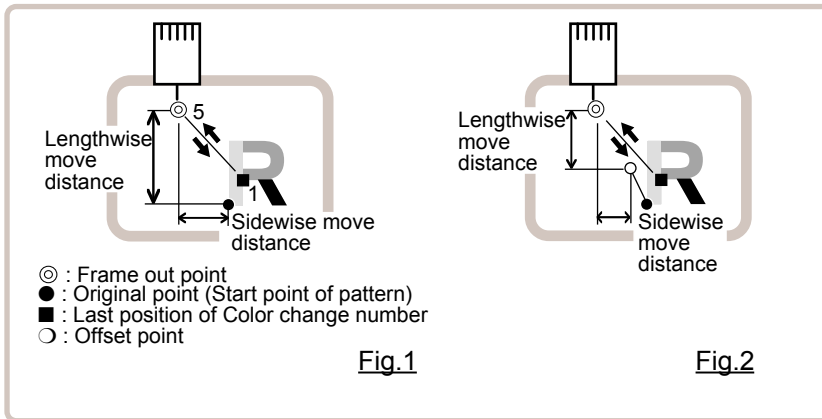
Offset point

● Frame out

A frame out command can be added to a design. By setting frameout to a *Color change number in a design, you can move the frame to a desired position automatically and stop it after the machine finishes sewing of that color change number.

When you resume operation, the frame has an automatic return to previous position and you can continue sewing. (Fig.1)

This function will be convenient for trimming threads while embroidering or for sewing applique etc.



Selection of color change number P 5-F

Set Color change number to execute frameout.

Teaching input

Set position of frame out and the distance of movement will be the frame out distance.

Usually move distance to frame out point is input, with original point as pivot.(Fig.1)

In case offset is set, the move distance is input with offset point as pivot.(Fig.2)

- You can set number of stitches or Color change number to make frame out in plural, but frame out point is limited to one place. The point set finally becomes good for making frame out. The point set finally becomes good for making frame out.

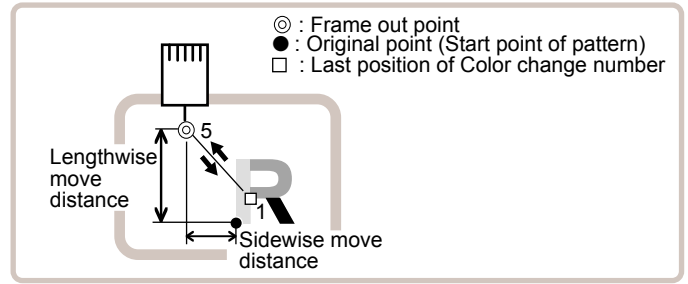
Direct input

You can set the position of frame out directly by inputting by the number keys. You can also change the position of a frame out set by "Teaching input".

Normally, the distance to the frameout point is input with the original point as a pivot. (Fig. 1) In case where an offset is set, the move distance to frameout position is input with offset point as pivot. (Fig.2)

Teaching input

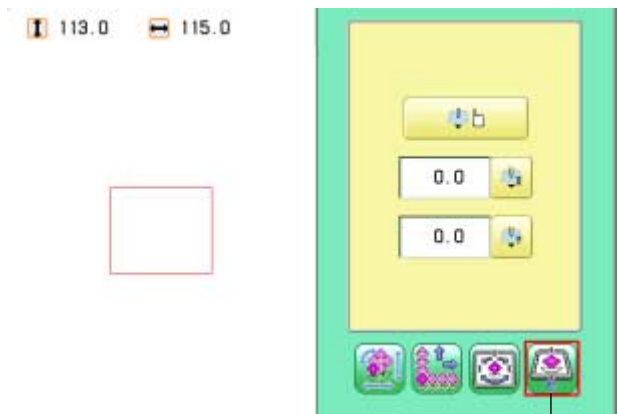
Move the frame and the position will be saved as the frame out.



1. When the machine is stopped, press



2. Select "SETTING" and select (Frame out).



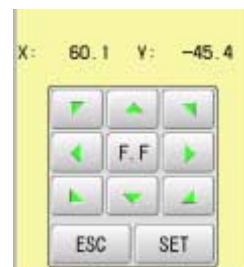
Frame out

3. Select



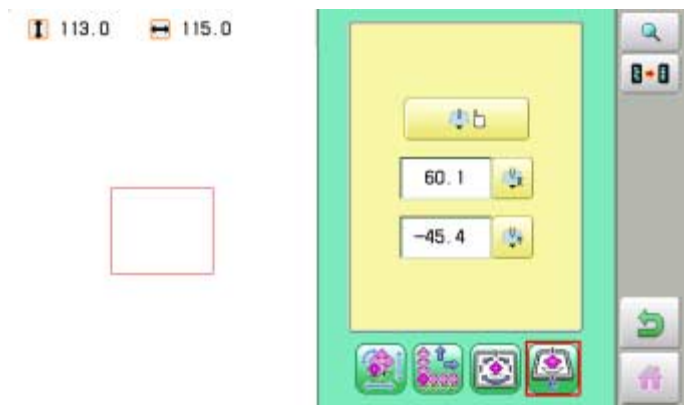
4. Move the frame to the frame out position.

Setting is cancelled.



5. Press

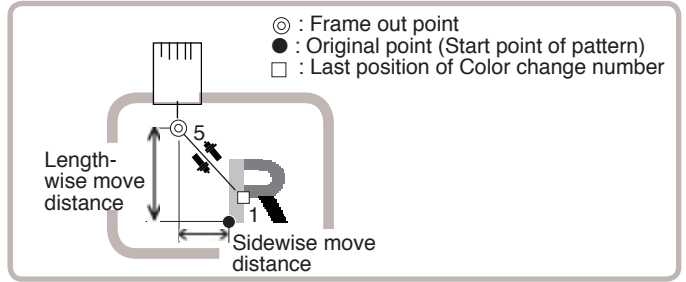
The setting is fixed.



- The pattern data may be shown.
- Setting is returned to the default.
- To return to Menu mode.
- to return to Drive mode.


Direct input

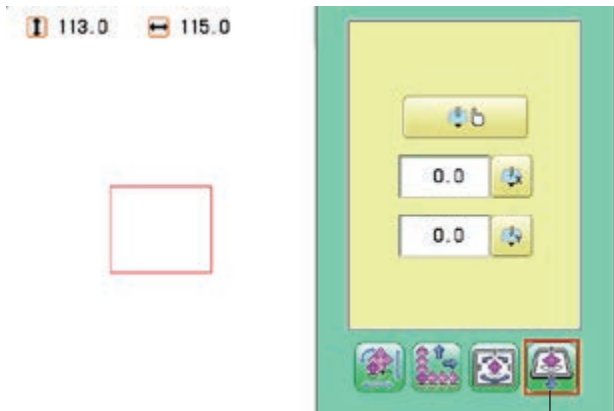
You can change the position of your frame out by using this function. You can change the moving distance of the frame out and change the frame out position, which saved by “Teaching input”.





1. When the machine is stopped, press .





2. Select “SETTING” and select  (Frame out).



Frame out

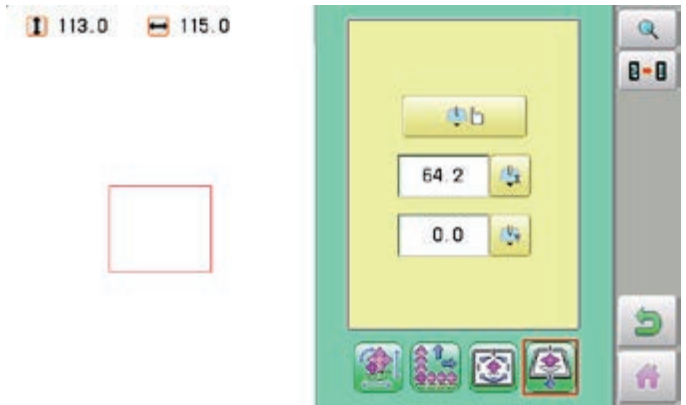
3. Select  (X axis distance) or  (Y axis distance) and select the number.





-  Changing is cancelled.
-  Numbers are deleted.



4. Press .

The setting is fixed.





-  The pattern data may be shown.
-  Setting is returned to the default.
-  To return to Menu mode.
-  to return to Drive mode.



MACHINE SETTINGS


15-1

Before embroidering, check the basic settings of the machine.

The rest of the settings can be left at default values (as indicated by underline below).

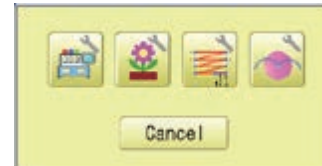
No. Display	Setting <small>Default is underlined</small>	Contents
2 Tightness level	- (Loose) <u>□</u> (Normal) + (Tight)	The machine adjusts thread tightness level by controlling the timing of frame move. By default it is set to "Normal".
3 TRD. break back	1 ~ 50 (<u>6</u>) ... 0	When thread is broken, the stitch will undo itself for the specified number of stitch. • The stitch undoes itself by the specified number of stitch in this setting. • The stitch does not undo.
4 All head mending	Yes <u>No</u>	The machine mends threads only on heads with detected thread break. The machine mends threads for all heads irrespective of thread
5 Width data limit	1 - <u>13</u> mm (13=12.7)	When stitch length exceeds this length, the machine divides it by this jump length and creates multiple movements. Width data limit becomes 12.7mm only when setting value is set to 13. Please use a smaller number when you use thick and heavy material.
6 Quick start mode	Yes..... <u>No</u>	If you set to "No", the machine will increase speed slowly. Please select "No." when you have a problem with skipped stitches on the beginning stitch after thread trim. • The machine sews up to 3 stitches slowly after thread cut. • The machine sews up to 5 stitches slowly after thread cut.
7 Auto thread cut	<u>Yes</u> No	This performs automatic thread cut after color change and stop.
8 Cut at jump data	1 ~ 8 (<u>3</u>)..... 0.....	When a set number of continuous jumps exists in pattern data, the machine cuts threads before jumping. • Machine trims the thread on setting number of constant jump. • Does not trim.
9 Cut at null jump	<u>Yes</u> No.....	This sets thread cuts before null jumps (isolated jumps with no net movement) • Does trim on empty jump data. • Does not trim on empty jump data.
10 CHG. always cut	Yes..... <u>No</u>	Forces a trim at every color change. • Always thread trim before color change. • If data does not have trim function at color change point, machine does not trim.
11 Length of TRD.cut	Max. Long <u>Normal</u> Short Min. Needle.....	The machine cuts upper threads to a longer length. • The upper threads of each needle will be cut off by registered length.  15-3
12 Slow (mend out)	<u>Yes</u> No	When mending finishes and all heads start to embroider again, machine speed to be decelerated for safety purpose.
13 Width data all	-1.0 ~ 1.0mm <u>0.0</u> mm.....	This is to alter the widths of all satin stitches for all the designs in the memory. • Adjust satin stitch width by selected amount. • Does not adjust width.
14 TRD. break detect	Quick 3 ~ ~ <u>Normal</u> ~ ~ Slow 3 Off Needle.....	Sensitivity selection of the thread break detect sensor. By default it is set to "Normal". • You can set sensitivity of thread break detection needle by needle.  15-4
15 Convert cap	Yes <u>No</u>	When you install the cap drive frame on the machine, the machine will convert (rotate) your design automatically.
16 Revers frame move	Yes <u>No</u>	Frame will be moved in the opposite direction of the arrow key.
17 STR.Auto Position	<u>Yes</u> No	Machine remembers & returns to last sewn position after sewing interruption even if operator has moved the frame after interrupt.
18 Embroidery weight	Light Middle <u>Heavy</u>	This setting for heavy duty material depends by material weight. Normally, please select "middle" or "Heavy" for Border frame. Machine speed is decreased automatically, when you select "middle " or "heavy".

No. Display	Setting Default is underlined	Contents
19 Expand cap limit	1 ~ 10mm <u>0</u>	The direction of Y-axis of the embroidery area (standard) is extended in the direction of the brim of the cap.  If the embroidery area is extended too much, there is a possibility that a needle and pressure foot may hit a frame and may be damaged. Before start sewing, please check carefully the embroidery area by trace function etc.. • The embroidery area is extended with the set-up size. • The embroidery area is not extended.
20 Frameout position	0 ~ <u>100</u> ~ 330mm	Set movement of frameout in the drive menu.
21 Display inch	<u>Yes</u> No	• Display the unit of dimensions at an inch. • Display the unit of dimensions by millimeters meter.
22 Trace speed	0 ~ <u>100</u> ~ 300	You can change the Tracing speed. "100" mean the normal speed. If you change the number bigger, the speed decrease.
23 Display off timer	1 ~ <u>240</u> (min.)	The machine turns off the display screen when the time without any operation exceeds the time entered in the parameter. Timer function is "off" when setting value is set to "0"
24 Design disp mode	<u>All</u> Change	• When drive mode, highlight all color change number on the LCD Display. • Highlight only current color change number.
25 Drawing“Real Pattern”	<u>Yes</u> No	Display pattern with realistic image on the screen.
26 Operation Sound	<u>Yes</u> No	Make beep sound when button or key of touch panel is pressed.
27 Notification Sound	<u>Yes</u> No	Make beep sound when the machine is stopped.
28 FW/BW Lock Count (1st.)	<u>0</u> ~ 100	In "Stitch number forward", when the key is pressed continuously, the "Key lock" function is activated and the frame will move by the one stitch continuously even the finger is released from the key. Set number of stitches until "Key lock" function is activated. The "Key lock" function will be disabled when the number of stitches is set to "0".
29 FW/BW Lock Count (10st.)	<u>0</u> ~ 100	In "Stitch number forward", when the key is pressed continuously, the "Fast forward"(10 stitches) function is activated and the frame will move continuously even the finger is released from the key. Set number of stitches until "Fast forward" function is activated. The "Fast forward" function will be disabled when the number of stitches is set to "0".
30 Cross mark type		Selection of the cross mark (pointer) type.
31 PC Keyboard Layout	<u>Yes</u> No	Selection of the keyboard layout. • PC (QWERTY) • Alphabetical order

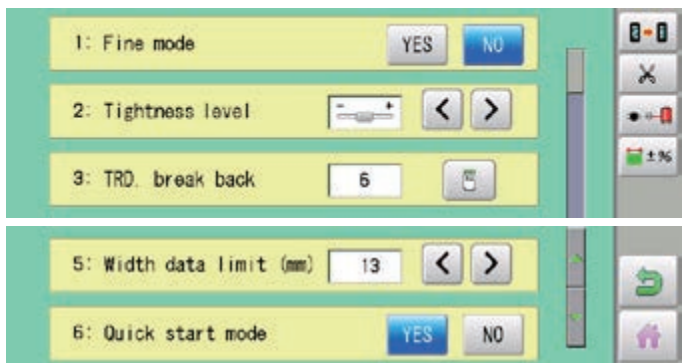
1. When the machine is stopped, press  .



2. Select "OPTION".



3. Select  .



4. Select desired setting item and change the setting.

You can move to next page by pressing  .

Press  to return to Menu mode.

Press  to return to Drive mode.

Detailed explanation of machine settings



11 Length of TRD.cut


If you select "Needle" with this setting, the upper threads of each needle will be cut off by registered length.

The length of each thread can be set up taking the following steps.

1. Follow the steps 1.- 3. on the previous page and the display shows machine setting page.

2. Press .

3. Change the setting on the needle number you would like to change with  .

Press  when returning the setting on all the needle numbers to default.

4. Press .

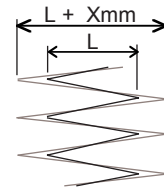


13 Width data all

This function adds additional width to all satin stitches in a design. This is otherwise set in the "Settings" function (P 14-3), in which case any changes made to the setting from this screen will have no effect.

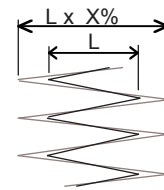
You can also set detailed adjustment with using "Width data multi-step" function. Please note that the value of "Width data all" should be set "0.0mm" to activate above function. The step of setting is as follows.

Width data all



Setting : X mm


Width data multi-step





Setting : X%

1. Follow the steps 1.- 3. on the previous page and the display shows machine setting page.

2. Press .

3. Change the setting on the each width you would like to change with .

Press  when the setting on all the each width.

Press  when returning the setting on all the each width to "0%".

4. Press .





15 TRD. break detect


If you select “Needle” with this setting, you can set sensitivity of thread break detection needle by needle.

You can be set up taking the following steps.

1. Follow the steps 1.- 3. on the page 15-2a and the display shows machine setting page.

2. Press .

3. Change the setting on the needle number you would like to change with  .

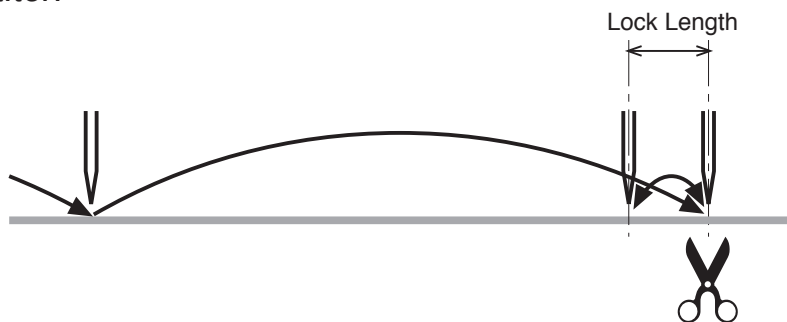
Press  when returning the setting on all the needle numbers to default.



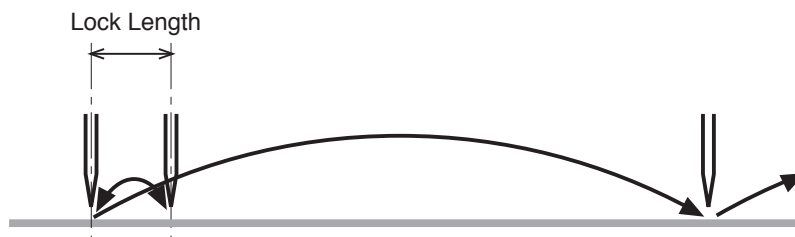
This machine adds lock stitches automatically as default setting at start and thread cut point. These lock stitches prevent upper thread from fraying and coming off from needle hole. The length and number of lock stitches (start / thread cut) can be adjusted with following setting items.

- * At start of embroidery, if upper thread comes off often even default setting, it is recommendable to change setting of STR. Lock stitch from AUTO to ON and adjust STR. Lock Length longer.


Ex. Cut Lock stitch

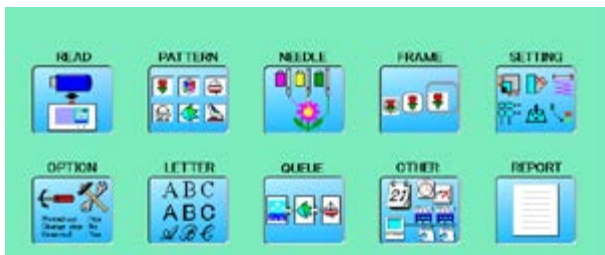


Ex. STR. Lock stitch



SETTING ITEM	SETTING RANGE (Default is underlined)	CONTENTS
1 Cut Lock stitch	OFF ON <u>AUTO</u>	: Remove lock stitch when the machine cuts threads. : Add lock stitch per SETTING ITEM 2 and 3 when the machine cuts threads. : Add lock stitch when length of the stitch before thread cut is longer than length set at SETTING ITEM 2.
2 Cut Lock Length	0.4~ <u>0.7</u> ~1.2mm	: Set lock stitch length when "ON" or "AUTO" on SETTING ITEM 1 Cut Lock stitch is selected.
3 Cut Lock Count	1 ~ <u>2</u> ~ 3	: Set number of lock stitch when "ON" on SETTING ITEM 1 Cut Lock stitch is selected.
4 STR. Lock stitch	OFF ON <u>AUTO</u>	Add Lock stitch when the machine starts sewing. : Remove lock stitch when the machine starts. : Add lock stitch per SETTING ITEM 5 and 6. : Add lock stitch when length of the stitch before the machine starts sewing cut is longer than length set at SETTING ITEM 5.
5 STR. Lock Length	0.4~ <u>0.7</u> ~1.6mm	: Set length of lock stitch when "ON" or "AUTO" on SETTING ITEM 4 Cut Lock stitch is selected.
6 STR. Lock Count	1 ~ <u>2</u>	: Set number of lock stitch when "ON" on SETTING ITEM 4 Cut Lock stitch is selected.

1. When the machine is stopped, press .



2. Select "OPTION".



3. Select .

4. Select desired setting item and change the setting.

Press  when returning the setting to default.




Press  to return to Menu mode.

Press  to return to Drive mode.

When the optional device is mounted to the machine, setting at the embroidery machine is required.

Concerning the details of setting, please refer the instruction manual of each device.

In case the embroidery machine has no optional device, please skip this page.

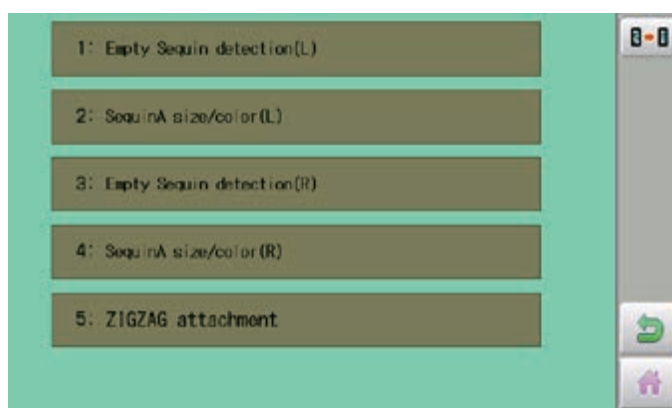
1. When the machine is stopped, press  .




2. Select "OPTION".



3. Select  .



4. Select setting item and change its setting.

Press  to reset all the sequin settings to default.

Press  to return to Menu mode.

Press  to return to Drive mode.




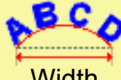



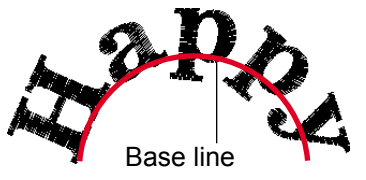
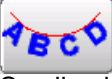
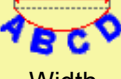




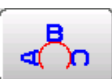




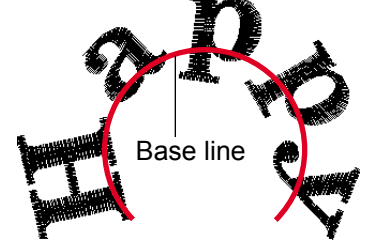





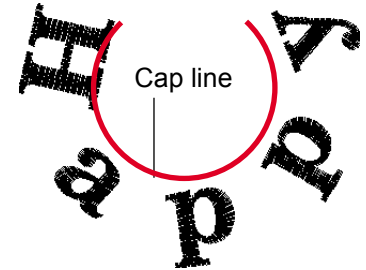
Selecting letters using the built-in fonts.


You can create monogramming data by using built-in alphabet, numbers and symbols.

You can choose layout method of monogramming data from horizontal, arch, or circle layout.

Save lettering embroidery data to design memory automatically.

Layout method

<p> Horizontal (straight line)</p> <p>Base line is horizontally laid out.</p>	<p>Increase or decrease by 5(mm or degrees) Set by entering value.</p>	<p>Cap line</p>  <p>Base line</p>
<p> Arch (upward)</p> <p>Increase or decrease by 5. Set by entering value. Baseline is formed a round arch in an upward direction. Change settings of baseline's width and height. Press SET after setting is firmed.</p>	<p> Width - + </p> <p> Height - + </p>	 <p>Base line</p>
<p> Arch (downward)</p> <p>Cap line is formed a round arch in a downward direction. Change settings of capline's width and depth. Press SET after setting is firmed.</p>	<p> Width - + </p> <p> Height - + </p>	<p>Cap line</p>  <p>Base line</p>
<p> Circle (upward)</p> <p>Baseline is formed a circle in an upward direction. Change settings of baseline's diameter and angle. Press SET after setting is firmed.</p>	<p> Diameter - + </p> <p> Angle - + </p>	<p>Cap line</p>  <p>Base line</p>
<p> Circle (downward)</p> <p>Capline is formed a circle in an downward direction. Change settings of cap line's diameter and angle. Press SET after setting is firmed.</p>	<p> Diameter - + </p> <p> Angle - + </p>	<p>Cap line</p>  <p>Base line</p>

1. When the machine is stopped, press  .




2. Select "LETTER".



Letter selection

Select letters. One data can contain up to 26 letters including space.

3. Select letter.

 The screen is switched to basic script or cyrillic script.


 All the letters are deleted.

 Basic script



 Biacritic script

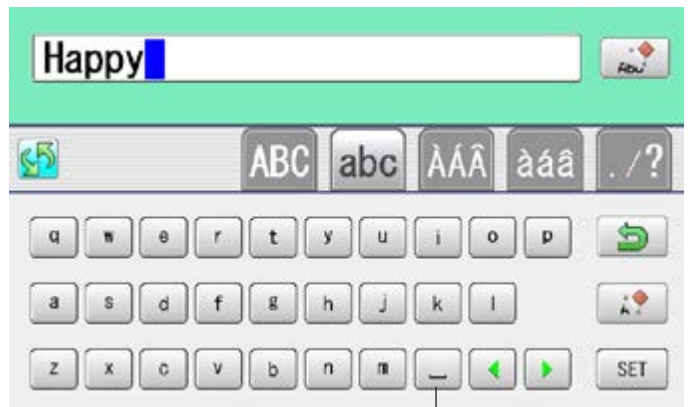
 Cyrillic script

 Symbol

 The screen returns to menu.

 Selected letter or number is deleted.


  The cursor moves left and right.





Space or Delete

Except for the space between letters, space is eliminated.



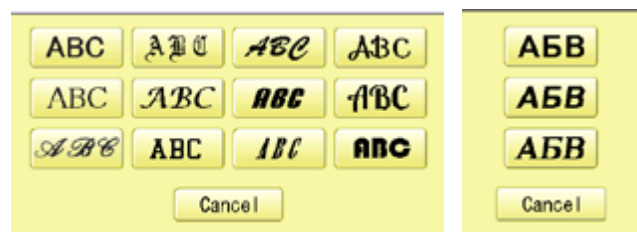
The display of Cyrillic script after pressing .

4. Press  when you are finished with the letter selection.

Fix your setting and you can select fonts.
For fonts, refer to [BUILT-IN FONT LIST].  26-3

Basic script (Diacritic)

Cyrillic script

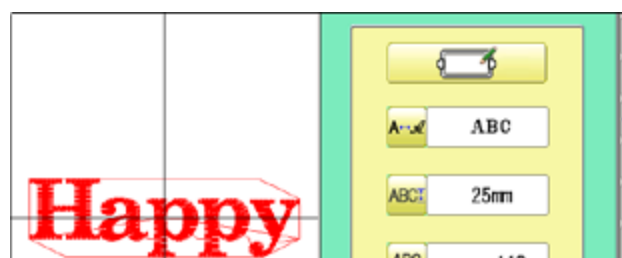


Font Selection

Enables you to select the preferred font.  26-3

5. Select the font.

Fix your setting and go to next step.



Letter Height selection

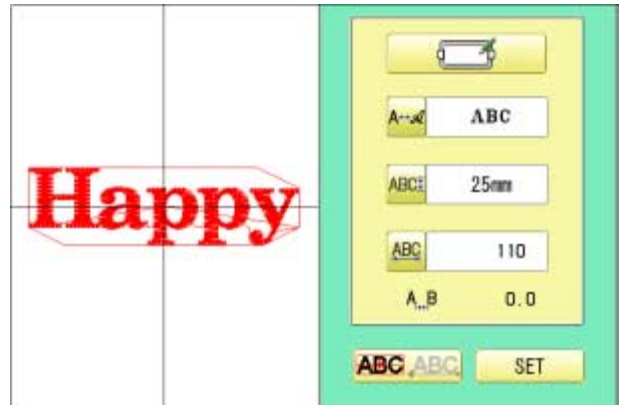
Select the letter height.

6. Select .




7. Select desired height.

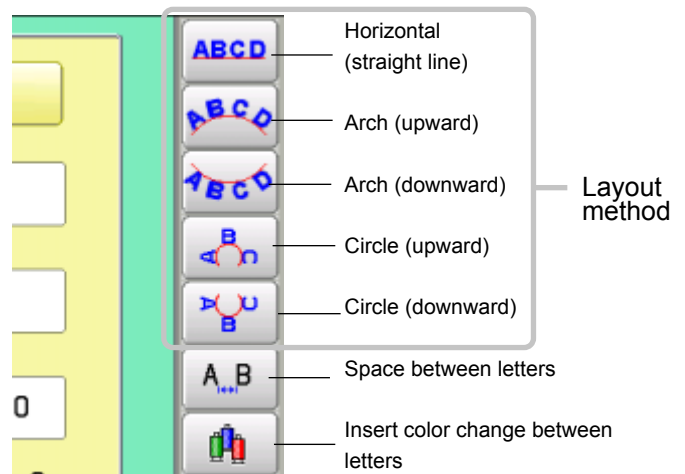
After the height setting is fixed and now line length can be selected.



Layout method


Select layout method.

8. When you would like to change layout method, select either layout method from the right submenu.  16-1 Initial layout method is horizontal (straight line).



Line Length

When layout method is "horizontal", you can change line length. For other layout method than "horizontal", line length is not used.

9. Select  when "horizontal" in layout method is selected. Go to the procedure when other style than "horizontal" in layout method is selected.





9. Select the number.

 Setting is canceled.




10. Press .


 Return to the Letter selection.


 Return to the Font Selection.

 Return to the Letter Height selection.

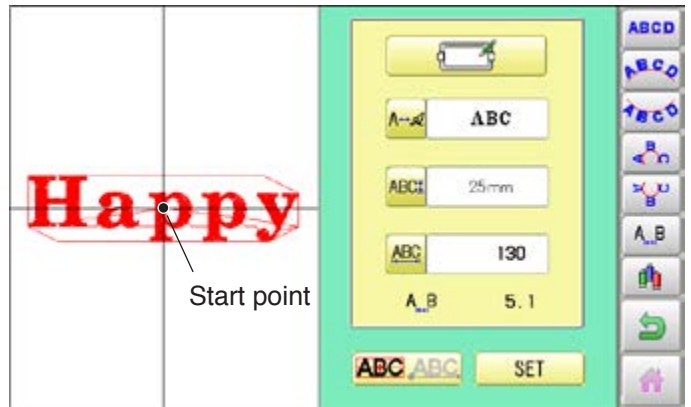
 Return to the Line Length.

You can change start point of monogramming data.

 : Start point is the center of monogramming data.

 : Start point is the center of monogramming data.

Start point is the center of baseline or capline for “arch” and “circle” layout.




Create

You can create embroidery data from the letter settings.

11. Press .

The new pattern data will be created. Then you will return to menu mode.

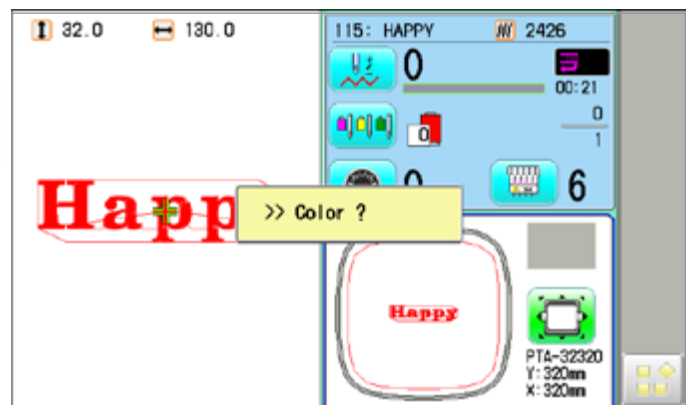
Press  and go to Running Screen.

You can see letter created as embroidery data.

The first 8 letters will be shown as the name of the pattern which you have made by letter selection.

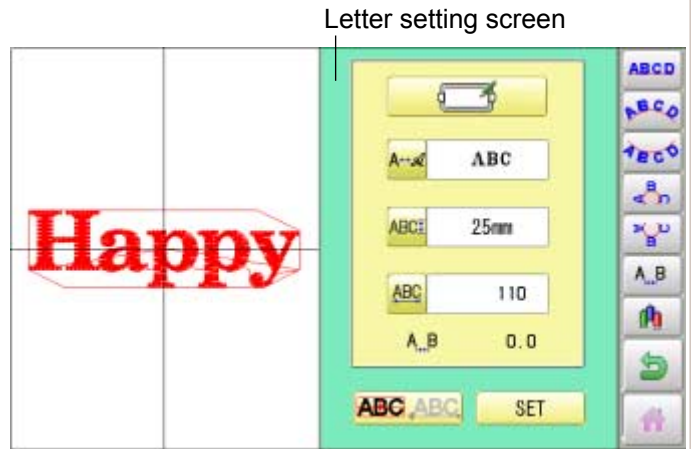



Press  to return to Menu mode.

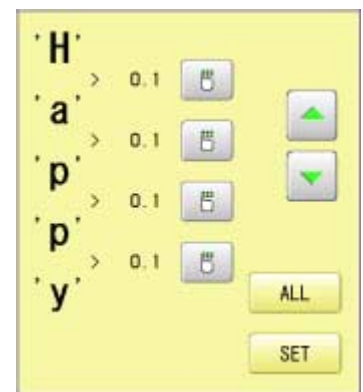



Space between letters

Space can be added between letters.



1. Press  on the letter setting screen.




2. Select  on space between letters you would like to change.



3. Enter value.



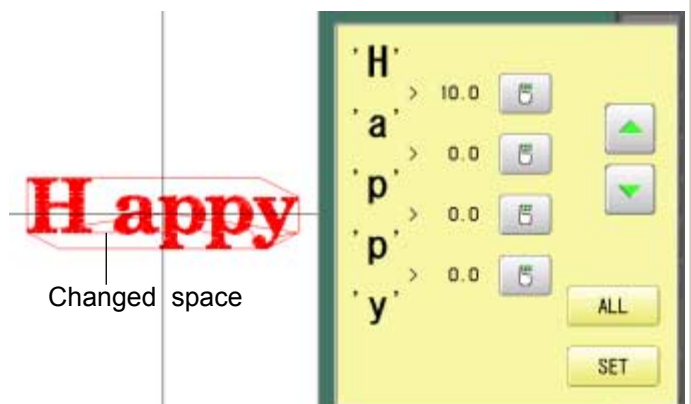
4. Press .

When you would like to make the same value on all the space at the same time select

 and enter value of the space.

Press .

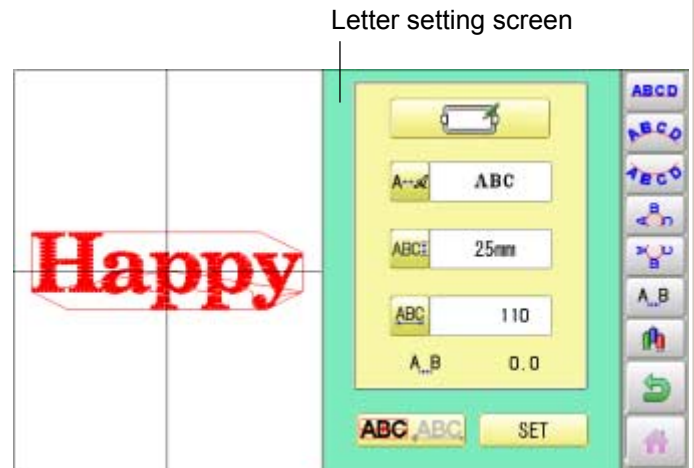
All the space settings are firmed.




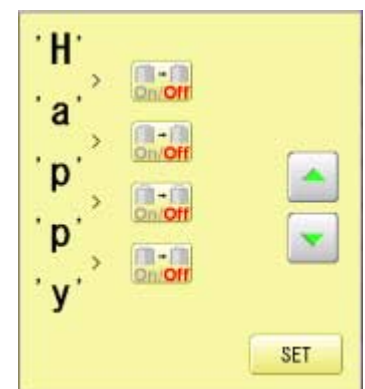



Color change between letters


Color change can be made between letters.




1. Press  on the letter setting screen.






2. Select  on space between letters you would like to change.

 Setting of space between letters is ON.

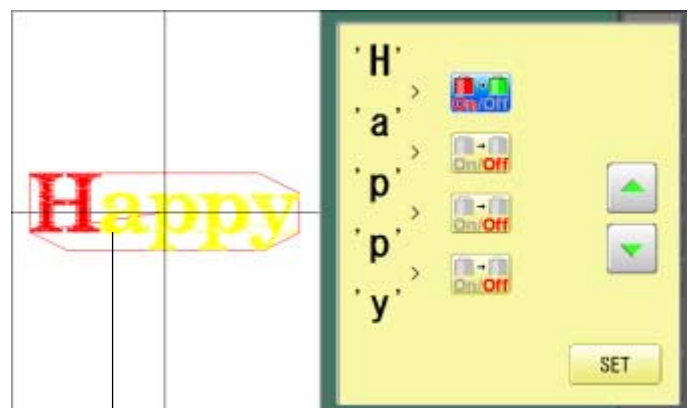
 Setting of space between le is OFF.

Setting of space can switched by pressing

 and .


Press .

The settings are firmed.



Color change setting is made

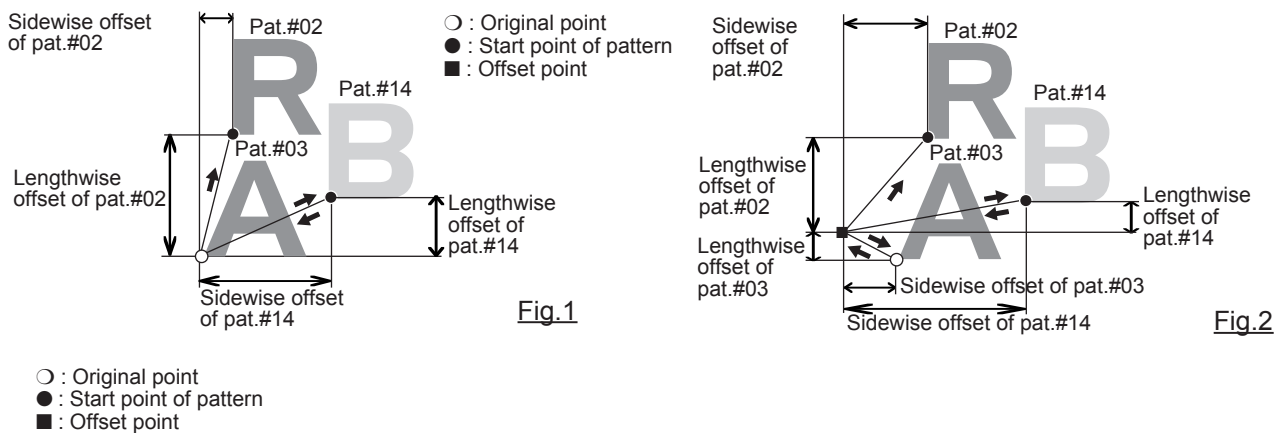
- When color change setting is made for the space between letters you can set needle number of the letters of both sides of the space whose color change setting is ON.

 3-9, 5-E

This sets up a succession of patterns that can be embroidered in any desired sequence. The machine will proceed with the *various settings set to each pattern.

- If you embroider a pattern like in Fig.1, you will need to set an offset as a pivot to each pattern in advance. If the offset is set to the first pattern like in Fig. 2, you will need to set a setoff point to the first pattern with the offset of the other pattern as a pivot. P14-8
- If automatic original point return is set, the machine will return to the original point when finished. If automatic original point return is not set, the embroider will finish at the end point of the last pattern.

Setting example



Alter and Execution

This registers Queued patterns in order, and executes.

Needle bar selection and Pattern settings

Needle bar selection and Pattern Settings for patterns selected to QUEUE operation can be applied by the following steps.

Registration of QUEUE setting

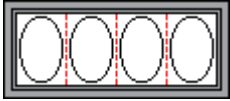
Up to 10 QUEUE settings can be registered.

Read QUEUE setting

Read registered QUEUE setting.

QUEUE has 2 different mode.

■ Once mode is changed to another mode, design data registered in QUEUE will be cleared.



Standard Mode

Combine several patterns as one design data and make same embroidery at all machine head. (Fig. 1)

Setting example

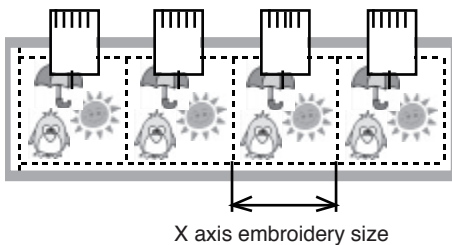
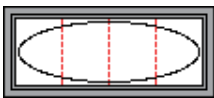


Fig. 1



Continuous Mode

Allocate different patterns to each machine head and make one large size embroidery. (Fig.2, 3)
Using this function and allocate several pattern data which is divided from one large design to each machine head, you can make one large size embroidery up to the size of border frame. (Fig. 4)

Setting example

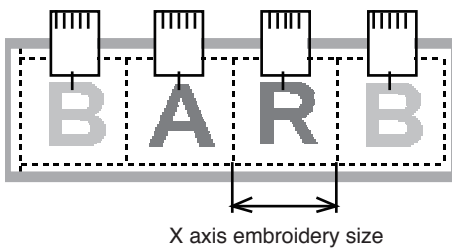


Fig. 2

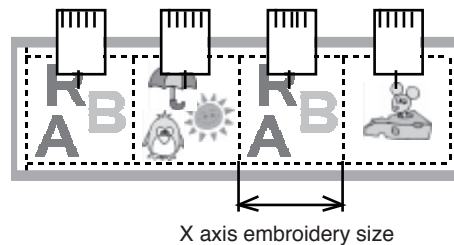


Fig. 3

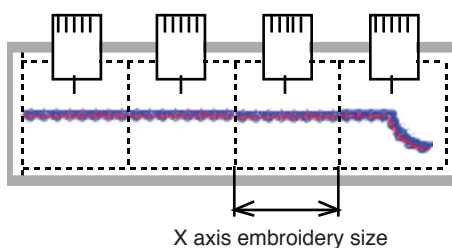


Fig. 4

How to make design data for continuous embroidery

When you make continuous embroidery using several machine head, please keep the following points in mind.

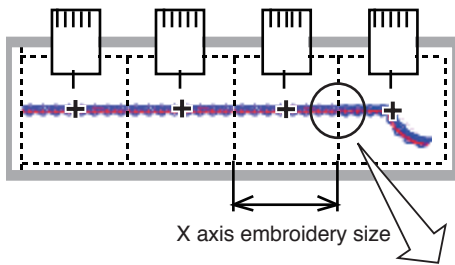


Fig. 1

+ : Start point of pattern

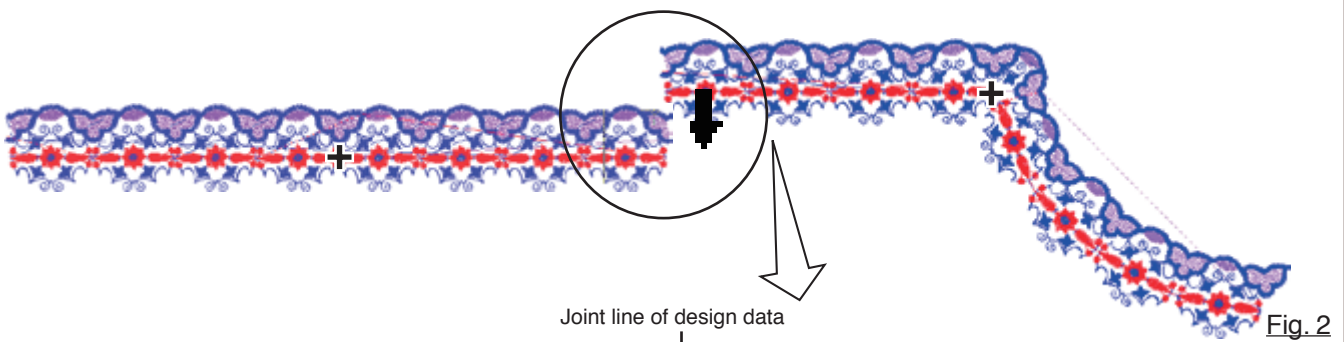


Fig. 2

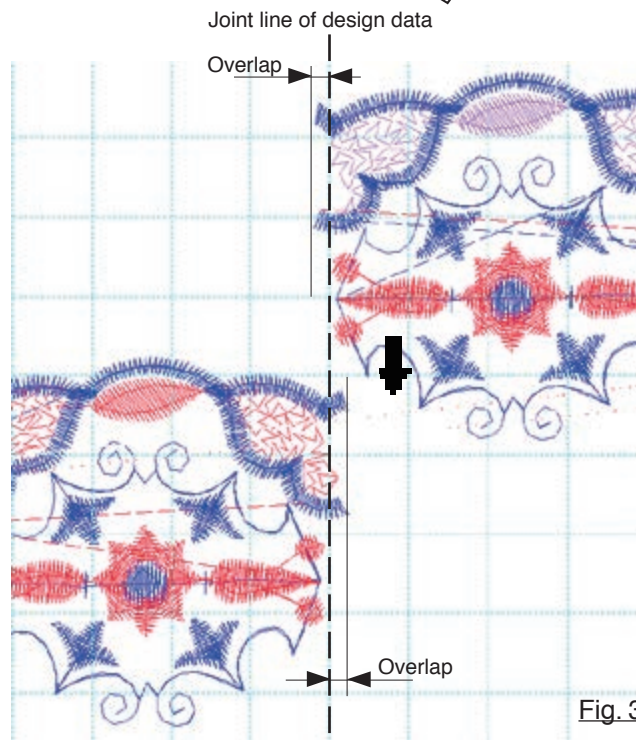


Fig. 3


- To avoid a gap at joint line of design data, design data should be created with overlap area. (within 4mm) (Fig. 3)
- For easy positioning of design data on machine, start point of design data should be center of embroidery area of X axis. (Fig. 3)
On machine you need to adjust only position of Y axis.

Alter and Execution (Standard Mode)

This allows you to sew any combination of designs in sequence (up to 30 designs), and executes.

Once "QUEUE" is set, the pattern data registered and set in the "QUEUE" is embroidered until pattern data in "READ" is selected.

Therefore, you need to select other pattern data in "READ" to cancel QUEUE.

1. When the machine is stopped, press .

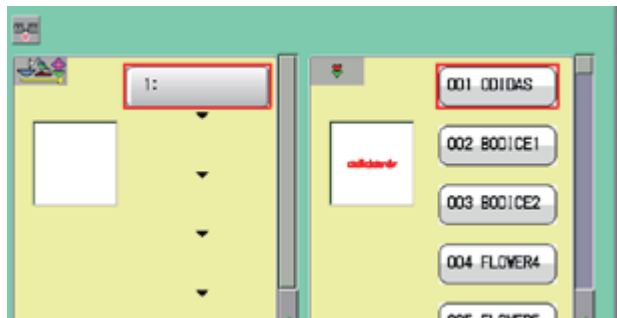


2. Select "QUEUE".




3. Select  "Standard Mode".

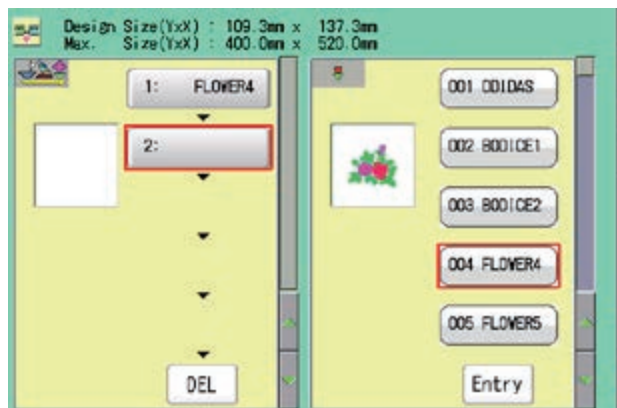
The left side shows the pattern data.



4. Select desired pattern and press .

The selected pattern is shown to the left.

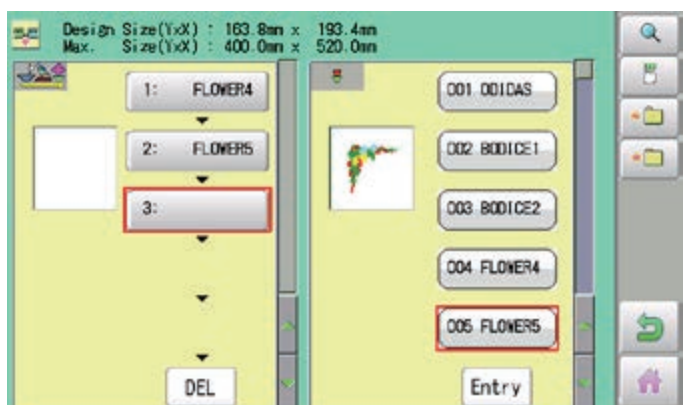
If you need to erase the design, press .



5. Select desired pattern and press .

The selected pattern is shown to the left.

If you select other memory pattern data continuously, repeat step 5.

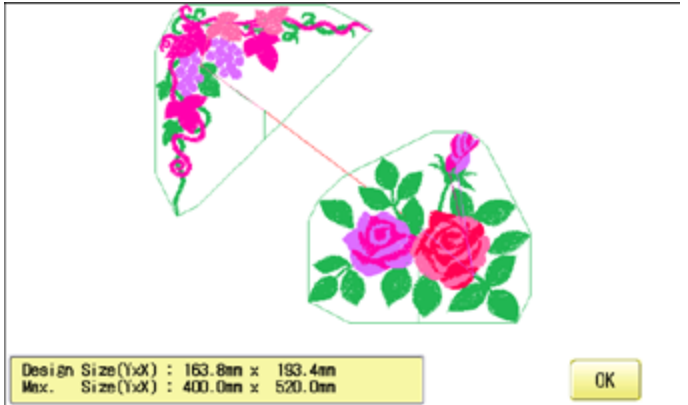


6. Combined design can be seen on Screen. To show combined design, please press

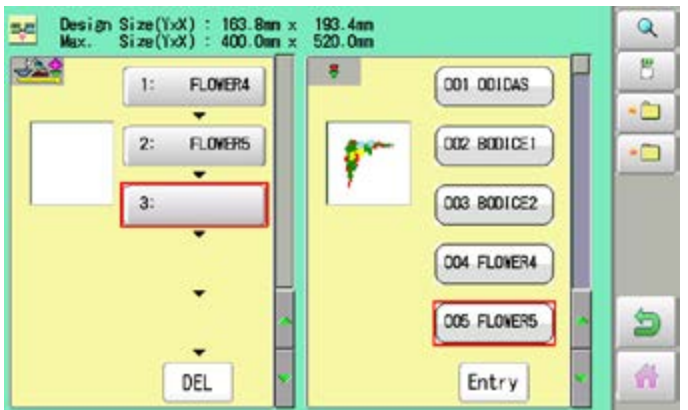


Illustration of the pattern selected will be displayed.

In case you do not need to check combined design, please go to step no.8.



7. Press 



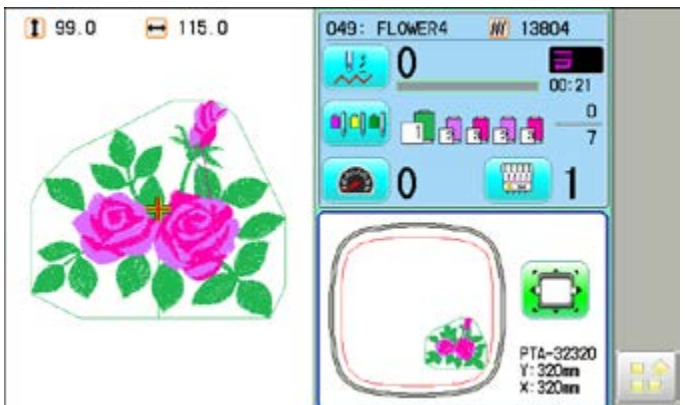
8. Press . (Standard control box)

--- Check pattern data ---

Go to step no.9. (10.4' control box)



9. Press 




10. Press 

The machine will start a Queue embroidery with Queue operation in registered order. After finishing your last design, the display will show ">>End" and the machine will stop.

>>End

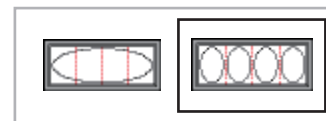
Alter and Execution (Continuous Mode)

This allows you to create continuous embroidery design by selecting some design (up to 30 designs) and allocating designs to embroidery heads.

1. When the machine is stopped, press .

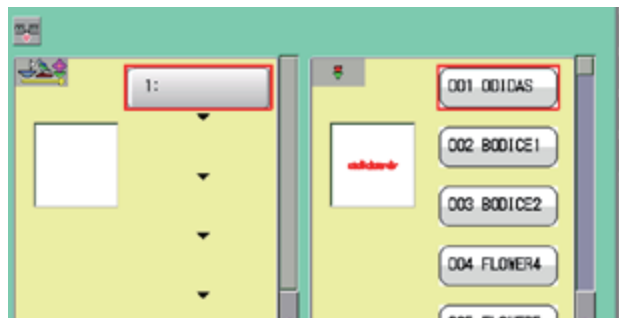


2. Select "QUEUE".

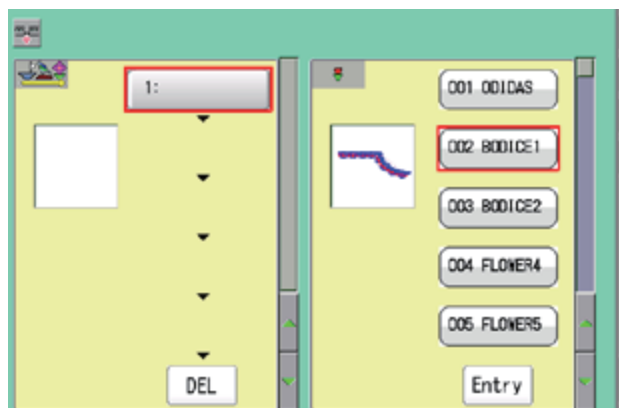


3. Select  "Continuous Mode".

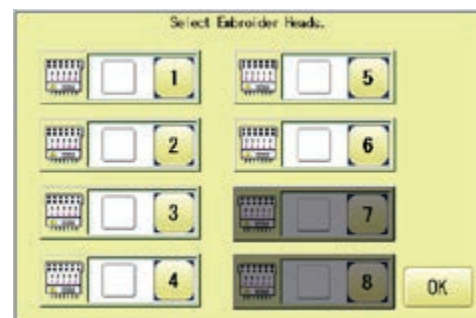
The left side shows the pattern data.



4. Select desired pattern.



5. Press .



6. Select head which selected design data should be allocated.

You can select plural machine heads.

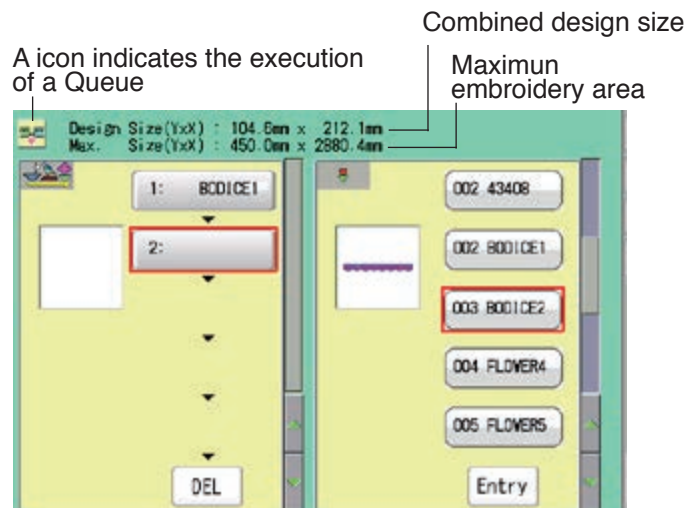


QUEUE

17-3c

7. Press  .

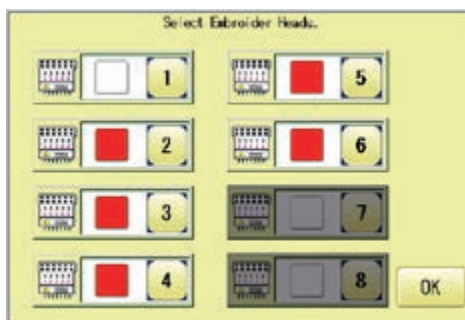
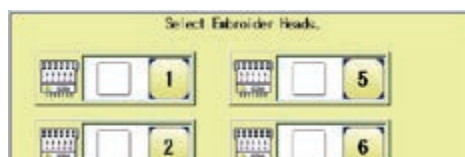
If you need to erase the design, press  .



8. Select desired pattern, press  .

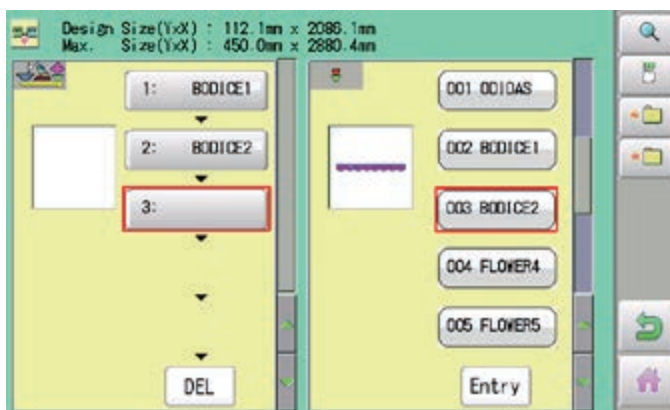
9. Select head which selected design data should be allocated.

You can select plural machine heads.



10. Press  .

11. Repeat step 8-10 and allocate required design data to required machine head.

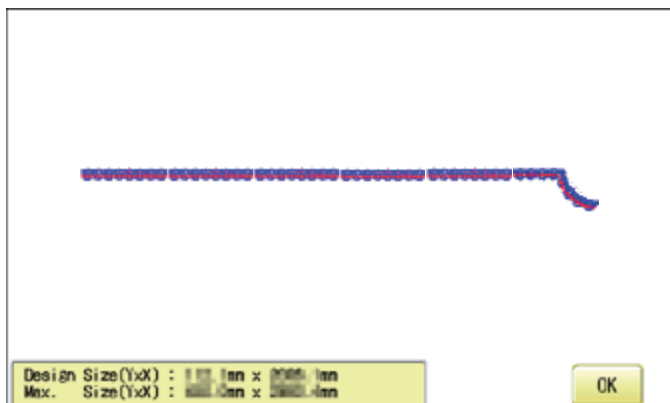


12. Combined design can be seen on Screen. To show combined design, please press



Illustration of the pattern selected will be displayed.

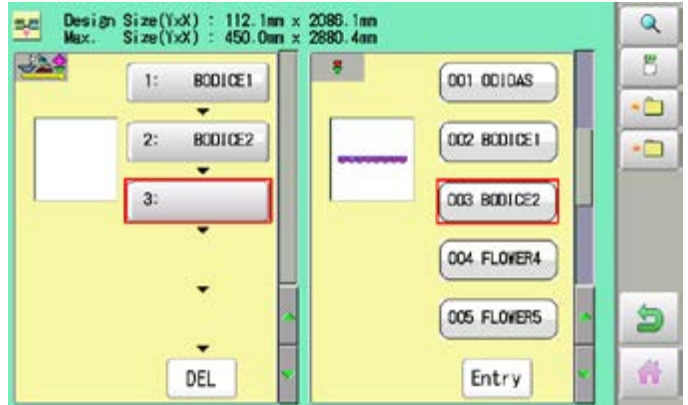
In case you do not need to check combined design, please go to step no.14.



QUEUE

17-3d

13. Press  .




14. Press  . (Standard control box)


Go to step no.15. (10.4' control box)






15. Press  .



16. According to instruction of “JUMP SETTING” on screen, set “JUMP” on each machine head, and press  to confirm.

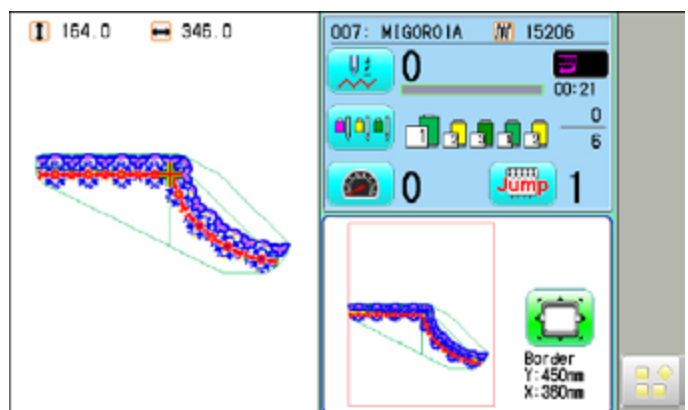
 3-3b




In case start point of all selected design is center of X-axis( 17-1c), execute “Center” ( 9-4) for moving frame to center position.



Press  and move the frame to the original

point with the  and adjust position for


Y-axis .



17. Press  and press  (Trace).  6-4

Press , and the embroidering frame moves for the design trace.  10-4

Make sure that the pressure foot and needle do not touch the frame.

Press , and trace is stopped.

After tracing each design, frame movement is stopped.

Go on to step 19 if you want to start embroidering without tracing.

18. Select “Yes” and press  to trace next design data.

Screen of step no.17 will be shown until finishing of trace for all registered design.


In case you want to skip tracing, press



19. Press .

The machine will start a Queue embroidery with Queue operation in registered order.

After tracing each design, frame movement is stopped.

20. According to instruction of “JUMP SETTING” on screen, set “JUMP” on each machine head, and press  to confirm.

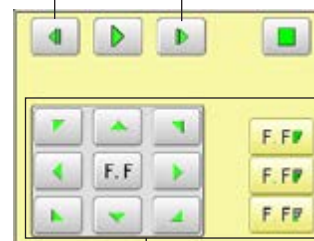
21. Press .

Screen shows image of design.

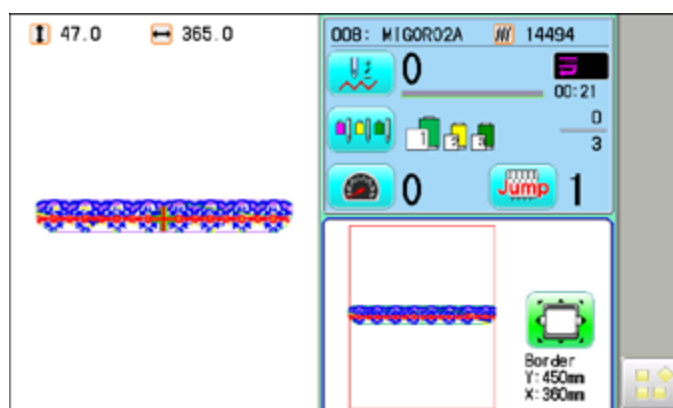
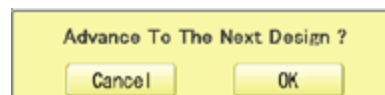
22. Repeat step 19-21 till end of all design data registered.

After finishing your last design, the display will show “>>End” and the machine will stop.

Backward only when pressing
Forward only when pressing




Frame move



>>End

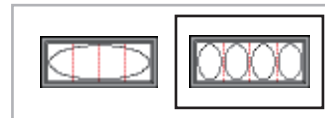
Needle bar selection and Pattern settings



Needle bar selection and Pattern Settings for patterns selected to QUEUE operation can be applied by the following steps.

1. When the machine is stopped, press .



2. Select "QUEUE".



3. Select  "Standard Mode" or  "Continuous Mode".

The selected pattern is shown to the left.





4. Select desired pattern.



5. Press .



6. Select desired setting.


Please refer pages mentioned below for setting.
 "Needle bar selection"  5-E,
 "Pattern settings"  14-1

Needle bar selection




Pattern settings




7. After setting, press .

For setting of “Needle Bar Selection”[NEEDLE] and “Pattern Setting”[SETTING] to other design, please do steps no.4-7.



Press  to return to Menu mode.

Press  to return to Drive mode.

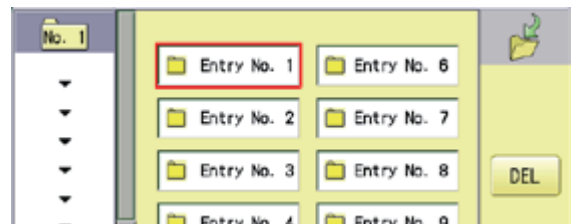
Registration of QUEUE setting

Up to 10 QUEUE settings can be registered in each mode.
Once you register QUEUE you can select registered QUEUE setting anytime.

1. According to step of “Alter”, select patterns.




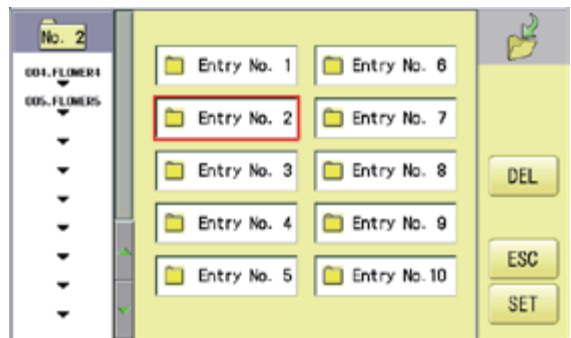
2. Select .



3. Select registration No. and press .

When pattern data is not displayed on the left side on the screen, no pattern data is registered in the holder of the setting No.

 Registration is deleted.




4. Press .

QUEUE setting is registered as setting No.2.




Press  to return to Menu mode.

Press  to return to Drive mode.

■ In case you delete pattern from machine memory, QUEUE setting which has deleted pattern will be deleted too. (Erasing patterns from memory  5-B)

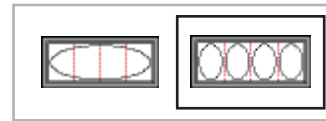
READ QUEUE setting



Read registered QUEUE setting.

1. When the machine is stopped, press .



2. Select "QUEUE".

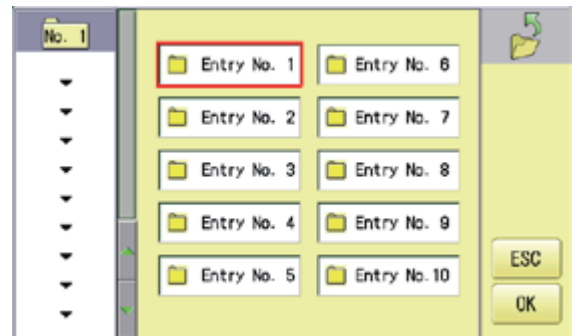


3. Select  "Standard Mode" or  "Continuous Mode".

Once mode is changed to another mode, design data registered in QUEUE will be cleared.



3. Select .



4. Select number and press .

QUEUE setting is selected.



Press  to return to Menu mode.

Press  to return to Drive mode.

● Create network

Network setting is required in order to connect the embroidery machine with PC's network management software (HAPPY link LAN) .

You do not have to do this setting when you do not connect the machine with the network.

- Note: HAPPY link LAN is a software designed to be used at LAN (Local Area Network) connection between the software installed PC (server) and the software-enabled embroidery machine(s).

If this network is connected with other network, you might not be able to communicate due to the overlapping of IP address and other code.

If PC or machine that is connected with other network has to be inevitably connected with Happy link LAN, you might change network settings as specified in this manual.

In this case, the settings are required by your network administrator or person(s) of network knowledge.

Wired LAN connection

Wired LAN connection create network connection between the embroidery machine and PC with a LAN cable.

There are 2 types of Wired LAN connection methods.

HUB connection

PC via switching HUB connects with the embroidery machine.

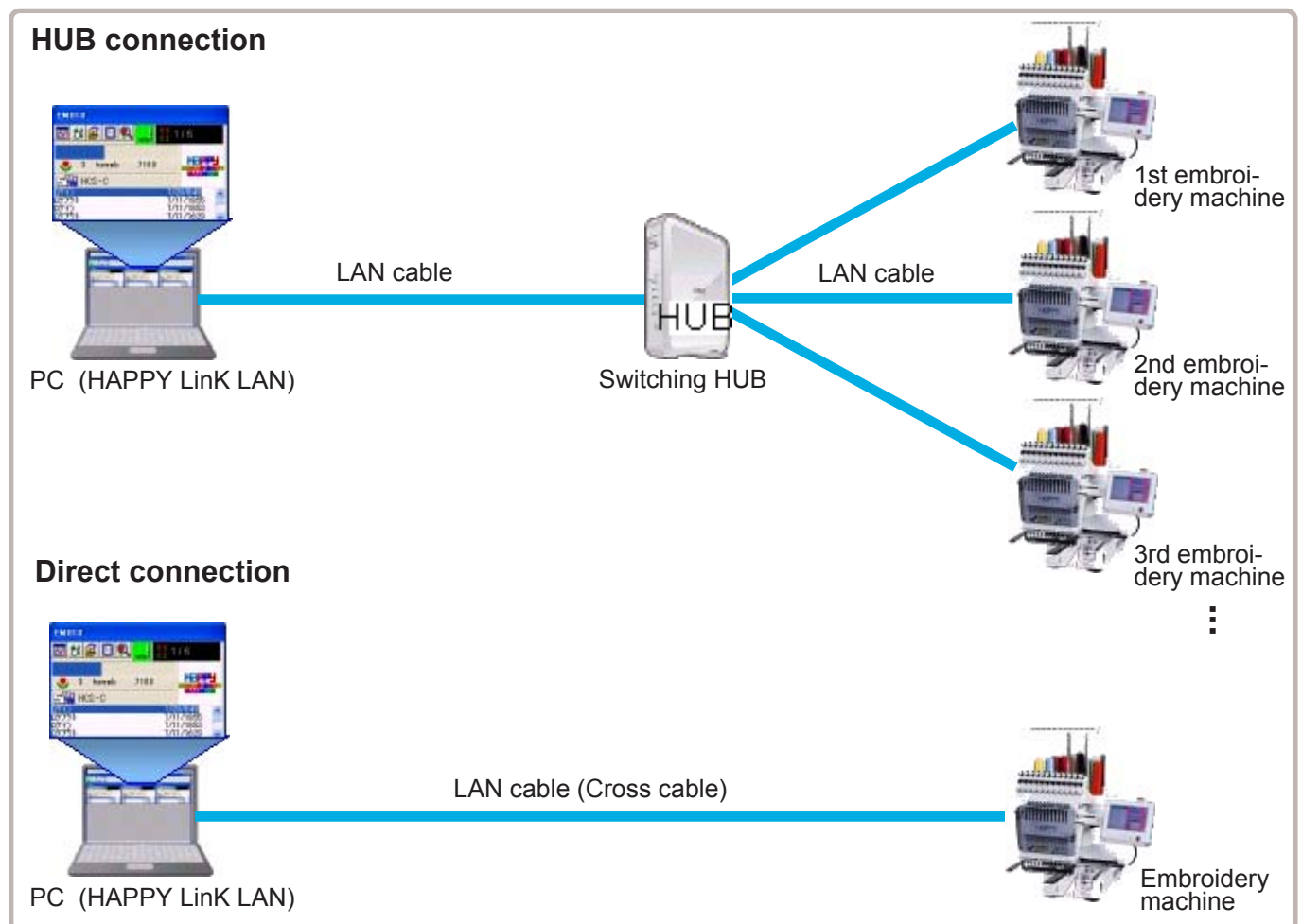
You can connect PC with multiple embroidery machines.

Direct connection

You can connect PC with a machine with crossover cable and without HUB if you connect PC with only one machine.

However, a straight cable can be also used for this connection if your PC's LAN port recognizes the type of cable.

You cannot connect PC with multiple embroidery machines.



●Wire LAN connection setting

Set the value based on network management software (HAPPY link LAN).

Boot the network management software (HAPPY link LAN) on the PC before setting the embroidery machine.

1. When the machine is stopped, press





2. Select "OTHER".



3. Press



4. When you set values on the embroidery machine as the 1st machine connected to network, check if each setting item shall be default settings.

Press  and  and move to operation no 9 if there is no change of setting required.



Default settings

Port No. : 7891
 Server IP : 192.168. 1. 1
 Machine IP : 192.168. 1. 10
 Subnet mask : 255.255.255. 0


Set values on the 2nd machine or later machine based on the following "Setup of Machine IP address".

Press  to change.

Press right /left of   to select the

setting point, and press up/down of   to select the number.



5. Press .



Setup of Machine IP address

Examples : 192.168. 1.

If you have 2 or more machines, add one to the number enclosed in boxes on the right corner of Machine IP address like the examples shown below.

Leave other values than Machine IP address as they are and do not make any changes of these values.

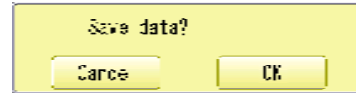
Add one to default value [10] such as [11] for 2nd machine and [12] for 3rd machine.

Machine IP address is a Decimal number.

Machine IP address is shown by incrementing the number by one as follows.

10, 11, 12, 13, 14, 15, 16, 17, 18, 19, 20, 21, 22, 23, 24, 25, 26, 27 ~

6. Press **OK**.



7. Press **OK**.

The machine will be rebooted and show Drive mode in the display.

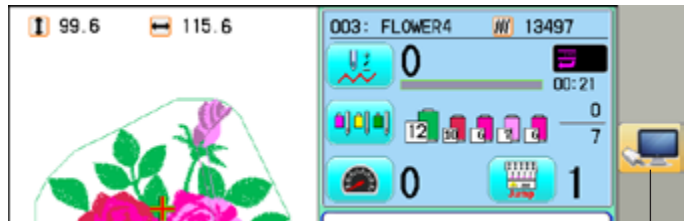


9. Press **Next**.

The machine will automatically connect with HAPPY link LAN booted on the PC.

LAN connection indicator is displayed.

If LAN connection indicator is not displayed in the screen, refer to the following causes and countermeasures.



LAN connection indicator

Causes and countermeasures

- ① Is IP address overlapped on the machine with other machine that creates LAN connection?
If so, set IP address so that IP Address on each machine is not overlapped.
- ② "HAPPY link LAN" is not booted.
If not booted, boot "HAPPY link LAN" on the PC. LAN is not recognized before HAPPY link LAN is booted.
- ③ Is IP Address in "HAPPY link LAN" set correctly?
Set up the IP Address correctly based on the "HAPPY Link LAN" manual.
- ④ Are PC network settings set correctly? Set up the PC network settings correctly based on the "HAPPY Link LAN" manual.
- ⑤ Press **LAN** at step 5.

● Version information and software update

Software version installed in the machine is displayed.
Software can be updated to the latest version.

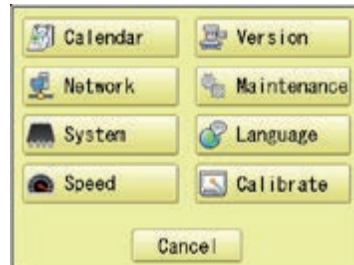
Preparation for update file

Contact your distributor to obtain the latest update file.
Use the appropriate update file for your machine.
Put update file in the root directory of USB memory.

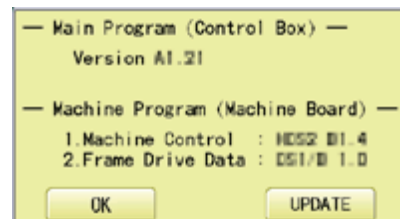
1. When the machine is stopped, press .



2. Select "OTHER".



3. Press .



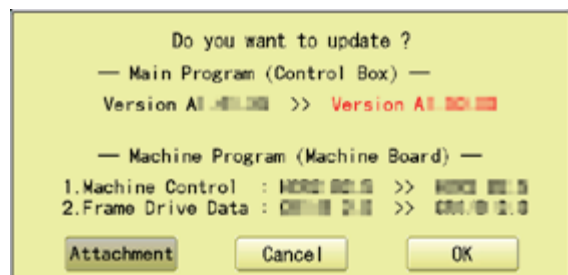
4. Confirm version number.

Press  to return to MENU screen.

The display returns to MENU.

When updating, insert USB memory including update file into the controller and press

.



5. Press **OK** to update the machine software.

Press **Attachment** to update the software which is related to installed attachment (sequin device etc.).

Update is starts.
Do not turn on power during updating.

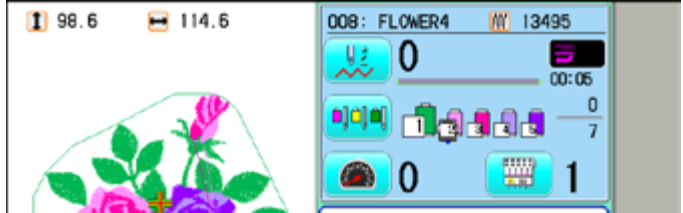
The machine will reboot once update is complete.

```
[ Install_HAPPY_***.*** ]   version *.*.*
In preparation . . .
Starting UpDate
```




6. Press **Next**.

The display will return to Drive mode.



● Language

Change the language displayed on control box.

1. When the machine is stopped, press .



2. Select "OTHER".

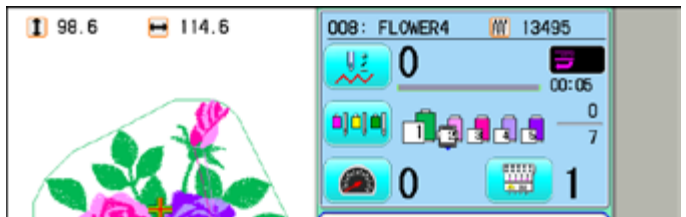


3. Press  Language.



4. Select the Language.

The language has been changed, and the display returns to Drive mode.



● Calibrate

Calibration for the touch panel LCD.

Touch panel is already adjusted and you do not need adjustment of the panel.

If the screen does not recognize correct position of each icon and you cannot operate, please adjust the screen as follows:

1. When the machine is stopped, press



2. Select "OTHER".



3. Press



4. Press

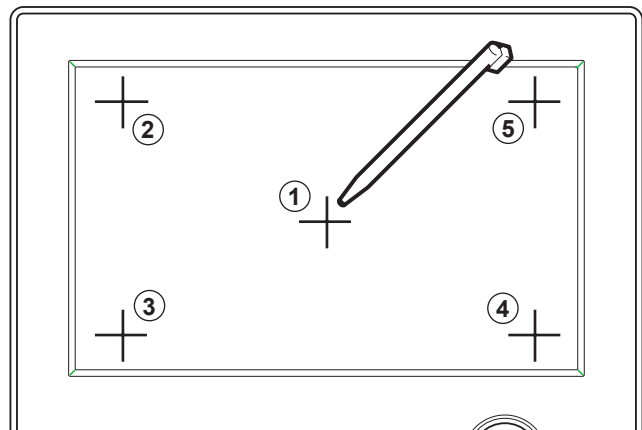


Prepare built-in stylus.



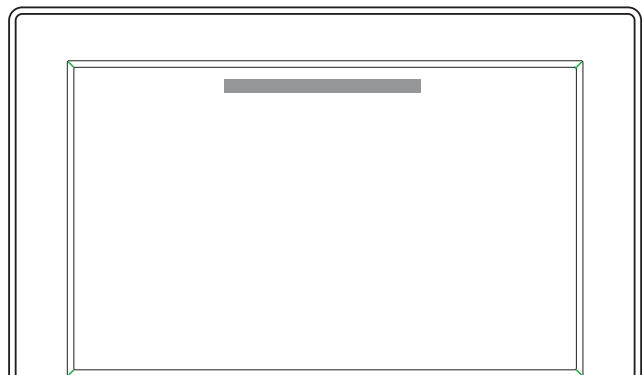
5. Press the center of "+" displayed in screen in numerical order by a stylus.

"+" will appear in numerical order.



6. Press the 5th "+" by stylus.


The screen shows "New calibration settings have been measure ..." at small letters.



7. Press the screen with a finger (any location is okay).

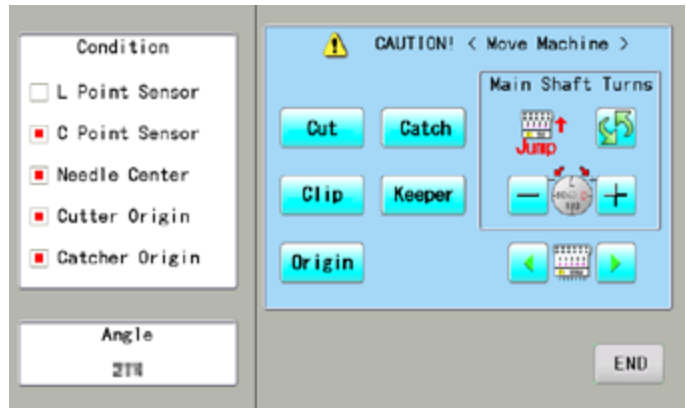
After this operation, you can press the screen with a finger.
Adjustment is complete, and the screen returns to Menu mode.



Press  to return to Drive mode.

● User maintenance mode

User maintenance mode has 8 items as below.
Indicates point which sensors are active.




Button	Machine movement
Change jump	Change the needle bar's movement. "JUMP" : Needle Jump, "DRIVE" : Needle Drive
Upper shaft turns	Upper shaft turns clockwise and counterclockwise. When release button, upper shaft stops. ⚠ Caution: please be careful that Needles for all head move at once.
Needle change	Move the sewing head to the adjustment needle in the direction of the arrows.
Cut	Cutter Open/Close When cutter is open position, cutter move to close position. When cutter is close position, cutter move to open position. ⚠ Caution: please be careful that cutter for all head move at once.
Catch	Catcher Open/Close When catcher is open position, cutter move to close position. When catcher is close position, cutter move to open position.
Clip	Clip-type thread holder (option) When clip is open position, clip move to close position. When clip is close position, clip move to open position.
Keeper	Keeper When keeper is open position, keeper move to close position. When keeper is close position, keeper move to open position.
Origin	Standby position In case, each equipment position without standby position, as example "Upper shaft is not at C point, Thread cut blade is not at stop position, Thread Catcher is open position", this key work for back to standby position automatically.

Conditions

L point sensor	The point that indicator becomes RED is L-point, when upper shaft is turned.
C point sensor	The point that indicator becomes RED is C-point, when upper shaft is turned.
Needle sensor	The point that indicator becomes RED is needle position, when moving head is moved.
Origin point of cutter	The point that indicator becomes RED is origin point of cutter.
Origin point of thread catcher	The point that indicator becomes RED is origin point of thread catcher.

Angle

Indicate angle of upper shaft.
Please use dial when you need to know precision angle.

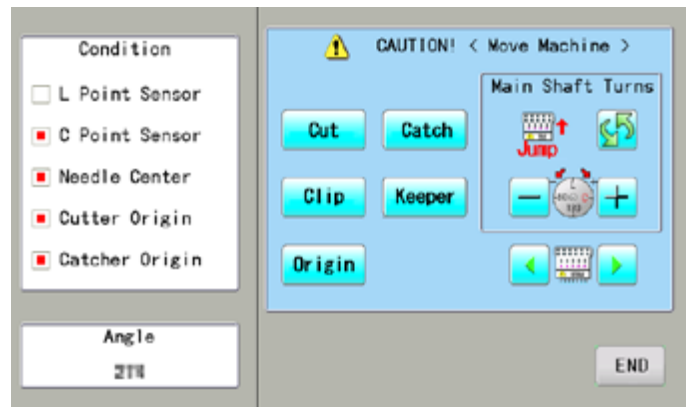
1. When the machine is stopped, press .




2. Press  "OTHER".



3. Press .




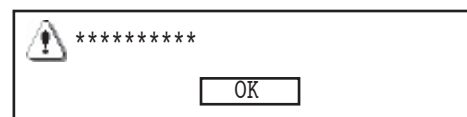
4. Press one key and check machine movement.


 **CAUTION: To prevent accidents;**
The machine moves quickly.
Keep hands away from the machine.

One equipment was not standby position, machine show following message when you press key.

- C point : Upper shaft is not at C point.
- Cut blade : Thread cut blade is not at standby position.
- Thread Catcher : Thread Catcher is open position.

Please press  for back to standby position and repeat step 4 again.



Press  to return to Menu mode.

Indicating operation record of machine.


●Production data

Last 10 records of following production data will be displayed.

Time of power on/off, and number of operated stitches will be recorded in machine memory.

If the machine is switched on without embroidery operation, it will not be recorded in memory.

[Power ON] The time when machine main switch is turned on
 [Power OFF] The time when machine main switch is turned off
 [Embroidery Stitches] The number of embroidered stitches while main switch is turned on

1. When the machine is stopped, press  .



2. Select "REPORT".



3. Select  .

Time of power on
month/day/year/
hour:minute:second

Time of power off
(1st raw is time of
reporting.)

Number
of stitches

No.	Power ON - Power OFF	Stitches
1	12/19/2013/14:08:24 - 12/19/2013/14:13:02	0
2	12/11/2013/11:29:46 - 12/11/2013/14:09:34	62159
3	12/09/2013/11:45:32 - 12/09/2013/12:00:00	163
4	11/28/2013/12:49:33 - 11/28/2013/15:48:10	20702
5	11/28/2013/09:09:19 - 11/28/2013/11:59:10	35253
6	11/26/2013/10:45:54 - 11/26/2013/20:05:10	142106
7	11/15/2013/09:49:32 - 11/15/2013/19:06:33	3253
8	11/15/2013/09:27:10 - 11/15/2013/09:48:54	22
9	11/13/2013/12:53:37 - 11/13/2013/20:36:38	26908
10	11/12/2013/09:34:59 - 11/12/2013/09:35:32	160
	07/11/2013/10:30:19 - 12/19/2013/14:13:02	634560

4. In order to exit the mode, proceed to the step 5.

If you want to delete the record, press



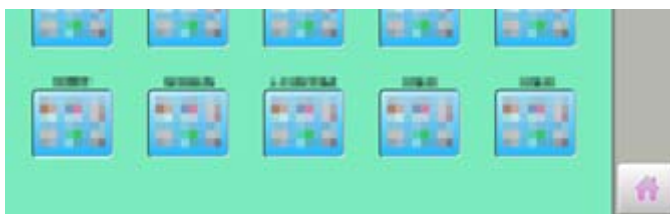
Time of deleting
record or power on

Current time
(time of viewing
the report)

Number of
stitches after
deleting record

5. Press  .

The display returns to MENU.




Press  to return to Drive mode.



Save the report

You can save the displayed records in CSV format.

Insert the USB memory into the machine and press  button then, new folder named "Production Report" will be made and the report data will be saved as file name "Stitch Report_*****".


● Detailed production data

You can view following detailed production data for each user. (Max 4,096 data)

ITEMS

[No.]	Number	: Sequence number of the records
[User] *1	User ID	: The ID number of embroidery machine operator
	User Name	: The name of embroidery machine operator
[Design]	Design ID	: The ID number of embroidery design
	Design Name	: The name of embroidery design
[Stiche]	Stitches	: The number of stitches of embroidery design
[Pro.]	Output	: Quantities of production
[TTL.]	Total time (min.)	: The total required time (minutes) to complete the embroidery design
[RUN]	Running time (min.)	: The machine running time to embroider the design
[PAUSE]	Pause time (min.)	: The pause time in the middle of embroidery
[Run %]	Operating rate (%)	: Running time / Total time
[Pro./H]	Productivity	: Quantity of the production per hour
[BRK.]	Number of thread breakage	: The number of thread breakage within one production cycle

*1 :When machine main switch is operated (On/Off), "Power off <-> on" will be displayed in "User Name" section.

1. When the machine is stopped, press 



2. Select "REPORT".



3. Select 

No.	User	Design	Stitches	Pro.	TTL	RUN	PAUSE	BRK.	Pro./H	BRK.
1	001: HAPPY User1	001:0001	805	1	2	2	0	0000	24	0
2	001: HAPPY User1	002:0002	817	1	2	2	0	0000	24	0
3	001: HAPPY User1	003:0003	753	1	2	2	0	0000	22	0
4	Power Off <-> On		0	0	0	0	1	00	0	0
5	Power Off <-> On		0	0	0	0	1	00	0	0
6	001: HAPPY User1	004:0004	711	1	2	2	0	0000	26	0
7	001: HAPPY User1	005:0005	1279	1	3	3	0	0000	17	0
8	002: HAPPY User2	006:0006	911	1	2	2	0	0000	24	0
9	002: HAPPY User2	007:0007	1221	1	3	3	0	0000	19	0
10	002: HAPPY User2	008:0008	929	1	2	2	0	0000	22	0
11	002: HAPPY User2	009:0009	1206	1	3	3	0	0000	18	0
12	003: HAPPY User3	010:0010	1034	1	2	2	0	0000	20	0
13	Power Off <-> On		0	0	0	0	1	00	0	0
14	003: HAPPY User3	012:0012	1206	1	3	3	0	0000	16	0
15	003: HAPPY User3	015:0015	1247	1	12	3	10	190	4	0
16	004: HAPPY User4	022:0022	948	1	3	3	0	0000	18	0
17	Power Off <-> On		0	0	0	0	1	00	0	0
18	005: HAPPY User5	031:0031	1522	1	3	3	0	0000	15	0
19	005: HAPPY User5	032:0032	1446	1	3	3	0	0000	16	0
20	005: HAPPY User5	033:0033	1104	1	3	3	0	0000	19	0

4. In order to exit the mode, proceed to the step 5.

If you want to delete the record, press



4. Press 

The display returns to MENU.


Press  to return to Drive mode.





Save the report

You can save the displayed records in CSV format.

Insert the USB memory into the machine and press  button then, new folder named "ProductionReport" and "RunningLog" will be made and the following files will be saved.

ProductionReport (Holder)

"ProductionReport-Standard_*****" : This file contains the output data in each piece of embroidery production.

"ProductionReport-Arranged_*****" : This file contains the output data which is totalized in user and design.

"ProductionReport-Arranged2_*****" : This file contains the output data in each day of running ratio.

RunningLog (Holder)

"RunLog_*****" : The monthly report of running time per hour of each day.
This report is remained after 13 months.

ITEMS

[No.]	: Sequence number of the records
[User ID]	: The ID number of embroidery machine operator
[User Name]*1	: The name of embroidery machine operator
[Machine Name] *2	: The embroidery machine name of embroidery design
[Design ID]	: The ID number of embroidery design
[Design Name]	: The name of embroidery design
[Stitches]	: The number of stitches of embroidery design
[Output]	: Quantities of production
[Start of Design] *2	: The time embroidery is started
[End of Design] *2	: The time embroidery is completed
[Total time (min.)]	: The total required time (minutes) to complete the embroidery design
[Run (min.)]	: The machine running time to embroider the design
[Pause (min.)]	: The pause time in the middle of embroidery
[Power OFF] *2	: The time main switch is turned off
[Power ON] *2	: The time main switch is turned on
[Power OFF time] *2	: The elapsed time while main switch is turned off.
[Run Ratio]	: Running time / Total time
[Pause Ratio] *2	: Pause time / Total time
[Productivity/hour]	: Quantity of the production per hour
[Thread Break]	: The number of thread breakage within one production cycle
[Error] *2	: The number of error message within one production cycle
[Interval (min.)] *2	: The time period from machine power on till start of embroidery or the time after completion of embroidery until it starts the next embroidery.


*1 :When machine main switch is operated (On/Off), "Power off <> on" will be displayed.

*2 :These items will not be shown in the display.

● Record of thread break

This function will show thread break data of each needles.


In case of Multi-head embroidery machine, data line for each head will be displayed.

1. When the machine is stopped, press .



2. Select "REPORT".



3. Select .

	Head number					Needle number														
Head No	1	2	3	4	5	6	7	8	9	10	11	12	13	14	15	16	17	18	19	20
Head 1	119	0	0	20	0	0	1	8	10	10	10	10	10	10	10	10	10	10	10	10
Head 2	0	0	0	40	0	0	3	8	10	10	10	10	10	10	10	10	10	10	10	10
Total :	299																			
	Total																			

4. In order to exit the mode, proceed to the step 5.

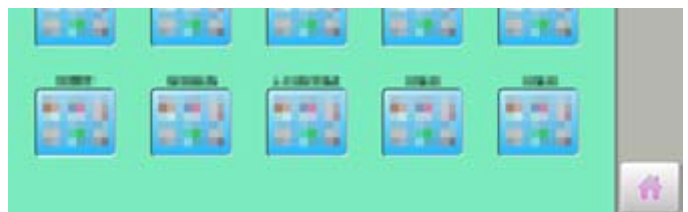
If you want to delete the record, press




4. Press .


The display returns to MENU.

Press  to return to Drive mode.



 Save the report

You can save the displayed records in CSV format.


Insert the USB memory into the machine and press  button then, new folder named "Production Report" will be made and the report data will be saved as file name "BreakReport_*****".

●The date and time of error message

You can view code and time of the error message and last 100 times of the data will be held.

●The number of error message

You can view the total number of each error messages which is occurred in the embroidery machine.

1. When the machine is stopped, press .



2. Select "REPORT".



3. Select .

 The screen is switched to date or number.

The date and time of error message

No.	Error	Date	Time	No.	Error	Date	Time
1	E-141	2013/12/26	08:37:04	16	E-105	2013/12/17	15:09:08
2	E-116	2013/12/26	08:35:40	17	E-105	2013/12/17	15:08:37
3	E-141	2013/12/24	15:45:23	18	E-105	2013/12/17	14:58:30
4	E-061	2013/12/24	14:09:40	19	E-105	2013/12/17	14:58:19
5	E-141	2013/12/24	12:51:20	20	E-105	2013/12/17	14:58:16
6	E-110	2013/12/24	12:44:39	21	E-105	2013/12/17	14:58:11
7	E-110	2013/12/24	11:37:00	22	E-105	2013/12/17	14:58:01
8	E-110	2013/12/24	11:36:59	23	E-105	2013/12/17	14:57:51
9	E-110	2013/12/24	11:36:50	24	E-105	2013/12/17	14:57:41
10	E-110	2013/12/24	11:36:41	25	E-105	2013/12/17	14:57:31
11	E-110	2013/12/24	11:36:32	26	E-105	2013/12/17	14:57:21
12	E-110	2013/12/24	11:36:23	27	E-105	2013/12/17	14:57:11
13	E-110	2013/12/24	11:36:14	28	E-105	2013/12/17	14:57:01
14	E-193	2013/12/19	15:28:55	29	E-193	2013/12/6	10:41:44
15	E-193	2013/12/19	15:15:21	30	E-061	2013/12/5	12:58:29

4. In order to exit the mode, proceed to the step 5.

If you want to delete the record, press



The number of error message

Error Count	Error Count	Error Count	Error Count	Error Count					
E-000	0	E-015	0	E-030	0	E-045	0	E-060	1
E-001	0	E-016	0	E-031	0	E-046	0	E-061	20
E-002	0	E-017	0	E-032	0	E-047	0	E-062	0
E-003	0	E-018	2	E-033	0	E-048	0	E-063	0
E-004	0	E-019	0	E-034	0	E-049	0	E-064	0
E-005	0	E-020	0	E-035	0	E-050	26	E-065	0
E-012	0	E-027	0	E-042	0	E-057	0	E-072	0
E-013	0	E-028	0	E-043	0	E-058	0	E-073	0
E-014	0	E-029	0	E-044	0	E-059	0	E-074	0

5. Press .


The display returns to MENU.

Press  to return to Drive mode.




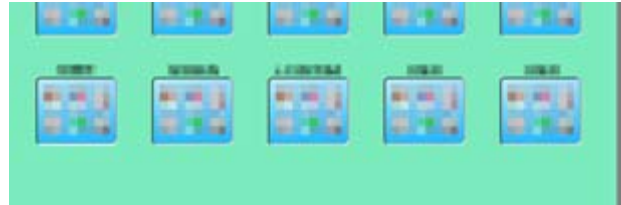
 Save the report

You can save the displayed records in CSV format.

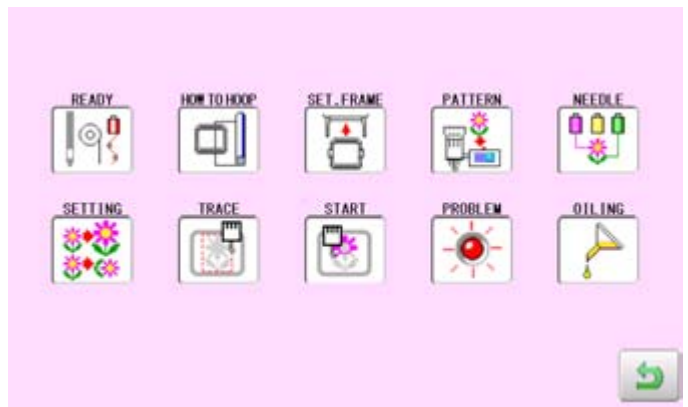
Insert the USB memory into the machine, Insert the USB memory into the machine and press  button then, new folder named "Production Report" will be made and the following files will be saved.

The GUIDE offers tips and step-by-step help for embroidering with the machine. In each stage of embroidery operation there is an easy to follow guide available.

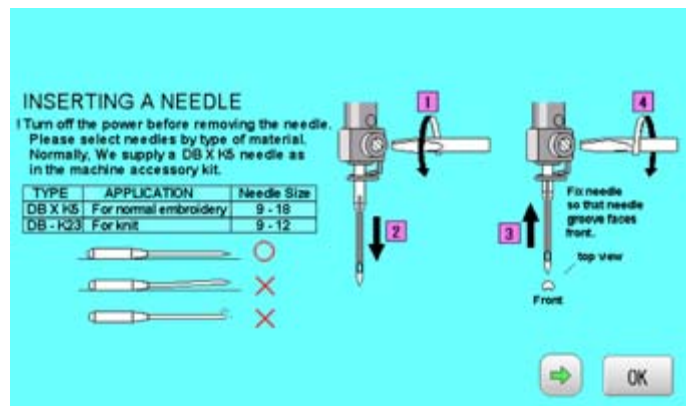
1. When the machine is stopped, press .



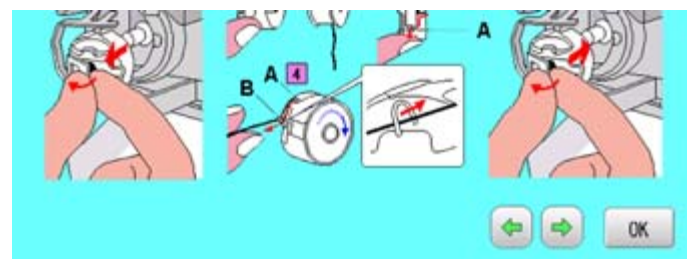
2. Select  "GUIDE".




3. Select desired item.




4. You can move to next page by pressing



5. Press .

You will return to the guide menu.



Press  to return to Menu mode.

If screen saver is set, images saved in the machine are displayed on the screen in numerical order when the machine is stopped and is not in operation for a certain amount of time. Screen saver is cancelled when any place on the touch screen is touched.

■ If the setting time of “display off timer” on “OPTION” is shorter than one of screen saver, screen saver is not displayed.

Make sure the setting time of “display off timer” is longer than one of screen saver when both screen saver and “display off timer” are used. 15-2

Start-up time

Set the time to start screen saver

1. When the machine is stopped, press .



2. Select “SCREEN”.



3. Press .



4. Select the number. (Unit : minute)

- Changing is cancelled.
- Numbers are deleted.



5. Press .



6. Press .


The setting is fixed and display returns to MENU.

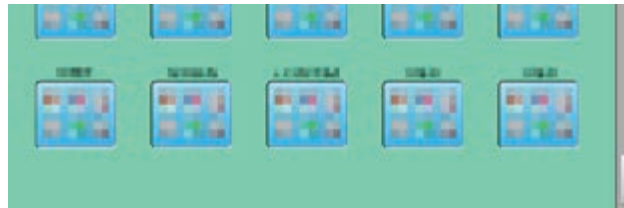
Press to return to Drive mode.




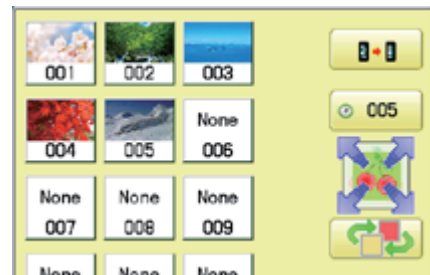
Slide direction

Set the slide direction of the screen saver image switched to the next image displayed on the screen.

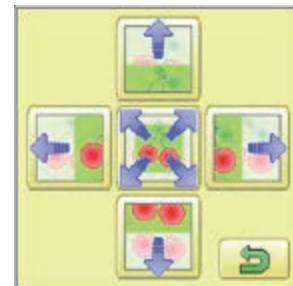
1. When the machine is stopped, press .



2. Select  "SCREEN".



3. Press .

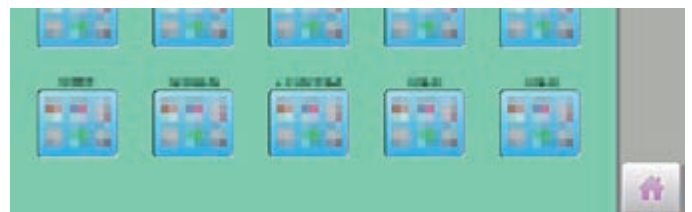



4. Select the direction.



5. Press .

The setting is fixed and display returns to MENU.




Press  to return to Drive mode.

Change and delete image(s)

This is done to change or delete screen saver image(s) 5 images are pre-installed in 001 thru 005.

Maximum 12 images can be saved by adding images.

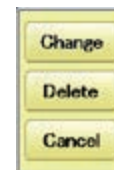
1. When an image is changed, insert the USB memory into the machine.
2. When the machine is stopped, press .





2. Select  "SCREEN".



4. Select the image to be unwanted or deleted saved on the screen.



3. Press .

-  Image is deleted.
-  Setting is cancelled.




4. Select Image file.
Press the image file name you would like to add on the screen.

Ex: The new image is added in the 006.



5. Press .


The setting is fixed and display returns to MENU.

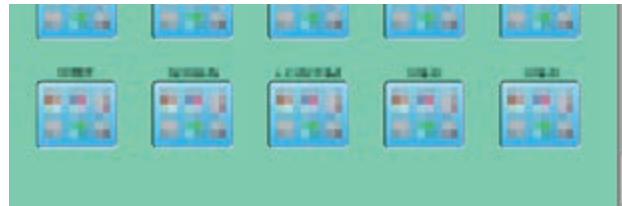
Press  to return to Drive mode.

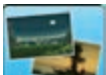


Initialization of registered images in the machine

Screen saver images to set current status to initial status (factory setting).
 Original images in 001 to 005 are restored although they are deleted.
 All the images saved in 006 to 012 are deleted.

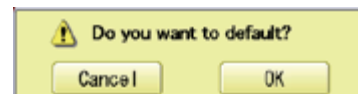
1. When the machine is stopped, press .




2. Select  "SCREEN".



3. Press .



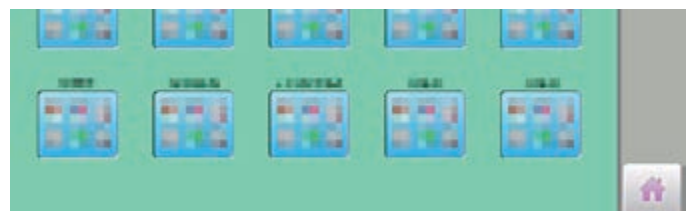
4. Press .


 Initialization is cancelled.



5. Press .

The setting is fixed and display returns to MENU.



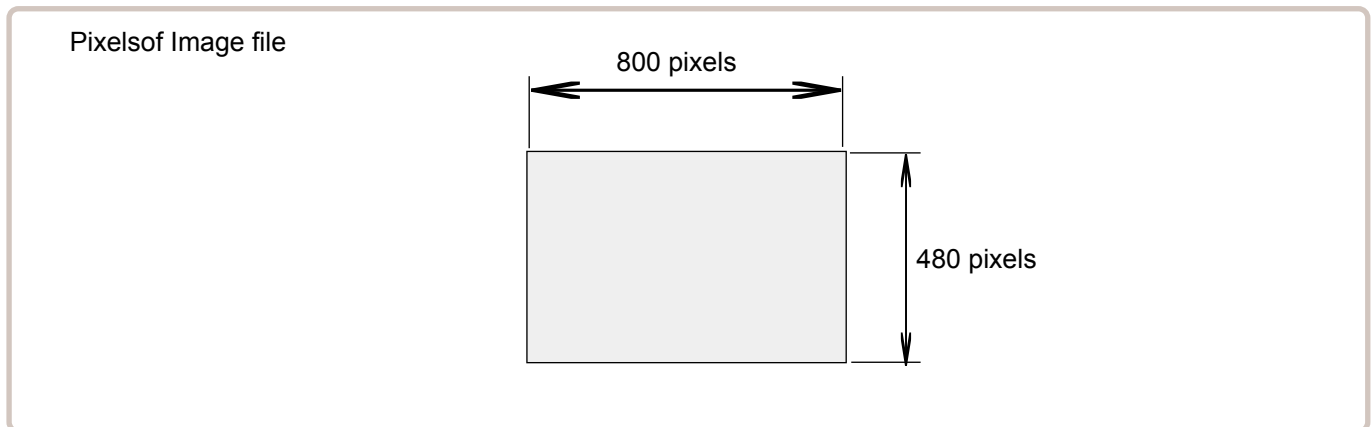
Press  to return to Drive mode.

How to make the screen saver image

You can display any image(s) in addition to pre-installed images.

Create image(s) to meet the following specifications by using your image editing software.

Save the image(s) in USB flash memory.



File format

BMP format

Ex : "*****.bmp"

Pixels

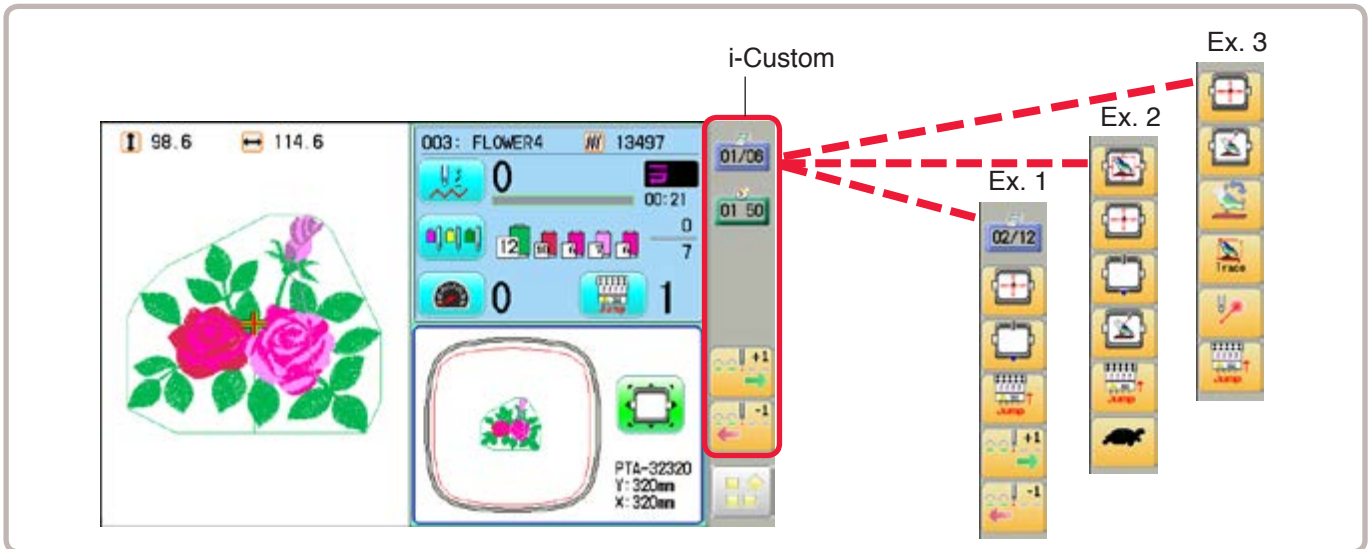
800 x 480 is recommended.

1600 x 1200 can be displayed. However, capacity of the file is larger and the machine consumes the memory for pattern data.






The number of color

Maximum 24 bits color (full color)









You can place frequently used key icons freely on the right side of Drive mode screen.






















Display icons to be placed

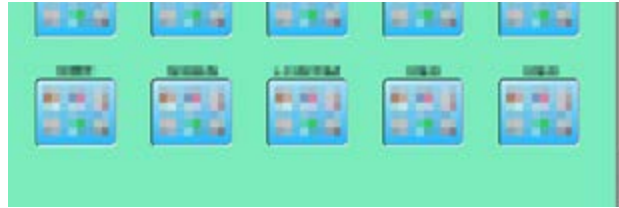
-  **Calendar**
Current year, month date is displayed.
-  **Clock**
Current time is displayed.
-  **LAN connection**  22-2a
This indicates the machine connects with LAN. By pressing this icon, you can retrieve embroidery design from connected PC and load the design to the machine.
-  **Wireless LAN (Option)**
This indicates the machine recognizes wireless LAN device.

Keys icons to be placed

-  **Stitch number forward**
Move the frame forward or backward by the one stitch.
-  **Design centering**
Move design to the center of frame.
-  **Center**
Moves the embroidery frame to the center automatically.
-  **Frame out**  15-2
Move frame to the front position which was set before.
-  **Original point return**  3-6
This returns the frame to *pattern origin point.
-  **Origin registration**
Register the current frame position as origin.

-  **Trace**
When pressed while at the beginning of design, the embroidery frame moves following the outer edge of the design.
-  **Register**
Register will restore the position of the frame to the last point before a power failure even if the point of origin or the pattern itself were changed.
-  **Pointer (Option)**
Turn on and off the laser pointer.
-  **Jump**  3-5
Turn on and off the Jump.
-  **Low speed operation**  3-5
Turn on and off the Low speed operation.
-  **Position alignment by defining 2 points**  9-8
Embroidery position is aligned by defining 2 points.
-  **Convert**  9-5
Rotate and mirror invert selected pattern data.
-  **Width adjustment**
This setting adjusts stitch width.  14-3
-  **Preset (Offset)**
This select the Offset position.  14-A
-  **Read USB**
Read embroidery data from USB memory.
-  **Read PC**
Read embroidery data from PC.
-  **Interrupt**  22-2b
It is possible to perform reading design and other operations even while machine is embroidering.

1. When the machine is stopped, press .



2. Select  "i-CUSTOM".






3. Select a desired custom icon.



4. Select display or key icon(s) from the gray frame.
When changing to other display or key icon(s),



When you select the desired display or key, repeat steps 3 and 4 .

-  Changed to the page of i-CUSTOM.
-  Selected i-CUSTOM is deleted.
-  Setting is returned to the default.



The desired key change has been made.

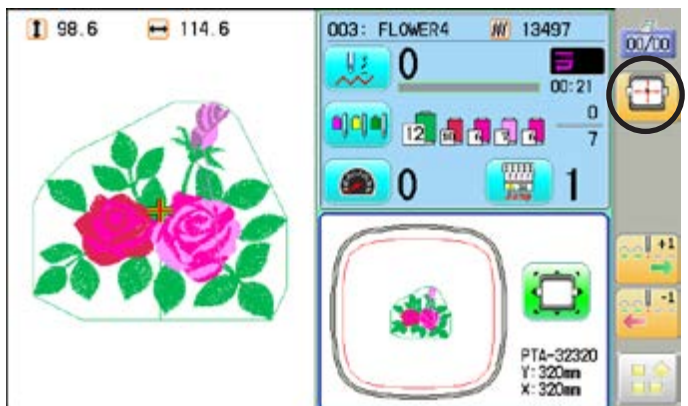
5. Press .

The setting is fixed and to return to Menu mode.



6. Press .

Custom icon change is made.






 **LAN connection**  **SEARCH**

This indicates the machine connects with LAN.
 Design folder settings on the "Happy Link LAN" is required before reading pattern data.
 Please refer to "Happy Link LAN" System INSTRUCTION MANUAL regarding the settings method.
 The pattern data can be read through the designated folder and sub-folders.

- The retrieval function will not work when same pattern name is saved in selected folder and sub-folder.

Barcode reader

Barcode reader from third parties which is connected to USB port of the control box (Standard-A receptacle) can also be used for retrieving design name.
 The barcode reader should be set to add code "CR+LF" at end of the data.
 Please refer to instruction manual of the barcode reader for setting and operation.











1. Press  .
 or  , then press  .

Currently selected pattern name is displayed.



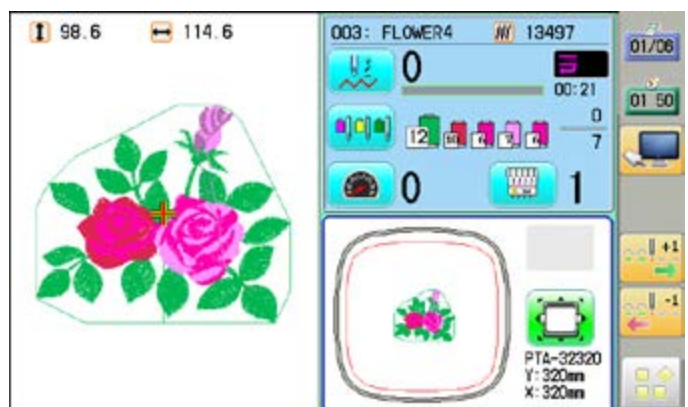
2. Enter the pattern name.
 The maximum number of characters in a design name is 24 letters or numbers.
 For correct retrieval, all characters need to match exactly.
 Normally, extension name is not required when the pattern name is displayed correctly.



-   The cursor moves left and right.
-   The screen is switched.
-   Enter the extension.
-  All the letters are deleted.
-  The letter is deleted before the cursor position.
-  The screen returns to drive mode.
-  Read retrieved pattern from PC.

3. Press  .

Read retrieved pattern from PC, then return to Drive mode..

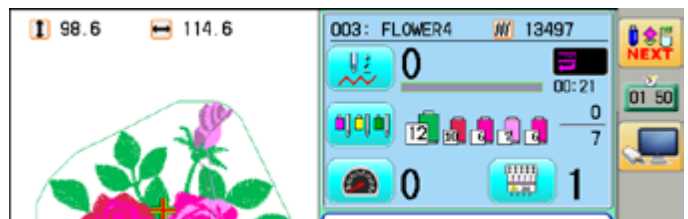


Interrupt

It is possible to perform reading design and other operations even while machine is embroidering.

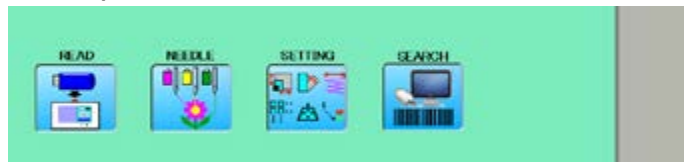
Press above icon, then Interrupt menu will open to access each functions.

- Compared with menu mode, there are some functions (displayed in gray) which can't be used in the interrupt menu.





1. Press  .

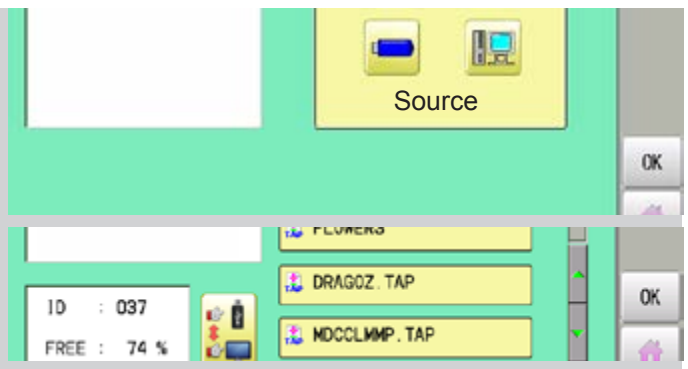
Interrupt menu




2. Press  "READ".


Select [USB] or [PC] from Source window, then press  .

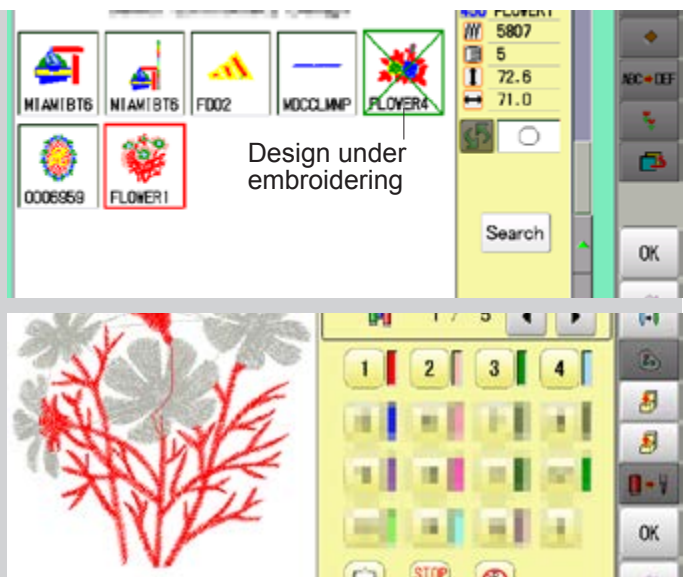
Select pattern for reading design, then press  to return Interrupt menu.




- Press  "NEEDLE".


Select the pattern and press  .


Perform Needle bar selection, then press  to return Interrupt menu.



Press  "SETTING".




Select the pattern and press .

Perform Pattern setting, then press  to return Interrupt menu.



Press  "SEEARCH".

Please refer to  22-2a about "Search" function.




Press  to return to Drive mode.

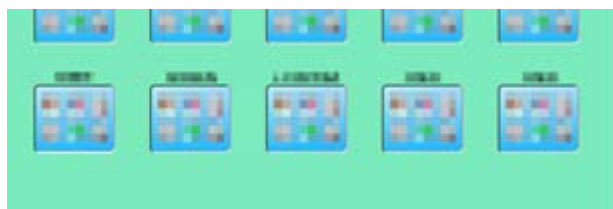
When machine operators have been registered as user, you can manage the right to operate the embroidery machine and you can collect the production data of each user.

●Registration of administrator

Registration and change of administrator's name and password.

Only registered administrator has the right to access the user management function.

1. When the machine is stopped, press .

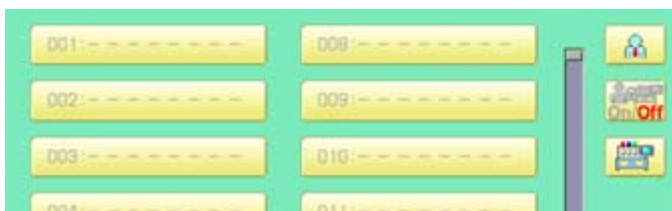



2. Select  "USER".



3. Press .

The display when password is not set.



When administrator's password is set, enter password and press .

The display when password is set.







 Cancelled.

 Numbers are deleted.

4. Press .







5. Press , in case you do not need to change the administrator's name.



When you prefer to change the administrator's name, move cursor with   then, enter new name from the keyboard and press .



The maximum number of characters is 16 letters.

-  Uppercase and lowercase letter are switched.
-  All the letters are deleted.
-  Selected number is deleted.
-  Cancelled.

6. Enter arbitrary 6 digits number as password.
Enter "000000" if you do not want to use password.
Please keep your password safe.


-  Cancelled.
-  Numbers are deleted.


CAUTION
If you lost the password, you may not be able to access the User management function.
Please contact your dealer, if you have forgotten or lost your password.

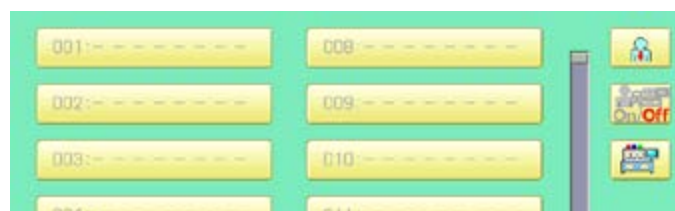


7. Press .


Password is fixed.

8. Push  to activate the User management function.

The icon will be changed to .



Proceed to step 9, if you do not want to use the User management function.

9. Press , when you want to change the machine name.

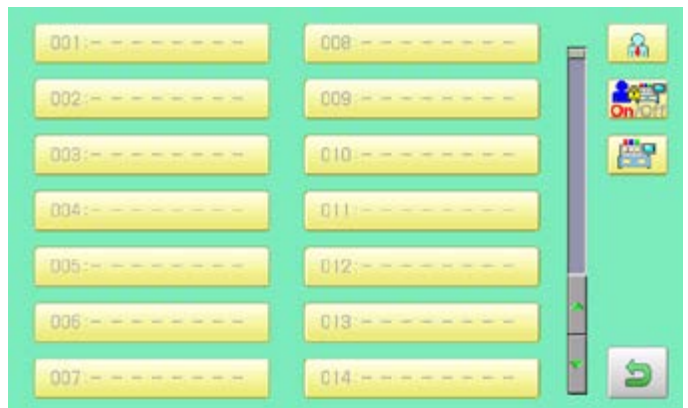


10. Enter new [Machine name] and press



Please note that the [Machine name] will be recorded as an item of the Production data.
The maximum number of characters is 15 letters.

If the Machine name is not to be changed, proceed to Step 11.




11. Press .

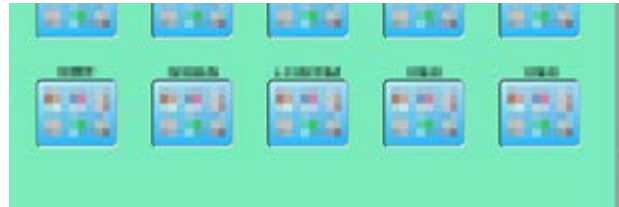
The setting is fixed and to return to Menu mode.



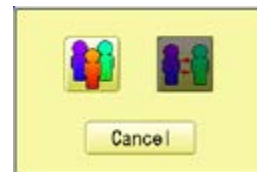
●Registration of user

Registration and change of user name and password.
The maximum 250 user can be registered.

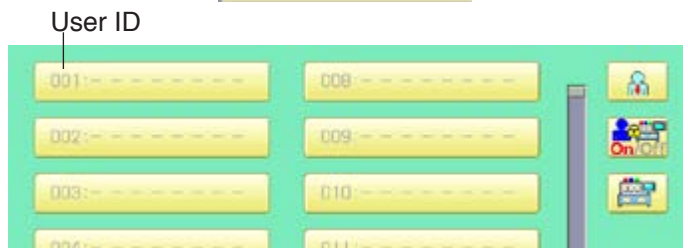
1. When the machine is stopped, press  .



2. Select  “USER”.



3. Press  .



4. Select desired ID number.



5. Enter user name from key board then, press



The maximum number of characters is 16 letters.



Cursor are moved.



Uppercase and lowercase letter are switched.



All the letters are deleted.



Selected number is deleted.



Cancelled.



6. Enter arbitrary 6 digits number as password.

Enter "000000" if you do not want to use password.

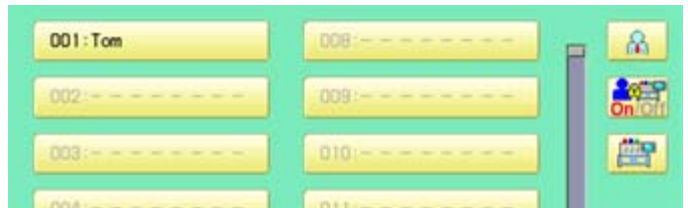
 Cancelled.

 Numbers are deleted.



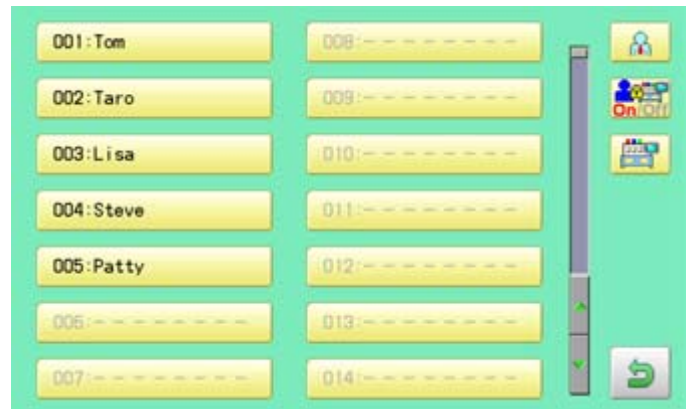
7. Press .

The setting is fixed.



8. To continue registering other user, repeat the procedure from step 4 to 7.

Proceed to step 9, if you do not want to register user name.



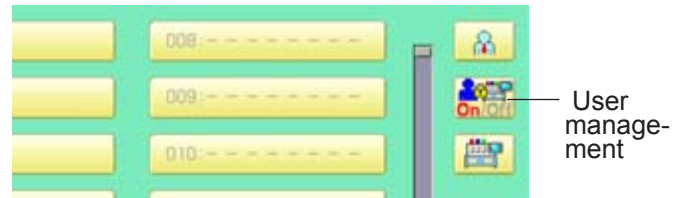
9. Press .


The setting is fixed and to return to Menu mode.



● Selection of user (Login)

You can select user name and login, when User management function has been activated beforehand.



1. When the machine is stopped, press .



2. Select  "USER".



3. Press .



4. Select user or administrator

If password has not been set, the screen will be changed as step 6.

5. Enter the password.



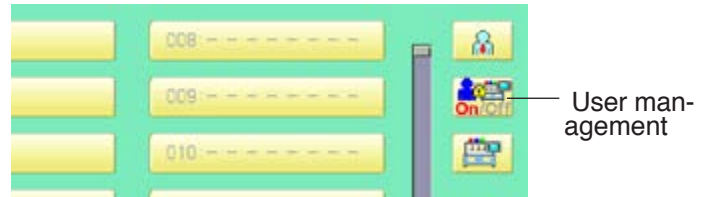
6. Press .

To return to Menu mode.



● Selection of user (Login) at power ON

The user selection menu will be displayed, when User management function has been activated beforehand.



1. Turn on the power switch.



2. Press **Next**.

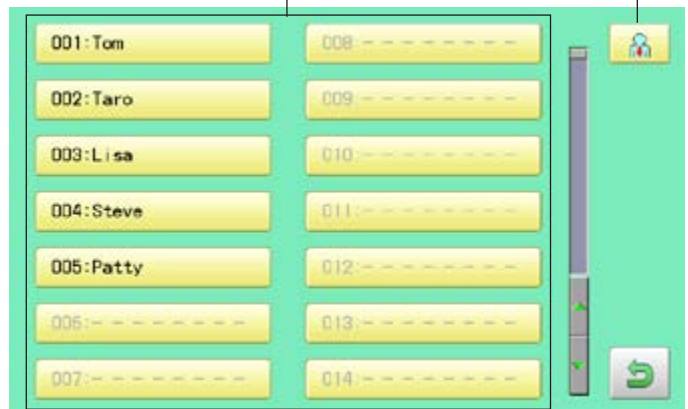
After the carriage and frame move slightly, the embroidery frame will return to the previous position automatically.

CAUTION: To prevent accidents.

The embroidery frame and carriage will move. Please keep hands clear for your safety.

User

Administrator



3. Select user or administrator

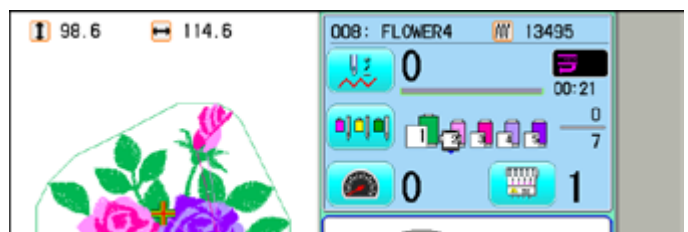
If password has not been set, the screen will be changed as step 5.

4. Enter the password.



5. Press **SET**.

Machine becomes ready for operation.

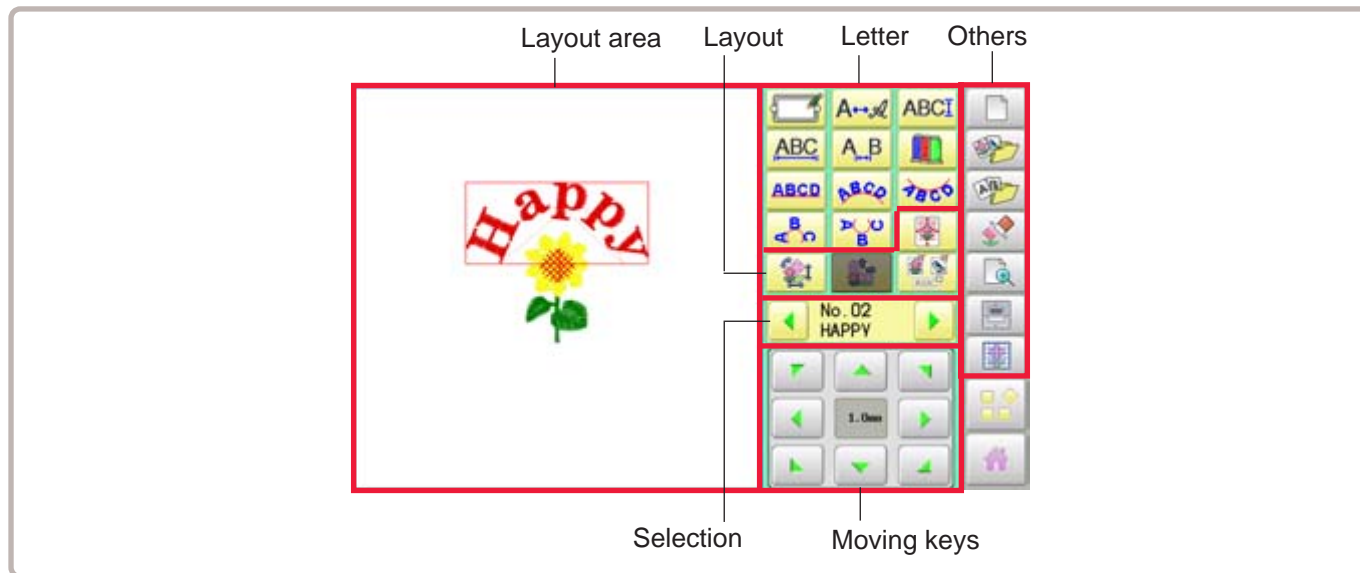


Combined pattern data can be made by putting pattern(s) and letter(s) anywhere you like on the layout window.

The pattern data can be saved to the machine for embroidering.

■ When "PATTERN SETTING" is set on the selected design, these setting will be taken over to the new design.

■ The number of color change function (Color change) for combined pattern data shall not exceed 250.



Layout area

Display the area for pattern layout



With "Layout area" key, you can change the area for pattern layout.

Letter



Letters

Changing the Letter.



Font

Changing the font.



Height

Changing the height.



Line length

Changing the line length.



Space [P](#) 16-5

Changing the spacet.



Color change between letters [P](#) 16-6

Color change can be made between letters.



Layout method [P](#) 16-1

Changing the layout method of the letterst.

Layout



Centering

Move the pattern to center of the Layout area.



Pattern settings [P](#) 14-2 ~ 14-4, 9-5

Various pattern settings such as scaling, width adjustment, rotate angle and convert design.



Repeat [P](#) 14-5

Copy the design as user-specified number in the X and Y directions.

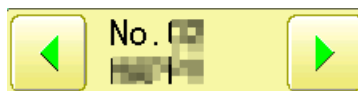
Please note that the repeat function does not work at letter layout.



Multiple patterns movement [P](#) 22-F

Select multiple patterns and move position together.

Selection



Selecting the pattern.

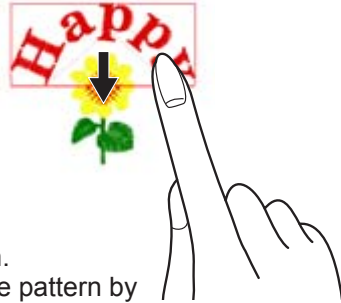
Display selected pattern number (sequence number of layout) and pattern name.

Moving keys



Move selected pattern.
You can also move the pattern by pressing desired position on the screen.

With pressing **1.0mm**, you can change the steps of movement to 1.0mm.



Others



Layout area [P 22-G](#)

Change display area for pattern layout.



Pattern selection

Select desired pattern for layout



Letter selection

Enter desired letters for layout.



Delete

Delete selected pattern (letters)



Zoom [P 22-H](#)

Zoom in and zoom out the pattern layout.
The selected patterns can be moved with keeping desired scale.



View all

Display whole pattern image when the layout area is set more than 100mm.




Grid [P 22-I](#)

Display grid with desired scale.

This instruction is based on an example in the right drawing.



1. When the machine is stopped, press .



2. Select  "LAYOUT".



Pattern selection

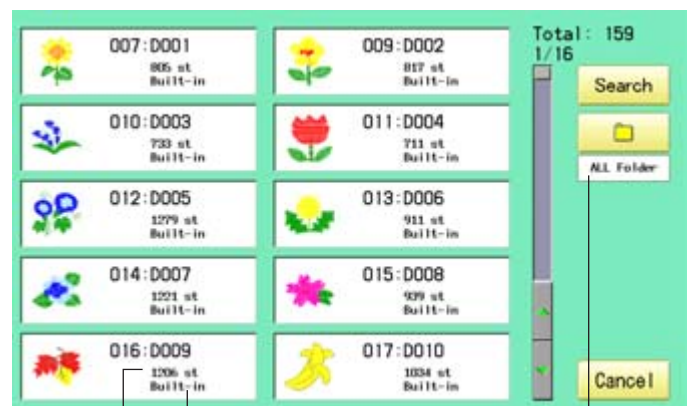
3. Press .

All pattern data stored in the machine memory will be displayed.



Searching the patterns. [P 11-D](#)

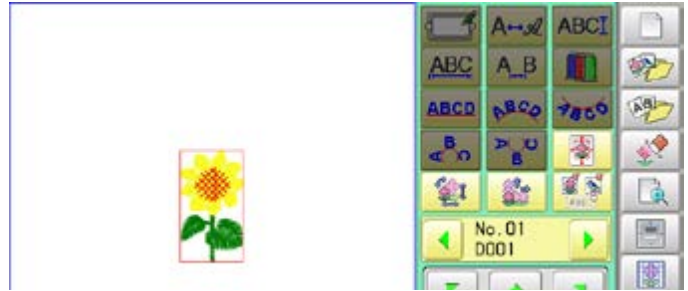
Selecting the folder.



Stitches of pattern

Display the folder name to search
The folder name which the pattern is saved

4. Select the pattern




Letter selection

5. Press .



6. Select letter.

Select letters. One data can contain up to 26 letters including space.

 The screen is switched to basic script or cyrillic script.

 All the letters are deleted.

 Basic script


 Diacritic script

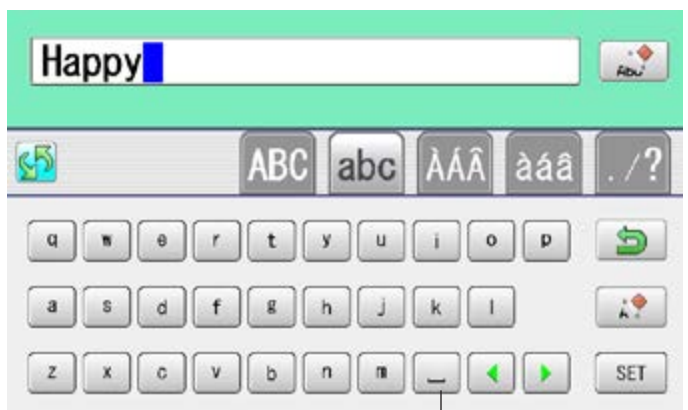
 Cyrillic script

 Symbol

 The screen returns to menu.

 Selected letter or number is deleted.


 The cursor moves left and right.




Space or Delete

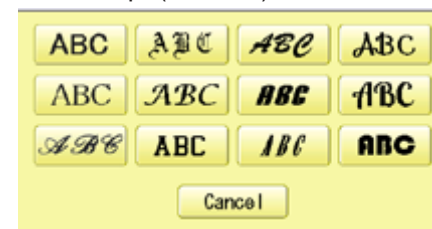


Except for the space between letters, space is eliminated.

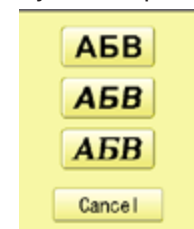
7. Press  when you are finished with the letter selection.

Fix your setting and you can select fonts.
For fonts, refer to [BUILT-IN FONT LIST].  26-3

Basic script (Diacritic)



Cyrillic script

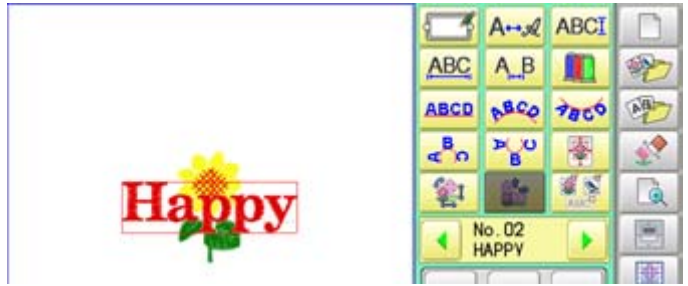


Font Selection

8. Select the font.



9. Select desired height.

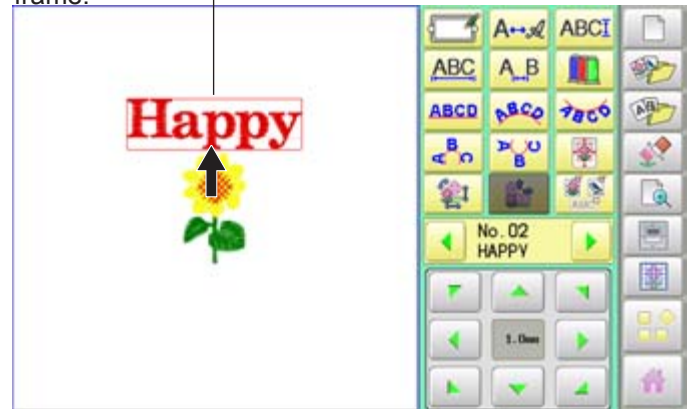


The selected letter (pattern) is displayed with rectangular frame.

10. Move letters with



The selected letters (pattern) can be moved.



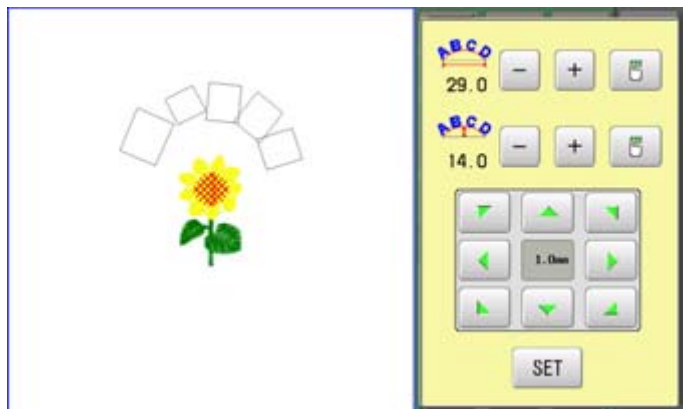
Layout method

11. Select 

Adjust width and height of arch if necessary.

 16-1

You can move letters with



12. Press 



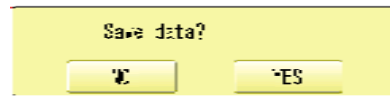
13. Move letters with



Saving

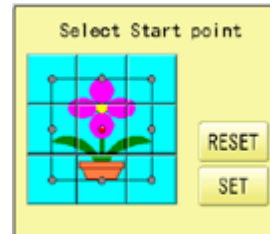
Save the laid pattern data.


14. Press  or .



15. Press .

Select start point of embroidery from 9 preset points which are located around or center of the pattern.



 The start point of first selected pattern will be set as the start point of combined deign.

16. Press .

Saving pattern name is displayed.




17. Go on to next step, if the pattern name is not to be changed.

When you would like to change the letters, select each digit in the existing name with



Then select each digit in the existing name. Select word.

The maximum number of characters in a design name is eight letters or numbers.

 All the letters and/or numbers are deleted.

 Selected letter or number is deleted.

 Renaming is cancelled.

18. Press .

The new design is saved and the display return to Menu mode or Drive mode.





Multiple patterns selection

Select all or multiple patterns and move the position together.

1. Change pattern with **-** **+**, then press



The desired pattern is selected.
Make sure that the selected pattern is displayed with rectangular frame.



Switch status between selected and non-selected

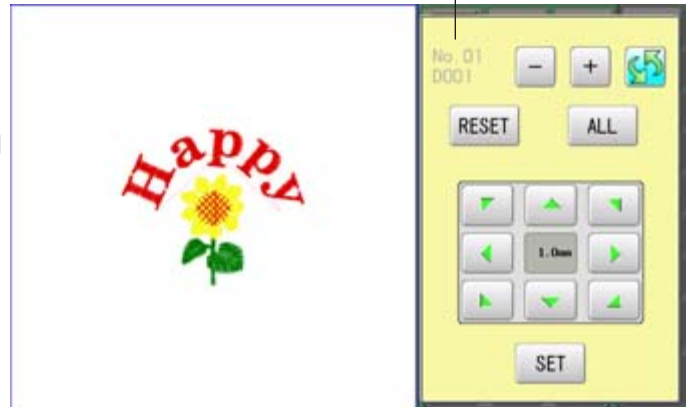


Set all patterns as non-selected.

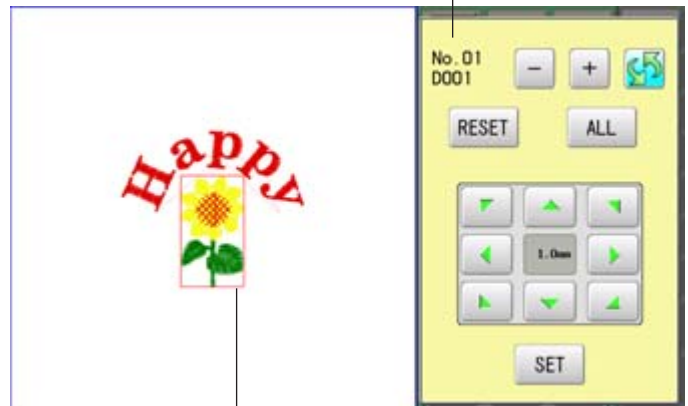


Set all patterns as selected.

Non-selected pattern (gray)



Selected pattern (black)



The selected pattern is displayed with rectangular frame.



An example when all patterns are selected.

2. Move selected pattern with



3. Press **SET**.

Selected pattern will be moved.

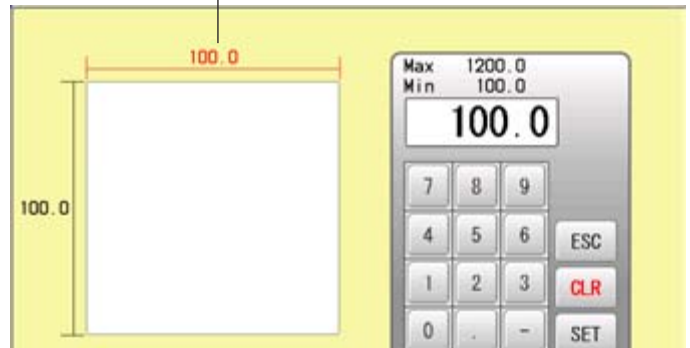


Layout area

Change the size of layout area.

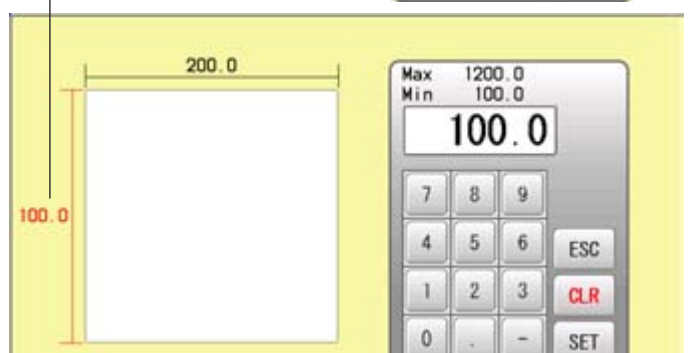
1. Enter X axis distance.

X direction is displayed in red. (It is ready to enter figure)



2. Press **SET**.

Y direction is displayed in red. (It is ready to enter figure)

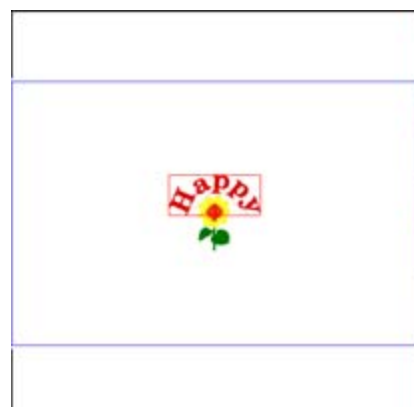


3. Enter Y axis distance.



4. Press **SET**.

The size of layout area is changed.

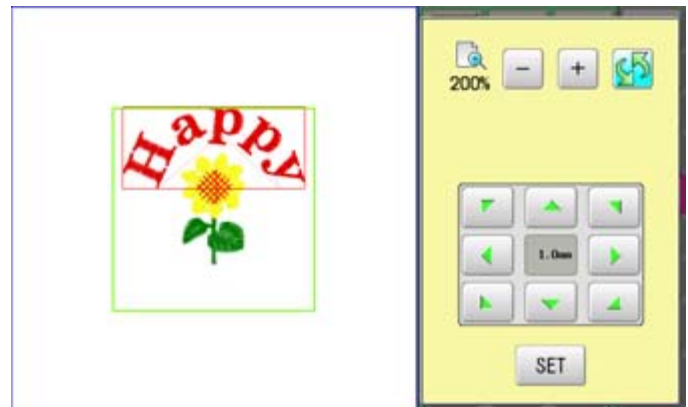






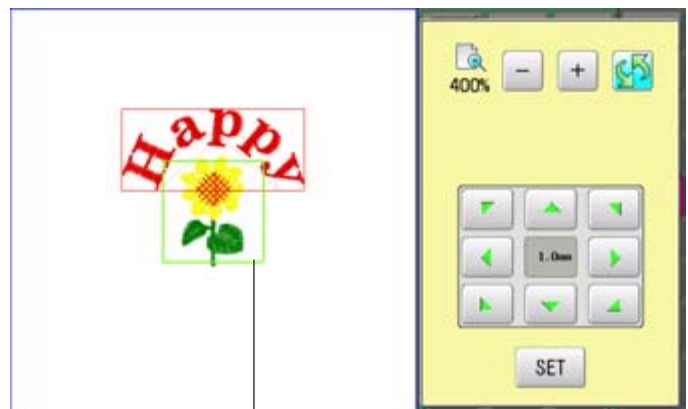
Zoom

Zoom in and zoom out the display of pattern.

The selected patterns can be moved with keeping desired display scale.



1. Change display scale with  .



It is the area to display design after zooming function.

2. Press .

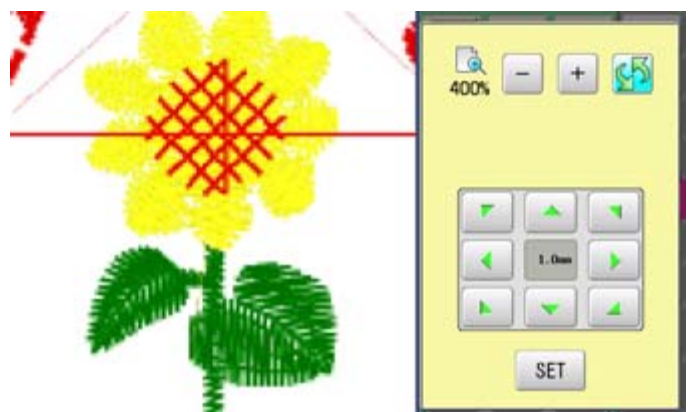
The pattern is displayed with desired scale.



Switch zoom function between on and off.



Move selected pattern.



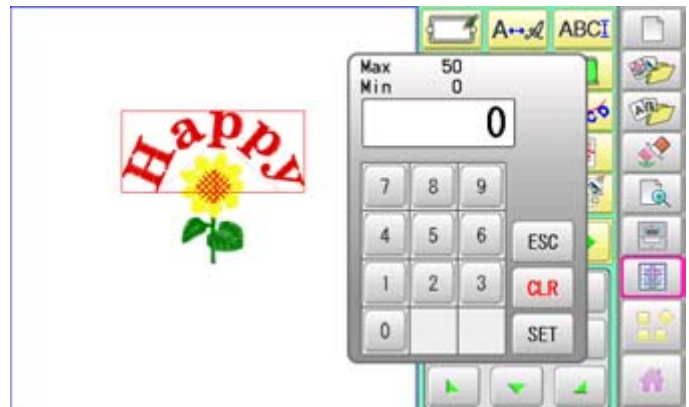
3. Press .

Exit from zoom function.



Grid

Display grid in the layout area with desired scale.
 The snap function will work when you move the pattern by finger or stylus.
 Then, the center of the pattern and cross line of the grid will match automatically.



1. Enter size of the grid.



2. Press **SET**.

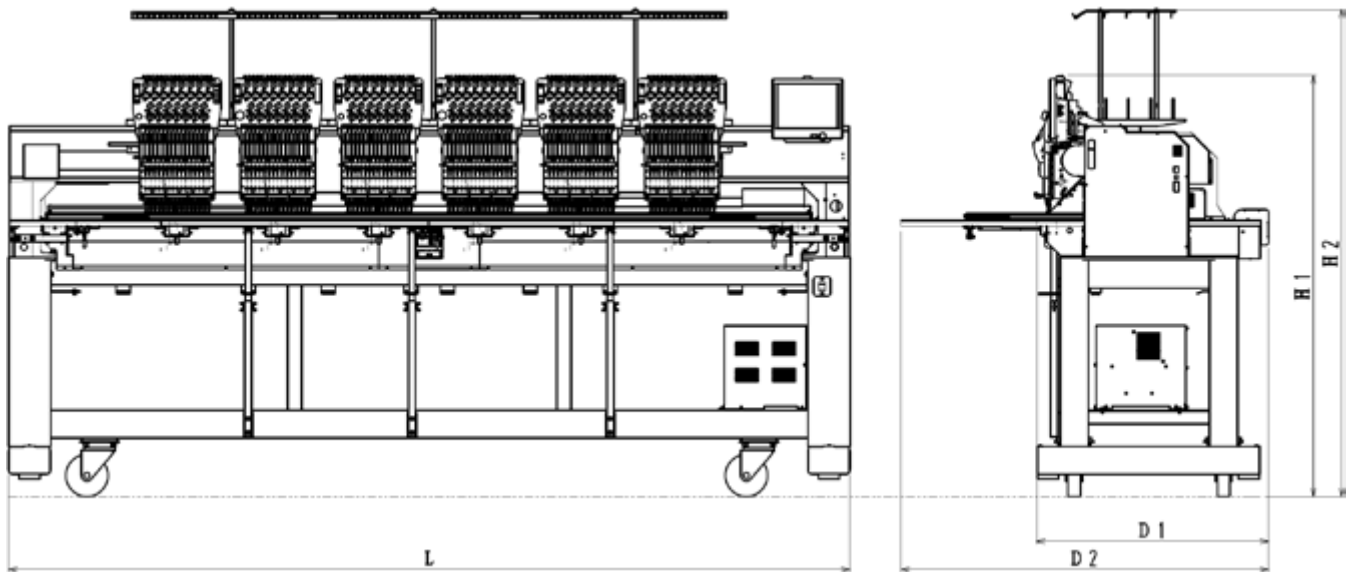
The grid is displayed.

Enter "0" if you do not use the grid.



SPECIFICATIONS

23-1



MODEL	Head	Needles	Needle distance	Max EMB. Area (Flat)	Largest Tubular Frame size *1	Max Speed (Flat, Yublar) *3	Max Speed (Cap) *3	Power Consumption		Weight (kg)	Dimensions L x D1 (D2) x H1 (H2)
HCR3-1502	2	15	500	450 x 500	420 x 440	1,200	1,000	520VA	320W	480	1,980 x 830 (1,320) x 1,510 (1,740)
HCR3-1504	4		360	450 x 360	320 x 320	1,100		580VA	340W	550	2,280 x 830 (1,320) x 1,510 (1,740)
HCR3-X1504	4		500	450 x 500	420 x 440			800	3,000 x 830 (1,320) x 1,510 (1,740)		
HCR3-1506	6		360	450 x 360	320 x 320	740VA		410W		790	
HCR3-X1506	6		500	450 x 500	420 x 440	1,030					
HCR3-1508	8		360	450 x 360	320 x 320	860VA		540W	1,020	3,980 x 830 (1,320) x 1,510 (1,740)	
HCR3-X1508	8		500	450 x 500	420 x 440				1,470		5,420 x 830 (1,320) x 1,510 (1,740)

Voltage	1 phase 200 - 240V -10% +6%
Frequency	50 / 60Hz
Environmental condition	Temperature 0 ~ 40° C Moisture 45 ~ 85 %
Embroidery area (Y x X)	Normal cap frame (Option) 70 mm x 180 mm, 2.8" x 7.1" Max.*2 Wide cap frame (Option) 85 mm x 360 mm, 3.3" x 14.2" Max.*2
Memory capacity	About 40,000,000 stitches
Registered pattern	999 pat.

*1 Actual embroidery area will be restricted in accordance with inner frame size.

*2 Actual embroidery area will be restricted in accordance with shape of a cap.

*3 Maximum machine speed may change by sewing condition, such as pattern, material and etc.

■ Specifications are subject to change without notice.



CAUTION: To prevent accidents.

When performing maintenance, be sure power switch is "OFF".

●Oiling

The machine will periodically prompt periodically for lubrication based on the number of stitches sewn.

When powered on, the machine will display an icon and letter to indicate that lubrication is necessary. 5-3

A	Place to oil
B	Place to oil

Please lubricate the specified oil locations according to the instructions below.

Running the machine without proper oiling will damage the machine.

Lint will gather in and around the rotary hook.

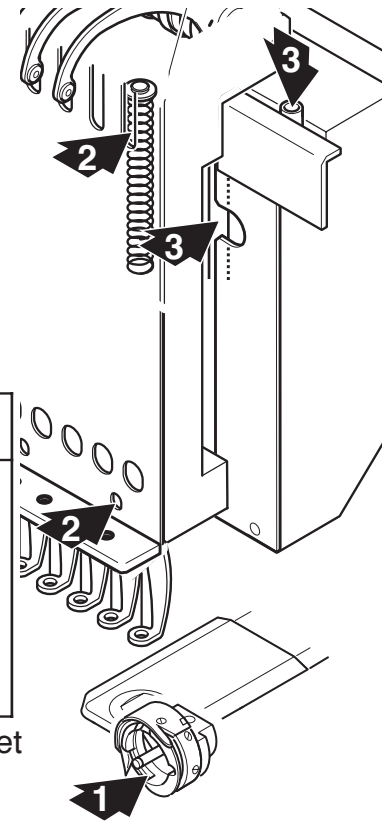
Rotary hooks then wear which will cause the threads to break.

Please clean lint with a brush and run the machine idly for 2 ~ 3 minutes.

Mark	No.	Place to oil	Specified oil
A	1	Rotary hook (Lubricate with oil slightly with a small brush and sewing machine oil between the outer and inner rotary hook parts.)	Sewing machine oil
B	2	Needle bar	
	3	Head shaft	

■ When oiling the head shaft, please move the head to the left and set it to needle No. 1.

■ Too much oil may stain fabrics and threads.



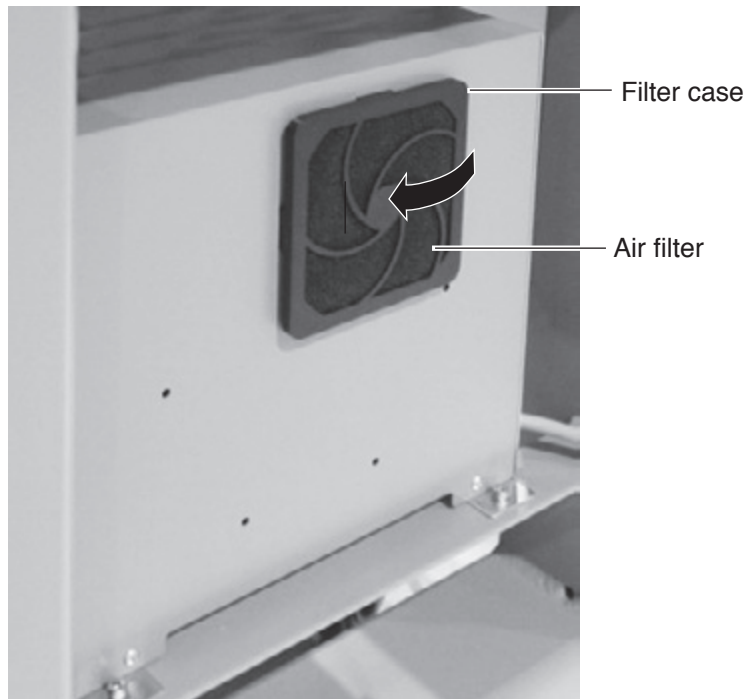
●Cleaning the air filter

Clean the filter at least once a week.

(Every, it's very dusty)

Take out the filter case and remove the air filter, and clean it.

To use machine without cleaning the filter causes overheating and trouble of machine.



●Cleaning the rotary hook

If the rotary hook is clogged with waste thread or dust, it will degrade the stitch quality of the embroidery or may cause other problems.

For a long sewing life, please keep the rotary hook clean.

Use the included brush for cleaning the hook.

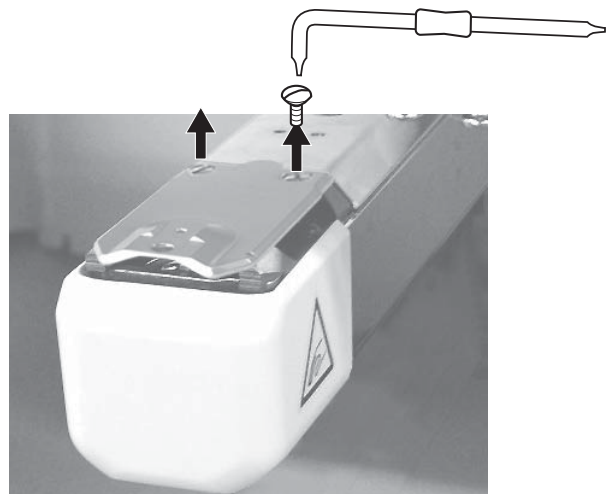



●Cleaning the thread cutting knife

If the thread cutting knife is clogged with waste thread or dust, the knife will not work correctly.

Please keep the thread cutting knife and device clean.

1. Remove set screw (2 pieces) by offset driver and remove the needle plate.

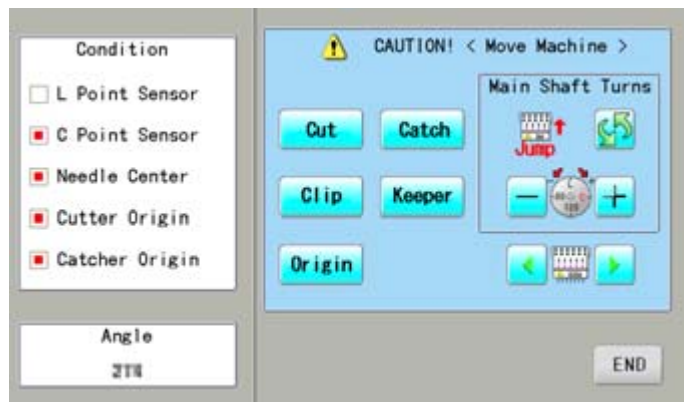


2. When the machine is stopped, press 

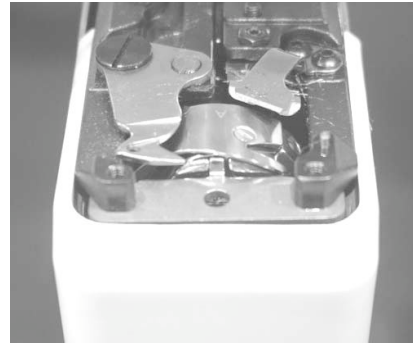
and Press  "OTHER".



3. Press  Maintenance.



CAUTION: To prevent accidents.
The thread cutting knife moves quickly.
Keep your hands away from the machine.



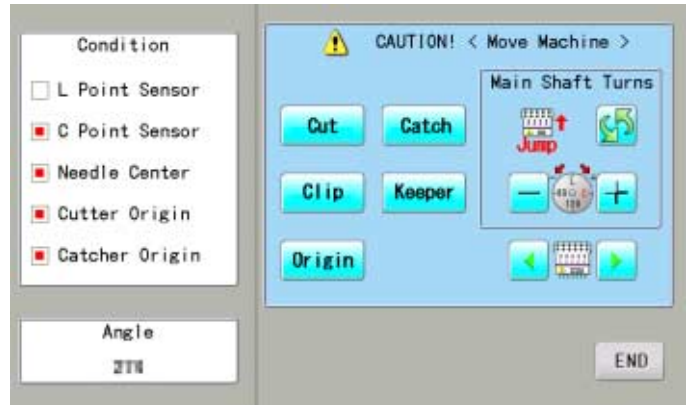
4. Press **Cut**.

In maintenance mode, pressing this button causes the moving knife to open and stop at max open position.

5. Remove any waste thread and dust from the knife assembly and surrounding area.

6. Press **Cut**.

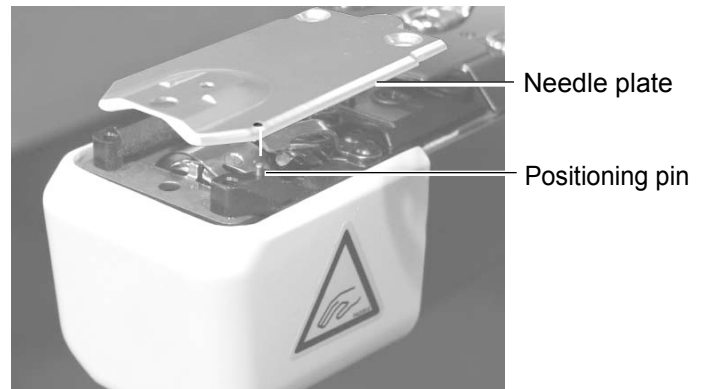
Moving knife returns to the original position.



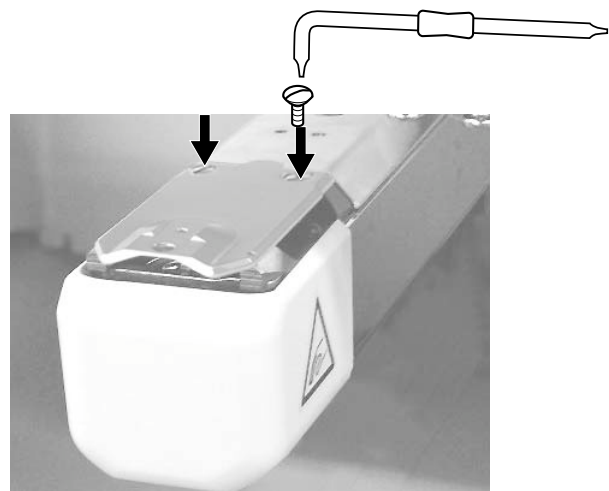
Press **END** to return to Menu mode.

7. Put the needle plate on the bed.

Please insert positioning pin to hole of the needle plate.



8. Tight set screws (2 pieces) for fix the needle plate.



The machine has an extensive error code list to aid in troubleshooting when problems occur, as listed below. Upon error, press **OK** to release the error and correct it according to the list below.



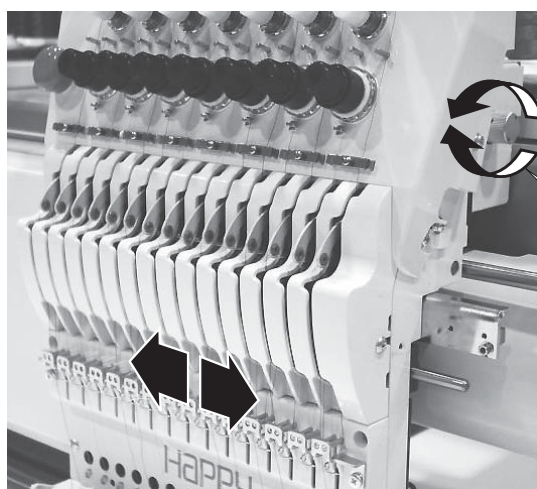
When errors occur frequently, please contact your dealer.

Automatic errors backup

The machine recovers from some errors (E-050, E-190, E-193) automatically after detecting the error(s) by it self. In cases where the machine does not recover from the error automatically, follow the "Solutions" below according to the indicated error number.

CAUTION: To prevent accidents.
In case of "Automatic errors backup", the machine's sudden movement might be caused without showing errors or messages after its stoppage.

No.	Display	Error	Solutions	Page
001	Circuit board	Abnormality detected in control circuit board	Power down machine and, after 10 seconds, power on again.	
002	Power source	Power failure or abnormal voltage		
004	System memory	System memory fault		
014	Fan Alarm	Cooling fan fault	Contact your Dealer.	
015	Inverter trip	Sewing motor-related trouble. Overload, short circuit, trouble with motor drive unit	Cut power and turn main shaft by hand. If turns normally, power on again. Fig. 2	
016	Alarm X unit	X-motor-related trouble, i.e. x-motor overload, short circuit, problem with motor drive unit	Power off machine, test pantograph movement manually. Check for any abnormality throughout full range of motion. If none found, power on again	
017	Alarm Y unit	Y-motor-related trouble, i.e. x-motor overload, short circuit, problem with motor drive unit		
018	Main shaft	Main shaft will not turn.	Turn main shaft manually at least 1 full turn & ensure that it turns freely, clearing any jam. Then, re-initialize machine system and speed.	25-1 25-2
020	Needle detect	Machine not detecting current needle # correctly, or needle bar selection unit is off its stop position. Trouble with position-detecting circuit board.	Turn needle bar selector to the fixed position (marked area shown below in Fig.1).	



Turn the needle bar selection knob to the moving head situational position.

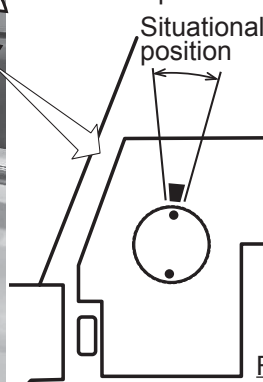


Fig. 1

Turn the main shaft with 5mm wrench clockwise.

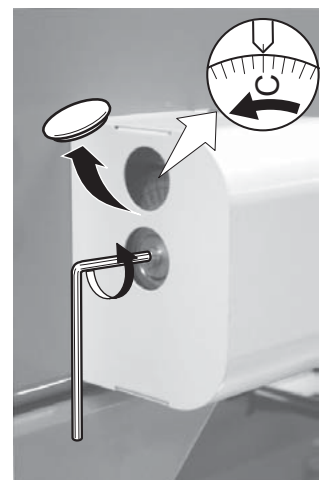
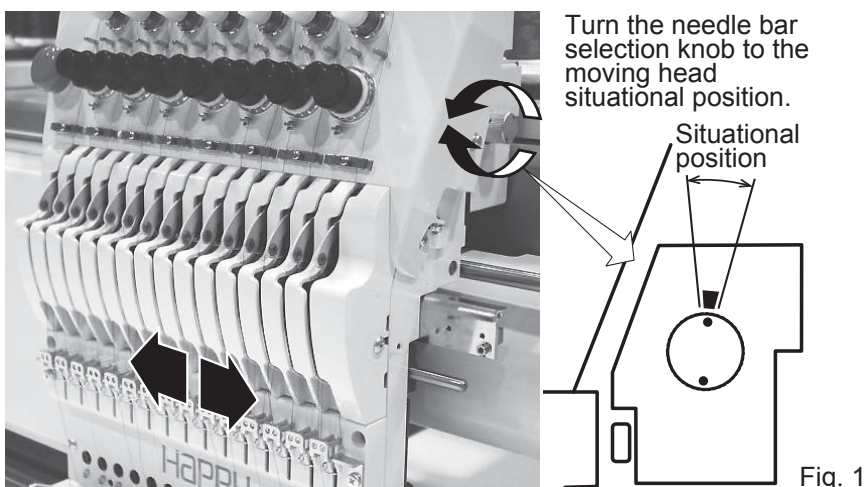


Fig. 2

No.	Display	Error	Solutions	Page
021 022	Needle move	Motor for needle bar selection unit has stopped partway through its path. No movement due to malfunction of thread take-up lever or trouble of position-detecting circuit board	After fixing malfunction of needle and thread take-up lever, turn needle bar selector shaft with wrench to have it set at center of fixed position (range within which needle bar selector doesn't move) Fig. 1	
024	Needle center	Needle bar stop position is off-center; needle bar stop position is out of place.	Turn needle bar selector with 3mm hex wrench to have it set at center of fixed position (scope within which needle bar selector doesn't move).	
025	Needle over	Needle # out of range of actual needles on given machine.	Fig. 1	
026	Needle differ	Needle # differs between		
030	Slow mismatch	Improper speed adjustment at low speed. Speed does not decrease below 100rpm at low speed.	Re-initialize machine system and speed.	25-1 25-2
050	C point	Main shaft is stopped in a position other than "C" point	See Fig. 2 below.	24-5
051	L sensor	Timing detection board fault, or marred photo-sensor. Malfunction of "Lowest needle position" sensor [PH2] on detection circuit board. Improper adjustment of slit plate.	Check to see if photo sensor is clean or if the slit plate contacts sensor. Re-initialize machine system and speed.	25-1 25-2
052	C sensor	Timing board detection fault, or marred photo-sensor. Malfunction of "Color change position" sensor [PH1] on timing detection circuit board. Improper adjustment of slit plate.		
060	X limit	Frame/pantograph has moved beyond sewing area along X-axis.	Return frame within sewing area using the frame movement keys on the control box!	
061	Y limit	Frame/pantograph has moved beyond sewing area along Y-axis.	Check pattern size and center mark to ensure that it is within size range of selected hoop and also properly centered.	
063	Drive Setup	During embroidery, preparation for frame movement did not complete within predetermined time.	Malfunction of "Lowest needle position" sensor on detection circuit board, Improper adjustment. Re-initialize machine speed. If this condition occurs frequently, contact your Dealer.	25-2
064	X Center sens.	Trouble with X-Carriage sensor, Improper position adjustment, sensor relay board fault, cable fault.	Contact your Dealer.	
065	Y Center sens.	Trouble with Y-Carriage sensor, Improper position adjustment, sensor relay board fault, cable fault.		
066	Frame drive	During embroidery, frame movement did not complete within predetermined moving time.	If this condition occurs frequently, contact your Dealer.	



ERRORS AND WHAT TO DO

24-3

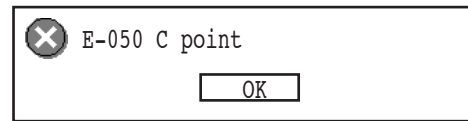
No.	Display	Error	Solutions	Page
067	Position data	Loss of embroidery frame coordinate data.	If this condition occurs frequently, contact your Dealer.	
068	Position set	Failure to read embroidery frame sensor signal. (Return)	Check if position sensor is dirty. Turn off power source, then turn on again. If problem still persists, contact your Dealer.	
069	Position Entry	Failure to read embroidery frame sensor signal. (Entry)		
070	Safety sensor	Safety sensor has been tripped.	Clear area around safety sensor. Ensure that sewing area are clear.	
090	Miss reception	Error has occurred during data transfer (via cable) between machine and PC.	Try reading pattern data again. Verify that transmission speed setting is correct at (1) transfer software; (2) device manager of PC and (3) RS-232C speed of machine.	5-4
091	No send	Machine has not received data for > 10 seconds during data transfer.		
103	Data format	Machine unable to determine format of pattern data.	Verify format of pattern data and fix if necessary.	10-3
104	Miss function	Timing to read pattern data does not conform.	Read pattern data again from the start.	5-4
105	Dual function	Data has been detected in the pattern that has ambiguous/dual function.	Read pattern data again from the start.	5-4
106	No function	Interval between start read time and time of reception of actual pattern data is too grea.	Check quality of design data.	
108	Improper read	While reading pattern data, error has occurred in internal processing.	Read pattern data again from the start.	5-4
110	Memory full	Memory has filled while reading in a design.	Delete unnecessary patterns from machine memory and try again.	5-B
111	Change over	While reading pattern data, # of color changes (color No.) has exceeded 250.	Divide pattern data such that number of color changes of each segment is less than 250.	
112	Data error	Pattern data of current design is damaged.	Delete pattern and re-load.	5-B
114	Id over	# of patterns in control panel memory has exceeded the maximum of 999.	Delete unnecessary patterns from machine memory and try again.	5-B
116	Not found Id	Specified pattern does not exist.	Check setting.	
118	Trace data over	Over 1024 stitches trace data were created during reading of pattern data.	Set maximum stitch length to embroidery area of pattern data within 2m (lengthwise) x 2m (sideways).	
120	Memory error	Fault in retaining contents of pattern memory.	If this occurs frequently, it is likely that LCD-CE board is faulty. Contact your Dealer.	
130	Disk error	Unable to communicate continuously with memory media.	Power down machine and after a 10 seconds, power on again. If error remains, contact your Dealer.	
131	Device no ready	Memory media is not set.	Check if memory media is properly set.	5-5
133	Bad card	Improper or faulty memory media.	Memory media that media reading unit can't read or faulty media or un-initialized media.	5-5
141	Not found name	Designated pattern is not found.	Memory card is not correct.	5-5
142	Disk full	Memory media is full to capacity.	Clear unnecessary patterns or use a different memory media.	
143	Multi name	Another pattern with same name has been detected while attempting to write to memory media.	Change name, use a different memory media, or overwrite existing pattern.	

ERRORS AND WHAT TO DO

24-4

No.	Display	Error	Solutions	Page
190	Cut blade	Thread cut knife is not at stop position.	Follow the instructions below.	24-5
191	Cut Sensor	Thread cut knife is not at stop position.	Check if threads are jammed around the thread cutting knife. Press the thread cutting button 2~3 times. If error remains, contact your Dealer.	23-2 23-4
193	Catcher	Thread catch hook is off its position. Limit switch to detect position is not "OFF".	Please follow the example below: 1. Check whether thread was actually cut by thread cutting knife. If not, cut thread and return catch hook to its normal position. 2. If thread is actually cut, check if thread catch hook on head has returned to its position completely.	24-6
203	Install data	Error has occurred during update of program.	Check an update program.	
215	Frm. drive err	Frame movement did not complete during normal movement. (Time over)	If this condition occurs frequently, contact your Dealer.	
217	Frm.drive data	Frame movement data loose.		
255	Default Error	During embroidery, frame movement did not complete until main shaft reach "Lowest needle position".	Re-initialize machine speed setting. Check adjustment of upper shaft timing. (C point / L point) If this condition occurs frequently, contact your Dealer	25-2

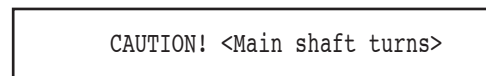
What to do when Stop position of main shaft is out of place (error E-050)



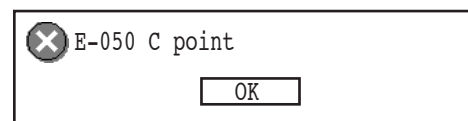
1. Press .
2. Select "Auto".




The main shaft turns 2 to 3 times and returns to a stop position ("C" point) automatically. The display returns to drive mode.



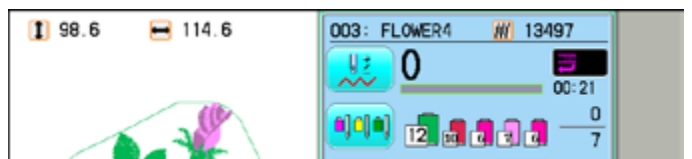
When you cannot clear by the method above (Auto)



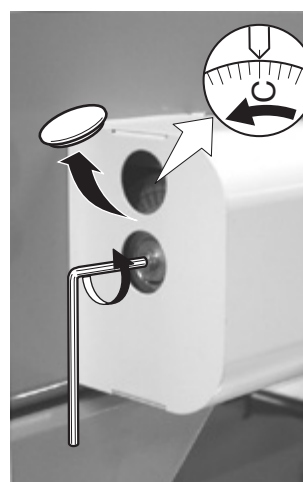
1. Press .
2. Select "Manual".



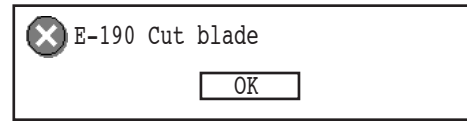
The error status is released and the display shows "drive mode".



3. Remove the cap over the small hole in the rear of the machine. Using a 5mm wrench, Please turn the main shaft and adjust it to the "C" point.



What to do for “Thread cut knife is not at the stop position (error E-190)”

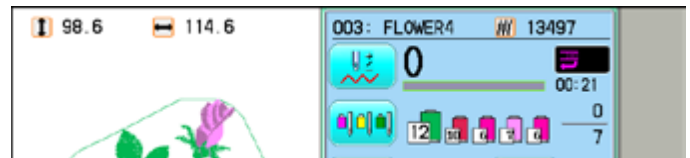


1. Press .

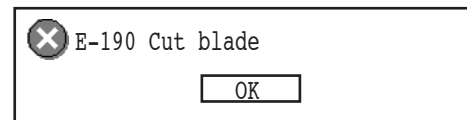


2. Select “Auto”.

The display returns to the drive mode.



When you cannot clear by the method above (Auto)

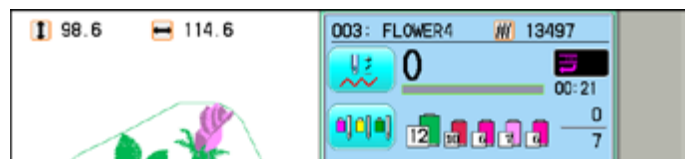


1. Press .

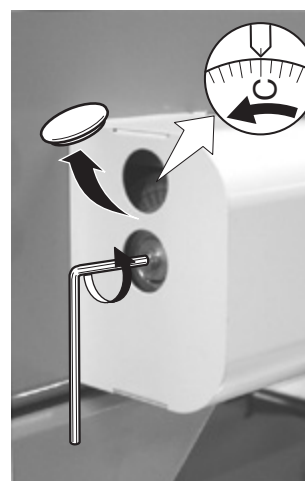



2. Select “Manual”.

The error status is released and the display shows “drive mode”.



3. Using a 5mm wrench, Please turn the main shaft and adjust it to the “C” point.



4. When the machine is stopped, press 

and Press  "OTHER".



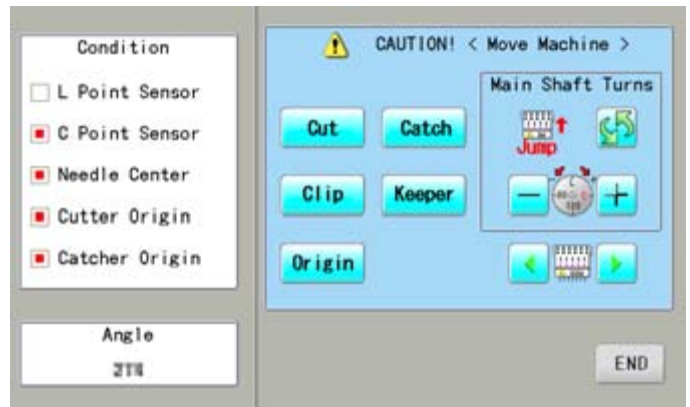
5. Press  Maintenance.

6. Press .


You should hear the sound of moving knife opening.

7. Press .

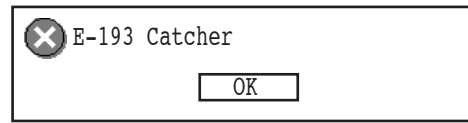
You should hear the sound of moving knife returning to the closed position.



Press  to return to Menu mode.

Press  once again to return to Drive mode.

What to do for “Thread catch hook is off its position (error E-193)”

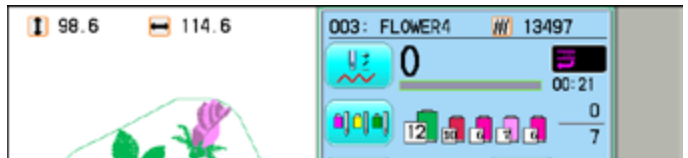


1. Press .

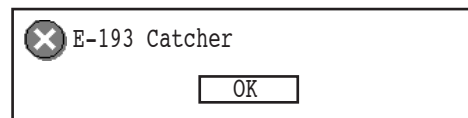


2. Select “Auto”.

The thread catch hook returns to the original position.
The display returns to drive mode.



When you cannot clear by the method above (Auto)

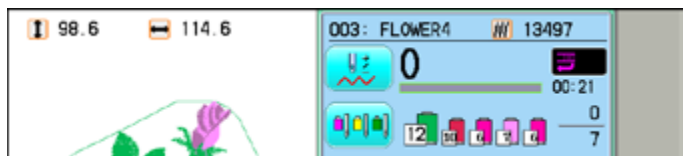


1. Press .



2. Select “Manual”.



The Error status is cleared and the display shows “drive mode”.



3. Refer to the page in the section (ERRORS AND WHAT TO DO), and determine what may be preventing the hook from returning to the original position, and follow the steps outlined. [P 24-3](#)

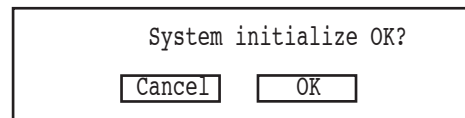
● Re-Initialization of machine system

Perform this function only to fix problems with the machine.
 When performed, all settings in the "OPTION" menu are lost.
 Be sure to reset the "OPTION" menu after performing this function.

1. When the machine is stopped, press  and Press  "OTHER".



2. Press .



3. Press  to carry out.

Formatting of the machines systems are carried out.
 Indicate HAPPY logo in screen.



If you cancel, press the .

The display returns to MENU.



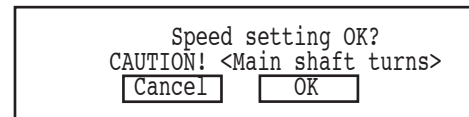
● Initializing of machine speed

If you have E-18, E-30, E-51 or E-52 while sewing, Please try initializing the machine settings.

1. When the machine is stopped, press  and Press  "OTHER".

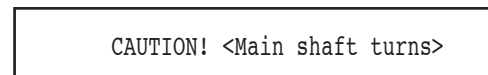


2. Press .

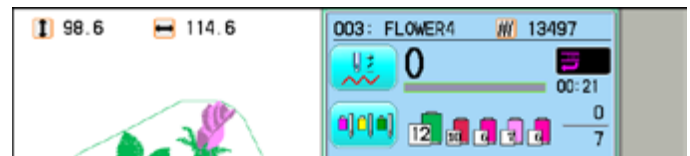


3. Press  to execute.

The machine will display a warning, then start turning the main shaft automatically. The speed will slowly increase from slowest speed to maximum and then stop automatically and return to Drive mode.



If you cancel, press the .



The display returns to MENU.

PROBLEM	CAUSE	CORRECTION	PAGE
Upper thread breaks	Machine not properly threaded. Needle inserted incorrectly. Thread tension too tight. Poor thread quality. Dry hook Empty stitches or continuous tiny stitches in design data. Thread is tangled in an upper thread cone.	Re-thread machine. Re-insert needle. (remember, needles have a front and back!) Readjust thread tension. Replace with good quality thread. Oil the hook. Turn on stitch sweep function, then read design data in again. Un-tangle thread.	4-6 4-1 8-1 23-1b 10-3
Lower (bobbin) thread breaks	Bobbin threaded incorrectly. Bobbin wound unevenly or too full. Thread tension too tight. Dirt on the hook. Dry hook	Re-thread the bobbin. Re-wind the bobbin. Readjust thread tension. Clean the hook. Oil the hook	4-5 4-4 4-5 23-2 23-1b
Thread break lamp lights up despite thread not being broken (False thread breaks)	Upper thread is not passing around the rotary tension disc.	Thread upper thread correctly.	4-7
Machine skips stitches	Needle inserted incorrectly. Bent or blunt needle. Incorrect size of needle.	Re-insert needle. Insert new needle. Choose correct size needle for fabric	4-1 4-1 4-2
Fabric puckers	Machine not properly threaded. Bobbin threaded incorrectly. Blunt needle. Thread tension too tight.	Re-thread machine. Re-thread the bobbin. Insert new needle. Readjust thread tension.	4-6 4-5 4-1 8-1
Machine makes loose stitches or loops	Bobbin threaded incorrectly. Machine not properly threaded. Tension not adjusted properly.	Re-thread the bobbin. Re-thread machine. Readjust thread tension.	4-5 4-6 4-5, 8-1
Poor tension balance	Bobbin threaded incorrectly. Machine not properly threaded. Dry hook	Re-thread the bobbin. Re-thread machine. Oil rotary hook.	4-5 4-6 23-1b
Poor design registration	Fabric not hooped correctly. Garment is made of elastic material. Hoop not installed into machine properly.	Set hooping correctly. Use correct backing and ensure that design has proper underlay. Set hoop correctly.	6-2, 7-6 7-9 6-2, 7-6 7-9 6-3, 7-6 7-9
Needle breaks	Bent or blunt needle. Needle setting incorrect. Thin needle against material. Poor hooping.	Insert new needle. Re-insert needle. Change to thicker needle. Re-hoop fabric.	4-1 4-1 4-2
Machine runs with difficulty	Dirt on the hook race.	Clean rotary hook. Oil rotary hook.	23-2 23-1b
Machine does not get Electric Power	Cord not plugged into electrical outlet. Power switch is not turned on.	Insert plug fully into outlet. Turn on the switch.	 5-1
Can not set power switch ON position	Emergency stop button in locked position.	Release emergency stop button lock.	3-3

Thread break back

With this setting, drive frame backs up several stitches after a thread break before stopping.

Color change number

The Needle number (thread color) to be sewn can be set to each Color change number. For example, if a pattern is divided by a color change function in 2 places, 3 color change numbers exist in the pattern. When the needle number is set to its respective color change number, the pattern is sewn in 3 colors.

Memory pattern

Patterns stored in memory.

Start point of the frame

This is the point where the frame begins to move before the machine starts sewing.

Various function settings

A general term for Needle bar selection, Convert, Pattern adjustment, Repeat sewing, Offset and frame out which are set in the pattern data.

Zero stitch

This is a stitch whose net movement in both the X- and Y- direction is zero, and the needle lands in the same position.

Original Point

The frame position where the machine embroiders the pattern from the beginning is automatically registered as the original point.

Stitches

This is the minimum unit within the pattern data. There are different types of such "stitches": "stitches" that command determine the sewing sequence; "functions" that dictate functions such as jumps, thread cut, etc; "sideways movement distance" and "lengthwise movement distance" that command the movement distance of the frame.

Auto origin

This returns the frame automatically to the original point upon finishing the embroidery.

Tubular round frame, Tubular square frame

The frames made by HAPPY and used for cylinder sewing, such as on T-shirts, bags, etc. These frames have brackets at both sides.

Memory media

What saves design data by things, such as memory card and a USB memory.

Data format

This is the format that the pattern data is converted into/

Color change stop

When a color change stop is assigned to a color change number, the machine embroiders the set color change and stops.

Conversion

This is a user-adjustable design setting of a given pattern that allows rotation in increments of 90 degrees.

Basic script, Diacritic script


<p>ABC</p>	<p>ABCDEFGHIJKLMNOPQRSTUVWXYZ abcdefghijklmnopqrstuvwxyz 0123456789,./!<>()&-@_: ÀÁÂÃÄÅÆÇÐĎÈÉÊËĚÍÎÏŇŃÓÔÕÖŐØŒ ŘŠŤÙÚÛÜŮÝŽ àáâãäåæççďèéêëěíîïňňóôõöőøœ řšťùúûüůýžß</p>
<p>ABC</p>	<p>ABCDEFGHIJKLMNOPQRSTUVWXYZ abcdefghijklmnopqrstuvwxyz 0123456789,./!<>()&- '@_: ÀÁÂÃÄÅÆÇÐĎÈÉÊËĚÍÎÏŇŃÓÔÕÖŐØŒ ŘŠŤÙÚÛÜŮÝŽ àáâãäåæççďèéêëěíîïňňóôõöőøœ řšťùúûüůýžß</p>
<p>ABC</p>	<p><i>ABCDEFGHIJKLMNOPQRSTUVWXYZ abcdefghijklmnopqrstuvwxyz 0123456789,./!<>()&- '@_ ÀÁÂÃÄÅÆÇÐĎÈÉÊËĚÍÎÏŇŃÓÔÕÖŐØŒ ŘŠŤÙÚÛÜŮÝŽ àáâãäåæççďèéêëěíîïňňóôõöőøœ řšťùúûüůýžß</i></p>
<p>ABC</p>	<p>A B C D E F G H I J K L M N O P Q R S T U V W X Y Z abcdefghijklmnopqrstuvwxyz 0123456789,./!<>()&- '@_: À Á Â Ã Ä Å Æ Ç Ð Ď È É Ê Ë Ě Í Î Ï Ň Ń Ó Ô Õ Ö Ő Ø Œ Ř Š Ť Ù Ú Û Ü Ů Ý Ž à á â ã ä å æ ç ç ď è é ê ë ě í î ï ň ů ó ô õ ö ő ø œ ř š ť ù ú û ü ů ý ž ß</p>
<p>ABC</p>	<p><i>ABCDEFGHIJKLMNOPQRSTUVWXYZ abcdefghijklmnopqrstuvwxyz 0123456789,./!<>()&- '@_: À Á Â Ã Ä Å Æ Ç Ð Ď È É Ê Ë Ě Í Î Ï Ň Ń Ó Ô Õ Ö Ő Ø Œ Ř Š Ť Ù Ú Û Ü Ů Ý Ž à á â ã ä å æ ç ç ď è é ê ë ě í î ï ň ů ó ô õ ö ő ø œ ř šť ù ú û ü ů ý ž ß</i></p>

<p>ABC</p>	<p>A B C D E F G H I J K L M N O P Q R S T U V W X Y Z A B C D E F G H I J K L M N O P Q R S T U V W X Y Z 0 1 2 3 4 5 6 7 8 9 , . / ! ? < > () & - ' @ _ : À Á Â Ã Ä Å Æ Ç È É Ê Ë Ì Í Î Ï Ñ Ò Ó Ô Õ Ö Ø Ù Ř Š Ť Ů Ú ů Ű ű Ų ų Ŵ Ŷ ŷ À Á Â Ã Ä Å Æ Ç È É Ê Ë Ì Í Î Ï Ñ Ò Ó Ô Õ Ö Ø Ù Ř Š Ť Ů Ú ů Ű ű Ų ų Ŵ Ŷ ŷ</p>
<p><i>ABC</i></p>	<p><i>A B C D E F G H I J K L M N O P Q R S T U V W X Y Z</i> <i>a b c d e f g h i j k l m n o p q r s t u v w x y z</i> <i>0 1 2 3 4 5 6 7 8 9 . / ! ? < > () & - ' @ _ :</i> <i>À Á Â Ã Ä Å Æ Ç È É Ê Ë Ì Í Î Ï Ñ Ò Ó Ô Õ Ö Ø Ù</i> <i>Ř Š Ť Ů Ú ů Ű ű Ų ų Ŵ Ŷ ŷ</i> <i>à á â ã ä å æ ç è é ê ë ì í î ï ñ ò ó ô õ ö ø ù</i> <i>ř š ť ů ú ů Ű ű Ų ų Ŵ Ŷ ŷ</i></p>
<p>ABC</p>	<p>A B C D E F G H I J K L M N O P Q R S T U V W X Y Z A B C D E F G H I J K L M N O P Q R S T U V W X Y Z 0 1 2 3 4 5 6 7 8 9 , . / ! ? < > () & - ' @ _ : À Á Â Ã Ä Å Æ Ç È É Ê Ë Ì Í Î Ï Ñ Ò Ó Ô Õ Ö Ø Ù Ř Š Ť Ů Ú ů Ű ű Ų ų Ŵ Ŷ ŷ À Á Â Ã Ä Å Æ Ç È É Ê Ë Ì Í Î Ï Ñ Ò Ó Ô Õ Ö Ø Ù Ř Š Ť Ů Ú ů Ű ű Ų ų Ŵ Ŷ ŷ</p>
<p><i>ABC</i></p>	<p><i>A B C D E F G H I J K L M N O P Q R S T U V W X Y Z</i> <i>a b c d e f g h i j k l m n o p q r s t u v w x y z</i> <i>0 1 2 3 4 5 6 7 8 9 . / ! ? < > () & - ' @ _ :</i> <i>À Á Â Ã Ä Å Æ Ç È É Ê Ë Ì Í Î Ï Ñ Ò Ó Ô Õ Ö Ø Ù</i> <i>Ř Š Ť Ů Ú ů Ű ű Ų ų Ŵ Ŷ ŷ</i> <i>à á â ã ä å æ ç è é ê ë ì í î ï ñ ò ó ô õ ö ø ù</i> <i>ř š ť ů ú ů Ű ű Ų ų Ŵ Ŷ ŷ</i></p>
<p>ABC</p>	<p>A B C D E F G H I J K L M N O P Q R S T U V W X Y Z a b c d e f g h i j k l m n o p q r s t u v w x y z 0 1 2 3 4 5 6 7 8 9 , . / ! ? < > () & - ' @ _ : À Á Â Ã Ä Å Æ Ç È É Ê Ë Ì Í Î Ï Ñ Ò Ó Ô Õ Ö Ø Ù Ř Š Ť Ů Ú ů Ű ű Ų ų Ŵ Ŷ ŷ à á â ã ä å æ ç è é ê ë ì í î ï ñ ò ó ô õ ö ø ù ř š ť ů ú ů Ű ű Ų ų Ŵ Ŷ ŷ</p>

ABC	<p>A B C D E F G H I J K L M N O P Q R S T U V W X Y Z a b c d e f g h i j k l m n o p q r s t u v w x y z 0 1 2 3 4 5 6 7 8 9 , . / ! ? < > () & - ' @ _ : À Á Â Ã Ä Å Æ Ç È É Ê Ë Ì Í Î Ï Ñ Ò Ó Ô Õ Ö Ø Ù Ř Š Ť Ù Ú Û Ü Ý Ž à á â ã ä å æ ç è é ê ë ì í î ï ñ ò ó ô õ ö ø ø œ ř š ť ù ú û ü ý ž ß</p>
ABC	<p>A B C D E F G H I J K L M N O P Q R S T U V W X Y Z a b c d e f g h i j k l m n o p q r s t u v w x y z 0 1 2 3 4 5 6 7 8 9 , . / ! ? < > () & - ' @ _ : À Á Â Ã Ä Å Æ Ç È É Ê Ë Ì Í Î Ï Ñ Ò Ó Ô Õ Ö Ø Ù Ř Š Ť Ù Ú Û Ü Ý Ž à á â ã ä å æ ç è é ê ë ì í î ï ñ ò ó ô õ ö ø ø œ ř š ť ù ú û ü ý ž ß</p>





































































































Cyrillic script

АБВ	<p>А Б В Г Д Е Ё Ж З И Й К Л М Н О П Р С Т У Ф Х Ц Ч Ш Щ Ъ Ы Ь Э Ю Я Г Г Ъ Е С І І Ј Л Њ Ъ Ъ К Ў Ц а б в г д е ё ж з и й к л м н о п р с т у ф х ц ч ш щ ъ ы ь э ю я г г ъ е с і і ј л њ њ к ѳ ц 0 1 2 3 4 5 6 7 8 9 , . / ! ? < > () & - ' @ _ :</p>
АБВ	<p>А Б В Г Д Е Ё Ж З И Й К Л М Н О П Р С Т У Ф Х Ц Ч Ш Щ Ъ Ы Ь Э Ю Я Г Г Ъ Е С І І Ј Л Њ Ъ Ъ К Ў Ц а б в г д е ё ж з и й к л м н о п р с т у ф х ц ч ш щ ъ ы ь э ю я г г ъ е с і і ј л њ њ к ѳ ц 0 1 2 3 4 5 6 7 8 9 , . / ! ? < > () & - ' @ _ :</p>
АБВ	<p>А Б В Г Д Е Ё Ж З И Й К Л М Н О П Р С Т У Ф Х Ц Ч Ш Щ Ъ Ы Ь Э Ю Я Г Г Ъ Е С І І Ј Л Њ Ъ Ъ К Ў Ц а б в г д е ё ж з и й к л м н о п р с т у ф х ц ч ш щ ъ ы ь э ю я г г ъ е с і і ј л њ њ к ѳ ц 0 1 2 3 4 5 6 7 8 9 , . / ! ? < > () & - ' @ _ :</p>

Those fonts are created by  (www.i-cliqq.com)

BUILT-IN PATTERN LIST

26-4

 D001	 D002	 D003	 D004	 D005	 D061	 D062	 D063	 D064	 D065
 D006	 D007	 D008	 D009	 D010	 D066	 D067	 D068	 D069	 D070
 D011	 D012	 D013	 D014	 D015	 D071	 D072	 D073	 D074	 D075
 D016	 D017	 D018	 D019	 D020	 D076	 D077	 D078	 D079	 D080
 D021	 D022	 D023	 D024	 D025	 D081	 D082	 D083	 D084	 D085
 D026	 D027	 D028	 D029	 D030	 D086	 D087	 D088	 D089	 D090
 D031	 D032	 D033	 D034	 D035	 D091	 D092	 D093	 D094	 D095
 D036	 D037	 D038	 D039	 D040	 D096	 D097	 D098	 D099	 D100
 D041	 D042	 D043	 D044	 D045					
 D046	 D047	 D048	 D049	 D050					
 D051	 D052	 D053	 D054	 D055					
 D056	 D057	 D058	 D059	 D060					

BUILT IN PATTERN includes clip art from [Master clip] created by H2soft (Fax:+81-422-28-5211 E-mail:support@office4dc.co.jp).



HappyJapan Inc.

HEAD OFFICE 3-3515, Tachiyagawa, Yamagata-city, 990-2251, Japan
Phone: +81-23-686-2272 Fax: +81-23-686-2243

TOKYO OFFICE 2-9-5, Taito, Taito-Ku, Tokyo 110-0016, Japan
Phone: +81-3-3834-0711 Fax: +81-3-3835-8917