

Service Manual

PIONEER
The future of sound and vision.

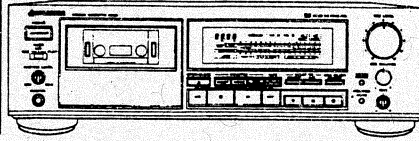

ORDER NO.
ARP1526

STEREO CASSETTE DECK

CT-S800

CT-939

MODEL CT-S800 AND CT-939 HAVE TWO VERSIONS :

Type	Applicable model		Power requirement	Export destination
	CT-S800	CT-939		
KU / CA	○	—	AC120V only	U. S. A. and Canada
HEM	—	○	AC220V, 240V (switchable) *	European continent

* Change of the primary wiring, please refer to page 17.

- This service manual is applicable to the CT-S800/KU/CA and CT-939/HEM types.
- For the CT-939/HEM type, refer to page 51.
- The CT-939 is the same as the CT-S800 except for the color.
- The CT-939 is not equipped with a remote control terminal (SR terminal).
- Ce manuel pour le service comprend les explications en français de réglage.
- Este manual de servicio trata del método ajuste escrito en español.

CONTENTS

1. SPECIFICATIONS	2	8. ELECTRICAL PARTS LIST	25
2. PANEL FACILITIES	3	9. ADJUSTMENTS	30
3. DISASSEMBLY	7	9. RÉGLAGE	37
4. PACKING	9	9. AJUSTE	44
5. EXPLODED VIEWS AND PARTS LIST	10	10. SAFETY INFORMATION	50
6. SCHEMATIC DIAGRAM	17	11. FOR CT-939/HEM TYPES	51
7. P.C. BOARDS CONNECTION DIAGRAM	21		

PIONEER ELECTRONIC CORPORATION 4-1, Meguro 1-Chome, Meguro-ku, Tokyo 153, Japan
PIONEER ELECTRONICS SERVICE INC. P.O. Box 1760, Long Beach, California 90801 U.S.A.
PIONEER ELECTRONICS OF CANADA, INC. 505 Cochrane Drive, Markham, Ontario L3R 8E3 Canada
PIONEER ELECTRONIC [EUROPE] N.V. Keetberglaan 1, 2740 Beveren, Belgium
PIONEER ELECTRONICS AUSTRALIA PTY. LTD. 178-184 Boundary Road, Braeside, Victoria 3195, Australia TEL: [03] 580-9911

SI © APR. 1988 Printed in Japan

1. SPECIFICATIONS

Systems	4 track, 2-channel stereo
Heads	Recording and playback head Laser amorphous playback head/ Hard permalloy recording head combination × 1
Motors	Erasing head:(Ferrite head) × 1 DC servo capstan motor × 1 DC reel motor × 1 DC auxiliary motor × 1
Wow & Flutter	0.024%(WRMS) ± 0.06%(DIN)
Fast winding time	Approximately 80 seconds (C-60 tape)
Frequency response (-20 dB recording)	
Metal tape	20 Hz to 22,000 Hz
Chrome tape	20 Hz to 21,000 Hz
Normal tape	20 Hz to 21,000 Hz
Signal-to-noise ratio	
DOLBY NR OFF	More than 60 dB
Noise Reduction Effect	
DOLBY NR B type ON	More than 10 dB (at 5 kHz)
DOLBY NR C type ON	More than 19 dB (at 5 kHz)
Harmonic distortion	No more than 0.6% (0 dB)
Input	LINE: 67 mV (Input impedance: 50 kΩ)
Output	LINE: 316 mV (Output impedance: 1.4 kΩ) Headphones: 0.8 mW (Load impedance 8Ω VR Max.)

Subfunctions

- 3-mode counter (4-digit electronic counter)
- Auto Tape Loose Canceller function
- Meter range selection (WIDE/EXPAND)
- Auto Monitor function (TAPE/SOURCE auto selection)
- Power Eject (OPEN/CLOSE)
- Music Search (over ± 15 selections)
- Tape Return/Return play
- Headphones jack (with volume control)
- Bias control
- MPX filter
- Auto Space Recording Mute
- Auto Tape Selector
- Playback/Recording timer start function
- Dolby Noise Reduction (B/C)
- Dolby HX Pro system
- FL Level Meter Peak-hold function (15 + 1 segments)
- System remote control available (Not provided in the European model)

Miscellaneous

Power Requirements

U.S., Canadian models	AC 120V, 60 Hz
European model	AC 220V, 50/60 Hz
U.K., Australian models	AC 240V, 50/60 Hz
U.S. military and other destination models	AC 110V/120V - 127V/220V/240V, 50/60 Hz (switchable)

Power Consumption

U.S., Canadian models	25W
European model	28W
U.S. military, other destination models	28W

Dimensions 420(W) × 133.5(H) × 372(D) mm
16-9/16(W) × 5-1/4(H) × 14-5/8(D) in

Weight (without package)

U.S., Canadian, European models	9.6 kg (21 lb 2 oz)
U.S. military, other destination models	9.7 kg (21 lb 4 oz)

Accessories

Operating instructions	1
Connecting cords	2
Control cord (Not provided in the European model)	1

NOTE:

Specifications and design subject to possible modifications without notice, due to improvements.

2. PANEL FACILITIES

• FRONT PANEL

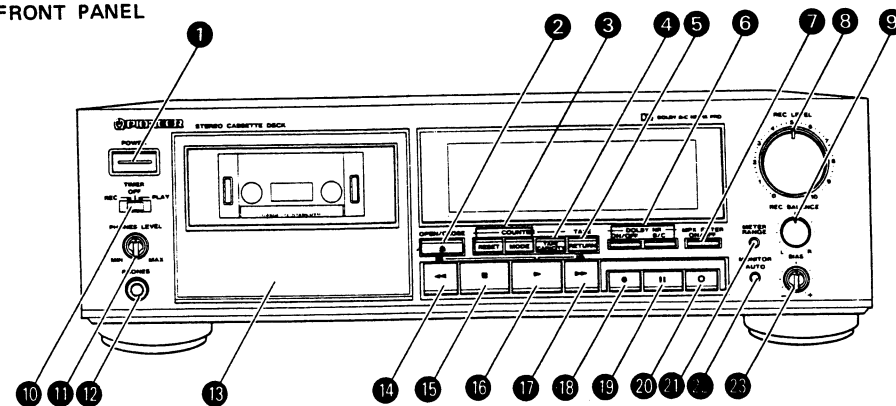

① POWER switch

Turn the power on.
After the power is turned on, the dotted lines in the level meter flash for approximately 4 seconds until the circuits of the unit have stabilized. The unit will not operate during this time even if one of the operation buttons is pressed.

② Cassette door OPEN/CLOSE button

NOTE:

If the cassette door is closed while the unit is turned OFF, and the power is then turned ON, the cassette door may open and close after pressing one of the operation buttons. This occurs when the microprocessor resets the door mechanism to its initial state and does not indicate any malfunctioning of the unit.

③ COUNTER selectors

RESET:
Resets the counter indication to "0000."

MODE:

Each time this button is pressed, one of the following three modes is set in sequence.

- Normal tape counter
- Time counter (displays the elapsed playback or recording time)
- Remaining time counter (displays the remaining time of the tape)

④ TAPE CAPACITY selector

To indicate the correct time value in the remaining time counter mode, this selector must be set in accordance with the tape used.

→ C90 → C80L → C60 → C46L ←

⑤ TAPE RETURN button

This button is used in the tape counter mode to fast forward or rewind the tape to a point near the counter reading "0000".

⑥ DOLBY NR selectors

ON/OFF:
Used to turn the Dolby NR system circuits ON or OFF.

B/C:

With the ON/OFF switch in the ON position, Dolby B or C can be selected with this switch.

⑦ MPX FILTER switch

This switch is effective only during recording with Dolby NR.

⑧ REC LEVEL control

⑨ REC BALANCE control

10 TIMER mode selector

REC: Set to this position for timer recording.

PLAY: Set to this position for timer playback.

OFF: When the timer is not to be used, set the selector to this position. (Normally leave the selector in this position.)

11 PHONES LEVEL control

12 PHONES jack

13 Cassette door

14 Rewind (◀◀) button

Press this button to rewind the tape. When the button is pressed during playback, the tape rewinds to the beginning of the current selection, and playback starts. If the button is pressed twice, the tape rewinds to the selection before the current selection. (see page 11)

15 Stop (■) button

16 Play (▶) button

17 Fast forward (▶▶) button

Press this button to fast forward the tape. When the button is pressed during playback, the tape advances to the beginning of the next selection, and playback starts. If the button is pressed twice, the tape rewinds to the selection after the next selection. (see page 11)

18 Recording (●) button

When this button is pressed, the unit is set to one-touch recording pause (recording standby mode).

19 Pause (■) button

The tape transport can be momentarily stopped by pressing this button during recording or playback. Press the button again to restart operation. The button does not operate during fast forward or rewind.

20 Record muting (MUTE ○) button

Press this button to create an unrecorded space during recording.

21 METER RANGE selector

Selects WIDE or EXPAND as scale range for the level meter.

22 MONITOR selector AUTO

For monitoring the sound during recording, this switch can be used to switch between source sound and just recorded sound.

23 Rec BIAS control

It is possible to adjust the bias according to the tape used and the source to be recorded.

• OPERATING DISPLAY

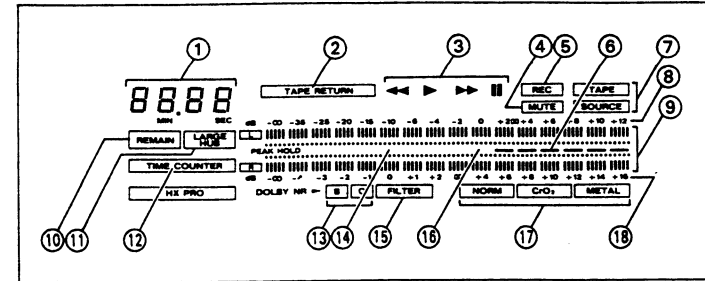

1 Counter

- The counter has three display modes. (See page 9)
If the cassette door is open, the message "OPEN" is displayed.
During music search the number of selections is displayed.

2 TAPE RETURN

Lights up during tape return operation.

3 Tape transport modes

- ◀◀: Lights up when rewinding the tape.
▶: Lights up during playback, playback pause, recording pause and recording. Flashes during music search.
▶▶: Lights up when fast forwarding the tape.
■: Lights up in the pause mode.

4 MUTE

Flashes and lights during recording mute operation.

5 REC

Lights up during recording.

6 Warning zone

Changes according to the type of tape used and to the selected meter range.

7 Monitor source

TAPE: Recorded sound
SOURCE: Original source sound

8 Scale for WIDE range

9 Level

L: Left channel
R: Right channel

The [] mark indicates the reference level for the Dolby A system.

10 REMAIN

Lights up when the remaining time counter mode is selected.

11 LARGE HUB

Lights up when the TAPE CAPACITY selector is pressed, the remaining time counter mode, and the Large Hub mode is set.

12 TIME COUNTER

Lights up in the time counter mode.

13 DOLBY NR B/C

Indicates the selected Dolby Noise Reduction system, B or C.

14 0 dB position for EXPAND range

15 MPX FILTER

Lights up when the MPX FILTER switch is pressed while the Dolby NR system is ON.

16 0 dB position for WIDE range

17 Tape type

The unit will automatically detect and display the tape type (NORMAL/CrO2/METAL) of the cassette inserted. When tape is inserted, METAL is displayed.

18 Scale for EXPAND range

• CONNECTION

Connection of input and output cords

- The cords to be used have white and red pin plugs.
- Connect white plugs to the left channel (L), and red plugs to the right channel (R), making sure that the colors match. Take particular care to insert the plugs all the way in.

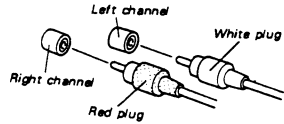

Connection to an audio timer

For details on the connection to an audio timer, refer to the instruction manual of the audio timer.

(Not provided in the European model.)

CONTROL IN jack

Connect this jack to the CONTROL OUT jack of a component equipped with the Pioneer System Remote Control (bearing the  mark) using the supplied mini-plug cord, and you will be able to operate the component using the system remote control.

CONTROL OUT jack

Intermediary output of remote control signals from the above input jack. Connect it to the CONTROL IN jack of another component compatible with the Pioneer System Remote Control.

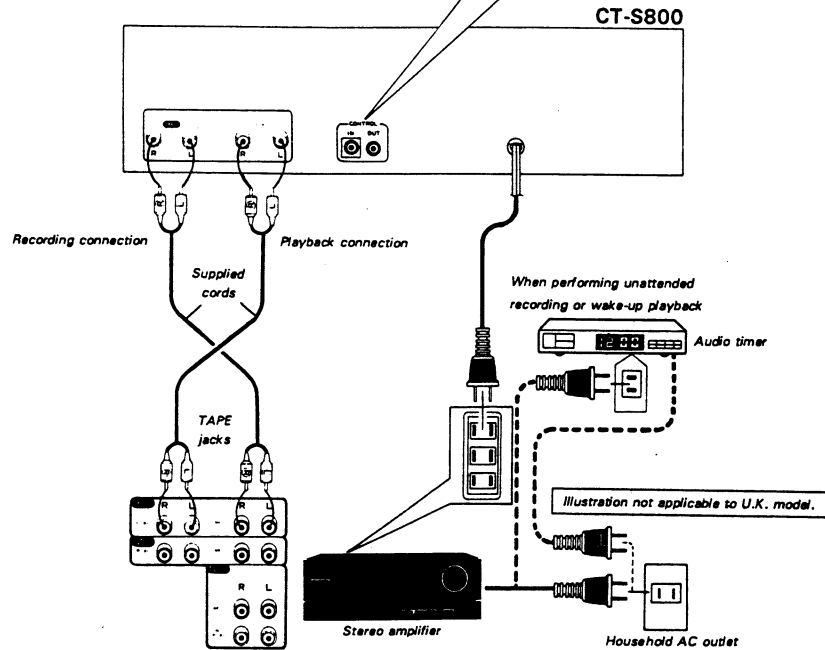

3. DISASSEMBLY

3-1. REMOVAL OF COVER

1. Remove the three screws ① and the four screws ②, and remove the cover.

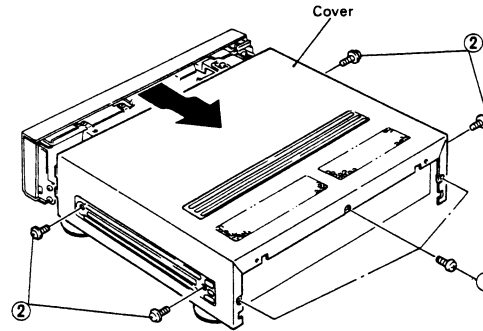

Fig. 3-1. Removal of cover

3-2. REMOVAL OF FRONT PANEL

1. Remove the six screws ① and remove the front panel.

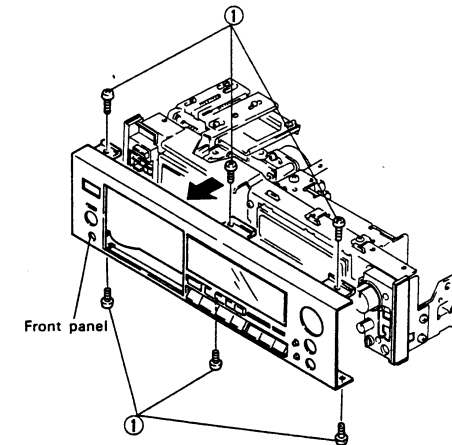

Fig. 3-2. Removal of front panel

3-3. REMOVAL OF MECHANISM UNIT

1. Remove slide SW knob A ①.
2. Remove the two screws ② and remove the side panel (L).
3. Remove the six screws ③ and remove the mechanism unit while rotating in the direction indicated by the arrow.

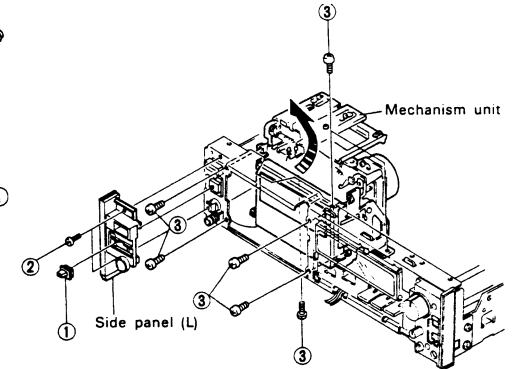

Fig. 3-3. Removal of mechanism unit

3-4. REMOVAL OF AMPLIFIER UNIT

1. Remove the ten screws ① and the four screws ②, and remove the rear panel.
2. Remove the two poly slider washers and remove the VR knob assembly (A) and VR knob B together with the VR shaft.
3. Remove the two screws ③ and remove the INPUT VR unit together with the VR holder.
4. Remove the two screws ④ and the rivet ④, and remove the shield plate.
5. Remove the two screws ⑤ and remove the OSC·HX unit together with the PCB holder.
6. Remove the three push-buttons.
7. Remove the five screws ⑥ and remove the amplifier unit.

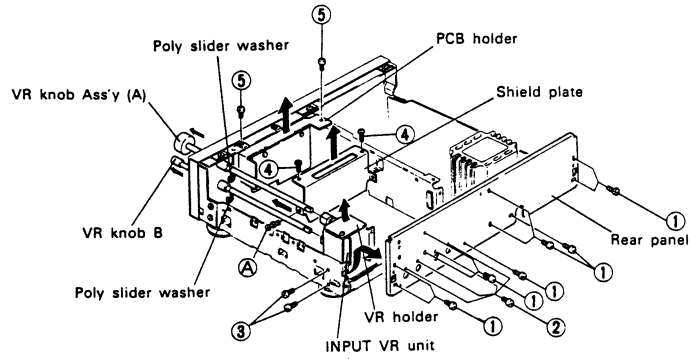

Fig. 3-4-1. Removal of amplifier unit (1)

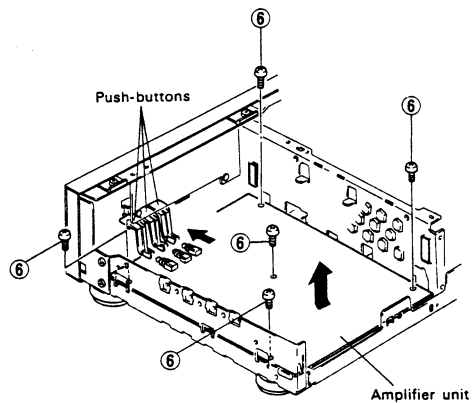
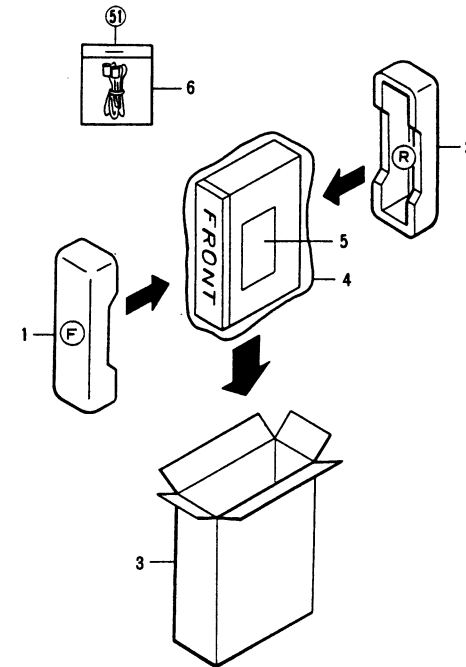

Fig. 3-4-2. Removal of amplifier unit (2)

4. PACKING

Parts list

Mark	No.	Part No.	Description
	1	RHA1021	Pad (F)
	2	RHA1022	Pad (R)
	3	RHG1074	Packing case
	4	RHX-034	Packing sheet
	5	RRB1026	Operating instructions (English)
	6	RDE-010	Connect cord
	51		Connect cord assembly



5. EXPLODED VIEWS AND PARTS LIST

5.1 EXTERIOR

NOTES:

- Parts without part number cannot be supplied.
- The Δ mark found on some component parts indicates the importance of the safety factor of the part. Therefore, when replacing, be sure to use parts of identical designation.
- For your parts Stock Control, the fast moving items are indicated with the marks $\star\star$ and \star .
 $\star\star$ GENERALLY MOVES FASTER THAN \star .
- This classification shall be adjusted by each distributor because it depends on model number, temperature, humidity, etc.
- Parts marked by "O" are not always kept in stock. Their delivery time may be longer than usual or they may be unavailable.

Parts List of Exterior

Mark	No.	Part No.	Description	Mark	No.	Part No.	Description
Δ	1	CM-22C	Strain relief		41	BBZ40P080FCC	Screw
Δ	2	PDG1015	AC power cord		42	BBZ30P060FCC	Screw
$\Delta\star\star$	3	REK-074	Fuse (FU103 1.6A/125V)		43	IBZ30P080FCC	Screw
$\Delta\star\star$	4	REK-080	Fuse (FU101, FU102 1A/125V)		44	BBT30P080FZK	Screw
$\Delta \star$	5	RTT1060	Power transformer (T1)		45	BBZ40P160FCC	Screw
\star	6	SLF-401C	Diode (D11)		46	FBT40P080FZK	Screw
	7	DBK-106	Mounting plate		47	BBZ26P080FZK	Screw
	8	PNB1109	Absorber B		101		Tape mechanism unit
	9	RBF1019	Washer		102		Power transformer sheet
	10	RBH1150	Spring		103		Tape mechanism sheet
					104		VR rod
	11	RBL-059	Cassette plate spring		105		Main chassis
	12	RBM-014	Nylon rivet 3.5x5.5				
	13	REB-223	Cover cushion (D)		106		Panel stay
	14	REB1038	Stabilizer B		107		Center stay
	15	REB1057	Rubber spacer (A)		108		VR holder
					109		P.C.B holder
	16			110		Shield plate
	17	RNH-184	Cord clamper				
	18	AMR1159	Leg assembly		111		PS holder
	19	PAC1208	Knob (PHONES LEVEL)		112		VR rod guide
	20	RAC-668	Knob A (TIMER)		113		Joint
					114		P.C.B stud
	21	RAC1203	Button (POWER)		115		Cassette plate
	22	RAC1204	Button (DOLBY, MPX)				
	23	RAC1205	Button (COUNTER)		116		Front panel
	24	RAC1206	Button (CONTROL)		117		Rear panel
	25	RAC1262	VR knob B		118		Fuse caution label
					119		FL unit
	26	RAH1214	FL filter		120		SW unit
	27	RAP1003	Under escutcheon				
	28	RNK1284	Door		121		Power supply unit
	29	RNK1285	Button holder		122		OSC.HX unit
	30	RXA1158	VR knob assembly (A)		123		Timer unit
					124		Control unit
	31	RXA1160	Button assembly (MONITOR)		125		BIAS VR unit
	32	RAH1197	Door lens		126		Headphone unit
	33	RAH1198	FL panel		127		Input VR unit
	34	RAH1200	Side panel (L)		128		Amp unit
	35	RAH1201	Side panel (R)				
	36	RAH1196	Door panel				
	37	RXX1064	Cassette plate assembly				
	38	RXX1092	Bonnet				
	39	RXX1096	Front panel assembly				
	40	RXX1065	Door assembly				

1

2

3

4

5

6

A

A

B

B

C

C

D

D

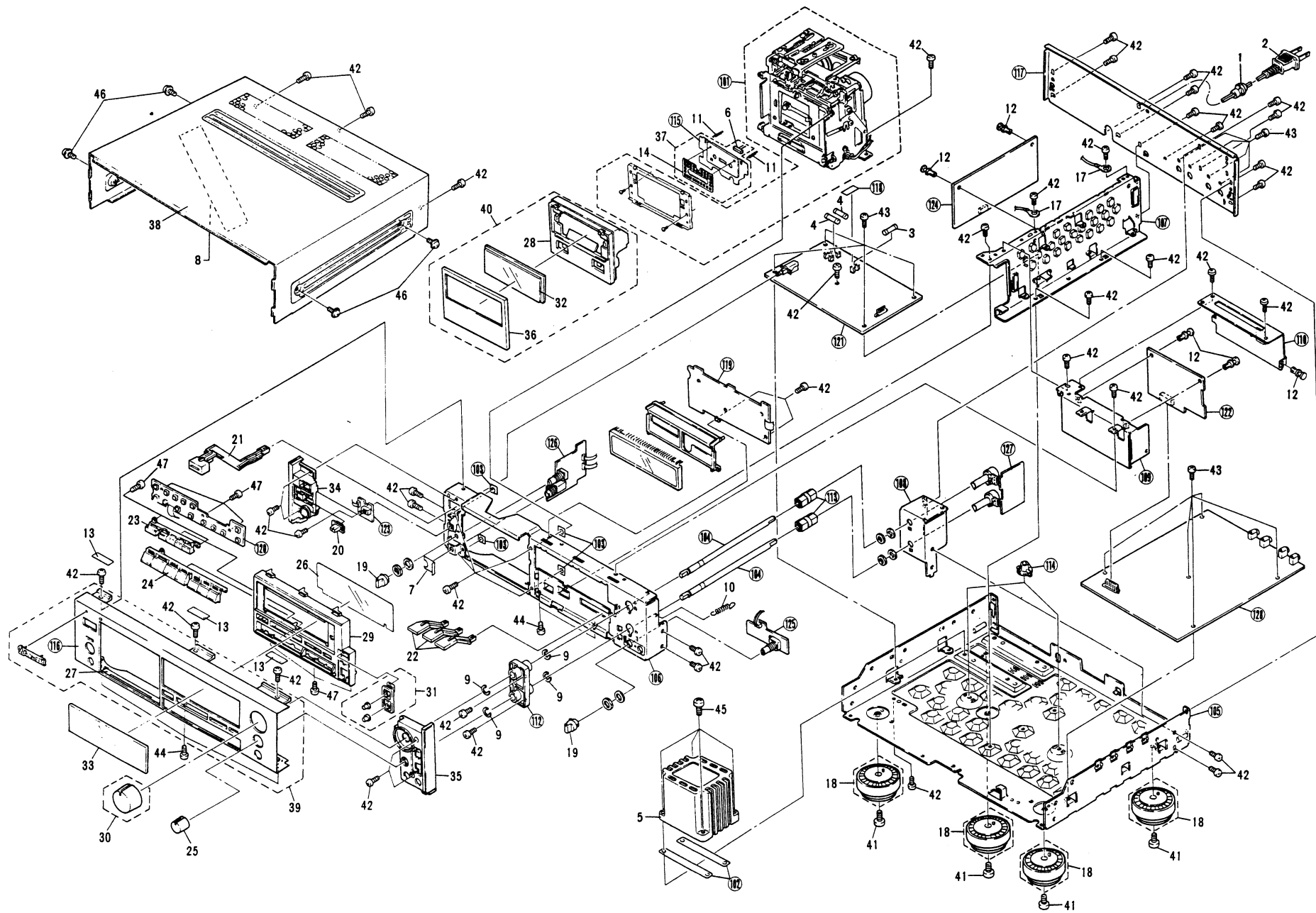

1

2

3

4

5

6

1

2

3

4

5

6

5. 2 MECHANISM UNIT

A

B

C

D

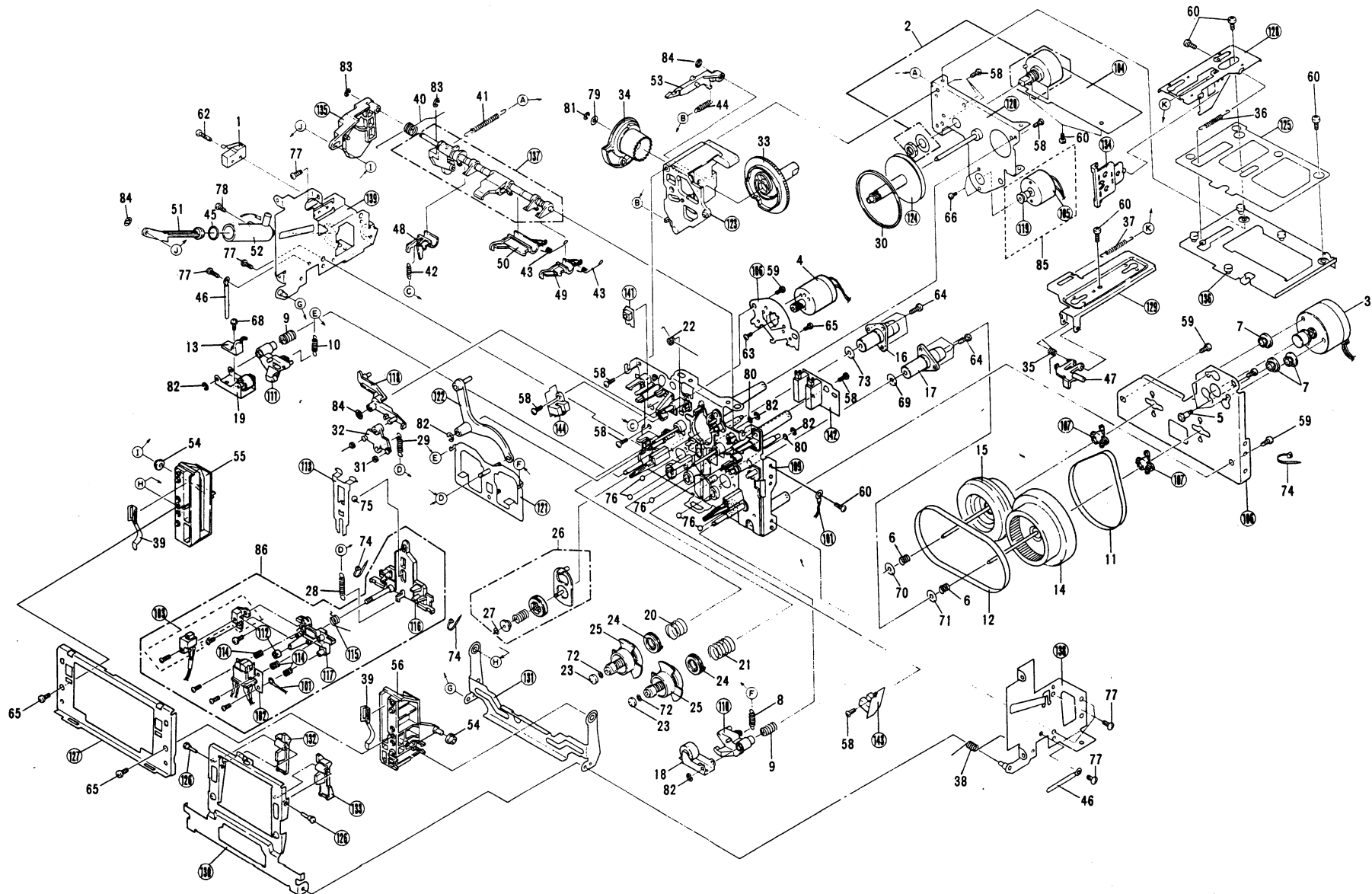

Par

Ma

★
★
★

★
★

★

A

B

C

D

1

2

3

4

5

6

Part List of Mechanism Unit

Mark	No.	Part No.	Description	Mark	No.	Part No.	Description	
A	★★	1	RSF-031	Micro switch		56	RNL-850	Pocket (R)
	★★	2	RSX-059	Rotary encoder		57	RBF-057	Polyslider washer
	★★	3	RXM1016	Capstan motor assembly		58	BBZ26P080FZK	Screw
	★★	4	RXM1018	Reel motor assembly		59	BBZ30P080FZK	Screw
		5	RBA-064	Step screw		60	BCZ30P060FMC	Screw
		6	RBL-044	Thrust spring		61	BMZ20P080FZK	Screw
		7	REB-408	Rubber cushion		62	BMZ23P100FZK	Screw
		8	RBL-028	Pinch spring		63	BMZ26P030FZK	Screw
		9	RBL-030	Pinch thrust spring		64	BMZ26P060FZK	Screw
		10	RBL-098	Pinch spring (SUB)		65	BMZ30P080FZK	Screw
B	★★	11	REB-501	Capstan belt		66	JGZ20P025FMC	Screw
	★★	12	REB-509	Capstan belt (A)		67	PMA26P050FZK	Screw
		13	RNL-016	Tape guide		68	PMA26P060FZK	Screw
		14	RXA1176	Flywheel assembly		69	RBF-030	Oil stopper
		15	RXA1177	Flywheel assembly (SUB)		70	RBF-069	Thrust washer (A)
		16	RXB-362	Metal holder assembly A		71	RBF-070	Thrust washer (B)
		17	RXB-466	Metal holder assembly B		72	RBF-076	Slider washer
		18	RXB-876	Pinch roller arm (B) assembly		73	RBF-077	Oil stopper
		19	RXB-877	Pinch roller arm (A) assembly		74	REC-371	Binder
		20	RBL-031	BT spring (A)		75	REF-022	Steel ball (φ 3)
C		21	RBL-032	BT spring (B)		76	REF-023	Steel ball (φ 4)
		22	RBL-033	Idler pressure spring		77	VCT30P060FZK	Screw
		23	RNK-815	Reel shaft cap B		78	VCZ26P080FMC	Screw
		24	RXB-751	BT disc assembly		79	WA26N070W040	Washer
		25	RXB-874	Reel base assembly		80	WA32D080D050	Washer
		26	RXB-875	Take-up idler assembly		81	YE20FUC	E ring
		27	RBF-065	Polyslider washer		82	YE25FUC	E ring
		28	RBL-037	Head base spring	★★	83	YE30FUC	E ring
		29	RBL-038	Brake spring		84	YS24FBT	Washer
		30	REB-502	Drive belt		85	RXX1055	Power motor assembly
D		31	REB-511	Brake shoe		86	RXX1060	Head base assembly
		32	RNL-723	Brake		101		Earth lead wire assembly
		33	RNL-729	Cam gear		102		R/P head
		34	RXB-884	Side cam gear assembly		103		Erase head assembly
		35	RBH1136	Arm shock-absorb spring		104		Connector unit
		36	RBH1137	Plate (A) return spring		105		Power motor
		37	RBH1138	Plate (B) return spring		106		Reel motor mounting plate
		38	RBH1142	Frame return spring		107		Flywheel holder
		39	RBL-027	Pocket spring (A)		108		Thrust holder
		40	RBL-039	Eject spring		109		Mechanism chassis assembly
E		41	RBL-040	Half pressure spring		110		Pressure arm (R)
		42	RBL-041	Rec arm spring		111		Pressure arm (L)
		43	RBL-042	Detect arm spring		112		Adjustment nut
		44	RBL-043	Lock lever spring		113		Head base pressure spring
		45	REB-447	O ring		114		Head adjust spring (C)
		46	RNH-184	Cord clamper		115		Hight spring
		47	RNK1297	Arm		116		Head base
		48	RNL-733	Rec detect arm		117		Sub head base
		49	RNL-734	CrO ₂ detect arm		118		Brake lever
		50	RNL-735	Metal detect arm		119		First pulley
F		51	RNL-739	Piston		120		Gear chassis assembly
		52	RNL-740	Cylinder		121		Pinch base assembly
		53	RNL-741	Lock lever		122		Pinch lever assembly
		54	RNL-742	Collar		123		Gear base assembly
		55	RNL-849	Pocket (L)		124		Second pulley assembly
						125		Absorber

Mark	No.	Part No.	Description
	126		Cassette clamp shaft
	127		Pocket frame
	128		Plate (A)
	129		Plate (B)
	130		Frame
	131		Door arm
	132		Cassette clamper (L)
	133		Cassette clamper (R)
	134		Side plate
	135		Eject lever
	136		Top frame assembly
	137		Shift shaft assembly
	138		Door frame (R) assembly
	139		Door frame (L) assembly
	140	
	141		Rec switch unit
	142		Tape selector unit
	143		Sensor unit (A)
	144		Sensor unit (B)

2SA970
2SC2240

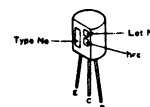

2SA1283
2SC3243

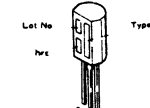

2SA1309A
2SC3311A

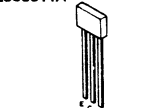

2SB950
2SD1276

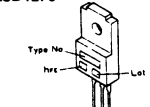

2SD1302

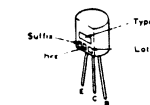

2SK246

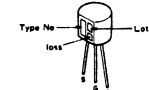

2SK389

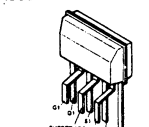

BA335
BA6138

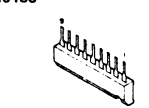

BA6109

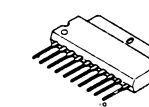

LC7570

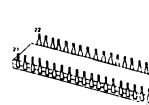

M5201L
M5218L
M5220L
M5233L

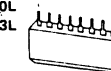

M5218P

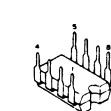

μPC1297CA

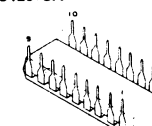

μPD4050BC

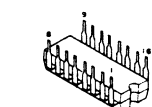

2SA936

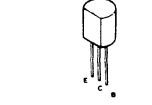

CX20188

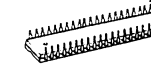

PD4148

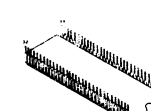

NJM78M09FA

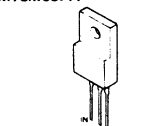

NJM79M09FA

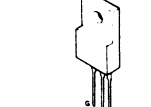

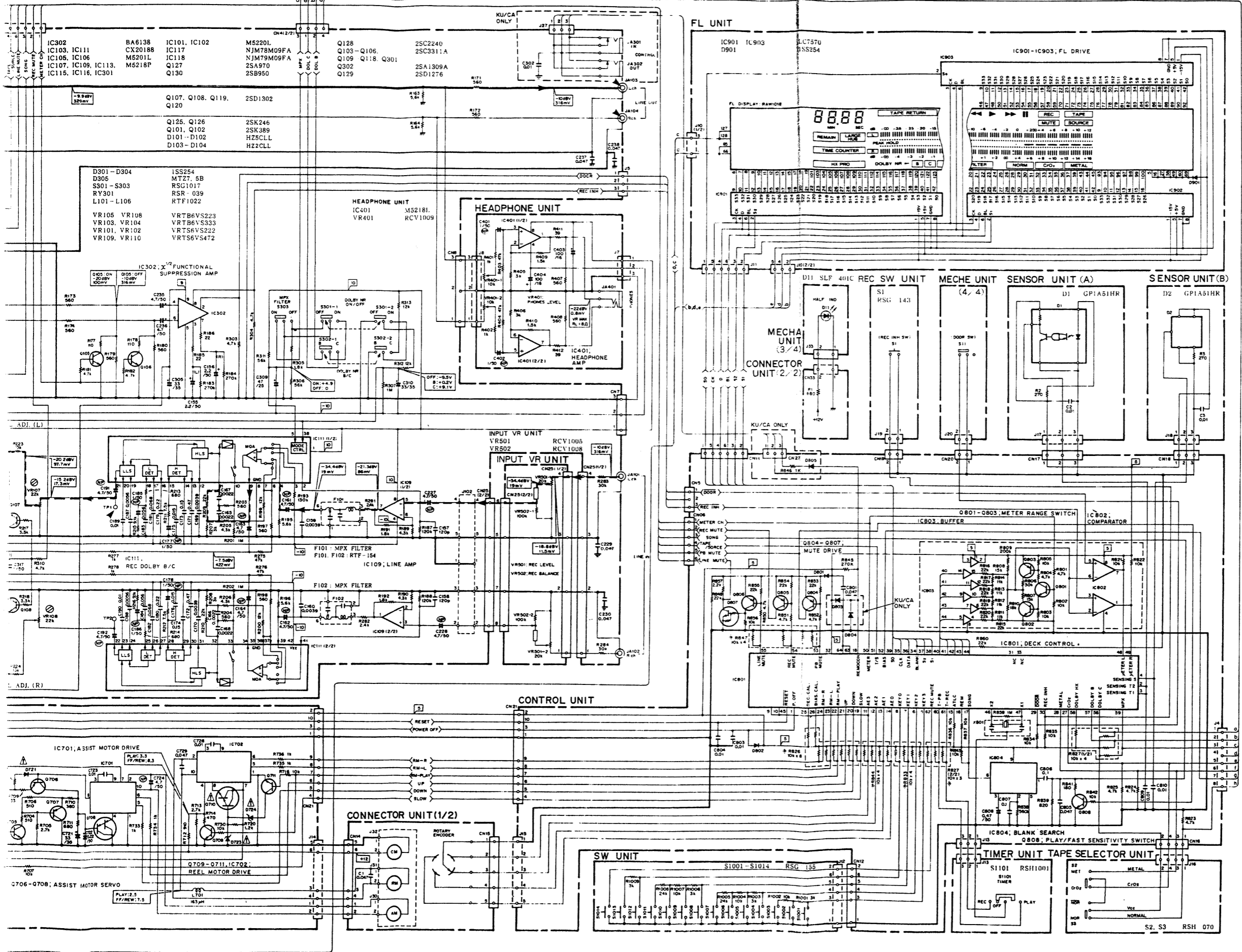

- POWER SUPPLY UNIT**
- | | |
|------------------------------|------------|
| IC701, IC702 | BA6109 |
| Q702 | 2SA1283 |
| Q706, Q707, Q713, Q715 | 2SA1309A |
| Q708 | 2SA936 |
| Q705, Q709, Q711, Q712, Q714 | 2SC3311A |
| Q701, Q703, Q704, Q710 | 2SD1276 |
| D723 | MTZ10C |
| D716 | MTZ13B |
| D718, D719 | MTZ6.2B |
| D724 | MTZ6.8C |
| D713 | RD2.7EB1 |
| | (RD2.7EB2) |
| D709 | 1B2Z1-LC2 |
| D711 | 1B2Z1-LC2 |
| D714, D715, D720, D723 | 1SR35 100A |
| D705, D706, D722 | 1SS254 |
| D701, D704 | 10DF2FA9 |
| D717 | MTZ12B |
| S701 | RSA-063 |
| L701 | RTF-160 |
| C733 | RCG-013 |
| C701, C702 | RCH1013 |
| C720 | RCH1010 |
- CONTROL UNIT**
- | | |
|------------|------------|
| IC804 | BA335 |
| IC802 | M5233L |
| IC801 | PD4148B |
| IC803 | μ PD4050BC |
| Q803-Q806 | 2SA1309A |
| Q807 | DTC143ES |
| Q801, Q802 | 2SC3311A |
| Q808 | 2SD1302 |
| D801-D805 | 1SS254 |
| R826 | DCN1009 |
| R844, R847 | RCX1008 |
| R833 | RCX1009 |
| R827 | RCX1010 |
| X801 | VSS1014 |
- 1. RESISTORS**
Indicated in Ω, 1/4W, 1/6W and 1/8W. ±5% tolerance unless otherwise noted; k: kΩ, M: MΩ, (F): ±1%, (G): ±2%, (K): ±10%, (M): ±20% tolerance
- 2. CAPACITORS**
Indicated in capacity (μF)/voltage (V) unless otherwise noted; p, pF. Indication without voltage is 50V except electrolytic capacitor.
- 3. VOLTAGE, CURRENT**
□: DC voltage (V) at no input signal; Value in () is DC voltage at rated power.
- 4. SWITCHES**
The underlined indicates the switch position.
- AMP UNIT**
- | | | |
|------|------------|--------|
| S301 | DOLBY NR | ON-OFF |
| S302 | DOLBY NR | B-C |
| S303 | MPX FILTER | ON-OFF |
- SW UNIT**
- | | | |
|-------|---------------|---|
| S1001 | STOP | ■ |
| S1002 | REW | ◀ |
| S1003 | REC | ● |
| S1004 | OPEN/CLOSE | ▲ |
| S1005 | FF | ▶ |
| S1006 | PAUSE | ■ |
| S1007 | TAPE RETURN | ◀ |
| S1008 | PLAY | ▶ |
| S1009 | COUNTER RESET | ■ |
| S1010 | COUNTER MODE | ■ |
| S1011 | HUB | ■ |
| S1012 | METER RANGE | ■ |
| S1013 | MONITOR AUTO | ■ |
| S1014 | REC MUTE | ○ |
- TAPE SELECTOR SELECTOR UNIT**
- | | | |
|----|-------------|---------------|
| S2 | TAPE SELECT | METAL-CR2 |
| S3 | TAPE SELECT | NORMAL-NORMAL |
- TIMER UNIT**
- | | | |
|-------|-------|--------------|
| S1101 | TIMER | REC-OFF-PLAY |
|-------|-------|--------------|
- REC SW UNIT**
- | | | |
|----|---------|--------|
| S1 | REC INH | OFF-ON |
|----|---------|--------|
- MECHA UNIT**
- | | | |
|------|------|----------|
| S011 | DOOR | OFF-OPEN |
|------|------|----------|
- POWER SUPPLY UNIT**
- | | | |
|------|--------------|---|
| S701 | POWER ON-OFF | ■ |
|------|--------------|---|
- 5. OTHERS**
⊙: Signal route.
⊙: Adjusting point.
The ⊙ mark found on some component parts indicates the importance of the safety factor of the part. Therefore, when replacing, be sure to use parts of identical designation.
⊗: marked capacitors and resistors have parts numbers.
- This is the basic schematic diagram, but the actual circuit may vary due to improvements in design.

5. P.C. BOARDS CONNECTION DIAGRAM

AMP UNIT

A

MECHA UNIT (1/3)

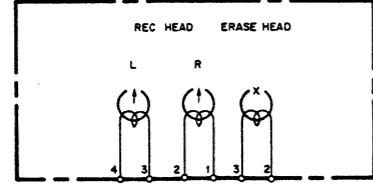

OSC. HX UNIT

IC601 Q606
VR601 VR602
Q608 Q609 Q610 Q611 Q617 Q602 Q603 Q601 Q607 Q605 Q604
VR605 VR603 VR604

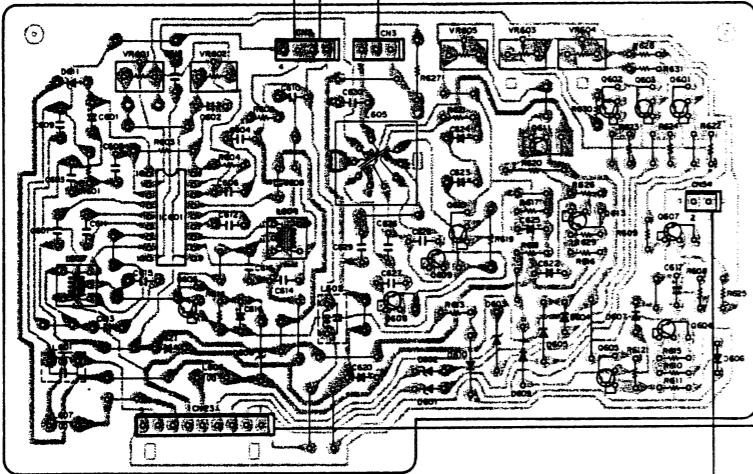

B

C

INPUT VR UNIT

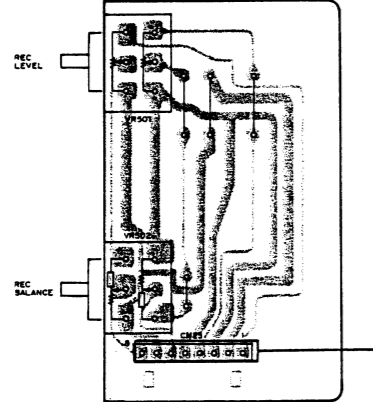

MECHA UNIT (2/3)

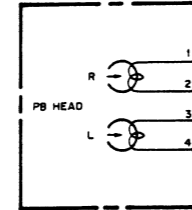

D

BIAS VR UNIT

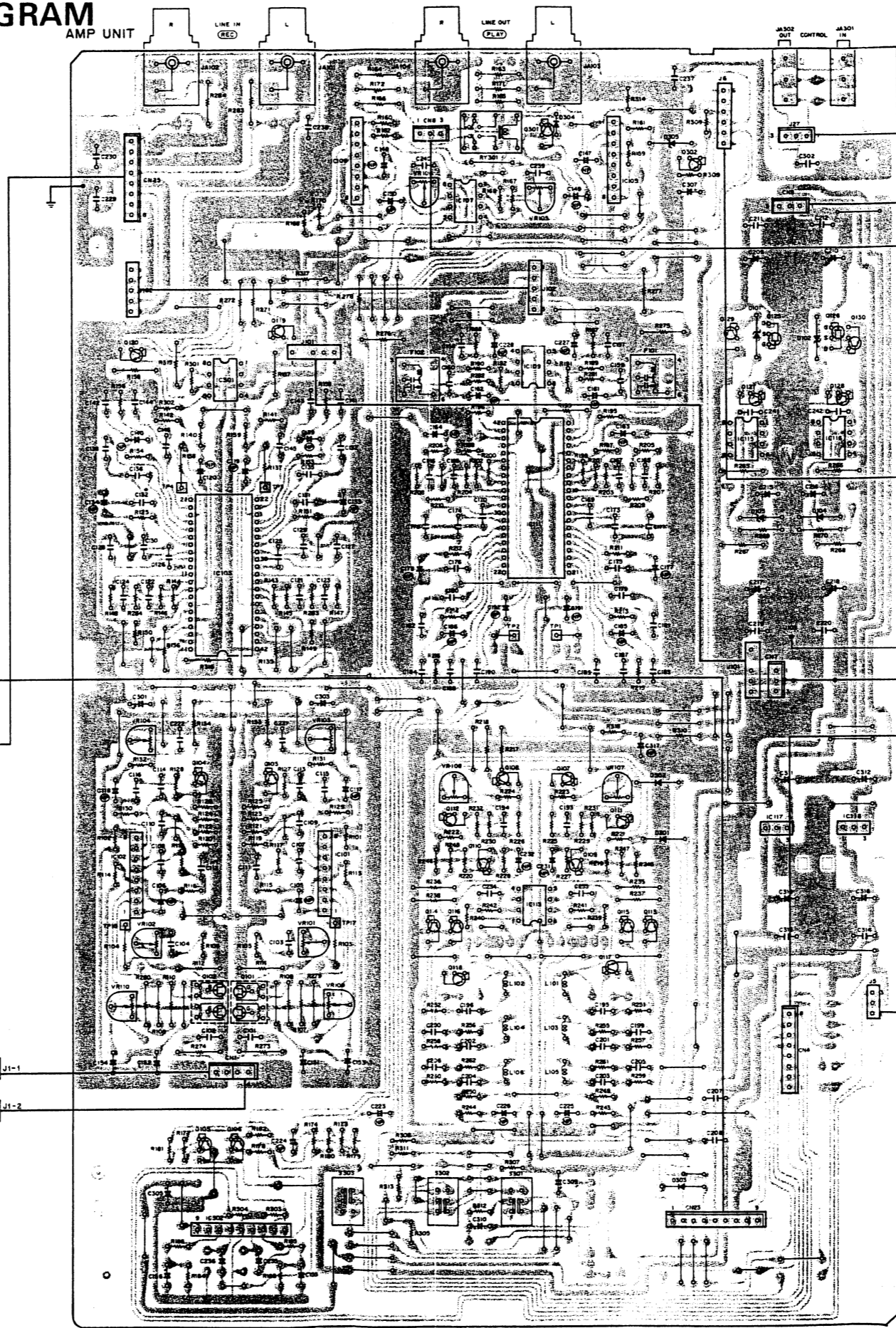
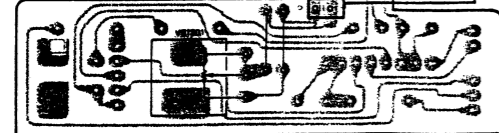

FL UNIT

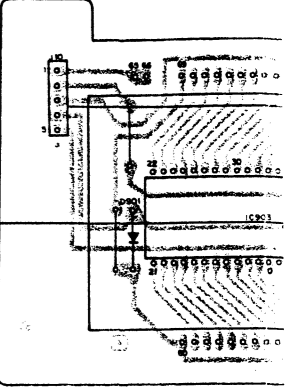

CONTROL UNIT

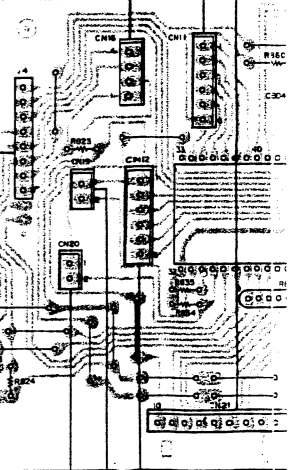

SW UNIT

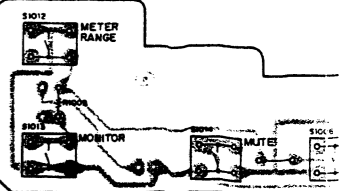

1

2

3

4

5

6

7

8

9

10

11

12

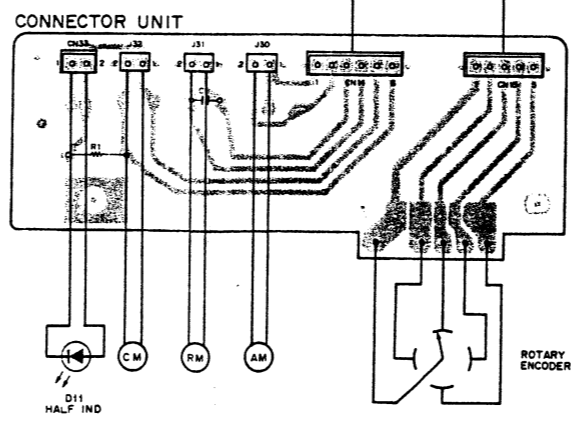
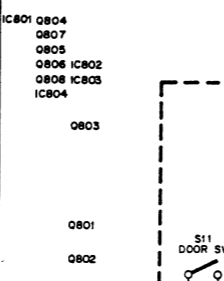
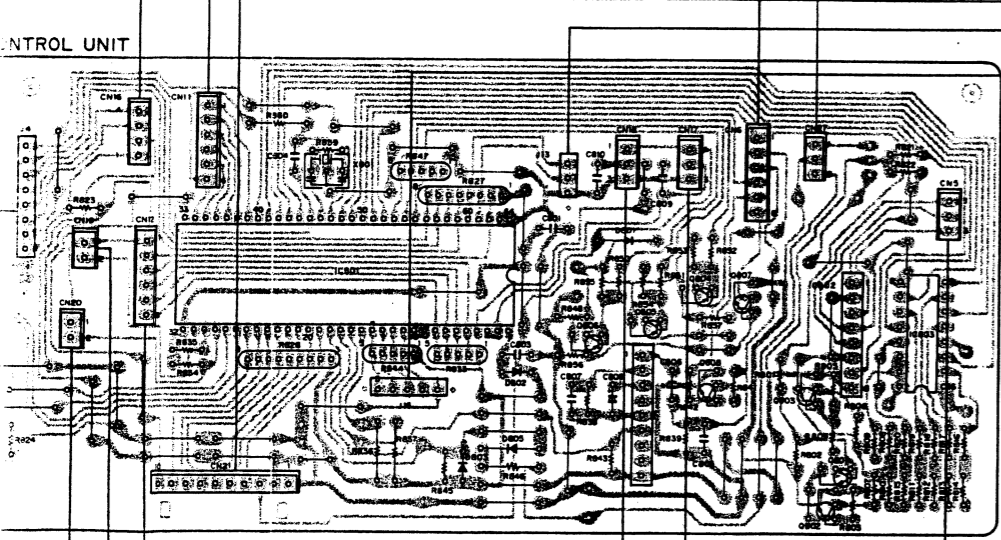
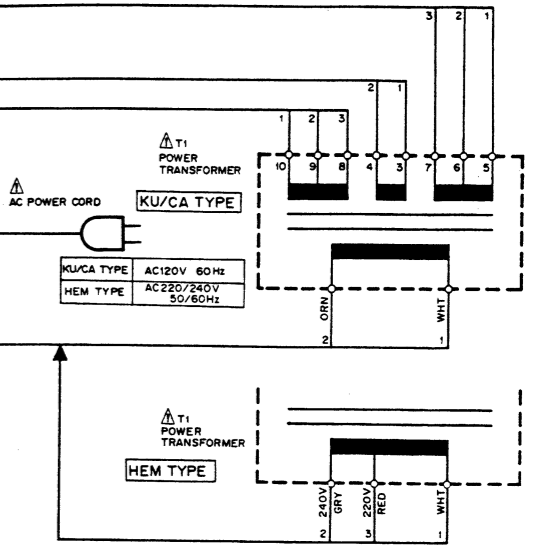
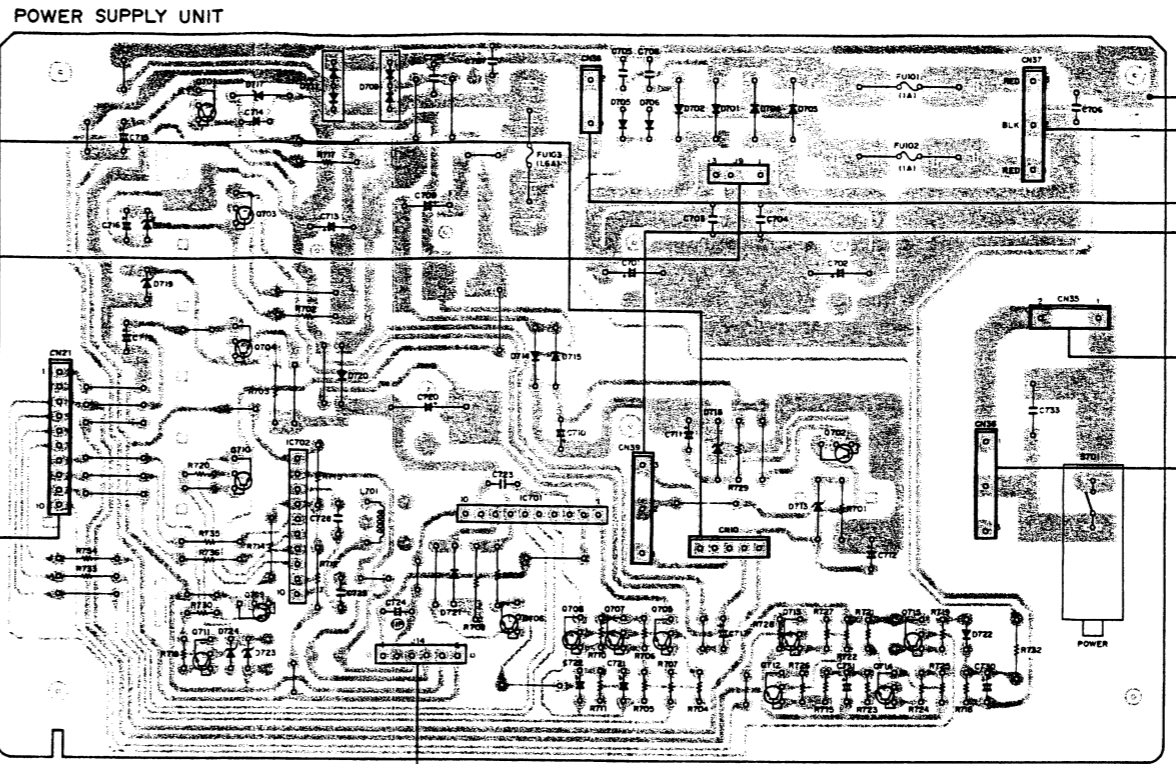
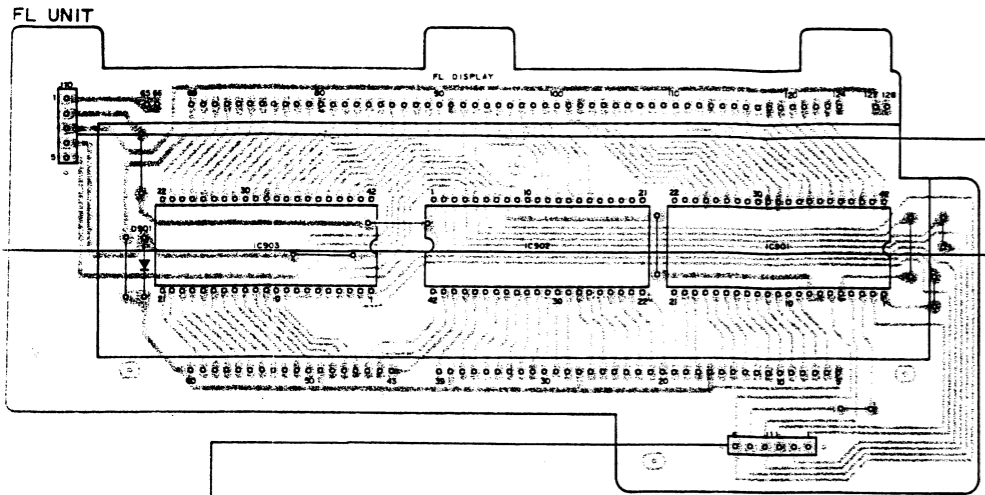

MECHA UNIT (3/3)

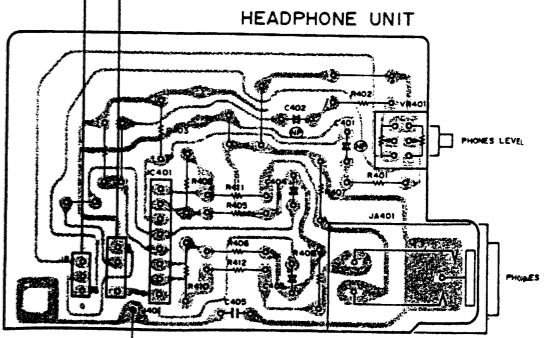
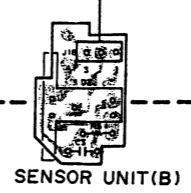
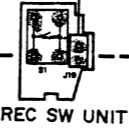
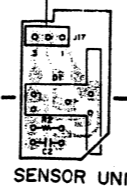
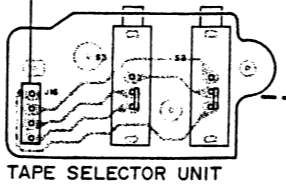
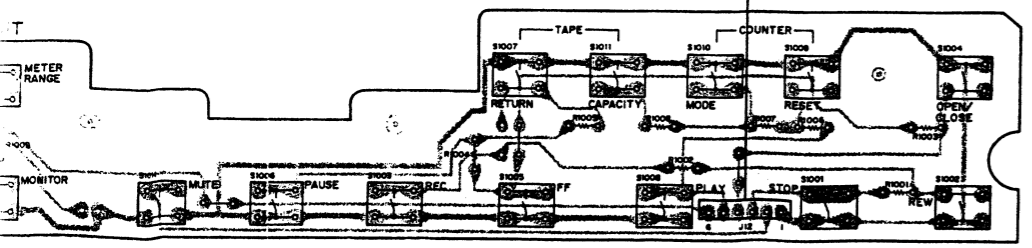
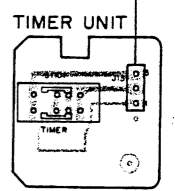

7

8

9

10

11

12

A

B

C

D

8. ELECTRICAL PARTS LIST

NOTES :

- Parts without part number cannot be supplied.
- Parts marked by "O" are not always kept in stock. Their delivery time may be longer than usual or they may be unavailable
- The Δ mark found on some component parts indicates the importance of the safety factor of the part. Therefore, when replacing, be sure to use parts of identical designation.
- For your parts Stock Control, the fast moving items are indicated with the marks ★★ and ★.
- ★★ **GENERALLY MOVES FASTER THAN ★.**

This classification shall be adjusted by each distributor because it depends on model number, temperature, humidity, etc.

- When ordering resistors, first convert resistance values into code form as shown in the following examples.

Ex.1 When there are 2 effective digits (any digit apart from 0), such as 560 ohm and 47k ohm (tolerance is shown by J=5%, and K=10%).

560 Ω	56×10 ¹	561	RD1/4PS	561J
47k Ω	47×10 ³	473	RD1/4PS	473J
0.5 Ω	0R5		RN2H	05K
1 Ω	010		RS1P	010K

Ex.2 When there are 3 effective digits (such as in high precision metal film resistors).

5.62k Ω	562×10 ¹	5621	RN1/4SR	5621F
---------	---------------------	------	-------	---------	-------

Miscellaneous Parts

P.C. BOARD ASSEMBLIES

Mark	Symbol & Description	Part No.
	Control unit	
	PL unit	
	SW unit	
Δ	Power supply unit	
	OSC.HX unit	
	Timer unit	
	BIAS VR unit	
	Headphone unit	
	INPUT VR unit	
	Amp unit	
	REC SW unit	
	Tape selector unit	
	Connector unit	
	Sensor unit (A)	
	Sensor unit (B)	

OTHERS

Mark	Symbol & Description	Part No.
Δ★★	FU103 Fuse (1.6A)	REK-102
Δ★★	FU101, FU102 Fuse (1A)	REK-100
★	T1 Power transformer	RTT1061
Δ	AC power cord	PDG1003
	D11 LED	SLF-401C
★★	S11 Micro switch	RSF-031
★★	Rotary encoder	RSX-059
★★	Capstan motor assembly	RXM1016
★★	Reel motor assembly	RXM1018
★★	Power motor assembly	RXX1055
★★	Head base assembly	RXX1060

Control Unit

SEMICONDUCTORS

Mark	Symbol & Description	Part No.
	IC804	BA335
	IC802	M5233L
	IC801	PD4148B
	IC803	μ PD4050BC
	Q807	DTC143ES
	Q803-Q806	2SA1309A
	Q801, Q802	2SC3311A
	Q808	2SD1302
	D801-D805	1SS254

CAPACITORS

Mark	Symbol & Description	Part No.
	C808	CEASR47M50
	C806, C807	CGCYX104K25
	C805	CGCYX473K25
	C803, C804, C809, C810	CKCYF103Z50
	C801	CKCYF473Z50

RESISTORS

Mark	Symbol & Description	Part No.
	R826 (10k×8)	DCN1009
	R844, R847 (10k×4)	RCX1008
	R833 (22k×4)	RCX1009
	R827 (10k×7)	RCX1010
	R836, R837, R846	RD¼PM□□□J
	R806-R820	RN¼PQ□□□□
	Other resistors	RD¼PM□□□J

OTHERS

Mark	Symbol & Description	Part No.
	CN21 Connector socket	W-D2510
	X801 Ceramic resonator (4.19MHz)	VSS1014

FL Unit

SEMICONDUCTORS

Mark	Symbol & Description	Part No.
	IC901-IC903 D901	LC7570 1SS254

OTHERS

Mark	Symbol & Description	Part No.
	Fluorecent tube	RAW1018

SW Unit

SWITCHES

Mark	Symbol & Description	Part No.
	S1001-S1014 Tact switch (\blacksquare , \blacktriangleleft , \bullet , \blacktriangleright , \blacksquare , II, TAPE RETURN, \blacktriangleright , COUNTER RESET, COUNTER MODE, TAPE CAPACITY, METER RANGE, MONITOR, \circ)	RSG-155

RESISTORS

Mark	Symbol & Description	Part No.
	All resistors	RD $\frac{1}{2}$ PM $\square\square\square$ J

Power Supply Unit

SEMICONDUCTORS

Mark	Symbol & Description	Part No.
Δ	IC701, IC702 Q702 Q706, Q707, Q713, Q715 Q708 Q705, Q709, Q711, Q712, Q714	BA6109 2SA1283 2SA1309A 2SA936 2SC3311A
\perp	Q701, Q703, Q704, Q710 D723 D716 D718, D719 D724	2SD1276 MTZ10C MTZ138 MTZ5.2B MTZ6.8C
\perp	D717 D713	MTZ12B RD2.7EB1 (RD2.7EB2)
\perp	D709 D711 D714, D715, D720, D721	1B2C1-LC2 1B2Z1-LC2 1SR35-100A
\perp	D705, D706, D722 D701-D704	1SS254 10DF2FA9

SWITCH

Mark	Symbol & Description	Part No.
Δ	S701 (POWER)	RSA-063

COIL

Mark	Symbol & Description	Part No.
	L701 Line coil filter	RTF-160

CAPACITORS

Mark	Symbol & Description	Part No.
	C724 C722 C717, C719 C714-C716 C710	CEANP4R7M50 CEASR22M50 CEAS101M10 CEAS101M25 CEAS102M25
	C709 C711, C712, C721, C731 C713 C730 C723, C728	CEAS222M25 CEAS330M35 CEAS332M25 CEAS4R7M50 CKCYF103Z50
Δ	C703-C708, C729, C732, C734 C720 (6800 μ F/25V) C701, C702 (2200 μ F/25V) C733 (0.01 μ F/250V)	CKCYF473Z50 RCH1010 RCH1013 VCG-044

RESISTORS

Mark	Symbol & Description	Part No.
	R708 R702, R703, R717, R729 R701, R709, R712-R714, R732-R736 Other resistors	RS1LMF010J RD $\frac{1}{2}$ PMF $\square\square\square$ J RD $\frac{1}{2}$ PM $\square\square\square$ J RD $\frac{1}{2}$ PM $\square\square\square$ J

OTHERS

Mark	Symbol & Description	Part No.
	CN21 Connector	W-P9810

OSC.HX Unit

SEMICONDUCTORS

Mark	Symbol & Description	Part No.
	IC601 Q601-Q603 Q605, Q606 Q608-Q610 Q604, Q607, Q613	μ PC1297CA DTC114ES 2SA1309A 2SC3243 2SC3311A
	Q611 D601-D603 D611 D608	2SD1276 MTZ11B RD2.7EB-F RD3.0FB1 (RD3.0FB2) 1SS254
	D604-D607, D609, D610	

COILS

Mark	Symbol & Description	Part No.
	L603, L604 Stop up coil L605 OSC coil L606, L607 Line coil L601, L602 Trap coil	RTD1011 RTD1014 RTF-101 RTF-163

CAPACITORS

Mark	Symbol & Description	Part No.
	C618 C609, C610 C622 C620, C621 C601, C602, C619, C623-C625	CCCCH120J50 CCCSL470K500 CEAS100M50 CEAS221M16 CEAS330M35
	C617 C607, C608, C626 C627, C628 C629 C605, C606	CEAS4R7M50 CFTXA223J50 CFTXA332J50 CFTXA682J50 CGCYX103K25
	C611, C612 C615, C616 C613, C614 C603, C604 C630	CKCYF473Z50 CGCYX473K25 CGCYB391J500 CKPUYB821K50 CQPA822J100

RESISTORS

Mark	Symbol & Description	Part No.
	VR601, VR602, VR604, VR605 Semi-fixed (10k)	VRTG6HS103
	VR603 Semi-fixed (22k) R627 R619	VRTG6HS222 RS1LMF010J RD $\frac{1}{2}$ PMF6R8J
	R603, R620 Other resistors	RD $\frac{1}{2}$ PM $\square\square\square$ J RD $\frac{1}{2}$ PM $\square\square\square$ J

OTHERS

Mark	Symbol & Description	Part No.
	CN23 Connector socket	W-D2509

Timer Unit

SWITCH

Mark	Symbol & Description	Part No.
	S1101 Slide SW (TIMER REC-OFF-PLAY)	RSH1001

BIAS VR Unit

RESISTORS

Mark	Symbol & Description	Part No.
	VR1201 Variable resistor 5k-B (BIAS)	RCV1007

Headphone Unit

SEMICONDUCTOR

Mark	Symbol & Description	Part No.
	IC401	M5218L

CAPACITORS

Mark	Symbol & Description	Part No.
	C401, C402 C403, C404 C405	CEYANP010M5C CEZA101M16 CGCYX473K25

RESISTORS

Mark	Symbol & Description	Part No.
	VR401 Variable resistor 10k-B \times 2 (PHONES LEVEL) Other resistors	RCV1009 RD $\frac{1}{2}$ PM $\square\square\square$ J

OTHERS

Mark	Symbol & Description	Part No.
	JA401 (PHONES)	RKN1002

INPUT VR Unit

RESISTORS

Mark	Symbol & Description	Part No.
	VR501 Variable resistor 20k-A \times 2 (REC LEVEL)	RCV1005
	VR502 Variable resistor 100k-MN (REC BALANCE)	RCV1008

OTHERS

Mark	Symbol & Description	Part No.
	CN25 Connector socket	W-D2508

Amp Unit

SEMICONDUCTORS

Mark	Symbol & Description	Part No.
	IC302 IC103, IC111 IC105, IC106 IC107, IC109, IC113, IC115, IC116, IC301 IC101, IC102	BA6138 CX20188 M5201L M5218P M5220L
Δ	IC117 IC118	NJM78M09FA NJM79M09FA
Δ	Q302 Q127 Q130	2SA1309A 2SA970 2SB950
Δ	Q128 Q103-Q106, Q109-Q118, Q301 Q129 Q107, Q108, Q119, Q120 Q125, Q126	2SC2240 2SC3311A 2SD1276 2SD1302 2SK246
Δ	Q101, Q102 D103, D104 D101, D102 D305 D301-D304	2SK389 HZ2CLL HZ5CLL MTZ7.5B 1SS254

SWITCHES AND RELAY

Mark	Symbol & Description	Part No.
	S301-S303 Push switch (MPX FILTER, DOLBY B/C, DOLBY ON/OFF)	RSG1017
	RY301 Relay	RSR-039

COILS

Mark	Symbol & Description	Part No.
	L101-L106 Coil (5.6mH)	RTF1022

CAPACITORS

Mark	Symbol & Description	Part No.
	C133, C134, C139, C140, C117, C178, C185, C186, C317	CEANP010M50
	C155, C156	CEAS2R2M50
	C311, C312	CEAS221M25
	C305, C310	CEAS330M35
	C235, C236, C307	CEAS4R7M50
	C309	CEAS470M25
	C315, C316	CEAS471M16
	C149, C150, C231, C232	CEYANP010M50
	C105, C106, C117-C120, C147, C148, C161-C164, C191, C192, C223-C228	CEYANP4R7M50
	C151-C154, C215-C218, C301, C303	CEZA101M16
	C209, C210	CEZA221M25
	C145, C146, C189, C190, C195, C196, C201, C202	CFTXA103J50
	C107, C108, C207, C208	CFTXA152J50
	C131, C132, C175, C176	CFTXA153J50
	C129, C130, C173, C174	CFTXA154J50
	C111, C112	CFTXA182J50
	C121-C124, C165-C168, C239, C240	CFTXA222J50
	C135, C136, C179, C180	CFTXA224J50
	C221, C222	CFTXA332J50
	C233, C234	CFTXA334J50
	C125, C126, C159, C160, C169, C170, C193, C194	CFTXA392J50
	C113, C114	CFTXA473J50
	C127, C128, C171, C172	CFTXA474J50
	C143, C144, C187, C188, C199, C200, C205, C206	CFTXA562J50
	C103, C104, C141, C142, C183, C184	CFTXA563J50
	C137, C138, C181, C182	CFTXA683J50
	C203, C204	CFTXA822J50
	C219, C220, C229, C230, C237, C238, C313, C314	CGCYX473K25
	C211, C212, C302	CKCYF103Z50
	C157, C158	CKPUYB121K50
	C115, C116	CKPUYB151K50
	C241, C242	CKPUYB21K50
	C101, C102	CKSF151J50
	C109, C110	CKSF301J50

RESISTORS

Mark	Symbol & Description	Part No.
	VR105-VR108	VRTB6VS223
	Semi-fixed (22k)	
	VR103, VR104	VRTB6VS333
	Semi-fixed (33k)	
	VR101, VR102	VRTS6VS222
	Semi-fixed (2.2k)	
	VR109, VR110	VRTS6VS472
	Semi-fixed (4.7k)	
	R115-R120	RD $\frac{1}{4}$ PU□□□J
	R103, R104, R107-R112, R273, R274, R279, R280, R283, R284	RDR $\frac{1}{4}$ PM□□□J
	R133-R138, R157, R158, R163-R166, R171, R172, R193, R217, R218, R235- R238, R265-R272, R275-R278, R310, R315-R317	RD $\frac{1}{4}$ PM□□□J
	Other resistors	RD $\frac{1}{4}$ PM□□□J

OTHERS

Mark	Symbol & Description	Part No.
	JA101, JA103 1P Pin jack (W) (Lch LINE IN/OUT)	RKB1010
	JA102, JA104 1P Pin jack (R) (Rch LINE IN/OUT)	RKB1011
	JA301, JA302 (Remote control IN/OUT)	RKN1004
	CN25 Connector	W-P9808
	CN23 Connector	W-P9809
	MPX Filter	RTF-154

REC SW Unit

SWITCH

Mark	Symbol & Description	Part No.
	S1 Tact switch (REC INH)	RSG-143

Tape selector Unit

SWITCH

Mark	Symbol & Description	Part No.
	S2, S3 Slide switch (NORMAL, CrO ₂ METAL)	RSH-070

Connector Unit

CAPACITOR

Mark	Symbol & Description	Part No.
	C1	CKCYF473Z50

RESISTOR

Mark	Symbol & Description	Part No.
	R1	RD $\frac{1}{4}$ PM681J

Sensor Unit (A)

SEMICONDUCTOR

Mark	Symbol & Description	Part No.
	D1 Photo interrupter	GP1A51HR

CAPACITOR

Mark	Symbol & Description	Part No.
	C2	CKPUYY103N16

RESISTOR

Mark	Symbol & Description	Part No.
	R2	RD $\frac{1}{4}$ PM271J

Sensor Unit (B)

SEMICONDUCTOR

Mark	Symbol & Description	Part No.
	D2 Photo interrupter	GP1A51HR

CAPACITOR

Mark	Symbol & Description	Part No.
	C3	CKPUYY103N16

RESISTOR

Mark	Symbol & Description	Part No.
	R3	RD $\frac{1}{4}$ PM271J

9. ADJUSTMENT

9-1. MECHANISM RELATED ADJUSTMENT

1. Tape running and azimuth adjustment				2. Tape Speed Adjustment		
No.	Mode	Adjustment Location	Specifications	Mode	Adjustment Location	Specifications
1			Insert half mirror in side A (set screws at front).	PLAY	Capstan motor adjustment hole (Refer to Fig. 3.)	Adjust so that the playback frequency is 3015 ± 5 Hz at the beginning of winding of test tape STD-301.
2	PLAY	Height adjustment nut (Refer to Fig. 1.)	Playback the above tape and adjust so that there is no curling of the tape in the guide section of the head. (Refer to Fig. 2.)	PLAY		Playback test tape STD-301 again and confirm that the above specifications are satisfied.
3	PLAY	Azimuth adjustment screw (Refer to Fig. 1.)	Playback test tape STD-331B and adjust so that the 10 kHz output level is maximum and also so that there is no phase difference between L-ch and R-ch.			
4			Check Item 2 above again and adjust again if it does not satisfy the specifications. (Be sure to adjust Item 3 when Item 2 is adjusted.)			

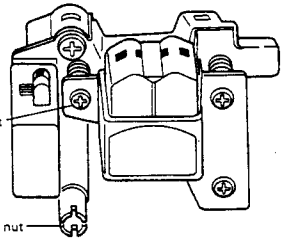

Azimuth adjustment screw

Height adjustment nut

Fig. 1.

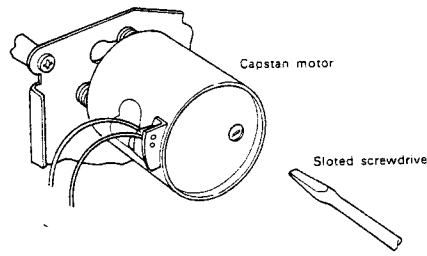

Capstan motor

Slotted screwdriver

Fig. 3.

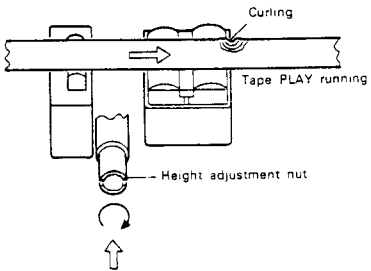

Curling

Tape PLAY running

Height adjustment nut

Fig. 2.

3. Adjustment of Air Damper

Adjustment Location	Specifications
Cylinder adjustment screw (Refer to Fig. 4.)	Make sure that the door opens smoothly, there is no two-stage motion, and that there is no bounding when it opens completely. (Perform with no cassette half inserted.)

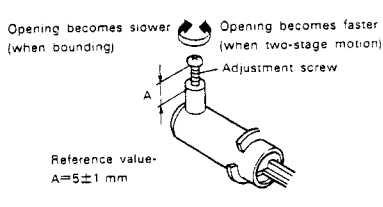

Opening becomes slower (when bounding)

Opening becomes faster (when two-stage motion)

Adjustment screw

Reference value-
A=5±1 mm

Fig. 4.

9-2 ELECTRICAL ADJUSTMENT

Adjustment Conditions

- The mechanical adjustments must be completed first.
- The head must be cleaned and demagnetized.
- Turn power on allow the deck to warm up for at least a few minutes before commencing any electrical adjustments.
- The reference signal is 0 dBv = 1 Vrms.
- Connect a 50 kilo-ohm (or between 47 to 52 kilo-ohm) load resistance to the OUTPUT terminals.
- Unless otherwise specified, the switches listed below are left in the positions indicated.
DOLBY NR :OFF
TAPE SELECTOR :NORM

Test Tapes

- STD-331B :Playback adjustments (See Fig.9-1)
- STD-608A :NORMAL blank tape
- STD-620 :CrO₂ blank tape
- STD-610 :METAL blank tape

List of Adjustments

Playback sections

- Head azimuth adjustment.
- Playback equalizer adjustment.
- Playback frequency response check.
- Playback level adjustment.
- Playback time constant switching check.

Recording sections

- Bias oscillator adjustment.
- Erase current adjustment.
- Recording bias adjustment.
- Recording level adjustment.
- Recording and playback frequency response check.
- Level meter adjustment.
- DC balance adjustment.

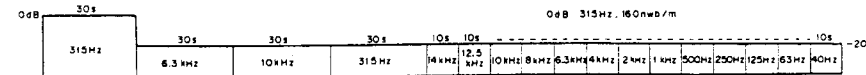

Fig. 9-1 . Constants of the test tape STD-331B

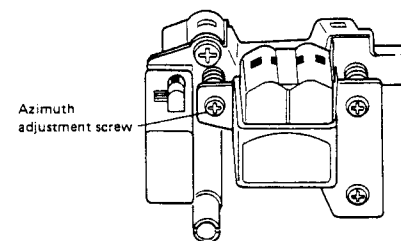

Fig. 9-2 . Head azimuth adjustment

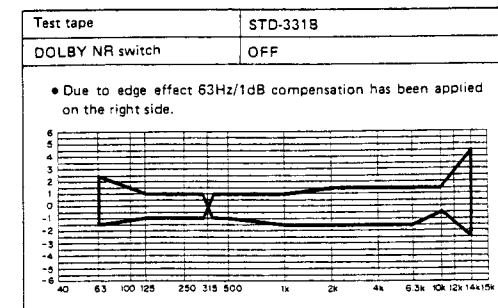

Fig. 9-3 . Allowable playback frequency response zone

PLAYBACK SECTION

1. Head Azimuth Adjustment

• Turn VR103, VR104 to mechanical center positions.

NO	Mode	Input signal & test tape	Adjustment location	Measuring location	Adjustment value	Remarks
1	PLAY	Play the 10kHz/-20dB section of STD-331B test tape.	Head azimuth adjustment screw. (See Fig.9-2)	LINE OUT	Maximum playback signal level.	
2	STOP	Lock the screw with screw lock after completing adjustment.				

2. Playback Equalizer Adjustment

NO	Mode	Input signal & test tape	Adjustment location	Measuring location	Adjustment value	Remarks
1	PLAY	Play the 315Hz and 10 kHz/-20dB portion of the STD-331B test atpe.	VR101 (Lch) VR102 (Rch)	LINE OUT	Adjust the 10 kHz level to 0.5 dB ± 0.5 dB in respect to the 315Hz playback level.	
2	PLAY	Play various frequencies at -20dB on the STD-331B test tape.	Check		The results must lie in the zone shown in Fig. 9-3.	

3. Playback Frequency Response Check

NO	Mode	Input signal & test tape	Adjustment location	Measuring location	Adjustment value	Remarks
1	PLAY	STD-331B	-	LINE OUT	The allowable zone shown in Fig. 9-3 is to be satisfied.	

4. Playback Level Adjustment

• This adjustment determines the DOLBY NR level, and must be performed with great care.

No	Mode	Input signal & test tape	Adjustment location	Measuring location	Adjustment value	Remarks
1	PLAY	Play the 315Hz/0dB section of the STD-331B test tape.	VR 103 (Lch) VR 104 (Rch)	TP.3 (Lch) TP.4 (Rch)	-15.2 dBv	

5. Playback Time Constant Switching Check

• Put the deck into playback mode with no cassette loaded.

• Check that the noise level changes at the line playback output terminals when the TAPE SELECTOR switch is changed.

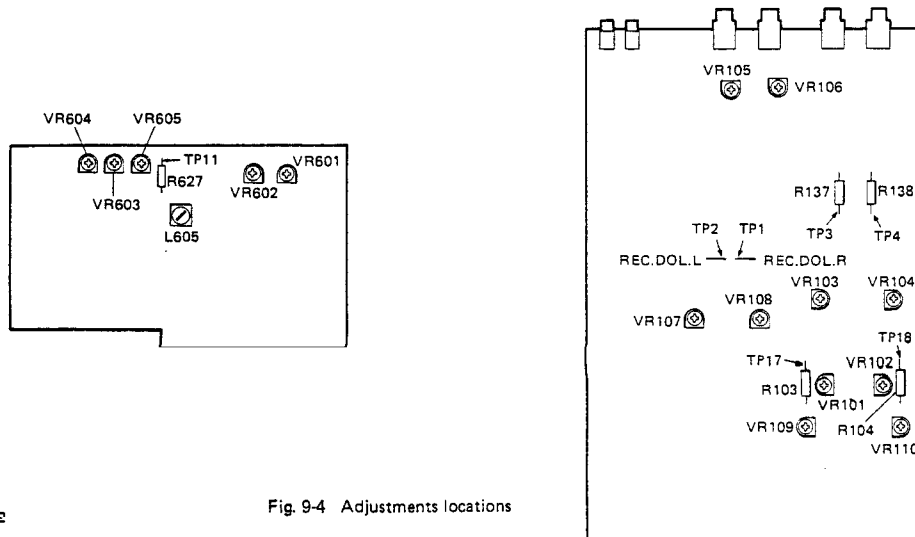

Fig. 9-4 Adjustments locations

RECORDING SECTION

1. Bias Oscillator Adjustment

NO	Mode	Input signal & test tape	Adjustment location	Measuring location	Adjustment value	Remarks
1	REC	Load the STD-610 test tape with no input signal.	L605	TP.11	106kHz±300Hz	

2. Erase Current Adjustment

NO	Mode	Input signal & test tape	Adjustment location	Measuring location	Adjustment value	Remarks
1	REC	Load the STD-610 test tape with no input signal.	VR605	TP11	170mV AC	

3. Recording Bias Adjustment

3-1. Overbias Adjustment						
No.	Mode	Input signal & test tape	Adjustment location	Measuring location	Adjustment value	Remarks
1	REC/ PAUSE	Apply a 6.3kHz/10dBv (-10VU meter reading) signal to the Line input terminals and insert STD-608A.		LINE OUT L, R terminals		
2	REC -PLAY	Record and play back the 6.3kHz signal at -10dBv input level.	NOR VR601 (L) VR602 (R)		NOR 3.0dB overbias	Turn control clockwise past the peak to assure proper overbias value.
3		Record the 6.3kHz/-10dBv signal on STD-620 and play back.	CrO ₂	VR603 (L/R)	Cr ₂ 2.5dB overbias	
4		Record the 6.3kHz/-10dBv signal on STD-610 and play back.	METAL	VR604 (L/R)	METAL 1.0dB overbias	
5 Turn control clockwise past the peak to assure proper overbias value.						
3-2. Frequency Response Adjustment						
No.	Mode	Input signal & test tape	Adjustment location	Measuring location	Adjustment value	Remarks
1	REC/ PAUSE	Apply a 315Hz/-20dBv signal to the Line input terminals and insert STD-608A.		LINE OUT L, R terminals		
2	REC -PLAY	Record and play back the 315Hz signal and a 10kHz signal at -20dBv input level.	NOR VR601 (L) VR602 (R)		Record and play back repeatedly, comparing the 315Hz and 10kHz playback levels, and adjust to +0.5±0.5dB.	
3		Record the 10kHz/315Hz, -20dBv signal on STD-620 and play back.	CrO ₂	VR603 (L/R)	+0.5±1.0dB	
4		Record the 10kHz/315Hz, -20dBv signal on STD-610 and play back.	METAL	VR604 (L/R)	+0.5±1.0dB	
5 Check distortion value after adjustment is completed and confirm that there is no underbias.						

4. Recording Level Adjustment

NO	Mode	Input signal & test tape	Adjustment location	Measuring location	Adjustment value	Remarks
1.	STOP	Set the TAPE SELECTOR switch to the NORM position.				
2.	REC/ PAUSE	Apply a 315 Hz/0 dBv signal to the Line input terminals.	Rec Level control	TP.1 (Lch) TP.2 (Rch)	-15.2 dBv	
3.	STOP	Set the DOLBY NR switch to the ON position. (DOLBY B)				
4.	REC/ PLAY	Record the above signal onto the STD-608A test tape, and playback.	VR 107 (Lch) VR 108 (Rch)	TP.3 (Lch) TP.4 (Rch)	-15.2 dBv	
5.	STOP	Set the TAPE SELECTOR switch to the CrO ₂ position.				
6.	REC/ PLAY	Record the above signal onto the STD-620 test tape, and playback.	Check	TP.3 (Lch) TP.4 (Rch)	-15.2 dBv ± 1.5 dB	
7.	STOP	Set the TAPE SELECTOR switch to the METAL position.				
8.	REC/ PLAY	Record the above signal onto the STD-610 test tape, and playback.	Check	TP.3 (Lch) TP.4 (Rch)	-15.2 dBv ± 1.5 dB	

5. Recording and Playback Frequency Response Check

NO	Mode	Input signal & test tape	Adjustment location	Measuring location	Adjustment value	Remarks
1.	STOP	Set the TAPE SELECTOR switch to the NORM position.				
2.	REC/ PLAY	STD-608A (NORM) NR:OFF/ON (TYPE B, C)	Check	LINE OUT	The allowable zone shown in Fig. 9-5 is to be satisfied.	
3.	STOP	Set the TAPE SELECTOR switch to the CrO ₂ position.				
4.	REC/ PLAY	STD-620(CrO ₂) NR:OFF/ON (TYPE B, C)	Check	LINE OUT	The allowable zone shown in Fig. 9-6 is to be satisfied.	
5.	STOP	Set the TAPE SELECTOR switch to the METAL position.				
6.	REC/ PLAY	STD-610(METAL) NR:OFF/ON (TYPE B, C)	Check	LINE OUT	The allowable zone shown in Fig. 9-7 is to be satisfied.	

6. Level Meter Adjustment

NO	Mode	Input signal & test tape	Adjustment location	Measuring location	Adjustment value	Remarks
1.	REC/ PAUSE	Apply a 315 Hz/-10 dBv (316 mV) signal to the Line input terminals.	VR105 (Lch) VR106 (Rch)	TP.1 (Lch) TP.2 (Rch)	Check that the level meters "0 dB" light up within -15.2dBv ± 0.5dB of the signal output level.	Perform at the expanded mode.

7. DC Balance Adjustment

No	Mode	Input signal & test tape	Adjustment location	Measuring location	Adjustment value	Remarks
1.			VR109 (Lch) VR110 (Rch)	TP.17 (Lch) TP.18 (Rch)	0V±0.2V	

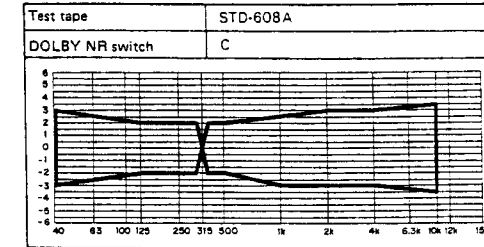
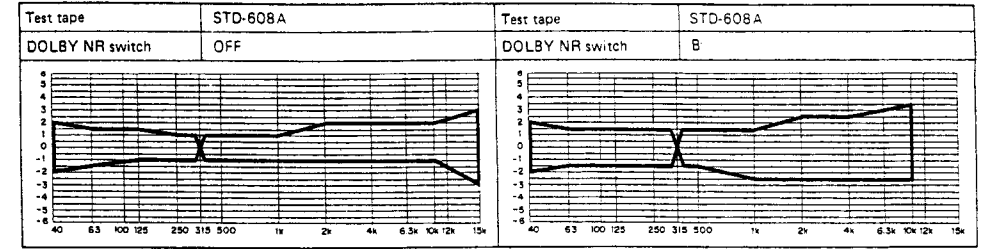

Fig.9-5 Recording/Playback frequency-response allowance range (NORM)

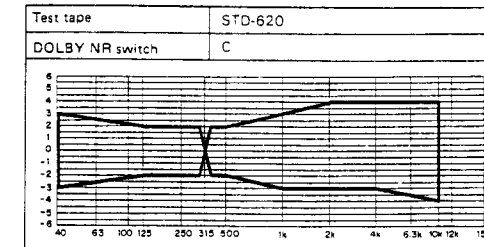
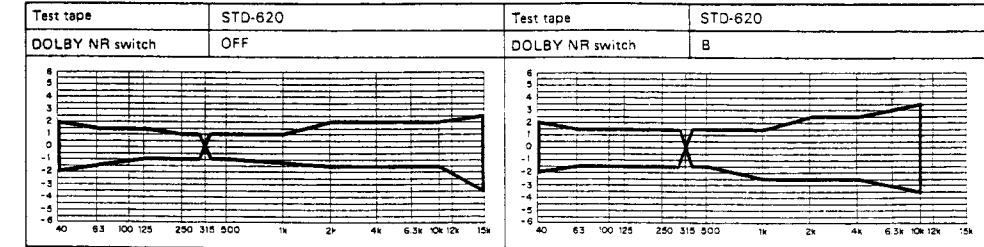

Fig.9-6 Recording/Playback frequency-response allowance range (CrO₂)

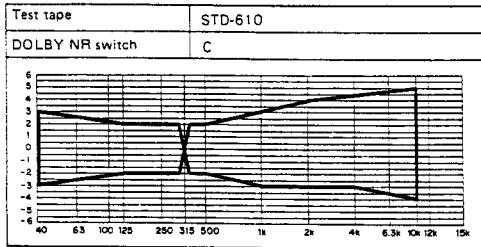
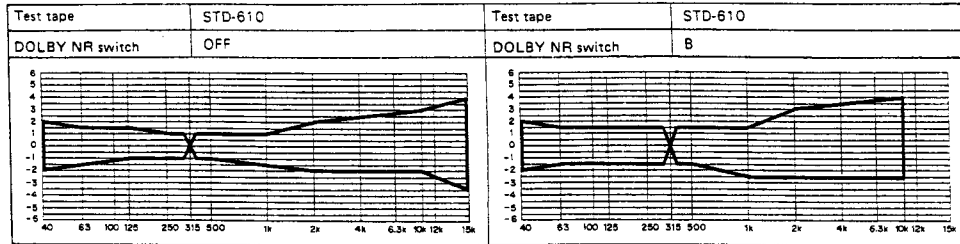

Fig. 9-7 Recording/Playback frequency-response allowance range (METAL)

9. RÉGLAGE

9-1. RÉGLAGE LIÉ AU MÉCANISME

1. Réglage d'azimuth et de défilement de bande				2. Réglage de vitesse de bande						
N°	Mode	Emplacement de réglage	Spécifications	Mode	Emplacement de réglage	Spécifications				
1	---	---	Insérer le demi-miroir dans le côté A (régler les vis à l'avant).	PLAY	Orifice de réglage de moteur de cabestan (Se reporter à la Fig. 3.)	Régler pour que la fréquence de reproduction soit de 3015 ± 5 Hz au début de l'enroulement de la bande d'essai STD-301.				
2	PLAY	Ecrou de réglage de hauteur (Se reporter à la Fig. 1.)	Reproduire la bande ci-dessus et régler pour qu'il n'y ait pas d'ondulation de la bande dans la section guide de la tête. (Se reporter à la Fig. 2.)	PLAY	---	Reproduire à nouveau la bande d'essai STD-301 et vérifier que les spécifications mentionnées ci-dessus sont satisfaites.				
3	PLAY	Vis de réglage d'azimuth (Se reporter à la Fig. 1.)	Reproduire la bande d'essai STD-331B et régler pour que le niveau de sortie de 10 kHz soit maximum et également pour qu'il n'y ait pas de déphasage entre le canal gauche et le canal droit.	<p>Moteur de cabestan</p> <p>Tournevis standard</p> <p>Fig. 3.</p>						
4	Vérifier à nouveau l'article 2 ci-dessus et régler s'il ne satisfait pas les spécifications. (Toujours régler l'article 3 lorsque l'article 2 est réglé.)									
<p>Vis de réglage d'azimuth</p> <p>Ecrou de réglage de hauteur</p> <p>Fig. 1.</p>				<h3>3. Réglage d'amortisseur pneumatique</h3> <table border="1"> <thead> <tr> <th>Emplacement de réglage</th> <th>Spécifications</th> </tr> </thead> <tbody> <tr> <td>Vis de réglage de cylindre (Se reporter à la fig. 4.)</td> <td>S'assurer que la porte s'ouvre sans accrocs, qu'il n'y a pas de mouvement en deux étapes et qu'il n'y a pas de saut lorsqu'elle s'ouvre complètement. (Effectuer sans cassette à moitié insérée.)</td> </tr> </tbody> </table>			Emplacement de réglage	Spécifications	Vis de réglage de cylindre (Se reporter à la fig. 4.)	S'assurer que la porte s'ouvre sans accrocs, qu'il n'y a pas de mouvement en deux étapes et qu'il n'y a pas de saut lorsqu'elle s'ouvre complètement. (Effectuer sans cassette à moitié insérée.)
Emplacement de réglage	Spécifications									
Vis de réglage de cylindre (Se reporter à la fig. 4.)	S'assurer que la porte s'ouvre sans accrocs, qu'il n'y a pas de mouvement en deux étapes et qu'il n'y a pas de saut lorsqu'elle s'ouvre complètement. (Effectuer sans cassette à moitié insérée.)									
<p>Ondulation</p> <p>Défilement de lecture de bande</p> <p>Ecrou de réglage de hauteur</p> <p>Fig. 2.</p>				<p>L'ouverture devient plus lente (en cas de saut)</p> <p>L'ouverture devient plus rapide (en cas de mouvement en deux étapes)</p> <p>Vis de réglage</p> <p>A</p> <p>[Valeur de référence] $A = 5 \pm 1$ mm</p> <p>Fig. 4.</p>						

9-2 REGLAGES ELECTRIQUES

Conditions de réglage

1. Les réglages mécaniques doivent tout d'abord être terminés.
2. Les têtes doivent être nettoyées et démagnétisées.
3. Mettre la platine sous tension et la laisser chauffer pendant au moins quelques minutes avant de commencer les réglages électriques.
4. Le signal de référence est de 0 dBv = 1 Vrms.
5. Connecter une résistance de charge de 50 kohms (tolérance 47 à 52 kohms) aux bornes de sortie (OUPUT).
6. Sauf indication contraire, les commutateurs ci-dessous doivent être laissés sur les positions indiquées.
DOLBY NR :OFF
Sélecteur de bande (TAPE SELECTOR): NORM

Bandes d'essai

- STD-331B : Réglages de la lecture
(Voir Fig.9-1)
- STD-608A : Bande vierge de type normal
- STD-620 : Bande vierge de type chrome
- STD-610 : Bande vierge de type métal

Liste des réglages

Sections de lecture

1. Réglage de l'azimut de la tête.
2. Réglage de l'égaliseur de lecture.
3. Vérification de la réponse en fréquence de lecture.
4. Réglage du niveau de lecture.
5. Vérification de la commutation de constante de temps de lecture.

Sections d'enregistrement

1. Réglage de l'oscillateur de polarisation.
2. Réglage du courant d'effacement.
3. Réglage de la polarisation d'enregistrement.
4. Réglage du niveau d'enregistrement.
5. Vérification de la réponse en fréquence d'enregistrement et de lecture.
6. Réglage de l'indicateur de niveau.
7. Réglage d'équilibre CC.

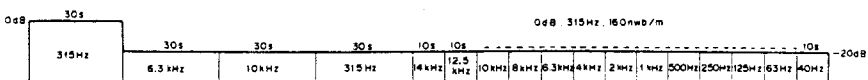

Fig. 9-1 Constantes de la bande d'essai STD-331B

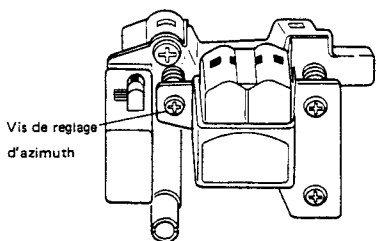

Fig. 9-2 Réglage de l'azimut de la tête

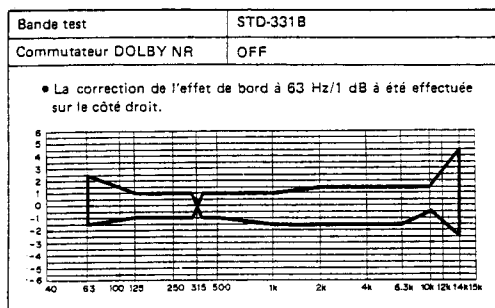

Fig. 9-3 Tolérance de la zone de réponse en fréquence de lecture

SECTION DE LECTURE

1. Réglage de l'azimut de la tête

- Tourner VR103, VR104 sur leur position centrale mécanique.

NO	Mode	Signal d'entrée et bande d'essai	Points de réglage	Points de mesure	Valeur de réglage	Remarques
1.	PLAY	Reproduire la section 10 kHz/ -20 dB de la bande d'essai STD-331B.	Vis de réglage de l'azimut de la tête. (Voir fig.9-2)	Sortie de ligne (LINE OUT)	Niveau du signal de reproduction maximum.	
2.	STOP	Verrouiller la vis avec le verrouillage de vis après avoir terminé le réglage.				

2. Réglage de l'égaliseur de lecture

NO	Mode	Signal d'entrée et bande d'essai	Points de réglage	Points de mesure	Valeur de réglage	Remarques
1.	PLAY	Reproduire la partie 315 Hz et 10 kHz/ -20 dB de la bande d'essai STD-331B.	VR 101 (can. G) VR 102 (can. D)	Sortie de ligne (LINE OUT)	Régler le niveau 10 kHz sur 0,5 dB ± 0,5 dB par rapport au niveau de reproduction 315 Hz.	
2.	PLAY	Reproduire les diverses fréquences à -20 dB sur la bande d'essai STD-331B.	Vérifier	Les résultats doivent se trouver dans la zone indiquée sur la fig.9-3.		

3. Vérification de la réponse en fréquence de lecture

NO	Mode	Signal d'entrée et bande d'essai	Points de réglage	Points de mesure	Valeur de réglage	Remarques
1.	PLAY	STD-331B	—	Sortie de ligne (LINE OUT)	La zone de tolérance indiquée sur la fig. 9-3 doit être respectée.	

4. Réglage du niveau de lecture

- Ce réglage détermine le niveau DOLBY NR et il doit être effectué très soigneusement.

NO	Mode	Signal d'entrée et bande d'essai	Points de réglage	Points de mesure	Valeur de réglage	Remarques
1.	PLAY	Reproduire la section 315 Hz/0 dB de la bande d'essai STD-331B.	VR 103 (can. G) VR 104 (can. D)	TP.3 (can. G) TP.4 (can. D)	-15,2 dBv	

5. Vérification de la commutation de constante de temps de lecture.

- Mettre la platine dans le mode de lecture sans charger de cassette.

- Vérifier que le niveau de parasites change aux bornes de sortie de lecture de ligne lorsque la position du sélecteur de bande (TAPE SELECTOR) est changée.

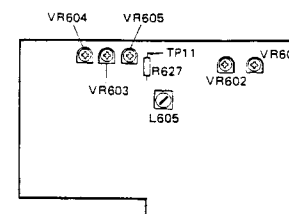
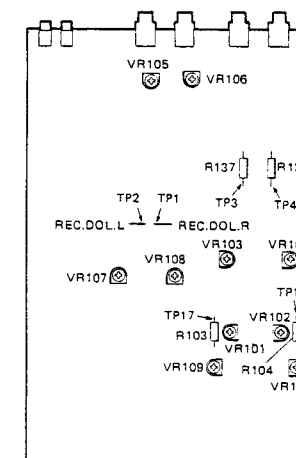

Fig. 9-4 Emplacement des réglages



SECTIONS D'ENREGISTREMENT

1. Réglage de l'oscillateur de polarisation

NO	Mode	Signal d'entrée et bande d'essai	Points de réglage	Points de mesure	Valeur de réglage	Remarques
1.	REC	Charger la bande d'essai STD-610 et n'introduire aucun signal.	L605	TP.11	106kHz±300Hz	

2. Réglage du courant d'effacement

NO	Mode	Signal d'entrée et bande d'essai	Points de réglage	Points de mesure	Valeur de réglage	Remarques
1.	REC	Charger la bande d'essai STD-610 et n'introduire aucun signal.	VR605	TP11	170mV AC	

3. Réglage de polarisation d'enregistrement

3-1. Réglage de surpolarisation						
N°	Mode	Signal d'entrée/bande d'essai	Point de réglage	Point de mesure	Valeur de réglage	Remarques
1	REC/PAUSE	Appliquer un signal de 6,3 kHz/ -10 dB (indication de compteur -10 VU) aux bornes d'entrée de ligne et insérer STD-608A.	—	Bornes G, D de sortie de ligne (LINE OUT)	—	
2	REC -PLAY	Enregistrer et reproduire le signal de 6,3 kHz à un niveau d'entrée de -10 dBv.	NOR VR601 (L) VR602 (R)		NOR Surpolarisation de 3,0 dB	Tourner la commande dans le sens des aiguilles d'une montre après la crête pour assurer une bonne valeur de surpolarisation.
3		Enregistrer le signal de 6,3 kHz/ -10 dBv sur STD-620 et reproduire.	CrO2 VR603 (L/R)		CrO2 Surpolarisation de 2,5 dB	
4		Enregistrer le signal de 6,3 kHz/ -10 dBv sur STD-610 et reproduire.	METAL VR604 (L/R)		METAL Surpolarisation de 1,0 dB	
5 Tourner la commande dans le sens des aiguilles d'une montre au-delà de la crête pour garantir que la valeur de surpolarisation soit correcte.						
3-2. Réglage de réponse en fréquence						
N	Mode	Signal d'entrée/bande d'essai	Point de réglage	Point de mesure	Valeur de réglage	Remarques
1	REC/PAUSE	Appliquer un signal de 315 Hz/ -20 dB aux bornes d'entrée de ligne et insérer STD-608A.	—	Bornes G, D de sortie de ligne (LINE OUT)	—	
2	REC -PLAY	Enregistrer et reproduire le signal de 315 Hz et un signal de 10 kHz à un niveau d'entrée de -20 dB.	NOR VR601 (L) VR602 (R)		Enregistrer et reproduire de manière répétée, en comparant les niveaux de lecture des signaux 315 Hz et 10 kHz et ajuster à +0,5 dB±0,5 dB.	
3		Enregistrer le signal de 10 kHz/ 315 Hz, -20 dB sur STD-620 et reproduire.	CrO2 VR603 (L/R)		+0,5±1,0 dB	
4		Enregistrer le signal de 10 kHz/ 315 Hz, -20 dB sur STD-610 et reproduire.	METAL VR604 (L/R)		+0,5±1,0 dB	
5 Vérifier la valeur de distorsion après la fin du réglage et confirmer qu'il n'y a pas de souspolarisation.						

4. Réglage du niveau d'enregistrement

NO	Mode	Signal d'entrée et bande d'essai	Points de réglage	Points de mesure	Valeur de réglage	Remarques
1.	STOP	Régler le sélecteur de bande (TAPE SELECTOR) sur la position NORM.				
2.	REC PAUSE	Appliquer un signal de 315 Hz/0 dBv aux bornes d'entrée de ligne.	Commande de niveau d'enregistrement (REC LEVEL)	TP.1 (can.G) TP.2 (can.D)	-15,2 dBv	
3.		Régler le commutateur DOLBY NR sur la position ON. (DOLBY B)				
4.	REC/LAY	Enregistrer le signal ci-dessus sur la bande d'essai STD-608A et le reproduire.	VR 107 (can. G) VR 108 (can. D)	TP.3 (can.G) TP.4 (can.D)	-15,2 dBv	
5.	STOP	Régler le sélecteur de bande (TAPE SELECTOR) sur la position CrO2.				
6.	REC/PLAY	Enregistrer le signal ci-dessus sur la bande d'essai STD-620 et le reproduire.	Vérifier	TP.3 (can.G) TP.4 (can.D)	-15,2 dBv ± 1,5 dB	
7.	STOP	Régler le sélecteur de bande (TAPE SELECTOR) sur la position METAL.				
8.	REC/PLAY	Enregistrer le signal ci-dessus sur la bande d'essai STD-610 et le reproduire.	Vérifier	TP.3 (can.G) TP.4 (can.D)	-15,2 dBv ± 1,5 dB	

5. Vérification de la réponse en fréquence d'enregistrement et de lecture

NO	Mode	Signal d'entrée et bande d'essai	Points de réglage	Points de mesure	Valeur de réglage	Remarques
1.	STOP	Régler le sélecteur de bande (TAPE SELECTOR) sur la position NORM.				
2.	REC/PLAY	STD-608A (NORM) VR:OFF/ON(TYPE B, C)	Vérifier	Sortie de ligne (LINE OUT)		La zone de tolérance indiquée sur la fig. 9-5 doit être respectée.
3.	STOP	Régler le sélecteur de bande (TAPE SELECTOR) sur la position CrO2.				
4.	REC/PLAY	STD-620(CrO2) NR:OFF/ON(TYPE B, C)	Vérifier	Sortie de ligne (LINE OUT)		La zone de tolérance indiquée sur la fig. 9-6 doit être respectée.
5.	STOP	Régler le sélecteur de bande (TAPE SELECTOR) sur la position METAL.				
6.	REC/PLAY	STD-610(METAL) NR:OFF/ON(TYPE B, C)	Vérifier	Sortie de ligne (LINE OUT)		La zone de tolérance indiquée sur la fig. 9-7 doit être respectée.

6. Réglage de l'indicateur de niveau

NO	Mode	Signal d'entrée et bande d'essai	Points de réglage	Points de mesure	Valeur de réglage	Remarques
1.	REC. PAUSE	Appliquer un signal de 315 Hz/ -10 dBv (316 mV) aux bornes d'entrée de ligne.	VR105 (can.G) VR106 (can.D)	TP.1 (can.G) TP.2 (can.D)		Vérifier que les indicateurs de niveau "0 dB" s'allument dans la limite -15,2 dBv ± 0,5 dB du niveau de sortie du signal. Effectuer ces opérations dans le mode expansion.

7. Réglage d'équilibre CC

NO	Mode	Signal d'entrée et bande d'essai	Points de réglage	Points de mesure	Valeur de réglage	Remarques
1.			VR109 (can.G) VR110 (can.D)	TP.17 (can.G) TP.18 (can.D)	0V±0,2V	

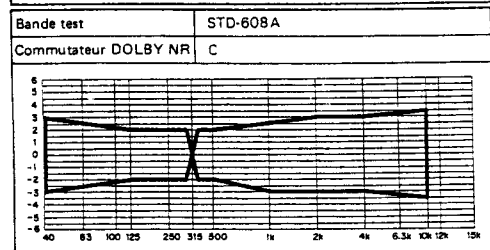
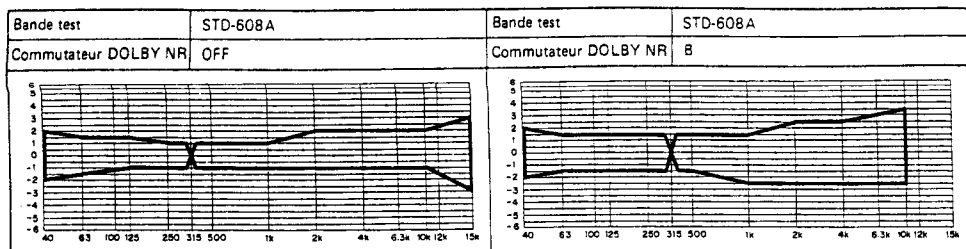

Fig. 9-5 Tolérance de la réponse en fréquence d'enregistrement/lecture (NORM)

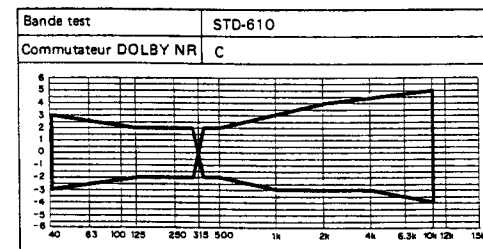
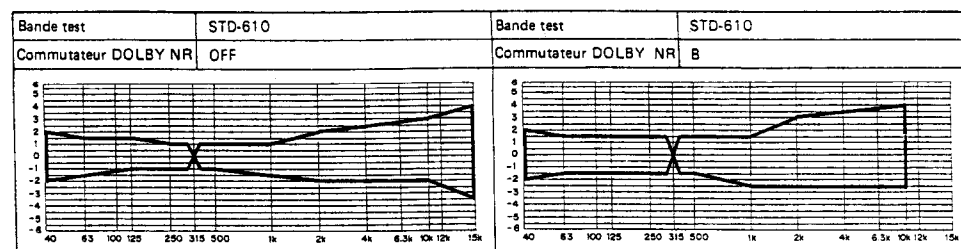

Fig. 9-7 Tolérance de la réponse en fréquence d'enregistrement/lecture (METAL)

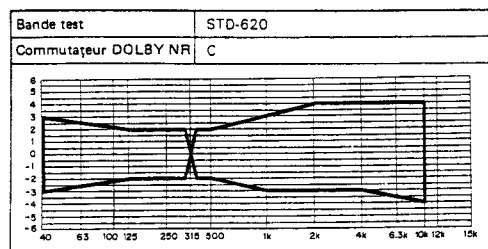
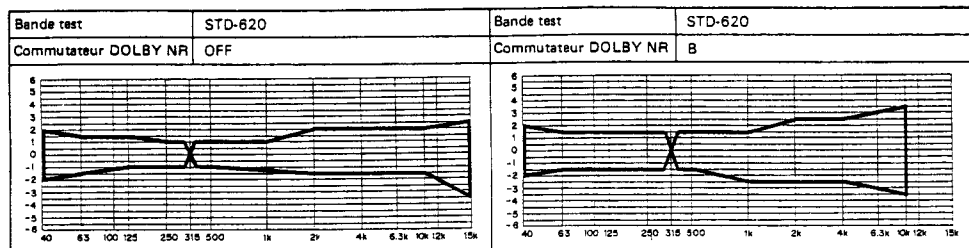
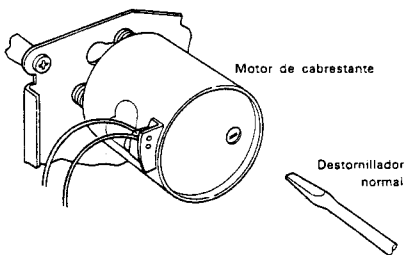
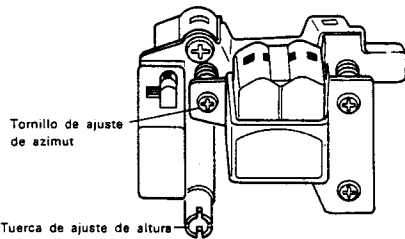
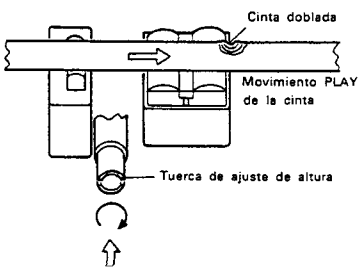
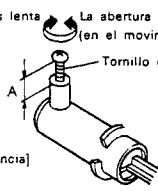

Fig. 9-6 Tolérance de la réponse en fréquence d'enregistrement/lecture (CrO₂)

9. AJUSTE

9-1. AJUSTE DEL MECANISMO RELACIONADO

1. Ajuste del azimut y movimiento de la cinta				2. Ajuste de velocidad de cinta							
N.º	Modo	Punto de ajuste	Especificaciones	Modo	Punto de ajuste	Especificaciones					
1	—	—	Inserte medio espejo en el lado A (fije los tornillos de delante).	PLAY	Agujero de ajuste del motor de cabrestante (Consulte la figura 3.)	Ajuste de forma que la frecuencia de reproducción sea de 3015 ± 5 Hz al comienzo del bobinado de la cinta de prueba STD-301.					
2	PLAY	Tuerca de ajuste de altura (Consulte la figura 1)	Reproduzca la cinta de arriba y ajústela de forma que no esté doblada en la sección guía de la cabeza. (Consulte la figura 2.)	PLAY	—	Reproduzca de nuevo la cinta de prueba STD-301 y confirme si se satisfacen las especificaciones de arriba.					
3	PLAY	Tornillo de ajuste de azimut (Consulte la figura 1.)	Reproduzca la cinta de prueba STD-331B y ajústela de forma que el nivel de salida de 10 kHz sea el máximo, y que no exista diferencia de fase entre el canal izquierdo y el canal derecho.	 <p>Motor de cabrestante Destornillador normal</p> <p>Figura 3.</p>							
4	Compruebe de nuevo el ítem 2 de arriba y ajuste si no se satisfacen las especificaciones. (Asegúrese de ajustar el ítem 3 después de haber ajustado el ítem 2.)										
 <p>Tornillo de ajuste de azimut Tuerca de ajuste de altura</p> <p>Figura 1.</p>				<p>3. Ajuste del amortiguador de aire</p> <table border="1"> <thead> <tr> <th>Punto de ajuste</th> <th>Especificaciones</th> </tr> </thead> <tbody> <tr> <td>Tornillo de ajuste del cilindro (Consulte la figura 4.)</td> <td>Asegúrese de que la puerta se abra suavemente, que no haya un movimiento de dos etapas y que no salte cuando se abra completamente. (Realice este trabajo sin insertar medio casete.)</td> </tr> </tbody> </table>				Punto de ajuste	Especificaciones	Tornillo de ajuste del cilindro (Consulte la figura 4.)	Asegúrese de que la puerta se abra suavemente, que no haya un movimiento de dos etapas y que no salte cuando se abra completamente. (Realice este trabajo sin insertar medio casete.)
Punto de ajuste	Especificaciones										
Tornillo de ajuste del cilindro (Consulte la figura 4.)	Asegúrese de que la puerta se abra suavemente, que no haya un movimiento de dos etapas y que no salte cuando se abra completamente. (Realice este trabajo sin insertar medio casete.)										
 <p>Cinta doblada Movimiento PLAY de la cinta Tuerca de ajuste de altura</p> <p>Figura 2.</p>				<p>La abertura se hace más lenta (cuando salta)</p> <p>La abertura se hace más rápida (en el movimiento de dos etapas)</p>  <p>Tornillo de ajuste</p> <p>[Valor de referencia] A = 5 ± 1 mm</p> <p>Figura 4.</p>							

9-2 AJUSTES ELÉCTRICOS

Condiciones de ajuste

- Los ajustes mecánicos deben haberse completado primero.
- La cabeza debe estar limpia y desmagnetizada.
- Encienda la alimentación para permitir que el magnetófono se caliente durante unos pocos minutos por lo menos antes de realizar cualquier ajuste eléctrico.
- La señal de referencia es de $0\text{dB} = 1\text{Vrms}$.
- Conecte una resistencia de $50\text{ k}\Omega$ (o entre 47 y $52\text{ k}\Omega$) en los terminales OUTPUT.
- A menos que se especifique lo contrario, los conmutadores indicados más abajo deben dejarse en las posiciones indicadas.
DOLBY NR : OFF
TAPE SELECTOR : NORM

Cintas de prueba

- STD-331B : Ajustes de reproducción (Consulte la Fig.9-1)
- STD-608A : Cinta virgen NORMAL
- STD-620 : Cinta virgen de CrO₂
- STD-610 : Cinta virgen de METAL

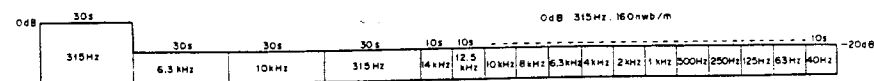

Fig. 9-1 Constantes de la cinta de prueba STD-331B

Lista de ajustes

Secciones de reproducción

- Ajuste de azimut de la cabeza
- Ajuste del ecualizador de reproducción
- Verificación de la respuesta de frecuencia de reproducción
- Ajuste del nivel de reproducción
- Verificación de conmutación de la constante de tiempo de reproducción

Secciones de grabación

- Ajuste del oscilador de polarización
- Ajuste de la corriente de borrado
- Ajuste de la polarización de grabación
- Ajuste del nivel de grabación
- Verificación de la respuesta de frecuencia de grabación y reproducción
- Ajuste del medidor de nivel
- Ajuste de equilibrio de CC

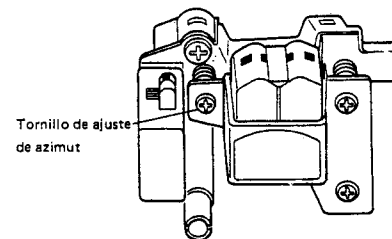

Fig. 9-2 Ajuste de azimut de la cabeza

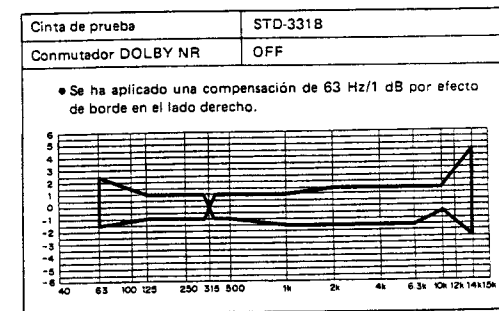

Fig. 9-3 Zona permitida de respuesta de frecuencia de reproducción

SECCIÓN DE REPRODUCCIÓN

1. Ajuste del azimut de la cabeza

• Gire VR103 y VR104 a las posiciones del centro mecánico.

N.º	Modo	Señal de entrada y cinta de prueba	Punto de ajuste	Punto de medición	Valor de ajuste	Comentarios
1.	PLAY	Reproduzca la sección de 10kHz - 20dB de la cinta de prueba STD-331B.	Tomillo de ajuste del azimut de la cabeza. (Vea la figura 9-2)	LINE OUT	Nivel máximo de la señal de reproducción.	
2.	STOP	Bloquee el tornillo con su cierre una vez finalizado el ajuste.				

2. Ajuste del ecualizador de reproducción

N.º	Modo	Señal de entrada y cinta de prueba	Punto de ajuste	Punto de medición	Valor de ajuste	Comentarios
1.	PLAY	Reproduzca la parte de 315Hz y 10 kHz - 20dB de la cinta de prueba STD-331B.	VR 101 (Lch) VR 102 (Rch)	LINE OUT	Ajuste el nivel de 10 kHz a 0,5 dB ± 0,5 dB respecto al nivel de reproducción de 315Hz.	
2.	PLAY	Reproduzca varias frecuencias a - 20dB en la cinta de prueba STD-331B.	Check	Los resultados deben estar en la zona mostrada en la figura 9-3.		

3. Verificación de la respuesta de frecuencia de reproducción

N.º	Modo	Señal de entrada y cinta de prueba	Punto de ajuste	Punto de medición	Valor de ajuste	Comentarios
1.	PLAY	STD-331B	-	LINE OUT	Debe cumplirse con la zona permisible mostrada en la figura 9-3.	

4. Ajuste del nivel de reproducción

• Este ajuste determina el nivel DOLBY NR y debe realizarse con mucho cuidado.

N.º	Modo	Señal de entrada y cinta de prueba	Punto de ajuste	Punto de medición	Valor de ajuste	Comentarios
1.	PLAY	Produzca la parte de 315Hz/0dB de la cinta de prueba STD-331B.	VR 103 (Lch) VR 104 (Rch)	TP.3 (Lch) TP.4 (Rch)	-15,2 dBv	

5. Verificación de conmutación de la constante de tiempo de reproducción

• Ponga el magnetón en el modo de reproducción sin introducir ningún cassette.

• Verifique si el nivel de ruido cambia en los terminales de salida de reproducción al cambiar la posición del conmutador TAPE SELECTOR.

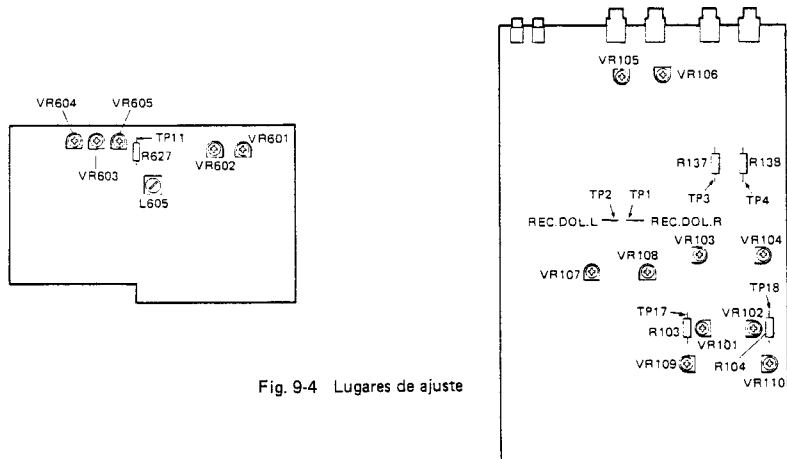

Fig. 9-4 Lugares de ajuste

SECCIÓN DE GRABACIÓN

1. Ajuste del oscilador de polarización

N.º	Modo	Señal de entrada y cinta de prueba	Punto de ajuste	Punto de medición	Valor de ajuste	Comentarios
1.	REC	Introduzca la cinta de prueba STD-610 sin señal de entrada.	L605	TP.11	106kHz±300Hz	

2. Ajuste de la corriente de borrado

N.º	Modo	Señal de entrada y cinta de prueba	Punto de ajuste	Punto de medición	Valor de ajuste	Comentarios
1.	REC	Introduzca la cinta de prueba STD-610 sin señal de entrada.	VR605	TP11	170mV AC	

3. Ajuste de polarización de grabación

3-1. Ajuste de sobrepolarización							
N.º	Modo	Señal de entrada y cinta de prueba	Ubicación de ajuste		Ubicación de medición	Valor de ajuste	Observaciones
1	REC/ PAUSE	Aplique una señal de 6,3kHz/ -10dBv (indicación del vómeto de -10VU) en los terminales de entrada de línea e introduzca la STD-608A.	---		Terminales LINE OUT L R	---	
2	REC -PLAY	Grabe y reproduzca la señal de 6,3kHz al nivel de entrada de -10dBv.	NOR	VR601 (L) VR602 (R)		NOR Sobrepolarización de 3dB	Gire el control hacia la derecha hasta pasar el valor de cresta para asegurar un valor de sobrepolarización apropiado.
3		Grabe la señal de 6,3kHz/ -10dBv en la STD-620 y reproduzca.	CrO ₂	VR603 (L/R)		CrO ₂ Sobrepolarización de 2,5dB	
4		Grabe la señal de 6,3kHz/ -10dBv en la STD-610 y reproduzca.	METAL	VR604 (L/R)		METAL Sobrepolarización de 1dB	
5	Gire el control hacia la derecha, sobrepasando el pico, para asegurar un valor de sobrepolarización apropiado.						
3-2. Ajuste de respuesta de frecuencia							
N.º	Modo	Señal de entrada y cinta de prueba	Ubicación de ajuste		Ubicación de medición	Valor de ajuste	Observaciones
1	REC/ PAUSE	Aplique una señal de 315Hz/ -20dBv a los terminales de entrada en línea e inserte la STD-608A.	---		Terminales LINE OUT L R	---	
2	REC -PLAY	Grabe y reproduzca la señal de 315Hz y la señal de 10kHz a un nivel de entrada de -20dBv.	NOR	VR601 (L) VR602 (R)			Grabe y reproduzca repetidamente, comparando los niveles de reproducción de 315Hz y 10 kHz, y ajuste a +0,5 dB±0,5 dB.
3		Grabe las señales de 10kHz/ 315Hz, -20dBv en la STD-620 y reproduzca.	CrO ₂	VR603 (L/R)		+0,5±1,0dB	
4		Grabe las señales de 10kHz/ 315Hz, -20dBv en la STD-610 y reproduzca.	METAL	VR604 (L/R)		+0,5±1,0dB	
5	Compruebe el valor de distorsión después de finalizar el ajuste y confirme que no haya subpolarización.						

4. Ajuste del nivel de grabación

N.º	Modo	Señal de entrada y cinta de prueba	Punto de ajuste	Punto de medición	Valor de ajuste	Comentarios
1.	STOP	Ponga el conmutador TAPE SELECTOR en la posición NORM.				
2.	REC/PAUSE	Aplique una señal de 315Hz/0dBv a los terminales de entrada de línea.	Control de nivel de grabación	TP.1 (Lch) TP.2 (Rch)	-15.2 dBv	
3.		Ponga el conmutador DOLBY NR en la posición ON. (DOLBY B)				
4.	REC/LAY	Grabe la señal de arriba en la cinta de prueba STD-608A y reproduzca.	VR 107 (Lch) VR 108 (Rch)	TP.3 (Lch) TP.4 (Rch)	-15.2 dBv	
5.	STOP	Ponga el conmutador TAPE SELECTOR en la posición CrO ₂ .				
6.	REC/PLAY	Grabe la señal de arriba en la cinta de prueba STD-620 y reproduzca.	Verifique	TP.3 (Lch) TP.4 (Rch)	-15.2 dBv ± 1.5 dB	
7.	STOP	Ponga el conmutador TAPE SELECTOR en la posición METAL.				
8.	REC/PLAY	Grabe la señal de arriba en la cinta de prueba STD-610 y reproduzca.	Verifique	TP.3 (Lch) TP.4 (Rch)	-15.2 dBv ± 1.5 dB	

5. Verificación de la respuesta de frecuencia de grabación y reproducción

N.º	Modo	Señal de entrada y cinta de prueba	Punto de ajuste	Punto de medición	Valor de ajuste	Comentarios
1.	STOP	Ponga el conmutador TAPE SELECTOR en la posición NORM.				
2.	REC/PLAY	STD-6084 (NORM) VR:OFF/ON(TYPE B, C)	Verifique	LINE OUT		Debe cumplirse con la zona permisible mostrada en la figura 9-5.
3.	STOP	Ponga el conmutador TAPE SELECTOR en la posición CrO ₂ CrO ₂ .				
4.	REC/PLAY	STD-620(CrO ₂) NR:OFF/ON(TYPE B, C)	Verifique	LINE OUT		Debe cumplirse con la zona permisible mostrada en la figura 9-6.
5.	STOP	Ponga el conmutador TAPE SELECTOR en la posición METAL.				
6.	REC/PLAY	STD-610(METAL) NR:OFF/ON(TYPE B, C)	Verifique	LINE OUT		Debe cumplirse con la zona permisible mostrada en la figura 9-7.

6. Ajuste del medidor de nivel

N.º	Modo	Señal de entrada y cinta de prueba	Punto de ajuste	Punto de medición	Valor de ajuste	Comentarios
1.	REC/PAUSE	Aplique una señal de 315Hz/-10dBv (316mV) a los terminales de entrada de línea.	VR105 (Lch) VR106 (Rch)	TP.1 (Lch) TP.2 (Rch)		Verifique si se encienden los medidores de nivel "0dB" cuando el nivel de salida de la señal sea -15.2 dBv ± 0.5 dB. Reajuste en el modo de expansión.

7. Ajuste de equilibrio de CC

N.º	Modo	Señal de entrada y cinta de prueba	Punto de ajuste	Punto de medición	Valor de ajuste	Comentarios
1.			VR109 (Lch) VR110 (Rch)	TP.17 (Lch) TP.18 (Rch)	0V±0.2V	

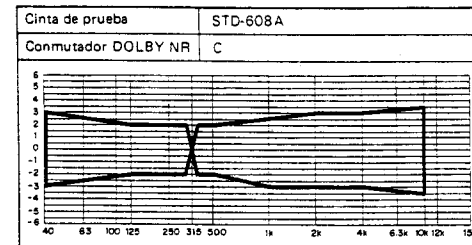
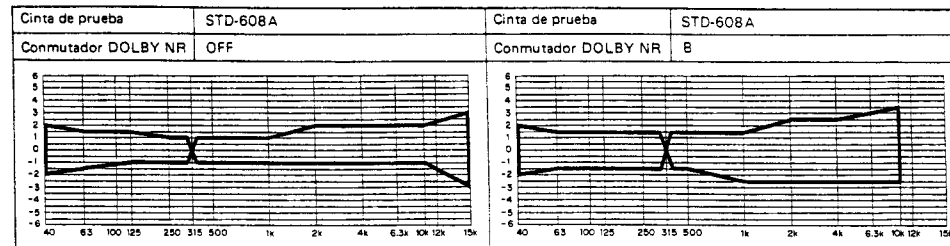

Fig. 9-5 Margenes permisibles de respuesta de frecuencia de grabación/reproducción (NORM)

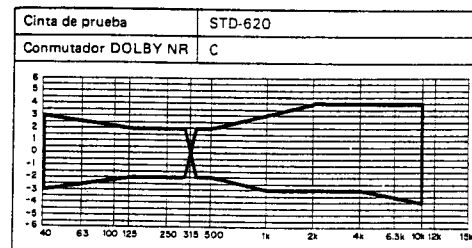
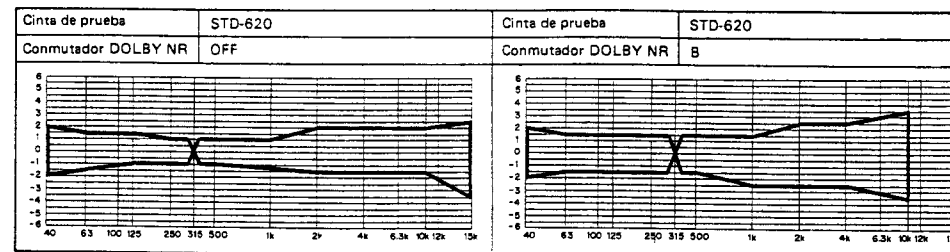

Fig. 9-6 Margenes permisibles de respuesta de frecuencia de grabación/reproducción (CrO₂)

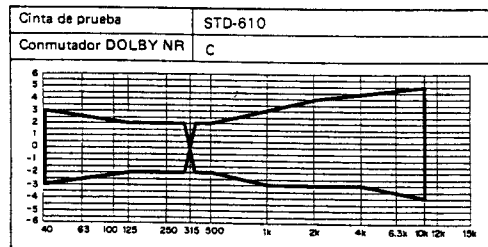
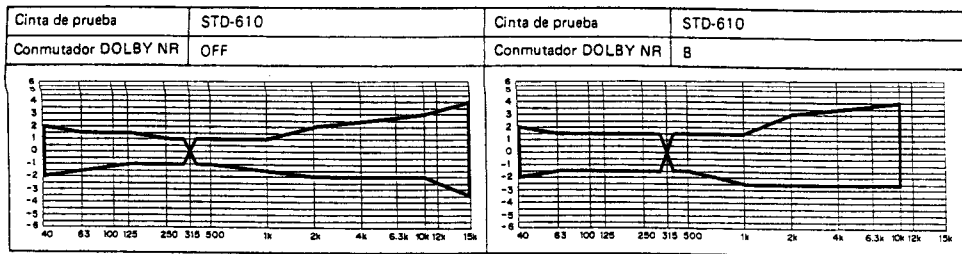

Fig. 9-7 Margenes permisibles de respuesta de frecuencia de grabación/reproducción (METAL)

10. SAFETY INFORMATION

1. SAFETY PRECAUTIONS

The following check should be performed for the continued protection of the customer and service technician.

LEAKAGE CURRENT CHECK

Measure leakage current to a known earth ground (water pipe, conduit, etc.) by connecting a leakage current tester such as Simpson Model 229-2 or equivalent between the earth ground and all exposed metal parts of the appliance (input/output terminals, screwheads, metal overlays, control shaft, etc.). Plug the AC line cord of the appliance directly into a 120V AC 60Hz outlet and turn the AC power switch on. Any current measured must not exceed 0.5mA.

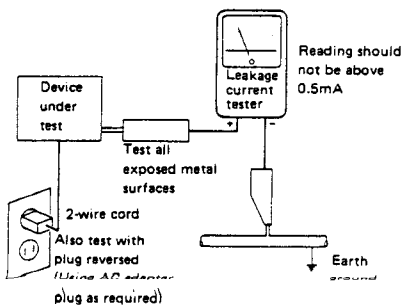

AC Leakage Test

ANY MEASUREMENTS NOT WITHIN THE LIMITS OUTLINED ABOVE ARE INDICATIVE OF A POTENTIAL SHOCK HAZARD AND MUST BE CORRECTED BEFORE RETURNING THE APPLIANCE TO THE CUSTOMER.

2. PRODUCT SAFETY NOTICE

Many electrical and mechanical parts in the appliance have special safety related characteristics. These are often not evident from visual inspection nor the protection afforded by them necessarily can be obtained by using replacement components rated for voltage, wattage, etc. Replacement parts which have these special safety characteristics are identified in this Service Manual.

Electrical components having such features are identified by marking with a Δ on the schematics and on the parts list in this Service Manual.

The use of a substitute replacement component which does not have the same safety characteristics as the PIONEER recommended replacement one, shown in the parts list in this Service Manual, may create shock, fire, or other hazards.

Product Safety is continuously under review and new instructions are issued from time to time. For the latest information, always consult the current PIONEER Service Manual. A subscription to, or additional copies of, PIONEER Service Manual may be obtained at a nominal charge from PIONEER.

11. FOR CT-939/HEM TYPE

CONTRAST OF MISCELLANEOUS PARTS

NOTES:

- Parts without part number cannot be supplied.
- The Δ mark found on some component parts indicates the importance of the safety factor of the part. Therefore, when replacing, be sure to use parts of identical designation.
- For your parts Stock Control, the fast moving items are indicated with the marks $\Delta\Delta$ and Δ .
- $\Delta\Delta$ GENERALLY MOVES FASTER THAN Δ .
- This classification shall be adjusted by each distributor because it depends on model number, temperature, humidity, etc.
- Parts marked by "O" are not always kept in stock. Their delivery time may be longer than usual or they may be unavailable.

The CT-939/HEM type is the same as the CT-S800/KU/CA type with the exception of the following sections.

Mark	Symbol & Description	Part No.		Remarks
		CT-S800 KU/CA type	CT-939 HEM type	
	Amp unit	Non supply	Non supply	
	Control unit	Non supply	Non supply	
	Strain relief	CM-22C	CM-22B	
	AC power cord	PDG1015	PDG1003	
Δ	FU101, FU102 Fuse (1A/125V)	REK-080	
$\Delta\Delta$	FU101, FU102 Fuse (T1A/250V)	REK-100	
$\Delta\Delta$	FU103 Fuse (1.6A/125V)	REK-074	
$\Delta\Delta$	FU103 Fuse (T1.6A/250V)	REK-102	
Δ	T1 Power transformer (AC120V)	RTT1060	
Δ	T1 Power transformer (AC220/240V)	RTT1061	
	FL filter	RAH1214	RAH1184	
	Front panel assembly	RXX1096	RXX1098	
	Packing case	RHG1074	RHG1075	
	Operating instruction (English)	RRB1026	
	Operating instruction (English, French, German, Italian, Dutch, Swedish, Spanish, Portuguese)	RRE1015	
	Door panel	RAH1196	RAH1313	
	Door assembly	RXX1065	RXX1097	

AMP UNIT

The amp unit (for CT-939/HEM type) is the same as the amp unit (for CT-S800/KU/CA type) with the exception of the following sections.

Mark	Symbol & Description	Part No.		Remarks
		CT-S800 KU/CA type	CT-939 HEM type	
	C302 JA301, JA302 (REMOTE CONTROL IN/OUT)	CKCYF103Z50 RKN1004	

CONTROL UNIT

The control unit (for CT-939/HEM type) is the same as the control unit (for CT-S800/KU/CA type) with the exception of the following sections.

Mark	Symbol & Description	Part No.		Remarks
		CT-S800 KU/CA type	CT-939 HEM type	
★	D803-D805 R846	1SS254 RD¼PM102J	

NOTE : For the circuit diagrams and pattern diagrams for each destination, refer to pages 17 - 24.