

Battery Charger CB-2LY

This product is not intended to be serviced. Should the product cease to function in its intended manner, it should be returned to the manufacturer or be discarded.

This power unit is intended to be correctly orientated in a vertical or floor mount position.

IMPORTANT SAFETY INSTRUCTIONS-SAVE THESE INSTRUCTIONS.

DANGER-TO REDUCE THE RISK OF FIRE OR ELECTRIC SHOCK, CAREFULLY FOLLOW THESE INSTRUCTIONS.

For connection to a supply not in the U.S.A., use an attachment plug adapter of the proper configuration for the power outlet.

This battery charger is for exclusive use with Battery Pack NB-6L (1.00 Ah). There is a danger of explosion if other battery packs are used.

Trademark Acknowledgments

- The SDHC logo is a trademark.

Disclaimer

- Reprinting, transmitting, or storing in a retrieval system any part of this guide without the permission of Canon is prohibited.
- Canon reserves the right to change the contents of this guide at any time without prior notice.
- Illustrations and screenshots in this guide may differ slightly from the actual equipment.
- Every effort has been made to ensure that the information contained in this guide is accurate and complete. However, if you notice any errors or omissions, please contact the Canon customer service center indicated on the customer support list included with the product.
- The above items notwithstanding, Canon accepts no liability for damages due to mistaken operation of the products.

Canon

DIGITAL CAMERA

PowerShot D10

Camera User Guide

Canon

PowerShot D10

Camera User Guide



ENGLISH



- Make sure you read this guide before using the camera.
- Store this guide safely so that you can use it in the future.

Checking the Package Contents

Check if the following items are included in your camera package. If anything is missing, contact the retailer from which you purchased the camera.

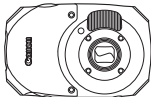

Camera

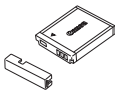

Battery Pack NB-6L
(with Terminal Cover)



Battery Charger
CB-2LY/CB-2LYE

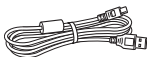

Interface Cable
IFC-400PCU

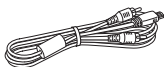

AV Cable
AVC-DC400

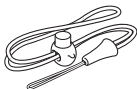

Wrist Strap
WS-DC8



Strap Mount



Camera User Guide
(This Guide)



DIGITAL CAMERA
Solution Disk



Warranty
Card



"Canon Customer
Support" Leaflet



Also refer to the PDF manuals on the CD-ROM. After installation, shortcut icons appear on the desktop. If the software installation fails, you can find the manuals in the Readme folder on the CD-ROM.

- **Personal Printing Guide**
Read when you want to connect the camera to a printer and print.
- **Software Starter Guide**
Read when you want to connect the camera to a computer.
- Detailed user guides (PDF format) for the included ZoomBrowser EX and ImageBrowser programs are available on the Canon website (English only):
<http://web.canon.jp/imaging/information-e.html>



- A memory card is not included.
- Adobe Reader is required to view the PDF manuals.

Read This First

Test Shots

Take some initial test shots and play them back to make sure the images were recorded correctly. Please note that Canon Inc., its subsidiaries and affiliates, and its distributors are not liable for any consequential damages arising from any malfunction of a camera or accessory, including memory cards, that results in the failure of an image to be recorded or to be recorded in a way that is machine readable.

Warning Against Copyright Infringement

The images recorded with this camera are intended for personal use. Do not record images that infringe upon copyright laws without the prior permission of the copyright holder. Please be advised that in certain cases the copying of images from performances, exhibitions, or commercial properties by means of a camera or other device may contravene copyright or other legal rights even if the image was shot for personal use.

Warranty Limitations

This camera's warranty is only effective in the country of sale. If there is a problem with the camera while abroad, please return it to the country of sale before proceeding with a warranty claim to a Canon Customer Support Help Desk. For Canon Customer Support contacts, please see the customer support list supplied with your camera.

LCD Monitor

The LCD monitor is produced with extremely high-precision manufacturing techniques. More than 99.99% of the pixels operate to specification, but occasionally non-performing pixels may appear as bright or dark dots. This is not a malfunction and has no effect on the recorded image.

Camera Body Temperature

Please take care when operating the camera for an extended period as the camera body may become warm. This is not a malfunction.

Memory Cards

The various types of memory cards that can be used in this camera are collectively referred to as memory cards in this guide.

About the Waterproof, Dustproof, and Shock Resistant Capability of this Camera

This camera is subjected to Canon standard testing. However, it is not guaranteed that this camera will not damage or malfunction. (For more information about waterproof, dustproof, and shock resistant specifications, see p. 157)



Be sure to read the Cautions regarding the waterproof, dustproof, and shock resistant capabilities of the camera on pp. 14, 15.

What Do You Want to Do?

Shoot

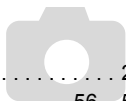

- Shoot, leaving it to the camera to make settings 26
- Shoot to match special conditions. 56 – 59

Take good people shots



Take good landscapes



Shoot various other scenes



- Focus on faces 26, 65, 80
- Shoot in places where I cannot use the flash (turn off the flash) 60
- Shoot pictures with me in them too (self-timer). 64, 65
- Insert the date and time into my shots 63
- Take close-up pictures of subjects (macro shooting) 69
- Take sepia toned or black and white pictures 75
- Change the size of picture I want to take (recording pixels) 70
- Take pictures continuously 72
- Shoot without the effects of camera shake
(image stabilization) 136
- Shoot without the effects of camera shake even in
low light conditions (High ISO Auto) 59, 73

- Maintain the focus on moving subjects (Servo AF)..... 82
- Make dark subjects appear brighter (i-Contrast)..... 87

View



- Look at my pictures..... 29
- Automatically play back pictures (slideshow) 105
- Look at my pictures on a TV 109
- Quickly search pictures..... 102, 103
- Erase pictures 29, 110
- Protect pictures from accidental erasure..... 114

Shoot/View Movies

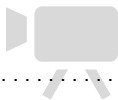

- Shoot movies 32
- View movies 34

Print

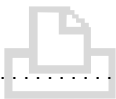

- Easily print pictures..... 30

Save

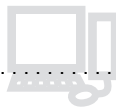

- Save images to a computer 35

Other



- Turn off sounds..... 49
- Use the camera abroad..... 17, 131







Table of Contents

Chapters 1 – 3 explain the basic operations and frequently used functions of this camera. Chapters 4 onward explain the advanced functions, letting you learn more as you read each chapter.

Checking the Package Contents	2
Read This First	3
What Do You Want to Do?	4
Conventions Used in this Guide	8
Safety Precautions.....	9

1 Getting Started 13

Cautions When Using this Waterproof, Dustproof, and Shock Resistant Camera .. 14



Charging the Battery	16
Inserting the Battery and Memory Card	18
Setting the Date and Time	21
Setting the Display Language	23
Formatting Memory Cards	24
Pressing the Shutter Button.....	25
 Taking Pictures	26
 Viewing Images	29
 Erasing Images	29
 Printing Images	30
 Shooting Movies.....	32
 Viewing Movies	34
Transferring Images to a Computer.....	35
Accessories	38
Separately Sold Accessories	40

2 Learning More..... 41



Components Guide.....	42
Information Displayed on the Screen.....	44
Indicator	46

























 FUNC. Menu – Basic Operations.....	47
MENU Menu – Basic Operations....	48
Changing the Sound Settings	49
Changing the Screen Brightness	50
Returning the Camera to Default Settings	51
Low Level Memory Card Formatting	52
Power Saving Function (Auto Power Down)	53
Clock Functions.....	53

3 Shooting in Special Conditions and Commonly Used Functions..... 55

SCN Shooting in Various Conditions	56
 Turning the Flash Off.....	60
Zooming in More Closely on Subjects (Digital Zoom).....	61
Inserting the Date and Time.....	63
 Using the Self-Timer.....	64
 Using the Face Self-Timer.....	65

4 Selecting Settings Yourself..... 67

P Shooting in Program AE	68
 Turning the Flash On.....	68
 Shooting Close-ups (Macro).....	69
 Shooting Far Away Subjects (Infinity).....	69
Changing the Recording Pixels.....	70

Changing the Image Quality (Compression Ratio)	70
 Adjusting the Brightness (Exposure Compensation)	72
 Continuous Shooting	72
Changing the ISO Speed	73
Adjusting the White Balance	74
Changing the Tone of an Image (My Colors)	75
 Shooting Using the Two Second Self-Timer	76
 Customizing the Self-Timer	77
Shooting Using a TV Monitor	77
Changing the Composition with the Focus Lock.....	78
5 Getting More Out of Your Camera 79	
Changing the AF Frame Mode.....	80
Magnifying the Focal Point.....	81
AF-L Shooting with the AF Lock	82
Shooting with Servo AF	82
MF Shooting in Manual Focus Mode	83
 Selecting the Person to Focus On (Face Select).....	84
Changing the Metering Mode.....	85
AE-L Shooting with the AE Lock	85
FE-L Shooting with the FE Lock	86
 Shooting with Slow Synchro	86
 Making Dark Subjects Appear Brighter (i-Contrast)	87
 Red-Eye Correction	88
Checking for Shut Eyes	89
 Shooting Long Exposures	90
Changing the Color and Shooting... ..	91
 Shooting Stitch Assist Images .	94
6 Using Various Functions for Shooting Movies 95	
Changing the Movie Mode	96
Changing the Image Quality.....	96
AE Lock/Exposure Shift.....	97
Other Shooting Functions.....	98
Playback Functions	98
 Editing	99
7 Using Playback and Other Functions..... 101	
 Searching Images (Index Display).....	102
 Viewing Images in Filtered Playback.....	103
 Viewing Slideshows	105
Checking the Focus.....	107
 Magnifying Images	108
 Changing Image Transitions.....	108
Viewing Images on a TV	109
 Erasing All Images.....	110
 Protecting Images.....	114
 Organizing Images by Category (My Category)	116
 Rotating Images.....	118
 Resizing Images	119
 Trimming	120
 Adding Effects with the My Colors Function.....	121
 Making Dark Subjects Appear Brighter (i-Contrast).....	122
 Correcting the Red-Eye Effect ..	123
Printing from the Print List (DPOF)	124
Selecting Images for Printing (DPOF)	125

8 Customizing the Camera ..129

Changing Functions.....	130
Changing Shooting Functions.....	134
Changing Playback Functions	137
Changing the Start-up Image or Sound	137

9 Useful Information..... 139

Using Household Power.....	140
Changing the Strap	141
Changing the Front Cover.....	143
Troubleshooting	144
List of Messages that Appear on the Screen	147
Functions Available in Each Shooting Mode	150
Menus	152
Handling Precautions	156
Specifications	157
Index	160

Conventions Used in this Guide

- Icons are used in the text to represent the camera buttons and switches.
- Language that displays on the screen appears inside [] (square brackets).
- The directional buttons and FUNC./SET button are represented by the following icons.

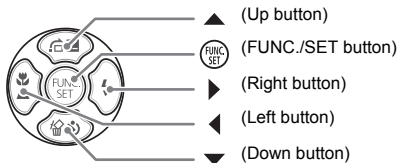

- : Troubleshooting tips.
- : Hints for getting more out of your camera.
- : Things you should be careful about.
- : Supplemental information.
- (p. xx): Reference pages. “xx” stands for page number.
- This chapter assumes all functions are at their default settings.

Safety Precautions

- Before using the camera, please ensure that you read the safety precautions described below. Always ensure that the camera is operated correctly.
- The safety precautions noted on the following pages are intended to prevent injuries to yourself and other persons, or damage to the equipment.
- Be sure to also check the guides included with any separately sold accessories you use.



Warning Denotes the possibility of serious injury or death.



Caution Denotes the possibility of injury.

Caution Denotes the possibility of damage to the equipment.

Warning

Camera

- **Do not trigger the flash in close proximity to human eyes.**
Exposure to the intense light produced by the flash may damage eyesight. In particular, remain at least one meter (39 inches) away from infants when using the flash.

- **Store this equipment out of the reach of children and infants.**
Strap: Putting the strap around a child's neck could result in asphyxiation.
Memory card, day/date battery: Dangerous if accidentally swallowed. If this occurs, contact a doctor immediately.

- **Do not attempt to disassemble or alter any part of the equipment that is not expressly described in this guide.**
- **To avoid the risk of injury, do not touch the interior of the camera if it has been dropped or otherwise damaged.**
- **Stop operating the camera immediately if it emits smoke, a strange smell, or otherwise behaves abnormally.**
- **Do not use organic solvents such as alcohol, benzene, or thinner to clean the equipment.**
- **Do not allow liquids or foreign objects to enter the camera.**
This could result in electrical shock or fire.
If liquid or foreign objects come into contact with the camera interior, immediately turn the camera power off and remove the battery.

- **Use only recommended power sources.**
Using other power sources could result in electrical shock or fire.

- **Do not use the shoulder, neck, or carabiner straps while underwater.**
There is a danger of these straps becoming wrapped around the neck or otherwise causing injury or accident. While underwater, use the wrist strap included with this unit.

Battery, Battery Charger

- Use only recommended batteries.
- Do not place the battery near or in direct flame.
- Do not let the battery come into contact with water (e.g. sea water) or other liquids.
- Do not attempt to disassemble, alter or apply heat to the battery.

- **Avoid dropping or subjecting the battery to severe impacts.**

This may cause explosions or leaks, resulting in fire, injury and damage to the surroundings. In the event that a battery leaks and the eyes, mouth, skin or clothing contacts these substances, immediately flush with water and seek medical assistance. If the battery charger becomes wet, unplug it from the outlet and consult your camera distributor or the closest Canon Customer Support Help Desk.

-
- **Use only the specified battery charger to charge the battery.**
 - **Do not cut, damage, alter or place heavy items on the power cord.**
 - **Unplug the power cord periodically and wipe away any dust and dirt that has collected on the plug, the exterior of the power outlet, and the surrounding area.**
 - **Do not handle the power cord with wet hands.**

This could result in electrical shock or fire.

Other Warnings

- **Do not play the supplied CD-ROM(s) in any CD player that does not support data CD-ROMs.**

Playing the CD-ROM(s) in an audio CD player (music player) could damage the speakers. It is also possible to suffer hearing loss from listening with headphones to the loud sounds of a CD-ROM played on a music CD player.

Caution

- **Be careful not to bang the camera or subject it to strong impacts or shocks when hanging it by the strap.**

This could lead to injury or damage the camera.

- **Do not use the equipment in a manner that exceeds the rated capacity of the electrical outlet or wiring accessories. Do not use if the power cord or plug are damaged, or not fully plugged into the outlet.**

This could result in electrical shock or fire.

- **Avoid using, placing or storing the camera in the following places.**

- Places subject to strong sunlight.
- Places subject to temperatures above 40 °C (104 °F).
- Humid or dusty areas.

These could cause leakage, overheating or an explosion, resulting in fire, burns or other injuries. High temperatures may also cause deformation of the casing.

- **Do not allow dirt or metal objects (such as pins or keys) to contact the charger terminals or plug.**

This could result in electrical shock, fire or other damage.

- **Playing back for a long time may cause feelings of discomfort.**

Caution

- **Do not aim the camera at bright light sources (the sun, etc.).**
Doing so may cause malfunctions or damage the image sensor.
- **This camera cannot be used underwater at a depth greater than 10 m (33 ft.), or in hot springs and other mineralized waters.**
This may cause damage or water leakage.
- **When opening the cover on the beach or in a windy area, take care that sand or dust does not get inside the camera.**
- **Do not use the flash with dirt, dust or other items stuck to the surface, or if it is covered by your fingers or clothing.**
This may cause the camera to malfunction.
- **Unplug the battery charger from the power outlet after recharging is complete, or when you are not using it.**
- **Do not place anything, such as cloth, on top of the battery charger while it is charging.**
Leaving the unit plugged in for a long period of time may cause it to overheat and distort, resulting in fire.
- **Remove and store the battery when you are not using the camera.**
If the battery is left inside the camera, damage caused by leakage may occur.
- **Before you discard batteries, cover the terminals with tape or other insulators.**
Contacting other metal materials in waste containers may lead to fire or explosions.
- **Keep the battery out of the reach of pets.**
If the battery is bitten, this could cause leakage, overheating or an explosion, resulting in fire, burns or other injuries.
- **Do not sit in a chair with the camera in your pocket.**
Doing so may cause malfunctions or damage the LCD monitor.
- **When putting the camera in your bag, ensure that hard objects do not come into contact with the LCD monitor.**
- **Do not attach accessories to the strap.**
If this occurs, it may cause malfunctions or damage the LCD monitor.





Getting Started

This chapter explains preparations before shooting, how to shoot in **AUTO** (Auto) mode, and then how to view, erase and print the images you take. The latter part of this chapter explains how to shoot and view movies and transfer images to a computer.

Attaching the Strap/Holding the Camera

- After attaching the strap to the strap mount, insert the strap mount into the camera and turn until it clicks. There are four places on the camera where the strap mount can be attached. To remove the strap mount, hold the release button while turning the strap mount counterclockwise.
- Be sure to place the strap around your wrist when shooting to avoid dropping the camera. This camera will sink in water.
- Keep your arms tight against your body while holding the camera firmly by the sides. Be sure that your fingers do not block the flash.

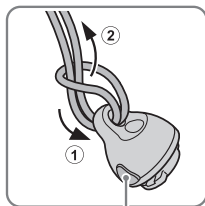

Release button

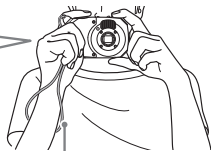
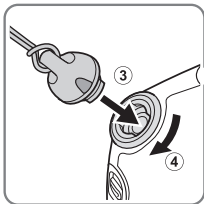

Strap

Cautions When Using this Waterproof, Dustproof, and Shock Resistant Camera

You can enjoy using this camera in the rain, on the beach, while skiing, or underwater within a depth of 10 m (33 ft.). However, it can not be used in hot springs or other mineralized waters. Please be aware that Canon is not liable for any damage to the camera, batteries, memory cards, or saved data caused by water leakage due to mistaken operation of the product.

This camera is subjected to Canon standard testing. However, it is not guaranteed that this camera will not damage or malfunction. (For more information about waterproof, dustproof, and shock resistant specifications, see p. 157)

Cautions Before Using This Camera

- Be sure the memory card/battery and the terminal covers are fully closed. If either of the covers are not fully closed while the camera is wet, water may get inside the camera and cause damage (p. 19).
- Be sure that the waterproof seals inside the covers and the areas around them are kept free from scratches and foreign objects such as sand, dirt, or hair. Not doing so may result in leaks (pp. 18, 30). If the waterproof seal is damaged, do not use the camera underwater.
- Avoid opening and closing the covers while on the beach or near water. Change memory cards and batteries in a dry place protected from sea breezes.
- Do not open the covers if the camera is wet. If there is moisture on the camera, wipe it off with a soft, dry cloth until it is completely dry.

Cautions While Using This Camera

- Do not use this camera in water deeper than 10 m (33 ft.).
- Do not expose the camera to strong impacts or shocks while underwater. Impacts could cause the covers to open or otherwise compromise the waterproof ability of the camera.
- This camera is deemed shock resistant by Canon standard testing (p. 157). However, strong impacts could scratch the camera or cause it to malfunction. Do not allow the camera to fall a great distance or expose it to excessive shocks.

Cautions After Using This Camera and Camera Care

- Attempting to wipe sand or dirt directly off the camera's surface may cause scratches.
- If the camera is dirty, or if you have been using it in water, wash it completely with fresh water (e.g. tap water below 30 °C (86 °F)) as soon as possible. After using this camera at the beach it is recommended that you soak the camera in fresh water for a few hours in order to completely remove any salt deposits. Be sure the memory card / battery and terminal covers are fully closed in order to prevent water from getting inside the camera.
- After washing the camera, dry it completely by wiping it with a soft, dry cloth. Allowing salt to remain on the camera for long periods of time could cause the metal parts to rust or cause the buttons to stick. After washing and drying the camera, check that the buttons are functioning normally.
- Do not use any chemicals to clean the camera. Also, do not use silicon grease on the waterproof seals. (Silicon grease is used on waterproof cases for other cameras.) This may cause damage or water leakage.
- Before storing your camera, be sure that there is no sand or other foreign objects on the waterproof seals. Foreign objects could degrade the seal and cause water leakage and damage to the camera.

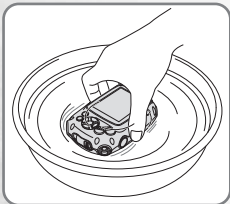

About the Waterproof Seals

- Scratches or cracks in the waterproof seals could cause damage or leaks. Contact the closest *Canon Customer Support Help Desk* for immediate repair. The waterproof seal will be replaced on a chargeable basis.

Charging the Battery

Use the included charger to charge the battery.

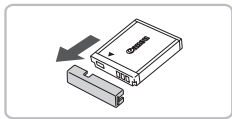

1 Remove the cover.

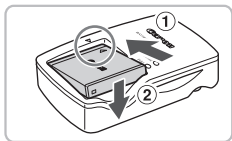

2 Insert the battery.

- Align the ▲ marks on the battery and charger, then insert the battery by sliding it in ① and down ②.

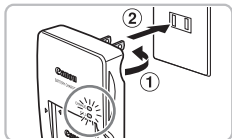

3 Charge the battery.

- For CB-2LY: Flip out the plug ① and plug the charger into a power outlet ②.
- For CB-2LYE: Plug the power cord into the charger, then plug the other end into a power outlet.
- ▶ The charge lamp lights red and charging starts.
- The charge lamp will light green when charging has finished. Charging takes approx. 1 hour and 55 minutes.



4 Remove the battery.

- Unplug the battery charger from the power outlet, then remove the battery by sliding it in ① and up ②.



To protect the battery and prolong its life, do not charge it for longer than 24 hours continuously.

Approximate Number of Shots That Can Be Taken



Number of shots	LCD monitor on.*	220 shots
Playback Time (Hours)	6 hours	

* The number of shots that can be taken is based on the Camera & Imaging Products Association (CIPA) measurement standard.

- Under some shooting conditions, fewer shots can be taken.

Battery Charge Indicator

An icon or message will appear on the screen indicating the battery's charge state.

Display	Summary
	Good.
	Slightly depleted, but sufficient.
 (Blinking red)	Nearly depleted.
"Change the battery pack."	Depleted. Recharge the battery.



Using the battery and charger effectively

- Charge the battery on the day, or the day before, it will be used. Charged batteries continue to discharge naturally even if they are not used.



Attach the cover to a charged battery so that the ▲ mark is visible.

- How to store the battery for long periods.**

Deplete and remove the battery from the camera. Attach the terminal cover and store the battery. Storing a battery for long periods of time (about a year) without depleting it may shorten its life span or affect its performance.

- The battery charger can also be used when abroad.**

The charger can be used in regions that have 100 – 240 V (50/60 Hz) AC power. If the plug does not fit the outlet, use a commercially available plug adapter. Do not use devices, such as electrical transformers for foreign travel, because they will cause malfunctions.

- The battery may develop a bulge.**

This is a normal characteristic of the battery and does not indicate a problem. However, if the battery bulges to the point where it will no longer fit into the camera, please contact a Canon Customer Support Help Desk.

- If the battery is quickly depleted even after charging, it has reached the end of its life span.**

Purchase a new battery.

Inserting the Battery and Memory Card

Insert the included battery and a memory card into the camera.

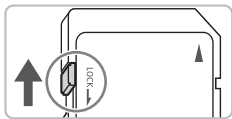

1 Check the card's write-protect tab.

- If the memory card has a write-protect tab, you will not be able to record images if the tab is in the locked position. Slide the tab up until you hear a click.

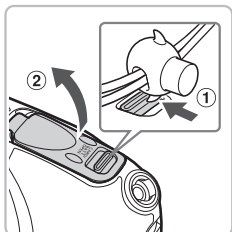

2 Open the cover.

- Using your finger or the wrist strap fastener, move the lock in the direction of arrow ①, while simultaneously opening the lid as shown in ②.

Waterproof seal Terminals

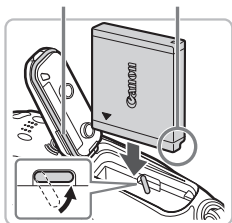

3 Insert the battery.

- Insert the battery as shown until it locks into place with a click.
- Be sure to insert the battery in the correct direction or it will not properly lock into place.
- Be careful not to damage the waterproof seal when inserting the battery.

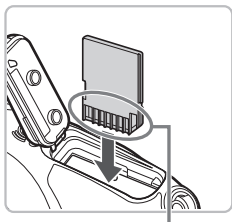

Terminals

4 Insert the memory card.

- Insert the memory card as shown until it locks into place with a click.
- Be sure the memory card is oriented correctly. Inserting the memory card in the wrong direction could damage the camera.
- Be careful not to damage the waterproof seal when inserting the memory card.

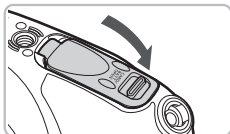

5 Close the cover.

- Press the cover closed as shown in the figure until it clicks into place.
- Be sure the lock has returned to the correct position as shown in the figure.



- Do not open the covers when the camera is wet or submerged in water. If the camera is wet, wipe it off with a soft, dry cloth until it is completely dry.
- Be sure that the waterproof seals and the areas around them are kept free from scratches and foreign objects such as sand, dirt, or hair. Not doing so may result in leaks (pp. 18, 30).
- Avoid opening and closing the covers while on the beach or near water. Change memory cards and batteries in a dry place protected from sea breezes.

Removing the Battery and Memory Card

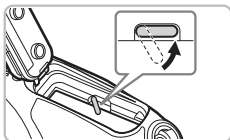

Remove the battery.

- Open the cover and press the battery lock in the direction of the arrow.
- ▶ The battery will pop up.

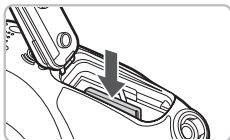

Remove the memory card.

- Push the memory card in until you hear a click, then slowly release it.
- ▶ The memory card will pop up.

Approximate Number of Shots per Memory Card

Memory Card	2 GB	8 GB
Number of shots	626	2505

- Values are based on the default settings.
- The number of shots that can be taken will vary depending on camera settings, the subject and the memory card used.

? Can you check the number of shots that can be taken?

You can check the number of shots that can be taken when the camera is in a Shooting Mode (p. 26).



Number of shots that can be taken

Compatible Memory Cards

- SD memory cards
- SDHC memory cards 
- MultiMediaCard
- MMCplus memory cards
- HC MMCplus Card

? What is the write-protect tab?

SD and SDHC memory cards have a write-protect tab. If this tab is in the locked position, [Card Locked!] will appear on the screen and you will not be able to take or erase images.

Setting the Date and Time

The Date/Time settings screen will appear the first time the camera is turned on. Since the dates and times recorded into your images are based on these settings, be sure to set them.

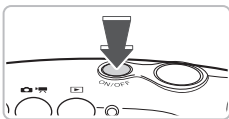

1 Turn on the camera.

- Press the power button.
- ▶ The Date/Time screen will appear.



2 Set the date and time.

- Press the ◀▶ buttons to select an option.
- Press the ▲▼ buttons to set a value.



3 Make the setting.



- Press the  button.
- ▶ Once the date and time have been set, the Date/Time screen will close.
- Pressing the power button will turn off the camera.

? Reappearing Date/Time screen

Set the correct date and time. If you have not set the date and time, the Date/Time screen will appear each time you turn on the camera.



Daylight saving time settings

If you select  in Step 2 and press the ▲▼ buttons and select , you will set the time to daylight savings (1 hour ahead).

Changing the Date and Time

You can change the current date and time settings.







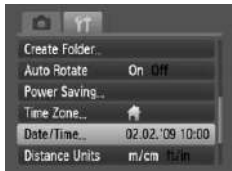

1 Display the menus.

- Press the **MENU** button.



2 Select [Date/Time] in the tab.

- Press the   buttons to select the  tab.
- Press the   buttons to select [Date/Time], then press the  button.



3 Change the date and time.

- Follow Steps 2 and 3 on p. 21 to adjust the setting.
- To close the menus, press the **MENU** button.



Date/Time battery

- The camera has a built-in date/time battery (backup battery) that allows the date/time settings to be retained about three weeks after the battery pack has been removed.
- By inserting a charged battery or connecting an AC adapter kit (sold separately, p. 40) the date/time battery can be charged in about 4 hours even if the camera is not turned on.
- If the date/time battery is depleted, the Date/Time menu will appear when you turn the camera on. Follow the steps on p. 21 to set the date and time.

Setting the Display Language

You can change the language displayed in the LCD monitor menus and messages.

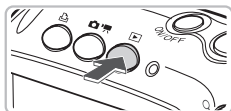

1 Set the playback mode.

- Press the button.

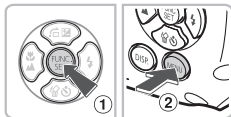

2 Display the settings screen.

- Press and hold the button ①, then immediately press the **MENU** button ②.



3 Set the display language.

- Press the buttons to select a language, then press the button.
- ▶ Once the display language has been set, the language menu will close.



? What if the clock appears when the button is pressed?

The clock will display if too much time passes between pressing the button and the **MENU** button in Step 2. If the clock appears, press the button to remove the clock and repeat Step 2.



You can also change the display language by pressing the **MENU** button, selecting the tab, and selecting the [Language] menu item.

Formatting Memory Cards

Before you use a new memory card or one that has been used in other devices, you should format the card with this camera. Formatting (initializing) a memory card erases all data on the memory card. As you cannot retrieve the erased data, exercise adequate caution before formatting the memory card.



1 Display the menus.

- Press the **MENU** button.

2 Select [Format].

- Press the **◀▶** buttons to select the **YT** tab.
- Press the **▲▼** buttons to select [Format], then press the **FUNC SET** button.

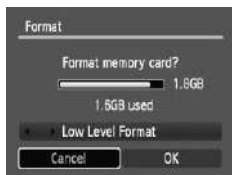
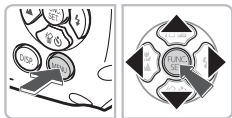

3 Format the memory card.

- Press the **◀▶** buttons to select [OK], then press the **FUNC SET** button.
- ▶ The memory card will be formatted.
- ▶ When formatting has finished, the menu screen will reappear.



Formatting or erasing data on a memory card merely changes the file management information on the card and does not ensure its contents are completely erased. Be careful when transferring or disposing of a memory card. When disposing of a memory card, take precautions such as physically destroying the card to prevent personal information leaks.



The total capacity of the memory card displayed in the formatting screen may be less than indicated on the memory card.

Pressing the Shutter Button

The shutter button has two stops. To take images that are in focus, be sure to first press the shutter button lightly (halfway) to focus, then take the shot.

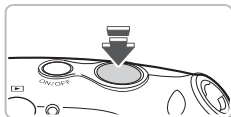

1 Press halfway (lightly to the first stop).

- ▶ The camera focuses and automatically selects the necessary settings for shooting, such as the brightness.
- ▶ When the camera focuses, it will beep twice and the indicator will light green.

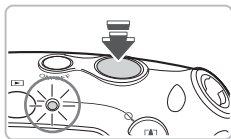

2 Press fully (to the second stop).

- ▶ The camera plays the shutter sound and takes the shot.
- Since the shot is being taken while the shutter sound plays, be careful not to move the camera.

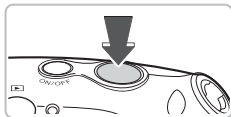

Does the length of the shutter sound change?

- Since the time required to shoot differs according to the scene you want to take, the length of the shutter sound may change.
- If the camera or subject moves while the shutter sound is playing, the recorded image may be blurry.



If you just press the shutter button fully without pausing halfway, the image may not be in focus.

AUTO Taking Pictures

Since the camera can determine the subject and shooting conditions, you can let it automatically select the best settings for the scene and just shoot. The camera can also detect and focus on faces, setting the color and brightness to optimal levels.



1 Check to Make Sure the Covers are Closed.

- If either of the covers are not fully closed while the camera is wet, water may get inside the camera and cause damage.

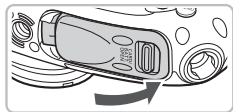

2 Turn on the camera.

- Press the power button.
- ▶ The start-up sound will play, and the startup screen will appear.
- Pressing the power button again will turn the camera off.

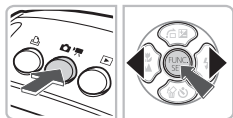
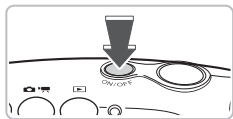



3 Select the **AUTO mode.**

- After pressing the / button, use the buttons to select **AUTO** and press .
- When you point the camera toward the subject, the camera will make a slight noise as it determines the scene.
- ▶ The camera focuses on the subject it judges to be the main subject, and displays the icon for the determined scene in the upper left of the screen.
- ▶ When faces are detected, a white frame appears on the face of the main subject, while gray frames appear on other detected faces.
- ▶ Even if the detected faces move, the camera will follow the faces within a certain range.





4 Compose the shot.

- Pressing the  button will zoom in on your subject, making it appear larger. Pressing the  button will zoom out from your subject, making it appear smaller.

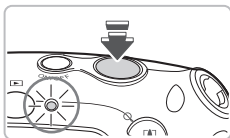

5 Focus.

- Press the shutter button halfway to focus.
- ▶ When the camera focuses, it will beep twice and the indicator will light green (orange when the flash will fire).
- ▶ Green AF frames appear where the subject is in focus.
- ▶ Several AF frames will appear when the camera focuses on more than one point.



AF Frames

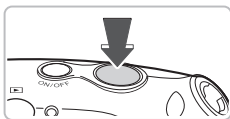



6 Shoot.

- Press the shutter button fully.
- ▶ The camera will play the shutter sound and shoot. The flash will automatically fire in low light conditions.
- ▶ The indicator will blink green while the image is recorded to the memory card.
- ▶ The image will appear on the screen for about two seconds.
- You can take a second picture even while an image is displayed by pressing the shutter button.







What if...

● The camera does not play any sounds?















Pressing the **DISP.** button while turning on the camera power will turn off all sounds except for warning sounds. To turn the sounds on, press the **MENU** button, select the  tab, and then select **[Mute]**. Use the   buttons to select **[Off]**.

Taking Pictures

- The image comes out dark even if the flash fired when shooting?**
 Your subject is too far away. When you have pressed  so that the camera is at maximum wide angle, your shooting range is 30 cm – 3.2 m (1.0 – 10 ft.). Your shooting range is about 30 cm – 2.0 m (1.0 – 6.6 ft.) when you have pressed  and the camera is at maximum telephoto.
- The camera beeps once when the shutter button is pressed halfway?**
 Your subject is too close. When you have pressed  so that the camera is at maximum wide angle, move about 3 cm (1.2 in.) or more away from your subject and shoot. Move about 30 cm (1.0 ft.) or more away when you have pressed  and the camera is at maximum telephoto.
- The lamp lights when the shutter button is pressed halfway.**
 To reduce red-eye and to assist in focusing, the lamp may light when shooting in dark areas.
- The ⚡ icon blinks when you try to take an image?**
 When flash recharging begins, the flash icon will blink. You will be able to shoot once charging is complete.

Scene Icons

The camera displays an icon for the scene it has determined and then automatically focuses and selects the optimum settings for subject brightness and color.

Background Subject	Bright		Including Blue Skies		Sunsets	Dark	
		Backlit		Backlit			When Using Tripod
People					–		 *
Subjects Other Than People Landscapes	AUTO		AUTO			AUTO	 *
Close Subjects					–		–
Icon Background Color	Gray		Light Blue		Orange	Dark Blue	

* Displays when the camera is attached to a tripod.



Under certain conditions, the icon that displays may not match the actual scene. Especially when there is an orange or blue colored background (a wall for example),  or the “Blue Skies” icons may appear and it may not be possible to shoot with the appropriate color. If this happens, try shooting in the **P** mode (p. 68). While underwater, it is recommended to use the Underwater scene mode (p. 58).

Viewing Images

You can view your images on the screen.

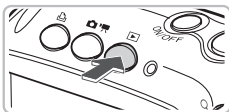





1 Select the playback mode.

- Press the  button.
- ▶ The last image you took will appear.



2 Select an image.

- Pressing the  button will cycle through the images in reverse order.
- Pressing the  button will cycle through the images in the order they were taken.
- The images change more quickly if you keep the  buttons pressed, but they will appear coarse.
- After you have switched from shooting mode to playback mode, press  again to restore the shooting screen.
- Pressing the  button while the camera is off, turns the camera on in playback mode. Pressing it again turns the camera off. Pressing the shutter button halfway in playback mode switches the camera to shooting mode.



Erasing Images

You can select and erase images one at a time. Please note that erased images cannot be recovered. Exercise adequate caution before erasing an image.

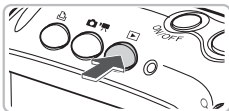

1 Select the playback mode.

- Press the  button.
- ▶ The last image you took will appear.



2 Select an image to erase.

- Press the  buttons to display an image to erase.





3 Erase the image.

- Press the ▼ button.
- ▶ [Erase?] appears.
- Press the ◀▶ buttons to select [Erase], then press the  button.
- ▶ The displayed image will be erased.
- To exit instead of erasing, press the ◀▶ buttons to select [Cancel], then press the  button.

Printing Images

You can easily print the images you have taken if you connect the camera to a PictBridge compliant printer (sold separately).

Items to Prepare

- Camera and PictBridge compliant printer (sold separately)
- Interface cable supplied with the camera (p. 2)

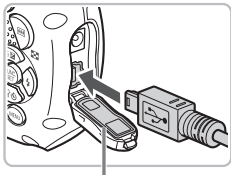
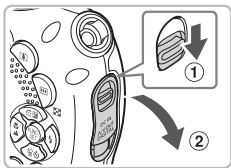

Waterproof seal

1 Turn off the camera and printer.



2 Connect the camera to the printer.

- While pressing the lock in the direction of arrow ①, open the cover in the direction of arrow ②. Insert the cable's smaller plug as shown in the figure, making sure it is fully inserted into the camera.
- Insert the cable's larger plug into the printer. For connection details, refer to the user guide provided with the printer.
- Be careful not to damage the waterproof seal when inserting the cable's plug.

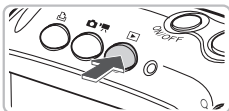
3 Turn on the printer.





4 Turn on the camera.

- Press the  button to turn on the camera.
- ▶  **SET** will appear.



5 Select an image to print.

- Press the   buttons to select an image and press the  button.
- ▶ Printing will start.
- If you want to print additional images, repeat Step 5 after printing has completed.
- After printing has completed, turn off the camera and printer, and unplug the interface cable.









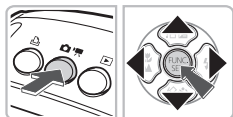

- Refer to the *Personal Printing Guide* for details on the best ways to print.
- For more information on Canon printers (sold separately) with PictBridge support, please see pp. 38, 39.

Shooting Movies

The camera can automatically select all settings so that you can shoot movies just by pressing the shutter button.



1 Select the mode.



- Press the  /  button, then use the   buttons to select .
- Use the   buttons to select , then press the  button.



Shooting Time



2 Compose the shot.

- Pressing the  button will zoom in on your subject, making it appear larger. Pressing the  button will zoom out from your subject, making it appear smaller.

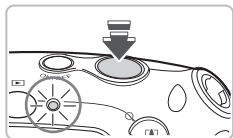

3 Focus.

- Press the shutter button halfway to focus.
- ▶ When the camera focuses, it will beep twice and the indicator will light green.

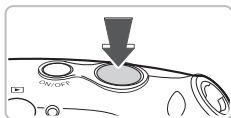

4 Shoot.

- Press the shutter button fully.
- ▶ The camera will start shooting the movie, and [● Rec] and the elapsed time will appear on the screen.
- Once shooting begins, take your finger off the shutter button.
- If you change the composition of your shot during shooting, the focus will stay the same, but the brightness and tone will automatically adjust.
- Due to the waterproof casing, recording volume will be low. You can increase volume levels during playback to enjoy the movie.
- Do not touch or cover the microphone during shooting. If water droplets have gotten into the microphone, wipe them away with a soft cloth.
- Do not press any buttons other than the shutter button. Otherwise, the sound the buttons make will be recorded in the movie.



Elapsed Time

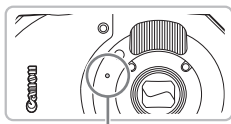

Microphone

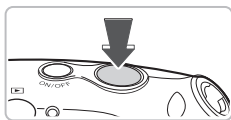

5 Stop shooting.

- Press the shutter button fully again.
- ▶ The camera will beep once and stop shooting the movie.
- ▶ The indicator will blink green, and the movie will record to the memory card.
- ▶ Shooting will automatically stop when the memory card fills.

Estimated Shooting Times

Memory Card	2 GB	8 GB
Shooting Time	23 min. 49 sec.	1 hr. 35 min. 11 sec.

- Shooting times are based on default settings. Shooting time can be checked on the screen in Step 1.
- Recording will automatically stop when either the clip file size reaches 4 GB or the recording time reaches approximately 1 hour.

▶ Viewing Movies

You can view your movies on the screen.

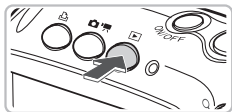

1 Select the playback mode.

- Press the **▶** button.
- ▶ The last image you shot will appear.
- ▶ **SET** appears on movies.



2 Select a movie.

- Press the **◀▶** buttons to select a movie, then press the **FUNC/SET** button.
- ▶ The movie control panel will appear on the screen.



3 Play the movie.

- Press the **◀▶** buttons to select **▶** (Play), then press the **FUNC/SET** button.
- ▶ The movie will play.
- You can pause/resume the movie by pressing the **FUNC/SET** button again.
- Press the **▲▼** buttons to adjust the volume.
- After the movie finishes, **SET** appears.



- When watching a movie on a computer, frames may drop, it may not play smoothly, and the audio may stop suddenly depending on the computer's capabilities.
- If you use the supplied software to copy the movie back onto the memory card, you can play back the movie smoothly. For enhanced playback you can also connect the camera to a TV.

Transferring Images to a Computer

You can use the included software to transfer your camera images to a computer.

System Requirements

Even though these are recommended system requirements, not all computer functions can be guaranteed.

Windows

OS	Windows Vista (including Service Pack 1) Windows XP Service Pack 2, Service Pack 3	
Computer model	The above OS should be pre-installed on computers with built-in USB ports.	
CPU	Viewing images	Pentium 1.3 GHz or higher
	Viewing movies	Core2 Duo 1.66 GHz or higher
RAM	Viewing images	Windows Vista: 1 GB or more Windows XP: 512 MB or more
	Viewing movies	1 GB or more
Interface	USB	
Free Hard Disk Space	Canon Utilities	ZoomBrowser EX: 200 MB or more PhotoStitch: 40 MB or more
Display	1,024 × 768 pixels or higher	

Macintosh

OS	Mac OS X v10.4 – v10.5	
Computer model	The above OS should be pre-installed on computers with built-in USB ports.	
CPU	Viewing images	PowerPC G4/G5 or Intel Processor
	Viewing movies	Core Duo 1.66 GHz or higher
RAM	Viewing images	512 MB or more
	Viewing movies	1 GB or more
Interface	USB	
Free Hard Disk Space	Canon Utilities	ImageBrowser: 300 MB or more PhotoStitch: 50 MB or more
Display	1,024 × 768 pixels or higher	

Preparations

Windows XP and Mac OS X (v10.4) are used for these explanations.

1 Install the software.

Windows



- 1 Place the DIGITAL CAMERA Solution Disk in the computer's CD-ROM drive. Begin installation.

- 2 Install the software.

- Click [Easy Installation] and follow the onscreen instructions to proceed with the installation.



- 3 When the install finishes, click [Restart] or [Finish].

- 4 Remove the CD-ROM.

- Remove the CD-ROM when your desktop screen appears.



Macintosh

- Place the CD-ROM in the computer's CD-ROM drive and double-click the  icon.
- Click [Install], and follow the onscreen instructions to proceed with the installation.

2 Connect the camera to the computer.

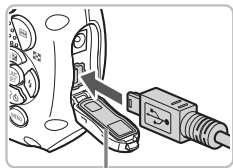

Waterproof seal

- Turn off the camera.
- Connect the camera to the computer as shown in Step 2 on p. 30.
- Be careful not to damage the waterproof seal when inserting the cable's plug.

3 Turn on the camera.

- Press the  button to turn on the camera.

4 Open CameraWindow.



Windows

- Select [Canon CameraWindow] and click [OK].
- ▶ CameraWindow will appear.
- If CameraWindow does not appear, click the [Start] menu and select [All Programs] or [Programs], followed by [Canon Utilities] ▶ [CameraWindow] ▶ [CameraWindow] ▶ [CameraWindow].



Macintosh

- ▶ CameraWindow will appear when you establish a connection between the camera and computer.
- If CameraWindow does not appear, click the [CameraWindow] icon on the Dock (the bar which appears at the bottom of the desktop).



Transferring Images to a Computer



- Click [Transfer Untransferred Images].
- ▶ All images not previously transferred will transfer to the computer.
- After the transfer finishes, turn off the camera and unplug the cable.
- For further operations, refer to the *Software Starter Guide*.



Images transferred to the computer will be sorted by date and saved in separate folders in the "My Pictures" folder for Windows or the "Pictures" folder for Macintosh.

Accessories

Supplied with Camera



Strap mount,
Wrist Strap
WS-DC8

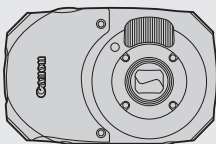

AV Cable AVC-DC400*1



Interface Cable IFC-400PCU*1



Battery Pack NB-6L
(with Terminal Cover)*1



Battery Charger
CB-2LY/CB-2LYE*1



DIGITAL CAMERA
Solution Disk

Accessory Kits *5

Soft Case SD-DC70 *4 *5



Shoulder and Neck Strap Set
STP-DC1 *4 *5



Carabiner Strap
STP-DC2 *4 *5



Front Cover Set
FC-DC1*5

*1 Also available for purchase separately.

*2 See the user guide supplied with the printer for more information on the printer and interface cables.

*3 The power cords and adapters in accessory packs ACK-DC10 and ACK-DC30 are also compatible for this camera. (DC Couplers are not used on this camera.)

*4 Cannot be used underwater.

*5 May not be available in all regions. A general accessory kit containing the strap, cover, and soft case sets may be available depending on location.

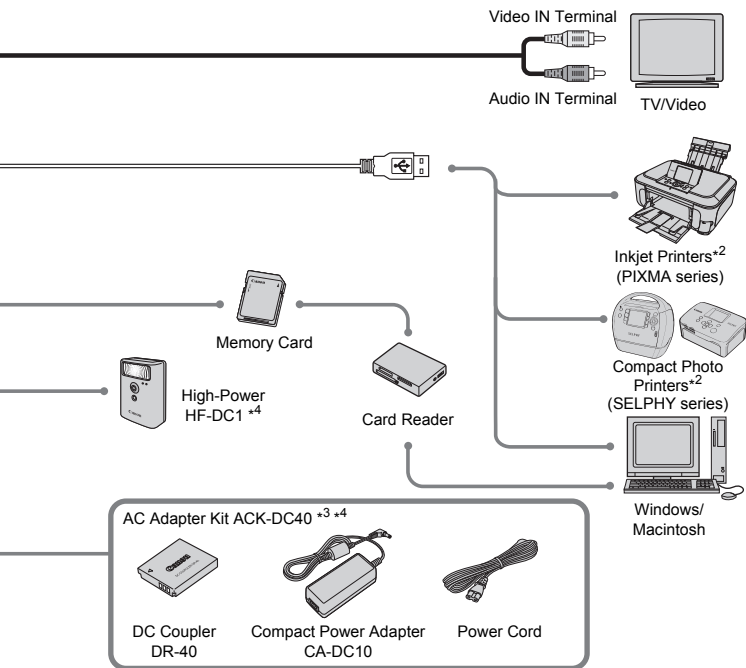

Use of genuine Canon accessories is recommended.

This product is designed to achieve excellent performance when used with genuine Canon accessories. Canon shall not be liable for any damage to this product and/or accidents such as fire, etc., caused by the malfunction of non-genuine Canon accessories (e.g., a leakage and/or explosion of a battery pack). Please note that this warranty does not apply to repairs arising out of the malfunction of non-genuine Canon accessories, although you may request such repairs on a chargeable basis.

CAUTION

RISK OF EXPLOSION IF BATTERY IS REPLACED BY AN INCORRECT TYPE.
DISPOSE OF USED BATTERIES ACCORDING TO LOCAL REGULATION.

Separately Sold Accessories

The following camera accessories are sold separately. Some accessories are not sold in some regions, or may no longer be available.

Power Supplies

- **AC Adapter Kit ACK-DC40**

This kit lets you power the camera using household power. Recommended for powering the camera for an extended period of time or when connecting to a computer. Cannot be used to charge the battery inside the camera.

- **Battery Charger CB-2LY/CB-2LYE**

An adapter for charging Battery Pack NB-6L.

- **Battery Pack NB-6L**

Rechargeable lithium-ion battery.



The battery charger can also be used when abroad.

The charger can be used in regions that have 100 – 240 V (50/60 Hz) AC power. If the plug does not fit the outlet, use a commercially available plug adapter. Do not use devices such as electrical transformers for foreign travel because they will cause malfunctions.

Other Accessories

- **Shoulder and Neck Strap Set STP-DC1**

A shoulder and neck strap set easily attachable to the camera.

- **Carabiner Strap STP-DC2**

A carabiner strap easily attachable to the camera.

- **Front Cover Set FC-DC1**

You can change the color of your camera's front cover. This set comes with three different colored covers and an installation tool.

- **High-Power Flash HF-DC1**

This attachable supplementary flash can illuminate subjects that are too distant for the light from the built-in flash to reach.

2

Learning More





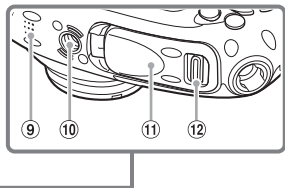
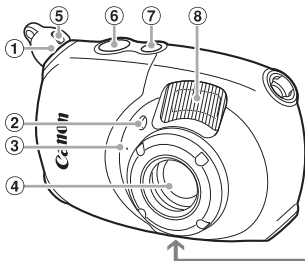

This chapter explains the parts of the camera and what displays on the screen, as well as the basic operating instructions.

Components Guide



- ① Strap Mount (p. 13)
- ② Lamp (AF Assist Beam (p. 134)/
Red-Eye Reduction Lamp (p. 134)/
Self-Timer Lamp (p. 65))
- ③ Microphone (p. 33)
- ④ Lens
- ⑤ Release button (p. 13)
- ⑥ Shutter Button (p. 25)
- ⑦ Power Button
- ⑧ Flash (pp. 60, 68)
- ⑨ Speaker
- ⑩ Tripod Socket
- ⑪ Memory Card / Battery Cover (p. 18)
- ⑫ Memory Card / Battery Cover Lock
(p. 18)

(Shooting) / (Movie) Button

Use the  /  button and the     buttons to change the shooting mode.

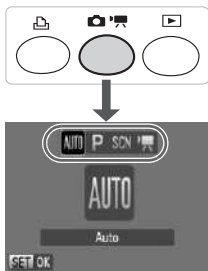

Auto Mode (AUTO)

You can leave it to the camera to select settings (p. 26).

Program AE mode (P)

You can set various functions in order to take the picture you want (p. 68).

Special Scene Mode (SCN)

The camera can automatically select all settings appropriate for the conditions so that you can take images just by pressing the shutter button (p. 56).

Movie Mode (Movie icon)

For shooting movies (p. 32).

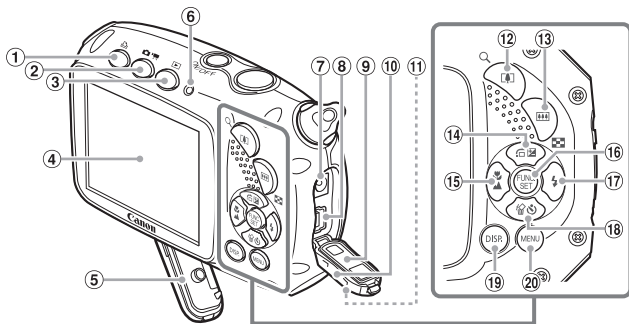

- ① (Direct Print) Button
(pp. 30, 124, 136)
- ② (Shooting/Movie) Button (p. 79)
- ③ (Playback) Button (pp. 29, 101)
- ④ Screen (LCD Monitor) (p. 44)
- ⑤ Waterproof seal (p. 18)
- ⑥ Indicator (p. 46)
- ⑦ DC IN Terminal
- ⑧ A/V OUT (Audio/Video Output) and DIGITAL Terminal (pp. 30, 35, 109)
- ⑨ Waterproof seal (p. 30)
- ⑩ Terminal Cover (p. 30)
- ⑪ Terminal Cover Lock (p. 30)
- ⑫ Zoom Button
Shooting: (Telephoto) (p. 27)
Playback: (Magnify) (p. 108)
- ⑬ Zoom Button
Shooting: (Wide Angle) (p. 27)
Playback: (Index) (p. 102)
- ⑭ (Exposure) (p. 72/
 (Jump) (p. 103)/ Button
- ⑮ (Macro) (p. 69)/ (Infinity) (p. 69)/
MF Manual Focus (p. 83)/ Button
- ⑯ **FUNC./SET** (Function/Set) Button (p. 47)
- ⑰ (Flash) (pp. 60, 68)/ Button
- ⑱ (Self-Timer) (pp. 64, 65, 76, 77)/
 (Single Image Erase) (p. 29)/
 Button
- ⑲ **DISP.** (Display) Button (pp. 44, 45)
- ⑳ **MENU** Button (p. 48)

(Playback) Button

Press this button while in shooting mode to switch between playback mode and shooting mode. Press this button while the camera is turned off to switch between playback mode and off mode.

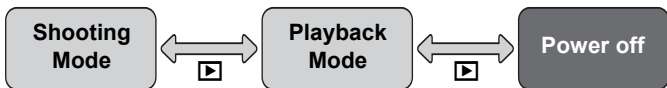

Information Displayed on the Screen

Shooting (Information Display)

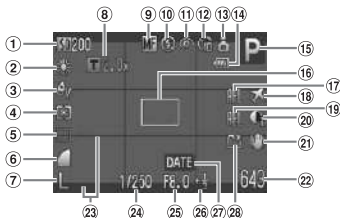

- ① ISO Speed (p. 73)
- ② White Balance (p. 74)
- ③ My Colors (p. 75)
- ④ Metering Modes (p. 85)
- ⑤ Drive Mode (p. 72)
- ⑥ Image Quality (Compression) (p. 70)
- ⑦ Recording Pixels (p. 70)
- ⑧ Digital Zoom Magnification (p. 61), Digital Tele-Converter (p. 62)
- ⑨ Macro (p. 69), Infinity (p. 69), Manual Focus (p. 83)
- ⑩ Flash Mode (pp. 60, 68, 86)
- ⑪ Red-Eye Correction (p. 88)
- ⑫ Self-Timer (pp. 64, 65, 76, 77)
- ⑬ Camera Orientation* (p. 17)
- ⑭ Battery Charge Indicator (p. 17)
- ⑮ Shooting Mode (p. 27), AE Point Frame (p. 85)
- ⑯ AF Lock (p. 82)
- ⑰ Time Zone (p. 131)
- ⑱ AE Lock (p. 85), FE Lock (p. 86)
- ⑲ i-Contrast (p. 87)
- ⑳ Image Stabilizer (p. 136)
- ㉑ Still Images: Recordable shots (pp. 20, 71) Movies: Remaining Time (pp. 33, 97)
- ㉒ Disp. Overlay (p. 135)
- ㉓ Shutter Speed
- ㉔ Aperture Value
- ㉕ Exposure Compensation (p. 72)
- ㉖ Date Taken/Recorded (p. 63)
- ㉗ Create Folder (p. 132)

* : Standard, : Held vertically

When shooting, the camera detects if it is held vertically or horizontally, and adjusts settings accordingly for the best shot. It also detects orientation during playback, so you can hold the camera in either orientation and it will automatically rotate images for correct viewing.

This function may not operate correctly when the camera is pointed straight up or down.

Switching the Display

You can change the display using the **DISP.** button.



No Information Display



Information Display

Playback (Detailed Information Display)

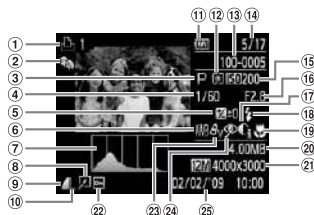

- | | | |
|---|--|---|
| ① Print List (p. 124) | ⑪ Battery Charge Indicator (p. 17) | ⑲ Macro (p. 69), Infinity (p. 69), Manual Focus (p. 83) |
| ② My Category (p. 116) | ⑫ Metering Modes (p. 85) | ⑳ File Size (pp. 70, 96) |
| ③ Shooting Mode | ⑬ Folder Number - File Number (p. 132) | ㉑ Still Images: Recording Pixels (p. 70) |
| ④ Shutter Speed | ⑭ Displayed Image Number /Total Number of Images | ㉒ Movies: Movie Length (p. 97) |
| ⑤ Exposure Compensation (p. 72) | ⑮ ISO Speed (p. 73) | ⑳ Protect (p. 114) |
| ⑥ White Balance (p. 74) | ⑯ Aperture Value, Image Quality (Movies) (p. 96) | ㉓ My Colors (pp. 75, 121) |
| ⑦ Histogram (p. 46) | ⑰ i-Contrast (pp. 87, 122) | ㉔ Red-Eye Correction (pp. 88, 123) |
| ⑧ Image Editing (pp. 119 –123) | ⑱ Flash Sync (p. 68) | ㉕ Shooting Date and Time (p. 63) |
| ⑨ Image Quality (Compression) (p. 70), MOV (Movies) (p. 96) | | |
| ⑩ Recording Pixels (p. 70) | | |

Switching the Display

You can change the display using the **DISP.** button.



No Information Display



Simple Information Display



Detailed Information Display



Focus Check Display (p. 107)



You can also switch the display by pressing the **DISP.** button while the image displays shortly after shooting. However, the Simple Information will not display.

Display in Dark Conditions during Shooting

The display automatically brightens when shooting in dark conditions, allowing you to check the composition (Night Display function). However, the brightness of the image on the screen, and the brightness of the actual image recorded may be different. Screen noise may appear and the movement of the subject may appear somewhat jagged on the screen. This has no effect on the recorded image.

Overexposure Warning during Playback

In “Detailed Information Display” (p. 45), overexposed areas of the image flash on the screen.

Histogram during Playback

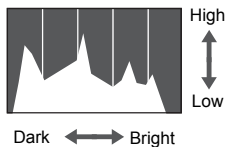

- The graph that appears in “Detailed Information Display” (p. 45) is called the histogram. The histogram shows the distribution and amount of brightness of an image. When the graph approaches the right side, the image is bright, but when it approaches the left side, the image is dark, and in this way you can judge the exposure.

Indicator

The indicator on the back of the camera (p. 43) will light or blink under the following conditions.

Colors	Status	Operation Status
Green	Lights	Shooting preparation complete (p. 27)/Display Off (p. 130)
	Blinks	Recording/reading/transmitting image data (p. 27)
Orange	Lights	Shooting preparation complete (flash on) (p. 27)
	Blinks	Camera shake warning (p. 60)



When the indicator blinks green, data is being recorded to/read from the memory card or various information is being transmitted. Do not turn off the power, open the memory card slot/battery cover, shake or jolt the camera. These actions may corrupt the image data or cause the camera or memory card to malfunction.

Commonly used shooting functions can be set with the FUNC. menu. The menu and menu items differ depending on the shooting mode (p. 150).

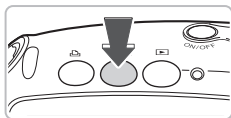

1 Select a shooting mode.

- Press the / button, then use the buttons to select the desired shooting mode. Then press the button.
- When **SCN** or is selected, use the buttons to select the desired shooting mode. Then press the button.



2 Display the FUNC. menu.

- ▶ Press the button.



Selectable Options
Menu Items

3 Select a menu item.

- Press the buttons to select a menu item.
- ▶ The selectable settings for the menu item appear at the lower part of the screen.

4 Select an option.

- Press the buttons to select an option.
- You can also select settings by pressing the **DISP.** button on options that display .



5 Make the setting.

- Press the button.
- ▶ The shooting screen will reappear and the setting you selected will display on the screen.

MENU Menu – Basic Operations

Various functions can be set from the menus. The menu items are organized under tabs, such as for shooting (📷) and playback (▶). The menu items differ depending on the mode (pp. 152 – 155).



1 Display the menu.

- Press the MENU button.



2 Select a tab.

- Press the ◀▶ buttons, or press the zoom button (p. 43) to select a tab (category).

3 Select a menu item.

- Press the ▲▼ buttons to select a menu item.
- Some items require you to press the FUNC SET button to display a submenu in which you change the setting.



4 Select an option.

- Press the ◀▶ buttons to select an option.

5 Make the setting.

- Press the MENU button.
- The standard screen will reappear.

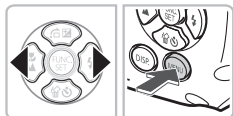

Changing the Sound Settings

You can silence or adjust the volume of camera sounds.

Muting Sounds



1 Display the menu.

- Press the **MENU** button.

2 Select [Mute].

- Press the **◀▶** buttons to select the **☰☱** tab.
- Press the **▲▼** buttons to select [Mute], then use the **◀▶** buttons to select [On].

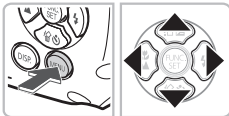

Adjusting the Volume



1 Display the menu.

- Press the **MENU** button.

2 Select [Volume].

- Press the **◀▶** buttons to select the **☰☱** tab.
- Press the **▲▼** buttons to select [Volume], then press the **FUNC. SET** button.

3 Change the volume.

- Press the **▲▼** buttons to select an item, then use the **◀▶** buttons to adjust the volume.

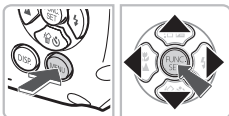

Changing the Screen Brightness

The screen brightness can be changed in two ways.

With the MENU Button



1 Display the menu.

- Press the MENU button.

2 Select [LCD Brightness].

- Press the ◀▶ buttons to select the ƒƒ tab.
- Press the ▲▼ buttons to select [LCD Brightness].

3 Change the brightness.

- Press the ◀▶ buttons to change the brightness.
- Press the MENU button again to complete the setting.

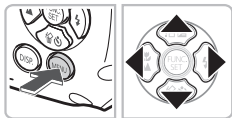

With the DISP. Button

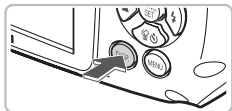

- Press the DISP. button for more than one second.
- ▶ The screen increases to maximum brightness regardless of the setting in the ƒƒ tab.
- Pressing the DISP. button again for more than one second will return the screen to the original brightness.



- The next time you turn on the camera, the screen will be at the brightness setting selected in the ƒƒ tab.
- When you have set the brightness to its highest setting in the ƒƒ tab, you cannot change the brightness with the DISP. button.

Returning the Camera to Default Settings

When you have mistakenly changed a setting, you can reset the camera to the default settings.



1 Display the menu.

- Press the **MENU** button.

2 Select [Reset All].

- Press the **◀▶** buttons to select the **☰** tab.
- Press the **▲▼** buttons to select [Reset All], then press the **FUNC SET** button.

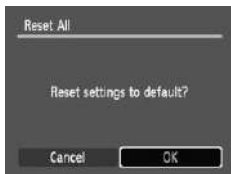
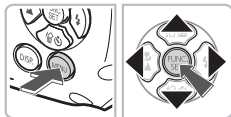

3 Reset the settings.

- Press the **◀▶** buttons to select [OK], then press the **FUNC SET** button.
- ▶ The camera will reset to the default settings.



Are there functions that cannot be reset?

- The [Date/Time] (p. 21) in the **☰** tab, [Language] (p. 23), [Video System] (p. 109), [Time Zone] (p. 131), the image registered as [Start-up Image] (p. 137).
- The saved data for custom white balance (p. 74).
- Colors that were selected in Color Accent (p. 91) or Color Swap (p. 92).

Low Level Memory Card Formatting

Perform low level formatting when you think that the recording/reading speed of a memory card has dropped. Low level formatting a memory card completely erases all data on the memory card. As you cannot retrieve the erased data, exercise adequate caution before formatting the memory card.



1 Display the menu.

- Press the MENU button.

2 Select [Format].

- Press the ◀▶ buttons to select the ȲȲ tab.
- Press the ▲▼ buttons to select [Format], then press the  button.

3 Perform the low level format.

- Press the ▲▼ buttons to select [Low Level Format], then use the ◀▶ buttons to display ✓.
- Press the ▲▼◀▶ buttons to select [OK], then press the  button.
- ▶ Low level formatting starts.

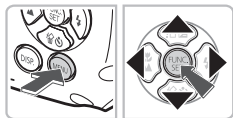
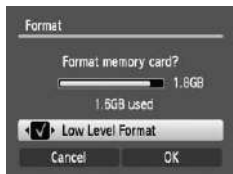

? About low level formatting

When the [Memory card error] message appears, or when the camera does not work correctly, low level formatting the memory card may solve the problem. Copy the images from the memory card to a computer or other device before low level formatting.



- Low level formatting may take longer than standard formatting (p. 24), since all recorded data are erased.
- You can stop a low level format of a memory card by selecting [Stop]. When stopping low level formatting, the data will be erased but the memory card can be used without problem.

Power Saving Function (Auto Power Down)

To save battery power, the camera shuts down automatically when it is not operated for a certain time.

Power Saving during Shooting

The monitor will turn off approximately 1 minute after the camera is last operated, and the indicator on the back of the camera lights green. After about 2 more minutes, the power will turn off. If the monitor is turned off but the indicator is still green, pressing the shutter button halfway (p. 25) turns on the monitor and shooting can continue.

Power Saving during Playback

The power will turn off approximately 5 minutes after the camera is last operated.







- You can turn off the Power Saving Function (p. 130).
- You can adjust the time before the monitor turns off (p. 130).

Clock Functions

You can check the current time.



- Hold the  button pressed.
- ▶ A screen like that on the left appears showing the current time.
- You can change the display color by changing the camera's orientation and pressing the   buttons.
- Press the  button to cancel the clock display.



Press and hold the  button, then press the power button to display the clock.

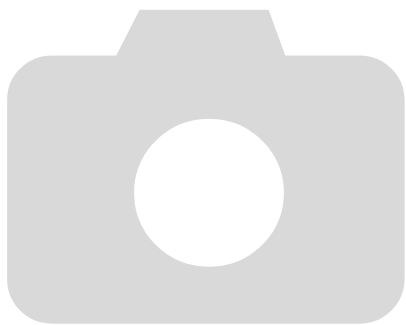



3

Shooting in Special Conditions and Commonly Used Functions

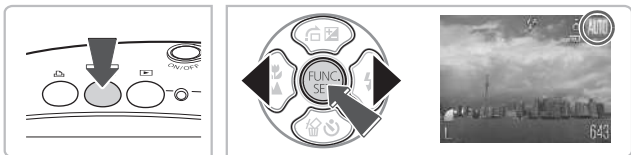
This chapter explains how to shoot in different conditions, as well as how to use other common functions, such as the flash and self-timer.



- When you select a mode that matches a particular set of conditions, the camera will automatically select any necessary settings. All you need do is press the shutter button to take an optimized picture.
- This chapter assumes the mode is set to  (Auto) for “ Turning the Flash Off” (p. 60) to “ Using the Face Self-Timer” (p. 65).

SCN Shooting in Various Conditions

The camera will select the necessary settings for the conditions in which you wish to shoot when you select the matching mode.

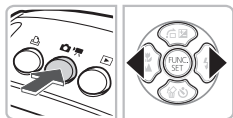

1 Select the shooting mode.

- After pressing the / button, use the buttons to select **SCN**.

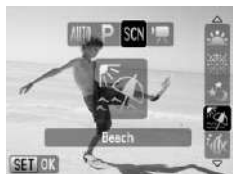

2 Select the desired shooting mode.

- Use the buttons to select a shooting mode, then press the button.
- The default setting is .

3 Shoot.



Take portraits (Portrait)

- Produces a soft effect when photographing people.



Take landscapes (Landscape)

- For shooting majestic landscapes.



Take snapshots at night (Night Snapshot)

- Lets you take beautiful snapshots of people against city nightscapes or night backgrounds.
- If you hold the camera firmly, you can take pictures with reduced camera shake, even without a tripod.



Take shots of kids and pets (Kids&Pets)

- Lets you capture subjects that move around, such as children and pets, without missing photo opportunities.



Take indoor shots (Indoor)

- Lets you shoot indoors with natural colors.



Shoot sunsets (Sunset)

- Lets you take shots of sunsets in vivid colors.



Take shots of fireworks (Fireworks)

- Lets you take shots of fireworks in vivid colors.



Take shots of people at the beach (Beach)

- Lets you take bright shots of people on sandy beaches where the reflected sunlight is strong.



Shoot underwater (Underwater)

- For shooting underwater landscapes and creatures with natural tones.



Take shots of aquatic life in an aquarium (Aquarium)

- Lets you take natural-colored shots of aquatic life in indoor aquariums.



Take shots of foliage (Foliage)

- Lets you shoot trees and leaves, such as new growth, autumn leaves or blossoms, in vivid colors.



Take shots of people in snow (Snow)

- Lets you take bright, natural-colored shots of people against snowy backgrounds.



ISO 3200 Shoot using high ISO speed (ISO3200)

- Sets the ISO speed to 3200, and lets you shoot without camera shake or subject blurring even in low light conditions.
- Recording pixels are set to **M3** (1600 × 1200 pixels, p. 70).



- In **FA**, **SA**, **PA**, **PK** or **PK** mode, images may appear coarse because the ISO speed (p. 73) is increased to match the shooting conditions.
- In **SA** mode, attach the camera to a tripod to prevent the camera from moving and blurring the image. Additionally, you are recommended to set [IS Mode] to [Off] (p. 136).
- In **ISO 3200** mode, images may appear coarse.

Turning the Flash Off





You can shoot with the flash turned off.



1 Press the  button.



2 Select .

- Press the  buttons to select , then press the  button.
- ▶  will appear on the screen.
- Follow the steps above to return the setting to .



? What if the indicator blinks orange and a flashing  appears?



When you press the shutter button halfway in low light conditions where camera shake is likely, the indicator will blink orange and a flashing  will appear on the screen. Attach the camera to a tripod to prevent it from moving.

Zooming in More Closely on Subjects (Digital Zoom)

You can use the digital zoom to zoom up to a maximum of 12x and capture subjects that are too far away for the optical zoom (p. 27) to enlarge. The images may appear coarse, however, depending on the recording pixel setting (p. 70) and the zoom factor used.



1 Press the button.

- Hold the  button until zooming stops.
- ▶ When you release the  button, the largest possible zoom factor without image deterioration, and  will appear.





2 Press the button again.

- ▶ The digital zoom will further zoom in on the subject.

Zoom Factors at which Images Deteriorate

Recording Pixels	Optical Zoom	Digital Zoom
L	3.0x →	
M1	3.7x →	
M2	4.6x →	
M3		7.5x →
S		12x →

-  : No image deterioration (zoom factor appears white)
-  : Image deterioration (zoom factor appears blue)
- : Maximum zoom factor without deterioration (Safety Zoom)



Turning off the digital zoom

To turn off the digital zoom, press the **MENU** button, select the  tab, and select [Digital Zoom] and the [Off] option.



The focal length when using digital zoom is 105 – 420 mm (35mm film equivalent).

T Digital Tele-Converter

The focal length of the lens can be increased by an equivalent of 1.5x or 2.0x. This enables a faster shutter speed and less chance of camera shake than the zoom (including digital zoom) used by itself at the same zoom factor.

The images may appear coarse, however, depending on the combination of recording pixel (p. 70) and digital tele-converter settings used.

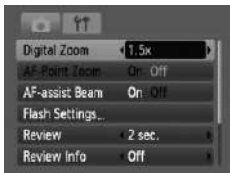

1 Select [Digital Zoom].

- Press the **MENU** button.
- Press the ◀▶ buttons to select the  tab, then press the ▲▼ buttons to select [Digital Zoom].

2 Accept the setting.

- Press the ◀▶ buttons to select [1.5x] or [2.0x].
- Pressing the **MENU** button will restore the shooting screen.
- ▶ The view will be enlarged, and **T** and the zoom factor will display on the screen.
- To return to standard digital zoom, select [Digital Zoom] and the [Standard] option.

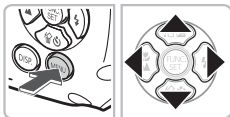

Combinations that Cause Image Deterioration

- Using [1.5x] at a recording pixel setting of **L** or **M1** will cause image deterioration (**T** and the zoom factor will display in blue).
- Using [2.0x] at a recording pixel setting of **L**, **M1** or **M2** will cause image deterioration (**T** and the zoom factor will display in blue).



- The respective focal lengths when using [1.5x] and [2.0x] are 52.5 – 157.5 mm and 70 – 210 mm (35mm film equivalent).
- The digital tele-converter cannot be used together with the digital zoom.

Inserting the Date and Time

You can insert the shooting date and time in the lower right corner of an image. Once inserted, however, they cannot be deleted. Be sure to check beforehand that the date and time are correctly set (p. 21).



1 Select [Date Stamp].

- Press the **MENU** button.
- Press the ◀▶ buttons to select the  tab, then press the ▲▼ buttons to select [Date Stamp].

2 Accept the setting.

- Use the ◀▶ buttons to select [Date] or [Date & Time].
- Pressing the **MENU** button will restore the shooting screen.
- ▶ [DATE] will appear on the screen.

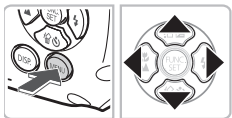

3 Shoot.

- ▶ You can insert the shooting date and time in the image's lower right corner.
- To restore to the original setting, select [Off] in Step 2.



Inserting and printing the date and time in images which do not have an embedded date and time

- Use the **DPOF print settings** (p. 125) to print.
- Use the **included software to print**.
Refer to the *Software Starter Guide* for details.
- **Connect the camera to a printer to print**.
Refer to the *Personal Printing Guide* for details.

Using the Self-Timer



The self-timer can be used to shoot a group photo that includes the camera operator. The camera will activate approximately 10 seconds after the shutter button is pressed.



1 Press the ▼ button.



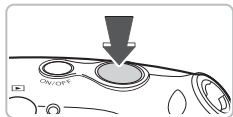

2 Select .

- Press the ▲▼ buttons to select , then press the  button.
- ▶ Once set,  will appear.



3 Shoot.

- Press the shutter button halfway to focus on the subject, then press it fully. To cancel shooting after the self-timer has already started, press .
- ▶ When the self-timer starts, the lamp blinks and the self-timer sound plays.
- ▶ Two seconds before the shutter releases, the lamp and sound speed up (the lamp remains lit when the flash will fire).
- To restore the original setting, select  in Step 2.

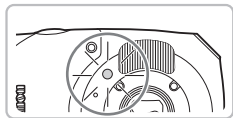

You can change the delay time and number of shots (p. 77).

Using the Face Self-Timer

Once you compose the shot, such as for a group photo, and press the shutter button, the camera will take three shots in a row two seconds after it detects your face (p. 80) when you enter the composition.



1 Select

- Follow Step 2 on p. 64 and select 

2 Compose the shot and press the shutter button halfway.

- Make sure a green frame appears on the face of the focused subject and white frames appear on other faces.

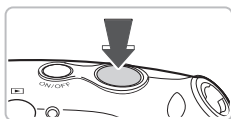

3 Press the shutter button fully.

- ▶ The camera will enter shooting stand-by, and [Look straight at camera to start count down] will appear on the screen.
- ▶ The lamp will blink and the self-timer sound will play.



4 Join the subjects and look at the camera.

- ▶ When the camera detects a new face, the lamp and sound will speed up (the lamp remains lit when the flash will fire), and two seconds later the shutter will release.
- ▶ The second and third shots will continue in succession.
- To restore the original setting, select  in Step 2 on p. 64.

What if a face is not detected?

Even if your face is not detected after joining the subjects, the shutter will release approximately 30 seconds later.

Changing the number of shots

For the screen in Step 1, press the **MENU** button, then press the   buttons to change the number of shots. Press the  button to accept the setting.



4

Selecting Settings Yourself

In this chapter you will learn how to use the various functions in **P** mode to progressively advance your shooting skills.

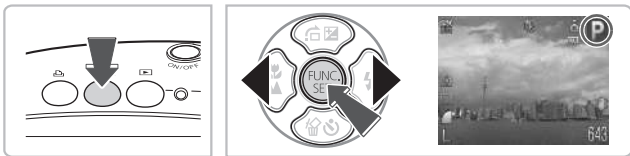

- This chapter assumes that the shooting mode is set to **P**.
- **P** stands for Program AE.
- Before attempting to shoot using a function explained in this chapter in modes other than **P** mode, check if the function is available in those modes (pp. 150 – 153).

P Shooting in Program AE

You can select the settings for various functions to suit your preferences. AE stands for Auto Exposure.



1 Select the shooting mode.

- After pressing the / button, use the buttons to select **P** and press .

2 Adjust the settings according to your purposes (pp. 68 – 77).

3 Shoot.



What if the shutter speed and aperture value are displayed in red?

If a correct exposure cannot be obtained when pressing the shutter button halfway, the shutter speed and aperture value display in red. Try the following settings to obtain the correct exposure.

- Turn on the flash (p. 68)
- Select a higher ISO speed (p. 73)

⚡ Turning the Flash On

You can make the flash fire every time you shoot. At maximum wide angle, the flash range is approximately 30 cm – 3.2 m (1.0 – 10 ft.), and at maximum telephoto, it is 30 cm – 2.0 m (1.0 – 6.6 ft.).





Select .

- After pressing the button, press the buttons to select , then press the .
- ▶ Once set, will appear.





Shooting Close-ups (Macro)

You can shoot an object at a close distance or even shoot extreme close-ups of it.

The possible shooting range is approximately 3 – 50 cm (1.2 in. – 1.6 ft.) from the end of the lens when the  button is pressed and the camera is at maximum wide angle, and approximately 30 – 50 cm (1.0 – 1.6 ft.) when the  button is pressed to maximum telephoto.



Select .

- After pressing the  button, press the  buttons to select , then press the  button.
- ▶ Once set,  will appear.

Using

You are recommended to attach the camera to a tripod and shoot in , to prevent the camera from moving and blurring the image (p. 76).





 The edges of the image may darken if the flash fires.

Shooting Far Away Subjects (Infinity)

You can shoot landscapes and far away subjects. The focusing range is 3 m (9.8 ft.) and greater from the camera.



Select .

- After pressing the  button, press the  buttons to select , then press the  button.
- ▶ Once set,  will appear.

Changing the Recording Pixels

You can select the recording pixels (image size) from six settings.



1 Select the recording pixels.

- After pressing the **FUNC SET** button, press the **▲▼** buttons to select **L**.

2 Select an option.

- Press the **◀▶** buttons to select an option, then press the **FUNC SET** button.
- ▶ The setting you selected will display on the screen.



If you select **W**, you cannot use the Digital Zoom (p. 61) or Digital Tele-Converter (p. 62).

Changing the Image Quality (Compression Ratio)

You can select from the following two levels of image quality:

▲ (Fine), **■** (Normal).



1 Select the image quality.

- After pressing the **FUNC SET** button, press the **▲▼** buttons to select **▲**.

2 Select an option.

- Press the **◀▶** buttons to select an option, then press the **FUNC SET** button.
- ▶ The setting you selected will display on the screen.

Approximate Values for Recording Pixels and Image Quality

Recording Pixels	Compression Ratio	Single Image Data Size (Approx. KB)	Number of Recordable Images	
			2 GB	8 GB
L (Large) 12 M/4000 × 3000		3084	626	2505
		1474	1280	5116
M1 (Medium 1) 8 M/3264 × 2448		2060	930	3721
		980	1920	7675
M2 (Medium 2) 5 M/2592 × 1944		1395	1365	5457
		695	2672	10679
M3 (Medium 3) 2 M/1600 × 1200		558	3235	12927
		278	6146	24562
S (Small) 0.3 M/640 × 480		150	10245	40937
		84	15368	61406
W (Widescreen) 4000 × 2248		2311	830	3318
		1105	1707	6822

• The values in the table are measured according to Canon standards and may change depending on the subject, memory card and camera settings.

Approximate Values for Paper Size

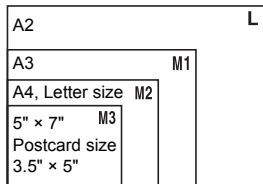



- **S** Suitable for sending images as e-mail attachments.
- **W** For printing on wide size paper.

Adjusting the Brightness (Exposure Compensation)

You can adjust the standard exposure set by the camera in 1/3-stop increments in the range of -2 to +2.



Select the exposure compensation.

- After pressing the  button, press the  buttons to adjust the exposure compensation, then press the  button.
- ▶ The compensation range you set will display on the screen.

Continuous Shooting





You can shoot continuously at about 1.1 images/second.



1 Select the drive mode.

- After pressing the  button, press the  buttons to select .

2 Select .

- Press the  buttons to select , then press the  button.
- ▶ Once set,  will appear on the screen.

3 Shoot.

- ▶ As long as you hold the shutter button down, the camera will shoot successive images.



- Cannot be used with the self-timer (pp. 64, 65, 76, 77).
- For continuous shooting, the focus and exposure are locked when the shutter button is pressed halfway.
- As the number of images increases, the shooting intervals may take longer.
- If the flash fires, shooting intervals may take longer.



Changing the ISO Speed









1 Select the ISO speed.

- After pressing the  button, press the   buttons to select .

2 Select an option.

- Press the   buttons to select an option, then press the .
- ▶ The setting you selected will display on the screen.

Approximate Values for ISO Speed

	Automatically adjusts the ISO speed to the shooting mode and shooting conditions.	
  	Low	Fine weather conditions, outdoor shooting.
 	↓	Cloudy, Twilight
	High	Nightsapes, Dark interiors



Changing the ISO speed

- Lowering the ISO speed results in sharper images, but there may be an increased chance of image blurring in certain shooting conditions.
- Raising the ISO speed results in a faster shutter speed, reducing camera shake and letting the flash reach greater distances to the subject. The images, however, will appear coarse.



- When the camera is set to , you can press the shutter button halfway to display the automatically set ISO speed.
- With ISO3200 you can set an even faster speed (p. 59).

Adjusting the White Balance

The white balance (WB) function sets the optimal white balance for natural looking colors.



1 Select the white balance.

- After pressing the **FUNC SET** button, press the **▲▼** buttons to select **AWB**.

2 Select an option.

- Press the **◀▶** buttons to select an option, then press the **FUNC SET** button.
- ▶ The setting you selected will display on the screen.

AWB Auto	Automatically sets the optimal white balance for the shooting conditions.
Day Light	Fine weather conditions, outdoor shooting
Cloudy	Cloudy, shady, twilight conditions
Tungsten	Tungsten, bulb-type (3-wavelength) fluorescent lighting
Fluorescent	Warm-white fluorescent, cool-white fluorescent, warm-white-type (3-wavelength) fluorescent lighting
Fluorescent H	Daylight fluorescent, daylight-type (3-wavelength) fluorescent lighting
Underwater	Sets the optimum white balance for taking pictures underwater. Reduces blue tones to produce natural, vibrant hues.
Custom	Manually sets a custom white balance.

Custom White Balance

You can adjust the white balance to the light source at the shooting location. Make sure that you set the white balance under the lighting conditions of the shooting scene.



- In Step 2 above, select .
- Make sure the entire screen is filled with the white subject, then press the **DISP** button.
- ▶ The tint on the screen will change when a white balance data is set.

Changing the Tone of an Image (My Colors)

You can change the tone of an image to sepia or black and white when shooting.



1 Select My Colors.

- After pressing the button, press the to select .

2 Select an option.

- Press the to select an option, then press the .
- ▶ The setting you selected will display on the screen.
- After shooting, return the setting to .

My Colors Off	—
Vivid	Emphasizes the contrast and color saturation for a vivid impression.
Neutral	Tones down the contrast and color saturation for neutral hues.
Sepia	Sepia tones.
B/W	Black and white.
Positive Film	Like the Vivid Red, Vivid Green or Vivid Blue effects, produces intense natural appearing colors like those obtained with positive film.
Lighter Skin Tone	Makes skin tones lighter.
Darker Skin Tone	Makes skin tones darker.
Vivid Blue	Emphasizes blue tints. Makes the sky, ocean and other blue subjects more vivid.
Vivid Green	Emphasizes green tints. Makes mountains, foliage and other green subjects more vivid.
Vivid Red	Emphasizes red tints. Makes red subjects more vivid.
Custom Color	You can adjust contrast, sharpness, and color saturation etc. to your preference.



- The white balance cannot be set in the and modes (p. 74).
- In the and modes, colors other than people's skin color may change. You may not obtain the expected results with some skin colors.

AC Custom Color

The contrast, sharpness, color saturation, red, green, blue, and skin tones in an image can be selected and set from 5 different levels.



- Follow Step 2 on page 75 and select **AC**, then press the **DISP.** button.
- Press the **▲▼** buttons to select an option, then use the **◀▶** buttons to select a value.
- The more to the right, the stronger/deeper the effect gets, the more to the left, the weaker/lighter the effect gets.
- Press the **DISP.** button to accept the setting.

2 Shooting Using the Two Second Self-Timer

You can set the self-timer to a delay of approximately two seconds.



Select 2.

- After pressing the **▼** button, press the **▲▼** buttons to select **2**, then press the **FUNC/SET** button.
- Once set, **2** will appear.
- Follow Step 3 in “**2** Using the Self-Timer” (p. 64) to shoot.

Customizing the Self-Timer



You can set the time delay (0 – 30 seconds) and the number of shots taken (1 – 10 shots).



1 Select .

- After pressing the ▼ button, press the ▲▼ buttons to select , then immediately press the MENU button.

2 Select the settings.

- Press the ▲▼ buttons to select [Delay] or [Shots].
- Press the ◀▶ buttons to select a value, then press the  button.
- Follow Step 3 in “ Using the Self-Timer” (p. 64) to shoot.

What if the number of shots is set to two or more shots?

- Exposure and white balance settings are set with the first shot.
- When you set the time delay for more than 2 seconds, the self-timer lamp and sound speed up 2 seconds before the shutter releases (when the flash will fire, the lamp lights).



- If the flash fires, the shooting interval may be longer.
- If you set a high number of shots, the shooting interval may be longer.
- If the memory card becomes full, shooting stops automatically.

Shooting Using a TV Monitor

You can use a TV to display the camera screen content.

- Connect the camera to a TV as described in “Viewing Images on a TV” (p. 109).
- Shooting procedures are the same as when using the camera’s monitor.

Changing the Composition with the Focus Lock

While you press and hold the shutter button halfway, the focus and exposure are fixed. You can now recompose and shoot. This is called Focus Lock.

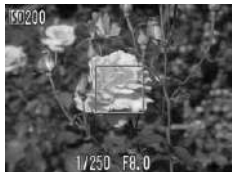

1 Focus.

- Center the subject you want in focus, and press the shutter button halfway.
- Confirm that the AF Frame on the subject is green.



2 Recompose.

- Hold the shutter button pressed halfway and recompose the scene.

3 Shoot.

- Press the shutter button fully.

5

Getting More Out of Your Camera

This chapter serves as the advanced version of Chapter 4 and explains how to take pictures using various functions.

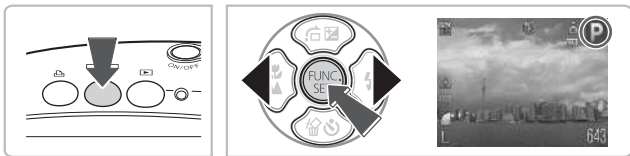

- This chapter assumes that the shooting mode is set to **P**.
- “* Shooting Long Exposures” (p. 90), “Changing the Color and Shooting” (p. 91) and “ Shooting Stitch Assist Images” (p. 94) assume you have set the shooting mode to **SCN** and selected the corresponding mode.
- Before attempting to shoot using a function explained in this chapter in modes other than **P** mode, check if the function is available in those modes (pp. 150 – 153).

Changing the AF Frame Mode

You can change the AF (Auto Focus) frame mode to match the conditions you want to shoot.



Select [AF Frame].

- Press the **MENU** button, select the tab, select [AF Frame], then press the buttons to select an option.

Face AiAF

- Detects people's faces and sets the focus, exposure (evaluative metering only) and white balance (**AWB** only).
- When the camera is pointed at subjects, a white frame appears on the face the camera judges to be the main subject, and gray frames (max. 2) will appear on other faces. When the shutter button is pressed halfway, up to 9 green frames will appear on faces on which the camera focuses.



- If a face is not detected and only gray frames (no white frame) appear, up to 9 green frames will appear on the areas the camera focuses on when the shutter button is pressed halfway.
- Examples of faces that cannot be detected:
 - Subjects that are far away or extremely close.
 - Subjects that are dark or light.
 - Faces turned to the side or at a diagonal, or faces with a portion hidden.
- The camera may mistakenly identify non-human subjects as a face.
- If the camera cannot focus when you press the shutter button halfway, the AF frame will not appear.

Center

The AF frame is fixed at the center. This is effective for focusing on a specific point.



You can reduce the AF frame size

- Press the **MENU** button, select the tab, then select the [AF Frame Size] menu item and [Small] option.
- The setting is configured to [Normal] when the Digital Zoom (p. 61) or Digital Tele-converter (p. 62) is used.



If the camera cannot focus when you press the shutter button halfway, the AF frame will turn yellow.

Magnifying the Focal Point

If you press the shutter button halfway, the AF frame will magnify and you can check the focus.



1 Select [AF-Point Zoom].

- Press the **MENU** button and select [AF-Point Zoom] on the tab. Use the **◀▶** buttons to select [On].



2 Check the focus.

- Press the shutter button halfway.
 - ▶ In [Face AiAF], the face selected as the main subject will appear magnified.
 - ▶ In [Center], the contents of the center AF frame will appear magnified.



What if the display does not magnify?

The display will not appear magnified in [Face AiAF] mode if a face cannot be detected (p. 80) or is too big in relation to the screen. In [Center] mode, it will not appear magnified if the camera cannot focus.



The magnified display will not appear when using the Digital Zoom (p. 61) or Digital Tele-Converter (p. 62), Servo AF (p. 82), or when connected to a TV (p. 77).

AFL Shooting with the AF Lock

The focus can be locked. After locking the focus, the focal distance will not change even when you release your finger from the shutter button.

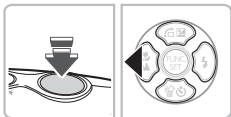

1 Lock the focus.

- Keep the shutter button pressed halfway and press the ◀ button.
- The focus locks and AFL is displayed on the screen.
- If you release your finger from the shutter button, and press the ◀ button once more, AFL will disappear and the focus will unlock.

2 Compose the scene and shoot.

Shooting with Servo AF

Since focus will be maintained on a subject while you press the shutter button halfway, you can shoot moving subjects without missing photo opportunities.



1 Select [Servo AF].

- Press the MENU button and select [Servo AF] on the tab, and use the ◀▶ buttons to select [On].

2 Focus.

- ▶ While the shutter button is pressed halfway, the focus will continue to adjust on the spot where the blue frame appears.



- The camera may not be able to focus in some conditions.
- You cannot shoot with the AF lock in this mode.
- You cannot set the Servo AF mode if you have set the [AF-Point Zoom] option in the tab to [On] (p. 81).
- Not available in Face Self-Timer (p. 65).

MF Shooting in Manual Focus Mode

When focusing cannot be achieved with autofocus, you can manually set an approximate focus and then press the shutter button halfway to fine-tune the focus range.

1 Press the ◀ button.



2 Select MF.

- After using the ◀▶ buttons to select MF, quickly press the ▲▼ buttons.
- MF appears on the screen, and the AF frame in the center of the screen is magnified.

3 Approximate focus.

- The side bar shows your focal point and a distance display. While looking at the magnified area, press the ▲▼ buttons to find an approximate focus. Then press the  button.



4 Fine-tune your focus.

- Pressing the shutter button halfway will fine-tune your focus.



Changing the Distance Units

Press the **MENU** button, then in the **⚙** tab, scroll down to [Distance Units] where you can select the desired units of measurement.



- For accurate focusing, it is recommended to use a tripod or to otherwise stabilize the camera.
- When using the digital zoom (p. 61), digital tele-converter (p. 62), or when using a television as a display (p. 77), you will be able to focus but the magnified area will not display.
- To turn off the magnified area, press the **MENU** button, and in the  tab, scroll down to [MF-Point Zoom] and select [Off].



Selecting the Person to Focus On (Face Select)

You can select a specific person's face to focus on and then shoot.

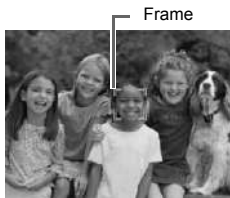
1 Register to the button (p. 136).



2 Set the Face Select mode.

- Point the camera toward the face and press the  button.
- ▶ After [Face Select: On] displays, a face frame  will appear around the face detected as the main subject.
- Even if the subject moves, the frame will follow the subject within a certain range.
- If a face is not detected,  will not appear.



3 Select the face on which to focus.

- If you press the  button, the frame will move to another face detected by the camera.
- When the frame has scrolled through all the detected faces, [Face Select: Off] will display, and the frame or frames for the current AF setting will appear.



4 Shoot.

- Press the shutter button halfway. The face frame of the selected face will change into a green .
- Press the shutter button fully to shoot.



Confirming the number of detected faces

Keeping the  button pressed will display the number of faces detected by the camera (35 at the most) (green: main subject's face, white: detected face).

Changing the Metering Mode

You can change the metering mode (brightness measuring function) to match the shooting conditions.





1 Select the metering mode.

- After pressing the **FUNC SET** button, press the **▲▼** buttons to select **☉**.

2 Select an option.

- Press the **◀▶** buttons to select an option, then press the **FUNC SET** button.
- ▶ The setting will display on the screen.

 Evaluative	Suitable for standard shooting conditions, including back lit shots. Automatically adjusts the exposure to match the shooting conditions.
 Center Weighted Avg.	Averages the light metered from the entire frame, but gives greater weight to the center.
 Spot	Only meters within the [] (Spot AE Point frame) that appears at the center of the screen.

AEL Shooting with the AE Lock

When you wish to take several shots with the same exposure, you can set the exposure and focus separately using the AE lock. AE stands for “Auto Exposure”.



1 Lock the exposure.

- Point the camera toward the subject and press the **▲** button while pressing the shutter button halfway.
- ▶ When **AEL** appears, the exposure will be set.
- If you release your finger from the shutter button and press the **▲** button again, **AEL** will disappear and the AE will unlock.

2 Compose the scene and shoot.



FEL Shooting with the FE Lock

Just as with the AE lock (p. 85), you can lock the exposure for shooting with the flash. FE stands for “Flash Exposure”.

1 Select (p. 68).



2 Lock the exposure.

- Point the camera toward the subject and press the  button while pressing the shutter button halfway.
- ▶ The flash will fire and when FEL appears, the flash output will be retained.
- If you release your finger from the shutter button and press the  button again, FEL will disappear and the FE will unlock.









3 Compose the scene and shoot.

Shooting with Slow Synchro

You can make the main subject, such as people, appear bright by having the camera provide the appropriate illumination with the flash. At the same time, you can use a slow shutter speed to brighten the background that the light from the flash cannot reach.



Select .

- After pressing the  button, press the   buttons to select  , then press the  button.
- ▶ Once set,   will appear on the screen.
- Even if the flash fires, ensure that the subject does not move until the shutter sound ends.





Attach the camera to a tripod to prevent the camera from moving and blurring the image. It is recommended to set the [IS Mode] to [Off] when shooting with a tripod (p. 136).

C_i Making Dark Subjects Appear Brighter (i-Contrast)

The camera can automatically detect and compensate for faces or subjects that appear dark in certain shooting conditions.



Select [i-Contrast].

- Press the **MENU** button, select [i-Contrast] from the  tab, and use the   buttons to select [Auto].
- ▶ **C_i** will appear on the screen.



Under some conditions, the image may appear coarse or the exposure setting may not be suitable.



You can correct recorded images (p. 122).

① Red-Eye Correction

You can automatically correct red eyes in images taken with the flash.



1 Select [Flash Settings].

- Press the **MENU** button, select [Flash Settings] from the tab and press the button.



2 Adjust the setting.

- Press the buttons to select [Red-Eye Corr.] and press the buttons to select [On].
- ▶ will appear on the screen (p. 44).



Red-eye correction may be applied to other red parts than red eyes. For example, when red make-up has been used around eyes.





- You can correct recorded images (p. 123).
- If you press the button as shown on the screen in Step 2 and then press the **MENU** button, the Flash Settings screen will display.

Checking for Shut Eyes

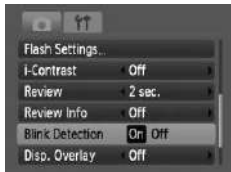
When the camera detects that there is a possibility that people have their eyes shut,  appears.





1 Select [Blink Detection].

- Press the **MENU** button, select the  tab, and then select [Blink Detection]. Use the   buttons to select [On].

2 Shoot.

- When a person with shut eyes is detected, a frame and  appear for a few seconds.



In ,  and  mode, the function is only available for the last image shot.

★ Shooting Long Exposures

You can set the shutter speed to a range between 1 and 15 seconds to shoot long exposures. However, you should attach the camera to a tripod to prevent the camera from moving and blurring the image.



1 Select ★.

- Follow Step 2 on p. 56 to select ★.

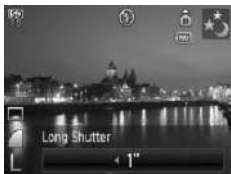

2 Select the shutter speed.

- Press the ▲ button.
- Press the ◀▶ buttons, select shutter speed and press the  button.

3 Confirm the exposure.

- When you press the shutter button halfway, the exposure for the selected shutter speed will appear.



- The brightness of the image may differ from the brightness of the screen in Step 3 when the shutter button was pressed halfway.
- When shutter speeds of 1.3 seconds or slower are used, images are processed to eliminate noise after being taken. A certain amount of processing time may be needed before you can take the next shot.
- It is recommended to set the [IS Mode] to [Off] when shooting with a tripod (p. 136).



If the flash fires, the image may be overexposed. If this happens, set the flash to  and shoot.

Changing the Color and Shooting

You can change the look of an image when shooting. However, the shooting conditions may cause the image to become coarse, or the colors may not come out as expected.

Color Accent

You can select to retain a single color and change the rest to black and white in a composition.



1 Select .

- Follow Step 2 on p. 56 to select .

2 Press the DISP. button.

- The unchanged image and the Color Accent image will both display.
- The color for default settings is green.





Recorded color

3 Specify the color.

- Position the center frame so it is filled with the color you want and press the  button.
- ▶ The specified color will be recorded.

4 Specify the range of colors.

- Press the   buttons to change the range of colors to be retained.
- Select a negative value to limit the range of colors. Select a positive value to extend the range of colors to similar colors.
- Pressing the DISP. button accepts the setting and restores the shooting screen.



- Using the flash may cause unexpected results in this mode.
- The recorded color will be saved even if you turn off the power.

Color Swap

You can swap one color in an image for another when recording it. You can only swap one color.



1 Select .

- Follow Step 2 on p. 56 to select .



2 Press the DISP. button.

- The unchanged image and the Color Swap image will both display.
- The default setting is to change green to gray.



3 Specify the color to be swapped.

- Position the center frame so it is filled with the color you want and press the ◀ button.
- ▶ The specified color will be recorded.



4 Specify the target color.

- Position the center frame so it is filled with the color you want and press the ▶ button.
- ▶ The specified color will be recorded.

5 Specify the range of colors to be swapped.

- Press the ▲▼ buttons to adjust the range of colors affected.
- Select a negative value to limit the range of colors. Select a positive value to extend the range of colors to similar colors.
- Pressing the **DISP.** button accepts the setting and restores the shooting screen.



- Using the flash may cause unexpected results in this mode.
- The recorded color and range of colors will be saved even if you turn off the power.
- Under some conditions, the image may appear coarse.





Shooting Stitch Assist Images

Large subjects can be split into several shots that can later be merged together using the included software on a computer to create a panoramic image.



1 Select or .

- Follow Step 2 on p. 56 to select  or .

2 Take the first shot.

- ▶ The exposure and white balance will be set with the first shot.



3 Take subsequent shots.

- Overlap part of the first shot when taking the second shot.
- Minor discrepancies in the overlapping portions will be corrected when the images are merged.
- You can repeat the procedure for the second shot to take up to 26 shots.
- When you have finished taking shots, proceed to Step 4.

4 Finish shooting.

- Press the  button.



5 Merge the images on a computer.



- For details on how to merge the images, refer to the *Software Starter Guide*.





This function is not available when a TV is used as the monitor (p. 77).

6

Using Various Functions for Shooting Movies

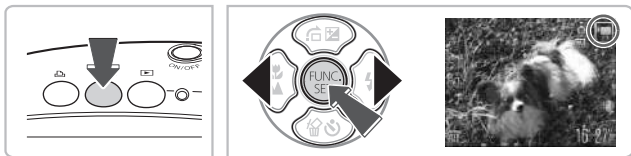
This chapter provides more advanced information than the “ Shooting Movies” and “ Viewing Movies” sections of Chapter 1.



- This chapter assumes that the shooting mode is set to .

Changing the Movie Mode

You can select between three movie modes.



1 Select a movie mode.

- After pressing the / button, use the buttons to select .

2 Select an option.

- Press the buttons to select an option, then press the button.
- ▶ The setting will display on the screen.

Standard	For shooting standard quality movies.
Color Accent	These shooting modes let you change all colors except the selected color to black and white, or exchange the selected color for another color, when shooting. See “Changing the Color and Shooting” (p. 91) for details.
Color Swap	



Under some conditions, colors may not turn out as expected in the and mode.

Changing the Image Quality

You can select between two image quality settings.



1 Select the image quality.

- After pressing the button, press the buttons to select .

2 Select an option.

- Press the buttons to select an option, and press the button.
- ▶ The setting will display on the screen.

Image Quality Table

Image Quality (Recording Pixels/Frame Rate)	Content
$\overline{640}$ 640 × 480 pixels, 30 frames/sec.	For shooting standard quality movies.
$\overline{320}$ 320 × 240 pixels, 30 frames/sec.	Since the number of the recording pixels is smaller, the image quality will be lower than with $\overline{640}$, but you can record three times the length.

Estimated Shooting Time

Image Quality (Frame Rate)	Shooting Time	
	2 GB	8 GB
$\overline{640}$	23 min. 49 sec.	1 hr. 35 min. 11 sec.
$\overline{320}$	1 hr. 13 min. 10 sec.	4 hrs. 52 min. 24 sec.

- Based on Canon's testing standards.
- Recording will automatically stop when either the clip file size reaches 4 GB or the recording time reaches approximately 1 hour.
- Recording may stop even if the maximum clip length has not been reached on some memory cards. SD Speed Class 4 or higher memory cards are recommended.

AE Lock/Exposure Shift

You can set the exposure or change it in 1/3 steps within a range of ± 2 .



1 Focus.

- Press the shutter button halfway to focus.

2 Lock the exposure.



- Press the \blacktriangle button to lock the exposure. The exposure shift bar appears.
- Press the \blacktriangle button again to release the lock.

3 Change the exposure.

- While watching the screen, press the \blacktriangleleft buttons to adjust the brightness.

4 Shoot.





Other Shooting Functions

The following functions can be used in the same way as for still images. For  and  modes, the functions with an * attached can be used in the same way as for still images.

- **Zooming in More Closely on Subjects (Digital Zoom) (p. 61)**



You can use the digital zoom, but the optical zoom cannot be used. If you want to shoot at the maximum zoom factor, you should adjust the optical zoom to the maximum before shooting.

The sound of the zoom will be recorded.



-  **Using the Self-Timer (p. 64)***
-  **Shooting Close-ups (Macro) (p. 69)***
-  **Shooting Far Away Subjects (Infinity) (p. 69)***
- **Adjusting the White Balance (p. 74)**
- **Changing the Tone of an Image (My Colors) (p. 75)**
-  **Shooting Using the Two Second Self-Timer (p. 76)***
- **Shooting Using a TV Monitor (p. 77)***
- **AF Shooting with the AF Lock (p. 82)**
- **MF Shooting in Manual Focus Mode (p. 83)**
- **Turning off the AF Assist Beam (p. 134)***
- **Displaying the Overlay (p. 135)***
[3:2 Guide] is not available.
- **Changing the IS-Mode Settings (p. 136)***
You can switch between [Continuous] and [Off].

Playback Functions

The following functions can be used in the same way as for still images.

-  **Erasing Images (p. 29)**
-  **Searching Images (Index Display) (p. 102)**
-  **Viewing Images in Filtered Playback (p. 103)**
-  **Viewing Slideshows (p. 105)**
-  **Changing Image Transitions (p. 108)**
- **Viewing Images on a TV (p. 109)**
-  **Erasing All Images (p. 110)**
-  **Protecting Images (p. 114)**
-  **Organizing Images by Category (My Category) (p. 116)**
-  **Rotating Images (p. 118)**

Summary for “▶ Viewing Movies” (p. 34)

↶	Exit
▶	Playback
▶▶	Slow Motion Playback (you can use the ◀▶ buttons to adjust the speed. Sound will not play back.)
◀◀	Display the first frame
◀◀◀	Previous frame (Rewind if you hold down the  button.)
▶▶▶	Next frame (Fast forward if you hold down the  button.)
▶▶▶▶	Display the last frame
✂	Edit (p. 99)
	Displays when connected to a PictBridge compliant printer (p. 30). Refer to the <i>Personal Printing Guide</i> for details.

✂ Editing

You can trim the beginnings and ends of recorded movies in one-second increments.



Movie Editing Panel







Movie Editing Bar

1 Select ✂.

- Follow Step 3 on p. 34, select ✂ and press the  button.
- ▶ The movie editing panel and the movie editing bar will display.

2 Set the editing range.

- Press the ▲▼ buttons and select  or .
- Press the ◀▶ buttons to move . ✂ will display at each one-second interval. If you select , you can trim the beginning of the movie from ✂. If you select , you can trim the end of the movie from ✂.

- ▶ Even if you move **▼** to a point other than a **✂** point, only the portion from the nearest **✂** to the left will be trimmed when **⏏** is selected. Only the portion from the nearest **✂** to the right will be trimmed when **⏏** is selected.
- The section selected with **▼** will be the section of the movie that remains after editing.

3 Check the edited movie.

- Press the **▲▼** buttons to select **▶** (Play), then press the **FUNC SET** button. The edited movie will play.
- To edit the movie again, repeat Step 2.
- To cancel editing, press the **▲▼** buttons, and select **↶**. After pressing the **FUNC SET** button, press the **◀▶** buttons to select [OK], and press the **FUNC SET** button.



4 Save the edited movie.

- Press the **▲▼** buttons to select **▶**, then press the **FUNC SET** button.
- Press the **◀▶** buttons to select [New File], then press the **FUNC SET** button.
- ▶ The movie will be saved as a new file.



- When [Overwrite] in Step 4 is selected, the unedited movie is overwritten with the edited movie, erasing the original movie.
- When there is not enough space left on the memory card, only [Overwrite] can be selected.
- If the battery is depleted partway through editing, the edited movie clips may not be saved. When editing movies, you should use a fully charged battery or the separately sold AC adapter kit (pp. 40, 140).

7

Using Playback and Other Functions

The first part of this chapter explains various ways to play back and edit images. The latter part explains how to specify images for printing.

- Press the  button to select the Playback mode before operating the camera.



- It may not be possible to play back or edit images that have been edited on a computer, had their file name changed, or have been taken on a different camera.
- The edit function (pp. 119 – 123) cannot be used if the memory card does not have free space available.

Searching Images (Index Display)

Displaying multiple images at a time lets you quickly find the image you want.







1 Press the button.

- ▶ Images will display in an index. The selected image will have a green frame and be enlarged.



2 Select an image.

- Press the     buttons to select images.
- Press the  button to display the selected image by itself.

Images in Sets of 9



Jump bar



1 Press the button.

- ▶ Images will display in an index.



2 Press the button again.

- The jump bar will be displayed and a green frame appears around the currently displayed images.

3 Change the displayed images.

- Press the   buttons to switch between sets of 9 images.
- Pressing the  button will restore the index display.



If the jump bar is displayed, pressing   while holding the  button will jump to either the first or last set of images.







Viewing Images in Filtered Playback

When there are many images on the memory card, you can filter and display them by a specified condition. You can also delete (p. 110) or protect (p. 114) all images at once in the filtered condition.

Setting the Conditions



- In Single Image Playback, press the **▲** button.
- Press the **▲▼** buttons and select a jump method.
- If you press the **DISP.** button, you can switch Information Display on or off.

 Jump Shot Date	Displays the images shot on the specified date.
 Jump to My Category	Displays the images of the specified category (p. 116).
 Jump to Folder	Displays the images in a specified folder.
 Jump to Movie	Jumps to a movie.
 Jump 10 Images	Jumps over 10 images at a time.
 Jump 100 Images	Jumps over 100 images at a time.

Search by , , and



Target Filters

1 Select a target filter.

- Use the **◀▶** buttons to select a filter (excluding .
- Pressing the **MENU** button restores the single image display.



2 Viewing images using filter playback.

- If you press the **FUNC SET** button, filter playback will start. ☑ and a blue frame will appear.
- If you press the **◀▶** buttons, the target images selected in Step 1 will display.
- If you press the **▲** button, it will cancel filter playback.

Jump by **↶10** and **↷100** Images



- If you press the **◀▶** buttons, the display will advance to the image that is the selected number of images away.
- Pressing the **MENU** button restores the single image display.

? What if you can't select a target?

When you select **↶10** in Step 1 on p. 103, you can only select **10** if there are no images sorted into categories. Also, you can only select 1 target when there are only images with the same date in **↶10** and only 1 folder has been created in **↶10**.



Filter playback



In filter playback (Step 2), you can view filtered images with “**Searching Images (Index Display)**” (p. 102), “**Viewing Slideshows**” (p. 105), and “**Magnifying Images**” (p. 108). However, if you change the category (p. 116), or edit an image and save it as a new image (pp. 119 – 123), [Display All Images] will display, and filter playback will cancel.

Viewing Slideshows



You can automatically play back images recorded to a memory card. Each image displays for approximately 3 seconds.





1 Select [Slideshow].

- Press the **MENU** button and select the  tab, then select [Slideshow] and press the  button.

2 Select [Start].

- Press the  buttons to select [Start], then press the  button.
- ▶ A few seconds after “Loading image...” displays, the slideshow will start.
- You can pause/restart a slideshow by pressing the  button again.
- Press the **MENU** button to stop the slideshow.





- If you press the  buttons during playback, the image will switch. If you press and hold down the  buttons you can fast-forward through images.
- The power saving function does not work during slideshows (p. 53).

Changing Settings



You can change the time that slideshow images are displayed, transition effects and set the slideshow to repeat. You can select from seven transition effects when switching between images. You can also select which images to play back.



1 Select [Slideshow].

- Press the **MENU** button and select the  tab, then select [Slideshow] and press the  button.

2 Make the setting.

- Press the  buttons and select an item, then press the  buttons and adjust the setting.

Playback Filter

All Images	Plays back all images.
Date	Plays back images from a specified shooting date (See below).
My Category	Plays back images from a specified category (See below, p. 116).
Folder	Plays back images from a specified folder (See below).
Movies	Plays back movies only.
Still images	Plays back still images only.

Select Images for Playback by Type

You can select which images to play back within the playback filters: Date, My Category, and Folder.



1 Select the playback filter option and press **FUNC SET** button.

- ▶ The playback filter selection screen will display.

2 Press the ▲▼ buttons to select a playback filter, then press **FUNC SET** button.

- ▶ Once set, ✓ will appear.
- You can display the images within the option by pressing the ◀▶ buttons.
- ▶ Images will play back in the order they were selected. However, if [My Category] is selected, images will appear in order of their image number.

3 Press the MENU button.

- ▶ The selected options will be set, and the slideshow screen will reappear.

Checking the Focus

You can magnify the area of a recorded image that was inside the AF frame or the area of a face that was detected to check the focus.



1 Press the **DISP.** button, and switch to the focus check display (p. 45).

- ▶ A white frame will appear where the AF frame or face was when the focus was set.
- ▶ A gray frame will appear on a face detected during playback.
- ▶ The area within the orange frame appears magnified.



2 Change the magnification level or location.

- Press the **Q** button once.
- Use the **Q** or  button to change the display size, and the **▲▼◀▶** buttons to change the display position while checking the focus.

3 Switch frames.











- Pressing the  button will switch to a different frame.
- Pressing the **MENU** button resets the display to Step 1.

Q Magnifying Images



Approximate Location of Displayed Area

Press the Q button.



- The display will zoom in on the image and **SET**  will appear, if you continue to hold the Q button, it will continue to zoom in up to a factor of 10x.
- If you press the    buttons, you can move the location of the displayed area.
- When **SET**  appears on the screen, press the  button to zoom out, or hold it to return to single image view.
- If you press the **FUNC SET**  button, **SET**  will display and you will be able to use the   buttons to switch between images at the same level of magnification. Press the **FUNC SET**  button again to return to normal.

Changing Image Transitions

You can select from four transition effects when switching between images in single image playback.



Select [Transition].

- Press the **MENU** button and select the  tab, then select [Transition] and use the   buttons to select a transition effect.
- Press the **MENU** button to accept the setting.

Viewing Images on a TV

Using the supplied AV cable, you can connect the camera to a TV to view images you have shot.

Items to Prepare

- Camera and TV
- AV cable supplied with the camera (p. 2)

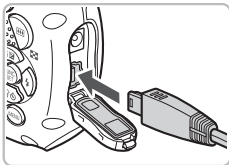

1 Turn off the camera and TV.

2 Connect the camera to the TV.

- Open the camera's terminal cover and fully insert the plug of the supplied AV cable into the camera's A/V OUT terminal.
- Insert the cable plug fully into the video input terminals as shown in the illustration.

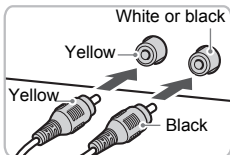

3 Turn on the TV and switch it to the input to which the cable is connected.

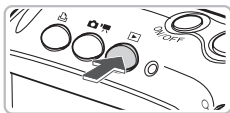

4 Turn on the camera.

- Press the  button to turn on the camera.
- ▶ The image will appear on the TV (nothing will appear on the monitor of the camera).
- After you finish viewing, turn off the camera and TV, and unplug the AV cable.

? What if the images don't properly display on the TV?



Images will not display correctly if the camera's video output setting (NTSC/PAL) does not match the TV system. Press the **MENU** button, select the  tab and [Video System] to switch to the correct video system.

Erasing All Images

You can select images and erase them in groups. Since erased images cannot be recovered, exercise adequate caution before erasing. Protected images (p. 114) cannot be erased.



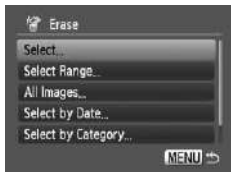

1 Select [Erase].

- Press the **MENU** button, select the  tab and [Erase], and press the  button.



2 Select a selection method.

- Press the   buttons, select a selection method, and press the  button.
- Press the **MENU** button to return to the menu screen.







Selecting Images Individually

1 Select [Select].

- Follow Step 2 above to select [Select] and press the  button.



2 Select images.

- Press the   buttons, select the image and press the  button.
- ▶ Once set,  will appear on the screen.
- Pressing the  button once more will cancel the selection, and  will disappear.
- To select multiple images, repeat the above operation.



3 Press the MENU button.

4 Erase.

- Press the ◀▶ buttons, select [OK] and press the  button.



Select Range

1 Select [Select Range].

- Follow Step 2 on p. 110 to select [Select Range] and press the  button.





2 Select the starting image.

- Press the  button.
- Press the ◀▶ buttons, select the image and press the  button.





3 Select the ending image.

- Press the ▶ button, select [Last image] and press the  button.
- You cannot select images before the first image.
- Press the ◀▶ buttons to select an image, and press the  button.





4 Erase.



- Press the  button to select [Erase], then press the  button.

Select All Images

1 Select [All Images].

- Follow Step 2 on p. 110 to select [All Images] and press the  button.

2 Erase.

- Press the   buttons, select [OK] and press the  button.





Select by Category

1 Select [Select by Date], [Select by Category] or [Select by Folder].

- Follow Step 2 on p. 110 to select a category and press the  button.



2 Select a menu item.

- Press the ▲▼ buttons, select the items to set and press the  button.
- If you press the ◀▶ buttons, you can display the images within the category.
- ▶ Once set, ✓ will appear on the screen.
- Pressing the  button again deselects the category and ✓ disappears.

3 Press the MENU button.

4 Erase.

- Press the ◀▶ buttons select [OK] and press the  button.



? What if you cannot select [Select by Category]?



If there are no images that have been sorted into categories (p. 116), you will not be able to select [Select by Category] in Step 1.

Protecting Images

You can protect important images so that they cannot be erased by the camera (pp. 29, 110).





1 Select [Protect].

- Press the **MENU** button and select the  tab, then select [Protect] and press the  button.



2 Select a selection method.

- Press the   buttons to select a selection method, and press the  button.
- Press the **MENU** button to return to the menu screen.



If you format the memory card (pp. 24, 52), protected images will also be erased.







Protected images cannot be erased with the camera's erase function. To erase an image, cancel protection first.

Selecting Images Individually



Select [Select].

- Follow Step 2 above to select [Select], and press the  button.
- Follow Step 2 on p. 110 to select an image.
- ▶ Once set,  will appear on the screen.
- Pressing the  button again deselects the image and  will disappear.
- To select multiple images, repeat the above operation.

Select Range



1 Select [Select Range].

- Follow Step 2 on p. 114 to select [Select Range] and press the **FUNC SET** button.
- Follow Steps 2 and 3 on p. 111 to select images.

2 Protect images.

- Press the **▼** button, select [Protect] and press the **FUNC SET** button.

Select All Images



1 Select [All Images].

- Follow Step 2 on p. 114 to select [All Images] and press the **FUNC SET** button.

2 Protect images.

- Press the **▲▼** buttons, select [Protect] and press the **FUNC SET** button.

Select by Category



1 Select [Select by Date], [Select by Category] or [Select by Folder].

- Follow Step 2 on p. 114 to select the type and press the **FUNC SET** button.
- Follow Steps 2 and 3 on p. 113 to select images.

2 Protect images.

- Press the **▲▼** buttons, select [Protect] and press the **FUNC SET** button.



You can unlock groups of protected images if you select [Unlock] in Step 2, while in [Select Range], [All Images] or [Select by Category].



Organizing Images by Category (My Category)

You can categorize images. You can also use the categorized images in the following functions.

- Viewing Images in Filtered Playback (p. 103), Slideshow (p. 105), Erase All (p. 110), Protect (p. 114), Print Settings (DPOF) (p. 125)



1 Select [My Category].

- Press the **MENU** button and select the  tab, then select [My Category] and press the  button.













2 Make the setting.

- Press the  buttons, select a category and press the  button.
- Press the **MENU** button to return to the menu screen.



Images are automatically categorized by shooting condition as they are shot.

: Images taken in , ,  modes, or pictures taken with the [AF Frame] set to [Face AiAF].

: Images detected as , or  when taken in  (Auto), or , , modes.

: Images taken in , , , , ,  modes.

Selecting Images Individually



Select [Select].

- Follow Step 2 on p. 116 to select [Select] and press the **FUNC SET** button.
- Follow Step 2 on p. 110 to select images.
- Press the **▲▼** buttons, select a category and press the **FUNC SET** button.
- ▶ Once set, **✓** will appear on the screen.
- Pressing the **FUNC SET** button again deselects the category and **✓** disappears.
- To select multiple images, repeat the above operation.

Select Range



1 Select [Select Range].

- Follow Step 2 on p. 116 to select [Select Range] and press the **FUNC SET** button.
- Follow Steps 2 and 3 on page 111 to select images.
- Press the **▼** button to select an item, then press the **◀▶** buttons, and select a type.

2 Select the setting.

- Press the **▼** button to select [Select] and press the **FUNC SET** button.





If you select [Deselect] in Step 2, you can deselect all of the images in the [Select Range] category.

Rotating Images

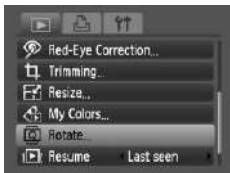
You can change the orientation of an image and save it.





1 Select [Rotate].

- Press the **MENU** button and select the  tab, then select [Rotate] and press the  button.



2 Rotate the image.



- Press the   buttons to select an image to rotate.
- The image will rotate 90° with each press of the  button.
- Pressing the **MENU** button will restore the menu screen.

Resizing Images

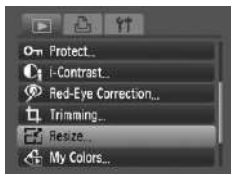

You can resize images to a lower pixel setting and save the resized image as a separate file.





1 Select [Resize].

- Press the **MENU** button and select the  tab, then select [Resize] and press the  button.

2 Select an image.



- Press the  buttons to select the image and press the  button.

3 Select an image size.

- Press the  buttons to select an option, then press the  button.
 - ▶ The [Save new image?] screen will appear.





4 Save the new image.

- Press the  buttons to select [OK] and press the  button.
 - ▶ The image will be saved as a new file.



5 Display the new image.

- When you press the **MENU** button, the [Display new image?] screen will appear. If you press the  buttons to select [Yes] and press the  button, the saved image will display.



- You cannot resize an image to a larger size.
- You cannot resize images taken with the **W** and **XS** settings.

Trimming

You can cut out a portion of a recorded image and save it as a new image file.

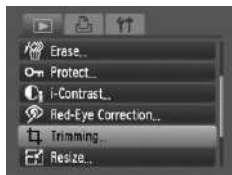

Trimming Area

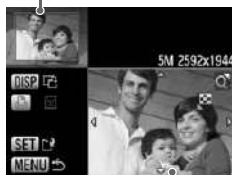

Trimming Area Display

Recorded pixels after trimming



1 Select [Trimming].

- Press the **MENU** button, select the **▶** tab and [Trimming], then press the **FUNC SET** button.

2 Select an image.

- Press the **◀▶** buttons to select the image and press the **FUNC SET** button.

3 Adjust the trimming area.

- ▶ A green frame will appear around the portion of the image to be trimmed.
- ▶ The original image will display in the upper left and the trimmed image will display in the lower right.
- If you press the **■** or **○** button, you can change the frame size.
- If you press the **▲▼◀▶** buttons, you can move the frame.
- If you press the **DISP.** button, you can change the vertical/horizontal orientation of the frame.
- In an image with a detected face, a gray frame will appear around faces located in the upper left of the frame, and the frame can be used for trimming. You can switch between frames by pressing the **📄** button.
- Press the **FUNC SET** button.

4 Save as a new image and display.

- Perform Steps 4 and 5 on p. 119.





- **W**, **S** and **XS** images cannot be trimmed.
- Trimming is only possible for images shot at aspect ratio 4:3 (vertical 3:4).
- The number of recorded pixels in a trimmed image will be smaller than before trimming.

Adding Effects with the My Colors Function

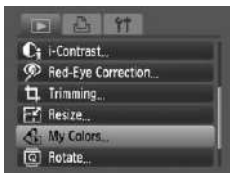

You can change the color of an image and save it as a separate image. Refer to p. 75 for details on each menu item.







1 Select [My Colors].

- Press the **MENU** button, select the  tab and [My Colors], and press the  button.

2 Select an image.

- Press the   buttons to select the image and press the  button.

3 Select a menu option.

- Press the   buttons to select an option, then press the  button.
- After selecting the menu option, you can zoom the image by following the operations in “Q Magnifying Images” (p. 108).
- If you press the  button during magnified display, you can switch to the original image. Pressing the **MENU** button restores the menu screen.

4 Save as a new image and display.

- Perform Steps 4 and 5 on p. 119.





- If you repeatedly change the color of an image, the quality will gradually deteriorate and you may not achieve the expected color.
- The coloration of images changed with this function may vary from those recorded with the My Colors function (p. 75).

Making Dark Subjects Appear Brighter (i-Contrast)



Detects and compensates for dark sections of subjects or people's faces and saves the image as a separate file. You can select 4 levels of correction: [Auto], [Low], [Medium] or [High].



1 Select [i-Contrast].

- Press the **MENU** button, select the  tab and [i-Contrast], then press the  button.

2 Select an image.

- Press the   buttons to select the image and press the  button.

3 Select an option.

- Press the   buttons to select an option, then press the  button.

4 Save as a new image and display.

- Perform Steps 4 and 5 on p. 119.



What if the image wasn't corrected by the [Auto] option as well as you would like?

Select [Low], [Medium] or [High] and adjust the image.





- Under some conditions, the image may appear coarse or the exposure setting may not be suitable.
- Repeatedly adjusting the same image may cause the quality to deteriorate.

Correcting the Red-Eye Effect

You can automatically correct red eyes in images and save them as new files.



1 Select [Red-Eye Correction].

- Press the **MENU** button, select the  tab and [Red-Eye Correction], then press the  button.

2 Select an image.





- Press the   buttons, select the image.

3 Correct the image.

- When you press the , red-eye detected by the camera will be corrected and a frame will appear around the corrected portion.
- You can zoom the image using the procedures in “Q Magnifying Images” (p. 108).



4 Save as a new image and display.

- Press the    buttons to select [New File], and press the  button.
- ▶ The image will be saved as a new file.
- Perform Step 5 on p. 119.



- Some images may not be properly corrected.
- When [Overwrite] in Step 4 is selected, the uncorrected image is overwritten with the corrected data, erasing the original image.
- Protected images cannot be overwritten.

Printing from the Print List (DPOF)

You can add images to the print list (DPOF) directly after shooting or while in playback by pressing the  button. You can print from a print list simply by connecting your camera and printer. These selection methods comply with the DPOF (Digital Print Order Format) standards.

Easily Add Images to the Print List











1 Select an image.

- Press the   buttons to select the image.

2 Press the button (videos will be excluded).

3 Print list.

- Press the   buttons and select the number of prints, press the   buttons to select [Add] and press the  button.
- To cancel adding images, select the added images and press the  button, then press the   buttons to select [Remove] and press the  button.

Print Added Images

The following examples use the Canon SELPHY series printers. Please also refer to the *Personal Printing Guide*.

Number of copies to print



1 Connect the camera to the printer (p. 30).

2 Print.

- Press the   buttons, select [Print now] and press the  button.
- ▶ Printing will start.
- ▶ If you stop the printer during printing and start again, it will start from the next print.

Selecting Images for Printing (DPOF)



You can select certain images on a memory card for printing (up to 998 images) and specify the number of print copies so they can be printed together or processed at a photo developer service. These selection methods comply with the DPOF (Digital Print Order Format) standards.

Print Settings

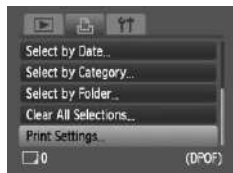

You can set the print type, date and file number. These settings apply to all images selected for printing.



1 Select [Print Settings].

- Press the **MENU** button and select the  tab, then select [Print Settings] and press the  button.

2 Adjust the settings.

- Press the  buttons to select a menu item, then press the  buttons to select an option.
 - ▶ Pressing the **MENU** button accepts the settings and restores the menu screen.

Print Type	Standard	Prints one image per page.
	Index	Prints several reduced size images per page.
	Both	Prints both standard and index formats.
Date	On	Prints the date from the shooting information.
	Off	–
File No.	On	Prints the file number.
	Off	–
Clear DPOF data	On	Removes all print settings after printing.
	Off	–



- Some printers or photo developer services may not be able to reflect all of the print settings in the output.
-  may display when using a memory card with print settings set by a different camera. These settings will be overwritten by those set by your camera.
- Images with the date embedded always print with the date, regardless of the [Date] setting. As a result, some printers may print the date twice on these images if [Date] is also set to [On].



- With [Index] selected, the [Date] and [File No.] options cannot be set to [On] at the same time.
- The date will be printed in the style set in the [Date/Time] function in the tab (p. 21).

Selecting the Number of Copies



1 Select [Select Images & Qty.].

- Press the **MENU** button and select the tab, then select [Select Images & Qty.] and press the button.

2 Select an image.

- Press the buttons to select an image, then press the .
- ▶ You will be able to set the number of print copies.
- If you select [Index], appears on the screen.
- Press the button again to deselect the images. will disappear.

3 Set the number of prints.

- Press the buttons to set the number of prints (maximum 99).
- Repeat Steps 2 and 3 to select other images and the number of prints for each.
- You cannot set the number of print copies for Index prints. You can only select which images to print in Step 2.
- ▶ Pressing the **MENU** button accepts the settings and restores the menu screen.





Select Range



1 Select [Select Range].

- Select [Select Range] in Step 1 on p. 126 and press the  button.
- Select images according to Steps 2 and 3 on p. 111.

2 Make print settings.

- Press the   buttons, select [Order] and press the  button.

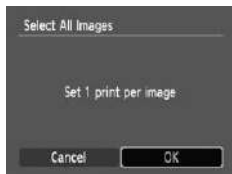

Set All Images to Print Once



1 Select [Select All Images].

- Select [Select All Images] from the screen in Step 1 on p. 126 and press the  button.

2 Make print settings.

- Press the   buttons, select [OK] and press the  button.

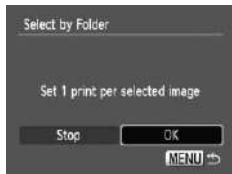

Select by Category



1 Select [Select by Date], [Select by Category] or [Select by Folder].

- Follow Step 1 on p. 126 to select a type and press the  button.
- Follow Steps 2 and 3 on p. 113 to select images.



2 Make print settings.

- Press the   buttons, select [OK] and press the  button.

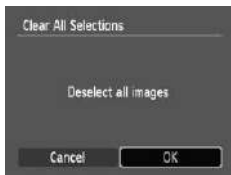
Clearing All Selections



Select [Clear All Selections].

- Select [Clear All Selections] in Step 1 on p. 126, and press the  button.
- Press the ◀▶ buttons to select [OK], then press the  button.
- ▶ All selections will be cleared.

8

Customizing the Camera

You can customize various functions to suit your shooting preferences. The first part of this chapter explains convenient and commonly used functions. The latter part explains how to change shooting and playback settings to suit your purposes.



Changing Functions

You can customize convenient and commonly used functions from the **FT** tab (p. 48).

Turning off the Power Saving Function

You can set the power saving function (p. 53) to [Off]. Setting it to [On] is recommended to save battery power.



- Select [Power Saving], then press the **FUNC SET** button.
- Press the **▲▼** buttons to select [Auto Power Down], then use the **◀▶** buttons to select [Off].
- If you set the Power Saving function to [Off], be careful not to forget to turn off the camera after use.

Setting the Screen Shut-Off Time

You can adjust the time the screen takes to shut off automatically (p. 53). This also works when [Auto Power Down] is set to [Off].

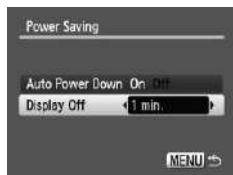







- Select [Power Saving], then press the **FUNC SET** button.
- Press the **▲▼** buttons to select [Display Off], then use the **◀▶** buttons to select a time.
- In order to save battery power, it is recommended to select less than [1 min.].

Using the World Clock





When traveling abroad, you can record images with local dates and times simply by switching the time zone setting if you pre-register the destination time zones. You can enjoy the convenience of not having to switch the Date/Time settings.







1 Set the home time zone.

- Select [Time Zone] and press the  button.
- When setting this for the first time, confirm the information that displays on the screen at the left, and press the  button.
- Press the  buttons to select the home time zone, then press the  button. To set daylight saving time (adds 1 hour), press the  buttons to select .



2 Set the world time zone.

- Press the  buttons to select , then press the  button.
- Press the  buttons to select the destination time zone, then press the  button.
- You can also set the daylight saving time as in Step 1.

3 Select the world time zone.

- Press the  buttons and select [Home/World].
- Press the  buttons to select , then press the **MENU** button.
- ▶  will appear in the [Time Zone] or shooting screen (p. 44).



If you change the date or time in the  setting (p. 21), your  time and date will automatically change.

Changing the File Number Assignment

Images you shoot are automatically assigned file numbers in the order they were taken, from 0001 – 9999, and saved to folders of up to 2,000 images. You can change the file number assignment.



- Select [File Numbering], then press the  buttons to select an option.

Continuous

Even if you shoot using a new memory card, the file numbers are assigned consecutively until an image with the number 9999 is taken/saved.

Auto Reset

If you replace the memory card with a new one, file numbering begins with 0001 again.







- If you use a memory card already containing images, the newly assigned file numbers may continue the existing numbering for both the [Continuous] and [Auto Reset] settings. If you want to start over with file number 0001, format the memory card before use (pp. 24, 52).
- Refer to the *Software Starter Guide* for information regarding folder structure or image types.

Creating a Folder

You can create new folders in which to save images.





- Select [Create Folder], then press the  button.
- Select [Create New Folder], then press the  buttons to select .
-  will display on the screen (p. 44) when shooting, and shots will be recorded into a new folder.

Creating Folders by Day and Time

You can set a day and time for folder creation.



- Select [Create Folder], then press the  button.
- Select [Auto Create], then press the  buttons to select an interval.
- Select [Time], then press the  buttons to set a time.
- The new folder will be created on the set day and time. Images shot after the creation date are saved to the new folder.

Turning off Auto Rotate

When you play back images on the camera, images shot in vertical orientation automatically rotate and display vertically. You can turn off this function.

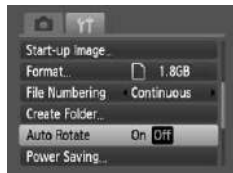

- Select [Auto Rotate], then press the  buttons to select [Off].

Changing Shooting Functions

If you set the shooting mode to **P** (p. 68), you can change the settings in the  tab (p. 48).





Before attempting to shoot using a function explained in this chapter in modes other than **P** mode, check if the function is available in those modes (pp. 150 – 153).

Turning off the Red-Eye Reduction Function

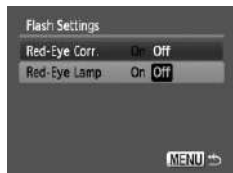
The red-eye reduction lamp lights in order to reduce the red-eye effect that occurs when shooting in dark conditions with the flash. You can turn off this function.



- Select [Flash Settings], then press the  button.
- Press the  buttons to select [Red-Eye Lamp], then press the  buttons to select [Off].

Turning off the AF Assist Beam

The lamp will automatically light to assist focusing in low light conditions when you press the shutter button halfway. You can turn off the lamp.



- Select [AF-assist Beam], then press the  buttons to select [Off].

Changing the Image Display Time

You can change the length of time the images display directly after shooting.

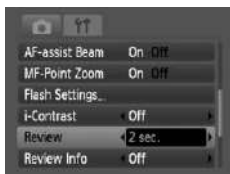

- Select [Review], then press the ◀▶ buttons to select an option.

Off	No image displays.
Hold	The image displays until you press the shutter button halfway.

Changing the Image Display Right After Shooting

You can change the image display that appears after shooting.

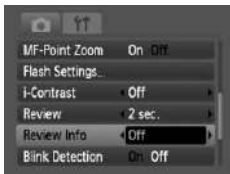

- Select [Review Info], then press the ◀▶ buttons to select an option.

Detailed	Displays detailed information (p. 45).
Focus Check	The area inside the AF frame is magnified, allowing you to check the focus. The procedure is the same as in "Checking the Focus" (p. 107).

Displaying the Overlay

You can display gridlines for vertical and horizontal guidance, or a 3:2 guide to confirm the printable area for L size or postcard size prints.

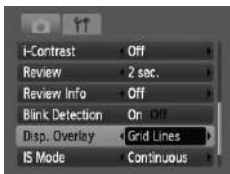

- Select [Disp. Overlay], then press the ◀▶ buttons to select an option.

Grid Lines	A grid overlays the display.
3:2 Guide	The areas outside the 3:2 range are grayed out. This area will not print when printing on paper with a 3:2 aspect ratio.
Both	Both grid lines, and the 3:2 guide will display.



- In **W** mode, you cannot set [3:2 Guide] or [Both].
- Grid Lines will not be recorded on the image.
- The gray areas displayed with [3:2 Guide] are the areas that will not be printed. The actual image recorded will include the portion in the gray areas.

Changing the IS-Mode Settings

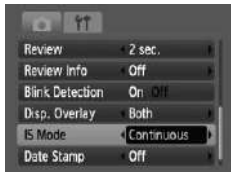

- Select [IS Mode], then press the **◀▶** buttons to select an option.





Continuous	Image stabilization is always on. You can confirm the result directly on the display, which makes it easier to check the composition or focus.
Shoot Only	Image stabilization is only active at the moment of shooting.
Panning	Image stabilization only counters up and down motion. This option is recommended for shooting objects moving horizontally.

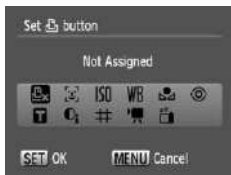

- If camera shake is too strong, attach the camera to a tripod. It is recommended to set the IS Mode to [Off] when the camera is fixed to a tripod.
- When using [Panning], hold the camera horizontally. Image stabilization does not work when the camera is held vertically.

Registering Functions to the Button



- Select [Set > button], then press the  button.
- Press the **▲▼◀▶** buttons to select the functions to register, then press the  button.
- ▶ Pressing the  button will call up the registered function.



- Press if you want to cancel a function.
- When this symbol is shown on the bottom right of an icon, the function cannot be used in the current shooting mode or function setting.
- In , each press of the button records white balance data (p. 74), and the white balance settings also change to .

Changing Playback Functions

You can adjust the settings in the tab by pressing the button (p. 48).

Selecting the Image that First Displays in Playback

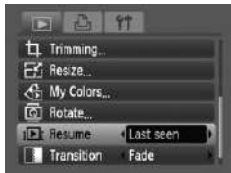

- Select [Resume], then press the to select an option.

Last seen	Resumes with the image last viewed.
Last shot	Resumes with the most recently shot image.

Changing the Start-up Image or Sound

In the tab, you can change the sounds played for each camera operation or set the start-up image that appears when the camera power is turned on.

Change Sounds





- Select [Sound Options], then press the button.
- Press the to select an option.
- Press the to change the sound.

1	Preset sound.
2	You can register your sounds using the supplied software (ZoomBrowser EX/ImageBrowser) (p. 138).

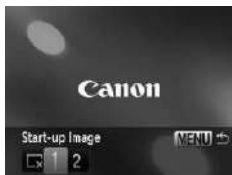
Changing the Start-up Screen







- Select [Start-up Image], then press the  button.
- Press the   buttons to change the image.

<input type="checkbox"/> x	No start-up image.
1	Preset image.
2	You can register images that you have taken.







Setting a Recorded Image as the Start-up Screen Image

When you press the  button and set the camera to playback mode, you can register sounds and images.



- Select [Start-up Image], then press the  button.
- Press the   buttons to select [2], then press the  button.



- Press the   buttons to select an image, then press the  button.
- Press the   buttons to select [OK], then press the  button to complete registration.



Any previously registered start-up image will be overwritten when registering a new start-up image.



Using the included software to register sounds and the start-up screen image

You can register sounds and start-up screen images that come with the included software to the camera. Refer to the *Software Starter Guide* for details.

9

Useful Information

This chapter introduces how to use the AC adapter kit (sold separately), troubleshooting tips and contains lists of functions. The index also appears at the end.



Using Household Power

If you use AC Adapter Kit ACK-DC40 (sold separately), you can use the camera without worrying about how much charge is left in the battery. The DR-40 coupler included with the adapter kit cannot be used with this camera.

1 Turn off the camera.

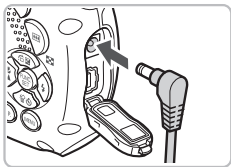

2 Plug the cord into the camera.

- Open the cover and fully insert the plug into the camera's terminal.

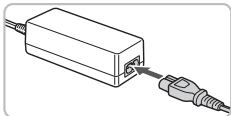

3 Connect the power cord.

- Connect the power cord to the compact power adapter, then plug the other end into a power outlet.
- You can turn the camera on to use it.
- After you finish, turn off the camera and unplug the power cord from the power outlet.



Do not unplug the plug or power cord with the camera turned on. This could erase images you have taken or damage the camera.

Changing the Strap

Using the Shoulder and Neck Strap Set STP-DC1 (Sold Separately) or Carabiner Strap STP-DC2 (Sold Separately), you can easily change straps to suit your location.

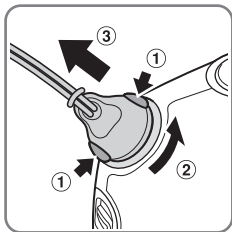

1 Changing the Strap.

- Using the instructions on p. 13 remove the wrist strap from the camera and attach the desired strap.

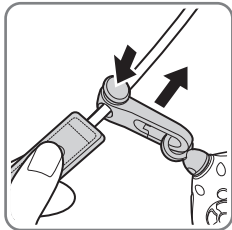

- You can adjust the length of the shoulder strap.

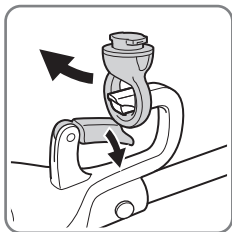

- You can remove the carabiner from the supplied strap mount.

Changing the Strap

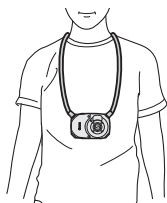

Neck strap

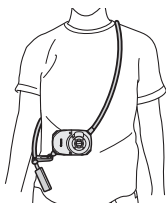

Shoulder strap



Carabiner strap



Do not use the neck, shoulder, or carabiner straps in water. While underwater, use the wrist strap included with this unit (p. 2).

Changing the Front Cover

You can change the front cover using the Front Cover Set FC-DC1 (Sold Separately).

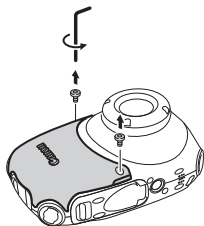

1 Remove the screws.

- Using the tool included in the accessory set, remove the two screws.
- Take care not to lose the screws. However, spare screws are included with the accessory set.

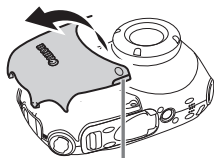

Removal tab

2 Remove the front cover.

- Using the removal tab, lift the cover in the direction of the arrow to remove.

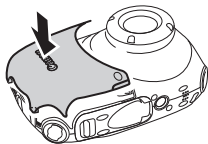

3 Put on a new cover.

- Place the desired cover as shown in the image, and press it until it clicks into place.
- Make sure there is no space between the front cover and the camera.

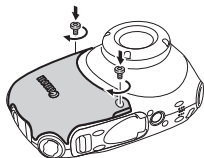

4 Screw in the cover.

- Replace the screws removed in Step 1.



Do not remove other screws besides the two on the front cover.

Troubleshooting

If you think there is a problem with the camera, first check the following. If the items below do not solve your problem, contact a Canon Customer Support Help Desk as listed on the included customer support list.

Power

You pressed the power button, but nothing happened.

- Confirm that the battery is properly inserted (p. 18).
- Confirm that the memory card/battery cover is securely closed (p. 19).
- If the battery terminals are dirty, battery performance will decrease. Clean the terminals with a cotton swab and re-insert the battery several times.

Battery is consumed quickly.

- Battery performance decreases at low temperatures. Warm the battery by such methods as placing them in your pocket with the terminal cover on.

TV output

Image is distorted or not showing on TV (p. 109).

Shooting

Cannot shoot.

- When in playback (p. 29), press the shutter button halfway (p. 25).

Camera screen is black at start-up.

- Images that have been edited on a computer, have had their name changed, or that have been taken with another camera may not display correctly when set as a start-up screen.

Screen does not display properly in dark places (p. 46).

Screen does not display properly while shooting.

Please note, the following will not be recorded in still images, but will be recorded in movies.

- When the camera is subjected to powerful light sources, the display may darken.
- Under fluorescent lighting, the screen may flicker.
- When shooting bright light sources, a bar of light (purplish red) may appear on the screen.

The icon blinks when you try to shoot (p. 28).

appears when the shutter button was pressed halfway (p. 60).

- Set the [IS mode] to [Continuous] (p. 136).
- Set the flash to  (p. 68).
- Increase the ISO speed (p. 73).
- Attach the camera to a tripod.

Image is blurred.

- Press the shutter button halfway to focus, then shoot (p. 25).
- Shoot the subject within the focusing distance (p. 157).
- Set the [AF-assist Beam] to [On] (p. 134).
- Confirm that functions which you do not intend to use (macro, etc.) are not set.
- Shoot using the focus lock or AF lock (pp. 78, 82).

Even when you press the shutter button halfway, the frame does not appear, and the camera does not focus.

- If you center on the light and dark contrasting area of the subject and press the shutter button halfway, or repeatedly press the shutter button halfway, the frame will appear and the camera will focus.

Subject is too dark.

- Set the flash to  (p. 68).
- Adjust the brightness with exposure compensation (p. 72).
- Adjust the brightness with the i-Contrast function (pp. 87, 122).
- Use the AE lock, or spot metering to shoot (p. 85).

Subject is too bright (overexposed).



- Set the flash to  (p. 60).
- Adjust the brightness with exposure compensation (p. 72).
- Use the AE lock, or spot metering to shoot (p. 85).
- The subject is too bright due to ambient lighting.

Image is dark even though the flash fired (p. 28).

- Increase the ISO speed (p. 73).
- Shoot within an appropriate distance for flash photography (p. 68).

Image taken using the flash is too bright (overexposed).

- Shoot within an appropriate distance for flash photography (p. 68).
- Set the flash to  (p. 60).

White dots appear on the image when shooting with the flash.

- Light from the flash has reflected off dust particles or other objects in the air.

Image appears rough or grainy.

- Shoot with the ISO speed on a lower setting (p. 73).
- Depending on the shooting mode, when shooting in a high ISO speed the image may appear rough or grainy (p. 59).

Eyes appear red (p. 88).

- Set the [Red-Eye Lamp] to [On] (p. 134). When shooting with the flash, the lamp (on the front of the camera) lights (p. 42), and for approximately 1 second while the camera is reducing red-eye, it is not possible to shoot. It is more effective if the subject is looking directly at the lamp. Even better results can be obtained by increasing the lighting in indoor settings or approaching closer to the subject.

Recording images to the memory card takes a long time, or continuous shooting slows down.

- Perform a low-level format of the memory card in the camera (p. 52).

When you can't make settings for shooting functions or FUNC. menu.

- The items in which settings can be made differ depending on the shooting mode. Refer to "Functions Available in Each Shooting Mode" (pp. 150 – 153).

Shooting movies

Correct shooting time does not display, or stops.

- Format the memory card in the camera, or use a memory card capable of recording at high speeds. Even when the shooting time does not display properly, the video recorded will be the length that it was actually shot (p. 33).

❗ displayed on the LCD monitor, and shooting ended automatically.

Camera's internal memory was insufficient. Try one of the following.

- Perform a low-level format of the memory card in the camera (p. 52).
- Lower the recorded pixels (p. 97).
- Use a memory card capable of recording at high speeds.

Zoom does not operate.

- You can use the digital zoom while recording, but not the optical zoom (p. 98).

Playback

Cannot play back images or movies.

- If the file name or folder structure is changed on a computer, you may not be able to play back images or movies. Refer to the *Software Starter Guide* for information regarding folder structure or file names.

Playback stops, or audio cuts out.

- Use a card that has been formatted on this camera (pp. 24, 52).
- If you copy a movie to a memory card that reads slowly, playback may interrupt momentarily.
- You may experience frame dropping and audio breakup when playing back a movie on a computer with insufficient system resources.

List of Messages that Appear on the Screen

If error messages appear on the LCD monitor, try one of the following solutions.

No memory card

- The memory card is not installed in the correct direction. Install the memory card in the correct direction (p. 18).

Card locked!

- The SD memory card or SDHC memory card's write protect tab is set to "LOCK". Unlock the write protect tab (p. 18).

Cannot record!

- You attempted to shoot an image without the a memory card, or with a memory card installed incorrectly. Install the memory card in the correct direction when shooting (p. 18).

Memory card error (p. 52)

- Contact your Canon Customer Support Help Desk as there may be a problem with the camera.

Memory card full

- There is not enough free space on the memory card to shoot (pp. 26, 55, 67, 79) or edit images (pp. 119 – 123). Erase the images (pp. 29, 110) to open space for new images, or insert an empty memory card (p. 18).

Change the battery pack (p. 18)

No image.

- There are no images recorded on the memory that can be displayed.

Protected! (p. 114)

Unidentified Image/Incompatible JPEG/Image too large./RAW

- Unsupported images or data, or corrupted image data cannot be displayed.
- Images manipulated on a computer, that have had their file name changed, or have been taken with a different camera may not display.

Cannot magnify!/Cannot rotate/Cannot modify image/Cannot register this image!/Cannot modify/Cannot assign to category

- Incompatible images cannot be magnified (p. 108), rotated (p. 118), edited (pp. 119 – 123), registered to the start-up screen (p. 138), categorized (p. 116), or added to a print list (p. 125).
- Images manipulated on a computer, that have had their file name changed, or have been taken with a different camera may not be magnified, rotated, edited, registered to the start-up screen, categorized, or added to a print list.
- Movies cannot be magnified (p. 108), edited (pp. 119 – 123), added to a print list (p. 124), or registered to the start-up screen (p. 138).

Cannot select!

- When selecting the selection range (pp. 111, 115, 117, 127), you tried to select a starting image that was after the last image or you tried to select an ending image that was before the starting image.
- You tried to select more than 501 images in the selection range (pp. 111, 115, 117, 127).

Too many marks.

- You selected more than 998 images to print settings. Select less than 998 images (p. 125).

Cannot complete!

- Print settings could not be saved correctly. Reduce the number of selected images and try again (p. 125).

Naming error!

- The file name could not be created because there is an image with the same name as the folder that the camera is attempting to create, or the highest possible file number has already been reached (p. 132). In the **FILE** menu, change [File Numbering] to [Auto reset] (p. 132) or format the memory card (pp. 24, 52).

Communication error

- Images could not be transferred to the computer or printed due to the large amount of images (approx. 1000) stored on the memory card. Use a commercially available USB card reader to transfer the images. To print, insert the memory card into the printer's card slot to print.

Lens error, restart camera

- A lens error was detected. Press the power button to turn the camera off and back on (p. 42). If this error message continues to display, contact your Canon Customer Support Help Desk as there may be a problem with the lens.

Exx (xx: number)

- A camera error was detected. Press the power button to turn the camera off and back on (p. 42).
- If an error code displays directly after taking a picture, the shot may not have been recorded. Check image in playback mode.
- If this error code reappears, note the number and contact your Canon Customer Support Help Desk as there may be a problem with the camera.



Functions Available in Each Shooting Mode

Function	Shooting modes		P	SCN		
Exposure Compensation (p. 72)/Exposure Shift (p. 97)		—	○	○	○	○
Flash (pp. 60, 68, 86)		○	○	○	○	○
		—	○	○	○	○
		—	○	—	*6	*6
		○	○	○	○	○
Focusing Zone (p. 69, 83)	All Range	○	—	—	—	—
		—	○	○	○	○
		—	○	○	—	○
	MF	—	○	○	○	○
Self-Timer (pp. 64, 65, 76, 77)		○	○	○	○	○
		○	○	○	○	○
		○	○	○	○	○
	*1	○	○	○	○	○
AF Lock (p. 82)		—	○	—	—	—
AE Lock / FE Lock (pp. 85, 86)		—	○	—	—	—
TV Display (p. 77)		○	○	○	○	○
Information Display (p. 44)	Information Display	○	○	○	○	○
	No Information Display	○	○	○	○	○

FUNC. Menu						
ISO Speed (p. 73)		○	○	○	○	○
		—	○	—	—	—
White Balance (p. 74)	AWB	○	○	○	○	○
		—	○	—	—	—
My Colors (p. 75)		—	○	—	—	—
Metering Mode (p. 85)		○	○	○	○	○
	[] [.] [.]	—	○	—	—	—
Drive Mode (p. 72)		○	○	○	○	○
		—	○	○	○	○
Image Quality (Compression Ratio) (p. 70)		○	○	○	○	○
Recording Pixels (pp. 70, 96)	L M1 M2 M3 S W	○	○	○	○	○
		—	—	—	—	—

*1 Possible settings: 0 – 30 seconds in [Delay], and 1 – 10 shots in [Shots].

*2 FE Lock is unavailable. *3 ISO3200 (p. 59) is set by default. *4 M3 is set by default.

Functions Available in Each Shooting Mode

SCN															
○	○	○	○	—	○	○	○	○	○	—	—	○	○	—	
○	○	○	—	—	○	○	—	○	○	—	○	—	—	—	
○	○	○	—	○	○	○	○	○	○	—	○	○	—	—	
—	—	*6	—	*6	—	—	—	—	—	—	—	○	—	—	
○	○	○	○	○	○	○	○	○	○	○	○	○	—	—	
—	—	—	—	—	—	—	—	—	—	—	—	—	—	—	
○	○	○	○	○	○	○	○	○	○	○	○	○	○	○	
—	○	—	—	○	○	○	○	○	○	○	○	○	○	○	
—	○	—	—	○	○	○	○	○	○	○	○	○	○	○	
○	○	○	—	—	○	○	○	○	○	○	○	—	○	○	
○	○	○	○	○	○	○	○	○	○	○	○	○	○	○	
○	○	○	○	○	○	○	○	○	○	○	○	○	○	○	
○	○	○	—	○	○	○	○	○	○	○	—	—	—	—	
○	○	○	○	○	○	○	○	○	○	○	—	—	—	—	
—	—	—	—	○	—	—	—	—	—	—	—	—	○	—	
—	—	—	—	—	—	—	—	—	—	—	—	—	*2	—	
○	○	○	○	○	○	○	○	○	○	○	○	—	○	○	
○	○	○	○	○	○	○	○	○	○	○	○	○	○	○	
○	○	○	○	○	○	○	○	○	○	○	—	—	○	—	





FUNC. Menu														
○	○	○	○	—	○	○	○	○	○	*3	○	○	○	○
—	—	—	—	○	—	—	—	—	—		—	—	—	—
○	○	○	○	○	○	○	○	○	○	○	○	○	○	○
—	—	—	—	○	—	—	—	—	—	—	—	○	○	—
—	—	—	—	○	—	—	—	—	—	—	—	○	○	—
○	○	○	○	○	○	○	○	○	○	○	○	○	○	○
—	—	—	—	—	—	—	—	—	—	—	—	—	—	—
○	○	○	○	○	○	○	○	○	○	○	○	○	○	○
○	○	○	○	○	○	○	○	○	○	○	○	—	—	—
○	○	○	○	○	○	○	○	○	○	○	○	○	—	—
○	○	○	○	○	○	○	○	○	○	*4	○	*5	—	—
—	—	—	—	—	—	—	—	—	—	—	—	—	○	○

○ Selectable — Not selectable

*5 **W** is not selectable. *6 Not selectable, but turned on when the flash is fired.

Menus

Shooting Menu

Function	Shooting modes	AUTO	P	SCN		
						
AF Frame (p. 80)	Face AiAF	○	○	○	○	○
	Center	—	○	○	○	○
AF Frame Size (p. 80)	Normal/Small	—	○	—	—	—
Servo AF (p. 82)	On/Off	—	○	○	○	○
Digital Zoom (p. 61)	Standard/Off	○	○	○	○	○
	1.5x / 2.0x	○	○	○	○	○
AF-Point Zoom (p. 81)	On/Off	○	○	○	○	○
AF-assist Beam (p. 134)	On/Off	○	○	○	○	○
MF-Point Zoom (p. 83)	On/Off	—	○	○	○	○
Flash Settings (pp. 88, 134)	Red-Eye Corr. On/Off	○	○	○	○	○
	Red-Eye Lamp On/Off	○	○	○	○	○
i-Contrast (p. 87)	Off/Auto	*1	○	—	—	—
Review (p. 135)	Off/2 – 10 sec./Hold	○	○	○	○	○
Review Info (p. 135)	Off/Detailed/Focus Check	○	○	○	○	○
Blink Detection (p. 89)	On/Off	○	○	○	○	○
Disp. Overlay (p. 135)	Off/Grid Lines	○	○	○	○	○
	3:2 Guide/Both	○	○	○	○	○
IS Mode (p. 136)	Continuous/Off	*1	○	○	○	○
	Shoot Only/Panning	—	○	○	○	○
Date Stamp (p. 63)	Off/Date/Date & Time	○	○	○	○	○
Set  button (p. 136)		○	○	○	○	○

*1 Always [On]. *2 Available when  is selected.

SCN																
○	○	○	—	○	○	○	○	○	○	○	○	—	—	—		
○	○	○	—	○	○	○	○	○	○	○	○	—	—	—		
—	—	—	—	—	—	—	—	—	—	—	—	—	—	—		
○	○	○	—	○	○	○	○	○	○	○	○	○	—	—		
○	○	○	○	○	○	○	○	○	○	—	—	—	○	—		
○	○	○	○	○	○	○	○	○	○	—	—	—	—	—		
○	○	○	○	○	○	○	○	○	○	○	○	—	—	—		
○	○	○	—	○	○	○	*2	○	○	○	○	○	○	○		
○	○	○	—	—	○	○	○	○	○	○	○	—	—	—		
○	○	○	—	○	○	○	○	○	○	—	—	—	—	—		
○	○	○	—	○	○	○	○	○	○	—	○	○	—	—		
—	—	—	—	—	—	—	—	—	—	—	—	—	—	—		
○	○	○	○	○	○	○	○	○	○	○	○	○	—	—		
○	○	○	○	○	○	○	○	○	○	○	○	—	—	—		
○	○	○	—	—	○	—	○	○	○	—	○	—	—	—		
○	○	○	○	○	○	○	○	○	○	○	○	—	○	○		
○	○	○	○	○	○	○	○	○	○	○	○	—	—	—		
○	○	○	○	○	○	○	○	○	○	○	○	○	○	○		
○	○	○	○	○	○	○	○	○	○	○	○	○	—	—		
○	○	○	○	○	○	○	○	○	○	—	○	—	—	—		
○	○	○	○	○	○	○	○	○	○	○	○	○	○	○		

○ Selectable — Not selectable

Set up Menu

Item	Options/Summary	Ref. Page
Mute	On/Off*	p. 49
Volume	Set all operation sounds (5 levels).	p. 49
Sound Options	Set the sounds played for each camera operation.	p. 137
LCD Brightness	Set within a range of ± 2 .	p. 50
Start-up Image	Add an image as start-up image.	p. 138
Format	Formats card, erasing all data.	pp. 24, 52
File Numbering	Continuous*/Auto Reset	p. 132
Create Folder	Create New Folder/Auto Create	p. 132
Auto Rotate	On*/Off	p. 133
Power Saving	Auto Power Down: On*/Off Display Off: 10, 20 or 30 sec./1*, 2 or 3 min.	pp. 53, 130
Time Zone	Home/World	p. 131
Date/Time	Date and time settings.	p. 22
Distance Units	m/cm* ft/in	p. 83
Video System	NTSC/PAL	p. 109
Language	Select displayed language.	p. 23
Reset All	Returns camera to default settings.	p. 51

* Default setting

Playback Menu

Item	Options/Summary	Ref. Page
Slideshow	Plays back images and movies automatically.	p. 105
My Category	Categorizes images and movies.	p. 116
Erase	Erases images and movies.	p. 110
Protect	Protects images and movies.	p. 114
i-Contrast	Corrects dark portions of images.	p. 122
Red-Eye Correction	Corrects red eyes in images.	p. 123
Trimming	Trims portions of images.	p. 120
Resize	Resizes and saves images.	p. 119
My Colors	Adjusts colors in images.	p. 121
Rotate	Rotates images and movies.	p. 118
Resume	Last seen*/Last shot	p. 137
Transition	Fade*/Slide 1/Slide 2/Off	p. 108

* Default setting

Print Menu

Item	Options/Summary	Ref. Page
Print	Displays printing screen.	p. 30
Select Images & Qty.	Selects individual images for printing.	p. 126
Select Range	Selects starting and ending images for printing.	p. 127
Select All Images	Selects all images for printing.	p. 127
Select by Date	Selects images for printing by date.	p. 127
Select by Category	Selects images for printing by category.	p. 127
Select by Folder	Selects images for printing by folder.	p. 127
Clear All Selections	Cancel all settings for printing.	p. 128
Print Settings	Sets the printing style.	p. 125

Handling Precautions

Equipment

- This camera is a high-precision electronic device. Do not allow it to fall a great distance or subject it to excessive impacts.
- Never place the camera close to magnets or motors that generate strong electromagnetic fields. Exposure to strong magnetic fields may cause malfunctions or corrupt image data.
- If water droplets have fallen or dirt is stuck on the camera or LCD monitor, wipe with a dry soft cloth or eyeglass wiper. Do not rub or apply force.
- Never use cleaners containing organic solvents to wipe the camera or LCD monitor.
- Use a commercially available blower brush to remove dust from the lens. For stubborn dirt contact the closest Canon Customer Support Help Desk as listed on the customer support leaflet supplied with your camera.
- When you move the camera rapidly from cold to hot temperatures, condensation may form on the internal or external surfaces of the camera. To avoid condensation, put the camera in an airtight, resealable plastic bag and let it adjust to temperature changes slowly before removing it from the bag.
- If condensation has occurred, opening the memory card/battery cover or terminal cover could cause damage. Do not open the covers until the moisture has completely evaporated.



For handling instructions after the camera has been used underwater, please see Cautions After Using This Camera and Camera Care (p. 15).

Memory Cards

- A memory card is a high-precision electronic device. Do not bend, apply force or subject it to strong impacts. Doing so may corrupt image data recorded on the memory card.
- Do not spill liquids on the memory card. Do not touch the memory card's terminals with your hands or metallic objects.
- Do not store memory cards near a TV, speakers or other devices that generate magnetic fields or static electricity. Doing so may corrupt image data recorded on the memory card.
- Do not store memory cards in hot, humid or dusty locations.

Specifications

Camera Effective Pixels	Approx. 12.1 million
Image Sensor	1/2.3-inch type CCD (Total number of pixels: Approx. 12.7 million)
Lens	6.2 (W) – 18.6 (T) mm 35mm film equivalent: 35 (W) – 105 (T) mm F2.8 (W) – F4.9 (T)
Waterproof Capability	Meets JIS/ IEC protection class IPX8* For use within a depth of 10 meters
Dustproof Capability	Meets JIS/ IEC protection class IP6X*
Shock Resistant Capability	Canon standard based on MIL Standard 810F Method 516.5 Selecting Procedure IV (A US Defense Standard) * Testing Conditions: <ul style="list-style-type: none">• Drop height: 1.22 m (4 ft.).• Drop surface: Wood.• Drop direction: Each surface (6 surfaces), each angle (4 angles) for a total of 10.• Number of drops: Each surface and each angle 3 times for a total of 30. * The camera is subjected to Canon standard testing conditions. However, it is not guaranteed that this camera will not damage or malfunction.
Digital Zoom	Approx. 4.0x (Up to approx. 12x in combination with the optical zoom)
LCD Monitor	2.5 inch-type TFT LCD color monitor Approx. 230,000 dots, Picture coverage 100%
AF Frame Mode	Face AiAF/Center
Servo AF	On / Off
Focusing Range (from end of lens)	Auto: 3 cm (1.2 in.) – infinity (W)/30 cm (1.0 ft.) – infinity (T) Normal: 30 cm (1.0 ft.) – infinity Macro: 3 – 50 cm (1.2 in. – 1.6 ft.) (W)/30 – 50 cm (1.0 – 1.6 ft.) (T) Infinity: 3 m (9.8 ft.) – infinity Manual Focus: 3 cm (1.2 in.) – infinity (W)/30 cm (1.0 ft.) – infinity (T) Kids&Pets: 1 m (3.3 ft.) – infinity
Shutter	Mechanical shutter and electronic shutter
Shutter Speed	1 – 1/1500 sec. 15 – 1/1500 sec. (Total shutter speed range)
Image Stabilization	Lens-shift type
Metering Type	Evaluative, Center-weighted average or Spot
Exposure Compensation	±2 stops in 1/3-stop increments
ISO speed (Standard Output Sensitivity, Recommended Exposure Index)	Auto, ISO 80 / 100 / 200 / 400 / 800 / 1600
White Balance	Auto, Day Light, Cloudy, Tungsten, Fluorescent, Fluorescent H, Underwater, Custom
Built-in Flash	Auto, On, Slow Synchro, Off * Red-eye reduction/Red-eye correction settings available
Built-in Flash Range	30 cm – 3.2 m (1.0 – 10 ft.) (W/ 30 cm – 2.0 m (1.0 – 6.6 ft.) (T)
Shooting Modes	Shooting mode: Auto, Program AE, SCN, Movie Special Scene Mode: Portrait, Landscape, Night Snapshot,

Specifications

	Kids&Pets, Indoor, Sunset, Fireworks, Long Shutter, Beach, Underwater, Aquarium, Foliage, Snow, ISO3200, Color Accent, Color Swap, Stitch Assist
	Movie mode: Standard, Color Accent, Color Swap
Continuous Shooting	Approx. 1.1 images/sec.
Self-timer	FaceSelf-Timer, Approx. 10 sec./Approx. 2-sec. delay, Custom Timer
i-Contrast	Off/Auto
Recording Media	SD memory card, SDHC memory card, MultiMediaCard, MMCplus memory card, HC MMCplus memory card
File Format	Design rule for camera file system and DPOF compliant
Data Type	Still images: Exif 2.2 (JPEG) Movies: MOV (Image data: H.264, Audio data: Linear PCM) (Mono)
Compression	Fine, Normal
Number of Recording Pixels (Still images)	Large: 4000 × 3000 pixels Medium 1: 3264 × 2448 pixels Medium 2: 2592 × 1944 pixels Medium 3: 1600 × 1200 pixels Small: 640 × 480 pixels
(Movies)	Widescreen: 4000 × 2248 pixels 640 × 480 pixels (30 frames/sec.) 320 × 240 pixels (30 frames/sec.)
Number of Possible Shots	Approx. 220 images (Based on CIPA standardized measurement)
Audio	Quantization: 16 bit Sampling Rate: 44.100 kHz
Playback Function	Single Image Playback, Video Playback, Magnified Focus, Index Playback, Magnified Playback, Jump, Slideshow
Editing Function	Erase, Protect, My Category, Resize, My Colors, i-Contrast, Trimming, Rotate, Red-Eye Correction
Direct Print Type	PictBridge capable
Interface	Hi-Speed USB (Dedicated connector (female) with unified type of digital, audio and video*) * mini-B compatible
Communication Settings	MTP, PTP
Power	Battery Pack NB-6L (rechargeable lithium-ion battery) AC adapter kit ACK-DC40
Operating Temperatures*	-10 – 40 °C (14 – 104 °F) * The NB-6L battery pack is not designed for -10 – 0°C (14 – 32 °F) conditions. As a result, it may temporarily not function optimally.
Operating Humidity	10 – 90%
Dimensions (excluding protrusions)	103.6 × 66.9 × 48.8 mm (4.08 × 2.63 × 1.92 in.)
Weight (camera body only)	Approx. 190 g (6.7 oz.)

Battery Pack NB-6L

Type	Rechargeable lithium-ion battery
Voltage	3.7 V DC
Capacity	1000 mAh
Charging cycles	Approx. 300 times
Operating temperature	0 – 40 °C (32 – 104 °F)
Dimensions	34.4 × 41.8 × 6.9 mm (1.35 × 1.65 × 0.27 in.)
Weight	Approx. 21 g (0.74 oz.)

Battery Charger CB-2LY/CB-2LYE

Rated input	100 – 240 V AC (50/60 Hz), 0.085 A (100 V) – 0.05 A (240 V)
Rated output	4.2 V DC, 700 mA
Charge time	Approx. 1 hour 55 min.
Operating temperature	0 – 40 °C (32 – 104 °F)
Dimensions	58.6 × 86.4 × 24.1 mm (2.31 × 3.40 × 0.95 in.)
Weight	Approx. 70 g (2.47 oz.) (CB-2LY) Approx. 61 g (2.15 oz.) (CB-2LYE, excluding power cord)

- All data is based on tests by Canon.
- The finished product, or exterior may differ from this report.

About MPEG-4 Licensing

This product is licensed under AT&T patents for the MPEG-4 standard and may be used for encoding MPEG-4 compliant video and/or decoding MPEG-4 compliant video that was encoded only (1) for a personal and non-commercial purpose or (2) by a video provider licensed under the AT&T patents to provide MPEG-4 compliant video.

No license is granted or implied for any other use for MPEG-4 standard.

* Notice displayed in English as required.

**USA and Canada only:**

The Lithium ion/polymer battery that powers the product is recyclable.

Please call 1-800-8-BATTERY for information on how to recycle this battery.

For CA, USA only

Included lithium battery contains Perchlorate Material - special handling may apply.

See www.dtsc.ca.gov/hazardouswaste/perchlorate/ for details.

Index

Numerics

3:2 Guide 135

A

AC Adapter Kit 40, 140
Accessories 38
AE Lock 85, 97
AF Assist Beam 134
AF Frame 27
AF → Focus
AF Lock 82
Aquarium (Scene Mode) 58
AV Cable 2, 109

B

Battery
Battery Charger 2, 16, 40
Charge Indicator 17
Charging 16
Date/Time Battery 22
Power Saving 53
Beach (Scene Mode) 58
Black and White Images 75

C

Camera
Default Settings 51
Holding 13
Camera Shake 60, 136
Clock Functions 53
Color Accent
(Scene Mode) 91, 96
Color Swap
(Scene Mode) 92, 96
Components Guide 42
Compression Ratio
→ Image Quality (Compression Ratio)
Continuous Shooting 72

D

Date and Time
Adding to Image 63
Changing 22
Date/Time Battery 22
Setting 21
Date/Time → Date and Time

Default Settings 51
DIGITAL CAMERA
Solution Disk 2, 36
Digital Tele-Converter 62
Digital Zoom 61
Disp. Overlay 135
Display Language 23
DPOF 124, 125

E

Editing
i-Contrast 122
My Colors 121
Red-Eye Correction 123
Resizing (Making Images Smaller) 119
Trimming 120
Enlarged Display 108
Erasing 29
Erasing All Images 110
Error Messages 147
Exposure
AE Lock 85
Compensation 72
FE Lock 86

F

Face AiAF 80
Face Select 84
Face Self-Timer 65
FE Lock 86
File Number 132
Fireworks (Scene Mode) 57
Flash
Off 60
On 68
Slow Synchro 86
Supplementary Flash 40
Focus
AF Frame 27
AF Frame Mode 80
AF Lock 82
AF-Point Zoom 81
Face Select 84
Servo AF 82
Focus Check 107
Focus Lock 78
Foliage (Scene Mode) 58

- Format 24
 Low Level Format 52
- FUNC. Menu
 Basic Operations 47
 List 150
- G**
- Grid Lines 135
- H**
- High ISO Speed 59, 73
 High-Power Flash 40
 Histogram 46
 Household Power 140
- I**
- i-Contrast 87, 122
- Image
 Editing → Editing
 Erasing Images 29
 Playback → Viewing
 Protect 114
 Image Quality (Compression Ratio) 70
 Indicator 43, 46
 Indoor (Scene Mode) 57
 Infinity 69
 Interface Cable 2, 30
 ISO Speed 73
 ISO3200 (Scene Mode) 59
- K**
- Kids&Pets (Scene Mode) 57
- L**
- Lamp 42
 Red-Eye Reduction Lamp 134
 Landscape (Scene Mode) 56
 Language Settings 23
 LCD Monitor → Screen
 Long Shutter (Scene Mode) 90
 Low Level Format 52
- M**
- Macro Mode 69
 Manual Focus 83
 Memory Card 20
 Available Shots 20
- Formatting 24, 52
 Recordable Number of Images 71
- Menu
 Basic Operations 48
 List 152
- Metering Mode 85
- MMCplus/HC MMCplus Memory Card
 → Memory Card
- Movie
 Editing 99
 Estimated Shooting Time 97
 Image Quality (Frame Rate) 96
 Mode 96
 Recording Pixels 97
 Shooting Time 33
 Viewing (Playback) 34
- MultiMedia Card → Memory Card
- My Category 116
 My Colors 75, 121
- N**
- Night Snapshot (Scene Mode) 57
 Number of Shots 17
- P**
- Panoramic image 94
 PictBridge 30
 Playback Button 29, 43
 Playback → Viewing
 Portrait (Scene Mode) 56
 Postcard Size 71
 Power Button 42
 Power → Battery
 Power Saving 53, 130
 Print List 124
 Printer 30
 Printing 30
 Program AE 68
- R**
- Recording Pixels (Image Size) 70
- Red-Eye
 Correction 123
 Red-Eye Correction 88
 Reduction 134
 Red-Eye Reduction Lamp 134
 Resizing (Making Images Smaller) 119
 Rotating Images 118

S

Scene Mode	56
Screen	
Display Language	23
Information Displayed	44
Menu Operations	47, 48
Switching the Display	44, 45
SD/SDHC Card → Memory Card	
Self-Timer	
10 second Self-Timer	64
Changing Delay and Number of Shots ..	77
Face Self-Timer	65
Two Second Self-Timer	76
Sepia Tones	75
Servo AF	82
Shooting Date and Time → Date and Time	
Shooting/Movie Button	42
Shutter Button	25
Slideshow	105
Snow (Scene Mode)	58
Software	
DIGITAL CAMERA	
Solution Disk	2, 36
Transferring Images to a Computer	35
Sound	49
Stitch Assist (Scene Mode)	94
Strap	2, 13
Changing	141
Strap mount	2
Sunset (Scene Mode)	57
Supplementary Flash	40

T

Terminal	30, 36, 109, 140
Transferring Images to a Computer	35
Transition	108
Trimming	120
Troubleshooting	144
TV	
Shooting Using a TV Monitor	77
Viewing Images on a TV	109

U

Underwater (Scene Mode)	58
Using When Abroad	17

V

Video → Movie	
Viewing (Playback)	
Enlarged Display	108
Filtered Playback	103
Index Display	102
Single Image Playback	29
Slideshow	105
Viewing Images on a TV	109

W

Waterproof Camera	14
Waterproof seal	18, 30
White Balance	74
Widescreen (Recording Pixels)	70, 71
World Clock	131
Wrist Strap → Strap	

Z

Zoom	27, 32, 61
------------	------------

FCC Notice

(Digital Camera, Model PC1352 systems)

This device complies with Part 15 of the FCC Rules. Operation is subject to the following two conditions;

- (1) this device may not cause harmful interference, and
- (2) this device must accept any interference received, including interference that may cause undesired operation.

Note: This equipment has been tested and found to comply with the limits for Class B digital devices, pursuant to Part 15 of the FCC rules. These limits are designed to provide reasonable protection against harmful interference in a residential installation. This equipment generates, uses and can radiate radio frequency energy and, if not installed and used in accordance with the instructions, may cause harmful interference to radio communications. However, there is no guarantee that interference will not occur in a particular installation. If this equipment does cause harmful interference to radio or television reception, which can be determined by turning the equipment off and on, the user is encouraged to try to correct the interference by one or more of the following measures:

- Reorient or relocate the receiving antenna.
- Increase the separation between the equipment and receiver.
- Connect the equipment into an outlet on a circuit different from that to which the receiver is connected.
- Consult the dealer or an experienced radio/TV technician for help.

The cable with the ferrite core provided with the digital camera must be used with this equipment in order to comply with Class B limits in Subpart B of Part 15 of the FCC rules.

Do not make any changes or modifications to the equipment unless otherwise specified in the manual. If such changes or modifications should be made, you could be required to stop operation of the equipment.

Canon U.S.A., Inc.

One Canon Plaza, Lake Success, NY 11042, U.S.A.

Tel No. (516) 328-5600

Canadian Radio Interference Regulations

This Class B digital apparatus complies with Canadian ICES-003.