

PRODUCT SELECTION LOCATOR

SECTION	SPECIFICATION
1	300V Instrumentation Cables 1000
2	600V Instrumentation Cables 2000
3	600V Flexible Control and Power Cables 3000
4	600V Multi Conductor Control and Power Cables 4000
5	600V Industrial Power Cables 5000
6	2.4kV – 35kV Industrial Medium-Voltage Cables 6000
7	600V – 35kV Industrial Armored Cables 7000
8	600V – 28kV TECK90 Armored Control and Power Cables 8000
Technical Information	A – F

Table of Contents

Date of Issue 01/09

Section 1 300V Instrumentation Cables

SPECIFICATION NO.	PRODUCT DESCRIPTION	REVISION DATE
1050	CHTC® XLPE/HYP, Instrumentation, Shielded 300V, UL Type PLTC, Overall Shielded Pairs/Triads	Jan. 2009
1100	CHTC® XLPE/HYP, Instrumentation, Shielded 300V, UL Type PLTC, Individual and Overall Shielded Pairs	Jan. 2009
1150	CVTC® XLPE/PVC, Instrumentation, Shielded 300V, UL Type PLTC, Overall Shielded Pairs/Triads	Jan. 2008
1200	CVTC® XLPE/PVC, Instrumentation, Shielded 300V, UL Type PLTC, Individual and Overall Shielded Pairs	Jan. 2008
1250	PVIC® PVC/PVC, Instrumentation, Shielded 300V, UL Type PLTC/ITC, Overall Shielded Pairs/Triads	Jan. 2008
1300	PVIC® PVC/PVC, Instrumentation, Shielded 300V, UL Type PLTC/ITC, Individual and Overall Shielded Pairs	Jan. 2009
1350	PVIC® PVC/PVC, Instrumentation, Shielded 300V, UL Type PLTC/ITC, Individual and Overall Shielded Triads	Jan. 2008

Section 2 600V Instrumentation Cables

SPECIFICATION NO.	PRODUCT DESCRIPTION	REVISION DATE
2050†	CHTC® XLPE/HYP, Instrumentation, Shielded 600V, UL Type TC, Individual and Overall Shielded Pairs/Triads	Jan. 2009
2100†	FREP® FR-EPR/CPE, Instrumentation, Shielded 600V, UL Type TC, Overall Shielded Pairs/Triads	Jan. 2008
2150†	FREP® FR-EPR/CPE, Instrumentation, Shielded 600V, UL Type TC, Individual and Overall Shielded Pairs	Jan. 2008
2200	FREP® FR-EPR/CPE, Instrumentation, Shielded 600V, UL Type TC, Individual and Overall Shielded Triads	Jan. 2008
2250	Arctic-Flex® XLPE/ARCTIC-PVC, Instrumentation, Shielded 600V, UL Type TC, CSA Type CIC, Overall Shielded Pairs/Triads	Jan. 2008
2300	Arctic-Flex® XLPE/ARCTIC-PVC, Instrumentation, Shielded 600V, UL Type TC, CSA Type CIC, Individual and Overall Shielded Pairs	Jan. 2008
2350	CVTC® XLPE/PVC, Instrumentation, Shielded 600V, UL Type TC, Overall Shielded Pairs/Triads	Jan. 2008
2400	CVTC® XLPE/PVC, Instrumentation, Shielded 600V, UL Type TC, Individual and Overall Shielded Pairs	Jan. 2008
2450†	VNTC® PVC/Nylon/PVC, Instrumentation, Shielded 600V, UL Type TC, Overall Shielded Pairs/Triads	Jan. 2008
2500†	VNTC® PVC/Nylon/PVC, Instrumentation, Shielded 600V, UL Type TC, Individual and Overall Shielded Pairs	Jan. 2008
2600†	GenFree™ XLPO/LSZH, Instrumentation, Shielded 600V, UL Type TC-LS, Overall Shielded Pairs/Triads	Feb. 2008
2625†	GenFree™ XLPO/LSZH, Instrumentation, Shielded 600V, UL Type TC-LS, Individual and Overall Shielded Pairs	Feb. 2008
2650	GenFree™ XLPO/LSZH, Instrumentation, Shielded 600V, UL Type TC-LS, Individual and Overall Shielded Triads	Feb. 2008

†Indicates these products are stocked by General Cable.

Table of Contents

Date of Issue 01/09

Section 3 600V Flexible Control and Power Cables

SPECIFICATION NO.		PRODUCT DESCRIPTION	REVISION DATE
3050	Super Flexing	XLPE/NYLON/HYP, Thermoset Super Flexing Control 600V, UL Type TC/CSA CIC	Jan. 2008
3100	PNH®	PVC/NYLON/HYP, Thermoset Continuous Flexing Control 600V, UL Type TC/CSA AWM	Jan. 2008
3150	NVN®	PVC/NYLON/NEOPRENE, Thermoset Flexible Control 600V, UL Type TC	Jan. 2008
3200	PNP	PVC/NYLON/NITRILE/PVC, Thermoset Continuous Flexing Control 600V, UL Type TC/CSA AWM	Jan. 2008
3250	MTW	PVC/NYLON/PVC, Thermoplastic Flexible Control 600V, UL Type MTW/CSA AWM	Jan. 2008
3300	Festoon	PVC/PVC, Thermoplastic Extreme Flexing Festoon Control and Power 600V, UL/CSA Type Festoon	Jan. 2008

Section 4 600V Multi Conductor Control and Power Cables

SPECIFICATION NO.		PRODUCT DESCRIPTION	REVISION DATE
4050†	CHTC®	XLPE/HYP, Control, Unshielded 600V, UL Type TC—E-2 Color Code	Jan. 2009
4075†	CHTC®	XLPE/HYP, Control, Unshielded 600V, UL Type TC—E-1 Color Code	Jan. 2009
4100†	CHTC®	XLPE/HYP, Low-Voltage Power, Unshielded 600V, UL Type TC-ER—Method 4 Color Code	Jan. 2009
4150	EHTC®	FR-EPR/HYP, Control, Unshielded 600V, UL Type TC (18 AWG/16 AWG)—E-2 Color Code	Jan. 2008
4200	EHTC®	FR-EPR/HYP, Control, Unshielded 600V, UL Type TC (14 AWG—10 AWG)—E-2 Color Code	Jan. 2008
4250	EHTC®	FR-EPR/HYP, Low-Voltage Power, Unshielded 600V, UL Type TC-ER—Method 4 Color Code	Jan. 2009
4300†	FREP®	FR-EPR/CPE, Control, Unshielded 600V, UL Type TC-ER—E-2 Color Code	Jan. 2008
4310†	FREP®	FR-EPR/CPE, Control, Unshielded 600V, UL Type TC-ER—E-1 Color Code	Jan. 2008
4325†	FREP®	FR-EPR/CPE, Control, Shielded 600V, UL Type TC-ER, Overall Shielded—E-2 Color Code	Jan. 2008
4350†	FREP®	FR-EPR/CPE, Low-Voltage Power, Unshielded 600V, UL Type TC-ER—Method 4 Color Code	Jan. 2009
4400	Arctic-Flex®	XLPE/ARCTIC-PVC, Control, Unshielded 600V, UL Type TC-ER, CSA Type RW90 XLPE, CSA TYPE TC	Jan. 2008
4450	Arctic-Flex®	XLPE/ARCTIC-PVC, Low-Voltage Power, Unshielded 600V, UL Type TC-ER, CSA Type RW90 XLPE, CSA TYPE TC	Jan. 2009
4500†	CVTC®	XLPE/PVC, Control, Unshielded 600V, UL Type TC-ER—E-2 Color Code	Jan. 2008
4550†	CVTC®	XLPE/PVC, Low-Voltage Power, Unshielded 600V, UL Type TC-ER—Method 4 Color Code	Jan. 2009

†Indicates these products are stocked by General Cable.

Table of Contents

Date of Issue 01/09

Section 4 (cont'd.) 600V Multi Conductor Control and Power Cables

SPECIFICATION NO.	PRODUCT DESCRIPTION	REVISION DATE
4575	CVTC® VFD XLPE/PVC, Low-Voltage Power, Shielded 2000V, UL Type TC-ER—Method 4 Color Code	Jan. 2009
4580	CVTC® VFD XLPE/PVC, Low-Voltage Power, Copper Tape Shielded 2000V, UL Type TC-ER—Method 4 Color Code	Jan. 2009
4600†	VNTC® PVC/NYLON/PVC, Control, Unshielded 600V, UL Type TC-ER (18 AWG/16 AWG)—E-2 Color Code	Jan. 2008
4650†	VNTC® PVC/NYLON/PVC, Control, Unshielded 600V, UL Type TC-ER (14 AWG—10 AWG)—E-2 Color Code	Jan. 2008
4700†	VNTC® PVC/NYLON/PVC, Control, Shielded 600V, UL Type TC-ER, Overall Shielded—E-2 Color Code	Jan. 2008
4750†	VNTC® PVC/NYLON/PVC, Low-Voltage Power, Unshielded 600V, UL Type TC-ER—Method 4 Color Code	Jan. 2009
4800	20/10 PE/PVC/PVC, Control, Unshielded 600V (18 AWG/16 AWG)—E-1 Color Code	Jan. 2008
4850	20/10 PE/PVC/PVC, Control, Unshielded 600V (14 AWG—10 AWG)—E-1 Color Code	Jan. 2008
4900†	GenFree™ XLPO/LSZH, Control 600V, UL Type TC-LS-ER—E-2 Color Code	Feb. 2008
4925	GenFree™ XLPO/LSZH, Control, Shielded 600V, UL Type TC-LS-ER, Overall Shielded—E-2 Color Code	Feb. 2008
4950†	GenFree™ XLPO/LSZH, Low-Voltage Power, Unshielded 600V, UL Type TC-LS—Method 4 Color Code	Feb. 2008

Section 5 600V Industrial Power Cables

SPECIFICATION NO.	PRODUCT DESCRIPTION	REVISION DATE
5050†	DuraSheath® EPR/HYP, Low-Voltage Power, Unshielded 600V, UL Type RHH/RHW-2/USE-2 LS	Jan. 2008
5100	Unicon® FREP® FR-EPR, Low-Voltage Power, Unshielded 600V, UL Type RHH/RHW-2/USE-2	Jan. 2008
5150	XHHW-2 VW-1 XLPE, Control and Low-Voltage Power, Unshielded 600V, UL Type SIS/XHHW-2, VW-1 Rated	Jan. 2008
5200†	XHHW-2 XLPE, Low-Voltage Power, Unshielded 600V, UL Type XHHW-2, c(UL) RW-90	Jan. 2008
5250†	Unicon® XLPE XLPE, Low-Voltage Power, Unshielded 600V, UL Type RHH/RHW-2/USE-2	Jan. 2009
5300†	Super Vu-Tron® EPR/CPE, Diesel Locomotive Cable 2000V, Type DLO, 600V, UL Type RHH/RHW, 1000V, CSA Type R90	Oct. 2008
5350†	GenFree™ LSZH XLPO, Low-Smoke, Zero-Halogen (LSZH), Low-Voltage Power, Unshielded 600V, Type RHH/RHW-LS/USE, CSA AWM I A/B, Class B	Aug. 2008
5400†	GenFree™ LSZH XLPO, Low-Smoke, Zero-Halogen (LSZH), Low-Voltage Power, Unshielded 600V, Type RHH/RHW-LS/USE, CSA AWM I A/B, Class I	Aug. 2008

†Indicates these products are stocked by General Cable.

Table of Contents

Date of Issue 01/09

Section 5 (cont'd.)

600V Industrial Power Cables

SPECIFICATION NO.	PRODUCT DESCRIPTION	REVISION DATE
5500 [†]	RW90 XLPE, Building Wire 600V, CSA Type RW90 (-40°C), Single Conductor, Copper	Jan. 2009
5550 [†]	RW90 XLPE, Building Wire 600V, CSA Type RW90 (-40°C), Single Conductor, Aluminum	Jan. 2009
5600 [†]	RWU90 XLPE, Building Wire 1000V, CSA Type RWU90 (-40°C), Single Conductor, Copper	Jan. 2009
5650 [†]	RWU90 XLPE, Building Wire 1000V, CSA Type RWU90 (-40°C), Single Conductor, Aluminum	Jan. 2009
5700 [†]	RHH/RHW-2 XLPE, Low-Voltage Power, Unshielded 2000V, UL Type RHH/RHW-2, Single Conductor, Aluminum	Oct. 2008

Section 6 2.4kV – 35kV Industrial Medium-Voltage Cables

SPECIFICATION NO.	PRODUCT DESCRIPTION	REVISION DATE
6050 [†]	DuraSheath® EPR/HYP, Medium-Voltage Power, Non-Shielded 2400V, UL Type MV-90	Jan. 2008
6100 [†]	UniShield® EPR/Copper Wire Shield/CPE, Medium-Voltage Power, Shielded 5kV and 8kV, UL Type MV-105, 133% / 100% Ins. Levels, 115 Mils	Jan. 2009
6150 [†]	Uniblend® EPR/Copper Tape Shield/PVC, Medium-Voltage Power, Shielded 5kV and 8kV, UL Type MV-105, 133% / 100% Ins. Levels, 115 Mils	Jan. 2009
6175	Uniblend® EPR/Copper Tape Shield/CPE, Medium-Voltage Power, Shielded 5kV and 8kV, UL Type MV-105, 133% / 100% Ins. Levels, 115 Mils	Jan. 2009
6180	GenFree™ Uniblend® EPR/Copper Tape Shield/LSZH, Medium-Voltage Power, Shielded 5kV and 8kV, UL Type MV-105, 133% / 100% Ins. Levels, 115 Mils	Jan. 2009
6200	Copper Wire Shield TRXLPE/Copper Wire Shield/PVC, Medium-Voltage Power 5kV, UL Type MV-105, 100% Ins. Level, 90 Mils	Jan. 2008
6250 [†]	Uniblend® EPR/Copper Tape Shield with Overall PVC Jacket Medium-Voltage Power, Shielded, 5kV and 8kV, UL Type MV-105 133% / 100% Ins. Levels, 115 Mils, Three Conductor	Jan. 2009
6275	Uniblend® EPR/Copper Tape Shield with Overall CPE Jacket Medium-Voltage Power, Shielded, 5kV and 8kV, UL Type MV-105 133% / 100% Ins. Levels, 115 Mils, Three Conductor	Jan. 2009
6280	GenFree™ Uniblend® EPR/Copper Tape Shield with Overall LSZH Jacket Medium-Voltage Power, Shielded, 5kV and 8kV, UL Type MV-105 133% / 100% Ins. Levels, 115 Mils, Three Conductor	May 2008
6300 [†]	UniShield® EPR/Copper Wire Shield/CPE, Medium-Voltage Power, Shielded 15kV, UL Type MV-105, 133% Ins. Level, 220 Mils	Jan. 2009
6350 [†]	Uniblend® EPR/Copper Tape Shield/PVC, Medium-Voltage Power, Shielded 15kV, UL Type MV-105, 133% Ins. Level, 220 Mils	Jan. 2009
6375	Uniblend® EPR/Copper Tape Shield/CPE, Medium-Voltage Power, Shielded 15kV, UL Type MV-105, 133% Ins. Level, 220 Mils	Jan. 2009
6380	GenFree™ Uniblend® EPR/Copper Tape Shield/LSZH, Medium-Voltage Power, Shielded 15kV, UL Type MV-105, 133% Ins. Level, 220 Mils	Jan. 2009
6400	Copper Wire Shield TRXLPE/Copper Wire Shield/PVC, Medium-Voltage Power 15kV, UL Type MV-105, 133% Ins. Level, 220 Mils	Jan. 2008

[†]Indicates these products are stocked by General Cable.

Table of Contents

Date of Issue 01/09

Section 6 (cont'd.) 2.4kV – 35kV Industrial Medium-Voltage Cables

SPECIFICATION NO.	PRODUCT DESCRIPTION	REVISION DATE
6450 [†]	Uniblend [®] EPR/Copper Tape Shield with Overall PVC Jacket Medium-Voltage Power, Shielded, 15kV, UL Type MV-105 133% Ins. Level, 220 Mils, Three Conductor	Jan. 2008
6475	Uniblend [®] EPR/Copper Tape Shield with Overall CPE Jacket Medium-Voltage Power, Shielded, 15kV, UL Type MV-105 133% Ins. Level, 220 Mils, Three Conductor	Jan. 2009
6480	GenFree™ Uniblend [®] EPR/Copper Tape Shield with Overall LSZH Jacket Medium-Voltage Power, Shielded, 15kV, UL Type MV-105 133% Ins. Level, 220 Mils, Three Conductor	May 2008
6500	UniShield [®] EPR/Copper Wire Shield/CPE, Medium-Voltage Power, Shielded 25kV and 35kV, UL Type MV-105, 133% / 100% Ins. Levels, 345 Mils	Jan. 2009
6550 [†]	Uniblend [®] EPR/Copper Tape Shield/PVC, Medium-Voltage Power, Shielded 25kV and 35kV, UL Type MV-105, 133% / 100% Ins. Levels, 345 Mils	Jan. 2009
6575	Uniblend [®] EPR/Copper Tape Shield/CPE, Medium-Voltage Power, Shielded 25kV and 35kV, UL Type MV-105, 133% / 100% Ins. Levels, 345 Mils	Jan. 2009
6580	GenFree™ Uniblend [®] EPR/Copper Tape Shield/LSZH, Medium-Voltage Power, Shielded 25kV and 35kV, UL Type MV-105, 133% / 100% Ins. Levels, 345 Mils	Jan. 2009
6600	Uniblend [®] EPR/Copper Tape Shield with Overall PVC Jacket Medium-Voltage Power, Shielded, 25kV and 35kV, UL Type MV-105 133% / 100% Ins. Levels, 345 Mils, Three Conductor	Jan. 2008

Section 7 600V – 35kV Industrial Armored Cables

SPECIFICATION NO.	PRODUCT DESCRIPTION	REVISION DATE
7050 [†]	Duralox [®] XLPE/AIA/PVC, Control, Armored 600V, UL Type MC, Multi Conductor	Jan. 2009
7100 [†]	Duralox [®] XLPE/AIA/PVC, Power, Armored 600V, UL Type MC, Three and Four Conductor (8 AWG—4/0 AWG)	Jan. 2008
7150 [†]	Duralox [®] XLPE/AIA/PVC, Power, Armored 600V, UL Type MC, Three and Four Conductor (250 kcmil—1000 kcmil)	Jan. 2008
7160 [†]	Duralox [®] XLPE/AIA/PVC, Power, Armored, with Enhanced Ground Wires (50%) 600V, UL Type MC, Three Conductor (1/0 AWG—1000 kcmil)	Jan. 2008
7200 [†]	Duralox [®] EPR/AIA/PVC, Power, Non-Shielded, Armored 2400V, UL Type MV-90 or MC, Three Conductor	Jan. 2008
7250 [†]	Duralox [®] Uniblend [®] EPR/AIA/PVC, Power, Shielded, Armored 5kV/8kV, UL Type MV-105 or MC, 133% / 100% Ins. Levels, 115 Mils, Three Conductor	Jan. 2008
7300 [†]	Duralox [®] Uniblend [®] EPR/AIA/PVC, Power, Shielded, Armored 15kV, UL Type MV-105 or MC, 133% Ins. Level, 220 Mils, Three Conductor	Jan. 2008
7310 [†]	Duralox [®] Uniblend [®] EPR/AIA/PVC, Power, Shielded, Armored, with Enhanced Ground Wires (50%) 15kV, UL Type MV-105 or MC, 133% Ins. Level, 220 Mils, Three Conductor	Jan. 2008
7350	Duralox [®] Uniblend [®] EPR/AIA/PVC, Power, Shielded, Armored 25kV, UL Type MV-105 or MC, 100% Ins. Level, 260 Mils, Three Conductor	Jan. 2008
7400	Duralox [®] Uniblend [®] EPR/AIA/PVC, Power, Shielded, Armored 35kV, UL Type MV-105 or MC, 100% Ins. Level, 345 Mils, Three Conductor	Jan. 2008

[†]Indicates these products are stocked by General Cable.

Table of Contents

Date of Issue 01/09

Section 8 600V – 28kV TECK90 Armored Control and Power Cables

SPECIFICATION NO.	PRODUCT DESCRIPTION	REVISION DATE
8025 [†]	TECK90 XLPE/PVC/AIA/PVC, Control, Armored 600V, CSA TECK90, Multi Conductor, 14 AWG	Jan. 2009
8050 [†]	TECK90 XLPE/PVC/AIA/PVC, Control, Armored 600V, CSA TECK90, Multi Conductor, 12 AWG	Jan. 2009
8075 [†]	TECK90 XLPE/PVC/AIA/PVC, Control, Armored 600V, CSA TECK90, Multi Conductor, 10 AWG	Jan. 2009
8100	TECK90 XLPE/PVC/AIA/PVC, Power, Armored 1000V, CSA TECK90, Single Conductor	Jan. 2008
8125	TECK90 XLPE/PVC/AIA/PVC, Control and Power, Armored 1000V, CSA TECK90, Two Conductor	Jan. 2008
8150 [†]	TECK90 XLPE/PVC/AIA/PVC, Control and Power, Armored 1000V, CSA TECK90, Three Conductor	Jan. 2008
8175 [†]	TECK90 XLPE/PVC/AIA/PVC, Control and Power, Armored 1000V, CSA TECK90, Four Conductor	Jan. 2008
8200	TECK90 XLPE/PVC/AIA/PVC, Power/Control Composite 600V, CSA TECK90, Three Power and Three 14 AWG Control Conductors	Jan. 2008
8225	TECK90 XLPE/PVC/AIA/PVC, Power, Unshielded, Armored 5kV, CSA TECK90, Single Conductor	Jan. 2009
8250 [†]	TECK90 XLPE/PVC/AIA/PVC, Power, Unshielded, Armored 5kV, CSA TECK90, Three Conductor	Jan. 2009
8275	HVTECK TRXLPE/Wire Shield/PVC/AIA/PVC, Power, Shielded, Armored 5kV, CSA HVTECK, 100% / 133% Ins. Levels, 90 Mils, Single Conductor	Jan. 2009
8300	HVTECK TRXLPE/Wire Shield/PVC/AIA/PVC, Power, Shielded, Armored 5kV, CSA HVTECK, 133% Ins. Level, 115 Mils, Single Conductor	Jan. 2008
8325	HVTECK TRXLPE/Tape Shield/PVC/AIA/PVC, Power, Shielded, Armored 5kV, CSA HVTECK, 100% / 133% Ins. Levels, 90 Mils, Three Conductor	Jan. 2009
8350	HVTECK TRXLPE/Tape Shield/PVC/AIA/PVC, Power, Shielded, Armored 5kV, CSA HVTECK, 133% Ins. Level, 115 Mils, Three Conductor	Jan. 2008
8375	HVTECK TRXLPE/Wire Shield/PVC/AIA/PVC, Power, Shielded, Armored 15kV, CSA HVTECK, 100% Ins. Level, 175 Mils, Single Conductor	Jan. 2008
8400	HVTECK TRXLPE/Wire Shield/PVC/AIA/PVC, Power, Shielded, Armored 15kV, CSA HVTECK, 133% Ins. Level, 220 Mils, Single Conductor	Jan. 2008
8425	HVTECK TRXLPE/Tape Shield/PVC/AIA/PVC, Power, Shielded, Armored 15kV, CSA HVTECK, 100% Ins. Level, 175 Mils, Three Conductor	Jan. 2008
8450 [†]	HVTECK TRXLPE/Tape Shield/PVC/AIA/PVC, Power, Shielded, Armored 15kV, CSA HVTECK, 133% Ins. Level, 220 Mils, Three Conductor	Jan. 2008
8475	HVTECK TRXLPE/Tape Shield/PVC/AIA/PVC, Power, Shielded, Armored 25kV, CSA HVTECK, 100% Ins. Level, 260 Mils, Three Conductor	Jan. 2008
8500	HVTECK TRXLPE/Tape Shield/PVC/AIA/PVC, Power, Shielded, Armored 25kV, CSA HVTECK, 133% Ins. Level, 320 Mils, Three Conductor	Jan. 2008
8525	HVTECK TRXLPE/Tape Shield/PVC/AIA/PVC, Power, Shielded, Armored 28kV, CSA HVTECK, 133% Ins. Level, 345 Mils, Three Conductor	Jan. 2008
8550	VERTITECK® TECK90 XLPE/PVC/GSIA/PVC, Power, Unshielded, Armored 1kV, CSA TECK90, Three Conductor	Jan. 2008

[†]Indicates these products are stocked by General Cable.

Table of Contents

Date of Issue 01/09

Section 8 (cont'd.) 600V – 28kV TECK90 Armored Control and Power Cables

SPECIFICATION NO.	PRODUCT DESCRIPTION	REVISION DATE
8575 VERTITECK® TECK90	XLPE/PVC/GSIA/PVC, Power, Unshielded, Armored 5kV, CSA TECK90, 90 Mils, Three Conductor	Jan. 2008
8625 VERTITECK® HVTECK	TRXLPE/Tape Shield/PVC/GSIA/PVC, Power, Shielded, Armored 15kV, CSA HVTECK, 100% Ins. Level, 175 Mils, Three Conductor	Jan. 2008
8700 [†] ACWU	XLPE/AIA/PVC, Control, Armored 600V, CSA ACWU90 (-40°C), Single Conductor	Jan. 2008
8750 [†] ACWU	XLPE/AIA/PVC, Control, Armored 600V, CSA ACWU90 (-40°C), Three Conductor	Jan. 2009
8775 [†] ACWU	XLPE/AIA/PVC, Control, Armored 600V, CSA ACWU90 (-40°C), Four Conductor	Jan. 2009

[†]Indicates these products are stocked by General Cable.

Table of Contents

Date of Issue 01/09

Section A General Technical Information

SPECIFICATION NO.	DESCRIPTION	REVISION DATE
A005	Glossary	Jan. 2008
A025	Reference Standards	Jan. 2008
A050	Checklist for Specifications	Jan. 2008
A075	NEC and CSA Designations	Jan. 2008
A100	Common Color Sequence	Jan. 2008
A150	Metric Conversion Factors	Jan. 2008
A200	Reel Capacity Chart	Jan. 2008

Section B Conductor Data

SPECIFICATION NO.	DESCRIPTION	REVISION DATE
B005	Conductor Reference	Jan. 2008
B025	Class B Conductors for General Wiring	Jan. 2008
B030	Class C Conductors for General Wiring	Jan. 2008
B035	Class H Conductors for General Wiring	Jan. 2008
B040	Class I Conductors for General Wiring	Jan. 2008
B045	Class K Conductors for General Wiring	Jan. 2008

Section C Material Properties

SPECIFICATION NO.	DESCRIPTION	REVISION DATE
C005	Thermoplastic Jacket and Insulation Material Properties	Jan. 2008
C010	Thermoset Jacket and Insulation Material Properties	Jan. 2008

Section D Handling and Storage Recommendations

SPECIFICATION NO.	DESCRIPTION	REVISION DATE
D005	Recommended Reel Handling Practices	Jan. 2008
D025	Recommended Cable Handling Practices	Jan. 2009
D050	Recommended Cable Storage Practices	Jan. 2008

Table of Contents

Date of Issue 01/09

Section E Cable Installation Guidelines

SPECIFICATION NO.	DESCRIPTION	REVISION DATE
E005	Pre-Installation Instructions	Jan. 2008
E025	Installation — Overview and Checklist	Jan. 2008
E050	Installation — Feed-In Setups	Jan. 2008
E075	Installation — Conductor Maximum Pulling Tensions	Jan. 2008
E100	Installation — Training and Bending Limitations	Jan. 2008
E125	Installation — Maximum Sidewall Pressure	Jan. 2009

Section F Cable Testing

SPECIFICATION NO.	DESCRIPTION	REVISION DATE
F005	DC “HI-POT” Pre-Test Guidelines for MV Cables	Jan. 2008
F025	DC “HI-POT” Testing Guidelines for MV Cables	Jan. 2008
F075	Field Electrical “HI-POT” Testing Guidelines	Jan. 2008
F100	Emergency Overload Current Guidelines	Jan. 2008
F125	Short Circuit Current Calculation Overview	Jan. 2008
F150	Short Circuit Current for Copper Shields	Jan. 2008



Making Contact with the World



Building Bridges in the Sky



Directing Traffic without Gridlock

General Cable is a leader in the development, design, manufacture, marketing and distribution of copper, aluminum and fiber optic wire and cable for the energy, industrial, specialty and communications markets.

Our products inspire progress worldwide... customers use our value-added products to create global infrastructure that improves the standard of living for people everywhere.

Each day we're building business momentum — developing ideas into innovative solutions and industry-leading products, expanding geographic access and furthering our investment in highly capable associates, Lean manufacturing, material science and technology resources.

General Cable is influencing the world... with more than two-thirds of our sales generated outside North America and more than 14,000 associates in 46 manufacturing facilities throughout 23 countries. As the fifth largest wire and cable manufacturer, we are the One Company that is connecting the world.

Energy Cables

Our cables carry energy across the world — through the air, underground and under the sea. Increasing demand for energy is accelerating investment in exploration, extraction, power generation, transmission and distribution — whether based on coal, natural gas, oil, nuclear, wind or water.

Industrial & Specialty Cables

We have the competitive product mix and global reach to support the production of oil, gas and petrochemical; construction of new factories and maintenance of existing industrial facilities; factory automation; and special applications such as military, nuclear, marine, mining, transit and automotive.

Communications Cables

Our cables keep information flowing — facilitating a non-stop stream of words and images around the world. We meet the high-speed bandwidth needs of global communications networks from fiber optic submarine communications cables, copper and fiber aerial and underground cables, to copper and fiber optic enterprise cables and system solutions.

World Headquarters

General Cable
4 Tesseneer Drive,
Highland Heights, KY
41076-9753 U.S.A.



300V Instrumentation Cables

SPECIFICATION NO.		PRODUCT DESCRIPTION	REVISION DATE
1050	CHTC®	XLPE/HYP, Instrumentation, Shielded 300V, UL Type PLTC, Overall Shielded Pairs/Triads	Jan. 2009
1100	CHTC®	XLPE/HYP, Instrumentation, Shielded 300V, UL Type PLTC, Individual and Overall Shielded Pairs	Jan. 2009
1150	CVTC®	XLPE/PVC, Instrumentation, Shielded 300V, UL Type PLTC, Overall Shielded Pairs/Triads	Jan. 2008
1200	CVTC®	XLPE/PVC, Instrumentation, Shielded 300V, UL Type PLTC, Individual and Overall Shielded Pairs	Jan. 2008
1250	PVIC®	PVC/PVC, Instrumentation, Shielded 300V, UL Type PLTC/ITC, Overall Shielded Pairs/Triads	Jan. 2008
1300	PVIC®	PVC/PVC, Instrumentation, Shielded 300V, UL Type PLTC/ITC, Individual and Overall Shielded Pairs	Jan. 2009
1350	PVIC®	PVC/PVC, Instrumentation, Shielded 300V, UL Type PLTC/ITC, Individual and Overall Shielded Triads	Jan. 2008

CHTC®

XLPE/HYP, Instrumentation, Shielded
300V, UL Type PLTC, Overall Shielded Pairs/Triads

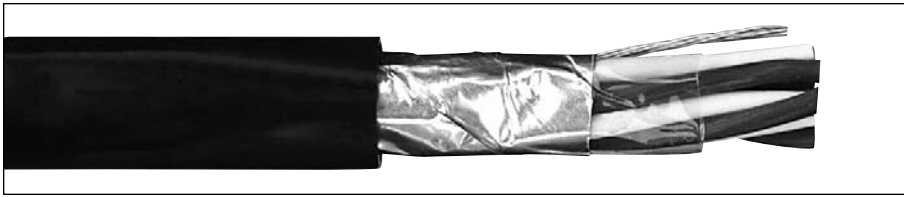

Product Construction

Conductor:

- 20 AWG thru 16 AWG tinned, annealed copper per ASTM B33
- Class B stranding per ASTM B8

Insulation:

- Flame-retardant Cross-Linked Polyethylene (XLPE)
- Color-coded: per ICEA Method 1; Pairs - black and white. Triads - black, white and red. One conductor in each pair or triad is printed alpha-numerically for easy identification

Shield:

Overall shielded pairs/triads

- Overall shield is Flexfoil® aluminum/polyester in contact with stranded tinned copper drain wire

Jacket:

- Low-lead Hypalon® Chlorosulfonated Polyethylene (CSPE)/Elastomer blend

Print:

- GENERAL CABLE® (WC) CHTC XX/PS/TS XXAWG CU/XLP/HYP SHIELDED (UL) TYPE PLTC 90°C SUN RES OIL RES I & II PLUS DAY/MONTH/YEAR OF MFG SEQUENTIAL FOOTAGE MARK

Options:

- Bare copper conductor
- Class C stranding
- Individual and overall shielded pairs/triads
- Thermoplastic Low-Smoke, Zero-Halogen (LSZH) jacket
- In accordance with UL subject 2250 as Instrumentation Tray Cable (ITC)
- Other constructions available upon request

Applications:

- Typical applications include audio, intercom, control, energy management and alarm circuits
- In free air or raceways in accordance with NEC
- Permitted for use in Class I Division 2 industrial hazardous locations per NEC
- In ducts, cable trays or conduit
- In accordance with UL subject 13 as Power-Limited Circuit Cable
- In class 3 circuits in accordance with NEC

Features:

- Rated at 90°C
- Ripcord applied to all cables with jacket thickness of 60 mils or less
- Oil-resistant jacket
- Sunlight- and weather-resistant
- Excellent electrical, thermal and physical properties
- Excellent moisture resistance
- Excellent flame resistance
- "Heavy duty" rating per ICEA standards
- Excellent low temperature cold bend characteristics
- Meets cold bend test at -35°C

Compliances:

Industry Compliances:

- UL 13 Type PLTC
- UL 1581

Flame Tests Compliances:

- UL 1581 VW-1
- IEEE 383
- IEEE 1202
- CSA FT-4

Other Compliances:

- EPA 40 CFR, Part 261 for leachable lead content per TCLP
- OSHA acceptable

Packaging:

- Material cut to length and shipped on non-returnable wood reels

CATALOG NUMBER	NO. OF PAIRS/TRIADS	COND. SIZE (AWG)	COND. STRAND	MINIMUM AVG. INSULATION THICKNESS		MINIMUM AVG. JACKET THICKNESS		NOMINAL CABLE O.D.		COPPER WEIGHT		NET WEIGHT	
				INCHES	mm	INCHES	mm	INCHES	mm	LBS/1000FT	kg/km	LBS/1000FT	kg/km

**OVERALL SHIELDED PAIRS/TRIADS
20 AWG CONDUCTORS**

337770*	1	20	7/0121	0.012	0.30	0.035	0.89	0.230	5.84	9	14	27	40
337780*	1 TRI	20	7/0121	0.012	0.30	0.035	0.89	0.240	6.10	13	19	33	49
337790*	2	20	7/0121	0.012	0.30	0.040	1.02	0.320	8.13	17	25	48	71
309660*	4	20	7/0121	0.012	0.30	0.040	1.02	0.370	9.40	31	47	73	109
309670*	8	20	7/0121	0.012	0.30	0.050	1.27	0.500	12.70	60	90	138	205
309680*	12	20	7/0121	0.012	0.30	0.050	1.27	0.575	14.61	89	133	186	277
337800*	16	20	7/0121	0.012	0.30	0.060	1.52	0.665	16.89	118	176	248	369
337810*	20	20	7/0121	0.012	0.30	0.060	1.52	0.740	18.80	148	220	300	446
309690*	24	20	7/0121	0.012	0.30	0.060	1.52	0.795	20.19	177	263	350	521
311640*	36	20	7/0121	0.012	0.30	0.070	1.78	1.005	25.53	264	392	525	781
309700*	50	20	7/0121	0.012	0.30	0.070	1.78	1.175	29.85	365	544	697	1037

**OVERALL SHIELDED PAIRS/TRIADS
18 AWG CONDUCTORS**

337820*	1	18	7/0152	0.015	0.38	0.035	0.89	0.245	6.22	13	19	32	48
337830*	1 TRI	18	7/0152	0.015	0.38	0.035	0.89	0.255	6.48	18	26	40	60
337840*	2	18	7/0152	0.015	0.38	0.040	1.02	0.350	8.89	23	34	58	86
337850*	4	18	7/0152	0.015	0.38	0.050	1.27	0.425	10.80	44	65	99	147
337860*	8	18	7/0152	0.015	0.38	0.050	1.27	0.545	13.84	86	127	173	257
337870*	12	18	7/0152	0.015	0.38	0.060	1.52	0.640	16.26	127	189	245	365
337880*	16	18	7/0152	0.015	0.38	0.060	1.52	0.730	18.54	169	251	318	473
337890*	20	18	7/0152	0.015	0.38	0.060	1.52	0.810	20.57	210	313	392	583
337900*	24	18	7/0152	0.015	0.38	0.070	1.78	0.895	22.73	252	375	450	670
337910*	36	18	7/0152	0.015	0.38	0.070	1.78	1.095	27.81	377	561	672	1000
337920*	50	18	7/0152	0.015	0.38	0.070	1.78	1.255	31.88	523	778	904	1345

**OVERALL SHIELDED PAIRS/TRIADS
16 AWG CONDUCTORS**

309520*	1	16	7/0192	0.015	0.38	0.035	0.89	0.270	6.86	18	28	41	61
337930*	1 TRI	16	7/0192	0.015	0.38	0.035	0.89	0.285	7.24	27	40	54	80
337940*	2	16	7/0192	0.015	0.38	0.050	1.27	0.430	10.92	36	53	85	126
337950*	4	16	7/0192	0.015	0.38	0.050	1.27	0.490	12.45	69	102	135	201
337960*	8	16	7/0192	0.015	0.38	0.060	1.52	0.650	16.51	135	201	246	366
337970*	12	16	7/0192	0.015	0.38	0.060	1.52	0.755	19.18	202	300	346	515
337980*	16	16	7/0192	0.015	0.38	0.060	1.52	0.845	21.46	268	399	444	661
337990*	20	16	7/0192	0.015	0.38	0.060	1.52	0.900	22.86	335	498	552	821
338000*	24	16	7/0192	0.015	0.38	0.070	1.78	1.020	25.91	401	597	655	975
338010*	36	16	7/0192	0.015	0.38	0.070	1.78	1.225	31.12	601	894	649	966
338020*	50	16	7/0192	0.015	0.38	0.080	2.03	1.415	35.94	834	1241	1308	1947

Dimensions and weights are nominal; subject to industry tolerances.
*Non-stock item, minimum runs apply. Please consult Customer Service for price and delivery.



CHTC®

XLPE/HYP, Instrumentation, Shielded
300V, UL Type PLTC, Individual and Overall Shielded Pairs



Product Construction

Conductor:

- 20 AWG thru 16 AWG tinned, annealed copper per ASTM B33
- Class B stranding per ASTM B8

Insulation:

- Flame-retardant Cross-Linked Polyethylene (XLPE)
- Color-coded: per ICEA Method 1; Pairs - black and white. One conductor in each pair is printed alpha-numerically for easy identification

Shield:

- **Individual and overall shielded pairs**
- Individual pairs are 100% shielded with Flexfoil® aluminum/polyester in contact with stranded tinned copper drain wire
- Overall shield is Flexfoil® aluminum/polyester in contact with stranded tinned copper drain wire

Jacket:

- Low-lead Hypalon® Chlorosulfonated Polyethylene (CSPE)/Elastomer blend

Print:

- GENERAL CABLE® (WC) CHTC XX/SPS XX AWG CU/XLP/HYP SHIELDED (UL) TYPE PLTC 90°C SUN RES OIL RES I & II DAY/MONTH/YEAR OF MFG SEQUENTIAL FOOTAGE MARK

Options:

- Bare copper conductor
- Class C stranding
- Overall shielded pairs
- Thermoplastic Low-Smoke, Zero-Halogen (LSZH) jacket
- In accordance with UL subject 2250 as Instrumentation Tray Cable (ITC)
- Other constructions available upon request

Applications:

- Typical applications include audio, intercom, control, energy management and alarm circuits
- In free air or raceways in accordance with NEC
- Permitted for use in Class I Division 2 industrial hazardous locations per NEC
- In ducts, cable trays or conduit
- In accordance with UL subject 13 as Power-Limited Circuit Cable
- In class 3 circuits in accordance with NEC

Features:

- Rated at 90°C
- Ripcord applied to all cables with jacket thickness of 60 mils or less
- Oil-resistant jacket
- Sunlight- and weather-resistant
- Excellent electrical, thermal and physical properties
- Excellent moisture resistance
- Excellent flame resistance
- "Heavy duty" rating per ICEA standards
- Excellent low temperature cold bend characteristics
- Meets cold bend test at -35°C

Compliances:

Industry Compliances:

- UL 13 Type PLTC
- UL 1581

Flame Tests Compliances:

- UL 1581 VW-1
- IEEE 383
- IEEE 1202
- CSA FT-4

Other Compliances:

- EPA 40 CFR, Part 261 for leachable lead content per TCLP
- OSHA acceptable

Packaging:

- Material cut to length and shipped on non-returnable wood reels

CATALOG NUMBER	NO. OF PAIRS	COND. SIZE (AWG)	COND. STRAND	MINIMUM AVG. INSULATION THICKNESS		MINIMUM AVG. JACKET THICKNESS		NOMINAL CABLE O.D.		COPPER WEIGHT		NET WEIGHT	
				INCHES	mm	INCHES	mm	INCHES	mm	LBS/1000FT	kg/km	LBS/1000FT	kg/km

INDIVIDUAL AND OVERALL SHIELDED PAIRS 20 AWG CONDUCTORS

338030*	2	20	7/.0121	0.012	0.30	0.040	1.02	0.340	8.64	21	31	54	80
309540*	4	20	7/.0121	0.012	0.30	0.050	1.27	0.415	10.54	40	60	93	138
309550*	8	20	7/.0121	0.012	0.30	0.050	1.27	0.525	13.34	78	116	157	234
309560*	12	20	7/.0121	0.012	0.30	0.060	1.52	0.645	16.38	117	147	233	347
338040*	16	20	7/.0121	0.012	0.30	0.060	1.52	0.715	18.16	155	231	294	438
338050*	20	20	7/.0121	0.012	0.30	0.060	1.52	0.785	19.94	193	287	357	531
309570*	24	20	7/.0121	0.012	0.30	0.070	1.78	0.875	22.23	231	344	422	628
309580*	36	20	7/.0121	0.012	0.30	0.070	1.78	1.045	26.54	346	515	620	923
338060*	50	20	7/.0121	0.012	0.30	0.070	1.78	1.215	30.86	479	713	828	1232

INDIVIDUAL AND OVERALL SHIELDED PAIRS 18 AWG CONDUCTORS

338070*	2	18	7/.0152	0.015	0.38	0.050	1.27	0.415	10.54	28	41	76	113
338080*	4	18	7/.0152	0.015	0.38	0.050	1.27	0.475	12.07	53	79	113	168
338090*	8	18	7/.0152	0.015	0.38	0.060	1.52	0.605	15.37	104	155	203	302
338100*	12	18	7/.0152	0.015	0.38	0.060	1.52	0.750	19.05	155	231	300	446
338110*	16	18	7/.0152	0.015	0.38	0.060	1.52	0.830	21.08	206	307	383	570
338120*	20	18	7/.0152	0.015	0.38	0.070	1.78	0.945	24.00	254	378	483	719
338130*	24	18	7/.0152	0.015	0.38	0.070	1.78	1.045	26.54	308	459	571	850
338140*	36	18	7/.0152	0.015	0.38	0.070	1.78	1.225	31.12	461	687	816	1214
338150*	50	18	7/.0152	0.015	0.38	0.080	2.03	1.450	36.83	640	952	1119	1665

INDIVIDUAL AND OVERALL SHIELDED PAIRS 16 AWG CONDUCTORS

338160*	2	16	7/.0192	0.015	0.38	0.050	1.27	0.440	11.18	40	60	92	137
338170*	4	16	7/.0192	0.015	0.38	0.050	1.27	0.545	13.84	78	116	163	243
338180*	8	16	7/.0192	0.015	0.38	0.060	1.52	0.965	24.51	153	228	287	427
338190*	12	16	7/.0192	0.015	0.38	0.060	1.52	0.885	22.48	229	341	437	650
338200*	16	16	7/.0192	0.015	0.38	0.070	1.78	0.980	24.89	304	453	553	823
338210*	20	16	7/.0192	0.015	0.38	0.070	1.78	1.080	27.43	380	566	680	1012
338220*	24	16	7/.0192	0.015	0.38	0.070	1.78	1.235	31.37	455	677	800	1191
338230*	36	16	7/.0192	0.015	0.38	0.080	2.03	1.405	35.69	662	985	1108	1649
338240*	50	16	7/.0192	0.015	0.38	0.080	2.03	1.640	41.66	945	1408	1523	2267

Dimensions and weights are nominal; subject to industry tolerances.

*Non-stock item, minimum runs apply. Please consult Customer Service for price and delivery.



Phone: 888-593-3355
www.generalcable.com

CVTC®

XLPE/PVC, Instrumentation, Shielded
300V, UL Type PLTC, Overall Shielded Pairs/Triads



Product Construction

Conductor:

- 18 AWG and 16 AWG bare, annealed copper per ASTM B3
- Class B stranding per ASTM B8

Insulation:

- Flame-retardant Cross-Linked Polyethylene (XLPE)
- Color-coded: per ICEA Method 1; pairs - black and white. Triads - black, white and red. One conductor in each pair or triad is printed alpha-numerically for easy identification

Shield:

Overall shielded pairs/triads

- Overall shield is Flexfoil® aluminum/polyester in contact with stranded tinned copper drain wire

Jacket:

- Flame-retardant and sunlight-resistant Polyvinyl Chloride (PVC)

Print:

- GENERAL CABLE® (WC) CVTC XX/PS/TS XXAWG FR-XLP/PVC SHIELDED (UL) TYPE PLTC 90°C SUN RES PLUS DAY/MONTH/YEAR OF MFG SEQUENTIAL FOOTAGE MARK

Options:

- Tinned copper conductor
- Class C stranding
- Individual and overall shielded pairs/triads
- Ethylene Propylene Rubber (EPR) insulation
- In accordance with UL subject 2250 as Instrumentation Tray Cable (ITC)
- Other constructions available upon request

Applications:

- In free air and raceways in accordance with NEC
- Typical applications include audio, intercom, control, energy management and alarm circuits
- In ducts, cable trays or conduit
- In accordance with UL Subject 13 as Power-Limited Circuit Cable
- In Class 3 circuits in accordance with NEC
- Permitted for use in Class I Division 2 industrial hazardous locations per NEC

Features:

- Rated at 90°C
- Ripcord applied to all cables with jacket thickness of 60 mils or less
- Abrasion- and chemical-resistant
- Excellent electrical properties
- Sunlight- and weather-resistant
- Meets cold bend test at -25°C

Compliances:

Industry Compliances:

- UL 13 Type PLTC
- UL 1581

Flame Tests Compliances:

- UL 1581 VW-1
- IEEE 383

Other Compliances:

- EPA 40 CFR, Part 261 for leachable lead content per TCLP
- OSHA acceptable

Packaging:

- Material cut to length and shipped on non-returnable wood reels

CATALOG NUMBER	NO. OF PAIRS/TRIADS	COND. SIZE (AWG)	COND. STRAND	MINIMUM AVG. INSULATION THICKNESS		MINIMUM AVG. JACKET THICKNESS		NOMINAL CABLE O.D.		COPPER WEIGHT		NET WEIGHT	
				INCHES	mm	INCHES	mm	INCHES	mm	LBS/1000FT	kg/km	LBS/1000FT	kg/km

**OVERALL SHIELDED PAIRS/TRIADS
18 AWG CONDUCTORS**

366140*	1	18	7/.0152	0.015	0.38	0.035	0.89	0.235	5.97	13	19	32	48
342930*	1 TRI	18	7/.0152	0.015	0.38	0.040	1.02	0.250	6.35	18	27	40	60
342940*	2	18	7/.0152	0.015	0.38	0.040	1.02	0.365	9.27	25	37	56	83
342950*	4	18	7/.0152	0.015	0.38	0.050	1.27	0.440	11.18	46	68	98	146
342960*	8	18	7/.0152	0.015	0.38	0.050	1.27	0.550	13.97	87	129	175	260
342970*	12	18	7/.0152	0.015	0.38	0.060	1.52	0.675	17.15	129	192	250	372
342980*	16	18	7/.0152	0.015	0.38	0.060	1.52	0.750	19.05	171	254	317	472
342990*	20	18	7/.0152	0.015	0.38	0.060	1.52	0.785	19.94	211	314	392	583
343000*	24	18	7/.0152	0.015	0.38	0.060	1.52	0.905	22.99	253	377	476	708
343010*	36	18	7/.0152	0.015	0.38	0.070	1.78	1.080	27.43	377	561	681	1013
343020*	50	18	7/.0152	0.015	0.38	0.070	1.78	1.245	31.62	524	780	913	1359

**OVERALL SHIELDED PAIRS/TRIADS
16 AWG CONDUCTORS**

366150*	1	16	7/.0192	0.015	0.38	0.035	0.89	0.262	6.65	19	28	42	63
343030*	1 TRI	16	7/.0192	0.015	0.38	0.040	1.02	0.280	7.11	27	40	53	79
343040*	2	16	7/.0192	0.015	0.38	0.050	1.27	0.430	10.92	37	55	81	121
343050*	4	16	7/.0192	0.015	0.38	0.050	1.27	0.490	12.45	71	106	131	195
343060*	8	16	7/.0192	0.015	0.38	0.060	1.52	0.650	16.51	135	201	254	378
343070*	12	16	7/.0192	0.015	0.38	0.060	1.52	0.755	19.18	203	302	350	521
343080*	16	16	7/.0192	0.015	0.38	0.060	1.52	0.845	21.46	270	402	451	671
343090*	20	16	7/.0192	0.015	0.38	0.070	1.78	0.880	22.35	334	497	545	811
343100*	24	16	7/.0192	0.015	0.38	0.070	1.78	1.020	25.91	400	595	657	978
343110*	36	16	7/.0192	0.015	0.38	0.070	1.78	1.220	30.99	599	891	965	1423
343120*	50	16	7/.0192	0.015	0.38	0.080	2.03	1.405	35.69	831	1237	1322	1967

Dimensions and weights are nominal; subject to industry tolerances.

*Non-stock item, minimum runs apply. Please consult Customer Service for price and delivery.



Phone: 888-593-3355
www.generalcable.com

CVTC®

XLPE/PVC, Instrumentation, Shielded
300V, UL Type PLTC, Individual and Overall Shielded Pairs



Product Construction

Conductor:

- 18 AWG and 16 AWG bare, annealed copper per ASTM B3
- Class B stranding per ASTM B8

Insulation:

- Flame-retardant Cross-Linked Polyethylene (XLPE)
- Color-coded: per ICEA Method 1; pairs - black and white. One conductor in each pair is printed alpha-numerically for easy identification

Shield:

- **Individual and overall shielded pairs**
- Individual pairs are 100% shielded with Flexfoil® aluminum/polyester in contact with stranded tinned copper drain wire
- Overall shield is Flexfoil® aluminum/polyester in contact with stranded tinned copper drain wire

Jacket:

- Flame-retardant and sunlight-resistant Polyvinyl Chloride (PVC)

Print:

- GENERAL CABLE® (WC) CVTC XX/SPS XXAWG FR-XLP/PVC SHIELDED (UL) TYPE PLTC 90°C SUN RES PLUS DAY/MONTH/YEAR OF MFG SEQUENTIAL FOOTAGE MARK

Options:

- Tinned copper conductor
- Class C stranding
- Overall shielded pairs
- Ethylene Propylene Rubber (EPR) insulation
- In accordance with UL subject 2250 as Instrumentation Tray Cable (ITC)
- Other constructions available upon request

Applications:

- In free air and raceways in accordance with NEC
- Typical applications include audio, intercom, control, energy management and alarm circuits
- In ducts, cable trays or conduit
- In accordance with UL Subject 13 as Power-Limited Circuit Cable
- In Class 3 circuits in accordance with NEC
- Permitted for use in Class I Division 2 industrial hazardous locations per NEC

Features:

- Rated at 90°C
- Ripcord applied to all cables with jacket thickness of 60 mils or less
- Abrasion- and chemical-resistant
- Excellent electrical properties
- Sunlight- and weather-resistant
- Meets cold bend test at -25°C

Compliances:

Industry Compliances:

- UL 13 Type PLTC
- UL 1581

Flame Tests Compliances:

- UL 1581 VW-1
- IEEE 383

Other Compliances:

- EPA 40 CFR, Part 261 for leachable lead content per TCLP
- OSHA acceptable

Packaging:

- Material cut to length and shipped on non-returnable wood reels

CATALOG NUMBER	NO. OF PAIRS	COND. SIZE (AWG)	COND. STRAND	MINIMUM AVG. INSULATION THICKNESS		MINIMUM AVG. JACKET THICKNESS		NOMINAL CABLE O.D.		COPPER WEIGHT		NET WEIGHT	
				INCHES	mm	INCHES	mm	INCHES	mm	LBS/1000FT	kg/km	LBS/1000FT	kg/km

INDIVIDUAL AND OVERALL SHIELDED PAIRS 18 AWG CONDUCTORS

343140*	2	18	7/.0152	0.015	0.38	0.050	1.27	0.410	10.41	30	45	73	109
343150*	4	18	7/.0152	0.015	0.38	0.050	1.27	0.475	12.07	55	82	117	174
343160*	8	18	7/.0152	0.015	0.38	0.050	1.27	0.605	15.37	105	156	215	320
343170*	12	18	7/.0152	0.015	0.38	0.060	1.52	0.750	19.05	156	232	308	458
343180*	16	18	7/.0152	0.015	0.38	0.060	1.52	0.830	21.08	207	308	392	583
343190*	20	18	7/.0152	0.015	0.38	0.070	1.78	0.955	24.26	252	375	494	735
343200*	24	18	7/.0152	0.015	0.38	0.070	1.78	1.030	26.16	302	449	583	868
343210*	36	18	7/.0152	0.015	0.38	0.070	1.78	1.210	30.73	452	673	830	1235
343220*	50	18	7/.0152	0.015	0.38	0.080	2.03	1.425	36.20	637	948	1145	1704

INDIVIDUAL AND OVERALL SHIELDED PAIRS 16 AWG CONDUCTORS

343240*	2	16	7/.0192	0.015	0.38	0.050	1.27	0.455	11.56	42	63	96	143
343250*	4	16	7/.0192	0.015	0.38	0.050	1.27	0.530	13.46	80	119	160	238
343260*	8	16	7/.0192	0.015	0.38	0.060	1.52	0.710	18.03	155	231	293	436
343270*	12	16	7/.0192	0.015	0.38	0.060	1.52	0.855	21.72	230	342	425	632
343280*	16	16	7/.0192	0.015	0.38	0.070	1.78	0.955	24.26	306	455	563	838
343290*	20	16	7/.0192	0.015	0.38	0.070	1.78	1.055	26.80	375	558	664	988
343300*	24	16	7/.0192	0.015	0.38	0.070	1.78	1.160	29.46	456	679	780	1161
343310*	36	16	7/.0192	0.015	0.38	0.080	2.03	1.380	35.05	674	1003	1137	1692
343320*	50	16	7/.0192	0.015	0.38	0.080	2.03	1.580	40.13	945	1406	1518	2259

Dimensions and weights are nominal; subject to industry tolerances.

*Non-stock item, minimum runs apply. Please consult Customer Service for price and delivery.



Phone: 888-593-3355
www.generalcable.com

PVIC®

PVC/PVC, Instrumentation, Shielded
300V, UL Type PLTC/ITC, Overall Shielded Pairs/Triads

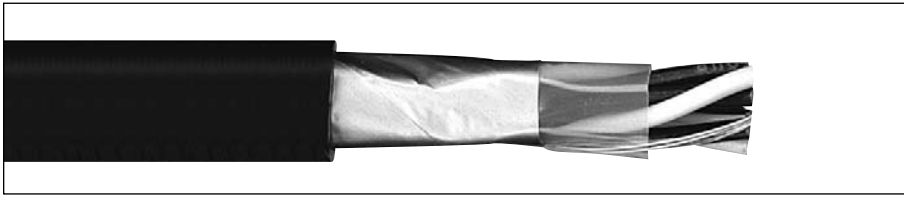

Product Construction

Conductor:

- 20 AWG thru 16 AWG bare, annealed copper per ASTM B3
- Class B stranding per ASTM B8

Insulation:

- Polyvinyl Chloride (PVC)
- Color-coded: per ICEA Method 1; Pairs - black and white. Triads - black, white and red. One conductor in each pair or triad is printed alpha-numerically for easy identification

Shield:

- Overall shielded pairs/triads
- Overall shield is Flexfoil® aluminum/polyester in contact with stranded tinned copper drain wire

Jacket:

- Sunlight-resistant Polyvinyl Chloride (PVC)

Print:

- GENERAL CABLE® (WC) PVIC® XX/PS/TS XXAWG PVC/PVC SHIELDED (UL) TYPE PLTC OR ITC 105°C SUN RES MONTH/YEAR OF MFG SEQUENTIAL FOOTAGE MARK

Options:

- Tinned copper conductor
- Class C stranding
- Other constructions available upon request

Applications:

- In free air and raceways in accordance with NEC
- Typical applications include audio, intercom, control, energy management and alarm circuits
- In ducts, cable trays or conduit
- In accordance with UL Subject 13 as Power-Limited Circuit Cable
- In Class 3 circuits in accordance with NEC Article 725
- In accordance with UL subject 2250 as Instrumentation Tray Cable (ITC)
- Permitted for use in Class I Division 2 industrial hazardous locations per NEC Article 501-4(b) for UL Type PLTC/ITC cables
- Per NEC Article 727 for Type PLTC/ITC

Features:

- Rated at 105°C
- Good electrical properties
- Oil- and sunlight-resistant
- Flame-retardant
- Good mechanical properties
- Meets cold bend test at -25°C

Compliances:

Industry Compliances:

- UL Type PLTC/ITC

Flame Tests Compliances:

- IEEE 383 (70,000 BTU/hr)
- UL Subject 13 (70,000 BTU/hr) for PLTC
- UL Subject 2250 (70,000 BTU/hr) for ITC

Other Compliances:

- Meets EPA 40 CFR, Part 261 for leachable lead content per TCLP method
- OSHA acceptable

Packaging:

- Material cut to length and shipped on non-returnable wood reels

CATALOG NUMBER	NO. OF PAIRS/TRIADS	COND. SIZE (AWG)	COND. STRAND	MINIMUM AVG. INSULATION THICKNESS		MINIMUM AVG. JACKET THICKNESS		NOMINAL CABLE O.D.		COPPER WEIGHT		NET WEIGHT	
				INCHES	mm	INCHES	mm	INCHES	mm	LBS/1000FT	kg/km	LBS/1000FT	kg/km

OVERALL SHIELDED PAIRS/TRIADS 20 AWG CONDUCTORS

325900*	1	20	7/.0121	0.012	0.30	0.040	1.02	0.220	5.59	9	13	28	42
325910*	1 TRI	20	7/.0121	0.012	0.30	0.040	1.02	0.241	6.12	12	18	34	51
325920*	2	20	7/.0121	0.012	0.30	0.040	1.02	0.255	6.48	17	25	41	60
325940*	4	20	7/.0121	0.012	0.30	0.042	1.07	0.321	8.15	30	45	65	97
339620*	8	20	7/.0121	0.012	0.30	0.050	1.27	0.475	12.07	54	80	104	154
348090*	12	20	7/.0121	0.012	0.30	0.050	1.27	0.545	13.84	83	124	195	290
334630*	16	20	7/.0121	0.012	0.30	0.050	1.27	0.605	15.37	107	159	248	369
348100*	20	20	7/.0121	0.012	0.30	0.060	1.52	0.650	16.51	135	201	309	460
759610*	24	20	7/.0121	0.012	0.30	0.060	1.52	0.740	18.80	153	228	376	559
339650*	36	20	7/.0121	0.012	0.30	0.060	1.52	0.850	21.59	238	354	530	789
339660*	50	20	7/.0121	0.012	0.30	0.070	1.78	0.970	24.64	330	491	713	1061

OVERALL SHIELDED PAIRS/TRIADS 18 AWG CONDUCTORS

325830*	1	18	7/.0152	0.015	0.38	0.040	1.02	0.240	6.10	12	18	35	52
325840*	1 TRI	18	7/.0152	0.015	0.38	0.040	1.02	0.264	6.71	18	27	44	66
325850*	2	18	7/.0152	0.015	0.38	0.042	1.07	0.325	8.26	25	37	55	82
325880*	4	18	7/.0152	0.015	0.38	0.042	1.07	0.357	9.07	46	68	90	133
348020*	8	18	7/.0152	0.015	0.38	0.060	1.52	0.646	16.41	87	129	192	285
348030*	12	18	7/.0152	0.015	0.38	0.060	1.52	0.670	17.02	129	192	293	436
348040*	16	18	7/.0152	0.015	0.38	0.060	1.52	0.750	19.05	171	254	374	556
339670*	20	18	7/.0152	0.015	0.38	0.060	1.52	0.780	19.81	211	314	449	668
339680*	24	18	7/.0152	0.015	0.38	0.070	1.78	0.915	23.24	253	377	564	839
791720*	36	18	7/.0152	0.015	0.38	0.070	1.78	1.030	26.16	453	674	787	1171
339690*	50	18	7/.0152	0.015	0.38	0.070	1.78	1.180	29.97	524	780	1059	1576

OVERALL SHIELDED PAIRS/TRIADS 16 AWG CONDUCTORS

325770*	1	16	7/.0192	0.015	0.38	0.040	1.02	0.273	6.93	18	27	45	67
325780*	1 TRI	16	7/.0192	0.015	0.38	0.042	1.07	0.297	7.54	27	40	58	86
325790*	2	16	7/.0192	0.015	0.38	0.042	1.07	0.344	8.74	37	55	74	109
325810*	4	16	7/.0192	0.015	0.38	0.053	1.35	0.481	12.22	71	106	132	197
339700*	8	16	7/.0192	0.015	0.38	0.060	1.52	0.726	18.44	135	201	259	385
298830*	12	16	7/.0192	0.015	0.38	0.060	1.52	0.755	19.18	203	302	408	607
760530*	16	16	7/.0192	0.015	0.38	0.070	1.78	0.845	21.46	270	402	526	783
339710*	20	16	7/.0192	0.015	0.38	0.070	1.78	0.905	22.99	334	497	655	975
339720*	24	16	7/.0192	0.015	0.38	0.070	1.78	1.030	26.16	400	595	803	1195
339730*	36	16	7/.0192	0.015	0.38	0.070	1.78	1.165	29.59	599	891	1122	1670
339740*	50	16	7/.0192	0.015	0.38	0.080	2.03	1.355	34.42	831	1237	1544	2298

Dimensions and weights are nominal; subject to industry tolerances.

*Non-stock item, minimum runs apply. Please consult Customer Service for price and delivery.



Phone: 888-593-3355
www.generalcable.com

PVIC®

PVC/PVC, Instrumentation, Shielded
300V, UL Type PLTC/ITC, Individual and Overall Shielded Pairs



Product Construction

Conductor:

- 20 AWG thru 16 AWG bare, annealed copper per ASTM B3
- Class B stranding per ASTM B8

Insulation:

- Polyvinyl Chloride (PVC)
- Color-coded: per ICEA Method 1; Pairs - black and white. One conductor in each pair is printed alpha-numerically for easy identification

Shield:

- Individual and overall shielded pairs
- Individual pairs are 100% shielded with Flexfoil® aluminum/polyester in contact with stranded tinned copper drain wire
- Overall shield is Flexfoil® aluminum/polyester in contact with stranded tinned copper drain wire

Jacket:

- Sunlight-resistant Polyvinyl Chloride (PVC)

Print:

- GENERAL CABLE® (WC) PVC XX/SPS XXAWG PVC/PVC SHIELDED (UL) TYPE PLTC OR ITC 105°C SUN RES MONTH/YEAR OF MFG SEQUENTIAL FOOTAGE MARK

Options:

- Tinned copper conductor
- Class C stranding
- Other constructions available upon request

Applications:

- In free air and raceways in accordance with NEC
- Typical applications include audio, intercom, control, energy management and alarm circuits
- In ducts, cable trays or conduit
- In accordance with UL Subject 13 as Power-Limited Circuit Cable
- In Class 3 circuits in accordance with NEC Article 725
- In accordance with UL subject 2250 as Instrumentation Tray Cable (ITC)
- Permitted for use in Class I Division 2 industrial hazardous locations per NEC Article 501-4(b) for UL Type PLTC/ITC cables
- Per NEC Article 727 for Type PLTC/ITC

Features:

- Rated at 105°C
- Good electrical properties
- Oil- and sunlight-resistant
- Flame-retardant
- Good mechanical properties
- Meets cold bend test at -25°C

Compliances:

Industry Compliances:

- UL Type PLTC/ITC

Flame Tests Compliances:

- IEEE 383 (70,000 BTU/hr)
- UL Subject 13 (70,000 BTU/hr) for PLTC
- UL Subject 2250 (70,000 BTU/hr) for ITC

Other Compliances:

- Meets EPA 40 CFR, Part 261 for leachable lead content per TCLP method
- OSHA acceptable

Packaging:

- Material cut to length and shipped on non-returnable wood reels

CATALOG NUMBER	NO. OF PAIRS	COND. SIZE (AWG)	COND. STRAND	MINIMUM AVG. INSULATION THICKNESS		MINIMUM AVG. JACKET THICKNESS		NOMINAL CABLE O.D.		COPPER WEIGHT		NET WEIGHT	
				INCHES	mm	INCHES	mm	INCHES	mm	LBS/1000FT	kg/km	LBS/1000FT	kg/km

INDIVIDUAL AND OVERALL SHIELDED PAIRS 20 AWG CONDUCTORS

325930*	2	20	7/.0121	0.012	0.30	0.040	1.02	0.316	8.03	22	33	46	69
325950*	4	20	7/.0121	0.012	0.30	0.042	1.07	0.325	8.26	39	58	76	113
339750*	8	20	7/.0121	0.012	0.30	0.050	1.27	0.426	10.82	71	106	148	220
339760*	12	20	7/.0121	0.012	0.30	0.060	1.52	0.640	16.26	83	124	223	332
348110*	16	20	7/.0121	0.012	0.30	0.060	1.52	0.705	17.91	165	246	280	417
339770*	20	20	7/.0121	0.012	0.30	0.060	1.52	0.780	19.81	175	260	339	504
339780*	24	20	7/.0121	0.012	0.30	0.060	1.52	0.845	21.46	209	311	397	591
348120*	36	20	7/.0121	0.012	0.30	0.070	1.78	1.015	25.78	324	482	586	872
341790*	50	20	7/.0121	0.012	0.30	0.070	1.78	1.190	30.23	433	644	786	1170

INDIVIDUAL AND OVERALL SHIELDED PAIRS 18 AWG CONDUCTORS

325860*	2	18	7/.0152	0.015	0.38	0.042	1.07	0.380	9.65	30	45	61	91
325890*	4	18	7/.0152	0.015	0.38	0.042	1.07	0.410	10.41	55	82	100	149
348060*	8	18	7/.0152	0.015	0.38	0.060	1.52	0.485	12.32	105	156	212	316
348070*	12	18	7/.0152	0.015	0.38	0.060	1.52	0.760	19.30	156	232	315	469
760420*	16	18	7/.0152	0.015	0.38	0.060	1.52	0.845	21.46	207	308	401	597
339800*	20	18	7/.0152	0.015	0.38	0.070	1.78	0.955	24.26	252	375	505	752
339810*	24	18	7/.0152	0.015	0.38	0.070	1.78	1.040	26.42	302	449	596	887
339820*	36	18	7/.0152	0.015	0.38	0.070	1.78	1.215	30.86	452	673	846	1259
339830*	50	18	7/.0152	0.015	0.38	0.080	2.03	1.450	36.83	628	935	1165	1734

INDIVIDUAL AND OVERALL SHIELDED PAIRS 16 AWG CONDUCTORS

325800*	2	16	7/.0192	0.015	0.38	0.042	1.07	0.346	8.79	42	63	80	119
325820*	4	16	7/.0192	0.015	0.38	0.053	1.35	0.506	12.85	80	119	151	225
298880*	8	16	7/.0192	0.015	0.38	0.060	1.52	0.665	16.89	155	231	288	429
298890*	12	16	7/.0192	0.015	0.38	0.060	1.52	0.855	21.72	230	342	435	647
759770*	16	16	7/.0192	0.015	0.38	0.070	1.78	0.970	24.64	306	455	575	856
339840*	20	16	7/.0192	0.015	0.38	0.070	1.78	1.080	27.43	375	558	705	1049
759780*	24	16	7/.0192	0.015	0.38	0.070	1.78	1.165	29.59	456	679	828	1232
339850*	36	16	7/.0192	0.015	0.38	0.080	2.03	1.390	35.31	674	1003	1215	1808
339860*	50	16	7/.0192	0.015	0.38	0.090	2.29	1.655	42.04	935	1391	1670	2485

Dimensions and weights are nominal; subject to industry tolerances.

*Non-stock item, minimum runs apply. Please consult Customer Service for price and delivery.



Phone: 888-593-3355
www.generalcable.com

PVIC®

PVC/PVC, Instrumentation, Shielded
300V, UL Type PLTC/ITC, Individual and Overall Shielded Triads



Product Construction

Conductor:

- 20 AWG thru 16 AWG bare, annealed copper per ASTM B3
- Class B stranding per ASTM B8

Insulation:

- Polyvinyl Chloride (PVC)
- Color-coded: per ICEA Method 1; Triads - black, white and red. One conductor in each triad is printed alpha-numerically for easy identification

Shield:

- **Individual and overall shielded triads**
- Individual triads are 100% shielded with Flexfoil® aluminum/polyester in contact with stranded tinned copper drain wire
- Overall shield is Flexfoil® aluminum/polyester in contact with stranded tinned copper drain wire

Jacket:

- Sunlight-resistant Polyvinyl Chloride (PVC)

Print:

- GENERAL CABLE® (WC) PVC XX/STS XXAWG PVC/PVC SHIELDED (UL) TYPE PLTC OR ITC 105°C SUN RES MONTH/YEAR OF MFG SEQUENTIAL FOOTAGE MARK

Options:

- Tinned copper conductor
- Class C stranding
- Other constructions available upon request

Applications:

- In free air and raceways in accordance with NEC
- Typical applications include audio, intercom, control, energy management and alarm circuits
- In ducts, cable trays or conduit
- In accordance with UL Subject 13 as Power-Limited Circuit Cable
- In Class 3 circuits in accordance with NEC Article 725
- In accordance with UL subject 2250 as Instrumentation Tray Cable (ITC)
- Permitted for use in Class I Division 2 industrial hazardous locations per NEC Article 501-4(b) for UL Type PLTC/ITC cables
- Per NEC Article 727 for Type PLTC/ITC

Features:

- Rated at 105°C
- Good electrical properties
- Oil and sunlight resistance
- Flame-retardant
- Good mechanical properties
- Meets cold bend test at -25°C

Compliances:

Industry Compliances:

- UL Type PLTC/ITC

Flame Tests Compliances:

- IEEE 383 (70,000 BTU/hr)
- UL Subject 13 (70,000 BTU/hr) for PLTC
- UL Subject 2250 (70,000 BTU/hr) for ITC

Other Compliances:

- Meets EPA 40 CFR, Part 261 for leachable lead content per TCLP method
- OSHA acceptable

Packaging:

- Material cut to length and shipped on non-returnable wood reels

CATALOG NUMBER	NO. OF TRIADS	COND. SIZE (AWG)	COND. STRAND	MINIMUM AVG. INSULATION THICKNESS		MINIMUM AVG. JACKET THICKNESS		NOMINAL CABLE O.D.		COPPER WEIGHT		NET WEIGHT	
				INCHES	mm	INCHES	mm	INCHES	mm	LBS/1000FT	kg/km	LBS/1000FT	kg/km

INDIVIDUAL AND OVERALL SHIELDED TRIADS 20 AWG CONDUCTORS

339870*	2 TRI	20	7/.0121	0.012	0.30	0.040	1.07	0.340	8.64	26	39	59	88
339880*	4 TRI	20	7/.0121	0.012	0.30	0.040	1.07	0.365	9.27	48	71	97	144
339890*	8 TRI	20	7/.0121	0.012	0.30	0.050	1.27	0.566	14.38	97	144	187	279
339900*	12 TRI	20	7/.0121	0.012	0.30	0.060	1.52	0.705	17.91	145	216	287	427
339910*	16 TRI	20	7/.0121	0.012	0.30	0.060	1.52	0.780	19.81	192	286	365	543
339920*	20 TRI	20	7/.0121	0.012	0.30	0.060	1.52	0.860	21.84	240	357	440	655
339930*	24 TRI	20	7/.0121	0.012	0.30	0.070	1.78	0.955	24.26	288	429	541	805
339940*	36 TRI	20	7/.0121	0.012	0.30	0.070	1.78	1.115	28.32	431	641	767	1141

INDIVIDUAL AND OVERALL SHIELDED TRIADS 18 AWG CONDUCTORS

325870*	2 TRI	18	7/.0152	0.015	0.38	0.040	1.07	0.321	8.15	38	57	77	115
339960*	4 TRI	18	7/.0152	0.015	0.38	0.050	1.27	0.444	11.28	73	109	143	213
348010*	8 TRI	18	7/.0152	0.015	0.38	0.060	1.52	0.691	17.55	147	219	275	409
760300*	12 TRI	18	7/.0152	0.015	0.38	0.060	1.52	0.840	21.34	215	320	412	613
339980*	16 TRI	18	7/.0152	0.015	0.38	0.070	1.78	0.960	24.38	286	426	550	819
339990*	20 TRI	18	7/.0152	0.015	0.38	0.070	1.78	1.060	26.92	357	531	668	994
340000*	24 TRI	18	7/.0152	0.015	0.38	0.070	1.78	1.145	29.08	428	637	785	1168
340010*	36 TRI	18	7/.0152	0.015	0.38	0.080	2.03	1.365	34.67	641	954	1151	1713

INDIVIDUAL AND OVERALL SHIELDED TRIADS 16 AWG CONDUCTORS

340020*	2 TRI	16	7/.0192	0.015	0.38	0.040	1.07	0.367	9.32	54	80	104	154
340030*	4 TRI	16	7/.0192	0.015	0.38	0.050	1.27	0.502	12.75	108	161	195	290
340040*	8 TRI	16	7/.0192	0.015	0.38	0.060	1.52	0.786	19.96	218	324	375	558
340050*	12 TRI	16	7/.0192	0.015	0.38	0.070	1.78	0.970	24.64	325	484	597	888
340060*	16 TRI	16	7/.0192	0.015	0.38	0.070	1.78	1.075	27.31	433	644	765	1138
340070*	20 TRI	16	7/.0192	0.015	0.38	0.070	1.78	1.195	30.35	541	805	933	1388
340080*	24 TRI	16	7/.0192	0.015	0.38	0.080	2.03	1.310	33.27	649	966	1125	1674
340090*	36 TRI	16	7/.0192	0.015	0.38	0.080	2.03	1.540	40.39	972	1447	1620	2411

Dimensions and weights are nominal; subject to industry tolerances.

*Non-stock item, minimum runs apply. Please consult Customer Service for price and delivery.



Phone: 888-593-3355
www.generalcable.com

600V Instrumentation Cables

2050[†]	CHTC [®]	XLPE/HYP, Instrumentation, Shielded 600V, UL Type TC, Individual and Overall Shielded Pairs/Triads	Jan. 2009
2100[†]	FREP [®]	FR-EPR/CPE, Instrumentation, Shielded 600V, UL Type TC, Overall Shielded Pairs/Triads	Jan. 2008
2150[†]	FREP [®]	FR-EPR/CPE, Instrumentation, Shielded 600V, UL Type TC, Individual and Overall Shielded Pairs	Jan. 2008
2200	FREP [®]	FR-EPR/CPE, Instrumentation, Shielded 600V, UL Type TC, Individual and Overall Shielded Triads	Jan. 2008
2250	Arctic-Flex [®]	XLPE/ARCTIC-PVC, Instrumentation, Shielded 600V, UL Type TC, CSA Type CIC, Overall Shielded Pairs/Triads	Jan. 2008
2300	Arctic-Flex [®]	XLPE/ARCTIC-PVC, Instrumentation, Shielded 600V, UL Type TC, CSA Type CIC, Individual and Overall Shielded Pairs	Jan. 2008
2350	CVTC [®]	XLPE/PVC, Instrumentation, Shielded 600V, UL Type TC, Overall Shielded Pairs/Triads	Jan. 2008
2400	CVTC [®]	XLPE/PVC, Instrumentation, Shielded 600V, UL Type TC, Individual and Overall Shielded Pairs	Jan. 2008
2450[†]	VNTC [®]	PVC/Nylon/PVC, Instrumentation, Shielded 600V, UL Type TC, Overall Shielded Pairs/Triads	Jan. 2008
2500[†]	VNTC [®]	PVC/Nylon/PVC, Instrumentation, Shielded 600V, UL Type TC, Individual and Overall Shielded Pairs	Jan. 2008
2600[†]	GenFree [™]	XLPO/LSZH, Instrumentation, Shielded 600V, UL Type TC-LS, Overall Shielded Pairs/Triads	Feb. 2008
2625[†]	GenFree [™]	XLPO/LSZH, Instrumentation, Shielded 600V, UL Type TC-LS, Individual and Overall Shielded Pairs	Feb. 2008
2650	GenFree [™]	XLPO/LSZH, Instrumentation, Shielded 600V, UL Type TC-LS, Individual and Overall Shielded Triads	Feb. 2008

[†]Indicates these products are stocked by General Cable

CHTC®

XLPE/HYP, Instrumentation, Shielded
600V, UL Type TC, Individual and Overall Shielded Pairs/Triads

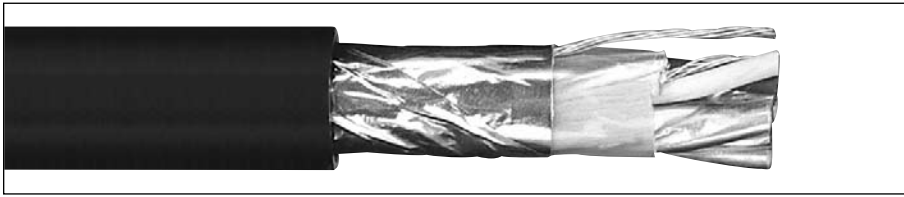

Product Construction

Conductor:

- 18 AWG and 16 AWG tinned, annealed copper per ASTM B33
- Class B stranding per ASTM B8

Insulation:

- Flame-retardant Cross-Linked Polyethylene (XLPE)
- Color-coded: per ICEA Method 1; Pairs - black and white. Triads - black, white and red. One conductor in each pair or triad is printed alpha-numerically for easy identification

Shield:

- **Individual and overall shielded pairs/triads**
- Individual pairs/triads are 100% shielded with Flexfoil® aluminum/polyester in contact with stranded tinned copper drain wire
- Overall shield is Flexfoil® aluminum/polyester in contact with stranded tinned copper drain wire

Jacket:

- Low-Lead Hypalon® Chlorosulfonated Polyethylene (CSPE)/Elastomer blend

Print:

- GENERAL CABLE® (WC) CHTC® XX/SPS/STS XXAWG SHIELDED CU/XLP/HYP SHIELDED (UL) TYPE TC 600V 90°C WET OR DRY SUN RES OIL RES I & II DAY/MONTH/YEAR OF MFG SEQUENTIAL FOOTAGE MARK

Options:

- 300V Type PLTC
- Bare copper conductor
- Class C stranding
- Overall shielded pairs/triads
- EHTC®—Ethylene Propylene Rubber (EPR) insulation
- Thermoplastic Low-Smoke, Zero-Halogen (LSZH) jacket
- Other constructions available upon request

Applications:

- In free air, raceways or direct burial
- In wet or dry locations
- Permitted for use in Class I Division 2 industrial hazardous locations per NEC

Features:

- Rated at 90°C wet or dry
- Ripcord applied to all cables with jacket thickness of 60 mils or less
- Oil-resistant jacket
- Sunlight- and weather-resistant
- Excellent electrical, thermal and physical properties
- Excellent moisture resistance
- Excellent flame resistance
- "Heavy duty" rating per ICEA standards
- Excellent low temperature cold bend characteristics
- Meets cold bend test at -35°C

Compliances:

Industry Compliances:

- UL Type RFH-2, FFH-2 conductors
- UL 1277 Type TC
- UL 1581
- ICEA S-82-552
- ICEA S-73-532

Flame Tests Compliances:

- UL 1581 VW-1
- UL 1277
- IEEE 383
- IEEE 1202
- CSA FT-4
- ICEA T-29-520

Other Compliances:

- EPA 40 CFR, Part 261 for leachable lead content per TCLP
- OSHA acceptable

Packaging:

- Material cut to length and shipped on non-returnable wood reels

CATALOG NUMBER	NO. OF PAIRS/TRIADS	COND. SIZE (AWG)	COND. STRAND	MINIMUM AVG. INSULATION THICKNESS		MINIMUM AVG. JACKET THICKNESS		NOMINAL CABLE O.D.		COPPER WEIGHT		NET WEIGHT	
				INCHES	mm	INCHES	mm	INCHES	mm	LBS/1000 FT	kg/km	LBS/1000 FT	kg/km

OVERALL SHIELDED PAIRS/TRIADS 18 AWG CONDUCTORS

285150	1	18	7/.0152	0.030	0.76	0.045	1.52	0.315	8.15	13	19	49	73
337620*	1 TRI	18	7/.0152	0.030	0.76	0.045	1.14	0.335	8.51	18	26	64	95
337630*	2	18	7/.0152	0.030	0.76	0.045	1.14	0.510	12.95	28	42	92	137
337640*	4	18	7/.0152	0.030	0.76	0.060	1.52	0.630	16.00	53	79	167	249
337650*	8	18	7/.0152	0.030	0.76	0.080	2.03	0.855	21.72	104	155	326	485
337660*	12	18	7/.0152	0.030	0.76	0.080	2.03	1.030	26.16	155	231	441	656
337670*	16	18	7/.0152	0.030	0.76	0.080	2.03	1.140	28.96	206	307	554	824
337680*	20	18	7/.0152	0.030	0.76	0.080	2.03	1.265	32.13	256	381	676	1006
337690*	24	18	7/.0152	0.030	0.76	0.080	2.03	1.450	36.83	308	459	795	1183
337700*	36	18	7/.0152	0.030	0.76	0.110	2.79	1.650	41.91	461	687	1118	1664
337710*	50	18	7/.0152	0.030	0.76	0.110	2.79	2.085	52.96	637	948	1616	2405

INDIVIDUAL AND OVERALL SHIELDED PAIRS/TRIADS 16 AWG CONDUCTORS

240990	1	16	7/.0192	0.030	0.76	0.045	1.52	0.345	8.76	19	28	61	91
241510	1 TRI	16	7/.0192	0.030	0.76	0.045	1.52	0.360	9.10	28	42	85	127
241010	2	16	7/.0192	0.030	0.76	0.060	1.52	0.585	14.86	40	60	130	193
232560	4	16	7/.0192	0.030	0.76	0.060	1.52	0.675	17.15	78	116	204	304
241000*	8	16	7/.0192	0.030	0.76	0.080	2.03	0.915	23.24	153	228	394	586
252370	12	16	7/.0192	0.030	0.76	0.080	2.03	1.110	28.19	229	341	548	816
337720*	16	16	7/.0192	0.030	0.76	0.080	2.03	1.350	34.29	304	453	713	1061
337730*	20	16	7/.0192	0.030	0.76	0.080	2.03	1.365	34.67	380	566	850	1265
337740*	24	16	7/.0192	0.030	0.76	0.080	2.03	1.570	39.88	455	677	1001	1490
337750*	36	16	7/.0192	0.030	0.76	0.110	2.79	1.980	50.29	682	1014	1548	2304
337760*	50	16	7/.0192	0.030	0.76	0.110	2.79	2.165	54.99	946	1408	2020	3006

Dimensions and weights are nominal; subject to industry tolerances.

*Non-stock item, minimum runs apply. Please consult Customer Service for price and delivery.



Phone: 888-593-3355
www.generalcable.com

FREP®

FR-EPR/CPE, Instrumentation, Shielded
600V, UL Type TC, Overall Shielded Pairs/Triads

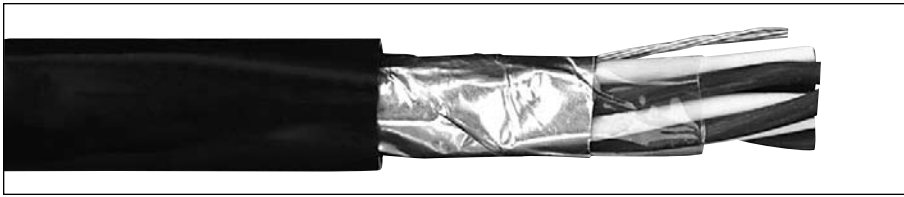

Product Construction

Conductor:

- 18 AWG and 16 AWG tinned, annealed copper per ASTM B33
- Class B stranding per ASTM B8

Insulation:

- Flame-retardant Ethylene Propylene Rubber (FR-EPR) Type II
- Color-coded: per ICEA Method 1; Pairs - black and white. Triads - black, white and red. One conductor in each pair or triad is printed alpha-numerically for easy identification

Shield:

- Overall shielded pairs/triads
- Overall shield is Flexfoil® aluminum/polyester in contact with stranded tinned copper drain wire

Jacket:

- Flame-retardant thermoplastic Chlorinated Polyethylene (CPE)

Print:

- GENERAL CABLE® (WC) FREP® XX/PS/TS XXAWG EPR/CPE SHIELDED UL TYPE TC 90°C WET OR DRY 600V DIR BUR SUN RES DAY/MONTH/YEAR OF MFG SEQUENTIAL FOOTAGE MARK

Options:

- Bare copper conductor
- Class C stranding
- Individual and overall shielded pairs/triads
- CCTC—Cross-Linked Polyethylene (XLPE) insulation
- FREP® XL-flame-retardant, thermoset Chlorinated Polyethylene (XL-CPE) jacket
- FREP® II-flame-retardant, thermoplastic Low-Smoke, Zero-Halogen (LSZH) Polyolefin jacket
- FREP® 300V-UL Type PLTC
- Other constructions available upon request

Applications:

- In free air, raceways or direct burial
- In wet or dry locations
- Permitted for use in Class 1 Division 2 industrial hazardous locations per NEC

Features:

- Rated at 90°C wet or dry
- Ripcord applied to all cables with jacket thickness of 60 mils or less
- Excellent physical, thermal and electrical properties
- Excellent moisture resistance
- Excellent resistance to compression cuts and heat deformation
- Excellent flame resistance—burns to an ash; does not exhibit thermoplastic drip
- Low coefficient of friction for easy pulling
- Sunlight- and weather-resistant
- Excellent low temperature cold bend characteristics
- Meets cold bend test at -40°C

Compliances:

Industry Compliances:

- UL 1277 Type TC
- UL 1581
- ICEA S-82-552

Flame Tests Compliances:

- UL 1581 VW-1
- UL 1277
- IEEE 383
- IEEE 1202
- CSA FT-4
- ICEA T-29-520

Other Compliances:

- EPA 40 CFR, Part 261 for leachable lead content per TCLP
- OSHA acceptable

Packaging:

- Material cut to length and shipped on non-returnable wood reels

CATALOG NUMBER	NO. OF PAIRS/TRIADS	COND. SIZE (AWG)	COND. STRAND	MINIMUM AVG. INSULATION THICKNESS		MINIMUM AVG. JACKET THICKNESS		NOMINAL CABLE O.D.		COPPER WEIGHT		NET WEIGHT	
				INCHES	mm	INCHES	mm	INCHES	mm	LBS/1000 FT	kg/km	LBS/1000 FT	kg/km

OVERALL SHIELDED PAIRS/TRIADS 18 AWG CONDUCTORS

287650*	1	18	7/.0152	0.025	0.64	0.045	1.14	0.300	7.62	13	19	42	63
325250*	1 TRI	18	7/.0152	0.025	0.64	0.045	1.14	0.315	8.00	18	26	53	79
337010*	2	18	7/.0152	0.025	0.64	0.045	1.14	0.420	10.67	23	34	75	112
337020*	4	18	7/.0152	0.025	0.64	0.045	1.14	0.490	12.45	44	65	117	174
337030*	8	18	7/.0152	0.025	0.64	0.060	1.52	0.675	17.15	86	127	224	333
337040*	12	18	7/.0152	0.025	0.64	0.060	1.52	0.775	19.69	127	189	305	454
294580*	16	18	7/.0152	0.025	0.64	0.080	2.03	0.925	23.50	169	251	425	632
337050*	20	18	7/.0152	0.025	0.64	0.080	2.03	1.025	26.04	210	313	510	759
337060*	24	18	7/.0152	0.025	0.64	0.080	2.03	1.105	28.07	252	375	604	899
337070*	36	18	7/.0152	0.025	0.64	0.080	2.03	1.360	34.54	377	561	865	1287
337080*	50	18	7/.0152	0.025	0.64	0.080	2.03	1.555	39.50	523	778	1144	1703

OVERALL SHIELDED PAIRS/TRIADS 16 AWG CONDUCTORS

314960	1	16	7/.0192	0.025	0.64	0.045	1.14	0.320	8.13	18	28	52	77
279690	1 TRI	16	7/.0192	0.025	0.64	0.045	1.14	0.335	8.51	26	39	66	98
283170*	2	16	7/.0192	0.025	0.64	0.045	1.14	0.460	11.68	36	54	95	141
283180*	4	16	7/.0192	0.025	0.64	0.060	1.52	0.560	14.22	69	103	171	254
337090*	8	16	7/.0192	0.025	0.64	0.060	1.52	0.740	18.80	135	201	294	438
283190*	12	16	7/.0192	0.025	0.64	0.080	2.03	0.900	22.86	202	300	438	652
337100*	16	16	7/.0192	0.025	0.64	0.080	2.03	1.015	25.78	268	399	560	833
337110*	20	16	7/.0192	0.025	0.64	0.080	2.03	1.130	28.70	335	498	680	1012
337120*	24	16	7/.0192	0.025	0.64	0.080	2.03	1.215	30.86	401	597	807	1201
337130*	36	16	7/.0192	0.025	0.64	0.080	2.03	1.505	38.23	601	894	1160	1726
337140*	50	16	7/.0192	0.025	0.64	0.080	2.03	2.095	53.21	834	1241	1702	2533

Dimensions and weights are nominal; subject to industry tolerances.

*Non-stock item, minimum runs apply. Please consult Customer Service for price and delivery.



Phone: 888-593-3355
www.generalcable.com

FREP®

FR-EPR/CPE, Instrumentation, Shielded
600V, UL Type TC, Individual and Overall Shielded Pairs

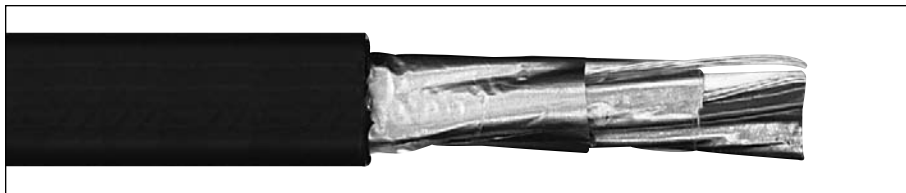

Product Construction

Conductor:

- 18 AWG and 16 AWG tinned, annealed copper per ASTM B33
- Class B stranding per ASTM B8

Insulation:

- Flame-retardant Ethylene Propylene Rubber (FR-EPR) Type II
- Color-coded: per ICEA Method 1; Pairs - black and white. One conductor in each pair is printed alpha-numerically for easy identification

Shield:

Individual and overall shielded pairs

- Individual pairs are 100% individually shielded with Flexfoil® aluminum/polyester in contact with stranded tinned copper drain wire
- Overall shield is Flexfoil® aluminum/polyester in contact with stranded tinned copper drain wire

Jacket:

- Flame-retardant thermoplastic Chlorinated Polyethylene (CPE)

Print:

- GENERAL CABLE® (WC) FREP® XX/SPS XXAWG EPR/CPE SHIELDED UL TYPE TC 90°C WET OR DRY 600V DIR BUR SUN RES DAY/MONTH/YEAR OF MFG SEQUENTIAL FOOTAGE MARK

Options:

- Bare copper conductor
- Class C stranding
- Overall shielded pairs
- CCTC—Cross-Linked Polyethylene (XLPE) insulation
- FREP® XL-flame-retardant, thermoset Chlorinated Polyethylene (XL-CPE) jacket
- FREP® II-flame-retardant, thermoplastic Low-Smoke, Zero-Halogen (LSZH) Polyolefin jacket
- FREP® 300V-UL Type PLTC
- Other constructions available upon request

Applications:

- In free air, raceways or direct burial
- In wet or dry locations
- Permitted for use in Class I Division 2 industrial hazardous locations per NEC

Features:

- Rated at 90°C wet or dry
- Ripcord applied to all cables with jacket thickness of 60 mils or less
- Excellent physical, thermal and electrical properties
- Excellent moisture resistance
- Excellent resistance to compression cuts and heat deformation
- Excellent flame resistance—burns to an ash; does not exhibit thermoplastic drip
- Low coefficient of friction for easy pulling
- Sunlight- and weather-resistant
- Excellent low temperature cold bend characteristics
- Meets cold bend test at -40°C

Compliances:

Industry Compliances:

- UL 1277 Type TC
- UL 1581
- ICEA S-82-552

Flame Tests Compliances:

- UL 1581 VW-1
- UL 1277
- IEEE 383
- IEEE 1202
- CSA FT-4
- ICEA T-29-520

Other Compliances:

- EPA 40 CFR, Part 261 for leachable lead content per TCLP
- OSHA acceptable

Packaging:

- Material cut to length and shipped on non-returnable wood reels

CATALOG NUMBER	NO. OF PAIRS	COND. SIZE (AWG)	COND. STRAND	MINIMUM AVG. INSULATION THICKNESS		MINIMUM AVG. JACKET THICKNESS		NOMINAL CABLE O.D.		COPPER WEIGHT		NET WEIGHT	
				INCHES	mm	INCHES	mm	INCHES	mm	LBS/1000 FT	kg/km	LBS/1000 FT	kg/km

INDIVIDUAL AND OVERALL SHIELDED PAIRS 18 AWG CONDUCTORS

279700	2	18	7/.0152	0.025	0.64	0.045	1.14	0.473	12.01	27	41	83	124
279710	4	18	7/.0152	0.025	0.64	0.060	1.52	0.586	14.88	53	78	152	226
279720*	8	18	7/.0152	0.025	0.64	0.060	1.52	0.751	19.08	103	153	259	385
279730*	12	18	7/.0152	0.025	0.64	0.080	2.03	0.948	24.08	153	228	398	592
279740*	16	18	7/.0152	0.025	0.64	0.080	2.03	1.050	26.67	206	307	502	747
319270*	20	18	7/.0152	0.025	0.64	0.080	2.03	1.185	30.10	254	378	623	927
279750*	24	18	7/.0152	0.025	0.64	0.080	2.03	1.220	30.99	311	463	709	1055
337240*	36	18	7/.0152	0.025	0.64	0.080	2.03	1.474	37.44	461	687	1008	1500
337250*	50	18	7/.0152	0.025	0.64	0.110	2.79	1.780	45.21	640	952	1454	2164

INDIVIDUAL AND OVERALL SHIELDED PAIRS 16 AWG CONDUCTORS

280500	2	16	7/.0192	0.025	0.64	0.045	1.14	0.500	12.70	40	59	103	153
280520	4	16	7/.0192	0.025	0.64	0.060	1.52	0.650	16.51	77	114	189	281
280530	6	16	7/.0192	0.025	0.64	0.060	1.52	0.755	19.18	115	171	268	399
280540	8	16	7/.0192	0.025	0.64	0.060	1.52	0.840	21.34	151	225	330	491
279760	12	16	7/.0192	0.025	0.64	0.080	2.03	1.065	27.05	226	337	506	753
280990*	16	16	7/.0192	0.025	0.64	0.080	2.03	1.185	30.10	305	453	643	957
337260*	20	16	7/.0192	0.025	0.64	0.080	2.03	1.320	33.53	380	566	777	1156
279770*	24	16	7/.0192	0.025	0.64	0.080	2.03	1.485	37.72	455	677	932	1387
288260*	36	16	7/.0192	0.025	0.64	0.080	2.03	1.760	44.70	683	1016	1410	2098
288250*	50	16	7/.0192	0.025	0.64	0.110	2.79	2.035	51.69	946	1408	1883	2802

Dimensions and weights are nominal; subject to industry tolerances.

*Non-stock item, minimum runs apply. Please consult Customer Service for price and delivery.



Phone: 888-593-3355
www.generalcable.com

FREP®

FR-EPR/CPE, Instrumentation, Shielded
600V, UL Type TC, Individual and Overall Shielded Triads

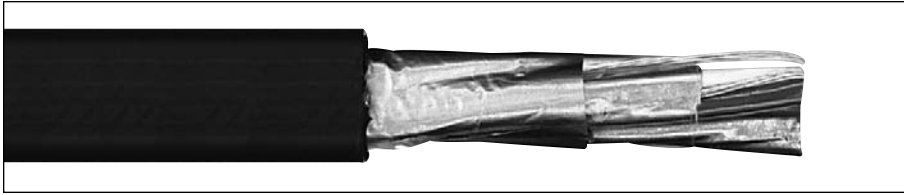

Product Construction

Conductor:

- 18 AWG and 16 AWG tinned, annealed copper per ASTM B33
- Class B stranding per ASTM B8

Insulation:

- Flame-retardant Ethylene Propylene Rubber (FR-EPR) Type II
- Color-coded: per ICEA Method 1; Triads - black, white and red. One conductor in each triad is printed alpha-numerically for easy identification

Shield:

Individual and overall shielded triads

- Individual triads are 100% shielded with Flexfoil® aluminum/polyester in contact with stranded tinned copper drain wire
- Overall shield is Flexfoil® aluminum/polyester in contact with stranded tinned copper drain wire

Jacket:

- Flame-retardant thermoplastic Chlorinated Polyethylene (CPE)

Print:

- GENERAL CABLE® (WC) FREP® XX/STS XXAWG EPR/CPE SHIELDED UL TYPE TC 90°C WET OR DRY 600V DIR BUR SUN RES DAY/MONTH/YEAR OF MFG SEQUENTIAL FOOTAGE MARK

Options:

- Bare copper conductor
- Class C stranding
- Overall shielded pairs/triads
- CCTC—Cross-Linked Polyethylene (XLPE) insulation
- FREP® XL-flame-retardant, thermoset Chlorinated Polyethylene (XL-CPE) jacket
- FREP® II-flame-retardant, thermoplastic Low-Smoke, Zero-Halogen (LSZH) polyolefin jacket
- FREP® 300V-UL Type PLTC
- Other constructions available upon request

Applications:

- In free air, raceways or direct burial
- In wet or dry locations
- Permitted for use in Class I Division 2 industrial hazardous locations per NEC

Features:

- Rated at 90°C wet or dry
- Ripcord applied to all cables with jacket thickness of 60 mils or less
- Excellent physical, thermal and electrical properties
- Excellent moisture resistance
- Excellent resistance to compression cuts and heat deformation
- Excellent flame resistance—burns to an ash; does not exhibit thermoplastic drip
- Low coefficient of friction for easy pulling
- Sunlight- and weather-resistant
- Excellent low temperature cold bend characteristics
- Meets cold bend test at -40°C

Compliances:

Industry Compliances:

- UL 1277 Type TC
- UL 1581
- ICEA S-82-552

Flame Tests Compliances:

- UL 1581 VW-1
- UL 1277
- IEEE 383
- IEEE 1202
- CSA FT-4
- ICEA T-29-520

Other Compliances:

- EPA 40 CFR, Part 261 for leachable lead content per TCLP
- OSHA acceptable

Packaging:

- Material cut to length and shipped on non-returnable wood reels

CATALOG NUMBER	NO. OF TRIADS	COND. SIZE (AWG)	COND. STRAND	MINIMUM AVG. INSULATION THICKNESS		MINIMUM AVG. JACKET THICKNESS		NOMINAL CABLE O.D.		COPPER WEIGHT		NET WEIGHT	
				INCHES	mm	INCHES	mm	INCHES	mm	LBS/1000 FT	kg/km	LBS/1000 FT	kg/km

INDIVIDUAL AND OVERALL SHIELDED TRIADS 18 AWG CONDUCTORS

337150*	2 TRI	18	7/.0152	0.025	0.64	0.060	1.52	0.560	14.22	38	57	127	189
319250*	4 TRI	18	7/.0152	0.025	0.64	0.060	1.52	0.640	16.26	73	109	201	299
319260*	8 TRI	18	7/.0152	0.025	0.64	0.080	2.03	0.825	20.96	144	214	343	510
337160*	12 TRI	18	7/.0152	0.025	0.64	0.080	2.03	1.065	27.05	218	324	528	786
294540*	16 TRI	18	7/.0152	0.025	0.64	0.080	2.03	1.180	29.97	290	431	675	1005
337170*	20 TRI	18	7/.0152	0.025	0.64	0.080	2.03	1.310	33.27	361	538	825	1228
337180*	24 TRI	18	7/.0152	0.025	0.64	0.080	2.03	1.500	38.10	433	645	972	1447
337190*	36 TRI	18	7/.0152	0.025	0.64	0.080	2.03	1.740	44.20	649	965	1470	2188

INDIVIDUAL AND OVERALL SHIELDED TRIADS 16 AWG CONDUCTORS

280950*	2 TRI	16	7/.0192	0.025	0.64	0.060	1.52	0.615	15.62	57	84	159	237
280960*	4 TRI	16	7/.0192	0.025	0.64	0.060	1.52	0.705	17.91	108	160	249	371
280970*	8 TRI	16	7/.0192	0.025	0.64	0.080	2.03	0.850	21.59	217	323	472	702
287410*	12 TRI	16	7/.0192	0.025	0.64	0.080	2.03	1.160	29.46	328	487	683	1016
337200*	16 TRI	16	7/.0192	0.025	0.64	0.080	2.03	1.290	32.77	436	649	879	1308
337210*	20 TRI	16	7/.0192	0.025	0.64	0.080	2.03	1.380	35.05	545	811	1058	1575
337220*	24 TRI	16	7/.0192	0.025	0.64	0.080	2.03	1.615	41.02	653	972	1266	1884
337230*	36 TRI	16	7/.0192	0.025	0.64	0.110	2.79	1.920	48.77	979	1457	1918	2854

Dimensions and weights are nominal; subject to industry tolerances.

*Non-stock item, minimum runs apply. Please consult Customer Service for price and delivery.



Phone: 888-593-3355
www.generalcable.com

Arctic-Flex®

XLPE/ARCTIC-PVC, Instrumentation, Shielded
600V, UL Type TC, CSA Type CIC, Overall Shielded Pairs/Triads

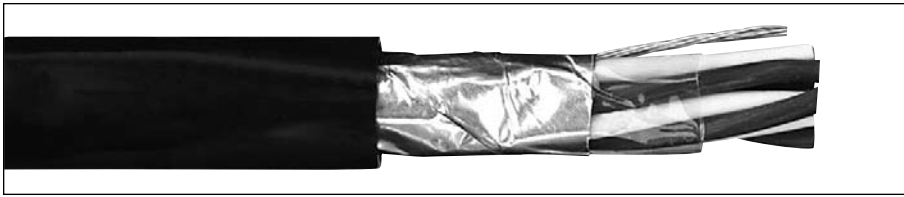

Product Construction

Conductor:

- 18 AWG and 16 AWG tinned, annealed copper per ASTM B3
- Class B stranding per ASTM B8

Insulation:

- Flame-retardant Cross-Linked Polyethylene (XLPE)
- Color-coded: per ICEA Method 1; pairs - black and white. Triads - black, white, and red. One conductor in each pair or triad is printed alpha-numerically for easy identification

Shield:

Overall shielded pairs/triads

- Overall Shield is Flexfoil® aluminum/polyester in contact with stranded tinned copper drain wire

Jacket:

- Flame-retardant and sunlight-resistant Arctic-grade Polyvinyl Chloride (PVC)

Print:

- GENERAL CABLE® (WC) (UL) TYPE TC ARCTIC-FLEX® FR-XLP/PVC XX PS/TS XX AWG SHIELDED 90C WET OR DRY SUN RES DIR BUR 600V - CSA TYPE CIC SHIELDED INSTRUMENTATION CABLE XLPE 90C WET OR DRY -40 FT-4 PLUS DAY/MONTH/YEAR OF MFG SEQUENTIAL FOOTAGE MARK

Options:

- Bare copper
- Class C stranding
- E-2 Color Code
- CSA Rated TC for 14 AWG and larger
- Other constructions available upon request

Applications:

- Industrial lighting, control and signaling circuits
- Primary installations in cable trays, raceways or outdoor applications where supported by a messenger wire
- In wet or dry locations

Features:

- Rated 90°C wet or dry
- Ripcord applied to all cables with jacket thickness of 60 mils or less
- Sunlight- and weather-resistant
- Meets CSA cold impact test at -40°C
- Meets ICEA and CSA cold bend test at -65°C

Compliances:

Industry Compliances:

- UL 1277 Type TC
- UL 1581
- CSA C22.2 No. 239 Type CIC

Flame Tests Compliances:

- UL 1581 VW-1
- UL 1277
- CSA FT-4
- IEEE 383

Other Compliances:

- EPA 40 CFR, Part 261 for leachable lead content per TCLP
- OSHA acceptable

Packaging:

- Material cut to lengths and shipped on non-returnable wood reels

CATALOG NUMBER	NO. OF PAIRS/TRIADS	COND. SIZE (AWG)	COND. STRAND	MINIMUM AVG. INSULATION THICKNESS		MINIMUM AVG. JACKET THICKNESS		NOMINAL CABLE O.D.		COPPER WEIGHT		NET WEIGHT	
				INCHES	mm	INCHES	mm	INCHES	mm	LBS/1000 FT	kg/km	LBS/1000 FT	kg/km

OVERALL SHIELDED PAIRS/TRIADS 18 AWG CONDUCTORS

366170*	1	18	7/.0152	0.030	0.76	0.045	1.14	0.315	8.00	12	18	46	68
347630*	1 TRI	18	7/.0152	0.030	0.76	0.045	1.14	0.340	8.64	18	26	57	85
347640*	2	18	7/.0152	0.030	0.76	0.045	1.14	0.450	11.43	23	34	88	131
347650*	4	18	7/.0152	0.030	0.76	0.045	1.14	0.560	14.22	44	65	144	214
347660*	8	18	7/.0152	0.030	0.76	0.060	1.52	0.750	19.05	94	140	263	391
347670*	12	18	7/.0152	0.030	0.76	0.080	2.03	0.850	21.59	141	210	358	533
347680*	16	18	7/.0152	0.030	0.76	0.080	2.03	1.010	25.65	187	278	461	686
347690*	20	18	7/.0152	0.030	0.76	0.080	2.03	1.085	27.56	233	347	600	893
347700*	24	18	7/.0152	0.030	0.76	0.080	2.03	1.210	30.73	279	415	761	1043
347710*	36	18	7/.0152	0.030	0.76	0.080	2.03	1.500	38.10	418	622	1005	1496
347720*	50	18	7/.0152	0.030	0.76	0.080	2.03	2.570	65.28	580	863	1603	2386

OVERALL SHIELDED PAIRS/TRIADS 16 AWG CONDUCTORS

366180*	1	16	7/.0192	0.030	0.76	0.045	1.14	0.345	8.76	19	28	32	48
347730*	1 TRI	16	7/.0192	0.030	0.76	0.045	1.14	0.360	9.14	27	40	71	106
347740*	2	16	7/.0192	0.030	0.76	0.045	1.14	0.560	14.22	36	53	121	181
347750*	4	16	7/.0192	0.030	0.76	0.060	1.52	0.650	16.51	69	102	186	277
347760*	8	16	7/.0192	0.030	0.76	0.060	1.52	0.810	20.57	135	201	324	482
347770*	12	16	7/.0192	0.030	0.76	0.080	2.03	1.000	25.40	202	300	486	723
347780*	16	16	7/.0192	0.030	0.76	0.080	2.03	1.120	28.45	268	399	616	917
347790*	20	16	7/.0192	0.030	0.76	0.080	2.03	1.170	29.72	335	498	734	1092
347800*	24	16	7/.0192	0.030	0.76	0.080	2.03	1.440	36.58	401	597	894	1330
347810*	36	16	7/.0192	0.030	0.76	0.080	2.03	1.650	41.91	601	894	1254	1866
347820*	50	16	7/.0192	0.030	0.76	0.110	2.79	2.020	51.31	834	1241	1800	2679

Dimensions and weights are nominal; subject to industry tolerances.

*Non-stock item, minimum runs apply. Please consult Customer Service for price and delivery.



Phone: 888-593-3355
www.generalcable.com

Arctic-Flex®

XLPE/ARCTIC-PVC, Instrumentation, Shielded
600V, UL Type TC, CSA Type CIC, Individual and Overall Shielded Pairs



Product Construction

Conductor:

- 18 AWG and 16 AWG tinned, annealed copper per ASTM B3
- Class B stranding per ASTM B8

Insulation:

- Flame-retardant Cross-Linked Polyethylene (XLPE)
- Color-coded: per ICEA Method 1; pairs - black and white. One conductor in each pair is printed alpha-numerically for easy identification

Shield:

Individual and overall shielded pairs

- Individual pairs are 100% shielded with Flexfoil® aluminum/polyester in contact with stranded tinned copper drain wire
- Overall shield is Flexfoil® aluminum/polyester in contact with stranded tinned copper drain wire

Jacket:

- Flame-retardant and sunlight-resistant Arctic-grade Polyvinyl Chloride (PVC)

Print:

- GENERAL CABLE® (WC) (UL) TYPE TC ARCTIC-FLEX® FR-XLP/PVC XX SPS/STS XX AWG SHIELDED 90C WET OR DRY SUN RES DIR BUR 600V - CSA TYPE CIC SHIELDED INSTRUMENTATION CABLE XLPE 90C WET OR DRY -40 FT-4 PLUS DAY/MONTH/YEAR OF MFG SEQUENTIAL FOOTAGE MARK

Options:

- Bare copper
- Class C stranding
- E-2 Color Code
- CSA Rated TC for 14 AWG and larger
- Other constructions available upon request

Applications:

- Industrial lighting, control and signaling circuits
- Primary installations in cable trays, raceways or outdoor applications where supported by a messenger wire
- In wet or dry locations

Features:

- Rated 90°C wet or dry
- Ripcord applied to all cables with jacket thickness of 60 mils or less
- Sunlight- and weather-resistant
- Meets CSA cold impact test at -40°C
- Meets ICEA and CSA cold bend test at -65°C

Compliances:

Industry Compliances:

- UL 1277 Type TC
- UL 1581
- CSA C22.2 No. 239 Type CIC

Flame Tests Compliances:

- UL 1581 VW-1
- UL 1277
- CSA FT-4
- IEEE 383

Other Compliances:

- EPA 40 CFR, Part 261 for leachable lead content per TCLP
- OSHA acceptable

Packaging:

- Material cut to lengths and shipped on non-returnable wood reels

CATALOG NUMBER	NO. OF PAIRS	COND. SIZE (AWG)	COND. STRAND	MINIMUM AVG. INSULATION THICKNESS		MINIMUM AVG. JACKET THICKNESS		NOMINAL CABLE O.D.		COPPER WEIGHT		NET WEIGHT	
				INCHES	mm	INCHES	mm	INCHES	mm	LBS/1000 FT	kg/km	LBS/1000 FT	kg/km

INDIVIDUAL AND OVERALL SHIELDED PAIRS 18 AWG CONDUCTORS

347830*	2	18	7/.0152	0.030	0.76	0.045	1.14	0.515	13.08	30	45	93	138
347840*	4	18	7/.0152	0.030	0.76	0.060	1.52	0.625	15.88	55	82	167	248
347850*	8	18	7/.0152	0.030	0.76	0.060	1.52	0.805	20.45	105	156	304	460
347860*	12	18	7/.0152	0.030	0.76	0.080	2.03	1.020	25.91	156	232	449	668
347870*	16	18	7/.0152	0.030	0.76	0.080	2.03	1.130	28.70	207	308	554	824
347880*	20	18	7/.0152	0.030	0.76	0.080	2.03	1.235	31.37	252	375	666	991
347890*	24	18	7/.0152	0.030	0.76	0.080	2.03	1.465	37.21	308	458	794	1182
347900*	36	18	7/.0152	0.030	0.76	0.080	2.03	1.630	41.40	461	686	1122	1670
347910*	50	18	7/.0152	0.030	0.76	0.110	2.79	1.975	50.17	640	952	1598	2378

INDIVIDUAL AND OVERALL SHIELDED PAIRS 16 AWG CONDUCTORS

347920*	2	16	7/.0192	0.030	0.76	0.060	1.52	0.595	15.11	42	63	132	196
347930*	4	16	7/.0192	0.030	0.76	0.060	1.52	0.695	17.65	80	119	212	315
347940*	8	16	7/.0192	0.030	0.76	0.060	1.52	0.900	22.86	155	231	395	588
347950*	12	16	7/.0192	0.030	0.76	0.080	2.03	1.110	28.19	230	342	578	860
347960*	16	16	7/.0192	0.030	0.76	0.080	2.03	1.260	32.00	306	455	733	1091
347970*	20	16	7/.0192	0.030	0.76	0.080	2.03	1.315	33.40	375	558	845	1258
347980*	24	16	7/.0192	0.030	0.76	0.080	2.03	1.510	38.35	456	679	1009	1502
347990*	36	16	7/.0192	0.030	0.76	0.110	2.79	1.820	46.23	674	1003	1259	1874
348000*	50	16	7/.0192	0.030	0.76	0.110	2.79	2.095	53.21	946	1408	2032	3024

Dimensions and weights are nominal; subject to industry tolerances.

*Non-stock item, minimum runs apply. Please consult Customer Service for price and delivery.



Phone: 888-593-3355
www.generalcable.com

CVTC®

XLPE/PVC, Instrumentation, Shielded
600V, UL Type TC, Overall Shielded Pairs/Triads



Product Construction

Conductor:

- 18 AWG and 16 AWG bare, annealed copper per ASTM B3
- Class B stranding per ASTM B8

Insulation:

- Flame-retardant Cross-Linked Polyethylene (XLPE)
- Color-coded: per ICEA Method 1; Pairs - black and white. Triads - black, white and red. One conductor in each pair or triad is printed alpha-numerically for easy identification

Shield:

Overall shielded pairs/triads

- Overall shield is Flexfoil® aluminum/polyester in contact with stranded tinned copper drain wire

Jacket:

- Flame-retardant and sunlight-resistant Polyvinyl Chloride (PVC)

Print:

- GENERAL CABLE® (WC) CVTC® XX/PS/TS XXAWG FR-XLP/PVC SHIELDED (UL)TYPE TC 90°C WET OR DRY DIR BUR SUN RES 600V MONTH/YEAR OF MFG SEQUENTIAL FOOTAGE MARK

Options:

- 300V Type PLTC
- Tinned copper conductor
- Class C stranding
- Individual and overall shielded pairs/triads
- EVTC—Ethylene Propylene Rubber (EPR) insulation
- Other constructions available upon request

Applications:

- In free air, raceways or direct burial
- In wet or dry locations
- Permitted for use in Class I Division 2 industrial hazardous locations per NEC

Features:

- Rated at 90°C wet or dry
- Ripcord applied to all cables with jacket thickness of 60 mils or less
- Abrasion- and chemical-resistant
- Excellent electrical properties
- Sunlight- and weather-resistant
- Meets cold bend test at -25°C

Compliances:

Industry Compliances:

- UL 1277 Type TC
- UL 1581
- ICEA S-82-552
- ICEA S-73-532

Flame Tests Compliances:

- UL 1581 VW-1
- UL 1277
- IEEE 383
- IEEE 1202
- CSA FT-4

Other Compliances:

- EPA 40 CFR, Part 261 for leachable lead content per TCLP
- OSHA acceptable

Packaging:

- Material cut to length and shipped on non-returnable wood reels

CATALOG NUMBER	NO. OF PAIRS/TRIADS	COND. SIZE (AWG)	COND. STRAND	MINIMUM AVG. INSULATION THICKNESS		MINIMUM AVG. JACKET THICKNESS		NOMINAL CABLE O.D.		COPPER WEIGHT		NET WEIGHT	
				INCHES	mm	INCHES	mm	INCHES	mm	LBS/1000 FT	kg/km	LBS/1000 FT	kg/km

OVERALL SHIELDED PAIRS/TRIADS 18 AWG CONDUCTORS

366160*	1	18	7/.0152	0.030	0.76	0.045	1.14	0.315	8.00	12	18	46	68
337270*	1 TRI	18	7/.0152	0.030	0.76	0.045	1.14	0.340	8.64	18	26	58	86
337360*	2	18	7/.0152	0.030	0.76	0.045	1.14	0.450	11.43	23	34	88	131
337280*	4	18	7/.0152	0.030	0.76	0.045	1.14	0.560	14.22	44	65	144	214
337290*	8	18	7/.0152	0.030	0.76	0.060	1.52	0.750	19.05	94	140	263	391
337300*	12	18	7/.0152	0.030	0.76	0.080	2.03	0.850	21.59	141	210	358	533
337310*	16	18	7/.0152	0.030	0.76	0.080	2.03	1.010	25.65	187	278	461	686
337320*	20	18	7/.0152	0.030	0.76	0.080	2.03	1.085	27.56	233	347	600	893
337330*	24	18	7/.0152	0.030	0.76	0.080	2.03	1.210	30.73	279	415	701	1043
337340*	36	18	7/.0152	0.030	0.76	0.080	2.03	1.500	38.10	418	622	1005	1496
337350*	50	18	7/.0152	0.030	0.76	0.080	2.03	2.570	65.28	580	863	1603	2386

OVERALL SHIELDED PAIRS/TRIADS 16 AWG CONDUCTORS

319810*	1	16	7/.0192	0.030	0.76	0.045	1.14	0.345	8.76	19	28	32	48
319870*	1 TRI	16	7/.0192	0.030	0.76	0.045	1.14	0.360	9.14	27	40	72	107
337370*	2	16	7/.0192	0.030	0.76	0.045	1.14	0.560	14.22	36	53	121	180
382260*	4	16	7/.0192	0.030	0.76	0.060	1.52	0.650	16.51	69	102	186	277
337390*	8	16	7/.0192	0.030	0.76	0.060	1.52	0.810	20.57	135	201	324	482
337400*	12	16	7/.0192	0.030	0.76	0.080	2.03	1.000	25.40	202	300	486	723
337410*	16	16	7/.0192	0.030	0.76	0.080	2.03	1.120	28.45	268	399	616	917
337420*	20	16	7/.0192	0.030	0.76	0.080	2.03	1.170	29.72	335	498	734	1092
337430*	24	16	7/.0192	0.030	0.76	0.080	2.03	1.440	36.58	401	597	894	1330
337440*	36	16	7/.0192	0.030	0.76	0.080	2.03	1.650	41.91	601	894	1254	1866
337450*	50	16	7/.0192	0.030	0.76	0.110	2.79	2.020	51.31	834	1241	1800	2679

Dimensions and weights are nominal; subject to industry tolerances.

*Non-stock item, minimum runs apply. Please consult Customer Service for price and delivery.



Phone: 888-593-3355
www.generalcable.com

CVTC®

XLPE/PVC, Instrumentation, Shielded
600V, UL Type TC, Individual and Overall Shielded Pairs



Product Construction

Conductor:

- 18 AWG and 16 AWG bare, annealed copper per ASTM B3
- Class B stranding per ASTM B8

Insulation:

- Flame-retardant Cross-Linked Polyethylene (XLPE)
- Color-coded: per ICEA Method 1; Pairs - black and white. One conductor in each pair is printed alpha-numerically for easy identification

Shield:

- **Individual and overall shielded pairs**
- Individual pairs are 100% shielded with Flexfoil® aluminum/polyester in contact with stranded tinned copper drain wire
- Overall shield is Flexfoil® aluminum/polyester in contact with stranded tinned copper drain wire

Jacket:

- Flame-retardant and sunlight-resistant Polyvinyl Chloride (PVC)

Print:

- GENERAL CABLE® (WC) CVTC® XX/SPS XXAWG FR-XLP/PVC SHIELDED (UL)TYPE TC 90°C WET OR DRY DIR BUR SUN RES 600V PLUS MONTH/YEAR OF MFG SEQUENTIAL FOOTAGE MARK

Options:

- 300V Type PLTC
- Tinned copper conductor
- Class C stranding
- Overall shielded pairs/triads
- EVTC—Ethylene Propylene Rubber (EPR) insulation
- Other constructions available upon request

Applications:

- In free air, raceways or direct burial
- In wet or dry locations
- Permitted for use in Class I Division 2 industrial hazardous locations per NEC

Features:

- Rated at 90°C wet or dry
- Ripcord applied to all cables with jacket thickness of 60 mils or less
- Abrasion- and chemical-resistant
- Excellent electrical properties
- Sunlight- and weather-resistant
- Meets cold bend test at -25°C

Compliances:

Industry Compliances:

- UL 1277 Type TC
- UL 1581
- ICEA S-82-552
- ICEA S-73-532

Flame Tests Compliances:

- UL 1581 VW-1
- UL 1277
- IEEE 383
- IEEE 1202
- CSA FT-4

Other Compliances:

- EPA 40 CFR, Part 261 for leachable lead content per TCLP
- OSHA acceptable

Packaging:

- Material cut to length and shipped on non-returnable wood reels

CATALOG NUMBER	NO. OF PAIRS	COND. SIZE (AWG)	COND. STRAND	MINIMUM AVG. INSULATION THICKNESS		MINIMUM AVG. JACKET THICKNESS		NOMINAL CABLE O.D.		COPPER WEIGHT		NET WEIGHT	
				INCHES	mm	INCHES	mm	INCHES	mm	LBS/1000 FT	kg/km	LBS/1000 FT	kg/km

INDIVIDUAL AND OVERALL SHIELDED PAIRS 18 AWG CONDUCTORS

319820*	2	18	7/.0152	0.030	0.76	0.045	1.14	0.515	13.08	28	41	95	141
319840*	4	18	7/.0152	0.030	0.76	0.060	1.52	0.625	15.88	53	53	170	253
319850*	8	18	7/.0152	0.030	0.76	0.060	1.52	0.805	20.45	104	155	292	435
337460*	12	18	7/.0152	0.030	0.76	0.080	2.03	1.020	25.91	155	231	442	658
337470*	16	18	7/.0152	0.030	0.76	0.080	2.03	1.130	28.70	206	307	554	824
337480*	20	18	7/.0152	0.030	0.76	0.080	2.03	1.235	31.37	254	378	666	991
337490*	24	18	7/.0152	0.030	0.76	0.080	2.03	1.465	37.21	308	459	802	1194
337500*	36	18	7/.0152	0.030	0.76	0.080	2.03	1.630	41.40	461	687	1116	1661
337510*	50	18	7/.0152	0.030	0.76	0.110	2.79	1.975	50.17	640	952	1598	2378

INDIVIDUAL AND OVERALL SHIELDED PAIRS 16 AWG CONDUCTORS

337520*	2	16	7/.0192	0.030	0.76	0.060	1.52	0.595	15.11	40	60	135	201
337530*	4	16	7/.0192	0.030	0.76	0.060	1.52	0.695	17.65	78	116	214	318
337540*	8	16	7/.0192	0.030	0.76	0.060	1.52	0.900	22.86	153	228	399	594
337550*	12	16	7/.0192	0.030	0.76	0.080	2.03	1.110	28.19	229	341	584	869
337560*	16	16	7/.0192	0.030	0.76	0.080	2.03	1.260	32.00	304	453	712	1060
337570*	20	16	7/.0192	0.030	0.76	0.080	2.03	1.315	33.40	380	566	845	1258
337580*	24	16	7/.0192	0.030	0.76	0.080	2.03	1.510	38.35	455	677	1009	1502
337590*	36	16	7/.0192	0.030	0.76	0.110	2.79	1.820	46.23	682	1014	1259	1874
337600*	50	16	7/.0192	0.030	0.76	0.110	2.79	2.095	53.21	946	1408	2032	3024

Dimensions and weights are nominal; subject to industry tolerances.

*Non-stock item, minimum runs apply. Please consult Customer Service for price and delivery.



Phone: 888-593-3355
www.generalcable.com

VNTC®

PVC/Nylon/PVC, Instrumentation, Shielded
600V, UL Type TC, Overall Shielded Pairs/Triads

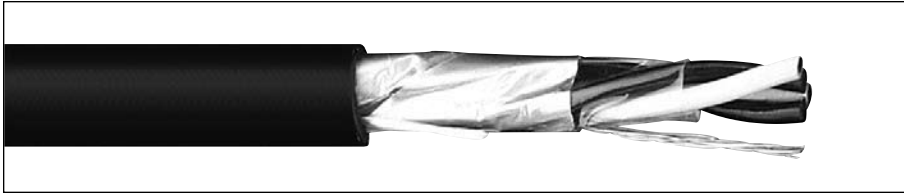

Product Construction

Conductor:

- 18 AWG thru 14 AWG bare, annealed copper per ASTM B3
- Class B stranding per ASTM B8

Insulation:

- Flame-retardant Polyvinyl Chloride (PVC) with clear Polyamide (nylon)
- Color-coded: per ICEA Method 1; Pairs - black and white. Triads - black, white and red. One conductor in each pair or triad is printed alpha-numerically for easy identification

Shield:

Overall shielded pairs/triads

- Overall shield is Flexfoil® aluminum/polyester in contact with stranded tinned copper drain wire

Jacket:

- Flame-retardant, moisture- and sunlight-resistant Polyvinyl Chloride (PVC)

Print:

- GENERAL CABLE® (WC) VNTC® XX/PS/TS XXAWG SHIELDED (UL) TYPE TC 600V TFN SUN RES DIR BUR DAY/MONTH/YEAR OF MFG SEQUENTIAL FOOTAGE MARK

Options:

- Tinned copper conductor
- Class C stranding
- Individual and overall shielded pairs/triads
- Other constructions available upon request

Applications:

- In free air, raceways or direct burial
- In wet or dry locations
- Permitted for use in Class I Division 2 industrial hazardous locations per NEC

Features:

- Rated at 90°C dry, 75°C wet
- Ripcord applied to all cables with jacket thickness of 60 mils or less
- Provides sunlight, cold bend and cold impact resistance
- Offer the smallest cable O.D. available for suitable applications
- Provides excellent oil and chemical resistance
- Provides a long service life
- Meets cold bend test at -25°C

Compliances:

Industry Compliances:

- UL 1277 Type TC
- UL 1581
- NEC Type TFN conductors

Flame Tests Compliances:

- UL 1277
- IEEE 383
- IEEE 1202
- CSA FT-4

Other Compliances:

- EPA 40 CFR, Part 261 for leachable lead content per TCLP
- OSHA acceptable

Packaging:

- Material cut to length and shipped on non-returnable wood reels

CATALOG NUMBER	NO. OF PAIRS/TRIADS	COND. SIZE (AWG)	COND. STRAND	MINIMUM AVG. INSULATION THICKNESS		MINIMUM AVG. JACKET THICKNESS		NOMINAL CABLE O.D.		COPPER WEIGHT		NET WEIGHT	
				INCHES	mm	INCHES	mm	INCHES	mm	LBS/1000 FT	kg/km	LBS/1000 FT	kg/km

**OVERALL SHIELDED PAIRS/TRIADS
18 AWG CONDUCTORS**

235020	1	18	7/.0152	0.020	0.51	0.045	1.14	0.280	7.11	12	19	41	61
239210	1 TRI	18	7/.0152	0.020	0.51	0.045	1.14	0.300	7.62	18	27	49	73
235910	2	18	7/.0152	0.020	0.51	0.045	1.14	0.440	11.18	23	34	72	107
319740*	3	18	7/.0152	0.020	0.51	0.045	1.14	0.465	11.81	33	50	90	134
235980	4	18	7/.0152	0.020	0.51	0.045	1.14	0.505	12.83	44	65	110	164
336830*	5	18	7/.0152	0.020	0.51	0.060	1.52	0.570	14.48	55	82	144	214
336840*	7	18	7/.0152	0.020	0.51	0.060	1.52	0.585	14.86	75	112	177	263
230760*	12	18	7/.0152	0.020	0.51	0.060	1.52	0.770	19.56	127	189	277	412
270970*	16	18	7/.0152	0.020	0.51	0.080	2.03	0.825	20.96	168	250	355	528
336850*	20	18	7/.0152	0.020	0.51	0.080	2.03	0.905	22.99	210	313	455	677
230750*	24	18	7/.0152	0.020	0.51	0.080	2.03	1.020	25.91	252	375	544	810
230800*	36	18	7/.0152	0.020	0.51	0.080	2.03	1.150	29.21	378	562	763	1135
336860*	50	18	7/.0152	0.020	0.51	0.080	2.03	1.405	35.69	525	781	1036	1542

**OVERALL SHIELDED PAIRS/TRIADS
16 AWG CONDUCTORS**

230830	1	16	7/.0192	0.020	0.51	0.045	1.14	0.300	7.62	20	29	52	77
230840	1 TRI	16	7/.0192	0.020	0.51	0.045	1.14	0.315	8.00	27	40	61	91
238410*	2	16	7/.0192	0.020	0.51	0.045	1.14	0.470	11.94	37	54	93	138
239200*	3	16	7/.0192	0.020	0.51	0.045	1.14	0.505	12.83	53	79	117	174
230790*	4	16	7/.0192	0.020	0.51	0.060	1.52	0.575	14.61	69	103	160	238
336870*	5	16	7/.0192	0.020	0.51	0.060	1.52	0.610	15.49	87	129	190	283
336880*	7	16	7/.0192	0.020	0.51	0.060	1.52	0.630	16.00	117	174	239	356
244590*	12	16	7/.0192	0.020	0.51	0.060	1.52	0.825	20.96	201	299	370	551
244610*	16	16	7/.0192	0.020	0.51	0.080	2.03	0.970	24.64	267	397	513	763
336890*	20	16	7/.0192	0.020	0.51	0.080	2.03	1.010	25.65	337	502	628	935
230780*	24	16	7/.0192	0.020	0.51	0.080	2.03	1.135	28.83	398	592	740	1101
230820*	36	16	7/.0192	0.020	0.51	0.080	2.03	1.375	34.93	595	886	1063	1582
230810*	50	16	7/.0192	0.020	0.51	0.080	2.03	1.570	39.88	833	1240	1435	2136

**OVERALL SHIELDED PAIRS/TRIADS
14 AWG CONDUCTORS**

237490	1	14	7/.0242	0.015	0.38	0.045	1.14	0.325	8.26	28	42	62	92
--------	---	----	---------	-------	------	-------	------	-------	------	----	----	----	----

Dimensions and weights are nominal; subject to industry tolerances.

*Non-stock item, minimum runs apply. Please consult Customer Service for price and delivery.



Phone: 888-593-3355
www.generalcable.com

VNTC®

PVC/Nylon/PVC, Instrumentation, Shielded
600V, UL Type TC, Individual and Overall Shielded Pairs

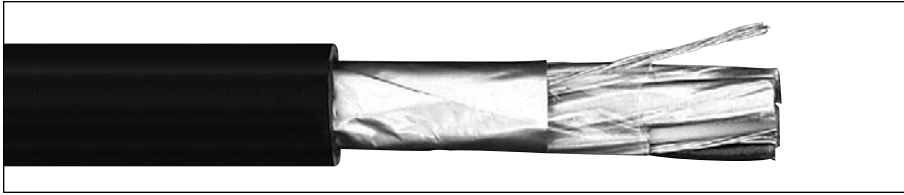

Product Construction

Conductor:

- 18 AWG and 16 AWG bare, annealed copper per ASTM B3
- Class B stranding per ASTM B8

Insulation:

- Flame-retardant Polyvinyl Chloride (PVC) with clear Polyamide (nylon)
- Color-coded: per ICEA Method 1; Pairs - black and white. One conductor in each pair is printed alpha-numerically for easy identification

Shield:

- **Individual and overall shielded pairs**
- Individual pairs are 100% shielded with Flexfoil® aluminum/polyester in contact with stranded tinned copper drain wire
- Overall shield is Flexfoil® aluminum/polyester in contact with stranded tinned copper drain wire

Jacket:

- Flame-retardant and sunlight-resistant Polyvinyl Chloride (PVC)

Print:

- GENERAL CABLE® (WC) VNTC® XX/SPS XXAWG SHIELDED (UL) TYPE TC 600V TFN SUN RES DIR BUR PLUS DAY/MONTH/YEAR OF MFG SEQUENTIAL FOOTAGE MARK

Options:

- Tinned copper conductor
- Class C stranding
- Overall shielded pairs/triads
- Other constructions available upon request

Applications:

- In free air, raceways or direct burial
- In wet or dry locations
- Permitted for use in Class I Division 2 industrial hazardous locations per NEC

Features:

- Rated at 90°C dry, 75°C wet
- Ripcord applied to all cables with jacket thickness of 60 mils or less
- Provides sunlight, cold bend and cold impact resistance
- Offer the smallest cable O.D. available for suitable applications
- Provides excellent oil and chemical resistance
- Provides a long service life
- Meets cold bend test at -25°C

Compliances:

Industry Compliances:

- UL 1277 Type TC
- UL 1581
- NEC Type TFN conductors

Flame Tests Compliances:

- UL 1277
- IEEE 383
- IEEE 1202
- CSA FT-4

Other Compliances:

- EPA 40 CFR, Part 261 for leachable lead content per TCLP
- OSHA acceptable

Packaging:

- Material cut to length and shipped on non-returnable wood reels

CATALOG NUMBER	NO. OF PAIRS	COND. SIZE (AWG)	COND. STRAND	MINIMUM AVG. INSULATION THICKNESS		MINIMUM AVG. JACKET THICKNESS		NOMINAL CABLE O.D.		COPPER WEIGHT		NET WEIGHT	
				INCHES	mm	INCHES	mm	INCHES	mm	LBS/1000 FT	kg/km	LBS/1000 FT	kg/km

**INDIVIDUAL AND OVERALL SHIELDED PAIRS
18 AWG CONDUCTORS**

235970*	2	18	7/.0152	0.020	0.51	0.045	1.14	0.445	11.30	28	41	84	125
336900*	3	18	7/.0152	0.020	0.51	0.045	1.14	0.480	12.19	46	68	106	158
235900*	4	18	7/.0152	0.020	0.51	0.045	1.14	0.555	14.10	53	79	145	216
336910*	5	18	7/.0152	0.020	0.51	0.060	1.52	0.580	14.73	74	110	169	252
336920*	7	18	7/.0152	0.020	0.51	0.060	1.52	0.650	16.51	102	152	219	326
241020*	12	18	7/.0152	0.020	0.51	0.060	1.52	0.845	21.46	193	287	390	506
336930*	16	18	7/.0152	0.020	0.51	0.080	2.03	0.960	24.38	229	341	473	704
336940*	20	18	7/.0152	0.020	0.51	0.080	2.03	1.050	26.67	283	421	594	884
241030*	24	18	7/.0152	0.020	0.51	0.080	2.03	1.175	29.85	340	506	689	1025
243880*	36	18	7/.0152	0.020	0.51	0.080	2.03	1.380	35.05	508	756	979	1457
256300*	50	18	7/.0152	0.020	0.51	0.080	2.03	1.615	41.02	705	1049	1371	1960

**INDIVIDUAL AND OVERALL SHIELDED PAIRS
16 AWG CONDUCTORS**

237180	2	16	7/.0192	0.020	0.51	0.045	1.14	0.495	12.57	44	65	105	156
235990*	3	16	7/.0192	0.020	0.51	0.045	1.14	0.520	13.21	64	95	137	204
237160	4	16	7/.0192	0.020	0.51	0.045	1.14	0.600	15.24	84	125	188	280
336950*	5	16	7/.0192	0.020	0.51	0.060	1.52	0.655	16.64	105	157	224	333
336960*	7	16	7/.0192	0.020	0.51	0.060	1.52	0.710	18.03	145	216	290	432
235750	8	16	7/.0192	0.020	0.51	0.060	1.52	0.760	19.30	155	224	307	457
242870	12	16	7/.0192	0.020	0.51	0.060	1.52	0.940	23.88	244	363	498	741
237130*	16	16	7/.0192	0.020	0.51	0.080	2.03	1.055	26.80	324	482	635	945
277820*	20	16	7/.0192	0.020	0.51	0.080	2.03	1.175	29.85	407	605	768	1143
242860*	24	16	7/.0192	0.020	0.51	0.080	2.03	1.350	34.29	486	724	903	1344
243890*	36	16	7/.0192	0.020	0.51	0.080	2.03	1.480	37.59	732	1089	1290	1920
244600*	50	16	7/.0192	0.020	0.51	0.080	2.03	1.810	45.97	1011	1504	1809	2692

Dimensions and weights are nominal; subject to industry tolerances.

*Non-stock item, minimum runs apply. Please consult Customer Service for price and delivery.



Phone: 888-593-3355
www.generalcable.com

GenFree™

XLPO/LSZH, Instrumentation, Shielded
600V, UL Type TC-LS, Overall Shielded Pairs/Triads



Product Construction

Conductor:

- 18 AWG and 16 AWG tinned, annealed copper per ASTM B33
- Class B stranding per ASTM B8

Insulation:

- Flame-retardant, Low-Smoke, Cross-Linked Polyolefin (XLPO)
- Color-coded: per ICEA Method 1; Pairs - black and white. Triads - black, white and red. One conductor in each pair or triad is printed alpha-numerically for easy identification

Shield:

Overall shielded pairs/triads

- Overall shield is Flexfoil® aluminum/polyester in contact with stranded tinned copper drain wire

Jacket:

- Flame-retardant, Sunlight-resistant, Low-Smoke, Zero-Halogen Polyolefin (LSZH)

Print:

- GENERAL CABLE® (WC) GENFREE™ XX/PS/TS XXAWG XLPO/LSZH SHIELDED UL TYPE TC-LS 90°C WET OR DRY 600V DIR BUR SUN RES ROHS DAY/MONTH/YEAR OF MFG SEQUENTIAL FOOTAGE MARK

Options:

- Class C stranding
- Individual and overall shielded pairs/triads
- Other constructions available upon request

Applications:

- In free air, raceways, aerial or direct burial
- In wet or dry locations
- Permitted for use in Class I Division 2 industrial hazardous locations per NEC

Features:

- Rated at 90°C wet or dry
- Ripcord applied to all cables with jacket thickness of 60 mils or less
- Excellent physical and electrical properties
- Excellent moisture resistance
- Excellent resistance to compression and impact
- Chemical-resistant
- Low coefficient of friction for easy pulling
- Sunlight- and weather-resistant
- Meets cold bend test at -30°C
- Low-Smoke, Zero-Halogen jacket is environmentally safe
- Low-Smoke, Zero-Halogen jacket reduces the amount of toxic and corrosive gases emitted during combustion, providing a safer environment for personnel and equipment during the hazards of fire

Compliances:

Industry Compliances:

- UL 1277 Type TC-LS
- UL 1581
- ROHS Compliant

Flame Tests Compliances:

- UL 1581
- UL 1277
- UL 1685
- IEEE 1202

Other Compliances:

- EPA 40 CFR, Part 261 for leachable lead content per TCLP
- OSHA acceptable

Packaging:

- Material cut to length and shipped on non-returnable wood reels

CATALOG NUMBER	NO. OF PAIRS/TRIADS	COND. SIZE (AWG)	COND. STRAND	MINIMUM AVG. INSULATION THICKNESS		MINIMUM AVG. JACKET THICKNESS		NOMINAL CABLE O.D.		COPPER WEIGHT		NET WEIGHT	
				INCHES	mm	INCHES	mm	INCHES	mm	LBS/1000 FT	kg/km	LBS/1000 FT	kg/km

OVERALL SHIELDED PAIRS/TRIADS 18 AWG CONDUCTORS

393710*	1	18	7/.0152	0.030	0.76	0.045	1.14	0.315	8.00	13	19	46	68
393720*	1 TRI	18	7/.0152	0.030	0.76	0.045	1.14	0.340	8.64	18	26	58	86
393730*	2	18	7/.0152	0.030	0.76	0.045	1.14	0.450	11.43	23	34	88	131
393740*	4	18	7/.0152	0.030	0.76	0.045	1.14	0.560	14.22	44	65	144	214
393750*	8	18	7/.0152	0.030	0.76	0.060	1.52	0.750	19.05	86	127	263	391
393760*	12	18	7/.0152	0.030	0.76	0.080	2.03	0.850	21.59	127	189	358	533
393770*	16	18	7/.0152	0.030	0.76	0.080	2.03	1.010	25.65	169	251	461	686
393780*	20	18	7/.0152	0.030	0.76	0.080	2.03	1.085	27.56	210	313	600	893
393790*	24	18	7/.0152	0.030	0.76	0.080	2.03	1.210	30.73	252	375	701	1043
393800*	36	18	7/.0152	0.030	0.76	0.080	2.03	1.500	38.10	377	561	1005	1496
393810*	50	18	7/.0152	0.030	0.76	0.080	2.03	2.570	65.28	523	778	1603	2386

OVERALL SHIELDED PAIRS/TRIADS 16 AWG CONDUCTORS

393820	1	16	7/.0192	0.030	0.76	0.045	1.14	0.345	8.76	18	28	32	48
393830	1 TRI	16	7/.0192	0.030	0.76	0.045	1.14	0.360	9.14	26	39	72	107
393840*	2	16	7/.0192	0.030	0.76	0.045	1.14	0.560	14.22	36	54	121	180
393850*	4	16	7/.0192	0.030	0.76	0.060	1.52	0.650	16.51	69	103	186	277
393860*	8	16	7/.0192	0.030	0.76	0.060	1.52	0.810	20.57	135	201	324	482
393870*	12	16	7/.0192	0.030	0.76	0.080	2.03	1.000	25.40	202	300	486	723
393880*	16	16	7/.0192	0.030	0.76	0.080	2.03	1.120	28.45	268	399	616	917
393890*	20	16	7/.0192	0.030	0.76	0.080	2.03	1.170	29.72	335	498	734	1092
393900*	24	16	7/.0192	0.030	0.76	0.080	2.03	1.440	36.58	401	597	894	1330
393910*	36	16	7/.0192	0.030	0.76	0.080	2.03	1.650	41.91	601	894	1254	1866
393920*	50	16	7/.0192	0.030	0.76	0.110	2.79	2.020	51.31	834	1241	1800	2679

Dimensions and weights are nominal; subject to industry tolerances.

*Non-stock item, minimum runs apply. Please consult Customer Service for price and delivery.



Phone: 888-593-3355
www.generalcable.com

GenFree™

XLPO/LSZH, Instrumentation, Shielded
600V, UL Type TC-LS, Individual and Overall Shielded Pairs

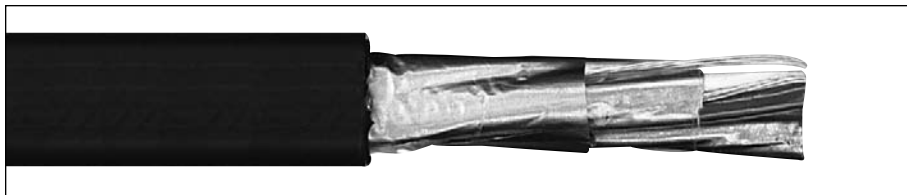

Product Construction

Conductor:

- 18 AWG and 16 AWG tinned, annealed copper per ASTM B33
- Class B stranding per ASTM B8

Insulation:

- Flame-retardant, Low-Smoke, Cross-Linked Polyolefin (XLPO)
- Color-coded: per ICEA Method 1; Pairs - black and white. One conductor in each pair is printed alpha-numerically for easy identification

Shield:

Individual and overall shielded pairs

- Individual pairs are 100% individually shielded with Flexfoil® aluminum/polyester in contact with stranded tinned copper drain wire
- Overall shield is Flexfoil® aluminum/polyester in contact with stranded tinned copper drain wire

Jacket:

- Flame-retardant, Sunlight-resistant, Low-Smoke, Zero-Halogen Polyolefin (LSZH)

Print:

- GENERAL CABLE® (WC) GENFREE™ XX/SPS XXAWG XLPO/LSZH SHIELDED UL TYPE TC-LS 90°C WET OR DRY 600V DIR BUR SUN RES ROHS DAY/MONTH/YEAR OF MFG SEQUENTIAL FOOTAGE MARK

Options:

- Class C stranding
- Overall shielded pairs
- Other constructions available upon request

Applications:

- In free air, raceways, aerial or direct burial
- In wet or dry locations
- Permitted for use in Class I Division 2 industrial hazardous locations per NEC

Features:

- Rated at 90°C wet or dry
- Ripcord applied to all cables with jacket thickness of 60 mils or less
- Excellent physical and electrical properties
- Excellent moisture resistance
- Excellent resistance to compression and impact
- Chemical-resistant
- Low coefficient of friction for easy pulling
- Sunlight- and weather-resistant
- Meets cold bend test at -30°C
- Low-Smoke, Zero-Halogen jacket is environmentally safe
- Low-Smoke, Zero-Halogen jacket reduces the amount of toxic and corrosive gases emitted during combustion, providing a safer environment for personnel and equipment during the hazards of fire

Compliances:

Industry Compliances:

- UL 1277 Type TC-LS
- UL 1581
- ROHS Compliant

Flame Tests Compliances:

- UL 1581
- UL 1277
- UL 1685
- IEEE 1202

Other Compliances:

- EPA 40 CFR, Part 261 for leachable lead content per TCLP
- OSHA acceptable

Packaging:

- Material cut to length and shipped on non-returnable wood reels

CATALOG NUMBER	NO. OF PAIRS	COND. SIZE (AWG)	COND. STRAND	MINIMUM AVG. INSULATION THICKNESS		MINIMUM AVG. JACKET THICKNESS		NOMINAL CABLE O.D.		COPPER WEIGHT		NET WEIGHT	
				INCHES	mm	INCHES	mm	INCHES	mm	LBS/1000 FT	kg/km	LBS/1000 FT	kg/km

INDIVIDUAL AND OVERALL SHIELDED PAIRS 18 AWG CONDUCTORS

393930	2	18	7/.0152	0.030	0.76	0.045	1.14	0.510	12.95	27	41	92	137
393940	4	18	7/.0152	0.030	0.76	0.060	1.52	0.630	16.00	53	78	167	249
393950*	8	18	7/.0152	0.030	0.76	0.080	2.03	0.855	21.72	103	153	326	485
393960*	12	18	7/.0152	0.030	0.76	0.080	2.03	1.030	26.16	153	228	441	656
393970*	16	18	7/.0152	0.030	0.76	0.080	2.03	1.140	28.96	206	307	554	824
393980*	20	18	7/.0152	0.030	0.76	0.080	2.03	1.265	32.13	254	378	676	1006
393990*	24	18	7/.0152	0.030	0.76	0.080	2.03	1.450	36.83	311	463	795	1183
394000*	36	18	7/.0152	0.030	0.76	0.010	2.79	1.650	41.91	461	687	1118	1664
394010*	50	18	7/.0152	0.030	0.76	0.010	2.79	2.085	52.96	640	952	1616	2405

INDIVIDUAL AND OVERALL SHIELDED PAIRS 16 AWG CONDUCTORS

394020	2	16	7/.0192	0.030	0.76	0.060	1.52	0.585	14.86	40	59	130	193
394030	4	16	7/.0192	0.030	0.76	0.060	1.52	0.675	17.15	77	114	204	304
394040	6	16	7/.0192	0.030	0.76	0.060	1.52	0.800	20.32	115	171	301	447
394050	8	16	7/.0192	0.030	0.76	0.080	2.03	0.915	23.24	151	225	394	586
394060	12	16	7/.0192	0.030	0.76	0.080	2.03	1.110	28.19	226	337	548	816
394070*	16	16	7/.0192	0.030	0.76	0.080	2.03	1.350	34.29	305	453	713	1061
394080*	20	16	7/.0192	0.030	0.76	0.080	2.03	1.365	34.67	380	566	850	1265
394090*	24	16	7/.0192	0.030	0.76	0.080	2.03	1.570	39.88	455	677	1001	1490
394100*	36	16	7/.0192	0.030	0.76	0.110	2.79	1.980	50.29	683	1016	1548	2304
394110*	50	16	7/.0192	0.030	0.76	0.110	2.79	2.165	54.99	946	1408	2020	3006

Dimensions and weights are nominal; subject to industry tolerances.

*Non-stock item, minimum runs apply. Please consult Customer Service for price and delivery.



GenFree™

XLPO/LSZH, Instrumentation, Shielded
600V, UL Type TC-LS, Individual and Overall Shielded Triads

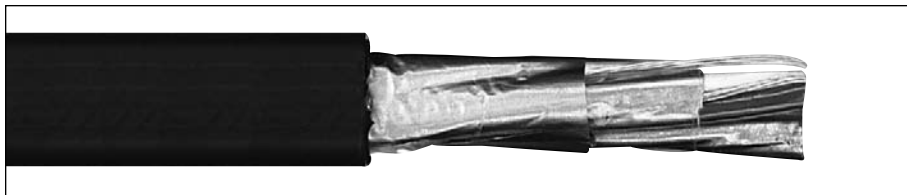

Product Construction

Conductor:

- 18 AWG and 16 AWG tinned, annealed copper per ASTM B33
- Class B stranding per ASTM B8

Insulation:

- Flame-retardant, Low-Smoke, Cross-Linked Polyolefin (XLPO)
- Color-coded: per ICEA Method 1; Triads - black, white and red. One conductor in each triad is printed alpha-numerically for easy identification

Shield:

Individual and overall shielded triads

- Individual triads are 100% shielded with Flexfoil® aluminum/polyester in contact with stranded tinned copper drain wire
- Overall shield is Flexfoil® aluminum/polyester in contact with stranded tinned copper drain wire

Jacket:

- Flame-retardant, Sunlight-resistant, Low-Smoke, Zero-Halogen Polyolefin (LSZH)

Print:

- GENERAL CABLE® (WC) GENFREE™ XX/STS XXAWG XLPO/LSZH SHIELDED UL TYPE TC-LS 90°C WET OR DRY 600V DIR BUR SUN RES ROHS DAY/MONTH/YEAR OF MFG SEQUENTIAL FOOTAGE MARK

Options:

- Class C stranding
- Overall shielded pairs/triads
- Other constructions available upon request

Applications:

- In free air, raceways, aerial or direct burial
- In wet or dry locations
- Permitted for use in Class I Division 2 industrial hazardous locations per NEC

Features:

- Rated at 90°C wet or dry
- Ripcord applied to all cables with jacket thickness of 60 mils or less
- Excellent physical and electrical properties
- Excellent moisture resistance
- Excellent resistance to compression and impact
- Chemical-resistant
- Low coefficient of friction for easy pulling
- Sunlight- and weather-resistant
- Meets cold bend test at -30°C
- Low-Smoke, Zero-Halogen jacket is environmentally safe
- Low-Smoke, Zero-Halogen jacket reduces the amount of toxic and corrosive gases emitted during combustion, providing a safer environment for personnel and equipment during the hazards of fire

Compliances:

Industry Compliances:

- UL 1277 Type TC-LS
- UL 1581
- ROHS Compliant

Flame Tests Compliances:

- UL 1581
- UL 1277
- UL 1685
- IEEE 1202

Other Compliances:

- EPA 40 CFR, Part 261 for leachable lead content per TCLP
- OSHA acceptable

Packaging:

- Material cut to length and shipped on non-returnable wood reels

CATALOG NUMBER	NO. OF TRIADS	COND. SIZE (AWG)	COND. STRAND	MINIMUM AVG. INSULATION THICKNESS		MINIMUM AVG. JACKET THICKNESS		NOMINAL CABLE O.D.		COPPER WEIGHT		NET WEIGHT	
				INCHES	mm	INCHES	mm	INCHES	mm	LBS/1000 FT	kg/km	LBS/1000 FT	kg/km

INDIVIDUAL AND OVERALL SHIELDED TRIADS 18 AWG CONDUCTORS

394120*	2 TRI	18	7/.0152	0.030	0.76	0.060	1.52	0.595	15.11	38	57	150	223
394130*	4 TRI	18	7/.0152	0.030	0.76	0.060	1.52	0.690	17.53	74	110	231	344
394140*	8 TRI	18	7/.0152	0.030	0.76	0.080	2.03	0.940	23.88	145	216	435	647
394150*	12 TRI	18	7/.0152	0.030	0.76	0.080	2.03	1.135	28.83	217	323	612	911
394160*	16 TRI	18	7/.0152	0.030	0.76	0.080	2.03	1.265	32.13	289	430	773	1150
394170*	20 TRI	18	7/.0152	0.030	0.76	0.080	2.03	1.405	35.69	361	537	935	1391
394180*	24 TRI	18	7/.0152	0.030	0.76	0.080	2.03	1.565	39.75	432	643	1097	1633
394190*	36 TRI	18	7/.0152	0.030	0.76	0.110	2.79	1.860	47.24	647	963	1662	2473

INDIVIDUAL AND OVERALL SHIELDED TRIADS 16 AWG CONDUCTORS

394200*	2 TRI	16	7/.0192	0.030	0.76	0.060	1.52	0.640	16.26	57	84	183	272
394210*	4 TRI	16	7/.0192	0.030	0.76	0.060	1.52	0.745	18.92	111	165	494	735
394220*	8 TRI	16	7/.0192	0.030	0.76	0.080	2.03	1.015	25.78	219	326	549	817
394230*	12 TRI	16	7/.0192	0.030	0.76	0.080	2.03	1.230	31.24	328	487	777	1156
394240*	16 TRI	16	7/.0192	0.030	0.76	0.080	2.03	1.370	34.80	437	650	988	1470
394250*	20 TRI	16	7/.0192	0.030	0.76	0.080	2.03	1.525	38.74	545	811	1120	1667
394260*	24 TRI	16	7/.0192	0.030	0.76	0.110	2.79	1.760	44.70	654	973	1530	2277
394270*	36 TRI	16	7/.0192	0.030	0.76	0.110	2.79	2.015	51.18	979	1457	2142	3188

Dimensions and weights are nominal; subject to industry tolerances.

*Non-stock item, minimum runs apply. Please consult Customer Service for price and delivery.



Phone: 888-593-3355
www.generalcable.com

600V Flexible Control and Power Cables

SPECIFICATION NO.		PRODUCT DESCRIPTION	REVISION DATE
3050	Super Flexing	XLPE/NYLON/HYP, Thermoset Super Flexing Control 600V, UL Type TC/CSA CIC	Jan. 2008
3100	PNH®	PVC/NYLON/HYP, Thermoset Continuous Flexing Control 600V, UL Type TC/CSA AWM	Jan. 2008
3150	NVN®	PVC/NYLON/NEOPRENE, Thermoset Flexible Control 600V, UL Type TC	Jan. 2008
3200	PNP	PVC/NYLON/NITRILE/PVC, Thermoset Continuous Flexing Control 600V, UL Type TC/CSA AWM	Jan. 2008
3250	MTW	PVC/NYLON/PVC, Thermoplastic Flexible Control 600V, UL Type MTW/CSA AWM	Jan. 2008
3300	Festoon	PVC/PVC, Thermoplastic Extreme Flexing Festoon Control and Power 600V, UL/CSA Type Festoon	Jan. 2008

Super Flexing

XLPE/NYLON/HYP, Thermoset Super Flexing Control
600V, UL Type TC/CSA CIC

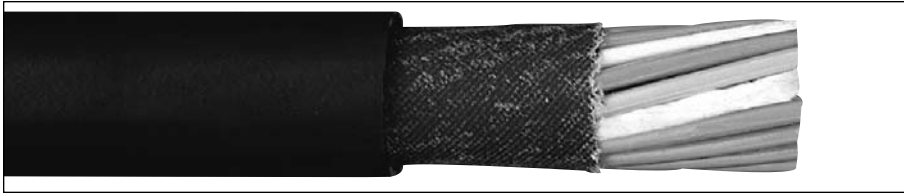

Product Construction

Conductor:

- 18 AWG thru 10 AWG fully annealed stranded bare copper per ASTM B3
- Class M-18 AWG thru 16 AWG
- Class K-14 AWG thru 10 AWG
- Stranding per ASTM B8

Insulation:

- Thermoset Cross-Linked Polyethylene (XLPE) with clear Polyamide (nylon)
- Color-coded: all conductors red, except #2 is white and #3 is green, all with alpha-numeric designations

Jacket:

- Lead-Free Hypalon® Chlorosulfonated Polyethylene (CSPE)/Elastomer blend

Print:

- GENERAL CABLE® BRAND REX BRAND (WC) SUPER FLEXING (UL) TYPE TC 600V 90°C DRY 75°C WET XXAWG XX COND/CSA CIC 90°C 600V XLPE -25°C FT4

Applications:

- Any continuous flexing application requiring a small diameter flexible cable
- Robots
- Machine tools
- Car body and vehicle assembly
- Material handling equipment
- Power tracks

Features:

- Rated at 90°C, 75°C wet
- Extremely flexible with long flex life
- Small diameter
- Thermoset rubber insulation and jacket
- Oil-resistant
- Suitable for indoor and outdoor applications
- Meets cold bend test at -30°C
- Meets cold impact test at -25°C

Compliances:

Industry Compliances:

- UL Type TC / CSA CIC

Flame Tests Compliances:

- IEEE 1202 (70,000 BTU/hr) CSA FT4
- IEEE 383 (70,000 BTU/hr)

Other Compliances:

- Meets EPA 40 CFR, part 261 for leachable lead content per TCLP method
- OSHA acceptable

Packaging:

- Material cut to length and shipped on non-returnable wood reels

CATALOG NUMBER	NO. OF COND.	COND. SIZE (AWG)	COND. STRAND	MINIMUM AVG. INSULATION THICKNESS		MINIMUM AVG. JACKET THICKNESS		NOMINAL CABLE O.D.		COPPER WEIGHT		NET WEIGHT		MINIMUM BEND RADIUS	
				INCHES	mm	INCHES	mm	INCHES	mm	LBS/1000FT	kg/km	LBS/1000FT	kg/km	INCHES	mm

18 AWG CONDUCTORS

338950*	6	18	41/34	0.020	0.51	0.045	1.14	0.390	9.91	32	48	93	138	3.0	76.2
338960*	8	18	41/34	0.020	0.51	0.045	1.14	0.455	11.30	42	63	116	173	3.5	88.9
338970*	12	18	41/34	0.020	0.51	0.045	1.14	0.490	12.45	63	94	155	231	4.0	101.6
338980*	16	18	41/34	0.020	0.51	0.060	1.52	0.570	14.48	84	125	211	314	4.5	114.3
338990*	22	18	41/34	0.020	0.51	0.060	1.52	0.650	16.51	116	173	272	405	5.0	127.0
339000*	31	18	41/34	0.020	0.51	0.060	1.52	0.750	19.05	163	243	366	545	6.0	152.4
339010*	41	18	41/34	0.020	0.51	0.080	2.03	0.880	22.35	216	321	498	741	7.0	177.8
339020*	60	18	41/34	0.020	0.51	0.080	2.03	1.000	25.40	316	470	676	1006	8.0	203.2

16 AWG CONDUCTORS

339030*	6	16	65/34	0.020	0.51	0.045	1.14	0.430	10.92	50	74	122	182	3.5	88.9
339040*	8	16	65/34	0.020	0.51	0.045	1.14	0.490	12.45	66	98	152	226	4.0	101.6
270230*	12	16	65/34	0.020	0.51	0.060	1.52	0.575	14.61	99	147	216	321	4.5	114.3
219390*	16	16	65/34	0.020	0.51	0.060	1.52	0.630	16.00	132	196	277	412	5.0	127.0
218990*	22	16	65/34	0.020	0.51	0.060	1.52	0.725	18.42	182	271	368	548	5.5	139.7
524310*	31	16	65/34	0.020	0.51	0.060	1.52	0.835	21.21	256	381	491	731	6.5	165.1
218970*	41	16	65/34	0.020	0.51	0.080	2.03	0.985	25.02	339	504	683	1016	8.0	203.2
710580*	60	16	65/34	0.020	0.51	0.080	2.03	1.115	28.32	496	738	912	1357	9.0	228.6

14 AWG CONDUCTORS

339050*	6	14	41/30	0.020	0.51	0.045	1.14	0.460	11.68	80	119	159	237	3.5	88.9
339060*	8	14	41/30	0.020	0.51	0.060	1.52	0.560	14.22	107	159	219	326	4.5	114.3
339070*	12	14	41/30	0.020	0.51	0.060	1.52	0.620	15.72	160	238	295	439	5.0	127.0
339080*	16	14	41/30	0.020	0.51	0.060	1.52	0.680	17.27	213	317	375	558	5.5	139.7
339090*	22	14	41/30	0.020	0.51	0.060	1.52	0.785	19.94	293	437	495	737	6.0	152.4

12 AWG CONDUCTORS

264980*	6	12	65/30	0.020	0.51	0.060	1.52	0.555	14.10	129	192	238	354	4.5	114.3
339100*	8	12	65/30	0.020	0.51	0.060	1.52	0.635	16.13	172	256	300	446	5.0	127.0
226130*	12	12	65/30	0.020	0.51	0.060	1.52	0.705	17.91	258	384	433	644	5.5	139.7
339110*	16	12	65/30	0.020	0.51	0.060	1.52	0.780	19.81	344	512	535	796	6.0	152.4
339120*	22	12	65/30	0.020	0.51	0.080	2.03	0.945	24.00	473	704	789	1174	7.5	190.5

10 AWG CONDUCTORS

339130*	6	10	105/30	0.026	0.66	0.060	1.52	0.655	16.64	205	305	350	521	5.0	127.0
339140*	8	10	105/30	0.026	0.66	0.060	1.52	0.755	19.18	274	408	450	670	6.0	152.4
339150*	12	10	105/30	0.026	0.66	0.080	2.03	0.885	22.48	411	612	675	1005	7.0	177.8
339160*	16	10	105/30	0.026	0.66	0.080	2.03	1.145	29.08	548	816	905	1347	9.0	228.6

Dimensions and weights are nominal; subject to industry tolerances.

*Non-stock item, minimum runs apply. Please consult Customer Service for price and delivery.

PNH[®]

PVC/NYLON/HYP, Thermoset Continuous Flexing Control
600V, UL Type TC/CSA AWM



Product Construction

Conductor:

- 18 AWG thru 12 AWG fully annealed stranded bare copper per ASTM B3
- Class M-18 AWG thru 16 AWG
- Class K-14 AWG thru 12 AWG
- Stranding per ASTM B8

Insulation:

- Flame-retardant Polyvinyl Chloride (PVC) with clear Polyamide (nylon)
- Color-coded: all conductors are red, except #2 is white and #3 is green. All with alpha-numeric designations

Jacket:

- Lead-Free Hypalon[®] Chlorosulfonated Polyethylene (CSPE)/Elastomer blend

Print:

- GENERAL CABLE[®] BRAND REX BRAND (WC) PNH FLEX 90°C 600V TYPE TC XX/C XXAWG(TFFN) OR (THHW/THWN) (UL)/CSA AWM IIA 90°C 600V FT1

Applications:

- Any continuous flexing application requiring a small diameter flexible cable
- Robots
- Machine tools
- Car body and vehicle assembly
- Material handling equipment
- Power tracks

Features:

- Rated at 90°C
- Extremely flexible with long flex life
- Small diameter
- Thermoset rubber jacket
- Oil-resistant
- Suitable for indoor or outdoor applications
- Meets cold bend test at -40°C

Compliances:

Industry Compliances:

- UL Type TC / CSA AWM

Flame Tests Compliances:

- IEEE 1202 (70,000 BTU/hr) CSA FT4
- IEEE 383 (70,000 BTU/hr)

Other Compliances:

- Meets EPA 40 CFR, part 261 for leachable lead content per TCLP method
- OSHA acceptable

Packaging:

- Material cut to length and shipped on non-returnable wood reels

CATALOG NUMBER	NO. OF COND.	COND. SIZE (AWG)	COND. STRAND	MINIMUM AVG. INSULATION THICKNESS		MINIMUM AVG. JACKET THICKNESS		NOMINAL CABLE O.D.		COPPER WEIGHT		NET WEIGHT		MINIMUM BEND RADIUS	
				INCHES	mm	INCHES	mm	INCHES	mm	LBS/1000FT	kg/km	LBS/1000FT	kg/km	INCHES	mm

18 AWG CONDUCTORS

338470*	6	18	41/34	0.020	0.51	0.045	1.14	0.390	9.91	32	48	93	138	3.0	76.2
338480*	8	18	41/34	0.020	0.51	0.045	1.14	0.455	11.30	42	63	116	173	3.5	88.9
338490*	12	18	41/34	0.020	0.51	0.045	1.14	0.490	12.45	63	94	155	231	4.0	101.6
338500*	16	18	41/34	0.020	0.51	0.060	1.52	0.570	14.48	84	125	211	314	4.5	114.3
338510*	22	18	41/34	0.020	0.51	0.060	1.52	0.650	16.51	112	167	272	405	5.0	127.0

16 AWG CONDUCTORS

338520*	6	16	65/34	0.020	0.51	0.045	1.14	0.430	10.92	50	74	122	182	3.5	88.9
338530*	8	16	65/34	0.020	0.51	0.045	1.14	0.490	12.45	66	98	152	226	3.9	99.1
338540*	12	16	65/34	0.020	0.51	0.060	1.52	0.575	14.61	99	147	216	321	4.5	114.3
338550*	16	16	65/34	0.020	0.51	0.060	1.52	0.630	16.00	132	196	277	412	5.0	127.0
338560*	22	16	65/34	0.020	0.51	0.060	1.52	0.725	18.42	182	271	368	548	5.5	139.7

14 AWG CONDUCTORS

338570*	6	14	41/30	0.020	0.51	0.045	1.14	0.460	11.68	80	119	159	186	3.7	94.0
338580*	8	14	41/30	0.020	0.51	0.060	1.52	0.560	14.22	107	159	219	326	4.5	114.3
338590*	12	14	41/30	0.020	0.51	0.060	1.52	0.670	17.02	160	238	295	439	5.0	127.0
338600*	16	14	41/30	0.020	0.51	0.060	1.52	0.680	17.27	213	317	375	558	5.5	139.7
338610*	22	14	41/30	0.020	0.51	0.060	1.52	0.785	19.94	293	436	495	736	6.0	152.4

12 AWG CONDUCTORS

338620*	6	12	65/30	0.020	0.51	0.060	1.52	0.555	14.10	129	192	238	354	4.5	114.3
338630*	8	12	65/30	0.020	0.51	0.060	1.52	0.635	16.13	172	256	300	446	5.0	127.0
338640*	12	12	65/30	0.020	0.51	0.060	1.52	0.705	17.91	258	384	433	644	5.5	139.7
338650*	16	12	65/30	0.020	0.51	0.060	1.52	0.780	19.81	344	512	535	796	6.0	152.4
338660*	22	12	65/30	0.020	0.51	0.080	2.03	0.945	24.00	473	704	789	1174	7.5	190.5

Dimensions and weights are nominal; subject to industry tolerances.

*Non-stock item, minimum runs apply. Please consult Customer Service for price and delivery.

NVN®

PVC/NYLON/NEOPRENE, Thermoset Flexible Control
600V, UL Type TC

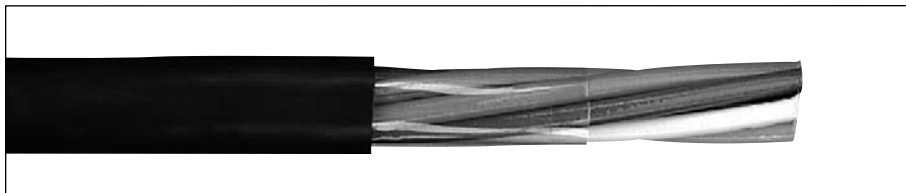

Product Construction

Conductor:

- 18 AWG thru 12 AWG fully annealed stranded bare copper per ASTM B3
- Class C stranding per ASTM B8

Insulation:

- Flame-retardant Polyvinyl Chloride (PVC) with clear Polyamide (nylon)
- Color-coded: per ICEA method 1: Table E-2 (Does not include white or green)

Jacket:

- Thermosetting Neoprene

Print:

- GENERAL CABLE® BRAND REX BRAND (WC) NVN 90°C FLEXIBLE CONTROL CABLE 600V TYPE TC SUN RES XX/C XXAWG (TFFN) OR (THHN/THWN) (UL)

Applications:

- Tight installations
- Trays, conduits and raceways
- Cranes and hoists
- Pendant stations
- Load lifts and platforms
- Recommended for moderate flex applications

Features:

- Rated at 90°C
- Moderate flex cable
- Small diameter
- Thermosetting rubber jacket
- Flame-retardant
- Suitable for indoor and outdoor applications
- Meets cold bend test at -40°C

Compliances:

Industry Compliances:

- UL Type TC - 600V

Flame Tests Compliances:

- IEEE 1202 (70,000 BTU/hr)
- IEEE 383 (70,000 BTU/hr)

Other Compliances:

- Meets EPA 40 CFR, part 261 for leachable lead content per TCLP method
- OSHA acceptable

Packaging:

- Material cut to length and shipped on non-returnable wood reels

CATALOG NUMBER	NO. OF COND.	COND. SIZE (AWG)	COND. STRAND	MINIMUM AVG. INSULATION THICKNESS		MINIMUM AVG. JACKET THICKNESS		NOMINAL CABLE O.D.		COPPER WEIGHT		NET WEIGHT		MINIMUM BEND RADIS	
				INCHES	mm	INCHES	mm	INCHES	mm	LBS/1000FT	kg/km	LBS/1000FT	kg/km	INCHES	mm

18 AWG CONDUCTORS

554420*	4	18	19/.0092	0.020	0.51	0.045	1.14	0.310	7.87	21	31	65	97	2.5	63.5
624740*	8	18	19/.0092	0.020	0.51	0.045	1.14	0.420	10.67	42	63	116	173	3.3	83.8
624750*	10	18	19/.0092	0.020	0.51	0.045	1.14	0.450	11.43	53	79	135	201	3.6	91.5
624760*	12	18	19/.0092	0.020	0.51	0.045	1.14	0.465	11.81	63	94	137	204	3.7	94.0
624010*	16	18	19/.0092	0.020	0.51	0.045	1.14	0.515	13.08	85	126	175	260	4.1	104.1
624780*	19	18	19/.0092	0.020	0.51	0.060	1.52	0.570	14.48	100	149	192	286	4.6	116.8
624790*	24	18	19/.0092	0.020	0.51	0.060	1.52	0.660	16.76	127	189	297	442	5.3	134.6
686890*	30	18	19/.0092	0.020	0.51	0.060	1.52	0.695	17.65	158	235	345	513	5.6	142.2

16 AWG CONDUCTORS

625160*	4	16	19/.0117	0.020	0.51	0.045	1.14	0.345	8.76	33	49	85	126	2.8	71.1
625200*	8	16	19/.0117	0.020	0.51	0.045	1.14	0.465	11.81	66	98	153	228	3.7	94.0
625220*	10	16	19/.0117	0.020	0.51	0.045	1.14	0.500	12.70	83	124	179	266	4.0	101.6
625230*	12	16	19/.0117	0.020	0.51	0.045	1.14	0.520	13.21	100	149	186	277	4.2	106.7
625250*	16	16	19/.0117	0.020	0.51	0.045	1.14	0.605	15.37	133	198	257	382	4.8	121.9
625270*	19	16	19/.0117	0.020	0.51	0.060	1.52	0.635	16.13	158	235	320	476	5.1	129.5
625280*	24	16	19/.0117	0.020	0.51	0.060	1.52	0.735	18.67	199	296	403	600	5.9	149.9
625290*	30	16	19/.0117	0.020	0.51	0.060	1.52	0.775	19.69	249	371	476	708	6.2	157.5

14 AWG CONDUCTORS

624950*	4	14	19/.0147	0.020	0.51	0.045	1.14	0.375	9.53	53	79	117	174	3.0	76.2
624980*	8	14	19/.0147	0.020	0.51	0.045	1.14	0.485	12.32	105	156	181	269	3.9	99.1
624990*	10	14	19/.0147	0.020	0.51	0.060	1.52	0.595	15.11	132	196	270	402	4.8	121.9
625000*	12	14	19/.0147	0.020	0.51	0.060	1.52	0.615	15.62	158	235	278	414	4.9	124.5
625020*	16	14	19/.0147	0.020	0.51	0.060	1.52	0.675	17.15	210	313	353	525	5.4	137.2
625030*	19	14	19/.0147	0.020	0.51	0.060	1.52	0.710	18.03	250	372	449	668	5.7	144.8
625040*	24	14	19/.0147	0.020	0.51	0.060	1.52	0.825	20.96	316	470	565	841	6.6	167.6
625050*	30	14	19/.0147	0.020	0.51	0.080	2.03	0.920	23.37	394	586	727	1082	7.4	188.0

12 AWG CONDUCTORS

324820*	4	12	19/.0185	0.020	0.51	0.045	1.14	0.420	10.67	84	125	157	234	3.4	86.4
624850*	8	12	19/.0185	0.020	0.51	0.060	1.52	0.575	14.61	167	249	272	405	4.6	116.9
624860*	10	12	19/.0185	0.020	0.51	0.060	1.52	0.670	17.02	209	311	369	549	5.4	137.2
624870*	12	12	19/.0185	0.020	0.51	0.060	1.52	0.690	17.53	250	372	389	579	5.5	139.7
624890*	16	12	19/.0185	0.020	0.51	0.060	1.52	0.765	19.43	334	497	503	749	6.1	155.0
624900*	19	12	19/.0185	0.020	0.51	0.060	1.52	0.805	20.45	397	591	638	949	6.5	165.1
624910*	24	12	19/.0185	0.020	0.51	0.080	2.03	0.980	24.89	501	746	841	1252	7.8	198.1
624920*	30	12	19/.0185	0.020	0.51	0.080	2.03	1.040	26.42	626	932	1017	1513	8.3	210.8

Dimensions and weights are nominal; subject to industry tolerances.

*Non-stock item, minimum runs apply. Please consult Customer Service for price and delivery.

PNP

PVC/NYLON/NITRILE/PVC, Thermoset Continuous Flexing Control
600V, UL Type TC/CSA AWM



Product Construction

Conductor:

- 16 AWG fully annealed stranded bare copper per ASTM B3
- Class M stranding per ASTM B8

Insulation:

- Flame-retardant Polyvinyl Chloride (PVC) with clear Polyamide (nylon)
- Color-coded: all conductors red, except #2 is white, the last conductor in each construction is green/yellow. All with alpha-numeric designations

Jacket:

- Thermosetting Nitrile/Polyvinyl Chloride (PVC)

Print:

- GENERAL CABLE® BRAND REX BRAND (WC) T-15071 (XX/16) PNP 16 AWG XX COND (UL) TYPE TC 600V 90°C (TFFN 16 AWG XX COND) CSA AWM IIA 90°C 600V FT1

Applications:

- Any continuous flexing application requiring a small diameter flexible cable
- Robots
- Machine tools
- Car body and vehicle assembly
- Plant automation equipment
- Flexible cable tracks

Features:

- Rated at 90°C dry, 75°C wet
- Flame-retardant
- Small diameter
- Oil-resistant
- Thermoset rubber jacket
- Meets cold bend test at -25°C

Compliances:

Industry Compliances:

- UL Type TC/CSA AWM

Flame Tests Compliances:

- IEEE 1202 (70,000 BTU/hr)
- IEEE 383 (70,000 BTU/hr)

Other Compliances:

- Meets EPA 40 CFR, part 261 for leachable lead content per TCLP method
- OSHA acceptable

Packaging:

- Material cut to length and shipped on non-returnable wood reels

CATALOG NUMBER	NO. OF COND.	COND. SIZE (AWG)	COND. STRAND	MINIMUM AVG. INSULATION THICKNESS		MINIMUM AVG. JACKET THICKNESS		NOMINAL CABLE O.D.		COPPER WEIGHT		NET WEIGHT		MINIMUM BEND RADIUS	
				INCHES	mm	INCHES	mm	INCHES	mm	LBS/1000FT	kg/km	LBS/1000FT	kg/km	INCHES	mm

16 AWG CONDUCTORS

338460*	11	16	65/34	0.020	0.51	0.060	1.52	0.580	14.73	91	135	190	283	4.50	114.3
293950*	12	16	65/34	0.020	0.51	0.060	1.52	0.580	14.73	99	147	195	290	4.50	114.3
338440*	16	16	65/34	0.020	0.51	0.060	1.52	0.635	16.13	132	196	251	374	5.00	127.0
307650*	17	16	65/34	0.020	0.51	0.060	1.52	0.670	17.02	140	208	275	409	5.25	133.4
293960*	19	16	65/34	0.020	0.51	0.060	1.52	0.705	17.91	157	233	304	452	5.50	139.7
311880*	21	16	65/34	0.020	0.51	0.060	1.52	0.770	19.56	174	258	339	504	6.00	152.4
306420*	22	16	65/34	0.020	0.51	0.060	1.52	0.770	19.56	182	270	346	515	6.00	152.4
288010*	25	16	65/34	0.020	0.51	0.060	1.52	0.815	22.70	207	308	401	597	6.50	165.1
338450*	31	16	65/34	0.020	0.51	0.080	2.03	0.890	22.61	256	380	483	719	7.00	177.8
293970*	33	16	65/34	0.020	0.51	0.080	2.03	0.890	22.61	273	406	506	753	7.00	177.8
288020*	41	16	65/34	0.020	0.51	0.080	2.03	0.975	24.77	339	504	622	922	7.75	196.8
307660*	42	16	65/34	0.020	0.51	0.080	2.03	0.975	24.77	347	516	629	932	7.75	196.8
292150*	47	16	65/34	0.020	0.51	0.080	2.03	1.025	26.04	388	577	684	1018	8.25	209.6
307370*	49	16	65/34	0.020	0.51	0.080	2.03	1.055	26.80	405	602	724	1077	8.50	215.9
293980*	60	16	65/34	0.020	0.51	0.080	2.03	1.125	28.58	496	738	851	1266	9.00	228.6
292160*	65	16	65/34	0.020	0.51	0.080	2.03	1.180	29.97	537	799	927	1380	9.50	241.3

Dimensions and weights are nominal; subject to industry tolerances.

*Non-stock item, minimum runs apply. Please consult Customer Service for price and delivery.

MTW

PVC/NYLON/PVC, Thermoplastic Flexible Control
600V, UL Type MTW/CSA AWM

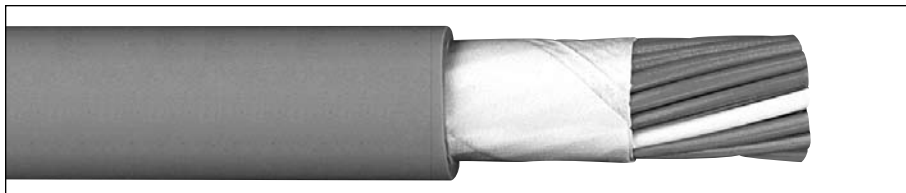

Product Construction

Conductor:

- 18 AWG thru 10 AWG fully annealed stranded bare copper per ASTM B3
- Class M-18 AWG thru 16 AWG
- Class K-14 AWG thru 10 AWG
- Stranding per ASTM B8

Insulation:

- Flame-retardant Polyvinyl Chloride (PVC) with clear Polyamide (nylon)
- Color-coded: all conductors red, except #2 is white and #3 is green. All with alpha-numeric designations

Jacket:

- Heat-, moisture- and oil-resistant Polyvinyl Chloride (PVC)

Print:

- GENERAL CABLE® BRAND REX BRAND (WC) TYPE MTW FLEXING 600V (UL) NO OF COND/ AWG SIZE/CSA AWM IIA 90°C 600V FT1

Applications:

- Pendant cable
- Machine tool
- Internal machine connections
- Material handling equipment
- Moderate flex

Features:

- Rated at 90°C
- Moisture- and oil-resistant
- Heavy-duty PVC jacket
- Meets cold bend test at -25°C

Compliances:

- Industry Compliances:**
 - UL Type MTW/CSA AWM
- Other Compliances:**
 - Meets EPA 40 CFR, part 261 for leachable lead content per TCLP method
 - OSHA acceptable
 - RoHS compliant

Packaging:

- Material cut to length and shipped on non-returnable wood reels

CATALOG NUMBER	NO. OF COND.	COND. SIZE (AWG)	COND. STRAND	MINIMUM AVG. INSULATION THICKNESS		MINIMUM AVG. JACKET THICKNESS		NOMINAL CABLE O.D.		COPPER WEIGHT		NET WEIGHT		MINIMUM BEND RADIUS	
				INCHES	mm	INCHES	mm	INCHES	mm	LBS/1000FT	kg/km	LBS/1000FT	kg/km	INCHES	mm

18 AWG CONDUCTORS

339170*	6	18	41/34	0.020	0.51	0.045	1.14	0.400	10.16	32	48	88	131	3.0	76.2
339180*	8	18	41/34	0.020	0.51	0.045	1.14	0.455	11.56	42	63	108	161	3.5	88.9
339190*	12	18	41/34	0.020	0.51	0.045	1.14	0.500	12.70	63	94	144	214	4.0	101.6
339200*	16	18	41/34	0.020	0.51	0.060	1.52	0.580	14.73	84	125	196	292	4.5	114.3
339210*	22	18	41/34	0.020	0.51	0.060	1.52	0.660	16.76	116	173	252	375	5.0	127.0
339220*	31	18	41/34	0.020	0.51	0.060	1.52	0.760	19.30	163	243	325	484	6.0	152.4
339230*	41	18	41/34	0.020	0.51	0.080	2.03	0.890	22.61	216	321	460	685	7.0	177.8
339240*	60	18	41/34	0.020	0.51	0.080	2.03	1.010	25.65	316	470	617	918	8.0	203.2

16 AWG CONDUCTORS

339250*	6	16	65/34	0.020	0.51	0.045	1.14	0.440	11.18	50	74	113	168	3.5	88.9
339260*	8	16	65/34	0.020	0.51	0.045	1.14	0.500	12.70	66	98	141	210	4.0	101.6
339270*	12	16	65/34	0.020	0.51	0.060	1.52	0.585	14.86	99	147	214	318	4.5	114.3
339280*	16	16	65/34	0.020	0.51	0.060	1.52	0.640	16.26	132	196	263	391	5.0	127.0
339290*	22	16	65/34	0.020	0.51	0.060	1.52	0.735	18.67	182	271	377	561	5.5	139.7
339300*	31	16	65/34	0.020	0.51	0.060	1.52	0.845	21.46	256	381	518	771	6.5	165.1
339310*	41	16	65/34	0.020	0.51	0.080	2.03	0.995	25.27	339	504	652	970	8.0	203.2
339320*	60	16	65/34	0.020	0.51	0.080	2.03	1.125	28.58	496	738	909	1353	9.0	228.2

14 AWG CONDUCTORS

339330*	6	14	41/30	0.020	0.51	0.045	1.14	0.470	11.94	80	119	149	222	3.5	88.9
339340*	8	14	41/30	0.020	0.51	0.060	1.52	0.570	14.48	107	159	204	304	4.5	114.3
339350*	12	14	41/30	0.020	0.51	0.060	1.52	0.630	16.00	160	238	279	415	5.0	127.0
339360*	16	14	41/30	0.020	0.51	0.060	1.52	0.690	17.53	213	317	354	527	5.5	139.7
339370*	22	14	41/30	0.020	0.51	0.060	1.52	0.795	20.19	293	436	467	695	6.0	152.4

12 AWG CONDUCTORS

339380*	6	12	65/30	0.020	0.51	0.060	1.52	0.565	14.35	129	192	226	336	4.5	114.3
339390*	8	12	65/30	0.020	0.51	0.060	1.52	0.645	16.38	172	256	289	430	5.0	127.0
339400*	12	12	65/30	0.020	0.51	0.060	1.52	0.715	18.16	258	384	398	592	5.5	139.7
339410*	16	12	65/30	0.020	0.51	0.060	1.52	0.790	20.07	344	512	506	753	6.0	152.4
339420*	22	12	65/30	0.020	0.51	0.080	2.03	0.955	24.26	473	704	720	1072	7.5	190.0

10 AWG CONDUCTORS

339430*	6	10	105/30	0.026	0.66	0.060	1.52	0.665	16.89	205	305	329	490	5.0	127.0
339440*	8	10	105/30	0.026	0.66	0.060	1.52	0.765	19.43	274	408	424	631	6.0	152.4
339450*	12	10	105/30	0.026	0.66	0.080	2.03	0.895	22.73	411	612	604	899	7.0	177.8
339460*	16	10	105/30	0.026	0.66	0.080	2.03	1.155	29.34	548	816	852	1268	9.0	228.6

Dimensions and weights are nominal; subject to industry tolerances.

*Non-stock item, minimum runs apply. Please consult Customer Service for price and delivery.

Festoon

PVC/PVC, Thermoplastic Extreme Flexing Festoon Control and Power
600V, UL/CSA Type Festoon

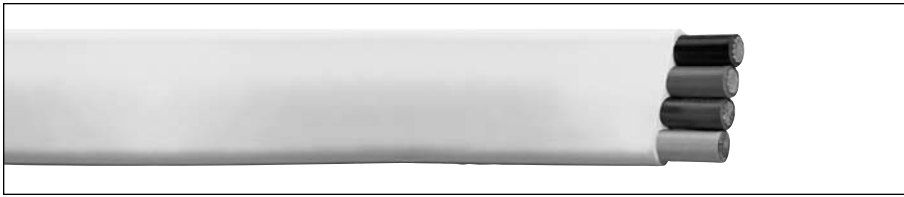

Product Construction

Conductor:

- 16 AWG thru 2 AWG fully annealed stranded bare copper per ASTM B3
- Class M - 16 AWG
- Class K - 14 AWG thru 2 AWG
- Stranding per ASTM B8

Insulation:

- Flame-retardant Polyvinyl Chloride (PVC)
- Color-coded: per ICEA Method 1; Table E-2 (does not include white or green). All with alpha-numeric designations

Jacket:

- Flame-retardant Polyvinyl Chloride (PVC) - yellow or black

Print:

- E-24573 PVC T-XXXXX 105°C 600V VW-1 (UL)-FESTOON CABLE OUTDOOR XX/C XX/AWG-CSA LL9755 105°C 600V FT1

Applications:

- Cranes and hoists
- Festooning systems
- Track systems
- Robots
- Conveyors
- Telescoping jetways

Features:

- Rated at 105°C
- Designed for continuous extreme flexing applications
- Anti-coiling in festoon applications
- Small bending radii
- Flat construction allows for stacking
- Oil- and chemical-resistant
- Indoor or outdoor use
- Meets cold bend test at -55°C

Compliances:

- Industry Compliances:**
 - UL listed/CSA certified flat festoon cable
- Flame Tests Compliances:**
 - UL VW-1/CSA FT1
- Other Compliances:**
 - Meets EPA 40 CFR, part 261 for leachable lead content per TCLP method
 - OSHA Acceptable

Packaging:

- Material cut to length and shipped on non-returnable wood reels

CATALOG NUMBER	NO. OF COND.	COND. SIZE (AWG)	COND. STRAND	MINIMUM AVG. INSULATION THICKNESS		MINIMUM AVG. JACKET THICKNESS		NOMINAL CABLE O.D.		COPPER WEIGHT		NET WEIGHT	
				INCHES	mm	INCHES	mm	INCHES	mm	LBS/1000FT	kg/km	LBS/1000FT	kg/km
16 AWG CONDUCTORS													
¥245310*	4	16	65/34	0.030	0.76	0.035	0.89	0.200 x 0.580	5.1 x 14.73	31.92	47.05	91	135
419630*	4	16	65/34	0.030	0.76	0.035	0.89	0.200 x 0.580	5.1 x 14.73	31.92	47.05	91	135
¥245320*	8	16	65/34	0.030	0.76	0.035	0.89	0.200 x 1.110	5.1 x 28.20	63.84	95.00	173	257
404010*	8	16	65/34	0.030	0.76	0.035	0.89	0.200 x 1.110	5.1 x 28.20	63.84	95.00	173	257
¥245330*	12	16	65/34	0.030	0.76	0.035	0.89	0.200 x 1.605	5.1 x 40.77	95.76	142.50	253	377
404020*	12	16	65/34	0.030	0.76	0.035	0.89	0.200 x 1.605	5.1 x 40.77	95.76	142.50	253	377
14 AWG CONDUCTORS													
¥245340*	4	14	41/30	0.030	0.76	0.035	0.89	0.210 x 0.710	5.33 x 18.54	51.52	76.67	116	173
404030*	4	14	41/30	0.030	0.76	0.035	0.89	0.210 x 0.710	5.33 x 18.54	51.52	76.67	116	173
¥245350*	8	14	41/30	0.030	0.76	0.035	0.89	0.210 x 1.175	5.33 x 29.85	103.04	153.33	224	333
404090*	8	14	41/30	0.030	0.76	0.035	0.89	0.210 x 1.175	5.33 x 29.85	103.04	153.33	224	333
¥245360*	12	14	41/30	0.030	0.76	0.035	0.89	0.210 x 1.700	5.33 x 43.18	154.56	230.00	330	491
403990*	12	14	41/30	0.030	0.76	0.035	0.89	0.210 x 1.700	5.33 x 43.18	154.56	230.00	330	491
12 AWG CONDUCTORS													
¥245370*	4	12	65/30	0.030	0.76	0.035	0.89	0.230 x 0.710	5.84 x 18.54	83.04	123.57	160	238
404040*	4	12	65/30	0.030	0.76	0.035	0.89	0.230 x 0.710	5.84 x 18.54	83.04	123.57	160	238
¥245380*	5	12	65/30	0.030	0.76	0.035	0.89	0.230 x 0.865	5.84 x 21.97	103.80	154.47	195	290
238800*	5	12	65/30	0.030	0.76	0.035	0.89	0.230 x 0.865	5.84 x 21.97	103.80	154.47	195	290
¥365680*	7	12	65/30	0.030	0.76	0.035	0.89	0.230 x 1.340	5.84 x 34.04	145.32	216.25	271	403
404080*	7	12	65/30	0.030	0.76	0.035	0.89	0.230 x 1.340	5.84 x 34.04	145.32	216.25	271	403
¥245390*	8	12	65/30	0.030	0.76	0.035	0.89	0.230 x 1.650	5.84 x 41.91	166.08	247.14	307	457
404330*	8	12	65/30	0.030	0.76	0.035	0.89	0.230 x 1.650	5.84 x 41.91	166.08	247.14	307	457
10 AWG CONDUCTORS													
¥245400*	4	10	105/30	0.030	0.76	0.045	1.14	0.270 x 0.880	6.86 x 22.35	132.32	196.91	241	359
404000*	4	10	105/30	0.030	0.76	0.045	1.14	0.270 x 0.880	6.86 x 22.35	132.32	196.91	241	359
8 AWG CONDUCTORS													
¥245410*	4	8	168/30	0.045	1.14	0.045	1.14	0.365 x 1.190	9.27 x 30.23	212.40	316.07	405	603
406320*	4	8	168/30	0.045	1.14	0.045	1.14	0.365 x 1.190	9.27 x 30.23	212.40	316.07	405	603
6 AWG CONDUCTORS													
¥245420*	4	6	266/30	0.060	1.52	0.045	1.14	0.430 x 1.450	10.92 x 36.83	332.88	495.36	612	911
404050*	4	6	266/30	0.060	1.52	0.045	1.14	0.430 x 1.450	10.92 x 36.83	332.88	495.36	612	911
¥332010*	5	6	266/30	0.060	1.52	0.045	1.14	0.430 x 1.735	10.92 x 44.07	416.10	619.20	747	1112
434680*	5	6	266/30	0.060	1.52	0.045	1.14	0.430 x 1.735	10.92 x 44.07	416.10	619.20	747	1112
4 AWG CONDUCTORS													
¥245440*	4	4	420/30	0.060	1.52	0.045	1.14	0.490 x 1.690	12.45 x 42.93	560.00	833.34	750	1116
404060*	4	4	420/30	0.060	1.52	0.045	1.14	0.490 x 1.690	12.45 x 42.93	560.00	833.34	750	1116
2 AWG CONDUCTORS													
¥245450*	4	2	665/30	0.060	1.52	0.045	1.14	0.560 x 1.955	14.23 x 49.66	852.00	1267.86	1273	1894
404070*	4	2	665/30	0.060	1.52	0.045	1.14	0.560 x 1.955	14.23 x 49.66	852.00	1267.86	1273	1894

Dimensions and weights are nominal; subject to industry tolerances.

* Non-stock item, minimum runs apply. Please consult Customer Service for price and delivery.

¥ Indicates black jacketed cables.



600V Multi Conductor Control and Power Cables

SPECIFICATION NO.	PRODUCT DESCRIPTION	REVISION DATE
4050 [†]	CHTC [®] XLPE/HYP, Control, Unshielded 600V, UL Type TC—E-2 Color Code	Jan. 2009
4075 [†]	CHTC [®] XLPE/HYP, Control, Unshielded 600V, UL Type TC—E-1 Color Code	Jan. 2009
4100 [†]	CHTC [®] XLPE/HYP, Low-Voltage Power, Unshielded 600V, UL Type TC-ER—Method 4 Color Code	Jan. 2009
4150	EHTC [®] FR-EPR/HYP, Control, Unshielded 600V, UL Type TC (18 AWG/16 AWG)—E-2 Color Code	Jan. 2008
4200	EHTC [®] FR-EPR/HYP, Control, Unshielded 600V, UL Type TC (14 AWG—10 AWG)—E-2 Color Code	Jan. 2008
4250	EHTC [®] FR-EPR/HYP, Low-Voltage Power, Unshielded 600V, UL Type TC-ER—Method 4 Color Code	Jan. 2009
4300 [†]	FREP [®] FR-EPR/CPE, Control, Unshielded 600V, UL Type TC-ER—E-2 Color Code	Jan. 2008
4310 [†]	FREP [®] FR-EPR/CPE, Control, Unshielded 600V, UL Type TC-ER—E-1 Color Code	Jan. 2008
4325 [†]	FREP [®] FR-EPR/CPE, Control, Shielded 600V, UL Type TC-ER, Overall Shielded—E-2 Color Code	Jan. 2008
4350 [†]	FREP [®] FR-EPR/CPE, Low-Voltage Power, Unshielded 600V, UL Type TC-ER—Method 4 Color Code	Jan. 2009
4400	Arctic-Flex [®] XLPE/ARCTIC-PVC, Control, Unshielded 600V, UL Type TC-ER, CSA Type RW90 XLPE, CSA TYPE TC	Jan. 2008
4450	Arctic-Flex [®] XLPE/ARCTIC-PVC, Low-Voltage Power, Unshielded 600V, UL Type TC-ER, CSA Type RW90 XLPE, CSA TYPE TC	Jan. 2009
4500 [†]	CVTC [®] XLPE/PVC, Control, Unshielded 600V, UL Type TC-ER—E-2 Color Code	Jan. 2008
4550 [†]	CVTC [®] XLPE/PVC, Low-Voltage Power, Unshielded 600V, UL Type TC-ER—Method 4 Color Code	Jan. 2009
4575	CVTC [®] VFD XLPE/PVC, Low-Voltage Power, Shielded 2000V, UL Type TC-ER—Method 4 Color Code	Jan. 2009
4580	CVTC [®] VFD XLPE/PVC, Low-Voltage Power, Copper Tape Shielded 2000V, UL Type TC-ER—Method 4 Color Code	Jan. 2009
4600 [†]	VNTC [®] PVC/NYLON/PVC, Control, Unshielded 600V, UL Type TC-ER (18 AWG/16 AWG)—E-2 Color Code	Jan. 2008
4650 [†]	VNTC [®] PVC/NYLON/PVC, Control, Unshielded 600V, UL Type TC-ER (14 AWG—10 AWG)—E-2 Color Code	Jan. 2008

[†]Indicates these products are stocked by General Cable

600V Multi Conductor Control and Power Cables

SPECIFICATION NO.		PRODUCT DESCRIPTION	REVISION DATE
4700 [†]	VNTC [®]	PVC/NYLON/PVC, Control, Shielded 600V, UL Type TC-ER, Overall Shielded—E-2 Color Code	Jan. 2008
4750 [†]	VNTC [®]	PVC/NYLON/PVC, Low-Voltage Power, Unshielded 600V, UL Type TC-ER—Method 4 Color Code	Jan. 2009
4800	20/10	PE/PVC/PVC, Control, Unshielded 600V (18 AWG/16 AWG)—E-1 Color Code	Jan. 2008
4850	20/10	PE/PVC/PVC, Control, Unshielded 600V (14 AWG—10 AWG)—E-1 Color Code	Jan. 2008
4900 [†]	GenFree [™]	XLPO/LSZH, Control 600V, UL Type TC-LS-ER—E-2 Color Code	Feb. 2008
4925	GenFree [™]	XLPO/LSZH, Control, Shielded 600V, UL Type TC-LS-ER, Overall Shielded—E-2 Color Code	Feb. 2008
4950 [†]	GenFree [™]	XLPO/LSZH, Low-Voltage Power, Unshielded 600V, UL Type TC-LS—Method 4 Color Code	Feb. 2008

[†]Indicates these products are stocked by General Cable

CHTC®
XLPE/HYP, Control, Unshielded
600V, UL Type TC—E-2 Color Code

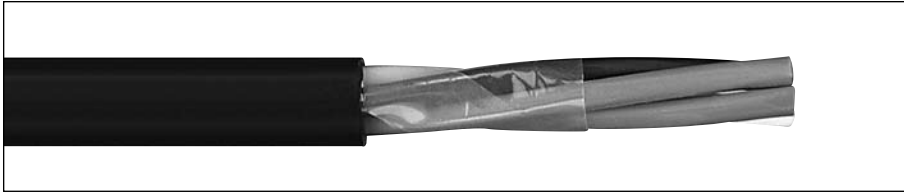

CATALOG NUMBER	NO. OF COND.	COND. SIZE (AWG)	COND. STRAND	MINIMUM AVG. INSULATION THICKNESS		MINIMUM AVG. JACKET THICKNESS		NOMINAL CABLE O.D.		COPPER WEIGHT		NET WEIGHT	
				INCHES	mm	INCHES	mm	INCHES	mm	LBS/1000 FT	kg/km	LBS/1000 FT	kg/km
16 AWG MULTI CONDUCTORS													
241420	2	16	7/.0192	0.030	0.76	0.045	1.14	0.340	8.64	17	25	61	91
312500	3	16	7/.0192	0.030	0.76	0.045	1.14	0.360	9.14	25	37	73	109
312510	4	16	7/.0192	0.030	0.76	0.045	1.14	0.390	9.91	33	49	91	135
312520	5	16	7/.0192	0.030	0.76	0.045	1.14	0.420	10.67	41	61	110	164
241430	7	16	7/.0192	0.030	0.76	0.045	1.14	0.460	11.68	58	86	141	210
241440	9	16	7/.0192	0.030	0.76	0.060	1.52	0.565	14.35	74	110	199	296
14 AWG MULTI CONDUCTORS													
223650*	2 Flat	14	7/.0242	0.030	0.76	0.045	1.14	.290 x .365	5.84 x 9.27	26	39	68	101
272270	2	14	7/.0242	0.030	0.76	0.045	1.14	0.370	9.40	26	39	75	112
223790	3	14	7/.0242	0.030	0.76	0.045	1.14	0.390	9.91	39	59	95	141
223780	4	14	7/.0242	0.030	0.76	0.045	1.14	0.425	10.80	53	78	118	176
223770	5	14	7/.0242	0.030	0.76	0.045	1.14	0.465	11.81	66	98	143	213
223750	7	14	7/.0242	0.030	0.76	0.045	1.14	0.505	12.83	92	137	179	266
223760	9	14	7/.0242	0.030	0.76	0.060	1.52	0.620	15.75	118	176	249	371
223640	12	14	7/.0242	0.030	0.76	0.060	1.52	0.700	17.78	158	235	317	472
223670*	19	14	7/.0242	0.030	0.76	0.060	1.52	0.815	20.70	250	372	467	695
232850*	37	14	7/.0242	0.030	0.76	0.080	2.03	1.130	28.70	490	730	899	1338
12 AWG MULTI CONDUCTORS													
260730*	2 Flat	12	7/.0305	0.030	0.76	0.045	1.14	.250 x .400	6.35 x 10.16	50	74	85	126
272260	2	12	7/.0305	0.030	0.76	0.045	1.14	0.410	10.41	51	76	98	146
223910	3	12	7/.0305	0.030	0.76	0.045	1.14	0.435	11.05	64	95	127	189
223930	4	12	7/.0305	0.030	0.76	0.045	1.14	0.475	12.07	85	126	160	238
223920	5	12	7/.0305	0.030	0.76	0.045	1.14	0.520	13.21	106	158	194	289
224080	7	12	7/.0305	0.030	0.76	0.060	1.52	0.595	15.11	168	251	264	393
224070	9	12	7/.0305	0.030	0.76	0.060	1.52	0.695	17.65	191	285	345	513
224090	12	12	7/.0305	0.030	0.76	0.060	1.52	0.780	19.81	255	380	435	647
265940*	19	12	7/.0305	0.030	0.76	0.080	2.03	0.955	24.26	403	600	690	1027
347050*	37	12	7/.0305	0.030	0.76	0.080	2.03	1.265	32.13	741	1103	1393	2073
10 AWG MULTI CONDUCTORS													
361350*	2 Flat	10	7/.0385	0.030	0.76	0.045	1.14	.270 x .445	6.86 x 11.30	66	98	117	174
355210	2	10	7/.0385	0.030	0.76	0.045	1.14	0.455	5.26	67	100	126	188
224100	3	10	7/.0385	0.030	0.76	0.045	1.14	0.485	12.32	100	150	176	262
224110	4	10	7/.0385	0.030	0.76	0.060	1.52	0.560	14.22	134	199	240	357
224120*	5	10	7/.0385	0.030	0.76	0.060	1.52	0.615	15.62	167	249	291	433
224130*	7	10	7/.0385	0.030	0.76	0.060	1.52	0.670	17.02	234	349	376	560
347060*	9	10	7/.0385	0.030	0.76	0.060	1.52	0.765	19.43	302	449	456	679
347070*	12	10	7/.0385	0.030	0.76	0.080	2.03	0.905	22.99	404	601	636	946

Dimensions and weights are nominal; subject to industry tolerances.
*Non-stock item, minimum runs apply. Please consult Customer Service for price and delivery.

Product Construction

Conductor:

- 16 AWG thru 10 AWG fully annealed stranded tinned copper per ASTM B33
- Class B stranding per ASTM B8

Insulation:

- Flame-retardant Cross-Linked Polyethylene (XLPE)
- Color-coded per ICEA Method 1; Table E-2 plus alpha-numeric printed numbers (Does not include white or green)

Jacket:

- Low-lead Hypalon® Chlorosulfonated Polyethylene (CSPE)/Elastomer blend

Print

- GENERAL CABLE® (WC) CHTC® XX/C XXAWG CU/XLPE/HYP (UL) TYPE TC XHHW-2 CDRS DIR BUR SUN RES OIL RES I & II 600V DAY/MONTH/ YEAR OF MFG SEQUENTIAL FOOTAGE MARK

Options:

- 2kV version
- Bare copper conductor
- Class C stranding
- E-1 Color Code—See Spec 4075
- Overall shielded multi conductor
- Ethylene Propylene Rubber (EPR) insulation—See EHTC® Spec 4200
- Thermoplastic Low-Smoke, Zero-Halogen (LSZH) jacket
- Flame-retardant, Polyvinyl Chloride (PVC) jacket—See CVTC® Spec 4500
- Other constructions available upon request

Applications:

- In free air, raceways or direct burial
- In wet or dry locations
- Permitted for use in Class I, Div. 2 industrial hazardous locations per NEC Article 501 and Class 1 circuits per NEC

Features:

- Rated at 90°C wet or dry
- Ripcord applied to all cables with jacket thickness of 60 mils or less
- Excellent physical, thermal and electrical properties
- Excellent moisture resistance
- Excellent resistance to crush, compression cuts and heat deformation
- Excellent flame resistance
- Oil-resistant jacket
- “Heavy Duty” rating per ICEA standards
- Sunlight- and weather-resistant
- Excellent low temperature cold bend characteristics
- Meets cold bend test at -35°C

Compliances:

- Industry Compliances:**
- UL 44 Type XHHW-2
 - UL 1277 Type TC
 - UL 1581
 - ICEA S-73-532
 - ICEA S-95-658/NEMA WC70

Flame Tests Compliances:

- UL 1581 VW-1
- UL 1277
- IEEE 383
- IEEE 1202
- CSA FT-4
- ICEA T-29-520

Other Compliances:

- EPA 40 CFR, Part 261 for leachable lead content per TCLP
- OSHA acceptable

Packaging:

- Material cut to length and shipped on non-returnable wood reels



CHTC®

XLPE/HYP, Control, Unshielded
600V, UL Type TC—E-1 Color Code

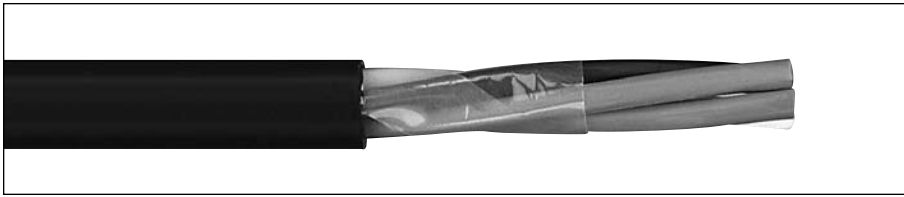

Product Construction

Conductor:

- 14 AWG thru 10 AWG fully annealed stranded tinned copper per ASTM B33
- Class B stranding per ASTM B8

Insulation:

- Flame-retardant Cross-Linked Polyethylene (XLPE)
- Color-coded per ICEA Method 1; Table E-1

Jacket:

- Low-lead Hypalon® Chlorosulfonated Polyethylene (CSPE)/Elastomer blend

Print

- GENERAL CABLE® (WC) CHTC® XX/C XXAWG CU/XLP/HYP (UL) TYPE TC XHHW-2 CDRS DIR BUR SUN RES OIL RES I & II 600V DAY/MONTH/YEAR OF MFG SEQUENTIAL FOOTAGE MARK

Options:

- 2kV version
- Bare copper conductor
- Class C stranding
- E-2 Color Code—See Spec 4050
- Overall shielded multi conductor
- Ethylene Propylene Rubber (EPR) insulation—See EHTC Spec 4200
- Thermoplastic Low-Smoke, Zero-Halogen (LSZH) jacket
- Flame-retardant, Polyvinyl Chloride (PVC) jacket—See CVTC® Spec 4500
- Other constructions available upon request

Applications:

- In free air, raceways or direct burial
- In wet or dry locations
- Permitted for use in Class I, Div. 2 industrial hazardous locations per NEC Article 501 and Class 1 circuits per NEC

Features:

- Rated at 90°C wet or dry
- Ripcord applied to all cables with jacket thickness of 60 mils or less
- Excellent physical, thermal and electrical properties
- Excellent moisture resistance
- Excellent resistance to crush, compression cuts and heat deformation
- Excellent flame resistance
- Oil-resistant jacket
- "Heavy Duty" rating per ICEA standards
- Sunlight- and weather-resistant
- Excellent low temperature cold bend characteristics
- Meets cold bend test at -35°C

Compliances:

- Industry Compliances:**
- UL 44 Type XHHW-2
 - UL 1277 Type TC
 - UL 1581
 - ICEA S-73-532
 - ICEA S-95-658/NEMA WC70

Flame Tests Compliances:

- UL 1581 VW-1
- UL 1277
- IEEE 383
- IEEE 1202
- CSA FT-4
- ICEA T-29-520

Other Compliances:

- EPA 40 CFR, Part 261 for leachable lead content per TCLP
- OSHA acceptable

Packaging:

- Material cut to length and shipped on non-returnable wood reels

CATALOG NUMBER	NO. OF COND.	COND. SIZE (AWG)	COND. STRAND	MINIMUM AVG. INSULATION THICKNESS		MINIMUM AVG. JACKET THICKNESS		NOMINAL CABLE O.D.		COPPER WEIGHT		NET WEIGHT	
				INCHES	mm	INCHES	mm	INCHES	mm	LBS/1000 FT	kg/km	LBS/1000 FT	kg/km

14 AWG MULTI CONDUCTORS

256260*	2 Flat	14	7/.0242	0.030	0.76	0.045	1.14	.230 x .365	5.84 x 9.27	26	39	68	101
330580	2	14	7/.0242	0.030	0.76	0.045	1.14	0.370	9.40	26	39	75	112
244160	3	14	7/.0242	0.030	0.76	0.045	1.14	0.390	9.91	39	59	95	141
239640	4	14	7/.0242	0.030	0.76	0.045	1.14	0.425	10.80	53	78	118	176
239700	5	14	7/.0242	0.030	0.76	0.045	1.14	0.465	11.81	66	98	143	213
237500	7	14	7/.0242	0.030	0.76	0.045	1.14	0.505	12.83	92	137	179	266
239660	9	14	7/.0242	0.030	0.76	0.060	1.52	0.620	15.75	118	176	249	371
252400	12	14	7/.0242	0.030	0.76	0.060	1.52	0.700	17.78	158	235	317	472
252410*	19	14	7/.0242	0.030	0.76	0.060	1.52	0.815	20.70	250	372	467	695
383980*	25	14	7/.0242	0.030	0.76	0.080	2.03	1.000	25.40	330	491	632	941
383990*	30	14	7/.0242	0.030	0.76	0.080	2.03	1.050	26.67	398	592	731	1088
384000*	37	14	7/.0242	0.030	0.76	0.080	2.03	1.130	28.70	490	730	899	1338

12 AWG MULTI CONDUCTORS

233320*	2 Flat	12	7/.0305	0.030	0.76	0.045	1.14	.230 x .400	6.35 x 10.16	50	74	85	126
239670	2	12	7/.0305	0.030	0.76	0.045	1.14	0.410	10.41	51	76	98	146
233330	3	12	7/.0305	0.030	0.76	0.045	1.14	0.435	11.05	64	95	127	189
239680	4	12	7/.0305	0.030	0.76	0.045	1.14	0.475	12.07	85	126	160	238
239650	5	12	7/.0305	0.030	0.76	0.045	1.14	0.520	13.21	106	158	194	289
243530	7	12	7/.0305	0.030	0.76	0.060	1.52	0.595	15.11	168	251	264	393
239620	9	12	7/.0305	0.030	0.76	0.060	1.52	0.695	17.65	191	285	345	513
252360	12	12	7/.0305	0.030	0.76	0.060	1.52	0.780	19.81	255	380	435	647
252230*	19	12	7/.0305	0.030	0.76	0.080	2.03	0.955	24.26	403	600	690	1027
384010*	25	12	7/.0305	0.030	0.76	0.080	2.03	1.095	27.81	515	767	858	1277
384020*	30	12	7/.0305	0.030	0.76	0.080	2.03	1.175	29.85	618	920	997	1484
384030*	37	12	7/.0305	0.030	0.76	0.080	2.03	1.265	32.13	741	1103	1393	2073

10 AWG MULTI CONDUCTORS

384040*	2 Flat	10	7/.0385	0.030	0.76	0.045	1.14	.270 x .445	6.86 x 11.30	66	98	117	174
243540	2	10	7/.0385	0.030	0.76	0.045	1.14	0.455	5.26	67	100	126	188
239630	3	10	7/.0385	0.030	0.76	0.045	1.14	0.485	12.32	100	150	176	262
233310	4	10	7/.0385	0.030	0.76	0.060	1.52	0.560	14.22	134	199	240	357
262680*	5	10	7/.0385	0.030	0.76	0.060	1.52	0.615	15.62	167	249	291	433
375010*	7	10	7/.0385	0.030	0.76	0.060	1.52	0.670	17.02	234	349	376	560
235680*	9	10	7/.0385	0.030	0.76	0.060	1.52	0.765	19.43	302	449	456	679
375470*	12	10	7/.0385	0.030	0.76	0.080	2.03	0.905	22.99	404	601	636	946

Dimensions and weights are nominal; subject to industry tolerances.

*Non-stock item, minimum runs apply. Please consult Customer Service for price and delivery.



Phone: 888-593-3355
www.generalcable.com

CHTC®

XLPE/HYP, Low-Voltage Power, Unshielded 600V, UL Type TC-ER¹ – Method 4 Color Code



Features (cont'd.):

- Excellent moisture resistance
- Excellent resistance to crush, compression cuts and heat deformation
- Excellent flame resistance
- Excellent low temperature cold bend characteristics
- "Heavy duty" rating per ICEA standards
- Sunlight- and weather-resistant
- Oil-resistant jacket
- Meets cold bend test at -35°C
- Meets the crush and impact requirements of Type MC cable for 2 AWG and larger

Product Construction

Conductor:

- 14 AWG thru 500 kcmil tinned, annealed copper per ASTM B33
- Class B stranding per ASTM B8

Insulation:

- Flame-retardant Cross-Linked Polyethylene (XLPE)
- Color-coded: per ICEA Method 4; Individual conductors colored black with conductor number surface printed in contrasting ink

Ground:

- Uninsulated tinned annealed copper per ASTM B3
- Class B stranding per ASTM B8

Jacket:

- Low-lead Hypalon® Chlorosulfonated Polyethylene (CSPE)/Elastomer blend

Print:

- GENERAL CABLE® (WC) CHTC® XX/C XXAWG WITH GRND CU/XLP/HYP (UL) TYPE TC-ER¹ XHHW-2 CDRS DIR BUR SUN RES 600V MONTH/ YEAR OF MFG SEQUENTIAL FOOTAGE MARK

Options:

- Bare copper conductor
- Class C stranding
- 2 kV version
- E-1 or E-2 Color Code
- Overall shielded multi conductor
- Insulated ground conductor
- Flame-retardant Ethylene Propylene Rubber (EPR) insulation – See EHTC® Spec 4250
- Thermoplastic Low-Smoke, Zero-Halogen (LSZH) jacket
- Other constructions available upon request

Applications:

- In free air, raceways or direct burial
- In wet or dry locations
- Permitted for Exposed Run 'ER' use in accordance with NEC for 2 AWG and larger
- Permitted for use in Class 1 Division 2 industrial hazardous locations per NEC

Features:

- Rated at 90°C wet or dry
- Ripcord applied to all cables with jacket thickness of 60 mils or less
- Excellent physical, thermal and electrical properties

Compliances:

Industry Compliances:

- UL 44 Type XHHW-2
- UL 1277 Type TC-ER for 2 AWG and larger
- UL 1581
- ICEA S-95-658/NEMA WC70

Flame Tests Compliances:

- UL 1581 VW-1
- UL 1277
- IEEE 383
- IEEE 1202
- CSA FT-4
- ICEA T-29-520

Other Compliances:

- EPA 40 CFR, Part 261 for leachable lead content per TCLP
- OSHA acceptable

Packaging:

- Material cut to length and shipped on non-returnable wood reels

CATALOG NUMBER	NO. OF COND.	COND. SIZE (AWG/kcmil)	COND. STRAND	GROUND WIRE SIZE (AWG)	MINIMUM AVG. INSULATION THICKNESS		MINIMUM AVG. JACKET THICKNESS		NOMINAL CABLE O.D.		COPPER WEIGHT		NET WEIGHT	
					INCHES	mm	INCHES	mm	INCHES	mm	LBS/1000 FT	kg/km	LBS/1000 FT	kg/km
14 AWG - 500 kcmil MULTI CONDUCTORS														
383790*	3	14	7/.0242	14	0.030	0.76	0.045	1.14	0.425	10.80	53	78	118	176
309340*	3	12	7/.0305	12	0.030	0.76	0.045	1.14	0.475	12.07	85	126	160	238
282570*	3	10	7/.0385	10	0.030	0.76	0.060	1.52	0.526	14.22	134	199	240	357
282580	3	8	7/.0486	10	0.045	1.14	0.060	1.52	0.660	16.76	190	283	223	332
282590*	4	8	7/.0486	10	0.045	1.14	0.060	1.52	0.725	18.42	242	360	421	627
282600	3	6	7/.0612	8	0.045	1.14	0.060	1.52	0.745	18.92	301	448	481	716
282610*	4	6	7/.0612	8	0.045	1.14	0.060	1.52	0.820	20.83	384	571	600	893
282620	3	4	7/.0772	8	0.045	1.14	0.080	2.03	0.890	22.61	448	667	702	1045
282630*	4	4	7/.0772	8	0.045	1.14	0.080	2.03	0.975	24.77	578	861	882	1313
282640	3	2	7/.0974	6	0.045	1.14	0.080	2.03	1.020	25.91	716	1066	1024	1524
282650*	4	2	7/.0974	6	0.045	1.14	0.080	2.03	1.120	28.45	919	1368	1295	1927
366070*	3	1	19/.0664	6	0.055	1.40	0.080	2.03	1.120	28.45	872	1298	1199	1784
366080*	4	1	19/.0664	6	0.055	1.40	0.080	2.03	1.235	31.37	1136	1691	1704	2536
282660*	3	1/0	19/.0745	6	0.055	1.40	0.080	2.03	1.240	31.50	1081	1609	1505	2240
338860*	4	1/0	19/.0745	6	0.055	1.40	0.080	2.03	1.330	33.78	1413	2103	1830	2723
282670*	3	2/0	19/.0837	6	0.055	1.40	0.080	2.03	1.340	34.04	1341	1996	1810	2694
292410*	4	2/0	19/.0837	6	0.055	1.40	0.080	2.03	1.480	37.59	1760	2619	2326	3462
366090*	3	3/0	19/.0940	4	0.055	1.40	0.080	2.03	1.420	36.07	1717	2555	2437	3627
366100*	4	3/0	19/.0940	4	0.055	1.40	0.080	2.03	1.570	39.88	2245	3341	3123	4648
282680*	3	4/0	19/.1055	4	0.055	1.40	0.080	2.03	1.575	40.01	2132	3173	2725	4055
338880*	4	4/0	19/.1055	4	0.055	1.40	0.110	2.79	1.765	44.83	2796	4161	3909	5817
338890*	3	250	37/.0822	4	0.065	1.65	0.110	2.79	1.755	44.58	2494	3712	3605	5365
338900*	4	250	37/.0822	4	0.065	1.65	0.110	2.79	1.935	49.15	3282	4884	4571	6803
282690*	3	350	37/.0973	3	0.065	1.65	0.110	2.79	2.010	51.05	3477	5174	4423	6582
338910*	4	350	37/.0973	3	0.065	1.65	0.110	2.79	2.180	55.37	4577	6811	6068	9030
282710*	3	500	37/.1162	2	0.065	1.65	0.110	2.79	2.305	58.55	4938	7349	6097	9074
331150*	4	500	37/.1162	2	0.065	1.65	0.110	2.79	2.555	64.90	6509	9647	7905	11764

Dimensions and weights are nominal; subject to industry tolerances.

*Non-stock item, minimum runs apply. Please consult Customer Service for price and delivery.

¹Approved as TYPE TC-ER for Exposed Run applications of 2 AWG and larger defined by NEC.



Phone: 888-593-3355
www.generalcable.com

EHTC®

FR-EPR/HYP, Control, Unshielded
600V, UL Type TC (18 AWG/16 AWG)—E-2 Color Code

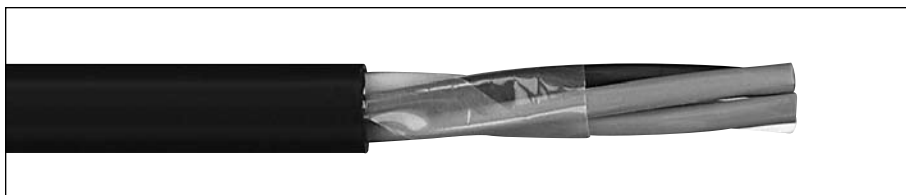

Product Construction

Conductor:

- 18 AWG and 16 AWG tinned, annealed copper per ASTM B33
- Class B stranding per ASTM B8

Insulation:

- Flame-retardant Ethylene Propylene Rubber (FR-EPR) Type II
- Color-coded per ICEA Method 1; Table E-2 (does not include white or green)

Jacket:

- Low-lead Hypalon Chlorosulfonated Polyethylene (CSPE)/Elastomer blend

Print

- GENERAL CABLE® (WC) EHTC® XX/C XXAWG EPR/HYP UL TYPE TC 90° WET OR DRY CDRS BUR SUN RES 600V, DAY/MONTH/YEAR OF MFG SEQUENTIAL FOOTAGE MARK

Options:

- 2kV version
- Bare copper conductors
- Class C stranding
- Insulated or uninsulated ground conductors
- Overall shielded multi conductors
- Duralox® aluminum interlocked armor
- E-1 Color Code
- Flame-retardant Polyvinyl Chloride (PVC) jacket
- Thermoplastic Low-Smoke, Zero-Halogen (LSZH) jacket
- Flame-retardant Thermoplastic Chlorinated Polyethylene (CPE)—See FREP® Spec 4300
- Other constructions available upon request

Applications:

- In free air, raceways or direct burial
- In wet or dry locations
- At temperature as low as -35°C
- In Class I Division 2 industrial hazardous locations per NEC

Features:

- Rated at 90°C wet or dry
- Ripcord applied to all cables with jacket thickness of 60 mils or less
- Excellent physical, thermal and electrical properties
- Excellent moisture resistance
- Excellent resistance to crush, compression cuts and heat deformation
- Excellent flame resistance
- Excellent low temperature cold bend characteristics
- Good abrasion resistance
- Low moisture absorption characteristics
- "Heavy duty" rated per ICEA standards
- Meets cold bend test at -35°C

Compliances:

Industry Compliances:

- UL 1277 Type TC
- UL 1581
- ICEA S-73-532
- ICEA S-95-658/NEMA WC70

Flame Tests Compliances:

- UL 1581 VW-1
- UL 1277
- IEEE 383
- IEEE 1202
- CSA FT-4
- ICEA T-29-520

Other Compliances:

- EPA 40 CFR, Part 261 for leachable lead content per TCLP
- OSHA acceptable

Packaging:

- Material cut to length and shipped on non-returnable wood reels

CATALOG NUMBER	NO. OF COND.	COND. SIZE (AWG)	COND. STRAND	MINIMUM AVG. INSULATION THICKNESS		MINIMUM AVG. JACKET THICKNESS		NOMINAL CABLE O.D.		COPPER WEIGHT		NET WEIGHT	
				INCHES	mm	INCHES	mm	INCHES	mm	LBS/1000 FT	kg/km	LBS/1000 FT	kg/km

18 AWG MULTI CONDUCTORS

366190*	2 Flat	18	7/.0152	0.025	0.64	0.045	1.14	.192 x .290	4.88 x 7.37	10	15	37	55
343330*	2	18	7/.0152	0.025	0.64	0.045	1.14	0.295	7.49	10	15	45	67
343340*	3	18	7/.0152	0.025	0.64	0.045	1.14	0.310	7.88	15	23	55	82
343350*	4	18	7/.0152	0.025	0.64	0.045	1.14	0.340	8.64	20	30	67	100
343360*	5	18	7/.0152	0.025	0.64	0.045	1.14	0.365	9.27	26	38	79	118
343370*	7	18	7/.0152	0.025	0.64	0.045	1.14	0.395	10.03	36	53	97	144
343380*	9	18	7/.0152	0.025	0.64	0.045	1.14	0.455	11.56	46	69	123	183
343390*	10	18	7/.0152	0.025	0.64	0.045	1.14	0.485	12.32	51	76	137	204
343400*	12	18	7/.0152	0.025	0.64	0.045	1.14	0.510	12.95	61	91	153	228
343410*	15	18	7/.0152	0.025	0.64	0.060	1.52	0.580	14.73	77	114	202	301
343420*	19	18	7/.0152	0.025	0.64	0.060	1.52	0.625	15.88	97	144	243	362
343430*	25	18	7/.0152	0.025	0.64	0.060	1.52	0.720	18.29	128	190	301	448
343440*	30	18	7/.0152	0.025	0.64	0.060	1.52	0.770	19.56	154	229	345	513
343450*	37	18	7/.0152	0.025	0.64	0.060	1.52	0.830	21.08	189	281	414	616

16 AWG MULTI CONDUCTORS

366200*	2 Flat	16	7/.0192	0.025	0.64	0.045	1.14	.204 x .314	5.18 x 7.98	16	24	46	68
343460*	2	16	7/.0192	0.025	0.64	0.045	1.14	0.320	8.13	16	24	55	82
343470*	3	16	7/.0192	0.025	0.64	0.045	1.14	0.340	8.67	24	36	69	130
343480*	4	16	7/.0192	0.025	0.64	0.045	1.14	0.365	9.27	32	48	85	126
343490*	5	16	7/.0192	0.025	0.64	0.045	1.14	0.400	10.20	40	60	102	152
343500*	7	16	7/.0192	0.025	0.64	0.045	1.14	0.430	10.90	56	84	127	189
343510*	9	16	7/.0192	0.025	0.64	0.045	1.14	0.500	12.70	72	108	162	241
343520*	10	16	7/.0192	0.025	0.64	0.060	1.52	0.565	14.40	80	119	197	293
343530*	12	16	7/.0192	0.025	0.64	0.060	1.52	0.590	14.97	97	144	221	329
343540*	15	16	7/.0192	0.025	0.64	0.060	1.52	0.640	16.26	121	180	270	402
343550*	19	16	7/.0192	0.025	0.64	0.060	1.52	0.690	17.53	153	228	327	487
343560*	25	16	7/.0192	0.025	0.64	0.060	1.52	0.795	20.19	201	299	424	631
343570*	30	16	7/.0192	0.025	0.64	0.080	2.03	0.890	22.61	242	360	508	756
343580*	37	16	7/.0192	0.025	0.64	0.080	2.03	0.955	24.26	298	443	609	906

Dimensions and weights are nominal; subject to industry tolerances.

*Non-stock item, minimum runs apply. Please consult Customer Service for price and delivery.



EHTC[®]

**FR-EPR/HYP, Control, Unshielded
600V, UL Type TC (14 AWG – 10 AWG) – E-2 Color Code**

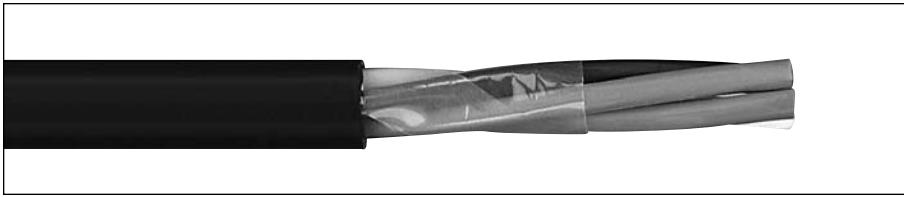

Product Construction

Conductor:

- 14 AWG thru 10 AWG tinned, annealed copper per ASTM B33
- Class B stranding per ASTM B8

Insulation:

- Flame-retardant Ethylene Propylene Rubber (FR-EPR) Type II
- Color-coded per ICEA Method 1; Table E-2 (does not include white or green)

Jacket:

- Low-lead Hypalon Chlorosulfonated Polyethylene (CSPE)/Elastomer blend

Print

- GENERAL CABLE[®] (WC) EHTC[®] XX/C XXAWG EPR/HYP UL TYPE TC XHHW-2 CDRS BUR SUN RES 600V, DAY/MONTH/ YEAR OF MFG SEQUENTIAL FOOTAGE MARK

Options:

- 2kV version
- Bare copper conductors
- Class C stranding
- Insulated or uninsulated ground conductors
- Overall shielded multi conductors
- Duralox[®] aluminum interlocked armor
- E-1 Color Code
- Flame-retardant Polyvinyl Chloride (PVC) jacket
- Thermoplastic Low-Smoke, Zero-Halogen (LSZH) jacket
- Flame-retardant Thermoplastic Chlorinated Polyethylene (CPE) – See FREP[®] Spec 4300
- Other constructions available upon request

Applications:

- In free air, raceways or direct burial
- In wet or dry locations
- At temperature as low as -35°C
- In Class I Division 2 industrial hazardous locations per NEC

Features:

- Rated at 90°C wet or dry
- Ripcord applied to all cables with jacket thickness of 60 mils or less
- Excellent physical, thermal and electrical properties
- Excellent moisture resistance
- Excellent resistance to crush, compression cuts and heat deformation
- Excellent flame resistance
- Excellent low temperature cold bend characteristics
- Good abrasion resistance
- Low moisture absorption characteristics
- "Heavy duty" rated per ICEA standards
- Meets cold bend test at -35°C

Compliances:

Industry Compliances:

- UL 44 Type XHHW-2
- UL 1277 Type TC
- UL 1581
- ICEA S-73-532
- ICEA S-95-658/NEMA WC70

Flame Tests Compliances:

- UL 1581 VW-1
- UL 1277
- IEEE 383
- IEEE 1202
- CSA FT-4
- ICEA T-29-520

Other Compliances:

- EPA 40 CFR, Part 261 for leachable lead content per TCLP
- OSHA acceptable

Packaging:

- Material cut to length and shipped on non-returnable wood reels

CATALOG NUMBER	NO. OF COND.	COND. SIZE (AWG)	COND. STRAND	MINIMUM AVG. INSULATION THICKNESS		MINIMUM AVG. JACKET THICKNESS		NOMINAL CABLE O.D.		COPPER WEIGHT		NET WEIGHT	
				INCHES	mm	INCHES	mm	INCHES	mm	LBS/1000 FT	kg/km	LBS/1000 FT	kg/km

14 AWG MULTI CONDUCTORS

262130*	2 Flat	14	7/.0242	0.030	0.76	0.045	1.14	.230 x .365	5.84 x 9.27	26	38	68	101
343590*	2	14	7/.0242	0.030	0.76	0.045	1.14	0.370	9.40	26	39	76	113
262140*	3	14	7/.0242	0.030	0.76	0.045	1.14	0.390	9.91	39	59	97	144
248240*	4	14	7/.0242	0.030	0.76	0.045	1.14	0.425	10.80	53	78	120	179
262150*	5	14	7/.0242	0.030	0.76	0.045	1.14	0.465	11.81	66	98	145	216
262160*	7	14	7/.0242	0.030	0.76	0.045	1.14	0.505	12.83	92	137	183	272
343600*	9	14	7/.0242	0.030	0.76	0.060	1.52	0.620	15.75	118	176	254	378
248290*	12	14	7/.0242	0.030	0.76	0.060	1.52	0.700	17.78	158	235	323	481
343630*	19	14	7/.0242	0.030	0.76	0.060	1.52	0.815	20.71	250	372	477	710
262190*	25	14	7/.0242	0.030	0.76	0.080	2.03	1.000	25.40	330	491	645	960
343640*	30	14	7/.0242	0.030	0.76	0.080	2.03	1.050	26.70	398	592	746	1110
343650*	37	14	7/.0242	0.030	0.76	0.080	2.03	1.130	28.71	490	729	919	1368

12 AWG MULTI CONDUCTORS

343660*	2 Flat	12	7/.0305	0.030	0.76	0.045	1.14	.250 x .400	6.35 x 10.16	50	76	88	131
343670*	2	12	7/.0305	0.030	0.76	0.045	1.14	0.410	10.41	51	76	99	147
343680*	3	12	7/.0305	0.030	0.76	0.045	1.14	0.435	11.05	64	95	129	192
343690*	4	12	7/.0305	0.030	0.76	0.045	1.14	0.475	12.07	85	127	163	243
262200*	5	12	7/.0305	0.030	0.76	0.045	1.14	0.520	13.21	106	158	198	295
343700*	7	12	7/.0305	0.030	0.76	0.060	1.52	0.595	15.11	168	250	269	400
343710*	9	12	7/.0305	0.030	0.76	0.060	1.52	0.695	17.65	191	285	351	522
343730*	12	12	7/.0305	0.030	0.76	0.060	1.52	0.780	19.81	255	380	443	659
343750*	19	12	7/.0305	0.030	0.76	0.080	2.03	0.955	24.26	403	600	703	1046
343760*	25	12	7/.0305	0.030	0.76	0.080	2.03	1.115	28.32	515	767	875	1302
343770*	30	12	7/.0305	0.030	0.76	0.080	2.03	1.150	29.21	618	920	1017	1513
343780*	37	12	7/.0305	0.030	0.76	0.080	2.03	1.240	31.50	741	1103	1421	2115

10 AWG MULTI CONDUCTORS

343790*	2 Flat	10	7/.0385	0.030	0.76	0.045	1.14	.270 x .445	6.86 x 11.30	66	98	119	177
343800*	2	10	7/.0385	0.030	0.76	0.045	1.14	0.455	11.6	67	100	134	199
343810*	3	10	7/.0385	0.030	0.76	0.045	1.14	0.485	12.3	100	150	178	265
264990*	4	10	7/.0385	0.030	0.76	0.060	1.52	0.560	14.2	134	199	243	362
343820*	5	10	7/.0385	0.030	0.76	0.060	1.52	0.615	15.6	167	249	295	439
343830*	7	10	7/.0385	0.030	0.76	0.060	1.52	0.670	17.0	234	349	382	568
343840*	9	10	7/.0385	0.030	0.76	0.060	1.52	0.765	19.4	302	449	492	732
343860*	12	10	7/.0385	0.030	0.76	0.080	2.03	0.905	23.0	404	601	662	985

Dimensions and weights are nominal; subject to industry tolerances.

*Non-stock item, minimum runs apply. Please consult Customer Service for price and delivery.



EHTC®

FR-EPR/HYP, Low-Voltage Power, Unshielded
600V, UL Type TC-ER¹ – Method 4 Color Code



Features (cont'd.):

- UL 44 Type XHHW-2, VW-1, 600V
- Excellent physical, thermal and electrical properties
- Excellent resistance to moisture
- Excellent resistance to crush, compression cuts and heat deformation
- Excellent flame resistance
- "Heavy Duty" rated per ICEA standards
- Excellent low temperature cold bend characteristics
- Meets cold bend test at -35°C
- Meets the crush and impact requirements of Type MC cable for 2 AWG and larger

Product Construction

Conductors:

- 14 AWG thru 500 kcmil tinned, annealed copper per ASTM B33
- Class B stranding per ASTM B8

Insulation:

- Flame-retardant Ethylene Propylene Rubber (FR-EPR) Type II
- Color-coded per ICEA Method 4; Individual conductors colored black with conductor number surface printed in contrasting ink

Ground:

- Uninsulated tinned annealed copper per ASTM B3
- Class B stranding per ASTM B8.

Jacket:

- Low-lead Hypalon Chlorosulfonated Polyethylene (CSPE)/Elastomer blend

Print:

- GENERAL CABLE® (WC) EHTC® XX/C XXAWG WITH GRND EPR/HYP (UL)TYPE TC-ER¹ XHHW-2 CDRS DIR BUR SUN RES 600V DAY/MONTH/ YEAR OF MFG SEQUENTIAL FOOTAGE MARK

Options:

- 2kV version
- Bare copper conductors
- Insulated ground conductor
- Cross-Linked Polyethylene (XLPE) insulation
- Flame-retardant Polyvinyl Chloride (PVC) jacket
- Thermoplastic Low-Smoke, Zero-Halogen (LSZH) jacket
- Flame-retardant Thermoplastic Chlorinated Polyethylene (CPE)—See FREP® Spec 4350
- Class C stranding
- E-1 or E-2 Color Code
- Other constructions available upon request

Applications:

- In free air, raceways or direct burial
- In wet or dry locations
- Permitted for Exposed Run 'ER' use in accordance with NEC for 2 AWG and larger
- In Class I Division 2 industrial hazardous locations per NEC

Features:

- Rated at 90°C wet or dry
- Ripcord applied to all cables with jacket thickness of 60 mils or less

Compliances:

Industry Compliances:

- UL 44 Type XHHW-2
- UL 1277 Type TC-ER for 2 AWG & larger
- UL 1581
- ICEA S-95-658/NEMA WC70

Flame Tests Compliances:

- UL 1581 VW-1
- UL 1277
- IEEE 383
- IEEE 1202
- CSA FT-4
- ICEA T-29-520

Other Compliances:

- EPA 40 CFR, Part 261 for leachable lead content per TCLP
- OSHA acceptable

Packaging:

- Material cut to length and shipped on non-returnable wood reels

CATALOG NUMBER	NO. OF COND.	COND. SIZE (AWG/kcmil)	COND. STRAND	GROUND WIRE SIZE (AWG)	MINIMUM AVG. INSULATION THICKNESS		MINIMUM AVG. JACKET THICKNESS		NOMINAL CABLE O.D.		COPPER WEIGHT		NET WEIGHT	
					INCHES	mm	INCHES	mm	INCHES	mm	LBS/1000 FT	kg/km	LBS/1000 FT	kg/km
14 AWG - 500 kcmil MULTI CONDUCTORS														
383800*	3	14	7/.0242	14	0.030	0.76	0.045	1.14	0.425	10.80	53	78	118	176
383810*	3	12	7/.0305	12	0.030	0.76	0.045	1.14	0.475	12.07	85	126	160	238
383820*	3	10	7/.0385	10	0.030	0.76	0.060	1.52	0.526	14.22	134	199	240	357
261000*	3	8	7/.0486	10	0.045	1.14	0.060	1.52	0.660	16.76	190	283	223	332
338670*	4	8	7/.0486	10	0.045	1.14	0.060	1.52	0.725	18.42	242	360	421	627
366210*	3	6	7/.0612	8	0.045	1.14	0.060	1.52	0.745	18.92	301	448	481	716
338680*	4	6	7/.0612	8	0.045	1.14	0.060	1.52	0.820	20.83	384	571	600	893
261010*	3	4	7/.0772	8	0.045	1.14	0.080	2.03	0.890	22.61	448	667	702	1045
338690*	4	4	7/.0772	8	0.045	1.14	0.080	2.03	0.975	24.77	578	860	882	1313
338700*	3	2	7/.0974	6	0.045	1.14	0.080	2.03	1.020	25.91	716	1066	1024	1524
338710*	4	2	7/.0974	6	0.045	1.14	0.080	2.03	1.120	28.45	919	1368	1295	1927
366220*	3	1	19/.0664	6	0.055	1.40	0.080	2.03	1.120	28.45	872	1298	1199	1784
366230*	4	1	19/.0664	6	0.055	1.40	0.080	2.03	1.235	31.37	1136	1691	1704	2536
338720*	3	1/0	19/.0740	6	0.055	1.40	0.080	2.03	1.240	31.50	1081	1609	1505	2240
338730*	4	1/0	19/.0740	6	0.055	1.40	0.080	2.03	1.330	33.78	1413	2103	1830	2723
338740*	3	2/0	19/.0837	6	0.055	1.40	0.080	2.03	1.340	34.04	1341	1996	1810	2694
338750*	4	2/0	19/.0837	6	0.055	1.40	0.080	2.03	1.480	37.59	1760	2619	2326	3462
366240*	3	3/0	19/.0940	4	0.055	1.40	0.080	2.03	1.420	36.07	1717	2555	2437	3627
366250*	4	3/0	19/.0940	4	0.055	1.40	0.080	2.03	1.570	39.88	2245	3341	3123	4648
360990*	3	4/0	19/.1055	4	0.055	1.40	0.080	2.03	1.575	40.01	2132	3173	2725	4055
338770*	4	4/0	19/.1055	4	0.055	1.40	0.110	2.79	1.765	44.83	2796	4161	3909	5817
338780*	3	250	37/.0822	4	0.065	1.65	0.110	2.79	1.755	44.58	2494	3712	3605	5365
338790*	4	250	37/.0822	4	0.065	1.65	0.110	2.79	1.935	49.15	3282	4884	4571	6803
338800*	3	350	37/.0973	3	0.065	1.65	0.110	2.79	2.010	51.05	3477	5174	4423	6582
338310*	4	350	37/.0973	3	0.065	1.65	0.110	2.79	2.180	55.37	4577	6811	6068	9030
338820*	3	500	37/.1162	2	0.065	1.65	0.110	2.79	2.305	58.55	4938	7349	6097	9074
338830*	4	500	37/.1162	2	0.065	1.65	0.110	2.79	2.555	64.90	6509	9687	7905	11764

Dimensions and weights are nominal; subject to industry tolerances.
*Non-stock item, minimum runs apply. Please consult Customer Service for price and delivery.
¹Approved as TYPE TC-ER for Exposed Run applications of 2 AWG and larger defined by NEC.



FREP®

FR-EPR/CPE, Control, Unshielded
600V, UL Type TC-ER¹ – E-2 Color Code

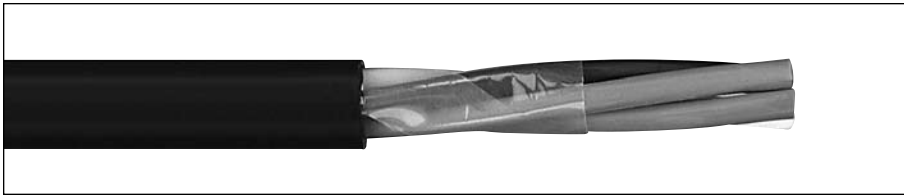

Product Construction

Conductor:

- 14 AWG thru 10 AWG fully annealed stranded tinned copper per ASTM B33
- Class B stranding per ASTM B8

Insulation:

- Flame-retardant Ethylene Propylene Rubber (FR-EPR) Type II
- Color-coded: per ICEA Method 1; Table E-2 (Does not include white or green)

Jacket:

- Flame-retardant thermoplastic Chlorinated Polyethylene (CPE)

Print

- GENERAL CABLE® (WC) FREP® XX/C XXAWG EPR/CPE (UL) TYPE TC-ER¹ XHHW-2 CDRS 90°C WET OR DRY 600V DIR BUR SUN RES DAY/MONTH/YEAR OF MFG SEQUENTIAL FOOTAGE MARK

Options:

- 2kV version
- Bare copper conductor
- Class C stranding
- E-1 Color Code—See Spec 4310
- Overall shielded multi conductor
- Flame-retardant Cross-Linked Polyethylene (FR-XLPE) insulation
- Thermoplastic Low-Smoke, Zero-Halogen (LSZH) jacket
- Other constructions available upon request

Applications:

- In free air, raceways or direct burial
- In wet or dry locations
- Permitted for Exposed Run 'ER' use in accordance with NEC for 3 or more conductors
- Approved for direct burial, Class I, Div. 2 industrial hazardous locations per NEC

Features:

- Rated at 90°C wet or dry
- Ripcord applied to all cables with jacket thickness of 60 mils or less
- Excellent physical, thermal and electrical properties
- Sunlight- and weather-resistant
- Excellent moisture resistance
- Excellent resistance to compression cuts and heat deformation
- Low coefficient of friction for easy pulling
- Excellent flame resistance—burns to ash; does not exhibit thermoplastic drip
- Excellent low temperature cold bend characteristics
- Meets cold bend test at -40°C
- Meets the crush and impact requirements of Type MC cable for 3 or more conductors

Compliances:

Industry Compliances:

- UL 44 Type XHHW-2
- UL 1277 Type TC-ER for 3 or more conductors
- UL 1581
- ICEA S-73-532

Flame Tests Compliances:

- UL 1581 VW-1
- UL 1277
- IEEE 383
- IEEE 1202
- CSA FT-4
- ICEA T-29-520

Other Compliances:

- EPA 40 CFR, Part 261 for leachable lead content per TCLP
- OSHA acceptable

Packaging:

- Material cut to length and shipped on non-returnable wood reels

CATALOG NUMBER	NO. OF COND.	COND. SIZE (AWG)	COND. STRAND	MINIMUM AVG. INSULATION THICKNESS		MINIMUM AVG. JACKET THICKNESS		NOMINAL CABLE O.D.		COPPER WEIGHT		NET WEIGHT	
				INCHES	mm	INCHES	mm	INCHES	mm	LBS/1000 FT	kg/km	LBS/1000 FT	kg/km

14 AWG MULTI CONDUCTORS

279560	2 Flat	14	7/.0242	0.030	0.76	0.045	1.14	.365 x .230	9.30 x 5.80	26	38	61	91
305320*	2	14	7/.0242	0.030	0.76	0.045	1.14	0.370	9.40	26	39	71	106
280180	3	14	7/.0242	0.030	0.76	0.045	1.14	0.390	9.91	39	59	92	137
280190	4	14	7/.0242	0.030	0.76	0.045	1.14	0.425	10.80	53	78	115	171
279870	5	14	7/.0242	0.030	0.76	0.045	1.14	0.465	11.81	66	98	139	207
280200	7	14	7/.0242	0.030	0.76	0.045	1.14	0.505	12.83	92	137	173	257
280210	9	14	7/.0242	0.030	0.76	0.060	1.52	0.620	15.75	118	176	240	357
279880	12	14	7/.0242	0.030	0.76	0.060	1.52	0.700	17.78	158	235	301	448
279580	19	14	7/.0242	0.030	0.76	0.060	1.52	0.815	20.70	250	372	468	696
279590	25	14	7/.0242	0.030	0.76	0.080	2.03	0.935	23.75	323	481	624	929
347080*	30	14	7/.0242	0.030	0.76	0.080	2.03	1.030	26.16	387	576	747	1112
279600*	37	14	7/.0242	0.030	0.76	0.080	2.03	1.110	28.19	466	694	875	1302

12 AWG MULTI CONDUCTORS

279840	2 Flat	12	7/.0305	0.030	0.76	0.045	1.14	.400 x .245	10.20 x 6.20	40	60	82	122
307690*	2	12	7/.0305	0.030	0.76	0.045	1.14	0.410	10.41	41	61	94	140
280170	3+ Gmd	12	7/.0305	0.030	0.76	0.045	1.14	0.410	10.41	85	127	148	220
280300	3	12	7/.0305	0.030	0.76	0.045	1.14	0.435	11.05	64	95	124	185
280310	4	12	7/.0305	0.030	0.76	0.045	1.14	0.475	12.07	85	127	157	234
280320	5	12	7/.0305	0.030	0.76	0.045	1.14	0.520	13.21	106	158	191	284
279890	7	12	7/.0305	0.030	0.76	0.060	1.52	0.595	15.11	149	221	268	399
280330	9	12	7/.0305	0.030	0.76	0.060	1.52	0.695	17.65	191	285	337	502
280340	12	12	7/.0305	0.030	0.76	0.060	1.52	0.765	19.43	247	368	428	637
279610	19	12	7/.0305	0.030	0.76	0.080	2.03	0.940	23.88	391	582	688	1024
295400*	25	12	7/.0305	0.030	0.76	0.080	2.03	1.095	27.81	515	767	854	1271
347100*	30	12	7/.0305	0.030	0.76	0.080	2.03	1.150	29.21	618	920	1002	1491
301870	37	12	7/.0305	0.030	0.76	0.080	2.03	1.240	31.50	762	1134	1240	1845

10 AWG MULTI CONDUCTORS

279570	2 Flat	10	7/.0385	0.030	0.76	0.045	1.14	.445 x .270	11.30 x 6.90	64	95	113	168
305340*	2	10	7/.0385	0.030	0.76	0.045	1.14	0.455	11.56	65	97	128	190
279680	3+ Gmd	10	7/.0385	0.030	0.76	0.045	1.14	0.485	12.32	134	199	225	335
280410	3	10	7/.0385	0.030	0.76	0.045	1.14	0.485	12.32	100	150	172	256
279900	4	10	7/.0385	0.030	0.76	0.060	1.52	0.560	14.22	134	199	234	348
279620	5	10	7/.0385	0.030	0.76	0.060	1.52	0.615	15.62	167	249	284	423
279630	7	10	7/.0385	0.030	0.76	0.060	1.52	0.670	17.02	234	349	381	567
279640	9	10	7/.0385	0.030	0.76	0.060	1.52	0.760	19.30	295	440	464	691
279650	12	10	7/.0385	0.030	0.76	0.080	2.03	0.905	22.99	402	598	651	696

Dimensions and weights are nominal; subject to industry tolerances.

*Non-stock item, minimum runs apply. Please consult Customer Service for price and delivery.

¹Approved as TYPE TC-ER for Exposed Run applications of 3 or more conductors as defined by NEC.



Phone: 888-593-3355
www.generalcable.com

FREP®

FR-EPR/CPE, Control, Unshielded
600V, UL Type TC-ER¹—E-1 Color Code

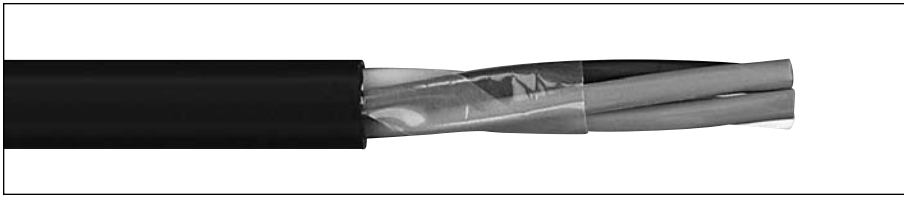

Product Construction

Conductor:

- 14 AWG thru 10 AWG fully annealed stranded tinned copper per ASTM B33
- Class B stranding per ASTM B8

Insulation:

- Flame-retardant Ethylene Propylene Rubber (FR-EPR) Type II
- Color-coded per ICEA Method 1; Table E-1 (Includes white or green)

Jacket:

- Flame-retardant thermoplastic Chlorinated Polyethylene (CPE)

Print

- GENERAL CABLE® (WC) FREP® XX/C XXAWG EPR/CPE (UL) TYPE TC-ER¹ XHHW-2 CDRS 90°C WET OR DRY 600V DIR BUR SUN RES DAY/MONTH/YEAR OF MFG SEQUENTIAL FOOTAGE MARK

Options:

- 2kV version
- Bare copper conductor
- Class C stranding
- E-2 Color Code—See Spec 4300
- Overall shielded multi conductor
- Flame-retardant Cross-Linked Polyethylene (FR-XLPE) insulation
- Thermoplastic Low-Smoke, Zero-Halogen (LSZH) jacket
- Other constructions available upon request

Applications:

- In free air, raceways or direct burial
- In wet or dry locations
- Permitted for Exposed Run 'ER' use in accordance with NEC for 3 or more conductors
- Approved for direct burial, Class I, Div. 2 industrial hazardous locations per NEC

Features:

- Rated at 90°C wet or dry
- Ripcord applied to all cables with jacket thickness of 60 mils or less
- Excellent physical, thermal and electrical properties
- Sunlight- and weather-resistant
- Excellent moisture resistance
- Excellent resistance to compression cuts and heat deformation
- Low coefficient of friction for easy pulling
- Excellent flame resistance—burns to ash; does not exhibit thermoplastic drip
- Excellent low temperature cold bend characteristics
- Meets cold bend test at -40°C
- Meets the crush and impact requirements of Type MC cable for 3 or more conductors

Compliances:

Industry Compliances:

- UL 44 Type XHHW-2
- UL 1277 Type TC-ER for 3 or more conductors
- UL 1581
- ICEA S-73-532
- ICEA S-95-658/NEMA WC70

Flame Tests Compliances:

- UL 1581 VW-1
- UL 1277
- IEEE 383
- IEEE 1202
- CSA FT-4
- ICEA T-29-520

Other Compliances:

- EPA 40 CFR, Part 261 for leachable lead content per TCLP
- OSHA acceptable

Packaging:

- Material cut to length and shipped on non-returnable wood reels

CATALOG NUMBER	NO. OF COND.	COND. SIZE (AWG)	COND. STRAND	MINIMUM AVG. INSULATION THICKNESS		MINIMUM AVG. JACKET THICKNESS		NOMINAL CABLE O.D.		COPPER WEIGHT		NET WEIGHT	
				INCHES	mm	INCHES	mm	INCHES	mm	LBS/1000 FT	kg/km	LBS/1000 FT	kg/km

14 AWG MULTI CONDUCTORS

280590	2 Flat	14	7/.0242	0.030	0.76	0.045	1.14	.365 x .230	9.30 x 5.80	26	38	61	91
280230	3	14	7/.0242	0.030	0.76	0.045	1.14	0.390	9.91	39	59	92	137
280240	4	14	7/.0242	0.030	0.76	0.045	1.14	0.425	10.80	53	78	115	171
280250	5	14	7/.0242	0.030	0.76	0.045	1.14	0.465	11.81	66	98	139	207
280260	7	14	7/.0242	0.030	0.76	0.045	1.14	0.505	12.83	92	137	173	257
280270	9	14	7/.0242	0.030	0.76	0.060	1.52	0.620	15.75	118	176	240	357
280280	12	14	7/.0242	0.030	0.76	0.060	1.52	0.700	17.78	158	235	301	448
280290*	19	14	7/.0242	0.030	0.76	0.060	1.52	0.815	20.70	250	372	468	696
385350*	25	14	7/.0242	0.030	0.76	0.080	2.03	0.935	23.75	323	481	624	929
385360*	30	14	7/.0242	0.030	0.76	0.080	2.03	1.030	26.16	387	576	747	1112
385370*	37	14	7/.0242	0.030	0.76	0.080	2.03	1.110	28.19	466	694	875	1302

12 AWG MULTI CONDUCTORS

279850	2 Flat	12	7/.0305	0.030	0.76	0.045	1.14	.400 x .245	10.20 x 6.20	40	60	82	122
280350*	2	12	7/.0305	0.030	0.76	0.045	1.14	0.410	10.41	41	61	94	140
280360	3	12	7/.0305	0.030	0.76	0.045	1.14	0.435	11.05	64	95	124	185
279910	4	12	7/.0305	0.030	0.76	0.045	1.14	0.475	12.07	85	127	157	234
280370	5	12	7/.0305	0.030	0.76	0.045	1.14	0.520	13.21	106	158	191	284
280380	7	12	7/.0305	0.030	0.76	0.060	1.52	0.595	15.11	149	221	268	399
280390*	9	12	7/.0305	0.030	0.76	0.060	1.52	0.695	17.65	191	285	337	502
280400	12	12	7/.0305	0.030	0.76	0.060	1.52	0.765	19.43	247	368	428	637
383930*	19	12	7/.0305	0.030	0.76	0.080	2.03	0.940	23.88	391	582	688	1024
383940*	25	12	7/.0305	0.030	0.76	0.080	2.03	1.095	27.81	515	767	854	1271
383950*	30	12	7/.0305	0.030	0.76	0.080	2.03	1.150	29.21	618	920	1002	1491
330800*	37	12	7/.0305	0.030	0.76	0.080	2.03	1.240	31.50	762	1134	1240	1845

10 AWG MULTI CONDUCTORS

280600*	2 Flat	10	7/.0385	0.030	0.76	0.045	1.14	.445 x .270	11.30 x 6.90	64	95	113	168
280420*	2	10	7/.0385	0.030	0.76	0.045	1.14	0.455	11.56	65	97	128	190
279920	3	10	7/.0385	0.030	0.76	0.045	1.14	0.485	12.32	100	150	172	256
279930	4	10	7/.0385	0.030	0.76	0.060	1.52	0.560	14.22	134	199	234	348
330990*	5	10	7/.0385	0.030	0.76	0.060	1.52	0.615	15.62	167	249	284	423
280430*	7	10	7/.0385	0.030	0.76	0.060	1.52	0.670	17.02	234	349	381	567
382880*	9	10	7/.0385	0.030	0.76	0.060	1.52	0.760	19.30	295	440	464	691
383970*	12	10	7/.0385	0.030	0.76	0.080	2.03	0.950	22.99	402	598	651	969

Dimensions and weights are nominal; subject to industry tolerances.

*Non-stock item, minimum runs apply. Please consult Customer Service for price and delivery.

¹Approved as TYPE TC-ER for Exposed Run applications of 3 or more conductors as defined by NEC.



Phone: 888-593-3355
www.generalcable.com

FREP®

FR-EPR/CPE, Control, Shielded
600V, UL Type TC-ER¹, Overall Shielded—E-2 Color Code

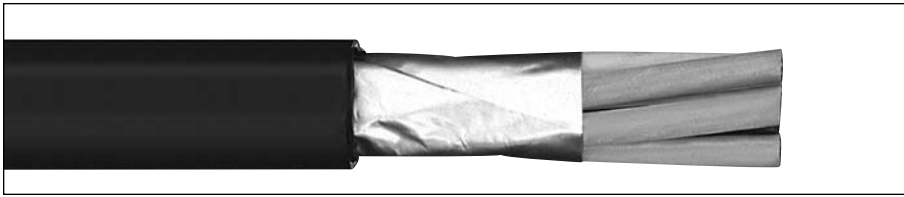

Product Construction

Conductor:

- 16 AWG thru 10 AWG fully annealed stranded tinned copper per ASTM B33
- Class B stranding per ASTM B8

Insulation:

- Flame-retardant Ethylene Propylene Rubber (FR-EPR) Type II
- Color-coded per ICEA Method 1; Table E-2 (Does not include white or green)

Shield:

- Overall shielded multi-conductor cable
- Overall shield is Flexfoil® aluminum/polyester in contact with stranded tinned copper drain wire

Jacket:

- Flame-retardant Thermoplastic Chlorinated Polyethylene (CPE)

Print

- GENERAL CABLE® (WC) SHIELDED FREP® XX/C XXAWG EPR/CPE (UL) TYPE TC-ER¹ XHHW-2 CDRS 90°C WET OR DRY 600V DIR BUR SUN RES DAY/MONTH/YEAR OF MFG SEQUENTIAL FOOTAGE MARK

Options:

- 2kV version
- Bare copper conductor
- Class C stranding
- E-1 Color Code
- Unshielded multi conductors
- Flame-retardant Cross-Linked Polyethylene (FR-XLPE) insulation
- Thermoplastic Low-Smoke, Zero-Halogen (LSZH) jacket
- Other constructions available upon request

Applications:

- In free air, raceway and direct burial
- In wet or dry locations
- Permitted for Exposed Run 'ER' use in accordance with NEC for 3 or more conductors
- Approved for direct burial, Class I, Div. 2 industrial hazardous locations per NEC

Features:

- Rated at 90°C wet or dry
- Ripcord applied to all cables with jacket thickness of 60 mils or less
- Excellent physical, thermal and electrical properties
- Sunlight- and weather-resistant
- Excellent moisture resistance
- Excellent resistance to compression cuts and heat deformation
- Low coefficient of friction for easy pulling
- Excellent flame resistance—burns to ash; does not exhibit thermoplastic drip
- Excellent low temperature cold bend characteristics
- Meets cold bend test at -40°C
- Meets the crush and impact requirements of Type MC cable for 3 conductors or more

Compliances:

- **Industry Compliances:**
 - UL 44 Type XHHW-2
 - UL 1277 Type TC-ER for 3 or more conductors
 - UL 1581
 - ICEA S-73-532
- **Flame Tests Compliances:**
 - UL 1581 VW-1
 - UL 1277
 - IEEE 383
 - IEEE 1202
 - CSA FT-4
 - ICEA T-29-520
- **Other Compliances:**
 - EPA 40 CFR, Part 261 for leachable lead content per TCLP
 - OSHA acceptable

Packaging:

- Material cut to length and shipped on non-returnable wood reels

CATALOG NUMBER	NO. OF COND.	COND. SIZE (AWG)	COND. STRAND	MINIMUM AVG. INSULATION THICKNESS		MINIMUM AVG. JACKET THICKNESS		NOMINAL CABLE O.D.		COPPER WEIGHT		NET WEIGHT	
				INCHES	mm	INCHES	mm	INCHES	mm	LBS/1000 FT	kg/km	LBS/1000 FT	kg/km

OVERALL SHIELDED MULTI CONDUCTORS 16 AWG CONDUCTORS

280470	2	16	7/.0192	0.025	0.64	0.045	1.14	0.320	8.13	19	28	52	77
280490	3	16	7/.0192	0.025	0.64	0.045	1.14	0.335	8.51	27	40	66	98

OVERALL SHIELDED MULTI CONDUCTORS 14 AWG CONDUCTORS

280980*	2	14	7/.0242	0.030	0.76	0.045	1.14	0.375	9.53	29	43	74	110
354800*	3	14	7/.0242	0.030	0.76	0.045	1.14	0.395	10.03	42	63	95	141
305300*	4	14	7/.0242	0.030	0.76	0.045	1.14	0.430	10.92	55	82	118	176
354810*	5	14	7/.0242	0.030	0.76	0.045	1.14	0.470	11.94	68	101	142	211
354820*	7	14	7/.0242	0.030	0.76	0.045	1.14	0.510	12.95	94	140	176	262
367120*	9	14	7/.0242	0.030	0.76	0.060	1.52	0.625	15.88	121	180	243	362
354830*	12	14	7/.0242	0.030	0.76	0.060	1.52	0.705	17.91	160	238	304	452
305360*	19	14	7/.0242	0.030	0.76	0.060	1.52	0.820	20.83	252	375	471	701
367130*	25	14	7/.0242	0.030	0.76	0.080	2.03	0.940	25.53	325	484	627	933
367140*	30	14	7/.0242	0.030	0.76	0.080	2.03	1.035	26.29	389	579	750	1116
367150*	37	14	7/.0242	0.030	0.76	0.080	2.03	1.115	28.32	468	696	878	1307

OVERALL SHIELDED MULTI CONDUCTORS 12 AWG CONDUCTORS

367160*	2	12	7/.0305	0.030	0.76	0.045	1.14	0.415	10.45	43	64	97	144
367170*	3	12	7/.0305	0.030	0.76	0.045	1.14	0.440	11.18	66	98	127	189
326650*	4	12	7/.0305	0.030	0.76	0.045	1.14	0.480	12.19	87	129	160	238
367180*	5	12	7/.0305	0.030	0.76	0.045	1.14	0.525	13.34	108	162	194	289
326660*	7	12	7/.0305	0.030	0.76	0.060	1.52	0.600	15.24	151	225	271	403
367190*	9	12	7/.0305	0.030	0.76	0.060	1.52	0.700	17.78	193	287	340	506
326640*	12	12	7/.0305	0.030	0.76	0.060	1.52	0.770	19.56	249	371	431	641
326670*	19	12	7/.0305	0.030	0.76	0.080	2.03	0.945	24.00	393	585	691	1028
367200*	25	12	7/.0305	0.030	0.76	0.080	2.03	1.100	27.94	517	769	857	1275
367210*	30	12	7/.0305	0.030	0.76	0.080	2.03	1.155	29.80	620	923	1005	1496
367220*	37	12	7/.0305	0.030	0.76	0.080	2.03	1.245	31.62	764	1137	1243	1850

OVERALL SHIELDED MULTI CONDUCTORS 10 AWG CONDUCTORS

311900*	2	10	7/.0385	0.030	0.76	0.045	1.14	0.460	11.68	68	101	131	195
367230*	3	10	7/.0385	0.030	0.76	0.045	1.14	0.490	12.45	103	155	175	260
311910*	4	10	7/.0385	0.030	0.76	0.060	1.52	0.565	14.35	136	202	237	353
367240*	5	10	7/.0385	0.030	0.76	0.060	1.52	0.620	15.75	170	253	287	427
367250*	7	10	7/.0385	0.030	0.76	0.060	1.52	0.675	17.15	237	353	384	571
367260*	9	10	7/.0385	0.030	0.76	0.060	1.52	0.765	19.43	298	443	467	695
367270*	12	10	7/.0385	0.030	0.76	0.080	2.03	0.910	23.11	404	601	654	973

Dimensions and weights are nominal; subject to industry tolerances.

*Non-stock item, minimum runs apply. Please consult Customer Service for price and delivery.

¹Approved as TYPE TC-ER for Exposed Run applications of 3 or more conductors as defined by NEC.



Phone: 888-593-3355
www.generalcable.com

FREP®

FR-EPR/CPE, Low-Voltage Power, Unshielded
600V, UL Type TC-ER¹ – Method 4 Color Code



Features (cont'd.):

- Excellent moisture resistance
- Excellent resistance to crush, compression cuts and heat deformation
- Excellent low temperature cold bend characteristics
- Excellent flame resistance—burns to ash; does not exhibit thermoplastic drip
- Low coefficient of friction for easy pulling
- Sunlight- and weather-resistant
- Meets cold bend test at -40°C
- Meets the crush and impact requirements of Type MC cable for 2 AWG and larger

Product Construction

Conductor:

- 14 AWG thru 750 kcmil tinned, annealed copper per ASTM B33
- Class B stranding per ASTM B8

Insulation:

- Flame-retardant Ethylene Propylene Rubber (FR-EPR) Type II
- Color-coded per ICEA Method 4; Individual conductors colored black with conductor number surface printed in contrasting ink

Ground:

- Uninsulated tinned annealed copper per ASTM B3
- Class B stranding per ASTM B8

Jacket:

- Flame-retardant thermoplastic Chlorinated Polyethylene (CPE)

Print:

- GENERAL CABLE® (WC) OR (MI) FREP® XX/C XXAWG WITH GRND EPR/CPE (UL) TYPE TC-ER¹ XHHW-2 CDRS 90°C WET OR DRY 600V DIR BUR SUN RES DAY/MONTH/YEAR OF MFG SEQUENTIAL FOOTAGE MARK

Options:

- 2kV version
- Bare copper conductor
- Class C stranding
- E-1 or E-2 Color Code
- Insulated ground conductors
- Overall shielded multi conductors
- Flame-retardant Cross-Linked Polyethylene (FR-XLPE) insulation
- Flame-retardant, Thermoplastic Low-Smoke, Zero-Halogen (LSZH) jacket
- Other constructions available upon request

Applications:

- In free air, raceways or direct burial
- In wet or dry locations
- Permitted for Exposed Run 'ER' use in accordance with NEC for 3 or more conductors
- Permitted for use in Class 1 Division 2 industrial hazardous locations per NEC

Features:

- Rated at 90°C wet or dry
- Ripcord applied to all cables with jacket thickness of 60 mils or less
- Excellent physical, thermal and electrical properties

Compliances:

Industry Compliances:

- UL 44 Type XHHW-2
- UL 1277 Type TC-ER
- UL 1581
- ICEA S-95-658/NEMA WC70

Flame Tests Compliances:

- UL 1581 VV-1
- UL 1277
- IEEE 383
- IEEE 1202
- CSA FT-4
- ICEA T-29-520

Other Compliances:

- EPA 40 CFR, Part 261 for leachable lead content per TCLP
- OSHA acceptable

Packaging:

- Material cut to length and shipped on non-returnable wood reels

CATALOG NUMBER	NO. OF COND.	COND. SIZE (AWG/kcmil)	COND. STRAND	GROUND WIRE SIZE (AWG)	MINIMUM AVG. INSULATION THICKNESS		MINIMUM AVG. JACKET THICKNESS		NOMINAL CABLE O.D.		COPPER WEIGHT		NET WEIGHT	
					INCHES	mm	INCHES	mm	INCHES	mm	LBS/1000 FT	kg/km	LBS/1000 FT	kg/km
14 AWG - 750 kcmil MULTI CONDUCTORS														
383830*	3	14	7/.0242	14	0.030	0.76	0.045	1.14	0.430	10.92	55	82	118	176
383840*	3	12	7/.0305	12	0.030	0.76	0.045	1.14	0.480	12.19	87	129	160	238
383850*	3	10	7/.0385	10	0.030	0.76	0.060	1.52	0.565	14.35	136	202	237	353
279660	3	8	7/.0486	10	0.045	1.14	0.060	1.52	0.655	16.64	190	283	314	467
279670	4	8	7/.0486	10	0.045	1.14	0.060	1.52	0.720	18.29	242	360	393	585
283210	3	6	7/.0612	8	0.045	1.14	0.060	1.52	0.740	18.80	297	442	456	679
300380	4	6	7/.0612	8	0.045	1.14	0.060	1.52	0.790	20.07	384	571	561	835
283200	3	4	7/.0772	8	0.045	1.14	0.080	2.03	0.880	22.35	442	658	642	955
295390*	4	4	7/.0772	8	0.045	1.14	0.080	2.03	0.950	24.13	578	861	822	1223
293600	3	2	7/.0974	6	0.045	1.14	0.080	2.03	1.010	25.65	703	1046	979	1457
295890*	4	2	7/.0974	6	0.045	1.14	0.080	2.03	1.090	27.69	919	1368	1235	1838
297730*	3	1	19/.0664	6	0.055	1.40	0.080	2.03	1.120	28.45	872	1298	1021	1594
356740*	4	1	19/.0664	6	0.055	1.40	0.080	2.03	1.235	31.37	1136	1691	1521	2264
283220	3	1/0	19/.0745	6	0.055	1.40	0.080	2.03	1.225	31.12	1069	1591	1439	2142
294530*	4	1/0	19/.0745	6	0.055	1.40	0.080	2.03	1.330	33.78	1413	2103	1820	2709
284560	3	2/0	19/.0837	6	0.055	1.40	0.080	2.03	1.300	33.02	1340	1994	1720	2560
295360*	4	2/0	19/.0837	6	0.055	1.40	0.080	2.03	1.440	36.58	1760	2619	2208	3286
325700*	3	3/0	19/.0940	4	0.055	1.40	0.080	2.03	1.420	36.07	1717	2555	2176	3238
365750*	4	3/0	19/.0940	4	0.055	1.40	0.080	2.03	1.570	39.88	2245	3341	2788	3405
325110	3	4/0	19/.1055	4	0.055	1.40	0.080	2.03	1.540	39.12	2130	3170	2614	3890
346980*	4	4/0	19/.1055	4	0.055	1.40	0.110	2.79	1.790	45.47	2796	4161	3495	5201
300780*	3	250	37/.0822	4	0.065	1.65	0.110	2.79	1.760	44.70	2494	3712	3184	4738
346990*	4	250	37/.0822	4	0.065	1.65	0.110	2.79	1.915	48.64	3282	4884	4019	5981
325120	3	350	37/.0973	3	0.065	1.65	0.110	2.79	1.960	49.78	3474	5170	4187	6231
347000*	4	350	37/.0973	3	0.065	1.65	0.110	2.79	2.165	54.99	4577	6811	5436	8090
298020	3	500	37/.1162	2	0.065	1.65	0.110	2.79	2.245	57.02	4934	7343	5847	8702
14407.546500*	4	500	37/.1162	2	0.065	1.65	0.110	2.79	2.475	62.87	6509	9687	7607	11321
14407.247000*	3	750	61/.1109	1	0.080	2.03	0.140	3.56	2.810	71.37	7278	10831	9145	13610
14407.547000*	4	750	61/.1109	1	0.080	2.03	0.140	3.56	3.115	79.12	9712	14453	11805	17569

Dimensions and weights are nominal; subject to industry tolerances.

*Non-stock item, minimum runs apply. Please consult Customer Service for price and delivery.

¹Approved as TYPE TC-ER for Exposed Run applications of 3 or more conductors as defined by NEC.



Phone: 888-593-3355
www.generalcable.com

Arctic-Flex®

XLPE/ARCTIC-PVC, Control, Unshielded
600V, UL Type TC-ER¹, CSA Type RW90 XLPE, CSA TYPE TC

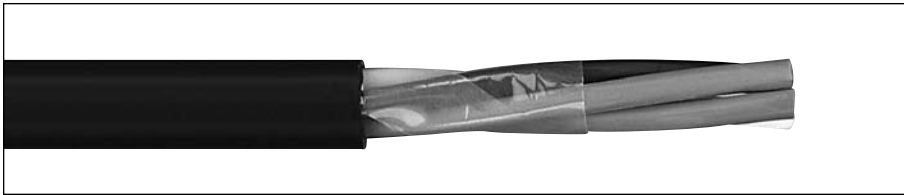

Product Construction

Conductor:

- 14 AWG thru 10 AWG tinned, annealed copper per ASTM B3
- Class B stranding per ASTM B8

Insulation:

- Flame-retardant Cross-Linked Polyethylene (XLPE) Color-coded per CSA Standard C22.2 No. 38 as follows:

Number of color coding of circuit conductors

No. of Cond.	Color Code
2	blk, wht
3	blk, red, blu
4	blk, red, blu, wht
≥5	all black

All conductors for all constructions are alpha-numeric printed

Jacket:

- Flame-retardant and sunlight-resistant Arctic-grade Polyvinyl Chloride (PVC)

Print:

- GENERAL CABLE® (WC) (UL) TYPE TC-ER¹ ARCTIC-FLEX® XX/C XXAWG FR-XLP/PVC XHHW-2 CDRS 90C WET OR DRY SUN RES DIR BUR 600V - (CSA) TYPE RW90 XLPE -40C TC FT-4 600V PLUS DAY/MONTH/YEAR OF MFG SEQUENTIAL FOOTAGE MARK

Options:

- Bare copper, class C stranding
- Uninsulated ground (bonding) conductor
- Optional color code as specified per CSA standard C22.2 No. 38 for two to four conductor cable
- Non-UL 1000 volt CSA Type RW90 XLPE, CSA Type TC
- Other constructions available upon request

Applications:

- Industrial lighting, control and signaling circuits
- Approved for direct burial, Class I, Div. 2 industrial hazardous locations per NEC for UL Type TC cables. In Canada, protection may be required by inspection authority per Canadian electrical code
- Permitted for Exposed Run 'ER' use in accordance with NEC for 3 or more conductors
- Approved for cable in tray, industrial hazardous locations, Class I, Zone 2, and Class II, Division 2 per CEC rules 18-156 and 18-252 when used with certified HL glands

Features:

- Rated 90°C wet or dry
- Ripcord applied to all cables with jacket thickness of 60 mils or less
- Meets CSA cold impact test at -40°C
- Meets ICEA and CSA cold bend test at -65°C
- Meets the crush and impact requirements of Type MC cable

Compliances:

Industry Compliances:

- ICEA S-73-532
- ICEA S-95-658/NEMA WC70
- UL 44 Type XHHW-2
- UL 1277 Type TC-ER for 3 or more conductors
- UL 1581
- CSA C22.2 No. 38 XLPE RW90
- CSA C22.2 No. 230 Type TC

Flame Tests Compliances:

- UL 1581 VW-1
- UL 1277
- IEEE 383
- CSA FT-4

Other Compliances:

- EPA 40 CFR, Part 261 for leachable lead content per TCLP
- OSHA acceptable

Packaging:

- Material cut to lengths and shipped on non-returnable wood reels

CATALOG NUMBER	NO. OF COND.	COND. SIZE (AWG)	COND. STRAND	MINIMUM AVG. INSULATION THICKNESS		MINIMUM AVG. JACKET THICKNESS		NOMINAL CABLE O.D.		COPPER WEIGHT		NET WEIGHT	
				INCHES	mm	INCHES	mm	INCHES	mm	LBS/1000 FT	kg/km	LBS/1000 FT	kg/km

14 AWG MULTI CONDUCTORS

347340*	2	14	7/.0242	0.030	0.76	0.045	1.14	0.405	10.29	25	37	71	106
347350*	3	14	7/.0242	0.030	0.76	0.045	1.14	0.390	9.91	40	59	90	134
347360*	4	14	7/.0242	0.030	0.76	0.045	1.14	0.425	10.80	53	79	113	168
347370*	5	14	7/.0242	0.030	0.76	0.045	1.14	0.465	11.81	66	99	140	208
347380*	7	14	7/.0242	0.030	0.76	0.045	1.14	0.590	14.99	93	138	176	262
347390*	9	14	7/.0242	0.030	0.76	0.060	1.52	0.620	15.75	119	177	245	365
347400*	12	14	7/.0242	0.030	0.76	0.060	1.52	0.680	17.27	159	237	302	449
347410*	19	14	7/.0242	0.030	0.76	0.060	1.52	0.800	20.32	252	375	460	685
347420*	25	14	7/.0242	0.030	0.76	0.060	1.52	0.985	25.02	323	481	641	954
347430*	30	14	7/.0242	0.030	0.76	0.080	2.03	1.050	26.67	387	576	740	1101
347440*	37	14	7/.0242	0.030	0.76	0.080	2.03	1.130	28.70	490	729	888	1322

12 AWG MULTI CONDUCTORS

347450*	2	12	7/.0305	0.030	0.76	0.045	1.14	0.410	10.41	41	61	96	143
347460*	3	12	7/.0305	0.030	0.76	0.045	1.14	0.435	11.05	65	96	125	186
347470*	4	12	7/.0305	0.030	0.76	0.045	1.14	0.475	12.07	86	128	157	234
347480*	5	12	7/.0305	0.030	0.76	0.045	1.14	0.520	13.21	108	160	191	284
347490*	7	12	7/.0305	0.030	0.76	0.060	1.52	0.595	15.11	150	224	260	387
347500*	9	12	7/.0305	0.030	0.76	0.060	1.52	0.695	17.65	193	288	340	506
347510*	12	12	7/.0305	0.030	0.76	0.060	1.52	0.780	19.81	258	385	429	638
347520*	19	12	7/.0305	0.030	0.76	0.080	2.03	0.930	23.62	403	600	681	1013
347530*	25	12	7/.0305	0.030	0.76	0.080	2.03	1.095	27.81	515	767	885	1317
347540*	30	12	7/.0305	0.030	0.76	0.080	2.03	1.150	29.21	618	920	1005	1496
347550*	37	12	7/.0305	0.030	0.76	0.080	2.03	1.240	31.50	741	1103	1185	1764

10 AWG MULTI CONDUCTORS

347560*	2	10	7/.0385	0.030	0.76	0.045	1.14	0.455	11.56	67	100	130	193
347570*	3	10	7/.0385	0.030	0.76	0.045	1.14	0.485	12.32	101	150	168	250
347580*	4	10	7/.0385	0.030	0.76	0.060	1.52	0.515	13.08	135	200	229	341
347590*	5	10	7/.0385	0.030	0.76	0.060	1.52	0.615	15.62	167	249	281	418
347600*	7	10	7/.0385	0.030	0.76	0.060	1.52	0.670	17.02	234	349	377	561
347610*	9	10	7/.0385	0.030	0.76	0.060	1.52	0.785	19.94	295	440	479	713
347620*	12	10	7/.0385	0.030	0.76	0.080	2.03	0.895	22.73	402	598	644	958

Dimensions and weights are nominal; subject to industry tolerances.

*Non-stock item, minimum runs apply. Please consult Customer Service for price and delivery.

¹Approved as TYPE TC-ER for Exposed Run applications of 3 or more conductors as defined by NEC.



Arctic-Flex®

XLPE/ARCTIC-PVC, Low-Voltage Power, Unshielded
600V, UL Type TC-ER¹, CSA Type RW90 XLPE, CSA TYPE TC



Applications (cont'd.):

- Approved for cable in tray, industrial hazardous locations, Class I, Zone 2, and Class II, Division 2 per CEC rules 18-156 and 18-252 when used with certified HL cable glands

Features:

- Rated 90°C wet or dry
- Ripcord applied to all cables with jacket thickness of 60 mils or less
- Meets CSA cold impact test at -40°C
- Meets ICEA and CSA cold bend test at -65°C
- Meets the crush and impact requirements of Type MC cable

Compliances:

- Industry Compliances:**
- UL 44 Type XHHW-2
 - UL 1277 Type TC-ER for 3 or more conductors
 - UL 1581
 - ICEA S-95-658/NEMA WC70
 - CSA C22.2 No. 38 RW90 XLPE
 - CSA C22.2 No. 230 Type TC

Flame Tests Compliances:

- UL 1581 VW-1
- UL 1277
- IEEE 383
- IEEE 1202
- CSA FT-4

Other Compliances:

- EPA 40 CFR, Part 261 for leachable lead content per TCLP
- OSHA acceptable

Packaging:

- Material cut to lengths and shipped on non-returnable wood reels

Product Construction

Conductor:

- 8 AWG thru 500 kcmil bare, annealed copper per ASTM B3
- Class B stranding per ASTM B8

Insulation:

- Flame-retardant Cross-Linked Polyethylene (XLPE) Color-coded per CSA Standard C22.2 No. 38 as follows:

Number of color coding of circuit conductors

No. of Cond.	Color Code
2	blk, wht
3	blk, red, blu
4	blk, red, blu, wht
≥5	all black

All conductors for all constructions are alphanumeric printed

Ground (Bonding) Conductor:

- Uninsulated bare annealed copper per ASTM B3
- Class B stranding per ASTM B8

Jacket:

- Flame-retardant and sunlight-resistant Arctic-grade Polyvinyl Chloride (PVC)

Print:

- GENERAL CABLE® (WC) (UL) TYPE TC-ER¹ ARCTIC-FLEX® XX/C XXAWG WITH GRND FR-XLP/PVC XHHW-2 CDRS 90C WET OR DRY SUN RES DIR BUR 600V (CSA) TYPE RW90 XLPE -40C TC FT-4 600V PLUS DAY/MONTH/YEAR OF MFG SEQUENTIAL FOOTAGE MARK

Options:

- Tinned copper
- Class C stranding
- Overall shielded multi conductors
- Optional Color Code as specified per CSA standard C22.2 No. 38 for two to four conductor cable
- Non-UL 1000 volt CSA Type RW90 XLPE, CSA Type TC
- Other constructions are available upon request

Applications:

- Industrial power and control circuits
- Permitted for Exposed Run 'ER' use in accordance with NEC for 3 or more conductors
- Approved for direct burial, Class I, Div. 2 industrial hazardous locations per NEC for UL Type TC cables. In Canada protection may be required by inspection authority per Canadian electrical code

CATALOG NUMBER	NO. OF COND.	COND. SIZE (AWG/kcmil)	COND. STRAND	GROUND WIRE SIZE (AWG)	MINIMUM AVG. INSULATION THICKNESS		MINIMUM AVG. JACKET THICKNESS		NOMINAL CABLE O.D.		COPPER WEIGHT		NET WEIGHT	
					INCHES	mm	INCHES	mm	INCHES	mm	LBS/1000 FT	kg/km	LBS/1000 FT	kg/km
8 AWG - 500 kcmil MULTI CONDUCTORS														
347150*	3	8	7/.0486	10	0.045	1.14	0.060	1.52	0.640	16.26	190	283	314	467
347160*	4	8	7/.0486	10	0.045	1.14	0.060	1.52	0.705	17.91	242	360	385	573
347170*	3	6	7/.0612	8	0.045	1.14	0.060	1.52	0.720	18.29	301	448	445	662
347180*	4	6	7/.0612	8	0.045	1.14	0.060	1.52	0.790	20.07	384	571	558	830
347190*	3	4	7/.0772	8	0.045	1.14	0.080	2.03	0.875	22.23	448	667	653	972
347200*	4	4	7/.0772	8	0.045	1.14	0.080	2.03	0.950	24.13	578	862	820	1220
347210*	3	2	7/.0974	6	0.045	1.14	0.080	2.03	1.000	25.40	716	1066	964	1435
347220*	4	2	7/.0974	6	0.045	1.14	0.080	2.03	1.095	27.81	919	1368	1214	1807
371280*	3	1	19/.0664	6	0.055	1.40	0.080	2.03	1.120	28.45	872	1298	1199	1784
371290*	4	1	19/.0664	6	0.055	1.40	0.080	2.03	1.235	31.37	1136	1691	1704	2536
347230*	3	1/0	19/.0745	6	0.055	1.40	0.080	2.03	1.215	30.86	1081	1609	1414	2104
347240*	4	1/0	19/.0745	6	0.055	1.40	0.080	2.03	1.340	34.04	1413	2103	1825	2716
347250*	3	2/0	19/.0837	6	0.055	1.40	0.080	2.03	1.310	33.27	1341	1996	1706	2539
347260*	4	2/0	19/.0837	6	0.055	1.40	0.080	2.03	1.450	36.83	1760	2619	2223	3308
371300*	3	3/0	19/.0940	4	0.055	1.40	0.080	2.03	1.420	36.07	1717	2555	2437	3627
371310*	4	3/0	19/.0940	4	0.055	1.40	0.080	2.03	1.570	39.88	2245	3341	3123	4648
347270*	3	4/0	19/.1055	4	0.055	1.40	0.080	2.03	1.540	39.12	2132	3173	2600	3869
347280*	4	4/0	19/.1055	4	0.055	1.40	0.110	2.79	1.765	44.83	2796	4161	3444	5125
347290*	3	250	37/.0822	4	0.065	1.65	0.110	2.79	1.750	44.45	2494	3712	3142	4676
347300*	4	250	37/.0822	4	0.065	1.65	0.110	2.79	1.930	49.02	3282	4884	4048	6024
347310*	3	350	37/.0973	3	0.065	1.65	0.110	2.79	1.970	50.04	3474	5170	4230	6295
347320*	4	350	37/.0973	3	0.065	1.65	0.110	2.79	2.180	55.37	4577	6811	5470	8140
347330*	3	500	37/.1162	2	0.065	1.65	0.110	2.79	2.250	57.15	4938	7349	5829	8675

Dimensions and weights are nominal; subject to industry tolerances.

*Non-stock item, minimum runs apply. Please consult Customer Service for price and delivery.

¹Approved as TYPE TC-ER for Exposed Run applications of 3 or more conductors as defined by NEC.



Phone: 888-593-3355
www.generalcable.com

CVTC®

XLPE/PVC, Control, Unshielded
600V, UL Type TC-ER¹ – E-2 Color Code

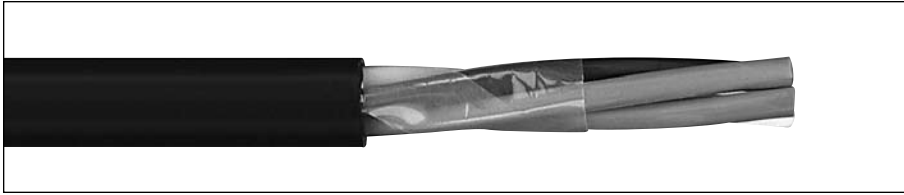

Product Construction

Conductor:

- 14 AWG thru 10 AWG fully annealed stranded bare copper per ASTM B3
- Class B stranding per ASTM B8

Insulation:

- Flame-retardant Cross-Linked Polyethylene (XLPE)
- Color-coded per ICEA Method 1; Table E-2 (Does not include white or green)

Jacket:

- Flame-retardant, moisture- and sunlight-resistant Polyvinyl Chloride (PVC)

Print

- GENERAL CABLE® (WC) CVTC® XX/C XXAWG FR-XLP/PVC (UL) TYPE TC-ER¹ XHHW-2 CDRS DIR BUR SUN RES 90°C WET OR DRY 600V DAY/MONTH/YEAR OF MFG SEQUENTIAL FOOTAGE MARK

Options:

- Tinned copper conductor
- Class C stranding
- E-1 Color Code
- Overall shielded multi conductors
- Ethylene Propylene Rubber (EPR) insulation
- Low-lead Hypalon Chlorosulfonated Polyethylene (CSPE)/Elastomer blend – See CHTC® Spec 4050
- Insulated or uninsulated ground conductor
- Other constructions available upon request

Applications:

- In free air, raceways and direct burial
- In wet or dry locations
- Approved for direct burial, Class I, Div. 2 industrial hazardous locations per NEC
- Permitted for Exposed Run 'ER' use in accordance with NEC for 3 or more conductors

Features:

- Rated at 90°C wet or dry
- Ripcord applied to all cables with jacket thickness of 60 mils or less
- Excellent electrical properties
- Abrasion- and chemical-resistant
- Sunlight- and weather-resistant
- Meets cold bend test at -25°C
- Meets the crush and impact requirements of Type MC cable

Compliances:

Industry Compliances:

- UL 44 Type XHHW-2
- UL 1277 Type TC-ER for 3 or more conductors
- UL 1581
- ICEA S-73-532
- ICEA S-95-658/NEMA WC 70

Flame Tests Compliances:

- UL 1581 VW-1
- UL 1277
- IEEE 383
- IEEE 1202
- CSA FT-4

Other Compliances:

- EPA 40 CFR, Part 261 for leachable lead content per TCLP
- OSHA acceptable

Packaging:

- Material cut to length and shipped on non-returnable wood reels

CATALOG NUMBER	NO. OF COND.	COND. SIZE (AWG)	COND. STRAND	MINIMUM AVG. INSULATION THICKNESS		MINIMUM AVG. JACKET THICKNESS		NOMINAL CABLE O.D.		COPPER WEIGHT		NET WEIGHT	
				INCHES	mm	INCHES	mm	INCHES	mm	LBS/1000 FT	kg/km	LBS/1000 FT	kg/km

14 AWG MULTI CONDUCTORS

770460	2 Flat	14	7/.0242	0.030	0.76	0.045	1.14	.235 x .370	5.97 x 9.40	25	37	62	92
771080*	2	14	7/.0242	0.030	0.76	0.045	1.14	0.365	9.27	25	37	73	109
770530	3	14	7/.0242	0.030	0.76	0.045	1.14	0.390	9.91	40	59	93	138
770610	4	14	7/.0242	0.030	0.76	0.045	1.14	0.425	10.80	53	79	116	173
770420	5	14	7/.0242	0.030	0.76	0.045	1.14	0.465	11.81	66	99	140	208
770560	7	14	7/.0242	0.030	0.76	0.045	1.14	0.590	14.99	93	138	176	262
770540	9	14	7/.0242	0.030	0.76	0.060	1.52	0.620	15.75	119	177	245	365
770470	12	14	7/.0242	0.030	0.76	0.060	1.52	0.680	17.27	159	237	302	449
770550	19	14	7/.0242	0.030	0.76	0.060	1.52	0.800	20.32	252	375	460	685
770450*	25	14	7/.0242	0.030	0.76	0.080	2.03	0.985	25.02	323	481	641	954
295320*	30	14	7/.0242	0.030	0.76	0.080	2.03	1.050	26.67	387	571	740	1101
770430*	37	14	7/.0242	0.030	0.76	0.080	2.03	1.130	28.70	490	729	888	1322

12 AWG MULTI CONDUCTORS

770480	2 Flat	12	7/.0305	0.030	0.76	0.045	1.14	.245 x .400	6.22 x 10.16	40	60	86	128
346920*	2	12	7/.0305	0.030	0.76	0.045	1.14	0.410	10.41	41	61	96	143
365720	3+ Gmd	12	7/.0305	0.030	0.76	0.045	1.14	0.435	11.05	86	128	143	213
770570	3	12	7/.0305	0.030	0.76	0.045	1.14	0.435	11.05	65	96	125	186
770490	4	12	7/.0305	0.030	0.76	0.045	1.14	0.475	12.07	86	128	157	234
770410	5	12	7/.0305	0.030	0.76	0.045	1.14	0.515	13.08	108	160	191	284
770950	7	12	7/.0305	0.030	0.76	0.060	1.52	0.595	15.11	150	224	260	387
770580	9	12	7/.0305	0.030	0.76	0.060	1.52	0.695	17.65	193	288	340	506
770520	12	12	7/.0305	0.030	0.76	0.060	1.52	0.780	19.81	258	385	429	638
770700*	19	12	7/.0305	0.030	0.76	0.080	2.03	0.930	23.62	403	600	681	1013
347110*	25	12	7/.0305	0.030	0.76	0.080	2.03	1.095	27.81	515	767	885	1317
347120*	30	12	7/.0305	0.030	0.76	0.080	2.03	1.150	29.21	618	920	1005	1496
347130*	37	12	7/.0305	0.030	0.76	0.080	2.03	1.240	31.50	741	1103	1185	1764

10 AWG MULTI CONDUCTORS

770590	2 Flat	10	7/.0385	0.030	0.76	0.045	1.14	.290 x .480	7.37 x 12.19	66	98	114	170
346930*	2	10	7/.0385	0.030	0.76	0.045	1.14	0.455	11.56	67	100	130	193
770670	3+ Gmd	10	7/.0385	0.030	0.76	0.045	1.14	0.485	12.32	135	200	201	299
770600	3	10	7/.0385	0.030	0.76	0.045	1.14	0.485	12.32	101	150	173	257
770370	4	10	7/.0385	0.030	0.76	0.060	1.52	0.515	13.08	135	200	236	351
770380	5	10	7/.0385	0.030	0.76	0.060	1.52	0.615	15.62	167	249	287	427
770900	7	10	7/.0385	0.030	0.76	0.060	1.52	0.670	17.02	234	349	371	552
770390*	9	10	7/.0385	0.030	0.76	0.060	1.52	0.785	19.94	295	440	479	713
770400	12	10	7/.0385	0.030	0.76	0.080	2.03	0.895	22.73	402	598	644	958

Dimensions and weights are nominal; subject to industry tolerances.

*Non-stock item, minimum runs apply. Please consult Customer Service for price and delivery.

¹Approved as TYPE TC-ER for Exposed Run applications of 3 or more conductors as defined by NEC.



Phone: 888-593-3355
www.generalcable.com

CVTC®

XLPE/PVC, Low-Voltage Power, Unshielded 600V, UL Type TC-ER¹ – Method 4 Color Code



Applications (cont'd.):

- Permitted for Exposed Run 'ER' use in accordance with NEC

Features:

- Rated at 90°C wet or dry
- Ripcord applied to all cables with jacket thickness of 60 mils or less
- Abrasion- and chemical-resistant
- Excellent electrical properties
- Sunlight- and weather-resistant
- Meets cold bend test at -25°C
- Meets the crush and impact requirements of Type MC cable

Compliances:

- Industry Compliances:**
 - UL 44 Type XHHW-2
 - UL 1277 Type TC-ER
 - UL 1581
 - ICEA S-95-658/NEMA WC70

Flame Tests Compliances:

- UL 1581 VW-1
- UL 1277
- IEEE 383
- IEEE 1202
- CSA FT-4

Other Compliances:

- EPA 40 CFR, Part 261 for leachable lead content per TCLP
- OSHA acceptable

Packaging:

- Material cut to length and shipped on non-returnable wood reels

Product Construction

Conductor:

- 14 AWG thru 750 kcmil bare, annealed copper per ASTM B3
- Class B stranding per ASTM B8

Insulation:

- Flame-retardant Cross-Linked Polyethylene (XLPE)
- Color-coded per ICEA Method 4; Individual conductors colored black with conductor number surface printed in contrasting ink

Ground:

- Uninsulated bare annealed copper per ASTM B3
- Class B stranding per ASTM B8

Jacket:

- Flame-retardant, moisture- and sunlight-resistant Polyvinyl Chloride (PVC)

Print:

- GENERAL CABLE® (PLANT OF MFG) CVTC®
XX/C XXAWG WITH GRND FR-XLP/PVC UL TYPE

Print (cont'd.):

TC-ER¹ XHHW-2 CDRS 90°C WET OR DRY 600V
DAY/MONTH/YEAR SEQUENTIAL FOOTAGE
MARK

Options:

- Tinned copper conductor
- Class C stranding
- E-1 or E-2 Color Code
- Insulated ground conductors
- Overall shielded multi conductors
- Flame-retardant Ethylene Propylene Rubber (EPR) insulation
- Low-lead Hypalon Chlorosulfonated Polyethylene (CSPE)/Elastomer blend—See CHTC® Spec 4100
- ICEA 1000V rated cable
- Other constructions available upon request

Applications:

- In free air, raceways or direct burial
- In wet or dry locations
- Permitted for use in Class I Division 2 industrial hazardous locations per NEC

CATALOG NUMBER	NO. OF COND.	COND. SIZE (AWG/kcmil)	COND. STRAND	GROUND WIRE SIZE (AWG)	MINIMUM AVG. INSULATION THICKNESS		MINIMUM AVG. JACKET THICKNESS		NOMINAL CABLE O.D.		COPPER WEIGHT		NET WEIGHT	
					INCHES	mm	INCHES	mm	INCHES	mm	LBS/1000 FT	kg/km	LBS/1000 FT	kg/km

14 AWG - 750 kcmil MULTI CONDUCTORS

383860*	3	14	7/.0242	14	0.030	0.76	0.045	1.14	0.425	10.80	53	79	116	173
383870*	3	12	7/.0305	12	0.030	0.76	0.045	1.14	0.475	12.07	86	128	157	234
383880*	3	10	7/.0385	10	0.030	0.76	0.060	1.52	0.515	13.08	135	200	236	351
783160	3	8	7/.0486	10	0.045	1.14	0.060	1.52	0.640	16.26	190	283	314	467
783190	4	8	7/.0486	10	0.045	1.14	0.060	1.52	0.705	17.91	242	360	385	573
339470	3	6	7/.0612	8	0.045	1.14	0.060	1.52	0.720	18.29	301	448	445	662
339480	4	6	7/.0612	8	0.045	1.14	0.060	1.52	0.790	20.07	384	571	558	830
783330	3	4	7/.0772	8	0.045	1.14	0.080	2.03	0.875	22.23	448	667	653	972
339500*	4	4	7/.0772	8	0.045	1.14	0.080	2.03	0.950	24.13	578	862	820	1220
325610	3	2	7/.0974	6	0.045	1.14	0.080	2.03	1.000	25.40	716	1066	964	1435
329520*	4	2	7/.0974	6	0.045	1.14	0.080	2.03	1.095	27.81	919	1368	1214	1807
352150*	3	1	19/.0664	6	0.055	1.40	0.080	2.03	1.120	28.45	872	1298	1199	1784
371250*	4	1	19/.0664	6	0.055	1.40	0.080	2.03	1.235	31.37	1136	1691	1704	2536
339530	3	1/0	19/.0745	6	0.055	1.40	0.080	2.03	1.215	30.86	1081	1609	1414	2104
339540*	4	1/0	19/.0745	6	0.055	1.40	0.080	2.03	1.340	34.04	1413	2103	1825	2716
339550	3	2/0	19/.0837	6	0.055	1.40	0.080	2.03	1.310	33.27	1341	1996	1706	2539
339560*	4	2/0	19/.0837	6	0.055	1.40	0.080	2.03	1.450	36.83	1760	2619	2223	3308
371260*	3	3/0	19/.0940	4	0.055	1.40	0.080	2.03	1.420	36.07	1717	2555	2437	3627
371270*	4	3/0	19/.0940	4	0.055	1.40	0.080	2.03	1.570	39.88	2245	3341	3123	4648
783230	3	4/0	19/.1055	4	0.055	1.40	0.080	2.03	1.540	39.12	2132	3173	2600	3869
339570*	4	4/0	19/.1055	4	0.055	1.40	0.110	2.79	1.765	44.83	2796	4161	3444	5125
328540*	3	250	37/.0822	4	0.065	1.65	0.110	2.79	1.750	44.45	2494	3712	3142	4676
339590*	4	250	37/.0822	4	0.065	1.65	0.110	2.79	1.930	49.02	3282	4884	4048	6024
222570	3	350	37/.0973	3	0.065	1.65	0.110	2.79	1.970	50.04	3474	5170	4230	6295
339600*	4	350	37/.0973	3	0.065	1.65	0.110	2.79	2.180	55.37	4577	6811	5470	8140
222710	3	500	37/.1162	2	0.065	1.65	0.110	2.79	2.250	57.15	4938	7349	5829	8675
06790.086500*	4	500	37/.1162	2	0.065	1.65	0.110	2.79	2.475	62.87	6509	9687	7579	11279
06790.077000*	3	750	61/.1109	1	0.080	2.03	0.140	3.56	2.810	71.37	7278	10831	9101	13544
06790.047000*	4	750	61/.1109	1	0.080	2.03	0.140	3.56	3.115	79.12	9712	14453	11746	17480

Dimensions and weights are nominal; subject to industry tolerances.

*Non-stock item, minimum runs apply. Please consult Customer Service for price and delivery.

¹Approved as TYPE TC-ER for Exposed Run applications of 3 or more conductors as defined by NEC.



Phone: 888-593-3355
www.generalcable.com

CVTC® VFD

XLPE/PVC, Low-Voltage Power, Shielded
2000V, UL Type TC-ER¹—Method 4 Color Code



Features:

- Rated at 90°C wet or dry
- Dual shield provides maximum shield coverage required for Variable Frequency Drive (VFD) applications
- Meets crush and impact requirements to Type MC cable
- Abrasion- and chemical-resistant
- Excellent electrical properties
- Sunlight- and weather-resistant

Product Construction

Conductor:

- 14 AWG thru 500 kcmil fully annealed tinned stranded copper
- Class B stranding per ASTM B8

Insulation:

- Flame-retardant Cross-Linked Polyethylene (XLPE)—90°C, VW-1
- Color-coded per ICEA Method 4; Individual conductors colored black with conductor number surface printed in contrasting ink

Ground:

- 3 symmetrically placed annealed tinned copper conductors in direct contact with shield
- Class B stranding per ASTM B8

Dual Shield:

- Overall tinned copper braided shield in conjunction with an aluminum/polymer tape shield

Jacket:

- Flame-retardant, moisture- and sunlight-resistant Polyvinyl Chloride (PVC)—Black

Print:

- GENERAL CABLE® (WC) CVTC® VFD XX/C XXAWG WITH GRND FR-XLP/PVC (UL) TYPE TC-ER RHH or RHW-2 CDRS 90°C WET OR DRY 2000V DIR BUR SUN RES DAY/MONTH/YEAR SEQUENTIAL FOOTAGE MARK

Applications:

- For use with AC motors controlled by Pulse Width Modulated Inverter in VFD applications rated up to 2000 volts. These motor drive systems require cables that are designed to prevent radio frequency interference (RFI) which can lead to malfunction
- In raceways, cable trays or direct burial
- In wet or dry locations
- Permitted for use in Class 1, Division 2 industrial hazardous locations per NEC
- Permitted for Exposed Run 'ER' use in accordance with NEC

Compliances:

- **Industry Compliances:**
 - UL 1277 Type TC-ER
 - UL Type RHH or RHW-2 conductors per UL 44
- **Flame Test Compliances:**
 - IEEE 383
 - IEEE 1202
- **Other Compliances:**
 - EPA 40 CFR, Part 261 for leachable lead content per TCLP
 - OSHA acceptable

Packaging:

- Material cut to length and shipped on non-returnable wood reels

CATALOG NUMBER	NO. OF COND.	COND. SIZE (AWG/kcmil)	COND. STRAND	GROUND WIRE SIZE (AWG)	MINIMUM AVG. INSULATION THICKNESS		MINIMUM AVG. JACKET THICKNESS		NOMINAL CABLE O.D.		COPPER WEIGHT		NET WEIGHT	
					INCHES	mm	INCHES	mm	INCHES	mm	LBS/1000 FT	kg/km	LBS/1000 FT	kg/km
14 AWG - 500 kcmil MULTI CONDUCTORS														
384730*	3	14	7/.0242	3 x 18	0.060	1.52	0.060	1.52	0.565	14.35	79	118	190	283
384740*	3	12	7/.0305	3 x 16	0.060	1.52	0.060	1.52	0.605	15.37	114	170	236	351
384750*	3	10	7/.0385	3 x 14	0.060	1.52	0.060	1.52	0.665	16.89	172	256	313	466
384760*	3	8	7/.0486	3 x 14	0.070	1.78	0.060	1.52	0.785	19.94	234	348	420	625
384770*	3	6	7/.0612	3 x 12	0.070	1.78	0.080	2.03	0.910	23.11	354	527	605	900
384780*	3	4	7/.0772	3 x 12	0.070	1.78	0.080	2.03	1.010	25.65	507	755	800	1191
384790*	3	2	7/.0974	3 x 10	0.070	1.78	0.080	2.03	1.315	28.83	783	1165	1126	1676
384800*	3	1/0	19/.0745	3 x 6	0.090	2.29	0.080	2.03	1.390	35.31	1251	1861	1832	2726
384810*	3	2/0	19/.0837	3 x 6	0.090	2.29	0.080	2.03	1.490	37.85	1511	2248	2134	3175
384820*	3	3/0	19/.0940	3 x 5	0.090	2.29	0.080	2.03	1.595	40.51	1897	2823	2553	3799
384830*	3	4/0	19/.1055	3 x 4	0.090	2.29	0.110	2.79	1.775	45.09	2355	3504	3254	4842
384840*	3	250	37/.0822	3 x 4	0.105	2.67	0.110	2.79	1.940	49.28	2719	4046	3726	5544
384850*	3	350	37/.0973	3 x 2	0.105	2.67	0.110	2.79	2.160	54.86	3883	5778	5040	7500
384860*	3	500	37/.1162	3 x 1	0.105	2.67	0.110	2.79	2.440	61.98	5507	8194	6809	10132

Dimensions and weights are nominal; subject to industry tolerances.
*Non-stock item, minimum runs apply. Please consult Customer Service for price and delivery.
¹Approved as TYPE TC-ER for Exposed Run applications of 3 or more conductors as defined by NEC.



CVTC® VFD

XLPE/PVC, Low-Voltage Power, Copper Tape Shielded
2000V, UL Type TC-ER—Method 4 Color Code



Features:

- Rated at 90°C wet or dry
- Overlapped bare copper tape shield provides necessary shield coverage required for Variable Frequency Drive (VFD) applications
- Meets crush and impact requirements for Type MC cable
- Abrasion- and chemical-resistant
- Excellent electrical properties
- Sunlight- and weather-resistant

Product Construction

Conductor:

- 14 AWG thru 500 kcmil fully annealed bare stranded copper
- Class B stranding per ASTM B8

Insulation:

- Flame-retardant Cross-Linked Polyethylene (XLPE)—90°C, VW-1
- Color-coded per ICEA Method 4; Individual conductors colored black with conductor number surface printed in contrasting ink

Ground:

- 3 symmetrically placed annealed bare copper conductors in direct contact with shield
- Class B stranding per ASTM B8

Metallic Shield:

- Overall 5 mil annealed bare copper tape shield with 50% overlap

Jacket:

- Flame-retardant, moisture- and sunlight-resistant Polyvinyl Chloride (PVC)—Black

Print:

- GENERAL CABLE® (WC) CVTC® VFD XX/C XXAWG WITH GRNDS FR-XLP/PVC (UL) TYPE TC-ER RHH or RHW-2 CDRS 90°C WET OR DRY 2000V DIR BUR SUN RES DAY/MONTH/YEAR SEQUENTIAL FOOTAGE MARK

Applications:

- For use with AC motors controlled by Pulse Width Modulated Inverter in VFD applications rated up to 2000 volts. These motor drive systems require cables that are designed to prevent radio frequency interference (RFI) which can lead to malfunction
- In raceways, cable trays or direct burial
- In wet or dry locations
- Permitted for use in Class 1, Division 2 industrial hazardous locations per NEC
- Permitted for Exposed Run 'ER' use in accordance with NEC

Compliances:

Industry Compliances:

- UL 1277 Type TC-ER, 2000V
- UL Type RHH or RHW-2 conductors per UL 44

Flame Test Compliances:

- IEEE 383
- IEEE 1202

Other Compliances:

- EPA 40 CFR, Part 261 for leachable lead content per TCLP
- OSHA acceptable

Packaging:

- Material cut to length and shipped on non-returnable wood reels

CATALOG NUMBER	NO. OF COND.	COND. SIZE (AWG/kcmil)	COND. STRAND	GROUND WIRE SIZE (AWG)	MINIMUM AVG. INSULATION THICKNESS		MINIMUM AVG. JACKET THICKNESS		NOMINAL CABLE O.D.		COPPER WEIGHT		NET WEIGHT	
					INCHES	mm	INCHES	mm	INCHES	mm	LBS/ 1000 FT	kg/km	LBS/ 1000 FT	kg/km
14 AWG - 500 kcmil MULTI CONDUCTORS														
395070V	3	14	7/.0242	3 x 18	0.060	1.52	0.060	1.52	0.580	14.73	91	135	212	315
395080V	3	12	7/.0305	3 x 16	0.060	1.52	0.060	1.52	0.615	15.37	127	189	260	387
395090V	3	10	7/.0385	3 x 14	0.060	1.52	0.060	1.52	0.670	17.02	183	272	329	490
395100V	3	8	7/.0486	3 x 14	0.070	1.78	0.060	1.52	0.770	19.56	246	366	441	656
395110V	3	6	7/.0612	3 x 12	0.070	1.78	0.080	2.03	0.895	22.73	368	548	618	920
395120V	3	4	7/.0772	3 x 12	0.070	1.78	0.080	2.03	0.995	25.27	522	777	830	1235
395130V	3	2	7/.0974	3 x 10	0.070	1.78	0.080	2.03	1.125	28.58	801	1192	1152	1714
395140V*	3	1/0	19/.0745	3 x 6	0.090	2.29	0.080	2.03	1.385	35.18	1348	2006	1853	2757
395150V	3	2/0	19/.0837	3 x 6	0.090	2.29	0.080	2.03	1.480	37.59	1616	2405	2169	3227
395160V*	3	3/0	19/.0940	3 x 5	0.090	2.29	0.080	2.03	1.590	40.39	2010	2991	2619	3897
395170V	3	4/0	19/.1055	3 x 4	0.090	2.29	0.110	2.79	1.780	45.21	2517	3745	3241	4823
395180V*	3	250	37/.0822	3 x 4	0.105	2.67	0.110	2.79	1.940	49.28	2895	4308	3763	5599
395190V	3	350	37/.0973	3 x 2	0.105	2.67	0.110	2.79	2.160	54.86	4089	6084	5109	7602
395200V	3	500	37/.1162	3 x 1	0.105	2.67	0.110	2.79	2.455	62.36	5693	8471	6933	10316

Dimensions and weights are nominal; subject to industry tolerances.

*Non-stock item, minimum runs apply. Please consult Customer Service for price and delivery.

VNTC®

PVC/NYLON/PVC, Control, Unshielded
600V, UL Type TC-ER¹ (18 AWG/16 AWG) – E-2 Color Code

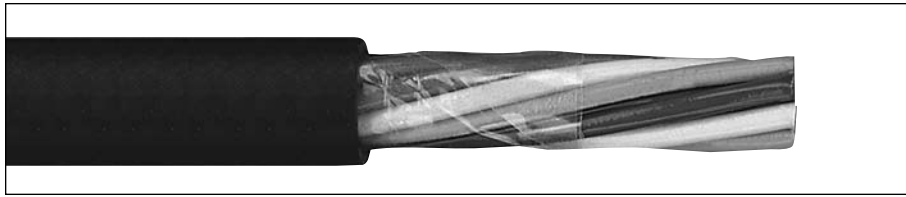

Product Construction

Conductor:

- 18 AWG and 16 AWG fully annealed stranded bare copper to ASTM B3
- Class B stranding per ASTM B8

Insulation:

- Flame-retardant Polyvinyl Chloride (PVC) with clear Polyamide (nylon)
- Color-coded per ICEA Method 1; Table E-2 plus alpha-numeric printed numbers (Does not include white or green)

Jacket:

- Flame-retardant, moisture- and sunlight-resistant Polyvinyl Chloride (PVC)

Print

- GENERAL CABLE® (WC) VNTC® XX/C XXAWG (UL) TYPE TC-ER¹ TFN SUN RES DIR BUR 600V DAY/MONTH/YEAR OF MFG SEQUENTIAL FOOTAGE MARK

Options:

- Tinned copper conductor
- Class C stranding
- E-1 Color Code
- Overall shielded multi conductors
- Other constructions available upon request

Applications:

- In free air, raceways or direct burial
- In wet or dry locations
- Approved for direct burial, Class I, Div. 2 industrial hazardous locations per NEC
- Permitted for Exposed Run 'ER' use in accordance with NEC for 3 or more conductors

Features:

- Rated at 90°C dry, 75°C wet
- Ripcord applied to all cables with jacket thickness of 60 mils or less
- Provides outstanding sunlight, cold bend and cold impact resistance
- Offers the smallest cable O.D. available for suitable applications
- Provides long service life
- Provides good oil and chemical resistance
- Meets cold bend test at -25°C
- Meets the crush and impact requirements of Type MC cable

Compliances:

Industry Compliances:

- UL 66 NEC Type TFN conductors
- UL 1277 Type TC-ER for 3 or more conductors
- UL 1581
- ICEA S-95-658

Flame Tests Compliances:

- UL 1277
- IEEE 383
- IEEE 1202
- CSA FT-4

Other Compliances:

- EPA 40 CFR, Part 261 for leachable lead content per TCLP
- OSHA acceptable

Packaging:

- Material cut to length and shipped on non-returnable wood reels

CATALOG NUMBER	NO. OF COND.	COND. SIZE (AWG)	COND. STRAND	MINIMUM AVG. INSULATION THICKNESS		MINIMUM AVG. JACKET THICKNESS		NOMINAL CABLE O.D.		COPPER WEIGHT		NET WEIGHT	
				INCHES	mm	INCHES	mm	INCHES	mm	LBS/1000 FT	kg/km	LBS/1000 FT	kg/km

18 AWG MULTI CONDUCTORS

236090	2 Flat	18	7/0.152	0.020	0.51	0.045	1.14	.190 x .285	4.80 x 7.20	10	15	36	54
318050*	2	18	7/0.152	0.020	0.51	0.045	1.14	0.270	6.86	11	19	38	57
245920	3	18	7/0.152	0.020	0.51	0.045	1.14	0.285	7.24	15	23	46	68
236100	4	18	7/0.152	0.020	0.51	0.045	1.14	0.310	7.87	20	30	56	83
244680	5	18	7/0.152	0.020	0.51	0.045	1.14	0.335	8.51	26	38	65	97
244660	7	18	7/0.152	0.020	0.51	0.045	1.14	0.360	9.14	36	53	82	122
264570*	9	18	7/0.152	0.020	0.51	0.045	1.14	0.420	10.67	46	69	105	156
233270*	10	18	7/0.152	0.020	0.51	0.045	1.14	0.425	10.80	51	76	114	170
236120	12	18	7/0.152	0.020	0.51	0.045	1.14	0.445	11.30	61	91	131	195
244720*	15	18	7/0.152	0.020	0.51	0.045	1.14	0.485	12.32	77	114	162	241
236130	19	18	7/0.152	0.020	0.51	0.060	1.52	0.570	14.48	97	144	209	311
236140*	25	18	7/0.152	0.020	0.51	0.060	1.52	0.655	16.64	128	190	266	396
347140*	30	18	7/0.152	0.020	0.51	0.060	1.52	0.695	17.65	154	229	310	461
236150	37	18	7/0.152	0.020	0.51	0.060	1.52	0.745	18.92	189	281	371	552

16 AWG MULTI CONDUCTORS

236160	2 Flat	16	7/0.192	0.020	0.51	0.045	1.14	.200 x .310	5.08 x 7.87	16	24	42	71
245580	2	16	7/0.192	0.020	0.51	0.045	1.14	0.300	7.62	20	29	50	74
236170	3	16	7/0.192	0.020	0.51	0.045	1.14	0.315	8.00	24	36	60	89
236180	4	16	7/0.192	0.020	0.51	0.045	1.14	0.340	8.64	32	48	74	110
236190	5	16	7/0.192	0.020	0.51	0.045	1.14	0.370	9.40	40	60	97	144
236210	7	16	7/0.192	0.020	0.51	0.045	1.14	0.400	10.16	56	84	111	165
243640	9	16	7/0.192	0.020	0.51	0.045	1.14	0.460	11.68	72	108	141	210
236230*	10	16	7/0.192	0.020	0.51	0.045	1.14	0.495	12.57	80	119	154	229
236240	12	16	7/0.192	0.020	0.51	0.045	1.14	0.505	12.83	97	144	178	265
244650*	15	16	7/0.192	0.020	0.51	0.060	1.52	0.605	15.37	121	180	239	356
236260	19	16	7/0.192	0.020	0.51	0.060	1.52	0.635	16.13	153	228	284	423
236280	25	16	7/0.192	0.020	0.51	0.060	1.52	0.705	17.91	201	299	364	542
244670*	30	16	7/0.192	0.020	0.51	0.060	1.52	0.760	19.30	242	360	426	634
236290*	37	16	7/0.192	0.020	0.51	0.080	2.03	0.880	22.35	306	455	552	821

Dimensions and weights are nominal; subject to industry tolerances.

*Non-stock item, minimum runs apply. Please consult Customer Service for price and delivery.

¹Approved as TYPE TC-ER for Exposed Run applications of 3 or more conductors as defined by NEC.



Phone: 888-593-3355
www.generalcable.com

VNTC®

PVC/NYLON/PVC, Control, Unshielded
600V, UL Type TC-ER¹ (14 AWG – 10 AWG) – E-2 Color Code

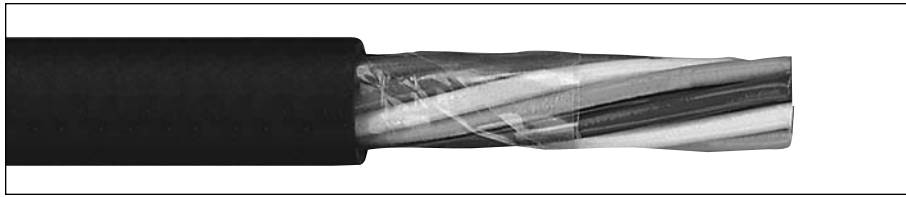

Product Construction

Conductor:

- 14 AWG thru 10 AWG fully annealed stranded bare copper per ASTM B3
- Class B stranding per ASTM B8

Insulation:

- Flame-retardant Polyvinyl Chloride (PVC) with clear Polyamide (nylon)
- Color-coded per ICEA Method 1; Table E-2 plus alpha-numeric printed numbers (Does not include white or green)

Jacket:

- Flame-retardant, moisture and sunlight-resistant Polyvinyl Chloride (PVC)

Print

- GENERAL CABLE® (WC) VNTC® XX/C XXAWG (UL) TYPE TC-ER¹ THHN/THWN SUN RES DIR BUR 600V DAY/MONTH/ YEAR OF MFG SEQUENTIAL FOOTAGE MARK

Options:

- Tinned copper conductor
- Class C stranding
- E-1 Color Code
- Overall shielded multi conductors
- Other constructions available upon request

Applications:

- In free air, raceways and direct burial
- In wet or dry locations
- Approved for direct burial, Class I, Div. 2 industrial hazardous locations per NEC
- Permitted for Exposed Run 'ER' use in accordance with NEC for 3 or more conductors

Features:

- Rated at 90°C dry, 75°C wet
- Ripcord applied to all cables with jacket thickness of 60 mils or less
- Provides outstanding sunlight, cold bend and cold impact resistance
- Offers the smallest cable O.D. available for suitable applications
- Provides long service life
- Provides good oil and chemical resistance
- Meets cold bend test at -25°C
- Meets the crush and impact requirements of Type MC cable

Compliances:

Industry Compliances:

- UL 83 NEC Type THHN/THWN conductors
- UL 1277 Type TC-ER for 3 or more conductors
- UL 1581
- ICEA S-95-658

Flame Tests Compliances:

- UL 1277
- IEEE 383
- IEEE 1202
- CSA FT-4

Other Compliances:

- EPA 40 CFR, Part 261 for leachable lead content per TCLP
- OSHA acceptable

Packaging:

- Material cut to length and shipped on non-returnable wood reels

CATALOG NUMBER	NO. OF COND.	COND. SIZE (AWG)	COND. STRAND	MINIMUM AVG. INSULATION THICKNESS		MINIMUM AVG. JACKET THICKNESS		NOMINAL CABLE O.D.		COPPER WEIGHT		NET WEIGHT	
				INCHES	mm	INCHES	mm	INCHES	mm	LBS/1000 FT	kg/km	LBS/1000 FT	kg/km

14 AWG MULTI CONDUCTORS

235040	2 Flat	14	7/.0242	0.020	0.51	0.045	1.14	.210 x .320	5.33 x 8.13	25	37	54	80
245590*	2	14	7/.0242	0.020	0.51	0.045	1.14	0.320	8.13	26	39	64	95
235050	3	14	7/.0242	0.020	0.51	0.045	1.14	0.345	8.76	39	58	80	119
235060	4	14	7/.0242	0.020	0.51	0.045	1.14	0.365	9.27	52	77	100	149
235070	5	14	7/.0242	0.020	0.51	0.045	1.14	0.410	10.41	65	97	118	176
235080	7	14	7/.0242	0.020	0.51	0.045	1.14	0.445	11.30	90	134	153	228
235090	9	14	7/.0242	0.020	0.51	0.060	1.52	0.505	12.83	116	173	213	317
235110	12	14	7/.0242	0.020	0.51	0.060	1.52	0.595	15.11	155	231	267	397
235130	19	14	7/.0242	0.020	0.51	0.060	1.52	0.695	17.65	245	365	396	589
235150	25	14	7/.0242	0.020	0.51	0.060	1.52	0.785	19.94	323	481	507	755
235160*	30	14	7/.0242	0.020	0.51	0.080	2.03	0.895	22.73	387	576	637	948
235170	37	14	7/.0242	0.020	0.51	0.080	2.03	0.970	24.64	478	711	766	1140

12 AWG MULTI CONDUCTORS

234580	2 Flat	12	7/.0305	0.020	0.51	0.045	1.14	.225 x .360	5.72 x 9.14	40	60	74	110
260150*	2	12	7/.0305	0.020	0.51	0.045	1.14	0.355	9.02	41	61	85	127
234590	3	12	7/.0305	0.020	0.51	0.045	1.14	0.385	9.78	86	128	131	195
255090	3+Grnd	12	7/.0305	0.020	0.51	0.045	1.14	0.385	9.78	86	128	131	195
234600	4	12	7/.0305	0.020	0.51	0.045	1.14	0.420	10.67	86	128	138	205
226420	5	12	7/.0305	0.020	0.51	0.045	1.14	0.445	11.30	108	160	165	246
234620	7	12	7/.0305	0.020	0.51	0.045	1.14	0.490	12.45	144	214	217	323
226500	9	12	7/.0305	0.020	0.51	0.060	1.52	0.605	15.37	185	275	297	442
234640	12	12	7/.0305	0.020	0.51	0.060	1.52	0.675	17.15	247	368	377	561
243600	19	12	7/.0305	0.020	0.51	0.060	1.52	0.785	19.94	391	582	568	845
243610*	25	12	7/.0305	0.020	0.51	0.080	2.03	0.940	23.88	515	767	775	1153
321720*	30	12	7/.0305	0.020	0.51	0.080	2.03	1.030	26.16	618	920	919	1368
234680*	37	12	7/.0035	0.020	0.51	0.080	2.03	1.105	28.07	762	1134	1100	1637

10 AWG MULTI CONDUCTORS

236300	2 Flat	10	7/.0385	0.026	0.66	0.045	1.14	.260 x .425	6.60 x 10.80	64	95	108	161
243630*	2	10	7/.0385	0.026	0.66	0.045	1.14	0.420	10.67	65	97	115	171
236310	3	10	7/.0385	0.026	0.66	0.045	1.14	0.450	11.43	131	195	191	284
255080*	3+Grnd	10	7/.0385	0.026	0.66	0.045	1.14	0.450	11.43	131	195	191	284
236320	4	10	7/.0385	0.026	0.66	0.045	1.14	0.505	12.83	135	200	209	311
236330	5	10	7/.0385	0.026	0.66	0.060	1.52	0.570	14.48	169	252	268	399
236340	7	10	7/.0385	0.026	0.66	0.060	1.52	0.620	15.75	236	351	350	521
243620*	9	10	7/.0385	0.026	0.66	0.060	1.52	0.725	18.42	295	440	440	655
236350	12	10	7/.0385	0.026	0.66	0.060	1.52	0.815	20.70	404	602	584	869

Dimensions and weights are nominal; subject to industry tolerances.

*Non-stock item, minimum runs apply. Please consult Customer Service for price and delivery.

¹Approved as TYPE TC-ER for Exposed Run applications of 3 or more conductors as defined by NEC.



Phone: 888-593-3355
www.generalcable.com

VNTC®

PVC/NYLON/PVC, Control, Shielded
600V, UL Type TC-ER¹, Overall Shielded—E-2 Color Code

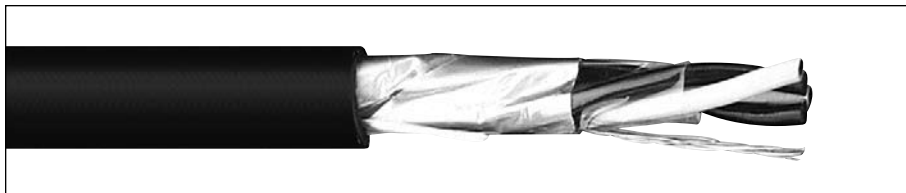

Product Construction

Conductor:

- 18 AWG thru 10 AWG fully annealed stranded bare copper per ASTM B3
- Class B stranding per ASTM B8

Insulation:

- Flame-retardant Polyvinyl Chloride (PVC) with clear Polyamide (nylon)
- Color-coded per ICEA Method 1; Table E-2 plus alpha-numeric printed numbers (Does not include white or green)

Shield:

- Overall shielded multi conductor
- Overall shield is Flexfoil® aluminum/polyester, in contact with stranded tinned copper drain wire

Jacket:

- Flame-retardant, moisture- and sunlight-resistant Polyvinyl Chloride (PVC)

Print

- GENERAL CABLE® (WC) SHIELDED VNTC® XX/C XX AWG (UL) TYPE TC-ER¹ TFN OR THHN/THWN SUN RES DIR BUR 600V DAY/MONTH/YEAR OF MFG SEQUENTIAL FOOTAGE MARK

Options:

- Tinned copper conductor
- Class C stranding
- E-1 Color Code
- Unshielded multi conductors
- Other constructions available upon request

Applications:

- In free air, raceways and direct burial
- In wet or dry locations
- Approved for direct burial, Class I, Div. 2 industrial hazardous locations per NEC
- Permitted for Exposed Run 'ER' use in accordance with NEC for 3 or more conductors

Features:

- Rated at 90°C dry, 75°C wet
- Ripcord applied to all cables with jacket thickness of 60 mils or less
- Provides outstanding sunlight, cold bend and cold impact resistance
- Offers the smallest cable O.D. available for suitable applications
- Provides long service life
- Provides good oil and chemical resistance
- Meets cold bend test at -25°C
- Meets the crush and impact requirements of Type MC cable

Compliances:

- **Industry Compliances:**
 - UL 1277 Type TC-ER for 3 or more conductors
 - UL 1581
 - UL 66 NEC Type TFN conductors (16 & 18 AWG)
 - UL 83 NEC Type THHN/THWN conductors (14 through 10 AWG)
 - ICEA S-95-658
- **Flame Tests Compliances:**
 - UL 1277
 - IEEE 383
 - IEEE 1202
 - CSA FT-4
- **Other Compliances:**
 - EPA 40 CFR, Part 261 for leachable lead content per TCLP
 - OSHA acceptable

Flame Tests Compliances:

- UL 1277
- IEEE 383
- IEEE 1202
- CSA FT-4

Other Compliances:

- EPA 40 CFR, Part 261 for leachable lead content per TCLP
- OSHA acceptable

Packaging:

- Material cut to length and shipped on non-returnable wood reels

CATALOG NUMBER	NO. OF COND.	COND. SIZE (AWG)	COND. STRAND	MINIMUM AVG. INSULATION THICKNESS		MINIMUM AVG. JACKET THICKNESS		NOMINAL CABLE O.D.		COPPER WEIGHT		NET WEIGHT	
				INCHES	mm	INCHES	mm	INCHES	mm	LBS/1000 FT	kg/km	LBS/1000 FT	kg/km

**OVERALL SHIELDED MULTI CONDUCTORS
18 AWG CONDUCTORS**

261130	2	18	7/.0152	0.020	0.51	0.045	1.14	0.280	7.11	12	19	40	60
261140	3	18	7/.0152	0.020	0.51	0.045	1.14	0.290	7.37	18	26	49	73
261150	4	18	7/.0152	0.020	0.51	0.045	1.14	0.310	7.87	23	34	58	86
260000*	5	18	7/.0152	0.020	0.51	0.045	1.14	0.340	8.64	28	41	70	104
259980*	7	18	7/.0152	0.020	0.51	0.045	1.14	0.370	9.40	39	58	89	132

**OVERALL SHIELDED MULTI CONDUCTORS
16 AWG CONDUCTORS**

247620	2	16	7/.0192	0.020	0.51	0.045	1.14	0.300	7.62	20	29	52	77
261160	3	16	7/.0192	0.020	0.51	0.045	1.14	0.320	8.13	28	41	63	94
243710	4	16	7/.0192	0.020	0.51	0.045	1.14	0.350	8.89	36	53	77	115
266580*	5	16	7/.0192	0.020	0.51	0.045	1.14	0.370	9.40	44	65	91	135
243740*	7	16	7/.0192	0.020	0.51	0.045	1.14	0.410	10.41	60	89	119	177
243560*	9	16	7/.0192	0.020	0.51	0.045	1.14	0.470	11.97	76	113	150	223
229600*	12	16	7/.0192	0.020	0.51	0.045	1.14	0.510	12.95	100	149	185	275

**OVERALL SHIELDED MULTI CONDUCTORS
14 AWG CONDUCTORS**

243660	2	14	7/.0242	0.020	0.51	0.045	1.14	0.330	8.38	31	46	67	100
243720	3	14	7/.0242	0.020	0.51	0.045	1.14	0.350	8.89	44	65	84	125
243650	4	14	7/.0242	0.020	0.51	0.045	1.14	0.380	9.65	57	85	104	155
243570*	5	14	7/.0242	0.020	0.51	0.045	1.14	0.400	10.16	70	104	123	183
243580	7	14	7/.0242	0.020	0.51	0.045	1.14	0.440	11.18	96	142	161	240

**OVERALL SHIELDED MULTI CONDUCTORS
12 AWG CONDUCTORS**

243670	2	12	7/.0305	0.020	0.51	0.045	1.14	0.370	9.40	43	64	83	124
243810*	3	12	7/.0305	0.020	0.51	0.045	1.14	0.390	9.91	64	95	111	165
243840	4	12	7/.0305	0.020	0.51	0.045	1.14	0.420	10.67	85	126	139	207

**OVERALL SHIELDED MULTI CONDUCTORS
10 AWG CONDUCTORS**

243770*	2	10	7/.0385	0.026	0.66	0.045	1.14	0.430	10.92	68	101	119	177
243820*	3	10	7/.0385	0.026	0.66	0.045	1.14	0.460	11.68	101	150	162	241
243690*	4	10	7/.0385	0.026	0.66	0.045	1.14	0.500	12.70	133	198	205	305

Dimensions and weights are nominal; subject to industry tolerances.

*Non-stock item, minimum runs apply. Please consult Customer Service for price and delivery.

¹Approved as TYPE TC-ER for Exposed Run applications of 3 or more conductors as defined by NEC.



VNTC®

PVC/NYLON/PVC, Low-Voltage Power, Unshielded
600V, UL Type TC-ER¹ – Method 4 Color Code

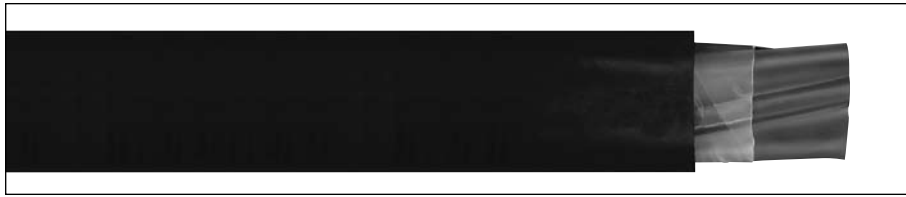

Features:

- Rated at 90°C dry, 75°C wet
- Ripcord applied to all cables with jacket thickness of 60 mils or less
- Provide outstanding sunlight, cold bend and cold impact resistance
- Offer the smallest cable O.D. available for suitable applications
- Provide good oil and chemical resistance
- Provides a long service life
- Meets cold bend test at -25°C
- Meets the crush and impact requirements of Type MC cable

Product Construction

Conductor:

- 14 AWG thru 500 kcmil bare, annealed copper per ASTM B3
- Class B stranding per ASTM B8

Insulation:

- Flame-retardant Polyvinyl Chloride (PVC) with clear Polyimide (nylon)
- Color-coded per ICEA Method 4; Individual conductors colored black with conductor number surface printed in contrasting ink

Ground:

- Uninsulated bare annealed copper per ASTM B3
- Class B stranding per ASTM B8

Jacket:

- Flame-retardant, moisture- and sunlight-resistant Polyvinyl Chloride (PVC)

Print:

- GENERAL CABLE® (WC) VNTC® XX/C XXAWG WITH GRND (UL) TYPE TC-ER¹ THHN/THWN CDRS DIR BUR SUN RES 600V DAY/MONTH/YEAR OF MFG SEQUENTIAL FOOTAGE MARK

Options:

- Tinned copper conductor
- Class C stranding
- Insulated ground conductors
- 5 mil bare copper tape shield with 25% overlap
- Other constructions available upon request

Applications:

- In free air, raceways or direct burial
- In wet or dry locations
- Permitted for use in Class I Division 2 industrial hazardous locations per NEC
- Permitted for Exposed Run 'ER' use in accordance with NEC

Compliances:

Industry Compliances:

- NEC Type THHN/THWN conductors
- UL 1277 Type TC-ER
- UL 1581

Flame Tests Compliances:

- UL 1277
- IEEE 383
- IEEE 1202
- CSA FT-4

Other Compliances:

- EPA 40 CFR, Part 261 for leachable lead content per TCLP
- OSHA acceptable

Packaging:

- Material cut to length and shipped on non-returnable wood reels

CATALOG NUMBER	NO. OF COND.	COND. SIZE (AWG/kcmil)	COND. STRAND	GROUND WIRE SIZE (AWG)	MINIMUM AVG. INSULATION THICKNESS		MINIMUM AVG. JACKET THICKNESS		NOMINAL CABLE O.D.		COPPER WEIGHT		NET WEIGHT	
					INCHES	mm	INCHES	mm	INCHES	mm	LBS/1000 FT	kg/km	LBS/1000 FT	kg/km
14 AWG - 500 kcmil MULTI CONDUCTORS														
383890*	3	14	7/.0242	14	0.020	0.51	0.045	1.14	0.365	9.27	52	77	100	149
234250	3	12	7/.0305	12	0.020	0.51	0.045	1.14	0.420	10.67	86	128	138	205
234260	3	10	7/.0385	10	0.020	0.51	0.045	1.14	0.505	12.83	135	200	209	311
386700**	3	10	7/.0385	10	0.020	0.51	0.045	1.14	0.505	12.83	135	200	209	311
236370	3	8	7/.0486	10	0.036	0.91	0.060	1.52	0.600	15.24	189	281	308	458
236380	4	8	7/.0486	10	0.036	0.91	0.060	1.52	0.655	16.64	241	359	373	555
226410	3	6	7/.0612	8	0.036	0.91	0.060	1.52	0.690	17.53	300	446	434	646
231980	4	6	7/.0612	8	0.036	0.91	0.060	1.52	0.760	19.30	383	570	533	793
236400	3	4	7/.0772	8	0.048	1.22	0.080	2.03	0.875	22.28	446	664	650	967
236410*	4	4	7/.0772	8	0.048	1.22	0.080	2.03	0.970	24.64	578	860	824	1226
236420	3	2	7/.0974	6	0.048	1.22	0.080	2.03	1.000	25.40	710	1057	964	1435
236430*	4	2	7/.0974	6	0.048	1.22	0.080	2.03	1.100	27.94	919	1368	1227	1826
236440	3	1/0	19/.0745	6	0.059	1.50	0.080	2.03	1.225	31.12	1080	1607	1447	2153
219580*	4	1/0	19/.0745	6	0.059	1.50	0.080	2.03	1.360	34.54	1413	2103	1830	2723
243760	3	2/0	19/.0837	6	0.059	1.50	0.080	2.03	1.320	33.53	1340	1994	1754	2610
219610*	4	2/0	19/.0837	6	0.059	1.50	0.080	2.03	1.455	36.96	1760	2619	2252	3351
221560	3	4/0	19/.1055	4	0.059	1.50	0.080	2.03	1.545	39.24	2130	3170	2630	3914
329240*	4	4/0	19/.1055	4	0.059	1.50	0.110	2.79	1.770	44.96	2796	4161	3502	5212
222490	3	250	37/.0822	4	0.070	1.78	0.110	2.79	1.740	44.20	2494	3696	3177	4728
297050*	4	250	37/.0822	4	0.070	1.78	0.110	2.79	1.945	49.40	3281	4883	4107	6112
226430	3	350	37/.0973	3	0.070	1.78	0.110	2.79	1.990	50.55	3474	5170	4263	6344
297060*	4	350	37/.0973	3	0.070	1.78	0.110	2.79	2.190	55.63	4586	6825	5585	8312
219630	3	500	37/.1162	2	0.070	1.78	0.110	2.79	2.270	57.66	4934	7343	5890	8765
222510*	4	500	37/.1162	2	0.070	1.78	0.110	2.79	2.505	63.63	6509	9687	7694	11450

Dimensions and weights are nominal; subject to industry tolerances.

*Non-stock item, minimum runs apply. Please consult Customer Service for price and delivery.

**E-2 Color Code.

¹Approved as TYPE TC-ER for Exposed Run applications as defined by NEC.



Phone: 888-593-3355
www.generalcable.com

20/10

PE/PVC/PVC, Control, Unshielded
600V (18 AWG/16 AWG)—E-1 Color Code

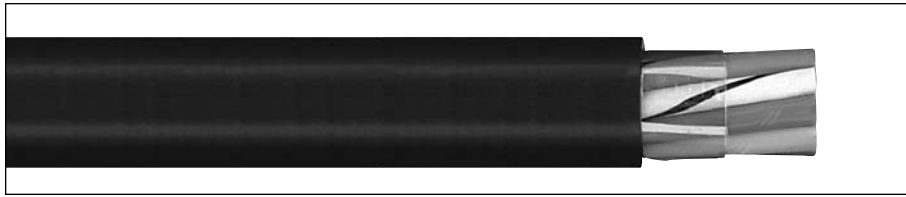

Product Construction

Conductor:

- 18 AWG and 16 AWG
- Bare, annealed copper per ASTM B3
- Class B stranding per ASTM B8

Insulation:

- Clear Polyethylene (PE)

Conductor Jacket:

- Color-coded Polyvinyl Chloride (PVC)
- Color-coded per ICEA Method 1; Table E-1 (includes white and green)

Cable Core:

- Conductors are cabled with non-hygroscopic fillers as necessary, and an overall binder tape

Overall Jacket:

- Flame-retardant and sunlight-resistant Polyvinyl Chloride (PVC)

Print:

- GENERAL CABLE® SUBSTATION CONTROL CABLE X/C XXAWG CU/PE/PVC 75°C 600V YEAR OF MFG SEQUENTIAL FOOTAGE MARK

Options:

- Tinned copper conductors
- Class C stranding per ASTM B8
- Insulated or uninsulated ground conductors
- Copper tape shield or aluminum/polymer tape shield with tinned copper drain wire over cable core
- Bare or tinned copper braided basket weave shield
- Duralox® aluminum or galvanized steel interlocked armor
- Intergrabon® Moisture Barrier system
- Corrugated copper tape shield longitudinally applied

Applications:

- For applications where environmental factors require cable characteristics including flame-retardance, resistance to chemicals, abrasion and resistance to the harmful effects of sunlight and weather
- May be installed in ducts, cable trays, conduit, Class I Division 2 industrial hazardous locations or continuous rigid cable supports

Features:

- Rated at 75°C
- Thermoplastic PE insulation provides chemical resistance and excellent electrical properties
- Flame-retardant PVC conductor jacket is color-coded for easy circuit identification
- Flame-retardant PVC overall jacket provides abrasion, chemical, sunlight and weathering resistance

Compliances:

Industry Compliances:

- ICEA S-73-532

Other Compliances:

- Meets EPA 10 CFR, Part 261 for leachable lead content per TCLP method

CATALOG NUMBER	NO. OF COND.	COND. SIZE (AWG/kcmil)	MINIMUM AVG. INSULATION THICKNESS		MINIMUM AVG. JACKET THICKNESS		NOMINAL CABLE O.D.		COPPER WEIGHT		NET WEIGHT	
			INCHES	mm	INCHES	mm	INCHES	mm	LBS/1000 FT	kg/km	LBS/1000 FT	kg/km

18 AWG MULTI CONDUCTORS

365290*	2 Flat	18	0.025	0.64	0.045	1.14	.200 x .300	5.10 x 7.50	10	15	39	58
365300*	2	18	0.025	0.64	0.045	1.14	0.30	7.6	10	15	41	61
363310*	3	18	0.025	0.64	0.045	1.14	0.31	7.9	15	23	49	73
543640*	4	18	0.025	0.64	0.045	1.14	0.34	8.6	20	30	60	89
365320*	5	18	0.025	0.64	0.045	1.14	0.37	9.4	25	38	71	106
365330*	7	18	0.025	0.64	0.045	1.14	0.40	10.2	36	53	90	134
365340*	9	18	0.025	0.64	0.045	1.14	0.46	11.7	46	68	113	168
547230*	12	18	0.025	0.64	0.045	1.14	0.51	13.0	61	91	145	216
365350*	19	18	0.025	0.64	0.060	1.52	0.63	16.0	96	143	229	341

16 AWG MULTI CONDUCTORS

283530*	2 Flat	16	0.025	0.64	0.045	1.14	.210 x .320	5.30 x 8.10	16	24	43	84
365360*	2	16	0.025	0.64	0.045	1.14	0.32	8.1	16	24	49	73
365370*	3	16	0.025	0.64	0.045	1.14	0.34	8.6	24	36	62	92
647530*	4	16	0.025	0.64	0.045	1.14	0.37	9.4	32	48	77	115
283540*	5	16	0.025	0.64	0.045	1.14	0.40	10.2	40	60	92	137
365380*	7	16	0.025	0.64	0.045	1.14	0.43	10.9	56	84	118	176
365390*	9	16	0.025	0.64	0.045	1.14	0.50	12.7	73	108	148	220
647550*	12	16	0.025	0.64	0.060	1.52	0.59	15.0	97	144	209	311
365400*	19	16	0.025	0.64	0.060	1.52	0.69	17.5	153	228	304	452

Dimensions and weights are nominal; subject to industry tolerances.

*Non-stock item, minimum runs apply. Please consult Customer Service for price and delivery.

20/10

PE/PVC/PVC, Control, Unshielded
600V (14 AWG—10 AWG)—E-1 Color Code

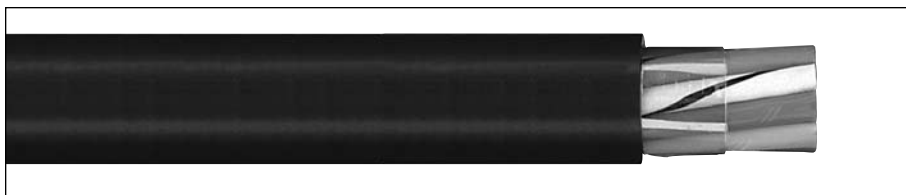

Product Construction

Conductor:

- 14 AWG thru 10 AWG
- Bare, annealed copper per ASTM B3
- Class B stranding per ASTM B8

Insulation:

- Clear Polyethylene (PE)

Conductor Jacket:

- Color-coded Polyvinyl Chloride (PVC)
- Color-coded per ICEA Method 1; Table E-1 (includes white and green)

Cable Core:

- Conductors are cabled with non-hygroscopic fillers as necessary, and an overall binder tape

Overall Jacket:

- Flame-retardant and sunlight-resistant Polyvinyl Chloride (PVC)

Print:

- GENERAL CABLE® SUBSTATION CONTROL CABLE X/C XXAWG CU/PE/PVC 75°C 600V YEAR OF MFG SEQUENTIAL FOOTAGE MARK

Options:

- Tinned copper conductors
- Class C stranding per ASTM B8
- Insulated or uninsulated ground conductors
- Copper tape shield or aluminum/polymer tape shield with tinned copper drain wire over cable core
- Bare or tinned copper braided basket weave shield
- Duralox® aluminum or galvanized steel interlocked armor
- Intergrabon® Moisture Barrier system
- Corrugated copper tape shield longitudinally applied

Applications:

- For applications where environmental factors require cable characteristics including flame-retardance, resistance to chemicals, abrasion and resistance to the harmful effects of sunlight and weather
- May be installed in ducts, cable trays, conduit, Class 1 Division 2 industrial hazardous locations or continuous rigid cable supports

Features:

- Rated at 75°C
- Thermoplastic PE insulation provides chemical resistance and excellent electrical properties
- Flame-retardant PVC conductor jacket is color-coded for easy circuit identification
- Flame-retardant PVC overall jacket provides abrasion, chemical, sunlight and weathering resistance

Compliances:

Industry Compliances:

- ICEA S-73-532

Other Compliances:

- Meets EPA 10 CFR, Part 261 for leachable lead content per TCLP method

CATALOG NUMBER	NO. OF COND.	COND. SIZE (AWG/kcmil)	MINIMUM AVG. INSULATION THICKNESS		MINIMUM AVG. JACKET THICKNESS		NOMINAL CABLE O.D.		COPPER WEIGHT		NET WEIGHT	
			INCHES	mm	INCHES	mm	INCHES	mm	LBS/1000 FT	kg/km	LBS/1000 FT	kg/km

14 AWG MULTI CONDUCTORS

269080*	2 Flat	14	0.030	0.76	0.045	1.14	.230 x .370	5.30 x 9.30	25	38	57	85
647560*	2	14	0.030	0.76	0.045	1.14	0.37	9.4	26	38	66	98
365410*	3	14	0.030	0.76	0.045	1.14	0.39	9.9	38	57	87	130
267950*	4	14	0.030	0.76	0.045	1.14	0.42	10.7	51	76	108	161
286130*	5	14	0.030	0.76	0.045	1.14	0.46	11.7	64	95	130	194
365240*	7	14	0.030	0.76	0.045	1.14	0.50	12.7	90	133	173	258
365430*	9	14	0.030	0.76	0.060	1.52	0.62	15.8	116	172	236	351
647590*	12	14	0.030	0.76	0.060	1.52	0.69	17.5	154	229	300	447
647600*	19	14	0.030	0.76	0.060	1.52	0.80	20.3	244	363	443	659

12 AWG MULTI CONDUCTORS

257750*	2 Flat	12	0.030	0.76	0.045	1.14	.250 x .400	6.40 x 10.30	40	60	82	122
257770*	2	12	0.030	0.76	0.045	1.14	0.40	10.2	41	61	87	130
267830*	3	12	0.030	0.76	0.045	1.14	0.43	10.9	61	91	116	173
257730*	4	12	0.030	0.76	0.045	1.14	0.47	11.9	81	121	147	219
270720*	5	12	0.030	0.76	0.045	1.14	0.52	13.2	102	152	180	268
256750*	7	12	0.030	0.76	0.060	1.52	0.59	15.0	143	212	255	380
270730*	9	12	0.030	0.76	0.060	1.52	0.68	17.3	184	273	321	478
267860*	12	12	0.030	0.76	0.060	1.52	0.77	19.6	245	364	412	613
647650*	19	12	0.030	0.76	0.080	2.03	0.94	23.9	388	577	654	973

10 AWG MULTI CONDUCTORS

257760*	2 Flat	10	0.030	0.76	0.045	1.14	.270 x .450	6.90 x 11.40	64	96	110	164
257780*	2	10	0.030	0.76	0.045	1.14	0.45	11.4	65	96	130	194
267840*	3	10	0.030	0.76	0.045	1.14	0.48	12.2	97	96	170	253
257740*	4	10	0.030	0.76	0.060	1.52	0.52	13.2	129	144	235	350
257790*	5	10	0.030	0.76	0.060	1.52	0.60	15.2	162	192	286	426
257800*	7	10	0.030	0.76	0.060	1.52	0.66	16.8	227	241	365	543
261690*	9	10	0.030	0.76	0.060	1.52	0.76	19.3	292	337	466	694
257810*	12	10	0.030	0.76	0.080	2.03	0.90	22.9	389	434	626	932
271740*	19	10	0.030	0.76	0.080	2.03	1.05	26.7	616	579	930	1384

Dimensions and weights are nominal; subject to industry tolerances.

*Non-stock item, minimum runs apply. Please consult Customer Service for price and delivery.

GenFree™

XLPO/LSZH, Control
600V, UL Type TC-LS-ER¹—E-2 Color Code



Product Construction

Conductor:

- 14 AWG thru 10 AWG fully annealed stranded tinned copper per ASTM B33
- Class B stranding per ASTM B8

Insulation:

- Flame-retardant, Low-Smoke, Cross-Linked Polyolefin (XLPO)
- Color-coded: per ICEA Method 1; Table E-2 (Does not include white or green)

Jacket:

- Flame-retardant, Sunlight-resistant, Low-Smoke, Zero-Halogen Polyolefin (LSZH)

Print

- GENERAL CABLE® (WC) GENFREE™ XX/C XXAWG XLPO/LSZH (UL) TYPE TC-LS-ER¹ XHHW-2 CDRS 90°C WET OR DRY 600V DIR BUR SUN RES ROHS DAY/MONTH/YEAR OF MFG SEQUENTIAL FOOTAGE MARK

Options:

- Class C stranding
- E-1 Color Code
- Overall shielded multi conductor
- Other constructions available upon request

Applications:

- In free air, raceways, aerial or direct burial
- In wet or dry locations
- Permitted for use in Class I Division 2 industrial hazardous locations per NEC
- Permitted for Exposed Run (ER) use in accordance with the NEC for 3 or more conductors

Features:

- Rated at 90°C wet or dry
- Ripcord applied to all cables with jacket thickness of 60 mils or less
- Excellent physical and electrical properties
- Excellent moisture resistance
- Excellent resistance to compression and impact
- Chemical-resistant
- Low coefficient of friction for easy pulling
- Sunlight- and weather-resistant
- Meets cold bend test at -30°C
- Low-Smoke, Zero-Halogen jacket is environmentally safe
- Low-Smoke, Zero-Halogen jacket reduces the amount of toxic and corrosive gases emitted during combustion, providing a safer environment for personnel and equipment during the hazards of fire
- Meets the crush and impact requirements of Type MC cable for 3 or more conductors

Compliances:

- Industry Compliances:**
- UL 44 Type XHHW-2
 - UL 1277 Type TC-LS-ER
 - UL 1581
 - ROHS Compliant
- Flame Tests Compliances:**
- UL 1581
 - UL 1277
 - UL 1685
 - IEEE 1202
- Other Compliances:**
- EPA 40 CFR, Part 261 for leachable lead content per TCLP
 - OSHA acceptable

Packaging:

- Material cut to length and shipped on non-returnable wood reels

CATALOG NUMBER	NO. OF COND.	COND. SIZE (AWG)	COND. STRAND	MINIMUM AVG. INSULATION THICKNESS		MINIMUM AVG. JACKET THICKNESS		NOMINAL CABLE O.D.		COPPER WEIGHT		NET WEIGHT	
				INCHES	mm	INCHES	mm	INCHES	mm	LBS/1000 FT	kg/km	LBS/1000 FT	kg/km

14 AWG MULTI CONDUCTORS

394280	2 Flat	14	7/.0242	0.030	0.76	0.045	1.14	.365 x .230	9.30 x 5.80	26	38	61	91
394290*	2	14	7/.0242	0.030	0.76	0.045	1.14	0.370	9.40	26	39	71	106
394300	3	14	7/.0242	0.030	0.76	0.045	1.14	0.390	9.91	39	59	92	137
394310	4	14	7/.0242	0.030	0.76	0.045	1.14	0.425	10.80	53	78	115	171
394320	5	14	7/.0242	0.030	0.76	0.045	1.14	0.465	11.81	66	98	139	207
394330	7	14	7/.0242	0.030	0.76	0.045	1.14	0.505	12.83	92	137	173	257
394340	9	14	7/.0242	0.030	0.76	0.060	1.52	0.620	15.75	118	176	240	357
394350	12	14	7/.0242	0.030	0.76	0.060	1.52	0.700	17.78	158	235	301	448
394360	19	14	7/.0242	0.030	0.76	0.060	1.52	0.815	20.70	250	372	468	696
394370*	25	14	7/.0242	0.030	0.76	0.080	2.03	0.935	23.75	323	481	624	929
394380*	30	14	7/.0242	0.030	0.76	0.080	2.03	1.030	26.16	387	576	747	1112
394390*	37	14	7/.0242	0.030	0.76	0.080	2.03	1.110	28.19	466	694	875	1302

12 AWG MULTI CONDUCTORS

394400	2 Flat	12	7/.0305	0.030	0.76	0.045	1.14	.400 x .245	10.20 x 6.20	40	60	82	122
394410*	2	12	7/.0305	0.030	0.76	0.045	1.14	0.410	10.41	41	61	94	140
394420 ²	3+ Gmd	12	7/.0305	0.030	0.76	0.045	1.14	0.410	10.41	85	127	148	220
394430	3	12	7/.0305	0.030	0.76	0.045	1.14	0.435	11.05	64	95	124	185
394440	4	12	7/.0305	0.030	0.76	0.045	1.14	0.475	12.07	85	127	157	234
394450	5	12	7/.0305	0.030	0.76	0.045	1.14	0.520	13.21	106	158	191	284
394460	7	12	7/.0305	0.030	0.76	0.060	1.52	0.595	15.11	149	221	268	399
394470	9	12	7/.0305	0.030	0.76	0.060	1.52	0.695	17.65	191	285	337	502
394480	12	12	7/.0305	0.030	0.76	0.060	1.52	0.765	19.43	247	368	428	637
394490	19	12	7/.0305	0.030	0.76	0.080	2.03	0.940	23.88	391	582	688	1024
394500*	25	12	7/.0305	0.030	0.76	0.080	2.03	1.095	27.81	515	767	854	1271
394510*	30	12	7/.0305	0.030	0.76	0.080	2.03	1.150	29.21	618	920	1002	1491
394520*	37	12	7/.0305	0.030	0.76	0.080	2.03	1.240	31.50	762	1134	1240	1845

10 AWG MULTI CONDUCTORS

394530	2 Flat	10	7/.0385	0.030	0.76	0.045	1.14	.445 x .270	11.30 x 6.90	64	95	113	168
394540*	2	10	7/.0385	0.030	0.76	0.045	1.14	0.455	11.56	65	97	128	190
394550 ²	3+ Gmd	10	7/.0385	0.030	0.76	0.045	1.14	0.485	12.32	134	199	225	335
394560	3	10	7/.0385	0.030	0.76	0.045	1.14	0.485	12.32	100	150	172	256
394570	4	10	7/.0385	0.030	0.76	0.060	1.52	0.560	14.22	134	199	234	348
394580	5	10	7/.0385	0.030	0.76	0.060	1.52	0.615	15.62	167	249	284	423
394590	7	10	7/.0385	0.030	0.76	0.060	1.52	0.670	17.02	234	349	381	567
394600	9	10	7/.0385	0.030	0.76	0.060	1.52	0.760	19.30	295	440	464	691
394610	12	10	7/.0385	0.030	0.76	0.080	2.03	0.905	22.99	402	598	651	696

Dimensions and weights are nominal; subject to industry tolerances.
¹Non-stock item, minimum runs apply. Please consult Customer Service for price and delivery.
²Approved as -ER for Exposed Run applications of 3 or more conductors as defined by the NEC.
³This construction does not require an -ER mark.



GenFree™

XLPO/LSZH, Control, Shielded
600V, UL Type TC-LS-ER¹, Overall Shielded—E-2 Color Code



Product Construction

Conductor:

- 16 AWG thru 10 AWG fully annealed stranded tinned copper per ASTM B33
- Class B stranding per ASTM B8

Insulation:

- Flame-retardant, Low-Smoke, Cross-Linked Polyolefin (XLPO)
- Color-coded per ICEA Method 1; Table E-2 (Does not include white or green)

Shield:

- Overall shielded multi-conductor cable
- Overall shield is Flexfoil® aluminum/polyester in contact with stranded tinned copper drain wire

Jacket:

- Flame-retardant, Sunlight-resistant, Low-Smoke, Zero-Halogen Polyolefin (LSZH)

Print

- GENERAL CABLE® (WC) SHIELDED GENFREE™ XX/C XXAWG XLPO/LSZH (UL) TYPE TC-LS-ER¹ XHHW-2 CDRS 90°C WET OR DRY 600V DIR BUR SUN RES ROHS DAY/MONTH/YEAR OF MFG SEQUENTIAL FOOTAGE MARK

Options:

- Class C stranding
- E-1 Color Code
- Unshielded multi conductors
- Other constructions available upon request

Applications:

- In free air, raceway, aerial and direct burial
- In wet or dry locations
- Permitted for use in Class I Division 2 industrial hazardous locations per NEC
- Permitted for Exposed Run (ER) use in accordance with the NEC for 3 or more conductors

Features:

- Rated at 90°C wet or dry
- Ripcord applied to all cables with jacket thickness of 60 mils or less
- Excellent physical and electrical properties
- Excellent moisture resistance
- Excellent resistance to compression and impact
- Chemical-resistant
- Low coefficient of friction for easy pulling
- Sunlight- and weather-resistant
- Meets cold bend test at -30°C
- Low-Smoke, Zero-Halogen jacket is environmentally safe
- Low-Smoke, Zero-Halogen jacket reduces the amount of toxic and corrosive gases emitted during combustion, providing a safer environment for personnel and equipment during the hazards of fire
- Meets the crush and impact requirements of Type MC cable for 3 or more conductors

Compliances:

- **Industry Compliances:**
 - UL 44 Type XHHW-2
 - UL 1277 Type TC-LS-ER
 - UL 1581
 - ROHS Compliant
- **Flame Tests Compliances:**
 - UL 1581
 - UL 1277
 - UL 1685
 - IEEE 1202
- **Other Compliances:**
 - EPA 40 CFR, Part 261 for leachable lead content per TCLP
 - OSHA acceptable

Packaging:

- Material cut to length and shipped on non-returnable wood reels

CATALOG NUMBER	NO. OF COND.	COND. SIZE (AWG)	COND. STRAND	MINIMUM AVG. INSULATION THICKNESS		MINIMUM AVG. JACKET THICKNESS		NOMINAL CABLE O.D.		COPPER WEIGHT		NET WEIGHT	
				INCHES	mm	INCHES	mm	INCHES	mm	LBS/1000 FT	kg/km	LBS/1000 FT	kg/km

OVERALL SHIELDED MULTI CONDUCTORS 16 AWG CONDUCTORS

394960*	2	16	7/0192	0.025	0.64	0.045	1.14	0.320	8.13	19	28	52	77
394630*	3	16	7/0192	0.025	0.64	0.045	1.14	0.335	8.51	27	40	66	98

OVERALL SHIELDED MULTI CONDUCTORS 14 AWG CONDUCTORS

394640*	2	14	7/0242	0.030	0.76	0.045	1.14	0.375	9.53	29	43	74	110
394650*	3	14	7/0242	0.030	0.76	0.045	1.14	0.395	10.03	42	63	95	141
394660*	4	14	7/0242	0.030	0.76	0.045	1.14	0.430	10.92	55	82	118	176
394670*	5	14	7/0242	0.030	0.76	0.045	1.14	0.470	11.94	68	101	142	211
394680*	7	14	7/0242	0.030	0.76	0.045	1.14	0.510	12.95	94	140	176	262
394690*	9	14	7/0242	0.030	0.76	0.060	1.52	0.625	15.88	121	180	243	362
394700*	12	14	7/0242	0.030	0.76	0.060	1.52	0.705	17.91	160	238	304	452
394710*	19	14	7/0242	0.030	0.76	0.060	1.52	0.820	20.83	252	375	471	701
394720*	25	14	7/0242	0.030	0.76	0.080	2.03	0.940	25.53	325	484	627	933
394730*	30	14	7/0242	0.030	0.76	0.080	2.03	1.035	26.29	389	579	750	1116
394740*	37	14	7/0242	0.030	0.76	0.080	2.03	1.115	28.32	468	696	878	1307

OVERALL SHIELDED MULTI CONDUCTORS 12 AWG CONDUCTORS

394750*	2	12	7/0305	0.030	0.76	0.045	1.14	0.415	10.45	43	64	97	144
394760*	3	12	7/0305	0.030	0.76	0.045	1.14	0.440	11.18	66	98	127	189
394770*	4	12	7/0305	0.030	0.76	0.045	1.14	0.480	12.19	87	129	160	238
394780*	5	12	7/0305	0.030	0.76	0.045	1.14	0.525	13.34	108	162	194	289
394790*	7	12	7/0305	0.030	0.76	0.060	1.52	0.600	15.24	151	225	271	403
394800*	9	12	7/0305	0.030	0.76	0.060	1.52	0.700	17.78	193	287	340	506
394810*	12	12	7/0305	0.030	0.76	0.060	1.52	0.770	19.56	249	371	431	641
394820*	19	12	7/0305	0.030	0.76	0.080	2.03	0.945	24.00	393	585	691	1028
394830*	25	12	7/0305	0.030	0.76	0.080	2.03	1.100	27.94	517	769	857	1275
394840*	30	12	7/0305	0.030	0.76	0.080	2.03	1.155	29.80	620	923	1005	1496
394850*	37	12	7/0305	0.030	0.76	0.080	2.03	1.245	31.62	764	1137	1243	1850

OVERALL SHIELDED MULTI CONDUCTORS 10 AWG CONDUCTORS

394860*	2	10	7/0385	0.030	0.76	0.045	1.14	0.460	11.68	68	101	131	195
394870*	3	10	7/0385	0.030	0.76	0.045	1.14	0.490	12.45	103	155	175	260
394880*	4	10	7/0385	0.030	0.76	0.060	1.52	0.565	14.35	136	202	237	353
394890*	5	10	7/0385	0.030	0.76	0.060	1.52	0.620	15.75	170	253	287	427
394900*	7	10	7/0385	0.030	0.76	0.060	1.52	0.675	17.15	237	353	384	571
394910*	9	10	7/0385	0.030	0.76	0.060	1.52	0.765	19.43	298	443	467	695
394920*	12	10	7/0385	0.030	0.76	0.080	2.03	0.910	23.11	404	601	654	973

Dimensions and weights are nominal; subject to industry tolerances.

*Non-stock item, minimum runs apply. Please consult Customer Service for price and delivery.

¹Approved as -ER for Exposed Run applications of 3 or more conductors as defined by the NEC.



GenFree™

XLPO/LSZH, Low-Voltage Power, Unshielded
600V, UL Type TC-LS—Method 4 Color Code



Features (cont'd.):

- Meets cold bend test at -30°C
- Low-Smoke, Zero-Halogen jacket is environmentally safe
- Low-Smoke, Zero-Halogen jacket reduces the amount of toxic and corrosive gases emitted during combustion, providing a safer environment for personnel and equipment during the hazards of fire

Compliances:

- Industry Compliances:**
- UL 44 Type XHHW-2
 - UL 1277 Type TC-LS
 - UL 1581
 - ROHS Compliant

Flame Tests Compliances:

- UL 1581
- UL 1277
- UL 1685
- IEEE 1202

Other Compliances:

- EPA 40 CFR, Part 261 for leachable lead content per TCLP
- OSHA acceptable

Packaging:

- Material cut to length and shipped on non-returnable wood reels

Product Construction

Conductor:

- 14 AWG thru 750 kcmil tinned, annealed copper per ASTM B33
- Class B stranding per ASTM B8

Insulation:

- Flame-retardant, Low-Smoke, Cross-Linked Polyolefin (XLPO)
- Color-coded per ICEA Method 4; Individual conductors colored black with conductor number surface printed in contrasting ink

Ground:

- Uninsulated tinned annealed copper per ASTM B3
- Class B stranding per ASTM B8

Jacket:

- Flame-retardant, Sunlight-resistant, Low-Smoke, Zero-Halogen Polyolefin (LSZH)

Print:

- GENERAL CABLE® (WC) OR (M) GENFREE™ XX/C XXAWG XLPO/LSZH (UL) TYPE TC-LS XHHW-2 CDRS 90°C WET OR DRY 600V DIR BUR SUN RES ROHS DAY/MONTH/YEAR OF MFG SEQUENTIAL FOOTAGE MARK

Options:

- Class C stranding
- E-1 or E-2 Color Code
- Insulated ground conductors
- Overall shielded multi conductors
- Other constructions available upon request

Applications:

- In free air, raceways, aerial or direct burial
- In wet or dry locations
- Permitted for use in Class 1 Division 2 industrial hazardous locations per NEC

Features:

- Rated at 90°C wet or dry
- Ripcord applied to all cables with jacket thickness of 60 mils or less
- Excellent physical, thermal and electrical properties
- Excellent moisture resistance
- Excellent resistance to crush, compression and impact
- Chemical-resistant
- Low coefficient of friction for easy pulling
- Sunlight- and weather-resistant

CATALOG NUMBER	NO. OF COND.	COND. SIZE (AWG/kcmil)	COND. STRAND	GROUND WIRE SIZE (AWG)	MINIMUM AVG. INSULATION THICKNESS		MINIMUM AVG. JACKET THICKNESS		NOMINAL CABLE O.D.		COPPER WEIGHT		NET WEIGHT	
					INCHES	mm	INCHES	mm	INCHES	mm	LBS/1000 FT	kg/km	LBS/1000 FT	kg/km
14 AWG - 750 kcmil MULTI CONDUCTORS														
394930*	3	14	7/.0242	14	0.030	0.76	0.045	1.14	0.430	10.92	55	82	118	176
394940*	3	12	7/.0305	12	0.030	0.76	0.045	1.14	0.480	12.19	87	129	160	238
394950*	3	10	7/.0385	10	0.030	0.76	0.060	1.52	0.565	14.35	136	202	237	353
14428.030800	3	8	7/.0486	10	0.045	1.14	0.060	1.52	0.655	16.64	190	283	314	467
14428.040800*	4	8	7/.0486	10	0.045	1.14	0.060	1.52	0.720	18.29	242	360	393	585
14428.030600	3	6	7/.0612	8	0.045	1.14	0.060	1.52	0.740	18.80	297	442	456	679
14428.040600*	4	6	7/.0612	8	0.045	1.14	0.060	1.52	0.790	20.07	384	571	561	835
14428.030400	3	4	7/.0772	8	0.045	1.14	0.080	2.03	0.880	22.35	442	658	642	955
14428.040400*	4	4	7/.0772	8	0.045	1.14	0.080	2.03	0.950	24.13	578	861	822	1223
14428.030200	3	2	7/.0974	6	0.045	1.14	0.080	2.03	1.010	25.65	703	1046	979	1457
14428.040200*	4	2	7/.0974	6	0.045	1.14	0.080	2.03	1.090	27.69	919	1368	1235	1838
14428.030100*	3	1	19/.0664	6	0.055	1.40	0.080	2.03	1.120	28.45	872	1298	1021	1594
14428.040100*	4	1	19/.0664	6	0.055	1.40	0.080	2.03	1.235	31.37	1136	1691	1521	2264
14428.035100	3	1/0	19/.0745	6	0.055	1.40	0.080	2.03	1.225	31.12	1069	1591	1439	2142
14428.045100*	4	1/0	19/.0745	6	0.055	1.40	0.080	2.03	1.330	33.78	1413	2103	1820	2709
14428.035200	3	2/0	19/.0837	6	0.055	1.40	0.080	2.03	1.300	33.02	1340	1994	1720	2560
14428.045200*	4	2/0	19/.0837	6	0.055	1.40	0.080	2.03	1.440	36.58	1760	2619	2208	3286
14428.035300*	3	3/0	19/.0940	4	0.055	1.40	0.080	2.03	1.420	36.07	1717	2555	2176	3238
14428.045300*	4	3/0	19/.0940	4	0.055	1.40	0.080	2.03	1.570	39.88	2245	3341	2788	3405
14428.035400	3	4/0	19/.1055	4	0.055	1.40	0.080	2.03	1.540	39.12	2130	3170	2614	3890
14428.045400*	4	4/0	19/.1055	4	0.055	1.40	0.110	2.79	1.790	45.47	2796	4161	3495	5201
14428.036000*	3	250	37/.0822	4	0.065	1.65	0.110	2.79	1.760	44.70	2494	3712	3184	4738
14428.046000*	4	250	37/.0822	4	0.065	1.65	0.110	2.79	1.915	48.64	3282	4884	4019	5981
14428.036200	3	350	37/.0973	3	0.065	1.65	0.110	2.79	1.960	49.78	3474	5170	4187	6231
14428.046200*	4	350	37/.0973	3	0.065	1.65	0.110	2.79	2.165	54.99	4577	6811	5436	8090
14428.036500	3	500	37/.1162	2	0.065	1.65	0.110	2.79	2.245	57.02	4934	7343	5847	8702
14428.046500*	4	500	37/.1162	2	0.065	1.65	0.110	2.79	2.475	62.87	6509	9687	7607	11321
14428.037000*	3	750	61/.1109	1	0.080	2.03	0.140	3.56	2.810	71.37	7278	10831	9145	13610
14428.047000*	4	750	61/.1109	1	0.080	2.03	0.140	3.56	3.115	79.12	9712	14453	11805	17569

Dimensions and weights are nominal; subject to industry tolerances.

*Non-stock item, minimum runs apply. Please consult Customer Service for price and delivery.



Phone: 888-593-3355
www.generalcable.com

600V Industrial Power Cables

SPECIFICATION NO.	PRODUCT DESCRIPTION	REVISION DATE
5050 [†]	DuraSheath® EPR/HYP, Low-Voltage Power, Unshielded 600V, UL Type RHH/RHW-2/USE-2 LS	Jan. 2008
5100	Unicon® FREP® FR-EPR, Low-Voltage Power, Unshielded 600V, UL Type RHH/RHW-2/USE-2	Jan. 2008
5150	XHHW-2 VW-1 XLPE, Control and Low-Voltage Power, Unshielded 600V, UL Type SIS/XHHW-2, VW-1 Rated	Jan. 2008
5200 [†]	XHHW-2 XLPE, Low-Voltage Power, Unshielded 600V, UL Type XHHW-2, c(UL) RW-90	Jan. 2008
5250 [†]	Unicon® XLPE XLPE, Low-Voltage Power, Unshielded 600V, UL Type RHH/RHW-2/USE-2	Jan. 2009
5300 [†]	Super Vu-Tron® EPR/CPE, Diesel Locomotive Cable 2000V, Type DLO, 600V, UL Type RHH/RHW, 1000V, CSA Type R90	Oct. 2008
5350 [†]	GenFree™ LSZH XLPO, Low-Smoke, Zero-Halogen (LSZH), Low-Voltage Power, Unshielded 600V, Type RHH/RHW-LS/USE, CSA AWM I A/B, Class B	Aug. 2008
5400 [†]	GenFree™ LSZH XLPO, Low-Smoke, Zero-Halogen (LSZH), Low-Voltage Power, Unshielded 600V, Type RHH/RHW-LS/USE, CSA AWM I A/B, Class I	Aug. 2008
5500 [†]	RW90 XLPE, Building Wire 600V, CSA Type RW90 (-40°C), Single Conductor, Copper	Jan. 2009
5550 [†]	RW90 XLPE, Building Wire 600V, CSA Type RW90 (-40°C), Single Conductor, Aluminum	Jan. 2009
5600 [†]	RWU90 XLPE, Building Wire 1000V, CSA Type RWU90 (-40°C), Single Conductor, Copper	Jan. 2009
5650 [†]	RWU90 XLPE, Building Wire 1000V, CSA Type RWU90 (-40°C), Single Conductor, Aluminum	Jan. 2009
5700 [†]	RHH/RHW-2 XLPE, Low-Voltage Power, Unshielded 2000V, UL Type RHH/RHW-2, Single Conductor, Aluminum	Oct. 2008

[†]Indicates these products are stocked by General Cable

DuraSheath®

EPR/HYP, Low-Voltage Power, Unshielded
600V, UL Type RHH/RHW-2/USE-2 LS



Product Construction

Conductor:

- 14 AWG thru 1000 kcmil tin-coated copper compressed Class B stranding per ASTM B33 and B8

Insulation:

- Flame-retardant Ethylene Propylene Rubber (EPR) colored for contrast with black low-lead Hypalon® Chlorosulfonated Polyethylene (CSPE)/Elastomer blend

Print:

- GENERAL CABLE® (MI) DURASHEATH LL TYPE USE-2 OR RHH OR RHW-2 LS VW-1 (SIZE) EP 600 VOLTS SUN RES FOR CT USE (UL) DAY/MONTH/YEAR OF MFG SEQUENTIAL FOOTAGE MARK

* Sizes smaller than 1/0 AWG do not include "FOR CT USE"

Applications:

- Ideally suited for use in a broad range of commercial, industrial and utility applications where reliability is a major concern and where maximum performance will be demanded
- In free air, raceways or direct burial
- For use in aerial, conduit, open tray and underground duct/installations

Features:

- Rated at 90°C wet or dry
- Deformation-resistant at high temperatures
- Excellent moisture resistance, exceeds UL 44
- Stable electrical properties over a broad temperature range
- Excellent flexibility at low temperatures; suitable for installation in sub-zero conditions
- Extra-tough, mechanically rugged composite insulation and jacket construction
- Resistant to most oils and chemicals
- UV/sunlight-resistant
- Meets UL-44 cold bend test at -40°C
- Colors available upon request

Compliances:

Industry Compliances:

- National Electric Code (NEC)
- ICEA S-95-658 / NEMA WC70
- "FOR CT USE" on 1/0 AWG and larger in accordance with the NEC
- UL 44 Type RHH/RHW-2
- UL 854 Type USE-2
- Low-smoke rating per UL

Compliances (cont'd.):

Flame Tests Compliances:

- UL 1581 VW-1
- For 1/0 AWG and larger: IEEE 383, IEEE 1202/CSA FT-4

Optional Flame Tests:

(See General Cable Sales Representative)

Other Compliances:

- EPA 40 CFR, Part 261 for leachable lead content per TCLP
- OSHA acceptable

Packaging:

- Material cut to length and shipped on non-returnable wood reels

CATALOG NUMBER	COND. SIZE (AWG/kcmil)	COND. STRAND	NOMINAL COND. DIAMETER		MINIMUM AVG. INSULATION				MINIMUM AVG. JACKET				COPPER WEIGHT		NET WEIGHT	
					THICKNESS		DIAMETER		THICKNESS		DIAMETER		LBS/1000 FT	kg/km	LBS/1000 FT	kg/km
			INCHES	mm	INCHES	mm	INCHES	mm	INCHES	mm						
14 AWG - 1000 kcmil CONDUCTORS																
14511.411400	14	7/.0242	0.07	1.78	0.030	0.76	0.14	3.56	0.015	0.38	0.17	4.32	13	19	24	36
14511.411200	12	7/.0305	0.09	2.29	0.030	0.76	0.16	4.06	0.015	0.38	0.19	4.83	20	30	33	49
14511.411000	10	7/.0385	0.12	3.05	0.030	0.76	0.18	4.57	0.015	0.38	0.21	5.33	32	48	48	71
14511.410800	8	7/.0486	0.15	3.81	0.045	1.14	0.24	6.10	0.015	0.38	0.28	7.11	50	75	77	115
14511.410600	6	7/.0612	0.18	4.57	0.045	1.14	0.28	7.11	0.030	0.76	0.35	8.89	81	121	122	182
14511.410400	4	7/.0772	0.23	5.84	0.045	1.14	0.33	8.38	0.030	0.76	0.39	9.91	129	192	178	265
14511.710200	2	7/.0974	0.29	7.37	0.045	1.14	0.39	9.91	0.030	0.76	0.46	11.68	205	305	265	394
14511.715100	1/0	19/.0740	0.37	9.40	0.055	1.40	0.48	12.19	0.045	1.14	0.58	14.73	326	485	422	628
14511.715200	2/0	19/.0837	0.41	10.41	0.055	1.40	0.53	13.46	0.045	1.14	0.63	16.00	411	612	518	771
14511.715400	4/0	19/.1055	0.52	13.21	0.055	1.40	0.64	16.26	0.045	1.14	0.74	18.80	653	972	785	1168
14511.716000	250	37/.0822	0.56	14.22	0.065	1.65	0.70	17.78	0.065	1.65	0.85	21.59	772	1149	960	1429
14511.716200	350	37/.0973	0.67	17.02	0.065	1.65	0.81	20.57	0.065	1.65	0.96	24.38	1081	1609	1299	1933
14511.716500	500	37/.1162	0.80	20.32	0.065	1.65	0.94	23.88	0.065	1.65	1.09	27.69	1542	2295	1803	2683
14511.717000	750	61/.1109	0.98	24.89	0.080	2.03	1.15	29.21	0.065	1.65	1.31	33.27	2316	3447	2664	3965
14511.717500	1000	61/.1280	1.13	28.70	0.080	2.03	1.31	33.27	0.065	1.65	1.46	37.08	3806	5664	3989	5936

Dimensions and weights are nominal; subject to industry tolerances.



Phone: 888-593-3355
www.generalcable.com

Unicon® FREP®

FR-EPR, Low-Voltage Power, Unshielded
600V, UL Type RHH/RHW-2/USE-2



Product Construction

Conductor:

- 14 AWG thru 1000 kcmil stranded annealed bare copper compressed Class B stranding per ASTM B8

Insulation:

- Flame-retardant Ethylene Propylene Rubber (EPR)

Print:

- GENERAL CABLE® (MI) UNICON® FREP® TYPE USE-2 OR RHH OR RHW-2 VW-1 SIZE (AWG OR KCMIL) 600 VOLTS SUN RES FOR CT USE (UL) DAY/MONTH/YEAR OF MFG SEQUENTIAL FOOTAGE MARK

* Sizes smaller than 1/0 AWG do not include "FOR CT USE"

Options:

- 2kV version
- Tinned copper conductor
- Class C stranding
- Unicon® XLPE-Flame-retardant Cross-Linked Polyethylene (XLPE) insulation
- Other constructions available upon request

Applications:

- Ideally suited for use in broad range of commercial, industrial and utility applications where reliability is the major concern, where maximum performance will be demanded and where space is limited
- In free air, raceways or direct burial in accordance with NEC

Features:

- Rated at 90°C wet or dry
- Smaller cable diameter
- Excellent electrical, thermal and physical properties
- Excellent resistance to moisture
- Excellent resistance to crush, compression cuts and heat deformation
- Excellent flame-resistance
- Excellent low temperature cold bend characteristics
- Meets cold bend test at -25°C

Compliances:

Industry Compliances:

- National Electrical Code (NEC)
- UL 44 Type RHH/RHW-2
- UL 854 Type USE-2
- ICEA S-95-658/NEMA WC70)
- "FOR CT USE" on 1/0 AWG and larger in accordance with NEC
- UL Listed VW-1

Flame Tests Compliances:

- UL 1581 VW-1
- For 1/0 AWG and larger: IEEE 383, IEEE 1202/CSA FT4, ICEA T-29-520

Other Compliances:

- EPA 40 CFR, Part 261 for leachable lead content per TCLP
- OSHA acceptable

Packaging:

- Material cut to length and shipped on non-returnable wood reels

CATALOG NUMBER	COND. SIZE (AWG/kcmil)	COND. STRAND	NOMINAL COND. DIAMETER		MINIMUM AVG. INSULATION THICKNESS		NOMINAL CABLE O.D.		COPPER WEIGHT		NET WEIGHT	
			INCHES	mm	INCHES	mm	INCHES	mm	LBS/1000 FT	kg/km	LBS/1000 FT	kg/km
14 AWG - 1000 kcmil CONDUCTORS												
14101.211400*	14	7/.0242	0.07	1.78	0.045	1.14	0.17	4.32	13	19	24	36
14101.211200*	12	7/.0305	0.09	2.29	0.045	1.14	0.19	4.83	20	30	33	49
14101.211000*	10	7/.0385	0.12	3.05	0.045	1.14	0.21	5.33	32	48	48	71
14101.210800*	8	7/.0486	0.15	3.81	0.060	1.52	0.27	6.86	50	75	78	116
14101.210600*	6	7/.0612	0.18	4.57	0.060	1.52	0.31	7.87	81	121	114	170
14101.210400*	4	7/.0772	0.23	5.84	0.060	1.52	0.36	9.14	129	192	169	252
14101.210200*	2	7/.0974	0.29	7.37	0.060	1.52	0.42	10.67	205	305	254	378
14101.215100*	1/0	19/.0740	0.37	9.40	0.080	2.03	0.53	13.46	326	485	402	598
14101.215200*	2/0	19/.0837	0.41	10.41	0.080	2.03	0.58	14.73	411	612	500	744
14101.215400*	4/0	19/.1055	0.52	13.21	0.080	2.03	0.69	17.53	653	972	759	1130
14101.216000*	250	37/.0822	0.56	14.22	0.095	2.41	0.77	19.56	772	1149	905	1347
14101.216200*	350	37/.0973	0.67	17.02	0.095	2.41	0.87	22.10	1081	1609	1235	1838
14101.216500*	500	37/.1162	0.80	20.32	0.095	2.41	1.00	25.40	1542	2295	1728	2572
14101.217000*	750	61/.1109	0.98	24.89	0.110	2.79	1.22	30.99	2316	3447	2573	3829
14101.217500*	1000	61/.1280	1.13	28.70	0.110	2.79	1.37	34.80	3086	4593	3402	5063

Dimensions and weights are nominal; subject to industry tolerances.

*Non-stock item, minimum runs apply. Please consult Customer Service for price and delivery.



Phone: 888-593-3355
www.generalcable.com

XHHW-2 VW-1

XLPE, Control and Low-Voltage Power, Unshielded
600V, UL Type SIS¹/XHHW-2, VW-1 Rated



Product Construction

Conductor:

- 18 AWG thru 500 kcmil tinned, annealed copper per ASTM B33
- Class B stranding per ASTM B8

Insulation:

- Flame-retardant Cross-Linked Polyethylene (XLPE)
- Color code: Gray

Print:

For 18 AWG and 16 AWG:

- GENERAL CABLE® (WC) 1C XXAWG COPPER XLPE SIS TYPE 600V 90C YEAR OF MFG

For 14 AWG thru 4 AWG:

- GENERAL CABLE® (WC) 1C XXAWG COPPER XLPE TYPE SIS/XHHW-2 VW-1 (UL) 600V 90C YEAR OF MFG

For 2 AWG and larger:

- GENERAL CABLE® (WC) 1C XXAWG COPPER XLPE TYPE XHHW-2 VW-1 SUN RES FOR CT USE (UL) YEAR OF MFG SEQUENTIAL FOOTAGE MARK

* Sizes smaller than 1/0 AWG do not include "FOR CT USE"

Applications:

- For use in power and control circuits in switchboards, control panels and raceways in applications not exceeding 600 volts
- Acceptable for use in OSHA regulated installations

Features:

- Rated at 90°C wet or dry
- UL Listed as SIS/XHHW-2[‡] and XHHW-2^{‡‡} for general power or control wiring in accordance with the National Electrical Code
- Sizes 1/0 and larger for CT USE
- Excellent flame resistance
- Sunlight-resistant
- Excellent physical, thermal and electrical properties

Compliances:

Industry Compliances:

- UL Type SIS/XHHW-2[‡]—600V
- UL type XHHW-2^{‡‡}—600V
- ICEA S-95-658/NEMA WC70
- 1/0 and larger are listed "SUN RES FOR CT USE" in accordance with NEC

Flame Tests Compliances:

- UL 44 VW-1

Other Compliances:

- Meets EPA 40 CFR, Part 261 for leachable lead content per TCLP method
- OSHA acceptable

Packaging:

- Material to be shipped on spools or non-returnable wood reels

[‡] UL Type SIS/XHHW-2 for sizes 14 AWG thru 4/0 AWG

^{‡‡} UL Type XHHW-2 for sizes 250 kcmil thru 500 kcmil

CATALOG NUMBER	COND. SIZE (AWG/kcmil)	COND. STRAND	NOMINAL COND. DIAMETER		MINIMUM AVG. INSULATION THICKNESS		NOMINAL CABLE O.D.		COPPER WEIGHT		NET WEIGHT	
			INCHES	mm	INCHES	mm	INCHES	mm	LBS/1000 FT	kg/km	LBS/1000 FT	kg/km
18 AWG - 500 kcmil CONDUCTORS												
381500*	18	7/.0152	0.05	1.27	0.030	0.76	0.11	2.74	5	8	9	14
381510*	16	7/.0192	0.06	1.47	0.030	0.76	0.12	3.05	8	12	13	20
381520*	14	7/.0242	0.07	1.80	0.030	0.76	0.13	3.38	13	19	19	28
381530*	12	7/.0305	0.09	2.29	0.030	0.76	0.15	3.86	20	30	27	41
381540*	10	7/.0385	0.11	2.87	0.030	0.76	0.18	4.45	32	48	41	61
381550*	8	7/.0486	0.14	3.56	0.045	1.14	0.24	6.05	51	76	69	102
381560*	6	7/.0612	0.18	4.57	0.045	1.14	0.28	6.99	81	121	103	153
381570*	4	7/.0772	0.23	5.84	0.045	1.14	0.32	8.18	129	192	156	232
06591.210200*	2	7/.0974	0.29	7.37	0.045	1.14	0.38	9.68	205	305	239	355
06591.215100*	1/0	19/.0745	0.36	9.14	0.055	1.40	0.48	12.14	326	485	373	556
06591.215200*	2/0	19/.0837	0.41	10.41	0.055	1.40	0.52	13.28	411	612	464	691
06591.215300*	3/0	19/.0940	0.46	11.68	0.055	1.40	0.57	14.55	518	771	579	862
06591.215400*	4/0	19/.1055	0.51	12.95	0.055	1.40	0.63	15.98	653	972	722	1075
06591.216000*	250	37/.0822	0.56	14.22	0.065	1.65	0.70	17.75	772	1149	860	1280
06591.216200*	350	37/.0973	0.66	16.76	0.065	1.65	0.80	20.37	1081	1609	1185	1764
06591.216500*	500	37/.1162	0.79	20.07	0.065	1.65	0.93	23.65	1544	2298	1669	2484

Dimensions and weights are nominal; subject to industry tolerances.

*Non-stock item, minimum runs apply. Please consult Customer Service for price and delivery.

¹SIS on sizes 4 AWG and smaller



Phone: 888-593-3355
www.generalcable.com

XHHW-2

XLPE, Low-Voltage Power, Unshielded
600V, UL Type XHHW-2, c(UL) RW-90



Product Construction

Conductor:

- 8 AWG thru 750 kcmil annealed bare copper per ASTM B3
- Class B stranding per ASTM B8

Insulation:

- Flame-retardant Cross-Linked Polyethylene (XLPE) – Black

Print:

- GENERAL CABLE® (MI) AWG/KCMIL TYPE XHHW-2 (UL) TYPE RW90 C(UL) 600V MONTH/YEAR OF MFG SEQUENTIAL FOOTAGE MARK

Options:

- Tinned copper conductor
- Full colored insulation

Applications:

- General purpose building wire for use in air, cable tray or approved raceways
- Industrial environments where superior insulation toughness and chemical resistance is required
- Maximum operating temperature not to exceed 90°C in dry or wet locations

Features:

- Rated at 90°C wet or dry
- Smaller cable O.D.
- Excellent electrical, thermal and physical properties
- Excellent resistance to moisture
- Excellent resistance to crush, compression cuts and heat deformation

Compliances:

- National Electric Code (NEC)
- UL 44 Stranded for rubber-insulated wires and cables and UL 854
- ICEA S-95-658/NEMA WC70
- UL listed as Type XHHW-2
- c(UL) Type RW-90
- OSHA acceptable

Packaging:

- Material cut to length and shipped on non-returnable wood reels

CATALOG NUMBER	COND. SIZE (AWG/kcmil)	COND. STRAND	NOMINAL COND. DIAMETER		MINIMUM AVG. INSULATION THICKNESS		NOMINAL CABLE O.D.		COPPER WEIGHT		NET WEIGHT	
			INCHES	mm	INCHES	mm	INCHES	mm	LBS/1000 FT	kg/km	LBS/1000 FT	kg/km
8 AWG - 750 kcmil CONDUCTORS												
798751	8	7/.0486	0.14	3.56	0.045	1.14	0.24	6.10	51	76	65	97
496517	6	7/.0612	0.18	4.57	0.045	1.14	0.28	7.11	81	121	99	147
358172	4	7/.0772	0.23	5.84	0.045	1.14	0.33	8.38	129	192	152	226
760698	2	7/.0974	0.29	7.37	0.045	1.14	0.39	9.91	205	305	233	347
288411	1/0	19/.0740	0.36	9.14	0.055	1.40	0.48	12.19	326	485	364	572
629439	2/0	19/.0837	0.41	10.41	0.055	1.40	0.53	13.46	411	612	453	674
321736	4/0	19/.1055	0.51	12.95	0.055	1.40	0.63	16.00	653	972	706	1051
309824	250	37/.0822	0.56	14.22	0.065	1.65	0.70	17.78	722	1074	837	1246
935802	350	37/.0973	0.66	16.76	0.065	1.65	0.80	20.32	1081	1609	1157	1722
840671*	400	37/.1040	0.73	18.54	0.065	1.65	0.87	22.10	1235	1838	1322	1967
592915	500	37/.1162	0.79	20.07	0.065	1.65	0.93	23.62	1544	2298	1634	2432
369093	600	61/.1109	0.87	22.10	0.080	2.03	1.04	26.42	1853	2758	1972	2935
878916	750	61/.1280	0.98	24.89	0.080	2.03	1.15	29.21	2316	3447	2448	3643

Dimensions and weights are nominal; subject to industry tolerances.

*Non-stock item, minimum runs apply. Please consult Customer Service for price and delivery.

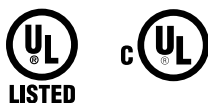

Unicon® XLPE

XLPE, Low-Voltage Power, Unshielded
600V, UL Type RHH/RHW-2/USE-2

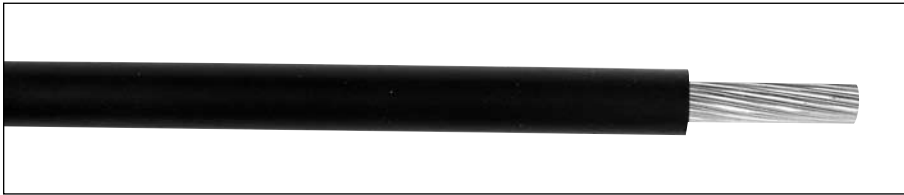

Features (cont'd.):

- Excellent resistance to moisture
- Excellent resistance to crush, compression cuts and heat deformation
- Excellent flame resistance
- Excellent low temperature cold bend characteristics
- Meets cold bend test at -25°C

Compliances:

Industry Compliances:

- National Electrical Code (NEC)
- ICEA S-95-658 / NEMA WC70
- "FOR CT USE" on 1/0 AWG and larger in accordance with NEC
- UL 44 Type RHH/RHW-2
- UL 854 Type USE-2

Flame Tests Compliances:

- UL 1581 VW-1
- For 1/0 AWG and larger: IEEE 383, IEEE 1202/CSA FT-4, ICEA T-29-520

Optional Flame Tests:

(See General Cable Sales Representative)

Other Compliances:

- EPA 40 CFR, Part 261 for leachable lead content per TCLP
- OSHA acceptable

Packaging:

- Material cut to length and shipped on non-returnable wood reels

Product Construction

Conductor:

- 14 AWG thru 1000 kcmil stranded annealed bare copper compressed class B stranding per ASTM B8

Insulation:

- Flame-retardant Cross-Linked Polyethylene (XLPE) – Black

Print:

For 14 AWG – 4 AWG:

- GENERAL CABLE® (PLANT OF MFG) UNICON®-XLP TYPE USE-2 OR RHH OR RHW-2 VW-1 SIZE (AWG OR KCMIL) 600 VOLTS SUN RES (UL) DAY/MONTH/YEAR OF MFG SEQUENTIAL FOOTAGE MARK

For 2 AWG and larger:

- GENERAL CABLE® (PLANT OF MFG) UNICON®-XLP TYPE USE-2 OR RHH OR RHW-2 VW-1 (SIZE) 600 VOLTS SUN RES FOR CT USE (UL) DAY/MONTH/YEAR OF MFG SEQUENTIAL FOOTAGE MARK

* Sizes smaller than 1/0 AWG do not include "FOR CT USE"

Options:

- 2 kV version
- Tinned copper conductor
- Class C stranding
- Various colors available
- Unicon® FREP® – Flame-retardant Ethylene Propylene Rubber (EPR) insulation
- Other constructions available upon request

Applications:

- Ideally suited for use in a broad range of commercial, industrial and utility applications where reliability is a major concern, where maximum performance will be demanded and where space is limited
- In free air, raceways or direct burial in accordance with NEC

Features:

- Rated at 90°C wet or dry
- Smaller cable O.D.
- Excellent electrical, thermal and physical properties

CATALOG NUMBER	COND. SIZE (AWG/kcmil)	COND. STRAND	NOMINAL COND. DIAMETER		MINIMUM AVG. INSULATION THICKNESS		NOMINAL CABLE O.D.		COPPER WEIGHT		NET WEIGHT	
			INCHES	mm	INCHES	mm	INCHES	mm	LBS/1000 FT	kg/km	LBS/1000 FT	kg/km
14 AWG - 1000 kcmil CONDUCTORS												
364830*	14	7/.0242	0.07	1.78	0.045	1.14	0.17	4.32	13	19	24	36
364840*	12	7/.0305	0.09	2.29	0.045	1.14	0.19	4.83	20	30	33	49
364850*	10	7/.0385	0.12	3.05	0.045	1.14	0.21	5.33	32	48	48	71
16602.210800*	8	7/.0486	0.15	3.81	0.060	1.52	0.27	6.86	50	75	78	116
16602.210600*	6	7/.0612	0.18	4.57	0.060	1.52	0.31	7.87	81	121	114	170
16602.210400*	4	7/.0772	0.23	5.84	0.060	1.52	0.36	9.14	129	192	169	252
16602.210200	2	7/.0974	0.29	7.37	0.060	1.52	0.42	10.67	205	305	254	378
16602.215100	1/0	19/.0740	0.37	9.40	0.080	2.03	0.53	13.46	326	485	403	600
16602.215200	2/0	19/.0837	0.41	10.41	0.080	2.03	0.58	14.73	411	612	501	746
16602.215400	4/0	19/.1055	0.52	13.21	0.080	2.03	0.69	17.53	653	972	760	1131
16602.216000	250	37/.0822	0.56	14.22	0.095	2.41	0.77	19.56	772	1149	906	1349
16602.216200	350	37/.0973	0.67	17.02	0.095	2.41	0.87	22.10	1081	1609	1237	1841
16602.216500	500	37/.1162	0.80	20.32	0.095	2.41	1.00	25.40	1542	2295	1730	2575
16602.217000	750	61/.1109	0.98	24.89	0.110	2.79	1.22	30.99	2316	3447	2576	3834
16602.217500*	1000	61/.1280	1.13	28.70	0.110	2.79	1.37	34.80	3086	4593	3405	5068

Dimensions and weights are nominal; subject to industry tolerances.

*Non-stock item, minimum runs apply. Please consult Customer Service for price and delivery.



Phone: 888-593-3355
www.generalcable.com

Super Vu-Tron®

EPR/CPE, Diesel Locomotive Cable

2000V, Type DLO; 600V, UL Type RHH/RHW; 1000V, CSA Type R90

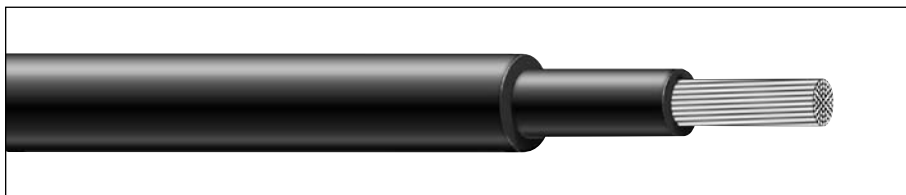

Applications:

- Diesel electric locomotives
- Telecom power supply
- Oil and gas drilling rigs
- Mining and earth-moving equipment
- Shipyards
- Motor leads
- Where flexible power leads must be installed in conduit or raceways

Product Construction:

Conductor:

- 10 AWG through 777.7 kcmil stranded tinned annealed copper per AAR 589

Insulation:

- Premium-grade 90°C EP

Jacket:

- Chlorinated Polyethylene (CPE), Black

Jacket Marking:

- SIZES 10 THROUGH 1 AWG - CAROL SUPER VU-TRON® (SIZE) (STRANDING) 90C DLO 2000 VOLTS P-7K-123040 MSHA CSA R90 1000V (UL) RHH OR RHW 600 VOLTS
- SIZES 1/0 THROUGH 646.4 - CAROL SUPER VU-TRON® (SIZE) 90C DLO 2000 VOLTS P-7K-123040 MSHA CSA R90 1000V (-40C) FT-1 - (UL) RHH OR RHW 600 VOLTS SUNLIGHT RESISTANT FOR CT USE
NOTE: (535.3 AND 646.4 MCM PRINTED (UL) RHH OR RHW 2000 VOLTS)
- SIZE 777.7 MCM ONLY - CAROL SUPER VU-TRON® C(UL) TYPE RHW-2 2KV VW-1 FOR CT USE TYPE DLO 2000V 90C P-102 MSHA

Features:

- 90°C temperature rating
- Excellent impact and abrasion resistance
- Resists oils, acids, alkalis, heat, flame
- Flexible tinned copper stranding
- FT4 upon request

Industry Approvals:

- UL Listed
- Accepted for listing as flame-resistant by MSHA
- CSA R90
- RoHS Compliant

Packaging:

- Lengths cut to order

CATALOG NUMBER	AWG OR MCM	COND. STRAND	NOMINAL INSULATION THICKNESS		NOMINAL O.D.		CURRENT AMPS		APPROX. NET WEIGHT LBS/MFT(S)
			INCHES	mm	INCHES	mm	(1)	(2)	
10 AWG - 777.7 kcmil DLO - 2000 VOLTS									
81910	10	27/24	0.045	1.14	0.26	6.60	40	55	60
81908	8	37/24	0.060	1.52	0.34	8.64	55	80	95
81906	6	61/24	0.060	1.52	0.40	10.16	75	105	145
81904	4	105/24	0.060	1.52	0.46	11.68	95	140	205
81902	2	154/24	0.060	1.52	0.52	13.21	130	190	295
81901	1	224/24	0.080	2.03	0.65	16.51	150	220	440
81911	1/0	280/24	0.080	2.03	0.69	17.53	170	260	515
81920	2/0	329/24	0.080	2.03	0.73	18.54	195	300	580
81930	3/0	456/24	0.080	2.03	0.81	20.57	225	350	770
81940	4/0	551/24	0.080	2.03	0.87	22.10	260	405	930
81926	262.6	650/24	0.095	2.41	1.00	25.40	296	467	1130
81931	313.3	777/24	0.095	2.41	1.06	26.92	326	522	1295
81937	373.7	925/24	0.095	2.41	1.10	27.94	362	591	1545
81944	444.4	1110/24	0.095	2.41	1.23	31.24	400	652	1820
81953	535.3	1332/24	0.120	3.05	1.34	34.04	445	728	2195
81964	646.4	1609/24	0.120	3.05	1.45	36.83	493	815	2560
81977	777.7	1924/24	0.120	3.05	1.50	38.10	546	904	3050

Dimensions and weights are nominal; subject to industry tolerances.

*Non-stock item, minimum runs apply. Please consult Customer Service for price and delivery.

(1) Ampacities based on 90°C Conductor and 30°C Ambient temperature based on the National Electrical Code- for not more than three current-carrying conductors inches raceway, cable or earth.

(2) Ampacities based on single-conductor inches free air. 90°C conductor temperature and an ambient air temperature of 30°C inches accordance with National Electrical Code® (NEC).

(S) Actual shipping weight may vary.



GenFree™ LSZH

XLPO, Low-Smoke, Zero-Halogen (LSZH), Low-Voltage Power, Unshielded
600V, Type RHH/RHW-LS/USE, CSA AWM I A/B, Class B



Product Construction

Conductor:

- 14 AWG thru 750 kcmil tinned coated compressed copper per ASTM B3 and B33. Class B stranding per ASTM B8.

Composite Insulation/Jacket:

- Flame-retardant, oil-resistant, limited smoke, Cross-Linked Polyolefin (XLPO), Black

Print:

- GENERAL CABLE® (PLANT OF MFG) (UL) TYPE USE OR RHH OR RHW-LS VW-1 (SIZE) 600V OIL RES. I SUN RES. FOR CT USE*/CSA AWM I A/B 105°C 600V FT4 MONTH/YEAR OF MFG SEQUENTIAL FOOTAGE MARK

* Sizes smaller than 1/0 AWG do not include "FOR CT USE"

Options:

- Available in Blue, Green, Red and Gray

Applications:

- General purpose 600V Power Cable Applications
- For use in conduit, open tray, underground duct and aerial installations when properly supported and installed
- RHH/RHW ratings for installation in conduit or raceway

Applications (cont'd.):

- USE rating for Direct Burial Applications
- CT-rated for installation in Cable Tray – 1/0 AWG and larger
- For use in all closed environments or populated spaces such as auditoriums, arenas and health facilities where more stringent specifications for smoke and toxicity emission levels are desired
- Ideally suited for use in a broad range of commercial and Industrial applications where reliability is the major concern, where maximum performance is demanded and where space is limited

Features:

- UL Type RHH/RHW/USE Rated at 90°C dry, 75°C wet
- CSA AWM I A/B Rated at 105°C
- UL AWM styles 3237 and 3578
- Smooth surface for reduced coefficient of friction for ease of installation
- Excellent moisture resistance
- Excellent resistance to salt water
- Available in colors for ease of phase identification
- Minimum acid gas emissions under combustion
- Meets cold bend test at -40°C
- Meets UL Oil Res. I and II

Compliances:

- UL 44 Standard for Rubber Insulated Wire
- UL 758 Standard for Appliance Wiring Material
- UL 854 Standard for Service Entrance Cable
- UL 1685 Standard for Vertical Tray Fire Propagation and Smoke Release Test for Electrical and Optical Fiber Cables
- Telcordia GR347 Core
- UL Listed VW-1
- ICEA S-95-658/NEMA WC 70
- IEEE 1202 (70,000 BTU/hr)
- IEEE 383 (70,000 BTU/hr)
- Sizes 1/0 AWG and larger are listed "FOR CT USE"
- CSA FT4
- CSA Standard C22.2 No. 0.3
- CSA Standard C22.2 No. 210.2
- Meets EPA 40 CFR, Part 261 for leachable lead content per TCLP method
- OSHA acceptable

Packaging:

- Material cut to length and shipped on non-returnable wood reels

CATALOG NUMBER	COND. SIZE (AWG/kcmil)	COND. STRAND (CLASS B)	NOMINAL COND. DIAMETER		MINIMUM AVG. INSULATION THICKNESS		NOMINAL CABLE O.D.		COPPER WEIGHT		NET WEIGHT	
			INCHES	mm	INCHES	mm	INCHES	mm	LBS/1000 FT	kg/km	LBS/1000 FT	kg/km
14 AWG - 750 kcmil CONDUCTORS, CLASS B												
14311.011400	14	7/.0242	0.07	1.78	0.045	1.14	0.17	4.32	13	19	18	27
14311.011200	12	7/.0305	0.09	2.29	0.045	1.14	0.19	4.83	20	30	25	37
14311.011000	10	7/.0385	0.12	3.05	0.045	1.14	0.22	5.59	32	48	38	57
14311.010800	8	7/.0486	0.15	3.81	0.060	1.52	0.28	7.11	50	75	58	86
14311.010600	6	7/.0612	0.18	4.57	0.060	1.52	0.31	7.87	81	121	116	173
14311.010400	4	7/.0772	0.23	5.84	0.060	1.52	0.36	9.14	129	192	171	254
14311.010200	2	7/.0974	0.28	7.11	0.060	1.52	0.42	10.67	205	305	257	382
14311.010100	1	19/.0644	0.32	8.13	0.080	2.03	0.49	12.45	258	385	331	493
14311.015100	1/0	19/.0745	0.36	9.14	0.080	2.03	0.53	13.46	326	485	406	604
14311.015200	2/0	19/.0837	0.41	10.41	0.080	2.03	0.58	14.73	411	612	495	737
14311.015300	3/0	19/.0940	0.46	11.68	0.080	2.03	0.63	16.00	518	771	612	911
14311.015400	4/0	19/.1055	0.51	12.95	0.080	2.03	0.68	17.27	653	972	757	1126
14311.016000	250	37/.0822	0.56	14.22	0.095	2.41	0.76	19.30	772	1149	905	1347
14311.016200	350	37/.0973	0.66	16.76	0.095	2.41	0.87	22.10	1081	1609	1237	1841
14311.016500	500	37/.1162	0.79	20.07	0.095	2.41	1.00	25.40	1544	2298	1728	2571
14311.017000	750	61/.1109	0.97	24.64	0.110	2.79	1.21	30.73	2316	3447	2572	3827

Dimensions and weights are nominal; subject to industry tolerances.



Phone: 888-593-3355
www.generalcable.com

GenFree™ LSZH

XLPO, Low-Smoke, Zero-Halogen (LSZH), Low-Voltage Power, Unshielded
600V, Type RHH/RHW-LS/USE, CSA AWM I A/B, Class I*



Features (cont'd.):

- Available in colors for ease of phase identification
- Minimum acid gas emissions under combustion
- Meets cold bend test at -40°C
- Meets UL Oil Res. I and II

Compliances:

- UL 44 Standard for Rubber Insulated Wire
- UL 758 Standard for Appliance Wiring Material
- UL 854 Standard for Service Entrance Cable
- UL 1685 Standard for Vertical Tray Fire Propagation and Smoke Release Test for Electrical and Optical Fiber Cables
- Telcordia GR347 Core
- UL Listed VW-1
- ICEA S-95-658/NEMA WC 70
- IEEE 1202 (70,000 BTU/hr)
- IEEE 383 (70,000 BTU/hr)
- Sizes 1/0 AWG and larger are listed "FOR CT USE"
- CSA FT4
- CSA Standard C22.2 No. 0.3
- CSA Standard C22.2 No. 210.2
- Meets EPA 40 CFR, Part 261 for leachable lead content per TCLP method
- OSHA acceptable

Product Construction

Conductor:

- 14 AWG thru 750 kcmil tinned coated copper per ASTM B3 and B33. Class I stranding per ASTM B8

Composite Insulation/Jacket:

- Flame-retardant, oil-resistant, limited smoke, Cross-Linked Polyolefin (XLPO), Black

Print:

- GENERAL CABLE® (PLANT OF MFG) (UL) TYPE USE OR RHH OR RHW-LS VW-1 (SIZE) 600V OIL RES. I SUN RES. FOR CT USE/CSA AWM I A/B 105°C 600V FT4 MONTH/YEAR OF MFG SEQUENTIAL FOOTAGE MARK

* Sizes smaller than 1/0 AWG do not include "FOR CT USE"

Options:

- Available in Blue, Green, Red and Gray

Applications:

- General purpose 600V Power Cable Applications
- For use in conduit, open tray, underground duct and aerial installations when properly supported and installed

Applications (cont'd.):

- RHH/RHW ratings for installation in conduit or raceway
- USE rating for Direct Burial Applications
- CT rated for installation in Cable Tray – 1/0 AWG and larger
- For use in all closed environments or populated spaces such as auditoriums, arenas and health facilities where more stringent specifications for smoke and toxicity emission levels are desired
- Ideally suited for use in a broad range of commercial and Industrial applications where reliability is the major concern, where maximum performance is demanded and where space is limited

Features:

- UL Type RHH/RHW/USE Rated at 90°C dry, 75°C wet
- CSA AWM I A/B Rated at 105°C
- UL AWM styles 3237 and 3578
- Smooth surface for reduced coefficient of friction for ease of installation
- Excellent moisture resistance
- Excellent resistance to salt water

Packaging:

- Material cut to length and shipped on non-returnable wood reels

CATALOG NUMBER	COND. SIZE (AWG/kcmil)	COND. STRAND (CLASS I)*	NOMINAL COND. DIAMETER		MINIMUM AVG. INSULATION THICKNESS		NOMINAL CABLE O.D.		COPPER WEIGHT		NET WEIGHT	
			INCHES	mm	INCHES	mm	INCHES	mm	LBS/1000 FT	kg/km	LBS/1000 FT	kg/km
14 AWG - 750 kcmil CONDUCTORS, CLASS I												
14315.011400	14	41	0.07	1.88	0.045	1.14	0.18	4.57	14	20	20	29
14315.011200	12	65	0.09	2.39	0.045	1.14	0.20	5.08	21	31	27	40
14315.011000	10	65	0.12	3.15	0.045	1.14	0.23	5.84	33	48	39	58
14315.010800	8	41	0.16	4.06	0.060	1.52	0.29	7.37	51	76	59	87
14315.010600	6	63/24	0.21	5.33	0.060	1.52	0.34	8.64	80	119	120	179
14315.010400	4	105/24	0.26	6.60	0.060	1.52	0.38	9.65	134	199	184	274
14315.010200	2	161/24	0.32	8.13	0.060	1.52	0.45	11.43	205	305	266	396
14315.010100	1	210/24	0.38	9.65	0.080	2.03	0.55	13.97	261	389	356	530
14315.015100	1/0	259/24	0.42	10.67	0.080	2.03	0.59	14.99	329	489	433	644
14315.015200	2/0	329/24	0.47	11.94	0.080	2.03	0.64	16.26	417	621	529	787
14315.015300	3/0	413/24	0.53	13.46	0.080	2.03	0.71	18.03	524	780	654	973
14315.015400	4/0	532/24	0.61	15.49	0.080	2.03	0.78	19.81	682	1014	831	1237
14315.016000	250	608/24	0.65	16.51	0.095	2.41	0.85	21.59	779	1159	946	1408
14315.016200	350	851/24	0.78	19.81	0.095	2.41	1.00	25.40	1095	1630	1301	1936
14315.016500	500	1221/24	0.95	24.13	0.095	2.41	1.16	29.46	1517	2258	1821	2710
14315.017000	750	1850/24	1.11	28.19	0.110	2.79	1.36	34.54	2408	3584	2723	4052

Dimensions and weights are nominal; subject to industry tolerances.
*Class I: sizes 8 AWG and larger.



RW90

XLPE, Building Wire
600V, CSA Type RW90 (-40°C), Single Conductor, Copper



Product Construction:

Conductor:

- 14 AWG thru 1000 kcmil compressed stranded plain copper

Insulation:

- Heat- and moisture-resistant, low-temperature Cross-Linked Polyethylene (XLPE), Type RW90, -40°C
- Color code: 8 AWG thru 2 AWG – black, white, red, blue, green; 1 AWG and larger– black (other colors available subject to minimum order quantity)

Print:

- GENERAL CABLE BICC® BRAND SQ-CSA RW90 XLPE SIZE (AWG OR KCMIL) CU 600V (-40°C) YEAR OF MFG SEQUENTIAL METER MARKING NOTE: For black insulation, add – SUN RES

Option:

- For 1000 volt applications, use RWU90

Applications:

- In accordance with Canadian Electrical Code (CEC), Part 1 – 19th Edition
- For wiring exposed to the weather (black color only)
- For use in raceways (except cable trays) in dry, damp or wet locations in accordance with Canadian Electrical Code (CEC)
- Refer to CEC, Table 19 for conditions of use

Features:

- Rated at 90°C wet or dry
- Meets cold bend and cold impact tests at -40°C

Compliances:

- CSA standard C 22.2 No. 38
- CSA Approval number: LL7319C

Packaging:

- 8 AWG thru 350 kcmil: 300m or 1500m reels
- 500 kcmil: 300m or 1200m reels
- 600 kcmil and 750m kcmil: 600m reels

Note: Not for sale in the U.S.

COND. SIZE (AWG/kcmil)	COND. STRAND	NOMINAL COND. O.D.**		MIN. AVG. INS. THICKNESS		NOMINAL DIAMETER (OVER) INSULATION		COPPER WEIGHT		NET WEIGHT		AMPACITY** 30°C AMBIENT
		INCHES	mm	INCHES	mm	INCHES	mm	LBS/1000 FT	kg/km	LBS/1000 FT	kg/km	
14 AWG - 1000 kcmil CONDUCTORS												
14	1	0.07	1.78	0.030	0.76	0.13	3.20	12	19	18	27	15
14	7/.0242	0.07	1.78	0.030	0.76	0.13	3.37	13	19	18	27	15
12	1	0.08	2.03	0.030	0.76	0.14	3.63	20	30	26	39	20
12	7/.0305	0.09	2.29	0.030	0.76	0.15	3.86	20	30	26	39	20
10	1	0.10	2.54	0.030	0.76	0.16	4.16	31	48	39	58	30
10	7/.0385	0.12	3.05	0.030	0.76	0.17	4.32	32	48	39	58	30
8	7/.0486	0.14	3.56	0.045	1.14	0.24	5.60	51	76	62	92	45
6	7/.0612	0.18	4.57	0.045	1.14	0.27	6.90	81	121	94	140	65
4	7/.0772	0.23	5.84	0.045	1.14	0.32	8.10	129	192	146	217	85
3	7/.0867	0.25	6.35	0.045	1.14	0.34	8.70	163	242	180	268	105
2	7/.0974	0.28	7.11	0.045	1.14	0.38	9.60	205	305	225	335	120
1	19/.0664	0.32	8.13	0.055	1.40	0.43	10.90	258	385	283	421	140
1/0	19/.0745	0.36	9.14	0.055	1.40	0.47	11.80	326	485	353	526	155
2/0	19/.0837	0.41	10.41	0.055	1.40	0.51	13.00	411	611	441	656	185****
3/0	19/.0940	0.46	11.68	0.055	1.40	0.56	14.20	518	771	552	821	210
4/0	19/.1055	0.51	12.95	0.055	1.40	0.62	15.60	653	972	690	1027	235
250	37.0822	0.56	14.22	0.065	1.65	0.69	17.60	772	1149	822	1224	265
300	37.0900	0.61	15.49	0.065	1.65	0.75	18.90	926	1378	981	1460	295
350	37/.0973	0.66	16.76	0.065	1.65	0.80	20.20	1081	1609	1144	1702	325
400*	37/.1040	0.71	18.03	0.065	1.65	0.84	21.40	1235	1838	1235	1838	345
500	37/.1162	0.79	20.06	0.065	1.65	0.93	23.50	1544	2297	1602	2384	395
600	61/.0992	0.87	22.10	0.080	2.03	1.03	26.20	1883	2802	1943	2892	455
750	61/.1109	0.97	24.64	0.080	2.03	1.14	28.80	2316	3446	2406	3580	500
1000*	61/.1280	1.12	28.45	0.080	2.03	1.29	32.60	3088	4595	3201	4763	585

Dimensions and weights are nominal; subject to industry tolerances.

*Non-stock item, minimum runs apply. Please consult Customer Service for price and delivery.

**For compact-stranded constructions, the number of wires may be reduced as follows:

19-Wire Constructions - 18 Wires Minimum 37-Wire Constructions - 35 Wires Minimum 61-Wire Constructions - 58 Wires Minimum

***Based on CEC Part 1-19th Edition, Table 2 for three conductors in raceway (conduit). For underground installations, refer to CEC, Rule 4-004 for ampacity rating.

****For 3 wires, 120/240V and 120/208V residential services or subservices, the allowable ampacity for 2/0 AWG shall be 200A. In this case, the 5% adjustment of Rule 8-106(1) cannot be applied.

RW90

XLPE, Building Wire
600V, CSA Type RW90 (-40°C), Single Conductor, Aluminum

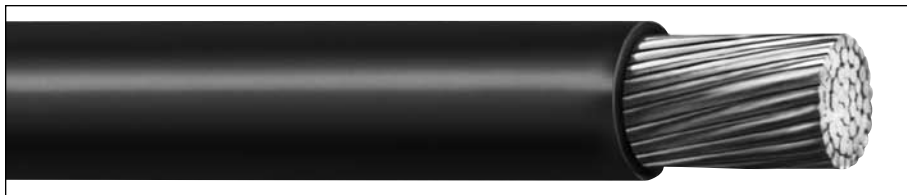

Product Construction:

Conductor:

- 8 AWG thru 1000 kcmil compact stranded Aluminum ACM (8000 Series)

Insulation:

- Heat- and moisture-resistant, low-temperature Cross-Linked Polyethylene (XLPE) – Type RW90, -40°C
- Color code: 8 AWG thru 2 AWG – black, white, red, blue, green; 1 AWG and larger– black (other colors available subject to minimum order quantity)

Print:

- GENERAL CABLE BICC® BRAND SQ-CSA RW90 XLPE SIZE (AWG OR KCMIL) AL ACM — 600V (-40°C) YEAR OF MFG SEQUENTIAL METER MARKING
NOTE: For black insulation, add – SUN RES

Option:

- For 1000 Volt applications, use RWU90 XLPE Aluminum ACM

Applications:

- In accordance with Canadian Electrical Code (CEC), Part 1 – 19th Edition
- For wiring exposed to the weather (black color only)
- For use in raceways (except cable trays) in dry, damp or wet locations in accordance with Canadian Electrical Code (CEC)
- Refer to CEC, Table 19 for conditions of use
- For Termination and Splicing of Aluminum Conductors, refer to CEC Rule 12-118

Features:

- Rated at 90°C wet or dry
- Meets cold bend and cold impact tests at -40°C

Compliances:

- CSA standard C 22.2 No. 38
- CSA Approval File Number LL7319C

Packaging:

- 8 AWG thru 400 kcmil: 300m or 1500m reels
- 500 kcmil: 300m or 1200m reels
- 600 kcmil and 750m kcmil: 600m reels

Note: Not for sale in the U.S.

COND. SIZE (AWG/kcmil)	COND. STRAND	NOMINAL COND. O.D.**		MIN. AVG. INS. THICKNESS		NOMINAL DIAMETER (OVER) INSULATION		ALUMINUM WEIGHT		NET WEIGHT		AMPACITY*** 30°C AMBIENT
		INCHES	mm	INCHES	mm	INCHES	mm	LBS/1000 FT	kg/km	LBS/1000 FT	kg/km	
8 AWG - 1000 kcmil CONDUCTORS												
8	7/.0486	0.13	3.30	.045	1.14	0.24	6.0	16	23	27	40	30
6	7/.0612	0.17	4.32	.045	1.14	0.27	6.9	25	37	38	57	55****
4	7/.0772	0.21	5.33	.045	1.14	0.32	8.1	39	59	56	84	65
3	7/.0867	0.24	6.10	.045	1.14	0.35	8.8	50	74	68	101	75
2	7/.0974	0.27	6.86	.045	1.14	0.38	9.6	63	93	83	123	95****
1	19/.0664	0.30	7.62	.055	1.40	0.44	11.0	79	117	107	160	105
1/0	19/.0745	0.34	8.64	.055	1.40	0.48	12.1	99	148	131	195	120
2/0	19/.0837	0.38	9.65	.055	1.40	0.52	13.2	125	186	161	239	145
3/0	19/.0940	0.42	10.67	.055	1.40	0.57	14.5	158	235	198	295	165
4/0	19/.1055	0.48	12.19	.055	1.40	0.63	16.0	199	296	245	364	185****
250	37/.0822	0.52	13.21	.065	1.65	0.69	17.6	235	350	292	435	215
300	37/.0900	0.57	14.48	.065	1.65	0.75	18.9	282	420	345	513	240
350	37/.0973	0.62	15.75	.065	1.65	0.80	20.2	329	490	397	590	260
400*	37/.1040	0.66	16.76	.065	1.65	0.84	21.4	376	559	449	667	290
500	37/.1162	0.74	18.80	.065	1.65	0.93	23.5	471	701	551	820	330
600	61/.0992	0.81	20.57	.080	2.03	1.03	26.2	565	841	670	998	370
750	61/.1109	0.91	23.11	.080	2.03	1.14	23.8	706	1050	824	1226	405
1000*	61/.1280	1.06	26.92	.080	2.03	1.29	32.6	941	1400	1078	1604	480

Dimensions and weights are nominal; subject to industry tolerances.

*Non-stock item, minimum runs apply. Please consult Customer Service for price and delivery.

**For compact-stranded constructions, the number of wires may be reduced as follows:

19-Wire Constructions - 18 Wires Minimum

37-Wire Constructions - 35 Wires Minimum

61-Wire Constructions - 58 Wires Minimum

***Based on CEC Part 1-19th Edition, Table 2 for three conductors in raceway (conduit). For underground installations, refer to CEC, Rule 4-004 for ampacity rating.

****For 3 wires, 120/240V and 120/208V residential services or subservices, the allowable ampacity for 2/0 AWG shall be 200A. In this case, the 5% adjustment of Rule 8-106(1) cannot be applied.

RWU90

XLPE, Building Wire

1000V, CSA Type RWU90 (-40°C), Single Conductor, Copper



Product Construction:

Conductor:

- 8 AWG thru 1000 kcmil compressed stranded plain copper

Insulation:

- Heat- and moisture-resistant, low-temperature Cross-Linked Polyethylene (XLPE), Type RWU90, -40°C
- Color code: 8 AWG thru 2 AWG – black, white, red, blue, green; 1 AWG and larger– black (other colors available subject to minimum order quantity)

Print:

- GENERAL CABLE BICC® BRAND SQ-CSA RWU90 XLPE SIZE (AWG OR KCMIL) CU 1000V (-40°C) YEAR OF MFG SEQUENTIAL METER MARKING
NOTE: For black insulation, add – SUN RES

Applications:

- In accordance with Canadian Electrical Code (CEC), Part 1 – 19th Edition
- For wiring exposed to the weather (black color only)
- For use in raceways (except cable trays) in dry, damp or wet locations in accordance with Canadian Electrical Code (CEC)
- Approved for direct burial per CEC Rule 12-012
- For service entrance below ground
- Refer to CEC, Table 19 for conditions of use

Features:

- Rated at 90°C wet or dry
- Meets cold bend and cold impact tests at -40°C

Compliances:

- CSA standard C 22.2 No. 38
- CSA certification (file) number: LL7319C

Packaging:

- 8 AWG thru 350 kcmil: 300m or 1500m reels
- 500 kcmil: 300m or 1200m reels

Note: Not for sale in the U.S.

COND. SIZE (AWG/kcmil)	COND. STRAND	NOMINAL COND. O.D.**		MIN. AVG. INS. THICKNESS		NOMINAL DIAMETER (OVER) INSULATION		COPPER WEIGHT		NET WEIGHT		AMPACITY*** 30°C AMBIENT
		INCHES	mm	INCHES	mm	INCHES	mm	LBS/1000 FT	kg/km	LBS/1000 FT	kg/km	
8 AWG - 1000 kcmil CONDUCTORS												
8	7/.0486	0.14	3.56	0.080	2.03	0.31	7.80	51	76	73	109	45
6	7/.0612	0.18	4.57	0.080	2.03	0.34	8.70	81	121	108	160	65
4	7/.0772	0.23	5.84	0.080	2.03	0.40	9.90	129	192	161	239	85
3	7/.0867	0.25	6.35	0.080	2.03	0.42	10.60	163	242	197	293	105
2	7/.0974	0.28	7.11	0.080	2.03	0.45	11.40	205	305	242	361	120
1/0	19/.0745	0.36	9.14	0.095	2.41	0.55	13.90	326	485	379	565	155
2/0	19/.0837	0.41	10.41	0.095	2.41	0.60	15.00	411	611	469	698	185****
3/0	19/.0940	0.46	11.68	0.095	2.41	0.64	16.20	518	771	583	867	210
4/0	19/.1055	0.51	12.95	0.095	2.41	0.70	17.70	653	972	724	1077	210
250	37/.0822	0.56	14.22	0.110	2.79	0.78	19.90	772	1149	866	1289	235
300	37/.0900	0.61	15.49	0.110	2.79	0.84	21.20	926	1378	926	1547	265
350	37/.0973	0.66	16.76	0.110	2.79	0.90	22.50	1081	1609	1189	1769	325
500	37/.1162	0.79	20.06	0.110	2.79	1.02	25.80	1544	2297	1667	2481	395
600	61/.0992	0.87	22.10	0.110	2.79	1.12	28.50	1883	2802	2027	3016	455
750	61/.1109	0.97	24.64	0.125	3.18	1.23	31.24	2316	3446	2505	3728	500
1000*	61/.1280	1.12	28.45	0.125	3.18	1.38	35.05	3088	4595	3323	4945	585

Dimensions and weights are nominal; subject to industry tolerances.

*Non-stock item, minimum runs apply. Please consult Customer Service for price and delivery.

**For compact-stranded constructions, the number of wires may be reduced as follows:

19-Wire Constructions - 18 Wires Minimum

37-Wire Constructions - 35 Wires Minimum

61-Wire Constructions - 58 Wires Minimum

***Based on CEC Part 1-19th Edition, Table 2 for three conductors in raceway (conduit). For underground installations, refer to CEC, Rule 4-004 for ampacity rating.

****For 3 wires, 120/240V and 120/208V residential services or subservices, the allowable ampacity for 2/0 AWG shall be 200A. In this case, the 5% adjustment of Rule 8-106(1) cannot be applied.

RWU90

XLPE, Building Wire

1000V, CSA Type RWU90 (-40°C), Single Conductor, Aluminum

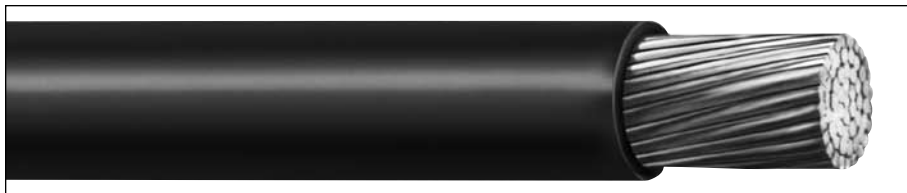

Product Construction:

Conductor:

- 8 AWG thru 1000 kcmil compact stranded Aluminum ACM (8000 Series)

Insulation:

- Heat- and moisture-resistant, low-temperature Cross-Linked Polyethylene (XLPE), Type RWU90, -40°C
- Color code: 8 AWG thru 2 AWG – black, white, red, blue, green; 1 AWG and larger– black (other colors available subject to minimum order quantity)

Print:

- GENERAL CABLE BICC® BRAND SQ-CSA RWU90 XLPE SIZE (AWG OR KCMIL) AL ACM 1000V (-40°C) YEAR OF MFG SEQUENTIAL METER MARKING
NOTE: For black insulation, add – SUN RES

Applications:

- In accordance with Canadian Electrical Code (CEC), Part 1 – 19th Edition
- For wiring exposed to the weather (black color only)
- For use in raceways (except cable trays) in dry, damp or wet locations in accordance with Canadian Electrical Code (CEC)
- Approved for direct burial per CEC rule 12-012
- For service entrance below ground
- Refer to CEC, Table 19 for conditions of use
- For Termination and Splicing of Aluminum Conductors, refer to CEC Rule 12-118

Features:

- Rated at 90°C wet or dry
- Meets cold bend and cold impact tests at -40°C

Industry Compliances:

- CSA standard C 22.2 No. 38
- CSA Approval File Number LL7319C

Packaging:

- 8 AWG thru 400 kcmil: 300m or 1500m reels
- 500 kcmil: 300m or 1200m reels
- 600 kcmil and 750m kcmil: 600m reels

Note: Not for sale in the U.S.

COND. SIZE (AWG/kcmil)	COND. STRAND	NOMINAL COND. O.D.**		MIN. AVG. INS. THICKNESS		NOMINAL DIAMETER (OVER) INSULATION		ALUMINUM WEIGHT		NET WEIGHT		AMPACITY*** 30°C AMBIENT
		INCHES	mm	INCHES	mm	INCHES	mm	LBS/1000 FT	kg/km	LBS/1000 FT	kg/km	
8 AWG - 1000 kcmil CONDUCTORS												
8	7/.0486	0.13	3.30	0.080	2.03	0.31	7.70	16	23	39	58	30
6	7/.0612	0.17	4.32	0.080	2.03	0.34	8.70	25	37	52	78	50****
4	7/.0772	0.21	5.33	0.080	2.03	0.39	9.90	39	59	72	107	65
3	7/.0867	0.24	6.10	0.080	2.03	0.42	10.60	50	74	85	127	75
2	7/.0974	0.27	6.86	0.080	2.03	0.45	11.40	63	93	102	151	95****
1	19/.0664	0.30	7.62	0.095	2.41	0.52	13.10	79	117	132	197	105
1/0	19/.0745	0.34	8.64	0.095	2.41	0.56	14.10	99	148	158	235	120
2/0	19/.0837	0.38	9.65	0.095	2.41	0.60	15.30	125	186	190	283	145
3/0	19/.0940	0.42	10.67	0.095	2.41	0.65	16.50	158	235	229	341	165
4/0	19/.1055	0.48	12.19	0.095	2.41	0.78	18.00	199	296	279	415	185****
250	37.0822	0.52	13.21	0.110	2.79	0.84	19.90	235	350	335	498	215
300	37.0900	0.57	14.48	0.110	2.79	0.89	21.20	282	420	391	581	240
350	37/.0973	0.62	15.75	0.110	2.79	0.89	22.60	329	490	446	663	260
400*	37/.1040	0.66	16.76	0.110	2.79	0.93	23.70	376	559	500	743	290
500	37/.1162	0.74	18.80	0.110	2.79	1.02	25.80	471	701	608	905	330
600	61/.0992	0.81	20.57	0.125	3.17	1.12	28.50	565	841	733	1091	370
750	61/.1109	0.91	23.11	0.125	3.17	1.23	31.10	706	1050	893	1329	405
1000*	61/.1280	1.06	26.92	0.125	3.17	1.38	34.90	941	1400	1155	1718	480

Dimensions and weights are nominal; subject to industry tolerances.

*Non-stock item, minimum runs apply. Please consult Customer Service for price and delivery.

**For compact-stranded constructions, the number of wires may be reduced as follows:

19-Wire Constructions - 18 Wires Minimum

37-Wire Constructions - 35 Wires Minimum

61-Wire Constructions - 58 Wires Minimum

***Based on CEC Part 1-19th Edition, Table 2 for three conductors in raceway (conduit). For underground installations, refer to CEC, Rule 4-004 for ampacity rating.

****For 3 wires, 120/240V and 120/208V residential services or subservices, the allowable ampacity for 2/0 AWG shall be 200A. In this case, the 5% adjustment of Rule 8-106(1) cannot be applied.

RHH/RHW-2

XLPE, Low-Voltage Power, Unshielded
2000V, UL Type RHH/RHW-2, Single Conductor, Aluminum

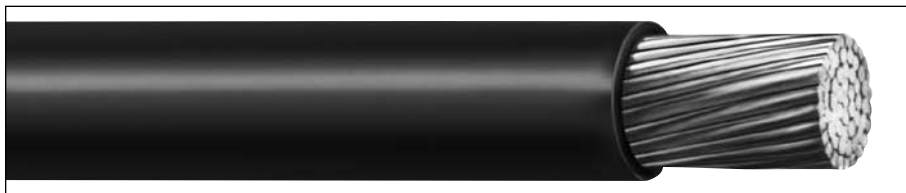

Features:

- Rated at 90°C wet or dry
- UV resistant - black is marked SR
- Smaller cable O.D.
- Excellent electrical, thermal and physical properties
- Excellent resistance to moisture
- Excellent resistance to crush, compression cuts and heat deformation

Compliances:

- National Electric Code (NEC)
- UL 44 Stranded for rubber-insulated wires and cables
- ICEA S-95-685/NEMA WC70
- UL listed as Type RHH/RHW-2
- OSHA acceptable

Packaging:

- Material cut to length and shipped on non-returnable wood reels

Product Construction:

Conductor:

- 8 AWG thru 1000 kcmil compacted aluminum ACM (AA-8000 Series)

Insulation:

- Flame-retardant Cross-Linked Polyethylene (XLPE) - Black

Print:

- GENERAL CABLE (SQ) AWG/KCMIL TYPE RHH/RHW-2 (UL) 2000V YEAR OF MFG SEQUENTIAL FOOTAGE MARK

Applications:

- For use from the lower control box at the base of the wind power tower and out to the step-up transformer through conduit
- General purpose building wire for use in air and approved raceways
- Industrial environments where superior insulation toughness and chemical resistance is required
- Maximum operating temperature not to exceed 90°C in wet or dry locations

CATALOG NUMBER	CONDUCTOR SIZE (AWG/kcmil)	COND. STRAND	NOMINAL CONDUCTOR DIAMETER		MINIMAL AVERAGE INSULATION THICKNESS		NOMINAL CABLE O.D.		NOMINAL ALUMINUM WEIGHT		NET WEIGHT	
			INCHES	mm	INCHES	mm	INCHES	mm	LBS/1000 FT	kg/km	LBS/1000 FT	kg/km
8 AWG - 1000 kcmil CONDUCTORS												
522582M*	8	7/W	0.134	3.4	0.070	1.78	0.285	7.20	15.49	23.05	38.15	56.78
650981M*	6	7/W	0.169	4.1	0.070	1.78	0.320	8.10	24.60	36.61	51.08	76.01
589692M*	4	7/W	0.213	5.4	0.070	1.78	0.360	9.10	40.20	59.82	71.50	106.40
313406M*	2	2/W	0.268	6.8	0.070	1.78	0.420	10.70	62.40	92.86	100.10	148.96
149512M*	1	18/W	0.301	7.6	0.090	2.29	0.495	12.60	77.81	115.79	133.76	199.05
827197M*	1/0	18/W	0.339	8.6	0.090	2.29	0.530	13.50	100.12	148.99	160.82	239.32
977766M*	2/0	18/W	0.379	9.6	0.090	2.29	0.580	14.70	123.90	184.38	191.50	284.97
861898M*	3/0	18/W	0.426	10.8	0.090	2.29	0.615	15.60	156.22	232.47	228.68	340.30
763699M*	4/0	18/W	0.476	12.1	0.090	2.29	0.665	16.90	201.40	299.70	281.10	418.31
607078M*	250	35/W	0.524	13.3	0.105	2.70	0.745	18.90	233.50	347.47	336.15	500.23
506887M*	350	35/W	0.619	15.7	0.105	2.70	0.840	21.30	330.90	492.41	448.90	668.00
292686M*	500	35/W	0.740	18.8	0.105	2.70	0.960	24.40	467.10	695.09	604.77	899.96
526839M	600	58/W	0.820	20.8	0.105	2.70	1.040	26.40	559.50	832.59	710.14	1056.76
883753M*	750	58/W	0.910	23.1	0.120	3.05	1.175	29.90	700.50	1042.41	901.20	1341.08
614607M	1000	58/W	1.060	26.9	0.120	3.05	1.325	33.70	939.00	1397.33	1168.00	1738.10

Dimensions and weights are nominal; subject to industry tolerances.

2.4kV – 35kV Industrial Medium-Voltage Cables

SPECIFICATION NO.	PRODUCT DESCRIPTION	REVISION DATE
6050 [†]	DuraSheath® EPR/HYP, Medium-Voltage Power, Non-Shielded 2400V, UL Type MV-90	Jan. 2008
6100 [†]	UniShield® EPR/Copper Wire Shield/CPE, Medium-Voltage Power, Shielded 5kV and 8kV, UL Type MV-105, 133% / 100% Ins. Levels, 115 Mils	Jan. 2009
6150 [†]	Uniblend® EPR/Copper Tape Shield/PVC, Medium-Voltage Power, Shielded 5kV and 8kV, UL Type MV-105, 133% / 100% Ins. Levels, 115 Mils	Jan. 2009
6175	Uniblend® EPR/Copper Tape Shield/CPE, Medium-Voltage Power, Shielded 5kV and 8kV, UL Type MV-105, 133% / 100% Ins. Levels, 115 Mils	Jan. 2009
6180	GenFree™ Uniblend® EPR/Copper Tape Shield/LSZH, Medium-Voltage Power, Shielded 5kV and 8kV, UL Type MV-105, 133% / 100% Ins. Levels, 115 Mils	Jan. 2009
6200	Copper Wire Shield TRXLPE/Copper Wire Shield/PVC, Medium-Voltage Power 5kV, UL Type MV-105, 100% Ins. Level, 90 Mils	Jan. 2008
6250 [†]	Uniblend® EPR/Copper Tape Shield with Overall PVC Jacket Medium-Voltage Power, Shielded, 5kV and 8kV, UL Type MV-105 133% / 100% Ins. Levels, 115 Mils, Three Conductor	Jan. 2009
6275	Uniblend® EPR/Copper Tape Shield with Overall CPE Jacket Medium-Voltage Power, Shielded, 5kV and 8kV, UL Type MV-105 133% / 100% Ins. Levels, 115 Mils, Three Conductor	Jan. 2009
6280	GenFree™ Uniblend® EPR/Copper Tape Shield with Overall LSZH Jacket Medium-Voltage Power, Shielded, 5kV and 8kV, UL Type MV-105 133% / 100% Ins. Levels, 115 Mils, Three Conductor	May 2008
6300 [†]	UniShield® EPR/Copper Wire Shield/CPE, Medium-Voltage Power, Shielded 15kV, UL Type MV-105, 133% Ins. Level, 220 Mils	Jan. 2009
6350 [†]	Uniblend® EPR/Copper Tape Shield/PVC, Medium-Voltage Power, Shielded 15kV, UL Type MV-105, 133% Ins. Level, 220 Mils	Jan. 2009
6375	Uniblend® EPR/Copper Tape Shield/CPE, Medium-Voltage Power, Shielded 15kV, UL Type MV-105, 133% Ins. Level, 220 Mils	Jan. 2009
6380	GenFree™ Uniblend® EPR/Copper Tape Shield/LSZH, Medium-Voltage Power, Shielded 15kV, UL Type MV-105, 133% Ins. Level, 220 Mils	Jan. 2009
6400	Copper Wire Shield TRXLPE/Copper Wire Shield/PVC, Medium-Voltage Power 15kV, UL Type MV-105, 133% Ins. Level, 220 Mils	Jan. 2008
6450 [†]	Uniblend® EPR/Copper Tape Shield with Overall PVC Jacket Medium-Voltage Power, Shielded, 15kV, UL Type MV-105 133% Ins. Level, 220 Mils, Three Conductor	Jan. 2008

[†]Indicates these products are stocked by General Cable

2.4kV – 35kV Industrial Medium-Voltage Cables

SPECIFICATION NO.	PRODUCT DESCRIPTION	REVISION DATE
6475	Uniblend® EPR/Copper Tape Shield with Overall CPE Jacket Medium-Voltage Power, Shielded, 15kV, UL Type MV-105 133% Ins. Level, 220 Mils, Three Conductor	Jan. 2009
6480	GenFree™ Uniblend® EPR/Copper Tape Shield with Overall LSZH Jacket Medium-Voltage Power, Shielded, 15kV, UL Type MV-105 133% Ins. Level, 220 Mils, Three Conductor	May 2008
6500	UniShield® EPR/Copper Wire Shield/CPE, Medium-Voltage Power, Shielded 25kV and 35kV, UL Type MV-105, 133% / 100% Ins. Levels, 345 Mils	Jan. 2009
6550[†]	Uniblend® EPR/Copper Tape Shield/PVC, Medium-Voltage Power, Shielded 25kV and 35kV, UL Type MV-105, 133% / 100% Ins. Levels, 345 Mils	Jan. 2009
6575	Uniblend® EPR/Copper Tape Shield/CPE, Medium-Voltage Power, Shielded 25kV and 35kV, UL Type MV-105, 133% / 100% Ins. Levels, 345 Mils	Jan. 2009
6580	GenFree™ Uniblend® EPR/Copper Tape Shield/LSZH, Medium-Voltage Power, Shielded 25kV and 35kV, UL Type MV-105, 133% / 100% Ins. Levels, 345 Mils	Jan. 2009
6600	Uniblend® EPR/Copper Tape Shield with Overall PVC Jacket Medium-Voltage Power, Shielded, 25kV and 35kV, UL Type MV-105 133% / 100% Ins. Levels, 345 Mils, Three Conductor	Jan. 2008

[†]Indicates these products are stocked by General Cable

DuraSheath®

EPR/HYP, Medium-Voltage Power, Non-Shielded 2400V, UL Type MV-90

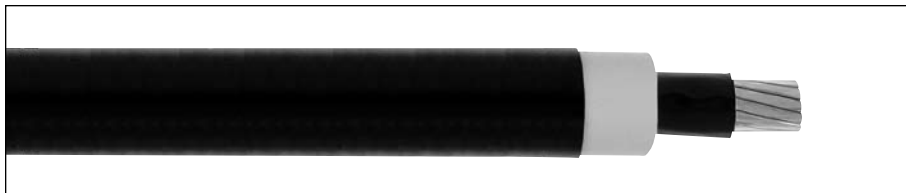

Product Construction

Conductor:

- 8 AWG thru 1000 kcmil annealed bare copper compact Class B strand

Extruded Strand Shield (ESS):

- Extruded thermoset semi-conducting stress-control layer over conductor

Insulation:

- Ethylene Propylene Rubber (EPR) insulation, colored to contrast with the black jacket material

Jacket:

- Low-Lead Chlorosulfonated Polyethylene (CSPE)/Elastomer blend

Print:

- GENERAL CABLE® (MI) SIZE (AWG or KCMIL) COMPACT CU DURASHEATH® LL 2400V NONSHIELDED EP TYPE MV-90 WET OR DRY SUN RES FOR CT USE OIL RES II (UL) MONTH/YEAR OF MFG SEQUENTIAL FOOTAGE MARK

* Sizes smaller than 1/0 AWG do not include "FOR CT USE"

Options:

- Multi conductor constructions
- Other constructions available upon request

Applications:

- Proven record of reliable performance through extensive use in these applications: pulp and paper mills, petrochemical plants, sewage treatment facilities, water treatment plants, steel mills, textile mills, utility power generating stations, scrubbers and other environmental protections systems, railroad and mining facilities
- For use in industrial and utility applications, where ease of installation is a major concern because of limited space and exposure to personnel is minimal
- For use in wet or dry locations when installed in accordance with NEC
- For use in aerial, conduit, open tray and underground duct installations

Features:

- Rated at 90°C
- Excellent heat and moisture resistance
- Flexibility for easy handling
- High dielectric strength
- Low moisture absorption
- Electrical stability under stress
- Low dielectric loss
- Chemical- and sunlight-resistant
- Simplification of splicing and terminating by elimination of need to handle cable shield
- Extra-tough, mechanically rugged composite insulation and jacket construction
- Meets cold bend test at -35°C

Compliances:

- National Electric Code (NEC)
- ICEA S-96-659/NEMA WC71
- UL 1072
- FAA L824 specification for cable for Underground Airport Lighting Circuits
- UL listed as Type MV-90 for use in accordance with NEC
- Sizes 1/0 AWG and larger are listed and marked "Sunlight-Resistant FOR CT USE" in accordance with NEC and also meet IEEE 383 (70,000 BTU/hr)
- Listed "oil-resistant II"
- Meets EPA 40 CFR, Part 261 for leachable lead content per TCLP method
- OSHA acceptable

Packaging:

- Material cut to length and shipped on non-returnable wood reels

CATALOG NUMBER	COND. SIZE (AWG/kcmil)	NOMINAL CONDUCTOR DIAMETER		NOMINAL EXTRUDED STRAND SHIELD DIAMETER		NOMINAL INSULATION THICKNESS		NOMINAL INSULATION DIAMETER		NOMINAL CABLE O.D.		COPPER WEIGHT		NET WEIGHT	
		INCHES	mm	INCHES	mm	INCHES	mm	INCHES	mm	INCHES	mm	LBS/1000 FT	kg/km	LBS/1000 FT	kg/km

2400V, UL TYPE MV-90

14901.410800*	8	0.14	3.56	0.15	3.81	0.125	3.18	0.41	10.41	0.58	14.73	51	76	196	292
14901.410600	6	0.17	4.32	0.19	4.83	0.125	3.18	0.44	11.18	0.62	15.75	81	121	241	359
14901.410400	4	0.22	5.59	0.23	5.84	0.125	3.18	0.49	12.45	0.66	16.76	129	192	308	458
14901.410200	2	0.27	6.86	0.29	7.37	0.125	3.18	0.55	13.97	0.72	18.29	205	305	408	607
14901.410100*	1	0.31	7.87	0.33	8.38	0.125	3.18	0.58	14.73	0.76	19.30	259	385	476	708
14901.415100	1/0	0.34	8.64	0.36	9.14	0.125	3.18	0.62	15.75	0.79	20.07	326	485	562	836
14901.415200	2/0	0.38	9.65	0.41	10.41	0.125	3.18	0.66	16.76	0.84	21.34	411	612	666	991
14901.415300*	3/0	0.43	10.92	0.45	11.43	0.125	3.18	0.71	18.03	0.92	23.37	518	771	823	1225
14901.415400	4/0	0.48	12.19	0.50	12.70	0.125	3.18	0.76	19.30	0.97	24.64	653	972	983	1463
14901.416000	250	0.53	13.46	0.55	13.97	0.140	3.56	0.84	21.34	1.08	27.43	772	1149	1183	1761
14901.416200	350	0.62	15.75	0.64	16.26	0.140	3.56	0.93	23.62	1.17	29.72	1080	1607	1545	2299
14901.416500	500	0.74	18.80	0.77	19.56	0.140	3.56	1.06	26.92	1.30	33.02	1544	2298	2077	3091
14901.417000	750	0.91	23.11	0.94	23.88	0.155	3.94	1.26	32.00	1.54	39.12	2316	3447	3040	4524
14901.417500*	1000	1.06	26.92	1.09	27.69	0.155	3.94	1.42	36.07	1.70	43.18	3086	4593	3913	5823

Dimensions and weights are nominal; subject to industry tolerances.

*Non-stock item, minimum runs apply. Please consult Customer Service for price and delivery.



Phone: 888-593-3355
www.generalcable.com

UniShield®

EPR/Copper Wire Shield/CPE, Medium-Voltage Power, Shielded
5kV and 8kV, UL Type MV-105, 133% / 100% Ins. Levels, 115 MILS



Product Construction

Conductor:

- 2 AWG thru 1000 kcmil annealed bare copper compact Class B strand

Extruded Strand Shield (ESS):

- Extruded thermoset semi-conducting stress-control layer over conductor

Insulation:

- Ethylene Propylene Rubber (EPR) insulation colored to contrast with black conducting shield layers

Composite Insulation Shield and Jacket:

- Six corrugated copper drain wires embedded in composite layers of semi-conducting thermoset copolymer and semi-conducting black flame-retardant Chlorinated Polyethylene (CPE)

Print:

- GENERAL CABLE® (DI) (MO/YR OF MANUFACTURE) LIGHTNING BOLT SYMBOL 1/C SIZE (AWG OR KCMIL) COMPACT CU UNISHIELD® (INSULATION THICKNESS) EPR DRTP SEMI-CON CPE JKT TYPE MV-105 (VOLTAGE) KV% INSULATION LEVEL SUN RES FOR CT USE (UL) SEQUENTIAL FOOTAGE MARK

* Sizes smaller than 1/0 AWG do not include "FOR CT USE"

Applications:

- Installed in a broad range of commercial, industrial and utility projects such as pulp and paper mills, petrochemical plants, steel mills, textile mills, water and sewage treatment facilities, environmental protection systems, railroads, mines and fossil fuel utility generating stations
- Suitable for use in wet or dry locations when installed in accordance with NEC
- For use in aerial, conduit, open tray and underground duct installations
- For use in direct burial if installed in a system with a ground conductor that is in close proximity, and conforms with NEC 250.4 (A) (5)

Features:

- Rated at 105°C
- Reduced conductor size and shield system provides the smallest premium medium-voltage shielded power cable with full insulation
- Smaller outside dimensions reduce the size of duct needed or increase the ampacity per duct
- All features contribute to faster and easier installation
- Superior cold bend and cold impact performance
- Stable and constant shield short circuit performance
- Excellent heat and moisture resistance
- Outstanding corona resistance
- Flexibility for easy handling
- High dielectric strength
- Low dielectric loss

Features (cont'd.):

- Low moisture absorption
- Electrical stability under stress
- Chemical-resistant
- Sunlight-resistant
- Meets cold bend test at -55°C

Compliances:

- National Electrical Code (NEC)
- UL 1072
- ICEA S-93-639/NEMA WC74
- ICEA S-97-682
- AEIC CS8
- UL listed as Type MV-105 for use in accordance with NEC
- UL 1685 (Sizes 1/0 AWG and larger) UL Flame Exposure Test
- Sizes 1/0 AWG and larger are listed and marked "Sunlight-Resistant FOR CT USE" in accordance with NEC
- IEEE 1202 (70,000 BTU/hr)/CSA FT4
- Meets EPA 40 CFR, Part 2671 for leachable lead content per TCLP method
- OSHA acceptable

Optional Flame Tests:

- ICEA T-29-520 (210,000 BTU/hr)

Packaging:

- Material cut to length and shipped on non-returnable wood reels. Lengths in excess of 10,000 lbs. are provided on returnable steel reels that require a deposit
- Extra charges apply for cuts less than 1000 ft., lagging, pulling eyes, paralleling and triplexing

CATALOG NUMBER	COND. SIZE (AWG/kcmil)	NOMINAL CONDUCTOR DIAMETER INCHES	INSULATION DIAMETER INCHES		DRAIN WIRE SIZE (AWG)	NOMINAL CABLE				COPPER WEIGHT		AMPACITY		CONDUIT SIZING (3) (INCHES)
			MIN.	MAX.		DIAMETER		WEIGHT		LBS/1000 FT	kg/km	CONDUIT IN AIR (1)	UNDERGROUND DUCT (2)	
						INCHES	mm	LBS/1000 FT	kg/km					

5kV AND 8kV, UL TYPE MV-105, 133% / 100% INS. LEVELS, 115 MILS

19101.650200	2	0.27	0.510	0.590	20	0.71	18.03	404	601	225	335	165	165	2.5
19101.655100	1/0	0.34	0.580	0.655	20	0.78	19.81	555	825	346	515	215	215	2.5
19101.665200	2/0	0.38	0.620	0.695	19	0.83	21.08	666	990	436	649	255	245	3
19101.665300*	3/0	0.43	0.665	0.745	19	0.88	22.35	791	1177	562	808	290	275	3
19101.665400	4/0	0.48	0.720	0.795	19	0.93	23.62	951	1415	678	1010	330	315	3
19101.676000	250	0.53	0.770	0.850	18	1.01	25.65	1112	1655	804	1196	365	345	3.5
19101.676200	350	0.62	0.870	0.945	18	1.11	28.19	1463	2176	1113	1656	440	415	3.5
19101.686500	500	0.74	0.990	1.065	17	1.24	31.50	2003	2980	1585	2358	535	500	4
19101.687000	750	0.91	1.170	1.250	17	1.44	36.57	2875	4278	2357	3507	655	610	5
19101.667500*	1000	1.06	1.320	1.400	16	1.61	40.89	3746	5574	3138	4669	755	690	5

*Non-stock item, minimum runs apply. Please consult Customer Service for price and delivery.

(1) Ampacities are in accordance with Table 310-73 of the NEC for triplexed or three single conductor copper cable in isolated conduit in air, based on a conductor temperature of 105°C (221°F) and an ambient air temperature of 40°C (104°F).

(2) Ampacities are in accordance with Table 310-77 of the NEC for triplexed or three single conductor copper cable in underground ducts (three conductors per duct), based on a conductor temperature of 105°C (221°F) and an ambient earth temperature of 20°C (68°F), electrical duct arrangement per Figure 310.60 Detail 1, 100% load factor, and earth thermal resistance (rho) of 90.

(3) Based on nominal cable diameters, three single cables in the duct (PVC Schedule 40) with no ground wire and a maximum of 40% fill. Jam ratio has been considered, but it should be checked for individual installations.

Dimensions and weights are nominal; subject to industry tolerances.

Note: a) Sizes smaller than 1/0 AWG do not include "FOR CT USE"

b) The NESC Lightning bolt symbol is on all UniShield® constructions



Phone: 888-593-3355
www.generalcable.com

Uniblend®

EPR/Copper Tape Shield/PVC, Medium-Voltage Power, Shielded
5kV and 8kV, UL Type MV-105, 133% / 100% Ins. Levels, 115 MILS



Features:

- Rated at 105°C
- Excellent heat and moisture resistance
- Excellent flame resistance
- Outstanding corona resistance
- Flexibility for easy handling
- High dielectric strength
- Low moisture absorption
- Electrical stability under stress
- Low dielectric loss
- Chemical-resistant
- Meets cold bend test at -35°C

Compliances:

- National Electrical Code (NEC)
- UL 1072
- ICEA S-93-639/NEMA WC74
- ICEA S-97-682
- AIEC CS8
- UL listed as Type MV-105 for use in accordance with NEC
- UL 1685 (Sizes 1/0 AWG and larger) UL Flame Exposure Test
- Sizes 1/0 AWG and larger are listed and marked "Sunlight-Resistant FOR CT USE" in accordance with NEC
- IEEE 1202 (70,000 BTU/hr)/CSA FT4
- Meets EPA 40 CFR, Part 2671 for leachable lead content per TCLP method
- OSHA acceptable
- Optional Flame Tests:**
- ICEA T-29-520 (210,000 BTU/hr)

Packaging:

- Material cut to length and shipped on non-returnable wood reels. Lengths in excess of 10,000 lbs. are provided on returnable steel reels that require a deposit
- Extra charges apply for cuts less than 1000 ft., lagging, pulling eyes, paralleling and triplexing

Product Construction

Conductor:

- 6 AWG thru 1000 kcmil annealed bare copper compact Class B strand

Extruded Strand Shield (ESS):

- Extruded thermoset semi-conducting stress-control layer over conductor

Insulation:

- Ethylene Propylene Rubber (EPR) insulation, colored to contrast with the black conducting shield layers

Extruded Insulation Shield (EIS):

- Thermoset semi-conducting polymeric layer free stripping from insulation

Metallic Shield:

- 5 mil annealed copper tape with an overlap of 25%

Jacket:

- Flame-retardant, moisture- and sunlight-resistant Polyvinyl Chloride (PVC)

Print:

- GENERAL CABLE® (DI) (MO/YR OF MANUFACTURE) LIGHTNING BOLT SYMBOL 1/C SIZE (AWG OR KCMIL) COMPACT CU UNIBLEND® (INSULATION THICKNESS) EPR

Print (cont'd.):

TYPE MV-105 (VOLTAGE) KV% INSULATION
LEVEL SUN RES FOR CT USE (UL) SEQUENTIAL
FOOTAGE MARK

* Sizes smaller than 1/0 AWG do not include "FOR CT USE"

Options:

- PVC jacket colors other than black
- Flame-retardant, Chlorinated Polyethylene (CPE) jacket
- Low-Smoke, Zero-Halogen (LSZH) jacket
- STRANDFILL® – blocked conductor. Tested in accordance with ICEA T-31-610

Applications:

- Superior performance in petrochemical plants, pulp and paper mills, sewage and water treatment plants, environmental protection systems, railroads, mines, utility power generating stations, steel mills, textile plants and other industrial three-phase applications
- For use in wet or dry locations when installed in accordance with NEC
- For use in aerial, conduit, open tray and underground duct installations
- For use in direct burial if installed in a system with a ground conductor that is in close proximity, and conforms with NEC 250.4 (A) (5)

CATALOG NUMBER	COND. SIZE (AWG/kcmil)	NOMINAL CONDUCTOR DIAMETER		INSULATION DIAMETER INCHES		NOMINAL JACKET THICKNESS		NOMINAL CABLE				COPPER WEIGHT		AMPACITY		CONDUIT SIZING (3) (INCHES)
		INCHES	MIN.	MAX.	INCHES	mm	DIAMETER		WEIGHT		LBS/1000 FT	kg/km	CONDUIT IN AIR (1)	UNDERGROUND DUCT (2)		
							INCHES	mm	LBS/1000 FT	kg/km						
5kV AND 8kV, UL TYPE MV-105, 133% / 100% INS. LEVELS, 115 MILS																
17001.120600*	6	0.17	0.415	0.490	0.060	1.52	0.65	16.51	295	439	126	188	93	97	2	
17001.120400*	4	0.22	0.455	0.535	0.060	1.52	0.70	17.15	365	543	178	265	120	125	2.5	
17001.120200	2	0.27	0.510	0.590	0.060	1.52	0.76	19.05	471	701	259	385	165	165	2.5	
17001.120100*	1	0.31	0.545	0.620	0.060	1.52	0.79	20.07	539	802	315	468	190	185	2.5	
17001.125100	1/0	0.34	0.580	0.655	0.060	1.52	0.82	21.08	623	927	386	575	215	215	3	
17001.125200	2/0	0.38	0.620	0.695	0.060	1.52	0.86	22.10	728	1083	474	706	255	245	3	
17001.125300*	3/0	0.43	0.665	0.745	0.080	2.03	0.94	24.38	886	1318	585	871	290	275	3	
17001.135400	4/0	0.48	0.720	0.795	0.080	2.03	1.00	25.65	1053	1567	725	1080	330	315	3	
17001.136000	250	0.53	0.770	0.850	0.080	2.03	1.05	27.18	1199	1784	849	1263	365	345	3.5	
17001.136200	350	0.62	0.870	0.945	0.080	2.03	1.14	29.72	1559	2320	1165	1735	440	415	3.5	
17001.136500	500	0.74	0.990	1.065	0.080	2.03	1.27	33.53	2088	3107	1639	2439	535	500	4	
17001.137000	750	0.91	1.170	1.250	0.080	2.03	1.45	38.35	2962	4407	2427	3611	655	610	5	
17001.637500	1000	1.06	1.330	1.400	0.080	2.03	1.60	42.42	3815	5677	3210	4777	755	690	5	

*Non-stock item, minimum runs apply. Please consult Customer Service for price and delivery.

(1) Ampacities are in accordance with Table 310-73 of the NEC for triplexed or three single conductor copper cable in isolated conduit in air, based on a conductor temperature of 105°C (221°F) and an ambient air temperature of 40°C (104°F).

(2) Ampacities are in accordance with Table 310-77 of the NEC for triplexed or three single conductor copper cable in underground ducts (three conductors per duct), based on a conductor temperature of 105°C (221°F) and an ambient earth temperature of 20°C (68°F), electrical duct arrangement per Figure 310.60 Detail 1, 100% load factor, and earth thermal resistance (rho) of 90.

(3) Based on nominal cable diameters, three single cables in the duct (PVC Schedule 40) with no ground wire and a maximum of 40% fill. Jam ratio has been considered, but it should be checked for individual installations.

Dimensions and weights are nominal; subject to industry tolerances.

Note: a) Sizes smaller than 1/0 AWG do not include "FOR CT USE"

b) The NESC Lightning bolt symbol is on all Uniblend® constructions



Phone: 888-593-3355
www.generalcable.com

Uniblend®

EPR/Copper Tape Shield/CPE, Medium-Voltage Power, Shielded
5kV and 8kV, UL Type MV-105, 133% / 100% Ins. Levels, 115 MILS



Features:

- Rated at 105°C
- Excellent heat and moisture resistance
- Excellent flame resistance
- Outstanding corona resistance
- Flexibility for easy handling
- High dielectric strength
- Low moisture absorption
- Electrical stability under stress
- Low dielectric loss
- Chemical-resistant
- Meets cold bend test at -35°C

Compliances:

- National Electrical Code (NEC)
- UL 1072
- ICEA S-93-639/NEMA WC74
- ICEA S-97-682
- AEIC CS8
- UL listed as Type MV-105 for use in accordance with NEC
- UL 1685 (Sizes 1/0 AWG and larger) UL Flame Exposure Test
- Sizes 1/0 AWG and larger are listed and marked "Sunlight-Resistant FOR CT USE" in accordance with NEC
- IEEE 1202 (70,000 BTU/hr)/CSA FT4
- Meets EPA 40 CFR, Part 2671 for leachable lead content per TCLP method
- OSHA acceptable
- Optional Flame Tests:**
- ICEA T-29-520 (210,000 BTU/hr)

Packaging:

- Material cut to length and shipped on non-returnable wood reels. Lengths in excess of 10,000 lbs. are provided on returnable steel reels that require a deposit
- Extra charges apply for cuts less than 1000 ft., lagging, pulling eyes, paralleling and triplexing

Product Construction

Conductor:

- 6 AWG thru 1000 kcmil annealed bare copper compact Class B strand

Extruded Strand Shield (ESS):

- Extruded thermoset semi-conducting stress-control layer over conductor

Insulation:

- Ethylene Propylene Rubber (EPR) insulation, colored to contrast with the black conducting shield layers

Extruded Insulation Shield (EIS):

- Thermoset semi-conducting polymeric layer free stripping from insulation

Metallic Shield:

- 5 mil annealed copper tape with an overlap of 25%

Jacket:

- Flame-retardant, moisture- and sunlight-resistant Chlorinated Polyethylene (CPE)

Print:

- GENERAL CABLE® (DI) (MO/YR OF MANUFACTURE) LIGHTNING BOLT SYMBOL 1/C SIZE (AWG OR KCMIL) COMPACT CU

Print (cont'd.):

UNIBLEND® CPE JKT (INSULATION THICKNESS)
EPR TYPE MV-105 (VOLTAGE) KV% INSULATION
LEVEL SUN RES FOR CT USE (UL) SEQUENTIAL
FOOTAGE MARK

* Sizes smaller than 1/0 AWG do not include "FOR CT USE"

Options:

- PVC jacket
- Low-Smoke, Zero-Halogen (LSZH) jacket
- STRANDFILL® - blocked conductor. Tested in accordance with ICEA T-31-610

Applications:

- Superior performance in petrochemical plants, pulp and paper mills, sewage and water treatment plants, environmental protection systems, railroads, mines, utility power generating stations, steel mills, textile plants and other industrial three-phase applications
- For use in wet or dry locations when installed in accordance with NEC
- For use in aerial, conduit, open tray and underground duct installations
- For use in direct burial if installed in a system with a ground conductor that is in close proximity, and conforms with NEC 250.4 (A) (5)

CATALOG NUMBER	COND. SIZE (AWG/kcmil)	NOMINAL CONDUCTOR DIAMETER		INSULATION DIAMETER INCHES		NOMINAL JACKET THICKNESS		NOMINAL CABLE				COPPER WEIGHT		AMPACITY		CONDUIT SIZING (3) (INCHES)
		INCHES	MIN.	MAX.	INCHES	mm	DIAMETER		WEIGHT		LBS/1000 FT	kg/km	CONDUIT IN AIR (1)	UNDERGROUND DUCT (2)		
							IN	mm	LBS/1000 FT	kg/km						
5kV AND 8kV, UL TYPE MV-105, 133% / 100% INS. LEVELS, 115 MILS																
17101.120600*	6	0.17	0.415	0.490	0.060	1.52	0.65	16.51	293	436	126	188	93	97	2	
17101.120400*	4	0.22	0.455	0.535	0.060	1.52	0.70	17.15	363	540	178	265	120	125	2.5	
17101.120200*	2	0.27	0.510	0.590	0.060	1.52	0.76	19.05	469	698	259	385	165	165	2.5	
17101.120100*	1	0.31	0.545	0.620	0.060	1.52	0.79	20.07	537	799	315	468	190	185	2.5	
17101.125100*	1/0	0.34	0.580	0.655	0.060	1.52	0.82	21.08	621	924	386	575	215	215	3	
17101.125200*	2/0	0.38	0.620	0.695	0.060	1.52	0.86	22.10	726	1080	474	706	255	245	3	
17101.125300*	3/0	0.43	0.665	0.745	0.080	2.03	0.94	24.38	883	1314	585	871	290	275	3	
17101.135400*	4/0	0.48	0.720	0.795	0.080	2.03	1.00	25.65	1049	1561	725	1080	330	315	3	
17101.136000*	250	0.53	0.770	0.850	0.080	2.03	1.05	27.18	1195	1778	849	1263	365	345	3.5	
17101.136200*	350	0.62	0.870	0.945	0.080	2.03	1.14	29.72	1555	2314	1165	1735	440	415	3.5	
17101.136500*	500	0.74	0.990	1.065	0.080	2.03	1.27	33.53	2083	3100	1639	2439	535	500	4	
17101.137000*	750	0.91	1.170	1.250	0.080	2.03	1.45	38.35	2981	4436	2427	3611	655	610	5	
17101.137500*	1000	1.06	1.330	1.400	0.080	2.03	1.60	42.42	3808	5666	3210	4777	755	690	5	

*Non-stock item, minimum runs apply. Please consult Customer Service for price and delivery.

(1) Ampacities are in accordance with Table 310-73 of the NEC for triplexed or three single conductor copper cable in isolated conduit in air, based on a conductor temperature of 105°C (221°F) and an ambient air temperature of 40°C (104°F).

(2) Ampacities are in accordance with Table 310-77 of the NEC for triplexed or three single conductor copper cable in underground ducts (three conductors per duct), based on a conductor temperature of 105°C (221°F) and an ambient earth temperature of 20°C (68°F), electrical duct arrangement per Figure 310.60 Detail 1, 100% load factor, and earth thermal resistance (rho) of 90.

(3) Based on nominal cable diameters, three single cables in the duct (PVC Schedule 40) with no ground wire and a maximum of 40% fill. Jam ratio has been considered, but it should be checked for individual installations.

Dimensions and weights are nominal; subject to industry tolerances.

Note: a) Sizes smaller than 1/0 AWG do not include "FOR CT USE"

b) The NESC Lightning bolt symbol is on all Uniblend® constructions



Phone: 888-593-3355
www.generalcable.com

GenFree™ Uniblend®

EPR/Copper Tape Shield/LSZH, Medium-Voltage Power, Shielded
5kV and 8kV, UL Type MV-105, 133% / 100% Ins. Levels, 115 Mils

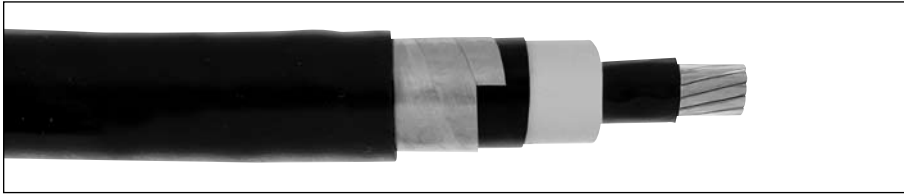

Features:

- Rated at 105°C
- Excellent heat and moisture resistance
- Excellent flame resistance
- Outstanding corona resistance
- Flexibility for easy handling
- High dielectric strength
- Low moisture absorption
- Electrical stability under stress
- Low dielectric loss
- Chemical-resistant
- Meets cold bend test at -35°C

Compliances:

- National Electrical Code (NEC)
- UL 1072
- ICEA S-93-639/NEMA WC74
- ICEA S-97-682
- AIEC CS8
- UL listed as Type MV-105 for use in accordance with NEC
- UL 1685 (Sizes 1/0 AWG and larger) UL Flame Exposure Test
- Sizes 1/0 AWG and larger are listed and marked "Sunlight-Resistant FOR CT USE" in accordance with NEC
- IEEE 1202 (70,000 BTU/hr)/CSA FT4
- Meets EPA 40 CFR, Part 2671 for leachable lead content per TCLP method
- OSHA acceptable
- Optional Flame Tests:**
- ICEA T-29-520 (210,000 BTU/hr)

Packaging:

- Material cut to length and shipped on non-returnable wood reels. Lengths in excess of 10,000 lbs. are provided on returnable steel reels that require a deposit
- Extra charges apply for cuts less than 1000 ft., lagging, pulling eyes, paralleling and triplexing

Product Construction

Conductor:

- 6 AWG thru 1000 kcmil annealed bare copper compact Class B strand

Extruded Strand Shield (ESS):

- Extruded thermoset semi-conducting stress-control layer over conductor

Insulation:

- Ethylene Propylene Rubber (EPR) insulation, colored to contrast with the black conducting shield layers

Extruded Insulation Shield (EIS):

- Thermoset semi-conducting polymeric layer free stripping from insulation

Metallic Shield:

- 5 mil annealed copper tape with an overlap of 25%

Jacket:

- Flame-retardant, moisture- and sunlight-resistant, Low-Smoke, Zero-Halogen Polyolefin (LSZH)

Print:

- GENERAL CABLE® (DI) (MO/YR OF MANUFACTURE) LIGHTNING BOLT SYMBOL 1/C SIZE (AWG OR KCMIL) COMPACT CU GENFREE™ UNIBLEND® LSZH JKT (INSULATION THICKNESS) EPR TYPE MV-105 (VOLTAGE) KV% INSULATION LEVEL SUN RES FOR CT USE (UL) SEQUENTIAL FOOTAGE MARK

* Sizes smaller than 1/0 AWG do not include "FOR CT USE"

Options:

- STRANDFILL® – blocked conductor. Tested in accordance with ICEA T-31-610

Applications:

- Superior performance in petrochemical plants, pulp and paper mills, sewage and water treatment plants, environmental protection systems, railroads, mines, utility power generating stations, steel mills, textile plants and other industrial three-phase applications
- For use in wet or dry locations when installed in accordance with NEC
- For use in aerial, conduit, open tray and underground duct installations
- For use in direct burial if installed in a system with a ground conductor that is in close proximity, and conforms with NEC 250.4 (A) (5)

CATALOG NUMBER	COND. SIZE (AWG/kcmil)	NOMINAL CONDUCTOR DIAMETER		INSULATION DIAMETER INCHES		NOMINAL JACKET THICKNESS		NOMINAL CABLE				COPPER WEIGHT		AMPACITY		CONDUIT SIZING (3) (INCHES)
		INCHES	MAX.	MIN.	MAX.	INCHES	mm	DIAMETER		WEIGHT		LBS/1000 FT	kg/km	CONDUIT IN AIR (1)	UNDERGROUND DUCT (2)	
								INCHES	mm	LBS/1000 FT	kg/km					
5KV AND 8KV, UL TYPE MV-105, 133% / 100% INS. LEVELS, 115 MILS																
17201.120600*	6	0.17	0.415	0.490	0.060	1.52	0.65	16.51	295	439	126	188	93	97	2	
17201.120400*	4	0.22	0.455	0.535	0.060	1.52	0.70	17.15	365	543	178	265	120	125	2.5	
17201.120200*	2	0.27	0.510	0.590	0.060	1.52	0.76	19.05	471	701	259	385	165	165	2.5	
17201.120100*	1	0.31	0.545	0.620	0.060	1.52	0.79	20.07	539	802	315	468	190	185	2.5	
17201.125100*	1/0	0.34	0.580	0.655	0.060	1.52	0.82	21.08	623	927	386	575	215	215	3	
17201.125200*	2/0	0.38	0.620	0.695	0.060	1.52	0.86	22.10	728	1083	474	706	255	245	3	
17201.125300*	3/0	0.43	0.665	0.745	0.080	2.03	0.94	24.38	886	1318	585	871	290	275	3	
17201.135400*	4/0	0.48	0.720	0.795	0.080	2.03	1.00	25.65	1053	1567	725	1080	330	315	3	
17201.136000*	250	0.53	0.770	0.850	0.080	2.03	1.05	27.18	1199	1784	849	1263	365	345	3.5	
17201.136200*	350	0.62	0.870	0.945	0.080	2.03	1.14	29.72	1559	2320	1165	1735	440	415	3.5	
17201.136500*	500	0.74	0.990	1.065	0.080	2.03	1.27	33.53	2088	3107	1639	2439	535	500	4	
17201.137000*	750	0.91	1.170	1.250	0.080	2.03	1.45	38.35	2962	4407	2427	3611	655	610	5	
17201.637500*	1000	1.06	1.330	1.400	0.080	2.03	1.60	42.42	3815	5677	3210	4777	755	690	5	

*Non-stock item, minimum runs apply. Please consult Customer Service for price and delivery.

(1) Ampacities are in accordance with Table 310-73 of the NEC for triplexed or three single conductor copper cable in isolated conduit in air, based on a conductor temperature of 105°C (221°F) and an ambient air temperature of 40°C (104°F).

(2) Ampacities are in accordance with Table 310-77 of the NEC for triplexed or three single conductor copper cable in underground ducts (three conductors per duct), based on a conductor temperature of 105°C (221°F) and an ambient earth temperature of 20°C (68°F), electrical duct arrangement per Figure 310.60 Detail 1, 100% load factor, and earth thermal resistance (rho) of 90.

(3) Based on nominal cable diameters, three single cables in the duct (PVC Schedule 40) with no ground wire and a maximum of 40% fill. Jam ratio has been considered, but it should be checked for individual installations.

Dimensions and weights are nominal; subject to industry tolerances.

Note: a) Sizes smaller than 1/0 AWG do not include "FOR CT USE"

b) The NESC Lightning bolt symbol is on all Uniblend® constructions



Phone: 888-593-3355
www.generalcable.com

Copper Wire Shield

TRXLPE/Copper Wire Shield/PVC, Medium-Voltage Power
5kV, UL Type MV-105, 100% Ins. Level, 90 Mils

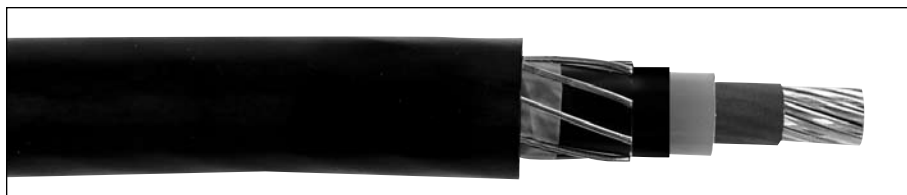

Product Construction

Conductor:

- 6 AWG thru 1000 kcmil annealed bare copper Class B compressed strand in accordance with ASTM B3 and B8

Extruded Strand Shield (ESS):

- Extruded thermoset semi-conducting stress control layer over conductor

Insulation:

- Tree Retardant Cross-Linked Polyethylene (TRXLPE)

Extruded Insulation Shield (EIS):

- Thermoset semi-conducting polymeric layer free stripping from insulation

Metallic Shield:

- A concentric serve of 24 AWG annealed solid bare copper wires over which shall be applied a lapped non-metallic tape

Jacket:

- Flame-retardant, moisture- and sunlight-resistant Polyvinyl Chloride (PVC)

Print:

- GENERAL CABLE® (DI) (MO/YR OF MANUFACTURE) LIGHTNING BOLT SYMBOL 1/C SIZE (AWG OR KCMIL) CU (INSULATION THICKNESS) TRXLPE TYPE MV-105 (VOLTAGE) KV% INSULATION LEVEL SUN RES (UL) SEQUENTIAL FOOTAGE MARK

Options:

- Sizes 1/0 AWG and larger are listed and marked "Sunlight-Resistant FOR CT USE" in accordance with NEC and in accordance with UL 1685 (70,000 BTU/hr)
- STRANDFILL® – blocked conductor. Tested in accordance with ICEA T-31-610

Applications:

- For use in wet or dry locations when installed in accordance with NEC
- For use in aerial, conduit, open tray and underground duct installations where cost effectiveness is a factor
- For use in direct burial if installed in a system with a ground conductor that is in close proximity, and conforms with NEC 250.4 (A) (5)

Features:

- Rated at 105°C
- Triple tandem extrusion of the strand shield, insulation and insulation shield provides a virtually perfect cable core
- Excellent resistance to electro-chemical treeing, heat, moisture and a wide variety of industrial chemicals
- PVC jacket provides mechanical protection of the shielding system during installation, as well as protection from many industrial chemicals
- Sunlight-resistant
- Meets cold bend test at -35°C

Compliances:

- National Electrical Code (NEC)
- ICEA S-93-639/NEMA WC74
- ICEA S-97-682
- AEIC CS8
- UL 1072
- UL listed as Type MV-105 for use in accordance with NEC
- Meets EPA 40 CFR, Part 261 for leachable lead content per TCLP method
- OSHA acceptable

Packaging:

- Material cut to length and shipped on non-returnable wood reels. Lengths in excess of 10,000 lbs. are provided on returnable steel reels that require a deposit
- Extra charges apply for cuts less than 1000 ft., lagging, pulling eyes, paralleling and plexing

CATALOG NUMBER	COND. SIZE (AWG/kcmil)	NOMINAL CONDUCTOR DIAMETER INCHES	INSULATION DIAMETER INCHES		NOMINAL JACKET THICKNESS		NOMINAL CABLE				COPPER WEIGHT		AMPACITY		CONDUIT SIZING (3) (INCHES)	
			MIN.	MAX.	INCHES	mm	DIAMETER		WEIGHT		LBS/1000 FT	kg/km	CONDUIT IN AIR (1)	UNDERGROUND DUCT (2)		
							INCHES	mm	LBS/1000 FT	kg/km						
5kV, UL TYPE MV-105, 100% INS. LEVELS, 90 MILS																
17241.010600*	6	0.18	0.370	0.445	0.060	1.52	0.67	17.02	250	372	93	138	84	92	2.5	
17241.010400*	4	0.23	0.420	0.495	0.060	1.52	0.72	18.29	317	472	141	210	110	120	2.5	
17241.010200*	2	0.29	0.475	0.555	0.060	1.52	0.77	19.55	420	625	217	323	145	155	2.5	
17241.015100*	1/0	0.37	0.555	0.630	0.060	1.52	0.85	21.59	580	863	338	503	200	210	3	
17241.015200*	2/0	0.41	0.600	0.675	0.060	1.52	0.89	22.61	670	997	427	635	225	235	3	
17241.015400*	4/0	0.52	0.705	0.780	0.080	2.03	1.04	26.42	1000	1488	669	996	305	310	3.5	
17241.016000*	250	0.56	0.760	0.835	0.080	2.03	1.10	28.19	1155	1719	788	1173	355	345	3.5	
17241.016200*	350	0.67	0.865	0.940	0.080	2.03	1.20	30.48	1505	2240	1097	1632	430	415	4	
17241.016500*	500	0.80	0.990	1.070	0.080	2.03	1.36	34.54	2060	3066	1563	2325	530	505	5	
17241.017000*	750	0.97	1.180	1.255	0.080	2.03	1.53	38.86	2868	4268	2340	3482	665	630	5	
17241.017500*	1000	1.12	1.325	1.405	0.080	2.03	1.66	42.16	3684	5482	3113	4632	770	720	6	

*Non-stock item, minimum runs apply. Please consult Customer Service for price and delivery.

(1) Ampacities are in accordance with Table 310-73 of the NEC for triplexed or three single conductor copper cable in isolated conduit in air, based on a conductor temperature of 105°C (221°F) and an ambient air temperature of 40°C (104°F).

(2) Ampacities are in accordance with Table 310-77 of the NEC for triplexed or three single conductor copper cable in underground ducts (three conductors per duct), based on a conductor temperature of 105°C (221°F) and an ambient earth temperature of 20°C (68°F), electrical duct arrangement per Figure 310.60 Detail 1, 100% load factor, and earth thermal resistance (rho) of 90.

(3) Based on nominal cable diameters, three single cables in the duct (PVC Schedule 40) with no ground wire and a maximum of 40% fill. Jam ratio has been considered, but it should be checked for individual installations.

Dimensions and weights are nominal; subject to industry tolerances.

Note: The NESC Lighting bolt symbol is on all Unblend® constructions.



Phone: 888-593-3355
www.generalcable.com

Uniblend®

EPR/Copper Tape Shield with Overall PVC Jacket, Medium-Voltage Power, Shielded 5kV and 8kV, UL Type MV-105, 133% / 100% Ins. Levels, 115 Mils, Three Conductor



Features:

- Rated at 105°C
- Excellent heat and moisture resistance
- Outstanding corona resistance
- Flexibility for easy handling
- High dielectric strength
- Low moisture absorption
- Electrical stability under stress
- Low dielectric loss
- Chemical-resistant
- Meets cold bend test at -35°C

Product Construction

Conductor:

- 6 AWG thru 1000 kcmil annealed bare copper compact Class B strand

Extruded Strand Shield (ESS):

- Extruded thermoset semi-conducting stress-control layer over conductor

Insulation:

- Ethylene Propylene Rubber (EPR) insulation, colored to contrast with the black conducting shield layers

Extruded Insulation Shield (EIS):

- Thermoset semi-conducting polymeric layer free stripping from insulation

Metallic Shield:

- 5mil annealed copper tape with an overlap of 25%

Grounding Conductor:

- 1 bare grounding conductor may be in contact with metallic shielding tape

Overall Jacket:

- Flame-retardant, moisture- and sunlight-resistant Polyvinyl Chloride (PVC)

Print:

- GENERAL CABLE® (DI) (MO/YR OF MANUFACTURE) LIGHTNING BOLT SYMBOL 3/C SIZE (AWG OR KCMIL) COMPACT CU UNIBLEND® (INSULATION THICKNESS) EPR TYPE MV-105 (VOLTAGE) KV% INSULATION LEVEL SUN RES FOR CT USE (UL) SEQUENTIAL FOOTAGE MARK

Options:

- PVC jacket colors other than black
- Flame-retardant, Chlorinated Polyethylene (CPE) jacket
- Low-Smoke, Zero-Halogen (LSZH) jacket
- Jacketed singles
- UniShield® singles
- STRANDFILL® – blocked conductor. Tested in accordance with ICEA T-31-610
- 3 bare copper ground wires
- Covered ground wires

Applications:

- Suited for use in a broad range of commercial, industrial and utility applications, where reliability is the major concern, space is limited and ease of installation is critical
- In wet or dry locations when installed in accordance with NEC
- In aerial, direct burial, conduit, open tray and underground duct installations

Compliances:

- National Electrical Code (NEC)
- UL 1072
- ICEA S-93-639/NEMA WC74
- ICEA S-97-682
- AEIC CS8
- UL listed as Type MV-105 for use in accordance with NEC
- UL 1685 (70,000 BTU/hr)
- Meets EPA 40 CFR, Part 261 for leachable lead content per TCLP method
- OSHA acceptable

Optional Flame Tests:

- IEEE 1202 (70,000 BTU/hr)/CSA FT4
- ICEA T-29-520 (210,000 BTU/hr)

Packaging:

- Material cut to length and shipped on non-returnable wood reels. Lengths in excess of 10,000 lbs. are provided on returnable steel reels that require a deposit
- Extra charges apply for cuts less than 1000 ft., lagging, pulling eyes, paralleling and plexing

CATALOG NUMBER	COND. SIZE (AWG/kcmil)	NOMINAL CONDUCTOR DIAMETER INCHES	INSULATION DIAMETER INCHES		GROUND WIRE (AWG)	NOMINAL OVERALL JKT THICKNESS		NOMINAL CABLE				COPPER WEIGHT		AMPACITY	
			MIN.	MAX.		INCHES	mm	DIAMETER		WEIGHT		LBS/1000 FT	kg/km	CONDUIT IN AIR (1)	UNDERGROUND DUCT (2)
								INCHES	mm	LBS/1000 FT	kg/km				
5kV AND 8kV, UL TYPE MV-105, 133% / 100% INS. LEVELS, 115 MILS, THREE CONDUCTOR															
15493.400600	6	0.17	0.415	0.490	6	0.080	2.03	1.29	32.77	939	1397	460	685	92	95
15493.400400	4	0.22	0.455	0.535	6	0.080	2.03	1.39	35.31	1158	1723	616	917	120	125
15493.400200	2	0.27	0.510	0.590	6	0.080	2.03	1.51	38.35	1511	2249	860	1279	165	160
15493.405100	1/0	0.34	0.580	0.655	4	0.080	2.03	1.67	42.42	2030	3021	1290	1919	215	210
15493.405200	2/0	0.38	0.620	0.695	4	0.080	2.03	1.82	46.23	2449	3645	1556	2315	245	235
15493.405400	4/0	0.48	0.720	0.795	3	0.110	2.79	2.07	52.58	3438	5116	2344	3488	320	305
15493.406000*	250	0.53	0.770	0.850	2	0.110	2.79	2.15	54.61	3968	5904	2759	4105	350	335
15493.406200	350	0.62	0.870	0.945	2	0.110	2.79	2.36	59.94	5009	7454	3713	5525	430	400
15493.406500	500	0.74	0.990	1.065	1	0.110	2.79	2.64	67.06	6793	10065	5191	7724	525	485
15493.407000*	750	0.91	1.170	1.250	1/0	0.140	3.56	3.14	79.76	9833	14633	7629	11352	635	585
15493.407500*	1000	1.06	1.330	1.400	2/0	0.140	3.56	3.48	88.39	12601	18753	10070	14985	725	660

*Non-stock item, minimum runs apply. Please consult Customer Service for price and delivery.

(1) Ampacities are in accordance with Table 310-75 of the NEC for three conductor copper cable in isolated conduit in air, based on a conductor temperature of 105°C (221°F) and an ambient air temperature of 40°C (104°F).

(2) Ampacities are in accordance with Table 310-79 of the NEC for three conductor copper cable in underground ducts (three conductors per duct), based on a conductor temperature of 105°C (221°F) and an ambient earth temperature of 20°C (68°F), electrical duct arrangement per Figure 310.60 Detail 1, 100% load factor, and earth thermal resistance (rho) of 90.

Dimensions and weights are nominal; subject to industry tolerances.

Note: a) All sizes are "FOR CT USE"

b) The NESC Lightning bolt symbol is on all Uniblend® constructions



Phone: 888-593-3355
www.generalcable.com

Uniblend®

EPR/Copper Tape Shield with Overall CPE Jacket, Medium-Voltage Power, Shielded 5kV and 8kV, UL Type MV-105, 133% / 100% Ins. Levels, 115 Mils, Three Conductor



Features:

- Rated at 105°C
- Excellent heat and moisture resistance
- Outstanding corona resistance
- Flexibility for easy handling
- High dielectric strength
- Low moisture absorption
- Electrical stability under stress
- Low dielectric loss
- Chemical-resistant
- Meets cold bend test at -35°C

Product Construction

Conductor:

- 6 AWG thru 1000 kcmil annealed bare copper compact Class B strand

Extruded Strand Shield (ESS):

- Extruded thermoset semi-conducting stress-control layer over conductor

Insulation:

- Ethylene Propylene Rubber (EPR) insulation, colored to contrast with the black conducting shield layers

Extruded Insulation Shield (EIS):

- Thermoset semi-conducting polymeric layer free stripping from insulation

Metallic Shield:

- 5mil annealed copper tape with an overlap of 25%

Grounding Conductor:

- 1 bare grounding conductor may be in contact with metallic shielding tape

Overall Jacket:

- Flame-retardant, moisture- and sunlight-resistant Chlorinated Polyethylene (CPE)

Print:

- GENERAL CABLE® (DI) (MO/YR OF MANUFACTURE) LIGHTNING BOLT SYMBOL 3/C SIZE (AWG OR KCMIL) COMPACT CU UNIBLEND® CPE JKT (INSULATION THICKNESS) EPR TYPE MV-105 (VOLTAGE) KV% INSULATION LEVEL SUN RES FOR CT USE (UL) SEQUENTIAL FOOTAGE MARK

Options:

- PVC jacket
- Low-Smoke, Zero-Halogen (LSZH) jacket
- Jacketed singles
- UniShield® singles
- STRANDFILL® – blocked conductor. Tested in accordance with ICEA T-31-610
- 3 bare copper ground wires
- Covered ground wires

Applications:

- Suited for use in a broad range of commercial, industrial and utility applications, where reliability is the major concern, space is limited and ease of installation is critical
- In wet or dry locations when installed in accordance with NEC
- In aerial, direct burial, conduit, open tray and underground duct installations

Compliances:

- National Electrical Code (NEC)
- UL 1072
- ICEA S-93-639/NEMA WC74
- ICEA S-97-682
- AEIC CS8
- UL listed as Type MV-105 for use in accordance with NEC
- UL 1685 (70,000 BTU/hr)
- OSHA acceptable

Optional Flame Tests:

- IEEE 1202 (70,000 BTU/hr)/CSA FT4
- ICEA T-29-520 (210,000 BTU/hr)

Packaging:

- Material cut to length and shipped on non-returnable wood reels. Lengths in excess of 10,000 lbs. are provided on returnable steel reels that require a deposit
- Extra charges apply for cuts less than 1000 ft., lagging, pulling eyes, paralleling and plexing

CATALOG NUMBER	COND. SIZE (AWG/kcmil)	NOMINAL CONDUCTOR DIAMETER INCHES	INSULATION DIAMETER INCHES		GROUND WIRE (AWG)	NOMINAL OVERALL JKT THICKNESS		NOMINAL CABLE				COPPER WEIGHT		AMPACITY	
			MIN.	MAX.		INCHES	mm	DIAMETER		WEIGHT		LBS/1000 FT	kg/km	CONDUIT IN AIR (1)	UNDERGROUND DUCT (2)
								INCHES	mm	LBS/1000 FT	kg/km				
5kV AND 8kV, UL TYPE MV-105, 133% / 100% INS. LEVELS, 115 MILS, THREE CONDUCTOR															
15593.400600*	6	0.17	0.415	0.490	6	0.080	2.03	1.29	32.77	939	1397	460	685	92	95
15593.400400*	4	0.22	0.455	0.535	6	0.080	2.03	1.39	35.31	1158	1723	616	917	120	125
15593.400200*	2	0.27	0.510	0.590	6	0.080	2.03	1.51	38.35	1511	2249	860	1279	165	160
15593.405100*	1/0	0.34	0.580	0.655	4	0.080	2.03	1.67	42.42	2030	3021	1290	1919	215	210
15593.405200*	2/0	0.38	0.620	0.695	4	0.080	2.03	1.82	46.23	2449	3645	1556	2315	245	235
15593.405400*	4/0	0.48	0.720	0.795	3	0.110	2.79	2.07	52.58	3438	5116	2344	3488	320	305
15593.406000*	250	0.53	0.770	0.850	2	0.110	2.79	2.15	54.61	3968	5904	2759	4105	350	335
15593.406200*	350	0.62	0.870	0.945	2	0.110	2.79	2.36	59.94	5009	7454	3713	5525	430	400
15593.406500*	500	0.74	0.990	1.065	1	0.110	2.79	2.64	67.06	6793	10065	5191	7724	525	485
15593.407000*	750	0.91	1.170	1.250	1/0	0.140	3.56	3.14	79.76	9833	14633	7629	11352	635	585
15593.407500*	1000	1.06	1.330	1.400	2/0	0.140	3.56	3.48	88.39	12601	18753	10070	14985	725	660

*Non-stock item, minimum runs apply. Please consult Customer Service for price and delivery.

(1) Ampacities are in accordance with Table 310-75 of the NEC for three conductor copper cable in isolated conduit in air, based on a conductor temperature of 105°C (221°F) and an ambient air temperature of 40°C (104°F).

(2) Ampacities are in accordance with Table 310-79 of the NEC for three conductor copper cable in underground ducts (three conductors per duct), based on a conductor temperature of 105°C (221°F) and an ambient earth temperature of 20°C (68°F), electrical duct arrangement per Figure 310.60 Detail 1, 100% load factor, and earth thermal resistance (rho) of 90.

Dimensions and weights are nominal; subject to industry tolerances.

Note: a) Sizes smaller than 4/0 AWG do not include "FOR CT USE"

b) The NESC Lightning bolt symbol is on all Uniblend® constructions



Phone: 888-593-3355
www.generalcable.com

GenFree™ Uniblend®

EPR/Copper Tape Shield with Overall LSZH Jacket, Medium-Voltage Power, Shielded 5kV and 8kV, UL Type MV-105, 133% / 100% Ins. Levels, 115 Mils, Three Conductor



Features:

- Rated at 105°C
- Excellent heat and moisture resistance
- Outstanding corona resistance
- Flexibility for easy handling
- High dielectric strength
- Low moisture absorption
- Electrical stability under stress
- Low dielectric loss
- Chemical-resistant
- Meets cold bend test at -35°C

Product Construction

Conductor:

- 6 AWG thru 1000 kcmil annealed bare copper compact Class B strand

Extruded Strand Shield (ESS):

- Extruded thermoset semi-conducting stress-control layer over conductor

Insulation:

- Ethylene Propylene Rubber (EPR) insulation, colored to contrast with the black conducting shield layers

Extruded Insulation Shield (EIS):

- Thermoset semi-conducting polymeric layer free stripping from insulation

Metallic Shield:

- 5 mil annealed copper tape with an overlap of 25%

Grounding Conductor:

- 1 bare grounding conductor may be in contact with metallic shielding tape

Overall Jacket:

- Flame-retardant, moisture- and sunlight-resistant, Low-Smoke, Zero-Halogen Polyolefin (LSZH)

Print:

- GENERAL CABLE® (DI) (MO/YR OF MANUFACTURE) LIGHTNING BOLT SYMBOL 3/C SIZE (AWG OR KCMIL) COMPACT CU GENFREE™ UNIBLEND® LSZH JKT (INSULATION THICKNESS) EPR TYPE MV-105 (VOLTAGE) KV% INSULATION LEVEL SUN RES FOR CT USE (UL) SEQUENTIAL FOOTAGE MARK

Options:

- STRANDFILL® – blocked conductor. Tested in accordance with ICEA T-31-610
- 3 bare copper ground wires
- Covered ground wires

Applications:

- Suited for use in a broad range of commercial, industrial and utility applications, where reliability is the major concern, space is limited and ease of installation is critical
- In wet or dry locations when installed in accordance with NEC
- In aerial, direct burial, conduit, open tray and underground duct installations

Compliances:

- National Electrical Code (NEC)
- UL 1072
- ICEA S-93-639/NEMA WC74
- ICEA S-97-682
- ICEA T-33-655
- AEIC CS8
- UL listed as Type MV-105 for use in accordance with NEC
- UL 1685 (70,000 BTU/hr)
- OSHA acceptable

Optional Flame Tests:

- IEEE 1202 (70,000 BTU/hr)/CSA FT4
- ICEA T-29-520 (210,000 BTU/hr)

Packaging:

- Material cut to length and shipped on non-returnable wood reels. Lengths in excess of 10,000 lbs. are provided on returnable steel reels that require a deposit
- Extra charges apply for cuts less than 1000 ft., lagging, pulling eyes, paralleling and plexing

CATALOG NUMBER	COND. SIZE (AWG/kcmil)	NOMINAL CONDUCTOR DIAMETER		INSULATION DIAMETER INCHES		GROUND WIRE (AWG)	NOMINAL OVERALL JKT THICKNESS		NOMINAL CABLE				COPPER WEIGHT		AMPACITY	
		INCHES	MIN.	MAX.	INCHES		INCHES	mm	DIAMETER		WEIGHT		LBS/1000 FT	kg/km	CONDUIT IN AIR (1)	UNDERGROUND DUCT (2)
									INCHES	mm	LBS/1000 FT	kg/km				
5kV AND 8kV, UL TYPE MV-105, 133% / 100% INS. LEVELS, 115 MILS, THREE CONDUCTOR																
15693.400600*	6	0.17	0.415	0.490	6	0.080	2.03	1.29	32.77	939	1397	460	685	92	95	
15693.400400*	4	0.22	0.455	0.535	6	0.080	2.03	1.39	35.31	1158	1723	616	917	120	125	
15693.400200*	2	0.27	0.510	0.590	6	0.080	2.03	1.51	38.35	1511	2249	860	1279	165	160	
15693.405100*	1/0	0.34	0.580	0.655	4	0.080	2.03	1.67	42.42	2030	3021	1290	1919	215	210	
15693.405200*	2/0	0.38	0.620	0.695	4	0.080	2.03	1.82	46.23	2449	3645	1556	2315	245	235	
15693.405400*	4/0	0.48	0.720	0.795	3	0.110	2.79	2.07	52.58	3438	5116	2344	3488	320	305	
15693.406000*	250	0.53	0.770	0.850	2	0.110	2.79	2.15	54.61	3968	5904	2759	4105	350	335	
15693.406200*	350	0.62	0.870	0.945	2	0.110	2.79	2.36	59.94	5009	7454	3713	5525	430	400	
15693.406500*	500	0.74	0.990	1.065	1	0.110	2.79	2.64	67.06	6793	10065	5191	7724	525	485	
15693.407000*	750	0.91	1.170	1.250	1/0	0.140	3.56	3.14	79.76	9833	14633	7629	11352	635	585	
15693.407500*	1000	1.06	1.330	1.400	2/0	0.140	3.56	3.48	88.39	12601	18753	10070	14985	725	660	

*Non-stock item, minimum runs apply. Please consult Customer Service for price and delivery.

(1) Ampacities are in accordance with Table 310-75 of the NEC for three conductor copper cable in isolated conduit in air, based on a conductor temperature of 105°C (221°F) and an ambient air temperature of 40°C (104°F).

(2) Ampacities are in accordance with Table 310-79 of the NEC for three conductor copper cable in underground ducts (three conductors per duct), based on a conductor temperature of 105°C (221°F) and an ambient earth temperature of 20°C (68°F), electrical duct arrangement per Figure 310.60 Detail 1, 100% load factor, and earth thermal resistance (rho) of 90.

Dimensions and weights are nominal; subject to industry tolerances.

Note: a) Sizes smaller than 1/0 AWG do not include "FOR CT USE"

b) The NESC Lightning bolt symbol is on all Uniblend® constructions



UniShield®

EPR/Copper Wire Shield/CPE, Medium-Voltage Power, Shielded
15kV, UL Type MV-105, 133% Ins. Level, 220 Mils

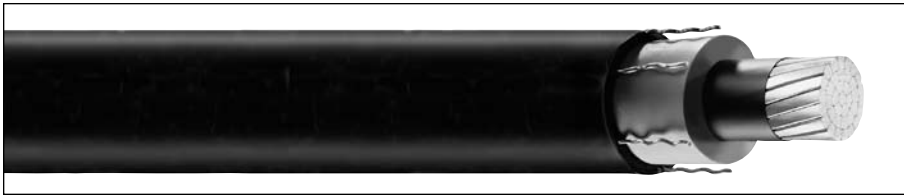

Features (cont'd.):

- Excellent heat and moisture resistance
- Outstanding corona resistance
- Flexibility for easy handling
- High dielectric strength
- Low dielectric loss
- Low moisture absorption
- Electrical stability under stress
- Chemical-resistant
- Sunlight-resistant
- Meets cold bend test at -55°C

Product Construction

Conductor:

- 2 AWG thru 1000 kcmil annealed bare copper compact Class B strand

Extruded Strand Shield (ESS):

- Extruded thermoset semi-conducting stress-control layer over conductor

Insulation:

- Ethylene Propylene Rubber (EPR) insulation colored to contrast with black conducting shield layers

Composite Insulation Shield and Jacket:

- Six corrugated copper drain wires embedded in composite layers of semi-conducting thermoset copolymer and semi-conducting black flame-retardant Chlorinated Polyethylene (CPE)

Print:

- GENERAL CABLE® (DI) (MO/YR OF MANUFACTURE) LIGHTNING BOLT SYMBOL 1/C SIZE (AWG OR KCMIL) COMPACT CU UNISHIELD® (INSULATION THICKNESS) EPR DRTP SEMI-CON CPE JKT TYPE MV-105 (VOLTAGE) KV% INSULATION LEVEL SUN RES FOR CT USE (UL) SEQUENTIAL FOOTAGE MARK

* Sizes smaller than 1/0 AWG do not include "FOR CT USE"

Applications:

- Installed in a broad range of commercial, industrial and utility projects such as pulp and paper mills, petrochemical plants, steel mills, textile mills, water and sewage treatment facilities, environmental protection systems, railroads, mines and fossil fuel utility generating stations
- Suitable for use in wet or dry locations when installed in accordance with NEC
- For use in aerial, conduit, open tray and underground duct installations
- For use in direct burial if installed in a system with a ground conductor that is in close proximity, and conforms with NEC 250.4 (A) (5)

Features:

- Rated at 105°C
- Reduced conductor size and shield system provides the smallest premium medium-voltage shielded power cable with full insulation
- Smaller outside dimensions reduce the size of duct needed or increase the ampacity per duct
- All features contribute to faster and easier installation
- Superior cold bend and cold impact performance
- Stable and constant shield short circuit performance

Compliances:

- National Electrical Code (NEC)
- UL 1072
- ICEA S-93-639/NEMA WC74
- ICEA S-97-682
- AEIC CS8
- UL listed as Type MV-105 for use in accordance with NEC
- UL 1685 (Sizes 1/0 AWG and larger) UL Flame Exposure Test
- Sizes 1/0 AWG and larger are listed and marked "Sunlight-Resistant FOR CT USE" in accordance with NEC
- IEEE 1202 (70,000 BTU/hr)/CSA FT4
- Meets EPA 40 CFR, Part 2671 for leachable lead content per TCLP method
- OSHA acceptable

Optional Flame Tests:

- ICEA T-29-520 (210,000 BTU/hr)

Packaging:

- Material cut to length and shipped on non-returnable wood reels. Lengths in excess of 10,000 lbs. are provided on returnable steel reels that require a deposit
- Extra charges apply for cuts less than 1000 ft., lagging, pulling eyes, paralleling and triplexing

CATALOG NUMBER	COND. SIZE (AWG/kcmil)	NOMINAL CONDUCTOR DIAMETER INCHES	INSULATION DIAMETER INCHES		DRAIN WIRE SIZE (AWG)	NOMINAL CABLE				COPPER WEIGHT		AMPACITY			CONDUIT SIZING (4) (INCHES)
			MIN.	MAX.		DIAMETER		WEIGHT		LBS/1000 FT	kg/km	CONDUIT IN AIR (1)	UNDERGROUND DUCT (2)	TRAY (3)	
						INCHES	mm	LBS/1000 FT	kg/km						
15kV[‡], UL TYPE MV-105, 133% INS. LEVEL, 220 MILS															
19161.660200	2	0.27	0.710	0.800	19	0.93	23.88	555	835	230	342	165	165	-	3
19161.675100	1/0	0.34	0.780	0.865	18	1.01	25.91	734	1102	358	533	215	215	220	3.5
19161.675200	2/0	0.38	0.820	0.905	18	1.05	27.18	844	1259	443	659	255	245	250	3.5
19161.665300*	3/0	0.43	0.865	0.955	18	1.10	28.45	978	1458	550	818	290	275	290	3.5
19161.675400	4/0	0.48	0.920	1.005	18	1.16	29.72	1151	1716	685	1019	330	315	335	4
19161.686000	250	0.53	0.970	1.060	17	1.23	31.50	1325	1984	813	1210	365	345	370	4
19161.686200	350	0.62	1.070	1.155	17	1.33	33.78	1691	2530	1122	1669	440	415	460	5
19161.686500	500	0.74	1.190	1.275	17	1.46	37.08	2238	3344	1585	2358	535	500	575	5
19161.697000	750	0.91	1.370	1.460	16	1.67	42.42	3174	4739	2368	3523	655	610	745	6
19161.307500*	1000	1.06	1.520	1.610	16	1.86	47.24	4122	6133	3138	4669	755	690	890	6

*Non-stock item, minimum runs apply. Please consult Customer Service for price and delivery.

(1) Ampacities are in accordance with Table 310-73 of the NEC for triplexed or three single conductor copper cable in isolated conduit in air, based on a conductor temperature of 105°C (221°F) and an ambient air temperature of 40°C (104°F).

(2) Ampacities are in accordance with Table 310-77 of the NEC for triplexed or three single conductor copper cable in underground ducts (three conductors per duct), based on a conductor temperature of 105°C (221°F) and an ambient earth temperature of 20°C (68°F), electrical duct arrangement per Figure 310.60 Detail 1, 100% load factor, and earth thermal resistance (rho) of 90.

(3) Ampacities are based on single conductor Type MV-105 sizes #1/0 AWG and larger in an uncovered tray in accordance with Section 392-13(B) of the NEC at an ambient air temperature of 40°C (104°F); the ampacities are based on 75% of the values per Table 310-69. For cable trays with unventilated covers for more than 6 feet, the ampacities shall not exceed 95% of the values shown above.

(4) Based on nominal cable diameters, three single cables in the duct (PVC Schedule 40) with no ground wire and a maximum of 40% fill. Jam ratio has been considered, but it should be checked for individual installations.

[‡]100% insulation level is available upon request

Dimensions and weights are nominal; subject to industry tolerances.

Note: a) Sizes smaller than 1/0 AWG do not include "FOR CT USE"

b) The NESC Lightning bolt symbol is on all UniShield® constructions



Uniblend®

EPR/Copper Tape Shield/PVC, Medium-Voltage Power, Shielded
15kV, UL Type MV-105, 133% Ins. Level, 220 Mils



Features:

- Rated at 105°C
- Excellent heat and moisture resistance
- Excellent flame resistance
- Outstanding corona resistance
- Flexibility for easy handling
- High dielectric strength
- Low moisture absorption
- Electrical stability under stress
- Low dielectric loss
- Chemical-resistant
- Meets cold bend test at -35°C

Compliances:

- National Electrical Code (NEC)
- UL 1072
- ICEA S-93-639/NEMA WC74
- ICEA S-97-682
- AIEC CS8
- UL listed as Type MV-105 for use in accordance with NEC
- UL 1685 (Sizes 1/0 AWG and larger) UL Flame Exposure Test
- Sizes 1/0 AWG and larger are listed and marked "Sunlight-Resistant FOR CT USE" in accordance with NEC
- IEEE 1202 (70,000 BTU/hr)/CSA FT4
- Meets EPA 40 CFR, Part 2671 for leachable lead content per TCLP method
- OSHA acceptable
- Optional Flame Tests:**
- ICEA T-29-520 (210,000 BTU/hr)

Packaging:

- Material cut to length and shipped on non-returnable wood reels. Lengths in excess of 10,000 lbs. are provided on returnable steel reels that require a deposit
- Extra charges apply for cuts less than 1000 ft., lagging, pulling eyes, paralleling and triplexing

Product Construction

Conductor:

- 2 AWG thru 1000 kcmil annealed bare copper compact Class B strand

Extruded Strand Shield (ESS):

- Extruded thermoset semi-conducting stress-control layer over conductor

Insulation:

- Ethylene Propylene Rubber (EPR) insulation, colored to contrast with the black conducting shield layers

Extruded Insulation Shield (EIS):

- Thermoset semi-conducting polymeric layer free stripping from insulation

Metallic Shield:

- 5 mil annealed copper tape with an overlap of 25%

Jacket:

- Flame-retardant, moisture- and sunlight-resistant Polyvinyl Chloride (PVC)

Print:

- GENERAL CABLE® (DI) (MO/YR OF MANUFACTURE) LIGHTNING BOLT SYMBOL 1/C SIZE (AWG OR KCMIL) COMPACT CU UNIBLEND® (INSULATION THICKNESS) EPR

Print (cont'd.):

TYPE MV-105 (VOLTAGE) KV% INSULATION
LEVEL SUN RES FOR CT USE (UL) SEQUENTIAL
FOOTAGE MARK

* Sizes smaller than 1/0 AWG do not include
"FOR CT USE"

Options:

- PVC jacket colors other than black
- Flame-retardant, Chlorinated Polyethylene (CPE) jacket
- Low-Smoke, Zero-Halogen (LSZH) jacket
- STRANDFILL® – blocked conductor. Tested in accordance with ICEA T-31-610
- 100% insulation level

Applications:

- Superior performance in petrochemical plants, pulp and paper mills, sewage and water treatment plants, environmental protection systems, railroads, mines, utility power generating stations, steel mills, textile plants and other industrial three-phase applications
- For use in wet or dry locations when installed in accordance with NEC
- For use in aerial, conduit, open tray and underground duct installations
- For use in direct burial if installed in a system with a ground conductor that is in close proximity, and conforms with NEC 250.4 (A) (5)

CATALOG NUMBER	COND. SIZE (AWG/kcmil)	NOMINAL CONDUCTOR DIAMETER INCHES	INSULATION DIAMETER INCHES		NOMINAL JACKET THICKNESS		NOMINAL CABLE				COPPER WEIGHT		AMPACITY			CONDUIT SIZING (4) (INCHES)
			MIN.	MAX.	INCHES	mm	INCHES	mm	INCHES	mm	LBS/1000 FT	kg/km	LBS/1000 FT	kg/km	CONDUIT IN AIR (1)	
15kV[‡], UL TYPE MV-105, 133% INS. LEVEL, 220 MILS																
17031.130200	2	0.27	0.710	0.800	0.080	2.03	0.99	25.14	658	979	276	411	165	165	-	3
17031.130100*	1	0.31	0.745	0.830	0.080	2.03	1.02	25.91	733	1090	332	494	190	185	-	3.5
17031.135100	1/0	0.34	0.780	0.865	0.080	2.03	1.06	26.92	825	1228	403	600	215	215	220	3.5
17031.135200	2/0	0.38	0.820	0.905	0.080	2.03	1.10	27.94	938	1396	492	732	255	245	250	3.5
17031.135300*	3/0	0.43	0.865	0.955	0.080	2.03	1.14	28.95	1078	1604	603	897	290	275	290	3.5
17031.135400	4/0	0.48	0.920	1.005	0.080	2.03	1.21	30.73	1261	1876	743	1105	330	315	335	3.5
17031.136000	250	0.53	0.970	1.060	0.080	2.03	1.25	31.75	1407	2093	866	1289	365	345	370	4
17031.136200	350	0.62	1.070	1.155	0.080	2.03	1.35	34.29	1783	2653	1184	1761	440	415	460	5
17031.136500	500	0.74	1.190	1.275	0.080	2.03	1.47	37.34	2331	3468	1657	2466	535	500	575	5
17031.137000	750	0.91	1.370	1.460	0.080	2.03	1.65	41.91	3234	4812	2445	3638	655	610	745	6
17031.137500	1000	1.06	1.520	1.610	0.110	2.79	1.86	47.24	4219	6278	3228	4803	755	690	890	6

*Non-stock item, minimum runs apply. Please consult Customer Service for price and delivery.

(1) Ampacities are in accordance with Table 310-73 of the NEC for triplexed or three single conductor copper cable in isolated conduit in air, based on a conductor temperature of 105°C (221°F) and an ambient air temperature of 40°C (104°F).

(2) Ampacities are in accordance with Table 310-77 of the NEC for triplexed or three single conductor copper cable in underground ducts (three conductors per duct), based on a conductor temperature of 105°C (221°F) and an ambient earth temperature of 20°C (68°F), electrical duct arrangement per Figure 310.60 Detail 1, 100% load factor, and earth thermal resistance (rho) of 90.

(3) Ampacities are based on single conductor Type MV-105 sizes #1/0 AWG and larger in an uncovered tray in accordance with Section 392-13(B) of the NEC at an ambient air temperature of 40°C (104°F); the ampacities are based on 75% of the values per Table 310-69. For cable trays with unventilated covers for more than 6 feet, the ampacities shall not exceed 95% of the values shown above.

(4) Based on nominal cable diameters, three single cables in the duct (PVC Schedule 40) with no ground wire and a maximum of 40% fill. Jam ratio has been considered, but it should be checked for individual installations.

‡100% insulation level is available upon request

Dimensions and weights are nominal; subject to industry tolerances.

Note: a) Sizes smaller than 1/0 AWG do not include "FOR CT USE"

b) The NESC Lightning bolt symbol is on all Uniblend® constructions



Phone: 888-593-3355
www.generalcable.com

Uniblend®

EPR/Copper Tape Shield/CPE, Medium-Voltage Power, Shielded
15kV, UL Type MV-105, 133% Ins. Level, 220 Mils



Features:

- Rated at 105°C
- Excellent heat and moisture resistance
- Excellent flame resistance
- Outstanding corona resistance
- Flexibility for easy handling
- High dielectric strength
- Low moisture absorption
- Electrical stability under stress
- Low dielectric loss
- Chemical-resistant
- Meets cold bend test at -35°C

Compliances:

- National Electrical Code (NEC)
- UL 1072
- ICEA S-93-639/NEMA WC74
- ICEA S-97-682
- AEIC CS8
- UL listed as Type MV-105 for use in accordance with NEC
- UL 1685 (Sizes 1/0 AWG and larger) UL Flame Exposure Test
- Sizes 1/0 AWG and larger are listed and marked "Sunlight-Resistant FOR CT USE" in accordance with NEC
- IEEE 1202 (70,000 BTU/hr)/CSA FT4
- Meets EPA 40 CFR, Part 2671 for leachable lead content per TCLP method
- OSHA acceptable

Optional Flame Tests:

- ICEA T-29-520 (210,000 BTU/hr)

Packaging:

- Material cut to length and shipped on non-returnable wood reels. Lengths in excess of 10,000 lbs. are provided on returnable steel reels that require a deposit
- Extra charges apply for cuts less than 1000 ft., lagging, pulling eyes, paralleling and triplexing

Product Construction

Conductor:

- 2 AWG thru 1000 kcmil annealed bare copper compact Class B strand

Extruded Strand Shield (ESS):

- Extruded thermoset semi-conducting stress-control layer over conductor

Insulation:

- Ethylene Propylene Rubber (EPR) insulation, colored to contrast with the black conducting shield layers

Extruded Insulation Shield (EIS):

- Thermoset semi-conducting polymeric layer free stripping from insulation

Metallic Shield:

- 5 mil annealed copper tape with an overlap of 25%

Jacket:

- Flame-retardant, moisture- and sunlight-resistant Chlorinated Polyethylene (CPE)

Print:

- GENERAL CABLE® (DI) (MO/YR OF MANUFACTURE) LIGHTNING BOLT SYMBOL 1/3 SIZE (AWG OR KCMIL) COMPACT CU

Print (cont'd.):

UNIBLEND® CPE JKT (INSULATION THICKNESS)
EPR TYPE MV-105 (VOLTAGE) KV% INSULATION
LEVEL SUN RES FOR CT USE (UL) SEQUENTIAL
FOOTAGE MARK

* Sizes smaller than 1/0 AWG do not include "FOR CT USE"

Options:

- PVC jacket
- Low-Smoke, Zero-Halogen (LSZH) jacket
- STRANDFILL® - blocked conductor. Tested in accordance with ICEA T-31-610
- 100% insulation level

Applications:

- Superior performance in petrochemical plants, pulp and paper mills, sewage and water treatment plants, environmental protection systems, railroads, mines, utility power generating stations, steel mills, textile plants and other industrial three-phase applications
- For use in wet or dry locations when installed in accordance with NEC
- For use in aerial, conduit, open tray and underground duct installations
- For use in direct burial if installed in a system with a ground conductor that is in close proximity, and conforms with NEC 250.4 (A) (5)

CATALOG NUMBER	COND. SIZE (AWG/kcmil)	NOMINAL CONDUCTOR DIAMETER INCHES	INSULATION DIAMETER INCHES		NOMINAL JACKET THICKNESS		NOMINAL CABLE				COPPER WEIGHT		AMPACITY			CONDUIT SIZING (4) (INCHES)		
			MIN.	MAX.	INCHES	mm	DIAMETER		WEIGHT		LBS/1000 FT	kg/km	LBS/1000 FT	kg/km	CONDUIT IN AIR (1)		UNDERGROUND DUCT (2)	TRAY (3)
							INCHES	mm	LBS/1000 FT	kg/km								
15kV[†], UL TYPE MV-105, 133% INS. LEVEL, 220 MILS																		
17131.130200*	2	0.27	0.710	0.800	0.080	2.03	0.99	25.14	655	975	276	411	165	165	-	3		
17131.130100*	1	0.31	0.745	0.830	0.080	2.03	1.02	25.91	730	1086	332	494	190	185	-	3.5		
17131.135100*	1/0	0.34	0.780	0.865	0.080	2.03	1.06	26.92	820	1220	403	600	215	215	220	3.5		
17131.135200*	2/0	0.38	0.820	0.905	0.080	2.03	1.10	27.94	933	1388	492	732	255	245	250	3.5		
17131.135300*	3/0	0.43	0.865	0.955	0.080	2.03	1.14	28.95	1072	1595	603	897	290	275	290	3.5		
17131.135400*	4/0	0.48	0.920	1.005	0.080	2.03	1.21	30.73	1248	1857	743	1105	330	315	335	3.5		
17131.136000*	250	0.53	0.970	1.060	0.080	2.03	1.25	31.75	1402	2086	866	1289	365	345	370	4		
17131.136200*	350	0.62	1.070	1.155	0.080	2.03	1.35	34.29	1778	2646	1184	1761	440	415	460	5		
17131.136500*	500	0.74	1.190	1.275	0.080	2.03	1.47	37.34	2325	3460	1657	2466	535	500	575	5		
17131.137000*	750	0.91	1.370	1.460	0.080	2.03	1.65	41.91	3250	4836	2445	3638	655	610	745	6		
17131.637500*	1000	1.06	1.520	1.610	0.110	2.79	1.86	47.24	4209	6263	3228	4803	755	690	890	6		

*Non-stock item, minimum runs apply. Please consult Customer Service for price and delivery.

- (1) Ampacities are in accordance with Table 310-73 of the NEC for triplexed or three single conductor copper cable in isolated conduit in air, based on a conductor temperature of 105°C (221°F) and an ambient air temperature of 40°C (104°F).
- (2) Ampacities are in accordance with Table 310-77 of the NEC for triplexed or three single conductor copper cable in underground ducts (three conductors per duct), based on a conductor temperature of 105°C (221°F) and an ambient earth temperature of 20°C (68°F), electrical duct arrangement per Figure 310.60 Detail 1, 100% load factor, and earth thermal resistance (rho) of 90.
- (3) Ampacities are based on single conductor Type MV-105 sizes #1/0 AWG and larger in an uncovered tray in accordance with Section 392-13(B) of the NEC at an ambient air temperature of 40°C (104°F); the ampacities are based on 75% of the values per Table 310-69. For cable trays with unventilated covers for more than 6 feet, the ampacities shall not exceed 95% of the values shown above.
- (4) Based on nominal cable diameters, three single cables in the duct (PVC Schedule 40) with no ground wire and a maximum of 40% fill. Jam ratio has been considered, but it should be checked for individual installations.

†100% insulation level is available upon request

Dimensions and weights are nominal; subject to industry tolerances.

Note: a) Sizes smaller than 1/0 AWG do not include "FOR CT USE"

b) The NESC Lightning bolt symbol is on all Uniblend® constructions



Phone: 888-593-3355
www.generalcable.com

GenFree™ Uniblend®

EPR/Copper Tape Shield/LSZH, Medium-Voltage Power, Shielded
15kV, UL Type MV-105, 133% Ins. Level, 220 Mils



Features:

- Rated at 105°C
- Excellent heat and moisture resistance
- Excellent flame resistance
- Outstanding corona resistance
- Flexibility for easy handling
- High dielectric strength
- Low moisture absorption
- Electrical stability under stress
- Low dielectric loss
- Chemical-resistant
- Meets cold bend test at -35°C

Compliances:

- National Electrical Code (NEC)
- UL 1072
- ICEA S-93-639/NEMA WC74
- ICEA S-97-682
- AEIC CS8
- UL listed as Type MV-105 for use in accordance with NEC
- UL 1685 (Sizes 1/0 AWG and larger) UL Flame Exposure Test
- Sizes 1/0 AWG and larger are listed and marked "Sunlight-Resistant FOR CT USE" in accordance with NEC
- IEEE 1202 (70,000 BTU/hr)/CSA FT4
- Meets EPA 40 CFR, Part 267.1 for leachable lead content per TCLP method
- OSHA acceptable
- Optional Flame Tests:**
- ICEA T-29-520 (210,000 BTU/hr)

Product Construction

Conductor:

- 2 AWG thru 1000 kcmil annealed bare copper compact Class B strand

Extruded Strand Shield (ESS):

- Extruded thermoset semi-conducting stress-control layer over conductor

Insulation:

- Ethylene Propylene Rubber (EPR) insulation, colored to contrast with the black conducting shield layers

Extruded Insulation Shield (EIS):

- Thermoset semi-conducting polymeric layer free stripping from insulation

Metallic Shield:

- 5 mil annealed copper tape with an overlap of 25%

Jacket:

- Flame-retardant, moisture- and sunlight-resistant, Low-Smoke, Zero-Halogen Polyolefin (LSZH)

Print:

- GENERAL CABLE® (DI) (MO/YR OF MANUFACTURE) LIGHTNING BOLT SYMBOL 1/C SIZE (AWG OR KCMIL) COMPACT CU GENFREE™ UNIBLEND® LSZH JKT (INSULATION THICKNESS) EPR TYPE MV-105 (VOLTAGE) KV% INSULATION LEVEL SUN RES FOR CT USE (UL) SEQUENTIAL FOOTAGE MARK

* Sizes smaller than 1/0 AWG do not include "FOR CT USE"

Options:

- STRANDFILL® – blocked conductor. Tested in accordance with ICEA T-31-610
- 100% insulation level

Applications:

- Superior performance in petrochemical plants, pulp and paper mills, sewage and water treatment plants, environmental protection systems, railroads, mines, utility power generating stations, steel mills, textile plants and other industrial three-phase applications
- For use in wet or dry locations when installed in accordance with NEC
- For use in aerial, conduit, open tray and underground duct installations
- For use in direct burial if installed in a system with a ground conductor that is in close proximity, and conforms with NEC 250.4 (A) (5)

Packaging:

- Material cut to length and shipped on non-returnable wood reels. Lengths in excess of 10,000 lbs. are provided on returnable steel reels that require a deposit
- Extra charges apply for cuts less than 1000 ft., lagging, pulling eyes, paralleling and triplexing

CATALOG NUMBER	COND. SIZE (AWG/kcmil)	NOMINAL CONDUCTOR DIAMETER INCHES	INSULATION DIAMETER INCHES		NOMINAL JACKET THICKNESS		NOMINAL CABLE				COPPER WEIGHT		AMPACITY			CONDUIT SIZING (4) (INCHES)
			MIN.	MAX.	INCHES	mm	DIAMETER		WEIGHT		LBS/1000 FT	kg/km	CONDUIT IN AIR (1)	UNDERGROUND DUCT (2)	TRAY (3)	
							INCHES	mm	LBS/1000 FT	kg/km						

15kV[±], UL TYPE MV-105, 133% INS. LEVEL, 220 MILS

17231.130200*	2	0.27	0.710	0.800	0.080	2.03	0.99	25.14	658	979	276	411	165	165	-	3
17231.130100*	1	0.31	0.745	0.830	0.080	2.03	1.02	25.91	733	1090	332	494	190	185	-	3.5
17231.135100*	1/0	0.34	0.780	0.865	0.080	2.03	1.06	26.92	825	1228	403	600	215	215	220	3.5
17231.135200*	2/0	0.38	0.820	0.905	0.080	2.03	1.10	27.94	938	1396	492	732	255	245	250	3.5
17231.135300*	3/0	0.43	0.865	0.955	0.080	2.03	1.14	28.95	1078	1604	603	897	290	275	290	3.5
17231.135400*	4/0	0.48	0.920	1.005	0.080	2.03	1.21	30.73	1261	1876	743	1105	330	315	335	3.5
17231.136000*	250	0.53	0.970	1.060	0.080	2.03	1.25	31.75	1407	2093	866	1289	365	345	370	4
17231.136200*	350	0.62	1.070	1.155	0.080	2.03	1.35	34.29	1783	2653	1184	1761	440	415	460	5
17231.136500*	500	0.74	1.190	1.275	0.080	2.03	1.47	37.34	2331	3468	1657	2466	535	500	575	5
17231.137000*	750	0.91	1.370	1.460	0.080	2.03	1.65	41.91	3234	4812	2445	3638	655	610	745	6
17231.137500*	1000	1.06	1.520	1.610	0.110	2.79	1.86	47.24	4219	6278	3228	4803	755	690	890	6

*Non-stock item, minimum runs apply. Please consult Customer Service for price and delivery.

- (1) Ampacities are in accordance with Table 310-73 of the NEC for triplexed or three single conductor copper cable in isolated conduit in air, based on a conductor temperature of 105°C (221°F) and an ambient air temperature of 40°C (104°F).
- (2) Ampacities are in accordance with Table 310-77 of the NEC for triplexed or three single conductor copper cable in underground ducts (three conductors per duct), based on a conductor temperature of 105°C (221°F) and an ambient earth temperature of 20°C (68°F), electrical duct arrangement per Figure 310.60 Detail 1, 100% load factor, and earth thermal resistance (rho) of 90.
- (3) Ampacities are based on single conductor Type MV-105 sizes #1/0 AWG and larger in an uncovered tray in accordance with Section 392-13(B) of the NEC at an ambient air temperature of 40°C (104°F); the ampacities are based on 75% of the values per Table 310-69. For cable trays with unventilated covers for more than 6 feet, the ampacities shall not exceed 95% of the values shown above.
- (4) Based on nominal cable diameters, three single cables in the duct (PVC Schedule 40) with no ground wire and a maximum of 40% fill. Jam ratio has been considered, but it should be checked for individual installations.

†100% insulation level is available upon request

Dimensions and weights are nominal; subject to industry tolerances.

Note: a) Sizes smaller than 1/0 AWG do not include "FOR CT USE"

b) The NESC Lightning bolt symbol is on all Uniblend® constructions



Copper Wire Shield

TRXLPE/Copper Wire Shield/PVC, Medium-Voltage Power
15kV, UL Type MV-105, 133% Ins. Level, 220 Mils

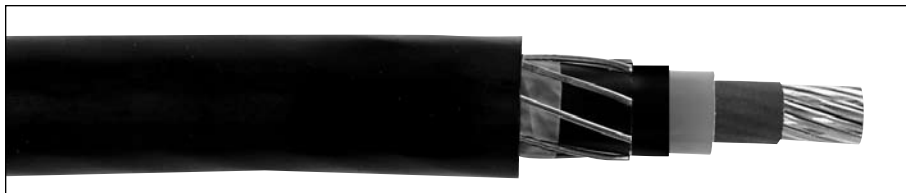

Features:

- Rated at 105°C
- Triple tandem extrusion of the strand shield, insulation and insulation shield provides a virtually perfect cable core
- Excellent resistance to electro-chemical treeing, heat, moisture and a wide variety of industrial chemicals
- PVC jacket provides mechanical protection of the shielding system during installation as well as protection from many industrial chemicals
- Sunlight-resistant
- Meets cold bend test at -35°C

Compliances:

- National Electrical Code (NEC)
- ICEA S-93-639/NEMA WC74
- ICEA S-97-682
- AEIC CS8
- UL 1072
- UL listed as Type MV-105 for use in accordance with NEC
- Meets EPA 40 CFR, Part 261 for leachable lead content per TCLP method
- OSHA acceptable

Packaging:

- Material cut to length and shipped on non-returnable wood reels. Lengths in excess of 10,000 lbs. are provided on returnable steel reels that require a deposit
- Extra charges apply for cuts less than 1000 ft., lagging, pulling eyes, paralleling and triplexing

Product Construction

Conductor:

- 2 AWG thru 1000 kcmil annealed bare copper, Class B compressed strand in accordance with ASTM B3 and B8

Extruded Strand Shield (ESS):

- Extruded thermoset semi-conducting stress-control layer over conductor

Insulation:

- Tree Retardant Cross-Linked Polyethylene (TRXLPE)

Extruded Insulation Shield (EIS):

- Thermoset semi-conducting polymeric layer free stripping from insulation

Metallic Shield:

- A concentric serve of 24 AWG annealed solid bare copper wires over which shall be applied a lapped non-metallic tape

Jacket:

- Flame-retardant, moisture- and sunlight-resistant Polyvinyl Chloride (PVC)

Print:

- GENERAL CABLE® (DI) (MO/YR OF MANUFACTURE) LIGHTNING BOLT SYMBOL 1/C SIZE (AWG OR KCMIL) CU (INSULATION THICKNESS) TRXLPE TYPE MV-105 (VOLTAGE) KV% INSULATION LEVEL SUN RES (UL) SEQUENTIAL FOOTAGE MARK

Options:

- Sizes 1/0 AWG and larger are listed and marked "Sunlight-Resistant FOR CT USE" in accordance with NEC and in accordance with UL 1685 (70,000 BTU/hr)
- STRANDFILL® – blocked conductor. Tested in accordance with ICEA T-31-610

Applications:

- For use in wet or dry locations when installed in accordance with NEC
- For use in aerial, conduit, open tray and underground duct installations where cost effectiveness is a factor
- For use in direct burial if installed in a system with a ground conductor that is in close proximity, and conforms with NEC 250.4 (A) (5)

CATALOG NUMBER	COND. SIZE (AWG/kcmil)	NOMINAL CONDUCTOR DIAMETER INCHES	INSULATION DIAMETER INCHES		NOMINAL JACKET THICKNESS		NOMINAL CABLE				COPPER WEIGHT		AMPACITY			CONDUIT SIZING (4) (INCHES)
			MIN.	MAX.	INCHES	mm	DIAMETER		WEIGHT		LBS/1000 FT	kg/km	CONDUIT IN AIR (1)	UNDERGROUND DUCT (2)	TRAY (3)	
							INCHES	mm	LBS/1000 FT	kg/km						
15kV*, UL TYPE MV-105, 133% INS. LEVEL, 220 MILS																
17245.010200*	2	0.29	0.725	0.815	0.080	2.03	1.05	26.67	600	893	221	329	165	165	-	3.5
17245.010100*	1	0.33	0.765	0.855	0.080	2.03	1.09	27.68	671	998	274	408	190	185	-	3.5
17245.015100*	1/0	0.37	0.805	0.895	0.080	2.03	1.13	28.27	761	1132	342	509	215	215	220	3.5
17245.015200*	2/0	0.41	0.850	0.935	0.080	2.03	1.18	29.97	871	1296	427	635	255	245	250	4
17245.015400*	4/0	0.52	0.955	1.045	0.080	2.03	1.29	32.76	1179	1754	672	1000	330	315	335	4
17245.016000*	250	0.56	1.010	1.100	0.080	2.03	1.34	34.03	1327	1974	791	1177	365	345	370	5
17245.016200*	350	0.67	1.115	1.200	0.080	2.03	1.45	36.83	1700	2529	1105	1644	440	415	460	5
17245.016500*	500	0.80	1.240	1.330	0.080	2.03	1.57	39.87	2236	3327	1568	2333	535	500	575	5
17245.017000*	750	0.97	1.430	1.520	0.110	2.79	1.82	46.23	3225	4798	2344	3488	655	610	745	6
17245.017500*	1000	1.12	1.575	1.670	0.110	2.79	1.97	50.04	4090	6086	3114	4634	755	690	890	6

*Non-stock item, minimum runs apply. Please consult Customer Service for price and delivery.

(1) Ampacities are in accordance with Table 310-73 of the NEC for triplexed or three single conductor copper cable in isolated conduit in air, based on a conductor temperature of 105°C (221°F) and an ambient air temperature of 40°C (104°F).

(2) Ampacities are in accordance with Table 310-77 of the NEC for triplexed or three single conductor copper cable in underground ducts (three conductors per duct), based on a conductor temperature of 105°C (221°F) and an ambient earth temperature of 20°C (68°F), electrical duct arrangement per Figure 310.60 Detail 1, 100% load factor, and earth thermal resistance (rho) of 90.

(3) Ampacities are based on single conductor Type MV-105 sizes #1/0 AWG and larger in an uncovered tray in accordance with Section 392-13(B) of the NEC at an ambient air temperature of 40°C (104°F); the ampacities are based on 75% of the values per Table 310-69. For cable trays with unventilated covers for more than 6 feet, the ampacities shall not exceed 95% of the values shown above.

(4) Based on nominal cable diameters, three single cables in the duct (PVC Schedule 40) with no ground wire and a maximum of 40% fill. Jam ratio has been considered, but it should be checked for individual installations.

†100% insulation level is available upon request

Dimensions and weights are nominal; subject to industry tolerances.

Note: The NESC Lightning bolt symbol is on all Uniblend® constructions.



Phone: 888-593-3355
www.generalcable.com

Uniblend®

EPR/Copper Tape Shield with Overall PVC Jacket, Medium-Voltage Power, Shielded 15kV, UL Type MV-105, 133% Ins. Level, 220 Mils, Three Conductor



Applications (cont'd.):

- For use in direct burial if installed in a system with a ground conductor that is in close proximity, and conforms with NEC 250.4 (A) (5)

Features:

- Rated at 105°C
- Excellent heat and moisture resistance
- Outstanding corona resistance
- Flexibility for easy handling
- High dielectric strength
- Low moisture absorption
- Electrical stability under stress
- Low dielectric loss
- Chemical-resistant
- Meets cold bend test at -35°C

Compliances:

- National Electrical Code (NEC)
- UL 1072
- ICEA S-93-639/NEMA WC74
- ICEA S-97-682
- AEIC CS8
- UL listed as Type MV-105 for use in accordance with NEC
- UL 1685 (70,000 BTU/hr)
- Meets EPA 40 CFR, Part 261 for leachable lead content per TCLP method
- OSHA acceptable

Optional Flame Tests:

- IEEE 1202 (70,000 BTU/hr)/CSA FT4
- ICEA T-29-520 (210,000 BTU/hr)

Packaging:

- Material cut to length and shipped on non-returnable wood reels. Lengths in excess of 10,000 lbs. are provided on returnable steel reels that require a deposit
- Extra charges apply for cuts less than 1000 ft., lagging, pulling eyes, paralleling and plexing

Product Construction

Conductor:

- 2 AWG thru 1000 kcmil annealed bare copper compact Class B strand

Extruded Strand Shield (ESS):

- Extruded thermoset semi-conducting stress-control layer over conductor

Insulation:

- Ethylene Propylene Rubber (EPR) insulation, colored to contrast with the black conducting shield layers

Extruded Insulation Shield (EIS):

- Thermoset semi-conducting polymeric layer free stripping from insulation

Metallic Shield:

- 5 mil annealed copper tape with an overlap of 25%

Grounding Conductor:

- 1 bare grounding conductor may be in contact with metallic shielding tape

Overall Jacket:

- Flame-retardant, moisture- and sunlight-resistant Polyvinyl Chloride (PVC)

Print:

- GENERAL CABLE® (DI) (MO/YR OF MANUFACTURE) LIGHTNING BOLT SYMBOL 3/C SIZE (AWG OR KCMIL) COMPACT CU UNIBLEND® (INSULATION THICKNESS) EPR TYPE MV-105 (VOLTAGE) KV% INSULATION LEVEL SUN RES FOR CT USE (UL) SEQUENTIAL FOOTAGE MARK

Options:

- PVC jacket colors other than black
- Flame-retardant, Chlorinated Polyethylene (CPE) jacket
- Low-Smoke, Zero-Halogen (LSZH) jacket
- Jacketed singles
- UniShield® singles
- STRANDFILL® – blocked conductor. Tested in accordance with ICEA T-31-610
- 3 bare copper ground wires
- Covered ground wires

Applications:

- Suited for use in a broad range of commercial, industrial and utility applications, where reliability is the major concern, space is limited and ease of installation is critical
- In wet or dry locations when installed in accordance with NEC
- In aerial, direct burial, conduit, open tray and underground duct installations

CATALOG NUMBER	COND. SIZE (AWG/kcmil)	NOMINAL CONDUCTOR DIAMETER INCHES	INSULATION DIAMETER INCHES		GROUND WIRE (AWG)	NOMINAL OVERALL JKT THICKNESS INCHES	NOMINAL CABLE				COPPER WEIGHT		AMPACITY			
			MIN.	MAX.			DIAMETER		WEIGHT		LBS/1000 FT	kg/km	CONDUIT IN AIR (1)	UNDERGROUND DUCT (2)	DIRECT BURIAL (3)	
							INCHES	mm	LBS/1000 FT	kg/km						
15kV[‡], UL TYPE MV-105, 133% INS. LEVEL, 220 MILS, THREE CONDUCTOR																
15493.440200	2	0.27	0.710	0.800	6	0.110	2.79	2.04	51.82	2226	3313	913	1358	165	160	185
15493.445100*	1/0	0.34	0.780	0.865	4	0.110	2.79	2.20	55.88	2811	4183	1343	1998	215	210	240
15493.445200	2/0	0.38	0.820	0.905	4	0.110	2.79	2.30	58.42	3163	4707	1609	2394	245	235	275
15493.445400	4/0	0.48	0.920	1.005	3	0.110	2.79	2.52	64.01	4203	6255	2398	3567	320	305	360
15493.446000*	250	0.53	0.970	1.060	2	0.110	2.79	2.66	67.56	4775	7106	2812	4184	350	335	400
15493.446200	350	0.62	1.070	1.155	2	0.110	2.79	2.94	74.68	6182	9200	3766	5604	430	400	490
15493.446500	500	0.74	1.190	1.275	1	0.140	3.56	3.21	81.53	7686	11438	5244	7803	525	485	600
15493.447000*	750	0.91	1.370	1.460	1/0	0.140	3.56	3.61	91.69	10978	16337	7682	11431	635	585	745
15493.447500*	1000	1.06	1.520	1.610	2/0	0.140	3.56	3.99	101.35	13983	20810	10124	15064	725	660	860

*Non-stock item, minimum runs apply. Please consult Customer Service for price and delivery.

(1) Ampacities are in accordance with Table 310-75 of the NEC for three conductor copper cable in isolated conduit in air, based on a conductor temperature of 105°C (221°F) and an ambient air temperature of 40°C (104°F).

(2) Ampacities are in accordance with Table 310-79 of the NEC for three conductor copper cable in underground ducts (three conductors per duct), based on a conductor temperature of 105°C (221°F) and an ambient earth temperature of 20°C (68°F), electrical duct arrangement per Figure 310.60 Detail 1, 100% load factor, and earth thermal resistance (rho) of 90.

(3) Ampacities are based on single conductor Type MV-105 sizes #1/0 AWG and larger in an uncovered tray in accordance with Section 392-13(B) of the NEC at an ambient air temperature of 40°C (104°F); the ampacities are based on 75% of the values per Table 310-71. For cable trays with unventilated covers for more than 6 feet, the ampacities shall not exceed the values in NEC Table 310-75.

‡100% insulation level is available upon request

Dimensions and weights are nominal; subject to industry tolerances.

Note: a) All sizes are "FOR CT USE"

b) The NESC Lightning bolt symbol is on all Uniblend® constructions



Phone: 888-593-3355
www.generalcable.com

Uniblend®

EPR/Copper Tape Shield with Overall CPE Jacket, Medium-Voltage Power, Shielded 15kV, UL Type MV-105, 133% Ins. Level, 220 Mils, Three Conductor



Features:

- Rated at 105°C
- Excellent heat and moisture resistance
- Outstanding corona resistance
- Flexibility for easy handling
- High dielectric strength
- Low moisture absorption
- Electrical stability under stress
- Low dielectric loss
- Chemical-resistant
- Meets cold bend test at -35°C

Product Construction

Conductor:

- 2 AWG thru 1000 kcmil annealed bare copper compact Class B strand

Extruded Strand Shield (ESS):

- Extruded thermoset semi-conducting stress-control layer over conductor

Insulation:

- Ethylene Propylene Rubber (EPR) insulation, colored to contrast with the black conducting shield layers

Extruded Insulation Shield (EIS):

- Thermoset semi-conducting polymeric layer free stripping from insulation

Metallic Shield:

- 5 mil annealed copper tape with an overlap of 25%

Grounding Conductor:

- 1 bare grounding conductor may be in contact with metallic shielding tape

Overall Jacket:

- Flame-retardant, moisture- and sunlight-resistant Chlorinated Polyethylene (CPE)

Print:

- GENERAL CABLE® (DI) (MO/YR OF MANUFACTURE) LIGHTNING BOLT SYMBOL 3/C SIZE (AWG OR KCMIL) COMPACT CU UNIBLEND® CPE JKT (INSULATION THICKNESS) EPR TYPE MV-105 (VOLTAGE) KV% INSULATION LEVEL SUN RES FOR CT USE (UL) SEQUENTIAL FOOTAGE MARK

Options:

- PVC jacket
- Low-Smoke, Zero-Halogen (LSZH) jacket
- Jacketed singles
- UniShield® singles
- STRANDFILL® – blocked conductor. Tested in accordance with ICEA T-31-610
- 3 bare copper ground wires
- Covered ground wires

Applications:

- Suited for use in a broad range of commercial, industrial and utility applications, where reliability is the major concern, space is limited and ease of installation is critical
- In wet or dry locations when installed in accordance with NEC
- In aerial, direct burial, conduit, open tray and underground duct installations
- For use in direct burial if installed in a system with a ground conductor that is in close proximity, and conforms with NEC 250.4 (A) (5)

Compliances:

- National Electrical Code (NEC)
- UL 1072
- ICEA S-93-639/NEMA WC74
- ICEA S-97-682
- AEIC CS8
- UL listed as Type MV-105 for use in accordance with NEC
- UL 1685 (70,000 BTU/hr)
- OSHA acceptable

Optional Flame Tests:

- IEEE 1202 (70,000 BTU/hr)/CSA FT4
- ICEA T-29-520 (210,000 BTU/hr)

Packaging:

- Material cut to length and shipped on non-returnable wood reels. Lengths in excess of 10,000 lbs. are provided on returnable steel reels that require a deposit
- Extra charges apply for cuts less than 1000 ft., lagging, pulling eyes, paralleling and plexing

CATALOG NUMBER	COND. SIZE (AWG/kcmil)	NOMINAL CONDUCTOR DIAMETER INCHES	INSULATION DIAMETER INCHES		GROUND WIRE (AWG)	NOMINAL OVERALL JKT THICKNESS INCHES	NOMINAL CABLE				COPPER WEIGHT		AMPACITY				
			MIN.	MAX.			DIAMETER		WEIGHT		LBS/1000 FT	kg/km	LBS/1000 FT	kg/km	CONDUIT IN AIR (1)	UNDERGROUND DUCT (2)	DIRECT BURIAL (3)
							INCHES	mm	LBS/1000 FT	kg/km							
15kV*, UL TYPE MV-105, 133% INS. LEVEL, 220 MILS, THREE CONDUCTOR																	
15593.440200*	2	0.27	0.710	0.800	6	0.110	2.79	2.04	51.82	2226	3313	913	1358	165	160	185	
15593.445100*	1/0	0.34	0.780	0.865	4	0.110	2.79	2.20	55.88	2811	4183	1343	1998	215	210	240	
15593.445200*	2/0	0.38	0.820	0.905	4	0.110	2.79	2.30	58.42	3163	4707	1609	2394	245	235	275	
15593.445400*	4/0	0.48	0.920	1.005	3	0.110	2.79	2.52	64.01	4203	6255	2398	3567	320	305	360	
15593.446000*	250	0.53	0.970	1.060	2	0.110	2.79	2.66	67.56	4775	7106	2812	4184	350	335	400	
15593.446200*	350	0.62	1.070	1.155	2	0.110	2.79	2.94	74.68	6182	9200	3766	5604	430	400	490	
15593.446500*	500	0.74	1.190	1.275	1	0.140	3.56	3.21	81.53	7686	11438	5244	7803	525	485	600	
15593.447000*	750	0.91	1.370	1.460	1/0	0.140	3.56	3.61	91.69	10978	16337	7682	11431	635	585	745	
15593.447500*	1000	1.06	1.520	1.610	2/0	0.140	3.56	3.99	101.35	13938	20810	10124	15064	725	660	860	

*Non-stock item, minimum runs apply. Please consult Customer Service for price and delivery.

(1) Ampacities are in accordance with Table 310-75 of the NEC for three conductor copper cable in isolated conduit in air, based on a conductor temperature of 105°C (221°F) and an ambient air temperature of 40°C (104°F).

(2) Ampacities are in accordance with Table 310-79 of the NEC for three conductor copper cable in underground ducts (three conductors per duct), based on a conductor temperature of 105°C (221°F) and an ambient earth temperature of 20°C (68°F), electrical duct arrangement per Figure 310.60 Detail 1, 100% load factor, and earth thermal resistance (rho) of 90.

(3) Ampacities are based on single conductor Type MV-105 sizes #1/0 AWG and larger in an uncovered tray in accordance with Section 392-13 (B) of the NEC at an ambient air temperature of 40°C (104°F); the ampacities are based on 75% of the values per Table 310-71. For cable trays with unventilated covers for more than 6 feet, the ampacities shall not exceed the values in NEC Table 310-75.

‡100% insulation level is available upon request

Dimensions and weights are nominal; subject to industry tolerances.

Note: a) Sizes smaller than 4/0 AWG do not include "FOR CT USE"

b) The NESC Lightning bolt symbol is on all Uniblend® constructions



Phone: 888-593-3355
www.generalcable.com

GenFree™ Uniblend®

EPR/Copper Tape Shield with Overall LSZH Jacket, Medium-Voltage Power, Shielded 15kV, UL Type MV-105, 133% Ins. Level, 220 Mils, Three Conductor



Features:

- Rated at 105°C
- Excellent heat and moisture resistance
- Outstanding corona resistance
- Flexibility for easy handling
- High dielectric strength
- Low moisture absorption
- Electrical stability under stress
- Low dielectric loss
- Chemical-resistant
- Meets cold bend test at -35°C

Product Construction

Conductor:

- 2 AWG thru 1000 kcmil annealed bare copper compact Class B strand

Extruded Strand Shield (ESS):

- Extruded thermoset semi-conducting stress-control layer over conductor

Insulation:

- Ethylene Propylene Rubber (EPR) insulation, colored to contrast with the black conducting shield layers

Extruded Insulation Shield (EIS):

- Thermoset semi-conducting polymeric layer free stripping from insulation

Metallic Shield:

- 5 mil annealed copper tape with an overlap of 25%

Grounding Conductor:

- 1 bare grounding conductor may be in contact with metallic shielding tape

Overall Jacket:

- Flame-retardant, moisture- and sunlight-resistant, Low-Smoke, Zero-Halogen Polyolefin (LSZH)

Print:

- GENERAL CABLE® (DI) (MO/YR OF MANUFACTURE) LIGHTNING BOLT SYMBOL 3/C SIZE (AWG OR KCMIL) COMPACT CU GENFREE™ UNIBLEND® LSZH JKT (INSULATION THICKNESS) EPR TYPE MV-105 (VOLTAGE) KV% INSULATION LEVEL SUN RES FOR CT USE (UL) SEQUENTIAL FOOTAGE MARK

Options:

- STRANDFILL® – blocked conductor. Tested in accordance with ICEA T-31-610
- 3 bare copper ground wires
- Covered ground wires

Applications:

- Suited for use in a broad range of commercial, industrial and utility applications, where reliability is the major concern, space is limited and ease of installation is critical
- In wet or dry locations when installed in accordance with NEC
- In aerial, direct burial, conduit, open tray and underground duct installations
- For use in direct burial if installed in a system with a ground conductor that is in close proximity, and conforms with NEC 250.4 (A) (5)

Compliances:

- National Electrical Code (NEC)
- UL 1072
- ICEA S-93-639/NEMA WC74
- ICEA S-97-682
- ICEA T-33-655
- AEIC CS8
- UL listed as Type MV-105 for use in accordance with NEC
- UL 1685 (70,000 BTU/hr)
- OSHA acceptable

Optional Flame Tests:

- IEEE 1202 (70,000 BTU/hr)/CSA FT4
- ICEA T-29-520 (210,000 BTU/hr)

Packaging:

- Material cut to length and shipped on non-returnable wood reels. Lengths in excess of 10,000 lbs. are provided on returnable steel reels that require a deposit
- Extra charges apply for cuts less than 1000 ft., lagging, pulling eyes, paralleling and plexing

CATALOG NUMBER	COND. SIZE (AWG/kcmil)	NOMINAL CONDUCTOR DIAMETER INCHES	INSULATION DIAMETER INCHES		GROUND WIRE (AWG)	NOMINAL OVERALL JKT THICKNESS INCHES	NOMINAL CABLE				COPPER WEIGHT		AMPACITY				
			MIN.	MAX.			DIAMETER		WEIGHT		LBS/1000 FT	kg/km	LBS/1000 FT	kg/km	CONDUIT IN AIR (1)	UNDERGROUND DUCT (2)	DIRECT BURIAL (3)
							INCHES	mm	LBS/1000 FT	kg/km							
15kV[‡], UL TYPE MV-105, 133% INS. LEVEL, 220 MILS, THREE CONDUCTOR																	
15793.440200*	2	0.27	0.710	0.800	6	0.110	2.79	2.04	51.82	2226	3313	913	1358	165	160	185	
15793.445100*	1/0	0.34	0.780	0.865	4	0.110	2.79	2.20	55.88	2811	4183	1343	1998	215	210	240	
15793.445200*	2/0	0.38	0.820	0.905	4	0.110	2.79	2.30	58.42	3163	4707	1609	2394	245	235	275	
15793.445400*	4/0	0.48	0.920	1.005	3	0.110	2.79	2.52	64.01	4203	6255	2398	3567	320	305	360	
15793.446000*	250	0.53	0.970	1.060	2	0.110	2.79	2.66	67.56	4775	7106	2812	4184	350	335	400	
15793.446200*	350	0.62	1.070	1.155	2	0.110	2.79	2.94	74.68	6182	9200	3766	5604	430	400	490	
15793.446500*	500	0.74	1.190	1.275	1	0.140	3.56	3.21	81.53	7686	11438	5244	7803	525	485	600	
15793.447000*	750	0.91	1.370	1.460	1/0	0.140	3.56	3.61	91.69	10978	16337	7682	11431	635	585	745	
15793.447500*	1000	1.06	1.520	1.610	2/0	0.140	3.56	3.99	101.35	13938	20810	10124	15064	725	660	860	

*Non-stock item, minimum runs apply. Please consult Customer Service for price and delivery.

(1) Ampacities are in accordance with Table 310-75 of the NEC for three conductor copper cable in isolated conduit in air, based on a conductor temperature of 105°C (221°F) and an ambient air temperature of 40°C (104°F).

(2) Ampacities are in accordance with Table 310-79 of the NEC for three conductor copper cable in underground ducts (three conductors per duct), based on a conductor temperature of 105°C (221°F) and an ambient earth temperature of 20°C (68°F), electrical duct arrangement per Figure 310.60 Detail 1, 100% load factor, and earth thermal resistance (rho) of 90.

(3) Ampacities are based on single conductor Type MV-105 sizes #1/0 AWG and larger in an uncovered tray in accordance with Section 392-13 (B) of the NEC at an ambient air temperature of 40°C (104°F); the ampacities are based on 75% of the values per Table 310-71. For cable trays with unventilated covers for more than 6 feet, the ampacities shall not exceed the values in NEC Table 310-75.

‡100% insulation level is available upon request

Dimensions and weights are nominal; subject to industry tolerances.

Note: a) Sizes smaller than 1/0 AWG do not include "FOR CT USE"

b) The NESC Lightning bolt symbol is on all Uniblend® constructions



Phone: 888-593-3355
www.generalcable.com

UniShield®

EPR/Copper Wire Shield/CPE, Medium-Voltage Power, Shielded
25kV and 35kV, UL Type MV-105, 133% / 100% Ins. Levels, 345 Mils



Features (cont'd.):

- Stable and constant shield short circuit performance
- Excellent heat and moisture resistance
- Outstanding corona resistance
- Flexibility for easy handling
- High dielectric strength
- Low dielectric loss
- Low moisture absorption
- Electrical stability under stress
- Chemical-resistant
- Sunlight-resistant
- Meets cold bend test at -55°C

Product Construction

Conductor:

- 1/0 AWG thru 1000 kcmil annealed bare copper compact Class B strand

Extruded Strand Shield (ESS):

- Extruded thermoset semi-conducting stress-control layer over conductor

Insulation:

- Ethylene Propylene Rubber (EPR) insulation colored to contrast with black conducting shield layers

Composite Insulation Shield and Jacket:

- Six corrugated copper drain wires embedded in composite layers of semi-conducting thermoset copolymer and semi-conducting black flame-retardant Chlorinated Polyethylene (CPE)

Print:

- GENERAL CABLE® (DI) (MO/YR OF MANUFACTURE) LIGHTNING BOLT SYMBOL 1/C SIZE (AWG OR KCMIL) COMPACT CU UNISHIELD® (INSULATION THICKNESS) EPR DRTP SEMI-CON CPE JKT TYPE MV-105 (VOLTAGE) KV% INSULATION LEVEL SUN RES FOR CT USE (UL) SEQUENTIAL FOOTAGE MARK

* Sizes smaller than 1/0 AWG do not include "FOR CT USE"

Options:

- 25kV 100% Insulation Level
- 35kV 133% Insulation Level

Applications:

- Installed in a broad range of commercial, industrial and utility projects such as pulp and paper mills, petrochemical plants, steel mills, textile mills, water and sewage treatment facilities, environmental protection systems, railroads, mines and fossil fuel utility generating stations
- Suitable for use in wet or dry locations when installed in accordance with NEC
- For use in aerial, conduit, open tray and underground duct installations
- For use in direct burial if installed in a system with a ground conductor that is in close proximity, and conforms with NEC 250.4 (A) (5)

Features:

- Rated at 105°C
- Reduced conductor size and shield system provide the smallest premium medium-voltage shielded power cable with full insulation
- Smaller outside dimensions reduce the size of duct needed or increase the ampacity per duct
- All features contribute to faster and easier installation
- Superior cold bend and cold impact performance

Compliances:

- National Electrical Code (NEC)
- UL 1072
- ICEA S-93-639/NEMA WC74
- ICEA S-97-682
- AEIC CS8
- UL listed as Type MV-105 for use in accordance with NEC
- UL 1685 (Sizes 1/0 AWG and larger) UL Flame Exposure Test
- Sizes 1/0 AWG and larger are listed and marked "Sunlight-Resistant FOR CT USE" in accordance with NEC
- IEEE 1202 (70,000 BTU/hr)/CSA FT4
- Meets EPA 40 CFR, Part 2671 for leachable lead content per TCLP method
- OSHA acceptable

Optional Flame Tests:

- ICEA T-29-520 (210,000 BTU/hr)

Packaging:

- Material cut to length and shipped on non-returnable wood reels. Lengths in excess of 10,000 lbs. are provided on returnable steel reels that require a deposit
- Extra charges apply for cuts less than 1000 ft., lagging, pulling eyes, paralleling and triplexing

CATALOG NUMBER	COND. SIZE (AWG/kcmil)	NOMINAL CONDUCTOR DIAMETER INCHES	INSULATION DIAMETER INCHES		DRAIN WIRE SIZE (AWG)	NOMINAL CABLE				COPPER WEIGHT		AMPACITY			
			MIN.	MAX.		DIAMETER		WEIGHT		LBS/1000 FT	kg/km	CONDUIT IN AIR (1)	UNDERGROUND DUCT (2)	DIRECT BURIAL (3)	CONDUIT SIZING (4)
						INCHES	mm	LBS/1000 FT	kg/km						

25kV* & 35kV**, UL TYPE MV-105, 133% / 100% INS. LEVEL, 345 MILS

19261.685100*	1/0	0.34	1.020	1.120	17	1.29	32.77	1014	1509	367	546	215	215	295	4
19261.685200*	2/0	0.38	1.060	1.160	17	1.36	34.54	1163	1731	452	672	255	245	335	5
19261.685300*	3/0	0.43	1.105	1.205	17	1.41	35.81	1310	1949	559	832	290	275	380	5
19261.685400*	4/0	0.48	1.160	1.260	17	1.43	36.32	1442	2146	694	1033	330	315	435	5
19261.686000*	250	0.53	1.210	1.315	16	1.51	38.35	1645	2448	824	1226	365	345	475	5
19261.686200*	350	0.62	1.310	1.410	16	1.60	40.64	2024	3012	1133	1685	440	415	575	5
19261.686500*	500	0.74	1.430	1.530	16	1.74	44.20	2608	3881	1596	2374	535	500	700	6
19261.687000*	750	0.91	1.610	1.710	16	1.95	49.78	3596	5351	2368	3523	655	610	865	6
19261.687500*	1000	1.06	1.760	1.865	16	2.11	53.59	4513	6715	3138	4669	755	690	1005	8

*Non-stock item, minimum runs apply. Please consult Customer Service for price and delivery.

(1) Ampacities are in accordance with Table 310-73 of the NEC for triplexed or three single conductor copper cable in isolated conduit in air, based on a conductor temperature of 105°C (221°F) and an ambient air temperature of 40°C (104°F).

(2) Ampacities are in accordance with Table 310-77 of the NEC for triplexed or three single conductor copper cable in underground ducts (three conductors per duct), based on a conductor temperature of 105°C (221°F) and an ambient earth temperature of 20°C (68°F), electrical duct arrangement per Figure 310.60 Detail 1, 100% load factor, and earth thermal resistance (rho) of 90.

(3) Ampacities are in accordance with Table 310-81 of the NEC for single insulated copper conductors directly buried in earth, based on a conductor temperature of 105°C (221°F) and an ambient earth temperature of 20°C (68°F), arrangement per Figure 310.06 Detail 9, 100% load factor, and earth thermal resistance (rho) of 90.

(4) Based on nominal cable diameters, three single cables in the duct (PVC Schedule 40) with no ground wire and a maximum of 40% fill. Jam ratio has been considered, but it should be checked for individual installations.

†100% insulation level is available upon request

**133% insulation level is available upon request

Dimensions and weights are nominal; subject to industry tolerances.

Note: a) Sizes smaller than 1/0 AWG do not include "FOR CT USE"

b) The NESC Lightning bolt symbol is on all UniShield® constructions



Phone: 888-593-3355
www.generalcable.com

Uniblend®

EPR/Copper Tape Shield/PVC, Medium-Voltage Power, Shielded
25kV and 35kV, UL Type MV-105, 133% / 100% Ins. Levels, 345 MILS

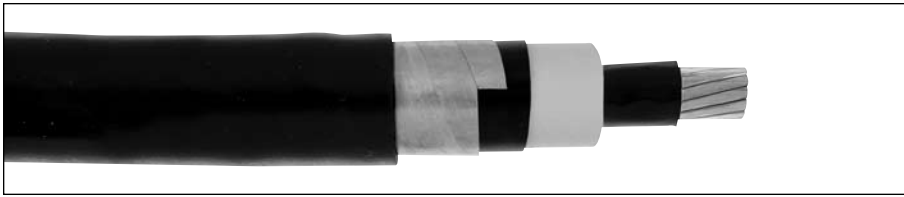

Features:

- Rated at 105°C
- Excellent heat and moisture resistance
- Excellent flame resistance
- Outstanding corona resistance
- Flexibility for easy handling
- High dielectric strength
- Low moisture absorption
- Electrical stability under stress
- Low dielectric loss
- Chemical-resistant
- Meets cold bend test at -35°C

Compliances:

- National Electrical Code (NEC)
- UL 1072
- ICEA S-93-639/NEMA WC74
- ICEA S-97-682
- AEIC CS8
- UL listed as Type MV-105 for use in accordance with NEC
- UL 1685 (Sizes 1/0 AWG and larger) UL Flame Exposure Test
- Sizes 1/0 AWG and larger are listed and marked "Sunlight-Resistant FOR CT USE" in accordance with NEC
- IEEE 1202 (70,000 BTU/hr)/CSA FT4
- Meets EPA 40 CFR, Part 2671 for leachable lead content per TCLP method
- OSHA acceptable
- Optional Flame Tests:**
- ICEA T-29-520 (210,000 BTU/hr)

Packaging:

- Material cut to length and shipped on non-returnable wood reels. Lengths in excess of 10,000 lbs. are provided on returnable steel reels that require a deposit
- Extra charges apply for cuts less than 1000 ft., lagging, pulling eyes, paralleling and triplexing

Product Construction

Conductor:

- 1/0 AWG thru 1000 kcmil annealed bare copper compact Class B strand

Extruded Strand Shield (ESS):

- Extruded thermoset semi-conducting stress-control layer over conductor

Insulation:

- Ethylene Propylene Rubber (EPR) insulation, colored to contrast with the black conducting shield layers

Extruded Insulation Shield (EIS):

- Thermoset semi-conducting polymeric layer free stripping from insulation

Metallic Shield:

- 5 mil annealed copper tape with an overlap of 25%

Jacket:

- Flame-retardant, moisture- and sunlight-resistant Polyvinyl Chloride (PVC)

Print:

- GENERAL CABLE® (DI) (MO/YR OF MANUFACTURE) LIGHTNING BOLT SYMBOL 1/C SIZE (AWG OR KCMIL) COMPACT CU UNIBLEND® (INSULATION THICKNESS) EPR

Print (cont'd.):

TYPE MV-105 (VOLTAGE) KV% INSULATION LEVEL SUN RES FOR CT USE (UL) SEQUENTIAL FOOTAGE MARK

* Sizes smaller than 1/0 AWG do not include "FOR CT USE"

Options:

- PVC jacket colors other than black
- Flame-retardant, Chlorinated Polyethylene (CPE) jacket
- Low-Smoke, Zero-Halogen (LSZH) jacket
- STRANDFILL® - blocked conductor. Tested in accordance with ICEA T-31-610
- 25kV 100% Insulation Level
- 35kV 133% Insulation Level

Applications:

- Superior performance in petrochemical plants, pulp and paper mills, sewage and water treatment plants, environmental protection systems, railroads, mines, utility power generating stations, steel mills, textile plants and other industrial three-phase applications
- For use in wet or dry locations when installed in accordance with NEC
- For use in aerial, conduit, open tray and underground duct installations
- For use in direct burial if installed in a system with a ground conductor that is in close proximity, and conforms with NEC 250.4 (A) (5)

CATALOG NUMBER	COND. SIZE (AWG/kcmil)	NOMINAL CONDUCTOR DIAMETER INCHES	INSULATION DIAMETER INCHES		NOMINAL JACKET THICKNESS		NOMINAL CABLE				COPPER WEIGHT		AMPACITY			
			MIN.	MAX.	INCHES	mm	DIAMETER		WEIGHT		LBS/1000 FT	kg/km	CONDUIT IN AIR (1)	UNDERGROUND DUCT (2)	DIRECT BURIAL (3)	CONDUIT SIZING (4)
							INCHES	mm	LBS/1000 FT	kg/km						

25kV* AND 35kV , UL TYPE MV-105, 133% / 100% INS. LEVELS, 345 MILS**

17061.135100	1/0	0.34	1.020	1.115	0.080	2.03	1.31	33.27	1090	1622	425	633	215	215	295	5
17061.135200*	2/0	0.38	1.060	1.160	0.080	2.03	1.35	34.29	1211	1802	514	765	255	245	335	5
17061.135300*	3/0	0.43	1.105	1.205	0.080	2.03	1.40	35.56	1360	2024	625	930	290	275	380	5
17061.135400	4/0	0.48	1.160	1.260	0.080	2.03	1.45	36.83	1547	2302	765	1138	330	315	435	5
17061.136000*	250	0.53	1.210	1.315	0.080	2.03	1.51	38.35	1712	2547	888	1322	365	345	475	5
17061.136200	350	0.62	1.310	1.410	0.080	2.03	1.60	40.64	2108	3137	1206	1794	440	415	575	5
17061.136500	500	0.74	1.430	1.530	0.080	2.03	1.78	45.21	2783	4141	1679	2498	535	500	700	6
17061.137000*	750	0.91	1.610	1.710	0.110	2.79	1.96	49.78	3733	5555	2467	3670	655	610	865	6
17061.137500*	1000	1.06	1.760	1.865	0.110	2.79	2.10	53.59	4651	6921	3250	4836	755	690	1005	8

*Non-stock item, minimum runs apply. Please consult Customer Service for price and delivery.

(1) Ampacities are in accordance with Table 310-73 of the NEC for triplexed or three single conductor copper cable in isolated conduit in air, based on a conductor temperature of 105°C (221°F) and an ambient air temperature of 40°C (104°F).

(2) Ampacities are in accordance with Table 310-77 of the NEC for triplexed or three single conductor copper cable in underground ducts (three conductors per duct), based on a conductor temperature of 105°C (221°F) and an ambient earth temperature of 20°C (68°F), electrical duct arrangement per Figure 310.60 Detail 1, 100% load factor, and earth thermal resistance (rho) of 90.

(3) Ampacities are in accordance with Table 310-81 of the NEC for single insulated copper conductors directly buried in earth, based on a conductor temperature of 105°C (221°F) and an ambient earth temperature of 20°C (68°F), arrangement per Figure 310.06 Detail 9, 100% load factor, and earth thermal resistance (rho) of 90.

(4) Based on nominal cable diameters, three single cables in the duct (PVC Schedule 40) with no ground wire and a maximum of 40% fill. Jam ratio should be checked for individual installations.

*100% insulation level is available upon request

**133% insulation level is available upon request

Dimensions and weights are nominal; subject to industry tolerances.

Note: a) Sizes smaller than 1/0 AWG do not include "FOR CT USE"

b) The NESC Lightning bolt symbol is on all Uniblend® constructions



Phone: 888-593-3355
www.generalcable.com

Uniblend®

EPR/Copper Tape Shield/CPE, Medium-Voltage Power, Shielded
25kV and 35kV, UL Type MV-105, 133% / 100% Ins. Levels, 345 MILS



Features:

- Rated at 105°C
- Excellent heat and moisture resistance
- Excellent flame resistance
- Outstanding corona resistance
- Flexibility for easy handling
- High dielectric strength
- Low moisture absorption
- Electrical stability under stress
- Low dielectric loss
- Chemical-resistant
- Meets cold bend test at -35°C

Compliances:

- National Electrical Code (NEC)
- UL 1072
- ICEA S-93-639/NEMA WC74
- ICEA S-97-682
- AEIC CS8
- UL listed as Type MV-105 for use in accordance with NEC
- UL 1685 (Sizes 1/0 AWG and larger) UL Flame Exposure Test
- Sizes 1/0 AWG and larger are listed and marked "Sunlight-Resistant FOR CT USE" in accordance with NEC
- IEEE 1202 (70,000 BTU/hr)/CSA FT4
- Meets EPA 40 CFR, Part 2671 for leachable lead content per TCLP method
- OSHA acceptable

Optional Flame Tests:

- ICEA T-29-520 (210,000 BTU/hr)

Packaging:

- Material cut to length and shipped on non-returnable wood reels. Lengths in excess of 10,000 lbs. are provided on returnable steel reels that require a deposit
- Extra charges apply for cuts less than 1000 ft., lagging, pulling eyes, paralleling and triplexing

Product Construction

Conductor:

- 1/0 AWG thru 1000 kcmil annealed bare copper compact Class B strand

Extruded Strand Shield (ESS):

- Extruded thermoset semi-conducting stress-control layer over conductor

Insulation:

- Ethylene Propylene Rubber (EPR) insulation, colored to contrast with the black conducting shield layers

Extruded Insulation Shield (EIS):

- Thermoset semi-conducting polymeric layer free stripping from insulation

Metallic Shield:

- 5 mil annealed copper tape with an overlap of 25%

Jacket:

- Flame-retardant, moisture- and sunlight-resistant Chlorinated Polyethylene (CPE)

Print:

- GENERAL CABLE® (DI) (MO/YR OF MANUFACTURE) LIGHTNING BOLT SYMBOL 1/C SIZE (AWG OR KCMIL) COMPACT CU UNIBLEND® CPE JKT (INSULATION THICKNESS)

Print (cont'd.):

EPR TYPE MV-105 (VOLTAGE) KV% INSULATION LEVEL SUN RES FOR CT USE (UL) SEQUENTIAL FOOTAGE MARK

* Sizes smaller than 1/0 AWG do not include "FOR CT USE"

Options:

- PVC jacket
- Low-Smoke, Zero-Halogen (LSZH) jacket
- STRANDFILL® - blocked conductor. Tested in accordance with ICEA T-31-610
- 25kV 100% Insulation Level
- 35kV 133% Insulation Level

Applications:

- Superior performance in petrochemical plants, pulp and paper mills, sewage and water treatment plants, environmental protection systems, railroads, mines, utility power generating stations, steel mills, textile plants and other industrial three-phase applications
- For use in wet or dry locations when installed in accordance with NEC
- For use in aerial, conduit, open tray and underground duct installations
- For use in direct burial if installed in a system with a ground conductor that is in close proximity, and conforms with NEC 250.4 (A) (5)

CATALOG NUMBER	COND. SIZE (AWG/kcmil)	NOMINAL CONDUCTOR DIAMETER INCHES	INSULATION DIAMETER INCHES		NOMINAL JACKET THICKNESS INCHES	NOMINAL CABLE				COPPER WEIGHT		AMPACITY			CONDUIT SIZING (4) (INCHES)		
			MIN.	MAX.		DIAMETER		WEIGHT		LBS/1000 FT	kg/km	LBS/1000 FT	kg/km	CONDUIT IN AIR (1)		UNDERGROUND DUCT (2)	DIRECT BURIAL (3)
						INCHES	mm	LBS/1000 FT	kg/km								
25kV* AND 35kV** , UL TYPE MV-105, 133% / 100% INS. LEVELS, 345 MILS																	
17161.135100*	1/0	0.340	1.020	1.120	0.080	1.31	33.27	1066	1586	425	633	215	215	295	5		
17161.135200*	2/0	0.380	1.060	1.160	0.080	1.35	34.29	1187	1766	514	765	255	245	335	5		
17161.135300*	3/0	0.430	1.105	1.205	0.080	1.40	35.56	1335	1986	625	930	290	275	380	5		
17161.135400*	4/0	0.480	1.160	1.260	0.080	1.45	36.83	1516	2256	765	1138	330	315	435	5		
17161.136000*	250	0.530	1.210	1.315	0.080	1.51	38.35	1681	2501	888	1322	365	345	475	5		
17161.136200*	350	0.630	1.310	1.410	0.080	1.60	40.64	2075	3088	1206	1794	440	415	575	5		
17161.136500*	500	0.740	1.430	1.530	0.080	1.78	45.21	2644	3934	1679	2498	535	500	700	6		
17161.137000*	750	0.910	1.610	1.710	0.110	1.96	49.78	3687	5486	2467	3670	655	610	865	6		
17161.137500*	1000	1.060	1.760	1.865	0.110	2.10	53.59	4603	6849	3250	4836	755	690	1005	8		

*Non-stock item, minimum runs apply. Please consult Customer Service for price and delivery.

(1) Ampacities are in accordance with Table 310-73 of the NEC for triplexed or three single conductor copper cable in isolated conduit in air, based on a conductor temperature of 105°C (221°F) and an ambient air temperature of 40°C (104°F).

(2) Ampacities are in accordance with Table 310-77 of the NEC for triplexed or three single conductor copper cable in underground ducts (three conductors per duct), based on a conductor temperature of 105°C (221°F) and an ambient earth temperature of 20°C (68°F), electrical duct arrangement per Figure 310.60 Detail 1, 100% load factor, and earth thermal resistance (rho) of 90.

(3) Ampacities are in accordance with Table 310-81 of the NEC for single insulated copper conductors directly buried in earth, based on a conductor temperature of 105°C (221°F) and an ambient earth temperature of 20°C (68°F), arrangement per Figure 310.06 Detail 9, 100% load factor, and earth thermal resistance (rho) of 90.

(4) Based on nominal cable diameters, three single cables in the duct with no ground wire and a maximum of 40% fill. Jam ratio should be checked for individual installations.

*100% insulation level is available upon request

**133% insulation level is available upon request

Dimensions and weights are nominal; subject to industry tolerances.

Note: a) Sizes smaller than 1/0 AWG do not include "FOR CT USE"

b) The NESC Lightning bolt symbol is on all Uniblend® constructions



GenFree™ Uniblend®

EPR/Copper Tape Shield/LSZH, Medium-Voltage Power, Shielded
25kV and 35kV, UL Type MV-105, 133% / 100% Ins. Levels, 345 MILS

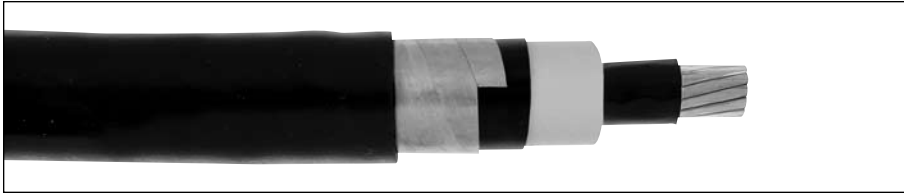

Features:

- Rated at 105°C
- Excellent heat and moisture resistance
- Excellent flame resistance
- Outstanding corona resistance
- Flexibility for easy handling
- High dielectric strength
- Low moisture absorption
- Electrical stability under stress
- Low dielectric loss
- Chemical-resistant
- Meets cold bend test at -35°C

Compliances:

- National Electrical Code (NEC)
- UL 1072
- ICEA S-93-639/NEMA WC74
- ICEA S-97-682
- AEIC CS8
- UL listed as Type MV-105 for use in accordance with NEC
- UL 1685 (Sizes 1/0 AWG and larger) UL Flame Exposure Test
- Sizes 1/0 AWG and larger are listed and marked "Sunlight-Resistant FOR CT USE" in accordance with NEC
- IEEE 1202 (70,000 BTU/hr)/CSA FT4
- Meets EPA 40 CFR, Part 2671 for leachable lead content per TCLP method
- OSHA acceptable
- Optional Flame Tests:**
- ICEA T-29-520 (210,000 BTU/hr)

Packaging:

- Material cut to length and shipped on non-returnable wood reels. Lengths in excess of 10,000 lbs. are provided on returnable steel reels that require a deposit
- Extra charges apply for cuts less than 1000 ft., lagging, pulling eyes, paralleling and triplexing

Product Construction

Conductor:

- 1/0 AWG thru 1000 kcmil annealed bare copper compact Class B strand

Extruded Strand Shield (ESS):

- Extruded thermoset semi-conducting stress-control layer over conductor

Insulation:

- Ethylene Propylene Rubber (EPR) insulation, colored to contrast with the black conducting shield layers

Extruded Insulation Shield (EIS):

- Thermoset semi-conducting polymeric layer free stripping from insulation

Metallic Shield:

- 5 mil annealed copper tape with an overlap of 25%

Jacket:

- Flame-retardant, moisture- and sunlight-resistant, Low-Smoke, Zero-Halogen Polyolefin (LSZH)

Print:

- GENERAL CABLE® (DI) (MO/YR OF MANUFACTURE) LIGHTNING BOLT SYMBOL 1/C SIZE (AWG OR KCMIL) COMPACT CU GENFREE™ UNIBLEND® LSZH JKT (INSULATION THICKNESS) EPR TYPE MV-105 (VOLTAGE) KV% INSULATION LEVEL SUN RES FOR CT USE (UL) SEQUENTIAL FOOTAGE MARK

* Sizes smaller than 1/0 AWG do not include "FOR CT USE"

Options:

- STRANDFILL® - blocked conductor. Tested in accordance with ICEA T-31-610
- 25kV 100% Insulation Level
- 35kV 133% Insulation Level

Applications:

- Superior performance in petrochemical plants, pulp and paper mills, sewage and water treatment plants, environmental protection systems, railroads, mines, utility power generating stations, steel mills, textile plants and other industrial three-phase applications
- For use in wet or dry locations when installed in accordance with NEC
- For use in aerial, conduit, open tray and underground duct installations
- For use in direct burial if installed in a system with a ground conductor that is in close proximity, and conforms with NEC 250.4 (A) (5)

CATALOG NUMBER	COND. SIZE (AWG/kcmil)	NOMINAL CONDUCTOR DIAMETER INCHES	INSULATION DIAMETER INCHES		NOMINAL JACKET THICKNESS		NOMINAL CABLE				COPPER WEIGHT		AMPACITY			CONDUIT SIZING (4) (INCHES)
			MIN.	MAX.	INCHES	mm	DIAMETER		WEIGHT		LBS/1000 FT	kg/km	CONDUIT IN AIR (1)	UNDERGROUND DUCT (2)	DIRECT BURIAL (3)	
							INCHES	mm	LBS/1000 FT	kg/km						
25kV* AND 35kV** , UL TYPE MV-105, 133% / 100% INS. LEVELS, 345 MILS																
17261.135100*	1/0	0.34	1.020	1.115	0.080	2.03	1.31	33.27	1090	1622	425	633	215	215	295	5
17261.135200*	2/0	0.38	1.060	1.160	0.080	2.03	1.35	34.29	1211	1802	514	765	255	245	335	5
17261.135300*	3/0	0.43	1.105	1.205	0.080	2.03	1.40	35.56	1360	2024	625	930	290	275	380	5
17261.135400*	4/0	0.48	1.160	1.260	0.080	2.03	1.45	36.83	1547	2302	765	1138	330	315	435	5
17261.136000*	250	0.53	1.210	1.315	0.080	2.03	1.51	38.35	1712	2547	888	1322	365	345	475	5
17261.136200*	350	0.62	1.310	1.410	0.080	2.03	1.60	40.64	2108	3137	1206	1794	440	415	575	5
17261.136500*	500	0.74	1.430	1.530	0.080	2.03	1.78	45.21	2783	4141	1679	2498	535	500	700	6
17261.137000*	750	0.91	1.610	1.710	0.110	2.79	1.96	49.78	3733	5555	2467	3670	655	610	865	6
17261.137500*	1000	1.06	1.760	1.865	0.110	2.79	2.10	53.59	4651	6921	3250	4836	755	690	1005	8

*Non-stock item, minimum runs apply. Please consult Customer Service for price and delivery.

(1) Ampacities are in accordance with Table 310-73 of the NEC for triplexed or three single conductor copper cable in isolated conduit in air, based on a conductor temperature of 105°C (221°F) and an ambient air temperature of 40°C (104°F).

(2) Ampacities are in accordance with Table 310-77 of the NEC for triplexed or three single conductor copper cable in underground ducts (three conductors per duct), based on a conductor temperature of 105°C (221°F) and an ambient earth temperature of 20°C (68°F), electrical duct arrangement per Figure 310.60 Detail 1, 100% load factor, and earth thermal resistance (rho) of 90.

(3) Ampacities are in accordance with Table 310-81 of the NEC for single insulated copper conductors directly buried in earth, based on a conductor temperature of 105°C (221°F) and an ambient earth temperature of 20°C (68°F), arrangement per Figure 310.06 Detail 9, 100% load factor, and earth thermal resistance (rho) of 90.

(4) Based on nominal cable diameters, three single cables in the duct (PVC Schedule 40) with no ground wire and a maximum of 40% fill. Jam ratio should be checked for individual installations.

*100% insulation level is available upon request

**133% insulation level is available upon request

Dimensions and weights are nominal; subject to industry tolerances.

Note: a) Sizes smaller than 1/0 AWG do not include "FOR CT USE"

b) The NESC Lightning bolt symbol is on all Uniblend® constructions



Uniblend®

EPR/Copper Tape Shield with Overall PVC Jacket, Medium-Voltage Power, Shielded 25kV and 35kV, UL Type MV-105, 133% / 100% Ins. Levels, 345 MILS, Three Conductor



Features:

- Rated at 105°C
- Excellent heat and moisture resistance
- Outstanding corona resistance
- Flexibility for easy handling
- High dielectric strength
- Low moisture absorption
- Electrical stability under stress
- Low dielectric loss
- Chemical-resistant
- Meets cold bend test at -35°C

Product Construction

Conductor:

- 1/0 AWG thru 750 kcmil annealed bare copper compact Class B strand

Extruded Strand Shield (ESS):

- Extruded thermoset semi-conducting stress control layer over conductor

Insulation:

- Ethylene Propylene Rubber (EPR) insulation colored to contrast with black conducting shield layers

Extruded Insulation Shield (EIS):

- Thermoset semi-conducting polymeric layer free stripping from insulation

Metallic Shield:

- 5 mil annealed copper tape with an overlap of 25%

Grounding Conductor:

- 1 bare grounding conductor may be in contact with metallic shielding tape

Overall Jacket:

- Flame-retardant, moisture- and sunlight-resistant Polyvinyl Chloride (PVC)

Print:

- GENERAL CABLE® (DI) (MO/YR OF MANUFACTURE) LIGHTNING BOLT SYMBOL 3/C SIZE (AWG OR KCMIL) COMPACT CU UNIBLEND® (INSULATION THICKNESS) EPR TYPE MV-105 (VOLTAGE) KV% INSULATION LEVEL SUN RES FOR CT USE (UL) SEQUENTIAL FOOTAGE MARK

Options:

- PVC jacket colors other than black
- Flame-retardant, Chlorinated Polyethylene (CPE) jacket
- Low-Smoke, Zero-Halogen (LSZH) jacket
- Jacketed singles
- UniShield® singles
- STRANDFILL® - blocked conductor. Tested in accordance with ICEA T-31-610
- 3 bare copper ground wires
- Covered ground wires
- 25kV 100% Insulation Level
- 35kV 133% Insulation Level

Applications:

- Suited for use in a broad range of commercial, industrial and utility applications, where reliability is the major concern, space is limited and ease of installation is critical
- Suitable for use in wet or dry locations when installed in accordance with NEC
- In aerial, direct burial, conduit, open tray and underground duct installations

Compliances:

- National Electrical Code (NEC)
- UL 1072
- ICEA S-93-639/NEMA WC74
- ICEA S-97-682
- AEIC CS8
- UL listed as Type MV-105 for use in accordance with NEC
- UL 1685 (70,000 BTU/hr)
- Meets EPA 40 CFR, Part 2671 for leachable lead content per TCLP method
- OSHA acceptable
- Optional Flame Tests:**
- IEEE 1202 (70,000 BTU/hr)/CSA FT4
- ICEA T-29-520 (210,000 BTU/hr)

Packaging:

- Material cut to length and shipped on non-returnable wood reels. Lengths in excess of 10,000 lbs. are provided on returnable steel reels that require a deposit
- Extra charges apply for cuts less than 1000 ft., lagging, pulling eyes, paralleling and triplexing

CATALOG NUMBER	COND. SIZE (AWG/kcmil)	NOMINAL CONDUCTOR DIAMETER INCHES	INSULATION DIAMETER INCHES		GROUND WIRE (AWG)	NOMINAL OVERALL JKT THICKNESS		NOMINAL CABLE				COPPER WEIGHT		AMPACITY				
			MIN.	MAX.		INCHES	mm	DIAMETER		WEIGHT		LBS/1000 FT	kg/km	LBS/1000 FT	kg/km	CONDUIT IN AIR (1)	UNDERGROUND DUCT (2)	DIRECT BURIAL (3)
								INCHES	mm	LBS/1000 FT	kg/km							
25kV* AND 35kV**, UL TYPE MV-105, 133% / 100% INS. LEVELS, 345 MILS, THREE CONDUCTOR																		
15493.485100*	1/0	0.34	1.020	1.115	4	0.110	2.79	2.73	69.34	3672	5464	1410	2098	215	210	255		
15493.485200*	2/0	0.38	1.060	1.160	4	0.110	2.79	2.81	71.37	4061	6042	1675	2492	245	235	290		
15493.485400*	4/0	0.48	1.160	1.260	3	0.140	3.56	3.10	78.74	5313	7906	2465	3668	320	305	375		
15493.486000*	250	0.53	1.210	1.315	2	0.140	3.56	3.21	81.53	6214	9246	2879	4284	350	335	410		
15493.486200*	350	0.62	1.310	1.410	2	0.140	3.56	3.42	86.86	7138	10621	3834	5705	430	400	495		
15493.486500*	500	0.74	1.430	1.530	1	0.140	3.56	3.68	93.47	9012	13410	5312	7904	525	485	590		
15493.487000*	750	0.91	1.610	1.710	1/0	0.140	3.56	4.10	104.14	12030	17901	7750	11532	635	585	720		

*Non-stock item, minimum runs apply. Please consult Customer Service for price and delivery.

(1) Ampacities are in accordance with Table 310-75 of the NEC for three conductor copper cable in isolated conduit in air, based on a conductor temperature of 105°C (221°F) and an ambient air temperature of 40°C (104°F).

(2) Ampacities are in accordance with Table 310-79 of the NEC for three conductor copper cable in underground ducts (three conductors per duct), based on a conductor temperature of 105°C (221°F) and an ambient earth temperature of 20°C (68°F), electrical duct arrangement per Figure 310.60 Detail 1, 100% load factor, and earth thermal resistance (rho) of 90.

(3) Ampacities are in accordance with Table 310-83 of the NEC for single insulated copper conductors directly buried in earth, based on a conductor temperature of 105°C (221°F) and an ambient earth temperature of 20°C (68°F), arrangement per Figure 310.60 Detail 5, 100% load factor, and earth thermal resistance (rho) of 90.

¥100% insulation level is available upon request

¥¥133% insulation level is available upon request

Dimensions and weights are nominal; subject to industry tolerances.

Note: a) All sizes are "FOR CT USE"

b) The NESC Lightning bolt symbol is on all Uniblend® constructions



Phone: 888-593-3355
www.generalcable.com

Uniblend®

EPR/Copper Tape Shield/PVC, Medium-Voltage Power, Shielded
35kV, UL Type MV-105, 133% Ins. Level, 420 MILS



Features:

- Rated at 105°C
- Excellent heat and moisture resistance
- Excellent flame resistance
- Outstanding corona resistance
- Flexibility for easy handling
- High dielectric strength
- Low moisture absorption
- Electrical stability under stress
- Low dielectric loss
- Chemical-resistant
- Meets cold bend test at -35°C

Product Construction

Conductor:

- 1/0 AWG thru 1000 kcmil annealed bare copper compact Class B strand

Extruded Strand Shield (ESS):

- Extruded thermoset semi-conducting stress-control layer over conductor

Insulation:

- Ethylene Propylene Rubber (EPR) insulation, colored to contrast with the black conducting shield layers

Extruded Insulation Shield (EIS):

- Thermoset semi-conducting polymeric layer free stripping from insulation

Metallic Shield:

- 5 mil annealed copper tape with an overlap of 25%

Jacket:

- Flame-retardant, moisture- and sunlight-resistant Polyvinyl Chloride (PVC)

Print:

- GENERAL CABLE® (DI) (MO/YR OF MANUFACTURE) LIGHTNING BOLT SYMBOL 1/C SIZE (AWG OR KCMIL) COMPACT CU UNIBLEND® (INSULATION THICKNESS) EPR

Print (cont'd.):

TYPE MV-105 (VOLTAGE) KV% INSULATION
LEVEL SUN RES FOR CT USE (UL) SEQUENTIAL
FOOTAGE MARK

Options:

- PVC jacket colors other than black
- Flame-retardant, Chlorinated Polyethylene (CPE) jacket
- Low-Smoke, Zero-Halogen (LSZH) jacket
- STRANDFILL® - blocked conductor. Tested in accordance with ICEA T-31-610

Applications:

- Superior performance in petrochemical plants, pulp and paper mills, sewage and water treatment plants, environmental protection systems, railroads, mines, utility power generating stations, steel mills, textile plants and other industrial three-phase applications
- For use in wet or dry locations when installed in accordance with NEC
- For use in aerial, conduit, open tray and underground duct installations
- For use in direct burial if installed in a system with a ground conductor that is in close proximity, and conforms with NEC 250.4 (A) (5)

Compliances:

- National Electrical Code (NEC)
- UL 1072
- ICEA S-93-639/NEMA WC74
- ICEA S-97-682
- AEIC CS8
- UL listed as Type MV-105 for use in accordance with NEC
- Sizes 1/0 AWG and larger are listed and marked "Sunlight-Resistant FOR CT USE" in accordance with NEC
- IEEE 1202 (70,000 BTU/hr) CSA FT4
- Meets EPA 40 CFR, Part 2671 for leachable lead content per TCLP method
- OSHA acceptable
- **Optional Flame Tests:**
- ICEA T-29-520 (210,000 BTU/hr)

Packaging:

- Material cut to length and shipped on non-returnable wood reels. Lengths in excess of 10,000 lbs. are provided on returnable steel reels that require a deposit
- Extra charges apply for cuts less than 1000 ft., lagging, pulling eyes, paralleling and triplexing

CATALOG NUMBER	COND. SIZE (AWG/kcmil)	NOMINAL CONDUCTOR DIAMETER		INSULATION DIAMETER INCHES		NOMINAL JACKET THICKNESS		NOMINAL CABLE				AMPACITY			CONDUIT SIZING (4) (INCHES)		
		INCHES	MM	MIN.	MAX.	INCHES	mm	DIAMETER		WEIGHT		COPPER WEIGHT		CONDUIT IN AIR (1)		UNDERGROUND DUCT (2)	DIRECT BURIAL (3)
								INCHES	mm	LBS/1000 FT	kg/km	LBS/1000 FT	kg/km				
35kV, UL TYPE MV-105, 133% INS. LEVEL, 420 MILS																	
17071.135100*	1/0	0.34	1.160	1.265	0.080	2.03	1.47	37.34	1253	1864	437	650	215	215	295	5	
17071.135200*	2/0	0.38	1.200	1.305	0.080	2.03	1.49	37.85	1378	2050	525	781	255	245	335	5	
17071.135300*	3/0	0.43	1.245	1.355	0.080	2.03	1.53	38.86	1532	2280	636	946	290	275	380	5	
17071.135400*	4/0	0.48	1.300	1.405	0.080	2.03	1.59	40.39	1716	2553	776	1155	330	315	435	6	
17071.136000*	250	0.53	1.350	1.460	0.080	2.03	1.64	41.66	1888	2809	899	1338	365	345	475	6	
17071.136200*	350	0.62	1.450	1.555	0.110	2.79	1.79	45.47	2396	3565	1217	1811	440	415	575	6	
17071.136500*	500	0.74	1.570	1.675	0.110	2.79	1.91	48.50	2986	4443	1690	2515	535	500	700	6	
17071.137000*	750	0.91	1.750	1.860	0.110	2.79	2.09	53.09	3954	5884	2477	3685	655	610	865	6	
17071.137500*	1000	1.06	1.900	2.010	0.110	2.79	2.25	57.15	4885	7269	3263	4855	755	690	1005	8	

*Non-stock item, minimum runs apply. Please consult Customer Service for price and delivery.

(1) Ampacities are in accordance with Table 310-73 of the NEC for triplexed or three single conductor copper cable in isolated conduit in air, based on a conductor temperature of 105°C (221°F) and an ambient air temperature of 40°C (104°F).

(2) Ampacities are in accordance with Table 310-77 of the NEC for triplexed or three single conductor copper cable in underground ducts (three conductors per duct), based on a conductor temperature of 105°C (221°F) and an ambient earth temperature of 20°C (68°F), electrical duct arrangement per Figure 310.60 Detail 1, 100% load factor, and earth thermal resistance (rho) of 90.

(3) Ampacities are in accordance with Table 310-81 of the NEC for single insulated copper conductors directly buried in earth, based on a conductor temperature of 105°C (221°F) and an ambient earth temperature of 20°C (68°F), arrangement per Figure 310.06 Detail 9, 100% load factor, and earth thermal resistance (rho) of 90.

(4) Based on nominal cable diameters, three single cables in the duct (PVC Schedule 40) with no ground wire and a maximum of 40% fill. Jam ratio should be checked for individual installations.

Dimensions and weights are nominal; subject to industry tolerances.

Note: The NESCL Lightning bolt symbol is on all Uniblend® constructions



Phone: 888-593-3355
www.generalcable.com

600V – 35kV Industrial Armored Cables

SPECIFICATION NO.	PRODUCT DESCRIPTION	REVISION DATE
7050 [†] Duralox [®]	XLPE/AIA/PVC, Control, Armored 600V, UL Type MC, Multi Conductor	Jan. 2009
7100 [†] Duralox [®]	XLPE/AIA/PVC, Power, Armored 600V, UL Type MC, Three and Four Conductor (8 AWG—4/0 AWG)	Jan. 2008
7150 [†] Duralox [®]	XLPE/AIA/PVC, Power, Armored 600V, UL Type MC, Three and Four Conductor (250 kcmil—1000 kcmil)	Jan. 2008
7160 [†] Duralox [®]	XLPE/AIA/PVC, Power, Armored, with Enhanced Ground Wires (50%) 600V, UL Type MC, Three Conductor (1/0 AWG—1000 kcmil)	Jan. 2008
7200 [†] Duralox [®]	EPR/AIA/PVC, Power, Non-Shielded, Armored 2400V, UL Type MV-90 or MC, Three Conductor	Jan. 2008
7250 [†] Duralox [®] Uniblend [®]	EPR/AIA/PVC, Power, Shielded, Armored 5kV/8kV, UL Type MV-105 or MC, 133% / 100% Ins. Levels, 115 Mils, Three Conductor	Jan. 2008
7300 [†] Duralox [®] Uniblend [®]	EPR/AIA/PVC, Power, Shielded, Armored 15kV, UL Type MV-105 or MC, 133% Ins. Level, 220 Mils, Three Conductor	Jan. 2008
7310 [†] Duralox [®] Uniblend [®]	EPR/AIA/PVC, Power, Shielded, Armored, with Enhanced Ground Wires (50%) 15kV, UL Type MV-105 or MC, 133% Ins. Level, 220 Mils, Three Conductor	Jan. 2008
7350 Duralox [®] Uniblend [®]	EPR/AIA/PVC, Power, Shielded, Armored 25kV, UL Type MV-105 or MC, 100% Ins. Level, 260 Mils, Three Conductor	Jan. 2008
7400 Duralox [®] Uniblend [®]	EPR/AIA/PVC, Power, Shielded, Armored 35kV, UL Type MV-105 or MC, 100% Ins. Level, 345 Mils, Three Conductor	Jan. 2008

[†]Indicates these products are stocked by General Cable

Duralox®

XLPE/AIA/PVC, Control, Armored
600V, UL Type MC, Multi Conductor

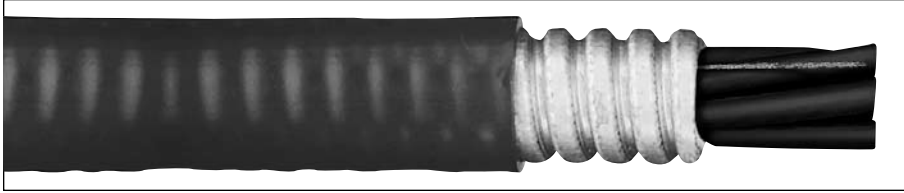

Features:

- Rated at 90°C wet or dry
- Sunlight-resistant
- Provides excellent oil and chemical resistance
- Excellent crush resistance
- Provides a long service life
- Flame-retardant and resistant to moisture
- Cost-effective alternative to installations in conduit
- Meets cold bend test at -25°C

Compliances:

- UL 1569
- UL 44
- ICEA S-95-658/NEMA WC 70
- UL Type MC- 600 volts
- NEC Type XHHW-2 conductors
- IEEE 383 (70,000 BTU/hr)
- UL 1581 (70,000 BTU/hr)
- IEEE 1202 (70,000 BTU/hr)/CSA FT4
- ICEA T-29-520 (210,000 BTU/hr)
- Meets EPA 40 CFR part 261 for leachable lead content per TCLP method
- OSHA acceptable

Packaging:

- Material cut to length and shipped on non-returnable wood reels, while lengths in excess of 10,000 lbs. are provided on returnable steel reels that require a deposit. Extra charges apply for cuts less than 1000 ft., lagging, pulling eyes, paralleling and plexing

Product Construction

Conductor:

- 14 AWG thru 10 AWG bare, compressed copper
- Class B stranding per ASTM B3 and B8

Insulation:

- Flame-retardant Cross-Linked Polyethylene (XLPE)
- Color-coded: per ICEA Method 1; Table E-2 (does not include white or green)

Ground:

- Annealed bare copper Class B stranding per ASTM B8

Armor:

- Aluminum Interlocked Armor (AIA)

Jacket:

- Flame-retardant, moisture- and sunlight-resistant Polyvinyl Chloride (PVC)—Black

Print:

- GENERAL CABLE® XX/C XX AWG (UL) TYPE MC XHHW-2 CDRS DIR BUR SUN RES FOR CT USE 600V MONTH-YEAR SEQUENTIAL FOOTAGE MARK

Options:

- Tinned copper conductors
- E-1 color code
- Copper tape shield or aluminum/polymer tape shield with tinned copper drain wire over cable core
- Inner jacket only, outer jacket only, or both
- Galvanized Steel Interlocked Armor (GSIA)
- Other constructions available upon request

Applications:

- In all raceways or direct burial
- In wet or dry locations
- Permitted for use in Class I Division 2, Class II Division 2, and Class III Division 1 and 2 per NEC Article 334

CATALOG NUMBER	NO. OF COND.	COND. SIZE (AWG)	MINIMUM INSULATION THICKNESS		GRND. WIRE SIZE (AWG)	NOM. DIA. (OVER) ARMOR		NOMINAL JACKET THICKNESS		NOMINAL CABLE O.D.		COPPER WEIGHT		NET WEIGHT	
			INCHES	mm		INCHES	mm	INCHES	mm	INCHES	mm	LBS/1000FT	kg/km	LBS/1000FT	kg/km
14 AWG - MULTI CONDUCTOR - 600V															
346410*	2	14	0.030	0.76	14	0.49	12.5	0.050	1.27	0.60	15.3	39	58	175	261
346420	3	14	0.030	0.76	14	0.52	13.2	0.050	1.27	0.63	16.0	52	78	183	273
346430*	4	14	0.030	0.76	14	0.55	14.0	0.050	1.27	0.66	16.8	65	97	233	347
346440	5	14	0.030	0.76	14	0.59	15.0	0.050	1.27	0.69	17.6	79	118	246	367
346450	7	14	0.030	0.76	14	0.64	16.3	0.050	1.27	0.74	18.8	104	155	297	443
346460*	9	14	0.030	0.76	14	0.72	18.3	0.050	1.27	0.83	21.1	130	193	379	564
346470*	12	14	0.030	0.76	14	0.80	20.3	0.050	1.27	0.90	22.9	168	250	460	685
346480*	19	14	0.030	0.76	14	0.99	25.2	0.050	1.27	1.02	25.9	259	385	621	924
346490*	25	14	0.030	0.76	14	1.07	27.2	0.050	1.27	1.17	29.7	337	502	776	1155
346500*	37	14	0.030	0.76	14	1.19	30.3	0.050	1.27	1.29	32.8	492	732	1043	1533
12 AWG - MULTI CONDUCTOR - 600V															
346510*	2	12	0.030	0.76	12	0.53	13.5	0.050	1.27	0.64	16.3	64	96	218	324
346520	3	12	0.030	0.76	12	0.56	14.3	0.050	1.27	0.66	16.8	83	124	227	338
346530	4	12	0.030	0.76	12	0.60	15.3	0.050	1.27	0.71	18.1	103	154	272	405
346540	5	12	0.030	0.76	12	0.64	16.3	0.050	1.27	0.75	19.1	129	192	336	500
346550	7	12	0.030	0.76	12	0.70	17.8	0.050	1.27	0.81	20.6	165	246	380	566
346560*	9	12	0.030	0.76	12	0.78	19.8	0.050	1.27	0.89	22.6	214	319	479	713
346570*	12	12	0.030	0.76	12	0.86	21.9	0.050	1.27	0.97	24.7	279	416	596	887
346580*	19	12	0.030	0.76	12	0.99	25.2	0.050	1.27	1.10	28.0	428	637	830	1235
346590*	25	12	0.030	0.76	12	1.18	30.0	0.050	1.27	1.28	32.5	557	829	1058	1575
346600*	37	12	0.030	0.76	12	1.31	33.3	0.050	1.27	1.41	35.8	793	1180	1403	2088
10 AWG - MULTI CONDUCTOR - 600V															
346610	3	10	0.030	0.76	10	0.61	15.5	0.050	1.27	0.72	18.3	131	195	301	448
346620	4	10	0.030	0.76	10	0.66	16.8	0.050	1.27	0.77	19.6	164	244	355	529

Dimensions and weights are nominal; subject to industry tolerances.
*Non-stock item, minimum runs apply. Please consult Customer Service for price and delivery.



Duralox®

XLPE/AIA/PVC, Power, Armored
600V, UL Type MC, Three and Four Conductor (8 AWG - 4/0 AWG)

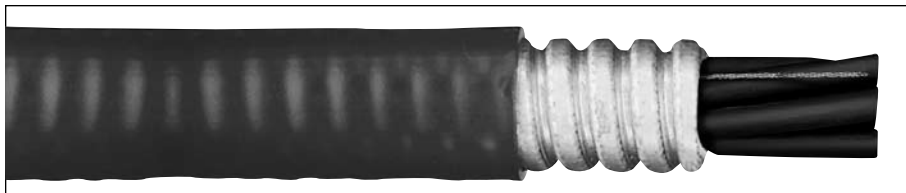

Product Construction

Conductors:

- 8 AWG thru 4/0 AWG bare copper compressed
- Class B stranding per ASTM B8

Insulation:

- Cross-Linked Polyethylene (XLPE)
- Color-coded: per ICEA method 3; Table E-2

Ground:

- Annealed bare copper Class B stranding per ASTM B8

Armor:

- Aluminum Interlocked Armor (AIA)

Jacket:

- Flame-retardant, moisture- and sunlight-resistant Polyvinyl Chloride (PVC) –Black

Print:

- GENERAL CABLE® SIZE (AWG OR KCMIL) 3/C OR 4/C (AS APPLICABLE) TYPE XHHW-2 CDRS 1/C SIZE AWG GRD SUN RES FOR CT USE DIR BUR 600V (UL) MONTH/YEAR SEQUENTIAL FOOTAGE MARK

Options:

- Other constructions available upon request

Applications:

- Ideally suited for use in a broad range of commercial, industrial and utility applications, where maximum performance is demanded, ease of installation desired and fire resistance is critical
- Permitted for use in Class I, Class II, Division 2, Class III Division 1 and 2 hazardous locations per the NEC
- Installed in both exposed or concealed work, wet or dry locations, indoors or outdoors and cable trays

Features:

- Rated at 90°C wet or dry
- Provides excellent oil and chemical resistance
- Excellent crush resistance
- Provides a long service life
- Cost-effective alternative to installations in conduit
- Meets cold bend test at -25°C

Compliances:

- National Electric Code (NEC)
- UL 1569
- UL 44
- ICEA S-95-658/NEMA WC 70
- UL Type MC- 600 volts
- NEC Type XHHW-2 conductors
- IEEE 383 (70,000 BTU/hr)
- UL 1581 (70,000 BTU/hr)
- IEEE 1202 (70,000 BTU/hr)/CSA FT4
- ICEA T-29-520 (210,000 BTU/hr)
- Meets EPA 40 CFR part 261 for leachable lead content per TCLP method
- OSHA acceptable

Packaging:

- For U.S. customers, material cut to length and shipped on non-returnable wood reels, while lengths in excess of 10,000 lbs. are provided on returnable steel reels that require a deposit. Extra charges apply for cuts less than 1000 ft., lagging, pulling eyes, paralleling and plaxing

CATALOG NUMBER	NO. OF COND.	COND. SIZE (AWG)	GRND. WIRE SIZE (AWG)	MINIMUM INSULATION THICKNESS		NOM. DIA. (OVER) ARMOR		NOMINAL JACKET THICKNESS		NOMINAL CABLE O.D.		COPPER WEIGHT		NET WEIGHT	
				INCHES	mm	INCHES	mm	INCHES	mm	INCHES	mm	LBS/1000FT	kg/km	LBS/1000FT	kg/km
8 AWG - 4/0 AWG - THREE AND FOUR CONDUCTOR - 600V															
346630	3	8	10	0.045	1.14	0.74	18.8	0.050	1.27	0.84	21.4	189	281	420	625
346640*	4	8	10	0.045	1.14	0.80	20.3	0.050	1.27	0.90	22.9	241	359	507	755
11298.030600	3	6	8	0.045	1.14	0.84	21.4	0.050	1.27	0.95	24.2	300	446	567	844
11298.040600*	4	6	8	0.045	1.14	0.91	23.1	0.050	1.27	1.01	25.6	383	570	670	997
11298.030400	3	4	8	0.045	1.14	0.94	23.9	0.050	1.27	1.05	26.7	447	665	757	1127
11298.040400*	4	4	8	0.045	1.14	1.03	26.2	0.050	1.27	1.13	28.7	577	859	912	1357
11298.030200	3	2	6	0.045	1.14	1.07	27.2	0.050	1.27	1.18	30.0	710	1057	1075	1600
11298.040200*	4	2	6	0.045	1.14	1.18	30.0	0.050	1.27	1.28	32.5	919	1368	1295	1927
11298.030100*	3	1	6	0.055	1.40	1.19	30.3	0.050	1.27	1.29	32.8	873	1299	1269	1889
11298.040100*	4	1	6	0.055	1.40	1.31	33.3	0.050	1.27	1.41	35.9	1136	1691	1596	2375
11298.035100	3	1/0	6	0.055	1.40	1.27	32.3	0.050	1.27	1.38	35.1	1081	1609	1528	2274
11298.045100*	4	1/0	6	0.055	1.40	1.40	35.6	0.050	1.27	1.50	38.1	1512	2250	1913	2847
11298.035200	3	2/0	6	0.055	1.40	1.37	34.8	0.050	1.27	1.48	37.6	1341	1996	1860	2768
11298.045200*	4	2/0	6	0.055	1.40	1.51	38.2	0.050	1.27	1.61	40.9	1760	2619	2345	3490
11298.035300*	3	3/0	4	0.055	1.40	1.48	37.6	0.050	1.27	1.59	40.4	1717	2555	2259	3362
11298.045300*	4	3/0	4	0.055	1.40	1.66	42.2	0.050	1.27	1.78	45.3	2245	3341	2878	4283
11298.035400	3	4/0	4	0.055	1.40	1.66	42.2	0.060	1.52	1.79	45.5	2130	3170	2840	4226
11298.045400*	4	4/0	4	0.055	1.40	1.78	45.2	0.060	1.52	1.90	48.3	2796	4161	3586	5336

Dimensions and weights are nominal; subject to industry tolerances.

*Non-stock item, minimum runs apply. Please consult Customer Service for price and delivery.



Phone: 888-593-3355
www.generalcable.com

Duralox®

XLPE/AIA/PVC, Power, Armored
600V, UL Type MC, Three and Four Conductor (250 kcmil - 1000 kcmil)

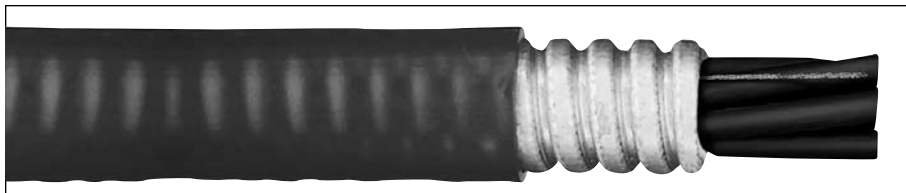

Product Construction

Conductors:

- 250 kcmil thru 1000 kcmil bare copper compressed
- Class B stranding per ASTM B8

Insulation:

- Cross-Linked Polyethylene (XLPE)
- Color-coded: Per ICEA method 3; Table E-2

Ground:

- Annealed bare copper Class B stranding per ASTM B8

Armor:

- Aluminum Interlocked Armor (AIA)

Jacket:

- Flame-retardant, moisture- and sunlight-resistant Polyvinyl Chloride (PVC)—Black

Print:

- GENERAL CABLE® SIZE (AWG OR KCMIL) 3/C OR 4/C (AS APPLICABLE) TYPE XHHW-2 CDRS 1/C SIZE AWG GRD SUN RES FOR CT USE DIR BUR 600V (UL) MONTH/YEAR SEQUENTIAL FOOTAGE MARK

Options:

- Other constructions available upon request

Applications:

- Ideally suited for use in a broad range of commercial, industrial and utility applications, where maximum performance is demanded, ease of installation desired and fire resistance is critical
- Permitted for use in Class I, Class II, Division 2, Class III Division 1 and 2 hazardous locations per the NEC
- Installed in both exposed or concealed work, wet or dry locations, indoors or outdoors and cable trays

Features:

- Rated at 90°C wet or dry
- Provides excellent oil and chemical resistance
- Excellent crush resistance
- Provides a long service life
- Cost-effective alternative to installations in conduit
- Meets cold bend test at -25°C

Compliances:

- National Electric Code (NEC)
- UL 1569
- UL 44
- ICEA S-95-658/NEMA WC 70
- UL Type MC- 600 volts
- NEC Type XHHW-2 conductors
- IEEE 383 (70,000 BTU/hr)
- UL 1581 (70,000 BTU/hr)
- IEEE 1202 (70,000 BTU/hr)/CSA FT4
- ICEA T-29-520 (210,000 BTU/hr)
- Meets EPA 40 CFR part 261 for leachable lead content per TCLP method
- OSHA acceptable

Packaging:

- For U.S. customers, material cut to length and shipped on non-returnable wood reels, while lengths in excess of 10,000 lbs. are provided on returnable steel reels that require a deposit. Extra charges apply for cuts less than 1000 ft., lagging, pulling eyes, paralleling and plaxing

CATALOG NUMBER	NO. OF COND.	COND. SIZE (AWG)	GRND. WIRE SIZE (AWG)	MINIMUM INSULATION THICKNESS		NOM. DIA. (OVER) ARMOR		NOMINAL JACKET THICKNESS		NOMINAL CABLE O.D.		COPPER WEIGHT		NET WEIGHT	
				INCHES	mm	INCHES	mm	INCHES	mm	INCHES	mm	LBS/1000FT	kg/km	LBS/1000FT	kg/km
250 kcmil - 1000 kcmil - THREE AND FOUR CONDUCTOR - 600V															
11298.036000	3	250	4	0.065	1.65	1.81	46.0	0.060	1.52	1.94	49.3	2495	3713	3295	4903
11298.046000*	4	250	4	0.065	1.65	1.95	49.5	0.060	1.52	2.07	52.6	3282	4884	4174	6211
11298.036200	3	350	3	0.065	1.65	2.03	51.6	0.060	1.52	2.16	54.9	3474	5170	4400	6548
11298.046200*	4	350	3	0.065	1.65	2.20	55.9	0.060	1.52	2.32	59.0	4576	6810	5608	8345
11298.036500	3	500	2	0.065	1.65	2.30	58.5	0.075	1.91	2.46	62.5	4934	7343	6126	9116
11298.046500*	4	500	2	0.065	1.65	2.51	63.8	0.075	1.91	2.66	67.6	6509	9687	7825	11644
11298.037000*	3	750	1	0.080	2.03	2.74	69.6	0.075	1.91	2.89	73.4	7351	10940	8806	13104
11298.047000*	4	750	1	0.080	2.03	3.04	77.2	0.075	1.91	3.21	81.6	9713	14455	11494	17104
11298.037500*	3	1000	1/0	0.080	2.03	3.07	78.0	0.075	1.91	3.24	82.3	9783	14559	11476	17077
11298.047500*	4	1000	1/0	0.080	2.03	3.41	86.6	0.075	1.91	3.58	91.0	12932	19245	14931	22218

Dimensions and weights are nominal; subject to industry tolerances.

*Non-stock item, minimum runs apply. Please consult Customer Service for price and delivery.



Duralox®

XLPE/AIA/PVC, Power, Armored, with Enhanced Ground Wires (50%)
600V, UL Type MC, Three Conductor (1/0 AWG—1000 kcmil)

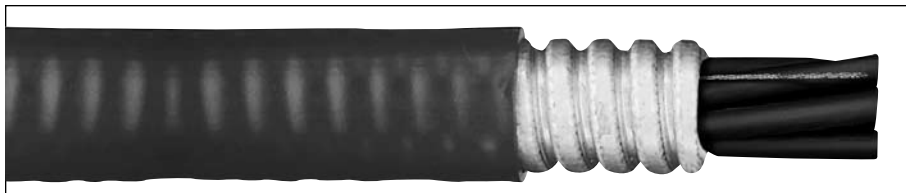

Product Construction

Conductors:

- 1/0 AWG thru 1000 kcmil bare copper compressed
- Class B stranding per ASTM B8

Insulation:

- Cross-Linked Polyethylene (XLPE)
- Color-coded: Per ICEA method 3; Table E-2

Ground:

- Annealed bare copper Class B stranding per ASTM B8

Armor:

- Aluminum Interlocked Armor (AIA)

Jacket:

- Flame-retardant, moisture- and sunlight-resistant Polyvinyl Chloride (PVC)—Black

Print:

- GENERAL CABLE® SIZE (AWG OR KCMIL) 3/C TYPE XHHW-2 CDRS 1/C SIZE AWG GRD SUN RES FOR CT USE DIR BUR 600V (UL) MONTH/YEAR SEQUENTIAL FOOTAGE MARK

Options:

- Other constructions available upon request

Applications:

- Ideally suited for use in a broad range of commercial, industrial and utility applications, where maximum performance is demanded, ease of installation desired and fire resistance is critical
- Permitted for use in Class I, Class II, Division 2, Class III Division 1 and 2 hazardous locations per the NEC
- Installed in both exposed or concealed work, wet or dry locations, indoors or outdoors and cable trays

Features:

- Rated at 90°C wet or dry
- Provides excellent oil and chemical resistance
- Excellent crush resistance
- Provides a long service life
- Cost-effective alternative to installations in conduit
- Meets cold bend test at -25°C

Compliances:

- National Electric Code (NEC)
- UL 1569
- UL 44
- ICEA S-95-658/NEMA WC 70
- UL Type MC- 600 volts
- NEC Type XHHW-2 conductors
- IEEE 383 (70,000 BTU/hr)
- UL 1581 (70,000 BTU/hr)
- IEEE 1202 (70,000 BTU/hr)/CSA FT4
- ICEA T-29-520 (210,000 BTU/hr)
- Meets EPA 40 CFR part 261 for leachable lead content per TCLP method
- OSHA acceptable

Packaging:

- For U.S. customers, material cut to length and shipped on non-returnable wood reels, while lengths in excess of 10,000 lbs. are provided on returnable steel reels that require a deposit. Extra charges apply for cuts less than 1000 ft., lagging, pulling eyes, paralleling and plexing

CATALOG NUMBER	NO. OF COND.	COND. SIZE (AWG)	GRND. WIRE SIZE (AWG)	MINIMUM INSULATION THICKNESS		NOM. DIA. (OVER) ARMOR		NOMINAL JACKET THICKNESS		NOMINAL CABLE O.D.		COPPER WEIGHT		NET WEIGHT	
				INCHES	mm	INCHES	mm	INCHES	mm	INCHES	mm	LBS/1000FT	kg/km	LBS/1000FT	kg/km

1/0 AWG - 1000 kcmil - THREE CONDUCTOR - 600V

11298.515100*	3	1/0	3x6	0.055	1.40	1.27	32.3	0.050	1.27	1.38	35.1	1247	1858	1694	2524
11298.515200*	3	2/0	3x6	0.055	1.40	1.37	34.8	0.050	1.27	1.48	37.6	1507	2245	2026	3019
11298.515300*	3	3/0	3x5	0.055	1.40	1.48	37.6	0.050	1.27	1.59	40.4	1939	2889	2481	3697
11298.515400*	3	4/0	3x4	0.055	1.40	1.66	42.2	0.060	1.52	1.79	45.5	2395	3569	3105	4626
11298.516000*	3	250	3x4	0.065	1.65	1.81	46.0	0.060	1.52	1.94	49.3	2760	4112	3560	5304
11298.516200*	3	350	3x2	0.065	1.65	2.03	51.6	0.060	1.52	2.16	54.9	3944	5877	4870	7256
11298.516500	3	500	3x1	0.065	1.65	2.30	58.5	0.075	1.91	2.46	62.5	5473	8155	6665	9931
11298.517000*	3	750	3x2/0	0.080	2.03	2.74	69.6	0.075	1.91	2.89	73.4	8022	11953	9477	14121
11298.517500*	3	1000	3x3/0	0.080	2.03	3.07	78.0	0.075	1.91	3.24	82.3	10629	15837	12322	18360

Dimensions and weights are nominal; subject to industry tolerances.

*Non-stock item, minimum runs apply. Please consult Customer Service for price and delivery.



Duralox®

EPR/AIA/PVC, Power, Non-Shielded, Armored
2400V, UL Type MV-90 or MC, Three Conductor

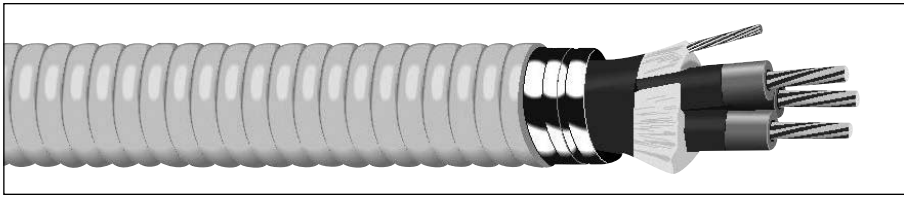

Product Construction

Conductors:

- 6 AWG thru 1000 kcmil bare copper, compact Class B strand

Extruded Strand Shield (ESS):

- Extruded thermoset semi-conducting stress control layer over conductor

Insulation:

- Ethylene Propylene Rubber (EPR) colored to contrast with black conducting shield layer

Ground:

- Annealed bare copper Class B stranding per ASTM B8

Armor:

- Aluminum Interlocked Armor (AIA)

Jacket:

- Flame-retardant, moisture- and sunlight-resistant polyvinyl chloride (PVC)—Yellow

Print:

- GENERAL CABLE® SIZE (KCMIL OR AWG)
COMPACT CU 3/C GENERAL CABLE 115 MILS
EPR TYPE MV-90 OR MC 3/C SIZE AWG GRD
SUN RES FO R CT USE DIR BUR
2400V NON-SHIELDED (UL) MONTH-YEAR
LIGHTNING BOLT SYMBOL SEQUENTIAL
FOOTAGE MARK

Options:

- Other constructions available upon request

Applications:

- Ideally suited for use in a broad range of commercial, industrial and utility applications where reliability is the major concern, maximum performance will be demanded, space is limited, ease of installation is critical and fire resistance is necessary
- May be installed in wet or dry locations, indoors or outdoors and in exposed or concealed work
- May be used in cable trays or on approved supports in protected areas
- Permitted for use in Class I, Class II Division 2, Class III Divisions 1 and 2 hazardous locations per the NEC

Features:

- Rated at 90°C wet or dry
- Excellent heat and moisture resistance
- Outstanding corona resistance
- Flexibility for easy handling
- High dielectric strength
- Low moisture absorption
- Electrical stability under stress
- Low dielectric loss
- Chemical- and radiation-resistant
- Excellent crush resistance
- Flame or sunlight resistance
- Cost-effective alternative to installations in conduit
- Meets the cold bend test at -25°C

Compliances:

- National Electric Code (NEC)
- ICEA S-96-659/NEMA WC-71
- UL Listed as Type MV or Type MC
- UL 1072
- UL 1569
- IEEE 1202 (70,000 BTU/hr)
- IEEE 383 (70,000 BTU/hr)
- UL 1581 (70,000 BTU/hr)
- ICEA T-29-520 (210,000 BTU/hr)
- ICEA T-30-520 (70,000 BTU/hr)
- Meets EPA 40 CFR part 261 for leachable lead content per TCLP method
- OSHA acceptable

Packaging:

- Material cut to length and shipped on non-returnable wood reels, while lengths in excess of 10,000 lbs. are provided on returnable steel reels that require a deposit. Extra charges apply for cuts less than 1000 ft., lagging, pulling eyes, paralleling and plexing

CATALOG NUMBER	NO. OF COND.	COND. SIZE (AWG)	COND. DIA. INCHES	GRND. WIRE SIZE (AWG)	MINIMUM INSULATION THICKNESS		NOM. DIA. (OVER) ARMOR		NOMINAL JACKET THICKNESS		NOMINAL CABLE O.D.		COPPER WEIGHT		NET WEIGHT	
					INCHES	mm	INCHES	mm	INCHES	mm	INCHES	mm	LBS/1000FT	kg/km	LBS/1000FT	kg/km
6 AWG - 1000 kcmil - THREE CONDUCTOR - 115 MILS INS. (2.92 mm) - 2400V																
17471.580600	3	6	0.17	6	0.115	2.92	1.16	29.4	0.050	1.27	1.27	32.2	327	487	854	1272
17471.580400	3	4	0.21	6	0.115	2.92	1.26	31.9	0.050	1.27	1.37	34.7	473	704	1056	1572
17471.580200	3	2	0.27	6	0.115	2.92	1.37	34.8	0.050	1.27	1.48	37.6	703	1047	1363	2030
17471.585100*	3	1/0	0.34	4	0.115	2.92	1.61	41.0	0.060	1.52	1.74	44.3	1118	1665	2003	2982
17471.585200	3	2/0	0.38	4	0.115	2.92	1.71	43.3	0.060	1.52	1.84	46.6	1376	2049	2326	3463
17471.585400	3	4/0	0.48	3	0.115	2.92	1.92	48.7	0.060	1.52	2.05	52.0	2143	3191	3256	4848
17471.586000*	3	250	0.52	3	0.115	2.92	2.00	50.7	0.060	1.52	2.13	54.1	2503	3727	3689	5493
17471.586200	3	350	0.62	2	0.115	2.92	2.21	56.0	0.060	1.52	2.34	59.3	3479	5180	4825	7184
17471.586500	3	500	0.74	1	0.115	2.92	2.46	62.6	0.075	1.91	2.63	66.7	4933	7345	6567	9778
17471.587000*	3	750	0.91	1/0	0.115	2.92	2.83	72.0	0.075	1.91	3.00	76.1	7347	10940	9320	13877
17471.587500*	3	1000	1.07	1/0	0.115	2.92	3.16	80.3	0.085	2.16	3.35	85.0	9680	14414	12023	17902

Dimensions and weights are nominal; subject to industry tolerances.

*Non-stock item, minimum runs apply. Please consult Customer Service for price and delivery.



Duralox® Uniblend®

EPR/AIA/PVC, Power, Shielded, Armored

5kV/8kV, UL Type MV-105 or MC, 133% / 100% Ins. Levels, 115 Mils, Three Conductor

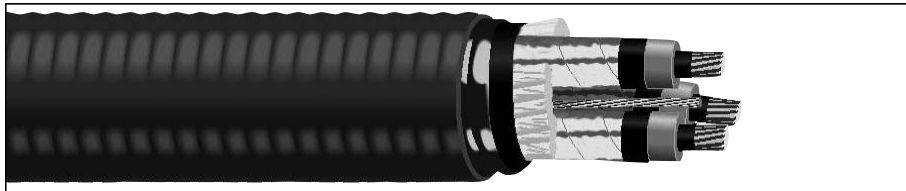

Features:

- Rated at 105°C wet or dry
- Excellent heat and moisture resistance
- Outstanding corona resistance
- Flexibility for easy handling
- High dielectric strength
- Low moisture absorption
- Electrical stability under stress
- Low dielectric loss
- Chemical- and radiation-resistant
- Excellent crush resistance
- Cost-effective alternative to installations in conduit
- Meets cold bend test at -25°C

Product Construction

Conductors:

- 6 AWG thru 1000 kcmil bare, compact copper Class B strand

Extruded Strand Shield (ESS):

- Thermoset semi-conducting extruded stress control layer over conductor

Insulation:

- Ethylene Propylene Rubber (EPR) insulation, colored to contrast with black conducting layers

Extruded Insulation Shield (EIS):

- Thermoset semi-conducting polymeric layer free stripping from insulation

Shield:

- 5 mil annealed copper tape with a minimum 25% overlap

Ground:

- Annealed bare copper Class B stranding per ASTM B8

Armor:

- Aluminum Interlocked Armor (AIA)

Jacket:

- Flame-retardant, moisture- and sunlight-resistant Polyvinyl Chloride (PVC)—Yellow

Print:

- GENERAL CABLE® SIZE (KCMIL OR AWG) COMPACT CU 3/C (INS THICKNESS) MILS EPR TYPE MV-105 OR MC 3/C SIZE AWG GRD VOLTAGE kV% INS LEVEL SUN RES FOR CT USE DIR BUR (UL) LIGHTING BOLT SYMBOL MONTH-YEAR SEQUENTIAL FOOTAGE MARK

Options:

- Other constructions available upon request

Applications:

- Ideally suited for use in a broad range of commercial, industrial and utility applications where reliability is the major concern, maximum performance is demanded, space is limited, ease of installation is critical and fire resistance is necessary
- Installed in wet or dry locations, indoors or outdoors, in exposed or concealed work
- May be used in cable trays or on approved support in protected areas
- Permitted for use in Class I, Class II Division 2, Class III Divisions 1 and 2 hazardous locations per the NEC

Compliances:

- National Electric Code (NEC)
- UL 1072
- ICEA S-93-639/NEMA WC-74
- AEIC CS8
- UL listed as Type MV-105
- IEEE 1202 (70,000 BTU/hr)/CSA FT4
- IEEE 383 (70,000 BTU/hr)
- UL 1581 (70,000 BTU/hr)
- ICEA T-29-520 (210,000 BTU/hr)
- ICEA T-30-520 (70,000 BTU/hr)
- Meets EPA 40 CFR part 261 for leachable lead content per TCLP method
- OSHA acceptable

Packaging:

- Material cut to length and shipped on non-returnable wood reels, while lengths in excess of 10,000 lbs. are provided on returnable steel reels that require a deposit. Extra charges apply for cuts less than 1000 ft., lagging, pulling eyes, paralleling and plexing

CATALOG NUMBER	NO. OF COND.	COND. SIZE (AWG)	COND. DIA. INCHES	INSULATION DIAMETER				GRND. WIRE SIZE (AWG)	NOM. DIA. (OVER) ARMOR		NOMINAL JACKET THICKNESS		NOMINAL CABLE O.D.		COPPER WEIGHT		NET. WEIGHT W/AL ARMOR	
				MIN. INCHES	mm	MAX. INCHES	mm		INCHES	mm	INCHES	mm	INCHES	mm	LBS/1000FT	kg/km	LBS/1000FT	kg/km

6 AWG - 1000 kcmil - THREE CONDUCTOR -

W/JACKET OVER ARMOR, 5kV 133% INS. LEVEL OR 8kV, 100% INS. LEVEL, 115 MILS INS. (2.92 mm)

17473.530600*	3	6	0.17	0.42	10.5	0.49	12.5	6	1.33	33.8	0.050	1.27	1.44	36.6	462	688	1133	1687
17473.530400*	3	4	0.21	0.46	11.6	0.54	13.7	6	1.43	36.2	0.050	1.27	1.54	39.1	619	922	1354	2016
17473.530200	3	2	0.27	0.51	13.0	0.59	14.9	6	1.64	41.6	0.060	1.52	1.77	44.9	864	1286	1819	2708
17473.535100*	3	1/0	0.34	0.58	14.7	0.66	16.7	4	1.79	45.3	0.060	1.52	1.92	48.6	1298	1933	2364	3520
17473.535200	3	2/0	0.38	0.62	15.7	0.70	17.7	4	1.87	47.5	0.060	1.52	2.00	50.8	1566	2332	2696	4014
17473.535400	3	4/0	0.48	0.72	18.3	0.80	20.3	3	2.09	53.2	0.060	1.52	2.22	56.5	2360	3514	3687	5490
17473.536000*	3	250	0.52	0.77	19.6	0.85	21.5	3	2.21	56.0	0.060	1.52	2.34	59.3	2735	4072	4165	6202
17473.536200	3	350	0.62	0.87	22.1	0.95	24.1	2	2.41	61.3	0.075	1.91	2.57	65.4	3736	5563	5436	8094
17473.536500	3	500	0.74	0.99	25.1	1.07	27.1	1	2.64	67.0	0.075	1.91	2.84	72.0	5222	7776	7170	10676
17473.537000*	3	750	0.91	1.17	29.7	1.25	31.8	1/0	3.06	77.8	0.085	2.16	3.25	82.4	7684	11441	10084	15015
17473.537500*	3	1000	1.07	1.33	33.8	1.40	35.6	1/0	3.39	86.1	0.085	2.16	3.57	90.8	10057	14975	12793	19049

Dimensions and weights are nominal; subject to industry tolerances.

*Non-stock item, minimum runs apply. Please consult Customer Service for price and delivery.



Phone: 888-593-3355
www.generalcable.com

Duralox® Uniblend®

EPR/AIA/PVC, Power, Shielded, Armored
15kV, UL Type MV-105 or MC, 133% Ins. Level, 220 Mils, Three Conductor

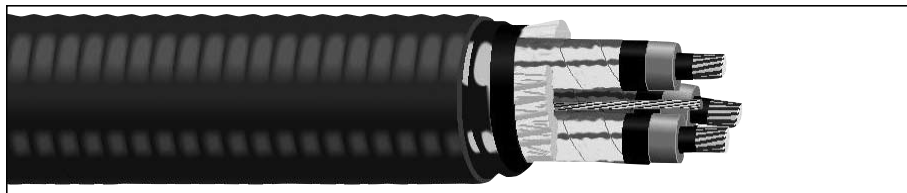

Features:

- Rated at 105°C wet or dry
- Excellent heat and moisture resistance
- Outstanding corona resistance
- Flexibility for easy handling
- High dielectric strength
- Low moisture absorption
- Electrical stability under stress
- Low dielectric loss
- Chemical- and radiation-resistant
- Excellent crush resistance
- Cost-effective alternative to installations in conduit
- Meets cold bend test at -25°C

Product Construction

Conductors:

- 2 AWG thru 1000 kcmil bare, compact copper Class B strand

Extruded Strand Shield (ESS):

- Thermoset semi-conducting extruded stress control layer over conductor

Insulation:

- Ethylene Propylene Rubber (EPR) insulation, colored to contrast with black conducting layers

Extruded Insulation Shield (EIS):

- Thermoset semi-conducting polymeric layer free stripping from insulation

Shield:

- 5 mil annealed copper tape with a minimum 25% overlap

Ground:

- Annealed bare copper Class B stranding per ASTM B8

Armor:

- Aluminum Interlocked Armor (AIA)

Jacket:

- Flame-retardant, moisture- and sunlight-resistant Polyvinyl Chloride (PVC)—Red

Print:

- GENERAL CABLE® SIZE (KCMIL OR AWG) COMPACT CU 3/C (INS THICKNESS) MILS EPR TYPE MV-105 OR MC 3/C SIZE AWG GRD VOLTAGE kV% INS LEVEL SUN RES FOR CT USE DIR BUR (UL) LIGHTING BOLT SYMBOL MONTH-YEAR SEQUENTIAL FOOTAGE MARK

Options:

- Other constructions available upon request

Applications:

- Ideally suited for use in a broad range of commercial, industrial and utility applications where reliability is the major concern, maximum performance is demanded, space is limited, ease of installation is critical and fire resistance is necessary
- Installed in wet or dry locations, indoors or outdoors, in exposed or concealed work
- May be used in cable trays or on approved support in protected areas
- Permitted for use in Class I, Class II Division 2, Class III Divisions 1 and 2 hazardous locations per the NEC

Compliances:

- National Electric Code (NEC)
- UL 1072
- ICEA S-93-639/NEMA WC-74
- AEIC CS8
- UL listed as Type MV-105
- IEEE 1202 (70,000 BTU/hr)/CSA FT4
- IEEE 383 (70,000 BTU/hr)
- UL 1581 (70,000 BTU/hr)
- ICEA T-29-520 (210,000 BTU/hr)
- ICEA T-30-520 (70,000 BTU/hr)
- Meets EPA 40 CFR part 261 for leachable lead content per TCLP method
- OSHA acceptable

Packaging:

- Material cut to length and shipped on non-returnable wood reels, while lengths in excess of 10,000 lbs. are provided on returnable steel reels that require a deposit. Extra charges apply for cuts less than 1000 ft., lagging, pulling eyes, paralleling and plexing

CATALOG NUMBER	NO. OF COND.	COND. SIZE (AWG/ kcmil)	COND. DIA. INCHES	INSULATION DIAMETER				GRND. WIRE SIZE (AWG)	NOM. DIA. (OVER) ARMOR		NOMINAL JACKET THICKNESS		NOMINAL CABLE O.D.		COPPER WEIGHT		NET. WEIGHT W/AL ARMOR	
				MIN. INCHES	mm	MAX. INCHES	mm		INCHES	mm	INCHES	mm	INCHES	mm	LBS/ 1000FT	kg/ km	LBS/ 1000FT	kg/ km

**2 AWG - 1000 kcmil - THREE CONDUCTOR -
W/JACKET OVER ARMOR, 15kV 133% INS. LEVEL, 220 MILS INS. (5.59 mm)**

17476.530200	3	2	0.27	0.71	18.0	0.80	20.3	6	2.08	52.8	0.060	1.52	2.21	56.1	919	1368	2416	3597
17476.535100*	3	1/0	0.34	0.78	19.8	0.87	22.0	4	2.22	56.5	0.060	1.52	2.35	59.8	1352	2013	2997	4463
17476.535200	3	2/0	0.38	0.82	20.8	0.91	24.3	4	2.31	58.7	0.060	1.52	2.44	62.0	1620	2412	3371	5019
17476.535400	3	4/0	0.48	0.92	23.4	1.01	25.6	3	2.53	64.3	0.075	1.91	2.70	68.5	2114	3594	4502	6703
17476.536000*	3	250	0.53	0.97	24.6	1.06	26.9	3	2.65	67.2	0.075	1.91	2.81	71.3	2789	4153	5005	7452
17476.536200	3	350	0.62	1.07	27.2	1.16	29.4	2	2.85	72.4	0.075	1.91	3.01	76.6	3790	5643	6252	9309
17476.536500	3	500	0.74	1.19	30.2	1.28	32.4	1	3.11	79.0	0.085	2.16	3.30	83.7	5276	7856	8091	12047
17476.537000*	3	750	0.91	1.37	34.8	1.46	37.1	1/0	3.50	89.0	0.085	2.16	3.69	93.6	7738	11522	11086	16507
17476.537500*	3	1000	1.06	1.52	38.6	1.61	40.9	1/0	3.83	97.3	0.085	2.16	4.01	101.9	10111	15055	13870	20652

Dimensions and weights are nominal; subject to industry tolerances.

*Non-stock item, minimum runs apply. Please consult Customer Service for price and delivery.



Duralox® Uniblend®

EPR/AIA/PVC, Power, Shielded, Armored, with Enhanced Ground Wires (50%)
15kV, UL Type MV-105 or MC, 133% Ins. Level, 220 Mils, Three Conductor

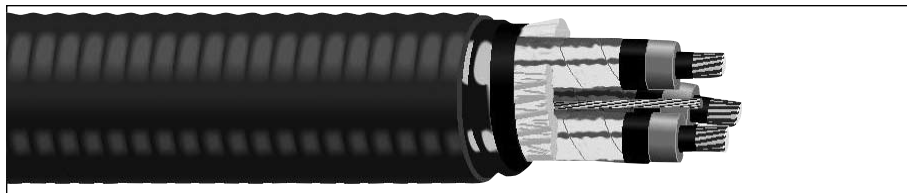

Features:

- Rated at 105°C wet or dry
- Excellent heat and moisture resistance
- Outstanding corona resistance
- Flexibility for easy handling
- High dielectric strength
- Low moisture absorption
- Electrical stability under stress
- Low dielectric loss
- Chemical- and radiation-resistant
- Excellent crush resistance
- Cost-effective alternative to installations in conduit
- Meets cold bend test at -25°C

Product Construction

Conductors:

- 1/0 AWG thru 1000 kcmil bare, compact copper Class B strand

Extruded Strand Shield (ESS):

- Thermoset semi-conducting extruded stress control layer over conductor

Insulation:

- Ethylene Propylene Rubber (EPR) insulation, colored to contrast with black conducting layers

Extruded Insulation Shield (EIS):

- Thermoset semi-conducting polymeric layer free stripping from insulation

Shield:

- 5 mil annealed copper tape with a minimum 25% overlap

Ground:

- Annealed bare copper Class B stranding per ASTM B8

Armor:

- Aluminum Interlocked Armor (AIA)

Jacket:

- Flame-retardant, moisture- and sunlight-resistant Polyvinyl Chloride (PVC)—Red

Print:

- GENERAL CABLE® SIZE (KCMIL OR AWG) COMPACT CU 3/C (INS THICKNESS) MILS EPR TYPE MV-105 OR MC 3/C SIZE AWG GRD VOLTAGE kV% INS LEVEL SUN RES FOR CT USE DIR BUR (UL) LIGHTING BOLT SYMBOL MONTH-YEAR SEQUENTIAL FOOTAGE MARK

Options:

- Other constructions available upon request

Applications:

- Ideally suited for use in a broad range of commercial, industrial and utility applications where reliability is the major concern, maximum performance is demanded, space is limited, ease of installation is critical and fire resistance is necessary
- Installed in wet or dry locations, indoors or outdoors, in exposed or concealed work
- May be used in cable trays or on approved support in protected areas
- Permitted for use in Class I, Class II Division 2, Class III Divisions 1 and 2 hazardous locations per the NEC

Compliances:

- National Electric Code (NEC)
- UL 1072
- ICEA S-93-639/NEMA WC-74
- AEIC CS8
- UL listed as Type MV-105
- IEEE 1202 (70,000 BTU/hr)/CSA FT4
- IEEE 383 (70,000 BTU/hr)
- UL 1581 (70,000 BTU/hr)
- ICEA T-29-520 (210,000 BTU/hr)
- ICEA T-30-520 (70,000 BTU/hr)
- Meets EPA 40 CFR part 261 for leachable lead content per TCLP method
- OSHA acceptable

Packaging:

- Material cut to length and shipped on non-returnable wood reels, while lengths in excess of 10,000 lbs. are provided on returnable steel reels that require a deposit. Extra charges apply for cuts less than 1000 ft., lagging, pulling eyes, paralleling and plexing

CATALOG NUMBER	NO. OF COND.	COND. SIZE (AWG/ kcmil)	COND. DIA. INCHES	INSULATION DIAMETER				GRND. WIRE SIZE (AWG)	NOM. DIA. (OVER) ARMOR		NOMINAL JACKET THICKNESS		NOMINAL CABLE O.D.		COPPER WEIGHT		NET. WEIGHT W/AL ARMOR	
				MIN. INCHES	mm	MAX. INCHES	mm		INCHES	mm	INCHES	mm	INCHES	mm	LBS/ 1000FT	kg/ km	LBS/ 1000FT	kg/ km

**1/0 AWG - 1000 kcmil - THREE CONDUCTOR -
W/JACKET OVER ARMOR, 15kV 133% INS. LEVEL, 220 MILS INS. (5.59 mm)**

17476.515100*	3	1/0	0.34	0.78	19.8	0.87	22.0	3x6	2.22	56.5	0.060	1.52	2.35	59.8	1469	2187	3119	4644
17476.515200*	3	2/0	0.38	0.82	20.8	0.91	24.3	3x6	2.31	58.7	0.060	1.52	2.44	62.0	1748	2603	3499	5210
17476.515400*	3	4/0	0.48	0.92	23.4	1.01	25.6	3x4	2.53	64.3	0.075	1.91	2.70	68.5	2661	3962	4752	7076
17476.516000*	3	250	0.53	0.97	24.6	1.06	26.9	3x4	2.65	67.2	0.075	1.91	2.81	71.3	3145	4683	5265	7840
17476.516200*	3	350	0.62	1.07	27.2	1.16	29.4	3x2	2.85	72.4	0.075	1.91	3.01	76.6	4212	6272	6674	9938
17476.516500	3	500	0.74	1.19	30.2	1.28	32.4	3x1	3.11	79.0	0.085	2.16	3.30	83.7	5807	8647	8550	12731
17476.517000*	3	750	0.91	1.37	34.8	1.46	37.1	3x2/0	3.50	89.0	0.085	2.16	3.69	93.6	8574	12767	11932	17767
17476.517500*	3	1000	1.06	1.52	38.6	1.61	40.9	3x3/0	3.83	97.3	0.085	2.16	4.01	101.9	11198	16674	14957	22271

Dimensions and weights are nominal; subject to industry tolerances.

*Non-stock item, minimum runs apply. Please consult Customer Service for price and delivery.



Duralox® Uniblend®

EPR/AIA/PVC, Power, Shielded, Armored
25kV, UL Type MV-105 or MC, 100% Ins. Level, 260 Mils, Three Conductor

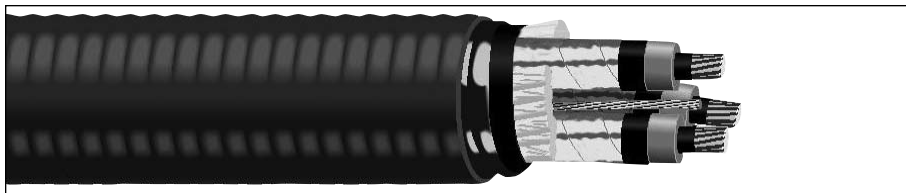

Features:

- Rated at 105°C wet or dry
- Excellent heat and moisture resistance
- Outstanding corona resistance
- Flexibility for easy handling
- High dielectric strength
- Low moisture absorption
- Electrical stability under stress
- Low dielectric loss
- Chemical- and radiation-resistant
- Excellent crush resistance
- Cost-effective alternative to installations in conduit
- Meets cold bend test at -25°C

Product Construction

Conductors:

- 1/0 AWG thru 1000 kcmil bare, compact copper Class B strand

Extruded Strand Shield (ESS):

- Thermoset semi-conducting extruded stress control layer over conductor

Insulation:

- Ethylene Propylene Rubber (EPR) insulation, colored to contrast with black conducting layers

Extruded Insulation Shield (EIS):

- Thermoset semi-conducting polymeric layer free stripping from insulation

Shield:

- 5 mil annealed copper tape with a minimum 25% overlap

Ground:

- Annealed bare copper Class B stranding per ASTM B8

Armor:

- Aluminum Interlocked Armor (AIA)

Jacket:

- Flame-retardant, moisture- and sunlight-resistant Polyvinyl Chloride (PVC)—Red

Print:

- GENERAL CABLE® SIZE (KCMIL OR AWG) COMPACT CU 3/C (INS THICKNESS) MILS EPR TYPE MV-105 OR MC 3/C SIZE AWG GRD VOLTAGE kV% INS LEVEL SUN RES FOR CT USE DIR BUR (UL) LIGHTING BOLT SYMBOL MONTH-YEAR SEQUENTIAL FOOTAGE MARK

Options:

- Other constructions available upon request

Applications:

- Ideally suited for use in a broad range of commercial, industrial and utility applications where reliability is the major concern, where maximum performance is demanded, space is limited, ease of installation is critical and fire resistance is necessary
- Installed in wet or dry locations, indoors or outdoors, in exposed or concealed work
- May be used in cable trays or on approved support in protected areas
- Permitted for use in Class I, Class II Division 2, Class III Divisions 1 and 2 hazardous locations per the NEC

Compliances:

- National Electric Code (NEC)
- UL 1072
- ICEA S-93-639/NEMA WC-74
- AEIC CS8
- UL listed as Type MV-105
- IEEE 1202 (70,000 BTU/hr)/CSA FT4
- IEEE 383 (70,000 BTU/hr)
- UL 1581 (70,000 BTU/hr)
- ICEA T-29-520 (210,000 BTU/hr)
- ICEA T-30-520 (70,000 BTU/hr)
- Meets EPA 40 CFR part 261 for leachable lead content per TCLP method
- OSHA acceptable

Packaging:

- Material cut to length and shipped on non-returnable wood reels, while lengths in excess of 10,000 lbs. are provided on returnable steel reels that require a deposit. Extra charges apply for cuts less than 1000 ft., lagging, pulling eyes, paralleling and plexing

CATALOG NUMBER	NO. OF COND.	COND. SIZE (AWG/ kcmil)	COND. DIA. INCHES	INSULATION DIAMETER				GRND. WIRE SIZE (AWG)	NOM. DIA. (OVER) ARMOR		NOMINAL JACKET THICKNESS		NOMINAL CABLE O.D.		COPPER WEIGHT		NET. WEIGHT W/AL ARMOR	
				MIN. INCHES	mm	MAX. INCHES	mm		INCHES	mm	INCHES	mm	INCHES	mm	LBS/ 1000FT	kg/ km	LBS/ 1000FT	kg/ km

**1/0 AWG - 1000 kcmil - THREE CONDUCTOR -
W/JACKET OVER ARMOR, 25kV, 100% INS. LEVEL, 260 MILS INS. (6.60 mm)**

17477.535100*	3	1/0	0.34	0.85	21.6	0.94	23.9	4	2.39	60.8	0.075	1.91	2.56	64.9	1372	2043	3358	5000
17477.535200*	3	2/0	0.38	0.89	22.6	0.98	24.9	4	2.48	63.0	0.075	1.91	2.64	67.1	1641	2443	3743	5573
17477.535400*	3	4/0	0.48	0.99	25.1	1.08	27.4	3	2.70	68.6	0.075	1.91	2.86	72.7	2435	3626	4807	7158
17477.536000*	3	250	0.53	1.04	26.4	1.14	28.8	3	2.81	71.5	0.075	1.91	2.98	75.6	2810	4184	5307	7902
17477.536200*	3	350	0.62	1.14	29.0	1.23	31.2	2	3.02	76.7	0.075	1.91	3.18	80.8	3811	5675	6595	9820
17477.536500*	3	500	0.74	1.26	32.0	1.35	34.3	1	3.28	83.3	0.085	2.16	3.46	88.0	5297	7887	8485	12634
17477.537000*	3	750	0.91	1.44	36.6	1.54	39.0	1/0	3.67	93.2	0.085	2.16	3.85	97.9	7758	11552	11491	17110
17477.517500*	3	1000	1.06	1.59	40.4	1.69	42.8	1/0	4.00	101.5	0.085	2.16	4.18	106.2	10132	15087	14303	21297

Dimensions and weights are nominal; subject to industry tolerances.

*Non-stock item, minimum runs apply. Please consult Customer Service for price and delivery.



Duralox® Uniblend®

EPR/AIA/PVC, Power, Shielded, Armored

35kV, UL Type MV-105 or MC, 100% Ins. Level, 345 Mils, Three Conductor

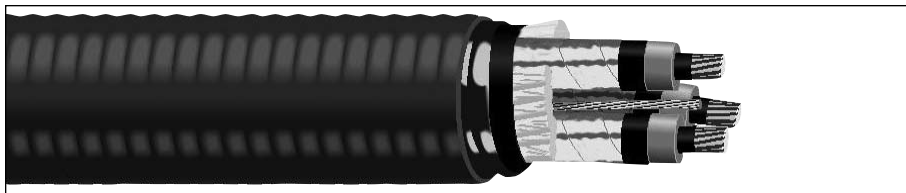

Features:

- Rated at 105°C wet or dry
- Excellent heat and moisture resistance
- Outstanding corona resistance
- Flexibility for easy handling
- High dielectric strength
- Low moisture absorption
- Electrical stability under stress
- Low dielectric loss
- Chemical- and radiation-resistant
- Excellent crush resistance
- Cost-effective alternative to installations in conduit
- Meets cold bend test at -25°C

Product Construction

Conductors:

- 1/0 AWG thru 750 kcmil bare, compact copper Class B strand

Extruded Strand Shield (ESS):

- Thermoset semi-conducting extruded stress control layer over conductor

Insulation:

- Ethylene Propylene Rubber (EPR) insulation, colored to contrast with black conducting layers

Extruded Insulation Shield (EIS):

- Thermoset semi-conducting polymeric layer free stripping from insulation

Shield:

- 5 mil annealed copper tape with a minimum 25% overlap

Ground:

- Annealed bare copper Class B stranding per ASTM B8

Armor:

- Aluminum Interlocked Armor (AIA)

Jacket:

- Flame-retardant, moisture- and sunlight-resistant Polyvinyl Chloride (PVC)—Red

Print:

- GENERAL CABLE® SIZE (KCMIL OR AWG) COMPACT CU 3/C (INS THICKNESS) MILS EPR TYPE MV-105 OR MC 3/C SIZE AWG GRD VOLTAGE kV% INS LEVEL SUN RES FOR CT USE DIR BUR (UL) LIGHTING BOLT SYMBOL MONTH-YEAR SEQUENTIAL FOOTAGE MARK

Options:

- Other constructions available upon request

Applications:

- Ideally suited for use in a broad range of commercial, industrial and utility applications where reliability is the major concern, maximum performance is demanded, space is limited, ease of installation is critical and fire resistance is necessary
- Installed in wet or dry locations, indoors or outdoors, in exposed or concealed work
- May be used in cable trays or on approved support in protected areas
- Permitted for use in Class I, Class II Division 2, Class III Divisions 1 and 2 hazardous locations per the NEC

Compliances:

- National Electric Code (NEC)
- UL 1072
- ICEA S-93-639/NEMA WC-74
- AEIC CS8
- UL listed as Type MV-105
- IEEE 1202 (70,000 BTU/hr)/CSA FT4
- IEEE 383 (70,000 BTU/hr)
- UL 1581 (70,000 BTU/hr)
- ICEA T-29-520 (210,000 BTU/hr)
- ICEA T-30-520 (70,000 BTU/hr)
- Meets EPA 40 CFR part 261 for leachable lead content per TCLP method
- OSHA acceptable

Packaging:

- Material cut to length and shipped on non-returnable wood reels, while lengths in excess of 10,000 lbs. are provided on returnable steel reels that require a deposit. Extra charges apply for cuts less than 1000 ft., lagging, pulling eyes, paralleling and plexing

CATALOG NUMBER	NO. OF COND.	COND. SIZE (AWG/ kcmil)	COND. DIA. INCHES	INSULATION DIAMETER				GRND. WIRE SIZE (AWG)	NOM. DIA. (OVER) ARMOR		NOMINAL JACKET THICKNESS		NOMINAL CABLE O.D.		COPPER WEIGHT		NET. WEIGHT W/AL ARMOR	
				MIN. INCHES	mm	MAX. INCHES	mm		INCHES	mm	INCHES	mm	INCHES	mm	LBS/ 1000FT	kg/ km	LBS/ 1000FT	kg/ km

1/0 AWG - 750 kcmil - THREE CONDUCTOR -

W/JACKET OVER ARMOR, 5vK, 100% INS. LEVEL, 345 MILS INS. (8.76 mm)

17480.535100*	3	1/0	0.34	1.02	25.9	1.12	28.4	4	2.77	70.4	0.075	1.91	2.93	74.5	1419	2113	4063	6050
17480.535200*	3	2/0	0.38	1.06	26.9	1.16	29.5	4	2.86	72.6	0.075	1.91	3.02	76.7	1687	2512	4441	6613
17480.535400*	3	4/0	0.48	1.16	29.5	1.26	32.0	3	3.08	78.2	0.075	1.91	3.24	82.3	2482	3696	5572	8297
17480.536000*	3	250	0.53	1.21	30.7	1.32	33.4	3	3.19	81.1	0.085	2.16	3.38	85.7	2856	4253	6165	9180
17480.536200*	3	350	0.62	1.31	33.3	1.41	35.8	2	3.40	86.3	0.085	2.16	3.58	91.0	3858	5745	7499	11166
17480.536500*	3	500	0.74	1.43	36.3	1.53	38.9	1	3.66	93.0	0.085	2.16	3.83	97.3	5344	7957	9400	13997
17480.537000*	3	750	0.91	1.61	40.9	1.71	43.4	1/0	4.05	102.9	0.085	2.16	4.23	107.5	7805	11622	12843	19123

Dimensions and weights are nominal; subject to industry tolerances.

*Non-stock item, minimum runs apply. Please consult Customer Service for price and delivery.



Phone: 888-593-3355
www.generalcable.com

600V – 28kV TECK90 Armored Control and Power Cables

SPECIFICATION NO.	PRODUCT DESCRIPTION	REVISION DATE
8025 [†]	TECK90 XLPE/PVC/AIA/PVC, Control, Armored 600V, CSA TECK90, Multi Conductor, 14 AWG	Jan. 2009
8050 [†]	TECK90 XLPE/PVC/AIA/PVC, Control, Armored 600V, CSA TECK90, Multi Conductor, 12 AWG	Jan. 2009
8075 [†]	TECK90 XLPE/PVC/AIA/PVC, Control, Armored 600V, CSA TECK90, Multi Conductor, 10 AWG	Jan. 2009
8100	TECK90 XLPE/PVC/AIA/PVC, Power, Armored 1000V, CSA TECK90, Single Conductor	Jan. 2008
8125	TECK90 XLPE/PVC/AIA/PVC, Control and Power, Armored 1000V, CSA TECK90, Two Conductor	Jan. 2008
8150 [†]	TECK90 XLPE/PVC/AIA/PVC, Control and Power, Armored 1000V, CSA TECK90, Three Conductor	Jan. 2008
8175 [†]	TECK90 XLPE/PVC/AIA/PVC, Control and Power, Armored 1000V, CSA TECK90, Four Conductor	Jan. 2008
8200	TECK90 XLPE/PVC/AIA/PVC, Power/Control Composite 600V, CSA TECK90, Three Power and Three 14 AWG Control Conductors	Jan. 2008
8225	TECK90 XLPE/PVC/AIA/PVC, Power, Unshielded, Armored 5kV, CSA TECK90, Single Conductor	Jan. 2009
8250 [†]	TECK90 XLPE/PVC/AIA/PVC, Power, Unshielded, Armored 5kV, CSA TECK90, Three Conductor	Jan. 2009
8275	HVTECK TRXLPE/Wire Shield/PVC/AIA/PVC, Power, Shielded, Armored 5kV, CSA HVTECK, 100% / 133% Ins. Levels, 90 Mils, Single Conductor	Jan. 2009
8300	HVTECK TRXLPE/Wire Shield/PVC/AIA/PVC, Power, Shielded, Armored 5kV, CSA HVTECK, 133% Ins. Level, 115 Mils, Single Conductor	Jan. 2008
8325	HVTECK TRXLPE/Tape Shield/PVC/AIA/PVC, Power, Shielded, Armored 5kV, CSA HVTECK, 100% / 133% Ins. Levels, 90 Mils, Three Conductor	Jan. 2009
8350	HVTECK TRXLPE/Tape Shield/PVC/AIA/PVC, Power, Shielded, Armored 5kV, CSA HVTECK, 133% Ins. Level, 115 Mils, Three Conductor	Jan. 2008
8375	HVTECK TRXLPE/Wire Shield/PVC/AIA/PVC, Power, Shielded, Armored 15kV, CSA HVTECK, 100% Ins. Level, 175 Mils, Single Conductor	Jan. 2008
8400	HVTECK TRXLPE/Wire Shield/PVC/AIA/PVC, Power, Shielded, Armored 15kV, CSA HVTECK, 133% Ins. Level, 220 Mils, Single Conductor	Jan. 2008
8425	HVTECK TRXLPE/Tape Shield/PVC/AIA/PVC, Power, Shielded, Armored 15kV, CSA HVTECK, 100% Ins. Level, 175 Mils, Three Conductor	Jan. 2008

[†]Indicates these products are stocked by General Cable

600V – 28kV TECK90 Armored Control and Power Cables

SPECIFICATION NO.		PRODUCT DESCRIPTION	REVISION DATE
8450[†]	HVTECK	TRXLPE/Tape Shield/PVC/AIA/PVC, Power, Shielded, Armored 15kV, CSA HVTECK, 133% Ins. Level, 220 Mils, Three Conductor	Jan. 2008
8475	HVTECK	TRXLPE/Tape Shield/PVC/AIA/PVC, Power, Shielded, Armored 25kV, CSA HVTECK, 100% Ins. Level, 260 Mils, Three Conductor	Jan. 2008
8500	HVTECK	TRXLPE/Tape Shield/PVC/AIA/PVC, Power, Shielded, Armored 25kV, CSA HVTECK, 133% Ins. Level, 320 Mils, Three Conductor	Jan. 2008
8525	HVTECK	TRXLPE/Tape Shield/PVC/AIA/PVC, Power, Shielded, Armored 28kV, CSA HVTECK, 133% Ins. Level, 345 Mils, Three Conductor	Jan. 2008
8550	VERTITECK® TECK90	XLPE/PVC/GSIA/PVC, Power, Unshielded, Armored 1kV, CSA TECK90, Three Conductor	Jan. 2008
8575	VERTITECK® TECK90	XLPE/PVC/GSIA/PVC, Power, Unshielded, Armored 5kV, CSA TECK90, 90 Mils, Three Conductor	Jan. 2008
8625	VERTITECK® HVTECK	TRXLPE/Tape Shield/PVC/GSIA/PVC, Power, Shielded, Armored 15kV, CSA HVTECK, 100% Ins. Level, 175 Mils, Three Conductor	Jan. 2008
8700[†]	ACWU	XLPE/AIA/PVC, Control, Armored 600V, CSA ACWU90 (-40°C), Single Conductor	Jan. 2008
8750[†]	ACWU	XLPE/AIA/PVC, Control, Armored 600V, CSA ACWU90 (-40°C), Three Conductor	Jan. 2009
8775[†]	ACWU	XLPE/AIA/PVC, Control, Armored 600V, CSA ACWU90 (-40°C), Four Conductor	Jan. 2009

[†]Indicates these products are stocked by General Cable

TECK90

XLPE/PVC/AIA/PVC, Control, Armored
600V, CSA TECK90, Multi Conductor, 14 AWG

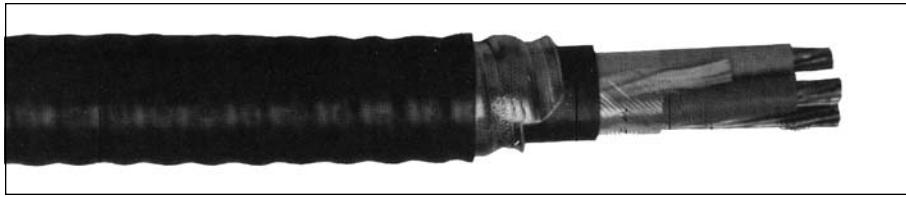

Product Construction

Conductors:

- 14 AWG bare copper Class B compressed concentric round to ASTM B8

Insulation:

- Cross-linked Polyethylene (XLPE) Type RW90
- Color-coded: 1 to 4 conductors—Black, Red, Blue and White; Over 4 conductors—per ICEA Method 4 individual conductors colored Black with conductor number surface printed in contrasting ink

Ground (Bonding) Conductor:

- The conductor consists of one uninsulated stranded bare copper conductor

Inner Jacket:

- Flame-retardant, moisture- and sunlight-resistant Polyvinyl Chloride (PVC)—Black

Armor:

- Aluminum Interlocked Armor (AIA)

Overall Jacket:

- ACID-FLAME-CHECK ✓✓[®] flame-retardant, moisture- and sunlight-resistant Polyvinyl Chloride (PVC)—Black

Print:

- GENERAL CABLE[®] ACID-FLAME-CHECK ✓✓[®] AG14 FT1 FT4 HL TECK90 XLPE (-40°C)#/C SIZE (14 AWG) 600V DIR BUR SUN RES CSA MONTH-YEAR SEQUENTIAL LENGTH MARK

Options:

- Galvanized Steel Interlocked Armor (GSIA)
- Other constructions available upon request

Applications:

- For exposed and concealed wiring in dry, damp or wet locations
- For use in ventilated, non-ventilated and ladder-type cable trays in dry, damp or wet locations
- For direct earth burial (with protection as required by inspection authority)
- For wiring in all hazardous locations when used with certified HL cable glands

Features:

- Rated at 90°C wet or dry
- Excellent crush, oil and chemical resistance
- Provides long service life
- Meets cold bend and impact tests at -40°C

Compliances:

- CSA Standard C22.2 No. 131 and No. 174
- CSA Approval number: LR1781
- CSA FT1 and FT4
- IEEE 383 (70,000 BTU/hr)
- UL 1581 (70,000 BTU/hr)
- IEEE 1202 (70,000 BTU/hr) CSA FT4
- ICEA T-30-520 (70,000 BTU/hr)
- Hazardous Location Rating: HL
- Meets EPA 40 CFR, part 261 for leachable lead content per TCLP method
- OSHA acceptable

Packaging:

- For Canadian customers, lengths are provided on returnable wood or steel reels that require a deposit. Extra charges apply for lagging, pulling eyes, paralleling and plexing
- For U.S. customers, material cut to length and shipped on non-returnable wood reels, while lengths in excess of 10,000 lbs. are provided on returnable steel reels that require a deposit. Extra charges apply for cuts less than 1000 ft., lagging, pulling eyes, paralleling and plexing

CATALOG NUMBER	NO. OF COND.	COND. SIZE (AWG)	GROUND WIRE SIZE (AWG)	NOMINAL DIAMETER (OVER)						COPPER WEIGHT		NET WEIGHT W/ARMOR				AMPACITY** (30°C AMBIENT)
				INSULATION		ARMOR		CABLE		LBS/1000 FT	kg/km	LBS/1000 FT		kg/km		
				INCHES	mm	INCHES	mm	INCHES	mm			AL	STEEL	AL	STEEL	

14 AWG—MULTI CONDUCTOR—30 MILS INS. (.76 mm), 600V

780220	2	14	14	0.13	3.4	0.58	14.8	0.67	16.9	39	58	195	310	290	462	15
780250	3	14	14	0.13	3.4	0.60	15.4	0.69	17.4	52	78	226	346	336	515	15
780280	4	14	14	0.13	3.4	0.64	16.2	0.72	18.3	68	101	256	385	381	573	15
794540	5	14	14	0.13	3.4	0.68	17.3	0.76	19.3	81	121	290	430	432	640	12
792940	6	14	14	0.13	3.4	0.72	18.3	0.80	20.3	95	142	316	464	471	691	12
780310	7	14	14	0.13	3.4	0.74	18.8	0.82	20.8	104	155	338	490	503	730	10.5
330090	8	14	14	0.13	3.4	0.79	20.1	0.87	22.2	117	174	373	537	555	799	10.5
792960	10	14	14	0.13	3.4	0.88	22.3	0.96	24.3	149	222	451	637	671	948	10.5
792980	12	14	14	0.13	3.4	0.90	23.0	0.99	25.0	176	262	511	702	761	1045	10.5
793000	15	14	14	0.13	3.4	0.96	24.3	1.04	26.3	217	323	586	791	872	1177	10.5
780290	20	14	14	0.13	3.4	1.13	28.7	1.21	30.8	285	424	789	1117	1174	1662	10.5
308190*	25	14	14	0.13	3.4	1.22	30.9	1.30	33.0	337	502	958	1315	1426	1957	9
333750*	30	14	14	0.13	3.4	1.28	32.5	1.36	34.6	402	599	1015	1390	1511	2069	9
330280*	40	14	14	0.13	3.4	1.40	35.6	1.48	37.7	531	791	1234	1649	1837	2454	9
299980*	50	14	14	0.13	3.4	1.52	38.5	1.60	40.6	661	984	1463	1916	2178	2851	7.5

Dimensions and weights are nominal; subject to industry tolerances.

*Non-stock item, minimum runs apply. Please consult Customer Service for price and delivery.

**Ampacity is based on CE Code Part 1: Table 2 for 3 conductors in raceway (conduit). Ampacity of 4 conductor cable is based on 3 current-carrying conductors and 1 neutral.

Ampacity at 5 or more conductors is modified by table 5C.

TECK90

XLPE/PVC/AIA/PVC, Control, Armored
600V, CSA TECK90, Multi Conductor, 12 AWG

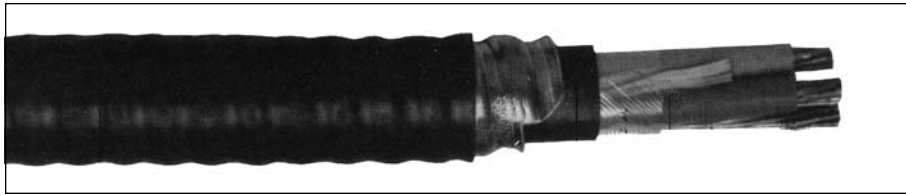

Product Construction

Conductor:

- 12 AWG bare copper Class B compressed concentric round to ASTM B8

Insulation:

- Cross-linked Polyethylene (XLPE) Type RW90
- Color-coded: 1 to 4 conductors—Black, Red, Blue and White; Over 4 conductors—per ICEA Method 4 individual conductors colored Black with conductor number surface printed in contrasting ink

Ground (Bonding) Conductor:

- The conductor consists of one uninsulated stranded bare copper conductor

Inner Jacket:

- Flame-retardant, moisture- and sunlight-resistant Polyvinyl Chloride (PVC)—Black

Armor:

- Aluminum Interlocked Armor (AIA)

Overall Jacket:

- ACID-FLAME-CHECK ✓✓® flame-retardant, moisture- and sunlight-resistant Polyvinyl Chloride (PVC)—Black

Print:

- GENERAL CABLE® ACID-FLAME-CHECK ✓✓® AG14 FT1 FT4 HL TECK90 XLPE (-40°C)#/C SIZE (12 AWG) 600V DIR BUR SUN RES CSA MONTH-YEAR SEQUENTIAL LENGTH MARK

Options:

- Galvanized Steel Interlocked Armor (GSIA)
- Other constructions available upon request

Applications:

- For exposed and concealed wiring in dry, damp or wet locations
- For use in ventilated, non-ventilated and ladder-type cable trays in dry, damp or wet locations
- For direct earth burial (with protection as required by inspection authority)
- For wiring in all hazardous locations when used with certified HL cable glands

Features:

- Rated at 90°C wet or dry
- Excellent crush, oil and chemical resistance
- Provides long service life
- Meets cold bend and impact tests at -40°C

Compliances:

- CSA Standard C22.2 No. 131 and No. 174
- CSA Approval number: LR1781
- CSA FT1 and FT4
- IEEE 383 (70,000 BTU/hr)
- UL 1581 (70,000 BTU/hr)
- IEEE 1202 (70,000 BTU/hr) CSA FT4
- ICEA T-30-520 (70,000 BTU/hr)
- Hazardous Location Rating: HL
- Meets EPA 40 CFR, part 261 for leachable lead content per TCLP method
- OSHA acceptable

Packaging:

- For Canadian customers, lengths are provided on returnable wood or steel reels that require a deposit. Extra charges apply for lagging, pulling eyes, paralleling and plexing
- For U.S. customers, material cut to length and shipped on non-returnable wood reels, while lengths in excess of 10,000 lbs. are provided on returnable steel reels that require a deposit. Extra charges apply for cuts less than 1000 ft., lagging, pulling eyes, paralleling and plexing

CATALOG NUMBER	NO. OF COND.	COND. SIZE (AWG)	GROUND WIRE SIZE (AWG)	NOMINAL DIAMETER (OVER)						COPPER WEIGHT		NET WEIGHT W/ARMOR				AMPACITY** (30°C AMBIENT)
				INSULATION		ARMOR		CABLE		LBS/1000 FT	kg/km	LBS/1000 FT		kg/km		
				INCHES	mm	INCHES	mm	INCHES	mm			AL	STEEL	AL	STEEL	

12 AWG—MULTI CONDUCTOR—30 MILS INS. (.76 mm), 600V

780210	2	12	14	0.15	3.9	0.62	15.8	0.70	17.9	55	82	228	352	340	524	20
780240	3	12	14	0.15	3.9	0.65	16.4	0.73	18.5	75	112	254	386	378	575	20
780320	4	12	14	0.15	3.9	0.69	17.4	0.77	19.5	96	143	293	434	436	646	20
312910	5	12	14	0.15	3.9	0.73	18.5	0.81	20.6	116	173	350	501	521	746	16
331190*	6	12	14	0.15	3.9	0.81	20.5	0.89	22.5	137	204	416	585	619	871	16
315020*	7	12	14	0.15	3.9	0.83	21.0	0.91	23.1	157	234	443	616	660	917	14
311560*	8	12	14	0.15	3.9	0.86	21.7	0.94	23.8	177	264	492	673	732	1002	14
304030*	10	12	14	0.15	3.9	0.95	24.2	1.04	26.2	219	326	555	757	826	1127	14
331130*	12	12	14	0.15	3.9	1.01	25.7	1.10	27.8	261	389	653	942	972	1402	14
312990*	15	12	14	0.15	3.9	1.07	27.2	1.16	29.3	322	480	757	1065	1127	1585	14
299950*	20	12	14	0.15	3.9	1.23	31.3	1.32	33.4	424	631	986	1346	1468	2003	14
307470*	25	12	14	0.15	3.9	1.33	33.8	1.42	35.9	527	785	1210	1602	1801	2384	12
318730*	30	12	14	0.15	3.9	1.40	35.6	1.49	37.7	630	938	1320	1735	1965	2582	12
346880*	40	12	14	0.15	3.9	1.54	39.1	1.64	41.6	837	1246	1725	2185	2567	3252	12
346890*	50	12	14	0.15	3.9	1.67	42.4	1.77	44.9	1044	1553	2055	2556	3058	3804	10

Dimensions and weights are nominal; subject to industry tolerances.

*Non-stock item, minimum runs apply. Please consult Customer Service for price and delivery.

** Ampacity is based on CE Code Part 1: Table 2 for 3 conductors in raceway (conduit). Ampacity of 4 conductor cable is based on 3 current-carrying conductors and 1 neutral.

Ampacity at 5 or more conductors is modified by table 5C.

TECK90

XLPE/PVC/AIA/PVC, Control, Armored
600V, CSA TECK90, Multi Conductor, 10 AWG

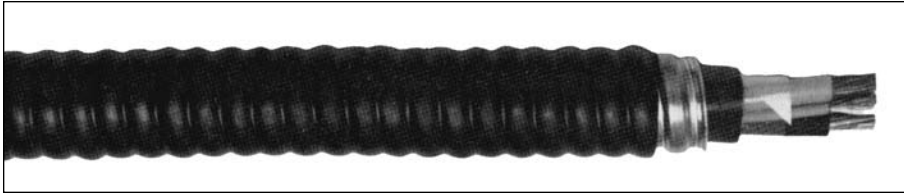

Features:

- Rated at 90°C wet or dry
- Excellent crush, oil and chemical resistance
- Provides long service life
- Meets cold bend and impact tests at -40°C

Compliances:

- CSA Standard C22.2 No. 131 and No. 174
- CSA Approval number: LR1781
- CSA FT1 and FT4
- IEEE 383 (70,000 BTU/hr)
- UL 1581 (70,000 BTU/hr)
- IEEE 1202 (70,000 BTU/hr) CSA FT4
- ICEA T-30-520 (70,000 BTU/hr)
- Hazardous Location Rating: HL
- Meets EPA 40 CFR, part 261 for leachable lead content per TCLP method
- OSHA acceptable

Packaging:

- For Canadian customers, lengths are provided on returnable wood or steel reels that require a deposit. Extra charges apply for lagging, pulling eyes, paralleling and plexing
- For U.S. customers, material cut to length and shipped on non-returnable wood reels, while lengths in excess of 10,000 lbs. are provided on returnable steel reels that require a deposit. Extra charges apply for cuts less than 1000 ft., lagging, pulling eyes, paralleling and plexing

Product Construction

Conductor:

- 10 AWG bare copper Class B compressed concentric round to ASTM B8

Insulation:

- Cross-linked Polyethylene (XLPE) Type RW90
- Color-coded: 1 to 4 conductors—Black, Red, Blue and White; Over 4 conductors—per ICEA Method 4 individual conductors colored Black with conductor number surface printed in contrasting ink

Ground (Bonding) Conductor:

- The conductor consists of one uninsulated stranded bare copper conductor
- Color-coded: per ICEA Method 4; Individual conductors colored Black with conductor number surface printed in contrasting ink

Inner Jacket:

- Flame-retardant, moisture- and sunlight-resistant Polyvinyl Chloride (PVC)—Black

Armor:

- Aluminum Interlocked Armor (AIA)

Overall Jacket:

- ACID-FLAME-CHECK ✓✓® flame-retardant, moisture- and sunlight-resistant Polyvinyl Chloride (PVC)—Black

Print:

- GENERAL CABLE® ACID-FLAME-CHECK ✓✓® AG14 FT1 FT4 HL TECK90 XLPE (-40°C)#/C SIZE (10 AWG) 600V DIR BUR SUN RES CSA MONTH-YEAR SEQUENTIAL LENGTH MARK

Options:

- Galvanized Steel Interlocked Armor (GSIA)
- Other constructions available upon request

Applications:

- For exposed and concealed wiring in dry, damp or wet locations
- For use in ventilated, non-ventilated and ladder-type cable trays in dry, damp or wet locations
- For direct earth burial (with protection as required by inspection authority)
- For wiring in all hazardous locations when used with certified HL cable glands

CATALOG NUMBER	NO. OF COND.	COND. SIZE (AWG)	GROUND WIRE SIZE (AWG)	NOMINAL DIAMETER (OVER)						COPPER WEIGHT		NET WEIGHT W/ARMOR				AMPACITY** (30°C AMBIENT)
				INSULATION		ARMOR		CABLE		LBS/ 1000 FT	kg/ km	LBS/ 1000 FT		kg/km		
				INCHES	mm	INCHES	mm	INCHES	mm			AL	STEEL	AL	STEEL	
10 AWG—MULTI CONDUCTOR—30 MILS INS. (.76 mm), 600V																
780200	2	10	12	0.18	4.5	0.67	17.0	0.75	19.0	87	130	275	411	410	612	30
780230	3	10	12	0.18	4.5	0.70	17.7	0.78	19.7	119	177	327	470	487	700	30
780270	4	10	12	0.18	4.5	0.74	18.8	0.83	20.9	150	223	413	565	615	841	30
319480*	5	10	12	0.18	4.5	0.82	20.9	0.91	22.9	184	274	473	644	704	959	24
333160*	6	10	12	0.18	4.5	0.88	22.2	0.96	24.3	217	323	515	717	766	1066	24
346870*	7	10	12	0.18	4.5	0.90	22.9	0.99	25.0	248	369	552	754	821	1122	21
318740*	8	10	12	0.18	4.5	0.93	23.6	1.02	25.7	282	420	613	830	912	1235	21
311570*	10	10	12	0.18	4.5	1.08	27.3	1.16	29.4	348	518	828	1181	1232	1757	21
317890*	12	10	12	0.18	4.5	1.15	29.2	1.23	31.3	414	617	916	1276	1363	1899	21
318750*	15	10	12	0.18	4.5	1.22	30.9	1.30	33.0	512	762	1084	1481	1613	2203	21
308180*	20	10	12	0.18	4.5	1.36	34.4	1.44	36.5	675	1005	1316	1750	1958	2604	21
307450*	25	10	12	0.18	4.5	1.47	37.3	1.55	39.4	835	1243	1612	2099	2399	3124	18
293570*	30	10	12	0.18	4.5	1.55	39.4	1.65	41.8	998	1493	1821	2323	2709	3457	18
307460*	40	10	12	0.18	4.5	1.71	43.4	1.81	45.9	1321	1966	2278	2837	3390	4222	18
346900*	50	10	12	0.18	4.5	1.87	47.5	1.97	49.9	1648	2453	2820	3557	4196	5293	15

Dimensions and weights are nominal; subject to industry tolerances.

*Non-stock item, minimum runs apply. Please consult Customer Service for price and delivery.

** Ampacity is based on CE Code Part 1: Table 2 for 3 conductors in raceway (conduit). Ampacity of 4 conductor cable is based on 3 current-carrying conductors and 1 neutral.

Ampacity at 5 or more conductors is modified by table 5C.

TECK90

XLPE/PVC/AIA/PVC, Power, Armored
1000V, CSA TECK90, Single Conductor

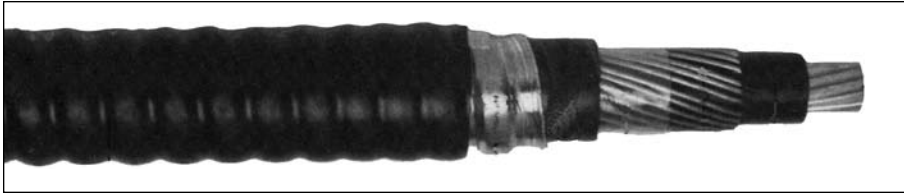

Product Construction

Conductor:

- 6 AWG thru 1000 kcmil bare copper compact Class B strand

Insulation:

- Cross-linked Polyethylene (XLPE) Type RW90
- Color-coded: Black

Ground (Bonding) Conductor:

- The conductor is a concentric serving of solid bare copper wires applied over the insulation

Inner Jacket:

- Flame-retardant, moisture- and sunlight-resistant Polyvinyl Chloride (PVC)—Black

Armor:

- Aluminum Interlocked Armor (AIA)

Overall Jacket:

- ACID-FLAME-CHECK ✓✓[®] flame-retardant, moisture- and sunlight-resistant Polyvinyl Chloride (PVC)—Black

Print:

- GENERAL CABLE[®] ACID-FLAME-CHECK ✓✓[®] AG14 FT1 FT4 HL TECK90 XLPE (-40°C)1/C SIZE (AWG OR KCMIL) 1000V DIR BUR SUN RES CSA MONTH-YEAR SEQUENTIAL LENGTH MARK

Options:

- Other constructions available upon request

Applications:

- For exposed and concealed wiring in dry, damp or wet locations
- For use in ventilated, non-ventilated and ladder-type cable trays in dry, damp or wet locations
- For direct earth burial (with protection as required by inspection authority)
- For wiring in all hazardous locations when used with certified HL cable glands

Features:

- Rated at 90°C wet or dry
- Excellent crush, oil and chemical resistance
- Provides long service life
- Cost effective alternative to installations in conduit
- Meets cold bend and impact tests at -40°C

Compliances:

- CSA Standard C22.2 No. 131 and No. 174
- CSA Approval number: LR1781
- CSA FT1 and FT4
- IEEE 383 (70,000 BTU/hr)
- UL 1581 (70,000 BTU/hr)
- IEEE 1202 (70,000 BTU/hr) CSA FT4
- ICEA T-30-520 (70,000 BTU/hr)
- Hazardous Location Rating: HL
- Meets EPA 40 CFR, part 261 for leachable lead content per TCLP method
- OSHA acceptable

Packaging:

- For Canadian customers, lengths are provided on returnable wood or steel reels that require a deposit. Extra charges apply for lagging, pulling eyes, paralleling and plexing
- For U.S. customers, material cut to length and shipped on non-returnable wood reels, while lengths in excess of 10,000 lbs. are provided on returnable steel reels that require a deposit. Extra charges apply for cuts less than 1000 ft., lagging, pulling eyes, paralleling and plexing

CATALOG NUMBER	NO. OF COND.	COND. SIZE (AWG/ kcmil)	GROUND WIRE SIZE (AWG)	MIN. AVG INS. THICKNESS		NOMINAL DIAMETER (OVER)						COPPER WEIGHT		NET WEIGHT		AMPACITY** (30°C AMBIENT)	
						INSULATION		ARMOR		CABLE		LBS/ 1000 FT	kg/ km	LBS/ 1000 FT	kg/km		
						INCHES	mm	INCHES	mm	INCHES	mm						INCHES
6 AWG THRU 1000 kcmil—SINGLE CONDUCTOR—1000V																	
11288.040600*	1	6	8	.060	1.52	0.31	7.8	0.68	17.3	0.77	19.6	137	204	320	470	100	
11288.050400*	1	4	6	.060	1.52	0.35	8.8	0.73	18.6	0.81	20.6	211	314	410	610	135	
11288.030300*	1	3	6	.060	1.52	0.38	9.8	0.76	19.3	0.84	21.4	244	363	450	680	155	
11288.050200*	1	2	6	.060	1.52	0.42	10.5	0.78	19.8	0.87	22.1	286	426	510	760	180	
11288.050100*	1	1	4	.080	2.03	0.49	12.5	0.88	22.4	0.96	24.4	390	581	680	1010	210	
11288.035100*	1	1/0	4	.080	2.03	0.53	13.5	0.91	23.2	1.00	25.4	458	682	760	1130	245	
11288.035200*	1	2/0	4	.080	2.03	0.58	14.7	0.95	24.1	1.04	26.4	544	810	860	1280	285	
11288.035300*	1	3/0	3	.080	2.03	0.63	15.9	1.03	26.2	1.12	28.5	685	1020	1080	1610	330	
11288.025400*	1	4/0	3	.080	2.03	0.69	17.5	1.08	27.5	1.17	29.7	820	1220	1270	1890	385	
11288.026000*	1	250	2	.090	2.29	0.75	19.2	1.21	30.8	1.29	32.8	980	1459	1490	2210	425	
11288.036200*	1	350	1	.090	2.29	0.86	21.7	1.30	33.0	1.39	35.3	1340	1994	1910	2840	530	
11288.026500*	1	500	1/0	.090	2.29	0.99	25.0	1.42	36.1	1.51	38.4	1750	2604	2510	3740	660	
11288.027000*	1	750	2/0	.090	2.29	1.16	29.4	1.59	40.4	1.69	43.0	2570	3825	3510	5230	845	
11288.027500*	1	1000	2/0	.090	2.29	1.31	33.2	1.81	46.0	1.90	48.3	3340	4970	4430	6590	1000	

Dimensions and weights are nominal; subject to industry tolerances.

*Non-stock item, minimum runs apply. Please consult Customer Service for price and delivery.

**Ampacity is based on CE Code Part 1: Table 1 (single conductor in free air) and Rule 4-004.

TECK90

XLPE/PVC/AIA/PVC, Control and Power, Armored
1000V, CSA TECK90, Two Conductor

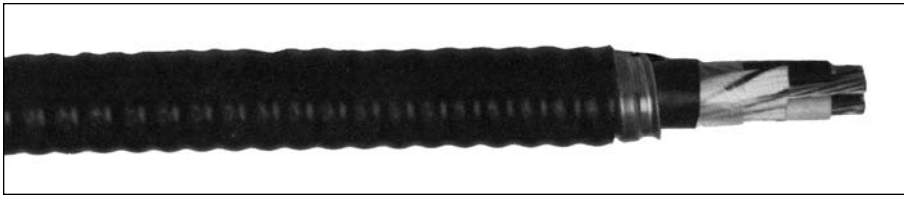

Product Construction

Conductor:

- 14 AWG thru 8 AWG bare copper Class B compressed concentric round to ASTM B8
- 6 AWG thru 1000 kcmil bare copper compact Class B strand

Insulation:

- Cross-linked Polyethylene (XLPE) Type RW90
- Color-coded: 14 AWG to 2 AWG—black and White; 1 AWG to 1000 kcmil—printed numbers

Ground (Bonding) Conductor:

- The conductor consists of one uninsulated stranded bare copper conductor

Inner Jacket:

- Flame-retardant, moisture- and sunlight-resistant Polyvinyl Chloride (PVC)—Black

Armor:

- Aluminum Interlocked Armor (AIA)

Overall Jacket:

- ACID-FLAME-CHECK ✓✓[®] flame-retardant, moisture- and sunlight-resistant Polyvinyl Chloride (PVC)—Black

Print:

- GENERAL CABLE[®] ACID-FLAME-CHECK ✓✓[®] AG14 FT1 FT4 HL TECK90 XLPE (-40°C) 2/C SIZE (AWG OR KCMIL) 1000V DIR BUR SUN RES CSA MONTH-YEAR SEQUENTIAL LENGTH MARK

Options:

- Galvanized Steel Interlocked Armor (GSIA)
- Other constructions available upon request

Applications:

- For exposed and concealed wiring in dry, damp or wet locations
- For use in ventilated, non-ventilated and ladder-type cable trays in dry, damp or wet locations
- For direct earth burial (with protection as required by inspection authority)
- For wiring in all hazardous locations when used with certified HL cable glands

Features:

- Rated at 90°C wet or dry
- Excellent crush, oil and chemical resistance
- Provides long service life
- Meets cold bend and impact tests at -40°C

Compliances:

- CSA Standard C22.2 No. 131 and No. 174
- CSA Approval numbers: LR1781
- CSA FT1 and FT4
- IEEE 383 (70,000 BTU/hr), UL 1581 (70,000 BTU/hr)
- IEEE 1202 (70,000 BTU/hr) CSA FT4
- ICEA T-30-520 (70,000 BTU/hr)
- Hazardous Location Rating: HL
- Meets EPA 40 CFR, part 261 for leachable lead content per TCLP method
- OSHA acceptable

Packaging:

- For Canadian customers, lengths are provided on returnable wood or steel reels that require a deposit. Extra charges apply for lagging, pulling eyes, paralleling and plexing
- For U.S. customers, material cut to length and shipped on non-returnable wood reels, while lengths in excess of 10,000 lbs. are provided on returnable steel reels that require a deposit. Extra charges apply for cuts less than 1000 ft., lagging, pulling eyes, paralleling and plexing

CATALOG NUMBER	NO. OF COND.	COND. SIZE (AWG/ kcmil)	GROUND WIRE SIZE (AWG)	MIN. AVG INS. THICKNESS		NOMINAL DIAMETER (OVER)						COPPER WEIGHT		NET WEIGHT W/ARMOR				AMPACITY** (30°C AMBIENT)
						INSULATION		ARMOR		CABLE		LBS/ 1000 FT	kg/ km	LBS/1000 FT		kg/km		
						INCHES	mm	INCHES	mm	INCHES	mm			INCHES	mm	AL	STEEL	

14 AWG THRU 1000 kcmil—TWO CONDUCTOR—1000V

794520*	2	14	14	.045	1.14	0.17	4.2	0.65	16.5	0.73	18.5	39	58	219	350	326	521	15
308550*	2	12	14	.045	1.14	0.18	4.6	0.69	17.6	0.77	19.6	55	82	255	412	380	613	20
793140*	2	10	12	.045	1.14	0.21	5.3	0.73	18.5	0.81	20.6	86	128	291	441	433	657	30
331260*	2	8	10	.045	1.14	0.24	6.1	0.82	20.8	0.90	22.9	137	204	392	564	584	840	45
11206.332083*	2	6	8	.060	1.52	0.31	7.8	0.94	23.9	1.02	25.9	215	320	556	758	827	1128	65
11288.040400*	2	4	8	.060	1.52	0.35	8.8	1.07	27.2	1.16	29.5	312	464	744	1052	1107	1565	85
11288.220300*	2	3	6	.060	1.52	0.38	9.8	1.15	29.2	1.23	31.3	415	618	905	1239	1347	1844	105
11288.040200*	2	2	6	.060	1.52	0.42	10.5	1.20	30.5	1.28	32.5	502	747	1030	1380	1533	2054	120
11288.020100*	2	1	6	.080	2.03	0.49	12.5	1.34	34.0	1.42	36.1	612	911	1235	1630	1838	2425	140
11288.045100*	2	1/0	6	.080	2.03	0.53	13.5	1.45	36.8	1.53	38.9	740	1101	1425	1854	2120	2759	155
11288.045200*	2	2/0	6	.080	2.03	0.58	14.8	1.50	38.1	1.58	40.1	922	1372	1660	2107	2470	3135	185
11288.045300*	2	3/0	4	.080	2.03	0.63	15.9	1.59	40.4	1.69	42.9	1190	1771	1995	2471	2969	3677	210
11288.145400*	2	4/0	4	.080	2.03	0.69	17.5	1.70	43.2	1.79	45.5	1466	2182	2350	2862	3497	4259	235
11288.226000*	2	250	4	.090	2.29	0.75	19.2	1.84	46.8	1.93	49.0	1709	2543	2779	3332	4135	4958	265
11288.226200*	2	350	3	.090	2.29	0.86	21.7	2.09	53.1	2.18	55.4	2373	3561	3650	4285	5431	6376	325
11288.226500*	2	500	3	.090	2.29	0.99	25.0	2.33	59.2	2.45	62.2	3316	4935	4895	5607	7284	8343	395
11288.227000*	2	750	2	.090	2.29	1.16	29.4	2.67	67.8	2.79	70.9	4941	7353	6872	7695	10226	11450	500
11288.227500*	2	1000	1	.090	2.29	1.31	33.2	2.98	75.7	3.10	78.8	6562	9766	8993	10376	13382	15439	585

Dimensions and weights are nominal; subject to industry tolerances.

*Non-stock item, minimum runs apply. Please consult Customer Service for price and delivery.

**Ampacity is based on CE Code Part 1: Table 2 (Three conductors in raceway [conduit]) and Rule 4-004.



Phone: 888-593-3355
www.generalcable.com

TECK90

XLPE/PVC/AIA/PVC, Control and Power, Armored
1000V, CSA TECK90, Three Conductor

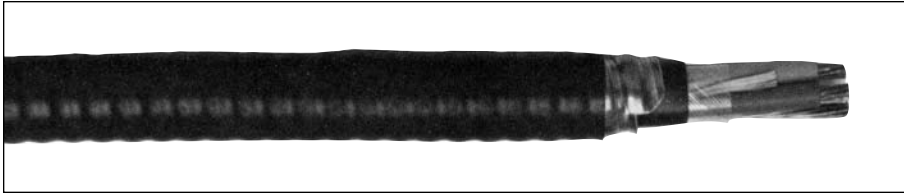

Product Construction

Conductor:

- 14 AWG thru 8 AWG bare copper Class B compressed concentric round to ASTM B8
- 6 AWG thru 1000 kcmil bare copper compact Class B strand

Insulation:

- Cross-linked Polyethylene (XLPE) Type RW90
- Color-coded: 14 AWG to 2 AWG—Black, Red and Blue; 1 AWG to 1000 kcmil—printed numbers

Ground (Bonding) Conductor:

- The conductor consists of one uninsulated stranded bare copper conductor

Inner Jacket:

- Flame-retardant, moisture- and sunlight-resistant Polyvinyl Chloride (PVC)—Black

Armor:

- Aluminum Interlocked Armor (AIA)

Overall Jacket:

- ACID-FLAME-CHECK ✓✓[®] flame-retardant, moisture- and sunlight-resistant Polyvinyl Chloride (PVC)—Black

Print:

- GENERAL CABLE[®] ACID-FLAME-CHECK ✓✓[®] AG14 FT1 FT4 HL TECK90 XLPE (-40°C) 3/C SIZE (AWG OR KCMIL) 1000V DIR BUR SUN RES CSA MONTH-YEAR SEQUENTIAL LENGTH MARK

Options:

- Galvanized Steel Interlocked Armor (GSIA)
- Other constructions available upon request

Applications:

- For exposed and concealed wiring in dry, damp or wet locations
- For use in ventilated, non-ventilated and ladder-type cable trays in dry, damp or wet locations
- For direct earth burial (with protection as required by inspection authority)
- For wiring in all hazardous locations when used with certified HL cable glands

Features:

- Rated at 90°C wet or dry
- Excellent crush resistance, oil and chemical resistance
- Provides long service life
- Meets cold bend and impact tests at -40°C

Compliances:

- CSA Standard C22.2 No. 131 and No. 174
- CSA Approval numbers: LR1781
- CSA FT1 and FT4
- IEEE 383 (70,000 BTU/hr), UL 1581 (70,000 BTU/hr)
- IEEE 1202 (70,000 BTU/hr) CSA FT4
- ICEA T-30-520 (70,000 BTU/hr)
- Hazardous Location Rating: HL
- Meets EPA 40 CFR, part 261 for leachable lead content per TCLP method
- OSHA acceptable

Packaging:

- For Canadian customers, lengths are provided on returnable wood or steel reels that require a deposit. Extra charges apply for lagging, pulling eyes, paralleling and plexing
- For U.S. customers, material cut to length and shipped on non-returnable wood reels, while lengths in excess of 10,000 lbs. are provided on returnable steel reels that require a deposit. Extra charges apply for cuts less than 1000 ft., lagging, pulling eyes, paralleling and plexing

CATALOG NUMBER	NO. OF COND.	COND. SIZE (AWG/kcmil)	GROUND WIRE SIZE (AWG)	MIN. AVG INS. THICKNESS		NOMINAL DIAMETER (OVER)						COPPER WEIGHT		NET WEIGHT W/ARMOR				AMPACITY** (30°C AMBIENT)
						INSULATION		ARMOR		CABLE		LBS/1000 FT	kg/km	LBS/1000 FT		kg/km		
						INCHES	mm	INCHES	mm	INCHES	mm			INCHES	mm	AL	STEEL	

14 AWG THRU 1000 kcmil—THREE CONDUCTOR—1000V

330520*	3	14	14	.045	1.14	0.17	4.2	0.67	17.0	0.76	19.3	52	77	261	398	388	592	15
780260	3	12	14	.045	1.14	0.18	4.6	0.72	18.3	0.80	20.3	75	112	299	445	445	662	20
331120	3	10	12	.045	1.14	0.21	5.3	0.79	20.1	0.88	22.4	124	185	374	539	557	802	30
793200	3	8	10	.045	1.14	0.24	6.1	0.86	21.9	0.94	23.9	189	281	486	666	723	991	45
11288.010600	3	6	8	.060	1.52	0.31	7.8	1.03	26.2	1.13	28.7	300	447	724	836	1078	1244	65
11288.010400	3	4	8	.060	1.52	0.35	8.8	1.16	29.5	1.25	31.8	447	665	970	1327	1444	1975	85
11288.010300	3	3	6	.060	1.52	0.38	9.8	1.22	31.0	1.30	33.0	582	866	1136	1509	1691	2246	105
11288.010200	3	2	6	.060	1.52	0.42	10.5	1.28	32.5	1.37	34.8	710	1056	1311	1702	1951	2533	120
11288.010100	3	1	6	.080	2.03	0.49	12.5	1.44	36.6	1.54	39.1	866	1288	1593	2045	2371	3043	140
11288.015100	3	1/0	6	.080	2.03	0.53	13.5	1.56	39.6	1.68	42.7	1069	1590	1906	2389	2837	3555	155
11288.015200	3	2/0	6	.080	2.03	0.58	14.8	1.65	41.9	1.77	45.0	1327	1974	2225	2732	3311	4066	185
11288.015300	3	3/0	4	.080	2.03	0.63	15.9	1.75	44.5	1.87	47.5	1670	2485	2666	3261	3967	4853	210
11288.015400	3	4/0	4	.080	2.03	0.69	17.5	1.86	47.2	1.98	50.3	2109	3138	3207	3806	4772	5664	235
11288.016000	3	250	4	.090	2.29	0.75	19.2	2.05	52.1	2.17	55.1	2470	3675	3800	4513	5655	6716	265
11288.016200	3	350	3	.090	2.29	0.86	21.7	2.26	57.4	2.40	61.0	3437	5114	4979	5906	7409	8789	325
11288.016500	3	500	3	.090	2.29	0.99	25.0	2.52	64.0	2.66	67.6	4839	7200	6586	7627	9798	11349	395
11288.017000*	3	750	2	.090	2.29	1.16	29.4	2.89	73.4	3.03	77.0	7225	10751	9267	10470	13790	15580	500
11288.017500*	3	1000	1	.090	2.29	1.31	33.2	3.28	83.3	3.44	87.4	9612	14303	12184	13566	18130	20187	585

Dimensions and weights are nominal; subject to industry tolerances.

*Non-stock item, minimum runs apply. Please consult Customer Service for price and delivery.

**Ampacity is based on CE Code Part 1: Table 2 (Three conductors in raceway [conduit]) and Rule 4-004.



Phone: 888-593-3355
www.generalcable.com

TECK90

XLPE/PVC/AIA/PVC, Control and Power, Armored
1000V, CSA TECK90, Four Conductor

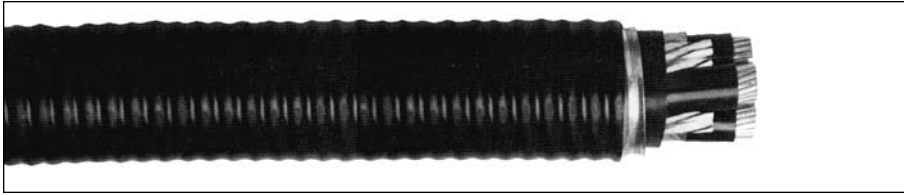

Product Construction

Conductor:

- 14 AWG thru 8 AWG bare copper Class B compressed concentric round to ASTM B8
- 6 AWG thru 1000 kcmil bare copper compact Class B strand

Insulation:

- Cross-linked Polyethylene (XLPE) Type RW90
- Color-coded: 14 AWG to 2 AWG—Black, Red, Blue and White; 1 AWG to 1000 kcmil—printed numbers

Ground (Bonding) Conductor:

- The conductor consists of one uninsulated stranded bare copper conductor

Inner Jacket:

- Flame-retardant, moisture- and sunlight-resistant Polyvinyl Chloride (PVC)—Black

Armor:

- Aluminum Interlocked Armor (AIA)

Overall Jacket:

- ACID-FLAME-CHECK ✓✓[®] flame-retardant, moisture- and sunlight-resistant Polyvinyl Chloride (PVC)—Black

Print:

- GENERAL CABLE[®] ACID-FLAME-CHECK ✓✓[®] AG14 FT1 FT4 HL TECK90 XLPE (-40°C) 4/C SIZE (AWG OR KCMIL) 1000V DIR BUR SUN RES CSA MONTH-YEAR SEQUENTIAL LENGTH MARK

Options:

- Galvanized Steel Interlocked Armor (GSIA)
- Other constructions available upon request

Applications:

- For exposed and concealed wiring in dry, damp or wet locations
- For use in ventilated, non-ventilated and ladder-type cable trays in dry, damp or wet locations
- For direct earth burial (with protection as required by inspection authority)
- For wiring in all hazardous locations when used with certified HL cable glands

Features:

- Rated at 90°C wet or dry
- Excellent crush, oil and chemical resistance
- Provides long service life
- Meets cold bend and impact tests at -40°C

Compliances:

- CSA Standard C22.2 No. 131 and No. 174
- CSA Approval numbers: LR1781
- CSA FT1 and FT4
- IEEE 383 (70,000 BTU/hr), UL 1581 (70,000 BTU/hr)
- IEEE 1202 (70,000 BTU/hr) CSA FT4
- ICEA T-30-520 (70,000 BTU/hr)
- Hazardous Location Rating: HL
- Meets EPA 40 CFR, part 261 for leachable lead content per TCLP method
- OSHA acceptable

Packaging:

- For Canadian customers, lengths are provided on returnable wood or steel reels that require a deposit. Extra charges apply for lagging, pulling eyes, paralleling and plexing
- For U.S. customers, material cut to length and shipped on non-returnable wood reels, while lengths in excess of 10,000 lbs. are provided on returnable steel reels that require a deposit. Extra charges apply for cuts less than 1000 ft., lagging, pulling eyes, paralleling and plexing

CATALOG NUMBER	NO. OF COND.	COND. SIZE (AWG)/ (kcmil)	GROUND WIRE SIZE (AWG)	MIN. AVG INS. THICKNESS		NOMINAL DIAMETER (OVER)						COPPER WEIGHT		NET WEIGHT W/ARMOR				AMPACITY** (30°C AMBIENT)
						INSULATION		ARMOR		CABLE				LBS/1000 FT		kg/km		
						INCHES	mm	INCHES	mm	INCHES	mm	INCHES	mm	LBS/1000 FT	kg/km	AL	STEEL	

14 AWG THRU 1000 kcmil—FOUR CONDUCTOR—1000V

321940*	4	14	14	.045	1.14	0.17	4.2	0.72	18.3	0.80	20.3	68	101	290	440	430	660	15
793180*	4	12	14	.045	1.14	0.18	4.6	0.79	20.1	0.88	22.4	96	143	357	521	531	776	20
793160*	4	10	12	.045	1.14	0.21	5.3	0.85	21.6	0.93	23.6	150	223	455	632	677	941	30
331250	4	8	10	.045	1.14	0.24	6.1	0.92	23.4	1.00	25.4	241	359	548	736	816	1096	45
11288.030600	4	6	8	.060	1.52	0.31	7.8	1.15	29.2	1.25	31.8	383	570	907	1261	1350	1877	65
11288.020400	4	4	8	.060	1.52	0.35	8.8	1.26	32.0	1.35	34.3	579	862	1168	1558	1738	2319	85
11288.020300	4	3	6	.060	1.52	0.38	9.8	1.31	33.3	1.40	35.6	748	1113	1373	1782	2043	2652	105
11288.020200	4	2	6	.060	1.52	0.42	10.5	1.37	34.8	1.46	37.1	919	1368	1583	2013	2356	2996	120
11288.040100	4	1	6	.080	2.03	0.49	12.5	1.60	40.6	1.72	43.7	1128	1679	2032	2551	3024	3796	140
11288.025100	4	1/0	6	.080	2.03	0.53	13.5	1.69	42.9	1.81	46.0	1398	2081	2365	2914	3520	4336	155
11288.025200	4	2/0	6	.080	2.03	0.58	14.8	1.79	45.5	1.91	48.5	1742	2593	2745	3331	4085	4957	185
11288.025300	4	3/0	4	.080	2.03	0.63	15.9	1.91	48.5	2.03	51.6	2223	3308	3398	4135	5057	6153	210
11288.045400	4	4/0	4	.080	2.03	0.69	17.5	2.09	53.1	2.21	56.1	2769	4121	4170	4983	6205	7415	235
11288.046000	4	250	4	.090	2.29	0.75	19.2	2.23	56.7	2.35	59.7	3249	4835	4789	5661	7126	8424	265
11288.026200	4	350	3	.090	2.29	0.86	21.7	2.46	62.5	2.60	66.0	4528	6738	6307	7264	9385	10809	325
11288.036500*	4	500	3	.090	2.29	0.99	25.0	2.76	70.1	2.90	73.7	6395	9516	8438	9515	12556	14159	395
11288.057000*	4	750	2	.090	2.29	1.16	29.4	3.24	82.3	3.42	86.9	9564	14232	12411	13683	18468	20360	500
11288.037500*	4	1000	1	.090	2.29	1.31	33.2	3.65	92.7	3.84	97.6	12885	19173	15800	23510	23500	34968	585

Dimensions and weights are nominal; subject to industry tolerances.

*Non-stock item, minimum runs apply. Please consult Customer Service for price and delivery.

**Ampacity is based on CE Code Part 1: Table 2 (Three conductors in raceway [conduit]) and Rule 4-004.

Ampacity of 4 conductor cable is based on 3 current-carrying conductors and 1 neutral.



Phone: 888-593-3355
www.generalcable.com

TECK90

XLPE/PVC/AIA/PVC, Power/Control Composite
600V, CSA TECK90, Three Power and Three 14 AWG Control Conductors

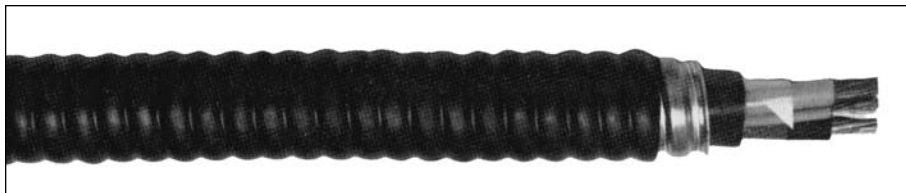

Product Construction

Conductor:

- 12 AWG thru 8 AWG bare copper Class B compressed concentric round to ASTM B8
- 6 AWG thru 4/0 AWG bare copper compact Class B strand

Insulation:

- Cross-Linked Polyethylene (XLPE) Type RW90
- Color-coded: 14 AWG to 2 AWG—Black, Red and Blue; 1 AWG to 4/0 AWG—printed numbers

Ground (Bonding) Conductor:

- The conductor consists of one uninsulated stranded bare copper conductor

Inner Jacket:

- Flame-retardant, moisture- and sunlight-resistant Polyvinyl Chloride (PVC)—Black

Armor:

- Aluminum Interlocked Armor (AIA)

Overall Jacket:

- ACID-FLAME-CHECK ✓✓® flame-retardant, moisture- and sunlight-resistant Polyvinyl Chloride (PVC)—Black

Print:

- GENERAL CABLE® ACID-FLAME-CHECK ✓✓® AG14 FT1 FT4 HL TECK90 XLPE (-40°C)3/C SIZE (AWG) +3/C #14 AWG 600V DIR BUR SUN RES CSA MONTH-YEAR SEQUENTIAL LENGTH MARK

Options:

- Galvanized Steel Interlocked Armor (GSIA)
- Other constructions available upon request

Applications:

- For exposed and concealed wiring in dry, damp or wet locations
- For use in ventilated, non-ventilated and ladder-type cable trays in dry, damp or wet locations
- For direct earth burial (with protection as required by inspection authority)
- For wiring in all hazardous locations when used with certified HL Cable Glands

Features:

- Rated at 90°C wet or dry
- Excellent crush, oil and chemical resistance
- Provides long service life
- Meets cold bend and impact tests at -40°C

Compliances:

- CSA Standard C22.2 No. 131 and No. 174
- CSA Approval numbers: LR1781
- CSA FT1 and FT4
- IEEE 383 (70,000 BTU/hr)
- UL 1581 (70,000 BTU/hr)
- IEEE 1202 (70,000 BTU/hr) CSA FT4
- ICEA T-30-520 (70,000 BTU/hr)
- Hazardous Location Rating: HL
- Meets EPA 40 CFR, part 261 for leachable lead content per TCLP method
- OSHA acceptable

Packaging:

- For Canadian customers, lengths are provided on returnable wood or steel reels that require a deposit. Extra charges apply for lagging, pulling eyes, paralleling and plexing
- For U.S. customers, material cut to length and shipped on non-returnable wood reels, while lengths in excess of 10,000 lbs. are provided on returnable steel reels that require a deposit. Extra charges apply for cuts less than 1000 ft., lagging, pulling eyes, paralleling and plexing

CATALOG NUMBER	NO. OF COND.	COND. SIZE (AWG)/ (kcmil)	GROUND WIRE SIZE (AWG)	MIN. AVG INS. THICKNESS		NOMINAL DIAMETER (OVER)						COPPER WEIGHT		NET WEIGHT W/ARMOR				AMPACITY** POWER COND. (30°C AMBIENT)
						INSULATION		ARMOR		CABLE				LBS/1000 FT		kg/km		
						INCHES	mm	INCHES	mm	INCHES	mm	INCHES	mm	LBS/1000 FT	kg/km	AL	STEEL	

12 AWG THRU 4/0 AWG—THREE POWER CONDUCTORS AND THREE 14 AWG CONTROL CONDUCTORS—30 MILS (.76 mm)—600V

333410*†	3	12	14	.030	0.76	0.15	3.9	0.78	19.8	0.86	21.8	114	170	356	519	530	789	20
311320*†	3	10	12	.030	0.76	0.18	4.5	0.81	20.6	0.89	22.6	158	235	416	586	619	921	30
311330*†	3	8	10	.045	1.14	0.24	6.1	0.95	24.0	1.00	25.4	208	310	541	729	805	1198	45
11288.210600*	3	6	8	.045	1.14	0.28	7.0	0.99	25.0	1.20	30.5	338	503	696	896	1035	1540	65
11288.210400*	3	4	8	.045	1.14	0.32	8.2	1.14	28.8	1.25	31.8	485	722	972	1293	1446	2151	85
11288.210200*	3	2	6	.045	1.14	0.38	9.7	1.27	32.3	1.39	35.2	747	1112	1295	1662	1927	2868	120
11288.210100*	3	1	6	.055	1.40	0.44	11.1	1.39	35.2	1.50	38.1	911	1356	1539	1941	2290	3408	140
11288.215100*	3	1/0	6	.055	1.40	0.48	12.2	1.47	37.3	1.59	40.3	1117	1662	1798	2227	2676	3982	155
11288.215200*	3	2/0	6	.055	1.40	0.53	13.3	1.57	39.8	1.71	43.3	1378	2051	2150	2609	3199	4760	185
11288.215300*	3	3/0	4	.055	1.40	0.58	17.1	1.68	42.5	1.82	46.1	1753	2609	2592	3087	3857	5740	210
11288.215400*	3	4/0	4	.055	1.40	0.63	16.0	1.80	45.7	1.94	49.1	2167	3225	3080	3615	4583	6820	235

Dimensions and weights are nominal; subject to industry tolerances.

*Non-stock item, minimum runs apply. Please consult Customer Service for price and delivery.

†Contact Customer Service for steel catalog number.

**Ampacity is based on CE Code Part 1: Table 2 (Three conductors in raceway [conduit]) and Rule 4-004.

TECK90

XLPE/PVC/AIA/PVC, Power, Unshielded, Armored
5kV, CSA TECK90, Single Conductor

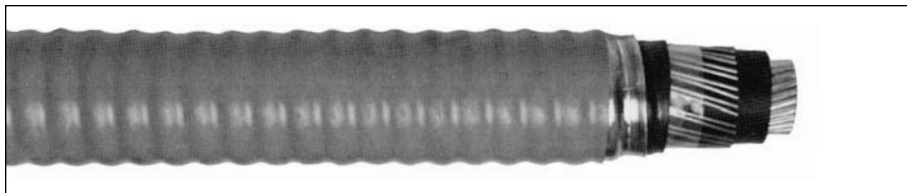

Product Construction

Conductor:

- 6 AWG thru 1000 kcmil bare copper compact Class B strand

Strand shield:

- A thermoset semi-conducting shield is extruded over the conductor

Insulation:

- Cross-Linked Polyethylene (XLPE) Type RW90
- Color-coded: Black

Ground (Bonding) Conductor:

- The conductor is a concentric serving of solid bare copper wires applied over the insulation

Inner Jacket:

- Flame-retardant, moisture- and sunlight-resistant Polyvinyl Chloride (PVC)—Black

Armor:

- Aluminum Interlocked Armor (AIA)

Overall Jacket:

- ACID-FLAME-CHECK ✓✓[®] flame-retardant, moisture- and sunlight-resistant Polyvinyl Chloride (PVC)—Orange

Print:

- GENERAL CABLE[®] ACID-FLAME-CHECK ✓✓[®] AG14 FT1 FT4 HL TECK90 XLPE (-40°C)1/C SIZE (AWG OR KCMIL) 5KV DIR BUR SUN RES CSA MONTH-YEAR SEQUENTIAL LENGTH MARK

Options:

- Other constructions available upon request

Applications:

- For exposed and concealed wiring in dry, damp or wet locations
- For use in ventilated, non-ventilated and ladder-type cable trays in dry, damp or wet locations
- For direct earth burial (with protection as required by inspection authority)
- For wiring in all hazardous locations when used with certified HL Cable Glands

Features:

- Rated at 90°C wet or dry
- Excellent crush, oil and chemical resistance
- Provides long service life
- Meets cold bend and impact tests at -40°C

Compliances:

- CSA Standard C22.2 No. 131 and No. 174
- CSA Approval numbers: LR1781
- CSA FT1 and FT4
- IEEE 383 (70,000 BTU/hr)
- UL 1581 (70,000 BTU/hr)
- IEEE 1202 (70,000 BTU/hr) CSA FT4,
- ICEA T-30-520 (70,000 BTU/hr)
- Hazardous Location Rating: HL
- Meets EPA 40 CFR, part 261 for leachable lead content per TCLP method
- OSHA acceptable

Packaging:

- For Canadian customers, lengths are provided on returnable wood or steel reels that require a deposit. Extra charges apply for lagging, pulling eyes, paralleling and plexing
- For U.S. customers, material cut to length and shipped on non-returnable wood reels, while lengths in excess of 10,000 lbs. are provided on returnable steel reels that require a deposit. Extra charges apply for cuts less than 1000 ft., lagging, pulling eyes, paralleling and plexing

CATALOG NUMBER	NO. OF COND.	COND. SIZE (AWG/kcmil)	GROUND WIRE SIZE (AWG)	NOMINAL DIAMETER (OVER)						COPPER WEIGHT		NET WEIGHT W/AL ARMOR		AMPACITY** (30°C AMBIENT)
				INSULATION		ARMOR		CABLE		LBS/1000 FT	kg/km	LBS/1000 FT	kg/km	
				INCHES	mm	INCHES	mm	INCHES	mm					

6 AWG THRU 1000 kcmil—SINGLE CONDUCTOR—UNSHIELDED—90 MILS INS. (2.29 mm)—5kV

17496.100600*	1	6	8	0.39	10.0	0.76	19.3	0.85	21.6	143	213	370	550	100
17496.100400*	1	4	6	0.43	10.5	0.84	21.4	0.93	23.7	223	332	490	730	135
17496.100300*	1	3	6	0.46	11.7	0.86	21.9	0.95	24.2	229	341	540	800	155
17496.100200*	1	2	6	0.49	12.5	0.89	22.6	0.98	24.9	301	448	590	890	180
17496.100100*	1	1	4	0.52	13.3	0.93	23.6	1.02	25.9	405	603	720	1060	210
17496.105100*	1	1/0	4	0.56	14.2	0.96	24.4	1.06	26.9	474	705	800	1190	245
17496.105200*	1	2/0	4	0.60	15.2	1.03	26.2	1.13	28.7	561	835	900	1350	285
17496.105300*	1	3/0	3	0.64	16.3	1.08	27.5	1.18	30.0	708	1054	1130	1680	330
17496.105400*	1	4/0	3	0.70	17.8	1.16	29.5	1.26	32.0	847	1261	1330	1970	385
17496.106000*	1	250	2	0.75	19.1	1.24	31.5	1.34	34.1	1012	1506	1530	2280	425
17496.106200*	1	350	1	0.85	21.5	1.34	34.0	1.44	36.6	1388	2066	1960	2910	530
17496.106500*	1	500	1/0	0.97	24.6	1.49	37.9	1.59	40.4	1548	2304	2570	3830	660
17496.107000*	1	750	2/0	1.15	29.2	1.68	42.7	1.78	45.2	2243	3338	3900	5800	845
17496.107500*	1	1000	2/0	1.30	33.0	1.86	47.3	1.96	49.8	2819	4195	4930	7340	1000

Dimensions and weights are nominal; subject to industry tolerances.

*Non-stock item, minimum quantity apply. Please consult Customer Service for price and delivery.

**Ampacity is based on CE Code Part 1: Table 1 (single conductor in free air) and Rule 4-004.

TECK90

XLPE/PVC/AIA/PVC, Power, Unshielded, Armored
5kV, CSA TECK90, Three Conductor

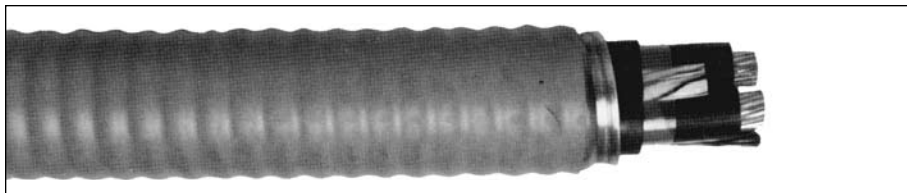

Product Construction

Conductor:

- 6 AWG thru 1000 kcmil bare copper compact Class B strand

Strand shield:

- A thermoset semi-conducting shield is extruded over the conductor

Insulation:

- Cross-Linked Polyethylene (XLPE) Type RW90
- Color-coded: Printed numbers

Ground (Bonding) Conductor:

- The conductor consists of one uninsulated stranded bare copper conductor

Inner Jacket:

- Flame-retardant, moisture- and sunlight-resistant Polyvinyl Chloride (PVC)—Black

Armor:

- Aluminum Interlocked Armor (AIA)

Overall Jacket:

- ACID-FLAME-CHECK ✓✓[®] flame-retardant, moisture- and sunlight-resistant Polyvinyl Chloride (PVC)—Orange

Print:

- GENERAL CABLE[®] ACID-FLAME-CHECK ✓✓[®] AG14 FT1 FT4 HL TECK90 XLPE (-40°C)3/C SIZE (AWG OR KCMIL) 5KV DIR BUR SUN RES CSA MONTH-YEAR SEQUENTIAL LENGTH MARK

Options:

- Galvanized Steel Interlocked Armor (GSIA)
- Other constructions available upon request

Applications:

- For exposed and concealed wiring in dry, damp or wet locations
- For use in ventilated, non-ventilated and ladder-type cable trays in dry, damp or wet locations
- For direct earth burial (with protection as required by inspection authority)
- For wiring in all hazardous locations when used with certified HL Cable Glands

Features:

- Rated at 90°C wet or dry
- Excellent crush, oil and chemical resistance
- Provides long service life
- Meets cold bend and impact tests at -40°C

Compliances:

- CSA Standard C22.2 No. 131 and No. 174
- CSA Approval numbers: LR1781
- CSA FT1 and FT4
- IEEE 383 (70,000 BTU/hr)
- UL 1581 (70,000 BTU/hr)
- IEEE 1202 (70,000 BTU/hr) CSA FT4
- ICEA T-30-520 (70,000 BTU/hr)
- Hazardous Location Rating: HL
- Meets EPA 40 CFR, part 261 for leachable lead content per TCLP method
- OSHA acceptable

Packaging:

- For Canadian customers, lengths are provided on returnable wood or steel reels that require a deposit. Extra charges apply for lagging, pulling eyes, paralleling and plexing
- For U.S. customers, material cut to length and shipped on non-returnable wood reels, while lengths in excess of 10,000 lbs. are provided on returnable steel reels that require a deposit. Extra charges apply for cuts less than 1000 ft., lagging, pulling eyes, paralleling and plexing

CATALOG NUMBER	NO. OF COND.	COND. SIZE (AWG/ kcmil)	GROUND WIRE SIZE (AWG)	NOMINAL DIAMETER (OVER)						COPPER WEIGHT		NET WEIGHT W/ARMOR				AMPACITY** (30°C AMBIENT)
				INSULATION		ARMOR		CABLE		LBS/ 1000 FT	kg/ km	LBS/1000 FT		kg/km		
				INCHES	mm	INCHES	mm	INCHES	mm			AL	STEEL	AL	STEEL	

6 AWG THRU 1000 kcmil—THREE CONDUCTOR—UNSHIELDED—90 MILS INS. (2.29 mm)—5kV

17496.020600	3	6	8	0.39	10.0	1.27	32.3	1.37	34.8	301	448	927	1340	1380	2000	65
17496.020400	3	4	8	0.43	10.5	1.37	34.8	1.47	37.4	442	658	1138	1590	1694	2370	85
17496.010300*	3	3	6	0.46	11.7	1.42	36.1	1.52	38.6	583	868	1310	1780	1950	2640	105
17496.020200	3	2	6	0.49	12.5	1.49	37.9	1.59	40.4	703	1046	1476	1980	2197	2940	120
17496.020100*	3	1	6	0.52	13.3	1.59	40.4	1.69	43.0	970	1444	1752	2230	2607	3350	140
17496.025100*	3	1/0	6	0.56	14.2	1.67	42.4	1.77	45.0	1082	1610	2012	2540	2994	3780	155
17496.025200	3	2/0	6	0.60	15.2	1.76	44.7	1.86	47.3	1343	1999	2334	2880	3473	4290	185
17496.035300*	3	3/0	4	0.64	16.3	1.87	47.5	1.97	50.1	1720	2560	2835	3370	4219	5010	210
17496.025400	3	4/0	4	0.70	17.8	1.98	50.3	2.08	52.9	2315	3445	3328	4090	4952	6090	235
17496.056000*	3	250	4	0.75	19.1	2.15	54.6	2.25	57.2	2469	3674	3910	4780	5819	7110	265
17496.026200	3	350	3	0.85	21.5	2.36	60.0	2.49	63.3	3476	5173	5102	6100	7592	9070	325
17496.046500*	3	500	3	0.97	24.6	2.62	66.6	2.75	69.9	4837	7198	6721	7880	10001	11720	395
17496.077000*	3	750	2	1.15	29.2	3.01	76.5	3.14	79.8	7224	10750	9469	11750	14090	17480	500
17496.017500*	3	1000	1	1.30	33.0	3.39	86.1	3.54	89.9	9715	14458	13790	15220	20520	22650	585

Dimensions and weights are nominal; subject to industry tolerances.

*Non-stock item, minimum runs apply. Please consult Customer Service for price and delivery.

**Ampacity is based on CE Code Part 1: Table 2 (Three conductors in raceway [conduit]) and Rule 4-004.

HVTECK

TRXLPE/Wire Shield/PVC/AIA/PVC, Power, Shielded, Armored
5kV, CSA HVTECK, 100% / 133% Ins. Levels, 90 MILS, Single Conductor

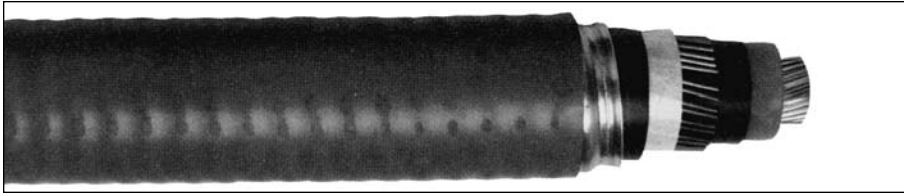

Product Construction

Conductor:

- 6 AWG thru 1000 kcmil bare copper compact Class B strand

Strand Shield:

- A thermoset semi-conducting strand shield is extruded over the conductor

Insulation:

- Tree-Retardant Cross-Linked Polyethylene (TR-XLPE)

Insulation Shield:

- A semi-conducting thermosetting layer, applied in a triple extrusive process, plus a concentric serving of solid copper wires acting as both a drain wire shield and as a grounding (bonding) conductor
- Color-Coded: Black insulation shield

Ground (Bonding) Conductor:

- The conductor is a concentric serving of solid copper wires applied over the thermosetting insulation shield

Inner Jacket:

- Flame-retardant, moisture- and sunlight-resistant Polyvinyl Chloride (PVC)—Black

Armor:

- Aluminum Interlocked Armor (AIA)

Overall Jacket:

- ACID-FLAME-CHECK ✓✓[®] flame-retardant, moisture- and sunlight-resistant Polyvinyl Chloride (PVC)—Orange

Print:

- GENERAL CABLE[®] 1/C SIZE (AWG OR KCMIL) COPPER CPT XLPE 5KV (100% OR 133% INS LEVEL) ACID-FLAME-CHECK ✓✓[®] CSA HL HVTECK (-40°C) FT4 DIR BUR SUN RES MONTH/YEAR (LIGHTNING BOLT SYMBOL) SEQUENTIAL LENGTH MARK

Options:

- Other constructions available upon request

Applications:

- For wiring in all hazardous locations when used with certified HL cable glands
- For exposed and concealed wiring in dry, damp or wet locations
- For use in ventilated, non-ventilated and ladder-type cable trays in dry, damp or wet locations
- For direct earth burial (with protection as required by inspection authority)

Features:

- Rated at 90°C wet or dry
- Excellent crush, oil and chemical resistance
- Provides long service life
- Cost-effective alternative to installations in conduit
- Meets cold bend and impact tests at -40°C

Compliances:

- CSA FT1 and FT4
- IEEE 383 (70,000 BTU/hr), UL 1581 (70,000 BTU/hr)
- IEEE 1202 (70,000 BTU/hr) CSA FT4
- ICEA T-30-520 (70,000 BTU/hr)
- ICEA T-29-520 (210,000 BTU/hr)
- Hazardous location rating: HL
- CSA Standard C68.3
- CSA Standard C22.2 No. 174
- CSA Approval (file) numbers: LR27161
- Meets EPA 40 CFR, part 261 for leachable lead content per TCLP method
- OSHA acceptable

Packaging:

- For Canadian customers, lengths are provided on returnable wood or steel reels that require a deposit. Extra charges apply for lagging, pulling eyes, paralleling and plexing
- For U.S. customers, material cut to length and shipped on non-returnable wood reels, while lengths in excess of 10,000 lbs. are provided on returnable steel reels that require a deposit. Extra charges apply for cuts less than 1000 ft., lagging, pulling eyes, paralleling and plexing

CATALOG NUMBER	NO. OF COND.	COND. SIZE (AWG/ kcmil)	GROUND WIRE SIZE (AWG)	NOMINAL DIAMETER (OVER)										COPPER WEIGHT		NET WEIGHT W/AL ARMOR		AMPACITY** (40°C AMBIENT)
				INSULATION		INSULATION SHIELD		INNER JACKET		ARMOR		CABLE		LBS/ 1000 FT	kg/ km	LBS/ 1000 FT	kg/ km	
				INCHES	mm	INCHES	mm	INCHES	mm	INCHES	mm	INCHES	mm					

**6 AWG THRU 1000 kcmil—SINGLE CONDUCTOR—SHIELDED,
100% AND 133% INS. LEVELS, 90 MILS INS. (2.29 mm)—5kV**

17496.700600*	1	6	8	0.39	10.0	0.47	11.9	0.68	17.3	0.90	22.9	0.99	25.2	144	214	510	770	112
17496.700400*	1	4	6	0.43	10.5	0.51	13.0	0.72	18.3	0.94	23.9	1.03	26.2	224	333	590	880	148
17496.700200*	1	2	6	0.49	12.5	0.57	14.5	0.78	19.8	1.03	26.2	1.12	28.5	302	449	750	1120	195
17496.700100*	1	1	4	0.52	13.3	0.60	15.3	0.81	20.6	1.06	27.0	1.15	29.2	406	604	870	1300	225
17496.705100*	1	1/0	4	0.56	14.2	0.63	16.0	0.88	22.4	1.13	28.7	1.22	31.0	475	707	1010	1500	260
17496.705200*	1	2/0	4	0.60	15.2	0.67	17.0	0.92	23.4	1.17	29.7	1.26	32.0	562	836	1120	1670	299
17496.705300*	1	3/0	3	0.64	16.3	0.71	18.1	0.97	24.7	1.22	31.0	1.31	33.3	709	1055	1300	1930	345
17496.705400*	1	4/0	3	0.70	17.8	0.76	19.3	1.02	25.9	1.27	32.3	1.36	34.6	843	1255	1470	2180	400
17496.706000*	1	250	2	0.75	19.1	0.82	20.8	1.10	28.0	1.38	35.1	1.48	37.6	1013	1508	1680	2500	444
17496.706200*	1	350	1	0.85	21.5	0.96	24.4	1.24	31.5	1.52	38.6	1.62	41.2	1389	2067	2120	3150	549
17496.706500*	1	500	1/0	0.97	24.6	1.04	26.4	1.34	34.0	1.62	41.2	1.72	43.7	1928	2869	2770	4130	688
17496.707000*	1	750	2/0	1.15	29.2	1.24	31.5	1.54	39.1	1.83	46.5	1.93	49.0	2820	4197	3780	5760	889
17496.707500*	1	1000	2/0	1.30	33.0	1.39	35.3	1.76	44.7	2.05	52.1	2.15	54.6	3607	5368	5010	7460	1061

Dimensions and weights are nominal; subject to industry tolerances.

*Non-stock item, minimum runs apply. Please consult Customer Service for price and delivery.

**Ampacity is based on ICEA Publication P 46-426 for 8kV cables.

Open circuit (shield/armor) is assumed. Ampacities at other voltage levels do not vary significantly. Special approval by local electrical inspection authorities may be required (Ref. CE Code Part 1, Appendix B, Rule 4-004).



Phone: 888-593-3355
www.generalcable.com

HVTECK

TRXLPE/Wire Shield/PVC/AIA/PVC, Power, Shielded, Armored
5kV, CSA HVTECK, 133% Ins. Level, 115 Mils, Single Conductor

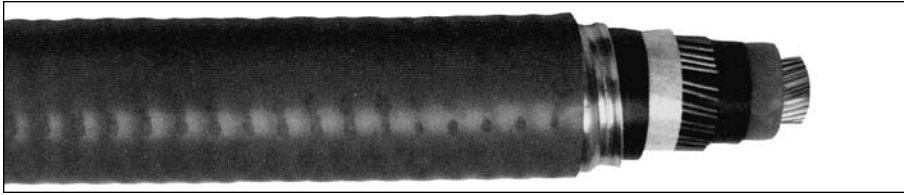

Product Construction

Conductor:

- 6 AWG thru 1000 kcmil bare copper compact Class B strand

Strand Shield:

- A thermoset semi-conducting strand shield is extruded over the conductor

Insulation:

- Tree-Retardant Cross-Linked Polyethylene (TR-XLPE)

Insulation Shield:

- A semi-conducting thermosetting layer, applied in a triple extrusion process, plus a concentric serving of solid copper wires acting as both a drain wire shield and as a grounding (bonding) conductor
- Color-Coded: Black insulation shield

Ground (Bonding) Conductor:

- The conductor is a concentric serving of solid copper wires applied over the thermosetting insulation shield

Inner Jacket:

- Flame-retardant, moisture- and sunlight-resistant Polyvinyl Chloride (PVC)—Black

Armor:

- Aluminum Interlocked Armor (AIA)

Overall Jacket:

- ACID-FLAME-CHECK ✓✓® flame-retardant, moisture- and sunlight-resistant Polyvinyl Chloride (PVC)—Orange

Print:

- GENERAL CABLE® 1/C SIZE (AWG OR KCMIL) COPPER CPT XLPE 5KV (133% INS LEVEL) ACID-FLAME-CHECK ✓✓® CSA HL HVTECK (-40°C) FT4 DIR BUR SUN RES MONTH/YEAR (LIGHTNING BOLT SYMBOL) SEQUENTIAL LENGTH MARK

Options:

- Other constructions available upon request

Applications:

- For wiring in all hazardous locations when used with certified HL cable glands
- For exposed and concealed wiring in dry, damp or wet locations
- For use in ventilated, non-ventilated and ladder-type cable trays in dry, damp or wet locations
- For direct earth burial (with protection as required by inspection authority)

Features:

- Rated at 90°C wet or dry
- Excellent crush, oil and chemical resistance
- Provide long service life
- Cost-effective alternative to installations in conduit
- Meets cold bend and impact tests at -40°C

Compliances:

- CSA FT1 and FT4
- IEEE 383 (70,000 BTU/hr), UL 1581 (70,000 BTU/hr)
- IEEE 1202 (70,000 BTU/hr) CSA FT4
- ICEA T-30-520 (70,000 BTU/hr)
- ICEA T-29-520 (210,000 BTU/hr)
- Hazardous location rating: HL
- CSA Standard C68.3
- CSA Standard C22.2 No. 174
- CSA Approval (file) numbers: LR27161
- Meets EPA 40 CFR, part 261 for leachable lead content per TCLP method
- OSHA acceptable

Packaging:

- For Canadian customers, lengths are provided on returnable wood or steel reels that require a deposit. Extra charges apply for lagging, pulling eyes, paralleling and plexing
- For U.S. customers, material cut to length and shipped on non-returnable wood reels, while lengths in excess of 10,000 lbs. are provided on returnable steel reels that require a deposit. Extra charges apply for cuts less than 1000 ft., lagging, pulling eyes, paralleling and plexing

CATALOG NUMBER	NO. OF COND.	COND. SIZE (AWG/ kcmil)	GROUND WIRE SIZE (AWG)	NOMINAL DIAMETER (OVER)										COPPER WEIGHT		NET WEIGHT W/AL ARMOR		AMPACITY** (40°C AMBIENT)
				INSULATION		INSULATION SHIELD		INNER JACKET		ARMOR		CABLE		LBS/ 1000 FT	kg/ km	LBS/ 1000 FT	kg/ km	
				INCHES	mm	INCHES	mm	INCHES	mm	INCHES	mm	INCHES	mm					

**6 AWG THRU 1000 kcmil—SINGLE CONDUCTOR—SHIELDED,
133% INS. LEVEL, 115 MILS INS. (2.92 mm) (TO AEIC)—5kV**

17496.710600*	1	6	8	0.44	11.2	0.51	13.0	0.73	18.6	0.95	24.2	1.04	26.4	145	216	550	820	112
17496.710400*	1	4	6	0.48	12.3	0.55	13.9	0.77	19.6	0.99	25.2	1.08	27.5	225	335	680	1010	148
17496.710200*	1	2	6	0.54	13.7	0.61	15.5	0.83	21.1	1.08	27.5	1.17	29.7	303	451	840	1250	195
17496.710100*	1	1	4	0.57	14.5	0.64	16.3	0.91	23.0	1.16	29.5	1.25	31.8	407	606	960	1430	225
17496.715100*	1	1/0	4	0.61	15.4	0.68	17.3	0.94	23.9	1.19	30.3	1.28	32.5	407	606	1060	1570	260
17496.715200*	1	2/0	4	0.65	16.4	0.72	18.3	0.98	25.0	1.23	31.3	1.32	33.6	476	708	1170	1740	299
17496.715300*	1	3/0	3	0.70	17.7	0.76	19.3	1.03	26.3	1.31	33.3	1.40	35.6	563	838	1350	2000	345
17496.715400*	1	4/0	3	0.75	18.9	0.81	20.6	1.08	27.5	1.36	34.6	1.45	36.9	710	1057	1520	2260	400
17496.716000*	1	250	2	0.80	20.3	0.87	22.1	1.16	29.6	1.44	36.6	1.53	38.9	849	1263	1730	2580	444
17496.716200*	1	350	1	0.94	23.9	1.01	25.7	1.29	32.8	1.57	39.9	1.67	42.4	1169	1740	2170	3230	549
17496.716500*	1	500	1/0	1.02	26.0	1.11	28.2	1.41	35.8	1.69	43.0	1.79	45.6	1390	2069	2860	4260	688
17496.717000*	1	750	2/0	1.20	30.6	1.29	32.8	1.60	40.7	1.89	48.0	1.99	50.6	2821	4198	3940	5860	889
17496.717500*	1	1000	2/0	1.35	34.3	1.44	36.6	1.81	46.0	2.10	53.4	2.20	55.9	3608	5369	5090	7570	1061

Dimensions and weights are nominal; subject to industry tolerances.

*Non-stock item, minimum runs apply. Please consult Customer Service for price and delivery.

**Ampacity is based on ICEA Publication P 46-426 for 8kV cables. Open circuit (shield/armor) is assumed.

Ampacities at other voltage levels do not vary significantly.

Special approval by local electrical inspection authorities may be required

(Ref. CE Code Part 1, Appendix B, Rule 4-004).



Phone: 888-593-3355
www.generalcable.com

HVTECK

TRXLPE/Tape Shield/PVC/AIA/PVC, Power, Shielded, Armored
5kV, CSA HVTECK, 100% / 133% Ins. Levels, 90 Mils, Three Conductor

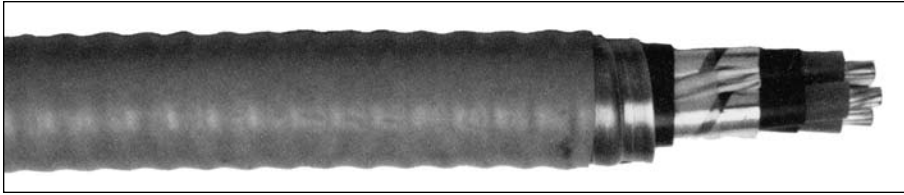

Features:

- Rated at 90°C wet or dry
- Excellent crush, oil and chemical resistance
- Provides long service life
- Cost-effective alternative to installations in conduit
- Meets cold bend and impact tests at -40°C

Compliances:

- CSA FT1 and FT4
- IEEE 383 (70,000 BTU/hr)
- UL 1581(70,000 BTU/hr)
- IEEE 1202 (70,000 BTU/hr) CSA FT4
- ICEA T-30-520 (70,000 BTU/hr)
- ICEA T-29-520 (210,000 BTU/hr)
- Hazardous location rating: HL
- CSA Standard C68.3
- CSA Standard C22.2 No. 174
- CSA Approval (file) numbers: LR27161
- Meets EPA 40 CFR, part 261 for leachable lead content per TCLP method
- OSHA acceptable

Packaging:

- For Canadian customers, lengths are provided on returnable wood or steel reels that require a deposit. Extra charges apply for lagging, pulling eyes, paralleling and plexing
- For U.S. customers, material cut to length and shipped on non-returnable wood reels, while lengths in excess of 10,000 lbs. are provided on returnable steel reels that require a deposit. Extra charges apply for cuts less than 1000 ft., lagging, pulling eyes, paralleling and plexing

Product Construction

Conductor:

- 6 AWG thru 1000 kcmil bare copper compact Class B strand

Strand Shield:

- A thermoset semi-conducting strand shield is extruded over the conductor

Insulation:

- Tree-Retardant Cross-Linked Polyethylene (TR-XLPE)

Insulation Shield:

- A semi-conducting thermosetting layer, applied in a triple extrusion process, plus a helically applied gapped copper tape
- Color-Coded: Black, Red or Blue colored tape placed longitudinally under the copper tape shield

Ground (Bonding) Conductor:

- The conductor consists of one uninsulated stranded bare copper conductor

Inner Jacket:

- Flame-retardant, moisture- and sunlight-resistant Polyvinyl Chloride (PVC)—Black

Armor:

- Aluminum Interlocked Armor (AIA)

Overall Jacket:

- ACID-FLAME-CHECK ✓✓® flame-retardant, moisture- and sunlight-resistant Polyvinyl Chloride (PVC)—Orange

Print:

- GENERAL CABLE® 3/C SIZE (AWG OR KCMIL) COPPER CPT XLPE 5KV (100% OR 133% INS LEVEL) ACID-FLAME-CHECK ✓✓® CSA HL HVTECK FT4 (-40°C) DIR BUR SUN RES MONTH/YEAR (LIGHTNING BOLT SYMBOL) SEQUENTIAL LENGTH MARK

Options:

- Galvanized Steel Interlocked Armor (GSIA)
- Other constructions available upon request

Applications:

- For wiring in all hazardous locations when used with certified HL cable glands
- For exposed and concealed wiring in dry, damp or wet locations
- For use in ventilated, non-ventilated and ladder-type cable trays in dry, damp or wet locations
- For direct earth burial (with protection as required by inspection authority)

CATALOG NUMBER	NO. OF COND.	COND. SIZE (AWG/ kcmil)	GROUND WIRE SIZE (AWG)	NOMINAL DIAMETER (OVER)										COPPER WEIGHT		NET WEIGHT W/ARMOR				AMPACITY** (40°C AMBIENT)
				INSULATION		INSULATION SHIELD		INNER JACKET		ARMOR		CABLE		LBS/1000 FT	kg/km	LBS/1000 FT		kg/km		
				INCHES	mm	INCHES	mm	INCHES	mm	INCHES	mm	INCHES	mm			AL	STEEL	AL	STEEL	
6 AWG THRU 1000 kcmil—THREE CONDUCTOR—SHIELDED, 100% / 133% INS. LEVELS, 90 MILS INS. (2.29 mm)—5kV																				
17496.740600*	3	6	8	0.39	10.0	0.47	11.9	1.17	29.7	1.45	36.9	1.54	39.2	349	519	1120	1590	1670	2360	93
17496.740400*	3	4	8	0.43	10.5	0.51	13.0	1.26	32.0	1.54	39.1	1.63	41.4	503	749	1350	1850	1670	2760	122
17496.740200*	3	2	6	0.49	12.5	0.57	14.5	1.39	35.3	1.67	42.4	1.77	45.0	771	1147	1740	2290	2590	3410	159
17496.740100*	3	1	6	0.52	13.3	0.60	15.3	1.45	36.9	1.73	43.9	1.83	46.5	939	1397	1960	2540	2920	3780	184
17496.745100*	3	1/0	6	0.56	14.2	0.63	16.0	1.53	38.9	1.81	46.0	1.91	48.5	1148	1708	2290	3010	3410	4490	211
17496.745200*	3	2/0	6	0.60	15.2	0.67	17.0	1.62	41.2	1.91	48.5	2.01	51.1	1414	2104	2620	3380	3900	5030	243
17496.745300*	3	3/0	4	0.64	16.3	0.71	18.1	1.78	45.2	2.07	52.6	2.17	55.1	1798	2668	3210	4040	4780	6020	279
17496.745400*	3	4/0	4	0.70	17.8	0.76	19.3	1.90	48.3	2.19	55.6	2.29	58.2	2212	3292	3720	4600	5530	6840	321
17496.746000*	3	250	4	0.75	19.1	0.82	20.8	2.01	51.1	2.30	58.4	2.43	61.8	2583	3844	4300	5240	6400	7800	355
17496.746200*	3	350	3	0.85	21.5	0.96	24.4	2.32	58.9	2.61	66.3	2.74	69.6	3569	5311	5480	6520	8160	9700	435
17496.746500*	3	500	3	0.97	24.6	1.04	26.4	2.48	63.0	2.77	70.4	2.90	73.7	4998	7438	7130	8280	10610	12320	536
17496.747000*	3	750	2	1.15	29.2	1.24	31.5	2.98	75.7	3.27	83.1	3.42	86.9	7440	11072	10330	11700	15370	17410	668
17496.747500*	3	1000	1	1.30	33.0	1.39	35.3	3.31	84.1	3.60	91.5	3.75	95.3	9860	14674	13080	14600	19460	21730	768

Dimensions and weights are nominal; subject to industry tolerances.
 *Non-stock item, minimum runs apply. Please consult Customer Service for price and delivery.
 **Ampacity is based on ICEA Publication P 46-426 for 8kV cables.
 Ampacities at other voltage levels do not vary significantly.
 Special approval by local electrical inspection authorities may be required (Ref. CE Code Part 1, Appendix B, Rule 4-004).



HVTECK

TRXLPE/Tape Shield/PVC/AIA/PVC, Power, Shielded, Armored
5kV, CSA HVTECK, 133% Ins. Level, 115 Mils, Three Conductor

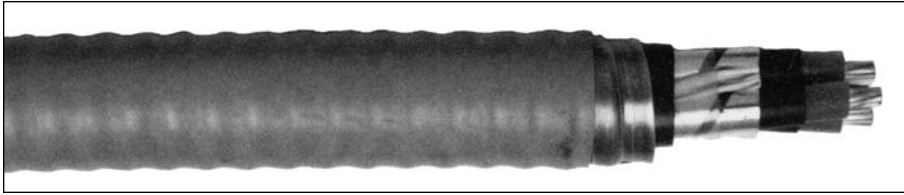

Features:

- Rated at 90°C wet or dry
- Excellent crush, oil and chemical resistance
- Provides long service life
- Cost-effective alternative to installations in conduit
- Meets cold bend and impact tests at -40°C

Compliances:

- CSA FT1 and FT4
- IEEE 383 (70,000 BTU/hr)
- UL 1581(70,000 BTU/hr)
- IEEE 1202 (70,000 BTU/hr) CSA FT4
- ICEA T-30-520 (70,000 BTU/hr)
- ICEA T-29-520 (210,000 BTU/hr)
- Hazardous location rating: HL
- CSA Standard C68.3
- CSA Standard C22.2 No. 174
- CSA Approval (file) numbers: LR27161
- Meets EPA 40 CFR, part 261 for leachable lead content per TCLP method
- OSHA acceptable

Packaging:

- For Canadian customers, lengths are provided on returnable wood or steel reels that require a deposit. Extra charges apply for lagging, pulling eyes, paralleling and plexing
- For U.S. customers, material cut to length and shipped on non-returnable wood reels, while lengths in excess of 10,000 lbs. are provided on returnable steel reels that require a deposit. Extra charges apply for cuts less than 1000 ft., lagging, pulling eyes, paralleling and plexing

Product Construction

Conductor:

- 6 AWG thru 1000 kcmil bare copper compact Class B strand

Strand Shield:

- A thermoset semi-conducting strand shield is extruded over the conductor

Insulation:

- Tree-Retardant Cross-Linked Polyethylene (TR-XLPE)

Insulation Shield:

- A semi-conducting thermosetting layer, applied in a triple extrusion process, plus a helically applied gapped copper tape
- Color-Coded: Black, Red or Blue colored tape placed longitudinally under the copper tape shield

Ground (Bonding) Conductor:

- The conductor consists of one uninsulated stranded bare copper conductor

Inner Jacket:

- Flame-retardant, moisture- and sunlight-resistant Polyvinyl Chloride (PVC)—Black

Armor:

- Aluminum Interlocked Armor (AIA)

Overall Jacket:

- ACID-FLAME-CHECK ✓✓® flame-retardant, moisture- and sunlight-resistant Polyvinyl Chloride (PVC)—Orange

Print:

- GENERAL CABLE® 3/C SIZE (AWG OR KCMIL) COPPER CPT XLPE 5KV (133% INS LEVEL) ACID-FLAME-CHECK ✓✓® CSA HL HVTECK FT4 (-40°C) DIR BUR SUN RES MONTH/YEAR (LIGHTNING BOLT SYMBOL) SEQUENTIAL LENGTH MARK

Options:

- Galvanized Steel Interlocked Armor (GSIA)
- Other constructions available upon request

Applications:

- For wiring in all hazardous locations when used with certified HL cable glands
- For exposed and concealed wiring in dry, damp or wet locations
- For use in ventilated, non-ventilated and ladder-type cable trays in dry, damp or wet locations
- For direct earth burial (with protection as required by inspection authority)

CATALOG NUMBER	NO. OF COND.	COND. SIZE (AWG/ kcmil)	GROUND WIRE SIZE (AWG)	NOMINAL DIAMETER (OVER)										COPPER WEIGHT		NET WEIGHT W/ARMOR				AMPACITY** (40°C AMBIENT)
				INSULATION		INSULATION SHIELD		INNER JACKET		ARMOR		CABLE		LBS/1000 FT	kg/km	LBS/1000 FT		kg/km		
				INCHES	mm	INCHES	mm	INCHES	mm	INCHES	mm	INCHES	mm			AL	STEEL	AL	STEEL	

6 AWG THRU 1000 kcmil—THREE CONDUCTOR—SHIELDED, 133% INS. LEVEL, 115 MILS INS. (2.92 mm) (TO AEIC)—5kV

17496.750600*	3	6	8	0.44	11.2	0.51	13.0	1.27	32.3	1.55	39.4	1.65	41.9	352	524	1270	1780	1890	2650	93
17496.750400*	3	4	8	0.48	12.3	0.55	13.9	1.37	34.8	1.65	41.9	1.75	44.5	505	752	1500	2040	2230	3040	122
17496.750200*	3	2	6	0.54	13.7	0.61	15.5	1.50	38.2	1.78	45.2	1.88	47.8	774	1152	1930	2630	2870	3910	159
17496.750100*	3	1	6	0.57	14.5	0.64	16.3	1.57	39.9	1.86	47.3	1.96	49.8	943	1403	2150	2880	3200	2490	184
17496.755100*	3	1/0	6	0.61	15.4	0.68	17.3	1.65	41.9	1.94	49.3	2.04	51.8	1151	1713	2430	3200	3620	4760	211
17496.755200*	3	2/0	6	0.65	16.4	0.72	18.3	1.80	45.6	2.09	53.1	2.19	55.7	1417	2109	2890	3720	4300	5540	243
17496.755300*	3	3/0	4	0.70	17.7	0.76	19.3	1.90	48.3	2.19	55.7	2.29	58.2	1796	2673	3360	4240	5000	6310	279
17496.755400*	3	4/0	4	0.75	18.9	0.81	20.6	2.01	51.0	2.30	58.5	2.43	61.8	2215	3296	3940	4870	5860	7240	321
17496.756000*	3	250	4	0.80	20.3	0.87	22.1	2.13	54.1	2.42	61.5	2.55	64.8	2583	3844	4470	5450	6650	8120	355
17496.756200*	3	350	3	0.94	23.9	1.01	25.7	2.43	61.8	2.72	69.1	2.85	72.4	3572	5316	5650	6730	8400	10020	435
17496.756500*	3	500	3	1.02	26.0	1.11	28.2	2.64	67.1	2.93	74.5	3.06	77.8	5004	7447	7440	8660	11070	12880	536
17496.757000*	3	750	2	1.20	30.6	1.29	32.8	3.10	78.8	3.39	86.1	3.54	89.9	7431	11059	10560	11980	15710	17830	668
17496.757500*	3	1000	1	1.35	34.3	1.44	36.6	3.42	86.9	3.71	94.3	3.86	98.1	9863	14678	13300	14870	19790	22130	768

Dimensions and weights are nominal; subject to industry tolerances.

*Non-stock item, minimum runs apply. Please consult Customer Service for price and delivery.

**Ampacity is based on ICEA Publication P 46-426 for 8kV cables.

Ampacities at other voltage levels do not vary significantly.

Special approval by local electrical inspection authorities may be required (Ref. CE Code Part 1, Appendix B, Rule 4-004).



Phone: 888-593-3355
www.generalcable.com

HVTECK

TRXLPE/Wire Shield/PVC/AIA/PVC, Power, Shielded, Armored
15kV, CSA HVTECK, 100% Ins. Level, 175 Mils, Single Conductor

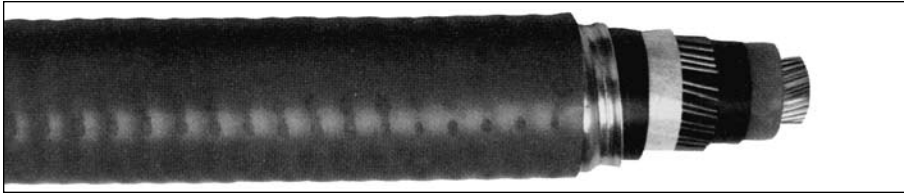

Features:

- Rated at 90°C wet or dry
- Excellent crush, oil and chemical resistance
- Provides long service life
- Cost-effective alternative to installations in conduit
- Meets cold bend and impact tests at -40°C

Compliances:

- CSA FT1 and FT4
- IEEE 383 (70,000 BTU/hr)
- UL 1581(70,000 BTU/hr)
- IEEE 1202 (70,000 BTU/hr) CSA FT4
- ICEA T-30-520 (70,000 BTU/hr)
- ICEA T-29-520 (210,000 BTU/hr)
- Hazardous location rating: HL
- CSA Standard C68.3
- CSA Standard C22.2 No. 174
- CSA Approval (file) numbers: LR27161
- Meets EPA 40 CFR, part 261 for leachable lead content per TCLP method
- OSHA acceptable

Packaging:

- For Canadian customers, lengths are provided on returnable wood or steel reels that require a deposit. Extra charges apply for lagging, pulling eyes, paralleling and plexing
- For U.S. customers, material cut to length and shipped on non-returnable wood reels, while lengths in excess of 10,000 lbs. are provided on returnable steel reels that require a deposit. Extra charges apply for cuts less than 1000 ft., lagging, pulling eyes, paralleling and plexing

Product Construction

Conductor:

- 2 AWG thru 1000 kcmil bare copper compact Class B strand

Strand Shield:

- A thermoset semi-conducting strand shield is extruded over the conductor

Insulation:

- Tree-Retardant Cross-Linked Polyethylene (TR-XLPE)

Insulation Shield:

- A semi-conducting thermosetting layer, applied in a triple extrusion process, plus a concentric serving of solid copper wires acting as both a drain wire shield and as a grounding (bonding) conductor
- Color-Coded: Black insulation shield

Ground (Bonding) Conductor:

- The conductor is a concentric serving of solid copper wires applied over the thermosetting insulation shield

Inner Jacket:

- Flame-retardant, moisture- and sunlight-resistant Polyvinyl Chloride (PVC) —Black

Armor:

- Aluminum Interlocked Armor (AIA)

Overall Jacket:

- ACID-FLAME-CHECK ✓✓® flame-retardant, moisture- and sunlight-resistant Polyvinyl Chloride (PVC) —Red

Print:

- GENERAL CABLE® 1/C SIZE (AWG OR KCMIL) COPPER CPT XLPE 15KV (100% INS LEVEL) ACID-FLAME-CHECK ✓✓® CSA HL HVTECK FT4 (-40°C) DIR BUR SUN RES MONTH/YEAR (LIGHTNING BOLT SYMBOL) SEQUENTIAL LENGTH MARK

Options:

- Other constructions available upon request

Applications:

- For wiring in all hazardous locations when used with certified HL cable glands
- For exposed and concealed wiring in dry, damp or wet locations
- For use in ventilated, non-ventilated and ladder-type cable trays in dry, damp or wet locations
- For direct earth burial (with protection as required by inspection authority)

CATALOG NUMBER	NO. OF COND.	COND. SIZE (AWG/ kcmil)	GROUND WIRE SIZE (AWG)	NOMINAL DIAMETER (OVER)										COPPER WEIGHT		NET WEIGHT W/AL ARMOR		AMPACITY** (40°C AMBIENT)	
				INSULATION		INSULATION SHIELD		INNER JACKET		ARMOR		CABLE		LBS/ 1000 FT	kg/ km	LBS/ 1000 FT	kg/ km		
				INCHES	mm	INCHES	mm	INCHES	mm	INCHES	mm	INCHES	mm						
2 AWG THRU 1000 kcmil—SINGLE CONDUCTOR—100% INS. LEVELS, 175 MILS INS. (4.45 mm)—15kV																			
17496.810200*	1	2	6	0.66	16.7	0.73	18.6	0.99	25.3	1.24	31.5	1.33	33.8	304	482	950	1420	195	
17496.810100*	1	1	4	0.69	17.5	0.76	19.3	1.03	26.1	1.28	32.5	1.37	34.8	408	607	1080	1600	225	
17496.815100*	1	1/0	4	0.73	18.5	0.80	20.3	1.06	27.0	1.31	33.3	1.40	35.6	477	710	1170	1750	259	
17496.815200*	1	2/0	4	0.77	19.5	0.84	21.3	1.10	27.9	1.35	34.3	1.44	36.6	564	839	1290	1920	298	
17496.815300*	1	3/0	3	0.82	20.8	0.88	22.4	1.15	29.2	1.40	35.6	1.49	37.9	711	1058	1470	2190	343	
17496.815400*	1	4/0	3	0.87	22.0	0.94	23.9	1.21	30.6	1.46	37.1	1.55	39.4	850	1265	1640	2450	397	
17496.816000*	1	250	2	0.93	23.5	0.99	25.2	1.28	32.5	1.53	38.9	1.63	41.4	1015	1511	1900	2830	440	
17496.816200*	1	350	1	1.07	27.2	1.15	29.2	1.43	36.3	1.71	43.5	1.81	46.0	1391	2070	2370	3530	543	
17496.816500*	1	500	1/0	1.14	29.0	1.23	31.2	1.54	39.1	1.83	46.5	1.93	49.1	1930	2872	3080	4590	678	
17496.817000*	1	750	2/0	1.32	33.6	1.41	35.9	1.78	45.2	2.07	52.6	2.17	55.2	2822	4200	4240	6320	872	
17496.817500*	1	1000	2/0	1.48	37.6	1.57	39.9	1.93	49.0	2.22	56.4	2.32	59.0	3609	5371	5280	7860	1040	

Dimensions and weights are nominal; subject to industry tolerances.

*Non-stock item, minimum runs apply. Please consult Customer Service for price and delivery.

**Ampacity is based on ICEA Publication P 46-426 for 15kV cables. Open circuit (shield/armor) is assumed. Ampacities at other voltage levels do not vary significantly.

Special approval by local electrical inspection authorities may be required (Ref. CE Code Part 1, Appendix B, Rule 4-004).



Phone: 888-593-3355
www.generalcable.com

HVTECK

TRXLPE/Wire Shield/PVC/AIA/PVC, Power, Shielded, Armored
15kV, CSA HVTECK, 133% Ins. Level, 220 Mils, Single Conductor

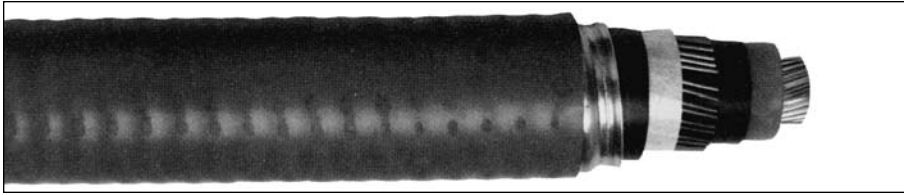

Features:

- Rated at 90°C wet or dry
- Excellent crush, oil and chemical resistance
- Provides long service life
- Cost-effective alternative to installations in conduit
- Meets cold bend and impact tests at -40°C

Compliances:

- CSA FT1 and FT4
- IEEE 383 (70,000 BTU/hr)
- UL 1581(70,000 BTU/hr)
- IEEE 1202 (70,000 BTU/hr) CSA FT4
- ICEA T-30-520 (70,000 BTU/hr)
- ICEA T-29-520 (210,000 BTU/hr)
- Hazardous location rating: HL
- CSA Standard C68.3
- CSA Standard C22.2 No. 174
- CSA Approval (file) numbers: LR27161
- Meets EPA 40 CFR, part 261 for leachable lead content per TCLP method
- OSHA acceptable

Packaging:

- For Canadian customers, lengths are provided on returnable wood or steel reels that require a deposit. Extra charges apply for lagging, pulling eyes, paralleling and plexing
- For U.S. customers, material cut to length and shipped on non-returnable wood reels, while lengths in excess of 10,000 lbs. are provided on returnable steel reels that require a deposit. Extra charges apply for cuts less than 1000 ft., lagging, pulling eyes, paralleling and plexing

Product Construction

Conductor:

- 2 AWG thru 1000 kcmil bare copper compact Class B strand

Strand Shield:

- A thermoset semi-conducting strand shield is extruded over the conductor

Insulation:

- Tree-Retardant Cross-Linked Polyethylene (TR-XLPE)

Insulation Shield:

- A semi-conducting thermosetting layer, applied in a triple extrusion process, plus a concentric serving of solid copper wires acting as both a drain wire shield and as a grounding (bonding) conductor
- Color-Coded: Black insulation shield

Ground (Bonding) Conductor:

- The conductor is a concentric serving of solid copper wires applied over the thermosetting insulation shield

Inner Jacket:

- Flame-retardant, moisture- and sunlight-resistant Polyvinyl Chloride (PVC)—Black

Armor:

- Aluminum Interlocked Armor (AIA)

Overall Jacket:

- ACID-FLAME-CHECK ✓✓® flame-retardant, moisture- and sunlight-resistant Polyvinyl Chloride (PVC)—Red

Print:

- GENERAL CABLE® 1/C SIZE (AWG OR KCMIL) COPPER CPT XLPE 15KV (133% INS LEVEL) ACID-FLAME-CHECK ✓✓® CSA HL HVTECK FT4 (-40°C) DIR BUR SUN RES MONTH/YEAR (LIGHTNING BOLT SYMBOL) SEQUENTIAL LENGTH MARK

Options:

- Other constructions available upon request

Applications:

- For wiring in all hazardous locations when used with certified HL cable glands
- For exposed and concealed wiring in dry, damp or wet locations
- For use in ventilated, non-ventilated and ladder-type cable trays in dry, damp or wet locations
- For direct earth burial (with protection as required by inspection authority)

CATALOG NUMBER	NO. OF COND.	COND. SIZE (AWG/ kcmil)	GROUND WIRE SIZE (AWG)	NOMINAL DIAMETER (OVER)										COPPER WEIGHT		NET WEIGHT W/AL ARMOR		AMPACITY** (40°C AMBIENT)	
				INSULATION		INSULATION SHIELD		INNER JACKET		ARMOR		CABLE		LBS/ 1000 FT	kg/ km	LBS/ 1000 FT	kg/ km		
				INCHES	mm	INCHES	mm	INCHES	mm	INCHES	mm	INCHES	mm						
2 AWG THRU 1000 kcmil—SINGLE CONDUCTOR—133% INS. LEVELS, 220 MILS INS. (5.59 mm)—15kV																			
17496.216500*	1	2	6	0.76	19.3	0.83	21.1	1.09	27.7	1.34	34.1	1.43	36.4	305	454	1028	1530	195	
17496.820100*	1	1	4	0.79	20.1	0.86	21.9	1.12	28.4	1.37	34.8	1.46	37.1	410	610	1170	1740	225	
17496.825100*	1	1/0	4	0.83	21.1	0.89	22.6	1.16	29.4	1.41	35.8	1.50	38.1	479	713	1270	1890	259	
17496.825200*	1	2/0	4	0.86	21.8	0.93	23.6	1.20	30.4	1.45	36.9	1.54	39.2	566	842	1390	2060	298	
17496.825300*	1	3/0	3	0.91	23.0	0.98	24.9	1.25	31.7	1.50	38.1	1.59	40.4	714	1063	1570	2340	343	
17496.825400*	1	4/0	3	0.96	24.3	1.03	26.2	1.30	33.0	1.58	40.2	1.68	42.7	854	1271	1780	2650	397	
17496.826000*	1	250	2	1.02	25.8	1.08	27.5	1.38	35.0	1.66	42.2	1.76	44.7	1020	1518	2010	2990	440	
17496.826200*	1	350	1	1.12	28.3	1.20	30.5	1.50	38.0	1.78	45.2	1.88	47.8	1396	2078	2490	3700	543	
17496.826500*	1	500	1/0	1.24	31.5	1.32	33.6	1.65	41.8	1.94	49.3	2.04	51.9	2828	4209	3220	4790	678	
17496.827000*	1	750	2/0	1.42	36.0	1.51	38.3	1.89	48.0	2.18	55.4	2.28	57.9	3616	5381	4390	6530	872	
17496.827500*	1	1000	2/0	1.57	39.9	1.68	42.6	2.05	52.1	2.34	59.5	2.48	63.0	8260	5550	5550	8260	1040	

Dimensions and weights are nominal; subject to industry tolerances.

*Non-stock item, minimum runs apply. Please consult Customer Service for price and delivery.

**Ampacity is based on ICEA Publication P 46-426 for 15kV cables. Open circuit (shield/armor) is assumed. Ampacities at other voltage levels do not vary significantly.

Special approval by local electrical inspection authorities may be required (Ref. CE Code Part 1, Appendix B, Rule 4-004).

HVTECK

TRXLPE/Tape Shield/PVC/AIA/PVC, Power, Shielded, Armored
15kV, CSA HVTECK, 100% Ins. Level, 175 Mils, Three Conductor

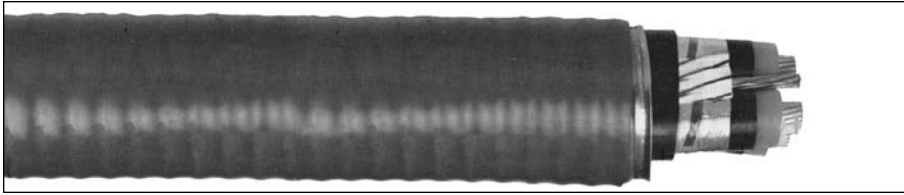

Features:

- Rated at 90°C wet or dry
- Excellent crush, oil and chemical resistance
- Provides long service life
- Cost-effective alternative to installations in conduit
- Meets cold bend and impact tests at -40°C

Compliances:

- CSA FT1 and FT4
- IEEE 383 (70,000 BTU/hr)
- UL 1581(70,000 BTU/hr)
- IEEE 1202 (70,000 BTU/hr) CSA FT4
- ICEA T-30-520 (70,000 BTU/hr)
- ICEA T-29-520 (210,000 BTU/hr)
- Hazardous location rating: HL
- CSA Standard C68.3
- CSA Standard C22.2 No. 174
- CSA Approval (file) numbers: LR27161
- Meets EPA 40 CFR, part 261 for leachable lead content per TCLP method
- OSHA acceptable

Packaging:

- For Canadian customers, lengths are provided on returnable wood or steel reels that require a deposit. Extra charges apply for lagging, pulling eyes, paralleling and plexing
- For U.S. customers, material cut to length and shipped on non-returnable wood reels, while lengths in excess of 10,000 lbs. are provided on returnable steel reels that require a deposit. Extra charges apply for cuts less than 1000 ft., lagging, pulling eyes, paralleling and plexing

Product Construction

Conductor:

- 2 AWG thru 1000 kcmil bare copper compact Class B strand

Strand Shield:

- A thermoset semi-conducting strand shield is extruded over the conductor

Insulation:

- Tree-Retardant Cross-Linked Polyethylene (TR-XLPE)

Insulation Shield:

- This consists of a semi-conducting thermosetting layer, applied in a triple extrusion process, plus a helically applied gapped copper tape
- Color-Coded: Black, Red or Blue colored tape placed longitudinally under the copper tape shield

Ground (Bonding) Conductor:

- The conductor consists of one uninsulated stranded bare copper conductor

Inner Jacket:

- Flame-retardant, moisture- and sunlight-resistant Polyvinyl Chloride (PVC)—Black

Armor:

- Aluminum Interlocked Armor (AIA)

Overall Jacket:

- ACID-FLAME-CHECK ✓✓® flame-retardant, moisture- and sunlight-resistant Polyvinyl Chloride (PVC)—Red

Print:

- GENERAL CABLE® 3/C SIZE (AWG OR KCMIL) COPPER CPT XLPE 15KV (100% INS LEVEL) ACID-FLAME-CHECK ✓✓® CSA HL HVTECK FT4 (-40°C) DIR BUR SUN RES MONTH/YEAR (LIGHTNING BOLT SYMBOL) SEQUENTIAL LENGTH MARK

Options:

- Galvanized Steel Interlocked Armor (GSIA)
- Other constructions available upon request

Applications:

- For wiring in all hazardous locations when used with certified HL cable glands
- For exposed and concealed wiring in dry, damp or wet locations
- For use in ventilated, non-ventilated and ladder-type cable trays in dry, damp or wet locations
- For direct earth burial (with protection as required by inspection authority)

CATALOG NUMBER	NO. OF COND.	COND. SIZE (AWG/ kcmil)	GROUND WIRE SIZE (AWG)	NOMINAL DIAMETER (OVER)										COPPER WEIGHT		NET WEIGHT W/ARMOR				AMPACITY** (40°C AMBIENT)
				INSULATION		INSULATION SHIELD		INNER JACKET		ARMOR		CABLE		LBS/ 1000 FT	kg/ km	LBS/1000 FT		kg/km		
				INCHES	mm	INCHES	mm	INCHES	mm	INCHES	mm	INCHES	mm			AL	STEEL	AL	STEEL	
2 AWG THRU 1000 kcmil—THREE CONDUCTOR—100% INS. LEVELS, 175 MILS INS. (4.45 mm)—15kV																				
17496.030200*	3	2	6	0.66	16.7	0.73	18.6	1.82	46.3	2.11	53.6	2.21	56.2	787	1171	2370	3220	3530	4790	164
17496.830100*	3	1	6	0.69	17.5	0.76	19.3	1.89	48.0	2.18	55.4	2.27	57.7	955	1421	2620	3490	3890	5190	187
17496.835100*	3	1/0	6	0.73	18.5	0.79	20.1	1.97	50.0	2.26	57.4	2.35	59.7	1163	1731	2900	3810	4320	5670	215
17496.835200*	3	2/0	6	0.77	19.5	0.84	21.3	2.06	52.3	2.34	59.5	2.46	62.5	1429	2127	3330	4280	4960	6370	246
17496.835300*	3	3/0	4	0.82	20.8	0.88	22.4	2.16	54.9	2.44	62.0	2.57	65.3	1812	2697	3840	4840	5720	7200	283
17496.835400*	3	4/0	4	0.87	22.0	0.93	23.7	2.27	57.7	2.56	65.1	2.68	68.1	2228	3316	4360	5410	6490	8050	325
17496.836000*	3	250	4	0.93	23.5	0.99	25.2	2.38	60.5	2.68	68.1	2.79	70.9	2598	3866	4880	5990	7260	8910	359
17496.836200*	3	350	3	1.06	26.9	1.15	29.2	2.73	69.4	3.02	76.7	3.14	79.8	3587	5338	6210	7430	9240	11060	438
17496.536500*	3	500	3	1.14	29.0	1.23	31.2	2.97	75.5	3.26	82.8	3.40	86.4	5013	7460	8549	9550	12721	14200	536
17496.837000*	3	750	2	1.32	33.6	1.41	35.9	3.35	85.1	3.64	92.5	3.77	95.8	7446	11081	11100	12640	16520	18810	669
17496.837500*	3	1000	1	1.47	37.4	1.56	39.6	3.72	94.5	3.97	100.8	4.17	105.9	9376	13953	13890	15580	20670	23180	770

Dimensions and weights are nominal; subject to industry tolerances.

*Non-stock item, minimum runs apply. Please consult Customer Service for price and delivery.

**Ampacity is based on ICEA Publication P 46-426 for 15kV cables. Ampacities at other voltage levels do not vary significantly.

Special approval by local electrical inspection authorities may be required (Ref. CE Code Part 1, Appendix B, Rule 4-004).

HVTECK

TRXLPE/Tape Shield/PVC/AIA/PVC, Power, Shielded, Armored
15kV, CSA HVTECK, 133% Ins. Level, 220 Mils, Three Conductor

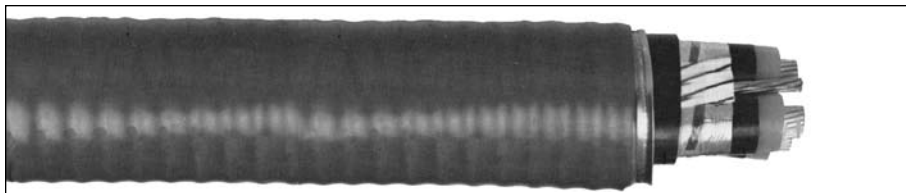

Features:

- Rated at 90°C wet or dry
- Excellent crush, oil and chemical resistance
- Provides long service life
- Cost-effective alternative to installations in conduit
- Meets cold bend and impact tests at -40°C

Compliances:

- CSA FT1 and FT4
- IEEE 383 (70,000 BTU/hr)
- UL 1581(70,000 BTU/hr)
- IEEE 1202 (70,000 BTU/hr) CSA FT4
- ICEA T-30-520 (70,000 BTU/hr)
- ICEA T-29-520 (210,000 BTU/hr)
- Hazardous location rating: HL
- CSA Standard C68.3
- CSA Standard C22.2 No. 174
- CSA Approval (file) numbers: LR27161
- Meets EPA 40 CFR, part 261 for leachable lead content per TCLP method
- OSHA acceptable

Packaging:

- For Canadian customers, lengths are provided on returnable wood or steel reels that require a deposit. Extra charges apply for lagging, pulling eyes, paralleling and plexing
- For U.S. customers, material cut to length and shipped on non-returnable wood reels, while lengths in excess of 10,000 lbs. are provided on returnable steel reels that require a deposit. Extra charges apply for cuts less than 1000 ft., lagging, pulling eyes, paralleling and plexing

Product Construction

Conductor:

- 2 AWG thru 750 kcmil bare copper compact Class B strand

Strand Shield:

- A thermoset semi-conducting strand shield is extruded over the conductor

Insulation:

- Tree-Retardant Cross-Linked Polyethylene (TR-XLPE)

Insulation Shield:

- This consists of a semi-conducting thermosetting layer, applied in a triple extrusion process, plus a helically applied gapped copper tape
- Color-Coded: Black, Red or Blue colored tape placed longitudinally under the copper tape shield

Ground (Bonding) Conductor:

- The conductor consists of one uninsulated stranded bare copper conductor

Inner Jacket:

- Flame-retardant, moisture- and sunlight-resistant Polyvinyl Chloride (PVC)—Black

Armor:

- Aluminum Interlocked Armor (AIA)

Overall Jacket:

- ACID-FLAME-CHECK ✓✓® flame-retardant, moisture- and sunlight-resistant Polyvinyl Chloride (PVC)—Red

Print:

- GENERAL CABLE® 3/C SIZE (AWG OR KCMIL) COPPER CPT XLPE 15KV (133% INS LEVEL) ACID-FLAME-CHECK ✓✓® CSA HL HVTECK FT4 (-40°C) DIR BUR SUN RES MONTH/YEAR (LIGHTNING BOLT SYMBOL) SEQUENTIAL LENGTH MARK

Options:

- Galvanized Steel Interlocked Armor (GSIA)
- Other options available upon request

Applications:

- For wiring in all hazardous locations when used with certified HL cable glands
- For exposed and concealed wiring in dry, damp or wet locations
- For use in ventilated, non-ventilated and ladder-type cable trays in dry, damp or wet locations
- For direct earth burial (with protection as required by inspection authority)

CATALOG NUMBER	NO. OF COND.	COND. SIZE (AWG/ kcmil)	GROUND WIRE SIZE (AWG)	NOMINAL DIAMETER (OVER)										COPPER WEIGHT		NET WEIGHT W/ARMOR				AMPACITY** (40°C AMBIENT)
				INSULATION		INSULATION SHIELD		INNER JACKET		ARMOR		CABLE		LBS/ 1000 FT	kg/ km	LBS/1000 FT		kg/km		
				INCHES	mm	INCHES	mm	INCHES	mm	INCHES	mm	INCHES	mm			AL	STEEL	AL	STEEL	

2 AWG THRU 750 kcmil—THREE CONDUCTOR—133% INS. LEVEL, 220 MILS INS. (5.59 mm)—15kV

17496.230200*	3	2	6	0.76	19.3	0.83	21.1	2.02	51.3	2.31	58.7	2.43	61.7	793	1180	2665	3518	3966	5235	164
17496.010100*	3	1	6	0.79	20.1	0.86	21.9	2.10	53.3	2.37	60.2	2.49	63.3	964	1435	3089	3930	4597	5850	187
17496.845100*	3	1/0	6	0.83	21.1	0.89	22.6	2.17	55.1	2.46	62.5	2.58	65.6	1175	1749	3300	4300	4900	6390	215
17496.015200*	3	2/0	6	0.86	21.8	0.93	23.6	2.26	57.3	2.55	64.8	2.67	67.8	1438	2140	3650	4690	5430	6980	246
17496.025300*	3	3/0	4	0.91	23.0	0.98	24.9	2.36	60.0	2.65	67.3	2.77	70.4	1821	2710	4140	5230	6160	7780	283
17496.035400*	3	4/0	4	0.96	24.3	1.03	26.2	2.47	62.8	2.76	70.1	2.88	73.2	2248	3345	4680	5810	6960	8650	325
17496.026000*	3	250	4	1.02	25.8	1.08	27.5	2.59	65.8	2.88	73.2	3.00	76.2	2607	3880	5275	6440	7850	9580	359
17496.046200	3	350	3	1.12	28.3	1.20	30.5	2.90	73.7	3.19	81.0	3.33	84.6	3597	5353	6842	8170	10181	12160	438
17496.056500	3	500	3	1.24	31.5	1.32	33.6	3.16	80.3	3.45	87.6	3.59	91.2	5022	7474	8513	10050	12668	14950	536
17496.037000	3	750	2	1.42	36.0	1.51	38.3	3.57	90.7	3.85	97.8	4.00	101.6	7452	11090	11507	13160	17122	19580	669

Dimensions and weights are nominal; subject to industry tolerances.

*Non-stock item, minimum runs apply. Please consult Customer Service for price and delivery.

**Ampacity is based on ICEA Publication P 46-426 for 15kV cables. Ampacities at other voltage levels do not vary significantly.

Special approval by local electrical inspection authorities may be required (Ref. CE Code Part 1, Appendix B, Rule 4-004).

HVTECK

TRXLPE/Tape Shield/PVC/AIA/PVC, Power, Shielded, Armored
25kV, CSA HVTECK, 100% Ins. Level, 260 Mils, Three Conductor

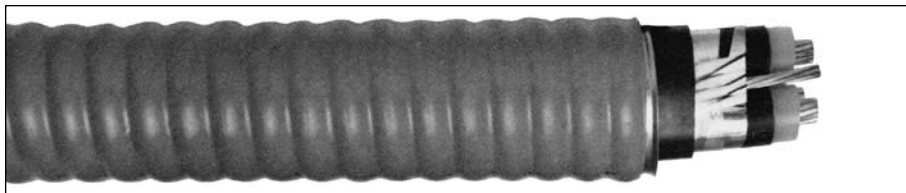

Features:

- Rated at 90°C wet or dry
- Excellent crush, oil and chemical resistance
- Provides long service life
- Cost-effective alternative to installations in conduit
- Meets cold bend and impact tests at -40°C

Compliances:

- CSA FT1 and FT4
- IEEE 383 (70,000 BTU/hr)
- UL 1581(70,000 BTU/hr)
- IEEE 1202 (70,000 BTU/hr) CSA FT4
- ICEA T-30-520 (70,000 BTU/hr)
- ICEA T-29-520 (210,000 BTU/hr)
- Hazardous location rating: HL
- CSA Standard C68.3
- CSA Standard C22.2 No. 174
- CSA Approval (file) numbers: LR27161
- Meets EPA 40 CFR, part 261 for leachable lead content per TCLP method
- OSHA acceptable

Packaging:

- For Canadian customers, lengths are provided on returnable wood or steel reels that require a deposit. Extra charges apply for lagging, pulling eyes, paralleling and plexing
- For U.S. customers, material cut to length and shipped on non-returnable wood reels, while lengths in excess of 10,000 lbs. are provided on returnable steel reels that require a deposit. Extra charges apply for cuts less than 1000 ft., lagging, pulling eyes, paralleling and plexing

Product Construction

Conductor:

- 1 AWG thru 500 kcmil bare copper compact Class B strand

Strand Shield:

- A thermoset semi-conducting strand shield is extruded over the conductor

Insulation:

- Tree-Retardant Cross-Linked Polyethylene (TR-XLPE)

Insulation Shield:

- This consists of a semi-conducting thermosetting layer, applied in a triple extrusion process, plus a helically applied gapped copper tape
- Color-Coded: Black, Red or Blue colored tape placed longitudinally under the copper tape shield

Ground (Bonding) Conductor:

- The conductor consists of one uninsulated stranded bare copper conductor

Inner Jacket:

- Flame-retardant, moisture- and sunlight-resistant Polyvinyl Chloride (PVC)—Black

Armor:

- Aluminum Interlocked Armor (AIA)

Overall Jacket:

- ACID-FLAME-CHECK ✓✓® flame-retardant, moisture- and sunlight-resistant Polyvinyl Chloride (PVC)—Black or as requested

Print:

- GENERAL CABLE® 3/C SIZE (AWG OR KCMIL) COPPER CPT XLPE 25KV (100% INS LEVEL) ACID-FLAME-CHECK ✓✓® CSA HL HVTECK FT4 (-40°C) DIR BUR SUN RES MONTH/YEAR (LIGHTNING BOLT SYMBOL) SEQUENTIAL LENGTH MARK

Options:

- Galvanized Steel Interlocked Armor (GSIA)
- Other constructions available upon request

Applications:

- For wiring in all hazardous locations when used with certified HL cable glands
- For exposed and concealed wiring in dry, damp or wet locations
- For use in ventilated, non-ventilated and ladder-type cable trays in dry, damp or wet locations
- For direct earth burial (with protection as required by inspection authority)

CATALOG NUMBER	NO. OF COND.	COND. SIZE (AWG/ kcmil)	GROUND WIRE SIZE (AWG)	NOMINAL DIAMETER (OVER)										COPPER WEIGHT		NET WEIGHT W/ARMOR				AMPACITY** (40°C AMBIENT)
				INSULATION		INSULATION SHIELD		INNER JACKET		ARMOR		CABLE		LBS/1000 FT	kg/km	LBS/1000 FT		kg/km		
				INCHES	mm	INCHES	mm	INCHES	mm	INCHES	mm	INCHES	mm			AL	STEEL	AL	STEEL	
1 AWG THRU 500 kcmil—THREE CONDUCTOR—100% INS. LEVEL, 260 MILS INS. (6.60 mm)—25kV																				
17496.850100*	3	1	6	0.87	22.1	0.94	23.9	2.26	57.5	2.55	64.8	2.67	67.8	973	1448	3250	4300	4840	6390	187
17496.855100*	3	1/0	6	0.91	23.1	0.97	24.6	2.34	59.5	2.63	66.8	2.74	69.6	1181	1758	3550	4630	5290	6890	215
17496.855200*	3	2/0	6	0.95	24.1	1.01	25.7	2.43	61.7	2.72	69.1	2.84	72.2	1446	2152	3930	5040	5850	7500	246
17496.855300*	3	3/0	4	0.99	25.1	1.06	26.9	2.54	64.5	2.82	71.6	2.94	74.7	1827	2719	4440	5600	6610	8340	283
17496.855400*	3	4/0	4	1.04	26.4	1.13	28.7	2.70	68.5	2.98	75.7	3.10	78.8	2249	3347	5090	6320	7580	9410	325
17496.856000*	3	250	4	1.10	27.9	1.18	30.1	2.87	72.9	3.16	80.3	3.29	83.6	2619	3898	5900	7220	8790	10750	359
17496.856200*	3	350	3	1.24	31.5	1.33	33.8	3.17	80.5	3.46	87.9	3.60	91.5	3606	5366	7180	8590	10680	12780	438
17496.856500*	3	500	3	1.32	33.5	1.41	35.8	3.34	84.9	3.63	92.2	3.76	95.5	5032	7489	8950	10480	13320	15590	536

Dimensions and weights are nominal; subject to industry tolerances.

*Non-stock item, minimum runs apply. Please consult Customer Service for price and delivery.

**Ampacity is based on ICEA Publication P 46-426 for 15kV cables. Ampacities at other voltage levels do not vary significantly.

Special approval by local electrical inspection authorities may be required (Ref. CE Code Part 1, Appendix B, Rule 4-004).

HVTECK

TRXLPE/Tape Shield/PVC/AIA/PVC, Power, Shielded, Armored
25kV, CSA HVTECK, 133% Ins. Level, 320 Mils, Three Conductor

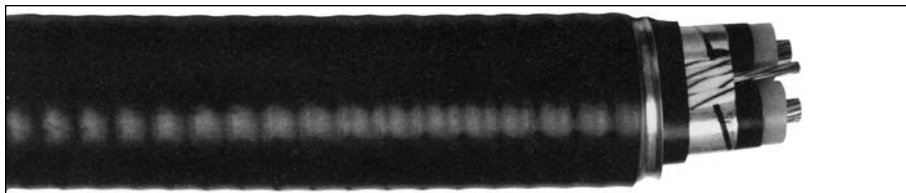

Features:

- Rated at 90°C wet or dry
- Excellent crush, oil and chemical resistance
- Provides long service life
- Cost-effective alternative to installations in conduit
- Meets cold bend and impact tests at -40°C

Compliances:

- CSA FT1 and FT4
- IEEE 383 (70,000 BTU/hr)
- UL 1581(70,000 BTU/hr)
- IEEE 1202 (70,000 BTU/hr) CSA FT4
- ICEA T-30-520 (70,000 BTU/hr)
- ICEA T-29-520 (210,000 BTU/hr)
- Hazardous location rating: HL
- CSA Standard C68.3
- CSA Standard C22.2 No. 174
- CSA Approval (file) numbers: LR27161
- Meets EPA 40 CFR, part 261 for leachable lead content per TCLP method
- OSHA acceptable

Packaging:

- For Canadian customers, lengths are provided on returnable wood or steel reels that require a deposit. Extra charges apply for lagging, pulling eyes, paralleling and plexing
- For U.S. customers, material cut to length and shipped on non-returnable wood reels, while lengths in excess of 10,000 lbs. are provided on returnable steel reels that require a deposit. Extra charges apply for cuts less than 1000 ft., lagging, pulling eyes, paralleling and plexing

Product Construction

Conductor:

- 1 AWG thru 350 kcmil bare copper compact Class B strand

Strand Shield:

- A thermoset semi-conducting strand shield is extruded over the conductor

Insulation:

- Tree-Retardant Cross-Linked Polyethylene (TR-XLPE)

Insulation Shield:

- This consists of a semi-conducting thermosetting layer, applied in a triple extrusion process, plus a helically applied gapped copper tape
- Color-Coded: Black, Red or Blue colored tape placed longitudinally under the copper tape shield

Ground (Bonding) Conductor:

- The conductor consists of one uninsulated stranded bare copper conductor

Inner Jacket:

- Flame-retardant, moisture- and sunlight-resistant Polyvinyl Chloride (PVC)—Black

Armor:

- Aluminum Interlocked Armor (AIA)

Overall Jacket:

- ACID-FLAME-CHECK ✓✓® flame-retardant, moisture- and sunlight-resistant Polyvinyl Chloride (PVC)—Black or as requested

Print:

- GENERAL CABLE® 3/C SIZE (AWG OR KCMIL) COPPER CPT XLPE 25KV (133% INS LEVEL) ACID-FLAME-CHECK ✓✓® CSA HL HVTECK FT4 (-40°C) DIR BUR SUN RES MONTH/YEAR (LIGHTNING BOLT SYMBOL) SEQUENTIAL LENGTH MARK

Options:

- Galvanized Steel Interlocked Armor (GSIA)
- Other constructions available upon request

Applications:

- For wiring in all hazardous locations when used with certified HL cable glands
- For exposed and concealed wiring in dry, damp or wet locations
- For use in ventilated, non-ventilated and ladder-type cable trays in dry, damp or wet locations
- For direct earth burial (with protection as required by inspection authority)

CATALOG NUMBER	NO. OF COND.	COND. SIZE (AWG/ kcmil)	GROUND WIRE SIZE (AWG)	NOMINAL DIAMETER (OVER)										COPPER WEIGHT		NET WEIGHT W/ARMOR				AMPACITY** (40°C AMBIENT)
				INSULATION		INSULATION SHIELD		INNER JACKET		ARMOR		CABLE		LBS/ 1000 FT	kg/ km	LBS/1000 FT		kg/km		
				INCHES	mm	INCHES	mm	INCHES	mm	INCHES	mm	INCHES	mm			AL	STEEL	AL	STEEL	
1 AWG THRU 350 kcmil—THREE CONDUCTOR—133% INS. LEVEL, 320 MILS INS. (8.13 mm)—25kV																				
17496.860100*	3	1	6	0.99	25.2	1.06	26.9	2.53	64.2	2.82	71.6	2.94	74.7	985	1466	3690	4850	5490	7210	187
17496.865100*	3	1/0	6	1.03	26.2	1.12	28.5	2.65	67.3	2.94	74.7	3.06	77.7	1193	1775	4110	5330	6120	7930	215
17496.865200*	3	2/0	6	1.07	27.2	1.16	29.5	2.74	69.6	3.03	77.0	3.15	80.0	1460	2173	4490	5740	6680	8540	246
17496.865300*	3	3/0	4	1.12	28.5	1.21	30.8	2.91	73.9	3.19	81.1	3.33	84.6	1842	2741	5270	6600	7840	9820	283
17496.865400*	3	4/0	4	1.17	29.8	1.26	32.0	3.02	76.7	3.31	84.1	3.44	87.4	2261	3365	5840	7220	8700	10740	325
17496.866000*	3	250	4	1.22	30.9	1.31	33.2	3.15	80.0	3.43	87.1	3.58	90.9	2629	3912	6440	7880	9590	11720	359
17496.866200*	3	350	3	1.37	34.8	1.45	36.9	3.44	87.4	3.73	94.8	3.88	98.6	3615	5380	7720	9250	11490	13770	438

Dimensions and weights are nominal; subject to industry tolerances.

*Non-stock item, minimum runs apply. Please consult Customer Service for price and delivery.

**Ampacity is based on ICEA Publication P 46-426 for 15kV cables. Ampacities at other voltage levels do not vary significantly. Special approval by local electrical inspection authorities may be required (Ref. CE Code Part 1, Appendix B, Rule 4-004).

HVTECK

TRXLPE/Tape Shield/PVC/AIA/PVC, Power, Shielded, Armored
28kV, CSA HVTECK, 133% Ins. Level, 345 Mils, Three Conductor

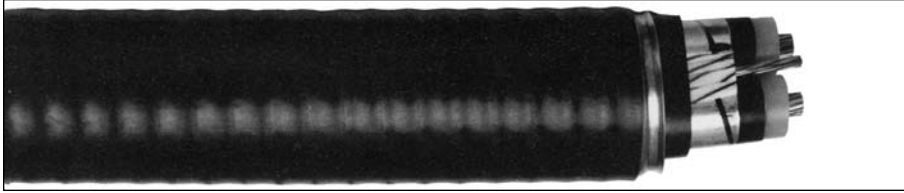

Features:

- Rated at 90°C wet or dry
- Excellent crush, oil and chemical resistance
- Provides long service life
- Cost-effective alternative to installations in conduit
- Meets cold bend and impact tests at -40°C

Compliances:

- CSA FT1 and FT4
- IEEE 383 (70,000 BTU/hr)
- UL 1581(70,000 BTU/hr)
- IEEE 1202 (70,000 BTU/hr) CSA FT4
- ICEA T-30-520 (70,000 BTU/hr)
- ICEA T-29-520 (210,000 BTU/hr)
- Hazardous location rating: HL
- CSA Standard C68.3
- CSA Standard C22.2 No. 174
- CSA Approval (file) numbers: LR27161
- Meets EPA 40 CFR, part 261 for leachable lead content per TCLP method
- OSHA acceptable

Packaging:

- For Canadian customers, lengths are provided on returnable wood or steel reels that require a deposit. Extra charges apply for lagging, pulling eyes, paralleling and plexing
- For U.S. customers, material cut to length and shipped on non-returnable wood reels, while lengths in excess of 10,000 lbs. are provided on returnable steel reels that require a deposit. Extra charges apply for cuts less than 1000 ft., lagging, pulling eyes, paralleling and plexing

Product Construction

Conductor:

- 1 AWG thru 350 kcmil bare copper compact Class B strand

Strand Shield:

- A thermoset semi-conducting strand shield is extruded over the conductor

Insulation:

- Tree-Retardant Cross-Linked Polyethylene (TR-XLPE)

Insulation Shield:

- This consists of a semi-conducting thermosetting layer, applied in a triple extrusion process, plus a helically applied gapped copper tape
- Color-Coded: Black, Red or Blue colored tape placed longitudinally under the copper tape shield

Ground (Bonding) Conductor:

- The conductor consists of one uninsulated stranded bare copper conductor

Inner Jacket:

- Flame-retardant, moisture- and sunlight-resistant Polyvinyl Chloride (PVC)—Black

Armor:

- Aluminum Interlocked Armor (AIA)

Overall Jacket:

- ACID-FLAME-CHECK ✓✓® flame-retardant, moisture- and sunlight-resistant Polyvinyl Chloride (PVC)—Black or as requested

Print:

- GENERAL CABLE® 3/C SIZE (AWG OR KCMIL) COPPER CPT XLPE 28KV (133% INS LEVEL) ACID-FLAME-CHECK ✓✓® CSA HL HVTECK FT4 (-40°C) DIR BUR SUN RES MONTH/YEAR (LIGHTNING BOLT SYMBOL) SEQUENTIAL LENGTH MARK

Options:

- Galvanized Steel Interlocked Armor (GSIA)
- Other constructions available upon request

Applications:

- For wiring in all hazardous locations when used with certified HL cable glands
- For exposed and concealed wiring in dry, damp or wet locations
- For use in ventilated, non-ventilated and ladder-type cable trays in dry, damp or wet locations
- For direct earth burial (with protection as required by inspection authority)

CATALOG NUMBER	NO. OF COND.	COND. SIZE (AWG)/ (kcmil)	GROUND WIRE SIZE (AWG)	NOMINAL DIAMETER (OVER)										COPPER WEIGHT		NET WEIGHT W/ARMOR				AMPACITY** (40°C AMBIENT)
				INSULATION		INSULATION SHIELD		INNER JACKET		ARMOR		CABLE		LBS/ 1000 FT	kg/ km	LBS/1000 FT		kg/km		
				INCHES	mm	INCHES	mm	INCHES	mm	INCHES	mm	INCHES	mm			AL	STEEL	AL	STEEL	
1 AWG THRU 350 kcmil—THREE CONDUCTOR—133% INS. LEVEL, 345 MILS INS. (8.76 mm)—28kV																				
17496.890100*	3	1	6	1.04	26.4	1.13	28.7	2.68	68.2	2.97	75.5	3.10	78.8	988	1470	3980	5210	5930	7750	187
17496.895100*	3	1/0	6	1.08	27.5	1.17	29.7	2.76	70.2	3.05	77.5	3.18	80.8	1200	1786	4360	5620	6490	8370	215
17496.895200*	3	2/0	6	1.12	28.5	1.21	30.8	2.92	74.2	3.21	81.6	3.36	85.4	1466	2182	4950	6280	7370	9350	246
17496.895300*	3	3/0	4	1.17	29.7	1.26	32.0	3.02	76.7	3.31	84.1	3.46	87.9	1848	2750	5490	6860	8160	10210	283
17496.895400*	3	4/0	4	1.22	31.0	1.31	33.3	3.14	79.6	3.43	87.2	3.58	90.9	2264	3369	6090	7510	9060	11180	325
17496.896000*	3	250	4	1.27	32.3	1.37	34.8	3.26	82.9	3.55	90.2	3.70	94.0	2635	3921	6660	8140	9910	12120	359
17496.896200*	3	350	3	1.42	36.1	1.51	38.4	3.56	90.5	3.85	97.8	4.00	101.6	3621	5389	7960	9540	11840	14190	438

Dimensions and weights are nominal; subject to industry tolerances.

*Non-stock item, minimum runs apply. Please consult Customer Service for price and delivery.

**Ampacity is based on ICEA Publication P 46-426 for 15kV cables. Ampacities at other voltage levels do not vary significantly.

Special approval by local electrical inspection authorities may be required (Ref. CE Code Part 1, Appendix B, Rule 4-004).

VERTITECK® TECK90

XLPE/PVC/GSIA/PVC, Power, Unshielded, Armored
1kV, CSA TECK90, Three Conductor

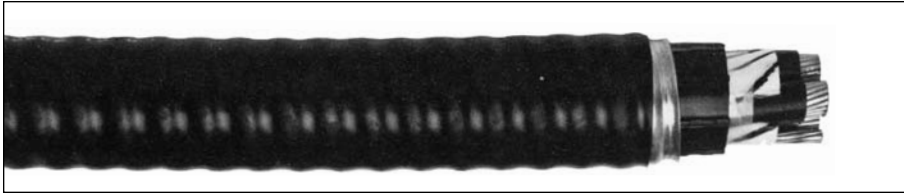

Features (cont'd.):

- Lighter than mine shaft cable with conventional steel wire armor (SWA)
- More flexible than SWA cables resulting in easier handling during installation
- Terminations and connections to electrical cabinets are similar to standard TECK90 cables
- Meets cold bend and impact tests at -40°C

Compliances:

- CSA FT1 and FT4
- IEEE 383 (70,000 BTU/hr)
- UL 1581 (70,000 BTU/hr)
- IEEE 1202 (70,000 BTU/hr)/CSA FT4
- ICEA T-30-520 (70,000 BTU/hr)
- Hazardous location rating: HL
- CSA Standard C22.2 No. 131 and No. 174
- CSA Approval (file) number: LR1781
- Meets EPA 40 CFR part 261 for leachable lead content per TCLP method
- OSHA acceptable

Packaging:

- For Canadian customers, lengths are provided on returnable wood or steel reels that require a deposit. Extra charges apply for lagging, pulling eyes, paralleling and plexing
- For U.S. customers, material cut to length and shipped on non-returnable wood reels, while lengths in excess of 10,000 lbs. are provided on returnable steel reels that require a deposit. Extra charges apply for cuts less than 1000 ft., lagging, pulling eyes, paralleling and plexing

Product Construction

Conductor:

- 1/0 AWG thru 1000 kcmil bare copper compact Class B strand

Insulation:

- Cross-Linked Polyethylene (XLPE) Type RW90
- Color-Coded: Printed numbers

Ground (Bonding) Conductor:

- The conductor consists of one uninsulated stranded bare copper conductor

Inner Jacket:

- Flame-retardant, moisture- and sunlight-resistant Polyvinyl Chloride (PVC) jacket with raised ribs—Black

Armor:

- Galvanized Steel Interlocked Armor (GSIA)

Overall Jacket:

- Acid-Flame-Check ✓✓® flame-retardant, moisture- and sunlight-resistant Polyvinyl Chloride (PVC)—Black

Print:

- GENERAL CABLE® ACID-FLAME-CHECK ✓✓® AG14 FT1 FT4 HL VERTITECK® GSIA XLPE (-40°C) 3/C SIZE (AWG OR KCMIL) 1000V DIR BUR SUN RES CSA MONTH-YEAR SEQUENTIAL LENGTH MARK

Options:

- Three ground (bonding) conductors
- Other constructions available upon request

Applications:

- For exposed and concealed wiring in dry, damp or wet locations
- For use in ventilated, non-ventilated and ladder-type cable trays in dry, damp, or wet locations
- For direct earth burial (with protection as required by inspection authority)
- For wiring in all hazardous locations when used with certified HL Cable glands
- Cost-effective alternative to installation in conduit
- Typical vertical installations include mine shafts, tall commercial buildings, inclined tunnels and vertical cable trays
(Note that the overall jacket is required for all damp and wet locations and for all corrosive environments: CE Code part 1 Rules 12-708 and 22-200)

Features:

- Rated at 90°C wet or dry
- The jacket under the armor (inner jacket) is designed with longitudinal raised ribs. The armor is then applied and bites into these ribs to provide a solidly locked construction. This feature enables the cable to be self-supporting (core will not slip) during vertical installation when cable weight is supported by the copper conductors

CATALOG NUMBER	NO. OF COND.	COND. SIZE (AWG/kcmil)	GROUND WIRE SIZE (AWG)	MIN. AVG. INSULATION THICKNESS		NOMINAL DIAMETER (OVER)						COPPER WEIGHT		NET WEIGHT W/STEEL ARMOR		AMPACITY** (30°C AMBIENT)	MAXIMUM SELF-SUPPORTING LENGTH***(m)
						INSULATION		ARMOR		CABLE							
						INCHES	mm	INCHES	mm	INCHES	mm	INCHES	mm	LBS/1000 FT	kg/km		
1/0 AWG THRU 1000 kcmil—THREE CONDUCTOR—1000V																	
11289.415100*	3	1/0	6	0.080	2.03	0.36	9.0	1.66	42.2	1.78	45.2	1082	1610	2520	3760	155	212
11289.415200*	3	2/0	6	0.080	2.03	0.54	13.8	1.75	44.5	1.87	47.5	1342	1997	2880	4280	185	232
11289.415300*	3	3/0	4	0.080	2.03	0.59	15.0	1.85	47.0	1.97	50.1	1719	2558	3360	5000	210	254
11289.415400*	3	4/0	4	0.080	2.03	0.64	16.3	1.96	49.8	2.08	52.9	2133	3174	4080	6080	235	260
11289.416000*	3	250	4	0.090	2.29	0.71	18.0	2.15	54.6	2.27	57.7	2498	3718	4790	7130	265	270
11289.416200*	3	350	3	0.090	2.29	0.81	20.4	2.36	60.0	2.50	63.5	2475	5171	6100	9080	325	288
11289.416500*	3	500	2	0.090	2.29	0.93	23.5	2.62	66.6	2.76	70.1	4891	7279	7900	11760	395	***
11289.417000*	3	750	2	0.090	2.29	1.10	27.9	2.99	76.0	3.13	79.5	7306	10873	10830	16110	500	***
11289.417500*	3	1000	1	0.090	2.29	1.25	31.8	3.38	85.6	3.54	89.9	9714	14456	13970	20780	585	***

Dimensions and weight are nominal; subject to industry tolerances.

*Non-stock item, minimum runs apply. Please consult Customer Service for price and delivery.

**Ampacity is based on CE Code Part 1: Table 2 (three conductors in raceway [conduit] and Rule 4-004.

***Maximum self-supporting lengths are based on safety factor of 5 and a tensile strength of 37,000 psi for soft drawn copper. Higher safety factors or lower tensile strength values may be required to address more stringent safety regulations.



VERTITECK® TECK90

XLPE/PVC/GSIA/PVC, Power, Unshielded, Armored
5kV, CSA TECK90, 90 Mils, Three Conductor

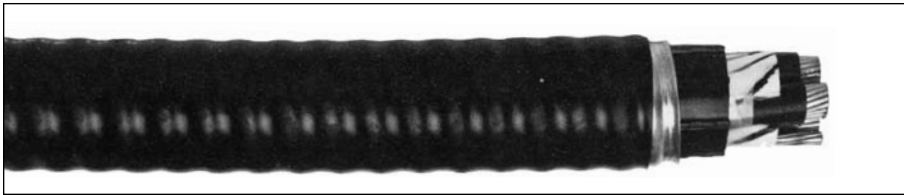

Product Construction

Conductor:

- 1/0 AWG thru 500 kcmil bare copper compact strand

Strand Shield:

- A thermoset semi-conducting strand shield is extruded over the conductor

Insulation:

- Cross-Linked Polyethylene (XLPE) Type RW90
- Color-Coded: Printed numbers

Ground (Bonding) Conductor:

- The conductor consists of one uninsulated stranded bare copper conductor

Inner Jacket:

- Flame-retardant, moisture- and sunlight-resistant Polyvinyl Chloride (PVC) jacket with raised ribs—Black

Armor:

- Galvanized Steel Interlocked Armor (GSIA)

Jacket:

- Acid-Flame-Check ✓✓® flame-retardant, moisture- and sunlight-resistant Polyvinyl Chloride (PVC)
- Color coded: Orange

Print:

- GENERAL CABLE® ACID-FLAME-CHECK ✓✓® AG14 FT1 FT4 HL VERTITECK® GSIA XLPE (-40°C) 3/C SIZE (AWG OR KCMIL) 5000V DIR BUR SUN RES CSA MONTH-YEAR SEQUENTIAL LENGTH MARK

Options:

- Three ground (bonding) conductors
- Other constructions available upon request

Applications:

- For exposed and concealed wiring in dry, damp or wet locations
- For use in ventilated, non-ventilated and ladder-type cable trays in dry, damp, or wet locations
- For direct earth burial (with protection as required by inspection authority)
- For wiring in all hazardous locations when used with certified HL Cable glands
- Cost-effective alternative to installation in conduit
- Typical vertical installations include mine shafts, tall commercial buildings, inclined tunnels and vertical cable trays
(Note that the overall jacket is required for all damp and wet locations and for all corrosive environments: CE Code part 1 Rules 12-708 and 22-200)

Features:

- Rated at 90°C wet or dry
- The jacket under the armor (inner jacket) is designed with longitudinal raised ribs. The armor is then applied and bites into these ribs to provide a solidly locked construction. This feature enables the cable to be self-supporting (core will not slip) during vertical installation when cable weight is supported by the copper conductors
- Lighter than mine shaft cable with conventional steel wire armor (SWA)
- More flexible than SWA cables resulting in easier handling during installation
- Terminations and connections to electrical cabinets are similar to standard TECK90 cables
- Meets cold bend and impact tests at -40°C

Compliances:

- CSA FT1 and FT4
- IEEE 383 (70,000 BTU/hr)
- UL 1581 (70,000 BTU/hr)
- IEEE 1202 (70,000 BTU/hr)/CSA FT4
- ICEA T-30-520 (70,000 BTU/hr)
- Hazardous location rating: HL
- CSA Standard C22.2 No. 131 and No. 174
- CSA Approval (file) number: LR1781
- Meets EPA 40 CFR part 261 for leachable lead content per TCLP method
- OSHA acceptable

Packaging:

- For Canadian customers, lengths are provided on returnable wood or steel reels that require a deposit. Extra charges apply for lagging, pulling eyes, paralleling and plexing
- For U.S. customers, material cut to length and shipped on non-returnable wood reels, while lengths in excess of 10,000 lbs. are provided on returnable steel reels that require a deposit. Extra charges apply for cuts less than 1000 ft., lagging, pulling eyes, paralleling and plexing

CATALOG NUMBER	NO. OF COND.	COND. SIZE (AWG/kcmil)	GROUND WIRE SIZE (AWG)	NOMINAL DIAMETER (OVER)						COPPER WEIGHT		NET WEIGHT W/STEEL ARMOR		AMPACITY** (30°C AMBIENT)	MAXIMUM SELF-SUPPORTING LENGTH*** (m)
				INSULATION		ARMOR		CABLE		LBS/1000 FT	kg/km	LBS/1000 FT	kg/km		
				INCHES	mm	INCHES	mm	INCHES	mm						
1/0 AWG THRU 500 kcmil—THREE CONDUCTOR—UNSHIELDED, 90 MILS INS. (2.29 mm)—5kV															
17497.055100*	3	1/0	6	0.56	14.2	1.77	45.0	1.87	47.5	1082	1610	2700	4020	155	200
17497.055200*	3	2/0	6	0.60	15.2	1.86	47.3	1.96	49.8	1343	1999	3060	4550	185	221
17497.055300*	3	3/0	4	0.65	16.4	1.97	50.0	2.07	52.6	1720	2560	3550	5280	210	240
17497.055400*	3	4/0	4	0.70	17.8	2.08	52.9	2.18	55.4	2315	3445	4290	6380	235	249
17497.056000*	3	250	4	0.75	19.1	2.25	57.2	2.35	59.7	2469	3674	4990	7430	265	251
17497.056200*	3	350	3	0.85	21.8	2.46	62.5	2.59	65.8	3476	5173	6340	9430	325	278
17497.056500*	3	500	2	0.98	24.9	2.72	69.1	2.85	72.4	4837	7198	8130	12100	395	230

Dimensions and weight are nominal; subject to industry tolerances.

*Non-stock item, minimum runs apply. Please consult Customer Service for price and delivery.

**Ampacity is based on CE Code Part 1: Table 2 (three conductors in raceway [conduit]) and Rule 4-004.

***Maximum self-supporting lengths are based on safety factor of 5 and a tensile strength of 37,000 psi for soft drawn copper. Higher safety factors or lower tensile strength values may be required to address more stringent safety regulations.

VERTITECK® HVTECK

TRXLPE/Tape Shield/PVC/GSIA/PVC, Power, Shielded, Armored
15kV, CSA HVTECK, 100% Ins. Level, 175 Mils, Three Conductor

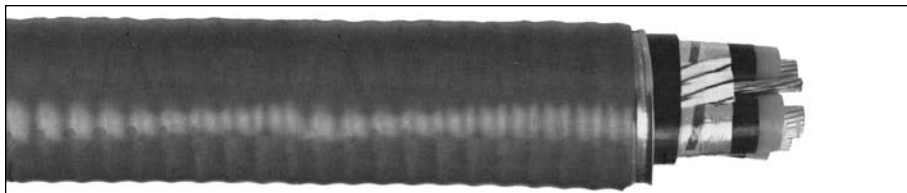

Features:

- Rated at 90°C wet or dry
- The jacket under the armor (inner jacket) is designed with longitudinal raised ribs. The armor is then applied and bites into these ribs to provide a solidly locked construction. This feature enables the cable to be self-supporting (core will not slip) during vertical installation when cable weight is supported by the copper conductors
- Lighter than mine shaft cable with conventional steel wire armor (SWA)
- More flexible than SWA cables resulting in easier handling during installation
- Terminations and connections to electrical cabinets are similar to standard TECK90 cables
- Meets cold bend and impact tests at -40°C

Product Construction

Conductor:

- 2 AWG thru 750 kcmil bare copper compact Class B strand

Strand Shield:

- A thermoset semi-conducting strand shield is extruded over the conductor

Insulation:

- Tree-Retardant Cross-Linked Polyethylene (TR-XLPE)

Insulation Shield:

- This consists of a semi-conducting thermosetting layer, applied in a triple extrusion process, plus a helically applied gapped copper tape
- Color Code: black, red, or blue colored tape placed longitudinally under the copper tape shield

Ground (Bonding) Conductor:

- The conductor consists of one uninsulated stranded bare copper conductor

Inner Jacket:

- Flame-retardant, moisture- and sunlight-resistant Polyvinyl Chloride (PVC)—Black

Armor:

- Galvanized Steel Interlocked Armor (GSIA)

Overall Jacket:

- ACID-FLAME-CHECK ✓✓® flame-retardant, moisture- and sunlight-resistant Polyvinyl Chloride (PVC)—Red

Print:

- GENERAL CABLE® ACID-FLAME-CHECK ✓✓® AG 14 FT1 FT4 HL VERTITECK® GSIA XLPE (-40°C) 3/C SIZE (AWG OR KCMIL) 15,000V DIR BUR SUN RES CSA MONTH-YEAR SEQUENTIAL LENGTH MARK

Options:

- Three ground (bonding) conductors

Applications:

- For exposed and concealed wiring in dry, damp or wet locations
 - For use in ventilated, non-ventilated and ladder-type cable trays in dry, damp or wet locations
 - For direct earth burial (with protection as required by inspection authority)
 - For wiring in all hazardous locations when used with certified HL Cable glands
 - Cost-effective alternative to installation in conduit
 - Typical vertical installations include mine shafts, tall commercial buildings, inclined tunnels and vertical cable trays
- (Note that the overall jacket is required for all damp and wet locations and for all corrosive environments: CE Code part 1 Rules 12-708 and 22-200)

Compliances:

- CSA FT1 and FT4
- IEEE 383 (70,000 BTU/hr)
- UL 1581(70,000 BTU/hr)
- IEEE 1202 (70,000 BTU/hr) CSA FT4
- ICEA T-30-520 (70,000 BTU/hr)
- ICEA T-29-520 (210,000 BTU/hr)
- Hazardous location rating: HL
- CSA Standard C68.3
- CSA Standard C22.2 No. 174
- CSA Approval (file) numbers: LR27161
- Meets EPA 40 CFR, part 261 for leachable lead content per TCLP method
- OSHA acceptable

Packaging:

- For Canadian customers, lengths are provided on returnable wood or steel reels that require a deposit. Extra charges apply for lagging, pulling eyes, paralleling and plexing
- For U.S. customers, material cut to length and shipped on non-returnable wood reels, while lengths in excess of 10,000 lbs. are provided on returnable steel reels that require a deposit. Extra charges apply for cuts less than 1000 ft., lagging, pulling eyes, paralleling and plexing

CATALOG NUMBER	NO. OF COND.	COND. SIZE (AWG/kcmil)	GROUND WIRE SIZE (AWG)	NOMINAL DIAMETER (OVER)								COPPER WEIGHT		NET WEIGHT		MAXIMUM SELF-SUPPORTING LENGTH** (M)
				INSULATION		INSULATION SHIELD		ARMOR		CABLE		LBS/1000 FT	kg/km	LBS/1000 FT	kg/km	
				INCHES	mm	INCHES	mm	INCHES	mm	INCHES	mm					
2 AWG THRU 750 kcmil—THREE CONDUCTOR—100% INS. LEVEL, 175 MILS INS. (4.45 mm)—15kV																
17497.440200*	3	2	6	0.67	17.0	0.72	18.3	2.30	58.4	2.46	62.5	845	1257	3761	5596	94
17497.440100*	3	1	6	0.70	17.8	0.76	19.3	2.37	60.2	2.53	64.3	1017	1513	4022	5985	110
17497.445100*	3	1/0	6	0.74	18.8	0.80	20.3	2.46	62.5	2.61	66.3	1229	1829	4385	6525	128
17497.445200*	3	2/0	6	0.78	19.8	0.84	21.3	2.55	64.8	2.71	68.8	1497	2228	4800	7142	147
17497.445300*	3	3/0	4	0.83	21.1	0.89	22.6	2.67	67.8	2.83	71.9	1882	2800	5354	7967	166
17497.445400*	3	4/0	4	0.88	22.4	0.94	23.9	2.79	70.9	2.95	74.9	2304	3428	5979	8897	188
17497.446000*	3	250	4	0.92	23.4	0.98	24.9	2.89	73.4	3.05	77.5	2677	3983	6518	9699	204
17497.446200*	3	350	3	1.02	25.9	1.09	27.7	3.15	80.0	3.33	84.6	3675	5468	8043	11968	231
17497.446500*	3	500	3	1.14	29.0	1.21	30.7	3.47	88.1	3.66	93.0	5111	7605	10132	15076	262
17497.447000*	3	750	2	1.32	33.5	1.39	35.3	3.86	98.0	4.04	102.6	7555	11242	13403	19944	298

Dimensions and weight are nominal; subject to industry tolerances.

*Non-stock item, minimum runs apply. Please consult Customer Service for price and delivery.

**Maximum self-supporting lengths are based on safety factor of 5 and a tensile strength of 37,000 psi for soft drawn copper. Higher safety factors or lower tensile strength values may be required to address more stringent safety regulations.



Phone: 888-593-3355
www.generalcable.com

ACWU

XLPE/AIA/PVC, Control, Armored
600V, CSA ACWU90 (-40°C), Single Conductor

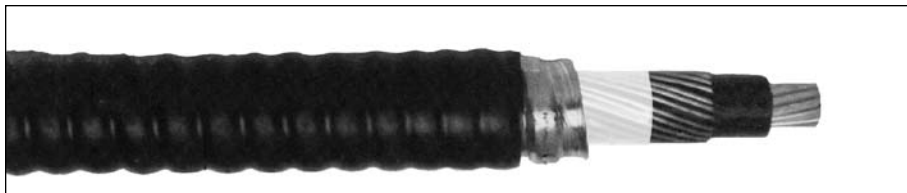

Product Construction

Conductor:

- 4/0 AWG thru 1000 kcmil bare ACM aluminum (8000 series Aluminum) compact Class B strand

Insulation:

- Cross-Linked Polyethylene (XLPE) Type RW90
- Color-coded: Black

Ground (Bonding) Conductor:

- The conductor is a concentric serving of solid bare aluminum (ACM) wires applied over the insulation

Armor:

- Aluminum Interlocked Armor (AIA)

Jacket:

- ACID-FLAME-CHECK ✓✓® flame-retardant, moisture- and sunlight-resistant Polyvinyl Chloride (PVC)—Black

Print:

- GENERAL CABLE® MI ACID-FLAME-CHECK ✓✓® AG14 FT4 HL ACWU90 XLPE (-40°C) 1/C SIZE (AWG OR KCMIL) AL 600V DIR BUR SUN RES CSA MONTH-YEAR SEQUENTIAL LENGTH MARK

Applications:

- For exposed and concealed wiring in dry, damp or wet locations
- For use in ventilated, non-ventilated and ladder-type cable trays in dry, damp or wet locations
- For direct earth burial (with protection as required by inspection authority)
- For wiring in all hazardous locations when used with certified HL Cable glands
- For service entrance installations

Features:

- Rated at 90°C wet or dry
- Excellent crush, oil and chemical resistance
- Provides long service life
- Cost-effective alternative to installations in conduit
- Meets cold bend and impact tests at -40°C

Compliances:

- CSA Standard C22.2 No. 51 and No. 174
- CSA FT1 and FT4
- IEEE 1202 (70,000 BTU/hr) CSA FT4
- IEEE 383 (70,000 BTU/hr)
- UL 1581 (70,000 BTU/hr)
- ICEA T-30-520 (70,000 BTU/hr)
- Hazardous location rating: HL
- Meets EPA 40 CFR, part 261 for leachable lead content per TCLP method
- OSHA acceptable

Packaging:

- For Canadian customers, nominal standard lengths are provided on returnable wood or steel reels that require a deposit. Extra charges apply for cut to length, lagging, pulling eyes, paralleling and plexing.

Note: Not for sale in the U.S.

CATALOG NUMBER	NO. OF COND.	COND. SIZE (AWG/kcmil)	GROUND WIRE SIZE (AWG)	MIN. AVG. INSULATION THICKNESS		NOMINAL DIAMETER (OVER)						ALUMINUM WEIGHT**		NET WEIGHT		AMPACITY*** (30°C AMBIENT)
						INSULATION		ARMOR		CABLE						
						INCHES	mm	INCHES	mm	INCHES	mm	INCHES	mm	LBS/1000 FT	kg/km	
4/0 AWG THRU 1000 kcmil—ONE CONDUCTOR—600V																
11281.015400	1	4/0	2	0.055	1.40	0.591	15.01	0.940	23.88	1.036	26.31	197	388	504	750	300
11281.016000	1	250	1	0.065	1.65	0.658	16.71	1.007	25.58	1.103	28.02	233	346	600	893	330
11281.016200	1	350	1/0	0.065	1.65	0.754	19.15	1.103	28.02	1.199	30.45	326	485	745	1107	415
11281.016500	1	500	2/0	0.065	1.65	0.872	22.15	1.221	31.01	1.317	33.45	467	695	952	1417	515
11281.016700	1	600	2/0	0.080	2.03	0.985	25.02	1.334	33.88	1.430	36.32	560	833	1099	1635	585
11281.017000	1	750	3/0	0.080	2.03	1.080	27.43	1.429	36.30	1.525	38.74	700	1042	1305	1942	670
11281.017500	1	1000	3/0	0.080	2.03	1.230	31.42	1.667	42.34	1.779	45.19	935	1392	1704	2536	800

Dimensions and weight are nominal; subject to industry tolerances.
 *Non-stock item, minimum runs apply. Please consult Customer Service for price and delivery.
 **Conductor and ground weight.
 ***Ampacity is based on CE Code Part 1: Table 3 (single conductor in free air) and Rule 4-004.

ACWU

XLPE/AIA/PVC, Control, Armored
600V, CSA ACWU90 (-40°C), Three Conductor

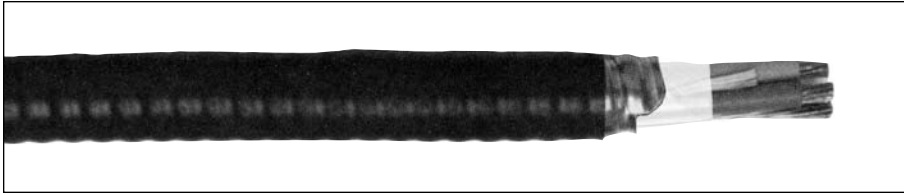

Product Construction

Conductor:

- 6 AWG thru 750 kcmil bare ACM aluminum (8000 series Aluminum) compact Class B strand

Insulation:

- Cross-Linked Polyethylene (XLPE) Type RW90
- Color-coded: 4 AWG to 2 AWG—Black, White and Red; 1/0 AWG to 750 kcmil—per ICEA Method 4 individual conductors colored Black with conductor number surface printed in contrasting ink

Ground (Bonding) Conductor:

- The conductor consists of one uninsulated stranded bare aluminum (ACM) conductor

Armor:

- Aluminum Interlocked Armor (AIA)

Jacket:

- ACID-FLAME-CHECK ✓✓[®] flame-retardant, moisture- and sunlight-resistant Polyvinyl Chloride (PVC)—Black

Print:

- GENERAL CABLE[®] MI ACID-FLAME-CHECK ✓✓[®] AG14 FT4 HL ACWU90 XLPE (-40°C)
3/C SIZE (AWG OR KCMIL) AL 600V DIR BUR
SUN RES CSA MONTH-YEAR SEQUENTIAL
LENGTH MARK

Applications:

- For exposed and concealed wiring in dry, damp or wet locations
- For use in ventilated, non-ventilated and ladder-type cable trays in dry, damp or wet locations
- For direct earth burial (with protection as required by inspection authority)
- For wiring in all hazardous locations when used with certified HL Cable glands
- For service entrance installations

Features:

- Rated at 90°C wet or dry
- Excellent crush, oil and chemical resistance
- Provides long service life
- Cost-effective alternative to installations in conduit
- Meets cold bend and impact tests at -40°C

Compliances:

- CSA Standard C22.2 No. 51 and No. 174
- CSA FT1 and FT4
- IEEE 1202 (70,000 BTU/hr) CSA FT4
- IEEE 383 (70,000 BTU/hr)
- UL 1581 (70,000 BTU/hr)
- ICEA T-30-520 (70,000 BTU/hr)
- Hazardous location rating: HL
- Meets EPA 40 CFR, part 261 for leachable lead content per TCLP method
- OSHA acceptable

Packaging:

- For Canadian customers, nominal standard lengths are provided on returnable wood or steel reels that require a deposit. Extra charges apply for cut to length, lagging and pulling eyes.

Note: Not for sale in the U.S.

CATALOG NUMBER	NO. OF COND.	COND. SIZE (AWG/kcmil)	GROUND WIRE SIZE (AWG)	MIN. AVG. INSULATION THICKNESS		NOMINAL DIAMETER (OVER)						ALUMINUM WEIGHT**		NET WEIGHT		AMPACITY*** (30°C AMBIENT)
						INSULATION		ARMOR		CABLE						
				INCHES	mm	INCHES	mm	INCHES	mm	INCHES	mm	LBS/1000 FT	kg/km	LBS/1000 FT	kg/km	
6 AWG THRU 750 kcmil—THREE CONDUCTOR—600V																
11281.030600	3	6	8	0.045	1.14	0.266	6.76	0.783	19.89	0.879	22.33	92	137	325	484	55
11281.030400	3	4	6	0.045	1.14	0.310	7.87	0.878	22.30	0.974	24.74	145	216	417	621	65
11281.030200	3	2	6	0.045	1.14	0.365	9.27	0.997	25.32	1.093	27.76	213	317	530	789	95
11281.035100	3	1/0	4	0.055	1.40	0.418	10.62	1.111	28.22	1.207	30.66	336	500	637	948	120
11281.035200	3	2/0	4	0.055	1.40	0.496	12.60	1.279	32.49	1.375	34.93	415	618	850	1265	145
11281.035300	3	3/0	4	0.055	1.40	0.543	13.79	1.380	35.05	1.476	37.49	513	763	996	1482	165
11281.035400	3	4/0	4	0.055	1.40	0.593	15.06	1.488	37.80	1.584	40.23	636	947	1161	1728	185
11281.036000	3	250	2	0.065	1.65	0.662	16.81	1.727	43.87	1.839	46.71	770	1146	1493	2222	215
11281.036200	3	350	2	0.065	1.65	0.757	19.23	1.931	49.05	2.043	51.89	1050	1562	1885	2805	260
11281.036500	3	500	1	0.065	1.65	0.878	22.30	2.192	55.68	2.304	58.52	1494	2223	2485	3698	330
11281.036700*	3	600	1	0.080	2.03	0.984	24.99	2.424	61.57	2.563	65.10	1791	2665	3035	4516	370
11281.037000	3	750	1/0	0.080	2.03	1.077	27.36	2.621	66.57	2.763	70.18	2221	3305	3597	5353	405

Dimensions and weight are nominal; subject to industry tolerances.
*Non-stock item, minimum runs apply. Please consult Customer Service for price and delivery.
**Conductor and ground weight.
***Ampacity is based on CE Code Part 1: Table 4 (three conductors in raceway [conduit]) and Rule 4-004.

ACWU

XLPE/AIA/PVC, Control, Armored 600V, CSA ACWU90 (-40°C), Four Conductor

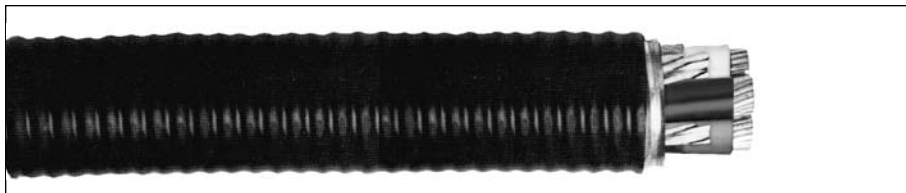

Product Construction

Conductor:

- 2 AWG thru 750 kcmil bare ACM aluminum (8000 series Aluminum) compact Class B strand

Insulation:

- Cross-Linked Polyethylene (XLPE) Type RW90
- Color-coded: 2 AWG—Black, White and Red; 1 AWG to 750 kcmil—per ICEA Method 4 individual conductors colored Black with conductor number surface printed in contrasting ink

Ground (Bonding) Conductor:

- The conductor consists of one uninsulated stranded bare aluminum (ACM) conductor

Armor:

- Aluminum Interlocked Armor (AIA)

Jacket:

- ACID-FLAME-CHECK ✓✓[®] flame-retardant, moisture- and sunlight-resistant Polyvinyl Chloride (PVC)—Black

Print:

- GENERAL CABLE[®] MI ACID-FLAME-CHECK ✓✓[®] AG14 FT4 HL ACWU90 XLPE (-40°C) 4/C SIZE (AWG OR KCMIL) AL 600V DIR BUR SUN RES CSA MONTH-YEAR SEQUENTIAL LENGTH MARK

Applications:

- For exposed and concealed wiring in dry, damp or wet locations
- For use in ventilated, non-ventilated and ladder-type cable trays in dry, damp or wet locations
- For direct earth burial (with protection as required by inspection authority)
- For wiring in all hazardous locations when used with certified HL Cable glands
- For service entrance installations

Features:

- Rated at 90°C wet or dry
- Excellent crush, oil and chemical resistance
- Provides long service life
- Cost-effective alternative to installations in conduit
- Meets cold bend and impact tests at -40°C

Compliances:

- CSA Standard C22.2 No. 51 and No. 174
- CSA FT1 and FT4
- IEEE 1202 (70,000 BTU/hr) CSA FT4
- IEEE 383 (70,000 BTU/hr)
- IEEE 1581 (70,000 BTU/hr)
- Hazardous location rating: HL
- Meets EPA 40 CFR, part 261 for leachable lead content per TCLP method
- OSHA acceptable

Packaging:

- For Canadian customers, nominal standard lengths are provided on returnable wood or steel reels that require a deposit. Extra charges apply for cut lengths, lagging and pulling eyes.

Note: Not for sale in the U.S.

CATALOG NUMBER	NO. OF COND.	COND. SIZE (AWG/kcmil)	GROUND WIRE SIZE (AWG)	MIN. AVG. INSULATION THICKNESS		NOMINAL DIAMETER (OVER)						ALUMINUM WEIGHT**		NET WEIGHT		AMPACITY*** (30°C AMBIENT)
						INSULATION		ARMOR		CABLE						
						INCHES	mm	INCHES	mm	INCHES	mm	INCHES	mm	LBS/1000 FT	kg/km	
2 AWG THRU 750 kcmil—FOUR CONDUCTOR—600V																
11281.040200	4	2	6	0.045	1.14	0.365	9.27	1.091	27.71	1.187	30.15	275	410	634	943	95
11281.040100	4	1	4	0.055	1.40	0.418	10.62	1.219	30.96	1.315	33.40	364	542	772	1149	105
11281.045100	4	1/0	4	0.055	1.40	0.456	11.58	1.311	33.30	1.407	35.74	435	648	869	1323	120
11281.045200	4	2/0	4	0.055	1.40	0.496	12.60	1.407	35.74	1.503	38.18	540	804	1037	1543	145
11281.045300	4	3/0	4	0.055	1.40	0.543	13.79	1.611	40.92	1.723	43.76	671	998	1337	1990	165
11281.045400	4	4/0	4	0.055	1.40	0.593	15.06	1.732	43.99	1.844	46.84	835	1243	1556	2316	185
11281.046000	4	250	2	0.065	1.65	0.662	16.81	1.898	48.21	2.010	51.05	1006	1497	1836	2732	215
11281.046200	4	350	2	0.065	1.65	0.757	19.23	2.127	54.03	2.239	56.87	1379	2052	2335	3475	260
11281.046500	4	500	1	0.065	1.65	0.878	22.30	2.419	61.44	2.561	65.05	1966	2925	3165	4710	330
11281.046700*	4	600	1	0.080	2.03	0.984	24.99	2.678	68.02	2.817	71.55	2362	3515	3773	5615	370
11281.047000	4	750	1/0	0.080	2.03	1.077	27.36	2.900	73.66	3.042	77.27	2929	4358	4482	6670	405

Dimensions and weight are nominal; subject to industry tolerances.
 *Non-stock item, minimum runs apply. Please consult Customer Service for price and delivery.
 **Conductor and ground weight.
 ***Ampacity is based on CE Code Part 1: Table 4 (three conductors in raceway [conduit]) and Rule 4-004.
 Ampacity of 4 conductor cable is based on 3 current-carrying conductors and 1 neutral.

Technical Information

Section A General Technical Information

SPECIFICATION NO.	DESCRIPTION	REVISION DATE
A005	Glossary	Jan. 2008
A025	Reference Standards	Jan. 2008
A050	Checklist for Specifications	Jan. 2008
A075	NEC and CSA Designations	Jan. 2008
A100	Common Color Sequence	Jan. 2008
A150	Metric Conversion Factors	Jan. 2008
A200	Reel Capacity Chart	Jan. 2008

Section B Conductor Data

SPECIFICATION NO.	DESCRIPTION	REVISION DATE
B005	Conductor Reference	Jan. 2008
B025	Class B Conductors for General Wiring	Jan. 2008
B030	Class C Conductors for General Wiring	Jan. 2008
B035	Class H Conductors for General Wiring	Jan. 2008
B040	Class I Conductors for General Wiring	Jan. 2008
B045	Class K Conductors for General Wiring	Jan. 2008

Section C Material Properties

SPECIFICATION NO.	DESCRIPTION	REVISION DATE
C005	Thermoplastic Jacket and Insulation Material Properties	Jan. 2008
C010	Thermoset Jacket and Insulation Material Properties	Jan. 2008

Section D Handling and Storage Recommendations

SPECIFICATION NO.	DESCRIPTION	REVISION DATE
D005	Recommended Reel Handling Practices	Jan. 2008
D025	Recommended Cable Handling Practices	Jan. 2009
D050	Recommended Cable Storage Practices	Jan. 2008

Technical Information

Section E Cable Installation Guidelines

SPECIFICATION NO.	DESCRIPTION	REVISION DATE
E005	Pre-Installation Instructions	Jan. 2008
E025	Installation — Overview and Checklist	Jan. 2008
E050	Installation — Feed-In Setups	Jan. 2008
E075	Installation — Conductor Maximum Pulling Tensions	Jan. 2008
E100	Installation — Training and Bending Limitations	Jan. 2008
E125	Installation — Maximum Sidewall Pressure	Jan. 2009

Section F Cable Testing

SPECIFICATION NO.	DESCRIPTION	REVISION DATE
F005	DC "HI-POT" Pre-Test Guidelines for MV Cables	Jan. 2008
F025	DC "HI-POT" Testing Guidelines for MV Cables	Jan. 2008
F075	Field Electrical "HI-POT" Testing Guidelines	Jan. 2008
F100	Emergency Overload Current Guidelines	Jan. 2008
F125	Short Circuit Current Calculation Overview	Jan. 2008
F150	Short Circuit Current for Copper Shields	Jan. 2008

Glossary

- Abrasion Resistance:** Ability of a wire, cable or material to resist surface wear.
- Accelerated Aging:** A test in which voltage, temperature, etc. are increased above normal operating values to obtain observable deterioration in a relatively short period of time. The plotted results give expected service life under normal conditions.
- ACM:** Aluminum conductor material.
- Accelerator:** A chemical additive that hastens a chemical reaction under specific conditions.
- Admittance:** The measure of the ease with which an alternating current flows in a circuit. The reciprocal of impedance.
- AEIC:** Association of Edison Illuminating Companies
- Aerial Cable:** A cable suspended in the air on poles or another overhead structure.
- Aging:** The change in properties of a material with time under specific conditions.
- AIA:** Aluminum Interlocked Armor.
- Alloy:** A metal formed by combining two or more different metals to obtain desirable properties.
- Alternating Current:** Electric current that continually reverses its direction. It is expressed in cycles per second (hertz or Hz).
- Ambient Temperature:** The temperature of the medium surrounding an object. Generally a lower temperature than the temperature at which the cable is operating.
- American Wire Gauge (AWG):** A standard North American system for designating wire diameter.
- Ampacity:** See Current Carrying Capacity.
- Ampere:** The unit of current. One ampere is the current flowing through one ohm of resistance at one volt potential.
- Analog:** A data format using continuous physical variables such as voltage amplitude or frequency variations.
- Anneal (Soften):** Relief of mechanical stress through heat and gradual cooling. Annealing copper renders it less brittle.
- Armor:** A protective metal covering commonly in the form of flexible interlocking aluminum or steel tape, steel wires or aluminum sheath.
- ASTM:** American Society for Testing and Materials.
- Attenuation:** The general term used to denote the decrease of power from one point to another. In fiber optics, the optical power loss per unit length is expressed logarithmically in decibels per kilometer (dB/km) at a specific wavelength.
- Audio Frequency:** The range of frequencies audible to the human ear. Usually 20-20,000 Hz.
- AWM:** Designation for appliance wiring material.
- Balanced Circuit:** One utilizing cables having two or more identical conductors with the same electromagnetic characteristics in relation to each other and to ground.
- Band Marking:** A continuous circumferential band applied to a conductor at regular intervals for identification.
- Bandwidth:** (1) The difference between the upper and lower limits of a given band of frequencies. Expressed in Hertz. (2) A measure of the maximum frequency range over which light intensity exiting a waveguide one kilometer in length can be varied before the attenuation varies 3dB from the mean. The greater the bandwidth, the greater the information-carrying capacity. Bandwidth is expressed in Megahertz (MHz)–Kilometer (km).
- Bending Radius:** Radius of curvature that a cable can be safely bent without any adverse effects.
- Binder:** A spirally served tape used for holding assembled cable components in place awaiting subsequent manufacturing operations.
- Bonding Conductor:** An insulated or uninsulated conductor forming part of the cable assembly which is used for the purpose of connecting non-current carrying parts of electrical equipment to a system grounding conductor.
- Braid:** A fibrous or metallic group of filaments interwoven in cylindrical shape to form a covering over one or more wires.
- Braid Angle:** The smaller of the two angles formed by the shielding strand and the axis of the cable being shielded.
- Braid Carrier:** A spool or bobbin on a braider that holds one group of strands or filaments consisting of a specific number of ends. The carrier revolves during braiding operations.
- Braid Ends:** The number of strands used to make up one carrier. The strands are wound side-by-side on the carrier bobbin and lie parallel in the finished braid.
- Breakdown Voltage:** The voltage at which the insulation between two conductors breaks down.
- B & S Gauge:** The same as American Wire Gauge (AWG).
- Buffer:** A protective coating over an optical fiber.
- Building Wire:** A general term used for light and power wiring products, 1000 volts or less.
- Bunch Stranding:** A group of wires of the same diameter twisted together without a predetermined pattern. Used in flexible cords and cables.
- Buried Cable:** A cable installed directly in the earth without use of underground conduit. Also called "direct burial cable."
- Butyl Rubber:** A synthetic rubber with good insulating properties (i.e. low voltage cords).

Glossary

- Cable:** An insulated conductor, or group of individually insulated conductors in one assembly.
- Cabling:** The twisting together of two or more insulated conductors to form a cable.
- Capacitance:** The ratio of the electrostatic charge on a conductor to the potential difference between the conductors required to maintain that charge. Units expressed in Farads.
- Capacitive Coupling:** Electrical interaction between two conductors caused by the capacitance between them.
- Capacitive Reactance (Xc):** The opposition to alternating current due to the capacitance of the cable or circuit. Measured in ohms.
- CE Code, CEC:** Canadian Electrical Code
- Certified Test Report (CTR):** A report providing actual test data on a cable. Tests are normally conducted by the Quality Control Department to confirm that the product being shipped conforms to specifications.
- Characteristic Impedance:** The impedance that, when connected to the output terminals of a transmission line of any length, makes the line appear infinitely long. The ratio of voltage to current at every point along a transmission line on which there are no standing waves.
- Circular Mil (cmil):** The area of a circle one mil (.001") in diameter (7.854×10^{-7} sq in). Used in expressing wire cross-sectional area.
- Circuit Sizes:** A popular term for building wire sizes 14 through 10 AWG.
- Cladding:** (1) A method of applying a layer of metal over another metal whereby the junction of the two metals is continuously welded. (2) A low refractive index material that surrounds the core of an optical fiber causing the transmitted light to travel down the core and protects against surface contaminant scattering.
- Coaxial Cable:** A cable consisting of two cylindrical conductors with a common axis, separated by a dielectric.
- Cold Flow:** Permanent deformation of the insulation or jacket due to mechanical force or pressure (not due to heat softening).
- Color Code:** A system for circuit identification through use of solid colors and contrasting tracers.
- Composite Cable:** One containing more than one type or gauge size of conductors (e.g. power and control conductors in one assembly).
- Compound:** An insulating or jacketing material made by mixing two or more polymeric ingredients.
- Concentric Stranded Conductors:** Manufactured to ASTM, ICEA and CSA standards. The most common fixed installation type conductors are: 1) Round—no diameter reduction; 2) Compressed—approximately 3% diameter reduction; 3) Compact—approximately 10% diameter reduction.
- Concentric Stranding:** A central wire surrounded by one or more layers of helically wound strands in a fixed round geometric arrangement.
- Concentricity:** The measurement of the location of the center of the conductor with respect to the geometric center of the surrounding insulation.
- Conductivity:** The capacity of a material to carry electrical current—usually expressed as a percentage of copper conductivity (copper being 100%).
- Conductor:** An uninsulated wire suitable for carrying electrical current.
- Conductor Shield:** An extrusion of black semi-conducting thermoses material over the conductor to provide a smooth interface with the insulation for even distribution of electrical stress.
- Conduit (Electrical Raceway):** A tube or pipe in which insulated wires and cables are run.
- Connector:** A device used to physically and electrically connect two or more conductors. Also used to physically connect cable to equipment.
- Continuity Check:** A test to determine whether electrical current flows continuously throughout the length of a single wire or individual wires in a cable.
- Continuous Vulcanization:** Simultaneous extrusion and vulcanization of rubber-like (thermoset) coating materials. Often referred to as CV.
- Control Cable:** A multi-conductor cable made for operation in control of signal circuits.
- Copolymer:** A compound resulting from the polymerization of two different monomers.
- Copperweld®:** The trade name of Flexo Wire Division (Copperweld Steel Corp.) for its copper-clad steel conductors.
- Cord:** A small, flexible, insulated wire or cable.
- Core:** In cables, a component or assembly of components over which additional components (shield, sheath, etc.) are applied.
- Corona:** A discharge due to ionization of air around a conductor due to a potential gradient exceeding a certain critical value.
- Coverage:** The percent of completeness with which a metal serving covers the underlying surface.
- CPE:** Chlorinated polyethylene can be used as either a thermoplastic or thermoset. It is a tough chemical- and oil-resistant material and makes an excellent jacket for industrial control cable. As a thermoset, it can be used as an oil-resistant cord jacket. Typical temperature ratings range from -35°C to 90°C. Other outstanding properties include low water absorption and super crush resistance, which are important attributes in industrial control applications.
- Creep:** The dimensional change with time of a material under a mechanical load.

Glossary

Cross-linked: Inter-molecular bonds between long-chain thermoplastic polymers by chemical or electron bombardment means. The properties of the resulting thermosetting material are usually improved (e.g. XLPE).

Crosstalk: Signal interference between nearby conductors caused by pickup of stray energy.

CSA: Canadian Standards Association

Current Carrying Capacity (Ampacity): The maximum current an insulated conductor can safely carry without exceeding its insulation and jacket temperature limitations.

Cut-Through Resistance: The ability of a material to withstand cutting from a sharp edge or small radius under pressure.

Decibel (dB): A unit to express differences of power level. Used to express power gain in amplifiers or power loss in passive circuits or cables. The units in which the ratio of two power levels, P_1 and P_2 , are expressed. The ratio in dB is given as $-10 \log_{10} (P_1/P_2)$.
 $P_2 \rightarrow \square \rightarrow P_1$

Delay Line: A cable made to provide very low velocity of propagation with long electrical delay for transmitted signals.

Derating Factor: A factor used to reduce the current carrying capacity of a wire when used in environments other than that for which the value was established.

Dielectric: Any insulating material between two conductors that permits electrostatic attraction and repulsion to take place across it.

Dielectric Constant (K): The ratio of the capacitance of a condenser with dielectric between the electrodes to the capacitance when air is between the electrodes. Also called Permittivity and Specific Inductive Capacity (SIC).

Dielectric Strength: The voltage which an insulation can withstand before breakdown occurs. Usually expressed as a voltage gradient (such as volts per mil).

Dielectric Test: A test in which a voltage higher than the rated voltage is applied for a specified time to determine the adequacy of the insulation under normal conditions. Sometimes called a "Hi-Pot" test (high potential).

Digital: A data format that uses discrete or separate physical levels to contain information.

Direct Burial Cable: A cable installed directly in the earth.

Direct Current: An electric current that flows in only one direction.

Direction of Lay: The lateral direction in which the strands of a conductor run over the top of the cable conductor as they recede from an observer looking along the axis of the conductor or cable. Also applies to twisted cable.

Dissipation Factor: The tangent of the loss angle of the insulating material. (Also referred to as loss tangent, $\tan \delta$ and approximate power factor.)

Drain Wire: The uninsulated wire in contact with an electrostatic shield throughout its length, in an instrumentation or control cable, used to discharge unwanted signals. Also provides a means of terminating laminated shields. Sometimes used to describe the metallic shielding wires of a power cable insulation shield.

Drawing: In wire manufacturing, pulling the metal through a die or series of dies to reduce diameter to a specified size.

Earth: British terminology for zero-reference "ground."

Eccentricity: Like concentricity, a measure of the center of a conductor's location with respect to the circular cross section of the insulation. Expressed as a percentage of displacement of one circle within the other.

EEMAC: Electrical and Electronic Manufacturers Association of Canada (U.S. counterpart is NEMA).

Elastomer: A rubber-like substance. Any material that will return to its original dimensions after being stretched or distorted.

Electrostatic Shield: A copper or laminated aluminum/Mylar® tape wrap around a signal or instrumentation circuit (pair, triad, etc.) to protect from the electric field radiated by a voltage source. The grounded shield intercepts static interference and carries it off to ground.

Elongation: The fractional increase in length of material stressed in tension.

EMI: Abbreviation for electromagnetic interference.

EMRC: Energy Mines and Resources Canada

EPDM: Ethylene-propylene-diene monomer rubber. A material with good electrical insulating properties.

EPR: Ethylene-propylene copolymer rubber. A material with good electrical insulating properties.

Equal Load Sharing: An even distribution of current between the parallel cables in a power circuit.

Equilay: See Unilay: More than one layer of helically laid wires with the length of the lay the same for each layer.

Farad: A unit of electrical capacity.

Fatigue Resistance: Resistance to metal crystallization which leads to conductors or wires breaking from flexing.

Ferrous: Composed of and/or containing iron. A ferrous metal exhibits magnetic characteristics (e.g. steel armor).

FEP: Fluorinated ethylene propylene insulated wire (see Teflon®).

Fiber: A single, separate optical transmission element characterized by core and cladding.

Fiber Optics: Light transmission through optical fibers for communication and signaling.

Glossary

Filled Cable: Cable construction in which the cable core is filled with a material that will prevent moisture or gasses from entering or passing through the cable.

Filler: 1) A material used in multi-conductor cables to occupy large interstices formed by the assembled conductors; 2) An inert substance added to a compound to improve properties.

Flat Cable: A cable with two essentially flat surfaces (e.g. NMD90).

Flat Conductor: A wire having a rectangular cross section as opposed to round or square conductors.

Flame Resistance: The ability of a material not to propagate flame once the heat source is removed (see FT1).

Flammability: The measure of the material's ability to support combustion.

Flex Life: The measurement of the ability of a conductor or cable to withstand repeated bending before breaking.

Flexibility: The ease with which a cable may be bent without sustaining damage.

FT1: One of several CSA flame test designations for wires and cables which pass the C22.2 No. 0.3 test requirements. (Other designations include FT2, FT4, etc.).

Fusion Splice: A splice accomplished by the application of localized heat sufficient to fuse or melt the ends of two lengths of optical fiber, forming a continuous single fiber.

Gauge: A term used to denote the physical size of a wire.

GND: Abbreviation for ground.

Graded-Index: A type of optical fiber in which the refractive index of the core is in the form of a parabolic curve, decreasing toward the cladding. This type of fiber provides high bandwidth capabilities.

Ground (GND): 1) A conducting connection between an electrical circuit and the earth, or other large conducting body, to serve as an earth thus making a complete electrical circuit; 2) Term used for non-current carrying conductor in a cable (see Bonding Conductor).

Halogen: A term used to identify any of the four elements chlorine, fluorine, bromine and iodine, grouped together because their chemical properties are similar.

Hard Drawn Copper Wire: Copper wire that has not been annealed after drawing.

Heat Shock: A test to determine stability of a material by sudden exposure to a high temperature for a short period of time.

Henry: The unit of inductance.

Hertz (Hz): A term replacing cycles-per-second as an indication of frequency.

Hi-Pot (High Potential): A test designated to determine the highest voltage that can be applied to a conductor without breaking down the insulation (see Dielectric Test).

High Voltage (HV): Generally, a wire or cable with an operating voltage of over 600 volts.

Hook-Up Wire: A wire used for low current, low voltage (under 1000 volts) applications within enclosed electronic equipment.

Hygroscopic: A material capable of absorbing moisture from the air.

Hypalon®: DuPont's trade name for their chlorosulfonated polyethylene, an ozone-resistant synthetic rubber.

ICEA (formerly IPCEA): Insulated Cable Engineers Association.

IEEE: Institute of Electrical and Electronics Engineers.

Impact Strength: A test for determining the mechanical punishment a cable can withstand without physical or electrical breakdown by impacting with a given weight, dropped a given distance, in a controlled environment.

Impedance: The total opposition that a circuit offers to the flow of alternating current or any other varying current at a particular frequency. It is a combination of resistance R and reactance X, measured in ohms.

Inductance: The property of a circuit or circuit element that opposes a change in current flow, thus causing current changes to lag behind voltage changes. It is measured in henrys.

Insulation: A material having good dielectric properties permitting close assembly of conductors in cable and equipment.

Insulation Level: A designation used to identify the insulation thickness required to protect a high voltage cable under ground fault conditions. Expressed as a percentage (e.g. 100% level, 133% level).

Insulation Shield (HV Cable): A two-part shield consisting of a non-metallic component and a metallic component. The first component is an extrusion of black semi-conducting thermoset material over the insulation, which provides uniform radial stress distribution across the insulation. The second component is a metallic shield which is typically copper tape or wire that functions as a bonding (grounding) conductor and/or a neutral conductor. The metallic shield also serves to conduct ground fault current in the event of insulation failure. See also Drain Wire.

Insulation Stress: High voltage stress which causes molecular separation in the insulation at sharp projections in the conductor. Controlled by conductor and insulation shielding, called a stress relief shield. Measured in volts per mil.

Interaxial Spacing: Center-to-center conductor spacing.

Interstices: Voids or valleys between individual strands in a conductor or between insulated conductors in a multi-conductor cable (interstitial spaces).

Glossary

- Irradiation:** In insulations, the exposure of the material to high energy emissions for the purpose of favorably altering the molecular structure by crosslinking.
- Jacket:** An outer covering, usually non-metallic, mainly used for protection against the environment.
- kcmil:** One thousand circular mils (MCM).
- kilo:** A prefix denoting 1000 (10^3).
- kV:** Kilovolt (1000 volts).
- Laminated Tape:** A tape consisting of two or more layers of different materials bonded together (e.g. aluminum/ Mylar®).
- Lay:** The length measured along the axis of a wire or cable required for a single strand (in stranded wire) or conductor (in cable) to make one complete turn about the axis of the conductor or cable.
- Lay Direction:** The twist in the cable as indicated by the top strands while looking along the axis of the cable away from the observer. Described as "right hand" or "left hand."
- Leakage Current:** The undesirable flow of current through or over the surface of an insulation.
- Line Drop (Voltage Drop):** A voltage loss occurring between any two points in a power circuit. Such loss, or drop, is due to the resistance, reactance or leakage of the circuit, type of cable and configuration.
- Line Voltage:** The value of the potential existing on a supply or power line. Rated voltage of cables.
- LOCA:** Abbreviation for loss of coolant accident, a system malfunction associated with nuclear generating stations.
- Longitudinal Shield:** A tape shield, flat or corrugated, applied longitudinally with the axis of the core being shielded.
- Loss Factor:** The product of the dissipation and dielectric constant of an insulating material.
- µA. Microampere:** One-millionth of an ampere (10^{-6}).
- mA. Milliampere:** One-thousandth of an ampere (10^{-3}).
- Magnetic Noise:** Caused by current frequency. An AC powerline creates a magnetic field around that cable, this magnetic field causes the magnetic noise in neighboring control or instrumentation circuits.
- MCM:** One thousand circular mils (kcmil).
- meg or mega:** A prefix denoting 1,000,000 (10^6).
- Megarad:** A unit for measuring radiation dosage.
- Messenger:** The linear supporting member, usually a high-strength steel wire, used as the supporting element of a suspended aerial cable. The messenger may be an integral part of the cable, or exterior to it.
- Mho:** The unit of conductivity. The reciprocal of an ohm.
- micro:** A prefix denoting one-millionth (10^{-6}).
- micron:** (m) Millionth of a meter = 10^{-6} meter.
- Mil:** A unit of length equal to one-thousandth of an inch (.001"). Common unit for insulation thickness.
- Milli:** A prefix denoting one-thousandth (10^{-3}).
- Modulus of Elasticity:** The ratio of stress to strain in an elastic material.
- Moisture Absorption:** The amount of moisture, in percentage, that a material will absorb under specified conditions.
- Moisture Resistance:** The ability of a material to resist absorbing moisture from the air or when immersed in water.
- Multi-Conductor Cable:** A cable consisting of two or more conductors, either cabled or laid in a flat parallel construction, with or without a common overall covering.
- Multi-Plexed Conductors:** Three or more completed cables together without fillers or common overall jacket. (Triplexed, 3-1|C; Quadruplet, 4-1|C)
- Mutual Capacitance:** Capacitance between two conductors when all other conductors, including ground, are connected together.
- Mylar®:** DuPont trade name for a polyester material.
- Nano:** A numerical prefix denoting one-billionth (10^{-9}).
- National Electrical Code (NEC):** A U.S. consensus standard published by the National Fire Protection Association (NFPA) and incorporated in OSHA regulations. (Canadian Counterpart is the CE Code).
- NEMA:** National Electrical Manufacturers Association. (Canadian counterpart is EEMAC).
- Neoprene:** A synthetic rubber with good resistance to oil, chemicals and flame. Also called polychloroprene.
- Nomex®:** DuPont trademark for a temperature-resistant, flame-retardant nylon.
- Non Hygroscopic:** A material incapable of taking up or absorbing moisture from the air.
- Nylon®:** An abrasion-resistant thermoplastic with good chemical resistance. A DuPont registered trademark.
- OHM:** The electrical unit of resistance.
- OSHA:** Abbreviation for the U.S. Occupational Safety and Health Act.
- Overlap:** The amount the trailing edge laps over the leading edge of a spiral tape wrap.
- Oxygen Index:** Percentage of oxygen necessary to support combustion in a gas mixture. Flame-retardant materials have a higher oxygen index.
- Pair:** Two insulated wires of a single circuit twisted together or laid parallel.
- Parallel Cable:** Two or more cables used to share the current in heavily loaded power circuits which permits the use of smaller conductors.

Glossary

- Percentage Conductivity:** Conductivity of a material expressed as a percentage of that of copper. Also used to indicate ratio of conductance between the phase conductor and the neutral in power cables.
- Pick:** Distance between two adjacent crossover points of braid filaments. The measurement in picks per inch indicates the degree of coverage.
- pico:** A prefix denoting one-millionth of one-millionth (10^{-12}).
- Pitch:** In flat cable, the nominal distance between the index edges of two adjacent conductors.
- Pitch Diameter:** Diameter of a circle passing through the center of the conductors in any layer of a multi-conductor cable.
- Plastic Deformation:** Change in dimensions under load that is not recovered when the load is removed.
- Plasticizer:** A chemical agent added to plastics to make them softer and more pliable.
- Plenum Cable:** Cable approved for installation in plenums, (e.g. suspended ceiling) without the need for conduit.
- Polyester:** Polyethylene terephthalate which is used extensively in the production of a high-strength, moisture-resistant film used as a cable core wrap (see Mylar®).
- Polyethylene (PE):** A thermoplastic material having excellent electrical and physical properties.
- Polymer:** A material of high molecular weight formed by the chemical union of monomers.
- Polyolefin:** A family of thermoplastics based upon the unsaturated hydrocarbons known as olefins. When combined with butylene or styrene polymers, they form compounds such as polyethylene and polypropylene.
- Polypropylene (PPE):** A thermoplastic similar to polyethylene but stiffer and having a higher softening point (temperature).
- Polyurethane/PUR:** This thermoplastic material is used primarily as a cable jacket material. It has excellent oxidation, oil and ozone resistance. Some formulations also have good flame resistance. It is a hard material with excellent abrasion resistance. It has outstanding “memory” properties, making it an ideal jacket material for retractile cords.
- Polyvinyl Chloride (PVC):** A general-purpose thermoplastic used for low voltage wire and cable insulation, and for jackets.
- Power Factor:** The ratio of resistance to impedance. The ratio of the actual power of an alternating current to apparent power. Mathematically, the cosine of the angle between the voltage applied and the current resulting.
- Primary Insulation:** The first layer of non-conductive material applied over a conductor, whose prime function is to act as electrical insulation.
- Pulling Eye:** A device fastened to a cable to which a hook may be attached in order to pull the cable.
- Quad:** Four insulated wires of a single circuit.
- REA:** Rural Electrification Administration. A branch of the U.S. Department of Agriculture.
- Reactance:** The opposition offered to the flow of alternating current by inductance or capacitance of a component or circuit.
- Reel Drum Diameter:** Diameter of the drum (or hub) of the reel.
- Reel Flange Diameter (Reel Height):** Diameter of the reel flanges.
- Reel Traverse:** Width of space between reel flanges.
- Reel Width:** Overall width of reel.
- Ridge Marker:** One or more ridges running laterally along the outer surface of an insulated wire or cable for purposes of identification.
- Root Mean Square (RMS):** The effective value of an alternating current or voltage.
- Rope Lay Conductor:** A conductor composed of a central core surrounded by one or more layers of helically laid groups of wires used in portable cables.
- Rubber:** A general term used to describe wire insulation and jackets made of thermosetting elastomers, such as natural or synthetic rubbers, EPR, neoprene, Hypalon, butyl rubber and others.
- SBR:** A copolymer of styrene and butadiene. Also GR-S or Buna-S. Most commonly used type of synthetic rubber.
- Self-Extinguishing:** The characteristic of a material whose flame is extinguished after the igniting flame is removed.
- Semi-Conductor:** In wire industry terminology, a material possessing electrical conductivity that falls somewhere between that of conductors and insulators. Usually made by adding carbon particles to an insulator (e.g. conductor shield and insulation shield). Not the same as semi-conductor materials such as silicon, germanium, etc. used for making transistors and diodes.
- Separator:** Pertaining to wire and cable, a layer of insulating material such as textile paper, Mylar®, etc. which is placed between a conductor and its dielectric, between a cable jacket and the components it covers or between various components of a multi-conductor cable. It can be utilized to improve stripping qualities, flexibility or can offer additional mechanical or electrical protection to the components it separates.
- Served Wire Armor (SWA):** Spiral wrap of galvanized steel wires applied around a cable to afford mechanical protection and increase the cable pulling tension characteristics (mineshaft, submarine cable, etc.). Also used to denote steel wire armor.
- Sheath:** The outer covering or jacket of a multi-conductor cable. Usually non-metallic.

Glossary

Shield (Electrostatic): In cables, a metallic layer placed around a conductor or group of conductors to prevent electrostatic interference between the enclosed wires and external fields. Also see Insulation Shield.

Shrink Tubing: Tubing which has been extruded, crosslinked and mechanically expanded which, when reheated, will return to its original diameter.

SIA: Steel Interlocked Armor.

Side Wall Bearing Pressure (SWBP): A term used in reference to the pressure on a cable which is being pulled around a curved surface under tension. If excessive, SWBP can damage cable components and reduce the life of the cable.

Signal Cable: A cable designed to carry current of usually less than one ampere per conductor to operate signal circuit devices.

Silicone: A material made from silicone and oxygen. Can be in thermosetting elastomer or liquid form. The thermosetting elastomer form is noted for high heat resistance.

Skin Effect: The tendency of alternating current to concentrate and to travel only on the surface of a conductor. Tendency increases with increase in frequency.

Sleeving: An extruded tube.

Spark Test: A test designed to locate imperfections (usually pin-holes) in the insulation of a wire or cable by application of voltage for a very short period of time while the wire is being drawn through the electrode field.

Specific Gravity: The ratio of the density (mass per unit volume) of a material to that of water.

Specific Inductive Capacity (SIC): Same as dielectric constant. See Dielectric Constant.

Tank Test: A voltage insulation test in which the insulated wire or cable is submerged in water and voltage is applied between the conductor and water serving as ground. Shielded cables are generally not tank tested due to the possibility of introducing contaminants on the outer surface of the insulation.

Teflon®: DuPont Company trademark for fluorocarbon resins. See FEP and TFE.

Temperature Rating: The maximum temperature at which an insulating material may be used in continuous operation without loss of its basic properties (i.e. operating, overload, short circuit). The minimum temperature for safe handling.

Tensile Strength: The pull stress required to break a given specimen. Measured in pounds per square inch. Also referred to as Ultimate Tensile Strength.

TFE: Tetrafluoroethylene. A thermoplastic material with good electrical insulating properties and chemical and heat resistance.

Thermoplastic: A material that can be softened repeatedly by heating and hardened by cooling through a temperature range characteristic of the plastic, and that in the softened state can be shaped by molding or extrusion.

Thermoset: A material that has been vulcanized by heat or other means and is substantially infusible and insoluble.

Three-Conductor Cable: Three insulated conductors assembled with other necessary cable components (shield, filler, etc.) to form a core, protected by an overall jacket.

Tinned Copper: Tin coating added to copper to aid in soldering and inhibit corrosion.

Tray: A cable tray system is a unit or assembly of units or sections, and associated fittings, made of non-combustible materials forming a rigid structural system used to support cables. Cable tray systems (previously termed Continuous Rigid Cable Supports) include ladders, troughs, channels, solid bottom trays and similar structures.

Tray Cable: A factory-assembled multi-conductor or multi-pair control, signal or power cable specifically approved under the Canadian Electrical Code for installation in trays.

Triad: Three insulated wires of a single circuit forming a unit. (Two or more units are cabled to form a multi-triad cable.)

Triplexed Cable: Three individual cables twisted together without fillers or a common overall jacket.

UL: Underwriters Laboratories. A non-profit independent organization, which operates a listing service for electrical and electronic materials and equipment. (Canadian counterpart is CSA).

UHF: Abbreviation for ultra high frequency, 300 to 3,000 MHz.

Unilay: A conductor with more than one layer of helically laid wires with the direction of lay and length of lay the same for all layers.

Velocity of Propagation: The speed of an electrical signal down a length of cable compared to speed in free space expressed as a percent. It is the reciprocal of the square root of the dielectric constant of the cable insulation.

VHF: Abbreviation for very high frequency, 30 to 300 MHz.

Voltage: The term most often used in place of electromotive force, potential, potential difference or voltage drop to designate the electric pressure that exists between two points and is capable of producing a current when a closed circuit is connected between two points.

Glossary

Voltage Rating: 1) The highest voltage that can be continuously applied to a wire in conformance with the standard or specification; 2) The “system” voltage printed on the wire or cable.

Volume Resistivity: The electrical resistance between opposite faces of a one cm. cube of insulating material, commonly expressed in ohms-meter.

Vulcanization: An irreversible process during which a compound, through a change in its chemical structure (e.g. cross-linking), becomes less plastic and more resistant to swelling by organic liquids and elastic properties are conferred, improved or extended over a greater range of temperatures.

VW-1: A flammability rating established by Underwriters Laboratories for wires and cables that pass a specially designed vertical flame test, formerly designated FR-1. Similar to CSA designation FT1.

Watt: A unit of electric power.

Wicking: The longitudinal flow of a liquid in a wire or cable due to capillary action.

Wire: A conductor; bare or insulated.

Yield Strength: The minimum stress at which a material will start to physically deform without further increase in load.

Reference Standards

AAR S-501: Specification for Wire and Cables

AAR 581.3: Specification for Single Conductor, Clean Stripping Rubber Insulated, 0-600 Volts, Neoprene Jacketed Cable for Locomotive and Car Equipment

AAR 589: Specification for Single Conductor Chlorosulfonated Polyethylene Integral Insulated-Jacketed, 0-300V, 0-600V Cable for Locomotive and Car Equipment

AEIC CS 1: Specifications for Solid-Type Impregnated-Paper-Insulated Metallic Sheathed Cable

AEIC CS2: Specifications for Impregnated-Paper and Laminated Paper-Polypropylene Insulated Cable, High-Pressure Pipe-Type

AEIC CS3: Specifications for Impregnated-Paper-Insulated, Metallic Sheathed Cable, Low Pressure Gas-Filled Type

AEIC CS4: Specifications for Impregnated-Paper-Insulated Low and Medium Pressure Self Contained Liquid Filled Cable

***AEIC CS5:** Specifications for Thermoplastic and Crosslinked Polyethylene Insulated Shielded Power Cables Rated 5 Through 69 kV

***AEIC CS6:** Specifications for Ethylene Propylene Rubber Insulated Shielded Power Cables Rated 5 Through 69 kV

AEIC CS7: Specifications for Crosslinked Polyethylene Insulated Shielded Power Cables Rated 46 Through 138 kV

AEIC CS8: Specification for Extended Dielectric, Shielded Power Cables Rated 5 through 46 kV

ANSI C2: National Electrical Safety Code

ANSI MC96.1: Thermocouple Extension Wire Calibration

ANSI N45.2: Packaging, Shipping, Receiving, Storage and Handling of Items for Nuclear Power Plants

ASTM B 1: Standard Specification for Hard-Drawn Copper Wire

ASTM B 2: Standard Specification for Medium-Hard-Drawn Copper Wire

ASTM B 3: Standard Specification for Soft or Annealed Copper Wire

ASTM B 8: Standard Specification for Concentric-Lay Stranded Copper Conductors, Hard, Medium-Hard or Soft

ASTM B 33: Standard Specification for Tinned Soft or Annealed Copper Wire for Electrical Purposes

ASTM B 105: Standard Specification for Hard-Drawn Copper Alloy Wires for Electrical Conductors

ASTM B 170: Standard Specification for Oxygen-Free Electrolytic Copper

ASTM B 172: Standard Specification for Rope-Lay-Stranded Copper Conductors Having Bunch-Stranded Members, for Electrical Conductors

ASTM B 173: Standard Specification for Rope-Lay-Stranded Copper Conductors Having Concentric-Stranded Members, for Electrical Conductors

ASTM B 174: Standard Specification for Bunch-Stranded Copper Conductors for Electrical Conductors

ASTM B 189: Standard Specification for Lead-Coated and Lead-Alloy-Coated Soft Copper Wire for Electrical Purposes

ASTM B 193: Standard Test Method for Resistivity of Electrical Conductor Materials

ASTM B 226: Standard Specification for Cored, Annular, Concentric-Lay-Stranded Copper Conductors

ASTM B 227: Standard Specification for Hard-Drawn Copper-Clad Steel Wire

ASTM B 228: Standard Specification for Concentric-Lay-Stranded Copper-Clad Steel Conductors

ASTM B 229: Standard Specification for Concentric-Lay-Stranded Copper and Copper-Clad Steel Composite Conductors

ASTM B 230: Standard Specification for Aluminum 1350-H19 Wire for Electrical Purposes

ASTM B 230M: Standard Specification for Aluminum 1350-H19 Wire for Electrical Purposes [Metric]

ASTM B 231: Standard Specification for Concentric-Lay-Stranded Aluminum 1350 Conductors

ASTM B 231 M: Standard Specification for Concentric-Lay-Stranded Aluminum 1350 Conductors [Metric]

ASTM B 232: Standard Specification for Concentric-Lay-Stranded Aluminum Conductors, Coated Steel-Reinforced (ACACARSR)

ASTM B 232M: Standard Specification for Concentric-Lay-Stranded Aluminum Conductors, Coated Steel-Reinforced (ACSR) [Metric]

ASTM B 233: Standard Specification for Aluminum 1350 Drawing Stock for Electrical Purposes

ASTM B 246: Standard Specification for Tinned Hard-Drawn and Medium-Hard-Drawn Copper Wire for Electrical Purposes

ASTM B 258: Standard Specification for Standard Nominal Diameters and Cross-Sectional Areas of AWG Sizes of Solid Round Wires Used as Electrical Conductors

ASTM B 263: Standard Test Method for Determination of Cross-Sectional Area of Stranded Conductors

ASTM B 286: Standard Specification for Copper Conductors for Use in Hookup Wire for Electronic Equipment

ASTM B 298: Standard Specification for Silver-Coated Soft or Annealed Copper Wire

ASTM B 324: Standard Specification for Nickel-Coated Soft or Annealed Copper Wire

ASTM B 341: Standard Specification for Aluminum-Coated (Aluminized) Steel Core Wire for Aluminum Conductors, Steel-Reinforced (ACSR/AZ)

ASTM B 341M: Standard Specification for Aluminum-Coated (Aluminized) Steel Core Wire for Aluminum Conductors, Steel-Reinforced (ACSR/AZ) [Metric]

ASTM B 355: Standard Specification for Nickel-Coated Soft or Annealed Copper Wire

ASTM B 397: Standard Specification for Concentric-Lay-Stranded Aluminum-Alloy 5005-H19 Conductors

* These standards or specifications have been rescinded by their organizations.

Reference Standards

ASTM B 398: Standard Specification for Aluminum-Alloy 6201-T81 Wire for Electrical Purposes

ASTM B 398M: Standard Specification for Aluminum-Alloy 6201-T81 Wire for Electrical Purposes [Metric]

ASTM B 399: Standard Specification for Concentric-Lay-Stranded Aluminum-Alloy 6201-T81 Conductors

ASTM B 399M: Standard Specification for Concentric-Lay-Stranded Aluminum-Alloy 6201-T81 Conductors [Metric]

ASTM B 400: Standard Specification for Compact Round Concentric-Lay-Stranded Aluminum 1350 Conductors

ASTM B 401: Standard Specification for Compact Round Concentric-Lay-Stranded Aluminum Conductors, Steel-Reinforced (ACSR/COMP)

ASTM B 416: Standard Specification for Concentric-Lay-Stranded Aluminum-Clad Steel Conductors

ASTM B 452: Standard Specification for Copper-Clad Steel Wire for Electronic Application

ASTM B 470: Standard Specification for Bonded Copper Conductors for Use in Hookup Wires for Electronic Equipment

ASTM B 496: Standard Specification for Compact Round Concentric-Lay-Stranded Copper Conductors

ASTM B 498: Standard Specification for Zinc-Coated (Galvanized) Steel Core Wire for Aluminum Conductors, Steel-Reinforced (ACSR)

ASTM B 498M: Standard Specification for Zinc-Coated (Galvanized) Steel Core Wire for Aluminum Conductors, Steel-Reinforced (ACSR) [Metric]

ASTM B 500: Standard Specification for Zinc-Coated (Galvanized), Zinc-5% Aluminum Mischmetal Alloy-Coated, and Aluminum-Coated (Aluminized) Stranded Steel Core for Aluminum Conductors, Steel-Reinforced (ACSR)

ASTM B 501: Standard Specification for Silver-Coated, Copper-Clad Steel Wire for Electronic Application

ASTM B 502: Standard Specification for Aluminum-Clad Steel Core Wire for Aluminum Conductors, Aluminum-Clad Steel Reinforced

ASTM B 520: Standard Specification for Tin-Coated, Copper-Clad Steel Wire for Electronic Application

ASTM B 524: Standard Specification for Concentric-Lay-Stranded Aluminum Conductors, Aluminum-Alloy Reinforced (ACAR, 1350/6201)

ASTM B 524M: Standard Specification for Concentric-Lay-Stranded Aluminum Conductors, Aluminum-Alloy Reinforced (ACAR, 1350/6201) [Metric]

ASTM B 549: Standard Specification for Concentric-Lay-Stranded Aluminum Conductors, Aluminum-Clad Steel Reinforced (ACSR/AW)

ASTM B 559: Standard Specification for Nickel-Coated, Copper-Clad Steel Wire for Electronic Application

ASTM B 606: Standard Specification for High-Strength Zinc-Coated (Galvanized) Steel Core Wire for Aluminum and Aluminum Alloy Conductors, Steel Reinforced

ASTM B 609: Standard Specification for Aluminum 1350 Round Wire, Annealed and Intermediate Tempers, for Electrical Purposes

ASTM B 609M: Standard Specification for Aluminum 1350 Round Wire, Annealed and Intermediate Tempers, for Electrical Purposes [Metric]

ASTM B 624: Standard Specification for High-Strength, High-Conductivity Copper-Alloy Wire for Electronic Application

ASTM B 682: Standard Specification for Standard Metric Sizes of Electrical Conductors

ASTM B 701: Standard Specification for Concentric-Lay-Stranded Self-Damping Aluminum Conductors, Steel-Reinforced (ACSR/SD)

ASTM B 711: Standard Specification for Concentric-Lay-Stranded Aluminum-Alloy Conductors, Steel Reinforced (AACSR) (6201)

ASTM B 738: Standard Specification for Fine-Wire Bunch-Stranded and Rope-Lay Bunch Stranded Copper Conductors for Use as Electrical Conductors

ASTM B 778: Standard Specification for Shaped Wire Compact Concentric-Lay-Stranded Aluminum Conductors (AAC/TW)

ASTM B 779: Standard Specification for Shaped Wire Compact Concentric-Lay-Stranded Aluminum Conductors, Steel Reinforced (ACSR/TW)

ASTM B 784: Standard Specification for Modified Concentric-Lay-Stranded Copper Conductors for Use in Insulated Electrical Cables

ASTM B 785: Standard Specification for Compact Round Modified Concentric-Lay-Stranded Copper Conductors for Use in Insulated Electrical Cables

ASTM B 786: Standard Specification for 19 Wire Combination Unilay-Stranded Aluminum 1350 Conductors for Subsequent Insulation

ASTM B 787: Standard Specification for 19 Wire Combination Unilay-Stranded Copper Conductors for Subsequent Insulation

ASTM B 801: Standard Specification for Concentric-Lay-Stranded Conductors of 8000 Series Aluminum Alloy for Subsequent Covering or Insulation

ASTM B 802: Standard Specification for Zinc-5% Aluminum-Mischmetal Alloy-Coated Steel Core Wire for Aluminum Conductors, Steel Reinforced (ACSR)

ASTM B 803: Standard Specification for High-Strength Zinc-5 % Aluminum-Mischmetal Alloy Coated Steel Core Wire for Aluminum and Aluminum-Alloy Conductors, Steel Reinforced

ASTM D 149: Standard Test Method for Dielectric Breakdown Voltage and Dielectric Strength of Solid Electrical Insulating Materials at Commercial Power Frequencies

ASTM D 470: Method of Testing Crosslinked Insulations and Jackets for Wire and Cable

ASTM D 866: Specification for Styrene-Butadiene (SBR) Synthetic Rubber Jacket for Wire and Cable

Reference Standards

ASTM D 1047: Specification for Polyvinyl Chloride (PVC) Jacket for Wire and Cable

ASTM D 1351: Specification for Polyethylene Insulation for Wire and Cable

ASTM D 1352: Specification for Ozone-Resisting Butyl Rubber Insulation for Wire and Cable

ASTM D 1523: Method for Synthetic Rubber Insulation for Wire and Cable, 90° Operation

ASTM D 1679: Specification for Synthetic Rubber Heat and Moisture-Resisting Insulation for Wire and Cable, 75°C Operation

ASTM D 2219: Specification for Polyvinyl Chloride (PVC) Insulation for Wire and Cable, 60° Operation

ASTM D 2220: Specification for Polyvinyl Chloride (PVC) Insulation for Wire and Cable, 75° Operation

ASTM D 2308: Specification for Polyethylene Jacket for Electrical Insulated Wire and Cable

ASTM D 2526: Specification for Ozone-Resisting Silicone Rubber Insulation for Wire and Cable

ASTM D 2655: Specification for Crosslinked Polyethylene Insulation for Wire and Cable Rated 0 to 2000V

ASTM D 2656: Specification for Crosslinked Polyethylene Insulation for Wire and Cable Rated 2001 to 35000V

ASTM D 2768: Specification for General-Purpose Ethylene-Propylene Rubber Jacket for Wire and Cable

ASTM D 2770: Specification for Ozone-Resisting Ethylene-Propylene Rubber Integral Insulation and Jacket for Wire and Cable

ASTM D 2802: Specification for Ozone-Resistant Ethylene-Propylene Rubber Insulation for Wire and Cable

ASTM D 3004: Specification for Extruded Thermosetting and Thermoplastic Semi-Conducting Conductor and Insulation Shields

ASTM D 3485: Specification for Smooth-Wall Coilable Polyethylene (PE) Conduit (Duct) for Preassembled Wire and Cable

ASTM D 3554: Specification for Track-Resistant Black Thermoplastic High Density Polyethylene Insulation for Wire and Cable

ASTM D 3555: Specification for Track-Resistant Black Crosslinked Thermosetting Polyethylene Insulation for Wire and Cable

ASTM D 4244: Specification for General-Purpose, Heavy-Duty and Extra-Heavy Duty Acrylonitrile-Butadiene/ Polyvinyl Chloride (NBR/PVC) Jackets for Wire and Cable

ASTM D 4245: Specification for Ozone-Resistant Thermoplastic Elastomer Insulation for Wire and Cable, 90°C Dry - 75°C Wet Operation

ASTM D 4246: Specification for Ozone-Resistant Thermoplastic Elastomer Insulation for Wire and Cable, 90°C Operation

ASTM D 4247: Specification for General-Purpose Black Heavy-Duty and Black Extra-Heavy Duty Polychloroprene Jackets for Wire and Cable

ASTM D 4313: Specification for General Purpose Heavy-Duty and Extra-Heavy-Duty Crosslinked Chlorinated Polyethylene Jackets for Wire and Cable

ASTM D 4314: Specification for General Purpose Heavy-Duty and Extra-Heavy-Duty Crosslinked Chlorosulfonated Polyethylene Jackets for Wire and Cable

ASTM D 4363: Specification for Thermoplastic Chlorinated Polyethylene Jacket for Wire and Cable

ASTM D 4496: Test Method of DC Resistance or Conductance of Moderately Conductive Materials

ASTM D 4568: Test Methods for Evaluating Compatibility Between Cable Filling and Flooding Compounds and Polyolefin Cable Materials

ASTM D 4967: Guide for Selecting Materials to Be Used for Insulation, Jacketing, and Strength Components in Fiber Optic Cables

CAN3-Z299.0: Guide for Selecting and Implementing the CAN3-Z299 Quality Assurance Program Standards

CAN3-Z299.1: Standard for Quality Assurance Program - Category 1

CAN3-Z299.2: Standard for Quality Assurance Program - Category 2

CAN3-Z299.3: Standard for Quality Assurance Program - Category 3

CAN3-Z299.4: Standard for Quality Assurance Program - Category 4

CAN/CSA C22.2 No. 211: Standard for Cord Sets and Power-Supply Cords

CAN/CSA C22.2 No. 48: Standard for Nonmetallic Sheathed Cable

CAN/CSA C22.2 No. 49: Standard for Flexible Cords and Cables

CAN/CSA C22.2 No. 51: Standard for Armored Cable

CAN/CSA C22.2 No. 96: Standard for Portable Power Cables

CAN/CSA C22.2 No. 130.1: Standard for Heat-Tracing Cable Systems for Use in Industrial Locations

CAN/CSA C22.2 No. 131: Standard for Type TECK 90 Cable

CAN/CSA C22.2 No. 203: Standard for Modular Wiring Systems for Office Furniture

CAN/CSA C22.2 No. 210.2: Standard for Appliance Wiring Material Products

CAN/CSA C22.2 No. 214: Standard for Communications Cables

CAN/CSA C22.2 No. 233: Standard for Cords and Cord Sets for Communication Systems

CAN/CSA C22.2 No. 239: Standard for Control and Instrumentation Cables

CAN/CSA C22.2 No. 241: IEEE Standard for Cable Joints for Use with Extruded Dielectric Cable Rated 5,000V Through 46,000V, and Cable Joints for Use with Laminated Dielectric Cable Rated 2,500V Through 500,000V (Adopted IEEE 404-1986)

CAN/CSA C22.3 No. 1: Standard for Overhead Systems

CAN/CSA C22.3 No. 8: Standard for Railway Electrification Guidelines

CAN/CSA C49.1: Standard for Round Wire, Concentric Lay, Overhead Electrical Conductors

Reference Standards

CAN/CSA C68.3: Standard for Shielded and Concentric Neutral Power Cables Rated 5-46 kV

CAN/CSA T529: Standard Design Guide for Telecommunications Wiring Systems in Commercial Buildings

CSA C22.1: Canadian Electrical Code, Part 1, Safety Standard for Electrical Installations

CSA C22.2 No. 0.3: Standard for Test Methods for Electrical Wires and Cables

CSA C22.2 No. 16: Standard for Insulated Conductors for Power-Operated Electronic Devices

CSA C22.2 No. 35: Standard for Extra-Low-Voltage Control Circuit Cables, Low-Energy Control Cable, and Extra-Low-Voltage Control Cable

CSA C22.2 No. 38: Standard for Thermoset Insulated Wires and Cables

CSA C22.2 No. 52: Standard for Service-Entrance Cables

CSA C22.2 No. 75: Standard for Thermoplastic-Insulated Wires and Cables

CSA C22.2 No. 116: Standard for Coil-Lead Wires

CSA C22.2 No. 123: Standard for Aluminum Sheathed Cables

CSA C22.2 No. 124: Standard for Mineral-Insulated Cable

CSA C22.2 No. 127: Standard for Equipment Wires

CSA C22.2 No. 129: Standard for Neutral Supported Cable

CSA C22.2 No. 130: Standard for Heating Cables and Heating Cable Sets

CSA C22.2 No. 138: Standard for Heat Tracing Cable and Cable Sets for Use in Hazardous Locations

CSA C22.2 No. 174: Standard for Cables and Cable Glands for Use in Hazardous Locations

CSA C22.2 No. 179: Standard for Airport Series Lighting Cables

CSA C22.2 No.188: Standard for Splicing Wire and Cable Connectors

CSA C22.2 No. 198.2: Standard for Underground Cable Splicing Kits

CSA C22.2 No. 208: Standard for Fire Alarm and Signal Cable

CSA C22.2 No. 222: Standard for Type FCC Under-Carpet Wiring System

CSA C22.2 No. 230: Standard for Tray Cable

CSA C22.2 No. 232: Standard for Optical Fiber Cables

CSA/CAN3 C22.3 No. 7: Standard for Underground Systems

CSA C49.2: Standard for Compact Aluminum Conductors Steel Reinforced (ACSR)

CSA C49.3: Standard for Aluminum Alloy 1350 Round Wire, All Tempers, for Electrical Purposes

CSA C49.4: Standard for Concentric-Lay Aluminum Stranded Conductors (ASC)

CSA C49.5: Standard for Compact Round Concentric-Lay Aluminum Stranded Conductors (Compact ASC)

CSA CAN3-C49.6: Standard for Zinc-Coated Steel Wires for Use in Overhead Electrical Conductors

CSA CAN3-C49.7: Standard for Aluminum Round Wires for Use in Overhead Electrical Conductors

CSA C68.1: Standard Specifications for Impregnated Paper-Insulated, Metallic-Sheathed Cable, Solid-Type

CSA C170.2: Standard for Polyethylene Protective Covering on Paper-Insulated Metallic Sheathed Power Cable

CSA C170.3: Standard for Polyvinyl-Chloride (PVC) Protective Covering on Paper-Insulated Metallic-Sheathed Power Cable

CSA M421: Standard for Use of Electricity in Mines

EIA/TIA-568: Commercial Building Telecommunications Wiring Standard

EIA/TIA-569: Commercial Building Standard for Telecommunications Pathways and Spaces

EIA/TIA-606: Administration Standard for the Telecommunications Infrastructure of Commercial Buildings

EIA/TIA TSB-36: Additional Cable Specifications for Unshielded Twisted Pair Cables (Technical Systems Bulletin 36)

EIA/TIA TSB-40: Additional Transmission Specifications for Unshielded Twisted Pair Connecting Hardware (Technical Systems Bulletin 40)

FP-4: TM-4 CSA CBC and UL CMR (Riser) Cable

FP-16: TD-16 Plastic Insulated, Two Parallel Conductor, Telephone Drop Wire

FP-28: Air Core, Solid PIC, ALPETH-DCAS Cable and PAP-DCAS Cable

FP-67: PHD Plastic Insulated and Jacketed, Four Conductor, Telephone Drop Wire

FP-68: TM-68 CSA PCC FT4, Shielded Inside Wiring Cable

FP-71: TM-28 CSA PCC FT4, Inside Wiring Cable

FP-75: PHILPLAST CSA PCC FT4, PVC Insulated and Jacketed, Switchboard Cable

FP-81: TM-81 CSA ZSW FT1, Telephone Station Wire

FP-90: CONCEL Cellular Polyethylene Insulated, Air Core, ALPETH-DCAS Sheathed, Telephone Cable

FP-93: TM-91, TM-92, TM-93 and TM-97, Filled, Buried Wire

FP-95: Quasi-Solid Polyethylene Insulated, Filled, Regular and Twin Core, ALPETH-DCAS Sheathed Cable

FP-98: CELSEAL Cellular Polyethylene Insulated, Filled, ALPETH-DCAS Sheathed Cable

FP-99: DUCTCEL Cellular Polyethylene Insulated, Air Core, ALPETH-DCAS Sheathed Telephone Cable

FP-8859: PHILSYM UL 444 CMR and CSA PCC FT4 Switchboard Cable

HP: See NEMA listing

ICEA P-32-382: ICEA Standards Publication for Short Circuit Characteristics of Insulated Cable

Reference Standards

ICEA P-45-482: ICEA Standards Publication for Short-Circuit Performance of Metallic Shields and Sheaths of Insulated Cable

ICEA P-53-426: ICEA/NEMA Standards Publication for Ampacities, Including Effect of Shield Losses for Single-Conductor Solid-Dielectric Power Cable 15 kV through 69 kV (NEMA WC 50)

ICEA P-54-440: ICEA/NEMA Standards Publication for Ampacities of Cables in Open-Top Cable Trays (NEMA WC 51)

ICEA P-79-561: ICEA Guide for Selecting Aerial Cable Messengers and Lashing Wires

ICEA S-56-434: ICEA/ANSI Standards Publication for Polyolefin Insulated Communications Cables for Outdoor Use

ICEA S-67-401: ICEA/NEMA Standards Publication for Steel Armor and Associated Coverings for Impregnated-Paper-Insulated Cables (NEMA WC 2)

ANSI/ICEA S-70-547: ICEA/ANSI Standards Publication for Weather-Resistant Polyolefin-Covered Wire and Cable

ICEA S-73-532: ICEA/NEMA/ANSI Standards Publication for Control Cables (NEMA WC 57)

ICEA S-75-381: ICEA/NEMA/ANSI Standards Publication for Portable and Power Feeder Cables for Use in Mines and Similar Applications (NEMA WC 58)

ANSI/ICEA S-76-474: ICEA/ANSI Standards Publication for Neutral-Supported Power Cable Assemblies with Weather-Resistant Extruded Insulation, 600 Volts

ICEA S-77-528: ICEA/ANSI Standards Publication for Outside Plant Communications Cables, Specifying Metric Wire Sizes

ICEA S-80-576: ICEA/ANSI Standards Publication for Communications Wire and Cable for Wiring of Premises

ANSI/ICEA S-81-570: Standard for 600 volt rated cables of Ruggedized Design For Direct Burial installations of single conductors or assemblies of single conductors.

ICEA S-82-552: ICEA/NEMA Standards Publication for Instrumentation Cables and Thermocouple Wire (NEMA WC 55)

ICEA S-83-596: ICEA/ANSI Standards Publication for Fiber Optic Premises Distribution Cable

ICEA S-84-608: ICEA/ANSI Standards Publication for Telecommunications Cable, Filled Polyolefin Insulated, Copper Conductor

ICEA S-85-625: ICEA/ANSI Standards Publication for Aircore, Polyolefin Insulated, Copper Conductor Telecommunications Cable

ICEA S-86-634: ICEA/ANSI Standards Publication for Buried Distribution and Service Wire, Filled Polyolefin Insulated, Copper Conductor

ICEA S-87-640: ICEA/ANSI Standards Publication for Fiber Optic Outside Plant Communication Cable

ICEA-S-93-639: ICEA/NEMA Standard for Shielded Power Cables Rated 5-46 KV for the Distribution of Electrical Energy (NEMA WC 74)

ANSI/ICEA-S-94-649: Standard for Concentric Neutral Cables Rated 5-46 KV

ICEA S-95-658: ICEA/NEMA Standard for Non-shielded Power Cables Rated 2000 Volts or Less for the Distribution of Electrical Energy (NEMA WC 70)

ICEA S-96-659: ICEA/NEMA Standard for Non-shielded Cables Rated 2001-5000 Volts for use in the Distribution of Electrical Energy (NEMA WC 71)

ANSI/ICEA S-97-682: Standard for Utility Shielded Power Cable Rated 5-46 KV

ANSI/ICEA S-105-692: Standard for 600 Volt Single Layer Thermoset Insulated Utility Underground Distribution Cable

ICEA T-22-294: ICEA Standard Test Procedures for Extended Time-Testing of Wire and Cable Insulations for Service in Wet Locations

ICEA T-25-425: ICEA Guide for Establishing Stability of Volume Resistivity for Conducting Polymeric Components of Power Cables

ICEA T-26-465: ICEA/NEMA Guide for Frequency of Sampling Extruded Dielectric Power, Control, Instrumentation and Portable Cables for Test (NEMA WC 54)

ICEA T-27-581: ICEA/NEMA Standard Test Methods for Extruded Dielectric Power, Control, Instrumentation and Portable Cables (NEMA WC 53)

ANSI/ICEA T-28-562: ICEA Standard Test Method for Measurement of Hot Creep of Polymeric Insulations

ICEA T-29-520: ICEA Standard for Vertical Tray Flame Tests at 210,000 Btu

ICEA T-30-520: ICEA Standard for Vertical Tray Flame Tests at 70,000 Btu

ICEA T-31-610: ICEA Standard for Water Penetration Resistance Test, Sealed Conductor

ICEA T-32-645: ICEA Standards Publication for Compatibility of Sealed Conductor Filer Compounds

IEC 92-3: International Electrotechnical Commission Electrical Installation in Ships - Part 3 Cables (Constructions, Testing and Installations)

IEEE 45: IEEE Recommended Practice for Electric Installations on Shipboard

IEEE 48: IEEE Standard Test Procedures and Requirements for High-Voltage Alternating Current Cable Terminations

IEEE 100: IEEE Standard Dictionary of Electrical and Electronics Terms

IEEE 141: IEEE Recommended Practice for Electric Power Distribution for Industrial Plants ("IEEE Red Book")

IEEE 142: IEEE Recommended Practice for Grounding of Industrial and Commercial Power Systems ("IEEE Green Book")

IEEE 241: IEEE Recommended Practice for Electric Power Systems in Commercial Buildings ("IEEE Gray Book")

IEEE 242: IEEE Recommended Practice for Protection and Coordination of Industrial and Commercial Power Systems ("IEEE Buff Book")

IEEE 323: IEEE Standard for Qualifying Class 1E Equipment for Nuclear Power Generating Stations

IEEE 383: IEEE Standard for Type Test of Class 1E Electric Cables, Field Splices and Connections for Nuclear Power Generating Stations

Reference Standards

IEEE 400: IEEE Guide for Making High-Direct-Voltage Tests on Power Cable Systems in the Field

IEEE 404: IEEE Standard for Cable Joints for Use with Extruded Dielectric Cable Rated 5,000V Through 46,000V, and Cable Joints for Use with Laminated Dielectric Cable Rated 2,500V Through 500,000V (Adopted as a National Standard of Canada, CAN/CSA-C22.2 No. 241)

IEEE 446: IEEE Recommended Practice for Emergency and Standby Power Systems for Industrial and Commercial Applications ("IEEE Orange Book")

IEEE 493: IEEE Recommended Practice for the Design of Reliable Industrial and Commercial Power Systems ("IEEE Gold Book")

IEEE 515: IEEE Recommended Practice for the Testing, Design, Installation, and Maintenance of Electrical Resistance Heat Tracing for Industrial Applications

IEEE 524: IEEE Guide to the Installation of Overhead Transmission Line Conductors

IEEE 525: IEEE Guide for the Design and Installation of Cable Systems in Substations

IEEE 575: IEEE Guide for the Application of Sheath-Bonding Methods for Single-Conductor Cables and the Calculation of Induced Voltages and Currents in Cable Sheaths

IEEE 576: IEEE Recommended Practice for Installation, Termination, and Testing of Insulated Power Cable as Used in the Petroleum and Chemical Industry

IEEE 590: IEEE Cable Plowing Guide

IEEE 602: IEEE Recommended Practice for Electric Systems in Health Care Facilities ("IEEE White Book")

IEEE 635: IEEE Guide for Selection and Design of Aluminum Sheaths for Power Cables

IEEE 644: IEEE Standard Procedures for Measurement of Power Frequency Electric and Magnetic Fields from AC Power Lines

IEEE 738: IEEE Standard for Calculation of Bare Overhead Conductor Temperature and Ampacity Under Steady-State Conditions

IEEE 789: IEEE Standard Performance Requirements for Communications and Control Cables for Application in High Voltage Environments

IEEE 802.3: IEEE Standard for Information Processing Systems - Local and Metropolitan Area Networks - Part 3: Carrier Sense Multiple Access with Collision Detection (CSMA/CD) Access Method and Physical Layer Specifications (ISO/IEC) (ANSI/IEEE Std 802.3)

IEEE 802.5: IEEE Standard for Information Technology - Local and Metropolitan Area Networks - Part 5: Token Ring Access Method and Physical Layer Specifications (ISO/IEC) (ANSI/IEEE Std 802.5)

IEEE 816: IEEE Guide for Determining the Smoke Generation of Solid Materials Used for Insulations and Coverings of Electric Wire and Cable

IEEE 844: IEEE Recommended Practice for Electrical Impedance, Induction, and Skin Effect Heating of Pipelines and Vessels

IEEE 1017: IEEE Recommended Practice for Field Testing Electric Submersible Pump Cable

IEEE 1018: IEEE Recommended Practice for Specifying Electric Submersible Pump Cable - Ethylene-Propylene Rubber Insulation

IEEE 1019: IEEE Recommended Practice for Specifying Electric Submersible Pump Cable - Polypropylene Insulation

IEEE 1120: IEEE Guide to the Factors to Be Considered in the Planning, Design, and Installation of Submarine Power and Communications Cables

IEEE 1202: IEEE Standard for Flame Testing of Cables for Use in Cable Tray in Industrial and Commercial Occupancies

IEEE/ICEA S-135: Power Cable Ampacities

Mil-C-17: General Specifications for Flexible and Semirigid Radio Frequency Cables

Mil-C-915F: General Specification for Electrical Cable and Conductors for Shipboard Use

Mil-C-13777: General Specification for Special Purpose Electrical Cable

Mil-C-24640: General Specification for Lightweight Electrical Cable for Shipboard Use

Mil-C-24643: General Specification for Low Smoke Electrical Cable and Conductors for Shipboard Use

Mil-C-27500: General Specification for Shielded and Unshielded Electrical Power Cable and Special Purpose Cable

Mil-C-85045: General Specification for Fiber Optic Cables [Metric]

Mil-W-16878: General Specification for Insulated Electrical Wire

Mil-W-22759: General Specification for Copper or Copper Alloy Fluoropolymer-Insulated Electrical Wire

Mil-W-81044: General Specification for Copper or Copper Alloy, Crosslinked Polyalkene, Crosslinked Alkane-Imide Polymer or Polyalkene Insulated Electrical Wire

Mil-W-81381: General Specification for Replacement Wire

Mil-W-85485: General Specification for Radio Frequency Absorptive Filter Line Electrical Cable

NAVSEA 6710782: Fiber Optic and Multimode Cable

NEMA HP 3: Electrical and Electronic PTFE (Polytetrafluoro-ethylene) Insulated High Temperature Hook-Up Wire; Types (600 Volt), EE (1000 Volt), and ET (250 Volt)

NEMA HP 4: Electrical and Electronic FEP Insulated High Temperature Hook-Up Wire; Types K, KK, and KT

NEMA HP 100: High Temperature Instrumentation and Control Cables

NEMA HP 100.1: High Temperature Instrumentation and Control Cables Insulated and Jacketed with FEP Fluorocarbons

NEMA HP 100.2: High Temperature Instrumentation and Control Cables Insulated and Jacketed with ETFE Fluoropolymers

NEMA HP 100.3: High Temperature Instrumentation and Control Cables Insulated and Jacketed with Cross-Linked (Thermoset) Polyolefin (XLPO)

Reference Standards

NEMA HP 100.4: High Temperature Instrumentation and Control Cables Insulated and Jacketed with ECTFE Fluoropolymers

NEMA WC 2: Steel Armor and Associated Coverings for Impregnated-Paper-Insulated Cables (ICEA S-67-401)

NEMA WC 3: Rubber-Insulated Wire and Cable for the Transmission and Distribution of Electrical Energy (ICEA S-19-81)

NEMA WC 5: Thermoplastic-Insulated Wire and Cable for the Transmission and Distribution of Electrical Energy (ICEA S-61-402)

NEMA WC 7: Cross-Linked-Thermosetting-Polyethylene-Insulated Wire and Cable for the Transmission and Distribution of Electrical Energy (ICEA S-66-524)

NEMA WC 8: Ethylene-Propylene-Rubber-Insulated Wire and Cable for the Transmission and Distribution of Electrical Energy (ICEA S-68-516)

NEMA WC 26: Wire and Cable Packaging

NEMA WC 50: Ampacities, Including Effect of Shield Losses for Single-Conductor Solid Dielectric Power Cable 15 kV through 69 kV (ICEA P-53-426)

NEMA WC 51: Ampacities of Cables in Open-Top Cable Trays (ICEA P-54-440)

NEMA WC 52: High Temperature and Electronic Insulated Wire-Impulse Dielectric Testing

NEMA WC 53: Standard Test Methods for Extruded Dielectric Power, Control, Instrumentation, and Portable Cables (ICEA T-27-581)

NEMA WC 54: Guide for Frequency of Sampling Extruded Dielectric Power, Control, Instrumentation, and Portable Cables for Test (ICEA T26-465)

NEMA WC 55: Instrumentation Cables and Thermocouple Wire (ICEA S-82-552)

NEMA WC 56: 3.0 kHz Insulation Continuity Proof Testing of Hook-Up Wire

NEMA WC 57: Standard for Control Cables (ICEA S-73-532)

NEMA WC 58: Standard for Portable and Power Feeder Cables for Use in Mines and Similar Applications (ICEA-S-75-381)

NEMA WC 61: Transfer Impedance Testing

NEMA WC 62: Repeated Spark/Impulse Dielectric Testing

NEMA WC 70: Standard for Non-shielded Power Cables Rated 2000 Volts or Less for the Distribution of Electrical Energy (ICEA S-95-658)

NEMA WC 71: Standard for Non-shielded Cables Rated 2001-5000 Volts for Use in the Distribution of Electrical Energy (ICEA S-96-659)

NEMA WC 74: Standard for Shielded Power Cables Rated 5-46 kV for the Distribution of Electrical Energy (ICEA S-93-639)

NFPA 70: National Electrical Code

NFPA 70HB: National Electrical Code Handbook

NFPA 262: Test for Fire and Smoke Characteristics of Wires and Cables

ONT M-302-84: Cable, Secondary, for Direct Burial

ONT M-355-82: Cable, Primary Submarine

ONT M-538-84: Cable, For Use in Generating Stations (5 kV and Above)

ONT M-570-84: Cable, For Use in Generating Stations (600V)

ONT M-695-88: Cable, Primary and Subtransmission Submarine, Concentric Neutral

SAE 1560: Low Tension, Thin Wall Primary Cable

SAE J1127: Battery Cable

SAE J1128: Low Tension Primary Cable

TIA: See EIA/TIA

UL 4: Standard for Armored Cable

UL 13: Standard for Power-Limited Circuit Cables

UL 44: Standard for Rubber-Insulated Wires and Cables

UL 62: Standard for Flexible Cord and Fixture Wire

UL 83: Standard for Thermoplastic-Insulated Wires and Cables

UL 183: Standard for Manufactured Wiring Systems

UL 444: Standard for Communications Cables

UL 486A: Standard for Wire Connectors and Soldering Lugs for Use With Copper Conductors

UL 486B: Standard for Wire Connectors and Soldering Lugs for Use With Aluminum Conductors

UL 486C: Standard for Splicing Wire Connectors

UL 486D: Standard for Insulated Wire Connectors for Use With Underground Conductors

UL 486E: Standard for Equipment Wiring Terminals for Use With Aluminum and/or Copper Conductors

UL 493: Standard for Thermoplastic-Insulated Underground Feeder and Branch-Circuit Cables

UL 498: Standard for Attachment Plugs and Receptacles

UL 514B: Standard for Fittings for Conduit and Outlet Boxes

UL 719: Standard for Nonmetallic-Sheathed Cables

UL 758: Standard for Appliance Wiring Material - Component

UL 814: Standard for Gas-Tube-Sign and Ignition Cable

UL 817: Standard for Cord Sets and Power-Supply Cords

UL 854: Standard for Service-Entrance Cables

UL 910: Standard for Test for Flame-Propagation and Smoke-Density Values for Electrical and Optical-Fiber Cables Used in Spaces Transporting Environmental Air

UL 1023: Standard for Household Burglar-Alarm System Units

UL 1063: Standard for Machine-Tool Wires and Cables

UL 1072: Standard for Medium-Voltage Power Cables

UL 1084: Standard for Hoistway Cables

UL 1263: Standard for Irrigation Cables

Reference Standards

UL 1277: Standard for Electrical Power and Control Tray Cables With Optional Optical Fiber Members

UL 1309: Standard for Marine Shipboard Cable

UL 1424: Standard for Cables for Power-Limited Fire-Protective-Signaling Circuits

UL 1426: Standard for Cables for Boats

UL 1446: Standard for Systems of Insulating Materials—General

UL 1462: Standard for Mobile Home Pipe Heating Cable

UL 1569: Standard for Metal-Clad Cables

UL 1581: Reference Standard for Electrical Wires, Cables and Flexible Cords

UL 1588: Standard for Roof and Gutter De-Icing Cable Units

UL 1666: Standard Test for Flame Propagation Height of Electrical and Optical-Fiber Cables Installed Vertically in Shafts

UL 1673: Standard for Electric Space Heating Cables

UL 1685: Standard for Vertical-Tray Fire-Propagation and Smoke-Release Test for Electrical and Optical-Fiber Cables

UL 1690: Standard for Data Processing (DP) Cables

UL 1712: Standard Tests for Ampacity of Insulated Electrical Conductors Installed in the Fire Protective System

UL 1807: Standard for Fire Resistant Cable Coating Materials

UL 2023: Standard Test Method for Flame and Smoke Characteristics of Nonmetallic Wiring Systems (Raceway and Conductors) for Environmental Air-Handling Spaces

UL 2029: Standard for Gas/Vapor-Blocked Cable Classified for Use in Class 1 Hazardous (Classified) Locations

UL 2049: Standard for Residential Pipe Heating Cable

UL 2556: Wire and Cable Test Methods

WC: See NEMA listing

Checklist for Specifications

Control Cable

- Conductor Tape
- AWG
- Solid
 - ___ Class B, concentric
 - ___ Flexible
- Bare/Coated
- Insulation
- Jacket
- Temperature rating
- Voltage rating
- Individual Conductor Listings
- Number of Conductors
- Identification Method
 - ___ Color code
 - ___ Numbering
 - ___ Tags
- Grounding
 - ___ Bare/Coated
 - ___ Size
 - ___ Insulated

Power Cable

- Size, AWG or kcmil
- Conductor Type (metal)
- Stranding
 - ___ Class B, compact
 - ___ Class B, concentric
 - ___ Class C
 - ___ Other
- Bare/Coated
- Conductor Shielding
 - ___ Extruded
 - ___ Tape
- Insulation
 - ___ EPR
 - ___ EVA
 - ___ FEP
 - ___ FR-EP
 - ___ LSZH
 - ___ Polyethylene/PVC
 - ___ PVC/Nylon
 - ___ Silicone
 - ___ XLPE
 - ___ Other
- Insulation Level
 - ___ 100%
 - ___ 133%

- Insulation Shielding
 - ___ Extruded
 - ___ Tape
- Metallic Shielding
 - ___ Bare/Coated
 - ___ Helical copper tapes
 - ___ Helical wires
 - ___ Longitudinal drain wires
 - ___ Other
- Jacket
 - ___ CPE
 - ___ CSPE
 - ___ LSZH/XLPO
 - ___ Neoprene
 - ___ Polyurethane
 - ___ PVC
 - ___ XLPE
 - ___ XL-CPE
 - ___ XL-LSZH
 - ___ Other
- Cable Assembly
 - ___ Cabled
 - ___ Multiconductor
 - ___ Other
- Grounding Conductors
 - ___ Bare/Coated
 - ___ Insulated/Uninsulated
 - ___ Quantity
 - ___ Size
- Neutral Conductors
 - ___ Bare/Coated
 - ___ Fillers
 - ___ Flame-retardant
 - ___ Fiber
 - ___ Quantity
 - ___ Insulated
 - ___ Paper
 - ___ Other
 - ___ Size
- Covering
 - ___ Corrugated continuous welded armor
 - ___ Interlocked armor
 - ___ Lead
 - ___ Nonmetallic
 - ___ Other
- Color
- Voltage rating
- Temperature rating
- Approvals

General Checklist

- Standards
 - ___ AEIC
 - ___ CANENA
 - ___ CSA
 - ___ ICEA
 - ___ IEC
 - ___ IEEE
 - ___ UL
 - ___ Other
- Testing Procedures
 - ___ AEIC
 - ___ CAN ENA
 - ___ CSA
 - ___ ICEA
 - ___ IEC
 - ___ IEEE
 - ___ UL
 - ___ Other
- Special Requirements
 - ___ Cold bend
 - ___ Direct burial
 - ___ Flame-retardant
 - ___ Oil-resistant
 - ___ Sunlight-resistant
 - ___ Other
- Documentation
 - ___ Certificates of Compliance
 - ___ Certified Test Reports
 - ___ Drawings
 - ___ Warranties
 - ___ Other
- System Characteristics
- Shipping Details
 - ___ Cut lengths
 - ___ Installation recommendation
 - ___ Lagging
 - ___ Returnable reels
 - ___ Other
- Identification
 - ___ Cable
 - ___ Circuit
 - ___ Reel

Note: This checklist must be accompanied by exact system details about the environment and electrical characteristics.

NEC and CSA Designations

NEC WIRE TYPE	DESCRIPTION
AWM	Appliance Wiring Material, Thermoplastic Insulation (PVC), With or Without Nylon, 105°C, Dry Locations
MV-HL	Suffix "-HL" Indicates Acceptable for Hazardous Locations
ITC	Instrumentation Tray Cable, Several Combinations for Insulations and Jacket Compounds
MV-LS	Suffix "-LS" Indicates Acceptable for Limited Smoke Applications
MC	Metal-Clad Cable, THHN or XHHW Individual Conductors, Aluminum or Steel Interlocked Armor
MTW	Machine Tool Wire, Thermoplastic Insulation (PVC), With or Without Nylon, 90°C, Dry Locations
MV-90	Medium Voltage Cable Rated at 90°C
MV-105	Medium Voltage Cable Rated at 105°C
PLTC	Power-Limited Tray Cable, Several Combinations of Insulations and Jacket Compounds
RHH	Rubber Equivalent Insulation (XLPE), High Heat Resistant, 90°C Rating, Dry or Damp Locations
RHW-2	Rubber Equivalent Insulation (XLPE), Heat Resistant, 90°C Rating, Wet Locations
SF-2	Silicone Insulated Fixture Wire, Solid or 2-Strand
SFF-2	Silicone Insulated Fixture Wire, Flexible Strand
SIS	Flame-Retardant Thermoset Switchboard Wire
TC	Tray Cable, Several Combinations of Insulation and Jacket Compounds, Cable Tray Use
TFFN	Thermoplastic Insulation (PVC), Flexible Fixture Wire, 90°C Rating, Dry Locations, Nylon Jacket
TFN	Thermoplastic Insulation (PVC), Fixture Wire, 90°C Rating, Dry Locations, Nylon Jacket
THHN	Thermoplastic Insulation (PVC), High Heat Resistant, 90°C Rating, Dry or Damp Locations, Nylon Jacket
THWN	Thermoplastic Insulation (PVC), Heat Resistant, 75°C Rating, Wet Locations, Nylon Jacket
USE-2	Underground Service Entrance, Cross-Linked Polyethylene Insulation (XLPE), Direct Burial, 90°C Rating
XHHW-2	Cross-Linked Polyethylene Insulation (XLPE), High Heat Resistant, 90°C Rating, Wet and Dry Locations

CSA WIRE TYPE	DESCRIPTION
AC-90	600 Volt XLPE Insulation Aluminum or Steel Interlocked Armored Cable
ACIC	300 or 600 Volt Armored Instrument and Control Cable. A CSA-type designation used to describe Armored Instrumentation and Control Cable. Available in either 300 Volt or 600 Volt with thermoset or thermoplastic insulation, this cable can be supplied with an overall shield, shielded pairs, shielded triads or unshielded in multi-conduction constructions from 2 to 72 conductors. The overall interlocked armor and PVC jacket provide a (-40°C), HL, FT4 product (CSA reference C22.2 No. 239)
ACWU90 (-40°C)	600 Volt XLPE Insulation Aluminum or Steel Interlocked Armored Cable with PVC jacket
HL (Hazardous Locations)	Designation for Hazardous Locations (CSA STD C22.2 No. 174)
NMD90	300 Volt Non-Metallic Sheath Cable with XLPE or PVC/Nylon Insulation
NMWU	300 Volt Non-Metallic Sheath Cable with PVC Insulation
RA90 (-40°C)	600 and 5000 Volt Single and Multiple Conductor with Seamless Corrugated Aluminum Armor. A CSA-type designation for single-conductor or multi-conductor constructions similar to AC90 and ACWU90, except no bonding (grounding) conductor is required in the cable assembly. Also, the armor is a corrugated aluminum sheath, which serves as a bonding (grounding) conductor. The overall PVC covering on RA90 is required for wet or direct burial applications (CSA reference standard C22.2 No. 123)
RW90 XLPE (-40°C)	600 and 5000 Volt Thermoset Insulation, 90°C Rating, Wet or Dry Locations
RWU90 XLPE (-40°C)	600 and 1000 Volt Thermoset Insulation, 90°C Rating, Direct Burial
SEW-2	600 Volt Silicone Rubber Insulated Equipment Wire Solid or 7-Strand
SEWF-2	600 Volt Silicone Rubber Insulated Equipment Wire with Flexible Strand
TECK90 (-40°C)	600 and 5000 Volt Single and Multiple Conductor Cable with Inner Jacket, Aluminum or Steel Interlocked Armor with PVC Jacket
TC	Tray Cable Certified for Use in Class 1 Division 2 Areas
TW75	600 Volt Thermoplastic (PVC) Insulated Cable Suitable for Wet Locations
TWU (-40°C)	600 Volt Thermoplastic (PVC) Insulated Cable Suitable for Direct Burial

Common Color Sequence

Table E1 Color Sequence

COND. NO.	BACKGROUND OR BASE COLOR	FIRST TRACER COLOR	SECOND TRACER COLOR	COND. NO.	BACKGROUND OR BASE COLOR	FIRST TRACER COLOR	SECOND TRACER COLOR
1	Black	-	-	20	Red	Green	-
2	White	-	-	21	Orange	Green	-
3	Red	-	-	22	Black	White	Red
4	Green	-	-	23	White	Black	Red
5	Orange	-	-	24	Red	Black	White
6	Blue	-	-	25	Green	Black	White
7	White	Black	-	26	Orange	Black	White
8	Red	Black	-	27	Blue	Black	White
9	Green	Black	-	28	Black	Red	Green
10	Orange	Black	-	29	White	Red	Green
11	Blue	Black	-	30	Red	Black	Green
12	Black	White	-	31	Green	Black	Orange
13	Red	White	-	32	Orange	Black	Green
14	Green	White	-	33	Blue	White	Orange
15	Blue	White	-	34	Black	White	Orange
16	Black	Red	-	35	White	Red	Orange
17	White	Red	-	36	Orange	White	Blue
18	Orange	Red	-	37	White	Red	Blue
19	Blue	Red	-				

Pair cables are Black, White and numbered. Triad cables are Black, White, Red and numbered.

**Method 4 -
All Conductors Black**

COND.	CONDUCTOR PRINTING
1st	"1-One"
2nd	"2-Two"
3rd	"3-Three"
4th	"4-Four"
5th	"5-Five"

Table E2 Color Sequence

COND. NO.	BACKGROUND OR BASE COLOR	TRACER COLOR	COND. NO.	BACKGROUND OR BASE COLOR	TRACER COLOR
1	Black	-	19	Orange	Blue
2	Red	-	20	Yellow	Blue
3	Blue	-	21	Brown	Blue
4	Orange	-	22	Black	Orange
5	Yellow	-	23	Red	Orange
6	Brown	-	24	Blue	Orange
7	Red	Black	25	Yellow	Orange
8	Blue	Black	26	Brown	Orange
9	Orange	Black	27	Black	Yellow
10	Yellow	Black	28	Red	Yellow
11	Brown	Black	29	Blue	Yellow
12	Black	Red	30	Orange	Yellow
13	Blue	Red	31	Brown	Yellow
14	Orange	Red	32	Black	Brown
15	Yellow	Red	33	Blue	Brown
16	Brown	Red	34	Blue	Brown
17	Black	Blue	35	Orange	Brown
18	Red	Blue	36	Yellow	Brown

Pair cables are Black, Red and numbered. Triad cables are Black, Red, Blue and numbered. Colors repeat after 36 conductors. There are no Green or White conductors or stripes.

Metric Conversion Factors

	To Convert From	To	Multiply By
Length	Inches	Millimeters	25.4
	Millimeters	Inches	0.03937
	Inches	Centimeters	2.54
	Centimeters	Inches	0.3937
	Feet	Meters	0.3048
	Meters	Feet	3.2808
	kilofeet (1000 ft)	kilometers	0.3048
	kilometers	kilofeet (1000 ft)	3.2808
Area	Square Inches	Square Millimeters	645.16
	Square Millimeters	Square Inches	0.00155
	Square Inches	Square Centimeters	6.4516
	Square Centimeters	Square Inches	0.155
	Square Inches	Circular Mils	1,273,240
	Circular Mils	Square Inches	7.854×10^{-7}
	Circular Mils	Square Millimeters	5.066×10^4
	Square Millimeters	Circular Mils	1973.51
Weight	Square Feet	Square Meters	0.0929
	Square Meters	Square Feet	10.764
	Pounds	Kilograms	0.4536
	Kilograms	Pounds	2.2046
	Pound/Kilofeet	Kilograms/Kilometer	1.4882
	Kilograms/Kilometer	Pounds/Kilofeet	0.6720
	Ohms/Kilofeet	Ohms/Kilometer	3.2808
	Ohms/Kilometer	Ohms/Kilofeet	0.3048
Electrical	Microfarads/Kilofeet	Microfarads/Kilometer	3.2808
	Microfarads/Kilometer	Microfarads/Kilofeet	0.3048
	Insulation Resistance: Megohms— Kilofeet	Megohms— Kilometer	0.3048
	Megohms— Kilometer	Megohms— Kilofeet	3.2808
Mechanical	Pounds/Square Inch	Kilo Pascal*	6.895
	Kilo Pascal*	Pounds/Square Inch	0.1432
	Pounds (force)	Newtons	4.448

* 1 Pascal = 1 newton/m²

Reel Capacity Chart



Phone: 888-593-3355
www.generalcable.com

WOOD REELS

Reel (FtxB)	30x18x12	36x24x17	40x24x17	45x28x21	50x32x24	58x32x28	72x36x36	84x36x48	90x36x48
RM Code	61-1215	61-1659	61-1808	61-2056	61-2253	61-2764	61-3655	61-4265	61-4366
Arbor Hole	2.75	3.06	3.06	3.06	3.06	3.06	3.06	3.5	3.5
Drive Hole	1	1	1	1.5	1.5	1.5	1.5	1.5	1.5
Drive Hole Radius	4.5	6	6	8.5	10	10	10	10	10
Clearance	1.5	2	2	2	2	2	2	2	3
Factor	509.3	1155.4	1582.8	2274.2	3227.7	4468.6	7847.4	9658.4	11205.2
Max Weight	750	1500	2000	3000	4800	6500	8000	9000	10,000
Net Weight	47	91	110	142	208	271	513	744	821
Cable OD									
.241 - .250	11040								
.251 - .260	10200								
.261 - .270	9460								
.271 - .280	8800								
.281 - .290	8200								
.291 - .300	7660								
.301 - .310	7180								
.311 - .320	6740	10790							
.321 - .330	6330	10110							
.331 - .340	5970	9610							
.341 - .350	5630	9030							
.351 - .360	5320	8490							
.361 - .370	5040	8100							
.371 - .380	4780	7620	10520						
.381 - .390	4530	7300	9940						
.391 - .400	4310	6880	9540						
.401 - .410	4100	6600	9030						
.411 - .420	3910	6230	8550	12580					
.421 - .430	3730	6000	8220	11940					
.431 - .440	3560	5660	7790	11330					
.441 - .450	3410	5450	7510	10910					
.451 - .460	3260	5250	7120	10370	15010				
.461 - .470	3120	4970	6880	10000	14290				
.471 - .480	2990	4700	6530	9510	13790				
.481 - .490	2870	4630	6310	9180	13150				
.491 - .500	2760	4390	6110	8880	12700				
.501 - .525	2500	4040	5530	8050	11540				
.526 - .550	2280	3650	5030	7330	10510				
.551 - .575	2090	3310	4580	6680	9610				
.576 - .600	1920	3080	4180	6110	8800				
.601 - .625	1770	2810	3910	5590	8050				
.626 - .650	1630	2630	3580	5240	7430	10420			
.651 - .675	1510	2400	3280	4820	6970	9630			
.676 - .700	1410	2260	3090	4530	6430	8900			
.701 - .725	1310	2070	2840	4180	5940	8260			
.726 - .750	1230	1950	2690	3950	5610	7800			
.751 - .775	1150	1840	2480	3650	5190	7250			
.776 - .800	1080	1690	2350	3460	4920	6870			
.801 - .825	1010	1610	2230	3200	4670	6400	11530		
.826 - .850	950	1530	2060	3040	4340	6090	10860		
.851 - .875	900	1450	1970	2900	4130	5680	10250		
.876 - .900	850	1340	1880	2690	3850	5420	9690		
.901 - .925	810	1280	1735	2570	3670	5060	9170	11290	
.926 - .950	760	1220	1660	2460	3510	4840	8700	10700	
.951 - .975	730	1170	1590	2280	3270	4630	8250	10160	
.976 - 1.000	690	1075	1525	2190	3130	4340	7850	9660	11210
1.001 - 1.050	630	990	1360	2010	2880	3990	7120	8760	10160
1.051 - 1.100	570	910	1260	1800	2590	3600	6490	7980	9260
1.101 - 1.150	520	810	1120	1670	2400	3250	5930	7300	8470
1.151 - 1.200	480	750	1040	1500	2160	3030	5450	6710	7780
1.201 - 1.250	440	700	980	1400	2020	2740	5020	6180	7170
1.251 - 1.300	410	650	870	1310	1820	2570	4640	5720	6630
1.301 - 1.350	380	580	820	1180	1710	2410	4320	5300	6150
1.351 - 1.400	350	550	770	1110	1610	2190	4000	4930	5720
1.401 - 1.450	330	520	690	1040	1460	2070	3730	4590	5330
1.451 - 1.500	310	490	650	990	1370	1950	3490	4290	4980
1.501 - 1.600	270	410	590	840	1230	1690	3070	3770	4380
1.601 - 1.700	240	370	500	760	1060	1520	2720	3340	3880
1.701 - 1.800		330	450	650	960	1325	2420	2980	3460
1.801 - 1.900			420	600	880	1210	2170	2680	3100
1.091 - 2.000				540	760	1060	1960	2410	2800
2.001 - 2.100				500	700	970	1740	2190	2540
2.101 - 2.200					650	900	1620	2000	2320
2.201 - 2.300					600	790	1480	1830	2120
2.301 - 2.400					520	740	1360	1680	1950
2.401 - 2.500					490	690	1260	1550	1790
2.501 - 2.600					460	640	1160	1430	1660
2.601 - 2.700					430	600	1080	1320	1540
2.701 - 2.800						530	1000	1230	1430
2.801 - 2.900						500	930	1150	1330
2.901 - 3.000						470	870	1070	1250
3.001 - 3.100						440	820	1010	1170
3.101 - 3.200						420	770	940	1090
3.201 - 3.300						400	720	890	1030
3.301 - 3.400						380	680	840	970
3.401 - 3.500							640	790	910

Conductor Reference

TABLE 1 – Conductor Reference Table – Stranded Bare Copper Conductor and Aluminum (ACM) Conductor

Stranded Bare Copper Conductor Standards

Conforms to:	ASTM B3	Soft or annealed copper wire
	ASTM B8	Concentric lay stranded copper conductors Class B, C and D
	ASTM B33	Tinned soft or annealed copper wire
	ASTM B172	Rope lay stranded copper conductors having bunch stranded members Classes I, K and M
	ASTM B173	Rope lay stranded copper conductors having concentric stranded members Classes G and H
	ASTM B174	Bunch stranded copper conductors
	ASTM B496	Compact round concentric lay stranded copper conductors

Concentric Stranding

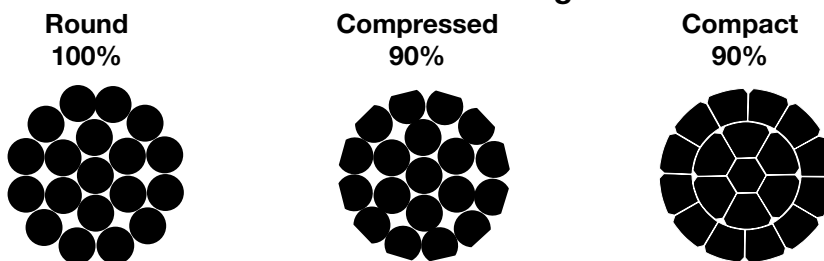

Class B Conductors for General Wiring

Copper Conductor

SIZE AWG/kcmil	STRANDING NO./STRAND DIA. INCHES	ASTM CLASS B					
		NOMINAL AREA		NOMINAL DIAMETER		NOMINAL WEIGHT	
		kcmil	mm ²	INCHES	mm	LBS/KFT	kg/km
22	7/.0100	0.64	0.32	0.030	0.76	2.2	3.3
20	7/.0121	1.02	0.52	0.036	0.91	3.2	4.8
18	7/.0152	1.62	0.82	0.045	1.14	5.0	7.4
16	7/.0192	2.58	1.31	0.056	1.42	8.0	12
14	7/.0242	4.11	2.08	0.071	1.80	12.7	18.9
12	7/.0305	6.53	3.31	0.090	2.29	20.2	30.1
10	7/.0385	10.38	5.26	0.113	2.87	32.1	47.8
9	7/.0432	13.09	6.63	0.127	3.23	40.4	60.1
8	7/.0486	16.51	8.37	0.141	3.58	51.0	74.4
7	7/.0545	20.82	10.5	0.158	4.01	64.3	95.7
6	7/.0612	26.24	13.3	0.178	4.52	81.1	121
5	7/.0688	33.09	16.8	0.200	5.08	102	152
4	7/.0772	41.74	21.2	0.225	5.72	129	192
3	7/.0867	52.62	26.7	0.252	6.40	163	243
2	7/.0974	66.36	33.6	0.283	7.19	205	305
1	19/.0664	83.69	42.4	0.322	8.18	258	384
1/0	19/.0745	105.6	53.5	0.362	9.19	326	485
2/0	19/.0837	133.1	67.4	0.406	10.3	411	612
3/0	19/.0940	167.8	85.0	0.458	11.6	518	771
4/0	19/.1055	211.6	107	0.512	13.0	653	972
250	37/.0822	250	127	0.558	14.2	772	1150
262.6	—	—	—	—	—	—	—
300	37/.0900	300	152	0.611	15.5	926	1380
313.1	—	—	—	—	—	—	—
350	37/.0973	350	177	0.661	16.8	1080	1607
373.7	—	—	—	—	—	—	—
400	37/.1040	400	203	0.706	17.9	1235	1838
444.4	—	—	—	—	—	—	—
500	37/.1162	500	253	0.789	20.0	1544	2297
535.3	—	—	—	—	—	—	—
592	—	—	—	—	—	—	—
600	61/.0992	600	304	0.866	22.0	1853	2757
646.4	—	—	—	—	—	—	—
750	61/.1109	750	380	0.968	24.6	2316	3446
777.7	—	—	—	—	—	—	—
1000	61/.1280	1000	507	1.117	28.4	3088	4595
1111	—	—	—	—	—	—	—

Dimensions and weights are nominal; subject to industry tolerances.

Class C Conductors for General Wiring

Copper Conductor

SIZE AWG/kcmil	STRANDING NO./STRAND DIA. INCHES	ASTM CLASS C					
		NOMINAL AREA		NOMINAL DIAMETER		NOMINAL WEIGHT	
		kcmil	mm ²	INCHES	mm	LBS/KFT	kg/km
22	19/.0063	0.64	0.32	0.031	0.79	2.3	3.4
20	19/.0080	1.02	0.52	0.038	0.97	3.8	5.7
18	19/.0092	1.62	0.82	0.044	1.12	5.0	7.4
16	19/.0117	2.58	1.31	0.056	1.42	8.0	12
14	19/.0147	4.11	2.08	0.071	1.80	12.7	18.9
12	19/.0185	6.53	3.31	0.089	2.26	20.2	30.1
10	19/.0234	10.38	5.26	0.112	2.85	32.1	47.8
9	19/.0262	13.09	6.63	0.123	3.12	40.4	60.1
8	19/.0295	16.51	8.37	0.139	3.53	51.0	74.4
7	19/.0331	20.82	10.5	0.156	3.96	64.3	95.7
6	19/.0372	26.24	13.3	0.175	4.45	81.0	121
5	19/.0417	33.09	16.8	0.203	5.16	102	152
4	19/.0469	41.74	21.2	0.229	5.82	129	192
3	19/.0526	52.62	26.7	0.256	6.50	163	243
2	19/.0591	66.36	33.6	0.288	7.32	205	305
1	37/.0476	83.69	42.4	0.325	8.26	258	384
1/0	37/.0534	105.6	53.5	0.364	9.25	326	485
2/0	37/.0600	133.1	67.4	0.410	10.4	411	612
3/0	37/.0673	167.8	85.0	0.459	11.7	518	771
4/0	37/.0756	211.6	107	0.516	13.1	653	972
250	31/.0640	250	127	0.562	14.3	774	1150
262.6	—	—	—	—	—	—	—
300	61/.0701	300	152	0.615	15.6	927	1380
313.1	—	—	—	—	—	—	—
350	61/.0757	350	177	0.664	16.9	1082	1610
373.7	—	—	—	—	—	—	—
400	61/.0810	400	203	0.711	18.1	1235	1838
444.4	—	—	—	—	—	—	—
500	61/.0905	500	253	0.794	20.2	1545	2299
535.3	—	—	—	—	—	—	—
592	—	—	—	—	—	—	—
600	91/.0812	600	304	0.893	22.7	1853	2757
646.4	—	—	—	—	—	—	—
750	91/.0908	750	380	0.999	25.4	2316	3446
777.7	—	—	—	—	—	—	—
1000	91/.1048	1000	507	1.153	29..3	3088	4595
1111	—	—	—	—	—	—	—

Dimensions and weights are nominal; subject to industry tolerances.

Class H Conductors for General Wiring

Copper Conductor

SIZE AWG/kcmil	STRANDING NO./STRAND DIA. INCHES	ASTM CLASS H					
		NOMINAL AREA		NOMINAL DIAMETER		NOMINAL WEIGHT	
		kcmil	mm ²	INCHES	mm	LBS/KFT	kg/km
22	—	—	—	—	—	—	—
20	—	—	—	—	—	—	—
18	—	—	—	—	—	—	—
16	—	—	—	—	—	—	—
14	—	—	—	—	—	—	—
12	—	—	—	—	—	—	—
10	—	—	—	—	—	—	—
9	—	—	—	—	—	—	—
8	133/.0111	16.51	8.37	0.164	4.17	52	77
7	133/.0126	20.82	10.5	0.190	4.83	67	100
6	133/.0140	26.24	13.3	0.204	5.18	82	122
5	133/.0158	33.09	16.8	0.231	5.87	105	156
4	133/.0177	41.74	21.2	0.260	6.60	132	196
3	133/.0199	52.62	26.7	0.292	7.42	167	248
2	133/.0223	66.36	33.6	0.327	8.31	208	310
1	259/.0180	83.69	42.4	0.363	9.22	266	396
1/0	259/.0202	105.6	53.5	0.407	10.3	334	497
2/0	259/.0227	133.1	67.4	0.458	11.6	422	628
3/0	259/.0255	167.8	85.0	0.515	13.1	533	793
4/0	259/.0286	211.6	107	0.579	14.7	670	997
250	427/.0242	250	127	0.627	15.9	795	1183
262.6	—	—	—	—	—	—	—
300	427/.0265	300	152	0.702	17.8	953	1418
313.1	—	—	—	—	—	—	—
350	427/.0286	350	177	0.740	18.8	1110	1652
373.7	—	—	—	—	—	—	—
400	427/.0306	400	203	0.809	20.5	1270	1890
444.4	—	—	—	—	—	—	—
500	427/.0342	500	253	0.900	22.9	1590	2366
535.3	—	—	—	—	—	—	—
592	—	—	—	—	—	—	—
600	703/.0292	600	304	1.022	26.0	1920	2857
646.4	—	—	—	—	—	—	—
750	703/.0327	750	380	1.122	28.5	2410	3586
777.7	—	—	—	—	—	—	—
1000	703/.0377	1000	507	1.294	32.9	3205	4769
1111	—	—	—	—	—	—	—

Dimensions and weights are nominal; subject to industry tolerances.

Class I Conductors for General Wiring

Copper Conductor

SIZE AWG/kcmil	STRANDING NO./STRAND DIA. INCHES	ASTM CLASS I					
		NOMINAL AREA		NOMINAL DIAMETER		NOMINAL WEIGHT	
		kcmil	mm ²	INCHES	mm	LBS/KFT	kg/km
22	—	—	—	—	—	—	—
20	—	—	—	—	—	—	—
18	—	—	—	—	—	—	—
16	—	—	—	—	—	—	—
14	—	—	—	—	—	—	—
12	—	—	—	—	—	—	—
10	27/24	10.91	5.53	0.123	3.12	33.7	50
9	—	—	—	—	—	—	—
8	37/24	14.95	7.57	0.138	3.50	46.0	68
7	—	—	—	—	—	—	—
6	61/24	24.64	12.5	0.190	4.83	77	114
5	91/24	36.76	19	0.240	6.10	113	168
4	105/24	42.42	21	0.260	6.60	132	196
3	125/24	50.5	25	0.285	7.24	155	231
2	150/24	60.6	31	0.320	8.13	189	281
1	225/24	90.9	46	0.385	9.78	280	417
1/0	275/24	111.1	56	0.435	11.0	346	515
2/0	325/24	131.3	66	0.470	11.9	403	600
3/0	450/24	181.8	92	0.545	13.8	567	844
4/0	550/24	222.2	112	0.580	14.7	684	1018
250	—	—	—	—	—	—	—
262.6	650/24	262.6	133	0.652	16	820	1220
300	—	—	—	—	—	—	—
313.1	775/24	313.1	159	0.700	18	960	1428
350	—	—	—	—	—	—	—
373.7	925/24	373.7	189	0.760	19	1105	1644
400	—	—	—	—	—	—	—
444.4	1100/24	444.4	225	0.850	21	1370	2038
500	—	—	—	—	—	—	—
535.3	1325/24	535.3	271	0.940	24	1700	2530
592	1480/24	597.9	303	0.970	25	1835	2730
600	—	—	—	—	—	—	—
646.4	1600/24	646.4	327	1.040	26	1992	2964
750	—	—	—	—	—	—	—
777.7	1925/24	777.7	394	1.120	28	2390	3556
1000	—	—	—	—	—	—	—
1111	2750/24	1111	563	1.340	34	3400	5059

Dimensions and weights are nominal; subject to industry tolerances.

Class K Conductors for General Wiring

Copper Conductor

SIZE AWG/kcmil	STRANDING NO./STRAND DIA. INCHES	ASTM CLASS K					
		NOMINAL AREA		NOMINAL DIAMETER		NOMINAL WEIGHT	
		kcmil	mm ²	INCHES	mm	LBS/KFT	kg/km
22	—	—	—	—	—	—	—
20	10/.010	1.02	0.52	0.036	0.91	3.2	4.8
18	16/.010	1.62	0.82	0.046	1.2	5.0	7.4
16	26/.010	2.58	1.31	0.057	1.4	7.8	12
14	41/.010	4.11	2.08	0.071	1.8	12.8	19.0
12	65/.010	6.53	3.31	0.088	2.2	20.3	30.2
10	105/.010	10.38	5.26	0.112	2.8	33.3	49.6
9	133/.010	13.09	6.63	0.150	3.8	42.4	63.1
8	168/.010	16.51	8.37	0.158	4.0	54.3	80.8
7	210/.010	20.82	10.5	0.175	4.4	66.8	99.4
6	266/.010	26.24	13.3	0.198	5.0	84.2	125
5	336/.010	33.09	16.8	0.261	6.6	106	158
4	420/.010	41.74	21.2	0.249	6.3	132	196
3	532/.010	52.62	26.7	0.298	7.6	169	251
2	665/.010	66.36	33.6	0.317	8.1	211	314
1	836/.010	83.69	42.4	0.356	9.0	266	396
1/0	1064/.010	105.6	53.5	0.401	10	338	503
2/0	1323/.010	133.1	67.4	0.501	13	425	632
3/0	1666/.010	167.8	85.0	0.562	14	535	796
4/0	2107/.010	211.6	107	0.632	16	676	1006
250	2499/.010	250	127	0.688	17	802	1193
262.6	2220/.010	222	112	0.680	17	850	1265
300	2989/.010	300	152	0.753	19	960	1428
313.1	3136/.010	313.6	159	0.750	19	969	1442
350	3458/.010	350	177	0.818	21	1120	1667
373.7	3737/.010	373.7	189	0.790	20	1210	1800
400	3990/.010	400	203	0.878	22	1290	1920
444.4	—	—	—	—	—	—	—
500	5054/.010	500	253	0.990	25	1635	2433
535.3	5320/.010	532	270	0.950	24	1641	2442
592	—	—	—	—	—	—	—
600	5985/.010	600	340	1.125	29	1950	2902
646.4	6466/.010	646.6	328	1.040	26	1987	2957
750	7448/.010	750	380	1.276	32	2427	3611
777.7	—	—	—	—	—	—	—
1000	9975/.010	1000	507	1.498	38	3250	4769
1111	—	—	—	—	—	—	—

Dimensions and weights are nominal; subject to industry tolerances.

Jacket and Insulation Material Properties

Thermoplastic Properties

INSULATION OR JACKET MATERIAL	CHLORINATED POLYETHYLENE (CPE)	POLYVINYL CHLORIDE (PVC)	LOW-DENSITY POLYETHYLENE	CELLULAR POLYETHYLENE	HIGH-DENSITY POLYETHYLENE	POLY-URETHANE	POLY-PROPYLENE	NYLON	TEFLON®	TPE
Oxidation Resistance	E	E	E	E	E	E	E	E	O	E
Heat Resistance	G-E	G-E	G	G-E	E	E	G	E	O	G
Oil Resistance	E	E	G-E	G-E	G-E	E	E	E	O	P
Low Temp. Flexibility	G	P-G	G-E	E	E	E	G	G	O	E
Weather, Sun Resistance	E	G-E	E	E	E	E	F-G	E	O	-
Ozone Resistance	E	E	E	E	E	E	E	E	E	E
Abrasion Resistance	E	F-G	F-G	G	E	F-G	O	E	G-E	F
Electrical Properties	F	F-G	E	E	E	E	P-F	F	E	G
Flame Resistance	F	E	P	P	P	P	P	P	O	F
Nuclear Radiation Resistance	G-E	P-F	G	G	G	F	G	F-G	P-F	F
Water Resistance	G	E	E	E	E	E	P	P-F	E	E
Acid Resistance	G-E	G-E	G-E	G-E	G-E	E	F	P-F	E	G
Alkali Resistance	G-E	G-E	G-E	G-E	G-E	E	F	E	E	G
Gasoline, Kerosene, Etc. (Aliphatic Hydrocarbons) Resistance	F	G-E	P-F	P-F	P-F	P-F	F	G	E	P
Benzol, Toluol, Etc. (Aromatic Hydrocarbons) Resistance	F	P-F	P	P	P	P-F	P	G	E	P
Degreaser Solvents (Halogenated Hydrocarbons) Resistance	P	P-F	P	P	P	P	P	G	E	P
Alcohol Resistance	G	G-E	E	E	E	E	P	P	E	E

P = Poor
F = Fair
G = Good
E = Excellent
O = Outstanding

Any given property can usually be improved by the use of selective compounding.
Dimensions and weights are nominal; subject to industry tolerance.

Jacket and Insulation Material Properties

Thermoset Properties

INSULATION OR JACKET MATERIAL	STYRENE BUTADIENE RUBBER (SBR)	NATURAL RUBBER	SYNTHETIC RUBBER	POLY-BUTADIENE	NEOPRENE	HYPALON® CHLORO-SULFONATED POLYETHYLENE (CSPE)	NITRILE OR RUBBER BUTADINE NITRILE (NBR)	NITRILE/POLY-CHLORIDE (NBR/PVC)	ETHYLENE PROPYLENE RUBBER (EPR)	CROSS-LINKED POLYETHYLENE (XLPE)	CHLORINATED POLYETHYLENE (CPE)	SILICONE RUBBER
Oxidation Resistance	F	F	G	G	G	E	F	E	G	E	E	E
Heat Resistance	F-G	F	F	F	G	E	G	G	E	G	E	G
Oil Resistance	P	P	P	P	G	G	G-E	G	F	G	G-E	F-G
Low Temp. Flexibility	F-G	G	E	E	F-G	F	F	F	G-E	O	F	O
Weather, Sun Resistance	F	F	F	F	G	E	F-G	G	E	G	E	O
Ozone Resistance	P	P	P	P	G	E	P	G	E	E	G-E	O
Abrasion Resistance	G-E	E	E	E	G-E	G	G-E	E	G	F-G	G-E	F
Electrical Properties	E	E	E	E	F	G	P	F	E	E	F-G	O
Flame Resistance	P	P	P	P	G	G	P	G	P	F-G	G	F-G
Nuclear Radiation Resistance	F-G	F-G	F-G	P	F-G	G	F-G	P	G	E	G	E
Water Resistance	G-E	G-E	E	E	G	G-E	G-E	E	G-E	G-E	G-E	G-E
Acid Resistance	F-G	F-G	F-G	F-G	G	E	G	G	G-E	G-E	E	F-G
Alkali Resistance	F-G	F-G	F-G	F-G	G	E	F-G	G	G-E	G-E	E	F-G
Gasoline, Kerosene, Etc. (Aliphatic Hydrocarbons) Resistance	P	P	P	P	G	F	E	G-E	P	F	F	P-F
Benzol, Toluol, Etc. (Aromatic Hydrocarbons) Resistance	P	P	P	P	P-F	F	G	G	F	F	F	P
Degreaser Solvents (Halogenated Hydrocarbons) Resistance	P	P	P	P	P	P-F	P	G	P	F	P	P-G
Alcohol Resistance	F	G	G	F-G	F	G	E	G	P	E	G-E	G

P = Poor
F = Fair
G = Good
E = Excellent
O = Outstanding

Any given property can usually be improved by the use of selective compounding.
Dimensions and weights are nominal; subject to industry tolerance.



Phone: 888-593-3355
www.generalcable.com

Recommended Reel Handling Practices

How to Handle Cable Reels

YES

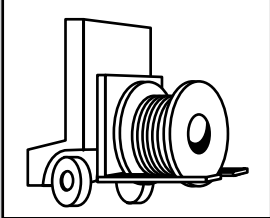

Cradle both reel flanges between forks.

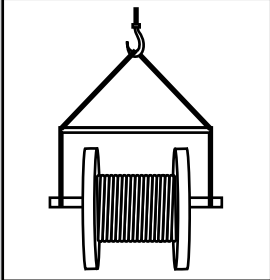

Reels can be hoisted with a shaft extended through both flanges.

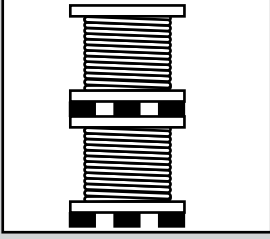

Place spacers under the bottom flange and between reels to create a space to insert the forks.

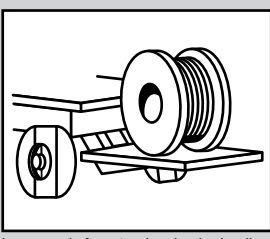

Lower reels from truck using hydraulic gate, hoist or fork lift. **LOWER CAREFULLY.**

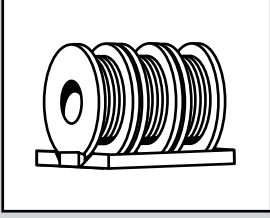

Always load with flanges on edge and chock and block securely.

NO

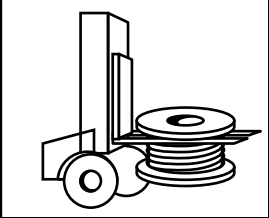

Do not lift by top flange. Cable or reel will be damaged.

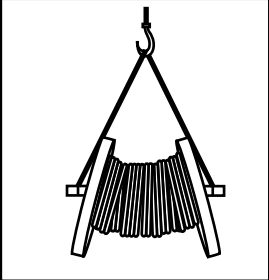

Use a spreader bar to prevent bending the reel flanges and mashing the cable.



Upended heavy reels will often arrive damaged. Refuse or receive subject to inspection for hidden damage.

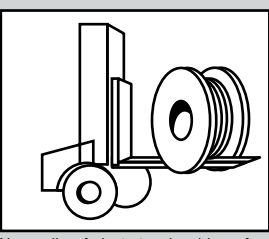

Never allow forks to touch cable surface or reel wrap.

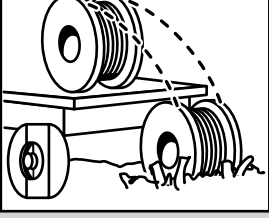

Never drop reels.

Recommended Cable Handling Practices

Unloading and Moving of Reels:

Cable reels are never shipped upended (flat side down). Cable reels that arrive in this manner should be rejected or received only after a thorough inspection for damage.

See "Recommended Reel Handling Practices" on the following pages.

Upon receipt, a cable's protective covering and/or lagging should be inspected for evidence of damage during shipment. If evidence of damage is found, a report should immediately be made to the carrier.

Under no circumstances should reels be dropped from the delivering vehicle to the ground.

Unloading and reel handling should be accomplished so that the equipment used does not contact the cable surface, and in the case of protective wrap, that the equipment does not contact the protective wrap.

If unloading and reel handling is accomplished by crane, either a cradle supporting the reel flanges or a shaft through the arbor hole should be used. If a fork lift is utilized, the forks must lift the reel at 90° to the flanges and the forks must be long enough to make complete lifting contact with both flanges. Under no circumstances should the forks come into contact with the cable surface or the protective wraps.

When a reel of cable is rolled from one point to another, care must be taken to see that there are no objects on the surface area which could contact or damage the cable surface or protective wrap.

If an inclined ramp is used for unloading, the ramp must be wide enough to contact both flanges completely. The stopping of the reels at the bottom shall be accomplished by using the reel flanges and not the surface of the cable.

Minimum Drum Diameters for Packaging Cables	
Type of Cable	Minimum Drum Diameter as a Multiple of Outside Diameter of Cable
1. Single and multiple conductor cable - unshielded 0-2000V	10
2. Single and multiple conductor cable - unshielded 2400V	12
3. Single and multiple conductor cable - wire shield (UniShield®) 5-35kV	12
4. Single and multiple conductor cable - helically applied tape shield (Uniblend®) 5-35kV	14
5. Single and multiple conductor cable - longitudinally applied flat tape shield (Type TC)	20
6. Single and multiple conductor cable - Interlocked Armor (Duralox®) 600V-35kV	14
7. Triplexed single conductors cabled together. The circumscribing overall diameter* shall be multiplied by the factor in 1 - 6 and then by the reduction factor.	.75

*Single conductor times 2.155 times

NEMA WC26 EEMAC201-2007 Binational Wire and Cable Packaging Standard

Recommended Cable Storage Practices

Storage and Storage Maintenance:

Finished cables have no established shelf-life. Moisture and atmospheric conditions can cause exposed conductors to oxidize and discolor. Uncovered/unsheltered cable will degrade due to exposure to direct sunlight and/or the elements. If the cables are protected, there should be no degradation of the insulation.

In general, any cable for use indoors should be stored indoors. Any cable suitable for installation outdoors is suitable for storage outdoors. Cables stored outdoors should have the ends sealed to prevent moisture ingress into the cable.

Cables should be stored in a sheltered area. While on the reel, cable should be covered with Masonite or a dark film wrap (to block the sun's rays and shield from the elements).

Cables with a cold temperature marking i.e. -10°C , -25°C , or -40°C may be stored outdoors. Cables without a cold temperature marking must be stored indoors.

Cable reels must remain in the upright position. Cable reels must not be stored on their sides. Reels must not be stacked.

Cable reels should be stored with the protective covering or lagging in place. If a length of cable has been cut from the reel, the cable end should be immediately resealed to prevent the entrance of moisture. If a part length is returned to storage, the reel's protective covering should be restored.

Wooden reels should be stored off the ground to prevent rotting. Reels should be stored on a flat, hard surface so that flanges do not sink into the earth. The weight of the reel and cable must be carried at all times by the reel flanges.

Cable reels and lagging must not be stored for an extended time period sitting in direct contact with water or dampness. Timbers or metal supports must be placed under the reel flanges to provide elevated storage of the reels away from the direct contact with water or damp soil.

Reels should be stored in an area where construction equipment, falling or flying objects or other materials will not contact the cable.

Cable should be stored in an area where chemicals or petroleum products will not be spilled or sprayed on the cable.

Cable should be stored in an area away from open fires or sources of high heat.

If the reels are relocated, they should be handled as suggested in the "Recommended Reel Handling Practices" section, and inspection made on each reel during the relocation.

If the cables are stored in a secure area and not exposed to the effects of the weather, an annual inspection should be satisfactory.

Where the reels are exposed to the weather, a bimonthly inspection should be performed to observe any sign of deterioration.

If the reels are exposed in a non-secure area, policing of the area at frequent intervals may be required depending on circumstances.

Records of delivery date, manufacturer, installation date, any extenuating circumstances, along with all test reports should be kept on file.

Pre-Installation Instructions

Pre-Installation

Overview

To ensure safety during cable installation and reliability once the cable is installed, you should confirm the following prior to installation:

- The cable selected is proper for your application
- The cable has not been damaged in transit or storage

Review all applicable state and national codes to verify that the cable chosen is appropriate for the job. Also, consult your local building authority.

Next, you must identify any existing cable damage and prevent any further damage from occurring. This is done through proper cable inspection, handling and storage.

Cable Inspection

Inspect every cable reel for damage before accepting the shipment. Be particularly alert for cable damage if:

- A reel is laying flat on its side
- Several reels are stacked
- Other freight is stacked on a reel
- Nails have been driven into reel flanges to secure shipping blocks
- A reel flange is damaged
- A cable covering is removed, stained or damaged
- A cable end seal is removed or damaged
- A reel has been dropped (hidden damage likely)

Cabling Handling

Remove all nails and staples from the reel flanges before moving a reel, and avoid all objects that could crush, gouge or impact the cable when moving. NEVER use the cable as a means to move a reel.

When unreeling, observe recommended bending radii, use swivels to prevent twisting and avoid overruns.

Installation—Overview and Checklist

Installation

Overview

Most cables are subjected to more mechanical stress during installation than they ever experience in actual operation. Needless to say, handling and pulling your cable according to manufacturer's recommendations is extremely important.

There are five main considerations in any cable installation:

- Ambient temperature
- Equipment
- Conduit fill
- Mechanical fit in raceway
- Physical limitations

Installation Temperature

Low temperatures are a cause for concern when installing cable. Cable should not be installed when temperatures are less than the cold bend temperature rating of the cable product plus 15°C (i.e., minimum installation temperature = cold bend temperature rating + 15°C). The cold bend temperature rating is indicated on the catalog Spec sheet.

Prior to performing a low temperature (less than 10°F or -12°C) cable installation, cable should be stored for a minimum of 24 hours at a temperature of 55°F (13°C) or higher.

Cable should be pulled more slowly and trained in place the same day it is removed from storage. Do not impact, drop, kink or bend cable sharply in low temperatures.

Equipment

The proper use of appropriate equipment is crucial to a successful cable installation. The equipment needed for most installations is detailed in the following checklist:

- 0-1/5/10 kip dynamometer
- basket grip pullers
- cable cutter
- cable end seals
- cable pulling lubricant
- cable tray bend sheaves
- cable tray rollers
- capstan-type puller
- diameter tape
- duct cleaning mandrels
- electric safety blankets and clamps
- extension cords and GFCI protection
- fish tape or string blower/vacuum
- floodlights
- gang rollers: with at least 4 ft. effective radius
- gloves
- guide-in flexible tubing (elephant trunks)
- hand winches (come-a-long)
- HI-POT tester
- lint-free rags
- make-up air blower & hose
- manhole edge sheave
- measuring tape
- personal protection equipment (PPE)
- plywood sheets
- portable electric generator
- pre-lubing devices
- pulling rope
- pump, diaphragm
- radios or telephones
- reel arbor
- reel brakes
- reel jacks
- several wire rope slings of various lengths
- shackles/clevis
- short ropes for temp tie-offs
- swivels
- warning flags, signs

Installation—Feed-In Setups

Cable Feed-In Setups

The following diagrams illustrate various cable feed-in setups:

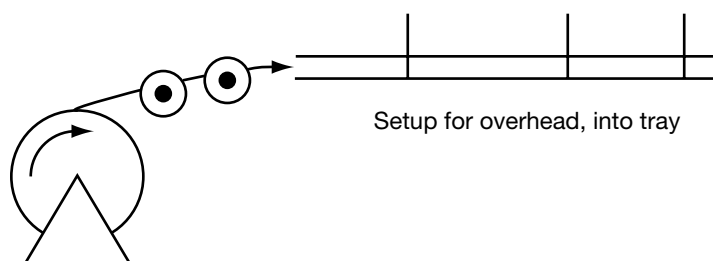
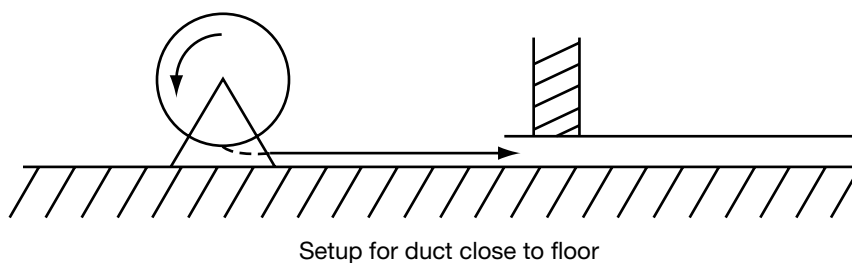
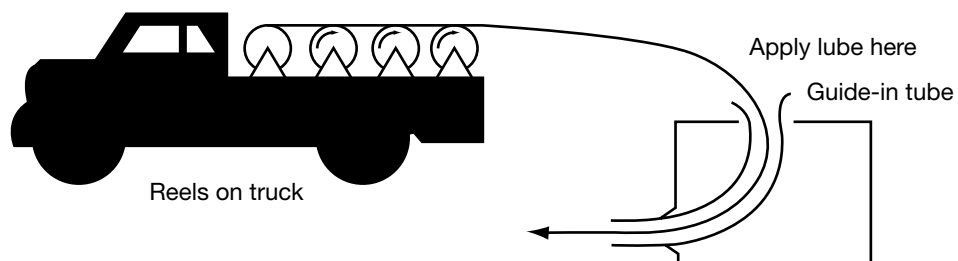

The feed-in setup should unreel the cable with a natural curvature (Figure 1) as opposed to a reverse "S" curvature (Figure 2).

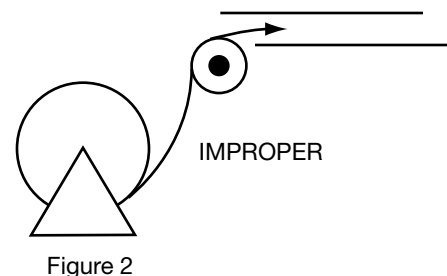
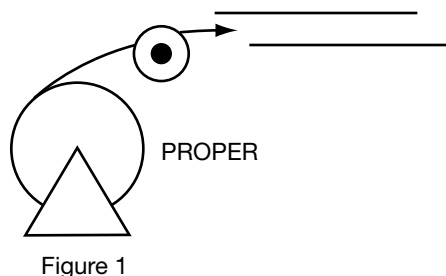

Installation—Feed-In Setups

Cable Feed-In Setups (continued)

Single sheaves should only be used for GUIDING cables. Arrange multiple blocks to maintain bending radii whenever cable changes direction or elevation.

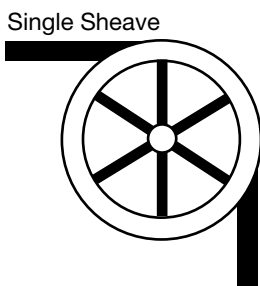

For pulling around bends, use conveyor sheave assemblies of appropriate radius series.

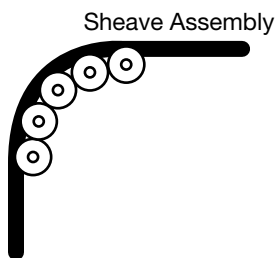

The pulleys must be positioned to ensure that the effective curvature is smooth and changes direction or elevation evenly at each pulley. Never allow a polygon curvature to occur (Figure 3).

The fit of a pulley around the cable is also important when pulling heavy weights (i.e. pulleys at the top of a vertical drop).

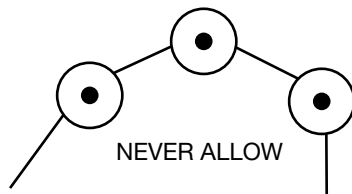
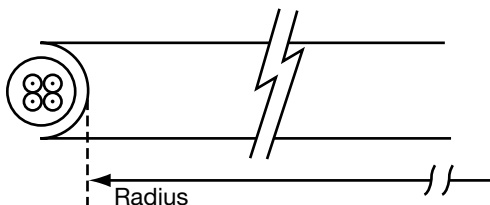

Figure 3

Remember to use the radius of the surface over which the cable is bent, not the outside flange diameter of the pulley. A "10 inch" cable sheave typically has a 10 inch outside diameter with a 6 inch inside diameter that provides an inside (bending) radius of 3 inches.



Installation—Conductor Maximum Pulling Tensions

Multiconductor Cables Having Equal-Sized Conductors;
In Parallel or as Multiplexed Assemblies

AWG/kcmil	MAXIMUM ALLOWABLE PULLING TENSION (LBS)					
	NUMBER OF CONDUCTORS					
	1	2	3	4	5	6
18	13	26	39	41	52	62
16	20	40	60	65	81	97
14	33	66	99	105	132	158
12	52	104	157	167	209	251
10	83	166	249	266	332	399
8	132	264	396	423	528	634
6	210	420	630	672	840	1008
4	334	668	1002	1069	1336	1603
2	531	1062	1593	1699	2124	2548
1	670	1339	2009	2142	2678	3214
1/0	845	1690	2534	2703	3379	4055
2/0	1065	2130	3194	3407	4259	5111
3/0	1342	2685	4027	4296	5370	6444
4/0	1693	3386	5078	5417	6771	8125
250	2000	4000	6000	6400	8000	9600
350	2800	5600	8400	8960	10000	10000
500	4000	8000	10000	10000	10000	10000
750	6000	10000	10000	10000	10000	10000
1000	8000	10000	10000	10000	10000	10000

The maximum allowable pulling tensions are for direct attachment to the conductor.

$$T = 0.008 \times \text{cmil} \times n, \text{ if } n \leq 3$$

$$T = 0.008 \times \text{cmil} \times n \times 0.8, \text{ if } n > 3$$

Installation—Conductor Maximum Pulling Tensions

Multiconductor Cables Having Equal-Sized Conductors, without Subassemblies

Number Of Conductors	MAXIMUM ALLOWABLE PULLING TENSION (LBS)				
	CONDUCTOR SIZE (AWG/kcmil)				
	18	16	14	12	10
2	26	40	66	104	166
3	39	60	99	157	249
4	41	65	105	167	266
5	52	81	132	209	332
6	62	97	158	251	399
7	73	113	184	293	465
8	83	129	210	334	531
9	93	145	237	376	598
10	104	161	263	418	664
12	124	194	316	502	797
14	145	226	368	585	930
15	156	242	395	627	996
16	166	258	421	669	1000
18	187	290	473	752	1000
19	197	306	500	794	1000
20	207	323	526	836	1000
22	228	355	549	919	1000
24	249	387	631	1000	1000
25	259	403	658	1000	1000
30	311	484	789	1000	1000
37	383	596	974	1000	1000

The maximum allowable pulling tensions are for multi conductor cables pulled into a raceway or cable tray using a basket grip or similar device secured directly to the cable jacket. It is recommended that a combination of basket grips and pulling eyes be used whenever possible.

$$T = 0.008 \times \text{cmil} \times n, \text{ if } n \leq 3$$

$$T = 0.008 \times \text{cmil} \times n \times 0.8, \text{ if } n > 3$$

Installation—Training and Bending Limitations

Physical Limitations Training and Bending

Overview

Training is the positioning of cable when it is not under tension. Bending is the positioning of cable when it is under tension. When installing cable, the object is to limit the mechanical forces so that the cable's physical and electrical characteristics are maintained for the expected service life. Bends in conductors, multiconductor cables or assemblies of conductors shall be made so that the cable will not be damaged.

A nonshielded cable can tolerate a sharper bend than a shielded cable. This is especially true for cables having helically applied metallic shielding tapes which, when bent too sharply, can separate or buckle and cut into the insulation. Remember that offsets are bends.

The problem is compounded by the fact that most tapes are under jackets that conceal such damage. The extruded polymers used for insulation shields have sufficient conductivity and coverage initially to pass acceptance testing, then fail prematurely due to corona at the shield/insulation interface.

Minimum Bending Radius in Accordance with National Electric Code

Voltage	Conductors	Shielding	Cable Types	Minimum Bending Radius as a Multiple of Conductor/Assembly Diameter		
600V	Single	Nonshielded	All	5X		
601-2000V			All	8X		
600V or 2000V	Multiconductor or Multiplexed	Nonshielded	TC or TC-ER	1 in. (25 mm) or less	Over 1 in. to 2 in. (>25 mm to 50 mm)	Over 2 in. (>50 mm)
				4X	5X	6X
			MC ³	7X		
		Shielded	All	12X		
			TC or TC-ER	12X		
			MC	12X/7X ¹		
Over 2000V	Single	Nonshielded	MV	8X		
			MC ³	7X		
		Shielded	MC and MV	12X ²		
	Multiconductor Multiplexed	Nonshielded	MC and MV	8X		
			Shielded	MC and MV	12X/7X ^{1,2}	
		Shielded	MC and MV	12X/7X ^{1,2}		

¹ 12 times the diameter of an individual shielded conductor or 7 times the overall cable diameter, whichever is greater.

² Since UniShield® is a unique construction, there are no applicable values for the bending radius in the NEC. However, General Cable recommends 8 times for single conductors, and for multiplexed or multi-conductor cables, it is 8 times the diameter of the individual conductors or 5 times the overall diameter, whichever is greater, in accordance with ANSI/CEA S-93-639 5-46kV *Shielded Power Cable for Use in the Transmission and Distribution of Electric Energy*.

³ Per 330.24B Interlocked-Type Armor or Corrugated Sheath.

Installation—Maximum Sidewall Pressure

Overview

Sidewall bearing pressure (SWBP), or sidewall loading, is the radial force exerted on a cable being pulled around a conduit bend or sheave. Excessive SWBP can crush a cable and is, therefore, one of the most restrictive factors in installations having bends and requiring high pulling tensions. SWBP is reduced by increasing the radius of bends.

The maximum tension that can safely be applied to the cable during installation can be calculated using the maximum SWBP for the cable and the radius of the bend it is traversing.

For example, a cable having a maximum SWBP of 300 lb/ft that is being pulled around a bend having a radius of 2 feet should have no more than $300 \text{ lbs/ft} \times 2 \text{ ft}$ or 600 lbs tension applied to it as the cable exits the bend.

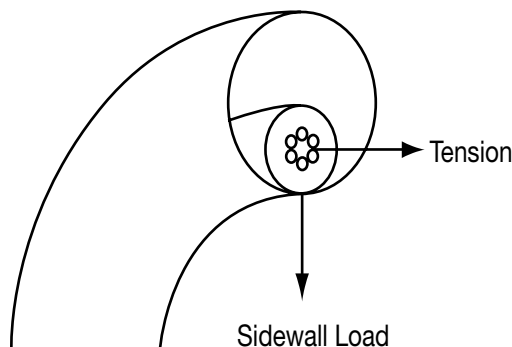

CABLE TYPE	SWBP (LBS/FT)
300V Nonshielded, 300V and 600V Shielded Control & Instrumentation	500
600V Nonshielded Control & Instrumentation	500
600V and 2400V Nonshielded Power	1000
5kV-35kV Shielded Power	1000
Interlocked Armored Cable (all voltage)	300

General Cable’s Approval List of Cable Pulling Lubricants

The following manufacturers, who are listed in the 2006 UL Electrical Construction Equipment Directory, provide wire pulling compounds intended for use as lubricants in installing electrical conductors in raceways. These manufacturers have had some of their products investigated by Underwriters Laboratories (UL) to determine their compatibility with conductor insulation and coverings.

Since it is not feasible to test every possible combination of cable material with every wire pulling compound, the installer should check with the pulling compound manufacturer or the cable manufacturer to determine compatibility between specific cable materials and the pulling compound.

The Listing Mark for these products includes the UL symbol, together with the word “LISTED,” a control number and the product name “Wire Pulling Compound.” Refer to the latest edition of the UL Electrical Construction Equipment Directory for the current listing of manufacturers of wire pulling compounds and their control numbers.

- | | |
|---------------------------------------|---|
| 3 M Company | J. C. Whitlam Mfg. Co. |
| American Bentonite International Inc. | Klein Tools Inc. |
| American Polywater Corp. | Madison Electric Products Inc. |
| Arnco Corp. | Rainbow Technology Corp. |
| Dura-Line Corp. | Rectorseal |
| Formulated Solutions LLC | Robinette Inc., DBA Electro Compounds Co. |
| Compound Co. | Thomas & Betts Corp. |
| Greenlee Textron | |
| Ideal Industries Inc.* | |

*Yellow 77 not recommended for use with UniShield® cables.

For LSZH jacketed cable, consult with pulling compound manufacturers.

Other wire pulling compounds may be suitable for use with General Cable constructions. Contact the wire pulling compound manufacturer regarding the suitability of their products with specific General Cable products.

DC “HI-POT” Pre-Test Guidelines for MV Cables

The test voltage should be increased in steps of 10kV, or minimum of 5 steps. The duration at each step should be long enough for the current to reach a steady value (1 minute suggested). The test current will momentarily increase for each voltage increment due to charging of the capacitance and the dielectric absorption characteristics of the insulation. Stabilized current should be recorded at each step.

The maximum test voltage should be maintained for 15 minutes (new cable, shielded) / 5 minutes (non-shielded). Leakage current should be recorded each minute after the maximum test voltage has been reached.

Increase of leakage current at any step point may be an indication of a cable insulation problem. Failure of the cable or cable accessories may result unless the voltage is rapidly reduced.

Otherwise, the leakage current should stabilize after about 5 minutes. Leakage current is essentially a function of the construction and length of cable but it can be influenced by the test conditions (wind and humidity) as well as the test apparatus (leads).

Typical leakage currents in the order of 100 – 150 microamperes or higher are not unusual. A defective installation is identified by increasing leakage current with time, at a fixed DC voltage.

All testing should be performed by qualified personnel taking all appropriate safety precautions.

DC “HI-POT” Testing Guidelines for MV Cable

DC High Potential (HI-POT) Testing of Medium-Voltage Power Cable

Overview

This procedure is intended to provide general guidelines for high potential DC testing of power cables.

All tests made after cable installation and during the guarantee period shall be made in accordance with applicable specifications.

All safety precautions must be observed during testing at high voltage.

Read and understand and follow the Operator’s Manual for the particular test set being used!

Test Equipment

Direct current test equipment is available commercially with a wide range of voltages. Accessory equipment necessary to safely conduct high voltage tests—such as safety barriers, rubber gloves and nonconducting hard hats—must be used; consult appropriate safety officer.

Test Procedures

See IEEE Standard 400 Article 5 Direct Voltage Testing. Acceptable procedures, although varying slightly in technique, have more or less been standardized as either a “withstand test” or a “time-leaking current test.”

Before performing any DC overpotential tests:

- All equipment must be disconnected from the cable circuit, i.e., taps, motors, circuit breakers, surge arrestors, etc. This will preclude damage to such equipment and will prevent test interruptions due to flashovers and/or trip-outs resulting from excessive leakage current.
- Establish adequate clearance between the circuit test ends and any grounded object, and to other equipment not under test (about 2.5 feet).
- Ground all circuit conductors not under test with all cable shields including nearby equipment.
- Consult termination manufacturers for maximum test voltage recommendations and time limitations.

The direct current test voltage may be applied either continuously or in predetermined steps to the maximum value in accordance with applicable specifications.

- **Continuous Method** – Apply test voltage at an approximate rise rate of 1 kV per second or 75% of the rated current output of the equipment, whichever is less. Some equipment will take longer to reach the maximum test voltage because of the amount of charging current.
- **Step Method** – Apply test voltage slowly in 5 to 7 increments of equal value to the maximum specified. Allow sufficient time at each stop for the leakage current to stabilize.

HI-POT TESTING PROCEDURES

Normally this requires only a few seconds unless cable circuits of high capacitance are involved. Record leakage current at each step.

Maintain the test voltage at the prescribed value for the time designated in applicable specifications. The following times are usually considered adequate: at the end of the test period, set the test set voltage control to zero, allow the residual voltage on the circuit to decay, then ground the conductor just tested.

CAUTION

It should be recognized that DC charges on cable can build up to potentially dangerous levels if grounds are removed too quickly. Maintain solid grounds after the test on the cable for at least 4 times the duration of the test. On exceptionally long cable lengths, it may be necessary to increase the grounding time. It is advantageous to maintain these grounds longer and while reconnecting circuit components.

- **Acceptance Testing** – After installation and before the cable is placed in regular service, the specified test voltage shall be applied for **15 consecutive minutes.**
- **Proof Testing** – At any time during the period of guarantee, the cable circuit may be removed from service and tested at a reduced voltage (normally 65 percent of the original acceptance value) for **5 consecutive minutes.**
- Record the leakage current at one minute intervals for the duration of the test time involved.

DC “HI-POT” Testing Guidelines for MV Cable

DC High Potential (HI-POT) Testing of Medium-Voltage Power Cable

Comments

The significance of conducting DC high-voltage tests on nonshielded, nonmetallic-sheathed cable is dependent upon the environment in which it is installed because the characteristics of the return circuits are unknown. The environment must be carefully considered or test results may not be significant. In fact, these tests can result in damage to the cable insulation.

Humidity, condensation and actual precipitation on the surface of a cable termination can increase the leakage current by several orders of magnitude. Humidity also increases the corona current, which indication is included in the total leakage current. Wind prevents the accumulation of space charges at all bare energized terminals.

This results in an increase of corona. It is most desirable to reduce or eliminate corona current at the bare metal extremities of cable or terminations. This may be accomplished by covering these areas with plastic envelopes, plastic or glass containers, plastic wrap or suitable electrical putty.

Routine periodic DC maintenance testing of cable for the evaluation of the insulation strength is not a common practice. Some power cable users have adopted a program of testing circuits during planned outages, preferring possible breakdowns during testing rather than experiencing a service outage. It is nearly impossible to recommend test voltage values for those maintenance tests with the history of the cable circuit. An arbitrary test voltage level could break down a cable circuit that would otherwise render long trouble-free service at normal operating AC voltage.

The main usefulness of DC high-voltage testing is to detect conducting particles left on the creepage surface during splicing or termination.

Test equipment should be supplied from a stable, constant voltage source. Do not use the same source that is supplying arc welders or other equipment causing line voltage fluctuations. The output voltage of the test set must be filtered and regulated. Consider using a portable, motor-driven alternator to energize test set.

The gradual decrease or non-increase of leakage current with respect to time at maximum test voltage is the acceptance criteria for DC HI-POT testing.

Testing Problems

Extra Leakage Current:

- Failure to guard against corona
- Failure to clean insulation surface
- Failure to keep cable ends dry
- Failure to provide adequate clearance to ground
- Improper shield termination

Erratic Readings:

- Fluctuating voltage to test set
- Improper test leads

Environmental Influences:

- High relative humidity
- Dampness, dew, fog
- Wind, snow

Results vs. Cable Life

To date there is no basis for correlation between DC test results and cable life expectancy.

Field Electrical "HI-POT" Testing Guidelines

Acceptance Testing

Acceptance testing is performed to detect any defects in cable insulation and terminations which may have resulted from poor workmanship or mechanical damage. This proof test confirms the integrity of the insulation and accessories before the cable is placed into service.

After installation and before the cable is placed in regular service, the test voltages specified in the ICEA S-97-682 Table should be applied for 15 consecutive minutes. Record the leakage current at one minute intervals for the duration of the test.

ICEA DC Field Test Voltages
ICEA S-97-682 Utility Shielded Power Cables Rated 5,000-46,000 Volts

Rated Voltage Phase-to-Phase (kV)	Conductor Size		Nominal Insulation Thickness (Insulation Level)				Maximum DC Field Test Voltages (kV)			
							During or After Installation		First 5 Years	
	AWG/kcmil	mm ²	100%		133%		100%	133%	100%	133%
			mils	mm	mils	mm				
5	8 - 1000	8.4 - 507	90	2.29	115	2.92	28	36	9	11
	> 1000	> 507	140	3.56	140	3.56				
8	6 - 1000	13.3 - 507	115	2.92	140	3.56	36	44	11	14
	> 1000	> 507	175	4.45	175	4.45				
15	2 - 1000	33.6 - 507	175	4.45	220	5.59	56	64	18	20
	> 1000	> 507	220	5.59						
25	1 - 2000	42.4 - 1013	260	6.60	320	8.13	80	96	25	30
28	1 - 2000	42.4 - 1013	280	7.11	345	8.76	84	100	26	31
35	1/0 - 2000	53.5 - 1013	345	8.76	420	10.7	100	124	31	39
46	4/0 - 2000	107.2 - 1013	445	11.3	580	14.7	132	172	41	54

DC test voltages are applied to discover gross problems such as improperly installed accessories or mechanical damage. DC testing is not expected to reveal deterioration due to aging in service. There is some evidence that DC testing of aged cross-linked polyethylene cables can lead to early cable failures. Information on this subject is available in EPRI project report TR-101245, "Effect of DC Testing in Extruding Cross-Linked Polyethylene Insulated Cables."

Dimensions and weights are nominal; subject to industry tolerances.

Emergency Overload Current Guidelines

The increase or decrease of the load current is not associated with an instantaneous change of the cable temperature. Hence, during emergency conditions, the cable may be overloaded for short periods of time at the maximum overload temperature of 130°C/140°C for cable rated at 90°C/105°C continuous.

Operations at the emergency overload temperature shall not exceed 1500 cumulative hours during the lifetime of the cable. Lower temperature for emergency overload conditions may be required due to the type of material used in the cable splices and terminations or environmental conditions.

Short Circuit Current Calculation Overview

The maximum short circuit current which is permitted to flow in the insulated conductor, or the metallic shielding and bonding (grounding) components, is dependent on the duration of the short circuit and the material used in the cable.

Insulated Conductors Formula

The graphs on the following pages show the short circuit capability of 10 AWG to 1000 kcmil, copper and aluminum, XLPE and EPR insulated conductors for various periods of time. These graphs are in accordance with ICEA publication P-32-382. The equations are based on the assumption that the duration of the short circuit is so short that the heat generated is contained within the conductor, taking into consideration the temperature limit of the insulation.

The graphs are derived from the following formula:

$$\begin{aligned} \text{Copper Conductor } \left[\frac{I}{A} \right]^2 t &= 0.0297 \log_{10} \left[\frac{T_2 + 234}{T_1 + 234} \right] \\ \text{Aluminum Conductor } \left[\frac{I}{A} \right]^2 t &= 0.0125 \log_{10} \left[\frac{T_2 + 228}{T_1 + 228} \right] \end{aligned}$$

Which simplify to:

$$\begin{aligned} \text{Copper Conductor } I &= \frac{0.07195 A}{\sqrt{t}} && \text{amperes for MV-90} \\ \text{Copper Conductor } I &= \frac{0.06773 A}{\sqrt{t}} && \text{amperes for MV-105} \\ \text{Aluminum Conductor } I &= \frac{0.0470 A}{\sqrt{t}} && \text{amperes for MV-90} \\ \text{Aluminum Conductor } I &= \frac{0.044 A}{\sqrt{t}} && \text{amperes for MV-105} \end{aligned}$$

Where: I = Short circuit current (amperes)
 A = Conductor cross-sectional area (circular mils)
 t = Short circuit duration (seconds)
 T₁ = Maximum normal operating temperature, 90°C for MV-90 or 105°C for MV-105
 T₂ = Maximum short circuit temperature, 250°C

Short Circuit Currents

Allowable Short Circuit Currents For Thermoset Insulated Copper Conductors
Rated For 90°C Maximum Continuous Operation

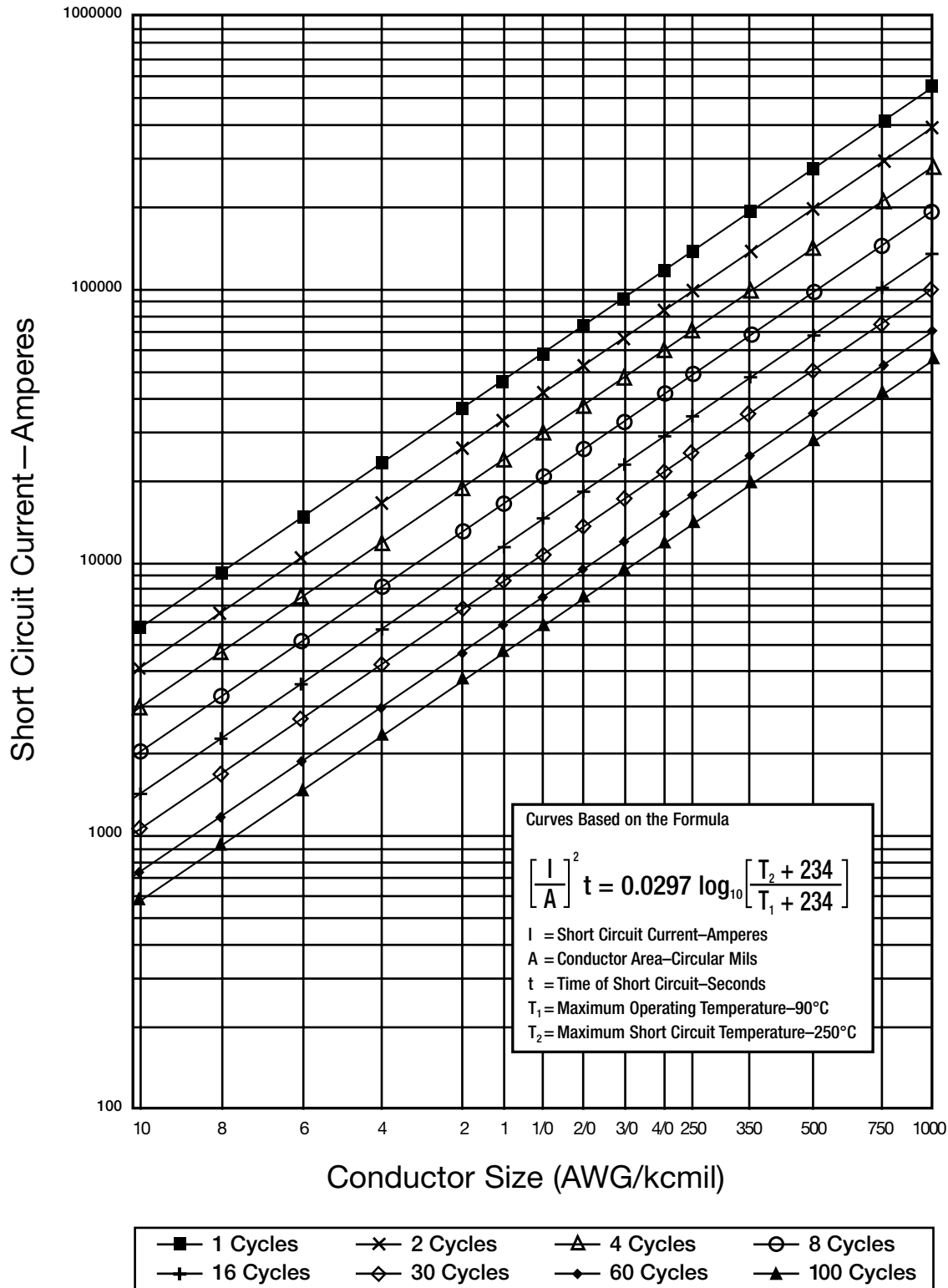

Reprinted with permission from ICEA P-32-382 Short Circuit characteristics of Insulated Conductors, Copyright 2006, Insulated Cable Engineers Association, Carrollton, GA 30112. This reprint is not the referenced subject, which is represented only by the standard in its entirety.

Short Circuit Currents

Allowable Short Circuit Currents For Thermoset Insulated Copper Conductors
Rated For 105°C Maximum Continuous Operation

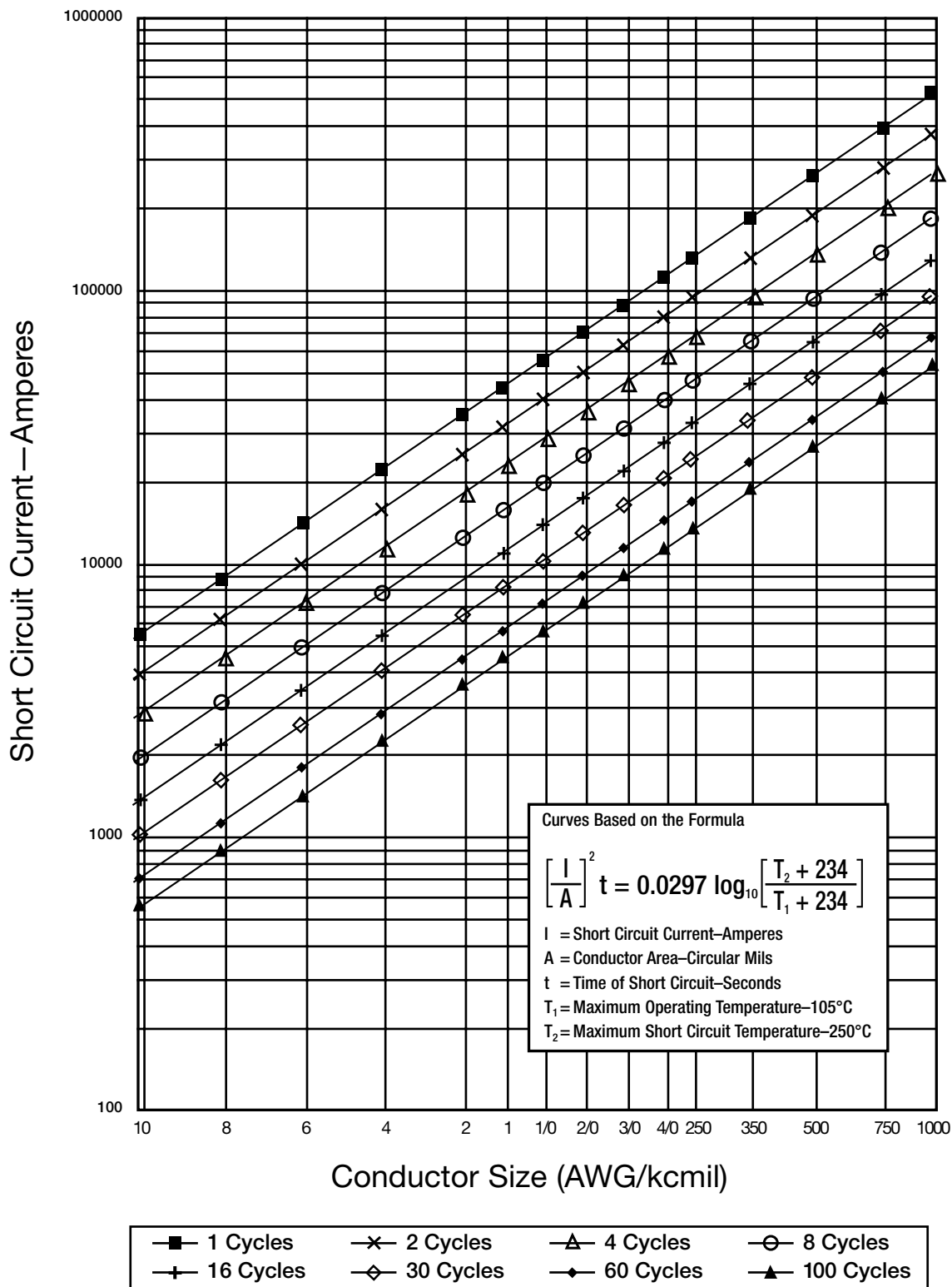

Reprinted with permission from ICEA P-32-382 Short Circuit characteristics of Insulated Conductors, Copyright 2006, Insulated Cable Engineers Association, Carrollton, GA 30112. This reprint is not the referenced subject, which is represented only by the standard in its entirety.

Short Circuit Currents

Allowable Short Circuit Currents For Thermoset Insulated Aluminum Conductors
Rated For 90°C Maximum Continuous Operation

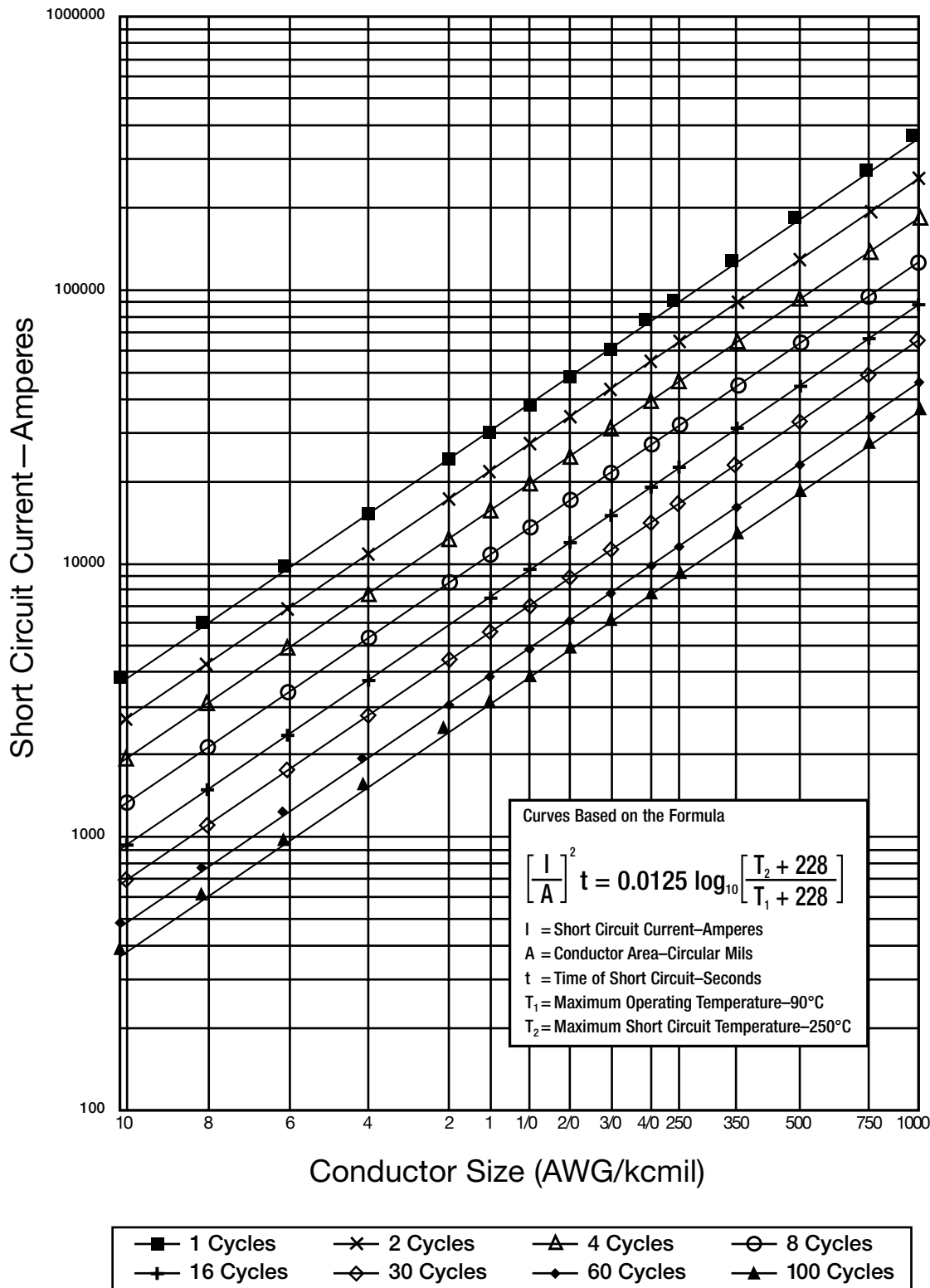

Reprinted with permission from ICEA P-32-382 Short Circuit characteristics of Insulated Conductors, Copyright 2006, Insulated Cable Engineers Association, Carrollton, GA 30112. This reprint is not the referenced subject, which is represented only by the standard in its entirety.

Short Circuit Currents

Allowable Short Circuit Currents For Thermoset Insulated Aluminum Conductors
Rated For 105°C Maximum Continuous Operation

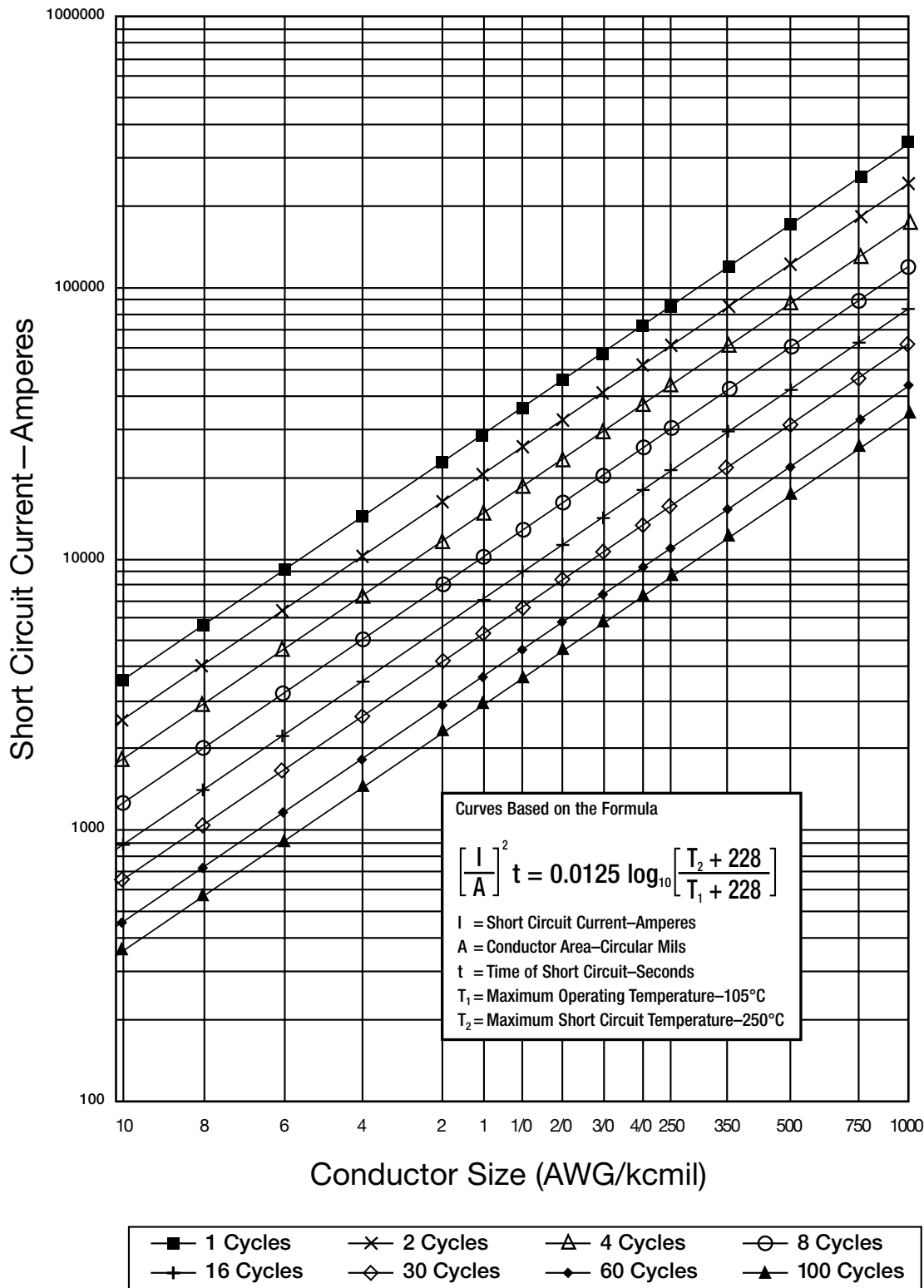

Reprinted with permission from ICEA P-32-382 Short Circuit characteristics of Insulated Conductors, Copyright 2006, Insulated Cable Engineers Association, Carrollton, GA 30112. This reprint is not the referenced subject, which is represented only by the standard in its entirety.

Short Circuit Current for Copper Shields

Formula—Short Circuit Current for Copper Shields

In the *three conductor* cables, a copper tape is applied over each extruded semi-conducting insulation shield with a helical gap. Because the three copper tape shields are cabled in intimate contact with the bonding (grounding) conductor, their combined total cross-sectional areas may be considered an integral shielding system for the purpose of calculating short circuit capacity. It is not possible however, to determine the contact resistance between the components, due to possible oxides or film which may form on the components or movement of the cable core during handling. It may be advisable to consider the short circuit capacity of the individual shields independently. Because the insulation shields are in thermal contact with the inner PVC jacket, the maximum short circuit temperature T2 is 200°C. Refer to ICEA P-45-482, "Short Circuit Performance of Metallic Shields and Sheaths on Insulated Cable," for calculations involving cables that have other operating parameters.

Under these temperature conditions the short circuit current formula is: $I = \frac{M \cdot A}{\sqrt{t}}$ amperes

TYPE OF SHIELD OR SHEATH	FORMULA FOR CALCULATING A
1. Wires applied either helically, as a braid or serving; or longitudinally with corrugations	nd_s^2
2. Helically applied tape, not overlapped	$1.27 nwb$
3. Helically applied flat tape, overlapped	$4 bd_m \times \sqrt{\frac{100}{2(100-L)}}$
4. Corrugated tape, longitudinally applied	$1.27[\pi(d_{is}+50)+B]b$
5. Tubular sheath	$4 bd_m$

Meaning of Symbols:

- A = Effective cross-sectional area, shield or sheath
- B = Tape overlap (mils) (usually 375)
- b = Thickness of tape (mils)
- d_{is} = Diameter over semiconducting insulation shields (mils)
- d_m = Mean diameter of shield or sheath (mils)
- d_s = Diameter of wires (mils)
- I = Short circuit current (amperes)
- w = Width of tape (mils)
- n = Number of serving or braid wires or tapes
- L = Overlap of tape (percent)
- t = Short circuit duration (seconds)
- M = 0.058 for 5-15kV cables
0.060 for 25-46kV cables

Formula—Short Circuit Currents for Copper Shields

Allowable Copper Shield Short Circuit Currents for 5–15 kV

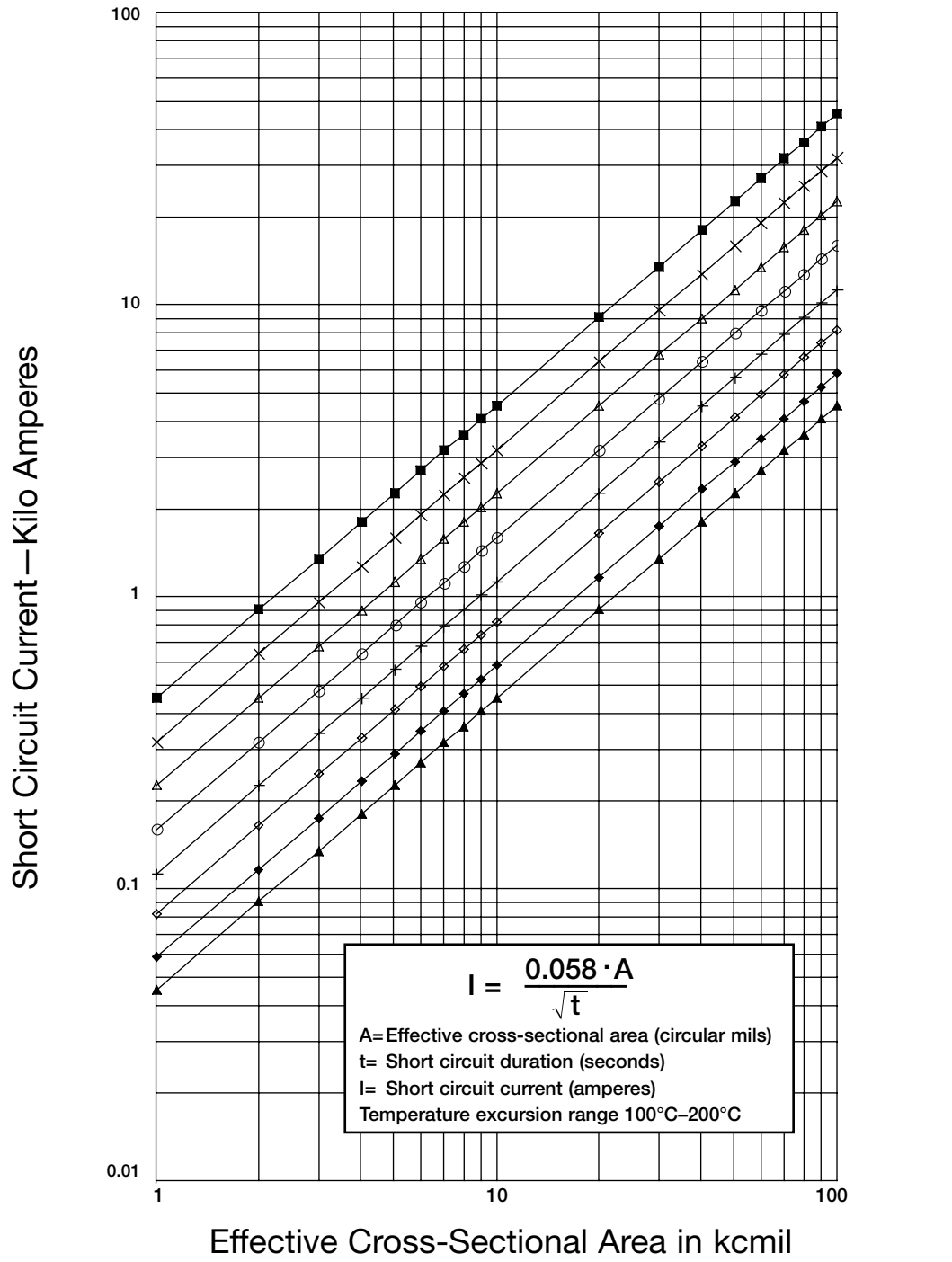

- | | | | |
|-------------|-------------|-------------|--------------|
| ■ 1 Cycles | × 2 Cycles | △ 4 Cycles | ○ 8 Cycles |
| + 16 Cycles | ◇ 30 Cycles | ◆ 60 Cycles | ▲ 100 Cycles |

Formula—Short Circuit Currents for Copper Shields

Allowable Copper Shield Short Circuit Currents for 25–46 kV

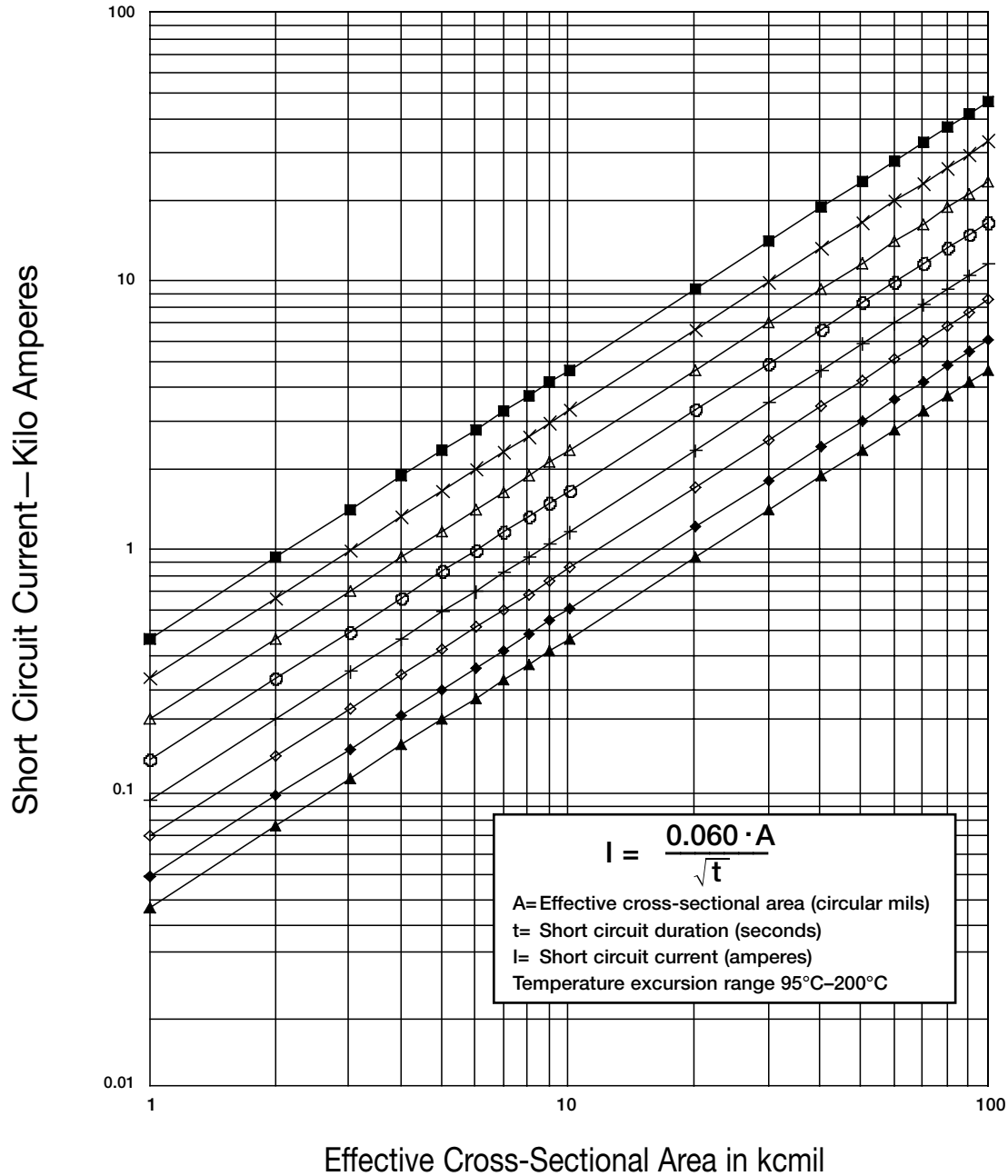

- | | | | |
|-------------|-------------|-------------|--------------|
| ■ 1 Cycles | × 2 Cycles | ▲ 4 Cycles | ⊖ 8 Cycles |
| + 16 Cycles | ◇ 30 Cycles | ◆ 60 Cycles | ▲ 100 Cycles |

Part Number Index

CATALOG NUMBER	PAGE	CATALOG NUMBER	PAGE	CATALOG NUMBER	PAGE	CATALOG NUMBER	PAGE
15493.445400.....	SPEC 6450	17001.120400.....	SPEC 6150	17201.120600.....	SPEC 6180	17473.535400.....	SPEC 7250
15493.446000.....	SPEC 6450	17001.120600.....	SPEC 6150	17201.125100.....	SPEC 6180	17473.536000.....	SPEC 7250
15493.446200.....	SPEC 6450	17001.125100.....	SPEC 6150	17201.125200.....	SPEC 6180	17473.536200.....	SPEC 7250
15493.446500.....	SPEC 6450	17001.125200.....	SPEC 6150	17201.125300.....	SPEC 6180	17473.536500.....	SPEC 7250
15493.447000.....	SPEC 6450	17001.125300.....	SPEC 6150	17201.135400.....	SPEC 6180	17473.537000.....	SPEC 7250
15493.447500.....	SPEC 6450	17001.135400.....	SPEC 6150	17201.136000.....	SPEC 6180	17473.537500.....	SPEC 7250
15493.485100.....	SPEC 6600	17001.136000.....	SPEC 6150	17201.136200.....	SPEC 6180	17476.515100.....	SPEC 7310
15493.485200.....	SPEC 6600	17001.136200.....	SPEC 6150	17201.136500.....	SPEC 6180	17476.515200.....	SPEC 7310
15493.485400.....	SPEC 6600	17001.136500.....	SPEC 6150	17201.137000.....	SPEC 6180	17476.515400.....	SPEC 7310
15493.486000.....	SPEC 6600	17001.137000.....	SPEC 6150	17201.637500.....	SPEC 6180	17476.516000.....	SPEC 7310
15493.486200.....	SPEC 6600	17001.637500.....	SPEC 6150	17231.130100.....	SPEC 6380	17476.516200.....	SPEC 7310
15493.486500.....	SPEC 6600	17031.130100.....	SPEC 6350	17231.130200.....	SPEC 6380	17476.516500.....	SPEC 7310
15493.487000.....	SPEC 6600	17031.130200.....	SPEC 6350	17231.135100.....	SPEC 6380	17476.517000.....	SPEC 7310
15593.400200.....	SPEC 6275	17031.135100.....	SPEC 6350	17231.135200.....	SPEC 6380	17476.517500.....	SPEC 7310
15593.400400.....	SPEC 6275	17031.135200.....	SPEC 6350	17231.135300.....	SPEC 6380	17476.530200.....	SPEC 7300
15593.400600.....	SPEC 6275	17031.135300.....	SPEC 6350	17231.135400.....	SPEC 6380	17476.535100.....	SPEC 7300
15593.405100.....	SPEC 6275	17031.135400.....	SPEC 6350	17231.136000.....	SPEC 6380	17476.535200.....	SPEC 7300
15593.405200.....	SPEC 6275	17031.136000.....	SPEC 6350	17231.136200.....	SPEC 6380	17476.535400.....	SPEC 7300
15593.405400.....	SPEC 6275	17031.136200.....	SPEC 6350	17231.136500.....	SPEC 6380	17476.536000.....	SPEC 7300
15593.406000.....	SPEC 6275	17031.136500.....	SPEC 6350	17231.137000.....	SPEC 6380	17476.536200.....	SPEC 7300
15593.406200.....	SPEC 6275	17031.137000.....	SPEC 6350	17231.137500.....	SPEC 6380	17476.536500.....	SPEC 7300
15593.406500.....	SPEC 6275	17031.137500.....	SPEC 6350	17241.010200.....	SPEC 6200	17476.537000.....	SPEC 7300
15593.407000.....	SPEC 6275	17061.135100.....	SPEC 6550	17241.010400.....	SPEC 6200	17476.537500.....	SPEC 7300
15593.407500.....	SPEC 6275	17061.135200.....	SPEC 6550	17241.010600.....	SPEC 6200	17477.517500.....	SPEC 7350
15593.440200.....	SPEC 6475	17061.135300.....	SPEC 6550	17241.015100.....	SPEC 6200	17477.535100.....	SPEC 7350
15593.445100.....	SPEC 6475	17061.135400.....	SPEC 6550	17241.015200.....	SPEC 6200	17477.535200.....	SPEC 7350
15593.445200.....	SPEC 6475	17061.136000.....	SPEC 6550	17241.015400.....	SPEC 6200	17477.535400.....	SPEC 7350
15593.445400.....	SPEC 6475	17061.136200.....	SPEC 6550	17241.016000.....	SPEC 6200	17477.536000.....	SPEC 7350
15593.446000.....	SPEC 6475	17061.136500.....	SPEC 6550	17241.016200.....	SPEC 6200	17477.536200.....	SPEC 7350
15593.446200.....	SPEC 6475	17061.137000.....	SPEC 6550	17241.016500.....	SPEC 6200	17477.536500.....	SPEC 7350
15593.446500.....	SPEC 6475	17061.137500.....	SPEC 6550	17241.017000.....	SPEC 6200	17477.537000.....	SPEC 7350
15593.447000.....	SPEC 6475	17101.120100.....	SPEC 6175	17241.017500.....	SPEC 6200	17480.535100.....	SPEC 7400
15593.447500.....	SPEC 6475	17101.120200.....	SPEC 6175	17245.010100.....	SPEC 6400	17480.535200.....	SPEC 7400
15693.400200.....	SPEC 6280	17101.120400.....	SPEC 6175	17245.010200.....	SPEC 6400	17480.535400.....	SPEC 7400
15693.400400.....	SPEC 6280	17101.120600.....	SPEC 6175	17245.015100.....	SPEC 6400	17480.536000.....	SPEC 7400
15693.400600.....	SPEC 6280	17101.125100.....	SPEC 6175	17245.015200.....	SPEC 6400	17480.536200.....	SPEC 7400
15693.405100.....	SPEC 6280	17101.125200.....	SPEC 6175	17245.015400.....	SPEC 6400	17480.536500.....	SPEC 7400
15693.405200.....	SPEC 6280	17101.125300.....	SPEC 6175	17245.016000.....	SPEC 6400	17480.537000.....	SPEC 7400
15693.405400.....	SPEC 6280	17101.135400.....	SPEC 6175	17245.016200.....	SPEC 6400	17496.010100.....	SPEC 8450
15693.406000.....	SPEC 6280	17101.136000.....	SPEC 6175	17245.016500.....	SPEC 6400	17496.010300.....	SPEC 8250
15693.406200.....	SPEC 6280	17101.136200.....	SPEC 6175	17245.017000.....	SPEC 6400	17496.015200.....	SPEC 8450
15693.406500.....	SPEC 6280	17101.136500.....	SPEC 6175	17245.017500.....	SPEC 6400	17496.017500.....	SPEC 8250
15693.407000.....	SPEC 6280	17101.137000.....	SPEC 6175	17261.135100.....	SPEC 6580	17496.020100.....	SPEC 8250
15693.407500.....	SPEC 6280	17101.137500.....	SPEC 6175	17261.135200.....	SPEC 6580	17496.020200.....	SPEC 8250
15793.440200.....	SPEC 6480	17131.130100.....	SPEC 6375	17261.135300.....	SPEC 6580	17496.020400.....	SPEC 8250
15793.445100.....	SPEC 6480	17131.130200.....	SPEC 6375	17261.135400.....	SPEC 6580	17496.020600.....	SPEC 8250
15793.445200.....	SPEC 6480	17131.135100.....	SPEC 6375	17261.136000.....	SPEC 6580	17496.025100.....	SPEC 8250
15793.445400.....	SPEC 6480	17131.135200.....	SPEC 6375	17261.136200.....	SPEC 6580	17496.025200.....	SPEC 8250
15793.446000.....	SPEC 6480	17131.135300.....	SPEC 6375	17261.136500.....	SPEC 6580	17496.025300.....	SPEC 8450
15793.446200.....	SPEC 6480	17131.135400.....	SPEC 6375	17261.137000.....	SPEC 6580	17496.025400.....	SPEC 8250
15793.446500.....	SPEC 6480	17131.136000.....	SPEC 6375	17261.137500.....	SPEC 6580	17496.026000.....	SPEC 8450
15793.447000.....	SPEC 6480	17131.136200.....	SPEC 6375	17471.580200.....	SPEC 7200	17496.026200.....	SPEC 8250
15793.447500.....	SPEC 6480	17131.136500.....	SPEC 6375	17471.580400.....	SPEC 7200	17496.030200.....	SPEC 8425
16602.210200.....	SPEC 5250	17131.137000.....	SPEC 6375	17471.580600.....	SPEC 7200	17496.035300.....	SPEC 8250
16602.210400.....	SPEC 5250	17131.637500.....	SPEC 6375	17471.585100.....	SPEC 7200	17496.035400.....	SPEC 8450
16602.210600.....	SPEC 5250	17161.135100.....	SPEC 6575	17471.585200.....	SPEC 7200	17496.037000.....	SPEC 8450
16602.210800.....	SPEC 5250	17161.135200.....	SPEC 6575	17471.585400.....	SPEC 7200	17496.046200.....	SPEC 8450
16602.215100.....	SPEC 5250	17161.135300.....	SPEC 6575	17471.586000.....	SPEC 7200	17496.046500.....	SPEC 8250
16602.215200.....	SPEC 5250	17161.135400.....	SPEC 6575	17471.586200.....	SPEC 7200	17496.056000.....	SPEC 8250
16602.215400.....	SPEC 5250	17161.136000.....	SPEC 6575	17471.586500.....	SPEC 7200	17496.056500.....	SPEC 8450
16602.216000.....	SPEC 5250	17161.136200.....	SPEC 6575	17471.587000.....	SPEC 7200	17496.077000.....	SPEC 8250
16602.216200.....	SPEC 5250	17161.136500.....	SPEC 6575	17471.587500.....	SPEC 7200	17496.100100.....	SPEC 8225
16602.216500.....	SPEC 5250	17161.137000.....	SPEC 6575	17473.530200.....	SPEC 7250	17496.100200.....	SPEC 8225
16602.217000.....	SPEC 5250	17161.137500.....	SPEC 6575	17473.530400.....	SPEC 7250	17496.100300.....	SPEC 8225
16602.217500.....	SPEC 5250	17201.120100.....	SPEC 6180	17473.530600.....	SPEC 7250	17496.100400.....	SPEC 8225
17001.120100.....	SPEC 6150	17201.120200.....	SPEC 6180	17473.535100.....	SPEC 7250	17496.100600.....	SPEC 8225
17001.120200.....	SPEC 6150	17201.120400.....	SPEC 6180	17473.535200.....	SPEC 7250	17496.105100.....	SPEC 8225

Part Number Index

CATALOG NUMBER	PAGE	CATALOG NUMBER	PAGE	CATALOG NUMBER	PAGE	CATALOG NUMBER	PAGE
17496.105200.....	SPEC 8225	17496.815300.....	SPEC 8375	19101.655100.....	SPEC 6100	230790.....	SPEC 2450
17496.105300.....	SPEC 8225	17496.815400.....	SPEC 8375	19101.665200.....	SPEC 6100	230800.....	SPEC 2450
17496.105400.....	SPEC 8225	17496.816000.....	SPEC 8375	19101.665300.....	SPEC 6100	230810.....	SPEC 2450
17496.106000.....	SPEC 8225	17496.816200.....	SPEC 8375	19101.665400.....	SPEC 6100	230820.....	SPEC 2450
17496.106200.....	SPEC 8225	17496.816500.....	SPEC 8375	19101.667500.....	SPEC 6100	230830.....	SPEC 2450
17496.106500.....	SPEC 8225	17496.817000.....	SPEC 8375	19101.676000.....	SPEC 6100	230840.....	SPEC 2450
17496.107000.....	SPEC 8225	17496.817500.....	SPEC 8375	19101.676200.....	SPEC 6100	231980.....	SPEC 4750
17496.107500.....	SPEC 8225	17496.820100.....	SPEC 8400	19101.686500.....	SPEC 6100	232560.....	SPEC 2050
17496.216500.....	SPEC 8400	17496.825100.....	SPEC 8400	19101.687000.....	SPEC 6100	232850.....	SPEC 4050
17496.230200.....	SPEC 8450	17496.825200.....	SPEC 8400	19161.307500.....	SPEC 6300	233270.....	SPEC 4600
17496.536500.....	SPEC 8425	17496.825300.....	SPEC 8400	19161.660200.....	SPEC 6300	233310.....	SPEC 4075
17496.700100.....	SPEC 8275	17496.825400.....	SPEC 8400	19161.665300.....	SPEC 6300	233320.....	SPEC 4075
17496.700200.....	SPEC 8275	17496.826000.....	SPEC 8400	19161.675100.....	SPEC 6300	233330.....	SPEC 4075
17496.700400.....	SPEC 8275	17496.826200.....	SPEC 8400	19161.675200.....	SPEC 6300	234250.....	SPEC 4750
17496.700600.....	SPEC 8275	17496.826500.....	SPEC 8400	19161.675400.....	SPEC 6300	234260.....	SPEC 4750
17496.705100.....	SPEC 8275	17496.827000.....	SPEC 8400	19161.686000.....	SPEC 6300	234580.....	SPEC 4650
17496.705200.....	SPEC 8275	17496.827500.....	SPEC 8400	19161.686200.....	SPEC 6300	234590.....	SPEC 4650
17496.705300.....	SPEC 8275	17496.830100.....	SPEC 8425	19161.686500.....	SPEC 6300	234600.....	SPEC 4650
17496.705400.....	SPEC 8275	17496.835100.....	SPEC 8425	19161.697000.....	SPEC 6300	234620.....	SPEC 4650
17496.706000.....	SPEC 8275	17496.835200.....	SPEC 8425	19261.685100.....	SPEC 6500	234640.....	SPEC 4650
17496.706200.....	SPEC 8275	17496.835300.....	SPEC 8425	19261.685200.....	SPEC 6500	234680.....	SPEC 4650
17496.706500.....	SPEC 8275	17496.835400.....	SPEC 8425	19261.685300.....	SPEC 6500	235020.....	SPEC 2450
17496.707000.....	SPEC 8275	17496.836000.....	SPEC 8425	19261.685400.....	SPEC 6500	235040.....	SPEC 4650
17496.707500.....	SPEC 8275	17496.836200.....	SPEC 8425	19261.686000.....	SPEC 6500	235050.....	SPEC 4650
17496.710100.....	SPEC 8300	17496.837000.....	SPEC 8425	19261.686200.....	SPEC 6500	235060.....	SPEC 4650
17496.710200.....	SPEC 8300	17496.837500.....	SPEC 8425	19261.686500.....	SPEC 6500	235070.....	SPEC 4650
17496.710400.....	SPEC 8300	17496.845100.....	SPEC 8450	19261.687000.....	SPEC 6500	235080.....	SPEC 4650
17496.710600.....	SPEC 8300	17496.850100.....	SPEC 8475	19261.687500.....	SPEC 6500	235090.....	SPEC 4650
17496.715100.....	SPEC 8300	17496.855100.....	SPEC 8475	149512M.....	SPEC 5700	235110.....	SPEC 4650
17496.715200.....	SPEC 8300	17496.855200.....	SPEC 8475	218970.....	SPEC 3050	235130.....	SPEC 4650
17496.715300.....	SPEC 8300	17496.855300.....	SPEC 8475	218990.....	SPEC 3050	235150.....	SPEC 4650
17496.715400.....	SPEC 8300	17496.855400.....	SPEC 8475	219390.....	SPEC 3050	235160.....	SPEC 4650
17496.716000.....	SPEC 8300	17496.856000.....	SPEC 8475	219580.....	SPEC 4750	235170.....	SPEC 4650
17496.716200.....	SPEC 8300	17496.856200.....	SPEC 8475	219610.....	SPEC 4750	235680.....	SPEC 4075
17496.716500.....	SPEC 8300	17496.856500.....	SPEC 8475	219630.....	SPEC 4750	235750.....	SPEC 2500
17496.717000.....	SPEC 8300	17496.860100.....	SPEC 8500	221560.....	SPEC 4750	235900.....	SPEC 2500
17496.717500.....	SPEC 8300	17496.865100.....	SPEC 8500	222490.....	SPEC 4750	235910.....	SPEC 2450
17496.740100.....	SPEC 8325	17496.865200.....	SPEC 8500	222510.....	SPEC 4750	235970.....	SPEC 2500
17496.740200.....	SPEC 8325	17496.865300.....	SPEC 8500	222570.....	SPEC 4550	235980.....	SPEC 2450
17496.740400.....	SPEC 8325	17496.865400.....	SPEC 8500	222710.....	SPEC 4550	235990.....	SPEC 2500
17496.740600.....	SPEC 8325	17496.866000.....	SPEC 8500	223640.....	SPEC 4050	236090.....	SPEC 4600
17496.745100.....	SPEC 8325	17496.866200.....	SPEC 8500	223650.....	SPEC 4050	236100.....	SPEC 4600
17496.745200.....	SPEC 8325	17496.890100.....	SPEC 8525	223670.....	SPEC 4050	236120.....	SPEC 4600
17496.745300.....	SPEC 8325	17496.895100.....	SPEC 8525	223750.....	SPEC 4050	236130.....	SPEC 4600
17496.745400.....	SPEC 8325	17496.895200.....	SPEC 8525	223760.....	SPEC 4050	236140.....	SPEC 4600
17496.746000.....	SPEC 8325	17496.895300.....	SPEC 8525	223770.....	SPEC 4050	236150.....	SPEC 4600
17496.746200.....	SPEC 8325	17496.895400.....	SPEC 8525	223780.....	SPEC 4050	236160.....	SPEC 4600
17496.746500.....	SPEC 8325	17496.896000.....	SPEC 8525	223790.....	SPEC 4050	236170.....	SPEC 4600
17496.747000.....	SPEC 8325	17496.896200.....	SPEC 8525	223910.....	SPEC 4050	236180.....	SPEC 4600
17496.747500.....	SPEC 8325	17497.055100.....	SPEC 8575	223920.....	SPEC 4050	236190.....	SPEC 4600
17496.750100.....	SPEC 8350	17497.055200.....	SPEC 8575	223930.....	SPEC 4050	236210.....	SPEC 4600
17496.750200.....	SPEC 8350	17497.055300.....	SPEC 8575	224070.....	SPEC 4050	236230.....	SPEC 4600
17496.750400.....	SPEC 8350	17497.055400.....	SPEC 8575	224080.....	SPEC 4050	236240.....	SPEC 4600
17496.750600.....	SPEC 8350	17497.056000.....	SPEC 8575	224090.....	SPEC 4050	236260.....	SPEC 4600
17496.755100.....	SPEC 8350	17497.056200.....	SPEC 8575	224100.....	SPEC 4050	236280.....	SPEC 4600
17496.755200.....	SPEC 8350	17497.056500.....	SPEC 8575	224110.....	SPEC 4050	236290.....	SPEC 4600
17496.755300.....	SPEC 8350	17497.440200.....	SPEC 8625	224120.....	SPEC 4050	236300.....	SPEC 4650
17496.755400.....	SPEC 8350	17497.440100.....	SPEC 8625	224130.....	SPEC 4050	236310.....	SPEC 4650
17496.756000.....	SPEC 8350	17497.445100.....	SPEC 8625	226130.....	SPEC 3050	236320.....	SPEC 4650
17496.756200.....	SPEC 8350	17497.445200.....	SPEC 8625	226410.....	SPEC 4750	236330.....	SPEC 4650
17496.756500.....	SPEC 8350	17497.445300.....	SPEC 8625	226420.....	SPEC 4650	236340.....	SPEC 4650
17496.757000.....	SPEC 8350	17497.445400.....	SPEC 8625	226430.....	SPEC 4750	236350.....	SPEC 4650
17496.757500.....	SPEC 8350	17497.446000.....	SPEC 8625	226500.....	SPEC 4650	236370.....	SPEC 4750
17496.810100.....	SPEC 8375	17497.446200.....	SPEC 8625	229600.....	SPEC 4700	236380.....	SPEC 4750
17496.810200.....	SPEC 8375	17497.446500.....	SPEC 8625	230750.....	SPEC 2450	236400.....	SPEC 4750
17496.815100.....	SPEC 8375	17497.447000.....	SPEC 8625	230760.....	SPEC 2450	236410.....	SPEC 4750
17496.815200.....	SPEC 8375	19101.650200.....	SPEC 6100	230780.....	SPEC 2450	236420.....	SPEC 4750



Part Number Index

CATALOG NUMBER	PAGE	CATALOG NUMBER	PAGE	CATALOG NUMBER	PAGE	CATALOG NUMBER	PAGE
236430.....	SPEC 4750	245350.....	SPEC 3300	271740.....	SPEC 4850	280590.....	SPEC 4310
236440.....	SPEC 4750	245360.....	SPEC 3300	272260.....	SPEC 4050	280600.....	SPEC 4310
237130.....	SPEC 2500	245370.....	SPEC 3300	272270.....	SPEC 4050	280950.....	SPEC 2200
237160.....	SPEC 2500	245380.....	SPEC 3300	277820.....	SPEC 2500	280960.....	SPEC 2200
237180.....	SPEC 2500	245390.....	SPEC 3300	279560.....	SPEC 4300	280970.....	SPEC 2200
237490.....	SPEC 2450	245400.....	SPEC 3300	279570.....	SPEC 4300	280980.....	SPEC 4325
237500.....	SPEC 4075	245410.....	SPEC 3300	279580.....	SPEC 4300	280990.....	SPEC 2150
238410.....	SPEC 2450	245420.....	SPEC 3300	279590.....	SPEC 4300	282570.....	SPEC 4100
238800.....	SPEC 3300	245440.....	SPEC 3300	279600.....	SPEC 4300	282580.....	SPEC 4100
239200.....	SPEC 2450	245450.....	SPEC 3300	279610.....	SPEC 4300	282590.....	SPEC 4100
239210.....	SPEC 2450	245580.....	SPEC 4600	279620.....	SPEC 4300	282600.....	SPEC 4100
239620.....	SPEC 4075	245590.....	SPEC 4650	279630.....	SPEC 4300	282610.....	SPEC 4100
239630.....	SPEC 4075	245920.....	SPEC 4600	279640.....	SPEC 4300	282620.....	SPEC 4100
239640.....	SPEC 4075	247620.....	SPEC 4700	279650.....	SPEC 4300	282630.....	SPEC 4100
239650.....	SPEC 4075	248240.....	SPEC 4200	279660.....	SPEC 4350	282640.....	SPEC 4100
239660.....	SPEC 4075	248290.....	SPEC 4200	279670.....	SPEC 4350	282650.....	SPEC 4100
239670.....	SPEC 4075	252230.....	SPEC 4075	279680.....	SPEC 4300	282660.....	SPEC 4100
239680.....	SPEC 4075	252360.....	SPEC 4075	279690.....	SPEC 2100	282670.....	SPEC 4100
239700.....	SPEC 4075	252370.....	SPEC 2050	279700.....	SPEC 2150	282680.....	SPEC 4100
240990.....	SPEC 2050	252400.....	SPEC 4075	279710.....	SPEC 2150	282690.....	SPEC 4100
241000.....	SPEC 2050	252410.....	SPEC 4075	279720.....	SPEC 2150	282710.....	SPEC 4100
241010.....	SPEC 2050	255080.....	SPEC 4650	279730.....	SPEC 2150	283170.....	SPEC 2100
241020.....	SPEC 2500	255090.....	SPEC 4650	279740.....	SPEC 2150	283180.....	SPEC 2100
241030.....	SPEC 2500	256260.....	SPEC 4075	279750.....	SPEC 2150	283190.....	SPEC 2100
241420.....	SPEC 4050	256300.....	SPEC 2500	279760.....	SPEC 2150	283200.....	SPEC 4350
241430.....	SPEC 4050	256750.....	SPEC 4850	279770.....	SPEC 2150	283210.....	SPEC 4350
241440.....	SPEC 4050	257730.....	SPEC 4850	279840.....	SPEC 4300	283220.....	SPEC 4350
241510.....	SPEC 2050	257740.....	SPEC 4850	279850.....	SPEC 4310	283530.....	SPEC 4800
242860.....	SPEC 2500	257750.....	SPEC 4850	279870.....	SPEC 4300	283540.....	SPEC 4800
242870.....	SPEC 2500	257760.....	SPEC 4850	279880.....	SPEC 4300	284560.....	SPEC 4350
243530.....	SPEC 4075	257770.....	SPEC 4850	279890.....	SPEC 4300	285150.....	SPEC 2050
243540.....	SPEC 4075	257780.....	SPEC 4850	279900.....	SPEC 4300	285890.....	SPEC 4350
243560.....	SPEC 4700	257790.....	SPEC 4850	279910.....	SPEC 4310	286130.....	SPEC 4850
243570.....	SPEC 4700	257800.....	SPEC 4850	279920.....	SPEC 4310	287410.....	SPEC 2200
243580.....	SPEC 4700	257810.....	SPEC 4850	279930.....	SPEC 4310	287650.....	SPEC 2100
243600.....	SPEC 4650	259980.....	SPEC 4700	280170.....	SPEC 4300	288010.....	SPEC 3200
243610.....	SPEC 4650	260000.....	SPEC 4700	280180.....	SPEC 4300	288020.....	SPEC 3200
243620.....	SPEC 4650	260150.....	SPEC 4650	280190.....	SPEC 4300	288250.....	SPEC 2150
243630.....	SPEC 4650	260730.....	SPEC 4050	280200.....	SPEC 4300	288260.....	SPEC 2150
243640.....	SPEC 4600	261000.....	SPEC 4250	280210.....	SPEC 4300	288411.....	SPEC 5200
243650.....	SPEC 4700	261010.....	SPEC 4250	280230.....	SPEC 4310	292150.....	SPEC 3200
243660.....	SPEC 4700	261130.....	SPEC 4700	280240.....	SPEC 4310	292160.....	SPEC 3200
243670.....	SPEC 4700	261140.....	SPEC 4700	280250.....	SPEC 4310	292410.....	SPEC 4100
243690.....	SPEC 4700	261150.....	SPEC 4700	280260.....	SPEC 4310	292686M.....	SPEC 5700
243710.....	SPEC 4700	261160.....	SPEC 4700	280270.....	SPEC 4310	293570.....	SPEC 8075
243720.....	SPEC 4700	261690.....	SPEC 4850	280280.....	SPEC 4310	293600.....	SPEC 4350
243740.....	SPEC 4700	262130.....	SPEC 4200	280290.....	SPEC 4310	293950.....	SPEC 3200
243760.....	SPEC 4750	262140.....	SPEC 4200	280300.....	SPEC 4300	293960.....	SPEC 3200
243770.....	SPEC 4700	262150.....	SPEC 4200	280310.....	SPEC 4300	293970.....	SPEC 3200
243810.....	SPEC 4700	262160.....	SPEC 4200	280320.....	SPEC 4300	293980.....	SPEC 3200
243820.....	SPEC 4700	262190.....	SPEC 4200	280330.....	SPEC 4300	294530.....	SPEC 4350
243840.....	SPEC 4700	262200.....	SPEC 4200	280340.....	SPEC 4300	294540.....	SPEC 2200
243880.....	SPEC 2500	262680.....	SPEC 4075	280350.....	SPEC 4310	294580.....	SPEC 2100
243890.....	SPEC 2500	264570.....	SPEC 4600	280360.....	SPEC 4310	295320.....	SPEC 4500
244160.....	SPEC 4075	264980.....	SPEC 3050	280370.....	SPEC 4310	295360.....	SPEC 4350
244590.....	SPEC 2450	264990.....	SPEC 4200	280380.....	SPEC 4310	295390.....	SPEC 4350
244600.....	SPEC 2500	265940.....	SPEC 4050	280390.....	SPEC 4310	295400.....	SPEC 4300
244610.....	SPEC 2450	266580.....	SPEC 4700	280400.....	SPEC 4310	295890.....	SPEC 4350
244650.....	SPEC 4600	267830.....	SPEC 4850	280410.....	SPEC 4300	297050.....	SPEC 4750
244660.....	SPEC 4600	267840.....	SPEC 4850	280420.....	SPEC 4310	297060.....	SPEC 4750
244670.....	SPEC 4600	267860.....	SPEC 4850	280430.....	SPEC 4310	297730.....	SPEC 4350
244680.....	SPEC 4600	267950.....	SPEC 4850	280470.....	SPEC 4325	298020.....	SPEC 4350
244720.....	SPEC 4600	269080.....	SPEC 4850	280490.....	SPEC 4325	298830.....	SPEC 1250
245310.....	SPEC 3300	270230.....	SPEC 3050	280500.....	SPEC 2150	298880.....	SPEC 1300
245320.....	SPEC 3300	270720.....	SPEC 4850	280520.....	SPEC 2150	298890.....	SPEC 1300
245330.....	SPEC 3300	270730.....	SPEC 4850	280530.....	SPEC 2150	299950.....	SPEC 8050
245340.....	SPEC 3300	270970.....	SPEC 2450	280540.....	SPEC 2150	299980.....	SPEC 8025

Part Number Index

CATALOG NUMBER	PAGE	CATALOG NUMBER	PAGE	CATALOG NUMBER	PAGE	CATALOG NUMBER	PAGE
300380.....	SPEC 4350	325110.....	SPEC 4350	337060.....	SPEC 2100	337750.....	SPEC 2050
300780.....	SPEC 4350	325120.....	SPEC 4350	337070.....	SPEC 2100	337760.....	SPEC 2050
301870.....	SPEC 4300	325250.....	SPEC 2100	337080.....	SPEC 2100	337770.....	SPEC 1050
304030.....	SPEC 8050	325610.....	SPEC 4550	337090.....	SPEC 2100	337780.....	SPEC 1050
305300.....	SPEC 4325	325700.....	SPEC 4350	337100.....	SPEC 2100	337790.....	SPEC 1050
305320.....	SPEC 4300	325770.....	SPEC 1250	337110.....	SPEC 2100	337800.....	SPEC 1050
305340.....	SPEC 4300	325780.....	SPEC 1250	337120.....	SPEC 2100	337810.....	SPEC 1050
305360.....	SPEC 4325	325790.....	SPEC 1250	337130.....	SPEC 2100	337820.....	SPEC 1050
306420.....	SPEC 3200	325800.....	SPEC 1300	337140.....	SPEC 2100	337830.....	SPEC 1050
307370.....	SPEC 3200	325810.....	SPEC 1250	337150.....	SPEC 2200	337840.....	SPEC 1050
307450.....	SPEC 8075	325820.....	SPEC 1300	337160.....	SPEC 2200	337850.....	SPEC 1050
307460.....	SPEC 8075	325830.....	SPEC 1250	337170.....	SPEC 2200	337860.....	SPEC 1050
307470.....	SPEC 8050	325840.....	SPEC 1250	337180.....	SPEC 2200	337870.....	SPEC 1050
307650.....	SPEC 3200	325850.....	SPEC 1250	337190.....	SPEC 2200	337880.....	SPEC 1050
307660.....	SPEC 3200	325860.....	SPEC 1300	337200.....	SPEC 2200	337890.....	SPEC 1050
307690.....	SPEC 4300	325870.....	SPEC 1350	337210.....	SPEC 2200	337900.....	SPEC 1050
308180.....	SPEC 8075	325880.....	SPEC 1250	337220.....	SPEC 2200	337910.....	SPEC 1050
308190.....	SPEC 8025	325890.....	SPEC 1300	337230.....	SPEC 2200	337920.....	SPEC 1050
308550.....	SPEC 8125	325900.....	SPEC 1250	337240.....	SPEC 2150	337930.....	SPEC 1050
309340.....	SPEC 4100	325910.....	SPEC 1250	337250.....	SPEC 2150	337940.....	SPEC 1050
309520.....	SPEC 1050	325920.....	SPEC 1250	337260.....	SPEC 2150	337950.....	SPEC 1050
309540.....	SPEC 1100	325930.....	SPEC 1300	337270.....	SPEC 2350	337960.....	SPEC 1050
309550.....	SPEC 1100	325940.....	SPEC 1250	337280.....	SPEC 2350	337970.....	SPEC 1050
309560.....	SPEC 1100	325950.....	SPEC 1300	337290.....	SPEC 2350	337980.....	SPEC 1050
309570.....	SPEC 1100	326640.....	SPEC 4325	337300.....	SPEC 2350	337990.....	SPEC 1050
309580.....	SPEC 1100	326650.....	SPEC 4325	337310.....	SPEC 2350	338000.....	SPEC 1050
309660.....	SPEC 1050	326660.....	SPEC 4325	337320.....	SPEC 2350	338010.....	SPEC 1050
309670.....	SPEC 1050	326670.....	SPEC 4325	337330.....	SPEC 2350	338020.....	SPEC 1050
309680.....	SPEC 1050	328540.....	SPEC 4550	337340.....	SPEC 2350	338030.....	SPEC 1100
309690.....	SPEC 1050	329240.....	SPEC 4750	337350.....	SPEC 2350	338040.....	SPEC 1100
309700.....	SPEC 1050	329520.....	SPEC 4550	337360.....	SPEC 2350	338050.....	SPEC 1100
309824.....	SPEC 5200	330090.....	SPEC 8025	337370.....	SPEC 2350	338060.....	SPEC 1100
311320.....	SPEC 8200	330280.....	SPEC 8025	337390.....	SPEC 2350	338070.....	SPEC 1100
311330.....	SPEC 8200	330520.....	SPEC 8150	337400.....	SPEC 2350	338080.....	SPEC 1100
311560.....	SPEC 8050	330580.....	SPEC 4075	337410.....	SPEC 2350	338090.....	SPEC 1100
311570.....	SPEC 8075	330800.....	SPEC 4310	337420.....	SPEC 2350	338100.....	SPEC 1100
311640.....	SPEC 1050	330990.....	SPEC 4310	337430.....	SPEC 2350	338110.....	SPEC 1100
311880.....	SPEC 3200	331120.....	SPEC 8150	337440.....	SPEC 2350	338120.....	SPEC 1100
311900.....	SPEC 4325	331130.....	SPEC 8050	337450.....	SPEC 2350	338130.....	SPEC 1100
311910.....	SPEC 4325	331150.....	SPEC 4100	337460.....	SPEC 2400	338140.....	SPEC 1100
312500.....	SPEC 4050	331190.....	SPEC 8050	337470.....	SPEC 2400	338150.....	SPEC 1100
312510.....	SPEC 4050	331250.....	SPEC 8175	337480.....	SPEC 2400	338160.....	SPEC 1100
312520.....	SPEC 4050	331260.....	SPEC 8125	337490.....	SPEC 2400	338170.....	SPEC 1100
312910.....	SPEC 8050	332010.....	SPEC 3300	337500.....	SPEC 2400	338180.....	SPEC 1100
312990.....	SPEC 8050	333160.....	SPEC 8075	337510.....	SPEC 2400	338190.....	SPEC 1100
313406M.....	SPEC 5700	333410.....	SPEC 8200	337520.....	SPEC 2400	338200.....	SPEC 1100
314960.....	SPEC 2100	333750.....	SPEC 8025	337530.....	SPEC 2400	338210.....	SPEC 1100
315020.....	SPEC 8050	334630.....	SPEC 1250	337540.....	SPEC 2400	338220.....	SPEC 1100
317890.....	SPEC 8075	336830.....	SPEC 2450	337550.....	SPEC 2400	338230.....	SPEC 1100
318050.....	SPEC 4600	336840.....	SPEC 2450	337560.....	SPEC 2400	338240.....	SPEC 1100
318730.....	SPEC 8050	336850.....	SPEC 2450	337570.....	SPEC 2400	338310.....	SPEC 4250
318740.....	SPEC 8075	336860.....	SPEC 2450	337580.....	SPEC 2400	338440.....	SPEC 3200
318750.....	SPEC 8075	336870.....	SPEC 2450	337590.....	SPEC 2400	338450.....	SPEC 3200
319250.....	SPEC 2200	336880.....	SPEC 2450	337600.....	SPEC 2400	338460.....	SPEC 3200
319260.....	SPEC 2200	336890.....	SPEC 2450	337620.....	SPEC 2050	338470.....	SPEC 3100
319270.....	SPEC 2150	336900.....	SPEC 2500	337630.....	SPEC 2050	338480.....	SPEC 3100
319480.....	SPEC 8075	336910.....	SPEC 2500	337640.....	SPEC 2050	338490.....	SPEC 3100
319740.....	SPEC 2450	336920.....	SPEC 2500	337650.....	SPEC 2050	338500.....	SPEC 3100
319810.....	SPEC 2350	336930.....	SPEC 2500	337660.....	SPEC 2050	338510.....	SPEC 3100
319820.....	SPEC 2400	336940.....	SPEC 2500	337670.....	SPEC 2050	338520.....	SPEC 3100
319840.....	SPEC 2400	336950.....	SPEC 2500	337680.....	SPEC 2050	338530.....	SPEC 3100
319850.....	SPEC 2400	336960.....	SPEC 2500	337690.....	SPEC 2050	338540.....	SPEC 3100
319870.....	SPEC 2350	337010.....	SPEC 2100	337700.....	SPEC 2050	338550.....	SPEC 3100
321720.....	SPEC 4650	337020.....	SPEC 2100	337710.....	SPEC 2050	338560.....	SPEC 3100
321736.....	SPEC 5200	337030.....	SPEC 2100	337720.....	SPEC 2050	338570.....	SPEC 3100
321940.....	SPEC 8175	337040.....	SPEC 2100	337730.....	SPEC 2050	338580.....	SPEC 3100
324820.....	SPEC 3150	337050.....	SPEC 2100	337740.....	SPEC 2050	338590.....	SPEC 3100

Part Number Index

CATALOG NUMBER	PAGE	CATALOG NUMBER	PAGE	CATALOG NUMBER	PAGE	CATALOG NUMBER	PAGE
347210.....	SPEC 4450	347880.....	SPEC 2300	366220.....	SPEC 4250	384770.....	SPEC 4575
347220.....	SPEC 4450	347890.....	SPEC 2300	366230.....	SPEC 4250	384780.....	SPEC 4575
347230.....	SPEC 4450	347900.....	SPEC 2300	366240.....	SPEC 4250	384790.....	SPEC 4575
347240.....	SPEC 4450	347910.....	SPEC 2300	366250.....	SPEC 4250	384800.....	SPEC 4575
347250.....	SPEC 4450	347920.....	SPEC 2300	367120.....	SPEC 4325	384810.....	SPEC 4575
347260.....	SPEC 4450	347930.....	SPEC 2300	367130.....	SPEC 4325	384820.....	SPEC 4575
347270.....	SPEC 4450	347940.....	SPEC 2300	367140.....	SPEC 4325	384830.....	SPEC 4575
347280.....	SPEC 4450	347950.....	SPEC 2300	367150.....	SPEC 4325	384840.....	SPEC 4575
347290.....	SPEC 4450	347960.....	SPEC 2300	367160.....	SPEC 4325	384850.....	SPEC 4575
347300.....	SPEC 4450	347970.....	SPEC 2300	367170.....	SPEC 4325	384860.....	SPEC 4575
347310.....	SPEC 4450	347980.....	SPEC 2300	367180.....	SPEC 4325	385350.....	SPEC 4310
347320.....	SPEC 4450	347990.....	SPEC 2300	367190.....	SPEC 4325	385360.....	SPEC 4310
347330.....	SPEC 4450	348000.....	SPEC 2300	367200.....	SPEC 4325	385370.....	SPEC 4310
347340.....	SPEC 4400	348010.....	SPEC 1350	367210.....	SPEC 4325	386700.....	SPEC 4750
347350.....	SPEC 4400	348020.....	SPEC 1250	367220.....	SPEC 4325	393710.....	SPEC 2600
347360.....	SPEC 4400	348030.....	SPEC 1250	367230.....	SPEC 4325	393720.....	SPEC 2600
347370.....	SPEC 4400	348040.....	SPEC 1250	367240.....	SPEC 4325	393730.....	SPEC 2600
347380.....	SPEC 4400	348060.....	SPEC 1300	367250.....	SPEC 4325	393740.....	SPEC 2600
347390.....	SPEC 4400	348070.....	SPEC 1300	367260.....	SPEC 4325	393750.....	SPEC 2600
347400.....	SPEC 4400	348090.....	SPEC 1250	367270.....	SPEC 4325	393760.....	SPEC 2600
347410.....	SPEC 4400	348100.....	SPEC 1250	369093.....	SPEC 5200	393770.....	SPEC 2600
347420.....	SPEC 4400	348110.....	SPEC 1300	371250.....	SPEC 4550	393780.....	SPEC 2600
347430.....	SPEC 4400	348120.....	SPEC 1300	371260.....	SPEC 4550	393790.....	SPEC 2600
347440.....	SPEC 4400	352150.....	SPEC 4550	371270.....	SPEC 4550	393800.....	SPEC 2600
347450.....	SPEC 4400	354800.....	SPEC 4325	371280.....	SPEC 4450	393810.....	SPEC 2600
347460.....	SPEC 4400	354810.....	SPEC 4325	371290.....	SPEC 4450	393820.....	SPEC 2600
347470.....	SPEC 4400	354820.....	SPEC 4325	371300.....	SPEC 4450	393830.....	SPEC 2600
347480.....	SPEC 4400	354830.....	SPEC 4325	371310.....	SPEC 4450	393840.....	SPEC 2600
347490.....	SPEC 4400	355210.....	SPEC 4050	375010.....	SPEC 4075	393850.....	SPEC 2600
347500.....	SPEC 4400	356740.....	SPEC 4350	375470.....	SPEC 4075	393860.....	SPEC 2600
347510.....	SPEC 4400	358172.....	SPEC 5200	381500.....	SPEC 5150	393870.....	SPEC 2600
347520.....	SPEC 4400	360990.....	SPEC 4250	381510.....	SPEC 5150	393880.....	SPEC 2600
347530.....	SPEC 4400	361350.....	SPEC 4050	381520.....	SPEC 5150	393890.....	SPEC 2600
347540.....	SPEC 4400	362950.....	SPEC 5250	381530.....	SPEC 5150	393900.....	SPEC 2600
347550.....	SPEC 4400	363310.....	SPEC 4800	381540.....	SPEC 5150	393910.....	SPEC 2600
347560.....	SPEC 4400	364830.....	SPEC 5250	381550.....	SPEC 5150	393920.....	SPEC 2600
347570.....	SPEC 4400	364840.....	SPEC 5250	381560.....	SPEC 5150	393930.....	SPEC 2625
347580.....	SPEC 4400	364850.....	SPEC 5250	381570.....	SPEC 5150	393940.....	SPEC 2625
347590.....	SPEC 4400	365240.....	SPEC 4850	382260.....	SPEC 2350	393950.....	SPEC 2625
347600.....	SPEC 4400	365290.....	SPEC 4800	382880.....	SPEC 4310	393960.....	SPEC 2625
347610.....	SPEC 4400	365300.....	SPEC 4800	383230.....	SPEC 4550	393970.....	SPEC 2625
347620.....	SPEC 4400	365320.....	SPEC 4800	383790.....	SPEC 4100	393980.....	SPEC 2625
347630.....	SPEC 2250	365330.....	SPEC 4800	383800.....	SPEC 4250	393990.....	SPEC 2625
347640.....	SPEC 2250	365340.....	SPEC 4800	383810.....	SPEC 4250	394000.....	SPEC 2625
347650.....	SPEC 2250	365350.....	SPEC 4800	383820.....	SPEC 4250	394010.....	SPEC 2625
347660.....	SPEC 2250	365360.....	SPEC 4800	383830.....	SPEC 4350	394020.....	SPEC 2625
347670.....	SPEC 2250	365370.....	SPEC 4800	383840.....	SPEC 4350	394030.....	SPEC 2625
347680.....	SPEC 2250	365380.....	SPEC 4800	383850.....	SPEC 4350	394040.....	SPEC 2625
347690.....	SPEC 2250	365390.....	SPEC 4800	383860.....	SPEC 4550	394050.....	SPEC 2625
347700.....	SPEC 2250	365400.....	SPEC 4800	383870.....	SPEC 4550	394060.....	SPEC 2625
347710.....	SPEC 2250	365410.....	SPEC 4850	383880.....	SPEC 4550	394070.....	SPEC 2625
347720.....	SPEC 2250	365430.....	SPEC 4850	383890.....	SPEC 4750	394080.....	SPEC 2625
347730.....	SPEC 2250	365680.....	SPEC 3300	383930.....	SPEC 4310	394090.....	SPEC 2625
347740.....	SPEC 2250	365720.....	SPEC 4500	383940.....	SPEC 4310	394100.....	SPEC 2625
347750.....	SPEC 2250	365750.....	SPEC 4350	383950.....	SPEC 4310	394110.....	SPEC 2625
347760.....	SPEC 2250	366070.....	SPEC 4100	383970.....	SPEC 4310	394120.....	SPEC 2650
347770.....	SPEC 2250	366080.....	SPEC 4100	383980.....	SPEC 4075	394130.....	SPEC 2650
347780.....	SPEC 2250	366090.....	SPEC 4100	383990.....	SPEC 4075	394140.....	SPEC 2650
347790.....	SPEC 2250	366100.....	SPEC 4100	384000.....	SPEC 4075	394150.....	SPEC 2650
347800.....	SPEC 2250	366140.....	SPEC 1150	384010.....	SPEC 4075	394160.....	SPEC 2650
347810.....	SPEC 2250	366150.....	SPEC 1150	384020.....	SPEC 4075	394170.....	SPEC 2650
347820.....	SPEC 2250	366160.....	SPEC 2350	384030.....	SPEC 4075	394180.....	SPEC 2650
347830.....	SPEC 2300	366170.....	SPEC 2250	384040.....	SPEC 4075	394190.....	SPEC 2650
347840.....	SPEC 2300	366180.....	SPEC 2250	384730.....	SPEC 4575	394200.....	SPEC 2650
347850.....	SPEC 2300	366190.....	SPEC 4150	384740.....	SPEC 4575	394210.....	SPEC 2650
347860.....	SPEC 2300	366200.....	SPEC 4150	384750.....	SPEC 4575	394220.....	SPEC 2650
347870.....	SPEC 2300	366210.....	SPEC 4250	384760.....	SPEC 4575	394230.....	SPEC 2650

Part Number Index

CATALOG NUMBER	PAGE	CATALOG NUMBER	PAGE	CATALOG NUMBER	PAGE	CATALOG NUMBER	PAGE
394240.....	SPEC 2650	394920.....	SPEC 4925	625160.....	SPEC 3150	783230.....	SPEC 4550
394250.....	SPEC 2650	394930.....	SPEC 4950	625200.....	SPEC 3150	783330.....	SPEC 4550
394260.....	SPEC 2650	394940.....	SPEC 4950	625220.....	SPEC 3150	791720.....	SPEC 1250
394270.....	SPEC 2650	394950.....	SPEC 4950	625230.....	SPEC 3150	792940.....	SPEC 8025
394280.....	SPEC 4900	394960.....	SPEC 4925	625250.....	SPEC 3150	792960.....	SPEC 8025
394290.....	SPEC 4900	395070.....	SPEC 4580	625270.....	SPEC 3150	792980.....	SPEC 8025
394300.....	SPEC 4900	395080.....	SPEC 4580	625280.....	SPEC 3150	793000.....	SPEC 8025
394310.....	SPEC 4900	395090.....	SPEC 4580	625290.....	SPEC 3150	793140.....	SPEC 8125
394320.....	SPEC 4900	395100.....	SPEC 4580	629439.....	SPEC 5200	793160.....	SPEC 8175
394330.....	SPEC 4900	395110.....	SPEC 4580	647530.....	SPEC 4800	793180.....	SPEC 8175
394340.....	SPEC 4900	395120.....	SPEC 4580	647550.....	SPEC 4800	793200.....	SPEC 8150
394350.....	SPEC 4900	395130.....	SPEC 4580	647560.....	SPEC 4850	794520.....	SPEC 8125
394360.....	SPEC 4900	395140.....	SPEC 4580	647590.....	SPEC 4850	794540.....	SPEC 8025
394370.....	SPEC 4900	395150.....	SPEC 4580	647600.....	SPEC 4850	798751.....	SPEC 5200
394380.....	SPEC 4900	395160.....	SPEC 4580	647650.....	SPEC 4850	80990.....	SPEC 2150
394390.....	SPEC 4900	395170.....	SPEC 4580	650981M.....	SPEC 5700	81901.....	SPEC 5300
394400.....	SPEC 4900	395180.....	SPEC 4580	686890.....	SPEC 3150	81902.....	SPEC 5300
394410.....	SPEC 4900	395190.....	SPEC 4580	710580.....	SPEC 3050	81904.....	SPEC 5300
394420.....	SPEC 4900	395200.....	SPEC 4580	759610.....	SPEC 1250	81906.....	SPEC 5300
394430.....	SPEC 4900	403990.....	SPEC 3300	759770.....	SPEC 1300	81908.....	SPEC 5300
394440.....	SPEC 4900	404000.....	SPEC 3300	759780.....	SPEC 1300	81910.....	SPEC 5300
394450.....	SPEC 4900	404010.....	SPEC 3300	760300.....	SPEC 1350	81911.....	SPEC 5300
394460.....	SPEC 4900	404020.....	SPEC 3300	760420.....	SPEC 1300	81920.....	SPEC 5300
394470.....	SPEC 4900	404030.....	SPEC 3300	760530.....	SPEC 1250	81926.....	SPEC 5300
394480.....	SPEC 4900	404040.....	SPEC 3300	760698.....	SPEC 5200	81930.....	SPEC 5300
394490.....	SPEC 4900	404050.....	SPEC 3300	763699M.....	SPEC 5700	81931.....	SPEC 5300
394500.....	SPEC 4900	404060.....	SPEC 3300	770370.....	SPEC 4500	81937.....	SPEC 5300
394510.....	SPEC 4900	404070.....	SPEC 3300	770380.....	SPEC 4500	81940.....	SPEC 5300
394520.....	SPEC 4900	404080.....	SPEC 3300	770390.....	SPEC 4500	81944.....	SPEC 5300
394530.....	SPEC 4900	404090.....	SPEC 3300	770400.....	SPEC 4500	81953.....	SPEC 5300
394540.....	SPEC 4900	404330.....	SPEC 3300	770410.....	SPEC 4500	81964.....	SPEC 5300
394550.....	SPEC 4900	406320.....	SPEC 3300	770420.....	SPEC 4500	81977.....	SPEC 5300
394560.....	SPEC 4900	419630.....	SPEC 3300	770430.....	SPEC 4500	827197M.....	SPEC 5700
394570.....	SPEC 4900	434680.....	SPEC 3300	770450.....	SPEC 4500	840671.....	SPEC 5200
394580.....	SPEC 4900	496517.....	SPEC 5200	770460.....	SPEC 4500	861898M.....	SPEC 5700
394590.....	SPEC 4900	506887M.....	SPEC 5700	770470.....	SPEC 4500	878916.....	SPEC 5200
394600.....	SPEC 4900	522582M.....	SPEC 5700	770480.....	SPEC 4500	883753M.....	SPEC 5700
394610.....	SPEC 4900	524310.....	SPEC 3050	770490.....	SPEC 4500	935802.....	SPEC 5200
394630.....	SPEC 4925	526839M.....	SPEC 5700	770520.....	SPEC 4500	977766M.....	SPEC 5700
394640.....	SPEC 4925	543640.....	SPEC 4800	770530.....	SPEC 4500		
394650.....	SPEC 4925	547230.....	SPEC 4800	770540.....	SPEC 4500		
394660.....	SPEC 4925	554420.....	SPEC 3150	770550.....	SPEC 4500		
394670.....	SPEC 4925	589692M.....	SPEC 5700	770560.....	SPEC 4500		
394680.....	SPEC 4925	592915.....	SPEC 5200	770570.....	SPEC 4500		
394690.....	SPEC 4925	607078M.....	SPEC 5700	770580.....	SPEC 4500		
394700.....	SPEC 4925	614607M.....	SPEC 5700	770590.....	SPEC 4500		
394710.....	SPEC 4925	624010.....	SPEC 3150	770600.....	SPEC 4500		
394720.....	SPEC 4925	624740.....	SPEC 3150	770610.....	SPEC 4500		
394730.....	SPEC 4925	624750.....	SPEC 3150	770670.....	SPEC 4500		
394740.....	SPEC 4925	624760.....	SPEC 3150	770700.....	SPEC 4500		
394750.....	SPEC 4925	624780.....	SPEC 3150	770900.....	SPEC 4500		
394760.....	SPEC 4925	624790.....	SPEC 3150	770950.....	SPEC 4500		
394770.....	SPEC 4925	624850.....	SPEC 3150	771080.....	SPEC 4500		
394780.....	SPEC 4925	624860.....	SPEC 3150	780200.....	SPEC 8075		
394790.....	SPEC 4925	624870.....	SPEC 3150	780210.....	SPEC 8050		
394800.....	SPEC 4925	624890.....	SPEC 3150	780220.....	SPEC 8025		
394810.....	SPEC 4925	624900.....	SPEC 3150	780230.....	SPEC 8075		
394820.....	SPEC 4925	624910.....	SPEC 3150	780240.....	SPEC 8050		
394830.....	SPEC 4925	624920.....	SPEC 3150	780250.....	SPEC 8025		
394840.....	SPEC 4925	624950.....	SPEC 3150	780260.....	SPEC 8150		
394850.....	SPEC 4925	624980.....	SPEC 3150	780270.....	SPEC 8075		
394860.....	SPEC 4925	624990.....	SPEC 3150	780280.....	SPEC 8025		
394870.....	SPEC 4925	625000.....	SPEC 3150	780290.....	SPEC 8025		
394880.....	SPEC 4925	625020.....	SPEC 3150	780310.....	SPEC 8025		
394890.....	SPEC 4925	625030.....	SPEC 3150	780320.....	SPEC 8050		
394900.....	SPEC 4925	625040.....	SPEC 3150	783160.....	SPEC 4550		
394910.....	SPEC 4925	625050.....	SPEC 3150	783190.....	SPEC 4550		