



KIT RANGE  
CATALOGUE



From a single/two-family setup...

... to a medium-size system (10 users)

### Scheme of expandable equipment up to 10 users

Example of installation with two-family PLANUXKIT

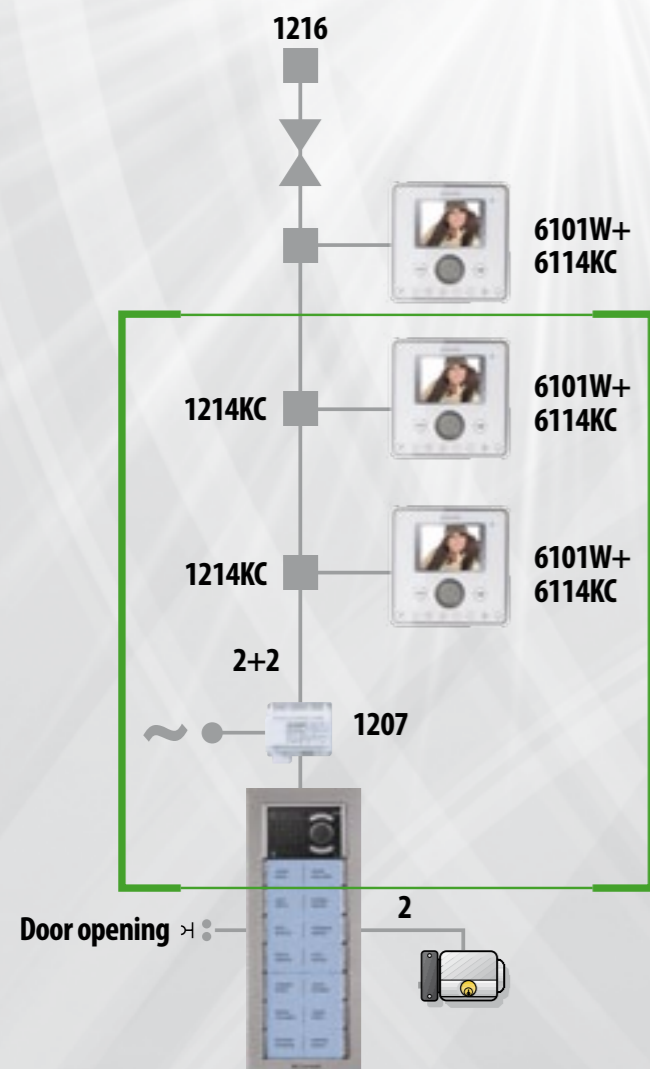

Composition of the kit



Expandable up to 10 users!



Comelit has designed two solutions capable of fulfilling all user requirements.

## KIT BASIC

The Basic kit consists of a **single** and/or **two-family** door-entry and video entry phone system set featuring an innovative and elegant design. The Basic range is easy to install and use, and is perfect for all residential solutions.

## KIT EVOLUTION

The Evolution kit retains the elegance and excellence of a Comelit product, but is enhanced with performance features allowing system expansion for **up to 10 users**, with the intercom function provided as standard.





# STYLE2<sup>kit</sup>



**Stylekit 2** is a single-family door-entry phone kit created by Comelit; it is extremely easy to install as it uses just 2 wires. Stylekit 2 features an original and innovative design, characterised by unmistakable and exclusive blue LEDs, large nameplates and high audio quality. An elegant desk base guarantees flexibility, to suit all requirements.

Single-Family  
Kit

**with IDEA**

**art. 8270**

The kit includes  
N°1 art. 2612  
N°1 art. 1200  
N°1 art. 3554  
N°1 art. 3561

## ACCESSORIES

Code	Description
2612	Style series basic intercom for 2-wire system
3560	Flush-mounted external unit 2 wires
3561	Surface-mounted external unit 2 wires
3554	Spare flush mounted box
4887	Waterproof housing for Idea surface-mounted entrance panel
4889	Waterproof shield for Idea flush-mounted entrance panel
1200	12Vac transformer with 230vac input
1229	Accessory - additional ringtone

# STYLE5<sup>kit</sup>



**Stylekit 5** is a 5-wire door-entry phone kit created by Comelit. Stylekit 5 features an original and innovative design, characterised by unmistakable and exclusive blue LEDs, large nameplates and high audio quality. The simple inclusion of an additional door-entry phone offers easy expansion and an elegant desk base guarantees flexibility, to suit all requirements. The external unit is wall-mounted, but the box art. 3554 used to install it as a flush-mounted product is also supplied as part of the package.

Single-Family Kit    Two-Family Kit    Three-Family Kit    Four-Family Kit

**with IDEA**

**art. 8271**

The kit includes  
N°1 art. 2602  
N°1 art. 1200  
N°1 art. 3554  
N°1 art. 3551

**with IDEA**

**art. 8272**

The kit includes  
N°2 art. 2602  
N°1 art. 1200  
N°1 art. 3554  
N°1 art. 3553

**with IDEA**

**art. 8273**

The kit includes  
N°3 art. 2602  
N°1 art. 1200  
N°1 art. 3573

**with IDEA**

**art. 8274**

The kit includes  
N°4 art. 2602  
N°1 art. 1200  
N°1 art. 3574

## ACCESSORIES

Code	Description
3550	Flush-mounted external unit
3551	Surface-mounted external unit
3552	Flush-mounted external unit
3553	Surface-mounted external unit
3573	3-Button external unit for 5-wire Stylekit
3574	4-Button external unit for 5-wire Stylekit
3554	Spare flush mounted box
4887	Waterproof housing for Idea surface-mounted entrance panel
4889	Waterproof shield for Idea flush-mounted entrance panel
1200	12Vac transformer with 230Vac input
2602	Style series 4 + 1 traditional system basic intercom
1122/A	12-24Vdc-ac general purpose relay
1229	Accessory - additional ringtone



# IKALL

# VANDALCOM



**82411**

The kit includes:  
N°1 art. 31162  
N°1 art. 33401  
N°1 art. 3311/25  
N°1 art. 3348  
N°1 art. 1610  
N°1 art. 1538  
N°1 art. 2602



**art. 82205**

The kit includes:  
N°1 art. 2602  
N°1 art. 1538  
N°1 art. 3160/1  
N°1 art. 3161/1  
N°1 art. 3262/1  
N°1 art. 1600



**art. 82305**

The kit includes:  
N°1 art. 2602  
N°1 art. 1538  
N°1 art. 3160/1  
N°1 art. 3161/2  
N°1 art. 3262/1  
N°1 art. 1600  
N°1 art. 3188

## ACCESSORIES

### Description

Spare parts and/or accessories are standard products of the traditional cabling system



# GENIUS kit



Particularly simple, versatile video intercom system, comprising a flush or surface mounted entrance panel. The b/w and colour monitor features an elegant gloss outer case with silk screen printing, and has 3 pushbuttons: door open, actuator (or free C/N.O.) and staircase lighting (or video request). GeniusKit allows call repetition by means of special terminals and duplication of the door open pushbutton even in the vicinity of the external unit. The standard configuration can be varied easily, by fitting additional monitors or telephones, or a second external video entry panel. Geniuskit can also provide for additional cameras and locks. The basic kit can be expanded to include up to 2 or more external units and 3 monitors per residential unit. Exapandable up to 16 internal units with art.1252.

## Single-Family B/W Kit with IDEA art. 8471

The kit includes  
 N° 1 art. 5801  
 N° 1 art. 5814K  
 N° 1 art. 4880  
 N° 1 art. 1205/B  
 N° 1 art. 1216  
 N° 1 art. 1214/2

## Two-Family B/W Kit with IDEA art. 8472

The kit includes  
 N° 2 art. 5801  
 N° 2 art. 5814K  
 N° 1 art. 4881  
 N° 1 art. 1205/B  
 N° 1 art. 1216  
 N° 2 art. 1214/2

## Single-Family Colour Kit with IDEA art. 8481

The kit includes  
 N° 1 art. 5802  
 N° 1 art. 5814KC  
 N° 1 art. 4882  
 N° 1 art. 1205/B  
 N° 1 art. 1216  
 N° 1 art. 1214KC

## Two-Family Colour Kit with IDEA art. 8482

The kit includes  
 N° 2 art. 5802  
 N° 2 art. 5814KC  
 N° 1 art. 4883  
 N° 1 art. 1205/B  
 N° 1 art. 1216  
 N° 2 art. 1214KC

### ACCESSORIES

Cod.	Description
4880	1 user external panel for B/W
4881	2 users external panel for B/W
4882	1 user entrance panel for colour
4883	2 User entrance panel for colour kit
3554	Spare flush mounted box
4887	Waterproof housing for Idea surface-mounted entrance panel
4889	Waterproof shield for Idea flush-mounted entrance panel
5801	Monitor Genius series B/W handset
5802	Monitor Genius series colour handset
5814K	Geniuskit B/W additional bracket
5814KC	Geniuskit colour additional bracket
5712	Desk base with bushing for Bravo/Genius monitor
2608	Style series Simplebus system basic intercom
2628	Style series Simplebus 2 system elegance intercom - white
2610	Style series Simplebus top/kit system elegance intercom
1229	Accessory - additional ringtone
1224A	Simplebus system digital switching device
4833/A	Line amplifier for simplebus video systems
4833C	Line amplifier for Simplebus color video systems

1122/A	12-24Vdc-ac general purpose relay
1256	Simplebus system digital relay actuator
1259/A	Switcher for remote cameras
1259C	Simplebus/colour kit for separate video cameras
1214/2	Simplebus 2 connection terminal
1214KC	Connecting terminal for color kit
1216	Simplebus/kit system terminal
1205/B	12Vac - 20vdc dual output power supply with 230vac input
1212/B	20Vdc 14va power supply with 230vac input
4576/100	Simplebus system Comelit cable 2x0.5 MM2 + 2x1.5 MM2 - 100 m
4576/500	Simplebus system Comelit cable 2x0.5 MM2 + 2x1.5 MM2 - 500 m
4578/100	Simplebus external Comelit 100 m cable 2x0.5 MM2 + 2x1.5 MM2
4578/500	Simplebus external Comelit 500 m cable 2x0.5 MM2 + 2x1.5 MM2



# SMART kit



A single and two-family colour video entry phone system kit. This consists of the new IDEA entrance panel and the new Smart monitor, which helps to minimise the overall dimensions. The privacy and intercom functions are standard features of the Smartkit. In order to use the intercom function, the single-family kit must be expanded with one or more additional door-entry phones/monitors. The kit can be used as a system base. The kits can be expanded to create solutions with 2 or more external units and 3 monitors per residential unit; this can be expanded to a maximum of 16 units through the addition of art. 1252.

## Single-Family Colour Kit with IDEA art. 8471S

The kit includes  
 N°1 art. 6302  
 N°1 art. 4882  
 N°1 art. 1205/B  
 N°1 art. 1215  
 N°1 art. 1216  
 N°1 art. 6117  
 N°1 art. 6320

## Two-Family Colour Kit with IDEA art. 8472S

The kit includes  
 N°2 art. 6302  
 N°1 art. 4883  
 N°1 art. 1205/B  
 N°2 art. 1215  
 N°1 art. 1216  
 N°2 art. 6117  
 N°2 art. 6320

### ACCESSORIES

Code	Description
4882	1 User entrance panel for colour kit
4883	2 User entrance panel for colour kit
3554	Spare flush mounted box
4887	Waterproof housing for Idea surface-mounted entrance panel
4889	Waterproof shield for Idea flush-mounted entrance panel
6302	Smart series sbc/kit system hands-free colour monitor
6312	Desk base with bushing for Smart monitor
6320	Surface-mounted support for Smart monitor
6333	Accessory - additional 5 buttons for Smart monitor
6117	Flush-mounted box for Planux and Smart monitor
6118	Plasterboard fixing kit for Planux and Smart monitors
2608	Style series Simplebus system basic intercom
2628	Style series Simplebus 2 system elegance intercom - white
2610	Style series Simplebus top/kit system elegance intercom
1229	Accessory - additional ringtone
1224A	Simplebus system digital switching device
4833C	Line amplifier for Simplebus color video systems

1122/A	12-24Vdc-ac general purpose relay
1256	Accessory - Simplebus system digital relay actuator
1259C	Accessory - Simplebus/colour kit for separate video cameras
1215	Connection terminal
1216	Simplebus/kit system terminal
1205/B	12Vac - 20vdc dual output power supply with 230vac input
1212/B	20Vdc 14va power supply with 230vac input
4576/100	Simplebus system Comelit cable 2x0.5 MM2 + 2x1.5 MM2 - 100 m
4576/500	Simplebus system Comelit cable 2x0.5 MM2 + 2x1.5 MM2 - 500 m
4578/100	Simplebus external Comelit 100 m cable 2x0.5 MM2 + 2x1.5 MM2
4578/500	Simplebus external Comelit 500 m cable 2x0.5 MM2 + 2x1.5 MM2



# BRAVO kit

Bravokit - the new video door entry system from Comelit. Based on technology exclusive to Comelit, Simplebus is the last word in simplicity. It comprises IKALL entrance panel, with clean and attractive lines and Bravo, the elegant video door entry monitor suitable for all types of residence. The kits are available in both colour and black and white versions. Both types are available in surface-mounted, single-family or two-family versions. The Bravokit includes the "privacy" function and the intercom function. In order to use the intercom function, the singlefamily kit must be expanded with one or more additional door entry telephones/ monitors. The basic kit can be expanded to include up to 2 or more external units and 3 monitors per residential unit. Expandable up to 16 internal units with art.1252.

# SMART kit

A single and two-family colour video entry phone system kit. This consists of the new IKALL entrance panel, with clean and attractive lines, and the new Smart monitor, which helps to minimise the overall dimensions. The privacy and intercom functions are standard features of the Smartkit. In order to use the intercom function, the single-family kit must be expanded with one or more additional door-entry phones/monitors. The kit can be used as a system base, to create systems to which a maximum of 10 residences are connected. The kits can be expanded to create solutions with 2 or more external units and 3 monitors per residential unit; this can be expanded to a maximum of 16 units through the addition of art. 1252.

## Single-Family B/W Kit with IKALL art. 8171I

The kit includes  
 N° 1 art. 5701  
 N° 1 art. 5714/K  
 N° 1 art. 4878K  
 N° 1 art. 1214/2  
 N° 1 art. 1207  
 N° 1 art. 1216

## Two-Family B/W Kit with IKALL art. 8173I

The kit includes  
 N° 2 art. 5701  
 N° 2 art. 5714/K  
 N° 1 art. 4879K  
 N° 2 art. 1214/2  
 N° 1 art. 1207  
 N° 1 art. 1216

## Single-Family Colour Kit with IKALL art. 8184I

The kit includes  
 N° 1 art. 5702  
 N° 1 art. 5714KC  
 N° 1 art. 4878KC  
 N° 1 art. 1214KC  
 N° 1 art. 1207  
 N° 1 art. 1216

## Two-Family Colour Kit with IKALL art. 8185I

The kit includes  
 N° 2 art. 5702  
 N° 2 art. 5714KC  
 N° 1 art. 4879KC  
 N° 2 art. 1214KC  
 N° 1 art. 1207  
 N° 1 art. 1216

## Single-Family Colour Kit with IKALL art. 8171IS

The kit includes  
 N° 1 art. 6302  
 N° 1 art. 6117  
 N° 1 art. 6320  
 N° 1 art. 1207  
 N° 1 art. 1215  
 N° 1 art. 1216  
 N° 1 art. 4878KC

## Two-Family Colour Kit with IKALL art. 8172IS

The kit includes  
 N° 2 art. 6302  
 N° 2 art. 6117  
 N° 2 art. 6320  
 N° 1 art. 1207  
 N° 2 art. 1215  
 N° 1 art. 1216  
 N° 1 art. 4879KC

### ACCESSORIES

Code	Description
4878K	iKall Simplebus kit single family B/W external unit
4878KC	iKall Simplebus kit single family colour external unit
4879K	iKall Simplebus kit two family B/W external unit
4879KC	iKall Simplebus kit two family colour external unit
31121	Natural anodised aluminium rain shield
31161	Natural anodised aluminium housing with rain shield
4680K	iKall series Simplebus kit B/W audio/video unit
4680KC	iKall series Simplebus kit colour audio/video unit
5701	Monitor Bravo series B/W handset
5702	Monitor Bravo series colour handset
5714/K	Bravokit B/W additional bracket
5714KC	Bravokit colour additional bracket
5712	Desk base with bushing for Bravo/Genius monitor
5733	Bravo monitor additional 4 buttons
5734	Bravo monitor additional 2 buttons and 2 leds
1207	Power supply for simplebus kit - iKall
2608	Style series Simplebus system basic intercom
2610	Style series Simplebus top/kit system elegance intercom

1229	Accessory - additional ringtone
1224A	Simplebus system digital switching device
4833/A	Line amplifier for Simplebus video systems
4833C	Line amplifier for Simplebus color video systems
1122/A	Simplebus system digital switching device
1256	Accessory - Simplebus system digital relay actuator
1259/A	Switcher for remote cameras
1259C	Accessory - Simplebus/colour kit for separate video cameras
1214/2	Simplebus 2 connection terminal
1214KC	Connecting terminal for color kit
1216	Simplebus/kit system terminal
1212/B	Simplebus/kit system terminal
4576/100	Simplebus system Comelit cable 2x0.5 Mm2 + 2x1.5 Mm2 - 100 m
4576/500	Simplebus system Comelit cable 2x0.5 MM2 + 2x1.5 MM2 - 500 m
4578/100	Simplebus external Comelit 100 m cable 2x0.5 MM2 + 2x1.5 MM2
4578/500	Simplebus external Comelit 500 m cable 2x0.5 MM2 + 2x1.5 MM2

### ACCESSORIES

Code	Description
4878KC	iKall simplebus kit single family colour external unit
4879KC	iKall simplebus kit two family colour external unit
31121	Natural anodised aluminium rain shield
31161	Natural anodised aluminium housing with rain shield
4680KC	iKall series simplebus kit colour audio/video unit
6302	Smart series sbc/kit system hands-free colour monitor
6312	Desk base with bushing for Smart monitor
6320	Surface-mounted support for Smart monitor
6333	Accessory - additional 5 buttons for Smart monitor
6117	Flush-mounted box for planux and Smart monitor
6118	Plasterboard fixing kit for planux and Smart monitors
1207	Power supply for simplebus kit - iKall
2608	Style series Simplebus system basic intercom
2628	Style series Simplebus 2 system elegance intercom - white
2610	Style series Simplebus top/kit system elegance intercom
1229	Accessory - additional ringtone

1224A	Simplebus system digital switching device
4833C	Line amplifier for Simplebus color video systems
1122/A	Simplebus system digital switching device
1256	Accessory - Simplebus system digital relay actuator
1259C	Accessory - Simplebus/colour kit for separate video cameras
1215	Connection terminal
1216	Simplebus/kit system terminal
1212/B	20Vdc 14va power supply with 230vac input
4576/100	Simplebus system Comelit cable 2x0.5 Mm2 + 2x1.5 Mm2 - 100 m
4576/500	Simplebus system Comelit cable 2x0.5 MM2 + 2x1.5 MM2 - 500 m
4578/100	Simplebus external Comelit 100 m cable 2x0.5 MM2 + 2x1.5 MM2
4578/500	Simplebus external Comelit 500 m cable 2x0.5 MM2 + 2x1.5 MM2



# PLANUX kit



## Single-Family Colour Kit with IKALL art. 8171IP

The kit includes  
 N° 1 art. 6101W  
 N° 1 art. 6101N  
 N° 1 art. 6114KC  
 N° 1 art. 6117  
 N° 1 art. 6120  
 N° 1 art. 1207  
 N° 1 art. 1214KC  
 N° 1 art. 1216  
 N° 1 art. 4878KC

## Two-Family Colour Kit with IKALL art. 8172IP

The kit includes  
 N° 2 art. 6101W  
 N° 2 art. 6101N  
 N° 2 art. 6114KC  
 N° 2 art. 6117  
 N° 2 art. 6120  
 N° 1 art. 1207  
 N° 2 art. 1214KC  
 N° 1 art. 1216  
 N° 1 art. 4878KC

A single and two-family colour video entry phone system kit. It consists of the new IKALL entrance panel, with clean and attractive lines, and the Planux monitor with touch-sensitive technology. The privacy and intercom functions are standard features of the Planux kit. In order to use the intercom function, the single-family kit must be expanded with one or more additional door-entry phones/monitors. The kit can be used as a system base, to create systems to which a maximum of 10 residences are connected. The kits can be expanded to create solutions with 2 or more external units and 3 monitors per residential unit; this can be expanded to a maximum of 16 units through the addition of art. 1252.

### ACCESSORIES

Code	Description
4878KC	iKall Simplebus kit single family colour external unit
4879KC	iKall Simplebus kit two family b/w external unit
31121	Natural anodised aluminium rain shield
31161	Natural anodised aluminium housing with rain shield
4680KC	iKall series Simplebus kit colour audio/video unit
6101B	Planux series hands-free colour monitor - absolute black
6101W	Planux series hands-free colour monitor - white
6114KC	Planuxkit colour additional bracket
6112	Desk base with junction box for Planux monitor
6117	Flush-mounted box for planux and Smart monitor
6118	Plasterboard fixing kit for planux and Smart monitors
6120	Surface-mounted support for Planux monitor
6121	High surface-mounted support for Planux monitor
6122	Tilting accessory for Planux monitors
1207	Power supply for simplebus kit - iKall
2608	Style series Simplebus system basic intercom
2628	Style series Simplebus 2 system elegance intercom - white
2610	Style series Simplebus top/kit system elegance intercom
1229	Accessory - additional ringtone

1224A	Simplebus system digital switching device
4833C	Line amplifier for Simplebus color video systems
1122/A	12-24Vdc-ac general purpose relay
1256	Accessory - Simplebus system digital relay actuator
1259C	Accessory - Simplebus/colour kit for separate video cameras
1214KC	Connecting terminal for colour kit
1216	Simplebus/kit system terminal
1212/B	20Vdc 14va power supply with 230vac input
4576/100	Simplebus system Comelit cable 2x0.5 Mm2 + 2x1.5 Mm2 - 100 m
4576/500	Simplebus system Comelit cable 2x0.5 Mm2 + 2x1.5 Mm2 - 500 m
4578/100	Simplebus external Comelit 100 m cable 2x0.5 Mm2 + 2x1.5 Mm2
4578/500	Simplebus external Comelit 500 m cable 2x0.5 Mm2 + 2x1.5 Mm2



# PLANUX LUX kit



## Single-Family Colour Kit with IKALL art. 8171IPLB

The kit includes  
 N° 1 art. 6101B/C  
 N° 1 art. 6114KC  
 N° 1 art. 6117  
 N° 1 art. 1207  
 N° 1 art. 1214KC  
 N° 1 art. 1216  
 N° 1 art. 4878KC

## Single-Family Colour Kit with IKALL art. 8171IPLW

The kit includes  
 N° 1 art. 6101W/C  
 N° 1 art. 6114KC  
 N° 1 art. 6117  
 N° 1 art. 1207  
 N° 1 art. 1214KC  
 N° 1 art. 1216  
 N° 1 art. 4878KC

A single colour video entry phone system kit. It includes the new IKALL entrance panel, with clean and attractive lines, and the Planux Lux monitor with touch-sensitive technology. The privacy and intercom functions are standard features of the Planux Lux and Planux Lux kit. In order to use the intercom function, the single-family kit must be expanded with one or more additional door-entry phones/monitors. The kit can be used as a system base, to create systems to which a maximum of 10 residences are connected. The kits can be expanded to create solutions with 2 or more external units and 3 monitors per residential unit; this can be expanded to a maximum of 16 units through the addition of art. 1252.

### ACCESSORIES

Code	Description
4878KC	iKall Simplebus kit single family colour external unit
4879KC	iKall Simplebus kit two family b/w external unit
31121	Natural anodised aluminium rain shield
31161	Natural anodised aluminium housing with rain shield
4680KC	iKall series Simplebus kit colour audio/video unit
6101B/C	Planux lux series hands-free colour monitor - black
6101W/C	Planux lux series hands-free colour monitor - white
6114KC	Planuxkit colour additional bracket
6117	Flush-mounted box for Planux and smart monitors
6118	Plasterboard fixing kit for Planux and smart monitors
6101L/C	White colour template for video Planux lux
6101N/C	Black colour template for video Planux lux
1207	Power supply for Simplebus kit - iKall
2608	Style series Simplebus system basic intercom
2628	Style series Simplebus 2 system elegance intercom - white
2610	Style series simplebus top/kit system elegance intercom
1229	Accessory - additional ringtone
1224A	Simplebus system digital switching device
4833C	Line amplifier for Simplebus color video systems

1122/A	12-24Vdc-ac general purpose relay
1256	Accessory - Simplebus system digital relay actuator
1259C	Accessory - Simplebus/colour kit for separate video cameras
1214KC	Connecting terminal for colour kit
1216	Simplebus/kit system terminal
1212/B	20Vdc 14va power supply with 230vac input
4576/100	Simplebus system Comelit cable 2x0.5 Mm2 + 2x1.5 Mm2 - 100 m
4576/500	Simplebus system Comelit cable 2x0.5 Mm2 + 2x1.5 Mm2 - 500 m
4578/100	Simplebus external Comelit 100 m cable 2x0.5 Mm2 + 2x1.5 Mm2
4578/500	Simplebus external Comelit 500 m cable 2x0.5 Mm2 + 2x1.5 Mm2

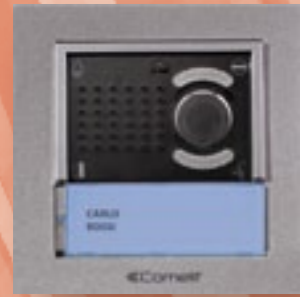

**PLANUX**  
memo  
with TOUCH SCREEN

# PLANUX kit MEMO



A single colour video entry phone system kit. It consists of the new IKALL entrance panel, with clean and attractive lines, and the PlanuxMemo monitor with touch-sensitive technology. The privacy and intercom functions are standard features of the PlanuxMemo kit. In order to use the intercom function, the single-family kit must be expanded with one or more additional door-entry phones/monitors. The kit can be used as a system base, to create systems to which a maximum of 10 residences are connected.

## Single-Family Colour Kit

with **IKALL**

art. **8171IPM**

The kit includes:

- N° 1 art. 6101WM
- N° 1 art. 6214C
- N° 1 art. 6117
- N° 1 art. 6120
- N° 1 art. 1207
- N° 1 art. 4888C
- N° 1 art. 4878KC

### ACCESSORIES

Code	Description
4878KC	iKall Simplebus kit single family colour external unit
31121	Natural anodised aluminium rain shield
31161	Natural anodised aluminium housing with rain shield
4680KC	IKall series Simplebus kit colour audio/video unit
6101WM	White Planux hands-free colour monitor with memovideo
6214C	Simplebus top bracket for Planux memo and Planux manager
6112	Desk base with junction box for Planux monitor
6117	Flush-mounted box for planux and Smart monitor
6118	Plasterboard fixing kit for planux and Smart monitors
6120	Surface-mounted support for Planux monitor
6121	High surface-mounted support for Planux monitor
6122	Tilting accessory for Planux monitors
1207	Power supply for simplebus kit - iKall
2608	Style series Simplebus system basic intercom
2628	Style series Simplebus 2 system elegance intercom - white
2610	Style series Simplebus top/kit system elegance intercom
1229	Accessory - additional ringtone
1224A	Simplebus system digital switching device
4833C	Line amplifier for Simplebus color video systems

4888C	Simplebus colour system power supply mixer
1122/A	12-24Vdc-ac general purpose relay
1256	Accessory - Simplebus system digital relay actuator
1259C	Switcher for remote cameras
1214/2C	Simplebus 2 and Simplebus colour connection terminal
1216	Simplebus/kit system terminal
1212/B	20Vdc 14va power supply with 230vac input
4576/100	Simplebus system Comelit cable 2x0.5 Mm2 + 2x1.5 Mm2 - 100 m
4576/500	Simplebus system Comelit cable 2x0.5 Mm2 + 2x1.5 Mm2 - 500 m
4578/100	Simplebus external Comelit 100 m cable 2x0.5 Mm2 + 2x1.5 Mm2
4578/500	Simplebus external Comelit 500 m cable 2x0.5 Mm2 + 2x1.5 Mm2

# VARIANTS

## Variant diagrams

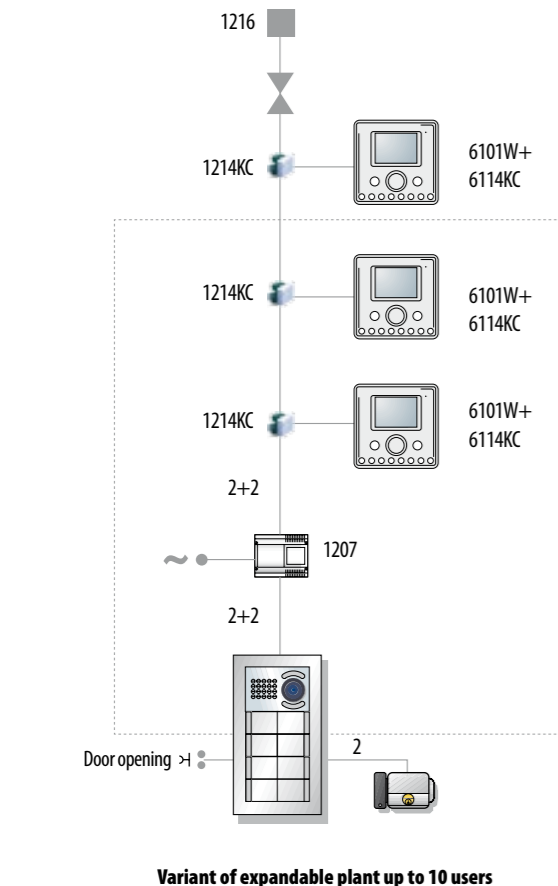
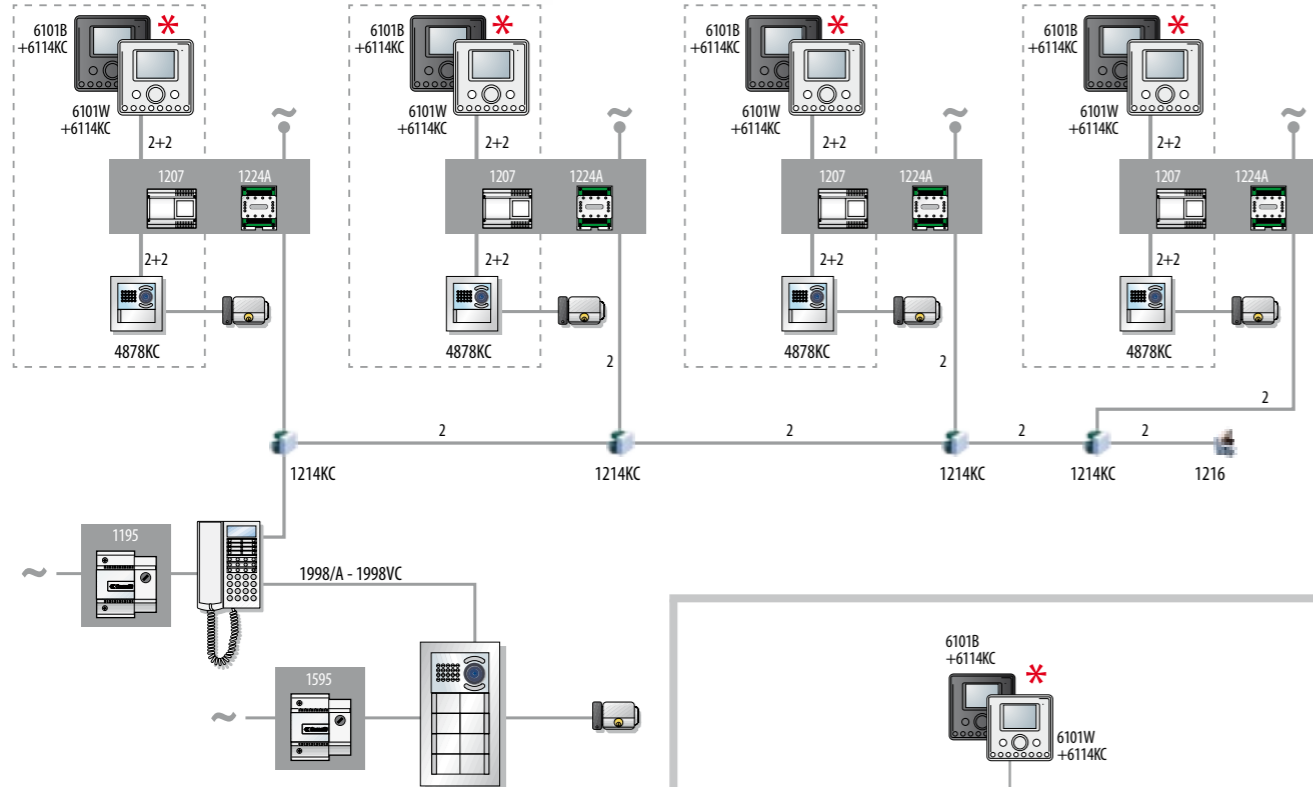

Variant of expandable plant up to 10 users

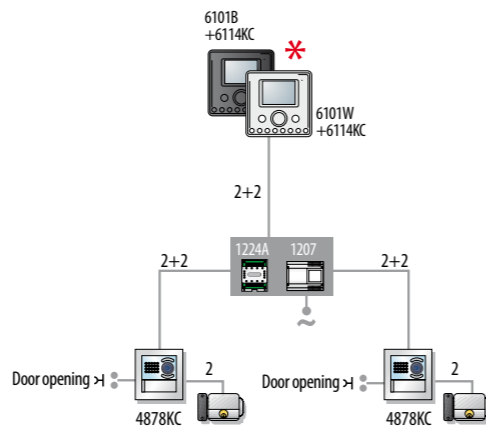

Variant with second entrance for single-family kit

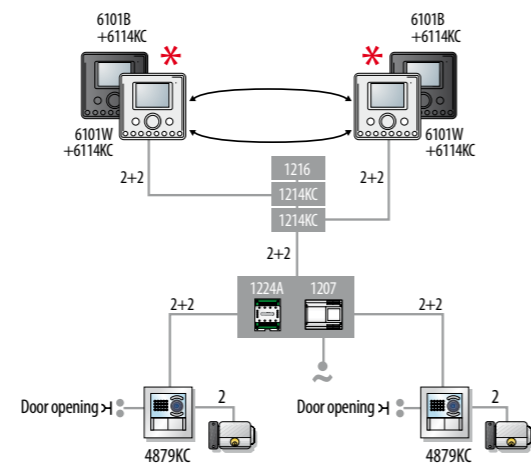

Variant with second entrance for two-family kit

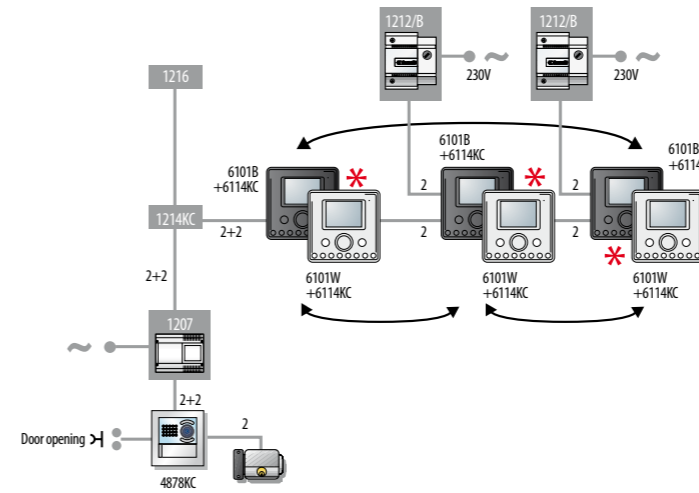

Variant with two additional monitors for single-family kit

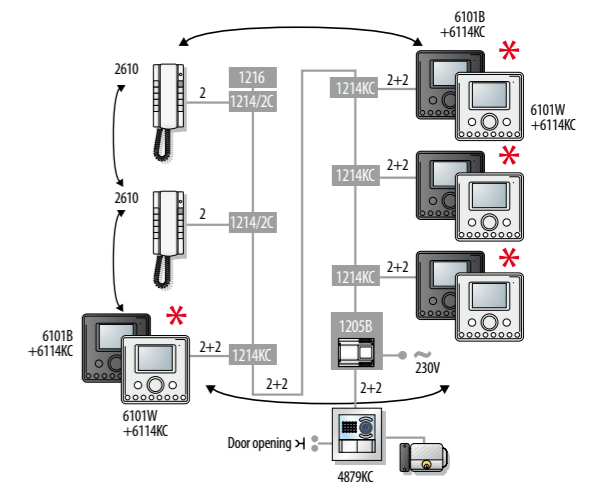

Variant with two additional monitors or entry phones for two-family kit

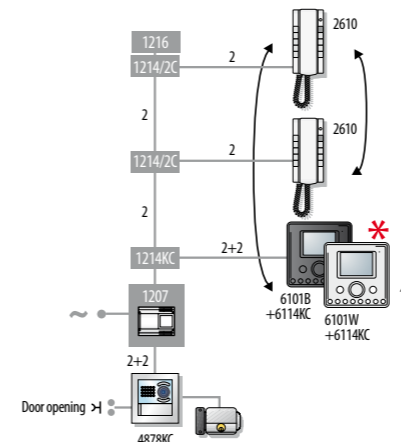

Variant with two additional entry phones for single-family kit

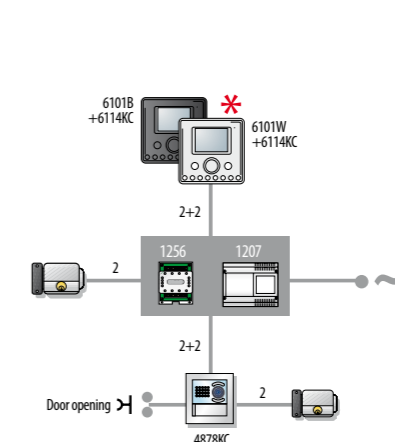

Variant with additional lock for single-family kit

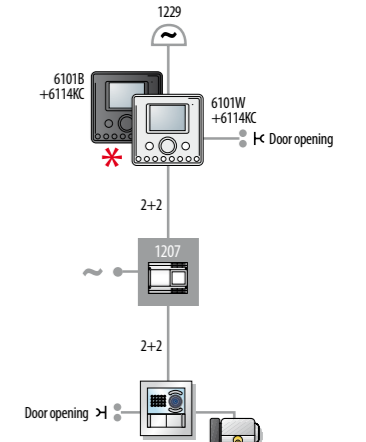

Variant with floor door call connection and additional bell for single and two-family kit

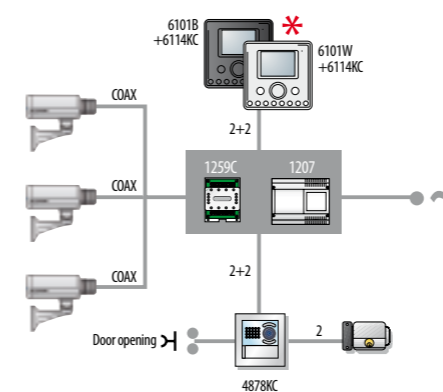

Variant with additional cameras for single-family kit

**\***

For **PLANUX LUX** monitor use  
art. 6101W/C + 6114KC  
or art. 6101B/C + 6114KC

For **SMART** monitor use  
art. 6302

For **BRAVO** monitor use  
art. 5702+5714K (COLOUR) or  
art. 5701+5714/K (B/W)

# ACCESSORIES



**4878K B/W single-family external unit simplebus - IKALL kit**  
Audio/video external unit with black 1-button faceplate, fitted with 4680K jack, die-cast aluminium module-holder frame and flushmounted box. Dimensions: 125x125x45 mm.

**4878KC Colour single-family external unit simplebus - IKALL kit**  
Audio/video external unit with black 1-button faceplate, fitted with 4680K jack, die-cast aluminium module-holder frame and flushmounted box. Dimensions: 125x125x45 mm.

**4879K B/W two-family external unit simplebus - IKALL kit**  
Audio/video external unit with black 2-button faceplate, fitted with 4680K jack, die-cast aluminium module-holder frame and flushmounted box. Dimensions: 125x125x45 mm.

**4879KC Colour two-family external unit simplebus - IKALL kit**  
Audio/video external unit with black 2-button faceplate, fitted with 4680K jack, die-cast aluminium module-holder frame and flushmounted box. Dimensions: 125x125x45 mm.



**31121 Natural anodised aluminium rain shield**  
Natural anodised aluminium rain shield. 1 module. Dimensions 154x152x44 mm.



**31161 Natural anodised aluminium housing with rain shield**  
Natural anodised aluminium housing with rain shield. 1 module. Dimensions 154x152x85 mm.



**4680K IKALL series simplebus kit b/w audio/video unit**  
Simplebus Color system audio/video unit with terminal block complete with front-adjustable wide-angle 1/4" B/W camera and LED camera illumination. Complete with terminal block and digital audio management system with Eco-cancelling, watertight loudspeaker and electrets microphone; loudspeaker volume can be adjusted from the front. Complete with microprocessor and DIP SWITCH with 8 positions for programming calls to users. Audiovisual indications for disabled individuals assistance request can be activated via programming. 33Vdc power supply via special power supply unit Art. 1595. On-board electronic lock-release function (3A), plus C, NC, NO contacts for 10A relay. For use in modules Art. 33410, 33411 and 33412. Dimensions: 102x55x38 mm.

**4680KC IKALL series simplebus kit colour audio/video unit**  
Simplebus Color system audio/video unit with terminal block complete with front-adjustable wide-angle 1/4" colour camera and LED camera illumination. Complete with terminal block and digital audio management system with Eco-cancelling, watertight loudspeaker and electrets microphone; loudspeaker volume can be adjusted from the front. Complete with microprocessor and DIP SWITCH with 8 positions for programming calls to users. Audiovisual indications for disabled individuals assistance request can be activated via programming. 33Vdc power supply via special power supply unit Art. 1595. On-board electronic lock-release function (3A), plus C, NC, NO contacts for 10A relay. For use in modules Art. 33410, 33411 and 33412. Dimensions: 102x55x38 mm.



**4880 1 user external panel for B/W kit**  
Flush/Surface-mounted external video entry phone (the external unit is surface mounted but a box art. 3554 is also provided to allow flush mounted installation of the external unit) with anodized aluminium facing and ample name holder slots, with LED rear-lighting. 12V AC power supply. Dimensions of external unit:

95x176x15 mm. Dimensions of flush-mounted box: 95,5x176x5x35 mm.

**4881 2 user entrance panel for B/W kit**  
Flush/Surface-mounted external video entry phone (the external unit is surface mounted but a box art. 3554 is also provided to allow flush mounted installation of the external unit) with anodized aluminium facing and ample name holder slots, with LED rear-lighting. 12V AC power supply. Dimensions of external unit: 95x176x15 mm. Dimensions of flush-mounted box: 95,5x176x5x35 mm.

**4882 2 user entrance panel for colour**  
Flush/Surface-mounted external video entry phone (the external unit is surface mounted but a box art. 3554 is also provided to allow flush mounted installation of the external unit) with anodized aluminium facing and ample name holder slots, with LED rear-lighting. 12V AC power supply. Dimensions of external unit: 95x176x15 mm. Dimensions of flush-mounted box: 95,5x176x5x35 mm.



**4883 2 user entrance panel for colour kit**  
Flush/surface-mounted external video entry phone (the external unit is surface mounted but a box art. 3554 is also provided to allow flush mounted installation of the external unit) with anodized aluminium facing and nameplate holder, with LED rear-lighting. 12V AC power supply. Dimensions of external unit: 95x176x15 mm. Dimensions of flushmountedbox: 95,5x176x5x35 mm.



**3550 Flush-mounted external unit**  
Flush-mounted door entry phone external unit with front in anodised aluminium and large nameholder label lit from the rear with an LED. Complete with speaker unit, adjustment of the 2 volumes, callgenerator, watertight loudspeaker and electret micro-phone. 12V AC power supply. Dimensions of external unit: 95x176x15 mm. Dimensions of flushmounted box: 95,5x176,5x35 mm.

**3551 Surface-mounted external unit**  
Surface-mounted door entry phone external unit with front in anodised aluminium and large nameholder label lit from the rear with an LED. Complete with speaker unit, adjustment of the 2 volumes, call generator, watertight loudspeaker and electret microphone. 12V AC power supply. Dimensions of external unit: 95x176x25mm.

**3552 Flush-mounted external unit**  
Flush-mounted door entry phone external unit with front in anodised aluminium and large nameholder label lit from the rear with an LED. Complete with speaker unit, adjustment of the 2 volumes, callgenerator, watertight loudspeaker and electret micro-phone. 12V AC power supply. Dimensions of external unit: 95x176x15 mm. Dimensions of flush-mounted box: 95,5x176,5x35 mm.

**3553 Surface-mounted external unit**  
Surface-mounted door entry phone external unit with front in anodised aluminium and large nameholder label lit from the rear with an LED. Complete with speaker unit, adjustment of the 2 volumes, call generator, watertight loudspeaker and electret microphone. 12V AC power supply. Dimensions of external unit: 95x176x25mm.

**3560 Flush-mounted external unit 2 wire**  
Flush-mounted door entry external unit with front in anodised aluminium and 1 aluminium call push-button, large name holder lit from the rear with an LED. Complete with speaker unit, adjustment of the 2 volumes, watertight loudspeaker and electret microphone. Dimensions of external unit: 95x176x15 mm.

**3561 Surface-mounted external unit**  
Flush-mounted door entry external unit with front in anodised aluminium and 2 aluminium call push-button, large name holder lit from the rear with an LED. Complete with speaker unit, adjustment of the 2 volumes, watertight loudspeaker and electret microphone. Dimensions of external unit: 95x176x15 mm.

**3573 3-button external unit for 5-wire STYLE kit**  
Flush-mounted door entry phone external unit with the faceplate in anodised aluminium and a single call pushbutton, large name holder backlit with the exclusive blue LED. Complete with speaker unit, call volume adjustment, call generator, watertight loudspeaker and electret microphone. 12V AC power supply. Dimensions of external unit: 95x176x15 mm.

**3574 4-button external unit for 5-wire STYLE kit**  
Flush-mounted door entry phone external unit with the faceplate in anodised aluminium and a single call pushbutton, large name holder backlit with the exclusive blue LED. Complete with speaker unit, call volume adjustment, call generator, watertight loudspeaker and electret microphone. 12V AC power supply. Dimensions of external unit: 95x176x15 mm.



**3554 Spare flush mounted box for IDEA**  
Flush-mounting box. Dimensions: 95,5x176,5x35mm.



**4887 Waterproof housing for idea surface-mounted entrance panel**  
Protection housing with rain shield for Idea wall-mounted keypad. Dimensions: 119x196x76 mm.



**4889 Waterproof shield for idea flush-mounted entrance panel**  
Protection visor with rain shield for Idea flush-mounted button pad. Dimensions: 115x195x52 mm.



**5801 Monitor GENIUS series B/W handset**  
Genius monitor with 4" B/W screen, white matt finish. Fitted as standard with blue door-open pushbutton and two grey pushbuttons for various functions. It has brightness control and a selector for the call volume, adjustable to three different positions (high, medium and low). It can be converted into a desk version using art. 5712. Dimensions: 204x225x63 mm.



**5802 Monitor GENIUS series colour handset**  
Genius monitor with 3,5" colour screen, white matt finish. Fitted as standard with blue door-open pushbutton and two grey pushbuttons for various functions. the brightness control and a selector for the call volume, adjustable to three different positions (high, medium and low). It can be converted into the desk version using art. 5712. Dimensions: 204x225x63 mm.



**5814K Geniuskit B/W additional bracket**  
Completion bracket for monitor art. 5801. Fitted with branch terminal art. 1214/2.

**5814KC Geniuskit colour additional bracket**  
Completion bracket for Genius monitor art. 5802. Provided with branch terminal 1214KC.



**5701 Monitor BRAVO series B/N handset**  
Handset version Bravo monitor with 4" B/W screen, The chrome keys, the brilliant white gloss finish combined with the silver colour base combined with the etched glass effect facia. It is fitted as standard with door open pushbuttons and two pushbuttons for various functions, signalling LED, brightness adjustment, contrast adjustment, and slide call volume adjustment. The Call tone function, which allows the call tone to be temporarily excluded, is standard and is obtained by positioning the call volume on zero. It can be converted into a desk version with art. 5712. Dimensions: 212x225x55 mm.



**5702 Monitor BRAVO series colour handset**  
Handset version Bravo monitor with 3,5" colour screen. The chrome keys, the brilliant white gloss finish combined with the silver colour base combined with the etched glass effect facia. It is fitted as standard with door open pushbuttons and two pushbuttons for various functions, signalling LED, brightness adjustment, contrast adjustment, and slide call volume adjustment. The "Call tone" function, which allows the call tone to be temporarily excluded, is standard and is obtained by positioning the call volume on zero. It can be converted into a desk version with art. 5712. Dimensions: 212x225x55 mm.



**5714/K Bravokit B/W additional bracket**  
Completion bracket for Bravo monitor art. 5701. Fitted with branch terminal art. 1214/2.

**5714KC Bravokit colour additional bracket**  
Completion bracket for Bravo monitor with colour Bravokit. Fitted with branch terminal art. 1214KC.



**5712 Desk base with bushing for Bravo/Genius monitor**  
Desk base. Allows conversion into desk version of all the GENIUS/BRAVO monitors both in the handset and hands-free versions. Complete with 2 mt of cable and connection box. Dimensions: 173x186.5x174 mm.



**5733 Bravo monitor additional 4 buttons**  
Card with 4 additional pushbuttons (N/O or for digital services), provided with screws. Can be inserted inside all the BRAVO series monitors rapidly without having to open the monitor.

**5734 Bravo monitor additional 2 buttons and 2 leds**  
Card with 2 additional pushbuttons (N/O or for digital services) and 2 additional LEDs, provided with screws. Can be inserted inside all the BRAVO series monitors rapidly without having to open the monitor.

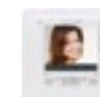

**6302 Smart series SBC/kit system hands-free colour monitor**  
Flush-mounted (on box Art. 6117) or Surface Mounted (with bracket Art. 6320) colour monitor with 3,5" screen and Full-Duplex hands-free audio. Allows audio volume adjustment, ringtone volume adjustment with privacy activation indicator light and brightness control. Fitted as standard with key button, audio enabling/disabling button with corresponding indication LEDs and 2 other buttons pre-set for self-ignition and switchboard call (these can, however, be programmed for various uses). It is normally used for local floor call management and call repetition, and comes complete with an 8-position DIP SWITCH for user code programming, as well as a second 8-position DIP SWITCH for programming management. Inclusion of the button card Art. 6333 allows a further 5 additional programmable buttons to be made available. The monitor can be used in SBC Simplebus TOP colour systems, or as an additional monitor for Simplebus KITS. Dimensions 138x138x24 mm.



**6312 Desk base with bushing for Smart monitor**  
Adjustable tilt desk base converts the Smart monitor into a desktop version. Complete with 1 x 2 m labelled RJ45 cable for connecting the monitor terminals to the clasp or to a civil series jack. Dimensions: 145x190x120 mm.



**6320 Supporto da parete per monitor Smart**  
Adjustable tilt desk base converts the Smart monitor into a desktop version. Complete with 1 x 2 m labelled RJ45 cable for connecting the monitor terminals to the Junction box or to a civil series jack. Dimensions: 145x190x120 mm.



**6333 Accessory for 5 additional buttons on the Smart monitor**  
Accessory for Smart monitor which allows the addition of 5 extra programmable buttons for digital services. Can be installed quickly, without opening up the monitor.



**6101B PLANUX series hands-free colour monitor - absolute black**  
Colour monitor with 3,5" On-Screen Display. With touch-sensitive technology and full-duplex hands-free function. Audio volume, call volume, colour, brightness and contrast adjustment. Ringtones can be customised, selecting from the 7 melodies provided. Backlit control panel consisting of: 1 key button, 1 enable/disable audio button, 1 privacy or doctor function button which can be selected via the menu (with red LED to indicate privacy enabled), 1 self-ignition button, 2 buttons for various uses and 4 buttons for entry, confirmation and navigation within the menus. The monitor, used in conjunction with art. 6112, can be converted into the desk version. Dimensions 145x145x33 mm.



**6101W PLANUX hands-free colour monitor - white**  
Colour monitor with 3.5" On-Screen Display. With touch-sensitive technology and full-duplex hands-free function. Audio volume, call volume, colour, brightness and contrast adjustment. Ringtones can be customised, selecting from the 7 melodies provided. Backlit control panel consisting of: 1 enable/disable audio button, 1 privacy or doctor function button which can be selected via the menu (with red LED to indicate privacy enabled), 1 self-ignition button, 2 buttons for various uses and 4 buttons for entry, confirmation and navigation within the menus. The monitor, used in conjunction with art. 6112, can be converted into the desk version. Dimensions 145x145x33 mm.

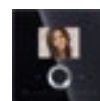

**6101B/C PLANUX LUX series hands-free colour monitor - black**  
Colour monitor with 3.5" On-Screen Display and glass cover. With touch-sensitive technology and full-duplex hands-free function. Audio volume, call volume, colour, brightness and contrast adjustment. Ringtones can be customised, selecting from the 7 melodies provided. Backlit control panel consisting of: 1 key button, 1 enable/disable audio button, 1 privacy or doctor function button which can be selected via the menu (with red LED to indicate privacy enabled), 1 self-ignition button, 2 buttons for various uses and 4 buttons for entry, confirmation and navigation within the menus. Dimensions 160x167x4 mm.

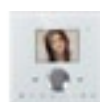

**6101W/C PLANUX LUX series hands-free colour monitor - white**  
Colour monitor with 3.5" On-Screen Display and glass cover. With touch-sensitive technology and full-duplex hands-free function. Audio volume, call volume, colour, brightness and contrast adjustment. Ringtones can be customised, selecting from the 7 melodies provided. Backlit control panel consisting of: 1 key button, 1 enable/disable audio button, 1 privacy or doctor function button which can be selected via the menu (with red LED to indicate privacy enabled), 1 self-ignition button, 2 buttons for various uses and 4 buttons for entry, confirmation and navigation within the menus. Dimensions 160x167x4 mm.



**6114K PLANUX kit colour additional bracket**  
The video door entry system is complete conversation privacy as standard. Handles local floor calls and call repetition as standard. Dimensions: 96x106x17 mm.



**6101L/C Template PLANUX LUX MONITOR White**



**6101N/C Template PLANUX LUX MONITOR Black**



**6112 Desk base with junction box for PLANUX monitor**  
Desk base allowing the Planux monitor to be converted for desk use, complete with two 2 m RJ45 headed cables: one for connection to the VIP network, the other to connect the extra terminals to the junction box. Dimensions: 145x190x120 mm.



**6117 Flush-mounted box for PLANUX and SMART monitors**  
Flush-mounted box for Planux and Smart monitors. Accessory art. 6122 can be used for tilting the Planux monitor. Dimensions: 132x132x50 mm.



**6118 Plasterboard installation kit for Planux and Smart monitors**  
Accessory allowing installation of Planux monitors on plasterboard walls, without the application of box art. 6117. Installation kit for plasterboard walls.



**6120 Surface-mounted support for PLANUX monitor**  
Short surface support for Planux monitor for use with tilt facility art 6122 Accessory art. 6122 cannot be used for tilting. Dimensions: 145x145x26 mm.



**6121 High surface-mounted support for PLANUX monitor**  
Long support for Planux monitor wall mounting Accessory art. 6122 can be used for tilting. Dimensions: 145x145x45 mm.



**6122 Tilting accessory for planux monitors**  
Accessory for tilting Planux monitors to be used in combination with the long support art.6121 and the flush-mounted box art. 6117. Dimensions: 136x136x40 mm.



**2602 STYLE series 4 +1 traditional system BASIC intercom**  
Telephone with electronic call, conversation button on the base, call tone-volume adjustment and privacy, door opener pushbutton and supplementary isolated pushbutton for additional services with independent common. With this model, addition of pushbuttons or supplementary LEDs is not possible. Dimensions: 95x215x58 mm.

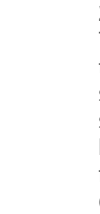

**2608 STYLE series simplebus system BASIC intercom**  
Telephone with electronic call call tone adjustment, privacy of speech, call tone privacy, door open pushbutton and supplementary pushbutton for porter switchboard call or free (C/N.O.). By means of selection jumper, the second pushbutton can be used to control actuator art. 1256. Allows management of the local floor call and call repetition. Complete with dip-switch with 8 positions for selection of the desired user code. With this model, addition of pushbuttons or supplementary LEDs is not possible. Dimensions: 95x215x58 mm. From the RI006 it is compatible with all SBTOP functions and products.



**2610 STYLE series Simplebus top/kit system ELEGANCE intercom**  
Telephone with electronic call, call volume adjustment, privacy of speech, call tone privacy. Fitted as standard with door open pushbuttons, porter switchboard call, actuator control Art. 1256 and LED for various functions (engaged and doctor function). Up to 6 supplementary pushbuttons can be added, of which a maximum of 3 LEDs. Allows management of the floor door call and call repetition. Complete with dip-switch with 8 positions for selection of the desired user code. Telephone to be used in mixed audio/video Simplebus 1, Simplebus 2 systems. Fitted with branch terminal art. 1214/2C. With this model, the facia can be replaced. From the RI010 it is compatible with all SBTOP functions and products. Allows direct intercommunication between users with the same address (without the aid of an interface or porter switchboard), transmission of alarm signals to the porter switchboard, separate call to main switchboard, secondary switchboard and guardian door-entry phone. Dimensions: 95x215x58 mm.



**2612 STYLE series BASIC intercom for 2-wire**  
Additional entry phone for kit 8270, with electronic call, call button on the base, call volume adjustment, privacy, door open pushbutton and free (C/N.O.) pushbutton. Dimensions: 95x215x58 mm.



**2628 STYLE series Simplebus2 system ELEGANCE intercom - white**  
Telephone with electronic call call volume adjustment, privacy call tone, privacy of speech. Fitted with door open pushbutton, switchboard call, actuator control art. 1256 and free (C/N.O.). Up to 6 supplementary pushbuttons can be added, of which a maximum of 3 LEDs. Allows management of the local floor call and call repetition. Complete with dip-switch with 8 positions for selection of the desired user code. Telephone to be used in mixed audio/video systems (Simplebus 1 and Simplebus 2) or in audio systems when the call repetition function is required. Fitted with terminal 1214/2. With this model, the can facia can be replaced. Dimensions: 95x215x58 mm. From the RI005 it is compatible with all SBTOP functions and products.



**1229 Accessory - additional ringtone**  
Additional bell for call repetition can be controlled directly from terminals S- and S+ of the brackets and/or from the telephones. Surfacemounted or on civil series 503 box. Dimensions: 110x75x29 mm.



**1224A Simplebus system digital switching device**  
Switching device for audio or audio-video systems with 2 or more entrances. Complete with 2 DIP SWITCHES with 8 positions for defining the user range of the riser. 12V AC power supply (use transformer Art. 1200/U). Dimensions: 60x85x35 mm (4 DIN modules).



**4833/A Line amplifier for SIMPLEBUS video systems**  
Video amplifier to be used in the following cases: 1. After the 50th monitor in systems with more than 50 monitors. 2. Each 150 m. (if twisted pair is used) or 100 m. (if normal cable is used) or 80 m. (if twisted and shielded pair is used). 3. At the base of each riser in systems with video main panel and audio or video secondary panels. 4. At the base of each riser in systems with main panel and star-connected risers (max 10). Power supplied at 12 VAC. Dimensions 66x85x35 mm (4 DIN modules).



**4833C Line amplifier for SIMPLEBUS color video systems**  
Amplifier for Simplebus Color video systems. Regenerates the riser signal regarding the video component. Complete with microcontroller for optimum operation management. For its use, follow the indications given in the technical documentation. Power supply: 12V AC or 20V DC. Only to be mounted on the part of the system on input into the mixers art. 4888CU (Simplebus 1 part). Dimensions: 66x85x35 mm (4 DIN modules).



**1122/A 12-24 Vdc-Ac general purpose relay**  
All systems. 12-24 V DC-AC 10 A relay for general uses. Can be controlled directly, for call repetition, from terminals S+ and S of the brackets and/or from the digital telephones Dimensions:68x85x35 mm (4 DIN modules).



**1256 Simplebus system digital relay actuator**  
Intelligent Simplebus device for controlling a 10 A (12-24 V relay contact) on board. It can be used in Simplebus 1 and Simplebus 2 systems. For use and programming of the function required, follow the indications given in the technical documentation. If used in mixed audio/video systems, the actuator relay needs terminal art. 1214/2 to be purchased separately. Power supply: 12V AC or 20V DC. Dimensions: 66x85x35 (4 DIN modules).



**1259/A Switcher for remote cameras**  
Module which allows modulation and transmission of the video signal coming from 3 B/W cameras visible sequentially together with the image coming from the external unit. Sequential switching of the cameras is possible by using the Bravo or Videocom monitor actuator pushbutton. Possibility of managing private cameras. Power supply: 12 V AC or 20 V DC. Dimensions: 60x85x35 mm (4 DIN modules).



**1259C Simplebus colour kit for separate video cameras**  
Module which allows modulation and transmission of the video signal coming from 3 colour cameras visible sequentially together with the image coming from the external unit. Sequential switching of the cameras is possible by using the Diva, Bravo or Genius actuator pushbutton. Possibility of managing private cameras. Power supply: 12 V AC or 20 V DC. Dimensions: 60x85x35 mm (4 DIN modules).



**1214/2 Simplebus 2 connection terminal**  
Line branch terminal. The terminal is to be mounted on the riser to branch towards brackets or telephones. It is provided as standard with the bracket art. 4714W/2.use. Dimensions: 53x95x65 mm (3 DIN modules).



**1214/2C Simplebus 2 and Simplebus colour connection terminal**  
Line branch terminal for GENIUS monitor. The terminal must be connected on the riser to be branched towards brackets or telephones.

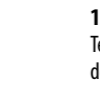

**1215 Simplebus2/colour/kit connection terminal**  
Terminal required when expanding the system with an additional SMART door entry monitor. Dimensions 20x20x25 mm.



**1216 Simplebus/kit system terminal**  
Line termination terminal. To be mounted at the end of the riser, according to the indications given in the technical documentation, to optimise distribution of the signals.



**1200 12Vac transformer with 230Vac input**  
Transformer with 230V primary winding, 12V AC / 900 mA secondary winding for continuous use. Dimensions: 53x95x65 mm (3 DIN modules).



**1205/B 12Vac - 20Vdc dual output power supply with 230Vac input**  
Technical characteristics: The transformer has 2 outputs: one to supply the external unit and the electric lock, and one to supply the monitor. Dimensions: 105x85x85 mm 500mA delayed protection fuse. Terminal board: AC230V input mains voltage ~ AC output for external unit and electric lock + - 20V DC output for the monitor power supply.

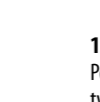

**1207 Dual power supply unit, output 33Vdc-20 Vdc, input 230 Vac**  
Power supply unit with overload and short circuit protection devices. It has two separate continuous outputs: one to power the external unit and electric lock, and the other to power the monitor. Input voltage 120-230 VAC. Dimensions: 105x85x85 mm (6 DIN modules).



**1212/B 20Vdc 14Va power supply with 230Vac input**  
Power supply with 230V AC input, 0-20V DC / 15VA output. The transformer is fitted with PTC internal protection. Dimensions:71.5x90x62 mm (4 DIN modules).



**4576/100 SIMPLEBUS system Comelit cable 2x0.5 mm2 + 2x1.5 mm2 - 100 m**  
Specific cable for Simplebus 1 systems consisting of two power supply conductors (1.5 mm<sup>2</sup>) and a small telephone braid for the signals. 100 mt coil.

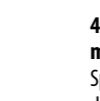

**4576/500 SIMPLEBUS system Comelit cable 2x0.5 mm2 + 2x1.5 mm2 - 500 m**  
Specific cable for Simplebus 1 systems consisting of two power supply conductors (1.5 mm<sup>2</sup>) and a small telephone braid for the signals. 500 mt coil.

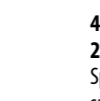

**4578/100 SIMPLEBUS external Comelit 100 m cable 2x0.5 mm2 + 2x1.5 mm2**  
Specific cable for outdoors for Simplebus systems 2 consisting of two power supply conductors (1.5 mm<sup>2</sup>) and a small telephone braid for the signals. 100 mt coil.

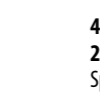

**4578/500 SIMPLEBUS external Comelit 500 m cable 2x0.5 mm2 + 2x1.5 mm2**  
Specific cable for outdoors for Simplebus systems 2 consisting of two power supply conductors (1.5 mm<sup>2</sup>) and a small telephone braid for the signals. 500 mt coil.



**Comelit**<sup>®</sup>  
Passion and Innovation

**[ I ] Comelit Group Spa**

Via Don Arrigoni 5  
24020 Rovetta S. Lorenzo  
Bergamo Italy  
Tel. +39 (0) 346 750011  
Fax +39 (0) 346 71436  
www.comelitgroup.com - info@comelit.it

**[ B ] Comelit Group Belgium**

Doornveld 170  
1731 Zellik (Asse)  
Tel. +32 24115099  
Fax +32 24115097  
www.comelit.be - info@comelit.be

**[ D ] Comelit Group Germany GmbH**

Brusseler Allee 23 - 41812 Erkelenz  
Tel. +49 243190151-23 - 49 243190151-24  
Fax +49 24319015125  
www.comelit.de  
info@comelit.de

**[ E ]**

**Comelit Group Spa- Sucursal en España**

Calle Pintor Roig i Soler 28  
08916 Badalona, Barcelona Spain  
+34 932430376  
+34 934084683  
www.comelit.es  
info@comelit.es

**[ F ] Comelit Immotec**

Siège: 18, rue Séjourné  
94000 CRETEIL CEDEX  
Tél. +33 (0) 1 43 53 97 97  
Fax +33 (0) 1 43 53 97 87  
www.comelit.fr  
contact@comelit-immotec.fr

**[ GR ] Comelit Hellas**

9 Epiru str. - 16452 Argiroupolis  
Athens Greece  
Tel. +30 210 99 68 605-6  
Fax +30 210 99 45 560  
www.comelit.gr - telergo@otenet.gr

**[ IRL ] Comelit Ireland**

Ground Floor  
14 Herbert Street - Dublin 2  
Tel. +353 (0) 1 619 0204  
Fax +353 (0) 1 619 0298  
www.comelit.ie - info@comelit.ie

**[ NL ] Comelit Nederland BV**

Buitendijks 1 - 3356 Lx Papendrecht  
Tel. +31 786511201  
Fax +31 786170955  
www.comelit.nl  
info@comelit.nl

**[ PRC ] Comelit (Shanghai)  
Electronics Co., Ltd**

5 Floor No. 4 Building No.30,  
Hongcao Road, Hi-Tech Park  
Caohejing,  
Shanghai, China  
Tel. +86-21-64519192/9737/3527  
Fax +86-21-64517710  
www.comelit.com.cn  
comelit@comelit.com.cn

**[ SG ] Comelit Far East**

Block 1002, Nr.06-1407  
Toa Payoh Industrial Park  
Singapore 319074  
Tel. +65 6352 3456  
Fax. +65 6352 8557  
office@comelit.sg

**[ UAE ] Comelit Group U.A.E.  
Middle East Office**

P.O. Box 54433  
Dubai U.A.E.  
Tel. +971 4 299 7533  
Fax +971 4 299 7534  
www.comelit.ae  
info@comelit.ae

**[ UK ] Comelit Group UK Ltd**

Unit 4 Mallow Park - Watchmead  
Welwyn Garden City Herts  
AL7 1GX  
Tel: +44 (0)1707377203  
Fax: +44 (0)1707377204  
www.comelitgroup.co.uk  
info@comelitgroup.co.uk

**[ USA ] Comelit Usa**

2021 S. Myrtle Avenue  
Monrovia, CA 91016  
Tel. +1 626 930 0388  
Fax +1 626 930 0488  
www.comelitusa.com  
sales@comelitusa.com

Via Don Arrigoni 5 - 24020 Rovetta S. Lorenzo - Bergamo [Italy]  
Ph. +39 (0) 346 750011 - Fax +39 (0) 34671436 - www.comelitgroup.com - info@comelit.it



023903 241297