



OPERATION & ASSEMBLY INSTRUCTIONS AND WARRANTY INFORMATION FOR ALL SUN CAPSULE UNITS

SUN CAPSULE - SPORT ***44/180/1.9/5.5***

This device is intended to provide ultraviolet light for the purpose of stimulating a tanning response in the skin.

“Contraindication: This product is contraindicated for use on persons under the age of 18 years.”

“Contraindication: This product must not be used if skin lesions or open wounds are present.”

“Warning: This product should not be used on individuals who have had skin cancer or have a family history of skin cancer.”

“Warning: Persons repeatedly exposed to UV radiation should be regularly evaluated for skin cancer.”

IMPORTANT: Warranty card on back page must be completed and mailed within 10 days of date of delivery

Sun Capsule | 1600 Osgood Street, North Andover, MA 01845 Tel:
800-272-8267 | Fax: 978-655-3076 | Online: www.suncapsule.com

Publication Date October 1, 2014

Version 100.1

F.D.A. Notice Important

The F.D.A. requires that this manual remain in your business at all times.

It must be made available to any F.D.A. official during an inspection of your establishment.

Always read and follow all instructions for the proper usage before operating your Sun Capsule tanning system.

Follow the exposure schedule based on the individual's skin type. Failure to do so may result in over-exposure.

The Sun Capsule is designed to be used by only one person at a time.

This manual contains instructions for repairs, recommended replacement components and accessories which are compatible with products, including compatible protective eyewear, ultraviolet lamps, timers and reflectors, which will, if installed or used as instructed, result in continued compliance with the standard. The manufacturer of the equipment is:

Sun Capsule
1600 Osgood Street, Suite 2006
North Andover, MA 01845

Tel: 800-272-8267

Fax: 978-655-3076

DANGER - Ultraviolet radiation. Follow instructions. Avoid overexposure. As with natural sunlight, overexposure can cause eye and skin injury and allergic reactions. Repeated exposure may cause premature aging of the skin and skin cancer.

WEAR PROTECTIVE EYEWEAR: FAILURE TO DO SO MAY RESULT IN SEVERE BURNS OR LONG-TERM INJURY TO THE EYES.

Medications or cosmetics may increase your sensitivity to the ultraviolet radiation. Consult a physician before using sunlamps if you are using medications or have a history of skin problems or believe yourself especially sensitive to sunlight. If you do not tan in the sun, you are unlikely to tan from the use of this product"

For your information

Recommended exposure position

The "FOOT PLACEMENT" indicators are located to give you the best overall tan in the shortest period of time. To achieve recommended exposure positions, place feet on indicators. The use of any other position may result in over-exposure.

RECOMMENDED EXPOSURE SCHEDULE					
SKIN TYPE	WEEK 1 1ST-3RD SESSIONS	WEEK 2 4TH-6TH SESSIONS	WEEK 3 7TH-10TH SESSIONS	WEEK 4 11TH-15TH SESSIONS	WEEKLY SUBSEQUENT SESSIONS
II - FAIR	2 MINUTES	3 MINUTES	5 MINUTES	7 MINUTES	10 MINUTES
III - AVERAGE	2 MINUTES	3 MINUTES	5 MINUTES	7 MINUTES	10 MINUTES
IV - BROWN	3 MINUTES	4 MINUTES	6 MINUTES	8 MINUTES	10 MINUTES
V - DARK BROWN	4 MINUTES	6 MINUTES	8 MINUTES	9 MINUTES	10 MINUTES

TANNING SESSIONS SHOULD BE LIMITED TO ONCE EVERY 48 HOURS. AN APPEARANCE OF TANNING NORMALLY APPEARS AFTER A FEW EXPOSURES AND MAXIMIZES AFTER (4) WEEKS OF EXPOSURE FOLLOWING RECOMMENDED SCHEDULE FOR YOUR SKIN.

INSTRUCTIONS ACCOMPANYING THIS PRODUCT SHOULD ALWAYS BE FOLLOWED TO AVOID OR MINIMIZE POTENTIAL INJURY

USE COSMOLUX VHR LONGLAMP 16202/220W

Dear Sun Capsule® Owner,

Congratulations! You have just purchased the finest, most advanced, ultra-high performance vertical tanning system the industry has to offer.

Enclosed you will find very important information regarding the safe operation of your Sun Capsule. Please read it carefully.

If you follow the recommended procedures for care and daily maintenance you can expect a lifetime of performance and profits from your Sun Capsule.

Anything less than the proper care can decrease the performance of your system and, in some cases, void your warranty.

On the rare occasion you have a problem with the operation of your Sun Capsule, please refer to the trouble shooting section before calling for service. Usually it is something simple and it will save time if a few quick checks have been performed before calling Sun Capsule.

Most importantly, when you have a question regarding the Sun Capsule, please do not hesitate to call us at 800-272-8267.

We are here to help you make your Sun Capsule the most successful profit center within your business.

Sincerely,

A handwritten signature in black ink, appearing to read "Tom Holland", with a large, stylized initial "T" that loops around the start of the name.

Thomas P. Holland, CEO
Sun Capsule

TABLE OF CONTENTS

FDA Notice	2
Exposure Schedule	3
Congratulations	4
Table of Contents	5

OWNERS MANUAL

TANNING PRECAUTIONS	6
Photosensitive Drug List (partial)	6
Allergic Reactions	7
Pregnant Women	7
Children	7
Protective Eye Goggles	7
Protective Guards	7

UNDERSTANDING YOUR SYSTEM

Daily Maintenance	7
Timer Operation	8
Connecting a Data Base to the Sun Capsule	8
Hour Meter	8
Emergency Entry Key	8
Changing Overhead Light	8
Peak Performance	8
Venting/Ducting of Fan	9
Changing Starters	10
Lamp End Blackening	10
Proper Lamp Installation	10
Lamp Replacement	10
Indoor Tanning Lotions, Oils and Moisturizers	11
Lamp Rotation for a 54 Lamp System	11

Assembly Instructions Table of Contents	13
---	----

ASSEMBLY INSTRUCTIONS

Connecting Your Sun Capsule to Power	30
Lamp Fixture Wiring Diagrams	31
System Schematics	35

Trouble Shooting Guide	37
Index	40
Warranty	41

Owner's Manual

PHOTOSENSITIVE DRUGS – The following is a partial list of some of the photosensitive drugs on the market. It is your responsibility to be aware of any customer using any drug considered photosensitive. These individuals under the influence of this type of drug can experience adverse effects and should avoid exposure to UV sources of all kinds. Doctors will advise persons taking these medications of possible adverse effects.

DANGER:

If you have been diagnosed by a doctor as being allergic to the sun or are currently taking photosensitive medications, consult your physician before using the Sun Capsule.

IMPORTANT INFORMATION BEFORE YOU TAN

Certain drugs do not mix well with ultraviolet light, either in its natural source or artificial. Below is a list of drugs, foods, and other substances which could make your skin super sensitive to sunlight:

Diuretics: To aid in water retention, also prescribed for high blood pressure. (For example: Hydrodiuril)

Diabetes Drugs: Orinase and Diabinese

Urinary Tract Infection: Treatments with Phenstiazines

Tranquilizers: Such as Thorazine

Antihistamines: Phenergan and Benadryl, particularly when used on the skin in ointment form

Antibiotics: Declomycin, Aureomycin, and Griseofulvin, a drug used in the treatment of ringworm

Coal Tar Treatment: for Psoriasis or chronic Eczema

Bacterial Infection: Treatments using Sulfanilamide.

Compounds Known as Furocoumarins or Psoralens: which sensitize skin to sunlight. They are prescribed for vitiligo (loss of skin pigmentation) and Psoriasis.

Anesthetics	Dilantin	Pheynibuzatone	Termail
Aresicals	Diuretics	Procaine	Terramycin
Aureomycin	Diuril	Psoralen Drugs	Tetracyclines
Barbiturates	Dyes	Pyrrolazote	Therahistin
Benzedyl	Estrone	Quinine	Thiazide
Compazine	5 Fu	Salicyclates	Thorazine
Cold and Silver Salts	Griseofulvin	Sparine	Tridione
Dartal	Hydrodiuril	Sulfanamides	Trilafon
Declomysin	Nadison	TBS	Vespirin
Diabinese	Orabetic Orinase	TCSA	
Diethylstillbestrol	Pacatal	Termail	

Coal Tar Products and Essential Oils: Bergamont, Cedar, Lime, Lavendar, and Vanillin

ALLERGIC REACTIONS TO UV – Some people may experience a reddening of the skin, usually contained to small areas of the body, such as arms, stomach area, etc., usually accompanied by an itching sensation. In many cases it may be nothing more than heat rash. In some cases it may be an allergic reaction to UV exposure, usually as a result of too much exposure in a given period of time for that particular skin type. You should be alert to any customer complaints pertaining to this and instruct the customer to avoid tanning, indoors or outdoors, until the symptoms have disappeared, usually within 24 hours. Once the customer resumes tanning, reduce the exposure schedule until their body has acclimated to the tanning process.

PREGNANT WOMEN – The only 100% safe answer to this question is to discourage expectant mothers from using the tanning system, unless they have a letter from their doctor.

CHILDREN – A good policy to adopt is: No children under 18 years of age without written consent from a parent, unless there are laws in your state or county that indicate otherwise. Keep young children away from the Sun Capsule. It is not a toy. The sunlamps are breakable and potentially dangerous.

PROTECTIVE EYE GOGGLES – Every customer must wear protective eyewear during a tanning session. One pair of goggles is provided with each Sun Capsule. It is advisable that each customer owns a pair of protective eyewear. This is the most sanitary (and profitable) way to conduct your business. It is advisable to remove contact lenses before each tanning session due to the dryness of the air.

PROTECTIVE GUARDS – DANGER: Keep hands and fingers away from protective fan guards, lamp guards and lamps. Serious injury and/or severe burns may result.

UNDERSTANDING YOUR SYSTEM

DAILY MAINTENANCE – Your Sun Capsule has been designed to be virtually maintenance free. Since the only body parts that come in contact with the system are the bottoms of the feet, close attention should be paid to this area on a daily basis. The floor can be wiped down with warm water and Lysol (1 gallon water to 3 teaspoons Lysol) or any other mild disinfectant solution you choose. This procedure should be performed as necessary, depending on traffic flow.

CAUTION: Clean Fast Flow Floor vent with damp cloth only. Avoid excess cleaning fluid dripping through the vent holes. Make sure floor is dry before next tanning customer enters booth.

Over time, the hand straps will become soiled. They can be removed and washed with warm soapy water.

The walls, ceiling and framework can be cleaned with any mild NON-ABRASIVE cleaner and a soft cloth. Ivory liquid and warm water works well. DO NOT ALLOW WATER OR ANY LIQUID CLEANERS TO COME IN CONTACT WITH THE FLUORESCENT SOCKETS OR SUNLAMPS.

DANGER – Never service the fan without first unplugging fan motor from junction box and shutting off power to the Sun Capsule. The fan blade should be cleaned when any noticeable build-up of dust is noted. Remove the grill from inside the booth and carefully wipe down the fan blades. (Use extreme caution, the edges of the blade are sharp.)

The lamps and metal guards can be cleaned using a vacuum cleaner with a soft furniture duster attachment. Acrylic guards (optional) should be cleaned regularly (both sides) with a high quality acrylic cleaner. Dust build up or body oils will greatly diminish the performance of your sun lamps.

Periodically, the lamps should be removed and wiped clean. NEVER USE ABRASIVE CLEANERS anywhere in the Sun Capsule.

DECORATIVE FRONT PANELS ONLY – When cleaning the wall panels do not use anything except Brilliance or equivalent high quality acrylic cleaner with a soft cloth. Use of products, such as Windex or paper towels, will result in damage to the panels and void warranty.

TIMER OPERATION – Your digital timer is solid state in design, giving you years and years of accurate and reliable timer settings. If you add a timer cord longer than 90' in total length, a transformer will be necessary to boost the 24 volt signal from the booth to the timer.

If using the timer in stand-alone use: After each session, your digital timer will read "0". To enter session time, simply press the (^) button until the desired time appears in the "window". If you go past the desired time, keep pressing the (^) button until the correct time is reached.

Starting the Tanning Session – The tanning session can be activated in two ways. (1) You can press the "START/STOP" button on the timer, or (2) the customer can press the "START" button in the Sun Capsule when they are ready to start tanning. #2 is the recommended procedure.

Stopping the Tanning Session – The tanning session can be terminated in two ways. (1) Press the "START/STOP" button on the timer. (2) the customer can place the "EMERGENCY SHUT OFF SWITCH" on the panel in the Sun Capsule to the "OFF" position. Note: Both these methods will terminate the tanning session but the time will continue to count down. If the customer decides to place the "EMERGENCY SHUT OFF" switch in the "ON" position, the tanning session will be reactivated, if there is still time remaining on the digital read-out.

IMPORTANT – "Emergency Shut Off" switch must be in the "ON" position before the Sun Capsule can be reactivated.

If using the timer with a database system:

Your Sun Capsule timer is compatible with most popular database systems. The Sun Capsule timer port for the daisy chain connection to the database takes a CAT-5 cable. If requested, this cable is supplied with your Sun Capsule timer. The CAT-5 cable, along with an adaptor and the RJ22 cable, joins in your daisy chain line the same as all your other equipment.

The only function the database manager provides is the convenience of a remote location to set the appropriate session times for the user.

HOURLY METER - The hour meter is located on the control panel above the "LIGHT" switch. It is non-resettable. It will allow you to keep track of total hours as well as when to change or rotate your sun lamps.

NOTE: The last digit is in "tenths" of 1 hour. It is easier to ignore the last digit and read only full hours. Example: 00015.2 is actually a little more than 15 hours.

EMERGENCY ENTRY KEY (SUN CAPSULE WITH ATTACHED DRESSING ROOM) – The Emergency Entry Key is on a chain (to prevent loss or misplacement) on top of the booth, mounted on the ceiling above the door.

CHANGING OVERHEAD LIGHT (SUN CAPSULE WITHOUT ATTACHED DRESSING ROOM)-
Do not exceed 10 watt, 12 volt bulb. Keep fingers from touching replacement bulb.

PEAK PERFORMANCE

Your Sun Capsule is the fastest vertical tanning system on the market today. It is a finely tuned, ultra-high performance tanning system, but you must be aware of the following factors that affect the tanning capabilities of the system.

VOLTAGE: Your system requires a minimum of 230 volts. A running voltage between 230 to 235 volts is required to attain peak performance. Please factor in the effect of other equipment running in the salon at the same time. In most cases a buck boost transformer will be necessary to achieve proper running voltage.

PROPER COOLING IS THE KEY TO PEAK PERFORMANCE AND LONG LAMP LIFE.

ROOM TEMPERATURE: Optimum performance can only be attained provided you supply adequate cooling to the system to begin with. To insure the highest output from your system, your room temperature should be between 73°F and 80°F. Room temperatures higher than or lower than the above temperatures may adversely affect the performance of the lamp. In the case of higher room temperatures, lamp life can be decreased as well.

Do not obstruct wall panel intake ports.

Do not feed air-conditioned air directly into the Sun Capsule. This will cause over-cooling of the lamps and reduced performance.

Keep the unit at least 6 inches away from any wall or obstruction and 12" from another Sun Capsule or tanning system. Air must be allowed to flow freely into the unit through the Fast Flow Floor Vent.

FAN OPERATION: Your Sun Capsule cooling fan is equipped with an adjustable delay timer that is preset at the factory for approximately 4 minutes. This allows for proper lamp cool down after each session. Anytime the Sun Capsule is energized, the 4 minute fan delay will be automatically activated.

VENTING/DUCTING OF FAN – It is important to keep the ambient temperature in the vicinity of the Sun Capsule between 73 F – 80 F. If you have very high ceilings or if your Sun Capsule sets in a very large open area, it may not be necessary to vent the exhaust air from the fan. If you have low ceilings or the Sun Capsule is in an enclosed room, it is important to employ a ducting system to remove the hot air.

If you have a “suspended” ceiling with a generous amount of dead air space above, the least expensive way of removing the hot air would be to fabricate a duct that would enclose the space between the fan motor grill and the suspended ceiling, allowing the air to fill the dead air space. See diagram.

IMPORTANT: Do not choke or restrict the airflow from the fan with ducting. Any reduction of airflow from cooling fan will result in a decrease in performance, overheating and potential damage to the VHR sunlamps.

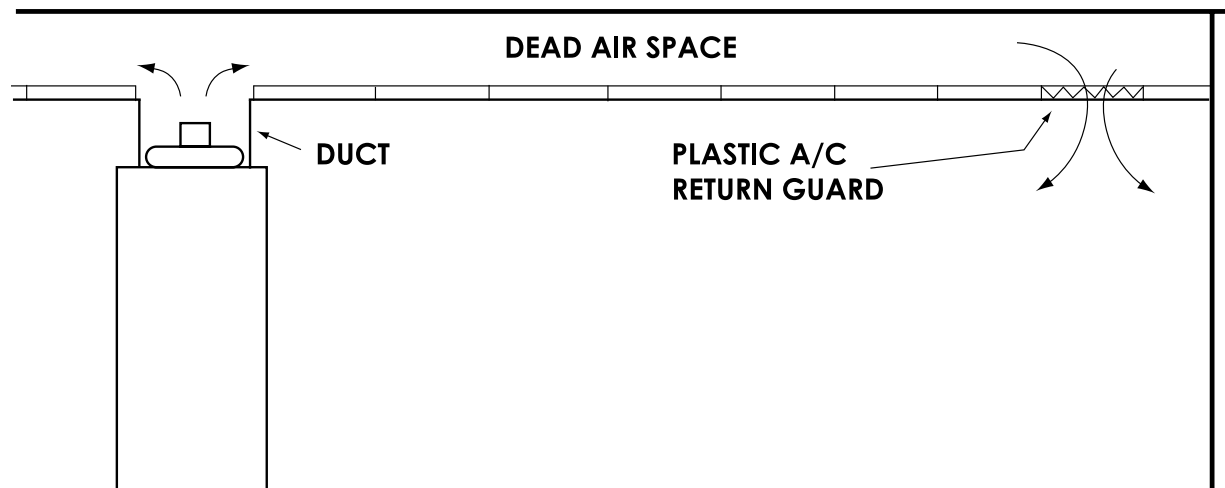

You must take some things into consideration when doing this. First you must have a way to get rid of the hot air in the dead air space or back pressure will build up, causing the temperature to rise in the Sun Capsule.

To accomplish this, install plastic A/C return grids near A/C ducts in your salon, allowing the air from the dead air space to filter down throughout your salon and mix with conditioned air.

If your Sun Capsule is in an enclosed room, you must make sure that you bring air into the room as fast as you take it out. This can be done with a full louvered door leading into the enclosed room. Keep in mind, whatever you do, you must replace the air being taken out of the room with an equal amount of fresh air.

Another method is to install more A/C. To determine the proper amount of A/C, consult your HVAC expert. Give them the total number of sunlamps and wattage of your specific model. That information will help them recommend what the best solution is for your given situation. Do not feed conditioned air directly into the Sun Capsule.

CHANGING STARTERS – Your Sun Capsule is equipped with electronic starters that carry a 10 year warranty from the manufacturer of the starters. Should a starter fail within that time period, the starter will be replaced free of charge according to warranty procedure.

LAMP END BLACKENING – Due to the high operating temperatures of the VHR sunlamps, lamp end blackening will occur. This does not adversely affect performance.

PROPER LAMP INSTALLATION – The manufacturing process of a sun lamp creates a phosphor coating that is slightly thicker at one end of the lamp than the other. By installing every other lamp with the manufacturer's label at the "top" (and every other lamp with the label at the bottom) a more uniform UV output will be attained.

LAMP REPLACEMENT

REMOVING METAL LAMP GUARDS: Each lamp guard is fastened to each lamp fixture with two fasteners at the top, two in the middle and two hooks at the bottom. Using a Phillips head screwdriver, back out the four fasteners and gently raise the lamp guard up and away from the lamp fixture.

REMOVING ACRYLIC LAMP GUARDS: Release locking mechanism at top of guard and carefully lift the guard up and off of the mounting posts.

REMOVING LAMPS: Rotate lamps until pin aligns with opening in socket. Be careful not to bend or break pins when removing lamps.

LAMPS FOR LIFE FOR LESS™: When you purchase a Sun Capsule you are automatically enrolled in Sun Capsule's Lamps For Life For Less™ program giving you access to the absolute lowest prices for all your lamp needs. Call 1-800-272-8267 for details.

INSTALLING LAMPS: Start by placing bi-pins in bottom socket, making sure to line up pins with slot in bottom socket. Next, insert top bi-pins in slot in top socket. Rotate lamp 90 degrees, making sure lamp socket is locked in place at both ends.

VERY IMPORTANT: Each VHR® lamp has a reflector built into the lamp. The reflector encompasses the solid white portion of the lamp. This must be rotated to the rear, enabling all UVA/UVB to be directed toward the customer. When lamp is properly installed, label will be facing you.

INSTALLING METAL LAMP GUARDS: Before you install lamp guards, make sure all lamps are working properly. Position lamp guard on the lamp fixture by inserting the hooks at the bottom of the lamp guard into the appropriate slots at the bottom of the fixture. Push the lamp guard down until the top holes in the lamp guard align with the top holes in the fixture. Align and insert the fasteners into threaded inserts and tighten securely.

INSTALLING ACRYLIC LAMP GUARDS: Line up opening on the sides of the acrylic guard with mounting posts. Push the guard onto the posts and down. Reposition locking mechanism.

INDOOR TANNING LOTIONS, OILS, AND MOISTURIZERS – You should carry at least one or two lines of top quality indoor tanning products. A good pre-tan base gel is recommended during the first week of tanning. After a base tan has been achieved, usually 4-5 sessions, an accelerator or amplifying lotion or oil can be used to enhance the tanning process.

Moisturizers should be encouraged throughout the tanning program. They should be applied after tanning. A lip protector should be used during tanning since the lips have no ability to produce melanin for protection.

REMEMBER: The tan produced by the Sun Capsule is a rich dark cosmetic tan. Make sure your customers understand that AN INDOOR TAN WILL NOT PROVIDE ADEQUATE PROTECTION AGAINST OVER-EXPOSURE TO NATURAL SUNLIGHT.

CAUTION: Your system is equipped with a Fast Flow Floor Vent. It is advisable to avoid any spray-type lotions or oils. The vaporized lotions will be carried throughout the tanning system via the rapidly moving air passing through the vent, resulting in slippery floors and cause for frequent clean up.

LAMP ROTATION (54 LAMP VERSION)

From the moment a new sun lamp is energized, it begins a gradual decrease in performance. VHR lamps tend to last approximately 500 to 600 hours. There are a few different ways to change lamps.

The most simple method is to let the lamps reach their life expectancy and then change all of the lamps at one time. The drawback to this method lies in the fact that by the time you change your lamps, they have reached their maximum life expectancy.

A more efficient method is through a lamp rotation process. This can be accomplished in any number of ways. The following example applies to the 54 lamp version and will take you through 2 rotations. After the second rotation you will be left with some lamps with 400 more hours on them. Put these lamps aside for future rotation(s).

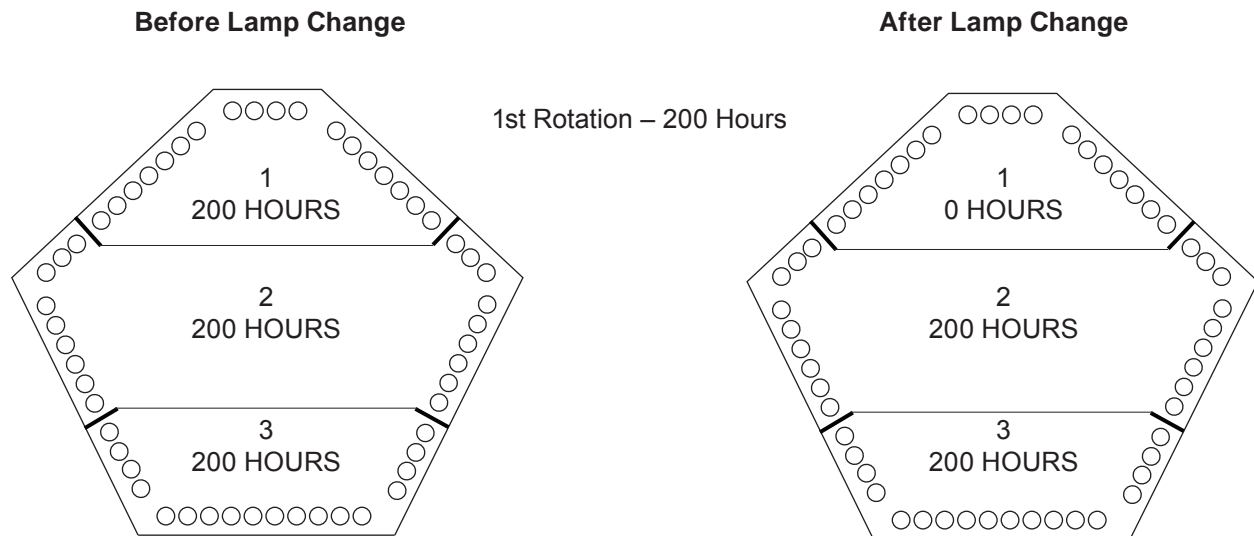

- Step 1. Remove 18 lamps from section 1. Mark them “200 hours”. Put aside for the 2nd rotation.
- Step 2. Install 18 new lamps into section 1.

Before Lamp Change

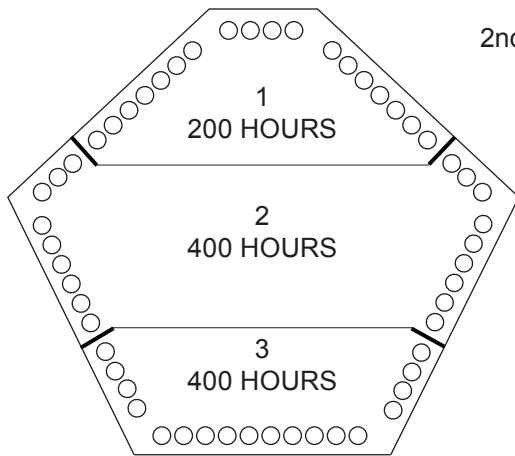

2nd Rotation – 400 Hours

After Lamp Change

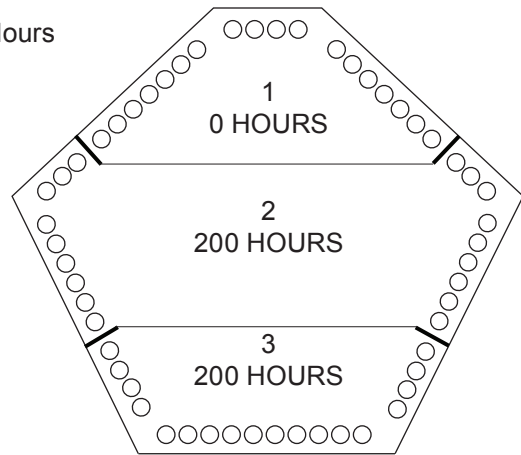

Step 1. Remove lamps from sections 2 & 3. Mark them "400 hours". Set aside for future rotations.

Step 2. Move lamps from section 1 to section 2.

Step 3. Install 18 new lamps in section 1.

Step 4. Install 18 lamps with 200 hours from 1st rotation into section 3.

Assembly Instructions Table of Contents

Power Supply Information	14
Very Important	15
Hardware List	16
Ready to Begin	16
Attaching Wall Panel Standoffs	17
Inserting Wall Panels in Corner Pieces	17
Ceiling Installation	20
Installing Inside Fan Guard	21
Lamp Fixture Installation	21
Optional Floor Lighting Package	21
Installing #6 Lamp Fixture	22
Raised Floor Panels	23
Dressing Room Light Strips	23
Threshold Installation	24
Door Assembly Installation	24
Installing #6 Lamp Fixture	25
Installing Grab Bar to #6 Lamp Fixture	25
Installing Fan Shut Off Switch	25
Installing Fan	26
Installing Overhead Light	26
Mounting Junction Box	26
Speaker and Stereo Hookup	27
Final Adjustments	28
Peak Performance Voltage	30
Wiring Diagrams	31
System Schematics	35
Trouble Shooting Guide	37
Index	40
Warranty	41

ASSEMBLY INSTRUCTIONS

5.5 Sided Sun Capsule Tanning Systems

With and Without Attached Dressing Rooms

IMPORTANT

A voltage between 230 to 235 volts* is required WHEN THE UNIT IS RUNNING to attain peak performance. Most salons experience a voltage drop of approximately 6 to 7 volts when the unit is in use. Also factor in the effect of other equipment running in the salon at the same time. A buck-boost transformer may be required to provide optimum voltage.

* Export Systems Only – 50 Hz systems must operate between 220 volts and 225 volts.

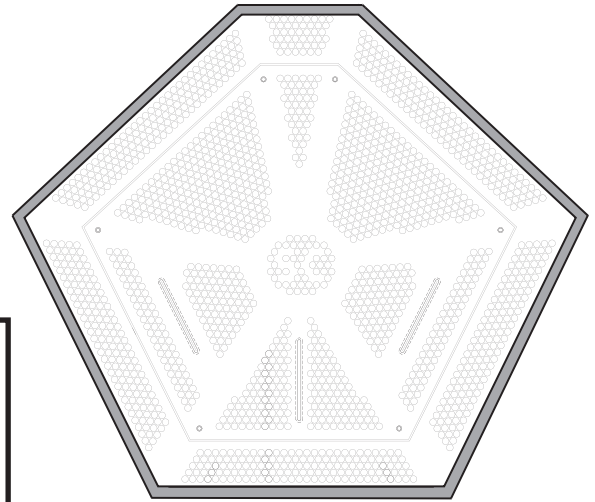

Sun Capsule I (Without Dressing Room)

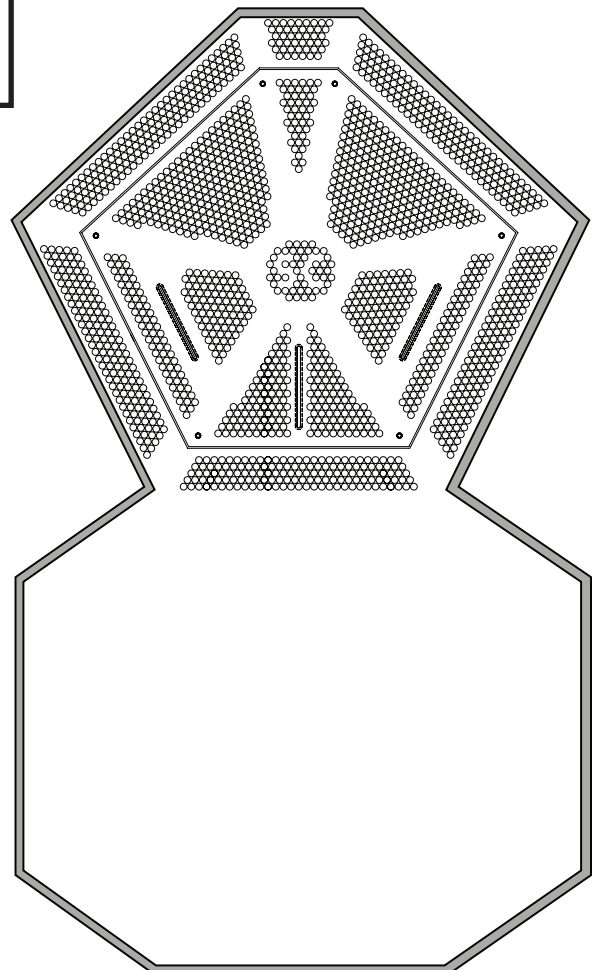

Sun Capsule II (With Dressing Room)

NOTE: An insulated earthing conductor that is identical in size, insulation material and thickness to the earthed and unearthed branch circuit supply conductors, except that it is green with or without one or more yellow stripes, is to be installed as part of the branch circuit that supplies the unit or system. The earthing conductor described is to be connected to earth at the service equipment – or if supplied by a separately derived system – at the supply transformer or motor-generator set.



“Unit must be wired by an authorized electrician in accordance with the National Electrical Code, ANSI/NFPA 70-1987, as well as all local codes.”

VERY IMPORTANT

READ THE FOLLOWING BEFORE YOU BEGIN ASSEMBLY.

Take the time to familiarize yourself with certain components that make up the Sun Capsule before you attempt to assemble the unit.

The following photos concentrate on the assembly of a Sun Capsule with a dressing room. The procedures are the same for a Sun Capsule without a dressing room.

For simplification purposes the Sun Capsule without a dressing room will be referred to as a **Sun Capsule I**. The Sun Capsule with a dressing room will be referred to as a **Sun Capsule II**.

The new modular design Sun Capsule tanning units have been engineered to be just about “Murphy proof” if you read the assembly manual.

The photos concentrate on the assembly of the shell, and some inherent problems and solutions that may be encountered during installation.

You will see that some pictures show lamp fixtures with metal guards and other pictures show lamp fixtures with (optional) acrylic guards. The installation procedures are the same for both.

The surface that the unit is to be assembled on will determine the degree of difficulty during assembly. If the surface is basically flat and level, the assembly is usually quite simple. Unfortunately, some surfaces are not flat and level and shimming of the booth may be required.

The assembly of the Sun Capsule will require temporary assistance for certain procedures. It may seem awkward at first, but once you’ve learned the “tricks-of-the-trade”, assembly should be effortless.

The Sun Capsule I has 4 wall panels with ventilation ports.

The Sun Capsule II has 10 wall panels: 4 wall panels with ventilation ports and 6 solid wall panels. The 4 wall panels with ventilation ports are designed to aid in the cooling of the sunlamps. The 6 solid wall panels are used to create the dressing room portion of the unit. One of the solid panels has two pre-drilled holes for mounting the double coat hook.

Another wall panel has two pre-drilled holes for the shelf.

Make sure both panels are positioned with pre-drilled holes closest to the ceiling in exact location as shown in Fig 1.

One panel has a pre-drilled hole for the retaining magnet. Make sure panel is positioned with hole closest to ceiling in exact location as shown in Fig 1.

The Sun Capsule I has 5 corner pieces: (1) doublewide corner piece, (2) without pre-drilled holes (red labels), (2) with pre-drilled holes for door mounting (green labels) (Fig 2)

If you are assembling an “Art Deco” or “Cosmo” (curved wall panels) model, the red labeled corner pieces can only be installed one way, as indicated on the label.

The Sun Capsule II has 11 corner pieces including (2) reverse bend corner pieces and (1) doublewide corner piece. (Fig 1) If you are assembling an “Art Deco” or “Cosmo” (curved wall panels) model, the blue labeled corner pieces can only be installed one way, as indicated on the label.

The Sun Capsule II contains two “reverse bend” corner pieces. These are used at the mid-points of the booth. Set these aside until needed (Fig 1).

IMPORTANT: Examine all framework corner pieces. Two corner pieces have three (3) pre-drilled holes and have green identifying labels. These corner pieces are for mounting the door assembly. Set these aside and use them at the front of the booth where the door opens.

On Sun Capsule II’s, two corner pieces have red identifying labels. These are to be used in the tanning area only – their angle is slightly different than the angle of those used in the dressing room.

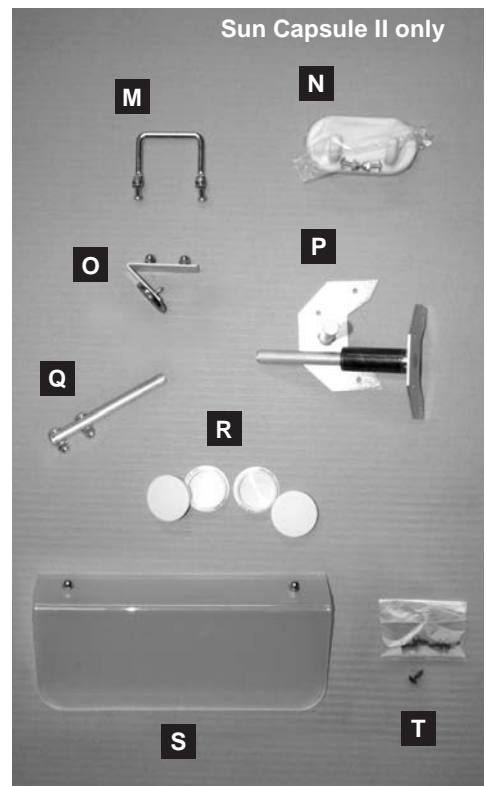
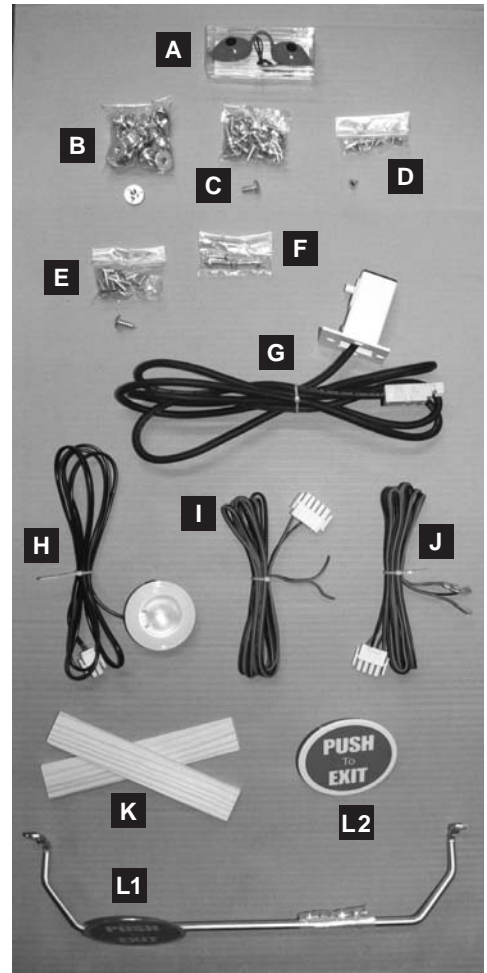

HARDWARE LIST

- A. Protective Eye Wear (1 pair)
- B. Stand Offs for Lamp Fixture Mounting (20)
- C. Stand Off Mounting Bolts 1/4-20 x 1" Phillips Truss head bolts (20)
- D. Hardware for Dress Plate and Door Assembly #8 x 3/8" Sheet Metal Screws (10)
- E. Fan Screws #14 x 3/4 " Phillips Pan Head (8)
- F. Threshold/Kick Plate Hardware 10-32 Machine Screw & Lock Nut (2) #10 Sheet Metal Screw (1)
- G. Fan Shut Off Switch with Cord
- H. 12 volt Overhead Courtesy Light
- I. 4 Pin Speaker Wire
- J. 5 Pin Timer Interface Cable
- K. Shims
- L.1. Wire Guards Handle
- L.2. Wire Guards Handle for Acrylics
- Sun Capsule II Only**
- M. Inside Door Handle with Hardware
- N. Double Coat Hook & Hardware
- O. Retaining Magnet, Washer and Hardware
- P. Hinge Pins and Sleeve
- Q. 160/200 Watt Only – Stop Pin and Hardware, White
- R. Decorative Plastic Plugs (4) for the Back of the #6 Fixture
- S. Acrylic Shelf
- T. Screws for Curved Panel Corners

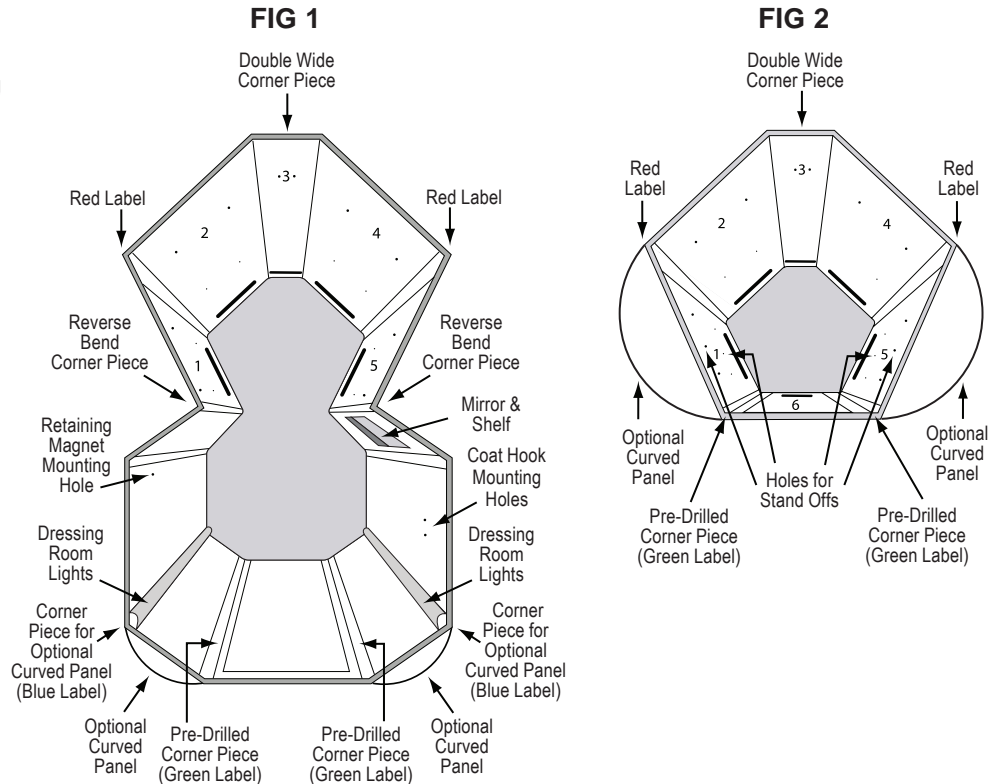

READY TO BEGIN

IMPORTANT: Do not remove protective cardboard from Fast Flow Floor Vent until booth is completely assembled.

Floor Saver Template – Included with your system is a 1/8" Masonite template that closely resembles the shape of your Sun Capsule. Its purpose is to protect your carpet or flooring from the effects of the UV light that filters through the vents in the Fast Flow Floor.

Place the template, smooth side down, in the exact spot your Sun Capsule will occupy once it has been assembled (Fig 5). For proper cooling of the high performance tanning lamps (and your customers) your Sun Capsule must be kept a minimum of 6" away from any wall or obstruction. Keep in mind the template is 3 inches smaller all the way around than the actual size of the Sun Capsule (Figure 4).

Floor Assembly – Center floor assembly on Floor Saver Template. (Fig 6). Do not remove protective cardboard until entire assembly is completed.

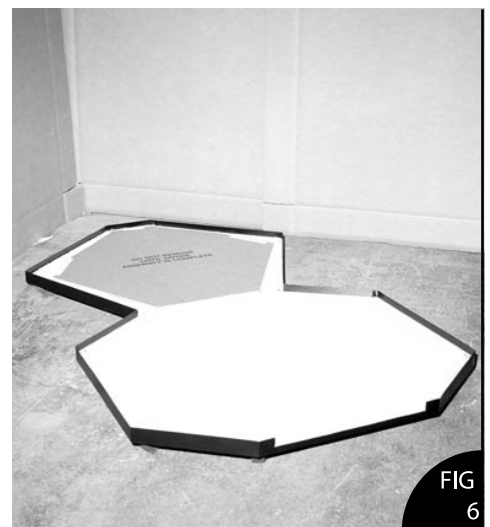
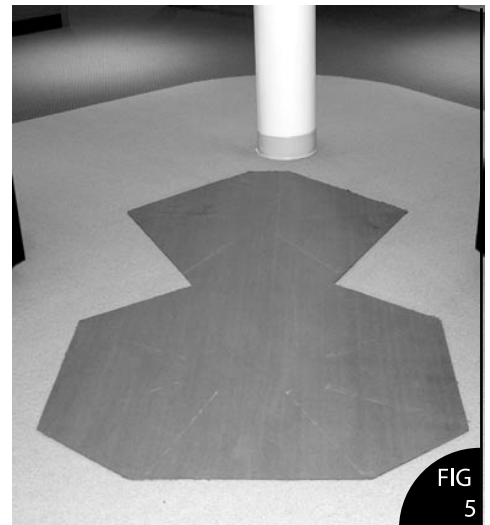
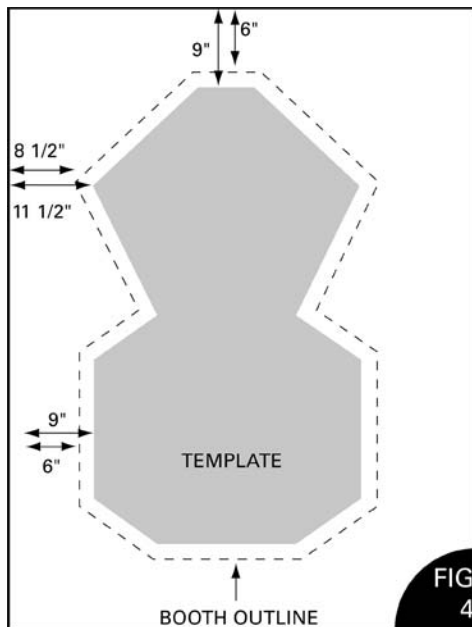

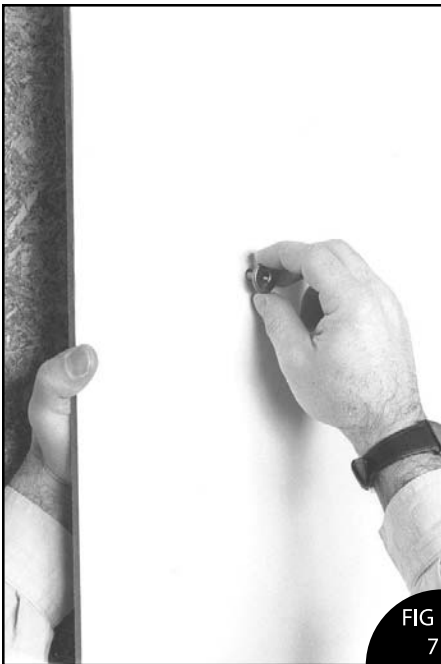

FIG 7



FIG 10

Attaching Wall Panel "Standoffs"

The four vented wall panels have four pre-drilled mounting holes. Insert 1/4" mounting bolts (Hardware List Item C) through wall panel and secure with stand off (Hardware List Item B) as shown in Fig 7 & Fig 8. Make sure standoffs are installed on interior white side of panel.

NOTE – Make sure bolt head is on exterior side of panel. (Fig 8) Do this for all four vented panels.

Locate doublewide corner piece - make sure vent hole is closest to floor.

Raise both bottom latches on doublewide corner piece as shown in Fig 9 and place the double wide corner piece in the position indicated in Fig 10. Make sure white corner piece trim rests behind both catches. (Fig 9)

Close Latches. (Fig 11 & 12)

NOTE: Latch is spring loaded, use caution when opening or closing latch.

Doublewide corner piece should stand on its own once it is latched into place. It is advisable that someone "steadies" assembly until next panel is installed.

INSERTING WALL PANELS INTO CORNER PIECES

Insert wall panel at angle as shown in Fig 13.

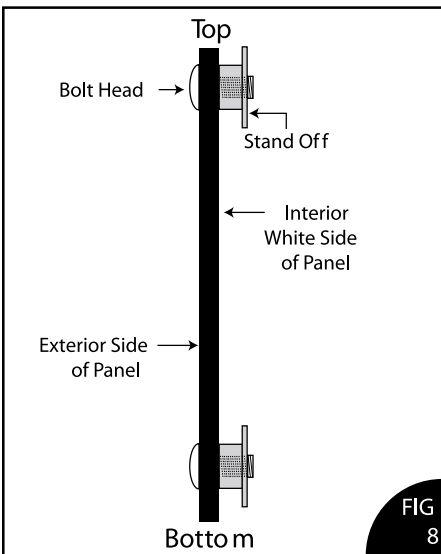

FIG 8



FIG 11



FIG 9

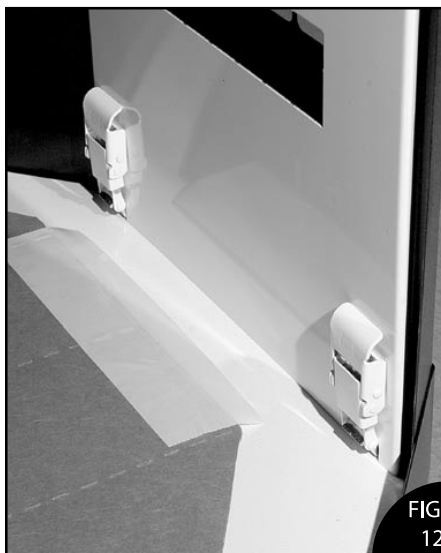

FIG 12



FIG 13



FIG 14



FIG 17

Pull panel down and into corner piece (Fig 14) pushing wall panel completely into corner piece at both top and bottom (Fig 15). Pull down on panel to make sure it is tight against the floor (Fig 14).

Install wall panel on other side of double wide corner piece (Fig 1 or 2) using above techniques. (Fig 16)

NOTE: Feel the top edge of corner piece to make sure wall panel is all the way into corner piece. (Fig 15)

Install both corner pieces with red identification labels (Fig 1 or 2) on wall panels, making sure white corner piece trim rests behind “catch”. (Fig 17 & 18)

WORKING TIP: Raise latch on corner piece assembly to “up” position before installing. Remember, starting the corner piece at an angle allows for corner piece to slide on easier (Fig 17). Push corner piece completely on to wall panel.

Close Latch.

INSTALLATION OF STAND OFFS FOR FLOURESCENT LIGHT FIXTURES FOR ILLUMINATION PACKAGE (OPTIONAL) SUN CAPSULE WITHOUT DRESSING ROOM ONLY

If you have the Art Deco model (illuminated curved wall panels), you will need to do the following before installing the curved wall panels:

Install stand-offs (hardware package item “C”) in the two pre-drilled holes in the wall panels adjacent to the door. Fig 2. Bolt head must be on the inside of panel and stand-off must be on the outside of panel.

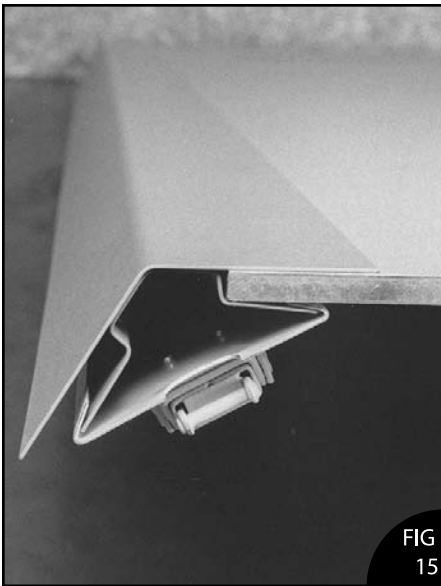

FIG 15

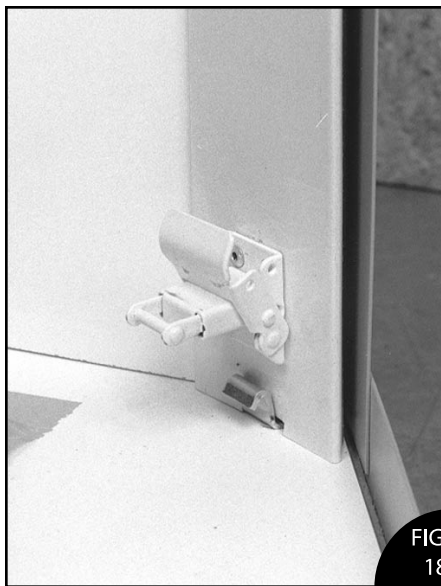

FIG 18



FIG 16



FIG 19

Install remaining vented wall panels.



FIG 20

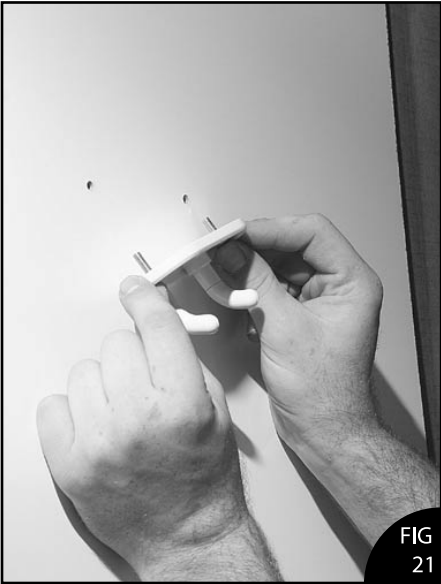

FIG 21



FIG 24

SUN CAPSULE I ONLY: Install two remaining corner pieces with pre-drilled holes for door assembly (green label). Make sure pre-drilled holes are facing inward as shown in Fig 25. **Proceed to ceiling installation on page 20.**

SUN CAPSULE II ONLY: Install reverse bend corner pieces and fasten latches. (Fig 19) Refer to Fig 1 for proper location.

Install remaining wall panel in reverse bend corner piece.

Attach shelf to appropriate wall panel using hardware item "S".

Install cornerpieces on both wall panels and secure bottom latches.



FIG 22



FIG 25

Attach retaining magnet to interior side of wall panel (Fig 1 for location) with acorn nuts on exterior of panel (Fig 20). See Hardware List Item O. Install wall panel with retaining magnet. (Fig 1)

COAT HOOK: Attach Coat Hook to wall panel as shown in Fig 21. Install wall panel with coat hook into next corner piece. (Fig 1)

Insert corner pieces on both wall panels & secure bottom latches. Be sure not to use corner pieces with pre-dilled holes. (Fig 22)

Install remaining wall panels. (Fig 23) If you are installing the "Classic" model (without curved exterior wall panels), the decorative wall panels have a "left" and "right" indicator at the top of each panel (as viewed from the front).

Install two remaining corner pieces with pre-drilled holes for door assembly (green label). Make sure pre-drilled holes are mounted as shown in Figures 24 & 25.

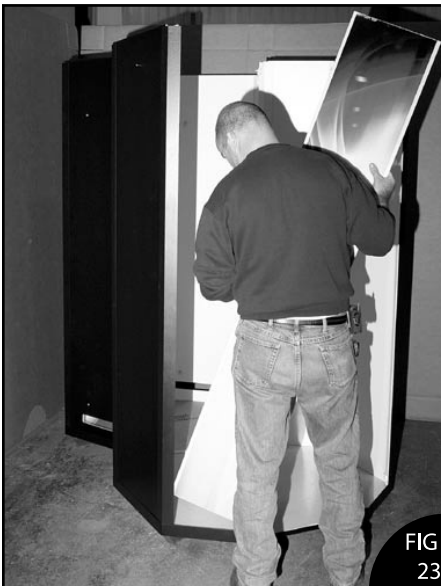

FIG 23

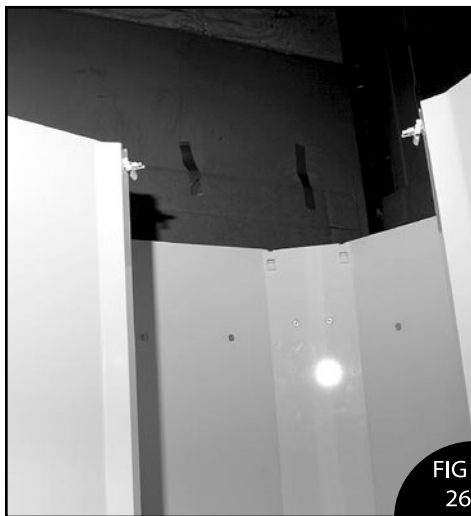

FIG 26

VERY IMPORTANT: Make sure that all wall panels are seated completely into corner pieces & are tight against the floor. Otherwise ceiling will be impossible to install.



FIG 27



FIG 30

CEILING INSTALLATION:

Place all upper latches in open position before installing ceiling (Fig 26).

NOTE: It is recommended that persons 5’10” or taller attempt this procedure, unless shorter people are equipped with platform shoes.

CAUTION: The ceiling must be handled by two people, otherwise bodily injury and/or damage to the ceiling may result. (Fig 27)

Set the ceiling in place, making sure that all of the wall panels and corner pieces fall within the ceiling trim. (Fig 27)

Be careful not to scratch the ceiling.

WORKING TIP: Start by making sure the wall panels and corner pieces at the back of the booth fall within the ceiling trim first. Then work your way around to the front.

VERY IMPORTANT – Make sure the white corner piece trim rests behind ceiling catches. (Fig 28).

It may be necessary to pull down on outside corners to seat ceiling on wall panels.(Fig 29)

If the apex of the corner piece does not line up with the apex of the ceiling trim, (as shown in Fig 30) gently strike corner piece with the palm of your hand (Fig 31). If necessary, do this to each corner before you attempt to secure the latches.

WORKING TIP: If your Sun Capsule is being assembled on an uneven floor, you may have gaps between the Sun Capsule floor and the wall panel or the ceiling and wall panel. This may make it difficult to secure the top latches. Gently rock the shell to get the ceiling to settle down on the wall panel.

Secure top latches (Figure 32).

WORKING TIP: It may be necessary to apply a “quick burst of pressure” to the latch to get it in place over the catch. To do this, place both thumbs as shown in Fig 33, and give a fast, firm push to the latch to get it over the catch. It may help to have someone pull down on the outside corner during procedure. (Fig 29)



FIG 28



FIG 31



FIG 29

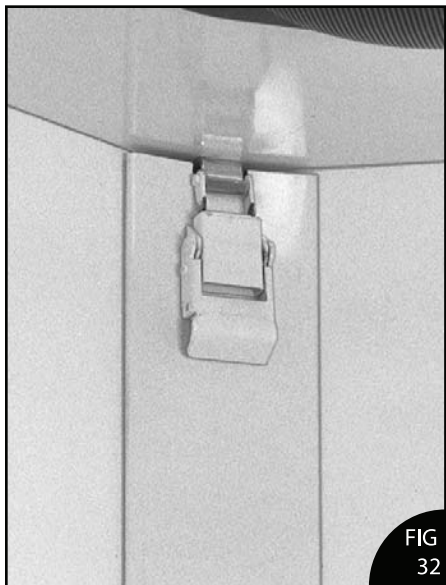

FIG 32

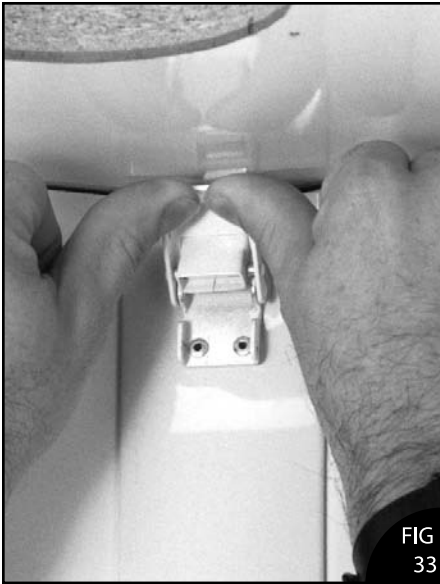

FIG 33



FIG 36



FIG 34



FIG 37



FIG 35



FIG 38

INSTALLING THE INSIDE FAN GUARD:

Line up the four mounting holes and secure the fan guard in place with supplied hardware (Hardware List Item E). (Fig 34)

Install decorative caps over each lock nut.

LAMP FIXTURE INSTALLATION:

IMPORTANT: The inside fan guard must be in place before installing lamp fixtures.

All lamp fixtures are numbered at top of fixture.

CAUTION: When installing lamp fixture(s) do not allow lamp fixture to scratch Linoleum floor or ceiling (Fig 35).

Position lamp fixture #5 by carefully leaning the fixture up against wall panel #5. (Fig 1) Feed the junction box assembly up through junction box hole in ceiling (Fig 36).

HINT: Make sure you place bottom of lamp fixture far enough into the booth (approx. 18 inches) before attempting to stand the fixture upright. Fig. 35

Remove protective film from fixture #5 dress plate. Install dress plate with appropriate screws from Hardware List Item D. (Fig 37)

Install lamp fixture #5 by centering the #5 lamp fixture on the wall panel. Feel behind the fixture to locate the relationship between the "stand offs" on wall and the "tear drops" in lamp fixture. Reach down, bending at the knees, and lift the fixture up until you feel the top "tear drops" fall behind the stand offs. (Figure 38)

Caution: If your Sun Capsule is equipped with metal guards, lift the lamp fixture at the heavy, double support wire only.

If your Sun Capsule is equipped with acrylic guards, lift the lamp fixture using openings in face of the acrylic guard.

Before lowering the fixture, push the bottom of the fixture against the wall panel and lower the fixture so that bottom "tear drops" fall behind bottom "Stand Offs".

IMPORTANT: Be sure to catch all 4 stand offs.

OPTIONAL FLOOR LIGHTING

PACKAGE: If your Sun Capsule has the optional floor lighting package, be sure to plug in cord to lower left side of the #5 lamp fixture before proceeding to next step. (Fig. 39)



Rest lamp fixture labeled #4 against the #4 wall panel (Fig 1 for reference).

Plug in power cord(s) before mounting lamp fixture(s) (Fig 40). Install lamp fixture #4 repeating above procedures.

Install lamp fixtures #3, #2, and #1 repeating above procedures.

INSTALLING #6 LAMP FIXTURE:

NOTE: The following instructions should be completed by two people.

Remove screws from ceiling and floor. (Fig 41)

Insert hinge pin into top hinge leaf on lamp fixture (Fig 42)

Lift lamp fixture into dressing room portion of unit.

While one person holds the lamp fixture steady, the other person tilts the lamp fixture back far enough to insert **hinge pin with collar** into lower hinge leaf. (Fig 43)

Move fixture assembly into position and attach top hinge pin to ceiling using previously removed screws. (Fig 44)

CAUTION: Do Not Over Tighten

Align bottom hinge pin with pre-drilled holes & attach bottom pin to floor using previously removed screws. (Fig 45)

Plug fixture #6 into fixture #1.





FIG 46

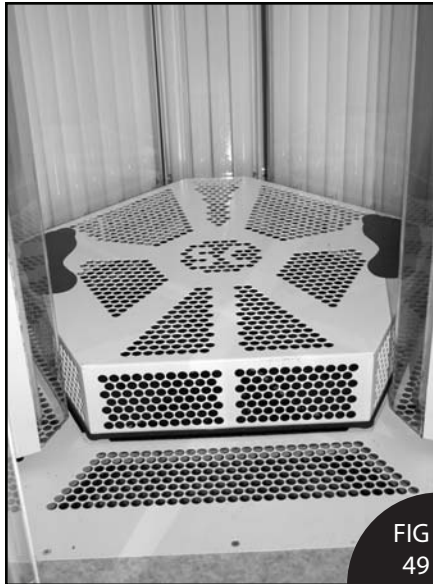

FIG 49

Install 4 white plugs into exposed teardrop openings in the back of #6 lamp fixture. (Fig 46 and Hardware list item Q)

RAISED FLOOR PLATE INSTALLATION:

If you have the optional lighting package, carefully place the raised floor plate on its side as shown in Fig 47.

Attach cord to plug in floor plate.

Lower floor plate into position as shown in Fig 48, making sure not to scratch the acrylic guards.

Make sure the 2 locating pins in the raised floor plate are firmly seated in the slots in the floor. Fig. 49.

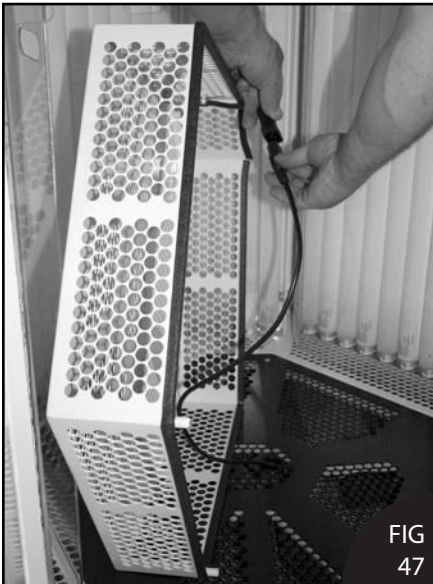

FIG 47



FIG 50

DRESSING ROOM LIGHT STRIPS (Optional):

Remove protective lamp cover from lamp fixture by removing screw at top and bottom of lamp cover. Feed cord-set through opening in ceiling as shown in Fig 50.

Mount fluorescent light strip on metal trim piece, making sure light fixture is firmly attached to both top and bottom "stand-offs". Fig 51. This is accomplished by applying a downward pressure along the entire light fixture.

Attach lamp cover to fixture.



FIG 48



FIG 51

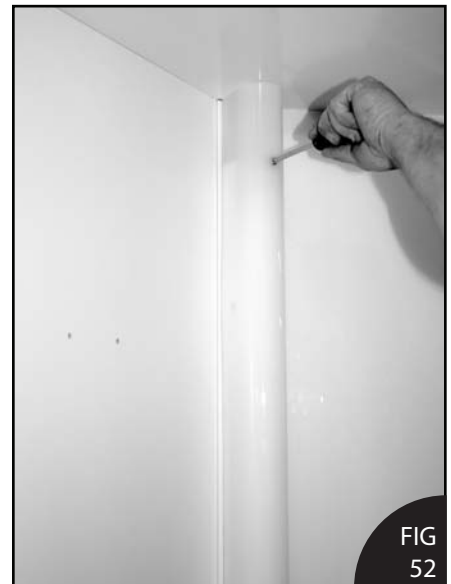

FIG 52



FIG 54

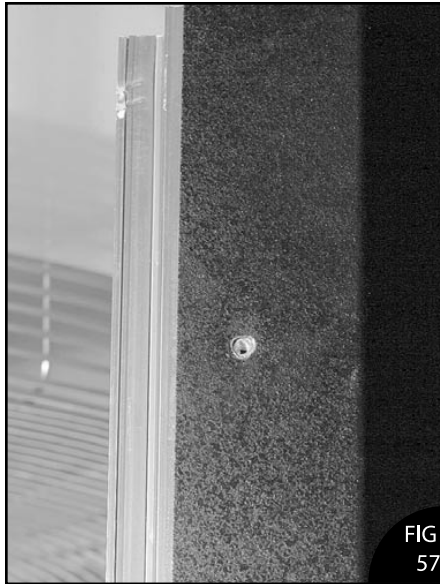

FIG 57

THRESHOLD INSTALLATION: Position threshold as shown in Fig 54. Secure with two 10-32 machine screws and lock nuts (outer holes) and one wood screw (center hole). (Hardware List Item F)

DOOR ASSEMBLY:

NOTE: All Sun Capsule I models must be mounted with hinge on left side. Sun Capsule II models are to be mounted with hinge on appropriate side according to decorative package.

Begin by inserting the door hinge assembly into the door corner piece groove (Fig 55). Pre-drilled pilot holes in the hinge assembly should line up with the pre-drilled holes in the corner piece when hinge is completely inserted into the corner piece. It may be necessary to lift the door assembly slightly to align the holes. Use appropriate screws (Hardware List Item D) to secure the hinge assembly to the corner piece.



FIG 55



FIG 58

DOOR STRIKER INSTALLATION: Insert the door striker in the remaining corner piece groove. Make sure striker is pushed down to the floor and magnet strip is facing out. Line up the pre-drilled pilot holes in the striker with the pre-drilled holes in the corner piece and secure with appropriate screws. Fig 56 & 57 (Hardware List Item D)

DOOR ADJUSTMENT: There is enough play in the pre-drilled corner piece holes to shift the door striker slightly to the left or right. For proper door closure, you should have approximately 1/8" gap between door and striker when door is in the closed position (Fig 58). Mating surfaces of the magnetic strips should line up and a solid feel should be obtained on door closure.

INSIDE DOOR HANDLE INSTALLATION FOR SUN CAPSULE II ONLY: Install the



FIG 56



FIG 59



FIG 60



FIG 61



FIG 64

INSTALLING #6 LAMP FIXTURE: (SUN CAPSULE I ONLY)

While one person steadies the door, the other person hangs the #6 lamp fixture on the door. (Fig 61). Use the heavy double support wires on the metal guard or the hand slots in the acrylic guard to lift fixture.

IMPORTANT: Make sure you catch all four stand-offs.

Plug fixture #6 into fixture #1.

INSTALLING GRAB BAR TO #6 LAMP FIXTURE (ALL MODELS WITH METAL GUARDS):

Removal of the lamp guard is required since the hardware will be installed through the back of the guard (Fig 62). Using appropriate hardware (Hardware List Item L) attach bar to lamp guard above the heavy double horizontal wire located just above waist high. The bar will rest on this wire (Fig 63).

NOTE: Make sure the heads of the bolts are on the back of the guard with decorative acorn nuts on the front.

Re-install lamp guard. Fig 64



FIG 62



FIG 65

INSTALLING PUSH PLATE TO #6 LAMP FIXTURE (ACRYLIC GUARD ONLY):

Using hardware mounted to acrylic guards, install Push Plate to acrylic lamp guard as shown in Fig. 64

FAN SHUT OFF SWITCH: The Fan "Shut Off" Switch (Hardware List Item G) allows for easier entrance and exit by shutting off the fan when the door is open. Feed fan shut off switch cord through hole in ceiling Fig 65. Remove the 4 screws in the ceiling and use them to install the fan shut off switch.

Make sure plastic plunger is facing in the proper direction See Fig 66. Refer to figure 67 if you have a Sun Capsule I. Place "Fan Shutoff Cord" under retaining clip already in place on the top of the ceiling. Make sure cord is clear of upper fan guard.



FIG 63



FIG 66

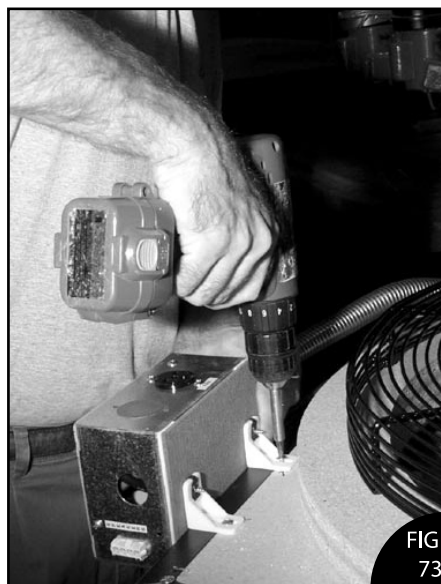
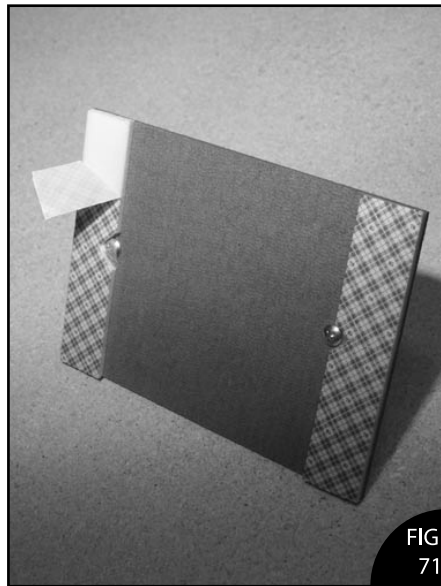
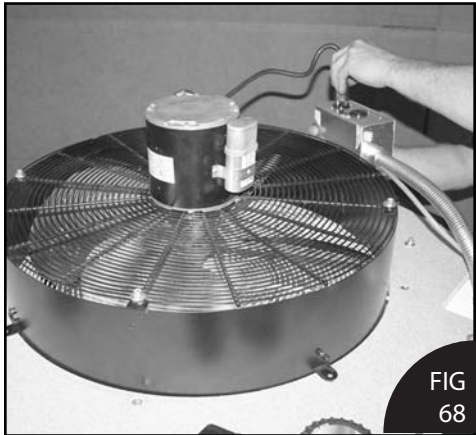
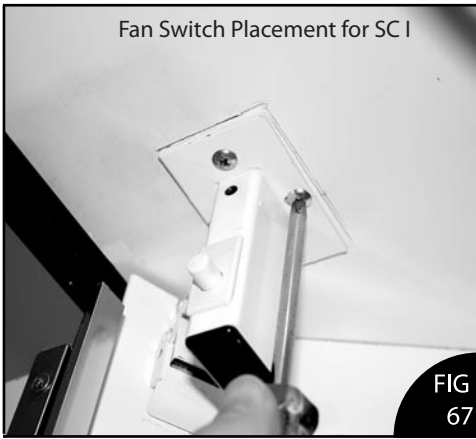

FAN INSTALLATION: To avoid damage to fan blade, carefully place the upper fan assembly over hole on top of ceiling. Line up the pilot holes in ceiling with mounting holes in upper fan assembly, making sure power cord will be able to reach the junction box shown in Figure 68. Fasten upper fan assembly to ceiling with appropriate screws making sure not to strip out holes in ceiling by overtightening screws. (Fig 69)

FOR UNITS WITHOUT THE OPTIONAL DRESSING ROOM LIGHTS: Installing Overhead Light by feeding lead wires of overhead light through hole in ceiling. Press light firmly into hole.

MOUNTING JUNCTION BOX: Locate junction box mounting bracket. Peel off protective tape (Fig 71) and mount to junction box as shown in Fig 72. BE SURE BRACKET IS ORIENTATED EXACTLY AS SHOWN IN THE FIG. 72

Locate pre-drilled holes on the top rear of the ceiling and mount junction box to ceiling using supplied screws Fig 73.

CAUTION: Do not overtighten screws.

Plug fan shut off switch cord into appropriate receptacle. Fig 74

Plug fan power plug into into appropriate receptacle.

Plug overhead light into appropriate receptacle.



FIG 74



FIG 77

RIGHT CHANNEL CONNECTION: The junction box terminal has a positive (red) connection for connecting to the right channel of your stereo receiver. The junction box terminal has a negative (black) connection for connecting to the right channel of your stereo receiver.

LEFT CHANNEL CONNECTION: The junction box terminal has a positive (red) connection for connecting to the left channel of your stereo receiver. The junction box terminal has a negative (black) connection for connecting to the left channel of your stereo receiver.

BE SURE TO CONNECT THE POSITIVE CONNECTIONS TO THE POSITIVE TERMINALS AND THE NEGATIVE CONNECTIONS TO THE NEGATIVE TERMINALS OR STEREO SPEAKERS / HEADPHONES WILL NOT FUNCTION PROPERLY.

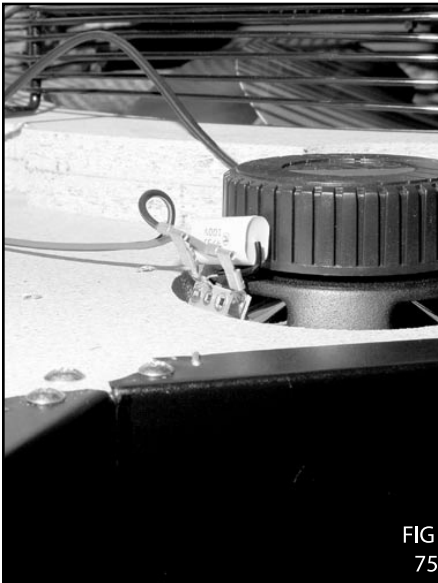

FIG 75

SPEAKER AND STEREO HOOKUP:

In the hardware kit, locate the white four prong male plug with four wires coming out of it. Two of these wires are positive (red) and two of these wires are negative (black).

Connect one of the positive (red) wires to the positive terminal on the right speaker, marked with a red indication. Connect one of the negative (black) wires to the negative terminal on the right speaker. (Fig 75)

Repeat above procedure for left speaker.

Plug the white 4 prong male plug into the corresponding white four prong female receptacle on the side of the junction box labeled "Speakers".

ATTENTION: BE SURE TO CONNECT THE POSITIVE WIRES TO THE POSITIVE TERMINALS AND THE NEGATIVE WIRES TO THE NEGATIVE TERMINALS OR SPEAKERS / HEADPHONES WILL NOT FUNCTION PROPERLY.

NOTE – The bottom row of terminals are only used if the stereo system is being daisy chained to another unit.

REMOTE TIMER – Plug the remote timer into the junction box. Timer works on a 12 volt system. The plug can be inserted only one way. Do not force.



FIG 76

STEREO CONNECTION: The stereo wires are not provided with the Sun Capsule.

Four stereo wires are going to be needed to complete this procedure.

Locate the four-clip terminal on the front of the junction box labeled Stereo. THE TOP ROW OF TERMINALS IS WHERE FOUR STEREO CONNECTIONS ARE GOING TO BE MADE.



FIG
78



FIG
81

FINAL ADJUSTMENTS: If your floor beneath the Sun Capsule is not level, the door will not be parallel to the ceiling framework. If this condition exists, the booth will need to be shimmed. When looking at the front of the booth, if the gap between the top of the front door frame and the ceiling trim is bigger on the right, then typically a shim will be necessary **under the bottom left corner of the door frame** (Fig 76) & vice versa. Do this by lifting the appropriate corner and slide a shim (supplied) or something similar under the 2" x 3" support at that corner. You may have to experiment until you get it perfect.(Fig 77)

PROTECTIVE CARDBOARD: Remove the cardboard that protects the Fast Flow Floor. Although this floor is quite durable, it is not scratchproof. Take care not to walk on surface with street shoes.



FIG
79



FIG
82

INSTALLING FLOURESCENT LIGHTS FOR SC I: Hang the flourescent light strips on the standoffs, making sure that light fixture is securely seated on both top and bottom stand-offs. Make sure that cord is located at the top fo the light fixture.

Do not install curved panels until instructed to do so.

INSTALLATION OF CURVED WALL PANELS - SUN CAPSULE WITH DRESSING ROOM ONLY:

Once you are satisfied with all the door adjustments, i.e. proper spacing between door and striker (Fig 58); door is square to the framework (possible shimming to accomplish this, Fig 77); door corner pieces.

Using a 5/32 inch drill bit, drill a hole through each of the (4) pilot holes located 2 at the top and 2 at the bottom. (Fig 78)

CAUTION: DRILL THROUGH THE OUTSIDE LAYER OF THE CORNER PIECE ONLY. BE CAREFUL NOT TO DRILL THROUGH THE WHITE METAL TRIM PIECE ON THE BACK SIDE OF THE CORNER PIECE.

Using the hardware supplied, (Hardware Item "T") drive a screw into the top and bottom holes of each corner piece (Fig 79)



FIG
80



FIG
83



FIG
84



FIG
87

The following should be accomplished by 2 people:

Start by inserting the decorative flexible panel into the track of the DOOR corner piece. Make sure the top of the panel is flush with the top of the booth. Then, insert the top of the other side of the panel into the adjacent corner piece. (Fig 87) Next, one person keeps pressure on the flexible panel as the other person works his way down the panel, all along inserting more of the panel into the track of the adjacent panel. (Fig 86)

Repeat procedure for opposite side.

If the panels are not perfectly aligned with the top of the booth, it is possible to slide the panel up or down in the track.



FIG
85



FIG
88

ELECTRICAL HOOK UP: Your Sun Capsule must be connected to power by a licensed electrician in accordance with the National & Local Electrical Codes.

We recommend using name brand circuit breakers at your electrical panel. They are heavy duty and eliminate nuisance tripping.



FIG
86

IMPORTANT

A RUNNING VOLTAGE BETWEEN 230 TO 235 VOLTS MUST BE ACHIEVED TO OBTAIN PEAK PERFORMANCE.

Please factor in the load of other equipment and air conditioning running in the salon at the same time.

If the voltage is higher or lower than this range **YOU MUST USE A BUCK BOOST TRANSFORMER TO DELIVER THE PROPER VOLTAGE.**

In the event a buck boost transformer is used it should be mounted as close to the service panel as possible. **NOTE:** A buck boost transformer will add 6 to 9 amps to the overall load at the service panel. In cases where incoming voltage readings are very low, two buck boost transformers wired in series may be necessary.

VERY IMPORTANT

There is NO NEUTRAL in any 60 Hz Sun Capsule VHR System!!!

*50 Hz systems must operate between 220 volts and 225 volts.

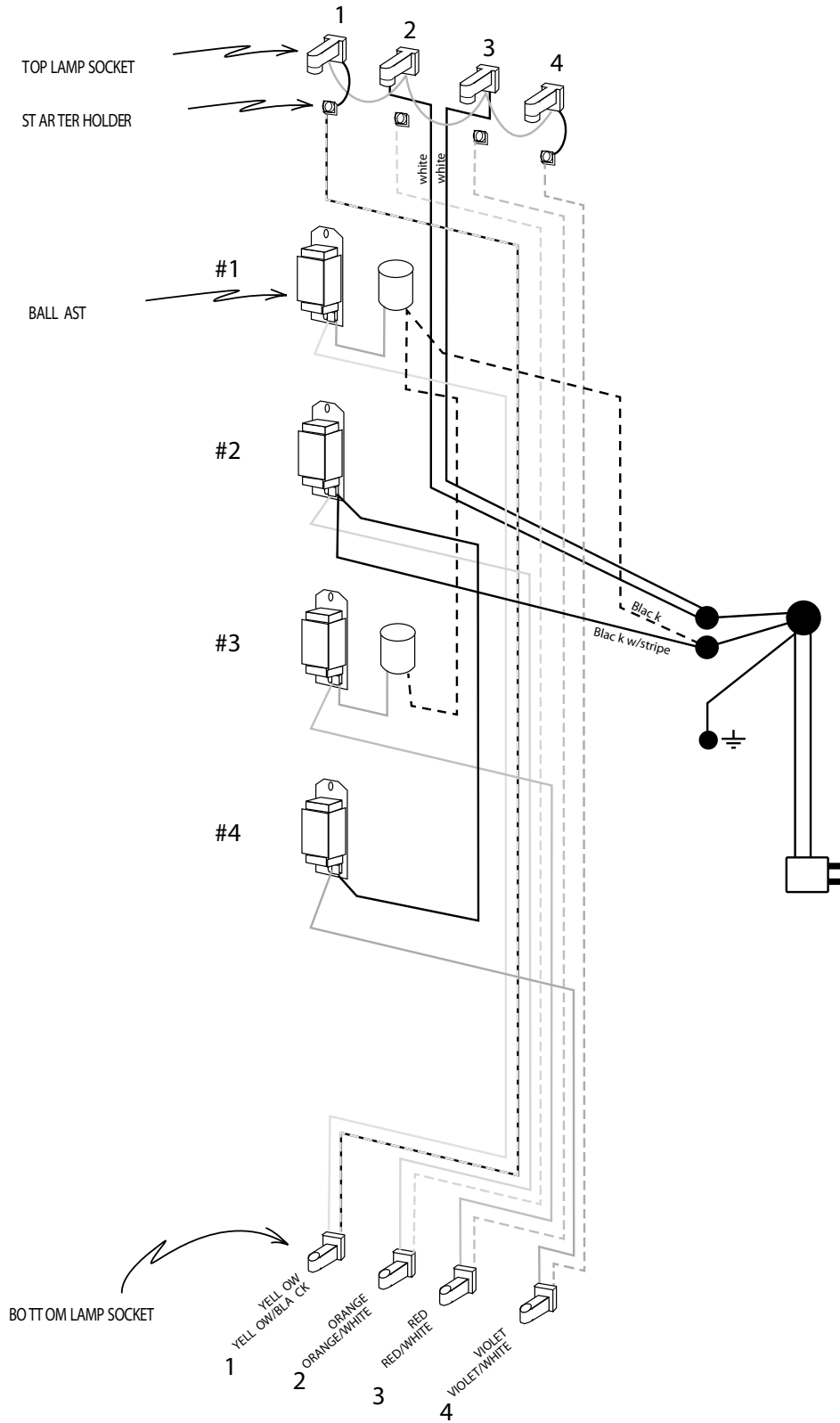

4 LAMP FIXTURE WIRING

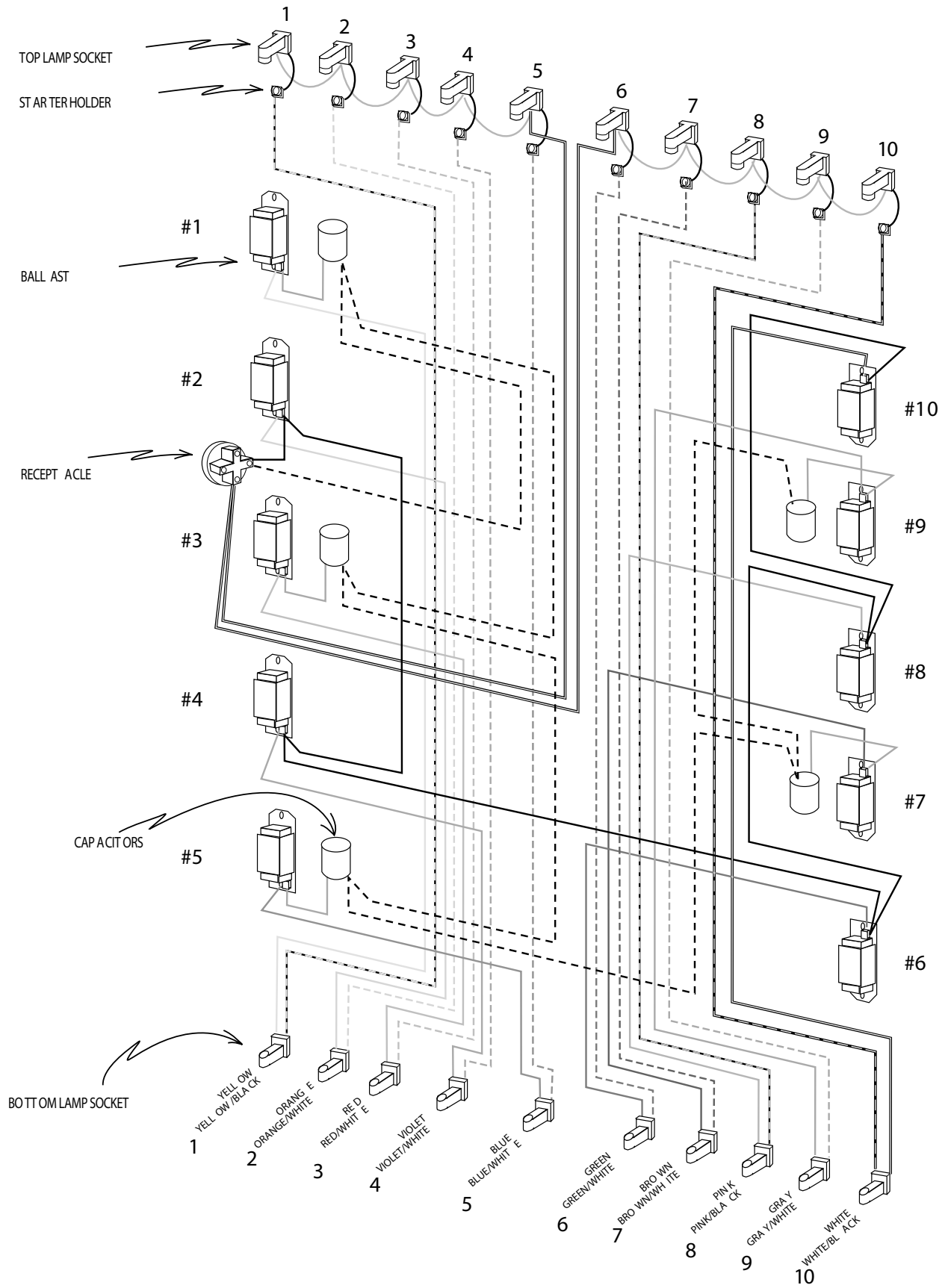

10 LAMP FIXTURE WIRING

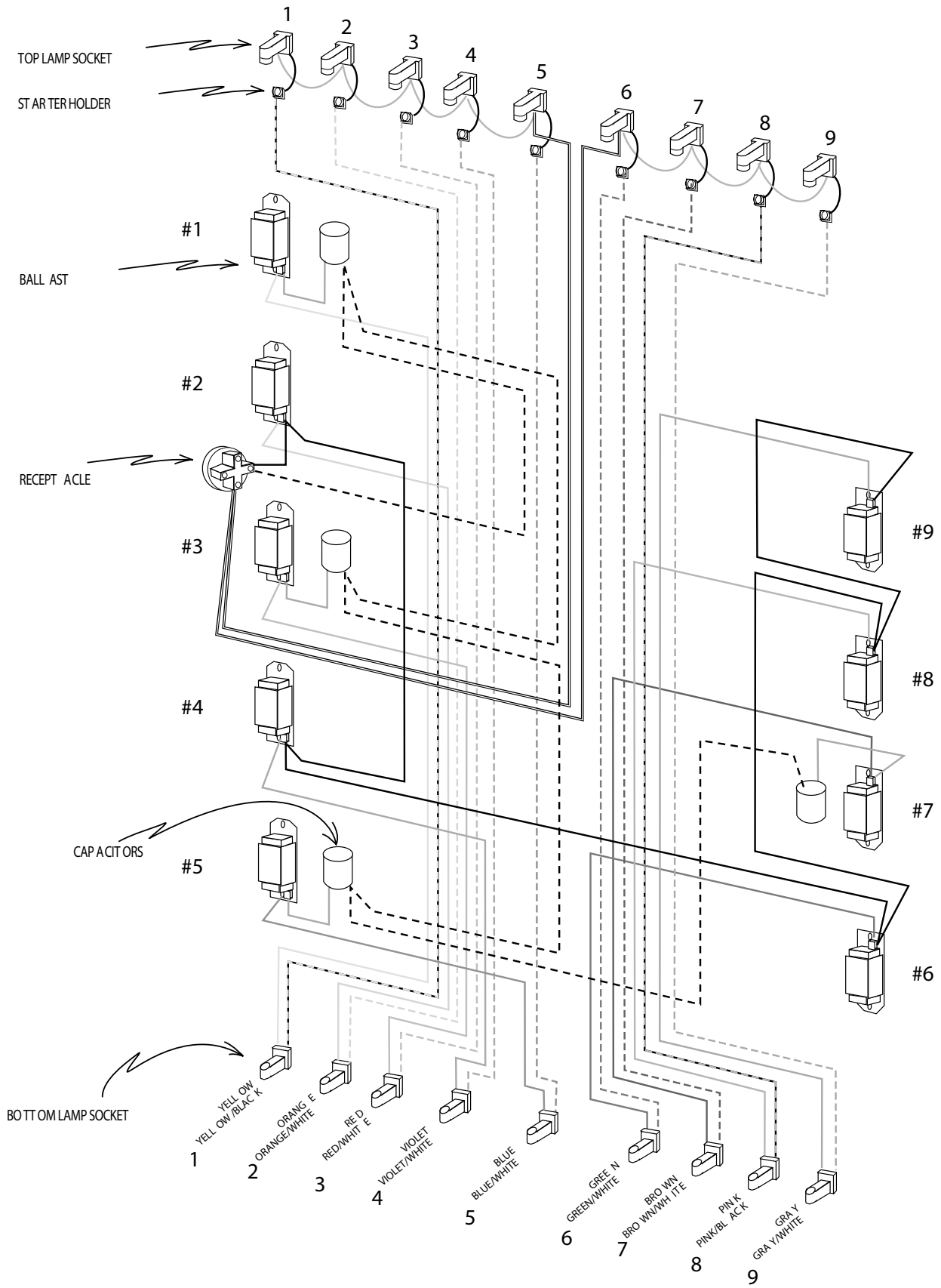

9 LAMP FIXTURE WIRING

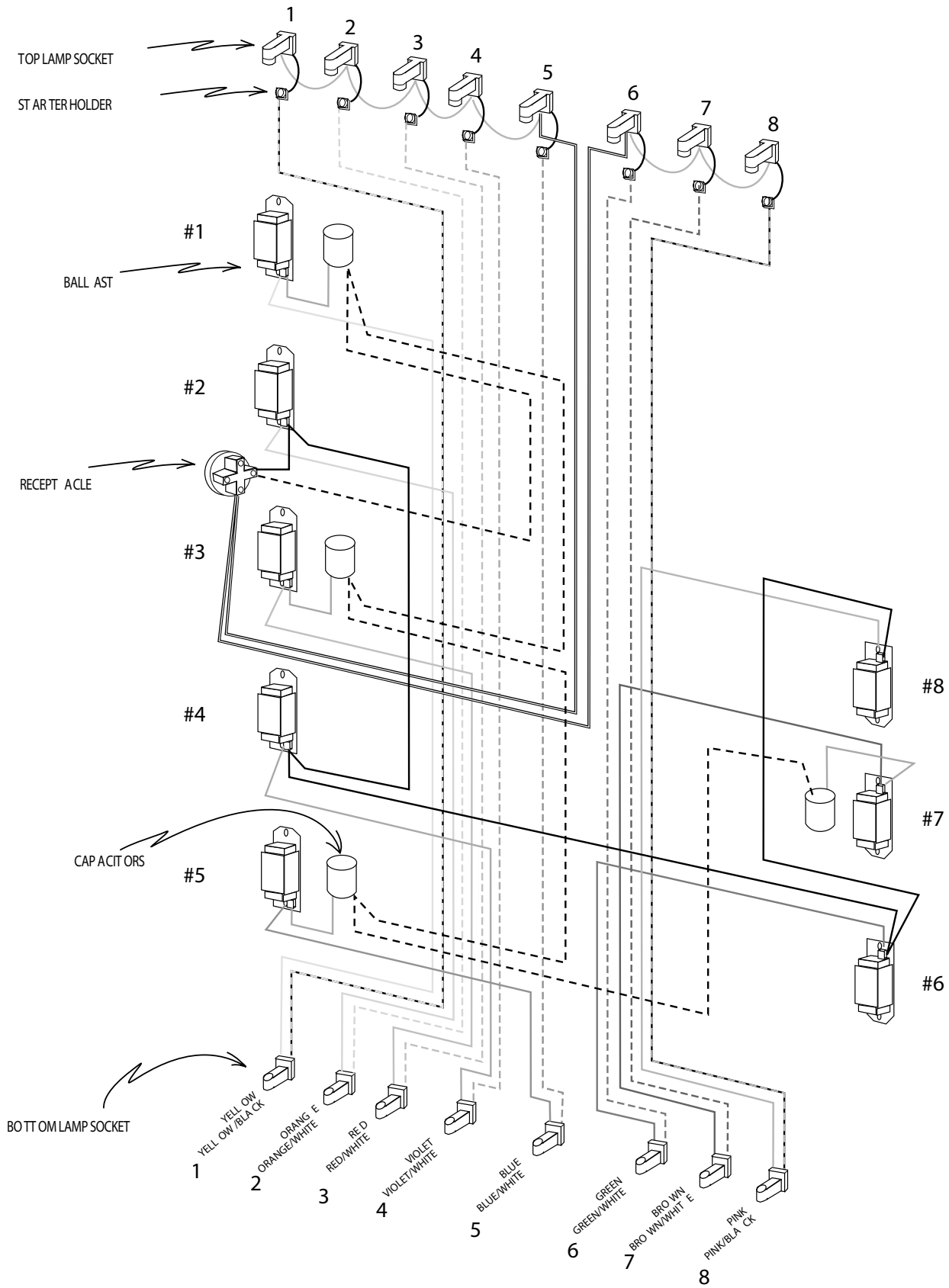

8 LAMP FIXTURE WIRING

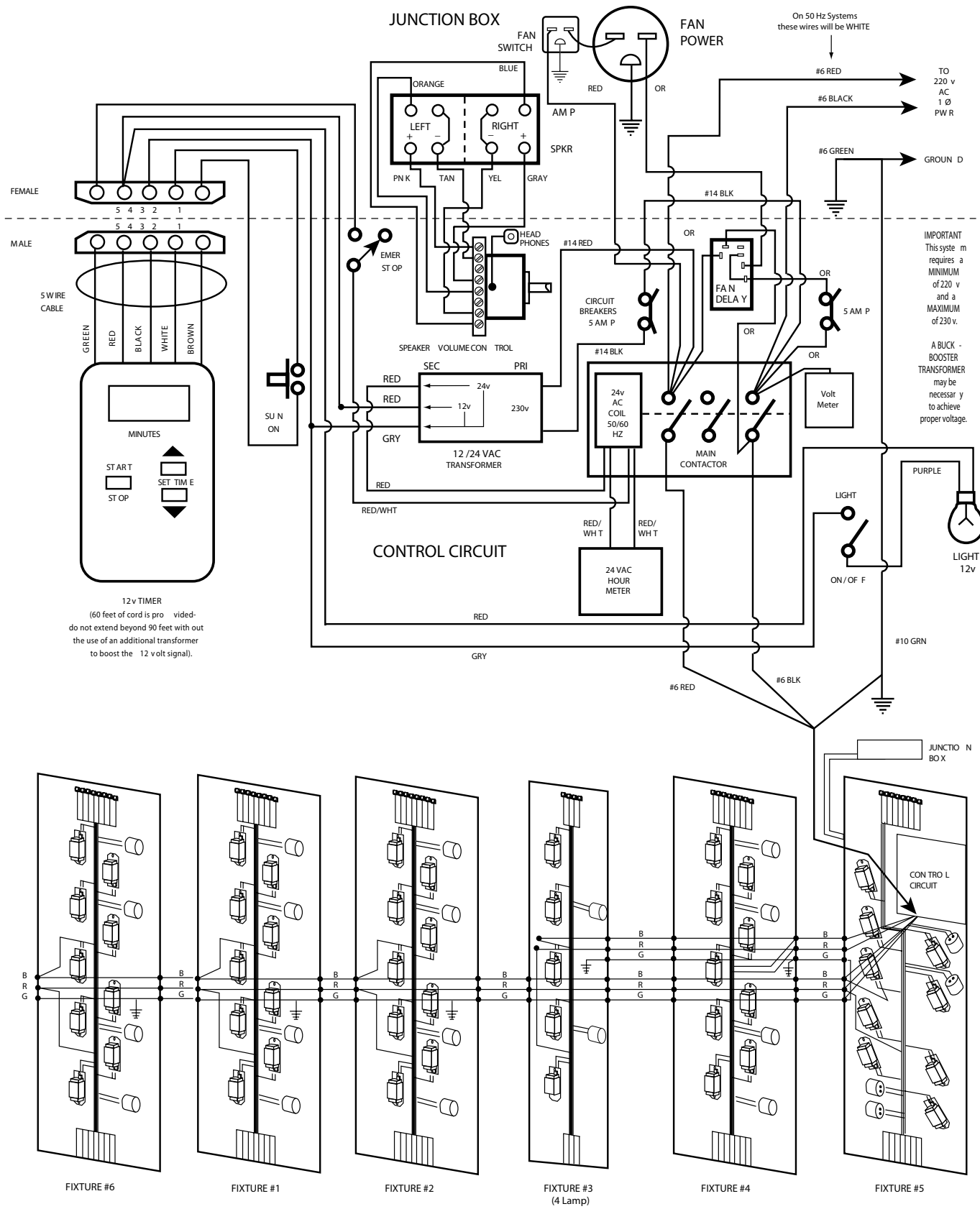

SINGLE PHASE SYSTEM SCHEMATIC

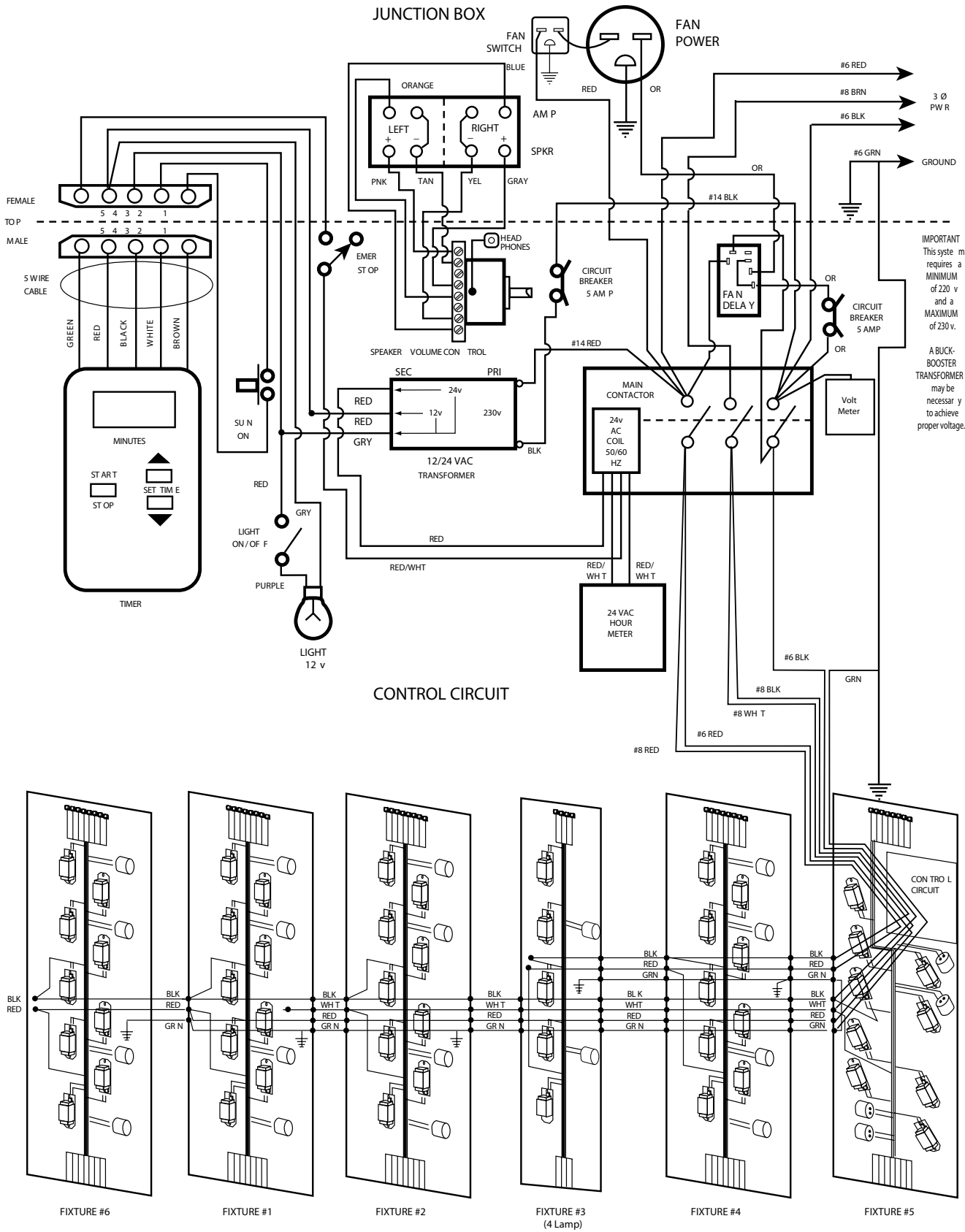

60 HZ 3/1 PHASE SYSTEM SCHEMATIC

General Trouble Shooting Guide

Tanning Unit Will Not Start:

1. Make sure the “Emergency Stop” switch on the control panel is in the “ON” position.(located on first lamp panel on the right when walking into the unit).
2. Make sure the voltmeter on the control panel indicates at least 230 volts.
3. If there is no voltage indication on the voltmeter, check your electrical service panel to verify the circuit breaker is in the “On” position. Turn circuit breaker to ‘off’ position and then place circuit breaker in ‘on’ position.
4. Isolation test: Unplug the timer cable from the junction box on top of the booth . Bend a bare metal paper clip, into a “U” shape. Insert one end into the first hole and the other end into the third hole (counting down from the top) of the “Remote Timer” receptacle on the junction box. If the booth starts with the paper clip in place, either the timer or timer cord is faulty. If the booth does not start, then the problem lies within the unit.

At this point call Sun Capsule Service at (978) 532-7517

One Lamp Will Not Start:

1. Replace the lamp in question with a lamp that works.
2. Replace the starter for the lamp in question with one that works.
3. Inspect top and bottom socket for cracks or other visible damage

THE PROCEEDING STEPS SHOULD BE PERFORMED BY A QUALIFIED SERVICE TECHNICIAN ONLY!

CAUTION: When trouble shooting components inside the lamp fixture, shut the power off at the circuit breaker.

REMOVE LAMP GUARD, LAMPS & LAMP FIXTURE COVER TO PERFORM THE FOLLOWING PROCEDURES:

4. Check the wires going to the top and bottom lamp sockets to ensure that they are firmly installed in the socket(s). Confirm this with a gentle tug on each wire at the socket. There should be a colored wire with a black or white stripe going to the starter holder of each top socket as well as a white ‘jumper’ wire connecting each top socket to the next top socket. Make sure wires are firmly inserted in top and bottom sockets. See wiring diagram in Sun Capsule Owners manual for further illustration.
5. Check the wires going to the ballast for the lamp in question. See wiring diagram in Owners manual. Make sure that wires are firmly inserted beneath screw terminals on ballast in question.

THINGS TO LOOK FOR:

Burnt or discolored wires at ballast terminal

Loose or broken wires

6. If it is odd numbered lamp (counting from left to right) that will not start, you need to check the capacitor for the lamp that won’t start.

CAUTION: You must discharge the capacitor(s) before you touch or try to remove them. Place a screwdriver across the terminal posts of the capacitor. A loud ‘pop’ may occur, this is normal. Now the capacitor is safe to handle.

The easiest way to verify a faulty capacitor is to replace the capacitor in question with one that works.

One or more Lamp Fixtures will not light:

A series of power cords with plugs carry the power from one lamp fixture to the next. It is important to check that all plugs are properly inserted into each fixture. NOTE: On some models, the number 3 and 4 lamp fixture has two cord sets. Make sure both cord sets are properly inserted.

Unit Does Not Come On At Times or Shuts Off During A Session:

1. If the timer cord has been lengthened beyond 90' in total length, a transformer may be necessary to boost the low voltage signal to the timer. To test this situation, unplug the timer from the end of the cord and plug the timer directly into the "Remote Timer" terminal on the junction box on top of the unit. This will bypass the cord between the timer and the booth. If the booth runs flawlessly with the timer plugged directly to the unit, the problem is with the cord.
2. If the timer cord has been cut and spliced back together to allow the cord to be installed through ceilings and walls to get to your front desk, check the connections for proper termination. To test this, unplug the timer from the end of the cord and plug the timer directly into the "Remote Timer" receptacle on the junction box on top of the booth. This will bypass the cord between the timer and the booth. If the booth runs flawlessly with the timer plugged directly to the booth, the problem is with the cord.
3. If a timer system other than the Sun Capsule digital timer is being used, disconnect the alternate timer and test with the Sun Capsule timer to determine if the foreign timer system is faulty. If the unit operates properly with the Sun Capsule timer in place, contact the manufacturer of the alternate timer for assistance.

Trouble Shooting Your Timer:

1. If you are using your Sun Capsule timer as a stand alone timer, the timer functions and operations are very basic. Should you somehow enter into the programming modes of the timer (the digital display begins to flash a series of random numbers) you can reset the timer in two ways: First, simply press the "Start/Stop" button and the timer should return to normal. Or, unplug the timer from the Sun Capsule and plug it back in. After you plug the timer back in, it will go through a series of random numbers, then reset back to zero.
2. Test for a faulty timer. Unplug the timer from the junction box on top of the booth. Using a bare metal paper clip bent into a "U" shape, insert one end into the first hole and the other end into the third hole (counting down from the top) of the "Remote Timer" receptacle on the junction box. If the booth comes on with the paper clip in place, either the timer or timer cord is faulty. If the booth does not come on the problem lies within the unit.
3. If using your Sun Capsule timer with a database system, the database will completely override the stand-alone functions of the timer. To disconnect the timer from the database, unplug the CAT-5 cables going into it. Then unplug the timer from the "Remote Timer" receptacle on the junction box and **plug it back in**. This will clear the timer from thinking it is still connected to the database. At this time you should be able to manually set time on the timer and start the tanning session.
4. If using your Sun Capsule timer with a database system, press the "Set Time" button on the timer. When hooked up properly to the database system, the timer will read "OL", which stands for "On Line". If your timer does not read "OL" check your cable connections to the timer. Note: The Sun Capsule timer takes a CAT-5 cable adapted to the RJ22 cable.
5. If your 'manager' is not recognizing the Sun Capsule timer and the timer does reads "OL" when the "Set Time" button is pressed, then reset power to the manager by unplugging it and plugging it back in. Also shut down the computer software and start it back up. After the manager and software re-scan, it should pick the timer back up.

Cooling Fan Will Not Come On:

1. Verify the fan has not come unplugged from the junction box on top of the unit.
2. Verify the fan shut-off switch has not come unplugged from the junction box on top of the unit. This switch will stop the fan from running when the door is opened during a tanning session or during the delay period (factory pre-set at approximately 4 minutes) after a tanning session. This switch will allow the fan to resume once the door is closed, provided the pre set fan delay time has not expired. Close the door completely, or manually push the switch in with your finger while a tanning session is running. If the fan does not come on, a service technician should inspect to see if the fan delay timer inside the number 5 lamp fixture is faulty.
3. There are two 5-amp circuit breakers on the control panel on the inside of the Sun Capsule. One of these breakers protects the fan motor. Check to see if one of the breakers is popped out. If so, push the breaker back in and restart the unit. If the breaker pops out again, a service technician should inspect to see if you have a 'short' in the wiring going to the fan motor or if you have a faulty circuit breaker.

INDEX

A

Acrylic Cleaner 7
Allergic Reactions 7
Antihistamines 6
Antibiotics 6
Assembly Instructions 14 -28

B

Bacterial Infection 6

C

Capacitor 37
Ceiling Installation 20
Children 7
Coal Tar Treatment 6
Curved Wall Panels 28, 29

D

Daily Maintenance 7
Decorative Front Panels 7
Diabetes Drugs 6
Digital Timer 8
Diuretics 6
Door Adjustment 24, 28
Door Assembly 24
Door Striker 24
Dressing Room Light Strip 23, 26
Ducting 9

E

Electrical Hookup 29
Emergency Entry Key 8
Emergency Shutoff Switch 8, 37

F

Fan Blade 7
Fan Guard 21
Fan Installation 26
Fan Operation 9
Fan Shutoff Switch 25
Fast Flow Floor Vent 7, 9, 11
Floor Assembly 16
Floor Lighting Package 21
Floor Saver Template 16

G

Grab Bar 25

H

Hand Straps 7
Hardware List 15, 16
Hinge Pins 22
Hour Meter 8
HVAC 10
Installing Lamp Guards 10

I

Installing Sunlamps 10
Itching 7

J

Junction Box 26

K

L

Lamp End Blackening 10
Lamp Fixture Installation 21
Lamp Fixture Wiring Diagram 31-34
Lamp Guards 10
Lamp Installation 10
Lamp Replacement 10
Lamp Rotation 11, 12
Latch 17
Lotions 11

M

Magnet 15, 18
Moisturizers 11

N

O

Overhead Light 8

P

Peak Performance 9
Photosensitive Drugs 6
Pregnant Women 7
Protective Eye Goggles 7
Protective Guards 7
Psoralens 6
Psoriasis 6

Q

R

Raised Floor Plate 23
Room Temperature 9

S

Schematic/Single Phase 35
Schematic/Three Phase 36
Starters 10
Stereo Hookup 27
Sunlamp Installation 10
Sunlamp Replacement 10

T

Threshold 24
Timer Operation 8
Tranquilizers 6
Transformer 8
Trouble Shooting 37

U

Ultraviolet Light 6
Urinary Tract Infection 6

V

Venting 9
Voltage 8, 14, 30

W

Wall Panels 17, 28

Wall Panel Standoffs 17

X

Y

Z

Cut along dotted line and mail warranty card back within 15 days of delivery.

Mail Warranty Card To:

Sun Capsule
1600 Osgood Street
Suite 2006
North Andover, MA 01845

Sun Capsule Limited Warranty Card
IMPORTANT: MAIL WARRANTY REGISTRATION NOW

NAME OF PURCHASER _____ DATE PURCHASED ___/___/___
NAME OF BUSINESS _____
ADDRESS _____ PHONE (____) _____
CITY _____ STATE _____ ZIP _____
Email _____
PURCHASED FROM _____
ADDRESS _____
CITY _____ STATE _____ ZIP _____
MODEL NUMBER _____ SERIAL NUMBER _____
COMPLEMENTS/CRITICISMS _____

Limited Warranties

Sun Capsule (the company) makes the following limited warranties (the "Limited Warranties") on its artificial sun tanning booth (the "Product"). These Limited Warranties extend to the original purchaser only; they do not extend to any other purchaser or transferee.

Limited Ninety (90) Day warranty on Parts and Labor ("Limited Ninety (90) Day Warranty"). The company warrants the parts contained in this Product against defects in materials and workmanship for a period of ninety (90) days after the date of original purchase. During this period the company will repair or replace, at its option, a defective part without charge to the original purchaser with the following exceptions:

- 1) Fluorescent lamps and starters are warranted against defects for a period of thirty (30) days from date of sale.
- 2) Only parts obtained through the company, its authorized dealers or distributors may be used. Transportation costs for parts shipped to the consumer and the return of defective parts to the company are not included.
- 3) Labor will be furnished without charge for ninety (90) days from date of purchase only. All labor and related charges must be authorized by the company prior to start of repairs, and must coincide with the company's established rates and time allotment policy.

Limited One Year Warranty on Parts ("Limited One Year Warranty"). The company warrants the electrical components contained in this product (except sun lamps and starters) against defects in materials and workmanship for one year to the original purchaser of the product. During this period, the company, will repair or replace, at its option, a defective part without charge to you. You must prepay all transportation and insurance charges to and from the company service location and, after the first 90 days, you must pay all labor charges involved in repairing or replacing the defective part. FAILURE TO RETURN DEFECTIVE PART WITHIN 30 DAYS OF RECEIVING REPLACEMENT PART WILL VOID WARRANTY.

Limited Lifetime Warranty on Framework (Limited Lifetime Warranty). The company warrants that all framework components, i.e. floor, ceiling, wall panels, framework, fixture housings, guards and anything not considered electrical in nature are covered by a Limited Lifetime Warranty against defects in materials and workmanship to the original purchaser. During this period the company will repair or replace, at its option, a defective part without charge to you. You must prepay all transportation and insurance charges to and from the company service location, and after the first 90 days, you must pay all labor charges involved in repairing or replacing the defective part. FAILURE TO RETURN DEFECTIVE PART WITHIN 30 DAYS OF RECEIVING REPLACEMENT PART WILL VOID WARRANTY.

CONDITIONS OF LIMITED WARRANTIES

It is imperative that the original customer completes and returns the enclosed warranty card within 10 days after purchase to insure valid registration and coverage for potential claims.

If the warranty card is not registered, proof of purchase from the company or its authorized dealer or distributor will be required prior to any consideration on warranty claims. This could result in service delays.

These warranties extend to the individual or legal entity, whose name appears on the warranty registration card filed with or whose name appears on the original sale document and may not be transferred to any other individual or legal entity.

These warranties do not apply to any failure of the product, or any parts of the product due to alterations, modifications, misuse, abuse, accident, improper maintenance, improper installation, normal wear and tear, discoloration of any materials or components due to UV light exposure or if the serial number on the product has been removed, altered or defaced. Adequate packaging must be used for returned goods to prevent freight damage.

THE COMPANY MAKES NO WARRANTIES (INCLUDING ANY WARRANTIES AS TO MERCHANT ABILITY OR FITNESS FOR A PARTICULAR PURPOSE) ON THE PARTS LISTED ABOVE. YOU ARE LIMITED TO THE WARRANTIES OF THE RESPECTIVE MANUFACTURERS OF THESE PARTS (IF SUCH WARRANTIES AVAILABLE TO YOU).

ALL WARRANTIES IMPLIED BY STATE LAW, INCLUDING THE IMPLIED WARRANTIES OF MERCHANTABILITY AND FITNESS FOR A PARTICULAR PURPOSE, ARE EXPRESSLY LIMITED TO THE DURATION OF THE LIMITED WARRANTIES SET FORTH ABOVE. Some states do not allow limitations on how long an implied warranty lasts, so the above limitation may not apply to you.

WITH THE EXCEPTION OF ANY WARRANTIES IMPLIED BY STATE LAWS AS HEREBY LIMITED, THE FOREGOING EXPRESS WARRANTIES ARE EXCLUSIVE AND NO OTHER EXPRESS WARRANTIES ARE GIVEN AND NO AFFIRMATION OF THE COMPANY, BY WORDS OR ACTION, SHALL CONSTITUTE A WARRANTY.

IN NO EVENT SHALL THE COMPANY BE LIABLE FOR CONSEQUENTIAL OR INCIDENTAL DAMAGES. Some states do not allow the exclusion or limitation of incidental or consequential damages so the above limitation may not apply to you.

No person, agent, or employee of the company is authorized to change, modify or extend the terms of these Limited Warranties in any other manner what so ever. These Limited Warranties give you specific legal rights and you may also have other rights which vary from state to state.

