

# **Nikon**

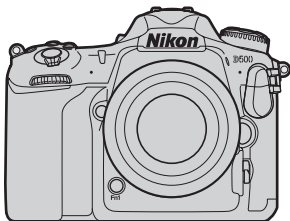

# **D500** Professional Setting Guide

— Sports AF Edition —

Revision 1.0

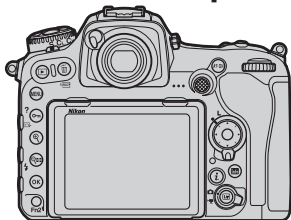

En

# Table of Contents

---

<b>Sports AF: Autofocus Basics</b> <b>CHECK IT OUT</b> ✓	3
• AF Mode: AF-C	3
• AF-Area Mode: 25-Point Dynamic-Area AF	3
• Focus Tracking with Lock-On	4
• The Standby Timer	5
<b>AF-Area Mode</b>	6
• Custom Settings <b>CHECK IT OUT</b> ✓	8
<b>Focus Points</b>	9
• Cross Sensors	10
• Teleconverters and Available Focus Points	11
<b>Sports AF: Custom Settings</b>	15
• a1: AF-C Priority Selection	16
• a3: Focus Tracking with Lock-On	18
• a6: Number of Focus Points	20
• a7: Store by Orientation	20
• a8: AF Activation	22
• a9: Limit AF-Area Mode Selection	23
• a10: Autofocus Mode Restrictions	23
• a11: Focus Point Wrap-Around	23
<b>Sports AF: Custom Control Assignments</b> <b>CHECK IT OUT</b> ✓	24
• Focus-Related Control Assignments	24
• Lens Focus Function Buttons	26
<b>Auto AF Fine-Tuning</b> <b>CHECK IT OUT</b> ✓	27
<b>Recommended AF Settings by Event</b>	30
• Overview: Settings by Event	30
• Soccer	34
• Winter Sports	35
• Gymnastics	46
• Athletics	52
• Aquatics	57

## Sports AF: Autofocus Basics **CHECK IT OUT** ✓

The following settings are suitable for most sports:

- **Autofocus mode:** AF-C
- **AF-area mode:** 25-point dynamic-area AF
- **Custom Settings**
  - ▶ **a1 AF-C priority selection:** Release
  - ▶ **a3 Focus tracking with lock-on**
    - > **Blocked shot AF response:** 2      **Subject motion:** Normal
  - ▶ **a10 Autofocus mode restrictions:** AF-C
  - ▶ **c2 Standby timer:** 1 min

### ● **AF Mode: AF-C**

Focus is adjusted continuously while the shutter-release button is pressed halfway or the **AF-ON** button is pressed.

### ● **AF-Area Mode: 25-Point Dynamic-Area AF**

If your subject briefly leaves the selected focus point, the camera will focus based on information from surrounding focus points. The following indicators are displayed while the AF-mode button is pressed.

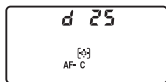

*Control panel*



*Focus-point display*



*Viewfinder*

## ● Focus Tracking with Lock-On

Custom Setting a3 (Focus tracking with lock-on) controls how autofocus responds to changes in the distance to the subject.

### Blocked Shot AF Response: 2

Increasing the speed with which the autofocus system reacts to blocked shots ensures that focus responds quickly to frequent subject changes.

### Subject Motion

Position the slider according to how your subject moves. The default (“normal”) position, midway between **Erratic** and **Steady**, is suited to a wide variety of subjects.

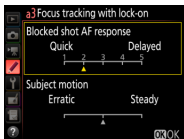

## ● The Standby Timer

*Choose long standby times* to keep the timer active and avoid the delay that occurs when it is reactivated (note that this increases the drain on the battery). If you're at a soccer match and the default six-second timer expires while you're waiting for a player to line up a corner kick, the delay may make you miss the golden moment following the kick. In situations like these, we suggest setting the timer to a minute or more.



See [pages 30–61](#) for the recommended AF settings for different sporting events.

## AF-Area Mode

Choose an AF-area mode according to your subject.

AF-area mode	Control panel	Viewfinder	Focus-point display	
			Selection	Shooting
Single-point AF	<b>S</b>	<b>S</b>		
25-point dynamic-area AF	<b>d 25</b>	<b>d 25</b>		
72-point dynamic-area AF	<b>d 72</b>	<b>d 72</b>		
153-point dynamic-area AF	<b>d 153</b>	<b>d 153</b>		
3D-tracking	<b>3d</b>	<b>3d</b>		
Group-area AF	<b>GrP</b>	<b>GrP</b>		
Auto-area AF	<b>Ruto</b>	<b>Ruto</b>		

---

---

## Description

The focus point is selected manually. The camera focuses on the subject in the selected focus point only. Choose for subjects you can keep framed in the selected focus point.

The focus point is selected manually. The camera focuses on the subject in the selected focus point when autofocus is initiated, but if the subject later leaves the selected point for brief periods, the camera will focus based on information from surrounding points (the edges of the area surrounding the selected focus point are shown by small dots, but all 25, 72, or 153 focus points in the area are used for focus). Choose for low-contrast subjects if the camera has difficulty focusing or for active subjects that are hard to keep framed in a single point, and increase the number of points if the subject is moving unpredictably or occupies a large area of the frame. Choose a setting one level higher for subjects at the edge of the frame.



The initial focus point is selected manually. While the shutter-release button is pressed halfway, the camera uses color information to track subjects that leave the selected focus point and selects new focus points as required.

The camera focuses using all the focus points in a group around the point selected by the user, reducing the risk of the camera focusing on the background. Choose for subjects that are difficult to photograph using a single focus point.

The camera automatically detects the subject and selects the focus point. Priority is given to the faces of any portrait subjects detected.

## ● Custom Settings **CHECK IT OUT** ✓

For faster AF-area mode selection, you can:

- **Assign specific AF-area modes to buttons using Custom Setting f1 (Custom control assignment, [page 24](#)):** If you assign 72-point dynamic-area AF to the **Pv** button and group-area AF to the lens focus function buttons, for example, and then select 25-point dynamic-area AF with the AF-mode button and sub-command dial, you can keep the **Pv** button pressed to take pictures with 72-point dynamic-area AF, keep a lens focus function button pressed to take pictures with group-area AF, or release both buttons to take pictures with 25-point dynamic-area AF.
- **Match AF-area mode to camera orientation using Custom Setting a7 (Store by orientation, [page 20](#)):** Select **Focus point and AF-area mode** to link AF-area mode selection to camera orientation.
- **Restrict AF-area mode selection using Custom Setting a9 (Limit AF-area mode selection, [page 23](#)).**

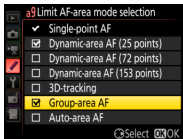
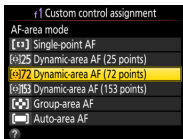



## Focus Points

The camera focuses using 153 focus points, of which the 55 shown in red at right can be selected by the user. The available cross sensors and focus points vary with the lens or teleconverter used ([pages 10–14](#)).

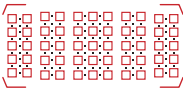

### Focus-Point Selection

The center focus point can be selected by pressing the center of the multi selector. See [page 20](#) for information on choosing the number of focus points available, [page 23](#) for information on configuring focus-area selection to “wrap around”.

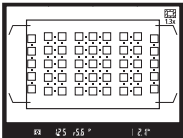

### 1.3× (18 × 12)

The focus points at the left and right edges of the display are not available when **1.3× (18 × 12)** is selected for **Choose image area**. Instead, the camera focuses using 117 focus points, of which 45 can be selected by the user. If another focus point is active when **1.3× (18 × 12)** is selected, focus will move to the closest available point. The previous selection will be restored if the user chooses another image area option without changing the focus point.



## ● Cross Sensors



The focus points with cross sensors are highlighted in green. All other focus points use line sensors.

Lens	Cross sensors
AF-S lenses other than those listed below with maximum apertures of f/4 or faster*	 <p>99 cross sensors</p>
<ul style="list-style-type: none"> <li>• AF-S DX Zoom-Nikkor 12–24mm f/4G IF-ED</li> <li>• AF-S Micro NIKKOR 60mm f/2.8G ED</li> <li>• AF-S NIKKOR 600mm f/4G ED VR</li> <li>• AF-S NIKKOR 600mm f/4E FL ED VR</li> <li>• AF-S Nikkor 600mm f/4D IF-ED II</li> <li>• AF-S Nikkor 600mm f/4D IF-ED</li> </ul>	 <p>63 cross sensors</p>
<ul style="list-style-type: none"> <li>• AF-S NIKKOR 200–400mm f/4G ED VR II</li> <li>• AF-S VR Zoom-Nikkor 200–400mm f/4G IF-ED</li> <li>• AF-S NIKKOR 500mm f/4G ED VR</li> <li>• AF-S Nikkor 500mm f/4D IF-ED II</li> <li>• AF-S Nikkor 500mm f/4D IF-ED</li> <li>• AF-S lenses with maximum apertures slower than f/4*</li> <li>• Non-AF-S lenses</li> </ul>	 <p>45 cross sensors</p>

\* At maximum zoom, in the case of zoom lenses.

## ● Teleconverters and Available Focus Points

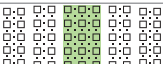
The focus points shown below are available for autofocus and electronic rangefinding when a teleconverter is used. Cross-sensor focus points are highlighted in green.

Teleconverter	Max. lens aperture	Focus points
<ul style="list-style-type: none"> <li>• TC-14E/TC-14E II/TC-14E III</li> <li>• TC-17E II</li> <li>• TC-20E/TC-20E II/TC-20E III</li> </ul>	f/2	 153 (55 selectable); 99 cross sensors
TC-14E/TC-14E II/TC-14E III	f/2.8	
<ul style="list-style-type: none"> <li>• TC-17E II</li> <li>• TC-20E/TC-20E II/TC-20E III</li> </ul>	f/2.8	 153 (55 selectable); 45 cross sensors
TC-14E/TC-14E II/TC-14E III	f/4	
TC-17E II	f/4	 37 (17 selectable); 25 cross sensors <sup>1</sup>
TC-800-1.25E ED	f/5.6	
TC-20E/TC-20E II/TC-20E III	f/4 <sup>2</sup>	 15 (9 selectable); 5 cross sensors <sup>1</sup>
TC-14E/TC-14E II/TC-14E III	f/5.6 <sup>2</sup>	

1. Points shown in gray support autofocus under some conditions.

2. With support for a combined aperture of f/8.

The focus points available for autofocus and electronic rangefinding when teleconverters are used in combination with different lenses are shown below (data are current as of April 2016).

#### AF-S NIKKOR 400mm f/2.8E FL ED VR and 70–200mm f/2.8G ED VR II

- **Alone or with TC-14E/TC-14E II/TC-14E III:**

153 (55 selectable); 99 cross sensors



- **With TC-17E II or TC-20E/TC-20E II/TC-20E III:**

153 (55 selectable); 45 cross sensors

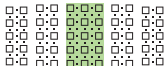

#### AF-S NIKKOR 500mm f/4E FL ED VR

- **Alone:** 153 (55 selectable); 99 cross sensors



- **With TC-14E/TC-14E II/TC-14E III:**

153 (55 selectable); 45 cross sensors

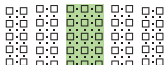

- **With TC-17E II:**

37 (17 selectable); 25 cross sensors



- **With TC-20E/TC-20E II/TC-20E III:**

15 (9 selectable); 5 cross sensors with support for a combined aperture of f/8



**AF-S NIKKOR 600mm f/4E FL ED VR**

- **Alone:** 153 (55 selectable); 63 cross sensors



- **With TC-14E/TC-14E II/TC-14E III:**  
153 (55 selectable); 45 cross sensors



- **With TC-17E II:**  
37 (17 selectable); 25 cross sensors



- **With TC-20E/TC-20E II/TC-20E III:**  
15 (9 selectable); 5 cross sensors with support for a combined aperture of f/8

**AF-S NIKKOR 200–400mm f/4G ED VR II**

- **Alone or with TC-14E/TC-14E II/TC-14E III:**  
153 (55 selectable); 45 cross sensors

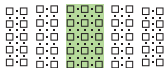

- **With TC-17E II:**  
37 (17 selectable); 25 cross sensors



- **With TC-20E/TC-20E II/TC-20E III:**  
15 (9 selectable); 5 cross sensors with support for a combined aperture of f/8



---

**AF-S NIKKOR 80–400mm f/4.5-5.6G ED VR and 200–500mm f/5.6E ED VR**

- **Alone:** 153 (55 selectable); 45 cross sensors



- **With TC-14E/TC-14E II/TC-14E III:**

15 (9 selectable); 5 cross sensors with support for a combined aperture of f/8



## Sports AF: Custom Settings

---

The following options are available in Custom Settings Group “a” (**Autofocus**).

---

a1 AF-C priority selection

---

a2 AF-S priority selection

---

a3 Focus tracking with lock-on

---

a4 3D-tracking face-detection

---

a5 3D-tracking watch area

---

a6 Number of focus points

---

a7 Store by orientation

---

a8 AF activation

---

a9 Limit AF-area mode selection

---

a10 Autofocus mode restrictions

---

a11 Focus point wrap-around

---

a12 Focus point options

---

a13 Manual focus ring in AF mode

---

## ● a1: AF-C Priority Selection

Custom Setting a1 (**AF-C priority selection**) controls whether the camera gives priority to focus or shutter release.

*Shutter-release button pressed all the way down*

 **Release:** Pictures can be taken whether or not the camera is in focus. Frame rates do not slow during burst photography.

 **Focus + release:** In burst mode, priority is given to focus for the first frame and to release for later frames, ensuring that the first frame is in focus and that no subsequent frames are missed. Frame rates do not slow.

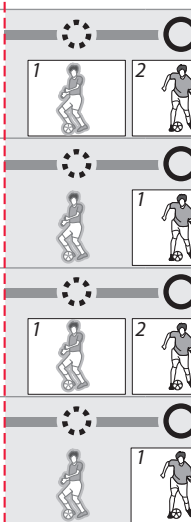

 **Release + focus:** In burst mode, priority is given to release for the first frame and to focus for later frames. Frame rates slow as needed to allow camera to focus.

 **Focus:** Pictures can only be taken when the camera is in focus.



Note: Release timing not exactly as shown.



: Subject not in focus    
 : Subject in focus    
 : Photo taken (frame number shown in top left corner)

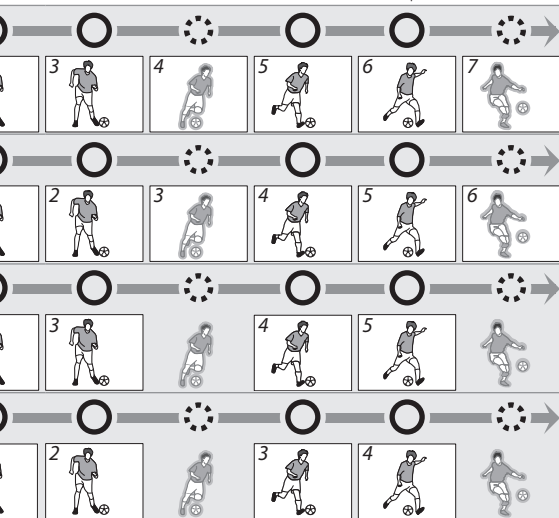

### ● a3: Focus Tracking with Lock-On

This menu contains two options: **Blocked shot AF response** and **Subject motion**.

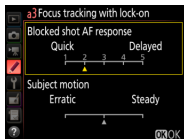

#### **Blocked Shot AF Response**

In continuous-servo AF, focus tracking with lock-on prevents the camera refocusing when your subject is briefly obscured by another object, ensuring that it will continue to track the main subject once the obstacle has moved away. Choose the length of time before the camera refocuses from **1 (Quick)**, **2**, **3**, **4**, and **5 (Delayed)**. Lock-on applies only while the camera is focusing; to focus at a new distance without waiting for lock-on to end, re-initiate autofocus.

*The camera will track and focus on objects at the same distance as the main subject. High values (slow response) make the camera slow to refocus on obstacles when the shot is blocked. Select low values (quick response) to quickly refocus on subjects passing in front of the camera and for improved response when switching rapidly from one subject to another.*

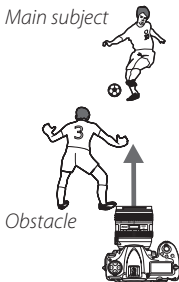



**Subject Motion**

Choose how the camera tracks subjects in motion. Choose **Steady** for subjects approaching the camera at a steady pace, like speed skaters or race cars on a track, **Erratic** for hockey players and other subjects prone to sudden stops and starts.

---

## ● a6: Number of Focus Points

Choose the focus points available for user selection.

- **AF55 55 points:** Choose from the 55 points shown at right. Use for precise framing. 
- **AF15 15 points:** Choose from the 15 points shown at right. Use for quick focus-point selection. 

## ● a7: Store by Orientation

This option lets you concentrate on shooting without having to worry about focus-point selection. Choose whether the camera uses the same focus point and AF-area mode in all orientations, or stores separate focus points and/or AF-area modes for use in “wide” (landscape) orientation, “tall” (portrait) orientation with the camera rotated 90° clockwise, or “tall” orientation with the camera rotated 90° counterclockwise. The options are **Focus point**, **Focus point and AF-area mode**, and **Off**.

- **Focus point:** Rotating the camera restores the focus point last selected in the chosen orientation. If you select **Off** after choosing this option, the camera will select the center focus point for all orientations.
- **Focus point and AF-area mode:** Rotating the camera restores the focus point and AF-area mode last selected in the chosen orientation.

Camera  
rotated 90°  
counterclockwise



Landscape (wide)  
orientation



Camera rotated  
90° clockwise



- **Off:** The same focus point and AF-area mode will be used regardless of camera orientation.

Camera  
rotated 90°  
counterclockwise



Landscape (wide)  
orientation



Camera rotated  
90° clockwise



## ● a8: AF Activation

Choose **AF-ON only** to split the functions of the **AF-ON** and shutter-release buttons so that the former is used for focus while the latter is used only to release the shutter. Lift your thumb from the **AF-ON** button to lock focus and take more shots at the current focus distance or prevent the camera refocusing when an object passes between you and your subject.

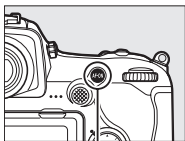

**AF-ON button**

Highlighting **AF-ON only** and pressing  displays an **Out-of-focus release** option; for sports photography, confirm that **Enable** is selected.

Custom Setting f1 (**Custom control assignment**) can be used to assign **AF-ON** to controls other than the **AF-ON** button. The lens focus function buttons on telephoto lenses equipped with a focus function selector will perform the same function as the camera **AF-ON** button when the selector is in the **AF-ON** position.

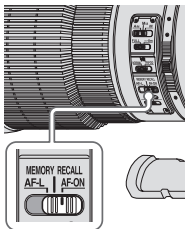

### ● a9: Limit AF-Area Mode Selection

Prevent the selection of unwanted AF-area modes. For example, you can select **Dynamic-area AF (25 points)** and **Group-area AF** to switch quickly back and forth between these two modes.

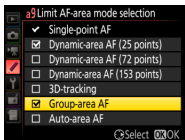

### ● a10: Autofocus Mode Restrictions

Prevent the selection of unwanted autofocus modes. For sports photography, you may find it convenient to choose **AF-C** to stop you accidentally selecting single-servo AF.

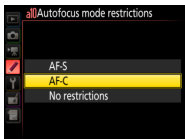

### ● a11: Focus Point Wrap-Around

Select **Wrap** if you frequently switch between widely separated focus points. Focus-point selection will “wrap around” from top to bottom, bottom to top, left to right, and right to left so that, for example, pressing  when a focus point on the right edge of the display is highlighted (①) selects the corresponding focus point on the left edge of the display (②).







## Sports AF: Custom Control Assignments **CHECK IT OUT** ✓

Custom Setting f1 (**Custom control assignment**) can be used to assign different roles, including focus-related functions, to camera controls such as the **Pv** and **Fn** buttons. Users of MB-D17 battery packs can in addition use Custom Setting f10 (**Assign MB-D17 buttons**) to choose the roles played by the buttons on the battery pack.







### ● Focus-Related Control Assignments

The following focus-related functions can be assigned to camera and battery-pack controls:

	D500						MB-D17	
	Pv	Fn1	Fn2	AF-ON	⊙	L.Fn	Fn	AF-ON
PRE <sup>[c]</sup> Preset focus point	✓	✓	—	—	✓	✓	✓	—
[ <sup>[c]</sup> ] AF-area mode	✓	✓	—	✓	✓	✓	—	✓
[ <sup>[c]</sup> ] AF-area mode + AF-ON	✓	✓	—	✓	✓	✓	—	✓
 AE/AF lock	✓	✓	—	✓	✓	✓	—	✓
 AF lock only	✓	✓	—	✓	✓	✓	—	✓
 AF-ON	✓	✓	—	✓	✓	✓	—	✓
=  Same as camera AF-ON button	—	—	—	—	—	—	—	✓

- **PRE<sup>[c]</sup> Preset focus point:** Pressing the control selects a preset focus point. To choose the point, select it and press the control while pressing the AF-mode button until the focus point flashes. If this option is assigned to the lens focus function buttons, you can select the preset focus point by pressing and holding a lens focus function button. Release the button to restore the original focus point selection.



- 
- [C] **AF-area mode:** Highlight this option and press  to select an AF-area mode (3D-tracking excluded). The selected mode will take effect while the control is pressed; releasing the control restores the original AF-area mode.
  - [C]  **AF-area mode + AF-ON:** As for **AF-area mode**, above, except that pressing the control also initiates autofocus.
  -  **AE/AF lock:** Focus and exposure lock while the control is pressed.
  -  **AF lock only:** Focus locks while the control is pressed.
  -  **AF-ON:** Pressing the control initiates autofocus.
  - =  **Same as camera AF-ON button:** The control performs the same function as that currently selected for the camera **AF-ON** button.

## ● Lens Focus Function Buttons

You can use  **Lens focus function buttons** to choose the role played by the focus function buttons when the focus function selector on the lens is set to **AF-L**. For fast-moving sports, choose **AF-area mode** to enable rapid AF-area mode selection.

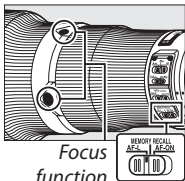

Focus  
function  
buttons

## Lenses with Focus Function Selectors

As of April 2016, the following lenses featured focus function selectors:

- AF-S NIKKOR 800mm f/5.6E FL ED VR
- AF-S NIKKOR 600mm f/4E FL ED VR
- AF-S NIKKOR 600mm f/4G ED VR
- AF-S NIKKOR 500mm f/4E FL ED VR
- AF-S NIKKOR 500mm f/4G ED VR
- AF-S NIKKOR 400mm f/2.8E FL ED VR
- AF-S NIKKOR 400mm f/2.8G ED VR
- AF-S NIKKOR 300mm f/2.8G ED VR II
- AF-S NIKKOR 200mm f/2G ED VR II
- AF-S NIKKOR 200–400mm f/4G ED VR II

## Auto AF Fine-Tuning **CHECK IT OUT** ✓

The D500 can fine-tune autofocus automatically. The results can be used with all lenses of the same type.



Use only as required. AF fine-tuning should be performed at the focus distance at which the lens is normally used; fine-tuning performed at short focus distances may be less effective with distant subjects and vice versa.

### **1** Ready the camera.

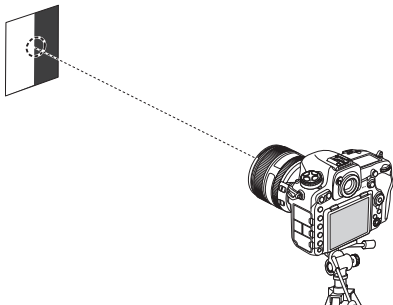
Mount the camera on a tripod and aim the camera at a flat, high-contrast subject parallel to the camera focal plane. Note that auto AF fine-tuning works best at maximum aperture and may not function in dark surroundings.



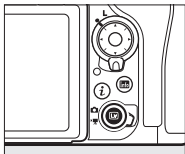

## 2 Start live view.

Rotate the live view selector to  and press the  button.



## 3 Adjust focus settings.

Rotate the focus-mode selector to **AF** and use the AF-mode button and command dials to select the following:

- Autofocus mode: **AF-S**
- AF-area mode:  (wide) or  (normal)

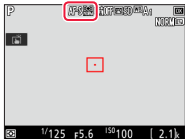

## 4 Select the center focus point.

Press the center of the multi selector to select the center focus point.

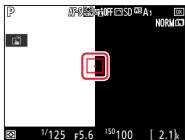

## 5 Focus.

Press the shutter-release button halfway to focus, then zoom in on the view through the lens to confirm that the subject is in focus.

**6** Perform auto AF fine-tuning.

Press the AF-mode and movie-record buttons simultaneously and keep them pressed until the dialog shown in Step 7 is displayed (this should take slightly over two seconds).

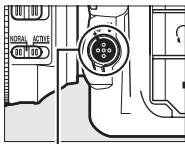

AF-mode button

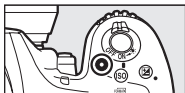

Movie-record button

**7** Save the new value.

Highlight **Yes** and press **OK** to add the AF fine-tuning value for the current lens to the saved values list (CPU lenses only). Note that only one value can be stored for each type of lens.

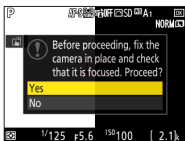
**8** Enable AF fine-tuning.

In the camera setup menu, select **AF fine-tune** > **AF fine-tune (On/Off)**, then highlight **On** and press **OK**.

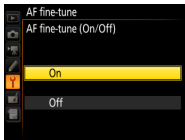

## Recommended AF Settings by Event

This section offers some advice on adjusting autofocus-related settings for different sporting events.

### ● Overview: Settings by Event

The settings for different events are summarized in the table below.

	Event	AF mode	AF-area mode
Winter sports	<a href="#">Soccer (page 34)</a>	AF-C	25-point dynamic-area AF
	<a href="#">Hockey (page 35)</a>		
	<a href="#">Ski jumping (from the side, page 36)</a>		
	<a href="#">Ski jumping (from the front, page 37)</a>		
	<a href="#">Alpine skiing (near gates, page 38)</a>		
	<a href="#">Alpine skiing (jumps, page 39)</a>		
	<a href="#">Singles figure skating (page 40)</a>		
	<a href="#">Pairs figure skating/ice dance (page 42)</a>		
	<a href="#">Speed skating (page 43)</a>		
	<a href="#">Short-track speed skating (page 44)</a>		
Gymnastics	<a href="#">Floor exercises (page 46)</a>		25- or 72-point dynamic- or auto-area AF
	<a href="#">Rhythmic gymnastics (page 48)</a>		25- or 72-point dynamic- or 3D-tracking

Custom Settings				
a1: AF-C priority selection	a3: Focus tracking with lock-on		a7: Store by orientation	
	Blocked shot AF response	Subject motion		
Release	2	Normal	Focus point	
	1 (Quick) or 2	Erratic		
	2	Normal	—	
	3		Normal or erratic	Focus point
			Normal	
			Steady	
			Normal	

Event		AF mode	AF-area mode
Gymnastics	<a href="#">Balance beam (page 50)</a>	AF-C	25- or 72-point dynamic- or 3D-tracking or auto-area AF
	<a href="#">Vault (page 51)</a>		25- or 72-point dynamic- or auto-area AF
	<a href="#">Rings and horizontal bar (page 51)</a>		25-point dynamic- or group-area AF
Athletics	<a href="#">Sprints (page 52)</a>		Single- or 25-point dynamic-area AF
	<a href="#">Hurdles (page 54)</a>		Single- or 25-point dynamic-area AF
	<a href="#">Marathons (from a vehicle, page 55)</a>		Group-area AF
	<a href="#">Shot put, discus, javelin, and hammer throw (page 55)</a>		25-point dynamic-area AF
	<a href="#">Long jump and triple jump (page 56)</a>		25- or 72-point dynamic-area AF
Aquatics	<a href="#">High jump and pole vault (page 56)</a>		25-point dynamic-area AF
	<a href="#">Synchronized swimming (page 57)</a>		Single-point AF
	<a href="#">Swimming (page 58)</a>	3D-tracking or auto-area- or 72-point dynamic-area AF	
	<a href="#">Diving (page 60)</a>		



## Recommended AF Settings by Event

Custom Settings				
a1: AF-C priority selection	a3: Focus tracking with lock-on		a7: Store by orientation	
	Blocked shot AF response	Subject motion		
Release	3	Normal	—	
	2	Normal or erratic		
	3		Normal	Focus point
			Erratic	—
			Normal	

---

## ● Soccer

Photographing soccer matches involves quick changes of focus and subjects that may be briefly obscured by foreground objects. The following autofocus settings are recommended:



- **Autofocus mode:** AF-C
- **AF-area mode:** 25-point dynamic-area AF
- **Custom Settings**
  - **a1 AF-C priority selection:** Release
  - **a3 Focus tracking with lock-on**
    - > **Blocked shot AF response:** 2      **Subject motion:** Normal
  - **a7 Store by orientation:** Focus point

## ● Winter Sports

Here are some suggested settings for photographers at the rink or on the slopes.

### Hockey

If you find yourself continually switching subjects as the puck passes from one player to another, select low values for Custom Setting a3 (**Focus tracking with lock-on**) >

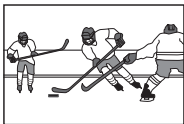

**Blocked shot AF response** to quickly refocus at new focus distances. Note, however, that the camera will refocus instantly when the subject leaves the focus point.

- **Autofocus mode:** AF-C
- **AF-area mode:** 25-point dynamic-area AF
- **Custom Settings**
  - ▶ a1 AF-C priority selection: Release
  - ▶ a3 Focus tracking with lock-on
    - > Blocked shot AF response: 1 (Quick) or 2
    - > Subject motion: Erratic
  - ▶ a7 Store by orientation: Focus point

## Ski Jumping

Choose settings according to whether you are at the side of the hill with jumpers crossing your field of view or at the bottom with jumpers coming toward you.

### From the Side

The following settings are recommended for shots taken from the side of the hill.

- **Autofocus mode:** AF-C
- **AF-area mode:** 25-point dynamic-area AF
- **Custom Settings**
  - ▶ **a1 AF-C priority selection:** Release
  - ▶ **a3 Focus tracking with lock-on**
    - > **Blocked shot AF response:** 2      **Subject motion:** Normal

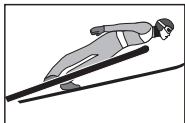

If you find the subject hard to track with 25 focus points, choose a dynamic-area AF mode with 72 or 153 points to increase the supplementary focus coverage available if the subject slips from the selected point. Note that when the subject is at the edge of the frame, the number of focus points available for dynamic-area AF drops; for coverage similar to 25 points, choose 72-point AF.



25-point AF (center)    25-point AF (edge)    72-point AF (edge)

### From the Front

When the subject is at the edge of the frame, the number of focus points available for dynamic-area AF drops; for coverage similar to 25-point AF, choose 72-point AF.

- Autofocus mode: AF-C
- AF-area mode: 25-point dynamic-area AF
- Custom Settings



▶ a1 AF-C priority selection: Release

▶ a3 Focus tracking with lock-on

> Blocked shot AF response: 2

Subject motion: Normal



25-point AF (center)

25-point AF (edge)

72-point AF (edge)

---

## Alpine Skiing

Choose settings according to whether the skier is near the gate or taking air over a jump.

### Near Gates

With a slow blocked-shot response of **5 (Delayed)** or **4**, the camera may be slow to switch back to the skier after focusing on a gate (the effect varies with the distance between



the gate and the skier). If you want to keep the **AF-ON** button pressed or the shutter-release button pressed half-way for continuous focus, you can choose **2** or **1 (Quick)** for improved focus switching (note that this increases the chance of the camera focusing on the gate). Alternatively, you can choose a slow setting such as **5 (Delayed)** or **4** and release the **AF-ON** or shutter-release button as needed to refocus after the camera has locked onto a gate.

- **Autofocus mode:** AF-C
- **AF-area mode:** 25-point dynamic-area AF
- **Custom Settings**
  - a1 AF-C priority selection: Release
  - a3 Focus tracking with lock-on
    - > **Blocked shot AF response:** 2      **Subject motion:** Normal

## **Jumps**

If you anticipate that the subject will come into view suddenly and will not overlap a gate, choose group-area AF. Group-area AF uses a selected group of 5 or more focus points, letting

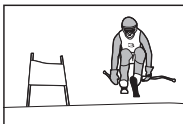

you track your subject in a wide area and ensuring that even small, fast-moving, and hard-to-frame subjects can reliably be captured in sharp focus.

- **Autofocus mode:** AF-C
- **AF-area mode:** Group-area AF
- **Custom Settings**
  - **a1 AF-C priority selection:** Release
  - **a3 Focus tracking with lock-on**
    - > **Blocked shot AF response:** 3      **Subject motion:** Normal

---

### ***Singles Figure Skating***

Auto-area AF is recommended if composition is a priority. To automatically switch focus points and AF-area modes as you go from “tall” (portrait) to “wide” (landscape) orientation and back again ([page 41](#)), select **Focus point and AF-area mode** for Custom Setting a7 (**Store by orientation**).



- **Autofocus mode:** AF-C
- **AF-area mode:** 25- or 72-point dynamic-area or group- or auto-area AF
- **Custom Settings**
  - a1 AF-C priority selection: Release
  - a3 Focus tracking with lock-on
    - > Blocked shot AF response: 3
    - Subject motion: Normal or erratic
  - a7 Store by orientation: Focus point



### Instant AF-Area Mode Selection

For flexible AF-area mode selection when photographing figure skating, select 25- or 72-point dynamic- or auto-area AF with the camera and assign group-area AF to the focus function buttons using Custom Setting f1

(**Custom control assignment**) > **Lfn** **Lens focus function buttons** (page 26). You can then press a focus function button to select group-area AF when framing shots of distant subjects with the camera in wide orientation, and release the button to switch to 25- or 72-point dynamic- or auto-area AF when framing shots of nearby subjects in tall orientation.

**CHECK IT OUT** ✓



#### Subject nearby

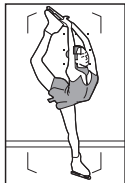

25-point dynamic-area AF



Auto-area AF

#### Distant subject

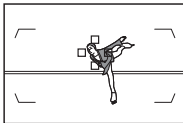

Group-area AF

### Pairs Figure Skating/Ice Dance

For events in which skaters frequently cross in front of one another, a slow blocked-shot response is recommended to improve tracking and prevent the focus point falling between the skaters.



- **Autofocus mode:** AF-C
- **AF-area mode:** Auto- or group-area AF
- **Custom Settings**
  - ▶ **a1 AF-C priority selection:** Release
  - ▶ **a3 Focus tracking with lock-on**
    - > **Blocked shot AF response:** 3      **Subject motion:** Normal
  - ▶ **a7 Store by orientation:** Focus point

Use group-area AF if the subjects are far away. For flexible AF-area mode selection, select auto-area AF with the camera and assign group-area AF to the focus function buttons using Custom Setting f1 (**Custom control assignment**) > **LFn Lens focus function buttons** ([page 26](#)). You can then press a focus function button to select group-area AF for distant subjects and release the button to switch to auto-area AF when your subjects are closer.

### **Speed Skating**

For more precise focus, use 25-point dynamic-area AF for wide-orientation upper-body shots and shots taken head-on. Switch to 72 points for tall-orientation shots with the skater near the edge of the frame.



- **Autofocus mode:** AF-C
- **AF-area mode:** 25- or 72-point dynamic-area AF
- **Custom Settings**
  - ▶ **a1 AF-C priority selection:** Release
  - ▶ **a3 Focus tracking with lock-on**
    - > **Blocked shot AF response:** 3      **Subject motion:** Steady
  - ▶ **a7 Store by orientation:** Focus point

When the subject is at the edge of the frame, the number of focus points available for dynamic-area AF drops; for coverage similar to 25-point AF, choose 72-point AF.

---

### Short-Track Speed Skating

The following settings are recommended:

- **Autofocus mode:** AF-C
- **AF-area mode:** 25-point dynamic- or group-area AF
- **Custom Settings**
  - ▶ a1 AF-C priority selection: Release
  - ▶ a3 Focus tracking with lock-on
    - > Blocked shot AF response: 3      Subject motion: Normal
  - ▶ a7 Store by orientation: Focus point

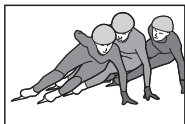

### Instant AF-Area Mode Selection

Group-area AF is a good choice when your subject is in the lead, but it may continue to focus on the leader even when your subject is back in the pack. For rapid AF-area mode selection when skaters switch positions, assign **AF-area mode** to the lens focus function buttons using Custom Setting f1 (**Custom control assignment**) > **Lfn** **Lens focus function buttons** (page 26).

Custom Setting f1 (**Custom control assignment**) > **Lfn** **Lens focus function buttons** (page 26).

**CHECK IT OUT** ✓

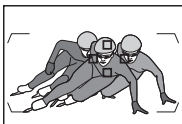

*Group-area AF  
(subject in lead)*

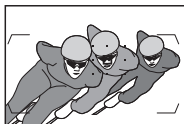

*25-point dynamic-area AF  
(subject in pack)*

---

## ● **Gymnastics**

Try these settings for gymnastics events.

### **Floor Exercises**

Auto-area AF is recommended if composition is a priority, but dynamic-area AF may be preferred if the background contains objects with regular, detailed patterns, as otherwise photos may not be in focus even if the in-focus indicator (●) is lit. If you are using dynamic-area AF, choose an option with a comparatively high number of focus points (□) to capture fast-moving subjects.



- **Autofocus mode:** AF-C
- **AF-area mode:** Auto-area AF or 25- or 72-point dynamic-area
- **Custom Settings**
  - ▶ a1 AF-C priority selection: Release
  - ▶ a3 Focus tracking with lock-on
    - > Blocked shot AF response: 3      Subject motion: Normal
  - ▶ a7 Store by orientation: Focus point

Select **Focus point and AF-area mode** for Custom Setting a7 (**Store by orientation**) to automatically switch focus points and AF-area modes as you rotate the camera ([page 20](#)). If you find yourself frequently changing focus points, choose **15 points** for Custom Setting a6 (**Number of focus points**) to reduce the number of focus points for quicker selection ([page 20](#)).

55 points  → 15 points 

---

### Rhythmic Gymnastics

For events with apparatuses, choose 3D-tracking, position the focus area over your subject (for best results, choose the uniform or another area of the subject that is a different color from the background), and press and hold the **AF-ON** button or keep the shutter-release button pressed halfway. The camera will automatically track the subject, letting you concentrate on composition. If you find that the camera has trouble tracking athletes against the stands, billboards, and other varied backgrounds, switch to 25- or 72-point dynamic-area AF.



- **Autofocus mode:** AF-C
- **AF-area mode:** 25- or 72-point dynamic-area AF or 3D-tracking
- **Custom Settings**
  - ▶ **a1 AF-C priority selection:** Release
  - ▶ **a3 Focus tracking with lock-on**
    - > **Blocked shot AF response:** 3      **Subject motion:** Normal
  - ▶ **a7 Store by orientation:** Focus point



Select **Focus point and AF-area mode** for Custom Setting a7 (**Store by orientation**) to automatically switch focus points and AF-area modes as you rotate the camera ([page 20](#)). If you find yourself frequently changing focus points when using dynamic-area AF, choose **15 points** for Custom Setting a6 (**Number of focus points**) to reduce the number of focus points for quicker selection ([page 20](#)).



---

## **Balance Beam**

Auto-area AF is recommended if composition is a priority, while 25-point dynamic-area AF is suggested for close-ups. When photographing events with frequent jumps or changes of direction, choose 3D-tracking, position the focus area over your subject (for best results, choose the uniform or another area of the subject that is a different color from the background), and press and hold the **AF-ON** button or keep the shutter-release button pressed halfway. The camera will automatically track the subject, letting you concentrate on composition. If you find that the camera has trouble tracking athletes against the stands, billboards, and other varied backgrounds, switch to 25- or 72-point dynamic-area AF.



- **Autofocus mode:** AF-C
- **AF-area mode:** 25- or 72-point dynamic-area or 3D-tracking or auto-area AF
- **Custom Settings**
  - a1 AF-C priority selection: Release
  - a3 Focus tracking with lock-on
    - > Blocked shot AF response: 3      Subject motion: Normal

### Vault

If you find the subject hard to frame, choose a dynamic-area AF mode with more focus points (□) or select auto-area AF. Auto-area AF in particular lets you concentrate on composition while leaving the camera in charge of choosing the focus point.

- Autofocus mode: AF-C
- AF-area mode: 25- or 72-point dynamic- or auto-area AF
- Custom Settings
  - ▶ a1 AF-C priority selection: Release
  - ▶ a3 Focus tracking with lock-on
    - > Blocked shot AF response: 2      Subject motion: Normal or erratic



If you can't see athletes on their approach, focus on the vault and then refocus when a vaulter comes into view.

### Rings and Horizontal Bar

If you find the subject hard to track using 25-point dynamic-area AF, choose a mode with more focus points (□).

- Autofocus mode: AF-C
- AF-area mode: 25- or 72-point dynamic-area or auto-area AF
- Custom Settings
  - ▶ a1 AF-C priority selection: Release
  - ▶ a3 Focus tracking with lock-on
    - > Blocked shot AF response: 3      Subject motion: Normal

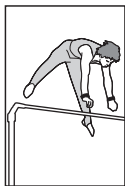

---

## ● Athletics

You may find these settings useful when photographing road running or track and field events.

### Sprints

Choose *25-point dynamic-area AF* when photographing approaching runners to help prevent the camera focusing on their hands, *group-area AF* for more reliable focus when photographing runners on the start line and in other shots taken at long range.



- **Autofocus mode:** AF-C
- **AF-area mode:** 25-point dynamic-area or group-area AF
- **Custom Settings**
  - a1 AF-C priority selection: Release
  - a3 Focus tracking with lock-on
    - > Blocked shot AF response: 3      Subject motion: Normal
  - a7 Store by orientation: Focus point

Select **Focus point and AF-area mode** for Custom Setting a7 (**Store by orientation**) to automatically switch focus points and AF-area modes as you rotate the camera between “tall” (portrait) orientations and “wide” (landscape) orientation for shots taken after the runner has crossed the finish line ([page 20](#)).

### Instant AF-Area Mode Selection

For flexible AF-area mode selection when photographing approaching runners, select 25-point dynamic-area AF with the camera and assign group-area AF to the focus function buttons using Custom Setting f1 (**Custom control assignment**) > **L/Fn Lens focus function buttons** (page 26). You can then press a focus function button to select group-area AF when your subject is far away and release the button as the runners approach to instantly switch to 25-point dynamic-area AF without taking your eye from the viewfinder.

**CHECK IT OUT** ✓

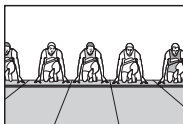

*Group-area AF  
(distant subject)*



*25-point dynamic-area AF  
(runner approaching)*

---

## ***Hurdles***

Choosing an AF-area mode with comparatively few focus points (single-point or 25-point dynamic-area AF) helps prevent the camera focusing on the hurdles or the hurdler's legs. You can refocus as needed if the camera focuses on the hurdles in the foreground.

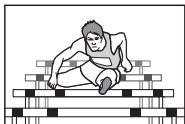

- **Autofocus mode:** AF-C
- **AF-area mode:** Single-point AF or 25-point dynamic-area AF
- **Custom Settings**
  - ▶ a1 AF-C priority selection: Release
  - ▶ a3 Focus tracking with lock-on
    - > Blocked shot AF response: 3      Subject motion: Normal
  - ▶ a7 Store by orientation: Focus point

Select **Focus point and AF-area mode** for Custom Setting a7 (**Store by orientation**) to automatically switch focus points and AF-area modes as you rotate the camera between “tall” (portrait) orientations and “wide” (landscape) orientation for shots taken after the hurdler has crossed the finish line ([page 20](#)).

### Marathons (from a Vehicle)

Choosing 25-point dynamic-area AF or single-point AF makes it easy to keep subjects in focus as they change position in the pack, but you could instead choose auto-area AF

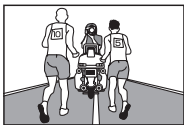

if you find it hard to keep your subject in the focus point when shooting from a moving vehicle. If your lens supports vibration reduction, choose **SPORT** (if available) or **ACTIVE** to reduce camera blur. **SPORT** also stabilizes the image in the viewfinder.

- Autofocus mode: AF-C
- AF-area mode: 25-point dynamic-area *or* single-point AF
- Custom Settings
  - ▶ a1 AF-C priority selection: Release
  - ▶ a3 Focus tracking with lock-on
    - > Blocked shot AF response: 3      Subject motion: Normal

### Shot Put, Discus, Javelin, and Hammer Throw

Choose group-area AF for more reliable focus when photographing these events from the front at long ranges.

- Autofocus mode: AF-C
- AF-area mode: Group-area AF
- Custom Settings
  - ▶ a1 AF-C priority selection: Release
  - ▶ a3 Focus tracking with lock-on
    - > Blocked shot AF response: 3      Subject motion: Normal



### Long Jump and Triple Jump

Choosing a dynamic-area AF mode with comparatively few focus points (□) when photographing long and triple jumps from the front helps prevent the camera focusing on the sand while still letting you capture subject motion.

- Autofocus mode: AF-C
- AF-area mode: 25-point dynamic-area AF
- Custom Settings
  - ▶ a1 AF-C priority selection: Release
  - ▶ a3 Focus tracking with lock-on
    - > Blocked shot AF response: 3      Subject motion: Erratic



### High Jump and Pole Vault

If you find it difficult to keep the subject in the frame, choose a dynamic-area AF mode with more focus points (□) or select auto-area AF.

- Autofocus mode: AF-C
- AF-area mode: 25- or 72-point dynamic-area AF
- Custom Settings
  - ▶ a1 AF-C priority selection: Release
  - ▶ a3 Focus tracking with lock-on
    - > Blocked shot AF response: 3      Subject motion: Erratic

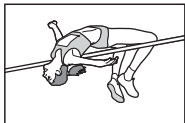



## ● Aquatics

### Synchronized swimming

- Autofocus mode: AF-C
- AF-area mode: 25-point dynamic-area AF
- Custom Settings
  - ▶ a1 AF-C priority selection: Release
  - ▶ a3 Focus tracking with lock-on
    - > Blocked shot AF response: 3
    - > Subject motion: Normal



---

## **Swimming**

Choosing single-point AF helps prevent the camera focusing on splashes (you can refocus as needed if the camera fails to focus on the main subject).



- **Autofocus mode:** AF-C
- **AF-area mode:** Single-point AF
- **Custom Settings**
  - **a1 AF-C priority selection:** Release
  - **a3 Focus tracking with lock-on**
    - > **Blocked shot AF response:** 3      **Subject motion:** Normal

### Instant AF-Area Mode Selection

**CHECK IT OUT** ✓

For flexible AF-area mode selection when photographing the start of a race, select single-point AF with the camera and assign group-area AF to the focus function buttons using Custom Setting f1 (**Custom control assignment**) >



> **Lfn** **Lens focus function buttons** ([page 26](#)).

You can then press a focus function button to select group-area AF when your subject is diving from the starting block and release the button once the swimmer is in the water to instantly switch to single-point AF without taking your eye from the viewfinder. AF-area mode can also be assigned to the **Pv**, **Fn1**, **Fn2**, or **AF-ON** button, to the center of the sub-selector, or to the **AF-ON** button on the optional MB-D17 battery pack ([page 24](#)).

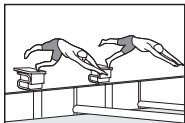

*Group-area AF (distant subject diving)*



*Single-point AF (subject swimming)*

## Diving

When photographing divers against *low-contrast, undifferentiated backgrounds*, choose 3D-tracking, position the focus area over your subject (for best results, choose the uniform

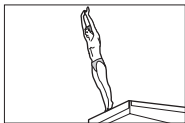

or another area of the subject that is a different color from the background), and press and hold the **AF-ON** button or keep the shutter-release button pressed halfway. The camera will automatically track the diver, letting you concentrate on composition. When photographing divers against the stands, billboards, and other *high-contrast backgrounds*, select 72-point dynamic-area AF.

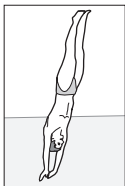

*Low-contrast background*



*High-contrast background*

- **Autofocus mode:** AF-C
- **AF-area mode:** 3D-tracking or auto-area or 72-point dynamic-area AF
- **Custom Settings**
  - ▶ a1 AF-C priority selection: Release
  - ▶ a3 Focus tracking with lock-on
    - > Blocked shot AF response: 3      Subject motion: Normal
  - ▶ a4 3D-tracking face-detection: Off

***Nikon***