

eX5000 Electronic Dartboard & Cabinet

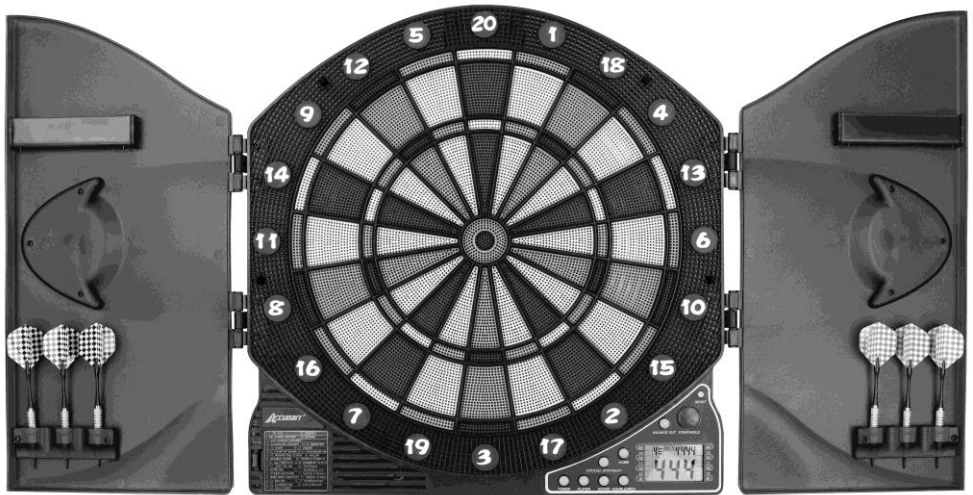

www.escaladesports.com
TO ORDER PARTS
Visit our website before returning to store



Instructions and Rules

817 Maxwell Ave. Evansville, IN 47711 / www.escaladesports.com

CPSIA#2-D5370- -JW

Congratulations! We hope you will have many hours of enjoyable use with your new product!



PLEASE KEEP YOUR INSTRUCTIONS!

- Your Model number is necessary should you need to contact us.
- Please read through this instruction book to familiarize yourself with all the parts and assembly steps.
- Refer to the Parts Identifier and verify that all parts have been included.
- For questions that may arise or for missing parts, **PLEASE CONTACT US BEFORE RETURNING THE DARTBOARD TO THE STORE**



CONTACT INFORMATION:

Hours: Mon.- Fri., 9:00 am to 5:00 pm EST

Replacement Parts: order online at www.escaladesports.com

Technical Support: customerservice@escaladesports.com / 1-800-526-0451

INDEX

Index.....	2
Mounting Instruction	4
Dartboard Functions	5
Game Table	8
Game Instructions	10
Important Notes.....	21
Descriptions.....	22



WARNING! This is not a child's toy. Adult supervision is required for children playing this game. Please read instructions carefully. Proper use of this set can avoid damage or injury.

Do not mix old and new batteries. Do not mix alkaline, standard (carbon-zinc), or rechargeable (nickel-cadmium) batteries.

Caution: changes or modifications not expressly approved by the party responsible for compliance could void the user's authority to operate the equipment.





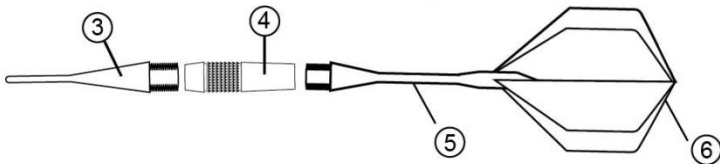

TOOLS REQUIRED FOR ASSEMBLY:

- Phillips Head Screwdrivers (or Power Driver) – not included
- Required 4 AA Batteries – not included
- AC Adapter (optional) – not included

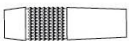

PARTS IDENTIFIER

<p>#1</p>  <p>MOUNTING HARDWARE 2 pcs</p>	<p>#2</p>  <p>SCREW ANCHOR 2 pcs</p>	<p>#3</p>  <p>TIP 12 pcs</p>
<p>#4</p>  <p>STEEL BARREL 6 pcs</p>	<p>#5</p>  <p>SHAFT 6 pcs</p>	<p>#6</p>  <p>FLIGHT 6 pcs</p>

UNPACKING THE GAME

Unpack your new dartboard carefully, making sure all parts are included. The following components are included in this set:

- 1 Electronic Dartboard
- 6 Darts (unassembled)
- Soft tip replacement pack
- Owner's Manual

MOUNTING INSTRUCTION

Choose a location to hang the dartboard where there is about 10 feet of open space in front of the board. The "toe-line" should be 7' 9 1/4" from the face of the dartboard.

Locate a wall stud and place a mark 75 inches from the floor. This mark is for the top screw hole. For the bottom two screws, you will measure down 15-1/4 inches from the top mark you just made (59-3/4 inches from the floor).

Insert mounting screws in the center of the marks you made.

Mount the dartboard on the wall by lining up the holes on the back with the screws. It may be necessary to adjust the screws until the board fits snugly against the wall.

Center of Bullseye should be 5' 8" from the floor when finished..

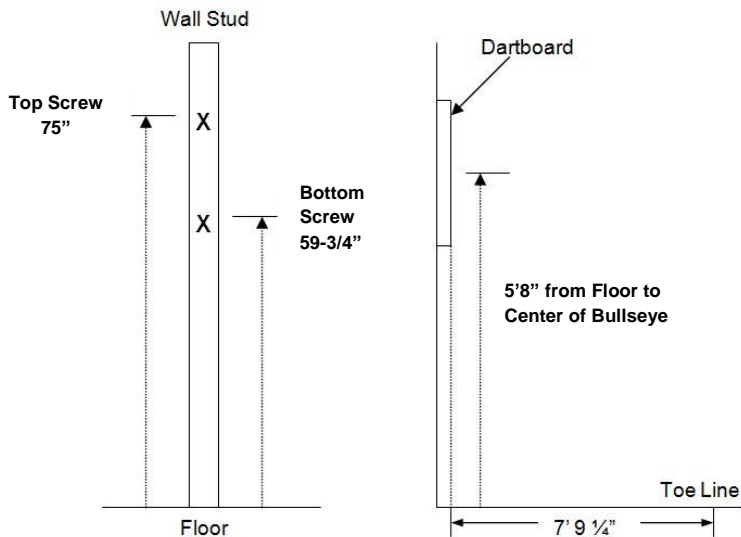

DARTBOARD FUNCTIONS

BUTTONS FUNCTION

POWER button - Press to turn game on or off. Dartboard has an automatic suspend mode to conserve power and battery life (if using batteries). The dartboard will make sound effect and display "SLEEP" on the display after approximately 3 minutes of non-use. However, the scores are stored in memory and can be restored by pressing any button.

RESET button - Cancels current score and returns to start of game.

SOUND button - Press to change volume to high, low, or off.

PLAYER / PAGE / SCORE button - This button is used at the start of each game to select the number of players you want to play the game. In addition, this button allows players to see other player scores of not on active display. This dartboard keeps track of up to 4 player scoring or 4 two-person teams. When playing with more than 2 players, some scores will be not be visible when not active. This button allows you to page through all players' scores as needed.

DOUBLE / MISS button - This button is used to activate the Double In/Double Out option for games which has Special Functions and only active on these games. Press the MISS button if you wish to register a dart that misses the target area.

BOUNCE OUT button - Decide before play if you want to count darts that do not remain in board ("bounce-outs") or not. If not, simply press the BOUNCE OUT button immediately after a bounce out occurs to deduct the score that registers.

VIRTUAL OPPONENT button - This button is used at the start Virtual Opponent mode. In this mode, player will play against computer.

START button - This multi-function button is used to:

- START the game when all options have been selected.
- CHANGE to the next player when one player is finished with his round.
This will put dartboard in HOLD status between rounds to allow player to remove darts from the target area.

GAME buttons - Press to page through the on-screen game menu.

DISPLAY PROTECTIVE FILM

This electronic dartboard may have a clear film over the entire display area to prevent scratching during shipping. It is recommended that this film be removed before play to enhance the display area visibility. To remove, simply lift edge, peel off, and discard.

ELECTRONIC DARTBOARD OPERATION

1. Press the **POWER** button to activate dartboard. A short musical introduction is played as the display goes through power-up test.
Press **GAME** buttons until desired game is displayed.

VIRTUAL OPPONENT FEATURE

This exciting feature allows solo player to play against the computer at one of five different levels of skill – only 1 player can compete against the Virtual Opponent competitor. This adds a level of competition to normally routine practice sessions.

To activate the Virtual Opponent:

1. Select the Game you wish to play.
2. Press **Virtual Opponent** button
Select Virtual Opponent skill level by pressing the **Virtual Opponent** button continually. Virtual Opponent Levels

Level 1	Professional
Level 2	Advanced
Level 3	Intermediate
Level 4	Novice
Level 5	Beginner

3. Press **START** to begin play.
When play begins:

The 'human' player throws first. After 3 darts are thrown, go to the board to take darts out and press **START** to change to the next player (Virtual Opponent). Watch as the Virtual Opponent's dart scores are registered on the display. After the Virtual Opponent completes his round, the board will **automatically reset** for the "human" player. Play continues until one player wins. **Good luck!**

SPECIAL FUNCTIONS

To make the game more challenging, some of games mode have the Special Functions. You may select the **DOUBLE** option to set additional restrictions on how to start and end the game. The choices are as follows:

- **Open In:** The scoring begins when any number is hit.
- **Open Out:** The player can finish the game with a hit on any number that reduces the score to exactly zero.
- **Double In:** To start, the player must hit a number in the double's ring or a double Bull's Eye. No score will be counted until this condition is met.
- **Double Out:** To win, the player must hit a number in the double's ring or a double Bull's Eye that reduces the score to exactly zero. A score leaving the player with "1" will BUST and revert back to the previous score. (This is because 1 isn't divisible by 2. For Example: If a player has 17 and throws a double 8, he/she is then left with 1 which will BUST and revert back to 17).

GAME TABLE

<u>GAME</u>	<u>DART GAME</u>	<u>GAME VARIATION</u>	<u>SPECIAL FUNCTIONS</u>
G01	_01	301	OPEN IN / OPEN OUT DOUBLE IN / OPEN OUT OPEN IN / DOUBLE OUT DOUBLE IN / DOUBLE OUT
G02		401	
G03		501	
G04		601	
G05		701	
G06		801	
G07		901	
G08	CRICKET	-	
G09	NO SCORE CRICKET	-	
G10	SCRAM	-	
G11	CUT-THROAT CRICKET	-	
G12	ADVANCE CRICKET	-	
G13	SHOOTER	6 ROUNDS	
G14		9 ROUNDS	
G15		12 ROUNDS	
G16	OVER	3 LIVES	
G17		5 LIVES	
G18		7 LIVES	
G19	UNDER	3 LIVES	
G20		5 LIVES	
G21		7 LIVES	
G22	COUNT UP	300	OPEN IN / OPEN OUT DOUBLE IN / OPEN OUT OPEN IN / DOUBLE OUT DOUBLE IN / DOUBLE OUT
G23		400	
G24		500	
G25		600	
G26		700	
G27		800	
G28		900	
G29	999		
G30	HI SCORE	3 ROUNDS	OPEN IN / OPEN OUT DOUBLE IN / OPEN OUT OPEN IN / DOUBLE OUT DOUBLE IN / DOUBLE OUT
G31		4 ROUNDS	
G32		5 ROUNDS	
G33		6 ROUNDS	
G34		7 ROUNDS	
G35		8 ROUNDS	
G36		9 ROUNDS	
G37		10 ROUNDS	
G38		11 ROUNDS	
G39		12 ROUNDS	
G40		13 ROUNDS	
G41		14 ROUNDS	
G42	ROUND THE CLOCK	R1 SINGLES	
G43		R5 SINGLES	
G44		R10 SINGLES	
G45		R15 SINGLES	

G46		R1 DOUBLES	
G47		R5 DOUBLES	
G48		R10 DOUBLES	
G49		R15 DOUBLES	
G50		R1 TRIPLES	
G51		R5 TRIPLES	
G52		R10 TRIPLES	
G53		R15 TRIPLES	
G54	KILLER	-	
G55	DOUBLE DOWN	-	
G56	DOUBLE DOWN 41	-	
G57		51	
G58		61	
G59	ALL FIVES	71	
G60		81	
G61		91	
G62		1	
G63	SHANGHAI	5	
G64		10	
G65		15	
G66	GOLF	9 HOLES	
G67		18 HOLES	
G68	FOOTBALL	-	
G69	BOWLING	-	
G70	BASEBALL	6 INNING	
G71		9 INNING	
G72	STEEPLECHASE	-	
G73	SHOVE A PENNY	-	
G74	NINE DART CENTURY	-	OPEN IN / OPEN OUT DOUBLE IN / OPEN OUT OPEN IN / DOUBLE OUT DOUBLE IN / DOUBLE OUT
G75	GREEN VS RED	-	
G76		3 LIVES	
G77	BIG SIX	5 LIVES	
G78		7 LIVES	
G79		15	
G80	HORSESHOES	18	
G81		21	
G82		24	
G83		3 LIVES	
G84	ELIMINATION	4 LIVES	
G85		5 LIVES	
G86	CAT & MOUSE	-	
G87		12	
G88	GOLD HUNT	15	
G89		18	
G90		21	

GAME INSTRUCTIONS

-01

301

This popular tournament and pub game is played by subtracting each dart from the starting number (301) until the player reaches exactly 0 (zero). If a player goes past zero it is considered a “*Bust!*” and the score returns to where it was at the start of that round. For example, if a player needs a 32 to finish the game and he/she hits a 20, 8, and 10 (totals 38), the score goes back to 32 for the next round.

In playing the game, the double in / double out option can be chosen (double out is the most widely used option).

- **Double In** - A double must be hit before points are subtracted from the total. In other words, a player’s scoring does not begin until a double is hit.
- **Double Out** - A double must be hit to end the game. This means that an even number is necessary to finish the game.
- **Double In and Double Out** - A double is required to start and end scoring of the game by each player.

Another variations is listed below:

401 Starting number 401

701 Starting number 701

501 Starting number 501

801 Starting number 801

601 Starting number 601

901 Starting number 901

Note: Each variation has Special Functions (Open In / Open Out; Double In / Double Out; Open In / Double Out; Double In / Double Out) .

CRICKET

Cricket is a strategic game for accomplished players and beginners alike. Players throw for numbers best suited for them and can force opponents to throw for numbers not as suitable for them. The object of Cricket is to “close” all of the appropriate numbers before one’s opponent while racking up the highest number of points.

Only the numbers 15 through 20 and the inner/outer bullseye are used. Each player must hit a number 3 times to “open” that segment for scoring (Refer to Tournament Cricket Scoring section for explanation on how players’ marks are registered). A player is then awarded the number of points of the “open” segment each time he/she throws a dart that lands in that segment, provided their opponent has not closed that segment. Hitting the double ring counts as two hits, and the triple ring counts as 3 hits.

Numbers can be opened or closed in any order. A number is “closed” when the other player(s) hit the open segment 3 times. Once a number has been “closed”, any player for the remainder of the game can no longer score on it.

Winning - The side closing all the numbers first and accumulating the highest point total is the winner. If a player “closes” all numbers first but is behind in points, he/she must continue to

score on the “open” numbers. If the player does not make up the point deficit before the opposing player(s) “closes” all the numbers, the opposing side wins. Play continues until all segments are closed - the winner is the player with the highest score.

Cricket Scoring Display

This dartboard utilizes a dedicated scoreboard within the scoring display that keeps track of each player’s segment status when playing Cricket. When Cricket is selected, individual characters will be utilized to register marks. There are 3 separate lights within each number (15 through 20 and bullseye). During play, one of the status lights will turn on (black will appear) as a segment is hit. If a double or triple of an active number is hit, 2 or 3 lights will turn on respectively.

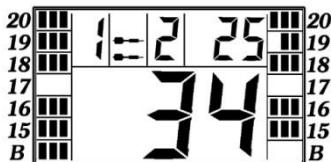

NO-SCORE CRICKET

Same rules as standard Cricket except there is no point scoring. The object of this version is to be the first to simply “close” all the appropriate numbers (15 through 20 and the bullseye).

SCRAM (For 2 players only)

This game is a variation of Cricket. The game consists of two rounds. The players have a different objective in each round. In round 1, player 1 tries to “close” (score 3 hits in each segment - 15 to 20 and bullseye). During this time, player 2 attempts to rack up as many points in the segments that the other player has not yet closed. Once player 1 has closed all segments, round 1 is complete. In round 2, each player’s roles are reversed. Now, player 2 tries to close all the segments while player 1 goes for points. The game is over when round 2 is complete (player 2 closes all segments). The player with the highest point total is the winner.

CUT-THROAT CRICKET

Same basic rules as standard Cricket except once scoring begins, points are added to your opponent(s) total. The object of this game is to end up with the fewest points. This variation of Cricket offers a different psychology to the players. Rather than adding to your own score and helping your own cause as in standard Cricket, Cut-Throat offers the benefit of racking up points for your opponent(s), digging him in a deeper hole. Competitive players will love this variation!

ADVANCED CRICKET

This difficult version of cricket was developed for the advanced player. Players must close out the segments (20,19,18,17,16,15 and bullseye) by using only triples and doubles! In this challenging game, doubles segments count as 1x the number, and triple segments count as

2x the number. The bullseye scoring is the same as in standard cricket. The first player to close out the numbers with the most points is the winner.

SHOOTER

This challenging game tests the players ability to “group together” darts within a segment during each round of play. The computer will randomly select the segment the players must shoot for at the start of each round – indicated by a flashing number in the display.

Scoring is as follows: Single segment = 1 Point Double segment = 2 Points
Triple segment = 3 Points Single Bullseye= 4 Points.

When the computer selects players to hit double Bullseye, the outer bull scores 2 points and the inner Bull scores 4 points. The player with the most points at the end of the rounds is the winner.

OVERS

The object of this game is to simply score higher (“over”) than your own previous three dart total score. Before play begins, players choose the amount of lives to be used by pressing the SELECT button. When a player fails to score “over “ their previous three-dart total, they will lose one life. When a player “equals” the previous three dart total, a life will also be lost. The LED screen on the right will light up once for each life taken away. The last player with a life remaining is the winner.

UNDERS

This game is the opposite of “Overs” Players must score less (“Under”) than their own previous three-dart total. The game begins with 180 (highest total possible) when the player shoots higher than his or her own previous three-dart total, they will lose a life. Each dart that hits outside the scoring area, including bounce outs will be penalized with 60 points added to your score. The last player with a life remaining is the winner.

COUNT- UP

COUNT- UP 300

The object of this game is to be the first player to reach the specified point total (300). Point total is specified when the game is selected. Each player attempts to score as many points as possible per round. Doubles and triples count 2 or 3 times the numerical value of each segment. For example a dart that lands in the triple 20 segment is scored as 60 points. The cumulative scores for each player will be displayed in the LCD display as the game progresses. *Additional variations of this game are listed below. The rules are the same except the point total varies as indicated in the number.*

COUNT- UP 400 COUNT- UP 600 COUNT- UP 800 COUNT- UP 999

COUNT- UP 500 COUNT- UP 700 COUNT- UP 900

Note: Each variation has Special Functions (Open In / Open Out; Double In / Double Out; Open In / Double Out; Double In / Double Out) .

HIGH SCORE

HIGH SCORE - 3 ROUNDS

The rules for this competitive game are simple - Rack up the most points in three rounds (nine darts) to win. Doubles and triples count as 2x and 3x that segment's score respectively. *Additional variations of this game are listed below. The rules are the same except the number of rounds varies as indicated in the number.*

HIGH SCORE - 4 ROUNDS

HIGH SCORE - 10 ROUNDS

HIGH SCORE - 5 ROUNDS

HIGH SCORE - 11 ROUNDS

HIGH SCORE - 6 ROUNDS

HIGH SCORE - 12 ROUNDS

HIGH SCORE - 7 ROUNDS

HIGH SCORE - 13 ROUNDS

HIGH SCORE - 8 ROUNDS

HIGH SCORE - 14 ROUNDS

HIGH SCORE - 9 ROUNDS

Note: Each variation has Special Functions (Open In / Open Out; Double In / Double Out; Open In / Double Out; Double In / Double Out) .

ROUND - THE - CLOCK

ROUND - THE - CLOCK - R1 singles

Each player attempts to score in each number from 1 through 20 and bullseye in order. Each player throws 3 darts per turn. If a correct number is hit, he/she tries for the next number in sequence. The first player to reach 20 is the winner.

The display will indicate which segment you are shooting for. A player must continue shooting for a segment until it is hit. The display will indicate the next segment you should shoot for.

There are many difficulty settings available for this game. Each game has the same rules, the differences are detailed as follows:

ROUND-THE-CLOCK 5 - Game starts at segment number 5

ROUND-THE-CLOCK 10 - Game starts at segment number 10

ROUND-THE-CLOCK 15 - Game starts at segment number 15

Since this game does not utilize point scoring, the double and triple rings count as single numbers.

We have added some additional levels of difficulty to this game for those looking for a real challenge!:

ROUND-THE-CLOCK Double - Player must score a Double in each segment from 1 through 20 in order.

ROUND-THE-CLOCK Double 5 - Game starts at double segment 5

ROUND-THE-CLOCK Double 10 - Game starts at double segment 10

ROUND-THE-CLOCK Double 15 - Game starts at double segment 15

ROUND-THE-CLOCK Triple - Player must score a Triple in each segment from 1 through 20 in order

ROUND-THE-CLOCK Triple 5 - Game starts at triple segment 5

ROUND-THE-CLOCK Triple 10 - Game starts at triple segment 10

ROUND-THE-CLOCK Triple 15 - Game starts at triple segment 15

KILLER

This game will really show who your friends are. The game can be played with as few as two players, but the excitement and challenge builds with even more players. To start, each player must select his number by throwing a dart at the target area. The LCD display will indicate "SEL" at this point. The number each player gets is his assigned number throughout the game. No two players can have the same number. Once each player has a number, the action starts. Your first objective is to establish yourself as a "Killer" by hitting the double segment of your number. Once your double is hit, you are a "Killer" for the rest of the game. Now, your objective is to "kill" your opponents by hitting their segment number until all their "lives" are lost. The last player to remain with lives is declared the winner. It is not uncommon for players to "team up" and go after the better player to knock him out of the game.

DOUBLE DOWN

Each player starts the game with 40 points. The object is to score as many hits in the active segment of the current round. The first round, the player must throw for the 15 segment. If no 15's are hit, his score is cut in half. If some 15's are hit, each 15 (doubles and triples count) is added to the starting total. The next round players throw for the 16.

Segment and hits are added to the new cumulative point total. Again, if no hits are registered, the point total is cut in half.

Each player throws for the numbers as indicated in the chart below in order (the LCD screen will indicate the active segment in which to throw). The player who completes the game with the most points is the winner.

	15	16	D	17	18	T	19	20	B	TOTAL
Player 1										
Player 2										

DOUBLE DOWN 41

This game follows similar rules as standard Double Down as described above with two exceptions. First, instead of going from 15 through 20 and bullseye, the sequence is reversed which will be indicated on the LCD display. Second, an additional round is included toward the end in which players must attempt to score three hits that add up to 41 points (20, 20, 1; 19, 19, 3; D10, D10, 1: etc.). This "41" round adds an extra level of difficulty to the game.

Remember, a player's score is cut in half if not successful, so the "41" round presents quite a challenge!

	20	19	D	18	17	T	16	15	41	B	TOTAL
Player 1											
Player 2											

ALL FIVES - 51

The entire board is in-play for this game (all segments are active). With each round (of 3 darts) each player has to score a total which is divisible by 5. Every "five" counts as one point. For example 10, 10, 5 = 25. Since 25 is divisible by 5 fives, this player scores 5 points (5 x 5 = 25).

If a player throws 3 darts that are not divisible by 5, no points are given. Also, the last dart of each round must land in a segment. If a player throws the third dart and it lands in the catch ring area (or misses the board completely), he earns no points even if the first two.

Darts are divisible by 5. This prevents a player from "tanking" the third throw if his first two are good. The first player to total fifty-one (51) "fives" is the winner. The LCD screen will keep track of the point totals. *Additional variations of this game are detailed below. The rules are the same except the total needed to win varies as indicated in the number following the game.*

ALL FIVES - 61

ALL FIVES - 81

ALL FIVES - 71

ALL FIVES - 91

SHANGHAI

SHANGHAI - 1

Each player must progress around the board from 1 through 20 in order. Players start at number 1 and throw 3 darts. The object is to score the most points possible in each round of 3 darts. Doubles and triples count toward your score. The player with the highest score after completing all twenty segments is the winner. *Additional variations of this game are listed below. The rules are the same except the starting segment varies as indicated in the number following the game.*

SHANGHAI 5 - Game starts at segment 5

SHANGHAI 10 - Game starts at segment 10

SHANGHAI 15 - Game starts at segment 15

GOLF

GOLF – 9 Holes

This is a dartboard simulation of the game golf (but you don't need clubs to play). The object is to complete a round of 9 through 18 "holes" with the lowest score possible. The Championship "course" consists of all par 3 holes making par 27 for a nine hole round or 54 for a round of 18. The segments 1 through 18 are used with each number representing a "hole." You must score 3 hits in each hole to move to the next hole. Obviously, double and triples affect your score as they allow you to finish a hole with fewer strokes. For example, throwing a triple on the first shot of a hole it is counted as an "eagle" and that player gets to complete that hole with 1 "stroke."

Note: The active player continues to throw darts until he "holes out" (scores 3 hits on the current hole). The voice announcer will indicate the player that is up - listen carefully to avoid shooting out of sequence. By the way, there are no "gimmes" in this game! *Additional variations of this game are detailed below. The rules are the same except the number of holes needed to play.*

GOLF – 18 Holes – Same as above except play lasts 18 holes (rounds)

FOOTBALL

Strap your helmet on for this game! The first thing necessary is to select each player's "playing field." Each player can do this by throwing a dart or by manually pressing a segment on the board. This is entirely up to you, but whichever segment is selected it.

Becomes your starting point which carries through the bullseye and directly across to the other side of the bullseye.

For example, if you select the 20 segment, you start on the double 20 (outer ring) and continue all the way through to the double 3. The "field" is made up of 11 individual segments and must be hit in order. So, keeping with the example above, you must throw darts in the following segments in this order:

Double 20 ... Outer Single 20 ... Triple 20 ... Inner Single 20 ...
Outer Bullseye ... Inner Bullseye ... Outer Bullseye ... Inner Single 3 ...
Triple 3 ... Outer Single 3 ... and finally a Double 3.

The First player to "score" is the winner. The LED display will keep track of your progress and indicate the segment you need to throw for next.

BOWLING

This dartboard adaptation of bowling is a real challenge! It is a difficult game in that you must be very accurate to Rack up a decent score. Player one starts the game. You must select your "alley" by either throwing dart or manually pressing segment of choice. Once alley isselected, you have 2 remaining darts to throw in which to score points or "pins."

Each specific segment in your "alley" is worth a given pin total:

<u>Segment</u>	<u>Score</u>
Double	9 pins
Outer Single	3 pins
Triple	10 pins
Inner Single	7 pins

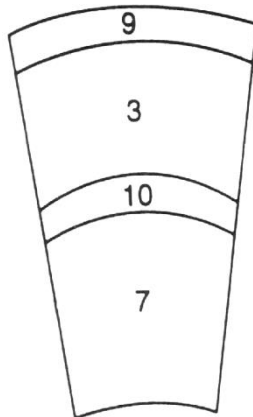

There are several rules for this game as follows:

1. A perfect game score would be 200 in this version of bowling
2. You cannot hit the same singles segment twice within the same "frame" (round). The second hit will count as zero point.
Hint: Try to hit each single to reach 10 points in the frame.
3. You can score 20 points per "frame" by hitting the triple segment twice.
4. Hitting the double segment with your second dart will only count as 10 points if you scored a double on your first throw. Otherwise you will score a total of 9 points by throwing a double with your second dart.

BASEBALL

BASEBALL – 6 Innings

This dartboard version of baseball takes a great deal of skill. As in the real game, a complete game consists of 9 innings. Each player throws 3 darts per "inning." The field is laid out as shown in the diagram.

<u>Segment</u>	<u>Result</u>
Singles segments	"Single" - one base
Doubles segment	"Double" - two bases
Triples segment	"Triple" - Three bases
Bullseye	"Home Run" (<i>can only be attempted on third dart of each round</i>)

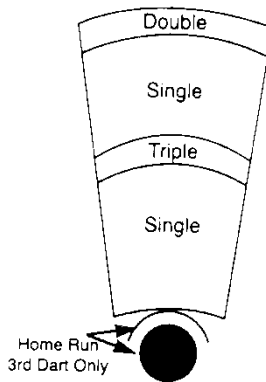

The object of the game is to score as many runs as possible each inning. The player with the most runs at the end of the game is the winner.

BASEBALL – 9 Innings – Same as above except 9 innings (rounds).

STEEPLECHASE

The object of this game is to be the first player to finish the “race” by being the first to complete the “track”. The track starts at the 20 segment and runs clockwise around the board to the 5 segment and ends with a bullseye. Sounds easy right? What has not yet been specified is that you must hit the inner single segment of each number to get through the course. This is the area between the bullseye and the triples ring. And, as with a real steeplechase, there are obstacles throughout the course to hurdle.

The four hurdles are found at the following places:

- | | | | |
|-------------------------|-----------|-------------------------|-----------|
| • 1 st fence | Triple 13 | • 2 nd fence | Triple 17 |
| • 3 rd fence | Triple 8 | • 4 th fence | Triple 5 |

The first player to complete the course and hit the bullseye wins the race.

SHOVE A PENNY

Only the numbers 15 through 20 and the bullseye are used. Singles are worth 1 point, doubles are worth 2, and triples are worth 3 points. Each player must throw for the numbers in order with the objective of scoring 3 points in each segment to move on to the next. If a player scores more than 3 points in any one number, the excess points are given to the next player. The first player to score 3 points in all segments (15 - 20 and bull) is the winner.

NINE-DART CENTURY

The object of this game is to attempt to score 100 points, or come as close as possible, after 3 rounds (9 darts). Doubles and triples count as 2x and 3x their value respectively. Going over 100 points is considered a “bust” and causes you to lose unless all players go over. In that case, the player closest to 100 wins (player that scored the lowest amount over 100).

Note: this game mode has Special Functions (Open In / Open Out; Double In / Double Out; Open In / Double Out; Double In / Double Out) .

GREEN VS. RED (2 players only)

This game is a race around the board, where skill at hitting doubles and triples pays off with victory. Player 1 is “green” and player 2 is “red”. Player 1 shoots for only doubles and triples that are green and works around the board clockwise. Player 2 starts at 20 and works around the board counter-clockwise, shooting for red segments (the temporary score display will indicate which segment to throw for). Note: a maximum of one double and one triple of the same number can be scored in a single round.

What’s more, hitting the wrong number (of your opponent’s color) subtracts that amount from your score - so be careful. The player with the most points after completion of the game is the winner.

BIG SIX

This game allows players to challenge their opponents to hit the targets of their choice. However, players must *earn* the chance of picking the next target for their opponent by making a hit on the current target first.

Single 6 is the first target to hit when the game begins. Before the game starts, players must agree on how many lives will be used by pressing SELECT button. Within the three throws, player 1 must hit a 6 to “save” their life. After the current target is hit, the next dart thrown will determine the opponents target. If player 1 fails to hit the current target within 3 darts, they will lose a life and a chance to determine the next target for player 2. Player 2 will shoot for the single 6 that player 1 missed. Singles, doubles and triples are all separate targets for this game. The object of the game is to force your opponent into losing lives by selecting tough targets for your opponent to hit such as “Double Bullseye” or “triple 20” The last player with a life left is the winner.

HORSESHOE

This 2 -player game uses only the 20 and 3 segments to represent the two horseshoe pits. Player 1 will shoot at the 20 segment and Player 2 will shoot at the 3 segment. Scoring is cumulated per round. First player to score 15 points is the winner.

Scoring is as follows:

- TRIPLE RING = Ringer 3 points
- DOUBLE RING = Leaner 2 points
- INNER SEGMENT (Small) = 1 point

Scores will only count for the player or team with the most points in that round. For example, if player 1 scores 3 points and player 2 scores 1 point, only player 1 will awarded 3 points for that round. Rounds continue until 15 points are scored. Adjustable Difficulty Settings for Horseshoes include games from 15- 25 points. Press the SELECT button before starting the game for these variations.

ELIMINATION

The object of the game is to “Eliminate” your opponents. The rules are very simple. Each player must score higher total points with 3 darts than the opponent before them. Each player starts with 3 lives. If the player fails to score higher total points than the previous opponents score, they lose one life. Tie scores will also result in a lost life. The winner is the last player with lives remaining. Press the **SELECT** button before starting to play with 4 or 5 lives per player.

CAT & MOUSE

This is a very challenging 2-player game that is best suited for players of advanced skill. One player will play the role of the cat and the other will be the mouse. The object of the game is for the mouse to get back to his hole before being caught by the cat. The mouse starts first from the “20” segment and proceeds counter-clockwise around the dartboard by hitting first the double segment and then the single of each segment. The cat starts back at the “18”

segment and proceeds counter clockwise around the dartboard to catch the mouse by hitting doubles only of each segment. If the mouse makes it all the way around the board back to the double 20, the mouse wins the game. If the cat hits the double segment that the mouse is on, the cat has caught the mouse and has won the game.

GOLD HUNTING

The object of this game is to find “gold.” You collect gold for each 50 points. Gold is only collected only if your score is exactly 50 or a multiple of 50 (100, 150, etc.) at any point during a round. However, since “gold” can make a person greedy, not only do you collect gold for every multiple of 50, you also steal 1 gold from all other players. Therefore, as you collect a gold, you take 1 gold from all other players who have gold.

This is a real back-and-forth game, but the player who reaches to selected total gold required first is the winner.

IMPORTANT NOTES

Stuck Segment

Occasionally, a dart will cause a segment to become wedged within the segment separator web. If this happens, all play will be suspended and the scoring display will indicate the segment number that is stuck.

To free the segment, simply remove the dart or broken tip from the segment. If the problem is still not solved, try wiggling the segment until it is loose. The game will then resume where it left off.

Broken Tips

From time to time a tip will break off and become stuck in the segment. Try to remove it with a pair of pliers or tweezers by grasping the exposed end and pulling it out of the segment. If this is not possible, you can attempt to push the tip through to the back of the segment. Use a nail that is smaller than the hole and gently push the tip until it falls through the other side. Be careful not to push too far and damage the circuitry behind the segment.

Don't be alarmed if tips break. This is a normal occurrence when playing soft tip darts. We include a pack of replacement tips that should keep you supplied for quite some time. When replacing tips, make sure you use the same type of tips that come with this dartboard.

Darts

It is recommended that you do not use darts that exceed 18 grams on this dartboard. The darts included with this dartboard average 10 grams and use standard soft tips. Replacement tips are available at most retailers carrying dart products. Look for soft tip dart accessories for all your electronic dart needs.

Cleaning your Electronic Dartboard

Your electronic dartboard will provide many hours of competition if cared for properly. Regular dusting of the cabinet is recommended using a damp cloth. A mild detergent can be used if necessary. The use of abrasive cleaners or cleaners that contain ammonia may cause damage and should not be used. Avoid spilling liquid onto the target area since it can result in permanent damage and is not covered by the warranty.

DESCRIPTIONS

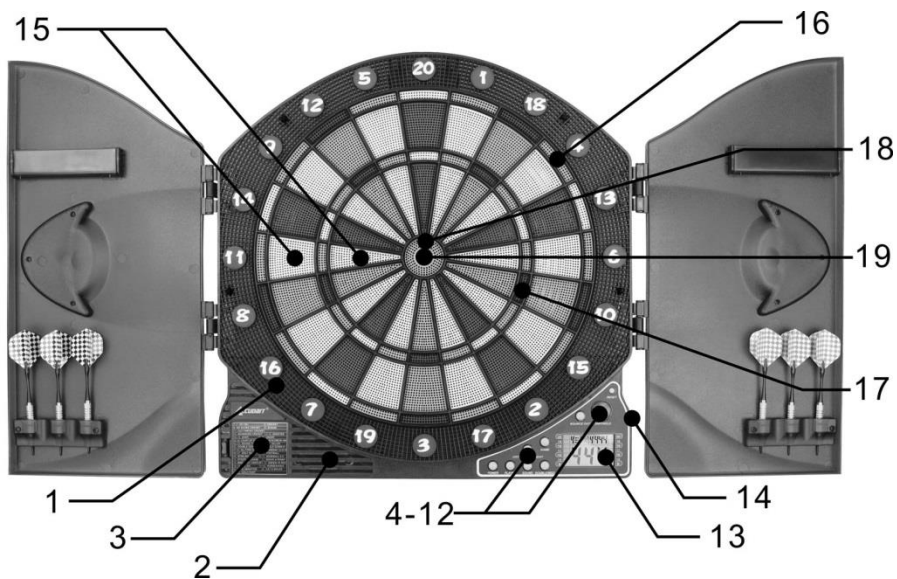

- | | |
|-------------------------|-----------------------------|
| 1. Catch Ring | 11. Bounce Out Button |
| 2. Speaker | 12. Virtual Opponent Button |
| 3. Menu | 13. LCD Display |
| 4. Power Button | 14. AC Adapter Jack |
| 5. Reset Button | 15. Single Ring |
| 6. Start / Hold Button | 16. Double Ring |
| 7. Player Button | 17. Triple Ring |
| 8. Sound Button | 18. Bullseye |
| 9. Double / Miss Button | 19. Double Bullseye |
| 10. Game Button | |

*Dartboard shown above may differ slightly from actual product.

LIMITED WARRANTY

Escalade®Sports (the Company) warrants the Product to be free from defects in workmanship and materials under normal use and conditions **FOR A PERIOD OF 90 DAYS FROM THE DATE OF ORIGINAL PURCHASE** in the United States and Canada.

Product Registration Card

The Product Registration Card must be filled out completely and mailed to the Company at the address printed on the card within 10 days from the date of your purchase of the Product.

What Is Covered

Except as provided below, this Limited Warranty covers all defects in materials and workmanship. This Limited Warranty is void if the Product is:

- Damaged through improper usage, negligence, misuse, abuse, transportation damage, acts of nature, or accident (including failure to follow the instructions supplied with the Product)
- Used in commercial applications or rentals
- Modified or repaired by anyone not authorized by the Company

What Is Not Covered

This Limited Warranty does not cover:

- Any expendable items such as batteries, light bulbs, fuses, accessories, cosmetic parts, tools and other items that wear out.
- due to normal usage. Any costs you may incur for delivery, installation, assembly or transport of your product.

What The Company Will Pay For

If during the Limited Warranty period, any part or component of the Product is found by the Company to be defective, the Company will, at its option, repair the Product, replace the Product with a new Product (either the same or an equivalent model) or cause the original retailer of the Product to exchange the Product with a new Product (either the same or an equivalent model) or refund the original purchase price of the Product, without charge for labor or parts. The Company's obligation to repair, replace or exchange the Product, however, shall be limited to the amount of the original purchase price of the Product.

How To Obtain Warranty Service

In order to enforce your rights under this Limited Warranty, you must follow these procedures:

- You must have completed and mailed the Product Registration Card to the Company within 10 days of purchase of the Product.
- You must include THE ORIGINAL COPY OF YOUR SALES RECEIPT.
- You must call the Company's Consumer Service Department at 1-800-526-0451 from 9:00 A.M. to 5:00 P.M. (EST) to notify the Company of the nature of the problem.
- If you are instructed to return the Product to the Company for servicing, you are responsible for shipping the Product, at your expense, to the address designated by the Company in packaging that will protect against further damage.
- You must also include your name, address, daytime telephone number, model number of the Product and a description of the problem.

THIS LIMITED WARRANTY IS AVAILABLE ONLY TO THE ORIGINAL PURCHASER OF THE PRODUCT AND IS VALID IN THE UNITED STATES AND CANADA ONLY.

THE COMPANY'S LIABILITY IS LIMITED TO THE REPAIR OR REPLACEMENT, AT ITS OPTION, OF ANY DEFECTIVE PRODUCT AND SHALL NOT INCLUDE ANY LIABILITY FOR INDIRECT, INCIDENTAL OR CONSEQUENTIAL DAMAGES OF ANY KIND.

THIS WARRANTY IS EXPRESSLY MADE IN LIEU OF ALL OTHER WARRANTIES, EXPRESSED OR IMPLIED. SOME STATES DO NOT ALLOW LIMITATIONS ON HOW LONG AN IMPLIED WARRANTY LASTS OR DO NOT ALLOW FOR EXCLUSION OF INCIDENTAL OR CONSEQUENTIAL DAMAGES. TO THAT EXTENT, THE ABOVE LIMITATIONS MAY NOT APPLY TO YOU.

This Limited Warranty gives you specific legal rights, but you may also have other rights that vary from state to state.

If you have questions regarding this Limited Warranty or the operation of the Product, you may call or write us:

Consumer Service Department

817 Maxwell Ave.

Evansville, IN 47711

1-800-526-0451

www.escaladesports.com

