

DH30 DIGITAL TELEPHONE HYBRID

TABLE OF CONTENTS

<i>SECTION</i>	<i>1</i>	<i>INTRODUCTION</i>	<i>4</i>
		<i>WHAT IS A HYBRID?</i>	<i>4</i>
		<i>DH30 FEATURES</i>	<i>4</i>
		<i>WHAT COMES WITH THE DH30?</i>	<i>6</i>
		<i>PRODUCT REGISTRATION AND TECHNICAL SUPPORT</i>	<i>6</i>
		<i>OPERATIONAL REQUIREMENTS</i>	<i>7</i>
<i>SECTION</i>	<i>2</i>	<i>CONNECTING THE EQUIPMENT</i>	<i>8</i>
		<i>TYPICAL DH30 DIGITAL INSTALLATION</i>	<i>8</i>
		<i>CONSOLE CONNECTIONS — DIGITAL AUDIO</i>	<i>8</i>
		<i>TYPICAL DH30 ANALOG INSTALLATION</i>	<i>9</i>
		<i>CONSOLE CONNECTIONS — ANALOG AUDIO</i>	<i>9</i>
		<i>ADDITIONAL CONNECTIONS</i>	<i>10</i>
<i>SECTION</i>	<i>3</i>	<i>SETUP AND OPERATION</i>	<i>12</i>
		<i>FRONT PANEL CONTROLS</i>	<i>12</i>
		<i>HANDLING CALLS</i>	<i>14</i>
		<i>RECORDING CALLS</i>	<i>15</i>
		<i>USING THE NAVIGATING BUTTONS AND ADJUSTING PARAMETERS</i>	<i>16</i>
		<i>VIEWING OF CHANGING SETTINGS THROUGH THE LCD PANEL</i>	<i>17</i>
		<i>USING PRESETS</i>	<i>18</i>
		<i>SETTING LEVELS</i>	<i>18</i>
<i>SECTION</i>	<i>4</i>	<i>AUTO MIX-MINUS AND ACOUSTIC ECHO CANCELLATION</i>	<i>19</i>
		<i>MIX-MINUS/ACOUSTIC ECHO CANCELLATION</i>	<i>19</i>
		<i>ECHO REDUCTION</i>	<i>20</i>
		<i>EC TRAIN</i>	<i>20</i>
		<i>DIAGNOSTICS</i>	<i>21</i>
		<i>TEST SIGNAL</i>	<i>21</i>
<i>SECTION</i>	<i>5</i>	<i>CUSTOMIZING YOUR SYSTEM</i>	<i>22</i>
		<i>SETTING CALLER PROCESSING</i>	<i>22</i>
		<i>SYSTEM PARAMETERS</i>	<i>25</i>
<i>SECTION</i>	<i>6</i>	<i>SPECIFICATIONS</i>	<i>28</i>
		<i>DIMENSIONS</i>	<i>28</i>
		<i>WEIGHT</i>	<i>28</i>
		<i>OPERATING TEMPERATURE</i>	<i>28</i>
		<i>FRONT PANEL CONTROLS</i>	<i>28</i>
		<i>REAR PANEL CONNECTORS</i>	<i>28</i>
		<i>TELEPHONE TRANSMIT</i>	<i>29</i>
		<i>TELEPHONE RECEIVE</i>	<i>30</i>
		<i>ECHO CANCELLATION/MIX-MINUS</i>	<i>30</i>
		<i>TELCO CANCELLATION</i>	<i>30</i>

TABLE OF CONTENTS (CONT.)

SECTION 7	PINOUTS	31
	REMOTE CONNECTOR	31
	RS232 CONNECTOR	31
	RECORD CONTROL	32
	LINE CONNECTOR	32
	SET CONNECTOR	32
	XLR CONNECTOR	32
SECTION 8	SERIAL COMMUNICATIONS PROTOCOL	33
SECTION 9	DH30 AUDIO FLOW	35
SECTION 10	COMPLIANCE	36
	FCC PART 15 COMPLIANCE	36
	FCC PART 68 COMPLIANCE	36
	IC COMPLIANCE	37
	INTERNATIONAL COMPLIANCE	38
SECTION 11	USER-DEFINED PRESETS WORKSHEET	39
SECTION 12	GLOSSARY	41

About Comrex

Comrex has been building reliable, high quality broadcast equipment since 1961. Our products are used daily in every part of the world by networks, stations and program producers.

Every product we manufacture has been carefully designed to function flawlessly, under the harshest conditions, over many years of use. Each unit we ship has been individually and thoroughly tested. Most items are available off-the-shelf, either directly from Comrex or from our stocking dealers.

Comrex stands behind its products. We promise that if you call us for technical assistance, you will talk directly with someone who knows about the equipment and will do everything possible to help you.

Our toll free number in North America is 800-237-1776. Product information along with engineering notes and user reports are available on our website at <http://www.comrex.com>. Our E-Mail address is info@comrex.com.

Warranty and Disclaimer

All equipment manufactured by Comrex Corporation is warranted by Comrex against defects in material and workmanship for one year from the date of original purchase, as verified by the return of the Warranty Registration Card. During the warranty period, we will repair or, at our option, replace at no charge a product that proves to be defective, provided you obtain return authorization from Comrex and return the product, shipping prepaid, to Comrex Corporation, 19 Pine Road, Devens, MA 01434 USA. For return authorization, contact Comrex at 978-784-1776 or fax 978-784-1717.

This Warranty does not apply if the product has been damaged by accident or misuse or as the result of service or modification performed by anyone other than Comrex Corporation.

With the exception of the warranties set forth above, Comrex Corporation makes no other warranties, expressed or implied or statutory, including but not limited to warranties of merchantability and fitness for a particular purpose, which are hereby expressly disclaimed. In no event shall Comrex Corporation have any liability for indirect, consequential or punitive damages resulting from the use of this product.

Copyright Notice

The Comrex proprietary code and licensed, third party proprietary code residing in and otherwise associated with this product are protected by copyright law and international treaties. Unauthorized reproduction or distribution of this product, or any portion of it, may result in civil and criminal sanctions, and will be prosecuted to the fullest extent of the law.

US Government Restricted Rights - Use, duplication, or disclosure by the US Government is subject to restrictions set forth in subparagraph (c)(1)(ii) of the Rights in Technical Data and Computer Software clause at DFARS (48 CFR) 252.227-7013 or subparagraphs (c)(1) and (2) of the Commercial Computer Software-Restricted Rights clause at FAR (48 CFR) 52.227-19, as applicable.

SECTION 1

INTRODUCTION

WHAT IS A HYBRID?

Simply put, a hybrid is a device that separates send and receive audio on a phone line. While the public switched telephone network utilizes separate channels for audio in each direction of a phone call, these two signals are mixed together before being sent to the end user. This way, only one pair of wires is required from your telephone to the telco central office. To use telephone company terms, the telephone network is a “4 wire” system, while the local loop is a “2 wire” system.

When recording or airing telephone conversations in a studio environment, it’s important that telephone audio be “4 wire.” This is because the audio program usually already contains the audio of the “studio host.” If the telephone audio also contains some of the “studio host,” these two signals will be added together by the mixing console. The effect will be distortion in the voice of the “studio host.” In essence, a hybrid converts the “2 wire” telephone line back into a “4 wire” audio path.

It seems counter-intuitive, but the main goal of a studio hybrid is to make the people in the studio sound better. If the hybrid isn’t working well, people speaking from the studio will sound “hollow” or like they’re “talking into a barrel.” This is due to the strange effect of mixing microphone audio with telephone “bleed-through.” Of course, our hybrids also improve the audio of callers, filtering out hum and noise as well as adjusting levels between loud and soft speakers.

It’s our opinion that with the advent of cheap telephones, cordless phones and cellphones, telephone audio has gotten decidedly worse in recent years. While a hybrid can cleanup noise to some extent, it can’t remove distortion caused by the far end telephone. If you find some calls sound good on air and some don’t, it’s probably due to the large disparity in audio quality of today’s telephone sets.

DH30 FEATURES

The DH30 provides a high quality telephone interface between a telephone line and audio equipment to help bring uniformity and high quality sound to a broadcast talk show environment. This telephone interconnection system uses digital hybrid technology to continually adapt to telephone-line conditions, providing consistent high-quality sound. Here is a list of the DH30 Digital Telephone Hybrid’s features:

- Selectable auto mix-minus and acoustic echo cancellation, allowing for operation in a variety of closed or open studio environments.

- Programmable auto-answer, auto-disconnect and caller control functions.
- Call monitoring capability with a built-in 2-watt monitoring amplifier and front-panel volume control.
- AES/EBU connections allow for a direct digital audio link between the DH30 and a digital console.
- Analog connections are made using the send and cue inputs and the caller and aux outputs.
- Each input and output has its own adjustable gain control, ensuring the best audio mix in every application.
- The DH30's 24-bit digital signal processing (DSP) produces high-quality audio with expansion, compression, equalization and bass boost capabilities. The downward expander, compressor and 3-band EQ allow you to fine tune the sound of the caller audio.
- The telephone echo cancellation provides a high quality telephone interface between a standard analog telephone line and user audio equipment. The primary function of the hybrid is to separate send and caller audio (null). The hybrid provides >55 dB send/caller isolation between 250 Hz to 3.5 kHz.
- The DH30 is easily customized. The Enter, Esc, Volume control buttons, and the LCD display provide useful control options, including integrated monitor amplifier with push-button volume control, adjustable caller audio control, adjustable three-band equalization, password protection and adjustable compressor/limiter and expander.
- The DH30 presets are the programmable operating parameters that control how the DH30 responds to the telephone line. The DH30 can store up to three presets. The unit ships with Preset 1 containing a set of default values. You can keep these settings or modify them, and you can also set up two additional presets. The Presets feature allows you to easily change to a completely different operating profile. If power is lost, the DH30 powers up with the last preset used, so custom presets are not lost.

*WHAT COMES WITH THE
DH30?*



DH30
(Domestic or International)



7-foot Modular
Telephone Cable



DH30 Installation and
Operations Manual



AC Power Cord

*PRODUCT REGISTRATION AND
TECHNICAL SUPPORT*

Please register your DH30 by filling out and returning the enclosed warranty registration card or by visiting our website www.comrex.com/warranty.html. When your DH30 is properly registered, Comrex can better serve you should you require technical assistance, need upgrades or new product information.

If you have any problems or simply need a question answered, please call us at 978-784-1776. Our toll free number in North America is 800-237-1776. Product information along with engineering notes and user reports are available on our website at <http://www.comrex.com>. Our email address is info@comrex.com.

OPERATIONAL REQUIREMENTS

The DH30 is designed to work in almost any acoustic environment. However, to improve audio quality and ease installation, we recommend that you take the following factors into consideration:

Acoustic Room Treatment — Rooms that have large areas of windows, white boards, hard floors, etc. are acoustically live. These areas increase the amount of audio reverberation in the room which, in turn, reduces audio quality. To achieve the best results using the DH30, you should minimize the amount of audio reverberation wherever possible. You can improve room acoustics by installing acoustic panels, drapes and other wall fabrics. Another way to improve overall room acoustics is to keep room noise (i.e. computers and fans) to a minimum.

Environmental — The room temperature at which the DH30 can operate ranges from 32–100 degrees F / 0–38 degrees C, with relative humidity of 0–80 percent.

Telephone Line — The DH30 operates on standard telephone lines and connects to a standard RJ11C modular jack. If you do not have an RJ11C jack where you want to install the DH30, call your telephone company for installation.

Equipment Placement — The DH30 is designed for installation in a standard 19-inch equipment rack.

Power — The DH30 automatically adjusts to voltages between 100–240 Vac, 50–60 Hz. Manual voltage switching is not required.

SECTION 2

CONNECTING THE EQUIPMENT

All equipment connections are made through the back panel. Position the DH30 so that the connectors are readily accessible and their pin orientation is visible. To use the functions associated with these connections, refer to “Setup and Operation,” beginning on page 12.

TYPICAL DH30 DIGITAL INSTALLATION

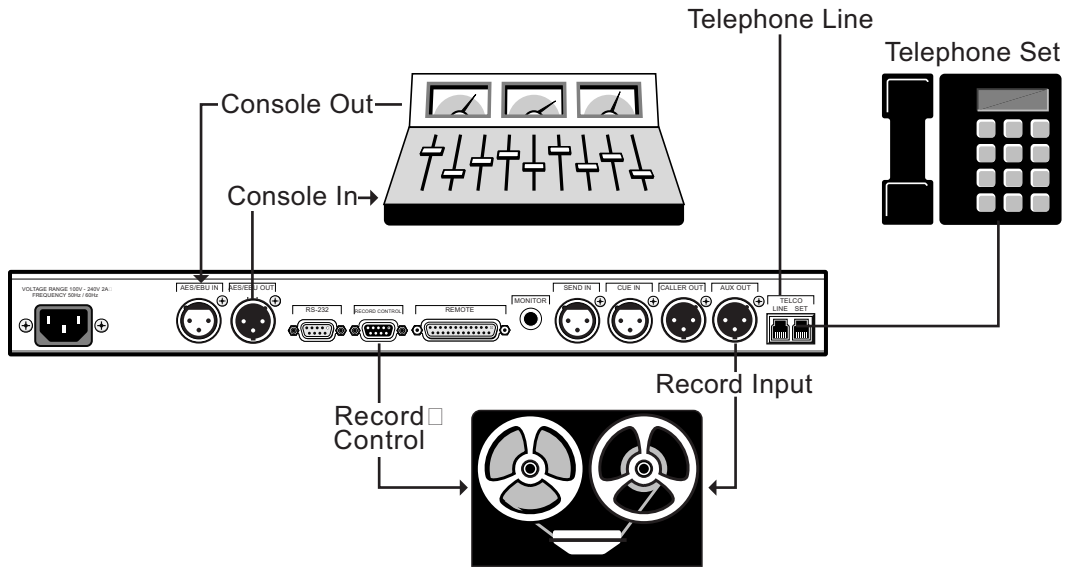

CONSOLE CONNECTIONS — DIGITAL AUDIO

AES/EBU In — This is the audio that the caller will hear. Connect an AES/EBU output from the studio console to the AES/EBU IN input of the DH30.



This connection provides a digital audio input directly to the Digital Signal Processor (DSP). The AES/EBU digital audio input is stereo. The left channel is designated as the send audio input and the right channel is the cue audio input. In order to enable this input, the AES/EBU sampling rate must be selected in the System Parameters menu.

AES/EBU Out — This is the output of the callers voice. Connect the AES/EBU OUT to an AES/EBU input channel of the studio console.



This connection provides a digital audio output directly from the DSP. The output sample rate follows the AES/EBU input sample rate. If no AES/EBU sample rate is provided, the rate defaults to 32 kHz.

The AES/EBU digital audio output is stereo. The left channel is designated as the caller audio out and the right channel contains the send or cue audio (whichever is selected via the CUE button).

Note: You should cycle power anytime you disconnect AES/EBU connectors from the DH30.

*TYPICAL DH30 ANALOG
INSTALLATION*

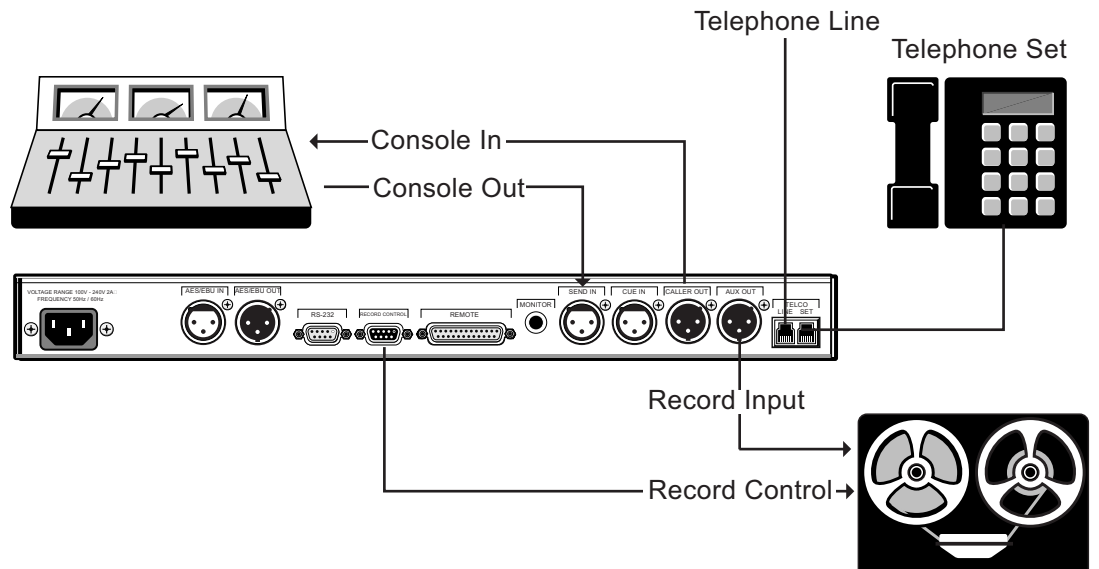

*CONSOLE CONNECTIONS
— ANALOG AUDIO*

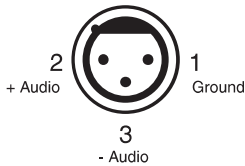

Send In — This is the audio that the caller will hear. Connect a mic or line output from the studio console to the SEND IN input of the DH30.

If the DH30's echo canceller feature is disabled, you must send mix-minus audio to the SEND IN connector. If you are using a microphone connected directly to the DH30 that requires phantom power, you will need to activate the phantom power circuit. Contact Comrex technical support.



Cue In — This is the audio the caller will hear when the cue feature, located on the front panel, is activated. Connect a mic or line output from the studio console to the CUE IN input of the DH30.

No auto mix-minus or acoustic echo cancellation is performed on the Cue audio, and therefore, the audio sent to this input must be a mix-minus.

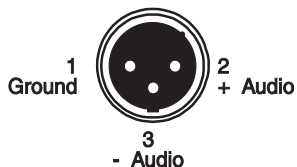

Caller Out — This is the output of the caller's voice. Connect the CALLER OUT to an input channel of the studio console.

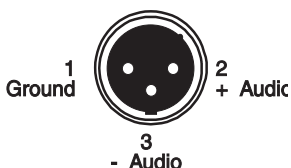

Aux Out — This is the output of the caller audio and the send or cue audio (whichever is selected via the CUE button). Connect the AUX OUT to an input channel of your studio console or recording device.

The caller/send mix is programmable through the front panel LCD display.

ADDITIONAL CONNECTIONS

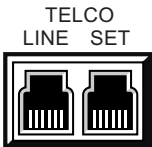

Telephone Line Connections — The DH30 operates on one standard POTS (plain old telephone service) analog telephone line or one analog extension from a PBX via a standard RJ11C modular jack. *Note: Some telephone lines do not provide battery voltage (dry line, no DC offset voltage). If your line does not, the DH30 may be configured by qualified personnel for dry line operation. Please contact Comrex technical support for details.*

- Line** — Plug your telephone line into the RJ11C LINE jack.
- Set** — Plug your telephone set into the RJ11C SET jack.

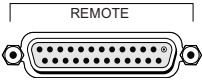

Remote — Connect a DB25 parallel cable to this connector to provide control and status via your console remote port or contact-closure switches. This connector also contains unbalanced audio inputs and outputs. See “Pinouts” on pages 31-32.



Monitor — Connect a speaker or mono headphones to this 1/4” phone jack to produce a 2-watt amplified audio signal for call monitoring. Only caller audio is present on this output. Stereo headphones will contain caller audio in one earpiece only.

The front panel volume buttons control the level of this output. See the “Setup and Operation” section on pages 12-13 for front panel usage.



Record Control — Control a tape deck or other external recording device with this DB9 RECORD CONTROL connector.

This DB9 female connector sends start, stop and enable commands for automatic telephone call recording. This connector provides control only. Use the AUX OUT connector to route audio to the recording device.

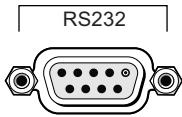

RS232 Serial Port — This DB9 female connector connects to the serial port of a PC or other RS232 device. The serial port settings are fixed at 9600 baud, 8-bit, no parity, 1 stop bit. This port receives commands to remotely control operation, request status or download firmware upgrades. Refer to “Serial Communications Protocol” on pages 33-34.

VOLTAGE RANGE 100V - 240V 2A
FREQUENCY 50Hz / 60Hz

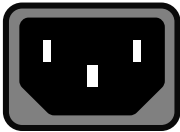

Power Connection — This connection automatically adjusts to accept voltages between 100–240 Vac, 50/60 Hz.

The AC power cord is an IEC type connector, which allows use of domestic US power cords as well as international power cords.

SECTION 3

SETUP AND OPERATION

As soon as you connect power and the DH30 completes its initialization cycle (about two seconds), it is functional. The factory default settings that are active upon power-up can accommodate basic operation. You can immediately use the hybrid to connect, disconnect and record calls.

Before initial use, it is recommended that the DH30 be calibrated to your telephone system and audio controls. Depending on your site's unique needs, some settings may require modification.

FRONT PANEL CONTROLS

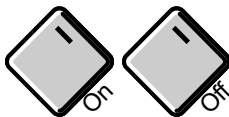

On and Off — When the DH30 is plugged in, it defaults with the hybrid off, indicated by the red OFF LED.

The ON button connects the DH30 to the telephone line and causes the hybrid to adapt to the line. Pressing the ON button while the DH30 is connected to a telephone line readapts the hybrid. A steady green LED indicates that the DH30 is on. A flashing green LED indicates an incoming call.

When the OFF button is pressed, the DH30 disconnects from the telephone line and mutes caller audio. The red OFF LED illuminates.



Record — The REC button controls the start or stop of an external recording device connected to the DH30 through the RECORD CONTROL output on the rear panel.

The RECORD LED flashes red when recording, appears solid red in record-ready (standby) mode and is not lit when record mode is off.

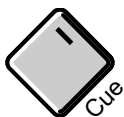

Cue — The CUE button enables the talent to speak to a caller off the air. When you press the CUE button, the CUE LED illuminates and audio from the cue input is routed to the caller. When the CUE button is off, the CUE LED turns off and audio from the send input is routed to the caller.

Neither auto mix-minus nor acoustic echo cancellation is performed on the cue input. Therefore, a mix-minus audio source must be provided to the cue input.

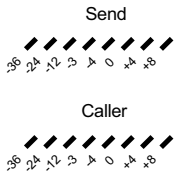

VU Meters (Send and Caller) — These LED's indicate the audio levels at the SEND and CALLER XLR connectors.

The SEND meter indicates the level of the audio sent to the caller. The input gain should be set so that the average send level is at 0 dBu with occasional peaks to +4 dBu.

The CALLER meter indicates the level of the audio being received by the hybrid. Caller processing (compressor, EQ, gain and the other caller processing parameters) is reflected in the CALLER meter reading.



Volume — The up and down arrows (▲/▼) raise or lower the volume level of the internal 2-watt power amplifier to the speaker or headphone connected to the MONITOR jack on the rear panel. Pressing a button once increases or decreases the level by 3 dB. Holding a button sweeps the volume up or down.

At power up, the monitor volume defaults to a nominal reference of 0dB. The volume may be adjusted between +18 dB and -27 dB. Reducing the volume past -27 dB turns off the monitor and mutes the power amplifier output, indicated by the solid red VOLUME LED.

Pressing ▲ and ▼ simultaneously will reset the volume to nominal (0 dBu).

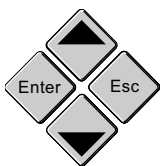

Enter, Esc, ▲/▼ — These four buttons allow you to navigate through the menus and adjust parameters on the adjacent LCD panel. They are also used in setting and entering the password.



LCD Display — This LCD display is a two-line, 16-character alphanumeric display. The first line displays the main menu categories. The second line displays the adjustable parameters.

HANDLING CALLS

Receiving a Call — To set up the DH30 for automatic answer or disconnect, refer to “System Parameters” (pages 25–26).

- **On-Air** — When a call rings on the telephone line connected to the DH30, the ON LED will flash and the telephone connected to the SET output will ring. Answer the call by pressing the ON button or activating the hybrid from your remote console control (if applicable). This routes the call through the hybrid, and the green ON LED illuminates. Upon connection, the DH30 automatically adjusts to line conditions.
- **Off-Air** — Answer the call by picking up the telephone handset and talking to your party over the telephone. Do not press ON.

Disconnecting a Call — If the call is routed through the DH30 (the ON LED is lit), press the OFF button to disconnect the call. The OFF LED illuminates, and the ON LED goes out. *Note: If the handset is off hook when the Off button is pressed, the caller will remain on the handset.*

If your call is through the handset only (the red OFF LED is lit), hang up when the conversation is complete.

Making a Call — Call the party normally, using your telephone handset. After the other party has answered, put the call on-air by pressing the ON button. The ON LED lights and the DH30 takes control of the call, disabling the telephone set. You may safely hang up the handset without disconnecting your call. When the conversation is complete, press the OFF button to disconnect the call. If you wish to take the caller off the air without hanging up, pick up the handset and then press the OFF button.

To make a telephone call off-air, call the party normally, using your telephone handset. After the other party has answered, conduct your call as you normally would and hang up the handset when finished.

RECORDING CALLS

The record function controls a recording device through the DB9 RECORD CONTROL connector. To use the record function, a recording device must be connected to the DB9 RECORD CONTROL connector. The AUX OUT connector of the DH30 must also be connected to the recording device.

The record function has three settings: off, record-ready (standby) and on (recording). Pressing the RECORD button has different effects, depending on whether the DH30 is on or off.

When the hybrid is recording, the LED flashes. When the hybrid is in record-ready mode, the LED is steady. And when the hybrid is not recording, the LED is not lit.

Recording Manually — When the hybrid is on, press RECORD to begin recording. The LED will flash. When you turn the hybrid off or when you press RECORD again, recording will stop and the LED will go off.

Using Record Ready — Press RECORD when the hybrid is off. The RECORD LED will illuminate. When the ON button is pressed, recording begins automatically and the RECORD LED flashes. When the hybrid is turned off or when you manually press the RECORD button again, recording stops and the RECORD LED becomes steady, indicating record-ready mode is still active. *Note: The ON and OFF buttons of the hybrid control the start and stop signals of the record connector in record-ready mode. This is ideal for unsupervised applications that use auto answer/disconnect in conjunction with recording devices.*

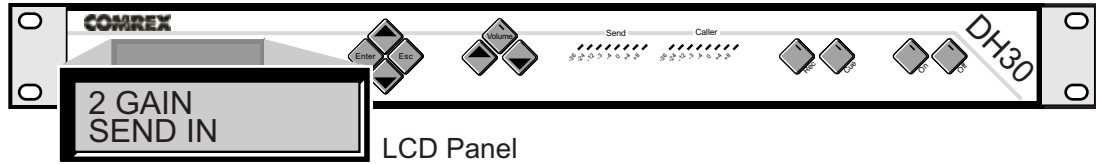

*USING THE NAVIGATING
BUTTONS AND ADJUSTING
PARAMETERS*

To scroll through the menu items on the LCD panel, press the UP and DOWN buttons. When a desired menu item is reached, press ENTER. Use the UP and DOWN buttons to scroll through the parameters. Press ESC to go back one level in the menu. At the end of the list of menu items, the menu will wrap around to the beginning.

Adjusting Parameters — As you enter a menu item and reach an adjustable parameter, the current value is displayed on the second line. To adjust the parameter, press ENTER. The parameter will begin to blink, indicating that the UP and DOWN buttons will adjust the value. As values are adjusted up and down, the change takes effect immediately. For example, as you adjust the caller out gain, you'll hear the level change. While adjusting a parameter up and down, an asterisk appears when the displayed value matches the preset value.

When you have adjusted the parameter to the desired value, press ENTER. This stores the value in the menu and it becomes the new preset value. If you press Esc, no changes will be made to the parameter, leaving the original setting as the preset value.

*VIEWING OR CHANGING
SETTINGS THROUGH THE
LCD PANEL*

The table below summarizes the settings available through the LCD panel. Refer to “User-Defined Presets Worksheet” (pages 39-40) for a worksheet version of this chart.

Menu Category	Selections	Function	Defaults
Presets		Store 3 Sets of Unique Configurations that can be Selected	
	Select Preset	Selects Preset 1, 2, or 3 - loads all parameters associated with selected preset	1
	Copy Preset	Copies settings from the active preset into one of the other two presets	N/A
	Recall Default	Restores settings to factory default for current preset	N/A
Gain		Set Gain for Inputs and Outputs	
	Send In	Adjusts send audio level as heard by caller	0dB
	Send Mic/Line	Adjusts send input for mic or line input	Line
	Cue In	Adjusts cue audio level as heard by caller	0dB
	Cue Mic/Line	Adjusts cue input for mic or line input	Line
	Call Out Gain	Adjusts caller's audio level out of DH30	0dB
	Aux Send	Adjusts send audio level at aux output	0dB
	Aux Caller	Adjusts caller's audio level at aux output	0dB
Caller Processing		Adjust Audio for Incoming Calls	
	3 Band EQ	Adjusts to tonal quality of the caller's voice	Bypass
	Compressor	Enables DH30 to handle wide range of caller voice levels	Bypass
	Expander	Attenuates line or background noise when caller is not talking	Bypass
	Bass Boost	Enhances caller bass	Bypass
	Caller Control	Allows talent to talk over caller	0dB
	Noise Burst	Toggles whether or not a noise burst is sent down telephone line when connection to the phone line is made	On
Echo Canceller		Adjust Auto Mix-Minus/AEC	
	Mix-minus/AEC	Turns mix-minus/acoustic echo cancellation on/off	On
	Echo Reduction	Selects echo reduction enhancement	Normal
	EC Train	Trains echo canceller to the room environment (acoustic) or studio (auto mix-minus) during setup	N/A
	Diagnostics	Displays measurements for troubleshooting	N/A
	Test Signal	Turns on/off noise generator to test receive or transmit	Off
System		Adjusts Various System Parameters	
	Auto Answer	Turns on/off automatic phone answer on first ring	Off
	Auto Disconnect	Selects type of auto disconnect	Off
	Remote Control	Sets remote on pin for momentary or latching control	Momentary
	Remote Auxpins	Selects aux pins for preset selection or audio muting control	Select Presets
	AES/EBU	Enable AES/EBU by selecting a sampling rate	Off
	Send to Aux	Selects type of send audio routed to aux output	Processed
	Set Passcode	Sets passcode used to lock and unlock adjustment presets	▲▲▲▼▼ Enter
	Version	Displays firmware version of DH30	N/A
Lock Panel		Locks Adjustment of Parameters	
	On/Off	Toggles adjustment of presets off and on, offering protection to preset parameters. "L" appears in the bottom right corner of LED screen when locked	Off

USING PRESETS

The DH30 allows the pre-configuration of up to three complete usage profiles through the Presets menu.

Preset 1

Preset 2

Preset 3

First, select the preset (Preset 1, Preset 2, or Preset 3). Within the **Preset** menu you can copy preset values into one of the other two presets, you can edit current parameters or you can choose to restore the values in that preset to the factory defaults (Recall Defaults option).

Any time you change values within the LCD menus, you are changing the values of the selected preset. Once you have entered changes in a preset, those values remain until they are manually reconfigured. Losing power does not affect the presets.

SETTING LEVELS

When adjusting levels, the hybrid should be connected to the telephone line. Have someone call the DH30 from another location. Answer the line by pressing the ON button. (If the auto-answer feature is active, the unit will answer the call after one complete ring.) Modify the level settings as follows:

1. Select **Gain** from the LCD panel, and use the ARROW keys to locate the appropriate function.
2. Press ENTER.
3. Use the ARROW buttons to adjust levels. (You can observe SEND IN and CALLER OUT level changes on the SEND and CALLER meter LED's.)
4. Press ENTER to save the value into the current-selected preset.

Submenu Options	Function	Hints for Setting
Send In Gain	The Send In level is set for a nominal input level of 0dB. This line-level input is adjustable from -20dB to 20dB	Adjust to select a value that registers 0dB on the Send meter LED
Send Mic/Line Gain	Adds 55 dB fixed gain	Set to LINE unless you are connecting directly to a microphone
Cue In Gain	The Cue In level is set for a nominal input level of 0dB. This input level is adjustable from -20dB to 20dB	With Cue audio selected, adjust to select a value that registers 0dB on the Send meter LED
Cue Mic/Line Gain	Adds 55 dB fixed gain	Set to LINE unless you are connecting directly to a microphone
Caller Out Gain	The Caller Out level is set for a nominal output value of 0dB. This output is adjustable from -20dB to 20dB	Adjust to match the nominal input level requirements of your console
Aux Send/Caller Output Gain	The Aux Send and Caller level is set for a nominal output value of 0dB. This output is adjustable from -20dB to 20dB	Adjust the balance of this and the previous option so they are matched in level for nominal input to your recorder from the AUX output

SECTION 4

AUTO MIX-MINUS AND ACOUSTIC ECHO CANCELLATION

*MIX-MINUS/ACOUSTIC ECHO
CANCELLATION*

The DH30 can cancel two types of echo — electronic and acoustic (room) echo. By setting the mix-minus/acoustic echo cancellation, you can cancel either or both types of echo.

Electronic Echo — is the echo caused by the caller’s audio being sent back to the caller through the mixing console. This can be prevented by creating a mix-minus at the mixing console. Mix-minus is the mix of all studio audio sources except caller audio.

The automatic mix-minus feature in this hybrid can be effective in removing the caller from the outgoing audio feed (the feed being sent back down the phone line). It does have its limitations, however. Because this mix-minus generation works on the same principles as the send-receive separation, changes in program level (e.g. riding a fader on the console) will cause the mix-minus feed to adapt, causing performance issues and audio distortion. The mix-minus generator is also very sensitive to non-linear processing (mic processors or compressor-limiters), so these must be left out of the signal chain. For the same reason, the mix-minus generation will cause severe distortion on overdriven audio levels.

In practice, whenever practical, we recommend creation of a true mix-minus feed in the studio rather than engaging this function. We consider this feature useful as a last resort, when no true mix-minus is technically possible.

Acoustic Echo — is the echo in a room environment. In an application such as a talk show, speaker audio may be picked up by microphones and fed back to the caller. Acoustic echo cancellation prevents this audio from being fed back to the caller.

Mix-minus and acoustic echo cancellation (AEC) are turned on and off through the **Echo Canceller** menu in the LCD panel. Although the DSP automatically adjusts to cancel echo, it is recommended you train the echo canceller to the echo when you first install the DH30. See “EC Train” on page 20.

1. Use the **ARROW** buttons to display **Echo Canceller**. Press **ENTER**.
2. Use **ARROW** buttons to display **Mix-Minus/AEC**.
3. Select **On** or **Off**, then press **ENTER** to activate your selection.
4. Press **ESC** to return to the previous menu level.

Note: If your mixing console is feeding mix-minus to the DH30 and you have removed acoustic echo in the studio, you should turn off the Mix-Minus/AEC function of the DH30.

ECHO REDUCTION

Echo reduction provides additional echo cancelling capability to the echo canceller in difficult acoustical environments. To activate, set the amount of non-linear processing the DH30 uses. The more aggressive the setting, the greater the chance of cutting off the caller's audio.

1. Use the **ARROW** buttons to display **Echo Canceller**. Press **ENTER**.
2. Use the **ARROW** buttons to display **Echo Reduction**. Press **ENTER**.
3. Use the **ARROW** buttons to display the appropriate option: **Off**, **Soft**, **Normal** (default), **Aggressive** or **Max**. Press **ENTER** to activate your selection.
4. Press **ESC** to return to the previous menu level.

EC TRAIN

Once mics and monitors are positioned in the studio and the levels are set on the mixing board, the DH30 should be trained to electronic and acoustic echo.

Training the DH30 — Select **Echo Canceller/EC Train** in the LCD display. The display shows both the **Echo Return Loss (ERL)** and the current **Echo Cancellation (EC)**.

1. Place a call and route it through the DH30, or have someone call in. If echo is present, continue with steps 2–7.
2. Select **EC Train** from the **Echo Canceller** menu and press **ENTER**. This sends a constant burst of white noise out of the **CALLER OUT** output. The EC Train uses this white noise to monitor how much noise comes back to the DH30 through the acoustic and electronic environment.
3. View the ERL reading on the DH30 LCD display. The ERL should be at a reading of 0 or below.
4. If the reading is in the positive, decrease the speaker monitor level and/or the caller audio level of the program mix until the ERL reading is 0 or lower.
5. Press **Esc**. This stops the white noise.
6. Have the person on the other end of the telephone line tell you if an echo is present.
7. If an echo is heard, go back to step one and read just your levels for an even lower reading OR adjust the amount of echo reduction (see the previous section “Echo Reduction”).

DIAGNOSTICS

The diagnostics feature is used to troubleshoot echo. This feature gives you the real time and average readings for:

TERL—Telephone Echo Return Loss
TEC—Telephone Echo Cancellation
TNLR—Telephone Non Linear Processing
AERL—Acoustic Echo Return Loss
AEC—Acoustic Echo Cancellation
ANLR—Acoustic Non Linear Processing

The Telephone Diagnostic Bits (TDB) and Acoustic Diagnostic Bits (ADB) readings are reserved for technical support troubleshooting.

To view these readings:

1. Use the **ARROW** buttons to display **Echo Canceller**. Press **ENTER**.
2. Select **Diagnostics**. Press **ENTER**.
3. Use the **ARROW** buttons to select the desired readout.
4. Press **ENTER** to generate a test signal.
5. Press **ENTER** to cycle through **Receive**, **Transmit**, and **Receive and Transmit** test signals.

Note: When generating tones during the diagnostic, you must scroll through all three readouts before the test signal ceases. Pressing Esc will take you out of the diagnostic, but will not stop the test signal.

TEST SIGNAL

When configuring your DH30, you can send a test signal through the monitor (Receive), through the telephone line (Transmit) or through both.

1. Use the **ARROW** buttons to display **Echo Canceller**. Press **ENTER**.
2. Use the **ARROW** buttons to select **Test Signal**. Press **ENTER**.
3. Use the **ARROW** buttons to select **Receive**, **Transmit** or **Both**.
4. Press **ENTER** to send the test signal.
5. To stop the signal, use the **ARROW** buttons to select **Off**.

SECTION 5

CUSTOMIZING YOUR SYSTEM

SETTING CALLER PROCESSING

The Caller Processing menu category in the LCD panel includes six sub-menu items for controlling various facets of the caller audio.

EQ (Equalizer) — The equalizer function is used to modify the tonal quality of the caller audio. The basic function is a simple three-band graphic equalizer. The adjustments to each band determine how much adjustment is made to the caller audio signal.

When active, the caller equalizer will have the following characteristics:

- LowBand = 250 Hz – 715 Hz
- MidBand = 715 Hz – 1,645 Hz
- HiBand = 1,645 Hz – 3,500 Hz

Adjustment in each band is from -12 to +12 dB.

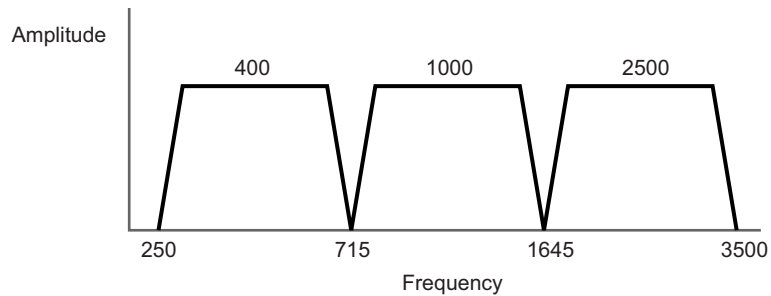

Compressor — The function of the compressor is to keep the caller output at the same level regardless of the incoming level. The caller level should be set to accommodate the quiet callers. The DH30 compresses, or attenuates, the louder levels.

The compressor works in conjunction with its threshold setting. The threshold setting is the level at which compression will begin. The ratio determines the attenuation applied to levels above threshold.

For example, a 2:1 ratio means that for every 2 dB the caller is above threshold, the audio level will increase only 1 dB. The larger the ratio, the more compression is applied. The limiter setting keeps the level from exceeding the threshold. The bypass setting disables the compressor.

- Ratio options are: Bypass, 2:1, 3:1, 4:1, 6:1 and Limiter.
- Threshold is referenced to the level of the caller audio on the VU meter. Adjustable from -20 dBu to 20 dBu.
- Post gain adds gain to all audio to compensate for compression. Adjustable from 0 to 20 dB.
- Attack sets the time required to compress when audio exceeds threshold. Adjustable from <1 to 50 ms.
- Release sets the time required to release compression when audio falls below threshold. Adjustable from 100 ms to 2000 ms (2 seconds).

Expander (Downward expander) — The expander reduces telephone line noise when the caller is not talking by decreasing audio gain when caller audio falls below the threshold level. As long as the caller audio remains above the threshold, the expander function remains at unity gain (no expansion). When the caller audio sample drops below the expander threshold, the expander function decreases the gain by the ratio determined at setup. *Note: If the expander threshold is set too high, the DH30 may treat the caller as noise. This results in downward expansion of caller audio.*

The expander has the following characteristics:

- Expansion ratio is adjustable in the following ratios: Bypass, 2:1, 3:1, 4:1 or 6:1.
- Threshold is referenced to the caller out level. Adjustable from -50 dBu to 0 dBu.
- Expansion attack time adjustable from <1 to 50 ms.
- Expansion release time adjustable from 100 ms to 2000 ms.

Bass Boost — Boosting the bass gives a fuller sound to the caller's audio by enhancing frequencies below 250 Hz. The front panel LCD program allows you to adjust the **Bass Boost** feature over a range of 0 to 10, with 10 being most enhanced. *Note: If you have increased the bass in the **Caller Processing** menu, you may need to add echo reduction to compensate.*

Caller Control — Caller control allows the talent to talk over the caller, reducing caller audio whenever send audio is present. When send audio is present, the caller will attenuate/duck by the amount adjusted. You can adjust the amount of caller attenuation provided, from 0 to -30 dB. A typical setting would be -6 to -12 dB.

Noise Burst — If activated, a momentary noise burst will be sent to the telephone line when turning the hybrid on. The noise burst allows the DSP to adapt the telephone echo canceller and provides a better null at the beginning of the call. Without the noise burst, the DSP may add attenuation on the caller audio until the DSP has adapted to an acceptable null.

The trade-off in setting noise burst on is that the caller hears a momentary noise burst, but the telephone audio is immediately adapted. Setting the noise burst off spares the caller the brief noise, but the DH30 may require 5 to 20 seconds to adapt.

Training the Telephone Echo Canceller

To retrain a connection to a telephone line, momentarily press the ON button after the hybrid is already connected to the telephone line. This initiates the same noise burst mentioned above and retrains the hybrid.

SYSTEM PARAMETERS

These parameters control the telephone connect and disconnect modes, remote control switching mode, quality of audio sent to the AUX OUT jack, sample rate for equipment synchronization, passcode protection, notice of the firmware version level and the panel locking feature.

Activating Auto Answer — In the auto-answer mode, the DH30 automatically answers telephone calls after one complete ring. Upon answering, the red OFF LED goes out and the green ON LED comes on. The call is routed through the digital hybrid and its connection to the console.

1. Select **Auto Answer** from the system menu and press ENTER.
2. Use the ARROW buttons to select **On**.
3. Press ESC to exit the function.

Activating Auto Disconnect — When the call is terminated, the digital hybrid senses the hang up and automatically turns the digital hybrid off. The green ON LED goes out and the red OFF LED comes on. The DH30 disconnects on all reorder tones with a cadence. Auto disconnect may not function as described with some PBX systems. Problems in auto-answer mode may be caused by ring timing. Also, some PBX systems do not provide loop drop or loop reversal when disconnecting calls. If your PBX only provides reorder tone or busy signals, the call-progress function must be enabled for auto-disconnect to function properly.

1. Select **Auto Disconnect** from the system menu and press ENTER.
2. Use the ARROW buttons to select the signal type the DH30 must detect before disconnecting the call: **Loop Drop Only**, **Call Progress Only** or **Loop Drop+CP**.
3. Press ESC to exit the function.

Remote Control — DH30 on and off functions can be remotely controlled by momentary or latching switches. To change the setting, select **Remote Control** from the system menu and press ENTER. Then select **Momentary** or **Latching** and press ENTER.

Momentary

If you prefer to use a momentary switch to remotely control the DH30, select **Momentary** in the **Remote Control** menu. Pins 1 and 2 when shorted to ground, will remotely turn the DH30 on and off respectively. *Note: The RECORD and CUE functions can only be activated by momentary closures. See Section 7 on pages 31-32 for pinout information.*

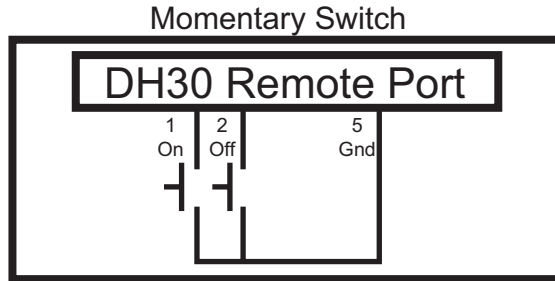

Latching

If you prefer to use a single switch to remotely control the DH30, then select **Latching** in the **Remote Control** menu.

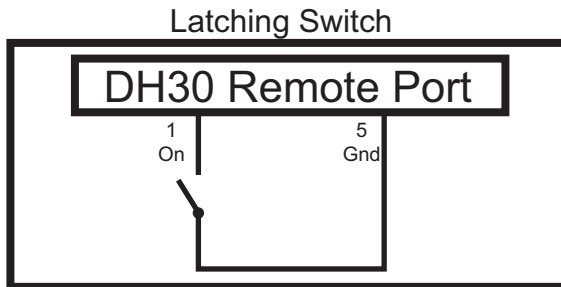

Remote Aux Pins — This feature offers pin reassignment to the preset/mute audio pins. When **Mute Audio** is selected — **Mute Caller** mutes the caller audio, **Mute Monitor** mutes the monitor output, and **Mute Send** mutes the send audio. When **Select Presets** is selected, you can choose between three user-programmed settings by activating the associated preset pin. See Section 7 on pages 31-32 for pinout information.

Send to Aux — This option determines the type of send audio that goes to AUX OUT and AES/EBU SEND output. Audio types include **Off**, **Processed** (echo cancelled and bandwidth limited), and **Full** (full bandwidth and not echo cancelled). If **Mix-Minus/AEC** is on, then **Send to Aux** must be **Off** or **Processed**.

AES/EBU — This option determines whether the **AES/EBU Input** is active, and if so, at what sampling rate it runs. Please note this option has changed in relation to the previous version of this product, which selected the sampling rate automatically. If you plan on using the AES/EBU INPUT, you must select the sampling rate in this menu. If no AES/EBU signal is applied to the input, this option must remain **Off**. If the sampling rate is chosen incorrectly or if an AES/EBU signal is not applied after choosing a sampling rate, the product will malfunction. If the **AES/EBU Input** remains **Off**, the AES/EBU OUTPUT will remain active, synchronized to an internal 32KHz sampling clock. If an AES/EBU input is applied (and the correct sampling rate option is chosen), the AES/EBU output will synchronize to the input sampling rate clock.

Set Passcode — The DH30 passcode can be user programmed. The default passcode is ▲▲▼▼ENTER.

1. Use the ARROW buttons to display **System**. Press ENTER.
2. Use the ARROW buttons to display **Passcode**. Press ENTER.
3. You will be prompted for a new five character passcode. The ▼, ▲, ESC, or ENTER keys are valid passcode keys.
4. Once you enter the new passcode, you will be prompted to verify the passcode.
5. If you enter the new passcode incorrectly, **Mismatch** will appear and you will have to begin again. If you enter it correctly, **Passcode Changed** will appear and the new passcode will be activated.

Version — Displays current operating version of the DH30.

Lock Panel — Toggles the lock on/off. You will need to enter the passcode to lock or unlock the panel controls. When the panel is locked, the user can select presets but cannot change the parameters of the presets. To verify that the panel is locked, an 'L' will appear in the bottom right corner of the LCD display.

SECTION 6

SPECIFICATIONS

<i>DIMENSIONS</i>	17.125"/43.5cm W x 1.75"/4.44cm H x 10.125"/25.7cm D Rackmount included for installation in a 19" rack
<i>WEIGHT</i>	6.7lbs/3.04kg (dry) 11.2lbs/5.08kg (shipping)
<i>OPERATING TEMPERATURE</i>	32-100°F/0-38°C 0-80% - Humidity
<i>FRONT PANEL CONTROLS</i>	LCD programming display, ENTER/ESC/▲▼ programming buttons, monitor volume control, send-level LED bar meter, caller-level LED bar meter, record, cue, hybrid ON/OFF, buttons with status LEDs
<i>REAR PANEL CONNECTORS</i>	<p>POWER: IEC Type Auto Adjusting, 100-240VAC, 2A, 50/60Hz, 30W</p> <p>AES/EBU IN: XLR pin 1 = ground, pin 2 = +phase, pin 3 = -phase; 32, 44.1, or 48kHz sample rate</p> <p>AES/EBU OUT: XLR pin 1 = ground, pin 2 = +phase, pin 3 = -phase; 32, 44.1, or 48kHz sample rate</p> <p>RS232: DB9 female connector 9,600 baud rate, used for status and control via a PC or other RS232 controller</p> <p>RECORD CONTROL: DB9 female Start, stop, and enable outputs are open collector outputs rated at 40VDC and 50mA maximum</p> <p>REMOTE: DB25 female Remote Send Input: 0dBu nominal, adjustable, unbalanced, 20k Ohm impedance</p> <p>Remote Caller and Aux Outputs: 0dBu nominal, adjustable, unbalanced, 50k Ohm impedance</p> <p>Control Inputs: Remotely activate any of the following functions with a simple switch closure to ground: ON, OFF, CUE and REC along with preset selection controls 1, 2 and 3 or with send, caller, and monitor mute controls.</p>

Status Outputs:

Remotely check the status of the hybrid with the ON, OFF, CUE, REC, send presence and caller presence status outputs. All status outputs are open collector outputs rated at 40VDC and 50mA maximum.

MONITOR OUTPUT: 1/4" stereo jack

tip = + phase, ring = -phase, sleeve = -phase
2W output into an 8 Ohm load

SEND INPUT: XLR female

Mic/Line selectable, -55 or 0dBu nominal, adjustable, balanced bridging, 20k Ohm impedance, selectable 12VDC Phantom Power

CUE IN: XLR female

Mic/Line selectable, -55 or 0dBu nominal, adjustable, balanced bridging, 20k Ohm impedance, selectable 12VDC Phantom Power

CALLER OUTPUT: XLR male

0dBu nominal, adjustable, balanced 50k Ohm impedance

AUX OUTPUT: XLR male

0dBu nominal, adjustable, balanced 50k Ohm impedance

TELCO LINE: RJ11 connector

POTS (plain old telephone service) line or analog extension from a PBX or dry line (no DC offset voltage). A-Lead supervision provided (see "Line Connector" pinout chart on page 32 for further details).

TELCO SET: RJ11 connector

A-Lead supervision provided (see "Set Connector" pinout chart on page 32 for further details).

TELEPHONE TRANSMIT

All measurements referenced at -15dBm level on the phone line.

FREQUENCY RESPONSE: +/- 1dB from 250Hz to 3.5kHz

DYNAMIC RANGE: >70dB

DISTORTION: <0.15%

TELEPHONE RECEIVE

All measurements referenced at -15 dBm level on the phone line with caller processing options bypassed.

FREQUENCY RESPONSE: +/- 1dB from 250Hz to 3.5kHz

DYNAMIC RANGE: >70dB

DISTORTION: <0.1%

ECHO CANCELLATION/MIX-MINUS

TAIL TIME: 120 milliseconds

NULL: 50dB

TELCO CANCELLATION

TAIL TIME: 32 milliseconds

NULL: 55dB

SECTION 7

PINOUTS

REMOTE CONNECTOR

Pin	Description	Pin	Description
1	Remote on *	14	Remote on Indication **
2	Remote off *	15	Remote off Indication **
3	Remote Record *	16	Record Indication **
4	Remote Cue *	17	Cue Indication **
5	Switch/Indicator Common	18	Indicator Common
† 6	Select Preset 1/Send Mute *	19	Send Presence Indicator **
† 7	Select Preset 2/Caller Mute *	20	Caller Presence Indicator **
8	N/C	21	Indicator Common
9	Unbalanced Send #	22	Unbalanced Audio Common #
10	Unbalanced Caller ##	23	Unbalanced Audio Common ##
11	Unbalanced Aux Out ###	24	Unbalanced Audio Common ##
† 12	Select Preset 3/Monitor Mute*	25	Switch Common
13	N/C		

* Remote control provided via contact closure to digital ground
 ** Remote indicators provided via open collector outputs, <40 V, 50 mA
 # 0dB line-level input with >20 kOhm impedance
 ## 0dB line level output with a <50 Ohm impedance
 † These control inputs will perform preset selection or audio path muting as set by the system menu selection of Remote aux pins

RS232 CONNECTOR

Pin	Description	Pin	Description
1	N/C	6	N/C
2	TXD	7	N/C
3	RXD	8	N/C
4	N/C	9	N/C
5	GROUND		

RECORD CONTROL

Pin	Description	Pin	Description
1	Start	6	Start Common
2	N/C	7	N/C
3	N/C	8	Stop Common
4	Stop	9	Record Enable Common
5	Record Enable		

LINE CONNECTOR

Pin	Description	Pin	Description
1	To pin 6 of SET RJ11C	4	Ring
*2	To pin 5 SET of RJ11C	*5	To pin 2 of SET RJ11C
3	Tip	6	To pin 1 of SET RJ11C

*When the ON button is illuminated on the DH30, an “A-Lead Closure” is provided between pins 2 and 5 of the LINE and SET jacks. This connection is useful for key telephone system such as the 1A2. If you connect the DH30 to an extension jack of a more modern PBX, you should first check to see if those wires are used for signalling or power. If so, do not connect them to the DH30. You may, however, use the pin 2-5 connection to control the hookswitch on a modified PBX phone. Contact Comrex technical support for more information.

SET CONNECTOR

Pin	Description	Pin	Description
1	To pin 6 of LINE RJ11C	4	Tip
*2	To pin 5 of LINE RJ11C	*5	To pin 2 of LINE RJ11C
3	Ring	6	To pin 1 of LINE RJ11C

XLR CONNECTOR

Pin	Description	Pin	Description
1	Ground	Tip	+ Phase audio
2	+ Phase audio	Ring	- Phase audio
3	- Phase audio	Sleeve	- Phase audio

SECTION 8

SERIAL COMMUNICATIONS PROTOCOL

The RS232 port on the DH30 is a serial communications port used to control DH30 operations through an external device such as a PC or a control device. This section describes the protocol and serial commands used to control the DH30.

The RS232 serial port runs at 9600 baud, no parity, eight data bits and one stop bit.

Serial commands to the DH30 can control the following types of operations: Hybrid On/Off, Cuing, Recording, Monitor volume, Preset selection and Detection of an Incoming Call.

Function	Serial Command	Returned Status
On/Off	TE<cr>	TE 0<cr> or TE1<cr>
Off	TE 0<cr>	TE 0
On	TE 1<cr>	TE 1
Cue Status	CUE<cr>	CUE 0 or CUE 1
Cue Off	CUE 0<cr>	CUE 0
Cue On	CUE 1<cr>	CUE 1
Cue Toggle	Cue 2<cr>	CUE 0 or CUE 1 (toggled)
Record Status	REC<cr>	REC 0/1/2/3
Record Off	REC 0<cr>	
Record On	REC 1<cr>	(see note below)
Record Toggle	REC 2<cr>	
Monitor Volume Up*	VOLUP<cr>	VOLUP
Monitor Volume Down	VOLDWN<cr>	VOLDWN
*no value give		
Current Preset	PRESET<cr>	PRESET 1
Select Preset 1	PRESET 1<cr>	PRESET 2
Select Preset 2	PRESET 2<cr>	PRESET 3
Select Preset 3	PRESET 3<cr>	
Incoming Call	N/A	RING
NOTE: The returned status is dependent on the current setting of the hybrid. See table below:		
Status Returned	Record-Ready	Recording
0	no	no
1	yes	no
2	no	yes
3	yes	yes

The structure of serial commands is an option/value, followed by a carriage return:

command x

Commands can be either UPPER CASE or lower case terminated by a carriage return. Characters are not echoed back to the sending device as they are sent. After a command has been sent, including the carriage return, the command is echoed back in uppercase with the new value followed by a DH30> command prompt.

For example, a command to turn Cue on would be formatted like this:

CUE 1<cr>

(CUE =function command, 1=On, as shown in the facing table.)

The returned response would be:

**CUE 1
DH30>**

If the Cue feature was off and the toggle Cue command was sent:

CUE 2<cr>

The returned response would be:

**CUE 1
DH30>**

Indicating that the Cue feature had been turned on.

To get status back on what the current setting is, send the command without a parameter. For example if the Cue function is on when the command is sent:

CUE<cr>

The response would be:

**CUE 1
DH30>**

SECTION 9

DH30 AUDIO FLOW

The diagram below shows all the audio inputs and outputs and associated gain blocks and mixing junctions. The inputs are on the left (however, the Telco LINE and SET jacks are both input and output). The outputs are on the right.

DH30 Audio Flow

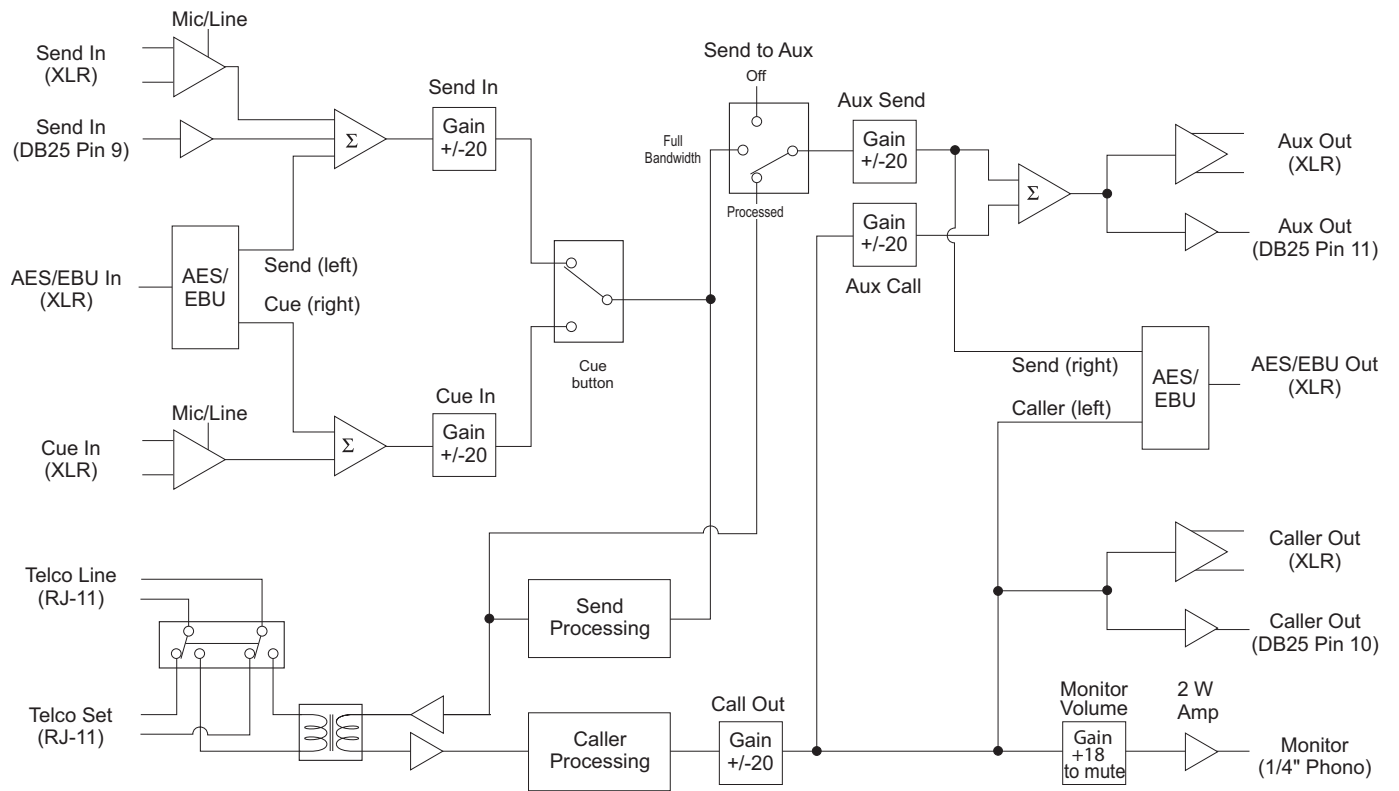

SECTION 10

COMPLIANCE

FCC PART 15 COMPLIANCE

This equipment has been tested and found to comply with the limits for a Class A digital device, pursuant to Part 15 of the FCC rules. These limits are designed to provide reasonable protection against harmful interference when the equipment is operated in a commercial environment. This equipment generates, uses and can radiate radio frequency energy and, if not installed and used in accordance with the instruction manual, may cause harmful interference to radio communications. Operation of this equipment in a residential area is likely to cause harmful interference, in which case the user will be required to correct the interference at his/her own expense.

Changes or modifications not expressly approved by Comrex Corporation could void the user's authority to operate the equipment.

FCC PART 68 COMPLIANCE

A label containing the FCC registration number and Ringer Equivalence Number (REN) for this equipment is prominently posted on the top plate near the rear of the equipment. If requested, this information must be provided to your telephone company.

USOC Jacks: This device uses RJ11C and RJ21X terminal jacks.

The REN is used to determine the quantity of devices which may be connected to the telephone line. Excessive REN's on the telephone line may result in the devices not ringing in response to an incoming call. In most, but not all areas, the sum of the REN's should not exceed five (5). To be certain of the number of devices that may be connected to the line, as determined by the total REN's, contact the telephone company to obtain the maximum REN's for the calling area.

If this equipment causes harm to the telephone network, the telephone company will notify you in advance that temporary discontinuance of service may be required. If advance notice is not practical, the telephone company will notify the customer as soon as possible. Also, you will be advised of your right to file a complaint with the FCC, if you believe it is necessary.

The telephone company may make changes in its facilities, equipment, operations or procedures that could affect the operation of the equipment. If this happens, the telephone company will provide advance notice for you to make the necessary modifications in order to maintain uninterrupted service.

If you experience problems with this equipment, contact Comrex Corporation, 19 Pine Road, Devens, MA 01434 or by telephone at 978-784-1776 for repair and warranty information. If the trouble is causing harm to the telephone network, the telephone company may request you remove the equipment from the network until the problem is resolved.

No user serviceable parts are contained in this product. If damage or malfunction occurs, contact Comrex Corporation for instructions on its repair or return.

This equipment cannot be used on telephone company provided coin service. Connection to Party Line Service is subject to state tariffs.

IC COMPLIANCE

NOTICE: The Industry of Canada label identifies certified equipment. This certification means that the equipment meets certain telecommunications network protective operational and safety requirements. The Department does not guarantee the equipment will operate to the user's satisfaction.

Before installing this equipment, users should ensure that it is permissible to be connected to the facilities of the local telecommunications company. The equipment must also be installed using an acceptable method of connection. In some cases, the company's inside wiring associated with a single line individual service may be extended by means of a certified connector assembly (telephone extension cord). The customer should be aware that compliance with the above conditions may not prevent degradation of service in some situations.

Repairs to certified equipment should be made by Comrex Corporation. Any repairs or alterations made by the user to this equipment, or equipment malfunctions, may give the telecommunications company cause to request the user to disconnect the equipment.

Users should ensure, for their own protection, that the electrical ground connections of the power utility, telephone lines, and internal metallic water pipe system, if present, are connected together. This precaution may be particularly important in rural areas.

CAUTION: Users should not attempt to make such connections themselves, but should contact the appropriate electrical inspection authority, or electrician, as appropriate.

INTERNATIONAL COMPLIANCE
(APPLIES TO
DH30 910-012-302)

Information for CTR21

The Digital Hybrid 30/DH30/910-012-302 has been approved in accordance with Council Decision 98/482/EC for pan-European single terminal connection to the public switched telephone network (PSTN). However, due to differences between the individual PSTN's provided in different countries, the approval does not, of itself, give an unconditional assurance of successful operation on every PSTN network termination point.

In the event of problems, you should contact your equipment supplier in the first instance.

Network Compatibility Declaration

Comrex Corporation, 19 Pine Road, Devens, MA 01434 USA declares that the product Digital Hybrid 30/DH30/910-012-302 is designed to be compatible with the following networks: Austria, Belgium, Denmark, Finland, France, Germany, Greece, Iceland, Ireland, Italy, Liechtenstein, Luxembourg, The Netherlands, Norway, Portugal, Spain, Sweden, Switzerland and United Kingdom.

SECTION 11

USER-DEFINED PRESETS WORKSHEET

Use these worksheets to record the presets you configure for your site. For descriptions of the menu options, refer to “Viewing or Changing Settings” through the LCD Panel on page 17.

Menu Categories	Submenu Selections	Submenu Parameters	Submenu Ranges	Factory Default	User Preset 1	User Preset 2	User Preset 3
Presets	Select Preset			Preset 1			
	Copy Preset			n/a			
	Recall Default			n/a			
Gain	Send In Gain		-20 to 20dB	0dB			
	Send In Preamp		Line	Line			
			Mic				
	Cue In Gain		-20 to 20dB	0dB			
	Cue In Preamp		Line	Line			
			Mic				
	Call Out Gain		-20 to 20dB	0dB			
	Aux Send Gain		-20 to 20dB	0dB			
Aux Call Gain		-20 to 20dB	0dB				
Caller	EQ	EQ Bypass	Off	On			
			On				
		EQ Low Band	-20 to 20dB	0dB			
		EQ Mid Band	-20 to 20dB	0dB			
		EQ High Band	-20 to 20dB	0dB			
	Compressor	Comp Ratio	Bypass	Bypass			
			2:1				
			3:1				
			4:1				
			6:1				
			Limiter				
		Comp Threshold	-20 to 20dB	0dB			
		Comp Post Gain	-20 to 20dB	0dB			
		Comp Attack	<1mS to 50mS	15mS			
		Comp Release	100 to 2000mS	500mS			
	Expander	Exp Ratio	Bypass	Bypass			
			2:1				
			3:1				
			4:1				
			6:1				
		Exp Threshold	-50 to 0dB	-40dB			
		Exp Attack	<1mS to 50mS	15mS			
		Exp Release	100 to 2000mS	500mS			
Bass Boost		0 to 30	0				
Caller Control		0 to -30dB	0dB				
Noise Burst		Off	On				
		On					

Menu Categories	Submenu Selections	Submenu Parameters	Submenu Ranges	Factory Default	User Preset 1	User Preset 2	User Preset 3
Echo Cancellor	Mix-minus/AEC		Off	On			
			On				
	Echo Reduction		Off	Normal			
			Soft				
			Normal				
			Aggressive				
			Maximum				
	EC Train		Off	Off			
			On				
	Diagnostics		Off	Off			
			TERL				
			TEC				
			TNLP				
			TDB				
			AERL				
			AEC				
			ANLP				
			ADB				
	Test Signal		Off	Off			
			Receive				
			Transmit				
			Rcv & Transmit				
System	Auto Answer		Off	Off			
			On				
	Auto Disconnect		Off	Off			
			Loop Drop Only				
			Call Prog Only				
			Loop Drop + CP				
	Remote Control		Momentary	Momentary			
			Latching				
	Remote Aux Pins		Mute Audio	Select Presets			
			Select Presets				
	Send to Aux		Off	Processed			
			Processed				
			Full bandwidth				
	AES/EBU		AES Off	AES Off			
			32000 kHz				
		44100 kHz					
		48000 kHz					
Set Passcode		New Passcode	▲▲▼▼ Enter				
Version**			Vx.x Date				
Lock Panel			Off	Off			
			On--"L" will appear in lower right corner of screen				

**Sub menu version will indicate the current version of code and the date implemented.

SECTION 12

GLOSSARY

AES/EBU — Audio Engineering Society/European Broadcasting Union. The protocol for communicating two-channel digital audio information over a serial link.

AEC — Acoustic Echo Cancellation. The process of removing echo before it returns to its source.

AERL — Acoustic Echo Return Loss. The amount of echo returned to the audio source in an acoustic environment.

Analog Line — A telephone line that is not digital.

Balanced Audio — A two-line audio signal without reference to ground (i.e. differential-mode audio).

Bass Boost — Spectral enhancement of frequencies below 250 Hz.

Bypass — A route where current flows around instead of through a component or circuit.

Cadence — Any tone on a telephone line that has a distinct pattern.

Call Progress Tones — Tones sent from the telephone switch to inform the caller or devices that a call has ended. These tones include a busy signal, dial tone, fast busy, or dual-tones.

Caller — The caller's voice as it enters the hybrid from the telephone line.

Caller Control — Suppression of caller audio when send audio is present.

Compressor — See Limiter.

Console — The audio mixer used to combine all programming sources. A console is also called a mixing board, a mixer, audio board, etc.

Cue — Audio heard by caller when cue mode is active.

Digital Signal Processing — Digitally modifying a signal to provide a specific function or output.

Dryline — A telephone circuit over which voice signals are transmitted and contains no DC offset voltage.

DSP — Digital Signal Processing/Processor.

Echo Cancellation — Digital removal of speaker audio that is picked up by the microphone.

Equalizer — A device that allows the user to tailor frequency response.

Expander — More accurately called the downward expander, this suppresses noise when the caller is not talking.

Handset — The hand-held part of a communications system, usually consisting of a speaker and microphone.

Hybrid — See Telephone Hybrid.

Latching — A control signal that remains in a fixed state until you release it. This is opposed to momentary control, which is a pulsed signal.

LED — Light emitting diode. A semiconductor diode used in an electronic display that emits a light when subjected to an applied voltage.

Limiter — A circuit whose output signal amplitude remains at a predetermined level despite variations in input signal amplitude.

Loop Drop — A temporary interruption on the telephone line's DC voltage.

Mix-Minus — Audio that must be sent to callers to prevent feedback on the audio system through the hybrid. Mix-Minus is a mix of all audio on the console, minus the caller's audio. Without a mix-minus feed, the caller audio appearing on the console is sent back to the caller, where it is retransmitted to the studio through the caller's telephone. This feedback can create anything from an echo to a howling squeal.

Noise Burst — A burst of white noise used by the hybrid to optimize echo cancellation and null performance.

Null — The ability of the analog hybrid to separate send audio from caller audio. (Also known as trans-hybrid loss or side tone.)

Off — The DH30 front panel control that disconnects callers who are active on the system. This control does not affect DH30 power.

On-Air — Callers are put on-air with the announcer so the listening audience can hear the conversation.

PBX — Private Branch Exchange. See Telephone Line.

Phantom Power — Power provided by audio equipment to power microphones that contain active components. This provides a DC offset voltage to the signal.

Pinouts — Configuration of signal-carrying lines on a connector.

Send — Refers to audio sent to the caller from the studio mixer or microphone.

TEC — Telephone Echo Cancellation. The process of removing echo before it returns to its source over a telephone line.

TERL — Telephone Echo Return Loss. The amount of echo returned to the audio source over a telephone line.

Telephone Hybrid — A device that converts a telephone line (2-wire, low-level signal) into a balanced, 4-wire, line-level signal with independent send and receive ports. A telephone hybrid provides the necessary electronic matching between the telephone line and the audio equipment. Generally referred to in this manual as simply “hybrid.”

Telephone Line — The line delivered by the telephone company to an individual subscriber. Sometimes known as a POTS (Plain Old Telephone Service) line, this is an analog line required by fax machines and modems. The DH30 requires analog telephone lines for its phone line connection. PBX systems or other digital telephone systems must be equipped with an analog extension for use with the DH30.

Threshold — A predetermined point for the start of operation of a circuit.

Unbalanced Audio — A circuit that is referenced to ground.

Wet Line — A telephone circuit over which voice signals are transmitted and contains DC offset voltage.