

### Product Identification



Prince Castle's DHB3PT-44D Chicken Holding Bin is designed for the Popeyes system to hold all your bone-in fried chicken better than ever before. Capable of holding up to 360 pieces of chicken, the DHB3PT-44D is designed to both hold and merchandise Popeyes' chicken in a dual line store format.



#### LIMITED WARRANTY

This product is warranted to be free from defects in material and/or workmanship for a period of 1 year from date of original installation, not to exceed 18 months from the date of manufacture.

Any component which proves to be faulty in material and/or workmanship will be replaced or repaired (at the option of Prince Castle, Inc.) without cost to the customer for parts and labor. This warranty covers on-location service (i.e. trip charges and/or mileage). Travel mileage is limited to 100 miles (200 Kilometers) round trip (one trip warranty) from an authorized service agency or its sub-service agency.

This warranty is subject to the following exceptions/conditions:

- Use of any non-genuine Prince Castle parts voids this warranty.
- All labor to be performed during regular work hours. Overtime premium (the incremental amount) will be charged to the customer.
- Damage caused by carelessness, neglect and/or abuse (e.g., dropping, tampering or altering parts, equipment damaged in shipment, by fire, flood or an act of God) is not covered under this warranty.
- All problems due to operation at voltages other than that specified on equipment nameplates are not covered by this warranty. Conversion to correct voltage is the customer's responsibility.
- This equipment must be serviced by Prince Castle Authorized Service Agency or a Prince Castle Service Technician during the warranty period.

#### TABLE OF CONTENTS

|                                     |   |
|-------------------------------------|---|
| Product Identification .....        | 1 |
| Safety Information .....            | 2 |
| Important!.....                     | 2 |
| Installation / Setup .....          | 2 |
| Initial Startup.....                | 3 |
| Recommended Settings .....          | 3 |
| Resetting to Factory Defaults ..... | 3 |
| Control Panel.....                  | 4 |
| Programming.....                    | 5 |
| Cleaning.....                       | 6 |
| Troubleshooting.....                | 6 |
| Parts & Service .....               | 7 |
| Wiring Diagram.....                 | 9 |



**PRINCE CASTLE INC.**  
WORLDWIDE 

355 East Kehoe Blvd. • Carol Stream, IL 60188  
Phone: 630-462-8800 • Toll Free: 1-800-PCASTLE  
Fax: 630-462-1460 • [www.PrinceCastle.com](http://www.PrinceCastle.com)

**Safety Information** | **Important!**

**⚠ WARNING**  
Indicates information important to the proper operation of the unit. Failure to observe may result in damage to the equipment and/or severe bodily injury or death.

**⚠ CAUTION**  
Indicates information important to the operation of the unit. Failure to observe may result in damage to the equipment.

Prince Castle reserves the right to change specifications and product design without notice. Such revisions do not entitle the buyer to corresponding changes, improvements, additions or replacements for previously purchased equipment.

**Installation / Setup**

Remove the unit from the carton and inspect for signs of damage. If there is damage to the unit:

- Notify the carrier within 24 hours of delivery,
- Save carton and packaging materials for inspection purposes,
- Contact your local dealer, or if purchased directly, the Prince Castle Sales Department at 1-800-722-7853 or 630-462-8800 to arrange for a replacement unit.

**NOTE:** When installing this unit, the ambient temperature at the mounting site should not exceed 37.8°C (100°F).

**⚠ CAUTION**  
All electrical connections must be in accordance with local electrical codes and any other applicable codes.  
Plug the unit into an applicable electrical receptacle.

**1**

A. Place the bin on a counter or workstation.  
B. Make power connection to the terminal block on the top of the bin. Required voltage is 120/208 TO 240 VOLTS SINGLE PHASE, and the connections are L1, L2, Neutral, and Earth Ground (see figure of wiring diagram).  
The bin draws 31 amps at 120/208 or 35 amps at 120/240 volts during the 35 min. warm-up.  
The current drops to approximately half when the heaters reach the set-point temperature.

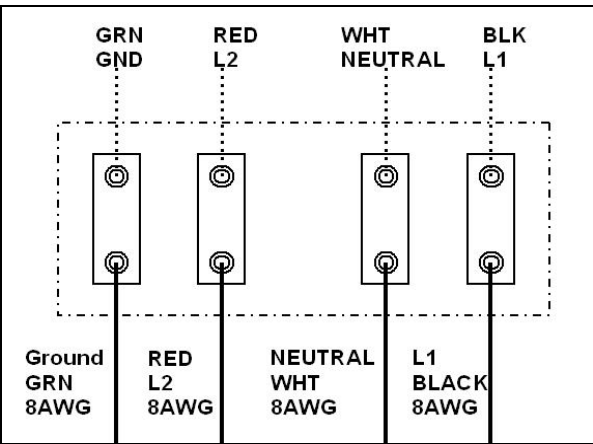

**2**

A. Turn the power switches ON.  
B. Allow 35 mins. for warm-up.

**3 Environmental Issues**

Airflow through the bin will adversely affect the performance of the bin. Sources of airflow include:

- Air conditioning vents
- Air currents
- Make-up air Inflows
- Drive-through window

None of the above should be directing airflow towards the bin or through the cavities of the bin. To check for airflow, remove a pan from a hot steam table and watch the direction of the steam coming out of the steam table.

The direction the steam flows is an indicator of the airflow direction and its intensity. There is no airflow if the steam flows straight up as it dissipates. There is an intense airflow if the steam quickly changes direction and flows parallel to the floor.

If there is airflow, check for the source(s). It is recommended that air diverters be installed to direct the airflow away from the bin.

Do NOT reduce the amount of cooled air brought into the building. Direct the flow of air away from the cavities of the Chicken Holding Bin.

## Initial Startup

 During the first few hours of operation, you may notice a faint odor. This is normal, and the odor disappears after the first few hours of use.

The bin is tested and calibrated at the factory before shipment. However, due to temperature and climate changes during shipment, the insulation in bin can absorb moisture.

The odor during the first few hours of use is from the drying out of the insulation (moisture is driven from the insulation's binders, a starch-like material).

If the florescent lights do not turn on, verify that the bulbs are seated in their sockets.

## Recommended Settings

The recommended settings listed below are starting points only. The final setting for each cavity is influenced by the airflow through the cavity. The airflow is influenced by the bins location relative to the Drive-Through window, the front door, and/or the air conditioning vents. The final setting must achieve the required serving temperature at the end of the hold time. Therefore, the setting of each cavity may have to be adjusted up or down from the recommended starting points listed below to meet the quality and temperature requirements.

 A higher setting yields hotter chicken, but in achieving a hotter temperature, more moisture is driven from the chicken. Thus, there must be a balance at the end of the maximum hold time, where the chicken is above a minimum serving temperature and all quality requirements are met.

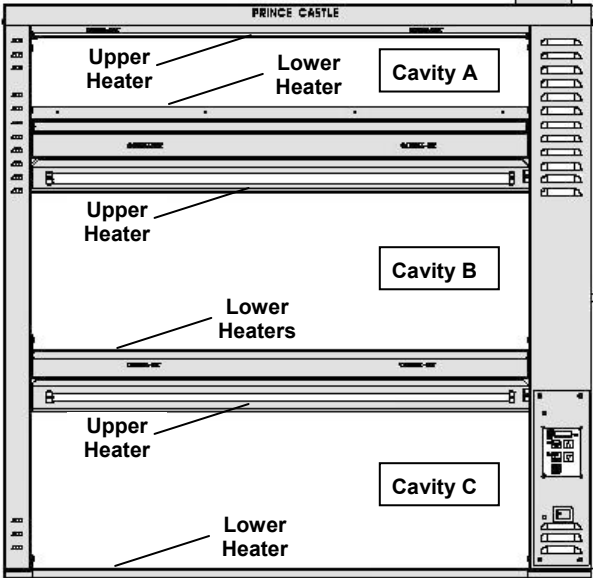

### 1 Cavity A Factory Settings

The recommended setting for the Upper Heater is 235°F and 180°F for the Lower Heater.

### 2 Cavity B & C Factory Settings

The default Set-Point for the Upper Heater is 35%. The Lower Heater default is OFF.

## Resetting to Factory Defaults

- To revert all settings back to the original factory defaults:
- A. Turn the unit off.
  - B. Press and hold both UP and DOWN arrows.
  - C. Turn the unit back on and wait 5 secs.
  - D. Release UP and DOWN arrows.

 All previously saved settings are lost upon resetting the defaults! Use with caution.

## Control Panel

### 1 Displays & Indicators

- The red indicator light next to the UPPER SHELF label indicates that the temperature being displayed is for the Upper Heater of the selected cavity.
- The red indicator light next to the PROG label is on when in the Programming Mode.
- The red indicator light next to the LOWER SHELF label indicates that the temperature being displayed is for the Lower Heater of the selected cavity.
- The red indicator light next to the HEAT label is on when power is applied to the heater zone being displayed on the control panel.
- The red indicator light next to ACTUAL TEMP label is on when the Actual Temperature is being displayed for the heater zone being displayed on the control panel.
- The red indicator light next to SET-POINT TEMP label is on when the Set-Point Temperature is being displayed for the heater zone being displayed on the control panel.
- The digital display shows the cavity and the associated temperature or Power On control values, for example:
  - For Cavity A, the display may show A235 for the UPPER HEATER
  - For Cavity B, the display may show B035 (percentage of heater capacity for the Upper Heater).
  - For Cavity C, the display may show C040 (percentage of heater capacity for the Upper Heater).

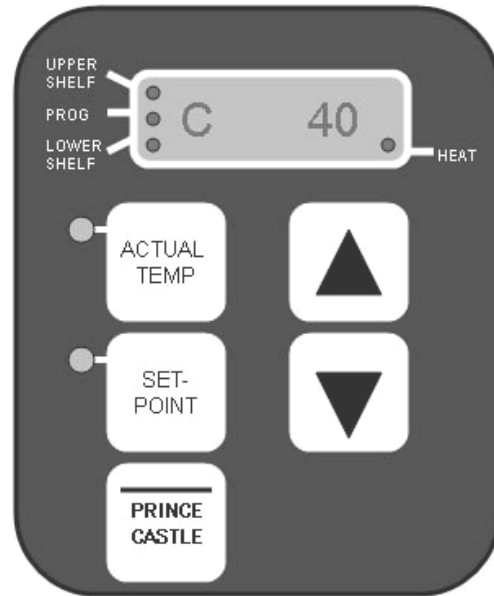

Control Panel

### 2 Control Panel Buttons

- **SET-POINT:** The Set-Point temperature is displayed for the selected heaters when this button is pressed during the operating mode. The SET-POINT indicator light is on when the Set-point mode is selected.  
To Program a heater, press and hold the PRINCE CASTLE button then press and hold the SET-POINT button for 5 secs. or until the PROG indicator light turns on. Use the UP and DOWN arrows to change the Set-Point temperature (Cavity A) or the percentage of heater value for the Upper and Lower Heaters in Cavities B and C.

 The Percentage of Power relates to utilities, and while increased percentage may be required to hold the product properly, it should be kept at the lowest possible setting to save utility consumption.

- **ACTUAL TEMP:** The Actual temperature is displayed only for the selected heaters of Cavity A when this button is pressed during the operating mode. **ACTUAL TEMP BUTTON DOES NOT FUNCTION FOR THE UPPER HEATER OF CAVITY B & C.** The ACTUAL TEMP LED indicator light is on when not in the Set-Point mode.

 This is not the actual air temperature, nor will it be the actual product temperature.

- **UP ARROW & DOWN ARROW:** When pressed in the operating mode, selects which heater zone is in the display on the control panel. The indicator light next to the UPPER SHELF or LOWER SHELF is on to indicate which heater in the cavity is selected.

## Programming

### 1 Cavity A – Programmed for Temperature

The temperature of the Upper and Lower Heaters can be adjusted from 150 to 260°F in one-degree increments. The recommended interval for Cavity A is  $\pm 5^\circ$ .

1. Use the UP or DOWN arrow buttons to select Cavity A and either the UPPER or LOWER SHELF.
2. Press the SET-POINT button. When the SET-POINT indicator light is on, the digital display shows the Set-Point temperature.

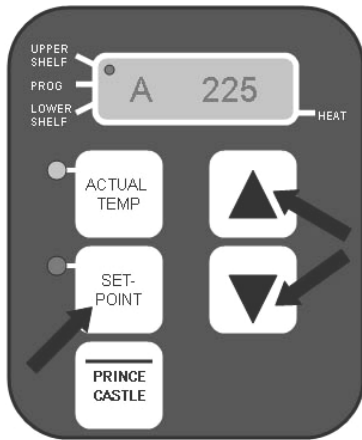

3. To change the temperature setting, press and hold the PRINCE CASTLE button; then press and hold the SET-POINT button. Hold both buttons until the PROG indicator light turns on.
4. Use the UP and DOWN arrow buttons to change the temperature.
5. Press the PRINCE CASTLE button to store the new value and to exit the PROGRAMMING mode.

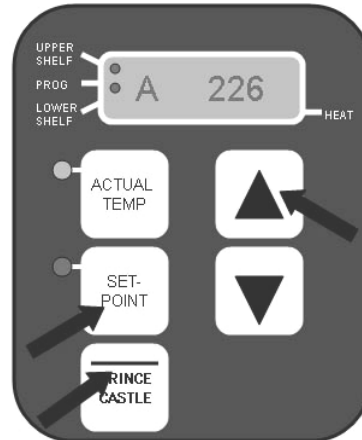

### 2 Cavity B & C Upper or Lower Heaters – Programmed for Percentage of Power

The Upper and Lower Heaters may be adjusted from 0% (OFF) to 100% of power. The temperature adjustment for the Upper Cavities B & C is an electronic Infinite Control. Use the UP or DOWN arrow buttons to select the Cavity B or C and the UPPER or LOWER Shelf. The recommended interval for Cavity B & C is  $\pm 5\%$ .

1. Press the SET-POINT button. When the SET-POINT indicator light is on, the digital display shows the Set-Point percentage of power value.

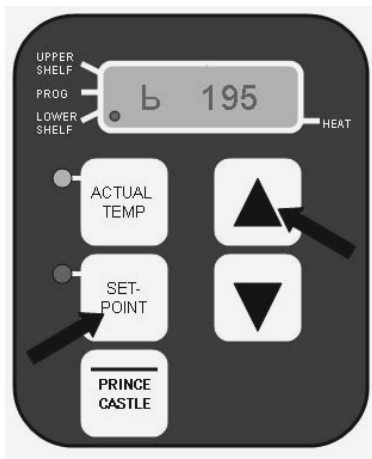

2. To change the Heater Power Percentage setting, press and hold the PRINCE CASTLE button then press and hold the SET-POINT button. Hold both buttons until the PROG indicator light appears.
3. Use the UP and DOWN arrow buttons to change the value.
4. Press the PRINCE CASTLE button to store the new value and to exit the PROGRAMMING mode.

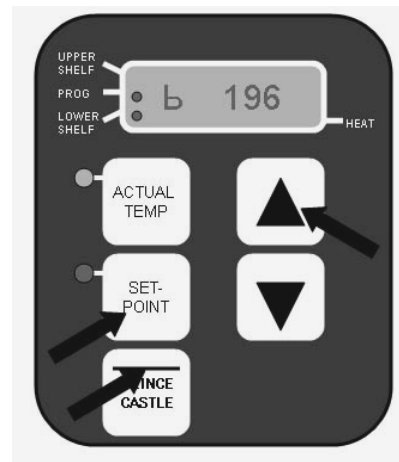

**Cleaning**

|  |  |
|--|--|
| <p><b>⚠ WARNING!</b><br/> <b>SHOCK/DAMAGE HAZARD!</b> This bin is not watertight. Do not clean with Water Jet / Jet Spray hose. Before cleaning, ensure all power switches are in the OFF position.</p>  | <p><b>⚠ CAUTION!</b><br/>                 Do NOT use any abrasive cleaners/scrubbers or any unapproved chemicals.</p>  |
| <p><b>1</b></p> <p>A. Turn the power switch to the OFF position.<br/>                 B. Allow the bin to cool down (approximately 35 mins.).<br/>                 C. When the unit has cooled, wipe down thoroughly with a damp cloth soaked in dishwashing solution.</p> | <p><b>2</b></p> <p>A. Use a second damp cloth to rinse the dishwashing solution.<br/>                 B. Spray with a sanitizer and wipe dry.<br/>                 C. Allow surfaces to dry thoroughly.</p> <div style="border: 1px solid black; padding: 5px; margin-top: 10px;"> <p> Do NOT turn power ON again until all surfaces are completely dry.</p> </div> |

**Troubleshooting**

**Testing for Proper Unit Temperature**

Temperature settings may vary, subject to location, elevation, weather, etc.  
 To determine if the factory settings of the unit are right for your location, follow these steps.

|  |   |
|--|---|
| <p><b>1</b></p> <p>Check the temperature of the chicken after it is pulled from the fryer and drained.<br/>                 The proper temperature should be 190-195°F for white meat or 195-200°F for dark meat.</p>  | <p><b>2</b></p> <p>Check the chicken by probing the meaty portion of one breast and one thigh.<br/>                 Ensure that the probe is not touching the bone. Record the time and temperature of the chicken and place the pieces in the holding bin.</p> |
| <p><b>3</b></p> <p>After 15 mins. and 30 mins., check the same two pieces of chicken again.<br/>                 If the temperature of the chicken drops by more than 40°F from the fryer to the end of the holding time, the unit temperature should be adjusted.</p> | <p><b>4</b></p> <p>After 30 mins., the internal temperature of the chicken should be 160°F or higher.<br/>                 If not, adjust the temperature or percentage of power accordingly.</p>   |

**Adjusting the Unit Temperature**

|  |   |
|--|---|
| <p><b>1</b></p> <p><b>CAVITY A</b><br/>                 To adjust the temperature of Cavity A, follow the instructions for Programming (see Page 5).</p>                 | <p><b>2</b></p> <p>Increase the temperature by 5°F, and allow the unit 30 mins. to adjust.<br/>                 Repeat the test for proper unit temperature in Cavity A.</p>                  |
| <p><b>3</b></p> <p><b>CAVITY B &amp; C</b><br/>                 To adjust the temperature of Cavity B &amp; C, follow the instructions for Programming (see Page 5).</p> | <p><b>4</b></p> <p>Increase the percentage of power by 5%, and allow the unit 30 mins. to adjust.<br/>                 Repeat the test for proper unit temperature in Cavities B &amp; C.</p> |

**Parts & Service**

| Parts List |            |                    |
|------------|------------|--------------------|
| Item       | Part No.   | Description        |
| 1.         | 88-793-02S | Fluorescent Lamp   |
| 2.         | 541-719S   | Display Board      |
| 3.         | 528-280S   | Power Board        |
| 4.         | 88-682S    | Lamp Holder        |
| 5.         | 528-101S   | IR Heater Panel    |
| 6.         | 65-048-07S | Relay              |
| 7.         | 65-058S    | Relay              |
| 8.         | 536-802S   | Overlay Display    |
| 9.         | 78-184S    | Power Switch       |
| 10.        | 528-085S   | Heater (Cavity A)  |
| 11.        | 528-264S   | Ballast            |
| 12.        | 528-298S   | Lower Heater Panel |

| Contact Information for Parts/Service   |   |
|---|---|
| <p><b>TO ORDER PARTS &amp; SERVICE</b><br/>                     Prince Castle, Inc.<br/>                     355 East Kehoe Blvd., Carol Stream, IL 60188<br/>                     Phone: 630-462-8800, Toll Free: 1-800-PCASTLE<br/>                     Fax: 630-462-1460<br/> <a href="http://www.PrinceCastle.com">www.PrinceCastle.com</a></p> | <p><b>OR refer to your Service Directory for an authorized Service Provider in your area.</b></p> |

Exploded View of Parts

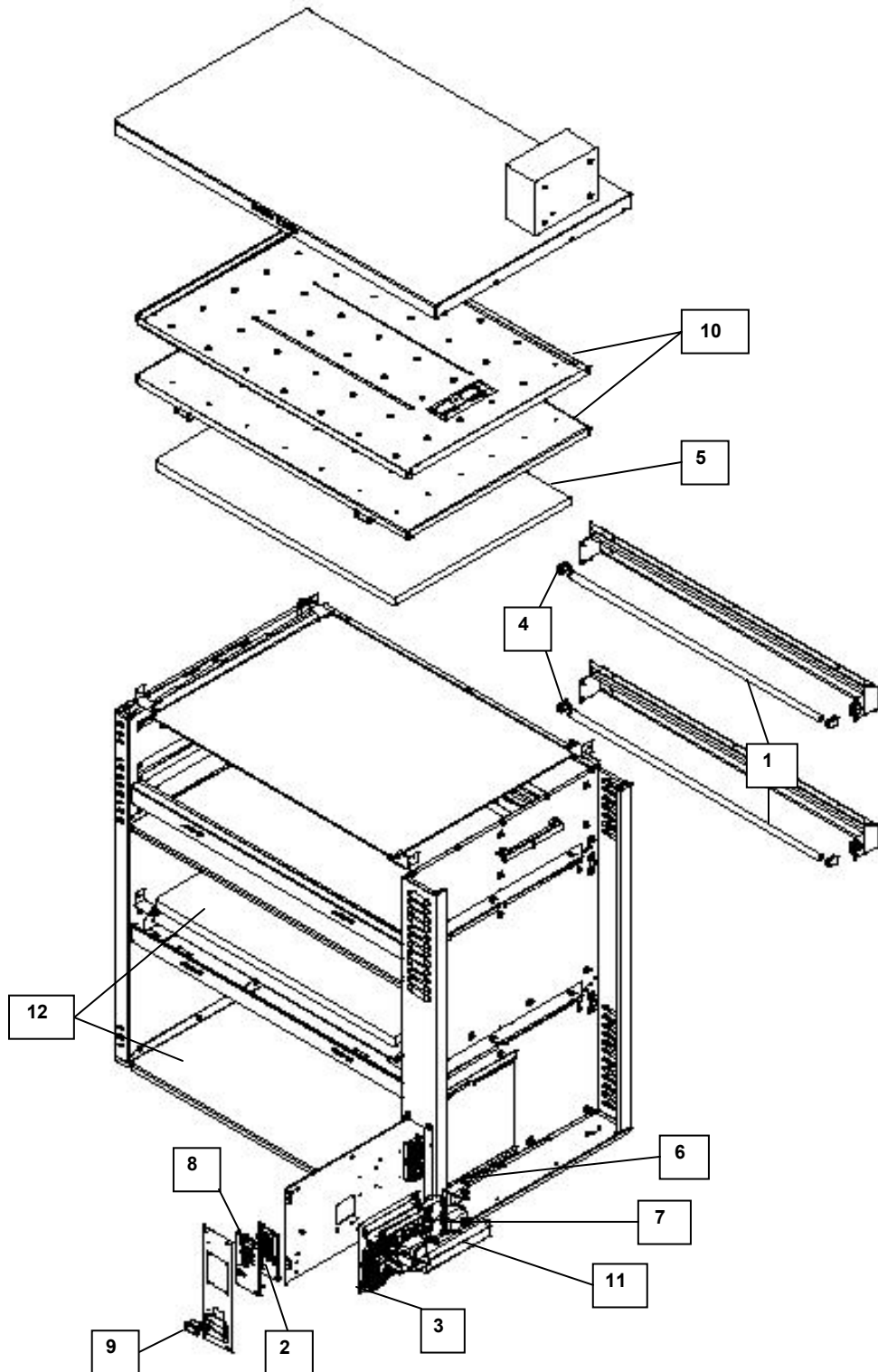



# Wiring Diagram

