

# Integra SERVICE MANUAL

## AV RECEIVER MODEL DTR-6.9

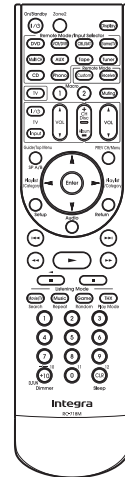
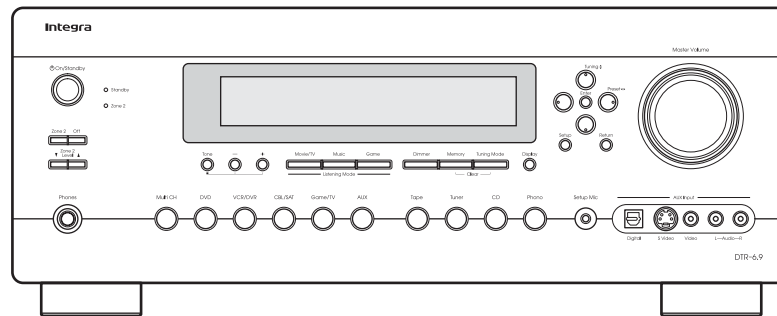

RC-718M

### Black model

B MDD	120V AC, 60Hz
B MMA	220V~240V AC, 50Hz

### SAFETY-RELATED COMPONENT WARNING!!

COMPONENTS IDENTIFIED BY MARK  ON THE SCHEMATIC DIAGRAM AND IN THE PARTS LIST ARE CRITICAL FOR RISK OF FIRE AND ELECTRIC SHOCK. REPLACE THESE COMPONENTS WITH ONKYO PARTS WHOSE PART NUMBERS APPEAR AS SHOWN IN THIS MANUAL.

MAKE LEAKAGE-CURRENT OR RESISTANCE MEASUREMENTS TO DETERMINE THAT EXPOSED PARTS ARE ACCEPTABLY INSULATED FROM THE SUPPLY CIRCUIT BEFORE RETURNING THE APPLIANCE TO THE CUSTOMER.

# EXPLODED VIEWS-1

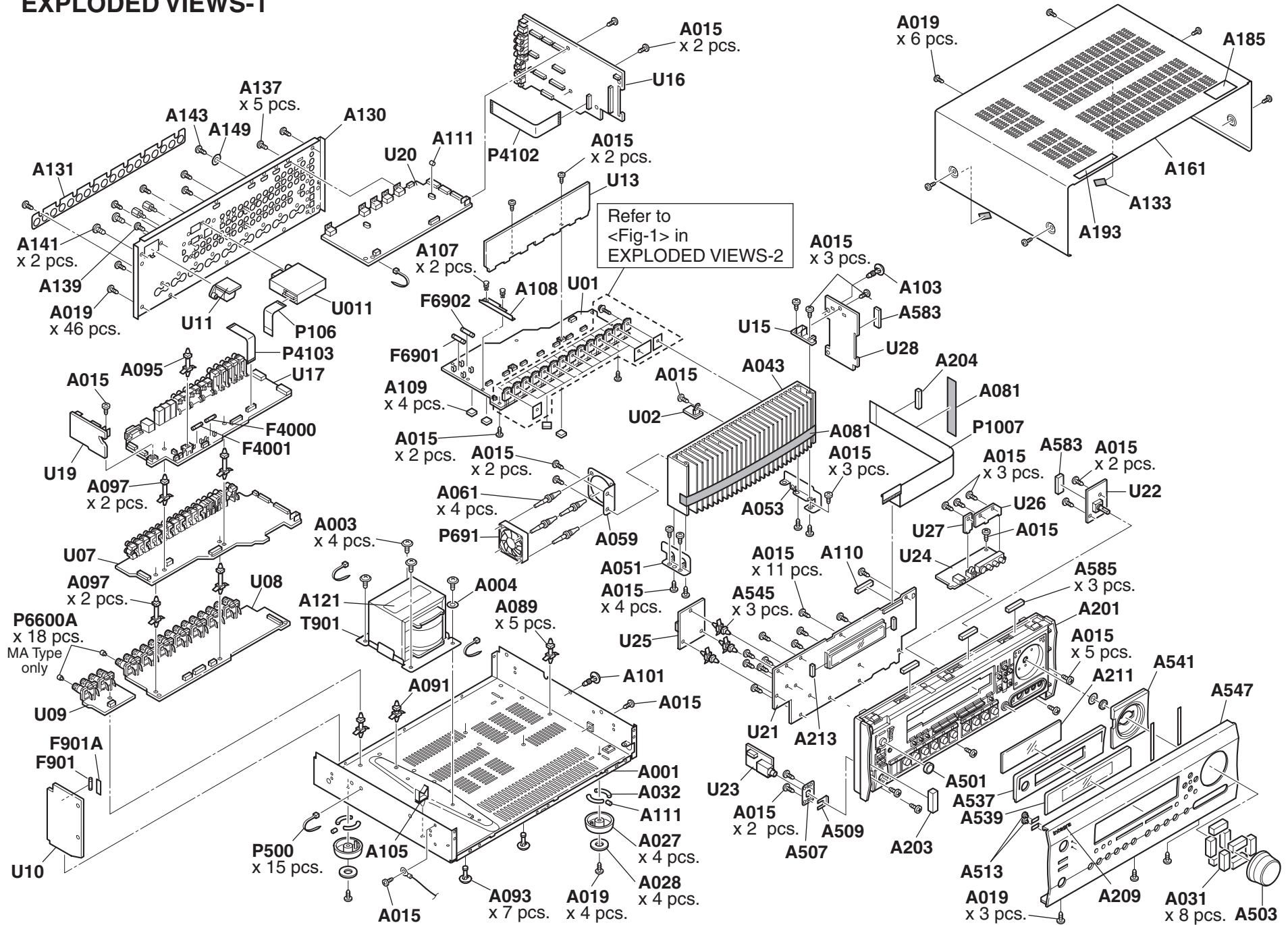

# EXPLODED VIEWS-2

<Fig-1>

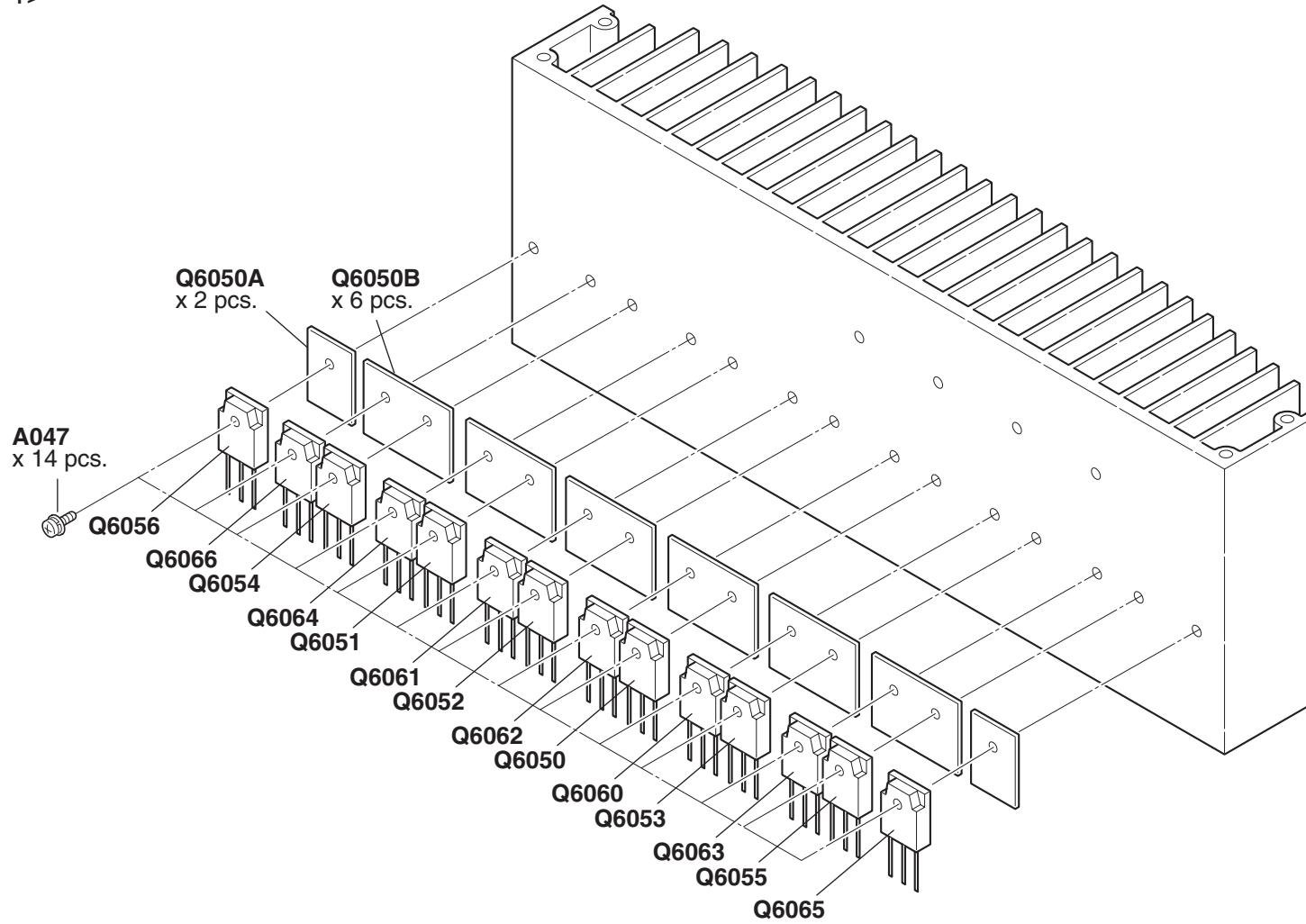

# BLOCK DIAGRAMS-1 AUDIO SECTION

1  
2  
3  
4  
5

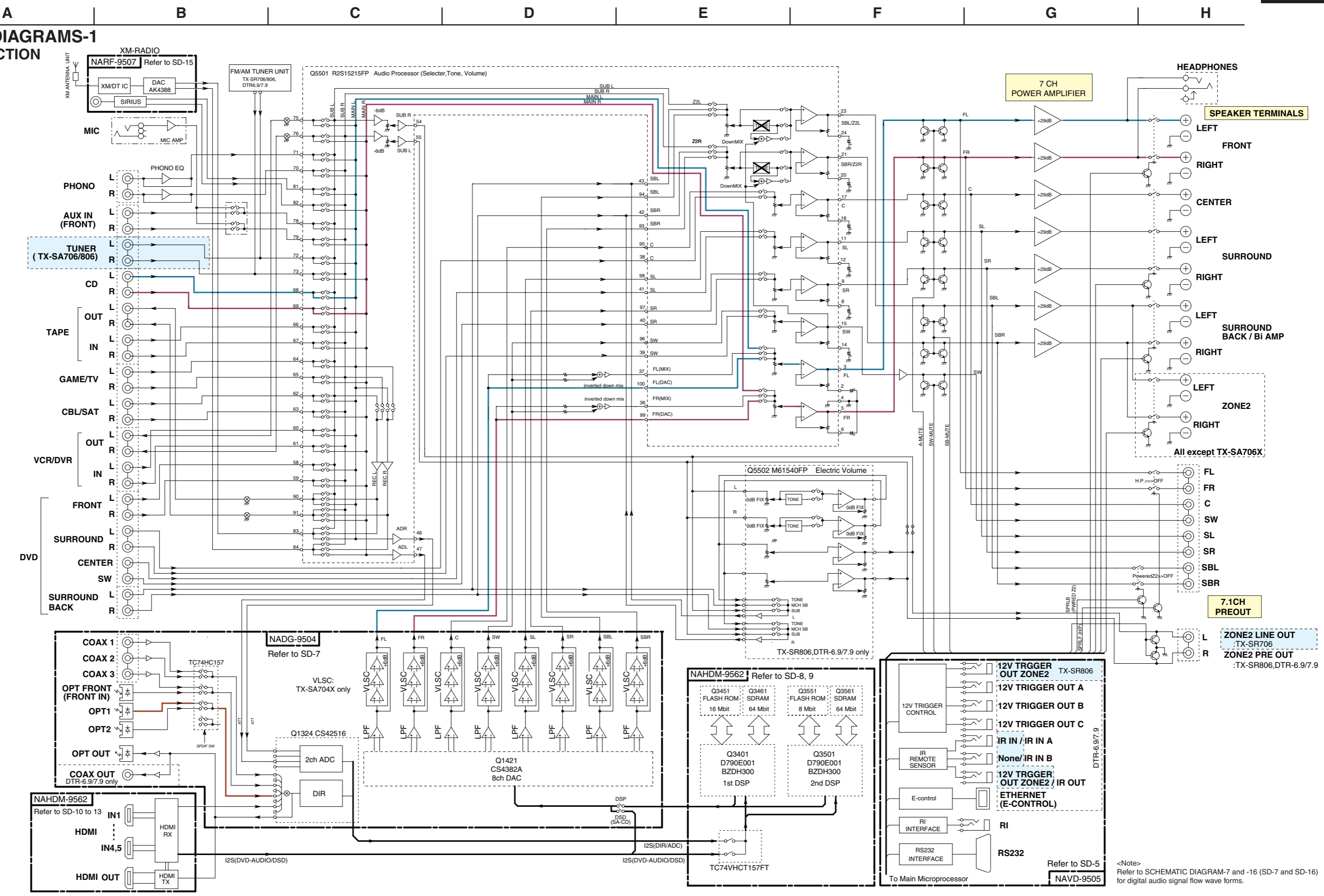

<Note>  
Refer to SCHEMATIC DIAGRAM-7 and -16 (SD-7 and SD-16)  
for digital audio signal flow wave forms.

**BLOCK DIAGRAMS-2**  
**VIDEO SECTION**

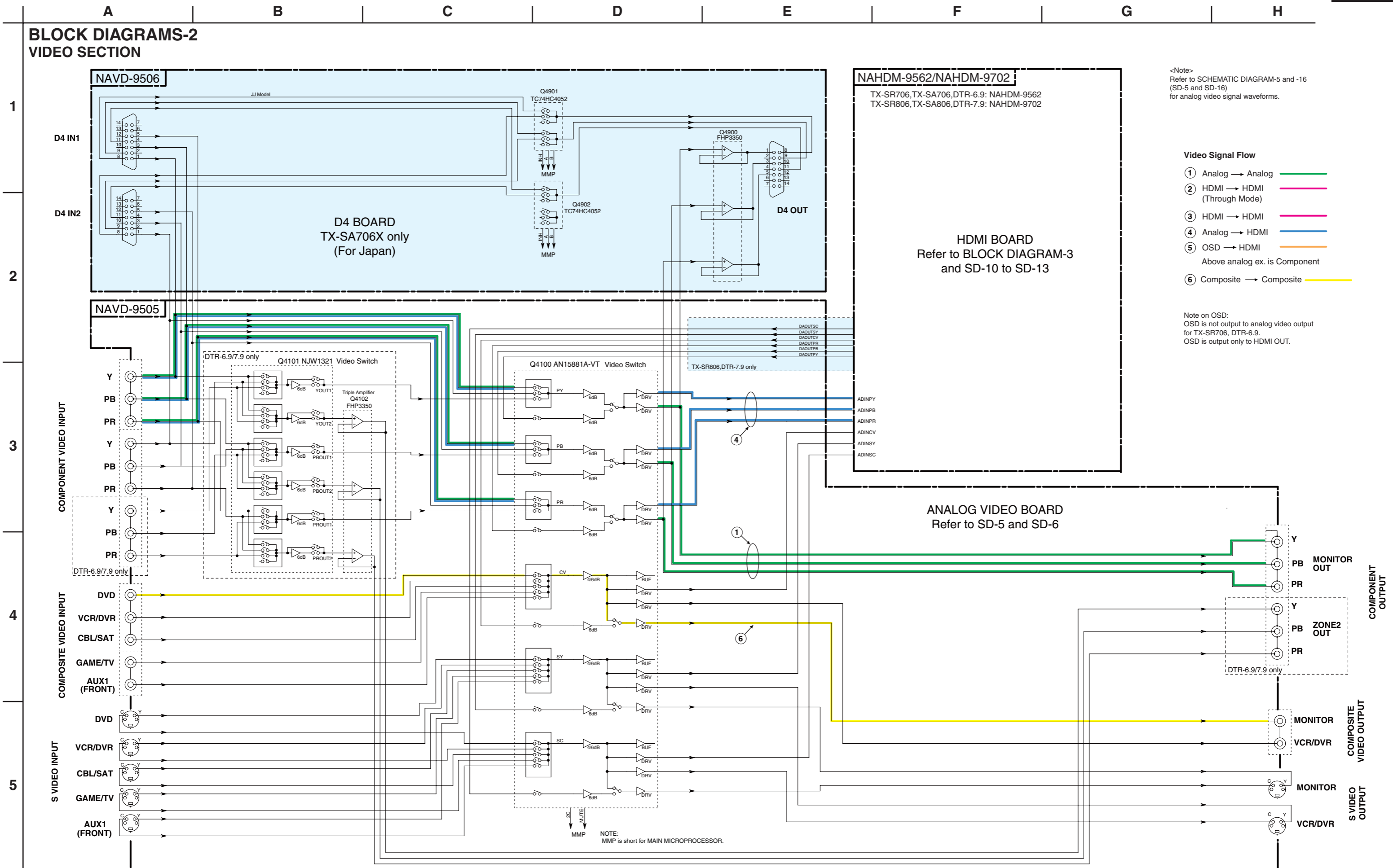

BLOCK DIAGRAMS-3  
HDMI SECTION

1  
2  
3  
4  
5

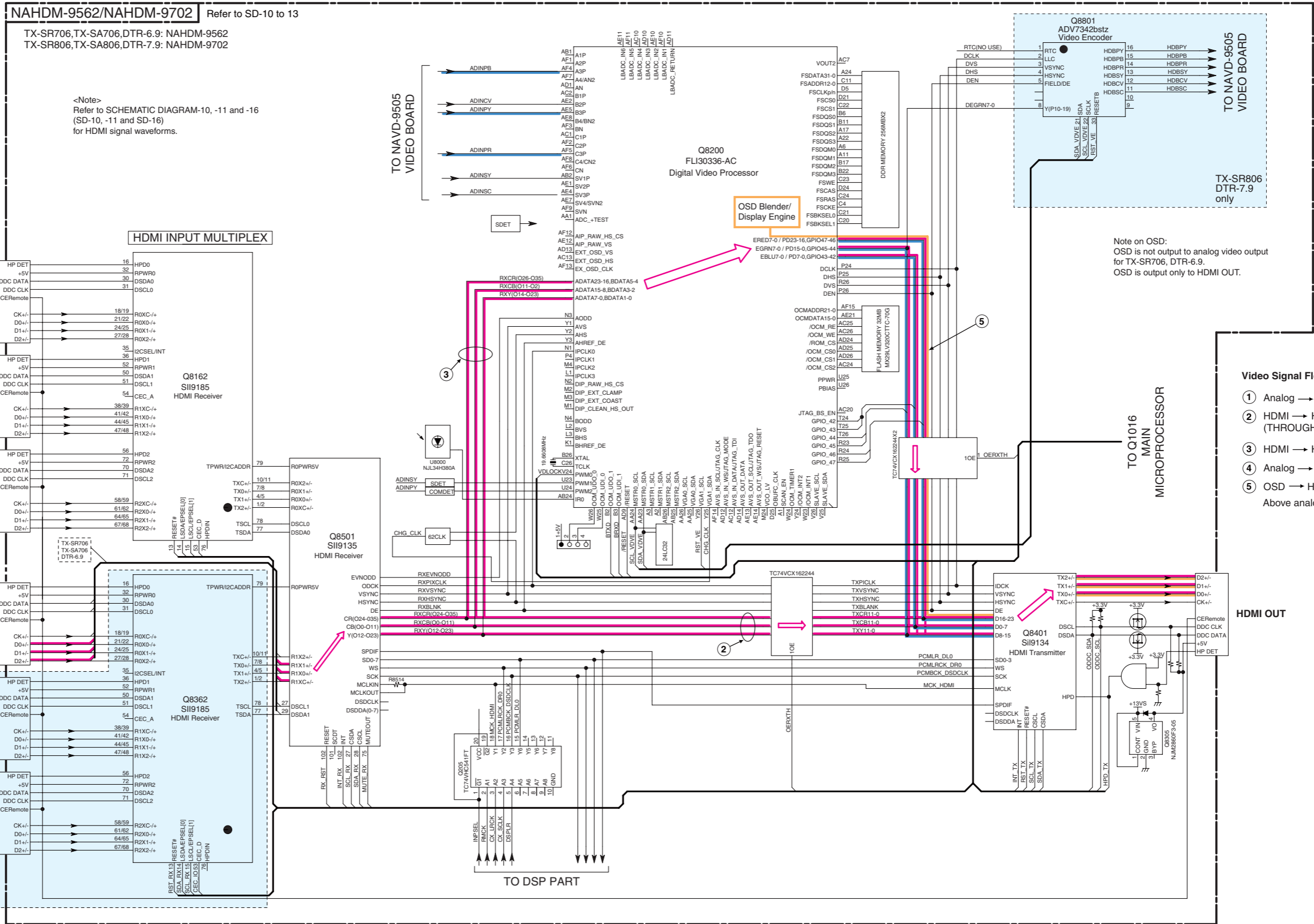

- Video Signal Flow**
- ① Analog → Analog
  - ② HDMI → HDMI (THROUGH MODE)
  - ③ HDMI → HDMI
  - ④ Analog → HDMI
  - ⑤ OSD → HDMI
- Above analog ex. is Component

# BLOCK DIAGRAMS-4 DSP SECTION

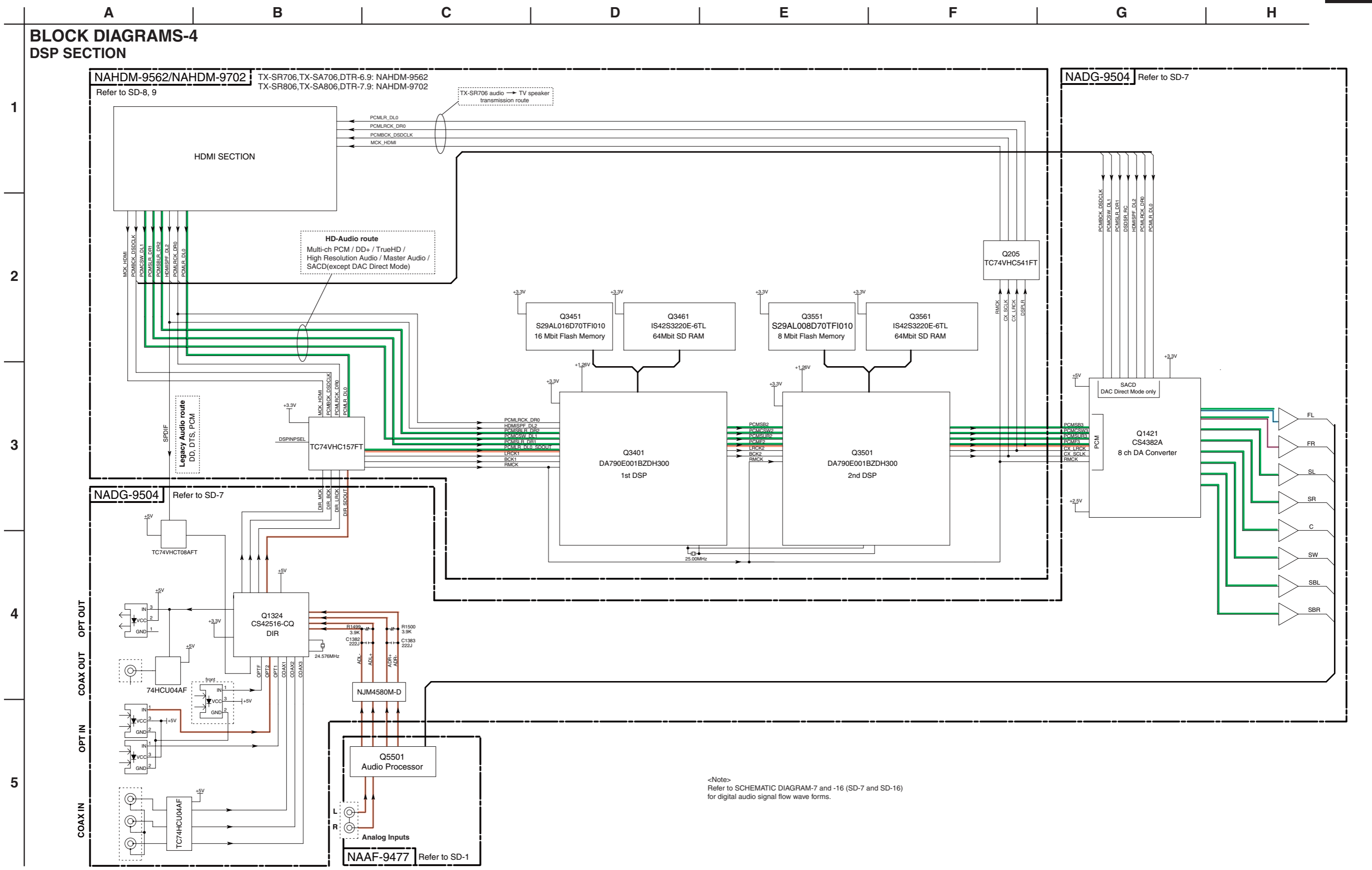

<Note>  
Refer to SCHEMATIC DIAGRAM-7 and -16 (SD-7 and SD-16)  
for digital audio signal flow wave forms.

# SCHEMATIC DIAGRAMS-1 (SD-1) AUDIO SECTION

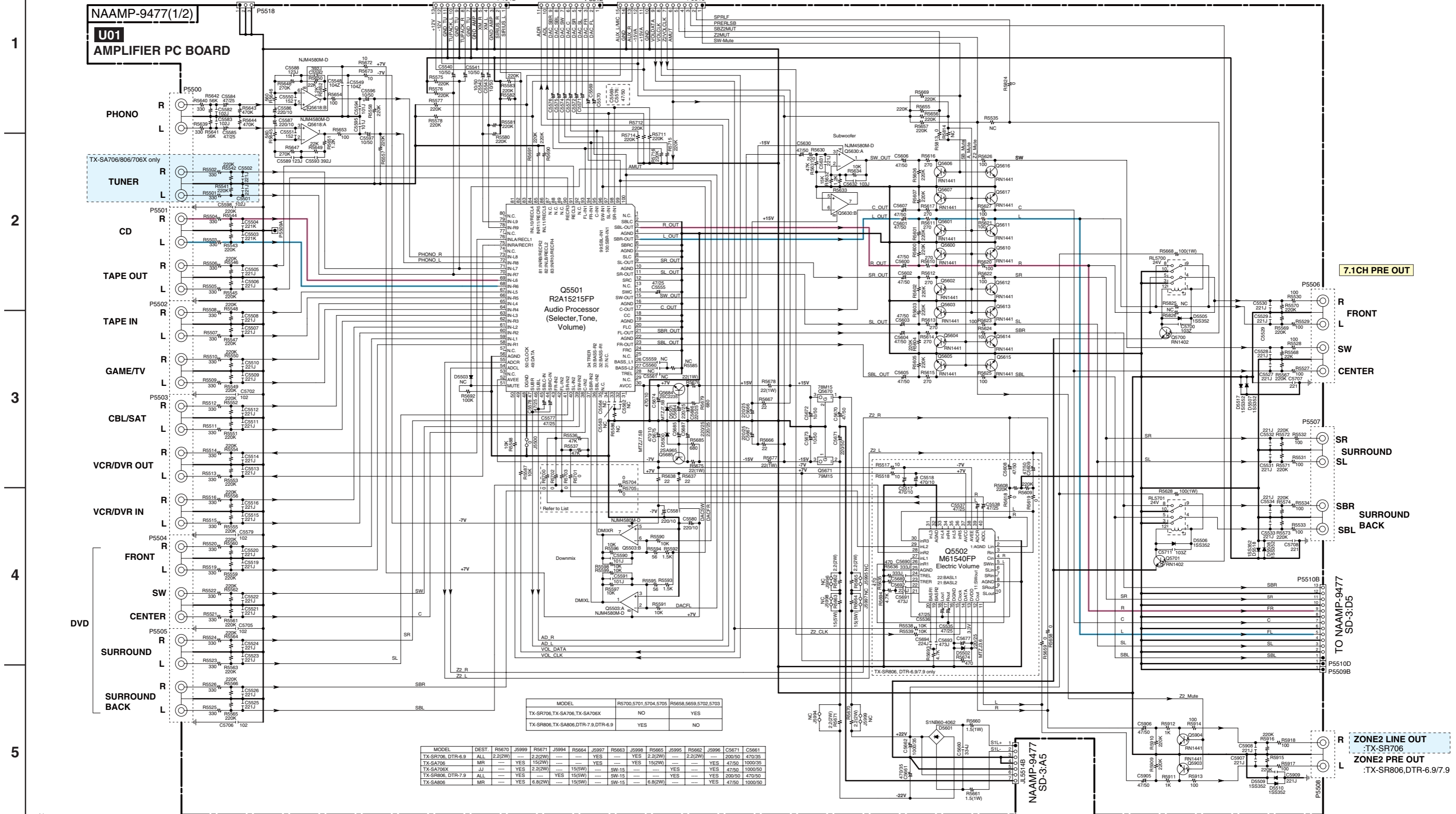

MODEL	R5700	5701	5704	5705	R5658	5659	5702	5703
TX-SR706, TX-SA706, TX-SA706X	NO				YES			
TX-SR806, TX-SA806, DTR-7.9, DTR-6.9	YES				NO			

MODEL	DEST.	R5670	J5999	R5671	J5994	R5664	J5997	R5663	J5998	R5665	J5995	R5662	J5996	C5671	C5661
TX-SR706, DTR-6.9	ALL	2.2(2W)	---	2.2(2W)	---	---	YES	---	YES	2.2(2W)	---	2.2(2W)	---	200/50	470/35
TX-SA706	MR	---	YES	15(2W)	---	---	YES	---	YES	15(2W)	---	---	---	47/50	1000/35
TX-SA706X	JJ	---	YES	2.2(2W)	---	15(SW)	---	SW-15	---	---	---	---	---	47/50	1000/50
TX-SR806, DTR-7.9	ALL	---	NLS	YES	15(SW)	---	YES	---	SW-15	---	---	---	---	200/50	470/50
TX-SA806	MR	---	YES	6.8(2W)	---	15(SW)	---	SW-15	---	6.8(2W)	---	---	---	47/50	1000/50

<Note>  
SD-x:XY is short for Schematic Diagram-x and each socket's location, X=A to H, Y=1 to 5.



SCHEMATIC DIAGRAMS-2 (SD-2)  
POWER AMPLIFIER SECTION-1

1

2

3

4

5

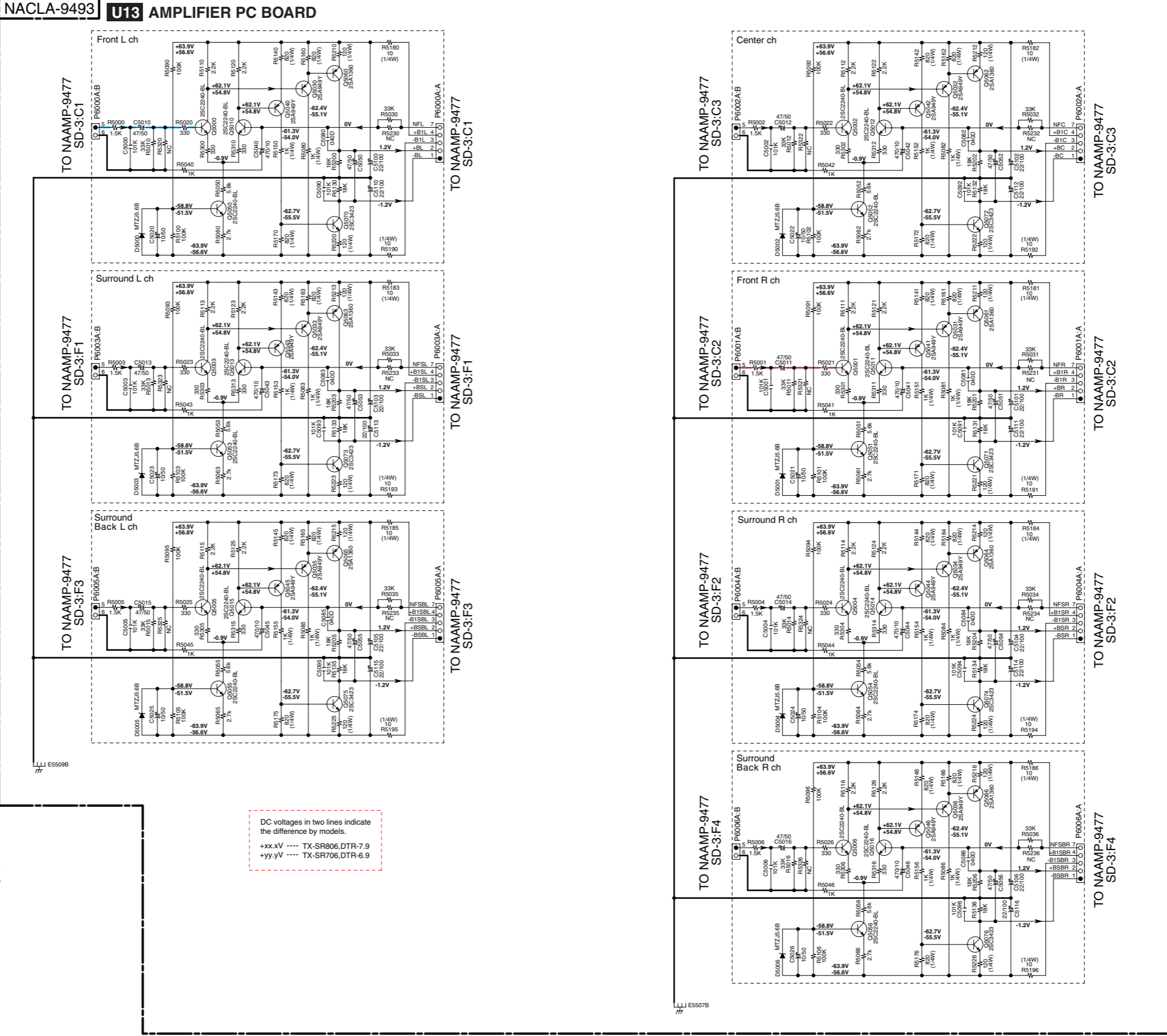

- NOTE
- THE COMPONENTS IDENTIFIED BY MARK  $\Delta$  ARE CRITICAL FOR SAFETY. REPLACE ONLY WITH PART NUMBER SPECIFIED.
  - BOLD VOLTAGE (MEASURED WITH VOLTMETER) IS DC VOLTAGE.(NO INPUT SIGNAL).
  - ALL PNP TRANSISTORS ARE EQUIVALENT TO 2SA1015-GR UNLESS OTHERWISE NOTED.
  - ALL NPN TRANSISTORS ARE EQUIVALENT TO 2SC1815-GR UNLESS OTHERWISE NOTED.
  - ALL DIODES ARE EQUIVALENT TO 1SS133 UNLESS OTHERWISE NOTED.
  - ELECTROLYTIC CAPACITORS (  $\text{---}\text{||}\text{---}$  ) ARE IN  $\mu\text{F/MV}$ .
  - ALL CAPACITORS ARE IN  $\text{pF}/50\text{VV}$  UNLESS OTHERWISE NOTED.  
EX) 030-3pF, 330-33pF, 331-330pF, 333-0.033 $\mu\text{F}$
  - ALL RESISTORS ARE IN OHMS 1/4WATTS UNLESS OTHERWISE NOTED.
  - THE THICK LINES ON PC BOARD ARE THE PRINTING SIDE OF THE PARTS.  
EX)  $\text{---}\text{---}\text{---}$  PRINTING SIDE
  - CIRCUIT IS SUBJECT TO CHANGE FOR IMPROVEMENT.

DC voltages in two lines indicate the difference by models.  
 +xx.xV ---- TX-SR806,DTR-7.9  
 +yy.yV ---- TX-SR706,DTR-6.9

DC voltages in two lines indicate the difference by models.  
 +xx.xV ---- TX-SR806,DTR-7.9  
 +yy.yV ---- TX-SR706,DTR-6.9

<Note>  
 SD-x:XY is short for Schematic Diagram-x and each socket's location, X=A to H, Y=1 to 5.

# SCHEMATIC DIAGRAMS-3 (SD-3) POWER AMPLIFIER SECTION-2

1  
2  
3  
4  
5

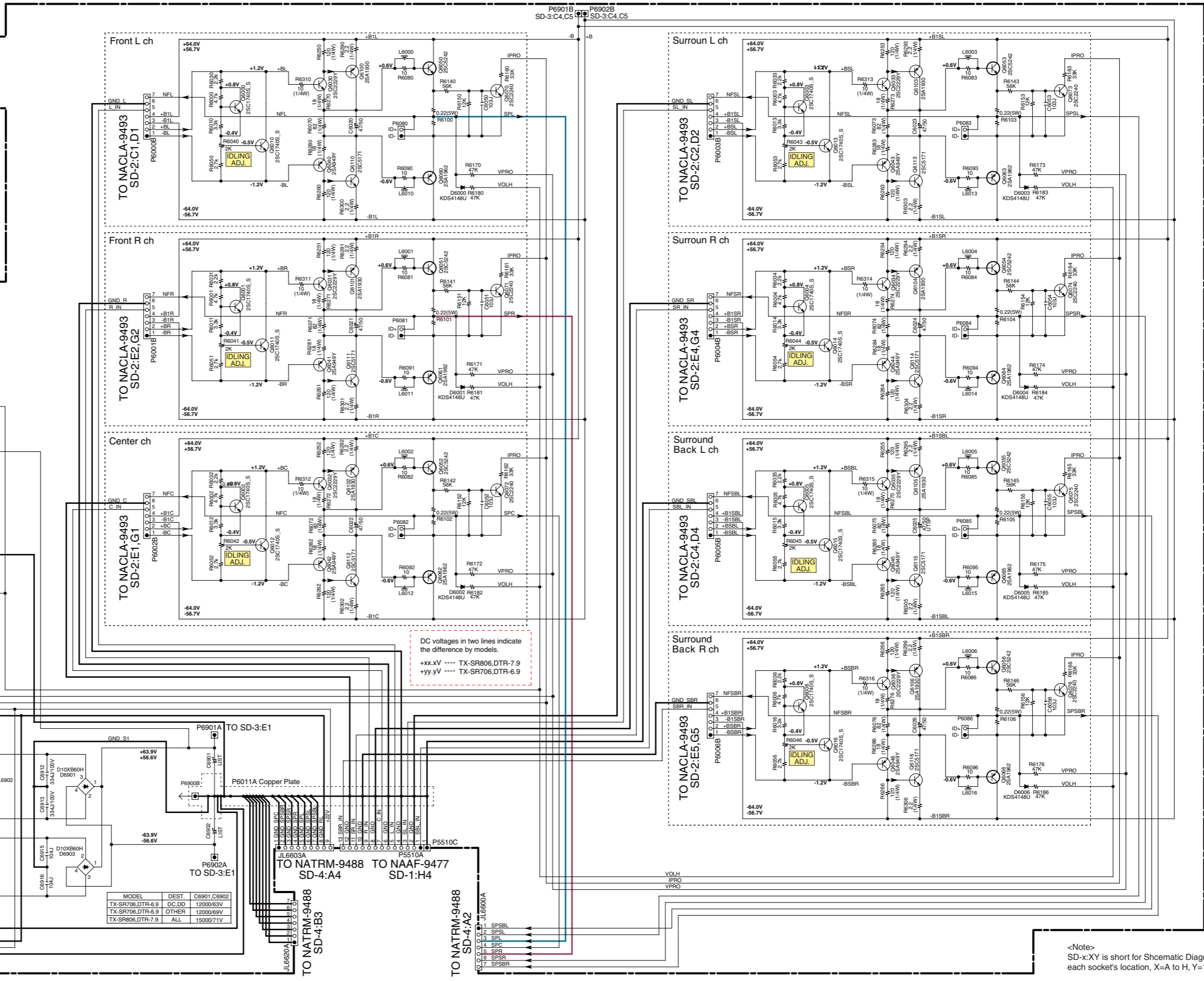
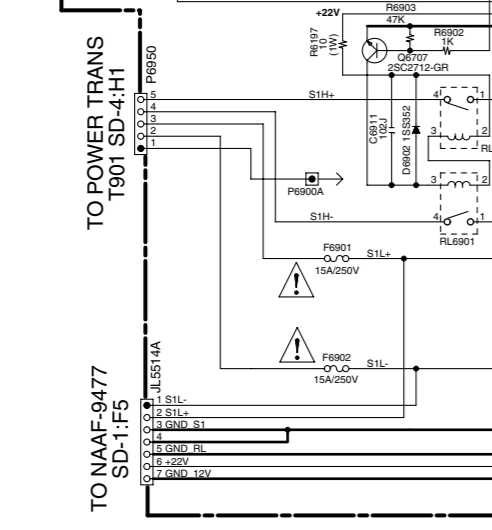
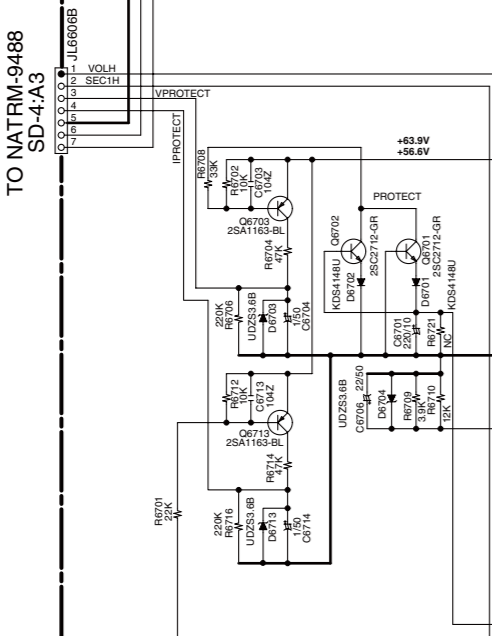
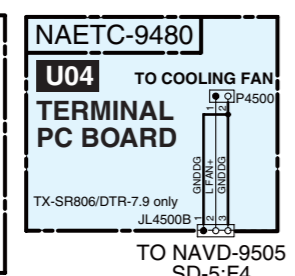
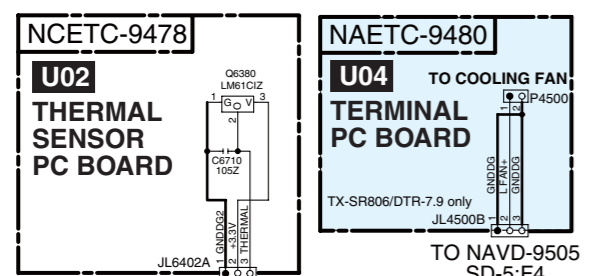
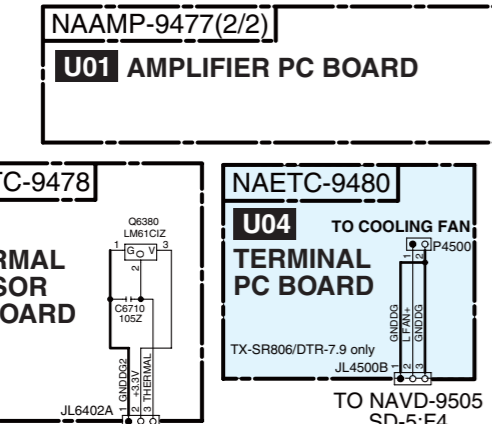

MODEL	DEST.	C8901.C8902
TX-SR706.DTR-6.9	DC.DD	12000/63W
TX-SR706.DTR-6.9	OTHER	12000/69W
TX-SR806.DTR-7.9	ALL	15000/71V

<Note>  
SD-x:XY is short for Schematic Diagram-x and each sockets location, X=A to H, Y=1 to 5.

**SCHEMATIC DIAGRAMS-4 (SD-4)**  
**SP TERMINAL AND POWER SUPPLY SECTION**

1  
2  
3  
4  
5

**NATRM-9488**  
**U08**  
**SP TERMINAL PC BOARD**

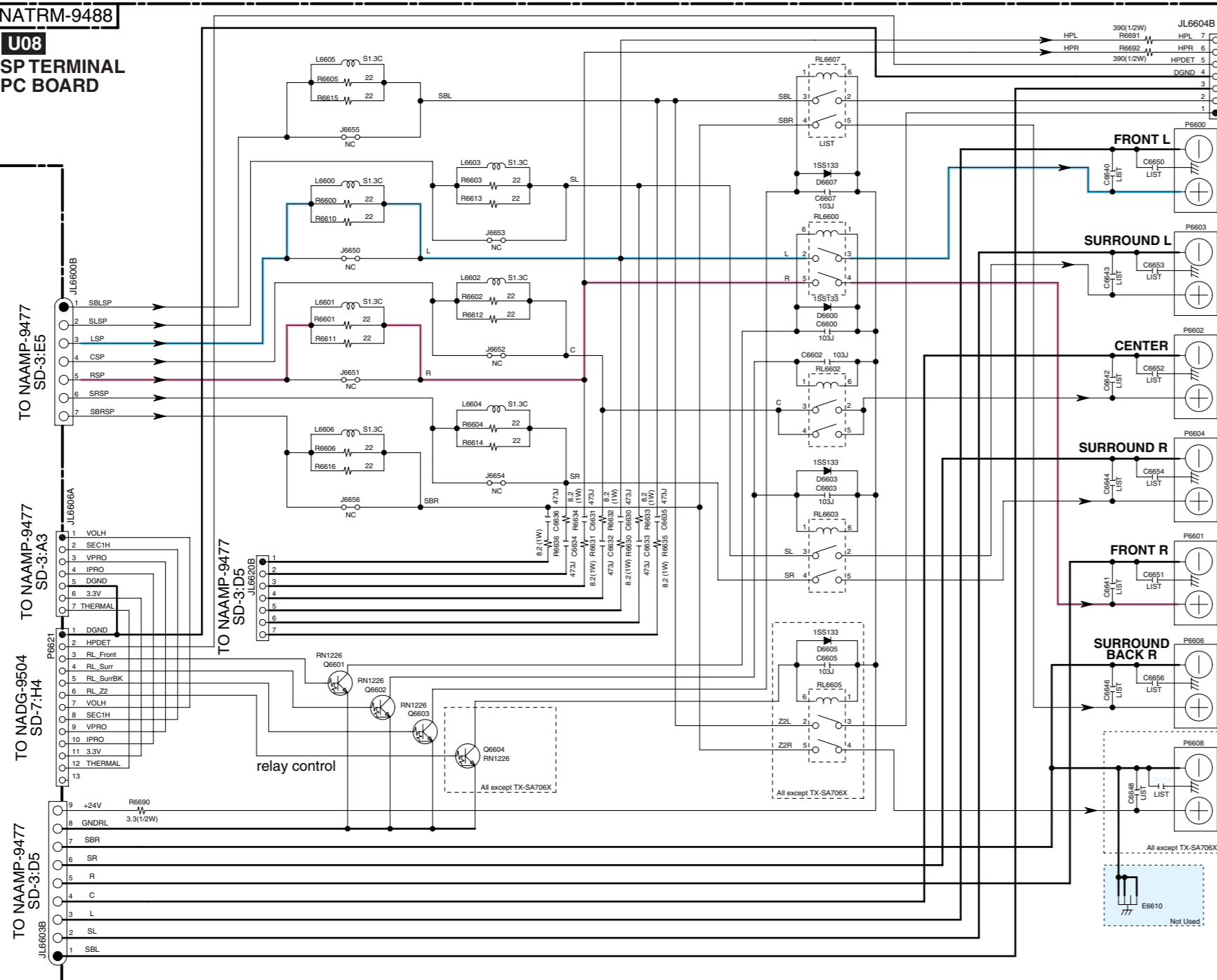

**NATRM-9489** **U08**  
**SP TERMINAL PC BOARD**

TO NAETC-9528 SD-14:G3

TO NAPS-9530 SD-14:B1

TO NAVD-9505 SD-6:A2

TO NAAMP-9477 SD-3:A4

ZONE 2 L

SURROUND BACK L

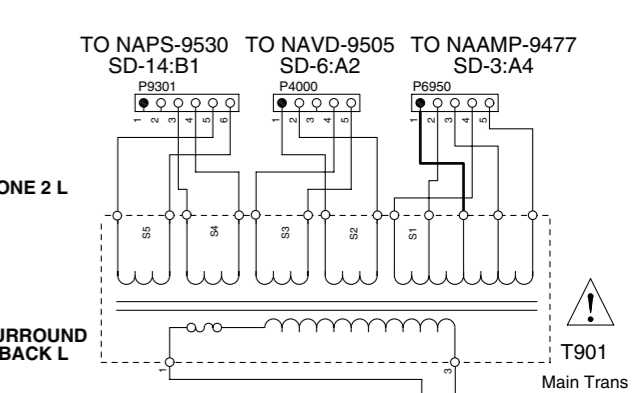

**NAPS-9491** **U11**  
**INLET PC BOARD**

All except TX-SR706 DC, DD

INLET

**NAPS-9490** **U10**  
**POWER SUPPLY PC BOARD**

TO NAVD-9505 SD6:A3

STBY Trans T902

Type	Rating
DC, DD, DT	NPT-1520JQ
MP, MA, MQ	NPT-1520GQ
MO, MQ, MT	NPT-1520GQ
TX-SA	NPT-1520GQ
JJ	NPT-1520JQ

TYPE	R921	R922
D	82	47
M, TX-SA	47	82
JJ	47	82

**AC CORD**

TX-SR706 DC, DD only

**POWER**

**U12** **POWER SUPPLY PC BOARD**

**NASW-9492**

**F901 RATING**

Type	TX-SR706	TX-SR806
DC, DD, DT	10A/125V	12A/125V
MP, MA, MQ	5A/250V	6.3A/250V
MT, MO	---	---
TX-SA	5A/250V	6.3A/250V
JJ	10A/125V	---

**Main Trans T901**

Type	TX-SR706	TX-SR806
DC, DD, DT	NPT-1570D	NPT-1571D
MP, MA, MQ	NPT-1570M	NPT-1571M
MO, MQ, MT	NPT-1570M	NPT-1571M
TX-SA	NPT-1570M	NPT-1571M
JJ	NPT-1571J	---

Type	DTR-6.9	DTR-7.9
DD	NPT-1570D	NPT-1571D
MA	NPT-1570M	NPT-1571M

- NOTE**
- THE COMPONENTS IDENTIFIED BY MARK ARE CRITICAL FOR SAFETY. REPLACE ONLY WITH PART NUMBER SPECIFIED.
  - BOLD VOLTAGE (MEASURED WITH VOLTMETER) IS DC VOLTAGE. (NO INPUT SIGNAL).
  - ALL PNP TRANSISTORS ARE EQUIVALENT TO 2SA1015-GR UNLESS OTHERWISE NOTED.
  - ALL NPN TRANSISTORS ARE EQUIVALENT TO 2SC1815-GR UNLESS OTHERWISE NOTED.
  - ALL DIODES ARE EQUIVALENT TO 1SS133 UNLESS OTHERWISE NOTED.
  - ELECTROLYTIC CAPACITORS ( ) ARE IN uF/WV.
  - ALL CAPACITORS ARE IN pF/50WV UNLESS OTHERWISE NOTED.
  - EX) 030- 3pF, 330- 33pF, 331- 330pF, 333- 0.033uF
  - ALL RESISTORS ARE IN OHMS 1/4WATTS UNLESS OTHERWISE NOTED.
  - THE THICK LINES ON PC BOARD ARE THE PRINTING SIDE OF THE PARTS.
  - EX) PRINTING SIDE
  - CIRCUIT IS SUBJECT TO CHANGE FOR IMPROVEMENT.

**C6640-6648**

TYPE	TX-SR706	TX-SA706	TX-SR806	TX-SA806	TX-SA706X	DTR-6.9	DTR-7.9
D	NC	---	NC	---	---	NC	NC
J	---	---	---	NC	---	---	---
M	472J	472J	472J	472J	---	472J	472J

**C6650-6658**

TYPE	TX-SR706	TX-SA706	TX-SR806	TX-SA806	TX-SA706X	DTR-6.9	DTR-7.9
D	102J	---	102J	---	---	102J	102J
J	---	---	---	---	NC	---	---
M	102J	102J	102J	102J	---	102J	102J

<Note>  
SD-x:XY is short for Schematic Diagram-x and each socket's location, X=A to H, Y=1 to 5.

# SCHEMATIC DIAGRAMS-5 (SD-5) VIDEO SECTION-1

1

2

3

4

5

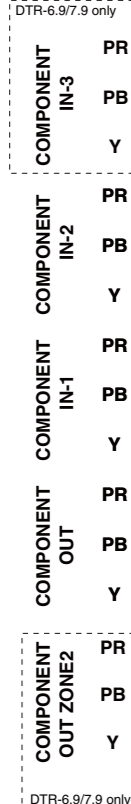
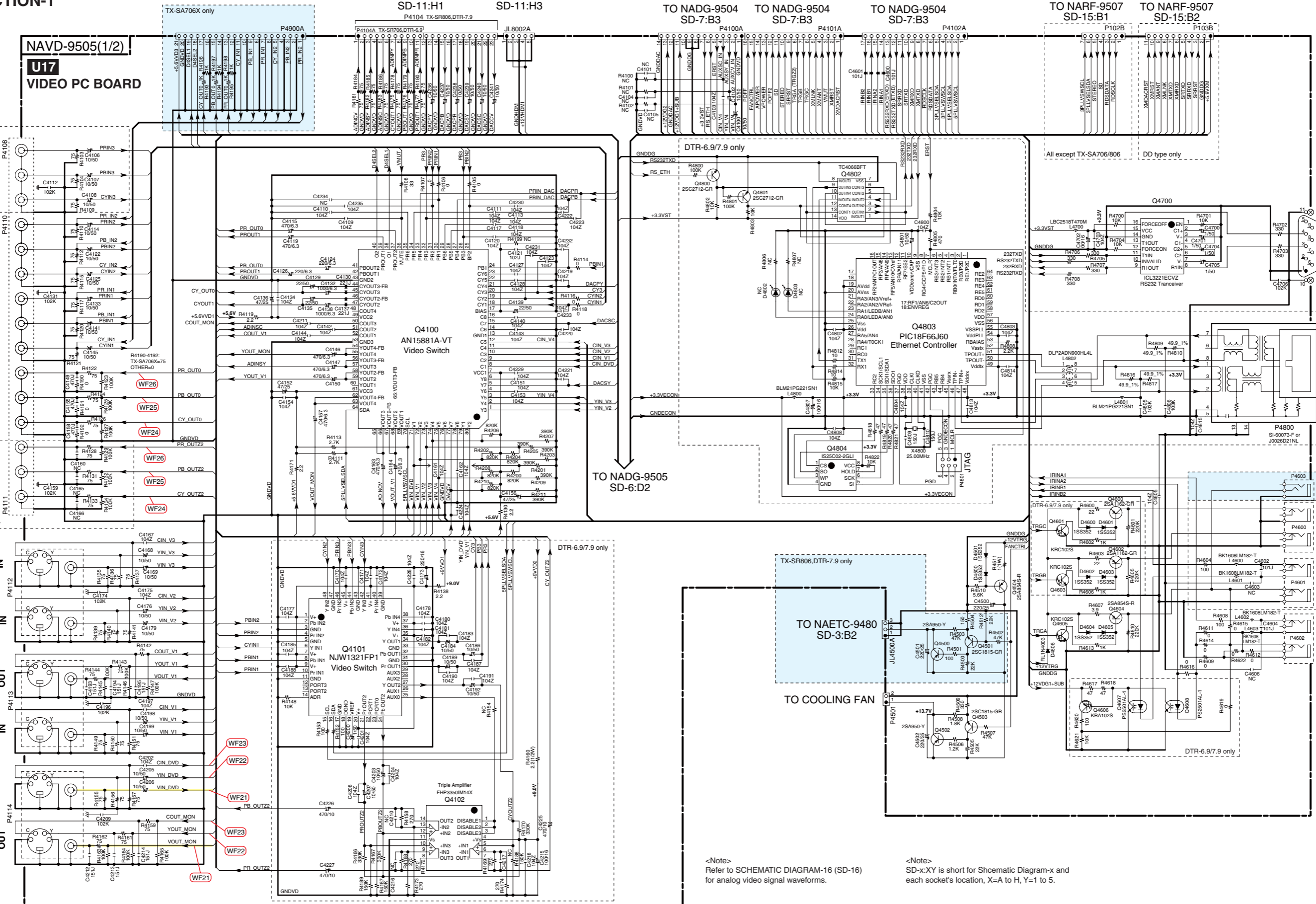

<Note>  
Refer to SCHEMATIC DIAGRAM-16 (SD-16)  
for analog video signal waveforms.

<Note>  
SD-x:XY is short for Shcematic Diagram-x and  
each socket's location, X=A to H, Y=1 to 5.

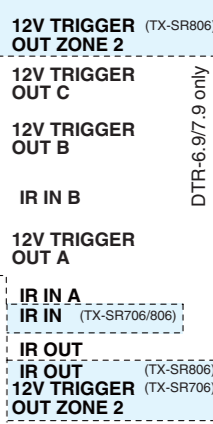

TX-SA706X:  
No 12V Trigger and  
IR terminals and parts

**SCHEMATIC DIAGRAMS-6 (SD-6)**  
**VIDEO SECTION-2**

<Note>  
SD-x:XY is short for Schematic Diagram-x and each socket's location, X=A to H, Y=1 to 5.

1

2

3

4

5

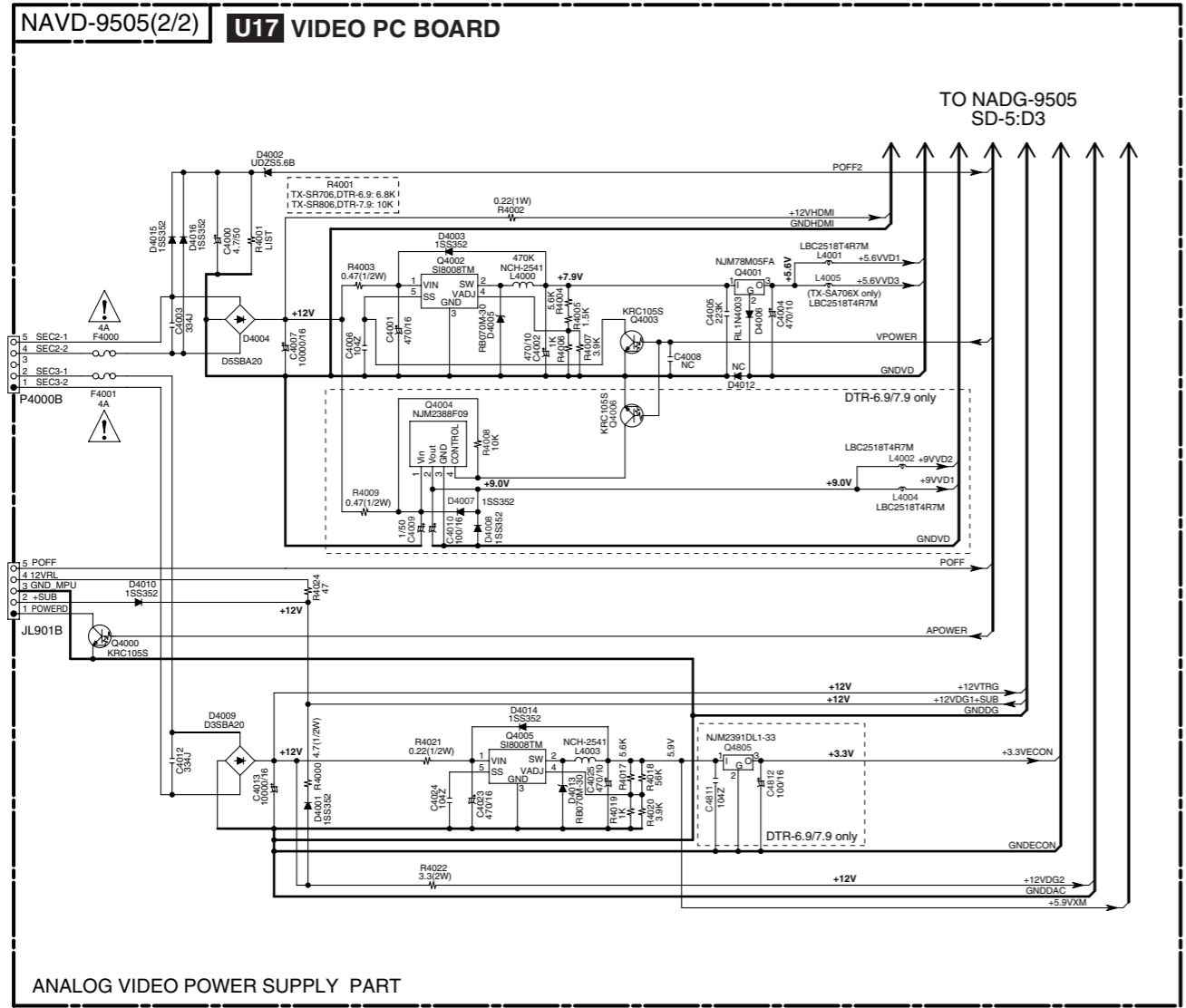

- NOTE**
- THE COMPONENTS IDENTIFIED BY MARK ARE CRITICAL FOR SAFETY. REPLACE ONLY WITH PART NUMBER SPECIFIED.
  - BOLD VOLTAGE (MEASURED WITH VOLTMETER) IS DC VOLTAGE.(NO INPUT SIGNAL).
  - ALL PNP TRANSISTORS ARE EQUIVALENT TO 2SA1015-GR UNLESS OTHERWISE NOTED.
  - ALL NPN TRANSISTORS ARE EQUIVALENT TO 2SC1815-GR UNLESS OTHERWISE NOTED.
  - ALL DIODES ARE EQUIVALENT TO 1SS133 UNLESS OTHERWISE NOTED.
  - ELECTROLYTIC CAPACITORS ( ) ARE IN uF/WV.
  - ALL CAPACITORS ARE IN pF/50WV UNLESS OTHERWISE NOTED.
  - EX) 030- 3pF, 330- 33pF, 331- 330pF, 333- 0.033uF
  - ALL RESISTORS ARE IN OHMS 1/4WATTS UNLESS OTHERWISE NOTED.
  - THE THICK LINES ON PC BOARD ARE THE PRINTING SIDE OF THE PARTS.
  - EX) PRINTING SIDE
  - CIRCUIT IS SUBJECT TO CHANGE FOR IMPROVEMENT.

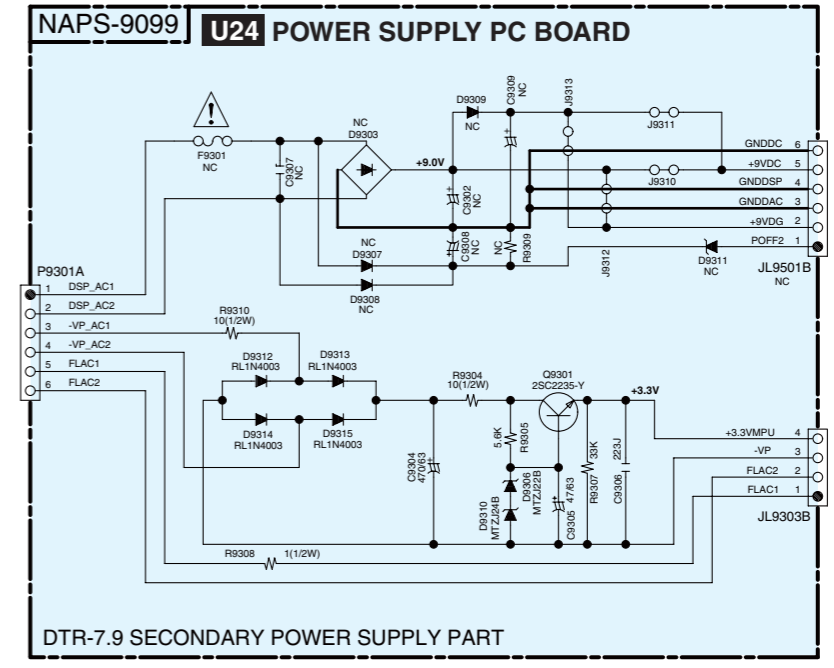
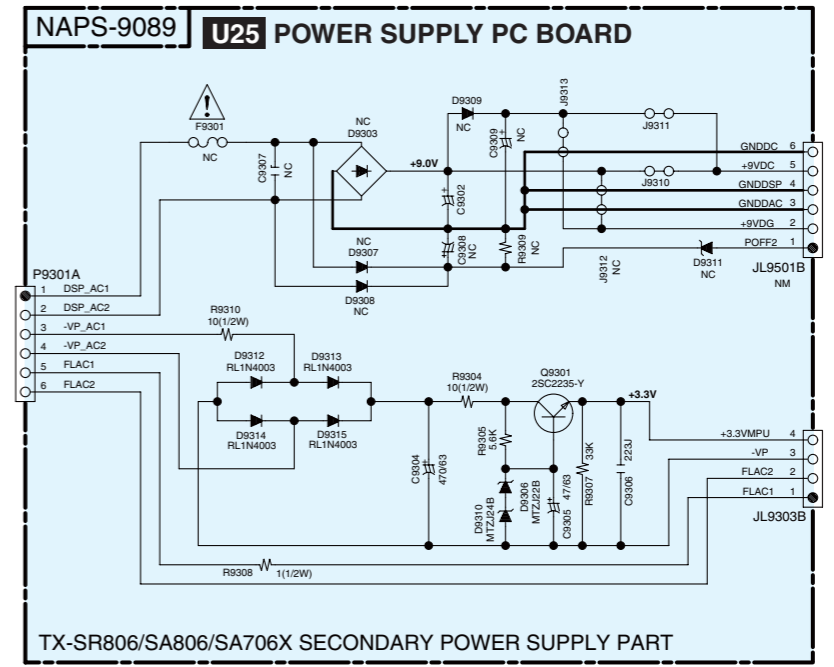



# SCHEMATIC DIAGRAMS-8 (SD-8) DSP SECTION-1

TX-SR706, TX-SA706, DTR-6.9: NAHDM-9562  
TX-SR806, TX-SA806, DTR-7.9: NAHDM-9702

<Note>  
SD-x:XY is short for Schematic Diagram-x and each socket's location, X=A to H, Y=1 to 5.

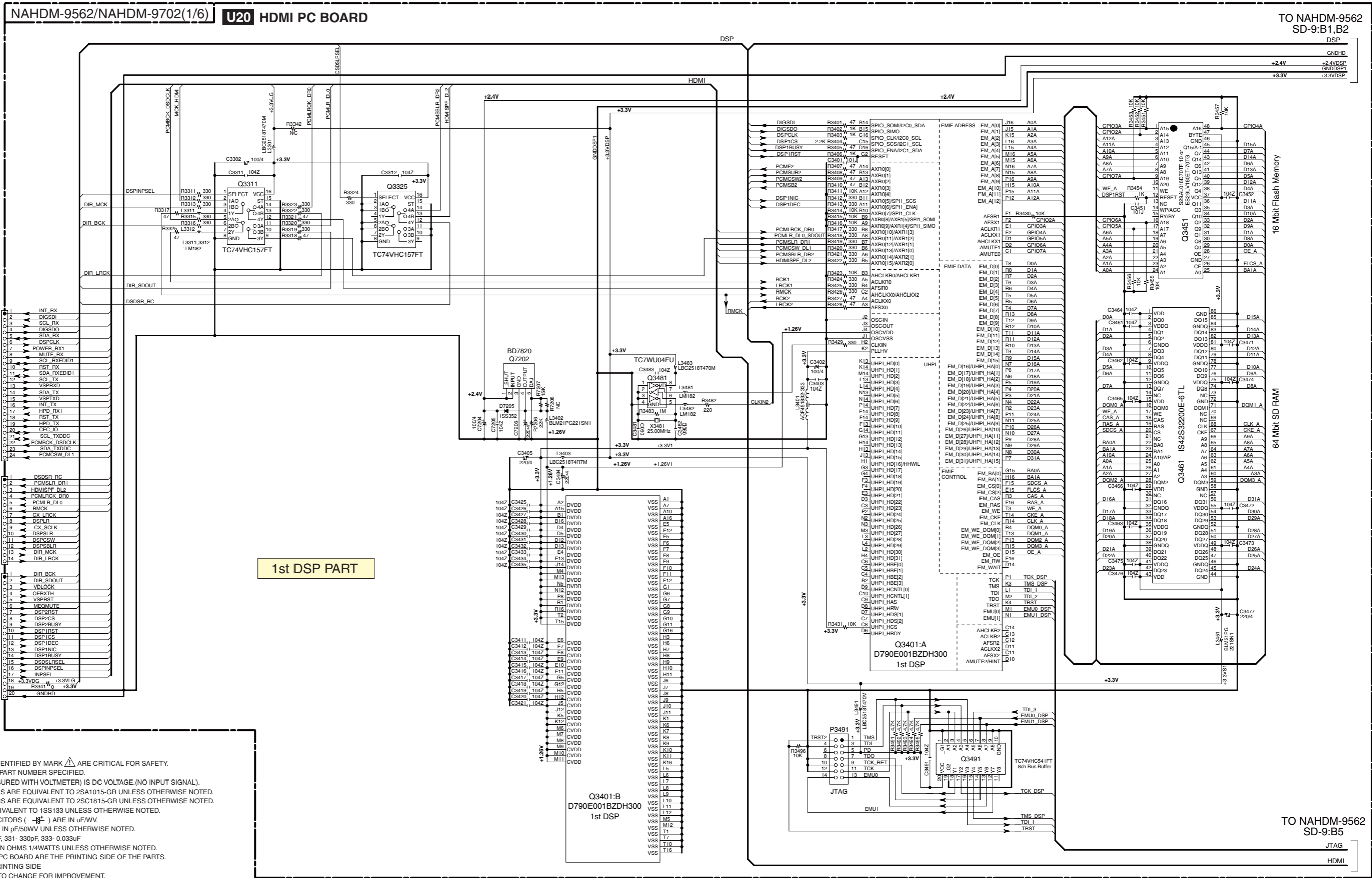

- NOTE**
- THE COMPONENTS IDENTIFIED BY MARK  $\Delta$  ARE CRITICAL FOR SAFETY. REPLACE ONLY WITH PART NUMBER SPECIFIED.
  - BOLD VOLTAGE (MEASURED WITH VOLTMETER) IS DC VOLTAGE (NO INPUT SIGNAL).
  - ALL PNP TRANSISTORS ARE EQUIVALENT TO 2SA1015-GR UNLESS OTHERWISE NOTED.
  - ALL NPN TRANSISTORS ARE EQUIVALENT TO 2SC1815-GR UNLESS OTHERWISE NOTED.
  - ALL DIODES ARE EQUIVALENT TO 1SS133 UNLESS OTHERWISE NOTED.
  - ELECTROLYTIC CAPACITORS (  $\text{---} \text{||} \text{---}$  ) ARE IN  $\mu\text{F/WV}$ .
  - ALL CAPACITORS ARE IN pF/50VWV UNLESS OTHERWISE NOTED.  
EX) 030-3pF, 330-33pF, 331-330pF, 333-0.033 $\mu\text{F}$
  - ALL RESISTORS ARE IN OHMS 1/4WATTS UNLESS OTHERWISE NOTED.
  - THE THICK LINES ON PC BOARD ARE THE PRINTING SIDE OF THE PARTS.  
EX)  $\text{---} \text{---} \text{---}$  PRINTING SIDE
  - CIRCUIT IS SUBJECT TO CHANGE FOR IMPROVEMENT.

1  
2  
3  
4  
5

TO NAHDM-9562 SD-9:B1,B2 DSP

TO NAHDM-9562 SD-9:B5 JTAG

HDMI

SCHEMATIC DIAGRAMS-9 (SD-9) DSP SECTION-2

TX-SR706, TX-SA706, DTR-6.9: NAHDM-9562  
TX-SR806, TX-SA806, DTR-7.9: NAHDM-9702

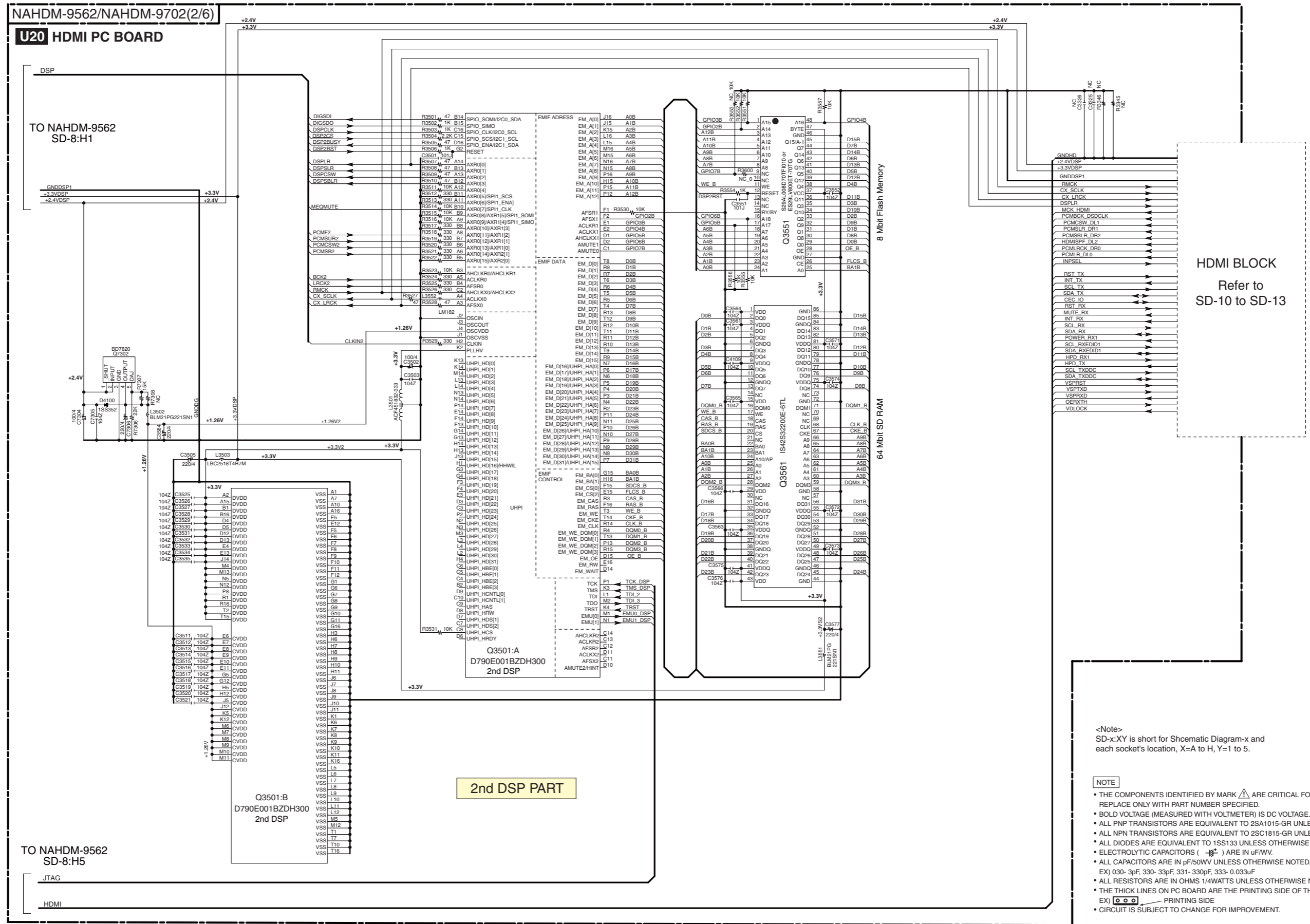

HDMI BLOCK  
Refer to  
SD-10 to SD-13

- <Note>  
SD-x:XY is short for Schematic Diagram-x and each socket's location, X=A to H, Y=1 to 5.
- NOTE**
- THE COMPONENTS IDENTIFIED BY MARK ARE CRITICAL FOR SAFETY. REPLACE ONLY WITH PART NUMBER SPECIFIED.
  - BOLD VOLTAGE (MEASURED WITH VOLTMETER) IS DC VOLTAGE.(NO INPUT SIGNAL).
  - ALL PNP TRANSISTORS ARE EQUIVALENT TO 2SA1015-GR UNLESS OTHERWISE NOTED.
  - ALL NPN TRANSISTORS ARE EQUIVALENT TO 2SC1815-GR UNLESS OTHERWISE NOTED.
  - ALL DIODES ARE EQUIVALENT TO 1SS133 UNLESS OTHERWISE NOTED.
  - ELECTROLYTIC CAPACITORS ( ) ARE IN uF/WV.
  - ALL CAPACITORS ARE IN pF/50WV UNLESS OTHERWISE NOTED.
  - EX) 030- 3pF, 330- 33pF, 331- 330pF, 333- 0.033uF
  - ALL RESISTORS ARE IN OHMS 1/4WATTS UNLESS OTHERWISE NOTED.
  - THE THICK LINES ON PC BOARD ARE THE PRINTING SIDE OF THE PARTS.
  - EX) PRINTING SIDE
  - CIRCUIT IS SUBJECT TO CHANGE FOR IMPROVEMENT.

1

2

3

4

5



# SCHEMATIC DIAGRAMS-10 (SD-10) HDMI SECTION-1

TX-SR706, TX-SA706, DTR-6.9: NAHDM-9562  
TX-SR806, TX-SA806, DTR-7.9: NAHDM-9702

## NAHDM-9562/NAHDM-9702(3/6) U20 HDMI PC BOARD

### HDMI INPUT PART-1

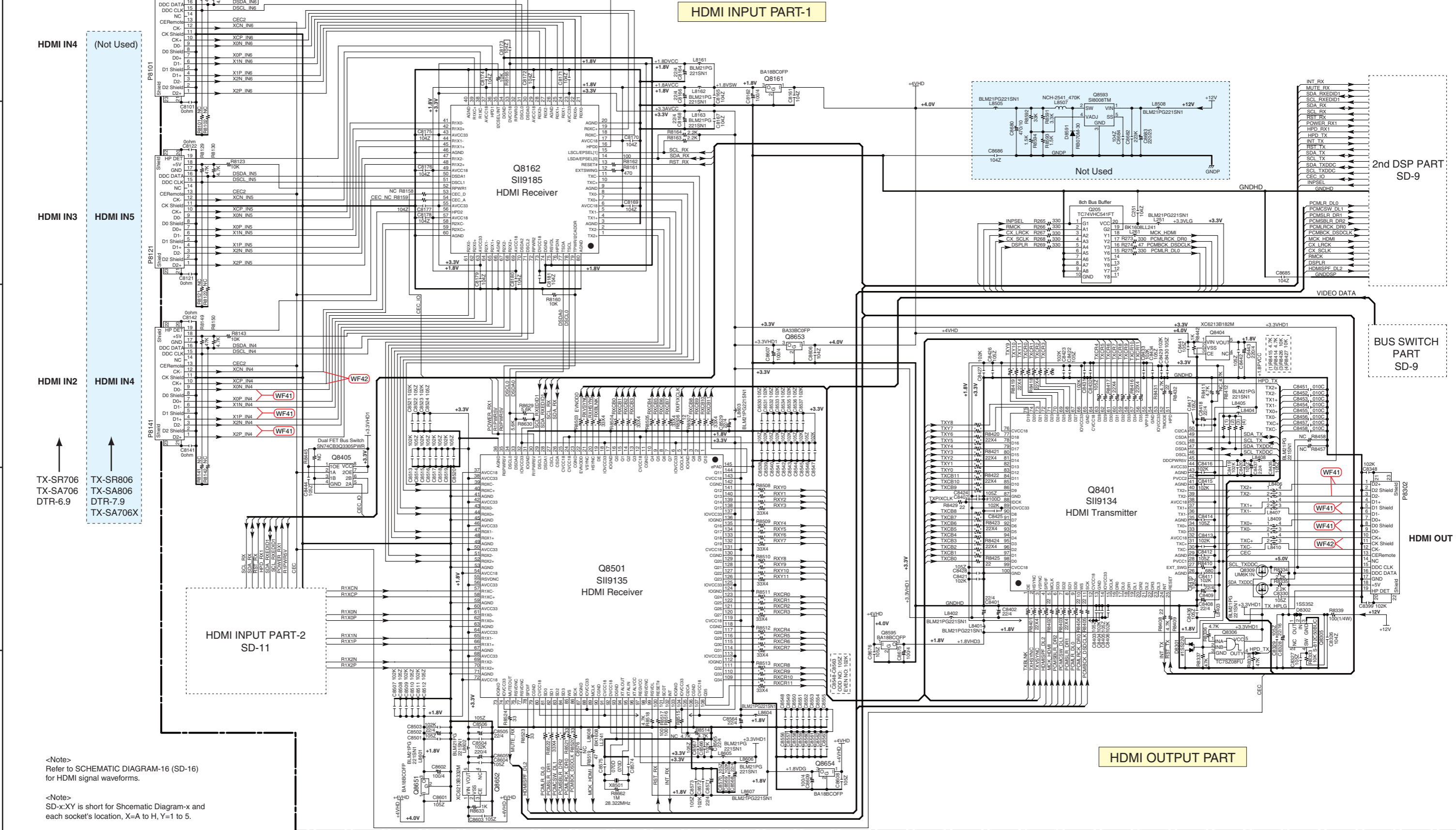

<Note>  
Refer to SCHEMATIC DIAGRAM-16 (SD-16)  
for HDMI signal waveforms.

<Note>  
SD-x:XY is short for Schematic Diagram-x and  
each socket's location, X=A to H, Y=1 to 5.

# SCHEMATIC DIAGRAMS-11 (SD-11) HDMI SECTION-2

<Note>  
SD-x:Y is short for Schematic Diagram-x and each socket's location, X=A to H, Y=1 to 5.

<Note>  
Refer to SCHEMATIC DIAGRAM-16 (SD-16) for HDMI signal waveforms.

- NOTE**
- THE COMPONENTS IDENTIFIED BY MARK  $\Delta$  ARE CRITICAL FOR SAFETY. REPLACE ONLY WITH PART NUMBER SPECIFIED.
  - BOLD VOLTAGE (MEASURED WITH VOLTMETER) IS DC VOLTAGE.(NO INPUT SIGNAL).
  - ALL PNP TRANSISTORS ARE EQUIVALENT TO 2SA1015-GR UNLESS OTHERWISE NOTED.
  - ALL PNP TRANSISTORS ARE EQUIVALENT TO 2SC1815-GR UNLESS OTHERWISE NOTED.
  - ALL DIODES ARE EQUIVALENT TO 1S1S13 UNLESS OTHERWISE NOTED.
  - ELECTROLYTIC CAPACITORS (  $\text{---}$  ) ARE IN  $\mu\text{F}/\text{VW}$ .
  - ALL CAPACITORS ARE IN  $\text{pF}/50\text{VW}$  UNLESS OTHERWISE NOTED.
  - EX) 030-3pF, 330-33pF, 331-330pF, 333-0.033 $\mu\text{F}$
  - ALL RESISTORS ARE IN OHMS 1/4WATTS UNLESS OTHERWISE NOTED.
  - THE THICK LINES ON PC BOARD ARE THE PRINTING SIDE OF THE PARTS.
  - EX)  $\square$  PRINTING SIDE
  - CIRCUIT IS SUBJECT TO CHANGE FOR IMPROVEMENT.

TX-SR706, TX-SA706, DTR-6.9: NAHDM-9562  
TX-SR806, TX-SA806, DTR-7.9: NAHDM-9702

## NAHDM-9562/NAHDM-9702(4/6) U20 HDMI PC BOARD

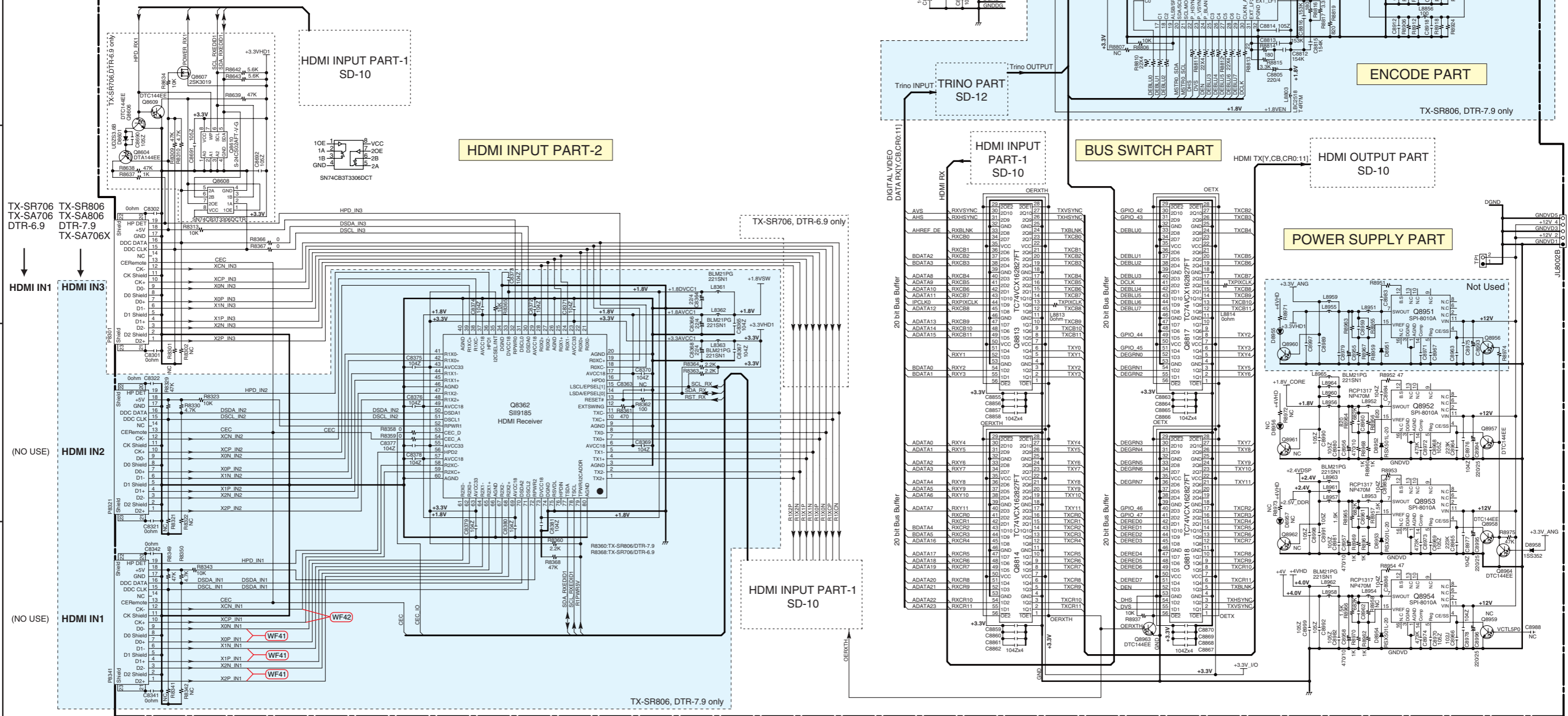

1

2

3

4

5

TO NAVD-9505  
SD-5:C1

TO NAVD-9505  
SD-5:D1

A B C D E F G H

SCHMATIC DIAGRAMS-12 (SD-12)  
HDMI SECTION-3

TX-SR706, TX-SA706, DTR-6.9: NAHDM-9562  
TX-SR806, TX-SA806, DTR-7.9: NAHDM-9702

NAHDM-9562/NAHDM-9702(5/6) U20 HDMI PC BOARD

HDMI TORINO PART

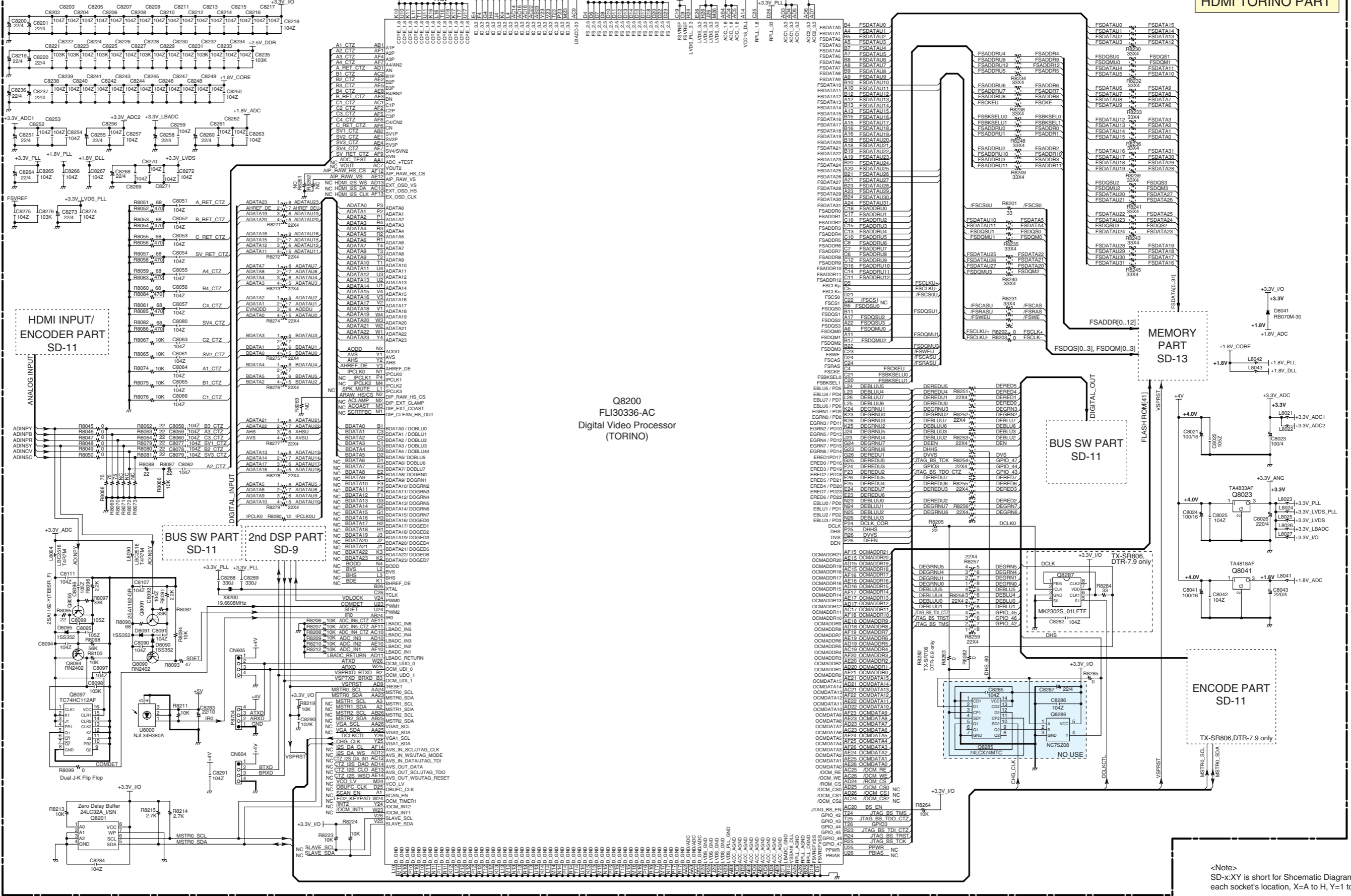

Q8200  
FLI30336-AC  
Digital Video Processor  
(TORINO)

MEMORY  
PART  
SD-13

BUS SW PART  
SD-11

BUS SW PART  
SD-11

2nd DSP PART  
SD-9

ENCODE PART  
SD-11

<Note>  
SD-x:Y is short for Schematic Diagram-x and  
each socket's location, X=A to H, Y=1 to 5.

# SCHEMATIC DIAGRAMS-13 (SD-13) HDMI SECTION-4

1

2

3

4

5

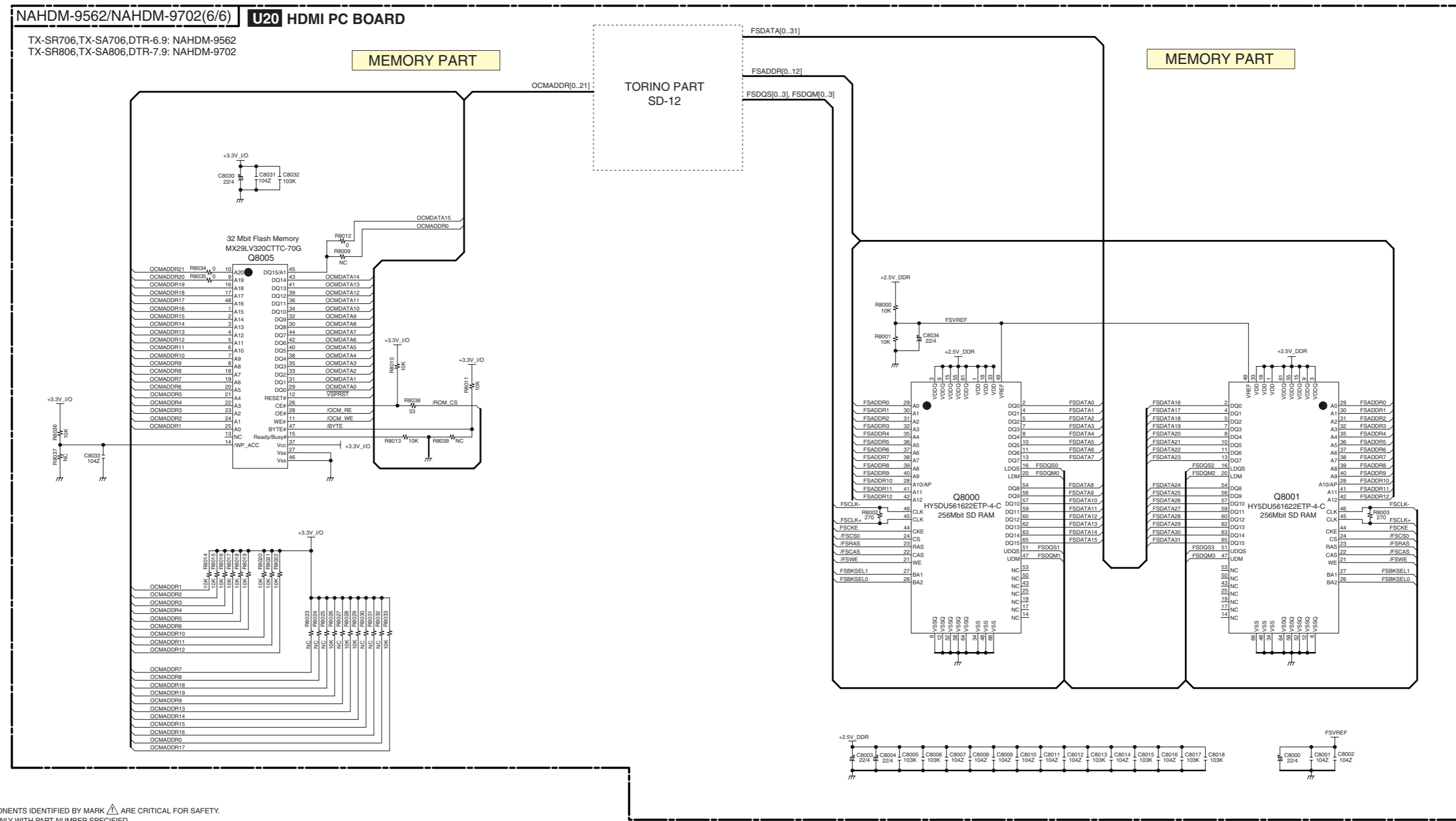

- NOTE**
- THE COMPONENTS IDENTIFIED BY MARK  $\Delta$  ARE CRITICAL FOR SAFETY. REPLACE ONLY WITH PART NUMBER SPECIFIED.
  - BOLD VOLTAGE (MEASURED WITH VOLTMETER) IS DC VOLTAGE.(NO INPUT SIGNAL).
  - ALL PNP TRANSISTORS ARE EQUIVALENT TO 2SA1015-GR UNLESS OTHERWISE NOTED.
  - ALL NPN TRANSISTORS ARE EQUIVALENT TO 2SC1815-GR UNLESS OTHERWISE NOTED.
  - ALL DIODES ARE EQUIVALENT TO 1SS133 UNLESS OTHERWISE NOTED.
  - ELECTROLYTIC CAPACITORS (  $\text{---} \text{||} \text{---}$  ) ARE IN  $\mu\text{F}$ .
  - ALL CAPACITORS ARE IN pF/50V UNLESS OTHERWISE NOTED.  
EX) 030- 3pF, 330- 33pF, 331- 330pF, 333- 0.033 $\mu\text{F}$
  - ALL RESISTORS ARE IN OHMS 1/4WATT'S UNLESS OTHERWISE NOTED.
  - THE THICK LINES ON PC BOARD ARE THE PRINTING SIDE OF THE PARTS.  
EX)  $\text{---} \text{---} \text{---}$  PRINTING SIDE
  - CIRCUIT IS SUBJECT TO CHANGE FOR IMPROVEMENT.

<Note>  
SD-x:XY is short for Shcematic Diagram-x and each socket's location, X=A to H, Y=1 to 5.



# SCHEMATIC DIAGRAMS-15 (SD-15) XM AND SIRIUS SECTION

1

2

3

4

5

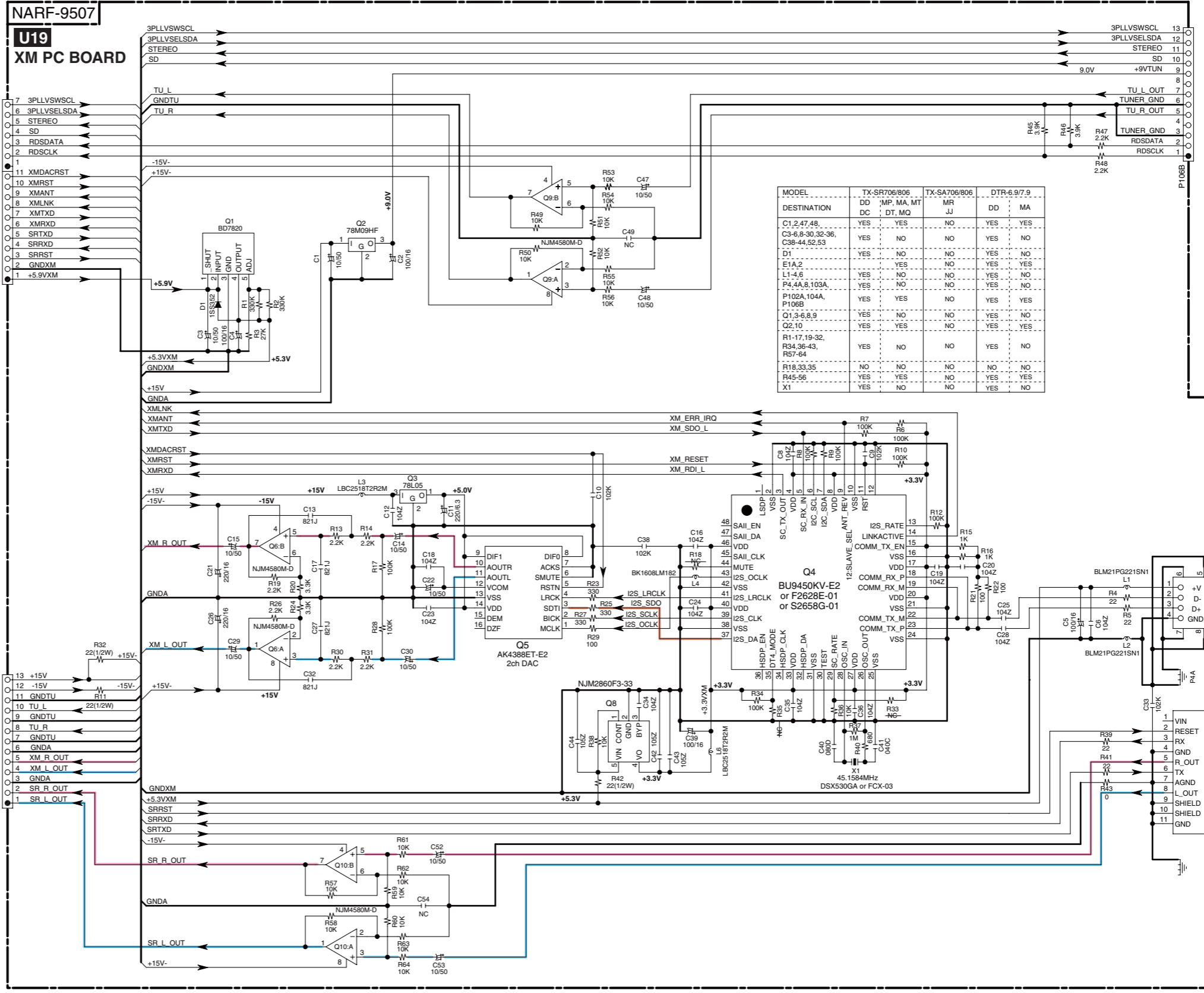

MODEL	TX-SR706/806	TX-SA706/806	DTR-6.9/7.9
DESTINATION	DD MP, MA, MT	MR JJ	DD MA
C1,2,47,48	YES	YES	NO
C3-6,8-30,32-36, C38-44,52,53	YES	NO	YES
D1	YES	NO	YES
E1A,2	YES	NO	YES
L1-4,6	YES	NO	YES
P4,4A,8,103A, P102A,104A, P106B	YES	YES	NO
Q1,3-6,8,9	YES	NO	YES
Q2,10	YES	YES	YES
R1-17,19-32, R34,36-43, R57-64	YES	NO	YES
R18,33,35	NO	NO	NO
R45-56	YES	YES	YES
X1	YES	NO	YES

<Note>  
SD-x:XY is short for Schematic Diagram-x and each socket's location, X=A to H, Y=1 to 5.

- NOTE**
- THE COMPONENTS IDENTIFIED BY MARK ARE CRITICAL FOR SAFETY. REPLACE ONLY WITH PART NUMBER SPECIFIED.
  - BOLD VOLTAGE (MEASURED WITH VOLTMETER) IS DC VOLTAGE (NO INPUT SIGNAL).
  - ALL PNP TRANSISTORS ARE EQUIVALENT TO 2SA1015-GR UNLESS OTHERWISE NOTED.
  - ALL NPN TRANSISTORS ARE EQUIVALENT TO 2SC1815-GR UNLESS OTHERWISE NOTED.
  - ALL DIODES ARE EQUIVALENT TO 1SS133 UNLESS OTHERWISE NOTED.
  - ELECTROLYTIC CAPACITORS ( ) ARE IN uF/WV.
  - ALL CAPACITORS ARE IN pF/50V UNLESS OTHERWISE NOTED.  
EX) 030- 3pF, 330- 33pF, 331- 330pF, 333- 0.033uF
  - ALL RESISTORS ARE IN OHMS 1/4WATTS UNLESS OTHERWISE NOTED.
  - THE THICK LINES ON PC BOARD ARE THE PRINTING SIDE OF THE PARTS.  
EX) PRINTING SIDE
  - CIRCUIT IS SUBJECT TO CHANGE FOR IMPROVEMENT.

# SCHEMATIC DIAGRAM-16(SD-16) WAVEFORM SECTION

1

### Digital Audio Waveform Part

**NOTE:**

- 1. (WF01) is short for (Waveform01)
- 2. Refer to SD-7(SCHEMATIC DIAGRAM-7) for the location of each waveform on circuit.
- 3. SD-x:XY is short for Schematic Diagram-x and each socket's location, X=A to H, Y=1 to 5.

LR CLOCK (SAI\_LRCK, CX\_LRCK)  
Fs=48kHz : DVD, Clock width=20.8us  
Fs=44.1kHz : CD, Clock width=22.7us

BIT CLOCK (SAI\_SLCK, CX\_SLCK)  
64Fs=3072kHz : DVD, Clock width=325ns  
64Fs=2822.4kHz : CD, Clock width=354ns

(WF01) OPT1 (SD-7:C5)

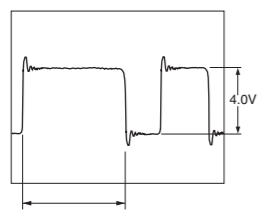

Duty varies according to audio data

(WF02) COAX1 (SD-7:C5)

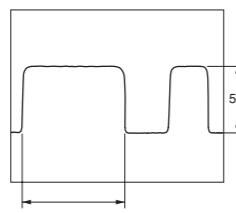

Duty always varies according to audio data

(WF03) SAI\_SDOUT (SD-7:D5)

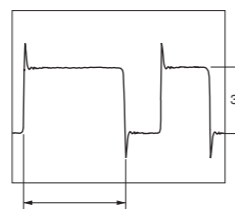

Duty varies according to audio data

(WF04) SAI\_LRCK (SD-7:D5)

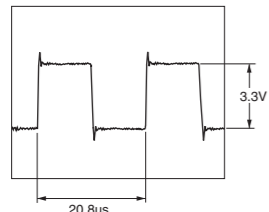

(WF05) SAI\_SLCK (SD-7:D5)

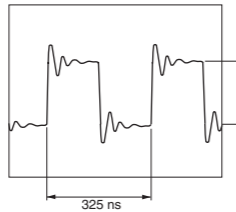

(WF06) PCMF3 (SD-7:E4)

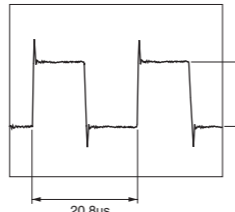

(WF07) CX\_LRCK (SD-7:E4)

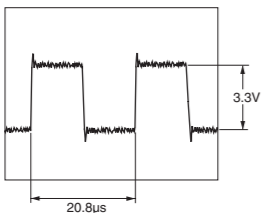

(WF08) CX\_SLCK (SD-7:E4)

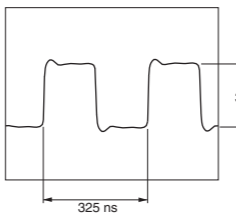

(WF09) FL+ (SD-7:F5)

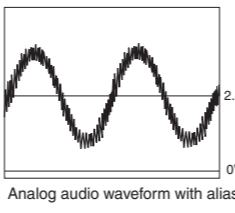

Analog audio waveform with aliasing noise

(WF10) DAC\_FL (SD-7:H2)

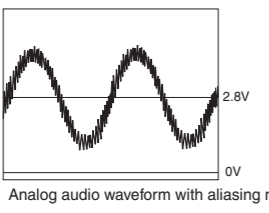

Analog audio waveform with aliasing noise

(WF10) DAC\_FL (SD-7:H2)

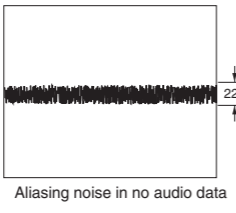

Aliasing noise in no audio data

2

3

4

5

### Video source color and pattern

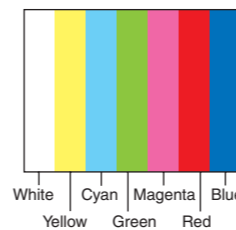

### Video Waveform Part

Composite waveform (WF21) SD-5:B5

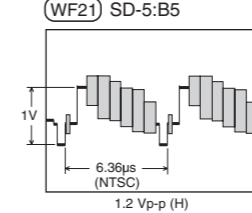

S-Video Y waveform (WF22) SD-5:B5

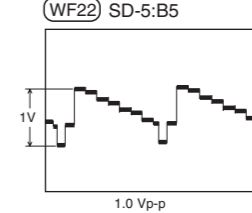

S-Video C waveform (WF23) SD-5:B5

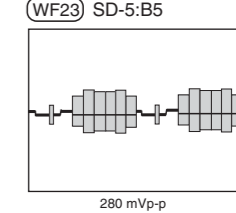

**NOTE:**

- 1. (WF21) is short for (Waveform21)
- 2. Refer to SD-5(SCHEMATIC DIAGRAM-5) for the location of each waveform on circuit.
- 3. SD-x:XY is short for Schematic Diagram-x and each socket's location, X=A to H, Y=1 to 5.
- 4. In the case that video outputs are not connected to video devices, video signal output levels are doubled.

Component Y waveform (WF24) SD-5:B2,B3

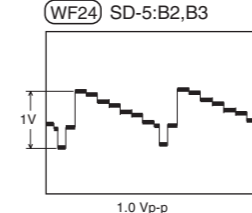

Component PB waveform (WF25) SD-5:B2,B3

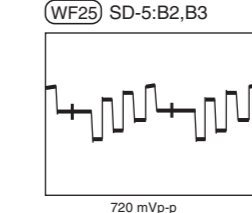

Component PR waveform (WF26) SD-5:B2

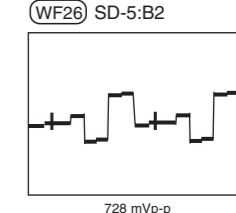

### HDMI Waveform Part

HDMI D0,D1,D2 waveform (WF41) SD-10:B3, H4 SD-11:B5

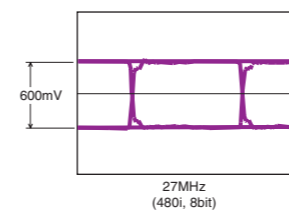
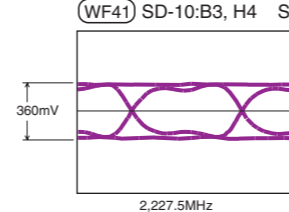

D0,D1,D2 Eye-pattern waveform, frequency and level vary according to video resolution, aspect and profile. Waveforms above are examples.

HDMI CK waveform (WF42) SD-10:B3, H4 SD-11:B5

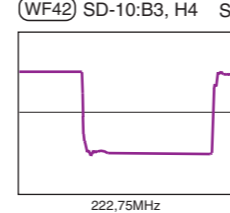

CK waveform, frequency and level differ according to video resolution, aspect and profile. D0,D1,D2 are just CK x10.

### FL Driver IC Control Waveform Part

SCK/SDATA waveform (WF61) SD-14:E3,F2

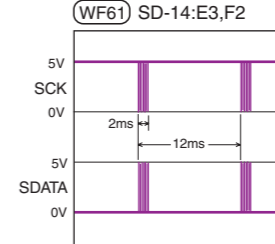

SCK/SDATA waveform (WF61) SD-14:E3,F2

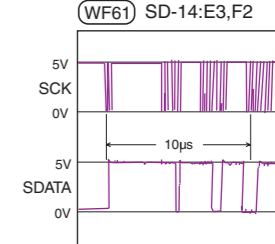

SDATA waveform varies according to the data content

SCK/CS waveform (WF62) SD-14:E3,F2

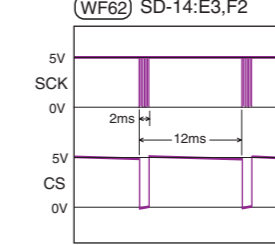

SCK/RESET waveform (WF63) SD-14:E3,F2

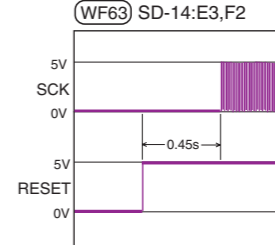

When power on

SCK/RESET waveform (WF63) SD-14:E3,F2

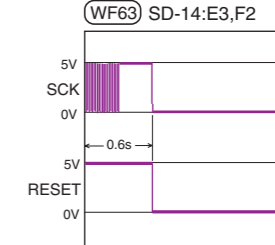

When power off

# BLOCK DIAGRAMS-1 AUDIO SECTION

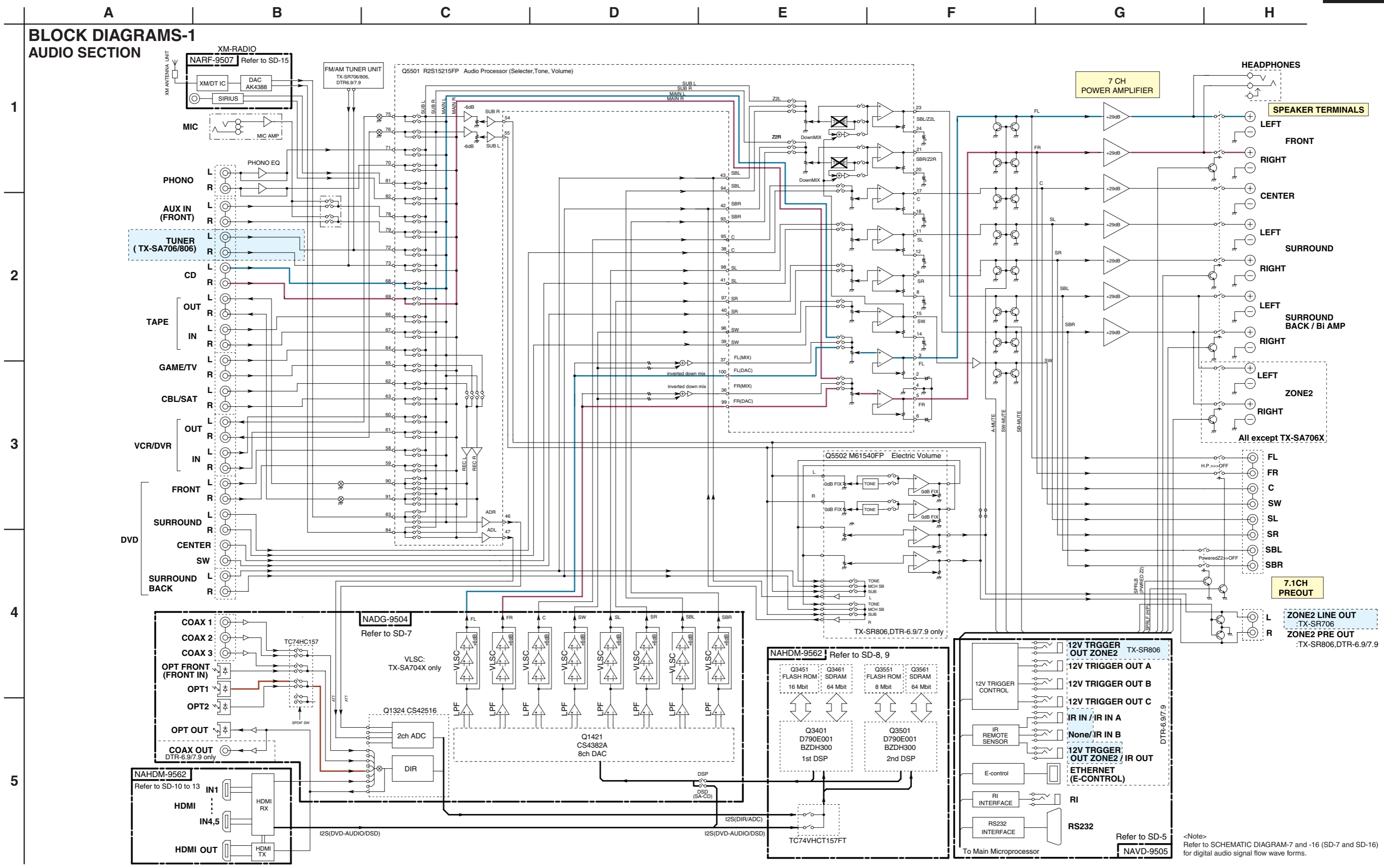

<Note>  
Refer to SCHEMATIC DIAGRAM-7 and -16 (SD-7 and SD-16)  
for digital audio signal flow wave forms.



# BLOCK DIAGRAMS-2 VIDEO SECTION

1

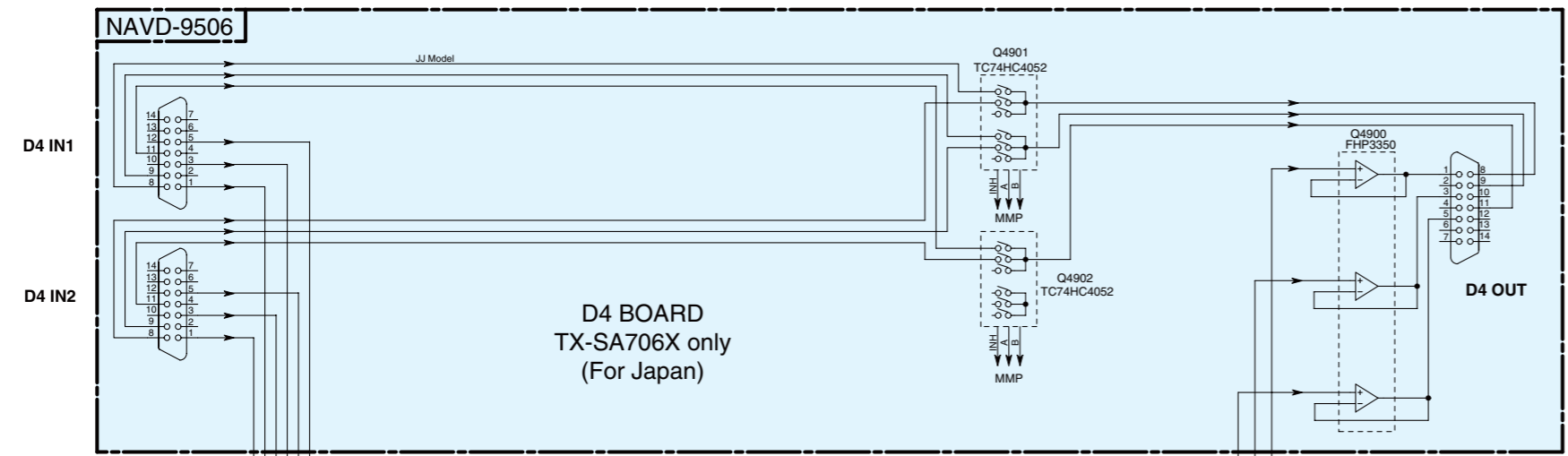

2

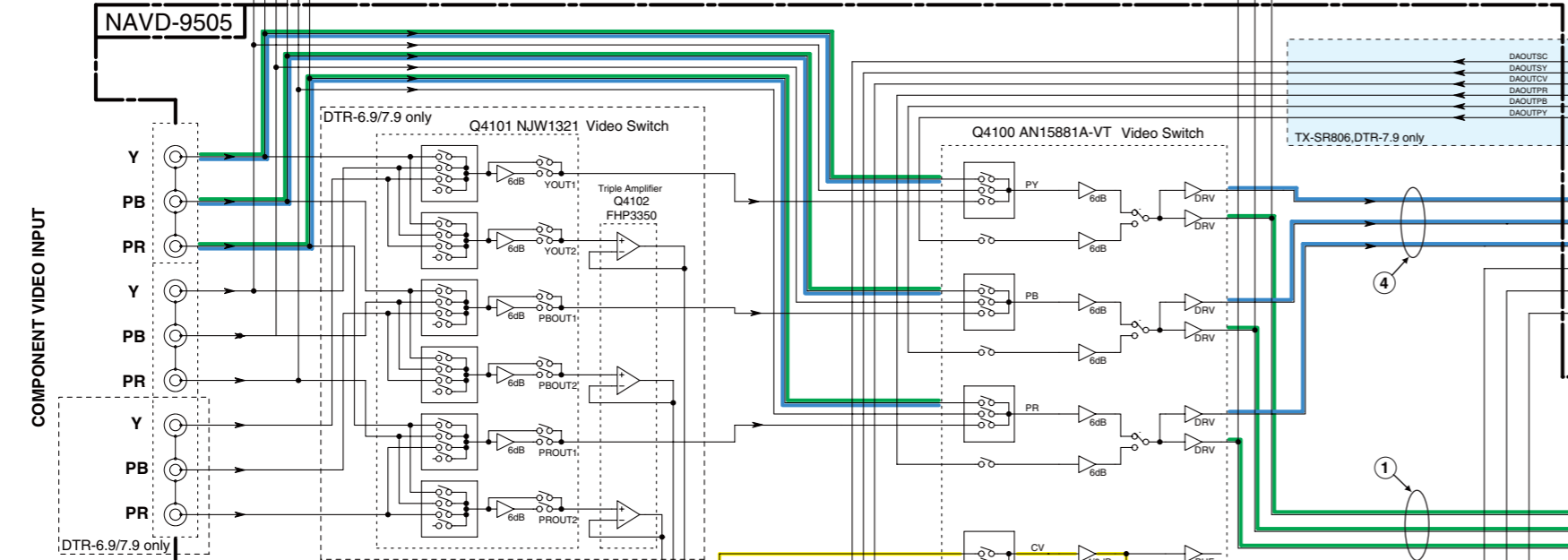

3

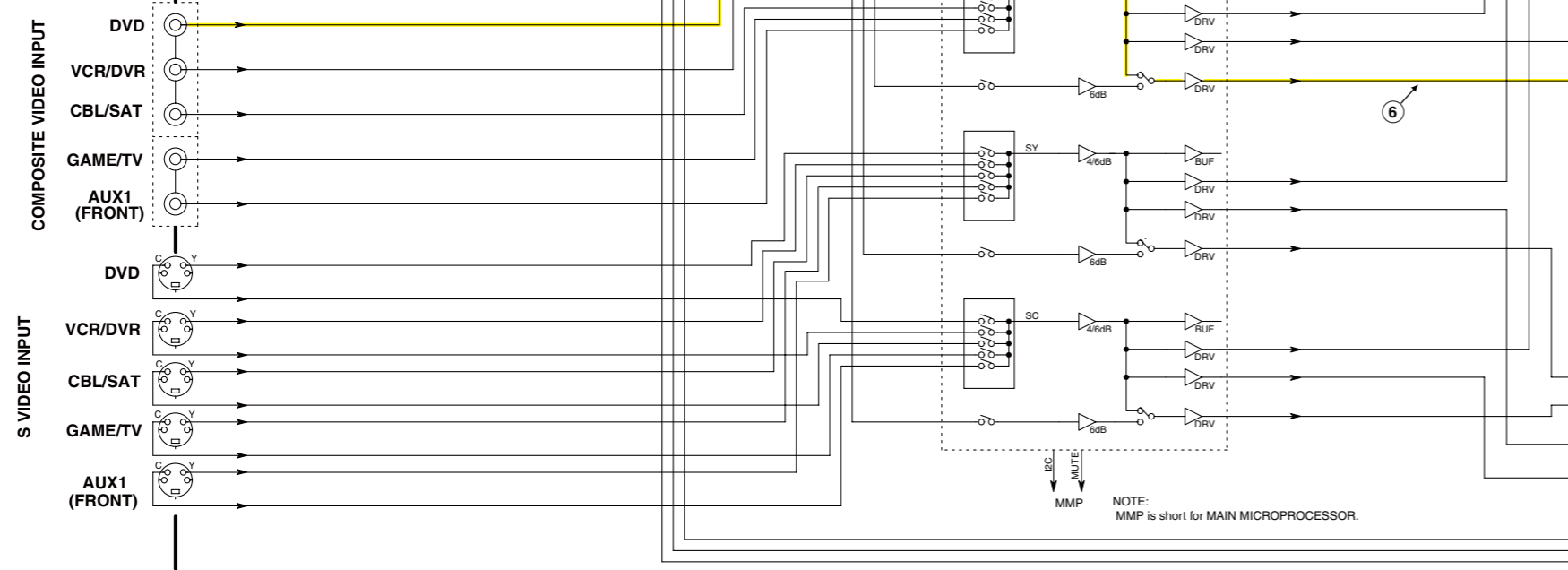

4

5

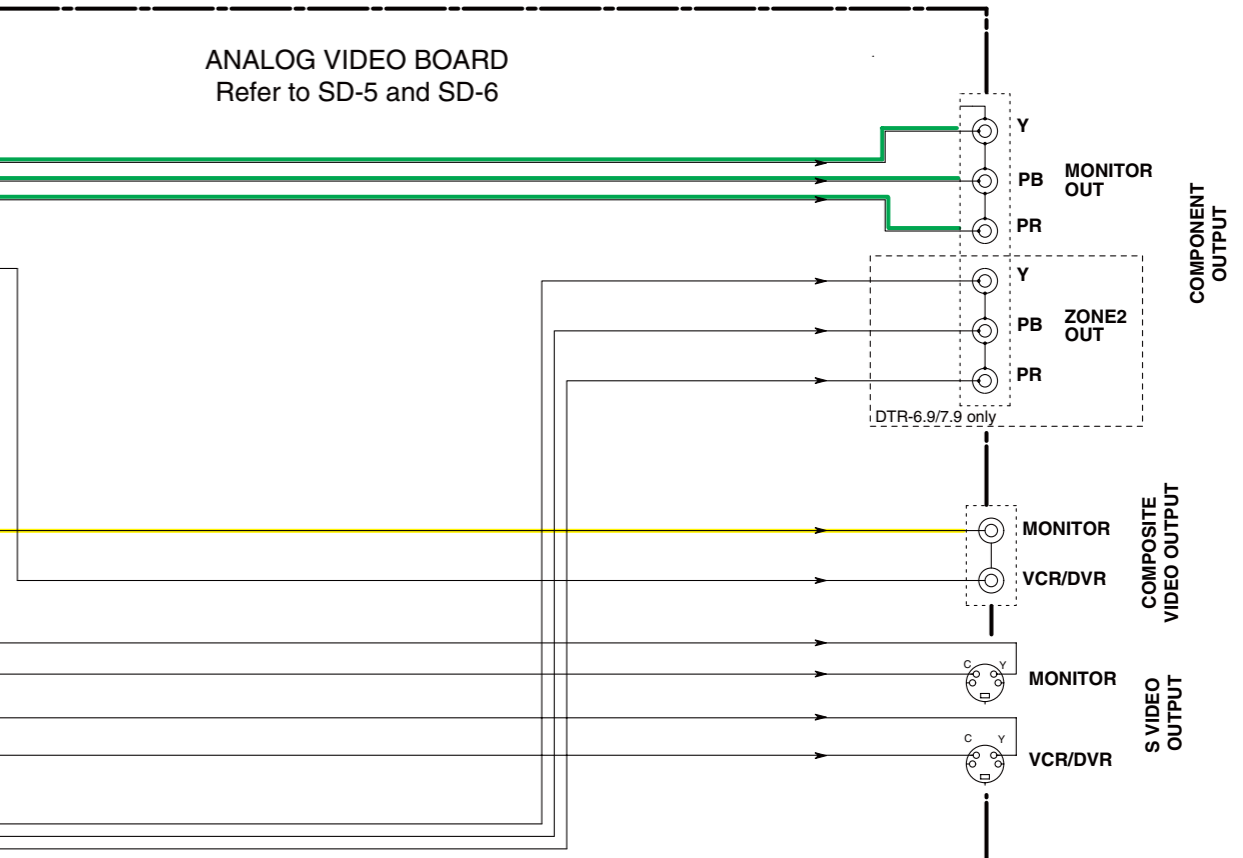
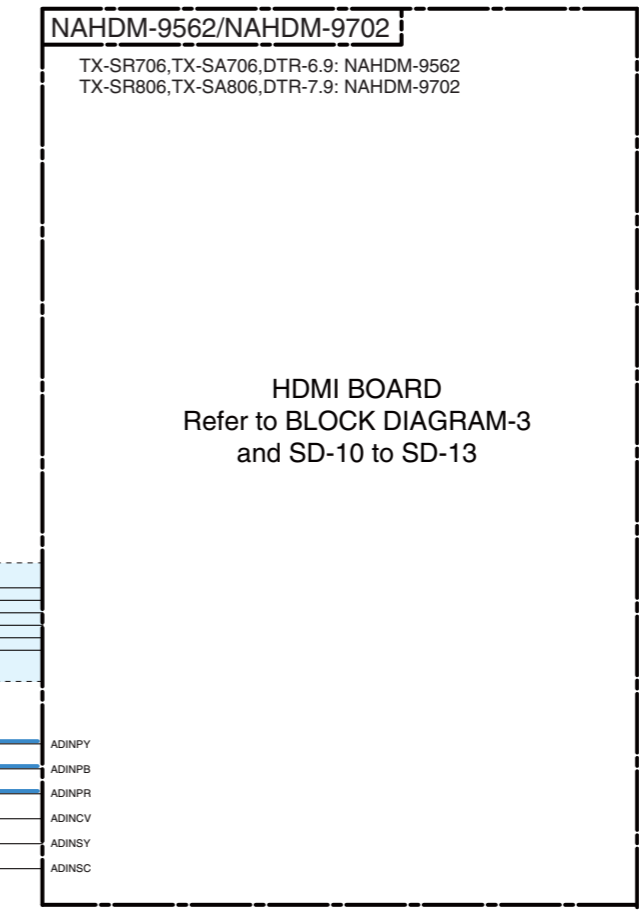

<Note>  
Refer to SCHEMATIC DIAGRAM-5 and -16  
(SD-5 and SD-16)  
for analog video signal waveforms.

- Video Signal Flow**
- ① Analog → Analog
  - ② HDMI → HDMI (Through Mode)
  - ③ HDMI → HDMI
  - ④ Analog → HDMI
  - ⑤ OSD → HDMI  
Above analog ex. is Component
  - ⑥ Composite → Composite

Note on OSD:  
OSD is not output to analog video output  
for TX-SR706, DTR-6.9.  
OSD is output only to HDMI OUT.

BLOCK DIAGRAMS-3  
HDMI SECTION

1  
2  
3  
4  
5

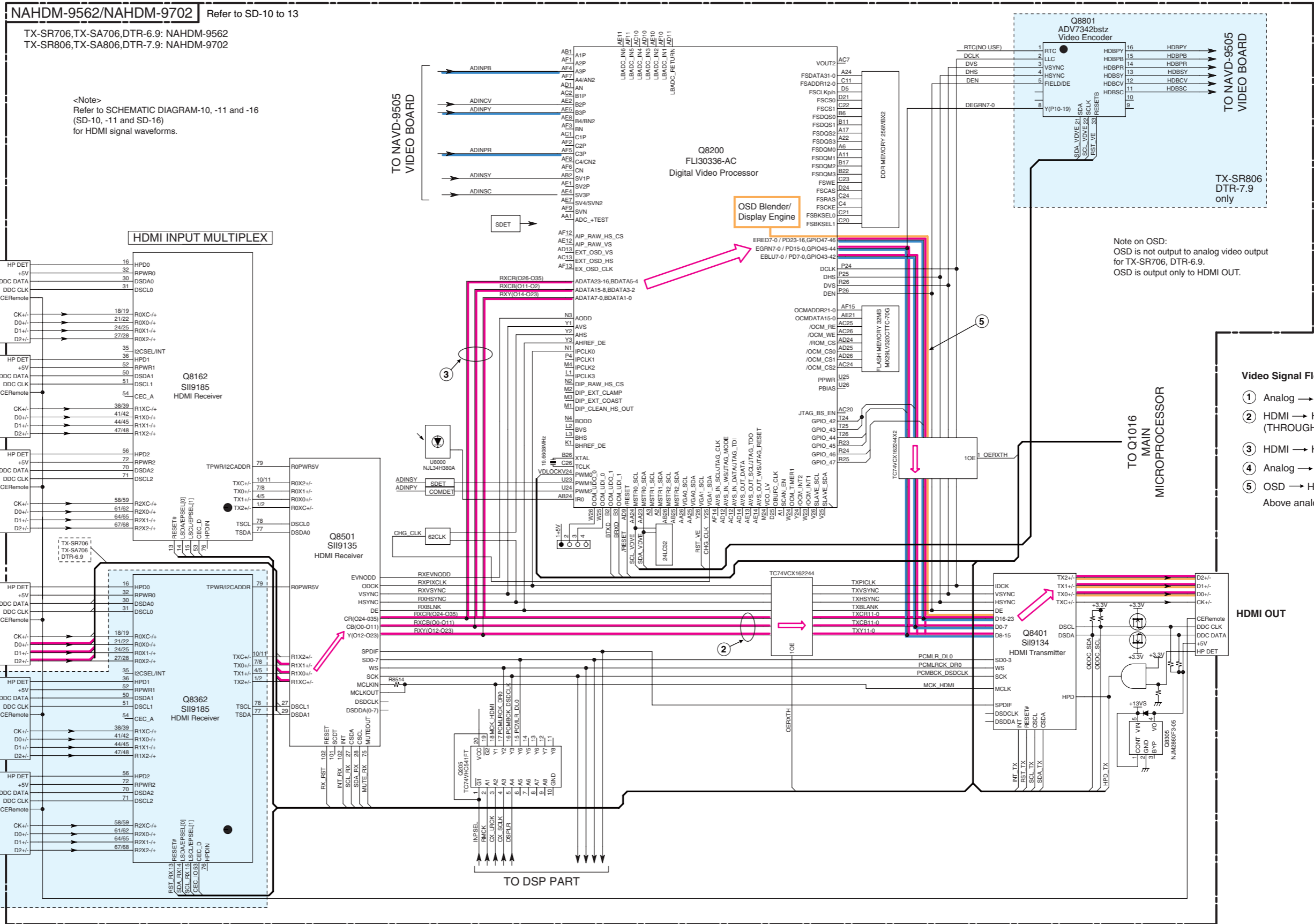

- Video Signal Flow**
- ① Analog → Analog
  - ② HDMI → HDMI (THROUGH MODE)
  - ③ HDMI → HDMI
  - ④ Analog → HDMI
  - ⑤ OSD → HDMI
- Above analog ex. is Component

BLOCK DIAGRAMS-4  
DSP SECTION

A B C D E F G H

1

2

3

4

5

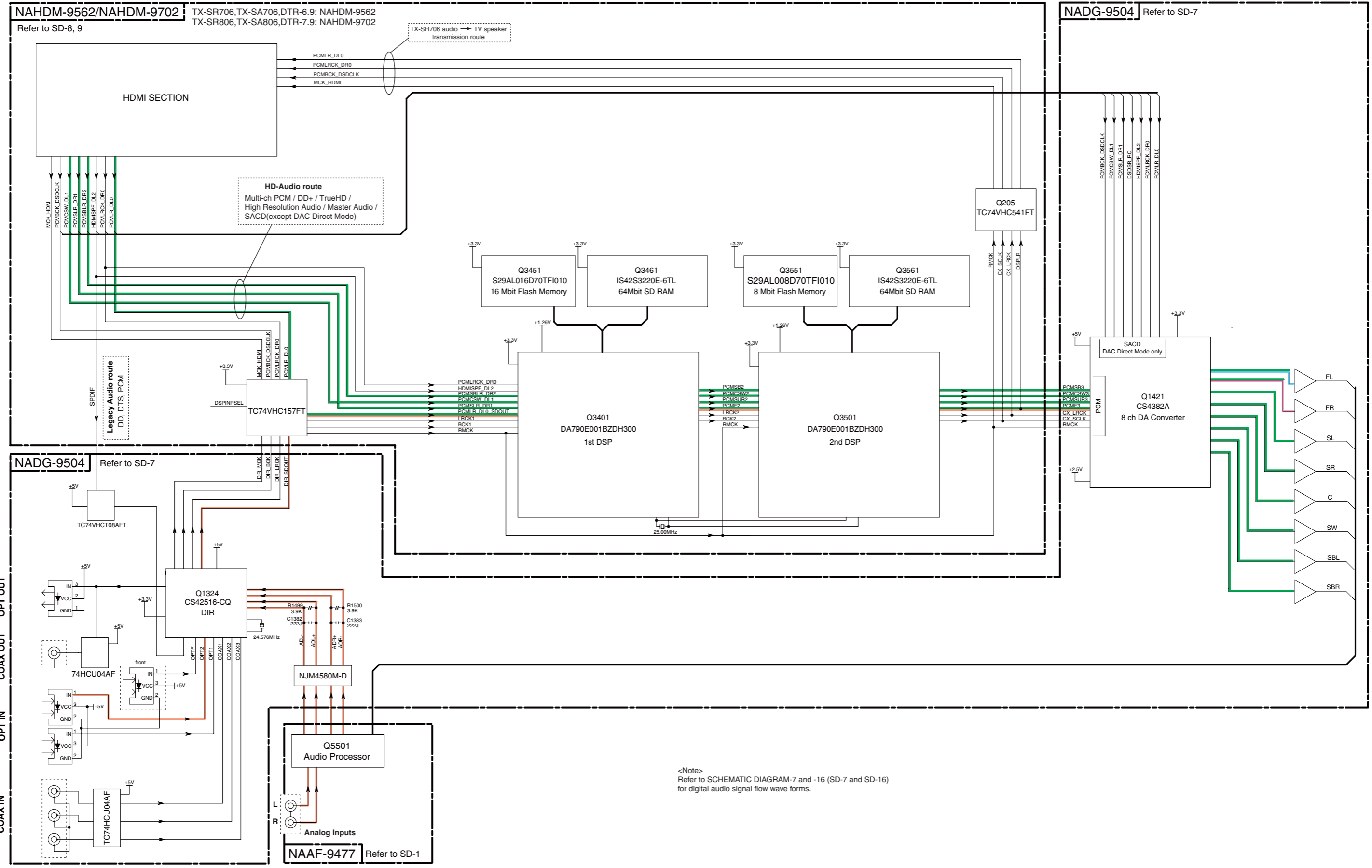

<Note>  
Refer to SCHEMATIC DIAGRAM-7 and -16 (SD-7 and SD-16)  
for digital audio signal flow wave forms.

# SCHEMATIC DIAGRAMS-1 (SD-1) AUDIO SECTION

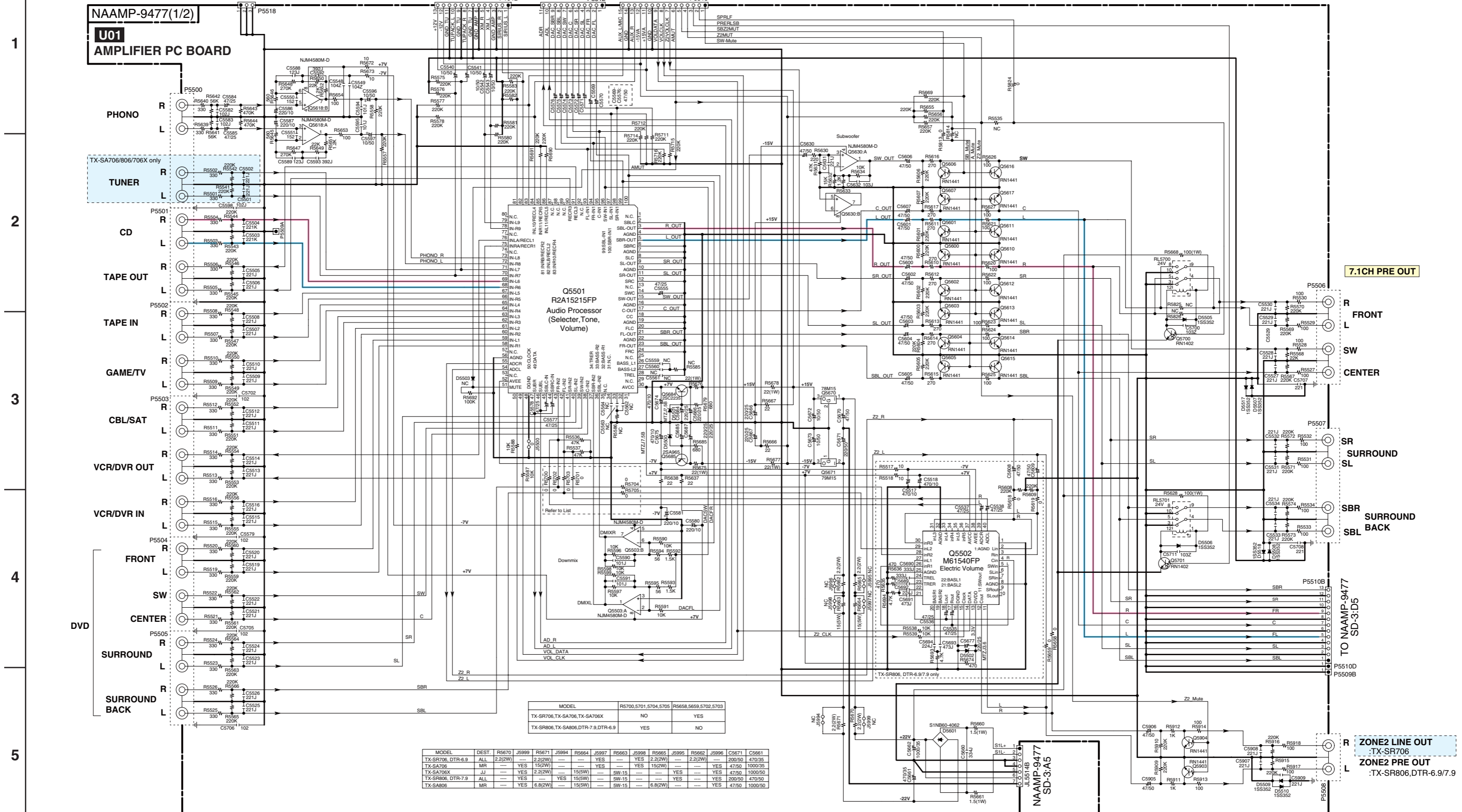

MODEL	R5700	5701	5704	5705	R5658	5659	5702	5703
TX-SR706, TX-SA706, TX-SA706X	NO				YES			
TX-SR806, TX-SA806, DTR-7.9, DTR-6.9	YES				NO			

MODEL	DEST.	R5670	J5999	R5671	J5994	R5664	J5997	R5663	J5998	R5665	J5995	R5662	J5996	C5671	C5661
TX-SR706, DTR-6.9	ALL	2.2(2W)	---	2.2(2W)	---	---	YES	---	YES	2.2(2W)	---	2.2(2W)	---	200/50	470/35
TX-SA706	MR	---	YES	15(2W)	---	---	YES	---	YES	15(2W)	---	---	---	47/50	1000/35
TX-SA706X	JJ	---	YES	2.2(2W)	---	15(SW)	---	SW-15	---	---	---	---	---	47/50	1000/50
TX-SR806, DTR-7.9	ALL	---	NLS	YES	15(SW)	---	YES	---	SW-15	---	---	---	---	200/50	470/50
TX-SA806	MR	---	YES	6.8(2W)	---	15(SW)	---	SW-15	---	6.8(2W)	---	---	---	47/50	1000/50

<Note>  
SD-x:XY is short for Schematic Diagram-x and each socket's location, X=A to H, Y=1 to 5.

SCHEMATIC DIAGRAMS-2 (SD-2)  
POWER AMPLIFIER SECTION-1

1

2

3

4

5

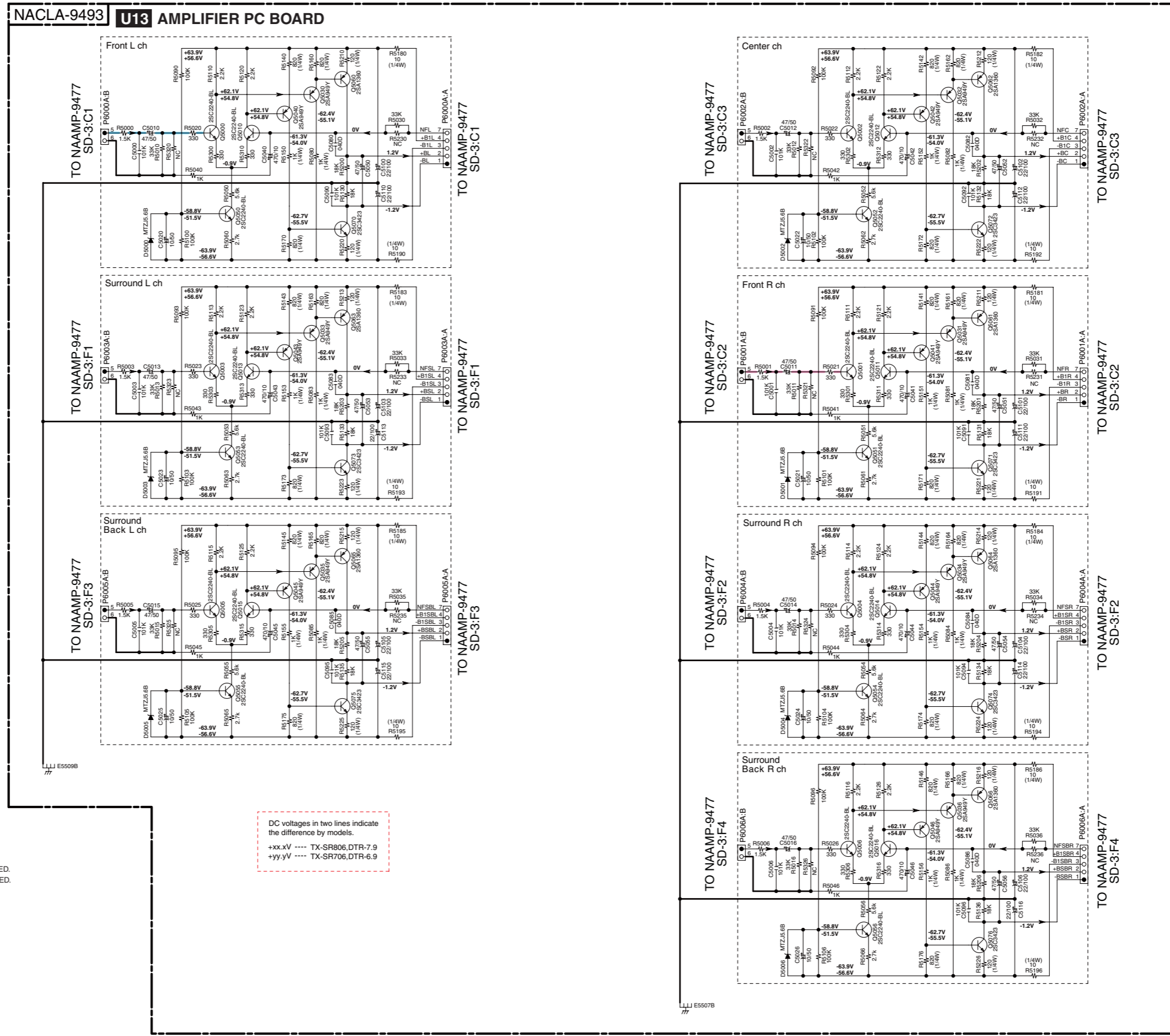

- NOTE**
- THE COMPONENTS IDENTIFIED BY MARK  $\Delta$  ARE CRITICAL FOR SAFETY. REPLACE ONLY WITH PART NUMBER SPECIFIED.
  - BOLD VOLTAGE (MEASURED WITH VOLTMETER) IS DC VOLTAGE.(NO INPUT SIGNAL).
  - ALL PNP TRANSISTORS ARE EQUIVALENT TO 2SA1015-GR UNLESS OTHERWISE NOTED.
  - ALL NPN TRANSISTORS ARE EQUIVALENT TO 2SC1815-GR UNLESS OTHERWISE NOTED.
  - ALL DIODES ARE EQUIVALENT TO 1SS133 UNLESS OTHERWISE NOTED.
  - ELECTROLYTIC CAPACITORS (  $\text{---}\text{||}\text{---}$  ) ARE IN  $\mu\text{F}/\text{MV}$ .
  - ALL CAPACITORS ARE IN  $\text{pF}/50\text{V}$  UNLESS OTHERWISE NOTED.  
EX) 030-3pF, 330-33pF, 331-330pF, 333-0.033 $\mu\text{F}$
  - ALL RESISTORS ARE IN OHMS 1/4WATTS UNLESS OTHERWISE NOTED.
  - THE THICK LINES ON PC BOARD ARE THE PRINTING SIDE OF THE PARTS.  
EX)  $\text{---}\text{||}\text{---}$  PRINTING SIDE
  - CIRCUIT IS SUBJECT TO CHANGE FOR IMPROVEMENT.

DC voltages in two lines indicate the difference by models.  
 +xx.xV ---- TX-SR806,DTR-7.9  
 +yy.yV ---- TX-SR706,DTR-6.9

DC voltages in two lines indicate the difference by models.  
 +xx.xV ---- TX-SR806,DTR-7.9  
 +yy.yV ---- TX-SR706,DTR-6.9

<Note>  
SD-x:XY is short for Schematic Diagram-x and each socket's location, X=A to H, Y=1 to 5.

# SCHEMATIC DIAGRAMS-3 (SD-3) POWER AMPLIFIER SECTION-2

1  
2  
3  
4  
5

**NAAMP-9477(2/2)**  
**U01 AMPLIFIER PC BOARD**

**NCETC-9478**  
**U02 THERMAL SENSOR PC BOARD**

**NAETC-9480**  
**U04 TO COOLING FAN TERMINAL PC BOARD**

TO NATRM-9488 SD-4:A3

TO POWER TRANS T901 SD-4:H1

TO NAAF-9477 SD-1:F5

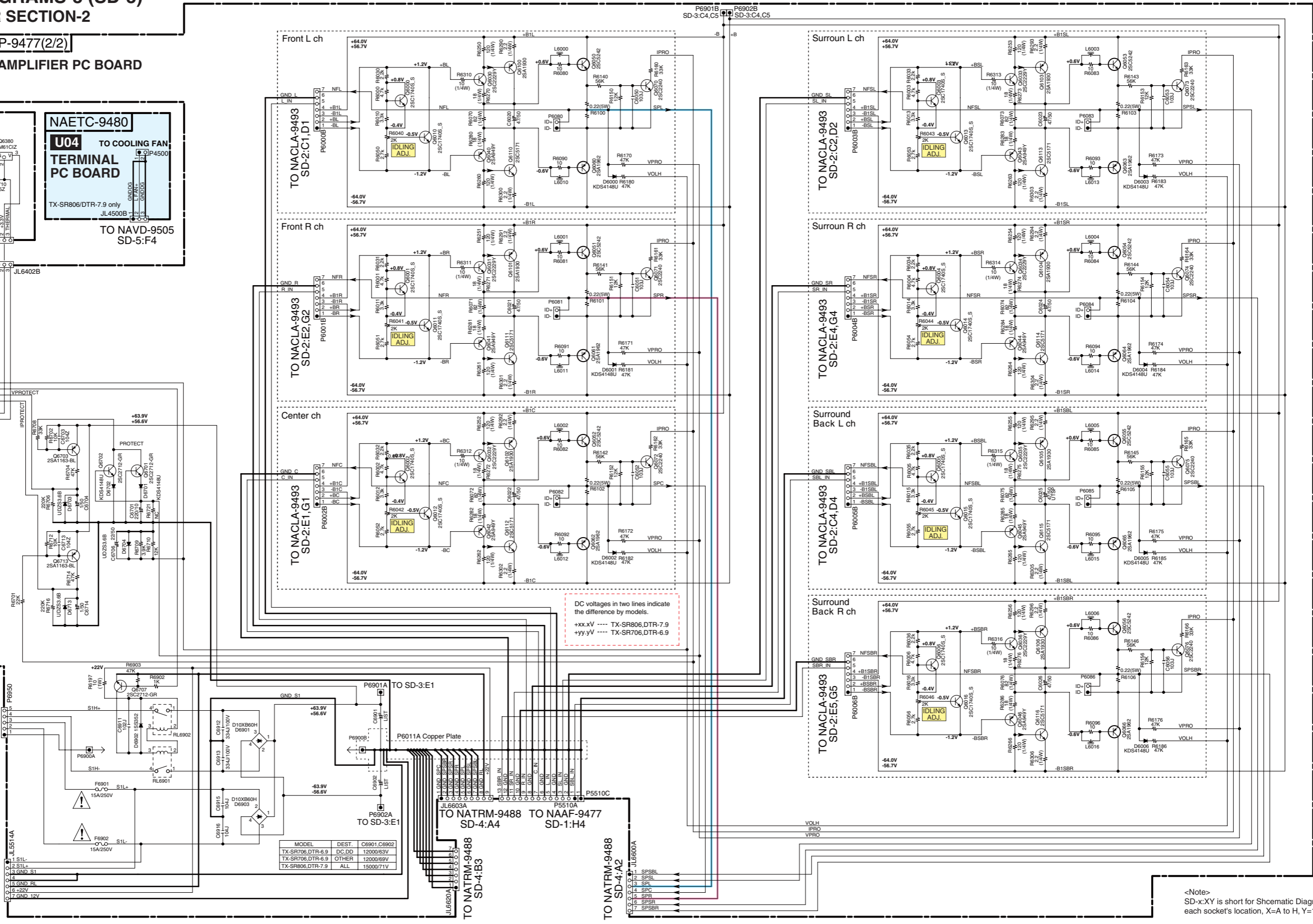

DC voltages in two lines indicate the difference by models.  
 +xx.xV ---- TX-SR806.DTR-7.9  
 +yy.yV ---- TX-SR706.DTR-6.9

MODEL	DEST.	C8901.C8902
TX-SR706.DTR-6.9	DC.DD	12000/63W
TX-SR706.DTR-6.9	OTHER	12000/69W
TX-SR806.DTR-7.9	ALL	15000/71V

<Note>  
SD-x:XY is short for Schematic Diagram-x and each sockets location, X=A to H, Y=1 to 5.

**SCHEMATIC DIAGRAMS-4 (SD-4)**  
**SP TERMINAL AND POWER SUPPLY SECTION**

1

2

3

4

5

**NATRM-9488**  
**U08**  
**SP TERMINAL PC BOARD**

**NATRM-9489**  
**U08**  
**SP TERMINAL PC BOARD**

TO NAPS-9530 SD-14:B1  
TO NAVD-9505 SD-6:A2  
TO NAAMP-9477 SD-3:A4

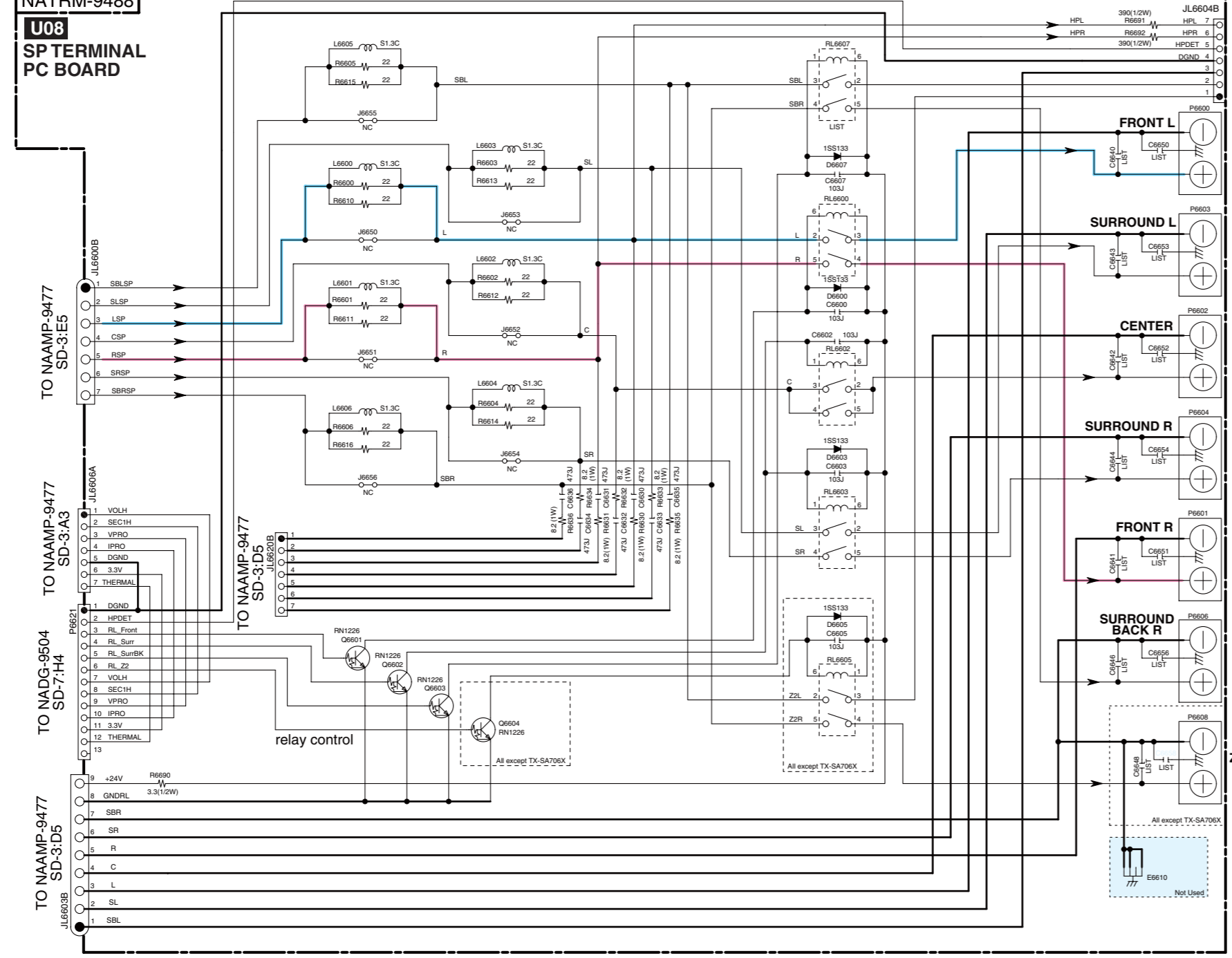

**NAPS-9491**  
**U11**  
**INLET PC BOARD**

**NAPS-9490**  
**U10**  
**POWER SUPPLY PC BOARD**

AC CORD  
TX-SR706  
DC, DD only

**U12**  
**POWER SUPPLY PC BOARD**  
**NASW-9492**

**F901 RATING**

Type	TX-SR706	TX-SR806
DC, DD, DT	10A/125V	12A/125V
MP, MA, MQ	5A/250V	6.3A/250V
MT, MO	---	---
TX-SA	5A/250V	6.3A/250V
JJ	10A/125V	---

**Main Trans T901**

Type	TX-SR706	TX-SR806
DC, DD, DT	NPT-1570D	NPT-1571D
MP, MA, MQ	NPT-1570M	NPT-1571M
MT, MO, MT	NPT-1570M	NPT-1571M
TX-SA	NPT-1570M	NPT-1571M
JJ	NPT-1571J	---

- NOTE**
- THE COMPONENTS IDENTIFIED BY MARK ARE CRITICAL FOR SAFETY. REPLACE ONLY WITH PART NUMBER SPECIFIED.
  - BOLD VOLTAGE (MEASURED WITH VOLTMETER) IS DC VOLTAGE. (NO INPUT SIGNAL).
  - ALL PNP TRANSISTORS ARE EQUIVALENT TO 2SA1015-GR UNLESS OTHERWISE NOTED.
  - ALL NPN TRANSISTORS ARE EQUIVALENT TO 2SC1815-GR UNLESS OTHERWISE NOTED.
  - ALL DIODES ARE EQUIVALENT TO 1SS133 UNLESS OTHERWISE NOTED.
  - ELECTROLYTIC CAPACITORS ( ) ARE IN uF/WV.
  - ALL CAPACITORS ARE IN pF/50WV UNLESS OTHERWISE NOTED.
  - EX) 030- 3pF, 330- 33pF, 331- 330pF, 333- 0.033uF
  - ALL RESISTORS ARE IN OHMS 1/4WATTS UNLESS OTHERWISE NOTED.
  - THE THICK LINES ON PC BOARD ARE THE PRINTING SIDE OF THE PARTS.
  - EX) PRINTING SIDE
  - CIRCUIT IS SUBJECT TO CHANGE FOR IMPROVEMENT.

**C6640-6648**

TYPE	TX-SR706	TX-SA706	TX-SR806	TX-SA806	TX-SA706X	DTR-6.9	DTR-7.9
D	NC	---	NC	---	---	NC	NC
J	---	---	---	NC	---	---	---
M	472J	472J	472J	472J	---	472J	472J

**C6650-6658**

TYPE	TX-SR706	TX-SA706	TX-SR806	TX-SA806	TX-SA706X	DTR-6.9	DTR-7.9
D	102J	---	102J	---	---	102J	102J
J	---	---	---	---	NC	---	---
M	102J	102J	102J	102J	---	102J	102J

<Note>  
SD-x:XY is short for Schematic Diagram-x and each socket's location, X=A to H, Y=1 to 5.

# SCHEMATIC DIAGRAMS-5 (SD-5) VIDEO SECTION-1

1

2

3

4

5

NAVD-9505(1/2)  
**U17**  
VIDEO PC BOARD

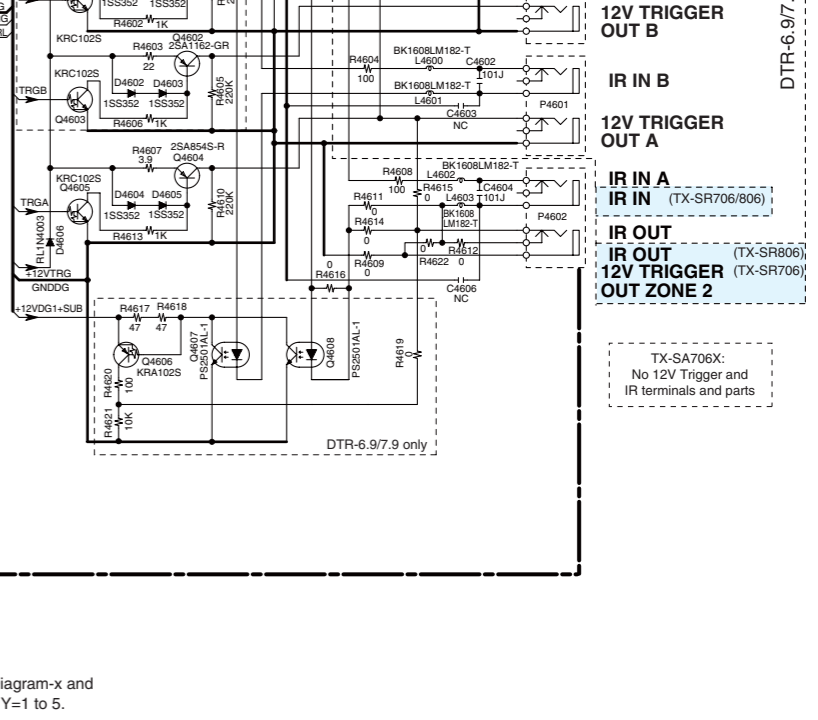
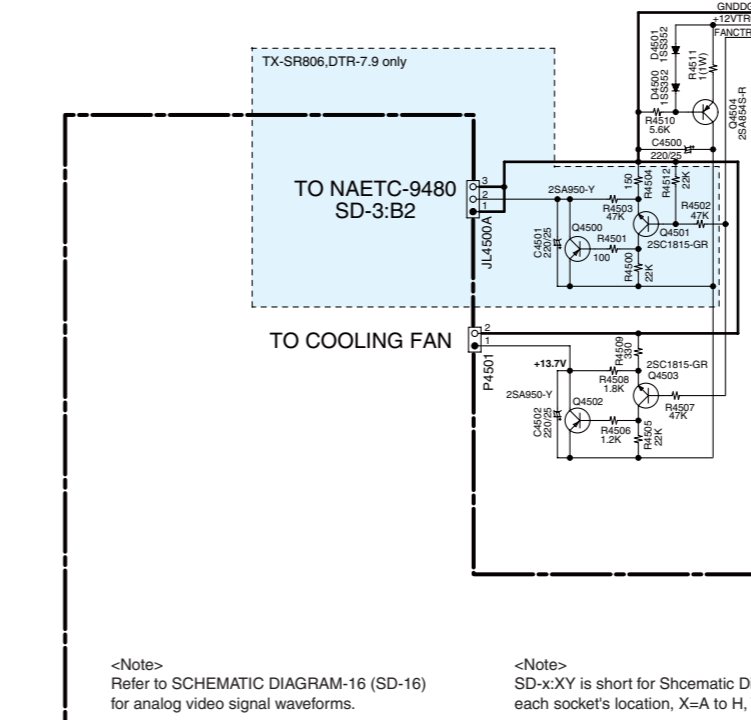
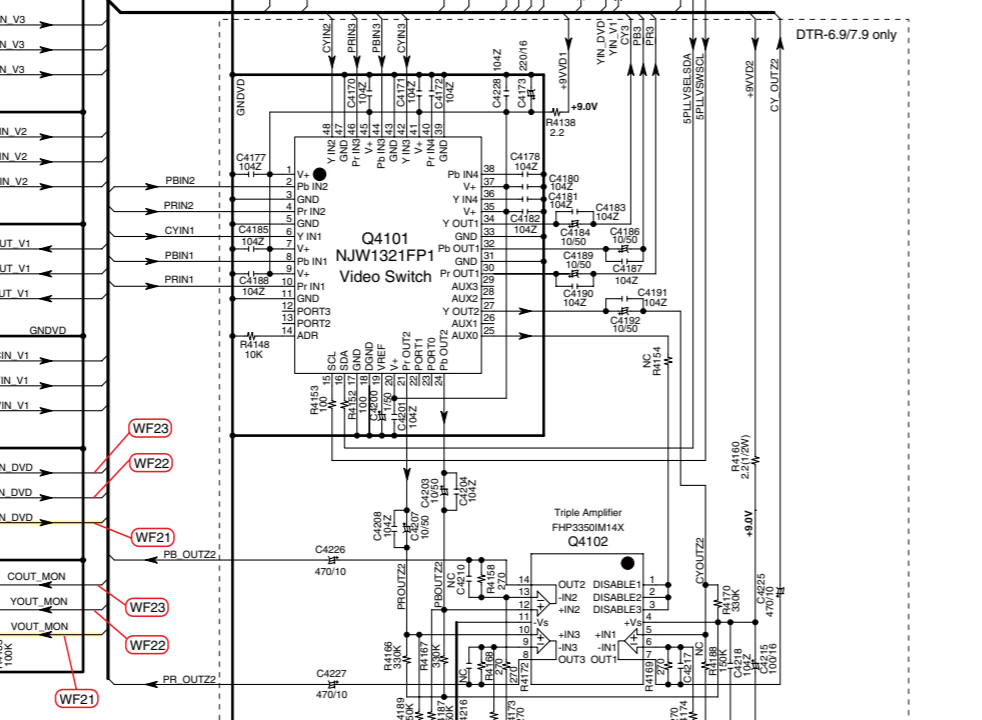
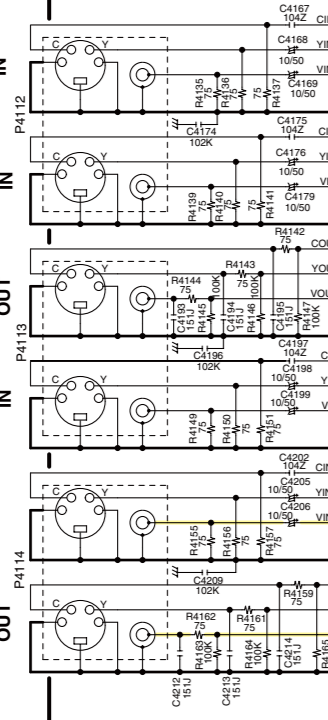
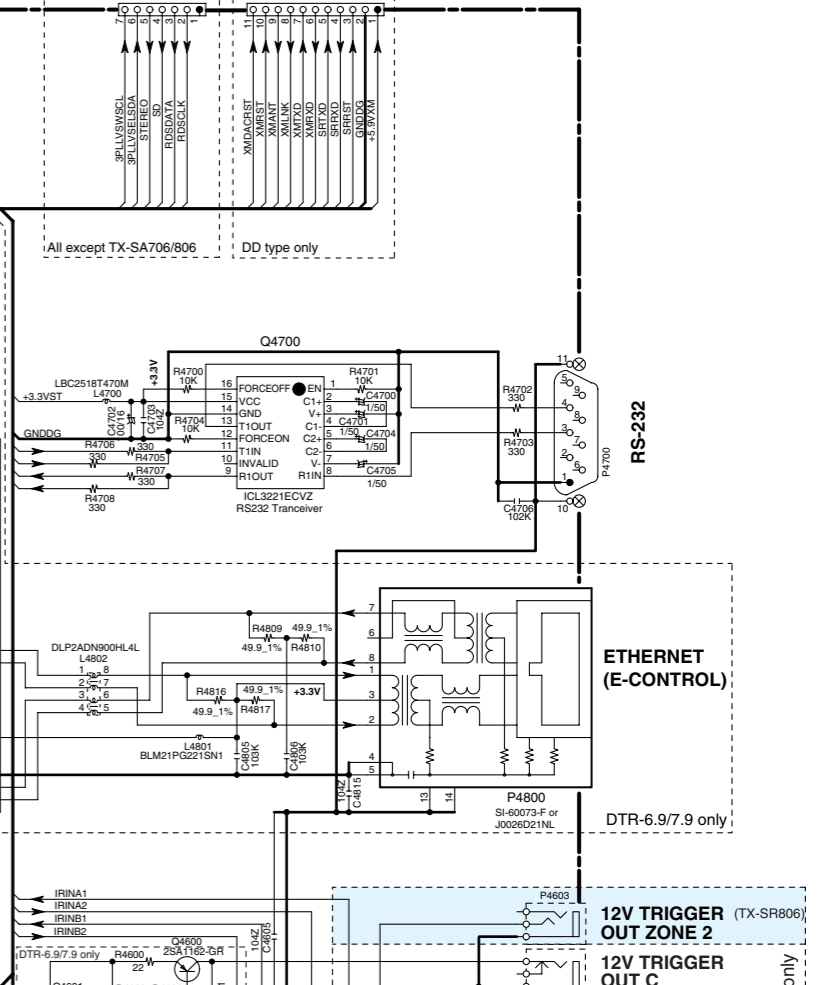
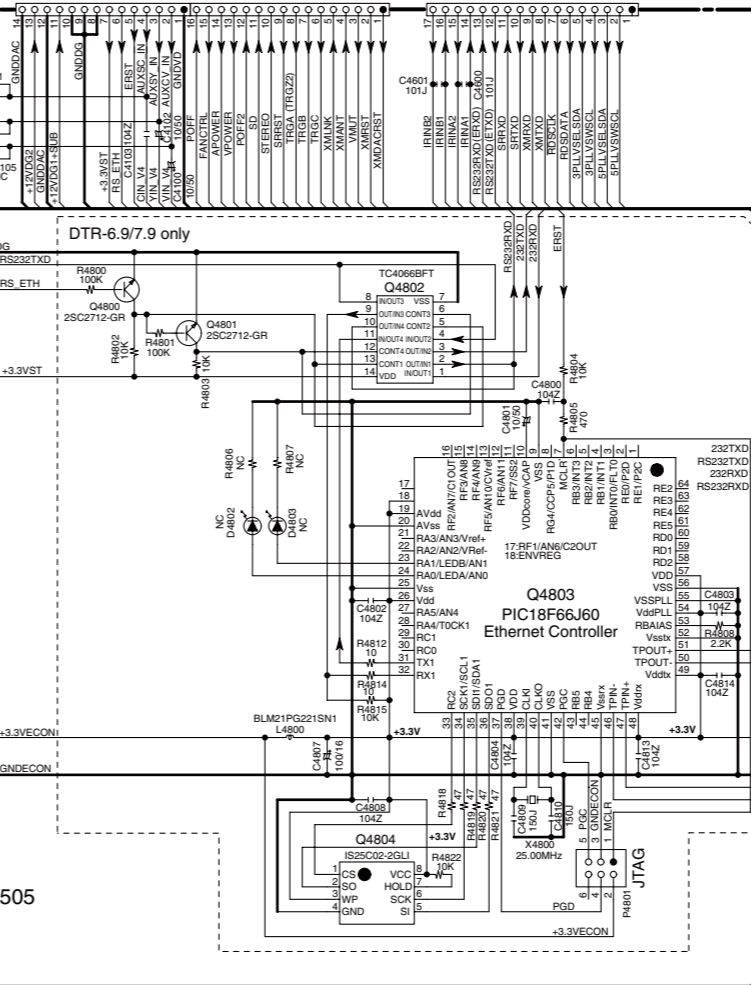
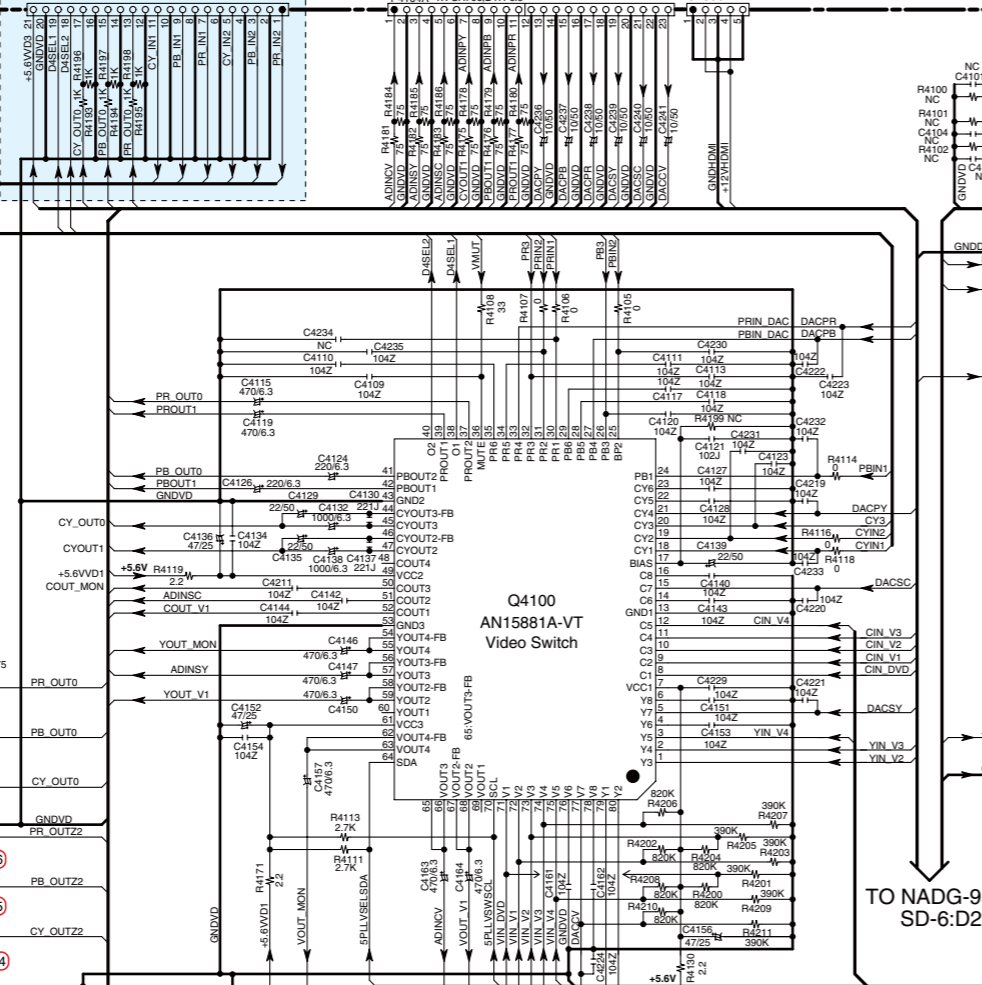
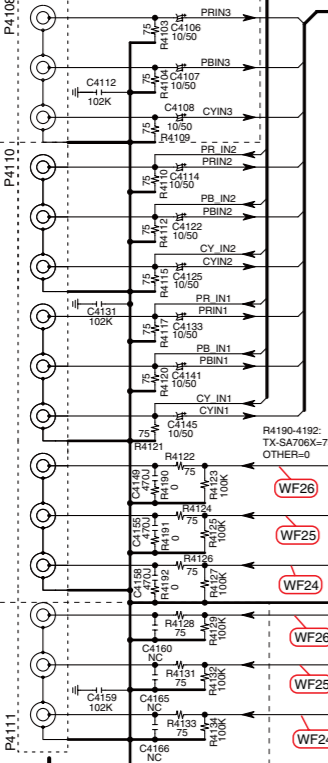

<Note>  
Refer to SCHEMATIC DIAGRAM-16 (SD-16)  
for analog video signal waveforms.

<Note>  
SD-x:Y is short for Schematic Diagram-x and  
each socket's location, X=A to H, Y=1 to 5.



SCHEMATIC DIAGRAMS-6 (SD-6)  
VIDEO SECTION-2

<Note>  
SD-x:XY is short for Schematic Diagram-x and  
each socket's location, X=A to H, Y=1 to 5.

1

2

3

4

5

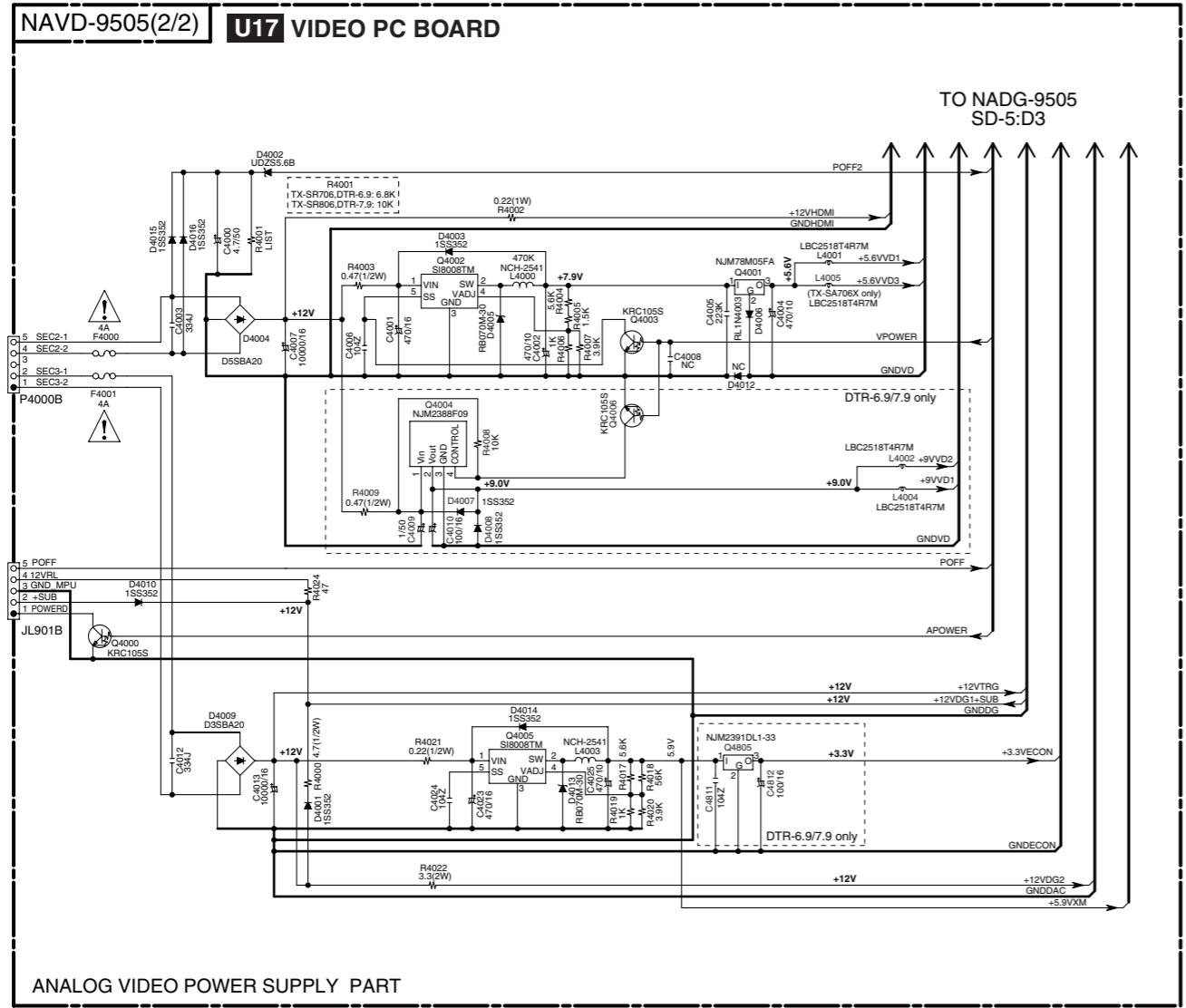

- NOTE**
- THE COMPONENTS IDENTIFIED BY MARK ARE CRITICAL FOR SAFETY. REPLACE ONLY WITH PART NUMBER SPECIFIED.
  - BOLD VOLTAGE (MEASURED WITH VOLTMETER) IS DC VOLTAGE.(NO INPUT SIGNAL).
  - ALL PNP TRANSISTORS ARE EQUIVALENT TO 2SA1015-GR UNLESS OTHERWISE NOTED.
  - ALL NPN TRANSISTORS ARE EQUIVALENT TO 2SC1815-GR UNLESS OTHERWISE NOTED.
  - ALL DIODES ARE EQUIVALENT TO 1SS133 UNLESS OTHERWISE NOTED.
  - ELECTROLYTIC CAPACITORS ( ) ARE IN uF/WV.
  - ALL CAPACITORS ARE IN pF/50WV UNLESS OTHERWISE NOTED.
  - EX) 030- 3pF, 330- 33pF, 331- 330pF, 333- 0.033uF
  - ALL RESISTORS ARE IN OHMS 1/4WATTS UNLESS OTHERWISE NOTED.
  - THE THICK LINES ON PC BOARD ARE THE PRINTING SIDE OF THE PARTS.
  - EX) PRINTING SIDE
  - CIRCUIT IS SUBJECT TO CHANGE FOR IMPROVEMENT.

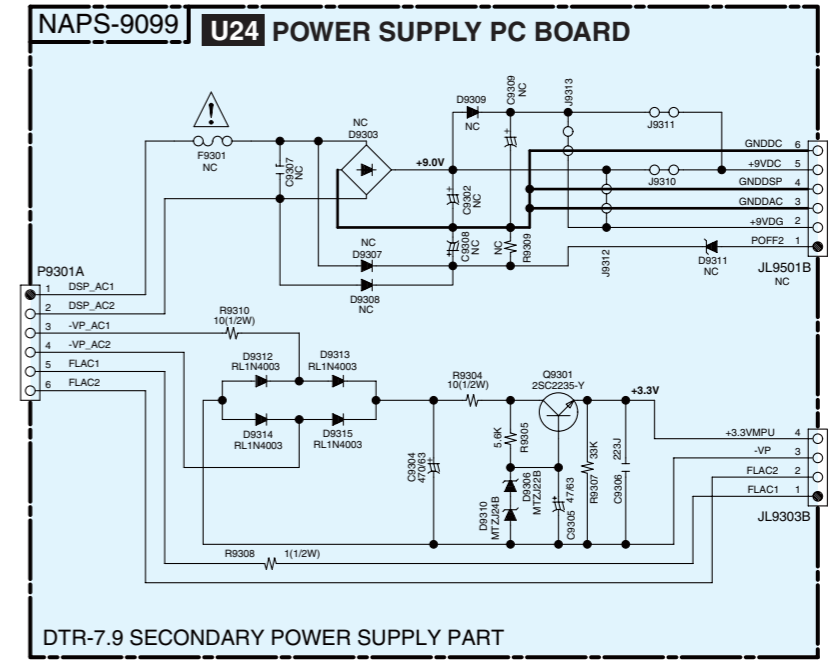
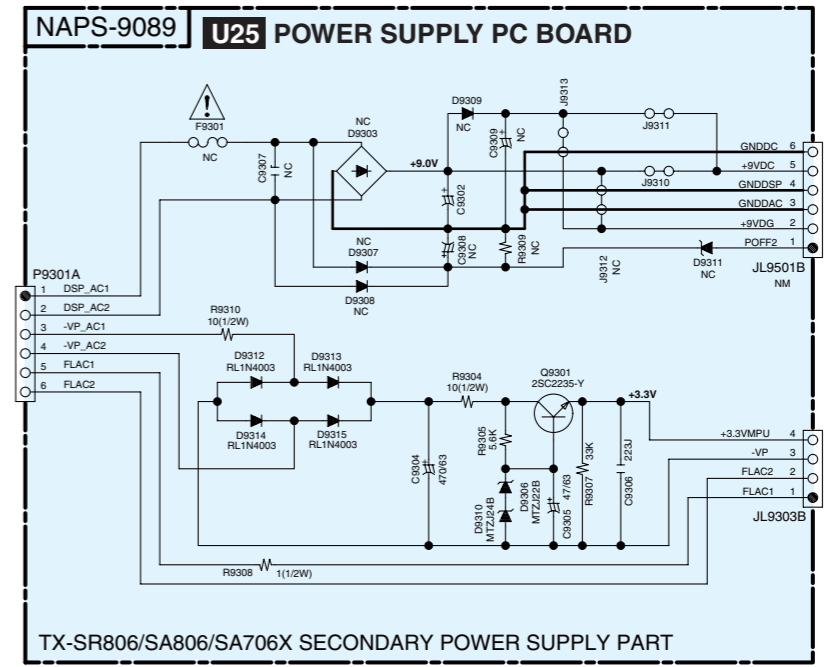

A B C D E F G H

SCHEMATIC DIAGRAMS-7 (SD-7)  
MICROPROCESSOR  
AND DAC SECTION

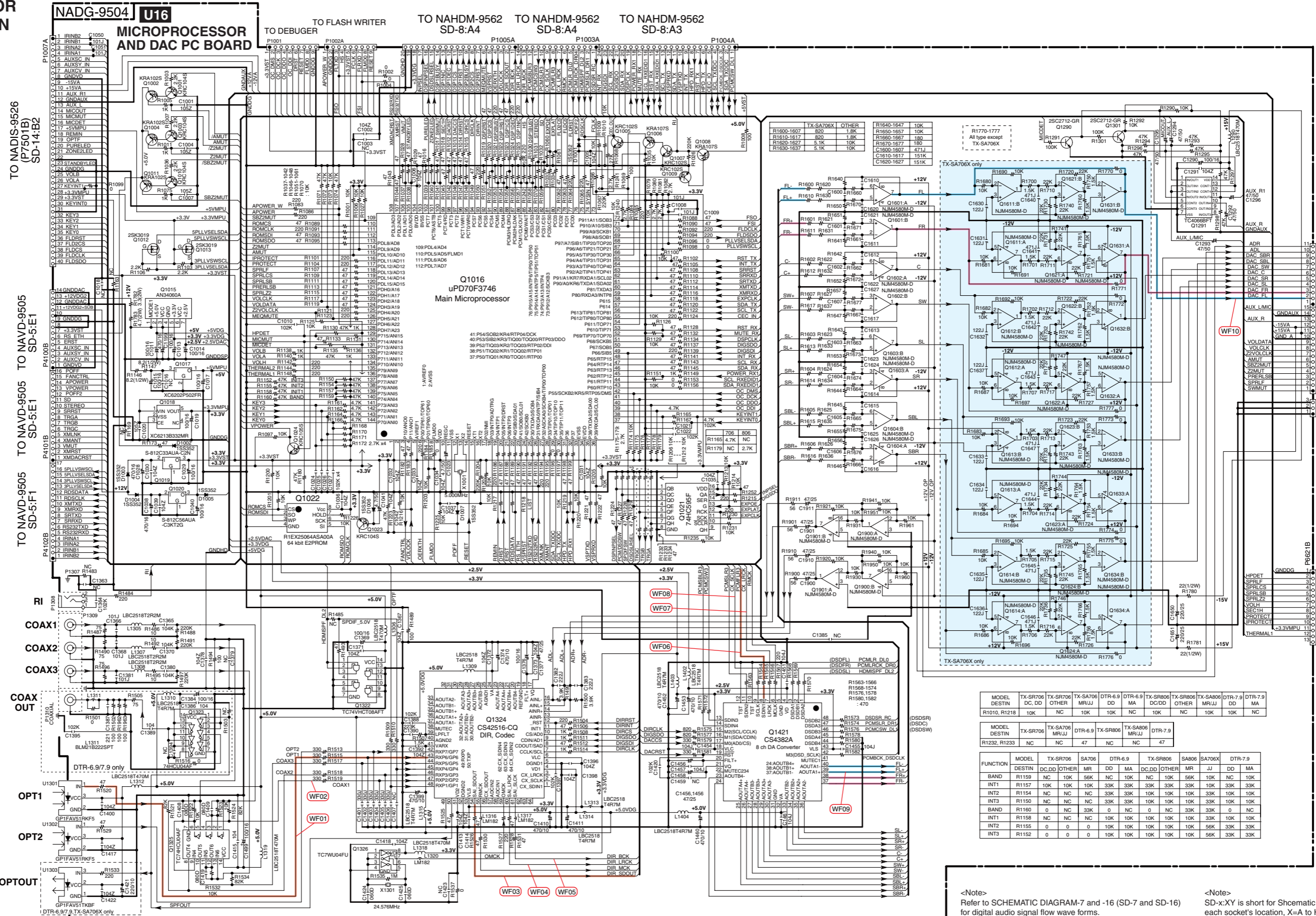

TX-SA706X OTHER

R1600-1607	820	1.8K
R1610-1617	820	1.8K
R1630-1637	5.1K	10K
R1600-1607	471J	
R1610-1617	151K	
R1620-1627	151K	

TX-SA706X only

R1680	10K
R1690	10K
R1700	22K
R1710	22K
R1720	22K
R1730	22K
R1740	22K
R1750	22K
R1760	22K
R1770	22K
R1780	22K
R1790	22K
R1800	22K
R1810	22K
R1820	22K
R1830	22K
R1840	22K
R1850	22K
R1860	22K
R1870	22K
R1880	22K
R1890	22K
R1900	22K
R1910	22K
R1920	22K
R1930	22K
R1940	22K
R1950	22K
R1960	22K
R1970	22K
R1980	22K
R1990	22K

All type except TX-SA706X

MODEL DESTIN	TX-SR706	TX-SR706	TX-SA706	DTR-6.9	DTR-6.9	DTR-6.9	TX-SR806	TX-SR806	TX-SR806	DTR-7.9	DTR-7.9
	DC,DD	OTHER	MR,UJ	DD	MA	DC,DD	OTHER	MR,UJ	DD	MA	DC,DD
R1010, R1218	10K	NC	10K	10K	NC	10K	NC	10K	10K	NC	NC

MODEL DESTIN	TX-SR706	TX-SR706	DTR-6.9	TX-SR806	TX-SA806	DTR-7.9
	NC	NC	47	NC	NC	47
R1232, R1233	NC	NC	47	NC	NC	47

FUNCTION	MODEL DESTIN	TX-SR706	TX-SR706	SA706	DTR-6.9	TX-SR806	SA806	SA706X	DTR-7.9			
		DC,DD	OTHER	MR	DD	MA	DC,DD	OTHER	MR	UJ	DD	MA
BAND	R1159	NC	10K	56K	NC	10K	NC	10K	56K	10K	33K	10K
INT1	R1157	10K	NC	33K	33K	33K	33K	33K	33K	33K	33K	33K
INT2	R1154	NC	NC	33K	33K	33K	33K	33K	33K	33K	33K	33K
INT3	R1150	NC	NC	33K	33K	33K	33K	33K	33K	33K	33K	33K
BAND	R1160	0	NC	33K	0	NC	0	NC	33K	0	NC	0
INT1	R1158	NC	NC	10K	10K	10K	10K	10K	10K	33K	10K	10K
INT2	R1155	0	0	10K	10K	10K	10K	10K	10K	33K	33K	33K
INT3	R1152	0	0	10K	10K	10K	10K	10K	10K	56K	33K	33K

<Note> Refer to SCHEMATIC DIAGRAM-7 and -16 (SD-7 and SD-16) for digital audio signal flow wave forms.

<Note> SD-x:Y is short for Schematic Diagram-x and each socket's location, X=A to H, Y=1 to 5.

# SCHEMATIC DIAGRAMS-8 (SD-8) DSP SECTION-1

TX-SR706, TX-SA706, DTR-6.9: NAHDM-9562  
TX-SR806, TX-SA806, DTR-7.9: NAHDM-9702

<Note>  
SD-x:XY is short for Schematic Diagram-x and each socket's location, X=A to H, Y=1 to 5.

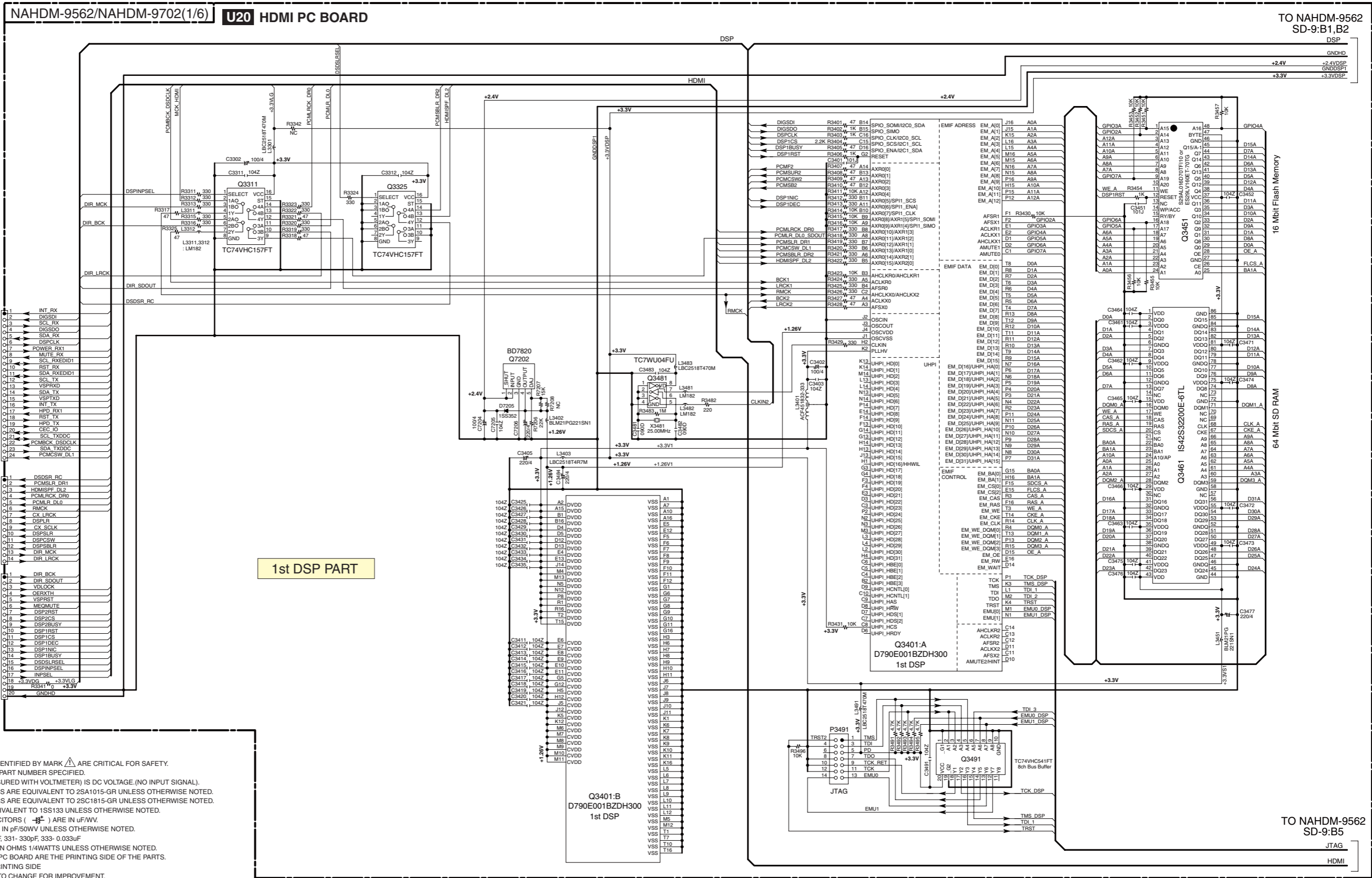

- NOTE**
- THE COMPONENTS IDENTIFIED BY MARK  $\Delta$  ARE CRITICAL FOR SAFETY. REPLACE ONLY WITH PART NUMBER SPECIFIED.
  - BOLD VOLTAGE (MEASURED WITH VOLTMETER) IS DC VOLTAGE (NO INPUT SIGNAL).
  - ALL PNP TRANSISTORS ARE EQUIVALENT TO 2SA1015-GR UNLESS OTHERWISE NOTED.
  - ALL NPN TRANSISTORS ARE EQUIVALENT TO 2SC1815-GR UNLESS OTHERWISE NOTED.
  - ALL DIODES ARE EQUIVALENT TO 1SS133 UNLESS OTHERWISE NOTED.
  - ELECTROLYTIC CAPACITORS (  $\text{---} \text{||} \text{---}$  ) ARE IN  $\mu\text{F/WV}$ .
  - ALL CAPACITORS ARE IN pF/50WV UNLESS OTHERWISE NOTED.  
EX) 030-3pF, 330-33pF, 331-330pF, 333-0.033 $\mu\text{F}$
  - ALL RESISTORS ARE IN OHMS 1/4WATTS UNLESS OTHERWISE NOTED.
  - THE THICK LINES ON PC BOARD ARE THE PRINTING SIDE OF THE PARTS.  
EX)  $\text{---} \text{---} \text{---}$  PRINTING SIDE
  - CIRCUIT IS SUBJECT TO CHANGE FOR IMPROVEMENT.

1  
2  
3  
4  
5

TO NAHDM-9562  
SD-9:B1,B2  
DSP

TO NAHDM-9562  
SD-9:B5  
JTAG

HDMI

SCHEMATIC DIAGRAMS-9 (SD-9) DSP SECTION-2

TX-SR706, TX-SA706, DTR-6.9: NAHDM-9562  
TX-SR806, TX-SA806, DTR-7.9: NAHDM-9702

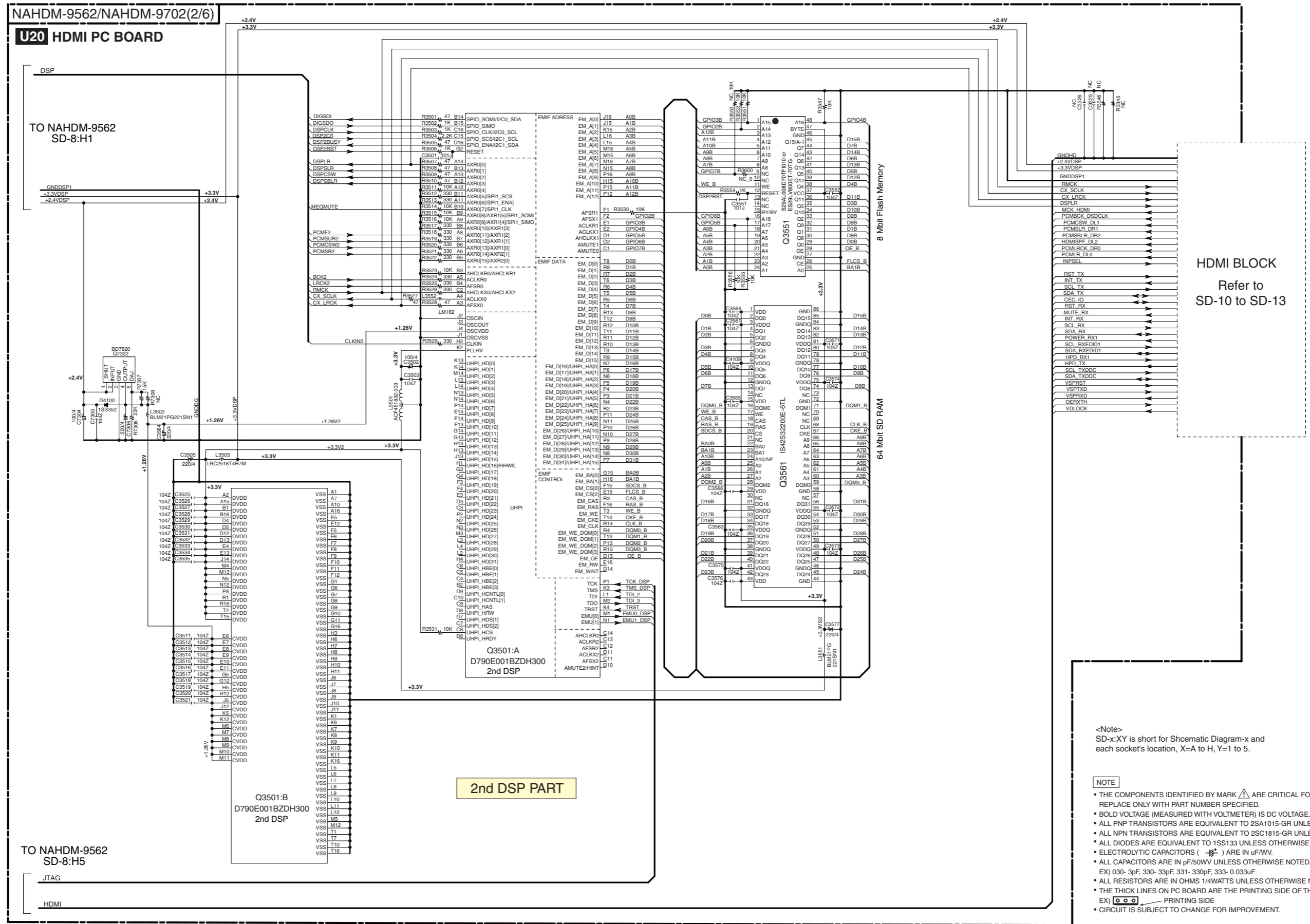

1

2

3

4

5

# SCHEMATIC DIAGRAMS-10 (SD-10) HDMI SECTION-1

TX-SR706, TX-SA706, DTR-6.9: NAHDM-9562  
TX-SR806, TX-SA806, DTR-7.9: NAHDM-9702

## NAHDM-9562/NAHDM-9702(3/6) U20 HDMI PC BOARD

### HDMI INPUT PART-1

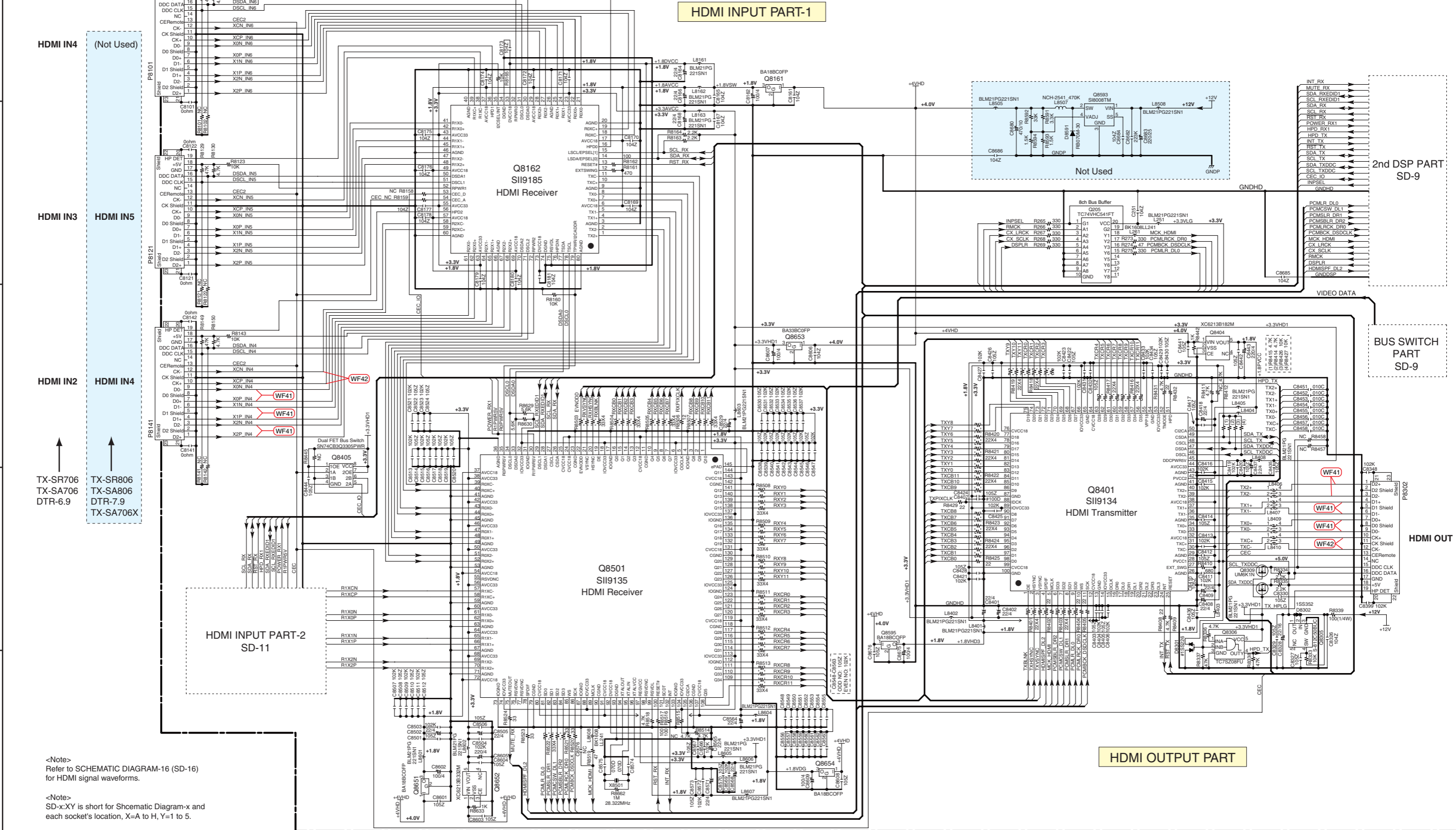

<Note>  
Refer to SCHEMATIC DIAGRAM-16 (SD-16)  
for HDMI signal waveforms.

<Note>  
SD-x:XY is short for Schematic Diagram-x and  
each socket's location, X=A to H, Y=1 to 5.

# SCHEMATIC DIAGRAMS-11 (SD-11) HDMI SECTION-2

<Note>  
SD-x:Y is short for Schematic Diagram-x and each socket's location, X=A to H, Y=1 to 5.

<Note>  
Refer to SCHEMATIC DIAGRAM-16 (SD-16) for HDMI signal waveforms.

- NOTE**
- THE COMPONENTS IDENTIFIED BY MARK  $\Delta$  ARE CRITICAL FOR SAFETY. REPLACE ONLY WITH PART NUMBER SPECIFIED.
  - BOLD VOLTAGE (MEASURED WITH VOLTMETER) IS DC VOLTAGE.(NO INPUT SIGNAL).
  - ALL PNP TRANSISTORS ARE EQUIVALENT TO 2SA1015-GR UNLESS OTHERWISE NOTED.
  - ALL PNP TRANSISTORS ARE EQUIVALENT TO 2SC1815-GR UNLESS OTHERWISE NOTED.
  - ALL DIODES ARE EQUIVALENT TO 1S1S13 UNLESS OTHERWISE NOTED.
  - ELECTROLYTIC CAPACITORS (  $\text{---}$  ) ARE IN  $\mu\text{F}/\text{VW}$ .
  - ALL CAPACITORS ARE IN  $\text{pF}/50\text{VW}$  UNLESS OTHERWISE NOTED.
  - EX) 030-3pF, 330-33pF, 331-330pF, 333-0.033 $\mu\text{F}$
  - ALL RESISTORS ARE IN OHMS 1/4WATTS UNLESS OTHERWISE NOTED.
  - THE THICK LINES ON PC BOARD ARE THE PRINTING SIDE OF THE PARTS.
  - EX)  $\square$  PRINTING SIDE
  - CIRCUIT IS SUBJECT TO CHANGE FOR IMPROVEMENT.

TX-SR706, TX-SA706, DTR-6.9: NAHDM-9562  
TX-SR806, TX-SA806, DTR-7.9: NAHDM-9702

## NAHDM-9562/NAHDM-9702(4/6) U20 HDMI PC BOARD

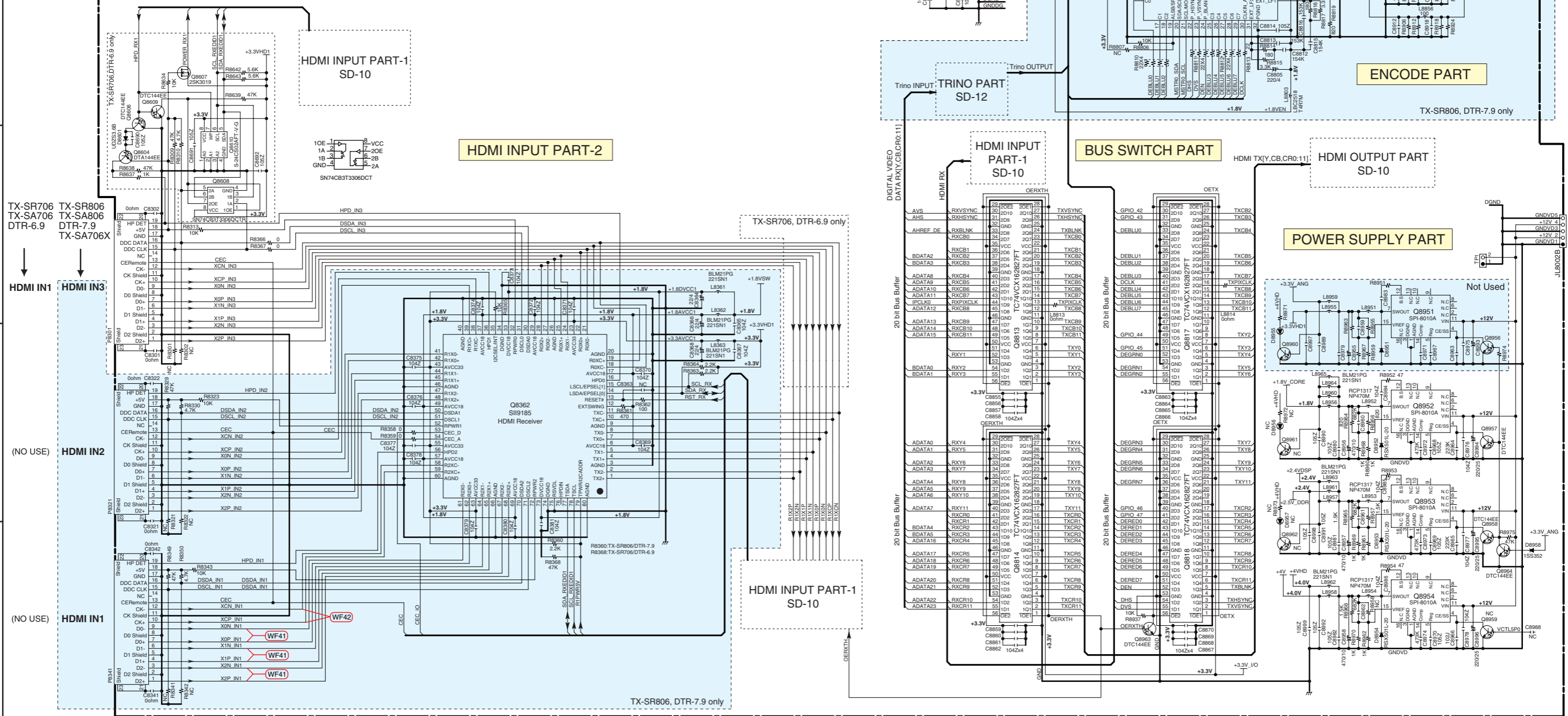

1

2

3

4

5

TO NAVD-9505  
SD-5:C1

TO NAVD-9505  
SD-5:D1

SCHEMATIC DIAGRAMS-12 (SD-12)  
HDMI SECTION-3

TX-SR706, TX-SA706, DTR-6.9: NAHDM-9562  
TX-SR806, TX-SA806, DTR-7.9: NAHDM-9702

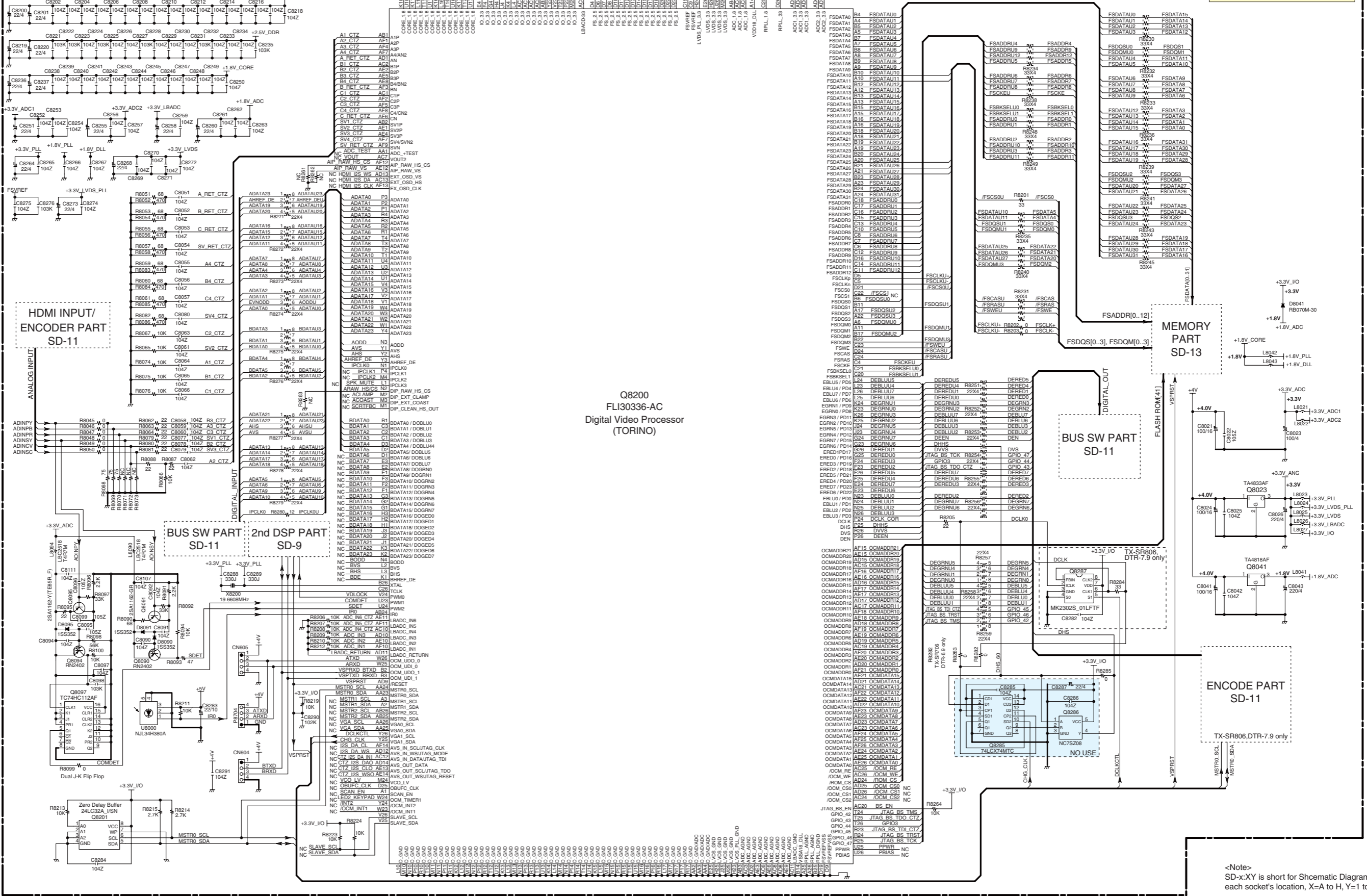
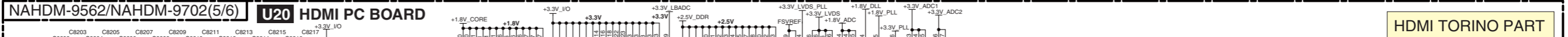

HDMI INPUT/  
ENCODER PART  
SD-11

BUS SW PART  
SD-11

2nd DSP PART  
SD-9

Q8200  
FLI30336-AC  
Digital Video Processor  
(TORINO)

BUS SW PART  
SD-11

MEMORY  
PART  
SD-13

ENCODE PART  
SD-11

<Note>  
SD-x:Y is short for Schematic Diagram-x and  
each socket's location, X=A to H, Y=1 to 5.

# SCHEMATIC DIAGRAMS-13 (SD-13) HDMI SECTION-4

1

2

3

4

5

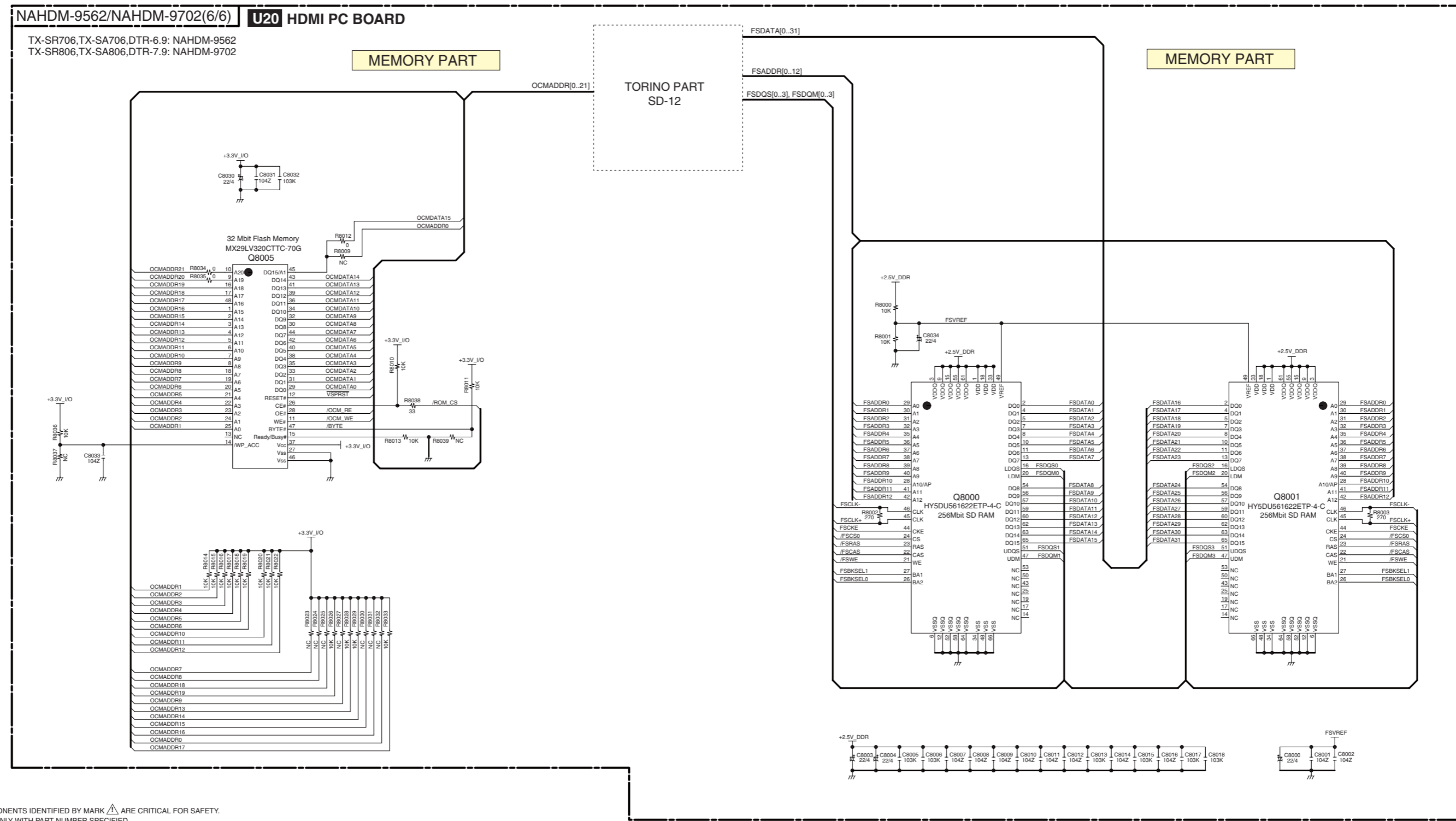

- NOTE**
- THE COMPONENTS IDENTIFIED BY MARK  $\Delta$  ARE CRITICAL FOR SAFETY. REPLACE ONLY WITH PART NUMBER SPECIFIED.
  - BOLD VOLTAGE (MEASURED WITH VOLTMETER) IS DC VOLTAGE.(NO INPUT SIGNAL).
  - ALL PNP TRANSISTORS ARE EQUIVALENT TO 2SA1015-GR UNLESS OTHERWISE NOTED.
  - ALL NPN TRANSISTORS ARE EQUIVALENT TO 2SC1815-GR UNLESS OTHERWISE NOTED.
  - ALL DIODES ARE EQUIVALENT TO 1SS133 UNLESS OTHERWISE NOTED.
  - ELECTROLYTIC CAPACITORS (  $\text{---}\text{||}\text{---}$  ) ARE IN  $\mu\text{F}$ .
  - ALL CAPACITORS ARE IN pF/50V UNLESS OTHERWISE NOTED.  
EX) 030- 3pF, 330- 33pF, 331- 330pF, 333- 0.033 $\mu\text{F}$
  - ALL RESISTORS ARE IN OHMS 1/4WATT'S UNLESS OTHERWISE NOTED.
  - THE THICK LINES ON PC BOARD ARE THE PRINTING SIDE OF THE PARTS.  
EX)  $\text{---}\text{---}\text{---}$  PRINTING SIDE
  - CIRCUIT IS SUBJECT TO CHANGE FOR IMPROVEMENT.

<Note>  
SD-x:XY is short for Shcematic Diagram-x and each socket's location, X=A to H, Y=1 to 5.



SCHEMATIC DIAGRAMS-14 (SD-14) DISPLAY SECTION

<Note> SD-x:XY is short for Schematic Diagram-x and each socket's location, X=A to H, Y=1 to 5.

1

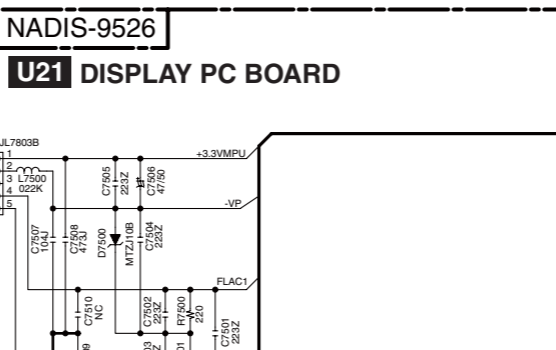
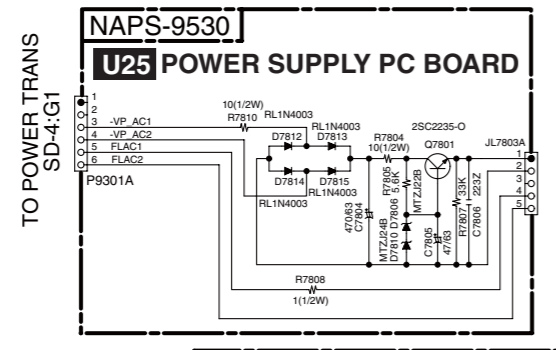

2

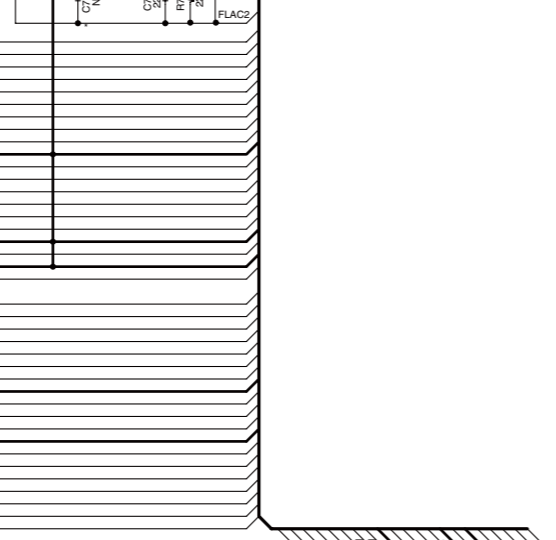
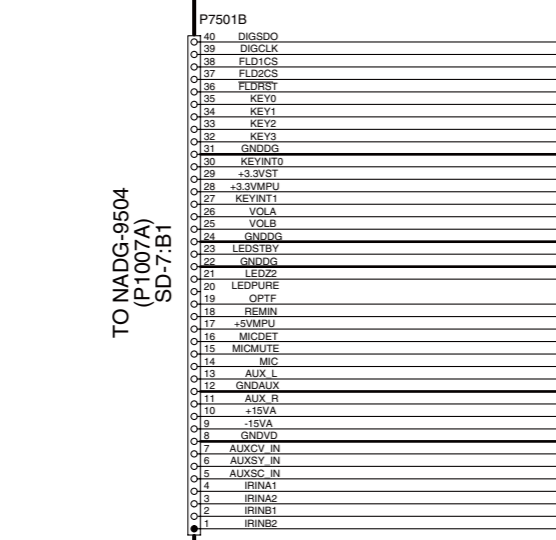

3

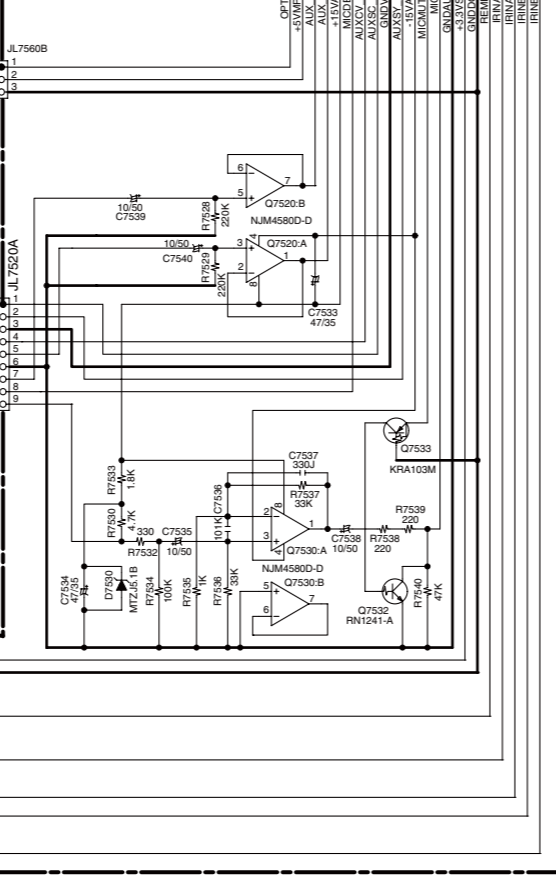
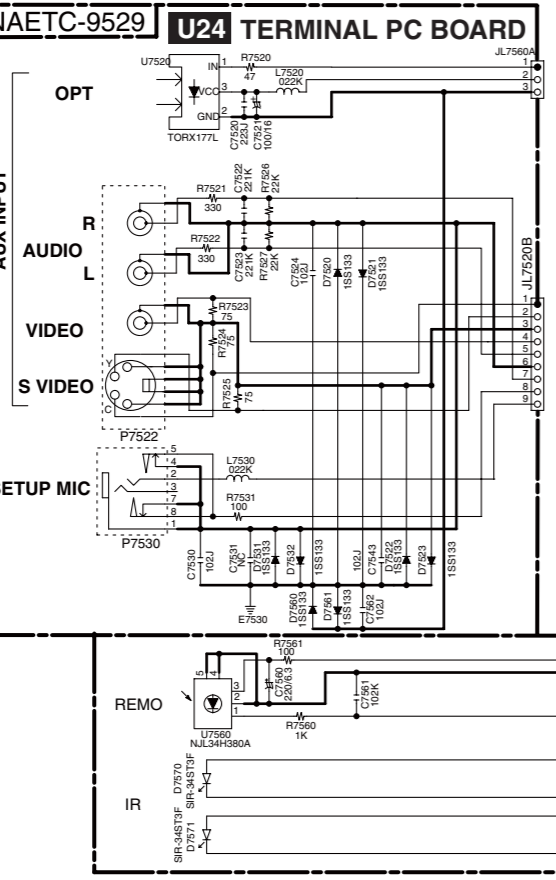

4

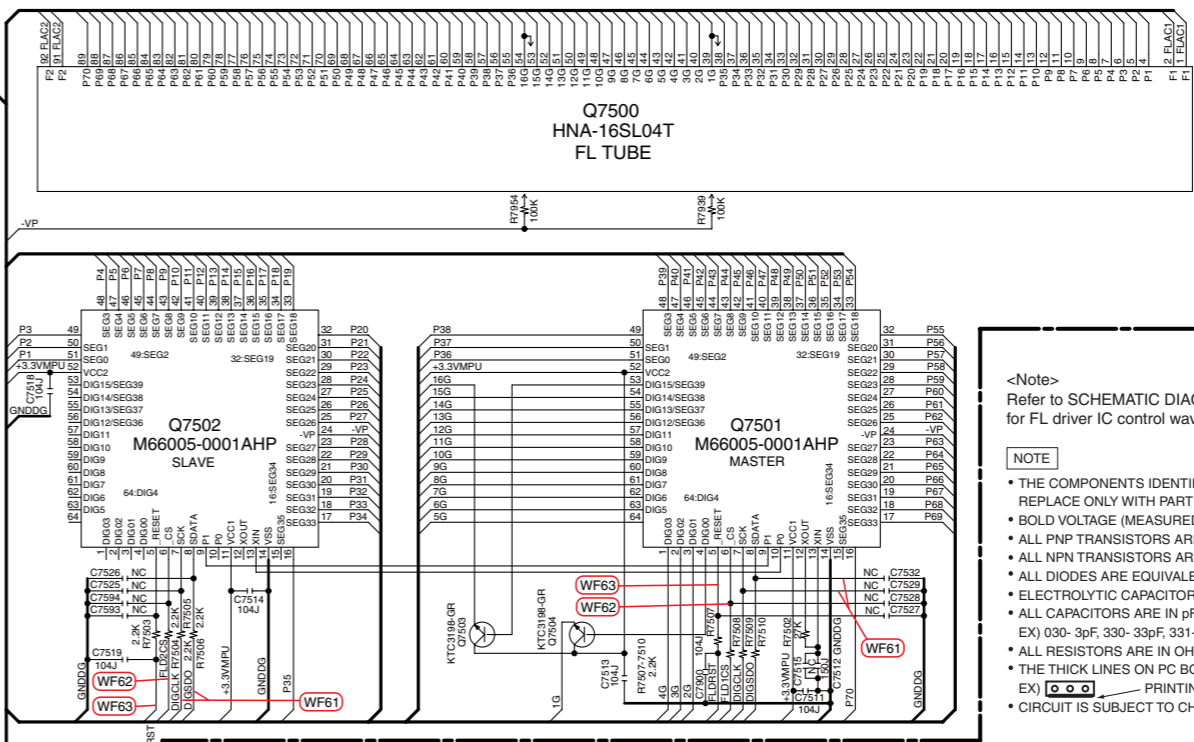

<Note> Refer to SCHEMATIC DIAGRAM-16 (SD-16) for FL driver IC control waveforms.  
NOTE  
• THE COMPONENTS IDENTIFIED BY MARK  $\Delta$  ARE CRITICAL FOR SAFETY. REPLACE ONLY WITH PART NUMBER SPECIFIED.  
• BOLD VOLTAGE (MEASURED WITH VOLTMETER) IS DC VOLTAGE.(NO INPUT SIGNAL).  
• ALL PNP TRANSISTORS ARE EQUIVALENT TO 2SA1015-GR UNLESS OTHERWISE NOTED.  
• ALL NPN TRANSISTORS ARE EQUIVALENT TO 2SC1815-GR UNLESS OTHERWISE NOTED.  
• ALL DIODES ARE EQUIVALENT TO 1SS133 UNLESS OTHERWISE NOTED.  
• ELECTROLYTIC CAPACITORS (  $\text{---}$  ) ARE IN uF/WV.  
• ALL CAPACITORS ARE IN pF/50WV UNLESS OTHERWISE NOTED.  
EX) 030-3pF, 330-33pF, 331-330pF, 333-0.033uF  
• ALL RESISTORS ARE IN OHMS 1/4WATTS UNLESS OTHERWISE NOTED.  
• THE THICK LINES ON PC BOARD ARE THE PRINTING SIDE OF THE PARTS.  
EX)  $\square$  PRINTING SIDE  
• CIRCUIT IS SUBJECT TO CHANGE FOR IMPROVEMENT.

5

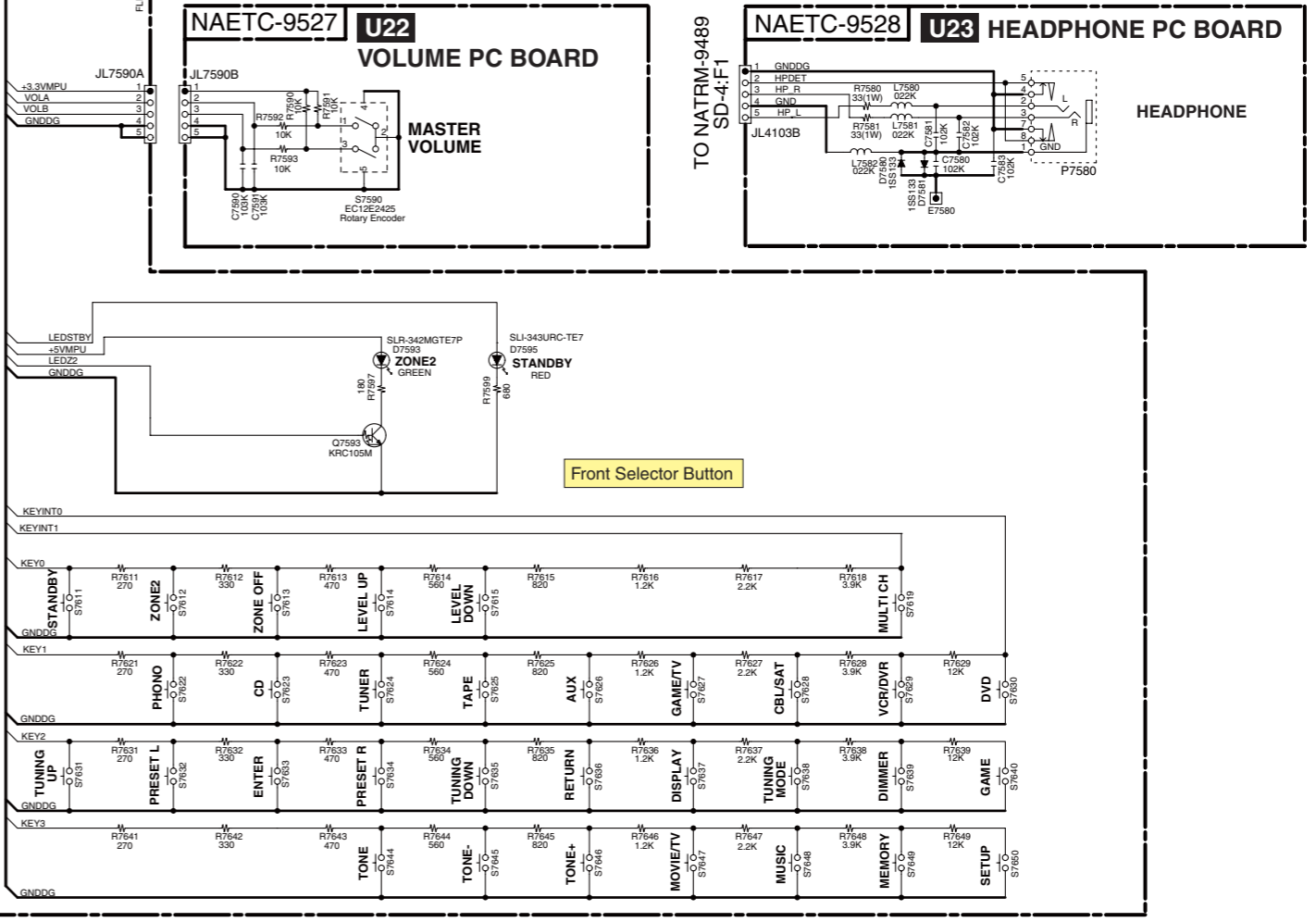

# SCHEMATIC DIAGRAMS-15 (SD-15) XM AND SIRIUS SECTION

1

2

3

4

5

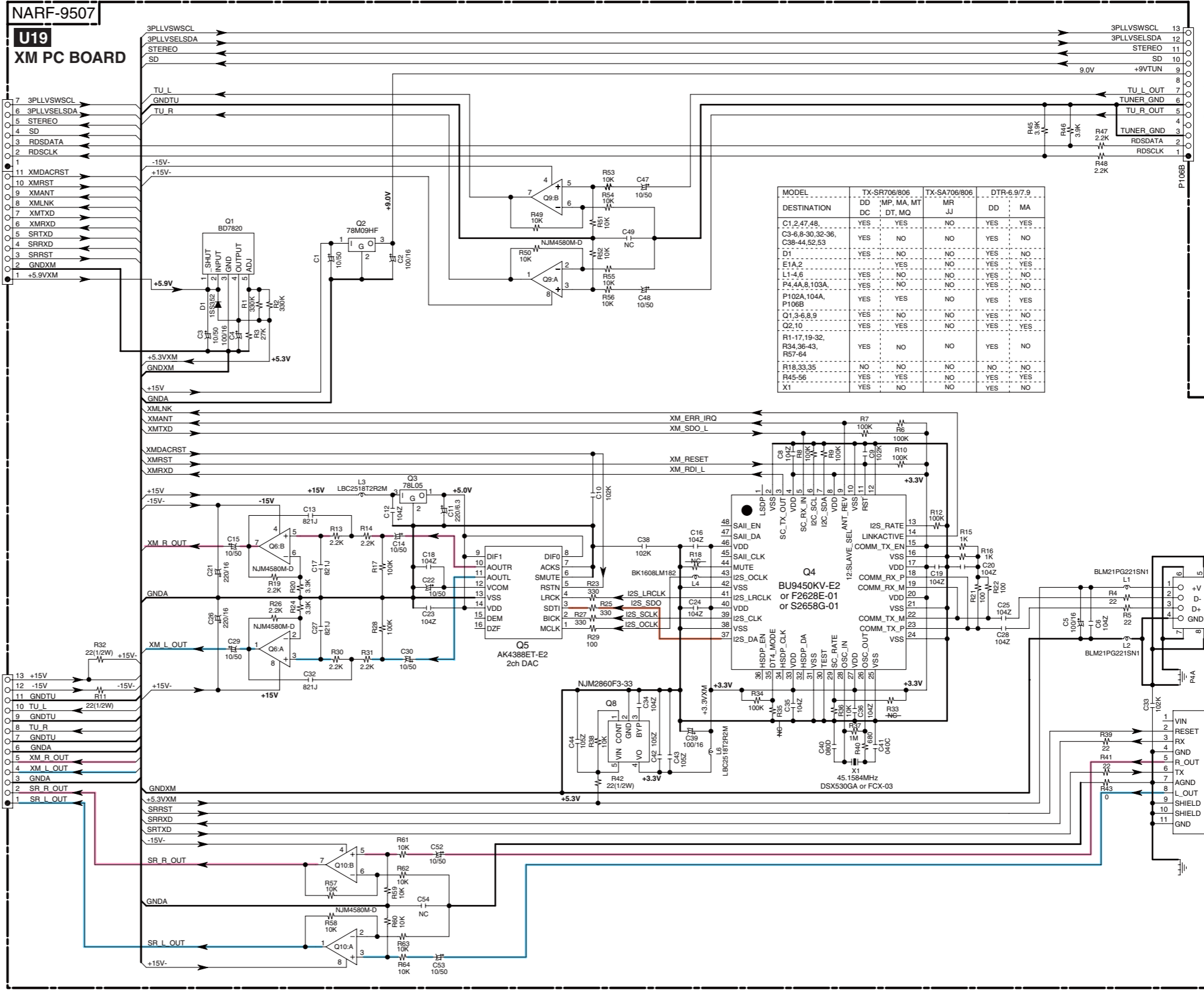

<Note>  
SD-x:XY is short for Schematic Diagram-x and each socket's location, X=A to H, Y=1 to 5.

- NOTE**
- THE COMPONENTS IDENTIFIED BY MARK ARE CRITICAL FOR SAFETY. REPLACE ONLY WITH PART NUMBER SPECIFIED.
  - BOLD VOLTAGE (MEASURED WITH VOLTMETER) IS DC VOLTAGE (NO INPUT SIGNAL).
  - ALL PNP TRANSISTORS ARE EQUIVALENT TO 2SA1015-GR UNLESS OTHERWISE NOTED.
  - ALL NPN TRANSISTORS ARE EQUIVALENT TO 2SC1815-GR UNLESS OTHERWISE NOTED.
  - ALL DIODES ARE EQUIVALENT TO 1SS133 UNLESS OTHERWISE NOTED.
  - ELECTROLYTIC CAPACITORS ( ) ARE IN uF/WV.
  - ALL CAPACITORS ARE IN pF/50V UNLESS OTHERWISE NOTED.  
EX) 030- 3pF, 330- 33pF, 331- 330pF, 333- 0.033uF
  - ALL RESISTORS ARE IN OHMS 1/4WATTS UNLESS OTHERWISE NOTED.
  - THE THICK LINES ON PC BOARD ARE THE PRINTING SIDE OF THE PARTS.  
EX) PRINTING SIDE
  - CIRCUIT IS SUBJECT TO CHANGE FOR IMPROVEMENT.

TO FM/AM  
TUNER UNIT

XM

SIRIUS

**SCHEMATIC DIAGRAM-16(SD-16)  
WAVEFORM SECTION**

1

**Digital Audio Waveform Part**

**NOTE:**

1. (WF01) is short for (Waveform01)
2. Refer to SD-7(SCHEMATIC DIAGRAM-7) for the location of each waveform on circuit.
3. SD-x:XY is short for Schematic Diagram-x and each socket's location, X=A to H, Y=1 to 5.

LR CLOCK (SAI\_LRCK, CX\_LRCK)

Fs=48kHz : DVD, Clock width=20.8us  
Fs=44.1kHz : CD, Clock width=22.7us

BIT CLOCK (SAI\_SLCK, CX\_SLCK)

64Fs=3072kHz : DVD, Clock width=325ns  
64Fs=2822.4kHz : CD, Clock width=354ns

(WF01) OPT1 (SD-7:C5)

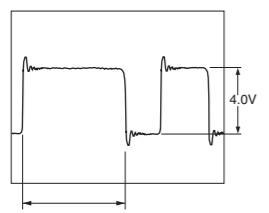

Duty varies according to audio data

(WF02) COAX1 (SD-7:C5)

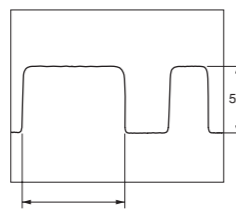

Duty always varies according to audio data

(WF03) SAI\_SDOUT (SD-7:D5)

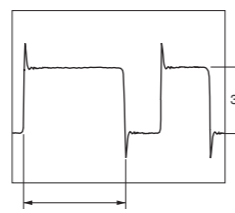

Duty varies according to audio data

(WF04) SAI\_LRCK (SD-7:D5)

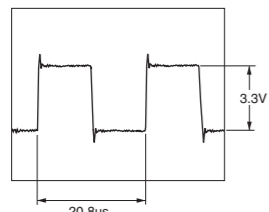

(WF05) SAI\_SLCK (SD-7:D5)

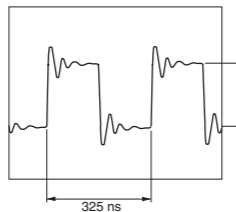

(WF06) PCMF3 (SD-7:E4)

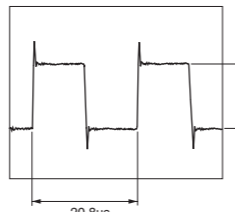

(WF07) CX\_LRCK (SD-7:E4)

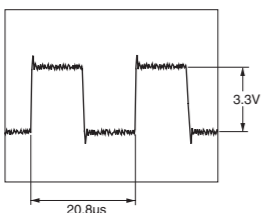

(WF08) CX\_SLCK (SD-7:E4)

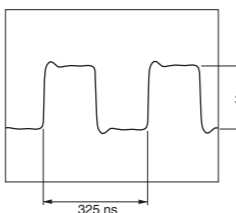

(WF09) FL+ (SD-7:F5)

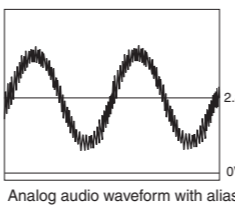

Analog audio waveform with aliasing noise

(WF10) DAC\_FL (SD-7:H2)

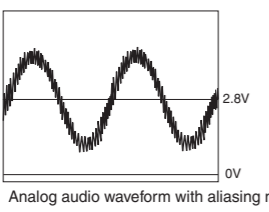

Analog audio waveform with aliasing noise

(WF10) DAC\_FL (SD-7:H2)

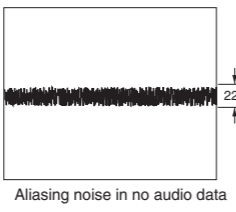

Aliasing noise in no audio data

2

**Video Waveform Part**

**Video source color and pattern**

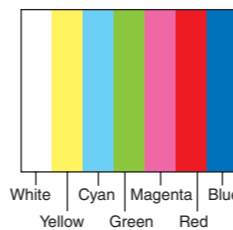

**Composite waveform**

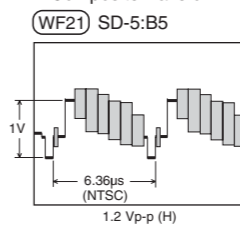

**S-Video Y waveform**

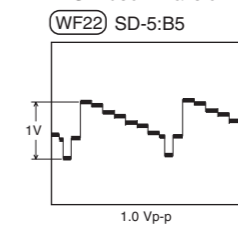

**S-Video C waveform**

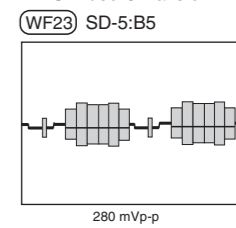

**NOTE:**

1. (WF21) is short for (Waveform21)
2. Refer to SD-5(SCHEMATIC DIAGRAM-5) for the location of each waveform on circuit.
3. SD-x:XY is short for Schematic Diagram-x and each socket's location, X=A to H, Y=1 to 5.
4. In the case that video outputs are not connected to video devices, video signal output levels are doubled.

**Component Y waveform**

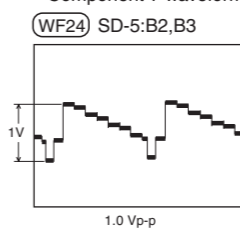

**Component PB waveform**

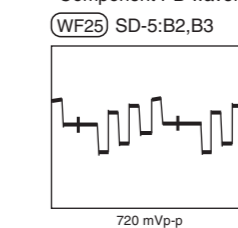

**Component PR waveform**

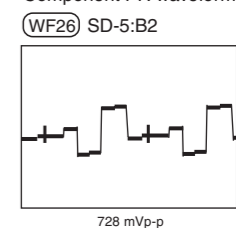

3

**HDMI Waveform Part**

**HDMI D0,D1,D2 waveform**

(WF41) SD-10:B3, H4 SD-11:B5

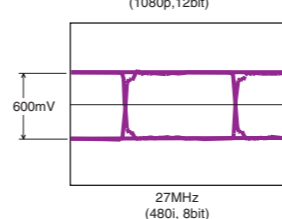
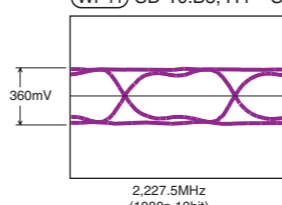

D0,D1,D2 Eye-pattern waveform, frequency and level vary according to video resolution, aspect and profile. Waveforms above are examples.

**HDMI CK waveform**

(WF42) SD-10:B3, H4 SD-11:B5

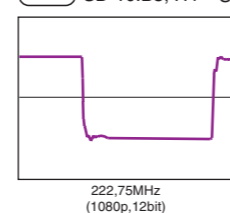

CK waveform, frequency and level differ according to video resolution, aspect and profile. D0,D1,D2 are just CK x10.

**FL Driver IC Control Waveform Part**

**SCK/SDATA waveform**

(WF61) SD-14:E3,F2

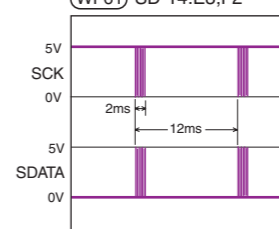

**SCK/SDATA waveform**

(WF61) SD-14:E3,F2

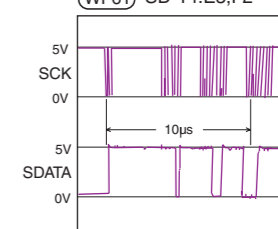

SDATA waveform varies according to the data content

**SCK/CS waveform**

(WF62) SD-14:E3,F2

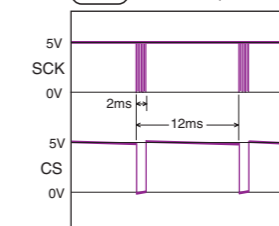

**SCK/RESET waveform**

(WF63) SD-14:E3,F2

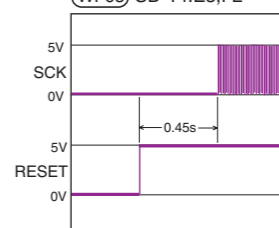

When power on

**SCK/RESET waveform**

(WF63) SD-14:E3,F2

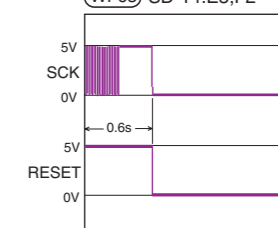

When power off

5

# PACKING PROCEDURE

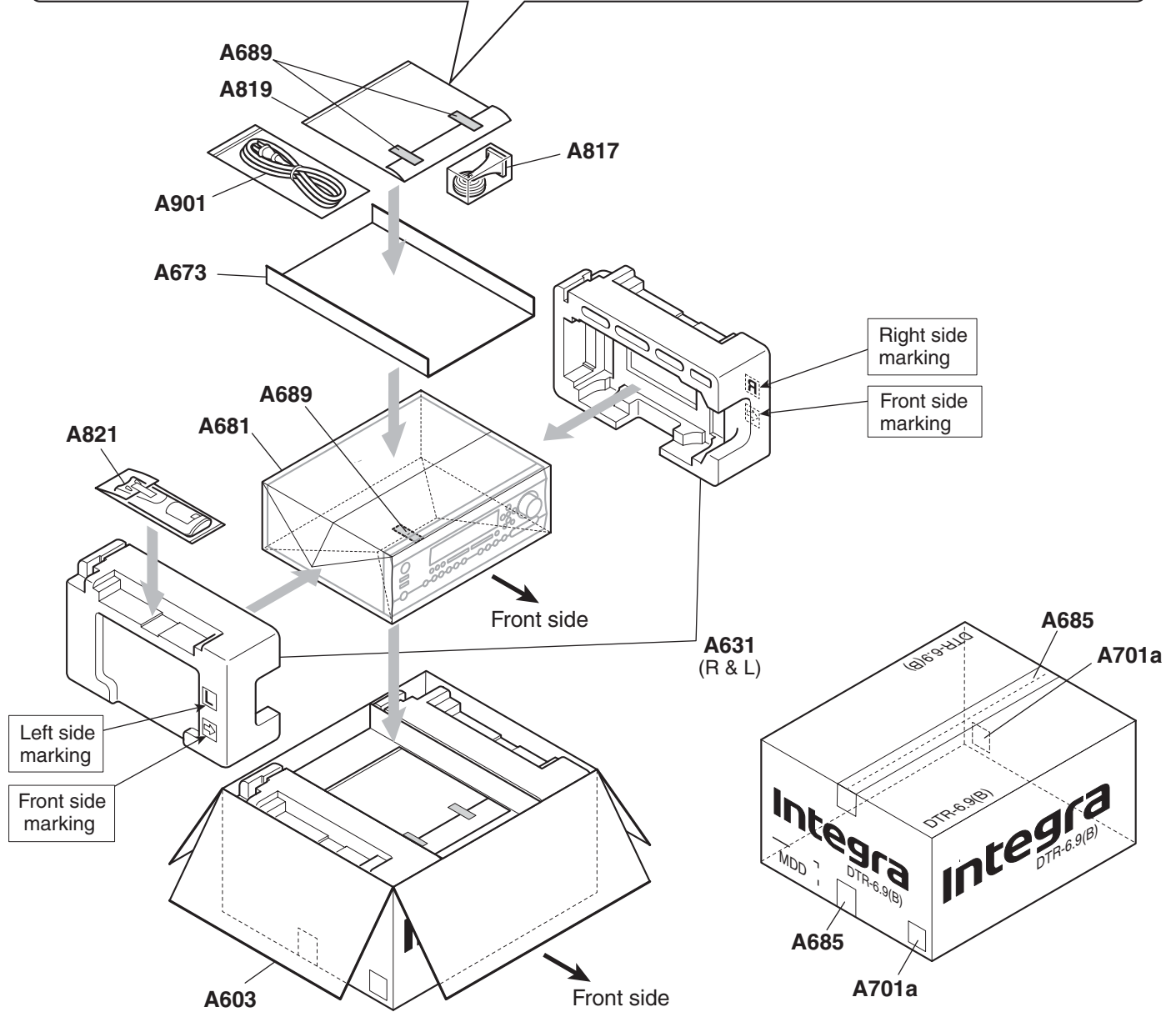
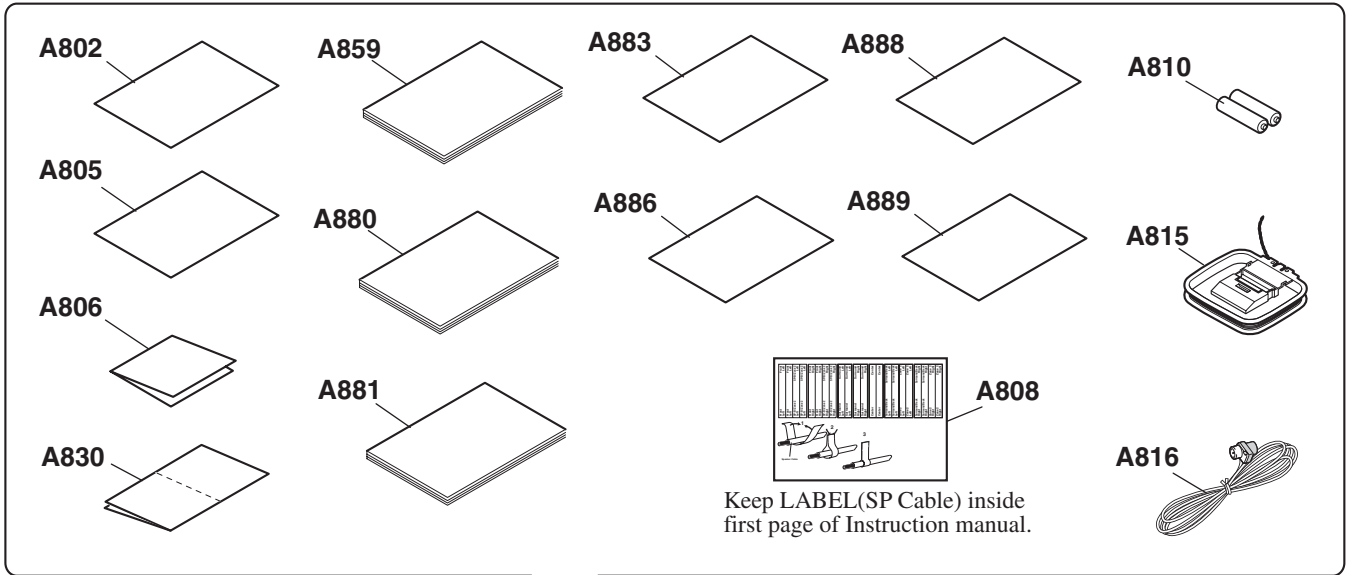

A B C D E F G H

PRINTED CIRCUIT BOARD VIEWS-1

**U01** POWER AMPLIFIER PC BOARD (NAAMP-9477)

Component side

1

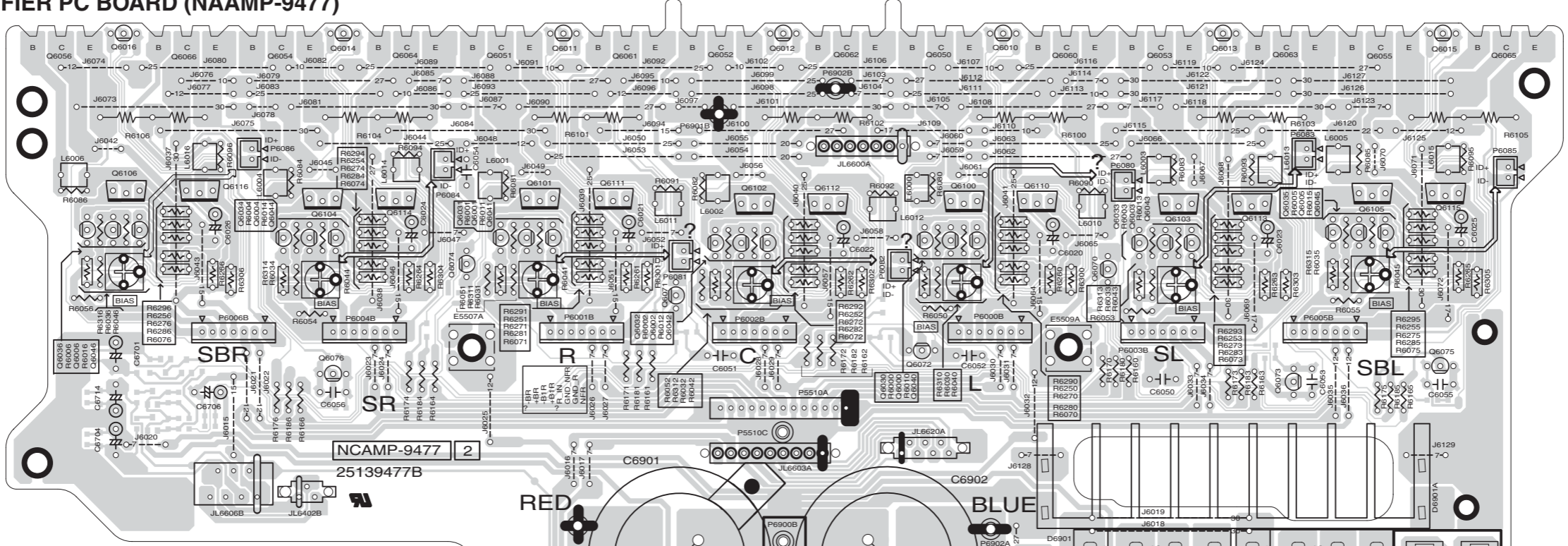

2

**U02** THERMAL SENSOR PC BOARD (NAETC-9478)  
Component side

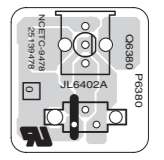

**U07** AMPLIFIER PC BOARD (NAASP-9483)

Component side

3

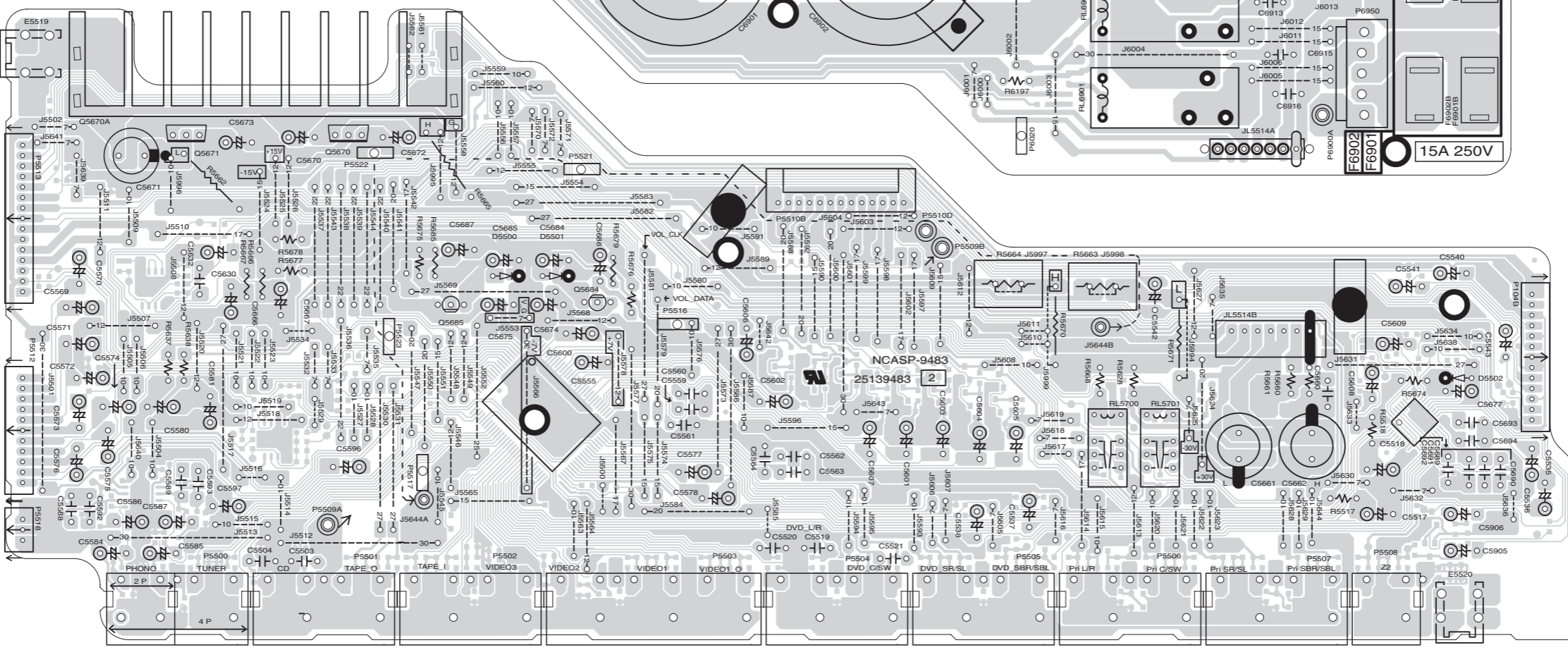

4

**U04** TERMINAL PC BOARD (NAETC-9480)  
Component side

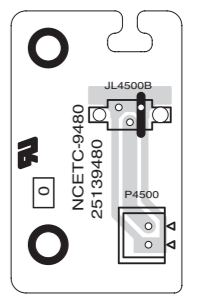

5

A B C D E F G H

PRINTED CIRCUIT BOARD VIEWS-2

**U01** POWER AMPLIFIER PC BOARD (NAAMP-9477)

Soldering side

1

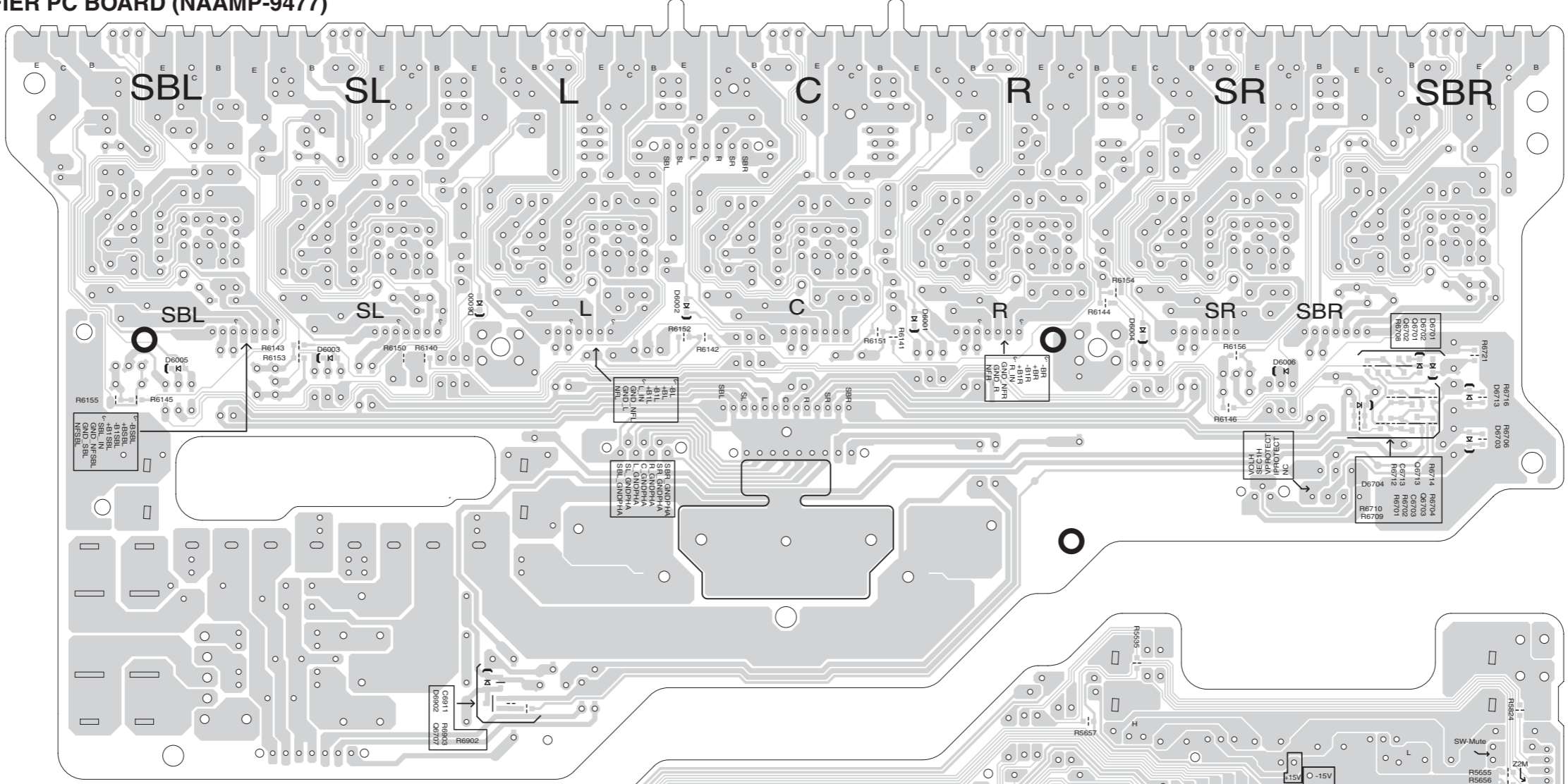

2

3

**U02** THERMAL SENSOR

PC BOARD

(NAETC-9478)

Soldering side

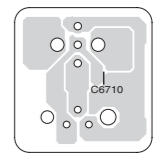

**U04** TERMINAL

PC BOARD

(NAETC-9480)

Soldering side

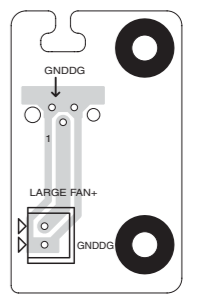

**U07** AMPLIFIER PC BOARD (NAASP-9483)

Soldering side

4

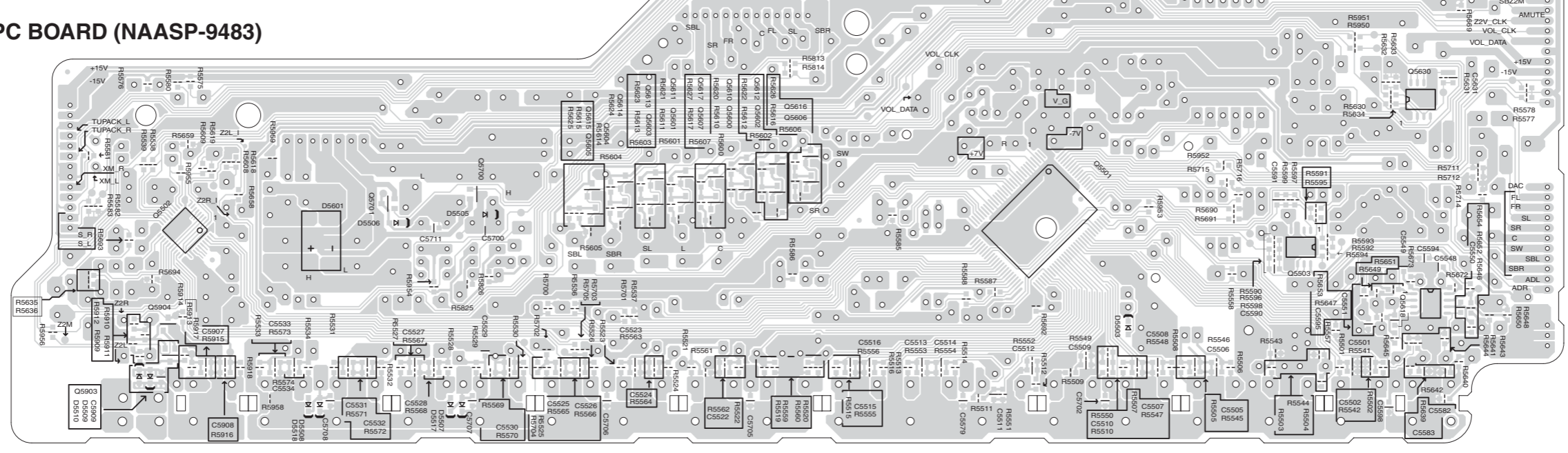

5

A B C D E F G H

PRINTED CIRCUIT BOARD VIEWS-3

**U13** AMPLIFIER PC BOARD (NACLA-9493)

Component side

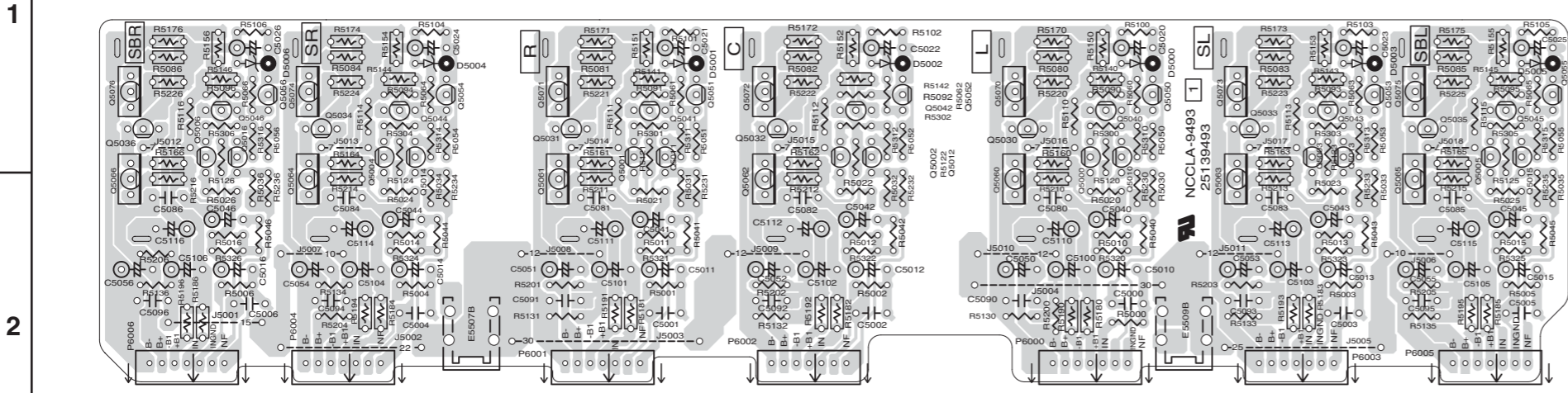

**U10** POWER SUPPLY PC BOARD (NAPS-9490)

Component side

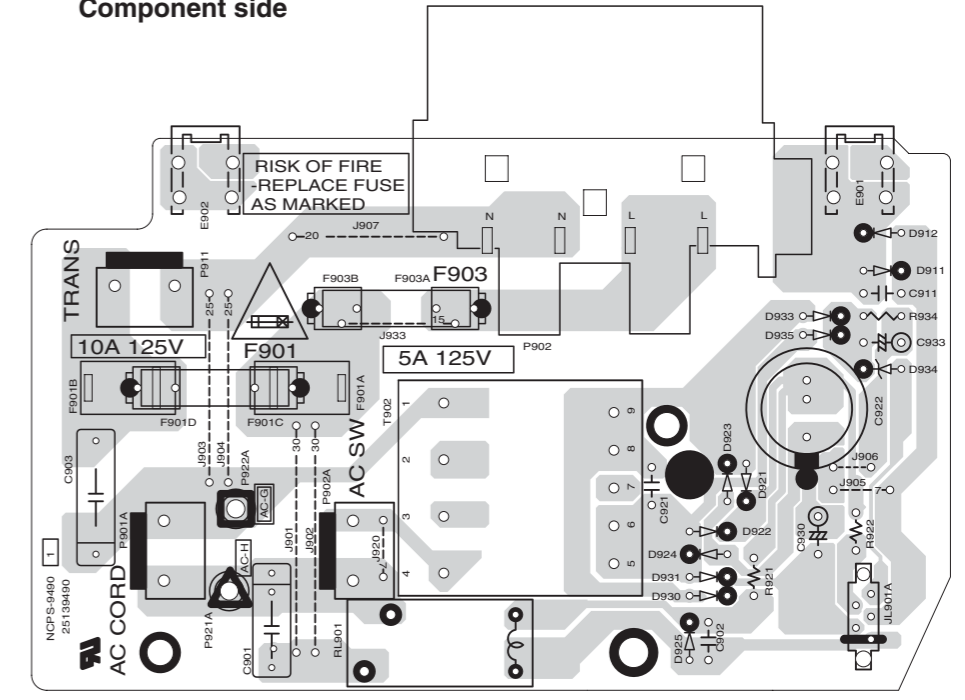

**U08** SP TERMINAL PC BOARD (NATRM-9488)

Component side

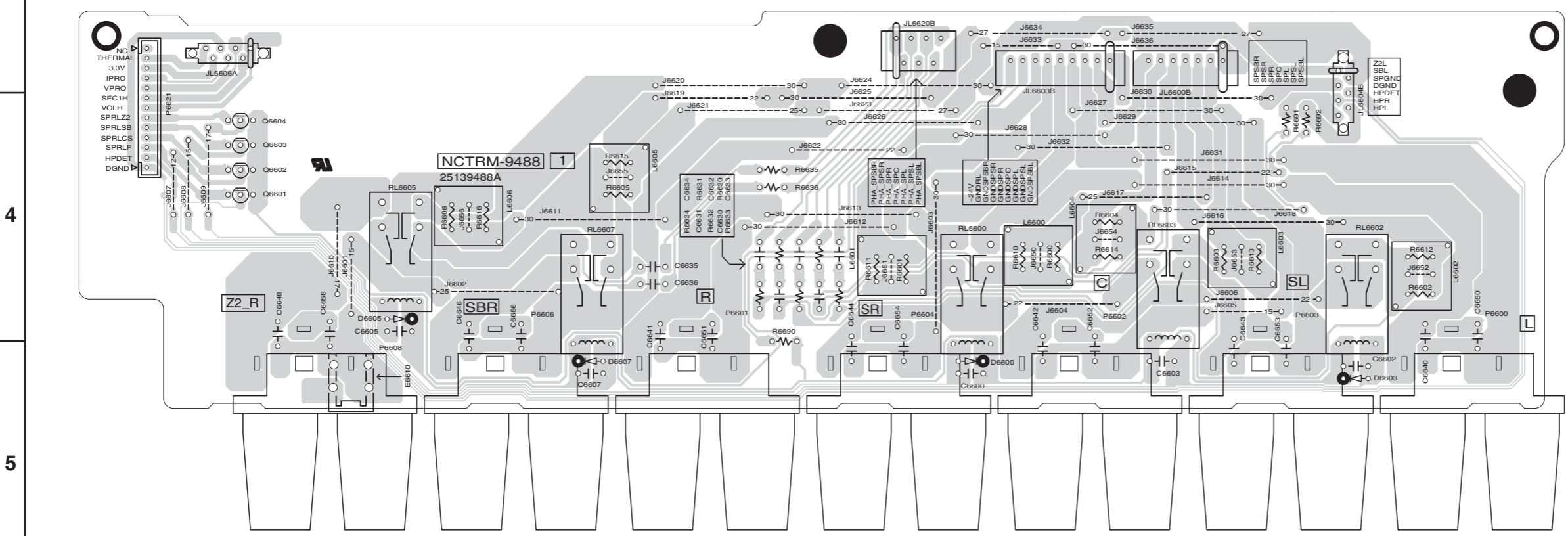

**U09** SP TERMINAL PC BOARD (NATRM-9489)

Component side

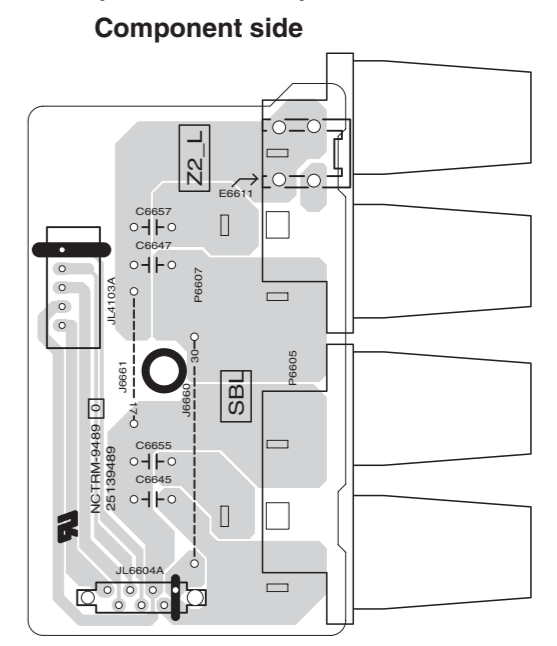

1

2

3

4

5

A B C D E F G H

**PRINTED CIRCUIT BOARD VIEWS-4**

**U13** AMPLIFIER PC BOARD (NACLA-9493)

Soldering side

1

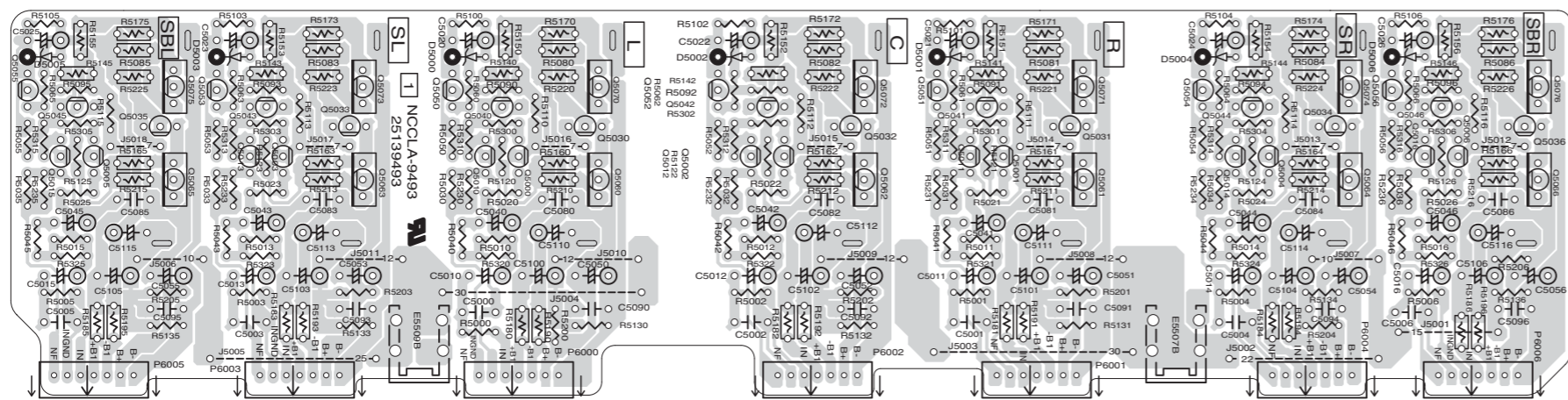

2

**U10** POWER SUPPLY PC BOARD (NAPS-9490)

Soldering side

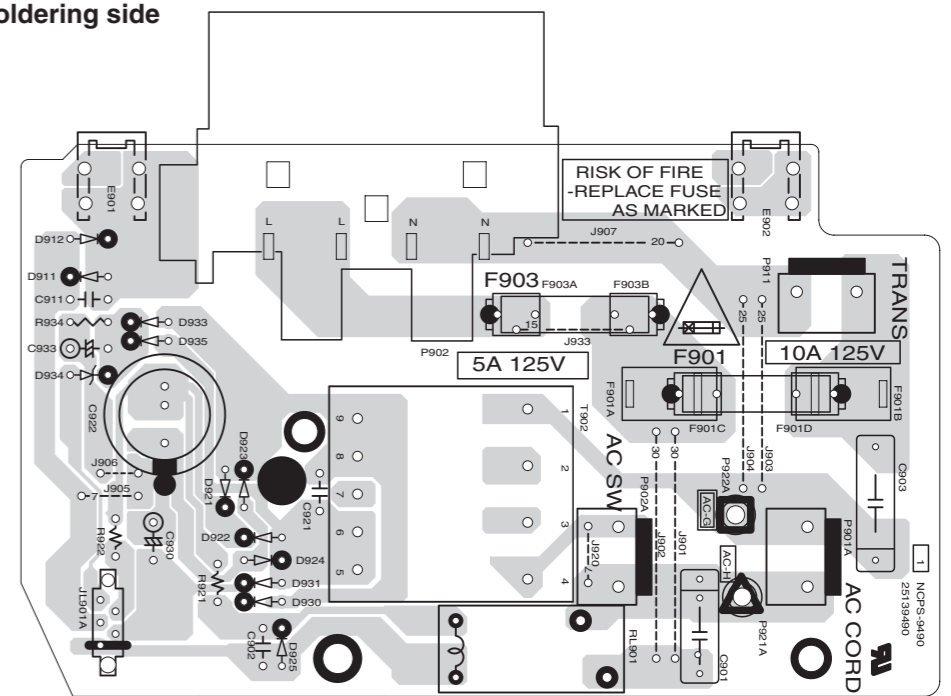

**U08** SP TERMINAL PC BOARD (NATRM-9488)

Soldering side

3

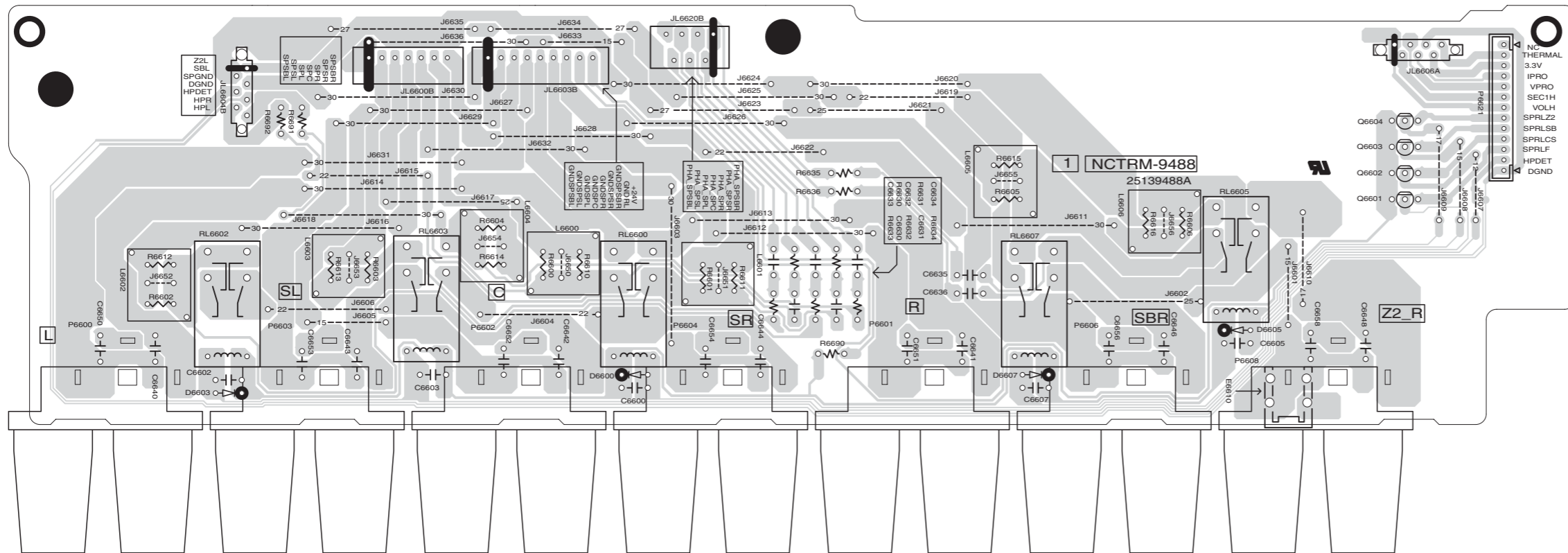

4

**U09** SP TERMINAL PC BOARD (NATRM-9489)

Soldering side

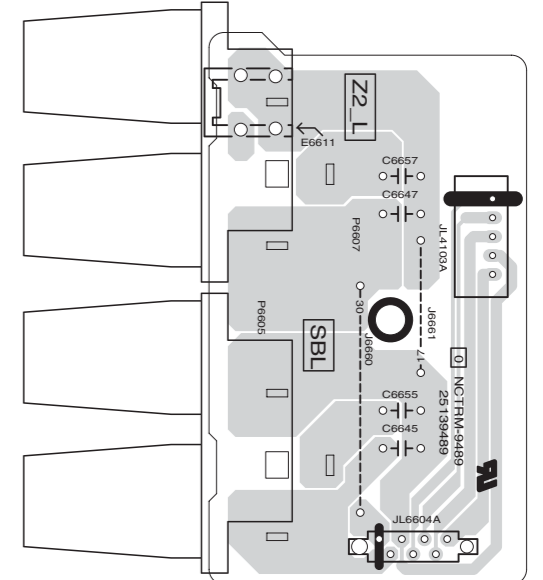

5



PRINTED CIRCUIT BOARD VIEWS-5

1

**U16** MICROPROCESSOR AND DAC PC BOARD (NADG-9504)

Side-A

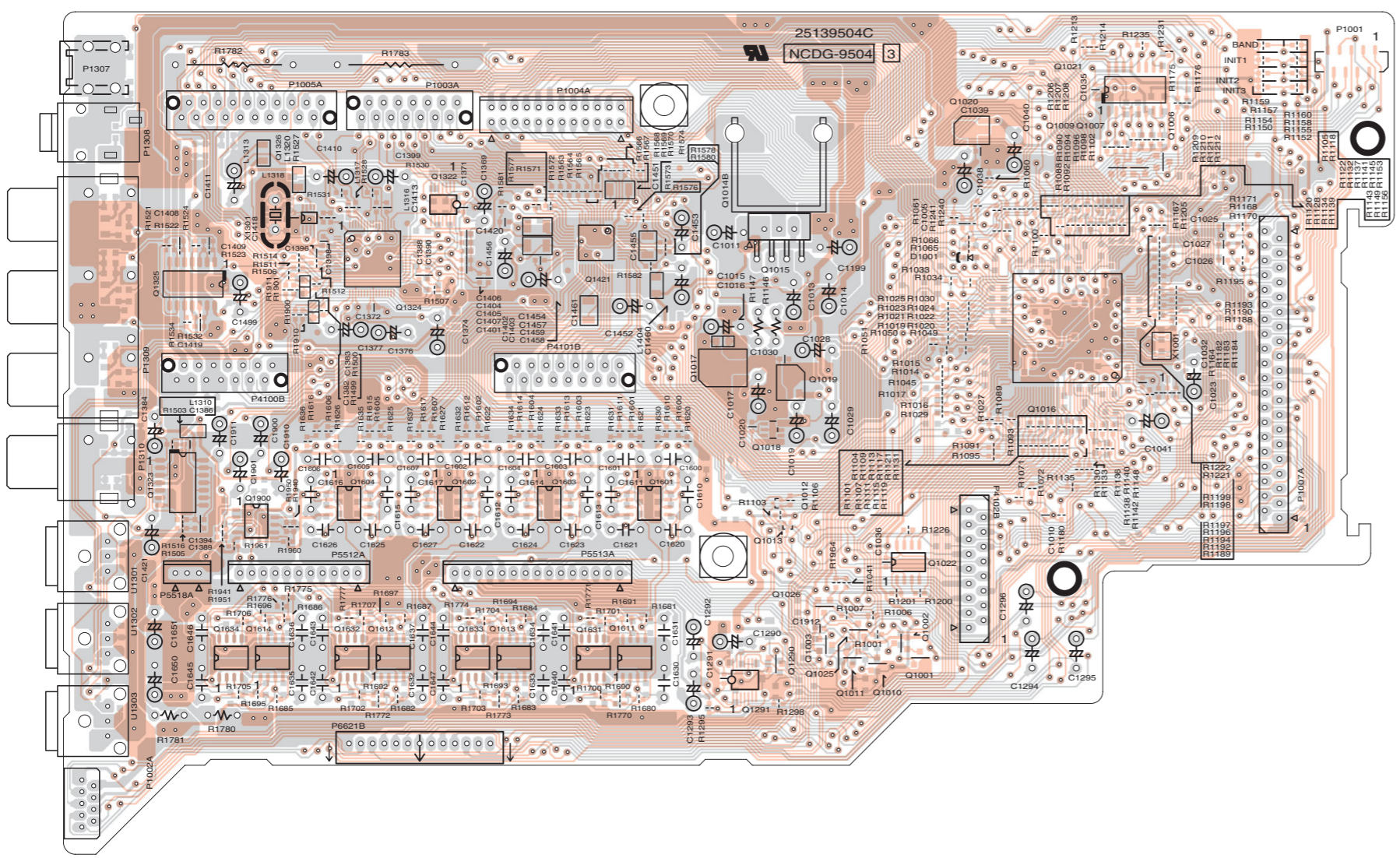

2

3

4

5

**U19** XM PC BOARD (NARF-9507)

Side-A

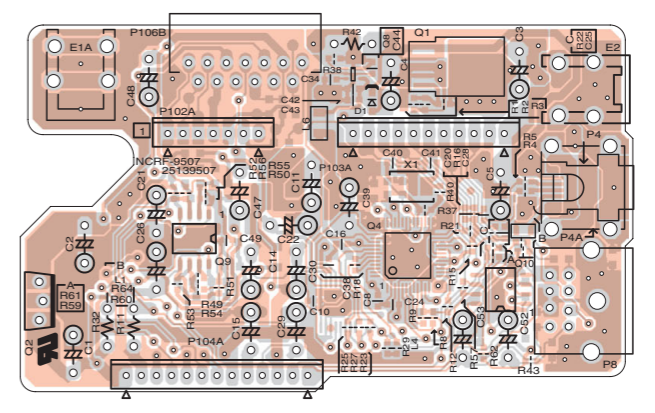

PRINTED CIRCUIT BOARD VIEWS-6

1

U16 MICROPROCESSOR AND DAC PC BOARD (NADG-9504)

Side-B

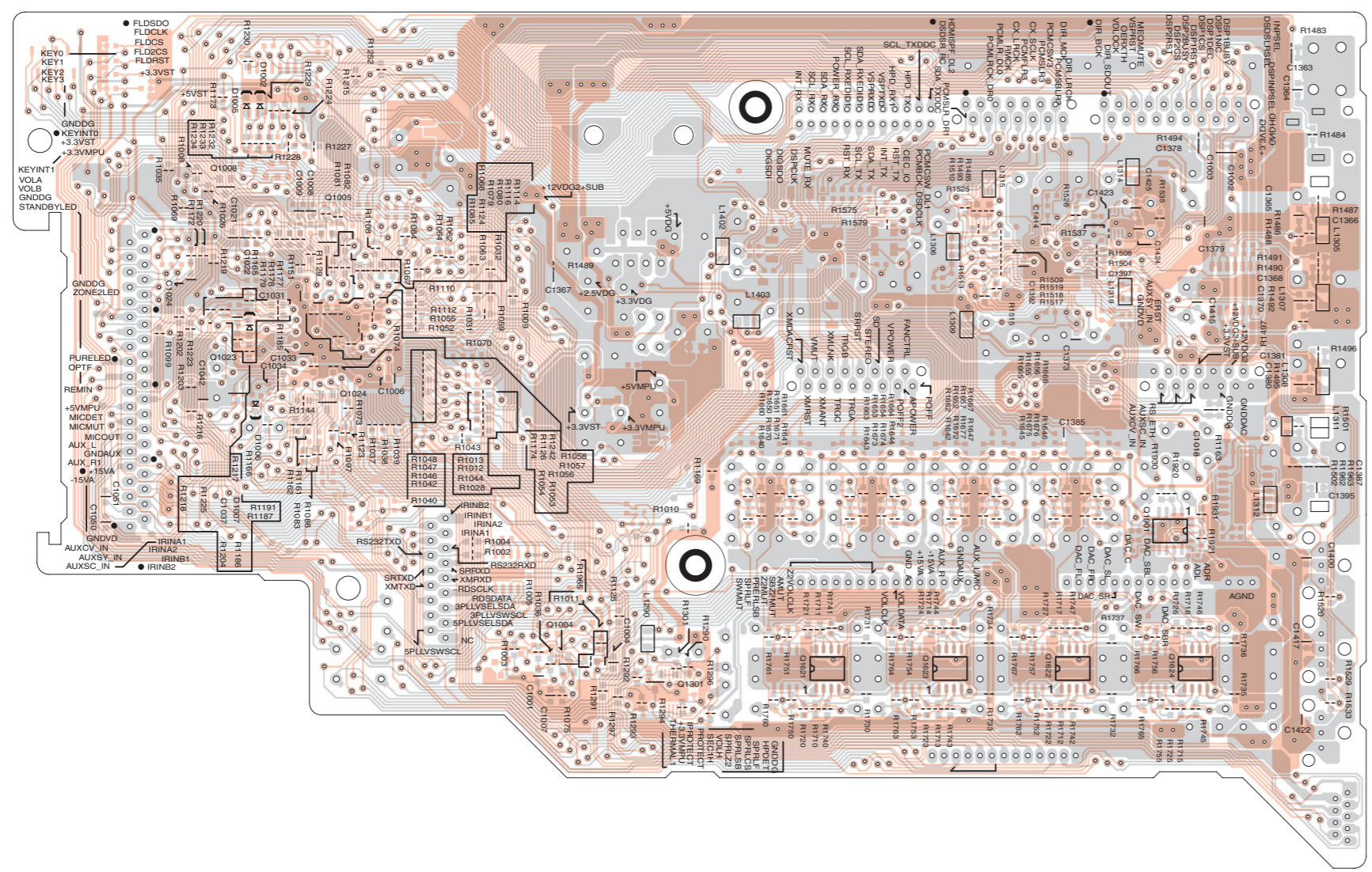

2

U19 XM PC BOARD (NARF-9507)

Side-B

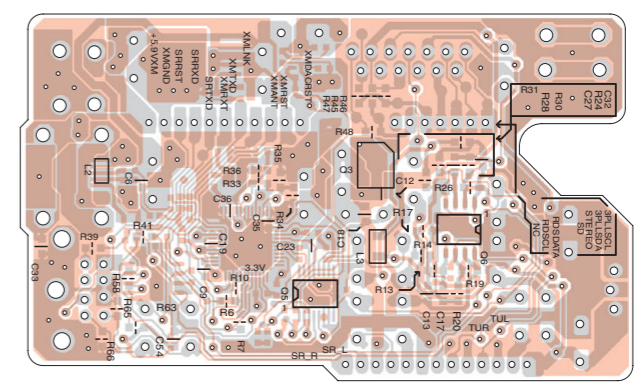

3

4

5

A B C D E F G H

PRINTED CIRCUIT BOARD VIEWS-7

1

U17 VIDEO PC BOARD (NAVD-9505)

Side-A

2

3

4

5

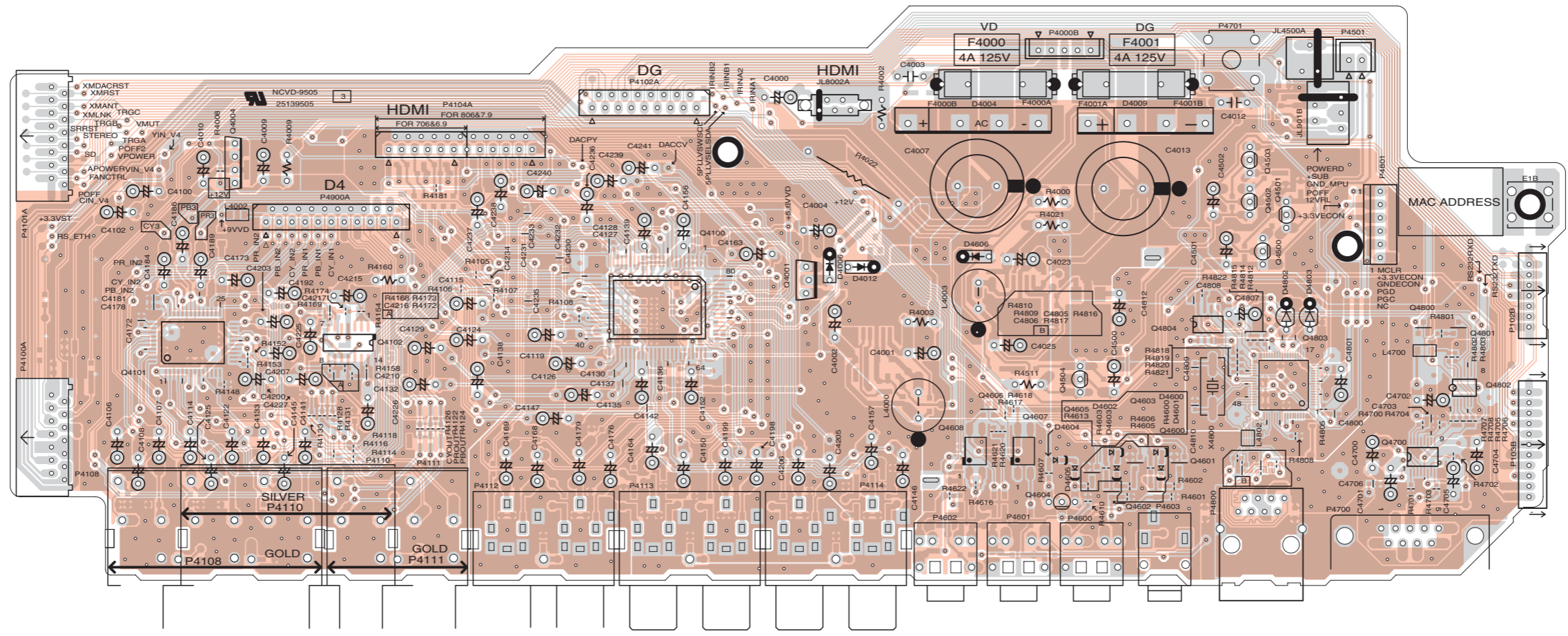

A B C D E F G H

PRINTED CIRCUIT BOARD VIEWS-8

1

U17 VIDEO PC BOARD (NAVD-9505)  
Side-B

2

3

4

5

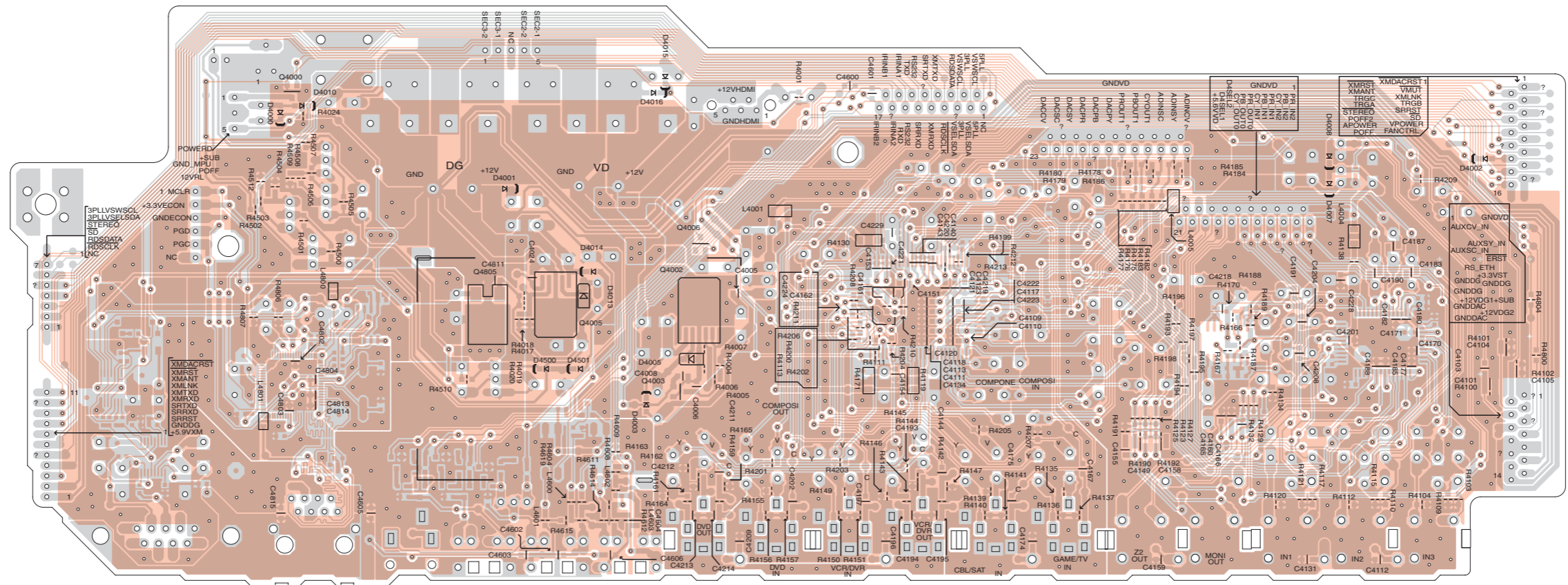

A

B

C

D

# PRINTED CIRCUIT BOARD VIEWS-9

## U20 HDMI PC BOARD (NAHDM-9562)

Side-A

1

2

3

4

5

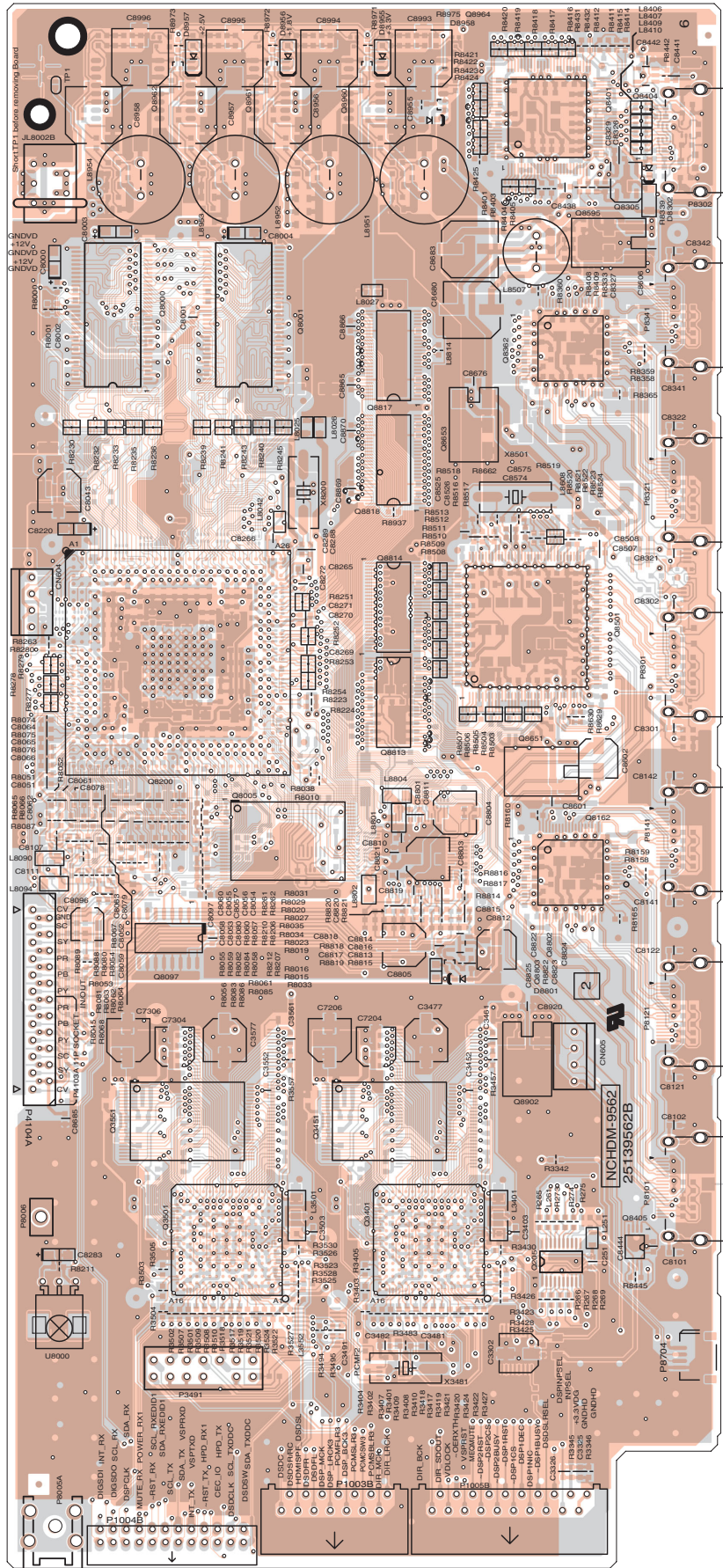

A

B

C

D

# PRINTED CIRCUIT BOARD VIEWS-10

**U20** HDMI PC BOARD  
 (NAHDM-9562)  
 Side-B

1

2

3

4

5

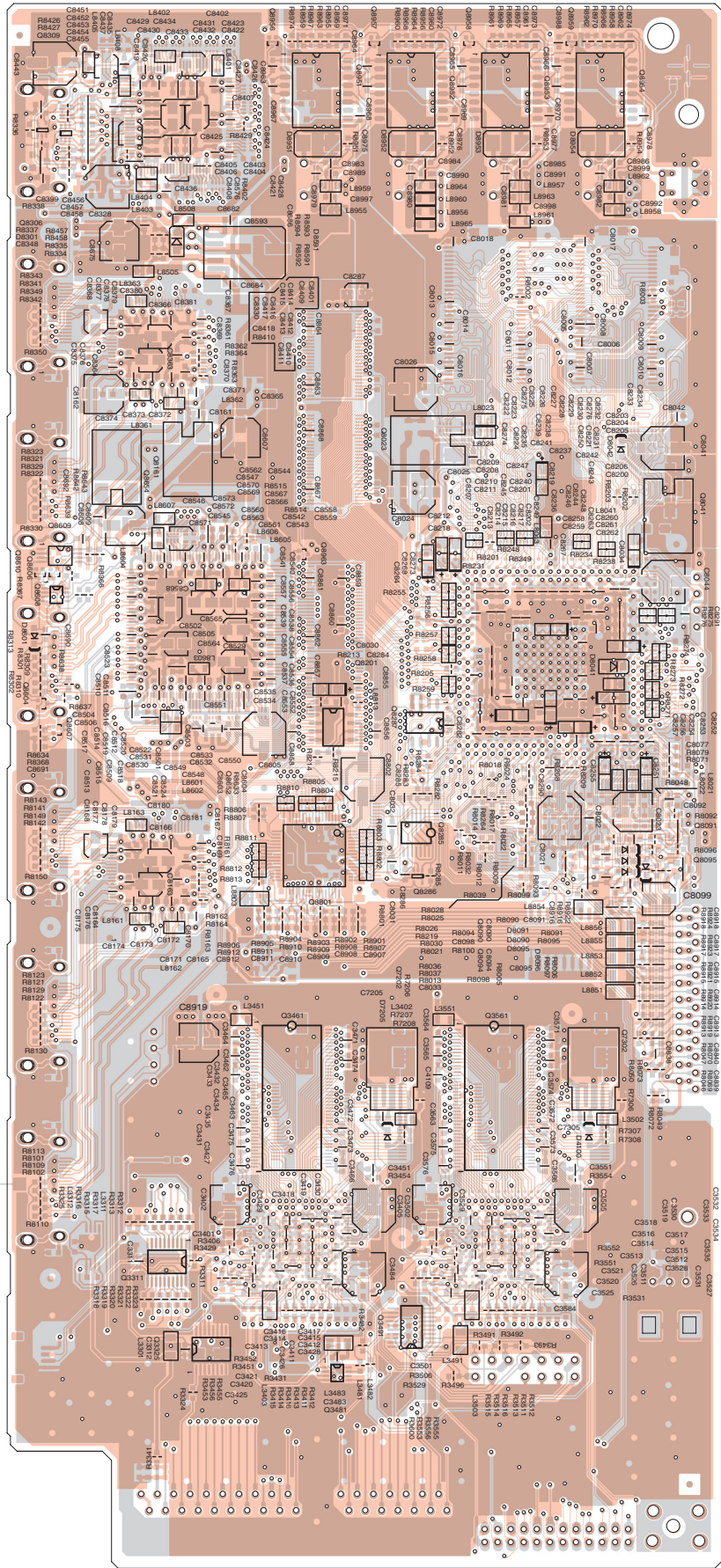



A B C D E F G H

PRINTED CIRCUIT BOARD VIEWS-12

1

**U25** POWER SUPPLY PC BOARD (NAPS-9530) Soldering side

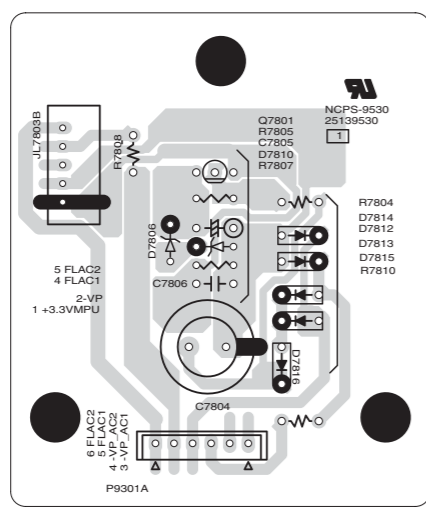

2

**U24** TERMINAL PC BOARD (NAETC-9529) Soldering side

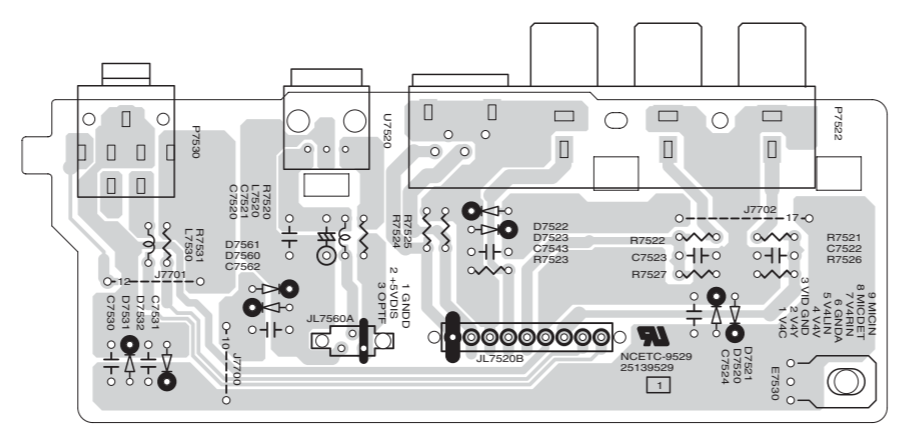

**U23** HEADPHONE PC BOARD (NAETC-9528) Soldering side

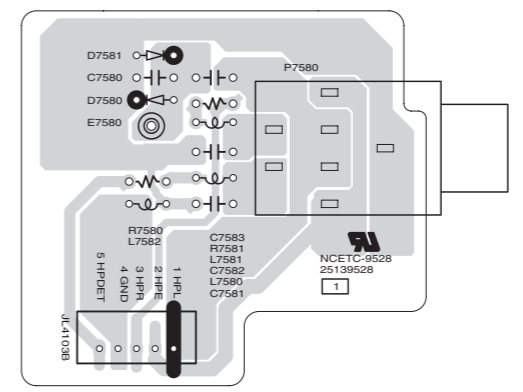

**U22** VOLUME PC BOARD (NAETC-9527) Soldering side

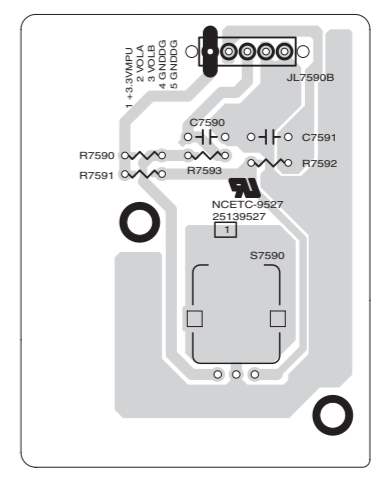

3

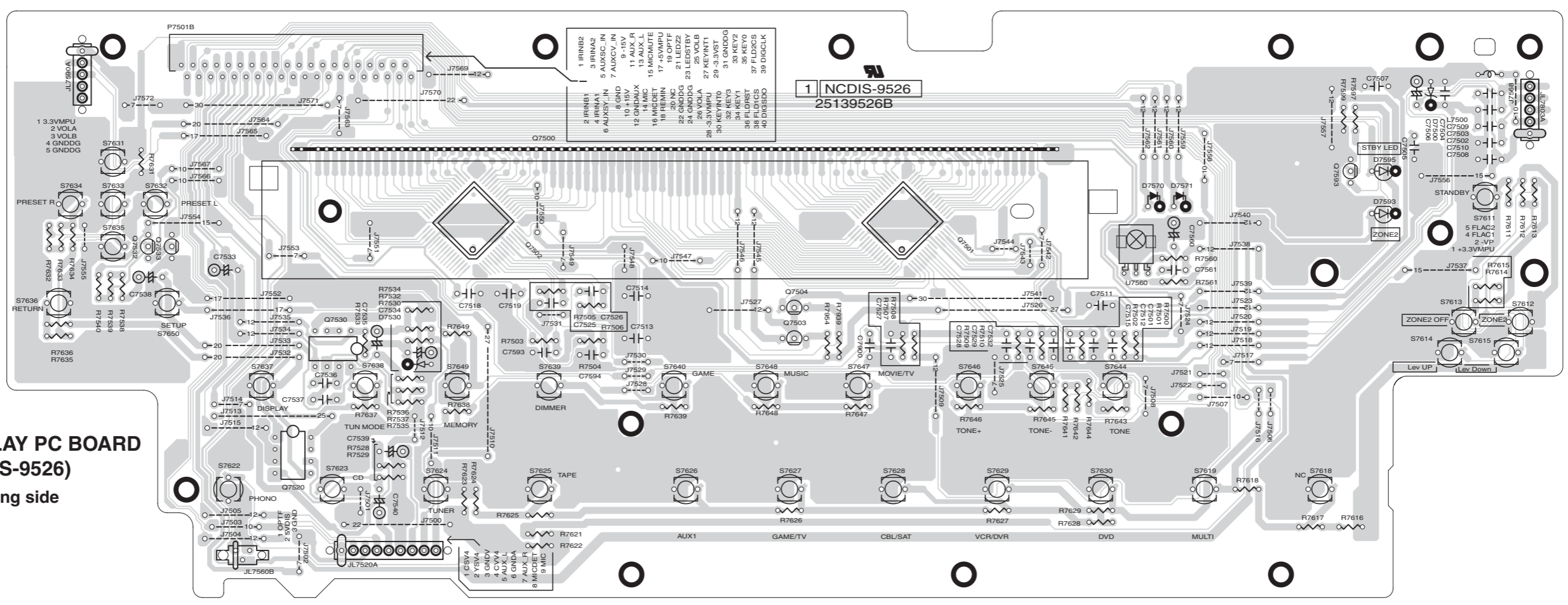

4

**U21** DISPLAY PC BOARD (NADIS-9526) Soldering side

5



# SERVICE PROCEDURE-1

## 1. Replacing the fuses

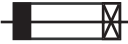
 This symbol located near the fuse indicates that the fuse used is show operating type. For continued protection against fire hazard, replace with same type fuse, For fuse rating, refer to the marking adjacent to the symbol.

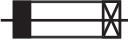
 Ce symbole indique que le fusible utilise est e lent. Pour une protection permanente, n'utiliser que des fusibles de meme type. Ce demier est indique la qu le present symbol est apposse.

<Notes>

<DD> : DTR-6.9 USA model

<MA> : DTR-6.9 Australian model

REF NO.	PART NAME	DESCRIPTION	PART NO.	REMARKS
F901	FUSE	10A-UL/T-233	252330GR	!, <DD>
F901	FUSE	5A-SE-EAK	252078GR	!, <MA>
F4000	FUSE	4A-UL/T-233	252325GR	!
F4001	FUSE	4A-UL/T-233	252325GR	!
F6901	FUSE	15A-TUL-250V	252303GR	!
F6902	FUSE	15A-TUL-250V	252303GR	!

## 2. To initialize the unit

1. Press and hold down VCR/DVR button, then press ON/STANDBY button when the unit is powered on.
2. After " Clear " is displayed, the preset memory and each mode stored in the memory are initialized and will return to the factory settings, and turn to Standby mode.

## 3. Safety check out

(U.S.A. model only)

After correcting the original service problem, perform the following safety check before releasing the unit to the customer.

### Leakage current Check

Measure the leakage current to a known earth ground (water pipe or conduct etc.) by connecting a leakage current tester between the earth ground and exposed metal parts of the unit (input/output ground terminals, screw heads or metal overlays etc.).

Plug the power supply cord directly into a 120Vac 60Hz wall socket and turn ON/STANDBY button on.

Any current measured must not exceed 0.5mA.

## 4. Memory Backup

This model uses not a capacitor but a EEPROM IC(Q1022) in order to retain radio presets and other settings.

So, memory contents will be kept eternally with no care.

## 5. Replacing Power Amplifier Parts

When a power amplifier of certain channel is broken and goes into Protect mode, the following parts in the channel must be replaced at the same time, because these parts get damage together in most cases.

Front L ch	Front R ch	Center ch	Surround L ch	Surround R ch	Surround Back L ch	Surround Back R ch
Q6050, Q6060	Q6051, Q6061	Q6052, Q6062	Q6053, Q6063	Q6054, Q6064	Q6055, Q6065	Q6056, Q6066
Q6030, Q6040	Q6031, Q6041	Q6032, Q6042	Q6033, Q6043	Q6034, Q6044	Q6035, Q6045	Q6036, Q6046
Q6010, Q6100	Q6011, Q6101	Q6012, Q6102	Q6013, Q6103	Q6014, Q6104	Q6015, Q6105	Q6016, Q6106
Q6110, C6020	Q6111, C6021	Q6112, C6022	Q6113, C6023	Q6114, C6024	Q6115, C6025	Q6116, C6026
R6070, R6100	R6071, R6101	R6072, R6102	R6073, R6103	R6074, R6104	R6075, R6105	R6076, R6106
R6250, R6260	R6251, R6261	R6252, R6262	R6253, R6263	R6254, R6264	R6255, R6265	R6256, R6266
R6270, R6280	R6271, R6281	R6272, R6282	R6273, R6283	R6274, R6284	R6275, R6285	R6276, R6286
R6290, R6300	R6291, R6301	R6292, R6302	R6293, R6303	R6294, R6304	R6295, R6305	R6296, R6306
R6310	R6311	R6312	R6313	R6314	R6315	R6316

## SERVICE PROCEDURE-2

### 6. Replacing microprocessors and flash memories

This page describes the method to write the firmware in the new chip which is replaced with broken one, and also to update it.

#### 1. Main microprocessor

Target IC: Q1016

It is not necessary to write the firmware directly in a new chip by a specific ROM writer.

Mount the chip on pcb and the pcb on the unit.

Refer to FIRMWARE UPDATE -2 &3 for the method.

#### 2. 1st DSP ROM

Target IC: Q3451

Must write the firmware directly in a new chip by the specific ROM writer before mounting on pcb.

ROM writer example: AF9708 (Ando Electric) and compatibles.

In the case of updating the firmware, refer to FIRMWARE UPDATE -4 & 5.

#### 3. 2nd DSP ROM

Target IC: Q3551

Must write the firmware directly in a new chip by the specific ROM writer before mounting on pcb.

ROM writer example: AF9708 (Ando Electric) and compatibles.

In the case of updating the firmware, refer to FIRMWARE UPDATE -4 & 5.

#### 4. Video processor (TORINO)

Target IC: Q8005

It is not necessary to write the firmware directly in a new chip by a specific ROM writer.

Mount the chip on pcb and the pcb on the unit.

However, this TORINO chip is impossible to remove from the pcb in order in the field service.

In the case of updating the firmware, refer to FIRMWARE UPDATE -6 to 12 for the method.

#### 5. Network (E-Control) (DTR-6.9/7.9 only)

Target IC: Q4803

It is not necessary to write the firmware directly in a chip.

Mount the chip on pcb and the pcb on the unit.

ROM writer " PICKit 2 (MICROCHIP) " and PC application for it are necessary.

This update is through JTAG socket P4801 on pcb: NAVD-9505.

# OPERATION CHECK-1

## SPEAKER PROTECT-1 (SPEAKER OUT DC VOLTAGE DETECTION)

**[When]**

1. Exchange power transistors (Q6050 - 6056, Q6060 - 6066).
2. Exchange amplifier PC board ass'y (NAAMP-9477, NACLA-9493).

**[Procedure]**

<Note>

No load. No input.

1. Press and hold down CD button, then press ON/STANDBY button while the unit is powered ON.  
" Test - \_ " is displayed only for 5 seconds.

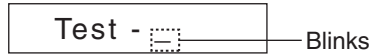

2. Press GAME/TV button, while the characters of " Test - \_ " are displayed.

The unit will be in the state of " Test-4-00 ".

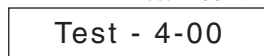

3. Repeatedly press TONE + button until the characters of " Test-4-22 " are displayed.

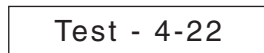

Check whether the operation starts and continues automatically as follows.

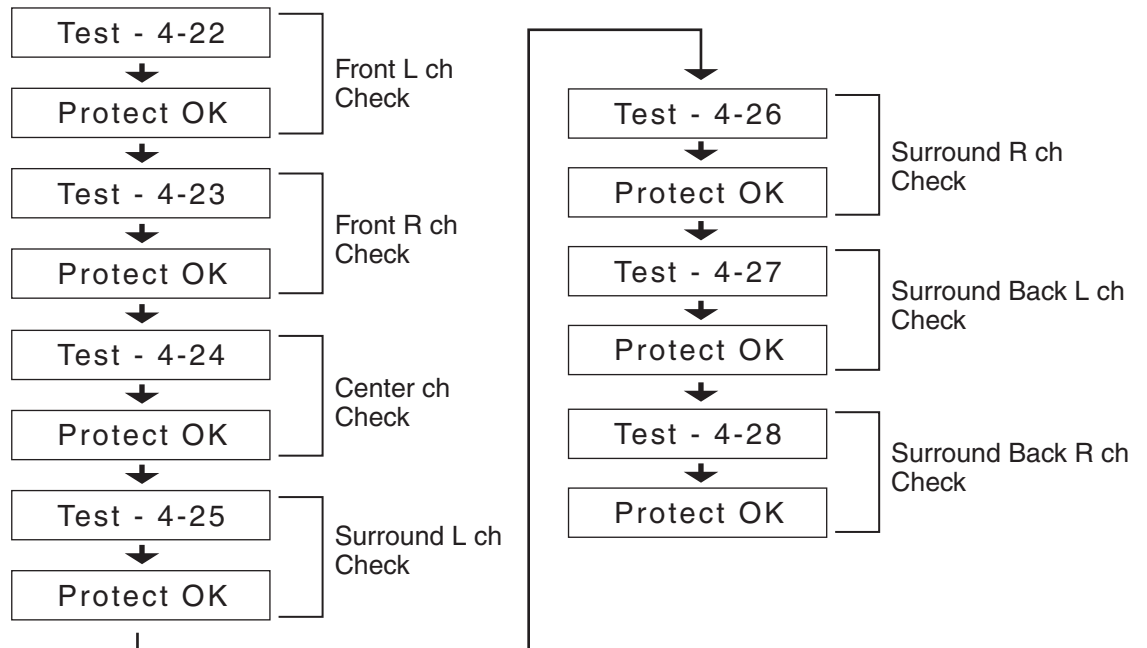

If all channels are OK, the characters of " Test - 4 - 36 " are displayed.

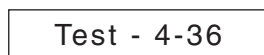

4. Press ON/STANDBY button to finish.



# OPERATION CHECK-2

## SPEAKER PROTECT-2 (SPEAKER OUT CURRENT DETECTION)

**[When]**

1. Exchange power transistors (Q6050 - 6056, Q6060 - 6066).
2. Exchange amplifier PC board ass'y (NAAMP-9477, NACLA-9493).

**[Procedure]**

<Note>

No input.

Do not check two or more channels at the same time.

Do not connect a dummy load to speaker terminals longer than 2 seconds.

1. Press and hold down CD button, then press ON/STANDBY button while the unit is powered ON.  
"Test - \_" is displayed only for 5 seconds.

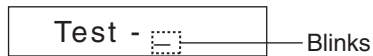

2. Press GAME/TV button, while "Test - \_" is displayed.  
The unit will be in the state of "Test-4-00".

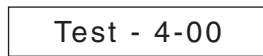

3. Repeatedly press TONE + button until "Test-4-36" is displayed. DSP outputs the pulse signal to all channels. Refer to Fig-1.

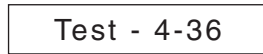

4. Connect the dummy load of 3 ohms to the Front L ch speaker terminals.  
At this time, confirm that the speaker relay is not turned off.

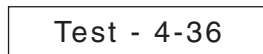

5. Connect the dummy load of 1 ohm to the Front L ch speaker terminals.  
At this time, confirm that the speaker relay is turned off and "Protect" is displayed.



Disconnect the dummy load immediately after checking the display of "Protect".

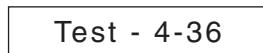

6. Check other channels according to the same procedures as 4 and 5.  
Front R, Center, Surround L, Surround R, Surround Back L, Surround R

7. Press ON/STANDBY button to finish.



Fig-1 Current detection test signal

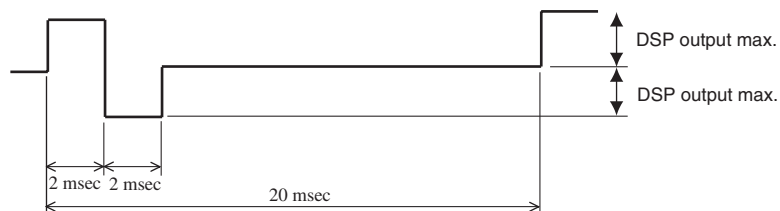

## OPERATION CHECK-3

### SPEAKER OUTPUT SENSOR AND THERMAL SENSOR

#### [When]

1. Exchange power transistors (Q6050 - 6056, Q6060 - 6066).
2. Exchange amplifier PC board ass'y (NAAMP-9477, NACLA-9493).
3. Exchange thermal sensor Q6380 or PC board ass'y (NAETC-9478).

#### [Procedure]

<Note>

No output. No input.

#### Output sensor (Speaker out AC voltage)

1. Press and hold down CD button, then press ON/STANDBY button while the unit is powered ON.  
"Test - \_" is displayed only for 5 seconds.

Test - \_  Blinks

2. Press GAME/TV button while "Test - \_" is displayed.  
The unit will be in the state of "Test-4-00".

Test - 4-00

3. Repeatedly press TONE + button until "Test-4-37" is displayed. DSP outputs 0 dBfs/1kHz audio signal to all power amplifiers.

Test - 4-37

4. At this time, confirm that the red characters of "FM STEREO" is displayed and relays RL6901/RL6902 are switched off.

Test - 4-37 

5. Press TONE + button until "Test-4-38" is displayed. DSP outputs 0 dBfs/1kHz audio signal to some power amplifiers.

Test - 4-38

6. At this time, confirm that the red characters of "FM STEREO" is displayed and relays RL6901/RL6902 are switched off.

Test - 4-38 

7. Press ON/STANDBY button to finish.



Clear  Turn off

#### Thermal sensor

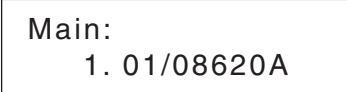
1. Press and hold down DISPLAY button, then press STANDBY/ON button when the unit is powered ON.  
The main microprocessor F/W version will be displayed only for 3 seconds.

<Ex.>   
Main:  
1. 01/08620A

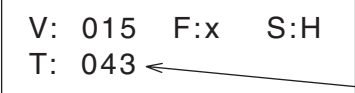
2. Press TONE button while the version is displayed. The temperatures of the thermal sensors (Q6380) will be displayed.

<Ex.>   
V: 015 F:x S:H  
T: 043  Unit is °C

3. Confirm that the displayed temperature is within +/-20°C from the ambient temperatures.

4. Press ON/STANDBY button to finish.

Clear  Turn off

## OPERATION CHECK-4

### Condition of Protect Mode

The unit will go into Protect Mode under the following conditions.  
(T: Thermal sensor temperature)

1. Thermal condition
  - Immediately at  $T \leq -30\text{ }^{\circ}\text{C}$
  - or
  - Immediately at  $T \geq 110\text{ }^{\circ}\text{C}$
  - or
  - After 10 minutes of  $100\text{ }^{\circ}\text{C} > T > 110\text{ }^{\circ}\text{C}$
2. Time condition
  - The unit will go into Protect Mode in 24 hours after powered ON.
3. Current condition
  - The unit will go into Protect Mode if speaker output AC current  $\geq 9\text{ A/ch}$ .
  - This condition is equivalent to OPERATION CHECK-2.

### Condition of Power Supply Voltage Control

The power supply voltage(VH or VL) for power amplifiers is changed by the relays: RL6901,06902 on NAAMP-9477.

$VH > VL$

T: Thermal sensor temperature

VOLH: The voltage at A/D input Pin #133 of Main microprocessor Q1016 (Refer to SD-3 and SD-7 of Schematic Diagrams).

#### Conditions:

**Speaker imp. = 6 or 8 ohm**

VH:  $0V < VOLH < 0.4V$

VL:  $0.4V < VOLH < 2.0V$ , 5 minutes

or

$2.0V < VOLH < 3.3V$ , 5 seconds

or

$T > 70\text{ }^{\circ}\text{C}$ , 3 minutes

**Speaker imp. = 4 ohm**

VL: At all times.

### Condition of Cooling Fan Operation

The cooling fan will stop or rotate under the following conditions.

VOLH	Thermal Sensor Temperature(T)			
	55°C	62°C	73°C	
0V	STOP	LOW SPEED	LOW SPEED	MID SPEED
0.4V	STOP	LOW SPEED	MID SPEED	HIGH SPEED
2.0V	MID SPEED	MID SPEED	MID SPEED	HIGH SPEED
3.3V				

Note:

“VOLH=0.4V” is equivalent to 0.8W(8 ohm, 7 ch)

“VOLH=2.0V” is equivalent to Max power(8 ohm, 3 ch)

## ADJUSTMENT PROCEDURE-1

### IDLING CURRENT ADJUSTMENT

#### [When]

Exchange Power transistor (Q6050 - Q6056, Q6060 - Q6066) and/or Amplifier PC board (NAAMP-9477).

#### [Procedure]

<Note> **No load and No signal**

Refer to <Fig-1> in " ADJUSTMENT PROCEDURE-2 " for the adjustment points and the test points.

1. Before idling adjustment, turn the trimming resistors to counter clockwise.
2. Connect the dc voltmeter to test points,  
using two 100 ohm resistors between the poles of the jig terminal and the dc voltmeter terminals.

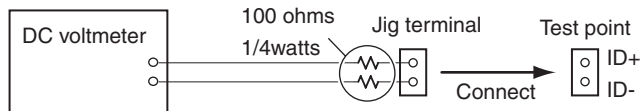

3. Connect the ac power cord to a wall outlet.
4. Press **On/Standby** button to turn the power on.
5. Adjust the trimming resistors as the following procedure immediately after power on.

Channel	Mark	Adjustment point (Trimming resistor)	Measuring point (Test point)	Adjustment value
Front Left	<b>L</b>	R6040	P6080	3.0 mV
Front Right	<b>R</b>	R6041	P6081	3.0 mV
Center	<b>C</b>	R6042	P6082	3.0 mV
Surround Left	<b>SL</b>	R6043	P6083	3.0 mV
Surround Right	<b>SR</b>	R6044	P6084	3.0 mV
Surround Back Left	<b>SBL</b>	R6045	P6085	3.0 mV
Surround Back Right	<b>SBR</b>	R6046	P6086	3.0 mV

6. Wait for 4 - 6 minutes. (Heat running)
7. Re-adjust the trimming resistors as the following procedure.

Channel	Adjustment point	Measured value	Adjustment value	Specifications (* In a stable state)
Front Left, Right and Center	R6040, R6041 and R6042	In case below 4 mV	→ 4 mV	6 +/- 1 mV
		In case 4 - 6 mV	→ No re-adjustment	
		In case over 6 mV	→ 6 mV	
Surround Left Surround Right Surround Back Left Surround Back Right	R6043, R6044, R6045 and R6046	In case below 4 mV	→ 4 mV	6 +/- 1 mV
		In case 4 - 6 mV	→ No re-adjustment	
		In case over 6 mV	→ 6 mV	

8. Disconnect the dc voltmeter.
9. Press **On/Standby** button to turn the power off.
10. Disconnect the ac power cord of the unit.

\* Idling currents are stabilized in about 10 minutes after power on.

# ADJUSTMENT PROCEDURE-2 IDLING CURRENT ADJUSTMENT

<Fig-1>

**U01**  
**AMPLIFIER PC BOARD**  
**(NAAMP-9477)**

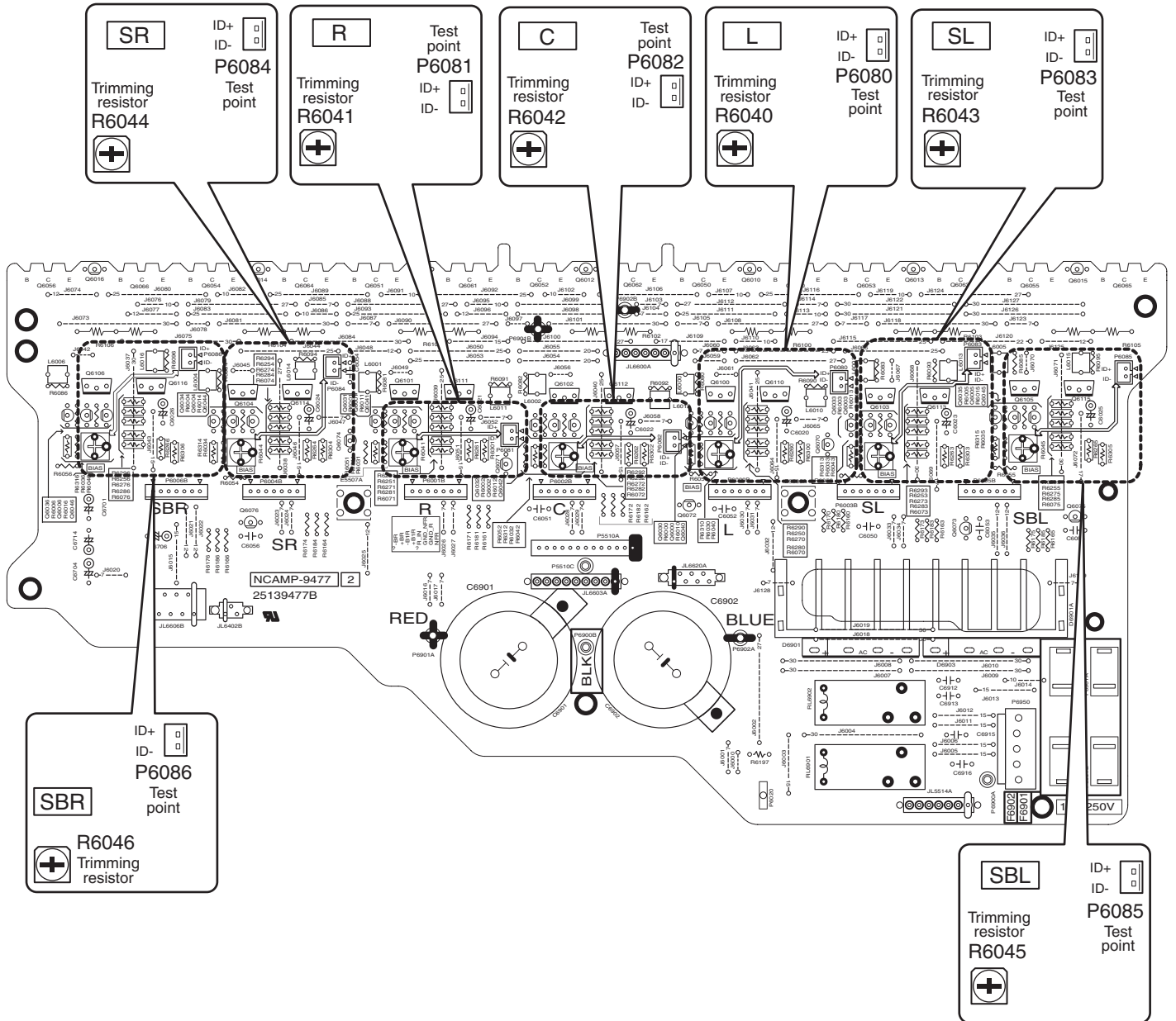



**DTR-6.9****<Note>**

Mechanical parts and pcb ass'y marked by **NSP** are generally unavailable because they are not in the Master Spare Parts List.

IC chip marked by "NSP" is impossible to remove form pcb, so it is unavailable too.

NOTE : THE COMPONENTS IDENTIFIED BY THE MARK  
! ARE CRITICAL FOR RISK OF FIRE AND  
ELECTRIC SHOCK. REPLACE ONLY WITH PART  
NUMBER SPECIFIED.

**<Notes>** <DD> : DTR-6.9 USA model  
<MA> : DTR-6.9 Australian model

**EXPLODED VIEW PARTS LIST**

REF. NO.	PART NAME	DESCRIPTION	Q'TY	PART NO(SN)	REMARKS
A001	CHASSIS	.	1	---	NSP
A003	SCREW	4TTC+8C(3BC)	4	830440089GR	
A004	SPACER	.	1	27270439	
A015	SCREW	3TTB+8B(3CM)SR	50	801637	
A019	SCREW	3TTB+8B(3BC)	55	838430088GR	
A027	LEG	.	4	27175419	
A028	CUSHION	(LEG)	4	28141660	
A031	CUSHION	(T10*A40*B10)	8	28141747	
A032	CUSHION	(BUTYL)	1	28141748	
A043	HEAT SINK	.	1	27160609A	
A047	SCREW	3SMS8W.SW+14B(CU)	14	801634	
A051	RETAINER	(HT-L7)	1	27142113	
A053	RETAINER	(HT-R7)	1	27142114	
A059	BRACKET	(FAN-S)	1	27131047	
A061	BUSHING	(FAN-S)	4	28170090	
A081	TAPE	TAPE(CLOTH-16U)	2	29110083	
A089	HOLDER	HOLDER KGLS-8S	5	27190480	
A091	HOLDER	KGLS-4S	1	27190009	
A093	HOLDER	KGPS-14RF	7	27190802	
A095	HOLDER	KGLS-14S	1	27190164	
A097	HOLDER	HOLDER KGLS-18S	4	27190470	
A101	HOLDER	KGLS-12RT	1	27190266	
A103	HOLDER	KGLS-10RT	1	27190428A	
A105	CLAMP	WS-2NS	1	27300833	
A107	RIVET	P-RIVET NRP-345	2	880009	
A108	RETAINER	(PC)	1	27142125	
A109	CUSHION	.	4	28141783	
A110	CUSHION	(PCB)	2	28141789	

A111	CUSHION	(BUTYL)	1	28141748	
A121	LABEL	(PT)	1	29364345	
A130	REAR PANEL	6.9MDD	1	27123828	<DD>
A130	REAR PANEL	6.9MMA	1	27123829A	<MA>
A131	LABEL	(SP)	1	29390382A	
A133	TAPE	TAPE(CLOTH-8U)	2	29110082	
A137	SCREW	3P+6FN(3BC)	5	82143006GR	
A139	SCREW	3P+6FN(3BC)	1	82143006GR	<DD>
A141	SCREW	4TTB+8C(3BC)	2	838440089GR	
A143	SCREW	3TTB+8B(3CM)SR	1	801637	<DD>
A149	WASHER	W3*10F(3BC)	1	87643010GR	
A161	COVER	(Bent)	1	28184997	
A161	COVER	(Not bent)	1	28184997Z	<DD>
A185	LABEL	(CAUTION)	1	29363796	
A193	LABEL	HOOKUP-INTEGRA	1	29363195	<DD>
A201	F BRACKET	.	1	27111427E	
A203	CUSHION	(T10*A40*B10)	1	28141747	
A204	CUSHION	.	1	28141637	
A209	BADGE	.	1	28135278	
A211	B PLATE	.	1	28133430	
A213	IB CUSHION	W15*3t TAPE	1	28141585	
A413	CUSHION	.	4	28141637	
A501	KNOB	(STANDBY)	1	28325756	
A503	KNOB	(VOL)AS	1	28326231A	
A507	RETAINER	(HP)	1	27141787	
A509	SNAP PLATE	SNAP PLATE	1	27301877	
A513	FACET	.	2	28198905	
A537	DECO FRM	DTR69	1	28159048	
A539	CLEAR PLT	(DTR69)	1	28192198	
A541	GUIDE	(VOL)	1	27268211	
A545	HOLDER	KGLS-4S	3	27190009	
A547	F PANEL	(MDD)	1	27213113A	<DD>
A547	F PANEL	(MMA)	1	27213114A	<MA>
A583	CUSHION	(T3*W35*D10)	2	28141741	
A585	CUSHION	t5*30*5	3	28141562	
F4000	FUSE	4A-UL/T-233	1	252325GR	!
F4000 or	FUSE	4A-T/UL-ST2	(1)	252257GR	!
F4001	FUSE	4A-UL/T-233	1	252325GR	!
F4001 or	FUSE	4A-T/UL-ST2	(1)	252257GR	!
F6901	FUSE	15A-TUL-250V	1	252303GR	!
F6902	FUSE	15A-TUL-250V	1	252303GR	!
F901	FUSE	10A-UL/T-233	1	252330GR	!, <DD>
F901 or	FUSE	10A-T/UL-ST2	(1)	252333GR	!, <DD>
F901	FUSE	5A-SE-EAK FUSE	1	252078GR	!, <MA>
F901 or	FUSE	5A-SE-TL250V	(1)	252278GR	!, <MA>

F901A	FUSELABEL	10A/125V	1	29362241	!, <DD>
F901A	LABEL	T5AL250V	1	29361938	!, <MA>
P1007	FFC	NCFC7-403522	1	2047403522	
P106	FFC	NCFC7-130522	1	2047130522	
P4102	FFC	NCFC7-172012	1	2047172012	
P4103	FFC	NCFC7-111012	1	2047111012	
P500	WIRE TIE	BSK-1	8	260208	
P6600A	P RIVET	JB-407A-C	18	880052	<MA>
P691	FAN	D05X-12TL	1	24502317	
P822	CLIP	CS-1U	1	27255004	
Q6050	TR	2SC5242-O	1	2202843	
Q6050 or	TR	2SC5242-R	(1)	2202842	
Q6050A	ISO SHEET	AC238	2	223024	
Q6050B	ISO SHEET	ISO SHEET	6	223041	
Q6051	TR	2SC5242-O	1	2202843	
Q6051 or	TR	2SC5242-R	(1)	2202842	
Q6052	TR	2SC5242-O	1	2202843	
Q6052 or	TR	2SC5242-R	(1)	2202842	
Q6053	TR	2SC5242-O	1	2202843	
Q6053 or	TR	2SC5242-R	(1)	2202842	
Q6054	TR	2SC5242-O	1	2202843	
Q6054 or	TR	2SC5242-R	(1)	2202842	
Q6055	TR	2SC5242-O	1	2202843	
Q6055 or	TR	2SC5242-R	(1)	2202842	
Q6056	TR	2SC5242-O	1	2202843	
Q6056 or	TR	2SC5242-R	(1)	2202842	
Q6060	TR	2SA1962-O	1	2202833	
Q6060 or	TR	2SA1962-R	(1)	2202832	
Q6061	TR	2SA1962-O	1	2202833	
Q6061 or	TR	2SA1962-R	(1)	2202832	
Q6062	TR	2SA1962-O	1	2202833	
Q6062 or	TR	2SA1962-R	(1)	2202832	
Q6063	TR	2SA1962-O	1	2202833	
Q6063 or	TR	2SA1962-R	(1)	2202832	
Q6064	TR	2SA1962-O	1	2202833	
Q6064 or	TR	2SA1962-R	(1)	2202832	
Q6065	TR	2SA1962-O	1	2202833	
Q6065 or	TR	2SA1962-R	(1)	2202832	
Q6066	TR	2SA1962-O	1	2202833	
Q6066 or	TR	2SA1962-R	(1)	2202832	

## &lt;Notes&gt;

When replacing the following the transistors, use ones of the same hfe rank as the original type.

Ref. No. : Q6050 - 6060, Q6051 - 6061, Q6052 - 6062, Q6053 - 6063, Q6054 - 6064, Q6055 - 6065, Q6056 - 6066

T901	P TRANS	NPT-1570D	1	2301931	!, <DD>
T901	P TRANS	NPT-1570M	1	2301932	!, <MA>

U01	AMPLIFIER PC board ass'y	NAAMP-9477-1F	1	1B209577-1F	
U02	THERMAL SENSOR PC board ass'y	NAETC-9478-1F	1	1B209578-1F	
U07	AMPLIFIER PC board ass'y	NAASP-9483-1F	1	1B209583-1F	
U08	SP TERMINAL PC board ass'y	NATRM-9488-1C	1	1B209588-1C	<DD>
		NATRM-9488-1B	1	1B209588-1B	<MA>
U09	SP TERMINAL PC board ass'y	NATRM-9489-1C	1	1B209589-1C	<DD>
		NATRM-9489-1B	1	1B209589-1B	<MA>
U10	POWER SUPPLY PC board ass'y	NAPS-9490-1C	1	1B209590-1C	<DD>
		NAPS-9490-1B	1	1B209590-1B	<MA>
U11	INLET PC board ass'y	NAETC-9491-1C	1	1B209591-1C	<DD>
		NAETC-9491-1B	1	1B209591-1B	<MA>
U13	AMPLIFIER PC board ass'y	NACLA-9493-1C	1	1B209593-1C	<DD>
		NACLA-9493-1B	1	1B209593-1B	<MA>
U15	HOLDER PC board ass'y	NAETC-9495-1C	1	---	NSP
		NAETC-9495-1B	1	---	NSP
U16	MICROPROCESSOR AND DAC PC board ass'y	NADG-9504-1F	1	1B209504-1F	<DD>
		NADG-9504-1G	1	1B209504-1G	<MA>
U17	VIDEO PC board ass'y	NAVD-9505-1F	1	1B209505-1F	<DD>
		NAVD-9505-1G	1	1B209505-1G	<MA>
U19	XM PC board ass'y	NARF-9507-1F	1	1B209507-1F	<DD>
		NARF-9507-1G	1	1B209507-1G	<MA>
U20	HDMI PC board ass'y	NAHDM-9562-1A	1	1B209562-1A	
U21	DISPLAY PC board ass'y	NADIS-9526-1A	1	1B209526-1A	
U22	VOLUME PC board ass'y	NAETC-9527-1A	1	1B209527-1A	
U23	HEADPHONE PC board ass'y	NAETC-9528-1A	1	1B209528-1A	
U24	TERMINAL PC board ass'y	NAETC-9529-1A	1	1B209529-1A	
U25	POWER SUPPLY PC board ass'y	NAPS-9530-1A	1	1B209530-1A	
U26	HOLDER PC board ass'y	NAETC-9531-1A	1	---	NSP
U27	HOLDER PC board ass'y	NAETC-9532-1A	1	---	NSP
U28	HOLDER PC board ass'y	NAETC-9533-1A	1	---	NSP
U011	TUNER UNIT	ENG06507QFUS	1	240156	<DD>
U011 or	TUNER UNIT	FAE385-A11US	(1)	240152	<DD>
U011	TUNER UNIT	FAE485-E11EU	1	240154	<MA>

DTR-6.9

**PC BOARD PARTS LIST**

- U01** AMPLIFIER PC BOARD(NAAMP-9477-1F)
- U02** THERMAL SENSOR PC BOARD(NAETC-9478-1F)
- U07** AMPLIFIER PC BOARD(NAASP-9483-1F)

CIRCUIT NO.	PART NAME	DESCRIPTION	Q'TY	PART NO. (SN)	REMARKS
Q5501	IC	R2A15215FP	1	22242516R3	
Q5502	IC	M61540FP	1	22242497R2	
Q5503	IC	NJM4580M-D	1	22241448R2	

Q5600	TR	RN1441	1	2215410R2
Q5601	TR	RN1441	1	2215410R2
Q5602	TR	RN1441	1	2215410R2
Q5603	TR	RN1441	1	2215410R2
Q5604	TR	RN1441	1	2215410R2
Q5605	TR	RN1441	1	2215410R2
Q5606	TR	RN1441	1	2215410R2
Q5607	TR	RN1441	1	2215410R2
Q5610	TR	RN1441	1	2215410R2
Q5611	TR	RN1441	1	2215410R2
Q5612	TR	RN1441	1	2215410R2
Q5613	TR	RN1441	1	2215410R2
Q5614	TR	RN1441	1	2215410R2
Q5615	TR	RN1441	1	2215410R2
Q5616	TR	RN1441	1	2215410R2
Q5617	TR	RN1441	1	2215410R2
Q5618	IC	NJM4580M-D	1	22241448R2
Q5630	IC	NJM4580M-D	1	22241448R2
Q5670	IC	78M15HF(NJM78M15FA)	1	222780155JRC
Q5670 or	IC	UPC78M15AHF-AZ	(1)	222780155NEC
Q5670A	HEAT SINK	RAD-196	1	27160545
Q5670B	SCREW	3P+10FN(3BC)	1	82143010GR
Q5671	IC	79M15HF(NJM79M15FA)	1	222790155JRC
Q5671 or	IC	UPC79M15HF-AZ	(1)	222790155NEC
Q5671 or	IC	79M15F(AN79M15F)	(1)	222790155MAT
Q5671B	SCREW	3P+10FN(3BC)	1	82143010GR
Q5684	TR	2SC2235-O(TPE6_F)	1	2211653T
Q5685	TR	2SA965-O(TPE6_F)	1	2211643T
Q5700	TR	RN1402	1	2214470R2
Q5701	TR	RN1402	1	2214470R2
Q5903	TR	RN1441	1	2215410R2
Q5904	TR	RN1441	1	2215410R2
Q6000	TR	2SC1740S-S	1	2213285T
Q6001	TR	2SC1740S-S	1	2213285T
Q6002	TR	2SC1740S-S	1	2213285T
Q6003	TR	2SC1740S-S	1	2213285T
Q6004	TR	2SC1740S-S	1	2213285T
Q6005	TR	2SC1740S-S	1	2213285T
Q6006	TR	2SC1740S-S	1	2213285T
Q6010	TR	2SC1740S-S	1	2213285T
Q6011	TR	2SC1740S-S	1	2213285T
Q6012	TR	2SC1740S-S	1	2213285T
Q6013	TR	2SC1740S-S	1	2213285T
Q6014	TR	2SC1740S-S	1	2213285T
Q6015	TR	2SC1740S-S	1	2213285T

Q6016	TR	2SC1740S-S	1	2213285T
Q6030	TR	2SC2229-Y(TPE6_F)	1	2211634T
Q6030 or	TR	2SC2229-O(TPE6_F)	(1)	2211633T
Q6031	TR	2SC2229-Y(TPE6_F)	1	2211634T
Q6031 or	TR	2SC2229-O(TPE6_F)	(1)	2211633T
Q6032	TR	2SC2229-Y(TPE6_F)	1	2211634T
Q6032 or	TR	2SC2229-O(TPE6_F)	(1)	2211633T
Q6033	TR	2SC2229-Y(TPE6_F)	1	2211634T
Q6033 or	TR	2SC2229-O(TPE6_F)	(1)	2211633T
Q6034	TR	2SC2229-Y(TPE6_F)	1	2211634T
Q6034 or	TR	2SC2229-O(TPE6_F)	(1)	2211633T
Q6035	TR	2SC2229-Y(TPE6_F)	1	2211634T
Q6035 or	TR	2SC2229-O(TPE6_F)	(1)	2211633T
Q6036	TR	2SC2229-Y(TPE6_F)	1	2211634T
Q6036 or	TR	2SC2229-O(TPE6_F)	(1)	2211633T
Q6040	TR	2SA949-O(TPE6_F)	1	2211353T
Q6040 or	TR	2SA949-Y(TPE6_F)	(1)	2211354T
Q6041	TR	2SA949-O(TPE6_F)	1	2211353T
Q6041 or	TR	2SA949-Y(TPE6_F)	(1)	2211354T
Q6042	TR	2SA949-O(TPE6_F)	1	2211353T
Q6042 or	TR	2SA949-Y(TPE6_F)	(1)	2211354T
Q6043	TR	2SA949-O(TPE6_F)	1	2211353T
Q6043 or	TR	2SA949-Y(TPE6_F)	(1)	2211354T
Q6044	TR	2SA949-O(TPE6_F)	1	2211353T
Q6044 or	TR	2SA949-Y(TPE6_F)	(1)	2211354T
Q6045	TR	2SA949-O(TPE6_F)	1	2211353T
Q6045 or	TR	2SA949-Y(TPE6_F)	(1)	2211354T
Q6046	TR	2SA949-O(TPE6_F)	1	2211353T
Q6046 or	TR	2SA949-Y(TPE6_F)	(1)	2211354T
Q6070	TR	2SC2229-O(TPE6_F)	1	2211633T
Q6070 or	TR	2SC2229-Y(TPE6_F)	(1)	2211634T
Q6071	TR	2SC2229-O(TPE6_F)	1	2211633T
Q6071 or	TR	2SC2229-Y(TPE6_F)	(1)	2211634T
Q6072	TR	2SC2229-O(TPE6_F)	1	2211633T
Q6072 or	TR	2SC2229-Y(TPE6_F)	(1)	2211634T
Q6073	TR	2SC2229-O(TPE6_F)	1	2211633T
Q6073 or	TR	2SC2229-Y(TPE6_F)	(1)	2211634T
Q6074	TR	2SC2229-O(TPE6_F)	1	2211633T
Q6074 or	TR	2SC2229-Y(TPE6_F)	(1)	2211634T
Q6075	TR	2SC2229-O(TPE6_F)	1	2211633T
Q6075 or	TR	2SC2229-Y(TPE6_F)	(1)	2211634T
Q6076	TR	2SC2229-O(TPE6_F)	1	2211633T
Q6076 or	TR	2SC2229-Y(TPE6_F)	(1)	2211634T
Q6100	TR	2SA1930(ONK_Q)	1	2203000
Q6100 or	TR	2SA2140-Q_P	(1)	2217151

Q6101	TR	2SA1930(ONK_Q)	1	2203000
Q6101 or	TR	2SA2140-Q_P	(1)	2217151
Q6102	TR	2SA1930(ONK_Q)	1	2203000
Q6102 or	TR	2SA2140-Q_P	(1)	2217151
Q6103	TR	2SA1930(ONK_Q)	1	2203000
Q6103 or	TR	2SA2140-Q_P	(1)	2217151
Q6104	TR	2SA1930(ONK_Q)	1	2203000
Q6104 or	TR	2SA2140-Q_P	(1)	2217151
Q6105	TR	2SA1930(ONK_Q)	1	2203000
Q6105 or	TR	2SA2140-Q_P	(1)	2217151
Q6106	TR	2SA1930(ONK_Q)	1	2203000
Q6106 or	TR	2SA2140-Q_P	(1)	2217151
Q6110	TR	2SC5171(ONK_Q)	1	2203010
Q6110 or	TR	2SC5993-Q_P	(1)	2217161
Q6111	TR	2SC5171(ONK_Q)	1	2203010
Q6111 or	TR	2SC5993-Q_P	(1)	2217161
Q6112	TR	2SC5171(ONK_Q)	1	2203010
Q6112 or	TR	2SC5993-Q_P	(1)	2217161
Q6113	TR	2SC5171(ONK_Q)	1	2203010
Q6113 or	TR	2SC5993-Q_P	(1)	2217161
Q6114	TR	2SC5171(ONK_Q)	1	2203010
Q6114 or	TR	2SC5993-Q_P	(1)	2217161
Q6115	TR	2SC5171(ONK_Q)	1	2203010
Q6115 or	TR	2SC5993-Q_P	(1)	2217161
Q6116	TR	2SC5171(ONK_Q)	1	2203010
Q6116 or	TR	2SC5993-Q_P	(1)	2217161
Q6380	IC	LM61CIZ	1	22242212
Q6380A	RETAINER	(PTH)	1	27141884-1
Q6701	TR	2SC2712-GR	1	2213145R2
Q6701 or	TR	KTC3875-GR	(1)	2216175R2
Q6702	TR	2SC2712-GR	1	2213145R2
Q6702 or	TR	KTC3875-GR	(1)	2216175R2
Q6703	TR	2SA1163-BL(TE85L_F)	1	2216756R2
Q6707	TR	2SC2712-GR	1	2213145R2
Q6707 or	TR	KTC3875-GR	(1)	2216175R2
Q6713	TR	2SA1163-BL(TE85L_F)	1	2216756R2
D5500	ZENER D	MTZJ7.5B	1	224470752T
D5501	ZENER D	MTZJ7.5B	1	224470752T
D5502	ZENER D	MTZJ3.6B	1	224470362T
D5505	C-DIODE	1SS352	1	223234R2
D5506	C-DIODE	1SS352	1	223234R2
D5507	C-DIODE	1SS352	1	223234R2
D5507 or	C-DIODE	KDS4148U	(1)	223283R2
D5507 or	C-DIODE	1SS355	(1)	223269R2
D5507 or	C-DIODE	MA2J110GL	(1)	223302R2

D5508	C-DIODE	1SS352	1	223234R2
D5508 or	C-DIODE	KDS4148U	(1)	223283R2
D5508 or	C-DIODE	1SS355	(1)	223269R2
D5508 or	C-DIODE	MA2J1110GL	(1)	223302R2
D5509	C-DIODE	1SS352	1	223234R2
D5509 or	C-DIODE	KDS4148U	(1)	223283R2
D5509 or	C-DIODE	1SS355	(1)	223269R2
D5509 or	C-DIODE	MA2J1110GL	(1)	223302R2
D5510	C-DIODE	1SS352	1	223234R2
D5510 or	C-DIODE	KDS4148U	(1)	223283R2
D5510 or	C-DIODE	1SS355	(1)	223269R2
D5510 or	C-DIODE	MA2J1110GL	(1)	223302R2
D5517	C-DIODE	1SS352	1	223234R2
D5517 or	C-DIODE	KDS4148U	(1)	223283R2
D5517 or	C-DIODE	1SS355	(1)	223269R2
D5517 or	C-DIODE	MA2J1110GL	(1)	223302R2
D5518	C-DIODE	1SS352	1	223234R2
D5518 or	C-DIODE	KDS4148U	(1)	223283R2
D5518 or	C-DIODE	1SS355	(1)	223269R2
D5518 or	C-DIODE	MA2J1110GL	(1)	223302R2
D5601	C-DIODE	S1NB60-4062	1	22380318R2
D6000	C-DIODE	1SS352	1	223234R2
D6000 or	C-DIODE	KDS4148U	(1)	223283R2
D6000 or	C-DIODE	1SS355	(1)	223269R2
D6000 or	C-DIODE	MA2J1110GL	(1)	223302R2
D6001	C-DIODE	1SS352	1	223234R2
D6001 or	C-DIODE	KDS4148U	(1)	223283R2
D6001 or	C-DIODE	1SS355	(1)	223269R2
D6001 or	C-DIODE	MA2J1110GL	(1)	223302R2
D6002	C-DIODE	1SS352	1	223234R2
D6002 or	C-DIODE	KDS4148U	(1)	223283R2
D6002 or	C-DIODE	1SS355	(1)	223269R2
D6002 or	C-DIODE	MA2J1110GL	(1)	223302R2
D6003	C-DIODE	1SS352	1	223234R2
D6003 or	C-DIODE	KDS4148U	(1)	223283R2
D6003 or	C-DIODE	1SS355	(1)	223269R2
D6003 or	C-DIODE	MA2J1110GL	(1)	223302R2
D6004	C-DIODE	1SS352	1	223234R2
D6004 or	C-DIODE	KDS4148U	(1)	223283R2
D6004 or	C-DIODE	1SS355	(1)	223269R2
D6004 or	C-DIODE	MA2J1110GL	(1)	223302R2
D6005	C-DIODE	1SS352	1	223234R2
D6005 or	C-DIODE	KDS4148U	(1)	223283R2
D6005 or	C-DIODE	1SS355	(1)	223269R2
D6005 or	C-DIODE	MA2J1110GL	(1)	223302R2



D6006	C-DIODE	ISS352	1	223234R2
D6006 or	C-DIODE	KDS4148U	(1)	223283R2
D6006 or	C-DIODE	ISS355	(1)	223269R2
D6006 or	C-DIODE	MA2J1110GL	(1)	223302R2
D6701	C-DIODE	ISS352	1	223234R2
D6701 or	C-DIODE	KDS4148U	(1)	223283R2
D6701 or	C-DIODE	ISS355	(1)	223269R2
D6701 or	C-DIODE	MA2J1110GL	(1)	223302R2
D6702	C-DIODE	ISS352	1	223234R2
D6702 or	C-DIODE	KDS4148U	(1)	223283R2
D6702 or	C-DIODE	ISS355	(1)	223269R2
D6702 or	C-DIODE	MA2J1110GL	(1)	223302R2
D6703	ZENER D	UDZS3.6B	1	224550360R2
D6704	ZENER D	UDZS3.6B	1	224550360R2
D6713	ZENER D	UDZS3.6B	1	224550360R2
D6901	DIODE	D10XB60H	1	22380337
D6901A	HEAT SINK	RAD-196	1	27160545
D6901B	TAPE	TAPE(CLOTH-8U)	1	29110082
D6901C	SCREW	3P+10FN(3BC)	2	82143010GR
D6902	C-DIODE	ISS352	1	223234R2
D6902 or	C-DIODE	KDS4148U	(1)	223283R2
D6902 or	C-DIODE	ISS355	(1)	223269R2
D6902 or	C-DIODE	MA2J1110GL	(1)	223302R2
D6903	DIODE	D10XB60H	1	22380337
L6000	FR CORE	*	1	5597-45502
L6001	FR CORE	*	1	5597-45502
L6002	FR CORE	*	1	5597-45502
L6003	FR CORE	*	1	5597-45502
L6004	FR CORE	*	1	5597-45502
L6005	FR CORE	*	1	5597-45502
L6006	FR CORE	*	1	5597-45502
L6010	FR CORE	*	1	5597-45502
L6011	FR CORE	*	1	5597-45502
L6012	FR CORE	*	1	5597-45502
L6013	FR CORE	*	1	5597-45502
L6014	FR CORE	*	1	5597-45502
L6015	FR CORE	*	1	5597-45502
L6016	FR CORE	*	1	5597-45502
C5501	C-CERA C	CC725CH1H-221J1	1	342102214R1
C5502	C-CERA C	CC725CH1H-221J1	1	342102214R1
C5503	TF C	ECQ-B50V-221K	1	374722215T
C5504	TF C	ECQ-B50V-221K	1	374722215T
C5507	C-CERA C	CC725CH1H-221J1	1	342102214R1
C5508	C-CERA C	CC725CH1H-221J1	1	342102214R1
C5509	C-CERA C	CC725CH1H-221J1	1	342102214R1

C5510	C-CERA C	CC725CH1H-221J1	1	342102214R1
C5511	C-CERA C	CC725CH1H-221J1	1	342102214R1
C5512	C-CERA C	CC725CH1H-221J1	1	342102214R1
C5515	C-CERA C	CC725CH1H-221J1	1	342102214R1
C5516	C-CERA C	CC725CH1H-221J1	1	342102214R1
C5517	UTSP C	CE04W10V-470M(UTSP)	1	397534717T
C5518	UTSP C	CE04W10V-470M(UTSP)	1	397534717T
C5519	TF C	ECQ-B50V-221K	1	374722215T
C5520	TF C	ECQ-B50V-221K	1	374722215T
C5521	TF C	ECQ-B50V-221K	1	374722215T
C5522	C-CERA C	CC725CH1H-221J1	1	342102214R1
C5523	C-CERA C	CC725CH1H-221J1	1	342102214R1
C5524	C-CERA C	CC725CH1H-221J1	1	342102214R1
C5525	C-CERA C	CC725CH1H-221J1	1	342102214R1
C5526	C-CERA C	CC725CH1H-221J1	1	342102214R1
C5527	C-CERA C	CC725CH1H-221J1	1	342102214R1
C5528	C-CERA C	CC725CH1H-221J1	1	342102214R1
C5529	C-CERA C	CC725CH1H-221J1	1	342102214R1
C5530	C-CERA C	CC725CH1H-221J1	1	342102214R1
C5531	C-CERA C	CC725CH1H-221J1	1	342102214R1
C5532	C-CERA C	CC725CH1H-221J1	1	342102214R1
C5533	C-CERA C	CC725CH1H-221J1	1	342102214R1
C5534	C-CERA C	CC725CH1H-221J1	1	342102214R1
C5535	UTSP C	CE04W25V-47M(UTSP)	1	397554707T
C5536	UTSP C	CE04W25V-47M(UTSP)	1	397554707T
C5537	UTSP C	CE04W25V-47M(UTSP)	1	397554707T
C5538	UTSP C	CE04W25V-47M(UTSP)	1	397554707T
C5540	UTSP C	CE04W50V-10M(UTSP)	1	397581007T
C5541	UTSP C	CE04W50V-10M(UTSP)	1	397581007T
C5542	UTSP C	CE04W50V-10M(UTSP)	1	397581007T
C5543	UTSP C	CE04W50V-10M(UTSP)	1	397581007T
C5548	C-CERA C	CK725F1E-104Z1	1	332161040R1
C5549	C-CERA C	CK725F1E-104Z1	1	332161040R1
C5550	C-CERA C	CK725B1H-152K1	1	332101525R1
C5551	C-CERA C	CK725B1H-152K1	1	332101525R1
C5555	UTSP C	CE04W25V-47M(UTSP)	1	397554707T
C5569	UTSP C	CE04W50V 47M(UTSP)	1	397584707T
C5570	UTSP C	CE04W50V 47M(UTSP)	1	397584707T
C5571	UTSP C	CE04W50V 47M(UTSP)	1	397584707T
C5572	UTSP C	CE04W50V 47M(UTSP)	1	397584707T
C5573	UTSP C	CE04W50V 47M(UTSP)	1	397584707T
C5574	UTSP C	CE04W50V 47M(UTSP)	1	397584707T
C5575	UTSP C	CE04W50V 47M(UTSP)	1	397584707T
C5576	UTSP C	CE04W50V 47M(UTSP)	1	397584707T
C5577	UTSP C	CE04W25V-47M(UTSP)	1	397554707T

C5578	UTSP C	CE04W25V-47M(UTSP)	1	397554707T
C5579	C-CERA C	CC725CH1H-102J1	1	342101024R1
C5580	UTSP C	CE04W10V-470M(UTSP)	1	397534717T
C5581	UTSP C	CE04W10V-470M(UTSP)	1	397534717T
C5582	C-CERA C	CC725CH1H-102J1	1	342101024R1
C5583	C-CERA C	CC725CH1H-102J1	1	342101024R1
C5584	UTSP C	CE04W25V-47M(UTSP)	1	397554707T
C5585	UTSP C	CE04W25V-47M(UTSP)	1	397554707T
C5586	UTSP C	CE04W10V-220M(UTSP)	1	397532217T
C5587	UTSP C	CE04W10V-220M(UTSP)	1	397532217T
C5588	TF C	ECQ-B50V-123J	1	374721234T
C5589	TF C	ECQ-B50V-123J	1	374721234T
C5590	C-CERA C	CC725CH1H-101J1	1	342101014R1
C5591	C-CERA C	CC725CH1H-101J1	1	342101014R1
C5592	TF C	ECQ-B50V-392J	1	374723924T
C5593	TF C	ECQ-B50V-392J	1	374723924T
C5594	C-CERA C	CC725CH1H-101J1	1	342101014R1
C5595	C-CERA C	CC725CH1H-101J1	1	342101014R1
C5596	UTSP C	CE04W50V-10M(UTSP)	1	397581007T
C5597	UTSP C	CE04W50V-10M(UTSP)	1	397581007T
C5598	C-CERA C	CC725CH1H-102J1	1	342101024R1
C5600	UTSP C	CE04W50V 47M(UTSP)	1	397584707T
C5601	UTSP C	CE04W50V 47M(UTSP)	1	397584707T
C5602	UTSP C	CE04W50V 47M(UTSP)	1	397584707T
C5603	UTSP C	CE04W50V 47M(UTSP)	1	397584707T
C5604	UTSP C	CE04W50V 47M(UTSP)	1	397584707T
C5605	UTSP C	CE04W50V 47M(UTSP)	1	397584707T
C5606	UTSP C	CE04W50V 47M(UTSP)	1	397584707T
C5607	UTSP C	CE04W50V 47M(UTSP)	1	397584707T
C5608	UTSP C	CE04W50V 47M(UTSP)	1	397584707T
C5609	UTSP C	CE04W50V 47M(UTSP)	1	397584707T
C5630	UTSP C	CE04W50V 47M(UTSP)	1	397584707T
C5631	C-CERA C	CC725CH1H-221J1	1	342102214R1
C5632	TF C	ECQ-B50V-103J	1	374721034T
C5660	MMT C	MMT50V-334J	1	375523344T
C5661	VR C	CE04W35V-470M(VR)	1	394664717T
C5662	VR C	CE04W35V-1000M(VR)	1	394661027S
C5666	UTSP C	CE04W25V-220M(UTSP)	1	397552217T
C5667	UTSP C	CE04W25V-220M(UTSP)	1	397552217T
C5670	UTSP C	CE04W50V 47M(UTSP)	1	397584707T
C5671	UTSP C	CE04W50V-220M(UTSP)	1	397582217T
C5672	UTSP C	CE04W50V-10M(UTSP)	1	397581007T
C5673	UTSP C	CE04W50V-10M(UTSP)	1	397581007T
C5674	UTSP C	CE04W10V-470M(UTSP)	1	397534717T
C5675	UTSP C	CE04W10V-470M(UTSP)	1	397534717T

C5677	UTSP C	CE04W25V-220M(UTSP)	1	397552217T
C5684	UTSP C	CE04W25V-220M(UTSP)	1	397552217T
C5685	UTSP C	CE04W25V-220M(UTSP)	1	397552217T
C5686	UTSP C	CE04W25V-220M(UTSP)	1	397552217T
C5687	UTSP C	CE04W25V-220M(UTSP)	1	397552217T
C5689	TF C	ECQ-V50V-333J	1	374723334T
C5690	TF C	ECQ-V50V-333J	1	374723334T
C5691	TF C	ECQ-V50V-473J	1	374724734T
C5692	TF C	ECQ-V50V-224J	1	374722244T
C5693	TF C	ECQ-V50V-473J	1	374724734T
C5694	TF C	ECQ-V50V-224J	1	374722244T
C5700	C-CERA C	CK725B1H-103K1	1	332101035R1
C5702	C-CERA C	CC725CH1H-102J1	1	342101024R1
C5705	C-CERA C	CC725CH1H-102J1	1	342101024R1
C5706	C-CERA C	CC725CH1H-102J1	1	342101024R1
C5707	C-CERA C	CC725CH1H-221J1	1	342102214R1
C5708	C-CERA C	CC725CH1H-221J1	1	342102214R1
C5711	C-CERA C	CK725B1H-103K1	1	332101035R1
C5905	UTSP C	CE04W50V 47M(UTSP)	1	397584707T
C5906	UTSP C	CE04W50V 47M(UTSP)	1	397584707T
C5907	C-CERA C	CC725CH1H-221J1	1	342102214R1
C5908	C-CERA C	CC725CH1H-221J1	1	342102214R1
C5909	C-CERA C	CC725CH1H-221J1	1	342102214R1
C6020	UTSP C	CE04W50V 47M(UTSP)	1	397584707T
C6021	UTSP C	CE04W50V 47M(UTSP)	1	397584707T
C6022	UTSP C	CE04W50V 47M(UTSP)	1	397584707T
C6023	UTSP C	CE04W50V 47M(UTSP)	1	397584707T
C6024	UTSP C	CE04W50V 47M(UTSP)	1	397584707T
C6025	UTSP C	CE04W50V 47M(UTSP)	1	397584707T
C6026	UTSP C	CE04W50V 47M(UTSP)	1	397584707T
C6050	TF C	ECQ-V50V-104J	1	374721044T
C6051	TF C	ECQ-V50V-104J	1	374721044T
C6052	TF C	ECQ-V50V-104J	1	374721044T
C6053	TF C	ECQ-V50V-104J	1	374721044T
C6054	TF C	ECQ-V50V-104J	1	374721044T
C6055	TF C	ECQ-V50V-104J	1	374721044T
C6056	TF C	ECQ-V50V-104J	1	374721044T
C6701	UTSP C	CE04W10V-220M(UTSP)	1	397532217T
C6703	C-CERA C	CK725F1H-104Z1	1	332151040R1
C6704	UTSP C	CE04W50V-1M(UTSP)	1	397580107T
C6706	UTSP C	CE04W50V-22M(UTSP)	1	397582207T
C6710	C-CERA C	CK725F1A-105Z1	1	332181050R1
C6713	C-CERA C	CK725F1H-104Z1	1	332151040R1
C6714	UTSP C	CE04W50V-2.2M(UTSP)	1	397580227T
C6901	ELECT C	CE69W71V-12000M	1	3504460A

C6902	ELECT C	CE69W71V-12000M	1	3504460A
C6911	C-CERA C	CC725CH1H-102J1	1	342101024R1
C6912	TF C	ECQ-V100-334J	1	374733344T
C6913	TF C	ECQ-V100-334J	1	374733344T
C6915	TF C	ECQ-V50V-104J	1	374721044T
C6916	TF C	ECQ-V50V-104J	1	374721044T
R5501	C-CARBON R	RN72K1J-331JE	1	435033314R1
R5502	C-CARBON R	RN72K1J-331JE	1	435033314R1
R5503	C-CARBON R	RN72K1J-331JE	1	435033314R1
R5504	C-CARBON R	RN72K1J-331JE	1	435033314R1
R5505	C-CARBON R	RN72K1J-331JE	1	435033314R1
R5506	C-CARBON R	RN72K1J-331JE	1	435033314R1
R5507	C-CARBON R	RN72K1J-331JE	1	435033314R1
R5508	C-CARBON R	RN72K1J-331JE	1	435033314R1
R5509	C-CARBON R	RN72K1J-331JE	1	435033314R1
R5510	C-CARBON R	RN72K1J-331JE	1	435033314R1
R5511	C-CARBON R	RN72K1J-331JE	1	435033314R1
R5512	C-CARBON R	RN72K1J-331JE	1	435033314R1
R5513	C-CARBON R	RN72K1J-331JE	1	435033314R1
R5514	C-CARBON R	RN72K1J-331JE	1	435033314R1
R5515	C-CARBON R	RN72K1J-331JE	1	435033314R1
R5516	C-CARBON R	RN72K1J-331JE	1	435033314R1
R5517	METAL O R	RS1WBJ-10	1	443621004T
R5518	METAL O R	RS1WBJ-10	1	443621004T
R5519	C-CARBON R	RN72K1J-331JE	1	435033314R1
R5520	C-CARBON R	RN72K1J-331JE	1	435033314R1
R5521	C-CARBON R	RN72K1J-331JE	1	435033314R1
R5522	C-CARBON R	RN72K1J-331JE	1	435033314R1
R5523	C-CARBON R	RN72K1J-331JE	1	435033314R1
R5524	C-CARBON R	RN72K1J-331JE	1	435033314R1
R5525	C-CARBON R	RN72K1J-331JE	1	435033314R1
R5526	C-CARBON R	RN72K1J-331JE	1	435033314R1
R5527	C-CARBON R	RN72K1J-101JE	1	435031014R1
R5528	C-CARBON R	RN72K1J-101JE	1	435031014R1
R5529	C-CARBON R	RN72K1J-101JE	1	435031014R1
R5530	C-CARBON R	RN72K1J-101JE	1	435031014R1
R5531	C-CARBON R	RN72K1J-101JE	1	435031014R1
R5532	C-CARBON R	RN72K1J-101JE	1	435031014R1
R5533	C-CARBON R	RN72K1J-101JE	1	435031014R1
R5534	C-CARBON R	RN72K1J-101JE	1	435031014R1
R5536	C-CARBON R	RN72K1J-473JE	1	435034734R1
R5537	C-CARBON R	RN72K1J-473JE	1	435034734R1
R5538	C-CARBON R	RN72K1J-103JE	1	435031034R1
R5539	C-CARBON R	RN72K1J-103JE	1	435031034R1
R5541	C-CARBON R	RN72K1J-224JE	1	435032244R1

R5542	C-CARBON R	RN72K1J-224JE	1	435032244R1
R5543	C-CARBON R	RN72K1J-224JE	1	435032244R1
R5544	C-CARBON R	RN72K1J-224JE	1	435032244R1
R5545	C-CARBON R	RN72K1J-224JE	1	435032244R1
R5546	C-CARBON R	RN72K1J-224JE	1	435032244R1
R5547	C-CARBON R	RN72K1J-224JE	1	435032244R1
R5548	C-CARBON R	RN72K1J-224JE	1	435032244R1
R5549	C-CARBON R	RN72K1J-224JE	1	435032244R1
R5550	C-CARBON R	RN72K1J-224JE	1	435032244R1
R5551	C-CARBON R	RN72K1J-224JE	1	435032244R1
R5552	C-CARBON R	RN72K1J-224JE	1	435032244R1
R5553	C-CARBON R	RN72K1J-224JE	1	435032244R1
R5554	C-CARBON R	RN72K1J-224JE	1	435032244R1
R5555	C-CARBON R	RN72K1J-224JE	1	435032244R1
R5556	C-CARBON R	RN72K1J-224JE	1	435032244R1
R5557	C-CARBON R	RN72K1J-224JE	1	435032244R1
R5558	C-CARBON R	RN72K1J-224JE	1	435032244R1
R5559	C-CARBON R	RN72K1J-224JE	1	435032244R1
R5560	C-CARBON R	RN72K1J-224JE	1	435032244R1
R5561	C-CARBON R	RN72K1J-224JE	1	435032244R1
R5562	C-CARBON R	RN72K1J-224JE	1	435032244R1
R5563	C-CARBON R	RN72K1J-224JE	1	435032244R1
R5564	C-CARBON R	RN72K1J-224JE	1	435032244R1
R5565	C-CARBON R	RN72K1J-224JE	1	435032244R1
R5566	C-CARBON R	RN72K1J-224JE	1	435032244R1
R5567	C-CARBON R	RN72K1J-224JE	1	435032244R1
R5568	C-CARBON R	RN72K1J-223JE	1	435032234R1
R5569	C-CARBON R	RN72K1J-224JE	1	435032244R1
R5570	C-CARBON R	RN72K1J-224JE	1	435032244R1
R5571	C-CARBON R	RN72K1J-224JE	1	435032244R1
R5572	C-CARBON R	RN72K1J-224JE	1	435032244R1
R5573	C-CARBON R	RN72K1J-224JE	1	435032244R1
R5574	C-CARBON R	RN72K1J-224JE	1	435032244R1
R5575	C-CARBON R	RN72K1J-224JE	1	435032244R1
R5576	C-CARBON R	RN72K1J-224JE	1	435032244R1
R5577	C-CARBON R	RN72K1J-223JE	1	435032234R1
R5578	C-CARBON R	RN72K1J-223JE	1	435032234R1
R5580	C-CARBON R	RN72K1J-224JE	1	435032244R1
R5581	C-CARBON R	RN72K1J-224JE	1	435032244R1
R5582	C-CARBON R	RN72K1J-224JE	1	435032244R1
R5583	C-CARBON R	RN72K1J-224JE	1	435032244R1
R5587	C-CARBON R	RN72K1J-103JE	1	435031034R1
R5588	C-CARBON R	RN72K1J-103JE	1	435031034R1
R5590	C-CARBON R	RN72K1J-103JE	1	435031034R1
R5591	C-CARBON R	RN72K1J-103JE	1	435031034R1

R5592	C-CARBON R	RN72K1J-152JE	1	435031524R1
R5593	C-CARBON R	RN72K1J-152JE	1	435031524R1
R5594	C-CARBON R	RN72K1J-560JE	1	435035604R1
R5595	C-CARBON R	RN72K1J-560JE	1	435035604R1
R5596	C-CARBON R	RN72K1J-103JE	1	435031034R1
R5597	C-CARBON R	RN72K1J-103JE	1	435031034R1
R5598	C-CARBON R	RN72K1J-103JE	1	435031034R1
R5599	C-CARBON R	RN72K1J-103JE	1	435031034R1
R5600	C-CARBON R	RN72K1J-224JE	1	435032244R1
R5601	C-CARBON R	RN72K1J-224JE	1	435032244R1
R5602	C-CARBON R	RN72K1J-224JE	1	435032244R1
R5603	C-CARBON R	RN72K1J-224JE	1	435032244R1
R5604	C-CARBON R	RN72K1J-224JE	1	435032244R1
R5605	C-CARBON R	RN72K1J-224JE	1	435032244R1
R5606	C-CARBON R	RN72K1J-224JE	1	435032244R1
R5607	C-CARBON R	RN72K1J-224JE	1	435032244R1
R5608	C-CARBON R	RN72K1J-224JE	1	435032244R1
R5609	C-CARBON R	RN72K1J-224JE	1	435032244R1
R5610	C-CARBON R	RN72K1J-271JE	1	435032714R1
R5611	C-CARBON R	RN72K1J-271JE	1	435032714R1
R5612	C-CARBON R	RN72K1J-271JE	1	435032714R1
R5613	C-CARBON R	RN72K1J-271JE	1	435032714R1
R5614	C-CARBON R	RN72K1J-271JE	1	435032714R1
R5615	C-CARBON R	RN72K1J-271JE	1	435032714R1
R5616	C-CARBON R	RN72K1J-271JE	1	435032714R1
R5617	C-CARBON R	RN72K1J-271JE	1	435032714R1
R5618	C-CARBON R	RN72K1J-000JE	1	435030004R1
R5619	C-CARBON R	RN72K1J-000JE	1	435030004R1
R5620	C-CARBON R	RN72K1J-101JE	1	435031014R1
R5621	C-CARBON R	RN72K1J-101JE	1	435031014R1
R5622	C-CARBON R	RN72K1J-101JE	1	435031014R1
R5623	C-CARBON R	RN72K1J-101JE	1	435031014R1
R5624	C-CARBON R	RN72K1J-101JE	1	435031014R1
R5625	C-CARBON R	RN72K1J-101JE	1	435031014R1
R5626	C-CARBON R	RN72K1J-101JE	1	435031014R1
R5627	C-CARBON R	RN72K1J-101JE	1	435031014R1
R5628	METAL O R	RS1WBJ-100	1	443621014T
R5630	C-CARBON R	RN72K1J-221JE	1	435032214R1
R5631	C-CARBON R	RN72K1J-473JE	1	435034734R1
R5632	C-CARBON R	RN72K1J-153JE	1	435031534R1
R5633	C-CARBON R	RN72K1J-122JE	1	435031224R1
R5634	C-CARBON R	RN72K1J-103JE	1	435031034R1
R5635	C-CARBON R	RN72K1J-471JE	1	435034714R1
R5636	C-CARBON R	RN72K1J-471JE	1	435034714R1
R5637	METAL O R	RS1/2WBJ-10	1	443521004T

R5638	METAL O R	RS1/2WBJ-10	1	443521004T
R5639	C-CARBON R	RN72K1J-331JE	1	435033314R1
R5640	C-CARBON R	RN72K1J-331JE	1	435033314R1
R5641	C-CARBON R	RN72K1J-563JE	1	435035634R1
R5642	C-CARBON R	RN72K1J-563JE	1	435035634R1
R5643	C-CARBON R	RN72K1J-474JE	1	435034744R1
R5644	C-CARBON R	RN72K1J-474JE	1	435034744R1
R5645	C-CARBON R	RN72K1J-561JE	1	435035614R1
R5646	C-CARBON R	RN72K1J-561JE	1	435035614R1
R5647	C-CARBON R	RN72K1J-274JE	1	435032744R1
R5648	C-CARBON R	RN72K1J-274JE	1	435032744R1
R5649	C-CARBON R	RN72K1J-223JE	1	435032234R1
R5650	C-CARBON R	RN72K1J-223JE	1	435032234R1
R5651	C-CARBON R	RN72K1J-122JE	1	435031224R1
R5652	C-CARBON R	RN72K1J-122JE	1	435031224R1
R5653	C-CARBON R	RN72K1J-101JE	1	435031014R1
R5654	C-CARBON R	RN72K1J-101JE	1	435031014R1
R5655	C-CARBON R	RN72K1J-224JE	1	435032244R1
R5656	C-CARBON R	RN72K1J-224JE	1	435032244R1
R5657	C-CARBON R	RN72K1J-224JE	1	435032244R1
R5660	METAL R	RNU1WCJ-1.5	1	453630154T
R5661	METAL R	RNU1WCJ-1.5	1	453630154T
R5662	METAL R	RNU2WCJ-2.2	1	452730224F
R5665	METAL R	RNU2WCJ-2.2	1	452730224F
R5666	CARBON R	R16J-22	1	417342204T
R5667	CARBON R	R16J-22	1	417342204T
R5668	METAL O R	RS1WBJ-100	1	443621014T
R5669	C-CARBON R	RN72K1J-224JE	1	435032244R1
R5670	METAL R	RNU2WCJ-2.2	1	452730224F
R5671	METAL R	RNU2WCJ-2.2	1	452730224F
R5672	C-CARBON R	RN72K1J-100JE	1	435031004R1
R5673	C-CARBON R	RN72K1J-100JE	1	435031004R1
R5674	METAL O R	RS1WBJ-470	1	443624714T
R5675	METAL O R	RS1WBJ-22	1	443622204T
R5676	METAL O R	RS1WBJ-22	1	443622204T
R5677	METAL O R	RS1WBJ-22	1	443622204T
R5678	METAL O R	RS1WBJ-22	1	443622204T
R5679	CARBON R	R16J-680	1	417346814T
R5685	CARBON R	R16J-680	1	417346814T
R5690	C-CARBON R	RN72K1J-224JE	1	435032244R1
R5691	C-CARBON R	RN72K1J-224JE	1	435032244R1
R5692	C-CARBON R	RN72K1J-104JE	1	435031044R1
R5693	C-CARBON R	RN72K1J-472JE	1	435034724R1
R5694	C-CARBON R	RN72K1J-472JE	1	435034724R1
R5700	C-CARBON R	RN72K1J-000JE	1	435030004R1



R5701	C-CARBON R	RN72K1J-000JE	1	435030004R1
R5704	C-CARBON R	RN72K1J-000JE	1	435030004R1
R5705	C-CARBON R	RN72K1J-000JE	1	435030004R1
R5711	C-CARBON R	RN72K1J-224JE	1	435032244R1
R5712	C-CARBON R	RN72K1J-224JE	1	435032244R1
R5714	C-CARBON R	RN72K1J-224JE	1	435032244R1
R5715	C-CARBON R	RN72K1J-224JE	1	435032244R1
R5716	C-CARBON R	RN72K1J-224JE	1	435032244R1
R5813	C-CARBON R	RN72K1J-000JE	1	435030004R1
R5824	C-CARBON R	RN72K1J-000JE	1	435030004R1
R5909	C-CARBON R	RN72K1J-224JE	1	435032244R1
R5910	C-CARBON R	RN72K1J-224JE	1	435032244R1
R5911	C-CARBON R	RN72K1J-102JE	1	435031024R1
R5912	C-CARBON R	RN72K1J-102JE	1	435031024R1
R5913	C-CARBON R	RN72K1J-101JE	1	435031014R1
R5914	C-CARBON R	RN72K1J-101JE	1	435031014R1
R5915	C-CARBON R	RN72K1J-224JE	1	435032244R1
R5916	C-CARBON R	RN72K1J-224JE	1	435032244R1
R5917	C-CARBON R	RN72K1J-101JE	1	435031014R1
R5918	C-CARBON R	RN72K1J-101JE	1	435031014R1
R5950	C-CARBON R	RN72K1J-000JE	1	435030004R1
R5951	C-CARBON R	RN72K1J-000JE	1	435030004R1
R5952	C-CARBON R	RN72K1J-000JE	1	435030004R1
R5953	C-CARBON R	RN72K1J-000JE	1	435030004R1
R5954	C-CARBON R	RN72K1J-000JE	1	435030004R1
R5955	C-CARBON R	RN72K1J-000JE	1	435030004R1
R5956	C-CARBON R	RN72K1J-000JE	1	435030004R1
R6000	CARBON R	R16J-4.7K	1	417344724T
R6001	CARBON R	R16J-4.7K	1	417344724T
R6002	CARBON R	R16J-4.7K	1	417344724T
R6003	CARBON R	R16J-4.7K	1	417344724T
R6004	CARBON R	R16J-4.7K	1	417344724T
R6005	CARBON R	R16J-4.7K	1	417344724T
R6006	CARBON R	R16J-4.7K	1	417344724T
R6010	CARBON R	R16J-3.3K	1	417343324T
R6011	CARBON R	R16J-3.3K	1	417343324T
R6012	CARBON R	R16J-3.3K	1	417343324T
R6013	CARBON R	R16J-3.3K	1	417343324T
R6014	CARBON R	R16J-3.3K	1	417343324T
R6015	CARBON R	R16J-3.3K	1	417343324T
R6016	CARBON R	R16J-3.3K	1	417343324T
R6030	CARBON R	R16J-2.2K	1	417342224T
R6031	CARBON R	R16J-2.2K	1	417342224T
R6032	CARBON R	R16J-2.2K	1	417342224T
R6033	CARBON R	R16J-2.2K	1	417342224T

R6034	CARBON R	R16J-2.2K	1	417342224T
R6035	CARBON R	R16J-2.2K	1	417342224T
R6036	CARBON R	R16J-2.2K	1	417342224T
R6040	TRIM R	N06HR2KBC	1	5210390T
R6041	TRIM R	N06HR2KBC	1	5210390T
R6042	TRIM R	N06HR2KBC	1	5210390T
R6043	TRIM R	N06HR2KBC	1	5210390T
R6044	TRIM R	N06HR2KBC	1	5210390T
R6045	TRIM R	N06HR2KBC	1	5210390T
R6046	TRIM R	N06HR2KBC	1	5210390T
R6050	CARBON R	R16J-2.7K	1	417342724T
R6051	CARBON R	R16J-2.7K	1	417342724T
R6052	CARBON R	R16J-2.7K	1	417342724T
R6053	CARBON R	R16J-2.7K	1	417342724T
R6054	CARBON R	R16J-2.7K	1	417342724T
R6055	CARBON R	R16J-2.7K	1	417342724T
R6056	CARBON R	R16J-2.7K	1	417342724T
R6070	NF CARBON R	R25J-82	1	415478204T
R6071	NF CARBON R	R25J-82	1	415478204T
R6072	NF CARBON R	R25J-82	1	415478204T
R6073	NF CARBON R	R25J-82	1	415478204T
R6074	NF CARBON R	R25J-82	1	415478204T
R6075	NF CARBON R	R25J-82	1	415478204T
R6076	NF CARBON R	R25J-82	1	415478204T
R6080	CARBON R	R16J-10	1	417341004T
R6081	CARBON R	R16J-10	1	417341004T
R6082	CARBON R	R16J-10	1	417341004T
R6083	CARBON R	R16J-10	1	417341004T
R6084	CARBON R	R16J-10	1	417341004T
R6085	CARBON R	R16J-10	1	417341004T
R6086	CARBON R	R16J-10	1	417341004T
R6090	CARBON R	R16J-10	1	417341004T
R6091	CARBON R	R16J-10	1	417341004T
R6092	CARBON R	R16J-10	1	417341004T
R6093	CARBON R	R16J-10	1	417341004T
R6094	CARBON R	R16J-10	1	417341004T
R6095	CARBON R	R16J-10	1	417341004T
R6096	CARBON R	R16J-10	1	417341004T
R6100	METAL PR	MPR5W+5W 0R22	1	4000233
R6100 or	METAL PR	RGC55 0.22	(1)	4000132
R6101	METAL PR	MPR5W+5W 0R22	1	4000233
R6101 or	METAL PR	RGC55 0.22	(1)	4000132
R6102	METAL PR	MPR5W+5W 0R22	1	4000233
R6102 or	METAL PR	RGC55 0.22	(1)	4000132
R6103	METAL PR	MPR5W+5W 0R22	1	4000233

R6103 or	METAL PR	RGC55 0.22	(1)	4000132
R6104	METAL PR	MPR5W+5W 0R22	1	4000233
R6104 or	METAL PR	RGC55 0.22	(1)	4000132
R6105	METAL PR	MPR5W+5W 0R22	1	4000233
R6105 or	METAL PR	RGC55 0.22	(1)	4000132
R6106	METAL PR	MPR5W+5W 0R22	1	4000233
R6106 or	METAL PR	RGC55 0.22	(1)	4000132
R6140	C-CARBON R	RN72K1J-563JE	1	435035634R1
R6141	C-CARBON R	RN72K1J-563JE	1	435035634R1
R6142	C-CARBON R	RN72K1J-563JE	1	435035634R1
R6143	C-CARBON R	RN72K1J-563JE	1	435035634R1
R6144	C-CARBON R	RN72K1J-563JE	1	435035634R1
R6145	C-CARBON R	RN72K1J-563JE	1	435035634R1
R6146	C-CARBON R	RN72K1J-563JE	1	435035634R1
R6150	C-CARBON R	RN72K1J-103JE	1	435031034R1
R6151	C-CARBON R	RN72K1J-103JE	1	435031034R1
R6152	C-CARBON R	RN72K1J-103JE	1	435031034R1
R6153	C-CARBON R	RN72K1J-103JE	1	435031034R1
R6154	C-CARBON R	RN72K1J-103JE	1	435031034R1
R6155	C-CARBON R	RN72K1J-103JE	1	435031034R1
R6156	C-CARBON R	RN72K1J-103JE	1	435031034R1
R6160	CARBON R	R16J-33K	1	417343334T
R6161	CARBON R	R16J-33K	1	417343334T
R6162	CARBON R	R16J-33K	1	417343334T
R6163	CARBON R	R16J-33K	1	417343334T
R6164	CARBON R	R16J-33K	1	417343334T
R6165	CARBON R	R16J-33K	1	417343334T
R6166	CARBON R	R16J-33K	1	417343334T
R6170	CARBON R	R16J-47K	1	417344734T
R6171	CARBON R	R16J-47K	1	417344734T
R6172	CARBON R	R16J-47K	1	417344734T
R6173	CARBON R	R16J-47K	1	417344734T
R6174	CARBON R	R16J-47K	1	417344734T
R6175	CARBON R	R16J-47K	1	417344734T
R6176	CARBON R	R16J-47K	1	417344734T
R6180	CARBON R	R16J-47K	1	417344734T
R6181	CARBON R	R16J-47K	1	417344734T
R6182	CARBON R	R16J-47K	1	417344734T
R6183	CARBON R	R16J-47K	1	417344734T
R6184	CARBON R	R16J-47K	1	417344734T
R6185	CARBON R	R16J-47K	1	417344734T
R6186	CARBON R	R16J-47K	1	417344734T
R6197	METAL O R	RS1/2WBJ-33	1	443523304T
R6250	NF CARBON R	R25J-120	1	415471214T
R6251	NF CARBON R	R25J-120	1	415471214T

R6252	NF CARBON R	R25J-120	1	415471214T
R6253	NF CARBON R	R25J-120	1	415471214T
R6254	NF CARBON R	R25J-120	1	415471214T
R6255	NF CARBON R	R25J-120	1	415471214T
R6256	NF CARBON R	R25J-120	1	415471214T
R6260	NF CARBON R	R25J-120	1	415471214T
R6261	NF CARBON R	R25J-120	1	415471214T
R6262	NF CARBON R	R25J-120	1	415471214T
R6263	NF CARBON R	R25J-120	1	415471214T
R6264	NF CARBON R	R25J-120	1	415471214T
R6265	NF CARBON R	R25J-120	1	415471214T
R6266	NF CARBON R	R25J-120	1	415471214T
R6270	NF CARBON R	R25J-18	1	415471804T
R6271	NF CARBON R	R25J-18	1	415471804T
R6272	NF CARBON R	R25J-18	1	415471804T
R6273	NF CARBON R	R25J-18	1	415471804T
R6274	NF CARBON R	R25J-18	1	415471804T
R6275	NF CARBON R	R25J-18	1	415471804T
R6276	NF CARBON R	R25J-18	1	415471804T
R6280	NF CARBON R	R25J-18	1	415471804T
R6281	NF CARBON R	R25J-18	1	415471804T
R6282	NF CARBON R	R25J-18	1	415471804T
R6283	NF CARBON R	R25J-18	1	415471804T
R6284	NF CARBON R	R25J-18	1	415471804T
R6285	NF CARBON R	R25J-18	1	415471804T
R6286	NF CARBON R	R25J-18	1	415471804T
R6290	NF CARBON R	R25J-2.2	1	415470224T
R6291	NF CARBON R	R25J-2.2	1	415470224T
R6292	NF CARBON R	R25J-2.2	1	415470224T
R6293	NF CARBON R	R25J-2.2	1	415470224T
R6294	NF CARBON R	R25J-2.2	1	415470224T
R6295	NF CARBON R	R25J-2.2	1	415470224T
R6296	NF CARBON R	R25J-2.2	1	415470224T
R6300	NF CARBON R	R25J-2.2	1	415470224T
R6301	NF CARBON R	R25J-2.2	1	415470224T
R6302	NF CARBON R	R25J-2.2	1	415470224T
R6303	NF CARBON R	R25J-2.2	1	415470224T
R6304	NF CARBON R	R25J-2.2	1	415470224T
R6305	NF CARBON R	R25J-2.2	1	415470224T
R6306	NF CARBON R	R25J-2.2	1	415470224T
R6310	NF CARBON R	R25J-10	1	415471004T
R6311	NF CARBON R	R25J-10	1	415471004T
R6312	NF CARBON R	R25J-10	1	415471004T
R6313	NF CARBON R	R25J-10	1	415471004T
R6314	NF CARBON R	R25J-10	1	415471004T

R6315	NF CARBON R	R25J-10	1	415471004T	
R6316	NF CARBON R	R25J-10	1	415471004T	
R6701	C-CARBON R	RN72K1J-223JE	1	435032234R1	
R6702	C-CARBON R	RN72K1J-103JE	1	435031034R1	
R6704	C-CARBON R	RN72K1J-473JE	1	435034734R1	
R6706	C-CARBON R	RN72K1J-224JE	1	435032244R1	
R6708	C-CARBON R	RN72K1J-333JE	1	435033334R1	
R6709	C-CARBON R	RN72K1J-392JE	1	435033924R1	
R6710	C-CARBON R	RN72K1J-123JE	1	435031234R1	
R6712	C-CARBON R	RN72K1J-103JE	1	435031034R1	
R6714	C-CARBON R	RN72K1J-333JE	1	435033334R1	
R6716	C-CARBON R	RN72K1J-563JE	1	435035634R1	
R6902	C-CARBON R	RN72K1J-102JE	1	435031024R1	
R6903	C-CARBON R	RN72K1J-473JE	1	435034734R1	
E5507A	TRM	NTM-1P232(M1700)	1	25060301	
E5509A	TRM	NTM-1P232(M1700)	1	25060301	
E5519	TRM(SCREW)	NEJITANSI M3	1	25065425	
F6901A	FUSE HOLDER	SN5051	1	250113	!
F6901B	FUSE HOLDER	SN5051	1	250113	!
F6902A	FUSE HOLDER	SN5051	1	250113	!
F6902B	FUSE HOLDER	SN5051	1	250113	!
J5664	PVC	UL1430#24 BLK	1	72910250505	
JL5514A	WIRE HOL	NSCT-7P898	1	25051111	
JL5514B	SOCKET	NSCT-7P99	1	25050271	
JL6402A	WIRE HOL	NSCT-3P874	1	25051087	
JL6402B	WIRE HOL	NSCT-3P874	1	25051087	
JL6600A	WIRE HOL	NSCT-7P898	1	25051111	
JL6603A	WIRE HOL	NSCT-9P900	1	25051113	
JL6606B	WIRE TRAP	NPLG-7P590	1	25055628	
JL6620A	WIRE HOL	NSCT-7P878	1	25051091	
P104B	SOCKET	NSCT-13P2193	1	25052296	
P5500	PIN JACK	NPJ-2PDBL249	1	25045424	
P5501	PIN JACK	NPJ-4PDRW393	1	25045582	
P5502	PIN JACK	NPJ-4PDRW393	1	25045582	
P5503	PIN JACK	NPJ-6PDBL380	1	25045565	
P5504	PIN JACK	NPJ-4PDGPRW659	1	25045888	
P5505	PIN JACK	NPJ-4PDELNT660	1	25045889	
P5506	PIN JACK	NPJ-4PDGPRW659	1	25045888	
P5507	PIN JACK	NPJ-4PDELNT660	1	25045889	
P5508	PIN JACK	NPJ-2PDBL249	1	25045424	
P5510A	SOCKET AS	NSAS-26P1742	1	2009991118UL	
P5510B	PLUG	NPLG-13P360	1	25055377	
P5510C	CRIMP AS	CRIMP SR805_2	1	20799170UL	
P5510D	CRIMP AS	CRIMP SR805_1	1	20799169UL	
P5512	SOCKET	NSCT-11P2191	1	25052294	

P5513	SOCKET	NSCT-15P2195	1	25052298	
P5518	SOCKET	NSCT-3P2183	1	25052286	
P5521	HOLDER	HOLDER(CLAMP)	1	27190540-1	
P5522	HOLDER	HOLDER(CLAMP)	1	27190540-1	
P5523	HOLDER	HOLDER(CLAMP)	1	27190540-1	
P6000B	PLUG	NPLG-7P0962	1	25056012	
P6001B	PLUG	NPLG-7P0962	1	25056012	
P6002B	PLUG	NPLG-7P0962	1	25056012	
P6003B	PLUG	NPLG-7P0962	1	25056012	
P6004B	PLUG	NPLG-7P0962	1	25056012	
P6005B	PLUG	NPLG-7P0962	1	25056012	
P6006B	PLUG	NPLG-7P0962	1	25056012	
P6011A	RETAINER	(BUS-D)	1	27142115A	
P6020	HOLDER	HOLDER(CLAMP)	1	27190540-1	
P6080	PLUG	NPLG-2P130	1	25055146	
P6081	PLUG	NPLG-2P130	1	25055146	
P6082	PLUG	NPLG-2P130	1	25055146	
P6083	PLUG	NPLG-2P130	1	25055146	
P6084	PLUG	NPLG-2P130	1	25055146	
P6085	PLUG	NPLG-2P130	1	25055146	
P6086	PLUG	NPLG-2P130	1	25055146	
P6900	CRIMP AS	CRIMP AS	1	2069925170UL	
P6901	CRIMP AS	CRIMP AS	1	2069925142UL	
P6902	CRIMP AS	CRIMP AS	1	2069925208UL	
P6950	PLUG	NPLG-5P152	1	25055168	
RL5700	RELAY	NRL-2P2A-DC24-174	1	25065659	
RL5701	RELAY	NRL-2P2A-DC24-174	1	25065659	
RL6901	RELAY	NRL-1P10A-DC12-140	1	25065584	
RL6902	RELAY	NRL-1P10A-DC12-140	1	25065584	

<b>U08</b>	<b>SP TERMINAL PC BOARD(NATRM-9488-1B/1C)</b>
<b>U09</b>	<b>SP TERMINAL PC BOARD(NATRM-9489-1B/1C)</b>
<b>U10</b>	<b>POWER SUPPLY PC BOARD(NAPS-9490-1B/1C)</b>
<b>U11</b>	<b>INLET PC BOARD(NAETC-9491-1B/1C)</b>
<b>U13</b>	<b>AMPLIFIER PC BOARD(NACLA-9493-1B/1C)</b>

CIRCUIT NO.	PART NAME	DESCRIPTION	Q'TY	PART NO. (SN)	REMARKS
Q5000	TR	2SC2240-BL(TPE2_F)	1	2211406T	
Q5001	TR	2SC2240-BL(TPE2_F)	1	2211406T	
Q5002	TR	2SC2240-BL(TPE2_F)	1	2211406T	
Q5003	TR	2SC2240-BL(TPE2_F)	1	2211406T	
Q5004	TR	2SC2240-BL(TPE2_F)	1	2211406T	
Q5005	TR	2SC2240-BL(TPE2_F)	1	2211406T	
Q5006	TR	2SC2240-BL(TPE2_F)	1	2211406T	
Q5010	TR	2SC2240-BL(TPE2_F)	1	2211406T	

Q5011	TR	2SC2240-BL(TPE2_F)	1	2211406T
Q5012	TR	2SC2240-BL(TPE2_F)	1	2211406T
Q5013	TR	2SC2240-BL(TPE2_F)	1	2211406T
Q5014	TR	2SC2240-BL(TPE2_F)	1	2211406T
Q5015	TR	2SC2240-BL(TPE2_F)	1	2211406T
Q5016	TR	2SC2240-BL(TPE2_F)	1	2211406T
Q5030	TR	2SA949-Y(TPE6_F)	1	2211354T
Q5031	TR	2SA949-Y(TPE6_F)	1	2211354T
Q5032	TR	2SA949-Y(TPE6_F)	1	2211354T
Q5033	TR	2SA949-Y(TPE6_F)	1	2211354T
Q5034	TR	2SA949-Y(TPE6_F)	1	2211354T
Q5035	TR	2SA949-Y(TPE6_F)	1	2211354T
Q5036	TR	2SA949-Y(TPE6_F)	1	2211354T
Q5040	TR	2SA949-Y(TPE6_F)	1	2211354T
Q5041	TR	2SA949-Y(TPE6_F)	1	2211354T
Q5042	TR	2SA949-Y(TPE6_F)	1	2211354T
Q5043	TR	2SA949-Y(TPE6_F)	1	2211354T
Q5044	TR	2SA949-Y(TPE6_F)	1	2211354T
Q5045	TR	2SA949-Y(TPE6_F)	1	2211354T
Q5046	TR	2SA949-Y(TPE6_F)	1	2211354T
Q5050	TR	2SC2240-BL(TPE2_F)	1	2211406T
Q5050 or	TR	2SC2240-GR	(1)	2211405T
Q5051	TR	2SC2240-BL(TPE2_F)	1	2211406T
Q5051 or	TR	2SC2240-GR	(1)	2211405T
Q5052	TR	2SC2240-BL(TPE2_F)	1	2211406T
Q5052 or	TR	2SC2240-GR	(1)	2211405T
Q5053	TR	2SC2240-BL(TPE2_F)	1	2211406T
Q5053 or	TR	2SC2240-GR	(1)	2211405T
Q5054	TR	2SC2240-BL(TPE2_F)	1	2211406T
Q5054 or	TR	2SC2240-GR	(1)	2211405T
Q5055	TR	2SC2240-BL(TPE2_F)	1	2211406T
Q5055 or	TR	2SC2240-GR	(1)	2211405T
Q5056	TR	2SC2240-BL(TPE2_F)	1	2211406T
Q5056 or	TR	2SC2240-GR	(1)	2211405T
Q5060	TR	2SA949-Y(TPE6_F)	1	2211354T
Q5061	TR	2SA949-Y(TPE6_F)	1	2211354T
Q5062	TR	2SA949-Y(TPE6_F)	1	2211354T
Q5063	TR	2SA949-Y(TPE6_F)	1	2211354T
Q5064	TR	2SA949-Y(TPE6_F)	1	2211354T
Q5065	TR	2SA949-Y(TPE6_F)	1	2211354T
Q5066	TR	2SA949-Y(TPE6_F)	1	2211354T
Q5070	TR	2SC2229-Y(TPE6_F)	1	2211634T
Q5071	TR	2SC2229-Y(TPE6_F)	1	2211634T
Q5072	TR	2SC2229-Y(TPE6_F)	1	2211634T
Q5073	TR	2SC2229-Y(TPE6_F)	1	2211634T

Q5074	TR	2SC2229-Y(TPE6_F)	1	2211634T	
Q5075	TR	2SC2229-Y(TPE6_F)	1	2211634T	
Q5076	TR	2SC2229-Y(TPE6_F)	1	2211634T	
Q6601	TR	RN1226	1	2214680T	
Q6602	TR	RN1226	1	2214680T	
Q6603	TR	RN1226	1	2214680T	
Q6604	TR	RN1226	1	2214680T	
D5000	ZENER D	MTZJ5.6B	1	224470562T	
D5001	ZENER D	MTZJ5.6B	1	224470562T	
D5002	ZENER D	MTZJ5.6B	1	224470562T	
D5003	ZENER D	MTZJ5.6B	1	224470562T	
D5004	ZENER D	MTZJ5.6B	1	224470562T	
D5005	ZENER D	MTZJ5.6B	1	224470562T	
D5006	ZENER D	MTZJ5.6B	1	224470562T	
D6600	DIODE	ISS133	1	223163T	
D6603	DIODE	ISS133	1	223163T	
D6605	DIODE	ISS133	1	223163T	
D6607	DIODE	ISS133	1	223163T	
D911	DIODE	ISS133	1	223163T	
D912	DIODE	ISS133	1	223163T	
D921	DIODE	ISS133	1	223163T	
D922	DIODE	ISS133	1	223163T	
D923	DIODE	ISS133	1	223163T	
D924	DIODE	ISS133	1	223163T	
D925	DIODE	ISS133	1	223163T	
D930	DIODE	ISS133	1	223163T	
D931	DIODE	ISS133	1	223163T	
D933	DIODE	ISS133	1	223163T	
D934	ZENER D	MTZJ3.6B	1	224470362T	
D935	DIODE	ISS133	1	223163T	
L6600	S COIL	S-1.3C	1	231176S	
L6601	S COIL	S-1.3C	1	231176S	
L6602	S COIL	S-1.3C	1	231176S	
L6603	S COIL	S-1.3C	1	231176S	
L6604	S COIL	S-1.3C	1	231176S	
L6605	S COIL	S-1.3C	1	231176S	
L6606	S COIL	S-1.3C	1	231176S	
T902	P TRANS	NPT-1520JQ	1	2301812A	!, <DD>
T902	P TRANS	NPT-1520GQ	1	2301813A	!, <MA>
C5000	TF C	ECQ-B50V-101K	1	374721015T	
C5001	TF C	ECQ-B50V-101K	1	374721015T	
C5002	TF C	ECQ-B50V-101K	1	374721015T	
C5003	TF C	ECQ-B50V-101K	1	374721015T	
C5004	TF C	ECQ-B50V-101K	1	374721015T	
C5005	TF C	ECQ-B50V-101K	1	374721015T	



C5006	TF C	ECQ-B50V-101K	1	374721015T
C5010	UTSJ C	CE04W25V-47M(UTSJ)	1	398054707T
C5011	UTSJ C	CE04W25V-47M(UTSJ)	1	398054707T
C5012	UTSJ C	CE04W25V-47M(UTSJ)	1	398054707T
C5013	UTSJ C	CE04W25V-47M(UTSJ)	1	398054707T
C5014	UTSJ C	CE04W25V-47M(UTSJ)	1	398054707T
C5015	UTSJ C	CE04W25V-47M(UTSJ)	1	398054707T
C5016	UTSJ C	CE04W25V-47M(UTSJ)	1	398054707T
C5020	UTSP C	CE04W50V-10M(UTSP)	1	397581007T
C5021	UTSP C	CE04W50V-10M(UTSP)	1	397581007T
C5022	UTSP C	CE04W50V-10M(UTSP)	1	397581007T
C5023	UTSP C	CE04W50V-10M(UTSP)	1	397581007T
C5024	UTSP C	CE04W50V-10M(UTSP)	1	397581007T
C5025	UTSP C	CE04W50V-10M(UTSP)	1	397581007T
C5026	UTSP C	CE04W50V-10M(UTSP)	1	397581007T
C5040	UTSP C	CE04W10V-470M(UTSP)	1	397534717T
C5041	UTSP C	CE04W10V-470M(UTSP)	1	397534717T
C5042	UTSP C	CE04W10V-470M(UTSP)	1	397534717T
C5043	UTSP C	CE04W10V-470M(UTSP)	1	397534717T
C5044	UTSP C	CE04W10V-470M(UTSP)	1	397534717T
C5045	UTSP C	CE04W10V-470M(UTSP)	1	397534717T
C5046	UTSP C	CE04W10V-470M(UTSP)	1	397534717T
C5050	UTSP C	CE04W50V 47M(UTSP)	1	397584707T
C5051	UTSP C	CE04W50V 47M(UTSP)	1	397584707T
C5052	UTSP C	CE04W50V 47M(UTSP)	1	397584707T
C5053	UTSP C	CE04W50V 47M(UTSP)	1	397584707T
C5054	UTSP C	CE04W50V 47M(UTSP)	1	397584707T
C5055	UTSP C	CE04W50V 47M(UTSP)	1	397584707T
C5056	UTSP C	CE04W50V 47M(UTSP)	1	397584707T
C5080	CERA C	CC45SL50V-040C	1	345020401T
C5081	CERA C	CC45SL50V-040C	1	345020401T
C5082	CERA C	CC45SL50V-040C	1	345020401T
C5083	CERA C	CC45SL50V-040C	1	345020401T
C5084	CERA C	CC45SL50V-040C	1	345020401T
C5085	CERA C	CC45SL50V-040C	1	345020401T
C5086	CERA C	CC45SL50V-040C	1	345020401T
C5090	TF C	ECQ-B50V-101K	1	374721015T
C5091	TF C	ECQ-B50V-101K	1	374721015T
C5092	TF C	ECQ-B50V-101K	1	374721015T
C5093	TF C	ECQ-B50V-101K	1	374721015T
C5094	TF C	ECQ-B50V-101K	1	374721015T
C5095	TF C	ECQ-B50V-101K	1	374721015T
C5096	TF C	ECQ-B50V-101K	1	374721015T
C5100	VR C	CE04W100V-22M(VR)	1	394692207T
C5101	VR C	CE04W100V-22M(VR)	1	394692207T

C5102	VR C	CE04W100V-22M(VR)	1	394692207T	
C5103	VR C	CE04W100V-22M(VR)	1	394692207T	
C5104	VR C	CE04W100V-22M(VR)	1	394692207T	
C5105	VR C	CE04W100V-22M(VR)	1	394692207T	
C5106	VR C	CE04W100V-22M(VR)	1	394692207T	
C5110	VR C	CE04W100V-22M(VR)	1	394692207T	
C5111	VR C	CE04W100V-22M(VR)	1	394692207T	
C5112	VR C	CE04W100V-22M(VR)	1	394692207T	
C5113	VR C	CE04W100V-22M(VR)	1	394692207T	
C5114	VR C	CE04W100V-22M(VR)	1	394692207T	
C5115	VR C	CE04W100V-22M(VR)	1	394692207T	
C5116	VR C	CE04W100V-22M(VR)	1	394692207T	
C6600	TF C	ECQ-B50V-103J	1	374721034T	
C6602	TF C	ECQ-B50V-103J	1	374721034T	
C6603	TF C	ECQ-B50V-103J	1	374721034T	
C6605	TF C	ECQ-B50V-103J	1	374721034T	
C6607	TF C	ECQ-B50V-103J	1	374721034T	
C6630	TF C	ECQ-V50V-473J	1	374724734T	
C6631	TF C	ECQ-V50V-473J	1	374724734T	
C6632	TF C	ECQ-V50V-473J	1	374724734T	
C6633	TF C	ECQ-V50V-473J	1	374724734T	
C6634	TF C	ECQ-V50V-473J	1	374724734T	
C6635	TF C	ECQ-V50V-473J	1	374724734T	
C6636	TF C	ECQ-V50V-473J	1	374724734T	
C6640	TF C	ECQ-B50V-472J	1	374724724T	<MA>
C6641	TF C	ECQ-B50V-472J	1	374724724T	<MA>
C6642	TF C	ECQ-B50V-472J	1	374724724T	<MA>
C6643	TF C	ECQ-B50V-472J	1	374724724T	<MA>
C6644	TF C	ECQ-B50V-472J	1	374724724T	<MA>
C6645	TF C	ECQ-B50V-472J	1	374724724T	<MA>
C6646	TF C	ECQ-B50V-472J	1	374724724T	<MA>
C6647	TF C	ECQ-B50V-472J	1	374724724T	<MA>
C6648	TF C	ECQ-B50V-472J	1	374724724T	<MA>
C6650	TF C	ECQ-B50V-102J	1	374721024T	
C6651	TF C	ECQ-B50V-102J	1	374721024T	
C6652	TF C	ECQ-B50V-102J	1	374721024T	
C6653	TF C	ECQ-B50V-102J	1	374721024T	
C6654	TF C	ECQ-B50V-102J	1	374721024T	
C6655	TF C	ECQ-B50V-102J	1	374721024T	
C6656	TF C	ECQ-B50V-102J	1	374721024T	
C6657	TF C	ECQ-B50V-102J	1	374721024T	
C6658	TF C	ECQ-B50V-102J	1	374721024T	
C901	IS C	ECQU2A103MLC	1	3800039S	!
C901 or	IS C	RE275V-103M	(1)	3500196S	!
C901 or	IS C	LE103-C3.5	(1)	3800042S	!

C902	TF C	ECQ-V50V-104J	1	374721044T	
C903	PLA C	MKP R46 104M	1	3800041S	!
C911	TF C	ECQ-B50V-102J	1	374721024T	
C921	TF C	ECQ-B50V-223J	1	374722234T	
C922	VR C	CE04W25V-2200M(VR)	1	394652227S	
C930	UTSP C	CE04W25V-100M(UTSP)	1	397551017T	
C933	UTSP C	CE04W50V-4.7M(UTSP)	1	397580477T	
R5000	CARBON R	R16J-1.5K	1	417341524T	
R5001	CARBON R	R16J-1.5K	1	417341524T	
R5002	CARBON R	R16J-1.5K	1	417341524T	
R5003	CARBON R	R16J-1.5K	1	417341524T	
R5004	CARBON R	R16J-1.5K	1	417341524T	
R5005	CARBON R	R16J-1.5K	1	417341524T	
R5006	CARBON R	R16J-1.5K	1	417341524T	
R5010	CARBON R	R16J-33K	1	417343334T	
R5011	CARBON R	R16J-33K	1	417343334T	
R5012	CARBON R	R16J-33K	1	417343334T	
R5013	CARBON R	R16J-33K	1	417343334T	
R5014	CARBON R	R16J-33K	1	417343334T	
R5015	CARBON R	R16J-33K	1	417343334T	
R5016	CARBON R	R16J-33K	1	417343334T	
R5020	CARBON R	R16J-330	1	417343314T	
R5021	CARBON R	R16J-330	1	417343314T	
R5022	CARBON R	R16J-330	1	417343314T	
R5023	CARBON R	R16J-330	1	417343314T	
R5024	CARBON R	R16J-330	1	417343314T	
R5025	CARBON R	R16J-330	1	417343314T	
R5026	CARBON R	R16J-330	1	417343314T	
R5030	CARBON R	R16J-33K	1	417343334T	
R5031	CARBON R	R16J-33K	1	417343334T	
R5032	CARBON R	R16J-33K	1	417343334T	
R5033	CARBON R	R16J-33K	1	417343334T	
R5034	CARBON R	R16J-33K	1	417343334T	
R5035	CARBON R	R16J-33K	1	417343334T	
R5036	CARBON R	R16J-33K	1	417343334T	
R5040	CARBON R	R16J-1K	1	417341024T	
R5041	CARBON R	R16J-1K	1	417341024T	
R5042	CARBON R	R16J-1K	1	417341024T	
R5043	CARBON R	R16J-1K	1	417341024T	
R5044	CARBON R	R16J-1K	1	417341024T	
R5045	CARBON R	R16J-1K	1	417341024T	
R5046	CARBON R	R16J-1K	1	417341024T	
R5050	CARBON R	R16J-5.6K	1	417345624T	
R5051	CARBON R	R16J-5.6K	1	417345624T	
R5052	CARBON R	R16J-5.6K	1	417345624T	

R5053	CARBON R	R16J-5.6K	1	417345624T
R5054	CARBON R	R16J-5.6K	1	417345624T
R5055	CARBON R	R16J-5.6K	1	417345624T
R5056	CARBON R	R16J-5.6K	1	417345624T
R5060	CARBON R	R16J-2.7K	1	417342724T
R5061	CARBON R	R16J-2.7K	1	417342724T
R5062	CARBON R	R16J-2.7K	1	417342724T
R5063	CARBON R	R16J-2.7K	1	417342724T
R5064	CARBON R	R16J-2.7K	1	417342724T
R5065	CARBON R	R16J-2.7K	1	417342724T
R5066	CARBON R	R16J-2.7K	1	417342724T
R5080	NF CARBON R	R25J-1.0K	1	415471024T
R5081	NF CARBON R	R25J-1.0K	1	415471024T
R5082	NF CARBON R	R25J-1.0K	1	415471024T
R5083	NF CARBON R	R25J-1.0K	1	415471024T
R5084	NF CARBON R	R25J-1.0K	1	415471024T
R5085	NF CARBON R	R25J-1.0K	1	415471024T
R5086	NF CARBON R	R25J-1.0K	1	415471024T
R5090	CARBON R	R16J-100K	1	417341044T
R5091	CARBON R	R16J-100K	1	417341044T
R5092	CARBON R	R16J-100K	1	417341044T
R5093	CARBON R	R16J-100K	1	417341044T
R5094	CARBON R	R16J-100K	1	417341044T
R5095	CARBON R	R16J-100K	1	417341044T
R5096	CARBON R	R16J-100K	1	417341044T
R5100	CARBON R	R16J-100K	1	417341044T
R5101	CARBON R	R16J-100K	1	417341044T
R5102	CARBON R	R16J-100K	1	417341044T
R5103	CARBON R	R16J-100K	1	417341044T
R5104	CARBON R	R16J-100K	1	417341044T
R5105	CARBON R	R16J-100K	1	417341044T
R5106	CARBON R	R16J-100K	1	417341044T
R5110	CARBON R	R16J-2.2K	1	417342224T
R5111	CARBON R	R16J-2.2K	1	417342224T
R5112	CARBON R	R16J-2.2K	1	417342224T
R5113	CARBON R	R16J-2.2K	1	417342224T
R5114	CARBON R	R16J-2.2K	1	417342224T
R5115	CARBON R	R16J-2.2K	1	417342224T
R5116	CARBON R	R16J-2.2K	1	417342224T
R5120	CARBON R	R16J-2.2K	1	417342224T
R5121	CARBON R	R16J-2.2K	1	417342224T
R5122	CARBON R	R16J-2.2K	1	417342224T
R5123	CARBON R	R16J-2.2K	1	417342224T
R5124	CARBON R	R16J-2.2K	1	417342224T
R5125	CARBON R	R16J-2.2K	1	417342224T

R5126	CARBON R	R16J-2.2K	1	417342224T
R5130	CARBON R	R16J-18K	1	417341834T
R5131	CARBON R	R16J-18K	1	417341834T
R5132	CARBON R	R16J-18K	1	417341834T
R5133	CARBON R	R16J-18K	1	417341834T
R5134	CARBON R	R16J-18K	1	417341834T
R5135	CARBON R	R16J-18K	1	417341834T
R5136	CARBON R	R16J-18K	1	417341834T
R5140	NF CARBON R	R25J-820	1	415478214T
R5141	NF CARBON R	R25J-820	1	415478214T
R5142	NF CARBON R	R25J-820	1	415478214T
R5143	NF CARBON R	R25J-820	1	415478214T
R5144	NF CARBON R	R25J-820	1	415478214T
R5145	NF CARBON R	R25J-820	1	415478214T
R5146	NF CARBON R	R25J-820	1	415478214T
R5150	NF CARBON R	R25J-1.0K	1	415471024T
R5151	NF CARBON R	R25J-1.0K	1	415471024T
R5152	NF CARBON R	R25J-1.0K	1	415471024T
R5153	NF CARBON R	R25J-1.0K	1	415471024T
R5154	NF CARBON R	R25J-1.0K	1	415471024T
R5155	NF CARBON R	R25J-1.0K	1	415471024T
R5156	NF CARBON R	R25J-1.0K	1	415471024T
R5160	NF CARBON R	R25J-820	1	415478214T
R5161	NF CARBON R	R25J-820	1	415478214T
R5162	NF CARBON R	R25J-820	1	415478214T
R5163	NF CARBON R	R25J-820	1	415478214T
R5164	NF CARBON R	R25J-820	1	415478214T
R5165	NF CARBON R	R25J-820	1	415478214T
R5166	NF CARBON R	R25J-820	1	415478214T
R5170	NF CARBON R	R25J-820	1	415478214T
R5171	NF CARBON R	R25J-820	1	415478214T
R5172	NF CARBON R	R25J-820	1	415478214T
R5173	NF CARBON R	R25J-820	1	415478214T
R5174	NF CARBON R	R25J-820	1	415478214T
R5175	NF CARBON R	R25J-820	1	415478214T
R5176	NF CARBON R	R25J-820	1	415478214T
R5180	NF CARBON R	R25J-10	1	415471004T
R5181	NF CARBON R	R25J-10	1	415471004T
R5182	NF CARBON R	R25J-10	1	415471004T
R5183	NF CARBON R	R25J-10	1	415471004T
R5184	NF CARBON R	R25J-10	1	415471004T
R5185	NF CARBON R	R25J-10	1	415471004T
R5186	NF CARBON R	R25J-10	1	415471004T
R5190	NF CARBON R	R25J-10	1	415471004T
R5191	NF CARBON R	R25J-10	1	415471004T

R5192	NF CARBON R	R25J-10	1	415471004T
R5193	NF CARBON R	R25J-10	1	415471004T
R5194	NF CARBON R	R25J-10	1	415471004T
R5195	NF CARBON R	R25J-10	1	415471004T
R5196	NF CARBON R	R25J-10	1	415471004T
R5200	CARBON R	R16J-18K	1	417341834T
R5201	CARBON R	R16J-18K	1	417341834T
R5202	CARBON R	R16J-18K	1	417341834T
R5203	CARBON R	R16J-18K	1	417341834T
R5204	CARBON R	R16J-18K	1	417341834T
R5205	CARBON R	R16J-18K	1	417341834T
R5206	CARBON R	R16J-18K	1	417341834T
R5210	NF CARBON R	R25J-120	1	415471214T
R5211	NF CARBON R	R25J-120	1	415471214T
R5212	NF CARBON R	R25J-120	1	415471214T
R5213	NF CARBON R	R25J-120	1	415471214T
R5214	NF CARBON R	R25J-120	1	415471214T
R5215	NF CARBON R	R25J-120	1	415471214T
R5216	NF CARBON R	R25J-120	1	415471214T
R5220	NF CARBON R	R25J-120	1	415471214T
R5221	NF CARBON R	R25J-120	1	415471214T
R5222	NF CARBON R	R25J-120	1	415471214T
R5223	NF CARBON R	R25J-120	1	415471214T
R5224	NF CARBON R	R25J-120	1	415471214T
R5225	NF CARBON R	R25J-120	1	415471214T
R5226	NF CARBON R	R25J-120	1	415471214T
R5300	CARBON R	R16J-330	1	417343314T
R5301	CARBON R	R16J-330	1	417343314T
R5302	CARBON R	R16J-330	1	417343314T
R5303	CARBON R	R16J-330	1	417343314T
R5304	CARBON R	R16J-330	1	417343314T
R5305	CARBON R	R16J-330	1	417343314T
R5306	CARBON R	R16J-330	1	417343314T
R5310	CARBON R	R16J-330	1	417343314T
R5311	CARBON R	R16J-330	1	417343314T
R5312	CARBON R	R16J-330	1	417343314T
R5313	CARBON R	R16J-330	1	417343314T
R5314	CARBON R	R16J-330	1	417343314T
R5315	CARBON R	R16J-330	1	417343314T
R5316	CARBON R	R16J-330	1	417343314T
R6600	CARBON R	R16J-22	1	417342204T
R6601	CARBON R	R16J-22	1	417342204T
R6602	CARBON R	R16J-22	1	417342204T
R6603	CARBON R	R16J-22	1	417342204T
R6604	CARBON R	R16J-22	1	417342204T

R6605	CARBON R	R16J-22	1	417342204T	
R6606	CARBON R	R16J-22	1	417342204T	
R6610	CARBON R	R16J-22	1	417342204T	
R6611	CARBON R	R16J-22	1	417342204T	
R6612	CARBON R	R16J-22	1	417342204T	
R6613	CARBON R	R16J-22	1	417342204T	
R6614	CARBON R	R16J-22	1	417342204T	
R6615	CARBON R	R16J-22	1	417342204T	
R6616	CARBON R	R16J-22	1	417342204T	
R6630	METAL R	RNU1WCJ-8.2	1	453630824T	
R6631	METAL R	RNU1WCJ-8.2	1	453630824T	
R6632	METAL R	RNU1WCJ-8.2	1	453630824T	
R6633	METAL R	RNU1WCJ-8.2	1	453630824T	
R6634	METAL R	RNU1WCJ-8.2	1	453630824T	
R6635	METAL R	RNU1WCJ-8.2	1	453630824T	
R6636	METAL R	RNU1WCJ-8.2	1	453630824T	
R6690	METAL R	RNU1WCJ-8.2	1	453630824T	
R6691	METAL O R	RS1/2WBJ-390	1	443523914T	
R6692	METAL O R	RS1/2WBJ-390	1	443523914T	
R921	METAL O R	RS1/2WBJ-82	1	443528204T	<DD>
R921	METAL O R	RS1/2WBJ-47	1	443524704T	<MA>
R922	METAL O R	RS1/2WBJ-47	1	443524704T	<DD>
R922	METAL O R	RS1/2WBJ-82	1	443528204T	<MA>
R934	CARBON R	R16J-33K	1	417343334T	
E5507B	TRM	NTM-1P233(M1969)	1	25060302	
E5509B	TRM	NTM-1P233(M1969)	1	25060302	
E7601	TRM(SCREW)	NEJITANSI M3	1	25065425	
E901	TRM(SCREW)	NEJITANSI M3	1	25065425	
E902	TRM(SCREW)	NEJITANSI M3	1	25065425	
F901C	FUSE HOL	NSCT-1P2031	1	25052133T	
F901D	FUSE HOL	NSCT-1P2031	1	25052133T	
JL4103A	SOCKET	NSCT-5P97	1	25050269	
JL6600B	SOCKET	NSCT-7P99	1	25050271	
JL6603B	SOCKET	NSCT-9P101	1	25050273	
JL6604A	WIRE HOL	NSCT-7P878	1	25051091	
JL6604B	WIRE HOL	NSCT-7P878	1	25051091	
JL6606A	WIRE HOL	NSCT-7P878	1	25051091	
JL6620B	WIRE TRAP	NPLG-7P590	1	25055628	
JL901A	WIRE HOL	NSCT-5P876	1	25051089	
P6000A	SOCKET	NSCT-7P2187	1	25052290	
P6001A	SOCKET	NSCT-7P2187	1	25052290	
P6002A	SOCKET	NSCT-7P2187	1	25052290	
P6003A	SOCKET	NSCT-7P2187	1	25052290	
P6004A	SOCKET	NSCT-7P2187	1	25052290	
P6005	SOCKET	NSCT-7P2187	1	25052290	

P6006	SOCKET	NSCT-7P2187	1	25052290	
P6600	TRM	NTM-2PDMCR400	1	25060472	
P6601	TRM	NTM-2PDMCR400	1	25060472	
P6602	TRM	NTM-2PDMCR400	1	25060472	
P6603	TRM	NTM-2PDMCR400	1	25060472	
P6604	TRM	NTM-2PDMCR400	1	25060472	
P6605	TRM	NTM-2PDMCR400	1	25060472	
P6606	TRM	NTM-2PDMCR400	1	25060472	
P6607	TRM	NTM-2PDMCR400	1	25060472	
P6608	TRM	NTM-2PDMCR400	1	25060472	
P6621	PLUG	NPLG-13P0968	1	25056018	
P907	AC INLET	NPLG-2P913	1	25055960	
P911	PLUG	NPLG-2P631	1	25055675	
P911 or	PLUG	1-1123724-2	(1)	25056402	
P921	CRIMP AS	CRIMP AS	1	206CC45109UL	
P922	CRIMP AS	CRIMP AS	1	206CC45101UL	
RL6600	RELAY	NRL-2P5A-DC24-158	1	25065618	
RL6600 or	RELAY	NRL-2P5A-DC24-193	(1)	25065703	
RL6602	RELAY	NRL-2P5A-DC24-158	1	25065618	
RL6602 or	RELAY	NRL-2P5A-DC24-193	(1)	25065703	
RL6603	RELAY	NRL-2P5A-DC24-158	1	25065618	
RL6603 or	RELAY	NRL-2P5A-DC24-193	(1)	25065703	
RL6605	RELAY	NRL-2P5A-DC24-158	1	25065618	
RL6605 or	RELAY	NRL-2P5A-DC24-193	(1)	25065703	
RL6607	RELAY	NRL-2P5A-DC24-158	1	25065618	
RL6607 or	RELAY	NRL-2P5A-DC24-193	(1)	25065703	
RL901	RELAY	NRL-1P10A-DC9-186	1	25065683	

- U16** MICROPROCESSOR AND DAC PC BOARD(NADG-9504-1F/1G)
- U17** VIDEO PC BOARD(NAVD-9505-1F/1G)
- U19** XM PC BOARD(NARF-9507-1F/1G)

CIRCUIT NO.	PART NAME	DESCRIPTION	Q'TY	PART NO. (SN)	REMARKS
U1301	PHT CP	JSR1165-001recieving	1	24120143	
U1301 or	PHT CP	GP1FAV51RK0F	(1)	24120129	
U1302	PHT CP	JSR1165-001recieving	1	24120143	
U1302 or	PHT CP	GP1FAV51RK0F	(1)	24120129	
U1303	PHT CP	JST1165-001transmitting	1	24120142	
U1303 or	PHT CP	GP1FAV51TKBF	(1)	24120132	
Q1	IC	BD7820	1	22242500R2	<DD>
Q2	IC	78M09HF(NJM78M09FA)	1	222780095JRC	
Q3	IC	78L05(NJM78L05UA)	1	222780053R2JR	<DD>
Q4	IC	BU9450KV-E2	1	22242505R2	<DD>
Q4 or	IC	F2628E-01	(1)	22242436R2	<DD>
Q4 or	IC	S2658G-01	(1)	22242535R2	<DC, DD>



Q5	IC	AK4388ET-E2	1	22242519R2	<DD>
Q6	IC	NJM4580M-D	1	22241448R2	<DD>
Q8	IC	NJM2860F3-33	1	22242087R2	<DD>
Q9	IC	NJM4580M-D	1	22241448R2	
Q10	IC	NJM4580M-D	1	22241448R2	<DD>
Q1001	TR	KRC104S	1	2216210R2	
Q1001 or	TR	RN1404	(1)	2214490R2	
Q1002	TR	KRA102S	1	2216220R2	
Q1002 or	TR	RN2402	(1)	2214530R2	
Q1003	TR	KRC104S	1	2216210R2	
Q1003 or	TR	RN1404	(1)	2214490R2	
Q1004	TR	KRA102S	1	2216220R2	
Q1004 or	TR	RN2402	(1)	2214530R2	
Q1005	TR	KRC102S	1	2216190R2	
Q1005 or	TR	DTC114EKA	(1)	2216250R2	
Q1005 or	TR	RN1402	(1)	2214470R2	
Q1006	TR	KRA107S	1	2216350R2	
Q1006 or	TR	DTA114YKA	(1)	2216480R2	
Q1006 or	TR	RN2407(TE85L_F)	(1)	2216360R2	
Q1007	TR	KRC102S	1	2216190R2	
Q1007 or	TR	DTC114EKA	(1)	2216250R2	
Q1007 or	TR	RN1402	(1)	2214470R2	
Q1008	TR	KRA107S	1	2216350R2	
Q1008 or	TR	DTA114YKA	(1)	2216480R2	
Q1008 or	TR	RN2407(TE85L_F)	(1)	2216360R2	
Q1009	TR	KRC102S	1	2216190R2	
Q1009 or	TR	DTC114EKA	(1)	2216250R2	
Q1009 or	TR	RN1402	(1)	2214470R2	
Q1010	TR	KRC104S	1	2216210R2	
Q1010 or	TR	RN1404	(1)	2214490R2	
Q1011	TR	KRA102S	1	2216220R2	
Q1011 or	TR	RN2402	(1)	2214530R2	
Q1012	TR	2SK3019	1	2216520R2	
Q1013	TR	2SK3019	1	2216520R2	
Q1014B	HEAT-SINK	HEAT-SINK(RAD-07)	1	27160029	
Q1014C	SCREW	3P+10FN(3BC)	1	82143010GR	
Q1015	IC	AN34060A	1	22242205	
Q1016	IC(MAIN MICROPROCESSOR)	MPD70F3746GJ-GAE-AX(0263)	1	222W0079R302630	
Q1017	IC	XC6202P502FR	1	22242331R2	
Q1018	IC	XC6213B332MR	1	22242277R2	
Q1019	IC	S-812C33AUA-C2N	1	22242222R2	
Q1020	IC	S-812C56AUA-C3K	1	22242207R2	
Q1021	IC	74HC595F	1	222745955R2	
Q1022	IC	R1EX25064ASA00A	1	22242581R2	
Q1023	TR	KRC104S	1	2216210R2	

Q1023 or	TR	RN1404	(1)	2214490R2
Q1024	TR	KRC105S	1	2217290R2
Q1024 or	TR	DTC123JKA	(1)	2216690R2
Q1024 or	TR	RN1405	(1)	2214500R2
Q1025	TR	KRA102S	1	2216220R2
Q1025 or	TR	RN2402	(1)	2214530R2
Q1026	TR	KRC104S	1	2216210R2
Q1026 or	TR	RN1404	(1)	2214490R2
Q1290	TR	2SC2712-GR	1	2213145R2
Q1291	IC	TC4066BFT	1	22284066MR2TO
Q1301	TR	2SC2712-GR	1	2213145R2
Q1322	IC	TC74VHCT08AFT	1	22274008GR2TO
Q1322 or	IC	TC74VHCT08AFT (EKJ)	(1)	22274008G1R2TO
Q1323	IC	74HCU04F	1	222740046R2
Q1324	IC	CS42516-CQZ(R)-D	1	22242294R2
Q1325	IC	74HCU04F	1	222740046R2
Q1326	IC	TC7WU04FU(TE12L_F)	1	22240935R2
Q1421	IC	CS4382A	1	22242529R2
Q1601	IC	NJM4580M-D	1	22241448R2
Q1602	IC	NJM4580M-D	1	22241448R2
Q1603	IC	NJM4580M-D	1	22241448R2
Q1604	IC	NJM4580M-D	1	22241448R2
Q1900	IC	NJM4580M-D	1	22241448R2
Q1901	IC	NJM4580M-D	1	22241448R2
Q4000	TR	KRC105S	1	2217290R2
Q4000 or	TR	RN1405	(1)	2214500R2
Q4001	IC	78M05(NJM78M05FA)	1	222780055JRC
Q4002	IC	SI8008TM	1	22242323R2
Q4003	TR	KRC105S	1	2217290R2
Q4003 or	TR	RN1405	(1)	2214500R2
Q4004	IC	NJM2388F09	1	22242383
Q4005	IC	SI8008TM	1	22242323R2
Q4006	TR	KRC105S	1	2217290R2
Q4006 or	TR	RN1405	(1)	2214500R2
Q4100	IC	AN15881A-VT	1	22242318R3
Q4101	IC	NJW1321FP1	1	22242381R3
Q4102	IC	FHP3350IM14X	1	22242470R2
Q4502	TR	2SA950-Y	1	2211504T
Q4502 or	TR	2SA950-O	(1)	2211503T
Q4503	TR	2SC1815-GR	1	2211255T
Q4503 or	TR	2SC1815-Y	(1)	2211254T
Q4504	TR	2SA854S-R	1	2217394T
Q4504 or	TR	2SB1240-R	(1)	2213794T
Q4600	TR	2SA1162-GR	1	2214375R2
Q4601	TR	KRC102S	1	2216190R2

Q4601 or	TR	RN1402	(1)	2214470R2	
Q4602	TR	2SA1162-GR	1	2214375R2	
Q4603	TR	KRC102S	1	2216190R2	
Q4603 or	TR	RN1402	(1)	2214470R2	
Q4604	TR	2SA854S-R	1	2217394T	
Q4604 or	TR	2SB1240-R	(1)	2213794T	
Q4605	TR	KRC102S	1	2216190R2	
Q4605 or	TR	RN1402	(1)	2214470R2	
Q4606	TR	KRA102S	1	2216220R2	
Q4606 or	TR	RN2402	(1)	2214530R2	
Q4607	PHT CP	PS2501AL-1	1	24120141R2	
Q4608	PHT CP	PS2501AL-1	1	24120141R2	
Q4700	IC	ICL3221ECVZ	1	22242268R2	
Q4800	TR	2SC2712-GR	1	2213145R2	
Q4801	TR	2SC2712-GR	1	2213145R2	
Q4802	IC	TC4066BFT	1	22284066MR2TO	
Q4803	IC(NETWORK)	PIC18F66J60(0237)	1	222W0072R302374	
Q4804	IC	IS25C02-2GLI	1	222W0075R2	
Q4805	IC	NJM2391DL1-33	1	22278033DR2JR	
Q4805 or	IC	TA48033AF(TE16L_NQ)	(1)	22278033DR2TO	
Q4805 or	IC	BA33BC0FP	(1)	22278033DR2RH	
Q4805 or	IC	TA48033BF(TE16L_NQ)	(1)	22278033DBR2TO	
D1	C-DIODE	1SS352	1	223234R2	<DD>
D1 or	C-DIODE	KDS4148U	(1)	223283R2	<DD>
D1 or	C-DIODE	MA2J111	(1)	223279R2	<DD>
D1001	C-DIODE	1SS352	1	223234R2	
D1001 or	C-DIODE	KDS4148U	(1)	223283R2	
D1001 or	C-DIODE	MA2J111	(1)	223279R2	
D1002	C-DIODE	1SS352	1	223234R2	
D1002 or	C-DIODE	KDS4148U	(1)	223283R2	
D1002 or	C-DIODE	MA2J111	(1)	223279R2	
D1005	C-DIODE	1SS352	1	223234R2	
D1005 or	C-DIODE	KDS4148U	(1)	223283R2	
D1005 or	C-DIODE	MA2J111	(1)	223279R2	
D1006	C-DIODE	1SS352	1	223234R2	
D1006 or	C-DIODE	KDS4148U	(1)	223283R2	
D1006 or	C-DIODE	MA2J111	(1)	223279R2	
D1007	C-DIODE	1SS352	1	223234R2	
D1007 or	C-DIODE	KDS4148U	(1)	223283R2	
D1007 or	C-DIODE	MA2J111	(1)	223279R2	
D4001	C-DIODE	1SS352	1	223234R2	
D4001 or	C-DIODE	KDS4148U	(1)	223283R2	
D4001 or	C-DIODE	MA2J111	(1)	223279R2	
D4002	ZENER D	UDZS5.6B	1	224550560R2	
D4002 or	ZENER D	MAZ8056-M	(1)	224750562R2	

D4003	C-DIODE	ISS352	1	223234R2
D4003 or	C-DIODE	KDS4148U	(1)	223283R2
D4003 or	C-DIODE	MA2J111	(1)	223279R2
D4004	DIODE	D5SBA20	1	22380130F
D4005	DIODE	RB070M-30	1	22380361R2
D4006	DIODE	RL1N4003	1	22380260T
D4007	C-DIODE	ISS352	1	223234R2
D4007 or	C-DIODE	KDS4148U	(1)	223283R2
D4007 or	C-DIODE	MA2J111	(1)	223279R2
D4008	C-DIODE	ISS352	1	223234R2
D4008 or	C-DIODE	KDS4148U	(1)	223283R2
D4008 or	C-DIODE	MA2J111	(1)	223279R2
D4009	DIODE	D3SBA20	1	22380271F
D4010	C-DIODE	ISS352	1	223234R2
D4010 or	C-DIODE	KDS4148U	(1)	223283R2
D4010 or	C-DIODE	MA2J111	(1)	223279R2
D4013	DIODE	RB070M-30	1	22380361R2
D4014	C-DIODE	ISS352	1	223234R2
D4014 or	C-DIODE	KDS4148U	(1)	223283R2
D4014 or	C-DIODE	MA2J111	(1)	223279R2
D4015	C-DIODE	ISS352	1	223234R2
D4015 or	C-DIODE	KDS4148U	(1)	223283R2
D4015 or	C-DIODE	MA2J111	(1)	223279R2
D4016	C-DIODE	ISS352	1	223234R2
D4016 or	C-DIODE	KDS4148U	(1)	223283R2
D4016 or	C-DIODE	MA2J111	(1)	223279R2
D4500	C-DIODE	ISS352	1	223234R2
D4500 or	C-DIODE	KDS4148U	(1)	223283R2
D4500 or	C-DIODE	MA2J111	(1)	223279R2
D4501	C-DIODE	ISS352	1	223234R2
D4501 or	C-DIODE	KDS4148U	(1)	223283R2
D4501 or	C-DIODE	MA2J111	(1)	223279R2
D4600	C-DIODE	ISS352	1	223234R2
D4600 or	C-DIODE	KDS4148U	(1)	223283R2
D4600 or	C-DIODE	MA2J111	(1)	223279R2
D4601	C-DIODE	ISS352	1	223234R2
D4601 or	C-DIODE	KDS4148U	(1)	223283R2
D4601 or	C-DIODE	MA2J111	(1)	223279R2
D4602	C-DIODE	ISS352	1	223234R2
D4602 or	C-DIODE	KDS4148U	(1)	223283R2
D4602 or	C-DIODE	MA2J111	(1)	223279R2
D4603	C-DIODE	ISS352	1	223234R2
D4603 or	C-DIODE	KDS4148U	(1)	223283R2
D4603 or	C-DIODE	MA2J111	(1)	223279R2
D4604	C-DIODE	ISS352	1	223234R2

D4604 or	C-DIODE	KDS4148U	(1)	223283R2	
D4604 or	C-DIODE	MA2J111	(1)	223279R2	
D4605	C-DIODE	1SS352	1	223234R2	
D4605 or	C-DIODE	KDS4148U	(1)	223283R2	
D4605 or	C-DIODE	MA2J111	(1)	223279R2	
D4606	DIODE	RL1N4003	1	22380260T	
L1	CHOKE COIL	BLM21PG221SN1	1	230949R2	<DD>
L2	CHOKE COIL	BLM21PG221SN1	1	230949R2	<DD>
L3	CHOKE COIL	LBC2518T2R2M	1	231364M022R2	<DD>
L4	EMIFIL	BK1608LM182-T	1	230958R1	<DD>
L6	CHOKE COIL	LBC2518T2R2M	1	231364M022R2	<DD>
L1290	CHOKE COIL	LBC2518T470M	1	231364M470R2	
L1305	CHOKE COIL	LBC2518T2R2M	1	231364M022R2	
L1306	CHOKE COIL	LBC2518T470M	1	231364M470R2	
L1307	CHOKE COIL	LBC2518T2R2M	1	231364M022R2	
L1308	CHOKE COIL	LBC2518T2R2M	1	231364M022R2	
L1309	CHOKE COIL	LBC2518T4R7M	1	231364M047R2	
L1310	CHOKE COIL	LBC2518T4R7M	1	231364M047R2	
L1311	CHOKE COIL	BLM21B222SPT	1	230921R2	
L1312	CHOKE COIL	LBC2518T470M	1	231364M470R2	
L1313	CHOKE COIL	LBC2518T4R7M	1	231364M047R2	
L1314	CHOKE COIL	LBC2518T4R7M	1	231364M047R2	
L1315	CHOKE COIL	LBC2518T4R7M	1	231364M047R2	
L1316	EMIFIL	BK1608LM182-T	1	230958R1	
L1317	EMIFIL	BK1608LM182-T	1	230958R1	
L1318	CHOKE COIL	LBC2518T470M	1	231364M470R2	
L1319	CHOKE COIL	LBC2518T470M	1	231364M470R2	
L1320	EMIFIL	BK1608LM182-T	1	230958R1	
L1402	CHOKE COIL	LBC2518T4R7M	1	231364M047R2	
L1403	CHOKE COIL	LBC2518T4R7M	1	231364M047R2	
L1404	CHOKE COIL	LBC2518T4R7M	1	231364M047R2	
L4000	CHOKE COIL	NCH-2541	1	231363K470A	
L4000 or	CHOKE COIL	0182-7310-470K-RB	1	231389	
L4001	CHOKE COIL	LBC2518T4R7M	1	231364M047R2	
L4002	CHOKE COIL	LBC2518T4R7M	1	231364M047R2	
L4003	CHOKE COIL	NCH-2541	1	231363K470A	
L4003 or	CHOKE COIL	0182-7310-470K-RB	1	231389	
L4004	CHOKE COIL	LBC2518T4R7M	1	231364M047R2	
L4600	EMIFIL	BK1608LM182-T	1	230958R1	
L4601	EMIFIL	BK1608LM182-T	1	230958R1	
L4602	EMIFIL	BK1608LM182-T	1	230958R1	
L4603	EMIFIL	BK1608LM182-T	1	230958R1	
L4700	CHOKE COIL	LBC2518T470M	1	231364M470R2	
L4800	CHOKE COIL	BLM21PG221SN1	1	230949R2	
L4801	CHOKE COIL	BLM21PG221SN1	1	230949R2	

L4802	CORE	DLP2ADN900HL4L	1	230990R2	
X1	CRYSTAL	DSX530GA 45.1584MHz	1	3010418R2	<DD>
X1 or	CRYSTAL	FCX-03 45.15840MHZ	( 1)	3010466R2	<DD>
X1001	CERA LOCK	CSTCR5M00G53-B0	1	3010356R2	
X1301	CRYSTAL	HC-49US24.576MHz	1	3010423T	
X4800	CRYSTAL	HC-49USSMD25.00MHz	1	3010444R2	
C1	UTSP C	CE04W50V-10M(UTSP)	1	397581007T	
C2	VR C	CE04W16V-100M(VR)	1	394641017T	
C3	UTSP C	CE04W50V-10M(UTSP)	1	397581007T	<DD>
C4	VR C	CE04W16V-100M(VR)	1	394641017T	<DD>
C5	VR C	CE04W16V-100M(VR)	1	394641017T	<DD>
C6	C-CERA C	CK725F1E-104Z1	1	332161040R1	<DD>
C8	C-CERA C	CK725F1E-104Z1	1	332161040R1	<DD>
C9	C-CERA C	CK725B1H-102K1	1	332101025R1	<DD>
C10	C-CERA C	CK725B1H-102K1	1	332101025R1	<DD>
C11	VR C	CE04W6.3V-220M(VR)	1	394622217T	<DD>
C12	C-CERA C	CK725F1E-104Z1	1	332161040R1	<DD>
C13	C-CERA C	CC725CH1H-821J1	1	342108214R1	<DD>
C14	UTSP C	CE04W50V-10M(UTSP)	1	397581007T	<DD>
C15	UTSP C	CE04W50V-10M(UTSP)	1	397581007T	<DD>
C16	C-CERA C	CK725F1E-104Z1	1	332161040R1	<DD>
C17	C-CERA C	CC725CH1H-821J1	1	342108214R1	<DD>
C18	C-CERA C	CK725F1E-104Z1	1	332161040R1	<DD>
C19	C-CERA C	CK725F1E-104Z1	1	332161040R1	<DD>
C20	C-CERA C	CK725F1E-104Z1	1	332161040R1	<DD>
C21	VR C	CE04W16V-220M(VR)	1	394642217T	
C22	UTSP C	CE04W50V-10M(UTSP)	1	397581007T	<DD>
C23	C-CERA C	CK725F1E-104Z1	1	332161040R1	<DD>
C24	C-CERA C	CK725F1E-104Z1	1	332161040R1	<DD>
C25	C-CERA C	CK725F1E-104Z1	1	332161040R1	<DD>
C26	VR C	CE04W16V-220M(VR)	1	394642217T	
C27	C-CERA C	CC725CH1H-821J1	1	342108214R1	<DD>
C28	C-CERA C	CK725F1E-104Z1	1	332161040R1	<DD>
C29	UTSP C	CE04W50V-10M(UTSP)	1	397581007T	<DD>
C30	UTSP C	CE04W50V-10M(UTSP)	1	397581007T	<DD>
C32	C-CERA C	CC725CH1H-821J1	1	342108214R1	<DD>
C33	C-CERA C	CK725B1H-102K1	1	332101025R1	<DD>
C34	C-CERA C	CK725F1E-104Z1	1	332161040R1	<DD>
C35	C-CERA C	CK725F1E-104Z1	1	332161040R1	<DD>
C36	C-CERA C	CK725F1E-104Z1	1	332161040R1	<DD>
C38	C-CERA C	CK725B1H-102K1	1	332101025R1	<DD>
C39	VR C	CE04W16V-100M(VR)	1	394641017T	<DD>
C40	C-CERA C	CC725CH1H-080D1	1	342100802R1	<DD>
C41	C-CERA C	CC725CH1H-040C1	1	342100401R1	<DD>
C42	C-CERA C	CK725F1A-105Z1	1	332181050R1	<DD>

C43	C-CERA C	CK725F1A-105Z1	1	332181050R1	<DD>
C44	C-CERA C	CK725F1A-105Z1	1	332181050R1	<DD>
C47	UTSP C	CE04W50V-10M(UTSP)	1	397581007T	
C48	UTSP C	CE04W50V-10M(UTSP)	1	397581007T	
C52	UTSP C	CE04W50V-10M(UTSP)	1	397581007T	<DD>
C53	UTSP C	CE04W50V-10M(UTSP)	1	397581007T	<DD>
C1001	C-CERA C	CK725F1A-105Z1	1	332181050R1	
C1002	C-CERA C	CK725F1E-104Z1	1	332161040R1	
C1004	C-CERA C	CK725F1A-105Z1	1	332181050R1	
C1005	C-CERA C	CK725F1E-104Z1	1	332161040R1	
C1006	C-CERA C	CK725F1E-104Z1	1	332161040R1	
C1007	C-CERA C	CK725F1A-105Z1	1	332181050R1	
C1008	C-CERA C	CC725CH1H-101J1	1	342101014R1	
C1009	C-CERA C	CC725CH1H-101J1	1	342101014R1	
C1010	C-CERA C	CK725B1H-102K1	1	332101025R1	
C1011	VR C	CE04W16V-100M(VR)	1	394641017T	
C1013	VR C	CE04W16V-100M(VR)	1	394641017T	
C1014	VR C	CE04W16V-100M(VR)	1	394641017T	
C1015	VR C	CE04W16V-100M(VR)	1	394641017T	
C1017	VR C	CE04W16V-100M(VR)	1	394641017T	
C1019	VR C	CE04W16V-100M(VR)	1	394641017T	
C1020	C-CERA C	CK725F1A-105Z1	1	332181050R1	
C1021	C-CERA C	CK725B1H-102K1	1	332101025R1	
C1022	C-CERA C	CK725B1H-102K1	1	332101025R1	
C1023	UTSP C	CE04W50V-4.7M(UTSP)	1	397580477T	
C1024	C-CERA C	CK725B1H-102K1	1	332101025R1	
C1025	C-CERA C	CK725B1H-102K1	1	332101025R1	
C1026	C-CERA C	CK725B1H-102K1	1	332101025R1	
C1027	C-CERA C	CK725B1H-102K1	1	332101025R1	
C1028	VR C	CE04W50V-10M(VR)	1	394681007T	
C1029	VR C	CE04W16V-100M(VR)	1	394641017T	
C1030	C-CERA C	CK725F1E-104Z1	1	332161040R1	
C1031	C-CERA C	CK725F1E-104Z1	1	332161040R1	
C1032	C-CERA C	CK725F1E-104Z1	1	332161040R1	
C1033	C-CERA C	CK725F1E-104Z1	1	332161040R1	
C1034	C-CERA C	CK725F1E-104Z1	1	332161040R1	
C1035	C-CERA C	CK725F1E-104Z1	1	332161040R1	
C1036	C-CERA C	CK725F1E-104Z1	1	332161040R1	
C1037	C-CERA C	CK725F1E-104Z1	1	332161040R1	
C1038	VR C	CE04W50V-10M(VR)	1	394681007T	
C1039	C-CERA C	CK725F1E-104Z1	1	332161040R1	
C1040	VR C	CE04W6.3V-470M(VR)	1	394624717T	
C1041	UTSP C	CE04W50V-4.7M(UTSP)	1	397580477T	
C1042	C-CERA C	CK725F1E-104Z1	1	332161040R1	
C1050	C-CERA C	CC725CH1H-101J1	1	342101014R1	

C1051	C-CERA C	CC725CH1H-101J1	1	342101014R1
C1199	VR C	CE04W16V-470M(VR)	1	394644717T
C1290	VR C	CE04W16V-100M(VR)	1	394641017T
C1291	C-CERA C	CK725F1E-104Z1	1	332161040R1
C1292	UTSP C	CE04W50V-10M(UTSP)	1	397581007T
C1293	UTSP C	CE04W50V-10M(UTSP)	1	397581007T
C1294	UTSP C	CE04W50V 47M(UTSP)	1	397584707T
C1295	UTSP C	CE04W50V 47M(UTSP)	1	397584707T
C1296	UTSP C	CE04W50V 47M(UTSP)	1	397584707T
C1364	C-CERA C	CK725B1H-102K1	1	332101025R1
C1365	C-CERA C	CK725B1C-104K1	1	332121045R1
C1366	C-CERA C	CC725CH1H-101J1	1	342101014R1
C1367	C-CERA C	CK725F1E-104Z1	1	332161040R1
C1368	C-CERA C	CC725CH1H-101J1	1	342101014R1
C1369	VR C	CE04W16V-100M(VR)	1	394641017T
C1370	C-CERA C	CK725B1C-104K1	1	332121045R1
C1371	C-CERA C	CK725F1E-104Z1	1	332161040R1
C1372	C-CERA C	CK725F1E-104Z1	1	332161040R1
C1373	C-CERA C	CK725F1E-104Z1	1	332161040R1
C1374	UTSP C	CE04W10V-470M(UTSP)	1	397534717T
C1376	VR C	CE04W16V-100M(VR)	1	394641017T
C1377	UTSJ C	CE04W25V-47M(UTSJ)	1	398054707T
C1378	C-CERA C	CK725F1E-104Z1	1	332161040R1
C1380	C-CERA C	CK725B1C-104K1	1	332121045R1
C1381	C-CERA C	CC725CH1H-101J1	1	342101014R1
C1382	C-FILM C	ECHU50V-222J	1	373022224R2
C1383	C-FILM C	ECHU50V-222J	1	373022224R2
C1384	VR C	CE04W16V-100M(VR)	1	394641017T
C1386	C-CERA C	CK725F1E-104Z1	1	332161040R1
C1387	C-CERA C	CC725CH1H-221J1	1	342102214R1
C1388	C-CERA C	CK725B1H-102K1	1	332101025R1
C1389	C-CERA C	CK725F1E-104Z1	1	332161040R1
C1390	C-CERA C	CK725B1H-223K1	1	332102235R1
C1392	C-CERA C	CK725F1E-104Z1	1	332161040R1
C1395	C-CERA C	CK725F1E-104Z1	1	332161040R1
C1396	C-CERA C	CK725F1E-104Z1	1	332161040R1
C1397	C-CERA C	CK725B1H-102K1	1	332101025R1
C1398	C-CERA C	CK725F1E-104Z1	1	332161040R1
C1399	UTSP C	CE04W10V-470M(UTSP)	1	397534717T
C1400	C-CERA C	CK725F1E-104Z1	1	332161040R1
C1401	C-CERA C	CC725CH1H-330J1	1	342103304R1
C1402	C-CERA C	CC725CH1H-330J1	1	342103304R1
C1403	C-CERA C	CC725CH1H-330J1	1	342103304R1
C1404	C-CERA C	CC725CH1H-330J1	1	342103304R1
C1405	C-CERA C	CC725CH1H-330J1	1	342103304R1



C1406	C-CERA C	CC725CH1H-330J1	1	342103304R1
C1408	C-CERA C	CC725CH1H-080D1	1	342100802R1
C1409	C-CERA C	CC725CH1H-080D1	1	342100802R1
C1410	UTSP C	CE04W10V-470M(UTSP)	1	397534717T
C1411	UTSP C	CE04W10V-470M(UTSP)	1	397534717T
C1413	C-CERA C	CK725F1E-104Z1	1	332161040R1
C1414	C-CERA C	CK725F1E-104Z1	1	332161040R1
C1415	C-CERA C	CK725F1E-104Z1	1	332161040R1
C1417	C-CERA C	CK725F1E-104Z1	1	332161040R1
C1418	C-CERA C	CK725F1E-104Z1	1	332161040R1
C1419	C-CERA C	CC725CH1H-080D1	1	342100802R1
C1420	C-CERA C	CK725B1H-102K1	1	332101025R1
C1421	UTSP C	CE04W10V-220M(UTSP)	1	397532217T
C1422	C-CERA C	CK725F1E-104Z1	1	332161040R1
C1424	C-CERA C	CC725CH1H-060D1	1	342100602R1
C1425	C-CERA C	CC725CH1H-060D1	1	342100602R1
C1451	C-FILM C	ECHU16V-104J	1	373041044R2
C1452	UTSP C	CE04W10V-470M(UTSP)	1	397534717T
C1453	UTSP C	CE04W10V-470M(UTSP)	1	397534717T
C1454	C-FILM C	ECHU16V-104J	1	373041044R2
C1455	C-FILM C	ECHU16V-104J	1	373041044R2
C1456	UTSP C	CE04W25V-47M(UTSP)	1	397554707T
C1457	C-FILM C	ECHU16V-104J	1	373041044R2
C1458	UTSJ C	CE04W25V-47M(UTSJ)	1	398054707T
C1460	UTSP C	CE04W10V-470M(UTSP)	1	397534717T
C1461	C-FILM C	ECHU16V-104J	1	373041044R2
C1499	VR C	CE04W16V-100M(VR)	1	394641017T
C1600	TF C	ECQ-B50V-471J	1	374724714T
C1601	TF C	ECQ-B50V-471J	1	374724714T
C1602	TF C	ECQ-B50V-471J	1	374724714T
C1603	TF C	ECQ-B50V-471J	1	374724714T
C1604	TF C	ECQ-B50V-471J	1	374724714T
C1605	TF C	ECQ-B50V-471J	1	374724714T
C1606	TF C	ECQ-B50V-471J	1	374724714T
C1607	TF C	ECQ-B50V-471J	1	374724714T
C1610	TF C	ECQ-B50V-151K	1	374721515T
C1611	TF C	ECQ-B50V-151K	1	374721515T
C1612	TF C	ECQ-B50V-151K	1	374721515T
C1613	TF C	ECQ-B50V-151K	1	374721515T
C1614	TF C	ECQ-B50V-151K	1	374721515T
C1615	TF C	ECQ-B50V-151K	1	374721515T
C1616	TF C	ECQ-B50V-151K	1	374721515T
C1617	TF C	ECQ-B50V-151K	1	374721515T
C1620	TF C	ECQ-B50V-151K	1	374721515T
C1621	TF C	ECQ-B50V-151K	1	374721515T

C1622	TF C	ECQ-B50V-151K	1	374721515T
C1623	TF C	ECQ-B50V-151K	1	374721515T
C1624	TF C	ECQ-B50V-151K	1	374721515T
C1625	TF C	ECQ-B50V-151K	1	374721515T
C1626	TF C	ECQ-B50V-151K	1	374721515T
C1627	TF C	ECQ-B50V-151K	1	374721515T
C1650	UTSP C	CE04W25V-220M(UTSP)	1	397552217T
C1651	UTSP C	CE04W25V-220M(UTSP)	1	397552217T
C1900	UTSP C	CE04W25V-47M(UTSP)	1	397554707T
C1901	UTSP C	CE04W25V-47M(UTSP)	1	397554707T
C1910	UTSP C	CE04W25V-47M(UTSP)	1	397554707T
C1911	UTSP C	CE04W25V-47M(UTSP)	1	397554707T
C1912	C-CERA C	CK725F1A-105Z1	1	332181050R1
C4000	UTSP C	CE04W50V-4.7M(UTSP)	1	397580477T
C4001	VR C	CE04W16V-470M(VR)	1	394644717T
C4002	UTSP C	CE04W10V-470M(UTSP)	1	397534717T
C4003	TF C	ECQ-V50V-334J	1	374723344T
C4004	UTSP C	CE04W10V-470M(UTSP)	1	397534717T
C4005	C-CERA C	CK725B1H-223K1	1	332102235R1
C4006	C-CERA C	CK725F1E-104Z1	1	332161040R1
C4007	ELECT C	CE04W18V-10000M(VZ)	1	3945H1037S
C4009	UTSP C	CE04W50V-1M(UTSP)	1	397580107T
C4010	VR C	CE04W16V-100M(VR)	1	394641017T
C4012	TF C	ECQ-V50V-334J	1	374723344T
C4013	ELECT C	CE04W18V-10000M(VZ)	1	3945H1037S
C4023	VR C	CE04W16V-470M(VR)	1	394644717T
C4024	C-CERA C	CK725F1E-104Z1	1	332161040R1
C4025	UTSP C	CE04W10V-470M(UTSP)	1	397534717T
C4100	UTSP C	CE04W50V-10M(UTSP)	1	397581007T
C4102	UTSP C	CE04W50V-10M(UTSP)	1	397581007T
C4103	C-CERA C	CK725F1E-104Z1	1	332161040R1
C4106	UTSP C	CE04W50V-10M(UTSP)	1	397581007T
C4107	UTSP C	CE04W50V-10M(UTSP)	1	397581007T
C4108	UTSP C	CE04W25V-47M(UTSP)	1	397554707T
C4109	C-CERA C	CK725F1E-104Z1	1	332161040R1
C4110	C-CERA C	CK725F1E-104Z1	1	332161040R1
C4111	C-CERA C	CK725F1E-104Z1	1	332161040R1
C4112	C-CERA C	CK725F1E-104Z1	1	332161040R1
C4113	C-CERA C	CC725CH1H-101J1	1	342101014R1
C4114	UTSP C	CE04W50V-10M(UTSP)	1	397581007T
C4115	VR C	CE04W6.3V-470M(VR)	1	394624717T
C4117	C-CERA C	CK725F1E-104Z1	1	332161040R1
C4118	C-CERA C	CK725F1E-104Z1	1	332161040R1
C4119	VR C	CE04W6.3V-470M(VR)	1	394624717T
C4120	C-CERA C	CC725CH1H-101J1	1	342101014R1

C4121	C-CERA C	CC725CH1H-102J1	1	342101024R1
C4122	UTSP C	CE04W50V-10M(UTSP)	1	397581007T
C4123	C-CERA C	CC725CH1H-101J1	1	342101014R1
C4124	VR C	CE04W6.3V-220M(VR)	1	394622217T
C4125	UTSP C	CE04W25V-47M(UTSP)	1	397554707T
C4126	VR C	CE04W6.3V-220M(VR)	1	394622217T
C4127	C-CERA C	CK725F1E-104Z1	1	332161040R1
C4128	C-CERA C	CK725F1E-104Z1	1	332161040R1
C4129	UTSP C	CE04W50V-22M(UTSP)	1	397582207T
C4130	C-CERA C	CC725CH1H-221J1	1	342102214R1
C4132	VR C	CE04W6.3V-220M(VR)	1	394622217T
C4133	UTSP C	CE04W50V-10M(UTSP)	1	397581007T
C4134	C-CERA C	CK725F1E-104Z1	1	332161040R1
C4135	UTSP C	CE04W50V-22M(UTSP)	1	397582207T
C4136	UTSP C	CE04W25V-47M(UTSP)	1	397554707T
C4137	C-CERA C	CC725CH1H-221J1	1	342102214R1
C4138	VR C	CE04W6.3V-220M(VR)	1	394622217T
C4139	UTSP C	CE04W50V-22M(UTSP)	1	397582207T
C4140	C-CERA C	CK725F1E-104Z1	1	332161040R1
C4141	UTSP C	CE04W50V-10M(UTSP)	1	397581007T
C4142	C-CERA C	CK725F1E-104Z1	1	332161040R1
C4143	C-CERA C	CK725F1E-104Z1	1	332161040R1
C4144	C-CERA C	CK725F1E-104Z1	1	332161040R1
C4145	UTSP C	CE04W25V-47M(UTSP)	1	397554707T
C4146	VR C	CE04W6.3V-470M(VR)	1	394624717T
C4147	VR C	CE04W6.3V-470M(VR)	1	394624717T
C4150	VR C	CE04W6.3V-470M(VR)	1	394624717T
C4151	C-CERA C	CK725F1E-104Z1	1	332161040R1
C4152	UTSP C	CE04W25V-47M(UTSP)	1	397554707T
C4153	C-CERA C	CK725F1E-104Z1	1	332161040R1
C4154	C-CERA C	CK725F1E-104Z1	1	332161040R1
C4156	UTSP C	CE04W25V-47M(UTSP)	1	397554707T
C4157	VR C	CE04W6.3V-470M(VR)	1	394624717T
C4159	C-CERA C	CK725B1H-102K1	1	332101025R1
C4161	C-CERA C	CK725F1E-104Z1	1	332161040R1
C4162	C-CERA C	CK725F1E-104Z1	1	332161040R1
C4163	VR C	CE04W6.3V-470M(VR)	1	394624717T
C4164	VR C	CE04W6.3V-470M(VR)	1	394624717T
C4167	C-CERA C	CK725F1E-104Z1	1	332161040R1
C4168	UTSP C	CE04W50V-10M(UTSP)	1	397581007T
C4169	UTSP C	CE04W50V-10M(UTSP)	1	397581007T
C4170	C-CERA C	CK725F1E-104Z1	1	332161040R1
C4171	C-CERA C	CK725F1E-104Z1	1	332161040R1
C4172	C-CERA C	CK725F1E-104Z1	1	332161040R1
C4173	VR C	CE04W16V-220M(VR)	1	394642217T

C4174	C-CERA C	CK725B1H-102K1	1	332101025R1
C4175	C-CERA C	CK725F1E-104Z1	1	332161040R1
C4176	UTSP C	CE04W50V-10M(UTSP)	1	397581007T
C4177	C-CERA C	CK725F1E-104Z1	1	332161040R1
C4178	C-CERA C	CK725F1E-104Z1	1	332161040R1
C4179	UTSP C	CE04W50V-10M(UTSP)	1	397581007T
C4180	C-CERA C	CK725F1E-104Z1	1	332161040R1
C4181	C-CERA C	CK725F1E-104Z1	1	332161040R1
C4182	C-CERA C	CK725F1E-104Z1	1	332161040R1
C4183	C-CERA C	CK725F1E-104Z1	1	332161040R1
C4184	VR C	CE04W50V-33M(VR)	1	394683307T
C4185	C-CERA C	CK725F1E-104Z1	1	332161040R1
C4186	UTSP C	CE04W50V-10M(UTSP)	1	397581007T
C4187	C-CERA C	CK725F1E-104Z1	1	332161040R1
C4188	C-CERA C	CK725F1E-104Z1	1	332161040R1
C4189	UTSP C	CE04W50V-10M(UTSP)	1	397581007T
C4190	C-CERA C	CK725F1E-104Z1	1	332161040R1
C4191	C-CERA C	CK725F1E-104Z1	1	332161040R1
C4192	UTSP C	CE04W50V-10M(UTSP)	1	397581007T
C4193	C-CERA C	CC725CH1H-151J1	1	342101514R1
C4194	C-CERA C	CC725CH1H-151J1	1	342101514R1
C4195	C-CERA C	CC725CH1H-151J1	1	342101514R1
C4196	C-CERA C	CK725B1H-102K1	1	332101025R1
C4197	C-CERA C	CK725F1E-104Z1	1	332161040R1
C4198	UTSP C	CE04W50V-10M(UTSP)	1	397581007T
C4199	UTSP C	CE04W50V-10M(UTSP)	1	397581007T
C4200	UTSP C	CE04W50V-1M(UTSP)	1	397580107T
C4201	C-CERA C	CK725F1E-104Z1	1	332161040R1
C4202	C-CERA C	CK725F1E-104Z1	1	332161040R1
C4203	UTSP C	CE04W50V-10M(UTSP)	1	397581007T
C4204	C-CERA C	CK725F1E-104Z1	1	332161040R1
C4205	UTSP C	CE04W50V-10M(UTSP)	1	397581007T
C4206	UTSP C	CE04W50V-10M(UTSP)	1	397581007T
C4207	UTSP C	CE04W50V-10M(UTSP)	1	397581007T
C4208	C-CERA C	CK725F1E-104Z1	1	332161040R1
C4209	C-CERA C	CK725B1H-102K1	1	332101025R1
C4211	C-CERA C	CK725F1E-104Z1	1	332161040R1
C4212	C-CERA C	CC725CH1H-151J1	1	342101514R1
C4213	C-CERA C	CC725CH1H-151J1	1	342101514R1
C4214	C-CERA C	CC725CH1H-151J1	1	342101514R1
C4215	VR C	CE04W16V-100M(VR)	1	394641017T
C4218	C-CERA C	CK725F1E-104Z1	1	332161040R1
C4219	C-CERA C	CK725F1E-104Z1	1	332161040R1
C4220	C-CERA C	CK725F1E-104Z1	1	332161040R1
C4221	C-CERA C	CK725F1E-104Z1	1	332161040R1

C4222	C-CERA C	CK725F1E-104Z1	1	332161040R1	
C4223	C-CERA C	CK725F1E-104Z1	1	332161040R1	
C4224	C-CERA C	CK725F1E-104Z1	1	332161040R1	
C4225	UTSP C	CE04W10V-470M(UTSP)	1	397534717T	
C4226	UTSP C	CE04W10V-470M(UTSP)	1	397534717T	
C4227	UTSP C	CE04W10V-470M(UTSP)	1	397534717T	
C4228	C-CERA C	CK725F1E-104Z1	1	332161040R1	
C4229	C-CERA C	CK725F1E-104Z1	1	332161040R1	
C4230	C-CERA C	CK725F1E-104Z1	1	332161040R1	
C4231	C-CERA C	CK725F1E-104Z1	1	332161040R1	
C4232	C-CERA C	CK725F1E-104Z1	1	332161040R1	
C4233	C-CERA C	CK725F1E-104Z1	1	332161040R1	
C4234	C-CERA C	CK725F1E-104Z1	1	332161040R1	
C4235	C-CERA C	CK725F1E-104Z1	1	332161040R1	
C4500	UTSP C	CE04W25V-220M(UTSP)	1	397552217T	
C4502	UTSP C	CE04W25V-220M(UTSP)	1	397552217T	
C4600	C-CERA C	CC725CH1H-101J1	1	342101014R1	
C4601	C-CERA C	CC725CH1H-101J1	1	342101014R1	
C4602	C-CERA C	CC725CH1H-101J1	1	342101014R1	
C4604	C-CERA C	CC725CH1H-101J1	1	342101014R1	
C4605	C-CERA C	CK725F1E-104Z1	1	332161040R1	
C4700	UTSP C	CE04W50V-1M(UTSP)	1	397580107T	
C4701	UTSP C	CE04W50V-1M(UTSP)	1	397580107T	
C4702	VR C	CE04W16V-100M(VR)	1	394641017T	
C4703	C-CERA C	CK725F1E-104Z1	1	332161040R1	
C4704	UTSP C	CE04W50V-1M(UTSP)	1	397580107T	
C4705	UTSP C	CE04W50V-1M(UTSP)	1	397580107T	
C4706	C-CERA C	CK725B1H-102K1	1	332101025R1	
C4800	C-CERA C	CK725F1E-104Z1	1	332161040R1	
C4801	UTSP C	CE04W50V-10M(UTSP)	1	397581007T	
C4802	C-CERA C	CK725F1E-104Z1	1	332161040R1	
C4803	C-CERA C	CK725F1E-104Z1	1	332161040R1	
C4804	C-CERA C	CK725F1E-104Z1	1	332161040R1	
C4805	C-CERA C	CK725B1H-103K1	1	332101035R1	
C4806	C-CERA C	CK725B1H-103K1	1	332101035R1	
C4807	VR C	CE04W16V-100M(VR)	1	394641017T	
C4808	C-CERA C	CK725F1E-104Z1	1	332161040R1	
C4809	C-CERA C	CC725CH1H-150J1	1	342101504R1	
C4810	C-CERA C	CC725CH1H-150J1	1	342101504R1	
C4811	C-CERA C	CK725F1E-104Z1	1	332161040R1	
C4812	VR C	CE04W16V-100M(VR)	1	394641017T	
C4813	C-CERA C	CK725F1E-104Z1	1	332161040R1	
C4814	C-CERA C	CK725F1E-104Z1	1	332161040R1	
C4815	C-CERA C	CK725F1E-104Z1	1	332161040R1	
R1	C-CARBON R	RN72K1J-334JE	1	435033344R1	<DD>

R2	C-CARBON R	RN72K1J-334JE	1	435033344R1	<DD>
R3	C-CARBON R	RN72K1J-273JE	1	435032734R1	<DD>
R4	C-CARBON R	RN72K1J-220JE	1	435032204R1	<DD>
R5	C-CARBON R	RN72K1J-220JE	1	435032204R1	<DD>
R6	C-CARBON R	RN72K1J-104JE	1	435031044R1	<DD>
R7	C-CARBON R	RN72K1J-104JE	1	435031044R1	<DD>
R8	C-CARBON R	RN72K1J-104JE	1	435031044R1	<DD>
R9	C-CARBON R	RN72K1J-104JE	1	435031044R1	<DD>
R10	C-CARBON R	RN72K1J-104JE	1	435031044R1	<DD>
R11	METAL O R	RS1/2WBJ-22	1	443522204T	
R12	C-CARBON R	RN72K1J-104JE	1	435031044R1	<DD>
R13	C-CARBON R	RN72K1J-222JE	1	435032224R1	<DD>
R14	C-CARBON R	RN72K1J-222JE	1	435032224R1	<DD>
R15	C-CARBON R	RN72K1J-102JE	1	435031024R1	<DD>
R17	C-CARBON R	RN72K1J-104JE	1	435031044R1	<DD>
R19	C-CARBON R	RN72K1J-222JE	1	435032224R1	<DD>
R20	C-CARBON R	RN72K1J-332JE	1	435033324R1	<DD>
R21	C-CARBON R	RN72K1J-101JE	1	435031014R1	<DD>
R22	C-CARBON R	RN72K1J-101JE	1	435031014R1	<DD>
R23	C-CARBON R	RN72K1J-331JE	1	435033314R1	<DD>
R24	C-CARBON R	RN72K1J-332JE	1	435033324R1	<DD>
R25	C-CARBON R	RN72K1J-331JE	1	435033314R1	<DD>
R26	C-CARBON R	RN72K1J-222JE	1	435032224R1	<DD>
R27	C-CARBON R	RN72K1J-331JE	1	435033314R1	<DD>
R28	C-CARBON R	RN72K1J-104JE	1	435031044R1	<DD>
R29	C-CARBON R	RN72K1J-101JE	1	435031014R1	<DD>
R30	C-CARBON R	RN72K1J-222JE	1	435032224R1	<DD>
R31	C-CARBON R	RN72K1J-222JE	1	435032224R1	<DD>
R32	METAL O R	RS1/2WBJ-22	1	443522204T	
R34	C-CARBON R	RN72K1J-104JE	1	435031044R1	<DD>
R36	C-CARBON R	RN72K1J-103JE	1	435031034R1	<DD>
R37	C-CARBON R	RN72K1J-105JE	1	435031054R1	<DD>
R38	C-CARBON R	RN72K1J-103JE	1	435031034R1	<DD>
R39	C-CARBON R	RN72K1J-220JE	1	435032204R1	<DD>
R40	C-CARBON R	RN72K1J-681JE	1	435036814R1	<DD>
R41	C-CARBON R	RN72K1J-220JE	1	435032204R1	<DD>
R42	METAL O R	RS1/2WBJ-22	1	443522204T	<DD>
R43	C-CARBON R	RN72K1J-000JE	1	435030004R1	<DD>
R45	C-CARBON R	RN72K1J-392JE	1	435033924R1	<MA>
R46	C-CARBON R	RN72K1J-392JE	1	435033924R1	<MA>
R47	C-CARBON R	RN72K1J-222JE	1	435032224R1	<MA>
R48	C-CARBON R	RN72K1J-222JE	1	435032224R1	<MA>
R49	C-CARBON R	RN72K1J-103JE	1	435031034R1	
R50	C-CARBON R	RN72K1J-103JE	1	435031034R1	
R51	C-CARBON R	RN72K1J-103JE	1	435031034R1	

R52	C-CARBON R	RN72K1J-103JE	1	435031034R1	
R53	C-CARBON R	RN72K1J-103JE	1	435031034R1	
R54	C-CARBON R	RN72K1J-103JE	1	435031034R1	
R55	C-CARBON R	RN72K1J-103JE	1	435031034R1	
R56	C-CARBON R	RN72K1J-103JE	1	435031034R1	
R57	C-CARBON R	RN72K1J-103JE	1	435031034R1	<DD>
R58	C-CARBON R	RN72K1J-103JE	1	435031034R1	<DD>
R59	C-CARBON R	RN72K1J-103JE	1	435031034R1	<DD>
R60	C-CARBON R	RN72K1J-103JE	1	435031034R1	<DD>
R61	C-CARBON R	RN72K1J-103JE	1	435031034R1	<DD>
R62	C-CARBON R	RN72K1J-103JE	1	435031034R1	<DD>
R63	C-CARBON R	RN72K1J-103JE	1	435031034R1	<DD>
R64	C-CARBON R	RN72K1J-103JE	1	435031034R1	<DD>
R1001	C-CARBON R	RN72K1J-103JE	1	435031034R1	
R1002	C-CARBON R	RN72K1J-000JE	1	435030004R1	
R1003	C-CARBON R	RN72K1J-222JE	1	435032224R1	
R1004	C-CARBON R	RN72K1J-000JE	1	435030004R1	
R1005	C-CARBON R	RN72K1J-102JE	1	435031024R1	
R1006	C-CARBON R	RN72K1J-103JE	1	435031034R1	
R1007	C-CARBON R	RN72K1J-222JE	1	435032224R1	
R1008	C-CARBON R	RN72K1J-101JE	1	435031014R1	
R1009	C-CARBON R	RN72K1J-103JE	1	435031034R1	
R1010	C-CARBON R	RN72K1J-103JE	1	435031034R1	<DD>
R1011	C-CARBON R	RN72K1J-102JE	1	435031024R1	
R1012	C-CARBON R	RN72K1J-470JE	1	435034704R1	
R1013	C-CARBON R	RN72K1J-470JE	1	435034704R1	
R1014	C-CARBON R	RN72K1J-470JE	1	435034704R1	
R1015	C-CARBON R	RN72K1J-470JE	1	435034704R1	
R1016	C-CARBON R	RN72K1J-470JE	1	435034704R1	
R1017	C-CARBON R	RN72K1J-470JE	1	435034704R1	
R1019	C-CARBON R	RN72K1J-470JE	1	435034704R1	
R1020	C-CARBON R	RN72K1J-470JE	1	435034704R1	
R1021	C-CARBON R	RN72K1J-221JE	1	435032214R1	
R1022	C-CARBON R	RN72K1J-470JE	1	435034704R1	
R1023	C-CARBON R	RN72K1J-470JE	1	435034704R1	
R1024	C-CARBON R	RN72K1J-221JE	1	435032214R1	
R1025	C-CARBON R	RN72K1J-221JE	1	435032214R1	
R1026	C-CARBON R	RN72K1J-224JE	1	435032244R1	
R1027	C-CARBON R	RN72K1J-103JE	1	435031034R1	
R1028	C-CARBON R	RN72K1J-470JE	1	435034704R1	
R1029	C-CARBON R	RN72K1J-470JE	1	435034704R1	
R1030	C-CARBON R	RN72K1J-221JE	1	435032214R1	
R1031	C-CARBON R	RN72K1J-221JE	1	435032214R1	
R1032	C-CARBON R	RN72K1J-221JE	1	435032214R1	
R1033	C-CARBON R	RN72K1J-470JE	1	435034704R1	

R1034	C-CARBON R	RN72K1J-470JE	1	435034704R1
R1035	C-CARBON R	RN72K1J-103JE	1	435031034R1
R1036	C-CARBON R	RN72K1J-222JE	1	435032224R1
R1037	C-CARBON R	RN72K1J-103JE	1	435031034R1
R1038	C-CARBON R	RN72K1J-103JE	1	435031034R1
R1039	C-CARBON R	RN72K1J-103JE	1	435031034R1
R1040	C-CARBON R	RN72K1J-103JE	1	435031034R1
R1041	C-CARBON R	RN72K1J-103JE	1	435031034R1
R1042	C-CARBON R	RN72K1J-103JE	1	435031034R1
R1043	C-CARBON R	RN72K1J-470JE	1	435034704R1
R1044	C-CARBON R	RN72K1J-470JE	1	435034704R1
R1045	C-CARBON R	RN72K1J-470JE	1	435034704R1
R1046	C-CARBON R	RN72K1J-103JE	1	435031034R1
R1047	C-CARBON R	RN72K1J-103JE	1	435031034R1
R1048	C-CARBON R	RN72K1J-103JE	1	435031034R1
R1049	C-CARBON R	RN72K1J-470JE	1	435034704R1
R1050	C-CARBON R	RN72K1J-221JE	1	435032214R1
R1051	C-CARBON R	RN72K1J-103JE	1	435031034R1
R1052	C-CARBON R	RN72K1J-103JE	1	435031034R1
R1053	C-CARBON R	RN72K1J-103JE	1	435031034R1
R1054	C-CARBON R	RN72K1J-103JE	1	435031034R1
R1055	C-CARBON R	RN72K1J-103JE	1	435031034R1
R1056	C-CARBON R	RN72K1J-103JE	1	435031034R1
R1057	C-CARBON R	RN72K1J-103JE	1	435031034R1
R1058	C-CARBON R	RN72K1J-103JE	1	435031034R1
R1059	C-CARBON R	RN72K1J-103JE	1	435031034R1
R1060	C-CARBON R	RN72K1J-103JE	1	435031034R1
R1061	C-CARBON R	RN72K1J-103JE	1	435031034R1
R1062	C-CARBON R	RN72K1J-470JE	1	435034704R1
R1063	C-CARBON R	RN72K1J-470JE	1	435034704R1
R1064	C-CARBON R	RN72K1J-221JE	1	435032214R1
R1065	C-CARBON R	RN72K1J-221JE	1	435032214R1
R1066	C-CARBON R	RN72K1J-470JE	1	435034704R1
R1067	C-CARBON R	RN72K1J-224JE	1	435032244R1
R1068	C-CARBON R	RN72K1J-273JE	1	435032734R1
R1069	C-CARBON R	RN72K1J-101JE	1	435031014R1
R1070	C-CARBON R	RN72K1J-103JE	1	435031034R1
R1071	C-CARBON R	RN72K1J-473JE	1	435034734R1
R1072	C-CARBON R	RN72K1J-473JE	1	435034734R1
R1073	C-CARBON R	RN72K1J-103JE	1	435031034R1
R1074	C-CARBON R	RN72K1J-473JE	1	435034734R1
R1075	C-CARBON R	RN72K1J-102JE	1	435031024R1
R1079	C-CARBON R	RN72K1J-103JE	1	435031034R1
R1080	C-CARBON R	RN72K1J-272JE	1	435032724R1
R1081	C-CARBON R	RN72K1J-272JE	1	435032724R1



R1082	C-CARBON R	RN72K1J-272JE	1	435032724R1
R1083	C-CARBON R	RN72K1J-221JE	1	435032214R1
R1084	C-CARBON R	RN72K1J-272JE	1	435032724R1
R1085	C-CARBON R	RN72K1J-221JE	1	435032214R1
R1086	C-CARBON R	RN72K1J-221JE	1	435032214R1
R1088	C-CARBON R	RN72K1J-470JE	1	435034704R1
R1089	C-CARBON R	RN72K1J-470JE	1	435034704R1
R1090	C-CARBON R	RN72K1J-470JE	1	435034704R1
R1091	C-CARBON R	RN72K1J-221JE	1	435032214R1
R1092	C-CARBON R	RN72K1J-221JE	1	435032214R1
R1093	C-CARBON R	RN72K1J-470JE	1	435034704R1
R1094	C-CARBON R	RN72K1J-221JE	1	435032214R1
R1095	C-CARBON R	RN72K1J-470JE	1	435034704R1
R1096	C-CARBON R	RN72K1J-000JE	1	435030004R1
R1097	C-CARBON R	RN72K1J-103JE	1	435031034R1
R1098	C-CARBON R	RN72K1J-000JE	1	435030004R1
R1100	C-CARBON R	RN72K1J-103JE	1	435031034R1
R1101	C-CARBON R	RN72K1J-221JE	1	435032214R1
R1102	C-CARBON R	RN72K1J-470JE	1	435034704R1
R1103	C-CARBON R	RN72K1J-222JE	1	435032224R1
R1104	C-CARBON R	RN72K1J-221JE	1	435032214R1
R1105	C-CARBON R	RN72K1J-470JE	1	435034704R1
R1106	C-CARBON R	RN72K1J-222JE	1	435032224R1
R1107	C-CARBON R	RN72K1J-470JE	1	435034704R1
R1108	C-CARBON R	RN72K1J-470JE	1	435034704R1
R1109	C-CARBON R	RN72K1J-470JE	1	435034704R1
R1110	C-CARBON R	RN72K1J-470JE	1	435034704R1
R1111	C-CARBON R	RN72K1J-470JE	1	435034704R1
R1112	C-CARBON R	RN72K1J-470JE	1	435034704R1
R1113	C-CARBON R	RN72K1J-470JE	1	435034704R1
R1114	C-CARBON R	RN72K1J-470JE	1	435034704R1
R1115	C-CARBON R	RN72K1J-470JE	1	435034704R1
R1116	C-CARBON R	RN72K1J-470JE	1	435034704R1
R1117	C-CARBON R	RN72K1J-470JE	1	435034704R1
R1118	C-CARBON R	RN72K1J-470JE	1	435034704R1
R1119	C-CARBON R	RN72K1J-470JE	1	435034704R1
R1120	C-CARBON R	RN72K1J-470JE	1	435034704R1
R1121	C-CARBON R	RN72K1J-221JE	1	435032214R1
R1122	C-CARBON R	RN72K1J-470JE	1	435034704R1
R1123	C-CARBON R	RN72K1J-221JE	1	435032214R1
R1124	C-CARBON R	RN72K1J-221JE	1	435032214R1
R1125	C-CARBON R	RN72K1J-103JE	1	435031034R1
R1126	C-CARBON R	RN72K1J-103JE	1	435031034R1
R1128	C-CARBON R	RN72K1J-470JE	1	435034704R1
R1129	C-CARBON R	RN72K1J-103JE	1	435031034R1

R1130	C-CARBON R	RN72K1J-473JE	1	435034734R1	
R1131	C-CARBON R	RN72K1J-102JE	1	435031024R1	
R1132	C-CARBON R	RN72K1J-470JE	1	435034704R1	
R1133	C-CARBON R	RN72K1J-470JE	1	435034704R1	
R1134	C-CARBON R	RN72K1J-470JE	1	435034704R1	
R1135	C-CARBON R	RN72K1J-473JE	1	435034734R1	
R1136	C-CARBON R	RN72K1J-102JE	1	435031024R1	
R1137	C-CARBON R	RN72K1J-470JE	1	435034704R1	
R1138	C-CARBON R	RN72K1J-102JE	1	435031024R1	
R1139	C-CARBON R	RN72K1J-221JE	1	435032214R1	
R1140	C-CARBON R	RN72K1J-102JE	1	435031024R1	
R1141	C-CARBON R	RN72K1J-470JE	1	435034704R1	
R1142	C-CARBON R	RN72K1J-221JE	1	435032214R1	
R1143	C-CARBON R	RN72K1J-470JE	1	435034704R1	
R1144	C-CARBON R	RN72K1J-221JE	1	435032214R1	
R1145	C-CARBON R	RN72K1J-470JE	1	435034704R1	
R1146	METAL R	RNU1/2WCJ-8.2	1	453530824T	
R1147	METAL R	RNU1/2WCJ-8.2	1	453530824T	
R1148	C-CARBON R	RN72K1J-221JE	1	435032214R1	
R1149	C-CARBON R	RN72K1J-102JE	1	435031024R1	
R1150	C-CARBON R	RN72K1J-333JE	1	435033334R1	
R1151	C-CARBON R	RN72K1J-473JE	1	435034734R1	
R1152	C-CARBON R	RN72K1J-103JE	1	435031034R1	
R1153	C-CARBON R	RN72K1J-000JE	1	435030004R1	
R1154	C-CARBON R	RN72K1J-333JE	1	435033334R1	
R1155	C-CARBON R	RN72K1J-103JE	1	435031034R1	
R1156	C-CARBON R	RN72K1J-000JE	1	435030004R1	
R1157	C-CARBON R	RN72K1J-333JE	1	435033334R1	
R1158	C-CARBON R	RN72K1J-103JE	1	435031034R1	
R1159	C-CARBON R	RN72K1J-103JE	1	435031034R1	<MA>
R1160	C-CARBON R	RN72K1J-000JE	1	435030004R1	<DD>
R1161	C-CARBON R	RN72K1J-472JE	1	435034724R1	
R1162	C-CARBON R	RN72K1J-472JE	1	435034724R1	
R1164	C-CARBON R	RN72K1J-472JE	1	435034724R1	
R1165	C-CARBON R	RN72K1J-472JE	1	435034724R1	
R1166	C-CARBON R	RN72K1J-472JE	1	435034724R1	
R1167	C-CARBON R	RN72K1J-472JE	1	435034724R1	
R1168	C-CARBON R	RN72K1J-272JE	1	435032724R1	
R1170	C-CARBON R	RN72K1J-272JE	1	435032724R1	
R1171	C-CARBON R	RN72K1J-272JE	1	435032724R1	
R1172	C-CARBON R	RN72K1J-272JE	1	435032724R1	
R1173	C-CARBON R	RN72K1J-470JE	1	435034704R1	
R1174	C-CARBON R	RN72K1J-103JE	1	435031034R1	
R1175	C-CARBON R	RN72K1J-272JE	1	435032724R1	
R1176	C-CARBON R	RN72K1J-272JE	1	435032724R1	

R1177	C-CARBON R	RN72K1J-272JE	1	435032724R1	
R1178	C-CARBON R	RN72K1J-272JE	1	435032724R1	
R1180	C-CARBON R	RN72K1J-473JE	1	435034734R1	
R1182	C-CARBON R	RN72K1J-470JE	1	435034704R1	
R1183	C-CARBON R	RN72K1J-470JE	1	435034704R1	
R1184	C-CARBON R	RN72K1J-221JE	1	435032214R1	
R1185	C-CARBON R	RN72K1J-000JE	1	435030004R1	
R1186	C-CARBON R	RN72K1J-221JE	1	435032214R1	
R1187	C-CARBON R	RN72K1J-470JE	1	435034704R1	
R1188	C-CARBON R	RN72K1J-470JE	1	435034704R1	
R1189	C-CARBON R	RN72K1J-470JE	1	435034704R1	
R1190	C-CARBON R	RN72K1J-470JE	1	435034704R1	
R1191	C-CARBON R	RN72K1J-470JE	1	435034704R1	
R1192	C-CARBON R	RN72K1J-470JE	1	435034704R1	
R1193	C-CARBON R	RN72K1J-470JE	1	435034704R1	
R1194	C-CARBON R	RN72K1J-221JE	1	435032214R1	
R1195	C-CARBON R	RN72K1J-221JE	1	435032214R1	
R1196	C-CARBON R	RN72K1J-000JE	1	435030004R1	
R1197	C-CARBON R	RN72K1J-000JE	1	435030004R1	
R1198	C-CARBON R	RN72K1J-470JE	1	435034704R1	
R1199	C-CARBON R	RN72K1J-470JE	1	435034704R1	
R1200	C-CARBON R	RN72K1J-103JE	1	435031034R1	
R1201	C-CARBON R	RN72K1J-103JE	1	435031034R1	
R1202	C-CARBON R	RN72K1J-103JE	1	435031034R1	
R1203	C-CARBON R	RN72K1J-103JE	1	435031034R1	
R1204	C-CARBON R	RN72K1J-224JE	1	435032244R1	
R1205	C-CARBON R	RN72K1J-103JE	1	435031034R1	
R1206	C-CARBON R	RN72K1J-103JE	1	435031034R1	
R1207	C-CARBON R	RN72K1J-103JE	1	435031034R1	
R1208	C-CARBON R	RN72K1J-103JE	1	435031034R1	
R1209	C-CARBON R	RN72K1J-103JE	1	435031034R1	
R1210	C-CARBON R	RN72K1J-103JE	1	435031034R1	
R1211	C-CARBON R	RN72K1J-103JE	1	435031034R1	
R1212	C-CARBON R	RN72K1J-103JE	1	435031034R1	
R1213	C-CARBON R	RN72K1J-103JE	1	435031034R1	
R1214	C-CARBON R	RN72K1J-103JE	1	435031034R1	
R1215	C-CARBON R	RN72K1J-221JE	1	435032214R1	
R1216	C-CARBON R	RN72K1J-103JE	1	435031034R1	
R1217	C-CARBON R	RN72K1J-103JE	1	435031034R1	
R1218	C-CARBON R	RN72K1J-103JE	1	435031034R1	<DD>
R1219	C-CARBON R	RN72K1J-103JE	1	435031034R1	
R1220	C-CARBON R	RN72K1J-103JE	1	435031034R1	
R1221	C-CARBON R	RN72K1J-470JE	1	435034704R1	
R1222	C-CARBON R	RN72K1J-470JE	1	435034704R1	
R1223	C-CARBON R	RN72K1J-473JE	1	435034734R1	

R1224	C-CARBON R	RN72K1J-470JE	1	435034704R1
R1225	C-CARBON R	RN72K1J-103JE	1	435031034R1
R1226	C-CARBON R	RN72K1J-103JE	1	435031034R1
R1227	C-CARBON R	RN72K1J-470JE	1	435034704R1
R1228	C-CARBON R	RN72K1J-470JE	1	435034704R1
R1229	C-CARBON R	RN72K1J-470JE	1	435034704R1
R1230	C-CARBON R	RN72K1J-221JE	1	435032214R1
R1231	C-CARBON R	RN72K1J-103JE	1	435031034R1
R1232	C-CARBON R	RN72K1J-470JE	1	435034704R1
R1233	C-CARBON R	RN72K1J-470JE	1	435034704R1
R1234	C-CARBON R	RN72K1J-470JE	1	435034704R1
R1235	C-CARBON R	RN72K1J-103JE	1	435031034R1
R1240	C-CARBON R	RN72K1J-103JE	1	435031034R1
R1241	C-CARBON R	RN72K1J-272JE	1	435032724R1
R1242	C-CARBON R	RN72K1J-103JE	1	435031034R1
R1252	C-CARBON R	RN72K1J-470JE	1	435034704R1
R1290	C-CARBON R	RN72K1J-103JE	1	435031034R1
R1291	C-CARBON R	RN72K1J-104JE	1	435031044R1
R1292	C-CARBON R	RN72K1J-103JE	1	435031034R1
R1293	C-CARBON R	RN72K1J-473JE	1	435034734R1
R1294	C-CARBON R	RN72K1J-473JE	1	435034734R1
R1295	C-CARBON R	RN72K1J-473JE	1	435034734R1
R1296	C-CARBON R	RN72K1J-473JE	1	435034734R1
R1297	C-CARBON R	RN72K1J-473JE	1	435034734R1
R1298	C-CARBON R	RN72K1J-473JE	1	435034734R1
R1301	C-CARBON R	RN72K1J-104JE	1	435031044R1
R1484	C-CARBON R	RN72K1J-221JE	1	435032214R1
R1486	C-CARBON R	RN72K1J-100JE	1	435031004R1
R1487	C-CARBON R	RN72K1J-750JE	1	435037504R1
R1488	C-CARBON R	RN72K1J-224JE	1	435032244R1
R1489	C-CARBON R	RN72K1J-101JE	1	435031014R1
R1490	C-CARBON R	RN72K1J-750JE	1	435037504R1
R1491	C-CARBON R	RN72K1J-224JE	1	435032244R1
R1492	C-CARBON R	RN72K1J-100JE	1	435031004R1
R1493	C-CARBON R	RN72K1J-470JE	1	435034704R1
R1494	C-CARBON R	RN72K1J-101JE	1	435031014R1
R1495	C-CARBON R	RN72K1J-100JE	1	435031004R1
R1496	C-CARBON R	RN72K1J-750JE	1	435037504R1
R1497	C-CARBON R	RN72K1J-224JE	1	435032244R1
R1499	C-CARBON R	RN72K1J-392JE	1	435033924R1
R1500	C-CARBON R	RN72K1J-392JE	1	435033924R1
R1502	C-CARBON R	RN72K1J-101JE	1	435031014R1
R1504	C-CARBON R	RN72K1J-221JE	1	435032214R1
R1505	C-CARBON R	RN72K1J-750JE	1	435037504R1
R1506	C-CARBON R	RN72K1J-470JE	1	435034704R1

R1507	C-CARBON R	RN72K1J-152JE	1	435031524R1
R1508	C-CARBON R	RN72K1J-102JE	1	435031024R1
R1509	C-CARBON R	RN72K1J-331JE	1	435033314R1
R1510	C-CARBON R	RN72K1J-331JE	1	435033314R1
R1511	C-CARBON R	RN72K1J-102JE	1	435031024R1
R1512	C-CARBON R	RN72K1J-470JE	1	435034704R1
R1513	C-CARBON R	RN72K1J-331JE	1	435033314R1
R1514	C-CARBON R	RN72K1J-102JE	1	435031024R1
R1515	C-CARBON R	RN72K1J-331JE	1	435033314R1
R1516	C-CARBON R	RN72K1J-000JE	1	435030004R1
R1517	C-CARBON R	RN72K1J-331JE	1	435033314R1
R1518	C-CARBON R	RN72K1J-331JE	1	435033314R1
R1519	C-CARBON R	RN72K1J-331JE	1	435033314R1
R1520	C-CARBON R	RN72K1J-470JE	1	435034704R1
R1521	C-CARBON R	RN72K1J-823JE	1	435038234R1
R1522	C-CARBON R	RN72K1J-103JE	1	435031034R1
R1523	C-CARBON R	RN72K1J-103JE	1	435031034R1
R1524	C-CARBON R	RN72K1J-823JE	1	435038234R1
R1525	C-CARBON R	RN72K1J-470JE	1	435034704R1
R1526	C-CARBON R	RN72K1J-470JE	1	435034704R1
R1527	C-CARBON R	RN72K1J-221JE	1	435032214R1
R1528	C-CARBON R	RN72K1J-470JE	1	435034704R1
R1529	C-CARBON R	RN72K1J-470JE	1	435034704R1
R1530	C-CARBON R	RN72K1J-470JE	1	435034704R1
R1531	C-CARBON R	RN72K1J-470JE	1	435034704R1
R1532	C-CARBON R	RN72K1J-103JE	1	435031034R1
R1533	C-CARBON R	RN72K1J-221JE	1	435032214R1
R1534	C-CARBON R	RN72K1J-823JE	1	435038234R1
R1535	C-CARBON R	RN72K1J-105JE	1	435031054R1
R1537	C-CARBON R	RN72K1J-000JE	1	435030004R1
R1563	C-CARBON R	RN72K1J-471JE	1	435034714R1
R1564	C-CARBON R	RN72K1J-471JE	1	435034714R1
R1565	C-CARBON R	RN72K1J-471JE	1	435034714R1
R1566	C-CARBON R	RN72K1J-471JE	1	435034714R1
R1567	C-CARBON R	RN72K1J-221JE	1	435032214R1
R1568	C-CARBON R	RN72K1J-471JE	1	435034714R1
R1569	C-CARBON R	RN72K1J-471JE	1	435034714R1
R1570	C-CARBON R	RN72K1J-471JE	1	435034714R1
R1571	C-CARBON R	RN72K1J-471JE	1	435034714R1
R1572	C-CARBON R	RN72K1J-471JE	1	435034714R1
R1573	C-CARBON R	RN72K1J-471JE	1	435034714R1
R1574	C-CARBON R	RN72K1J-471JE	1	435034714R1
R1575	C-CARBON R	RN72K1J-331JE	1	435033314R1
R1576	C-CARBON R	RN72K1J-471JE	1	435034714R1
R1577	C-CARBON R	RN72K1J-331JE	1	435033314R1

R1578	C-CARBON R	RN72K1J-471JE	1	435034714R1	
R1579	C-CARBON R	RN72K1J-331JE	1	435033314R1	
R1580	C-CARBON R	RN72K1J-471JE	1	435034714R1	
R1581	C-CARBON R	RN72K1J-331JE	1	435033314R1	
R1582	C-CARBON R	RN72K1J-471JE	1	435034714R1	
R16	C-CARBON R	RN72K1J-102JE	1	435031024R1	<DD>
R1600	C-CARBON R	RN72K1J-182JE	1	435031824R1	
R1601	C-CARBON R	RN72K1J-182JE	1	435031824R1	
R1602	C-CARBON R	RN72K1J-182JE	1	435031824R1	
R1603	C-CARBON R	RN72K1J-182JE	1	435031824R1	
R1604	C-CARBON R	RN72K1J-182JE	1	435031824R1	
R1605	C-CARBON R	RN72K1J-182JE	1	435031824R1	
R1606	C-CARBON R	RN72K1J-182JE	1	435031824R1	
R1607	C-CARBON R	RN72K1J-182JE	1	435031824R1	
R1610	C-CARBON R	RN72K1J-182JE	1	435031824R1	
R1611	C-CARBON R	RN72K1J-182JE	1	435031824R1	
R1612	C-CARBON R	RN72K1J-182JE	1	435031824R1	
R1613	C-CARBON R	RN72K1J-182JE	1	435031824R1	
R1614	C-CARBON R	RN72K1J-182JE	1	435031824R1	
R1615	C-CARBON R	RN72K1J-182JE	1	435031824R1	
R1616	C-CARBON R	RN72K1J-182JE	1	435031824R1	
R1617	C-CARBON R	RN72K1J-182JE	1	435031824R1	
R1620	C-CARBON R	RN72K1J-103JE	1	435031034R1	
R1621	C-CARBON R	RN72K1J-103JE	1	435031034R1	
R1622	C-CARBON R	RN72K1J-103JE	1	435031034R1	
R1623	C-CARBON R	RN72K1J-103JE	1	435031034R1	
R1624	C-CARBON R	RN72K1J-103JE	1	435031034R1	
R1625	C-CARBON R	RN72K1J-103JE	1	435031034R1	
R1626	C-CARBON R	RN72K1J-103JE	1	435031034R1	
R1627	C-CARBON R	RN72K1J-103JE	1	435031034R1	
R1630	C-CARBON R	RN72K1J-103JE	1	435031034R1	
R1631	C-CARBON R	RN72K1J-103JE	1	435031034R1	
R1632	C-CARBON R	RN72K1J-103JE	1	435031034R1	
R1633	C-CARBON R	RN72K1J-103JE	1	435031034R1	
R1634	C-CARBON R	RN72K1J-103JE	1	435031034R1	
R1635	C-CARBON R	RN72K1J-103JE	1	435031034R1	
R1636	C-CARBON R	RN72K1J-103JE	1	435031034R1	
R1637	C-CARBON R	RN72K1J-103JE	1	435031034R1	
R1640	C-CARBON R	RN72K1J-103JE	1	435031034R1	
R1641	C-CARBON R	RN72K1J-103JE	1	435031034R1	
R1642	C-CARBON R	RN72K1J-103JE	1	435031034R1	
R1643	C-CARBON R	RN72K1J-103JE	1	435031034R1	
R1644	C-CARBON R	RN72K1J-103JE	1	435031034R1	
R1645	C-CARBON R	RN72K1J-103JE	1	435031034R1	
R1646	C-CARBON R	RN72K1J-103JE	1	435031034R1	

R1647	C-CARBON R	RN72K1J-103JE	1	435031034R1
R1650	C-CARBON R	RN72K1J-103JE	1	435031034R1
R1651	C-CARBON R	RN72K1J-103JE	1	435031034R1
R1652	C-CARBON R	RN72K1J-103JE	1	435031034R1
R1653	C-CARBON R	RN72K1J-103JE	1	435031034R1
R1654	C-CARBON R	RN72K1J-103JE	1	435031034R1
R1655	C-CARBON R	RN72K1J-103JE	1	435031034R1
R1656	C-CARBON R	RN72K1J-103JE	1	435031034R1
R1657	C-CARBON R	RN72K1J-103JE	1	435031034R1
R1660	C-CARBON R	RN72K1J-181JE	1	435031814R1
R1661	C-CARBON R	RN72K1J-181JE	1	435031814R1
R1662	C-CARBON R	RN72K1J-181JE	1	435031814R1
R1663	C-CARBON R	RN72K1J-181JE	1	435031814R1
R1664	C-CARBON R	RN72K1J-181JE	1	435031814R1
R1665	C-CARBON R	RN72K1J-181JE	1	435031814R1
R1666	C-CARBON R	RN72K1J-181JE	1	435031814R1
R1667	C-CARBON R	RN72K1J-181JE	1	435031814R1
R1670	C-CARBON R	RN72K1J-181JE	1	435031814R1
R1671	C-CARBON R	RN72K1J-181JE	1	435031814R1
R1672	C-CARBON R	RN72K1J-181JE	1	435031814R1
R1673	C-CARBON R	RN72K1J-181JE	1	435031814R1
R1674	C-CARBON R	RN72K1J-181JE	1	435031814R1
R1675	C-CARBON R	RN72K1J-181JE	1	435031814R1
R1676	C-CARBON R	RN72K1J-181JE	1	435031814R1
R1677	C-CARBON R	RN72K1J-181JE	1	435031814R1
R1770	C-CARBON R	RN72K1J-000JE	1	435030004R1
R1771	C-CARBON R	RN72K1J-000JE	1	435030004R1
R1772	C-CARBON R	RN72K1J-000JE	1	435030004R1
R1773	C-CARBON R	RN72K1J-000JE	1	435030004R1
R1774	C-CARBON R	RN72K1J-000JE	1	435030004R1
R1775	C-CARBON R	RN72K1J-000JE	1	435030004R1
R1776	C-CARBON R	RN72K1J-000JE	1	435030004R1
R1777	C-CARBON R	RN72K1J-000JE	1	435030004R1
R1780	METAL O R	RS1/2WBJ-22	1	443522204T
R1781	METAL O R	RS1/2WBJ-22	1	443522204T
R1782	METAL O R	RS2WBJ-3.3	1	441720334F
R1783	METAL O R	RS2WBJ-4.7	1	441720474F
R1900	C-CARBON R	RN72K1J-560JE	1	435035604R1
R1901	C-CARBON R	RN72K1J-560JE	1	435035604R1
R1910	C-CARBON R	RN72K1J-560JE	1	435035604R1
R1911	C-CARBON R	RN72K1J-560JE	1	435035604R1
R1920	C-CARBON R	RN72K1J-103JE	1	435031034R1
R1921	C-CARBON R	RN72K1J-103JE	1	435031034R1
R1930	C-CARBON R	RN72K1J-103JE	1	435031034R1
R1931	C-CARBON R	RN72K1J-103JE	1	435031034R1

R1940	C-CARBON R	RN72K1J-103JE	1	435031034R1
R1941	C-CARBON R	RN72K1J-103JE	1	435031034R1
R1950	C-CARBON R	RN72K1J-103JE	1	435031034R1
R1951	C-CARBON R	RN72K1J-103JE	1	435031034R1
R1960	C-CARBON R	RN72K1J-103JE	1	435031034R1
R1961	C-CARBON R	RN72K1J-103JE	1	435031034R1
R1962	C-CARBON R	RN72K1J-101JE	1	435031014R1
R1963	C-CARBON R	RN72K1J-101JE	1	435031014R1
R1964	C-CARBON R	RN72K1J-222JE	1	435032224R1
R1965	C-CARBON R	RN72K1J-102JE	1	435031024R1
R4000	METAL R	RNU1/2WCJ-4.7	1	453530474T
R4001	C-CARBON R	RN72K1J-682JE	1	435036824R1
R4002	METAL R	RNU1WCJ-0.22	1	453632294T
R4003	METAL R	RNU1/2WCJ-0.47	1	453534794T
R4004	C-CARBON R	RN72K1J-562JE	1	435035624R1
R4005	C-CARBON R	RN72K1J-152JE	1	435031524R1
R4006	C-CARBON R	RN72K1J-102JE	1	435031024R1
R4007	C-CARBON R	RN72K1J-392JE	1	435033924R1
R4008	C-CARBON R	RN72K1J-103JE	1	435031034R1
R4009	METAL R	RNU1/2WCJ-0.47	1	453534794T
R4017	C-CARBON R	RN72K1J-562JE	1	435035624R1
R4018	C-CARBON R	RN72K1J-563JE	1	435035634R1
R4019	C-CARBON R	RN72K1J-102JE	1	435031024R1
R4020	C-CARBON R	RN72K1J-392JE	1	435033924R1
R4021	METAL R	RNU1/2WCJ-0.22	1	453532294T
R4022	METAL O R	RS2WBJ-3.3	1	441720334F
R4024	C-CARBON R	RN72K1J-470JE	1	435034704R1
R4103	C-CARBON R	RN72K1J-750JE	1	435037504R1
R4104	C-CARBON R	RN72K1J-750JE	1	435037504R1
R4108	C-CARBON R	RN72K1J-330JE	1	435033304R1
R4109	C-CARBON R	RN72K1J-750JE	1	435037504R1
R4110	C-CARBON R	RN72K1J-750JE	1	435037504R1
R4111	C-CARBON R	RN72K1J-272JE	1	435032724R1
R4112	C-CARBON R	RN72K1J-750JE	1	435037504R1
R4113	C-CARBON R	RN72K1J-272JE	1	435032724R1
R4115	C-CARBON R	RN72K1J-750JE	1	435037504R1
R4117	C-CARBON R	RN72K1J-750JE	1	435037504R1
R4119	C-CARBON R	RN72K2E-022JE	1	435220224R1
R4120	C-CARBON R	RN72K1J-750JE	1	435037504R1
R4121	C-CARBON R	RN72K1J-750JE	1	435037504R1
R4122	C-CARBON R	RN72K1J-750JE	1	435037504R1
R4123	C-CARBON R	RN72K1J-104JE	1	435031044R1
R4124	C-CARBON R	RN72K1J-750JE	1	435037504R1
R4125	C-CARBON R	RN72K1J-104JE	1	435031044R1
R4126	C-CARBON R	RN72K1J-750JE	1	435037504R1



R4127	C-CARBON R	RN72K1J-104JE	1	435031044R1
R4128	C-CARBON R	RN72K1J-750JE	1	435037504R1
R4129	C-CARBON R	RN72K1J-104JE	1	435031044R1
R4130	C-CARBON R	RN72K2E-022JE	1	435220224R1
R4131	C-CARBON R	RN72K1J-750JE	1	435037504R1
R4132	C-CARBON R	RN72K1J-104JE	1	435031044R1
R4133	C-CARBON R	RN72K1J-750JE	1	435037504R1
R4134	C-CARBON R	RN72K1J-104JE	1	435031044R1
R4135	C-CARBON R	RN72K1J-750JE	1	435037504R1
R4136	C-CARBON R	RN72K1J-750JE	1	435037504R1
R4137	C-CARBON R	RN72K1J-750JE	1	435037504R1
R4138	C-CARBON R	RN72K1J-022JE	1	435030224R1
R4139	C-CARBON R	RN72K1J-750JE	1	435037504R1
R4140	C-CARBON R	RN72K1J-750JE	1	435037504R1
R4141	C-CARBON R	RN72K1J-750JE	1	435037504R1
R4142	C-CARBON R	RN72K1J-750JE	1	435037504R1
R4143	C-CARBON R	RN72K1J-750JE	1	435037504R1
R4144	C-CARBON R	RN72K1J-750JE	1	435037504R1
R4145	C-CARBON R	RN72K1J-104JE	1	435031044R1
R4146	C-CARBON R	RN72K1J-104JE	1	435031044R1
R4147	C-CARBON R	RN72K1J-104JE	1	435031044R1
R4148	C-CARBON R	RN72K1J-103JE	1	435031034R1
R4149	C-CARBON R	RN72K1J-750JE	1	435037504R1
R4150	C-CARBON R	RN72K1J-750JE	1	435037504R1
R4151	C-CARBON R	RN72K1J-750JE	1	435037504R1
R4152	C-CARBON R	RN72K1J-101JE	1	435031014R1
R4153	C-CARBON R	RN72K1J-101JE	1	435031014R1
R4155	C-CARBON R	RN72K1J-750JE	1	435037504R1
R4156	C-CARBON R	RN72K1J-750JE	1	435037504R1
R4157	C-CARBON R	RN72K1J-750JE	1	435037504R1
R4158	C-CARBON R	RN72K1J-271JE	1	435032714R1
R4159	C-CARBON R	RN72K1J-750JE	1	435037504R1
R4160	METAL R	RNU1/2WCJ-2.2	1	453530224T
R4161	C-CARBON R	RN72K1J-750JE	1	435037504R1
R4162	C-CARBON R	RN72K1J-750JE	1	435037504R1
R4163	C-CARBON R	RN72K1J-104JE	1	435031044R1
R4164	C-CARBON R	RN72K1J-104JE	1	435031044R1
R4165	C-CARBON R	RN72K1J-104JE	1	435031044R1
R4166	C-CARBON R	RN72K1J-334JE	1	435033344R1
R4167	C-CARBON R	RN72K1J-334JE	1	435033344R1
R4168	C-CARBON R	RN72K1J-271JE	1	435032714R1
R4169	C-CARBON R	RN72K1J-271JE	1	435032714R1
R4170	C-CARBON R	RN72K1J-334JE	1	435033344R1
R4171	C-CARBON R	RN72K2E-022JE	1	435220224R1
R4172	C-CARBON R	RN72K1J-271JE	1	435032714R1

R4173	C-CARBON R	RN72K1J-271JE	1	435032714R1
R4174	C-CARBON R	RN72K1J-271JE	1	435032714R1
R4175	C-CARBON R	RN72K1J-750JE	1	435037504R1
R4176	C-CARBON R	RN72K1J-750JE	1	435037504R1
R4177	C-CARBON R	RN72K1J-750JE	1	435037504R1
R4181	C-CARBON R	RN72K1J-750JE	1	435037504R1
R4182	C-CARBON R	RN72K1J-750JE	1	435037504R1
R4183	C-CARBON R	RN72K1J-750JE	1	435037504R1
R4184	C-CARBON R	RN72K1J-750JE	1	435037504R1
R4185	C-CARBON R	RN72K1J-750JE	1	435037504R1
R4186	C-CARBON R	RN72K1J-750JE	1	435037504R1
R4187	C-CARBON R	RN72K1J-154JE	1	435031544R1
R4188	C-CARBON R	RN72K1J-154JE	1	435031544R1
R4189	C-CARBON R	RN72K1J-154JE	1	435031544R1
R4190	C-CARBON R	RN72K1J-000JE	1	435030004R1
R4191	C-CARBON R	RN72K1J-000JE	1	435030004R1
R4192	C-CARBON R	RN72K1J-000JE	1	435030004R1
R4212	C-CARBON R	RN72K1J-564JE	1	435035644R1
R4213	C-CARBON R	RN72K1J-564JE	1	435035644R1
R4505	C-CARBON R	RN72K1J-223JE	1	435032234R1
R4506	C-CARBON R	RN72K1J-122JE	1	435031224R1
R4507	C-CARBON R	RN72K1J-473JE	1	435034734R1
R4508	C-CARBON R	RN72K1J-182JE	1	435031824R1
R4509	C-CARBON R	RN72K1J-331JE	1	435033314R1
R4510	C-CARBON R	RN72K1J-562JE	1	435035624R1
R4511	METAL R	RNU1WCJ-1	1	453630104T
R4600	C-CARBON R	RN72K1J-220JE	1	435032204R1
R4601	C-CARBON R	RN72K1J-224JE	1	435032244R1
R4602	C-CARBON R	RN72K1J-102JE	1	435031024R1
R4603	C-CARBON R	RN72K1J-220JE	1	435032204R1
R4604	C-CARBON R	RN72K1J-101JE	1	435031014R1
R4605	C-CARBON R	RN72K1J-224JE	1	435032244R1
R4606	C-CARBON R	RN72K1J-102JE	1	435031024R1
R4607	C-CARBON R	RN72K1J-039JE	1	435030394R1
R4608	C-CARBON R	RN72K1J-101JE	1	435031014R1
R4609	C-CARBON R	RN72K1J-000JE	1	435030004R1
R4610	C-CARBON R	RN72K1J-224JE	1	435032244R1
R4611	C-CARBON R	RN72K1J-000JE	1	435030004R1
R4613	C-CARBON R	RN72K1J-102JE	1	435031024R1
R4617	C-CARBON R	RN72K1J-470JE	1	435034704R1
R4618	C-CARBON R	RN72K1J-470JE	1	435034704R1
R4619	C-CARBON R	RN72K1J-000JE	1	435030004R1
R4620	C-CARBON R	RN72K1J-101JE	1	435031014R1
R4621	C-CARBON R	RN72K1J-103JE	1	435031034R1
R4700	C-CARBON R	RN72K1J-103JE	1	435031034R1

R4701	C-CARBON R	RN72K1J-103JE	1	435031034R1	
R4702	C-CARBON R	RN72K1J-331JE	1	435033314R1	
R4703	C-CARBON R	RN72K1J-331JE	1	435033314R1	
R4704	C-CARBON R	RN72K1J-103JE	1	435031034R1	
R4705	C-CARBON R	RN72K1J-331JE	1	435033314R1	
R4707	C-CARBON R	RN72K1J-331JE	1	435033314R1	
R4800	C-CARBON R	RN72K1J-104JE	1	435031044R1	
R4801	C-CARBON R	RN72K1J-104JE	1	435031044R1	
R4802	C-CARBON R	RN72K1J-103JE	1	435031034R1	
R4803	C-CARBON R	RN72K1J-103JE	1	435031034R1	
R4804	C-CARBON R	RN72K1J-103JE	1	435031034R1	
R4805	C-CARBON R	RN72K1J-471JE	1	435034714R1	
R4808	C-CARBON R	RN72K1J-222JE	1	435032224R1	
R4809	C-CARBON R	MCR03EZPF49R9(49.9_1%)	1	4100037R2	
R4810	C-CARBON R	MCR03EZPF49R9(49.9_1%)	1	4100037R2	
R4812	C-CARBON R	RN72K1J-100JE	1	435031004R1	
R4814	C-CARBON R	RN72K1J-100JE	1	435031004R1	
R4815	C-CARBON R	RN72K1J-103JE	1	435031034R1	
R4816	C-CARBON R	MCR03EZPF49R9(49.9_1%)	1	4100037R2	
R4817	C-CARBON R	MCR03EZPF49R9(49.9_1%)	1	4100037R2	
R4818	C-CARBON R	RN72K1J-470JE	1	435034704R1	
R4819	C-CARBON R	RN72K1J-470JE	1	435034704R1	
R4820	C-CARBON R	RN72K1J-470JE	1	435034704R1	
R4821	C-CARBON R	RN72K1J-470JE	1	435034704R1	
R4822	C-CARBON R	RN72K1J-103JE	1	435031034R1	
E1A	TRM	NTM-1P233(M1969)	1	25060302	
E1B	TRM	NTM-1P232(M1700)	1	25060301	
E2	TRM(SCREW)	NEJITANSI M3	1	25065425	
F4000A	FUSE HOL	NSCT-1P2031	1	25052133T	
F4000B	FUSE HOL	NSCT-1P2031	1	25052133T	
F4001A	FUSE HOL	NSCT-1P2031	1	25052133T	
F4001B	FUSE HOL	NSCT-1P2031	1	25052133T	
JL8002A	WIRE HOL	NSCT-5P876	1	25051089	
JL901B	WIRE TRAP	NPLG-5P588	1	25055626	
P4	SOCKET	CAM-C16	1	25053104R2	<DD>
P4A	RETAINER	(XM)	1	27142048	<DD>
P8	SOCKET	YKF51-5397N	1	25053201	<DD>
P1002A	SOCKET	NSCT-9P2427	1	25052530	
P1003A	SOCKET	IMSA-9142S-14A	1	25053229	
P1004A	PLUG	IMSA-9111B-24	1	25056625	
P1005A	SOCKET	IMSA-9142S-20A	1	25053232	
P1007A	SOCKET	NSCT-40P2133	1	25052236	
P102A	PLUG	NPLG-7P0962	1	25056012	
P102B	SOCKET	NSCT-7P2187	1	25052290	
P103A	PLUG	NPLG-11P0966	1	25056016	<DD>

P103B	SOCKET	NSCT-11P2191	1	25052294	<DD>
P104A	PLUG	NPLG-13P0968	1	25056018	
P106B	SOCKET	NSCT-13P2143	1	25052246	
P1307	TRM(SCREW)	NEJITANSI M3	1	25065425	
P1308	JACK	YKB21-5130	1	25045387	
P1309	PIN JACK	NPJ-3PDO657	1	25045885	
P1309 or	PIN JACK	NPJ-3PDO431	( 1)	25045624	
P1310	JACK	NPJ-1PDOR296	1	25045478	
P4000B	PLUG	NPLG-5P119	1	25055135	
P4100A	PLUG	IMSA-9142B-14A	1	25056597	
P4100B	SOCKET	IMSA-9142S-14A	1	25053229	
P4101A	PLUG	IMSA-9142B-16A	1	25056598	
P4101B	SOCKET	IMSA-9142S-16A	1	25053230	
P4102A	SOCKET	NSCT-17P2110	1	25052213	
P4102B	SOCKET	NSCT-17P2110	1	25052213	
P4104A	SOCKET	NSCT-11P2104	1	25052207	
P4108	PIN JACK	NPJ-9PDGLR630	1	25045851	
P4108 or	PIN JACK	NPJ-9PDGLR520	( 1)	25045732	
P4111	PIN JACK	NPJ-6PDGLR649	1	25045874	
P4112	PIN JACK	NPJ-10PDSY628	1	25045849	
P4112 or	PIN JACK	NPJ-10PDBY481	( 1)	25045684	
P4113	PIN JACK	NPJ-10PDSY628	1	25045849	
P4113 or	PIN JACK	NPJ-10PDBY481	( 1)	25045684	
P4114	PIN JACK	NPJ-10PDSY628	1	25045849	
P4114 or	PIN JACK	NPJ-10PDBY481	( 1)	25045684	
P4501	PLUG	NPLG-2P83	1	25055099	
P4600	ST JACK	HSJ1002-01-6020	1	25045647	
P4601	ST JACK	HSJ1002-01-6020	1	25045647	
P4602	ST JACK	HSJ1002-01-6020	1	25045647	
P4700	SOCKET	7906-09FHA	1	25053103	
P4701	RETAINER	(JOINT)	1	27142069	
P4800	SOCKET	SI-60073-F	1	25053307	
P4800 or	SOCKET	J0026D21NL	( 1)	25053250	
P4801	PLUG	IMSA-9201B-1-06Z388-PT1	1	25056614	
P5512A	PLUG	NPLG-11P0966	1	25056016	
P5513A	PLUG	NPLG-15P0970	1	25056020	
P5518A	PLUG	NPLG-3P0958	1	25056008	
P6621B	SOCKET	NSCT-13P2193	1	25052296	

**U20 HDMI PC BOARD(NAHDM-9562-1A)**

CIRCUIT NO.	PART NAME	DESCRIPTION	Q'TY	PART NO. (SN)	REMARKS
Q205	IC	TC74VHC541FT(EKJ)	1	22274541E1R2TO	
Q3311	IC	TC74VHC157FT	1	22274157ER2TO	
Q3325	IC	TC74VHC157FT	1	22274157ER2TO	

Q3401	IC	D790E001BZDH300	1	---	NSP
Q3451	IC(DSP1 MEMORY)	S29AL016D70TFI010(0272)	1	222W0063R302726	
Q3451 or	IC(DSP1 MEMORY)	ES29LV160ET-70TG(0272)	(1)	222W0069R302726	
Q3461	IC	IS42S32200E-6TL	1	22242553R3	
Q3481	IC	TC7WU04FU(TE12L_F)	1	22240935R2	
Q3491	IC	TC74VHC541FT(EKJ)	1	22274541E1R2TO	
Q3501	IC	D790E001BZDH300	1	---	NSP
Q3551	IC(DSP2 MEMORY)	S29AL008D70TFI010(0273)	1	222W0062R302737	
Q3551 or	IC(DSP2 MEMORY)	ES29LV800ET-70TG(0273)	(1)	222W0068R302737	
Q3561	IC	IS42S32200E-6TL	1	22242553R3	
Q7202	IC	BD7820	1	22242300R2	
Q7302	IC	BD7820	1	22242300R2	
Q8000	IC	HY5DU561622ETP-4-C	1	22242450R3	
Q8000 or	IC	HY5DU561622FTP-4-C	(1)	22242577R3	
Q8001	IC	HY5DU561622ETP-4-C	1	22242450R3	
Q8001 or	IC	HY5DU561622FTP-4-C	(1)	22242577R3	
Q8005	IC(VIDEO MEMORY)	MX29LV320CTTC-70G(0264)	1	222W0052R30264A	
Q8023	IC	TA48033AF(TE16L_NQ)	1	22278033DR2TO	
Q8023 or	IC	TA48033BF(TE16L_NQ)	(1)	22278033DBR2TO	
Q8041	IC	TA48018AF(TE16L_NQ)	1	22278018DR2TO	
Q8090	TR	RN2402	1	2214530R2	
Q8090 or	TR	KRA102S	(1)	2216220R2	
Q8091	TR	2SA1162-GR	1	2214375R2	
Q8094	TR	RN2402	1	2214530R2	
Q8094 or	TR	KRA102S	(1)	2216220R2	
Q8095	TR	2SA1162-Y(TE85R_F)	1	2214374R2	
Q8097	IC	74HC112(TC74HC112AF)	1	222741125R2TO	
Q8161	IC	TA48018AF(TE16L_NQ)	1	22278018DR2TO	
Q8162	IC	SII9185ACTU	1	22242471R3	
Q8200	IC	FLI30336	1	---	NSP
Q8201	IC	24LC32A-I/SN	1	22242521R2	
Q8201 or	IC	BR24S32FJ-WE2	(1)	22242569R2	
Q8305	IC	S-812C50BUC-CSET2G	1	22242407R2	
Q8306	IC	NC7SZ08P5X_F042	1	22242482R2	
Q8306 or	IC	TC7SZ08FU(TE85L_F)	(1)	22242071R2TO	
Q8309	TR ARRAY	UM6K1N	1	226066R2	
Q8401	IC	SII9134CTU	1	22242394R3	
Q8404	IC	XC6213B182MR	1	22242443R2	
Q8405	IC	SN74CB3Q3305PWR	1	22242258R2	
Q8501	IC	SII9135CTU	1	---	NSP
Q8501 or	IC	SII9135ACTU	(1)	---	NSP
Q8595	IC	TA48018AF(TE16L_NQ)	1	22278018DR2TO	
Q8604	TR	DTA144EE	1	2216380R2	
Q8604 or	TR	KRA304E	(1)	2216440R2	
Q8606	TR	DTC144EE	1	2216390R2	

Q8606 or	TR	KRC404E	(1)	2216450R2
Q8607	TR	2SK3019	1	2216520R2
Q8608	IC	SN74CB3T3306DCT	1	22242454R2
Q8609	TR	DTC144EE	1	2216390R2
Q8609 or	TR	KRC404E	(1)	2216450R2
Q8610	IC	S-24CS02AFT-V-G	1	22242360R2
Q8651	IC	TA48018AF(TE16L_NQ)	1	22278018DR2TO
Q8652	IC	XC6213B332MR	1	22242277R2
Q8653	IC	TA48033AF(TE16L_NQ)	1	22278033DR2TO
Q8653 or	IC	TA48033BF(TE16L_NQ)	(1)	22278033DBR2TO
Q8654	IC	TA48018AF(TE16L_NQ)	1	22278018DR2TO
Q8813	IC	TC74VCX162827	1	22242395R2
Q8814	IC	TC74VCX162827	1	22242395R2
Q8817	IC	TC74VCX162827	1	22242395R2
Q8818	IC	TC74VCX162827	1	22242395R2
Q8902	IC	TA48033AF(TE16L_NQ)	1	22278033DR2TO
Q8902 or	IC	TA48033BF(TE16L_NQ)	(1)	22278033DBR2TO
Q8952	IC	SPI-8010A	1	22242437R2
Q8953	IC	SPI-8010A	1	22242437R2
Q8954	IC	SPI-8010A	1	22242437R2
Q8957	TR	DTC144EE	1	2216390R2
Q8957 or	TR	KRC404E	(1)	2216450R2
Q8958	TR	DTC144EE	1	2216390R2
Q8958 or	TR	KRC404E	(1)	2216450R2
Q8963	TR	DTC144EE	1	2216390R2
Q8963 or	TR	KRC404E	(1)	2216450R2
Q8964	TR	DTC144EE	1	2216390R2
Q8964 or	TR	KRC404E	(1)	2216450R2
D4100	C-DIODE	1SS352	1	223234R2
D4100 or	C-DIODE	KDS4148U	(1)	223283R2
D4100 or	C-DIODE	MA2J111	(1)	223279R2
D7205	C-DIODE	1SS352	1	223234R2
D7205 or	C-DIODE	KDS4148U	(1)	223283R2
D7205 or	C-DIODE	MA2J111	(1)	223279R2
D8041	DIODE	RB070M-30	1	22380361R2
D8090	C-DIODE	1SS352	1	223234R2
D8090 or	C-DIODE	KDS4148U	(1)	223283R2
D8090 or	C-DIODE	MA2J111	(1)	223279R2
D8091	C-DIODE	1SS352	1	223234R2
D8091 or	C-DIODE	KDS4148U	(1)	223283R2
D8091 or	C-DIODE	MA2J111	(1)	223279R2
D8095	C-DIODE	1SS352	1	223234R2
D8095 or	C-DIODE	KDS4148U	(1)	223283R2
D8095 or	C-DIODE	MA2J111	(1)	223279R2
D8096	C-DIODE	1SS352	1	223234R2

D8096 or	C-DIODE	KDS4148U	(1)	223283R2
D8096 or	C-DIODE	MA2J111	(1)	223279R2
D8301	C-DIODE	1SS226(TE85L_F)	1	223266R2
D8302	C-DIODE	1SS352	1	223234R2
D8302 or	C-DIODE	KDS4148U	(1)	223283R2
D8302 or	C-DIODE	MA2J111	(1)	223279R2
D8601	ZENER D	UDZS3.6B	1	224550360R2
D8952	DIODE	RSX501L-20	1	22380359R2
D8953	DIODE	RSX501L-20	1	22380359R2
D8954	DIODE	RSX501L-20	1	22380359R2
D8958	C-DIODE	1SS352	1	223234R2
D8958 or	C-DIODE	KDS4148U	(1)	223283R2
D8958 or	C-DIODE	MA2J111	(1)	223279R2
L251	CHOKE COIL	BLM21PG221SN1	1	230949R2
L261	EMIFIL	BK1608LL241-T	1	230959R1
L3301	CHOKE COIL	LBC2518T470M	1	231364M470R2
L3311	EMIFIL	BK1608LM182-T	1	230958R1
L3312	EMIFIL	BK1608LM182-T	1	230958R1
L3401	EMIFIL	ACF451832-333-T	1	230978R2
L3402	CHOKE COIL	BLM21PG221SN1	1	230949R2
L3403	CHOKE COIL	LBC2518T4R7M	1	231364M047R2
L3451	CHOKE COIL	BLM21PG221SN1	1	230949R2
L3481	EMIFIL	BK1608LM182-T	1	230958R1
L3482	EMIFIL	BK1608LM182-T	1	230958R1
L3483	CHOKE COIL	LBC2518T470M	1	231364M470R2
L3491	CHOKE COIL	LBC2518T470M	1	231364M470R2
L3501	EMIFIL	ACF451832-333-T	1	230978R2
L3502	CHOKE COIL	BLM21PG221SN1	1	230949R2
L3503	CHOKE COIL	LBC2518T4R7M	1	231364M047R2
L3551	CHOKE COIL	BLM21PG221SN1	1	230949R2
L3552	EMIFIL	BK1608LM182-T	1	230958R1
L8021	CHOKE COIL	BLM21PG221SN1	1	230949R2
L8022	CHOKE COIL	BLM21PG221SN1	1	230949R2
L8023	CHOKE COIL	BLM21PG221SN1	1	230949R2
L8024	CHOKE COIL	BLM21PG221SN1	1	230949R2
L8025	CHOKE COIL	BLM21PG221SN1	1	230949R2
L8026	CHOKE COIL	BLM21PG221SN1	1	230949R2
L8027	CHOKE COIL	BLM21PG221SN1	1	230949R2
L8041	CHOKE COIL	BLM21PG221SN1	1	230949R2
L8042	CHOKE COIL	BLM21PG221SN1	1	230949R2
L8043	CHOKE COIL	BLM21PG221SN1	1	230949R2
L8090	CHOKE COIL	LBC2518T4R7M	1	231364M047R2
L8094	CHOKE COIL	LBC2518T4R7M	1	231364M047R2
L8161	CHOKE COIL	BLM21PG221SN1	1	230949R2
L8162	CHOKE COIL	BLM21PG221SN1	1	230949R2

L8163	CHOKE COIL	BLM21PG221SN1	1	230949R2
L8401	CHOKE COIL	BLM21PG221SN1	1	230949R2
L8402	CHOKE COIL	BLM21PG221SN1	1	230949R2
L8403	CHOKE COIL	BLM21PG221SN1	1	230949R2
L8404	CHOKE COIL	BLM21PG221SN1	1	230949R2
L8405	CHOKE COIL	BLM21PG221SN1	1	230949R2
L8406	C-R NET	MNR12E0APJ000	1	43464900002R2
L8407	C-R NET	MNR12E0APJ000	1	43464900002R2
L8408	CHOKE COIL	BLM21PG221SN1	1	230949R2
L8409	C-R NET	MNR12E0APJ000	1	43464900002R2
L8410	C-R NET	MNR12E0APJ000	1	43464900002R2
L8601	CHOKE COIL	BLM21PG221SN1	1	230949R2
L8602	CHOKE COIL	BLM21PG221SN1	1	230949R2
L8603	CHOKE COIL	BLM21PG221SN1	1	230949R2
L8604	CHOKE COIL	BLM21PG221SN1	1	230949R2
L8605	CHOKE COIL	BLM21PG221SN1	1	230949R2
L8606	CHOKE COIL	BLM21PG221SN1	1	230949R2
L8607	CHOKE COIL	BLM21PG221SN1	1	230949R2
L8608	EMIFIL	BK1608LL241-T	1	230959R1
L8813	C-CARBON R	RN72K1J-000JE	1	435030004R1
L8814	C-CARBON R	RN72K1J-000JE	1	435030004R1
L8952	CHOKE COIL	RCPI317NP470M	1	231375M470
L8953	CHOKE COIL	RCPI317NP470M	1	231375M470
L8954	CHOKE COIL	RCPI317NP470M	1	231375M470
L8956	CHOKE COIL	BLM21PG221SN1	1	230949R2
L8957	CHOKE COIL	BLM21PG221SN1	1	230949R2
L8958	CHOKE COIL	BLM21PG221SN1	1	230949R2
L8960	CHOKE COIL	BLM21PG221SN1	1	230949R2
L8961	CHOKE COIL	BLM21PG221SN1	1	230949R2
L8962	CHOKE COIL	BLM21PG221SN1	1	230949R2
L8963	CHOKE COIL	BLM21PG221SN1	1	230949R2
L8964	CHOKE COIL	BLM21PG221SN1	1	230949R2
L8965	CHOKE COIL	BLM21PG221SN1	1	230949R2
X3481	CRYSTAL	HC-49USSMD25.00MHz	1	3010444R2
X8200	CRYSTAL	HC-49USSMD19.6608M	1	3010458R2
X8501	CRYSTAL	HC-49-28.332MHz	1	3010417R2
C251	C-CERA C	CK725F1E-104Z1	1	332161040R1
C3302	CHIP ELECT C	CEWX4V-100M	1	3981G1017R2
C3311	C-CERA C	CK725F1E-104Z1	1	332161040R1
C3312	C-CERA C	CK725F1E-104Z1	1	332161040R1
C3401	C-CERA C	CC725CH1H-101J1	1	342101014R1
C3402	CHIP ELECT C	CEWX4V-100M	1	3981G1017R2
C3403	C-CERA C	CK725F1E-104Z1	1	332161040R1
C3405	CHIP ELECT C	CEWX4V-220M	1	3981G2217R2
C3411	C-CERA C	CK725F1E-104Z1	1	332161040R1



C3412	C-CERA C	CK725F1E-104Z1	1	332161040R1
C3413	C-CERA C	CK725F1E-104Z1	1	332161040R1
C3414	C-CERA C	CK725F1E-104Z1	1	332161040R1
C3415	C-CERA C	CK725F1E-104Z1	1	332161040R1
C3416	C-CERA C	CK725F1E-104Z1	1	332161040R1
C3417	C-CERA C	CK725F1E-104Z1	1	332161040R1
C3418	C-CERA C	CK725F1E-104Z1	1	332161040R1
C3419	C-CERA C	CK725F1E-104Z1	1	332161040R1
C3420	C-CERA C	CK725F1E-104Z1	1	332161040R1
C3421	C-CERA C	CK725F1E-104Z1	1	332161040R1
C3425	C-CERA C	CK725F1E-104Z1	1	332161040R1
C3426	C-CERA C	CK725F1E-104Z1	1	332161040R1
C3427	C-CERA C	CK725F1E-104Z1	1	332161040R1
C3428	C-CERA C	CK725F1E-104Z1	1	332161040R1
C3429	C-CERA C	CK725F1E-104Z1	1	332161040R1
C3430	C-CERA C	CK725F1E-104Z1	1	332161040R1
C3431	C-CERA C	CK725F1E-104Z1	1	332161040R1
C3432	C-CERA C	CK725F1E-104Z1	1	332161040R1
C3433	C-CERA C	CK725F1E-104Z1	1	332161040R1
C3434	C-CERA C	CK725F1E-104Z1	1	332161040R1
C3435	C-CERA C	CK725F1E-104Z1	1	332161040R1
C3451	C-CERA C	CC725CH1H-101J1	1	342101014R1
C3452	C-CERA C	CK725F1E-104Z1	1	332161040R1
C3461	C-CERA C	CK725F1E-104Z1	1	332161040R1
C3462	C-CERA C	CK725F1E-104Z1	1	332161040R1
C3463	C-CERA C	CK725F1E-104Z1	1	332161040R1
C3464	C-CERA C	CK725F1E-104Z1	1	332161040R1
C3465	C-CERA C	CK725F1E-104Z1	1	332161040R1
C3466	C-CERA C	CK725F1E-104Z1	1	332161040R1
C3471	C-CERA C	CK725F1E-104Z1	1	332161040R1
C3472	C-CERA C	CK725F1E-104Z1	1	332161040R1
C3473	C-CERA C	CK725F1E-104Z1	1	332161040R1
C3474	C-CERA C	CK725F1E-104Z1	1	332161040R1
C3475	C-CERA C	CK725F1E-104Z1	1	332161040R1
C3476	C-CERA C	CK725F1E-104Z1	1	332161040R1
C3477	CHIP ELECT C	CEWX4V-220M	1	3981G2217R2
C3481	C-CERA C	CC725CH1H-090D1	1	342100902R1
C3482	C-CERA C	CC725CH1H-090D1	1	342100902R1
C3483	C-CERA C	CK725F1E-104Z1	1	332161040R1
C3484	CHIP ELECT C	CEWX4V-220M	1	3981G2217R2
C3491	C-CERA C	CK725F1E-104Z1	1	332161040R1
C3501	C-CERA C	CC725CH1H-101J1	1	342101014R1
C3502	CHIP ELECT C	CEWX4V-100M	1	3981G1017R2
C3503	C-CERA C	CK725F1E-104Z1	1	332161040R1
C3505	CHIP ELECT C	CEWX4V-220M	1	3981G2217R2

C3511	C-CERA C	CK725F1E-104Z1	1	332161040R1
C3512	C-CERA C	CK725F1E-104Z1	1	332161040R1
C3513	C-CERA C	CK725F1E-104Z1	1	332161040R1
C3514	C-CERA C	CK725F1E-104Z1	1	332161040R1
C3515	C-CERA C	CK725F1E-104Z1	1	332161040R1
C3516	C-CERA C	CK725F1E-104Z1	1	332161040R1
C3517	C-CERA C	CK725F1E-104Z1	1	332161040R1
C3518	C-CERA C	CK725F1E-104Z1	1	332161040R1
C3519	C-CERA C	CK725F1E-104Z1	1	332161040R1
C3520	C-CERA C	CK725F1E-104Z1	1	332161040R1
C3521	C-CERA C	CK725F1E-104Z1	1	332161040R1
C3525	C-CERA C	CK725F1E-104Z1	1	332161040R1
C3526	C-CERA C	CK725F1E-104Z1	1	332161040R1
C3527	C-CERA C	CK725F1E-104Z1	1	332161040R1
C3528	C-CERA C	CK725F1E-104Z1	1	332161040R1
C3529	C-CERA C	CK725F1E-104Z1	1	332161040R1
C3530	C-CERA C	CK725F1E-104Z1	1	332161040R1
C3531	C-CERA C	CK725F1E-104Z1	1	332161040R1
C3532	C-CERA C	CK725F1E-104Z1	1	332161040R1
C3533	C-CERA C	CK725F1E-104Z1	1	332161040R1
C3534	C-CERA C	CK725F1E-104Z1	1	332161040R1
C3535	C-CERA C	CK725F1E-104Z1	1	332161040R1
C3551	C-CERA C	CC725CH1H-101J1	1	342101014R1
C3552	C-CERA C	CK725F1E-104Z1	1	332161040R1
C3561	C-CERA C	CK725F1E-104Z1	1	332161040R1
C3563	C-CERA C	CK725F1E-104Z1	1	332161040R1
C3564	C-CERA C	CK725F1E-104Z1	1	332161040R1
C3565	C-CERA C	CK725F1E-104Z1	1	332161040R1
C3566	C-CERA C	CK725F1E-104Z1	1	332161040R1
C3571	C-CERA C	CK725F1E-104Z1	1	332161040R1
C3572	C-CERA C	CK725F1E-104Z1	1	332161040R1
C3573	C-CERA C	CK725F1E-104Z1	1	332161040R1
C3574	C-CERA C	CK725F1E-104Z1	1	332161040R1
C3575	C-CERA C	CK725F1E-104Z1	1	332161040R1
C3576	C-CERA C	CK725F1E-104Z1	1	332161040R1
C3577	CHIP ELECT C	CEWX4V-220M	1	3981G2217R2
C3584	CHIP ELECT C	CEWX4V-220M	1	3981G2217R2
C4109	C-CERA C	CK725F1E-104Z1	1	332161040R1
C7204	CHIP ELECT C	CEWX4V-100M	1	3981G1017R2
C7205	C-CERA C	CK725F1E-104Z1	1	332161040R1
C7206	CHIP ELECT C	CEWX4V-220M	1	3981G2217R2
C7304	CHIP ELECT C	CEWX4V-100M	1	3981G1017R2
C7305	C-CERA C	CK725F1E-104Z1	1	332161040R1
C7306	CHIP ELECT C	CEWX4V-220M	1	3981G2217R2
C8000	CHIP TANTAL	TCSCS0J226MAAR	1	396522207R2

C8000 or	CHIP TANTAL	F93-6.3V-22M	(1)	395522207R2
C8001	C-CERA C	CK725F1E-104Z1	1	332161040R1
C8002	C-CERA C	CK725F1E-104Z1	1	332161040R1
C8003	CHIP TANTAL	TCSCS0J226MAAR	1	396522207R2
C8003 or	CHIP TANTAL	F93-6.3V-22M	(1)	395522207R2
C8004	CHIP TANTAL	TCSCS0J226MAAR	1	396522207R2
C8004 or	CHIP TANTAL	F93-6.3V-22M	(1)	395522207R2
C8005	C-CERA C	CK725B1H-103K1	1	332101035R1
C8006	C-CERA C	CK725F1A-105Z1	1	332181050R1
C8007	C-CERA C	CK725F1A-105Z1	1	332181050R1
C8008	C-CERA C	CK725F1A-105Z1	1	332181050R1
C8009	C-CERA C	CK725F1A-105Z1	1	332181050R1
C8010	C-CERA C	CK725F1A-105Z1	1	332181050R1
C8011	C-CERA C	CK725F1A-105Z1	1	332181050R1
C8012	C-CERA C	CK725F1A-105Z1	1	332181050R1
C8013	C-CERA C	CK725F1A-105Z1	1	332181050R1
C8014	C-CERA C	CK725F1A-105Z1	1	332181050R1
C8015	C-CERA C	CK725F1A-105Z1	1	332181050R1
C8016	C-CERA C	CK725F1A-105Z1	1	332181050R1
C8017	C-CERA C	CK725F1A-105Z1	1	332181050R1
C8018	C-CERA C	CK725F1A-105Z1	1	332181050R1
C8021	CHIP ELECT C	CEWX16V-100M	1	398141017R2
C8022	C-CERA C	CK725F1A-105Z1	1	332181050R1
C8023	CHIP ELECT C	CEWX4V-100M	1	3981G1017R2
C8024	CHIP ELECT C	CEWX16V-100M	1	398141017R2
C8025	C-CERA C	CK725F1E-104Z1	1	332161040R1
C8026	CHIP ELECT C	CEWX4V-220M	1	3981G2217R2
C8030	CHIP TANTAL	TCSCS0J226MAAR	1	396522207R2
C8030 or	CHIP TANTAL	F93-6.3V-22M	(1)	395522207R2
C8031	C-CERA C	CK725F1E-104Z1	1	332161040R1
C8032	C-CERA C	CK725B1H-103K1	1	332101035R1
C8033	C-CERA C	CK725F1E-104Z1	1	332161040R1
C8034	CHIP TANTAL	TCSCS0J226MAAR	1	396522207R2
C8034 or	CHIP TANTAL	F93-6.3V-22M	(1)	395522207R2
C8041	CHIP ELECT C	CEWX16V-100M	1	398141017R2
C8042	C-CERA C	CK725F1E-104Z1	1	332161040R1
C8043	CHIP ELECT C	CEWX4V-220M	1	3981G2217R2
C8044	CHIP ELECT C	CEWX4V-220M	1	3981G2217R2
C8051	C-CERA C	CK725F1E-104Z1	1	332161040R1
C8052	C-CERA C	CK725F1E-104Z1	1	332161040R1
C8053	C-CERA C	CK725F1E-104Z1	1	332161040R1
C8054	C-CERA C	CK725F1E-104Z1	1	332161040R1
C8055	C-CERA C	CK725F1E-104Z1	1	332161040R1
C8056	C-CERA C	CK725F1E-104Z1	1	332161040R1
C8057	C-CERA C	CK725F1E-104Z1	1	332161040R1

C8058	C-CERA C	CK725F1E-104Z1	1	332161040R1
C8059	C-CERA C	CK725F1E-104Z1	1	332161040R1
C8060	C-CERA C	CK725F1E-104Z1	1	332161040R1
C8061	C-CERA C	CK725F1E-104Z1	1	332161040R1
C8062	C-CERA C	CK725F1E-104Z1	1	332161040R1
C8063	C-CERA C	CK725F1E-104Z1	1	332161040R1
C8064	C-CERA C	CK725F1E-104Z1	1	332161040R1
C8065	C-CERA C	CK725F1E-104Z1	1	332161040R1
C8066	C-CERA C	CK725F1E-104Z1	1	332161040R1
C8077	C-CERA C	CK725F1E-104Z1	1	332161040R1
C8078	C-CERA C	CK725F1E-104Z1	1	332161040R1
C8079	C-CERA C	CK725F1E-104Z1	1	332161040R1
C8080	C-CERA C	CK725F1E-104Z1	1	332161040R1
C8090	C-CERA C	CK725F1E-104Z1	1	332161040R1
C8091	C-CERA C	CK725F1E-104Z1	1	332161040R1
C8092	C-CERA C	CK725F1E-104Z1	1	332161040R1
C8094	C-CERA C	CK725B1C-104K1	1	332161040R1
C8095	C-CERA C	CK725B1A-105Z1	1	332131055R1
C8096	CHIP ELECT C	CEWX50V-2.2M	1	398180227R2
C8097	C-CERA C	CK725F1E-104Z1	1	332161040R1
C8098	C-CERA C	CK725B1H-103K1	1	332101035R1
C8099	CHIP ELECT C	CEWX50V-2.2M	1	398180227R2
C8101	C-CARBON R	RN72K1J-000JE	1	435030004R1
C8102	C-CARBON R	RN72K1J-000JE	1	435030004R1
C8107	C-CERA C	CK725F1E-104Z1	1	332161040R1
C8111	C-CERA C	CK725F1E-104Z1	1	332161040R1
C8121	C-CARBON R	RN72K1J-000JE	1	435030004R1
C8122	C-CARBON R	RN72K1J-000JE	1	435030004R1
C8141	C-CARBON R	RN72K1J-000JE	1	435030004R1
C8142	C-CARBON R	RN72K1J-000JE	1	435030004R1
C8161	C-CERA C	CK725F1E-104Z1	1	332161040R1
C8162	CHIP ELECT C	CEWX4V-100M	1	3981G1017R2
C8164	CHIP ELECT C	CEWX4V-22M	1	3981G2207R2
C8165	C-CERA C	CK725F1E-104Z1	1	332161040R1
C8166	CHIP ELECT C	CEWX4V-22M	1	3981G2207R2
C8167	C-CERA C	CK725F1E-104Z1	1	332161040R1
C8168	CHIP ELECT C	CEWX4V-22M	1	3981G2207R2
C8169	C-CERA C	CK725F1E-104Z1	1	332161040R1
C8170	C-CERA C	CK725F1E-104Z1	1	332161040R1
C8171	C-CERA C	CK725F1E-104Z1	1	332161040R1
C8172	C-CERA C	CK725F1E-104Z1	1	332161040R1
C8173	C-CERA C	CK725F1E-104Z1	1	332161040R1
C8174	C-CERA C	CK725F1E-104Z1	1	332161040R1
C8175	C-CERA C	CK725F1E-104Z1	1	332161040R1
C8176	C-CERA C	CK725F1E-104Z1	1	332161040R1

C8177	C-CERA C	CK725F1E-104Z1	1	332161040R1
C8178	C-CERA C	CK725F1E-104Z1	1	332161040R1
C8179	C-CERA C	CK725F1E-104Z1	1	332161040R1
C8180	C-CERA C	CK725F1E-104Z1	1	332161040R1
C8181	C-CERA C	CK725F1E-104Z1	1	332161040R1
C8200	CHIP TANTAL	TCSCS0J226MAAR	1	396522207R2
C8200 or	CHIP TANTAL	F93-6.3V-22M	(1)	395522207R2
C8201	CHIP TANTAL	TCSCS0J226MAAR	1	396522207R2
C8201 or	CHIP TANTAL	F93-6.3V-22M	(1)	395522207R2
C8202	C-CERA C	CK725F1E-104Z1	1	332161040R1
C8203	C-CERA C	CK725F1E-104Z1	1	332161040R1
C8204	C-CERA C	CK725F1E-104Z1	1	332161040R1
C8205	C-CERA C	CK725F1E-104Z1	1	332161040R1
C8206	C-CERA C	CK725F1E-104Z1	1	332161040R1
C8207	C-CERA C	CK725F1E-104Z1	1	332161040R1
C8208	C-CERA C	CK725F1E-104Z1	1	332161040R1
C8209	C-CERA C	CK725F1E-104Z1	1	332161040R1
C8210	C-CERA C	CK725F1E-104Z1	1	332161040R1
C8211	C-CERA C	CK725F1E-104Z1	1	332161040R1
C8212	C-CERA C	CK725F1E-104Z1	1	332161040R1
C8213	C-CERA C	CK725F1E-104Z1	1	332161040R1
C8214	C-CERA C	CK725F1E-104Z1	1	332161040R1
C8215	C-CERA C	CK725F1E-104Z1	1	332161040R1
C8216	C-CERA C	CK725F1E-104Z1	1	332161040R1
C8217	C-CERA C	CK725F1E-104Z1	1	332161040R1
C8218	C-CERA C	CK725F1E-104Z1	1	332161040R1
C8219	CHIP TANTAL	TCSCS0J226MAAR	1	396522207R2
C8219 or	CHIP TANTAL	F93-6.3V-22M	(1)	395522207R2
C8220	CHIP TANTAL	TCSCS0J226MAAR	1	396522207R2
C8220 or	CHIP TANTAL	F93-6.3V-22M	(1)	395522207R2
C8221	C-CERA C	CK725B1H-103K1	1	332101035R1
C8222	C-CERA C	CK725B1H-103K1	1	332101035R1
C8223	C-CERA C	CK725F1E-104Z1	1	332161040R1
C8224	C-CERA C	CK725B1H-103K1	1	332101035R1
C8225	C-CERA C	CK725F1E-104Z1	1	332161040R1
C8226	C-CERA C	CK725F1E-104Z1	1	332161040R1
C8227	C-CERA C	CK725B1H-103K1	1	332101035R1
C8228	C-CERA C	CK725F1E-104Z1	1	332161040R1
C8229	C-CERA C	CK725F1E-104Z1	1	332161040R1
C8230	C-CERA C	CK725F1E-104Z1	1	332161040R1
C8231	C-CERA C	CK725B1H-103K1	1	332101035R1
C8232	C-CERA C	CK725F1E-104Z1	1	332161040R1
C8233	C-CERA C	CK725F1E-104Z1	1	332161040R1
C8234	C-CERA C	CK725F1E-104Z1	1	332161040R1
C8235	C-CERA C	CK725B1H-103K1	1	332101035R1

C8236	CHIP TANTAL	TCSCS0J226MAAR	1	396522207R2
C8236 or	CHIP TANTAL	F93-6.3V-22M	(1)	395522207R2
C8237	CHIP TANTAL	TCSCS0J226MAAR	1	396522207R2
C8237 or	CHIP TANTAL	F93-6.3V-22M	(1)	395522207R2
C8238	C-CERA C	CK725F1E-104Z1	1	332161040R1
C8239	C-CERA C	CK725F1E-104Z1	1	332161040R1
C8240	C-CERA C	CK725F1E-104Z1	1	332161040R1
C8241	C-CERA C	CK725F1E-104Z1	1	332161040R1
C8242	C-CERA C	CK725F1E-104Z1	1	332161040R1
C8243	C-CERA C	CK725F1E-104Z1	1	332161040R1
C8244	C-CERA C	CK725F1E-104Z1	1	332161040R1
C8245	C-CERA C	CK725F1E-104Z1	1	332161040R1
C8246	C-CERA C	CK725F1E-104Z1	1	332161040R1
C8247	C-CERA C	CK725F1E-104Z1	1	332161040R1
C8248	C-CERA C	CK725F1E-104Z1	1	332161040R1
C8249	C-CERA C	CK725F1E-104Z1	1	332161040R1
C8250	C-CERA C	CK725F1E-104Z1	1	332161040R1
C8251	CHIP TANTAL	TCSCS0J226MAAR	1	396522207R2
C8251 or	CHIP TANTAL	F93-6.3V-22M	(1)	395522207R2
C8252	C-CERA C	CK725F1E-104Z1	1	332161040R1
C8253	C-CERA C	CK725F1E-104Z1	1	332161040R1
C8254	C-CERA C	CK725F1E-104Z1	1	332161040R1
C8255	CHIP TANTAL	TCSCS0J226MAAR	1	396522207R2
C8255 or	CHIP TANTAL	F93-6.3V-22M	(1)	395522207R2
C8256	C-CERA C	CK725F1E-104Z1	1	332161040R1
C8257	C-CERA C	CK725F1E-104Z1	1	332161040R1
C8258	CHIP TANTAL	TCSCS0J226MAAR	1	396522207R2
C8258 or	CHIP TANTAL	F93-6.3V-22M	(1)	395522207R2
C8259	C-CERA C	CK725F1E-104Z1	1	332161040R1
C8260	CHIP TANTAL	TCSCS0J226MAAR	1	396522207R2
C8260 or	CHIP TANTAL	F93-6.3V-22M	(1)	395522207R2
C8261	C-CERA C	CK725F1E-104Z1	1	332161040R1
C8262	C-CERA C	CK725F1E-104Z1	1	332161040R1
C8263	C-CERA C	CK725F1E-104Z1	1	332161040R1
C8264	CHIP TANTAL	TCSCS0J226MAAR	1	396522207R2
C8264 or	CHIP TANTAL	F93-6.3V-22M	(1)	395522207R2
C8265	C-CERA C	CK725F1E-104Z1	1	332161040R1
C8266	C-CERA C	CK725F1E-104Z1	1	332161040R1
C8267	C-CERA C	CK725F1E-104Z1	1	332161040R1
C8268	CHIP TANTAL	TCSCS0J226MAAR	1	396522207R2
C8268 or	CHIP TANTAL	F93-6.3V-22M	(1)	395522207R2
C8269	C-CERA C	CK725F1E-104Z1	1	332161040R1
C8270	C-CERA C	CK725F1E-104Z1	1	332161040R1
C8271	C-CERA C	CK725F1E-104Z1	1	332161040R1
C8272	C-CERA C	CK725F1E-104Z1	1	332161040R1

C8273	CHIP TANTAL	TCSCS0J226MAAR	1	396522207R2
C8273 or	CHIP TANTAL	F93-6.3V-22M	( 1)	395522207R2
C8274	C-CERA C	CK725F1E-104Z1	1	332161040R1
C8275	C-CERA C	CK725F1E-104Z1	1	332161040R1
C8276	C-CERA C	CK725B1H-103K1	1	332101035R1
C8282	C-CERA C	CK725F1E-104Z1	1	332161040R1
C8284	C-CERA C	CK725F1E-104Z1	1	332161040R1
C8288	C-CERA C	CC725CH1H-330J1	1	342103304R1
C8289	C-CERA C	CC725CH1H-330J1	1	342103304R1
C8290	C-CERA C	CK725B1H-102K1	1	332101025R1
C8291	C-CERA C	CK725F1E-104Z1	1	332161040R1
C8301	C-CARBON R	RN72K1J-000JE	1	435030004R1
C8302	C-CARBON R	RN72K1J-000JE	1	435030004R1
C8326	C-CERA C	CK725F1E-104Z1	1	332161040R1
C8327	C-CERA C	CK725F1A-105Z1	1	332181050R1
C8328	CHIP ELECT C	CEWX16V-22M	1	398142207R2
C8329	C-CERA C	CK725F1A-105Z1	1	332181050R1
C8330	C-CERA C	CK725F1A-105Z1	1	332181050R1
C8348	C-CARBON R	RN72K1J-000JE	1	435030004R1
C8399	C-CARBON R	RN72K1J-000JE	1	435030004R1
C8401	CHIP ELECT C	CEWX4V-22M	1	3981G2207R2
C8402	CHIP ELECT C	CEWX4V-22M	1	3981G2207R2
C8403	C-CERA C	CK725F1A-105Z1	1	332181050R1
C8404	C-CERA C	CK725B1H-102K1	1	332101025R1
C8405	C-CERA C	CK725F1A-105Z1	1	332181050R1
C8406	C-CERA C	CK725B1H-102K1	1	332101025R1
C8408	CHIP ELECT C	CEWX4V-22M	1	3981G2207R2
C8409	CHIP ELECT C	CEWX4V-22M	1	3981G2207R2
C8410	C-CERA C	CK725F1A-105Z1	1	332181050R1
C8411	C-CERA C	CK725B1H-102K1	1	332101025R1
C8412	C-CERA C	CK725F1A-105Z1	1	332181050R1
C8413	C-CERA C	CK725B1H-102K1	1	332101025R1
C8414	C-CERA C	CK725F1A-105Z1	1	332181050R1
C8415	C-CERA C	CK725B1H-102K1	1	332101025R1
C8416	C-CERA C	CK725B1H-102K1	1	332101025R1
C8417	C-CERA C	CK725F1A-105Z1	1	332181050R1
C8418	CHIP ELECT C	CEWX4V-22M	1	3981G2207R2
C8419	C-CERA C	CK725B1H-102K1	1	332101025R1
C8420	C-CERA C	CK725F1A-105Z1	1	332181050R1
C8421	C-CERA C	CK725B1H-102K1	1	332101025R1
C8422	C-CERA C	CK725F1A-105Z1	1	332181050R1
C8423	C-CERA C	CK725B1H-102K1	1	332101025R1
C8424	C-CERA C	CK725F1A-105Z1	1	332181050R1
C8425	C-CERA C	CK725B1H-102K1	1	332101025R1
C8426	C-CERA C	CK725F1A-105Z1	1	332181050R1

C8427	C-CERA C	CK725B1H-102K1	1	332101025R1
C8428	C-CERA C	CK725F1A-105Z1	1	332181050R1
C8429	C-CERA C	CK725B1H-102K1	1	332101025R1
C8430	C-CERA C	CK725F1A-105Z1	1	332181050R1
C8431	C-CERA C	CK725B1H-102K1	1	332101025R1
C8432	C-CERA C	CK725F1A-105Z1	1	332181050R1
C8433	C-CERA C	CK725B1H-102K1	1	332101025R1
C8434	C-CERA C	CK725F1A-105Z1	1	332181050R1
C8435	C-CERA C	CK725F1A-105Z1	1	332181050R1
C8436	C-CERA C	CK725F1A-105Z1	1	332181050R1
C8437	CHIP ELECT C	CEWX4V-22M	1	3981G2207R2
C8441	C-CERA C	CK725F1A-105Z1	1	332181050R1
C8442	C-CERA C	CK725F1A-105Z1	1	332181050R1
C8443	CHIP ELECT C	CEWX4V-220M	1	3981G2217R2
C8444	C-CERA C	CK725F1A-105Z1	1	332181050R1
C8451	C-CERA C	CC725CH1H-010C1	1	342100101R1
C8452	C-CERA C	CC725CH1H-010C1	1	342100101R1
C8453	C-CERA C	CC725CH1H-010C1	1	342100101R1
C8454	C-CERA C	CC725CH1H-010C1	1	342100101R1
C8455	C-CERA C	CC725CH1H-010C1	1	342100101R1
C8456	C-CERA C	CC725CH1H-010C1	1	342100101R1
C8457	C-CERA C	CC725CH1H-010C1	1	342100101R1
C8458	C-CERA C	CC725CH1H-010C1	1	342100101R1
C8501	C-CERA C	CK725F1A-105Z1	1	332181050R1
C8502	CHIP ELECT C	CEWX4V-22M	1	3981G2207R2
C8503	C-CERA C	CK725B1H-102K1	1	332101025R1
C8504	C-CERA C	CK725B1H-102K1	1	332101025R1
C8505	CHIP ELECT C	CEWX4V-22M	1	3981G2207R2
C8506	C-CERA C	CK725F1A-105Z1	1	332181050R1
C8507	C-CERA C	CK725B1H-102K1	1	332101025R1
C8508	C-CERA C	CK725F1A-105Z1	1	332181050R1
C8509	C-CERA C	CK725B1H-102K1	1	332101025R1
C8510	C-CERA C	CK725F1A-105Z1	1	332181050R1
C8511	C-CERA C	CK725B1H-102K1	1	332101025R1
C8512	C-CERA C	CK725F1A-105Z1	1	332181050R1
C8513	C-CERA C	CK725B1H-102K1	1	332101025R1
C8514	C-CERA C	CK725F1A-105Z1	1	332181050R1
C8515	C-CERA C	CK725B1H-102K1	1	332101025R1
C8516	C-CERA C	CK725F1A-105Z1	1	332181050R1
C8517	C-CERA C	CK725B1H-102K1	1	332101025R1
C8518	C-CERA C	CK725F1A-105Z1	1	332181050R1
C8519	C-CERA C	CK725B1H-102K1	1	332101025R1
C8520	C-CERA C	CK725F1A-105Z1	1	332181050R1
C8521	C-CERA C	CK725B1H-102K1	1	332101025R1
C8522	C-CERA C	CK725F1A-105Z1	1	332181050R1



C8523	C-CERA C	CK725B1H-102K1	1	332101025R1
C8524	C-CERA C	CK725F1A-105Z1	1	332181050R1
C8529	CHIP ELECT C	CEWX4V-22M	1	3981G2207R2
C8530	C-CERA C	CK725F1A-105Z1	1	332181050R1
C8531	C-CERA C	CK725B1H-102K1	1	332101025R1
C8532	C-CERA C	CK725F1A-105Z1	1	332181050R1
C8533	C-CERA C	CK725B1H-102K1	1	332101025R1
C8534	C-CERA C	CK725F1A-105Z1	1	332181050R1
C8535	C-CERA C	CK725B1H-102K1	1	332101025R1
C8536	C-CERA C	CK725F1A-105Z1	1	332181050R1
C8537	C-CERA C	CK725B1H-102K1	1	332101025R1
C8538	C-CERA C	CK725F1A-105Z1	1	332181050R1
C8539	C-CERA C	CK725B1H-102K1	1	332101025R1
C8540	C-CERA C	CK725F1A-105Z1	1	332181050R1
C8541	C-CERA C	CK725B1H-102K1	1	332101025R1
C8542	C-CERA C	CK725F1A-105Z1	1	332181050R1
C8543	C-CERA C	CK725B1H-102K1	1	332101025R1
C8544	C-CERA C	CK725F1A-105Z1	1	332181050R1
C8545	C-CERA C	CK725B1H-102K1	1	332101025R1
C8546	C-CERA C	CK725F1A-105Z1	1	332181050R1
C8547	C-CERA C	CK725B1H-102K1	1	332101025R1
C8548	C-CERA C	CK725F1A-105Z1	1	332181050R1
C8549	C-CERA C	CK725B1H-102K1	1	332101025R1
C8550	C-CERA C	CK725F1A-105Z1	1	332181050R1
C8551	C-CERA C	CK725B1H-102K1	1	332101025R1
C8552	C-CERA C	CK725F1A-105Z1	1	332181050R1
C8553	C-CERA C	CK725B1H-102K1	1	332101025R1
C8554	C-CERA C	CK725F1A-105Z1	1	332181050R1
C8555	C-CERA C	CK725B1H-102K1	1	332101025R1
C8556	C-CERA C	CK725F1A-105Z1	1	332181050R1
C8557	C-CERA C	CK725B1H-102K1	1	332101025R1
C8558	C-CERA C	CK725F1A-105Z1	1	332181050R1
C8559	C-CERA C	CK725B1H-102K1	1	332101025R1
C8560	C-CERA C	CK725F1A-105Z1	1	332181050R1
C8561	C-CERA C	CK725B1H-102K1	1	332101025R1
C8562	C-CERA C	CK725F1A-105Z1	1	332181050R1
C8563	C-CERA C	CK725B1H-102K1	1	332101025R1
C8564	CHIP ELECT C	CEWX4V-22M	1	3981G2207R2
C8565	CHIP ELECT C	CEWX4V-22M	1	3981G2207R2
C8566	C-CERA C	CK725B1H-102K1	1	332101025R1
C8567	C-CERA C	CK725F1A-105Z1	1	332181050R1
C8568	CHIP ELECT C	CEWX4V-22M	1	3981G2207R2
C8569	C-CERA C	CK725B1H-102K1	1	332101025R1
C8570	C-CERA C	CK725F1A-105Z1	1	332181050R1
C8571	CHIP ELECT C	CEWX4V-22M	1	3981G2207R2

C8572	C-CERA C	CK725B1H-102K1	1	332101025R1
C8573	C-CERA C	CK725F1A-105Z1	1	332181050R1
C8574	C-CERA C	CC725CH1H-070D1	1	342100702R1
C8575	C-CERA C	CC725CH1H-070D1	1	342100702R1
C8601	C-CERA C	CK725F1A-105Z1	1	332181050R1
C8602	CHIP ELECT C	CEWX4V-100M	1	3981G1017R2
C8603	C-CERA C	CK725F1A-105Z1	1	332181050R1
C8604	C-CERA C	CK725F1A-105Z1	1	332181050R1
C8605	CHIP ELECT C	CEWX4V-220M	1	3981G2217R2
C8606	C-CERA C	CK725F1E-104Z1	1	332161040R1
C8607	CHIP ELECT C	CEWX4V-100M	1	3981G1017R2
C8608	C-CERA C	CK725F1A-105Z1	1	332181050R1
C8609	CHIP ELECT C	CEWX4V-100M	1	3981G1017R2
C8675	CHIP ELECT C	CEWX4V-100M	1	3981G1017R2
C8676	C-CERA C	CK725F1A-105Z1	1	332181050R1
C8690	C-CERA C	CK725F1A-105Z1	1	332181050R1
C8691	C-CERA C	CK725F1A-105Z1	1	332181050R1
C8692	C-CERA C	CK725F1A-105Z1	1	332181050R1
C8838	C-CERA C	CC725CH1H-470J1	1	342104704R1
C8839	C-CERA C	CC725CH1H-470J1	1	342104704R1
C8840	C-CERA C	CC725CH1H-470J1	1	342104704R1
C8855	C-CERA C	CK725F1E-104Z1	1	332161040R1
C8856	C-CERA C	CK725F1E-104Z1	1	332161040R1
C8857	C-CERA C	CK725F1E-104Z1	1	332161040R1
C8858	C-CERA C	CK725F1E-104Z1	1	332161040R1
C8859	C-CERA C	CK725F1E-104Z1	1	332161040R1
C8860	C-CERA C	CK725F1E-104Z1	1	332161040R1
C8861	C-CERA C	CK725F1E-104Z1	1	332161040R1
C8862	C-CERA C	CK725F1E-104Z1	1	332161040R1
C8863	C-CERA C	CK725F1E-104Z1	1	332161040R1
C8864	C-CERA C	CK725F1E-104Z1	1	332161040R1
C8865	C-CERA C	CK725F1E-104Z1	1	332161040R1
C8866	C-CERA C	CK725F1E-104Z1	1	332161040R1
C8867	C-CERA C	CK725F1E-104Z1	1	332161040R1
C8868	C-CERA C	CK725F1E-104Z1	1	332161040R1
C8869	C-CERA C	CK725F1E-104Z1	1	332161040R1
C8870	C-CERA C	CK725F1E-104Z1	1	332161040R1
C8919	CHIP ELECT C	CEWX4V-100M	1	3981G1017R2
C8920	C-CERA C	CK725F1A-105Z1	1	332181050R1
C8956	CD C	UCD1A471MNLI GS	1	396634717R2
C8957	CD C	UCD1A471MNLI GS	1	396634717R2
C8958	CD C	UCD1A471MNLI GS	1	396634717R2
C8960	C-CERA C	CK725B1H-682K1	1	332106825R1
C8961	C-CERA C	CK725B1H-682K1	1	332106825R1
C8962	C-CERA C	CK725B1H-682K1	1	332106825R1

C8964	C-CERA C	CK725B1H-223K1	1	332102235R1
C8965	C-CERA C	CK725B1H-223K1	1	332102235R1
C8966	C-CERA C	CC725CH1H-102J1	1	342101024R1
C8968	C-CERA C	CK725F1A-105Z1	1	332181050R1
C8969	C-CERA C	CK725F1A-105Z1	1	332181050R1
C8970	C-CERA C	CK725F1A-105Z1	1	332181050R1
C8972	C-CERA C	CK725B1H-473K1	1	332104735R1
C8973	C-CERA C	CK725B1H-473K1	1	332104735R1
C8974	C-CERA C	CK725B1H-473K1	1	332104735R1
C8976	C-CERA C	CK725F1E-104Z1	1	332161040R1
C8977	C-CERA C	CK725F1E-104Z1	1	332161040R1
C8978	C-CERA C	CK725F1E-104Z1	1	332161040R1
C8980	C-CERA C	CK725F1A-105Z1	1	332181050R1
C8981	C-CERA C	CK725F1A-105Z1	1	332181050R1
C8982	C-CERA C	CK725F1A-105Z1	1	332181050R1
C8984	C-CERA C	CK725F1E-104Z1	1	332161040R1
C8985	C-CERA C	CK725F1E-104Z1	1	332161040R1
C8986	C-CERA C	CK725F1E-104Z1	1	332161040R1
C8990	C-CERA C	CK725F1A-105Z1	1	332181050R1
C8991	C-CERA C	CK725F1A-105Z1	1	332181050R1
C8992	C-CERA C	CK725F1A-105Z1	1	332181050R1
C8994	CD C	UCD1E221MNL1GS	1	396652217R2
C8995	CD C	UCD1E221MNL1GS	1	396652217R2
C8996	CD C	UCD1E221MNL1GS	1	396652217R2
C8998	C-CERA C	CK725F1A-105Z1	1	332181050R1
C8999	C-CERA C	CK725F1A-105Z1	1	332181050R1
R265	C-CARBON R	RN72K1J-331JE	1	435033314R1
R266	C-CARBON R	RN72K1J-331JE	1	435033314R1
R267	C-CARBON R	RN72K1J-331JE	1	435033314R1
R268	C-CARBON R	RN72K1J-331JE	1	435033314R1
R269	C-CARBON R	RN72K1J-331JE	1	435033314R1
R273	C-CARBON R	RN72K1J-331JE	1	435033314R1
R274	C-CARBON R	RN72K1J-470JE	1	435034704R1
R275	C-CARBON R	RN72K1J-331JE	1	435033314R1
R3311	C-CARBON R	RN72K1J-331JE	1	435033314R1
R3312	C-CARBON R	RN72K1J-331JE	1	435033314R1
R3313	C-CARBON R	RN72K1J-331JE	1	435033314R1
R3315	C-CARBON R	RN72K1J-331JE	1	435033314R1
R3316	C-CARBON R	RN72K1J-331JE	1	435033314R1
R3317	C-CARBON R	RN72K1J-470JE	1	435034704R1
R3318	C-CARBON R	RN72K1J-470JE	1	435034704R1
R3319	C-CARBON R	RN72K1J-331JE	1	435033314R1
R3320	C-CARBON R	RN72K1J-331JE	1	435033314R1
R3321	C-CARBON R	RN72K1J-470JE	1	435034704R1
R3322	C-CARBON R	RN72K1J-331JE	1	435033314R1

R3323	C-CARBON R	RN72K1J-331JE	1	435033314R1
R3324	C-CARBON R	RN72K1J-331JE	1	435033314R1
R3325	C-CARBON R	RN72K1J-470JE	1	435034704R1
R3341	C-CARBON R	RN72K1J-000JE	1	435030004R1
R3401	C-CARBON R	RN72K1J-470JE	1	435034704R1
R3402	C-CARBON R	RN72K1J-102JE	1	435031024R1
R3403	C-CARBON R	RN72K1J-102JE	1	435031024R1
R3404	C-CARBON R	RN72K1J-222JE	1	435032224R1
R3405	C-CARBON R	RN72K1J-470JE	1	435034704R1
R3406	C-CARBON R	RN72K1J-102JE	1	435031024R1
R3407	C-CARBON R	RN72K1J-470JE	1	435034704R1
R3408	C-CARBON R	RN72K1J-470JE	1	435034704R1
R3409	C-CARBON R	RN72K1J-470JE	1	435034704R1
R3410	C-CARBON R	RN72K1J-470JE	1	435034704R1
R3411	C-CARBON R	RN72K1J-103JE	1	435031034R1
R3412	C-CARBON R	RN72K1J-331JE	1	435033314R1
R3413	C-CARBON R	RN72K1J-331JE	1	435033314R1
R3414	C-CARBON R	RN72K1J-103JE	1	435031034R1
R3415	C-CARBON R	RN72K1J-103JE	1	435031034R1
R3416	C-CARBON R	RN72K1J-103JE	1	435031034R1
R3417	C-CARBON R	RN72K1J-331JE	1	435033314R1
R3418	C-CARBON R	RN72K1J-331JE	1	435033314R1
R3419	C-CARBON R	RN72K1J-331JE	1	435033314R1
R3420	C-CARBON R	RN72K1J-331JE	1	435033314R1
R3421	C-CARBON R	RN72K1J-331JE	1	435033314R1
R3422	C-CARBON R	RN72K1J-331JE	1	435033314R1
R3423	C-CARBON R	RN72K1J-103JE	1	435031034R1
R3424	C-CARBON R	RN72K1J-331JE	1	435033314R1
R3425	C-CARBON R	RN72K1J-331JE	1	435033314R1
R3426	C-CARBON R	RN72K1J-331JE	1	435033314R1
R3427	C-CARBON R	RN72K1J-470JE	1	435034704R1
R3428	C-CARBON R	RN72K1J-470JE	1	435034704R1
R3429	C-CARBON R	RN72K1J-331JE	1	435033314R1
R3430	C-CARBON R	RN72K1J-103JE	1	435031034R1
R3431	C-CARBON R	RN72K1J-103JE	1	435031034R1
R3451	C-CARBON R	RN72K1J-103JE	1	435031034R1
R3452	C-CARBON R	RN72K1J-103JE	1	435031034R1
R3453	C-CARBON R	RN72K1J-103JE	1	435031034R1
R3454	C-CARBON R	RN72K1J-102JE	1	435031024R1
R3455	C-CARBON R	RN72K1J-103JE	1	435031034R1
R3456	C-CARBON R	RN72K1J-103JE	1	435031034R1
R3457	C-CARBON R	RN72K1J-103JE	1	435031034R1
R3482	C-CARBON R	RN72K1J-221JE	1	435032214R1
R3483	C-CARBON R	RN72K1J-105JE	1	435031054R1
R3491	C-CARBON R	RN72K1J-472JE	1	435034724R1

R3492	C-CARBON R	RN72K1J-472JE	1	435034724R1
R3493	C-CARBON R	RN72K1J-472JE	1	435034724R1
R3494	C-CARBON R	RN72K1J-472JE	1	435034724R1
R3495	C-CARBON R	RN72K1J-472JE	1	435034724R1
R3496	C-CARBON R	RN72K1J-103JE	1	435031034R1
R3501	C-CARBON R	RN72K1J-470JE	1	435034704R1
R3502	C-CARBON R	RN72K1J-102JE	1	435031024R1
R3503	C-CARBON R	RN72K1J-102JE	1	435031024R1
R3504	C-CARBON R	RN72K1J-222JE	1	435032224R1
R3505	C-CARBON R	RN72K1J-470JE	1	435034704R1
R3506	C-CARBON R	RN72K1J-102JE	1	435031024R1
R3507	C-CARBON R	RN72K1J-470JE	1	435034704R1
R3508	C-CARBON R	RN72K1J-470JE	1	435034704R1
R3509	C-CARBON R	RN72K1J-470JE	1	435034704R1
R3510	C-CARBON R	RN72K1J-470JE	1	435034704R1
R3511	C-CARBON R	RN72K1J-103JE	1	435031034R1
R3512	C-CARBON R	RN72K1J-331JE	1	435033314R1
R3513	C-CARBON R	RN72K1J-331JE	1	435033314R1
R3514	C-CARBON R	RN72K1J-103JE	1	435031034R1
R3515	C-CARBON R	RN72K1J-103JE	1	435031034R1
R3516	C-CARBON R	RN72K1J-103JE	1	435031034R1
R3517	C-CARBON R	RN72K1J-331JE	1	435033314R1
R3518	C-CARBON R	RN72K1J-331JE	1	435033314R1
R3519	C-CARBON R	RN72K1J-331JE	1	435033314R1
R3520	C-CARBON R	RN72K1J-331JE	1	435033314R1
R3521	C-CARBON R	RN72K1J-331JE	1	435033314R1
R3522	C-CARBON R	RN72K1J-331JE	1	435033314R1
R3523	C-CARBON R	RN72K1J-103JE	1	435031034R1
R3524	C-CARBON R	RN72K1J-331JE	1	435033314R1
R3525	C-CARBON R	RN72K1J-331JE	1	435033314R1
R3526	C-CARBON R	RN72K1J-331JE	1	435033314R1
R3527	C-CARBON R	RN72K1J-470JE	1	435034704R1
R3528	C-CARBON R	RN72K1J-470JE	1	435034704R1
R3529	C-CARBON R	RN72K1J-331JE	1	435033314R1
R3530	C-CARBON R	RN72K1J-103JE	1	435031034R1
R3531	C-CARBON R	RN72K1J-103JE	1	435031034R1
R3551	C-CARBON R	RN72K1J-103JE	1	435031034R1
R3552	C-CARBON R	RN72K1J-103JE	1	435031034R1
R3554	C-CARBON R	RN72K1J-102JE	1	435031024R1
R3555	C-CARBON R	RN72K1J-103JE	1	435031034R1
R3556	C-CARBON R	RN72K1J-103JE	1	435031034R1
R3557	C-CARBON R	RN72K1J-103JE	1	435031034R1
R7206	C-CARBON R	RN72K1J-223JE	1	435032234R1
R7207	C-CARBON R	RN72K1J-153JE	1	435031534R1
R7306	C-CARBON R	RN72K1J-223JE	1	435032234R1

R7307	C-CARBON R	RN72K1J-153JE	1	435031534R1
R8000	C-CARBON R	RN72K1J-103JE	1	435031034R1
R8001	C-CARBON R	RN72K1J-103JE	1	435031034R1
R8002	C-CARBON R	RN72K1J-271JE	1	435032714R1
R8003	C-CARBON R	RN72K1J-271JE	1	435032714R1
R8005	C-CARBON R	RN72K1J-104JE	1	435031044R1
R8010	C-CARBON R	RN72K1J-103JE	1	435031034R1
R8011	C-CARBON R	RN72K1J-103JE	1	435031034R1
R8012	C-CARBON R	RN72K1J-000JE	1	435030004R1
R8013	C-CARBON R	RN72K1J-103JE	1	435031034R1
R8014	C-CARBON R	RN72K1J-103JE	1	435031034R1
R8015	C-CARBON R	RN72K1J-103JE	1	435031034R1
R8016	C-CARBON R	RN72K1J-103JE	1	435031034R1
R8017	C-CARBON R	RN72K1J-103JE	1	435031034R1
R8018	C-CARBON R	RN72K1J-103JE	1	435031034R1
R8019	C-CARBON R	RN72K1J-103JE	1	435031034R1
R8020	C-CARBON R	RN72K1J-103JE	1	435031034R1
R8021	C-CARBON R	RN72K1J-103JE	1	435031034R1
R8022	C-CARBON R	RN72K1J-103JE	1	435031034R1
R8026	C-CARBON R	RN72K1J-103JE	1	435031034R1
R8028	C-CARBON R	RN72K1J-103JE	1	435031034R1
R8029	C-CARBON R	RN72K1J-103JE	1	435031034R1
R8033	C-CARBON R	RN72K1J-103JE	1	435031034R1
R8034	C-CARBON R	RN72K1J-000JE	1	435030004R1
R8035	C-CARBON R	RN72K1J-000JE	1	435030004R1
R8036	C-CARBON R	RN72K1J-103JE	1	435031034R1
R8038	C-CARBON R	RN72K1J-330JE	1	435033304R1
R8045	C-CARBON R	RN72K1J-000JE	1	435030004R1
R8046	C-CARBON R	RN72K1J-000JE	1	435030004R1
R8047	C-CARBON R	RN72K1J-000JE	1	435030004R1
R8048	C-CARBON R	RN72K1J-000JE	1	435030004R1
R8049	C-CARBON R	RN72K1J-000JE	1	435030004R1
R8050	C-CARBON R	RN72K1J-000JE	1	435030004R1
R8051	C-CARBON R	RN72K1J-680JE	1	435036804R1
R8052	C-CARBON R	RN72K1J-471JE	1	435034714R1
R8053	C-CARBON R	RN72K1J-680JE	1	435036804R1
R8054	C-CARBON R	RN72K1J-471JE	1	435034714R1
R8055	C-CARBON R	RN72K1J-680JE	1	435036804R1
R8056	C-CARBON R	RN72K1J-471JE	1	435034714R1
R8057	C-CARBON R	RN72K1J-680JE	1	435036804R1
R8058	C-CARBON R	RN72K1J-471JE	1	435034714R1
R8059	C-CARBON R	RN72K1J-680JE	1	435036804R1
R8060	C-CARBON R	RN72K1J-680JE	1	435036804R1
R8061	C-CARBON R	RN72K1J-680JE	1	435036804R1
R8062	C-CARBON R	RN72K1J-220JE	1	435032204R1

R8063	C-CARBON R	RN72K1J-220JE	1	435032204R1
R8064	C-CARBON R	RN72K1J-220JE	1	435032204R1
R8065	C-CARBON R	RN72K1J-103JE	1	435031034R1
R8066	C-CARBON R	RN72K1J-103JE	1	435031034R1
R8067	C-CARBON R	RN72K1J-103JE	1	435031034R1
R8068	C-CARBON R	RN72K1J-750JE	1	435037504R1
R8069	C-CARBON R	RN72K1J-750JE	1	435037504R1
R8070	C-CARBON R	RN72K1J-750JE	1	435037504R1
R8074	C-CARBON R	RN72K1J-103JE	1	435031034R1
R8075	C-CARBON R	RN72K1J-103JE	1	435031034R1
R8076	C-CARBON R	RN72K1J-103JE	1	435031034R1
R8079	C-CARBON R	RN72K1J-220JE	1	435032204R1
R8080	C-CARBON R	RN72K1J-220JE	1	435032204R1
R8081	C-CARBON R	RN72K1J-220JE	1	435032204R1
R8082	C-CARBON R	RN72K1J-680JE	1	435036804R1
R8083	C-CARBON R	RN72K1J-471JE	1	435034714R1
R8084	C-CARBON R	RN72K1J-471JE	1	435034714R1
R8085	C-CARBON R	RN72K1J-471JE	1	435034714R1
R8086	C-CARBON R	RN72K1J-471JE	1	435034714R1
R8087	C-CARBON R	RN72K1J-220JE	1	435032204R1
R8088	C-CARBON R	RN72K1J-220JE	1	435032204R1
R8089	C-CARBON R	RN72K1J-271JE	1	435032714R1
R8090	C-CARBON R	RN72K1J-270JE	1	435032704R1
R8091	C-CARBON R	RN72K1J-222JE	1	435032224R1
R8092	C-CARBON R	RN72K1J-563JE	1	435035634R1
R8093	C-CARBON R	RN72K1J-470JE	1	435034704R1
R8094	C-CARBON R	RN72K1J-103JE	1	435031034R1
R8095	C-CARBON R	RN72K1J-220JE	1	435032204R1
R8096	C-CARBON R	RN72K1J-222JE	1	435032224R1
R8097	C-CARBON R	RN72K1J-563JE	1	435035634R1
R8098	C-CARBON R	RN72K1J-223JE	1	435032234R1
R8099	C-CARBON R	RN72K1J-000JE	1	435030004R1
R8100	C-CARBON R	RN72K1J-103JE	1	435031034R1
R8109	C-CARBON R	RN72K1J-473JE	1	435034734R1
R8110	C-CARBON R	RN72K1J-472JE	1	435034724R1
R8113	C-CARBON R	RN72K1J-103JE	1	435031034R1
R8123	C-CARBON R	RN72K1J-103JE	1	435031034R1
R8129	C-CARBON R	RN72K1J-473JE	1	435034734R1
R8130	C-CARBON R	RN72K1J-472JE	1	435034724R1
R8143	C-CARBON R	RN72K1J-103JE	1	435031034R1
R8149	C-CARBON R	RN72K1J-473JE	1	435034734R1
R8150	C-CARBON R	RN72K1J-472JE	1	435034724R1
R8160	C-CARBON R	RN72K1J-103JE	1	435031034R1
R8161	C-CARBON R	RN72K1J-471JE	1	435034714R1
R8162	C-CARBON R	RN72K1J-101JE	1	435031014R1

R8163	C-CARBON R	RN72K1J-222JE	1	435032224R1
R8164	C-CARBON R	RN72K1J-222JE	1	435032224R1
R8165	C-CARBON R	RN72K1J-103JE	1	435031034R1
R8201	C-CARBON R	RN72K1J-330JE	1	435033304R1
R8202	C-CARBON R	RN72K1J-000JE	1	435030004R1
R8203	C-CARBON R	RN72K1J-000JE	1	435030004R1
R8205	C-CARBON R	RN72K1J-220JE	1	435032204R1
R8206	C-CARBON R	RN72K1J-103JE	1	435031034R1
R8207	C-CARBON R	RN72K1J-103JE	1	435031034R1
R8208	C-CARBON R	RN72K1J-103JE	1	435031034R1
R8209	C-CARBON R	RN72K1J-103JE	1	435031034R1
R8210	C-CARBON R	RN72K1J-103JE	1	435031034R1
R8212	C-CARBON R	RN72K1J-103JE	1	435031034R1
R8213	C-CARBON R	RN72K1J-103JE	1	435031034R1
R8214	C-CARBON R	RN72K1J-272JE	1	435032724R1
R8215	C-CARBON R	RN72K1J-272JE	1	435032724R1
R8219	C-CARBON R	RN72K1J-103JE	1	435031034R1
R8223	C-CARBON R	RN72K1J-103JE	1	435031034R1
R8224	C-CARBON R	RN72K1J-103JE	1	435031034R1
R8230	C-R NET	RM7LJ330X04	1	43484733004R2
R8231	C-R NET	RM7LJ330X04	1	43484733004R2
R8232	C-R NET	RM7LJ330X04	1	43484733004R2
R8233	C-R NET	RM7LJ330X04	1	43484733004R2
R8234	C-R NET	RM7LJ330X04	1	43484733004R2
R8235	C-R NET	RM7LJ330X04	1	43484733004R2
R8236	C-R NET	RM7LJ330X04	1	43484733004R2
R8238	C-R NET	RM7LJ330X04	1	43484733004R2
R8239	C-R NET	RM7LJ330X04	1	43484733004R2
R8240	C-R NET	RM7LJ330X04	1	43484733004R2
R8241	C-R NET	RM7LJ330X04	1	43484733004R2
R8243	C-R NET	RM7LJ330X04	1	43484733004R2
R8245	C-R NET	RM7LJ330X04	1	43484733004R2
R8248	C-R NET	RM7LJ330X04	1	43484733004R2
R8249	C-R NET	RM7LJ330X04	1	43484733004R2
R8251	C-R NET	RM7LJ220X04	1	43484722004R2
R8252	C-R NET	RM7LJ220X04	1	43484722004R2
R8253	C-R NET	RM7LJ220X04	1	43484722004R2
R8254	C-R NET	RM7LJ220X04	1	43484722004R2
R8255	C-R NET	RM7LJ220X04	1	43484722004R2
R8256	C-R NET	RM7LJ220X04	1	43484722004R2
R8257	C-R NET	RM7LJ220X04	1	43484722004R2
R8258	C-R NET	RM7LJ220X04	1	43484722004R2
R8259	C-R NET	RM7LJ220X04	1	43484722004R2
R8264	C-CARBON R	RN72K1J-103JE	1	435031034R1
R8271	C-R NET	RM7LJ220X04	1	43484722004R2



R8272	C-R NET	RM7LJ220X04	1	43484722004R2
R8273	C-R NET	RM7LJ220X04	1	43484722004R2
R8274	C-R NET	RM7LJ220X04	1	43484722004R2
R8275	C-R NET	RM7LJ220X04	1	43484722004R2
R8276	C-R NET	RM7LJ220X04	1	43484722004R2
R8277	C-R NET	RM7LJ220X04	1	43484722004R2
R8278	C-R NET	RM7LJ220X04	1	43484722004R2
R8279	C-R NET	RM7LJ220X04	1	43484722004R2
R8280	C-CARBON R	RN72K1J-120JE	1	435031204R1
R8282	C-CARBON R	RN72K1J-000JE	1	435030004R1
R8283	C-CARBON R	RN72K1J-000JE	1	435030004R1
R8284	C-CARBON R	RN72K1J-330JE	1	435033304R1
R8285	C-CARBON R	RN72K1J-000JE	1	435030004R1
R8309	C-CARBON R	RN72K1J-473JE	1	435034734R1
R8310	C-CARBON R	RN72K1J-472JE	1	435034724R1
R8333	C-CARBON R	RN72K1J-103JE	1	435031034R1
R8334	C-CARBON R	RN72K1J-222JE	1	435032224R1
R8335	C-CARBON R	RN72K1J-222JE	1	435032224R1
R8336	C-CARBON R	RN72K1J-472JE	1	435034724R1
R8337	C-CARBON R	RN72K1J-473JE	1	435034734R1
R8338	C-CARBON R	RN72K1J-473JE	1	435034734R1
R8339	C-CARBON R	RN72K2E-101JE	1	435221014R1
R8368	C-CARBON R	RN72K1J-473JE	1	435034734R1
R8401	C-R NET	RM7LJ220X04	1	43484722004R2
R8402	C-CARBON R	RN72K1J-220JE	1	435032204R1
R8403	C-R NET	RM7LJ220X04	1	43484722004R2
R8404	C-CARBON R	RN72K1J-220JE	1	435032204R1
R8405	C-CARBON R	RN72K1J-220JE	1	435032204R1
R8408	C-CARBON R	RN72K1J-220JE	1	435032204R1
R8409	C-CARBON R	RN72K1J-472JE	1	435034724R1
R8410	C-CARBON R	RN72K1J-681JE	1	435036814R1
R8411	C-CARBON R	RN72K1J-472JE	1	435034724R1
R8414	C-CARBON R	RN72K1J-472JE	1	435034724R1
R8415	C-CARBON R	RN72K1J-472JE	1	435034724R1
R8416	C-R NET	RM7LJ220X04	1	43484722004R2
R8417	C-R NET	RM7LJ220X04	1	43484722004R2
R8418	C-R NET	RM7LJ220X04	1	43484722004R2
R8419	C-R NET	RM7LJ220X04	1	43484722004R2
R8420	C-R NET	RM7LJ220X04	1	43484722004R2
R8421	C-R NET	RM7LJ220X04	1	43484722004R2
R8422	C-R NET	RM7LJ220X04	1	43484722004R2
R8423	C-R NET	RM7LJ220X04	1	43484722004R2
R8424	C-R NET	RM7LJ220X04	1	43484722004R2
R8425	C-CARBON R	RN72K1J-220JE	1	435032204R1
R8426	C-CARBON R	RN72K1J-103JE	1	435031034R1

R8427	C-CARBON R	RN72K1J-103JE	1	435031034R1
R8429	C-CARBON R	RN72K1J-220JE	1	435032204R1
R8431	C-CARBON R	RN72K1J-472JE	1	435034724R1
R8432	C-CARBON R	RN72K1J-220JE	1	435032204R1
R8442	C-CARBON R	RN72K1J-102JE	1	435031024R1
R8503	C-R NET	RM7LJ330X04	1	43484733004R2
R8504	C-R NET	RM7LJ330X04	1	43484733004R2
R8505	C-R NET	RM7LJ330X04	1	43484733004R2
R8506	C-CARBON R	RN72K1J-120JE	1	435031204R1
R8507	C-R NET	RM7LJ330X04	1	43484733004R2
R8508	C-R NET	RM7LJ330X04	1	43484733004R2
R8509	C-R NET	RM7LJ330X04	1	43484733004R2
R8510	C-R NET	RM7LJ330X04	1	43484733004R2
R8511	C-R NET	RM7LJ330X04	1	43484733004R2
R8512	C-R NET	RM7LJ330X04	1	43484733004R2
R8513	C-R NET	RM7LJ330X04	1	43484733004R2
R8514	C-CARBON R	RN72K1J-472JE	1	435034724R1
R8516	C-CARBON R	RN72K1J-101JE	1	435031014R1
R8517	C-CARBON R	RN72K1J-101JE	1	435031014R1
R8518	C-CARBON R	RN72K1J-472JE	1	435034724R1
R8519	C-CARBON R	RN72K1J-470JE	1	435034704R1
R8520	C-CARBON R	RN72K1J-330JE	1	435033304R1
R8521	C-CARBON R	RN72K1J-330JE	1	435033304R1
R8522	C-R NET	RM7LJ330X04	1	43484733004R2
R8523	C-CARBON R	RN72K1J-330JE	1	435033304R1
R8524	C-CARBON R	RN72K1J-330JE	1	435033304R1
R8629	C-CARBON R	RN72K1J-562JE	1	435035624R1
R8630	C-CARBON R	RN72K1J-562JE	1	435035624R1
R8633	C-CARBON R	RN72K1J-102JE	1	435031024R1
R8634	C-CARBON R	RN72K1J-103JE	1	435031034R1
R8637	C-CARBON R	RN72K1J-102JE	1	435031024R1
R8638	C-CARBON R	RN72K1J-473JE	1	435034734R1
R8639	C-CARBON R	RN72K1J-473JE	1	435034734R1
R8642	C-CARBON R	RN72K1J-562JE	1	435035624R1
R8643	C-CARBON R	RN72K1J-562JE	1	435035624R1
R8662	C-CARBON R	RN72K1J-105JE	1	435031054R1
R8937	C-CARBON R	RN72K1J-103JE	1	435031034R1
R8952	C-CARBON R	RN72K1J-470JE	1	435034704R1
R8953	C-CARBON R	RN72K1J-470JE	1	435034704R1
R8954	C-CARBON R	RN72K1J-470JE	1	435034704R1
R8956	C-CARBON R	RN72K1J-821JE	1	435038214R1
R8957	C-CARBON R	RN72K1J-152JE	1	435031524R1
R8960	C-CARBON R	RN72K1J-102JE	1	435031024R1
R8961	C-CARBON R	RN72K1J-102JE	1	435031024R1
R8962	C-CARBON R	RN72K1J-102JE	1	435031024R1

R8964	C-CARBON R	RN72K1J-821JE	1	435038214R1
R8965	C-CARBON R	RN72K1J-152JE	1	435031524R1
R8966	C-CARBON R	RN72K1J-152JE	1	435031524R1
R8968	C-CARBON R	RN72K1J-102JE	1	435031024R1
R8969	C-CARBON R	RN72K1J-102JE	1	435031024R1
R8970	C-CARBON R	RN72K1J-102JE	1	435031024R1
R8975	C-CARBON R	RN72K1J-473JE	1	435034734R1
JL8002B	WIRE TRAP	NPLG-5P588	1	25055626
P1003B	PLUG	IMSA-9142B-14A	1	25056597
P1004B	SOCKET	IMSA-9111S-24L	1	25053259
P1005B	PLUG	IMSA-9142B-20A	1	25056600
P4104A	SOCKET	NSCT-11P2104	1	25052207
P4104Aor	SOCKET	NSCT-11P1605	(1)	25051818
P8005A	TRM(SCREW)	NEJITANSI M3	1	25065425
P8006	HOLDER	HOLDER(CLAMP)	1	27190540-1
P8101	SOCKET	YKF45-7037V	1	25053253R3
P8121	SOCKET	YKF45-7037V	1	25053253R3
P8141	SOCKET	YKF45-7037V	1	25053253R3
P8301	SOCKET	YKF45-7037V	1	25053253R3
P8302	SOCKET	YKF45-7037V	1	25053253R3
P8704	SOCKET	04FMN-SMT-A-TF	1	25052821R2

- U21** DISPLAY PC BOARD(NADIS-9526-1A)
- U22** VOLUME PC BOARD(NAETC-9527-1A)
- U23** HEADPHONE PC BOARD(NAETC-9528-1A)
- U24** TERMINAL PC BOARD(NAETC-9529-1A)
- U25** POWER SUPPLY PC BOARD(NAPS-9530-1A)

CIRCUIT NO.	PART NAME	DESCRIPTION	Q'TY	PART NO. (SN)	REMARKS
U7520	PHT CP	TORX177L	1	24120127	
U7560	REMO SENS	NJL34H380A	1	241365	
Q7500	FL TUBE	HNA-16SL04T	1	212266	
Q7501	IC	M66005-0001AHP	1	22242208R3	
Q7502	IC	M66005-0001AHP	1	22242208R3	
Q7503	TR	KTC3198-GR	1	2215985T	
Q7503 or	TR	2SC1815-GR	(1)	2211255T	
Q7504	TR	KTC3198-GR	1	2215985T	
Q7504 or	TR	2SC1815-GR	(1)	2211255T	
Q7520	IC	NJM4580D-D	1	22241112	
Q7530	IC	NJM4580D-D	1	22241112	
Q7532	TR	RN1241-A(TPE4_F)	1	2213631T	
Q7532 or	TR	RN1241-B	(1)	2213632T	
Q7533	TR	KRA103M	1	2215780T	
Q7533 or	TR	DTA124ES	(1)	2212600T	
Q7533 or	TR	RN2203	(1)	2213580T	

Q7593	TR	KRC105M	1	2215830T
Q7593 or	TR	DTC123JS	(1)	2213640T
Q7593 or	TR	RN1205	(1)	2214660T
Q7801	TR	2SC2235-O(TPE6_F)	1	2211653T
Q7801 or	TR	2SC2235-Y(TPE6_F)	(1)	2211654T
D7500	ZENER D	MTZJ10B	1	224471002T
D7520	DIODE	ISS133	1	223163T
D7521	DIODE	ISS133	1	223163T
D7522	DIODE	ISS133	1	223163T
D7523	DIODE	ISS133	1	223163T
D7530	ZENER D	MTZJ5.1B	1	224470512T
D7531	DIODE	ISS133	1	223163T
D7532	DIODE	ISS133	1	223163T
D7570	SPCF D	SIR-34ST3F	1	225456
D7571	SPCF D	SIR-34ST3F	1	225456
D7580	DIODE	ISS133	1	223163T
D7581	DIODE	ISS133	1	223163T
D7593	LED	SLR-342MGTE7P	1	225455T
D7595	LED	SLI-343URC-TE7	1	225449T
D7806	ZENER D	MTZJ22B	1	224472202T
D7810	ZENER D	MTZJ24B	1	224472402T
D7812	DIODE	RL1N4003	1	22380260T
D7813	DIODE	RL1N4003	1	22380260T
D7814	DIODE	RL1N4003	1	22380260T
D7815	DIODE	RL1N4003	1	22380260T
D7816	DIODE	RL1N4003	1	22380260T
L7500	CHOKE COIL	NCH-1561 022K	1	233526K022T
L7520	CHOKE COIL	NCH-1561 022K	1	233526K022T
L7530	CHOKE COIL	NCH-1561 022K	1	233526K022T
L7580	CHOKE COIL	NCH-1561 022K	1	233526K022T
L7581	CHOKE COIL	NCH-1561 022K	1	233526K022T
L7582	CHOKE COIL	NCH-1561 022K	1	233526K022T
C7501	CERA C	CK45F50V-223Z	1	335622230T
C7502	CERA C	CK45F50V-223Z	1	335622230T
C7503	CERA C	CK45F50V-223Z	1	335622230T
C7504	CERA C	CK45F50V-223Z	1	335622230T
C7505	CERA C	CK45F50V-223Z	1	335622230T
C7506	VR C	CE04W50V-47M(VR)	1	394684707T
C7507	MMT C	MMT50V-104J	1	375521044T
C7511	MMT C	MMT50V-104J	1	375521044T
C7512	CERA C	CC45SL50V-150J	1	345021504T
C7513	MMT C	MMT50V-104J	1	375521044T
C7514	MMT C	MMT50V-104J	1	375521044T
C7518	MMT C	MMT50V-104J	1	375521044T
C7519	MMT C	MMT50V-104J	1	375521044T

C7520	MMT C	MMT50V-223J	1	375522234T
C7521	VR C	CE04W16V-100M(VR)	1	394641017T
C7522	TF C	ECQ-B50V-221K	1	374722215T
C7523	TF C	ECQ-B50V-221K	1	374722215T
C7524	TF C	ECQ-B50V-102J	1	374721024T
C7530	TF C	ECQ-B50V-102J	1	374721024T
C7533	ELECT C	CE04W35V-47M	1	355764709T
C7534	ELECT C	CE04W35V-47M	1	355764709T
C7535	ELECT C	CE04W50V-10M	1	355781009T
C7536	TF C	ECQ-B50V-101K	1	374721015T
C7537	CERA C	CC45SL50V-330J	1	345023304T
C7538	UTSP C	CE04W50V-10M(UTSP)	1	397581007T
C7539	UTSP C	CE04W50V-10M(UTSP)	1	397581007T
C7540	UTSP C	CE04W50V-10M(UTSP)	1	397581007T
C7543	TF C	ECQ-B50V-102J	1	374721024T
C7560	ELECT C	CE04W6.3V-220M	1	355722219T
C7561	CERA C	CK45B50V-102K	1	335321025T
C7562	TF C	ECQ-B50V-102J	1	374721024T
C7580	CERA C	CK45B50V-102K	1	335321025T
C7581	CERA C	CK45B50V-102K	1	335321025T
C7582	CERA C	CK45B50V-102K	1	335321025T
C7583	CERA C	CK45B50V-102K	1	335321025T
C7590	CERA C	CK45F50V-103Z	1	335621030T
C7591	CERA C	CK45F50V-103Z	1	335621030T
C7804	VR C	CE04W63V-470M(VR)	1	394674717S
C7805	VR C	CE04W63V-47M(VR)	1	394674707T
C7806	CERA C	CK45F50V-223Z	1	335622230T
C7900	MMT C	MMT50V-104J	1	375521044T
R7500	CARBON R	R16J-220	1	417342214T
R7501	CARBON R	R16J-220	1	417342214T
R7502	CARBON R	R16J-27K	1	417342734T
R7503	CARBON R	R16J-2.2K	1	417342224T
R7504	CARBON R	R16J-2.2K	1	417342224T
R7505	CARBON R	R16J-2.2K	1	417342224T
R7506	CARBON R	R16J-2.2K	1	417342224T
R7507	CARBON R	R16J-2.2K	1	417342224T
R7508	CARBON R	R16J-2.2K	1	417342224T
R7509	CARBON R	R16J-2.2K	1	417342224T
R7510	CARBON R	R16J-2.2K	1	417342224T
R7520	CARBON R	R16J-47	1	417344704T
R7521	CARBON R	R16J-330	1	417343314T
R7522	CARBON R	R16J-330	1	417343314T
R7523	CARBON R	R16J-75	1	417347504T
R7524	CARBON R	R16J-75	1	417347504T
R7525	CARBON R	R16J-75	1	417347504T

R7526	CARBON R	R16J-22K	1	417342234T
R7527	CARBON R	R16J-22K	1	417342234T
R7528	CARBON R	R16J-220K	1	417342244T
R7529	CARBON R	R16J-220K	1	417342244T
R7530	CARBON R	R16J-4.7K	1	417344724T
R7531	CARBON R	R16J-100	1	417341014T
R7532	CARBON R	R16J-330	1	417343314T
R7533	CARBON R	R16J-1.8K	1	417341824T
R7534	CARBON R	R16J-100K	1	417341044T
R7535	CARBON R	R16J-1K	1	417341024T
R7536	CARBON R	R16J-33K	1	417343334T
R7537	CARBON R	R16J-33K	1	417343334T
R7538	CARBON R	R16J-220	1	417342214T
R7539	CARBON R	R16J-220	1	417342214T
R7540	CARBON R	R16J-47K	1	417344734T
R7560	CARBON R	R16J-1K	1	417341024T
R7561	CARBON R	R16J-100	1	417341014T
R7580	METAL O R	RS1WBJ-33	1	443623304T
R7581	METAL O R	RS1WBJ-33	1	443623304T
R7590	CARBON R	R16J-10K	1	417341034T
R7591	CARBON R	R16J-10K	1	417341034T
R7592	CARBON R	R16J-10K	1	417341034T
R7593	CARBON R	R16J-10K	1	417341034T
R7597	CARBON R	R16J-180	1	417341814T
R7599	CARBON R	R16J-680	1	417346814T
R7611	CARBON R	R16J-270	1	417342714T
R7612	CARBON R	R16J-330	1	417343314T
R7613	CARBON R	R16J-470	1	417344714T
R7614	CARBON R	R16J-560	1	417345614T
R7615	CARBON R	R16J-820	1	417348214T
R7616	CARBON R	R16J-1.2K	1	417341224T
R7617	CARBON R	R16J-2.2K	1	417342224T
R7618	CARBON R	R16J-3.9K	1	417343924T
R7621	CARBON R	R16J-270	1	417342714T
R7622	CARBON R	R16J-330	1	417343314T
R7623	CARBON R	R16J-470	1	417344714T
R7624	CARBON R	R16J-560	1	417345614T
R7625	CARBON R	R16J-820	1	417348214T
R7626	CARBON R	R16J-1.2K	1	417341224T
R7627	CARBON R	R16J-2.2K	1	417342224T
R7628	CARBON R	R16J-3.9K	1	417343924T
R7629	CARBON R	R16J-12K	1	417341234T
R7631	CARBON R	R16J-270	1	417342714T
R7632	CARBON R	R16J-330	1	417343314T
R7633	CARBON R	R16J-470	1	417344714T

R7634	CARBON R	R16J-560	1	417345614T
R7635	CARBON R	R16J-820	1	417348214T
R7636	CARBON R	R16J-1.2K	1	417341224T
R7637	CARBON R	R16J-2.2K	1	417342224T
R7638	CARBON R	R16J-3.9K	1	417343924T
R7639	CARBON R	R16J-12K	1	417341234T
R7641	CARBON R	R16J-270	1	417342714T
R7642	CARBON R	R16J-330	1	417343314T
R7643	CARBON R	R16J-470	1	417344714T
R7644	CARBON R	R16J-560	1	417345614T
R7645	CARBON R	R16J-820	1	417348214T
R7646	CARBON R	R16J-1.2K	1	417341224T
R7647	CARBON R	R16J-2.2K	1	417342224T
R7648	CARBON R	R16J-3.9K	1	417343924T
R7649	CARBON R	R16J-12K	1	417341234T
R7804	METAL O R	RS1/2WBJ-10	1	443521004T
R7805	CARBON R	R16J-5.6K	1	417345624T
R7807	CARBON R	R16J-33K	1	417343334T
R7808	METAL R	RNU1/2WCJ-1	1	453530104T
R7810	METAL O R	RS1WBJ-22	1	443622204T
R7939	CARBON R	R16J-100K	1	417341044T
R7954	CARBON R	R16J-100K	1	417341044T
E7530	RETAINER	MET37-0002	1	27142009T
E7580	CRIMP AS	.	1	2061712080UL
JL4103B	WIRE HOL	NSCT-5P896	1	25051109
JL7520A	WIRE HOL	NSCT-9P900	1	25051113
JL7520B	WIRE HOL	NSCT-9P900	1	25051113
JL7560A	WIRE HOL	NSCT-3P874	1	25051087
JL7560B	WIRE HOL	NSCT-3P874	1	25051087
JL7590A	WIRE HOL	NSCT-5P896	1	25051109
JL7590B	WIRE HOL	NSCT-5P896	1	25051109
JL7803A	WIRE HOL	NSCT-5P896	1	25051109
JL7803B	SOCKET	NSCT-5P97	1	25050269
P7501B	SOCKET	NSCT-40P2170	1	25052273
P7522	PIN JACK	NPJ-7PDB632	1	25045854
P7530	ST JACK	YKB21-5399N	1	25045853
P7580	JACK	YKB26-5153	1	25045385
P7610	HOLDER	(FL)	1	27191303
P9301A	PLUG	NPLG-6P120	1	25055136
S7590	R ENCODE	EVEHD1F3024B	1	25065695W
S7611	PUSH SW	NPS-111-S681	1	25035718T
S7611 or	PUSH SW	NPS-111-S677	(1)	25035714T
S7612	PUSH SW	NPS-111-S681	1	25035718T
S7612 or	PUSH SW	NPS-111-S677	(1)	25035714T
S7613	PUSH SW	NPS-111-S681	1	25035718T

S7613 or	PUSH SW	NPS-111-S677	(1)	25035714T
S7614	PUSH SW	NPS-111-S681	1	25035718T
S7614 or	PUSH SW	NPS-111-S677	(1)	25035714T
S7615	PUSH SW	NPS-111-S681	1	25035718T
S7615 or	PUSH SW	NPS-111-S677	(1)	25035714T
S7619	PUSH SW	NPS-111-S681	1	25035718T
S7619 or	PUSH SW	NPS-111-S677	(1)	25035714T
S7622	PUSH SW	NPS-111-S681	1	25035718T
S7622 or	PUSH SW	NPS-111-S677	(1)	25035714T
S7623	PUSH SW	NPS-111-S681	1	25035718T
S7623 or	PUSH SW	NPS-111-S677	(1)	25035714T
S7624	PUSH SW	NPS-111-S681	1	25035718T
S7624 or	PUSH SW	NPS-111-S677	(1)	25035714T
S7625	PUSH SW	NPS-111-S681	1	25035718T
S7625 or	PUSH SW	NPS-111-S677	(1)	25035714T
S7626	PUSH SW	NPS-111-S681	1	25035718T
S7626 or	PUSH SW	NPS-111-S677	(1)	25035714T
S7627	PUSH SW	NPS-111-S681	1	25035718T
S7627 or	PUSH SW	NPS-111-S677	(1)	25035714T
S7628	PUSH SW	NPS-111-S681	1	25035718T
S7628 or	PUSH SW	NPS-111-S677	(1)	25035714T
S7629	PUSH SW	NPS-111-S681	1	25035718T
S7629 or	PUSH SW	NPS-111-S677	(1)	25035714T
S7630	PUSH SW	NPS-111-S681	1	25035718T
S7630 or	PUSH SW	NPS-111-S677	(1)	25035714T
S7631	PUSH SW	NPS-111-S681	1	25035718T
S7631 or	PUSH SW	NPS-111-S677	(1)	25035714T
S7632	PUSH SW	NPS-111-S681	1	25035718T
S7632 or	PUSH SW	NPS-111-S677	(1)	25035714T
S7633	PUSH SW	NPS-111-S681	1	25035718T
S7633 or	PUSH SW	NPS-111-S677	(1)	25035714T
S7634	PUSH SW	NPS-111-S681	1	25035718T
S7634 or	PUSH SW	NPS-111-S677	(1)	25035714T
S7635	PUSH SW	NPS-111-S681	1	25035718T
S7635 or	PUSH SW	NPS-111-S677	(1)	25035714T
S7636	PUSH SW	NPS-111-S681	1	25035718T
S7636 or	PUSH SW	NPS-111-S677	(1)	25035714T
S7637	PUSH SW	NPS-111-S681	1	25035718T
S7637 or	PUSH SW	NPS-111-S677	(1)	25035714T
S7638	PUSH SW	NPS-111-S681	1	25035718T
S7638 or	PUSH SW	NPS-111-S677	(1)	25035714T
S7639	PUSH SW	NPS-111-S681	1	25035718T
S7639 or	PUSH SW	NPS-111-S677	(1)	25035714T
S7640	PUSH SW	NPS-111-S681	1	25035718T
S7640 or	PUSH SW	NPS-111-S677	(1)	25035714T



S7644	PUSH SW	NPS-111-S681	1	25035718T
S7644 or	PUSH SW	NPS-111-S677	(1)	25035714T
S7645	PUSH SW	NPS-111-S681	1	25035718T
S7645 or	PUSH SW	NPS-111-S677	(1)	25035714T
S7646	PUSH SW	NPS-111-S681	1	25035718T
S7646 or	PUSH SW	NPS-111-S677	(1)	25035714T
S7647	PUSH SW	NPS-111-S681	1	25035718T
S7647 or	PUSH SW	NPS-111-S677	(1)	25035714T
S7648	PUSH SW	NPS-111-S681	1	25035718T
S7648 or	PUSH SW	NPS-111-S677	(1)	25035714T
S7649	PUSH SW	NPS-111-S681	1	25035718T
S7649 or	PUSH SW	NPS-111-S677	(1)	25035714T
S7650	PUSH SW	NPS-111-S681	1	25035718T
S7650 or	PUSH SW	NPS-111-S677	(1)	25035714T

**DTR-6.9**

**PACKING PROCEDURE PARTS LIST**

REF. NO.	PART NAME	DESCRIPTION	Q'TY	PART NO(SN)	REMARKS
A603	CARTON	6.9MDD	1	29054866A	
A607	LABEL	(MMA)	2	29364968	<MA>
A631	PAD	(AS)	1	29092373A	
A673	SHEET	(PAD)	1	29096065A	
A681	POLY BAG	w850xd650	1	29100245	
A685	PP TAPE	W50 SBT-70	1	29110200	
A689	TAPE	(SEROHAN)NITTO NO.29	2	29110149	
A701a	UPC LABEL	DTR6.9MDD	1	29390361A	<DD>
A701a	EAN LABEL	DTR6.9MMA	1	29390359A	<MA>
A802	HANDBILL	(DS-A2X)US	1	29380150	<DD>
A802	HANDBILL	(DS-A2X)AUS	1	29380152	<MA>
A805	INST SHEET	En(XM RADIO)	1	29355602	<DD>
A806	HANDBILL	(SIRIUS)	1	29380149	<DD>
A808	LABEL	(SPCABLE)	1	29390189	
A810	BATTERY	R6/AA(UM-3)	2	3010194	
A810 or	BATTERY	R6/AA(UM-3)	(2)	3010054	
A815	ANT COIL	NMA-3057	1	232140	
A816	FM ANT AS	Type W	1	292191	
A817	MIC	MIC-7000	1	245044	
A819	POLY BAG	D250xd300xW300(t0.04)	1	29100256A	
A821	REMO CON	RC-718M	1	24140718	
A830	WRNTY CARD	(INTEGRA)	1	29365136	<DD>
A859	INS MANUAL	U9(RC707/708/709/710/711)	1	29344636A	
A880	INS MANUAL	En(DTR-6.9)	1	29344743	
A881	INS MANUAL	En(QSS)(DTR-6.9)	1	29344744	

A883	INST SHEET	WEEE	1	29355537	<MA>
A886	INST SHEET	En(606 RIHD)US	1	29355696	<DD>
A888	INST SHEET	U8FrEsItDeNISvCtCs(606 RIHD)	1	29355698	<MA>
A889	INST SHEET	En(606 RIHD)not US	1	29355699	<MA>
P901	AC CORD	AS-UC-2	1	253297KAW	!, <DD>
P901 or	AC CORD	AS-UC-2	( 1)	253352ATES	!, <DD>
P901	AC CORD	AS-SAA	1	253391VOL	!, <MA>

---

Integra Division of

**ONKYO CORPORATION**

Sales & Product Planning Div. : 2-1, Nisshin-cho, Neyagawa-shi, OSAKA 572-8540, JAPAN

Tel: 072-831-8023 Fax: 072-831-8163 <http://www.onkyo.com/>

Integra Division of

**ONKYO U.S.A. CORPORATION**

18 Park Way, Upper Saddle River, N.J. 07458, U.S.A.

Tel: 201-785-2600 Fax: 201-785-2650 <http://www.integrahometheater.com>