

DWR Series Wall Mount Rack



Middle Atlantic Products

EXCEPTIONAL SUPPORT & PROTECTION™

SEISMIC CERTIFIED



US PATENT# 7, 278, 183

EIA/TIA Compliant

UL LISTED

This pivoting, sectional wall cabinet is ideal for larger systems in both secured and non-secured areas

Features

- Available in 17", 22", 26" and 32" overall depths with 15", 20", 24" and 30" of useable depth
- Tool-Free Quick-Mount™ system for easy, one-person mounting of the center section to the backpan on the jobsite
- New center section rear channel accommodates slim power to save space
- Optional minimum-clearance latch allows side-by-side or interior corner mounting
- 16-gauge steel construction with 1/8" thick laser-cut corner braces
- Reversible padlockable center section is keyed differently from optional front door for security
- 2" knockouts, 4" knockouts for Wiremold 4000® Series raceways, and knockouts for UCP Series universal connector panels on side
- Grounding/bonding stud in top and bottom of center section and backpan facilitates proper grounding and bonding of electronic equipment, as per NEBS and NEC standards
- Finished in a durable black textured powder coat
- UL listed in the US and Canada

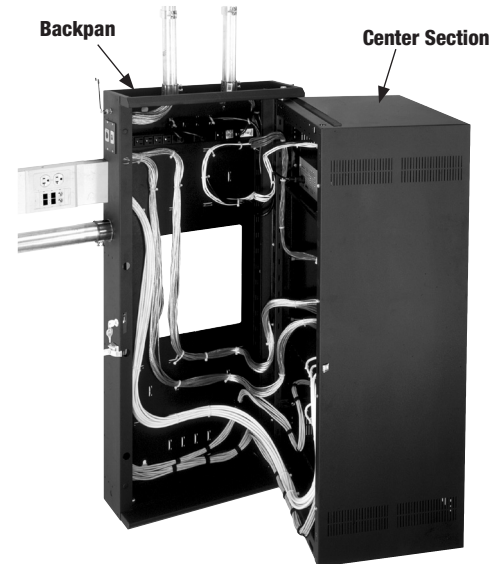

DWR-24-22

see inside for important information regarding useable depths

Architects' and Engineers' Specifications

EIA compliant 19" wall mount rack shall be Middle Atlantic Products model # DWR-____ (refer to chart). Overall dimensions shall be 23.4" W x ____" H x ____" D (refer to chart). Weight capacity shall be ____ lbs. Tool-Free Quick-Mount™ system enables one-person installation. Useable depth shall be ____" (refer to chart) and shall extend into the back pan 3.5". Center section and back pan shall be 16-gauge steel, phosphate pre-treated and finished in a black textured powder coat. Rackrail shall be constructed of 11-gauge steel with tapped 10-32 mounting holes in universal EIA spacing with black e-coat finish and marked rack spaces. Rack shall be constructed to swing open for component cabling access, center section shall pivot for either left or right opening. Rack shall have a rear knockout panel with 1/2", 3/4", 1", 1-1/2", 2" and 3" electrical knockouts installed in base, and a rear knockout panel with 1/2", 3/4", 1", 1-1/2", 2" and 3" electrical knockouts, four Decora® cutouts, and BNC knockouts for UHF/VHF antennas installed in top. Large laser knockout on back pan shall have a 12-1/2" x 12-1/2" cutout for electrical pull-box. Fan knockouts on top and bottom shall allow for installation of up to four 4-1/2" fans. Rack shall have 2" knockouts, 4" knockouts for Wiremold 4000® Series raceways, and knockouts for UCP Series universal connector panels on the side. Top, bottom and sides shall feature vertical vent pattern. DWR Series enclosures shall satisfy the 2007 & 2010 CBC; 2006, 2009 & 2012 IBC; ASCE 7-05 (2005 Edition) & ASCE 7-10 (2010 Edition) and the 2006 & 2009 editions of NFPA 5000 for use in areas of high seismicity, Seismic Use Group III, Zone 4 or Seismic Design Category (SDC) "D" with lateral force requirements for protecting 140 lbs. of essential equipment in locations with the highest level of seismicity and top floor or rooftop installations with an Importance factor (Ip) of 1.5 when used with DWRSR-ZL Latch. Rack shall be UL Listed in the US and Canada. Rack shall be GREENGUARD Indoor Air Quality Certified for Children and Schools. Rack shall comply with the requirements RoHS EU Directive 2002 / 95 / EC. Rack shall

be manufactured by an ISO 9001 and ISO 14001 registered company. Rack shall be warranted to be free from defects in materials or workmanship under normal use and conditions for the lifetime of the rack.

OPTIONS

- Front doors shall be reinforced 16-gauge steel, model # FD-XX (solid), VFD-XX (vented, 25% open area), LVFD-XX (vented, 64% open area), PFD-XX (plexi), (XX= # of rackspaces of DWR rack)
- Keyless Latch replaces keylock, fits front & rear doors, shall be models # LATCH
- Rear rail kit 11-gauge, 10-32 threaded, sold in pairs, hardware included, shall be model # DWR-RRXX
- Fan kits with two 4-1/2" exhaust fans, fan guards and vent blockers, shall be model # DWR-FK17 (fits DWR-xx-17), DWR-FK22 (fits DWR-xx-22), DWR-FK26 (fits DWR-xx-26), DWR-FK32 (fits DWR-xx-32)
- Vent Blockers used to promote active thermal management, shall be model # VBK-D17 (fits DWR-XX-17), VBK-SD22 (fits DWR-XX-22), VBK-E20 (fits DWR-XX-26)
- Optional cover plate / shelf kit shall be model # DWR-CVR
- Minimum-clearance latch shall allow side-by-side or corner mounting, shall be model # DWRSR-ZL

CUSTOMIZABLE SPECIFICATION CLIPS AVAILABLE AT MIDDLEATLANTIC.COM

DWR Series basic dimensions



All dimensions in inches unless otherwise noted [All dimensions in brackets are in millimeters]

**FRONT VIEW
(CENTER SECTION)**

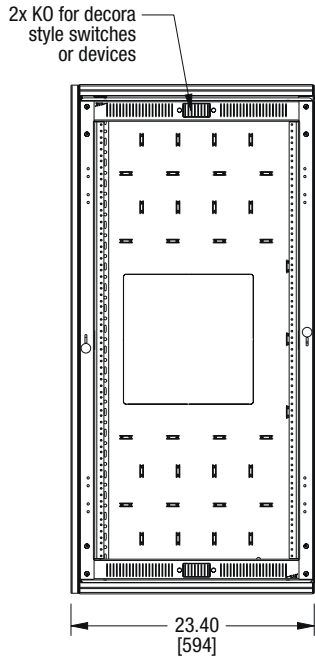

**FRONT VIEW
(BACK PAN)**

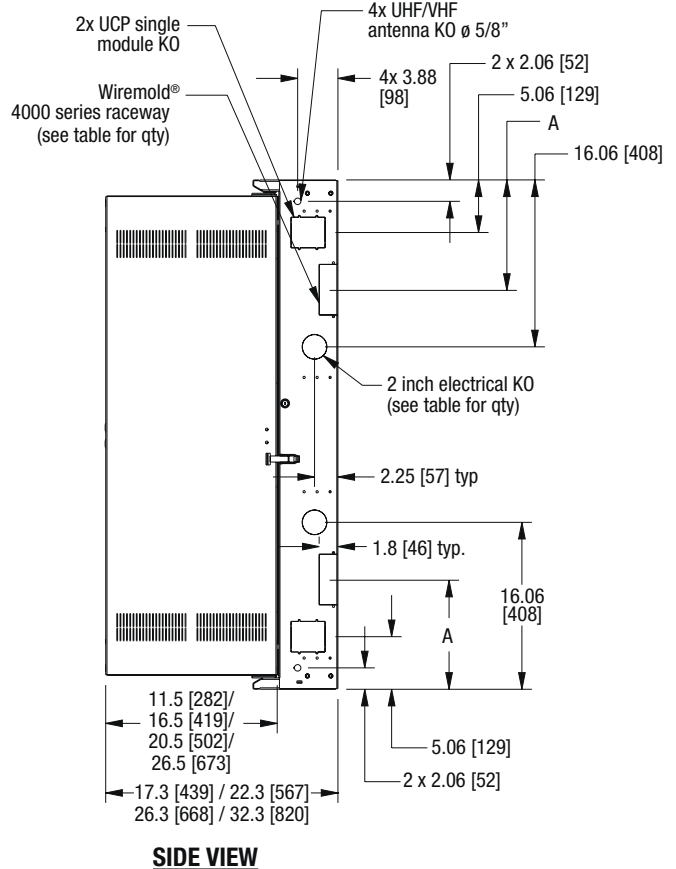
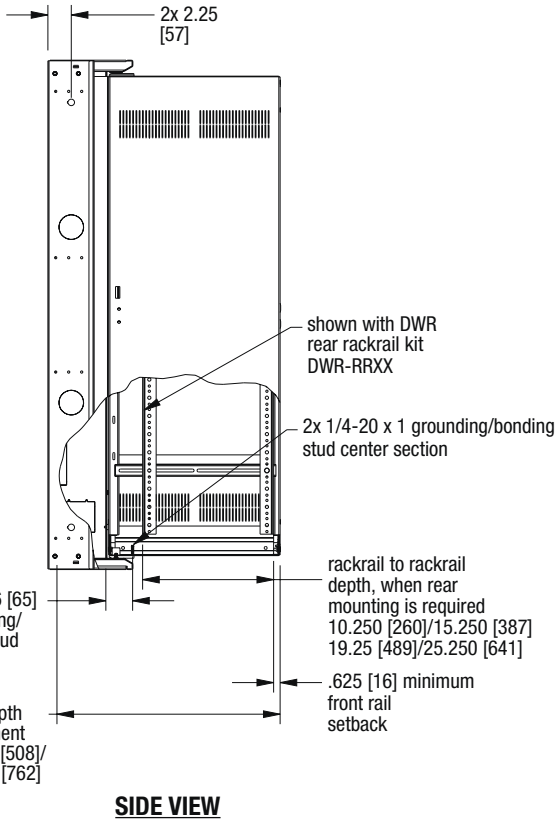
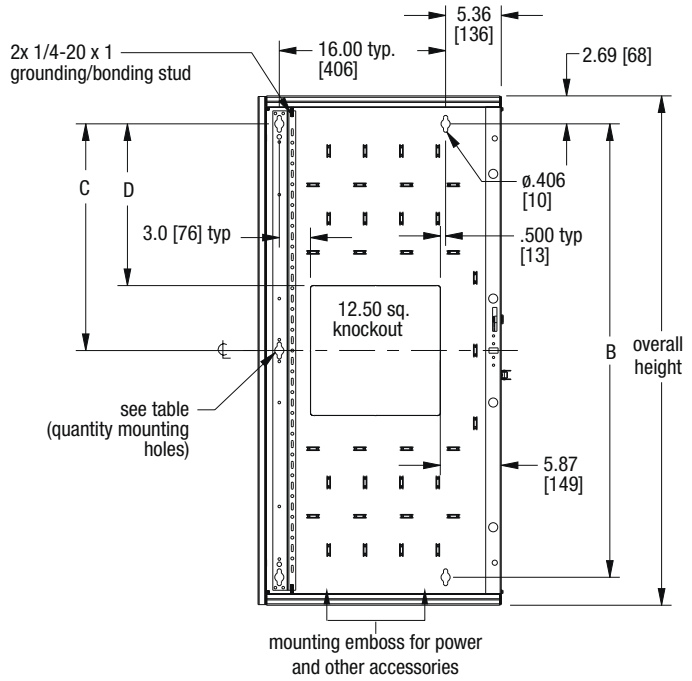

NOTES:
17", 22", 26", and 32" deep models are represented in this drawing
(DWR-XX-17) / (DWR-XX-22) / (DWR-XX-26) / (DWR-XX-32)

Part #	Overall Height	Racking Height	Useable Depth	Rackspaces	Weight Capacity	2" EKO Backpan Qty.	Wiremold 4000 Series Qty.	A Wiremold 4000 Series Spacing	B Mounting Hole Spacing	C Mounting Hole Spacing Hinge Side	D Knockout Top to Mounting Hole Spacing	Qty. of Mounting Holes
DWR-10-17	24.50 (622)	17.50 (445)	15	10 spaces	200 lbs.	-	1	12.25 (311)	19.13 (486)	19.13 (486)	3.31 [84]	4
DWR-10-22	24.50 (622)	17.50 (445)	20	10 spaces	200 lbs.	-	1	12.25 (311)	19.13 (486)	19.13 (486)	3.31 [84]	4
DWR-12-17	28.00 (711)	21.00 (533)	15	12 spaces	200 lbs.	-	1	14.00 (356)	22.63 (575)	22.63 (575)	5.06 [129]	4
DWR-12-22	28.00 (711)	21.00 (533)	20	12 spaces	200 lbs.	-	1	14.00 (356)	22.63 (575)	22.63 (575)	5.06 [129]	4
DWR-12-26	28.00 (711)	21.00 (533)	24	12 spaces	200 lbs.	-	1	14.00 (356)	22.63 (575)	22.63 (575)	5.06 [129]	4
DWR-12-32	28.00 (711)	21.00 (533)	30	12 spaces	200 lbs.	-	1	14.00 (356)	22.63 (575)	22.63 (575)	5.06 [129]	4
DWR-16-17	35.00 (889)	28.00 (711)	15	16 spaces	200 lbs.	-	1	17.50 (445)	29.63 (752)	29.63 (752)	8.56 [217]	4
DWR-16-22	35.00 (889)	28.00 (711)	20	16 spaces	200 lbs.	-	1	17.50 (445)	29.63 (752)	29.63 (752)	8.56 [217]	4
DWR-18-17	38.50 (978)	31.50 (800)	15	18 spaces	250 lbs.	-	1	19.25 (489)	33.13 (841)	33.13 (841)	10.31 [262]	4
DWR-18-22	38.50 (978)	31.50 (800)	20	18 spaces	250 lbs.	-	1	19.25 (489)	33.13 (841)	33.13 (841)	10.31 [262]	4
DWR-18-26	38.50 (978)	31.50 (800)	24	18 spaces	250 lbs.	-	1	19.25 (489)	33.13 (841)	33.13 (841)	10.31 [262]	4
DWR-18-32	38.50 (978)	31.50 (800)	30	18 spaces	250 lbs.	-	1	19.25 (489)	33.13 (841)	33.13 (841)	10.31 [262]	4
DWR-21-17	43.75 (1111)	36.75 (933)	15	21 spaces	250 lbs.	4	2	10.56 (268)	38.33 (975)	19.19 [487]	12.94 [329]	4
DWR-21-22	43.75 (1111)	36.75 (933)	20	21 spaces	250 lbs.	4	2	10.56 (268)	38.33 (975)	19.19 [487]	12.94 [329]	4
DWR-24-17	49.00 (1245)	42.00 (1067)	15	24 spaces	300 lbs.	4	2	10.56 (268)	43.63 (1108)	21.81 [554]	15.56 [395]	5
DWR-24-22	49.00 (1245)	42.00 (1067)	20	24 spaces	300 lbs.	4	2	10.56 (268)	43.63 (1108)	21.81 [554]	15.56 [395]	5
DWR-24-26	49.00 (1245)	42.00 (1067)	24	24 spaces	300 lbs.	4	2	10.56 (268)	43.63 (1108)	21.81 [554]	15.56 [395]	5
DWR-24-32	49.00 (1245)	42.00 (1067)	30	24 spaces	300 lbs.	4	2	10.56 (268)	43.63 (1108)	21.81 [554]	15.56 [395]	5
DWR-35-17	68.25 (1734)	61.25 (1558)	15	35 spaces	300 lbs.	4	2	10.56 (268)	62.83 (1597)	21.00 [533]	25.19 [640]	6
DWR-35-22	68.25 (1734)	61.25 (1558)	20	35 spaces	300 lbs.	4	2	10.56 (268)	62.83 (1597)	21.00 [533]	25.19 [640]	6
DWR-35-26	68.25 (1734)	61.25 (1558)	24	35 spaces	300 lbs.	4	2	10.56 (268)	62.83 (1597)	21.00 [533]	25.19 [640]	6

DWR Series basic dimensions

All dimensions in inches unless otherwise noted [All dimensions in brackets are in millimeters]

TOP VIEW

(knockout pictured in top view are also on the bottom view)

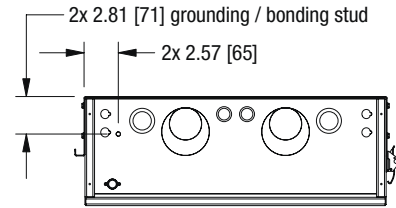
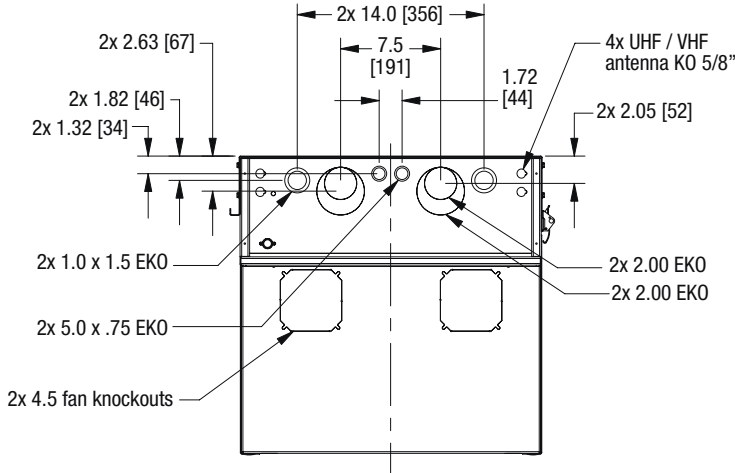

Useable Depth

Useable depth extends into backpan. Consider this when applications require large amounts of cables, connectors and/or conduit in the backpan.

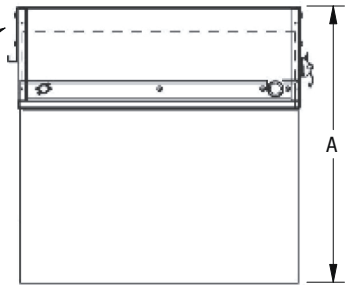

CENTER SECTION CLEARANCE

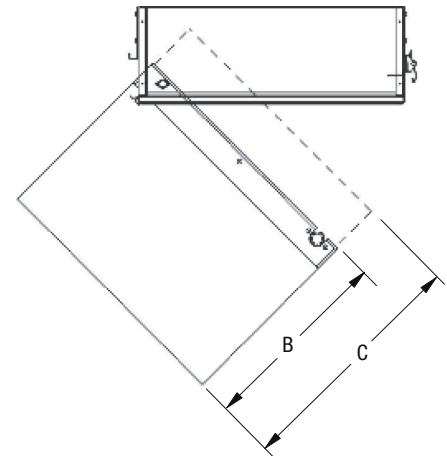
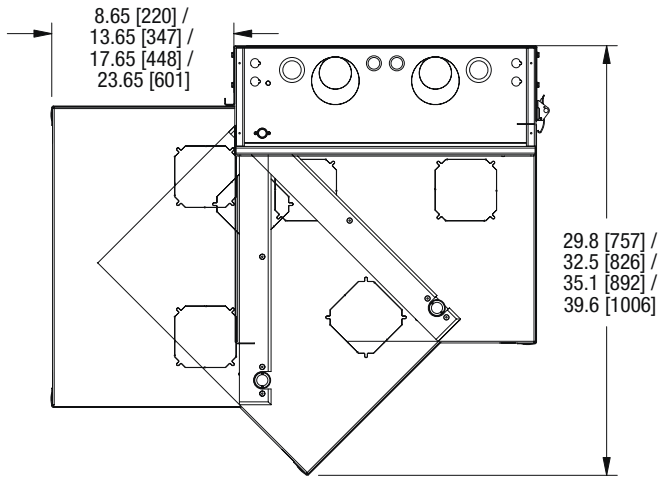

Part #	A Overall Depth	B Center Section Depth	C Useable Depth
DWR-XX-17	17.3 [439]	11.5 [292]	15.0 [381]
DWR-XX-22	22.3 [567]	16.5 [419]	20.0 [508]
DWR-XX-26	26.3 [668]	20.5 [521]	24.0 [610]
DWR-XX-32	32.3 [820]	26.5 [673]	30.0 [762]



DWR Series basic dimensions with Minimum-Clearance Latch installed



All dimensions in inches unless otherwise noted [All dimensions in brackets are in millimeters]

TOP VIEW

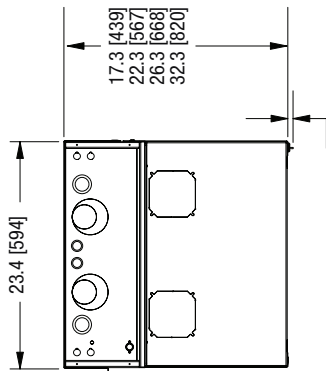

TOP VIEW
(2 DWR's fully opened)

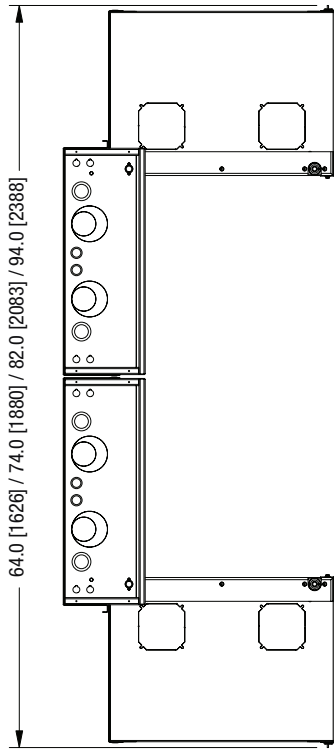

TOP VIEW
(2 DWR's closed position)

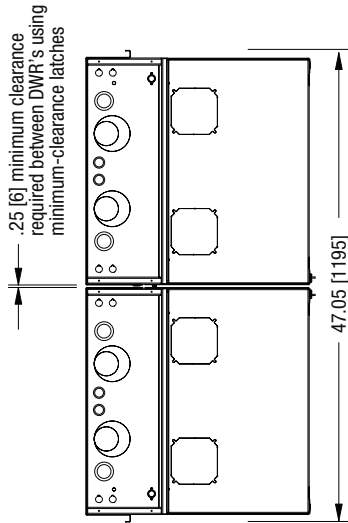

OPTIONAL DWRSR-ZL MINIMUM-CLEARANCE LATCH OPERATION:

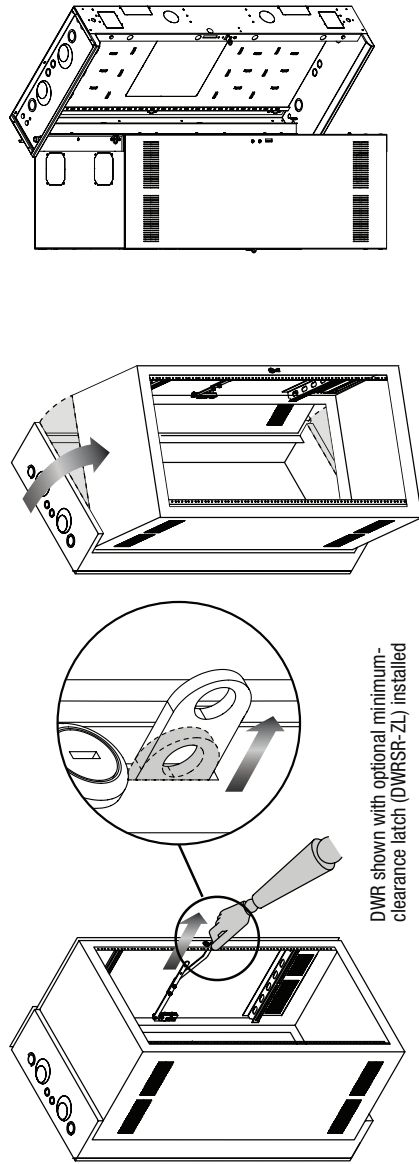

DWR shown with optional minimum-clearance latch (DWRSR-ZL) installed

CENTER SECTION TRIM POWER	
PART NUMBER	PD-2415 SERIES (QTY)
DWR-10-xx	1
DWR-12-xx	1
DWR-16-xx	1
DWR-18-xx	1
DWR-21-xx	1 or 2
DWR-24-xx	1 or 2
DWR-35-xx	1 or 2