

COMPLEX VARIABLES WITH APPLICATIONS

Third Edition

By A. David Wunsch
University of Massachusetts Lowell

SOLUTIONS MANUAL

By

A. David Wunsch

&

Michael F. Brown

Copyright 2004 Pearson Education Inc.
Publishing as Pearson Addison-Wesley, 75 Arlington Street, Boston, MA 02116

COMPLEX VARIABLES WITH APPLICATIONS

Third Edition

By A. David Wunsch
University of Massachusetts Lowell

SOLUTIONS MANUAL

By

A. David Wunsch

&

Michael F. Brown

Copyright 2004 Pearson Education Inc.
Publishing as Pearson Addison-Wesley, 75 Arlington Street, Boston, MA 02116

The bulky volume you are holding represents the solutions to all the problems in the 3rd edition of my textbook *Complex Variables with Applications*. Both Michael Brown and I have separately worked through all the solutions, but I can say with overwhelming confidence that in spite of this redundancy there are some remaining errors. Please tell me of any that you find. My e mail address is David_Wunsch@UML.edu (note the underscore). Those preferring an older medium of communication may write to me at the Electrical and Computer Engineering Dept. University of Massachusetts Lowell, Lowell, MA 01854. I promise to acknowledge all e-mail and postal mail that I receive. I would also appreciate learning of any errors in the textbook itself.

I plan to post corrections to both the book and this manual at the web address http://faculty.uml.edu/awunsch/Wunsch_Complex_Variables/

This manual has been written primarily for college faculty who are teaching from my text. Whether it is to be made freely available to students- perhaps at the school library- is a matter I leave up to each individual instructor. Notice however, that there is little point in assigning the textbook problems involving computer programming if students already have the MATLAB code supplied in this manual. Regarding this code, I must assert that I am not a professional programmer and I'm certain that in many cases the reader will find more efficient ways of solving the same problem.

Finally, I must apologize for the idiosyncrasies of the handwriting. They are my own and not to be blamed on Mr. Brown.

A. David Wunsch
Belmont, Massachusetts
July 8, 2004

$$e^{i\pi} + 1 = 0$$

TABLE OF CONTENTS

1 Complex Numbers

- 1.1 Introduction
- 1.2 More Properties of Complex Numbers
- 1.3 Complex Numbers and the Argand Plane
- 1.4 Integer and Fractional Powers of Complex Numbers
- 1.5 Points, Sets, Loci, and Regions in the Complex Plane

2 The Complex Function and its Derivative

- 2.1 Introduction
- 2.2 Limits and Continuity
- 2.3 The Complex Derivative
- 2.4 The Derivative and Analyticity
- 2.5 Harmonic Functions
- 2.6 Some Physical Applications of Harmonic Functions

3 The Basic Transcendental Functions

- 3.1 The Exponential Function
- 3.2 Trigonometric Functions
- 3.3 Hyperbolic Functions
- 3.4 The Logarithmic Function
- 3.5 Analyticity of the Logarithmic Function
- 3.6 Complex Exponentials
- 3.7 Inverse Trigonometric and Hyperbolic Functions
- 3.8 More on Branch Cuts and Branch Points
- Appendix: Phasors

4 Integration in the Complex Plane

- 4.1 Introduction to Line Integration
- 4.2 Complex Line Integration
- 4.3 Contour Integration and Green's Theorem
- 4.4 Path Independence, Indefinite Integrals, Fundamental Theorem of Calculus in the Complex Plane
- 4.5 The Cauchy Integral Formula and Its Extension
- 4.6 Some Applications of the Cauchy Integral Formula
- 8.8 Introduction to Dirichlet Problems- The Poisson Integral Formula for the Circle and Half Plane
- Appendix: Green's Theorem in the Plane

5 Infinite Series Involving a Complex Variable

- 5.1 Introduction and Review of Real Series
- 5.2 Complex Sequences and Convergence of Complex Series
- 5.3 Uniform Convergence of Series
- 5.4 Power Series and Taylor Series

- 5.5 Techniques for Obtaining Taylor Series Expansions
 - 5.6 Laurent Series
 - 5.7 Properties of Analytic Functions Related to Taylor Series:
Isolation of Zeros, Analytic Continuation, Zeta Function, Reflection
 - 8.8 The z Transformation
- Appendix: Fractals and the Mandelbrot Set

6 Residues and Their Use in Integration

- 6.1 Introduction, and Definition of the Residue
- 6.2 Isolated Singularities
- 6.3 Finding the Residue
- 6.4 Evaluation of Real Integrals with Residue Calculus, I
- 6.5 Evaluation of Integrals, II
- 6.6 Evaluation of Integrals, III
- 6.7 Integrals Involving Indented Contours
- 6.8 Contour Integrations Involving Branch Points and Branch Cuts
- 6.9 Residue Calculus Applied to Fourier Transforms
- 6.10 The Hilbert Transform
- 6.11 Uniform Convergence of Integrals and the Gamma Function
- 6.12 Principle of the Argument

7 Laplace Transforms and Stability of Systems

- 7.1 Laplace Transforms and Their Inversion
- 7.2 Stability -An Introduction
- 7.3 The Nyquist Stability Criterion
- 7.4 Generalized Functions, Laplace Transforms, and Stability

8 Conformal Mapping and Some of Its Applications

- 8.1 Introduction
 - 8.2 The Conformal Property
 - 8.3 One-to-One Mappings and Mappings of Regions
 - 8.4 The Bilinear Transformation
 - 8.5 Conformal Mapping and Boundary Value Problems
 - 8.6 More on Boundary Value Problems—Streamlines as Boundaries
 - 8.7 Boundary Value Problems with Sources
 - 8.8 The Schwarz-Christoffel Transformation
- Appendix: The Stream Function and Capacitance

9 Advanced Topics in Infinite Series and Products

- 9.1 The Use of Residues to Sum Certain Numerical Series
- 9.2 Partial Fraction Expansions of Functions with an Infinite Number of Poles
- 9.3 Introduction to Infinite Products
- 9.4 Expanding Functions in Infinite Products

1

Complex Numbers

Chapter 1
Section 1.1

- 1) $4x+3=0$, $x=-3/4$, rational number system
- 2) $x^2-x-1=0$, $x=\frac{1 \pm \sqrt{5}}{2}$ which is real but irrational. Need real number system
- 3) $x^2+x+1=0$ $x=\frac{-1 \pm \sqrt{-3}}{2}$ need complex number system
- 4) $\sin x=0$, $x=0$, integers 5) $\cos x=0$, $x=\pm \frac{\pi}{2}, \pm \frac{3\pi}{2}, \dots$ real number system odd ↑
- 6) $(x+2)(x+1)=0$ $x=-2, -1$, integers
- 7) $\sin(\log x)=0$, $x=1$, $\sin(\log 1)=0$, integers
- 8) $z^4=16$, $z=2$, integers 9) $z^4=-16$, $z=(-16)^{1/4}$ complex
- 10) a) $[1+10^{-2}+10^{-4}\dots] = \frac{1}{1-10^{-2}} = \frac{10^2}{100-1} = \frac{100}{99}$
- b) $23.2323\dots = 23 \frac{100}{99} = \frac{2300}{99}$
- c) $376.376376\dots = 376 [1+10^{-3}+10^{-6}+10^{-9}\dots]$
 $= 376 \frac{1}{1-10^{-3}} = 376 \frac{1000}{999} = \frac{376000}{999}$
- 11 (a) Consider $4.0404\dots = 4 [1+10^{-2}+10^{-4}\dots]$
 $= 4 \left[\frac{1}{1-10^{-2}} \right] = \frac{400}{99}$. Now $3.0404\dots$
 $= \frac{400}{99} - 1 = \frac{400-99}{99} = \frac{301}{99}$
- b) $.999\dots = .9 [1+10^{-1}+10^{-2}\dots]$
 $= .9 \frac{1}{1-10^{-1}} = \frac{.9}{1-.1} = \frac{.9}{.9} = 1$ q.e.d.
- 12(a) We begin by showing that the square of any odd number is odd. Let N_o be that number. Then $N_o = N_e + 1$ where N_e is even. Now $N_o^2 = N_e^2 + 2N_e + 1$
even
 $N_o^2 = \text{even} + 1 = \text{odd}$

Chapter 1
Sec. 1.1

12(a) continued. We showed that the square of an odd integer is odd. Thus the square root of a perfect square (that is even) must not be odd, \therefore is even.

12(b) $m^2 = 2n^2$, $2n^2$ is even, \therefore from part (a) the square root of $2n^2$, which is m , must be even.

12(c) $n^2 = \frac{m}{2} \cdot m$. Since m is even, $\frac{m}{2}$ is an integer. $\therefore n^2$ is even, and from (a) so is n .

12(d) We assumed that $\sqrt{2} = \frac{m}{n}$ can be expressed as the ratio of 2 integers having no common integer factor. Our assumption says that m and n both can't be even. This resulted in a contradiction, since in parts (b) and (c) we found that m and n were both even.

12(e). Assume $n + \sqrt{2}$ is rational = a

$a = n + \sqrt{2}$, $a - n = \sqrt{2}$. The left side is rational [the difference of rational numbers] but the right side is irrational. Have a contradiction.
Suppose $\sqrt{2}n^2$ is rational, then $\sqrt{2}n = a$ is rational $\frac{a}{n} = \sqrt{2}$. The left side is the quotient of rational numbers and is rational, the right side is irrational, have a contradiction.

Assume $a = \sqrt{\sqrt{2}}$ is rational $a^2 = \sqrt{2}$.
Left side is rational, right side is irrational.
Have contradiction.

(chap 1, page 2)

$$13(a) \quad x^2 + bx + c = 0 \quad x = \frac{-b \pm \sqrt{b^2 - 4c}}{2} = 1 \pm \sqrt{2} \quad b = -2, \frac{\sqrt{4 - 4c}}{2} = \sqrt{2}$$

$$\therefore \boxed{x^2 - 2x - 1 = 0} \text{ will work } 13(b) \quad x = \sqrt{\sqrt{2}} \quad x^4 = 2 \quad \boxed{x^4 - 2 = 0}$$

$$14(a) \text{ Using Matlab: } \text{exp}(1) = 2.718281828 \underbrace{45905}_{\text{pattern breaks}}$$

Use long format

$$(b) \quad 201/26 = 7.7\overline{3076923076923}$$

repeating decimals

the digits
307692 repeat

$$15 \quad \boxed{4 - 4i}$$

$$16 \quad -5 + 2i + 15i + 7i =$$

$$\boxed{16 + 22i}$$

$$17 \quad (3-2i)(4+3i)(3+2i) = (3-2i)(3+2i)(4+3i) =$$

$$(9+4)(4+3i) = \boxed{52 + i39}$$

chap 1
sec 1.1, continued

18) $(1+i)^3 = (1+i)^2 (1+i) = 2i(1+i) = -2+2i$

Imag part = $\boxed{2}$

19) $\text{Im}(1+i) = 1, [\text{Im}(1+i)]^3 = 1^3 = \boxed{1}$

20) $(x+iy)(u-iv)(x-iy)(u+iv) =$
 $(x+iy)(x-iy)(u-iv)(u+iv) = (x^2+y^2)(u^2+v^2)$
 $= \boxed{u^2x^2+v^2x^2+u^2y^2+v^2y^2}$

21) (a) binomial theorem
 $(a+b)^n = \sum_{k=0}^n \frac{n!}{(n-k)!k!} a^{n-k} b^k$

let $a=1, b=iy$

$(1+iy)^n = \sum_{k=0}^n \frac{(iy)^k n!}{(n-k)!k!}$

b) $(1+2i)^5 = \sum_{k=0}^5 \frac{(2i)^k 5!}{(5-k)!k!} =$

$\frac{5!}{5!} + \frac{(2i)5!}{4!1!} + \frac{(-4)5!}{3!2!} + \frac{-i85!}{2!3!} + \frac{165!}{1!4!} + \frac{i325!}{5!}$

Real part is $1 + \frac{(-4)(120)}{12} + 0 = 41$

Imag part is $(2)5 - 8 \cdot 10 + 32 = -38$

c) Use $(1+2i)^5$ in Matlab code.
 Will get $41 - i38$

22) $z_1 z_2 = (x_1 + iy_1)(x_2 + iy_2) = x_1 x_2 - y_1 y_2 + i(x_1 y_2 + x_2 y_1)$

$\text{Re}(z_1 z_2) = x_1 x_2 - y_1 y_2 = \text{Re } z_1 \text{Re } z_2 - \text{Im } z_1 \text{Im } z_2$

23) From the above $\text{Im}(z_1 z_2) = x_1 y_2 + x_2 y_1 = \text{Re } z_1 \text{Im } z_2 + \text{Re } z_2 \text{Im } z_1$

24)

Chap 1, sec 1.1

$$i, i^2 = -1, i^3 = -i, i^4 = -i \cdot i = 1$$

$i^5 = i$, etc. \therefore the four possible

values are $i, -1, -i, 1$

$$i^{n+4} = i^4 i^n, \text{ but } i^4 = 1, \therefore i^{n+4} = i^n$$

as)

$$i^{1023} = i^{1020} i^3 = i^{1020} (-i)$$

$$= (i^4)^{255} (-i) = 1^{255} (-i) = \boxed{-i}$$

(25) Find: $(1-i)^{1025}$, note: $(1-i)^2 = -2i$

$$(1-i)^{1025} = (1-i)^{1024} (1-i) = [(1-i)^2]^{512} (1-i)$$

$$= (-2i)^{512} (1-i) = 2^{512} (-1)^{512} i^{512} (1-i)$$

$$= 2^{512} [(i^4)^{128}] (1-i) = 2^{512} 1^{128} (1-i) = \boxed{2^{512} (1-i)}$$

27)

$$x = 2x$$

$$\therefore x = 0$$

$$y + 1 = 2y$$

$$\therefore y = 1, \text{ ans } \boxed{x=0, y=1}$$

28)

$$x^2 - y^2 + i2xy = y + ix$$

$$x^2 - y^2 = y, \quad 2xy = x \Rightarrow \text{assume } x \neq 0$$

$$2y = 1, \quad y = 1/2$$

$$x^2 - \frac{1}{4} = 1/2 \quad x^2 = 3/4, \quad x = \pm \sqrt{3}/2$$

Set of answers $\boxed{x = \pm \sqrt{3}/2, y = 1/2}$

Now assume $x = 0$, $2xy = x$ is satisfied

$$x^2 - y^2 = y \quad -y^2 = y \quad y + y^2 = 0$$

$$y(1+y) = 0, \quad y = 0 \text{ or } y = -1$$

Second set of answer $\boxed{x=0, y=0 \text{ or } -1}$

29)

$$e^{x^2+y^2} = e^{-2xy}$$

$$2y = 1, \therefore y = \frac{1}{2}$$

$$\text{Now } x^2 + y^2 = -2xy, \quad x^2 + y^2 + 2xy = 0$$

$$(x+y)^2 = 0 \quad \therefore x = -y, \quad x = -\frac{1}{2}$$

answer

$$\boxed{x = -\frac{1}{2}, y = \frac{1}{2}}$$

30)

$$\text{Log}(x+y) = 1$$

$$y = xy$$

$$\text{If } \text{Log}(x+y) = 1, \quad x+y = e$$

$$\text{Now assume } y \neq 0 \quad y = xy \Rightarrow x = 1$$

$$\text{Since } x+y = e, \quad y = e-1 \quad \text{Answer: } \boxed{x=1, y=e-1}$$

$$\text{Now assume } y = 0, \quad y = xy \text{ is satisfied}$$

$$x+y = e \Rightarrow x = e \quad \text{Answer } \boxed{x=e, y=0}$$

31)

$$[\text{Log}(x)-1]^2 = 1, \quad [\text{Log}(y)-1]^2 = 0 \quad \therefore \boxed{y=e}$$

$$\text{Log}(x)-1 = \pm 1, \quad \text{Log } x - 1 = -1$$

$$\text{Log } x = 0, \quad x = 1 \quad \text{or } \text{Log } x - 1 = 1$$

$$\text{Log } x = 2, \quad x = e^2$$

$$\text{Answer } \boxed{y=e, x=1 \text{ or } e^2}$$

32)

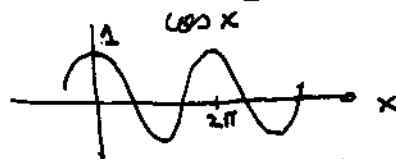
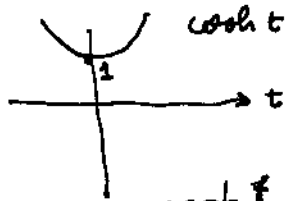

$\cosh(y-1) = \cos x$ can only be solved if $y=1$ and $x = 2n\pi, n=0, \pm 1, \pm 2, \dots$

Now need $\sin x = xy$ $\sin x = x$ ($\sin y = 1$)

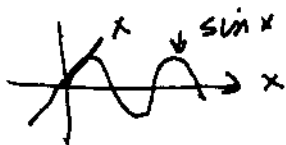

$\sin x = x$ if and only if $x=0$

so Answer

$$\boxed{x=0, y=1}$$

Sec 1.2

$$1) \quad z_1 - z_2 = (x_1 - x_2) + i(y_1 - y_2),$$

$$\overline{z_1 - z_2} = (x_1 - x_2) - i(y_1 - y_2) = x_1 - iy_1 - [x_2 - iy_2]$$

$$= \overline{z_1} - \overline{z_2}$$

$$2) \quad z_1 z_2 = (x_1 x_2 - y_1 y_2) + i[y_1 x_2 + y_2 x_1]$$

$$\overline{z_1 z_2} = (x_1 x_2 - y_1 y_2) - i[y_1 x_2 + y_2 x_1] =$$

$$(x_1 - iy_1)(x_2 - iy_2) = \overline{z_1} \overline{z_2}$$

$$3) \quad \frac{1}{z_1} = \frac{1}{x_1 + iy_1} = \frac{x_1 - iy_1}{x_1^2 + y_1^2}$$

$$\therefore \overline{\left(\frac{1}{z_1}\right)} = \frac{x_1 + iy_1}{x_1^2 + y_1^2} \quad \frac{1}{\overline{z_1}} = \frac{1}{x_1 - iy_1} = \frac{x_1 + iy_1}{x_1^2 + y_1^2}$$

$$\text{Thus } \overline{\left(\frac{1}{z_1}\right)} = \frac{1}{\overline{z_1}}$$

$$4) \quad \frac{z_1}{z_2} = \frac{x_1 + iy_1}{x_2 + iy_2} = \frac{(x_1 + iy_1)(x_2 - iy_2)}{x_2^2 + y_2^2} =$$

$$\frac{x_1 x_2 + y_1 y_2 + i[y_1 x_2 - y_2 x_1]}{x_2^2 + y_2^2} \quad \text{Now } z_1 \cdot \frac{1}{z_2}$$

$$= (x_1 + iy_1) \left[\frac{(x_2 - iy_2)}{x_2^2 + y_2^2} \right] = \frac{x_1 x_2 + y_1 y_2 + i[y_1 x_2 - y_2 x_1]}{x_2^2 + y_2^2}$$

$$\text{Thus } z_1 \cdot \frac{1}{z_2} = \overline{\left(\frac{z_1}{z_2}\right)}$$

$$\Rightarrow \overline{\left(\frac{x_1 + iy_1}{x_2 + iy_2}\right)} = \overline{\left(\frac{z_1}{z_2}\right)} = \frac{(x_1 + iy_1)(x_2 - iy_2)}{x_2^2 + y_2^2}$$

$$= \frac{x_1 x_2 + y_1 y_2 + i(y_1 x_2 - y_2 x_1)}{x_2^2 + y_2^2} = \frac{x_1 x_2 + y_1 y_2 + i[y_2 x_1 - y_1 x_2]}{x_2^2 + y_2^2}$$

$$\text{Now } \frac{\overline{z_1}}{\overline{z_2}} = \frac{x_1 - iy_1}{x_2 - iy_2} = \frac{(x_1 - iy_1)(x_2 + iy_2)}{x_2^2 + y_2^2} = \frac{x_1 x_2 + y_1 y_2 + i[y_2 x_1 - y_1 x_2]}{x_2^2 + y_2^2}$$

$$\text{Thus } \frac{\overline{z_1}}{\overline{z_2}} = \overline{\left(\frac{z_1}{z_2}\right)}$$

sec. 1.2 continued

$$6) \quad z_1 z_2 = x_1 x_2 - y_1 y_2 + i [y_1 x_2 + y_2 x_1]$$

$$\bar{z}_1 \bar{z}_2 = x_1 x_2 - y_1 y_2 - i [y_1 x_2 + y_2 x_1]$$

$\operatorname{Re} [z_1 z_2] = \operatorname{Re} [\bar{z}_1 \bar{z}_2]$. Alternatively:

$\operatorname{Re} [z_1 z_2] = \operatorname{Re} [\bar{z}_1 \bar{z}_2]$ since real part is unaffected by taking conj.

But $\bar{z_1 z_2} = \bar{z}_1 \bar{z}_2$ from prob 2

$$\therefore \operatorname{Re} [z_1 z_2] = \operatorname{Re} [\bar{z}_1 \bar{z}_2]$$

7) From part 6) $z_1 z_2 = x_1 x_2 - y_1 y_2 + i [y_1 x_2 + y_2 x_1]$

thus: $\bar{z}_1 \bar{z}_2 = x_1 x_2 - y_1 y_2 - i [y_1 x_2 + y_2 x_1]$

Note $\operatorname{Im} [z_1 z_2] = -\operatorname{Im} \bar{z}_1 \bar{z}_2 = y_1 x_2 + y_2 x_1$

8) $\frac{1}{1+2i} = \frac{1-2i}{1^2+2^2} = \boxed{\frac{1}{5} - i \frac{2}{5}}$

9) $i + \frac{1}{1-2i} = i + \frac{1+2i}{5} = \frac{1}{5} + \frac{7i}{5}$

$$\left(i + \frac{1}{1-2i}\right)^2 = \frac{1}{25} + \frac{14}{25}i - \frac{49}{25} =$$

$$= \boxed{-\frac{48}{25} + i \frac{14}{25}}$$

10) $\frac{3-4i}{1+2i} = \frac{(3-4i)(1-2i)}{5} = \frac{1}{5} [3-8+i[-4-6]]$

$$= \frac{1}{5} [-5-10i] = \boxed{-1-2i}$$

11) $\frac{3-4i}{1+2i} + \frac{3+4i}{1-2i}$. This must equal

2 $\operatorname{Re} \left[\frac{3-4i}{1+2i} \right] = \boxed{-2}$ 12) Use ans from 10

12) cont'd $2i + \frac{3-4i}{1+2i} = 2i + (-1-2i) = \boxed{-1}$

Sec 1.2 cont'd

$$13) \left(\frac{4-4i}{2+2i} \right)^7 = \left(\frac{2-2i}{1+i} \right)^7 = \left[2^7 \left[\frac{(1-i)}{1+i} \right]^7 \right]$$

$$= 2^7 \left[\frac{(1-i)^2}{2} \right]^7 = \frac{2^7}{2^7} (1-i)^{14} =$$

$$\left[(1-i)^2 \right]^7 = (-2i)^7 = (-1)^7 2^7 i^7 = i \cdot 2^7 = \boxed{128i}$$

14) $\left(\frac{4-4i}{2+2i} \right)^7 + \left(\frac{4+4i}{2-2i} \right)^7$. Note the second term is the conjugate of the first.

∴ ans is $2 \operatorname{Re} \left[\frac{4-4i}{2+2i} \right]^7 = 2 \operatorname{Re} [128i]$ (see prob 13)

= $\boxed{0}$

PROBLEM 15.

» 8

» $1/(1+2i)$

ans =

$0.2000 - 0.4000i$

» 9

» $(i+1/(1-2i))^2$

ans =

$-1.9200 + 0.5600i$

» 10

» $(3-4i)/(1+2i)$

ans =

$-1.0000 - 2.0000i$

» 11

» $(3-4i)/(1+2i) + (3+4i)/(1-2i)$

ans =

-2

» 12

» $2i + (3-4i)/(1+2i)$

ans =

-1

» 13

» $((4-4i)/(2+2i))^7$

ans =

$0 + 1.2800e+002i$

» 214

» $((4-4i)/(2+2i))^7 + ((4+4i)/(2-2i))^7$

ans =

0

16) $\overline{\left(\frac{z_1}{z_2 z_3}\right)} = \frac{\bar{z}_1}{\bar{z}_2 \bar{z}_3} = \frac{\bar{z}_1}{\bar{z}_2 \bar{z}_3} = \bar{z}_1 \frac{1}{\bar{z}_2 \bar{z}_3}$

this is not equal to $\bar{z}_1 \frac{1}{\bar{z}_2 \bar{z}_3}$ ∴ not true

17) $\overline{z_1 \bar{z}_2 z_3} = \bar{z}_1 \bar{\bar{z}_2} \bar{z}_3 = \bar{z}_1 z_2 \bar{z}_3$ g.e.d. true

18) $\overline{i(z_1 + z_2 + z_3)} = \bar{i}(\bar{z}_1 + \bar{z}_2 + \bar{z}_3) = -i(\bar{z}_1 + \bar{z}_2 + \bar{z}_3)$. This is not equal to $i(\bar{z}_1 + \bar{z}_2 + \bar{z}_3)$. ∴ not true

19) Consider z, \bar{z}_2, z_3 . Its conjugate is

$\overline{z, \bar{z}_2, z_3} = \bar{z}, \bar{\bar{z}_2}, \bar{z}_3 = \bar{z}, z_2, \bar{z}_3$

∴ $\text{Re}[z, \bar{z}_2, z_3] = \text{Re}[\bar{z}, z_2, \bar{z}_3]$ g.e.d. true

20) Consider z, \bar{z}_2, z_3 . Its conjugate

is $\overline{z, \bar{z}_2, z_3} = \bar{z}, z_2, \bar{z}_3$. If 2 quantities

are conjugates of each other, their imag. parts differ in sign. ∴ $\text{Im}(z, \bar{z}_2, z_3) = -\text{Im}(\bar{z}, z_2, \bar{z}_3)$

Note the minus sign. ∴ the result given in the problem is not true.

sec 1.2 continued

21) Observe that $\bar{z}_1, z_2, \bar{z}_3$ is the conjugate of z_1, \bar{z}_2, z_3 . Suppose $z = a + ib$
 $i\bar{z} = i(a - ib) = b + ia$. Now $\operatorname{Re}(i\bar{z}) = \operatorname{Im}(z)$
 $\therefore \operatorname{Re}(z_1, \bar{z}_2, z_3) = \operatorname{Im}(i\bar{z}_1, z_2, \bar{z}_3)$. Is True

22)

a) If $p + iq = (k + il)(m + in)$

$$\overline{p + iq} = \overline{(k + il)(m + in)}$$

$$p - iq = (k - il)(m - in)$$

Now if $(p + iq) = (k + il)(m + in) = km - ln + i(lm + kn)$

Equating reals
 $p = km - ln$, require $p \geq 0$ \therefore take

$p = |km - ln|$ since only p^2 is of interest.

Now equate imaginaries in the above:

$$q = lm + kn \quad \text{which means}$$

that $(p + iq) = (k + il)(m + in)$ is satisfied and

so is $(p - iq) = (k - il)(m - in)$ and so is

$$(p^2 + q^2) = (k^2 + l^2)(m^2 + n^2)$$

b) $(p^2 + q^2) = (p + iq)(p - iq) = (k + il)(m + in)(k - il)(m - in)$

Take $(p + iq) = (k + il)(m + in)$, $(p - iq) = (k - il)(m - in)$

The second eqn. is the conjugate of the first.

So if the 1st is satisfied, so is the second.

$$p + iq = km + ln + i[lm - kn], \quad \text{Take } p = km + ln$$

$$q = |lm - kn| \quad [\text{sign is made pos.}]$$

Sec 1.2 continued.

prob 22] cont'd

$$c) \quad (3^2 + 5^2)(2^2 + 7^2) = p^2 + q^2$$

$$k=3, l=5, m=2, n=7$$

$$p = |km - nl| = 29, q = lm + kn = 31$$

$$29^2 + 31^2 = (3^2 + 5^2)(2^2 + 7^2) = 1802$$

$$\text{Try } p = km + nl = 41, q = |lm - kn|$$

$$= 11$$

$$p^2 + q^2 = (12^2 + 5^2) = (11^2 + 1^2)(7^2 + 2^2) = 6466$$

$$\text{Take } k=11, l=1, m=7, n=2$$

$$\therefore |km - nl| = 75, lm + kn = 29, \boxed{p=75, q=29}$$

$$\text{Note } 75^2 + 29^2 = 6466$$

$$km + nl = 79, |lm - kn| = 15 \quad \boxed{p=79, q=15}$$

$$23) \frac{(c, d)}{(a, b)} = (e, f) \quad (c, d) = (a, b)(e, f)$$

$$(c, d) = (ae - bf, be + af) \quad (b) \text{ Thus}$$

$$ae - bf = c$$

$$be + af = d$$

(c) Apply Cramer's rule to this pair of linear simult. equations with unknowns e, f . assume $a \neq 0, b \neq 0$

$$e = \frac{\begin{vmatrix} c & -b \\ d & a \end{vmatrix}}{(a^2 + b^2)} = \frac{ac + bd}{a^2 + b^2} = e \quad a^2 + b^2 \neq 0$$

$$f = \frac{\begin{vmatrix} a & c \\ b & d \end{vmatrix}}{(a^2 + b^2)} = \frac{ad - bc}{a^2 + b^2} = f$$

$$\frac{ct + id}{a + ib} = \frac{(ct + id)(a - ib)}{a^2 + b^2} = \frac{ac + bd + i(ad - bc)}{a^2 + b^2}$$

$$= e + if. \text{ Thus } e = \frac{ac + bd}{a^2 + b^2}, f = \frac{ad - bc}{a^2 + b^2}$$

(same result).

[assuming $a^2 + b^2 \neq 0$]

sec 1.2 cont'd

Prob 24 | For $\frac{p}{q} = \frac{r}{s}$ require $q \neq 0$ and $s \neq 0$

Mult both sides by qs

$$\frac{pqs}{q} = \frac{r}{s} qs \quad ps = qr$$

SUMMARY: $\frac{p}{q} = \frac{r}{s}$ Necessary and sufficient

conditions: $q \neq 0$ and $s \neq 0$ and $ps = qr$

$$1 \quad |3-i| = \sqrt{3^2+1^2} = \boxed{\sqrt{10}}$$

$$2 \quad |(2i)(3+i)| = |2i| |3+i| = 2\sqrt{3^2+1^2} = \boxed{2\sqrt{10}}$$

$$3 \quad |(2-3i)(3+i)| = |2-3i| |3+i| = \sqrt{2^2+3^2} \sqrt{3^2+1^2}$$

$$= \sqrt{13} \sqrt{10} = \boxed{\sqrt{130}}$$

$$4 \quad |(2-3i)^2(3+i)^3| = |(2-3i)^2| |(3+i)^3|$$

$$= (4+9) (\sqrt{9+9})^3 = \boxed{13 \cdot (\sqrt{18})^3} = \boxed{993}$$

$$5 \quad |2i + 2i(3+i)| = |2i + 6i - 2| = |-2 + 8i|$$

$$= \sqrt{4+64} = \sqrt{68} = \boxed{2\sqrt{17}}$$

$$6 \quad \left| 1+i + \frac{1}{1+i} \right| = \left| (1+i) + \frac{(1-i)}{2} \right| = \left| \frac{3}{2} + \frac{i}{2} \right| = \sqrt{\frac{9}{4} + \frac{1}{4}}$$

$$= \boxed{\frac{\sqrt{10}}{2}}$$

$$7 \quad \left| \frac{(1+i)^5}{(2+3i)^5} \right| = \left| \frac{1+i}{2+3i} \right|^5 = \left| \frac{\sqrt{2}}{\sqrt{13}} \right|^5 = \left[\frac{\sqrt{2}}{\sqrt{13}} \right]^5 \approx .0093$$

$$8 \quad \left| \frac{(1-i)^n}{(2+2i)^n} \right| = \left| \frac{(\sqrt{2})^n}{2^n |1+i|^n} \right| = \left| \frac{(\sqrt{2})^n}{2^n (\sqrt{2})^n} \right| = \boxed{\frac{1}{2^n}}$$

$$9 \quad \left| \frac{1}{(1-i)} + \frac{1}{(1+i)} + \frac{5}{(1+2i)} \right| = \left| \frac{1+i}{2} + \frac{1-i}{2} + \frac{5(1-2i)}{5} \right|$$

$$= |1 + 1 - 2i| = |2 - 2i| = \boxed{2\sqrt{2}}$$

Sec 1.3 continued

10) $|\alpha + i\beta + \alpha - i\beta| = 1$
 $|2\alpha| = 1$ take $\alpha = 1/2$

$$\sqrt{\alpha^2 + \beta^2} + \sqrt{\alpha^2 + \beta^2} = 2 \quad \sqrt{\alpha^2 + \beta^2} = 1$$

$$\sqrt{\frac{1}{4} + \beta^2} = 1 \quad \frac{1}{4} + \beta^2 = 1, \quad \beta^2 = 3/4$$

$$\beta = \pm \sqrt{3}/2. \quad \text{Take ans. as } \boxed{\frac{1+i\sqrt{3}}{2}}$$

and $\boxed{\frac{1-i\sqrt{3}}{2}}$

11) $z_1 = \alpha + i\beta, \quad z_2 = \alpha - i\beta$

$$|z_1 + z_2| = a \quad 2|\alpha| = a, \quad \text{Try } \alpha = a/2$$

$$|z_1| + |z_2| = \frac{1}{a} \quad \sqrt{\alpha^2 + \beta^2} + \sqrt{\alpha^2 + \beta^2} = \frac{1}{a}$$

$$2\sqrt{\alpha^2 + \beta^2} = \frac{1}{a} \quad \alpha^2 + \beta^2 = \frac{1}{4a^2}$$

$$\frac{a^2}{4} + \beta^2 = \frac{1}{4a^2} \quad \beta^2 = \frac{1}{4} \left[\frac{1}{a^2} - a^2 \right] > 0$$

$$\beta = \pm \frac{1}{2} \sqrt{\frac{1}{a^2} - a^2}$$

answer: $z_1 = \frac{a}{2} + \frac{i}{2} \sqrt{\frac{1}{a^2} - a^2}$

$$z_2 = \frac{a}{2} - \frac{i}{2} \sqrt{\frac{1}{a^2} - a^2}$$

check $|z_1 + z_2| = a$

$$\sqrt{\frac{a^2}{4} + \frac{1}{4a^2} - \frac{a^2}{4}} + \sqrt{\frac{a^2}{4} + \frac{1}{4} (\frac{1}{a^2} - a^2)}$$

$$= 2 \sqrt{\frac{1}{4a^2}} = \frac{1}{a}$$

sec 1.3 continued

12] Because their difference is purely imaginary, their real parts must be identical. Let the numbers be

$$z_1 = x + iy \quad \text{and} \quad z_2 = x + i\beta$$

$$\text{Now } z_1 - z_2 = i \quad \therefore y - \beta = 1$$

$$z_1 z_2 = x^2 - y\beta + ix[y + \beta] = 2$$

$$\text{Now } x[y + \beta] = 0$$

$$\text{either } x = 0 \text{ or } y = -\beta$$

Suppose $x = 0$, then using $z_1 z_2 = 2$

$$\text{have } -y\beta = 2, \quad \beta = -2/y$$

$$\text{Since } y - \beta = 1 \quad \text{have } y + \frac{2}{y} = 1$$

Use quadratic formula, \uparrow has no real sol'n.

So Take $y = -\beta$, Now $y - \beta = 1$

$$y + y = 1, \quad y = 1/2, \quad \beta = -1/2$$

$$\text{Recall } x^2 - y\beta = 2 \quad x^2 + \frac{1}{4} = 2$$

$$x = \pm \sqrt{7}/2$$

$$\text{answers: } \boxed{\sqrt{7}/2 + i/2, \quad \sqrt{7}/2 - i/2}$$

$$\text{also } \boxed{-\sqrt{7}/2 + i/2, \quad -\sqrt{7}/2 - i/2}$$

$$13] \quad 1 - (-1) + i[4 - (-3)] = \boxed{2 + 7i}$$

$$14] \quad 5 \cos 30^\circ + i 5 \sin 30^\circ = \boxed{\frac{5\sqrt{3}}{2} + i \frac{5}{2}}$$

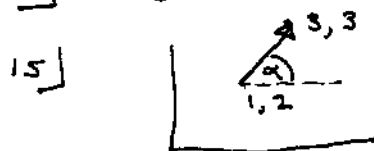

$$\cos \alpha = \frac{2}{\sqrt{5}}, \quad \sin \alpha = \frac{1}{\sqrt{5}}$$

$$a = 5 \cos \alpha = \boxed{2\sqrt{5} = a} \quad 5 \sin \alpha = \boxed{\sqrt{5} = b}$$

Sec 1.3 cont'd

16]

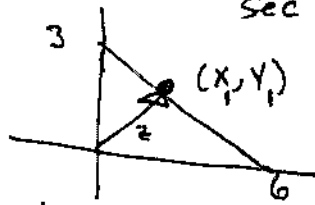

$$x + 2y = 6$$

$$z = a + ib \text{ or}$$

$$z = x_1 + iy_1, \quad x_1 + 2y_1 = 6, \quad y_1 = 3 - \frac{x_1}{2}$$

$$z = x_1 + i \left[3 - \frac{x_1}{2} \right]$$

slope of given line is $-1/2$

slope of vector is $\frac{3 - x_1/2}{x_1}$ must = 2

two slopes are neg. recip

$$3 - \frac{x_1}{2} = 2x_1; \quad x_1 = \frac{6}{5}, \quad y_1 = 3 - \frac{x_1}{2} = 3 - \frac{3}{5} = \frac{12}{5}$$

answer: $\boxed{\frac{6}{5} + i \frac{12}{5}}$ $\boxed{y_1 = \frac{12}{5}}$

17] Let $x_1 + iy_1$ be the vector = $a + ib$

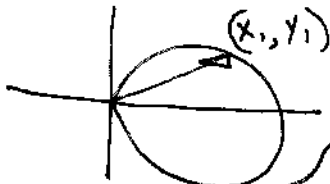

$$(x_1 - 1)^2 + y_1^2 = 1$$

$$x_1^2 - 2x_1 + 1 + y_1^2 = 1$$

$$\text{Now } \sqrt{x_1^2 + y_1^2} = 3/2$$

use here $x_1^2 + y_1^2 = 9/4$

$$\therefore -2x_1 + 1 + 9/4 = 1$$

$$\boxed{9/8 = x_1}$$

$$\text{Now } \left(\frac{9}{8}\right)^2 + y_1^2 = 9/4$$

$$\sqrt{9/4 - (9/8)^2} = y_1, \quad \boxed{y_1 = \frac{3}{8}\sqrt{7}}$$

18] ans is $\boxed{3.14} = \theta$ since $-\pi < \theta \leq \pi$

19] Notice the angle 3.15 exceeds π

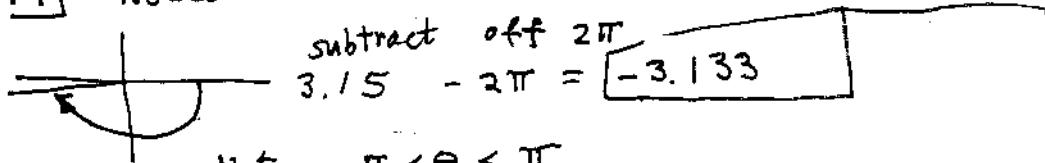

$$\text{subtract off } 2\pi$$

$$3.15 - 2\pi = \boxed{-3.133}$$

Note $-\pi < \theta \leq \pi$

sec 1.3 cont'd

20] $-3 \operatorname{cis}(3.14) = 3 \operatorname{cis}(3.14 + \pi)$

The angle $3.14 + \pi$ does not satisfy $-\pi < \theta \leq \pi$, But we can subtract off 2π

Use $3.14 + \pi - 2\pi = 3.14 - \pi = \boxed{-0.001593}$

The preceding is the princ. value.

21] $-4 \operatorname{cis}(73.7\pi) = 4 \operatorname{cis}(74.7\pi)$

can subtract 74π from argument

set $\theta = \boxed{.7\pi}$ = princ. value.

22] $3 \operatorname{cis}(1.1\pi) + 4 \operatorname{cis}(1.2\pi) = 12 \operatorname{cis}(2.3\pi)$

subtract π from arg, set $\boxed{.3\pi}$

23] $\frac{3 \angle 1.5\pi}{3 \angle -1.5\pi} = 1 \angle 3.14$

$-\pi < 3.14 \leq \pi$, $\boxed{3.14}$ is a princ. value

24] $\frac{3 \angle 1.5\pi}{3 \angle -1.5\pi} = 1 \angle 3.15$ 3.15 not a

princ. value, but we can subtract 2π

$3.15 - 2\pi = \boxed{-3.133}$

25] $5 \operatorname{cis}(-98.5\pi)$ we can add 98π

to the argument set $-.5\pi = \boxed{-\pi/2}$

26] $5 \operatorname{cis}(\pi^2) = 5 \operatorname{cis} 29.61$ does not

lie between $-\pi$ and π . Subtract 10π

$\therefore 29.61 - 10\pi = \boxed{-1.81}$

27] $3 [\cos 4 + i \sin(-4)] = \boxed{-1.96 + i 2.27}$

28] $4 [\cos \frac{\pi}{4} + i \sin \frac{\pi}{4}] = \boxed{2\sqrt{2} + i 2\sqrt{2}}$

sec 1.3 cont'd

29] $r = \sqrt{3+1} = 2$

$\theta = \frac{5\pi}{6}$ princ.

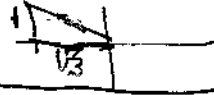

$2 \angle \frac{5\pi}{6} + 2k\pi$

P.V. when $k=0$

30] $(1+i)(-\sqrt{3}+i) = \sqrt{2} \angle \frac{\pi}{4} \cdot 2 \angle \frac{5\pi}{6}$

$= 2\sqrt{2} \angle \frac{13\pi}{12} = 2\sqrt{2} \angle \frac{-11\pi}{12}$

$2\sqrt{2} \angle \frac{-11\pi}{12} + 2k\pi$

P.V. when $k=0$

31] $\sqrt{2} \angle \frac{-3\pi}{4} (2 \angle \frac{5\pi}{6})^3$

$= \sqrt{2} * 8 \angle \frac{-3\pi}{4} + \frac{15\pi}{6} =$

$8\sqrt{2} \angle \frac{-3\pi}{4} + 2\frac{1}{2}\pi = 8\sqrt{2} \angle \frac{-3\pi}{4} + \frac{\pi}{2}$

$= 8\sqrt{2} \angle \frac{-\pi}{4} = 8\sqrt{2} \angle \frac{-\pi}{4} + 2k\pi$ P.V. $k=0$

32] $(-4+3i)^2 = 7-24i = \sqrt{7^2+24^2} \angle -\tan^{-1} \frac{24}{7} + 2k\pi$

$= 25 \angle -1.287 + 2k\pi$

P.V. when $k=0$.

33] angle $(z_1 * z_2) = 2.879$

angle $(z_1) + \text{angle}(z_2) = 2.879$

angle $(z_1 * z_3) = -2.8797$, angle $z_1 + \text{angle } z_3 = 3.40$

angle $(z_1 * z_3) \neq \text{angle } z_1 + \text{angle } z_3$ because angle $z_1 + \text{angle } z_3 = 3.4$ not a princ value, but -2.87 is princ. value

34

$$\frac{-1-i}{\sqrt{3+i}} = \frac{\sqrt{2} \angle \frac{-3\pi}{4}}{2 \angle \frac{\pi}{6}} = \frac{1}{\sqrt{2}} \angle \frac{-22\pi}{24}$$

$$= \boxed{\frac{1}{\sqrt{2}} \angle \frac{-11\pi}{12}}$$

$$35 \quad \frac{\sqrt{2} \angle \frac{-3\pi}{4} \cdot \angle \frac{\pi}{4}}{(2 \angle 30^\circ)^2} = \frac{\sqrt{2} \angle \frac{-\pi}{2}}{4 \angle \frac{\pi}{3}} = \boxed{\frac{1}{2\sqrt{2}} \angle \frac{-5\pi}{6}}$$

$$36 \quad \frac{\text{cis}(2\pi)}{\text{cis}(-4\pi/3)} = \text{cis}\left[\frac{6\pi}{3} + \frac{4\pi}{3}\right] = \text{cis}\left[\frac{10\pi}{3}\right]$$

$$= \text{cis}\left[3\frac{1}{3}\pi\right] = \text{cis}\left[-\frac{2\pi}{3}\right]$$

37

Eqn (1.3-7) $|z_1 + z_2| \leq |z_1| + |z_2|$.

If ^{vectors} z_1 and z_2 are both pointing in same direction, then equality will hold. (They cannot point in opposite directions). Thus for equality $\arg z_1 = \arg z_2 + 2k\pi$ where k is any integer.

38

next page

Sec 1.3 Cont'd

38] a) Given: $|z_1 + z_2| \leq |z_1| + |z_2|$

Use $-z_2$ in place of z_2

$|z_1 - z_2| \leq |z_1| + |-z_2|$ but $|-z_2| = |z_2|$

$\therefore |z_1 - z_2| \leq |z_1| + |z_2|$

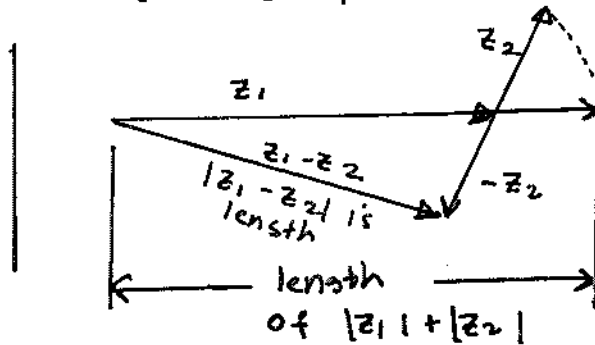

The leg of the triangle with length $|z_1 - z_2|$ must be \leq sum of lengths of remaining two legs, i.e. $|z_1| + |z_2|$

(b) If z_1 and $-z_2$ are in same direction equality will hold, i.e. z_1 and z_2 are in opposite directions, i.e. $\arg z_1 = -\arg z_2 + \pi + 2k\pi$, k is an integer.

39] a)

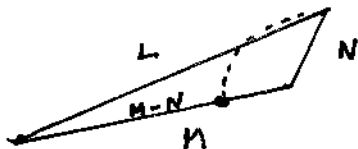

From figure,
 $L \geq M - N$

$M \geq N$

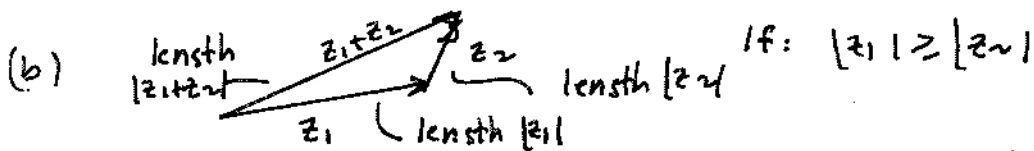

Referring to part (a) have

$|z_1 + z_2| \geq |z_1| - |z_2|$

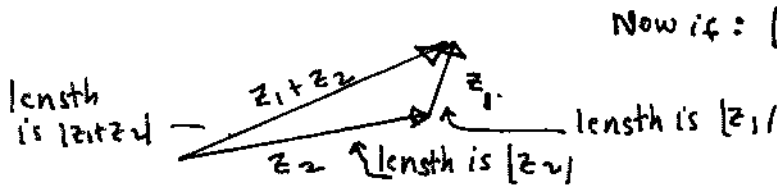

$|z_1 + z_2| \geq |z_2| - |z_1|$

[continued next pg]

sec 1.3 cont'd prob 39, (b) cont'd.

Explanation Eqn (1.3-20)

If $|z_2| \geq |z_1|$ then $||z_2| - |z_1|| = |z_2| - |z_1|$

If $|z_1| \geq |z_2|$ then $||z_2| - |z_1|| = |z_1| - |z_2|$

Thus by using $||z_2| - |z_1||$ we always get the required right hand side.

40) a)

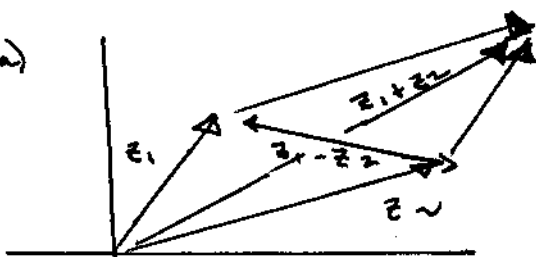

$$|z_1 - z_2|^2 + |z_1 + z_2|^2 =$$

$$(\bar{z}_1 - \bar{z}_2)(z_1 - z_2) + (\bar{z}_1 + \bar{z}_2)(z_1 + z_2) =$$

$$|z_1|^2 + |z_2|^2 - \bar{z}_1 z_2 - \bar{z}_2 z_1 + |z_1|^2 + |z_2|^2 + \bar{z}_1 z_2 + \bar{z}_2 z_1$$

$$= 2|z_1|^2 + 2|z_2|^2 \quad \text{g.e.d.}$$

b)

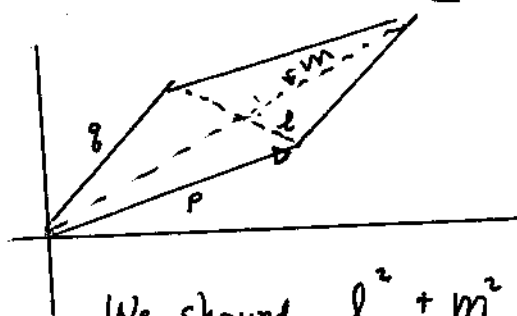

$$l = |z_1 - z_2|$$

$$m = |z_1 + z_2|$$

$$p = |z_2|, \quad q = |z_1|$$

We showed $l^2 + m^2 = 2(p^2 + q^2)$

9.11 (a) $(p - q)^2 \geq 0$ since $p - q$ is real.

$$p^2 - 2pq + q^2 \geq 0$$

$$p^2 + q^2 \geq 2pq \quad \text{reverse this}$$

$$2pq \leq p^2 + q^2, \quad \text{add } p^2 + q^2 \text{ to both sides}$$

$$p^2 + q^2 + 2pq \leq p^2 + q^2 + 2pq$$

$$(p + q)^2 \leq 2(p^2 + q^2) \quad \text{take square root both sides.}$$

$$p + q \leq \sqrt{2} \sqrt{p^2 + q^2} \quad \text{g.e.d.}$$

sec 1.3, prob 41, continued.

(b) Take $p = |\operatorname{Re} z|$, $q = |\operatorname{Im} z|$, $p^2 + q^2 = |\operatorname{Re} z|^2 + |\operatorname{Im} z|^2 = |z|^2$. Thus using the formula of part (a) we have: $|\operatorname{Re} z| + |\operatorname{Im} z| \leq \sqrt{2} \sqrt{|z|^2}$
or $|\operatorname{Re} z| + |\operatorname{Im} z| \leq \sqrt{2} |z|$.

(c) $1 + \sqrt{3} \leq \sqrt{2} \sqrt{1^2 + (\sqrt{3})^2}$. The left side of the preceding is $\approx 2.732\dots$. The right side is $\sqrt{2} * 2 \approx 2.828$. Since $2.732\dots < 2.828$ the inequality has worked.

(d). For equality $(p - q)^2 = 0$, $\therefore p = q$. $\therefore |\operatorname{Re} z| = |\operatorname{Im} z|$
Take $z = 1 + i$, then $|\operatorname{Re} z| + |\operatorname{Im} z| = 2$ while $\sqrt{2} |z| = \sqrt{2} \sqrt{1^2 + 1^2} = 2$, and $2 = 2$.

$$\underline{42} \quad \frac{1+i}{\sqrt{3}+i} = \frac{(1+i)(\sqrt{3}-i)}{4} = \frac{1}{4} \left[\sqrt{3}+1 + i[\sqrt{3}-1] \right]$$

Note, the argument of this is $\tan^{-1} \frac{\sqrt{3}-1}{\sqrt{3}+1}$
which must equal $\frac{\pi}{12}$. Q.e.d

$$\underline{43a} \quad (1+ia)(1+ib) = 1 - ab + i(a+b)$$

$$\arg[(1+ia)(1+ib)] = \arg(1+ia) + \arg(1+ib) \quad [1]$$

$$\arg[(1+ia)(1+ib)] = \arg[1 - ab + i(a+b)] \quad [2]$$

$$\arg(1+ia) = \tan^{-1} a, \quad \arg(1+ib) = \tan^{-1}(b) \quad [3]$$

$$\arg[1 - ab + i(a+b)] = \tan^{-1} \frac{a+b}{1-ab} \quad [4]$$

Use [4] and [3] in [2] and [1]

$$\text{Get } \tan^{-1} a + \tan^{-1} b = \tan^{-1} \left(\frac{a+b}{1-ab} \right)$$

Sec 1.3, prob 43, cont'd.

b) set $a = 1/2$, $b = 1/3$

$$\tan^{-1} \frac{1}{2} + \tan^{-1} \frac{1}{3} = \tan^{-1} \left[\frac{1/2 + 1/3}{1 - 1/6} \right] = \tan^{-1} (1)$$

$$\tan^{-1} (1) = \pi/4. \text{ Thus } \pi = 4 \cdot \left[\tan^{-1} \left(\frac{1}{3} \right) + \tan^{-1} \left(\frac{1}{2} \right) \right]$$

$$c) (1+ia)(1+ib)(1+ic) = (1-ab+i(a+b))(1+ic) =$$

$$\text{ans} [(1+ia)(1+ib)(1+ic)] = \text{arg} \left[\underbrace{1-ab-ac-bc + i[ab+bc-abc]}_{\text{this}} \right]$$

$$\text{ans}(1+ia) + \text{ans}(1+ib) + \text{ans}(1+ic) =$$

$$\tan^{-1} a + \tan^{-1} b + \tan^{-1} c = \tan^{-1} \left[\frac{ab+bc-abc}{1-ab-ac-bc} \right]$$

44 |

$$a) |z_1+z_2|^2 = (z_1+z_2)\overline{(z_1+z_2)} = (z_1+z_2)(\bar{z}_1+\bar{z}_2)$$

$$= z_1\bar{z}_1 + z_2\bar{z}_2 + \underbrace{z_1\bar{z}_2 + z_2\bar{z}_1}_{2\text{Re}(z_1\bar{z}_2)} = |z_1|^2 + |z_2|^2 + 2\text{Re}[z_1\bar{z}_2]$$

$$\text{Thus } |z_1+z_2|^2 = |z_1|^2 + |z_2|^2 + 2\text{Re}[z_1\bar{z}_2] \quad (1)$$

Now: $|\text{Re } z_1\bar{z}_2| \leq |z_1\bar{z}_2| = |z_1||z_2|$. This implies:

$$|z_1|^2 + |z_2|^2 + 2\text{Re}(z_1\bar{z}_2) \leq |z_1|^2 + |z_2|^2 + 2|z_1||z_2| \quad (2)$$

Combining (2) and (1) we have:

$$|z_1+z_2|^2 \leq |z_1|^2 + |z_2|^2 + 2|z_1||z_2| \quad \text{g.e.d.}$$

$$\textcircled{b} \text{ From the preceding } |z_1+z_2|^2 \leq (|z_1|+|z_2|)^2$$

Now take pos. square root both sides:

$$|z_1+z_2| \leq |z_1|+|z_2|$$

45 | next page

45]

Sec. 1.3
CONTINUED

$$a) (z_1 - z_2)(\overline{z_1 - z_2}) = |z_1 - z_2|^2 =$$

$$(z_1 - z_2)(\overline{z_1} - \overline{z_2}) = |z_1|^2 + |z_2|^2 - z_2 \overline{z_1} - z_1 \overline{z_2}$$

$$= |z_1|^2 + |z_2|^2 - [z_1 \overline{z_2} + \overline{z_1} z_2]. \quad \text{Note:}$$

$$z_1 \overline{z_2} + \overline{z_1} z_2 = z_1 \overline{z_2} + \overline{z_1 \overline{z_2}} = 2 \operatorname{Re}(z_1 \overline{z_2})$$

$$\text{Thus have } |z_1 - z_2|^2 = |z_1|^2 + |z_2|^2 - 2 \operatorname{Re}(z_1 \overline{z_2}). \quad \text{g.e.d.}$$

b)

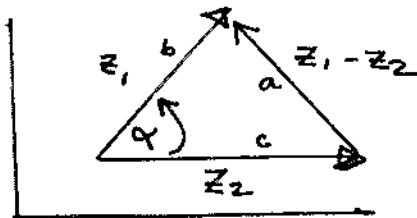
 z_2 is pos. real

$$|z_1 - z_2|^2 = |z_1|^2 + |z_2|^2 - 2 \operatorname{Re}(z_1 \overline{z_2})$$

$$\text{Take } |z_1 - z_2| = a, |z_1| = b, z_2 = |z_2| = c, \overline{z_2} = c$$

$$\text{Thus have } a^2 = b^2 + c^2 - 2 \operatorname{Re}(z_1 c). \quad \text{NOW}$$

$$\operatorname{Re}(z_1 c) = c \operatorname{Re} z_1 = c |z_1| \cos \alpha = cb \cos \alpha.$$

$$\text{Thus } a^2 = b^2 + c^2 - 2bc \cos \alpha \quad \text{g.e.d.}$$

Sec 1.4

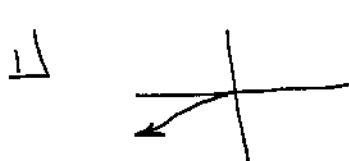
1)  $-\sqrt{3} - i = 2 \angle -\frac{5\pi}{6}$

$$\left[2 \angle -\frac{5\pi}{6} \right]^7 = 2^7 \angle \frac{-35\pi}{6} = 2^7 \angle -5\frac{5}{6}\pi$$

add 6π to angle $= 2^7 \angle \frac{\pi}{6} = \boxed{128 \angle \frac{\pi}{6}}$

2) $(1+i)^3 (\sqrt{3}+i)^3 = \left[\sqrt{2} \angle \frac{\pi}{4} \right]^3 \left[2 \angle \frac{\pi}{6} \right]^3$

$$= 2\sqrt{2} \cdot 8 \angle \frac{3\pi}{4} \angle \frac{3\pi}{2} = 16\sqrt{2} \angle \frac{5\pi}{4}$$

$$= \boxed{\sqrt{2} \cdot 16 \angle -\frac{3\pi}{4}}$$

3) Let $\theta = -\tan^{-1} \frac{4}{3}$, $(3-4i)^6 = 5^6 \angle 6\theta$

$$6\theta = -5.5638 \quad (3-4i)^6 = 5^6 \angle -5.5638$$

-5.5638 not prin. val., add on 2π , get $.7194$

ans $\boxed{5^6 \angle .7194}$

4) $(1-i\sqrt{3})^{-7} = \left(2 \angle -\frac{\pi}{3} \right)^{-7} = 2^{-7} \angle \frac{7\pi}{3}$

$7\pi/3 = 2\frac{1}{3}\pi$, not prin. value, subtr. 2π

get $\frac{1}{2^7} \angle \frac{\pi}{3} = \boxed{\frac{1}{128} \angle \frac{\pi}{3}}$

5) $(3+4i) = 5 \angle \tan^{-1} \frac{4}{3}$, $(3+4i)^{-6} = 5^{-6} \angle -6 \tan^{-1} \frac{4}{3}$

$$= 5^{-6} \angle -5.5638, \text{ angle is not prin.}$$

add 2π , ans $\boxed{\frac{1}{5^6} \angle .7194}$

$$6) (\cos \theta + i \sin \theta)^3 = \frac{\text{sec 1.4}}{\cos 3\theta + i \sin 3\theta}$$

$$= \cos^3 \theta + 3 \cos^2 \theta (i) (\sin \theta) + (3) (\cos \theta) (-\sin^2 \theta) - i \sin^3 \theta$$

$$= \cos 3\theta + i \sin 3\theta$$

a) Equate imaginaries

$$3 \cos^2 \theta \sin \theta - \sin^3 \theta = \sin 3\theta$$

b) Equate reals:

$$\cos 3\theta = \cos^3 \theta - 3 \cos \theta \sin^2 \theta$$

$$7) a) (\cos \theta + i \sin \theta)^n = \cos n\theta + i \sin n\theta$$

Use binomial theorem

$$\sum_{k=0}^n (\cos \theta)^{n-k} (i \sin \theta)^k \frac{n!}{(n-k)! k!} = \cos n\theta + i \sin n\theta$$

Equate reals:

$$\cos n\theta = \text{Real} \sum_{k=0}^n (\cos \theta)^{n-k} (i \sin \theta)^k \frac{n!}{(n-k)! k!}$$

$$\sin \theta = \sqrt{1 - \cos^2 \theta}$$

$$\rightarrow \cos n\theta = \text{Real} \sum_{k=0}^n (\cos \theta)^{n-k} (\sqrt{1 - \cos^2 \theta})^k i^k \frac{n!}{(n-k)! k!}$$

b) Now if k is odd i^k is imaginary
if k is even, i^k is real

Thus sum only even values of k . Suppose n is even, we let $k = 2m$, $m = 1, 2, \dots, \frac{n}{2}$.

$$i^k = (-1)^m \text{ since } k = 2m \text{ and } i^{2m} = (i^2)^m = (-1)^m$$

$$\cos n\theta = \sum_{m=0}^{n/2} \cos^{n-2m} \theta (\sqrt{1 - \cos^2 \theta})^{2m} (-1)^m \frac{n!}{(n-2m)! (2m)!}$$

$$\text{Note } (\sqrt{1 - \cos^2 \theta})^{2m} = (1 - \cos^2 \theta)^m$$

If n is odd, we need only sum as far as $\frac{n-1}{2}$ on m

$$\text{Thus } \cos n\theta = \sum_{m=0}^{\frac{n-1}{2}} \cos^{n-2m} \theta (1 - \cos^2 \theta)^m (-1)^m \frac{n!}{(n-2m)! (2m)!}$$

c) Take $n=4$

$$\cos 4\theta = \sum_{m=0}^2 \cos^{4-2m} \theta (1 - \cos^2 \theta)^m (-1)^m \frac{4!}{(4-2m)! (2m)!}$$

$$= \cos^4 \theta + \cos^2 \theta (1 - \cos^2 \theta) (-1) \frac{4!}{(2!)^2} + (1 - \cos^2 \theta)^2 = 8 \cos^4 \theta - 8 \cos^2 \theta + 1$$

Sec 1.4

$$7(d) T_5(x) = \sum_{m=0}^2 (x^{5-2m})(1-x^2)^m (-1)^m \frac{5!}{(5-2m)! (2m)!}$$

$$= x^5 + x^3(1-x^2)(-1) \frac{5!}{3! 2!} + x(1-x^2)^2 \frac{5!}{4!}$$

$$= 16x^5 - 20x^3 + 5x$$

$$8) \frac{(\cos \theta + i \sin \theta)^n}{(\cos \theta - i \sin \theta)^n} = \frac{\cos n\theta + i \sin n\theta}{[\cos(-\theta) + i \sin(-\theta)]^n}$$

$$= \frac{\cos n\theta + i \sin n\theta}{\cos(-n\theta) + i \sin(-n\theta)} = \frac{\cos n\theta + i \sin n\theta}{\cos n\theta - i \sin n\theta}$$

$$= \frac{\cancel{\cos n\theta} [1 + i \tan n\theta]}{\cancel{\cos n\theta} [1 - i \tan n\theta]} \quad \boxed{\text{p.e.d}}$$

$$9) (9i)^{1/2} = \sqrt{9} \left[\frac{\pi/2}{2} + \frac{2k\pi}{2} \quad k=0,1 \right]$$

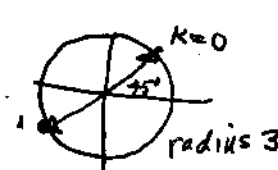
$$= 3 \left[\frac{\pi}{4} + k\pi \right] = \pm \left(\frac{3}{\sqrt{2}} + \frac{i3}{\sqrt{2}} \right)$$

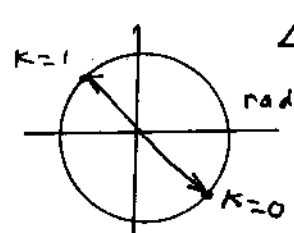
$$10) i^{-1/2} = 1 \left[\frac{\pi}{2} \left(\frac{-1}{\sqrt{2}} \right) + \frac{k\pi}{2} \quad k=0,1 \right]$$

$$= \pm \left[\frac{1}{\sqrt{2}} - \frac{i}{\sqrt{2}} \right]$$

$$11) (27i)^{1/3} = \sqrt[3]{27} \left[\frac{\pi}{2} \frac{1}{3} + \frac{2k\pi}{3} \quad k=0,1,2 \right]$$

$$= 3 \left[\frac{\pi}{6} + \frac{2k\pi}{3} \quad k=0,1,2 \right]$$

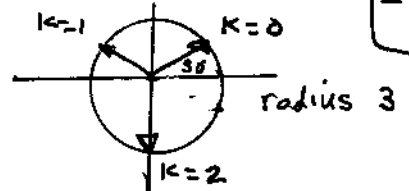
$$= 3 \cos \frac{\pi}{6} + i 3 \sin \frac{\pi}{6} = \begin{cases} 2.59 + i 1.5 & k=0 \\ -2.59 + i 1.5 & k=1 \\ -3i & k=2 \end{cases}$$

Sec 1.4 cont'd

12) $(1+i)^{1/3} = \sqrt[3]{\sqrt{2}} \angle \frac{\pi}{12} + \frac{2k\pi}{3} \quad k=0,1,2$

$= \sqrt[6]{2} \left[\cos \frac{\pi}{12} + i \sin \frac{\pi}{12} \right] = 1.0842 + i .2905$

$= \sqrt[6]{2} \left[\cos \left[\frac{3\pi}{4} \right] + i \sin \left[\frac{3\pi}{4} \right] \right] = -.7937 + i .7937$

$= \sqrt[6]{2} \left[\cos \left[\frac{17\pi}{12} \right] + i \sin \left[\frac{17\pi}{12} \right] \right] = -.2905 - i 1.0842$

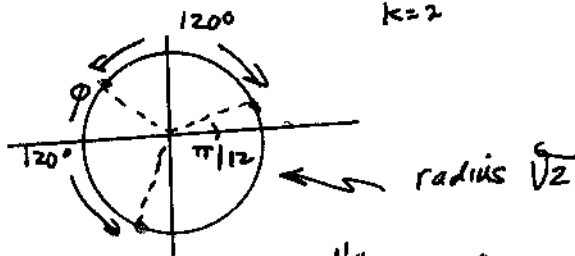

13) $(-64i)^{1/4} = \sqrt[4]{64} \angle \frac{-\pi}{8} + \frac{2k\pi}{4} \quad k=0,1,2,3$

$= 2\sqrt{2} \left[\cos \frac{\pi}{8} - i \sin \frac{\pi}{8} \right] (k=0) = 2.6131 - i 1.0824$

$= 2\sqrt{2} \left[\cos \frac{3\pi}{8} + i \sin \frac{3\pi}{8} \right] (k=1) = 1.0824 + i 2.6131$

$= 2\sqrt{2} \left[\cos \frac{7\pi}{8} + i \sin \frac{7\pi}{8} \right] (k=2) = -2.6131 + i 1.0824$

$= 2\sqrt{2} \left[\cos \frac{11\pi}{8} + i \sin \frac{11\pi}{8} \right] (k=3) = -1.0824 - i 2.6131$

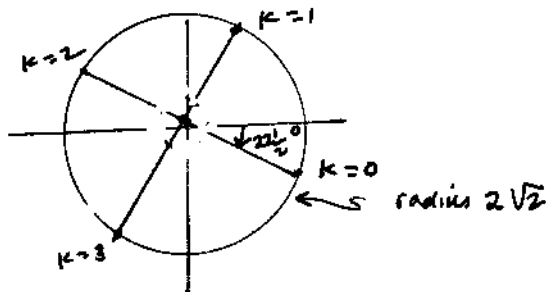

sec 1.4, cont'd

14) $-\sqrt{3} + i = 2 \angle \frac{5\pi}{6}$

$(-\sqrt{3} + i)^{-1/5} = \frac{1}{\sqrt[5]{2}} \angle \left[\frac{-\pi}{6} + \frac{2k\pi}{5} \right] \quad k=0,1,2,3,4$

$= \frac{1}{\sqrt[5]{2}} \left[\cos \frac{\pi}{6} - i \sin \frac{\pi}{6} \right] \quad k=0 = \boxed{.539 - .453i}$

$= \frac{1}{\sqrt[5]{2}} \left[\cos \left[\frac{7\pi}{30} \right] - i \sin \left[\frac{7\pi}{30} \right] \right] \quad k=1 = \boxed{.58 - .51i}$

$= \frac{1}{\sqrt[5]{2}} \left[\cos \left[\frac{29\pi}{30} \right] - i \sin \left[\frac{29\pi}{30} \right] \right] \quad k=2 = \boxed{.865 - i.091}$

$= \frac{1}{\sqrt[5]{2}} \left[\cos \left[\frac{41\pi}{30} \right] - i \sin \left[\frac{41\pi}{30} \right] \right] \quad k=3 = \boxed{.354 + i.795}$

$= \frac{1}{\sqrt[5]{2}} \left[\cos \left[\frac{53\pi}{30} \right] - i \sin \left[\frac{53\pi}{30} \right] \right] \quad k=4 = \boxed{.647 + i.583}$

15) $1^{1/3}$ has 3 values $1, \text{cis} \left(\frac{2\pi}{3} \right), \text{cis} \left(\frac{4\pi}{3} \right)$
 $1^{-1/3}$ has 3 values $1, \text{cis} \left(\frac{-2\pi}{3} \right), \text{cis} \left(\frac{-4\pi}{3} \right)$

Multiplying these together we have 9 possibilities of which 3 are numerically distinct
 The answers are $\boxed{1}$ $\text{cis} \left(\frac{2\pi}{3} \right) = \frac{-1 + i\sqrt{3}}{2}$

$\text{cis} \left[\frac{4\pi}{3} \right] = \frac{-1 - i\sqrt{3}}{2}$

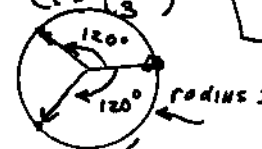

16) $(9i)^{3/2} = \left[\sqrt[2]{9} \right]^3 \angle \left[\frac{\pi}{2} \times \frac{3}{2} + \frac{(2k\pi)(3)}{2} \right] \quad k=0,1$

$= 27 \angle \left[\frac{3\pi}{4} + 3k\pi \right] \quad k=0,1$

$= \pm \boxed{[-19.09 + i 19.09]}$

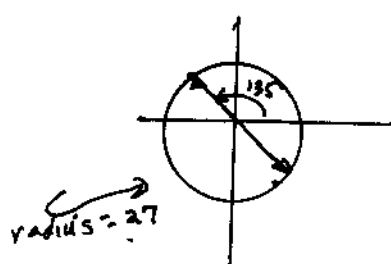

sec 1.4 cont'd

17]

$$(1+i)^{6/2} = (1+i)^3 = (2i)(1+i) = \boxed{-2+2i}$$

$$18] (1+i)^{4/6} = (1+i)^{2/3} = \sqrt[3]{2} \angle \frac{2}{3} \frac{\pi}{4} + 2k\pi \cdot \frac{2}{3}$$

$$= \sqrt[3]{2} \angle \frac{\pi}{6} + \frac{4k\pi}{3}$$

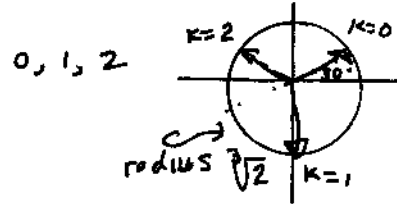

$$\boxed{1.09 + i.63}$$

$$\boxed{-i.285}$$

$$\boxed{-1.09 + i.63}$$

$$19] (64i)^{10/8} = (64i)^{5/4} = \sqrt[4]{64}^5 \angle \frac{\pi}{2} + \frac{5}{4} + 2k\pi \frac{5}{4}$$

$$= 128\sqrt{2} \angle \frac{5\pi}{8} + \frac{5k\pi}{2} \quad k=0, 1, 2, 3$$

$$= \pm \boxed{-69.27 + i.167.2} \quad k=0, 2$$

$$= \pm \boxed{-167.2 - i.69.27} \quad k=1, 3$$

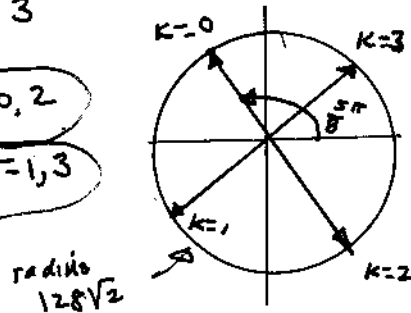

$$20] (1+i)^{-5/4} = \sqrt[4]{2}^{-5} \angle \frac{\pi}{4} \left(\frac{-5}{4} \right) + 2k\pi \left(\frac{-5}{4} \right)$$

$$= \frac{1}{\sqrt[4]{2}^5} \angle \frac{-5\pi}{16} - \frac{k\pi}{2} \quad k=0, 1, 2, 3$$

$$= \pm \boxed{.3602 - i.539} \quad k=0, 2$$

$$\pm \boxed{.539 + i.36} \quad k=1, 3$$

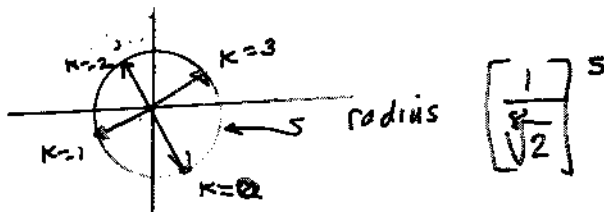

Sec 1.4 cont'd

[21] We will choose $k=2$. Thus $W = 1.682 \sqrt[3]{\frac{2i\pi}{8}}$

We will raise this to $\frac{4}{3}$ power. Thus: $\left[1.682 \sqrt[3]{\frac{2i\pi}{8}}\right]^{4/3}$
 $= \left[\sqrt[3]{1.682}\right]^4 \sqrt{\frac{4}{3} \frac{2i\pi}{8} + \frac{4}{3} * 2k\pi}$ $k=0,1,2$

$= 2 \sqrt{\frac{7\pi}{2} + \frac{4}{3} * 2k\pi} = 2 \sqrt{\left(\frac{7}{2}\right)\pi + \frac{8k\pi}{3}}$ $k=0,1,2$
 subtract 4π

$= 2 \sqrt{\frac{-\pi}{2} + 2k\pi + \frac{2}{3}k\pi} = 2 \sqrt{\frac{-\pi}{2} + \frac{2}{3}k\pi}$ roots plotted below
 subtract $2k\pi$

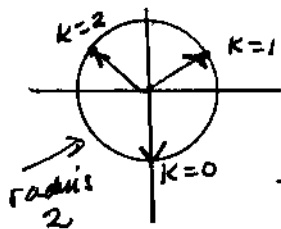

When $k=0$, the root $1.682 \sqrt[3]{\frac{2i\pi}{8}}$ when raised to the $\frac{4}{3}$ power yields $-i$. Thus $W^{4/3} + 2i = 0$ will be satisfied.

[22] $az^2 + bz + c = 0$, divide by a set

$z^2 + \frac{b}{a}z + \frac{c}{a} = 0$ Notice that $\left(z + \frac{b}{2a}\right)^2 - \frac{b^2}{4a^2} = z^2 + \frac{b}{a}z$
 use this here

$\left(z + \frac{b}{2a}\right)^2 - \frac{b^2}{4a^2} + \frac{c}{a} = 0$ set: $\left(z + \frac{b}{2a}\right)^2 = \frac{b^2}{4a^2} - \frac{c}{a} = \frac{b^2 - 4ac}{4a^2}$

$\left(z + \frac{b}{2a}\right)^2 = \frac{b^2 - 4ac}{4a^2}$ Take sq. root

both sides: $z + \frac{b}{2a} = \left(\frac{b^2 - 4ac}{4a^2}\right)^{1/2}$

$z = -\frac{b}{2a} + \left(\frac{b^2 - 4ac}{4a^2}\right)^{1/2} = -\frac{b}{2a} + \frac{[b^2 - 4ac]^{1/2}}{2a}$

Note: if a, b, c not real we do not necessarily get real roots or a pair of roots that are conjugates of each other.

this has in general 2 values that are negatives of each other.

Suppose $a=1, b=i, c=0$
 Equation is $z^2 + iz = 0$. Roots are $z=0, z=-i$
 These are not conjugates.

sec 1.4 cont'd

23

$$W^2 + W + 1/4 = 0$$

$$W = \frac{-1 \pm (1-i)^{1/2}}{2}$$

$$W = -\frac{1}{2} \pm \frac{1}{2} \sqrt{2}$$

$$\angle -\frac{\pi}{8}$$

plus sign
neg sign

.0493 - .2275i
-1.0493 + .2275i

24

$$W^2 + iW + 1 = 0$$

$$W = \frac{-i \pm (-1-4)^{1/2}}{2}$$

$$W = \frac{-i \pm i\sqrt{5}}{2}$$

$$W = \frac{i}{2} [-1 + \sqrt{5}]$$

$$W = \frac{i}{2} [-1 - \sqrt{5}]$$

25 $W^4 + W^2 + 1 = 0$, $W^2 = \frac{-1 \pm (-3)^{1/2}}{2}$

$$W^2 = \frac{-1 \pm i\sqrt{3}}{2}$$

$$W = \left(\frac{-1 \pm i\sqrt{3}}{2} \right)^{1/2}$$

$$W = 1 \angle \frac{2\pi/3}{2}$$

$$W = 1 \angle \pi/3 = \frac{1}{2} + i\frac{\sqrt{3}}{2}$$

$$W = \frac{-1 - i\sqrt{3}}{2}$$

$$\frac{-1}{2} + i\frac{\sqrt{3}}{2}$$

$$\frac{1}{2} - i\frac{\sqrt{3}}{2}$$

26 $W^6 + W^3 + 1 = 0$

$$(W^3)^2 + (W^3)^1 + 1 = 0$$

$$W^3 = \frac{-1 \pm (-1 \pm i\sqrt{3})^{1/2}}{2}$$

$$W^3 = \frac{-1 \pm i\sqrt{3}}{2}$$

$$W^3 = 1 \angle \frac{2\pi}{3}$$

$$W = 1 \angle \left(\frac{2\pi}{9} + \frac{2k\pi}{9} \right) \quad k=0,1,2$$

$$W = 1 \angle \left(\frac{-2\pi}{9} + \frac{2k\pi}{9} \right) \quad k=0,1,2$$

.766 + i.6428
.1736 + i.9848
-.9397 + i.342

.766 - i.6428
.1736 - i.9848
-.9397 - i.342

sec 1.4 cont'd

27) a) $(z-1)(z^n + z^{n-1} + \dots + z + 1) = z^{n+1} + z^n + \dots + z - z^n - z^{n-1} - \dots - 1 = (z^{n+1} - 1)$

b) $z^n + z^{n-1} + \dots + z + 1 = \frac{z^{n+1} - 1}{z - 1}$ for $z \neq 1$

Note $z = 1$ is not a root of the given equation.

The roots of $z^4 + z^3 + z^2 + z + 1 = 0$ are the roots of $z^5 - 1 = 0$ $z = \sqrt[5]{1}$

$z = \text{cis} \left[\frac{2k\pi}{5} \right] \quad k = 1, 2, 3, 4$

28) a) $z^{1/n} = \sqrt[n]{r} \angle \left[\frac{\theta}{n} + \frac{2k\pi}{n} \right] \quad k = 0, 1, 2, \dots, n-1$

SUM of roots $\sum_{k=0}^{n-1} \sqrt[n]{r} \text{cis} \left(\frac{\theta}{n} \right) \text{cis} \left(\frac{2k\pi}{n} \right)$

b) SUM of roots $= \sqrt[n]{r} \text{cis} \left(\frac{\theta}{n} \right) \sum_{k=0}^{n-1} \left[\text{cis} \left(\frac{2\pi}{n} \right) \right]^k$
 $= \sqrt[n]{r} \text{cis} \left(\frac{\theta}{n} \right) \frac{\left[\text{cis} \left(\frac{2\pi}{n} \right) \right]^n - 1}{\text{cis} \left(\frac{2\pi}{n} \right) - 1} = \sqrt[n]{r} \text{cis} \left(\frac{\theta}{n} \right) \frac{\text{cis}(2\pi) - 1}{\text{cis} \left(\frac{2\pi}{n} \right) - 1}$

$= 0$

29) a) $z = r \angle \theta, \quad z^{1/2} = \pm \sqrt{r} \angle \frac{\theta}{2} = \pm \sqrt{r} \left[\cos \frac{\theta}{2} + i \sin \frac{\theta}{2} \right]$. Now if $0 \leq \theta < \pi$

$\arg z^{1/2}$ is either in 1st quadrant or 3rd quad. If $\sin \theta/2$ is positive then $\cos \theta/2$ is positive or if $\sin \theta/2$ is negative then $\cos \theta/2$ is negative

Thus $z^{1/2} = \pm \sqrt{r} \left[\sqrt{\frac{1 + \cos \theta}{2}} + i \sqrt{\frac{1 - \cos \theta}{2}} \right]$

b) If $-\pi < \theta < 0$, then $\arg z^{1/2}$ is either in the 4th quadrant or the 2nd quadrant. Thus if $\sin[\theta/2]$ is positive $\cos \theta/2$ is neg. or vice-versa

Thus $z^{1/2} = \pm \sqrt{r} \left[-\sqrt{\frac{1 + \cos \theta}{2}} + i \sqrt{\frac{1 - \cos \theta}{2}} \right]$

sec 1.4

29) continued (c)

$$r=2 \quad \theta = -\pi/6$$

$$z^{1/2} = \pm \sqrt{2} \left[\sqrt{\frac{1 + \cos(\pi/6)}{2}} + i \sqrt{\frac{1 - \cos(\pi/6)}{2}} \right]$$

$$= \pm [1.366 + i.366]$$

$$r=2, \theta = -\pi/6 \quad z^{1/2} = \pm \sqrt{2} \left[-\sqrt{\frac{1 + \cos(\pi/6)}{2}} + i \sqrt{\frac{1 - \cos(\pi/6)}{2}} \right]$$

$$= \pm [-1.366 + i.366]$$

30) a) $(a+ib) = (x+iy)^{1/2}$. Square both sides $a^2 - b^2 + i2ab = x + iy$
 Equate corresponding parts: $x = a^2 - b^2$, $y = 2ab$.

b) Now if $y \neq 0$ it follows (since $y = 2ab$) that $a \neq 0$.
 Thus $b = y/(2a)$. Eliminating b from $x = a^2 - b^2$ we
 have: $x = a^2 - \frac{y^2}{4a^2}$ or $4a^2x = 4a^4 - y^2$ or
 $4a^4 - a^2x - \frac{y^2}{4} = 0$. Using the quadratic formula we
 get $a^2 = \frac{x \pm \sqrt{x^2 + y^2}}{2}$. The minus sign must be

rejected. Recall that $y^2 \neq 0$, Using the minus sign
 would require that $a^2 < 0$ which not possible since a
 is real.

(c) From (i) have $b^2 = a^2 - x$. Using result of (a)

$$\text{now have: } b^2 = \frac{x + \sqrt{x^2 + y^2}}{2} - \frac{2x}{2} = \frac{-x + \sqrt{x^2 + y^2}}{2}$$

d) $y = 2ab$. If $y > 0$, a and b are of like sign
 Thus if choose plus sign in 5) you'd better choose plus
 sign in 6). If choose minus sign in 5) must
 choose minus sign in 6).

sec 1.4, prob 30, cont'd

e) Since $y = 2ab$, if $y < 0$, then a and b are of opposite sign. Thus a plus sign in 5) means using a minus sign in 6) and vice-versa.

f) If $y = 0$ then (1) and (2) become $x = a^2 - b^2$, $0 = 2ab$. Thus at least one of the variables a and b must be zero. If $x > 0$, then $x = a^2 - b^2$ is satisfied if and only if $b = 0$. Thus $x = a^2$, $a = \pm \sqrt{x}$. If $x < 0$, then $x = a^2 - b^2$ is satisfied if and only if $a = 0$. Thus $x = -b^2$, $b^2 = -x$, $b = \pm \sqrt{-x}$. If $x = 0$, then $x = a^2 - b^2$ requires $a = b = 0$.

g) Need $(i)^{1/2}$. Take $x = 0, y = 1$. Thus $a = \pm \frac{1}{\sqrt{2}}$, $b = \pm \frac{1}{\sqrt{2}}$ from (5) and (6). Since $y > 0$, a and b are of like sign. Thus $i^{1/2} = \frac{1}{\sqrt{2}} + \frac{i}{\sqrt{2}}$ or $i^{1/2} = -\frac{1}{\sqrt{2}} - \frac{i}{\sqrt{2}}$.

31) a) Let $z = r \text{cis}(\theta)$, Assume $m \geq 1$. Then

$$z^{1/m} = \sqrt[m]{r} \text{cis} \left(\frac{\theta}{m} + \frac{2k\pi}{m} \right), \quad z^{-1/m} = \frac{1}{\sqrt[m]{r}} \text{cis} \left[\frac{-\theta}{m} + \frac{2k'\pi}{m} \right]$$

$k = 0, 1, 2, \dots, m-1$ $k' = 0, 1, \dots, m-1$

$$z^{1/m} z^{-1/m} = \frac{\sqrt[m]{r}}{\sqrt[m]{r}} \text{cis} \left[\frac{\theta}{m} + \frac{2k\pi}{m} \right] \text{cis} \left[\frac{-\theta}{m} + \frac{2k'\pi}{m} \right] =$$

$$= \text{cis} \left[\frac{2\pi}{m} [k - k'] \right]$$

$k = 0, 1, \dots, m-1$ $k' = 0, 1, \dots, m-1$ The preceding is not necessarily one.

If $m \leq -1$, the same argument applies except that k and k' both range from 0 to $|m| - 1$. Thus $z^{1/m} z^{-1/m}$ does not have to equal one if the roots are chosen randomly.

b) Yes, we can always find roots $z^{1/m}$ and $z^{-1/m}$ such that $z^{1/m} z^{-1/m} = 1$. In the expression $\text{cis} \left[\frac{2\pi}{m} (k - k') \right]$ we choose $k = k'$.

(a) Let $z = r \text{cis}(\theta)$. First compute $(z^n)^{1/m} =$

$$[r^n \angle n\theta]^{1/m} = \left[\sqrt[m]{r^n} \right]^n \text{cis} \left[\frac{n\theta}{m} + \frac{2k\pi}{m} \right] \quad k=0, 1, \dots, m-1$$

$$= \left[\sqrt[m]{r^n} \right]^n \text{cis} \left[\frac{n\theta}{m} \right] \text{cis} \left[\frac{2k\pi}{m} \right] \quad k=0, 1, \dots, m-1. \quad \text{Thus}$$

$$[z^n]^{1/m} = \left[\sqrt[m]{r^n} \right]^n \text{cis} \left[\frac{n\theta}{m} \right] \text{cis} \left[\frac{2k\pi}{m} \right], \quad k=0, 1, \dots, m-1 \quad [1]$$

Now compute: $[z^{1/m}]^n = \left[\sqrt[m]{r} \text{cis} \left[\frac{\theta}{m} + \frac{2k'\pi}{m} \right] \right]^n \quad k'=0, \dots, m-1$

$$= \sqrt[m]{r^n} \text{cis} \left[\frac{n\theta}{m} + \frac{2k'\pi n}{m} \right], \quad k'=0, \dots, m-1. \quad \text{Thus:}$$

$$[z^{1/m}]^n = \left(\sqrt[m]{r^n} \right)^n \text{cis} \left(\frac{n\theta}{m} \right) \text{cis} \left[\frac{2k'\pi n}{m} \right] \quad k'=0, 1, \dots, m-1 \quad [2]$$

To prove that results [1] and [2] are identical sets of complex numbers, we need prove only that the set of numbers $\text{cis} \left[\frac{2k\pi}{m} \right] \quad k=0, 1, \dots, m-1$ is identical to the set of numbers $\text{cis} \left[\frac{2k'\pi n}{m} \right] \quad k'=0, 1, \dots, m-1$

The set of values of $\text{cis} \left(\frac{2k\pi}{m} \right) \quad k=0, \dots, m-1$ are all obviously distinct (no two alike) since as we know they are uniformly spaced around the unit circle in the complex plane, with spacings of $\frac{2\pi}{m}$ between values. This is easily proved and is not given here. Let us prove that $\text{cis} \left(\frac{2k'\pi n}{m} \right), \quad k'=0, \dots, (m-1)$ is a set of m distinct values. Suppose there are two values that are the same, i.e. $\text{cis} \left(\frac{2k'\pi n}{m} \right) = \text{cis} \left[\frac{2k''\pi n}{m} \right]$

We assume $\text{cis} \left(\frac{2k'\pi n}{m} \right) = \text{cis} \left[\frac{2k''\pi n}{m} \right]$ where $k' > k''$ and $0 \leq k' \leq m-1, 0 \leq k'' \leq m-1$. This implies that $\frac{2k'\pi n}{m} - \frac{2k''\pi n}{m} = 2\pi L$ for some integer L , that is: $\frac{n(k'-k'')}{m} = L$ or $\frac{n}{m} = \frac{L}{k'-k''}$. Now notice that $k'-k'' \leq m-1$. The equation

$\frac{n}{m} = \frac{L}{k'-k''}$ is a contradiction since we assumed that $\frac{n}{m}$ is an irreducible fraction. Thus our assumption that $\text{cis} \left(\frac{2k'\pi n}{m} \right) = \text{cis} \left(\frac{2k''\pi n}{m} \right) \quad k' \neq k'', 0 \leq k' \leq m-1, 0 \leq k'' \leq m-1$ must be false. Therefore the values of $\text{cis} \left(\frac{2k'\pi n}{m} \right), \quad k'=0, 1, \dots, m-1$ must be numerically distinct (no two alike). We now prove that for each value of k' , $0 \leq k' \leq m-1$ there is just one value of $k, 0 \leq k \leq m-1$ such that $\text{cis} \left(\frac{2k'\pi n}{m} \right) = \text{cis} \left[\frac{2k\pi}{m} \right]$. Suppose we are given k' , then the following shows how to find k . We require that $\frac{2k'\pi n}{m} = \frac{2k\pi}{m} - 2\pi L$ where L is some integer and k satisfies $0 \leq k \leq m-1$. Thus $\frac{k}{m} = \frac{k'n}{m} - L$. Now if $\frac{k'n}{m}$ is an integer,

(continued, next pg.)

32(a) cont'd

We take $L = \frac{k'N}{m}$ and $k=0$ to satisfy this equation. If $\frac{k'N}{m}$ is not an integer, it must be of the form: $\frac{k'N}{m} = I + \frac{p}{m}$ where I is an integer and $1 \leq p \leq m-1$. Now take $L = I$ and the equation $\frac{k}{m} = \frac{k'N}{m} - L$ becomes $\frac{k}{m} = \frac{p}{m}$. We thus take $k=p$, where k will satisfy $0 \leq k \leq m-1$. Thus we have found the value of k corresponding to k' . In summary, the set of m different values of $\text{cis}\left(\frac{2k\pi}{m}\right)$ is identical to the set of values of $\text{cis}\left(\frac{2k'\pi}{m}\right)$, $k=0, \dots, m-1$, $k'=0, \dots, m-1$. Thus the sets of values generated in equations [1] and [2] [previous page] must be identical, [q.e.d].

32.](b) $1^{1/4} = \text{cis}\left[\frac{2k\pi}{4}\right]$, $k=0,1,2,3$, $[1^{1/4}]^2 = \left[\text{cis}\left[\frac{2k\pi}{4}\right]\right]^2$
 $= \text{cis}\left[k\pi\right]$, $k=0,1,2,3$, $= 1$ ($k=0$), -1 ($k=1$), 1 ($k=2$), -1 ($k=3$).
 Thus $[1^{1/4}]^2 = \pm 1$. Now consider $(1^2)^{1/4} = 1^{1/4} = \text{cis}\left(\frac{2k\pi}{4}\right)$ ($k=0,1,2,3$) which equals 1 if $k=0$, i if $k=1$, -1 if $k=2$, $-i$ if $k=3$. Thus $(1^2)^{1/4} = \pm 1$ and $\pm i$ [four different values] while $(1^{1/4})^2 = \pm 1$ (two different values).

33] next pg.

Sec. 1.4

33] a)

$$1^{1/m} = \text{cis}\left(\frac{2k\pi}{m}\right) \quad k=0, 1, 2, \dots, m-1, \quad 1^{1/m} = \text{cis}\left(\frac{\pi}{2m} + \frac{2k'\pi}{m}\right)$$

$$1^{1/m} = \text{cis}\left(\frac{\pi}{2m}\right) \text{cis}\left(\frac{2k'\pi}{m}\right) \quad k'=0, 1, \dots, m-1 \quad k'=0, 1, \dots, m-1$$

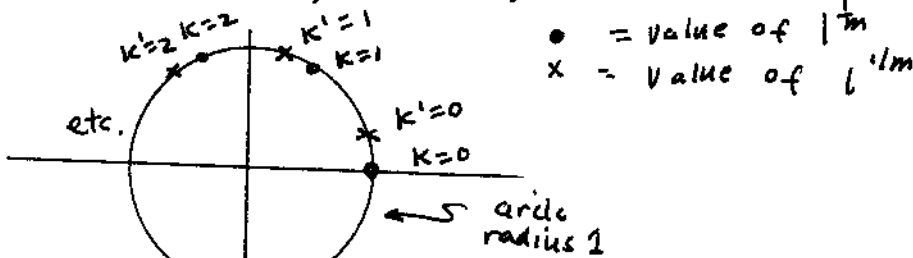

From the diagram, we see that by selecting $k=k'$ we have minimized $|1^{1/m} - i^{1/m}|$. Thus with this choice

$$\begin{aligned} |1^{1/m} - i^{1/m}| &= \left| \text{cis}\left(\frac{2\pi k}{m}\right) - \text{cis}\left(\frac{\pi}{2m}\right) \text{cis}\left(\frac{2\pi k'}{m}\right) \right| = \\ &= \left| \text{cis}\left(\frac{2\pi k}{m}\right) \left(1 - \text{cis}\left(\frac{\pi}{2m}\right)\right) \right| = \left| \text{cis}\left(\frac{2\pi k}{m}\right) \right| \left| 1 - \text{cis}\left(\frac{\pi}{2m}\right) \right| \\ &= \left| 1 - \text{cis}\left(\frac{\pi}{2m}\right) \right| = \left| 1 - \cos\left(\frac{\pi}{2m}\right) - i \sin\left(\frac{\pi}{2m}\right) \right| = \\ &= \sqrt{\left[1 - \cos\left(\frac{\pi}{2m}\right)\right]^2 + \sin^2\left(\frac{\pi}{2m}\right)} = \sqrt{1 - 2\cos\left(\frac{\pi}{2m}\right) + \cos^2\left(\frac{\pi}{2m}\right) + \sin^2\left(\frac{\pi}{2m}\right)} \\ &= \sqrt{2\left(1 - \cos\left(\frac{\pi}{2m}\right)\right)} = \sqrt{2 + 2\cos^2\left(\frac{\pi}{4m}\right)} = 2 \sin\left(\frac{\pi}{4m}\right) \end{aligned}$$

b) Refer to the figure of part (a). The magnitude of the vector for $1^{1/m} + i^{1/m}$ will be maximized if the angle between the vectors for $1^{1/m}$ and $i^{1/m}$ is minimized. This means we should use the same value for k and k' in the expressions for $1^{1/m}$ and $i^{1/m}$ given above. Thus

$$\begin{aligned} |1^{1/m} + i^{1/m}| &= \left| \text{cis}\left(\frac{2\pi k}{m}\right) + \text{cis}\left(\frac{\pi}{2m}\right) \text{cis}\left(\frac{2\pi k'}{m}\right) \right| \\ &= \left| \text{cis}\left(\frac{2\pi k}{m}\right) \right| \left| 1 + \text{cis}\left(\frac{\pi}{2m}\right) \right| = \left| 1 + \text{cis}\left(\frac{\pi}{2m}\right) \right| = \sqrt{\left[1 + \cos\left(\frac{\pi}{2m}\right)\right]^2 + \sin^2\left(\frac{\pi}{2m}\right)} \\ &= \sqrt{1 + \cos^2\left(\frac{\pi}{2m}\right) + 2\cos\left(\frac{\pi}{2m}\right) + \sin^2\left(\frac{\pi}{2m}\right)} = \sqrt{2\left[1 + \cos\left(\frac{\pi}{2m}\right)\right]} = \sqrt{2 + 2\cos^2\left(\frac{\pi}{4m}\right)} = \boxed{2 \cos\left(\frac{\pi}{4m}\right)} \end{aligned}$$

34

Let $z = cis \theta$ in problem 27 formula
 Then: $1 + cis \theta + (cis \theta)^2 + \dots + (cis \theta)^n = \frac{1 - [cis \theta]^{n+1}}{1 - cis \theta}$

Now use DeMoivre's Thm

$$1 + cis \theta + cis(2\theta) + cis(3\theta) + \dots + cis(n\theta) = \frac{1 - cis[(n+1)\theta]}{1 - cis \theta} \quad [1]$$

$$= \frac{cis[(n+1)\theta] - 1}{cis \theta - 1} = \frac{cis \left[\frac{(n+1)\theta}{2} \right]}{cis \frac{\theta}{2}} \left[\frac{cis \left[\frac{(n+1)\theta}{2} \right] - cis \left[-\frac{(n+1)\theta}{2} \right]}{cis \left(\frac{\theta}{2} \right) - cis \left(-\frac{\theta}{2} \right)} \right]$$

[Note that $cis \psi = cis(-\psi) = 2i \sin \psi$, ψ any real.]

$$\text{Thus } 1 + cis \theta + cis(2\theta) + \dots + cis(n\theta) = cis \left(\frac{n\theta}{2} \right) \left[\frac{\sin \frac{(n+1)\theta/2}{\sin(\theta/2)} \right] =$$

$$\left[\cos \frac{n\theta}{2} + i \sin \frac{n\theta}{2} \right] \left[\frac{\sin \frac{(n+1)\theta/2}{\sin \frac{\theta}{2}} \right] = 1 + \cos \theta + i \sin \theta + \cos 2\theta + i \sin 2\theta + \dots + \cos n\theta + i \sin n\theta$$

Now equate reals on each side of the preceding equation, and imaginaries:

$$\left(\cos \frac{n\theta}{2} \right) \left[\frac{\sin \frac{(n+1)\theta/2}{\sin \theta/2} \right] = 1 + \cos \theta + \cos 2\theta + \dots + \cos n\theta$$

$$\sin \frac{n\theta}{2} \left[\frac{\sin \frac{(n+1)\theta/2}{\sin(\theta/2)} \right] = \sin \theta + \sin 2\theta + \sin 3\theta + \dots + \sin n\theta \quad \text{q.e.d.}$$

35

From problem 27 have $1 + p + p^2 + \dots + p^n = \frac{1 - p^{n+1}}{1 - p}$
 where $p = z$.

$$\text{or } 1 + p + p^2 + \dots + p^{n-1} = \frac{1 - p^n}{1 - p} \quad \text{Take } p = cis \left(\frac{2\pi}{n} \right)$$

$$1 + cis \left(\frac{2\pi}{n} \right) + cis \left(\frac{4\pi}{n} \right) + \dots + cis \left[\frac{(2\pi)(n-1)}{n} \right] = \frac{1 - cis \left(\frac{2\pi n}{n} \right)}{1 - cis \left(\frac{2\pi}{n} \right)} = 0$$

Since $cis(2\pi) = 1$, Thus:

$$1 + cis \left(\frac{2\pi}{n} \right) + cis \left[\frac{4\pi}{n} \right] + \dots + cis \left[\frac{(2\pi)(n-1)}{n} \right] = 0$$

Break into reals and imaginaries:
 preceding

$$1 + \cos \left[\frac{2\pi}{n} \right] + \cos \left[\frac{4\pi}{n} \right] + \cos \left[\frac{6\pi}{n} \right] + \dots + \cos \left[\frac{2\pi(n-1)}{n} \right] = 0 \quad [\text{reals}]$$

$$\text{or } \left. \begin{aligned} \cos \left[\frac{2\pi}{n} \right] + \cos \left[\frac{4\pi}{n} \right] + \dots + \cos \left[\frac{2\pi(n-1)}{n} \right] &= -1 \\ \sin \left(\frac{2\pi}{n} \right) + \sin \left(\frac{4\pi}{n} \right) + \dots + \sin \left[\frac{(2\pi)(n-1)}{n} \right] &= 0 \end{aligned} \right\} \text{q.e.d.}$$

sec 1.4

36 | Matlab Code

$$W = [1 \ 1 \ 1 \ 1 \ 1 \ 1]$$

roots(W)

$$\text{ans} = \begin{matrix} .5 + .866i \\ .5 - .866i \\ -1 \\ -.5 + .866i \\ -.5 - .866i \end{matrix}$$

Can use $z^6 - 1 = 0$, $z = 1^{1/6}$

$$= \text{cis} \left[\frac{2k\pi}{6} \right] \quad k=1, 2, 3, 4, 5 \quad \text{but not } k=0$$

$$= \text{cis} \left[\frac{\pi}{3} \right] = .5 + .866i$$

$$= \text{cis} \left[\frac{2\pi}{3} \right] = -.5 + .866i$$

$$\therefore \text{cis} \left[\pi \right] = -1$$

$$\text{cis} \left[\frac{4\pi}{3} \right] = -.5 - .866i$$

$$\text{cis} \left[\frac{5\pi}{3} \right] = .5 - .866i$$

37 | (a) With MATLAB $z^{n/m} = \left[\sqrt[m]{r} \right]^n \angle \frac{\theta n}{m}$

where $-\pi < \theta \leq \pi$ [MATLAB uses principal argument]

$$\text{Thus } z^{n/m} = \left[\sqrt[m]{r} \right]^n \left[\cos \left[\frac{\theta n}{m} \right] + i \sin \left[\frac{\theta n}{m} \right] \right]$$

MATLAB: $6^{3/4} = .3827 + i .9239$

$(.3827 + i .9239)^{4/3} = i$ as expected.

Why: $6^{3/4} = \cos \left[\frac{\pi}{2} \cdot \frac{3}{4} \right] + i \sin \left[\frac{\pi}{2} \cdot \frac{3}{4} \right] = \text{cis} \left[\frac{3\pi}{8} \right]$

raise preceding to $\frac{4}{3}$. Note $-\pi < \frac{3\pi}{8} \leq \pi$

$$\therefore \left[6^{3/4} \right]^{4/3} = \left[\cos \left[\frac{3\pi}{8} \right] + i \sin \left[\frac{3\pi}{8} \right] \right]^{4/3}$$

$$= \cos \frac{\pi}{2} + i \sin \frac{\pi}{2} = \boxed{i}$$

Sec 1.4 continued.

32] (b) ^{From} MATLAB: $i^{5/2} = -0.707 - i.707$
 with MATLAB: $(i^{5/2})^{2/5} = (-0.707 - i.707)^{2/5} =$
 $.5878 - i.809$ which $\neq i$

Why? $i^{5/2} = \text{cis} \left[\frac{\pi}{2} \cdot \frac{5}{2} \right] + i \text{sm} \left[\frac{\pi}{2} \cdot \frac{5}{2} \right]$
 $= \text{cis} \left[\frac{5\pi}{4} \right] + i \text{sm} \left[\frac{5\pi}{4} \right] = -0.707 - i.707$

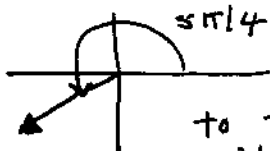

To raise the preceding to the $2/5$ power, MATLAB will use princ. arg.

Thus $(-0.707 - i.707)^{2/5} = \sqrt[5]{\left[\frac{-3\pi}{4} \cdot \frac{2}{5} \right]} = \text{cis} \left[-\frac{3\pi}{5} \right]$
 $= \boxed{.5878 - i.809}$

We did not recover i because in computing $(-0.707 - i.707)^{2/5}$ Matlab used the princ argument and not $\theta = \frac{5\pi}{4}$. Had it used $\frac{5\pi}{4}$, i would have been recovered.

sec 1.5

1) $\text{Re } z = -1/2, \quad x = -1/2$

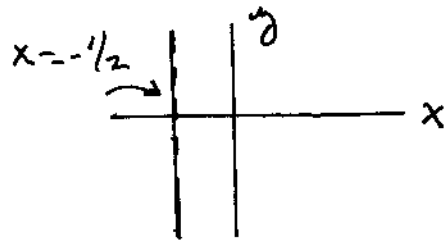

The solution is the line $x = -1/2$

2) $\text{Re}(z) = \text{Im}(z+i)$ $z = x+iy$
 $x = y+1$ $y = x-1$

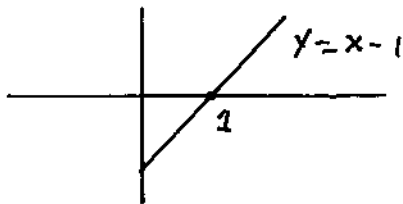

3) $\text{Re}(z) > \text{Im}(z+i)$
 $x > y+1$ $y < x-1$

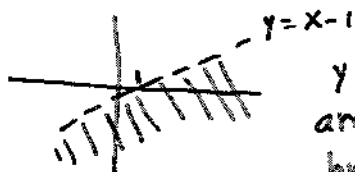

$y < x-1$ is the shaded area below the line $y = x-1$ but not including the line

4) $\text{Re}(z) \leq \text{Im}(z+i)$ $x \leq y+1$
 $y \geq x-1$

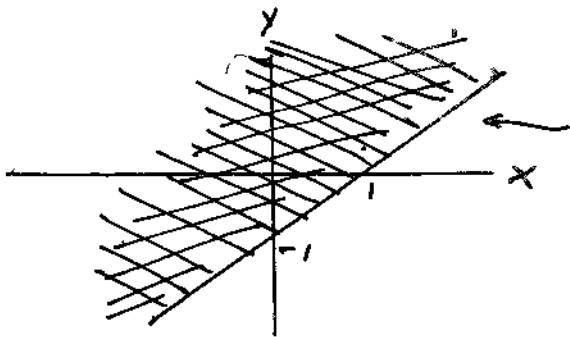

The area on the line and the shaded area above it

The line $y+1 = x$

Section 1.5

5 | $-1 < \operatorname{Re}(z) \leq \operatorname{Im}(z+i)$

$-1 < x \leq y+1$

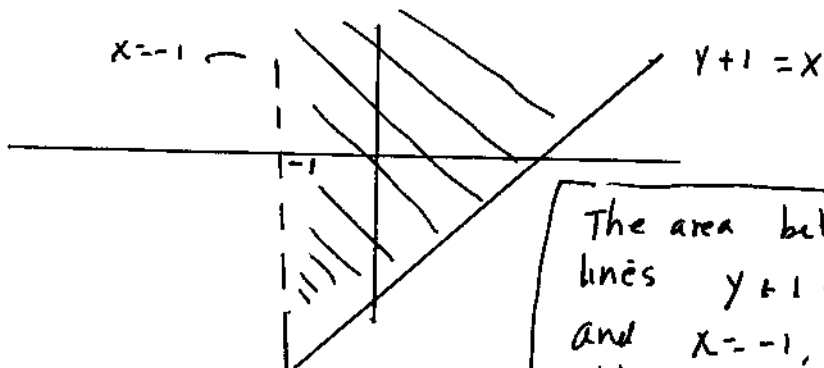

The area between the lines $y+1=x$ and $x=-1$, not including points on $x=-1$ but including those on $y+1=x$

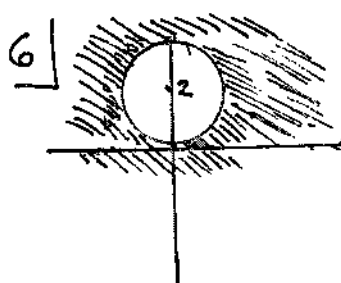

The points on and outside this circle.

7 | $z\bar{z} = x^2 + y^2 = 1+i$ Since left side is real, this has **no solution**

8 | $x^2 + y^2 = x$ $x^2 - x + y^2 = 0$
 $(x - \frac{1}{2})^2 + y^2 = \frac{1}{4} = (\frac{1}{2})^2$ Circle of radius $\frac{1}{2}$ centered at $(\frac{1}{2}, 0)$.

9 | $\operatorname{Re}(z) = \operatorname{Im}(z^2)$ $x = \operatorname{Im}[x^2 - y^2 + i2xy]$

$x = 2xy$ Satisfied if $x=0$, Suppose $x \neq 0$, Divided by x : $1 = 2y$, $y = \frac{1}{2}$

Answers **$x=0, -\infty < y < \infty$** or **$y = \frac{1}{2}, |x| > 0$**

sec 1.5 cont'd

10

$$\operatorname{Re}(z) < \operatorname{Re}(z^2) = \operatorname{Re}[x^2 - y^2 + i2xy]$$

$$x < x^2 - y^2$$

$$x^2 - x - y^2 > 0$$

$$\left(x - \frac{1}{2}\right)^2 - y^2 > \frac{1}{4}$$

$$\left(x - \frac{1}{2}\right)^2 - y^2 = \frac{1}{4}$$

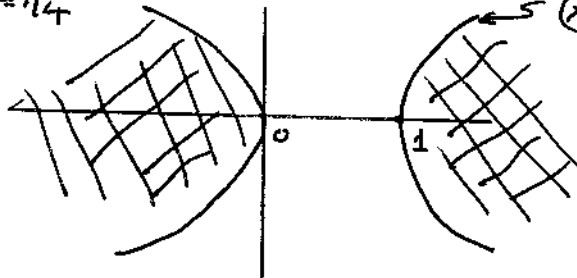

Solution is shaded area bounded by this set of hyperbolas but not including the hyperbolas themselves

11

Suppose $e^{|z|} = 1$ $|z| = 0$

Suppose $e^{|z|} = 2$, $|z| = \log 2$

Answer is disc centered at origin with center punched out. Outer radius is $\log 2$. Circumference $|z| = \log 2$ is included.

12

next page

sec 1.5

12

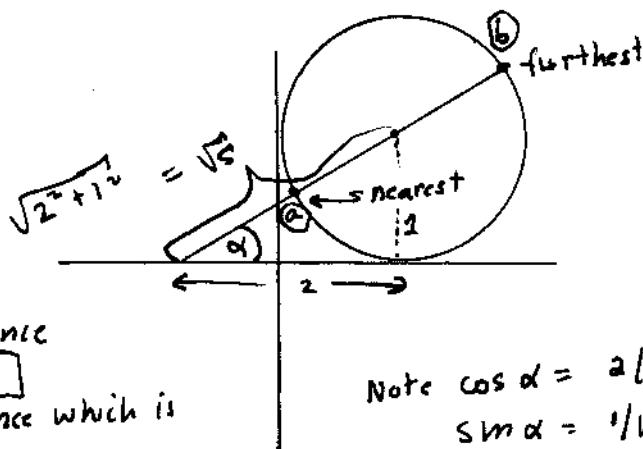

a is nearest distance
 which is $\sqrt{5} - 1$
 b is furthest distance which is
 $\sqrt{5} + 1$.

Note $\cos \alpha = \frac{2}{\sqrt{5}}$
 $\sin \alpha = \frac{1}{\sqrt{5}}$

To get coordinates of (a).

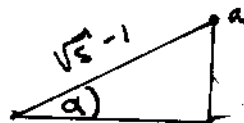

x coord = $-1 + (\sqrt{5} - 1) \cos \alpha$
 $= -1 + \frac{(\sqrt{5} - 1)2}{\sqrt{5}} = 1 - \frac{2}{\sqrt{5}}$, y coordinate is $(\sqrt{5} - 1) \sin \alpha = \frac{\sqrt{5} - 1}{\sqrt{5}}$

Similarly to get x coordinate of (b): $-1 + (\sqrt{5} + 1) \cos \alpha = 1 + \frac{2}{\sqrt{5}}$
 and y coordinate. $(\sqrt{5} + 1) \sin \alpha = \frac{\sqrt{5} + 1}{\sqrt{5}} = \frac{5 + \sqrt{5}}{5}$

13 $|z - i| < 1$

14 $|z - (-1 - 2i)| > 3$

or $|z + 1 + 2i| > 3$

15 $0 < |z - 2 + i| < 4$

16 $1 < |z + 1 - 3i| \leq 4$

17 $|z - 1| + |z + 1| = 2$

18 next pg.

Sec 1.5

18) a)

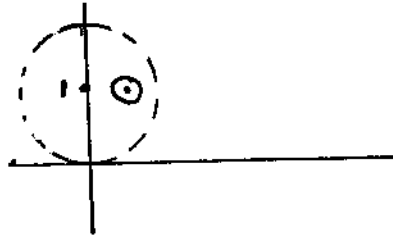

can

Use $|z - [0 + i]| < .1$

this not the only answer

b) $0 < |z - (.8 + i)| < .1$

19)

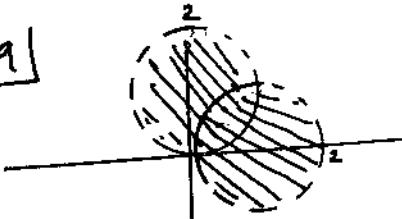

all the shaded area
The boundaries are not included. This is a domain since open and connected.

20)

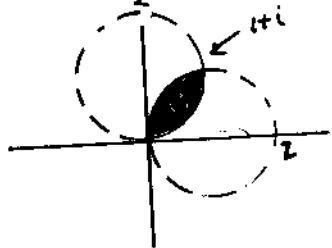

ans. is the shaded area, but the boundary points that lie on the arcs along $|z - i| = 1$ and $|z - i| = 1$ are not included. Is a domain. [open and connected]

21)

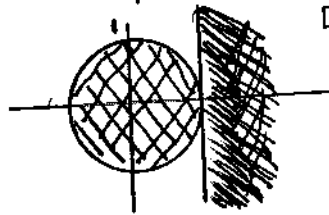

ans. is the shaded area and includes the points on the boundaries. Not a domain connected but not open.

22) There are no points common to both A and B. Answer is the null set. ^{Not a} domain.

23) $|z| > 0$. The origin $z = 0$ is a boundary point. It is not in the set

24)

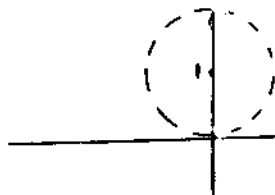

Boundary points are the points on the circle $|z - i| = 1$

They do not belong to the set.

Sec 1.5

$$25) \quad \frac{1}{3} < \frac{1}{|z-i|} \leq \frac{1}{2}$$

implies $3 > |z-i| \geq 2$

boundary points are on circle
 $|z-i|=3$ and do not belong to the
 set and are on circle $|z-i|=2$ and
 do belong

26) $\text{Log}|z| \geq 0$ implies that

$|z| \geq 1$. Boundary points are on
 circle $|z|=1$ and do belong to the set

27) The elements of the set are
 $e^{i/2}, e^{i/3}, e^{i/4}, \dots$ etc

Each element is a boundary point [draw a small
 circle around it]. However, $e^{i0} = i$ is also a
 boundary point but does not belong to the
 set. Every neighborhood of i contains members
 of the set as well as points not belonging to
 the set.

28) This set $-1 \leq \text{Re}(z) \leq 5$ [or $-1 \leq x \leq 5$]

The boundary points are on the lines $x=-1$
 and $x=5$ [$-\infty < y < \infty$]. The set is closed
 because it contains all its boundary points.

29) The boundary points lie along the lines
 $x=-1$ [$-\infty < y < \infty$] and $x=5$ [$-\infty < y < \infty$]. The points
 on the line $x=5$ do not belong to the set. \therefore set is not closed.

Sec 1.5

30] The set of points $ie, ie^{i/2}, ie^{i/3}, \dots$ has boundary point $ie^0 = i$ which does not belong to the set. \therefore set is not closed.

31] No, a boundary point is not necessarily an accumulation point. Consider for example the set consisting of just the one point $z=0$. This point is a boundary point but not an accumulation point. Any neighborhood of $z=0$ will not contain any elements of the set except $z=0$.

32] For problem 28, the accumulation points are all the points in the given set.

For problem 29, the accumulation points are all the points in the given set plus points on the line $\text{Re}(z) = 5$ [or $x=5, -\infty < y < \infty$]

For problem 30, the only accumulation point is at $z = i$.

33] $\sin\left(\frac{\pi}{x}\right) = 0 \quad \therefore \frac{\pi}{x} = n\pi, \quad x = \frac{1}{n}$

n is an integer. We require $y=0, x = \frac{1}{n}, n = \pm 2, \pm 3, \pm 4, \dots$ for a solution inside the unit circle. The points are on the real axis and cluster about $z=0$. The accumulation point is $z=0$. (It does not belong to the set since no finite value of n will produce $z=0$).

To prove that $z=0$ is an accum pt.: Consider the neighborhood $|z| < \epsilon$ where $\epsilon > 0$ is an arbitrary pos. number. Now consider a point for which $y=0$, and x is chosen such that $0 < x \leq \frac{\epsilon}{2}$ and $\frac{1}{x}$ is an integer. This point belongs to the given set and lies in the given neighborhood of $z=0$. \therefore any neighborhood of $z=0$ has a point in the set.

34

Sec 1.5

a)

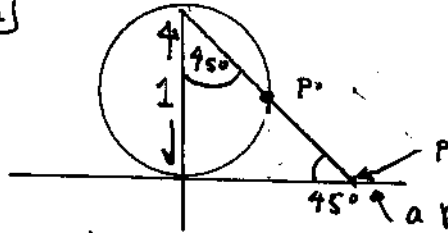

The point P gets projected onto a point P' lying on the equator of the sphere

Thus the unit circle $|z|=1$ gets projected onto the equator of the sphere.

b)

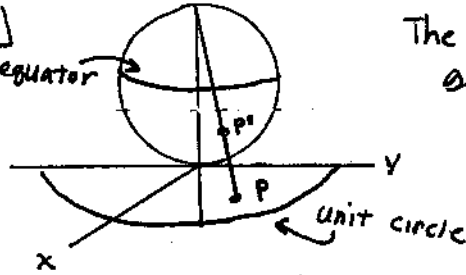

The points inside the unit circle get projected onto southern (lower) hemisphere, not including the equator.

c) The points outside the unit circle get projected onto northern hemisphere. Figure is similar to the one above

35

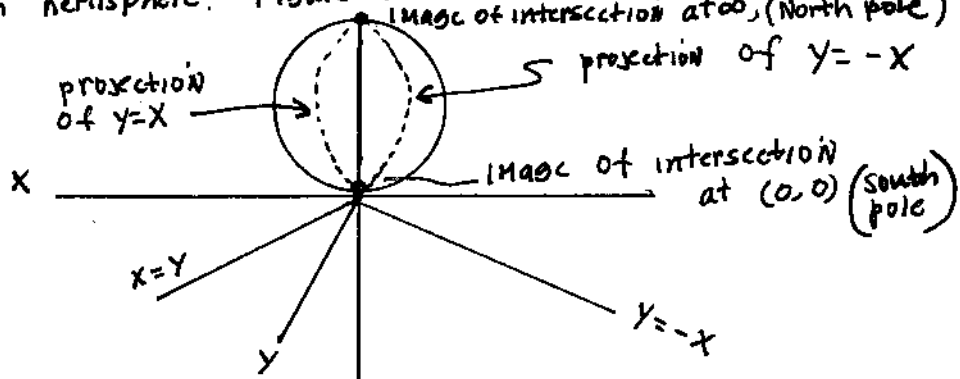

continued, next page

36

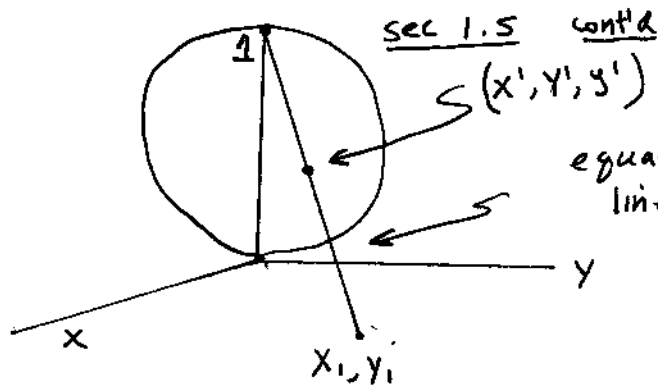

equation of this line

$$y = \frac{x_1 - x}{x_1} \quad (1)$$

$$y = \frac{y_1 - y}{y_1} \quad (2)$$

a) Equation of the sphere: $x^2 + y^2 + (z - \frac{1}{2})^2 = (\frac{1}{2})^2$

Notice from (1) and (2) that $x = x_1 [1 - y]$, $y = y_1 [1 - y]$
Use this in the equation of the sphere. Get

$$x_1^2 (y-1)^2 + y_1^2 (y-1)^2 + (y - \frac{1}{2})^2 = \frac{1}{4}$$

Put $x_1^2 + y_1^2 = r^2$. Thus $r^2 (y-1)^2 + (y - \frac{1}{2})^2 = \frac{1}{4}$

or $y^2 [r^2 + 1] - y [1 + 2r^2] + r^2 = 0$

Using the quadratic formula, we solve the preceding equation for y . We get two roots

$$y = \frac{r^2}{r^2 + 1} \quad \text{and} \quad y = 1.$$

We discard $y = 1$ as being an obvious solution (see the above figure) and

keep $y = \frac{r^2}{r^2 + 1} = \frac{x_1^2 + y_1^2}{x_1^2 + y_1^2 + 1}$ (this is called y' in the problem statement).

Now referring to $x = x_1 [1 - y]$ and $y = y_1 [1 - y]$ (at the top of this page) and using

$y = y'$ (just found) we have: $x' = x_1 [1 - y'] = x_1 \left[1 - \frac{x_1^2 + y_1^2}{x_1^2 + y_1^2 + 1} \right]$

Similarly $y' = y_1 [1 - y'] = y_1 \left[1 - \frac{x_1^2 + y_1^2}{x_1^2 + y_1^2 + 1} \right]$.

b) $x_1^2 + y_1^2 = r^2$

Using the equations from (a):

$$x' = x_1 \left[1 - \frac{r^2}{1 + r^2} \right] = \frac{x_1}{1 + r^2}, \quad y' = \frac{y_1}{1 + r^2}$$

$$x'^2 + y'^2 = \frac{x_1^2}{(1 + r^2)^2} + \frac{y_1^2}{(1 + r^2)^2} = \frac{x_1^2 + y_1^2}{(1 + r^2)^2} = \left(\frac{r}{1 + r^2} \right)^2$$

The radius of the circle on the sphere is $\frac{r}{1 + r^2}$
cont'd next pg.

36 (b). continued

Sec 1.5

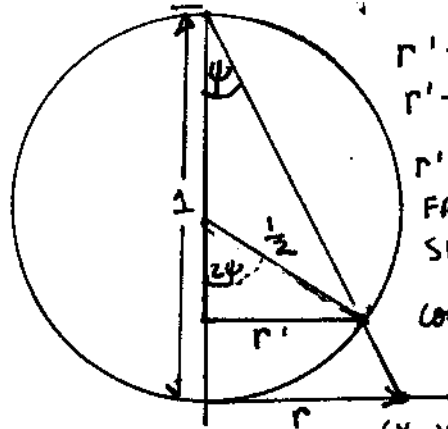

$$r' = ?$$

$$r' = \frac{1}{2} \sin(2\psi)$$

$$r' = \sin\psi \cos\psi$$

FROM THIS FIG.

$$\sin\psi = \frac{r}{\sqrt{1+r^2}}$$

$$\cos\psi = \frac{1}{\sqrt{1+r^2}}$$

(x, y) in complex
 z plane

$$r' = \sin\psi \cos\psi = \frac{r}{1+r^2} \quad \text{q.e.d.}$$

2

**The Complex Function and its
Derivative**

sec 2.1

1] Note that the denominator of the given function = 0 if $z = \pm i$ or if $x = \pm \frac{\pi}{2}, \pm \frac{3\pi}{2}, \dots$ or $x = \pm(n\pi - \frac{\pi}{2})$ $n=1, 2, 3, \dots$

Thus $f(z)$ is defined everywhere in the domain $|z| < 1$. Thus $f(z)$ fails to be defined nowhere in $|z| < 1$

2] The points $z = \pm i$ lie in the domain $|z| < 1$. The function is not defined at $z = \pm i$

3] if $x = \pm \frac{\pi}{2}$ and $x^2 + y^2 = 4$
 $y = \pm \sqrt{4 - \pi^2/4}$

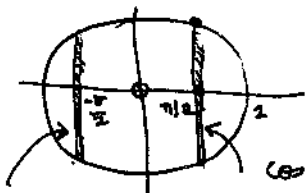

$\cos x = 0$ on this line. Thus in the domain $|z| < 2$, $f(z)$ is not defined at $z = \pm i$

or at any points on these two lines

$$x = \pm \pi/2, \quad -\sqrt{4 - \pi^2/4} < y < \sqrt{4 - \pi^2/4}$$

4] The domain $|z - (1+i)\frac{\pi}{2}| < \frac{\pi}{2}$ lies inside this circle. The points $\pm i$ are outside this domain.

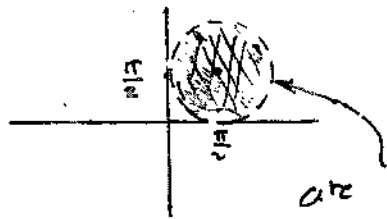

$\cos x = 0$ if $x = \frac{\pi}{2}$. Points on the line $x = \frac{\pi}{2}, 0 < y < \pi$ are in the domain and the function is undefined.

5] $f(1+2i) = (1+2i)^2 + 1 = 1 + 4i - 4 + 1$
 $= -2 + 4i$

6] $z\bar{z} = 5 \quad \frac{1}{z\bar{z} - 5}$ is undefined

sec 2.1 continued

$$7.] \quad 1+2i + \frac{1}{1+2i} + \operatorname{Im}(1+2i)$$

$$= 1+2i + \frac{1-2i}{5} + 2 = 3\frac{1}{5} + i\frac{8}{5} =$$

$$= \frac{16+8i}{5}$$

$$8.] \quad \frac{1+i2}{\cos 1 + i \sin 2} = \frac{1+2i}{.5403 + i .9093}$$

$$= 2.1085 + i .1531$$

$$9.] \quad \frac{1}{z+i} = \frac{1}{x+iy+i} = \frac{1}{x+i(y+1)} =$$

$$\frac{x-i(y+1)}{x^2+(y+1)^2} \quad \text{U} = \frac{x}{x^2+(y+1)^2},$$

$$V = \frac{-(y+1)}{x^2+(y+1)^2}$$

$$10.] \quad \frac{1}{z} + i = \frac{1}{x+iy} + i = \frac{x-iy}{x^2+y^2} + i$$

$$U = \frac{x}{x^2+y^2}, \quad V = \frac{-y}{x^2+y^2} + 1$$

$$11.] \quad x+iy + \frac{1}{x+iy} = x+iy + \frac{(x-iy)}{x^2+y^2}$$

$$U = x + \frac{x}{x^2+y^2}, \quad V = y - \frac{y}{x^2+y^2}$$

$$12.) \quad (x+iy)^3 + (x+iy) = x^3 + 3x^2iy + 3x(-y^2) - iy^3 + x+iy$$

$$U = x^3 - 3xy^2 + x$$

$$V = 3x^2y - y^3 + y$$

13.] This is just the conjugate of problem 12, since $(\bar{z})^3 = \overline{z^3}$

$$\therefore U = x^3 - 3xy^2 + x, \quad V = -3x^2y + y^3 - y$$

sec 2.1 cont'd

14

$$x + iy = \frac{1}{2}(z + \bar{z}) + i \frac{z - \bar{z}}{2i} =$$

$$\frac{z}{2} + \bar{z} + \frac{\bar{z}}{2} - \bar{z} = \frac{3}{2}z - \frac{1}{2}\bar{z}$$

15

$$\frac{z}{z + \bar{z}} + \frac{2i}{i(z - \bar{z})} = 2 \left[\frac{1}{z + \bar{z}} + \frac{1}{z - \bar{z}} \right]$$

$$= 2 \frac{2z}{(z + \bar{z})(z - \bar{z})} = \frac{4z}{z^2 - (\bar{z})^2}$$

16

$$i \frac{[z + \bar{z}]^2}{4} + \left(-\frac{1}{4}\right) (z - \bar{z})^2$$

$$= \frac{- (z - \bar{z})^2 + i(z + \bar{z})^2}{4}$$

17

write as $x + iy + \frac{x + iy}{x^2 + y^2} =$

$$z + \frac{z}{z\bar{z}} = z + 1/\bar{z}$$

18

z	$w = i(z + 1)$
a 1	$-1 + i = a'$
b $1 + i$	$-2 + i = b'$
c i	$-2 = c'$
d $-1 + i$	$-2 - i = d'$
e -1	$-1 - i = e'$

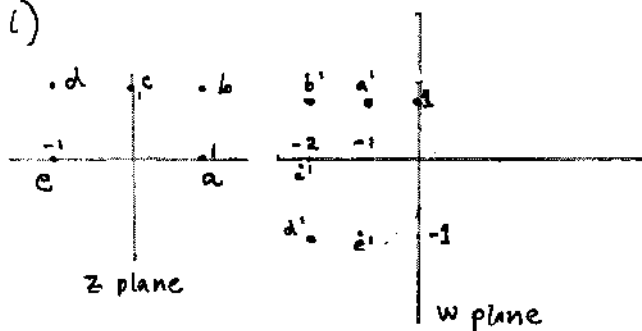

19

$$w = i/z$$

z is same as previous problem

$$w' = i/z$$

$$\begin{aligned} a' &= i \\ b' &= \frac{1}{2} + \frac{1}{2}i \\ c' &= 1 \end{aligned}$$

$$\begin{aligned} d' &= 1/2 - 1/2i \\ e' &= -i \end{aligned}$$

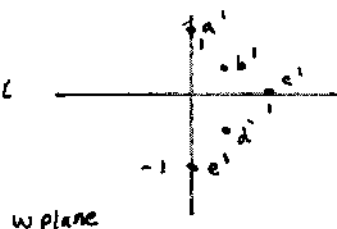

sec 2.1

20

	z
a	1
b	$1+i$
c	i
d	$-1+i$
e	-1

$W = \arg z$	
0	a'
$\pi/4$	b'
$\pi/2$	c'
$3\pi/4$	d'
π	e'

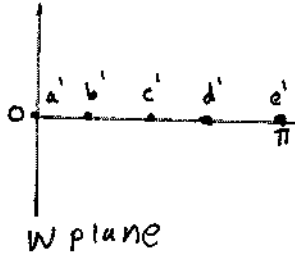

W plane

21) $W = z^3$, values of same as 20.

$W = z^3$	
1	a'
$-2+2i$	b'
$-i$	c'
$2+2i$	d'
-1	e'

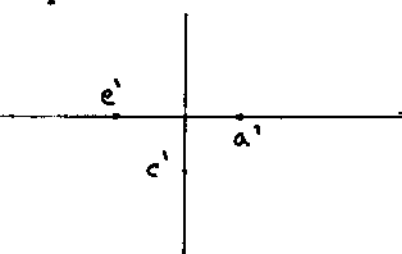

22) $f(z) = \frac{1}{z+i}$ $f(1/z) = \frac{1}{\frac{1}{z}+i} = \frac{z}{z+i}$

23) $f(f(z)) = \frac{1}{\left(\frac{1}{z+i}\right)+i} = \frac{z+i}{i(z+i)+1} = \frac{z+i}{iz}$

24) $f\left(\frac{1}{f(z)}\right) = ?$ $\frac{1}{f(z)} = z+i$

$\therefore f\left(\frac{1}{f(z)}\right) = \frac{1}{(z+i)+i} = \frac{1}{z+2i}$

25) $f(z+i) = \frac{1}{z+2i} = \frac{1}{x+i(y+2)} = \frac{x-i(y+2)}{x^2+(y+2)^2}$

$\therefore U = \frac{x}{x^2+(y+2)^2}, \quad V = \frac{-y-2}{x^2+(y+2)^2}$

```

%prob26(a) SECTION 2.1
t=[0:.1:1]*i
z=1+t;

w=z.^2+z;
u=real(w);v=imag(w);
plot(u,v,'*');grid;axis([-1 2 0 3])
title('PROBLEM 26 a')

```

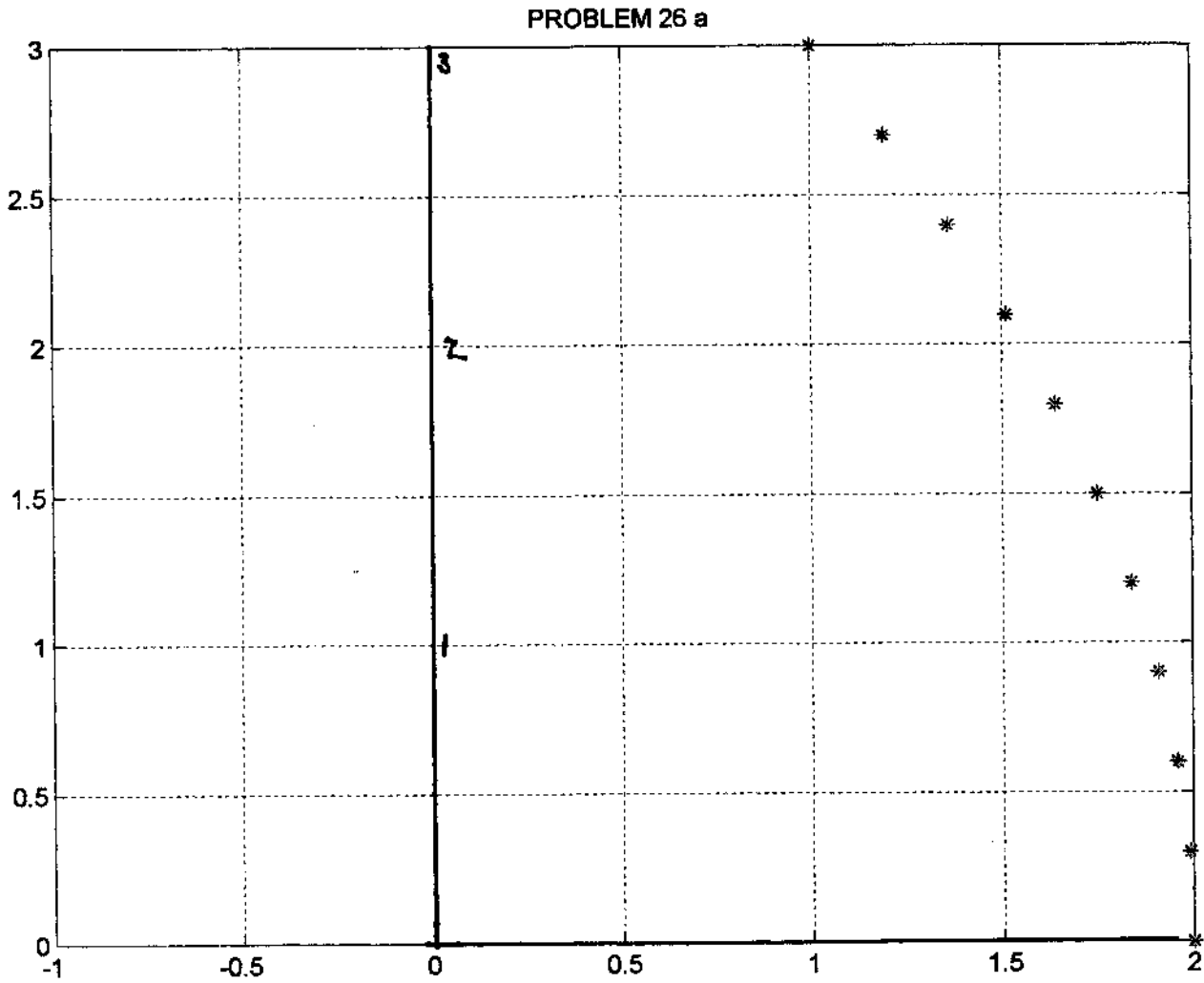

```
%prob26(b) SECTION 2.1
t=[0:.1:1]
z=i+t;

w=z.^2+z;
u=real(w);v=imag(w);
plot(u,v,'*');axis([-1 2 0 3]);grid;
title('PROBLEM 26 b')
```

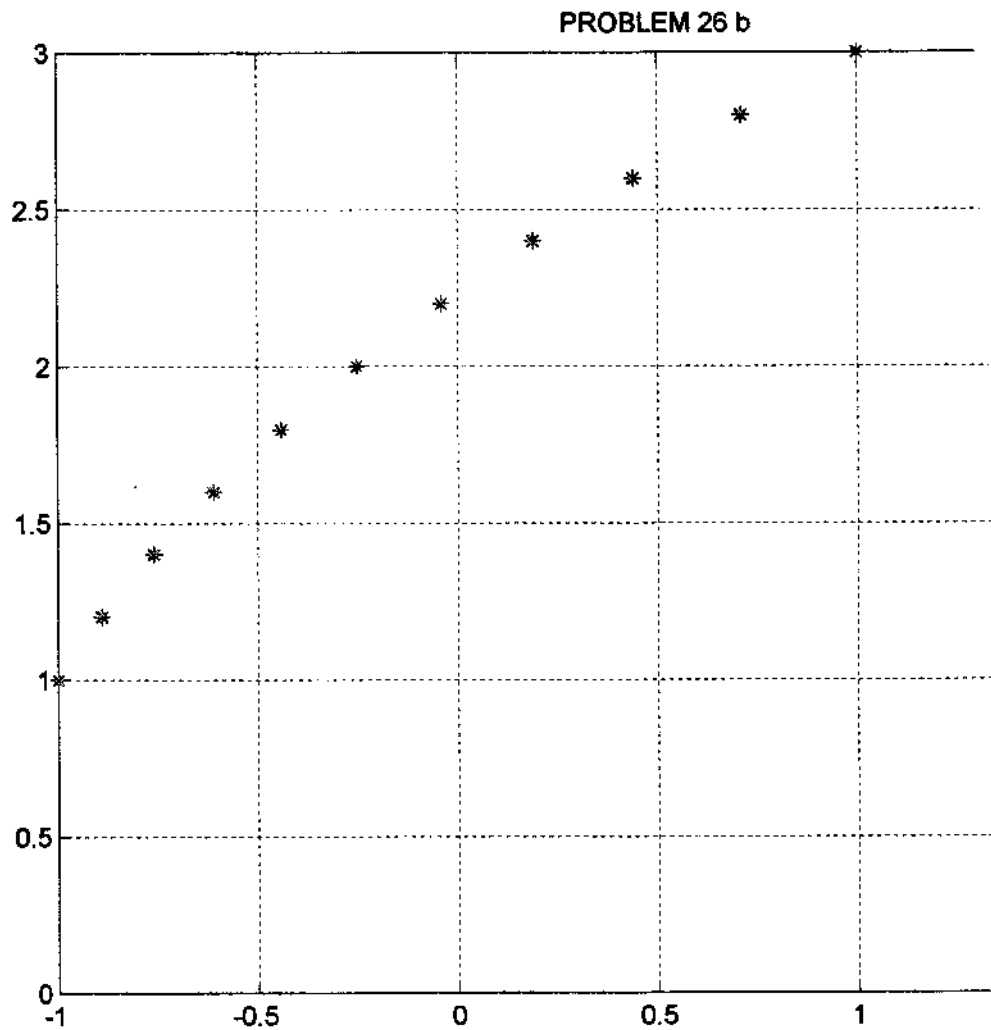

```
% prob 27(a) section 2.1
x=[-1:.05:1];
y=x;
[X,Y]=meshgrid(x,y);
Z=X+i*Y;
w=1./(Z-3*i/2);
wm=abs(w);
meshz(X,Y,wm);hold on
title('Magnitude of 1/(z-3*i/2)')

% prob 27(b), section 2.1
x=[-1:.05:1];
y=x;
[X,Y]=meshgrid(x,y);
Z=X+i*Y;
w=1./(Z-3*i/2);
wm=real(w);
meshz(X,Y,wm);hold on
surf(X,Y,wm);
title('Re 1/(z-3*i/2)')

% prob 27(c), section 2.1
x=[-1:.05:1];
y=x;
[X,Y]=meshgrid(x,y);
Z=X+i*Y;
w=1./((Z-3*i/2));
wm=imag(w);
meshz(X,Y,wm);hold on

title('Imag1/(z-3*i/2)')
```

Problem 27 (a)

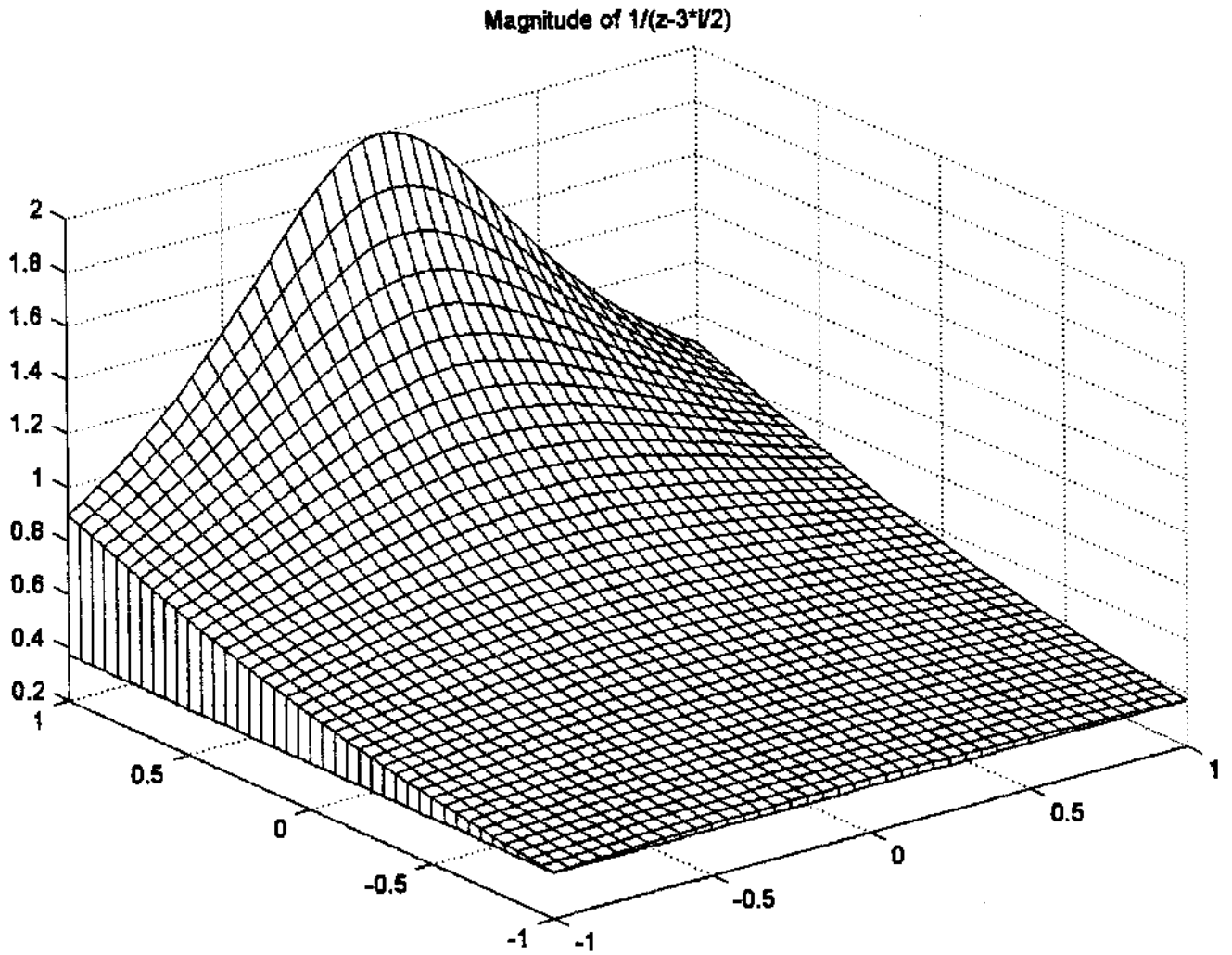

item 27 (b)

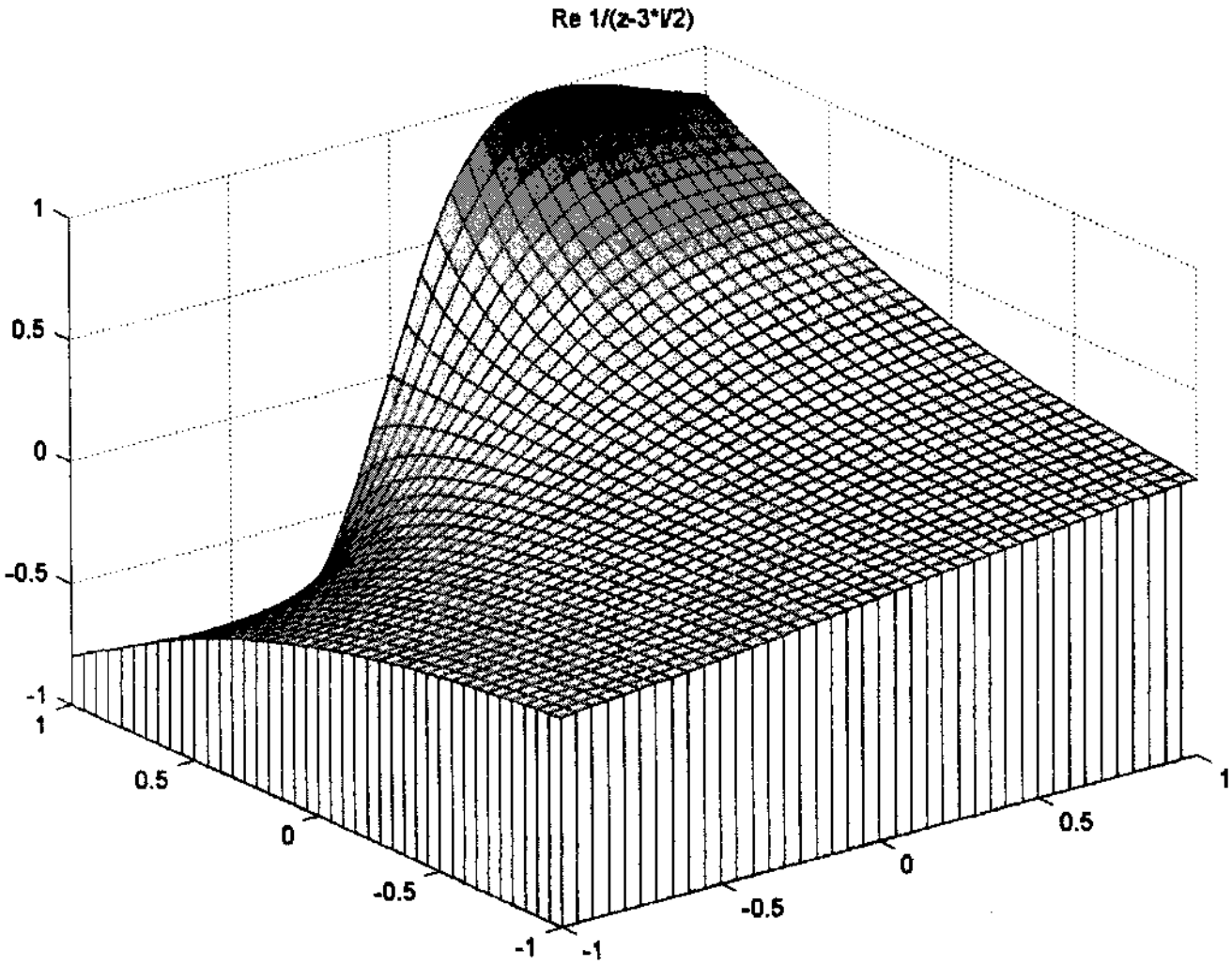

problem 27 (c)

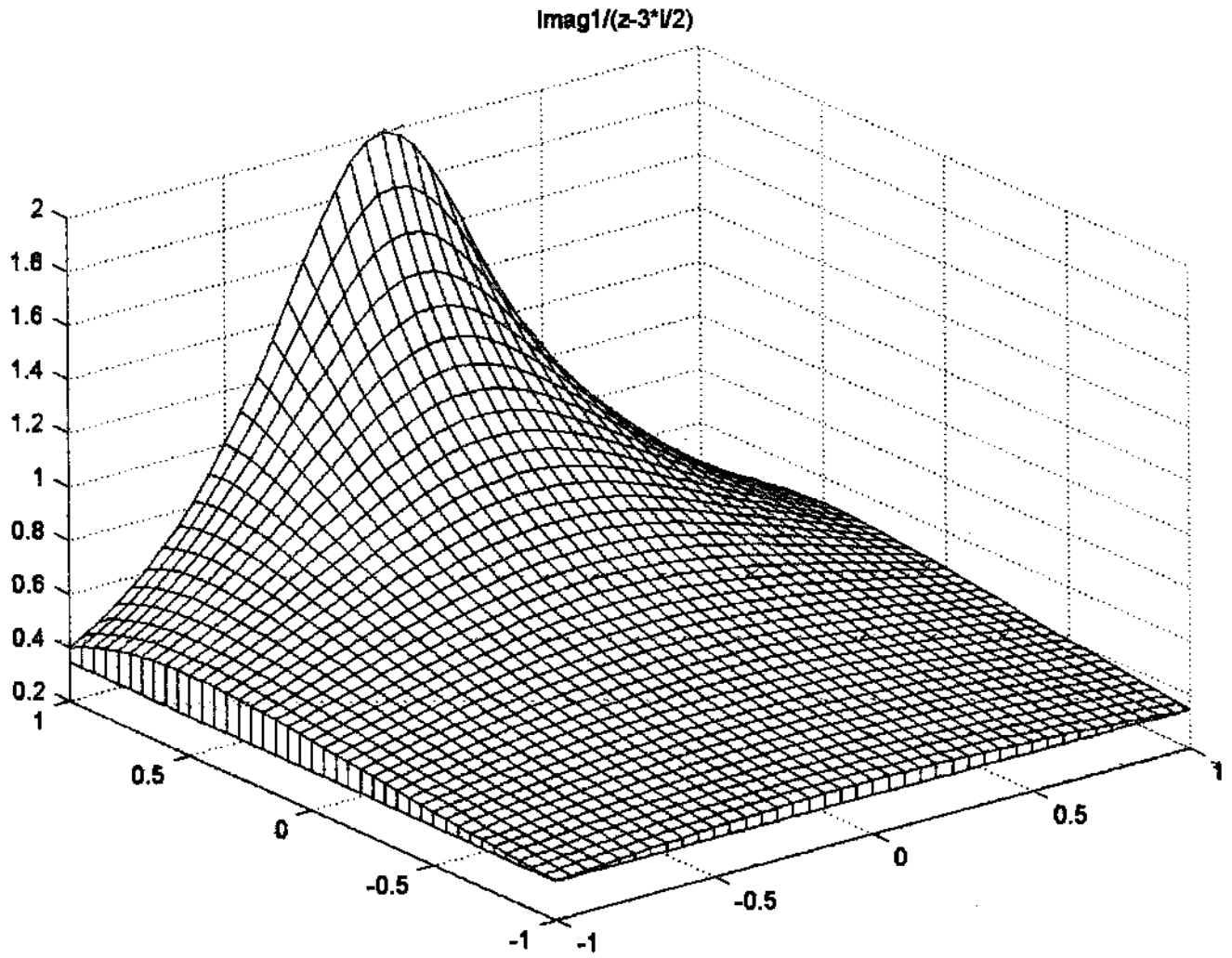

SEC 2.2

1) a) We need $|f(z) - f_0| < \epsilon$ for $0 < |z - z_0| < \delta$
 $f(z) = z, f_0 = z_0$

Thus need $|z - z_0| < \epsilon$ for $|z - z_0| < \delta$.
Just take $\delta = \epsilon$ (for example) and the requirement $|z - z_0| < \epsilon$
is satisfied in the deleted neighborhood of z_0 of radius δ .

b) $f(z)$ is defined at z_0
(and $f(z_0) = z_0$). Also $\lim_{z \rightarrow z_0} f(z) = z_0$

Finally, $\lim_{z \rightarrow z_0} f(z) = f(z_0)$ as required

2) Must first show $\lim_{z \rightarrow z_0} f(z) = C$. To do this we

require $|f(z) - C| < \epsilon$ for $0 < |z - z_0| < \delta$

But $f(z) = C$ (all z). Thus $|f(z) - C| = 0$
and the requirement $|f(z) - C| < \epsilon$ is satisfied
for all z . Now $f(z_0) = C$. Thus we have
 $\lim_{z \rightarrow z_0} f(z) = f(z_0)$ and continuity is proved
for all z .

3) $z^3 = z \cdot z \cdot z$ is a product of continuous
functions and is thus continuous.

$z^3 + i$ is a sum of continuous funcs,
and is therefore continuous

4) i is constant, \therefore continuous.

z^2 is continuous [product of 2 continuous funcs]

$z^2 + 9$ is sum of continuous funcs.

$z^2 + 9 = 0, z = \pm 3i$

$\frac{i}{z^2 + 9}$, quotient of continuous
functions is continuous except @ $\pm 3i$

sec 2.2 continued

5] z^4 being the product of continuous functions is continuous everywhere, $z^2 + 3z + 2$, sum of continuous functions is continuous everywhere. $\frac{1+i}{z^2+3z+2}$ a quotient of continuous

functions is continuous except where denom = 0

$$z^2 + 3z + 2 = 0, \quad [z = -1, z = -2] \quad z^4 + \frac{(1+i)}{z^2+3z+2}$$

is a sum of continuous functions [except where $z = -1, z = -2$]

6] Since $z+i$ is continuous for all z , so is $|z+i|$.

$(1+i)z$ is continuous everywhere. $\therefore |z+i| + (1+i)z$ [a sum of continuous functions] is continuous everywhere

7] Note that $x^2 - y^2 = \operatorname{Re}(z^2)$ is the real part of a continuous function and is therefore continuous everywhere. $z^2 + (x^2 - y^2)$ is the sum of functions that are continuous everywhere

8] $z = x+iy$ is continuous everywhere

$x = \operatorname{Re}(z)$, $y = \operatorname{Im}(z)$ are continuous everywhere

$\bar{z} = x-iy$ is the sum of continuous functions. $\therefore \bar{z}$ is continuous everywhere. $\frac{\bar{z}-i}{\bar{z}-i}$ is quotient of continuous functions and is therefore continuous except where $\bar{z}-i=0$, $\bar{z}=i$ $z=-i$

9] If $y=0$, $x > 0$, $f(z) = \frac{\sin x}{x} \rightarrow 1$ as $x \rightarrow 0$

If $x=0$, $y > 0$, $f(z) = \frac{isiny}{-iy} = \frac{siny}{-y} \rightarrow -1$ as $y \rightarrow 0$

If $x=y$, $f(z) = \frac{(1+i)\sin x}{(1-i)x} = \frac{i \sin x}{x} \rightarrow i$ as $x \rightarrow 0$, $y \rightarrow 0$

[Thus limit does not exist.]

Sec 2.2 cont'd

$$\text{10)} \quad f(z) = \frac{z-i}{z^2-3i-2} = \frac{(z-i)}{(z-2i)(z-i)}$$

If $z \neq i$ we can write the preceding

$$\text{as } f(z) = \frac{1}{(z-2i)} \quad z \neq i$$

$$\text{Note that } \lim_{z \rightarrow i} f(z) = \lim_{z \rightarrow i} \frac{1}{z-2i} = \frac{1}{i-2i} = i$$

Since $\lim_{z \rightarrow i} f(z) = i$ and $f(i) = i$, and they agree, then $f(z)$ is continuous @ $z = i$

$$\text{11)} \quad \text{a)} \quad f(z) = \frac{z^2-5z+6}{z^2-4} = \frac{(z-2)(z-3)}{(z-2)(z+2)}$$

If we assume $z \neq 2$, we can rewrite the preceding as $f(z) = \frac{z-3}{z+2}$. The limit

of this expression as $z \rightarrow 2$ is $-1/4$
 \therefore define $f(2) = -1/4$ to make $f(z)$ continuous at $z = 2$

$$\text{b)} \quad f(z) = \frac{z^4+10z^2+9}{z^2-4iz-3} = \frac{(z^2+9)(z^2+1)}{(z-3i)(z-i)}$$

$$= \frac{(z-3i)(z+3i)(z-i)(z+i)}{(z-3i)(z-i)} \quad \text{Now if } z \neq i, \text{ or } z \neq 3i$$

the preceding simplifies to $\frac{(z+3i)(z+i)}{(z+3i)(z+i)} = f(z)$
 Thus $\lim_{z \rightarrow 3i} (z+3i)(z+i) = -24$

$$\lim_{z \rightarrow i} (z+3i)(z+i) = -8$$

\therefore Take $f(3i) = -24, f(i) = -8$

Sec 2.2

12) a) Using definition: require

$$\left| \frac{z}{1+z} - 1 \right| < \epsilon \quad \text{provided } |z| > r(\epsilon)$$

or $\left| \frac{z - (1+z)}{1+z} \right| < \epsilon$ or $\left| \frac{1}{1+z} \right| < \epsilon, |z| > r,$

b) Recall that: $|1+z| \geq |z| - 1 > 0$ if $|z| > 1$

Now take $|z| > r, r > 1$

$$|1+z| \geq |z| - 1 > r - 1 > 0 \quad (\text{triangle ineq.})$$

or $\frac{1}{|1+z|} < \frac{1}{r-1}$ where $r < |z|, |z| > 1, r > 1$

We require $\frac{1}{r-1} < \epsilon$ or $r-1 > 1/\epsilon$
or $r > 1 + 1/\epsilon$

If $r > 1 + 1/\epsilon$, then $\frac{1}{r-1} < \epsilon$ and

$$\frac{1}{|1+z|} < \epsilon \quad \text{as required [if } |z| > r \text{]}$$

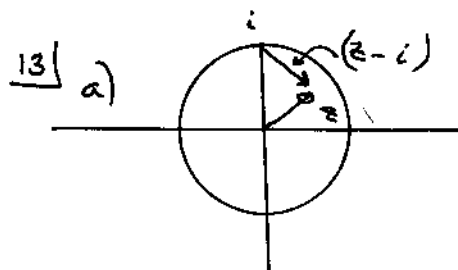

$|z-i|$ is max if

$$z = -i$$

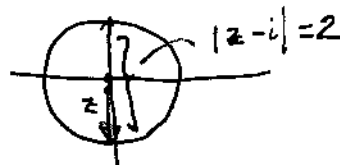

max $|z-i| = 2$, This occurs if $z = -i, M = 2$

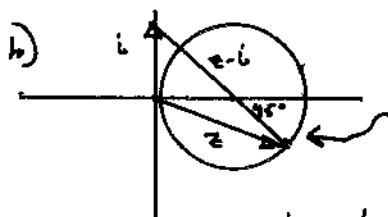

$|z-i|$ is max when $z-i$ goes thru center of circle

max is where $x = 1 + 1/\sqrt{2}, y = -1/\sqrt{2}$

$$|z-i| = \sqrt{\left(1 + \frac{1}{\sqrt{2}}\right)^2 + \left(-\frac{1}{\sqrt{2}}\right)^2} = \sqrt{2} \left[1 + \frac{1}{\sqrt{2}}\right] = 1 + \sqrt{2} \leq M$$

sec 2.2 cont'd

13 (c)

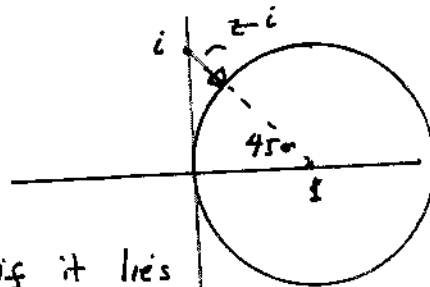

$|z-i|$ is min if it lies along line going thru center of circle

Occurs if $x = 1 - \frac{1}{\sqrt{2}}$, $y = \frac{1}{\sqrt{2}}$

What is $|z-i| = \sqrt{\left(1 - \frac{1}{\sqrt{2}}\right)^2 + \left(\frac{1}{\sqrt{2}}\right)^2}$

$= \sqrt{2} \left[1 - \frac{1}{\sqrt{2}}\right] = \sqrt{2} - 1 \quad \therefore M = \frac{1}{|z-i|} \Big|_{z=i}^{\text{min}} = \frac{1}{\sqrt{2} - 1}$

14 (a) $z^2 = x^2 - y^2 + i2xy$

$\text{Im}(z^2) = 2xy$ is continuous

$\therefore xy$ is continuous.

(b) The real part of g is xy which we know to be continuous

x is continuous $= \text{Re}(z)$, y is continuous $= \text{Im}(z)$

$\therefore x+y$ is continuous, and the imaginary part of $g(x,y)$ is continuous. Since the real part is continuous too, $g(x,y)$ must be continuous.

15] Consider $g(z) = 1 + \frac{1}{z^2}$ which does not have a limit as $z \rightarrow 0$ [becomes unbounded] and $h(z) = 1 - \frac{1}{z^2}$ which does not have a limit as $z \rightarrow 0$, for the same reason.

Let $f(z) = g(z) + h(z) = 2$ has a limit everywhere.

sec 2.2 cont'd

$$16) \left. \begin{aligned} g(z) &= 1 & \text{if } x \geq 0 \\ g(z) &= -1 & \text{if } x < 0 \end{aligned} \right\} \begin{array}{l} \text{no limit if} \\ x=0 \end{array}$$

$$\left. \begin{aligned} h(z) &= -1 & \text{if } x \geq 0 \\ h(z) &= 1 & \text{if } x < 0 \end{aligned} \right\} \begin{array}{l} \text{has no limit if} \\ x \neq 0 \end{array}$$

$g(z)h(z) = -1$ if $x \neq 0$, but has a limit of -1 everywhere in complex plane.

17 Assume $f(z)$ has a limit as $z \rightarrow z_0$

$$f(z) = g(z) + h(z), \quad f(z) - g(z)$$

has a limit as $z \rightarrow z_0$ (see Eq. 2.2-10 a)

But $f(z) - g(z) = h(z)$ and $h(z)$ by assumption does not have a limit as $z \rightarrow z_0$.

Thus we contradict ourselves by assuming that $g(z) + h(z)$ has a limit as $z \rightarrow z_0$

$$18) \text{ a) want } \left| \frac{1}{z} \right| > \rho \text{ for all } 0 < |z| < \delta$$

If $\left| \frac{1}{z} \right| > \rho$, $|z| < 1/\rho$. \therefore If take $\delta = 1/\rho$, we

have $\left| \frac{1}{z} \right| > \rho$ if $0 < |z| < \delta = 1/\rho$

$$\text{b) need } \left| \frac{1}{z-i} \right|^2 > \rho \text{ for } 0 < |z-i| < \delta$$

If $\left| \frac{1}{z-i} \right|^2 > \rho$, then $|z-i|^2 < 1/\rho$, $|z-i| < \sqrt{1/\rho}$

$$\therefore \text{ take } \delta = \sqrt{1/\rho}$$

c) In real calculus, one distinguishes between ∞ and $-\infty$.

Thus $\lim_{x \rightarrow 0^+} 1/x = \infty$ and $\lim_{x \rightarrow 0^-} 1/x = -\infty$ but

$\lim_{x \rightarrow 0} \frac{1}{x}$ does not exist [compare right and left hand limits]

See Thomas' Calculus, 10th ed, p. 115.

$$\text{d) Need } |z^2| > \rho \text{ for } |z| > r. \quad |z|^2 > \rho \text{ implies } |z| > \sqrt{\rho}$$

$$\therefore r = \sqrt{\rho}$$

Sec 2.3

```
%code for plots in probs 1 and 2
x1=linspace(-1,1,100);
y1=sin(abs(x1));
x2=linspace(0,2,1000);
y2=(abs(x2-1)).^(2/3);
% note, you cannot use (x2-1).^2/3 as it will not give
% the real root, but a complex one if x<1.The plot
% would be of real part
plot(x1,y1,x2,y2);grid;text(.1,.41,'problem 1')
text(1.1,.1,'problem 2')
title('problems 1 and 2 plots')
```

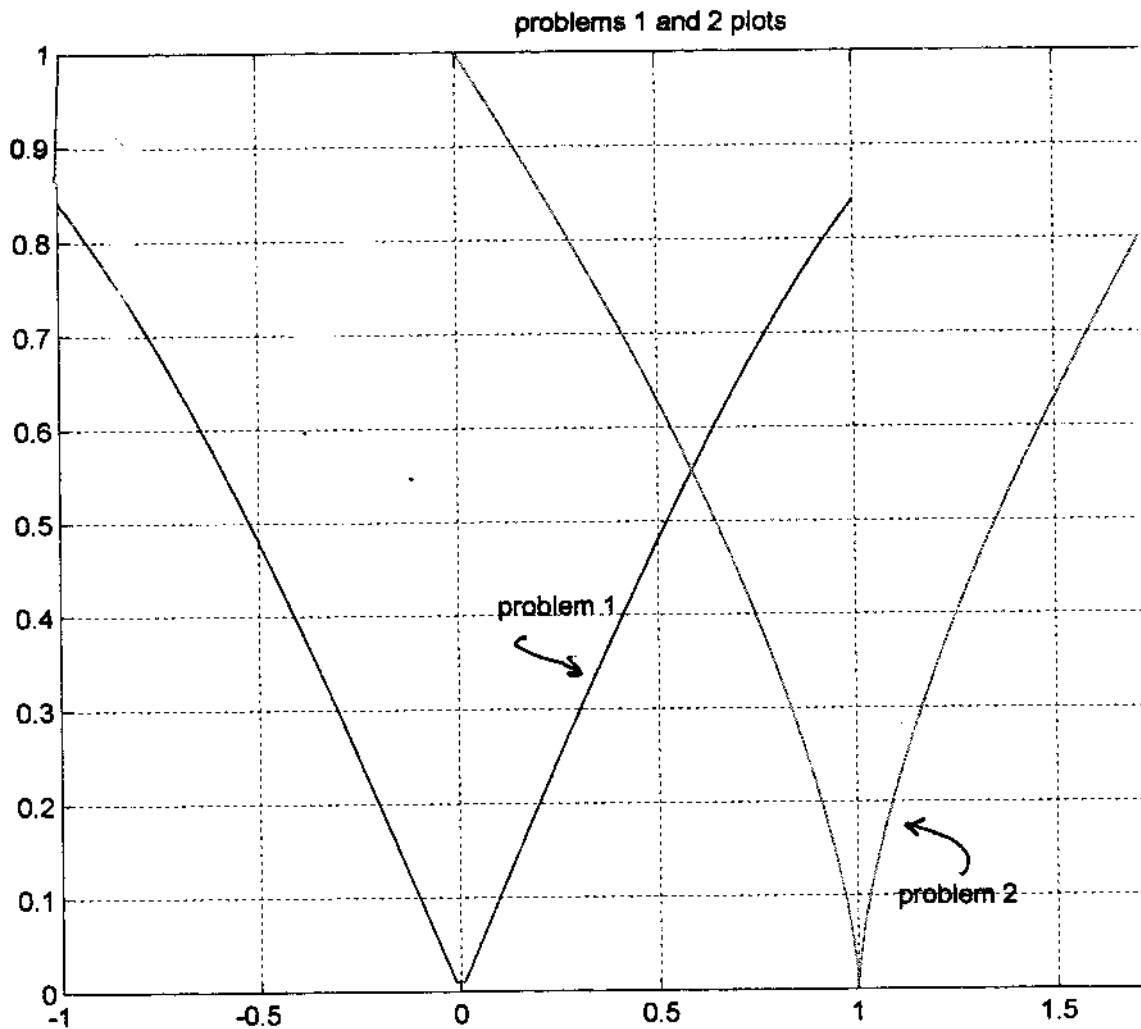

Sec 2.3



$\sin|x|$ is continuous at $x=0$ but has no deriv. at $x=0$
[See previous pg.]

2) $(x-1)^{2/3} = \left[\sqrt[3]{x-1} \right]^2$ if $x \geq 1$ [real root]

$\rightarrow (x-1)^{2/3} = \left[\sqrt[3]{|x-1|} \right]^2$ if $x \leq 1$

$\frac{2\pi}{3} + \frac{2k\pi}{3}$ $k=0,1,2$

put $k=2$ for real root

$= \left[\sqrt[3]{|x-1|} \right]^2$

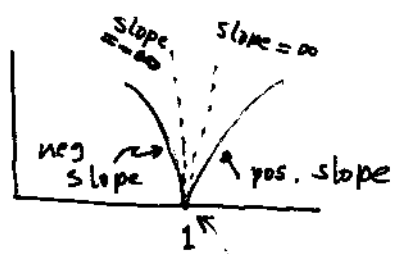

continuous at $x=1$, but $f'(1)$ does not exist
no deriv at $x=1$

3)

$$\lim_{\Delta z \rightarrow 0} \frac{f(z+\Delta z) - f(z)}{\Delta z} = \frac{\overline{z+\Delta z} - \overline{z}}{\Delta z}$$

$$= \frac{\overline{\Delta z}}{\Delta z} = \frac{|\Delta z| e^{-i \arg \Delta z}}{|\Delta z| e^{i \arg \Delta z}} = e^{-2i \arg(\Delta z)}$$

$\lim_{\Delta z \rightarrow 0}$

The preceding result depends on $\arg(\Delta z)$ and should be independent of direction ($\arg \Delta z$) if the limit is to exist.

sec 2.3

4] $f(z) = c$ $\frac{f(z+\Delta z) - f(z)}{\Delta z} = 0$

for all z . Deriv. exists for all z .

Can use C-R eqns too.

5] $u = 1, v = y$

$\frac{\partial u}{\partial x} = 0, \frac{\partial v}{\partial y} = 1$ $0 \neq 1$ nowhere

Deriv. exists nowhere.

6] $\frac{d}{dz} z^6 = 6z^5$ for all z [See. Ex. (2.3-4)]

7] $\frac{d}{dz} z^{-5} = -5z^{-6}$ all $z \neq 0$

8] $u = y, v = x$ $\frac{\partial u}{\partial x} = \frac{\partial v}{\partial y} = 0$

$\frac{\partial u}{\partial y} = 1, \frac{\partial v}{\partial x} = 1$ $\frac{\partial u}{\partial y} \neq -\frac{\partial v}{\partial x}$

No deriv. anywhere

9] $u = xy, v = xy$

$\frac{\partial u}{\partial x} = y, \frac{\partial v}{\partial y} = x$

$\frac{\partial u}{\partial x} = \frac{\partial v}{\partial y} \Rightarrow x = y$

$\frac{\partial u}{\partial y} = x, \frac{\partial v}{\partial x} = y$ $\frac{\partial u}{\partial y} = -\frac{\partial v}{\partial x} \Rightarrow x = -y$

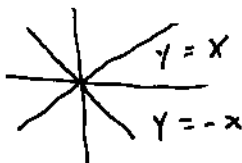

only solution $x=0, y=0$, or $z=0$

10] $u = x^2, v = y, \frac{\partial u}{\partial x} = 2x, \frac{\partial v}{\partial y} = 1$

$2x = 1, x = 1/2$ $\frac{\partial u}{\partial y} = -\frac{\partial v}{\partial x} = 0$

∴ Have deriv if $x = 1/2, -\infty < y < \infty$

or $\text{Re}(z) = 1/2$

Sec 2.3

11) $f(z) = x + iy$ Suppose $y > 0$

$f(z) = x + iy = z$ has a derivative

Thus $f(z)$ has a derivative for $\text{Im}(z) > 0$

Suppose $y < 0$ $f(z) = x - iy$

$$u = x, v = -y \quad \frac{\partial u}{\partial x} = 1 \neq \frac{\partial v}{\partial y} = -1, \text{ No deriv. if } y < 0$$

Suppose $y = 0$, is there a deriv?

Let $z_0 = x_0$, Take $\Delta z = i \Delta y$

$$\lim_{\Delta z \rightarrow 0} \frac{f(z_0 + \Delta z) - f(z_0)}{\Delta z} = \lim_{\Delta y \rightarrow 0} \frac{x_0 + i|\Delta y| - x_0}{i \Delta y} = \lim_{\Delta y \rightarrow 0} \frac{|\Delta y|}{\Delta y}$$

= 1 if $\Delta y > 0$, and = -1 if $\Delta y < 0$. Thus the limit does not exist if $y = 0$. To summarize:

$x + iy$ has a deriv. if and only if $\text{Im}(z) > 0$

or $y > 0$

12) $u = e^x, v = e^{2y}, \frac{\partial u}{\partial x} = \frac{\partial v}{\partial y}$

Means $e^x = 2e^{2y}, \frac{\partial u}{\partial x} = 0 = -\frac{\partial v}{\partial x}$ is satisfied.

$$e^x = 2e^{2y} \quad e^{x-2y} = 2, \quad x-2y = \text{Log } 2 \quad \text{(natural log)}$$

$y = \frac{x}{2} - \frac{1}{2} \text{Log } 2$ deriv exists on this line.

13) $u = y - 2xy, v = -x + x^2 - y^2$

$$\frac{\partial u}{\partial x} = -2y, \frac{\partial v}{\partial y} = -2y \quad \frac{\partial u}{\partial y} = 1 - 2x, \frac{\partial v}{\partial x} = -1 + 2x \quad \text{all } x, y$$

$$\frac{\partial u}{\partial y} = 1 - 2x, \frac{\partial v}{\partial x} = -1 + 2x, \frac{\partial u}{\partial x} = -2y, \frac{\partial v}{\partial y} = -2y$$

for all x, y , Thus deriv. exists everywhere in z plane.

Sec 2.3

14] $f(z) = (x-1)^2 + iy^2 + z^2$. Note: z^2 has a deriv for all z , \therefore We must find where

$(x-1)^2 + iy^2$ has a deriv.

$u = (x-1)^2, v = y^2, \frac{\partial u}{\partial x} = 2(x-1)$

$\frac{\partial v}{\partial y} = 2y$

$2(x-1) = 2y$

$(y = x-1)$, Note:

$\frac{\partial u}{\partial y} = -\frac{\partial v}{\partial x} = 0$ all z . Thus the derivative

of $(x-1)^2 + iy^2 + z^2$ exists only on the line $y = x-1$

15] $u = \cos x, v = -\sinh y$

$\frac{\partial u}{\partial x} = -\sin x, \frac{\partial v}{\partial y} = -\cosh y$

Note $\frac{\partial u}{\partial y} = -\frac{\partial v}{\partial x} = 0$

$\therefore \sin x = \cosh y$

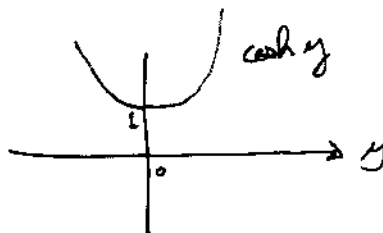
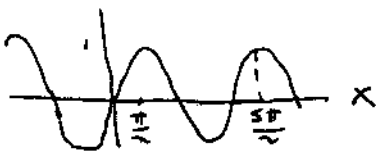

For solution, $y=0, x = \frac{\pi}{2}, \frac{5\pi}{2}, \frac{9\pi}{2}$

or $x = -\frac{3\pi}{2}, x = -\frac{7\pi}{2}, x = -\frac{11\pi}{2}$ equivalently: $x = \frac{\pi}{2} + 2n\pi, n=0,1,2,\dots$

16] Suppose $f(z) = 1/z, |z| > 1, f'(z) = -1/z^2$

deriv. exists. Suppose $f(z) = z, |z| < 1,$

$f'(z) = 1$. Let $1/z = z, z = \pm 1$.

On the circle $|z| = 1, f(z)$ is discontinuous except at $z = \pm 1$, so there is no derivative on the circle $|z| = 1$, except possibly at $z = \pm 1$. Now suppose you compute $f'(z)$ at $z = 1$, Take $\frac{\partial u}{\partial x} + i\frac{\partial v}{\partial x}$, $= \frac{f(x+\Delta x) - f(x)}{\Delta x} |_{z=1}$ get 1 if $\Delta x < 0$, get -1 if $\Delta x > 0$

\therefore The limit does not exist. A similar argument holds at $z = -1$, i.e. the limit does not exist. $f(z)$ has a derivative for all z except on circle $|z| = 1$.

Sec 2.3

17] \bar{z} has a derivative nowhere

let $g(z) = z + \bar{z} = 2x$, let $h(z) = z - \bar{z} = 2iy$

$g(z)$ and $h(z)$ have derivatives nowhere.

$f(z) = g(z) + h(z) = 2z$ has a derivative, all z .

18] If $\frac{d^2 f}{dz^2}$ exists, then $\frac{df}{dz}$ must exist. We

have from Eq. (2.3-6) that $\frac{df}{dz} = \frac{\partial u}{\partial x}(x,y) + i \frac{\partial v}{\partial x}(x,y)$

take $\Delta z = \Delta x$

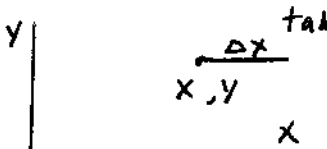

Thus $\frac{d^2 f}{dz^2} =$

$$\text{Thus } \frac{d^2 f}{dz^2} = \lim_{\Delta x \rightarrow 0} \left[\frac{\frac{\partial u(x+\Delta x, y)}{\partial x} + i \frac{\partial v(x+\Delta x, y)}{\partial x} - \frac{\partial u(x, y)}{\partial x} - i \frac{\partial v(x, y)}{\partial x}}{\Delta x} \right]$$

$$\frac{d^2 f}{dz^2} = \lim_{\Delta x \rightarrow 0} \left[\frac{\frac{\partial u(x+\Delta x, y)}{\partial x} - \frac{\partial u(x, y)}{\partial x}}{\Delta x} + i \frac{\frac{\partial v(x+\Delta x, y)}{\partial x} - \frac{\partial v(x, y)}{\partial x}}{\Delta x} \right]$$

$$= \frac{\partial^2 u}{\partial x^2} + i \frac{\partial^2 v}{\partial x^2} \quad (\text{first required identity})$$

Have from (2.3-8) that $\frac{df}{dz} = \frac{\partial v}{\partial y} - i \frac{\partial u}{\partial y}$

Take $\Delta z = i\Delta y$

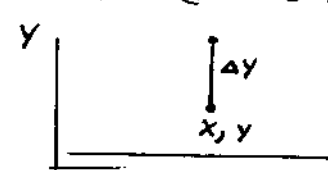

$$\text{Thus } \frac{d^2 f}{dz^2} = \lim_{\Delta y \rightarrow 0} \frac{\frac{\partial}{\partial y} v(x, y+\Delta y) - i \frac{\partial}{\partial y} u(x, y+\Delta y) - \frac{\partial}{\partial y} v(x, y) + i \frac{\partial}{\partial y} u(x, y)}{i\Delta y}$$

$$= \lim_{\Delta y \rightarrow 0} \left[\frac{\frac{\partial}{\partial y} u(x, y+\Delta y) - \frac{\partial}{\partial y} u(x, y)}{\Delta y} - i \frac{\frac{\partial}{\partial y} v(x, y+\Delta y) - \frac{\partial}{\partial y} v(x, y)}{\Delta y} \right]$$

$$= -\frac{\partial^2 u}{\partial y^2} - i \frac{\partial^2 v}{\partial y^2} = \frac{d^2 f}{dz^2} \quad (\text{second required identity})$$

19

We must show that $\lim_{z \rightarrow z_0} f(z) = f(z_0)$
or, equivalently, that $\lim_{\Delta z \rightarrow 0} f(z_0 + \Delta z) = f(z_0)$

$$\text{NOW } \lim_{\Delta z \rightarrow 0} \left[\frac{f(z_0 + \Delta z) - f(z_0)}{\Delta z} \right] \lim_{\Delta z \rightarrow 0} \Delta z =$$

$f'(z_0) \Delta z = 0$. Now apply Theorem 1(b).

$$\lim_{\Delta z \rightarrow 0} \left[\frac{f(z_0 + \Delta z) - f(z_0)}{\Delta z} \right] \lim_{\Delta z \rightarrow 0} \Delta z = \lim_{\Delta z \rightarrow 0} \left[\frac{f(z_0 + \Delta z) - f(z_0)}{\Delta z} \Delta z \right]$$

$$= \lim_{\Delta z \rightarrow 0} [f(z_0 + \Delta z) - f(z_0)] \quad \leftarrow \text{We have just proved this to be zero.}$$

THUS $\lim_{\Delta z \rightarrow 0} f(z_0 + \Delta z) - f(z_0) = 0$ or

$\lim_{\Delta z \rightarrow 0} f(z_0 + \Delta z) = f(z_0)$ which is equivalent
to $\lim_{z \rightarrow z_0} f(z) = f(z_0)$, as required.

Section 2.4

1)

$$U = XY, V = XY + X$$

$$\frac{\partial U}{\partial x} = Y \quad \frac{\partial V}{\partial y} = X$$

$$\therefore Y = X$$

$$\frac{\partial U}{\partial y} = X, \quad \frac{\partial V}{\partial x} = Y + 1$$

$$\therefore X = -Y - 1$$

$$X = -X - 1$$

$$X = -1/2 \\ Y = 1/2$$

deriv at $z = \frac{-1 - i}{2}$

$$f'(z) = \frac{\partial U}{\partial x} + i \frac{\partial V}{\partial x} \quad Y + i(Y+1) \Big|_{Y=1/2} = \frac{-1}{2} + \frac{i}{2} = f'(z)$$

f(z) not analytic anywhere, since its deriv. does not exist in a domain - only at one point.

2)

a) Note $1/z$ has a deriv for all $z \neq 0$

Look @ deriv. of $(x-1)^2 + ixy$, $u = (x-1)^2, v = xy$

$$\frac{\partial U}{\partial x} = \frac{\partial V}{\partial y}$$

$$2(x-1) = x$$

$$2x - 2 = x$$

$$x = 2$$

$$\frac{\partial U}{\partial y} = -\frac{\partial V}{\partial x}$$

$$0 = -y, \quad y = 0$$

Deriv only at $z = 2$

$$f'(z) = -1/z^2 + \frac{\partial U}{\partial x} + i \frac{\partial V}{\partial x} \quad \text{where } U = (x-1)^2 \\ V = xy$$

$$f'(z) = -\frac{1}{z^2} + 2(x-1) + iy$$

$$f'(2) = -\frac{1}{4} + 2 + i0 = 13/4 = 7/4$$

b) Function nowhere analytic, since deriv. does not exist in a domain.

3) a) $z^3 + \bar{z} + 1$ is a sum of entire functions and is analytic everywhere

b) $f'(z) = 3z^2 + 2\bar{z}$

$$f'(1+i) = 3[1+i]^2 + 2+2i = 2+8i$$

4) z^2 has a deriv. everywhere. cont'd

a) what about $(x-1)^2 + i(y-1)^2$

$$W = (x-1)^2, \quad V = (y-1)^2$$

$$\frac{\partial W}{\partial x} = 2(x-1) = \frac{\partial V}{\partial y} = 2(y-1)$$

$$(x-1) = (y-1)$$

$$x = y$$

$$\frac{\partial W}{\partial y} = 0 = -\frac{\partial V}{\partial x} \text{ is satisf. everywhere}$$

$z^2 + (x-1)^2 + i(y-1)^2$ has a deriv. only along the line $x = y$.

b)  deriv. along here.
Not a domain

c) $f'(z) = 2z + \frac{\partial W}{\partial x} + i \frac{\partial V}{\partial x}$
 $= 2z + 2(x-1) = 2 + 2i$ at $1, 1$

For any z_0 on this line, any neighborhood of z_0 will contain pts where $f'(z_0)$ does not exist. function is nowhere analytic

5 (a) $f(z) = \frac{1}{e^{2x} \cos 2y + i e^{2x} \sin 2y}$

Note: the denom $\neq 0$ proof:

$$e^{2x} \cos 2y + i e^{2x} \sin 2y = 0$$

$$\cos 2y + i \sin 2y = 0 \quad \text{since } e^{2x} \neq 0$$

$$|\cos 2y + i \sin 2y| = 1 \neq 0$$

$$f(z) = \frac{e^{2x} \cos 2y - i e^{2x} \sin 2y}{[e^{2x} \cos 2y]^2 + [e^{2x} \sin 2y]^2} =$$

$$= \frac{e^{2x} \cos 2y - i e^{2x} \sin 2y}{e^{4x} [\cos^2 + \sin^2]} = e^{-2x} \cos 2y - i e^{-2x} \sin 2y$$

Sec 2.4 cont'd

5(a) cont'd

$$u = e^{-2x} \cos 2y, \quad v = -e^{-2x} \sin 2y$$

$$\frac{\partial u}{\partial x} = -2e^{-2x} \cos 2y = \frac{\partial v}{\partial y} = -2e^{-2x} \cos 2y$$

$$\frac{\partial u}{\partial y} = -2e^{-2x} \sin 2y = -\frac{\partial v}{\partial x}$$

These are satisfied everywhere. Have an entire function.

$$5(b) \quad f'(z) = \frac{\partial u}{\partial x} + i \frac{\partial v}{\partial x} = -2e^{-2x} \cos 2y + i 2e^{-2x} \sin 2y$$

$$\text{at } 1 + i\pi/4 \text{ this equals: } -2e^{-2} \cos \frac{\pi}{2} + i 2e^{-2} \sin \frac{\pi}{2} \\ = 12e^{-2}$$

$$6) \quad a) \quad f(z) = z [\cos x \cosh y - i \sin x \sinh y]$$

Since z is an entire function, we need only show that $\cos x \cosh y - i \sin x \sinh y$ is entire. Product of entire functions is entire. Take $u = \cos x \cosh y$, $v = -\sin x \sinh y$

$$\frac{\partial u}{\partial x} = -\sin x \cosh y = \frac{\partial v}{\partial y} \quad \text{satisf. everywhere}$$

$$\frac{\partial v}{\partial x} = -\cos x \sinh y = -\frac{\partial u}{\partial y} \quad \text{satisf. everywhere}$$

∴ expression in brackets is entire function

$$b) \quad \frac{df}{dz} = [\cos x \cosh y - i \sin x \sinh y] +$$

$$z \frac{d}{dz} [\cos x \cosh y - i \sin x \sinh y]$$

$$= [\cos x \cosh y - i \sin x \sinh y] + z [\sin x \cosh y - i \cos x \sinh y]$$

used $\frac{\partial u}{\partial x} + i \frac{\partial v}{\partial x}$ \uparrow

6) cont'd

Sec 2.4

For $f'(i)$ put $x=0, y=1, z=i$

$$f'(i) = [\cosh 1] + i [-i \sinh 1]$$

$$= \cosh 1 + \sinh 1 = e$$

7) Let $u = \sin x \cosh y, v = \cos x \sinh y$

$$\frac{\partial u}{\partial x} = \cos x \cosh y = \frac{\partial v}{\partial y}$$

$$\frac{\partial v}{\partial x} = -\sin x \sinh y = -\frac{\partial u}{\partial y}$$

} satisfied
all x, y

$\therefore \sin x \cosh y + i \cos x \sinh y$ is an entire function

$$\frac{d}{dz} [\sin x \cosh y + i \cos x \sinh y]^5$$

$$= 5 [\sin x \cosh y + i \cos x \sinh y]^4 \text{ times}$$

$$\frac{d}{dx} [\sin x \cosh y + i \cos x \sinh y]$$

$$= 5 [\sin x \cosh y + i \cos x \sinh y]^4 \left[\frac{\partial u}{\partial x} + i \frac{\partial v}{\partial x} \right]$$

$$= 5 [\sin x \cosh y + i \cos x \sinh y]^4 [\cos x \cosh y - i \sin x \sinh y]$$

put $x=\pi, y=2$

$$5 [\sin \pi \cosh 2 + i \cos \pi \sinh 2]^4 [\cos \pi \cosh 2 - i \sin \pi \sinh 2]$$

$$= 5 [\sinh 2]^4 (-\cosh 2)$$

Sec 2.4 cont'd

8(a) z is entire
 $(1+iz)$ is entire func.

$\frac{z}{(1+iz)^4}$ is analytic except where

$$1+iz = 0 \quad \text{or} \quad z = -i$$

$$b) f'(z) = \frac{(1+iz)^{-4} - (z)^4 (1+iz)^{-5} i}{(1+iz)^8}$$

put $z = -i$

$$f'(-i) = \frac{2^4 + (i)^2 (4)(2)^3}{2^8} = \boxed{-\frac{1}{16}}$$

9) L'Hopital's rule applies since $g(i) = 0 = h(i)$
and $h'(i) = 2z - 3i \neq 0$ if $z = i$.

$$\lim_{z \rightarrow i} \frac{g}{h} = \lim_{z \rightarrow i} \frac{1 + 2z}{2z - 3i} = \frac{1 + 2i}{2i - 3i} = \frac{1 + 2i}{-i} = \boxed{i - 2}$$

10) L'Hopital's rule applies since $g(i) = 0 = h(i)$
and $h'(i) = 3z^2 + 1 \Big|_{z=i} = -2 \neq 0$

$$\lim_{z \rightarrow i} \frac{g}{h} = \lim_{z \rightarrow i} \frac{3z^2}{3z^2 + 1} \Big|_{z=i} = \frac{-3}{-2} = \frac{3}{2}$$

Sec 2.4 cont'd

11] Let $f(z) = g(z) + h(z)$.

Assume $f(z)$ has a deriv. at z_0 .

$f(z) - g(z)$ has a deriv at z_0

which equals $f'(z_0) - g'(z_0)$

[See Theorem 4, part (a)]

But $f'(z_0) - g'(z_0) = h'(z_0)$ which is known not to exist. \therefore you have obtained a contradiction by assuming that $f'(z_0)$ exists

12] Let $g(z) = x + iy$,

$$h(z) = -iy$$

$g(z) + h(z) = x + iy$ which has a derivative everywhere, is thus analytic.

Note that neither $g(z)$ or $h(z)$

satisfies the C-R eqns. anywhere in complex plane

13] (a) $f(z) = g(z)h(z)$

$$h(z) = f(z)/g(z) \quad \text{assuming } g(z) \neq 0$$

Now according to theorem 5, the quotient $f(z)/g(z)$ must be analytic at z_0 . But $f(z)/g(z) = h(z)$ which by assumption is not analytic at z_0 . \therefore you have obtained a contradiction by assuming that $g(z)h(z)$ is analytic.

sec 2.4 cont'd

14) Try $g(z) = \frac{z}{x} = 1 + i \frac{y}{x}$

which is nowhere analytic.

Try $h(z) = x$ which is nowhere analytic.

$g(z)h(z) = z$ which is entire.

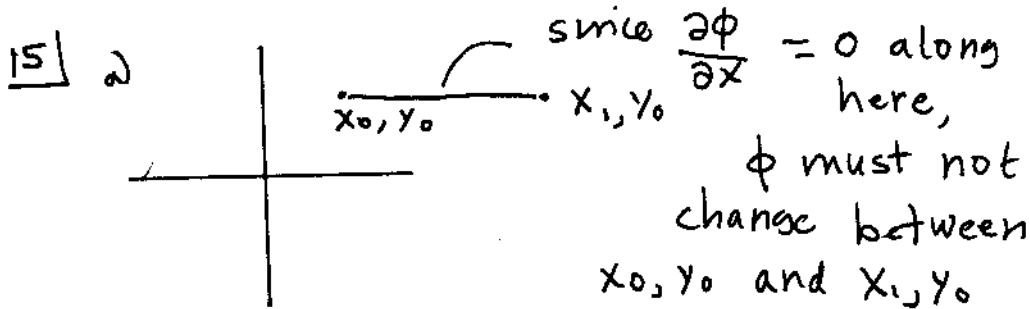

The same argument works here

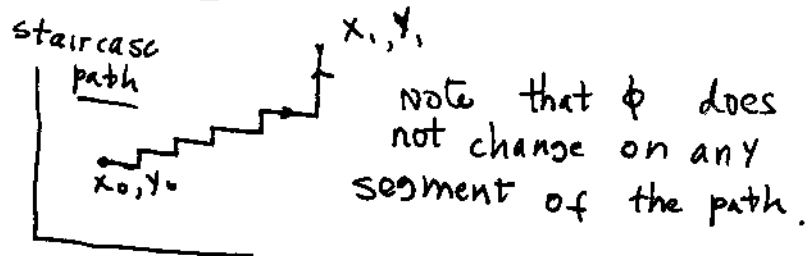
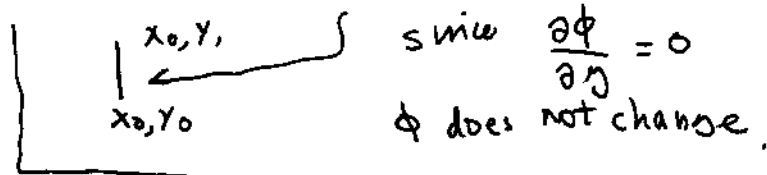

b) $\frac{\partial W}{\partial x} = \frac{\partial V}{\partial y}$ ← but $V = 0$ because func. is real

$\frac{\partial W}{\partial y} = -\frac{\partial V}{\partial x}$



$\frac{\partial W}{\partial x} = 0, \frac{\partial W}{\partial y} = 0$

W is constant
 from argument in part (a).

Note: if $f(z)$ is imag. $f(z) = 0 + iV$, $W = 0$
 and an analogous argument applies: V is constant.

sec 2.4 cont'd

16) $f(z) = u + iv$ is analytic. Assume $g(z) = u - iv$ is too.
 $f+g$ must be analytic, $2u(x,y) = f+g$ is real
 $\therefore u$ is constant. Now look at $f-g = 2iv$. $f-g$
the difference of 2 analytic functions is analytic and
purely imaginary. $\therefore v(x,y)$ is constant. This completes the proof
that f and g are constant

$$17) |u + iv| = k, \quad \bar{u} + v = k^2$$

$$\frac{k^2}{(u+iv)(u-iv)} = 1, \quad \frac{k^2}{u+iv} = u-iv$$

Now $\frac{k^2}{u+iv}$ is analytic. Thus $u-iv$
is analytic, however, if both $u+iv$
and $u-iv$ are analytic, then u and
 v are constants (see prev. problem).
Thus $f(z)$ is constant.

$$18) (a) f(z) = u(x,y) + iv(x,y)$$

$$f(\bar{z}) = \bar{f}(z) = u - iv \text{ by assumption}$$

Now, assume $f(\bar{z})$ is analytic

$f(z) + f(\bar{z})$ is analytic

$\therefore f(z) + \bar{f}(z)$ is analytic = $2u(x,y)$ (a real)

By problem 15, $u(x,y)$ is constant. (func.)

$f(z) - f(\bar{z})$ is analytic = $f(z) - \bar{f}(z) = 2iv(x,y)$

But $v(x,y)$ must be constant, by prob 15 (b)

$\therefore f(z)$ is constant, since u and v are.

(b) next pg.

sec 2.4 cont'd

18 (b) $f(z) = z^3 + z$ is entire and not constant. $f(\bar{z}) = (\bar{z})^3 + \bar{z} = \overline{(z^3 + z)}$

Since $f(\bar{z}) = \overline{f(z)}$ and $f(z)$ is entire and not constant then $f(\bar{z}) = (\bar{z})^3 + \bar{z}$ is not analytic anywhere in complex plane.

19

a) Assume $(\bar{z}+1)^2$ has a derivative.

Then, following the chain rule

$$\frac{d}{d\bar{z}} (\bar{z}+1)^2 = \left. \frac{d}{d\bar{z}} (z+1)^2 \right|_{\bar{z}} \cdot \frac{d\bar{z}}{d\bar{z}} = 2(\bar{z}+1) \frac{d\bar{z}}{d\bar{z}}$$

But $\frac{d\bar{z}}{d\bar{z}}$ does not exist. However if $\bar{z}+1=0$ or $z=-1$, the derivative might still exist. But the existence of the derivative at one point will not yield analyticity. (require a deriv. in a domain).

b) Assume $(\bar{z})^3$ has a derivative. Then, following the chain rule we have:

$$\frac{d}{d\bar{z}} (\bar{z})^3 = \left. \frac{d}{d\bar{z}} z^3 \right|_{z=\bar{z}} \cdot \frac{d\bar{z}}{d\bar{z}} = 3\bar{z}^2 \frac{d\bar{z}}{d\bar{z}}$$

But $d\bar{z}/d\bar{z}$ does not exist. Thus the above derivative $\frac{d}{d\bar{z}} (\bar{z})^3$ does not exist except possibly where $3\bar{z}^2 = 0$ [$z=0$]. But the existence of the derivative at one point will not produce analyticity.

201
 a) $f(t) = \cos t + i \sin t = e^{it} = 1 \angle t$. As t goes from 0 to 2π we trace out a unit circle.

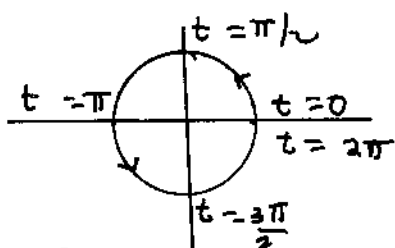

b) $f'(t) = -\sin t + i \cos t =$

$$\cos\left(t + \frac{\pi}{2}\right) + i \sin\left(t + \frac{\pi}{2}\right) = 1 \angle \left(t + \frac{\pi}{2}\right)$$

Note that the vectors $1 \angle t$ and $1 \angle \left(t + \frac{\pi}{2}\right)$ are perpendicular to each other.

c) The position and velocity vectors are at right angles because the motion is along a circle. The velocity vector is tangent to the circle at each point.

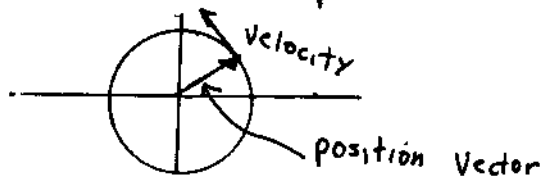

20/

sec 2.4 cont'd

(c) cont'd $f'(t) = -\sin t + i \cos t$

$f''(t) = -\cos t - i \sin t =$

$= \cos(t+\pi) + i \sin(t+\pi) = 1 \angle t+\pi$

The velocity is $1 \angle t+\pi/2$. The angles differ by $\pi/2$, so the vectors are at rt. angles.

(d)

20
 % problem sec 2.4
 t=linspace(0,2*pi,100);
 f=cos(t)./(1+.5*(cos(t)+i*sin(t)));
 x=real(f);
 y=imag(f);
 plot(x,y);hold on
 t1=linspace(0,2*pi,9);
 f1=cos(t1)./(1+.5*(cos(t1)+i*sin(t1)));
 x1=real(f1);y1=imag(f1);
 plot(x1,y1,'*')

plot on next pg.

$$(e) \quad f'(t) = \frac{-\sin t - \frac{1}{2}i}{\left[1 + \frac{1}{2}[\cos t + i \sin t]\right]^2}$$

20
 % problem sec 2.4, part(e)
 t=linspace(0,2*pi,100);
 f=(-sin(t)-.5*i)./(1+.5*(cos(t)+i*sin(t))).^2;
 x=real(f);
 y=imag(f);
 plot(x,y);hold on
 t1=linspace(0,2*pi,9);
 f1=(-sin(t1)-.5*i)./(1+.5*(cos(t1)+i*sin(t1))).^2;
 x1=real(f1);y1=imag(f1);
 plot(x1,y1,'*');grid

plot is on pg. after next.

20 (d)

continued

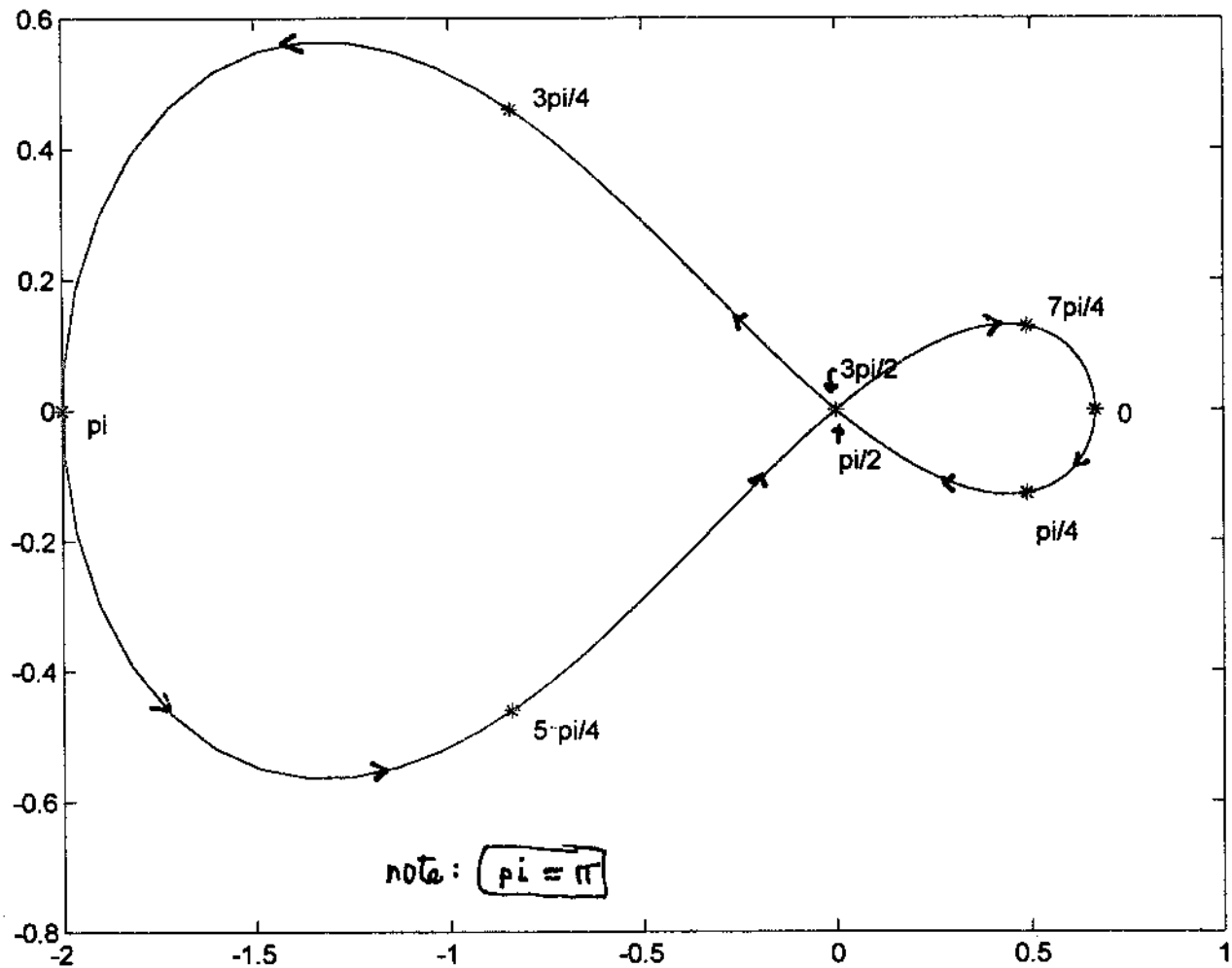

part d)

Problem 20 section 2.4

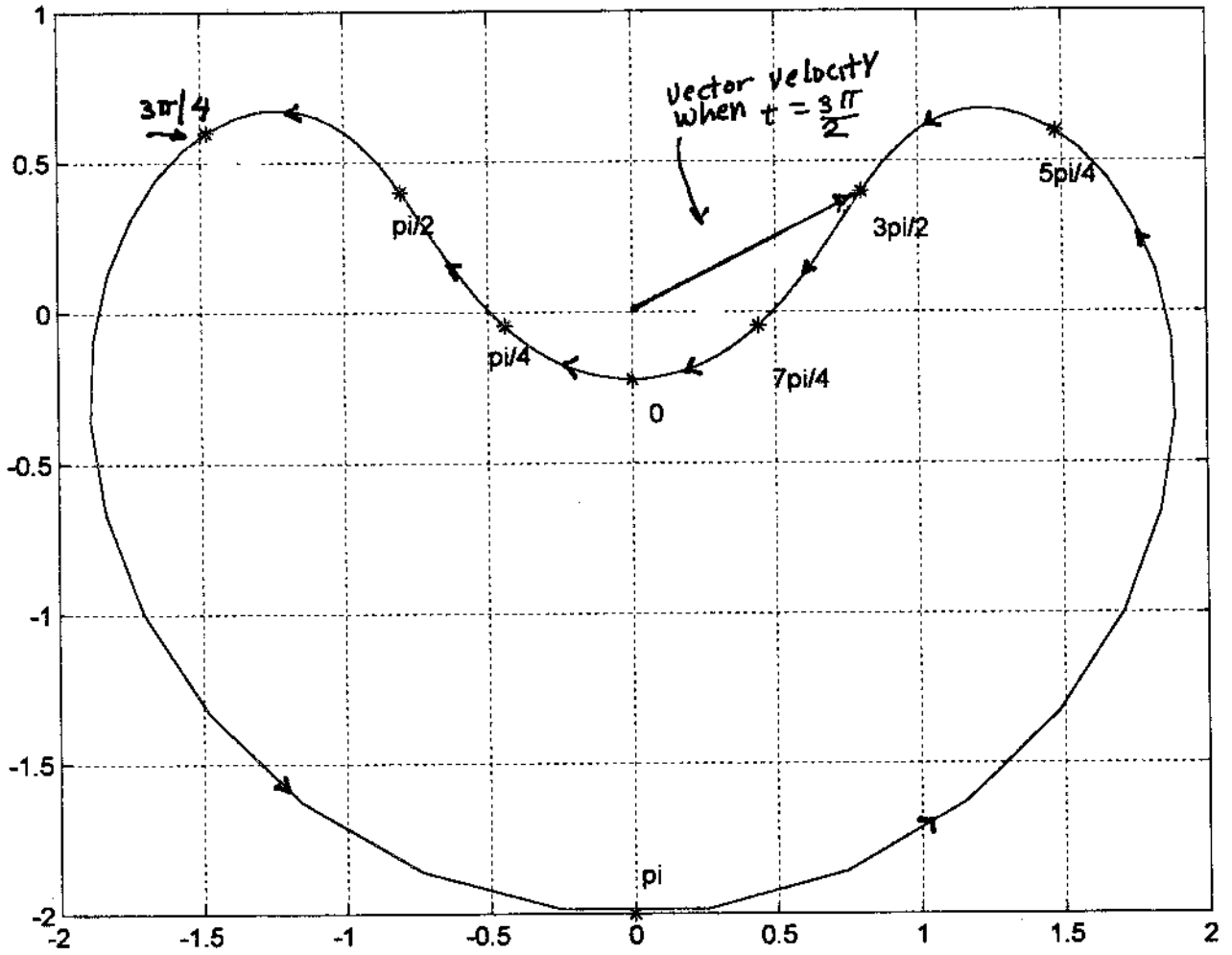

problem 20 section 2.4

211

sec 2.4,

$$\frac{\partial W}{\partial r} = \cos \theta, \quad \frac{1}{r} \frac{\partial V}{\partial \theta} = 0 \quad \therefore \cos \theta = 0$$

$$\frac{1}{r} \frac{\partial W}{\partial \theta} = -\frac{r \sin \theta}{r}, \quad \frac{\partial V}{\partial r} = 1$$

$$\frac{1}{r} \frac{\partial W}{\partial \theta} = -\frac{\partial V}{\partial r} \quad \circ \circ \quad \sin \theta = 1$$

If $\cos \theta = 0$ and $\sin \theta = 1$, then $\theta = \frac{\pi}{2}$

Derivative exists only on the ray $\theta = \frac{\pi}{2}$, $0 < r < \infty$. This is not a domain. $\circ \circ$ function not analytic.

221 $W = r^4 \sin 4\theta, \quad V = -r^4 \cos 4\theta$

$$\frac{\partial W}{\partial r} = 4r^3 \sin 4\theta, \quad \frac{1}{r} \frac{\partial V}{\partial \theta} = 4r^3 \sin 4\theta$$

$$\frac{\partial W}{\partial r} = \frac{1}{r} \frac{\partial V}{\partial \theta} \quad \text{for all } r \neq 0$$

$$\frac{1}{r} \frac{\partial W}{\partial \theta} = 4r^3 \cos(4\theta) = -\frac{\partial V}{\partial r} \quad \text{for all } r, \theta$$

The function is analytic for all $r \neq 0$

[that is for all $z \neq 0$]. If $z=0$ the proof breaks down

23]

$$u = u(r(x,y), \theta(x,y))$$

$$\text{Thus } \frac{\partial u}{\partial x} = \frac{\partial u}{\partial r} \bigg|_{\theta} \frac{\partial r}{\partial x} \bigg|_y + \frac{\partial u}{\partial \theta} \bigg|_r \frac{\partial \theta}{\partial x} \bigg|_y \quad [1]$$

$$\frac{\partial u}{\partial y} \quad (\text{same as [1] but swap } x \text{ and } y)$$

$$\frac{\partial v}{\partial x} \quad \text{same as [1] but put } v \text{ instead of } u$$

$$\frac{\partial v}{\partial y} \quad \text{same as [1] but put } v \text{ instead of } u, \text{ swap } x \text{ and } y.$$

$$(b) \quad r = \sqrt{x^2 + y^2}, \quad \frac{\partial r}{\partial x} \bigg|_y = \frac{x}{\sqrt{x^2 + y^2}} = \cos \theta$$

$$\theta = \tan^{-1}\left(\frac{y}{x}\right), \quad \frac{\partial \theta}{\partial x} \bigg|_y = \frac{1}{1 + y^2/x^2} \cdot \frac{-y}{x^2} = \frac{-y}{x^2 + y^2} = -\frac{y}{\sqrt{x^2 + y^2}} \cdot \frac{1}{\sqrt{x^2 + y^2}} = -\frac{\sin \theta}{r}$$

$$\frac{\partial r}{\partial y} \bigg|_x = \frac{y}{\sqrt{x^2 + y^2}} = \sin \theta, \quad \frac{\partial \theta}{\partial y} \bigg|_x = \frac{x}{\sqrt{x^2 + y^2}} \cdot \frac{1}{\sqrt{x^2 + y^2}} = \frac{\cos \theta}{r}$$

Use the preceding equations in [1]

$$\frac{\partial u}{\partial x} = \frac{\partial u}{\partial r} \cos \theta - \frac{\partial u}{\partial \theta} \frac{\sin \theta}{r}, \quad \frac{\partial v}{\partial x} = \frac{\partial v}{\partial r} \cos \theta - \frac{\partial v}{\partial \theta} \frac{\sin \theta}{r}$$

$$\frac{\partial u}{\partial y} = \frac{\partial u}{\partial r} \sin \theta + \frac{\partial u}{\partial \theta} \frac{\cos \theta}{r}$$

$$\frac{\partial u}{\partial y} = \frac{\partial u}{\partial r} \sin \theta + \frac{\partial u}{\partial \theta} \frac{\cos \theta}{r} \quad \text{similarly:}$$

$$\frac{\partial v}{\partial y} = \frac{\partial v}{\partial r} \sin \theta + \frac{\partial v}{\partial \theta} \frac{\cos \theta}{r}$$

$$(c) \quad \frac{\partial u}{\partial x} = \frac{\partial v}{\partial y} \quad \text{from (2.3-10 a)}$$

Using result of part (b):

$$\frac{\partial u}{\partial r} \cos \theta - \frac{1}{r} \frac{\partial u}{\partial \theta} \sin \theta = \frac{\partial v}{\partial r} \sin \theta + \frac{1}{r} \frac{\partial v}{\partial \theta} \cos \theta \quad [2]$$

$$\frac{\partial v}{\partial x} = -\frac{\partial u}{\partial y} \quad \text{from (2-3-10 b)}$$

Sec 2.4 prob 23(c) Cont'd

$$\frac{\partial V}{\partial r} \cos \theta - \frac{1}{r} \frac{\partial V}{\partial \theta} \sin \theta = -\frac{\partial u}{\partial r} \sin \theta - \frac{1}{r} \frac{\partial u}{\partial \theta} \cos \theta \quad [3]$$

Multiply [3] by $\sin \theta$ and [2] by $\cos \theta$ and add [2] [3]

Subtract
$$\frac{\partial V}{\partial r} \sin \theta \cos \theta - \frac{1}{r} \frac{\partial u}{\partial \theta} \sin \theta \cos \theta$$

from each side of the result, you get:

$$\frac{\partial u}{\partial r} \cos^2 \theta - \frac{1}{r} \frac{\partial V}{\partial \theta} \sin^2 \theta = \frac{1}{r} \frac{\partial V}{\partial \theta} \cos^2 \theta - \frac{\partial u}{\partial r} \sin^2 \theta$$

$$\text{or } \frac{\partial u}{\partial r} [\cos^2 \theta + \sin^2 \theta] = \frac{1}{r} \frac{\partial V}{\partial \theta} [\sin^2 \theta + \cos^2 \theta]$$

$$\text{or } \frac{\partial u}{\partial r} = \frac{1}{r} \frac{\partial V}{\partial \theta} \quad \text{g.e.d. Now multiply [2] by } (-\sin \theta)$$

and [3] by $(\cos \theta)$. Add the resulting eqns.

and add
$$\frac{\partial u}{\partial r} \sin \theta \cos \theta + \frac{1}{r} \sin \theta \cos \theta \frac{\partial V}{\partial \theta}$$
 to each side of the

result. Get:

$$\frac{\partial V}{\partial r} \cos^2 \theta + \frac{1}{r} \frac{\partial u}{\partial \theta} \sin^2 \theta = -\frac{\partial V}{\partial r} \sin^2 \theta - \frac{1}{r} \frac{\partial u}{\partial \theta} \cos^2 \theta$$

$$\frac{\partial V}{\partial r} [\cos^2 \theta + \sin^2 \theta] = -\frac{1}{r} \frac{\partial u}{\partial \theta} [\cos^2 \theta + \sin^2 \theta]$$

$$\text{or } \frac{\partial V}{\partial r} = -\frac{1}{r} \frac{\partial u}{\partial \theta} \quad \text{g.e.d.}$$

$$(a) f'(z) = \frac{\partial u}{\partial x} + i \frac{\partial v}{\partial x} = \frac{\partial u}{\partial r} \cos \theta - \frac{1}{r} \frac{\partial u}{\partial \theta} \sin \theta$$

$$+ i \left[\frac{\partial v}{\partial r} \cos \theta - \frac{1}{r} \frac{\partial v}{\partial \theta} \sin \theta \right]. \quad \text{But } -\frac{1}{r} \frac{\partial u}{\partial \theta} = \frac{\partial v}{\partial r}$$

$$\text{and } -\frac{1}{r} \frac{\partial v}{\partial \theta} = -\frac{\partial u}{\partial r} \quad (\text{the polar form of C-R equations})$$

$$\text{Hence } f'(z) = \frac{\partial u}{\partial x} + i \frac{\partial v}{\partial x} = \frac{\partial u}{\partial r} \cos \theta + \sin \theta \frac{\partial v}{\partial r}$$

$$+ i \left[\frac{\partial v}{\partial r} \cos \theta - \frac{\partial u}{\partial r} \sin \theta \right] = \left(\frac{\partial u}{\partial r} + i \frac{\partial v}{\partial r} \right) (\cos \theta - i \sin \theta) \quad \text{g.e.d.}$$

To get the other form of $f'(z)$ put in the

preceding expression for $f'(z)$ the following: $\frac{\partial u}{\partial r} - \frac{1}{r} \frac{\partial v}{\partial \theta}$

$$\frac{\partial v}{\partial r} = -\frac{1}{r} \frac{\partial u}{\partial \theta} \quad \text{Thus } f'(z) = \left(\frac{1}{r} \frac{\partial v}{\partial \theta} - \frac{i}{r} \frac{\partial u}{\partial \theta} \right) (\cos \theta - i \sin \theta)$$

$$= -\frac{1}{r} \left[\frac{\partial u}{\partial \theta} + i \frac{\partial v}{\partial \theta} \right] [\cos \theta - i \sin \theta] \quad \text{g.e.d.}$$

Section 2.5

1) $\phi = x^2 - y^4$

$\frac{\partial \phi}{\partial x} = 2x, \quad \frac{\partial^2 \phi}{\partial x^2} = 2$

$\frac{\partial \phi}{\partial y} = -4y^3, \quad \frac{\partial^2 \phi}{\partial y^2} = -12y^2$

$2 - 12y^2 = 0$

$12y^2 = 2, \quad y = \pm \sqrt{\frac{1}{6}}$

The equation is satisfied only on the lines $y = \pm \sqrt{1/6} \quad -\infty < x < \infty$

These sets of points are not a domain, thus the function is not harmonic.

2) $\phi = \sin(xy) \quad \frac{\partial^2 \phi}{\partial x^2} = -y^2 \sin(xy)$

$\frac{\partial^2 \phi}{\partial y^2} = -x^2 \sin(xy) \therefore -\sin(xy) [x^2 + y^2] = 0$

The preceding eqn is satisfied at the origin $(x=0, y=0)$ or on the hyperbolas

$xy = n\pi \quad [n=0, \pm 1, \pm 2 \dots]$

These sets of points are not a domain, \therefore func. not harmonic

3) $\phi = e^{ky} \sin(mx) \quad \frac{\partial^2 \phi}{\partial x^2} = -m^2 e^{ky} \sin(mx)$

$\frac{\partial^2 \phi}{\partial y^2} = k^2 e^{ky} \sin(mx)$

$\frac{\partial^2 \phi}{\partial x^2} + \frac{\partial^2 \phi}{\partial y^2} = 0$

$[k^2 - m^2] [e^{ky} \sin mx] = 0$

$k = \pm m$

4) $\phi = x^n - y^n \quad \frac{\partial^2 \phi}{\partial x^2} = (n)(n-1)x^{n-2}$

$\frac{\partial^2 \phi}{\partial y^2} = -(n)(n-1)y^{n-2}$

$(n)(n-1)[x^{n-2} - y^{n-2}] = 0$

$n=0, n=1$

$n=2$

or $x^{n-2} = y^{n-2}$

section 2.5

$$5) \frac{1}{z} = \frac{1}{x+iy} = \frac{x-iy}{x^2+y^2}$$

$$\text{Im} \left(\frac{1}{z} \right) = \frac{-y}{x^2+y^2} = \phi$$

$$\frac{\partial \phi}{\partial y} = - \left[\frac{-(x^2+y^2) - 2y^2}{(x^2+y^2)^2} \right] = - \left[\frac{x^2-y^2}{(x^2+y^2)^2} \right]$$

$$\frac{\partial^2 \phi}{\partial y^2} = - \left[\frac{-2y \cdot (x^2+y^2)^2 - (x^2-y^2) 2(x^2+y^2) 2y}{(x^2+y^2)^4} \right]$$

$$\frac{\partial^2 \phi}{\partial y^2} = \frac{-2y^3 + 6x^2y^2}{(x^2+y^2)^3}$$

similarly $\frac{\partial^2 \phi}{\partial x^2} = \frac{2y^3 - 6xy^2}{(x^2+y^2)^3}$

thus

$$\frac{\partial^2 \phi}{\partial x^2} + \frac{\partial^2 \phi}{\partial y^2} = 0 \quad \text{if } z \neq 0$$

$$6) z^3 = (x+iy)^3 = x^3 + 3x^2(iy) + 3x(iy)^2 - iy^3$$

$$\text{Re}(z^3) = x^3 - 3xy^2 = \phi$$

$$\frac{\partial \phi}{\partial x} = 3x^2 - 3y^2, \quad \frac{\partial^2 \phi}{\partial x^2} = 6x$$

$$\frac{\partial \phi}{\partial y} = -6xy, \quad \frac{\partial \phi}{\partial y^2} = -6x \quad \frac{\partial^2 \phi}{\partial x^2} + \frac{\partial^2 \phi}{\partial y^2} = 0$$

all x, y .

$$7) \phi = \cos x [e^y + e^{ky}]$$

$$\frac{\partial \phi}{\partial x} = -\cos x [e^y + e^{ky}]$$

$$\frac{\partial \phi}{\partial y} = \cos x [e^y + k e^{ky}]$$

$$-\cos x [e^y + e^{ky}] + \cos x [e^y + k e^{ky}] = 0 \quad k = \pm 1$$

Sec 2.5, cont'd

$$8] \quad \phi = g(x) [e^{2y} - e^{-2y}]$$

$$\frac{\partial^2 \phi}{\partial x^2} = \frac{d^2 g}{dx^2} [e^{2y} - e^{-2y}]$$

$$\frac{\partial^2 \phi}{\partial y^2} = g(x) + [e^{2y} - e^{-2y}]$$

$$\frac{\partial^2 \phi}{\partial x^2} + \frac{\partial^2 \phi}{\partial y^2} = 0 \quad \left[\frac{d^2 g}{dx^2} + g(x) \right] [e^{2y} - e^{-2y}] = 0$$

$$\frac{d^2 g}{dx^2} + 4g(x) = 0 \quad g(x) = A \cos 2x + B \sin 2x$$

$$A = 0 \text{ since } g(0) = 0$$

$$g'(x) = 2B \cos(2x)$$

$$g'(0) = 1 \Rightarrow B = 1/2$$

$$\therefore g(x) = \frac{1}{2} \sin 2x$$

$$9] \text{ a) } \phi = x^3 y - y^3 x + y^2 - x^2 + x$$

$$\frac{\partial^2 \phi}{\partial x^2} = 6xy - 2, \quad \frac{\partial^2 \phi}{\partial y^2} = -6xy + 2$$

The sum is zero.

$$\text{b) Take } \phi = u, \quad \frac{\partial u}{\partial x} = 3x^2 y - y^3 - 2x + 1 = \frac{\partial v}{\partial y}$$

$$v = \frac{3}{2} x^2 y^2 - \frac{y^4}{4} - 2xy + y + c(x)$$

$$\frac{\partial v}{\partial x} = 3xy^2 - 2y + \frac{dc}{dx} = \frac{\partial u}{\partial y} = -x^3 + 3x^2 y - 2y$$

$$dc/dx = -x^3, \quad c = -x^4/4 + D$$

$$v = \frac{3}{2} x^2 y^2 - \frac{y^4}{4} - 2xy + y - \frac{x^4}{4} + D$$

D is a constant.

sec 2.5 cont'd

9 cont'd

$$a) \quad v = x^3 y - y^3 x + y^2 - x^2 + x$$

$$\frac{\partial w}{\partial x} = \frac{\partial v}{\partial x} = x^3 - 3y^2 x + 2y$$

$$w = \frac{x^4}{4} - \frac{3}{2} x^2 y^2 + 2xy + c(y)$$

$$\text{Now use } \frac{\partial w}{\partial y} = -\frac{\partial v}{\partial x}$$

$$-3x^2 y + 2x + \frac{dc}{dy} = -3x^2 y + y^3 + 2x - 1$$

$$\frac{dc}{dy} = y^3 - 1, \quad c = \frac{y^4}{4} - y + D$$

$$\therefore w = \frac{x^4}{4} - \frac{3}{2} x^2 y^2 + 2xy + \frac{y^4}{4} - y + D$$

The answers to b) and c) are negatives of each other - if you neglect the arbitrary constants D and \bar{D} .

d) $\phi + i v$ is analytic,
Multiplies it by i

$\therefore -v + i \phi$ is analytic

Now by assumption $w + i \phi$ is analytic. $\therefore w = -v + \text{constant}$

If we neglect the constant,
 $w = -v$ as req'd.

This is confirmed in parts b) and c).

sec 2.5 cont'd

10) $f(z) = u + iV$ is analytic
 $-if(z) = V - iW$ is analytic.
 $g(z) = V + iW$ is analytic
 $g(z) - if(z)$ is analytic [sum of analyt. funcs]
 $g(z) - if(z) = 2V$ is real, and analytic.

∴ by exercise 15, sec 2.4
 V is constant.

$g(z) + if(z) = 2iW$ is imag. and analytic

∴ by exercise 15, sec 2.4
 W is constant.

Thus if $u + iV$ and $V + iW$ are both analytic, then W and V are constant.

11) $u = e^x \cos y + e^y \cos x + xy$, $\frac{\partial u}{\partial x} = e^x \cos y - e^y \sin x + y = \frac{\partial v}{\partial y}$
 $v = e^x \sin y - e^y \sin x + \frac{y^2}{2} + c(x)$, $\frac{\partial v}{\partial x} = e^x \sin y - e^y \cos x + \frac{dc}{dx}$
 $= -\frac{\partial u}{\partial y} = e^x \sin y - e^y \cos x - x$. $\frac{dc}{dx} = -x$, $c = -\frac{x^2}{2} + D$

$v = e^x \sin y - e^y \sin x + \frac{y^2}{2} - \frac{x^2}{2} + D$

12) $u = \tan^{-1}\left(\frac{x}{y}\right)$, $\frac{\partial u}{\partial x} = \frac{1/y}{1+x^2/y^2} = \frac{y}{y^2+x^2} = \frac{\partial v}{\partial y}$

$v = \frac{1}{2} \log(y^2+x^2) + c(x)$. $\frac{\partial v}{\partial x} = \frac{x}{x^2+y^2} + \frac{dc}{dx} = -\frac{\partial u}{\partial y}$

$-\frac{\partial u}{\partial y} = \frac{x/y^2}{1+x^2/y^2} = \frac{x}{x^2+y^2} = \frac{x}{x^2+y^2} + \frac{dc}{dx}$, $\frac{dc}{dx} = 0$, $c = D$

∴ $v = \frac{1}{2} \log(y^2+x^2) + D$

chap 2, 13 | Sec 2.5 cont'd

let $\phi = u+v$, show $\frac{\partial^2 \phi}{\partial x^2} + \frac{\partial^2 \phi}{\partial y^2} = 0$

$$\begin{aligned} \frac{\partial^2}{\partial x^2} (u+v) + \frac{\partial^2}{\partial y^2} (u+v) &= \frac{\partial^2}{\partial x^2} u + \frac{\partial^2}{\partial y^2} u + \frac{\partial^2}{\partial x^2} v + \frac{\partial^2}{\partial y^2} v \\ &= 0 \text{ since both } u \text{ and } v \text{ are harmonic.} \end{aligned}$$

let $\phi = uv$, $\frac{\partial^2}{\partial x^2} \phi = \frac{\partial^2}{\partial x^2} (uv) = \frac{\partial}{\partial x} \left[\frac{\partial u}{\partial x} v + \frac{\partial v}{\partial x} u \right]$
 $= \frac{\partial^2 u}{\partial x^2} v + 2 \frac{\partial u}{\partial x} \frac{\partial v}{\partial x} + u \frac{\partial^2 v}{\partial x^2}$. Similarly:

$$\frac{\partial^2}{\partial y^2} (uv) = \frac{\partial^2 u}{\partial y^2} v + 2 \frac{\partial u}{\partial y} \frac{\partial v}{\partial y} + u \frac{\partial^2 v}{\partial y^2}$$

Now $\left[\frac{\partial^2}{\partial x^2} + \frac{\partial^2}{\partial y^2} \right] [uv] = v \left[\frac{\partial^2 u}{\partial x^2} + \frac{\partial^2 u}{\partial y^2} \right] +$
 $u \left[\frac{\partial^2 v}{\partial x^2} + \frac{\partial^2 v}{\partial y^2} \right] + 2 \frac{\partial u}{\partial x} \frac{\partial v}{\partial x} + 2 \frac{\partial u}{\partial y} \frac{\partial v}{\partial y} =$

$$2 \left[\frac{\partial u}{\partial x} \frac{\partial v}{\partial x} + \frac{\partial u}{\partial y} \frac{\partial v}{\partial y} \right]. \text{ The preceding is not zero in general.}$$

$$e^{u+v} = e^u e^v = \phi, \quad \frac{\partial \phi}{\partial x} = e^{u+v} \left[\frac{\partial u}{\partial x} + \frac{\partial v}{\partial x} \right]$$

$$\frac{\partial^2 \phi}{\partial x^2} = e^{u+v} \left[\frac{\partial u}{\partial x} + \frac{\partial v}{\partial x} \right]^2 + e^{u+v} \left[\frac{\partial^2 u}{\partial x^2} + \frac{\partial^2 v}{\partial x^2} \right]$$

$$\frac{\partial^2 \phi}{\partial y^2} = e^{u+v} \left[\frac{\partial u}{\partial y} + \frac{\partial v}{\partial y} \right]^2 + e^{u+v} \left[\frac{\partial^2 u}{\partial y^2} + \frac{\partial^2 v}{\partial y^2} \right]$$

Sum the above, and use $\frac{\partial^2 u}{\partial x^2} + \frac{\partial^2 u}{\partial y^2} = 0$

$$\frac{\partial^2 \phi}{\partial x^2} + \frac{\partial^2 \phi}{\partial y^2} = e^{u+v} \left[\left(\frac{\partial u}{\partial x} + \frac{\partial v}{\partial x} \right)^2 + \left(\frac{\partial u}{\partial y} + \frac{\partial v}{\partial y} \right)^2 \right]$$

The preceding is in general $\neq 0$.

$\therefore e^{u+v}$ is not harmonic.

Sec 2.5 cont'd

14] Refer to problem 13, We have that ^{if} both u and v are harmonic, then

$$\left[\frac{\partial^2}{\partial x^2} + \frac{\partial^2}{\partial y^2} \right] (uv) = 2 \left[\frac{\partial u}{\partial x} \frac{\partial v}{\partial x} + \frac{\partial u}{\partial y} \frac{\partial v}{\partial y} \right]$$

Now put $\frac{\partial v}{\partial x} = -\frac{\partial u}{\partial y}$, $\frac{\partial v}{\partial y} = \frac{\partial u}{\partial x}$ in the bracketed expression. You will get zero.

15] $\phi = e^u \cos v$, $\frac{\partial \phi}{\partial x} = \phi \frac{\partial u}{\partial x} - e^u \sin v \frac{\partial v}{\partial x}$

$$\frac{\partial^2 \phi}{\partial x^2} = \frac{\partial \phi}{\partial x} \frac{\partial u}{\partial x} + \phi \frac{\partial^2 u}{\partial x^2} - e^u \sin v \frac{\partial u}{\partial x} \frac{\partial v}{\partial x} - e^u \cos v \left(\frac{\partial v}{\partial x} \right)^2 + e^u \sin v \frac{\partial^2 v}{\partial x^2}$$

$$\frac{\partial^2 \phi}{\partial x^2} = \frac{\partial \phi}{\partial x} \frac{\partial u}{\partial x} + \phi \frac{\partial^2 u}{\partial x^2} - e^u \sin v \frac{\partial u}{\partial x} \frac{\partial v}{\partial x} - \phi \left(\frac{\partial v}{\partial x} \right)^2 - e^u \sin v \frac{\partial^2 v}{\partial x^2}$$

$$\frac{\partial^2 \phi}{\partial x^2} = \frac{\partial \phi}{\partial x} \frac{\partial u}{\partial x} + \phi \left[\frac{\partial^2 u}{\partial x^2} - \left(\frac{\partial v}{\partial x} \right)^2 \right] - e^u \sin v \left[\frac{\partial u}{\partial x} \frac{\partial v}{\partial x} + \frac{\partial^2 v}{\partial x^2} \right]$$

similarly

$$\frac{\partial^2 \phi}{\partial y^2} = \frac{\partial \phi}{\partial y} \frac{\partial u}{\partial y} + \phi \left[\frac{\partial^2 u}{\partial y^2} - \left(\frac{\partial v}{\partial y} \right)^2 \right] - e^u \sin v \left[\frac{\partial u}{\partial y} \frac{\partial v}{\partial y} + \frac{\partial^2 v}{\partial y^2} \right]$$

Add the above, use fact that $\frac{\partial^2 v}{\partial x^2} + \frac{\partial^2 v}{\partial y^2} = 0$, and C-R eqns. put $\frac{\partial u}{\partial x} = \frac{\partial v}{\partial y}$, $\frac{\partial u}{\partial y} = -\frac{\partial v}{\partial x}$ in here

$$\frac{\partial^2 \phi}{\partial x^2} + \frac{\partial^2 \phi}{\partial y^2} = \frac{\partial \phi}{\partial x} \frac{\partial u}{\partial x} + \frac{\partial \phi}{\partial y} \frac{\partial u}{\partial y} + \phi \left[\left(\frac{\partial v}{\partial x} \right)^2 + \left(\frac{\partial v}{\partial y} \right)^2 \right]$$

$$\text{Now } \frac{\partial \phi}{\partial x} = \phi \frac{\partial u}{\partial x} - e^u \sin v \frac{\partial v}{\partial x}$$

$$\frac{\partial \phi}{\partial y} = \phi \frac{\partial u}{\partial y} - e^u \sin v \frac{\partial v}{\partial y}$$

$$\text{Thus } \frac{\partial^2 \phi}{\partial x^2} + \frac{\partial^2 \phi}{\partial y^2} = \phi \left(\frac{\partial u}{\partial x} \right)^2 - e^u \sin v \frac{\partial v}{\partial x} \frac{\partial u}{\partial x}$$

$$+ \phi \left[\frac{\partial u}{\partial y} \right]^2 - e^u \sin v \frac{\partial v}{\partial y} \frac{\partial u}{\partial y} - \phi \left(\frac{\partial v}{\partial x} \right)^2 - \phi \left(\frac{\partial v}{\partial y} \right)^2$$

$$= -e^u \sin v \left[\frac{\partial v}{\partial x} \frac{\partial u}{\partial x} + \frac{\partial v}{\partial y} \frac{\partial u}{\partial y} \right] = -e^u \sin v \left[-\frac{\partial u}{\partial x} \frac{\partial u}{\partial x} + \frac{\partial u}{\partial y} \frac{\partial u}{\partial y} \right]$$

use C-R eqns

= 0 Q.E.D.

$$\begin{aligned}
 [6] \phi &= \sin u \cosh v, \quad \frac{\partial \phi}{\partial x} = \cos u \cosh v \frac{\partial u}{\partial x} + \sin u \sinh v \frac{\partial v}{\partial x} \\
 \frac{\partial^2 \phi}{\partial x^2} &= \cos v \sin u \left[\left(\frac{\partial v}{\partial x} \right)^2 - \left(\frac{\partial u}{\partial x} \right)^2 \right] + \cos u \cosh v \frac{\partial^2 u}{\partial x^2} \\
 &+ \sin u \sinh v \frac{\partial^2 v}{\partial x^2} + 2 \cos u \sinh v \frac{\partial v}{\partial x} \frac{\partial u}{\partial x}. \text{ Similarly} \\
 \frac{\partial^2 \phi}{\partial y^2} &= \cosh v \sin u \left[\left(\frac{\partial v}{\partial y} \right)^2 - \left(\frac{\partial u}{\partial y} \right)^2 \right] + \cos u \cosh v \frac{\partial^2 u}{\partial y^2} \\
 &+ \sin u \sinh v \frac{\partial^2 v}{\partial y^2} + 2 \cos u \sinh v \frac{\partial v}{\partial y} \frac{\partial u}{\partial y}
 \end{aligned}$$

$$\begin{aligned}
 \text{Add: } \frac{\partial^2 \phi}{\partial x^2} + \frac{\partial^2 \phi}{\partial y^2} &= \cosh v \sin u \left[\left(\frac{\partial v}{\partial x} \right)^2 - \left(\frac{\partial u}{\partial x} \right)^2 + \left(\frac{\partial v}{\partial y} \right)^2 - \left(\frac{\partial u}{\partial y} \right)^2 \right] \\
 &+ \cos u \cosh v \left[\frac{\partial^2 u}{\partial x^2} + \frac{\partial^2 u}{\partial y^2} \right] + \sin u \sinh v \left[\frac{\partial^2 v}{\partial x^2} + \frac{\partial^2 v}{\partial y^2} \right] \\
 &+ 2 \cos u \sinh v \left[\frac{\partial v}{\partial x} \frac{\partial u}{\partial x} + \frac{\partial v}{\partial y} \frac{\partial u}{\partial y} \right]. \text{ Now in preceding}
 \end{aligned}$$

use $-\frac{\partial u}{\partial y}$ in place of $\frac{\partial v}{\partial x}$, and $\frac{\partial u}{\partial x}$ in place of $\frac{\partial v}{\partial y}$.

Also $\frac{\partial^2 u}{\partial x^2} + \frac{\partial^2 u}{\partial y^2} = 0$ and $\frac{\partial^2 v}{\partial x^2} + \frac{\partial^2 v}{\partial y^2} = 0$. Get

$$\frac{\partial^2 \phi}{\partial x^2} + \frac{\partial^2 \phi}{\partial y^2} = 0 \text{ as required.}$$

$$[7] a) (x+iy)^2 = u+iv, \quad u = x^2 - y^2, \quad v = 2xy$$

$$x^2 - y^2 = 1, \quad xy = 1, \quad (b) \quad x^2 - y^2 = 1, \quad y = 1/x, \quad x^2 - \frac{1}{x^2} = 1$$

$$x^4 - x^2 - 1 = 0, \quad x^2 = \frac{1 \pm \sqrt{1+4}}{2}, \quad x^2 > 0, \quad x^2 = \frac{1+\sqrt{5}}{2}, \\
 x = \sqrt{\frac{1+\sqrt{5}}{2}}, \quad y^2 = x^2 - 1 = \frac{\sqrt{5}-1}{2}, \quad y = \sqrt{\frac{\sqrt{5}-1}{2}}$$

$$c) \quad x^2 - y^2 = 1, \quad 2x dx - 2y dy = 0$$

$$\frac{dx}{dy} = \frac{x}{y} = \sqrt{\frac{1+\sqrt{5}}{\sqrt{5}-1}} \approx 1.62 \quad \text{curve } xy=1$$

$$\frac{dy}{dx} = -\frac{y}{x} \approx -\frac{1}{1.62}$$

∴ Slopes are neg. reciprocals.

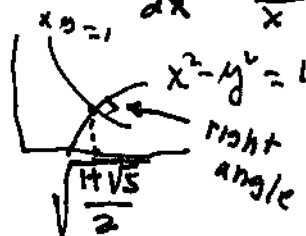

sec 2.5

$$18 a) \quad U = e^x \cos y, \quad V = e^x \sin y$$

$$\left. \begin{aligned} \frac{\partial U}{\partial x} &= e^x \cos y = \frac{\partial V}{\partial y} \\ -\frac{\partial U}{\partial y} &= \frac{\partial V}{\partial x} = e^x \sin y \end{aligned} \right\} \text{true, all } x, y$$

k=[1/2 1]
 % for sec 2.5 prob. 18. parts b), c)

```
for m=1:2
    x=linspace(0,pi/2,1000);
    y=acos(k(m)*exp(-x));
    plot(x,y);axis([0 pi/2 0 pi/2]);hold on
end
for m=1:2
    x=linspace(0,pi/2,1000);
    y=asin(k(m)*exp(-x));
    plot(x,y);axis([0 pi/2 0 pi/2]);hold on
end
grid
```

Note: for part (b)

$$U = e^x \cos y = 1, \quad y = \cos^{-1}(e^{-x})$$

If $U = 1/2$, set in a similar way

$$y = \cos^{-1}[(1/2)e^{-x}]$$

for part (c)

$$V = e^x \sin y, \quad \text{If } V = 1, \quad y = \sin^{-1}(e^{-x})$$

If $V = 1/2$, set in a similar way

$$y = \sin^{-1}(e^{-x})$$

18

Sec 2.5

$$d) \begin{aligned} e^x \cos y &= 1 \\ e^x \sin y &= 1/2 \end{aligned}$$

divide 2nd by 1st

$$\tan y = 1/2, \quad y = \arctan 1/2 \approx .4636$$

$$\sin y = .4472 \quad e^x = \frac{1}{(2)(.4472)}$$

$$x = \log \left[\frac{.5}{.4472} \right] = .1116 \quad \boxed{\text{plot on next pg.}}$$

$$e) \quad e^x \cos y = 1$$

$$e^x dx \cos y - e^x \sin y dy = 0$$

$$\frac{dy}{dx} = \cot y = \boxed{2} \quad \text{slope of } u = 1$$

$$e^x \sin y = 1/2 \quad e^x \cos y dy + e^x \sin y dx = 0$$

$$\frac{dy}{dx} = -\tan y = \boxed{-1/2} \quad \text{slope of } v = 1/2$$

These are neg. recip. of each other,

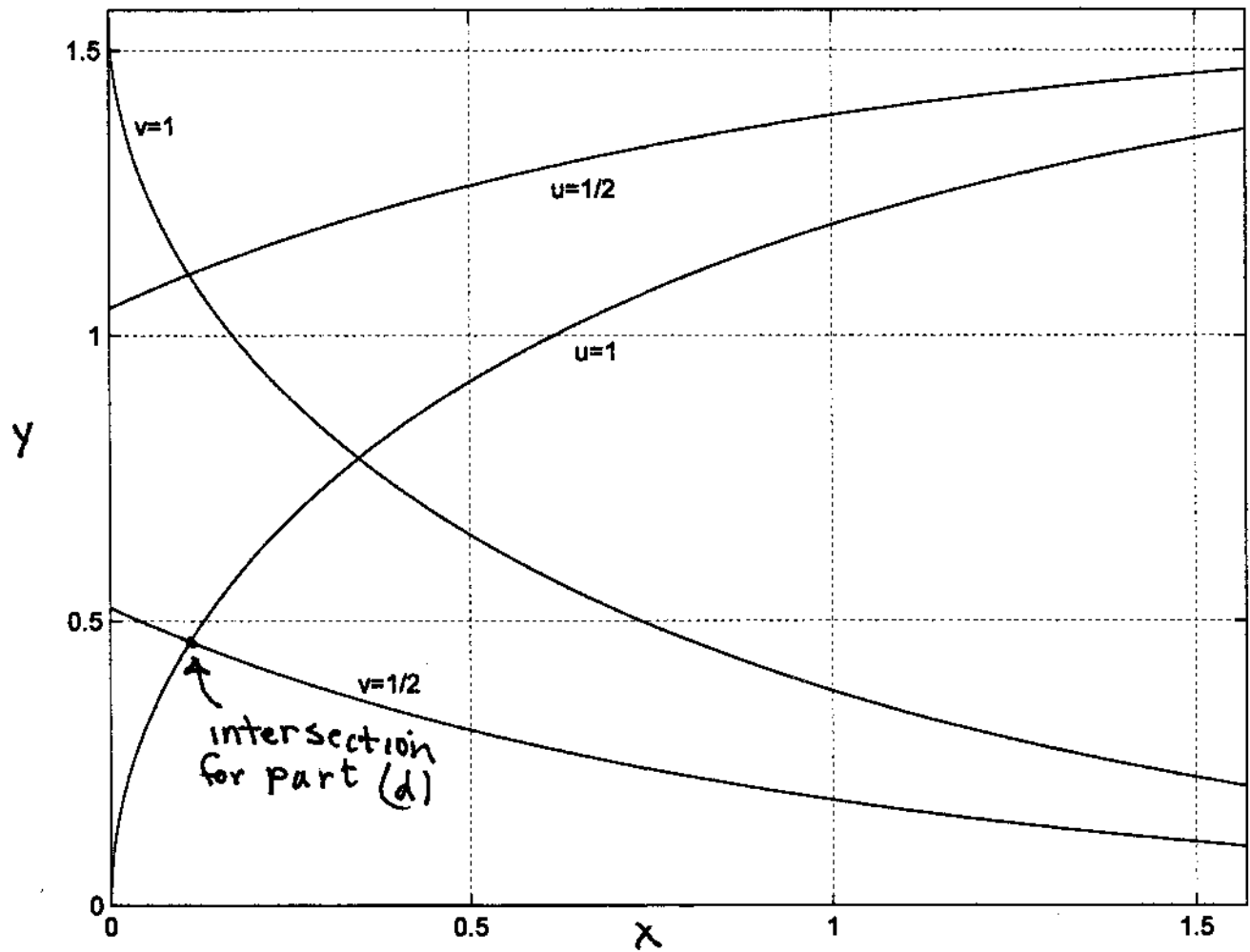

for problem 18(d), sec 2.5
Chap 2 page 50

sec 2.5

$$19) a) z^3 = (x+iy)^3 = x^3 + i3x^2y - 3xy^2 - iy^3$$

$$u = x^3 - 3xy^2, v = 3x^2y - y^3$$

$$u = 1, x^3 - 3xy^2 = 1$$

$$y^2 = \frac{x^3 - 1}{3x} \quad \text{eqn. of } u=1 \text{ curve}$$

$$\text{If } v = 1, 3x^2y - y^3 = 1$$

$$x^2 = \frac{y^3 + 1}{3y}$$

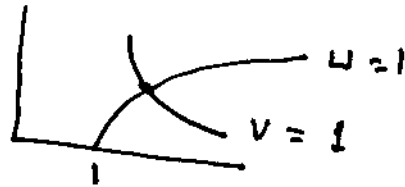

$$b) f(z) = z^3, z = r cis(\theta), z^3 = r^3 [\cos 3\theta + i \sin 3\theta]$$

$$u + iv = f(z), u = r^3 \cos 3\theta, v = r^3 \sin 3\theta, r^3 \cos 3\theta = 1$$

$$r^3 \sin 3\theta = 1 \quad \text{dividing these: } \tan 3\theta = 1, \theta = 15^\circ = \frac{\pi}{12}$$

$$r^3 \cos 45^\circ = 1, r^3 = \sqrt{2}, r = \sqrt[3]{2} \approx 1.122, x = r \cos \theta$$

$$x = 1.122 \cos 15^\circ = 1.083, y = 1.122 \sin 15^\circ = .290$$

$$c) u = x^3 - 3xy^2 = 1, v = 3x^2y - y^3$$

$$du = 0 = (3x^2 - 3y^2)dx - 6xy dy, \frac{dy}{dx} = \frac{3x^2 - 3y^2}{6xy} = \frac{x^2 - y^2}{2xy}$$

$$\text{At } x = 1.083, y = .290, \frac{dy}{dx} = 1.73, dv = 0 = 6xy dx + (3x^2 - 3y^2)dy$$

$$\frac{dy}{dx} = \frac{-6xy}{3x^2 - 3y^2} = \frac{-2xy}{x^2 - y^2} = \frac{-1}{1.73} = \underline{\underline{-.58}} \text{ at intersection.}$$

20

Sec 2.5

a) Begin with $\frac{\partial u}{\partial r} = \frac{1}{r} \frac{\partial v}{\partial \theta}$ [1] and $\frac{\partial v}{\partial r} = -\frac{1}{r} \frac{\partial u}{\partial \theta}$ [2]

Take $\frac{\partial}{\partial r}$ of [1] get $\frac{\partial^2 u}{\partial r^2} = -\frac{1}{r^2} \frac{\partial v}{\partial \theta} + \frac{1}{r} \frac{\partial}{\partial r} \frac{\partial v}{\partial \theta}$ [3]

Take $\frac{\partial}{\partial \theta}$ of [2] and divide both sides by r, get

Get $\frac{1}{r^2} \frac{\partial^2 u}{\partial \theta^2} = -\frac{1}{r} \frac{\partial^2 v}{\partial \theta \partial r}$ [4] Add [3] and [4] assume $\frac{\partial}{\partial r} \frac{\partial v}{\partial \theta} = \frac{\partial}{\partial \theta} \frac{\partial v}{\partial r}$

Get $\frac{\partial^2 u}{\partial r^2} + \frac{1}{r^2} \frac{\partial^2 u}{\partial \theta^2} = -\frac{1}{r^2} \frac{\partial v}{\partial \theta}$ [5]. From [1] $-\frac{1}{r} \frac{\partial u}{\partial r} = -\frac{1}{r} \frac{\partial v}{\partial \theta}$

Use this on right side of [5] $\frac{\partial^2 u}{\partial r^2} + \frac{1}{r^2} \frac{\partial^2 u}{\partial \theta^2} = 0$. Q.E.D. Now take $\frac{\partial}{\partial r}$ of [2].

Get $\frac{\partial^2 v}{\partial r^2} = \frac{1}{r^2} \frac{\partial u}{\partial \theta} - \frac{1}{r} \frac{\partial}{\partial r} \frac{\partial u}{\partial \theta}$ [6]. Now

take $\frac{\partial}{\partial \theta}$ of [1]. Get $\frac{\partial^2 u}{\partial \theta \partial r} = \frac{1}{r} \frac{\partial^2 v}{\partial \theta^2}$ or $\frac{1}{r^2} \frac{\partial^2 v}{\partial \theta^2} = \frac{1}{r} \frac{\partial^2 u}{\partial \theta \partial r}$ [7]. Add [6] and [7]

$\frac{\partial^2 v}{\partial r^2} + \frac{1}{r^2} \frac{\partial^2 v}{\partial \theta^2} = \frac{1}{r^2} \frac{\partial u}{\partial \theta}$ \leftarrow From [2] use here $\frac{1}{r^2} \frac{\partial u}{\partial \theta} = -\frac{1}{r} \frac{\partial v}{\partial r}$ Q.E.D.

Thus $\frac{\partial^2 v}{\partial r^2} + \frac{1}{r^2} \frac{\partial^2 v}{\partial \theta^2} + \frac{1}{r} \frac{\partial v}{\partial r} = 0$

b) next page

sec 2.5 cont'd

20 (b)

Continued

$$b) \frac{\partial u}{\partial r} = 2r \cos(2\theta), \quad \frac{\partial^2 u}{\partial r^2} = 2 \cos(2\theta),$$

$$\frac{\partial u}{\partial \theta} = -2r^2 \sin(2\theta), \quad \frac{\partial^2 u}{\partial \theta^2} = -4r^2 \cos(2\theta)$$

$$\frac{\partial^2 u}{\partial r^2} + \frac{1}{r^2} \frac{\partial^2 u}{\partial \theta^2} + \frac{1}{r} \frac{\partial u}{\partial r} = 2 \cos(2\theta) - 4 \cos(2\theta) + 2 \cos(2\theta)$$

$$= 0 \quad (\text{q.e.d.})$$

$$c) \frac{\partial u}{\partial r} = \frac{1}{r} \frac{\partial v}{\partial \theta}, \quad u = r^2 \cos(2\theta), \quad 2r \cos(2\theta) = \frac{1}{r} \frac{\partial v}{\partial \theta}$$

$$v(\theta) = r^2 \sin(2\theta) + C(r), \quad \frac{\partial v}{\partial r} = \frac{1}{r} \frac{\partial u}{\partial \theta}$$

$$2r \sin(2\theta) + \frac{dC}{dr} = \frac{2r^2}{r} \sin(2\theta) \cdot \frac{dC}{dr} = 0, \quad C = d \text{ (a constant)}$$

thus $v = r^2 \sin(2\theta) + \text{constant}$. Check Laplace's

$$\text{Eqn. } v = r^2 \sin(2\theta) + \text{const.} \quad \frac{\partial v}{\partial r} = 2r \sin(2\theta)$$

$$\frac{\partial^2 v}{\partial r^2} = 2 \sin(2\theta), \quad \frac{\partial v}{\partial \theta} = r^2 \cos(2\theta), \quad \frac{\partial^2 v}{\partial \theta^2} = -4r^2 \sin(2\theta)$$

$$\frac{\partial^2 v}{\partial r^2} + \frac{1}{r^2} \frac{\partial^2 v}{\partial \theta^2} + \frac{1}{r} \frac{\partial v}{\partial r} = 2 \sin(2\theta) - 4 \sin(2\theta) + 2 \sin(2\theta)$$

$$= 0 \quad \text{q.e.d.}$$

Sec 2.6

- (a) $\partial_x = -1 \frac{\partial \phi}{\partial x} = 3 = -1 \frac{\partial \phi}{\partial x} \therefore \phi = -30x + C(y)$
 $-4 = -1 \frac{\partial \phi}{\partial y}$. Thus $\frac{dC}{dy} = 40$, $C = 40y + d$ degrees
 $\phi = -30x + 40y + \text{constant}$. $\text{const} = 0$ $\phi = -30x + 40y$
- (b) $\phi = -30x + 40y$ $\frac{\partial \phi}{\partial x} = \frac{\partial \psi}{\partial x}$, $-30 = \frac{\partial \psi}{\partial x}$,
 $\psi = -30x + C(y)$, $\frac{\partial \psi}{\partial y} = -\frac{dC}{dy}$, $40 = -\frac{dC}{dy}$, $C = -40y + d$
 $\psi = -30x - 40y + \text{constant}$ (constant is zero).
- (c) $\phi = 0$, $-30x + 40y = 0$, $y = (3/4)x$; $\phi = 40 = -30x + 40y$
 $y = 1 + (3/4)x$; $\phi = -40$, $y = -1 + (3/4)x$

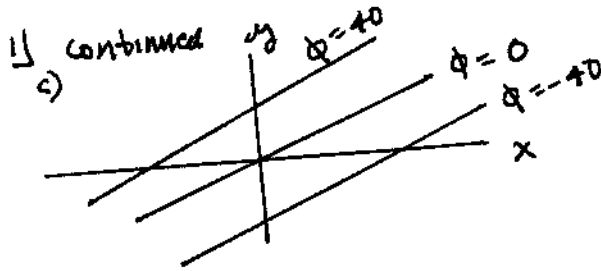

d) $\psi = 0, = -30y - 40x, x = -\frac{3}{4}y, y = -\frac{4}{3}x$
 $\psi = 40 = -30y - 40x, y = -\frac{4}{3}x - \frac{4}{3}; \psi = -40,$
 $y = -\frac{4}{3}x + \frac{4}{3}$

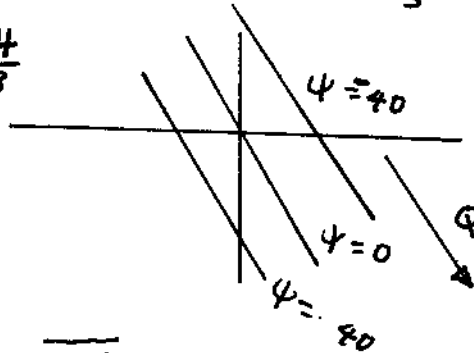

2 a) $v = \overline{\left(\frac{d\Phi}{dz}\right)} = \frac{1}{z^2}$. But $\frac{1}{z^2} = \frac{-1}{x^2 - y^2 + i2xy}$
 $= \frac{(x^2 - y^2 - i2xy)}{(x^2 - y^2)^2 + 4x^2y^2} = \frac{-(x^2 - y^2 - i2xy)}{x^4 - 2x^2y^2 + y^4 + 4x^2y^2}$
 $= \frac{-(x^2 - y^2 - i2xy)}{(x^2 + y^2)^2}$. Thus, $v = \frac{-(x^2 - y^2 + i2xy)}{(x^2 + y^2)^2} = v_x + i v_y$

If $x=1, y=1, \underline{v_x=0}, \underline{v_y = \frac{-2}{4} = -\frac{1}{2} = v_y}$

b) $\phi = \text{Re}\left[\frac{1}{z}\right] = \frac{x}{x^2 + y^2}, v_x = \frac{\partial\phi}{\partial x} = \frac{y^2 - x^2}{(x^2 + y^2)^2}$
 $v_y = \frac{\partial\phi}{\partial y} = \frac{-2xy}{(x^2 + y^2)^2}$. Putting $x=1, y=1$, set $v_x=0, v_y = \frac{-1}{2}$

c) $\phi = \frac{x}{x^2 + y^2} \Big|_{y=1} = \frac{1}{2}$. Thus $x^2 + y^2 = 2x$
 $x^2 - 2x + y^2 = 0, (x-1)^2 + y^2 = 1$ ← equipot.

d) $\psi = \text{Im}\left(\frac{1}{z}\right) = \frac{-y}{x^2 + y^2}$, at $(1,1), \psi = -\frac{1}{2}$
 Thus $\frac{y}{x^2 + y^2} = \frac{1}{2}, x^2 + (y-1)^2 = 1$ ← equation

sec 2.6 continued

3) a) $\Phi(z) = \underbrace{e^x \cos y}_\phi + i \underbrace{e^x \sin y}_\psi$, $\frac{d\Phi}{dz} = \frac{\partial \phi}{\partial x} + i \frac{\partial \psi}{\partial x}$
 $= e^x \cos y + i e^x \sin y$. $\underline{e} = -\left(\frac{d\Phi}{dz}\right) =$
 $-[e^x \cos y - i e^x \sin y]$. Thus \underline{e} at $1, i/2 = -\left[\underbrace{e \cos \frac{1}{2} - i e \sin \frac{1}{2}}_{e \operatorname{cis}(-1/2)} \right]$
 $= E_x + i E_y = -2.39 + i 1.30$

b) $\phi = e^x \cos y$, $E_x = -\frac{\partial \phi}{\partial x} = -e^x \cos y = -e \cos \frac{1}{2} = E_x$
 $E_y = -\frac{\partial \phi}{\partial y} = e^x \sin y = e \sin \frac{1}{2} = E_y$ $\bar{e} = E_x + i E_y = -e \operatorname{cis}(-1/2)$
as in (a)

c) $D_x = -0.85 \times 10^{-12} e \cos \frac{1}{2}$, $D_y = 0.85 \times 10^{-12} e \sin \frac{1}{2}$
 $D_x = -21 \cdot 10^{-12}$, $D_y = 11.5 \times 10^{-12}$

d) $\phi = e^x \cos y = \boxed{e \cos \frac{1}{2}}$
 $e^x \cos y = e \cos \frac{1}{2}$
 $y = \cos^{-1} \left[\frac{e \cos \frac{1}{2} e^{-x}}{e} \right]$
 see attached plot

Suppose $e \cos \frac{1}{2} e^{-x} = 1$
 $x = \log \left[\frac{e \cos \frac{1}{2}}{1} \right] = .8694$
 on our plot take $x \geq .8694$ to
 avoid taking \cos^{-1} of a number > 1

e) $\psi = e^x \sin y = e \sin \frac{1}{2}$,
 $y = \sin^{-1} \left[\frac{e \sin \frac{1}{2} e^{-x}}{e} \right]$
 see attached plot
 Suppose $e \sin \frac{1}{2} e^{-x} = 1$
 $x = \log \left[\frac{e \sin \frac{1}{2}}{1} \right] = .2684$
 for plot, take $x \geq .2684$
 to avoid taking \sin^{-1} of a number > 1

prob 3 (d,e) cont'd

```
k=[1/2 1]
% for sec 2.6prob3 (d,e)
%part d
x=linspace(0,pi/2,1000);
y=acos(exp(1)*cos(1/2)*exp(-x));
plot(x,y);axis([0 pi/2 0 pi/2]);hold on
%part e
y=asin(exp(1)*sin(1/2)*exp(-x));
plot(x,y);axis([0 pi/2 0 pi/2]);hold on
end
grid
```

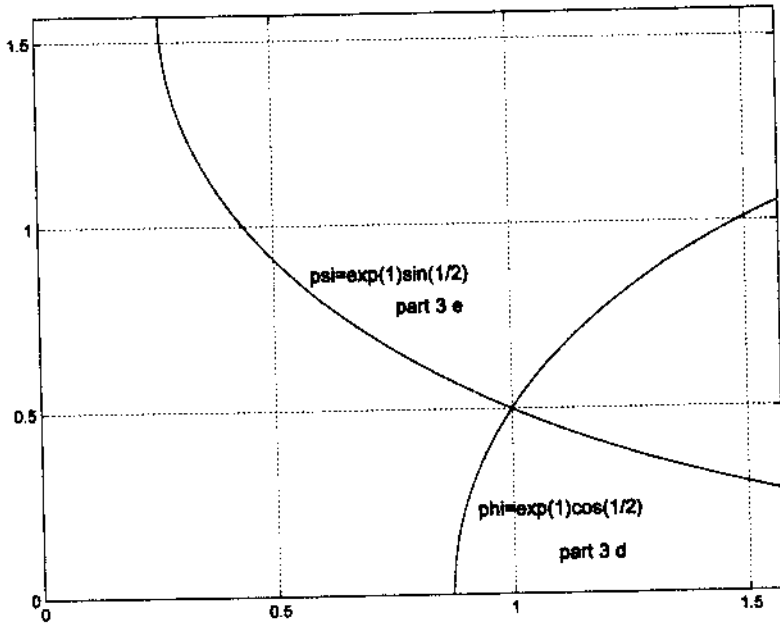

SEC 2.6 continued

4 (a) We require that D_x, D_y satisfy Eqn (2.6-3)

If $\underline{d} = y + ix, D_x = y, D_y = x, \frac{\partial D_x}{\partial x} + \frac{\partial D_y}{\partial y} = 0$

If $\underline{d} = x + iy, D_x = x, D_y = y, \frac{\partial D_x}{\partial x} + \frac{\partial D_y}{\partial y} = 2 \neq 0$

(b) $d = y + ix, D_x = y, D_y = x, -\epsilon \frac{\partial \phi}{\partial x} = D_x = y$

$\phi = -\frac{1}{\epsilon} xy + c(y)$. Recall $-\epsilon \frac{\partial \phi}{\partial y} = D_y = x$

Thus $x - \epsilon \frac{dc(y)}{dy} = x, \frac{dc}{dy} = 0, c = \text{const.}$

$\phi = -\frac{1}{\epsilon} xy + \text{const} \rightarrow -\frac{1}{\epsilon} xy = \phi$

$\phi = 0, -\frac{1}{\epsilon} xy = 0, \underline{x=0 \text{ or } y=0}$

$\phi = \frac{1}{\epsilon} = -\frac{1}{\epsilon} xy, xy = -1$

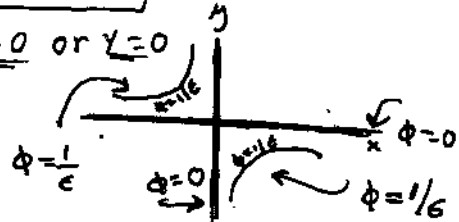

c) $\phi = -\frac{1}{\epsilon} xy, \frac{\partial \phi}{\partial x} = \frac{\partial \psi}{\partial y}, -\frac{y}{\epsilon} = \frac{\partial \psi}{\partial y}, \psi = -\frac{y^2}{2\epsilon} + c(x)$

$\frac{\partial \psi}{\partial x} = -\frac{\partial \phi}{\partial y}, \frac{dc}{dx} = \frac{x}{\epsilon}, c = \frac{x^2}{2\epsilon} + \text{const.}$

$\psi = \frac{x^2 - y^2}{2\epsilon} + \text{const. Const.} = 0 [\psi(0,0) = 0], \psi = \frac{x^2 - y^2}{2\epsilon}$

d) $\Phi = \phi + i\psi = -\frac{1}{\epsilon} [xy - i \frac{x^2 - y^2}{2\epsilon}] = \frac{i}{2\epsilon} [(x^2 - y^2) + i 2xy]$
 $= \frac{i}{2\epsilon} z^2 = \Phi(z)$

e) $\underline{e} = \underline{d}/\epsilon, E_x = \frac{D_x}{\epsilon} = \frac{y}{\epsilon} \Big|_1 = \frac{1}{\epsilon}$

$E_y = \frac{D_y}{\epsilon} = \frac{x}{\epsilon} \Big|_1 = \frac{1}{\epsilon}$. 2nd method $E_x + iE_y = -\left(\frac{d\Phi}{dz}\right) = \frac{1}{\epsilon} z =$

$\frac{1}{\epsilon} (x - iy) = \frac{y + ix}{\epsilon} = \frac{1+i}{\epsilon}$ at (1,1). Thus $E_x = \frac{1}{\epsilon} = E_y$

Third method: $\phi = -\frac{1}{\epsilon} xy, E_x = -\frac{\partial \phi}{\partial x} = \frac{y}{\epsilon}, E_y = -\frac{\partial \phi}{\partial y} = \frac{x}{\epsilon}$

$E_x = \frac{1}{\epsilon}, E_y = \frac{1}{\epsilon}$

Sec 2.6 continued

4(c) continued

Equipotential, $\phi = -\frac{1}{\epsilon} xy = -\frac{1}{\epsilon}$ at (1,1). Thus $xy=1$

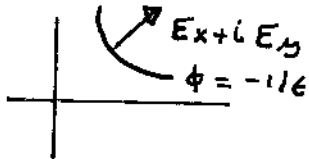

5 (a) $\Phi = (\cos \alpha - i \sin \alpha)(x + iy) = x \cos \alpha + y \sin \alpha + i[y \cos \alpha - x \sin \alpha] = \phi + i\psi$. Thus $\phi = x \cos \alpha + y \sin \alpha$

Equipotentials $x \cos \alpha + y \sin \alpha = \text{const.}$

$$dx \cos \alpha + dy \sin \alpha = 0 \quad \text{slope: } \frac{dy}{dx} = -\cot \alpha$$

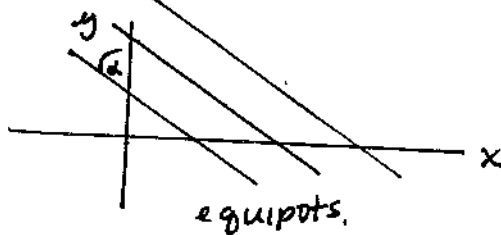

5(b) $\psi = y \cos \alpha - x \sin \alpha$

Streamlines:

$$y \cos \alpha - x \sin \alpha = \text{const.}$$

$$\text{slope } \frac{dy}{dx} = \tan \alpha$$

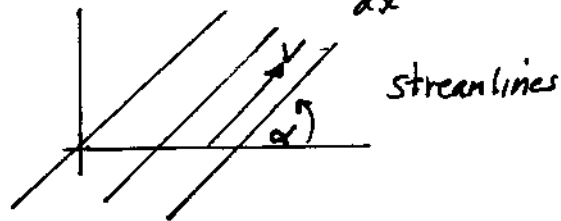

5(c)

$$\underline{N} = V_x + iV_y =$$

$$\overline{\left(\frac{d\Phi}{dz}\right)} = \cos \alpha + i \sin \alpha$$

The vector makes an angle α with positive x axis.

3

The Basic Transcendental Functions

sec 3.1

$$1) e^z = e^x [\cos y + i \sin y] = e^{x+iy}$$

$$e^{\bar{z}} = e^{x-iy} = e^x [\cos(-y) + i \sin(-y)]$$

$$e^{\bar{z}} = e^x [\cos y - i \sin y]$$

$$\overline{(e^z)} = e^x [\cos y + i \sin y] = e^z$$

$$2) e^{\frac{1}{2} + 2i} = e^{1/2} [\cos 2] + i e^{1/2} \sin 2 \\ = \boxed{-0.686 + i 1.499}$$

$$3) e^{\frac{1}{2} - 2i} = e^{1/2} \cos 2 - i e^{1/2} \sin 2 = \\ = \boxed{-0.686 - i 1.499}$$

$$4) e^{-i} = \cos(-1) + i \sin(-1) = \cos 1 - i \sin 1 \\ = 0.5403 - i 0.8415$$

$$5) \text{Add exponents, get } e^0 = \boxed{1}$$

$$6) (-i)^7 = (-1)^7 i^7 = (-1)(-i) = i$$

$$e^{(-i)^7} = e^i = 0.5403 + i 0.8415$$

$$7) (e^{-i})^7 = (\cos 1 - i \sin 1)^7 = \cos 7 - i \sin 7 \\ = \boxed{0.7539 - i 0.657}$$

$$8) e^{\frac{1}{1+i}} = e^{\frac{1-i}{2}} = e^{1/2} [\cos \frac{1}{2} - i \sin \frac{1}{2}] \\ = 1.4469 - i 0.7904$$

$$9.] \quad e^{e^{-i}} = e^{[\cos 1 - i \sin 1]} = e^{\cos 1} [\cos(\sin 1) - i \sin(\sin 1)] = \boxed{1.1438 - i 1.2799}$$

$$10.] \quad \arctan(1) = \frac{\pi}{4} + k\pi \quad k=0, \pm 1, \pm 2, \dots$$

$$e^{i \arctan(1)} = e^{i(\frac{\pi}{4} + k\pi)} = e^{ik\pi} e^{i\pi/4} = \frac{(1+i)}{\sqrt{2}} e^{ik\pi} = \frac{1+i}{\sqrt{2}} [\cos(k\pi)]$$

$$\frac{-(1+i)(-1)^k}{\sqrt{2}} \quad k=0, \pm 1, \pm 2, \pm 3, \dots = \frac{(-1)^k}{\sqrt{2}} (1+i)$$

$$11.] \quad (-2)^{1/2} = \pm i\sqrt{2}$$

$$e^{i\sqrt{2}} = \cos\sqrt{2} + i \sin\sqrt{2} = .1559 + i .9878$$

$$e^{-i\sqrt{2}} = \cos\sqrt{2} - i \sin\sqrt{2} = \boxed{.1559 - i .9878}$$

$$12.] \quad e^{-2} = .1353 \quad [e^{-2}]^{1/2} = \pm .3679$$

$$13.] \quad e^z = e$$

$$e^x [\cos y + i \sin y] = e$$

$$e^x = e, \quad \boxed{\lambda = 1} \quad \cos y + i \sin y = 1$$

$$\boxed{y = 2n\pi, \quad n=0, \pm 1, \pm 2, \dots}$$

$$14.] \quad f(z) = e^{iz}$$

$$f(z) = e^{ix} e^{-y} = e^{-y} [\cos x + i \sin x]$$

$$u = e^{-y} \cos x, \quad v = e^{-y} \sin x \quad e^{iz} \text{ is an entire function}$$

$$\frac{\partial u}{\partial x} = -e^{-y} \sin x = \frac{\partial v}{\partial y}$$

$$\frac{\partial u}{\partial y} = -e^{-y} \cos x = -\frac{\partial v}{\partial x}, \quad f'(z) = e^{iz} i$$

sec 3.1 cont'd

15) $e^{1/z}$ is analytic for all $z \neq 0$

$$e^{1/z} = e^{1/(x+iy)} = e^{(x-iy)/(x^2+y^2)}$$

$$= e^{\frac{x}{x^2+y^2}} \cos\left[\frac{y}{x^2+y^2}\right] - i e^{\frac{x}{x^2+y^2}} \sin\left[\frac{y}{x^2+y^2}\right]$$

$$u = e^{\frac{x}{x^2+y^2}} \cos\left[\frac{y}{x^2+y^2}\right], \quad v = -e^{\frac{x}{x^2+y^2}} \sin\left[\frac{y}{x^2+y^2}\right]$$

$$\frac{\partial u}{\partial x} = e^{\frac{x}{x^2+y^2}} \frac{y^2-x^2}{(x^2+y^2)^2} \cos\left[\frac{y}{x^2+y^2}\right] + e^{\frac{x}{x^2+y^2}} \left(\frac{\sin y}{x^2+y^2}\right) \frac{2xy}{(x^2+y^2)^2}$$

$$= \frac{\partial v}{\partial y}$$

$$\frac{\partial u}{\partial y} = \frac{-2xy e^{\frac{x}{x^2+y^2}} \cos\left[\frac{y}{x^2+y^2}\right]}{(x^2+y^2)^2}$$

$$- \frac{(x^2-y^2)}{(x^2+y^2)^2} e^{\frac{x}{x^2+y^2}} \sin\left[\frac{y}{x^2+y^2}\right] = -\frac{\partial v}{\partial x}$$

$$f'(z) = e^{1/z} \left(\frac{-1}{z^2}\right)$$

16) e^{e^z} is an entire function of an entire function. Is analytic everywhere

$$e^{e^z} = e^{e^{x+iy}} = e^{e^x [\cos y + i \sin y]}$$

$$= e^{e^x \cos y} \cos[e^x \sin y] + i e^{e^x \cos y} \sin[e^x \sin y]$$

$$u = e^{e^x \cos y} \cos[e^x \sin y], \quad v = e^{e^x \cos y} \sin[e^x \sin y]$$

$$\frac{\partial u}{\partial x} = e^{e^x \cos y} e^x \cos y \cos[e^x \sin y] + e^{e^x \cos y} (-1) \sin[e^x \sin y] e^{e^x \sin y}$$

$$= \frac{\partial v}{\partial y}$$

16. cont'd

sec 3.1

cont'd

$$\frac{\partial W}{\partial y} = e^{e^x \cos y} [s \cos y] e^x \cos (e^x s \cos y)$$

$$- \sin (e^x s \cos y) \cos y e^x e^{e^x \cos y} = -\frac{\partial V}{\partial x}$$

$$f'(z) = e^{e^z} e^z$$

$$17) \lim_{z \rightarrow i} \frac{z-i}{e^z - e^i} = \lim_{z \rightarrow i} \frac{1}{e^z} = \frac{1}{e^i} = e^{-i}$$

18) The fact that θ is real is not relevant. Look at $\lim_{z \rightarrow \pi} \frac{1+e^{iz}}{1-e^{2iz}}$

Numerator and denon are analytic

$$= \lim_{z \rightarrow \pi} \frac{e^{iz} i}{-e^{2iz} 2i} = \frac{-1}{2} \frac{e^{i\pi}}{e^{2i\pi}} = \frac{1}{2}$$

$$19) a) \frac{d}{dz} e^z e^{a-z} = e^z e^{a-z} + e^z e^{a-z} (-1) = 0$$

$$b) e^z e^{a-z} = k, \quad \text{put } z=a, \text{ know } e^0=1$$

$$e^a e^0 = k, \quad k=e^a$$

$$c) e^z e^{a-z} = e^a, \quad z=z_1, \quad a=z_1+z_2$$

$$e^{z_1} e^{z_1+z_2-z_1} = e^{z_1+z_2}$$

$$e^{z_1} e^{z_2} = e^{z_1+z_2}$$

g.e.d

sec 3.1 cont'd

20) $e^t \sin t = \text{Im} [e^{(1+i)t}]$

$$\begin{aligned} \frac{d^5}{dt^5} e^t \sin t &= \text{Im} \left[\frac{d^5}{dt^5} e^{(1+i)t} \right] \\ &= \text{Im} \left[(1+i)^5 e^t [\cos t + i \sin t] \right] = \\ &= -7(1+i)e^t [\cos t + i \sin t] = -7e^t [\cos t + \sin t] \end{aligned}$$

21)

```
» t=sym('t');
» diff(exp(2*t)*cos(2*t),7)
```

ans =

$$1024 \cdot \exp(2 \cdot t) \cdot \sin(2 \cdot t) + 1024 \cdot \exp(2 \cdot t) \cdot \cos(2 \cdot t)$$

22)

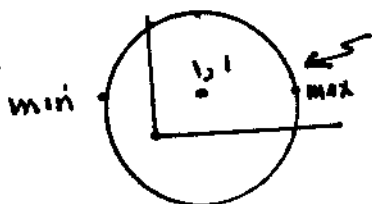

$|z - 1 - i| = 2$, circle rad 2, center $1+i$

$$|e^z| = e^x$$

e^x is max at $y=1, x=1$
 since x is max here

e^x is min at $y=1, x=-1$

23) $e^{z^2} = e^{x^2 - y^2 + i 2xy}$ $|e^{z^2}| = e^{x^2 - y^2}$

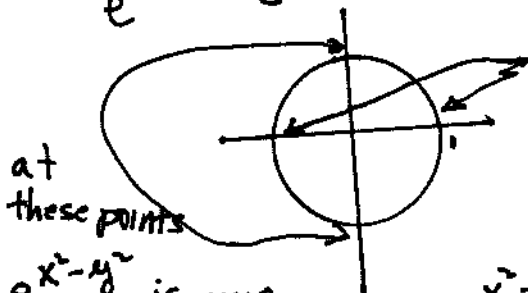

$e^{x^2 - y^2}$ is max here, $y=0, x=1$

$e^{x^2 - y^2} = e$, max value also $y=0, x=-1$

at these points $e^{x^2 - y^2}$ is min, $x=0, y=\pm 1, e^{x^2 - y^2} = e^{-1}$, min value

sec 3.1

$$24) a) f(t) = \text{Re} \left[\frac{1}{t-i} \right] = \text{Re} \left[\frac{t+i}{t^2+1} \right]$$

$$f^{(n)}(t) = \text{Re} \left[\frac{d^n}{dt^n} \frac{t+i}{t^2+1} \right] = \text{Re} \left[\frac{d^n}{dt^n} \frac{1}{t-i} \right]$$

$$= \text{Re} \left[\frac{(-1)^n n!}{(t-i)^{n+1}} \right] \quad n=1, 2, \dots$$

$$\frac{(-1)^n n!}{(t-i)^{n+1}} = \frac{(-1)^n n! (t+i)^{n+1}}{(t^2+1)^{n+1}} = \text{[use binom. thm]}$$

$$\frac{(-1)^n n! (n+1)!}{(t^2+1)^{n+1}} \sum_{p=0}^{n+1} \frac{i^p t^{n+1-p}}{(n+1-p)! p!}$$

We want the real part of the above.
This will involve i^p raised only to even powers.

to get only even powers of i^p , let $p=2k$ and sum only on integer k . If n is odd, $n+1$ is even, k goes from 0 to $\frac{n+1}{2}$

$$\text{Thus } \text{Re} \sum_{p=0}^{n+1} \frac{i^p t^{n+1-p}}{(n+1-p)! p!} = \sum_{k=0}^{(n+1)/2} \frac{(-1)^k t^{n+1-2k}}{(n+1-2k)! (2k)!}$$

Note $(-1)^n = -1$, n odd, $i^{2k} = (-1)^k$

\therefore for n odd

$$f^{(n)}(t) = \frac{(-1) n! (n+1)!}{(t^2+1)^{n+1}} \sum_{k=0}^{(n+1)/2} \frac{(-1)^k t^{n+1-2k}}{(n+1-2k)! (2k)!} \quad n, \text{ odd}$$

Now suppose n is even, $(-1)^n$ is 1
as above but $2k$ goes only up to n , or k ranges from 0 to $n/2$.

24(b) sec 3.1

cont'd

$$\frac{1}{t^2+1} = \text{Im} \frac{1}{t-i}$$

proceed as in part (a) but answer is

$$\frac{(-1)^n n! (n+1)!}{(t^2+1)^{n+1}} \text{Im} \left[\sum_{p=0}^{n+1} \frac{t^{n+1-p}}{(n+1-p)! p!} \right]$$

The imag terms come only from t^p raised to odd powers. Let $p = 2k+1$ $k=0, \dots, \frac{n+1}{2}$ if n is odd

Note $t^{2k+1} = (-1)^k i$

If n is odd $(-1)^n = (-1)$

If n is even, $(-1)^n = 1$, let $p = 2k+1$, $k=0, \dots, \frac{n}{2}$ if n is even

Thus if n is odd

$$f^{(n)}(t) = \frac{(-1)^n n! (n+1)!}{(t^2+1)^{n+1}} \sum_{k=0}^{\frac{n-1}{2}} (-1)^k \frac{t^{n-2k}}{(n-2k)! (2k+1)!}$$

and if n is even:

$$f^{(n)}(t) = \frac{(n!) (n+1)!}{(t^2+1)^{n+1}} \sum_{k=0}^{n/2} (-1)^k \frac{t^{n-2k}}{(n-2k)! (2k+1)!}$$

Sec 3.1 cont'd

25

a) Let $z = e^{j\psi}$, Then $P = 1 + z + z^2 + \dots + z^{N-1} = \frac{1 - z^N}{1 - z}$

$$P(\psi) = \frac{1 - e^{jN\psi}}{1 - e^{j\psi}} = \frac{e^{jN\psi/2} - 1}{e^{j\psi/2} - 1} = \frac{e^{jN\psi/2} \left[\frac{e^{-jN\psi/2} - 1}{e^{-j\psi/2} - 1} \right]}{e^{j\psi/2} \left[\frac{e^{-j\psi/2} - 1}{e^{-j\psi/2} - 1} \right]}$$

$$= \frac{e^{jN\psi/2}}{e^{j\psi/2}} \left[\frac{(\cos \frac{N\psi}{2} + j \sin \frac{N\psi}{2}) - [\cos \frac{N\psi}{2} - j \sin \frac{N\psi}{2}]}{(\cos \frac{\psi}{2} + j \sin \frac{\psi}{2}) - [\cos \frac{\psi}{2} - j \sin \frac{\psi}{2}]} \right] =$$

$$\frac{e^{jN\psi/2}}{e^{j\psi/2}} \frac{2j \sin \frac{N\psi}{2}}{2j \sin \frac{\psi}{2}} \quad \text{Thus } |P(\psi)| = \left| \frac{e^{jN\psi/2}}{e^{j\psi/2}} \right| \left| \frac{\sin \frac{N\psi}{2}}{\sin \frac{\psi}{2}} \right|$$

$$= \left| \frac{\sin \frac{N\psi}{2}}{\sin \frac{\psi}{2}} \right| \quad \text{p.c.d.}$$

b) Consider $\lim_{\psi \rightarrow 0} \frac{\sin \frac{N\psi}{2}}{\sin \frac{\psi}{2}} = \lim_{\psi \rightarrow 0} \frac{N \cos(\frac{N\psi}{2})}{\frac{1}{2} \cos \frac{\psi}{2}} = N$

Thus $\lim_{\psi \rightarrow 0} |P(\psi)| = N$

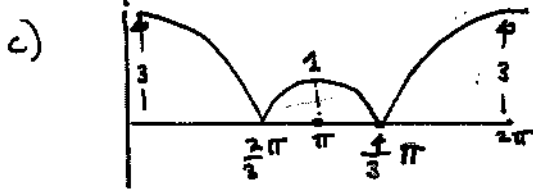

26

9) a) $\text{Re} \left[\frac{1 + re^{i\theta}}{1 - re^{i\theta}} \right] = \text{Re} \left[\frac{(1 + re^{i\theta})(1 - re^{-i\theta})}{(1 - re^{i\theta})(1 - re^{-i\theta})} \right]$

$$= \text{Re} \left[\frac{1 - r^2 + r[\cos\theta - \cos(-\theta)]}{1 + r^2 - r[\cos\theta + \cos(-\theta)]} \right] = \text{Re} \left[\frac{1 - r^2 + 2ir \sin\theta}{1 + r^2 - 2r \cos\theta} \right]$$

$$= \frac{1 - r^2}{1 + r^2 - 2r \cos\theta}$$

This is the real part of an analytic function and thus is harmonic, (satisfies Laplace's Eqn in a domain)

b) Taking the imaginary part of the preceding expression instead of the real part we have: $\frac{2r \sin \theta}{1+r^2-2r \cos \theta}$

27) a) $\phi = \text{Re}[e^{x+iy}] = e^x \cos y$, $\psi = \text{Im}[e^{x+iy}] = e^x \sin y$

b) $e^x \cos y = 0$, $y = \pm \frac{\pi}{2}$; $\phi = e^x \cos y = 1/2$, $\cos y = \frac{1}{2} e^{-x}$
 $y = \cos^{-1}[\frac{1}{2} e^{-x}]$ as $x \rightarrow \infty$, $y \rightarrow \cos^{-1}(0) = \frac{\pi}{2}$ or $-\frac{\pi}{2}$

If $x = \log 1/2 = -\log 2$, $y = \cos^{-1}(1) = 0$

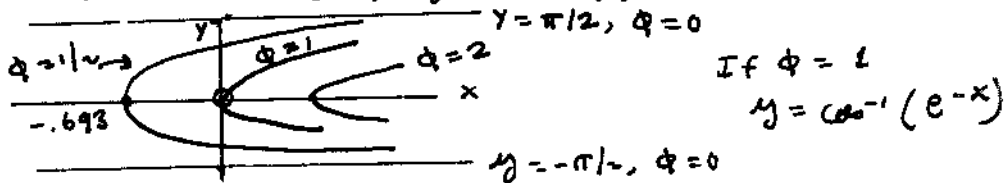

Now do streamlines:

If $\psi = 0$, $e^x \sin y = 0$, $y = 0$; If $\psi = 1/2$, $e^x \sin y = 1/2$; $y = \sin^{-1}(\frac{1}{2} e^{-x})$. As $x \rightarrow \infty$, $y \rightarrow 0$

If $x = \log 1/2 = -\log 2$, $y = \pi/2$; If $\psi = 2$,

$e^x \sin y = 1$, $y = \sin^{-1}(e^{-x})$. If $x = 0$, $y = \pi/2$

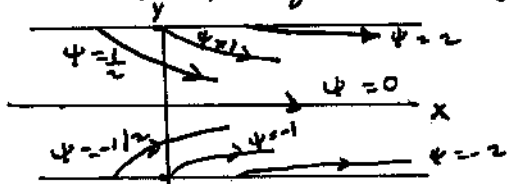

c) $\frac{d\Phi}{dz} = e^z = e^x [\cos y + i \sin y]$. $V_x + i V_y = \left(\frac{d\Phi}{dz}\right)$

If $x = 1$, $y = \pi/4$ have: $V_x = e \cos(\pi/4)$, $V_y = e \sin(\pi/4)$

$$\boxed{V_x = \frac{e}{\sqrt{2}}}, \quad \boxed{V_y = -\frac{e}{\sqrt{2}}}$$

Sec 3.2

$$1 \quad \sin(2+3i) = \sin 2 \cosh 3 + i \cos 2 \sinh 3$$

$$= (.909)(10.067) + (-.4161) * 10.0179$$

$$= \boxed{9.1545 - i 4.1689}$$

$$2) \quad \cos(-2+3i) = \cos 2 \cosh 3 + i \sin 2 \sinh 3$$

$$= (-.4161)(10.0677) + i .9093 (10.0179)$$

$$= \boxed{-4.1896 + i 9.1092}$$

$$3) \quad \tan(2+3i) = \frac{\sin 2 \cosh 3 + i \cos 2 \sinh 3}{\cos 2 \cosh 3 - i \sin 2 \sinh 3}$$

$$= \frac{\sin(2+3i)}{\cos(2+3i)} \quad \text{In problem 1, saw that}$$

$$\sin(2+3i) = 9.1545 - i 4.1689$$

$$\text{In problem 2} \quad \cos(-2+3i) = -4.1896 + i 9.1092$$

$$\therefore \cos(2+3i) = -4.1896 - i 9.1092$$

$$\text{Thus } \tan(2+3i) = \frac{9.1545 - i 4.1689}{-4.1896 - i 9.1092}$$

$$= \boxed{-0.0638 + i 1.0032}$$

sec 3.2

$$4) (i \sinh 1)^{1/2} = (i \sinh 1)^{1/2}$$

$$= \sqrt{\sinh 1} (\pm) \left[\frac{1+i}{\sqrt{2}} \right]$$

$$= \pm 0.7666 [1+i]$$

$$5) i^{1/2} = \pm \left(\frac{1+i}{\sqrt{2}} \right)$$

$$\operatorname{Re} i^{1/2} = \pm \left[\sin \frac{1}{\sqrt{2}} \cosh \frac{1}{\sqrt{2}} + i \cos \frac{1}{\sqrt{2}} \sinh \frac{1}{\sqrt{2}} \right]$$

$$= \pm [0.8189 + i 0.5835]$$

$$6) e^i = \cos 1 + i \sin 1$$

$$\operatorname{Re}(e^i) = \operatorname{Re}[\cos 1] \cosh[\sin 1]$$

$$+ i \cos[\cos 1] \sinh[\sin 1]$$

$$= 0.7075 + i 0.8098$$

$$7) \arg(2i) = \frac{\pi}{2} + 2k\pi$$

$$\text{or } \arg(2i) = i[\pi + k\pi]$$

$$\cos[(i)(\pi + 4k\pi)] = \cosh[\pi + 4k\pi]$$

$$k = 0, \pm 1, \pm 2, \dots$$

Sec 3.2 cont'd

$$\begin{aligned}
 8] \quad \cos(1+i) &= \cos 1 \cosh 1 - i \sin 1 \sinh 1 \\
 \sin[\cos 1 \cosh 1 - i \sin 1 \sinh 1] \\
 &= \sin[\cos 1 \cosh 1] \cosh[\sin 1 \sinh 1] \\
 &+ i \cos[\cos 1 \cosh 1] \sinh[\sin 1 \sinh 1] \\
 &= \boxed{1.133 - 1.7784i}
 \end{aligned}$$

$$9] \quad \begin{array}{c} \diagup \\ \text{---} \end{array} \sqrt{3} \quad \arg(1+i\sqrt{3}) = \frac{\pi}{3} + 2k\pi$$

$$\begin{aligned}
 \tan\left(i \left[\frac{\pi}{3} + 2k\pi\right]\right) &= \frac{\sin i \left[\frac{\pi}{3} + 2k\pi\right]}{\cos i \left[\frac{\pi}{3} + 2k\pi\right]} \\
 &= \frac{i \sinh\left[\frac{\pi}{3} + 2k\pi\right]}{\cosh\left[\frac{\pi}{3} + 2k\pi\right]} = \boxed{i \tanh\left[\frac{\pi}{3} + 2k\pi\right]} \\
 & \quad k=0, \pm 1, \pm 2, \dots
 \end{aligned}$$

$$\begin{aligned}
 10] \quad \tan i &= \frac{i \sinh 1}{\cosh 1} = i \tanh 1 \\
 \arg[i \tanh 1] &= \frac{\pi}{2} + 2k\pi \quad k=0, \pm 1, \pm 2, \dots
 \end{aligned}$$

$$\begin{aligned}
 11] \quad \cos i &= \cosh 1 \\
 e^{i \cosh 1} + e^{-i \cosh 1} &= \boxed{2 \cos[\cosh 1]}
 \end{aligned}$$

Sec 3.2

12) a) $\sin^2 z = \left(\frac{e^{iz} - e^{-iz}}{2i} \right)^2 = \frac{e^{2iz} + e^{-2iz} - 2}{-2}$

$\cos^2 z = \left(\frac{e^{iz} + e^{-iz}}{2} \right)^2 = \frac{e^{2iz} + e^{-2iz} + 2}{2}$

sum the above

Get $\frac{2+2}{2} = 1$ s.e.d

b) $(\cos^2 z + \sin^2 z) = (\cos z + i \sin z)(\cos z - i \sin z)$
 $= e^{iz} \cdot e^{-iz} = 1$ s.e.d

13) $\frac{d}{dz} \left[\frac{e^{iz} - e^{-iz}}{2i} \right] = \frac{e^{iz} i + e^{-iz} i}{2} = \frac{e^{iz} + e^{-iz}}{2} = \cos z$
 Similarly: $\frac{d}{dz} \left[\frac{e^{iz} + e^{-iz}}{2} \right] = \frac{i e^{iz} - i e^{-iz}}{2} = -\sin z$

14) $\cos^2 z = \left(\frac{e^{iz} + e^{-iz}}{2} \right)^2 = \frac{e^{2iz} + e^{-2iz} + 2}{2}$
 $= \frac{\cos 2z}{2} + \frac{1}{2}$

15) $\sin z = \frac{e^{iz} - e^{-iz}}{2i}$

$\sin(z + 2\pi) = \frac{e^{i(z+2\pi)} - e^{-i(z+2\pi)}}{2i} =$

$\frac{e^{iz} e^{i2\pi} - e^{-iz} e^{-i2\pi}}{2i} = \frac{e^{iz} - e^{-iz}}{2i}$ since $e^{\pm i2\pi} = 1$

Similarly: $\cos z = \frac{e^{iz} + e^{-iz}}{2}$, $\cos(z + 2\pi) = \frac{e^{i(z+2\pi)} + e^{-i(z+2\pi)}}{2} = \cos z$

Sec 3.2

16) $\sin z = 0$, $\sin(x+iy) = 0$, $\sin x \cosh y + i \cos x \sinh y = 0$. Thus $\sin x \cosh y = 0$ and $\cos x \sinh y = 0$. Since $\cosh y \neq 0$ (all y) it follows that $\sin x = 0$ or $x = n\pi$. If $x = n\pi$, then $\cos x \neq 0$, this means $\sinh y = 0$, which is only satisfied for $y = 0$. Thus $z = n\pi + i0$. All zeroes are real.

17) $\sin z = \cos z$, $\sin x \cosh y + i \cos x \sinh y = \cos x \cosh y - i \sin x \sinh y$. Equations corresponding parts: reals and imaginaries, set: $\sin x \cosh y = \cos x \cosh y$ and $\cos x \sinh y = -\sin x \sinh y$. Assume $y \neq 0$, then $\sinh y \neq 0$. Dividing our 2nd eqn. by $\sinh y$ and our first equation by $\cosh y$ we have:

$\cos x = -\sin x$ and $\sin x = \cos x$. These equations are both satisfied only if $\sin x = \cos x = 0$. There is no solution. Thus we now assume $y = 0$.

Since $\sinh y = 0$, the 2nd eqn. $\cos x \sinh y = -\sin x \sinh y$ is satisfied. We have $\sin x \cosh y = \cos x \cosh y$ now becomes $\sin x = \cos x$, or $x = \frac{\pi}{4} + k\pi$, k any integer. Thus solution is $z = \left(\frac{\pi}{4} + k\pi\right) + i0$

18) $\tan z = \frac{\sin z}{\cos z}$. Not analytic where $\cos z = 0$

$z = k\pi + \frac{\pi}{2}$, k any integer.

19) $\frac{1}{\cos(iz)}$ not analytic where $\cos(iz) = 0$

or $iz = n\pi + \frac{\pi}{2}$, or $z = -i\left(n\pi + \frac{\pi}{2}\right)$ n any integer.

20) $\frac{1}{\sin z \sin[(1+i)z]}$ not analytic where $\sin z = 0$ and or $\sin[(1+i)z] = 0$

$\sin z = 0$ if $z = k\pi$; (k integer) $\sin(1+i)z = 0$

if $(1+i)z = n\pi$, $z = \frac{n\pi}{(1+i)}$ (n integer).

Thus $f(z)$ not analytic at $z = \frac{n\pi}{(1+i)}$ and $z = k\pi$; k, n integer.

211

Sec 3.2

function not analytic where $\sqrt{3} \sin z - \cos z = 0$
or $\sqrt{3} \sin z = \cos z$ or $\sqrt{3} [\sin x \cosh y + i \cos x \sinh y] = \cos x \cosh y - i \sin x \sinh y$. Equate corresponding parts.
 $\sqrt{3} \sin x \cosh y = \cos x \cosh y$; $\sqrt{3} \cos x \sinh y = -\sin x \sinh y$.
Assume $y \neq 0$. Then $\sinh y \neq 0$. We can divide 2nd eqn. by $\sinh y$, and 1st eqn. by $\cosh y$. Get: $\sqrt{3} \sin x = \cos x$ and $\sqrt{3} \cos x = -\sin x$. The preceding can be solved only if $\sin x = \cos x = 0$

Since $\sin x = \cos x = 0$ has no solution, we must assume $y = 0$. Thus $\sqrt{3} \cos x \sinh y = -\sin x \sinh y$ is satisfied. Since $\cosh 0 = 1$, we have also:
 $\sqrt{3} \sin x = \cos x$, $\tan x = \frac{1}{\sqrt{3}}$, $x = \frac{\pi}{6} + k\pi$, k integer
answer $z = \frac{\pi}{6} + k\pi + i0$ (k integer).

Sec 3.2 cont'd
next pg.

Sec 3.2

22) a) $f(z) = \sin \frac{1}{z}$ $\frac{1}{z}$ analytic
except @ $z=0$, $\sin z$ is analytic for all z .
 $\therefore \sin \frac{1}{z}$ is analytic for all $z \neq 0$

$$\begin{aligned} \sin \frac{1}{z} &= \sin \frac{x-iy}{x^2+y^2} = \sin \left[\frac{x}{x^2+y^2} - i \frac{y}{x^2+y^2} \right] \\ &= \sin \frac{x}{x^2+y^2} \cosh \left[\frac{y}{x^2+y^2} \right] - i \cos \left(\frac{x}{x^2+y^2} \right) \sinh \frac{y}{x^2+y^2} \end{aligned}$$

b) $\frac{d}{dz} \sin \frac{1}{z} = \left(\cos \frac{1}{z} \right) \left(-\frac{1}{z^2} \right)$ analytic
all $z \neq 0$.

23]

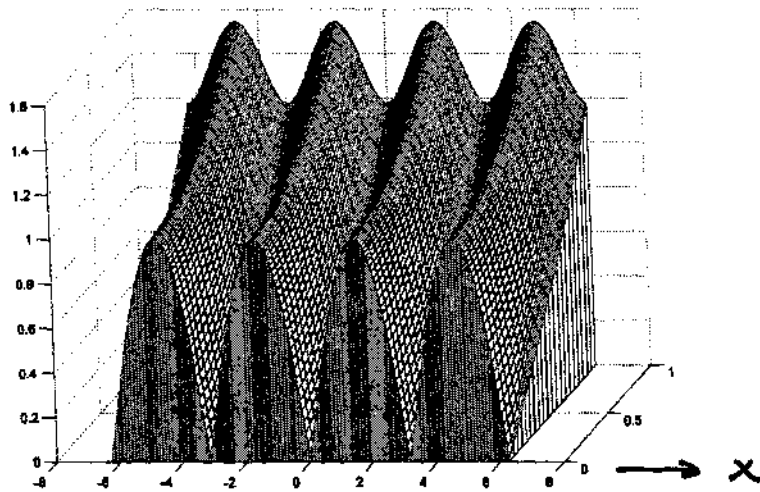

y \rightarrow Prob 23, sec 3.2
 $|\sin z|$

Sec 3.2
cont'd

Code for probs 23, 24

```
% prob 23,24 section 3.2
x=[-2*pi:.05:2*pi];
y=[0:.05:1];

[X,Y]=meshgrid(x,y);
Z=X+i*Y;
%w=sin(Z);problem 23
%w=cos(Z);problem 24
%wm=real(w);%problem 24
wm=imag(w);%problem 24
%wm=abs(w)%problem 23;
meshz(X,Y,wm);view(10,15)
```

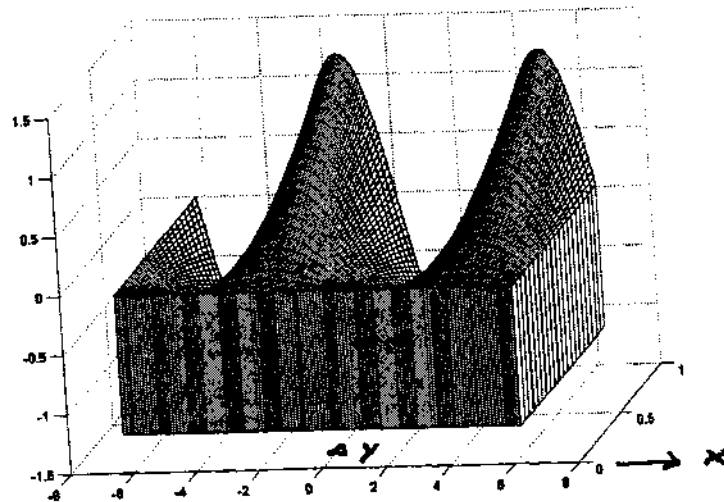

Prob 24, $\text{Im}(\cos z)$, $Y \geq 0$

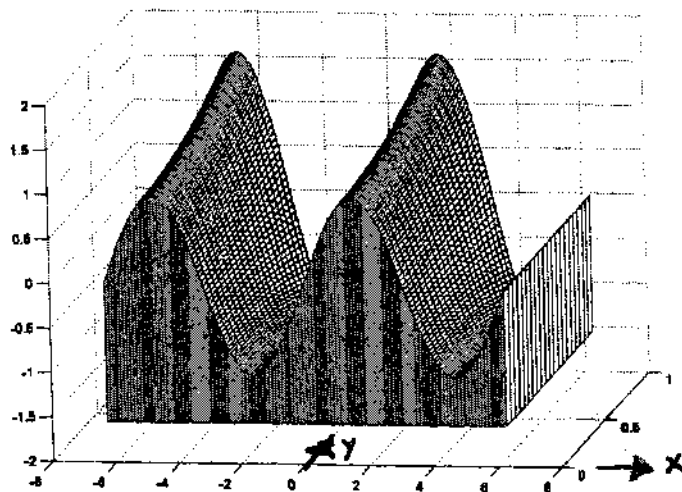

Prob 24, $\text{Re}(\cos z)$ for $Y \geq 0$

Sec 3.2 cont'd

$$25) |wz| = |\cos x \cosh y - i \sin x \sinh y|$$

$$= \sqrt{\cos^2 x \cosh^2 y + \sin^2 x \sinh^2 y} =$$

$$\sqrt{\cos^2 x [1 + \sinh^2 y] + \sin^2 x \sinh^2 y} =$$

$$\sqrt{\sinh^2 y [\sin^2 x + \cos^2 x] + \cos^2 x} = \sqrt{\sinh^2 y + \cos^2 x}$$

$$26) |sz| = |\sin x \cosh y + i \cos x \sinh y| = \sqrt{\sin^2 x \cosh^2 y + \cos^2 x \sinh^2 y}$$

put $\cosh^2 y = 1 + \sinh^2 y$.

$$\text{Thus } |sz| = \sqrt{\sin^2 x [1 + \sinh^2 y] + \cos^2 x \sinh^2 y} =$$

$$= \sqrt{\sinh^2 y [\sin^2 x + \cos^2 x] + \sin^2 x} = \sqrt{\sinh^2 y + \sin^2 x}$$

Sec 3.2 Continued

27] Use results of preceding two problems.

$$\begin{aligned} \text{Thus } |\cos z|^2 + |\sin z|^2 &= 2 \sinh^2 y + \sin^2 x + \cos^2 x \\ &= 2 \sinh^2 y + 1 = \sinh^2 y + \underbrace{1 + \sinh^2 y}_{\cosh^2 y} = \\ &\sinh^2 y + \cosh^2 y \quad \text{q.e.d.} \end{aligned}$$

$$28] \tan z = \frac{\sin z}{\cos z} = \frac{\sin x \cosh y + i \cos x \sinh y}{\cos x \cosh y - i \sin x \sinh y} =$$

$$\frac{[\sin x \cosh y + i \cos x \sinh y][\cos x \cosh y + i \sin x \sinh y]}{\cos^2 x \cosh^2 y + \sin^2 x \sinh^2 y} = \frac{N}{D}$$

Consider the denominator D

$$\cos^2 x \cosh^2 y + \sin^2 x \sinh^2 y = \cosh^2 y [1 - \sin^2 x]$$

$$+ \sin^2 x [\cosh^2 y - 1] = \cosh^2 y - \sin^2 x =$$

$$\frac{(1 + \cosh 2y) - [1 - \cos(2x)]}{2} = \frac{1}{2} [\cosh 2y + \cos(2x)] = D$$

Now consider numerator: N. The real part of N

$$\text{is } \cosh^2 y \sin x \cos x - \sinh^2 y \sin x \cos x =$$

$$\sin x \cos x [\cosh^2 y - \sinh^2 y] = \sin x \cos x = \frac{1}{2} \sin(2x)$$

Now consider imaginary part of numerator:

$$\cos^2 x \cosh y \sinh y + \sin^2 x \cosh y \sinh y = \cosh y \sinh y$$

$$= \frac{1}{2} \sinh(2y). \text{ Thus } \frac{N}{D} = \frac{\frac{1}{2} \sin(2x) + \frac{1}{2} i \sinh(2y)}{\frac{1}{2} [\cosh 2y + \cos 2x]}$$

Thus $\tan z =$

$$\text{thus } \tan z = \frac{\sin(2x) + i \sinh(2y)}{\cosh 2y + \cos 2x}. \quad \text{q.e.d.}$$

29]

$$\cot z = \frac{\cos z}{\sin z} = \frac{\cos x \cosh y - i \sin x \sinh y}{\sin x \cosh y + i \cos x \sinh y}$$

SEC 3.2 cont'd

29] cont'd

$$= \frac{[\cos x \cosh y - i \sin x \sinh y][\sin x \cosh y - i \cos x \sinh y]}{\sin^2 x \cosh^2 y + \cos^2 x \sinh^2 y}$$

$$= \frac{N}{D} \quad \text{Now consider } D = \sin^2 x \cosh^2 y + \cos^2 x \sinh^2 y$$

$$= \cosh^2 y [1 - \cos^2 x] + \cos^2 x [\cosh^2 y - 1] =$$

$$\cosh^2 y - \cos^2 x = \frac{1}{2} [1 + \cosh 2y - [1 + \cos 2x]] =$$

$$\frac{\cosh 2y - \cos 2x}{2} \quad \text{Now consider } \operatorname{Re}(N) =$$

$$\cosh^2 y \sin x \cos x - \sinh^2 y \sin x \cos x = \sin x \cos x [\cosh^2 y - \sinh^2 y] = \sin x \cos x = \frac{1}{2} \sin(2x).$$

$$\text{Now } \operatorname{Im}(N) = -\cos^2 x \sinh y \cosh y - \sin^2 x \sinh y \cosh y$$

$$= -[\sin^2 x + \cos^2 x] \sinh y \cosh y = -\frac{1}{2} \sinh(2y).$$

$$\text{Thus } \frac{N}{D} = \frac{\frac{1}{2} \sin(2x) - \frac{i}{2} \sinh(2y)}{\frac{1}{2} [\cosh 2y - \cos 2x]} = \frac{\sin 2x - i \sinh 2y}{\cosh 2y - \cos 2x}$$

q.e.d.

$$30(a) \quad |\sin z| = \sqrt{\sin^2 x \cosh^2 y + \cos^2 x \sinh^2 y}$$

$$\leq \sqrt{\sin^2 x \cosh^2 y + \cos^2 x \cosh^2 y} = \sqrt{\cosh^2 y} = |\cosh y|$$

since $\cosh y$ positive

$$\therefore |\sin z| \leq \cosh y$$

$$|\sin z| = \sqrt{\sin^2 x \cosh^2 y + \cos^2 x \sinh^2 y}$$

$$\geq \sqrt{\sin^2 x \sinh^2 y + \cos^2 x \sinh^2 y} = |\sinh y|$$

Thus $|\sinh y| \leq |\sin z|$

$$b) \quad \cos z = \cos x \cosh y - i \sin x \sinh y$$

$$|\cos z| = \sqrt{\cos^2 x \cosh^2 y + \sin^2 x \sinh^2 y}$$

$$|\cos z| \leq \sqrt{\cos^2 x \cosh^2 y + \sin^2 x \cosh^2 y} = \cosh y$$

$$\text{Similarly: } |\cos z| = \sqrt{\cos^2 x \cosh^2 y + \sin^2 x \sinh^2 y}$$

$$\geq \sqrt{\cos^2 x \sinh^2 y + \sin^2 x \sinh^2 y} = |\sinh y|$$

$$\therefore |\sinh y| \leq |\cos z| \leq \cosh y$$

Ex 3.3

$$1) \sinh z = \frac{e^z - e^{-z}}{2} = \frac{e^{x+iy} - e^{-x-iy}}{2} =$$

$$\frac{e^x}{2} [\cos y + i \sin y] - \frac{e^{-x}}{2} [\cos y - i \sin y] =$$

$$\frac{e^x - e^{-x}}{2} \cos y + i \left[\frac{e^x + e^{-x}}{2} \right] \sin y = \sinh x \cos y + i \cosh x \sin y. \quad \text{q.e.d.}$$

$$2) \cosh z = \frac{e^z + e^{-z}}{2} = \frac{e^{x+iy} + e^{-x-iy}}{2} = \frac{e^x}{2} [\cos y + i \sin y]$$

$$+ \frac{e^{-x}}{2} [\cos y - i \sin y] = \frac{e^x + e^{-x}}{2} \cos y + i \frac{e^x - e^{-x}}{2} \sin y$$
$$= \cosh x \cos y + i \sinh x \sin y \quad \text{q.e.d.}$$

$$3) \cosh^2 z - \sinh^2 z = \left[\frac{e^z + e^{-z}}{2} \right]^2 - \left[\frac{e^z - e^{-z}}{2} \right]^2$$
$$= \frac{[e^{2z} + 2 + e^{-2z}] - [e^{2z} - 2 + e^{-2z}]}{4} = 1 \quad \text{q.e.d.}$$

$$4) \sinh(z + 2\pi i) = \frac{e^{z+2\pi i} - e^{-(z+2\pi i)}}{2} =$$

$$\frac{e^{2\pi i} e^z - e^{-z} e^{-2\pi i}}{2} = \frac{e^z - e^{-z}}{2} = \sinh z \quad \text{q.e.d.}$$

Proof is similar for $\cosh(z + 2\pi i) = \cosh z$.

$$5) \sinh i\theta = \frac{e^{i\theta} - e^{-i\theta}}{2} = i \frac{e^{i\theta} - e^{-i\theta}}{2i} = i \sin \theta$$

$$\cosh i\theta = \frac{e^{i\theta} + e^{-i\theta}}{2} = \cos \theta$$

sec 3.3

$$\begin{aligned} 6) \quad \sinh(1+2i) &= \sinh 1 \cos 2 \\ &+ i \cosh 1 \sin 2 = 1.175 (-.416i) \\ &+ i 1.543 * .9093 = -.4891 + i 1.403 \end{aligned}$$

$$\begin{aligned} 7) \quad \sinh\left(1 + \frac{\pi}{2}i\right) &= \sinh 1 \cos\left(\frac{\pi}{2}\right) \\ &+ i \cosh 1 \sin\frac{\pi}{2} = i \cosh 1 \\ &= 1.543i \end{aligned}$$

$$\begin{aligned} 8) \quad \tanh\left(e^{i\pi/4}\right) &= \frac{\sinh\left[\frac{1+i}{\sqrt{2}}\right]}{\cosh\left[\frac{1+i}{\sqrt{2}}\right]} \\ &= \frac{\sinh\frac{1}{\sqrt{2}} \cos\frac{1}{\sqrt{2}} + i \cosh\left[\frac{1}{\sqrt{2}}\right] \sin\frac{1}{\sqrt{2}}}{\cosh\left[\frac{1}{\sqrt{2}}\right] \cos\left[\frac{1}{\sqrt{2}}\right] + i \sinh\left[\frac{1}{\sqrt{2}}\right] \sin\frac{1}{\sqrt{2}}} \\ &= .829 + i .423 \end{aligned}$$

$$\begin{aligned} 9) \quad \cos[i \operatorname{Log} n] &= \cosh[\operatorname{Log} n] \\ &= \frac{e^{2 \operatorname{Log} n} + e^{-2 \operatorname{Log} n}}{2} \end{aligned}$$

$$\frac{n + 1/n}{2} = \frac{n^2 + 1}{2n}$$

Sec 3.3

$$\begin{aligned}
 \underline{10)} \quad \frac{d}{dz} \sinh[5mz] &= \cosh[5mz] \omega z | i \\
 &= \cosh[5mi] \omega i = \cosh[isinh 1] \omega i \\
 &= \cos[sinh 1] \cosh 1 = 2.7371
 \end{aligned}$$

$$\begin{aligned}
 \underline{11)} \quad \frac{d}{dz} [\sin(\sinh z)] &= \cos[\sinh z] \cosh z | i \\
 &= \cos[sinh i] \cosh i = \cos[isinh 1] \cosh 1 \\
 &= \cosh[sinh 1] \cos 1 = .7431
 \end{aligned}$$

12) $\sinh(x+iy) = 0$, $\sinh x \cos y + i \cosh x \sin y = 0$
 $\therefore \sinh x \cos y = 0$ and $\cosh x \sin y = 0$. Since $\cosh x \neq 0$
 all x , we require $\sin y = 0$, $y = n\pi$. Now $\sinh x \cos n\pi$
 $= 0$ is satisfied only for $x = 0$. Thus ans. $z = 0 + i n\pi$ g.e.d

13] a)

$$\cosh z = 0, \quad \cosh(x+iy) = 0.$$

$\cosh x \cos y + i \sinh x \sin y = 0$. $\cosh x \cos y = 0$
 $\sinh x \sin y = 0$. Since $\cosh x \neq 0$, all x , we
 require $\cos y = 0$, or $y = \pm (2n+1)\frac{\pi}{2}$. Now

$$\sinh x \sin \left[\frac{(2n+1)\pi}{2} \right] = 0 \quad \text{has solution } x=0.$$

$$\text{Thus } z = 0 \pm i(2n+1)\frac{\pi}{2}, \quad n=0, 1, 2, \dots$$

(b) $\tanh z = \sinh z / \cosh z$ is analytic for all z
 except where $\cosh z = 0$. Thus $\tanh z$ not analytic
 at $z = \pm i(2n+1)\frac{\pi}{2}$.

14] $\frac{1}{\cosh[(1+i)z]}$ where is denominator $\neq 0$?

$$(1+i)z = \pm (n\pi + \frac{\pi}{2})i \quad n=0, 1, 2, 3 \dots \quad \left[\begin{array}{l} \text{the zeros} \\ \text{of } \cosh z \end{array} \right]$$

$$z = \pm \frac{(n\pi + \frac{\pi}{2})i}{(1+i)}$$

15] Not analytic where $\sinh z + \cosh z = 0$

$$\sinh z + \cosh z = e^z, \quad e^z \neq 0$$

∴ function is analytic everywhere

16] Not analytic where $\sinh[\pi z^2] = 0$

$$\circ \circ \pi z^2 = n\pi i \quad [\text{see problem 12}]$$

$$z^2 = ni \quad n=0, \pm 1, \pm 2, \dots$$

prob 16/1
cont'd

Sec 3.3 cont'd

Suppose $n = 0, 1, 2, \dots$
 $z^2 = ni$ $z = \sqrt{n} e^{i\pi/2} =$
 $= \sqrt{n} (\pm) \left[\frac{1+i}{\sqrt{2}} \right]$

Suppose $n = -1, -2, \dots$
 $z^2 = ni$, $z = \sqrt{-n} (\pm) \left[\frac{1-i}{\sqrt{2}} \right]$

17] $\sinh z = \sin z$, $\sinh x \cos y + i \cosh x \sin y =$
 $\sin x \cosh y + i \cos x \sinh y$. Thus require $[x=1]$
 $\sinh 1 \cos y = \sin 1 \cosh y$ and $\cosh 1 \sin y = \cos 1 \sinh y$
or $\cos y = .716 \cosh y$ and $\sin y = .3501 \sinh y$

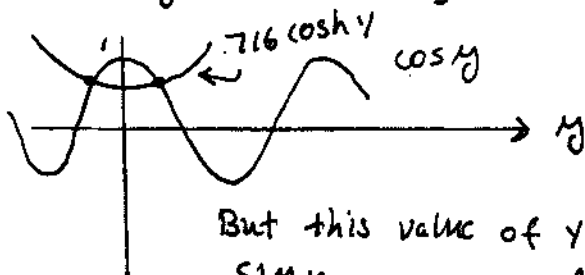

From graph
 $\cosh y = .716 \cos y$
 $\Rightarrow y = \pm .57$

But this value of y does not satisfy
 $\sin y = .3501 \sinh y$ } Thus $\sinh z - \sin z = 0$
has no sol'n on $x=1$

18] $\sinh z = \sinh x \cos y + i \cosh x \sin y$
 $|\sinh z|^2 = \sinh^2 x \cos^2 y + \cosh^2 x \sin^2 y =$
 $\sinh^2 x [1 - \sin^2 y] + \cosh^2 x \sin^2 y =$
 $\sinh^2 x + \sin^2 y \underbrace{[\cosh^2 x - \sinh^2 x]}_{=1} = \sinh^2 x + \sin^2 y$ B.E.D

sec 3.3

19] $\cosh z = \cosh x \cos y + i \sinh x \sin y$

$$|\cosh z|^2 = \cosh^2 x \cos^2 y + \sinh^2 x \sin^2 y =$$

$$\cosh^2 x \cos^2 y + \sinh^2 x [1 - \cos^2 y] = \sinh^2 x$$

$$+ \cos^2 y [\cosh^2 x - \sinh^2 x] = \frac{\sinh^2 x + \cos^2 y}{}$$

q.e.d Now put $\sinh^2 x = \cosh^2 x - 1$ and $\cos^2 y = 1 - \sin^2 y$. Get $|\cosh z|^2 = \cosh^2 x - \sin^2 y$

20] a) $\sin z + i \sinh z = 0$

$$\sin x \cos y + i \cos x \sinh y$$

$$+ i [\sinh x \cos y + i \cosh x \sin y] = 0$$

Equate reals

$$\sin x \cos y - \cosh x \sin y = 0$$

put $x = y$

$$\sin x \cosh x = \cosh x \sin x$$

satisfied

Equate Imaginaries:

$$\cos x \sinh y + \sinh x \cos y = 0$$

put $x = y$

$$2 \sinh x \cos x = 0$$

$$x = 0, \text{ or } x = \pm \left[\frac{n\pi + \pi}{2} \right] \quad n=0,1,2,3..$$

$$y = x$$

Sec 3.3

20 (b)

```
x=[0:.05:2];  
y=[0:.05:2];
```

```
[X,Y]=meshgrid(x,y);  
Z=X+i*Y;  
w=sin(Z)+i*sinh(Z);  
wm=abs(w);  
meshz(X,Y,wm);view(150,70)
```

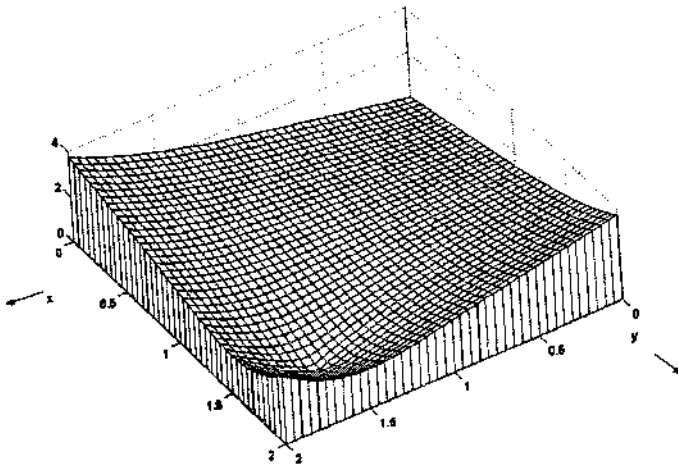

Section 3.4

$$1) \log e = \text{Log} e + i(0 + 2k\pi) = 1 + i 2k\pi, \quad k=0, \pm 1, \pm 2, \dots$$

Princ Value = 1

$$2) \log(1-i) = \text{Log} \sqrt{2} + i \left(-\frac{\pi}{4} + 2k\pi \right) \quad k=0, \pm 1, \pm 2$$

Princ Value = $\text{Log} \sqrt{2} - i \frac{\pi}{4} = .3466 - i \frac{\pi}{4}$

$$3) \log(-ie^2) = \text{Log} e^2 + i \left(-\frac{\pi}{2} + 2k\pi \right), \quad k=0, \pm 1, \dots$$

Princ Value = $2 - i \frac{\pi}{2}$

$$4) -\sqrt{3} + i = 2 \angle \frac{5\pi}{6}$$

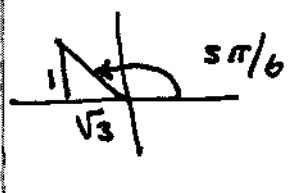

$$\log(-\sqrt{3} + i) = \text{Log} 2 + i \left[\frac{5\pi}{6} + 2k\pi \right] \quad k=0, \pm 1, \dots$$

$$5) \log e^i = \text{Log} 1 + i [1 + 2k\pi] = i [1 + 2k\pi]$$

Princ. Value = i

$$6) \log e^{1+i} = \text{Log} [e \angle 4] = \text{Log} e + i [4 + 2k\pi] = 1 + i [4 + 2k\pi] \quad k=0, \pm 1, \pm 2, \dots$$

The princ. value of \log is $1 + i [4 - 2\pi] \quad [k=-1]$

$= 1 - i 2.882$

$$7) (-\sqrt{3} + i)^4 = \left[2 \angle \frac{5\pi}{6} \right]^4 = 16 \angle \frac{20\pi}{6}$$

$= 16 \angle -\frac{2}{3}\pi \quad \text{Log} 16 \angle \frac{2}{3}\pi =$

$\text{Log} 16 + i \left[-\frac{2}{3}\pi + 2k\pi \right] \quad \text{princ value } \text{Log} 16 - i \frac{2}{3}\pi$

see next pg.

Section 3.4

7) continued $\log 16 = 2.7726$

$$\therefore \text{ans.} = 2.7726 + i \left[-\frac{2}{3}\pi + 2k\pi \right]$$

princ value $2.7726 - i 2\pi/3$

8) $e^{\log(i \sinh 1)} = i \sinh 1$

$$\log [i \sinh 1] = \text{Log} \sinh 1 + i \left[\frac{\pi}{2} + 2k\pi \right]$$

$$= .1614 + i \left[\frac{\pi}{2} + 2k\pi \right] \quad \text{princ value}$$

$$.1614 + i (\pi/2)$$

9) $e^{e^i} = e^{\cos 1 + i \sin 1}$

$$= e^{\cos 1} \angle \sin 1 \cdot \log \left[e^{\cos 1} \angle \sin 1 \right]$$

$$= \cos 1 + i [\sin 1 + 2k\pi] =$$

$$.5403 + i (.8415 + 2k\pi) \quad k=0, \pm 1, \pm 2$$

$.5403 + i .8415$ is princ value

10) $\text{Log} i = \text{Log} \frac{\pi}{2}, \quad \text{Log} \left[\frac{\pi}{2} \right] =$

$$\text{Log} \left(\frac{\pi}{2} \right) + i \left[\frac{\pi}{2} \right]$$

$$\log \left[\text{Log} \frac{\pi}{2} + i \left(\frac{\pi}{2} \right) \right] = \text{Log} \left[\sqrt{\left(\text{Log} \frac{\pi}{2} \right)^2 + \frac{\pi^2}{4}} \right]$$

$$+ i \left[\tan^{-1} \left(\frac{\pi/2}{\text{Log} \pi/2} \right) + 2k\pi \right] =$$

$$.4913 + i [1.2909 + 2k\pi] \quad k=0, \pm 1, \pm 2 \dots$$

for princ. value
 $k=0$

ii) Note, the equation cannot be true if $z=0$ since $\text{Log } z$ and $\text{Log } \bar{z}$ are undefined. Suppose $z \neq 0$ and z not negative real. Take $\theta = \arg z$, $-\pi < \theta < \pi$. Then $z = |z| e^{i\theta}$, $\bar{z} = |z| e^{-i\theta}$ $-\pi < \theta < \pi$

$$\text{Log } z = \text{Log}|z| + i\theta, \quad \text{Log } \bar{z} = \text{Log}|z| - i\theta$$

Note $\text{Log } z = \overline{\text{Log } \bar{z}} = \text{Log}|z| + i\theta$

Suppose z is negative real.

Then $\text{Log } z = \text{Log}|z| + i\pi$

$$\bar{z} = z \quad \text{Log } \bar{z} = \text{Log}|z| + i\pi$$

$$\overline{\text{Log } \bar{z}} = \text{Log}|z| - i\pi \neq \text{Log } z$$

∴ The equation is true if $z \neq 0$ and if z is not negative real.

12) $\text{Log } z = (1+i)$, $e^{\text{Log } z} = z$

$$e^{1+i} = z = e^{[\cos 1 + i \sin 1]} = 1.4687 + i 2.287$$

13) $[\text{Log } z]^2 + \text{Log } z + 1 = 0$

$$\text{Log } z = \frac{-1 \pm i\sqrt{3}}{2}$$

$$z = \exp\left[\frac{-1 + i\sqrt{3}}{2}\right] = .3929 + i .4620$$

with minus sign

$$z = \exp\left[\frac{-1 - i\sqrt{3}}{2}\right] = .3929 - i .4620$$

14) $e^z = e$

$$\text{Log } e^z = z + i 2k\pi$$

$$\text{Log } e = 1 + i 2m\pi$$

$$z + i 2k\pi = 1 + i 2m\pi$$

$$z = 1 + i 2n\pi \quad n = 0, \pm 1, \pm 2$$

Sec. 3.4, Continued

15. $e^z = e^{-z}$ $e^{2z} = 1$

Take logs each side $2z + i2k\pi = i2k\pi$

$$z = \frac{i}{2} [2k\pi - 2m\pi] = i n \pi, \quad n = 0, \pm 1, \pm 2, \dots$$

$$z = i n \pi, \quad n = 0, \pm 1, \pm 2, \dots$$

16] $e^z = e^{i^2 z}$ $z = i z + i 2k\pi$

$$z(1-i) = i 2k\pi \quad z = \frac{i 2k\pi}{(1-i)}$$

$$z = \frac{(1+i) i 2k\pi}{2} = k\pi [-1+i] \quad k = 0, \pm 1, \pm 2, \dots$$

17] $w = e^z, (w-1)^2 = w^2, w^2 - 2w + 1 = w^2, w = 1/2$
 $e^z = 1/2, z = \log \frac{1}{2} + i(2k\pi), \quad z = -\log 2 + i 2k\pi$

18] $(e^z - 1)^2 = e^z, w = e^z, (w-1)^2 = w, w^2 - 3w + 1 = 0$
 $w = \frac{3 \pm \sqrt{5}}{2}, e^z = \frac{3 \pm \sqrt{5}}{2}, z = \log \left[\frac{3 \pm \sqrt{5}}{2} \right] + i 2k\pi$
 $z = .9624 + i 2k\pi, \quad z = -.9624 + i 2k\pi$

19] $(e^z - 1)^3 = 1, (e^z - 1) = 1^{1/3} = 1, \text{cis}(\frac{2}{3}\pi)$
 and $\text{cis}(-\frac{2}{3}\pi)$

If $(e^z - 1) = 1, e^z = 2, \log 2 + i 2k\pi$

If $e^z - 1 = \cos \frac{2}{3}\pi + i \sin \frac{2}{3}\pi, e^z = \frac{1}{2} + i \frac{\sqrt{3}}{2}$,

$$z = \log \left[\frac{1}{2} + i \frac{\sqrt{3}}{2} \right] = i \left[\frac{1}{3}\pi + 2k\pi \right] \quad \text{If } e^z - 1 = \text{cis}(\frac{2}{3}\pi)$$

$$e^z = \frac{1}{2} - i \frac{\sqrt{3}}{2}, \quad i \left[-\frac{\pi}{3} + 2k\pi \right]$$

Sec 3.4 continued

20) $e^{4z} + e^{2z} + 1 = 0$. Let $u = e^{2z}$

$u^2 + u + 1 = 0$, $u = \frac{-1 \pm i\sqrt{3}}{2} = \text{cis}\left(\pm \frac{2\pi}{3}\right)$

$e^{2z} = \text{cis}\left(\pm \frac{2\pi}{3}\right)$, $2z = \log \text{cis}\left(\pm \frac{2\pi}{3}\right)$

$2z = i\left[\pm \frac{2\pi}{3} + 2k\pi\right]$, $z = i\left[\frac{\pi}{3} + k\pi\right]$ and

$z = i\left[-\frac{\pi}{3} + k\pi\right]$

21) $e^{e^z} = 1$, $e^z = \log 1 = i 2k\pi$, $k = 0, \pm 1, \pm 2, \dots$

$e^z = i 2k\pi$, suppose $k = 1, 2, \dots$,
 $z = \log(2k\pi) + i\left[\frac{\pi}{2} + 2m\pi\right]$, $k = 1, 2, 3, \dots$, $m = 0, \pm 1, \pm 2, \dots$

Suppose $k = -1, -2, -3, \dots$
 $z = \log|2k\pi| + i\left[-\frac{\pi}{2} + 2m\pi\right]$, $k = -1, -2, \dots$, $m = 0, \pm 1, \pm 2, \dots$

22) $\log i^2 = \log -1 = i\left[\pi + 2k\pi\right]$, $k = 0, \pm 1, \pm 2, \dots$

$2\log i = 2\left[i\left(\frac{\pi}{2} + 2k\pi\right)\right] = i\left[\pi + 4k\pi\right]$ $k = 0, \pm 1, \pm 2, \dots$

The sets are different

$\log i^2 = \dots -3\pi i, -\pi i, \pi i, 3\pi i, \dots$

$2\log i = -3\pi i, \pi i, 5\pi i, \dots$

The set of values of $2\log i$ are contained in the set of values of $\log i^2$

23) $\text{Re } \log(1 + e^{i\theta}) = \log|1 + e^{i\theta}| =$

$\frac{1}{2} \log|1 + e^{i\theta}|^2 = \frac{1}{2} \log(1 + e^{i\theta})(\overline{1 + e^{i\theta}}) =$

$\frac{1}{2} \log((1 + e^{i\theta})(1 + e^{-i\theta})) = \frac{1}{2} \log[1 + e^{i\theta} + e^{-i\theta} + 1]$

$= \frac{1}{2} \log[2 + 2\cos\theta] = \frac{1}{2} \log 2\cos^2\frac{\theta}{2} = \frac{2}{2} \log\left|\frac{2\cos\theta}{2}\right|$

$\log\left|2\cos\frac{\theta}{2}\right|$. q.e.d.

24]

sec 3.4 continued

$$\begin{aligned} \operatorname{Re} [\log (r e^{i\theta} - 1)] &= [\log |r e^{i\theta} - 1|] \\ &= \frac{1}{2} \log |r e^{i\theta} - 1|^2 = \frac{1}{2} \log [(r e^{i\theta} - 1) \overline{(r e^{i\theta} - 1)}] \\ &= \frac{1}{2} \log ((r e^{i\theta} - 1)(r e^{-i\theta} - 1)) = \frac{1}{2} \log (r^2 - r e^{i\theta} - r e^{-i\theta} + 1) \\ &= \frac{1}{2} \log (r^2 - 2r \cos \theta + 1) \end{aligned}$$

25]

a) Try $\log(-2) = \boxed{\log 2 + i\pi}$, try $\log(-ie)$

$$= \log e - \frac{i\pi}{2} = \boxed{1 - \frac{i\pi}{2}}. \text{ Thus } \log(-2) +$$

$$\log(-ie) = \log 2 + i\pi + 1 - \frac{i\pi}{2} = \log 2 + 1 + \frac{i\pi}{2}.$$

$$\text{Check } \log [(-2)(-ie)] = \log(2e i) = \log(2e) + \frac{i\pi}{2} \\ = \log 2 + 1 + \frac{i\pi}{2}.$$

b) Try $\log(-ie) = \boxed{1 - \frac{i\pi}{2}}$, $\log(-2) = \boxed{\log 2 - i\pi}$

$$\log\left(\frac{2i}{2e}\right) = \log\left(\frac{-ie}{-2}\right) = \log\left(\frac{ie}{2}\right) =$$

$$\log\left(\frac{e}{2}\right) + i\frac{\pi}{2} = (1 - \log 2) + \frac{i\pi}{2}. \quad \log z_1 - \log z_2$$

$$= \log(-ie) - \log(-2) = 1 - \log 2 + \frac{i\pi}{2}.$$

26] a) $z = (1+i) = \sqrt{2} \angle \pi/4$ $z^5 = (\sqrt{2})^5 \operatorname{cis} \left[\frac{5\pi}{4} \right]$

$$\text{Take } 5 \log z = 5 \log(1+i) = 5 \log \sqrt{2} + i \frac{5\pi}{4}.$$

$$\text{Take } \log z^5 = \log (\sqrt{2})^5 + i \frac{5\pi}{4} = 5 \log \sqrt{2} + i \frac{5\pi}{4}.$$

$$\text{Thus, } \therefore \text{ take } \underline{5 \log z = \log z^5} = 5 [\log \sqrt{2} + i \frac{\pi}{4}]$$

b) $5 \log(1+i) = 5 \log \sqrt{2} + i \frac{5\pi}{4}$. $\log(1+i)^5 =$

$$\log [(\sqrt{2})^5 \angle \frac{5\pi}{4}] = \log [(\sqrt{2})^5 \angle -\frac{3\pi}{4}] =$$

$$5 \log \sqrt{2} - i \frac{3\pi}{4} \text{ which is } \neq 5 \log(1+i) \quad \therefore \underline{\text{No}}$$

c) $\log(1+i)^2 = \log 2i = \log 2 + i(\pi/2)$. $2 \log(1+i) =$

$$2 [\log \sqrt{2} + i(\pi/4)] = \log 2 + i\pi/2. \text{ They agree. } \therefore \underline{\text{Yes}}$$

27]

sec 3.4 Cont'd

$$\log(-1)^2 = \log(1)^2 = \log 1 = i(2k\pi), k=0, \pm 1, \dots$$

$$= \pm i0, \pm i2\pi, \pm i4\pi, \pm i6\pi, \dots$$

$$\text{Now } 2 \log 1 = 2 [i2k\pi] = 0, \pm 4\pi i, \pm 8\pi i, \dots$$

The set of values of $2 \log 1$ is thus a subset of the values of $\log(-1)^2 = \log 1^2$.

Consider $2 \log(-1) = 2 [i(\pi + 2k\pi)] = i[2\pi + 4k\pi]$
 $= -6\pi i, -2\pi i, 2\pi i, 6\pi i, \dots$ The set of values of $2 \log(-1)$ is a subset of the values of $\log(-1)^2$ (or $\log 1^2$). However it's a different subset than the set of values of $2 \log 1$. None of the values agree.

Thus $2 \log 1 = 2 \log(-1)$ is false.

$$28] \text{ a) } \log(8i) = \log 8 + i \left[\frac{\pi}{2} + 2k\pi \right], k=0, \pm 1, \pm 2.$$

$$\log 8 = 3 \log 2, \text{ Thus } \frac{1}{3} \log(8i) = \log 2 + i \left[\frac{\pi}{6} + \frac{2}{3}k\pi \right], k=0, \pm 1, \pm 2.$$

$$\text{(b) } (8i)^{1/3} = \sqrt[3]{8} \operatorname{cis} \left[\frac{1}{3} \left(\frac{\pi}{2} + \frac{2m\pi}{3} \right) \right], m=0, 1, 2$$

$$(8i)^{1/3} = 2 \operatorname{cis} \left(\frac{\pi}{6} + \frac{2m\pi}{3} \right), m=0, 1, 2$$

$$\log(8i)^{1/3} = \log 2 + i \left[\frac{\pi}{6} + \frac{2m\pi}{3} + 2n\pi \right], n=0, \pm 1, \pm 2, \dots, m=0, 1, 2.$$

(c) Must show set of values of $\log 2 + i \left[\frac{\pi}{6} + \frac{2m\pi}{3} + 2n\pi \right]$ is equal to set of values of $\log 2 + i \left[\frac{\pi}{6} + \frac{2}{3}k\pi \right]$. Equivalently, ^{show} that set of values of $\frac{2}{3}k\pi = \text{set of values of } \frac{2}{3}m\pi + 2n\pi$ where $k=0, \pm 1, \pm 2, \dots, n=0, \pm 1, \pm 2, \dots$ and $m=0, 1, 2$. First assign values to m and n ; how choose k ?

If $\frac{2}{3}k\pi = \frac{2}{3}m\pi + 2n\pi$, then $k = m + 3n$. Since k can be any integer, the preceding is satisfied. Now assign a value to k , how choose m and n ? Since k is an integer, $k = 3N + R$, where N is an integer and R (remainder) = $0, 1/3, \text{ or } 2/3$. We let $n = N$ and $m = 0, 1, \text{ or } 2$ depending on R . Thus the set of values of $\frac{2}{3}k\pi$ equals set of values of $\frac{2}{3}m\pi + 2n\pi$ and the proof is completed.

29

sec 3.4 cont'd

$$\log(-1 + 10^{-9}i) = 4.99 \cdot 10^{-9} + i 3.14149$$

$$\log(-1 - 10^{-9}i) = 4.99 \cdot 10^{-9} - i 3.14149$$

These quantities differ by $\approx 2\pi i$

Reason: princ. arg of $-1 + 10^{-9}i \approx \pi$

princ arg of $-1 - 10^{-9}i \approx -\pi$

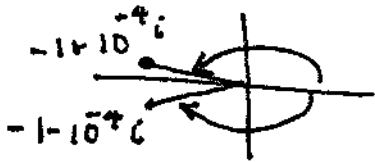

Sec 3.5

1) $u = \frac{1}{2} \text{Log}(x^2 + y^2), \quad v = \tan^{-1}(y/x) \quad [x \neq 0]$

$$\frac{\partial u}{\partial x} = \frac{1}{2} \times \frac{2x}{x^2 + y^2}, \quad \frac{\partial v}{\partial x} = \frac{1}{1 + \frac{y^2}{x^2}} \left(-\frac{y}{x^2} \right) = \frac{-y}{x^2 + y^2}$$

$$f'(z) = \frac{\partial u}{\partial x} + i \frac{\partial v}{\partial x} = \frac{x - iy}{x^2 + y^2} = \frac{1}{z} \quad \text{if } x \neq 0, z \neq 0$$

If $x=0$, use $v = \frac{\pi}{2} - \tan^{-1}\left(\frac{x}{y}\right), \quad \frac{\partial v}{\partial x} = \frac{-1}{1 + \frac{x^2}{y^2}} \cdot \frac{1}{y}$
 $= \frac{-y}{x^2 + y^2}$ assuming $y \neq 0$. Thus

$$f'(z) = \frac{\partial u}{\partial x} + i \frac{\partial v}{\partial x} = \frac{x - iy}{x^2 + y^2} \quad \text{if } y \neq 0, z \neq 0. \quad \text{or}$$

in general $\frac{df}{dz} = \frac{1}{z}$ if $z \neq 0$ b.e.d

2) a) This function is analytic in the z plane with the line $y=0, x \geq 0$ removed, i.e. in a cut z plane. The points of discontinuity have been eliminated.

b) $\log(-e^z) = \text{Log } e^z + i \text{arg}(-e^z) = z + i\pi$

c) non-negative reals do not appear in the domain of analyticity; they have been cut out (see a)

3)

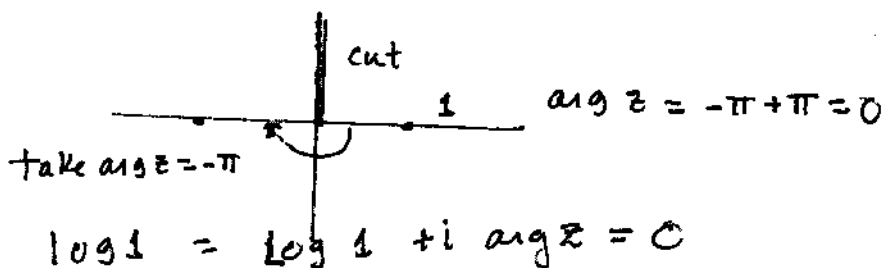

4)

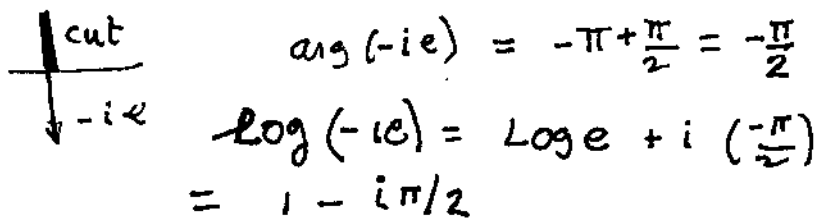

Sec 3.5 cont'd

5] $-e+ie$

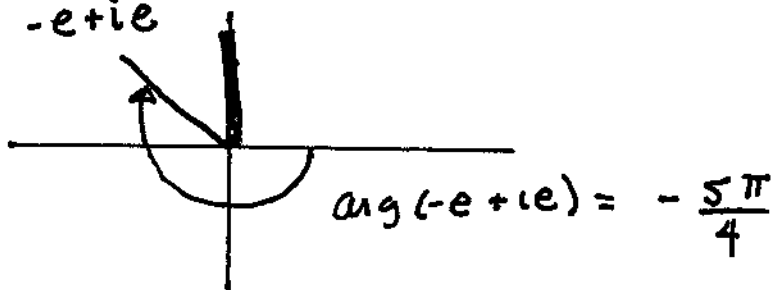

$$\log(-e+ie) = \text{Log}[e\sqrt{2}] - i\frac{5\pi}{4}$$

$$= 1.3466 - i\frac{5\pi}{4}$$

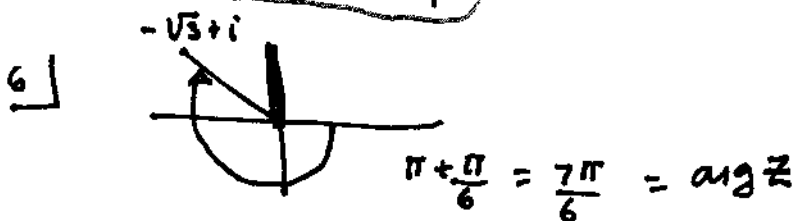

$$\log(-\sqrt{3}+i) = \text{Log} 2 - i\frac{7\pi}{6}$$

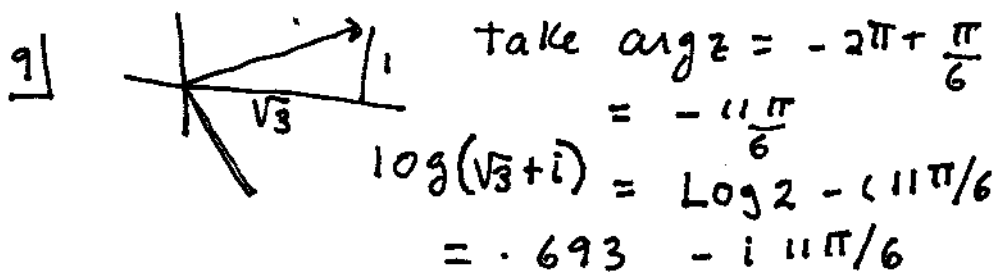
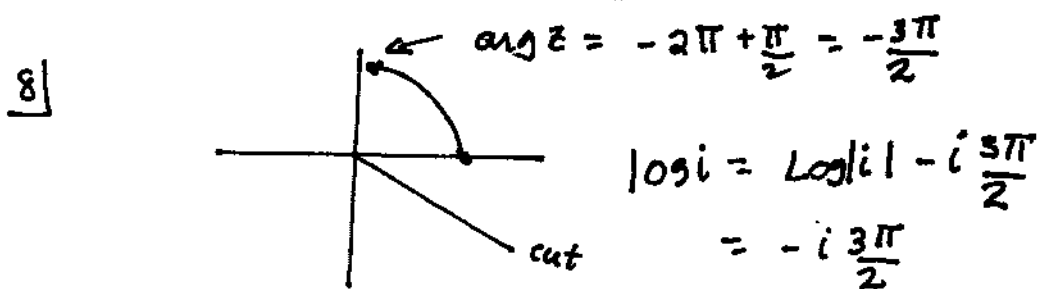
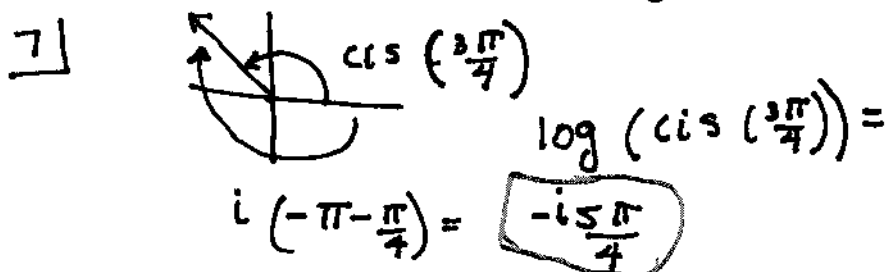

sec 3.5 cont'd

10

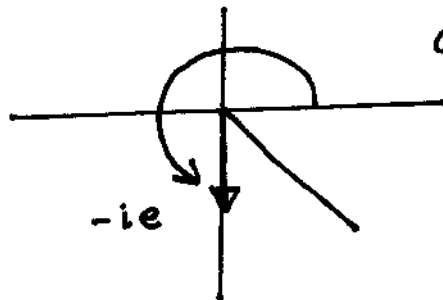

$$\arg z = -2\pi + \frac{3\pi}{2}$$

$$= -\frac{\pi}{2}$$

$$\log(-ie) = \operatorname{Log} e^{-i} = -i \frac{\pi}{2} = 1 - i \frac{\pi}{2}$$

11) a) We must remove points where the function $(z-i)$ is zero or negative real. These are on line $y=1, x \leq 0$.

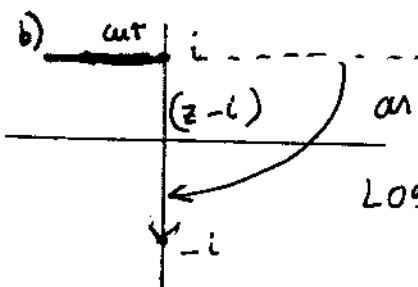

$$\arg(z-i) = \frac{-\pi}{2}$$

$$\operatorname{Log}(z-i)|_{-i} = \operatorname{Log}|-i-i| + i \left(-\frac{\pi}{2}\right) = \operatorname{Log} 2 + i \left(-\frac{\pi}{2}\right)$$

c)

$\frac{\operatorname{Log}[z-i]}{z-2i}$ has a singularity at $z=2i$ which lies in the given domain. But $\frac{\operatorname{Log}[z-i]}{z+2-i}$ has a singularity at $-2+i$ which lies along the branch cut. Thus $-2+i$ is not in the cut plane (the given domain).

SEC 3.5

12] a) $\text{Log } z = \text{Log } |z| + i \text{arg } z$ where $-\pi < \text{arg } z < \pi$

Now if $\text{arg } z$ lies between $-\pi$ and π , we can take $\text{arg } \frac{1}{z} = -\text{arg } z$ and we will have $-\pi < \text{arg } \frac{1}{z} < \pi$

Thus $\text{Log } \frac{1}{z} = \text{Log } \left| \frac{1}{z} \right| + i \text{arg} \left(\frac{1}{z} \right) = \text{Log } \left| \frac{1}{z} \right| - i \text{arg } z$
 $= -\text{Log } |z| - i \text{arg } z$ or $-\text{Log } z = \text{Log } \frac{1}{z}$ p.e.d

b)

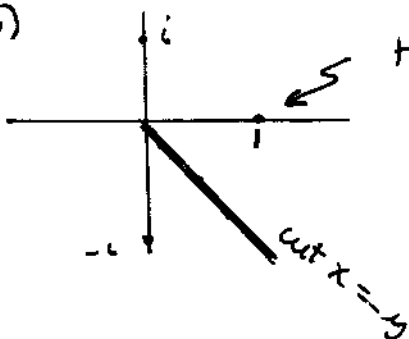

take $\log z / i = 0$

$\log i = i\pi/2$

$\log \left(\frac{1}{i} \right) = \log(-i) = i \frac{3\pi}{2}$

note $-\log i \neq \log \frac{1}{i}$

13] $\text{Log } [w]$ is analytic except where $w=0$, $w=\infty$ or w is negative real. Thus $\text{Log} \left[\frac{z-1}{z} \right]$ is analytic except where $z=1$, $z=0$ or $\frac{z-1}{z}$ is negative real.

Now $\frac{z-1}{z} = \frac{(x-1)+iy}{x+iy} = \frac{(x)(x-1)+iy+y^2}{x^2+y^2}$. For this to be negative real: $y=0$ and $(x)(x-1) < 0$. If $(x)(x-1) < 0$ then x and $(x-1)$ are of opposite sign, or $0 < x < 1$.

Thus to summarize: $\text{Log} \left[\frac{z-1}{z} \right]$ is analytic except if $z=1$, $z=0$, or $y=0$ with $0 < x < 1$. The branch cut must be the straight line going from $z=0$ to $z=1$.

14] $\text{Im} [(x+iy)^2 + 1] = 0 \Rightarrow xy = 0$ [1]

$\text{Re} [(x+iy)^2 + 1] \leq 0 \Rightarrow x^2 - y^2 + 1 \leq 0$ [2]. Suppose

satisfy [1] with $y=0$, then from [2] $x^2 + 1 \leq 0$. Impossible.

Suppose satisfy [1] with $x=0$. From [2] $y^2 \geq 1$ or $|y| \geq 1$. Thus cuts are along $x=0, y \geq 1$; or $x=0, y \leq -1$.

15] a) $\text{Log}(z)$ is analytic in the cut plane in which the line $y=0, x \leq 0$ is removed. $\text{Log}[\text{Log } z]$ will be analytic in this cut plane except where $(\text{Log } z)$ is real and non-positive.

15(a)

Sec. 3.5 cont'd

$\text{Log } z$ is real and non-positive if $y=0$ and $0 \leq x \leq 1$. Thus these points must be "cut out" of the complex plane to render $\text{Log}[\text{Log } z]$ analytic. In summary, $\text{Log}[\text{Log } z]$ is analytic in the cut plane in which the points along the line $y=0$, $x \leq 1$ have been removed.

15(b) $\frac{d}{dz} \text{Log } \text{Log } z = \frac{1}{\text{Log } z} \frac{d}{dz} \text{Log } z = \boxed{\frac{1}{z \text{Log } z}}$

c) $\text{Log}(\text{Log } z)$ is analytic in the cut plane of Fig 3.5-10. $\text{Log } \text{Log}(\text{Log } z)$ will be analytic in Fig 3.5-10 except we must also cut out those points where $\text{Log}(\text{Log } z)$ is real and non-positive. Now $\text{Log}[\text{Log } z]$ is real and non-positive if and only if $\text{Log } z$ is real and $0 \leq \text{Log } z \leq 1$, or $y=0$ and $1 \leq x \leq e$. Thus we must remove the line segment $y=0$, $1 \leq x \leq e$ in Fig 3.5-10. Final answer, branch cut $y=0$, $x \leq e$.

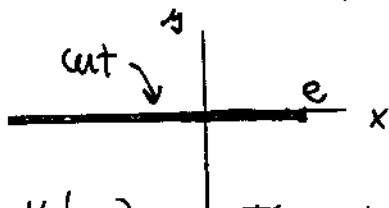

16(a) $\Phi = \phi + i\psi = \text{Log} \frac{1}{z} = -\text{Log } z$

$\phi = -\text{Log} \sqrt{x^2+y^2}$, $\psi = -\tan^{-1}(\frac{y}{x})$. Streamlines are rays emanating from origin.

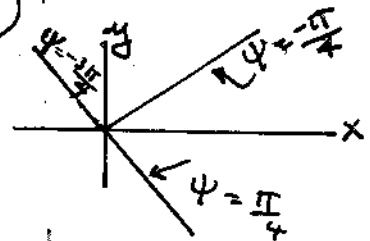

b) $-1 = -\text{Log} \sqrt{x^2+y^2} = \phi = -1$

$\therefore \sqrt{x^2+y^2} = e$ if $\phi = -1$

$0 = -\text{Log} \sqrt{x^2+y^2} = \phi = 0$

$\therefore \sqrt{x^2+y^2} = 1$ if $\phi = 0$

$1 = -\text{Log} \sqrt{x^2+y^2} = \phi = 1$ (c)

$\therefore \sqrt{x^2+y^2} = 1/e$ if $\phi = 1$

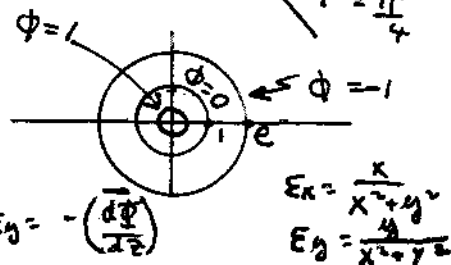

$E_x + iE_y = -\left(\frac{d\Phi}{dz}\right)$

$E_x = \frac{k}{x^2+y^2}$
 $E_y = \frac{y}{x^2+y^2}$

sec 3.5

prob 17

```
% section 3.5
x=[-2.5:.02+.001:2.5];
y=x;
[X,Y]=meshgrid(x,y);
Z=X+i*Y;
w=log(Z-1-1*i);
wm=real(w);%for real part
% wm=imag(w);% for imag part

meshz(X,Y,wm);%for imag partand real
view(45,45);
```

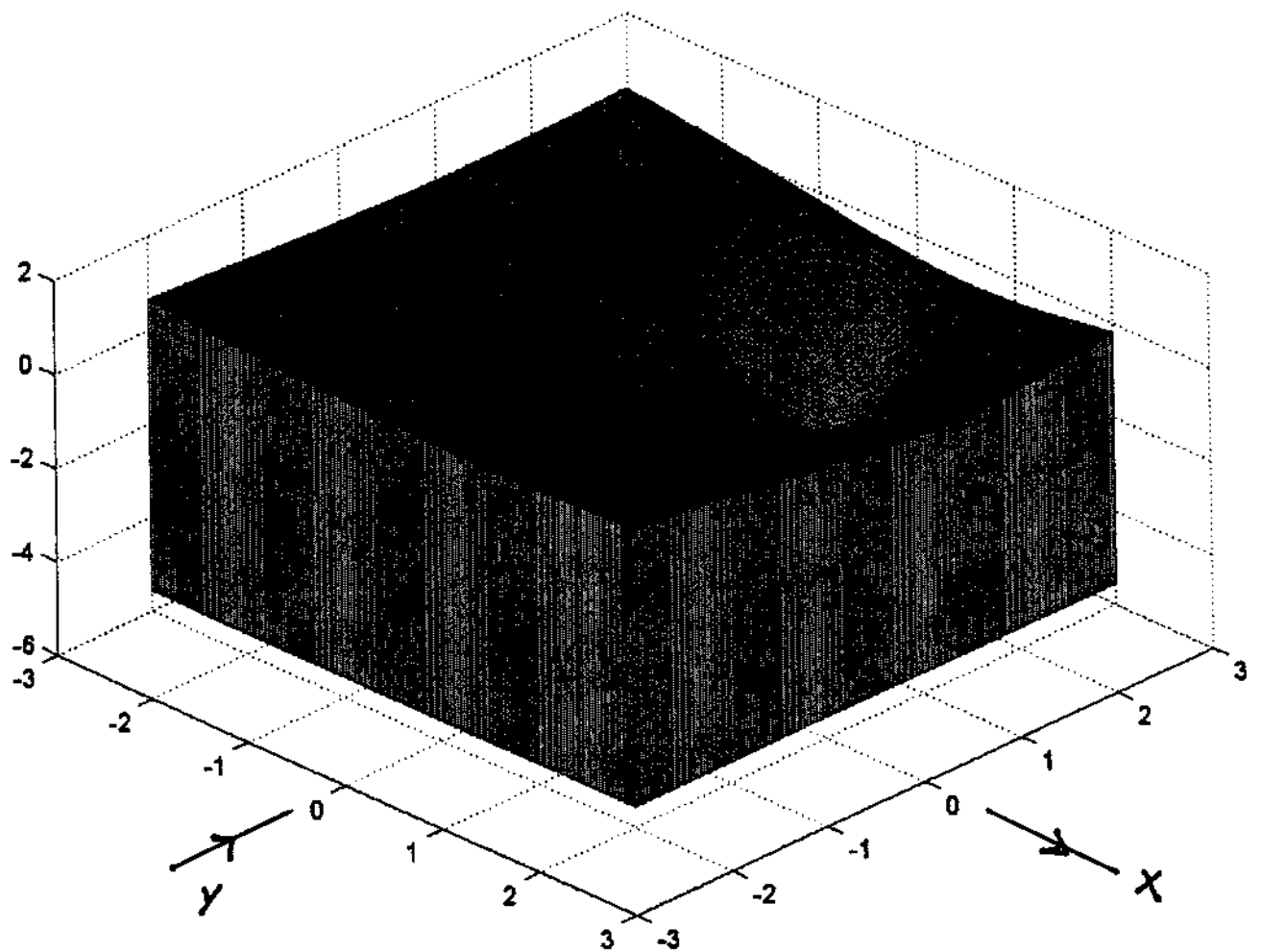

prob 17, sec 3.5
Real ($\text{Log}(z - 1 - i)$)

chap 3, R42

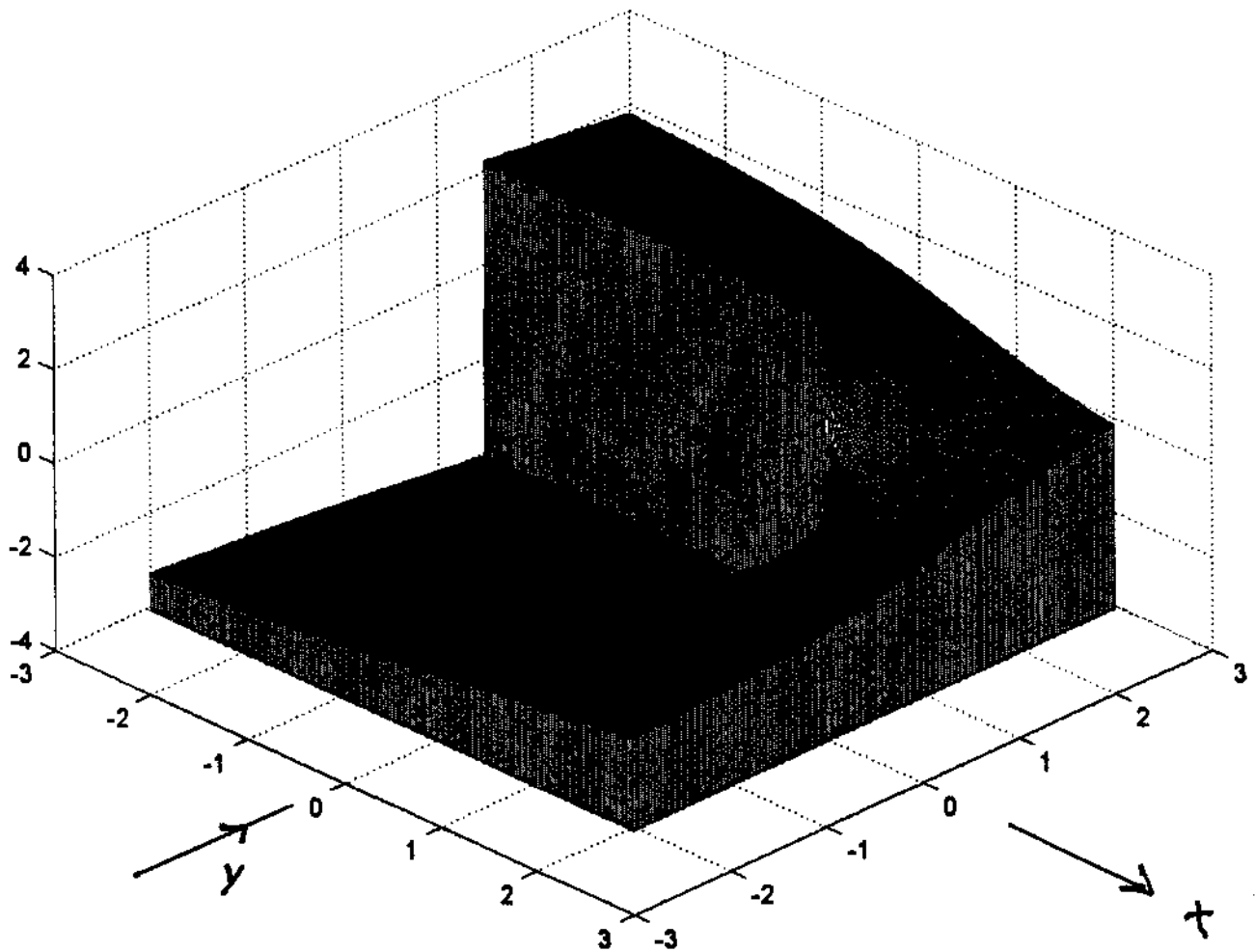

problem 17, sec 3.5
 $\text{Imag} [\text{Log}(z-1-i)]$

chap 3, p.43

Sec 3.6

$$1. \quad 1^{2i} = e^{2i \log 1} = e^{2i [L 2k\pi]} = e^{-4k\pi}$$

$k=0, \pm 1, \dots$, prin. value = 1

$$2. \quad i^{-i} = e^{-i \log i} = e^{-i \left[\frac{\pi}{2} + i 2k\pi \right]} = e^{\pi/2} e^{2k\pi}$$

$k=0, \pm 1, \dots$ prin. value = $e^{\pi/2} = \sqrt{e^\pi}$

$$3. \quad (\sqrt{3} + i)^{1-2i} = e^{(1-2i) \log(\sqrt{3} + i)}$$

$$= e^{(1-2i) \left(\log 2 + i \left(\frac{\pi}{6} + 2k\pi \right) \right)} =$$

$$e^{\log 2 + \frac{\pi}{3} + 4k\pi} e^{-2i \log 2 + i \left(\frac{\pi}{3} + 2k\pi \right)}$$

$$= 2 e^{\frac{\pi}{3} + 4k\pi} \left[\cos \left[2 \log 2 + \frac{\pi}{6} \right] + i \sin \left[-2 \log 2 + \frac{\pi}{6} \right] \right]$$

$k=0, \pm 1, \dots$

Prin. value $2e^{\pi/3} \left[\text{cis} \left(-2 \log 2 + \pi/6 \right) \right]$

$\approx 3.7068 - i 4.3292$

$$4. \quad (e^i)^i = (\cos 1 + i \sin 1)^i =$$

$$e^{i \log [\cos 1 + i \sin 1]} = e^{i \left[i(1 + 2k\pi) \right]} =$$

$$e^{-1 - 2k\pi}$$

$k=0, \pm 1, \dots$ prin. value = $e^{-1} \approx$

$\approx .3679$

$$5. \quad e^{e^i} = e^{\cos 1 + i \sin 1} =$$

$$e^{\cos 1} \left[\cos(\sin 1) + i \sin(\sin 1) \right]$$

Note, there is only one value by definition.

$\approx 1.1438 + i 1.2799$

sec 3.6

$$6) (1.1)^{1.1} = (1.1)^{\frac{11}{10}} =$$

$$e^{\frac{11}{10} (\text{Log } 1.1 + i 2k\pi)} =$$

$$e^{\frac{11}{10} \text{Log } 1.1} e^{i 2k\pi \frac{11}{10}} = e^{\frac{11}{10} \text{Log } 1.1} \text{cis} \left[\frac{2k\pi 11}{10} \right]$$

$k=0, 1, 2, \dots, 9$

There are 10 distinct values

$$\doteq 1.105 \left[\cos \left(\frac{22k\pi}{10} \right) + i \sin \left(\frac{22k\pi}{10} \right) \right] \quad k=0, \dots, 9$$

princ value $\doteq 1.105$

$$7) \pi^{1/2} = e^{\frac{1}{2} [\text{Log } \pi + i 2k\pi]} =$$

$$e^{\frac{1}{2} \text{Log } \pi} e^{-k\pi} \quad k=0, \pm 1, \pm 2, \dots$$

$$= e^{i \text{Log } \sqrt{\pi}} e^{-k\pi} \quad k=0, 1, 2, \dots$$

$$= e^{-k\pi} \text{cis} [\text{Log } \sqrt{\pi}] \quad \text{princ value}$$

$$\text{is } \text{cis} [\text{Log } \sqrt{\pi}] = \cos [\text{Log } \sqrt{\pi}] + i \sin (\text{Log } \sqrt{\pi})$$

$$\doteq .8406 + i .5416$$

$$8) (\text{Log } i)^{\pi/2} = \left(\frac{i\pi}{2} \right)^{\pi/2} = e^{\frac{\pi}{2} [\text{Log} \left(\frac{i\pi}{2} \right)]}$$

$$= e^{\frac{\pi}{2} [\text{Log} \frac{\pi}{2} + i (\frac{\pi}{2} + 2k\pi)]} = e^{\frac{\pi}{2} \text{Log} \frac{\pi}{2}} \text{cis} \left[\frac{\pi^2}{4} + k\pi^2 \right]$$

$$k=0, \pm 1, \dots \quad \text{princ. value } e^{\frac{\pi}{2} \text{Log} \frac{\pi}{2}} \text{cis} \left(\frac{\pi^2}{4} \right)$$

$$\doteq -1.5879 + i 1.2689$$

sec 3.6

$$\begin{aligned} \underline{9} \quad (1+i \tan 1)^{\sqrt{2}} &= \left(\sqrt{1+\tan^2 1} \angle 1 \right)^{\sqrt{2}} \\ &= (\sec 1 \angle 1)^{\sqrt{2}} = e^{\sqrt{2} (\text{Log sec } 1 + i (1+2k\pi))} \\ &= e^{\sqrt{2} \text{Log sec } 1} \angle \sqrt{2} (1+2k\pi) \end{aligned}$$

$$= e^{\sqrt{2} \text{Log sec } 1} \text{cis} \left[\sqrt{2} (1+2k\pi) \right] \quad k=0, \pm 1, \pm 2, \dots$$

$$\text{princ. value } e^{\sqrt{2} \text{Log sec } 1} \text{cis} \left[\sqrt{2} \right] =$$

$$.3725 + i 2.3592$$

$$\underline{10} \quad \sqrt{2}^{1+i \tan 1} = e^{(\text{Log } \sqrt{2}) (1+i \tan 1)}$$

$$= e^{[\text{Log } \sqrt{2} + i 2k\pi] [1+i \tan 1]} =$$

$$e^{\text{Log } \sqrt{2} - 2k\pi \tan 1} e^{i (\text{Log } \sqrt{2} \tan 1 + 2k\pi)}$$

$$= \sqrt{2} e^{-2k\pi \tan 1} \angle (\text{Log } \sqrt{2}) (\tan 1) \quad k=0, \pm 1, \dots$$

$$\text{princ. value is } \sqrt{2} \angle (\text{Log } \sqrt{2}) (\tan 1)$$

$$= \sqrt{2} \left[\cos [\text{Log } \sqrt{2} \tan 1] + i \sin (\text{Log } \sqrt{2} \tan 1) \right]$$

$$\doteq 1.2132 + i .7268$$

sec 3.6

$$\begin{aligned} 11) \quad z^i &= e^{i \log z} = e^{i [\operatorname{Log} |z| + i \arg z]} \\ &= e^{-\arg(z)} e^{i \operatorname{Log} |z|} = \\ &e^{-\arg z} [\cos [\operatorname{Log} |z|] + i \sin (\operatorname{Log} |z|)] \end{aligned}$$

The preceding is real, if and only if
 if $\sin (\operatorname{Log} |z|) = 0$ or $\operatorname{Log} |z| = n\pi$
 or $|z| = e^{n\pi}$, $n = 0, \pm 1, \pm 2, \dots$

12) let w be a complex number. In general we know
 $e^w = 1/e^w$. The proof is trivial, let $w = u + iv$
 $e^{u+iv} = e^u e^{iv} = \frac{1}{e^{-u} e^{-iv}} = \frac{1}{e^{-w}}$

Now $z^{-\beta} = e^{-\beta \log z}$ and $1/z^\beta = 1/e^{\beta \log z}$

Since $e^w = 1/e^{-w}$ it follows that $e^{-\beta \log z} = 1/e^{\beta \log z}$

13) We know that $e^a e^b = e^{a+b}$

Now $z^\alpha = e^{\alpha \log z}$, $z^\beta = e^{\beta \log z}$

$z^\alpha z^\beta = e^{\alpha \log z} e^{\beta \log z} = e^{\alpha \log z + \beta \log z}$

$= e^{(\alpha + \beta) \log z}$ Now by definition $z^{\alpha + \beta} = e^{(\alpha + \beta) \log z}$

Thus $z^\alpha z^\beta = z^{\alpha + \beta}$

14

sec 3.6

$$\therefore a) z^n = e^{n \log z} = e^{n [\log r + i(\theta + 2k\pi)]}$$

$$= e^{n \log r} e^{in\theta} e^{in2k\pi} = r^n \text{cis}(n\theta) \quad \text{p.e.d}$$

$$b) z^{n/m} = e^{\frac{n}{m} \log z} = e^{\frac{n}{m} [\log r + i(\theta + 2k\pi)]} =$$

$$e^{\frac{n}{m} \log r + i \left[\frac{\theta n}{m} + \frac{2k\pi n}{m} \right]} = e^{(n/m) \log r} \text{cis} \left[\frac{\theta n}{m} + \frac{2k\pi n}{m} \right]$$

$$= \left[\sqrt[m]{r} \right]^n \left[\cos \left[\frac{\theta n}{m} + \frac{2k\pi n}{m} \right] + i \sin \left[\frac{\theta n}{m} + \frac{2k\pi n}{m} \right] \right] \quad \text{this is same as 1.4-13 which has } m \text{ values}$$

$$c) z^c = e^{c [\log r + i(\theta + 2k\pi)]}, \quad k=0, \pm 1, \pm 2, \dots$$

$$= e^{c \log r} e^{i [c\theta + 2k\pi c]} = r^c \text{cis}(c\theta) \text{cis}(2k\pi c)$$

$k=0, \pm 1, \pm 2, \dots$. All the values of the preceding expression are numerically distinct. To prove this, assume that 2 of them are identical. Then you have $\text{cis}(2k\pi c) = \text{cis}(2k'\pi c)$, which can only be true if $2k\pi c - 2k'\pi c = 2m\pi$. or $c = \frac{m}{k-k'}$. But this is a contradiction since c is assumed irrational.

$$d) \text{ let } c = a + ib. \text{ Then } z^c = e^{(a+ib)[\log r + i(\theta + 2k\pi)]}$$

$$= e^{a \log r - b(\theta + 2k\pi) + i [b \log r + a(\theta + 2k\pi)]} =$$

$$e^{a \log r - b(\theta + 2k\pi)} \text{cis}(b \log r + a(\theta + 2k\pi)). \text{ The}$$

modulus: $|z^c|$ is thus $e^{a \log r - b(\theta + 2k\pi)}$

for $k=0, \pm 1, \pm 2, \dots$. Each of these values is numerically distinct, there is a new value for each new value of k . Thus there are an infinity of values of z^c provided $b = \text{Im } c \neq 0$

Sec 3.6

15) The flaw is in assuming that $e^{i\theta} = e^{(2\pi i)\frac{\theta}{2\pi}}$.

Let $p = 2\pi i$, $q = \frac{\theta}{2\pi}$. We are assuming that $e^{pq} = (e^p)^q$. In general this is not so, since e^{pq} is by definition single valued. By definition $e^{pq} = e^{\operatorname{Re}(pq)} \operatorname{cis}[\operatorname{Im}(pq)]$. But $(e^p)^q$ is by definition: $(e^p)^q = e^{q \operatorname{Log} e^p} = e^{q[p + i2k\pi]} = e^{qp} e^{i2k\pi q}$. The preceding is multivalued unless q is an integer, i.e. unless $\frac{\theta}{2\pi}$ is an integer, or $\theta = 2\pi n$. (Under these circumstances $e^{i\theta}$ is indeed equal to 1).

16) $f(z) = z^{2+i}$ $f'(z) = z^{1+i} (2+i)$

$$\begin{aligned} f'(i) &= (2+i) (i)^{1+i} = (2+i) e^{(1+i)\operatorname{Log} i} \\ &= (2+i) e^{(1+i)(i\pi/2)} = (2+i) e^{-\pi/2} e^{i\pi/2} \\ &= e^{-\pi/2} [-1+2i] \end{aligned}$$

17) $f(z) = z^{8/7}$, $f'(z) = \frac{8}{7} z^{1/7}$

$$\begin{aligned} f'(-128i) &= \frac{8}{7} e^{\frac{1}{7} [\operatorname{Log} 128 - i\pi/2]} \\ &= \frac{8}{7} \left[e^{\operatorname{Log} 2} e^{-i\pi/14} \right] = \frac{16}{7} \operatorname{cis} \left[\frac{-\pi}{14} \right] \end{aligned}$$

$\approx 2.2284 - i.5086$

18) $f(z) = z^{1/3+i}$, $f'(z) = \left(\frac{1}{3}+i\right) (z^{-2/3+i})$

$$\begin{aligned} f'(-8i) &= \left(\frac{1}{3}+i\right) e^{(-2/3+i)\operatorname{Log}(-8i)} = \left(\frac{1}{3}+i\right) e^{-2/3 \operatorname{Log} 8 + \frac{\pi}{2}} \operatorname{cis} \left[\operatorname{Log} 8 + \frac{\pi}{3} \right] \\ &= \left(\frac{1}{3}+i\right) e^{\pi/2} e^{-2/3 \operatorname{Log} 8} \operatorname{cis} \left[\operatorname{Log} 8 + \frac{\pi}{3} \right] = \left(\frac{1}{3}+i\right) \frac{e^{\pi/2}}{4} \operatorname{cis} \left[\operatorname{Log} 8 + \frac{\pi}{3} \right] \end{aligned}$$

$\approx -4.188 - i1.1965$

Sec 3.6

19) $f(z) = z^z = e^{z \operatorname{Log} z}$, $\frac{d}{dz} e^{z \operatorname{Log} z} = e^{z \operatorname{Log} z} [\operatorname{Log} z + 1]$

20) $f'(i)$ [see above] $= e^{i \operatorname{Log} i} [\operatorname{Log} i + 1] =$
 $e^{i(\frac{1}{2}\pi)} \left[\frac{i\pi}{2} + 1 \right] = e^{-\frac{\pi}{2}} \left[1 + i \frac{\pi}{2} \right]$

21) $f(z) = e^{\operatorname{sm} z \operatorname{Log} z}$ $\frac{df}{dz} = e^{\operatorname{sm} z \operatorname{Log} z} \left[\frac{\operatorname{sm} z}{z} + \operatorname{cos} z \operatorname{Log} z \right]$

Now put $z = i$, $\operatorname{Log} z = \frac{i\pi}{2}$, $\operatorname{sm} z = i \operatorname{sm} 1$, $\operatorname{cos} i = \operatorname{cosh} 1$

$\frac{df}{dz} = e^{-\frac{\pi}{2}} \operatorname{sm} 1 \left[\operatorname{sm} 1 + i \frac{\pi}{2} \operatorname{cosh} 1 \right] = .1855 + i .38264$

22) $f(z) = 2 \operatorname{cosh} z = e^{\operatorname{Log} 2} \operatorname{cosh} z$
 $= e^{\operatorname{Log} 2} \operatorname{cosh} z$ $\frac{d}{dz} e^{\operatorname{Log} 2} \operatorname{cosh} z = 2 \operatorname{cosh} z \operatorname{Log} 2 \operatorname{sm} h z$ (f(z) is entire)

23) $f(z) = i e^z = e^{(\operatorname{Log} i) e^z} = e^{i \frac{\pi}{2} e^z}$
 $\frac{df}{dz} = e^{i \frac{\pi}{2} e^z} \cdot i \frac{\pi}{2} e^z \Big|_{z=i} = e^{i \frac{\pi}{2} \operatorname{cis} 1} \cdot \frac{i\pi}{2} (\operatorname{cis} 1)$
 $= e^{i \frac{\pi}{2} [\operatorname{cos} 1 + i \operatorname{sm} 1]} \cdot \frac{i\pi}{2} \operatorname{cis} 1 = e^{-\frac{\pi}{2} \operatorname{sm} 1} \cdot \frac{i\pi}{2} \operatorname{cis} \left[1 + \frac{\pi}{2} \operatorname{cos} 1 \right]$
 $= -.4028 - i .1149$

Sec 3.6

24) $f(z) = 10^{z^3} = e^{\log 10 z^3}$

$\frac{df}{dz} = e^{\log 10 z^3} \log 10 \cdot 3z^2$. Put $z=1$,

$\log 10 = \log 10 + i 2k\pi$.

$\frac{df}{dz} = e^{(\log 10 + i 2k\pi) z^3} (\log 10 + i 2k\pi) 3z^2$. Must put

$k=0$ to make this real. Having chosen k , it follows that $\frac{df}{dz} = e^{(\log 10) z^3} \log 10 \cdot 3z^2$ exists

everywhere. Thus $f(z)$ is entire.

$\left. \frac{df}{dz} \right|_{1+i} = e^{(\log 10)(1+i)^3} \log 10 \cdot 3(1+i)^2 =$

$e^{(-2+2i)\log 10} \log 10 \cdot 3 \cdot 2i = .137 - 6.0148i$

25) $10^{e^z} = e^{\log 10 e^z} = e^{(\log 10 + i 2k\pi) e^z}$

Put $z = \frac{i\pi}{2}$, $e^z = i$, $f\left(\frac{i\pi}{2}\right) = e^{(\log 10 + i 2k\pi) i}$

To make $\left|f\left(\frac{i\pi}{2}\right)\right| = e^{-2\pi}$ we must take $k=1$. Thus:

$f(z) = e^{(\log 10 + i 2\pi) e^z}$

$f'(z) = e^{(\log 10 + i 2\pi) e^z} (\log 10 + i 2\pi) e^z$

$f'\left(\frac{i\pi}{2}\right) = e^{(\log 10 + i 2\pi) i}$

$(\log 10 + i 2\pi) i =$

$.00464 - i .0116$

26 |

Sec 3.6

```

clear
% problem 26 in section 3.6
nmax=50
a(1)=i;
for kk=2:nmax

    a(kk)=i.^a(kk-1);
    plot(real(a(kk)),imag(a(kk)), '*');hold on

end
plot(real(a(1)),imag(a(1)), '*')
a

```

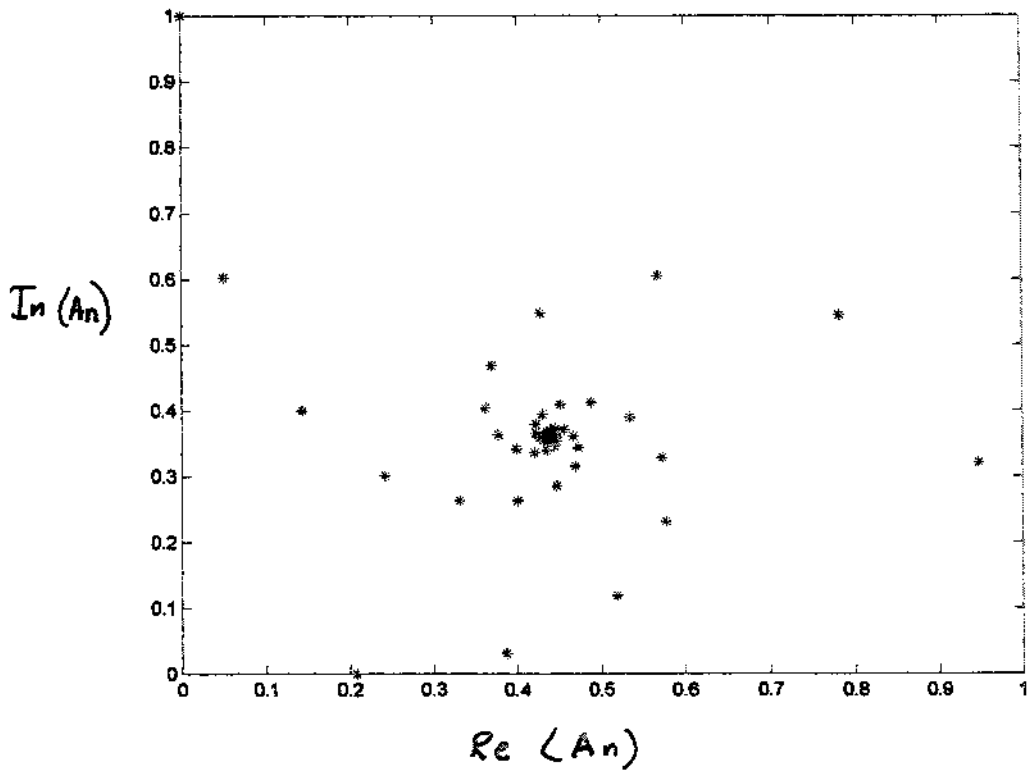

Note: we found that $A_{50} = .4402 + i .3595$ which agrees favorably with $.4383 + i .3606$ in Packer and Abbott. There are indeed 3 spirals.

$$\begin{aligned}
 c) \quad A_{n+1} &= \zeta^{A_n} & \lim_{n \rightarrow \infty} A_{n+1} &= A, & \lim_{n \rightarrow \infty} \zeta^{A_n} &= \zeta^{\lim_{n \rightarrow \infty} A_n} = \zeta^A \\
 \therefore A &= \zeta^A = e^{(i\pi/2)A} & \therefore A &= e^{i\pi/2} & \text{Using } A = .4383 + i .3606 & \\
 & & & & \text{agreement is excellent.} &
 \end{aligned}$$

Sec 3.6

$$27) a) z^n = e^{n \log z} = e^n [\text{Log} r + i\theta]$$

$$= e^{n \text{Log} r} e^{in\theta} = r^n e^{in\theta} \quad -\pi < \theta \leq \pi$$

Note that in the expression $e^{in\theta}$ we can add 2π to any value of θ and not alter the value of $e^{in\theta}$, since $e^{in\theta} = e^{in(\theta+2\pi)}$

In place of the values of θ satisfying $-\pi < \theta < 0$ we use θ satisfying $\pi < \theta < 2\pi$. We now have $z^n = r^n e^{in\theta}$ $0 \leq \theta < 2\pi$, which varies in a continuous manner thru the branch cut at $\theta = \pi$.

b) $e^{n \log z} = e^{n \log r} e^{in\theta}$ where $\theta = \arg z$, $r = |z|$

$e^{n \log z} = r^n e^{in\theta}$ Since $z = re^{i\theta}$ we have

$$\lim_{z \rightarrow 0} e^{n \log z} = \lim_{r \rightarrow 0^+} r^n e^{in\theta} = 0 \quad \text{q.e.d.}$$

The function $f(z) = e^{n \log z}$, $z \neq 0$, $f(0) = 0$ is continuous at $z = 0$ since $\lim_{z \rightarrow 0} f(z) = f(0)$

Let us find deriv. at $z = 0$ of $f(z)$, $f'(z) = \frac{f(z+\Delta z) - f(z)}{\Delta z}$

$$f'(z)|_{z=0} = \lim_{\Delta z \rightarrow 0} \frac{e^{n \log \Delta z} - 0}{\Delta z} = \frac{e^{n \log r} e^{in\theta}}{r e^{i\theta}} = \lim_{r \rightarrow 0^+} \frac{r^n e^{in\theta}}{r e^{i\theta}}$$

let $\Delta z = r e^{i\theta}$

$$= \lim_{r \rightarrow 0} r^{n-1} \frac{e^{in\theta}}{e^{i\theta}}$$

The preceding vanishes if $n > 1$ and equals 1 if $n = 1$. Thus $e^{n \log z}$ is differentiable at $z = 0$.

The function $f(z)$ as defined here is entire as it has a derivative everywhere in the complex plane. For all z it satisfies

$$\frac{d}{dz} f(z) = n z^{n-1}, \quad n \geq 1$$

Sec 3.7

(a) $z = \cos w = \frac{p+p^{-1}}{2}$, $p = e^{iw}$, $2z = p+p^{-1}$
 $2z^2 = p^2+1$, Use quadratic formula $p^2 - 2z^2p + 1 = 0$
 $p = z + (z^2-1)^{1/2} = z + i(1-z^2)^{1/2} = e^{iw}$. Take
 logs of both sides, $w = -i \log [z + i(1-z^2)^{1/2}]$
 Where $w = \cos^{-1}(z)$ q.e.d.

(b) $z = \tan w = \frac{\sin w}{\cos w} = \frac{(e^{iw} - e^{-iw})/i}{e^{iw} + e^{-iw}}$
 $= \frac{(p-p^{-1})/i}{p+p^{-1}}$ if $p = e^{iw}$ $z = \frac{(p-p^{-1})/i}{p+p^{-1}}$
 $z(p^2+1) = -i(p^2-1)$, $p^2 = \frac{i-z}{i+z}$, $p = \left(\frac{i-z}{i+z}\right)^{1/2} = e^{iw}$
 $i w = \log \left[\frac{i-z}{i+z}\right]^{1/2} = \frac{1}{2} \log \left[\frac{i-z}{i+z}\right] = -\frac{1}{2} \log \left[\frac{i+z}{i-z}\right]$
 $w = -\frac{i}{2} \log \left[\frac{i+z}{i-z}\right]$, but $w = \tan^{-1} z$. q.e.d.

(c) $z = \sinh w = \frac{e^w - e^{-w}}{2} = \frac{p-p^{-1}}{2}$, $p = e^w$
 $2z^2 = p^2 - 1$, $p^2 - 2z^2p - 1 = 0$, $p = z + (z^2+1)^{1/2} = e^w$
 $w = \sinh^{-1}(z) = \log [z + (z^2+1)^{1/2}]$ q.e.d.

(2) $\cos^{-1}(z) = -i \log [z + i(1-z^2)^{1/2}]$. We choose
 a particular branch of the sq. root and log and
 then differentiate. $\frac{d}{dz} (-i) \log [z + i(1-z^2)^{1/2}] =$
 $-i \frac{[1 + \frac{i}{2}(1-z^2)^{-1/2}(-2z)]}{z + i(1-z^2)^{1/2}} =$

$$\frac{d}{dz} \cos^{-1}(z) = -i \frac{[1 - \frac{iz}{(1-z^2)^{1/2}}]}{(1-z^2)^{1/2} [z + i(1-z^2)^{1/2}]}$$

$$= \frac{-1}{(1-z^2)^{1/2}} \quad \text{q.e.d.}$$

sec 3.7, prob 2, continued

$$(b) z = \sin w = \left(1 - \left(\frac{dz}{dw}\right)^2\right)^{1/2}, \quad w = \sin^{-1}(z)$$

$$z^2 = 1 - \left(\frac{dz}{dw}\right)^2, \quad 1 - z^2 = \left(\frac{dz}{dw}\right)^2, \quad \frac{dw}{dz} = \frac{1}{(1-z^2)^{1/2}}$$

$$= \frac{d}{dz} \sin^{-1} z, \quad \text{q.e.d.}$$

$$(c) \frac{d}{dz} \log \left[z + (z^2+1)^{1/2} \right] = \frac{1 + \frac{z}{(z^2+1)^{1/2}}}{z + (z^2+1)^{1/2}}$$

$$= \frac{1}{(z^2+1)^{1/2}} \cdot \text{q.e.d.} \quad \text{other method:}$$

$$z = \sinh w = (\cosh^2 w - 1)^{1/2} = \left(\left(\frac{dz}{dw} \right)^2 - 1 \right)^{1/2}$$

$$z^2 = \left(\frac{dz}{dw} \right)^2 - 1, \quad z^2 + 1 = \left(\frac{dz}{dw} \right)^2, \quad \frac{dw}{dz} = \frac{1}{(z^2+1)^{1/2}}$$

Where $w = \sinh^{-1}(z)$, q.e.d.

$$3] \sin^{-1}(z) + \cos^{-1}(z) = -i \log \left[z i + (1-z^2)^{1/2} \right]$$

$$-i \log \left[z + i(1-z^2)^{1/2} \right] = -i \log \left[(z i + (1-z^2)^{1/2}) (z + i(1-z^2)^{1/2}) \right]$$

$$= -i \log \left[z^2 i + i(1-z^2) \right] = -i \log i =$$

$$= -i \left[(i) \left(\frac{\pi}{2} + 2k\pi \right) \right] = \frac{\pi}{2} + 2k\pi \quad \text{q.e.d.}$$

$$4] \cos^{-1}(3) = -i \log \left[3 + i(1-3^2)^{1/2} \right] =$$

$$-i \log \left[3 + i(-8)^{1/2} \right] = -i \log \left[3 \pm 2\sqrt{2}i \right]$$

$$\text{With plus sign } -i \log \left[3 + 2\sqrt{2}i \right] = -i \left[\text{Log} \left[3 + 2\sqrt{2}i \right] \right.$$

$$\left. + i(2k\pi) \right] = \boxed{2k\pi - i 1.7627} \quad k=0, \pm 1, \dots$$

$$\text{With minus sign } -i \log \left[3 - 2\sqrt{2}i \right] =$$

$$= -i \left[\text{Log} \left[3 - 2\sqrt{2}i \right] + i2k\pi \right] = \boxed{2k\pi - i 1.7627}$$

sec 3.7

5) $\sinh w = i$ $w = \sinh^{-1} i =$

$$\log [i + (i^2 + 1)^{1/2}] = \log i = i \left[\frac{\pi}{2} + 2k\pi \right]$$

$k = 0, \pm 1, \pm 2, \dots$

6) $\cosh w = 1+i$, $w = \cosh^{-1}(1+i) =$
 $-i \log [(1+i) + i(1-2i)^{1/2}]$

What are values of $(1-2i)^{1/2}$? = $\pm [1.272 - i.7862]$

With plus sign:

$$\cosh^{-1} [1+i] = -i \log [(1+i) + i(1.272 - i.7862)]$$

$$= -i \log [1.7862 + i2.272] = \boxed{.9045 - i 1.0613 + 2k\pi}$$

With minus sign:

$$\cosh^{-1} [1+i] = -i \log [(1+i) - i(1.272 - i.7862)]$$

$$= -i \log [.2138 - i.272] = \boxed{-.9045 + i 1.0613 + 2k\pi}$$

7) $\sinh w = i\sqrt{2}$, $w = \log [\sqrt{2} + (-2+1)^{1/2}]$

$$= \log [i\sqrt{2} \pm i] \text{ with plus sign}$$

$$\text{get } \log [i(\sqrt{2}+1)] = \text{Log} [\sqrt{2}+1] + i \left(\frac{\pi}{2} + 2k\pi \right)$$

$$= \boxed{.8814 + i \left[\frac{\pi}{2} + 2k\pi \right]}$$

With MINUS sign get $\log [i[\sqrt{2}-1]] =$

$$= \text{Log} [\sqrt{2}-1] + i \left(\frac{\pi}{2} + 2k\pi \right) = \boxed{-.8814 + i \left(\frac{\pi}{2} + 2k\pi \right)}$$

8) $\cosh^2 w = -1$ $\cosh w = \pm i$ Use Eq. (3.7-5)

With plus sign: $\log [i \pm i\sqrt{2}] =$

$$\boxed{\text{Log} [\sqrt{2}+1] + i \left[\frac{\pi}{2} + 2k\pi \right]} \text{ and } \boxed{\text{Log} [\sqrt{2}-1] + i \left(\frac{-\pi}{2} + 2k\pi \right)}$$

With MINUS sign $\cosh w = -i$, get

$$\log [-i \pm i\sqrt{2}] = \text{Log} [\sqrt{2}-1] + i \left[\frac{\pi}{2} + 2k\pi \right] \text{ and } \text{Log} [\sqrt{2}+1] + \left[\frac{-\pi}{2} + 2k\pi \right]$$

Sec 3.7 continued

8] SUMMARY

$$\begin{aligned} & \operatorname{Log}[\sqrt{2}+1] + i\left(\frac{\pi}{2} + 2k\pi\right); \operatorname{Log}[\sqrt{2}+1] + i\left(-\frac{\pi}{2} + 2k\pi\right) \\ & \operatorname{Log}[\sqrt{2}-1] + i\left[\frac{\pi}{2} + 2k\pi\right]; \operatorname{Log}[\sqrt{2}-1] + i\left[-\frac{\pi}{2} + 2k\pi\right] \\ & = \boxed{.8814 + i\left[\frac{\pm\pi}{2} + 2k\pi\right]} \quad \text{and} \quad \boxed{-.8814 + i\left[\frac{\pm\pi}{2} + 2k\pi\right]} \end{aligned}$$

9] $\tan z = 2i$ $\tan^{-1}(2i) = \frac{1}{2} \log \left| \frac{1+2i}{1-2i} \right|$

$$= \frac{i}{2} \log[-3] = \frac{i}{2} [\operatorname{Log} 3 + i(\pi + 2k\pi)]$$

$$= -\left[\frac{\pi}{2} + k\pi\right] + \frac{1}{2} \operatorname{Log} 3 = \boxed{\frac{\pi}{2} + k\pi + 1.5493}$$

10] $\sin(\cos w) = 0$ $\cos w = n\pi$, $n = 0, \pm 1, \pm 2, \dots$ $w = \cos^{-1}(n\pi)$
 or $w = -i \log[n\pi + i(1-n^2\pi^2)^{1/2}]$. Suppose $n = 0$

$$w = -i \log(\pm i) = -i \left[\pm \frac{\pi}{2} + 2k\pi \right] i = \left(\pm \frac{\pi}{2} + 2k\pi \right) \quad k = 0, \pm 1, \pm 2, \dots$$

Suppose n is positive, $1, 2, 3, \dots$ then $w = -i \log[n\pi \pm i(1-n^2\pi^2)^{1/2}]$

$$w = -i \log[n\pi \pm \sqrt{n^2\pi^2-1}] = -i \left[\operatorname{Log}[n\pi \pm \sqrt{n^2\pi^2-1}] + i 2k\pi \right]$$

$$= 2k\pi - i \operatorname{Log}[n\pi \pm \sqrt{n^2\pi^2-1}] \quad k = 0, \pm 1, \pm 2, \dots \quad n = 1, 2, 3, \dots$$

Suppose n is negative, $-1, -2, -3, \dots$ Then $w = -i \log(|n\pi \pm \sqrt{n^2\pi^2-1}|(-i))$

$$\text{or } w = -i \left[\operatorname{Log} |n\pi \pm \sqrt{n^2\pi^2-1}| + i(\pi + 2k\pi) \right] =$$

$$\pi + 2k\pi - i \operatorname{Log} |n\pi \pm \sqrt{n^2\pi^2-1}|$$

SUMMARY OF SOLUTIONS:

$$w = \pm \frac{\pi}{2} + 2k\pi \quad \text{or} \quad w = 2k\pi - i \operatorname{Log}[n\pi \pm \sqrt{n^2\pi^2-1}] \quad n \text{ pos integer}$$

$$\text{or } w = \pi + 2k\pi - i \operatorname{Log} |n\pi \pm \sqrt{n^2\pi^2-1}| \quad n \text{ neg. integer.}$$

k is any integer in preceding. Now suppose $n = 0$.

$$w = \pm \frac{\pi}{2} + 2k\pi \quad k = 0, \pm 1, \pm 2, \dots \quad n = 0$$

11] $\sinh(\cos w) = 0$, $\cos w = i n \pi$ $n = 0, \pm 1, \pm 2, \dots$

$$w = -i \log [i n \pi + i(1+n^2\pi^2)^{1/2}] =$$

$$-i \log [i n \pi \pm i \sqrt{n^2\pi^2+1}] \quad \text{with plus sign}$$

Continued, next pg.

Sec 8.7 cont'd

$$W = -i \left[\text{Log} (n\pi + \sqrt{n^2\pi^2 + 1}) + i \left[\frac{\pi}{2} + 2k\pi \right] \right] =$$

$$\frac{\pi}{2} + 2k\pi - i \text{Log} (n\pi + \sqrt{n^2\pi^2 + 1}), \quad n=0, \pm 1, \pm 2, \dots, k=0, \pm 1, \pm 2, \dots$$

with minus sign

$$W = -i \left[\text{Log} |n\pi - \sqrt{n^2\pi^2 + 1}| + i \left(-\frac{\pi}{2} + 2k\pi \right) \right] =$$

$$-\frac{\pi}{2} + 2k\pi - i \text{Log} |n\pi - \sqrt{n^2\pi^2 + 1}| \quad n=0, \pm 1, \pm 2, \dots; k=0, \pm 1, \pm 2, \dots$$

12] $\sin^{-1} W = -i, \quad \sin[\sin^{-1} W] = \sin(-i)$

$$W = \sin(-i) = -i \sinh 1 = -i 1.1752$$

13] a) $\tan^{-1}(\tan z)$, $\tan z$ is single valued, \tan^{-1} is a multivalued function. $\tan^{-1}(\tan z)$

has multiple values; one value is z . This eqn. not true in general.

(b) $\tan^{-1}(z)$ is multivalued, but $\tan[\tan^{-1}(z)]$ is single valued and equals z . Thus eqn. true in general.

14] in general: $\sinh^{-1}(z) = \text{Log} [z + (z^2 + 1)^{1/2}]$

Now $z = x$ is real. $\sinh^{-1}(x) = \text{Log} [x \pm \sqrt{x^2 + 1}]$

$$= \text{Log} (x + \sqrt{x^2 + 1}) + i 2k\pi \quad \text{or} \quad \text{Log} |x - \sqrt{x^2 + 1}| + i [\pi + 2k\pi]$$

The only real value is obtained if $k=0$ and

we use $\sqrt{x^2 + 1}$, not $-\sqrt{x^2 + 1}$. Thus

$$\text{we take } \sinh^{-1}(x) = \text{Log} (x + \sqrt{x^2 + 1})$$

15] a) Assume first that x is $\gg 1$. $\sinh^{-1}(x) =$

$\text{Log} (x + \sqrt{x^2 + 1})$. But $\sqrt{x^2 + 1} \approx x$. Thus $\sinh^{-1}(x) \approx$

$\text{Log} (2x)$ if $x \gg 1$. Now suppose $x \ll -1$.

Note that $\sinh^{-1}(x) = \text{Log} (x + \sqrt{x^2 + 1}) =$

$$\text{Log} \left[\frac{(x + \sqrt{x^2 + 1})(x - \sqrt{x^2 + 1})}{x - \sqrt{x^2 + 1}} \right] = \text{Log} \left[\frac{-1}{x - \sqrt{x^2 + 1}} \right]$$

sec 3.7, 15 cont'd

Now if $x \ll -1$, $x - \sqrt{x^2 + 1} \approx x - |x| = 2x$.

Thus $\sinh^{-1}(x) \approx \log \frac{-1}{2x} = \log \frac{1}{2|x|} = -\log(2|x|)$.

(b)

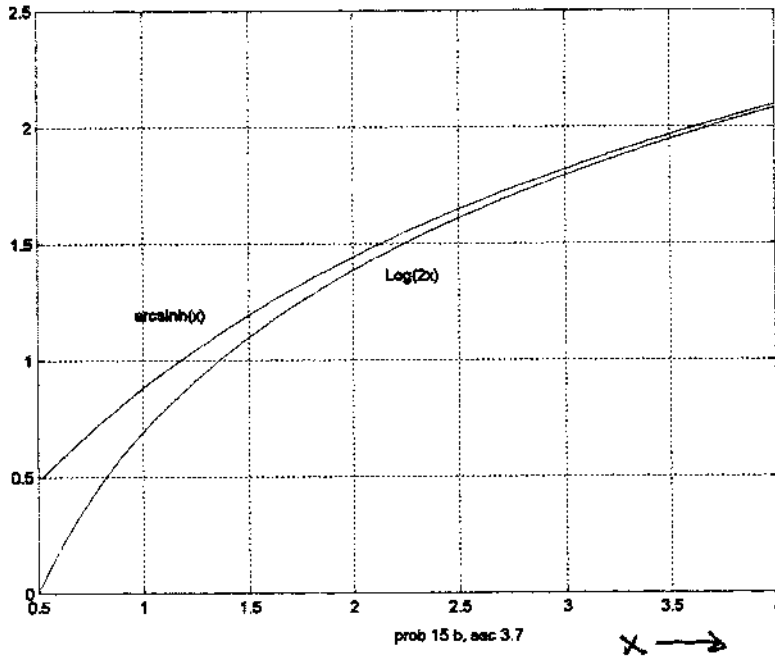

sec 3.7

$$16) \tanh^{-1}(e^{i\theta}) = \frac{1}{2} \log \left[\frac{1+e^{i\theta}}{1-e^{i\theta}} \right] =$$

$$\frac{1}{2} \log \left[\frac{e^{i\theta/2} (e^{-i\theta/2} + e^{i\theta/2})}{e^{i\theta/2} (e^{-i\theta/2} - e^{i\theta/2})} \right] = \frac{1}{2} \log \left[\frac{2 \cos \theta/2}{-2i \sin \theta/2} \right]$$

$$= \frac{1}{2} \log \left[i \cot \frac{\theta}{2} \right]$$

$$17) \tan^{-1} e^{i\theta} = \frac{1}{2} \log \left[\frac{1+e^{i\theta}}{1-e^{i\theta}} \right] = \frac{1}{2} \log \left[\frac{e^{i\pi/2} + e^{i\theta}}{e^{i\pi/2} - e^{i\theta}} \right]$$

Multiply numerator and denominator by $e^{-i\pi/4} e^{-i\theta/2}$

$$\tan^{-1} e^{i\theta} = \frac{1}{2} \log \left[\frac{e^{i(\frac{\pi}{4} - \frac{\theta}{2})} + e^{-i(\frac{\pi}{4} - \frac{\theta}{2})}}{e^{i(\frac{\pi}{4} - \frac{\theta}{2})} - e^{-i(\frac{\pi}{4} - \frac{\theta}{2})}} \right]$$

$$= \frac{1}{2} \log \left[\frac{2 \cos(\frac{\pi}{4} - \frac{\theta}{2})}{-2i \sin(\frac{\theta}{2} - \frac{\pi}{4})} \right] = \boxed{\frac{i}{2} \log \left[i \cot \left[\frac{\theta}{2} - \frac{\pi}{4} \right] \right]}$$

$$18) \sin^{-1}(z) = -i \log \left[z + (1-z^2)^{1/2} \right], \quad \cos(\sin^{-1} z) =$$

$$\frac{e^{\log [z + (1-z^2)^{1/2}]} + e^{-\log [z + (1-z^2)^{1/2}]} }{2}$$

$$= \frac{1}{2} [z + (1-z^2)^{1/2}] + \frac{1}{2} \left[\frac{1}{z + (1-z^2)^{1/2}} \right] =$$

$$\frac{1}{2} [z + (1-z^2)^{1/2}] + \frac{1}{2} \left[\frac{-z + (1-z^2)^{1/2}}{(z + (1-z^2)^{1/2})(-z + (1-z^2)^{1/2})} \right]$$

$$= \frac{1}{2} [z + (1-z^2)^{1/2}] + \frac{1}{2} \left[\frac{-z + (1-z^2)^{1/2}}{1} \right] = (1-z^2)^{1/2}$$

s.e.d.

19] ^{Sec 3.7} $\sin^{-1}(z) = -i \log [iz + (1-z^2)^{1/2}] =$

$-i \log [ix + (1-x^2)^{1/2}] \quad -1 \leq x \leq 1$

$= -i \left[\log \sqrt{x^2 + 1-x^2} + i \arg [ix + (1-x^2)^{1/2}] \right]$

$= -i \left[\log 1 + i \arg (ix + (1-x^2)^{1/2}) \right]$

$= \arg (ix + (1-x^2)^{1/2})$ which is a real quantity

2da) (b)

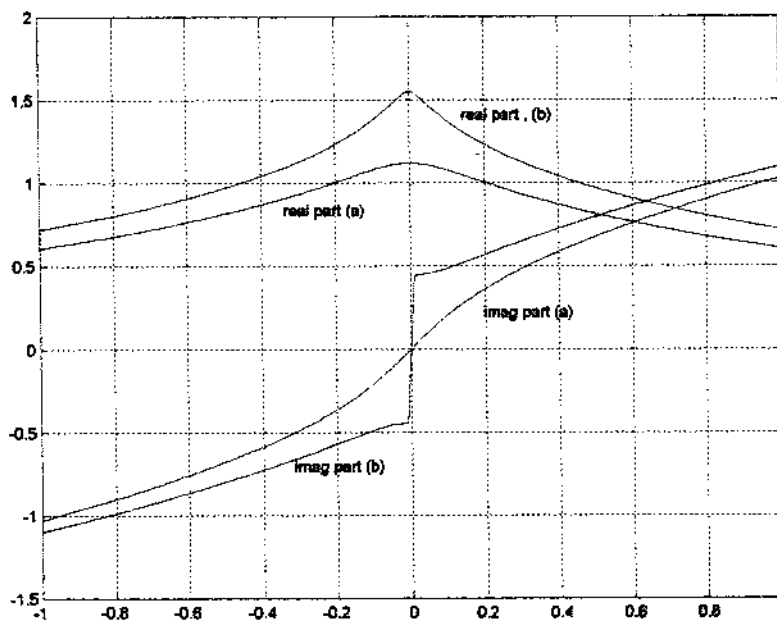

section 3.7, problem 20 parts a and b

sec 3.7

20 (a) cont'd
(b)

```
%for problem 20, section 3.7, parts a and b
a=1.1;
b=.9;
y=linspace(-1,1,100);
z=a+i*y;
zz=b+i*y;
ww=asin(zz);
w=asin(z);
plot(y,real(w),'g',y,imag(w),'r');grid;hold on
plot(y,real(ww),'b',y,imag(ww),'m')
```

(c)

```
% section 3.7, prob20. part (c)
x=[-2:.01:2];
y=[-1:.01:1];
```

```
[X,Y]=meshgrid(x,y);
Z=X+i*Y;
w=asin(Z);
wm=real(w);
%wm=imag(w);
meshz(X,Y,wm);
view(45,45);
```

use this line for
imag.
part.

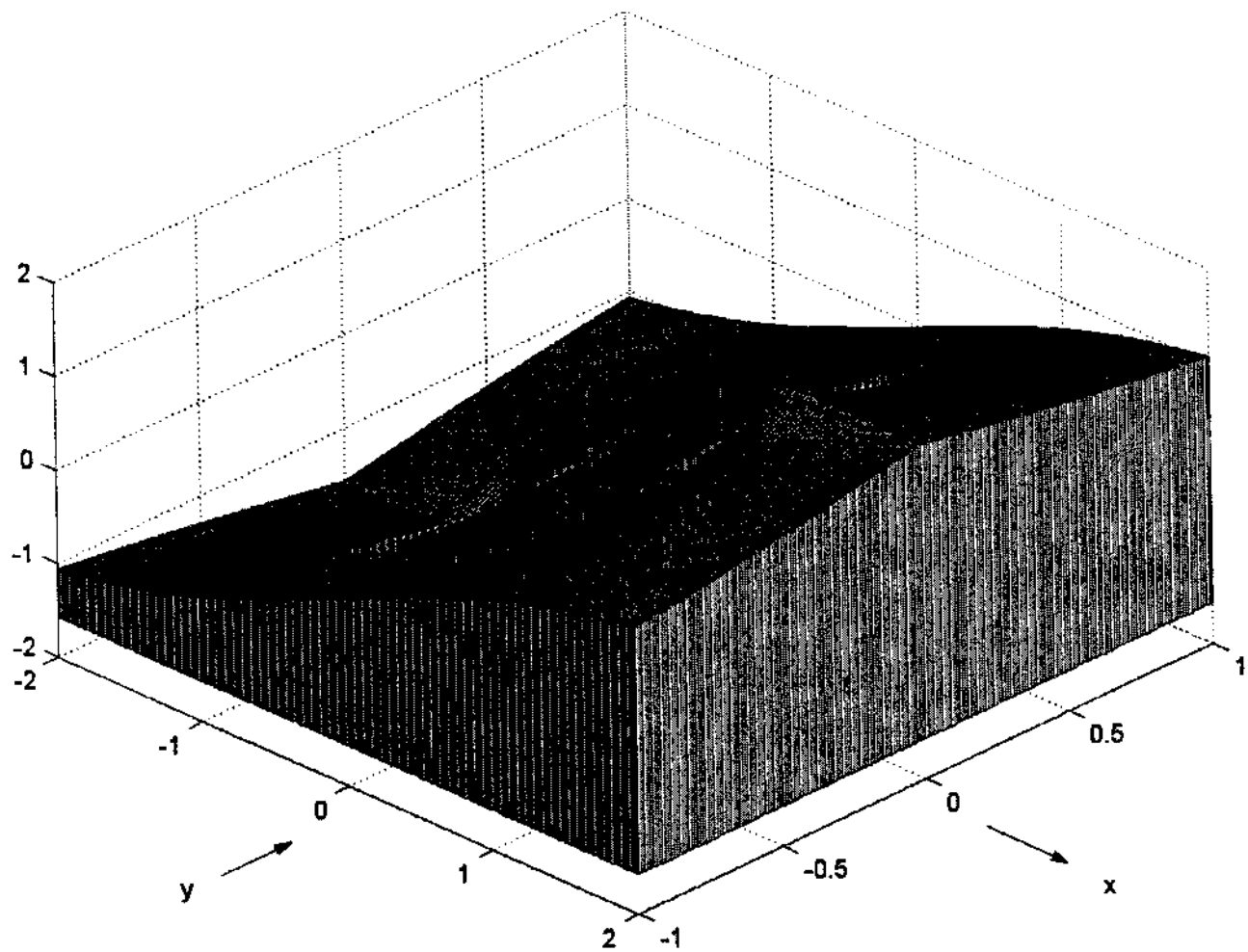

problem 20(c) sec. 3.7 real part

Chap 3, page 62

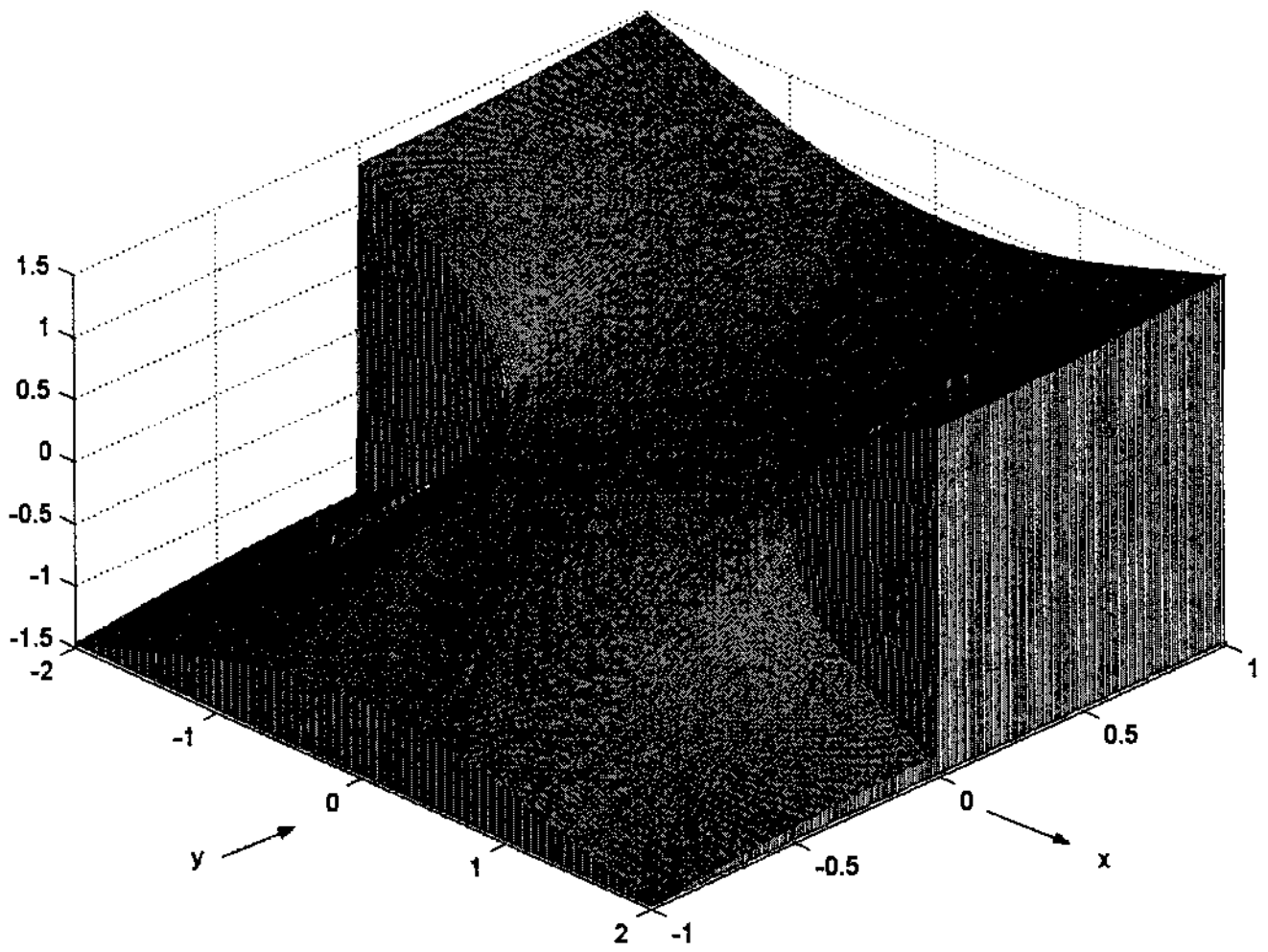

problem 20 (e), sec 3.7, mag part

Chap 3, page 63

d) Consider $\sin^{-1}(z) = -i \log \left[iz + (1-z^2)^{1/2} \right]$

Note that the ^{logarithmic} log function cannot exhibit a branch point in the z plane,

For this to happen $(z + (1-z^2)^{1/2}) = 0$

$$-z = (1-z^2)^{1/2} \Rightarrow -z^2 = 1-z^2, \quad 1=0, \text{ no sol'n}$$

Now $(1-z^2)^{1/2} = (z+1)^{1/2} (1-z)^{1/2}$ which has branch

pts. @ $z = \pm 1$. The function $(1-z^2)^{1/2}$ is

made single valued thru use of branch cuts

along the lines $x \leq -1, y=0$ and $x \geq 1, y=0$.

This causes the discontinuities observed in the plots.

The branch used by MATLAB can be defined as follows.

Put $z=0$ $\sin^{-1}(z) = -i \log [1^{1/2}]$. Use $1^{1/2} = 1$

Use princ value of Log. Get $\sin^{-1}(0) = 0$. This will agree with the 3 dimensional plots of $\sin^{-1}(z)$.

sec 3.8

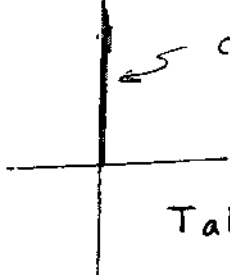
1)  cut $f(z) = z^{1/2}$, let $z = r \operatorname{cis} \theta$
 then $f(z) = \sqrt{r} \operatorname{cis} \left[\frac{\theta}{2} + k\pi \right]$
 Take $-\frac{3\pi}{2} < \theta < \frac{\pi}{2}$. Take $k=1$

So that when $z = 9$ [$r=9, \theta=0$] then
 $f(z) = -3$. If $z = 1, r=1, \theta=0$, thus
 $f(z) = 1 \angle 0 + \pi = \boxed{-1}$
 $f'(z) = \frac{1/2}{z^{1/2}} = \boxed{-1/2}$

2) Choose k and $-\frac{3\pi}{2} < \theta < \frac{\pi}{2}$ as in problem 1.
 Now $r=9, \theta = -\pi/2$.

$$f(z) = \sqrt{9} \operatorname{cis} \left[\frac{1}{2} \left(-\frac{\pi}{2} \right) + \pi \right]$$

$$= 3 \angle \frac{3\pi}{4} = 3 \left[\frac{-1}{\sqrt{2}} + \frac{i}{\sqrt{2}} \right] = f(z)$$

$$f'(z) = \frac{1/2}{z^{1/2}} = \frac{1}{6 \left[\frac{-1}{\sqrt{2}} + \frac{i}{\sqrt{2}} \right]} = \frac{1}{6} \left[\frac{-1}{\sqrt{2}} - \frac{i}{\sqrt{2}} \right] = f'(z)$$

3) Take k , and $-\frac{3\pi}{2} < \theta < \frac{\pi}{2}$ as above

$f(z) = \sqrt{r} \operatorname{cis} \left[\frac{\theta}{2} + \pi \right]$ $z = -1+i, r = \sqrt{2}$
 $\theta = -\frac{5\pi}{4}$ $f(z) = \sqrt{\sqrt{2}} \angle \left[-\frac{5\pi}{8} + \pi \right]$
 $= \sqrt{\sqrt{2}} \angle \frac{3\pi}{8} = \boxed{.4551 + i 1.0987} = f$
 $f'(z) = \frac{1}{2z^{1/2}} = \frac{.5}{.4551 + i 1.0987}$
 $= \boxed{.1609 - i .3884} = f'(z)$

4] $f(z) = \sqrt{r} \operatorname{cis}\left(\frac{\theta}{2} + \pi\right)$ sec 3.8, cont'd
 $-\frac{3\pi}{2} < \theta < \pi/2$ $r = \sqrt{9 \cdot 3 + 9^2} = 18$

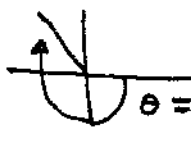
 $\theta = -\frac{4\pi}{3}$ radians. $f(z) = \sqrt{18} \angle \frac{-\frac{4\pi}{3} + \pi}{2} = \sqrt{18} \angle \frac{\pi}{3}$

$= \sqrt{18} \left[\cos \frac{\pi}{3} + i \sin \frac{\pi}{3} \right] = \frac{3}{\sqrt{2}} [1 + i\sqrt{3}] = f(z)$ $\frac{1}{2z^{1/2}} = f'(z)$

$\frac{1}{\sqrt{2} \cdot 3} \left[\frac{1}{1 + i\sqrt{3}} \right] = \frac{1 - i\sqrt{3}}{12 \sqrt{2}} = f'(z)$

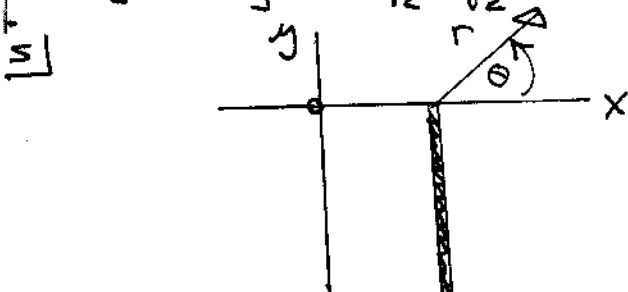

$(z-1)^{2/3} = \left(\sqrt[3]{r}\right)^2 \angle \frac{2}{3}\theta + \frac{2k\pi}{3} \cdot 2$

where $r = |z-1|$ and $\theta = \arg(z-1)$ where

$-\frac{\pi}{2} < \theta < \frac{3\pi}{2}$. To make $f(0) = 1$, take $\theta = \pi$

(at $z=0$), $r=1$ and $k=1$, Note $\operatorname{cis}\left[\frac{2}{3}\pi + \frac{4\pi}{3}\right]$

$= 1$. Now if $z = 1 + 8i$, $r=8$, $\theta = \pi/2$,

$f(z) = \left[\sqrt[3]{8}\right]^2 \angle \frac{2}{3} \frac{\pi}{2} + \frac{4\pi}{3} = 4 \operatorname{cis}\left[\frac{5\pi}{3}\right] = \boxed{2 - i2\sqrt{3}}$

$f'(z) = \frac{2}{3} (z-1)^{-1/3} = \frac{2}{3} \frac{(z-1)^{2/3}}{(z-1)} = \frac{2}{3} \frac{f(z)}{(z-1)}$

$= \frac{2}{3} \frac{(2 - i2\sqrt{3})}{8i} = \boxed{-.288 - i.1667}$

6] Take k and θ as in 5]. At $z = -1$, $r=2$, $\theta = \pi$

$f(z) = \left[\sqrt[3]{2}\right]^2 \angle \frac{2}{3}\pi + \frac{4\pi}{3} = \left[\sqrt[3]{2}\right]^2 = \boxed{1.587}$

$f'(z) = \frac{2}{3} \frac{f(z)}{(z-1)} = \frac{2/3}{-2} 1.587 = \boxed{-.5291}$

sec 3.8 cont'd

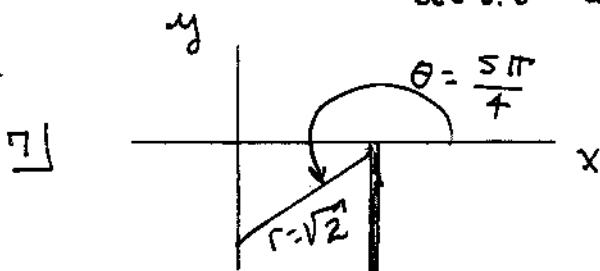

Take θ and k as in 5]. At $z = -1$, $r = \sqrt{2}$, $\theta = \frac{5\pi}{4}$

$$(z-1)^{2/3} = \left[\sqrt[3]{\sqrt{2}} \right]^2 \angle \left[\frac{5\pi}{4} \cdot \frac{2}{3} + \frac{4\pi}{3} \right] = \sqrt[3]{2} \text{cis} \left[\frac{10\pi}{12} + \frac{4\pi}{3} \right]$$

$$= \sqrt[3]{2} \text{cis} \left(\frac{13\pi}{6} \right) = \boxed{1.091 + i.6299}$$

$$f'(z) = \frac{2}{3} \frac{f(z)}{(z-1)} = \frac{2}{3} \frac{[1.091 + i.6299]}{(-1-1)} = \boxed{-.574 + i.159}$$

8]

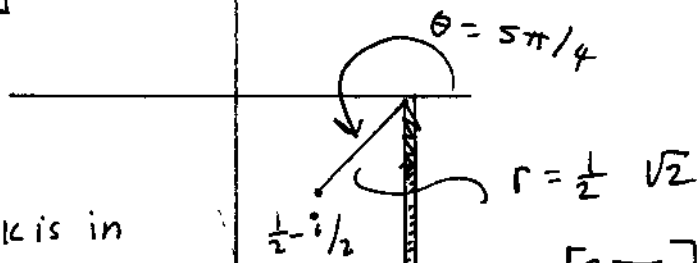

Take k is in problem 5.

$\theta = 5\pi/4$ at $\frac{1}{2} - \frac{i}{2}$

$$f(z) = \left[\sqrt[3]{\frac{1}{\sqrt{2}}} \right]^2 \text{cis} \left[\frac{5\pi}{4} \cdot \frac{2}{3} + \frac{4\pi}{3} \right]$$

$$= \sqrt[3]{\frac{1}{2}} \text{cis} \left[\frac{\pi}{6} \right] = \boxed{.6874 + i.397}$$

$$f'(z) = \frac{2}{3} \frac{f(z)}{(z-1)} = \frac{2/3 f(z)}{-\frac{1}{2} - \frac{i}{2}} = \frac{2/3 [.6874 + i.397]}{-\frac{1}{2} - \frac{i}{2}} = \boxed{-.7228 + i.1937}$$

9]

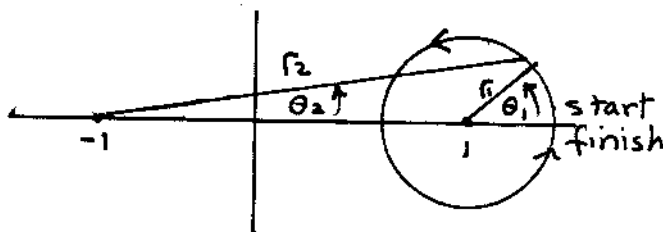

sec 3.8 continued

9] a) continued, refer to fig. on bottom previous page

$$(z-1) = r_1 \angle \theta_1, \quad (z+1) = r_2 \angle \theta_2. \quad \text{Thus}$$

$$(z^2-1)^{1/2} = \sqrt{r_1} \angle \frac{\theta_1}{2} + k\pi \quad \sqrt{r_2} \angle \frac{\theta_2}{2} + m\pi.$$

Suppose we begin at "start" on the contour and go once around it to "finish". The expression $\sqrt{r_1} \text{cis}(\frac{\theta_1}{2} + k\pi)$ will, at finish, be the negative of its value at "start" (since θ_1 increases by 2π). But $\sqrt{r_2} \text{cis}(\frac{\theta_2}{2} + m\pi)$ assumes the same value at start and finish. Thus in going once around the contour, $(z^2-1)^{1/2}$ changes sign. Evidently $z=1$ is a branch point. A similar argument applies if we encircle only $z=-1$

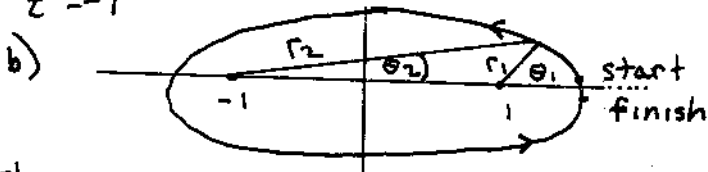

The argument is much like that in part (a). At

"start" $(z^2-1)^{1/2} = \sqrt{r_1} \text{cis}(k\pi) \sqrt{r_2} \text{cis}(m\pi)$

At "finish" $(z^2-1)^{1/2} = \sqrt{r_1} \text{cis}[\frac{2\pi}{2} + k\pi] \sqrt{r_2} \text{cis}[\frac{2\pi}{2} + m\pi]$

$= \sqrt{r_1} \text{cis}(k\pi) \sqrt{r_2} \text{cis}(m\pi)$. We have the same numerical values at "start" and finish for $(z^2-1)^{1/2}$. Thus by encircling both branch points we do not pass to a new branch of the function.

10]

a)

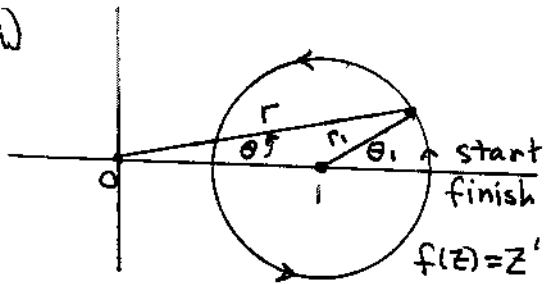

Let $z = r \text{cis} \theta$

$$(z-1) = r_1 \text{cis}(\theta_1)$$

Thus:

$$f(z) = z^{1/3} (z-1)^{1/3} =$$

$$\sqrt[3]{r} \text{cis}(\frac{\theta}{3} + \frac{2k\pi}{3}) \sqrt[3]{r_1} \text{cis}[\frac{\theta_1}{3} + \frac{2m\pi}{3}]$$

Sec 3.8

10) Cont'd We proceed once around the contour shown on previous pg. At "start" $f(z) = \sqrt[3]{r} \operatorname{cis}\left(\frac{2k\pi}{3}\right) \sqrt[3]{r_1} \operatorname{cis}\left(\frac{2m\pi}{3}\right)$. At "finish" θ_1 has increased by 2π , while $\theta = 0$. Thus $f(z) = \sqrt[3]{r} \operatorname{cis}\left[\frac{2k\pi}{3}\right] \sqrt[3]{r_1} \operatorname{cis}\left[\frac{2\pi}{3} + \frac{2m\pi}{3}\right]$. Thus $f(z)|_{\text{finish}} \div f(z)|_{\text{start}} = \operatorname{cis}\left[\frac{2\pi}{3}\right]$. The function $f(z)$ does not return to its original numerical value. Thus $z=1$ is a branch pt. A similar argument applies if we choose a contour enclosing $z=0$ (but not $z=1$).

b)

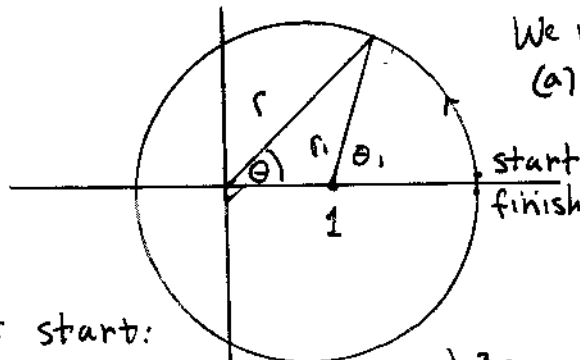

We proceed as in part (a) but go around the contour shown

At start:

$f(z) = \sqrt[3]{r} \operatorname{cis}\left(\frac{2k\pi}{3}\right) \sqrt[3]{r_1} \operatorname{cis}\left(\frac{2m\pi}{3}\right)$ while at finish $f(z) = \sqrt[3]{r} \operatorname{cis}\left(\frac{2\pi}{3} + \frac{2k\pi}{3}\right) \sqrt[3]{r_1} \operatorname{cis}\left(\frac{2\pi}{3} + \frac{2m\pi}{3}\right)$. Thus $f(z)|_{\text{finish}} \div f(z)|_{\text{start}} = \operatorname{cis}\left(\frac{4\pi}{3}\right)$ which $\neq 1$. Thus by encircling both branch points we do not return to original numerical value.

c)

This choice of cuts prevents encirclement of the branch pts $z=0$, $z=1$ as well as encirclement of both pts.

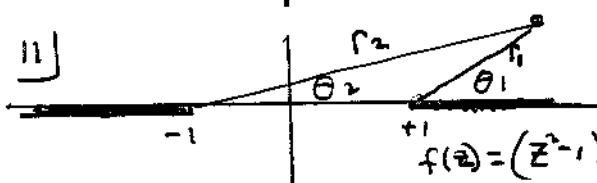

$$f(z) = (z^2 - 1)^{1/3} = \sqrt[3]{r_1} \operatorname{cis}\left[\frac{\theta_1 + 2k\pi}{3}\right] \cdot \sqrt[3]{r_2} \operatorname{cis}\left[\frac{\theta_2 + 2m\pi}{3}\right]$$

Sec 3.8 cont'd

11) continued If $z=0$, take $\theta_2=0$, $\theta_1=\pi$, $k=1$, $m=0$. Thus $f(0)=-1$. Now proceed to $z=i$.

Thus $r_1=r_2=\sqrt{z}$, $\theta_2=\frac{\pi}{4}$, $\theta_1=\frac{3\pi}{4}$.

$$\begin{aligned} \text{Thus } f(i) &= \sqrt[3]{\sqrt{z}} \operatorname{cis} \left[\frac{\pi}{4} + \frac{2\pi}{3} \right] \sqrt[3]{\sqrt{z}} \operatorname{cis} \left[\frac{\pi}{12} \right] \\ &= \sqrt[3]{2} \operatorname{cis} [\pi] = -\sqrt[3]{2} = \boxed{-1.2599} \end{aligned}$$

12) Choose θ_1, θ_2 as in problem 11. But if

$z=-i$, $\theta_2=-\frac{\pi}{4}$, $\theta_1=\frac{5\pi}{4}$. As in (11) at $z=-i$

$$\begin{aligned} r_1=r_2=\sqrt{z}, \text{ Thus } f(-i) &= \sqrt[3]{\sqrt{z}} \operatorname{cis} \left[\frac{5\pi}{4} + \frac{2\pi}{3} \right] \sqrt[3]{\sqrt{z}} \operatorname{cis} \left[\frac{\pi}{12} \right] \\ &= \sqrt[3]{2} \operatorname{cis} [\pi] = \boxed{-1.2599} \end{aligned}$$

13)

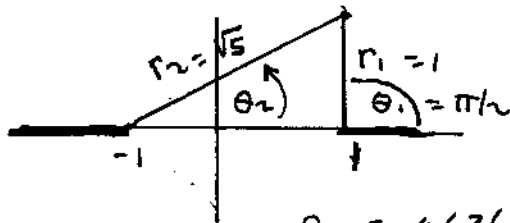

$\theta_2 = .7854$ radians

Proceed as in problem 11, $f(z)|_{z=-1+i} = 1 \operatorname{cis} \left[\frac{\pi}{6} + \frac{2\pi}{3} \right] \sqrt[3]{\sqrt{5}} \operatorname{cis} \left[\frac{.4636}{3} \right]$

$$= \boxed{-1.2196 + i.47177}$$

14) Not necessarily. $z^{1/2}$ has a branch point at $z=0$ so does $z^{3/2}$ but $z^{1/2} z^{3/2} = z^2$ is analytic at $z=0$

15) Yes. If we encircle the branch point of $f(z)$ once we proceed to a new numerical value, different from our starting value. The same must be true of $1/f(z)$, i.e. encircling the branch point of $f(z)$ we find that the starting and concluding values of $1/f(z)$ are not the same.

Sec 3.8, cont'd

16)

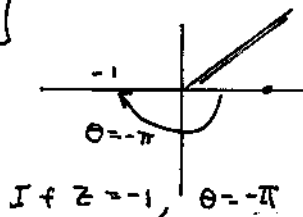

$$f(z) = z^{-1/4} (z^2 + 1) =$$

$$\frac{(z^2 + 1)}{\sqrt[4]{r} \left[\frac{\theta}{4} + \frac{2k\pi}{4} \right]}$$

if z pos. real
put $\theta = 0$, $k = 2$
for a neg. real result

$$2 \left[\text{cis} \left(-\frac{3\pi}{4} \right) \right] = \frac{\theta}{4} = -\frac{\pi}{4}, \quad f(z) = \frac{2}{\text{cis} \left(\frac{3\pi}{4} \right)} =$$

$$= -\frac{2}{\sqrt{2}} - i\frac{2}{\sqrt{2}} = \boxed{-\sqrt{2} - i\sqrt{2}}$$

17) choose k as in 16) $\theta = -\frac{3\pi}{2}$,

$$f(z) = \frac{-3}{\sqrt[4]{2} \text{cis} \left[-\frac{3\pi}{8} + \pi \right]} = \frac{3}{\sqrt[4]{2}} \text{cis} \left(\frac{3\pi}{8} \right) =$$

$$\boxed{.9654 + i 2.33}$$

18) choose k as in 16), $\theta = -\frac{3\pi}{4}$, $r = \sqrt{2}$,

$$(z^2 + 1) = 1 + 2i. \text{ Thus at } -1 - i, \quad f(z) = \frac{1 + 2i}{\sqrt[4]{2} \text{cis} \left[\frac{-3\pi + \pi}{4} \right]}$$

$$= \boxed{.2565 - i 2.034}$$

19) a) In our cut plane: $z^{1/2} = \sqrt{|z|} \text{cis} \left(\frac{\theta}{2} \right)$

where $-\pi < \theta < \pi$. Thus $\text{Re } z^{1/2} > 0$ and $\text{Re} (1 + z^{1/2}) > 1$. Consider $\log w$ where $w =$

$1 + z^{1/2}$ as described above. To pass from one branch of $\log w$ to another branch the argument of w must increase by 2π . But this is impossible if $\text{Re } w$ is ~~always~~ ^{positive} which is the case here in our cut z plane. Thus we can find a branch of $\log [1 + z^{1/2}]$ that is analytic in this cut plane with $z^{1/2}$ chosen as described.

(b) $\log (1 + z^{1/2})$ fails to be analytic where $1 + z^{1/2} = 0$ (a branch point of the log). For our choice of $z^{1/2}$ this occurs

19 cont'd

Sec 3.8 cont'd

at $z=1$. No matter what branch of the log is chosen, with our given branch of $z^{1/2}$ $\log(1+z^{1/2})$ will fail to be analytic at $z=1$.

(c) Choosing for example the principal branch of the log, we have $\frac{d}{dz} \text{Log}(1+z^{1/2}) =$

$$\frac{1}{1+z^{1/2}} \cdot \frac{1}{2} z^{-1/2} = \frac{1}{2} \left(\frac{1}{z+z^{1/2}} \right) \Big|_{z=i} =$$

$$\frac{(1/2)}{i + \frac{1}{\sqrt{2}} + \frac{i}{\sqrt{2}}} = \boxed{-i.036 - i.25}$$

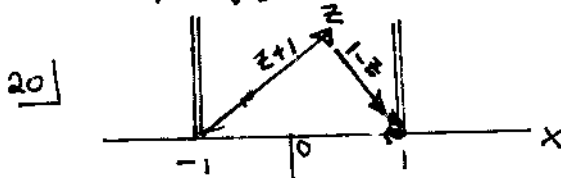

$$\text{sm}^{-1}(z) = -i \log [zi + (1-z^2)^{1/2}] =$$

$$= -i \log [zi + (z+1)^{1/2} (1-z)^{1/2}] \text{ with branches chosen as described } (1-z)^{1/2} = \sqrt{2} \text{ when } z=i$$

$$\text{Thus } \text{sm}^{-1}(i) = -i \log [-1 + \sqrt{2}] = -i \text{Log}[\sqrt{2}-1] = \boxed{.8814i}$$

$$\frac{d}{dz} \text{sm}^{-1}(z) = \frac{1}{(1-z^2)^{1/2}} \Big|_{z=i} = \boxed{\frac{1}{\sqrt{2}}}$$

$$\text{a)} (1-z)^{1/2} = \sqrt{|z+1|} \text{cis}(\theta_1/2) \sqrt{|1-z|} \text{cis}(\theta_2/2)$$

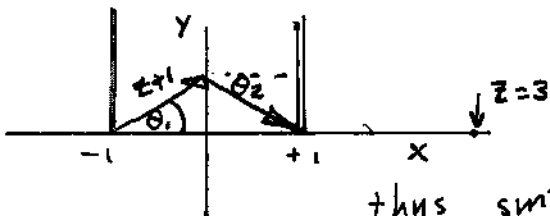

at $z=3$, $\theta_1 = 0$, $\theta_2 = \pi$

$$(1-z^2)^{1/2} = \sqrt{8}i$$

$$\text{thus } \text{sm}^{-1}(3) = -i \text{Log} [3i + \sqrt{8}i] =$$

$$\frac{\pi}{2} - i \text{Log} [3 + \sqrt{8}] = \boxed{\frac{\pi}{2} - i.7627}$$

$$\frac{d}{dz} \text{sm}^{-1}(z) = \frac{1}{(1-z^2)^{1/2}} = \frac{1}{\sqrt{8}i} = \boxed{-i.354}$$

22)

sec. 3.8 cont'd

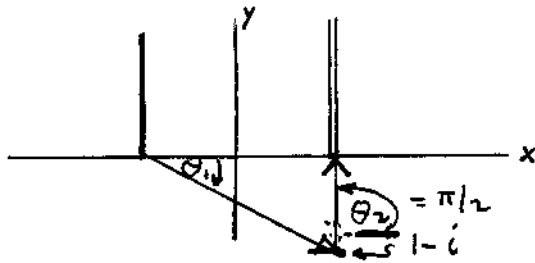

Using notation of z1 find that at $z = -i$ have $(1-z^2)^{1/2} =$

$1.2720 + i.786$. Thus $-i \log [zi + (1-z^2)^{1/2}] =$

$.66623 - i.1062$ at $-i$. $\frac{d}{dz} \sin^{-1}(z) = \frac{1}{(1-z^2)^{1/2}}$

$= \frac{1}{1.272 + i.786} = .5609 - i.3516$

23 (a)

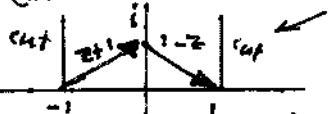

branch cuts for probs 20-22

As shown in problem 20

with this choice of cut $\sin^{-1}(i) = .8814i$

MATLAB

yields the same result

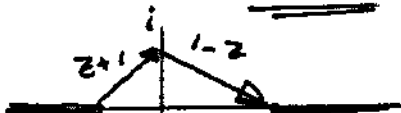

branch cuts for MATLAB

In both cases, $(1-z^2)^{1/2} = (1-z)^{1/2} (1+z)^{1/2}$
 $= \sqrt{2}$ when $z = i$, $\therefore -i \text{Log} [zi + (1-z^2)^{1/2}] = .8814i$

(b)

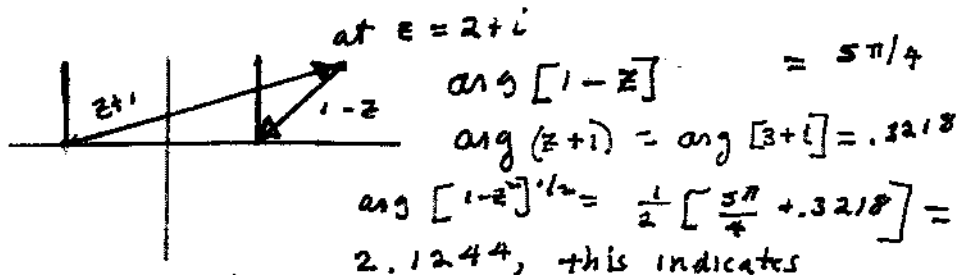

at $z = 2+i$

$\arg [1-z] = 5\pi/4$

$\arg (z+1) = \arg [3+i] = .3218$

$\arg [(1-z^2)^{1/2}] = \frac{1}{2} [\frac{5\pi}{4} + .3218] = 2.1244$, this indicates

$(1-z^2)^{1/2}$ has a neg real part, pos imag. part for this branch

$(1-z^2)^{1/2} = -1.118 + i.17989$

sec 3.8 cont'd

23(b), continue, using branches of probs 20-22

$$\sin^{-1}(2+i) = -i \operatorname{Log} \left[(2+i) + (-1.118 + i 1.7989) \right]$$

$$= \boxed{2.0782 - i 1.4694}$$

Note the sine of the preceding is $2+i$. From MATLAB, $\operatorname{Oct} \sin^{-1}(2+i) =$

$\boxed{1.0634 + i 1.4694}$. The sine of this expression is $2+i$.

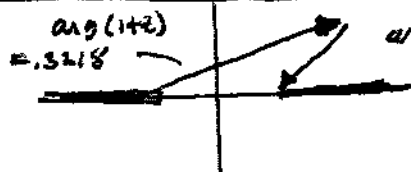

∴ the results disagree

24) $z^{1/2} = 3, z = 9$ a necessary cond.

$z^{1/2} \Big|_{z=9} = -3$ with this branch, but $-3-3 \neq 0$

∴ NO SOLUTION

25) Refer to previous problem, again $z = 9, 9^{1/2} = -3$
 $-3+3=0$. ∴ solution is $z=9$ solution is in domain of analyticity.

26) For our branch, $z^{1/2} = \sqrt{r} \operatorname{cis} \left(\frac{\theta}{2} + \pi \right)$ where $-\pi < \theta < \pi$.
 Now $z^{1/2} = -1 - i\sqrt{3}, z = -2 + i 2\sqrt{3} = 4 \operatorname{cis} \left(\frac{2\pi}{3} \right)$. Thus $z^{1/2} = 2 \operatorname{cis} \left[\frac{\pi}{3} + \pi \right] = -1 - i\sqrt{3}$
 and $z^{1/2} + 1 + i\sqrt{3} = 0$ if $z = -2 + i 2\sqrt{3}$ solution is in domain of analyticity

27) As in 26) we require that $z = 4 \operatorname{cis} \left(\frac{2\pi}{3} \right)$.

But: $z^{1/2} = -1 - i\sqrt{3}$ for this branch, and

$z^{1/2} - 1 - i\sqrt{3} \neq 0$. Thus NO SOLUTION in domain of analyticity

28) Using princ. values: $z = e^{i\pi/2 z}, z^{-1} = e^{-i\pi/2 z}$

Thus $2 \cos \left[\frac{\pi}{2} z \right] = 0$ $z = \pm 1, \pm 3, \pm 5, \dots$

or: $z = 2n+1, n = 0, \pm 1, \pm 2, \dots$

Appendix chap 3

$$1) V(t) = \operatorname{Re} \left[3 e^{(1+2i)t} \right] =$$

$$\operatorname{Re} \left[3 e^t [\cos 2t + i \sin 2t] \right] = 3 e^t \cos 2t$$

$$2) V(t) = \operatorname{Re} \left[i e^{(-1+2i)t} \right] =$$

$$\operatorname{Re} \left[i e^{-t} [\cos 2t + i \sin 2t] \right] = -e^{-t} \sin(2t)$$

$$3) \operatorname{Re} \left[2 e^{\pi/3} e^{(-2i)t} \right] = \operatorname{Re} \left[2 e^t e^{i(\pi/3 - 2t)} \right]$$

$$= 2 e^t \cos \left[\pi/3 - 2t \right]$$

$$4) \operatorname{Re} \left[i e^{-2it} \right] = \sin 2t$$

$$5) \operatorname{Re} \left[(1+i) e^{2it} \right] = \cos 2t - \sin 2t$$

$$\text{or } \operatorname{Re} \left[\sqrt{2} e^{i\pi/4} e^{2it} \right] = \operatorname{Re} \left[\sqrt{2} e^{i\left[\frac{\pi}{4} + 2t\right]} \right]$$

$$= \sqrt{2} \cos \left[\frac{\pi}{4} + 2t \right]$$

$$6.) \operatorname{Re} \left[(1 + e^{i\pi/4}) e^{\left[e^{-i\pi/6} \right] t} \right] = \operatorname{Re} \left[(1 + e^{i\pi/4}) e^{\left(\frac{\sqrt{3}}{2} - \frac{i}{2} \right) t} \right]$$

$$= e^{\frac{\sqrt{3}}{2}t} \cos \frac{t}{2} + e^{\frac{\sqrt{3}}{2}t} \cos \left[\frac{\pi}{4} - \frac{t}{2} \right]$$

$$7) V(t) = \operatorname{Re} \left[e^{(1+i)t} \exp \left[t e^{i\pi/4} \right] \right] = \operatorname{Re} \left[e^{(1+i)t} e^{\frac{t}{\sqrt{2}} + \frac{it}{\sqrt{2}}} \right]$$

$$= \operatorname{Re} \left[\exp \left[\frac{t}{\sqrt{2}} - \frac{t}{\sqrt{2}} \right] \exp i \left[\frac{t}{\sqrt{2}} + \frac{t}{\sqrt{2}} \right] \right]$$

$$= e^{\left(\frac{t}{\sqrt{2}} \right)} \cos \left[1 + \frac{t}{\sqrt{2}} \right]$$

Appendix A
chap. 3
cont'd

8] phasor = 1, $s = 2$

9] phasor = 1, $s = -2 + i3$

10] phasor = $-6i$, $s = -3 + 2i$

11] phasor = $-2i e^{-i\pi/6}$, $s = 4 + 2i$

12] phasor = $2 - i$, $s = i$

13] phasor does not exist two complex frequencies $s = -1 + i$ and $s = i$ are used.

14] phasor = $2 - i$, $s = -1 + i$

15] phasor = $2 - i e^{i\pi/4}$, $s = -1 + i$

16] $f(t) = \text{Re} [F_1 e^{(\sigma + i\omega)t}] = \text{Re} [F_2 e^{(\sigma + i\omega)t}]$ all t .

Let $t = 0$. Then $\text{Re } F_1 = \text{Re } F_2$. Now let

$F_1 = a + ib$, $F_2 = c + id$. Let $t = \frac{\pi}{2\omega}$. Then

$$\text{Re} [(a + ib) e^{(\sigma + i\omega) \frac{\pi}{2\omega}}] = \text{Re} [(c + id) e^{(\sigma + i\omega) \frac{\pi}{2\omega}}]$$

or $\text{Re} [(a + ib) i e^{\pi\sigma/(2\omega)}] = \text{Re} [(c + id) i e^{\pi\sigma/(2\omega)}]$

or $b = d$. Thus $\text{Im } F_1 = \text{Im } F_2$ so $F_1 = F_2$ q.e.d.

17] Property 3 $f(t) = \text{Re} [F e^{st}]$, $g(t) = \text{Re} [G e^{st}]$

$f(t) + g(t) = \text{Re} [F e^{st}] + \text{Re} [G e^{st}] = \text{Re} [(F + G) e^{st}]$ q.e.d

2nd part, property 3, $f(t) = \text{Re} [F e^{st}]$, $M f(t) =$

$M \text{Re} [F e^{st}] = \text{Re} [M F e^{st}]$ q.e.d. Now prove property 4:

$\text{Re} [(F + G) e^{st}] = \text{Re} [F e^{st} + G e^{st}] = \text{Re} [F e^{st}] + \text{Re} [G e^{st}] = f(t) + g(t)$ q.e.d

The above proof may be extended to functions of time $f(t) + g(t) + h(t) + \dots$, corresponding to phasors F, G, H, \dots , i.e. to 2 or more time functions and 2 or more phasors.

Appendix A, Chap 3, Cont'd

18] Proof of property 6:

$$\int^t f(t') dt' = \int^t \text{Re}[F e^{st'}] dt'$$

Let us assume that we can take Re operator out from under integral sign.

$$\int^t f(t') dt' = \text{Re} \int^t F e^{st'} dt' = \text{Re} \left(\frac{F e^{st}}{s} \right) \text{ q.e.d}$$

How justify swappin Re and \int operators? Let $F_0 = |F|$

let $F = F_0 e^{i\theta}$. Then $\int^t \text{Re}[F e^{st'}] dt' =$
 $\int^t \text{Re}[F_0 e^{i\theta} e^{(\sigma+i\omega)t'}] dt' = \int^t F_0 e^{\sigma t'} \cos(\omega t' + \theta) dt'$

However: $\text{Re} \int^t F e^{st'} dt' = \text{Re} \int^t F_0 e^{i\theta} e^{st'} dt'$
 $= \text{Re} \left[\int^t F_0 e^{\sigma t'} \cos(\omega t' + \theta) dt' + i \int^t F_0 e^{\sigma t'} \sin(\omega t' + \theta) dt' \right]$
 $= \int^t F_0 e^{\sigma t'} \cos(\omega t' + \theta) dt' = \int^t \text{Re}(F e^{st'}) dt'$

19] equate phasors on each side of diff. eqn. Note $s = \sigma$
 $R I + L \sigma I = V_0$ $I = \frac{V_0}{R + L \sigma}$ $i(t) = \text{Re} \left[\frac{V_0 e^{\sigma t}}{R + L \sigma} \right]$

$$= \boxed{\frac{V_0 e^{\sigma t}}{R + L \sigma}}$$

20] Take phasors of both sides of equation and equate them. $-i V_0 = R I + \frac{I}{sC}$ $s = i\omega$

Thus $I = \frac{-i V_0}{R + \frac{1}{i\omega C}}$ $i(t) = \text{Re} \left[\frac{-i V_0 e^{i\omega t}}{R + \frac{1}{i\omega C}} \right] =$

$$= \text{Re} \left[\frac{V_0 e^{-i\pi/2} e^{i\omega t}}{\sqrt{R^2 + 1/\omega^2 C^2}} \text{cis}(-\psi) \right]$$

$$\psi = \tan^{-1} \frac{1}{R\omega C}$$

$$= i(t) = \frac{V_0 \cos(\omega t - \pi/2 + \psi)}{\sqrt{R^2 + 1/\omega^2 C^2}} = \boxed{\frac{V_0 \sin(\omega t + \psi)}{\sqrt{R^2 + 1/(\omega C)^2}}}$$

Appendix, Chap 3, cont'd

21) Taking phasors on both sides of the d.e. get:

$$ms^2 X + \alpha s X + k X = F_0, \quad s = i\omega$$

a)
$$X = \frac{F_0}{-\omega^2 m + i\omega \alpha + k}$$

b)
$$x(t) = \operatorname{Re} \left[\frac{F_0 e^{i\omega t}}{-\omega^2 m + i\omega \alpha + k} \right] =$$

$$\operatorname{Re} \left[\frac{F_0 e^{i\omega t} e^{i\psi}}{\sqrt{(-\omega^2 m + k)^2 + \omega^2 \alpha^2}} \right]$$

$$\psi = \tan^{-1} \frac{\alpha \omega}{\omega^2 m - k}$$

$$x(t) = \frac{F_0 \cos(\omega t + \psi)}{\sqrt{(k - \omega^2 m)^2 + \alpha^2 \omega^2}}$$

4

Integration in the Complex Plane

Chap 4, sec 4.1

$$1] \int_{0,1}^{1,0} x y ds = \int_0^1 x (1-x^2) (\pm) \sqrt{1+4x^2} dx$$

Use plus sign since dx is pos. with these limits.

Get $\int_0^1 x (1-x^2) \sqrt{1+4x^2} dx$. Now use

$$ds = \pm \sqrt{1 + \left(\frac{dx}{dy}\right)^2} dy, \quad x = \sqrt{1-y}, \quad \frac{dx}{dy} = \frac{-1}{2\sqrt{1-y}}$$

$$\left(\frac{dx}{dy}\right)^2 = \frac{1}{4(1-y)} \quad \int_{y=1}^0 x y ds = \int_1^0 \sqrt{1-y} y \sqrt{1 + \frac{1}{4(1-y)}} dy$$

Use minus sign since dy is negative with these limits, need $ds \geq 0$

$$\int_{y=1}^0 x y ds = \int_0^1 y \sqrt{(1-y) + \frac{1}{4}} dy = \int_0^1 y \sqrt{\frac{5}{4} - y} dy$$

Let us evaluate: $\int_0^1 y \sqrt{\frac{5}{4} - y} dy$, let

$$u = \frac{5}{4} - y, \quad y = \frac{5}{4} - u, \quad dy = -du. \quad \text{Get}$$

$$\int_0^1 y \sqrt{\frac{5}{4} - y} dy = \int_{1/4}^{5/4} \left(\frac{5}{4} - u\right) u^{1/2} du =$$

$$\frac{2}{3} * \frac{5}{4} u^{3/2} \Big|_{1/4}^{5/4} - \frac{2}{5} u^{5/2} \Big|_{1/4}^{5/4} = \boxed{\frac{\sqrt{5} \cdot 5}{24} - \frac{11}{120}}$$

$$2] \int_0^1 (x+y+1) dx = \int_0^1 (x+x^2+1) dx =$$

$$\frac{1}{2} + \frac{1}{3} + 1 = \boxed{1\frac{5}{6}}$$

(Sec 4.1 cont'd)

$$3] \int_0^1 (x+y+1) dy = \int_0^1 \sqrt{y} + y + 1 dy = \frac{2}{3} + \frac{1}{2} + 1 = \boxed{\frac{17}{6}}$$

$$4] \int_0^1 x^2 y dx = \int_0^1 x^2 \sqrt{1-x^2} dx = \boxed{\pi/16}$$

* see standard tables

$$5] \int_1^0 x^2 y dy = \int_1^0 (1-y^2) y dy = \int_0^1 (y^2-1) y dy$$

$$= \boxed{-\frac{1}{4}}$$

$$6] \int_0^1 x^2 y \sqrt{1+(dy/dx)^2} dx = \int_0^1 x^2 \sqrt{1-x^2} \sqrt{1+\frac{x^2}{y^2}} dx$$

Note $(\frac{dy}{dx})^2 = \frac{x^2}{y^2}$ on C. $\sqrt{1+\frac{x^2}{y^2}} = \sqrt{\frac{1+x^2}{1-x^2}} = \frac{1}{\sqrt{1-x^2}}$

Thus $\int_0^1 x^2 \sqrt{1-x^2} \sqrt{1+\frac{x^2}{y^2}} dx = \int_0^1 x^2 dx = \boxed{\frac{1}{3}}$

$$7] x^2 + y^2 = 1, \quad 2x dx + 2y dy = 0, \quad dx = -\frac{y}{x} dy \text{ on C}$$

$$\int_{-1}^1 y dx = \int_{-1}^1 -\frac{y^2}{x} dy = \int_{-1}^1 \frac{-y^2}{\sqrt{1-y^2}} dy \quad \text{Use pos. sq. rt. since } x \geq 0.$$

$$\int_{-1}^1 \frac{y^2}{\sqrt{1-y^2}} dy = [\text{let } y = \sin \theta]$$

$$\int_{-\pi/2}^{\pi/2} \frac{-\sin^2 \theta}{\cos \theta} d\theta = \boxed{-\frac{\pi}{2}} \quad (\text{put } \sin^2 \theta = \frac{1}{2} - \frac{1}{2} \cos 2\theta)$$

$$8] \int_0^1 \frac{1}{2} - \frac{1}{2} \cos 2\theta d\theta = -\frac{\pi}{2}$$

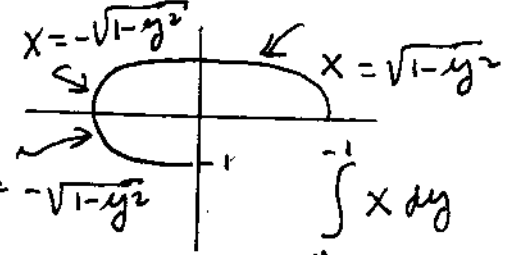

$$\int_{y=0}^1 x dy = \int_0^1 3\sqrt{1-y^2} dy$$

$$+ \int_0^1 -3\sqrt{1-y^2} dy + \int_0^{-1} -3\sqrt{1-y^2} dy = 3 \times 3 \int_0^1 \sqrt{1-y^2} dy$$

$$= 9 \int_0^{\pi/2} \cos^2 \theta d\theta = \boxed{\frac{9\pi}{4}} \quad \text{put } y = \sin \theta$$

sec. 4.2

$$1] \int_{0,0}^{1,1} [(x+1) + iy] [dx + i dy] = \int_{x=0}^1 (x+1) dx - \int_{y=0}^1 y dy$$

$$+ i \int_{x=0}^1 y dx + i \int_{y=0}^1 (x+1) dy =$$

$$\int_0^1 (x+1) dx - \int_0^1 y dy + i \int_0^1 x^2 dx + i \int_0^1 \sqrt{y} + 1 dy = \boxed{1 + 2i}$$

$$2] \Delta z_1 = \frac{1}{2} + i\frac{3}{2}, \quad \Delta z_2 = \frac{1}{2} + i\frac{1}{2}$$

$$z_1 = \frac{1}{4} + i(2x)(2-x) \Big|_{x=1/4} = \frac{1}{4} + i\frac{7}{8} = f(z_1)$$

$$z_2 = \frac{3}{4} + i(2x)(2-x) \Big|_{x=3/4} = \frac{3}{4} + i\frac{15}{8} = f(z_2)$$

$$f(z_1)\Delta z_1 + f(z_2)\Delta z_2 = \left(\frac{1}{4} + i\frac{7}{8}\right)\left(\frac{1}{2} + i\frac{3}{2}\right) + \left(\frac{3}{4} + i\frac{15}{8}\right)\left(\frac{1}{2} + i\frac{1}{2}\right)$$

$$= \boxed{-1\frac{3}{4} + i2\frac{1}{8}} \text{ approx method. Now do exact method!}$$

$$\int (x+iy)(dx+i dy) = \int_0^1 x dx - \int_0^1 y dy + i \int_{x=0}^1 y dx + i \int_0^1 x dy$$

$$\text{Now } \int_0^1 y dx = \int_0^1 (2x)(2-x) dx = 2 - \frac{2}{3}$$

$$\int_0^1 x dy = 4 \int_0^1 x(1-x) dx = 2 - \frac{4}{3}$$

$$\text{Thus } \int (x+iy)(dx+i dy) = \boxed{-1.5 + i2} \xleftarrow{\text{exact}} \text{ vs. } -1.75 + i2.25$$

Sec 4.2

Cont'd

3] Refer to problem 2. $\Delta z_1 + \Delta z_2 = \left(\frac{1}{2} + i\frac{3}{2}\right) + \left(\frac{1}{2} + \frac{i}{2}\right)$
 $= \boxed{1 + 2i}$. Now, by definition $\int_{0,0}^{1,2} dz = \lim_{n \rightarrow \infty} \sum_{k=1}^n \Delta z_k$

But $\sum_{k=1}^n \Delta z_k$ is just a vector going from 0,0 to 1,2 for all n. This must be the same as $\Delta z_1 + \Delta z_2$ (n=2).

4] $\int_{0,1}^{1,0} (x-iy)(dx+idy) = \int_{x=0}^1 x dx + \int_{y=1}^0 y dy + i \int_{y=1}^0 x dy - i \int_{x=0}^1 y dx$
 $= i \int_1^0 (1-y) dy - i \int_0^1 (1-x) dx = \boxed{-i}$

5] From prev. problem, have:

$$\int_0^1 x dx + \int_1^0 y dy + i \int_{y=1}^0 x dy - i \int_{x=0}^1 y dx$$

$$= i \int_{y=1}^0 x dy - i \int_{x=0}^1 y dx$$

In first of these, put $y = (x-1)^2$, $dy = 2(x-1) dx$

In second put $y = (x-1)^2$. Thus have

$$i \int_{y=1}^0 x dy - i \int_0^1 y dx = i \int_0^1 (x)(2)(x-1) dx - i \int_0^1 (x-1)^2 dx$$

$$= i \left[\left(\frac{2}{3} - 1\right) - (-1)\left(-\frac{1}{3}\right) \right] = \boxed{-i \frac{2}{3}}$$

sec 4.2

Cont'd

$$6] \int_0^1 x dy + \int_1^0 y dx - i \int_{x=0}^1 y dx + i \int_{y=1}^0 x dy$$

$$= -i \int_0^1 \sqrt{1-x^2} dx + i \int_1^0 \sqrt{1-y^2} dy = -2i \int_0^1 \sqrt{1-x^2} dx$$

put $x = \sin \theta$ etc. get: $\boxed{\frac{-\pi i}{2}}$ Compare with previous problem. The result depends on path.

$$7] a) \int_0^1 e^x dx = \boxed{e-1} \quad (b) \int_{y=0}^1 e^{(1+iy)} i dy =$$

$$ie \int_0^1 e^{iy} dy = ie \left[\int_0^1 \cos y + i \sin y dy \right] =$$

$$\boxed{e[(\cos 1 - 1) + i \sin 1]}$$

$$c) x=iy, \int_{x=-1}^0 (e^x + ix) (dx + i dx) =$$

$$(1+i) \left[\int_1^0 e^x e^{ix} dx \right] = (1+i) \left[\int_1^0 e^x \cos x dx + i \int_1^0 e^x \sin x dx \right]$$

$$= \frac{(1+i)}{2} \left[e^x (\cos x + \sin x) \Big|_1^0 + i e^x (\sin x - \cos x) \Big|_1^0 \right] =$$

$$\boxed{1 - e \cos 1 - i e \sin 1} \quad \text{[Sum of a) thru c) is zero]}$$

$$8] z = e^{it}, \frac{dz}{dt} = ie^{it}; \int_{+1}^{-1} \frac{1}{z} dz = \int_{t=0}^{\pi} \frac{1}{e^{it}} ie^{it} dt = \boxed{\pi i}$$

9] Proceed as in 8] but t goes from 0 to $-\pi$

$$\int_1^{-1} \frac{1}{z} dz = \int_{t=0}^{-\pi} \frac{1}{e^{it}} ie^{it} dt = \boxed{-\pi i}$$

$$10] \text{ Proceed as in probl. 8, } \bar{z} = e^{-it}, t \text{ goes here from } 0 \text{ to } \pi/2.$$

$$\int_1^i (\bar{z})^4 dz = \int_0^{\pi/2} e^{-i4t} i e^{it} dt$$

$$= \int_0^{\pi/2} (\cos 3t - i \sin 3t) dt i = \boxed{\frac{1-i}{3}}$$

Sec 4.2, cont'd

11) Note $(\frac{x}{2})^2 + y^2 = \cos^2 t + \sin^2 t = 1$.

As t goes from 0 to 2π x goes from 2 to -2 and back to 2 again, while y goes from 0 to 1 to -1 and back to zero. The whole ellipse is traced out.

$z = 2\cos t + i\sin t, \bar{z} = 2\cos t - i\sin t,$
 $dz = (-2\sin t + i\cos t) dt$. Thus $\int_{\gamma} i \bar{z} dz =$
 $\int_{t=0}^{\pi/2} (2\cos t - i\sin t) (-2\sin t + i\cos t) dt =$
 $\int_0^{\pi/2} (-3\sin t \cos t) dt + i \int_0^{\pi/2} 2\cos^2 t dt + i \int_0^{\pi/2} 2\sin^2 t dt$
 $= \boxed{\frac{-3}{2} + \pi i}$

12) $\int_{1+i}^{2+4i} z^2 dz = \int_{t=1}^2 (t + it^2)^2 [dt + i 2t dt]$
 $[\text{since } z = t + it^2, dz = (1 + i 2t) dt]$
 $= \int (t^2 + 2ait^3 - t^4)(1 + i 2t) dt =$
 $\int (t^2 + 2ait^3 - t^4) dt + i 2 \int (t^3 + 2it^4 - t^5) dt$
 $= \boxed{\frac{-86}{3} - i6}$

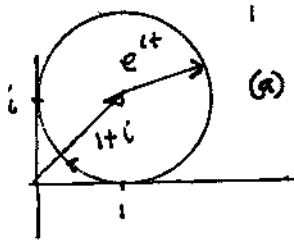

(a) $z = 1+i + e^{it}$
 t goes from $-\frac{\pi}{2}$ to π

13) (a)

(b) $\bar{z} = 1-i + e^{-it} = 1-i + \cos t - i\sin t,$
 $dz = e^{-it} i dt = i [\cos t + i\sin t] dt$
 $\int_1^i \bar{z} dz = \int_{-\pi/2}^{\pi} (1-i + \cos t - i\sin t) i [\cos t + i\sin t] dt$
 $= (1-i) \int_{-\pi/2}^{\pi} -\sin t dt + i(1-i) \int_{-\pi/2}^{\pi} \cos t dt + \int_{-\pi/2}^{\pi} i [\cos^2 t + \sin^2 t] dt = \boxed{i \left[\frac{2-\pi}{2} \right]}$

Sec 9.2

cont'd

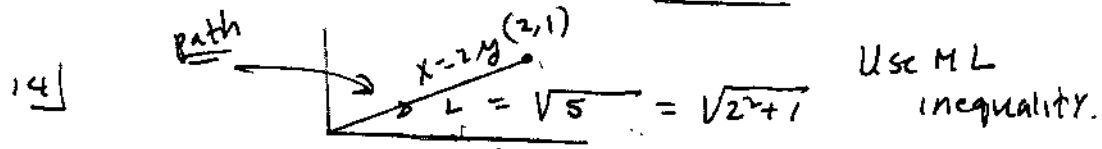

$|e^{z^2}| \leq M, \quad e^{z^2} = e^{x^2 - y^2 + i2xy}$
 $= e^{i2xy} e^{x^2 - y^2} \therefore |e^{z^2}| = |e^{i2xy}| |e^{x^2 - y^2}|$
 $e^{x^2 - y^2}, [x=2, y=1] = e^{3y^2}$ y is max at end of contour, $x=2, y=1$, Thus, take $M = e^3$
 $ML = e^3 \sqrt{5}$ q.e.d. $|z|$ min here at $\frac{1}{2} + \frac{i}{2}$

15.] Use ML inequality.

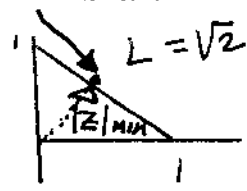

$|\frac{1}{z}|^4 \leq M$ on path
 $|\frac{1}{z}|^4 = \frac{1}{|z|^4}$ This expression is max when $|z|$ is minimum, i.e. on the middle of the path. $|z|_{min} = \frac{1}{\sqrt{2}}$, Thus
 $|\frac{1}{z}|^4 |_{max} = \frac{1}{(\frac{1}{\sqrt{2}})^4} = 4$. Thus $M = 4, ML = 4\sqrt{2}$ q.e.d.

16]

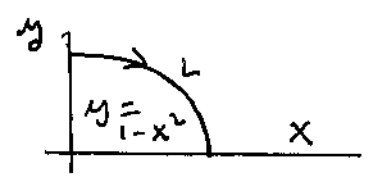

Use ML inequality.

$L = \int_0^1 \sqrt{1 + (\frac{dy}{dx})^2} dx$
 $\frac{dy}{dx} = -2x \quad L = \int_0^1 \sqrt{1 + 4x^2} dx = 2 \int_0^1 \sqrt{x^2 + (\frac{1}{2})^2} dx$
 $= x \sqrt{x^2 + \frac{1}{4}} + \frac{1}{4} \log [x + \sqrt{x^2 + \frac{1}{4}}] \Big|_0^1 = 1.47894 \dots < 1.479$
 $\therefore L < 1.479$

$|e^{i \text{Log } \bar{z}}| \leq M$. $\text{Log } \bar{z} = \log|z| - i\theta$
 Where $-\pi < \theta < \pi, \theta = \arg z$. $e^{i \text{Log } \bar{z}} = e^{i \log|z|} e^{-\theta}$
 $|e^{i \text{Log } \bar{z}}| = |e^{i \log|z|}| e^{-\theta} = e^{-\theta}$. This is max where θ is max. The max. value of θ on the path is $\pi/2$. Thus $M = e^{\pi/2}$
 $\therefore ML \leq e^{\pi/2} \cdot 1.479$ q.e.d.

17] (a) By definition $\int_a^b g(t) dt = \lim_{\substack{n \rightarrow \infty \\ \Delta t_k \rightarrow 0}} \sum_{k=1}^n g(t_k) \Delta t_k$

$$\left| \int_a^b g(t) dt \right| = \left| \lim_{\substack{n \rightarrow \infty \\ \Delta t_k \rightarrow 0}} \sum_{k=1}^n g(t_k) \Delta t_k \right| \quad (1)$$

By definition

$$\int_a^b |g(t)| dt = \lim_{\substack{n \rightarrow \infty \\ \Delta t_k \rightarrow 0}} \sum_{k=1}^n |g(t_k)| \Delta t_k \quad (2)$$

Now since magnitude of sum \leq sum of mags.

$$\left| \sum_{k=1}^n g(t_k) \Delta t_k \right| \leq \sum_{k=1}^n |g(t_k)| \Delta t_k$$

But if $b > a$, then $\Delta t_k > 0$ and $|\Delta t_k| = \Delta t_k$

Thus

$$\left| \sum_{k=1}^n g(t_k) \Delta t_k \right| \leq \sum_{k=1}^n |g(t_k)| \Delta t_k \quad (3)$$

The preceding inequality holds as $n \rightarrow \infty$, $\Delta t_k \rightarrow 0$

Thus using (2) and (1) and the preceding result:

$$\left| \int_a^b g(t) dt \right| \leq \int_a^b |g(t)| dt \quad \text{q.e.d.}$$

(b) $\left| \int_0^1 \sqrt{t} e^{t^2} dt \right| \leq \int_0^1 |\sqrt{t} e^{t^2}| dt$

$$= \int_0^1 \sqrt{t} dt = \boxed{\frac{2}{3}}$$

18] next page

Sec 4.2

Cont'd

18)

```
% for table 4.2-1, numerical integration
for n=1:10
u=1:n;
X=u/n;
Y=X.^2;
dx=1/n;
Xp=X-dx;
Yp=Xp.^2;
x=(X+Xp)/2;
y=x.^2;
fz=x+1+i*y;
dy=Y-Yp;
ss=fz.*(dx+i*dy);
val(n)=sum(ss);
p(n)=n;
end
a=[p' val.']
```

to evaluate the integral with a 50 term approximation, change ^{statement} for n=1:10 to n=50

sec 4.3

1) a) $P = -y, Q = x \quad \frac{\partial Q}{\partial x} - \frac{\partial P}{\partial y} = 2$

$$\frac{1}{2} \oint_C -y dx + x dy = \iint dx dy = \boxed{A = \text{area enclosed by } C}$$

b) $\oint \underbrace{\cos y}_P dx + \underbrace{\sin x}_Q dy = \iint \frac{\partial Q}{\partial x} - \frac{\partial P}{\partial y} dx dy =$

$$\iint (\cos x + \cos y) dx dy = \int_0^1 \cos x dx + \int_0^1 \cos y dy = 2 \sin 1$$

c) $\oint (x-iy)(dx+idy) = \oint x dx + iy dy + i \oint -y dx + x dy$

Apply Green = $\iint \frac{\partial y}{\partial x} - \frac{\partial x}{\partial y} dx dy + i \iint \frac{\partial x}{\partial x} - \frac{\partial y}{\partial y} dx dy$

$$= i \iint 2 dx dy = \boxed{2iA} \quad \left\{ \text{where } A \text{ is area enclosed} \right.$$

by the curve. Note: $\partial x / \partial x = 0 \quad \partial x / \partial y = 0$

sec 4.3 continued

2) Yes, the sing. pt is at $-2i$, outside unit circle

3)

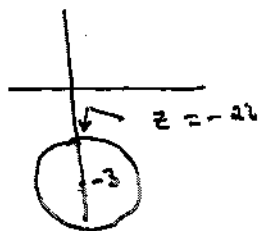

The sing. pt at $-2i$ is on the contour, \therefore No does not apply.

4) Does not apply since $e^{\bar{z}}$ nowhere analytic. Try Cauchy-Riemann Equations $u = e^x \cos y$, $v = -e^x \sin y$ OR use $\frac{d}{dz} e^{\bar{z}} = e^{\bar{z}} \frac{d}{dz} \bar{z}$. But $\frac{d}{dz} \bar{z}$ does not exist

5) No, $\text{Log } z$ not analytic at $z=0$, $z=0$ is on C

6) Yes since $\text{Log } z$ is analytic on and in C .

7] Study $(z-1)^4 = -1$ $(z-1) = \pm \frac{1+i}{\sqrt{2}}$

$$z = 1 \pm \frac{1+i}{\sqrt{2}}$$

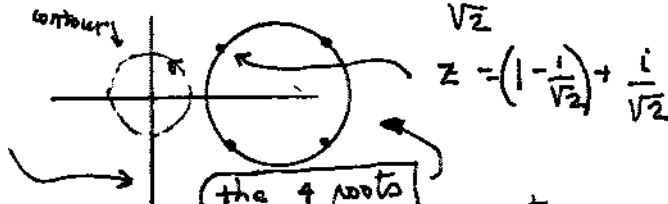

Compute the distance of the nearest two roots

from $z=0$. It is $\sqrt{\left(1 - \frac{1}{\sqrt{2}}\right)^2 + \frac{1}{2}}$. The preceding is greater than $\frac{1}{2}$. \therefore the theorem applies.

Yes

8) $e^z = 1$ if $z = 2k\pi$, $z=0$ inside C . \therefore No

$$9) z^2 + bz + 1 = 0, \quad z = -\frac{b}{2} \pm i \sqrt{1 - \frac{b^2}{4}}$$

10) $|z| = \sqrt{\frac{b^2}{4} + 1 - \frac{b^2}{4}} = 1$. The roots of $z^2 + bz + 1 = 0$

are on unit circle, outside C . \therefore Yes

10] ^{Theorem} does not apply, since require a closed contour.

Sec 4.3

11) $\oint f(z) dz = 0$ all C in D

$\oint (u+iv)(dx+idy) = 0$ all C in D

$\oint u dx - v dy + i \oint v dx + u dy = 0$ all C in D
separate reals and imags.

$\oint u dx - v dy = 0$ all C in D , $\oint v dx + u dy = 0$ all C in D

Take $P=U, Q=-V$ in first integral. Thus from Morera
 $-\frac{\partial V}{\partial x} = \frac{\partial U}{\partial y}$ in D . Take $P=V, Q=U$ in the second integral

Thus from Morera $\frac{\partial U}{\partial x} = \frac{\partial V}{\partial y}$ in D .

Since the C-R eqns are satisfied throughout D ,
 $f(z)$ is analytic.

12] and 13]

$\oint_{|z|=1} e^z dz = 0$, $z = e^{i\theta} = \cos\theta + i\sin\theta$, $dz = e^{i\theta} i d\theta$

$\oint e^z dz = 0 = \int_0^{2\pi} e^{\cos\theta + i\sin\theta} e^{i\theta} d\theta = 0$

$\int_0^{2\pi} e^{\cos\theta + i(\theta + \sin\theta)} d\theta = 0$

$\int_0^{2\pi} e^{\cos\theta} [\cos(\theta + \sin\theta) + i \sin(\theta + \sin\theta)] d\theta = 0$
 Equate real + imag. parts to zero on each side.

$\int_0^{2\pi} e^{\cos\theta} [\cos(\theta + \sin\theta)] d\theta = 0$ q.e.d (12)

$\int_0^{2\pi} e^{\cos\theta} [\sin(\theta + \sin\theta)] d\theta = 0$ q.e.d (13)

sec 4.3

14) and 15)

$$\oint e^{-cz^n} dz = 0$$

$$|z|=1, \text{ let } z = e^{i\theta}, z^n = e^{in\theta}, dz = e^{i\theta} i d\theta$$

$$\int_0^{2\pi} e^{-c[\cos n\theta + i \sin n\theta]} e^{i\theta} i d\theta = 0$$

$$\int_0^{2\pi} e^{i \sin n\theta} e^{i[\theta - c \cos n\theta]} d\theta = 0$$

$$\int_0^{2\pi} e^{i \sin(n\theta)} [\cos(\theta - c \cos n\theta) + i \sin(\theta - c \cos n\theta)] d\theta = 0$$

Equate reals and imag. to zero on each side

$$\int_0^{2\pi} e^{i \sin(n\theta)} \cos(\theta - c \cos(n\theta)) d\theta = 0 \quad \text{reals. (14) r.e.d.}$$

$$\int_0^{2\pi} e^{i \sin(n\theta)} \sin(\theta - c \cos(n\theta)) d\theta = 0 \quad \text{imag. (15) r.e.d.}$$

16) $\oint \frac{dz}{z-a} = 0$ [singularity is outside contour]

$$|z|=1 \quad z = e^{i\theta}, dz = e^{i\theta} i d\theta$$

$$= \int_0^{2\pi} \frac{e^{i\theta} i d\theta}{e^{i\theta} - a} = 0 \quad \text{Now, divide by } i$$

$$\int_0^{2\pi} \frac{e^{i\theta} (a + e^{i\theta})}{(e^{i\theta} - a)(e^{-i\theta} - a)} d\theta = 0 = \int_0^{2\pi} \frac{ae^{i\theta} + 1}{1 - a[e^{i\theta} + e^{-i\theta}] + a^2} d\theta$$

Equate the real part of the preceding to zero.

$$0 = \int_0^{2\pi} \frac{-a \cos \theta + 1}{1 + 2a \cos \theta + a^2} d\theta \quad [\text{r.e.d.}]$$

Sec 4.3

17]

let $z = z_0 + re^{i\theta}$, $z - z_0 = re^{i\theta}$

$dz = re^{i\theta} i d\theta$ $(z - z_0)^n = r^n e^{in\theta}$

$$\oint (z - z_0)^n dz = r \int_0^{2\pi} r^n e^{in\theta} i e^{i\theta} d\theta =$$

$$i r^{n+1} \int_0^{2\pi} e^{i(n+1)\theta} d\theta = i r^{n+1} \int_0^{2\pi} (\cos(n+1)\theta + i \sin(n+1)\theta) d\theta$$

assume $n \neq -1$

$$= i r^{n+1} \left[\frac{\sin(n+1)\theta}{(n+1)} - i \frac{\cos(n+1)\theta}{(n+1)} \right]_0^{2\pi} = 0 \quad \text{q.e.d.}$$

Now assume $n = -1$

$$\oint (z - z_0)^{-1} dz = \int_0^{2\pi} i r^0 e^0 d\theta = 2\pi i \quad \boxed{\text{q.e.d.}}$$

contour for problems 18-22

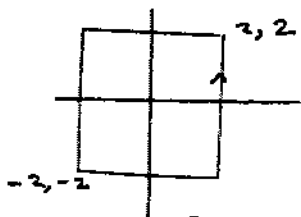

18] $\oint_{\text{square}} \frac{dz}{z-i} = \oint_c \frac{dz}{(z-i)}$ use $|z-i| = r$
 take $r = 1/2$
 $= \boxed{2\pi i}$ [taking $n = -1$ in prob 17]

19] $\oint_{\text{square}} \frac{dz}{(z-i)^4} = \oint_c \frac{dz}{(z-i)^4}$ use circle from 18]
 $= \boxed{0}$ [taking $n = -4$ in problem 17]

20] $\oint_{\text{square}} \frac{z dz}{z-i} = \oint_c \frac{(z-i) + i}{(z-i)} dz = \oint dz + i \oint \frac{1}{z-i} dz$

$\oint dz = 0$ $i \oint \frac{dz}{(z-i)} = i(2\pi i) = \boxed{-2\pi}$ see result in 18

sec 4.3

$$21) \oint_{\text{square}} \frac{(z+1)^m}{z^m} dz = \oint_{|z|=1} \frac{(z+1)^m}{z^m} dz =$$

$$\oint_{|z|=1} \sum_{k=0}^m \frac{m!}{(k!)(m-k)!} \frac{z^k}{z^m} dz \quad \text{all terms drop out except when } k=m-1$$

$$= \oint \frac{1}{z} \frac{m!}{(m-1)! 1!} dz = \boxed{2\pi i m}$$

$$22) \oint_{\text{square}} \frac{z^m}{(z-1)^m} dz = \oint_{|z-1|=1/2} \frac{z^m}{(z-1)^m} dz = \oint_{|z-1|=1/2} \frac{[1+(z-1)]^m}{(z-1)^m} dz$$

$$\oint_{|z-1|=1/2} \sum_{k=0}^m \frac{m!}{(m-k)! k!} (z-1)^k dz \quad \text{all terms drop out except when } k=m-1$$

$$= \oint_{|z-1|=1/2} \frac{m!}{(m-1)!} \frac{1}{(z-1)} dz = \boxed{2\pi i m}$$

23

$$\oint \frac{\text{Log } z}{(z+1)(z-3)} dz = \oint \text{Log } z \left[\frac{1/4}{z-3} - \frac{1/4}{z+1} \right] dz$$

$\frac{\text{Log } z}{z+1}$ is analytic on and in C , thus $\oint \frac{\text{Log } z}{z+1} dz = 0$

$$\text{Thus } \oint \frac{\text{Log } z}{(z+1)(z-3)} dz = \frac{1}{4} \oint \frac{\text{Log } z}{z-3} dz.$$

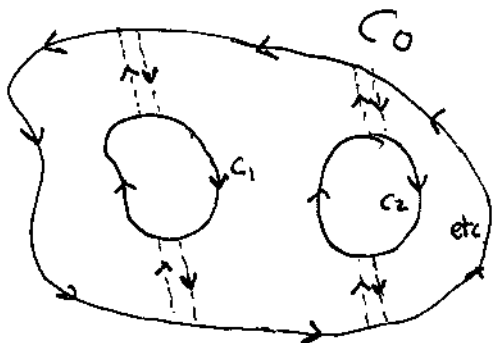

put cuts as shown,
Create 3 contours.

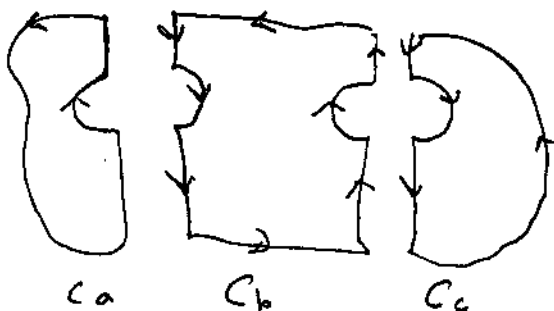

$$\left. \begin{aligned} \oint_{C_0} f(z) dz &= 0 \\ \oint_{C_1} f(z) dz &= 0 \\ \oint_{C_2} f(z) dz &= 0 \end{aligned} \right\} \text{from Cauchy Goursat}$$

Add the preceding three integrals together. Note that the integrals along the cuts cancel (opposite directions of integration)

$$\oint_{C_0+C_1+C_2} f(z) dz = 0 = \oint_{C_0} f(z) dz + \oint_{C_1} f(z) dz + \oint_{C_2} f(z) dz$$

$$\text{thus } \oint_{C_0} f(z) dz = - \oint_{C_1} f(z) dz - \oint_{C_2} f(z) dz \text{ etc.}$$

$$\oint_{C_0} f(z) dz = \oint_{C_1} f(z) dz + \oint_{C_2} f(z) dz \text{ etc.}$$

251

$$\frac{\sin z}{z^2-1} = \frac{\sin z}{(z+1)(z-1)} \text{ is analytic except at } z=\pm 1$$

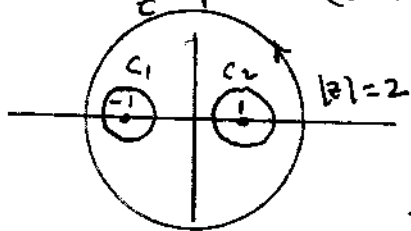

Use result of 24.

$$\oint_{C_0} \frac{\sin z}{z^2-1} dz = \oint_{C_1} \frac{\sin z}{z^2-1} dz + \oint_{C_2} \frac{\sin z}{z^2-1} dz$$

$C_1 = |z+1| = \frac{1}{2}$
 $C_2 = |z-1| = \frac{1}{2}$

Sec 4.4

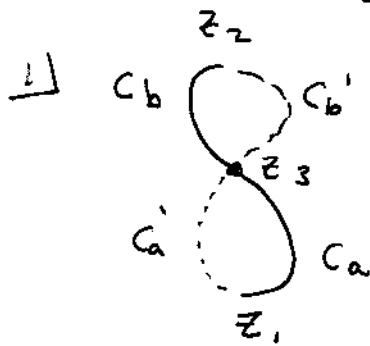

$$\int_{C_a}^{z_3} f(z) dz = \int_{z_1}^{z_3} f(z) dz$$

$$\int_{C_b}^{z_2} f(z) dz = \int_{z_3}^{z_2} f(z) dz$$

Add each side of the equation:

$$\int_{C_a} f(z) dz + \int_{C_b} f(z) dz = \int_{z_1}^{z_3} f(z) dz + \int_{z_3}^{z_2} f(z) dz$$

$$\int_{z_1}^{z_2} f(z) dz = \int_{z_1}^{z_2} f(z) dz$$

2) e^{iz} is entire, \therefore path not relevant

$$\frac{d}{dz} \frac{e^{iz}}{i} = e^{iz} \quad \therefore \text{answer} = \frac{e^{iz}}{i} \Big|_0^{4+2i}$$

$$= \frac{e^{-2} e^{4i} - 1}{i} = i [1 - e^{-2} e^{4i}]$$

$$3) 1+z^2 = \frac{d}{dz} \left[z + \frac{z^3}{3} \right] \quad \therefore \text{answer} = z + \frac{z^3}{3} \Big|_0^{4+2i}$$

$$= 4+2i + \frac{1}{3} [4+2i]^3 = \frac{28}{3} + i \frac{94}{3}$$

4) Note that the integrand has a singular point at $z=0$. The path avoids this point.

$$z + z^{-2} = \frac{d}{dz} \left[\frac{z^2}{2} - \frac{1}{z} \right] \quad \text{Now } \frac{z^2}{2} - \frac{1}{z}$$

is analytic in a domain containing the path and excluding $z=0$. \therefore answer = $\left[\frac{z^2}{2} - \frac{1}{z} \right] \Big|_0^{4+2i}$

$$= \frac{(4+2i)^2}{2} - \frac{1}{(4+2i)} - \frac{(1+i)^2}{2} + \frac{1}{1+i} = 6.3 + i 6.6$$

(Simplify with Matlab)

Sec 4.4

$$\begin{aligned} \int_0^{4+2i} e^z (\sinh z) dz &= \int_0^{4+2i} \frac{e^z [e^z - e^{-z}]}{2} dz \\ &= \int_0^{4+2i} \frac{e^{2z}}{2} dz - \frac{1}{2} \int_0^{4+2i} dz \\ &= \frac{e^{2z}}{4} \Big|_0^{4+2i} - z - i = \frac{e^{8+4i}}{4} - \frac{1}{4} - 2 - i \\ &= \frac{1}{4} e^{8+4i} - \frac{9}{4} - i \end{aligned}$$

$$\int_0^{4+2i} e^z \cosh(e^z) dz \quad \text{let } w = e^z$$

Note $\int \cosh w dw = \sinh w = \sinh e^z$

Note $\frac{d}{dz} \sinh(e^z) = e^z \cosh(e^z)$

answer = $\sinh(e^z) \Big|_0^{4+2i} = \sinh[e^{4+2i}] - \sinh 1$

$$\frac{z}{z^2-1} = \frac{1}{2} \left[\frac{1}{z-1} + \frac{1}{z+1} \right]$$

Now $\frac{d}{dz} \left[\frac{1}{2} \text{Log}(z-1) + \frac{1}{2} \text{Log}(z+1) \right] = \frac{z}{z^2-1}$

The Function $\frac{1}{2} [\text{Log}(z-1) + \text{Log}(z+1)]$ is analytic in a simply connected domain containing the path



branch cut for $\text{Log}(z-1) + \text{Log}(z+1)$

answer = $\frac{1}{2} [\text{Log}(z-1) + \text{Log}(z+1)] \Big|_{1+i}^{4+2i} =$

$\frac{1}{2} [\text{Log}(3+2i) + \text{Log}(5+2i)] - \text{Log}(1) - \text{Log}(2+i)$
(continued next page)

Sec 4.4

→ continued

$$\begin{aligned} & \frac{1}{2} [\text{Log}(3+2i) - \text{Log}i + \text{Log}(5+2i) - \text{Log}(2+i)] \\ &= \frac{1}{2} \left[\text{Log} \left(\frac{3+2i}{i} \right) + \text{Log} \left(\frac{5+2i}{2+i} \right) \right] = \\ & \frac{1}{2} \left[\text{Log} \frac{11+16i}{-1+2i} \right] \end{aligned}$$

8] a) $\int z dz$ is correct since $\frac{d}{dz} \frac{z^2}{2} = z$
 $\int \bar{z} dz$ is done incorrectly, $\frac{d}{dz} \left(\frac{\bar{z}^2}{2} \right) \neq \bar{z}$

(b) $\int_{0+i0}^{1+i} \bar{z} dz = \int_0^1 x dx + \int_0^1 y dy - i \int_0^1 y dx + i \int_0^1 x dy$
 put $y=x$ in 3rd integral, $x=y$ in 4th integral
 set $\int_{0,0}^{1,1} \bar{z} dz = \boxed{1}$

9] $\int_e^i \text{Log} z dz = z \text{Log} z - z \Big|_e^i$

$= i \text{Log} i - i - e \text{Log} e + e = \boxed{-\frac{\pi}{2} - i}$. This

procedure assumes that $\frac{d}{dz} [z \text{Log} z - z] = \text{Log} z$ along path (everywhere). This would not hold if path crossed the branch cut for $\text{Log} z$. The given path does not cross this branch cut.

10] Note: $\frac{d}{dz} \frac{(\text{Log} z)^2}{2} = \frac{\text{Log} z}{z}$ analytic in any domain not containing $z=0$ or points on the negative real axis. Our contour can lie in such a domain. Thus $\int_{1+i}^{-1-i} \frac{\text{Log} z}{z} dz = \frac{1}{2} (\text{Log} z)^2 \Big|_{1+i}^{-1-i}$
 $= \frac{1}{2} \left[\left(\text{Log} \sqrt{2} - i \frac{\pi}{4} \right)^2 - \left(\text{Log} \sqrt{2} + i \frac{\pi}{4} \right)^2 \right] = -i \pi \text{Log} 2 - \frac{\pi^2}{2}$

Sec 4.4

$$\begin{aligned} 11) \int_1^i z^{1/2} dz &= \frac{2}{3} z^{3/2} \Big|_1^i = \frac{2}{3} z z^{1/2} \Big|_1^i \\ &= \frac{2}{3} \left[i e^{i\pi/4} - 1 \right] = \frac{2}{3} \left[-1 - \frac{1}{\sqrt{2}} + \frac{i}{\sqrt{2}} \right] \end{aligned}$$

$$12) \text{ As above } \int_1^i z^{1/2} dz = \frac{2}{3} z z^{1/2} \Big|_1^i$$

$$z^{1/2} = \sqrt{|z|} \angle \frac{\theta}{2} + k\pi, \text{ take } k=1, -\pi < \theta < \pi$$

$$i^{1/2} = \frac{1}{\sqrt{2}} - \frac{i}{\sqrt{2}}, \quad 1^{1/2} = (-1)$$

$$\int_1^i z^{1/2} dz = \left(\frac{2}{3} \right) i \left[\frac{1}{\sqrt{2}} - \frac{i}{\sqrt{2}} \right] - \frac{2}{3} (-1) \times (-1)$$

$$= \frac{2}{3} + \frac{2}{3} \frac{1}{\sqrt{2}} - \frac{2}{3} \frac{i}{\sqrt{2}}$$

$$13) \int_1^i z dz = \int_1^i e^{z \log i} dz = \int_1^i e^{\frac{i\pi}{2} z} dz$$

The integrand $\exp(i\pi/2 z)$ is an entire function and is the derivative of $\frac{e^{\frac{i\pi}{2} z}}{\frac{i\pi}{2}}$ which is an entire function. Thus the given integral is independent of path. Equals $\frac{2 e^{\frac{i\pi}{2} z}}{i\pi} \Big|_1^i$

$$= \frac{2}{i\pi} \left[e^{-\frac{\pi}{2}} - e^{i\pi/2} \right] = \frac{-2i}{\pi} \left[e^{-\pi/2} - i \right]$$

Sec 4.4

14 | a) $\cos z \cosh z = \frac{e^{iz} + e^{-iz}}{2} \left(\frac{e^z + e^{-z}}{2} \right) = \frac{e^{(1+i)z} + e^{(-1-i)z} + e^{(-1+i)z} + e^{(1-i)z}}{4}$

The preceding is the derivative of $F(z) = \frac{1}{4} \left[\frac{e^{(1+i)z}}{1+i} + \frac{e^{(-1-i)z}}{-1-i} + \frac{e^{(-1+i)z}}{-1+i} + \frac{e^{(1-i)z}}{1-i} \right]$ (an entire function)

Thus $\int_0^1 \cos z \cosh z dz = \frac{1}{4} \left[\frac{e^{(1+i)} - 1}{1+i} + \frac{e^{(-1-i)} - 1}{-1-i} + \frac{e^{(-1+i)} - 1}{-1+i} + \frac{e^{(1-i)} - 1}{1-i} \right]$. Since $F(z)$ is entire,

path need not be specified.

Now: $\frac{1}{4} \left[\frac{e^{(-1+i)} - 1}{1+i} + \frac{e^{(-1-i)} - 1}{-1-i} + \frac{e^{(1-i)} - 1}{-1+i} + \frac{e^{(1+i)} - 1}{-1-i} \right] =$

$\frac{1}{4} \left[\frac{e^{-1} (e^{i-1} - 1)}{1+i} + \frac{e^{-1} (e^{-i-1} - 1)}{-1-i} + \frac{e^1 (e^{-i+1} - 1)}{-1+i} + \frac{e^1 (e^{i+1} - 1)}{-1-i} \right]$

$= \frac{1}{4} \left[e^{-1} (i \sin 1 - i \cos 1) + e^1 (i \sin 1 + i \cos 1) \right]$

$= \frac{i}{2} [\sin 1 \cosh 1 + \cos 1 \sinh 1]$

b) From MATLAB

```

> syms x
> int(cos(x)*cosh(x))
ans =
1/4*cos(x)*exp(x)+1/4*exp(x)*sin(x)-1/4*exp(-x)*cos(x)+1/4*exp(-x)*sin(x)
> pretty(ans)
1/4 cos(x) exp(x) + 1/4 exp(x) sin(x) - 1/4 exp(-x) cos(x)
+ 1/4 exp(-x) sin(x) = F(x)

```

Thus from MATLAB, $\frac{dF}{dx} = \cos x \cosh x$.

∴ $\frac{1}{4} \cos z e^z + \frac{1}{4} e^z \sin z - \frac{1}{4} e^{-z} \cos z + \frac{1}{4} e^{-z} \sin z = F(z)$

has derivative $\cos z \cosh z$ (an entire function)

Sec 4.4

14 (b) Continued.

Note $F(z) = \frac{1}{2} \cosh z \sinh z + \frac{1}{2} \sinh z \cosh z$

∴ ans. $\rightarrow \frac{1}{2} \cosh z \sinh z + \frac{1}{2} \sinh z \cosh z \Big|_0^L$
 $= \frac{1}{2} \cosh i \sinh i + \frac{1}{2} \sinh i \cosh i = \frac{i}{2} \cosh 1 \sinh 1$

$+ \frac{i}{2} \sinh 1 \cosh 1$ Which agrees with answer to (a).

15

a) To use principle of path independence we would require that the integrand $\frac{1}{z}$ be analytic in a simply connected domain containing both C_1 and C_2 . But this is impossible because $\frac{1}{z}$ is not analytic at $z=0$.

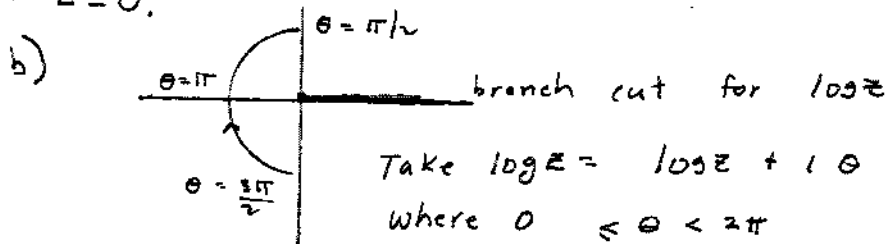

$\int_{C_2} \frac{1}{z} dz = \left. \log z \right|_{-i}^i = \log i - \log -i = i\frac{\pi}{2} - (-i\frac{\pi}{2}) = i\pi$

c) $\int_{C_2} \frac{1}{z} dz = \int_{\frac{3\pi}{2}}^{\frac{\pi}{2}} \frac{1}{e^{i\theta}} i e^{i\theta} d\theta = i \int_{\frac{3\pi}{2}}^{\frac{\pi}{2}} d\theta = -i\pi$

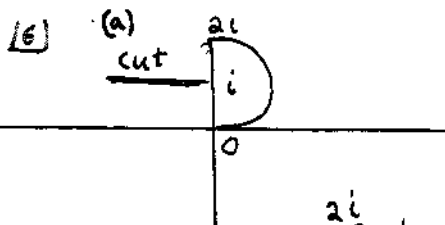

$\frac{d}{dz} \text{Log}(z-i) = \frac{1}{z-i}$

Use princ branch cut as shown

$\int_0^{2i} \frac{1}{(z-i)} dz = \text{Log}(z-i) \Big|_0^{2i} = \text{Log} i - \text{Log} -i = i\pi$

16]

SEC 4.4

(b) continued

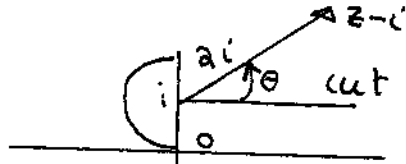

$\theta = \arg(z-i)$
than in part a.

Use a different branch of $\log(z-i)$. Take
 $\frac{d}{dz} \log(z-i) = \frac{1}{(z-i)}$ Now $\log(z-i) = \text{Log}|z-i| +$

$i \arg(z-i)$
 Take $0 < \arg(z-i) < 2\pi$
 $\int_0^{2i} \frac{1}{(z-i)} dz = \log(z-i) \Big|_0^{2i} = \log((z-i)-i)$
 $-\log[0-i] = i\frac{\pi}{2} - i\frac{3\pi}{2} = \boxed{-i\pi}$ ($z=2i$)

17]

a) You may apply princ. of path independence. Note that $(1/z^2)$ is analytic in a simply connected domain containing the path γ of integration.

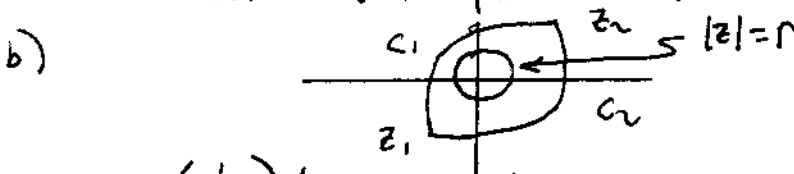

Note $\oint_{\text{(circle)}} (1/z^2) dz = 0$ (see sec 4.3)

$$\int_{z_1}^{z_2} \frac{1}{z^2} dz + \int_{z_2}^{z_1} \frac{1}{z^2} dz = \oint_{|z|=r} \frac{1}{z^2} dz$$

(princ. deformation of contours)

$$\int_{z_1}^{z_2} \frac{1}{z^2} dz + \int_{z_2}^{z_1} \frac{1}{z^2} dz = 0, \quad \int_{z_1}^{z_2} \frac{1}{z^2} dz = \int_{z_2}^{z_1} \frac{1}{z^2} dz$$

along C_2 along C_1

$$\int_{z_1}^{z_2} \frac{1}{z^2} dz = \int_{z_1}^{z_2} \frac{1}{z^2} dz$$

g.e.d.

18(a)

$$\int_1^i \frac{1}{z^2} dz = -\frac{1}{z} \Big|_1^i = 1 - \frac{1}{i} = \boxed{1+i}$$

18(b)

want $\frac{1}{z_1^2} (i-1) = 1+i$ or $z_1^2 = \frac{i-1}{1+i}$

or $z_1^2 = i$. Thus $|z_1| = 1$. On the path $|z_1| = 1$ only at the endpoints, i.e. only at $z_1 = 1$ or $z_1 = i$. Note that $1^2 = 1$, and $i^2 = -1$. Thus $z_1^2 = i$ cannot be satisfied on the given path.

19(a) Use $\boxed{\frac{-1}{z-i} + \text{constant}}$. The deriv. is $\frac{1}{(z-i)^2}$

(b) $\frac{-1}{1+i-i} + C = 0$, $C = +1$ $F(z) = \frac{-1}{z-i} + 1$

20(a)

$$\frac{d}{dz} \tan^{-1}(z) = \frac{1}{z^2+1} \quad \text{see Eqn (3.7-10).}$$

So take $F(z) = \boxed{\tan^{-1}(z) + \text{const}}$. Branch cuts extend outward from $z = \pm i$. They go to ∞ but do not pass into domain $|z| < 1$.

(b) $F\left(\frac{\pi}{4}\right) = \tan^{-1}\left(\frac{\pi}{4}\right) + C$. Take $\tan^{-1}\left(\frac{\pi}{4}\right) = 1$

$C = 0$. Thus $F(z) = \boxed{\tan^{-1}(z)}$

2) (a) $\frac{d}{dz} \frac{z^\alpha z}{\alpha+1} = \frac{d}{dz} \frac{z^{\alpha+1}}{\alpha+1} = \frac{(\alpha+1)z^\alpha}{\alpha+1} = z^\alpha$ g.e.d.

(b) $\int_{-i}^i z^i dz = (\text{see a}) = \frac{z^{i+1}}{i+1} \Big|_{-i}^i = \frac{z}{i+1} z^i \Big|_{-i}^i$
 $= \frac{z}{i+1} e^{i \log z} \Big|_{-i}^i = \frac{i}{i+1} e^{-\frac{\pi}{2}} + \frac{i}{i+1} e^{\frac{\pi}{2}} = \frac{2i}{i+1} \cosh\left(\frac{\pi}{2}\right)$

$$\int_{-i}^i i^z dz = \int_{-i}^i e^{z \log i} dz = \int_{-i}^i e^{\frac{i\pi}{2} z} dz = \frac{2}{i\pi} \left[e^{i \frac{\pi}{2} z} \right]_{-i}^i = \frac{2}{i\pi} \left[e^{-\frac{\pi}{2}} - e^{\frac{\pi}{2}} \right]$$

21 (b)

Sec. 4.4 cont'd

$$\int_{-i}^i z^2 dz = \frac{2}{\pi} * 2i \sinh \frac{\pi}{2}$$

$$= \frac{4}{\pi} i \sinh \left(\frac{\pi}{2} \right) \quad \text{Combining results:}$$

$$\int_{-i}^i (z^i - z^2) dz = \frac{2i}{i+1} \operatorname{cosh} \left(\frac{\pi}{2} \right) - \frac{4}{\pi} i \sinh \left(\frac{\pi}{2} \right)$$

$$= \left(i+1 \right) \operatorname{cosh} \frac{\pi}{2} - \frac{4i}{\pi} \sinh \left(\frac{\pi}{2} \right)$$

Sec 4.5

(a) $\oint_{C_0} \frac{f(z)}{z-z_0} dz = ?$ put $z = z_0 + re^{i\theta}$
 $dz = re^{i\theta} i d\theta$
 $z - z_0 = re^{i\theta}$

$$\oint_{C_0} \frac{f(z)}{(z-z_0)} dz = \int_{\theta=0}^{2\pi} \frac{f(z_0 + re^{i\theta})}{re^{i\theta}} re^{i\theta} i d\theta = i \int_0^{2\pi} f(z_0 + re^{i\theta}) d\theta$$

(b) putting $r \rightarrow 0+$

$$\oint_{C_0} \frac{f(z)}{(z-z_0)} dz = i \int_0^{2\pi} f(z_0) d\theta = i f(z_0) \int_0^{2\pi} d\theta = 2\pi i f(z_0)$$

(c) We have not justified this: $\lim_{r \rightarrow 0} \int_0^{2\pi} f(z_0 + re^{i\theta}) d\theta$
 $= \int_0^{2\pi} \lim_{r \rightarrow 0} f(z_0 + re^{i\theta}) d\theta$. We must justify change in order
of limiting processes.

recall, integral is a limit of a
SUM.

Sec 4.5

2) $\oint_{|z|=3} \frac{\sin z}{z-2} dz = 2\pi i \sin z \Big|_{z=2} = 2\pi i \sin 2$

3) $\frac{\sin z}{z-2}$ is analytic on and in C. \therefore answer = 0
 from Cauchy - Goursat

4) $\frac{\cosh z}{(z-3)(z-1)}$ has a singular point inside the contour
 at $z=1$. $\oint \frac{\cosh z}{(z-3)(z-1)} dz = \oint \frac{\cosh z}{z-3} dz = 2\pi i \frac{\cosh z}{z-3} \Big|_{z=1}$
 $= \frac{2\pi i \cosh 1}{-2} = -\pi i \cosh 1$

5) $\frac{1}{2\pi i} \oint \frac{\cosh(e^z)}{z^2-4z+3} dz = \frac{1}{2\pi i} \oint \frac{\cosh(e^z)}{(z-3)(z-1)} dz =$

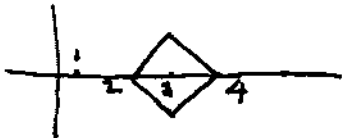

Note the sing. pt. @ $z=1$ is not enclosed.

$\frac{1}{2\pi i} \oint \frac{\cosh(e^z)}{z-3} dz = \frac{\cosh(e^z)}{z-1} \Big|_{z=3}$
 $= \frac{\cosh(e^3)}{2} = \frac{1}{2} \cosh(e^3)$

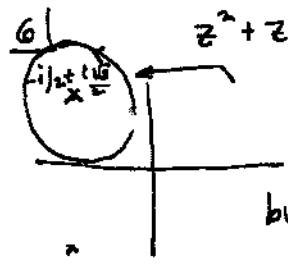

$z^2+z+1=0 \quad z = \frac{-1 \pm i\sqrt{3}}{2}$
 the contour encloses the singularity of the integrand at $\frac{-1 + i\sqrt{3}}{2}$ but not at $\frac{-1 - i\sqrt{3}}{2}$

$\oint \frac{e^{iz}}{z^2+z+1} dz = \oint \frac{e^{iz}}{z - (-1/2 - i\sqrt{3}/2)} dz =$
 $\frac{2\pi i e^{iz}}{z - (-1/2 - i\sqrt{3}/2)} \Big|_{z = -1/2 + i\sqrt{3}/2}$
 $= \frac{2\pi i e^{i[-1/2 + i\sqrt{3}/2]}}{i\sqrt{3}} = 2\pi e^{-\sqrt{3}/2} e^{-i/2}$

Sec 4.5

$$7) \frac{1}{2\pi i} \oint \frac{\text{Log } z}{z^2+9} dz = \frac{1}{2\pi i} \oint \frac{\text{Log } z}{z+3i} dz$$

$$z^2+9 = (z-3i)(z+3i)$$

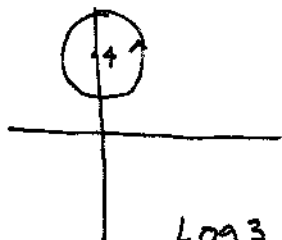

$$= \frac{\text{Log } z}{z+3i} \Big|_{z=3i} = \frac{\text{Log } 3i}{6i} =$$

$$\frac{\text{Log } 3 + i \left(\frac{\pi}{2}\right)}{6i} = \boxed{\frac{\pi}{12} - i \frac{1}{6} \text{Log } 3}$$

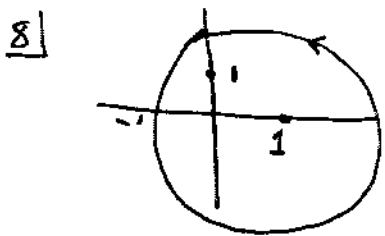

$$8) \frac{1}{2\pi i} \oint \frac{e^{iz}}{(z-i)^2} dz = \frac{d}{dz} e^{iz} \Big|_{z=i}$$

$$|z-1|=2 \quad = i e^{iz} \Big|_i = \boxed{i e^{-1}}$$

9) Same contour as in 8)

$$\oint \frac{z e^z}{(z-i)^2} = 2\pi i \frac{d}{dz} (z e^z) \Big|_{z=i} =$$

$$2\pi i \left[e^z + z e^z \right]_{z=i} = 2\pi i e^i [1+i] = 2\pi e^i [-1+i]$$

10) Same contour as in 8)

$$\frac{1}{2\pi i} \oint \frac{dz}{(z+2)(z-i)^2} = \frac{d}{dz} \frac{1}{(z+2)} \Big|_{z=i} = \frac{-1}{(z+2)^2} \Big|_{z=i}$$

$$= \boxed{\frac{-1}{(z+i)^2}}$$

$$11) f^{(n)}(z_0) = \frac{n!}{2\pi i} \oint \frac{f(z)}{(z-z_0)^{n+1}} dz, \quad \frac{f^{(n)}(z_0)}{n!} = \oint \frac{f(z)}{(z-z_0)^{n+1}} dz$$

Cauchy Int. Form. $n=2$
 $f(z) = \cos z$
 $f''(z) = -\cos z$
 $z_0 = i$
ans = $-\frac{1}{2} \cos z \Big|_i = \boxed{-\frac{1}{2} \cos i}$

sec 4.5

12] $z_0 = 0, \quad f^n(z_0) = \frac{n!}{2\pi i} \oint \frac{f(z)}{(z-z_0)^{n+1}} dz$

$f(z) = \sin 2z, \quad n = 14$

$$\frac{\frac{d^{14}}{dz^{14}} \sin 2z}{14!} \Big|_{z=0} = \frac{1}{2\pi i} \oint \frac{\sin(2z)}{z^{15}} dz$$

Note, any even derivative of $\sin(2z)$ has the form (constant) * $\sin(2z)$ [whose value is zero at $z=0$] \therefore answer is zero.

13]
$$\frac{\frac{d^{15}}{dz^{15}} \sin 2z}{15!} \Big|_{z=0} = \frac{1}{2\pi i} \oint \frac{\sin(2z)}{z^{16}} dz$$

$\therefore \frac{2\pi i}{15!} \frac{d^{15}}{dz^{15}} \sin 2z \Big|_{z=0} = \text{answer}$

$= \frac{2\pi i}{15!} 2^{15} (-1) \cos 2z \Big|_{z=0} = \boxed{\frac{-2^{16} \pi i}{15!}}$

14] If $F(z)$ has a derivative in a domain, as we have assumed, then it is analytic. Now see theorem 7. Thus if $F(z)$ is analytic, then dF/dz must be analytic. But $dF/dz = \bar{z}$ and \bar{z} is not analytic. Therefore the required $F(z)$ does not exist.

15] next page

15 a) sec 4.5 cont'd
 put $z_0 = 0$ in Cauchy, I.F.

$$\frac{2\pi i f^n(0)}{n!} = \oint_{|z|=1} \frac{f(z)}{z^{n+1}} dz$$

$$f(z) = e^{az} \quad f^n(z) = a^n e^{az}, \quad f^n(0) = a^n$$

$$\frac{2\pi i a^n}{n!} = \oint_{|z|=1} \frac{e^{az}}{z^{n+1}} dz$$

$$b) \frac{2\pi i a^n}{n!} = \int_{\theta=0}^{2\pi} \frac{e^a e^{i\theta}}{(e^{i\theta})^{n+1}} i e^{i\theta} d\theta$$

note $z = e^{i\theta}$
 $dz = e^{i\theta} i d\theta$

$$\frac{2\pi i a^n}{n!} = \int_0^{2\pi} e^{a[\cos\theta + i\sin\theta]} e^{-in\theta} i d\theta$$

$$\frac{2\pi i a^n}{n!} = \int_0^{2\pi} e^{a\cos\theta} e^{i[as\sin\theta - n\theta]} i d\theta$$

$$\frac{2\pi i a^n}{n!} = \int_0^{2\pi} e^{a\cos\theta} [\cos[as\sin\theta - n\theta] + i\sin[as\sin\theta - n\theta]] i d\theta$$

equate the real parts on each side of this eqn.
 and equate the imag part on each side.

$$\frac{2\pi i a^n}{n!} = \int_0^{2\pi} e^{a\cos\theta} \cos[as\sin\theta - n\theta] d\theta$$

$$0 = \int_0^{2\pi} e^{a\cos\theta} \sin[as\sin\theta - n\theta] d\theta$$

Sec 4.5

16) a) If $|a| > 1$, $\frac{1}{z-a}$ is analytic on and inside $|z|=1$. Thus $\oint \frac{dz}{z-a} = \boxed{0}$ [Cauchy-Goursat]

Now if $|a| < 1$, $\oint \frac{dz}{z-a} = 2\pi i \Big|_{z=a} = \boxed{2\pi i}$, Cauchy Integral Formula

b) \bar{z} is nowhere analytic, $\frac{1}{\bar{z}-a}$ is nowhere analytic

Thus neither the Cauchy-Goursat Theorem nor the Cauchy Integral Formula apply.

Suppose $|a| > 1$. $\oint \frac{dz}{\bar{z}-a} = \oint \frac{dz}{\frac{1}{z}-a} = \oint \frac{z dz}{1-az}$
 $= \frac{1}{-a} \oint \frac{z}{z-\frac{1}{a}} dz = \frac{2\pi i}{-a} \Big|_{z=1/a} = \boxed{-\frac{2\pi i}{a^2}} \quad |a| > 1$

Suppose $|a| < 1$

$\oint \frac{dz}{\bar{z}-a} = -\frac{1}{a} \oint \frac{z dz}{z-\frac{1}{a}}$ as above. The integrand is analytic in and on C. \therefore answer = $\boxed{0}$ for $|a| < 1$

The sets of answers to a) and b) are completely different.

17) $\oint \frac{dz}{z-a} = 2\pi i, |z| > a$ Cauchy Int. form

Put $z = e^{i\theta}, dz = e^{i\theta} i d\theta$

$\int_{\theta=0}^{2\pi} \frac{e^{i\theta} i d\theta}{e^{i\theta} - a} = 2\pi i$ Cancel i

$\int_0^{2\pi} \frac{(e^{i\theta})(e^{-i\theta} - a) d\theta}{(e^{i\theta} - a)(e^{-i\theta} - a)} = 2\pi$

$\int_0^{2\pi} \frac{1 - a \cos\theta - a i \sin\theta}{1 - 2a \cos\theta + a^2} d\theta = 2\pi$, Now equate real parts on each side of the preceding.

$\int_0^{2\pi} \frac{1 - a \cos\theta}{1 - 2a \cos\theta + a^2} d\theta = 2\pi$

Section 4.5

18)

$$\left| \oint_C \frac{f(z) dz}{(z-z_0-\Delta z_0)(z-z_0)} - \oint_C \frac{f(z) dz}{(z-z_0)^2} \right| =$$

$$\left| \oint_C \frac{f(z)}{(z-z_0)^2} \left[\frac{(z-z_0)}{(z-z_0-\Delta z_0)} - 1 \right] dz \right| =$$

$$\left| \oint_C \frac{f(z)}{(z-z_0)^2} \left[\frac{(z-z_0) - (z-z_0-\Delta z_0)}{z-(z_0+\Delta z_0)} \right] dz \right| = \left| \oint_C \frac{f(z) \Delta z_0 dz}{(z-z_0)^2 (z-z_0-\Delta z_0)} \right|$$

We consider $\lim_{\Delta z_0 \rightarrow 0}$ in the preceding integral.

For z on C , $|f(z)| \leq M$, $\frac{1}{|z-z_0|^2} \leq \frac{1}{b^2}$ $|z-z_0-\Delta z_0| \geq |z-z_0| - |\Delta z_0|$

Thus, $|z-z_0-\Delta z_0| \geq b - \frac{b}{2}$ and $\frac{1}{|z-z_0-\Delta z_0|} \leq \frac{2}{b}$
 Apply ML inequality $\left| \oint_C \frac{f(z) \Delta z_0}{(z-z_0)^2 (z-z_0-\Delta z_0)} dz \right| \leq \frac{M}{b^2} \cdot 2 \cdot L \cdot |\Delta z_0|$. The preceding $\rightarrow 0$ as $|\Delta z_0| \rightarrow 0$ as required

19)

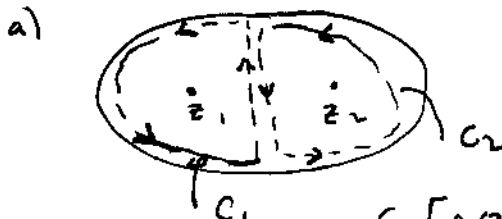

$$\frac{1}{2\pi i} \oint_C \frac{f(z) dz}{(z-z_1)(z-z_2)} = \frac{1}{2\pi i} \oint_{C_1} \frac{f(z)}{(z-z_1)} dz + \frac{1}{2\pi i} \oint_{C_2} \frac{f(z)}{(z-z_2)} dz$$

Note integrations cancel on the common internal path

$$= \frac{f(z_1)}{(z_1-z_2)} + \frac{f(z_2)}{z_2-z_1} \quad \text{from Cauchy Integ. formula applied to each integral.}$$

Section 4.5,

19 continued

(b) Extend the preceding technique, e.g. have

$z_1, z_2, z_3 \dots z_n$

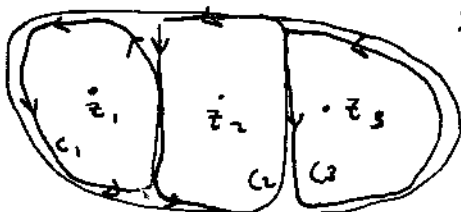

$$\frac{1}{2\pi i} \int \frac{f(z) dz}{(z-z_1)(z-z_2)(z-z_3)\dots(z-z_n)}$$

$$\begin{aligned} & \frac{1}{2\pi i} \oint_{C_1} \frac{f(z) / [(z-z_2)(z-z_3)\dots]}{(z-z_1)} dz + \frac{1}{2\pi i} \oint_{C_2} \frac{f(z) / [(z-z_1)(z-z_3)\dots]}{(z-z_2)} dz \\ & + \frac{1}{2\pi i} \oint_{C_3} \frac{f(z) / [(z-z_1)(z-z_2)]}{(z-z_3)} dz = \frac{f(z_1)}{(z_1-z_2)(z_1-z_3)\dots} + \frac{f(z_2)}{(z_2-z_1)(z_2-z_3)\dots} \\ & + \frac{f(z_3)}{(z_3-z_1)(z_3-z_2)\dots} + \dots + \frac{f(z_n)}{(z_n-z_1)(z_n-z_2)\dots(z_n-z_{n-1})} \end{aligned}$$

2) $\oint \frac{dz}{e^z(z^2-1)} dz = \oint \frac{dz}{e^z(z-1)(z+1)}$

Use: and $= 2\pi i \oint_{C_1} \frac{dz}{e^z(z+1)} + 2\pi i \oint_{C_2} \frac{dz}{e^z(z-1)}$

$= 2\pi i \left[\frac{e^{-1}}{2} + \frac{-e^{-1}}{2} \right] = -2\pi i \sinh 1$

22)

Sec 4.5 cont'd

$$z^2 - z + \frac{1}{2} = 0, \quad z = \frac{1 \pm i}{2}$$

$$(z^2 - z + \frac{1}{2}) = (z - [\frac{1+i}{2}]) (z - (\frac{1-i}{2}))$$

$$\oint_C \frac{\text{Log } z \, dz}{(z - \frac{1+i}{2}) (z - \frac{1-i}{2})} = 2\pi i \frac{\text{Log } z}{z - \frac{1-i}{2}} \Big|_{\frac{1+i}{2}} +$$

$$2\pi i \frac{\text{Log } z}{z - \frac{1+i}{2}} \Big|_{z = \frac{1-i}{2}} = \frac{2\pi i \text{Log} [\frac{1+i}{2}]}{i} + \frac{2\pi i \text{Log} [\frac{1-i}{2}]}{-i}$$

$$= \frac{2\pi i \text{Log} [\frac{1+i}{1-i}]}{i} = \boxed{\pi^2}$$

$$23) \oint \frac{dz}{(e^z)(z-1)^2(z+1)^2} = 2\pi i \frac{d}{dz} \frac{1}{(e^z)(z-1)^2} \Big|_{z=-1}$$

$$+ 2\pi i \frac{d}{dz} \frac{1}{e^z(z+1)^2} \Big|_{z=1} = 2\pi i \left[\frac{-[e^z(z-1)^2 + 2e^z(z-1)]}{[(e^z)(z-1)^2]^2} \Big|_{z=-1} \right.$$

$$\left. + \frac{-[e^z(z+1)^2 + e^z 2(z+1)]}{[e^z(z+1)^2]^2} \Big|_{z=1} \right] = \boxed{-\pi i e^{-1}}$$

Section 4.5

24 | a)

```
%problem 24 section 4.5
clear
dz(1)=exp(i*pi/4)-1; z(1)=exp(i*pi/8);
for j=2:8
    dz(j)=dz(j-1)*exp(i*pi/4);
    z(j)=z(j-1)*exp(i*pi/4);
end
fnc=[2.3368 + 1.9406i;
     0.8837 + 2.1700i;
     0.4111 + 1.5442i;
     0.3683 + 1.1482i;
     0.3683 + 0.8518i;
     0.4111 + 0.4558i;
     0.8837 - 0.1700i;
     2.3368 + 0.0594i];
fnc=fnc.';
y=fnc./z;
w=y.*dz;
sum(w)/(2*pi*i) ← the answer
%answer will be 0.9745 + 0.9745i
```

b) $e^{z+i} \Big|_{z=0} = 1+i$ compares favorably with $.9745 + i.9745$ from part (a).

25 | We can apply Cauchy Integral formula to fig 4.5-6. Thus.

$$\frac{1}{2\pi i} \int \frac{f(z)}{z-z_0} dz = f(z_0)$$



Notice cancellation of sum of integrals along \overleftrightarrow{AB} . Thus we are left with

$$\frac{1}{2\pi i} \oint_{C_0} \frac{f(z)}{z-z_0} dz + \frac{1}{2\pi i} \oint_{C_1} \frac{f(z)}{(z-z_0)} dz = f(z_0)$$

$$\frac{1}{2\pi i} \oint_{C_0} \frac{f(z)}{(z-z_0)} dz = f(z_0) - \frac{1}{2\pi i} \oint_{C_1} \frac{f(z)}{(z-z_0)} dz$$

Reverse direction on C_1

$$\frac{1}{2\pi i} \oint_{C_0} \frac{f(z)}{(z-z_0)} dz = f(z_0) + \frac{1}{2\pi i} \oint_{C_1} \frac{f(z)}{(z-z_0)} dz \quad \text{q.e.d}$$

sec 4.5

25] continued

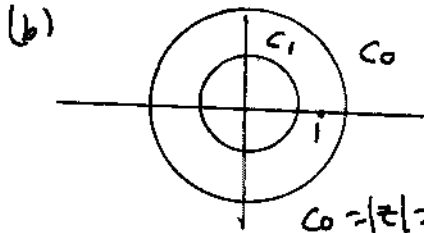

$\frac{1}{5\pi z}$ is analytic
on C_0 , C_1 and in the
domain between them.
 $z_0 = 1$

Thus:

$$C_0 = |z| = 2$$

$$C_1 = |z| = 1/2$$

$$\frac{1}{2\pi i} \oint_{C_0} \frac{f(z) dz}{(z-1)} = f(1) + \frac{1}{2\pi i} \oint_{C_1} \frac{f(z)}{(z-1)} dz$$

put $f(z) = \frac{1}{5\pi z}$, $f(1) = \frac{1}{5\pi \cdot 1}$

c) Apply same method as in (a)



sec 4.6

1) $\frac{1}{2\pi} \int_0^{2\pi} e^{e^{i\theta}} d\theta$ use (4.6-1), $z_0 = 0$, $f(z) = e^z$

$$\frac{1}{2\pi} \int_0^{2\pi} e^{e^{i\theta}} d\theta = e^z \Big|_0 = 1$$

2) $\int_{-\pi}^{\pi} e^{\cos\theta} \cos(\sin\theta) d\theta = \int_0^{2\pi} \dots d\theta$

Use Eq. (4.6-1). Consider previous problem

$$\frac{1}{2\pi} \int_0^{2\pi} e^{\cos\theta + i\sin\theta} d\theta = \frac{1}{2\pi} \int_0^{2\pi} e^{\cos\theta} e^{i\sin\theta} d\theta$$

$$= \frac{1}{2\pi} \int_0^{2\pi} e^{\cos\theta} [\cos(\sin\theta) + i\sin(\sin\theta)] d\theta$$

$= 1$, use real part only

$$\frac{1}{2\pi} \int_0^{2\pi} e^{\cos\theta} \cos(\sin\theta) d\theta = 1, \quad \int_0^{2\pi} e^{\cos\theta} \sin(\sin\theta) d\theta = 0$$

3) $\frac{1}{2\pi} \int_{-\pi}^{\pi} \cos^2\left(\frac{\pi}{6} + ae^{i\theta}\right) d\theta$ use

(4.6-1) taking $z_0 = \frac{\pi}{6}$, $r = a$, $f(z) = \cos^2 z$

$$\frac{1}{2\pi} \int_{-\pi}^{\pi} \dots d\theta = \frac{1}{2\pi} \int_0^{2\pi} \dots d\theta = \cos^2 z \Big|_{\frac{\pi}{6}} = \cos^2 \frac{\pi}{6} = \frac{3}{4}$$

4) Use Eqn (4.6-3a). Take $f(z) = \frac{1}{z^n + a}$, $z_0 = 0$

$r=1$, $z=e^{i\theta}$, $f(z) = \frac{1}{e^{in\theta} + a}$, $f(z) = \frac{e^{-in\theta}}{(e^{in\theta} + a)(e^{-in\theta} + a)}$

$$= \frac{a + \cos n\theta - i\sin n\theta}{1 + 2a\cos(n\theta) + a^2}, \quad u = \text{Re } f(z) = \frac{a + \cos n\theta}{1 + 2a\cos(n\theta) + a^2}$$

Because of periodicity of integrand, can change limits from $0 \rightarrow 2\pi$ to $-\pi \rightarrow \pi$.

$$2\pi u(0,0) = 2\pi \text{Re} \frac{1}{z^n + a} \Big|_{z=0} = \boxed{\frac{2\pi}{a}}$$

Section 4.6

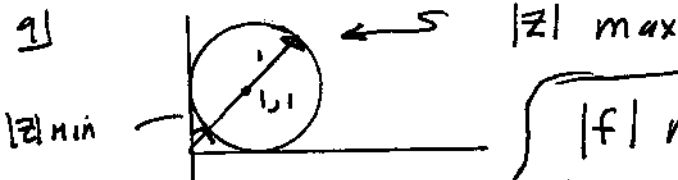

$|f|$ max at $(\sqrt{2} + 1) e^{i\pi/4}$
 $|f|$ max = $\sqrt{2} + 1$

$|f|$ min at $(\sqrt{2} - 1) e^{i\pi/4}$, $|f|$ min = $\sqrt{2} - 1$

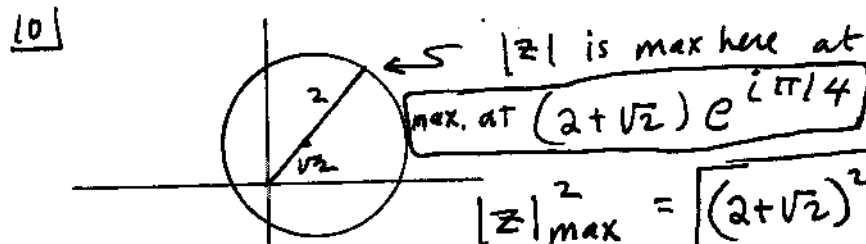

$|z|_{\max}^2 = (2 + \sqrt{2})^2$

$|z|^2$ min. at 0, 0

$|z|_{\min}^2 = 0$

the min. modulus thm does not apply since $f(z) = 0$ in \mathbb{R}

11 $|f(z)| = e^x$

max value = e^2 at $x=2, y=1$

min value = $e^0 = 1$ at $x=0, y=1$

12 From exercises, Sec 3.2

$| \sin z | = \sqrt{\sinh^2 y + \sin^2 x}$

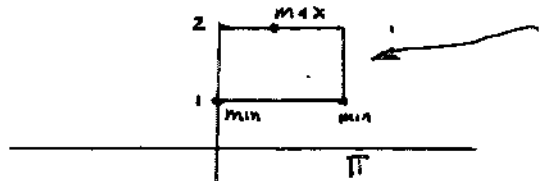

The max value must lie on this rectangular boundary

at $x=0, x=\pi$ the $\sin^2 x$ term vanishes so that $|\sin z| = \sinh y$

$\sinh 2 > \sinh 1$

On top boundary $|\sin z| = \sqrt{\sinh^2 2 + \sin^2 x}$

On bottom: $|\sin z| = \sqrt{\sinh^2 1 + \sin^2 x}$

∴ max is on top. $\sin^2 x$ is max at $x = \pi/2$

max occurs at $x = \pi/2, y = 2$. Max. value is $\sqrt{\sinh^2 2 + 1} = \cosh 2$

sec 4.6

5] Consider $\frac{1}{2\pi i} \oint \frac{\text{Log}(z^n+a)}{z} dz$ around $|z|=1$. Where are branch points of the Log ? where $z^n+a=0$
 $z = (-a)^{1/n}$. All the branch points lie on a circle of radius $\sqrt[n]{a} > 1$. None of the branch cuts [along which z^n+a is zero or negative real] intersect or enter the unit circle $|z|=1$. A typical branch cut for $\text{Log}(z^n+a)$ is shown below:

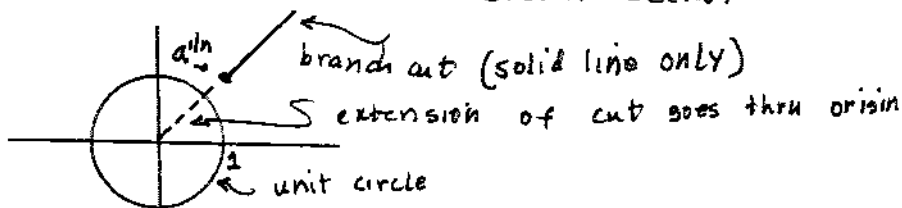

Thus $\text{Log}(z^n+a)$ is analytic on and inside the unit circle. We can apply Eq. (4.6-1) taking $r=1$, $f(z) = \text{Log}(z^n+a)$, $z_0=0$. Thus $\text{Log}(a) = \frac{1}{2\pi} \int_0^{2\pi} \text{Log}[e^{in\theta}+a] d\theta$ ←

Now $\text{Log}[e^{in\theta}+a] = \text{Log}|e^{in\theta}+a| + i \arg[e^{in\theta}+a]$ now equate Reals

$$\text{Re}(\text{Log} a) = \text{Log} a = \frac{1}{2\pi} \int_0^{2\pi} \text{Log}|e^{in\theta}+a| d\theta =$$

$$\frac{1}{4\pi} \int_0^{2\pi} \text{Log}|e^{in\theta}+a|^2 d\theta = \frac{1}{4\pi} \int_0^{2\pi} \text{Log}[(e^{in\theta}+a)(e^{-in\theta}+a)] d\theta$$

$$= \frac{1}{4\pi} \int_0^{2\pi} \text{Log}[a^2+1+2a \cos(n\theta)] d\theta$$

$$\therefore 4\pi \text{Log}(a) = \int_0^{2\pi} \text{Log}[a^2+1+2a \cos(n\theta)] d\theta$$

6] on $|z|=r$, average value is $\int_0^{2\pi} \frac{(x^2+y^2)}{2\pi} d\theta = g_{avg}$

$x = r \cos \theta$, $y = r \sin \theta$. $\therefore g_{avg} = \frac{1}{2\pi} \int_0^{2\pi} (r^2 \cos^2 \theta - r^2 \sin^2 \theta) d\theta = 0$
 since $\int_0^{2\pi} \cos^2 \theta d\theta = \int_0^{2\pi} \sin^2 \theta d\theta = \pi - \pi = 0$ $g_{avg} = g(\theta_0) = 0$

on $|z|=r$, $h_{avg} = \int_0^{2\pi} \frac{x^2+y^2}{2\pi} d\theta$, $x = r \cos \theta$
 $y = r \sin \theta$

$$h_{avg} = \frac{1}{2\pi} r^2 \int_0^{2\pi} (\cos^2 \theta + \sin^2 \theta) d\theta = r^2 = h_{avg}$$

$h(0,0) = 0 \neq h_{avg}$ [continued next page]

section 4.6

6] continued. Note that $g = x^2 - y^2 = \text{Re}(z^2)$ is the real part of an analytic function. Thus its average value on any circle in the complex plane must equal to the value of g at the center.

The function $h(x, y)$ is not harmonic and cannot be equal to the real part of an analytic function. There is no reason to argue that the value of $h(x, y)$ at the center of a circle must be equal to the average value on the circle.

7] a)

$$U(x_0, y_0) = U_0 = \frac{1}{2\pi} \int_0^{2\pi} U(z_0 + re^{i\theta}) d\theta = \left[\begin{array}{l} \text{Use} \\ \text{4 term} \\ \text{series} \\ \text{approx.} \end{array} \right]$$

$$\frac{1}{2\pi} \left[U[z_0 + re^{i0}] * \frac{\pi}{2} + U[z_0 + re^{i\pi/2}] * \frac{\pi}{2} \right.$$

$$\left. + U[z_0 + re^{i\pi}] * \frac{\pi}{2} + U[z_0 + re^{i3\pi/2}] * \frac{\pi}{2} \right] =$$

$$\frac{1}{4} [U_1 + U_2 + U_3 + U_4]$$

b) average of 4 values is 1.4687006

but $e^x \cos y \Big|_{1,1} =$ 1.4686939

```
%section 4.6 problem7, part (c)
r=linspace(.1,1,100);
u1=exp(1)*cos(1+r);u3=exp(1)*cos(1-r);
u2=cos(1)*exp(1+r);u4=cos(1)*exp(1-r);
avg=(u1+u2+u3+u4)/4;
exact=exp(1)*cos(1);
plot(r,avg);hold on
plot(r,exact,'LineWidth',2);
```

section 4.6

7) continued,

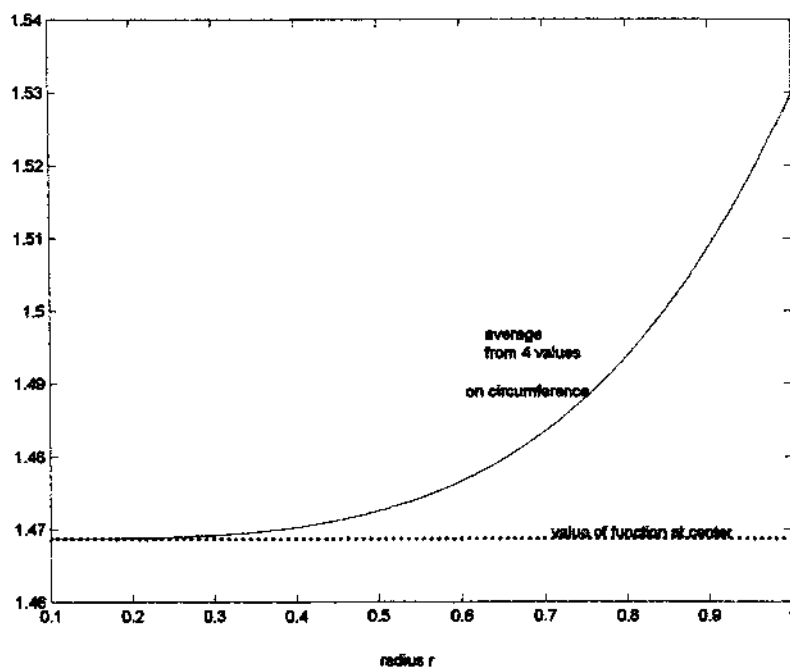

8) $g(z) = 1/f(z)$ is the quotient of 2 analytic functions: 1 and $f(z)$. Thus $g(z)$ is analytic at every interior point of R since $f(z)$ is analytic and $\neq 0$ at every such point. By the max. modulus theorem, the max. value of $|g(z)|$ in R must be on the boundary of R . Since $|g(z)|$ is max where $|f(z)|$ is min., it follows that the minimum value of $|f(z)|$ in R must be on the boundary of R .

Section 4.6

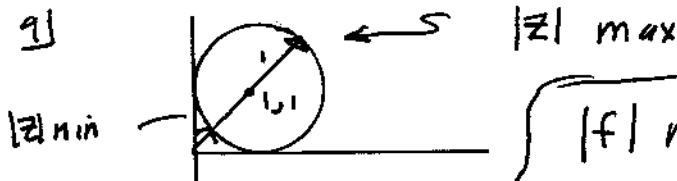

$|f|$ max at $(\sqrt{2} + 1) e^{i\pi/4}$
 $|f|$ max = $\sqrt{2} + 1$

$|f|$ min at $(\sqrt{2} - 1) e^{i\pi/4}$, $|f|$ min = $\sqrt{2} - 1$

10)

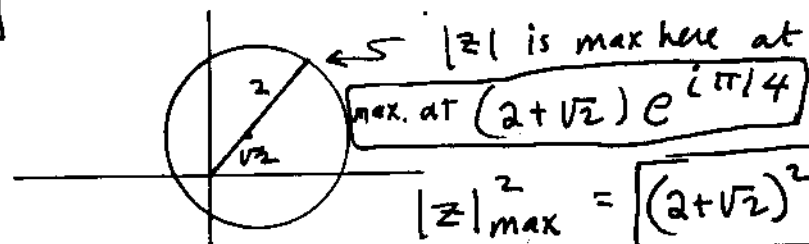

max. at $(2 + \sqrt{2}) e^{i\pi/4}$

$|z|_{\max}^2 = (2 + \sqrt{2})^2$

$|z|_{\min}^2$ min. at $0, 0$

$|z|_{\min} = 0$

the min. modulus thm does not apply since $f(z) = 0$ in \mathbb{R}

11) $|f(z)| = e^x$

max value = e^2 at $x=2, y=1$

min value = $e^0 = 1$ at $x=0, y=1$

12) From exercises, sec 3.2

$|\sin z| = \sqrt{\sinh^2 y + \sin^2 x}$

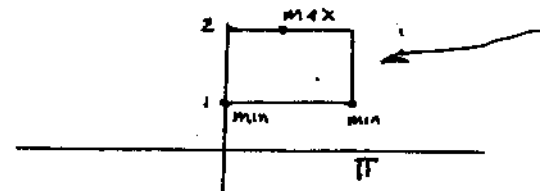

The max value must lie on this rectang. boundary
 at $x=0, x=\pi$ the $\sin^2 x$ term vanishes so that $|\sin z| = \sinh y$

On top boundary $|\sin z| = \sqrt{\sinh^2 y + \sin^2 x}$

On bottom: $|\sin z| = \sqrt{\sinh^2 y + \sin^2 x}$

∴ max is on top. $\sin^2 x$ is max at $x = \pi/2$

max occurs at $x = \pi/2, y = 2$. Max. value is $\sqrt{\sinh^2 2 + 1} = \cosh 2$

Section 4.6

12) continued. Note that $\sin z \neq 0$ in the given region since $\sin z = 0$ if and only if $z = k\pi$, k is an integer. \therefore can apply minimum modulus theory

$\sqrt{\sinh^2 y + \sin^2 x} = \sinh y$ if $x = 0$ or π . $\sinh y$ is smallest where y is smallest: $y = 1$. Thus minimum occurs at $x = 0, y = 1$ or $x = \pi, y = 1$ and the value of $|\sin z|$ is $\sinh 1$.

13) $F = U + iV$ analytic in R , $e^{F(z)}$ is analytic in R (an analytic func. of an analytic func.)

$|e^{F(z)}|$ has its max value on boundary of R .

$|e^{F(z)}| = |e^{U+iV}| = e^U$ has its max. value on boundary. But e^u is max. where u is max. (e^u is a monotonic func. of u). Thus u is max. on boundary.

14) Refer to previous problem. $e^{F(z)}$ is non-zero. Thus $|e^{F(z)}|$ has its min. value on boundary (min. modulus princ.) $|e^F| = e^u$ has its min. value on boundary. Therefore the min. value of u is on boundary of R

15)



Note u is harmonic

u max here

max at $1,0$

min at $0,1$

Sec 4.6 Cont'd

16] Since T is harmonic, max and min. values are on boundary, i.e. $r=1$.

$$\frac{d}{d\theta} \sin\theta \cos^2\theta = \cos\theta [\cos^2\theta - 2\sin^2\theta] = 0$$

$$\cos\theta = 0, \text{ or } \cos^2\theta - 2\sin^2\theta = 0$$

$$\text{Thus } \theta = +\frac{\pi}{2}, \theta = \frac{3\pi}{2}, \text{ or } \tan^2\theta = \frac{1}{2}$$

$$\text{For max or min, } \tan^2\theta = 1/2, \text{ thus } \sin\theta \cos^2\theta = \pm \frac{1}{\sqrt{3}} \frac{2}{3}$$

$$\text{Max} = \frac{2}{3\sqrt{3}}$$

$$\text{min} = -\frac{2}{3\sqrt{3}}$$

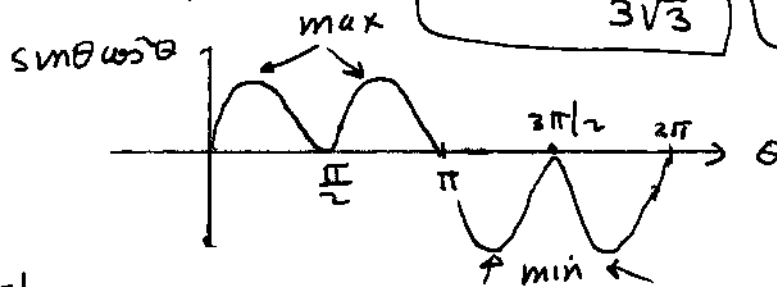

17]

$$(a) (a+b)^N = \sum_{k=0}^N a^k b^{N-k} \frac{N!}{(N-k)! k!} \quad \text{statement of binomial thm.}$$

let $N=2n$

let $a = \frac{1}{z}, b = z$

$$\left(\frac{1}{z} + z\right)^{2n} = \sum_{k=0}^{2n} \left(\frac{1}{z}\right)^k z^{2n-k} \frac{(2n)!}{(2n-k)! k!}$$

$$\left(z + \frac{1}{z}\right)^{2n} = \sum_{k=0}^{2n} z^{2n-2k} \frac{(2n)!}{(2n-k)! k!}$$

$$z^{-1} \left(z + \frac{1}{z}\right)^{2n} = \sum_{k=0}^{2n} \frac{(2n)!}{(2n-k)! k!} z^{2n-2k-1} \quad \text{g.e.d}$$

$$b) \oint_{|z|=1} z^{-1} \left(z + \frac{1}{z}\right)^{2n} dz = \sum_{k=0}^{2n} \frac{(2n)!}{(2n-k)! k!} \oint_{|z|=1} z^{2n-2k-1} dz$$

Note $\oint_{|z|=1} z^{2n-2k-1} dz = 2\pi i$ if $2n=2k$ (or $k=n$)
 $= 0$ if $k \neq n$ see Ex (4.3-10)

17] b)

Sec 4.6

cont'd

$$\oint z^{-1} \left(z + \frac{1}{z}\right)^{2n} dz = \frac{2\pi i (2n)!}{(2n-k)! k!} \Big|_{k=n}$$

$$= \frac{2\pi i (2n)!}{(n!)^2} \text{ q.e.d.}$$

(c) put $z = e^{i\theta}$, $dz = e^{i\theta} i d\theta$ $\left(z + \frac{1}{z}\right)^{2n} = (2\cos\theta)^{2n}$
 θ goes from $0 \rightarrow 2\pi$

$$\oint z^{-1} \left(z + \frac{1}{z}\right)^{2n} dz = \int_0^{2\pi} i (2\cos\theta)^{2n} d\theta = \frac{2\pi i (2n)!}{(n!)^2}$$

cancel i each side

(d) Since $2n$ is even, $\int_0^{2\pi} (\cos\theta)^{2n} d\theta = 4 \int_0^{\pi/2} (\cos\theta)^{2n} d\theta$

Note symmetry of $\cos\theta$ raised to even powers.

$$\int_0^{2\pi} (2\cos\theta)^{2n} d\theta = 2^{2n} \cdot 4 \int_0^{\pi/2} (\cos\theta)^{2n} d\theta$$

$$= \frac{(2\pi)(2n)!}{(n!)^2} \quad \text{or} \quad \int_0^{\pi/2} (\cos\theta)^{2n} d\theta = \frac{\pi}{2} \frac{(2n)!}{(n!)^2} 2^{-2n} \text{ q.e.d.}$$

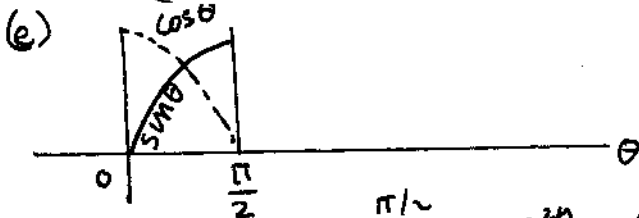

From symmetry, $\int_0^{\pi/2} (\sin\theta)^{2n} d\theta = \int_0^{\pi/2} (\cos\theta)^{2n} d\theta$

Thus $\int_0^{\pi/2} (\sin\theta)^{2n} d\theta = \frac{\pi}{2} \frac{(2n)!}{(n!)^2} 2^{-2n}$

18] (a) Note $zR_{n-1}(z) = z^n + z_0 z^{n-1} + z_0^2 z^{n-2} + \dots + z z_0^{n-1}$
 $z_0 R_{n-1}(z) = z_0 z^{n-1} + z_0^2 z^{n-2} + \dots + z_0^n$

subtracting 2nd line from first

$$zR_{n-1}(z) - z_0 R_{n-1}(z) = (z - z_0) R_{n-1}(z) = z^n - z_0^n \text{ q.e.d.}$$

Sec 4.6 cont'd

$$18(b) \quad p(z) = a_n z^n + a_{n-1} z^{n-1} + \dots + a_0$$

$$p(z_0) = a_n z_0^n + a_{n-1} z_0^{n-1} + \dots + a_0 = 0$$

Since z_0 is a root.

Subtract 2nd line from first:

$$p(z) = a_n (z^n - z_0^n) + a_{n-1} (z^{n-1} - z_0^{n-1}) + \dots + a_1 (z - z_0)$$

18(c) Use result of part (a) in the preceding.

Thus $(z^n - z_0^n) = (z - z_0) R_{n-1}(z)$ where R_{n-1} is a poly. of degree $(n-1)$ in z

$$z^{n-1} - z_0^{n-1} = (z - z_0) R_{n-2}(z), \quad z^{n-2} - z_0^{n-2} = (z - z_0) R_{n-3}(z)$$

etc.

Thus using these results in last line of (b)

$$p(z) = a_n (z - z_0) R_{n-1}(z) + a_{n-1} (z - z_0) R_{n-2}(z) + \dots + a_1 (z - z_0)$$

18(d) Factor out $(z - z_0)$ from the preceding line.

$$\text{Thus } p(z) = (z - z_0) [a_n R_{n-1}(z) + a_{n-1} R_{n-2}(z) + \dots + a_1]$$

The expression in the brackets is a polynomial of degree $(n-1)$ in z .

Sec 4.7

1) Physically the potential (Voltage) should be zero because we are exactly half way between the boundaries which are maintained at potentials of 1 volt and -1 volt respectively.

Let $\theta \rightarrow 0^+$

$$\begin{aligned} U(r, \theta) &= \frac{2}{\pi} \left[\tan^{-1} \left[\frac{1+r}{1-r} \tan \frac{\pi}{2} \right] + \tan^{-1} \left[\frac{1+r}{1-r} \cdot 0 \right] - \frac{\pi}{2} \right] \\ &= \frac{2}{\pi} \left[\tan^{-1} [\infty] + \tan^{-1}(0) - \frac{\pi}{2} \right] = \frac{2}{\pi} \left[\frac{\pi}{2} - \frac{\pi}{2} \right] = \boxed{0} \end{aligned}$$

sec 4.7

1 (b) Assume $0 < \theta < \pi$, let $r \rightarrow 1$

$$\lim_{r \rightarrow 1} \tan^{-1} \left[\frac{1+r}{1-r} \tan \left(\frac{\pi}{2} - \frac{\theta}{2} \right) \right] \rightarrow \tan^{-1} [+\infty] = \frac{\pi}{2}$$

$$\lim_{r \rightarrow 1} \tan^{-1} \left[\frac{1+r}{1-r} \tan \frac{\theta}{2} \right] \rightarrow \tan^{-1}(\infty) = \frac{\pi}{2}$$

$$\text{thus } r \rightarrow 1 \quad u(r, \theta) = \frac{2}{\pi} \left[\frac{\pi}{2} + \frac{\pi}{2} - \frac{\pi}{2} \right] = 1 \quad \text{q.e.d.}$$

Now assume $\pi < \theta < 2\pi$

$$\lim_{r \rightarrow 1} \tan^{-1} \left[\frac{1+r}{1-r} \tan \left(\frac{\pi}{2} - \frac{\theta}{2} \right) \right] \rightarrow \tan^{-1} [-\infty] = -\frac{\pi}{2}$$

$$\lim_{r \rightarrow 1} \tan^{-1} \left[\frac{1+r}{1-r} \tan \frac{\theta}{2} \right] \rightarrow \tan^{-1} [-\infty] = -\frac{\pi}{2}$$

$$\text{thus } r \rightarrow 1 \quad u(r, \theta) = \frac{2}{\pi} \left[-\frac{\pi}{2} - \frac{\pi}{2} + \frac{\pi}{2} \right] = -1 \quad \text{q.e.d.}$$

1 (c)

%for fig 4.7-3 and problem 1 sec 4.7

clear fig

clear

r=[.1 .3 .5 .7 .9];

thet=linspace(0,2*pi,200);

for j=1:length(r)

 q=(1+r(j))/(1-r(j));

 p2=pi/2;

 u1=2/pi*(atan(q*tan(p2-thet/2)))

 u2=2/pi*(atan(q*tan(thet/2)))

 u3=sign(thet-pi);

 u=u1+u2+u3

 plot(thet,u);hold on;

end

grid on

2] next pg.

$$2(a) \quad u(r, \theta) = \frac{1}{2\pi} \int_0^\pi \frac{(100)(R^2 - r^2) d\phi}{5^2 + r^2 - 2 \cdot 5 \cdot r \cos(\phi - \theta)} =$$

Let $x = \phi - \theta$ in the above

$$u(r, \theta) = \frac{1}{2\pi} \int_{-\theta}^{\pi - \theta} \frac{(100)(R^2 - r^2) dx}{5^2 + r^2 - 10r \cos(x)} \quad \begin{array}{l} \text{Use integral} \\ R=5 \end{array}$$

given in example 1, take $a = 25 + r^2$, $b = -10r$

$$u(r, \theta) = \frac{1}{2\pi} \times \frac{(25 - r^2) \times 100 \times 2}{\sqrt{(25 + r^2)^2 - 100r^2}} \tan^{-1} \left[\frac{\sqrt{a^2 - b^2}}{a + b} \tan \frac{x}{2} \right]_{-\theta}^{\pi - \theta}$$

Note $\frac{\sqrt{a^2 - b^2}}{a + b} = \frac{5 + r}{5 - r}$, $\frac{25 - r^2}{\sqrt{(25 + r^2)^2 - 100r^2}} = 1$

$$\text{Thus } u(r, \theta) = \frac{100}{\pi} \left[\tan^{-1} \left[\frac{5+r}{5-r} \tan \left[\frac{\pi - \theta}{2} \right] \right] + \tan^{-1} \left[\frac{5+r}{5-r} \tan \frac{\theta}{2} \right] \right]$$

if the \tan^{-1} is evaluated between $-\frac{\pi}{2}$ and $\frac{\pi}{2}$ the constant $C = \pi$ must be appended if $\pi < \theta < 2\pi$

2 (b) Assume $0 < \theta < \pi$

$$\lim_{r \rightarrow 5} \tan^{-1} \left[\frac{5+r}{5-r} \tan \left(\frac{\pi - \theta}{2} \right) \right] = \tan^{-1}(\infty) = \frac{\pi}{2}$$

$$\lim_{r \rightarrow 5} \tan^{-1} \left[\frac{5+r}{5-r} \tan \frac{\theta}{2} \right] = \tan^{-1}(\infty) = \frac{\pi}{2}$$

$$u(r, \theta) = \frac{100}{\pi} \left[\frac{\pi}{2} + \frac{\pi}{2} \right] = 100$$

Now assume $\pi < \theta < 2\pi$

$$\lim_{r \rightarrow 5} \tan^{-1} \left[\frac{5+r}{5-r} \tan \left(\frac{\pi - \theta}{2} \right) \right] = \tan^{-1}(-\infty) = -\frac{\pi}{2}$$

$$\lim_{r \rightarrow 5} \tan^{-1} \left[\frac{5+r}{5-r} \tan \frac{\theta}{2} \right] = \tan^{-1}(-\infty) = -\frac{\pi}{2}$$

$$u = \frac{100}{\pi} \left[-\frac{\pi}{2} - \frac{\pi}{2} + \pi \right] = 0$$

Sec 4.7

2 (c) % problem 2 sec 4.7

```
clear
r=[ 1 2 4 ];
thet=linspace(0,2*pi,200);
for j=1:length(r)
    q=(5+r(j))/(5-r(j));
    p2=pi/2;
    u1=100/pi*(atan(q*tan(p2-thet/2)));
    u2=100/pi*(atan(q*tan(thet/2)));
    u3=50*(1+sign(thet-pi));
    u=u1+u2+u3;
    plot(thet,u);hold on;
end
grid on
```

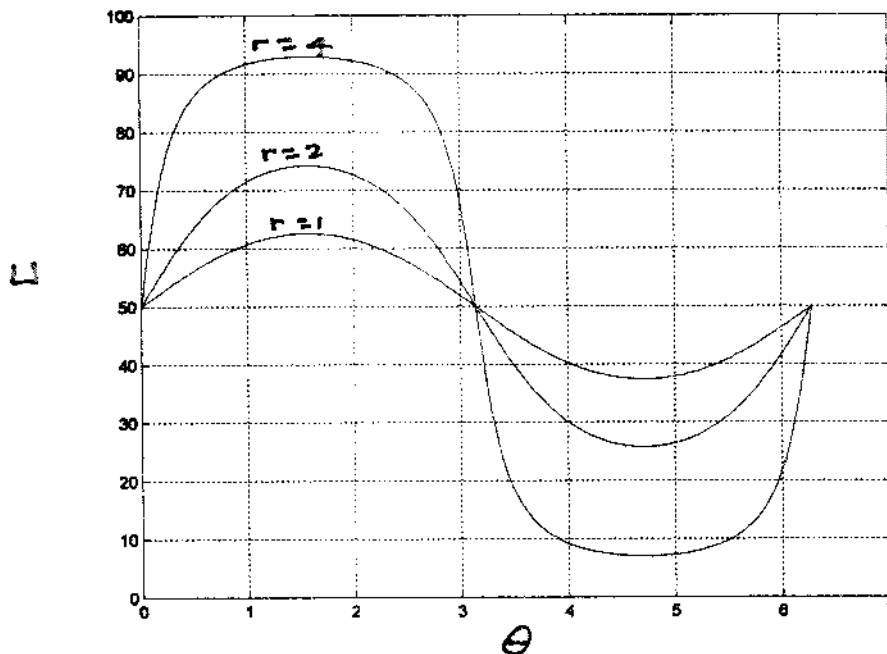

3)
$$U(r, \theta) = \frac{V_0}{2\pi} \int_0^{2\pi} \frac{R^2 - r^2 d\phi}{R^2 + r^2 - 2Rr \cos(\phi - \theta)}$$
 let $x = \phi - \theta$

Use formula given in example 1.

$$U(r, \theta) = \frac{V_0}{2\pi} (R^2 - r^2) \int_{-\theta}^{2\pi - \theta} \frac{dx}{R^2 + r^2 - 2Rr \cos x} = \text{(see next pg.)}$$

sec 4.7 cont'd

3 cont'd

$$u(r, \theta) = \frac{V_0}{2\pi} \frac{(R+r)(R-r)^2}{\sqrt{(R-r)^2(R+r)^2}} \tan^{-1} \left[\frac{\sqrt{(R-r)^2(R+r)^2} \tan \frac{\theta}{2}}{R^2 + r^2 - 2Rr} \right]_{-\theta}^{2\pi - \theta}$$

$$u(r, \theta) = \frac{V_0}{\pi} \left[\tan^{-1} \left[\frac{R+r}{R-r} \tan(\pi - \frac{\theta}{2}) \right] + \tan^{-1} \left[\frac{R+r}{R-r} \tan \frac{\theta}{2} \right] \right]$$

$\tan(\pi - \frac{\theta}{2}) = -\tan \frac{\theta}{2}$, let $y = \frac{R+r}{R-r} \tan \frac{\theta}{2}$

$u(r, \theta) = \frac{V_0}{\pi} [-\tan^{-1} y + \tan^{-1} y]$. Now \tan^{-1} is multivalued. $\tan^{-1} y - \tan^{-1} y = n\pi$, n integer.

We must choose $n = 1$ so that $u = V_0$, otherwise max. and min. principles are violated.

4) a)

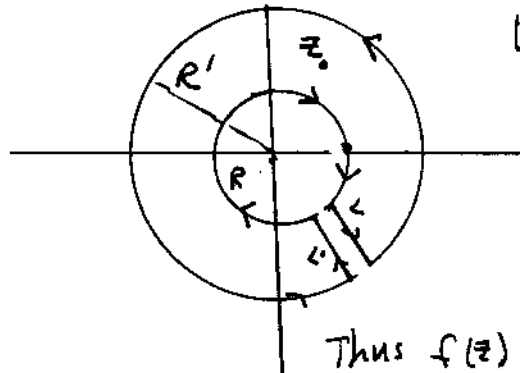

Use Cauchy Integral formula around contour shown. Note that integrals along L and L' cancel each other.

Thus $f(z) = \frac{1}{2\pi i} \oint_{|w|=R'} \frac{f(w)}{w-z} dw$

$+ \frac{1}{2\pi i} \oint_{|w|=R} \frac{f(w)}{(w-z)}$

b)

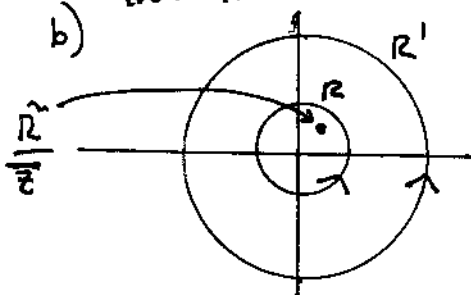

Using princ. of deformation of contours:

$\frac{1}{2\pi i} \oint_{|w|=R'} \frac{f(w)}{(w-z_1)} dw$

$= \frac{1}{2\pi i} \oint_{|w|=R} \frac{f(w)}{(w-z_1)} dw$

Sec 4.7 cont'd

4(b) cont'd, rearrange previous eqn.

$$0 = \frac{1}{2\pi i} \oint_{|w|=R'} \frac{f(w)}{(w-z_1)} dw + \frac{1}{2\pi i} \oint_{|w|=R'} \frac{f(w)}{(w-z_1)} dw$$

4(c) Note: $\left(\frac{1}{w-z}\right) - \frac{1}{(w-z_1)} = \frac{(z-z_1)}{(w-z)(w-z_1)}$
 $= \frac{z - \frac{R^2}{\bar{z}}}{(w-z)(w - \frac{R^2}{\bar{z}})}$ since $z_1 = \left(\frac{R^2}{\bar{z}}\right)$

Thus subtracting the formula in (b) from that in (a) we have the required result.

4(d) Note if $|w|=R'$, that $|w-z| \geq |w|-|z| = R' - |z|$.

Thus $\frac{1}{|w-z|} \leq \frac{1}{R'-|z|}$. Similarly $\frac{1}{|w - \frac{R^2}{\bar{z}}|} \leq \frac{1}{R' - \frac{R^2}{|z|}}$

$$\left| \int \frac{f(w) \left(z - \frac{R^2}{\bar{z}}\right)}{(w-z) \left(w - \frac{R^2}{\bar{z}}\right)} dw \right| \leq \frac{\left|z - \frac{R^2}{\bar{z}}\right|}{(R'-|z|) \left(R' - \frac{R^2}{|z|}\right)} \cdot \frac{M \cdot 2\pi R'}{L}$$

where $L = 2\pi R'$. The preceding $\rightarrow 0$ as $R' \rightarrow \infty$

4(e) $w = Re^{i\phi}$, $z = re^{i\theta}$, $dw = Re^{i\phi} i d\phi$

Thus $f(r, \theta) = \frac{1}{2\pi i} \oint \frac{f(w) (z - R^2/\bar{z})}{(w-z)(w - R^2/\bar{z})} dw =$

$$\frac{1}{2\pi} \int_0^{2\pi} \frac{f(R, \phi) \left[re^{i\theta} - \frac{R^2}{r} e^{i\theta} \right] Re^{i\phi} d\phi}{\left[Re^{i\phi} - re^{i\theta} \right] \left[Re^{i\phi} - \frac{R^2}{r} e^{i\theta} \right]}$$

Now follow the steps suggested in derivation of Eq (4.7-4) and reverse direction of integration, compensate with a minus sign. Get

$$f(r, \theta) = u + iv(r, \theta) = \frac{1}{2\pi} \int_0^{2\pi} \frac{[u(R, \phi) + iv(R, \phi)] [r^2 - R^2]}{R^2 + r^2 - 2Rr \cos(\phi - \theta)} d\phi \quad \left[\begin{array}{l} \text{Take} \\ \text{real part} \\ \text{each side.} \end{array} \right]$$

Sec 4.7, cont'd

5) a) Using (4.7-10)

$$u(r, \theta) = \frac{1}{2\pi} \int_0^\pi \frac{(100)(r^2 - R^2) d\phi}{5^2 + r^2 - 10r \cos(\phi - \theta)} \quad R=5$$

This is the negative of the integral evaluated in exercise (2). Refer to exercise 2 solution.

You now have:

$$u(r, \theta) = \frac{100}{\pi} \left[\tan^{-1} \left[\frac{5+r}{5-r} \tan \left[\frac{\pi - \theta}{2} \right] \right] + \tan^{-1} \left[\frac{5+r}{5-r} \tan \frac{\theta}{2} \right] \right]$$

You can remove minus by replacing $5-r$ with $r-5$ in the above

$$u(r, \theta) = \frac{100}{\pi} \left[\tan^{-1} \left[\frac{5+r}{r-5} \tan \left[\frac{\pi}{2} - \frac{\theta}{2} \right] \right] + \tan^{-1} \left[\frac{5+r}{r-5} \tan \frac{\theta}{2} \right] \right]$$

Suppose we agree that $-\frac{\pi}{2} \leq \tan^{-1}(\dots) \leq \frac{\pi}{2}$

Then assume that $0 < \theta < \pi$. Now as $r \rightarrow 5^+$

$$u(r, \theta) = \frac{100}{\pi} \left[\tan^{-1} [+\infty] + \tan^{-1} [\infty] \right] = \frac{100}{\pi} \left[\frac{\pi}{2} + \frac{\pi}{2} \right] = 100$$

Now assume $\pi < \theta < 2\pi$

$$\lim_{r \rightarrow 5^+} \tan^{-1} \left[\frac{r+5}{r-5} \tan \left[\frac{\pi}{2} - \frac{\theta}{2} \right] \right] = \tan^{-1} [-\infty] = -\frac{\pi}{2}$$

$$\lim_{r \rightarrow 5^+} \tan^{-1} \left[\frac{5+r}{r-5} \tan \frac{\theta}{2} \right] = \tan^{-1} [-\infty] = -\frac{\pi}{2}$$

To obtain $\lim_{r \rightarrow 5} u(r, \theta) = 0$, $\pi < \theta < 2\pi$ you must append a constant $C = \pi$ as described in the statement of the problem.

b) see discussion of (a)

$$c) u(r, \frac{\pi}{2}) = \frac{100}{\pi} \left[2 \tan^{-1} \left[\frac{5+r}{r-5} \right] \right]$$

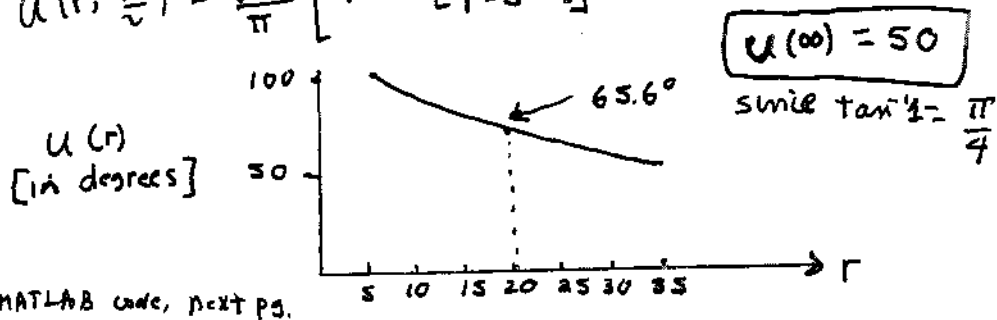

MATLAB code, next pg.

```

%for prob 5, (c) sec 4.7
5 c) clear fig
clear
r=linspace(5.001,50,100);
thet=pi/2;

q=(5+r)./(r-5);
p2=pi/2;
u1=100/pi*(atan(q*tan(p2-thet/2)));
u2=100/pi*(atan(q*tan(thet/2)));
u3=50*sign(thet-pi)+50;
u=u1+u2+u3;
plot(r,u);hold on;

```

grid on

```

5 d) %for prob 5, (d) sec 4.7
clear fig
clear
r=[ 5.5 7 10 15 25];
thet=linspace(0,2*pi,200);
for j=1:length(r)
    q=(5+r(j))/(r(j)-5);
    p2=pi/2;
    u1=100/pi*(atan(q*tan(p2-thet/2)));
    u2=100/pi*(atan(q*tan(thet/2)));
    u3=50*sign(thet-pi)+50;
    u=u1+u2+u3;
    plot(thet,u);hold on;
end; grid

```

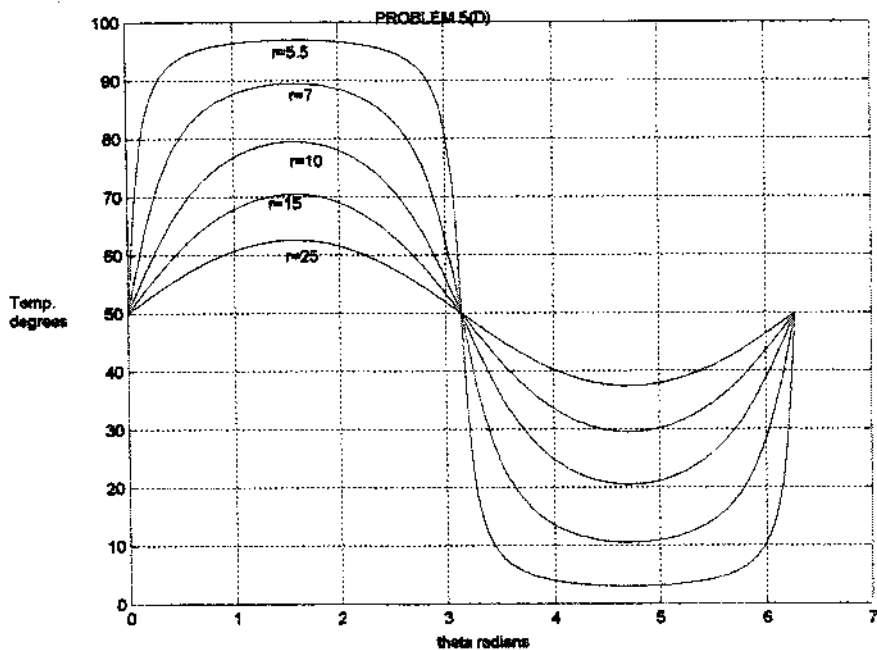

sec 4.7 cont'd

6) (a)

$$\begin{aligned} \phi(x, y) &= \frac{y}{\pi} \int_{-\infty}^{+\infty} \frac{\phi(u, \phi) du}{(u-x)^2 + y^2} = \frac{y}{\pi} \left[\int_{-\infty}^0 \frac{-V_0 du}{(u-x)^2 + y^2} \right. \\ &+ \left. \int_0^{\infty} \frac{V_0 du}{(u-x)^2 + y^2} \right] = \frac{y}{\pi} \left[\int_0^{-\infty} \frac{du}{(u-x)^2 + y^2} + \int_0^{\infty} \frac{du}{(u-x)^2 + y^2} \right] \\ &= \frac{V_0}{\pi} \left[\frac{1}{y} \left[\tan^{-1} \left[\frac{u-x}{y} \right] \right]_0^{-\infty} + \frac{1}{y} \left[\tan^{-1} \left[\frac{u-x}{y} \right] \right]_0^{\infty} \right] \\ &= \frac{V_0}{\pi} \left[2 \tan^{-1} \left(\frac{x}{y} \right) \right] \quad \text{recall } \tan^{-1} a = \frac{\pi}{2} - \tan^{-1}(a^{-1}) \end{aligned}$$

Thus $\phi(x, y) = \frac{2V_0}{\pi} \left[\frac{\pi}{2} - \tan^{-1} \left[\frac{y}{x} \right] \right] = V_0 - \frac{2V_0}{\pi} \tan^{-1} \left[\frac{y}{x} \right]$

Recall $\text{Im} [\text{Log} z] = \tan^{-1} \frac{y}{x}$ where $0 \leq \tan^{-1} \frac{y}{x} \leq \pi$

Thus $\phi(x, y) = V_0 - \frac{2V_0}{\pi} \text{Im} \text{Log} z$

b) $\phi = \frac{V_0}{2} = V_0 - \frac{2V_0}{\pi} \tan^{-1} \left(\frac{y}{x} \right) \therefore \tan^{-1} \frac{y}{x} = \frac{\pi}{4}$

or $\theta = \frac{\pi}{4}$ where $z = r \text{cis}(\theta)$

Similarly $\phi = -\frac{V_0}{2} = \frac{V_0}{2} - \frac{2V_0}{\pi} \tan^{-1} \left(\frac{y}{x} \right), \tan^{-1} \left(\frac{y}{x} \right) = \frac{3\pi}{4}$

$\theta = \frac{3\pi}{4}$

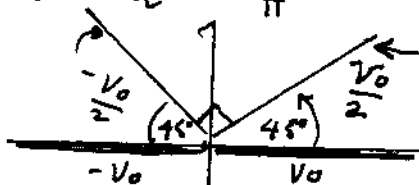

c)

$$E_x = -\frac{\partial \phi}{\partial x} = -\frac{2V_0}{\pi} \frac{y}{x^2 + y^2} \Big|_{1,1} = -\frac{V_0}{\pi}$$

$$E_y = -\frac{\partial \phi}{\partial y} = \frac{2V_0}{\pi} \frac{x}{x^2 + y^2} \Big|_{1,1} = \frac{V_0}{\pi}$$

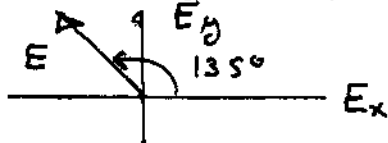

Sec 4.7

$$7. (a) \phi(x, y) = \frac{V_0}{\pi} \int_{-h}^h \frac{V_0}{(u-x)^2 + y^2} du =$$

$$\frac{V_0}{\pi} \frac{V_0}{y} \tan^{-1} \left[\frac{u-x}{y} \right] \Big|_{-h}^{+h} = \frac{V_0}{\pi} \left[\tan^{-1} \left(\frac{h-x}{y} \right) + \tan^{-1} \left[\frac{h+x}{y} \right] \right]$$

$$= \frac{V_0}{\pi} \left[-\tan^{-1} \left[\frac{x-h}{y} \right] + \tan^{-1} \left[\frac{x+h}{y} \right] \right] \quad \text{q.e.d.}$$

(b) If $x > h$, $\lim_{y \rightarrow 0^+} \tan^{-1} \left[\frac{x-h}{y} \right] = \frac{\pi}{2}$
 If $x < h$, $\lim_{y \rightarrow 0^+} \tan^{-1} \left[\frac{x-h}{y} \right] = -\pi/2$
 If $x > -h$, $\lim_{y \rightarrow 0^+} \tan^{-1} \left(\frac{x+h}{y} \right) = \frac{\pi}{2}$
 If $x < -h$, $\lim_{y \rightarrow 0^+} \tan^{-1} \left(\frac{x+h}{y} \right) = -\frac{\pi}{2}$

Thus.

$$\lim_{\substack{y \rightarrow 0^+ \\ x > h}} \phi(x, y) = \frac{V_0}{\pi} \left[-\frac{\pi}{2} + \frac{\pi}{2} \right] = 0$$

$$\lim_{\substack{y \rightarrow 0^+ \\ -h < x < h}} \phi(x, y) = \frac{V_0}{\pi} \left[\frac{\pi}{2} + \frac{\pi}{2} \right] = 2V_0$$

$$\lim_{\substack{y \rightarrow 0^+ \\ x < -h}} \phi(x, y) = \frac{V_0}{\pi} \left[\frac{\pi}{2} - \frac{\pi}{2} \right] = 0$$

(c) $\phi(0, y) = \frac{V_0}{\pi} \left[-\tan^{-1} \left(-\frac{h}{y} \right) + \tan^{-1} \left(\frac{h}{y} \right) \right] = \frac{2V_0}{\pi} \tan^{-1} \frac{h}{y}$
 $\phi(0, y) \approx 2V_0 h / (\pi y)$

If $y \gg h$,
 7 (d)

```
x=linspace(-5, 5, 100);
y=.5;
h=1;
q1=(x-h)/y;
q2=(x+h)/y;
```

```
u1=1/pi*(-atan(q1));
u2= 1/pi*(atan(q2));
u=u1+u2;
plot(x, u); grid
```

sec 4.7

9

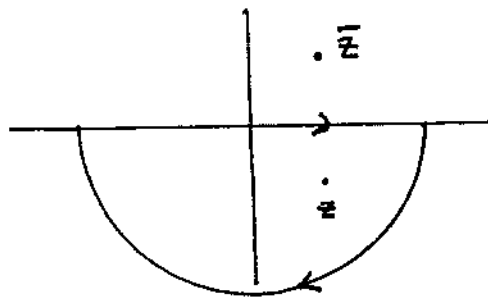

Apply Cauchy integral formula to contour shown. Note need for minus sign because of direction of integration

$$f(z) = \frac{-1}{2\pi i} \oint \frac{f(w)}{(w-z)} dw, \quad 0 = \frac{-1}{2\pi i} \oint \frac{f(w)}{(w-\bar{z})} dw$$

Subtract 2nd integral from first:

$$f(z) = \frac{-1}{2\pi i} \oint f(w) \left[\frac{z-\bar{z}}{(w-z)(w-\bar{z})} \right] dw$$

$$f(z) = \frac{-1}{2\pi i} \int_{-R}^R \frac{f(w) 2iy}{(w-z)(w-\bar{z})} dw + \frac{-1}{2\pi i} \int_{\text{arc}} \frac{f(w) 2iy}{(w-z)(w-\bar{z})} dw$$

→ on line $v=0$ $(w-z)(w-\bar{z}) = (u-x)^2 + y^2$

sec prob. $\int \rightarrow 0 \text{ as } R \rightarrow \infty$

$$f(z) = \frac{-iy}{\pi} \int_{-\infty}^{+\infty} \frac{f(u) du}{(u-x)^2 + y^2}$$

$$\phi(x,y) = \frac{-iy}{\pi} \int_{-\infty}^{+\infty} \frac{\phi(u,0) du}{(u-x)^2 + y^2}$$

Now put
 $f(z) = \phi(x,y) + i\psi(x,y)$
 $f(u) = \phi(u,0) + i\psi(u,0)$, equate real part of each side

5

**Infinite Series Involving a
Complex Variable**

Sec 5.1

$$1) \frac{1}{(1-x)} = \sum_{n=0}^{\infty} C_n X^n \quad C_0 = \frac{1}{(1-x)} \Big|_{x=0} = 1,$$

$$C_1 = \frac{1}{(1-x)^2} \Big|_{x=0} = 1, \quad C_2 = \frac{2}{(1-x)^3} \frac{1}{2!} \Big|_{x=0} = 1$$

$$\text{Similarly } C_3 = \frac{3 \cdot 2}{(1-x)^4} \frac{1}{3!} \Big|_{x=0} = 1$$

$$\sum_{n=0}^{\infty} C_n X^n = 1 + x + x^2 + x^3 \dots \quad n^{\text{th}} \text{ term is } X^n, n=0,1,\dots$$

$$2) C_0 = \frac{1}{(1+x)} \Big|_{x=0} = 1 \quad C_1 = \frac{-2}{(1+x)^3} \Big|_{x=0} = -2$$

$$C_2 = \frac{3 \cdot 2}{(1+x)^4} \frac{1}{2!} \Big|_{x=0} = 3, \quad C_3 = \frac{-4 \cdot 3 \cdot 2}{(1+x)^5} \frac{1}{3!} \Big|_{x=0} = 4 \dots$$

$$\text{Series } 1 - 2x + 3x^2 - 4x^3 \dots \quad \text{General term } (-1)^n (n+1) X^n$$

$$3) \frac{1}{1-x} \Big|_{x=-1} = C_0 = \frac{1}{2}, \quad C_1 = \frac{1}{(1-x)^2} \Big|_{x=-1} = \frac{1}{4}$$

$$C_2 = \frac{2}{(1-x)^3} \frac{1}{2!} \Big|_{x=-1} = \frac{1}{8}, \quad C_3 = \frac{3 \cdot 2}{(1-x)^4} \frac{1}{3!} \Big|_{x=-1} = \frac{1}{16}$$

$$\text{Series is } \frac{1}{2} + \frac{1}{4}(x+1) + \frac{1}{8}(x+1)^2 + \frac{1}{16}(x+1)^3 \dots$$

$$\text{General term } \frac{1}{2^{n+1}} (x+1)^n \quad n=0,1,2,\dots$$

$$4) C_0 = \sqrt{x} \Big|_{x=1} = 1, \quad C_1 = \frac{1}{2} \frac{1}{\sqrt{x}} \Big|_{x=1} = \frac{1}{2}$$

$$C_2 = \frac{-1}{4} \frac{1}{(\sqrt{x})^3} \frac{1}{2!} \Big|_{x=1} = -\frac{1}{8}, \quad C_3 = \frac{3}{8} \frac{1}{(\sqrt{x})^5} \frac{1}{3!} \Big|_{x=1}$$

$$= \frac{1}{16} \quad C_4 = \frac{-5 \cdot 3}{16} \frac{1}{(\sqrt{x})^7} \frac{1}{4!} \Big|_{x=1} = -\frac{5}{128}$$

$$\text{Series is } 1 + \frac{1}{2}(x-1) - \frac{1}{8}(x-1)^2 + \frac{1}{16}(x-1)^3 - \frac{5}{128}(x-1)^4 \dots$$

$$\text{General term is: } \frac{(-1)^{n+1} (2n-3)(2n-5)\dots(1)(x-1)^n}{2^n n!} \quad 1 \text{ if}$$

$n \neq 0$, and zeroth term is 1

sec 5.1 continued

5. $C_0 = \log(1-x)|_{x=0} = 0$, $C_1 = \frac{-1}{(1-x)}|_{x=0} = -1$
 $C_2 = \frac{-1}{(1-x)^2} \frac{1}{2!} |_{x=0} = \frac{-1}{2}$, $C_3 = \frac{-2}{(1-x)^3} \frac{1}{3!} |_{x=0} = \frac{-1}{3}$

Series $-(x) - \frac{1}{2}(x)^2 - \frac{1}{3}(x)^3 - \frac{x^4}{4} \dots$
 general term $\frac{(-1)(x)^n}{n}$ $n \geq 1$

6. $C_0 = 1$, $C_1 = 3|x^2|_{x=1} = 3$, $C_2 = \frac{3 \cdot 2x}{2} |_{x=1} = 3$, $C_3 = \frac{3 \cdot 2}{3!} = 1$,
 $C_4 = 0$, $C_5 = 0$, etc.

$\therefore x^3 = 1 + 3(x-1) + 3(x-1)^2 + x^3$ this is the entire series, there are no additional terms. it is a perfect representation of x^3 as the preceding.

Note $x^3 = (1+(x-1))^3$ is the same as the preceding.

7 a) $\sqrt{\frac{1}{2}} = 1 + (\frac{1}{2}-1)/2 - (\frac{1}{2}-1)^2/8 + \frac{1}{16}(\frac{1}{2}-1)^3$
 $= 1 - \frac{1}{4} - \frac{1}{32} - \frac{1}{128} = .7109375$. "exact value" = .707106

b) $x = 1/2$, $\log 1/2 = -(\frac{1}{2}) - \frac{1}{2}(\frac{1}{2})^2 - \frac{1}{3}(\frac{1}{2})^3 \dots$
 $= -\frac{1}{2} - \frac{1}{8} - \frac{1}{24} - \frac{1}{64} = -.6823\dots$, "exact value" $\log \frac{1}{2} = -.6931$

8) $\left| \frac{u_{n+1}}{u_n} \right| = |x| < 1$ conv. $\left| \frac{u_{n+1}}{u_n} \right| = |x| > 1$ div.

9) $\lim_{n \rightarrow \infty} \left| \frac{u_{n+1}}{u_n} \right| = \lim_{n \rightarrow \infty} \frac{(n+2)|x|^{n+1}}{(n+1)|x|^n} = \frac{1+2/n}{1+1/n} |x| = |x|$
 conv. for $|x| < 1$, div for $|x| > 1$

10) $\left| \frac{u_{n+1}}{u_n} \right| = \frac{2^{n+1}|x|^{n+1}}{(n+1)2^n|x|^n} = \frac{2}{1+\frac{1}{n}} |x| = 2|x| < 1$
 $|x| < 1/2$ abs. conv.

$|x| > 1/2$ div
 11) Note: $\frac{\sinh n}{e^n} = \frac{1}{2} \frac{e^n - e^{-n}}{e^n} = \frac{1}{2} [1 - e^{-2n}]$

$\left| \frac{u_{n+1}}{u_n} \right| = \frac{\frac{1}{2} [1 - e^{-2(n+1)}] |x+1|^{n+1}}{\frac{1}{2} [1 - e^{-2n}] |x+1|^n} = \frac{1 - e^{-2(n+1)}}{1 - e^{-2n}} |x+1| = |x+1|$
 $\lim_{n \rightarrow \infty} \dots$ [cont'd next pg]

sec 5.1 cont'd

11) continued

$$\lim_{n \rightarrow \infty} \left| \frac{u_{n+1}}{u_n} \right| = |x+1| < 1 \quad \text{abs. conv, } -2 < x < 0$$

div if $|x+1| > 1$ or $x > 0$ or $x < -2$

$$12) \left| \frac{u_{n+1}}{u_n} \right| = \frac{(n+1)^{n+1} |x^{n+1}| (n)!}{(n+1)! n^n |x^n|} =$$

$$\frac{1}{(n+1)} \frac{(n+1)^n}{n^n} (n+1) |x| = \lim_{n \rightarrow \infty} \left(1 + \frac{1}{n}\right)^n |x| = e|x| < 1 \quad \text{abs conv}$$

\therefore abs. conv. $|x| < 1/e$, div $|x| > 1/e$

13) $u_n = x^n$ if $x=1$, $u_n = 1^n$, as $n \rightarrow \infty$ this is 1

\therefore series diverges if $x=1$. If $x=-1$, then

$$u_n = (-1)^n, \quad \lim_{n \rightarrow \infty} \neq 0 \quad \text{[the limit does not exist]} \\ \therefore \text{series div.}$$

14) If $x=1$, $u_n = (n+1)1^n$

$$\lim_{n \rightarrow \infty} u_n = \infty \neq 0. \quad \therefore \text{series diverges.}$$

If $x=-1$, $u_n = (n+1)(-1)^n$ which has no limit as $n \rightarrow \infty$. \therefore series diverges

15) If $x=1/2$ $u_n = \frac{2^n (1/2)^n}{n} = 0$ if $n \rightarrow \infty$

\therefore test fails to apply

$$\text{If } x=-1/2 \quad u_n = \frac{2^n / (-2)^n}{n} = \frac{(-1)^n}{n} = 0 \text{ as } n \rightarrow \infty \\ \text{test fails}$$

16) Note $\sum_{n=1}^{\infty} \frac{1}{n^{3/2}}$ converges

$$\text{Now } 0 \leq \frac{\cos^2 nx}{n^{3/2}} \leq \frac{1}{n^{3/2}} \quad \text{all } n \geq 0, \text{ and } \hat{x}$$

$$\therefore \sum_{n=1}^{\infty} \frac{\cos^2 nx}{n^{3/2}} \text{ converges.}$$

Sec 5.1 cont'd

17.] Note $\sum_{n=1}^{\infty} \frac{1}{n^{1.1}}$ conv.

Suppose $x \geq 0$. Then $0 \leq \frac{\tanh(nx)}{n^{1.1}} \leq \frac{1}{n^{1.1}}$ for $n \geq 1$

since $0 \leq \tanh nx < 1$

Thus by comparison test: $\sum_{n=1}^{\infty} \frac{\tanh(nx)}{n^{1.1}}$ conv.

Suppose x is negative. Then $\tanh(nx) = -\tanh(n|x|)$

$$\sum_{n=1}^{\infty} \frac{\tanh(nx)}{n^{1.1}} = - \sum_{n=1}^{\infty} \frac{\tanh(n|x|)}{n^{1.1}}$$

But this series: $\sum_{n=1}^{\infty} \frac{\tanh(n|x|)}{n^{1.1}}$ has been shown to converge.

Thus for $x < 0$, $\sum_{n=1}^{\infty} \frac{\tanh(nx)}{n^{1.1}}$ converges.

18.] $\frac{1}{n^{1+nx}} \leq \frac{1}{n^{1+x}}$ for $n \geq 1$

But we know $\sum_{n=1}^{\infty} \frac{1}{n^{1+x}}$ conv. $\therefore \sum_{n=1}^{\infty} \frac{1}{n^{1+nx}}$ conv. for $x > 0$
[for $x > 0$]

19.] $\frac{1}{(\sqrt{n+x})^3} \leq \frac{1}{n^{3/2}}$ if $x \geq 0$

But $\sum_{n=1}^{\infty} \frac{1}{n^{3/2}}$ conv. $\therefore \sum_{n=1}^{\infty} \frac{1}{(\sqrt{n+x})^3}$ conv.

20.] The series $\sum_{n=1}^{\infty} \frac{1}{\sqrt{n}}$ diverges [take $p = 1/2$]

Now $1 + \cos^2 nx \geq 1$ $\therefore \frac{1 + \cos^2 nx}{n^{1/2}} \geq \frac{1}{n^{1/2}}$

Thus by the comparison test the

given series $\sum_{n=1}^{\infty} \frac{1 + \cos^2 nx}{\sqrt{n}}$ diverges.

Section 5.1 continued

21) $\coth nx = \frac{e^{nx} + e^{-nx}}{e^{nx} - e^{-nx}} = \frac{1 + e^{-2nx}}{1 - e^{-2nx}}$

Assume $x > 0$. Then $\coth nx > 1$

$\frac{\coth nx}{n} > \frac{1}{n}$ and from the comparison test

$\sum_{n=1}^{\infty} \frac{\coth nx}{n}$ diverges ^{for $x > 0$} since $\sum_{n=1}^{\infty} \frac{1}{n}$ diverges [take $p=1$]

Now, suppose $x < 0$, $\coth nx = -\coth n|x|$

But $\sum_{n=1}^{\infty} \frac{\coth n|x|}{n}$ diverges from the argument

that was used when $x > 0$. $\therefore \sum_{n=1}^{\infty} \frac{\coth nx}{n}$ diverges when $x < 0$

So in summary, $\sum_{n=1}^{\infty} \frac{\coth (nx)}{n}$ diverges for $|x| > 0$.

Section 5.2

1) a) $\frac{1}{1-\frac{1}{2}} = 1 + \frac{1}{2} + \frac{1}{4} + \frac{1}{8} + \frac{1}{16} + \frac{1}{32} \dots$ Take $z = 1/2$



Distance to terminus is $\frac{1}{|1-\frac{1}{2}|} = \frac{1}{\sqrt{\frac{5}{4}}} = \frac{2}{\sqrt{5}}$ miles

b) distance walked = $1 + \frac{1}{2} + \frac{1}{4} + \frac{1}{8} \dots = \frac{1}{(1-\frac{1}{2})} = 2$ miles

c) time = $\frac{2 \text{ miles}}{3 \text{ miles/hour}} = \frac{2}{3}$ hour = 40 minutes

The time required to complete each segment shrinks
 $\tau = \frac{1}{3} + \frac{1}{3^2} + \frac{1}{3^3} \dots$ (sum of times for each segment)

$= \frac{1}{3} [1 + \frac{1}{3} + \frac{1}{9} \dots] = \frac{2}{3}$ hour.

(d) $\frac{1}{1-.9i} = 1+.9i - .81 \dots$ distance walked = $\frac{1}{1-.9} = 1+.9+.81 \dots$
 distance walked = $\frac{1}{1-.9} = 10$ miles. At 3 miles per hour
 requires $\frac{10}{3} = 3$ hours, 20 minutes.

2) a) require $|z^n| < \epsilon$ for $n > N$
 $|z|^n < \epsilon$ for $n > N$

Take $0 < \epsilon < 1$

$$\therefore \frac{1}{|z|^n} > \frac{1}{\epsilon}$$

$$n \text{Log} \left| \frac{1}{z} \right| > \text{Log} \frac{1}{\epsilon}$$

$$n > \frac{\text{Log} \frac{1}{\epsilon}}{\text{Log} \left| \frac{1}{z} \right|} \text{ a pos. quantity}$$

Take N as a integer $\geq \frac{\text{Log} \left(\frac{1}{\epsilon} \right)}{\text{Log} \left| \frac{1}{z} \right|}$

b) Use Eq. 3.2-2(c), z, z^2, z^3, \dots has limit zero for $|z| < 1$
 $(1+e^{-z}), (1+e^{-2z}), \dots$ has limit 1 for $\text{Re } z > 1$

\therefore the given sequence has limit $1 \cdot 0 = 0$
 for $|z| < 1, \text{Re}(z) > 0$ [the prod. of limits.]

3) $|U_n| = |2iz|^n = 2^n |z|^n$

Suppose $|z| = \frac{1}{2}$, then $|U_n| = 1$ all n , and $|U_n|$ does not go to zero as $n \rightarrow \infty$. \therefore series div

Suppose $|z| > \frac{1}{2}$, then $2|z| > 1$. $|U_n| = (2|z|)^n$ goes to ∞ as $n \rightarrow \infty$. Since this is not zero seq. diverges

4) $|U_n| = (n+1) (\sqrt{2})^n |z+1|^n$. Suppose $|z+1| = \frac{1}{\sqrt{2}}$

$|U_n| = (n+1)$ which $\neq 0$ as $n \rightarrow \infty$

Suppose $|z+1| > \frac{1}{\sqrt{2}}$, then $|U_n| = (n+1) (\sqrt{2}|z+1|)^n \rightarrow \infty$ as $n \rightarrow \infty$ since $\sqrt{2}|z+1| > 1$. Series diverges.

5) $|U_n| = \frac{n (\sqrt{2})^n}{|z-2i|^n}$. If $|z-2i| = \sqrt{2}$, $|U_n| = n$

$|U_n| \rightarrow \infty$ as $n \rightarrow \infty$. Series diverges.

If $|z-2i| < \sqrt{2}$, $\frac{\sqrt{2}}{|z-2i|} > 1$ and $n \left| \frac{\sqrt{2}}{|z-2i|} \right|^n \rightarrow \infty$ as $n \rightarrow \infty$

Series diverges.

sec 5.2

$$6) |U_n| = \frac{z^n (n+1)^n}{n^n} |z+1+i|^n$$

If $|z+1+i| > 1/2$

$$|U_n| = \left(1 + \frac{1}{n}\right)^n \rightarrow e \text{ as } n \rightarrow \infty \text{ sec (5.2-2g)}$$

Since this limit $\neq 0$, series diverges.

If $|z+1+i| > 1/2$, $z/|z+1+i| > 1$.

$$|U_n| = \frac{z^n}{|z+1+i|^n} \left(1 + \frac{1}{n}\right)^n \rightarrow \infty \text{ as } n \rightarrow \infty$$

Since $\left(\frac{z}{|z+1+i|}\right)^n \rightarrow \infty$.

$$7) \left| \frac{U_{n+1}}{U_n} \right| = \frac{(n+1)^n}{n^n} \frac{|z+\frac{1}{2}|^{n+1}}{|z+1/2|^n} = \left(1 + \frac{1}{n}\right)^n |z+\frac{1}{2}| = |z+\frac{1}{2}| \text{ as } n \rightarrow \infty$$

\therefore series is abs. conv. $|z+1/2| < 1$ and diverges

for $|z+1/2| > 1$.

$$8) \left| \frac{U_{n+1}}{U_n} \right| = \left| \frac{(n+1)! \cdot e^{(n+2n+1)z}}{n! \cdot e^{n^2 z}} \right| = (n+1) \left| e^{(2n+1)z} \right| = (n+1) e^{\operatorname{Re} z (2n+1)}$$

as $n \rightarrow \infty$ $(n+1)e^{\operatorname{Re} z (2n+1)} \rightarrow 0$ if $\operatorname{Re} z < 0$ or $\operatorname{Re} z < 0$

If $\operatorname{Re} z \geq 0$ the preceding limit $\rightarrow \infty$ and series diverges.

$$9) \left| \frac{U_{n+1}}{U_n} \right| = \frac{|2+i|^{n+1}}{|z+i|^{n+1} |n+1+i|^2} \frac{|z+i|^n |n+1|^2}{|2+i|^n}$$

$$= \frac{\sqrt{5}}{|z+i|} \left| \frac{n+1}{n+1+i} \right|^2 = \frac{\sqrt{5}}{|z+i|} \left| 1 + \frac{i}{n} \right|^2 \xrightarrow{\text{as } n \rightarrow \infty} \frac{\sqrt{5}}{|z+i|}$$

\therefore series is abs conv. if $\frac{\sqrt{5}}{|z+i|} < 1$, $|z+i| > \sqrt{5}$

and diverges if $|z+i| < \sqrt{5}$

10)

sec 5.2

$$\left| \frac{u_{n+1}}{u_n} \right| = \frac{n! (n+1)^{n+1}}{(n+1)! n^n} \frac{|z|^n}{|z|^{n+1}} = \frac{(n+1) (n+1)^n}{(n+1) n^n} \frac{1}{|z|}$$

$$\left(\frac{n+1}{n} \right)^n \frac{1}{|z|} = \left(1 + \frac{1}{n} \right)^n \frac{1}{|z|} = \frac{e}{|z|} \text{ as } n \rightarrow \infty$$

$\therefore \left| \frac{e}{z} \right| < 1$, $|z| > e$, abs. conv. and $|z| < e$ div.

11)

$$(a) \quad 1 + z + z^2 + \dots + z^{n-1} = \frac{1 - z^n}{1 - z}$$

$$\text{let } N = n-1, \therefore n = N+1$$

$$1 + z + z^2 + \dots + z^N = \frac{1 - z^{N+1}}{1 - z}$$

$$\text{Let } z = e^{i\theta}$$

$$1 + e^{i\theta} + e^{i2\theta} + \dots + e^{iN\theta} = \frac{1 - e^{i(N+1)\theta}}{1 - e^{i\theta}}$$

$$\frac{e^{i(N+1)\theta/2}}{e^{i\theta/2}} \frac{e^{-i(N+1)\theta/2} - e^{i(N+1)\theta/2}}{e^{-i\theta/2} - e^{i\theta/2}} = e^{iN\theta/2} \frac{\sin(N+1)\theta/2}{\sin\theta/2}$$

$$(a) \quad \text{Equate reals} \quad 1 + \cos\theta + \cos 2\theta + \dots + \cos N\theta = \frac{\cos N\theta}{2} \frac{\sin(N+1)\theta/2}{\sin\theta/2}$$

$$b) \quad \text{Equate IMAGINARIO: } \sin\theta + \sin 2\theta + \dots + \sin N\theta = \frac{\sin N\theta}{2} \frac{\sin(N+1)\theta/2}{\sin\theta/2}$$

c) We cannot let $N \rightarrow \infty$ because the infinite series $\sum_{n=0}^{\infty} e^{in\theta}$ does not converge. Fails nth term

test since $\lim_{n \rightarrow \infty} |u_n| \neq 0$

d) %problem 11 (d) sec 5.2
 thet=linspace(0,2*pi,400);
 N=10;
 thet=thet+.000001;%to avoid dividing by zero
 s=0;
 for n=1:11
 s=cos((n-1)*thet)+s;
 end
 polar(thet,s);hold on
 ss=cos(N*thet/2).*sin((N+1)*thet/2)./sin(thet/2);
 polar(thet,ss,'r')

plot next page

11

Sec 5.2

continued

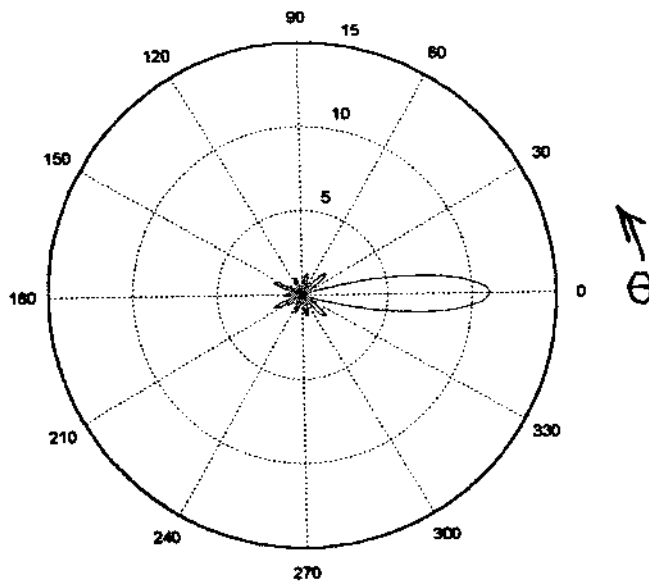

12

```
%problem12sec5.2
z=.5+.5*i;
s=0;
for n=1:25
    s=z^(n-1)+s
    plot(real(s),imag(s),'o');hold on
    grid
end
```

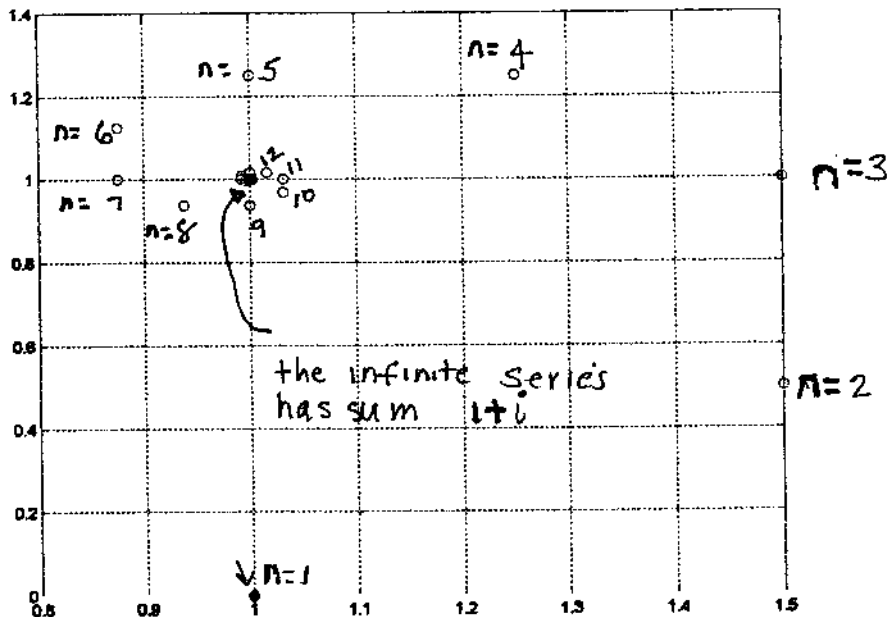

13

Sec 5.2

$$\frac{1}{1-z} = 1+z+z^2+\dots, \quad |z| < 1 \quad \text{put } (z-1)^{-1} \text{ in place of } z$$

$$\frac{1}{1-(z-1)^{-1}} = 1+(z-1)^{-1}+(z-1)^{-2}+(z-1)^{-3}+\dots \quad |z-1|^{-2} < 1$$

thus valid for $|z-1| < 1$

14) $\frac{1}{1-z} = 1+z+z^2+z^3+\dots$ $|z| < 1$ put $\frac{1}{z}$ in place of z

$$\frac{1}{1-1/z} = 1 + \frac{1}{z} + \frac{1}{z^2} + \frac{1}{z^3} + \dots \quad \left| \frac{1}{z} \right| < 1 \text{ or } |z| > 1$$

$$\frac{z}{z-1} = 1 + \frac{1}{z} + \frac{1}{z^2} + \frac{1}{z^3} + \dots \quad |z| > 1$$

15)

a. Want $1+2z+3z^2+4z^3+\dots$

$$\frac{1}{1-z} = \underbrace{1+z+z^2+z^3+\dots}_{|z| < 1} \quad \left(\frac{1}{1-z}\right)\left(\frac{1}{1-z}\right) = (1+z+z^2+\dots)(1+z+z^2+\dots)$$

$$\therefore \left(\frac{1}{1-z}\right)^2 = 1 + (1+1)z + (1+1+1)z^2 + \dots = 1+2z+3z^2+\dots \quad |z| < 1$$

(b) $\frac{1}{(1-z)^2} = 1+2z+3z^2+4z^3+\dots \quad |z| < 1$

$$\frac{1}{(1-z)^2} \left(\frac{1}{1-z}\right) = (1+2z+3z^2+4z^3+\dots)(1+z+z^2+\dots)$$

$$= 1 + (1+2)z + (1+2+3)z^2 + (1+2+3+4)z^3 + \dots$$

$$= \sum_{n=1}^{\infty} C_n z^{n-1} \quad \text{where } C_n = \sum_{j=1}^n j = \binom{n}{2} (n+1) \quad \text{g.e.d.}$$

16)

From Eq (5.2-9) $1+z+z^2+\dots+z^{n-1} = (1-z^n)/(1-z)$

differentiate both sides

$$1+2z+3z^2+\dots+(n-1)z^{n-2} = \frac{-nz^{n-1}(1-z) + (1-z^n)}{(1-z)^2}$$

$$1+2z+3z^2+\dots+(n-1)z^{n-2} = \frac{z^n(n-1) - nz^{n-1} + 1}{(1-z)^2}$$

Now put $(n+1)$ in place of n in the preceding

$$\underbrace{1+2z+3z^2+\dots+(n)z^{n-1}}_{n \text{ terms, } n^{\text{th}} \text{ partial sum}} = \frac{z^{n+1}n - (n+1)z^n + 1}{(1-z)^2} = \frac{z^n[n(z-1)-1] + 1}{(1-z)^2}$$

g.e.d.

Sec 5.2

17] From prob 16. $S_n = \frac{z^n [n(z-1) - 1] + 1}{(1-z)^2}$, $S = \frac{1}{(1-z)^2}$

$|S_n - S| = \frac{|z|^{n+1} |n(z-1) - 1|}{|1-z|^2}$. Require $|S_n - S| < \epsilon$ for $n > N$

Recall that $|z-1| < 2$ if $|z| < 1$. Now $|n(z-1) - 1| \leq n|z-1| + 1 < 2n + 1 \leq 3n$ since $|z| < 1$ and $n \geq 1$. Thus $|S_n - S| < \frac{|z|^{n+1} 3n}{|1-z|^2}$

We require $\frac{|z|^{n+1} 3n}{|1-z|^2} < \epsilon$ for $n > N$. Equivalently

$|z|^{n+1} 3n < \epsilon |1-z|^2$ or $\frac{1}{|z|^{n+1} n} > \frac{3}{\epsilon |1-z|^2}$ or

$n \log \frac{1}{|z|} - \log n > \log \frac{3}{\epsilon |1-z|^2}$. Now for $n \geq 1$, $n > \log n$

Thus we will require that $n \log \frac{1}{|z|} - n > \log \frac{3}{\epsilon |1-z|^2}$

or $n > \left[\log \frac{3}{\epsilon |1-z|^2} \right] / \left(\log \frac{1}{|z|} - 1 \right)$. Thus we take

N as any integer $\geq \left\lceil \log \frac{3}{\epsilon |1-z|^2} / \left[\log \frac{1}{|z|} - 1 \right] \right\rceil$ in Eq. 5.2-9

Sección 5.3

$$1) |u_j| = |(-z)^{j-1}| = |z|^{j-1} \leq .999^{j-1} \text{ if } |z| \leq .999$$

$$\text{Now } \sum_{j=1}^{\infty} (.999)^{j-1} = \frac{1}{1-.999} \quad \text{a convergent series of constants.}$$

$$\text{Thus take } M_j = (.999)^{j-1}$$

2) Note: the fact that the series begins with $j=0$ is immaterial. $|u_j| = \frac{j}{j+1} |z|^j$

$$\text{Now } |u_j| \leq \frac{j}{j+1} r^j \text{ if } |z| \leq r$$

$$\frac{j}{j+1} r^j \leq r^j \quad \therefore |u_j| \leq r^j$$

$$\text{Now } \sum_{j=0}^{\infty} r^j = \frac{1}{1-r} \text{ if } r < 1. \quad \text{conv. series of constants.}$$

$$\therefore \text{ take } M_j = r^j$$

$$3) \frac{|z^j|}{j!} \leq \frac{r^j}{j!} \text{ if } |z| \leq r.$$

$$\text{Now } \sum_{j=0}^{\infty} \frac{r^j}{j!} = e^r \text{ a convergent series if } r < \infty$$

$$\therefore M_j = \frac{r^j}{j!}$$

$$4) |u_n| = \frac{|n-i| |z|^n}{n^3} = \frac{\sqrt{n^2+1} |z|^n}{n^3} \leq \frac{\sqrt{n^2+n^2} |z|^n}{n^3} \\ = \frac{\sqrt{2}}{n^2} |z|^n \leq \frac{\sqrt{2}}{n^2} \text{ if } |z| \leq 1.$$

$$\text{Now } \sqrt{2} \sum_{n=1}^{\infty} \frac{1}{n^2} \text{ is known to converge.}$$

$$\therefore \text{ can take } M_n = \sqrt{2}/n^2$$

Section 5.3

$$\Rightarrow \left| \frac{e^{-nz}}{\text{Log}(nti)} \right| = \frac{e^{-nx}}{\left| \text{Log} \sqrt{n^2+1} + i \tan^{-1} \left(\frac{1}{n} \right) \right|}$$

$$\leq \frac{e^{-nx}}{\frac{1}{2} \text{Log}(n^2+1)} \leq \frac{e^{-nx}}{\frac{1}{2} \text{Log} 2} \leq \frac{e^{-na}}{\frac{1}{2} \text{Log} 2}$$

↑
for $n \geq 1$

The series $\sum_{n=1}^{\infty} \frac{e^{-na}}{\frac{1}{2} \text{Log} 2} = \sum_{n=1}^{\infty} \left[\frac{e^{-a}}{\frac{1}{2} \text{Log} 2} \right]^n$ converges.

It is a geometric series whose sum is $\frac{ze^{-a}}{\text{Log} 2}$.

\therefore Take $M_N = \frac{e^{-Na}}{\frac{1}{2} \text{Log} 2}$ and we have established

the uniform convergence of the given series.

Section 5.3

6) a) For absolute convergence, we require, by definition that $\sum_{j=1}^{\infty} |U_j(z)|$ converges.

Now $|U_j(z)| \leq M_j$ for all z in R .

and $\sum_{j=1}^{\infty} M_j$ is known to converge. Therefore by the comparison test $\sum_{j=1}^{\infty} |U_j(z)|$ converges

and the given series $\sum_{j=1}^{\infty} U_j(z)$ must be abs. conv.

b) From the definition of convergence

$$S(z) = \lim_{k \rightarrow \infty} \sum_{j=1}^k U_j(z)$$

$$\text{Thus } |S(z) - S_n(z)| = \left| \lim_{k \rightarrow \infty} \sum_{j=1}^k U_j(z) - \sum_{j=1}^n U_j(z) \right|$$

$$= \left| \lim_{k \rightarrow \infty} \left(\sum_{j=1}^k U_j(z) - \sum_{j=1}^n U_j(z) \right) \right|$$

now do a term by term subtraction. assume $k > n$

$$= \left| \lim_{k \rightarrow \infty} \sum_{j=n+1}^k U_j(z) \right|$$

recall that limit of a sum = sum of limits

c) From the triangle inequality

$$\left| \sum_{j=n+1}^k U_j(z) \right| \leq \sum_{j=n+1}^k |U_j(z)| \leq \sum_{j=n+1}^k M_j$$

since $|U_j(z)| \leq M_j$

$$\text{Thus } \left| \lim_{k \rightarrow \infty} \sum_{j=n+1}^k U_j(z) \right| \leq \lim_{k \rightarrow \infty} \sum_{j=n+1}^k M_j$$

d) continued next page.

sec 5.3

6 (d) continued

$$\sum_{j=n+1}^k M_j = \sum_{j=1}^k M_j - \sum_{j=1}^n M_j \quad k > n$$

$$\text{Now: } \lim_{k \rightarrow \infty} \sum_{j=n+1}^k M_j = \lim_{k \rightarrow \infty} \left[\sum_{j=1}^k M_j - \sum_{j=1}^n M_j \right]$$

$$= \lim_{k \rightarrow \infty} \sum_{j=1}^k M_j - \sum_{j=1}^n M_j = \left(\text{sum of: infinite } M \text{ series} \right) - \text{the } n^{\text{th}} \text{ partial sum of the } M \text{ series}$$

Now since the series $\sum_{j=1}^{\infty} M_j$ is known to converge, it must be true that given $\epsilon > 0$, there must exist N such that

$$\lim_{k \rightarrow \infty} \sum_{j=1}^k M_j - \sum_{j=1}^n M_j < \epsilon \quad \text{for } n > N.$$

Note that N is independent of z .

$$\text{Thus } \lim_{k \rightarrow \infty} \sum_{j=n+1}^k M_j < \epsilon \quad \text{for } n > N$$

$$\text{Therefore, from part (c) : } \left| \lim_{k \rightarrow \infty} \sum_{j=n+1}^k U_j(z) \right| < \epsilon \quad \text{for } n > N$$

and from part (b) we have $|S(z) - S_n(z)| < \epsilon$ for $n > N$. Where N is independent of z . Thus, uniform convergence is proved for the series $\sum_{j=1}^{\infty} U_j(z)$ for all z in R .

$$7] a) \quad \text{Log} \frac{1}{(1-z)} = z + \frac{z^2}{2} + \frac{z^3}{3} \dots \quad |z| < 1$$

$$z = iy, \quad |y| < 1 \quad \text{Log} \frac{1}{(1-iy)} = \text{Log} \left[\frac{1+iy}{1+y^2} \right] = \frac{1}{2} \text{Log} \frac{1+y^2}{1+y^2} - \frac{i}{3} \frac{y^3}{1+y^2} + \dots$$

$$\text{Log} \left[\frac{1+iy}{1+y^2} \right] = \text{Log} \frac{1}{\sqrt{1+y^2}} + i \tan^{-1} y = \dots$$

$$\text{Equating imag parts: } \tan^{-1} y = \frac{y}{1+y^2} - \frac{y^3}{3(1+y^2)^2} + \dots$$

$$\text{Now } \text{Log} \frac{1}{\sqrt{1+y^2}} = -\frac{1}{2} \text{Log} (1+y^2) = -\frac{y^2}{2} + \frac{y^4}{4} - \dots = \frac{1}{2} \text{Log} (1+y^2) = \frac{y^2}{2} - \frac{y^4}{4} + \frac{y^6}{6} - \dots$$

sec 5.3

7 (b) Take $\theta = \arcsin \frac{1}{\sqrt{3}}$, $\tan^{-1} \frac{1}{\sqrt{3}} = \frac{\pi}{6}$

$$\begin{aligned} \frac{\pi}{6} &= \frac{1}{\sqrt{3}} - \left(\frac{1}{\sqrt{3}}\right)^3 \frac{1}{3} + \left(\frac{1}{\sqrt{3}}\right)^5 \frac{1}{5} \dots \\ &= \frac{1}{\sqrt{3}} \left[1 - \frac{1}{3 \cdot 3} + \frac{1}{5 \cdot 3^2} - \frac{1}{7 \cdot 3^3} \dots \right] \end{aligned}$$

%prob7 sec 5.3, parts c and d

```
clear
con=6/sqrt(3);
format long
for k=1:20
    a(k)=(-1)^(k-1)/((2*k-1)*(3^(k-1)));
    n(k)=k;
    q(k)=con*sum(a);
end
v=[n' q']
q(20)
pi
pct_diff=100*(q(20)-pi)/pi
```

← for part (d)

n	n th partial sum
1.0000000000000000	3.46410161513775
2.0000000000000000	3.67920143567800
3.0000000000000000	3.15618147156995
4.0000000000000000	3.13785289159568
5.0000000000000000	3.14268474566389
6.0000000000000000	3.14138878546288
7.0000000000000000	3.14167431269884
8.0000000000000000	3.14156871594178
9.0000000000000000	3.14159977381151
10.0000000000000000	3.14159851893888
11.0000000000000000	3.14159338458388
12.0000000000000000	3.14159245428765
13.0000000000000000	3.14159271582838
14.0000000000000000	3.14159263454731
15.0000000000000000	3.14159265952171
16.0000000000000000	3.14159265173488
17.0000000000000000	3.14159265417258
18.0000000000000000	3.14159265348617
19.0000000000000000	3.14159265364783
20.0000000000000000	3.14159265357148

after 20 terms

pct_diff =
-5.858492835765456e-018

10th partial sum gives 3.14159
note, if you round this after the 9th digit get 3.14160.
If you round this off after the first 9 appears in the digits get 3.14159

Section 5.3

8) (a) $|z| \leq r$, $\left|\frac{1}{z}\right| \geq \frac{1}{r}$, $\text{Log} \left|\frac{1}{z}\right| \geq \text{Log} \frac{1}{r}$

since Log is a monotonic function its argument.

(b) $|z| \leq r$, $r < 1$. $|1-z| \geq 1-|z| \geq 1-r$
(triangle ineq.)

$\frac{1}{|1-z|} \leq \frac{1}{1-r}$ and $\frac{1}{\epsilon|1-z|} \leq \frac{1}{\epsilon(1-r)}$ and $\text{Log} \frac{1}{\epsilon|1-z|} \leq \text{Log} \frac{1}{\epsilon(1-r)}$

© From (a): $\frac{1}{\text{Log} \left|\frac{1}{z}\right|} \leq \frac{1}{\text{Log} \frac{1}{r}}$. Multiply the preceding

two inequalities $\frac{\text{Log} \frac{1}{\epsilon|1-z|}}{\text{Log} \left|\frac{1}{z}\right|} \leq \frac{\text{Log} \frac{1}{\epsilon(1-r)}}{\text{Log} \frac{1}{r}}$. Note

that both left and right hand sides in all these inequalities are positive since $\frac{1}{\epsilon|1-z|}$, $\frac{1}{\epsilon(1-r)}$, $\left|\frac{1}{z}\right|$ and $\frac{1}{r}$ are all > 1 if $\epsilon < \frac{1}{|z|}$, $|z| \leq r$, $r < 1$

(d) If $N \geq \frac{\text{Log} \frac{1}{\epsilon(1-r)}}{\text{Log} \left|\frac{1}{z}\right|}$ is satisfied, then $N \geq \frac{\text{Log} \frac{1}{\epsilon|1-z|}}{\text{Log} \left|\frac{1}{z}\right|}$

is also since $\text{Log} \frac{1}{\epsilon|1-z|} \geq \frac{\text{Log} \frac{1}{\epsilon(1-r)}}{\text{Log} \left|\frac{1}{z}\right|}$
Thus $|S(z) - S_n(z)| < \epsilon$ for $n > N$

9) (a) Note $S(z)$ is continuous (see Theorem 9)

$U_1(z), U_2(z) \dots$ etc. are continuous. The sum of the integrals of continuous functions is the integral of the sum. (see Eq. 4.1-8 (b))

(b) $|S(z) - S_n(z)| < \epsilon$ [for unif. conv. series]. Now use ML inequality.

10) $\oint_C S(z) dz = \oint_C \sum_{j=1}^{\infty} U_j(z) dz =$ (by theorem 10)

$= \sum_{j=1}^{\infty} \oint_C U_j(z) dz = 0$ since each $U_j(z)$ is analytic.

so by Morera's theorem: $S(z)$ is analytic in R .

$\frac{1}{2\pi i} \oint_C \frac{S(z') dz'}{(z'-z)^2} = \frac{1}{2\pi i} \oint_C \frac{U_1(z') dz'}{(z'-z)^2} +$

$\frac{1}{2\pi i} \oint_C \frac{U_2(z') dz'}{(z'-z)^2} + \dots$. Now apply Cauchy Int.

Formula to each term: $\frac{dS(z)}{dz} = \frac{dU_1}{dz} + \frac{dU_2}{dz} + \frac{dU_3}{dz} \dots$

or $S'(z) = \sum_{j=1}^{\infty} U_j'(z)$ s.e.d.

sec. 5.4

1) a) $C_0 = \sin z|_{z=0} = 0$, $C_1 = \frac{\cos z}{1!}|_{z=0} = 1$, $C_2 = \frac{-\sin z}{2!}|_{z=0} = 0$

$C_3 = -\frac{\cos z}{3!}|_{z=0} = -1/3!$, $\sin z = z - \frac{z^3}{3!} + \frac{z^5}{5!} - \dots$

b) $C_0 = \frac{\cos z}{0!}|_{z=0} = 1$, $C_1 = -\frac{\sin z}{1!}|_{z=0} = 0$, $C_2 = \frac{-\cos z}{2!}|_{z=0} = -\frac{1}{2!}$

$\cos z = 1 - \frac{z^2}{2!} + \frac{z^4}{4!} - \dots$

c) $\sinh z|_{z=0} = 0 = C_0$, $C_1 = \frac{\cosh z}{1!}|_{z=0} = 1$, $C_2 = \frac{\sinh z}{2!}|_{z=0} = 0$

$C_3 = \frac{\cosh z}{3!}|_{z=0} = 1/3!$, $\sinh z = z + \frac{z^3}{3!} + \frac{z^5}{5!} + \dots$

d) $C_0 = \cosh z|_{z=0} = 1$, $C_1 = \frac{\sinh z}{1!}|_{z=0} = 0$, $C_2 = \frac{\cosh z}{2!}|_{z=0} = \frac{1}{2!}$

$\cosh z = 1 + \frac{z^2}{2!} + \frac{z^4}{4!} + \dots$

2)

and C' are centered at z_0 .

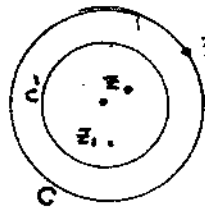

z_s (nearest sing. pt. to z_0)

$f(z_1) = \frac{1}{2\pi i} \oint_{C'} \frac{f(z) dz}{(z-z_0) - (z_1-z_0)}$

From Cauchy Int. Formula

$= \frac{1}{2\pi i} \oint_C \frac{f(z) dz}{(z-z_0) \left[1 - \frac{(z_1-z_0)}{(z-z_0)} \right]}$

$= \frac{1}{2\pi i} \int \frac{f(z)}{(z-z_0)} \left[1 + \frac{(z_1-z_0)}{(z-z_0)} + \frac{(z_1-z_0)^2}{(z-z_0)^2} + \dots \right] dz$

Integrate term by term, \Rightarrow set $\sum_{n=0}^{\infty} C_n (z_1-z_0)^n$

where $C_n = \frac{1}{2\pi i} \oint \frac{f(z)}{(z-z_0)^{n+1}} dz = \frac{f^{(n)}(z_0)}{n!}$ Using Cauchy Int Formula

Expansion is valid $|z_1-z_0| < |z_s-z_0|$

Section 5.4

$$3) C_0 = \left. \frac{1}{z} \right|_{z=i} = \frac{1}{i} = -i, \quad C_1 = \left. -\frac{1}{z^2} \right|_{z=i} = 1,$$

$$C_2 = \left. \frac{2}{z^3} \right|_{z=i} = 2i, \quad C_3 = \left. -\frac{3!}{z^4} \right|_{z=i} = -\frac{6}{i} = 6i$$

$$\therefore \frac{1}{z} = -i + (z-i) + i(z-i)^2 - (z-i)^3 + \dots$$

$$U_n = \frac{(-i)^{n-1}}{(n-1)!} (z-i)^n, \quad n=0, 1, 2, \dots$$

circle of conv. $|z-i|=1$

$$4) C_0 = \left. e^z \right|_{z=2+i} = e^{2+i}, \quad C_1 = \left. \frac{z}{1!} \right|_{z=2+i} = \frac{e^{2+i}}{1}$$

$$C_2 = \left. \frac{z^2}{2!} \right|_{z=2+i} = \frac{e^{2+i}}{2!}$$

$$e^z = e^{2+i} + \frac{e^{2+i}}{1} (z-2-i) + \frac{e^{2+i}}{2!} (z-2-i)^2 + \dots$$

$$U_n = \frac{e^{2+i}}{n!}, \quad n=0, 1, 2, \dots \quad \text{circle of conv. center } 2+i, r=\infty$$

$$5) C_0 = \left. \text{Log } z \right|_{z=e} = 1, \quad C_1 = \left. \frac{1}{z} \right|_{z=e} = e^{-1}$$

$$C_2 = \left. -\frac{1}{z^2} \right|_{z=e} = -\frac{e^{-2}}{2}, \quad C_3 = \left. \frac{2}{z^3} \right|_{z=e} = \frac{2}{3} e^{-3} \dots$$

$$\therefore \text{Log } z = 1 + e^{-1} (z-e) - \frac{e^{-2}}{2} (z-e)^2 + \dots$$

$$U_n = \frac{(-1)^{n-1} e^{-n}}{(n-1)!} (z-e)^n, \quad n \neq 0, \quad U_0 = 1, \quad n=0$$

Log z has sing. at $z=0$. Therefore circle of conv is $|z-e|=e$

$$6) C_0 = \frac{1}{(1+i)^2}, \quad C_1 = \left. -\frac{2}{z^3} \right|_{z=1+i} = \frac{-2}{(1+i)^3}, \quad C_2 = \left. \frac{3 \cdot 2}{(1+i)^4} \right|_{z=1+i} = \frac{3}{(1+i)^4}$$

$$\frac{1}{z^2} = \frac{1}{(1+i)^2} - \frac{2}{(1+i)^3} [z-1-i] + \frac{3}{(1+i)^4} (z-1-i)^2 - \dots$$

$$U_n = \frac{(n+1)}{(1+i)^{n+2}} (-1)^n (z-1-i)^n, \quad n=0, 1, \dots \quad \text{sing. pt at } z=0$$

circle of conv. $|z-1-i| = \sqrt{2}$

Sec 5.4 cont'd

7) $C_0 = \cosh z - \cos z \Big|_0 = 0, C_1 = \sinh z + \sin z \Big|_0 = 0$

$C_2 = \frac{\cosh z + \cos z}{2!} \Big|_0 = 1, C_3 = \frac{\sinh z - \sin z}{3!} \Big|_0 = 0$

$C_4 = \frac{\cosh z - \cos z}{4!} \Big|_0 = 0, C_5 = \frac{\sinh z + \sin z}{5!} \Big|_0 = 0$

$C_6 = \frac{\cosh z + \cos z}{6!} \Big|_0 = \frac{2}{6!}$

$\cosh z - \cos z = \frac{z^2}{2!} + \frac{z^4}{4!} + \frac{z^6}{6!} + \frac{z^8}{8!} + \dots$

$U_n = \frac{2(z^2)^n}{(2+4n)!} \quad n=0,1,2,\dots$

circle of conv. center $z=0, r=\infty$

8) $z^i = e^{i \text{Log } z}, C_0 = e^{i \text{Log } 1} = 1,$
 $C_1 = e^{i \text{Log } z} \Big|_1 = i z^{i-1} \Big|_1 = i, C_2 = \frac{i(i-1)z^{i-2}}{2!} = \frac{i(i-1)}{2!}$

general term: $U_0 = 1, U_n = \frac{i(i-1)\dots[i-(n-1)]}{n!} (z-1)^n, n \geq 1$

$e^{i \text{Log } z} = e^{i(\text{Log } r)} e^{-\theta}$ has branch point at $\theta=0$

circle of conv. $|z-1|=1$

9) $z^i = e^{z \text{Log } i} = e^{i\pi/2 z}$, Recall $e^z = 1 + z + z^2/2! + z^3/3! + \dots$

$\therefore e^{i\pi/2 z} = 1 + \frac{i\pi}{2} z + \frac{(i\pi/2)^2 z^2}{2!} + \frac{(i\pi/2)^3 z^3}{3!} + \dots$

$U_n = \frac{(i\pi/2)^n}{n!} \quad n=0,1,2,\dots$

circle of conv. center $=0, r=\infty$

10) a) $C_0 = z_0^5, C_1 = \frac{5z^4}{1!} \Big|_{z_0} = 5z_0^4, C_2 = \frac{20z^3}{2!} \Big|_{z_0} = 10z_0^3$

$C_3 = \frac{60z^2}{3!} \Big|_{z_0} = 10z_0^2, C_4 = \frac{120z}{4!} \Big|_{z_0} = 5z_0, C_5 = \frac{120}{5!} = 1$

b) $C_1, C_2, \dots = 0$

$z^5 = z_0^5 + 5z_0^4(z-z_0) + 10z_0^3(z-z_0)^2 + 10z_0^2(z-z_0)^3 + 5z_0(z-z_0)^4 + (z-z_0)^5$, valid all z . (b)

c) Using binomial theorem $[z_0 + (z-z_0)]^5 = \sum_{k=0}^5 \binom{5}{k} (z-z_0)^k z_0^{5-k}$ will get the same result as above

sec. 5.4 cont'd

11) a) $z^{1/2} = e^{\frac{1}{2} \text{Log} z}$ has a branch point ^{singularity} at $z=0$. It is not analytic in a neighborhood of $z=0$. Every neighborhood of $z=0$ has singular points of $z^{1/2}$ and a Taylor expansion is thus not possible. $x^{1/2} = \sum c_n x^n$ is this non-existent Taylor series specialized to the line $z=x$ and does not exist.

b) $z^{1/2} = e^{\frac{1}{2} \text{Log} z}$ is analytic at $z=1$ and an expansion is possible. $c_0 = z^{1/2} |_{z=1} = 1$, $c_1 = \frac{1}{2} z^{\frac{1}{2}-1} |_{z=1} = \frac{1}{2}$

$c_2 = \frac{(\frac{1}{2})(\frac{1}{2}-1)}{2} z^{\frac{1}{2}-2} = -\frac{1}{8}$. Series is valid for $|z-1| < 1$

Nearest singl. is at $z=0$. $z^{1/2} = 1 + \frac{1}{2}(z-1) - \frac{1}{8}(z-1)^2 \dots$

12] The series $1 + z/\text{Log} z + z^2/\text{Log}^2 z$ converges to $\frac{1}{1-z}$ only at $z=0$ and does not converge to $\frac{1}{1-z}$ in a neighborhood of $z=0$. The Taylor expansion ^{is} the only power series expansion in powers of z that will converge to $\frac{1}{1-z}$ in a neighborhood of $z=0$. \therefore Theorem 16 not contradicted

13] center of expansion is -1 , nearest singl. is at i , $r = \sqrt{1^2+1^2} = \sqrt{2}$

14] $\frac{1}{z^3+1}$ not analytic if $z^3 = -1$, $z = (-1)^{1/3}$, $z = -1$, $z = 1 \angle 60^\circ$, $1 \angle -60^\circ$.

Center of expansion is at i . $r = |i - 1 \angle 60^\circ| = .5176 = r$

15] center of expansion is at $(1+i)$ nearest singl. pt. of $\frac{1}{\cos z}$

$r = \sqrt{(1 - \pi/2)^2 + 1} = \sqrt{1 - \pi + \pi^2/4 + 1} =$

$\sqrt{2 - \pi + \pi^2/4}$ = radius

16] singl. p. ts of $\frac{1}{\text{Log} z}$ center of expansion is at $(1+2i)$ which is 2 units from nearest singl. pt. ($z=1$)

$\therefore r = 2$

17] $z^{1/2} = 1, z = 1$ if use princ. value.
 center of expansion is z , radius = 1, the
 nearest sing. point.

18] Note that if we use princ. branch of $z^{1/2}$
 that $z^{1/2} \neq -1$ since $z^{1/2} = \sqrt{r} [\cos \frac{\theta}{2} + i \sin \frac{\theta}{2}]$
 $-\pi < \theta \leq \pi$

Note that $z^{1/2}$ has a branch pt
 at $z=0$.

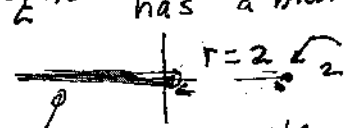

distance from center of expansion to nearest
 sing. point is **2**.

19] $\frac{1}{1-z} = \sum_{n=0}^{\infty} C_n (z+1)^n$

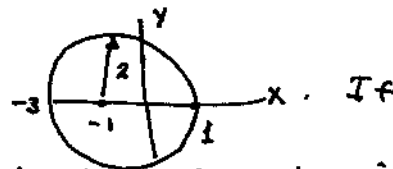

z is real, require $-3 < x < 1$ to be inside the circle.

Use ratio test in Eq. (5.1-2). $U_n = \frac{1}{2^{n+1}} (x+1)^{n+1}$

$U_{n+1} = \frac{1}{2^{n+2}} (x+1)^{n+2}$. Now $\left| \frac{U_{n+1}}{U_n} \right| = \frac{|x+1|}{2} < 1$ for
 abs. conv.

or $|x+1| < 2$ or $-3 < x < 1$ which is the same as
 already found. The series in Eq (5.1-6) works since
 $x = -\frac{1}{2}$ lies in circle of conv. But Eq (5.1-7) doesn't
 work since $x=2$ is outside.

20] sing. pts $1/(z^2+9)$ are $\pm 3i$

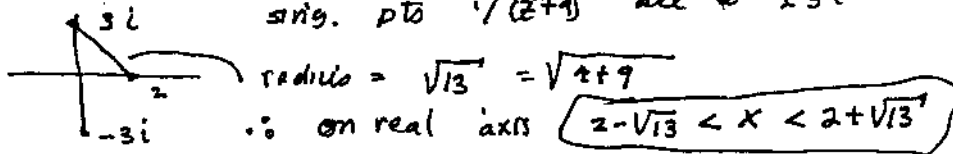

21] $x = 1/4$
 expansion valid for $0 < x < 1/2$

22] nearest sing. pt. to center of expansion:
 $r = \pi - 2$
 $\therefore 4 - \pi < x < \pi$
 $2 - (\pi - 2) = 4 - \pi$

23

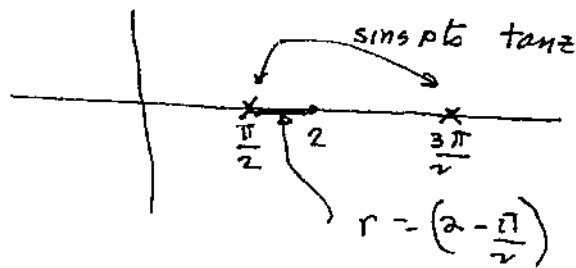

$$\tan x = \frac{\sin x}{\cos x}$$

$$\frac{\pi}{2} < x < 2 + 2 - \frac{\pi}{2} \quad \text{or} \quad \boxed{\frac{\pi}{2} < x < 4 - \frac{\pi}{2}}$$

24 Note $z^{1/2}$ has branch point at $z=0$

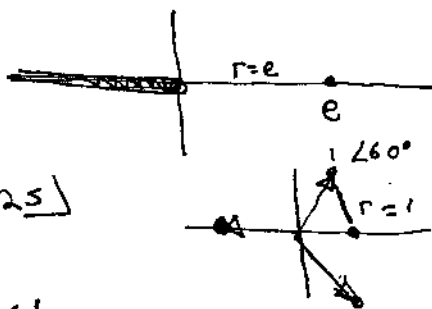

Series valid $0 < x < 2e$

$$z^3 + 1 = 0 \quad z = -1, \quad z = 1 \angle \pm 60^\circ$$

nearest
sing.
pts.

25

$$r = |1 - 1 \angle 60^\circ| = 1$$

$$\therefore \boxed{0 < x < 2}$$

26

```
clear
% problem number 26 section 5.4
for n=2:50
a(n)=n;
for k=1:n;
s(k)=1/gamma(k);
% note that gamma gives the factorial of k-1
end
v=flipr(s);
q=roots(v);

r(n)=min(abs(q));
end
plot(a,r);axis([2 length(a) 0 max(abs(r))]);grid
xlabel('NUMBER OF TERMS IN Nth PARTIAL SUM')
ylabel('DISTANCE OF NEAREST ZERO OF THE POLYNOMIAL APPROX TO z=0')
```

Note from the graph on the next page, that, as the number of terms in the N^{th} partial sum grows, the zeros of the polynomial approximation move further and further from $z=0$. Thus the disc within which the polynomial can represent e^z satisfactorily apparently grows in radius with increasing N .

Sec 5.4

26] cont'd

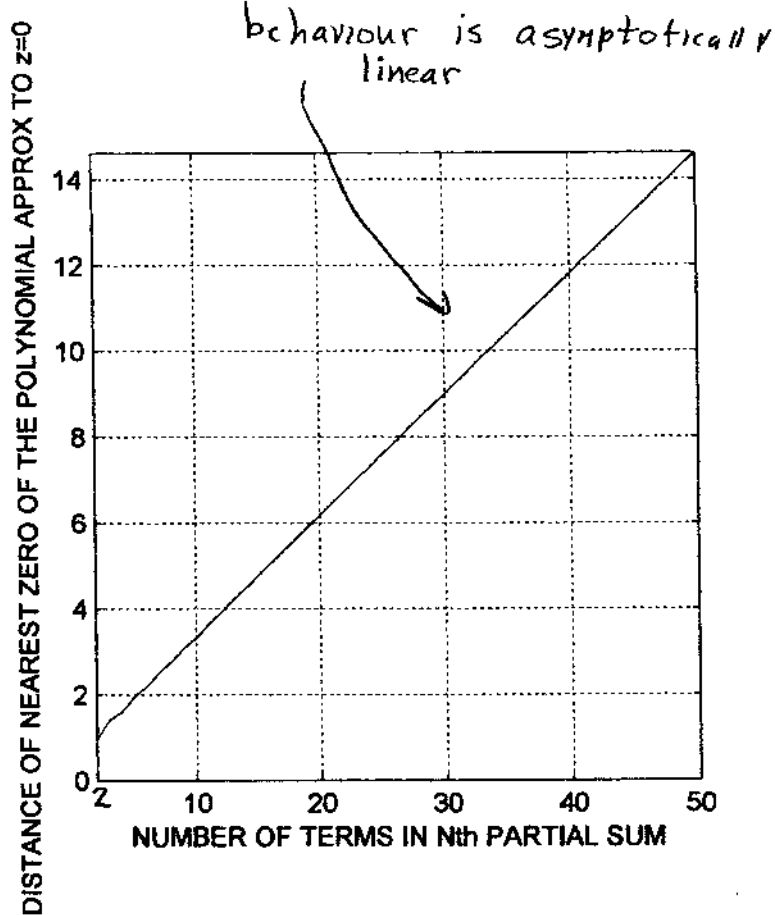

27]
$$e^z = 1 + z + \frac{z^2}{2!} + \dots \quad e^z - 1 = z + \frac{z^2}{2!} + \frac{z^3}{3!} + \dots$$

$|e^z - 1| \leq |z| + \frac{|z|^2}{2!} + \frac{|z|^3}{3!} + \dots$ triangle inequality.

$|e^z - 1| \leq |z| \left[1 + \frac{|z|}{2!} + \frac{|z|^2}{3!} + \dots \right]$ Now $|z| \leq 1$

$|e^z - 1| \leq |z| \left[1 + \frac{1}{2!} + \frac{1}{3!} + \frac{1}{4!} + \dots \right]$ ← expression in brackets is $e - 1$

28]
$$c_0 = (z^N - z_0^N)_{z_0} = 0, \quad c_1 = \frac{N z_0^{N-1}}{1!} \Big|_{z_0} = N z_0^{N-1}$$

$$c_2 = \frac{N(N-1) z_0^{N-2}}{2!}, \quad c_3 = \frac{N(N-1)(N-2) z_0^{N-3}}{3!}$$

in general:

$$c_n = \frac{N(N-1)\dots[N-(n-1)] z_0^{N-n}}{n!} \quad \text{Thus } z^N = z_0^N + \sum_{n=1}^N c_n (z - z_0)^n$$

Note $c_n = \frac{N! z_0^{N-n}}{(N-n)! n!}$ and $c_0 = z_0^N$

Thus
$$z^N = \sum_{n=0}^N \frac{N! z_0^{N-n}}{(N-n)! n!} (z - z_0)^n$$

sec 5.4 cont'd

28] cont'd.

Now put $z+z_0$ in place of z in the preceding equation

$$(z+z_0)^N = \sum_{n=0}^N \frac{N! z_0^{N-n} z^n}{(N-n)! n!} \quad \text{which is the binomial expansion}$$

29] a) $C_0 = \text{Log}(z) \Big|_{-1+i} = \text{Log} \sqrt{2} + i \frac{3\pi}{4}, \quad C_1 = \frac{1}{z} \Big|_{-1+i} =$

$$\frac{1}{\sqrt{2}} e^{i 3\pi/4}, \quad C_2 = \frac{-1/z^2}{2!} \Big|_{-1+i}, \quad C_3 = \frac{2/z^3}{3!},$$

$$C_n = \frac{(-1)^{n+1}}{n z^n} \Big|_{z=-1+i} = \frac{(-1)^{n+1}}{n (\sqrt{2})^n e^{i 3\pi n/4}} \quad \text{g.c.d. if } n \geq 1$$

b) Ratio test $\lim_{n \rightarrow \infty} \left| \frac{u_{n+1}}{u_n} \right| = \frac{n}{n+1} \frac{\sqrt{2}^n}{\sqrt{2}^{n+1}} |z+1-i| =$

$$\frac{|z+1-i|}{\sqrt{2}} < 1 \quad \text{for abs. conv.} \quad \text{or} \quad |z - (-1+i)| < \sqrt{2}$$

b) For the series of part (a), the nearest singularity to $-1+i$ lies on the branch cut of $\text{Log } z$

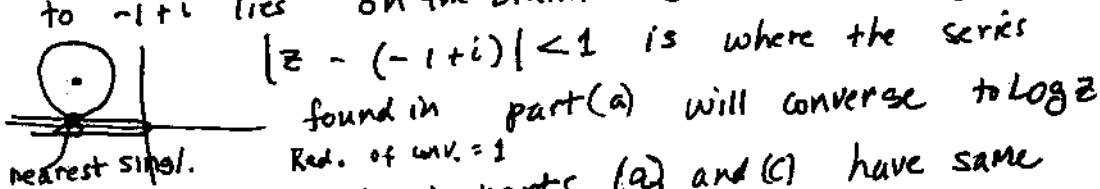

nearest singl.

Rad. of conv. = 1

The circles found in parts (a) and (c) have same centers but different radii. The radius in (a) is smaller.

30] a) $f(z) = \sum_{n=0}^{\infty} C_n z^n, \quad f(-z) = \sum_{n=0}^{\infty} C_n (-z)^n$

$$f(-z) = \sum_{n=0}^{\infty} (-1)^n C_n z^n = f(z). \quad \text{Now } g(z) = 0 = f(z) - f(-z)$$

$$0 = \sum_{n=0}^{\infty} C_n z^n - (-1)^n C_n z^n = \sum_{n=0}^{\infty} C_n (1 - (-1)^n) z^n$$

The Maclaurin expansion of $g(z)$ in the given domain must be such that all coeffs. are zero. Thus

$C_n [1 - (-1)^n] = 0$ all n . If n is even the preceding is satisfied. If n is odd we have $2C_n = 0$ or $C_n = 0$ (for n odd).

(b) $f(z) = \sum_{n=0}^{\infty} C_n z^n, \quad f(-z) = \sum_{n=0}^{\infty} C_n (-1)^n z^n = -f(z)$

30) cont'd

Sec 5.4 cont'd

$$f(z) + f(-z) = h(z) = 0 = \sum_{n=0}^{\infty} C_n [1 + (-1)^n] z^n$$

Since $h(z) = 0$ in a domain, all the coeffs.

$C_n [1 + (-1)^n] = 0$. If n is odd this is satisfied.

If n ^{even} have $2C_n = 0$ or $C_n = 0$

$$\text{c) } z \sin(z) = z \left[\frac{e^{iz} - e^{-iz}}{2i} \right] =$$

$$-z \sin(-z) = -z \left[\frac{e^{-i(-z)} - e^{i(-z)}}{2i} \right] = z \left[\frac{e^{iz} - e^{-iz}}{2i} \right] = z \sin z$$

Even function

C_1, C_3, C_5, \dots etc. vanish

$$z^2 \tan(z) = z^2 \frac{e^{iz} - e^{-iz}}{i [e^{iz} + e^{-iz}]} = -z^2 \tan(z)$$

$z^2 \tan(z)$ is an odd function, C_0, C_2, C_4, \dots vanish

$$\frac{\cosh z}{1+z^2} = \frac{1}{2} \frac{e^z + e^{-z}}{1+z^2} = \frac{\cosh(-z)}{1+(-z)^2} \text{ is an even func.}$$

$\therefore C_1, C_3, C_5, \dots$ vanish.

31) Use Cauchy ^{extended} integ. formula, $z_0 = 0$, contour is $|z| = r$. $\therefore \frac{f^n(0)}{n!} = \frac{1}{2\pi i} \int_{|z|=r} \frac{f(z)}{(z)^{n+1}} dz$

$$\left| \frac{f^n(0)}{n!} \right| = \left| \frac{1}{2\pi i} \int \frac{f(z)}{z^{n+1}} dz \right| \leq \frac{1}{2\pi} M \frac{2\pi r}{r^{n+1}}$$

Use ML Ineq.

$$\left| \frac{f(z)}{z^{n+1}} \right| \leq M \text{ or } \frac{|f(z)|}{r^{n+1}} \leq M. \text{ Now } |f(z)| \leq k$$

$$\therefore \frac{|f(z)|}{r^{n+1}} \leq \frac{k}{r^{n+1}} \therefore \text{take } M = \frac{k}{r^{n+1}}$$

$$\therefore \left| \frac{f^n(0)}{n!} \right| \leq \frac{1}{2\pi} \frac{k}{r^{n+1}} \cdot 2\pi r = \frac{k}{r^n}$$

recall $C_n = \frac{f^n(0)}{n!} \therefore |C_n| \leq \frac{k}{r^n}$ f.e.d.

Sec 5.4 cont'd

3.11 continued

b) Suppose $r=1$. On the contour
 $e^z = e^{r\cos\theta + i r\sin\theta}$ $|e^z| = e^{r\cos\theta}$

The preceding is max if $\theta = 0$, $\therefore |e^z| \leq e^{r\cos\theta} = e$
 $r=1$

From result of a) $|C_n| \leq \frac{e}{r^{n+1}} = e$ since $r=1$, g.e.d.

Suppose $r=2$, Then on the contour $|e^z| \leq e^{2\cos\theta} = e^2$

From result of a), $C_n \leq \frac{e^2}{r^n} = \frac{e^2}{2^n}$ since $r=2$
 g.e.d.

The known coefficients are $C_n = \frac{1}{n!}$, $n=0, 1, 2, \dots$

$C_0 = 1, C_1 = 1, C_2 = \frac{1}{2}, C_3 = \frac{1}{6}, C_4 = \frac{1}{24} \dots$

All of these coeffs. satisfy the 2 inequalities just derived.

c) From extended Cauchy Integral Formula:

$$\frac{f^n(z_0)}{n!} = \frac{1}{2\pi i} \oint_C \frac{f(z)}{(z-z_0)^{n+1}} dz$$

Take $C = |z-z_0|=r$, Assume $|f(z)| \leq K$ on C

$\therefore \frac{|f^n(z_0)|}{n!} \leq \frac{1}{2\pi} M 2\pi r$. Take $M = \frac{K}{r}$ as above.

$|C_n| \leq \frac{K}{r}$ as above. $|f(z)| \leq K$ on $|z-z_0|=r$

$e^z = \sum_{n=0}^{\infty} C_n (z-3)^n$, $C_n = \frac{1}{2\pi i} \int_{|z-3|=r} \frac{e^z}{(z-3)^{n+1}} dz$
 $|z-3|=r, z_0=3$

Suppose you take $r=1$

Now on $|z-3|=1$ $|e^z| \leq e^4$

$\therefore |C_n| \leq \frac{K}{r} = e^4$ g.e.d. Note: $C_0 = \frac{e^3}{1}, C_1 = \frac{e^3}{1}$,

$C_2 = \frac{e^3}{2}$ etc. and the inequality is satisfied.

32

sec 5.4

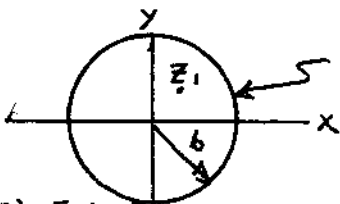
a)  $f(z) = \frac{1}{2\pi i} \oint_{C'} \frac{f(z)}{(z-z_1)} dz$

$$= \frac{1}{2\pi i} \oint_{C'} \frac{f(z)}{z} \left[\frac{1}{1 - \frac{z_1}{z}} \right] dz =$$

$$= \frac{1}{2\pi i} \oint_{C'} \frac{f(z)}{z} \left[1 + \frac{z_1}{z} + \frac{z_1^2}{z^2} + \dots + \frac{(z_1)^{n-1}}{(z)^{n-1}} + \frac{(z_1)^n}{(z)^n} \right] dz$$

$$= \frac{1}{2\pi i} \oint_{C'} f(z) \left[\frac{1}{z} + \frac{z_1}{z^2} + \frac{z_1^2}{z^3} + \dots + \frac{z_1^{n-1}}{z^n} + \frac{(z_1)^n}{z-z_1} \right] dz$$

(b) Integrate term by term:

$$\oint_{C'} z^k \frac{f(z)}{z^{k+1}} dz = z_1^k \int_{C'} \frac{f(z)}{z^{k+1}} dz = z_1^k \frac{f^{(k)}(0)}{k!}$$

Cauchy Int. Formula

$$f(z) = \sum_{k=0}^{n-1} \frac{f^{(k)}(0) z_1^k}{k!} + \underbrace{\frac{1}{2\pi i} \oint_{C'} \frac{f(z)}{(z-z_1)} \left(\frac{z_1}{z}\right)^n dz}_{R_n}$$

$$(c) |R_n| = \frac{|z_1|^n}{2\pi} \left| \int_{C'} \frac{f(z)}{z^n (z-z_1)} dz \right| \leq \frac{|z_1|^n}{2\pi} \underbrace{2\pi b M}_L$$

Where $\frac{|f(z)|}{|z|^n |z-z_1|} \leq M$ for z on C' . Note $|z| = b$ on C' .

Now on C' $b > |z_1|$ so $|z-z_1| \geq b - |z_1|$ triangle inequality.

$$\frac{1}{|z-z_1|} \leq \frac{1}{b-|z_1|}. \text{ On } C', |z|=b. \text{ Thus on } C'$$

$$\frac{1}{|z|^n |z-z_1|} \leq \frac{1}{b^n [b-|z_1|]}. \text{ On } C', f(z) \leq M$$

$$\text{Thus } \frac{f(z)}{|z|^n |z-z_1|} \leq \frac{M}{b^n (b-|z_1|)} \quad \text{Take right side as } M$$

$$\text{Thus } |R_n| \leq \frac{|z_1|^n}{2\pi} \frac{2\pi b M}{b^n [b-|z_1|]} \quad \text{q.e.d.}$$

32. cont'd

sec 5.4,

d) $|z_1| = |i| = 1$, $b = 2$ $b - |z_1| = 1$. $|\cosh z| \leq \cosh x$
 $\leq \cosh 2 = m$, since z is max. value of x on contour
 $n-1 = 10$ in formula, $n = 11$. $|R_n| \leq \frac{2 * \cosh 2}{2^{11}} = \frac{\cosh 2}{2^{10}}$

33. a) $f(z_2) = \sum_{n=0}^{\infty} C_n z_2^n$

$$C_n = \frac{f^{(n)}(z_2) \Big|_{z_2=0}}{n!} = \frac{1}{n!}$$

$$\therefore f(z_2) = \sum_{n=0}^{\infty} \frac{1}{n!} z_2^n$$

Now from Ex. (5.4-10) have

$$f(z) = \sum_{n=0}^{\infty} C_n (z-z_0)^n \quad C_n = \frac{f^{(n)}(z_0)}{n!}$$

Let $z = z_1 + z_2$, $z_0 = z_1$.

$$\therefore f(z_1 + z_2) = \sum_{n=0}^{\infty} \frac{f^{(n)}(z_1)}{n!} z_2^n$$

But $f^{(n)}(z_1) = f^{(n)}(z)$. Use this in the above

and factor out $f(z)$

$$f(z_1 + z_2) = f(z) \sum_{n=0}^{\infty} \frac{z_2^n}{n!}$$

This is $f(z)$ [see the above]

b) The answer is no. The reason is that both functions would have the same Maclaurin expansion: $f(z) = \sum_{n=0}^{\infty} \frac{z^n}{n!}$. The proof is complete

34. (a) $e^z - 1 = z + \frac{z^2}{2!} + \frac{z^3}{3!} \dots$

$$C_n = \frac{1}{n!} \quad n \geq 1$$

It's clear that $\frac{1}{n!} \leq n$ for $n \geq 2$ as predicted by Bieber.

The requirements

of the conjecture are satisfied, since $e^{z-1} = 0$, $z=0$ and $\frac{d}{dz}(e^z - 1) \Big|_{z=0} = 1$. $e^z - 1$ is analytic and univalent. Why? If $e^{z_1} - 1 = e^{z_2} - 1$, $e^{z_1} = e^{z_2}$. If $|z_1| < 1$ and $|z_2| < 1$ the only solution to this is $z_1 = z_2$. Recall that if $e^z = e^{z'}$, then $z - z' = i2k\pi$, $k=0, \pm 1, \pm 2, \dots$

Sec 5.4

34) b) continued ↖ The coeff. does not satisfy Bieberb.
 $f(z) = z + 3z^2$ is the Maclaurin Series. Note that $f(0) = 0$, $f'(0) = 1$. Is $f(z)$ univalent in the unit disc? Suppose $z + 3z^2 = 0$, $z(1 + 3z) = 0$
 $z = 0$, $z = -1/3$ both lie inside the unit circle.
 $\therefore f(0) = f(-1/3)$ and the function $f(z)$ is not univalent.

c) $\frac{1}{(1-z)^2} = 1 + 2z + 3z^2 + 4z^3 + \dots$
 $f(z) = \frac{z}{(1-z)^2} = z + 2z^2 + 3z^3 + \dots$

Note that $f(0) = 0$, $f'(0) = 1$ as required

Suppose $\frac{z}{(1-z)^2} = c$. Does this have 2 solutions inside the unit circle? $\frac{z}{c} = z^2 - 2z + 1$
 $z^2 - 2\left[\frac{1}{2c}\right]z + 1 = 0$. The 2 roots must have a product equal to 1. Thus if one is inside $|z| < 1$ the other is outside. The function is \therefore univalent.

Sec 5.5

1. $\frac{1}{1-w} = 1 + w + w^2 + \dots$ $|w| < 1$
 take $w = -az$

$\frac{1}{1+az} = 1 - az + a^2z^2 - \dots$ $| -az | < 1$, $|z| < \frac{1}{|a|}$

2) $\frac{1}{(1-w)^2} = 1 + 2w + 3w^2 + \dots$ $|w| < 1$
 $w = -z^2$, $\frac{1}{1+w^2} = 1 - z^2 + z^4 - \dots$ $| -z^2 | < 1$
 $|z|^2 < 1$, $|z| < 1$

3) $\frac{1}{(1-w)} = 1 + w + w^2 + \dots$ $|w| < 1$, let $w = -a-z$
 $\frac{1}{(1+a+z)} = 1 + (a+z) + (a+z)^2 + (a+z)^3 + \dots$ $| -a-z | < 1$
 or $|z+a| < 1$

SEC 5.5 continued

4 (a) $e^w = 1 + w + \frac{w^2}{2!} + \dots$ all w . $w = -z^2$

$$e^{-z^2} = 1 - z^2 + \frac{z^4}{2!} - \frac{z^6}{3!} + \frac{z^8}{4!} \dots$$

$\left\{ \begin{array}{l} -z^2 \text{ can have any value} \\ \therefore z \text{ can have any value} \end{array} \right.$

b) $C_n = \frac{f^{(n)}(z_0)}{n!}$ $f^{(10)}(0) = 10! C_n$

The coefficient of z^{10} is $\frac{-1}{5!}$ in the series of (a).

$$\therefore f^{(10)}(0) = \frac{-10!}{5!} = -10 \times 9 \times 8 \times 7 \times 6 = 30,240$$

5) $\frac{1}{z^2} = 1 - 2(z-1) + 3(z-1)^2 - 4(z-1)^3 + \dots$ $|z-1| < 1$

differentiate $-\frac{2}{z^3} = -2 + 3 \cdot 2(z-1) - 4 \cdot 3(z-1)^2 + \dots$

divide by -2.

$$\frac{1}{z^3} = 1 - \frac{3 \cdot 2}{2}(z-1) + \frac{4 \cdot 3}{2}(z-1)^2 - \dots$$
 $|z-1| < 1$

6) $\frac{1}{1-z} = 1 + z + z^2 + z^3 + \dots$, $\frac{1}{(1-z)^2} = 1 + 2z + 3z^2 + \dots$

$$\frac{2}{(1-z)^3} = 2 + 3 \cdot 2z + 4 \cdot 3z^2 + 5 \cdot 4z^3 + \dots$$

$$\frac{2 \cdot 2}{(1-z)^4} = 3 \cdot 2 + 4 \cdot 3 \cdot 2z + 5 \cdot 4 \cdot 3z^2 + 6 \cdot 5 \cdot 4z^3 + \dots$$

$$\frac{1}{(1-z)^4} = 1 + \frac{4 \cdot 3 \cdot 2z}{2 \cdot 2} + \frac{5 \cdot 4 \cdot 3z^2}{3 \cdot 2} + \frac{6 \cdot 5 \cdot 4z^3}{3 \cdot 2} + \dots$$

$$= \sum_{n=0}^{\infty} C_n z^n \quad C_n = \frac{(n+3)!}{3! \cdot n!}$$

Sec 5.5 continued

7]

This is a generalization of the previous question.

Observe that:
$$\frac{(N-1)!}{(1-z)^N} = (N-1)! z^0 + \frac{N!}{1!} z^1 + \frac{(N+1)!}{2!} z^2$$

$$\frac{(N+2)! z^3}{3!} + \dots$$

$$\frac{1}{(1-z)^N} = z^0 + \frac{N!}{(N-1)! 1!} z^1 + \frac{(N+1)! z^2}{(N-1)! 2!} + \frac{(N+2)! z^3}{(N-1)! 3!} + \dots$$

$$= \sum_{n=0}^{\infty} C_n z^n \quad \text{where } C_n = \frac{[N+(n-1)]!}{(N-1)! n!}$$

8] a)

$$\frac{1}{1+z^{12}} = 1 - z^{12} + z^{24} - z^{36} \dots \quad |z| < 1$$

$$\int_0^z \frac{1}{1+z^{12}} dz' = \int_0^z [1 - z'^{12} + z'^{24} - z'^{36} \dots] dz' =$$

$$= z - \frac{z^{13}}{13} + \frac{z^{25}}{25} - \frac{z^{37}}{37} \dots \quad |z| < 1$$

$$\int_0^z \frac{dz'}{1+z^{12}} = \tan^{-1}(z) \quad \text{see } \epsilon_0 (3.7-10)$$

$$\text{thus } \tan^{-1}(z) = \sum_{n=0}^{\infty} \frac{(-1)^n z^{2n+1}}{2n+1} \quad |z| < 1$$

$$b) \quad \arg \left[\left(1 + \frac{i}{2}\right) \left(1 + \frac{i}{3}\right) \right] = \arg \left[1 + \frac{i}{2}\right] + \arg \left[1 + \frac{i}{3}\right]$$

$$\arg \left[\frac{5}{6} + i \frac{5}{6} \right] = \tan^{-1} \frac{1}{2} + \tan^{-1} \frac{1}{3}$$

$$\tan^{-1} 1 = \tan^{-1} \frac{1}{2} + \tan^{-1} \frac{1}{3}$$

$$\frac{\pi}{4} = \tan^{-1} \frac{1}{2} + \tan^{-1} \frac{1}{3}$$

$$\frac{\pi}{4} = \frac{1}{2} - \frac{(1/2)^3}{3} + \frac{(1/2)^5}{5} - \frac{(1/2)^7}{7}$$

$$+ \frac{1}{3} - \frac{(1/3)^3}{3} + \frac{(1/3)^5}{5} - \frac{(1/3)^7}{7} \dots$$

Sec 5.5

8(b) cont'd

$$\frac{\pi}{4} = \left(\frac{1}{2} + \frac{1}{3}\right) - \frac{\left[\left(\frac{1}{2}\right)^3 + \left(\frac{1}{3}\right)^3\right]}{3} + \frac{\left[\left(\frac{1}{2}\right)^5 + \left(\frac{1}{3}\right)^5\right]}{5} - \dots$$

n^{th} term is

$$\frac{(-1)^n}{(2n+1)} \left[\left(\frac{1}{2}\right)^{2n+1} + \left(\frac{1}{3}\right)^{2n+1} \right] \quad n=0, 1, \dots$$

% two ten term series approximations to pi/4 for problems in sec 5.5

format long , Prob 8(c)

s=0;

for n=0:9

s=(-1)^n*(1/(2*n+1))+s;

end

s1=s

s=0;

for n=0:9

s=(-1)^n*(.5^(2*n+1)+(1/3)^(2*n+1))/(2*n+1)+s;

end

s2=s

exact=pi/4

ans.

s1 = 1st series

0.76045990473235

s2 = 2nd series

0.78539814490159

"exact" =

0.78539816339745

9(a) $S_i(z) = z - \frac{z^3}{2 \cdot 3 \cdot 0} + \frac{z^5}{5 \cdot 5 \cdot 0} - \frac{z^7}{7 \cdot 7 \cdot 0} \dots \dots \text{all } z$

$$\int_0^z S_i(z') dz' = \int_0^z z' dz' - \int_0^z \frac{z'^3}{3 \cdot 3 \cdot 0} dz' + \int_0^z \frac{z'^5}{5 \cdot 5 \cdot 0} dz' \dots$$

$$= \frac{z^2}{2} - \frac{z^4}{4 \cdot 3 \cdot 3 \cdot 0} + \frac{z^6}{6 \cdot 5 \cdot 5 \cdot 0} - \frac{z^8}{8 \cdot 7 \cdot 7 \cdot 0} = \sum_{n=1}^{\infty} c_n z^{2n} \quad \text{all } z$$

$$c_n = \frac{(-1)^{n+1}}{(2n)(2n-1)(2n-1)!}$$

(b) $\frac{(2i)^2}{2} - \frac{16}{4 \cdot 3 \cdot 3 \cdot 0} + \frac{(2i)^6}{6 \cdot 5 \cdot 5 \cdot 0} - \frac{2^8}{8 \cdot 7 \cdot 7 \cdot 0} = -2.24$

Sec 5.5 cont'd

10)

$$\int_0^P e^{i \frac{\pi}{2} t^2} dt = \int_0^P \cos\left(\frac{\pi}{2} t^2\right) dt + i \int_0^P \sin\left(\frac{\pi}{2} t^2\right) dt$$

$$= \int_0^P \left[1 + \frac{(i \frac{\pi}{2} t^2)^2}{2!} + \frac{(i \frac{\pi}{2} t^2)^3}{3!} + \dots \right] dt =$$

$$P + \frac{(i \frac{\pi}{2})^2}{2!} \frac{P^3}{3} + \frac{(i \frac{\pi}{2})^3}{3!} \frac{P^5}{5} + \frac{(i \frac{\pi}{2})^4}{4!} \frac{P^7}{7} + \dots$$

$$= \sum_{n=0}^{\infty} C_n P^{2n+1} \quad C_n = \frac{(i \frac{\pi}{2})^n}{n! (2n+1)}$$

b)

```
% for Cornu Spiral, problem 10 b) Sec 5.5
clear; hold off
p=linspace(0,1.5,16);
ss=zeros(size(p));

for k=1:length(p)
    for n=1:5
        N=n-1;
        ss(k)=(i*pi/2)^N*p(k)^(2*N+1)/(gamma(N+1)*(2*N+1))+ss(k);
    end
end
plot(ss); grid; hold on
clear
p=linspace(0,1.5,16);
ss=zeros(size(p));

for k=1:length(p)
    for n=1:10
        N=n-1;
        ss(k)=(i*pi/2)^N*p(k)^(2*N+1)/(gamma(N+1)*(2*N+1))+ss(k);
    end
end
plot(ss);
```

10(b)

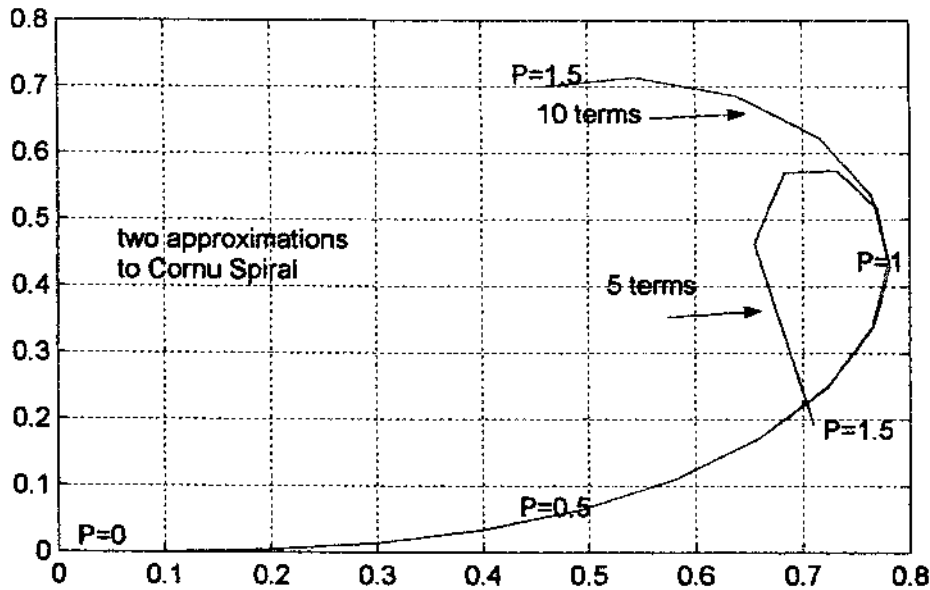

Cornu Spiral

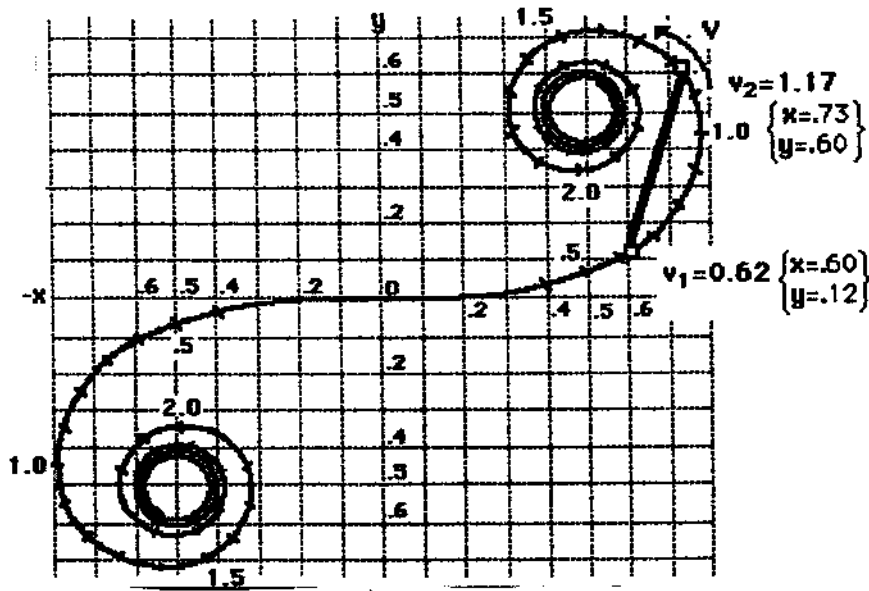

<http://hyperphysics.phy-astr.gsu.edu/hbase/phyopt/cornu.html>

Comment: By comparing the above 2 figures we see that to obtain a smooth coiled curve in the first quadrant we must use many terms and a fine spacing between points.

11

SEC 5.5

$$a) \frac{1}{1-z} = 1+z+z^2+z^3+\dots, \quad \left(\frac{1}{1-z}\right)^2 = 1+2z+3z^2+4z^3$$

↑ differentiate

$$\text{differentiate again } \frac{2}{(1-z)^3} = 2+3\cdot 2z+4\cdot 3z^2+$$

$$\frac{2z}{(1-z)^3} = 2z+3\cdot 2z^2+4\cdot 3z^3+\dots = \sum_{n=1}^{\infty} (n+1)(n)z^n$$

$$= \sum_{n=1}^{\infty} n^2 z^n + \sum_{n=1}^{\infty} n z^n$$

$$\frac{z}{(1-z)^2} = z+2z^2+3z^3+\dots = \sum_{n=1}^{\infty} n z^n \quad |z| < 1$$

Subtract this last result from the one before it.

$$\frac{2z}{(1-z)^3} - \frac{z}{(1-z)^2} = \sum_{n=1}^{\infty} n^2 z^n = z \frac{[2-(1-z)]}{(1-z)^3}$$

$$= \frac{z+z^2}{(1-z)^3} \quad \text{g.e.d.}$$

b) Put $z = \frac{1}{2}$ in the preceding result.

$$\sum_{n=1}^{\infty} n^2 \left(\frac{1}{2}\right)^n = \frac{1}{2} + 4 \times \frac{1}{4} + 9 \times \frac{1}{8} + 4 \times \frac{1}{16} + \dots$$

$$= \frac{\frac{1}{2} + \frac{1}{4}}{\left(1 - \frac{1}{2}\right)^3} = 8 \times \frac{3}{4} = 6$$

$$12] \cosh z = 1 + \frac{z^2}{2!} + \frac{z^4}{4!} + \dots \quad \text{all } z$$

$$\frac{1}{1-z} = 1+z+z^2+z^3+\dots \quad |z| < 1$$

$$\frac{\cosh z}{1-z} = \left(1 + \frac{z^2}{2!} + \frac{z^4}{4!} + \frac{z^6}{6!} + \dots\right) (1+z+z^2+z^3+\dots) = \sum_{n=0}^{\infty} C_n z^n =$$

$$= 1 + z + \left[1 + \frac{1}{2!}\right] z^2 + \left[1 + \frac{1}{2!}\right] z^3 + \left[1 + \frac{1}{2!} + \frac{1}{4!}\right] z^4 + \left[1 + \frac{1}{2!} + \frac{1}{4!}\right] z^5 + \dots$$

Valid for $|z| < 1$

$$C_n = 1 + \frac{1}{2!} + \frac{1}{4!} + \dots + \frac{1}{n!} \quad \text{if } n \text{ is even.}$$

$$C_n = 1 + \frac{1}{2!} + \frac{1}{4!} + \dots + \frac{1}{(n-1)!} \quad \text{if } n \text{ is odd}$$

B]

Sec 5.5 cont'd

$$\text{See Eqn (5.3-8)} \quad \text{Log}(1-z) = -1 \left[z + \frac{z^2}{2} + \frac{z^3}{3} + \frac{z^4}{4} + \dots \right] \quad |z| < 1$$

$$\frac{1}{1+z} = 1 - z + z^2 - z^3 + z^4 - \dots \quad |z| < 1$$

$$\begin{aligned} \frac{1}{1+z} \text{Log}(1-z) &= -1 \left[1 - z + z^2 - z^3 + z^4 - \dots \right] \left[z + \frac{z^2}{2} + \frac{z^3}{3} + \frac{z^4}{4} + \dots \right] \\ &= z(-1) + z^2 \left[1 - \frac{1}{2} \right] + z^3 \left[-1 + \frac{1}{2} - \frac{1}{3} \right] + z^4 \left[1 - \frac{1}{2} + \frac{1}{3} - \frac{1}{4} \right] + \dots \\ &= \sum_{n=1}^{\infty} C_n z^n \quad C_n = (-1)^n \left[1 - \frac{1}{2} + \frac{1}{3} - \frac{1}{4} + \dots + \frac{1}{n} \right] \end{aligned}$$

Series valid for $|z| < 1$

$$4) \quad a) \quad \frac{P}{Q} = \frac{A_1}{z-a_1} + \frac{A_2}{z-a_2} + \dots + \frac{A_n}{z-a_n}$$

$$\frac{P(z)}{c} = A_1 (z-a_2)(z-a_3)\dots(z-a_n) + A_2 (z-a_1)(z-a_3)\dots(z-a_n) + \dots + A_n (z-a_1)(z-a_2)\dots(z-a_{n-1})$$

b) Put $z = a_1$ in the preceding. All terms on right disappear except first. Have: $\frac{P(a_1)}{c} = A_1 (a_1 - a_2)(a_1 - a_3)\dots(a_1 - a_n)$

or $A_1 = \frac{P(a_1)}{c (a_1 - a_2)(a_1 - a_3)\dots(a_1 - a_n)}$. In general

$$A_j = \frac{P(a_j)}{c (a_j - a_1)(a_j - a_2)\dots(a_j - a_{j-1})(a_j - a_{j+1})\dots(a_j - a_n)}$$

$$c) \quad \lim_{z \rightarrow a_1} \left[\frac{(z-a_1) P(z)}{c (z-a_1)(z-a_2)\dots(z-a_n)} \right]$$

Use L'Hopital's rule

$$= \lim_{z \rightarrow a_1} \left[\frac{P(z) + P'(z)(z-a_1)}{(z-a_1) \frac{d}{dz} c (z-a_2)(z-a_3)\dots(z-a_n) + c (z-a_2)(z-a_3)\dots(z-a_n)} \right]$$

$$= \frac{P(a_1)}{c (a_1 - a_2)(a_1 - a_3)\dots(a_1 - a_n)} \quad \text{which is the same as } A_1 \text{ in part b}$$

cont'd 14] Sec 5.5 cont'd

14] Use part (c). $\frac{z}{(z^2+1)(z-2)} = \frac{a}{z-i} + \frac{b}{z+1} + \frac{c}{z-2}$

$a = \lim_{z \rightarrow i} \frac{z}{(2z)(z-2)} \Big|_i = \frac{1}{(2)(i-2)}$, $b = \lim_{z \rightarrow -1} \frac{z}{(2z)(z-2)} = \frac{1}{(2)(-1-2)}$

$c = \lim_{z \rightarrow 2} \frac{z}{z^2+1} = \frac{2}{5}$

15] $\frac{z}{(z-1)(z+2)} = \frac{1/3}{(z-1)} + \frac{2/3}{z+2} = \frac{1}{3} [1+z+z^2+\dots] + \frac{1}{3} \frac{1}{1+z/2}$
 $= \frac{1}{3} [1+z+z^2+\dots] + \frac{1}{3} [1 - \frac{z}{2} + \frac{z^2}{4} - \frac{z^3}{8} \dots]$ where $C_n = \left[\frac{1}{3} + \frac{1}{3} \frac{(-1)^n}{2^n} \right]$

16] $\frac{z}{(z+1)(z+2)} = \frac{-1}{(z+1)} + \frac{2}{(z+2)}$

$\frac{-1}{z+1} = \frac{-1}{z-1+2} = \frac{-1/2}{1 + \frac{z-1}{2}} = \frac{-1/2}{1 + \frac{z-1}{2}} \dots$
 $|z-1| < 2$

$\frac{2}{z+2} = \frac{2}{(z-1)+3} = \frac{2/3}{1 + (\frac{z-1}{3})} = \frac{2/3}{1 + (\frac{z-1}{3})} \dots$

add the two previous series:

$\frac{z}{(z+1)(z+2)} = \sum_{n=0}^{\infty} C_n (z-1)^n$, $C_n = \frac{-1}{2} \left(\frac{-1}{2}\right)^n + \frac{2}{3} \left(\frac{-1}{3}\right)^n$

17] $\frac{1}{z^2} = \frac{1}{[(z-(1+i)) + (1+i)]^2} = \frac{1}{(1+i)^2} \frac{1}{\left[1 + \frac{z-(1+i)}{(1+i)}\right]^2}$

$= \frac{1}{2i} \frac{1}{(1+W)^2}$ where $W = \frac{z-(1+i)}{1+i}$

$\frac{1}{(1+W)^2} = 1 - 2W + 3W^2 - 4W^3 \dots$ (see text) $|W| < 1$

$\frac{1}{2i} \frac{1}{(1+W)^2} = \frac{1}{2i} \sum_{n=0}^{\infty} C_n [z-(1+i)]^n$ where $C_n = \frac{(-1)^n (n+1)}{2i (1+i)^n}$

Since $|W| < 1$, require $\frac{|z-(1+i)|}{|1+i|} < 1$ or $|z-(1+i)| < \sqrt{2}$

18]

Sec 5.5 cont'd

$$\frac{1}{z^3} = \frac{1}{(z-i+i)^3} = \frac{1}{i^3} \frac{1}{\left[1 + \frac{z-i}{i}\right]^3} = \frac{i}{[1-i(z-i)]^3}$$

$\frac{1}{(1-w)^2} = 1 + 2w + 3w^2 + 4w^3 \dots$ (see text) Ex 5.3-16 c
differentiate the above

$$\frac{2}{(1-w)^3} = 2 + 3 \cdot 2w + 4 \cdot 3w^2 + 5 \cdot 4w^3 + \dots$$

$$\frac{1}{(1-w)^3} = \frac{1}{2} \sum_{n=0}^{\infty} (n+2)(n+1)w^n \quad |w| < 1, \text{ let } w = i(z-i)$$

$$\frac{1}{z^3} = \frac{i}{[1-i(z-i)]^3} = \frac{i}{2} \sum_{n=0}^{\infty} (n+2)(n+1) [i(z-i)]^n$$

$$= \sum_{n=0}^{\infty} c_n (z-i)^n \quad \text{where } c_n = \frac{i}{2} (n+2)(n+1) i^n, \quad |w| < 1$$

$\therefore |z-i| < 1$

19]

$$\frac{z+1}{(z-1)^2(z+2)} = \frac{a}{(z-1)} + \frac{b}{(z-1)^2} + \frac{c}{(z+2)}$$

$$z+1 = a(z-1)(z+2) + b(z+2) + c(z-1)^2$$

note $a = -c$ since coeff of $z^2 = 0$
on both right and left sides

put $z=1$ in preceding, get $b=2/3$, put $z=-2$
in same eqn. get $c=-1/9$. $\therefore a=1/9$

$$\frac{z+1}{(z-1)^2(z+2)} = \frac{1/9}{z-1} + \frac{2/3}{(z-1)^2} - \frac{1/9}{z+2}$$

$$\frac{1/9}{z-1} = \frac{1/9}{(z-2+1)} = \frac{1/9}{1 + \underbrace{(z-2)}_w} = \frac{1}{9} \left[1 - (z-2) + (z-2)^2 - \dots \right]$$

$|z-2| < 1$

$$\frac{2/3}{(z-1)^2} = \frac{2/3}{(z-2+1)^2} = \frac{2/3}{\left[1 + \underbrace{(z-2)}_w\right]^2} = \frac{2}{3} \left[1 - 2(z-2) + 3(z-2)^2 - \dots \right]$$

$|z-2| < 1$

$$\frac{-1/9}{z+2} = \frac{-1/9}{z-2+4} = \frac{-1/36}{1 + \underbrace{(z-2)}_w/4} = -1/36 \left[1 - \left(\frac{z-2}{4}\right) + \left(\frac{z-2}{4}\right)^2 - \dots \right]$$

$\left|\frac{z-2}{4}\right| < 1$

19. cont'd

sec 5.5 cont'd

add the 3 preceding series expansions of the partial fractions together. Get:

$$\frac{z+1}{(z-1)^2(z+2)} = \sum_{n=0}^{\infty} C_n (z-2)^n, \text{ valid for } |z-2| < 1$$

$$\text{Where } C_n = \frac{1}{9}(-1)^n + \frac{2}{3}(-1)^n(n+1) - \frac{1}{36} \frac{(-1)^n}{4^n}$$

20)
$$\frac{1}{(z-1)^2(z+1)^2} = \frac{a}{(z-1)^2} + \frac{b}{z-1} + \frac{c}{z+1} + \frac{d}{(z+1)^2}$$

$$1 = a(z+1)^2 + b(z-1)(z+1)^2 + c(z-1)^2 + d(z-1)^2(z+1)$$

put $z=1$, get $a=1/4$, put $z=-1$, $c=1/4$

Coeff of z^3 in preceding eqn. is $b+d=0$
 $0 = b+d$, $b = -d$. Now put $z=0$ in the above eqn. $a=1/4$, $c=1/4$, $d=-b$. Get

$$1 = \frac{1}{4} + b(-1) + \frac{1}{4} - b \Rightarrow b = -\frac{1}{4}, d = \frac{1}{4}$$

Thus
$$\frac{1}{(z-1)^2(z+1)^2} = \frac{1/4}{(z-1)^2} + \frac{-1/4}{z-1} + \frac{1/4}{(z+1)^2} + \frac{1/4}{z+1}$$

$$\frac{1/4}{(z-1)^2} = \frac{1/4}{(z-2+1)^2} = \frac{1/4}{(1+(z-2))^2} = \frac{1}{4} \left[1 - 2(z-2) + (3)(z-2)^2 - \dots \right]_{|z-2| < 1}$$

$$\frac{-1/4}{z-1} = \frac{-1/4}{z-2+1} = \frac{-1/4}{1+(z-2)} = -\frac{1}{4} \left[1 - (z-2) + (z-2)^2 - (z-2)^3 + \dots \right]_{|z-2| < 1}$$

$$\frac{1/4}{(z+1)^2} = \frac{1/4}{(z-2+3)^2} = \frac{1/4}{[3+(z-2)]^2} = \frac{1}{36} \left[\frac{1}{1 + \frac{(z-2)}{3}} \right]^2 =$$

$$\frac{1}{36} \left[1 - 2 \frac{(z-2)}{3} + 3 \frac{(z-2)^2}{3^2} - 4 \frac{(z-2)^3}{3^3} + \dots \right]_{\text{for } \left| \frac{z-2}{3} \right| < 1}$$

$|z-2| < 3$

$$\frac{1/4}{z+1} = \frac{1/4}{z-2+3} = \frac{1/4}{1 + \frac{z-2}{3}} = \frac{1}{12} \left[1 - \left(\frac{z-2}{3}\right) + \left(\frac{z-2}{3}\right)^2 - \left(\frac{z-2}{3}\right)^3 + \dots \right]_{\text{for } |z-2| < 3}$$

20] cont'd

Sec 5.5

add the series expansions of the 4 previous equations.

$$\frac{1}{(z-1)^2(z+1)^2} = \sum_{n=0}^{\infty} C_n (z-2)^n \quad |z-2| < 1$$

$$C_n = \frac{1}{4}(-1)^n(n+1) - \frac{1}{4}(-1)^n + \frac{1}{36} \frac{(-1)^n(n+1)}{3^n} + \frac{1}{36} \left[\frac{3}{3^n} (-1)^n \right]$$

$$= \frac{1}{4}(-1)^n n + \frac{1}{36} \frac{(-1)^n}{3^n} (n+4)$$

21)
$$\frac{1}{(z-2)(z+1)} = \frac{1/3}{(z-2)} + \frac{-1/3}{(z+1)}$$

$$\frac{-1/3}{z-2} = \frac{-1/6}{1-\frac{z}{2}} = -1/6 \left[1 + \frac{z}{2} + \frac{z^2}{4} + \frac{z^3}{8} + \dots \right] \quad |z| < 2$$

$$\frac{-1/3}{1+z} = -1/3 \left[1 - z + z^2 - z^3 + z^4 - \dots \right] \quad |z| < 1$$

add the 2 preceding series

$$\frac{1}{(z-2)(z+1)} = \sum_{n=0}^{\infty} d_n z^n, \quad d_n = \frac{1}{6} \left(\frac{1}{2^n} \right) - \frac{1}{3} (-1)^n$$

$$\frac{e^z}{(z-2)(z+1)} = \left[1 + \frac{z}{2!} + \frac{z^2}{3!} + \frac{z^3}{4!} + \dots \right] \left[d_0 + d_1 z + d_2 z^2 + d_3 z^3 + \dots \right]$$

$$\frac{e^z}{(z-2)(z+1)} = c_0 + c_1 z + c_2 z^2 + \dots$$

$$c_0 = d_0, \quad c_1 = d_0 + d_1, \quad c_2 = \frac{d_0}{2!} + \frac{d_1}{1!} + \frac{d_2}{0!}$$

$$c_3 = \frac{d_0}{3!} + \frac{d_1}{2!} + d_2 + d_3, \quad c_4 = \frac{d_0}{4!} + \frac{d_1}{3!} + \frac{d_2}{2!} + d_3 + d_4$$

$$C_n = \frac{d_0}{n!} + \frac{d_1}{(n-1)!} + \frac{d_2}{(n-2)!} + \dots + \frac{d_{n-1}}{1!} + \frac{d_n}{0!}$$

series valid $|z| < 1$

22) Taylor's Thm.
$$f(z) = \sum_{n=0}^{\infty} \frac{f^n(z_0)}{n!} (z-z_0)^n$$

$$C_n = \frac{f^n(z_0)}{n!}, \quad f^n(z_0) = n! C_n, \quad f^{10}(z_0) = 10! C_{10}$$

$$= 10! \left[\frac{10}{4} + \frac{1}{36} \cdot \frac{14}{3^{10}} \right]$$

$$\begin{array}{r}
 z+2 \\
 z^2-4 \overline{) z^3+2z^2+z-1} \\
 \underline{z^3} \qquad -4z \\
 2z^2+5z-1 \\
 \underline{2z^2} \quad -8 \\
 \hline
 5z+7
 \end{array}$$

$$\therefore \frac{z^3+2z^2+z-1}{z^2-4} = (z+2) + \frac{5z+7}{z^2-4} = 3+(z-1) + \frac{5z+7}{z^2-4}$$

$$= (z-1)+3 + \frac{5z+7}{z^2-4}$$

$$\frac{5z+7}{z^2-4} = \frac{a}{z-2} + \frac{b}{z+2}$$

$$5z+7 = a(z+2) + b(z-2) \quad a = \frac{17}{4}, \quad b = \frac{3}{4}$$

$$\frac{1}{4} \frac{1}{z-2} = \frac{-17/4}{1-(z-1)} = -17/4 [1 + (z-1) + (z-1)^2 + (z-1)^3 + \dots]$$

for $|z-1| < 1$

$$\frac{3}{4} \frac{1}{z+2} = \frac{3/4}{z-1+3} = \frac{1/4}{1+(z-1)/3} = \frac{1}{4} \left[1 - \frac{(z-1)}{3} + \frac{(z-1)^2}{9} - \dots \right]$$

for $|z-1| < 3$

add the 2 preceding series

$$\frac{5z+7}{z^2-4} = \sum_{n=0}^{\infty} d_n (z-1)^n \quad \text{where } d_n = -\frac{17}{4} + \frac{1}{4} \frac{(-1)^n}{3^n}$$

Now add the preceding series to $3+(z-1)$ and

$$\text{Set } \frac{z^3+2z^2+z-1}{z^2-4} = \sum_{n=0}^{\infty} C_n (z-1)^n \quad |z-1| < 1$$

$$\text{where } C_n = -\frac{17}{4} + \frac{1}{4} \frac{(-1)^n}{3^n} \quad \text{for } n \geq 2.$$

$$\text{If } n=0, \quad C_0 = 3 + d_0 = 3 - \frac{17}{4} + \frac{1}{4} = -1 = C_0$$

$$\text{If } n=1, \quad C_1 = 1 + d_1 = 1 - \frac{17}{4} - \frac{1}{12} = -\frac{10}{3} = C_1$$

Sec 5.5 cont'd

24)

$$\frac{\frac{a_0}{b_0} + \frac{1}{b_0} \left[a_1 - \frac{a_0}{b_0} b_1 \right] (z-z_0) + \left(\frac{a_2}{b_0} - \frac{a_1 b_1 + a_0 b_2 + a_0 b_1^2}{b_0^2} \right) (z-z_0)^2}{b_0 + b_1 (z-z_0) + b_2 (z-z_0)^2 + \dots}$$

$$\frac{a_0 + a_1 (z-z_0) + a_2 (z-z_0)^2 + \dots}{a_0 + \frac{a_0}{b_0} b_1 (z-z_0) + \frac{a_0}{b_0} b_2 (z-z_0)^2 + \dots}$$

$$\frac{\left(a_1 - \frac{a_0}{b_0} b_1 \right) (z-z_0) + \left(a_2 - \frac{a_0 b_2}{b_0} \right) (z-z_0)^2 + \dots}{\left(a_1 - \frac{a_0}{b_0} b_1 \right) (z-z_0) + \frac{b_1}{b_0} \left(a_1 - \frac{a_0}{b_0} b_1 \right) (z-z_0)^2 + \dots}$$

$$(z-z_0)^2 \left(\frac{a_2 - a_0 b_2}{b_0} - \frac{a_1 b_1}{b_0} + \frac{b_1^2 a_0}{b_0^2} \right) + \dots$$

The coefficients of $(z-z_0)^0$, $(z-z_0)^1$, $(z-z_0)^2$ in the quotient are identical to c_0, c_1, c_2 in Eq (5.5-11)

25) $\log(1+z) = z - \frac{z^2}{2} + \frac{z^3}{3} - \frac{z^4}{4} + \dots$ (see Eq (5.3-8), put $-z$ in place of z)
 $\cos z = 1 - \frac{z^2}{2} + \frac{z^4}{4!} - \frac{z^6}{6!} + \dots$

$$\frac{1 - \frac{z^2}{2!} + \frac{z^4}{4!} - \frac{z^6}{6!} + \dots}{z - \frac{z^2}{2} + \frac{z^3}{3} - \frac{z^4}{4} + \dots}$$

$$\frac{z - \frac{z^3}{2} + \frac{z^5}{4!}}{-\frac{z^2}{2} + \frac{5}{6} z^3}$$

$$\frac{-\frac{z^2}{2} + \frac{z^4}{4}}{\frac{5}{6} z^3 + \dots}$$

$$\frac{\log(1+z)}{\cos(z)} = z - \frac{1}{2} z^2 + \frac{5}{6} z^3 + \dots$$

26) \longleftarrow answer

$$\begin{array}{r}
 1+z+z^2+z^3+\dots \\
 \hline
 1+z \\
 1+z+z^2+z^3+z^4+\dots \\
 \hline
 -z^2-z^3-z^4-z^5\dots \\
 -z^2-z^3-z^4-z^5\dots \\
 \hline
 0 \text{ (remainder)}
 \end{array}$$

Explanation:

$$\frac{1+z}{1+z+z^2+z^3+\dots}$$

If the series in the denominator converges, then $|z| < 1$, and the sum of the series is $\frac{1}{1-z}$

$$\therefore \frac{1+z}{\frac{1}{1-z}} = 1+z^2 \text{ (same as above)}$$

note

$$\frac{z}{e^z-1} = \frac{1}{1+\frac{z}{2}+\frac{z^2}{24}+\dots}$$

27) a)

$$\begin{array}{r}
 1 + \frac{z}{2!} + \frac{z^2}{3!} + \dots \\
 \hline
 1 + \frac{z}{2!} + \frac{z^2}{3!} \\
 \hline
 -\frac{z}{2!} \quad -\frac{z^2}{3!} \\
 -\frac{z}{2!} \quad -\frac{z^2}{(2!)^2} \\
 \hline
 z^2 \left(\frac{1}{12} \right) \\
 z^2 \left(\frac{1}{12} \right)
 \end{array}$$

$$C_0 = 1, C_1 = -\frac{1}{2}, C_2 = \frac{1}{12} \quad B_0 = 0 \cdot 1 = 1, B_1 = \frac{1!}{-2} = -\frac{1}{2}$$

$$B_2 = \frac{2!}{12} = \frac{1}{6}$$

$$\begin{aligned}
 b) \quad g(z) &= f(z) + \frac{z}{2} = \frac{z}{e^z-1} + \frac{z}{2} = \frac{z}{e^z-1} + \frac{z}{2} \frac{(e^z-1)}{(e^z-1)} \\
 &= \frac{z}{2} \frac{(1+e^z)}{e^z-1} = \frac{z}{2} \frac{\cosh(z/2)}{\sinh(z/2)} = g(z). \text{ This is an}
 \end{aligned}$$

even function $g(z) = g(-z)$. Thus $g(z) = \sum_{n=0}^{\infty} d_n z^n$ where $d_n = 0$ if $n=1, 2, 3, \dots$ (odd)

$$\underbrace{\sum_{n=0}^{\infty} c_n z^n + z/2}_{f(z)} = \sum_{n=0}^{\infty} d_n z^n$$

27]

(cont'd)

SEC 5.5

Equate coeffs in the preceding

$$c_0 = d_0$$

$$c_1 + \frac{1}{2} = d_1, \quad d_1 = 0$$

$$c_1 = -\frac{1}{2} \quad (\text{which we knew})$$

$$c_2 = d_2$$

$$c_3 = d_3 = 0$$

etc.

thus $c_5 = 0, c_7 = 0, \dots, c_n = 0, n \text{ odd and } n > 1$

$$B_n = n! \cdot c_n, \quad B_n = 0, \quad n \text{ odd and } n > 1.$$

(c) $f(z) = \frac{1}{1 + \frac{z}{20} + \frac{z^2}{30} + \dots}$. At what point

(nearest $z=0$) is the denominator equal to zero?The denominator is $(\frac{e^z - 1}{z})$. Where is $(e^z - 1) = 0$?

$$e^z = 1. \quad z = \log 1 = i 2k\pi. \quad \text{Put } k = \pm 1. \quad z = \pm i 2\pi.$$

∴ series is valid in disc $|z| < 2\pi$

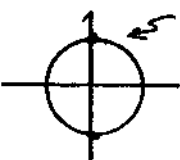
28 (a)  circle of conv. is $|z| = \pi/2$

$$\cosh z = 1 + \frac{z^2}{2!} + \frac{z^4}{4!} + \frac{z^6}{6!} + \dots$$

$$1 - \frac{z^2}{2} + z^4 \left(\frac{1}{(2!)^2} - \frac{1}{4!} \right) + z^6 \left[\frac{1}{4! \cdot 2} - \frac{1}{6!} - \frac{1}{2} \left(\frac{1}{4} - \frac{1}{4!} \right) \right] + \dots$$

$$\left(1 + \frac{z^2}{20} + \frac{z^4}{40} + \frac{z^6}{60} \right) \left(1 + \frac{z^2}{20} + \frac{z^4}{40} + \frac{z^6}{60} + \dots \right)$$

$$\frac{-z^2}{20} - \frac{z^4}{40} - \frac{z^6}{60}$$

$$\frac{-z^2}{2} - \frac{z^4}{(2!)^2} - \frac{z^6}{4! \cdot 20}$$

$$z^4 \left[\left(\frac{1}{(2!)^2} - \frac{1}{4!} \right) + z^2 \left[\frac{1}{4! \cdot 20} - \frac{1}{6!} \right] \right]$$

$$z^6 \left[\left(\frac{1}{(2!)^2} - \frac{1}{4!} \right) + z^2 \left[\frac{1}{4! \cdot 20} - \frac{1}{6!} - \frac{1}{2} \left(\frac{1}{4} - \frac{1}{4!} \right) \right] \right]$$

$$z^6 \left[\frac{1}{4! \cdot 20} - \frac{1}{6!} - \frac{1}{20} \left(\frac{1}{2!} - \frac{1}{4!} \right) \right]$$

28(a)

sec 5.5

cont'd

$$\frac{1}{\cosh z} = 1 - \frac{z^2}{2} + \left(\frac{1}{4} - \frac{1}{40}\right)z^4 + \left(\frac{1}{40} \cdot \frac{1}{2} - \frac{1}{60} \cdot \frac{1}{8} + \frac{1}{(2)(40)}\right)z^6$$

$$E_0 = 0! \times 1 = 1$$

$$E_2 = 2! \times \left(-\frac{1}{2}\right) = -1$$

$$E_4 = 4! \left[\frac{1}{4} - \frac{1}{40}\right] = 3! \cdot \frac{9}{10} = 5$$

$$6! = 720$$

$$E_6 = 6! \left[\frac{1}{40} \cdot \frac{1}{2} - \frac{1}{60} \cdot \frac{1}{8} + \frac{1}{2} \cdot \frac{1}{40}\right] =$$

$$15 - 1 - 90 + 15 = -61$$

The odd coeffs are zero because this is an even function (see prob 30, previous sec.)

(b) consider

$$\frac{1}{\cosh w} = \sum_{n=0}^{\infty} \frac{E_n}{n!} w^n \quad |w| < \frac{\pi}{2} \text{ from previous (part a)}$$

let $z = w$ in the above

$$\frac{1}{\cosh(z)} = \sum_{n=0}^{\infty} \frac{E_n}{n!} z^n \quad \cosh(z) = \cosh z$$

$$\frac{1}{\cosh z} = E_0 - \frac{E_2}{2!} z^2 + \frac{E_4}{4!} z^4 - \dots \quad |z| < \frac{\pi}{2}$$

$$(c) \left(\frac{z-z^3}{3!} + \frac{z^5}{5!} - \frac{z^7}{7!} \dots \right) \left(\frac{E_0}{0!} - \frac{E_2 z^2}{2!} + \frac{E_4 z^4}{4!} - \frac{E_6 z^6}{6!} \dots \right) = \tanh z$$

$$= \frac{E_0}{0!} z - \left(\frac{E_2}{10 \cdot 20} + \frac{E_0}{30 \cdot 0!} \right) z^3 + \left(\frac{E_4}{10 \cdot 40} + \frac{E_2}{30 \cdot 20} + \frac{E_0}{50 \cdot 0!} \right) z^5$$

$$- \left(\frac{E_6}{10 \cdot 60} + \frac{E_4}{30 \cdot 40} + \frac{E_2}{50 \cdot 20} + \frac{E_0}{70 \cdot 0!} \right) z^7 \dots \quad |z| < \frac{\pi}{2}$$

$$a) (1+z)^\alpha = e^{\alpha \operatorname{Log}(1+z)} \quad C_0 = (1+z)^\alpha \Big|_{z=0} = e^{\alpha \operatorname{Log} 1}$$

$$C_0 = e^0 = 1,$$

$$C_1 = \frac{\alpha(1+z)^\alpha}{1+z} \Big|_0 = \alpha, \quad C_2 = \frac{1}{2} \frac{\alpha(\alpha-1)(1+z)^\alpha}{(1+z)^2} \Big|_{z=0}$$

$$C_2 = \frac{\alpha(\alpha-1)}{2} \text{ in general for } n \geq 1 \quad C_n = \frac{\alpha(\alpha-1)\dots(\alpha-(n-1))}{(n!)} (1+z)^\alpha \Big|_{z=0}$$

$$C_n = \frac{\alpha(\alpha-1)\dots(\alpha-(n-1))}{n!}$$

29 continued

sec 5.5 cont'd

(b) From (a) $C_n = \frac{(\alpha)(\alpha-1)\dots(\alpha-(n-1))(1+z)^\alpha}{n! (1+z)^n} \Big|_{z=0} \quad n \geq 1$

Suppose $n = \alpha$

$C_\alpha = \frac{\alpha! (1+z)^\alpha}{\alpha! (1+z)^\alpha} \Big|_{z=0} = 1$

$C_{\alpha+1} = \frac{1}{(\alpha+1)!} \frac{d}{dz} \alpha! \frac{(1+z)^\alpha}{(1+z)^\alpha} = 0$

$C_{\alpha+2} = \frac{1}{(\alpha+2)!} \frac{d}{dz} 0 = 0 \quad \therefore C_n = 0, \quad n > \alpha$

$\therefore (1+z)^\alpha = C_0 + C_1 z + \dots + C_\alpha z^\alpha$ where C_n is given in part (a). $(1+z)^\alpha$ is entire if $\alpha \geq 0$ & integer. \therefore series $C_0 + \sum_{n=1}^{\infty} C_n z^n$ is valid all z .

30] a) Substitute $-z$ for z in the series of 29(b).
Get $(1-z)^\alpha = 1 - \alpha z + \frac{(\alpha)(\alpha-1)z^2}{2!} - \frac{(\alpha)(\alpha-1)(\alpha-2)z^3}{3!} \dots$

Now put $\alpha = -1/2$

$(1-z)^{-1/2} = \frac{1}{(1-z)^{1/2}} = 1 + \frac{1}{2} z + \frac{(\frac{1}{2})(\frac{3}{2})z^2}{2!} + \frac{(\frac{1}{2})(\frac{3}{2})(\frac{5}{2})z^3}{3!} \dots$

put $z = \frac{1}{2}$

$\frac{1}{(1-\frac{1}{2})^{1/2}} = \sqrt{2} = 1 + \frac{1}{4} + \frac{(\frac{3}{16})}{2!} + \frac{(\frac{15}{64})}{3!} = 1.3828$

vs. $1.4142 = \sqrt{2}$
2.3% error

(b) put z^2 in place of z in the series derived in part a)

$\frac{1}{(1-z^2)^{1/2}} = 1 + \frac{1}{2} z^2 + \frac{(\frac{1}{2})(\frac{3}{2})z^4}{2!} + \frac{1 \cdot 3 \cdot 5}{2^3} z^6 + \frac{1 \cdot 3 \cdot 5 \cdot 7}{2^4} z^8 \dots$

$|z| < 1$

(c) From the preceding:

$\frac{1}{(1-z^2)^{1/2}} = 1 + \frac{1}{2} z^2 + \frac{1 \cdot 3}{2^2} z^4 + \frac{1 \cdot 3 \cdot 5}{2^3} z^6 + \dots \quad |z| < 1$

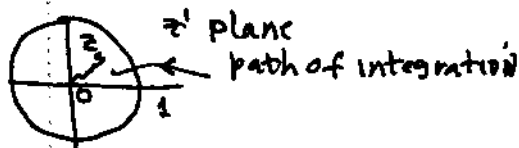

Integrate the preceding series term by term from 0 to z along path shown.

30 | cont'd sec 5.5 cont'd

Recall (see chap 3) $\frac{d}{dz} \sin^{-1}(z) = \frac{1}{(1-z^2)^{1/2}}$

$$\int_0^z \frac{dz'}{(1-z'^2)^{1/2}} = \sin^{-1}(z') \Big|_0^z = \sin^{-1}(z)$$

if we take $\sin^{-1}(0) = 0$

$$= \int_0^z \left(1 + \frac{1}{2} z'^2 + \frac{1 \cdot 3}{2^2} \frac{z'^4}{2!} + \frac{1 \cdot 3 \cdot 5}{2^3} \frac{z'^6}{3!} + \dots \right) dz' =$$

along path indicated

$$= z + \frac{z^3}{2 \cdot 3 \cdot 10} + \frac{1 \cdot 3 \cdot z^5}{2^2 \cdot 5 \cdot 2!} + \frac{1 \cdot 3 \cdot 5 \cdot z^7}{2^3 \cdot 7 \cdot 3!} + \dots = \sin^{-1}(z)$$

provided our branch of $\sin^{-1}(z)$ satisfies $\sin^{-1}(0) = 0$
and $\sin^{-1}(z)$ has no branch cuts inside $|z| = 1$.

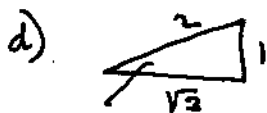

$$\sin^{-1}\left(\frac{1}{2}\right) = \frac{\pi}{6}$$

$$\frac{\pi}{6} \approx 30^\circ$$

put $z = 1/2$ in the preceding series

$$\therefore \frac{\pi}{6} \approx \frac{1}{2} + \frac{\frac{1}{8}}{2 \cdot 3} + \frac{1 \cdot 3 \cdot \left(\frac{1}{32}\right)}{2^2 \cdot 5 \cdot 2!} + \frac{1 \cdot 3 \cdot 5 \cdot \left(\frac{1}{128}\right)}{8 \cdot 7 \cdot 3!}$$

$$= .5235987$$

"Exact" value of $\frac{\pi}{6}$ is .5235987.....

Sec 5.6

$$1) \frac{\sinh z}{z^3} = \frac{z + \frac{z^3}{3!} + \frac{z^5}{5!} + \dots}{z^3} \quad z \neq 0$$

$$z^{-2} + \frac{1}{3!} + \frac{z^2}{5!} + \frac{z^4}{7!} + \dots \text{ for } |z| > 0 = \sum_{n=-1}^{\infty} U_n(z)$$

$$U_n = \frac{(z^2)^n}{(2n+3)!} \quad n \geq -1$$

or $\frac{\sinh z}{z^3} = \sum_{n=-1}^{\infty} C_n z^n$, $C_n = 0$, n odd
 $C_n = \frac{1}{(n+3)!}$, n even

$$2) \frac{\cos 1/z}{z^3} = \frac{1}{z^3} \left[1 - \frac{1}{2!} \frac{1}{z^2} + \frac{1}{4!} \frac{1}{z^4} - \frac{1}{6!} \frac{1}{z^6} + \dots \right]$$

$$= z^{-3} - \frac{z^{-5}}{2!} + \frac{z^{-7}}{4!} - \frac{z^{-9}}{6!} + \dots \quad |z| > 0$$

$$= \sum_{n=-\infty}^{-1} \frac{z^{2n-1}}{[-2-2n]!} \quad U_n = \frac{z^{2n-1}}{[-2-2n]!}$$

$$3) \sin \left(1 + \frac{1}{(z-1)} \right) = \sin 1 \cos \left(\frac{1}{(z-1)} \right) + \cos 1 \sin \left(\frac{1}{(z-1)} \right)$$

$$= \sin 1 \left[1 - \frac{\left(\frac{1}{(z-1)} \right)^2}{2!} + \frac{\left(\frac{1}{(z-1)} \right)^4}{4!} - \frac{\left(\frac{1}{(z-1)} \right)^6}{6!} + \dots \right]$$

$$+ \cos 1 \left[\left(\frac{1}{(z-1)} \right) - \frac{1}{(z-1)^3} \frac{1}{3!} + \frac{1}{(z-1)^5} \frac{1}{5!} - \dots \right]$$

$$= \frac{\cos 1}{5!} (z-1)^{-5} + \frac{\sin 1}{4!} (z-1)^{-4} - \frac{\cos 1}{3!} (z-1)^{-3}$$

$$- \frac{\sin 1}{2!} (z-1)^{-2} + \cos 1 (z-1)^{-1} + \sin 1 \quad |z-1| > 1$$

sec 5.6

3] cont'd

$$\sin \left(1 + \frac{1}{(z-1)} \right) = \sum_{n=-\infty}^{\infty} C_n (z-1)^n$$

$$C_n = \frac{(-1)^{n/2} \sin 1}{(-n)!} \quad \text{if } n \text{ is even}$$

$$C_n = \frac{(-1)^{(n+1)/2} \cos 1}{(-n)!} \quad \text{if } n \text{ is odd}$$

4] From Ex. (5.3-8)

$$-\operatorname{Log}(1-z') = z' + \frac{z'^2}{2} + \frac{z'^3}{3} \dots \quad (|z'| < 1)$$

$$\text{Let } z' = \frac{1}{(1-z)} \quad -z' = \frac{1}{z-1}$$

$$-\operatorname{Log} \left[1 + \frac{1}{(z-1)} \right] = -\frac{1}{(z-1)} + \frac{1}{2(z-1)^2} - \frac{1}{3(z-1)^3} \dots$$

$$\operatorname{Log} \left[1 + \frac{1}{(z-1)} \right] = \frac{1}{(z-1)} - \frac{1}{2(z-1)^2} + \frac{1}{3(z-1)^3} \dots$$

valid for $\left| \frac{1}{z-1} \right| < 1$ or $|z-1| > 1$

$$\operatorname{Log} \left[1 + \frac{1}{(z-1)} \right] = \sum_{n=-\infty}^{-1} C_n (z-1)^n \quad C_n = \frac{(-1)^{n+1}}{-n}$$

$$\text{or } = \sum_{n=-\infty}^{-1} U_n(z) \quad U_n = \frac{(-1)^n}{n} (z-1)^n \quad |z-1| > 1$$

5] $\left(z + \frac{1}{z} \right)^7$ use the binomial thm

$$= \sum_{n=0}^7 \binom{7}{n} z^{7-n} z^n = \sum_{n=0}^7 \frac{7!}{(7-n)! n!} z^7$$

$z \neq 0$

$$= z^{-7} + 7z^{-5} + 21z^{-3} + 35z + 21z^3 + 7z^5 + z^7 \quad \boxed{z \neq 0}$$

Sec 5.6

6] $\frac{1}{z+i}$ has sing. pt at $z = -i$

$$\begin{aligned} \frac{1}{z+i} &= \frac{1/z}{1+i/z} \quad \leftarrow \text{see eg. 5.5-16(b)} \\ &= \frac{1}{z} \left[1 - \frac{i}{z} + \frac{i^2}{z^2} + \frac{i^3}{z^3} \dots \right] \\ &= \frac{1}{z} - \frac{i}{z^2} + \frac{i^2}{z^3} + \frac{i^3}{z^4} + \dots \quad \left| \frac{i}{z} \right| < 1 \quad \therefore |z| > 1 \\ &= \sum_{n=-\infty}^{-1} (-1)(-i)^{1-n} z^n \quad U_n = (-1)(-i)^{1-n} z^n \\ & \quad \quad \quad n = -1, -2, \dots \end{aligned}$$

7] $\frac{1}{z+i} = \frac{1}{(z-i) + 2i} =$

$$\begin{aligned} &\frac{\frac{1}{z-i}}{1 + \frac{2i}{z-i}} \quad \text{see eg. 5.5-16(b)} \\ &= \frac{1}{z-i} \left[1 - \frac{2i}{z-i} + \frac{(2i)^2}{(z-i)^2} - \dots \right] \quad \left| \frac{2i}{z-i} \right| < 1 \\ & \quad \quad \quad \text{or } |z-i| > 2 \\ &= (z-i)^{-1} - 2i(z-i)^{-2} + (2i)^2(z-i)^{-3} - \dots \\ &= \sum_{n=-\infty}^{-1} (-2i)^{-n-1} (z-i)^n = \sum_{n=-\infty}^{-1} U_n \quad U_n = (-2i)^{-n-1} (z-i)^n \end{aligned}$$

Sec. 5.6 cont'd

$$8) \frac{1}{z-1} = \frac{1}{z+3-4} = \frac{1}{z+3} \left[\frac{1}{1 - \frac{4}{z+3}} \right]$$

$$= \frac{1}{z+3} \left[1 + \frac{4}{z+3} + \frac{16}{(z+3)^2} + \frac{64}{(z+3)^3} \dots \right] \quad \left| \frac{4}{z+3} \right| < 1$$

or $|z+3| > 4$

$$\frac{1}{z-1} = \frac{1}{z+3} + \frac{4}{(z+3)^2} + \frac{16}{(z+3)^3} + \frac{64}{(z+3)^4} \dots$$

$$= \sum_{n=-\infty}^{\infty} c_n (z+3)^n, \quad c_n = 4^{-n-1}$$

valid for $|z+3| > 4$
center is -3, inner radius=4

$$9) \frac{1}{z+2} = \frac{1}{(z-i) + (2+i)} = \frac{1}{z-i} \left[\frac{1}{1 + \frac{2+i}{z-i}} \right]$$

$$= \frac{1}{z-i} \left[1 - \frac{(2+i)}{z-i} + \frac{(2+i)^2}{(z-i)^2} \dots \right] \quad \text{valid } \left| \frac{2+i}{z-i} \right| < 1$$

or $|z-i| > \sqrt{5}$

$$\frac{1}{z+2} = \frac{1}{z-i} - \frac{(2+i)}{(z-i)^2} + \frac{(2+i)^3}{(z-i)^3} \dots \quad |z-i| > \sqrt{5}$$

$$= \sum_{n=-\infty}^{\infty} c_n (z-i)^n \quad c_n = (-1)^{|n|} (2+i)^{-n-1}$$

center at i
inner radius $\sqrt{5}$

$$10) \frac{z}{z-i} = \frac{z-i+i}{z-i} = 1 + \frac{i}{z-i} = 1 + \frac{i}{(z-1) - (i-1)}$$

$$1 + \frac{i}{(z-1) \left[1 - \frac{(i-1)}{z-1} \right]} = 1 + \frac{i}{z-1} \left[1 + \frac{i-1}{z-1} + \frac{(i-1)^2}{(z-1)^2} + \frac{(i-1)^3}{(z-1)^3} \dots \right]$$

valid for $\left| \frac{i-1}{z-1} \right| < 1$

or $|z-1| > \sqrt{2}$

$$\frac{z}{z-i} = 1 + \frac{i}{z-1} + i \frac{(i-1)}{(z-1)^2} + i \frac{(i-1)^2}{(z-1)^3} + \dots = 1 + \sum_{n=-\infty}^{\infty} c_n (z-1)^n$$

$$c_n = i (i-1)^{-n-1}$$

series valid for $|z-1| > \sqrt{2}$
center at $z=1$, inner radius $\sqrt{2}$

sec 5.6 cont'd

11) a) $\frac{1}{z(z-1)(z+3)} = \frac{-1/3}{z} + \frac{1/4}{z-1} + \frac{1/12}{z+3}$ $z \neq 0$
 $z \neq 1$
 $z \neq -3$

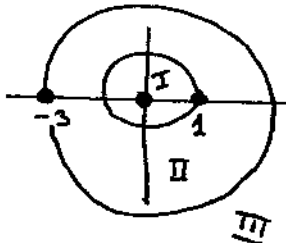

domains for Laurent series	
I	$0 < z < 1$
II	$1 < z < 3$
III	$ z > 3$

b) $\frac{1}{z-1} = \frac{-1/4}{1-z} = -\frac{1}{4} [1+z+z^2+\dots]$ $|z| < 1$ series A

$\frac{1}{z-1} = \frac{1/4z}{1-1/z} = \frac{1}{4z} [1+\frac{1}{z}+\frac{1}{z^2}+\dots]$ $|z| > 1$ series B

$\frac{1}{z+3} = \frac{1/36}{1+\frac{z}{3}} = \frac{1}{36} [1-\frac{z}{3}+\frac{z^2}{9}-\frac{z^3}{27}+\dots]$ $|z| < 3$ series C

$\frac{1}{z+3} = \frac{1}{12z} [1+\frac{3}{z}] = \frac{1}{12z} [1-\frac{3}{z}+\frac{3^2}{z^2}-\frac{3^3}{z^3}+\dots]$ $|z| > 3$ series D

for domain I, $0 < |z| < 1$

use $\frac{-1/3}{z} + \text{series A} + \text{series C} = \sum_{n=0}^{\infty} C_n z^n$

where $C_n = -\frac{1}{4} + \frac{1}{36} \frac{(-1)^n}{3^n}$

for domain II $1 < |z| < 3$

use $\frac{-1/3}{z} + \text{series B} + \text{series C} = \sum_{n=-\infty}^{-2} C_n z^n - \frac{z^{-1}}{12} + \sum_{n=0}^{\infty} C_n z^n$

$C_n = \frac{1}{4}$, $n \leq -2$ $C_n = \frac{1}{36} \frac{(-1)^n}{3^n}$, $n \geq 0$

for domain III $|z| > 3$

use $\frac{-1/3}{z} + \text{series B} + \text{series D} = \sum_{n=-\infty}^{-3} C_n z^n$

where $C_n = \frac{1}{4} + \frac{(-1)^{n+1}}{12} 3^{-n-1}$ $n \leq -3$

12) $f(z) = \frac{1}{z(z-2)} = -\frac{1}{2z} + \frac{1}{2(z-2)}$

need Laurent series in powers of $(z-1)$ valid for $|z-1| > 1$

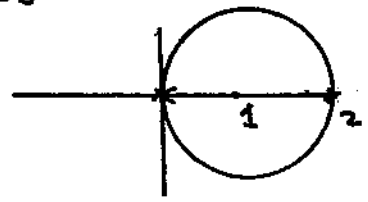

sec 5.6 cont'd

prob. 12, cont'd

$$\frac{-\frac{1}{z}}{z} = \frac{-\frac{1}{z}}{1+(z-1)} = \frac{\frac{1}{(z)(z-1)}}{1+\frac{1}{(z-1)}} = \frac{-\frac{1}{z} \left[\frac{1}{(z-1)} \right] \left[1 - \frac{1}{(z-1)} + \frac{1}{(z-1)^2} - \dots \right]}{1 + \frac{1}{(z-1)}}$$

$$= \frac{-\frac{1}{z} \left[\frac{1}{(z-1)} - \frac{1}{(z-1)^2} + \frac{1}{(z-1)^3} - \dots \right]}{1 + \frac{1}{(z-1)}} \quad |z-1| > 1 \quad \text{Series A}$$

$$\frac{1}{(z)(z-2)} = \frac{1/2}{(z-1)-1} = \frac{1}{(z)(z-1)} \left[\frac{1}{1 - \frac{1}{(z-1)}} \right]$$

$$= \frac{1}{(z)(z-1)} \left[1 + \frac{1}{(z-1)} + \frac{1}{(z-1)^2} + \dots \right] = \frac{1}{z} \left[\frac{1}{(z-1)} + \frac{1}{(z-1)^2} + \frac{1}{(z-1)^3} + \dots \right]$$

$|z-1| > 1$ Series B

Now add series A and series B

$$f(z) = \sum_{n=-\infty}^{\infty} C_n (z-1)^n \quad |z-1| > 1$$

$$C_n = \frac{1}{z} [1 + (-1)^n]$$

Note $C_n = 1$, n even
 $C_n = 0$, n odd

13) $f(z) = \frac{1}{(z)(z-4)} = \frac{1/4}{(z-4)} - \frac{1/4}{z}$

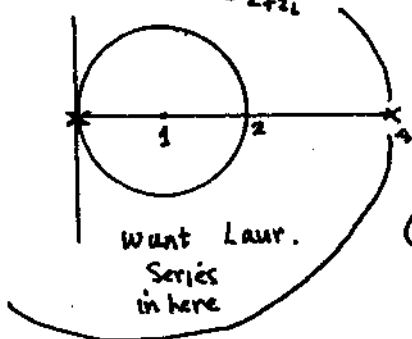

need L. Series valid for $1 < |z-1| < 3$

$$\frac{1}{(4)(z-4)} = \frac{1/4}{(z-1)-3} = \frac{1/12}{\left(\frac{z-1}{3} - 1\right)}$$

$$= \frac{-1}{12} \left[1 + \frac{(z-1)}{3} + \frac{(z-1)^2}{9} + \dots \right] \leftarrow |z-1| < 3 \quad \text{Series A}$$

$$\frac{-1/4}{z} = \frac{-1/4}{(z-1)+1} = \frac{-1}{(4)(z-1)} \frac{1}{1 + \frac{1}{(z-1)}} = \frac{-1}{4(z-1)} \left[1 - \frac{1}{(z-1)} + \frac{1}{(z-1)^2} - \dots \right]$$

Valid for $|z-1| > 1$

Series B

sec 5.6 cont'd

prob 13, cont'd

Add series A and series B

$$f(z) = \frac{1}{(4)(z-4)} - \frac{1}{4z} = \sum_{n=-\infty}^{+\infty} C_n (z-1)^n \quad 1 < |z-1| < 3$$

$$C_n = -\frac{1}{12} \frac{1}{3^n} \text{ for } n \geq 0; \quad C_n = -\frac{1}{4} (-1)^{n-1}, n < -1$$

14] $f(z) = \frac{1}{(z-1)(z-3)} = \frac{-1/2}{(z-1)} + \frac{1/2}{(z-3)}$

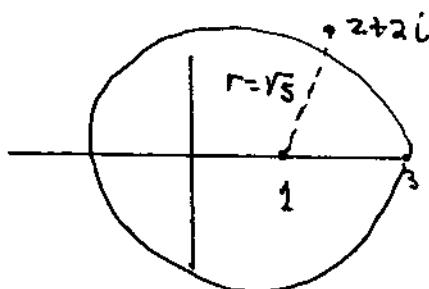

need a Laurent expansion
valid for $|z-1| > 2$

$$\frac{1/2}{z-3} = \frac{-1/2}{(z-1)-2} = \frac{1}{(2)(z-1)} \cdot \frac{1}{1 - \frac{2}{z-1}} = \frac{1}{(2)(z-1)} \left[1 + \frac{2}{z-1} + \frac{2^2}{(z-1)^2} + \dots \right]$$

$$f(z) = \frac{-1}{(2)(z-1)} + \frac{1}{2} \frac{1}{(z-1)} \left[1 + \frac{2}{z-1} + \frac{2^2}{(z-1)^2} + \dots \right]$$

$|z-1| > 2, \quad C_n = \frac{1}{2} 2^{-n-1}$

$$= \sum_{n=-\infty}^{-2} C_n (z-1)^n$$

$$= (2)^{-n-2} = C_n$$

15] $\frac{z-1}{z-1} = \frac{(z-1) - (1-i)}{(z-1)} = \frac{(z-1) + (1-i)}{(z-1)} =$

$$1 + \frac{(1-i)}{(z-1)} \text{ valid for } z \neq 1 = \sum_{n=-\infty}^{+\infty} C_n (z-1)^n \quad (z \neq 1)$$

{domain: $0 < |z-1| < \infty$ }

$C_0 = 1, \quad C_{-1} = (1-i)$ all other $C_n = 0$

16] $\frac{1}{(z-1)^3} + \frac{1}{z} = \frac{1}{(z-1)^3} + \frac{1}{1+(z-1)} = \frac{1}{(z-1)^3} + \frac{1}{z-1} \left[1 + \frac{1}{z-1} \right]$

$$= (z-1)^{-3} + \frac{1}{z-1} \left[1 - \frac{1}{z-1} + \frac{1}{(z-1)^2} - \frac{1}{(z-1)^3} + \dots \right] \quad |z-1| > 1$$

Sec 5.6 cont'd

16) cont'd

$$f(z) = \sum_{n=-\infty}^{-1} C_n (z-1) \quad |z-1| > 1$$

$$C_n = (-1)^{n-1} \quad n \neq -3$$

$$C_n = 2 \quad n = -3$$

17) $f(z) = \frac{1}{(z-1)^3} + z^3 \quad z \neq 1$

$$z^3 = \sum_{n=0}^{\infty} C_n (z-1)^n, \quad C_0 = 1, \quad C_1 = 3z^2|_1 = 3, \quad C_2 = \frac{6z}{2!}|_1 = 3$$

$$C_3 = \frac{6}{3!} = 1$$

$$f(z) = (z-1)^{-3} + 1 + 3(z-1) + 3(z-1)^2 + (z-1)^3 \quad z \neq 1$$

Valid $0 < |z-1|$

18) $e^{-x} = 1 - x + \frac{x^2}{2!} - \frac{x^3}{3!} + \frac{x^4}{4!} \dots$

$$\frac{e^{-x}}{x} = \frac{1}{x} - 1 + \frac{x}{2!} - \frac{x^2}{3!} + \frac{x^3}{4!} \dots$$

$$\int_a^b \frac{e^{-x}}{x} dx = \int_a^b \frac{1}{x} dx - \int_a^b dx + \int_a^b \frac{x}{2!} dx - \int_a^b \frac{x^2}{3!} dx \dots$$

$$= \text{Log} \frac{b}{a} - (b-a) + \frac{b^2 - a^2}{2 \cdot 2!} - \frac{(b^3 - a^3)}{3 \cdot 3!} \dots$$

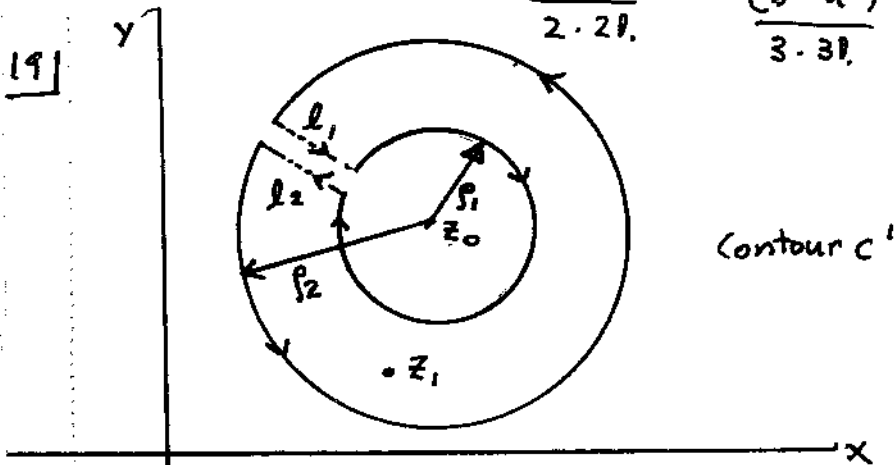

from Cauchy integral formula

$$f(z_1) = \frac{1}{2\pi i} \oint_{|z-z_0|=\rho_2} \frac{f(z)}{z-z_1} dz + \frac{1}{2\pi i} \oint_{|z-z_0|=\rho_1} \frac{f(z)}{(z-z_1)} dz$$

sec 5.6 cont'd

1a) cont'd.

$$f(z_1) = \frac{1}{2\pi i} \oint_{|z-z_0|=r_2} \frac{f(z)}{(z-z_1)} dz + \frac{1}{2\pi i} \oint_{|z-z_0|=r_1} \frac{f(z)}{(z_1-z)} dz$$

$$f(z_1) = \frac{1}{2\pi i} \oint_{|z-z_0|=r_2} \frac{f(z) dz}{(z-z_0) - (z_1-z_0)} + \frac{1}{2\pi i} \oint_{|z-z_0|=r_1} \frac{f(z) dz}{(z_1-z_0) - (z-z_0)}$$

I_A I_B

$$I_A = \frac{1}{2\pi i} \oint_{|z-z_0|=r_2} \frac{f(z) dz}{(z-z_0) \left[1 - \frac{(z_1-z_0)}{(z-z_0)} \right]} = \frac{1}{2\pi i} \oint_{|z-z_0|=r_2} \frac{f(z)}{(z-z_0)} \left[1 + \frac{(z_1-z_0)}{(z-z_0)} + \frac{(z_1-z_0)^2}{(z-z_0)^2} + \dots \right] dz$$

Series valid if $|z_1-z_0| < |z-z_0| = r_2$

Integrate the preceding, term by term.

$$I_A = \sum_{n=0}^{\infty} C_n (z_1-z_0)^n, \quad C_n = \frac{1}{2\pi i} \oint_{|z-z_0|=r_2} \frac{f(z)}{(z-z_0)^{n+1}} dz, \quad n=0,1,2,\dots$$

\leftarrow Eqn (1)

$$I_B = \frac{1}{2\pi i} \oint_{|z-z_0|=r_1} \frac{f(z)}{(z_1-z_0) \left[1 - \frac{(z-z_0)}{(z_1-z_0)} \right]} dz = \frac{1}{2\pi i (z_1-z_0)} \oint_{|z-z_0|=r_1} f(z) \left[1 + \frac{(z-z_0)}{(z_1-z_0)} + \frac{(z-z_0)^2}{(z_1-z_0)^2} + \dots \right] dz$$

\leftarrow Eqn (2)

$$\text{Here } C_n = \frac{1}{2\pi i} \oint_{|z-z_0|=r_1} f(z) (z-z_0)^{n-1} dz$$

The integrals in equations 1 and 2 can be performed around an identical contour $|z-z_0|=r$, where $r_1 < r \leq r_2$ by the princ. of deformation of contours.

Sec 5.6 cont'd

19) cont'd

Adding the series for IA and IB we get:

$$f(z) = \sum_{n=-\infty}^{+\infty} C_n (z_1 - z_0)^n, \quad C_n = \frac{1}{2\pi i} \oint_{|z-z_0|=r} \frac{f(z)}{(z-z_0)^{n+1}} dz$$

$$r_1 < r < r_2$$

20) $\text{Log } z$ (princ. branch) is defined by a branch cut along $y=0, x \leq 0$. $\text{Log } z$ is not analytic at points lying on the cut. $\therefore \text{Log } z$ not analytic in any annular region centered at $z=0$. \therefore Laur. Series not possible.

21) $\frac{1}{z^{1/2}} = \frac{1}{e^{\frac{1}{2} \text{Log } z}}$. This function has a

branch cut as described in prob. (20) above. \therefore

$\frac{\text{Im } z}{z^{1/2}}$ not analytic on line $y=0, x \leq 0$ and $\frac{\text{Im } z}{z^{1/2}}$

not analytic in any annular region centered at $z=0$.

\therefore a Laurent exp. in a deleted nshbd. of $z=0$ not possible.

22) Consider $z^{1/2} = \sum_{n=0}^{\infty} d_n (z-1)^n, \quad |z-1| < 1$

$$d_0 = 1, \quad d_1 = \frac{1/2 z^{-1/2}}{1!} \Big|_1 = \frac{1}{2}, \quad d_2 = \frac{(\frac{1}{2})(-\frac{1}{2}) z^{-3/2}}{2!} \Big|_1 = \frac{(\frac{1}{2})(-\frac{1}{2})}{2!},$$

$$d_3 = \frac{\frac{1}{2}(-\frac{1}{2})(-\frac{3}{2}) z^{-5/2}}{3!} \Big|_1 = \frac{(1)(-1)(-3)}{2^3}$$

$$d_4 = \frac{(1)(-1)(-3)(-5)}{2^4} \Big|_1 = \frac{(-1)(1 \cdot 3 \cdot 5)}{4!}$$

$$d_0 = 1, \quad d_1 = \frac{1}{2}, \quad d_n = \frac{(-1)^{n-1} 1 \cdot 3 \cdot 5 \cdots (2n-3)}{2^n (n!)} \quad n \geq 2$$

$$\frac{z^{1/2}}{z-1} = \frac{1}{z-1} \left[1 + \frac{1}{2}(z-1) + \frac{(-1)}{2^2} \frac{1}{2!} (z-1)^2 + \frac{(\frac{1}{2})(-\frac{1}{2})(-\frac{3}{2})}{3!} (z-1)^3 \right.$$

$$\left. + \frac{(-1)(1 \cdot 3 \cdot 5)}{2^4 \cdot 4!} (z-1)^4 + \dots \right] \quad \text{clear parens.}$$

$$0 < |z-1| < 1$$

Sec 5.6 Cont'd

22)

Cont'd $\frac{z^{1/2}}{z-1} = \sum_{n=-1}^{\infty} C_n (z-1)^n, C_{-1} = 1$

$C_0 = 1/2, C_n = \frac{(-1)^n \cdot 1 \cdot 3 \cdot 5 \cdots (2n-1)}{2^{n+1} (n+1)!}, n \geq 1$

23)

$\frac{1}{\sin z} = \sum_{n=-1}^{\infty} C_n z^n$. We know from example 4 that all even C_n are zero.

$\frac{1}{z - \frac{z^3}{3!} + \frac{z^5}{5!} - \frac{z^7}{7!} \dots} = \frac{C_{-1}}{z} + C_1 z + C_3 z^3 + C_5 z^5 \dots$

Now cross multiply:

$1 = \left(\frac{C_{-1}}{z} + C_1 z + C_3 z^3 + C_5 z^5 \dots \right) \left(z - \frac{z^3}{3!} + \frac{z^5}{5!} - \frac{z^7}{7!} \dots \right)$

Equate coeffs of z^{n+1} where n is odd and $n > -1$

$0 = \left[C_n - \frac{C_{n-2}}{3!} + \frac{C_{n-4}}{5!} \dots \pm \frac{C_{-1}}{(n+2)!} \right]$
 MINUS sign if $\frac{n+1}{2}$ is odd
 + sign if $\frac{n+1}{2}$ even

Now solve the preceding for C_n

$C_n = \frac{C_{n-2}}{3!} - \frac{C_{n-4}}{5!} + \frac{C_{n-6}}{7!} \dots \mp \frac{C_{-1}}{(n+2)!}$
 + sign if $\frac{n+1}{2}$ is odd
 - sign if $\frac{n+1}{2}$ even

(b) $C_5 = \frac{C_3}{3!} - \frac{C_{-1}}{5!} + \frac{C_{-1}}{7!}, n=5$
 $C_3 = \frac{C_1}{3!} - \frac{C_{-1}}{5!}, n=3$
 $C_1 = \frac{C_{-1}}{3!}, n=1$

sec 5.6 cont'd

prob 23(b) cont'd

we know $C_1 = 1$ (from example 4)

$\therefore C_1 = \frac{1}{20}, C_3 = \left(\frac{1}{30}\right)^2 - \frac{1}{50}$

$C_5 = \frac{1}{30} \left[\left(\frac{1}{30}\right)^2 - \frac{1}{50} \right] - \frac{1}{30 \cdot 50} + \frac{1}{70} = \underbrace{\left(\frac{1}{30}\right)^3 - \frac{2}{30 \cdot 50} + \frac{1}{70}}_{\text{answer}}$

23 (c) $\frac{1}{\sin w} = \sum_{n=-\infty}^{\infty} C_n W^n$ n is odd

let $W = iz$

$\frac{1}{\sin iz} = \sum_{n=-\infty}^{\infty} C_n (iz)^n$

$\sin iz = i \sinh z$

$\frac{1}{\sinh z} = \sum_{n=-\infty}^{\infty} i^{-n} C_n z^n = \sum_{n=-\infty}^{\infty} i^{n+1} C_n z^n = \sum_{n=-\infty}^{\infty} a_n z^n$

$\therefore \left[\begin{array}{l} a_n = i^{n+1} C_n \text{ where } n \text{ is odd.} \\ a_n = 0 \text{ if } n \text{ is even.} \end{array} \right]$

equivalently $a_n = (-1)^{(n+1)/2} C_n$ n is odd
 $a_n = 0$ n even

d) $\frac{1}{\sinh z} = a_{-1} z^{-1} + a_0 + a_1 z + a_2 z^2 + \dots$

$\frac{1}{z + \frac{z^3}{3!} + \frac{z^5}{5!} + \frac{z^7}{7!} + \dots} = a_{-1} z^{-1} + a_0 + a_1 z + a_2 z^2 + \dots$

$1 = \left(z + \frac{z^3}{3!} + \frac{z^5}{5!} + \frac{z^7}{7!} + \dots \right) (a_{-1} z^{-1} + a_0 + a_1 z + a_2 z^2 + \dots)$

$1 = a_{-1} \quad [z^0 \text{ term}]$

$0 = a_0 \quad [z^1 \text{ term}]$

$0 = a_1 + a_{-1} \quad [z^2 \text{ term}]$

$0 = \left[a_2 + a_0 \frac{z^2}{3!} \right] \cdot [z^3 \text{ term}]$

$0 = a_3 + \frac{a_1}{2!} + \frac{a_{-1}}{5!}$

$\therefore a_0, a_2, a_4, \dots$
 [all even] are zero

23

Sec 5.6 Cont'd

d) continued

$$a_1 = -\frac{a-1}{3!}$$

$$a_3 = -\left[\frac{a_1}{3!} + \frac{a-1}{5!}\right]$$

$$a_5 = -\left[\frac{a_3}{3!} + \frac{a_1}{5!} + \frac{a-1}{7!}\right]$$

$$\left[\begin{array}{l} \text{in general} \\ \text{for odd } n \end{array} \right] a_n = -\left[\frac{a_{n-2}}{3!} + \frac{a_{n-4}}{5!} + \frac{a_{n-6}}{7!} + \dots + \frac{a-1}{(n+2)!}\right]$$

$$a_1 = 1, a_1 = -1/3!$$

$$a_3 = -\left[\frac{-1/3!}{3!} + \frac{1}{5!}\right]$$

$$a_3 = -\left[\frac{(1/3!)^2}{3!} - \frac{1}{5!}\right]$$

23 e)

```

% sec 5.6 prob 23
clear
nm=5;
d(1)=1;
for k=2:nm
for j=1:k-1
    u(j)=gamma(2*k-2*j+2);
end
d(k)=-sum(d./u);
d;
end
nr=25;
r=linspace(.05,pi-.05,nr);
nth=91;
theta=linspace(0,2*pi,nth);
[T,R]=meshgrid(theta,r);
[X,Y]=pol2cart(T,R);
z=X+i*Y;
mm=length(d);
ff=0;
for p=1:mm
    ff=d(p)*z.^(2*p-3)+ff;
end
% ff=1./sinh(z); % use for fig (b)
meshz(X,Y,abs(ff));view(135,30);

```

Sec 5.6 continued
 23(e) cont'd

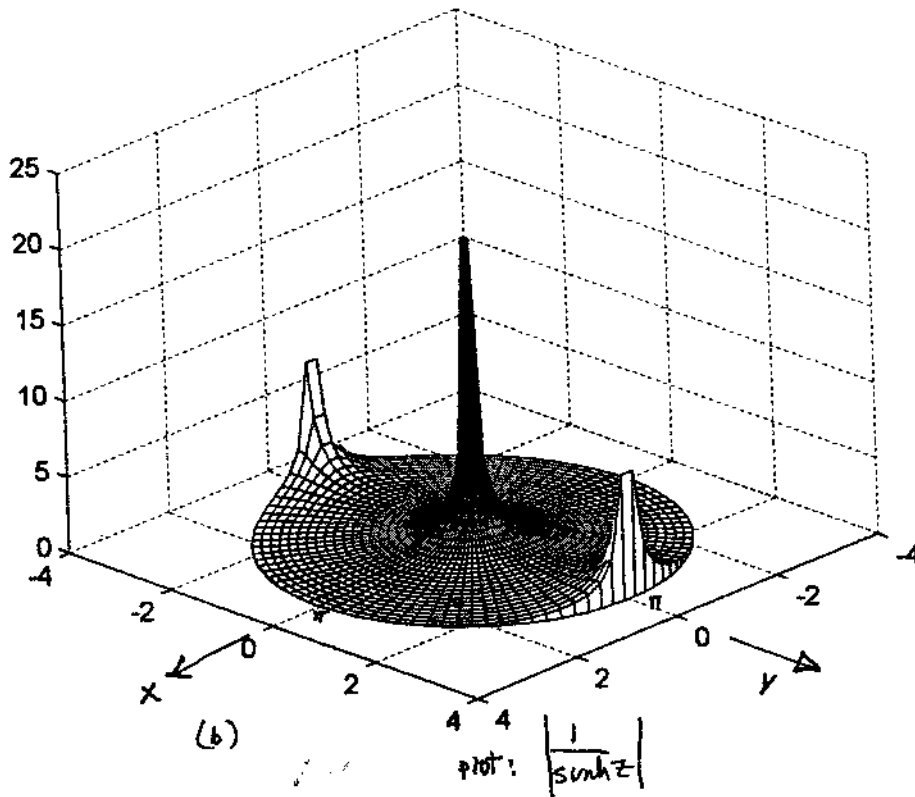
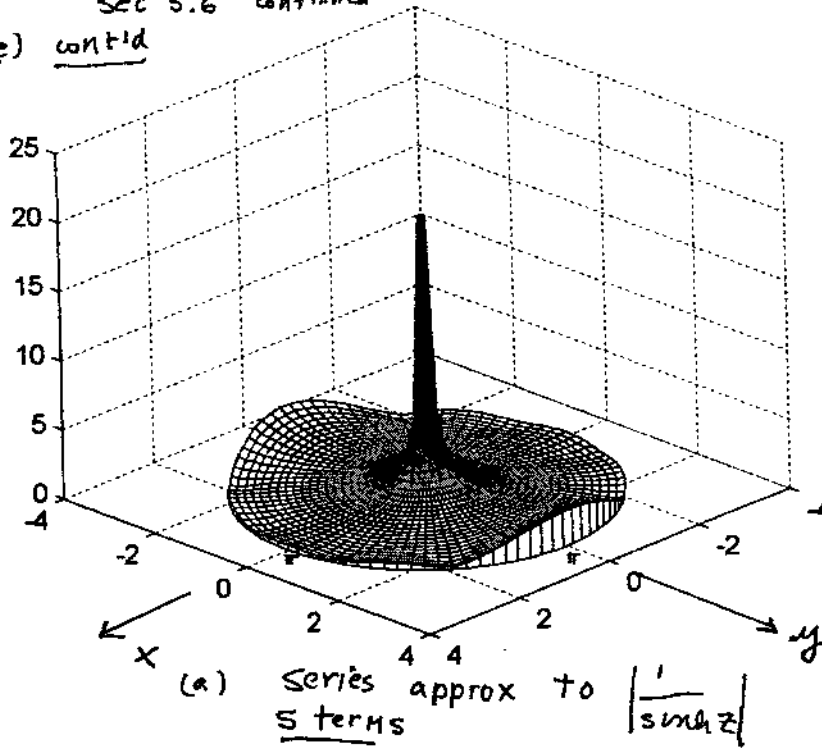

24) a) $\text{Log } z = \sum_{n=0}^{\infty} d_n (z-1)^n$ $d_0 = \text{Log } 1 = 0,$

$d_1 = \frac{1}{z} \Big|_1 = 1, \quad d_2 = -\frac{1}{2} \Big|_1 = -\frac{1}{2}, \quad d_3 = \frac{2}{z^3} \Big|_1 = \frac{1}{3}$

$d_4 = \frac{-3 \cdot 2}{z^4} \Big|_1 = -\frac{1}{4} \dots \quad d_n = \frac{(-1)^{n+1}}{n}$

$\text{Log } z = (z-1) - \frac{1}{2} (z-1)^2 + \frac{1}{3} (z-1)^3 \dots$

$\frac{1}{\text{Log } z} = \frac{1}{(z-1) - \frac{1}{2} (z-1)^2 + \frac{1}{3} (z-1)^3 \dots} = \sum_{n=-m}^{\infty} c_n (z-1)^n$

$\frac{z-1}{\text{Log } z} = \frac{z-1}{(z-1) - \frac{1}{2} (z-1)^2 + \frac{1}{3} (z-1)^3 \dots} = \dots c_{-2} (z-1)^{-2} + c_{-1} + c_0 (z-1) + c_1 (z-1)^2 + \dots$

Note $\lim_{z \rightarrow 1} \frac{z-1}{\text{Log } z} = 1, \quad \therefore c_{-2} = 0, c_{-3} = 0, \dots$

$c_n = 0, \quad n \leq -2.$

$\frac{z-1}{\text{Log } z} = c_{-1} + c_0 (z-1) + c_1 (z-1)^2 + \dots$

$\frac{1}{\text{Log } z} = \frac{c_{-1} + c_0 + c_1 (z-1) + c_2 (z-1)^2 + \dots}{(z-1)} \quad \therefore m=1$

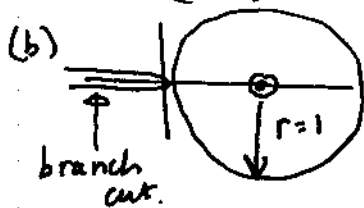

24 cont'd

sec 5.6 cont'd

$$(c) \frac{1}{\log z} = \frac{1}{(z-1) - \frac{1}{2}(z-1)^2 + \frac{1}{3}(z-1)^3 \dots} = \frac{C_{-1}}{(z-1)} + C_0 + C_1(z-1) + C_2(z-1)^2 \dots$$

(cross mult.)

$$1 - \left[(z-1) - \frac{1}{2}(z-1)^2 + \frac{1}{3}(z-1)^3 \dots \right] \left[\frac{C_{-1}}{(z-1)} + C_0 + C_1(z-1) + C_2(z-1)^2 \dots \right]$$

equate coeff of $(z-1)^0$ $1 = C_{-1}$

equate coeff of $(z-1)$ $0 = C_0 - \frac{1}{2}C_{-1}$

equate coeff of $(z-1)^2$ $0 = C_1 - \frac{1}{2}C_0 + \frac{1}{3}C_{-1}$

equate coeff of $(z-1)^{n+1}$

$$0 = C_n - \frac{1}{2}C_{n-1} + \frac{1}{3}C_{n-2} \dots \pm \frac{C_{-1}}{n+2}$$

Solve for C_n .

$$C_n = \frac{1}{2}C_{n-1} - \frac{1}{3}C_{n-2} \dots \pm \frac{C_{-1}}{n+2}$$

$C_{-1} = 1, C_0 = \frac{1}{2},$

$C_1 = \frac{1}{2}C_0 - \frac{1}{3}C_{-1} = \frac{1}{4} - \frac{1}{3} = -\frac{1}{12}$

$C_2 = \frac{1}{2}C_1 - \frac{1}{3}C_0 + \frac{1}{4}C_{-1} = -\frac{1}{24} - \frac{1}{6} + \frac{1}{4} = \frac{1}{24}$

$C_3 = \frac{1}{2}C_2 - \frac{1}{3}C_1 + \frac{1}{4}C_0 - \frac{1}{5}C_{-1} = \frac{1}{48} - \frac{1}{3}(-\frac{1}{12}) + \frac{1}{4}(\frac{1}{2}) - \frac{1}{5}$

$C_3 = -.026388 \dots$

$C_4 = \frac{1}{2}C_3 - \frac{1}{3}C_2 + \frac{1}{4}C_1 - \frac{1}{5}C_0 + \frac{1}{6}C_{-1}$

$C_4 = \frac{1}{2}(-.026388) - \frac{1}{72} - \frac{1}{72} - \frac{1}{10} + \frac{1}{6} = .01875 = \boxed{\frac{3}{16}}$

25) $\frac{z}{e^z - 1} = \sum_{n=0}^{\infty} \frac{B_n}{n!} z^n$

put az in place of z

$$\frac{az}{e^{az} - 1} = \sum_{n=0}^{\infty} \frac{B_n}{n!} (az)^n$$

Multiply the numer. and denom. by e^{-az}

$$\frac{az e^{-az}}{e^{az} - e^{-az}} = \sum_{n=0}^{\infty} \frac{B_n}{n!} (az)^n$$

sec 5.6 cont'd

25] cont'd

$$\frac{e^{-iz}}{e^{iz} - e^{-iz}} = \frac{1}{2iz} \sum_{n=0}^{\infty} \frac{B_n}{n!} (2iz)^n$$

put $-z$ in place of z in the above

$$\frac{e^{iz}}{e^{-iz} - e^{iz}} = \frac{1}{-2iz} \sum_{n=0}^{\infty} \frac{B_n}{n!} (-2iz)^n$$

$$\frac{e^{iz}}{e^{iz} - e^{-iz}} = \frac{1}{2iz} \sum_{n=0}^{\infty} \frac{B_n}{n!} (-2iz)^n$$

add these 2 series

$$\frac{\cos z}{\sin z} = \frac{1}{2iz} \sum_{n=0}^{\infty} \frac{B_n}{n!} (z^n) \cdot \underbrace{[2^n + (-2)^n]}$$

$$\cot z = \sum_{n=0}^{\infty} \frac{B_n z^{n-1}}{n!} 2^n \cdot \underbrace{[n \text{ even}]}$$

if n is odd,
this is zero
if n is even, this
is $2 * 2^n$

$$\cot z = \frac{B_0}{z} - \frac{B_2}{2!} z + \frac{B_4}{4!} z^3 - \frac{B_6}{6!} z^5 \dots$$

recall from probl. 23 that:

$$B_0 = 1, B_2 = \frac{1}{6}, B_4 = -\frac{1}{30}, B_6 = \frac{1}{42}$$

$$\cot z = \frac{1}{z} - \frac{1}{3} z - \frac{1}{30} z^3 - \frac{1}{42} z^5 \dots$$

$$\cot z = \frac{1}{z} - \frac{z}{3} - \frac{z^3}{45} - \frac{2z^5}{945} \dots$$

$$(b) \frac{\cos z}{\sin z} = \left(1 - \frac{z^2}{2!} + \frac{z^4}{4!} \dots\right) \left(\frac{1}{z} + \frac{z}{6} + \frac{z^3}{360} \dots\right)$$

$$= \frac{1}{z} + \left(\frac{1}{6} - \frac{1}{2}\right)z + \left[\frac{7}{360} - \frac{1}{12} + \frac{1}{40}\right]z^3 \dots$$

$$= \frac{1}{z} - \frac{1}{3}z - \frac{1}{45}z^3 \dots$$

Sec 5.6

$$26) \underbrace{e^{\frac{w}{2} (z - \frac{1}{z})}}_{\text{has sing. at } z=0} = \sum_{n=-\infty}^{+\infty} C_n z^n \quad 0 < |z|$$

has sing. at $z=0$

$$C_n = \frac{1}{2\pi i} \oint \frac{f(z)}{z^{n+1}} dz \quad \text{Laurent's Thm.}$$

$$C_n = \frac{1}{2\pi i} \oint \frac{e^{\frac{w}{2} (z - \frac{1}{z})}}{z^{n+1}} dz \quad \text{Let } z = e^{i\theta}$$

θ goes from $-\pi$ to π .

$$C_n = \frac{1}{2\pi i} \int_{-\pi}^{+\pi} \frac{e^{(w/2)[e^{i\theta} - e^{-i\theta}]} i e^{i\theta} d\theta}{e^{i n \theta} e^{i\theta}}$$

$$C_n = \frac{1}{2\pi} \int_{-\pi}^{+\pi} \frac{e^{i w \sin \theta}}{e^{i n \theta}} d\theta = \frac{1}{2\pi} \int_{-\pi}^{+\pi} e^{i [w \sin \theta - n\theta]} d\theta$$

$$C_n = \frac{1}{2\pi} \int_{-\pi}^{+\pi} \cos(n\theta - w \sin \theta) + i \sin(w \sin \theta - n\theta) d\theta$$

$$\text{Note } \int_{-\pi}^{+\pi} \underbrace{\sin(w \sin \theta - n\theta)}_{\text{odd functions, symm. limits}} d\theta = 0$$

odd functions, symm. limits

$$C_n = \frac{1}{2\pi} \int_{-\pi}^{+\pi} \cos(n\theta - w \sin \theta) d\theta = J_n(w)$$

$$27) a) e^{wz/2} e^{-\frac{w}{2z}} = \left[1 + \frac{wz}{2} + \frac{(wz)^2}{2!} + \frac{(wz)^3}{3!} \right] \left[1 + \left(-\frac{w}{2z}\right) + \frac{(-w)^2}{2!} + \right]$$

Mult. the series. Coeff of z^n , $n=0,1,2,\dots$

$$C_n = \left[\frac{(w/2)^n}{n! 0!} + \frac{(w/2)^{n+1}}{(n+1)! 1!} \left(-\frac{w}{2}\right) + \frac{(w/2)^{n+2}}{(n+2)! 2!} \left(\frac{w}{2}\right)^2 + \frac{(w/2)^{n+3}}{(n+3)! 3!} \left(-\frac{w}{2}\right)^3 + \dots \right]$$

$$= \sum_{k=0}^{\infty} \frac{(-1)^k (w/2)^{n+2k}}{k! (n+k)!} \quad \text{q.e.d.}$$

$$n=0,1,2,\dots$$

Sec 5.6

27(b)

```
% for prob 27 (b)
clear
x=linspace(0,10,100);

nm=[ 11 12 15];
for jj=1:3
    y=x.*0;
    for k=1:nm(jj)
        k=k-1;
        y=(-1)^k*(x/2).^(2*k)/(gamma(k+1))^2+y;
    end
    plot(x,y);hold on
end
y2=besselj(0,x);
plot(x,y2);grid
```

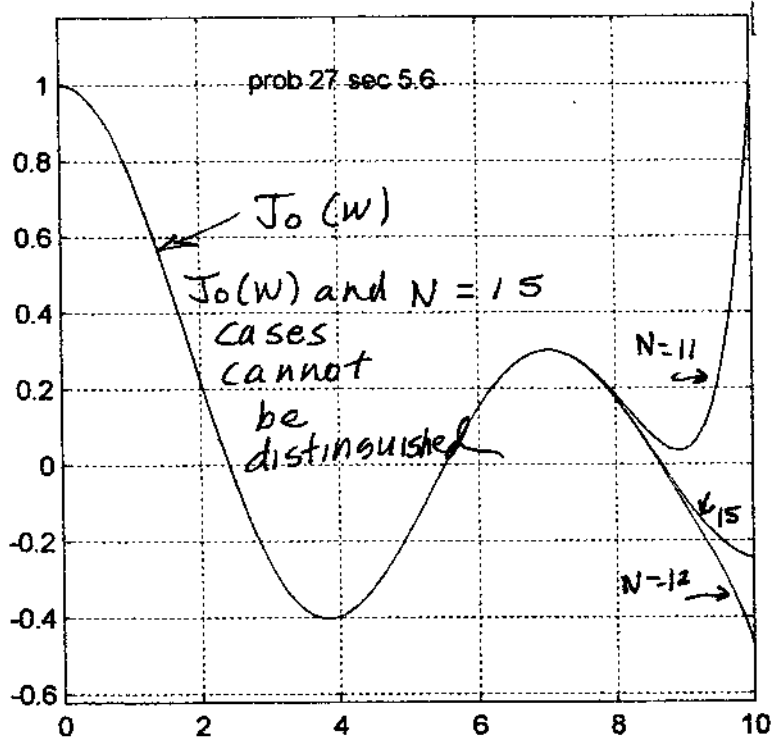

sec 5.7

1)

a) If $y=0$ have $z^3 - x^3$. But $z=x$ if $y=0$
 \therefore have $x^3 - x^3 = 0$ every^{where} on y axis.

b) There is no contradiction. If $f(z)=0$ throughout a domain its zeroes are not isolated. Note:

$x^3 - 3xy^2 - i[y^3 - 3x^2y] = (x+iy)^3 = z^3$
 Thus $f(z) = z^3 - z^3$ which is identically zero in any domain. Note, theorem 19 asserts that the zeroes of an analytic function^{in a domain} are isolated if the function is analytic and not identically zero in the domain.

2) a) $f(z) = e^z - e^{iy} = e^{x+iy} - e^{iy}$

If $x=0$ then $f(z) = e^{iy} - e^{iy} = 0$

b) No you can't conclude this. The theorem does not apply since $f(z)$ is nowhere analytic. Observe that $e^{iy} = \cos y + i \sin y$ is nowhere analytic.

3) ^{parts (a), (b)} For zero: $\frac{\pi}{z^2+1} = n\pi, \frac{1}{z^2+1} = n$

$z^2 = \frac{1}{n} - 1$, assume $n=1, z=0$, assume n positive and $n > 1$. Then $z = \pm i \sqrt{1 - \frac{1}{n}}$ (applies if $n=1$ too)

Note $|z| < 1$ for the above. Note if n is a neg. integer, then $|z| > 1$. $\therefore z = \pm i \sqrt{1 - \frac{1}{n}}, n = 1, 2, \dots$ gives all zeroes in domain $|z| < 1$. They are isolated.

(c) The accumulation points are at $\pm i$, since every neighborhood of i (or minus i) contains zeroes of the given $f(z)$. Note that $\pm i$ do not belong to the given domain.

sec 5.7 cont'd

4] $\frac{d}{dz} \cos z = -\sin z$, $-\sin z \Big|_{n\pi + \frac{\pi}{2}} = -\cos n\pi \neq 0$

zero is of order 1. (First deriv $\neq 0$ at zero.)

5] $\frac{d}{dz} \text{Log } z = \frac{1}{z} \Big|_1 = 1 \neq 0$. Since first deriv $\neq 0$ the zero is of order 1.

6] $\frac{(z^4-1)^2}{z} = \frac{(z^2+1)^2(z^2-1)^2}{z} = (z-i)^2 \frac{(z+i)^2(z^2-1)^2}{z}$

$= (z-i)^2 \phi(z)$. Note: $\phi(i) \neq 0$. \therefore zero is of order 2.

7] $z^3 \sin z = z^3 \left[z - \frac{z^3}{3!} + \frac{z^5}{5!} \dots \right] = z^4 \underbrace{\left[1 - \frac{z^2}{3!} + \frac{z^4}{5!} \dots \right]}_{\text{nonvanishing at 0}}$

zero order 4 at $z=0$

Now look at $z=\pi$.

$\frac{d}{dz} [z^3 \sin z] \Big|_{z=\pi} = 3z^2 \sin z + z^3 \cos(z) \Big|_{z=\pi} =$

$\pi^3 (-1) \neq 0$. zero is first order at $z=\pi$.

8] $f(z) = (z-z_0)^n \phi(z)$ $\phi(z_0) \neq 0$

$[f(z)]^m = (z-z_0)^{nm} \underbrace{[\phi(z)]^m}_{\neq 0 \text{ at } z_0}$ \therefore order of zero is nm

9] $\frac{d}{dz} (\text{Log } z - 1) \Big|_e = \frac{1}{z} \Big|_e = (1/e) \neq 0$. $(\text{Log } z - 1)$ has zero of order 1 and $(\text{Log } z - 1)^2$ has zero order 2.

10] Expand $\sin z$ about $z=\pi$. $\frac{d}{dz} \sin z \Big|_{z=\pi} = \cos \pi = -1$. $\sin z$ has zero of order 1 and $\sin^4 z$ has zero order 4.

11] $z^3 \sin z = z^3 \left[z - \frac{z^3}{3!} + \frac{z^5}{5!} \dots \right] = z^4 - \frac{z^6}{3!} + \frac{z^8}{5!} \dots$
has zero order 4. Thus $(z^3 \sin z)^2$ has zero order 8 at $z=0$.

sec 5.7 cont'd

12] $1+z+z^2+\dots = \frac{1}{(1-z)}$ if $|z| < 1$. Otherwise the series does not define a function, i.e. for $|z| \geq 1$ we do not have a function.

Now $f(z) = \frac{1}{(1-z)} = \sum_{n=0}^{\infty} c_n (z + \frac{3}{4})^n$
 $|z| < 1$

$$\frac{1}{1-z} = \frac{1}{1 - (z + \frac{3}{4}) + \frac{3}{4}} = \frac{1}{\frac{7}{4} - (z + \frac{3}{4})} = \frac{4/7}{1 - \frac{4}{7}(z + \frac{3}{4})}$$

$$= \frac{4}{7} \left[1 + \frac{4}{7}(z + \frac{3}{4}) + \left(\frac{4}{7}\right)^2 (z + \frac{3}{4})^2 + \dots \right] =$$

$$\sum_{n=0}^{\infty} c_n (z + \frac{3}{4})^n \quad c_n = \left(\frac{4}{7}\right)^{n+1}$$

(b) The series just found will converge to

$\frac{1}{(1-z)}$ if $\frac{4}{7} |z + \frac{3}{4}| < 1$ or $|z + \frac{3}{4}| < \frac{7}{4}$.

It represents an analytic continuation of $1+z+z^2+\dots$ $|z| < 1$ into a region extending beyond $|z| < 1$.

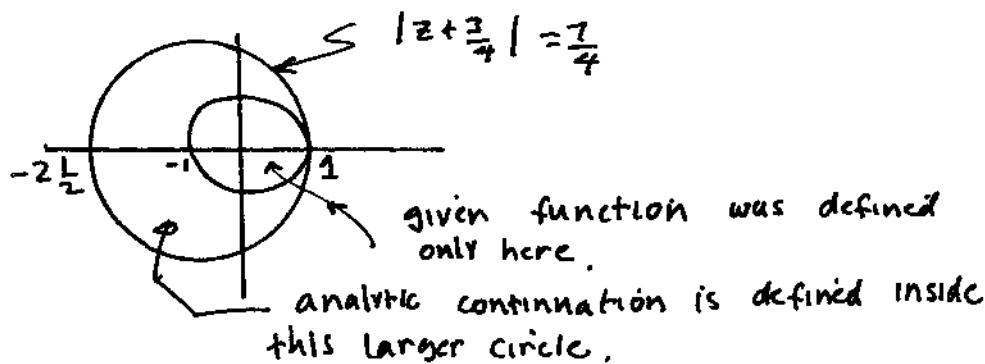

13] (a)

$$\int_0^{\infty} e^{2t} e^{-zt} dt = \lim_{L \rightarrow \infty} \int_0^L e^{2t} e^{-zt} dt =$$

$$\lim_{L \rightarrow \infty} \left. \frac{e^{t(2-z)}}{(2-z)} \right|_0^L = \lim_{L \rightarrow \infty} \frac{e^{L(2-z)}}{2-z} - \frac{1}{(2-z)} =$$

$$\lim_{L \rightarrow \infty} \frac{e^{L[2-x]} e^{-iLy}}{(2-z)} - \frac{1}{(2-z)} = \frac{-1}{(2-z)} = \frac{1}{z-2} \text{ if } x > 2$$

if $x = 2$ or $x < 2$ limit does not exist.

Sec 5.7 cont'd

13(b) cont'd

The analytic continuation of $\frac{1}{z-2}$ ($x > 2$) into the remainder of the complex plane is $\frac{1}{z-2}$ which is analytic for all $z \neq 2$.

14(a) $\int_0^z [2 + 3 \cdot 2W + 4 \cdot 3W^2 + 5 \cdot 4W^3 + \dots] dW =$
integrate term by term

$$2z + 3z^2 + 4z^3 + \dots = \sum_{n=1}^{\infty} (n+1)z^n. \text{ This}$$

Series converges for $|z| < 1$ (use the ratio test).

If $|z| < 1$ we have a convergent power series - its sum must be an analytic function. The series diverges for $|z| > 1$ (ratio test) so it does not define a function for $|z| > 1$.

(b) $\int_0^z f(z') dz' = \int_0^z 2z' + 3z'^2 + 4z'^3 + \dots dz'$
 $|z| < 1$ integrate term by term

$$\int_0^z f(z') dz' = z^2 + z^3 + z^4 + \dots \quad |z| < 1$$
$$= z^2 [1 + z + z^2 + \dots] = z^2 / (1-z) \quad |z| < 1$$

To find $f(z)$ in closed form differentiate both sides of the preceding. Get: $f(z) = \frac{d}{dz} \frac{z^2}{(1-z)} = \frac{2z(1-z) - z^2(-1)}{(1-z)^2}$

$$= \frac{2z - z^2}{(1-z)^2} \quad |z| < 1. \text{ The analytic continuation}$$

of the original series into the entire complex plane ($z \neq 1$) is $\frac{2z - z^2}{(1-z)^2}$.

Sec 5.7

15]

a)

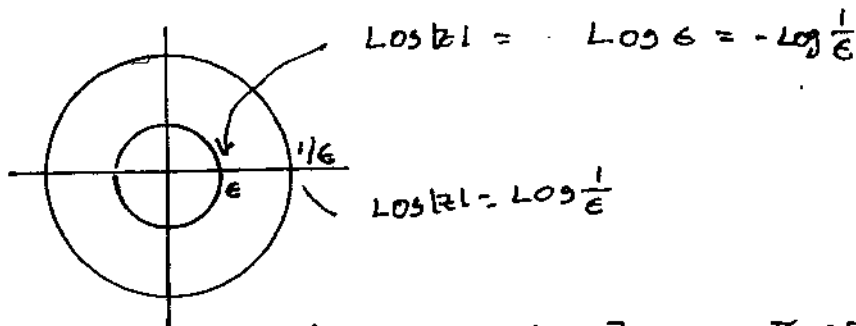

$$\text{Log } z = \text{Log } |z| + i\theta, \quad \theta = \arg z, \quad -\pi < \theta \leq \pi$$

in the given region $|\text{Log } z| \leq \left| \text{Log } \frac{1}{\epsilon} + i\pi \right|$

look at this series

$$\sum_{n=0}^{\infty} \frac{\left| \text{Log } \frac{1}{\epsilon} + i\pi \right|^n}{n!}$$

The preceding $\left| \text{Log } \frac{1}{\epsilon} + i\pi \right|$

is convergent and converges to e

We can apply the M test, taking M_n

as $\frac{\left| \text{Log } \frac{1}{\epsilon} + i\pi \right|^n}{n!}$ Now $U_n = \frac{(\text{Log } z)^n}{n!}$

In the given region $|U_n| \leq M_n$

i.e. $\left| \frac{(\text{Log } z)^n}{n!} \right| \leq \frac{\left| \text{Log } \frac{1}{\epsilon} + i\pi \right|^n}{n!}$

$\therefore \sum_{n=0}^{\infty} U_n(z)$ is uniformly convergent in

the given region $\epsilon \leq |z| \leq \frac{1}{\epsilon}$

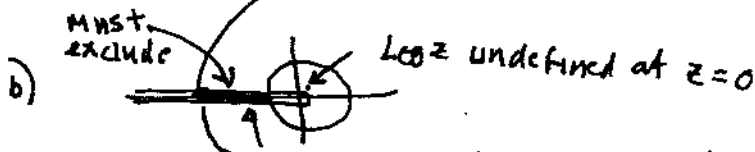

In $\arg \text{Log } z$ discontinuous here on cut

Note that $e^{\text{Log } z} = z$, all $z \neq 0$, z is entire

\therefore on the points in question $y=0, -\frac{1}{\epsilon} < x < \epsilon$

We take as the analytic continuation of the series simply $\boxed{z=x}$

sec 5.7

16 continued.

d) Note that $\sum_{n=1}^{\infty} \frac{1}{n}$ diverges.

$\therefore \zeta(z=1) = \sum_{n=1}^{\infty} \frac{1}{n}$ is not analytic at $z=1$.

This is the nearest singular point to center of expansion.

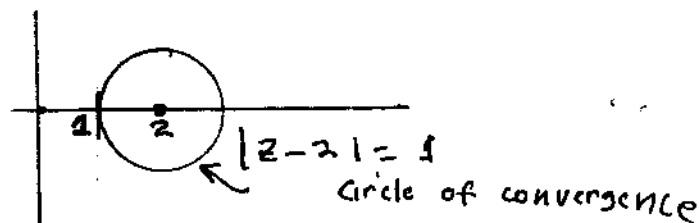

$$f(z) = \zeta(z) = \sum_{m=0}^{\infty} C_m (z-2)^m$$

$$C_m = \frac{y^{(m)}(z)}{m!}$$

$$C_0 = \sum_{n=1}^{\infty} e^{-z \operatorname{Log} n} \Big|_{z=2} = \sum_{n=1}^{\infty} \frac{1}{n^2} = \frac{\pi^2}{6}$$

$$C_1 = \frac{d}{dz} \sum_{n=1}^{\infty} e^{-z \operatorname{Log} n} \Big|_{z=2} = \sum_{n=1}^{\infty} e^{-z \operatorname{Log} n} (-\operatorname{Log} n) \Big|_{z=2}$$

$$C_1 = \sum_{n=1}^{\infty} \frac{1}{2^n} (-\operatorname{Log} n) = \sum_{n=1}^{\infty} \frac{1}{2^n} (-\operatorname{Log} n)$$

$$C_2 = \sum_{n=1}^{\infty} \frac{1}{2^n} \frac{(\operatorname{Log} n)^2}{2!} \Big|_{z=2}$$

$$C_m = \frac{1}{m!} \sum_{n=1}^{\infty} \frac{1}{2^n} (-\operatorname{Log} n)^m \quad m=0,1,2,\dots$$

$$e) \quad \zeta(z) = \sum_{n=1}^{\infty} \frac{1}{n^z} = \frac{1}{1^z} + \frac{1}{2^z} + \frac{1}{3^z} + \frac{1}{4^z} + \dots$$

$$\frac{\zeta(z)}{2^z} = \frac{1}{2^z} + \frac{1}{4^z} + \frac{1}{6^z} + \frac{1}{8^z} + \dots$$

$$\therefore \zeta(z) - \frac{\zeta(z)}{2^z} = \zeta \left[1 - \frac{1}{2^z} \right] = \frac{1}{1^z} + \frac{1}{3^z} + \frac{1}{5^z} + \frac{1}{7^z} + \frac{1}{9^z} + \frac{1}{11^z} + \dots$$

These are terms on the right of the form $\frac{1}{n^z}$, where n is even.

sec 5.7

16 (e) cont'd

$$\prod \left(1 - \frac{1}{2^n}\right) \left(\frac{1}{3^n}\right) = \frac{1}{3^2} + \frac{1}{9^2} + \frac{1}{15^2} + \frac{1}{21^2} + \frac{1}{27^2} + \dots$$

$$\prod \left(1 - \frac{1}{2^n}\right) - \prod \left(1 - \frac{1}{2^n}\right) \left(\frac{1}{3^n}\right) =$$

$$\frac{1}{1^2} + \frac{1}{5^2} + \frac{1}{7^2} + \frac{1}{11^2} + \frac{1}{13^2} + \frac{1}{17^2} + \dots$$

$$\therefore \prod \left(1 - \frac{1}{2^n}\right) \left(1 - \frac{1}{3^n}\right) = \frac{1}{1^2} + \frac{1}{5^2} + \frac{1}{7^2} + \frac{1}{11^2} + \frac{1}{13^2} + \dots$$

Note that on the right there are no terms of form $\frac{1}{n^2}$ where n is

divisible by the primes 2 or 3, which we have eliminated. Now divide the preceding equation by 5^2 , where 5 is the next

prime in the sequence 2, 3, 5

$$\prod \left(1 - \frac{1}{2^n}\right) \left(1 - \frac{1}{3^n}\right) \left(\frac{1}{5^n}\right) = \frac{1}{5^2} + \frac{1}{25^2} + \frac{1}{35^2} + \dots$$

Subtracting this from the preceding equation

we have:

$$\prod \left(1 - \frac{1}{2^n}\right) \left(1 - \frac{1}{3^n}\right) \left(1 - \frac{1}{5^n}\right) = \frac{1}{1^2} + \frac{1}{7^2} + \frac{1}{11^2} + \frac{1}{13^2} + \frac{1}{17^2} + \frac{1}{19^2} + \dots$$

There are no terms on the right of the form $\frac{1}{n^2}$ where n is divisible by the first three primes 2, 3, 5. Now repeat the process, dividing by 7^2 . In this way we go thru all the primes, and eliminate every term from the right side except $\frac{1}{1^2}$, since every whole number is a product of prime factors. Note $1^2 = e^{2 \log 1} = \boxed{1}$

sec 5.7

16 (e) continued.

Recall that $|z| = e^{z \log 1} = 1$

Thus $\prod \left(1 - \frac{1}{p^z}\right) \left(1 - \frac{1}{3^z}\right) \left(1 - \frac{1}{5^z}\right) \left(1 - \frac{1}{7^z}\right) \dots$ (all primes)
 $= 1$

16 f)

```
%for problem 16, sec. 5.7
x=linspace(.25,.75,25);
y=linspace(20.5,21.5,25);
[X Y]=meshgrid(x,y);
w=zeta(X+i*Y);
% mesh(x,y,real(1./w));axis([0 1 20.5 21.5 -35 35])
mesh(x,y,imag(1./w));axis([0 1 20.5 21.5 -35 35])
% mesh(x,y,abs(1./w));axis([0 1 20.5 21.5 0 35])
```

→ choose one

(f)

prob 16

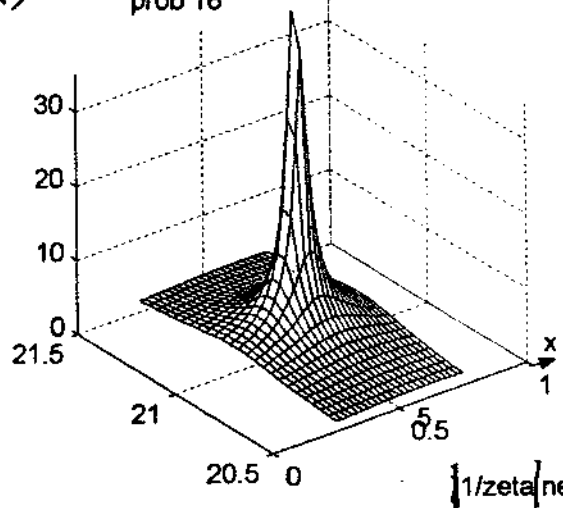

$$\left| \frac{1}{\zeta(s)} \right|$$

1/zeta near .5 + i21.022

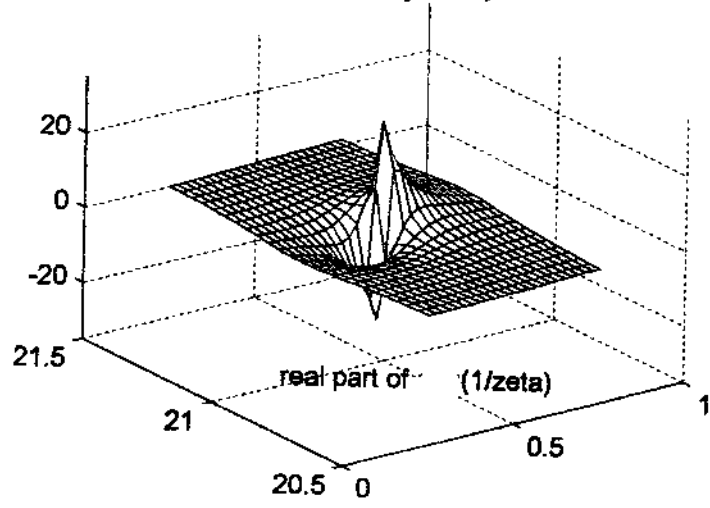

real part of (1/zeta)

SEC 5.7

16(f) cont'd

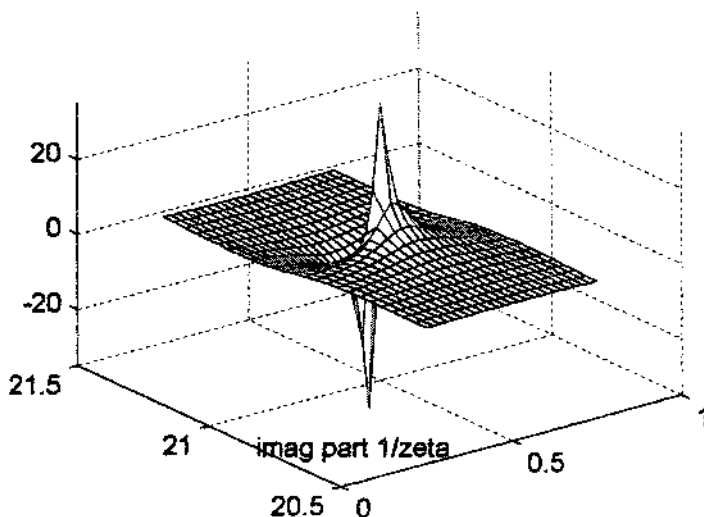

17

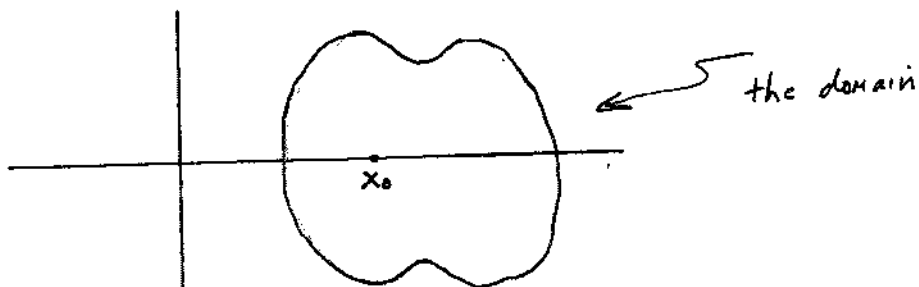

a)

$$f(z) = \sum_{n=0}^{\infty} c_n (z - x_0)^n \quad f^{(n)}(z = x_0) = c_n \cdot n!$$

$c_0 = f(x_0, 0)$ is real since $f(z) = U(x_0, 0) + iV(x_0, 0) = U(x_0, 0)$

Similarly $c_1 = \lim_{\Delta x \rightarrow 0} \frac{U(x_0 + \Delta x, 0) + iV(x_0 + \Delta x, 0) - U(x_0, 0) - iV(x_0, 0)}{\Delta x}$
 $= \frac{\partial U(x_0, 0)}{\partial x} \Big|_{x=x_0}$ is real

Similarly $c_2 = \frac{1}{2} \frac{\partial^2 U}{\partial x^2} \Big|_{x=x_0, y=0}$ is real
 $c_n = \frac{1}{n!} \frac{\partial^n U(x, 0)}{\partial x^n} \Big|_{x_0, 0}$ is real

b)

$$f(z) = \sum_{n=0}^{\infty} c_n (z - x_0)^n$$

$$f(\bar{z}_1) = \sum_{n=0}^{\infty} c_n (\bar{z}_1 - x_0)^n$$

$$\overline{f(\bar{z}_1)} = \sum_{n=0}^{\infty} \overline{c_n (\bar{z}_1 - x_0)^n} = \sum_{n=0}^{\infty} \bar{c}_n (z_1 - x_0)^n = \sum_{n=0}^{\infty} c_n (z_1 - x_0)^n$$

since $\bar{\bar{z}_1} = z_1, \bar{x_0} = x_0$

Thus $\overline{f(\bar{z}_1)} = f(z_1)$, Take conj both sides and get finally $f(\bar{z}_1) = \overline{f(z_1)}$ q.e.d.

(c)

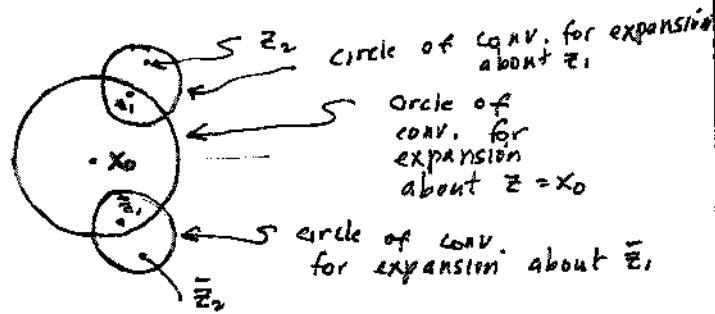

We have proved that $f(z) = \bar{f}(\bar{z})$
 This applies to derivs of all orders i.e.
 $f^n(z) = \overline{f^n(\bar{z})}$ To prove for $n=1$, notice

$$f'(z)|_{z=z_1} = \lim_{\Delta x \rightarrow 0} \frac{f(z_1 + \Delta x) - f(z_1)}{\Delta x}$$

$$f'(z)|_{z=\bar{z}_1} = \lim_{\Delta x \rightarrow 0} \frac{f(\bar{z}_1 + \Delta x) - f(\bar{z}_1)}{\Delta x}$$

these are conjugates.

This can be extended $n=2,3,\dots$

Suppose we expand $f(z)$ about $z = z_1$

$$[1] f(z) = \sum_{n=0}^{\infty} C_n (z - z_1)^n, \quad C_n = \frac{f^n(z_1)}{n!}$$

Now expand $f(z)$ about $z = \bar{z}_1$

$$[2] f(z) = \sum_{n=0}^{\infty} \bar{C}_n (z - \bar{z}_1)^n, \quad \bar{C}_n = \frac{f^n(\bar{z}_1)}{n!}$$

$$\text{Note } \bar{C}_n = C_n$$

Now assume that z_2 lies in the circle of conv. of the expansion about z_1 , and so \bar{z}_2 will lie in the circle of convergence of the expansion about \bar{z}_1 .

$$\text{Using series [1]} \quad f(z_2) = \sum_{n=0}^{\infty} C_n (z_2 - z_1)^n$$

$$\text{Using series [2]} \quad f(\bar{z}_2) = \sum_{n=0}^{\infty} \bar{C}_n (\bar{z}_2 - \bar{z}_1)^n$$

Now take conjugate of the preceding:

$$\overline{f(\bar{z}_2)} = \sum_{n=0}^{\infty} \overline{\bar{C}_n} (\overline{\bar{z}_2 - \bar{z}_1})^n = \sum_{n=0}^{\infty} C_n (z_2 - z_1)^n$$

$$\therefore \overline{f(\bar{z}_2)} = f(z_2) \quad \text{Since } \bar{C}_n = C_n$$

Take conj. both sides $f(\bar{z}_2) = \bar{f}(z_2)$ *q.e.d.*
 The procedure can be continued along a chain of circles of convergence.

Section 5.8

$$\begin{aligned}
 1) \quad \mathcal{Z}(e^{at}) &= ?, \quad \mathcal{Z}(e^{at}) = \frac{e^{a0}}{1} + \frac{e^{aT}}{z} + \frac{e^{a2T}}{z^2} + \frac{e^{a3T}}{z^3} + \dots \\
 &= \sum_{n=0}^{\infty} \left(\frac{e^{aT}}{z}\right)^n = \frac{1}{1 - \frac{e^{aT}}{z}} \quad \text{if } \left|\frac{e^{aT}}{z}\right| < 1 \text{ or } |e^{aT}| < |z| \\
 \frac{1}{1 - e^{aT}/z} &= \frac{z}{z - e^{aT}} \quad \text{g.c.d.}
 \end{aligned}$$

$$\begin{aligned}
 2) \quad \mathcal{Z}(b^t) &= \frac{b^0}{z^0} + \frac{b^T}{z^1} + \frac{b^{2T}}{z^2} + \frac{b^{3T}}{z^3} + \dots \\
 &= \sum_{n=0}^{\infty} \left(\frac{b^T}{z}\right)^n = \frac{1}{1 - \left(\frac{b^T}{z}\right)} = \frac{z}{z - b^T}
 \end{aligned}$$

if $\left|\frac{b^T}{z}\right| < 1$ or $|b^T| < |z|$.

$$3) \quad \mathcal{Z}[e^{c\alpha t}] = \frac{z}{z - e^{c\alpha T}} \quad \text{from prob. 1, } |z| > |e^{c\alpha T}|$$

$$\mathcal{Z}[e^{-c\alpha t}] = \frac{z}{z - e^{-c\alpha T}} \quad \text{from prob 1 } |z| > 1$$

add these 2 results and divide by $2i$

$$\begin{aligned}
 \mathcal{Z}[\sin \alpha t] &= \frac{z}{2i} \left[\frac{e^{c\alpha t} - e^{-c\alpha t}}{2i} \right] = \frac{z}{2i} \left[\frac{1}{z - e^{c\alpha T}} - \frac{1}{z - e^{-c\alpha T}} \right] \\
 &= \frac{z}{2i} \left[\frac{(z - e^{-c\alpha T}) - (z - e^{c\alpha T})}{z^2 - z(e^{c\alpha T} + e^{-c\alpha T}) + 1} \right] = \\
 &= \frac{z \sin(c\alpha T)}{z^2 - 2z \cos(c\alpha T) + 1} \quad |z| > 1
 \end{aligned}$$

Sec 5.8

4] Proceed as in 3, problem 1 USC:

$$\begin{aligned} \mathcal{Z}[\cos(\alpha T)] &= \mathcal{Z}\left[\frac{e^{i\alpha t} + e^{-i\alpha t}}{2}\right] = \\ &= \frac{\mathcal{Z}}{2} \left[\frac{1}{z - e^{i\alpha T}} + \frac{1}{z - e^{-i\alpha T}} \right] = \frac{\mathcal{Z}}{2} \left[\frac{(z - e^{-i\alpha T}) + (z - e^{i\alpha T})}{z^2 - z[e^{i\alpha T} + e^{-i\alpha T}] + 1} \right] \\ &= \frac{\mathcal{Z} [z - \cos(\alpha T)]}{z^2 - 2z \cos(\alpha T) + 1} \end{aligned}$$

5] Proceed as in 3]. Consider $\mathcal{Z}[\sinh(\alpha t)]$

$$= \mathcal{Z} \frac{1}{2} (e^{\alpha t} - e^{-\alpha t}) \text{ From problem 1: } a = \alpha$$

$$\mathcal{Z} e^{\alpha T} = \frac{\mathcal{Z}}{z - e^{\alpha T}} \text{ if } |z| > |e^{\alpha T}| = e^{\alpha T} \text{ since } \alpha \text{ real}$$

Put $-\alpha$ in place of α in the above. $\mathcal{Z} e^{-\alpha T} = \frac{\mathcal{Z}}{z - e^{-\alpha T}}$ if $|z| > e^{-\alpha T}$

Combining the precedents, we have

$$\mathcal{Z} \frac{1}{2} [e^{\alpha t} - e^{-\alpha t}] = \frac{\mathcal{Z}}{2} \frac{-e^{-\alpha T} + e^{\alpha T}}{(z - e^{\alpha T})(z - e^{-\alpha T})}$$

$$= \frac{\mathcal{Z} [\sinh(\alpha T)]}{z^2 - 2z \cosh(\alpha T) + 1}$$

where $|z| >$ larger of $e^{\alpha T}$ or $e^{-\alpha T}$
 or $|z| > e^{|\alpha|T}$

section 5.8

$$6] \mathcal{Z}[\cosh(\alpha t)] = \frac{\mathcal{Z}}{2} e^{\alpha t} + \frac{\mathcal{Z}}{2} e^{-\alpha t}$$

$$\frac{\mathcal{Z}}{2} e^{\alpha t} = \frac{\mathcal{Z}}{(2)(\mathcal{Z} - e^{\alpha T})}$$

using $a = \alpha$ in
 $|\mathcal{Z}| > e^{\alpha T}$ probl. 1

$$\frac{\mathcal{Z}}{2} e^{-\alpha t} = \frac{\mathcal{Z}}{(2)(\mathcal{Z} - e^{-\alpha T})}$$

$|\mathcal{Z}| > e^{-\alpha T}$
 using $a = -\alpha$ in probl. 1.

$$\therefore \mathcal{Z}[\cosh(\alpha t)] = \frac{\mathcal{Z}}{2} \left[\frac{1}{\mathcal{Z} - e^{\alpha T}} + \frac{1}{\mathcal{Z} - e^{-\alpha T}} \right]$$

$$= \frac{\mathcal{Z}}{2} \left[\frac{2\mathcal{Z} - e^{\alpha T} - e^{-\alpha T}}{\mathcal{Z}^2 - \mathcal{Z}(e^{\alpha T} + e^{-\alpha T}) + 1} \right] =$$

$$\mathcal{Z} \left[\frac{\mathcal{Z} - \cosh(\alpha T)}{\mathcal{Z}^2 - 2\mathcal{Z}\cosh(\alpha T) + 1} \right]$$

provided $|\mathcal{Z}| > e^{|\alpha|T}$

$$7] \mathcal{Z} f(t) = \frac{f(0T)}{\mathcal{Z}^0} + \frac{f(T)}{\mathcal{Z}} + \frac{f(2T)}{\mathcal{Z}^2} + \frac{f(3T)}{\mathcal{Z}^3} + \dots$$

$$= F(\mathcal{Z})$$

$$\mathcal{Z}(t f(t)) = \frac{0 f(0)}{\mathcal{Z}^0} + \frac{1T f(T)}{\mathcal{Z}^1} + \frac{2T f(2T)}{\mathcal{Z}^2} + \frac{3T f(3T)}{\mathcal{Z}^3} + \dots$$

Using the first equation, we have:

$$\frac{dF}{d\mathcal{Z}} = -\frac{f(T)}{\mathcal{Z}^2} - \frac{2f(2T)}{\mathcal{Z}^3} - \frac{3f(3T)}{\mathcal{Z}^4} - \dots$$

$$-ZT \frac{dF}{dZ} = \frac{Tf(T)}{\mathcal{Z}} + \frac{2Tf(2T)}{\mathcal{Z}^2} + \frac{3Tf(3T)}{\mathcal{Z}^3} + \dots \quad \text{which equals } \mathcal{Z}[t f(t)]$$

8] (a) section 5.8
 From example 1: $\sum u(t) = \frac{z}{(z-1)} = F(z)$

$$\frac{dF}{dz} = \frac{(z-1) - z}{(z-1)^2} = \frac{-1}{(z-1)^2} \quad \therefore -dF = \frac{1}{(z-1)^2}$$

$$-z^{-1} \frac{dF}{dz} = \frac{z^{-1}}{(z-1)^2} = \sum t u(t)$$

(b) $\sum (t^2 u(t)) = \sum (t \cdot t u(t)) = -z^{-1} \frac{d}{dz} F(z)$

where $F(z) = \frac{z^{-1}}{(z-1)^2}$ (taken from part a).

Thus:

$$\sum (t^2 u(t)) = -z^{-1} \frac{d}{dz} \frac{z^{-1}}{(z-1)^2} = -z^{-1} \frac{[(z-1)^2 - z \cdot 2(z-1)]}{(z-1)^4}$$

$$= -z^{-1} \frac{(z-1) - 2z}{(z-1)^3} = \frac{z^{-1} (z+1)}{(z-1)^3} \quad \text{g.e.d.}$$

9. Given $\sum u(t) = \frac{z}{(z-1)}$. Now see eqn 5.8-6

Put $k=1$. $\sum (f(t-T)) = z^{-1} F(z)$. Thus

$$\sum u(t-T) = \frac{1}{z} \sum u(t) = \frac{1}{(z-1)} \quad \text{g.e.d.}$$

10. $\sum [u(t) - u(t-T)] = \sum u(t) - \sum u(t-T)$

$$= \frac{z}{(z-1)} - \frac{1}{(z-1)} \quad (\text{from 9}) = \frac{z-1}{(z-1)} = 1$$

11. From eqn. 5.8-6. $\sum u(t-2T) = z^{-2} \sum u(t)$

$$= \frac{1}{z} \frac{1}{(z-1)} \quad \therefore \sum [u(t-T) - u(t-2T)] =$$

$$\left(\frac{1}{z-1} \right) - \frac{1}{z(z-1)} = \frac{(z-1)}{z(z-1)} = \frac{1}{z} \quad \text{where we}$$

use the result of 9 to get $\sum (u(t-T))$.

12] LoSW is analytic except for line $\text{Re } w = 0$, $\text{Im } w = 0$

$$\text{Now } \frac{z}{z-1} = \frac{(x+iy)(x-1-iy)}{(x-1)^2 + y^2} = \frac{(x)(x-1) + y^2 + i[y(x-1) - yx]}{(x-1)^2 + y^2}$$

Section 5.8 cont'd

prob 12, cont'd. Require $\text{Im}\left(\frac{z}{z-1}\right) = 0$

or $y(x-1) - yx = 0$ or $y = 0$. Require:

$\text{Real}\left(\frac{z}{z-1}\right) \leq 0$ or $(x)(x-1) + y^2 \leq 0$. Now $y=0$

from above. $\therefore x(x-1) \leq 0 \Rightarrow$ Thus $0 \leq x \leq 1$

\therefore Branch cut in z plane for $\text{Log}\left(\frac{z}{z-1}\right)$ is $y=0, 0 \leq x \leq 1$

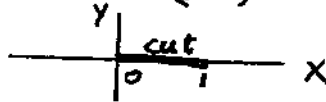

Recall $\frac{1}{1-w} = 1 + w + w^2 + w^3 + \dots$ $|w| < 1$

$$\int_0^w \frac{dw'}{1-w'} = \text{Log} \frac{1}{1-w} = w + \frac{w^2}{2} + \frac{w^3}{3} + \frac{w^4}{4} + \dots \quad |w| < 1$$

$$\therefore \text{Log} \frac{1}{1-\frac{1}{z}} = \frac{1}{z} + \frac{\left(\frac{1}{z}\right)^2}{2} + \frac{\left(\frac{1}{z}\right)^3}{3} + \frac{\left(\frac{1}{z}\right)^4}{4} + \dots \quad \left|\frac{1}{z}\right| < 1$$

or $|z| > 1$

$$\text{Log} \frac{z}{z-1} = \frac{1}{z} + \frac{\left(\frac{1}{z}\right)^2}{2} + \frac{\left(\frac{1}{z}\right)^3}{3} + \dots \quad |z| > 1$$

$$\text{Now } \sum \frac{\pi^k}{k} u(k-\pi) = \frac{\pi^1}{1} z^{-1} + \frac{\pi^2}{2!} z^{-2} + \frac{\pi^3}{3!} z^{-3} + \dots$$

$$= \frac{1}{z} + \frac{1}{2z^2} + \frac{1}{3z^3} + \dots = \text{Log}\left(\frac{z}{z-1}\right) \quad |z| > 1$$

$$\text{[3]} \quad \frac{1}{(z-1)^2} = \frac{1}{z^2 \left[1 - \frac{1}{z}\right]^2} = \text{recall } \frac{1}{(1-w)^2} = 1 + 2w + 3w^2 + \dots \text{ if } |w| < 1$$

$$\frac{1}{z^2} \left[1 + \frac{2}{z} + \frac{3}{z^2} + \frac{4}{z^3} + \dots \right] \quad \left|\frac{1}{z}\right| < 1$$

$$\frac{1}{(z-1)^2} = \frac{1}{z^2} + \frac{2}{z^3} + \frac{3}{z^4} + \dots$$

Thus $f(0\pi) = 0$
 $f(1\pi) = 0, f(n\pi) = n-1$
 $f(2\pi) = 1$ for $n \geq 1$

Section 5.8 continued

14)

$$\frac{1}{(z^4)(1-z)} = \frac{-1}{z^5 \left[1 - \frac{1}{z}\right]} = \frac{-1}{z^5} \left[1 + \frac{1}{z} + \frac{1}{z^2} + \dots\right]$$

$$= -\frac{1}{z^5} - \frac{1}{z^6} - \frac{1}{z^7} \dots \quad \text{Thus } f(nT) = 0, \quad n \leq 4$$

$$f(nT) = -1, \quad n \geq 5$$

15.) $e^{1/z} = 1 + \frac{1}{z} + \frac{1}{2!z^2} + \frac{1}{3!z^3} + \dots$ Thus $f(nT) = \frac{1}{n!}$
for $n \geq 0$

16) a) $\mathcal{Z}(f(t)) = \frac{f(0)}{z^0} + \frac{f(T)}{z} + \frac{f(2T)}{z^2} + \frac{f(3T)}{z^3} + \dots = F(z)$

$$\mathcal{Z}(e^{\beta t} f(t)) = \frac{f(0)}{z^0} e^0 + \frac{f(T)}{z} e^{\beta T} + \frac{f(2T)}{z^2} e^{2\beta T} + \frac{f(3T)}{z^3} e^{3\beta T} + \dots$$

$$\mathcal{Z}(e^{\beta t} f(t)) = \frac{f(0)}{\left(\frac{z}{e^{\beta T}}\right)^0} + \frac{f(T)}{\left(\frac{z}{e^{\beta T}}\right)^1} + \frac{f(2T)}{\left(\frac{z}{e^{\beta T}}\right)^2} + \dots$$

$$= \sum_{n=0}^{\infty} \frac{f(nT)}{\left(\frac{z}{e^{\beta T}}\right)^n} \quad \text{Now } \mathcal{Z} f(t) = \sum_{n=0}^{\infty} \frac{f(nT)}{z^n} = F(z)$$

Thus $\mathcal{Z}(e^{\beta t} f(t)) = F\left(\frac{z}{e^{\beta T}}\right) = F(z e^{-\beta T})$

16(b) From problem 3,

$$\mathcal{Z}(\sin \alpha T) = \frac{z \sin(\alpha T)}{z^2 - 2z \cos(\alpha T) + 1} = F(z) \quad \begin{matrix} |z| > 1 \\ \alpha \text{ real} \end{matrix}$$

Now using result from above

$$\mathcal{Z}(e^{\beta t} \sin(\alpha t)) = \frac{z e^{-\beta T} \sin(\alpha T)}{z^2 e^{-2\beta T} - 2z e^{-\beta T} \cos(\alpha T) + 1} \quad \text{for } \left|\frac{z}{e^{\beta T}}\right| > 1$$

$$= \frac{z e^{\beta T} \sin(\alpha T)}{z^2 - 2z e^{\beta T} \cos(\alpha T) + e^{2\beta T}} \quad \text{for } |z| > e^{\beta T}$$

Sec 5.8 continued

$$[7] \quad F(z) = \frac{f(0T)}{z^0} + \frac{f(T)}{z^1} + \frac{f(2T)}{z^2} + \frac{f(3T)}{z^3} + \dots \quad |z| > R$$

Multiply both sides by z^{n-1} or divide both sides by z^{1-n}

$$F(z)z^{n-1} = \frac{F(z)}{z^{1-n}} = \frac{f(0T)}{z^{1-n}} + \frac{f(T)}{z^{2-n}} + \frac{f(2T)}{z^{3-n}} + \dots$$

$$\frac{f((n-1)T)}{z^0} + \frac{f(nT)}{z^1} + \frac{f((n+1)T)}{z^2} + \frac{f((n+2)T)}{z^3} + \dots$$

Multiply both sides of the preceding by $\frac{1}{2\pi i}$ and integrate both sides around $|z|=R_0$, $R_0 > R$.

Integrate the right side term by term. Put

$$z = R_0 e^{i\theta}, \quad dz = R_0 e^{i\theta} i d\theta. \quad \text{Recall that}$$

$$\frac{1}{2\pi i} \int_0^{2\pi} \frac{dz}{z^m} = \frac{1}{2\pi i} \int_0^{2\pi} \frac{R_0 e^{i\theta} i d\theta}{R_0^m e^{im\theta}} = \begin{cases} 0 & \text{if } m \neq 1 \\ 1 & \text{if } m = 1 \end{cases}$$

Thus upon integration, all the terms in the series on the right $\rightarrow 0$ except the one with

$$\frac{f(nT)}{z^1}. \quad \text{We have } \frac{1}{2\pi i} \oint_{|z|=R_0} F(z)z^{n-1} dz =$$

$$\frac{1}{2\pi i} \int_0^{2\pi} f(nT) \frac{R_0 e^{i\theta} i d\theta}{R_0 e^{i\theta}} = f(nT). \quad \text{We can}$$

change to any closed contour lying in the domain $|z| > R$ provided the contour encloses $|z|=R$. (see princip. deformation of contours)

sec 5.8 cont'd

18]

a) Need $Z^{-1} \left(\frac{z}{z-1} \right) = Z^{-1} \left(\frac{1}{1-\frac{1}{z}} \right) = 1 + \frac{1}{z} + \frac{1}{z^2} + \frac{1}{z^3} + \dots$

$\therefore Z^{-1} \left(\frac{z}{z-1} \right) = 1 = f(nT)$

Need $Z^{-1} \left(\frac{1}{z-1} \right) = Z^{-1} \frac{1}{z} \left[\frac{1}{1-\frac{1}{z}} \right] = \frac{1}{z} + \frac{1}{z^2} + \frac{1}{z^3} + \dots$

$Z^{-1} \left(\frac{1}{z-1} \right) = g(nT), \quad g(nT) = 1 \quad n \geq 1$

$g(nT) = 0, \quad n \leq 0.$

$h(nT) = f(t) * g(t) = \sum_{k=0}^{\infty} f(kT) g((n-k)T)$
[convol.]

$= \sum_{k=0}^{\infty} 1 \cdot g((n-k)T) \quad \text{If } (n-k)T \text{ is } < 1$

then $g[(n-k)T] = 0.$

thus $h(nT) = Z^{-1} \left[\frac{z}{(z-1)^2} \right] = \sum_{k=0}^{n-1} g((n-k)T)$
"1" for

all values of argument in the sum.

$h(nT) = \underbrace{1+1+1}_{(n) \text{ terms}} = n = \underbrace{Z^{-1} \left[\frac{z}{(z-1)^2} \right]}_{\text{answer}}$

(b) $h(nT) = Z^{-1} \left(\frac{z}{(z-1)^2} \right) = \frac{1}{2\pi i} \oint_{|z|=R_0 > 1} \frac{z}{(z-1)^2} z^{n-1} dz$

$h(nT) = \frac{1}{2\pi i} \oint \frac{z^n}{(z-1)^2} dz$

Use extended Cauchy Integral formula. $f^n(z_0) = \frac{1}{n!} \oint \frac{f(z)}{(z-z_0)^{n+1}} dz$

$h(nT) = \frac{d}{dz} z^n \Big|_{z=1} = n z^{n-1} \Big|_{z=1} = \boxed{n} \leftarrow \text{ans.}$
(put n=1)

Sec 5.8, cont'd

$$1) a) \Gamma(z) = \int_0^{\infty} u^{z-1} e^{-u} du$$

$$\Gamma(z+1) = \int_0^{\infty} \underbrace{u^z}_f \underbrace{e^{-u}}_{dg} du$$

integrate by parts $\int f dg = fg - \int g df$

$$f = u^z, \quad g = \frac{e^{-u}}{-1}, \quad df = z u^{z-1} dz$$

$$\Gamma(z+1) = \frac{u^z e^{-u}}{-1} \Big|_0^{\infty} + \int_0^{\infty} e^{-u} z u^{z-1} dz$$

Vanishes.

$$\Gamma(z+1) = z \int_0^{\infty} e^{-u} u^{z-1} du$$

$\underbrace{\hspace{10em}}_{\Gamma(z)}$

at both upper and lower limits.

$$\Gamma(z+1) = z \Gamma(z)$$

$$b) \Gamma(1) = \int_0^{\infty} u^{1-1} e^{-u} du = \int_0^{\infty} e^{-u} du = 1$$

$$\left[\begin{array}{l} \Gamma(2) = 1 \Gamma(1) = 1 \\ \text{using formula of a} \end{array} \right], \quad \left[\begin{array}{l} \Gamma(3) = 2 \Gamma(2) = 2 \\ \text{using formula of a} \end{array} \right]$$

$$\Gamma(n+1) = n \Gamma(n) = (n)(n-1) \Gamma(n-1) = (n)(n-1)(n-2) \Gamma(n-2) \\ = (n)(n-1)(n-2)(n-3) \Gamma(n-3) = \dots$$

$$= \underbrace{(n)(n-1)(n-2) \dots [n - (n-1)]}_{n!} \Gamma(\underbrace{n - (n-1)}_1) = n!$$

$$c) \sum_{n=0}^{\infty} \frac{1}{\Gamma\left(\frac{1}{2} + 1\right)} = \frac{1}{\Gamma(1)} + \frac{1}{\Gamma(2)} + \frac{1}{\Gamma(3)} \\ + \frac{1}{\Gamma(4)} + \dots = 1 + \frac{1}{2} + \frac{1}{20 \cdot 2^2} + \frac{1}{30 \cdot 2^3} + \dots$$

$$e^{1/2} = 1 + \frac{1}{2} + \frac{1}{20} + \frac{1}{30} + \dots \leftarrow \text{these are equal [g.e.d.]}$$

Sec 5.8 cont'd

20]

a) $\sum e^{at} = \frac{z}{z - e^{aT}} = F(z) \quad |z| > |e^{aT}|$
 (prob 1)

$\sum \frac{1}{\Gamma(\frac{t}{T} + 1)} = e^{1/z} = G(z) \quad (\text{prob 19 (c)})$
 $|z| > 0$

$\sum \frac{e^{at}}{\Gamma(\frac{t}{T} + 1)} = \frac{1}{2\pi i} \oint_{|w|=\rho} \frac{F(w) G(z/w)}{w} dw \quad (5.8-13)$

$= \frac{1}{2\pi i} \oint_{|w|=\rho} \frac{w}{w - e^{aT}} \frac{e^{w/z}}{w} dw = e^{\frac{e^{aT}}{z}}$

$|w| = \rho$ Use Cauchy Integral Formula

(b) We have $\sum \left[\frac{1}{\Gamma(\frac{t}{T} + 1)} \right] = e^{1/z}$

thus, using problem (16 a) have:

$\sum \left[\frac{e^{at}}{\Gamma(\frac{t}{T} + 1)} \right] = e^{1/(ze^{-aT})} = e^{\frac{e^{aT}}{z}}$

21]

$f(t+T) - 2f(t) = 0, \quad f(0) = 2$
 + take the \sum transf. of the above

$\sum (f(t+T) - 2f(t)) = 0, \quad \text{Use Eqn 5.8-7}$

$\sum (f(t+T) - 2f(t)) = \sum F(z) - 2 \sum f(t) = 0, \quad \text{Thus}$

$\sum f(t+T) = \sum F(z) - 2z$

$\sum f(t+T) = \sum F(z) - 2z$

$F(z) = \frac{2z}{z-2} = 2 \left[\frac{1}{1 - \frac{2}{z}} \right] = 2 \left[1 + \frac{2}{z} + \frac{4}{z^2} + \frac{8}{z^3} + \dots \right]$

$= 2 + \frac{2^2}{z} + \frac{2^3}{z^2} + \frac{2^4}{z^3} + \dots$ Thus $f(nT) = 2^{n+1}$ ans.

22)

Consider $f(t+2T) - f(t+T) + f(t) = 0$

put $t = nT$, $T = 1$, $\mathcal{Z} f(t) = F(z)$

$\mathcal{Z} f(t+T) = \mathcal{Z} F(z - z f(0)) \stackrel{1}{=} \text{See 5.8-7}$

$\mathcal{Z} f(t+2T) = \mathcal{Z}^2 F(z) - \mathcal{Z}^2 f(0) - \mathcal{Z} f(1) \stackrel{1}{=} \mathcal{Z}^2 F(z) - \mathcal{Z}^2 - \mathcal{Z}$
 See 5.8-8

Thus have taking \mathcal{Z} transform of

$f(t+2T) - f(t+T) + f(t) = 0$ we have that:

$\mathcal{Z}^2 F(z) - \mathcal{Z}^2 - \mathcal{Z} - \mathcal{Z} F(z) + \mathcal{Z} + F(z) = 0$

$F(z) (z^2 - z + 1) = z^2$, $F(z) = \frac{z^2}{z^2 - z + 1}$

$z^2 - z + 1 = 0$ $z = \frac{1 \pm i\sqrt{3}}{2}$

Now use partial fractions:

$$\begin{aligned} \frac{1}{z^2 - z + 1} &= \frac{1}{i\sqrt{3}} \left[\frac{1}{z - \left(\frac{1+i\sqrt{3}}{2}\right)} - \frac{1}{z - \left(\frac{1-i\sqrt{3}}{2}\right)} \right] \\ &= \frac{1}{i\sqrt{3}z} \left[\sum_{n=0}^{\infty} \left(\frac{1+i\sqrt{3}}{2}\right)^n z^{-n} - \left(\frac{1-i\sqrt{3}}{2}\right)^n z^{-n} \right] \quad \text{note coeff of } z^0 \text{ is zero} \\ &= \frac{1}{i\sqrt{3}z} \sum_{n=1}^{\infty} \left[\left(\frac{1+i\sqrt{3}}{2}\right)^n - \left(\frac{1-i\sqrt{3}}{2}\right)^n \right] z^{-n} \\ &= \frac{1}{i\sqrt{3}} \sum_{n=1}^{\infty} \left[\left(\frac{1+i\sqrt{3}}{2}\right)^n - \left(\frac{1-i\sqrt{3}}{2}\right)^n \right] z^{-n-1} \\ &= \frac{1}{i\sqrt{3}} \sum_{n=0}^{\infty} \left[\left(\frac{1+i\sqrt{3}}{2}\right)^{n+1} - \left(\frac{1-i\sqrt{3}}{2}\right)^{n+1} \right] z^{-n-2} \end{aligned}$$

Thus: $\frac{z^2}{z^2 - z + 1} = \sum_{n=0}^{\infty} \frac{1}{i\sqrt{3}} \left[\left(\frac{1+i\sqrt{3}}{2}\right)^{n+1} - \left(\frac{1-i\sqrt{3}}{2}\right)^{n+1} \right] z^{-n} = F(z)$

thus $F(z) = \sum_{n=0}^{\infty} \frac{f(n)}{z^n}$ where: $f(n) = \frac{1}{2^{n+1}} \left[\left(\frac{1+i\sqrt{3}}{2}\right)^{n+1} - \left(\frac{1-i\sqrt{3}}{2}\right)^{n+1} \right]$

$f(n) = \frac{1}{i\sqrt{3}} \left[\left(\frac{1+i\sqrt{3}}{2}\right)^{n+1} - \left(\frac{1-i\sqrt{3}}{2}\right)^{n+1} \right] = \frac{1}{i\sqrt{3}} \left[e^{\frac{i\pi}{3}(n+1)} - e^{-\frac{i\pi}{3}(n+1)} \right]$

$= \frac{2}{\sqrt{3}} \left[\text{SM} \left[\frac{\pi(n+1)}{3} \right] \right]$

23] $f(t+2T) - f(t+T) - 2f(t) = 0$
 let $T=1, t=nT$

Take \mathbb{Z} transform of the above Use (5.8-8)
 (5.8-7). $(z^2 F(z) - z) - z F(z) - 2F(z) = 0$

$F(z) = \frac{z}{(z^2 - z - 2)}$ $z^2 - z - 2 = 0, z=2, z=-1$

$F(z) = \frac{2/3}{(z-2)} + \frac{1/3}{(z+1)}$

$\frac{2/3}{z-2} = \frac{2}{3z} \left[\frac{1}{1 - \frac{z}{2}} \right] = \frac{2}{3z} \left[1 + \frac{z}{2} + \frac{z^2}{2^2} + \dots \right]$

$\frac{1/3}{z+1} = \frac{1}{3z} \frac{1}{1 + 1/z} = \frac{1}{3z} \left[1 - \frac{1}{z} + \frac{1}{z^2} - \frac{1}{z^3} + \dots \right]$

$F(z) = \sum_{n=0}^{\infty} \frac{C_n}{z^{n+1}}$, adding the two above expressions

$C_n = \frac{2^n}{3} + \frac{(-1)^{n+1}}{3}$. Thus $f(0) = 0$
 $f(n) = \frac{2^n}{3} + \frac{(-1)^{n+1}}{3} \quad n \geq 1$

24] Consider $f(t+T) - f(t) = t$. Put $t=nT$,
 take $T=1$, get $f(n+1) - f(n) = n$. Take the
 \mathbb{Z} transform of both sides of: $f(t+T) - f(t) = t$.

From example 2 in text, $\mathbb{Z} t = \frac{z}{(z-1)^2}$

Also from (5.8-7), $\mathbb{Z} f(t+T) = z F(z) - z f(0)$

Thus get $z F(z) - z - F(z) = \frac{z}{(z-1)^2}$. Solve for $F(z)$

get: $F(z) = \frac{z}{(z-1)^3} + \frac{z}{(z-1)}$

Recall $\frac{1}{(1-w)^2} = 1 + 2w + 3w^2 + 4w^3 + \dots$. Differentiating get:

$\frac{1}{(1-w)^3} = 1 + \frac{3 \cdot 2w}{2} + \frac{4 \cdot 3w^2}{2} + \frac{5 \cdot 4w^3}{2} + \dots$

Sec 5.8 cont'd

prob. 24 cont'd

$$\frac{z}{(z-1)^3} = \frac{z}{z^3 \left[1 - \frac{1}{z}\right]^3} = \frac{1}{z^2} \left[1 + \frac{3 \cdot 2}{2} \frac{1}{z} + \frac{4 \cdot 3}{2} \frac{1}{z^2} + \frac{5 \cdot 4}{2} \frac{1}{z^3} + \dots \right]$$

$$= \frac{1}{z^2} + \frac{3 \cdot 2}{2} \frac{1}{z^3} + \frac{4 \cdot 3}{2} \frac{1}{z^4} + \frac{5 \cdot 4}{2} \frac{1}{z^5} + \dots$$

$$\frac{z}{z-1} = 1 + \frac{1}{z} + \frac{1}{z^2} + \frac{1}{z^3} + \dots$$

Adding the two preceding series we have:

$$F(z) = \sum_{n=0}^{\infty} \frac{C_n}{z^n}, \quad C_n = 1 + \frac{n(n-1)}{2}$$

$$\text{Thus } f(nT) = f(n) = 1 + \frac{n(n-1)}{2} = \frac{n^2 - n + 2}{2}$$

25] We need to solve $f(n+1) = f(n) + n^2$

or $f(n+1) - f(n) = n^2$ with $f(0) = 0$

Consider $f(t+\tau) - f(t) = t^2$ where $t = nT$, $\tau = 1$.

Take the z transform of both sides of the preceding equation: Recall that $\mathcal{Z}(t^2) = \frac{(z)(z+1)}{(z-1)^3}$ see problem 8(b). Also $\mathcal{Z}(f(t+\tau)) = z F(z) - z f(0)$. Thus transforming

have: $z F(z) - z f(0) = z F(z)$. Thus transforming

$$\text{have: } z F(z) - F(z) = \frac{(z)(z+1)}{(z-1)^3} \quad \text{or } F(z) = \frac{(z)(z+1)}{(z-1)^4}$$

Recall $\frac{1}{(1-w)^2} = 1 + 2w + 3w^2 + 4w^3 + \dots$, take derivative

$$\frac{1}{(1-w)^3} = 1 + \frac{3 \cdot 2w}{2} + \frac{4 \cdot 3w^2}{2} + \frac{5 \cdot 4w^3}{2} + \dots$$

Differentiate again:

$$\frac{1}{(1-w)^4} = \left. \frac{3 \cdot 2}{3 \cdot 2} + \frac{4 \cdot 3 \cdot 2w}{3 \cdot 2} + \frac{5 \cdot 4 \cdot 3w^2}{3 \cdot 2} + \dots \right\}$$

$$\frac{1}{(1-w)^4} = 1 + \frac{4 \cdot 2 \cdot 2}{6} w + \frac{5 \cdot 4 \cdot 3w^2}{6} + \frac{6 \cdot 5 \cdot 4}{6} w^3 + \dots$$

sec 5.8 cont'd

25] cont'd.

$$\frac{1}{(z-1)^4} = \frac{1}{z^4 \left[1 - \frac{1}{z}\right]^4} = \frac{1}{z^4} \left[1 + \frac{4 \cdot 3 \cdot 2}{6} \left(\frac{1}{z}\right) + \frac{5 \cdot 4 \cdot 3}{6} \left(\frac{1}{z}\right)^2 + \frac{6 \cdot 5 \cdot 4}{6} \left(\frac{1}{z}\right)^3 + \dots \right]$$

Now $F(z) = \frac{z^2}{(z-1)^4} + \frac{z}{(z-1)^4}$. Use this series

$$F(z) = \frac{1}{z^2} \left[1 + \frac{4 \cdot 3 \cdot 2}{6} \left(\frac{1}{z}\right) + \frac{5 \cdot 4 \cdot 3}{6} \left(\frac{1}{z}\right)^2 + \frac{6 \cdot 5 \cdot 4}{6} \left(\frac{1}{z}\right)^3 + \dots \right] + \frac{1}{z^3} \left[1 + \frac{4 \cdot 3 \cdot 2}{6} \left(\frac{1}{z}\right) + \frac{5 \cdot 4 \cdot 3}{6} \left(\frac{1}{z}\right)^2 + \dots \right]$$

add these series

$$= \sum_{n=2}^{\infty} \frac{c_n}{z^n} \quad c_n = \frac{1}{6} \left[\frac{(n+1)!}{(n-2)!} + \frac{n!}{(n-3)!} \right] \quad (n \geq 3)$$

Thus, $f(n) = \dots$ for $n \geq 3$; and $f(2) = 1$

26] a) We need $\sum [-L_{n+2} + 3L_{n+1} - L_n] = 0$

From Eqn (5.8-8) $\sum L_{n+2} = \sum i(n+2) = \sum_{i=1}^{\infty} i(n+2)$

$z^2 I(z) - z^2 L_0 - z L_1$. Note $\sum L_n = I(z)$

From Eqn (5.8-7) $\sum L_{n+1} = \sum i(n+1) = z I(z) - z L_0$

Thus transforming the given difference equation we have:

$$- [z^2 I(z) - z^2 L_0 - z L_1] + 3 [z I(z) - z L_0] - I(z) = 0$$

$$I(z) [-z^2 + 3z - 1] + z^2 L_0 + z L_1 - 3z L_0 = 0$$

Solve this for $I(z)$

$$\text{Get } I(z) = \frac{z^2 L_0 - 3z L_0 + z L_1}{z^2 - 3z + 1} = \frac{z [z L_0 - 3 L_0 + L_1]}{z^2 - 3z + 1}$$

Section 5.8

26] cont'd

(b) In zeroth mesh:
 $-\epsilon_0 + 2l_0 - l_1 = 0$, $l_1 = 2l_0 - \epsilon$. Use in part (a).

$$I(z) = \frac{z [z l_0 - 3l_0 + 2l_0 - \epsilon]}{z^2 - 3z + 1} = \frac{z l_0 [z - 1 - \frac{\epsilon}{l_0}]}{z^2 - 3z + 1}$$

$$= \frac{z \left(z - \left(1 + \frac{\epsilon}{l_0} \right) \right) l_0}{z^2 - 3z + 1}$$

(c) From the above $z \left(z - \left(1 + \frac{\epsilon}{l_0} \right) \right) = z^2 - z - \frac{z\epsilon}{l_0}$.

Now $z \left(z - \frac{3}{2} \right) + z \left(\frac{1}{2} - \frac{\epsilon}{l_0} \right) = z^2 - \frac{3}{2}z + \frac{1}{2}z - \frac{\epsilon z}{l_0} = z^2 - z - \frac{z\epsilon}{l_0}$. The same as this

We need $z^{-1} \left[\frac{z \left(z - \frac{3}{2} \right) + z \left(\frac{1}{2} - \frac{\epsilon}{l_0} \right)}{z^2 - 2 \cdot \frac{3}{2}z + 1} \right] l_0$

First consider:

$$z^{-1} \frac{(z) \left(z - \frac{3}{2} \right)}{z^2 - 2 \left(\frac{3}{2} \right) z + 1}$$

Refer to problem 6
 Take $t = n\pi$, $T = 1$

Let $\cosh(a) = \frac{3}{2}$. $a = \cosh^{-1} \left(\frac{3}{2} \right)$

Thus $z^{-1} \frac{(z) \left(z - \frac{3}{2} \right) l_0}{z^2 - 2 \times \frac{3}{2} z + 1} = l_0 \cosh(an)$

Next consider:

$$z^{-1} \frac{z \left(\frac{1}{2} - \frac{\epsilon}{l_0} \right)}{z^2 - 2 \times \frac{3}{2} z + 1}$$

Let $\cosh a = \frac{3}{2}$
 $\cosh^2 a - \sinh^2 a = 1$
 $\therefore \sinh a = \frac{\sqrt{5}}{2}$

Refer to problem 5

$$z^{-1} \frac{z}{z^2 - 2 \times \frac{3}{2} z + 1} = z^{-1} \left(\frac{1}{\frac{\sqrt{5}}{2}} \right) \frac{\frac{\sqrt{5}}{2} z}{z^2 - 2 \times \frac{3}{2} z + 1} = \frac{1}{\left(\frac{\sqrt{5}}{2} \right)} \frac{\sinh(an)}{\cosh a}$$

(c)
 Prob. 26, cont'd

Thus using the preceding:

$$Z^{-1} \frac{z \left(\frac{1}{2} - \frac{\epsilon}{l_0} \right) l_0}{z^2 - 2 \left(\frac{3}{2} \right) z + 1} = \frac{\left(\frac{1}{2} - \frac{\epsilon_0}{l_0} \right) l_0 \sinh(an)}{\left(\sqrt{5}/2 \right)}$$

Finally combining the preceding results:

$$Z^{-1} \left[\frac{(z)(z^{-3/2}) + z \left(\frac{1}{2} - \frac{\epsilon}{l_0} \right)}{z^2 - 2 \left(\frac{3}{2} \right) z + 1} \right] l_0 =$$

$$l_0 \left[\frac{\cosh(an) + \left(\frac{1}{2} - \frac{\epsilon}{l_0} \right) \sinh(an)}{\sqrt{5}/2} \right] \quad \text{where } a = \cosh^{-1} \left(\frac{3}{2} \right) > 1$$

d) $l_\nu = l_0 \left[\frac{\cosh a\nu + \left(\frac{1}{2} - \frac{\epsilon}{l_0} \right) \sinh(a\nu)}{\left(\sqrt{5}/2 \right)} \right]$ from (c) $n=\nu$

$$l_{\nu-1} = l_0 \left[\frac{\cosh a(\nu-1) + \left(\frac{1}{2} - \frac{\epsilon}{l_0} \right) \sinh[a(\nu-1)]}{\sqrt{5}/2} \right]$$

Referring to the statement of the problem, we have $l_\nu(2+R_L) = l_{\nu-1}$. Thus:

$$(2+R_L) \left[\frac{\cosh a\nu + \left(\frac{1}{2} - \frac{\epsilon}{l_0} \right) \sinh(a\nu)}{\sqrt{5}/2} \right] =$$

$$\left[\frac{\cosh a(\nu-1) + \left(\frac{1}{2} - \frac{\epsilon}{l_0} \right) \sinh a(\nu-1)}{\sqrt{5}/2} \right]. \quad \text{Solving the}$$

preceding for $\frac{\epsilon}{l_0}$ we have:

$$\frac{\epsilon}{l_0} = \frac{1}{2} + \frac{\sqrt{5}}{2} \frac{[(2+R_L) \cosh a\nu - \cosh a(\nu-1)]}{[(2+R_L) \sinh a\nu - \sinh a(\nu-1)]}$$

sec 5.8

27

```
% sec 5.8 prob 27
'part a'
syms T n z a y b
y=ztrans(exp(a*n*T))
pretty(y)

'part b'
check1=iztrans(y)

'part c'
check2=iztrans(exp(1/z))
```

← note: this program employs the Symbolic Math Toolbox of MATLAB.

```
>> sec5_8prob27

ans =

part a

y =

z/exp(a*T)/(z/exp(a*T)-1)
```

or: →

$$\frac{z}{\exp(a T) \left(\frac{z}{\exp(a T)} - 1 \right)}$$

```
ans =

part b

check1 =

exp(a*T)^n

ans =

part c

check2 =

1/n!
```

1) a) $|bn| = n^2$, want $\circ \circ n^2 > \delta$ for $n > N$
 $n^2 > \delta \Rightarrow n > \sqrt{\delta}$. $\circ \circ$ Take $n > N$
 where N is any integer $> \sqrt{\delta}$

(b) If this sequence has a limit it must be a non-negative real b . Then $|n^2 \cos(\frac{n\pi}{2}) - b| < \epsilon$ for $n > N$. Suppose n is even. $n^2 \cos(\frac{n\pi}{2}) = \pm n^2$
 Then $|n^2 \cos(\frac{n\pi}{2}) - b| \geq n^2 - b$. Then we require for even n , $n^2 - b < \epsilon$ for $n > N$. But the left side of this, $n^2 - b$ grows without bound as $n \rightarrow \infty$ and will exceed any preassigned value ϵ . Thus the sequence does not have a limit and must div.

Now must show sequence does not diverge to ∞ .
 For divergence to ∞ require $|n^2 \cos(\frac{n\pi}{2})| > \delta$
 for $n > N$. But if n is odd $n^2 \cos(\frac{n\pi}{2}) = 0$.
 $\circ \circ$ require $0 > \delta$ for $n > N$ which is impossible.

2) Using the original value c we generate the sequence:
 $z_0 = 0, z_1 = c, z_2 = c^2 + c, z_3 = (c^2 + c)^2 + c$
 $z_4 = [(c^2 + c)^2 + c]^2 + c$, etc. We know: $|z_n| \leq 2$
 for all n . Now consider the sequence generated using \bar{c} :
 $0, \bar{c}, \bar{c}^2 + \bar{c}, \dots$. These elements are $\bar{z}_0, \bar{z}_1, \bar{z}_2, \bar{z}_3, \dots$ where z_1, z_2, \dots were generated using c . Since $|\bar{z}_n| = |z_n|$ we know that $|\bar{z}_n| \leq 2$. Thus the sequence derived using \bar{c} does not div to ∞ and \bar{c} must lie in the Mandelbrot set.

3) a) Try $c = -1, z_0 = 0, z_1 = -1, z_2 = 0, z_3 = -1$,
 All z_n are either 0 or -1. The sequence does not diverge to ∞ and -1 is in the Mandelbrot set.
 Now try $c = 1, z_0 = 0, z_1 = 1, z_2 = 2, z_3 = 5, \dots$.
 Since $z_3 = 5, z_3 > 2$ it follows that $c = 1$ not in the set.

3

(b) Recall that -2 is in the Mandelbrot set. We have proved that all points satisfying $|c| > 2$ are not in the M set.

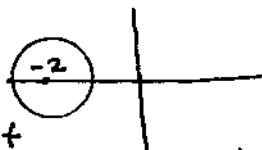

Therefore every neighborhood of $z = -2$ must contain at least one point not in the Mandelbrot set, and at least one point $[z = -2]$ in the set. Thus, (see definition of boundary point) $z = -2$ is a boundary point of the Mandelbrot set.

$$\forall z_{n+p} = z_n, \text{ Now } z_{n+p+1} = z_{n+p}^2 + c = z_n^2 + c = z_{n+1}$$

$$z_{n+p+2} = z_{n+1}^2 + c = z_{n+2} \text{ etc. Thus}$$

$$z_{n+2p} = z_{n+p} = z_n, \text{ and } z_{n+mp} = z_n$$

where $m \geq 0$ is any integer. Since $|z_n|$ is finite, $|z_{n+mp}|$ is finite for m arbitrarily large and the sequence z_1, z_2, \dots

does not diverge to ∞ . Thus c must belong to the Mandelbrot set.

An example: take $c = i$, $z_0 = 0$, $z_1 = i$,

$$z_2 = i^2 + i = -1 + i, \quad z_3 = (-1 + i)^2 + i = -i,$$

$$z_4 = -i^2 + i = -1 + i \text{ same as } z_2$$

5. Next pg.

Appendix chap 5

5 (a)
(b)

```

for problem5g, appendix to chap 5
format long
kk=1;
while kk>0
    c=input('the value of c=') in part (b) input i or .999999i
    nmax=1000;
    j=1;
    z=0;
    q=1;
    while j<= nmax
        z=z^2+c;
        if abs(z)>2
            disp('not in the set'); disp('number of iterations'); disp(j)
            q=0;
            break
        else
            j=j+1;
        end
    end
    if(q)
        disp('in the set'); disp('number of iterations was'); disp(j-1)
    else
        end
    kk=input('input a neg number to stop, a pos. to continue')
end
    
```

part b)
no
after 22
iterations
 $|z_n| > 2$
if
 $c = .999999i$
∴ this
c not
in set.

c) If you try $c = .37 + .357i$ in the above program, it will indicate that this number is most likely "in the set". If you try $c = .37 + .358i$ in the above program find it's not in set. Now experiment with different values on the line connecting the two above points. You find that $.37 + i .357987$ not in set while $.37 + i .357986$ is in the set.

Thus a boundary point must lie near these 2 values.

d)

```

% for problem5d, appendix to chap 5
kk=1;
while kk>0
    c=input('the value of c=') ← use .99i here
    nmax=10;                    at the
    j=1;                        prompt.
    z=0;
    while j<= nmax
        j
        z=z^2+c
        abs(z)
        j=j+1;
    end
    kk=input('input a neg number to stop, a pos. to continue')
end
    
```

The table
is verified

6

Appendix, Chap 5

```
% for problem 6 a) in appendix to chap 5
tic
cr=linspace(-2.25,.75,512);
ci=linspace(0,1.5,256);
[Cr, Ci]=meshgrid(cr,ci);
c=Cr+i*Ci;
nmax=200;
j=1;
z=0;
while j<= nmax
    ck=abs(z)<=2;
    ck=1*ck;
    z=z.*z.^ck+c.*ck;
    j=j+1;
end

dk=-1*ck;

p=pcolor(cr,ci,dk);
set(p,'EdgeColor','none');colormap(gray)
axis([-2.25 .75 -1.5 1.5]); ;hold on;
p=pcolor(cr,-ci,dk); colormap(gray)
set(p,'EdgeColor','none')
toc
```

```
% for problem 6 b) in appendix to chap 5
clear
tic
cr=linspace(0,.5,512);
ci=linspace(0,.5,256);
[Cr, Ci]=meshgrid(cr,ci);
c=Cr+i*Ci;
nmax=200;
j=1;
z=0;
while j<= nmax
    ck=abs(z)<=2;
    ck=1*ck;
    z=z.*z.^ck+c.*ck;
    j=j+1;
end
dk=-1*ck;
p=pcolor(cr,ci,dk);
set(p,'EdgeColor','none');colormap(gray)

toc
```

Figure on next page.

Appendix Chap 5

prob 6 b) continued.

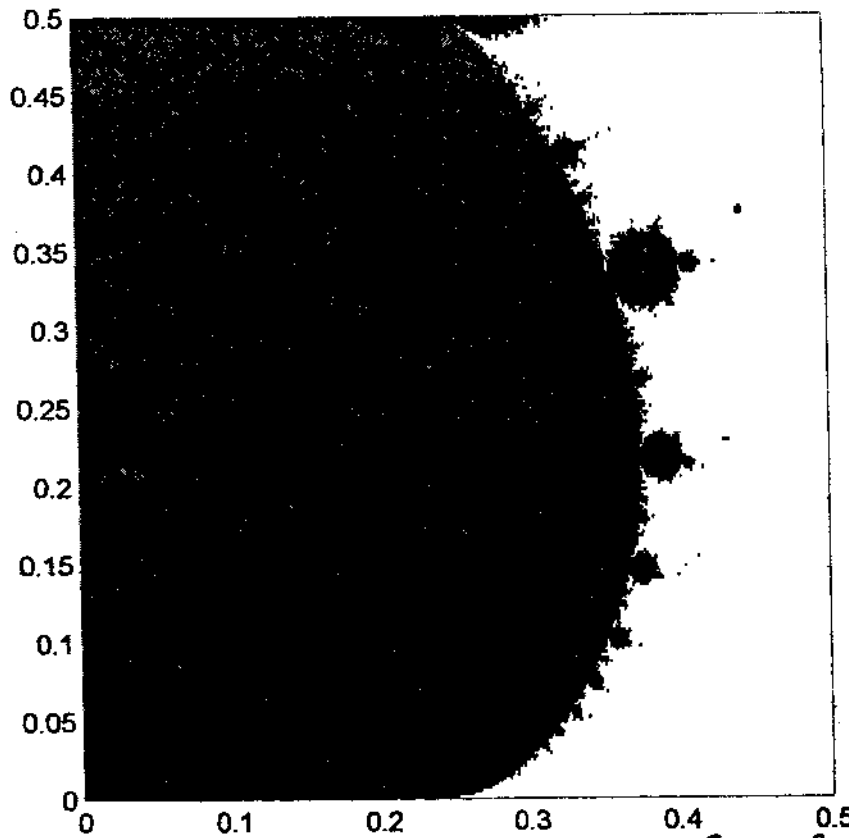

7] Consider z_0 , we have $z_1 = z_0^2 + c$, $z_2 = (z_0^2 + c)^2 + c$
 $z_3 = [(z_0^2 + c)^2 + c]^2 + c \dots$ etc. This sequence does not
 diverge to ∞ . Now put $-z_0$ in place of z_0 in the
 preceding expressions. We generate the same sequence,
 (which does not diverge to ∞). Thus $-z_0$ is in the same Julia set
 as z_0 .

8] We take $c = 0, 0^0$

$$z_0 = z_0, z_1 = z_0^2, z_2 = z_0^4, z_3 = z_0^8, \dots$$

$$z_n = (z_0)^{2^n}. \text{ We require } |z_n| < \infty \text{ as}$$

$n \rightarrow \infty$. $\therefore |z_0| < 1$. Thus our Julia set

for $c=0$ is the disc $|z| < 1$. The boundary is

$|z| = 1$ which is a smooth curve (not a fractal set).

Appendix, Chap 5

9] According to Mandelbrot: to obtain a connected filled Julia set, c must lie in the Mandelbrot set. Now assuming this is true of c , and taking $z_0 = 0$, we have $z_1 = c$, $z_2 = c^2 + c$, $z_3 = (c^2 + c)^2 + c$ etc. This sequence does not diverge to ∞ since it is precisely the sequence used to see if c lies in the Mandelbrot set. Thus $z = 0$ lies in the filled Julia set corresponding to a value of c in the Mandelbrot set.

$$\begin{aligned} 10] \quad z_0 &= \frac{1 + (1 - 4c)^{1/2}}{2}, & z_1 &= \left[\frac{1 + (1 - 4c)^{1/2}}{2} \right]^2 + c \\ z_1 &= \frac{1 + 2(1 - 4c)^{1/2} + (1 - 4c)}{4} + c & &= \frac{1 + (1 - 4c)^{1/2}}{2} \end{aligned}$$

Note $z_1 = z_0$, similarly $z_2 = z_1 = z_0$ etc.
All the elements of this sequence are identical.
It does not diverge to ∞ . So $\frac{1 + (1 - 4c)^{1/2}}{2}$
(both values) must lie in the filled Julia set for c .

6

Residues and Their Use in Integration

section 6.1

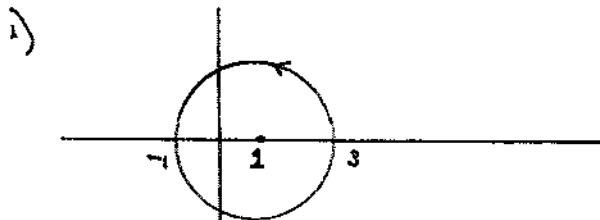

The function $f(z) = \frac{1}{(z-1)^2} + \frac{i}{z-1} + 2(z-1) + \frac{3}{z-4}$ has an isolated singular point at $z=1$, which is the only singular point enclosed by C . The residue is i , the coeff of $(z-1)^{-1}$. Note that $\frac{3}{z-4}$ is analytic at $z=1$. Thus the ans. is $2\pi i \times \text{Res at } 1 = 2\pi i \cdot i = \boxed{-2\pi}$

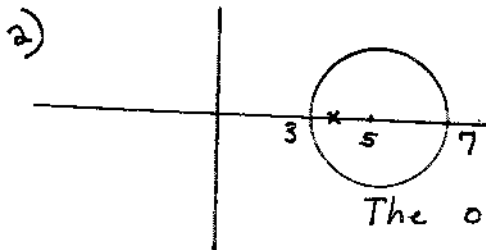

This contour encloses the singular point at $z=4$. The other terms $\frac{1}{(z-1)^2} + \frac{i}{z-1} + 2(z-1)$ are analytic on and inside the contour. The residue of the integrand at $z=4$ is 3. \therefore ans = $2\pi i \times 3 = \boxed{6\pi i}$

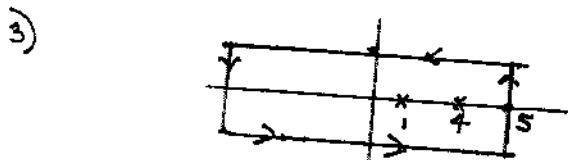

The contour encloses the singular points of the integrand at $z=1$ and $z=4$. The residues there are respectively i and 3. By the residue theorem ans = $2\pi i (3+i) = \boxed{2\pi i (3+i)}$

4) The residue of the expression

$$\sum_{n=-\infty}^{\infty} e^{-n^2} (n-1) (z-1)^n$$

is the coeff of $(z-1)^{-1}$, or $e^{-1}(-2)$

Since the singular point at $z=1$ is enclosed we have ans = $2\pi i e^{-1}(-2) = \boxed{-4\pi i/e}$

5) The contour $|z-i|=3$ encloses the singular point at $z=-i$. The residue is the coefficient of $(z+i)^{-1}$ which is $\frac{1}{-1!}$. \therefore ans = $\boxed{\frac{2\pi i}{-1!}}$

6) $\cosh \frac{1}{z}$ has an isolated sing. point at $z=0$.

$$\cosh w = 1 + \frac{w^2}{2!} + \frac{w^4}{4!} + \dots$$

$$\cosh \frac{1}{z} = 1 + \frac{1/z^2}{2!} + \frac{1/z^4}{4!} + \dots$$

The residue at $z=0$ is zero. [No z^{-1} term]

Thus the ans = $\boxed{0}$

7) $\sin \frac{1}{(z-1)}$ has an isolated sing. pt at $z=1$. The contour encloses $z=1$.

$$\text{Note } z \sin \frac{1}{(z-1)} = [1 + (z-1)] \sin \left[\frac{1}{(z-1)} \right]$$

$$= (1 + (z-1)) \left[\frac{1}{(z-1)} - \frac{1}{3!} \frac{1}{(z-1)^3} + \frac{1}{5!} \frac{1}{(z-1)^5} - \dots \right]$$

$$= \left[\frac{1}{(z-1)} - \frac{1}{3!} \frac{1}{(z-1)^3} + \frac{1}{5!} \frac{1}{(z-1)^5} - \dots \right] + \left[1 - \frac{1}{3!} \frac{1}{(z-1)^2} + \frac{1}{5!} \frac{1}{(z-1)^4} - \dots \right]$$

↑ the only term of form $[z-1]^{-1}$

\therefore residue = 1, ans = $\boxed{2\pi i}$

8]

Section 6.1

$\sin z = 0$ at $z = 0, \pm\pi, \pm 2\pi, \dots$. The contour encloses the sing. point of $1/\sin z$ at $z = 0$.

$$\frac{1}{\sin z} = \frac{1}{z - z^3/3! + z^5/5! - \dots}$$

Do the long division

$$\begin{array}{r} z^{-1} + z/3! \dots \\ z - z^3/3! + z^5/5! \overline{) 1} \\ \underline{-z^2 + z^4} \\ 3! \\ \underline{-z^2 + z^4} \\ 3! \end{array}$$

The coeff of z^{-1} is 1. $\therefore \text{res} \left[\frac{1}{\sin z}, 0 \right] = 1$

$\therefore \text{ans} = 2\pi i * \text{Res} = \boxed{2\pi i}$

9) Eqn (5.6-5): $C_n = \frac{1}{2\pi i} \oint_C \frac{f(z)}{(z-z_0)^{n+1}} dz$

C is any simple closed contour. We require $f(z)$ to be analytic in a domain containing path of integration. z_0 is inside C . Now assume that z_0 is an isolated singular point of $f(z)$ and let $n = -1$. Get $C_{-1} = \frac{1}{2\pi i} \oint_C f(z) dz = \text{Res} [f(z), z_0]$

10) Binomial thm: $(a+b)^n = \sum_{k=0}^n \frac{n!}{(n-k)! k!} a^{n-k} b^k$

Let $a = z, b = z^{-1}$
 $(z + \frac{1}{z})^n = \sum_{k=0}^n \frac{n!}{(n-k)! k!} z^{n-k} (z^{-1})^k = \sum_{n=0}^{\infty} \frac{n!}{(n-k)! k!} z^{n-2k}$

What is coeff of z^{-1} ? Require $z^{n-2k} = z^{-1}$
 $n-2k = -1, n = 2k-1, k = \frac{n+1}{2}$. This has an integer solution only if n is odd. If n is even, there is no integer solution and no z^{-1} term. Thus, n odd, $\text{Res} [z + \frac{1}{z}]^n$ at $z = 0$ is $\frac{n!}{(n-k)! k!}, k = \frac{n+1}{2}$, Res is $\frac{n!}{[n - (\frac{n+1}{2})]! (\frac{n+1}{2})!}$

Chap 6, Sec 6.1 cont'd

cont'd:

10) $\text{Res} \left(z + \frac{1}{z} \right)^n \Big|_{z=0}$ is $\frac{n!}{\left(n - \frac{n-1}{2} \right)! \left(\frac{n+1}{2} \right)!}$

$= \frac{n!}{\left(\frac{n-1}{2} \right)! \left(\frac{n+1}{2} \right)!}$ if n odd. If n even residue = 0.

Thus, $\oint_C \left(z + \frac{1}{z} \right)^n dz = \frac{2\pi i n!}{\left(\frac{n-1}{2} \right)! \left(\frac{n+1}{2} \right)!}$

for n odd. For n even, get 0.

11)

(a) Consider $(1+W)^{1/2} = \sum_{n=0}^{\infty} C_n W^n$, $|W| < 1$

$(1)^{1/2} = 1$. $C_0 = 1$, $C_1 = \frac{1}{2} (1+W)^{-1/2} \Big|_{W=0} = \frac{1}{2}$

$C_2 = \frac{(-1)}{2} \left(\frac{1}{2} \right)^2 \dots$

put $W = \frac{-1}{z^2}$, $\left(1 - \frac{1}{z^2} \right)^{1/2} = 1 - \frac{1}{2z^2} - \frac{1}{8z^4} + \dots$

(z) $\left(1 - \frac{1}{z^2} \right)^{1/2} = z - \frac{1}{2z} - \frac{1}{8z^3} \dots$ $|z| > 1$

(b)

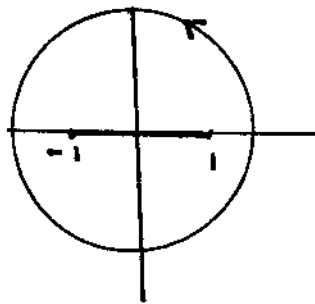

$\oint_{|z|=R} (z^2 - 1)^{1/2} dz = \oint_{|z|=R} z - \frac{1}{2z} - \frac{1}{8z^3} \dots dz$

all terms integrate to zero except

$\int \frac{-1}{2z} dz = 2\pi i \left(\frac{-1}{2} \right) = -\pi i$

12) $[1+W]^{-1/2} = \sum_{n=0}^{\infty} C_n W^n$, $|W| < 1$, $1^{1/2} = 1$

$C_0 = 1$, $C_1 = -1/2 [1+W]^{-3/2} \Big|_{W=0}$, $C_1 = -1/2$

$C_2 = \frac{3}{2} \times \frac{1}{2}$ etc. $(1+W)^{-1/2} = 1 - \frac{1}{2}W + \frac{3}{8}W^2 \dots$

Chap 6, sec 6.1 cont'd

12) cont'd

let $W = -1/z^2$

$$\left[1 - \frac{1}{z^2}\right]^{-1/2} = 1 + \frac{1}{2z^2} + \frac{3}{8} \frac{1}{z^4} + \dots$$

$$\oint \frac{dz}{(z^2-1)^{1/2}} = \oint \frac{dz}{z \left[1 - \frac{1}{z^2}\right]^{1/2}} = \oint \frac{dz}{z} \left[1 - \frac{1}{z^2}\right]^{-1/2}$$

$$= \oint \frac{1}{z} \left[1 + \frac{1}{2z^2} + \frac{3}{8z^4} + \dots\right] dz = \oint \frac{1}{z} dz = \boxed{2\pi i}$$

all terms integrate to zero except z^{-1}

Section 6.2

1) $\sinh W = W + W^3/3! + W^5/5! + \dots$

$W = 1/z$
 $\sinh(1/z) = z^{-1} + z^{-3}/3! + z^{-5}/5! + \dots$

Essential sing. because infinite number of neg. exponents, $c_{-5} = c_{-3} = 1$, $c_{-2} = 0$, $c_0 = 0$, $c_1 = 0$

2) $\cosh W = 1 + W^2/2! + W^4/4! + \dots$ $\cosh\left[\frac{1}{z-1}\right] =$

$$1 + \frac{(z-1)^{-2}}{2!} + \frac{(z-1)^{-4}}{4!} + \dots \quad (z-1)^3 \cosh\left[\frac{1}{z-1}\right] =$$

$$(z-1)^3 \left[1 + \frac{(z-1)^{-2}}{2!} + \frac{(z-1)^{-4}}{4!} + \dots\right] =$$

$$(z-1)^3 + \frac{(z-1)}{2!} + \frac{(z-1)^{-1}}{4!} + \frac{(z-1)^{-3}}{6!} + \dots$$

inf. number of neg. exponents

$c_{-2} = 0$, $c_{-1} = \frac{1}{4!}$, $c_0 = 0$, $c_1 = 1/2!$, $\boxed{\text{Res} = c_1}$

3) $e^{1/z} \sinh(1/z) = \frac{e^{1/z}}{2} [e^{1/z} - e^{-1/z}] =$

$$\frac{e^{2/z}}{2} - \frac{1}{2} = \frac{1}{2} \left(1 + \frac{2}{z} + \frac{2^2}{2!z^2} + \frac{2^3}{3!z^3} + \dots - 1\right)$$

$$= \frac{2}{2 \cdot z} + \frac{2^2}{2 \cdot 2!z^2} + \frac{2^3}{2 \cdot 3!z^3} + \dots$$

have inf. numb. neg. exponents.

$\boxed{c_0, c_1 = 0}$ $c_{-1} = 1$, $c_{-2} = 1$ $\boxed{\text{Res} = c_{-1} = 1}$

sec 6.2

$$4) z^{i/z} = e^{i \operatorname{Log} z / z} = 1 + \frac{i \operatorname{Log} z}{z} + \frac{i^2 (\operatorname{Log} z)^2}{2! z^2} + \dots$$

$$C_2 = -\frac{(\operatorname{Log} z)^2}{2}, \quad C_{-1} = i \operatorname{Log} z = \text{residue}$$

$C_0 = 1, C_1 = 0$. have essential sing, inf. no. neg. exponents.

$$5) \sum_{n=-\infty}^{\infty} C_n (z-i)^n = \left(1 + \frac{1}{(z-i)} + \frac{1}{2! (z-i)^2} + \frac{1}{3! (z-i)^3} + \dots \right) \left(1 + (z-i) + \frac{(z-i)^2}{2!} + \frac{(z-i)^3}{3!} + \dots \right)$$

$$= \sum_{n=-\infty}^{\infty} C_n (z-i)^n, \quad C_0 = 1 + 1 + \frac{1}{2!} + \frac{1}{3!} + \frac{1}{4!} + \dots$$

$$C_1 = \frac{1}{1! \cdot 0!} + \frac{1}{2! \cdot 1!} + \frac{1}{3! \cdot 2!} + \frac{1}{4! \cdot 3!} + \dots \quad C_{-1} = C_1 = \text{Residue}$$

$$C_2 = \frac{1}{2! \cdot 0!} + \frac{1}{3! \cdot 1!} + \frac{1}{4! \cdot 2!} + \frac{1}{5! \cdot 3!} + \dots \quad C_{-2} = C_2$$

In general

$$C_n = \frac{1}{n! \cdot 0!} + \frac{1}{(n+1)! \cdot 1!} + \frac{1}{(n+2)! \cdot 2!} + \dots \quad n \geq 0$$

$C_n = C_{-n} \quad n \leq 0$ have essential sing, since have inf. number of neg. exponents.

a) $\operatorname{Log} (1/z)$ is defined for all $z \neq 0$

$$e^{\operatorname{Log} (1/z)} = 1/z \quad z \neq 0$$

This is not an essential singularity but is a simple pole. Res. = 1

7)

```
% for problem 7(a) sec 6.2
x=linspace(-3,3,200);
y=linspace(-1,1,200);
[X,Y]=meshgrid(x,y);
z=X+i*Y;
f=((z+2).^2).*z.*((z-2).^2);
f=1./f;
f=abs(f); mesh(X,Y,f); AXIS([-2.5 2.5 -1 1 0 10]);
view(10,15)
```

7] (a) cont'd

Sec 6.2

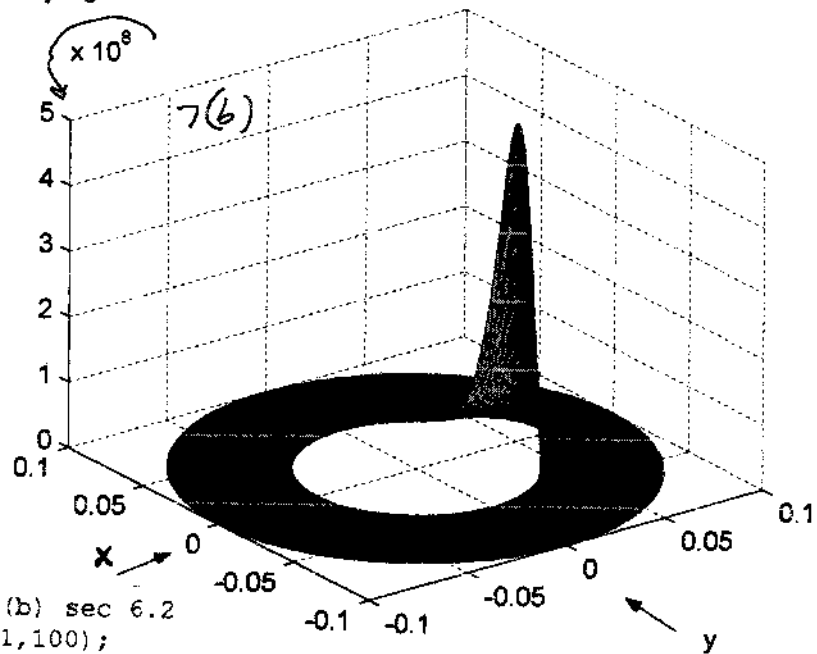
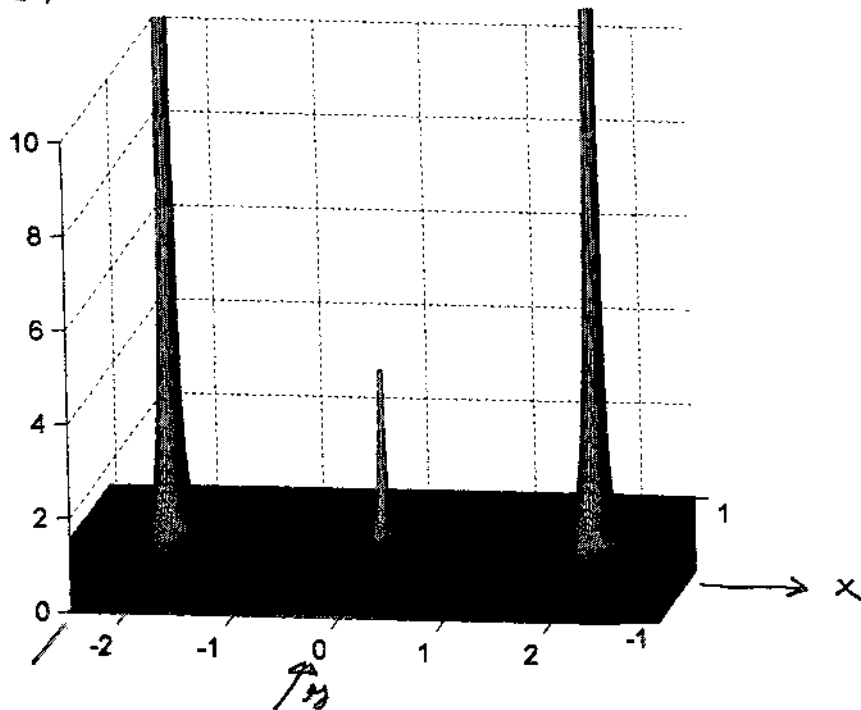

```
% problem 7 part (b) sec 6.2  
r=linspace(.05,.1,100);  
th=linspace(0,360,361);  
th=th/(360)*2*pi;  
% [TH,R]=meshgrid(th,r);
```

```
[X,Y]=pol2cart(TH,R);  
z=X+i*Y;  
f=exp(1./z);  
f=abs(f);  
mesh(X,Y,f)
```

Section 6.2, continued

$$8] \frac{e^z - 1}{z} = \frac{1 + z + z^2/2! + \dots - 1}{z} = \frac{1 + z/2! + \dots}{z} \xrightarrow{\lim_{z \rightarrow 0}} 1$$

define $f(z) = \boxed{1}$

$$9] \text{Log } z = \sum_{n=0}^{\infty} C_n (z-1)^n$$

$$C_0 = \text{Log } 1 = 0, \quad C_1 = \left. \frac{1}{z} \right|_1 = 1$$

$$C_2 = \left. \frac{-1/z^2}{2!} \right|_1 = -1/2$$

$$\therefore \text{Log } z = (z-1) - \frac{1}{2}(z-1)^2 + \dots$$

$$e^z - e = e + e(z-1) + e \frac{(z-1)^2}{2!} + \dots - e$$

$$= e(z-1) + e \frac{(z-1)^2}{2!} + \dots$$

$$\therefore \frac{e^z - e}{\text{Log } z} = \frac{e(z-1) + e(z-1)^2/2! + \dots}{(z-1) - 1/2(z-1)^2 + \dots}$$

$$\xrightarrow{\lim_{z \rightarrow 1}} \frac{e + e(z-1)/2! + \dots}{1 - 1/2(z-1) + \dots} = \boxed{e}$$

$$10] \frac{\sinh z}{z^2 + \pi^2} = \frac{\sinh z}{(z - i\pi)(z + i\pi)}$$

Use L'Hopital rule $\lim_{z \rightarrow i\pi} \frac{\sinh z}{z^2 + \pi^2} =$

$$\lim_{z \rightarrow i\pi} \frac{\cosh z}{2z} \Big|_{z=i\pi} = \frac{\cosh(i\pi)}{2i\pi} = \frac{\cos \pi}{2i\pi} =$$

$$\boxed{\frac{-1}{2i\pi}} \text{ at } z = i\pi$$

Similar $\lim_{z \rightarrow -i\pi} \frac{\sinh z}{z^2 + \pi^2} = \frac{\cosh(-i\pi)}{2z} = \frac{-1}{-2i\pi}$

$$= \boxed{\frac{1}{2i\pi}} \text{ at } z = -i\pi$$

sec. 6.2

$$11) \frac{z^2-1}{z^{1-i} z^{-1}} = \frac{z^2-1}{e^{i \operatorname{Log} z} (z-1) \operatorname{Log} i - e}$$

Use L'Hopital rule

$$\lim_{z \rightarrow 1} \frac{2z}{e^{i \operatorname{Log} z} \frac{1}{z} - e^{(z-1) \operatorname{Log} i} \operatorname{Log} i}$$

$$= \frac{2}{e^{i \operatorname{Log} 1} 1 - e^0 \operatorname{Log} i} = \frac{2}{i - \left(\frac{i\pi}{2}\right)}$$

$$= \frac{2i}{\frac{\pi}{2} - 1}$$

$$12) \frac{\operatorname{Log} z}{z^2-1} \quad \frac{\operatorname{Log} z}{e^{z \operatorname{Log} z} - 1}$$

use L'Hopital

$$\lim_{z \rightarrow 1} \frac{\frac{1}{z}}{e^{z \operatorname{Log} z} [1 - z \operatorname{Log} z]} = \frac{1}{[-1]} = \boxed{-1}$$

$$13) \operatorname{Log} \frac{1}{(1-z)} = z + \frac{z^2}{2} + \frac{z^3}{3} + \dots$$

$$\frac{1}{z} \operatorname{Log} \frac{1}{(1-z)} = \frac{z + z^2/2 + z^3/3 + \dots}{z} = 1 + \frac{z}{2} + \frac{z^2}{3} = \boxed{1}$$

$$14) \frac{1}{z^2} - \frac{\operatorname{Log} z}{z^2} =$$

$$\frac{1}{z^2} - \frac{1}{z^2} \left[1 - \frac{z^2}{2!} + \frac{z^4}{4!} \dots \right] = \frac{1}{2!} - \frac{z^2}{4!} \dots = \boxed{\frac{1}{2}}$$

Sec 6.2

15] $g(z) = c_m (z-z_0)^m + c_{m+1} (z-z_0)^{m+1} + \dots$

$h(z) = d_m (z-z_0)^m + d_{m+1} (z-z_0)^{m+1} + \dots$

where $c_m \neq 0$, $d_m \neq 0$ and $c_\nu = \frac{g^{(\nu)}(z_0)}{\nu!}$

and $d_\nu = \frac{h^{(\nu)}(z_0)}{\nu!}$ $\nu = m, m+1, m+2, \dots$

$f(z) = \frac{g}{h} = \frac{c_m (z-z_0)^m + c_{m+1} (z-z_0)^{m+1} + \dots}{d_m (z-z_0)^m + d_{m+1} (z-z_0)^{m+1} + \dots}$

$= \frac{c_m + c_{m+1} (z-z_0)^1 + c_{m+2} (z-z_0)^2 + \dots}{d_m + d_{m+1} (z-z_0)^1 + d_{m+2} (z-z_0)^2 + \dots}$

$\lim_{z \rightarrow z_0} f(z) = \frac{c_m}{d_m} = \frac{g^{(m)}(z_0)}{h^{(m)}(z_0)}$

(b) $f(z)$ has a Taylor expansion about z_0

obtained by dividing the series: $\frac{c_m + c_{m+1}(z-z_0)^1 + \dots}{d_m + d_{m+1}(z-z_0)^1 + \dots}$

$= a_0 + a_1(z-z_0) + \dots$ where $a_0 = \frac{c_m}{d_m}$. Thus there is no princ. part in Laurent expansion about z_0 .

We must define $f(z_0) = \frac{c_m}{d_m} = \frac{g^{(m)}(z_0)}{h^{(m)}(z_0)}$ to remove the sing.

15 (c) z^3 has zero of order 3

$(\sin z)^3 = (z - z^3/3! + z^5/5! - \dots)^3$ has a

zero of order 3. Third deriv of z^3 is 6.

What is 3rd deriv. of $(\sin z)^3 = \frac{d^3}{dz^3} 3 \sin^2 z \cos z$

$= \frac{d}{dz} [6 \sin z \cos^2 z - 3 \sin^3 z] = \frac{d}{dz} [6 \sin z - 9 \sin^3 z]$

$= 6 \cos z - 27 \sin^2 z \cos z = 6$ at $z=0$

$\frac{6}{6} = 1$

sec 6.2

161

(a) Note: we use $m = M, n = N$

$$\frac{g}{h} = \frac{b_m (z-z_0)^m + b_{m+1} (z-z_0)^{m+1} + b_{m+2} (z-z_0)^{m+2} \dots}{a_n (z-z_0)^n + a_{n+1} (z-z_0)^{n+1} + a_{n+2} (z-z_0)^{n+2} \dots}$$

Assume $n > m$

$$\begin{aligned} \lim_{z \rightarrow z_0} (z-z_0)^{n-m} \frac{g}{h} &= \frac{b_m (z-z_0)^n + b_{m+1} (z-z_0)^{n+1} + \dots}{a_n (z-z_0)^n + a_{n+1} (z-z_0)^{n+1} + \dots} \\ &= \frac{b_m + b_{m+1} (z-z_0) + \dots}{a_n + a_{n+1} (z-z_0) + \dots} = \frac{b_m}{a_n} \neq 0 \end{aligned}$$

the preceding shows a pole of order $n-m$

(b) suppose $n = m$

$$\begin{aligned} \lim_{z \rightarrow z_0} \frac{g}{h} &= \frac{b_n (z-z_0)^n + b_{n+1} (z-z_0)^{n+1} + \dots}{a_n (z-z_0)^n + a_{n+1} (z-z_0)^{n+1} + \dots} \\ &= \frac{b_n}{a_n} \quad (\text{see prob 15 a}) = \frac{g^{(n)}(z_0)}{h^{(n)}(z_0)} \end{aligned}$$

We define $f(z) = \frac{g^{(n)}(z_0)}{h^{(n)}(z_0)}$ to remove singl. if $n = m$

Suppose $n < m$

$$\begin{aligned} \lim_{z \rightarrow z_0} \frac{g/h}{(z-z_0)^{m-n}} &= \frac{b_m (z-z_0)^m + b_{m+1} (z-z_0)^{m+1} \dots}{a_n (z-z_0)^n + a_{n+1} (z-z_0)^{n+1} \dots} \quad \left\{ \begin{array}{l} \text{divide} \\ \text{num. +} \\ \text{denom.} \\ \text{by } (z-z_0)^n \end{array} \right\} \\ &= \frac{b_m (z-z_0)^{m-n} + b_{m+1} (z-z_0)^{m-n+1} \dots}{a_n + a_{n+1} (z-z_0) + \dots} = 0 \end{aligned}$$

define $f(z_0) = 0$ if $n < m$

sec 6.2

17) $\frac{1}{z^2+2z+1} = \frac{1}{(z+1)^2}$ have pole order 2 at -1 since denom. has zero of order 2.

18) $z^2+z+1=0 \quad z = \frac{-1 \pm i\sqrt{3}}{2}$

$$\frac{1}{z^2+z+1} = \frac{1}{\left[z - \left(\frac{-1+i\sqrt{3}}{2}\right)\right] \left[z - \left(\frac{-1-i\sqrt{3}}{2}\right)\right]}$$

simple poles at $z = \frac{-1 \pm i\sqrt{3}}{2}$

19) $z^3=1, \quad z = 1^{1/3} = 1 \angle 0, \quad 1 \angle 120^\circ, \quad 1 \angle -120^\circ$

$$\frac{1}{z^3-1} = \frac{1}{(z-1)(z-1 \angle 120^\circ)(z-1 \angle -120^\circ)}$$

simple poles at $z=1, \quad z = \frac{-1 \pm i\sqrt{3}}{2}$

20) $z^3-1 = (z-1)(z-1 \angle 120^\circ)(z-1 \angle -120^\circ)$
see previous problem.

$$\frac{z-1}{(z^3-1)^2} = \frac{z-1}{\left[(z-1)^2 (z-1 \angle 120^\circ)^2 (z-1 \angle -120^\circ)^2\right]}$$

$$= \frac{1}{(z-1)^2 [z-1 \angle 120^\circ]^2 [z-1 \angle -120^\circ]^2}$$

pole order 2 @ $z=1$, poles order 2 at $\frac{-1 \pm i\sqrt{3}}{2}$

21) $\frac{\sin z}{z^{10}(z+1)}$

simple pole at $z=-1$

$$\frac{\sin z}{z^{10}(z+1)} = \frac{z - z^3/3! + z^5/5! - \dots}{z^{10}(z+1)}$$

pole order 9 at $z=0$

sec 6.2 cont'd

22 for pole: $\cosh z = ae^z$, $\frac{e^z + e^{-z}}{2} = ae^z$

$e^z + e^{-z} = 2ae^z$, $e^{-z} = (2a-1)e^z$,

$e^{-2z} = (2a-1)$, $e^{2z} = 1/(2a-1)$

$2z = \text{Log} \left[\frac{1}{2a-1} \right]$ assume $a \neq 1/2$

if $a > 1/2$, $z = \frac{1}{2} \left[\text{Log} \left[\frac{1}{2a-1} \right] + i 2k\pi \right]$

$z = \frac{1}{2} \text{Log} \left[\frac{1}{2a-1} \right] + i k\pi$ pole if $a > 1/2$

if $a < 1/2$,

$z = \frac{1}{2} \left[\text{Log} \left[\frac{1}{1-2a} \right] + i (\pi + 2k\pi) \right]$

$z = \frac{1}{2} \text{Log} \left[\frac{1}{1-2a} \right] + i \left[\frac{\pi}{2} + k\pi \right]$ pole if $a < 1/2$

order of poles is one since denom.

$\cosh z - ae^z$ has a zero of order 1

i.e. $\frac{d}{dz} [\cosh z - ae^z] = \sinh z - ae^z \neq 0$

at the poles.

23] For poles: $10^z = e^z$, $e^{z \text{Log} 10} = e^z$

$z \text{Log} 10 = z + i 2k\pi$, $z = \frac{i 2k\pi}{\text{Log} 10 - 1}$, $k=0, \pm 1, \pm 2, \dots$
for poles

continued next page

23 | continued

$$\frac{d}{dz} [10^z - e^z] = \frac{d}{dz} [e^{z \log 10} - e^z] =$$

$$e^{z \log 10} \log 10 - e^z \neq 0 \quad \text{at the poles}$$

Thus $10^z - e^z$ has a zero of order 1 at the poles, and the given function has

simple poles.

24 | $\frac{\sinh z}{z \cosh z}$: Consider pole at $z=0$

$$\frac{\sinh z}{z \cosh z} = \frac{z + z^3/3! + z^5/5! + \dots}{z \left[z - \frac{z^3}{3!} + \frac{z^5}{5!} - \dots \right]}$$

Have simple pole at $z=0$ since numerator has zero of order 1, denom. zero of order 2.

Suppose $z \neq 0$, Have poles where $z = k\pi$
 k integer, but $\neq 0$. These are simple poles since denom. $z \cosh z$ has a zero of order one at $z = k\pi$, ($k \neq 0$),

25 | pole where $e^z + 1 = 0$,

$$\boxed{z = i(\pi + 2k\pi)}$$

pole

What is order of pole?

What is order of zero of $e^z + 1$ at $z = i(\pi + 2k\pi)$

$$(e^z + 1) = c_1 (z - i(\pi + 2k\pi)) + c_2 [z - i(\pi + 2k\pi)]^2 + \dots$$

$$c_1 = \frac{d}{dz} [e^z + 1]_{z = i(\pi + 2k\pi)} = (-1).$$

$(e^z + 1)$ has a zero of order 1 at the pole. Thus $(e^z + 1)^2$ has a zero of order 2 at the pole.

25) cont'd

Chap 6 sec 6.2 cont'd

ans. have poles of order 4 at $z = i(\pi + 2k\pi)$, k integer

26. For poles $\text{Log } z - 1 = 0$, $\text{Log } z = 1$, $z = e$, pole
 Now $\text{Log } z - 1$ has a zero of order 1 when $z = e$.
 But $\sin\left(\frac{\pi z}{e}\right)$ also has a zero of order 1 when $z = e$.
 Thus $\sin\left(\frac{\pi z}{e}\right)(\text{Log } z - 1)$ has a zero of order 2
 when $z = e$ and the given $f(z)$ has a pole
order 2 when $z = e$. Other poles:

$\sin\frac{\pi z}{e} = 0$ if $z = ke$, $k = 0, \pm 1, \pm 2, \dots$. But we
 exclude $k = 0, -1, -2, \dots$ since these values lie on
 the branch cut of $\text{Log } z$. The case $k = 1$,
 when $z = e$ has been treated above. If
 $k = 2, 3, \dots$ $\sin\frac{\pi z}{e}$ has a zero of order 1.
 Thus the given $f(z)$ has simple poles
 if $z = ke$, where $k = 2, 3, 4, 5, \dots$.

$$\begin{aligned} 27) \frac{\sin(1/z)}{(z+1/z)^3} &= \frac{z^3 \sin(1/z)}{(z^3)(z+1/z)^3} = \frac{z^3 \sin(1/z)}{(z^2+1)^3} \\ &= \frac{z^3 \sin(1/z)}{(z-i)^3(z+i)^3} \end{aligned}$$

poles order 3 at $z = \pm i$

28. $e^{2z} - i = 0$, $e^{2z} = i$, $2z = \text{Log } i = i\left[\frac{\pi}{2} + 2k\pi\right]$
 $z = i\left[\frac{\pi}{4} + k\pi\right]$. Now if $k = 0$ we have
 a removable singular point (Apply
 L'Hopital's rule to $\frac{\sin(z - i\frac{\pi}{4})}{e^{2z} - i}$ at $z = i\pi/4$).
 Otherwise, have a simple pole, since $e^{2z} - i$ has
 a zero of order 1 at $z = i\left(\frac{\pi}{4} + k\pi\right)$. Thus:
 (next ps.)

Chap 6 Sec 6.2, cont'd

Answer simple poles at $z = i\left(\frac{\pi}{2} + k\pi\right)$
 k any integer except 0.

29) $\frac{1}{z^{1/2} \sinh^4(z)}$ does not have a pole
 at $z=0$, has a branch point singl.
 due to $z^{1/2}$. $\sinh z = 0, z = ik\pi$
 $k=0, \pm 1, \pm 2, \dots$ $\sinh z$ has zeroes

of order 1 at $z = ik\pi$ [$\frac{d}{dz} \sinh z = \cosh z \neq 0$
 at $z = ik\pi$]. Thus

$\frac{1}{z^{1/2} \sinh^4(z)}$ has simple poles at $z = ik\pi$,
 $\sinh^4 z$ has a zero of order 4 at
 $z = ik\pi$. Finally $\frac{1}{z^{1/2} \sinh^2 z}$ has

poles of order 4 at $z = ik\pi, k$ any integer $\neq 0$

30) $\frac{1}{1+z^{1/2}}$, for pole: $-1 = z^{1/2}$

sq. both sides $1 = z$, necc. cond. for
 pole. What is $z^{1/2}$ at $z=1$, if use
 princ. branch? $e^{i/2 \text{Log} z} = z^{1/2}$. If
 $z=1, z^{1/2} = e^{i/2 \text{Log} 1} = 1$. Thus $z^{1/2} = 1$
 if $z=1$ and $z^{1/2} + 1 \neq 0$. Thus there is
no pole.

31) For pole $z=1$ (see previous problem).

31) cont'd

$$(z^{1/2}-1) = C_0(z-1)^0 + C_1(z-1) + C_2(z-1)^2 + \dots$$

$$C_0 = 0, \quad C_1 = \left. \frac{1}{2} z^{-1/2} \right|_{z=1} = \frac{1}{2}$$

$(z^{1/2}-1)$ has a zero of order 1 at $z=1$
 thus $\frac{1}{(z^{1/2}-1)^4}$ has a pole of order 4 at $z=1$.

32) $\text{Log } z$ is not analytic along the branch cut $y=0, -\infty \leq x \leq 0$.

$\frac{\text{Log } z}{z^2+1}$ has simple poles at $\pm i$

a) The domain $|z| < 1$ contains points on the branch cut

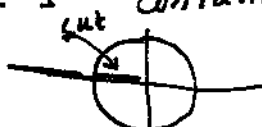

∴ answer is not meromorphic



The only singularity of $\frac{\text{Log } z}{z^2+1}$ in this domain is the pole @ $z=i$
 ∴ is meromorphic

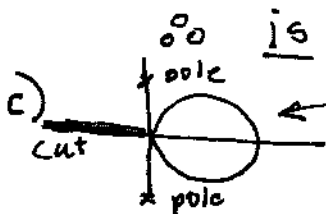

$\frac{\text{Log } z}{z^2+1}$ is analytic in domain $|z-1| < 1$ ∴ is meromorphic

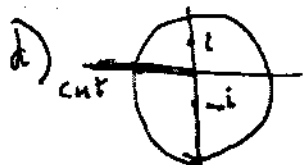

not meromorphic because points on branch cut lie in the domain.

33

Sec 6.2

$$f(z) = C_{-m} (z-z_0)^{-m} + C_{-(m-1)} (z-z_0)^{-(m-1)} + \dots$$

$$g(z) = C_n (z-z_0)^{-n} + C_{(n-1)} (z-z_0)^{-(n-1)} + \dots$$

$$f(z)g(z) = C_{-m} C_n (z-z_0)^{-(m+n)} + \dots$$

Since $C_{-m}, C_n \neq 0$, the most negative power in the above series is $-(m+n)$. Thus have pole order $m+n$.

$$34 \quad f+g = C_{-m} (z-z_0)^{-m} + \dots (z-z_0)^{-(m-1)} + \dots$$

(assume $m > n$)

The most negative power is $-m$.

35 | To prove this, consider a specific example

e.g. take $f(z) = \frac{\cos z}{z^2}$ and $g(z) = -\frac{1}{z^2} + \frac{1}{z}$

f has a pole of order 2 while $g(z)$ has a pole of order 2.

$$f+g = \frac{\cos z}{z^2} - \frac{1}{z^2} + \frac{1}{z} = \frac{\cos z - 1}{z^2} + \frac{1}{z}$$

$$= \frac{1 - \frac{z^2}{2!} + \frac{z^4}{4!} - \dots - 1}{z^2} + \frac{1}{z}$$

which has a pole of order 1 at $z=0$

36 | next pg.

36]

Sec 6.2

(a) $f(z) = \frac{1}{\sin(\frac{1}{z})}$. Note $\sin(\frac{1}{z}) = 0$ if $\frac{1}{z} = \pm(n\pi)$,

$\frac{1}{z} = \pm(n+1)\pi$, $\frac{1}{z} = \pm(n+2)\pi$ etc where $n \geq 1$ is

an integer. Thus $z = \pm \frac{1}{n\pi}$, $z = \pm \frac{1}{(n+1)\pi}$, $z = \pm \frac{1}{(n+2)\pi}$...
 are singular points of $\frac{1}{\sin(\frac{1}{z})}$. These points are simple

poles of $\frac{1}{\sin(\frac{1}{z})}$ since $\sin(\frac{1}{z})$ has a zero of order 1

at each of these points. Now suppose we take

$n \geq 1$ as an integer that satisfies also $n > \frac{1}{\pi\epsilon}$.

Then each of these poles of $\frac{1}{\sin(\frac{1}{z})}$ located at

$z = \pm \frac{1}{n\pi}$, $\pm \frac{1}{(n+1)\pi}$, $\pm \frac{1}{(n+2)\pi}$, $\pm \frac{1}{(n+3)\pi}$ etc. will satisfy $|z| < \epsilon$

(b) **No**, because there is no deleted neighborhood of $z=0$ throughout which $f(z)$ is analytic. By taking $n > \frac{1}{\pi\epsilon}$ we can find singular points of $\frac{1}{\sin(\frac{1}{z})}$ inside the given neighborhood.

(c) Consider $\frac{1}{\sinh[\frac{1}{z}]}$. Has singular points

at $z = \frac{\pm i}{n\pi}$, $\frac{\pm i}{(n+1)\pi}$, ... This

function will have singular points inside any deleted neighborhood: $0 < |z| < \epsilon$ [Take $n > \frac{1}{\pi\epsilon}$ to show this].

Sec 6.2

37] a) In N , $f(z)$ is everywhere analytic, by assumption. $(z-z_0)^2 f(z)$ is a product of analytic functions, $\therefore u(z)$ is analytic in N .

$$b) u'(z_0) = \lim_{z \rightarrow z_0} \frac{u(z) - u(z_0)}{z - z_0} = \lim_{z \rightarrow z_0} \frac{u(z)}{z - z_0}$$

$$= \lim_{z \rightarrow z_0} \frac{(z-z_0)^2 f(z)}{(z-z_0)} = \lim_{z \rightarrow z_0} (z-z_0) f(z)$$

Now $|f(z)| \leq M \quad \therefore |(z-z_0) f(z)| \leq M |z-z_0|$

$$\lim_{z \rightarrow z_0} |(z-z_0) f(z)| \leq \lim_{z \rightarrow z_0} M |z-z_0| = 0$$

$$\therefore \lim_{z \rightarrow z_0} (z-z_0) f(z) = 0 = u'(z_0) \quad \text{q.e.d.}$$

From part a) we know that $u(z)$ exists in $0 < |z-z_0| < a$ while from the above we know that $u'(z_0)$ exists. $\therefore u'(z)$ exists in the domain $|z-z_0| < a$. Thus $u(z)$ is analytic in the domain $|z-z_0| < a$. you can thus expand $u(z)$ in a Taylor series about z_0 .

$$c) u(z) = \sum_{n=0}^{\infty} C_n (z-z_0)^n \quad C_0 = u(z_0) = 0$$

$$C_1 = u'(z_0) = 0 \quad u(z) = \sum_{n=2}^{\infty} C_n (z-z_0)^n$$

$$= \sum_{n=0}^{\infty} C_{n+2} (z-z_0)^{n+2} = (z-z_0)^2 \sum_{n=0}^{\infty} C_{n+2} (z-z_0)^n$$

$= (z-z_0)^2 \cdot v(z)$ where $v(z) = \sum_{n=0}^{\infty} C_{n+2} (z-z_0)^n$ is the sum of a convergent power series and therefore analytic at z_0 .

$$d) u(z) = (z-z_0)^2 v(z) \text{ for } |z-z_0| < a$$

$$\text{while } u(z) = (z-z_0)^2 f(z) \text{ for } 0 < |z-z_0| < a$$

$$\therefore (z-z_0)^2 v(z) = (z-z_0)^2 f(z) \quad 0 < |z-z_0| < a$$

$v(z) = f(z) \quad z \neq z_0$. Now $\lim_{z \rightarrow z_0} v(z)$ exists because $v(z)$ is analytic at z_0 $\therefore \lim_{z \rightarrow z_0} f(z) = \lim_{z \rightarrow z_0} v(z)$ exists

$$e) \text{ Take } \lim_{z \rightarrow z_0} v(z) = K \quad \text{now } \lim_{z \rightarrow z_0} f(z) = K$$

Suppose we define $f(z_0) = K$. Then $f(z)$ is the sum of the convergent Taylor series $\sum_{n=0}^{\infty} C_{n+2} (z-z_0)^n$ for $|z-z_0| < a$ and is therefore analytic at z_0 .

Chap 6, sec 6.3

Let f, g, h be analytic in a deleted neighborhood of z_0 given by $0 < |z - z_0| < R$. Assume $0 < r < R$.

$$\frac{1}{2\pi i} \oint_{|z-z_0|=r} f(z) dz = \frac{1}{2\pi i} \oint_{|z-z_0|=r} g+h dz =$$

$$\frac{1}{2\pi i} \oint_{|z-z_0|=r} g dz + \frac{1}{2\pi i} \oint_{|z-z_0|=r} h dz$$

$$\text{Thus } \text{Res}[f(z), z_0] = \text{Res}[g, z_0] + \text{Res}[h, z_0]$$

(2) Can't have a residue of zero at a simple pole. $f(z) = \frac{C_{-1}}{(z-z_0)} + C_0 + C_1(z-z_0) + \dots$

$C_{-1} \neq 0$ if you have a simple pole. Thus residue $\neq 0$

You can have a residue of zero at a higher order pole, Consider e.g.

$$\frac{\cos z}{z^2} = \frac{1}{z^2} - \frac{1}{2!} + \frac{z^2}{4!} \dots \text{ has 2nd order}$$

pole at $z=0$ but residue = 0. You can

have a residue of zero at an essent. singularity

$$\text{Consider } e^{1/z} = 1 + 1/z + \frac{1}{z^2} + \dots$$

coeff. of z^{-1} is zero.

Chap 6, Sec 6.3

(3) $z^2 + z + 1 = 0 \quad z = \frac{-1 \pm i\sqrt{3}}{2}$
 $\frac{\cos z}{(z-z_1)(z-z_2)} \quad z_1 = \frac{-1 + i\sqrt{3}}{2}, \quad z_2 = \frac{-1 - i\sqrt{3}}{2}$
 z_1 and z_2 are poles of first order, (simple).

To set residues, use rule IV

Residue at $\frac{-1 + i\sqrt{3}}{2}$ is

$$\frac{\cos z}{2z+1} \Big|_{\frac{-1 + i\sqrt{3}}{2}} = \frac{\cos\left(\frac{-1 + i\sqrt{3}}{2}\right)}{i\sqrt{3}}$$

at $\frac{-1 - i\sqrt{3}}{2}$, Res is $\frac{\cos z}{2z+1} \Big|_{\frac{-1 - i\sqrt{3}}{2}} =$
 $= \frac{\cos\left(\frac{-1 - i\sqrt{3}}{2}\right)}{-i\sqrt{3}}$

4) $f(z) = \frac{1}{z} - \frac{e^z}{(z)(z+1)} + \frac{1}{(z-1)^4}$

Note: there is no pole at $z=0$. Reason:
 consider $\lim_{z \rightarrow 0} z f(z) = \lim_{z \rightarrow 0} \frac{1 - e^z}{z+1} + \frac{z}{(z-1)^4} = 1$
 which $\neq \infty$.

There is a simple pole at $z = -1$
 and pole order 4 at $z = 1$

Residue at $z = -1 \Rightarrow \lim_{z \rightarrow -1} (z+1) f(z)$
 $= \frac{-e^{-1}}{(-1)} + 0 = e^{-1}$

Chap 6, sec 6.3

$$5) \quad \frac{1}{z^{1/2}(z^2-9)^2} = \frac{1}{z^{1/2}(z+3)^2(z-3)^2}$$

there is no pole at $z=0$. There is no pole at $z=-3$ since these points are on the branch cut for $z^{1/2}$

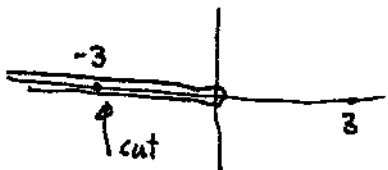

There is a pole of order 2 at $z=3$.

Note that $\frac{(z-3)^2}{z^{1/2}(z^2-9)}$ is finite and non zero at $z=3$.

$$\begin{aligned} \text{Res} &= \lim_{z \rightarrow 3} \frac{d}{dz} \frac{1}{z^{1/2}(z+3)^2} \quad (\text{Rule 2}) \\ &= \frac{-1}{z^2(z+3)^4} \left[\frac{1}{2} z^{-1/2} (z+3)^2 + 2 z^{1/2} (z+3) \right]_{z=3} \\ &= \frac{-1}{(3)(6)^4} \left[\frac{1}{2\sqrt{3}} + 36 + 2\sqrt{3} \cdot 6 \right] \\ &= -\frac{1}{3} \left[\frac{1}{72\sqrt{3}} + \frac{2\sqrt{3}}{6^3} \right] = \frac{-1}{3\sqrt{3}} \left[\frac{1}{72} + \frac{1}{36} \right] \\ &= \boxed{\frac{-1}{72\sqrt{3}}} \end{aligned}$$

6) Note $\cos \frac{\pi z}{2} \Big|_{z=1} = 0$. Expand in Taylor series about $z=1$. $\cos \left(\frac{\pi z}{2} \right) = C_0 + C_1(z-1) + \dots$
 $C_0 = 0$, $C_1 = -\frac{\pi}{2} \sin \frac{\pi z}{2} \Big|_{z=1} = -\frac{\pi}{2}$, $C_1 \neq 0$.
 So $\cos \frac{\pi z}{2}$ has a zero of order 1 at $z=1$.

Thus $\frac{\cos \left(\frac{\pi z}{2} \right)}{z^2(z-1)^2}$ has a pole of order 1 at $z=1$ (see rule 2 in sec 6.2). There is a pole of order 2 at $z=0$.

sec 6.3

6) cont'd

$$\text{Res at } z=0 = \lim_{z \rightarrow 0} \frac{d}{dz} \frac{\cos\left(\frac{\pi}{2}z\right)}{(z-1)^2} =$$

$$\frac{-\frac{\pi}{2} \sin\left(\frac{\pi}{2}z\right)(z-1)^2 - \cos\left(\frac{\pi}{2}z\right)2(z-1)}{(z-1)^4} \Big|_{z=0}$$

$$= \boxed{2} \text{ res. at } z=0$$

$$\text{Res at } z=1 \text{ is } \lim_{z \rightarrow 1} \frac{(z-1) \cos\left(\frac{\pi}{2}z\right)}{(z^2)(z-1)^2}$$

$$= \lim_{z \rightarrow 1} \frac{\cos\frac{\pi}{2}z}{(z^2)(z-1)} = \text{L'Hôp. rule} = \frac{-\frac{\pi}{2} \sin\left(\frac{\pi}{2}z\right)}{(2z)(z-1) + z^2}$$

$$\lim_{z \rightarrow 1}$$

$$= \boxed{-\pi/2}$$

7] See next pg.

Sec 6.3

7) $\frac{1}{(\text{Log } z)(z^2+1)^2}$. There is a simple pole at $z=1$. $\text{Log } z = (z-1) + c_2(z-1)^2 + \dots$ has a zero of order 1 at $z=1$

$$\text{Residue at } z=1 = \lim_{z \rightarrow 1} \frac{(z-1)}{[(z-1) + c_2(z-1)^2 + \dots] [z^2+1]^2}$$

Res. at $z=1$ is $1/4$

$$\frac{1}{(\text{Log } z)(z^2+1)^2} = \frac{1}{(\text{Log } z)(z-i)^2(z+i)^2}$$

poles order 2 at $z = \pm i$

$$\text{Res at } z=i = \lim_{z \rightarrow i} \frac{d}{dz} \frac{1}{(\text{Log } z)(z+i)^2}$$

$$= \lim_{z \rightarrow i} \left(\frac{-1}{z} (\text{Log } z)^{-2} (z+i)^{-2} + (\text{Log } z)^{-1} (-2)(z+i)^{-3} \right)$$

$$= \frac{i}{\pi^2} - \frac{i}{2\pi} = \text{Residue at } i$$

Similarly

$$\frac{-i}{\pi^2} - \frac{i}{2\pi} = \text{Residue at } -i$$

(8) $f(z) = \frac{\text{sinh } z - z}{z \text{ sinh } z}$. There is a removable

singl. at $z=0$. $f(z) = \left(z - \frac{z^3}{3!} + \frac{z^5}{5!} - \dots \right) - z$

$$= \frac{-\frac{z^3}{3!} + \frac{z^5}{5!} - \dots}{z \left[z + \frac{z^3}{3!} + \frac{z^5}{5!} + \dots \right]} \rightarrow 0 \text{ as } z \rightarrow 0$$

$$\text{sinh } (z) = 0 \text{ if } z = ik\pi, k=0, \pm 1, \pm 2, \dots$$

Chap 6, Sec 6.3, continued

8) continued

$\frac{z^k - z}{z \sinh z}$ has a simple pole at $z = ik\pi$ ($k = \pm 1, \pm 2, \pm 3, \dots$)

since $\sinh z$ has a zero of order 1 at $z = ik\pi$ ($k = \pm 1, \pm 2, \dots$)

$$\text{Res } f(z), ik\pi = \lim_{z \rightarrow ik\pi} \frac{z^k - z}{(z) \cosh z} =$$

$$\frac{\sinh(ik\pi) - ik\pi}{(ik\pi) \cosh(ik\pi)} = \frac{\sinh(k\pi) - k\pi}{k\pi \cosh(k\pi)}$$

Thus Residue at $z = ik\pi$, ($k \neq 0$) is:

$$(-1)^k \left[\frac{\sinh(k\pi)}{k\pi} - 1 \right]$$

9) $\frac{z^8 + 1}{z^4} = z^4 + z^{-4}$. We have

a pole of order 4 at $z = 0$. Residue = 0

since coeff. of z^{-1} is zero.

10) For pole $\text{Log } \frac{z}{e} = 1$, $\text{Log } z - 1 = 1$

$$\text{Log } z = 2, \quad \boxed{z = e^2 \text{ pole}}$$

$$\left(\text{Log } \frac{z}{e} - 1\right) = (\text{Log } z) - 2 = \sum_{n=1}^{\infty} c_n (z - e^2)^n$$

$$c_1 = \frac{1}{z} \Big|_{z=e^2} = e^{-2}, \quad c_2 = \frac{-1/z^2}{2} \Big|_{z=e^2} = -\frac{1}{2} e^{-4}$$

$$\left(\text{Log } \frac{z}{e} - 1\right) = e^{-2} (z - e^2) - \frac{1}{2} e^{-4} (z - e^2)^2 + \dots$$

$$\left(\text{Log } \frac{z}{e} - 1\right)^2 = e^{-4} (z - e^2)^2 - e^{-6} (z - e^2)^3 + \dots$$

10) cont'd Chap 6, sec 6.3 cont'd

$$\frac{1}{(\text{Log } \frac{z}{e} - 1)^2} = \frac{1}{e^{-2}(z-e)^2 - e^{-6}(z-e^2)^2 + \dots}$$

$$e^{-4}(z-e^2)^2 - e^{-6}(z-e^2)^3 \dots \frac{e^4(z-e^2)^{-2} + e^2(z-e^2)^{-1} \dots}{1 - e^{-2}(z-e^2) + \dots}$$

$$e^{-2}(z-e^2)$$

From above

have pole order 2 at $z = e^2$, residue is e^2

11) $f(z) = \frac{1}{\sin z^2}$ poles $z^2 = k\pi, k=0, \pm 1, \pm 2, \dots$

assume first $k=1, 2, 3, \dots$ (k positive), thus $z = \pm \sqrt{k\pi}$

let $\sin z^2 = C_0 + C_1(z \pm \sqrt{k\pi}) + C_2(z \pm \sqrt{k\pi})^2 + \dots$

$$C_0 = 0, \quad C_1 = \frac{d}{dz} \sin z^2 \Big|_{z = \pm \sqrt{k\pi}} = 2(\pm \sqrt{k\pi}) \cos k\pi$$

$= \pm 2\sqrt{k\pi} (-1)^k$. Since $C_1 \neq 0$, $\sin z^2$ has zero order 1 at

$z = \pm \sqrt{k\pi}$ and $f(z)$ has simple pole. Residue is $\frac{1}{2z \cos z^2} \Big|_{z = \pm \sqrt{k\pi}}$

$= \frac{(-1)^k}{(\pm) 2\sqrt{k\pi}}$. Thus at $z = \pm \sqrt{k\pi}, (k=1, 2, 3, \dots)$ have simple

poles, residue is $\frac{(-1)^k}{\pm 2\sqrt{k\pi}} \quad k=1, 2, 3, \dots$

Now suppose $k = -1, -2, -3, \dots$. For pole $z^2 = k\pi, z = \pm i\sqrt{|k|\pi}$

As above (pos. k), we find that $\sin z^2$ has a zero of order 1 at $z = \pm i\sqrt{|k|\pi}$. Thus residue is

$$\frac{1}{2z \cos z^2} \Big|_{z = \pm i\sqrt{|k|\pi}} = \frac{(-1)^k}{\pm i 2\sqrt{|k|\pi}} \quad k = -1, -2, -3, \dots \text{ at}$$

$z = \pm i\sqrt{|k|\pi}, k = -1, -2, -3, \dots$ (simple poles). Now consider $k=0, (z=0)$.

$$\frac{1}{\sin z^2} = \frac{1}{z^2 - \frac{(z^2)^3}{3!} + \frac{(z^2)^5}{5!} \dots} = z^{-2} + \frac{z^2}{3!} + \dots \quad (\text{by long division})$$

Since only even powers are generated, coeff. of $z^{-1} = 0$. Residue is zero at $z=0$ (where we have a pole of order 2).

Chap 6, sec 6.3 cont'd

12) $f(z) = \frac{1}{10^z - e^z}$. For pole: $10^z = e^z$

$e^{z \log 10} = e^z$ $z \log 10 = z + i 2k\pi$

$z \left(\log \frac{10}{e} \right) = i 2k\pi$; $z = \frac{i 2k\pi}{\log \frac{10}{e}}$ pole $k=0, \pm 1, \pm 2$

These are simple poles since $10^z - e^z$ has a zero of order 1 at each pole.

Residue: $\frac{1}{\frac{d}{dz} [10^z - e^z]} \Big|_{\text{at pole}} = \frac{1}{\frac{d}{dz} [e^{z \log 10} - e^z]}$

$= \frac{1}{\frac{e^{z \log 10}}{\log 10} - e^z} = \frac{1}{e^z \left[\log \frac{10}{e} \right]} = \frac{e^{-z}}{\log \frac{10}{e}}$

e^z at pole $- i (2k\pi) / \log(10/e)$

Residue: $\frac{e}{\log \frac{10}{e}}$ at pole $z = \frac{i 2k\pi}{\log \frac{10}{e}}$

13) $\frac{\cos(\frac{1}{z})}{\sin z}$ does not have a pole at $z=0$.

Has essential singl. Poles $z = k\pi, k = \pm 1, \pm 2, \dots$

These are simple poles since $\sin z$ has a zero of order 1 at $z = k\pi$.

Residue = $\frac{\cos(\frac{1}{z})}{\cos z} \Big|_{k\pi}$

$= (-1)^k \cos \left[\frac{1}{k\pi} \right]$

Thus have simple poles, $z = k\pi; k = \pm 1, \pm 2, \dots$

Residue $(-1)^k \cos \left[\frac{1}{k\pi} \right]$

Chap 6, Sec 6.3 cont'd,

14) want $e^{2z} + e^z + 1 = 0$ for pole.

let $w = e^z$, $w^2 + w + 1 = 0$ $w = \frac{-1 \pm i\sqrt{3}}{2}$

$e^z = \frac{-1 \pm i\sqrt{3}}{2} = e^{\pm i \frac{2\pi}{3}}$

$z = i \left[2k\pi \pm \frac{2\pi}{3} \right]$ location of poles.

these are simple poles since denominator of $f(z)$ has a zero of order 1 at these poles.

residue $\frac{1}{2e^{2z} + e^z} \Big|_{\text{at pole}} = \frac{-1}{2+e^z} \Big|_{\text{at pole}}$

$= \frac{-1}{2 + e^{\pm i \frac{2\pi}{3}}} = \frac{-1}{2 - \frac{1}{2} \pm i \frac{\sqrt{3}}{2}} = \frac{-2}{3 \pm i\sqrt{3}}$

Thus: simple poles $z = i \left[2k\pi \pm \frac{2\pi}{3} \right]$, $k = 0, \pm 1, \pm 2, \dots$

residue: $\frac{-2}{3 \pm i\sqrt{3}}$

15) (a) $g(z) = c_0 + c_1(z-z_0) + c_2(z-z_0)^2 + \dots$

$c_0 = g(z_0)$, $c_1 = g'(z_0)$, $c_2 = g''(z_0)/2$

$h(z) = d_2(z-z_0)^2 + d_3(z-z_0)^3 + \dots$

$d_2 = \frac{h''(z_0)}{2!}$, $d_3 = \frac{h'''(z_0)}{3!}$, compute: $\frac{g}{h}$

$$\frac{c_0 + c_1(z-z_0) + c_2(z-z_0)^2 + \dots}{d_2(z-z_0)^2 + d_3(z-z_0)^3 + \dots} = \frac{\frac{c_0}{d_2}(z-z_0)^{-2} + \left(\frac{c_1}{d_2} - \frac{c_0 d_3}{d_2^2}\right)(z-z_0)^{-1} + \dots}{c_0 + \frac{c_0 d_3}{d_2}(z-z_0) + \dots}$$

$\frac{\left(\frac{c_1}{d_2} - \frac{c_0 d_3}{d_2^2}\right)(z-z_0) + \dots}{c_0 + \frac{c_0 d_3}{d_2}(z-z_0) + \dots}$

Residue is $\frac{c_1}{d_2} - \frac{c_0 d_3}{d_2^2} = \frac{g'(z_0)}{\left(\frac{h''(z_0)}{2}\right)} - \frac{g(z_0) h'''(z_0)/6}{\frac{h''(z_0)^2}{4}}$ g.c.d.

Chap Sec 6.3, cont'd

15] (b)

$$g(z) = \cos z, \quad g'(z) = -\sin z$$

$$g(z_0) = \cos(e), \quad g'(z_0) = -\sin(e)$$

$$h(z) = (\operatorname{Log} z - 1)^2, \quad h'(z) = 2(\operatorname{Log} z - 1) \frac{1}{z}$$

$$= \frac{2}{z} (\operatorname{Log} z - 1), \quad h''(z) = -\frac{2}{z^2} [\operatorname{Log} z - 1] + \frac{2}{z^2}$$

$$= \frac{4}{z^2} - \frac{2}{z^2} \operatorname{Log} z, \quad h'''(z) = -\frac{8}{z^3} + \frac{4}{z^3} \operatorname{Log} z - \frac{2}{z^3}$$

$$= -\frac{10}{z^3} + \frac{4}{z^3} \operatorname{Log} z, \quad h'''(z_0) = 2e^{-2}$$

$$h'''(z_0) = -6e^{-3}$$

$$\operatorname{Res} = \frac{-2 \sin e}{2e^{-2}} - \frac{2 \cos(e) (-6e^{-3})}{3 \cdot 4e^{-4}}$$

$$= -e^2 \sin(e) + e \cos e$$

$$16.] \left(1 + \frac{1}{z}\right) \left(\frac{1}{z} - \frac{1/z^3}{3!} + \frac{1/z^5}{5!} \dots\right)$$

$$= \left(\frac{1}{z} - \frac{1/z^3}{3!} + \frac{1/z^5}{5!} \dots\right) + \frac{1}{z} \left[\frac{1}{z} - \frac{1/z^3}{3!} \dots\right]$$

$$\operatorname{Res} = 1 \quad @ \quad z=0$$

even powers only.

$$17.] \frac{1}{z^2 - 1} = \frac{1}{e^{z \operatorname{Log} z} - 1}$$

The first deriv of denom $\neq 0$ at $z=1$. \therefore have simple pole at $z=1$

$$\text{Use rule 4, Res @ } z=1 = \left. \frac{1}{e^{z \operatorname{Log} z} [1 + \operatorname{Log} z]} \right|_{z=1} = \frac{1}{1}$$

$$= 1$$

sec 6.3 cont'd

$$18) \operatorname{Res} \left(\frac{1}{z+i} \right)^5 \text{ at } z = -i = \boxed{0}$$

This is a 1 term Laurent series

$$19) \operatorname{Res} \left[\frac{\sin z}{(z+i)^5}, -i \right] = \lim_{z \rightarrow -i} \frac{d^4}{dz^4} \sin z$$

$$= \boxed{\frac{-i \sinh 1}{4!}}$$

$$20) \frac{z^{12}}{(z-1)^{10}} = \frac{[1+(z-1)]^{12}}{(z-1)^{10}} =$$

$$\frac{1}{(z-1)^{10}} \sum_{k=0}^{12} \binom{12}{k} (z-1)^k \quad (\text{binomial thm}).$$

$$\text{Coeff of } (z-1)^{-1} \text{ is } \frac{12!}{(12-9)! 9!} = \frac{12!}{9! 3!} = \text{res}$$

$$= \boxed{220} = \text{residue}$$

21) Have simple pole. Residue

$$\text{is } \frac{1}{\cosh [2 \operatorname{Log} z] \frac{2}{z}} \Big|_i = \frac{i}{2 \cosh [i\pi]} = \boxed{\frac{-i}{2}}$$

22) Have a simple pole since denominator has a zero of order 1.

$$\text{Residue at } 0 = \frac{1}{-\sin \left[\frac{\pi}{2} e^z + \sin z \right] \left[\frac{\pi}{2} e^z + \cos z \right]}$$

$$\frac{-1}{\left(1 + \frac{\pi}{2}\right)}$$

$$\begin{aligned}
 23) \quad \frac{1}{\sin(z)(e^z-1)} &= \frac{1}{\sin\left[\left(z\right)\left[z+\frac{z^2}{2!}+\frac{z^3}{3!}+\dots\right]\right]} \\
 &= \frac{1}{\sin\left[\frac{z^2}{2!}+\frac{z^3}{3!}+\frac{z^4}{4!}+\dots\right]} = \frac{1}{\left[\frac{z^2}{2!}+\frac{z^3}{3!}+\frac{z^4}{4!}+\dots\right] - \frac{1}{3!}\left[\frac{z^2}{2!}+\frac{z^3}{3!}+\dots\right]^3} \\
 &= \frac{1}{\frac{z^2}{2!}+\frac{z^3}{3!}+\dots} \cdot \frac{z^2 - \frac{1}{2}z^3 + \dots}{\left(\frac{z^2}{2!}+\frac{z^3}{3!}+\dots\right)\left(1+\frac{z}{2!}+\dots\right)} \\
 &\quad \leftarrow \text{Res} = -\frac{1}{2}
 \end{aligned}$$

24) $\frac{\cos(z-1)}{z^{10}}$ is analytic at $z=1$

thus answer is $\text{Res} \frac{z}{z-1} = \boxed{2}$

25) $\frac{z}{z-1}$ is analytic at $z=0$. Thus answer

$$\begin{aligned}
 &\text{is } \text{Res} \frac{\cos[z-1]}{z^{10}} \text{ at } z=0 \text{ or } \lim_{z \rightarrow 0} \frac{1}{9!} \frac{d^9}{dz^9} \cos[z-1] \\
 &= \left(\frac{1}{9!}\right) [-\sin(z-1)] \Big|_{z=0} = \boxed{\frac{\sin 1}{9!}}
 \end{aligned}$$

26) cont'd next pg.

Sec 6.3 cont'd

26) (a) $P(z) = z^n + z^{n-1} + \dots + 1$

$$P(z)(z-1) = zP - P = (z^{n+1} + z^n + \dots + z) - [z^n + z^{n-1} + \dots + 1]$$

$$= z^{n+1} - 1. \quad \text{Thus: } P = \frac{z^{n+1} - 1}{z - 1} \quad z \neq 1$$

$$\frac{1}{P} = \frac{1}{z^n + z^{n-1} + \dots + 1} = \frac{(z-1)}{z^{n+1} - 1} \quad z \neq 1$$

The poles of $1/P(z)$ must be those values of z for which $\frac{z-1}{z^{n+1}-1}$ becomes infinite,

Note that $z=1$ is not a pole of $1/P$.

poles: $z^{n+1} = 1 \quad z = 1^{1/(n+1)} \quad z \neq 1$

$$= \text{cis} \left[\frac{2k\pi}{n+1} \right] \quad k=1, 2, \dots, n \quad [\text{we must exclude } k=0 \text{ since this yields } z=1]$$

(b) To show that $\text{cis} \left[\frac{2\pi k}{n+1} \right] \quad k=1, 2, \dots, n$

is a simple pole of $\frac{z-1}{z^{n+1}-1}$, note that $(z-1)$ is non-zero at the pole and that $(z^{n+1}-1)$ has a zero of order 1 at the pole. Thus $(z-1)/(z^{n+1}-1)$ has a simple pole.

(c) $\text{Res} \frac{z-1}{z^{n+1}-1}$ at $\text{cis} \left[\frac{2\pi k}{n+1} \right]$ is

$$\frac{z-1}{(n+1)z^n} \Big|_{\text{cis} \left[\frac{2\pi k}{n+1} \right]} = \frac{\text{cis} \left[\frac{2\pi k}{n+1} \right] - 1}{(n+1) \text{cis} \left[\frac{2\pi k}{n+1} \right]}$$

Sec 6.3 cont'd

27)

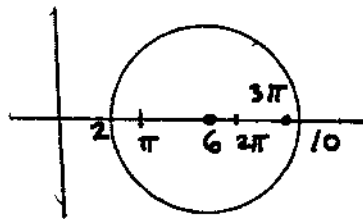

$\sin z = 0, z = k\pi$
poles inside contour
at $\pi, 2\pi, 3\pi$

$$\oint \frac{dz}{\sin z} = 2\pi i \sum \frac{1}{\cos z}, \pi, 2\pi, 3\pi = 2\pi i \left[\frac{1}{\cos \pi} + \frac{1}{\cos 2\pi} + \frac{1}{\cos 3\pi} \right]$$

$$= \boxed{-2\pi i}$$

28) $\oint \frac{\sinh(1/z)}{(z-1)} dz = 2\pi i \left[\text{Res} \frac{\sinh(1/z)}{z-1} \Big|_0 + \text{Res} \frac{\sinh(1/z)}{(z-1)} \Big|_1 \right]$

+ Res $\frac{\sinh(1/z)}{(z-1)} \Big|_1$

Res $\frac{\sinh(1/z)}{(z-1)} \Big|_0 = ? = \left(\frac{1}{z} + \frac{1}{z^3} + \frac{1}{z^5} + \dots \right) \cdot (1+z+z^2+\dots)$

coeff of z^{-1} is $-1 - \frac{1}{3!} - \frac{1}{5!} \dots = -\sinh 1$

Res $\frac{\sinh(1/z)}{(z-1)} \Big|_1 = \sinh 1$ $\sum \text{residues} = \boxed{0}$

29)

$\frac{\sin z}{\sinh^2 z}$ has poles at $z = ik\pi, k=0, \pm 1, \pm 2, \dots$

only the pole at $z=0$ is enclosed. This is a simple pole, res = $\lim_{z \rightarrow 0} z \frac{\sin z}{\sinh^2 z} = z \frac{z - z^3/3! + z^5/5! - \dots}{(z + z^3/3! + z^5/5! + \dots)^2}$

Res $\left[\frac{\sin z}{\sinh^2 z}, 0 \right] = 1 \quad \therefore \oint_{|z|=3} \frac{\sin z}{\sinh^2 z} dz = 2\pi i$

sec 6.3 cont'd

30] For pole: $\text{Log}[\text{Log}z] = 1$

$\text{Log}z = e, z = e^e \approx 15$ \therefore pole is simple since $\text{Log}[\text{Log}z] - 1$ enclosed has a non-vanishing first derivative at $z = e$. Res is

$$= \frac{1}{\frac{1}{\text{Log}z} \frac{1}{z}} = \frac{1}{\frac{1}{e} \frac{1}{e}} = z \text{Log}z = e^e e = e^{e+1}$$

ans. is $2\pi i e^{e+1}$

31] $\oint \frac{e^{1/z}}{z^2-1} dz = 2\pi i \sum_{\text{res}} \frac{e^{1/z}}{z^2-1}$ at $z=0$
 $|z-1|=1/2$ $z=1$

Res at $z=1$ is $\frac{e^{1/z}}{2z} = \frac{e}{2}$

To get res at $z=0$:

$$\frac{e^{1/z}}{z^2-1} = (-1) \left[1 + \frac{1}{z} + \frac{1}{2!} \frac{1}{z^2} + \frac{1}{3!} \frac{1}{z^3} \dots \right] \left[1 + z^2 + z^4 + z^6 \dots \right]$$

the coeff. of $z = 1$ is $(-1) \left[1 + \frac{1}{3!} + \frac{1}{5!} \dots \right]$
 $= -\sinh 1$

ans is $2\pi i \sum_{\text{residues}} = 2\pi i \left[\frac{1}{2} e - \sinh 1 \right] =$

$$2\pi i \left[\frac{e}{2} - \frac{1}{2} [e - e^{-1}] \right] = \frac{\pi i}{e}$$

Chap 6, sec 6.3 Cont'd

32) for poles: $\sinh z = 2e^z$, $\frac{e^z - e^{-z}}{2} = 2e^z$

$e^z - e^{-z} = 4e^z$, $3e^z = -e^{-z}$, $3e^{2z} = -1$

$e^{2z} = -1/3$, $2z = \text{Log } \frac{1}{3} + i[\pi + 2k\pi]$,

$z = \frac{1}{2} \text{Log } \left[\frac{1}{3} \right] + i \left[\frac{\pi}{2} + k\pi \right] = \text{Log } \frac{1}{\sqrt{3}} + i \left[\frac{\pi}{2} + k\pi \right]$

location of poles. Enclosed poles:

$z = \text{Log } \frac{1}{\sqrt{3}} + i \left[\frac{\pi}{2} \right]$ and $z = \text{Log } \frac{1}{\sqrt{3}} - i \frac{\pi}{2}$.

Residue at simple poles: $\frac{1}{\cosh z - 2e^z} \Big|_{z = \text{Log } \frac{1}{\sqrt{3}} \pm i \frac{\pi}{2}}$

$= \frac{1}{\sinh z + e^z - 2e^z} \Big|_{z = \text{Log } \frac{1}{\sqrt{3}} \pm i \frac{\pi}{2}} = e^z, z = \text{Log } \frac{1}{\sqrt{3}} \pm i \frac{\pi}{2}$

ans: $2\pi i \left[e^z \Big|_{z = \text{Log } \frac{1}{\sqrt{3}} + i \frac{\pi}{2}} + e^z \Big|_{z = \text{Log } \frac{1}{\sqrt{3}} - i \frac{\pi}{2}} \right]$

$= 2\pi i \left[e^{\text{Log } \frac{1}{\sqrt{3}}} (i) + e^{\text{Log } \frac{1}{\sqrt{3}}} (-i) \right] = \boxed{0}$

33) For pole $\sin(z^{1/2}) = 0$, $z^{1/2} = k\pi$

$z = k^2 \pi^2$, $k = 0, \pm 1, \pm 2, \dots$ If $k=1$, $z \approx 10$

pole is enclosed. Other poles not enclosed.

Residue is $\frac{1}{(\cos z^{1/2}) \frac{1}{2} z^{-1/2}} = \frac{2z^{1/2}}{\cos(z^{1/2})} \Big|_{\pi^2}$

$= \frac{2}{\cos(\pi)} \pi = -2\pi$. Ans $(2\pi i)(-2\pi) = \boxed{-4\pi^2 i}$

34) $\oint \frac{dz}{z-b} = \oint \frac{z dz}{|z|^2 - bz} = \oint \frac{z dz}{a^2 - bz}$ and by res.

pole at $\frac{a^2}{b}$. If $a > |b|$ pole at

$a \frac{a}{b}$ is outside $|z|=a$. so ans = 0

cont'd next pg.

Sec 6.3 cont'd

34 | cont'd

Now consider $\oint \frac{z dz}{a^2 - bz}$ if $a < |b|$

pole is at $a \frac{a}{b}$. But $a \frac{a}{|b|} < a$ is inside the contour, $|z| = a$.

ans = $2\pi i$ Res $\frac{z}{a^2 - bz}$ at $z = \frac{a^2}{b}$

$$= 2\pi i \frac{z}{-b} \Big|_{z = \frac{a^2}{b}} = \boxed{\frac{2\pi i a^2}{-b^2}} \quad a < |b|$$

$$35(a) \text{ Res}[f(z), z_0] = \frac{1}{2\pi i} \oint_C f(z) dz$$

$$= \frac{1}{2\pi i} \int_0^{2\pi} f(z_0 + re^{i\theta}) re^{i\theta} i d\theta =$$

$$\frac{1}{2\pi i} \left[\int_0^\pi f(z_0 + re^{i\theta}) re^{i\theta} d\theta + \int_\pi^{2\pi} f(z_0 + re^{i\theta}) re^{i\theta} d\theta \right]$$

in second integral put $\theta' = \theta - \pi$,

$$= \frac{1}{2\pi i} \left[\int_0^\pi f(z_0 + re^{i\theta}) re^{i\theta} d\theta + \int_0^\pi f(z_0 + re^{i(\theta'+\pi)}) re^{i(\theta'+\pi)} d\theta' \right]$$

Now $f(z_0 + re^{i\theta}) = f(z_0 + re^{i(\theta'+\pi)})$ and $e^{i(\theta'+\pi)} = -e^{i\theta'}$

\therefore the sum of these 2 integrals is zero. q.e.d

(b) does not apply to $\frac{1}{\sin z}$ since $\frac{1}{\sin z'} = -\frac{1}{\sin(-z')}$

odd sym.

does apply to $\frac{1}{\sin^2 z}$ at $z=0$ since

$$\left(\frac{1}{\sin z'}\right)^2 = \left[\frac{1}{\sin(-z')}\right]^2. \text{ Now consider } \frac{1}{1 - \sin\left(\frac{\pi}{2} z'\right)}$$

$$\text{look at } \left(1 - \sin\frac{\pi}{2}(1 \pm z')\right) = 1 - \sin\frac{\pi}{2} \cos\left(\pm\frac{\pi}{2} z'\right)$$

The preceding is independent of choice in \pm . \therefore has even sym. Residue is zero, \therefore does apply

Sec 6.3

35 (b) continued

look at $[(\pm z')^2 + 1]^2 = [2az' + z'^2]^2$

The value depends on choice of sign in \pm .
The argument does not apply.

$z^{-10} e^{1/z^2}$ has even sym. about $z=0$
since $z^{-10} e^{1/z^2} = (-z)^{-10} e^{1/(-z)^2}$

Res is zero. Does apply

36 (a) $\frac{1}{z^2(z^2+9)} = \frac{a}{z} + \frac{b}{z^2} + \frac{c}{z-3i} + \frac{d}{z+3i}$

$\text{Res} \left[\frac{1}{z^2(z^2+9)} \right]_{z=0} = \text{Res} \frac{a}{z} + \text{Res} \frac{b}{z^2} + \text{Res} \left[\frac{c}{z-3i} \right]$
at $z=0$ $+ \text{Res} \left[\frac{d}{z+3i} \right] =$

$= a$
 $\text{Res} \left[\frac{1}{(z^2)(z^2+9)} \right]_{z=3i} = \text{Res} \frac{a}{z} + \text{Res} \frac{b}{z^2} + \text{Res} \left[\frac{c}{z-3i} \right]$
at $z=3i$ $+ \text{Res} \left[\frac{d}{z+3i} \right]$

$\therefore \text{Res} \left[\frac{1}{(z^2)(z^2+9)} \right]_{z=3i} = c$
etc.

$\text{Res} \left[\frac{z}{z^2(z^2+9)} \right]_{z=0} = \text{Res} \left[\frac{a}{z} \right] + \text{Res} \left[\frac{b}{z} \right] + \text{Res} \left[\frac{cz}{z-3i} \right]$
 $z=0$ $+ \text{Res} \left[\frac{dz}{z+3i} \right]$
 $= b$

Sec 6.3

prob 36 b)

$$a = \operatorname{Res} \frac{1}{(z^2)(z^2+9)} \Big|_{z=0} = \lim_{z \rightarrow 0} \frac{d}{dz} (z^2+9)^{-1}$$

$$= \lim_{z \rightarrow 0} (-1)(z^2+9)^{-2}(2z) = 0$$

$$b = \operatorname{Res} \frac{1}{(z)(z^2+9)} \Big|_{z=0} = 1/9$$

$$c = \operatorname{Res} \frac{1}{z^2(z^2+9)} \Big|_{z=3i} = \frac{1}{(-9)(6i)} = \frac{i}{54}$$

$$d = \operatorname{Res} \frac{1}{(z^2)(z^2+9)} \Big|_{z=-3i} = \frac{1}{(-3)(-6i)} = \frac{-i}{54}$$

$$\therefore \frac{1}{z^2(z^2+9)} = \frac{1/9}{z^2} + \frac{i/54}{z-3i} - \frac{i/54}{z+3i}$$

$$= \frac{1/9}{z^2} + \frac{-1/9}{(z^2+9)} = \frac{1}{(z^2)(z^2+9)} \quad \text{q.e.d.}$$

$$a=0, b=1/9, c=i/54, d=-i/54$$

$$c) \frac{z}{(z+1)(z-1)^2} = \frac{a}{z+1} + \frac{b}{z-1} + \frac{c}{(z-1)^2}$$

$$a = \operatorname{Res} \frac{z}{(z+1)(z-1)^2} \Big|_{z=-1} = \frac{-1}{4}$$

$$b = \operatorname{Res} \frac{z}{(z+1)(z-1)^2} \Big|_{z=1} = \frac{d}{dz} \left[\frac{z}{z+1} \right] \Big|_{z=1}$$

$$= \frac{(z+1) - z}{(z+1)^2} \Big|_{z=1} = \frac{1}{4}$$

$$c = \operatorname{Res} \frac{(z-1)z}{(z+1)(z-1)^2} \Big|_{z=1} = 1/2$$

$$\therefore \frac{z}{(z+1)(z-1)^2} = \frac{-1/4}{z+1} + \frac{1/4}{z-1} + \frac{1/2}{(z-1)^2}$$

37] Since sec 6.3

have pole of order N

$$f(z) = C_{-N} (z-z_0)^{-N} + C_{-(N-1)} (z-z_0)^{-(N-1)} \\ + C_{-(N-2)} (z-z_0)^{-(N-2)} \dots$$

$$(z-z_0)^N f(z) = C_{-N} + C_{-(N-1)} (z-z_0) + C_{-(N-2)} (z-z_0)^2 \\ + \dots + C_{-(N-k)} (z-z_0)^k + C_{-(N-k)+1} (z-z_0)^{k+1} + \dots$$

Suppose you take the k^{th} derivative of both sides

$$\frac{\partial^k}{\partial z^k} [(z-z_0)^N f(z)] = C_{-(N-k)} k! + C_{-(N-k)+1} \frac{k!}{1!} (z-z_0) + \dots$$

Now put $z \rightarrow z_0$

$$\therefore \lim_{z \rightarrow z_0} \frac{\partial^k}{\partial z^k} [(z-z_0)^N f(z)] = k! C_{-(N-k)} \quad \text{where } k \geq 0$$

let $n = -(N-k)$, $k = n+N$

$$\therefore \lim_{z \rightarrow z_0} \frac{\partial^{n+N}}{\partial z^{n+N}} [(z-z_0)^N f(z)] = (n+N)! C_n$$

$$C_n = \lim_{z \rightarrow z_0} \frac{1}{(n+N)!} \frac{\partial^{n+N}}{\partial z^{n+N}} [(z-z_0)^N f(z)]$$

q.e.d.

b) $\frac{1}{\sin z}$ has pole of order 1 at $z=0$

$\therefore N=1$, want C_0

$$\therefore C_0 = \lim_{z \rightarrow 0} \frac{\partial}{\partial z} \frac{z}{\sin z} \Big|_{z=0}$$

$$= \lim_{z \rightarrow 0} \frac{\sin z - z \cos z}{\sin^2 z} \Big|_{z=0} \quad (\text{use L'Hop. again})$$

$$= \lim_{z \rightarrow 0} \frac{\cos z - \cos z + z \sin z}{2 \sin z \cos z} = \boxed{0}$$

Sec 6.3

38) a) $\text{Res} [1/z, \infty] = \frac{1}{2\pi i} \oint_{|z|=1} \frac{1}{z} dz = -\frac{1}{2\pi i} \oint_{|z|=1} \frac{1}{z} dz = -1$

b) $\text{Res} [z^n, \infty] = \frac{1}{2\pi i} \oint_{|z|=1} z^n dz = -\frac{1}{2\pi i} \oint_{|z|=1} z^n dz = 0$

if $n \geq 0$, [Analytic]. If $n \leq -2$, $-\frac{1}{2\pi i} \oint_{|z|=1} z^n dz = 0$ (Residue is 0)

c) $\text{Res} [e^{1/(z-i)}, \infty] = -\frac{1}{2\pi i} \oint_{|z|=2} e^{1/(z-i)} dz$

$= -\frac{1}{2\pi i} \oint_{|z|=2} \left(1 + \frac{1}{(z-i)} + \frac{1}{2(z-i)^2} + \dots\right) dz = -1$

d) $\text{Res} \left[\frac{1}{z^2+1}, \infty\right] = -\frac{1}{2\pi i} \oint_{|z|=2} \frac{1}{z^2+1} dz$ around $|z|=2$ = $-\sum_{\text{res}} \frac{1}{z^2+1}$ @ 4 poles

poles are at $\pm \left[\frac{1}{\sqrt{2}} \pm \frac{i}{\sqrt{2}}\right] = \pm e^{i\pi/4}$ and $\pm e^{i3\pi/4}$

$\text{Res} \left[\frac{1}{z^2+1}, \infty\right] = (-1) \sum \frac{1}{4z^3}$ at $\pm e^{i\pi/4}$ and $\pm e^{i3\pi/4}$

$= \frac{(-1)}{4} \left[\frac{1}{e^{i3\pi/4}} - \frac{1}{e^{i\pi/4}} + \frac{1}{e^{i\pi/4}} - \frac{1}{e^{i3\pi/4}} \right] = 0$

39(a) $\text{Res} [f(z), \infty] = \frac{1}{2\pi i} \oint_{|z|=R} f(z) dz$, $R > r$

$= \frac{1}{2\pi i} \oint_{|z|=R} C_{-2} z^{-2} + C_{-1} z^{-1} + C_0 + C_1 z + \dots dz$

$= -\frac{2\pi i}{2\pi i} C_{-1} = -C_{-1}$

b) $f(z) = \dots C_{-2} z^{-2} + C_{-1} z^{-1} + C_0 + C_1 z + \dots$ $|z| > r$

let $z = \frac{1}{w}$ $\left|\frac{1}{w}\right| > r, |w| < \frac{1}{r}$

$F(w) = f(1/w) = \dots C_{-2} w^2 + C_{-1} w + C_0 + C_1/w + C_2/w^2 + \dots$

$-w^{-2} F(w) = \dots -C_{-2} - C_{-1} w^{-1} - C_0 w^{-2} - C_1 w^{-3}$

$\text{Res} [-w^{-2} F(w), 0] = -C_{-1} = \text{Res} [f(z), \infty] = -\text{Res} [w^{-2} F(w), 0]$ $|w| < 1/r$

Sec 6.3

39 (c)

$$f(z) = \frac{z-1}{z+1} = \frac{z+1-2}{z+1} = 1 - \frac{2}{z+1}$$

$$= 1 - \frac{2/z}{1+1/z} = 1 - \frac{2}{z} \left[1 - \frac{1}{z} + \frac{1}{z^2} + \dots \right] =$$

$$1 - \frac{2}{z} + \frac{2}{z^2} - \frac{2}{z^3} + \dots \quad \text{Res} [f(z), \infty] = 2$$

39 (d)

$$-W^{-2} F(W) = \frac{-W^{-2} [1/W-1]}{1/W+1}$$

$$= \frac{-1}{W^2} \left[\frac{1-W}{1+W} \right] = \frac{1}{W^2} \left[\frac{W-1}{W+1} \right]$$

This has a pole of order 2 at $W=0$.

Residue is $\lim_{W \rightarrow 0} \frac{d}{dW} \left[\frac{W-1}{W+1} \right] =$

$$\lim_{W \rightarrow 0} \frac{(W+1) - (W-1)}{(W+1)^2} = 2 \quad \text{as in part (c)}$$

39e) $f(z) = \frac{a_n z^n + a_{n-1} z^{n-1} + \dots + a_0}{b_m z^m + b_{m-1} z^{m-1} + \dots + b_0}, \quad z = 1/W$

$$F(W) = \frac{\frac{a_n}{W^n} + \frac{a_{n-1}}{W^{n-1}} + \dots + a_0}{\frac{b_m}{W^m} + \frac{b_{m-1}}{W^{m-1}} + \dots + b_0}$$

$$F(W) = \frac{a_n W^{m-n} + a_{n-1} W^{m-n+1} + \dots + a_0 W^m}{b_m + b_{m-1} W + \dots + b_0 W^m}$$

$$-W^{-2} F(W) = - \left[\frac{a_n W^{m-n-2} + a_{n-1} W^{m-n+1-2} + \dots + a_0 W^{m-2}}{b_m + b_{m-1} W + \dots + b_0 W^m} \right]$$

cont'd next pg.

39 (e), cont'd. Sec 6.3

Since $m-n \geq 2$, the numerator terms $w^{m-n-2}, w^{m-n+1-2}, \dots, w^{m-2}$ all have non negative exponents thus $-w^{-2}F(w)$ is $\neq \infty$ as $w \rightarrow 0$ thus $-w^{-2}F(w)$ does not have a pole at $w=0$. It is analytic at $w=0$ and thus has a residue of zero at $w=0$. Thus $f(z)$ has residue zero at ∞ .

40 (a) Let C enclose all the singularities

$$\therefore \frac{1}{2\pi i} \oint_C f(z) dz = \sum_{\text{residues}} f(z) \text{ all singularities}$$

$$\frac{-1}{2\pi i} \oint_C f(z) dz = \text{Res}[f(z), \infty]$$

add the 2 equations

$$0 = \sum_{\text{residues}} f(z) + \text{Res}[f(z), \infty]$$

b) $\frac{z^3}{z^4+1}$ has poles, simple, at $\pm e^{i\pi/4}, \pm e^{i3\pi/4}$

Res is $\frac{1}{4}$ at each pole

\sum_{residues} at poles in finite plane is $\boxed{1}$

$$-w^{-2}F(w) = \frac{-w^{-2} \frac{1}{w^3}}{\frac{1}{w^4+1}} = \frac{-w^{-1}}{1+w^4} = \frac{-1}{w(1+w^4)}$$

Residue of the preceding at $w=0$ is -1

$\therefore \text{Res}[f(z), \infty] = -1$, the negative of the sum of the residues at the 4 poles, q.e.d.

c) next pg.

sec 6.3

40 c) $z^{10} + 1 = 0$ has 10 roots on the unit circle. The circle $|z| = 3$ encloses all 10. Therefore

$$\oint \frac{z^n}{z^{10} + 1} dz = -2\pi i \operatorname{Res} \left[\frac{z^n}{z^{10} + 1}, \infty \right]$$

Let $n = 8$, $f(z) = \frac{z^8}{z^{10} + 1}$

$$F(w) = \frac{w^{-8}}{w^{-10} + 1}, \quad -w^{-2} F(w) = \frac{-w^{-10}}{w^{-10} + 1}$$

$$= \frac{-1}{w^{10} + 1}$$

whose residue at zero is 0.
 $\therefore \operatorname{Res} [f(z), \infty] = 0$

Thus $\oint \frac{z^8}{z^{10} + 1} dz = 0$ if $n = 8$

If $n = 9$, $f(z) = \frac{z^9}{z^{10} + 1}$, $F(w) = \frac{w^{-9}}{w^{-10} + 1}$

$$F(w) = \frac{w}{w^{10} + 1}, \quad -w^{-2} F(w) = \frac{-1}{(w)(w^{10} + 1)}$$

$$\operatorname{Res} [-w^{-2} F(w), 0] = -1 = \operatorname{Res} [f(z), \infty]$$

$$\oint_{|z|=3} \frac{z^9}{z^{10} + 1} dz = 2\pi i \text{ if } n = 9$$

$n = 10$, $f(z) = \frac{z^{10}}{z^{10} + 1}$, $F(w) = \frac{w^{-10}}{w^{-10} + 1} = \frac{1}{w^{10} + 1}$

$$-w^{-2} F(w) = \frac{-1}{w^2 (w^{10} + 1)}$$

$$= \frac{d}{dw} \left(\frac{1}{w^{10} + 1} \right) \Big|_{w=0} = 0 \text{ if } n = 10$$

$\operatorname{Res} [-w^{-2} F(w), 0] = 0$ (pole order 2)

411

$$(a) \frac{1}{\sin z} = \sum_{n=-\infty}^{\infty} C_n z^n$$

Since $\frac{1}{\sin z}$ is analytic in the domain

$\pi < |z| < 2\pi$ we apply Eqn (5.6-5) taking as contour $|z| = R$, where $\pi < R < 2\pi$. Thus the contour lies in this ring shaped domain, and from (5.6-5) we have $C_n = \frac{1}{2\pi i} \oint \frac{1}{z^{n+1} \sin z} dz$

(b) Inside the contour, $\frac{1}{z^{n+1} \sin z}$ can have poles at $z=0$, and $z = \pm \pi$.

Thus: applying the residue theorem:

$$C_n = \sum_{\text{res. } z^{n+1} \sin z} \Big|_{z=0, +\pi, -\pi}$$

$$C_n = \text{Res} \left[\frac{1}{z^{n+1} \sin z}, 0 \right] + \text{Res} \left[\frac{1}{z^{n+1} \sin z}, \pi \right] + \text{Res} \left[\frac{1}{z^{n+1} \sin z}, -\pi \right]$$

thus $C_n = d_n + e_n + f_n$

$$(c) d_n = \text{Res} \left[\frac{1}{z^{n+1} \sin z}, 0 \right] =$$

$$\text{Res} \left[\frac{1}{z^{n+1} \left[z - \frac{z^3}{3!} + \frac{z^5}{5!} - \dots \right]}, 0 \right] = \text{Res} \left[\frac{1}{z^{n+2} - \frac{z^{n+4}}{3!} + \frac{z^{n+6}}{5!} - \dots}, 0 \right]$$

If $n \leq -2$, this function does not have a pole at $z=0$, it has a removable singularity. Thus its residue is zero.

d) cont'd next pg.

44

Sec 6.3 cont'd

$$(d) e_n = \frac{1}{z^{n+1} \cos z}, \pi = \frac{(-1)^n}{\pi^{n+1}}$$

$$f_n = \frac{1}{z^{n+1} \cos z}, -\pi = \frac{-1}{(-\pi)^{n+1}}$$

$$e_n + f_n = (-1)^n \left[\frac{1}{\pi^{n+1}} + \frac{1}{(-1)^{n+1} \pi^{n+1}} \right]$$

if n even, $e_n + f_n = 0$,

if n odd, $e_n + f_n = (-1)^n \left[\frac{2}{\pi^{n+1}} \right]$

$$(e) d_n = \text{Res} \left[\frac{1}{z^{n+1} \sin z}, 0 \right] =$$

$$\text{Res} \left[\frac{1}{z^{n+1} \left(z - \frac{z^3}{3!} + \frac{z^5}{5!} - \dots \right)}, 0 \right] \text{ at } z=0,$$

$$= \text{Res} \left[\frac{1}{z^{n+2} - \frac{z^{n+4}}{3!} + \dots}, 0 \right] \text{ at } z=0. \text{ If } n \text{ is}$$

even, the preceding series contains only even powers of z . If we perform a long division and obtain a Laurent expansion of $\frac{1}{z^{n+2} - \frac{z^{n+4}}{3!} + \dots}$ in powers of z we find that it contains only even powers of z . Thus the coeff of z^{-1} will be zero, and the residue will be zero, thus $d_n = 0$ _{even}

We have already shown

in part (d) that $e_n + f_n = 0$ if n is even,

Thus $c_n = d_n + e_n + f_n = 0$ if n is even.

$$\text{Let } n = -1, \quad d_{-1} = \text{Res} \left[\frac{1}{\sin z}, 0 \right] = 1$$

$$e_{-1} + f_{-1} = -2. \quad \text{Thus } c_{-1} = d_{-1} + e_{-1} + f_{-1} = \boxed{-1 = c_1}$$

Sec 6.3

41(e) cont'd

Let $n=1$. $d_1 = \text{Res} \left[\frac{1}{z^2 \sin z}, 0 \right] = \text{Res} \left[\frac{1}{z^2 \left[z - \frac{z^3}{3!} + \frac{z^5}{5!} \dots \right]}, 0 \right]$

$$\frac{z^{-3} + \frac{z^{-1}}{3!} \dots}{z^3 - \frac{z^5}{3!} + \dots} = \frac{1}{1 - \frac{z^2}{3!} \dots} \cdot \frac{z^{-3} + \frac{z^{-1}}{3!} \dots}{z^3 - \frac{z^5}{3!} + \dots}$$

Thus $d_1 = 1/3! = 1/6$

If $n=1$, $e_n + f_n = \frac{-2}{\pi^2}$. Thus $C_1 = d_1 + e_1 + f_1 = \frac{1}{6} - \frac{2}{\pi^2}$

Let $n=3$

$C_3 = \text{Res} \left[\frac{1}{z^4 \sin z}, 0 \right]$

$$\frac{1}{z^4 \sin z} = \frac{1}{z^5 - \frac{z^7}{3!} + \frac{z^9}{5!} \dots} = \frac{z^{-5} + \frac{z^{-3}}{3!} + \frac{7z^{-1}}{360} \dots}{z^5 - \frac{z^7}{3!} + \frac{z^9}{5!} \dots}$$

thus $\text{Res} \left[\frac{1}{z^4 \sin z}, 0 \right] = \frac{7}{360} = C_3$, $e_3 + f_3 = \frac{-2}{\pi^4}$

Thus: $C_3 = d_3 + e_3 + f_3 = \left[\frac{7}{360} - \frac{2}{\pi^4} \right] = C_3$

If $n \leq -3$, $d_n = 0$, thus C_n [for $n \leq -3$] = $e_n + f_n = \frac{-2}{\pi^{n+1}}$

42) $f(z) = C_{-m} (z-z_0)^{-m} + C_{-(m-1)} (z-z_0)^{-(m-1)} + \dots + C_{-1} (z-z_0)^{-1} + C_0 + C_1 (z-z_0) + \dots$

$(z-z_0)^N f(z) = C_{-m} (z-z_0)^{N-m} + C_{-(m-1)} (z-z_0)^{N-m+1} + \dots + C_{-1} (z-z_0)^{N-1} + C_0 (z-z_0)^N + C_1 (z-z_0)^{N+1} + \dots = \psi$ Taylor exp.

Here $N-m \geq 0$

cont'd next pg,

42) cont'd

Chap 6, sec 6.3 cont'd

$$\frac{d^{N-1}}{dz^{N-1}} \psi(z) = (N-1)(N-2)\dots 1 C_{-1} + (N)(N-1)\dots 2 C_0 (z-z_0) + (N+1)(N)(N-1)\dots 3 C_1 (z-z_0)^2 + \dots$$

$$\lim_{z \rightarrow z_0} \frac{d^{N-1}}{dz^{N-1}} \psi(z) = (N-1)! C_{-1} \dots$$

$$\text{Thus Res}[f(z), z_0] = \frac{1}{(N-1)!} \lim_{z \rightarrow z_0} \frac{d^{N-1}}{dz^{N-1}} [(z-z_0)^N f(z)]$$

$$(b) (z-z_0)^N f(z) = C_{-m} (z-z_0)^{N-m} + C_{-(m-1)} (z-z_0)^{N-m+1} + C_{-(m-2)} (z-z_0)^{N-m+2} + \dots + C_0 (z-z_0)^N + C_1 (z-z_0)^{N+1} + \dots$$

here $N-m < 0$. Consider first deriv.:

$$\frac{d}{dz} [(z-z_0)^N f(z)] = C_{-m} (N-m) (z-z_0)^{N-m-1} +$$

$$C_{-(m-1)} (N-m+1) (z-z_0)^{N-m} + \dots + C_0 N (z-z_0)^{N-1} + C_1 (N+1) (z-z_0)^N + \dots$$

Since $N-m < 0$, the preceding expression has a pole of order $m+1-N$ at $z=z_0$. Taking additional derivs. creates functions with yet higher order poles. Thus $\frac{d^{N-1}}{dz^{N-1}} (z-z_0)^N f(z)$ has a pole at $z=z_0$ if $N < m$ and must $\rightarrow \infty$ as $z \rightarrow z_0$.

Sec 6.4

$$1) \Gamma = \int \frac{z d\theta}{e^{i\theta} + e^{-i\theta}}$$

$$z = e^{i\theta}, dz = e^{i\theta} i d\theta = iz d\theta$$

$$I = \int \frac{z dz}{iz(z+z^{-1})} = \int \frac{z}{i} \frac{dz}{z^2+1} = \frac{z}{i} \tan^{-1}(z) + C$$

$$= \frac{z}{i} \frac{1}{2} \log \left(\frac{1+z}{1-z} \right) = \log \left[\frac{1+e^{i\theta}}{1-e^{i\theta}} \right] + C$$

Continued next pg.

Sec 6.4

1) continued

$$\int \frac{d\theta}{\cos\theta} = \log \left[\frac{(i+e^{i\theta})(-i-e^{-i\theta})}{(1-e^{i\theta})(-i-e^{-i\theta})} \right] + C$$

$$= \log \left[\frac{-ie^{-i\theta} - 1e^{i\theta}}{1+ie^{i\theta}-1e^{-i\theta}+1} \right] + C$$

$$= \log \left[\frac{-2i \cos\theta}{2-2\sin\theta} \right] = \log \left[\frac{-i \cos\theta}{1-\sin\theta} \right] + C$$

$$= \log \left[\frac{(-i \cos\theta)(1+\sin\theta)}{1-\sin^2\theta} \right] = \log \left[\frac{(-i) [1+\sin\theta]}{\cos\theta} \right] + C$$

$$= \log \left| \frac{[1+\sin\theta]}{\cos\theta} \right| + \underbrace{i \left(\frac{\pi}{2} \right)}_{\text{a constant}} + C \quad \text{q.e.d.}$$

$$2) \int_0^{2\pi} \frac{d\theta}{k-\sin\theta} = \oint_{|z|=1} \frac{dz}{(iz) \left[k - \left(\frac{z-z^{-1}}{2i} \right) \right]} =$$

$$\oint_{|z|=1} \frac{-2 dz}{z^2 - 2ikz - 1}$$

poles: $z^2 - 2ikz - 1 = 0$
 $z = k \pm i\sqrt{k^2-1}$

Assume first that $k > 1$, only the pole at $i[k - \sqrt{k^2-1}]$ is inside the contour.

Sec 6.4

2) Continued.

$$\oint \frac{-a dz}{z^2 - 2ikz - 1} = \frac{(2\pi i)(-2)}{2z - 2ik} \Big|_{z = ik - i\sqrt{k^2 - 1}}$$

$$= \frac{2\pi}{\sqrt{k^2 - 1}} \quad \text{g.e.d.} \quad \text{If } k < -1, \text{ then}$$

$z = ik + i\sqrt{k^2 - 1}$ is inside contour, but

$z = ik - i\sqrt{k^2 - 1}$ is outside the contour.

$$\text{Thus for } k < -1, \int_0^{2\pi} \frac{d\theta}{k - \sin\theta} = \frac{-4\pi i}{2z - 2ik} \Big|_{z = ik + i\sqrt{k^2 - 1}}$$

$$= \boxed{\frac{-2\pi}{\sqrt{k^2 - 1}} \text{ for } k < -1}$$

$$3) \int_{-\pi}^{\pi} \frac{d\theta}{a + b \cos\theta} = \oint_{|z|=1} \frac{dz}{iz \left[a + \frac{b}{2}(z + z^{-1}) \right]} =$$

$$\oint_{|z|=1} \frac{2 dz}{i(2az + b(z^2 + 1))} = \oint_{|z|=1} \frac{2 dz}{ib \left[z^2 + \frac{2a}{b}z + 1 \right]}$$

poles: $z = -\frac{a}{b} \pm \sqrt{\frac{a^2}{b^2} - 1}$. Since $a > b > 0$

(the case $b=0$ is trivial) we need only the pole at $-\frac{a}{b} + \sqrt{\frac{a^2}{b^2} - 1}$. the other pole is outside $|z|=1$.

$$\text{Thus: answer is } \frac{2\pi i \cdot 2}{i(2a + 2bz)} \Big|_{z = -\frac{a}{b} + \sqrt{\frac{a^2}{b^2} - 1}}$$

$$= \frac{2\pi}{\sqrt{a^2 - b^2}} \quad \text{g.e.d.}$$

$$7) \int_{-\pi/2}^{3\pi/2} \frac{\cos\theta d\theta}{a + b \cos\theta} = \oint \frac{(z + z^{-1})/2}{a + \frac{b}{2}(z + z^{-1})} \frac{dz}{iz}$$

$$= \oint \frac{(z^2 + 1) dz}{iz [2az + b(z^2 + 1)]} = \oint \frac{(z^2 + 1) dz}{biz [z^2 + \frac{2a}{b}z + 1]}$$

chap 6, sec 6.4 cont'd

4) cont'd

We have a pole at $z=0$. Residue at $z=0$ is $\frac{1}{ib}$. For other poles: $z^2 + \frac{2a}{b}z + 1 = 0$

$z = \frac{-a}{b} \pm \sqrt{\frac{a^2}{b^2} - 1}$. Only $\frac{-a}{b} + \sqrt{\frac{a^2}{b^2} - 1}$ is inside $|z|=1$. Residue is $\frac{(z^2+1)}{b iz (2z + \frac{2a}{b})}$, $z = \frac{-a}{b} + \sqrt{\frac{a^2}{b^2} - 1}$

Note: at pole $z^2+1 = -\frac{2a}{b}z$, $\frac{z^2+1}{z} = -\frac{2a}{b}$.

Thus, get: residue at $z = \frac{-a}{b} + \sqrt{\frac{a^2}{b^2} - 1}$

is $-\frac{1}{ib} \frac{a}{\sqrt{a^2 - b^2}}$. Answer = $2\pi i \sum$ residues.

Thus: $\int_{-\pi}^{\pi} \frac{a \cos \theta d\theta}{a + b \cos \theta} = 2\pi i \left[\frac{1}{ib} - \frac{a}{ib \sqrt{a^2 - b^2}} \right]$

$= \frac{2\pi}{b} \left[1 - \frac{a}{\sqrt{a^2 - b^2}} \right]$ g.e.d

S $\int_0^{2\pi} \cos^4 \theta d\theta = \oint \frac{(z - z^{-1})^4}{(2i)^4} \frac{dz}{iz}$

$\frac{(z - z^{-1})^4}{z} = \frac{(z^2 - 1)^4}{z^5}$

$\int_0^{2\pi} \cos^4 \theta d\theta = \oint \frac{1}{16i} \frac{(z^2 - 1)^4}{z^5} dz$

$= \oint \frac{1}{16i} \frac{1}{z^5} \sum_{k=0}^4 \frac{4!}{(4-k)! k!} (z^2)^{4-k} (-1)^k dz$

What is coeff of z^{-1} ?

ans. put $k=2$

$= \oint \frac{1}{16i} \frac{4!}{2! 2!} \frac{z^4}{z^5} dz = \frac{1}{16i} \frac{4!}{4} \times 2\pi i = \boxed{\frac{3\pi}{4}}$

g.e.d.

Sec 6.4

$$\text{6)} \int_0^{2\pi} (\cos \theta)^m d\theta = \oint_{|z|=1} \frac{1}{2^m} \left(z + \frac{1}{z}\right)^m \frac{dz}{iz}$$

$$= \oint_{|z|=1} \frac{1}{2^m} \frac{(z^2+1)^m dz}{i z^{m+1}} = \frac{2\pi i}{2^m} \text{Res} \left(\frac{(z^2+1)^m}{z^{m+1}} \right) \text{ at } z=0$$

Now $(z^2+1)^m = \sum_{k=0}^m \frac{m!}{(m-k)! k!} (z^2)^{m-k}$ If m is

odd, $\frac{1}{z^{m+1}} (z^2+1)^m$ will have only even powers of z and $\frac{1}{z^{m+1}} (z^2+1)^m$ has a residue of zero at $z=0$. Thus the given integral is zero.

Now assume m is even

$$\frac{1}{z^{m+1}} (z^2+1)^m = \frac{1}{z^{m+1}} \sum_{k=0}^m \frac{m!}{(m-k)! k!} (z^2)^{m-k}$$

$k = \frac{m}{2}$ in sum to generate the z^{-1} term.

coeff. of z^{-1} is $\frac{(m)!}{\left[\left(\frac{m}{2}\right)!\right]^2}$

Thus $\oint_{|z|=1} \frac{1}{2^m} \frac{(z^2+1)^m dz}{i z^{m+1}} = \frac{2\pi i}{2^m i} \frac{(m)!}{\left[\left(\frac{m}{2}\right)!\right]^2}$ g.e.d. m even.

$$\text{7)} \int_0^{2\pi} \frac{d\theta}{(a+b \sin \theta)^2} = \oint_{|z|=1} \frac{dz}{iz \left[a + \frac{b}{2i} (z - z^{-1}) \right]^2}$$

$$= \oint \frac{(iz)^2 dz}{iz \left[a iz + \frac{b}{2} (z^2 - 1) \right]^2} = \oint \frac{-z^2 dz}{(iz) \left(\frac{b}{2}\right)^2 \left[z^2 + \frac{2ai}{b} z - 1 \right]^2}$$

for poles: $z^2 + \frac{2ai}{b} z - 1 = 0$; $z = \frac{-ai}{b} \pm i \sqrt{\frac{a^2}{b^2} - 1}$

(assume $b \neq 0$; the case $b=0$ is trivial).

The only pole inside the unit circle is at $z = -ai/b + i \sqrt{\frac{a^2}{b^2} - 1}$

7) cont'd

Note $\left[z^2 + \frac{2ai}{b}z - 1 \right]^2 =$

$$\left[z - \left[\frac{-ai}{b} + i \sqrt{\frac{a^2}{b^2} - 1} \right] \right]^2 \left[z - \left[\frac{-ai}{b} - i \sqrt{\frac{a^2}{b^2} - 1} \right] \right]^2$$

Res $\frac{-z}{i \left(\frac{b}{2}\right)^2} \frac{1}{\left(z^2 + \frac{2ai}{b}z - 1\right)^2} =$

lim $z \rightarrow i \left[\frac{-a}{b} + \sqrt{\frac{a^2}{b^2} - 1} \right] \frac{d}{dz} \frac{-z}{i \left(\frac{b}{2}\right)^2 \left[z - i \left(\frac{-a}{b} - \sqrt{\frac{a^2}{b^2} - 1} \right) \right]^2}$

$$= \frac{(-1)}{\left[z - i \left(\frac{-a}{b} - \sqrt{\frac{a^2}{b^2} - 1} \right) \right]^2} - 2z \left[z - i \left[\frac{-a}{b} - \sqrt{\frac{a^2}{b^2} - 1} \right] \right]$$

$$= \frac{(-1)}{i \left(\frac{b}{2}\right)^2} \left[z - i \left(\frac{-a}{b} - \sqrt{\frac{a^2}{b^2} - 1} \right) \right]^4 \quad z = -\frac{ai}{b} + i \sqrt{\frac{a^2}{b^2} - 1}$$

$$= -\frac{i}{b^2} \frac{a}{b} \frac{1}{\left[\sqrt{\frac{a^2}{b^2} - 1} \right]^3} = \text{Residue}$$

thus $\int_0^{2\pi} \frac{d\theta}{(a + b \sin \theta)^2} = \frac{2\pi i (-i) a}{b^3} \frac{1}{\left(\sqrt{\frac{a^2}{b^2} - 1} \right)^3}$

$$= \frac{2\pi a}{\left(\sqrt{a^2 - b^2} \right)^3}$$

8) $\int_0^{2\pi} \frac{d\theta}{a + \sin^2 \theta} = \int_0^{2\pi} \frac{d\theta}{a + \frac{1}{2} - \frac{1}{2} \cos(2\theta)}$

$$= \oint_{|z|=1} \frac{dz}{iz \left[\left(a + \frac{1}{2} \right) - \frac{1}{4} (z^2 + z^{-2}) \right]} = \oint \frac{z dz}{i \left[\left(a + \frac{1}{2} \right) z^2 - \frac{1}{4} (z^4 + 1) \right]}$$

$$= \oint \frac{-4z dz}{i \left[z^4 - 4 \left(a + \frac{1}{2} \right) z^2 + 1 \right]}$$

for poles: $z^4 - 4 \left(a + \frac{1}{2} \right) z^2 + 1 = 0; z^2 = 2a + 1 \pm 2 \sqrt{a(a+1)}$

Section 6.4

8) cont'd

poles: $z^2 = 2a+1 \pm 2\sqrt{a(a+1)}$

with minus sign, $|z|^2 < 1$ you are inside contour
other root is outside. Thus need residues at

$$z = \pm \sqrt{(2a+1) - 2\sqrt{a(a+1)}}$$

Res of $\frac{-4z}{i[z^4 - 4(a+\frac{1}{2})z^2 + 1]}$ at pole

$$= \frac{-4z}{i[4z^3 - 8z(a+\frac{1}{2})]}$$

$$= \frac{1}{i[-z^2 + 2(a+\frac{1}{2})]} \Big|_{z = \pm \sqrt{(2a+1) - 2\sqrt{a(a+1)}}} = \frac{1}{i 2\sqrt{a(a+1)}} \text{ at both poles}$$

Thus: $\int_0^{2\pi} \frac{d\theta}{a + \sin^2 \theta} = \frac{2\pi i}{i\sqrt{a(a+1)}} = \frac{2\pi}{\sqrt{a(a+1)}} \text{ g.e.d}$

9) $\oint \frac{\cos \theta}{1 - 2a \cos \theta + a^2} d\theta = \oint \frac{(z+z^{-1}) \frac{dz}{iz}}{1 - 2a \left[\frac{z+z^{-1}}{2} \right] + a^2}$

$$= \frac{1}{2i} \oint \frac{z^2+1}{-az \left[z^2 - \frac{(a^2+1)}{a}z + 1 \right]} dz$$

there is a pole at $z=0$

Where are other poles? $z^2 - \frac{(a^2+1)}{a}z + 1 = 0$,

$z = a, z = \frac{1}{a}$. Assume $|a| > 1$. Thus we need residues at $z=0$ and $z = 1/a$.

Res $\frac{1}{2i} \frac{z^2+1}{-az \left[z^2 - (a+\frac{1}{a})z + 1 \right]}$ at 0 is $\frac{-1}{2ai}$

Res at $\frac{1}{a}$ is $\frac{1}{2i} \frac{z^2+1}{(-az) \left[2z - (a+\frac{1}{a}) \right]} \Big|_{z=\frac{1}{a}} = \frac{-1}{2ia} \left[\frac{1+a^2}{1-a^2} \right]$

$\sum \text{residues} = \frac{-1}{2ai} \left[1 + \frac{1+a^2}{1-a^2} \right] = \frac{-1}{(ia)(a^2-1)}$ thus answer $\frac{2\pi i \sum \text{residues}}{2\pi} = \frac{2\pi}{(a)(a^2-1)}$

10

Proceed as in problem 9 except that:

If $|a| < 1$ need residues at $z=0$ and $z=a$.

Residue at a is $\frac{1}{2i} \frac{z^2+1}{(-az) \left[z - \left(a + \frac{1}{a} \right) \right]} \Big|_{z=a}$
 $= \frac{-1}{2ia} \left[\frac{a^2+1}{a^2-1} \right]$.. Residue at $z=0$ same as

before. Thus answer $= 2\pi i \sum_{\text{residues}} =$

$$(2\pi i) \left[\frac{-1}{2ia} \right] \left[1 + \frac{a^2+1}{a^2-1} \right] = \frac{2\pi a}{1-a^2} \quad \text{q.e.d.}$$

11 $\int \frac{\cos n\theta}{\cosh a + \cos \theta} d\theta = \oint \frac{z^n + z^{-n}}{2} \frac{dz}{iz}$
 $= \oint \frac{z^n + z^{-n}}{(2z \cosh a + z^2 + 1)i} dz = I_A + I_B$

where $I_A = \oint \frac{z^n dz}{(2z \cosh a + z^2 + 1)i}$, $I_B = \oint \frac{dz}{z^n (2z \cosh a + z^2 + 1)}$

for poles: $z^2 + 2z \cosh a + 1 = 0$,

$$z = \frac{-2 \cosh a \pm \sqrt{4 \cosh^2 a - 4}}{2}, \quad z = -\cosh a \pm i \sinh a$$

Thus $z = -e^{-a}$ and $z = -e^a$ poles.

Since $a > 0$, need residue at $z = -e^{-a}$

Residue of $\frac{z^n}{(2z \cosh a + z^2 + 1)i}$ at $z = -e^{-a}$ is $\frac{(-1)^n e^{-na}}{2i \sinh a}$ [for I_A]

Residue of $\frac{z^{-n}}{(2z \cosh a + z^2 + 1)i}$ at $z = -e^{-a}$ is $\frac{(-1)^n e^{na}}{2i \sinh a}$ [for I_B]

The sum of these is $\frac{(-1)^n \cosh(na)}{i \sinh(a)}$

Chap 6, sec 6.4 cont'd

11) cont'd for IB need Res $\frac{1}{iz^n [z^2 + 2z \cosh a + 1]}$

at $z=0$. Have pole order n

Now $\frac{1}{z^2 + 2z \cosh a + 1} = \frac{1}{(z + e^{-a})(z + e^a)}$ using partial fracs.

$$\frac{1}{2 \sinh a} \left[\frac{-1}{z + e^a} + \frac{1}{z + e^{-a}} \right] =$$

$$\frac{1}{2 \sinh a} \left[-e^{-a} \sum_{n=0}^{\infty} [(-e^{-a})^n z^n + e^a (-e^a)^n z^n] \right]$$

Thus $\frac{1}{(z^n)(z^2 + 2z \cosh a + 1)}$ has residue at $z=0$

of $\frac{1}{2 \sinh a} \left[-e^{-a} (-e^{-a})^{n-1} + e^a (-e^a)^{n-1} \right] = \frac{(-1)^n \sinh na}{i \sinh a}$

Summing all three residues, get: $\frac{(-1)^n \cosh na - (-1)^n \sinh na}{i \sinh a}$

$= \frac{(-1)^n e^{-na}}{i \sinh a}$. Thus $2\pi i \sum \text{res} = \frac{(2\pi) (-1)^n e^{-na}}{\sinh a}$ g.e.d.

12)

$$\int_0^{2\pi} \frac{d\theta}{a^2 \sin^2 \theta + b^2 \cos^2 \theta} = \oint_{|z|=1} \frac{dz}{iz \left[\frac{a^2(z^2 - 2 + z^{-2})}{-4} + \frac{b^2}{4} [z^2 + 2 + z^{-2}] \right]}$$

$$= \oint \frac{4z dz}{i [(b^2 - a^2) z^4 + 2(b^2 + a^2) z^2 + b^2 - a^2]} = \oint \frac{4z dz}{i(b^2 - a^2) \left[z^4 + 2 \frac{(b^2 + a^2)}{b^2 - a^2} z^2 + 1 \right]}$$

poles: $z^4 + 2 \frac{(b^2 + a^2)}{b^2 - a^2} z^2 + 1 = 0$, $z^2 = (-1) \left[\frac{b^2 + a^2 \pm 2ab}{b^2 - a^2} \right]$

with plus sign: $z^2 = \frac{(-1)(b+a)}{(b-a)}$, with minus: $z^2 = \frac{(-1)(b-a)}{(b+a)}$

If b and a are of same sign, then $\left| \frac{(-1)(b+a)}{b-a} \right| > 1$

and $\left| \frac{(-1)(b-a)}{b+a} \right| < 1$. Thus need residues at both values of $z = \left(\frac{(-1)(b-a)}{b+a} \right)^{1/2}$

12) cont'd

Chap 6, sec 6.4 cont'd

Residue of $4z$

at pole

$$i(b^2 - a^2) \left[z^4 + 2 \frac{(b^2 + a^2)z^2}{(b^2 - a^2)} + 1 \right]$$

is $4z$

$$(i)(b^2 - a^2) \left[4z^3 + 4z \frac{(b^2 + a^2)}{b^2 - a^2} \right] = \frac{1}{(i)(b^2 - a^2) \left[z^2 + \frac{(b^2 + a^2)}{b^2 - a^2} \right]}$$

where $z^2 = \frac{(-1)(b-a)}{(b+a)}$ at

both poles enclosed. The residues at both poles are identical. Thus: each residue = $\frac{1}{2iab}$

$$\int_0^{2\pi} \frac{d\theta}{a^2 \sin^2 \theta + b^2 \cos^2 \theta} = 2\pi i \frac{2}{2iab} = \frac{2\pi}{ab} \text{ r.e.d.}$$

13 |
output

% prob 13, sec 6.4
syms x
syms d positive

f=1/(1+d -sin(x));
int(f,x,0,2*pi)
pretty(ans)

code

ans =

$$2 / (2*d + d^2)^{(1/2)*pi}$$

$$\frac{2 \pi}{(2d + d^2)^{1/2}}$$

now: $d = k-1$

$$= \frac{2\pi}{\sqrt{2(k-1) + (k-1)^2}} = \frac{2\pi}{\sqrt{k^2 - 1}}$$

Sec 6.4

14

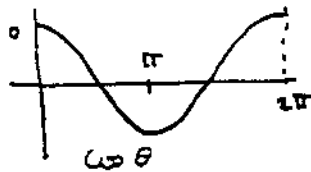

From symmetry:

$$\int_0^{\pi} \frac{\cos \theta}{5+4\cos \theta} d\theta = \frac{1}{2} \int_0^{2\pi} \frac{\cos \theta}{5+4\cos \theta} d\theta$$

Now the result of problem 3 can be applied (the contour integration is still around the unit circle).

$$\int_0^{\pi} \frac{\cos \theta}{5+4\cos \theta} d\theta = \frac{1}{2} \times \frac{2\pi}{b} \left[1 - \frac{a}{\sqrt{a^2-b^2}} \right] \quad \begin{matrix} a=5 \\ b=4 \end{matrix}$$

$$= \frac{\pi}{4} \left[1 - \frac{5}{3} \right] = \boxed{-\frac{\pi}{6}}$$

15

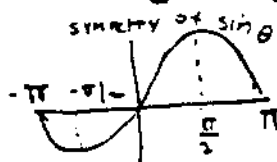

$$\int_{-\pi/2}^{\pi/2} \frac{\sin \theta}{5-4\sin \theta} d\theta = \frac{1}{2} \int_{-\pi}^{\pi} \frac{\sin \theta}{5-4\sin \theta} d\theta$$

$$= \frac{1}{2} \oint_{|z|=1} \frac{\frac{z-z^{-1}}{2i}}{5+ai[z-z^{-1}]} \frac{dz}{iz} = -\frac{1}{4} \oint \frac{(z^2-1) dz}{(z) [5z+2i(z^2-1)]}$$

$$= -\frac{1}{4} \oint \frac{(z^2-1) dz}{(2iz) [z^2 + 5z/2i - 1]}$$

$$\int_{-\pi/2}^{\pi/2} \frac{\sin \theta}{5-4\sin \theta} d\theta = -\frac{1}{4} \oint_{|z|=1} \frac{(z^2-1) dz}{2iz [z^2 + \frac{5}{2i}z - 1]}$$

pole at $z=0$, other poles $z^2 + \frac{5}{2i}z - 1 = 0$

$z = 2i, z = \frac{1}{2}$. Need Residues at $z=0, z = \frac{1}{2}$

$$\text{Res} \quad -\frac{1}{4} \frac{(z^2-1)}{(2iz) [z^2 + \frac{5}{2i}z - 1]} \quad \text{at } z=0 = -\frac{1}{8i}$$

$$\text{Res of same func. at } z = \frac{1}{2} = -\frac{5i}{24}$$

$$\text{Thus ans. } 2\pi i \sum \text{res} = 2\pi i \left[\frac{i}{8} - \frac{5i}{24} \right] = \boxed{-\frac{\pi}{6}}$$

16

Sec 6.4

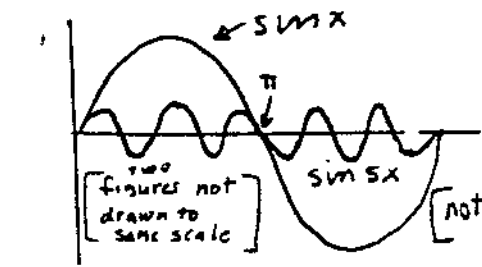

$$\int_0^{\pi} \sin^5 x \sin(5x) dx =$$

[note even symmetry about π of product of $\sin^5 x \sin 5x$]

$$\frac{1}{2} \int_0^{2\pi} \sin^5 x \sin(5x) dx = \frac{1}{2} \oint_{|z|=1} \frac{(z-z^{-1})^5}{32i} \frac{z^5 - z^{-5}}{2i} \frac{dz}{iz}$$

$$= \frac{1}{2} \oint_{|z|=1} \frac{(z^2-1)^5 (z^{10}-1)}{(32i)(2i) z''} dz = \oint_{|z|=1} \frac{(z^2-1)^5 (z^{10}-1)}{(-128i) z''} dz$$

To get

Residue: Note $(z^2-1)^5 = \sum_{k=0}^5 \frac{5!}{k!} \frac{(z^2)^{5-k} (-1)^k}{(5-k)!}$

$$\text{Thus } \frac{(z^2-1)^5 (z^{10}-1)}{(-128i) z''} = \frac{(z^{10}-1)}{-128i z''} \sum_{k=0}^5 \frac{5!}{k!} \frac{(z^2)^{5-k} (-1)^k}{(5-k)!}$$

The coefficient of $\frac{1}{z}$ in the preceding is: $\left[\frac{-1}{-128i} + \frac{-1}{-128i} \right]$

$$\int_0^{\pi} \sin^5 x \sin(5x) dx = \frac{2\pi i}{64i} = \boxed{\frac{\pi}{32}}$$

17) next pg.

Sec 6.4

$$\boxed{17} \int_{-\pi}^{\pi} \frac{\sin(2\theta)}{5-4\sin\theta} d\theta = \oint_{|z|=1} \frac{z^2 - z^{-2}}{2i} \frac{dz}{i z} \frac{1}{5+2i[z-z^{-1}]}$$

$$= -\frac{1}{2} \oint \frac{(z^4-1) dz}{z^2 [5z+2i(z^2-1)]}$$

Residue at $z=0$: $\lim_{z \rightarrow 0} -\frac{1}{2} \frac{d}{dz} \frac{z^4-1}{5z+2i(z^2-1)} = \frac{5}{8}$

For other poles: $(z^2-1) + \frac{5z}{2i} = 0$, $z = ai, z = \frac{1}{2}$

Need residue at $z = i/2$

Residue at $z = i/2 \Rightarrow \left. -\frac{1}{2} \frac{(z^4-1)}{z^2 [5+4iz]} \right|_{z=i/2} = -\frac{5}{8}$

$\sum_{\text{residues}} = 0$ Thus $\int_{-\pi}^{\pi} \frac{\sin(2\theta)}{5-4\sin\theta} d\theta = \boxed{0}$. Same result

can be obtained from symmetry argument without residues.

$\int_0^{\pi} \frac{\cos(2\theta)}{2-\cos\theta} d\theta = \left\{ \begin{array}{l} \text{note} \\ \text{SYMM.} \\ \text{about } \pi \end{array} \right\}$

$$\frac{1}{2} \int_0^{2\pi} \frac{\cos(2\theta)}{2-\cos\theta} d\theta =$$

$$\frac{1}{2} \oint_{|z|=1} \frac{\frac{z^2+z^{-2}}{2}}{2-\frac{(z+z^{-1})}{2}} \frac{dz}{iz} = \frac{1}{2i} \oint_{|z|=1} \frac{z^2+z^{-2}}{4z-(z^2+1)} dz$$

$= I_A + I_B$ Where $I_A = \frac{1}{2i} \oint_{|z|=1} \frac{z^2}{4z-z^2-1} dz$

and $I_B = \frac{1}{2i} \oint \frac{dz}{z^2 [4z-z^2-1]}$

18) cont'd

Chap 6, Sec 6.4 cont'd

First do $I_A = \frac{1}{-2i} \oint \frac{z^2}{z^2 - 4z + 1} dz$

poles: $z^2 - 4z + 1 = 0 \quad z = 2 \pm \sqrt{3}$. Need

residue, $z = 2 - \sqrt{3}$.

$I_A = \frac{2\pi i}{-2i} \frac{z^2}{2z - 4} \Big|_{z=2-\sqrt{3}}$

$= \frac{\pi}{2\sqrt{3}} (2 - \sqrt{3})^2$. Now I_B has pole at $2 - \sqrt{3}$

and 2nd order pole at $z = 0$

Res $\frac{1}{2i} \frac{1}{(z^2)(4z - z^2 - 1)} \Big|_{z=2-\sqrt{3}} = \frac{1}{(2i)(2-\sqrt{3})^2 2\sqrt{3}}$

Res $\frac{1}{(2i)(z^2)(4z - z^2 - 1)} \Big|_{z=0} = \lim_{z \rightarrow 0} \frac{1}{2i} \frac{z^2 - 4}{(4z - z^2 - 1)^2} = \frac{-2}{i}$

Thus $I_B = \frac{\pi}{2\sqrt{3}} (2 - \sqrt{3})^2 - 4\pi = \frac{\pi}{2\sqrt{3}} (2 + \sqrt{3})^2 - 4\pi$

$I_A + I_B = \frac{\pi}{2\sqrt{3}} [(2 - \sqrt{3})^2 + (2 + \sqrt{3})^2] - 4\pi = \boxed{\frac{7\pi}{\sqrt{3}} - 4\pi}$

19)

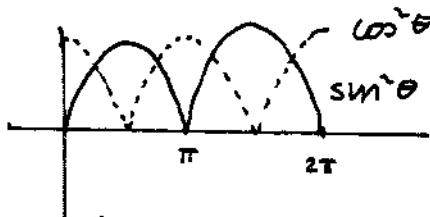

$\int_0^{\pi/2} \frac{\sin^2 \theta d\theta}{5 + 4 \cos^2 \theta} = \frac{1}{4} \int_0^{2\pi} \frac{\sin^2 \theta d\theta}{5 + 4 \cos^2 \theta}$

$= \frac{1}{4} \oint_{|z|=1} \frac{(-1/4) (z - z^{-1})^2}{5 + (z + z^{-1})^2} \frac{dz}{iz} = \frac{-1}{16i} \oint_{|z|=1} \frac{(z^2 - 2 + z^{-2}) z^2 dz}{z [z^2 + 7 + z^{-2}]}$

$= \frac{-1}{16i} \oint \frac{z^4 - 2z^2 + 1}{z [z^4 + 7z^2 + 1]} dz$ pole at $z = 0$

other poles: $z^4 + 7z^2 + 1 = 0, \quad z^2 = \frac{-7 \pm 3\sqrt{5}}{2}$

with plus sign poles are inside $|z|=1$

Thus $z^2 = \frac{-7 + 3\sqrt{5}}{2}, \quad z = \pm i \sqrt{\frac{7 - 3\sqrt{5}}{2}}$

19) cont'd

Chap 6, sec 6.4 cont'd

$$\text{Res } \frac{-1}{16i} \frac{z^4 - 2z^2 + 1}{(z)(z^4 + 7z^2 + 1)} \quad \text{at } z = \pm i \sqrt{\frac{7-3\sqrt{5}}{2}}$$

$$= \frac{-1}{16i} \frac{z^4 - 2z^2 + 1}{4z^4 + 14z^2} \Big|_{z = \pm i \sqrt{\frac{7-3\sqrt{5}}{2}}}$$

at pole: $z^4 + 7z^2 + 1 = 0$, $z^4 + 1 = -7z^2$

$$\text{residue} = \frac{-1}{16i} \frac{-9z^2}{2z^2 [2z^2 + 7]} = \frac{9}{16i(2)(2z^2 + 7)}$$

Now $z^2 = \left[\frac{-7+3\sqrt{5}}{2} \right]$, $2z^2 + 7 = 3\sqrt{5}$
(at pole)

Thus residue at $z = \pm i \sqrt{\frac{-3\sqrt{5}+7}{2}} = \frac{3}{32i\sqrt{5}}$

[there are two of these]

$$\text{Res } \frac{-1}{16i} \frac{z^4 - 2z^2 + 1}{(z)(z^4 + 7z^2 + 1)} \Big|_{z=0} = \frac{-1}{16i}$$

ans: $2\pi i \sum \text{res} = 2\pi i \left[\frac{-1}{16i} + \frac{2 \cdot 3}{32i\sqrt{5}} \right] = \frac{\pi}{8} \left[\frac{3}{\sqrt{5}} - 1 \right]$

Chap 6 sec 6.5

1) $\int_0^{\infty} e^{-2x} dx = \lim_{L \rightarrow \infty} \int_0^L e^{-2x} dx = \lim_{L \rightarrow \infty} \left[\frac{e^{-2x} - 1}{-2} \right]$
 $= \frac{1}{2}$ exists.

2) $\lim_{L \rightarrow \infty} \int_0^L e^{2x} dx = \lim_{L \rightarrow \infty} \left[\frac{e^{2x} - 1}{2} \right]$ does not exist

3) $\lim_{L \rightarrow \infty} \int_0^L x e^{-2x} dx = \lim_{L \rightarrow \infty} \left[e^{-2x} \right] \left[\frac{x}{-2} - \frac{1}{4} \right]_0^L$
 $= e^{-2L} \left[\frac{L}{-2} - \frac{1}{4} \right] + \frac{1}{4} = \frac{1}{4}$ exists

sec 6.5 cont'd

$$4) \lim_{L \rightarrow \infty} \int_0^L \frac{x}{x^2+1} dx = \lim_{L \rightarrow \infty} \left. \frac{1}{2} \log(x^2+1) \right|_0^L$$

$$= \lim_{L \rightarrow \infty} \frac{1}{2} \log[L^2+1] \quad \boxed{\text{does not exist}}$$

$$5) \lim_{L \rightarrow \infty} \int_{-L}^L e^{-x} dx = \lim_{L \rightarrow \infty} e^{-L} - e^{-L} \quad \text{does not exist}$$

$$6) \int_{-\infty}^{\infty} e^{-|x|} dx = 2 \int_0^{\infty} e^{-x} dx = 2 e^{-x} \Big|_0^{\infty} = 2$$

C. P. Value exists

$$\Rightarrow \lim_{L \rightarrow \infty} \int_{-L}^L \frac{x^2+x}{x^2+1} dx = \lim_{L \rightarrow \infty} \int_{-L}^L \left[1 + \frac{x}{x^2+1} - \frac{1}{x^2+1} \right] dx =$$

$$= \lim_{L \rightarrow \infty} 2L - 2 \tan^{-1} L \quad \boxed{\text{does not exist}}$$

$$b) \lim_{L \rightarrow \infty} \int_{-L}^L \frac{x-1}{1+x^2} dx = \lim_{L \rightarrow \infty} \left[\int_{-L}^L \frac{1}{1+x^2} dx \right]$$

$$= \lim_{L \rightarrow \infty} -2 \tan^{-1} L = -2 * \frac{\pi}{2} = -\pi \quad \boxed{\text{exists}}$$

9) a) Consider $\lim_{a \rightarrow \infty} \int_0^b \sin x dx + \int_{-a}^0 \sin x dx =$

$$(1 - \cos b) + (\cos a - 1) = \cos a - \cos b \quad \text{does not exist.}$$

b) $\lim_{L \rightarrow \infty} \int_{-L}^L \sin x dx = \lim_{L \rightarrow \infty} [\cos(-L) - \cos(L)] = 0 \quad \boxed{\text{exists}}$

c) standard def. $\lim_{a \rightarrow \infty, b \rightarrow \infty} \int_0^b \frac{1}{x^2+1} dx + \int_{-a}^0 \frac{1}{1+x^2} dx$

$$= \tan^{-1} b + \tan^{-1} a = \frac{\pi}{2} + \frac{\pi}{2} = \pi$$

chap 6, sec 6.5 cont'd

9) cont'd
 Cauchy p.v. $\lim_{L \rightarrow \infty} \int_{-L}^L \frac{1}{1+x^2} dx = \lim_{L \rightarrow \infty} \tan^{-1} L + \tan^{-1} L = \pi$

d) $\int_{-a}^b f(x) dx = \text{exists}$. The preceding
 $\lim_{a \rightarrow \infty}$
 $\lim_{b \rightarrow \infty}$ must also exist if $a=b=L$

thus $\lim_{L \rightarrow \infty} \int_{-L}^L f(x) dx$ exists.

10) $f(x) = \frac{1}{x^2+1} = f(-x) \therefore$ true

11) $f(x) = \frac{1}{x^2+x+1}$, $f(-x) = \frac{1}{x^2-x+1} \neq f(x)$
 \therefore untrue

12) $f(x) = \frac{\cos x}{x^2+1} = f(-x) \therefore$ true

13) $f(x) = \frac{\tanh x}{x^2+1} = -f(-x)$ Note $\int_{-\infty}^{\infty} \frac{\tanh x}{x^2+1} dx = 0$
un true since $f(x) \neq f(-x)$

14) $f(x) = \frac{x}{x^2+1} = -f(-x) \therefore$ true

15) $\int_{-\infty}^{\infty} \frac{x+1}{x^2+1} dx = \int_{-\infty}^{\infty} \frac{x}{x^2+1} dx + \int_{-\infty}^{\infty} \frac{dx}{x^2+1} =$

$\int_{-\infty}^{\infty} \frac{dx}{x^2+1} \neq 0 \therefore$ untrue [odd sym]

16) $\int_{-\infty}^{\infty} \frac{1+\sin x}{x^2+x^2+1} dx = \int_{-\infty}^{\infty} \frac{1}{x^2+x^2+1} dx + \int_{-\infty}^{\infty} \frac{\sin x}{x^2+x^2+1} dx$

$\int_{-\infty}^{\infty} \frac{1+\sin x}{x^2+x^2+1} dx = \int_{-\infty}^{\infty} \frac{1}{x^2+x^2+1} dx \neq 0$ untrue odd func.

Sec 6.5 cont'd

17) Note that $\frac{x \sin(x^2)}{x^4 + x^2 + 1}$ is an odd function!

$$\therefore \int_{-\infty}^{\infty} \frac{x \sin(x^2)}{x^4 + x^2 + 1} dx = 0 \quad \boxed{\text{true}}$$

$$18) \int_{-\infty}^{\infty} \frac{x e^{ix}}{x^4 + x^2 + 1} dx = \int_{-\infty}^{\infty} \frac{x [\cos x + i \sin x]}{x^4 + x^2 + 1} dx$$

$$= \int_{-\infty}^{\infty} \frac{x \cos x}{x^4 + x^2 + 1} dx + i \int_{-\infty}^{\infty} \frac{x \sin x}{x^4 + x^2 + 1} dx$$

integrand is odd

$$= i \int_{-\infty}^{\infty} \frac{x \sin x}{x^4 + x^2 + 1} dx \quad \boxed{\text{true}}$$

∴ integral is zero

19) $z^2 + z + 1 = 0 \quad z = \frac{-1 \pm i\sqrt{3}}{2}$

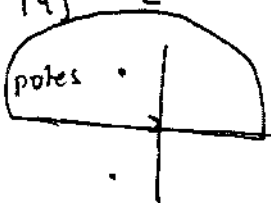

$$\int_{-\infty}^{\infty} \frac{dx}{x^2 + x + 1} = 2\pi i \operatorname{Res} \frac{1}{z^2 + z + 1} @ \frac{-1 + i\sqrt{3}}{2}$$

Residue is $\frac{g}{h'}$ = $\frac{1}{2z+1} \Big|_{\frac{-1 + i\sqrt{3}}{2}} = \frac{1}{i\sqrt{3}}$

Rule 4

$$\text{ans} = \frac{2\pi i}{i\sqrt{3}} = \boxed{\frac{2\pi}{\sqrt{3}}}$$

20) $z^2 + z + 1 = 0, \quad z = \frac{-1 \pm i\sqrt{3}}{2}$ poles. $z = \pm i$ poles

contour \times

$$\int_{-\infty}^{\infty} \frac{dx}{(x^2 + x + 1)(x^2 + 1)} = 2\pi i \sum \operatorname{res} \frac{1}{(z^2 + z + 1)(z^2 + 1)}$$

at $i, \frac{-1 + i\sqrt{3}}{2}$

use g/h' for res. [Rule 4]

$$= 2\pi i \left[\frac{1}{(2z+1)(z^2+1)} \Big|_{\frac{-1 + i\sqrt{3}}{2}} + \frac{1}{(z^2+z+1)(2z)} \Big|_{z=i} \right]$$

sec 6.5 cont'd

20 cont'd

$$= 2\pi i \left[\frac{1}{(i\sqrt{3}) \left(\frac{1}{2} - i\frac{\sqrt{3}}{2}\right)} - \frac{1}{2} \right]$$

$$= 2\pi i \left[\frac{\left(\frac{1}{2} + i\frac{\sqrt{3}}{2}\right)}{i\sqrt{3}} - \frac{1}{2} \right] = \boxed{\frac{\pi}{\sqrt{3}}}$$

21) $\int_0^{\infty} \frac{x^4}{x^6+1} dx = \frac{1}{2} \int_{-\infty}^{\infty} \frac{x^4}{x^6+1} dx$

$z^6 = -1, \quad z = (-1)^{1/6} = 1 \angle 30^\circ, 1 \angle 90^\circ, 1 \angle 150^\circ$
 $1 \angle -30^\circ, 1 \angle -90^\circ, 1 \angle -150^\circ$

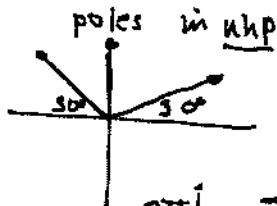

ans = $\frac{2\pi i}{2} \sum \text{res} \frac{z^4}{z^6+1} @ 1 \angle 30^\circ, 1 \angle 90^\circ, 1 \angle 150^\circ$

Use Rule 4, $= \pi i \sum \frac{z^4}{6z^5}$ at 3 poles

$= \frac{\pi i}{6} [1 \angle -30^\circ + 1 \angle -90^\circ + 1 \angle -150^\circ] = \boxed{\frac{\pi}{3}}$

$= -2i$

22) $\int_{-\infty}^{\infty} \frac{x^3+x^2+x+1}{x^4+1} dx = \int_{-\infty}^{\infty} \frac{x^2+1}{x^4+1} dx$

Note $\int_{-\infty}^{\infty} \frac{x^3+x}{x^4+1} dx = 0$ [odd integrand]

$z^4+1=0, \quad z = e^{i\pi/4}, e^{i3\pi/4}$ poles in u.h.p

$\int_{-\infty}^{\infty} \frac{x^2+1}{x^4+1} dx = 2\pi i \sum \text{res} \frac{x^2+1}{x^4+1}$ poles in u.h.p. [simple poles]

$= 2\pi i \left[\sum \frac{x^2+1}{4x^3} \text{ at } e^{i\pi/4}, e^{i3\pi/4} \right]$

$= \frac{2\pi i}{4} [e^{-i\pi/4} + e^{-i3\pi/4} + e^{-i3\pi/4} + e^{-i\pi/4}] = \frac{2\pi i}{4} \frac{(-4i)}{\sqrt{2}} = \boxed{\pi\sqrt{2}}$

continued

$$\begin{aligned}
 \underline{23} \quad \int_0^{\infty} \frac{dx}{(x^2+a^2)^2} &= \frac{1}{2} \int_{-\infty}^{\infty} \frac{dx}{(x^2+a^2)^2} = \\
 \frac{1}{2} 2\pi i \operatorname{Res} \left[\frac{1}{(z^2+a^2)^2}, ai \right] &= \pi i \lim_{z \rightarrow ai} \frac{d}{dz} \frac{(z-ai)^2}{(z-ai)^2(z+ai)^2} \\
 &= \pi i \left. \frac{-2}{(z+ai)^3} \right|_{z=ai} = \frac{-2\pi i}{(2ai)^3} = \boxed{\frac{\pi}{4a^3}}
 \end{aligned}$$

$$\begin{aligned}
 \underline{24} \quad \int_{-\infty}^{\infty} \frac{dx}{(x+a)^2+b^2} \\
 (z+a)^2+b^2=0, \quad (z+a)^2=-b^2 \quad (z+a)=\pm ib \\
 z = -a \pm ib \quad \text{poles} \quad \begin{array}{c} x+b \\ | \\ a \\ \hline \end{array} \quad \text{ans} = 2\pi i \operatorname{Res} \frac{1}{(z+a)^2+b^2} \\
 = \frac{2\pi i}{2(z+a)} \Big|_{-a+ib} = \boxed{\frac{\pi}{b}} \quad \text{at } -a+ib
 \end{aligned}$$

25

$$(z \pm ia)^n = 0$$

$$z = \mp ia$$

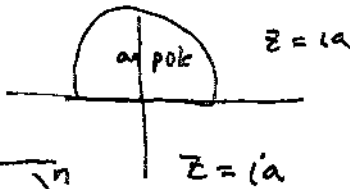

$$\int_{-\infty}^{\infty} \frac{dx}{(x-ia)^n} = 2\pi i \operatorname{Res} \frac{1}{(z-ia)^n}$$

$$= 0 \text{ if } n \geq 2 \quad [\text{one term Laurent Series}]$$

suppose $\lim_{n \rightarrow \infty} \int_{-\infty}^{\infty} \frac{dx}{(x+ia)^n} = 0$ since $\frac{1}{(z+ia)^n}$ is analytic on and inside C .

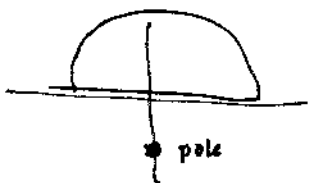

26

$$\int_{-\infty}^{+\infty} \frac{x^3 + x^2}{(x^2+1)(x^2+4)} dx$$

degree of denom = 4
degree of num = 3

theorem does not apply since $4-3=1$. We require a difference of at least 2.

$$\int_{-\infty}^{\infty} \frac{x^3 + x^2}{(x^2+1)(x^2+4)} dx = \lim_{L \rightarrow \infty} \int_{-L}^L \frac{x^3}{(x^2+1)(x^2+4)} dx + \lim_{L \rightarrow \infty} \int_{-L}^L \frac{x^2}{(x^2+1)(x^2+4)} dx$$

odd funct. $\rightarrow 0$

$$\text{Thus, } \int_{-\infty}^{+\infty} \frac{(x^3 + x^2) dx}{(x^2+1)(x^2+4)} = \int_{-\infty}^{+\infty} \frac{x^2 dx}{(x^2+1)(x^2+4)} =$$

$$2\pi i \operatorname{Res} \frac{z^2}{(z^2+1)(z^2+4)} \text{ at } i, 2i = 2\pi i \left[\frac{-1}{6i} + \frac{1}{3i} \right] = \boxed{\frac{\pi}{2}}$$

Sec 6.5 cont'd

27) a) $\int_0^{\infty} \frac{dx}{(x^2+a^2)(x^2+b^2)} = \frac{1}{2} 2\pi i \stackrel{\text{res.}}{=} \frac{1}{(z^2+a^2)(z^2+b^2)}$
at ai, ib

ASSUME first $a \neq b$

$$= \frac{1}{2} * 2\pi i \left[\frac{1}{(aia)(b^2-a^2)} + \frac{1}{(aib)(a^2-b^2)} \right] =$$

$$\frac{\pi}{a} \left[\frac{1}{(b^2-a^2)} \left(\frac{1}{a} - \frac{1}{b} \right) \right] = \frac{\pi}{a} \left[\frac{1}{(b^2-a^2)} \frac{b-a}{ab} \right] = \frac{\pi}{2(b+a)(ab)}$$

ASSUME $a = b$, Have pole order 2 at $z = ai$

$$\int_0^{\infty} \dots dx = \frac{1}{2} * 2\pi i \lim_{z \rightarrow ai} \frac{d}{dz} \frac{1}{(z+ia)^2} = \frac{\pi}{4a^3}$$

This result can be obtained by putting $b \rightarrow a$ in the original answer $\frac{\pi}{2(b+a)(ab)}$

```

b) % problem 27_b section 6.5
syms a b positive
syms x
f=1/(x^2+a^2)*1/(x^2+b^2);
int(f,0,inf)
pretty(ans)
f=1/(x^2+a^2)*1/(x^2+a^2);
int(f,0,inf)
pretty(ans)
    
```

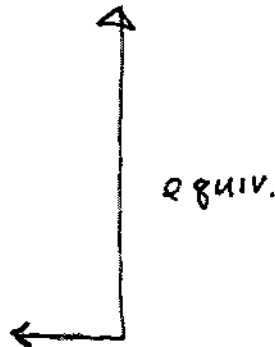

$$\frac{1}{2} \frac{\pi}{a^2(-a^2+b^2)} + \frac{1}{2} \frac{\pi}{(-b^2+a^2)b^2}$$

note the tilde ~ reminds us that a and b are reals.

computer output when $b = a$

$$\frac{1}{4} \frac{\pi}{a^3}$$

28] $\int_{-\infty}^{+\infty} \frac{dx}{ax^2+bx+c} = 2\pi i \operatorname{Res} \frac{1}{az^2+bz+c} \text{ at } z = \frac{-b+i\sqrt{4ac-b^2}}{2a}$ sec 6.5 cont'd

$$\int_{-\infty}^{+\infty} \frac{dx}{ax^2+bx+c} = \frac{2\pi i}{2az+b} \Big|_{z = \frac{-b+i\sqrt{4ac-b^2}}{2a}}$$

$$= \frac{2\pi}{\sqrt{4ac-b^2}}$$

29] Refer to 28, Now have 2nd order pole

$$\int_{-\infty}^{+\infty} \frac{dx}{(ax^2+bx+c)^2} = 2\pi i \lim_{z \rightarrow \frac{-b+i\sqrt{4ac-b^2}}{2a}} \frac{1}{a^2} \frac{d}{dz} \left[\frac{1}{z - \frac{(b-i\sqrt{4ac-b^2})}{2a}} \right]^2$$

$$= \frac{2\pi i}{a^2} \lim_{z \rightarrow \frac{-b+i\sqrt{4ac-b^2}}{2a}} \frac{-2}{\left(z - \left[\frac{-b-i\sqrt{4ac-b^2}}{2a} \right] \right)^3}$$

$$= \frac{4\pi a^3}{a^2 [(4ac-b^2)^{3/2}]} = \frac{4\pi a}{(4ac-b^2)^{3/2}} = \frac{4\pi a}{(\sqrt{4ac-b^2})^3}$$

check $-\frac{d}{dc} \int_{-\infty}^{+\infty} \frac{dx}{ax^2+bx+c} = \int_{-\infty}^{+\infty} \frac{dx}{(ax^2+bx+c)^2}$

$$= -\frac{d}{dc} \frac{2\pi}{\sqrt{4ac-b^2}} = \frac{4\pi a}{(\sqrt{4ac-b^2})^3}$$

30] $\int_0^{\infty} \frac{dx}{x^{100}+1} = \pi i \sum_{\text{res}} \frac{1}{z^{100}+1}$ at poles in uhp.

Where are poles? $z = (-1)^{1/100} = e^{i\frac{\pi}{100}} e^{i2\frac{k\pi}{100}}$
 $k=0,1,\dots,99$

only the poles for $k=0,\dots,49$ are in uhp.

Residue = $\frac{1}{100z^{99}} = \frac{z}{100z^{100}} = \frac{-z}{100}$ at pole.

$$\int_0^{\infty} \frac{dx}{x^{100}+1} = \frac{\pi i}{-100} \sum_{k=0}^{49} e^{i\pi/100} e^{i\frac{2k\pi}{100}}$$

30) cont'd

$$\sum_{k=0}^{49} e^{i2k\pi/100} = \sum_{k=0}^{49} \left[e^{i\frac{2\pi}{100}} \right]^k = \text{SUM Geom. Series}$$

$$= \frac{1 - \left(e^{i\frac{2\pi}{100}} \right)^{50}}{1 - e^{i2\pi/100}} = \frac{2}{1 - e^{-i\frac{2\pi}{100}}} = \frac{2e^{-i\pi/100}}{-2i \sin\left[\frac{\pi}{100}\right]}$$

Thus: $\int_0^{\infty} \frac{dx}{x^{100}+1} = \frac{\pi i}{-100} \frac{e^{i\pi/100}}{2} e^{-i\pi/100} = \frac{\pi}{100}$

31)

$$\int_{-\infty}^{+\infty} \frac{dx}{x^4+x^3+x^2+x+1} = \int_{-\infty}^{+\infty} \frac{1-x}{1-x^5} dx = \frac{-2i \sin\left[\frac{\pi}{5}\right]}{\sin\left[\frac{\pi}{5}\right]}$$

$2\pi i \sum \text{res } \frac{1-z}{1-z^5}$ poles in uhp

$z^5=1, z=1^{1/5},$ poles in uhp : $\text{cis}\left[\frac{2\pi}{5}\right], \text{cis}\left[\frac{4\pi}{5}\right]$

$$= 2\pi i \sum \frac{[1-z]}{-5z^4} \quad z = \text{cis}\left[\frac{2\pi}{5}\right], z = \text{cis}\left[\frac{4\pi}{5}\right]$$

$$\sum 2\pi i \frac{z[1-z]}{-5z^5} = \sum \frac{2\pi i [z[1-z]]}{-5} \left[z = \text{cis}\left[\frac{2\pi}{5}\right], \text{cis}\left[\frac{4\pi}{5}\right] \right]$$

$$= \frac{2\pi i}{5} \left[\text{cis}\left[\frac{2\pi}{5}\right] \left[\text{cis}\left[\frac{2\pi}{5}\right] - 1 \right] + \text{cis}\left[\frac{4\pi}{5}\right] \left[\text{cis}\left[\frac{4\pi}{5}\right] - 1 \right] \right]$$

$$= \frac{2\pi i}{5} \left[\text{cis}\left[\frac{8\pi}{5}\right] - \text{cis}\left[\frac{2\pi}{5}\right] \right] = \frac{4\pi}{5} \sin\left[\frac{2\pi}{5}\right]$$

32)

$$\int_{-\infty}^{\infty} \frac{P(x)}{Q(x)} dx = -2\pi i \sum_{\text{res}} \frac{P(z)}{Q(z)} \text{ all poles in l.h.p.}$$

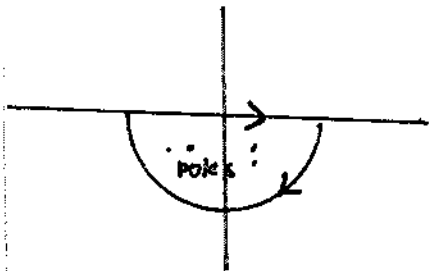

minus sign due to
neg. direction of
integration

33

$$(a) \int_{-\infty}^{+\infty} \frac{x^2}{x^4+1} dx = -2\pi i \sum_{\text{res}} \frac{z^2}{z^4+1} =$$

$$\sum -\frac{2\pi i}{4z} \text{ at } e^{-i\pi/4}, e^{-i3\pi/4} = \frac{\pi}{2i} \left[e^{i\pi/4} + e^{i3\pi/4} \right]$$

$$= \frac{\pi}{2i} \sqrt{2} i = \frac{\pi}{\sqrt{2}}$$

$$(b) \int_{-\infty}^{+\infty} \frac{x^2}{x^4+x^2+1} dx = -2\pi i \sum_{\text{res}} \frac{z^2}{z^4+z^2+1} \text{ at } e^{-i\pi/3}$$

$$= -2\pi i \sum \frac{z^2}{4z^3+2z} = -2\pi i \sum \frac{z}{4z^2+2} \text{ at poles in l.h.p.}$$

$$= -2\pi i \left[\frac{e^{-i\pi/3}}{4 * e^{-i2\pi/3} + 2} + \frac{e^{-i2\pi/3}}{4 * e^{-i4\pi/3} + 2} \right] = \frac{\pi}{\sqrt{3}}$$

34

$$\int_{-\infty}^{+\infty} \frac{2 dx}{e^x + e^{-x}} = 2 \int_0^{\infty} \frac{dx}{x(x+1/x)}$$

$$x = e^u, dx = e^u du, du = \frac{dx}{x}$$

$$2 \int_0^{\infty} \frac{dx}{x^2+1} = \int_{-\infty}^{+\infty} \frac{dx}{x^2+1} = 2\pi i \text{Res} \frac{1}{z^2+1} \Big|_{at i}$$

$$= \frac{2\pi i}{2i} = \pi$$

35

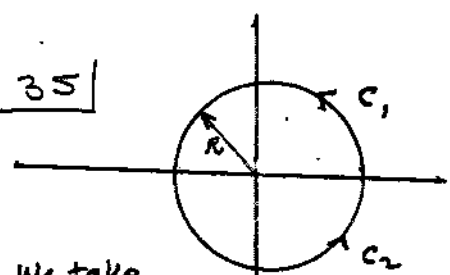

We take R large enough so that all poles are enclosed.

C_1 is $^{\text{arc}} |z|=R, \text{Im} z \ge 0$
 C_2 is $|z|=R, \text{Im} z \le 0$

$$\frac{1}{2\pi i} \oint_{|z|=R} f(z) dz = \sum_{\text{all poles}} \frac{P(z)}{Q'(z)}$$

$$\frac{1}{2\pi i} \int_{C_1} f(z) dz + \frac{1}{2\pi i} \int_{C_2} f(z) dz = \sum_{\text{all poles}} \frac{P(z)}{Q'(z)}$$

Sec 6.5

35

cont'd

letting $R \rightarrow \infty$ $\int_{C_1} f(z) dz \rightarrow 0$ see Eg 6.5-10
 and similarly $\int_{C_2} f(z) dz \rightarrow 0$ (its counterpart in lower half plane)

thus $0 = \sum_{\text{res}} \frac{P(z)}{Q(z)}$

(b) poles are at $z^3 = -1$, $z = -1$,
 $z = \text{cis}(\frac{\pi}{3})$, $z = \text{cis}(\frac{-\pi}{3})$

Residue: $\frac{z}{3z^2} = \frac{1}{3z}$

$\sum_{\text{residues}} = -\frac{1}{3} + \frac{1}{3 \text{cis}(\frac{\pi}{3})} + \frac{1}{3 \text{cis}(\frac{-\pi}{3})} =$

$\frac{1}{3} [1 + \text{cis}(\frac{-\pi}{3}) + \text{cis}(\frac{\pi}{3})] = 0$

36

(a) Note that $\int_0^{\infty} \frac{x}{x^4+1} dx \neq \frac{1}{2} \int_{-\infty}^{\infty} \frac{x}{x^4+1} dx$

We do not have necessary symmetry, method does not apply.

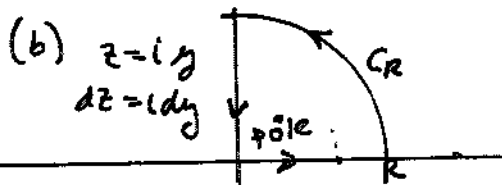

$\int_0^R \frac{x dx}{x^4+1} + \int_{C_R} \frac{z dz}{z^4+1} + \int_R^0 \frac{i y i dy}{(iy)^4+1} = 2\pi i \text{Res} \frac{z}{z^4+1}$
 at pole in first quad.

as $R \rightarrow \infty$ $\int \frac{z dz}{z^4+1} \rightarrow 0$ [use ML inequality]

(c) $\int_0^{\infty} \frac{x dx}{x^4+1} + \int_R^0 \frac{-iy dy}{y^4+1} = 2\pi i \frac{z}{4z^3} \Big|_{z=e^{i\pi/4}}$

$2 \int_0^{\infty} \frac{x dx}{x^4+1} = \frac{\pi}{2}$, $\int_0^{\infty} \frac{x dx}{x^4+1} = \frac{\pi}{4} = \frac{\pi}{2}$

sec 6.5

37)(a)

$$P = a_n z^n + a_{n-1} z^{n-1} + \dots + a_0$$

$$|P| \leq |a_n z^n| + |a_{n-1} z^{n-1}| + |a_{n-2} z^{n-2}| + \dots + |a_0|$$

$$\leq |A z^n| + |A z^{n-1}| + \dots + |A z^0| \leq \underbrace{|A z^n| + |A z^{n-1}| + \dots + |A z^0|}_{n+1 \text{ terms}}$$

note $|z| \geq 1$

$$= (n+1) A |z|^n$$

(b) To prove that $|g| \geq 1 - \left| \frac{b_{m-1}}{b_m z} + \frac{b_{m-2}}{b_m z^2} + \dots + \frac{b_0}{b_m z^m} \right| \geq 0$

we must show that $\left| \frac{b_{m-1}}{b_m} \frac{1}{z} + \frac{b_{m-2}}{b_m z^2} + \dots + \frac{b_0}{b_m z^m} \right| \leq 1$
for $|z| \geq 2mB$.

Now $\left| \frac{b_{m-1}}{b_m} \frac{1}{z} + \frac{b_{m-2}}{b_m} \frac{1}{z^2} + \dots + \frac{b_0}{b_m z^m} \right| \leq \left| \frac{b_{m-1}}{b_m} \left| \frac{1}{z} \right| + \dots + \frac{|b_0|}{|b_m| |z|^m} \right|$

$$\leq \left| \frac{b_{m-1}}{b_m} \frac{1}{|z|} + \dots + \frac{|b_0|}{|b_m| |z|^m} \right| \quad \text{since } |z| \geq 1$$

Now $\frac{1}{|z|} \leq \frac{1}{2mB}$, $\frac{1}{|z|^2} \leq \frac{1}{2m^2}$. Thus $\left| \frac{b_{m-1}}{b_m} \frac{1}{|z|} \right| \leq \frac{1}{2m}$ etc.

$$\left| \frac{b_{m-1}}{b_m} \frac{1}{z} + \frac{b_{m-2}}{b_m} \frac{1}{z^2} + \dots + \frac{b_0}{b_m z^m} \right| \leq \underbrace{\frac{1}{2m} + \frac{1}{2m} + \dots + \frac{1}{2m}}_{m \text{ terms}} = \frac{1}{2}$$

as req'd.

Thus $|g| \geq 1 - \left| \frac{b_{m-1}}{b_m z} + \frac{b_{m-2}}{b_m z^2} + \dots + \frac{b_0}{b_m z^m} \right|$

Since $\left| \frac{b_{m-1}}{b_m z} + \frac{b_{m-2}}{b_m z^2} + \dots + \frac{b_0}{b_m z^m} \right| \leq \frac{1}{2}$

$|g| \geq \frac{1}{2}$ for $|z| \geq 2mB$

(c) $Q(z) = b_m z^m g(z)$, $|Q| = |b_m| |z|^m |g(z)|$

$|Q| \geq |b_m| |z|^m \frac{1}{2}$ $|z| \geq 2mB$

(d) $\left| \frac{P}{Q} \right| \leq \frac{(n+1) A |z|^n}{|b_m| |z|^m \frac{1}{2}} = \frac{2(n+1) A}{|b_m| |z|^{m-n}}$

$d = m-n$ q.e.d

38

$$z = r e^{i \frac{2\pi}{n}}$$

$$z^n = r^n e^{i 2\pi}$$

$$dz = r e^{i \frac{2\pi}{n}} dr$$

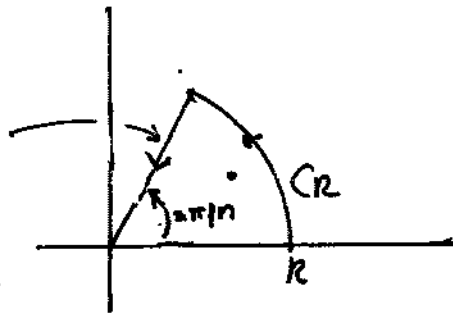

poles:

$$z^{n+1} = 0$$

$$z = (-1)^{1/n}$$

$$= \text{cis}\left(\frac{\pi}{n}\right) \text{cis}\left[\frac{2\pi k}{n}\right]$$

$k=0, \dots, n-1$

the only pole enclosed

is that at $\text{cis}\left(\frac{\pi}{n}\right)$

$$\int_0^R \frac{x^m dx}{x^{n+1}} + \int_{C_R} \frac{z^m dz}{z^{n+1}} + \int_R^0 \frac{r^m e^{i \frac{2\pi m}{n}}}{r^{n+1}} dr e^{i \frac{2\pi}{n}}$$

$$= 2\pi i \frac{z^m}{n z^{n-1}} \Big|_{z = \text{cis}\left(\frac{\pi}{n}\right)} = \frac{2\pi i z^{m+1}}{n z^n \text{cis}\left(\frac{\pi}{n}\right)}$$

$$= -\frac{2\pi i}{n} \text{cis}\left[\frac{\pi}{n}\right] (m+1)$$

let $R \rightarrow \infty$, integral on $C_R \rightarrow 0$

$$\int_0^\infty \frac{x^m dx}{x^{n+1}} \left[1 - e^{i \frac{2\pi(m+1)}{n}} \right] = -\frac{2\pi i}{n} e^{i \frac{\pi}{n} (m+1)}$$

$$\int_0^\infty \frac{x^m dx}{x^{n+1}} = \frac{2\pi i e^{i \frac{\pi}{n} (m+1)}}{(m) \left[e^{i \frac{2\pi}{n} (m+1)} - 1 \right]} = \frac{\pi}{(n) \left[\sin \frac{\pi}{n} (m+1) \right]}$$

39

a)

$$\int_0^\infty \frac{u^{l-1} du}{u^{lk+1}} = \int_0^\infty \frac{x^l x^{l-1} dx}{x^{lk+1}} = \int_0^\infty \frac{x^l dx}{x^{lk+1}}$$

$x = u^{1/l}, x^l = u, u^{1/l} = x^{1/l}, du = \frac{1}{l} x^{l-1} dx$

Now use: result of 38, taking $m=l, n=lk$

$$\int_0^\infty \frac{u^{l-1} du}{u^{lk+1}} = \frac{l}{lk} \frac{\pi}{\sin \left[\frac{\pi}{lk} (l+1) \right]} = \frac{\pi}{k \sin \left[\frac{\pi (l+1)}{lk} \right]}$$

lk-22

39 (b)

Chap 6, Sec 6.5 cont'dtake $l=4, k=5$

$$\int_0^{\infty} \frac{u^{l-1}}{u^k+1} du = \frac{\pi}{(k) \sin\left[\frac{\pi}{20} \cdot 5\right]} =$$
$$\frac{\pi}{5 \sin\left(\frac{\pi}{4}\right)} = \boxed{\frac{\sqrt{2}\pi}{5}}$$

Sec 6.6

1) $z^2 + 9 = 0, z = \pm 3i$



$$\int_{-\infty}^{\infty} \frac{\cos 2x}{x^2 + 9} dx = \text{Re } 2\pi i \text{ Res } \frac{e^{i2z}}{z^2 + 9} \text{ at } 3i$$

$$= \text{Re } 2\pi i \left. \frac{e^{i2z}}{2z} \right|_{3i} = \text{Re } \frac{\pi}{3} e^{-6} = \boxed{\frac{\pi}{3} e^{-6}}$$

2) $\int_{-\infty}^{\infty} \frac{x \sin 2x}{x^2 + 3} dx = \text{Im } 2\pi i \text{ Res } \frac{ze^{i2z}}{z^2 + 3} \text{ at } \sqrt{3}i$

$$\text{Im } \left. \frac{2\pi i z e^{i2z}}{2z} \right|_{z=\sqrt{3}i} = \boxed{\pi e^{-2\sqrt{3}}}$$

3) $\int_{-\infty}^{\infty} \frac{x e^{cx}}{(x-1)^2 + 9} dx = 2\pi i \text{ Res } \frac{ze^{cz}}{(z-1)^2 + 9} \text{ @ } z = 1 + 3i$

$(z-1)^2 = -9$

$z-1 = \pm 3i, z = 1 + 3i \text{ in uhp.}$

$$= \pi \left. \frac{ze^{cz}}{2(z-1)} \right|_{1+3i} = \frac{\pi(1+3i)e^{c(1+3i)}}{3}$$

$$= \boxed{\left(\frac{1+i}{\sqrt{3}} \right) e^{-3} e^i \pi}$$

4) $\int_0^{\infty} \frac{x^3 \sin(2x)}{x^4 + 16} dx = \frac{1}{2} \text{Im } 2\pi i \sum_{\text{res}} \frac{z^3 e^{i2z}}{z^4 + 16} \text{ at poles in uhp}$

$z^4 = -16, z^2 = \pm 4i, z = 2 \angle \pi/4 \text{ in uhp}$
 $z = 2 \angle 3\pi/4 \text{ in uhp}$

$$= \text{Im } \pi i \sum \frac{z^3}{4z^3} e^{i2z} \text{ in uhp}$$

$$= \text{Im } \frac{\pi i}{4} \left[e^{i2(2) \left[\frac{1+i}{\sqrt{2}} \right]} + e^{i2(2) \left[\frac{-1+i}{\sqrt{2}} \right]} \right]$$

$$= \text{Im } \frac{\pi i}{4} \left[e^{i2\sqrt{2} [1+i]} + e^{i2\sqrt{2} [-1+i]} \right]$$

$$= \text{Im } \frac{\pi i}{4} \left[e^{-2\sqrt{2}} 2 \cos(2\sqrt{2}) \right] = \boxed{\frac{\pi}{2} e^{-2\sqrt{2}} \cos(2\sqrt{2})}$$

sec 6.6 continued

$$5) \int_{-\infty}^{\infty} \frac{x \sin 2x}{x^2 + x + 1} dx = \text{Im } 2\pi i \text{ Res } \frac{z e^{i2z}}{z^2 + z + 1}$$

at $-\frac{1}{2} + \frac{i\sqrt{3}}{2}$

$$\left[z^2 + z + 1 = 0, z = \frac{-1 + i\sqrt{3}}{2} \text{ in uhp} \right]$$

$$= \text{Im } 2\pi i \frac{z e^{i2z}}{2z+1} \Big|_{z = \frac{-1 + i\sqrt{3}}{2}} = \text{Im } \frac{2\pi i e^{-\sqrt{3}-i}}{\sqrt{3}} \left(-\frac{1}{2} + \frac{i\sqrt{3}}{2} \right)$$

$$= \text{Im } \frac{2\pi}{\sqrt{3}} e^{-\sqrt{3}} e^{-i} e^{i2\pi/3} = \boxed{\frac{2\pi}{\sqrt{3}} e^{-\sqrt{3}} \sin\left(\frac{2\pi}{3} - 1\right)}$$

$$6) \int_{-\infty}^{\infty} \frac{(x-1) \cos 2x}{x^2 + x + 1} dx = \text{Re } 2\pi i \text{ Res } \frac{(z-1) e^{i2z}}{z^2 + z + 1}$$

$z = \frac{-1 + i\sqrt{3}}{2}$ uhp pole

$$= \text{Re } 2\pi i \frac{(z-1) e^{i2z}}{(2z+1)} \Big|_{z = \frac{-1 + i\sqrt{3}}{2}} =$$

$$\text{Re } 2\pi i \frac{\left[\frac{-3 + i\sqrt{3}}{2} \right] e^{i[-1 + i\sqrt{3}]}}{i\sqrt{3}} =$$

$$\text{Re } \frac{\pi i \left[-3 + i\sqrt{3} \right] e^{-i} e^{-\sqrt{3}}}{i\sqrt{3}} = \text{Re} \left[\pi \left[-\sqrt{3} + i \right] e^{-\sqrt{3}} e^{-i} \right]$$

$$= \text{Re} \left[\pi \left(-\sqrt{3} + i \right) e^{-\sqrt{3}} \left(\cos 1 - i \sin 1 \right) \right] =$$

$$- \pi \sqrt{3} e^{-\sqrt{3}} \cos 1 + \pi e^{-\sqrt{3}} \sin 1 = \pi e^{-\sqrt{3}} \left[\sin 1 - \sqrt{3} \cos 1 \right]$$

$$7) \int_{-\infty}^{\infty} \frac{(x^3 + x^2) \cos(\sqrt{2}x)}{x^4 + 1} dx = \int_{-\infty}^{\infty} \frac{x^2}{x^4 + 1} \cos(\sqrt{2}x) dx$$

because $\frac{x^3}{x^4 + 1} \cos(\sqrt{2}x)$ is an odd function

$$\int_{-\infty}^{\infty} \frac{x^2}{x^4 + 1} \cos(\sqrt{2}x) dx = \text{Re } 2\pi i \sum \frac{z^2}{z^4 + 1} e^{i\sqrt{2}z}$$

in uhp = $\left[\frac{1}{\sqrt{2}} + \frac{i}{\sqrt{2}} \right]$
at $e^{i\pi/4}$ and $e^{i3\pi/4}$

$$= \text{Re} \left[\frac{\pi i}{2} \left(e^{i(1+i-\pi/4)} + e^{i(-1+i-3\pi/4)} \right) \right]$$

$$= \text{Re} \left[\frac{\pi i}{2} e^{-1} \left[\frac{2i \sin 1}{\sqrt{2}} - \frac{2i \cos 1}{\sqrt{2}} \right] \right]$$

$$= \boxed{\frac{\pi}{\sqrt{2}} e^{-1} \left[\cos 1 - \sin 1 \right]}$$

Sec 6.6

$$8) \int_{-\infty}^{\infty} \frac{x e^{i x/3}}{(x-i)^2+4} dx = \pi i \operatorname{Res} \frac{z e^{i z/3}}{(z-i)^2+4} \quad z = 3i$$

$$(z-i)^2 = -4, (z-i) = \pm 2i, z = 3i, \bar{z} = -i$$

$$= 2\pi i \left. \frac{z e^{i z/3}}{2(z-i)} \right|_{z=3i} = \frac{2\pi i \cdot 3i e^{-1}}{(2)2i} = \frac{3\pi i e^{-1}}{2}$$

$$9) z^4 + z^2 + 1 = 0 \quad z^2 = \frac{-1 \pm \sqrt{3}}{2} = e^{i \frac{2\pi}{3}}, e^{-i \frac{2\pi}{3}}$$

$$z = e^{i \pi/3} \text{ in uhp, } e^{i 2\pi/3} \text{ in uhp}$$

$$\int_{-\infty}^{\infty} \frac{x e^{i x}}{x^4 + x^2 + 1} dx = 2\pi i \sum_{\text{res}} \frac{z e^{i z}}{z^4 + z^2 + 1} \text{ at } e^{i \pi/3} \text{ and } e^{i 2\pi/3}$$

$$= 2\pi i \sum \frac{z e^{i z}}{4z^3 + 2z} = \frac{2\pi i}{2} \sum \frac{e^{i z}}{2z^2 + 1} \text{ at } e^{i \pi/3}, e^{i 2\pi/3}$$

$$= \pi i \left[\frac{e^{i[\frac{1}{2} + i\sqrt{3}/2]}}{2e^{i 2\pi/3} + 1} + \frac{e^{i[-\frac{1}{2} + i\sqrt{3}/2]}}{2e^{i 4\pi/3} + 1} \right]$$

$$= \pi i \left[e^{-\sqrt{3}/2} \right] \left[\frac{e^{i/2}}{i\sqrt{3}} + \frac{e^{-i/2}}{-i\sqrt{3}} \right] = \frac{2\pi i e^{-\sqrt{3}/2}}{\sqrt{3}} i \sin\left(\frac{1}{2}\right)$$

$$10) \int_0^{\infty} \frac{x \sin x}{(x^2+1)(x^2+16)} dx = \operatorname{Im} 2\pi i \operatorname{Res} \frac{z e^{i z}}{(z^2+1)(z^2+16)}$$

$$z = \pm i, z = \pm 4i \text{ poles}$$

at poles at
i and 4i

$$= \operatorname{Im} \frac{2\pi i}{2} \left[\frac{z e^{i z}}{(2z)(z^2+16)} \Big|_{z=i} + \frac{z e^{i z}}{(z^2+1)(2z)} \Big|_{z=4i} \right]$$

$$= \operatorname{Im} \frac{2\pi i}{2} \left[\frac{e^{-1}}{15} + \frac{e^{-4}}{-15} \right] = \frac{\pi}{30} [e^{-1} - e^{-4}]$$

sec 6.6

$$11) \int_0^{\infty} \frac{x^2 \cos x}{(x^2+1)(x^2+16)} dx = \frac{1}{2} \operatorname{Re} 2\pi i \left[\sum_{\text{res}} \frac{z^2 e^{iz}}{(z^2+1)(z^2+16)} \right]$$

Poles in uhp

$$= \operatorname{Re} \left[\pi i \left(\frac{z^2 e^{iz}}{(2z)(z^2+16)} \Big|_{z=i} + \frac{z^2 e^{iz}}{(z^2+1)(2z)} \Big|_{z=4i} \right) \right]$$

$$= \operatorname{Re} \left[\pi i \left[\frac{i}{2} \frac{e^{-1}}{15} + \frac{4i}{2} \frac{e^{-4}}{(-15)} \right] \right] =$$

$$\frac{\pi}{2} \left[\frac{4}{15} e^{-4} - \frac{1}{15} e^{-1} \right]$$

$$12) \int_{-\infty}^{\infty} \frac{(x^3+x^2+x) \sin\left(\frac{x}{2}\right)}{(x^2+1)(x^2+4)} dx = \int_{-\infty}^{\infty} \frac{(x^3+x) \operatorname{Im}\left(\frac{e^{ix/2}\right)}{(x^2+1)(x^2+4)} dx$$

$\frac{\operatorname{Im}\left(\frac{x^3+x}{(x^2+1)(x^2+4)} e^{ix/2}\right)}{(x^2+1)(x^2+4)}$ is an odd function.

$$= \operatorname{Im} 2\pi i \sum_{\text{res}} \frac{(z^3+z) e^{iz/2}}{(z^2+1)(z^2+4)} \text{ at } i, 2i$$

$$= \operatorname{Im} 2\pi i \left[\frac{z^3+z}{(2z)(z^2+4)} e^{iz/2} \Big|_{z=i} + \frac{(z^3+z) e^{iz/2}}{(z^2+1)(2z)} \Big|_{z=2i} \right]$$

$$= \operatorname{Im} \frac{2\pi i}{2} \left[\frac{-1+i}{3} e^{-1/2} + \frac{-4+1}{(-3)} e^{-1} \right] = \boxed{\pi e^{-1}}$$

$$13) \int_{-\infty}^{\infty} \frac{\cos x}{(x^2+4)^2} dx = \operatorname{Re} \frac{2\pi i}{2} \operatorname{Res} \frac{e^{iz}}{(z^2+4)^2} \text{ at } 2i \text{ [pole order 2]}$$

$$= \operatorname{Re} \pi i \frac{d}{dz} \frac{e^{iz}}{(z+2i)^2} = \operatorname{Re} \pi i \left[\frac{ie^{iz}(z+2i)^2 - 2(z+2i)e^{iz}}{(z+2i)^4} \right] =$$

$$= \operatorname{Re} \pi i \left[\frac{ie^{-2}(4i)^2 - 2(4i)e^{-2}}{(4i)^4} \right] =$$

$$\operatorname{Re} \left[\pi i \left[\frac{-16e^{-2} - 8ie^{-2}}{16 \times 16} \right] \right] = \frac{\pi 24}{16 \times 16} e^{-2} = \boxed{\frac{3\pi}{32} e^{-2}}$$

14]

Sec 6.6

$$\sin(mx) \sin(nx) = \frac{1}{2} [\cos(m-n)x - \cos(m+n)x]$$

$$\int_0^{\infty} \frac{\sin(mx) \sin(nx)}{a^2 + x^2} dx = \frac{1}{2} \int_0^{\infty} \frac{\cos(m-n)x}{a^2 + x^2} dx$$

$$- \frac{1}{2} \int \frac{\cos(m+n)x}{a^2 + x^2} dx = \frac{1}{4} \left[\int_{-\infty}^{+\infty} \frac{\cos(m-n)x}{a^2 + x^2} dx \right.$$

$$\left. - \int_{-\infty}^{+\infty} \frac{\cos(m+n)x}{a^2 + x^2} dx \right] = \operatorname{Re} \frac{2\pi i}{4} \left[\operatorname{res} \frac{e^{i(m-n)z}}{a^2 + z^2} \Big|_{ia} \right.$$

$$\left. - \operatorname{res} \frac{e^{i(m+n)z}}{a^2 + z^2} \Big|_{ia} \right] = \frac{\pi i}{2} \left[\frac{e^{-(m-n)a}}{2ia} \right.$$

$$\left. - \frac{e^{-(m+n)a}}{2ia} \right] = \frac{\pi}{2a} e^{-ma} \left[\frac{e^{na} - e^{-na}}{2} \right]$$

$$= \frac{\pi}{2a} e^{-ma} \sinh(na)$$

15) $\frac{\cos x}{x^2+1}$ is an even function of x

$$\text{Thus } \int_0^{\infty} \frac{\cos x}{x^2+1} dx = \frac{1}{2} \int_{-\infty}^{+\infty} \frac{\cos x}{x^2+1} dx \text{ which}$$

can be evaluated with Eq. (6.6-12a),

Now $\frac{\sin x}{x^2+1}$ is an odd function of x

$$\text{Thus } \int_0^{\infty} \frac{\sin x}{x^2+1} dx \neq \frac{1}{2} \int_{-\infty}^{+\infty} \frac{\sin x}{x^2+1} dx$$

and we cannot use Eq (6.6-12b) to solve our problem.

Sec 6.6

16]

a) If $|f(z)| \leq \frac{\mu}{|z|^k}$ for all $|z| \geq R_0$ in lower half plane

then:

$$\lim_{R \rightarrow \infty} \int_{C_2} f(z) e^{i\nu z} dz \text{ for } \nu < 0 = 0$$

Proof is similar to Eqn (6.6-4)

$$\int_{-R}^R \frac{P(x)}{Q(x)} e^{i\nu x} dx + \int_{C_2} \frac{P(z)}{Q(z)} e^{i\nu z} dz = -2\pi i \sum_{\text{res}} \frac{P}{Q} e^{i\nu z}$$

poles in lhp
MINUS sign since poles enclosed in neg. sense

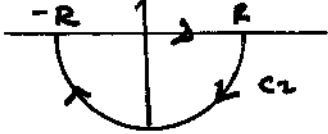

Contour closed semi-circle,

let $R \rightarrow \infty$ in the preceding eqn. Thus $\int_{C_2} \dots dz \rightarrow 0$

$$\int_{-\infty}^{+\infty} \frac{P(x)}{Q(x)} e^{i\nu x} dx = -2\pi i \sum_{\text{res}} \frac{P(z)}{Q(z)} e^{i\nu z}$$

$$\int_{-\infty}^{+\infty} \frac{P}{Q} [\cos \nu x + i \sin \nu x] dx = -2\pi i \sum_{\text{res}} \frac{P}{Q} e^{i\nu z}$$

poles in l.h.p.

(c) separate real + imag parts

$$\int_{-\infty}^{+\infty} \frac{P}{Q} \cos \nu x dx = \text{Re} \left[-2\pi i \sum_{\text{res}} \frac{P}{Q} e^{i\nu z} \right]$$

poles, lhp

$$\int_{-\infty}^{+\infty} \frac{P}{Q} \sin \nu x dx = \text{Im} \left[\text{the above} \right]$$

d) For $\omega < 0$,



poles at $\frac{-1-i}{\sqrt{2}}$ $\frac{1-i}{\sqrt{2}}$

$$\int_{-\infty}^{+\infty} \frac{e^{i\omega x}}{x^2+1} dx = -2\pi i \sum_{\text{res}} \frac{e^{i\omega z}}{z^2+1}$$

$$= -\frac{2\pi i}{4} \left[\frac{e^{i\omega z}}{z^2} \Big|_{\frac{-1-i}{\sqrt{2}}} + \frac{e^{i\omega z}}{z^2} \Big|_{\frac{1-i}{\sqrt{2}}} \right] = -\frac{\pi i}{2} \left[e^{\omega/\sqrt{2}} \right] \left[\frac{e^{-i\omega/\sqrt{2}}}{i} + \frac{e^{i\omega/\sqrt{2}}}{-i} \right]$$

sec 6.6

16(d) continued

for $\omega < 0$ $\int_{-\infty}^{\infty} \frac{x e^{i\omega x}}{x^4+1} dx = i\pi e^{\omega/\sqrt{2}} \sin(\omega/\sqrt{2})$

Take Imag part each side

$$\int_{-\infty}^{\infty} \frac{x \sin(\omega x)}{x^4+1} dx = \pi e^{\omega/\sqrt{2}} \sin(\omega/\sqrt{2})$$

Take real part each side

$$\int_{-\infty}^{\infty} \frac{x \cos(\omega x)}{x^4+1} dx = 0 \quad \text{must be}$$

true because integrand is an odd func.
 suppose $\omega = 0$. $\int_{-\infty}^{\infty} \frac{x e^{i\omega x}}{x^4+1} dx = \int_{-\infty}^{\infty} \frac{x}{x^4+1} dx = 0$

Note: if $\omega \leq 0$ $e^{\omega/\sqrt{2}} = e^{-|\omega|/\sqrt{2}}$ odd func.
 \therefore for all $\omega \neq 0$ $\int_{-\infty}^{\infty} \frac{x e^{i\omega x}}{x^4+1} dx = i\pi e^{-|\omega|/\sqrt{2}} \sin(\omega/\sqrt{2})$

The preceding also holds for $\omega = 0$ since the integral on the left is zero [integrand is odd] and $\sin(\omega/\sqrt{2}) = 0$ if $\omega = 0$.

17(a) $\int_{-\infty}^{\infty} \frac{x \sin \omega x}{x^2+1} dx = \text{Im } 2\pi i \text{ Res } \frac{e^{i\omega z}}{z^2+1} \Big|_{z=i}$

$= \text{Im } 2\pi i \frac{e^{i\omega z}}{2z} \Big|_{z=i} = \pi e^{-\omega}$. This was

derived assuming $\omega > 0$. \therefore cannot use when $\omega = 0$.

b) for $\omega < 0$, $\int_{-\infty}^{\infty} \frac{x \sin \omega x}{x^2+1} dx = -\text{Im } 2\pi i \text{ Res } \frac{e^{i\omega z}}{z^2+1}$
 at $z = -i$
 $= -\text{Im } 2\pi i e^{\omega} = -\pi e^{\omega}$ $\omega < 0$. This is

same as $-\pi e^{-|\omega|}$ if $\omega < 0$. Note if $\omega = 0$

$\int_{-\infty}^{\infty} \frac{\sin \omega x}{x^2+1} dx = \int 0 dx = 0$. \therefore for all ω

we have $\int_{-\infty}^{\infty} \frac{\sin \omega x}{x^2+1} dx = \pi e^{-|\omega|} \text{sgn}(\omega)$

18) $(z+1)^2+1=0, (z+1)^2=-1, z+1=\pm i$

$z=-1\pm i$, pole in lhp at $z=-1-i$

$$\int_{-\infty}^{+\infty} \frac{e^{-zx}}{(x+1)^2+1} dx = -2\pi i \operatorname{Res}_{z=-1-i} \frac{e^{-z^2}}{(z+1)^2+1}$$

$$= -2\pi i \frac{e^{-z^2}}{2(z+1)} \Big|_{z=-1-i} = \frac{-\pi i}{(-i)} e^{-i[-1-i]}$$

$$= \boxed{\pi e^{-1} e^i}$$

19) $z^4+1=0$, poles at $\operatorname{cis}(\frac{\pi}{4}), \operatorname{cis}(-\frac{\pi}{4})$
 $\operatorname{cis}[\frac{3\pi}{4}], \operatorname{cis}[-\frac{3\pi}{4}]$

$$\int_{-\infty}^{+\infty} \frac{(x^3+1)e^{-zx}}{(x^4+1)} dx = -2\pi i \sum \operatorname{Res} \left(\frac{z^3+1}{z^4+1} \right) e^{-iz} \text{ at } \begin{matrix} e^{-i\pi/4} \\ e^{-i3\pi/4} \end{matrix}$$

$$= -2\pi i \left[\sum \frac{1+z^3}{4z^3} e^{-iz} \right] \text{ at } \begin{matrix} e^{-i\pi/4} \\ e^{-i3\pi/4} \end{matrix}$$

$$= -\frac{2\pi i}{4} \left[\sum z^{-3} e^{-iz} + \sum e^{-iz} \right] \text{ at } \begin{matrix} e^{-i\pi/4} \\ e^{-i3\pi/4} \end{matrix}$$

$$= -\frac{2\pi i}{4} \left[\frac{-1+i}{\sqrt{2}} e^{-i \left[\frac{1-i}{\sqrt{2}} \right]} + \frac{1+i}{\sqrt{2}} e^{-i \left[\frac{-1-i}{\sqrt{2}} \right]} \right]$$

$$+ e^{-i \left[\frac{1-i}{\sqrt{2}} \right]} + e^{-i \left[\frac{-1-i}{\sqrt{2}} \right]}$$

$$= \boxed{\frac{\pi}{\sqrt{2}} e^{-1/\sqrt{2}} \left[\cos \frac{1}{\sqrt{2}} + \sin \frac{1}{\sqrt{2}} \right] - i\pi e^{-1/\sqrt{2}} \cos \frac{1}{\sqrt{2}}}$$

sec 6.6

20)

(a) $\frac{1}{x-i}$ is not a real poly. in x

(b) $\int_{-\infty}^{+\infty} \frac{1}{2i} \left[\frac{e^{i2x} - e^{-i2x}}{(x-i)} \right] dx =$

$\frac{1}{2i} \int_{-\infty}^{+\infty} \frac{e^{i2x}}{(x-i)} dx - \frac{1}{2i} \int_{-\infty}^{+\infty} \frac{e^{-i2x}}{(x-i)} dx$

$= \frac{1}{2i} 2\pi i \operatorname{Res} \frac{e^{i2z}}{z-i} \Big|_i = \boxed{\pi e^{-2}}$

since $(z-i)$ is analytic in l.h.p.

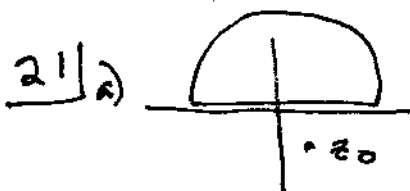

contour for $\nu > 0$

ans = $2\pi i \operatorname{Res} \frac{e^{\nu z}}{(z-z_0)^n}$

\therefore ans. = 0

at pole in uhp. \rightarrow there is none

b) $\int_{-\infty}^{\infty} \frac{e^{\omega x}}{(x-z_0)^n} dx = 2\pi i \operatorname{Res} \frac{e^{\omega z}}{(z-z_0)^n}$

at pole in uhp

pole is of order n

\therefore ans = $2\pi i \frac{1}{(n-1)!} \lim_{z \rightarrow z_0} \frac{d^{n-1}}{dz^{n-1}} \left[\frac{(z-z_0)^n e^{\omega z}}{(z-z_0)^n} \right]$

$= \frac{2\pi i}{(n-1)!} (\omega)^{n-1} e^{\omega z} \Big|_{z_0} = \frac{2\pi i}{(n-1)!} (\omega)^{n-1} e^{\omega z_0}$

c) $\nu = 1, n = 4, z_0 = i$
ans is $\frac{2\pi i}{3!} i^3 e^{i \cdot i} = \boxed{\frac{\pi}{3} e^{-1}}$

Sec 6.6
 22(a) Show that $\lim_{z \rightarrow 0} \frac{e^{lmz} - e^{lnz}}{z} \neq \infty$ with L'Hopital's Rule

$$= \lim_{z \rightarrow 0} \frac{m e^{lmz} - n e^{lnz}}{1} = l(m-n) \quad \text{use this value for } f'(0) \text{ to remove sing.}$$

b) $\oint_D \frac{(e^{lmz} - e^{lnz})}{z} dz = 0$ [func is analytic in uhp]



as $R \rightarrow \infty$ $\int \frac{e^{lmz} - e^{lnz}}{z} dz \rightarrow 0$

on $\int \frac{e^{lmz}}{z} dz$ and $\int \frac{e^{lnz}}{z} dz$ [use Jordan's Lemma]

∴ passing to the limit

$$\int_{-\infty}^{\infty} \frac{e^{lmx} - e^{lnx}}{x} dx = 0$$

Set Imag. part = 0

$$\int_{-\infty}^{\infty} \frac{\cos mx - \cos nx}{x} dx = 0$$

integrand is even function

$$\text{so } \int_0^{\infty} \frac{\sin mx - \sin nx}{x} dx = 0 \quad \begin{matrix} m > 0 \\ n > 0 \end{matrix}$$

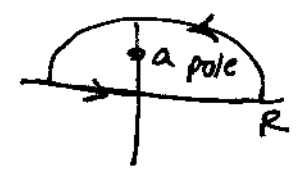
c)  $\int \frac{e^{lmz} - e^{lnz}}{(z)(z^2 + a^2)} dz = 2\pi i \text{ Res } \frac{e^{lmz} - e^{lnz}}{(z)(z^2 + a^2)} \text{ at } ai$

let $R \rightarrow \infty$

$$\int_{-\infty}^{\infty} \frac{e^{lmx} - e^{lnx}}{(x)(x^2 + a^2)} dx = \frac{2\pi i \text{ Res } e^{lmz} - e^{lnz}}{(z)(z^2 + a^2)} \text{ at } ai$$

Take Imag. part, both sides

$$\int_{-\infty}^{\infty} \frac{\sin mx - \sin nx}{(x)(x^2 + a^2)} dx = \text{Im} \left[\frac{2\pi i (e^{lma} - e^{lna})}{(z)(z^2 + a^2)} \right]_{z=ai}$$

$$= \text{Im} \left[\frac{2\pi i [e^{-ma} - e^{-na}]}{-2a^2} \right] = \frac{\pi}{a^2} [e^{-na} - e^{-ma}]$$

sec 6.6

$$\int_{-\infty}^{\infty} \frac{\cos^2\left(\frac{\pi x}{2}\right)}{x^4-1} dx = \operatorname{Re} \int_{-\infty}^{\infty} \frac{\frac{1}{2}(1+e^{i\pi x})}{x^4-1} dx$$

$\frac{\cos^2 \pi x}{2} = \frac{1 + \cos 2\pi x}{2}$ Note $\frac{1+e^{i\pi z}}{z^4-1}$ has a removable sing at $z=1$

Using L'Hopital's rule $\lim_{z \rightarrow 1} \frac{1+e^{i\pi z}}{z^4-1} = \frac{i\pi}{4z^3} = \frac{i\pi}{4}$

Since this $\neq \infty$, have removable sing. at $z=1$

The preceding argument also holds at $z=-1$

$z^4=1 \quad z = \pm 1, \pm i, -i$

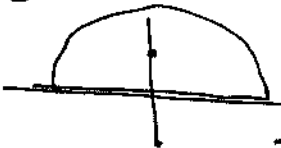

$$\lim_{R \rightarrow \infty} \frac{1}{2} \int_{-R}^R \frac{1+e^{i\pi x}}{x^4-1} dx + \frac{1}{2} \int_{\text{arc}} \frac{1+e^{i\pi z}}{z^4-1} dz = \frac{2\pi i}{2} \operatorname{Res} \frac{1+e^{i\pi z}}{z^4-1} \text{ at } i = \frac{\pi i (1+e^{i\pi i})}{4z^3} \Big|_{z=i}$$

$$= -\frac{\pi}{4} (1+e^{-\pi})$$

Take real part of each side:

$$\int_{-\infty}^{\infty} \frac{\cos^2 \frac{\pi x}{2}}{x^4-1} dx = \int_{-\infty}^{\infty} \frac{\operatorname{Re} \left[\frac{1+e^{i\pi x}}{2} \right]}{x^4-1} dx = -\frac{\pi}{4} (1+e^{-\pi})$$

23

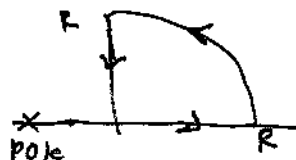

$$\int_0^R \frac{e^{-x}}{x+1} dx + \int_{\text{arc}} \frac{e^{-z}}{z+1} dz + \int_R^0 \frac{e^{-iy}}{iy+1} i dy = 0$$

pole is outside contour.

Let $R \rightarrow \infty$

$$\int_0^{\infty} \frac{e^{-x}}{x+1} dx + \int_0^{\infty} \frac{e^{-iy}}{iy+1} i dy = 0$$

$$\int_0^{\infty} \frac{e^{-x}}{x+1} dx = - \int_0^{\infty} \frac{e^{-iy}}{iy+1} i dy = \int_0^{\infty} \frac{e^{-iy}}{y-i} dy$$

s.e.d.

24]

Sec 6.6

$$(a) \quad \frac{e^{iz} - 1}{z} = \frac{1 + iz + \frac{(iz)^2}{2!} + \dots - 1}{z} =$$

$i + \frac{-z}{2!} + \dots$ A convergent Taylor series

∴ No singularity if define $f(0) = i$

(b)

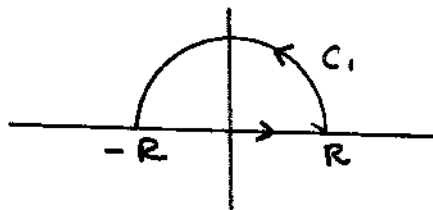

$\frac{e^{iz} - 1}{z}$ is analytic on and inside this contour

$$\text{Thus } \int_{-R}^R \frac{e^{ix} - 1}{x} dx + \int_{C_1} \frac{e^{iz} - 1}{z} dz = 0$$

put $e^{ix} = \cos x + i \sin x$,

$$\int_{-R}^R \frac{\cos x - 1}{x} dx + i \int_{-R}^R \frac{\sin x}{x} dx = \int_{C_1} \frac{1}{z} dz - \int_{C_1} \frac{e^{iz}}{z} dz$$

$$(c) \quad \int_{C_1} \frac{1}{z} dz = \int_0^\pi \frac{1}{Re^{i\theta}} i R e^{i\theta} d\theta = \pi i$$

$$\lim_{R \rightarrow \infty} \int_{C_1} \frac{e^{iz}}{z} dz = 0 \quad [\text{see Theorem 5}] \quad \text{Thus:}$$

$$\int_{-\infty}^{+\infty} \frac{\cos x - 1}{x} dx + i \int_{-\infty}^{+\infty} \frac{\sin x}{x} dx = \pi i$$

— Equate reals

$$\text{on each side: } \int_{-\infty}^{+\infty} \frac{\cos x - 1}{x} dx = 0$$

$$\int_{-\infty}^{+\infty} \frac{\sin x}{x} dx = \pi \quad \frac{\sin x}{x} \text{ is an even func.}$$

$$\int_0^\infty \frac{\sin x}{x} dx = \frac{\pi}{2}$$

25) a)

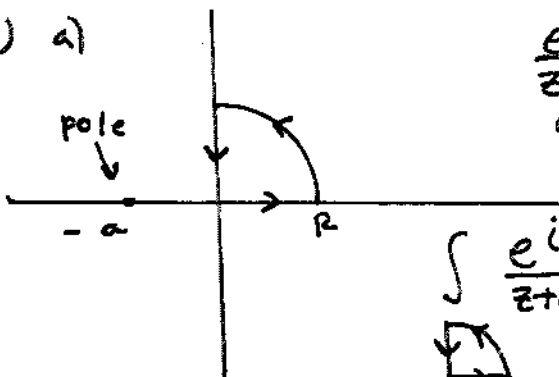

$\frac{e^{iz}}{z+a}$ is analytic on this contour.

$$\int \frac{e^{iz}}{z+a} dz = 0$$

Cauchy-Goursat thm.

b)

on C_1 $|z|=R, [R>a]$

$$\left| \frac{1}{z+a} \right| = \left| \frac{1}{Re^{i\theta}+a} \right|$$

$$\leq \frac{1}{|Re^{i\theta}-a|} = \frac{1}{R-a} \leq \frac{1}{R-\frac{R}{2}} \quad \left[\text{for } R \text{ suffic. large} \right]$$

assume $R > 2a$

Thus $\left| \frac{1}{z+a} \right| \leq \frac{2}{R}$

$$\left| \int \frac{e^{iz}}{z+a} dz \right| = \left| \int_0^{\pi/2} \frac{e^{iRe^{i\theta}} iRe^{i\theta} d\theta}{(Re^{i\theta}+a)} \right|$$

$$\leq R \int_0^{\pi/2} \frac{2}{R} |e^{iRe^{i\theta}}| d\theta$$

Now refer to eqns (6.6-6) - (6.6-9) to complete the argument that as $R \rightarrow \infty$ $\left| \int \frac{e^{iz}}{(z+a)} dz \right| = 0$

$$\int_0^R \frac{e^{ix}}{(x+a)} dx + \int_{C_1} \frac{e^{iz}}{z+a} dz + \int_0^R \frac{e^{iz}}{(z+a)} dz = 0$$

$z=iR$
put $z=iY$
 $dz=i dY$

$$\int_0^\infty \frac{e^{ix}}{(x+a)} dx + \int_\infty^0 \frac{e^{i[iy]}}{iy+a} i dy = 0$$

let

$$\int_0^\infty \frac{e^{ix+i \sin x}}{(x+a)} dx = \int_0^\infty \frac{i e^{-y}}{(iy+a)} dy$$

Cont'd Sec 6.6 Prob 23

$$(d) \int_0^{\infty} \frac{\cos x}{x+a} dx + i \int_0^{\infty} \frac{\sin x}{x+a} dx = \int_0^{\infty} \frac{(i)[a-iy] e^{-y}}{a^2+y^2} dy$$

$$\int_0^{\infty} \frac{\cos x}{x+a} dx + i \int_0^{\infty} \frac{\sin x}{x+a} dx = \int_0^{\infty} \frac{y+ia}{a^2+y^2} e^{-y} dy$$

Equate real part on each side:

$$\int_0^{\infty} \frac{\cos x}{(x+a)} dx = \int_0^{\infty} \frac{y e^{-y}}{a^2+y^2} dy$$

Equate imag. parts on each side

$$\int_0^{\infty} \frac{\sin x}{x+a} dx = a \int_0^{\infty} \frac{e^{-y}}{a^2+y^2} dy$$

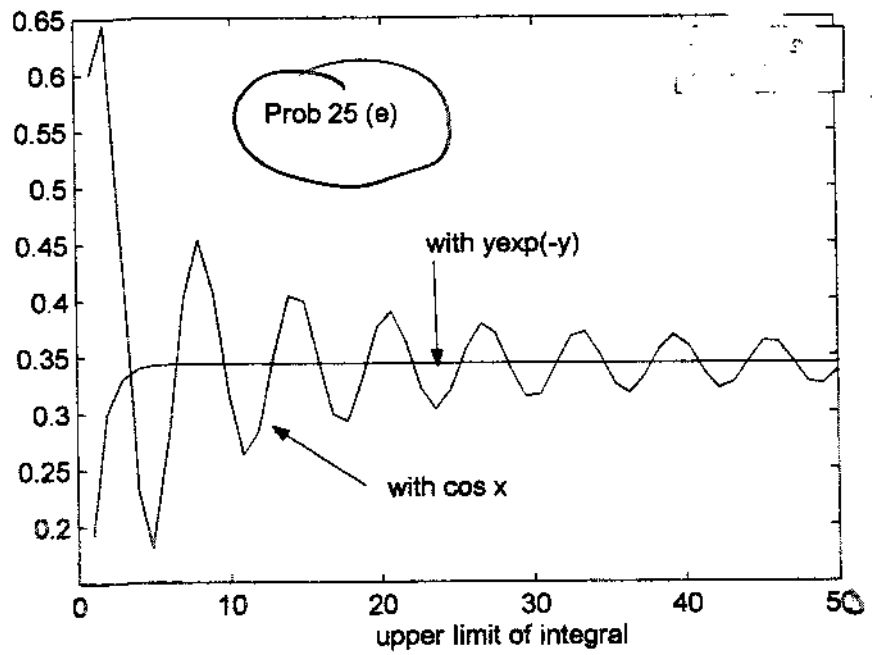

```
R=linspace(1, 50, 51);
f1=inline('cos(x)/(x+1)');
f2=inline('exp(-x).*x./(x.^2+1)');
```

code for 25(e)

```
n=length(R);
for j=1:n
    I1(j)=quadl(f1, 0, R(j));
    I2(j)=quadl(f2, 0, R(j));
end
plot(R, I1, R, I2)
```

e) The expression with e^{-y} is much less sensitive.

26(a)

Chap 6 sec. 6

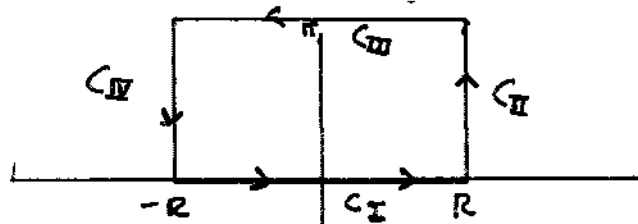

$$\cosh z = 0 \text{ if}$$

$$z = i \left[\frac{\pi}{2} + 2k\pi \right] \quad k=0, \pm 1, \pm 2, \dots$$

only $z = i \left[\frac{\pi}{2} \right]$
is enclosed by the
contour.

$$\int_C \frac{e^{iz}}{\cosh z} dz = \frac{2\pi i \operatorname{Res} e^{iz}}{\cosh z} \text{ at } i\frac{\pi}{2}$$

$$= \frac{2\pi i e^{-\pi/2}}{\sinh \left[\frac{i\pi}{2} \right]} = 2\pi e^{-\pi/2}$$

(b) on C_3 , $z = x + i\pi$, on C_1 , $z = x$

$$\int_{C_I} \frac{e^{ix}}{\cosh x} dx + \int_{C_{III}} \frac{e^{i(x+i\pi)}}{\cosh [x+i\pi]} dx +$$

$$\int_{C_{II}} \frac{e^{iz}}{\cosh z} dz + \int_{C_{IV}} \frac{e^{iz}}{\cosh z} dz = 2\pi e^{-\pi/2}$$

$$(c) \cosh [x+i\pi] = -\cosh x,$$

$$\int_{-R}^R \frac{e^{ix}}{\cosh x} dx + \int_{-R}^R \frac{e^{-\pi} e^{ix}}{\cosh x} dx + \int_{C_{II}} + \int_{C_{IV}} = 2\pi e^{-\pi/2}$$

$$\int_{-R}^R \frac{e^{ix}}{\cosh x} [1 + e^{-\pi}] dx + \int_{C_{II}} \int_{C_{IV}} \frac{e^{iz}}{\cosh z} dz = 2\pi e^{-\pi/2}$$

261

Chap 6, Sec 6.6

(d) On C_{II} and C_{IV} $\left| \frac{e^{iz}}{\cosh z} \right| \leq \left| \frac{1}{\cosh z} \right| \leq$

$$\frac{1}{\sqrt{\sinh^2 x + \cos^2 y}} \leq \frac{1}{\sqrt{\sinh^2 R + 1}} \leq \frac{1}{\sinh R}$$

$$\left| \int \frac{e^{iz}}{\cosh z} dz \right| \leq ML = \frac{\pi}{\sinh R} \rightarrow 0 \quad [as R \rightarrow \infty]$$

C_{II} Similarly argument applies on C_{IV}

Let's $R \rightarrow \infty$, integrals on C_{II} and C_{IV} go to zero. Thus using (c):

$$\int_{-\infty}^{+\infty} \frac{e^{ix}}{\cosh x} dx [1 + e^{-\pi}] = \pi e^{-\pi/2}$$

$$\int_{-\infty}^{+\infty} \frac{\cos x + i \sin x}{\cosh x} dx = \frac{2\pi e^{-\pi/2}}{1 + e^{-\pi}}$$

Equate real part of each side

$$\int_{-\infty}^{+\infty} \frac{\cos x}{\cosh x} dx = \frac{2\pi e^{-\pi/2}}{1 + e^{-\pi}} = \frac{\pi}{\cosh(\frac{\pi}{2})}$$

$$\int_0^{\infty} \frac{\cos x}{\cosh x} dx = \frac{\pi}{2 \cosh(\frac{\pi}{2})} \quad \text{since } \frac{\cos x}{\cosh x} \text{ is an even function.}$$

Sec 6.6

29)

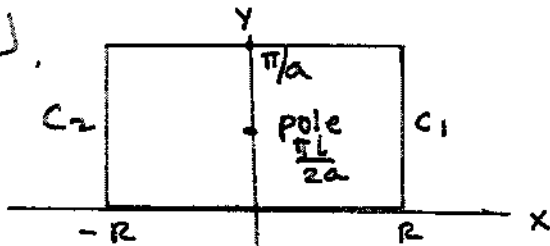

$$\int_{-R}^R \frac{\cosh x}{\cosh ax} dx + \int_{C_1} \frac{\cosh z}{\cosh az} dz + \int_{x=R}^{x=-R} \frac{\cosh [x + i\frac{\pi}{a}]}{\cosh [ax + i\pi]} dx$$

$$+ \int_{C_2} \frac{\cosh z}{\cosh [az]} dz = 2\pi i \operatorname{Res} \frac{\cosh z}{\cosh(az)} \quad z = \frac{i\pi}{2a}$$

$$= 2\pi i \frac{\cosh z}{a \sinh(az)} \Big|_{\left(\frac{i\pi}{2a}\right)} = \frac{2\pi i \cos \left[\frac{\pi}{2a}\right]}{a i \sin \left[\frac{\pi}{2}\right]} = \frac{2\pi}{a} \cos \left[\frac{\pi}{2a}\right]$$

$$\int_{-R}^R \frac{\cosh x}{\cosh ax} dx + \int_{-R}^R \frac{\cosh [x + i\frac{\pi}{a}]}{\cosh(ax)} dx + \int_{C_1} \dots \int_{C_2} dz = \frac{2\pi}{a} \cos \left[\frac{\pi}{2a}\right]$$

$$\cosh \left[x + i\frac{\pi}{a} \right] = \cosh x \cos \frac{\pi}{a} + i \sinh x \sin \frac{\pi}{a}$$

let $R \rightarrow \infty$, assume integrals on C_1 and C_2 go to zero [will prove]. Now equate the real parts of the preceding eqn.

$$\int_{-\infty}^{+\infty} \frac{\cosh x}{\cosh(ax)} dx \left[\underbrace{1 + \cos \frac{\pi}{a}}_{= 2 \cos^2 \left[\frac{\pi}{2a}\right]} \right] = \frac{2\pi}{a} \cos \left[\frac{\pi}{2a}\right]$$

continued

27) cont'd sec 6.6

$$\int_{-\infty}^{+\infty} \frac{\cosh x}{\cosh(ax)} dx = \frac{\pi}{a \cos \left[\frac{\pi}{2a} \right]}$$

to show that integral on $C_1 \rightarrow 0$ as $R \rightarrow \infty$

$$\left| \int \frac{\cosh z}{\cosh(az)} dz \right| \leq ML, \quad L = \frac{\pi}{a}$$

$$|\cosh z| = \sqrt{\sinh^2 x + \cos^2 y}$$

$$\left| \frac{\cosh z}{\cosh(az)} \right|_{\text{on } C_1} = \frac{\sqrt{\sinh^2 R + \cos^2 y}}{\sqrt{\sinh^2 aR + \cos^2 y}} \leq \frac{\sqrt{\sinh^2 R + 1}}{\sinh aR}$$

$$= \frac{e^{aR}}{\sinh(aR)} = \frac{e^R + e^{-R}}{e^{aR} - e^{-aR}} \leq \frac{e^R}{e^{aR} - e^{-aR}} \rightarrow 0 \text{ as } R \rightarrow \infty \text{ if } a > 1$$

A similar proof applies on C_2

28

$1 + e^{az} = 0$
 $az = \log(-1)$
 $z = i \left[\frac{\pi}{a} + \frac{2k\pi}{a} \right]$

$\int_{-R}^R \frac{e^x}{1+e^{ax}} dx + \int_R^{-R} \frac{e^{x+i\frac{2\pi}{a}}}{1+e^{a[x+i\frac{2\pi}{a}]}} dx + \int_{i\pi/a}^{-R+i\pi/a} \frac{e^z}{1+e^{az}} dz + \int_{-R+i\pi/a}^R \frac{e^z}{1+e^{az}} dz$

$= 2\pi i \operatorname{Res} \frac{e^z}{1+e^{az}} \text{ at } (i\pi/a)$

continued next pg.

Chap 6, sec 6.6

28] cont'd

$$\int_{-R}^R \frac{e^x}{1+e^{ax}} dx \left[1 - e^{\frac{i2\pi}{a}} \right] + \int_{c_1} \text{and} \int_{c_2} \frac{e^z}{1+e^{az}} dz =$$

$$2\pi i \frac{e^z}{ae^{az}} \Big|_{i\frac{\pi}{a}} = \frac{2\pi i e^{i\pi/a}}{a [e^{i\pi}]} = \frac{-2\pi i e^{i\pi/a}}{a}$$

let $R \rightarrow \infty$, assume \int_{c_1} and $\int_{c_2} \rightarrow 0$ (which will be proved)

Thus $\int_{-\infty}^{+\infty} \frac{e^x}{1+e^{ax}} dx = \frac{2\pi i e^{i\pi/a}}{a [e^{i2\pi/a} - 1]}$

$= \frac{\pi/a}{\sin(\pi/a)}$. Proof that $\lim_{R \rightarrow \infty} \int_{c_1} \frac{e^z}{1+e^{az}} dz = 0$

$\left| \frac{e^z}{1+e^{az}} \right|_{\text{on } c_1} = \frac{e^R}{|1+e^{a(R+i\pi)}|} \leq \frac{e^R}{e^{aR-1}}$

Thus $\left| \int_{c_1} \frac{e^z}{1+e^{az}} dz \right| \leq \left[\frac{e^R}{e^{aR-1}} \right] 2\pi \rightarrow 0$ as $R \rightarrow \infty$ [if $a > 1$]

29]

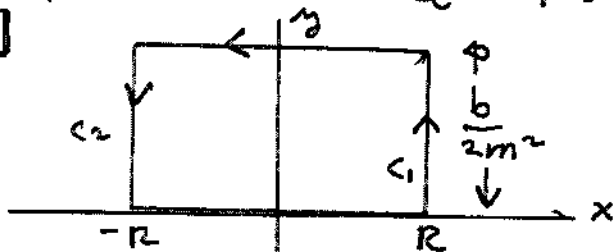

$$\int_{-R}^R e^{-m^2 x^2} dx + \int_{c_1} e^{-m^2 z^2} dz + \int_{x=R}^{x=-R} e^{-m \left[x + \frac{i b}{2m^2} \right]^2} dx + \int_{c_2} e^{-m^2 z^2} dz = 0$$

let $R \rightarrow \infty$, Assume that integrals along c_1 and $c_2 \rightarrow 0$ in the limit.

sec 6.6

29) cont'd

(we will establish behavior along C_1 and C_2 later). Thus

$$\int_{-\infty}^{\infty} e^{-m^2 x^2} dx = \int_{-\infty}^{\infty} e^{-m^2 \left[x + \frac{ib}{2m^2} \right]} dx$$

$$\int_{-\infty}^{\infty} e^{-m^2 x^2} dx = \int_{-\infty}^{\infty} e^{-m^2 \left[x^2 + \frac{ixb}{m^2} - \frac{b^2}{4m^2} \right]} dx$$

$$\int_{-\infty}^{\infty} e^{-m^2 x^2} dx = \int_{-\infty}^{\infty} e^{-m^2 x^2} e^{-ixb} dx e^{\frac{b^2}{4m^2}}$$

$$e^{-\frac{b^2}{4m^2}} \int_{-\infty}^{\infty} e^{-m^2 x^2} dx = \int_{-\infty}^{\infty} e^{-m^2 x^2} [\cos xb - i \sin xb] dx$$

$$e^{-\frac{b^2}{4m^2}} \frac{\sqrt{\pi}}{m} = \int_{-\infty}^{\infty} e^{-m^2 x^2} [\quad] dx$$

equating real parts on each side of the equation we get the desired result.

Now to show: $\int_{C_1} e^{-m^2 z^2} dz \rightarrow 0$ as $R \rightarrow \infty$

$$\left| \int_{C_1} e^{-m^2 z^2} dz \right| = \left| \int_{C_1} e^{-m^2 [x^2 - y^2 + i2xy]} dz \right| \leq$$

$$e^{-\left[R^2 - \left(\frac{b}{2m} \right)^2 \right]} \frac{b}{2m^2} \rightarrow 0 \quad \text{as } R \rightarrow \infty$$

A similar argument applies to the integral along C_2

30 a)

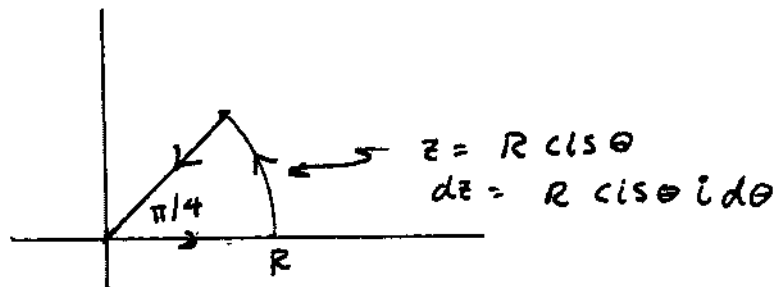

30

(a) contour

$$\int_0^R e^{zx^2} dx + \int_{\text{arc}} e^{iR^2 \text{cis}(2\theta)} R \text{cis}\theta i d\theta + \int_{x=R/\sqrt{2}}^0 e^{i[x^2-y^2+izx^2]} (dx+idy) = 0$$

put $x=y$
on
this
contour

$$\int_0^R \cos x^2 + i \sin x^2 dx + \int_0^{\pi/4} e^{iR^2 \text{cis}(2\theta)} R e^{i\theta} i d\theta$$

$$= \int_0^{R/\sqrt{2}} e^{-2x^2} dx (1+i)$$

(b) $\left| \int_0^{\pi/4} e^{iR^2 \text{cis}(2\theta)} R e^{i\theta} i d\theta \right| \leq \int_0^{\pi/4} |e^{iR^2 \text{cis}(2\theta)}| R d\theta$

$$|e^{iR^2 \text{cis}(2\theta)}| = |e^{iR^2 [\cos 2\theta + i \sin 2\theta]}| = e^{-R^2 \sin 2\theta}$$

Thus $\left| \int_0^{\pi/4} e^{iR^2 \text{cis}(2\theta)} R e^{i\theta} i d\theta \right| \leq R \int_0^{\pi/4} e^{-R^2 \sin 2\theta} d\theta$

$$= \int_0^{\pi/2} e^{-R^2 \sin \phi} \frac{d\phi}{2} \leq \frac{R}{2} \int_0^{\pi/2} e^{-R^2 \left[\frac{2}{\pi} \phi \right]} d\phi$$

$$= \frac{R}{2} \left(\frac{-\pi}{2R^2} \right) [e^{-R^2} - 1] \rightarrow 0 \text{ as } R \rightarrow \infty$$

(c) Passing to limit $R \rightarrow \infty$ in part (a) and using result of part (b):

$$\int_0^{\infty} \cos x^2 + i \sin x^2 dx = (1+i) \left[\int_0^{\infty} e^{-2x^2} dx \right]$$

Now equate corresponding parts [real and imag] on each side:

$$\int_0^{\infty} \cos x^2 dx = \int_0^{\infty} e^{-2x^2} dx = \frac{1}{2} \sqrt{\frac{\pi}{2}} \leftarrow$$

$$\int_0^{\infty} \sin x^2 dx = \int_0^{\infty} e^{-2x^2} dx = \frac{1}{2} \frac{\sqrt{\pi}}{\sqrt{2}} \left[\text{see prob 23} \right]$$

30(c)

Chap 6, sec 6.6 cont'd• (c) cont'd

$$\int_0^{\infty} \cos x^2 dx = \frac{1}{2} \sqrt{\frac{\pi}{2}}, \text{ let } \frac{\pi}{2} u^2 = x^2$$

$$\sqrt{\frac{\pi}{2}} du = dx \quad \int_0^{\infty} \cos \left[\frac{\pi}{2} u^2 \right] \sqrt{\frac{\pi}{2}} du = \frac{1}{2} \sqrt{\frac{\pi}{2}}$$

$$\int_0^{\infty} \cos \left[\frac{\pi}{2} u^2 \right] du = 1/2, \text{ Similarly for } \int_0^{\infty} \sin \left[\frac{\pi}{2} u^2 \right] du = 1/2.$$

Now consider: $\int_0^{\infty} \sin \left[\frac{\pi}{2} u^2 \right] du = 1/2$

let $\frac{\pi}{2} u^2 = bw^2$, assume $b > 0$.

$$\sqrt{\frac{\pi}{2}} u = \sqrt{b} w, \quad \sqrt{\frac{\pi}{2}} du = \sqrt{b} dw$$

$$\int_0^{\infty} \sin [bw^2] \sqrt{\frac{2}{\pi}} \sqrt{b} dw = \frac{1}{2}$$

Thus $\int_0^{\infty} \sin bw^2 dw = \frac{1}{2} \sqrt{\frac{\pi}{2}} \frac{1}{\sqrt{b}}$ for $b > 0$

and $\int_{-\infty}^{\infty} \sin bw^2 dw = \sqrt{\frac{\pi}{2}} \frac{1}{\sqrt{b}}$ $b > 0$

The integral is an odd function of b .
Thus to accommodate both signs for b

$$\int_{-\infty}^{+\infty} \sin bw^2 dw = \pm \sqrt{\frac{\pi}{2}} \frac{1}{\sqrt{|b|}}$$

where \pm conforms to the sign of the real quantity b

A similar argument shows that $\int_{-\infty}^{+\infty} \cos bw^2 dw = \sqrt{\frac{\pi}{2}} \frac{1}{\sqrt{b}}$ for $b > 0$

The preceding ^{integral} is an even function of b . Thus

$$\int_{-\infty}^{+\infty} \cos bw^2 dw = \sqrt{\frac{\pi}{2}} \frac{1}{\sqrt{|b|}} \text{ for any real } b.$$

1) a) $\oint \frac{z+1}{z} dz = 2\pi i \operatorname{Res} \frac{z+1}{z} \Big|_{z=0} = \boxed{2\pi i}$

b) $\int_{|z|=1} \frac{z+1}{z} dz = \int_0^{2\pi} (1 + \frac{1}{z}) dz$ put $z = e^{i\theta}$
 $= \int_0^{2\pi} (1 + e^{-i\theta}) i e^{i\theta} d\theta$
 $= [e^{i\theta} - 1] + \pi i = \boxed{-2 + \pi i}$

c) The ans. to b \neq $\frac{1}{2}$ ans. to (a). Note the requirement $r \rightarrow 0+$ in theorem 6

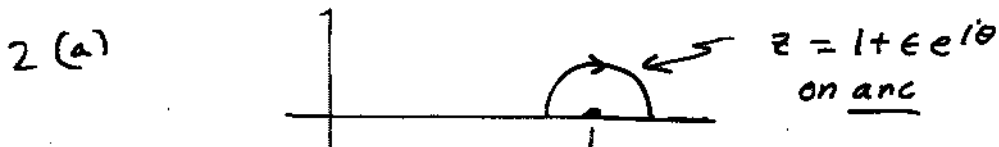

$$\int_{1-\epsilon}^{1+\epsilon} \frac{z+1}{(z-1)} dz = \int_{\theta=\pi}^0 \frac{(2 + \epsilon e^{i\theta}) i \epsilon e^{i\theta}}{\epsilon e^{i\theta}} d\theta$$

$$= \int_{\theta=\pi}^0 i [2 + \epsilon e^{i\theta}] d\theta = -2\pi i + \epsilon e^{i\theta} \Big|_{\pi}^0$$

$$= -2\pi i + 2\epsilon$$

2 (b) let $\epsilon \rightarrow 0+$ get $-2\pi i$

Now $-2\pi i \stackrel{1}{2} \operatorname{Re} \left[\frac{z+1}{z-1} ; 1 \right] = -2\pi i * \frac{1}{2} * 2 = \boxed{-2\pi i}$
 as above

3

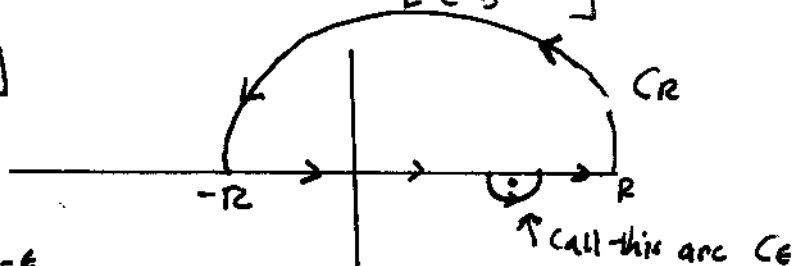

$$\int_{-R}^{1-\epsilon} \frac{e^{13x}}{x-1} dx + \int_{C_\epsilon} \frac{e^{13z}}{z-1} dz + \int_{1+\epsilon}^R \frac{e^{13x}}{(x-1)} dx + \int_{C_R} \frac{e^{13z}}{(z-1)} dz = 2\pi i \operatorname{Res} \frac{e^{13z}}{z-1}$$

at $z=1$

Chap 6, sec 6.7 cont'd

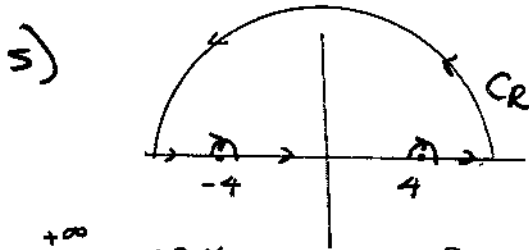

$$\int_{-\infty}^{+\infty} \frac{e^{i2x}}{(x^2-16)} dx = \pi i \left[\text{Res} \frac{e^{i2z}}{z^2-16}, 4 \right] - \pi i \left[\text{Res} \frac{e^{i2z}}{z^2-16}, -4 \right]$$

$$\oint_{CR} \frac{e^{i2z}}{z^2-16} dz = 0 \quad \text{let } R \rightarrow \infty$$

$$\int_{-\infty}^{+\infty} \frac{\cos 2x}{x^2-16} dx + i \int_{-\infty}^{+\infty} \frac{\sin 2x}{x^2-16} dx = \frac{\pi i e^{i8}}{8} + \frac{\pi i e^{-i8}}{-8}$$

$$\int_{-\infty}^{+\infty} \frac{\cos 2x}{x^2-16} dx = -\frac{\pi}{4} \quad \left[\frac{e^{i8} - e^{-i8}}{2i} \right] = \boxed{-\frac{\pi \sin 8}{4}}$$

6)

$$\int_{-\infty}^{+\infty} \frac{e^{ix}}{(x-\frac{\pi}{2})(x-\pi)} dx = \pi i \text{Res} \frac{e^{iz}}{(z-\frac{\pi}{2})(z-\pi)} \text{ at } \frac{\pi}{2}$$

$$- \pi i \text{Res} \frac{e^{iz}}{(z-\frac{\pi}{2})(z-\pi)} \text{ at } \pi = 0$$

$$\int_{-\infty}^{+\infty} \frac{\cos x}{(x-\frac{\pi}{2})(x-\pi)} dx + i \int_{-\infty}^{+\infty} \frac{\sin x}{(x-\frac{\pi}{2})(x-\pi)} dx = \frac{\pi i e^{i\frac{\pi}{2}}}{-\frac{\pi}{2}}$$

$$\frac{+\pi i e^{i\pi}}{\frac{\pi}{2}} \quad \text{Equate imag parts}$$

$$\int_{-\infty}^{+\infty} \frac{\sin x}{(x-\frac{\pi}{2})(x-\pi)} dx = \boxed{-2}$$

7)

$$\int_{-\infty}^{+\infty} \frac{e^{ix}}{(x-\frac{\pi}{2})(x^2+1)} dx = \pi i \text{Res} \frac{e^{iz}}{(z-\frac{\pi}{2})(z^2+1)} \text{ at } \frac{\pi}{2}$$

$$= 2\pi i \text{Res} \frac{e^{iz}}{(z-\frac{\pi}{2})(z^2+1)} \text{ at } z=i$$

Chap 6, sec 6.7 cont'd

7) cont'd

$$\int_{-\infty}^{+\infty} \frac{\cos x + i \sin x}{(x - \frac{\pi}{2})(x^2 + 1)} dx = \pi i \operatorname{Res} \frac{e^{iz}}{(z - \frac{\pi}{2})(z^2 + 1)} \text{ at } \frac{\pi}{2}$$

$$+ 2\pi i \operatorname{Res} \frac{e^{iz}}{(z - \frac{\pi}{2})(z^2 + 1)} \text{ at } i = \frac{\pi i e^{i\pi/2}}{(\frac{\pi^2}{4} + 1)} + \frac{2\pi i e^{-1}}{(i - \frac{\pi}{2})(2i)}$$

$$= \frac{-\pi}{(1 + \frac{\pi^2}{4})} + \frac{\pi e^{-1}}{1 + \frac{\pi^2}{4}} (-i - \frac{\pi}{2}) \quad \text{Equate real parts on each side}$$

$$\int_{-\infty}^{+\infty} \frac{\cos x}{(x - \frac{\pi}{2})(x^2 + 1)} dx = \boxed{\frac{-\pi}{(1 + \frac{\pi^2}{4})} \left[1 + e^{-1} \left(\frac{\pi}{2} \right) \right]}$$

8) Note that $\frac{e^{i\pi/2 z} - i}{(z-1)^2}$ has a simple pole

at $z=1$.

$$\text{Thus } \int_{-\infty}^{+\infty} \frac{e^{i\frac{\pi}{2}x}}{(x-1)^2} dx = \pi i \operatorname{Res} \left[\frac{e^{i\frac{\pi}{2}z} - i}{(z-1)^2} \right]_{z=1} = 0$$

$$\int_{-\infty}^{+\infty} \frac{\cos[\frac{\pi}{2}x] + i \sin[\frac{\pi}{2}x] - i}{(x-1)^2} dx = \pi i \operatorname{Res} \left[\frac{e^{i\frac{\pi}{2}z} - i}{(z-1)^2}, 1 \right]$$

$$= \pi i \left[\frac{i\frac{\pi}{2} e^{i\frac{\pi}{2}z}}{(z-1)^2} \right]_{z=1} = \frac{-i\pi^2}{2}$$

Equate real parts on both sides:

$$\int_{-\infty}^{+\infty} \frac{\cos[\frac{\pi x}{2}]}{(x-1)^2} dx = \boxed{0}. \text{ This can be established}$$

without using residues; use a symmetry argument.

Chap 6, Sec 6.7 cont'd

a) for poles $az^2+bz+c=0$, $z = \frac{-b}{2a} \pm \frac{\sqrt{b^2-4ac}}{2a}$

Thus: $\int_{-\infty}^{+\infty} \frac{e^{imx} dx}{ax^2+bx+c} = \pi i \sum_{\text{res}} \frac{e^{imz}}{a z^2+bz+c}$ at $\frac{-b}{2a} \pm \frac{\sqrt{b^2-4ac}}{2a}$

= 0

$\int_{-\infty}^{+\infty} \frac{e^{imx} dx}{ax^2+bx+c} = \pi i \left[\frac{e^{imz}}{2az+b} \Big|_{z=\frac{-b}{2a} + \frac{\sqrt{b^2-4ac}}{2a}} + \frac{e^{imz}}{2az+b} \Big|_{z=\frac{-b}{2a} - \frac{\sqrt{b^2-4ac}}{2a}} \right]$

$\int_{-\infty}^{+\infty} \frac{\cos mx}{ax^2+bx+c} dx = \text{Re} \left[\frac{(\pi i)}{\sqrt{b^2-4ac}} \left[e^{im \left[\frac{-b+\sqrt{b^2-4ac}}{2a} \right]} - e^{im \left[\frac{-b-\sqrt{b^2-4ac}}{2a} \right]} \right] \right]$

= $\text{Re} \left[\frac{e^{-imb/(2a)} (\pi i)}{\sqrt{b^2-4ac}} 2i \sin \frac{m\sqrt{b^2-4ac}}{2a} \right] =$

$\frac{-2\pi \cos \left[\frac{mb}{2a} \right] \sin \left[\frac{m\sqrt{b^2-4ac}}{2a} \right]}{\sqrt{b^2-4ac}}$

b) $\int_{-\infty}^{+\infty} \frac{e^{imx}}{x^4-b^4} dx = \pi i \sum \text{Res} \frac{e^{imz}}{z^4-b^4}$ at $z = \pm b$
 = $2\pi i \text{Res} \frac{e^{imz}}{z^4-b^4}$ at $z = ib$

$\int_{-\infty}^{+\infty} \frac{e^{imx}}{x^4-b^4} dx = \pi i \left[\frac{e^{imb}}{4b^3} + \frac{e^{-imb}}{-4b^3} \right] + \frac{2\pi i e^{-mb}}{4 \cdot (ib)^3}$

Equating reals:

$\int_{-\infty}^{+\infty} \frac{\cos(mx)}{x^4-b^4} dx = \frac{-\pi}{2b^3} \sin(mb) - \frac{\pi e^{-mb}}{2b^3}$

Chap 6, Sec 6.7 cont'd

11)

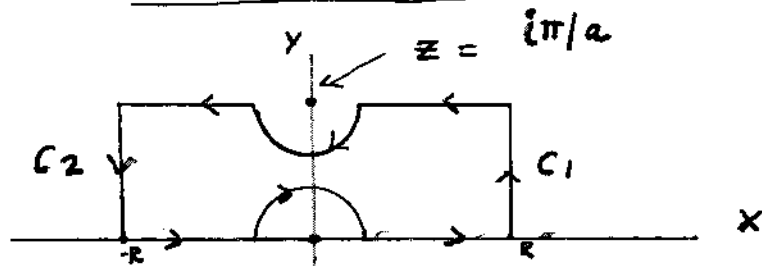

$$\int_{-R}^R \frac{e^{Lbx}}{\sinh(ax)} dx + \int_{C_1} \dots + \int_{C_2} \frac{e^{Lbz}}{\sinh(az)} dz$$

$$+ \int_{-R}^R \frac{e^{i b [x + \frac{\pi i}{a}]} dx}{\sinh[a(x + \frac{\pi i}{a})]} = \pi i \operatorname{Res} \frac{e^{ibz}}{\sinh(az)} \Big|_{z = \frac{\pi i}{a}}$$

$$+ \pi i \operatorname{Res} \frac{e^{ibz}}{\sinh(az)} \Big|_{z=0}$$

Note: $\sinh[ax + i\pi] = -\sinh ax$

Let $R \rightarrow \infty$, integrals over C_1 and $C_2 \rightarrow 0$

$$\int_{-\infty}^{+\infty} \frac{e^{Lbx}}{\sinh(ax)} dx \left[1 + e^{-\frac{b}{a}\pi} \right] = \frac{\pi i e^{-\frac{\pi b}{a}}}{-a} + \frac{\pi i}{a}$$

$$\int_{-\infty}^{+\infty} \frac{e^{Lbx}}{\sinh(ax)} dx = \frac{\pi i [-e^{-\pi b/a} + 1]}{a [1 + e^{-\frac{b}{a}\pi}]}$$

Equate I.M.S. parts on both sides:

$$\int_{-\infty}^{+\infty} \frac{\sin(bx)}{\sinh(ax)} dx = \frac{\pi}{a} \tanh \left[\frac{\pi b}{2a} \right]$$

The argument that $\int_{C_1 \text{ and } C_2} \frac{e^{ibz}}{\sinh(az)} dz \rightarrow 0$ as $R \rightarrow \infty$

is similar to that presented in prob 22, sec 6.6, and is not given here.

Chap 6, sec 6.7

12)

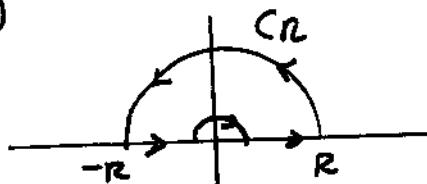

$$\int_{-R}^R \frac{e^{ix}}{x} dx + -\pi i \operatorname{Res} \frac{e^{iz}}{z} \Big|_0$$

$$+ \int_{CR} \frac{e^{iz}}{z} dz = 0 \quad \text{as } R \rightarrow \infty$$

letting $R \rightarrow \infty$

$$\int_{-\infty}^{+\infty} \frac{\cos x + i \sin x}{x} dx = \pi i \quad \text{[Jordan's Lemma]}$$

Equate imaginary parts, both sides:

$$\int_{-\infty}^{+\infty} \frac{\sin x}{x} dx = \pi$$

13) Use same contour as in prev. problem.

$$\int_{-R}^R \frac{1 - e^{2ix}}{2x^2} dx - \pi i \operatorname{Res} \left[\frac{1 - e^{2iz}}{2z^2}, 0 \right]$$

$$+ \int_{CR} \frac{1 - e^{2iz}}{2z^2} dz = 0$$

↓ 0 as $R \rightarrow \infty$

Note $\frac{1 - e^{2iz}}{2z^2}$ has a simple pole at $z = 0$

Thus $\int_{-\infty}^{+\infty} \frac{1 - \cos 2x - i \sin 2x}{2x^2} dx = \pi i \operatorname{Res} \frac{1 - e^{2iz}}{2z^2} \Big|_{z=0}$

$$= \frac{(\pi i)(-2i)}{2} = \pi, \quad \text{Equate real parts each side}$$

$$\int_{-\infty}^{+\infty} \frac{\sin^2 x}{x^2} dx = \pi$$

14)

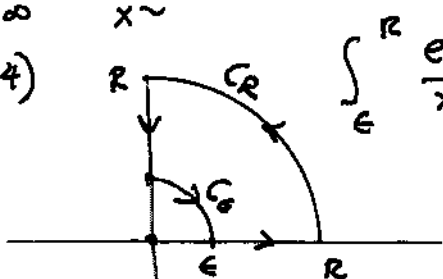

$$\int_{\epsilon}^R \frac{e^{ix}}{x} dx + \int_{CR} \frac{e^{iz}}{z} dz + \int_{\epsilon}^R \frac{e^{i(x+iy)}}{x+iy} dx + \int_{C\epsilon} \frac{e^{iz}}{z} dz = 0$$

$$+ \int_{C\epsilon} \frac{e^{iz}}{z} dz = 0$$

make change of var. $x = y$

let $R \rightarrow \infty, \epsilon \rightarrow 0+$, Use Jordan's Lemma on C_R .

$$\int_0^{\infty} \frac{\cos x + i \sin x}{x} \frac{-e^{-x}}{x} dx = \frac{1}{4} 2\pi i \operatorname{Res} \frac{e^{iz}}{z} \Big|_0$$

$$= \frac{\pi i}{2}$$

Chap 6, sec 6.7 cont'd

14) Cont'd Equate real parts in prev. Eqn.

$$\int_0^{\infty} \frac{\cos x - e^{-x}}{x} dx = 0$$

15)

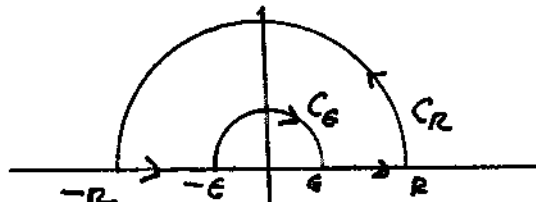

$$\int_{-R}^{-\epsilon} \frac{e^{iax} - e^{ibx}}{x^2} dx + \int_{C_\epsilon} \frac{e^{iaz} - e^{ibz}}{z^2} dz + \int_{\epsilon}^R \frac{e^{iax} - e^{ibx}}{x^2} dx + \int_{C_R} \frac{e^{iaz} - e^{ibz}}{z^2} dz = 0$$

Let $R \rightarrow \infty$, $\epsilon \rightarrow 0+$, Note $\frac{e^{iaz} - e^{ibz}}{z^2}$ has a simple pole at $z=0$

$$\int_{-\infty}^{+\infty} \frac{e^{iax} - e^{ibx}}{x^2} dx - \pi i \operatorname{Res} \left[\frac{e^{iaz} - e^{ibz}}{z^2}, 0 \right] = 0$$

$$\int_{-\infty}^{+\infty} \frac{\cos ax - \cos bx}{x^2} dx + i \int_{-\infty}^{+\infty} \frac{\sin ax - \sin bx}{x^2} dx =$$

$(\pi i)(i)(a-b)$. Equate real parts on each side to get ans.

Chap 6 sec 6.8

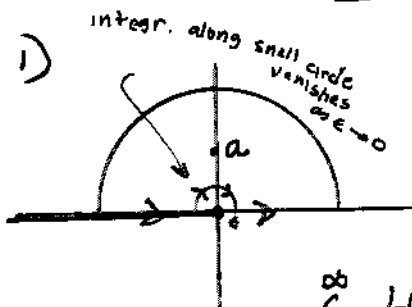

$$\int_0^{\infty} \frac{\operatorname{Log} x}{x^2 + a^2} dx + \int_{-\infty}^0 \frac{\operatorname{Log}|x| + i\pi}{x^2 + a^2} dx$$

$$= 2\pi i \operatorname{Res} \frac{\operatorname{Log} z}{z^2 + a^2} \Big|_{z=ia}$$

$$= 2 \int_0^{\infty} \frac{\operatorname{Log} x}{x^2 + a^2} dx + \int_0^{\infty} \frac{i\pi}{x^2 + a^2} dx = \frac{2\pi i}{2ia} \operatorname{Log}(ia)$$

$$= \frac{\pi}{a} \left[\operatorname{Log} a + i \frac{\pi}{2} \right]. \text{ Equate real parts on each side}$$

$$\int_0^{\infty} \frac{\operatorname{Log} x}{x^2 + a^2} dx = \frac{\pi}{2a} \operatorname{Log} a$$

Chap 6, sec 6.8, cont'd

2)

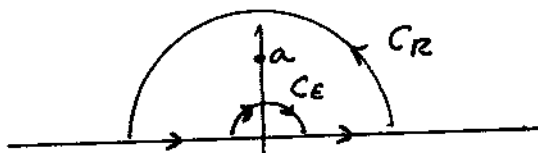

$$\int_{\epsilon}^R \frac{\text{Log } x \, dx}{(x^2+a^2)^2} + \int_{C_R} \frac{\text{Log } z}{(z^2+a^2)^2} dz + \int_{-R}^{-\epsilon} \frac{\text{Log } x + i\pi}{(x^2+a^2)^2} dx + \int_{C_\epsilon} \frac{\text{Log } z}{(z^2+a^2)^2} dz = 2\pi i \text{Res} \frac{\text{Log } z}{(z^2+a^2)^2}$$

$$\int_{C_\epsilon} \frac{\text{Log } z}{(z^2+a^2)^2} dz = 2\pi i \text{Res} \frac{\text{Log } z}{(z^2+a^2)^2}$$

Let $R \rightarrow \infty, \epsilon \rightarrow 0^+$

$$2 \int_0^\infty \frac{\text{Log } x \, dx}{(x^2+a^2)^2} + i\pi \int_{-\infty}^0 \frac{dx}{(x^2+a^2)^2} =$$

$$2\pi i \left[\frac{\frac{1}{2} (z+ia)^2 - (\text{Log } z)^2 (z+ia)}{(z+ia)^4} \right]_{z=ia}$$

Equate real part of each side, $\text{Log } ia = \text{Log } a + i\frac{\pi}{2}$

$$2 \int_0^\infty \frac{\text{Log } x}{(x^2+a^2)^2} dx = \frac{\pi}{2a^3} [\text{Log } a - 1]$$

$$\int_0^\infty \frac{\text{Log } x \, dx}{(x^2+a^2)^2} = \frac{\pi}{4a^3} \left[\text{Log} \frac{a}{e} \right]$$

(3)

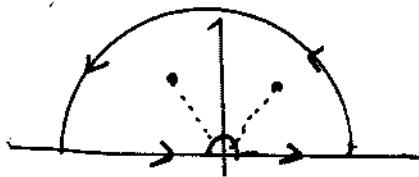

$$z^4 + a^4 = 0$$

in uhp. $z = a \text{cis} \left(\frac{\pi}{4} \right)$

$$z = a \text{cis} \left[\frac{3\pi}{4} \right]$$

$$\int_{-\infty}^0 \frac{x^2 \text{Log } x \, dx}{x^4+a^4} + \int_{-\infty}^0 \frac{x^2 i\pi}{x^4+a^4} dx + \int_0^\infty \frac{x^2 \text{Log } x}{x^4+a^4} dx$$

$$= 2\pi i \sum \text{res.} \frac{z^2 \text{Log } z}{z^4+a^4} \text{ at } a \angle \frac{\pi}{4} \text{ and at } a \angle \frac{3\pi}{4}$$

Sec 6.8 cont'd

3) cont'd $2 \int_0^{\infty} \frac{x^2 \text{Log} x}{x^4 + a^4} dx = \text{Re} \left[2\pi i \sum_{\text{res}} \frac{z^2 \text{Log} z}{z^4 + a^4} \right]$

$= \text{Re} \left[2\pi i \sum \frac{z^2 \text{Log} z}{4z^3} \text{ at } \left. \begin{array}{l} \text{at } a \angle \pi/4 \\ \text{and } a \angle 3\pi/4 \end{array} \right\} \right]$

$= \text{Re} \left[\frac{\pi i}{2} \left[\frac{\text{Log} a + i\pi/4}{a e^{i\pi/4}} + \frac{\text{Log} a + i3\pi/4}{a e^{i3\pi/4}} \right] \right]$

$\therefore \int_0^{\infty} \frac{x^2 \text{Log} x}{x^4 + a^4} dx = \frac{\pi}{a} \frac{\sqrt{2}}{4} \text{Log} a + \frac{\pi^2 \sqrt{2}}{16 a}$

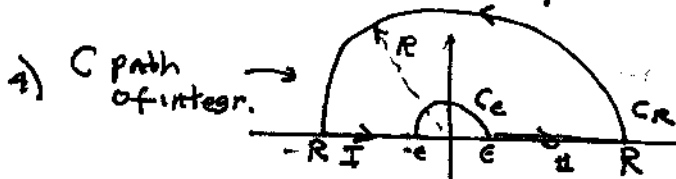

1) C path of integr.

$\int_C \frac{\text{Log} z}{z^4 + z^2 + 1} dz = 2\pi i \sum_{\text{res, uhp}} \frac{\text{Log} z}{z^4 + z^2 + 1}$

poles of $\frac{\text{Log} z}{z^4 + z^2 + 1}$

zeros of $z^4 + z^2 + 1 = 0$

$z^2 = \frac{-1 \pm i\sqrt{3}}{2}$, zeros in uhp are at

$z = \left[\frac{-1 \pm i\sqrt{3}}{2} \right]^{1/2}$ $1 \angle 60^\circ, 1 \angle 120^\circ$

poles are at $1 \angle 60^\circ, 1 \angle 120^\circ$ in uhp.

$\int_{-R}^{-\epsilon} \frac{\text{Log}|x| + i\pi}{x^4 + x^2 + 1} dx + \int_{C_\epsilon} \frac{\text{Log} z}{z^4 + z^2 + 1} dz + \int_{\epsilon}^R \frac{\text{Log} x}{x^4 + x^2 + 1} dx$

$+ \int_{C_R} \frac{\text{Log} z}{z^4 + z^2 + 1} dz = 2\pi i \sum_{\text{res}} \frac{\text{Log} z}{z^4 + z^2 + 1} \text{ at } \left. \begin{array}{l} 1 \angle 60^\circ \\ 1 \angle 120^\circ \end{array} \right\}$

on C_R , $\int_{C_R} = 0$ USE ML inequality
 $L = \pi R$
 $M = \frac{\text{Log} R}{R^4 - R^2 - 1} \ll \frac{R}{R^4 - R^2 - 1}$

NOTE $\lim_{R \rightarrow \infty} M L = 0$
 Similarly $C_\epsilon \int = 0$ as $\epsilon \rightarrow 0+$ see Example 1

4) cont'd Sec 6.8 cont'd

letting $\epsilon \rightarrow 0^+$, $R \rightarrow \infty$:

$$\int_{-\infty}^{\infty} \frac{\text{Log}|x| + i\pi}{x^4 + x^2 + 1} dx + \int_0^{\infty} \frac{\text{Log} x}{x^4 + x^2 + 1} dx$$

$$= 2\pi i \sum_{\text{res}} \frac{\text{Log} z}{z^4 + z^2 + 1} \text{ at } i\sqrt{3}, i\sqrt{12}$$

$$2 \int_0^{\infty} \frac{\text{Log} x}{x^4 + x^2 + 1} dx + i\pi \int_0^{\infty} \frac{1}{x^4 + x^2 + 1} dx = 2\pi i \sum \frac{\text{Log} z}{4z^3 + 2z}$$

at $i\sqrt{3}$
 $i\sqrt{12}$

$$= \frac{2\pi i}{2} \left[\frac{i\pi/3}{-2 + \frac{1}{2} + \frac{i\sqrt{3}}{2}} + \frac{i2\pi/3}{2 + \frac{1}{2} + \frac{i\sqrt{3}}{2}} \right]$$

$$= -\frac{\pi^2}{3} \left[\frac{-\frac{3}{2} - \frac{i\sqrt{3}}{2} + 3 - i\sqrt{3}}{\frac{9}{4} + \frac{3}{4}} \right] = -\frac{\pi^2}{6} [1 - i\sqrt{3}]$$

$$= 2 \int_0^{\infty} \frac{\text{Log} x}{x^4 + x^2 + 1} dx + i\pi \int_0^{\infty} \frac{1}{x^4 + x^2 + 1} dx$$

$$\text{so } \frac{\pi}{6} \sqrt{3} = \int_0^{\infty} \frac{1}{x^4 + x^2 + 1} dx, \quad -\frac{\pi^2}{12} = \int_0^{\infty} \frac{\text{Log} x}{x^4 + x^2 + 1} dx$$

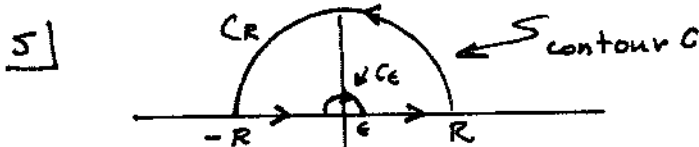

$$\int_C \frac{\text{Log}^2 z}{z^2 + 1} dz = 2\pi i \text{Res} \frac{\text{Log}^2 z}{z^2 + 1} \text{ at } z=i$$

$$\int_{-R}^{-\epsilon} \frac{(\text{Log}|x| + i\pi)^2}{x^2 + 1} dx + \int_{\epsilon}^R \frac{(\text{Log} x)^2}{x^2 + 1} dx + \int_{C_C} \frac{\text{Log}^2 z}{z^2 + 1} dz = 2\pi i \frac{\text{Log}^2 i}{2i}$$

on C_R $\left| \int \frac{\text{Log}^2 z}{z^2 + 1} dz \right| < \left[\frac{\text{Log}^2 R}{R^2 - 1} \right] \pi R$, let $u = \text{Log} R$
 as $R \rightarrow \infty$, $u \rightarrow \infty$

$$ML = \frac{u^2 \pi e^u}{e^{2u} - 1} = \frac{u^2 \pi e^u}{e^u 2 \sinh u} = \frac{u^2 \pi}{2 \sinh u} \rightarrow 0 \text{ as } u \rightarrow \infty$$

[use $\sinh u = u + \frac{u^3}{3!} + \frac{u^5}{5!} + \dots$]

sec 6.8

$$\leq \text{cont'd on } C_\epsilon \int \frac{\text{Log}^2 z}{z^2+1} dz \leq \frac{|\text{Log} \epsilon + i\pi|^2}{1-\epsilon^2} \pi \epsilon$$

$$= \left(\frac{\text{Log}^2 \epsilon + \pi^2}{1-\epsilon^2} \right) \pi \epsilon$$

let $\epsilon \rightarrow 0+$, let $-u = \text{Log} \epsilon$

as $\epsilon \rightarrow 0+$, $u \rightarrow \infty$

$$\epsilon = e^{-u}$$

$$= \left(\frac{u^2 + \pi^2}{1-e^{-2u}} \right) \pi e^{-u} \rightarrow 0 \text{ as } u \rightarrow \infty$$

passing to the limits:

$$\int_{-\infty}^0 \frac{(\text{Log}|x| + i\pi)^2}{x^2+1} dx + \int_0^{\infty} \frac{(\text{Log} x)^2}{x^2+1} dx = \pi \left(\frac{\pi}{2} \right)^2$$

$$\int_{-\infty}^0 \frac{\text{Log}^2|x| + 2i\pi \text{Log} x - \pi^2}{x^2+1} dx + \int_0^{\infty} \frac{\text{Log}^2 x}{x^2+1} dx = -\frac{\pi^3}{4}$$

Equating reals

$$2 \int_0^{\infty} \frac{\text{Log}^2 x}{x^2+1} dx - \pi^2 \int_0^{\infty} \frac{dx}{x^2+1} = -\frac{\pi^3}{4}$$

$$\text{So } 2 \int_0^{\infty} \frac{\text{Log}^2 x}{x^2+1} dx = \pi^3/4 \quad \int_0^{\infty} \frac{\text{Log}^2 x}{x^2+1} dx = \frac{\pi^3}{8}$$

6) (a)

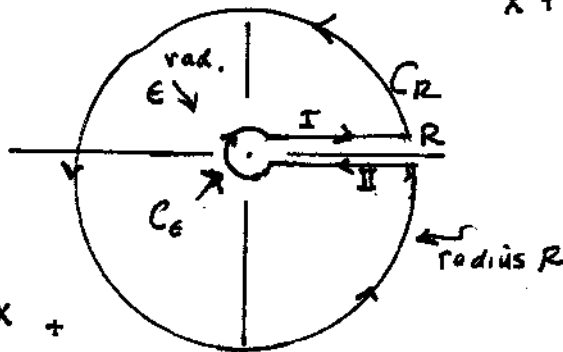

$$\int \frac{x \text{Log} x}{x^2+x^2+1} dx +$$

$$\int_{C_R} \frac{z \text{Log} z}{z^2+z^2+1} dz + \int_{\Gamma} \frac{x (\text{Log} x + i\pi) dx}{x^2+x^2+1} + \int_{C_\epsilon} \frac{z \text{Log} z}{z^2+z^2+1} dz$$

$$= 2\pi i \sum_{\text{res}} \frac{z \text{Log} z}{z^2+z^2+1} \text{ at all poles.}$$

sec 6.8

G(a) continued

Use ML inequality to argue that as

$$\epsilon \rightarrow 0+, \int \frac{z \operatorname{Log} z}{z^4 + z^2 + 1} dz = 0, \text{ take } L = \pi \epsilon$$

$$\left| \frac{z \operatorname{Log} z}{z^4 + z^2 + 1} \right| \leq \frac{\epsilon |\operatorname{Log} \epsilon|}{1 - \epsilon^4 - \epsilon^2}$$

Similarly, as $R \rightarrow \infty$, integral over $C_R = 0$

$$\begin{aligned} \therefore \int_0^\infty \frac{x \operatorname{Log} x}{x^4 + x^2 + 1} dx + \int_\infty^0 \frac{x \operatorname{Log} x}{x^4 + x^2 + 1} dx \\ + \int_0^\infty \frac{L 2\pi x}{x^4 + x^2 + 1} dx = 2\pi i \sum_{\text{res}} \frac{z \operatorname{Log} z}{z^4 + z^2 + 1} \text{ at all poles} \end{aligned}$$

$$\therefore \int_0^\infty \frac{x}{x^4 + x^2 + 1} dx = - \sum_{\text{res}} \frac{z \operatorname{Log} z}{z^4 + z^2 + 1} \text{ at all poles}$$

where are poles? $z^4 + z^2 + 1 = 0$

$$z^2 = \frac{-1 \pm i\sqrt{3}}{2}$$

$$= \begin{matrix} 1 \angle 120^\circ \\ 1 \angle -120^\circ \end{matrix}$$

$$\boxed{\begin{matrix} z = 1 \angle 60^\circ, 1 \angle -60^\circ \\ z = 1 \angle 240^\circ, z = 1 \angle 120^\circ \\ \text{poles.} \end{matrix}}$$

Residue is $\frac{z \operatorname{Log} z}{4z^3 + 2z} = \frac{\operatorname{Log} z}{2(z^2 + 1)}$ at the pole.

$$\sum_{\text{residues}} = \frac{-1}{2} \left[\frac{1 \angle \pi/3}{2 \angle 120^\circ + 1} + \frac{i 2\pi/3}{2 \angle 240^\circ + 1} + \frac{i 4\pi/3}{2 \angle 120^\circ + 1} + \frac{i 5\pi/3}{2 \angle -120^\circ + 1} \right]$$

note, we are not using princ. value of log.

for example $\operatorname{Log} (1 \angle -60^\circ) = \operatorname{Log} [300^\circ] = \operatorname{Log} \left[1 \angle \frac{5\pi}{3} \right]$

$$\begin{aligned} \sum_{\text{residues}} &= \frac{-1}{2} \left[\frac{1 \angle 5\pi/3}{1 \angle \sqrt{3}} + \frac{i 7\pi/3}{-1 \angle \sqrt{3}} \right] = \frac{\pi}{3\sqrt{3}} = 1 \angle 5\pi/3 \end{aligned}$$

Prob 6

Sec 6.8

b)

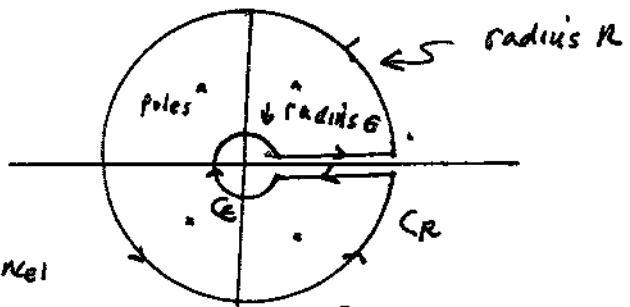

$$\int_{C_\epsilon} \frac{P(x)}{Q(x)} \log x dx + \int_{C_R} \frac{P(z)}{Q(z)} \log z dz + \int_{C_\epsilon} \frac{(\log x + i2\pi)P}{Q} dx$$

$$+ \int_{C_\epsilon} \frac{P(z)}{Q(z)} \log z dz = 2\pi i \sum_{\text{res}} \frac{P(z)}{Q(z)} \log z \quad \text{all poles}$$

[all zeros of Q(z)]

On C_R $\left| \int \frac{P(z)}{Q(z)} \log z dz \right| \leq M \pi R$

$$\left| \log z \frac{P(z)}{Q(z)} \right| \leq \frac{M}{R^2} \log R \quad \text{for } |z| \geq R_0$$

See problem 37 in sec 6.5

$$\lim_{R \rightarrow \infty} \frac{M}{R^2} \log R \pi R = 0$$

make change of variable $w = \log R$

$$\frac{1}{R} = \frac{1}{e^w}, \text{ let } w \rightarrow \infty$$

Similarly $\lim_{\epsilon \rightarrow 0} \int_{C_\epsilon} \frac{P(z)}{Q(z)} \log z dz = 0$

(see e.g. Example 1 in sec 6.8 for similar limit)

Passing to limits:

$$\int_{-\infty}^{\infty} \frac{i 2\pi P(x)}{Q(x)} dx = 2\pi i \sum_{\text{res}} \frac{P(z)}{Q(z)} \log z \quad \text{all poles}$$

$$\int_0^{\infty} \frac{P(x)}{Q(x)} dx = - \sum_{\text{res}} \frac{P(z)}{Q(z)} \log(z) \quad \text{all poles}$$

check: $\int_0^{\infty} \frac{1}{x^2+1} dx = - \sum_{\text{res}} \frac{1}{z^2+1} \log(z) \text{ at } \pm i$

$$= - \frac{\log i}{2i} - \frac{\log(-i)}{-2i} = \frac{-i\pi/2}{2i} - \frac{[i\pi/2]}{-2i}$$

$$= \frac{3\pi}{4} - \frac{\pi}{4} = \frac{\pi}{2} \quad \text{g.e.d}$$

not princ value

chap 6, sec 6.8

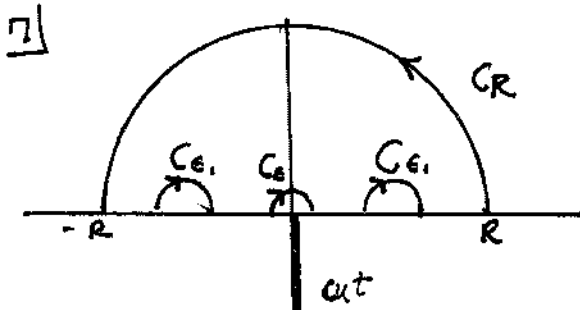

$$\int_{-\infty}^{\infty} \frac{\text{Log}|x|}{x^2-a^2} + \int_{-\infty}^0 \frac{i\pi}{x^2-a^2} dx - \pi i \text{Res} \frac{\text{Log } z}{z^2-a^2} \Big|_{z=-a}$$

$$- \pi i \text{Res} \frac{\text{Log } z}{z^2-a^2} \Big|_{z=a} = 0 \quad \text{equating reals}$$

$$2 \int_0^{\infty} \frac{\text{Log } x}{x^2-a^2} dx = \text{Re} \left[\text{Res} \left[\frac{\pi i \text{Log } z}{z^2-a^2} \text{ at } a + \frac{\pi i \text{Log } z}{z^2-a^2} \text{ at } -a \right] \right]$$

$$= \text{Re} \left[\frac{\pi i \text{Log } a}{2a} + \frac{\pi i (\text{Log } a + i\pi)}{-2a} \right]$$

$$\therefore \int_0^{\infty} \frac{\text{Log } x dx}{x^2-a^2} = \frac{\pi^2}{4a} \quad \text{s.e.d.}$$

8] see next pg.

Sec 6.8

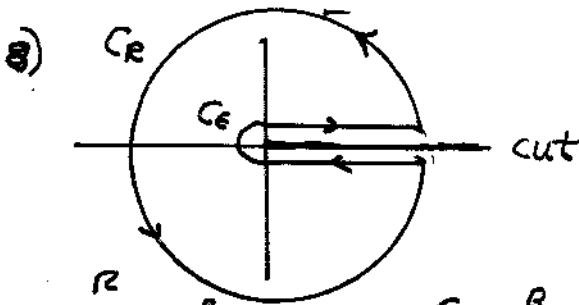

$$e^{-i\beta\pi} \int_0^R \frac{x^\beta}{(x+a)^2} dx + \int_{C_R} \frac{z^\beta}{(z+a)^2} dz + \int_0^\epsilon \frac{x^\beta e^{i2\pi\beta}}{(x+a)^2} dx$$

$$+ \int_{C_\epsilon} \frac{z^\beta}{(z+a)^2} dz = 2\pi i \operatorname{Res}_{z=-a} \frac{z^\beta}{(z+a)^2} \Big|_{z=-a}$$

as $R \rightarrow \infty$, $\epsilon \rightarrow 0^+$ integrals on C_ϵ and $C_R \rightarrow 0$ [provided $-1 < \beta < 1$]

$$\int_0^\infty \frac{x^\beta}{(x+a)^2} dx [1 - e^{i2\pi\beta}] = 2\pi i \beta z^{\beta-1} \Big|_{z=-a}$$

$$= \frac{2\pi i \beta z^\beta}{z} = \frac{2\pi i \beta (-a)^\beta}{-a} = \frac{-2\pi i \beta}{a} e^{i\pi\beta} a^\beta$$

$$\int_0^\infty \frac{x^\beta}{(x+a)^2} dx (-2i) \sin(\beta\pi) = \frac{-2\pi i \beta a^\beta}{a}$$

$$\int_0^\infty \frac{x^\beta dx}{(x+a)^2} = \frac{\pi}{a} \frac{\beta a^\beta}{\sin(\beta\pi)}$$

9) Use same contour as prob 8. let $R \rightarrow \infty$, $\epsilon \rightarrow 0^+$

$$\text{Thus } \int_0^\infty \frac{x^\beta}{x^2+a^2} dx [1 - e^{i2\pi\beta}] = 2\pi i \sum_{\text{res}} \frac{z^\beta}{z^2+a^2} \text{ at } ia \text{ and } -ia$$

$$= 2\pi i \left[\frac{(ia)^\beta}{2ia} + \frac{(-ia)^\beta}{-2ia} \right]. \text{ Note: } i^\beta = e^{\beta \log i}$$

$e^{\beta i\pi/2}$ for our branch of z^β . Similarly:
 $(-i)^\beta = e^{\beta \log(-i)} = e^{\beta 3i\pi/2}$

$$\text{Thus: } \int_0^\infty \frac{x^\beta}{x^2+a^2} dx = \frac{\pi}{a} \left[\frac{e^{i\beta\pi/2} a^\beta - e^{\beta i 3\pi/2} a^\beta}{1 - e^{i2\pi\beta}} \right]$$

Chap 6, sec 6.8 cont'd

9) cont'd

cont'd

$$\int_0^{\infty} \frac{x^{\beta}}{x^2+a^2} dx = \frac{\pi}{a} \frac{a^{\beta}}{e^{i\pi\beta}} \left[\frac{e^{i\beta\pi/2} a^{\beta} - e^{i3\pi/2} a^{\beta}}{-2i \sin(\pi\beta)} \right]$$

$$= \frac{\pi a^{\beta}}{a} \frac{\cos(\frac{\pi\beta}{2})}{\sin\pi\beta} = \frac{\pi a^{\beta}}{2a \cos(\frac{\pi\beta}{2})}$$

10)

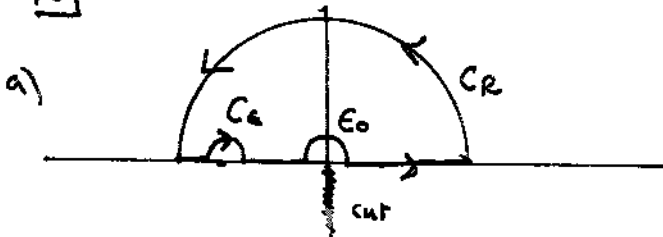

$$\int_{-\infty}^0 \frac{dx}{|x|^{1/\alpha} (x+1)} e^{i\pi/\alpha} + -\pi i \operatorname{Res} \frac{1}{z^{\alpha} (z+1)}, z=-1$$

$$+ \int_0^{\infty} \frac{dx}{x^{1/\alpha} (x+1)} = 0 \quad \text{Let } I_1 = \int_0^{\infty} \frac{dx}{x^{1/\alpha} (x+1)}$$

and let $I_2 = \int_{-\infty}^0 \frac{dx}{|x|^{1/\alpha} (x+1)}$

Thus $I_1 + I_2 e^{-i\pi/\alpha} = \frac{\pi i}{e^{i\pi/\alpha}} = \pi i e^{-i\pi/\alpha}$

Equating real parts on each side
 $I_1 + I_2 \cos \frac{\pi}{\alpha} = \pi \sin(\frac{\pi}{\alpha})$, Equating imag parts:
 $-I_2 \sin \frac{\pi}{\alpha} = \pi \cos \frac{\pi}{\alpha}$. Solving the preceding get $I_1 = \pi / (\sin \frac{\pi}{\alpha})$

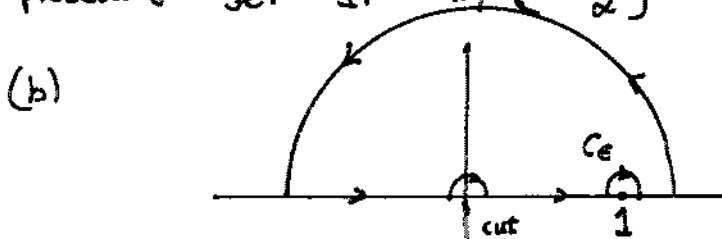

$$\int_0^{\infty} \frac{dx}{x^{1/\alpha} (x-1)} + \frac{-1}{2} 2\pi i \operatorname{Res} \frac{1}{z^{1/\alpha} (z-1)} \text{ at } z=1 + \int_{-\infty}^0 \frac{dx}{|x|^{1/\alpha} e^{i\pi/\alpha} (x-1)} = 0$$

cont'd

Chap 6, 6.8 cont'd

Let $I_1 = \int_0^{\infty} \frac{dx}{x^{1/d}(x-1)}$, let $I_2 = \int_{-\infty}^0 \frac{dx}{|x|^{1/d}(x-1)}$

$I_1 + I_2 e^{-i\pi/d} = \pi i$

Equating reals $I_1 + I_2 \cos(\frac{\pi}{d}) = 0$

Equating imag parts $-I_2 \sin \frac{\pi}{d} = \pi$

$I_2 = \frac{-\pi}{\sin \frac{\pi}{d}}$. Hence $I_1 = \pi \cot \frac{\pi}{d}$

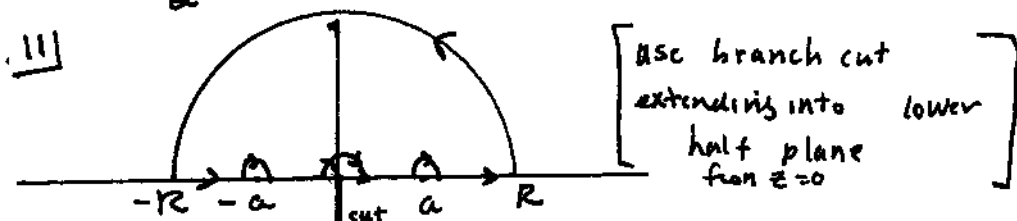

$\int_{-\infty}^0 \frac{|x|^{1/d} e^{i\pi/d}}{x^2 - a^2} dx + \int_0^{\infty} \frac{x^{1/d}}{x^2 - a^2} dx - \pi i \operatorname{Res} \frac{z^{1/d}}{z^2 - a^2}, z = -a$

$- \pi i \operatorname{Res} \frac{z^{1/d}}{z^2 - a^2}, (z = a) = 0$

$\int_0^{\infty} \frac{x^{1/d} dx}{x^2 - a^2} [1 + e^{i\pi/d}] = \frac{\pi i a^{1/d}}{2a} + \frac{\pi i a^{1/d} e^{i\pi/d}}{-2a}$

$\int_0^{\infty} \frac{x^{1/d} dx}{x^2 - a^2} = \frac{\pi i}{2a} a^{1/d} \frac{[1 - e^{i\pi/d}]}{1 + e^{i\pi/d}} =$

$\frac{\pi}{2a} a^{1/d} \tan \left[\frac{\pi}{2d} \right] = \frac{\pi}{2a} a^{1/d} \frac{[1 - \cos \frac{\pi}{d}]}{\sin \frac{\pi}{d}}$

Since $1 - \cos \frac{\pi}{d} = 2 \sin^2 \frac{\pi}{2d}$ and $\sin \frac{\pi}{d} = 2 \sin \frac{\pi}{2d} \cos \frac{\pi}{2d}$

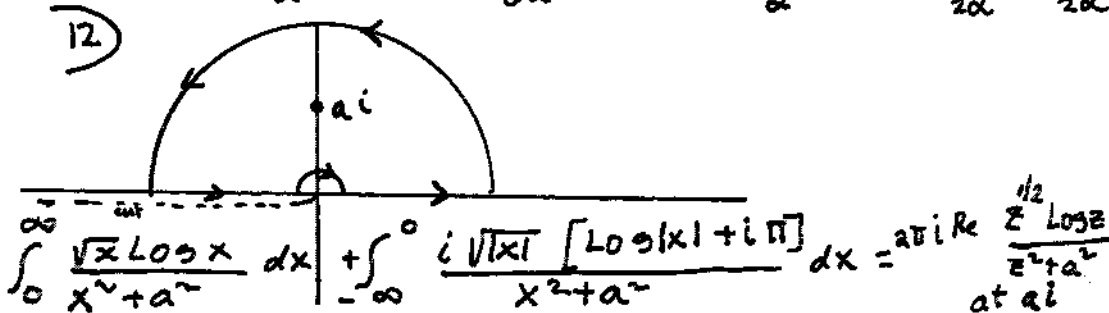

12) cont'd

Chap 6, sec 6.8 cont'd

$$\int_0^{\infty} \frac{\sqrt{x} \operatorname{Log} x}{x^2+a^2} dx \left[1+i \right] - \pi \int_0^{\infty} \frac{\sqrt{x} dx}{x^2+a^2}$$

$$= \frac{2\pi i (a)^{1/2}}{2ai} \operatorname{Log}(ai) = \frac{\pi}{a} \sqrt{a} \frac{(1+i)}{\sqrt{2}} \left[\operatorname{Log} a + i \frac{\pi}{2} \right]$$

let $I_1 = \int_0^{\infty} \frac{\sqrt{x} \operatorname{Log} x}{x^2+a^2} dx$, $I_2 = \int_0^{\infty} \frac{\sqrt{x} dx}{x^2+a^2}$

$$I_1(i) - \pi I_2 = \frac{\pi}{\sqrt{a}} \frac{(1+i)}{\sqrt{2}} \left[\operatorname{Log} a + i \frac{\pi}{2} \right]$$

Equate real parts on each side

$$I_1 = \frac{\pi}{\sqrt{a}} \frac{1}{\sqrt{2}} \left[\operatorname{Log} a + \frac{\pi}{2} \right] \quad \text{q.e.d.}$$

Equating imag. parts, and using the preceding result, will set: $\int_0^{\infty} \frac{\sqrt{x} dx}{x^2+a^2} = \frac{\pi}{\sqrt{2}a}$

13)

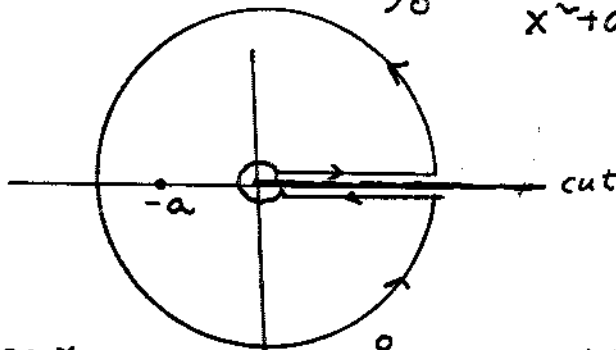

$$\int_0^{\infty} \frac{\operatorname{Log} x}{x^{1/\beta} (x+a)} dx + \int_{\infty}^0 \frac{\operatorname{Log} x + i 2\pi}{(x^{1/\beta} e^{i 2\pi/\beta}) (x+a)} dx$$

$$= 2\pi i \operatorname{Res} \frac{\operatorname{Log} z}{z^{1/\beta} (z+a)} \left[a - a \right]$$

Let $I = \int_0^{\infty} \frac{\operatorname{Log} x}{x^{1/\beta} (x+a)} dx$

$$I \left[1 - e^{-i \frac{2\pi}{\beta}} \right] = 2\pi i e^{-i \frac{2\pi}{\beta}} \int_0^{\infty} \frac{dx}{x^{1/\beta} (x+a)}$$

$$2\pi i \left[\frac{\operatorname{Log} a + i \frac{\pi}{\beta}}{a^{1/\beta} e^{i \frac{\pi}{\beta}}} \right]$$

Sec 6.8

13 cont'd

Let $I' = \int_0^{\infty} \frac{dx}{x^{1/\beta} (x+a)}$

Thus: $e^{-\pi i/\beta} I - 2\pi i e^{-\pi i/\beta} I' = \frac{2\pi i [Losa + i\pi]}{a^{1/\beta} e^{i\pi/\beta}}$

$I \sin \frac{\pi}{\beta} - I' \pi e^{-\pi i/\beta} = \frac{\pi [Losa + i\pi]}{a^{1/\beta}}$

Equating imaginary parts:

$I' = \int_0^{\infty} \frac{dx}{\sqrt[\beta]{x} (x+a)} = \frac{\pi}{\sqrt[\beta]{a} \sin(\frac{\pi}{\beta})}$

Equating real parts, and using the above:

$I = \frac{\pi}{\sqrt[\beta]{a} \sin \frac{\pi}{\beta}} \left[\pi \cot \left(\frac{\pi}{\beta} \right) + Losa \right]$

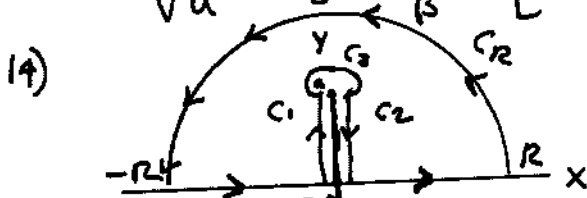

(4)

$$\int_{-R}^{0-} \text{Log} \left[\frac{a^2 + x^2}{x^2} \right] e^{i\nu x} dx + \int_{C_1} \text{Log} \left[\frac{a^2 + z^2}{z^2} \right] e^{-\nu y} i dy$$

$$+ \int_{C_2} \text{Log} \left[\frac{a^2 + z^2}{z^2} \right] e^{-\nu y} i dy + \int_{0+}^R \text{Log} \left[\frac{a^2 + x^2}{a^2} \right] e^{i\nu x} dx$$

$$+ \int_{C_3} \text{Log} \left[\frac{a^2 + z^2}{z^2} \right] e^{i\nu z} dz + \int_{C_4} \text{Log} \left[\frac{a^2 + z^2}{z^2} \right] e^{i\nu z} dz = 0$$

$\text{Log} \left[\frac{a^2 + z^2}{z^2} \right] = \text{Log} \left[1 + \frac{a^2}{z^2} \right] = \frac{a^2}{z^2} - \frac{1}{2} \left(\frac{a^2}{z^2} \right)^2 + \dots$

for: $|z| > a$

Using this series in $\int_{C_3} \dots dz$, and applying Jordan's Lemma we find that $\int_{C_3} \text{Log} \left[\frac{a^2 + z^2}{z^2} \right] e^{i\nu z} dz \rightarrow 0$ as $R \rightarrow \infty$.

[Also $\int_{C_4} \rightarrow 0$ as radius $C_3 \rightarrow 0+$].

Sec 6.8

14) Cont'd let $R \rightarrow \infty$ [drop integrals on C_R and C_3]

$$\int_{-\infty}^{+\infty} \text{Log} \left[\frac{a^2+x^2}{x^2} \right] \cos(\nu x) dx + \int_{0}^a \text{Log} \left[\frac{a^2+z^2}{z^2} \right] e^{-\nu y} e^{i y} dy$$

$$+ \int_a^0 \text{Log} \left[\frac{a^2+z^2}{z^2} \right] e^{-\nu y} i dy = 0$$

on C_2 $\text{Log} \left[\frac{a^2+z^2}{z^2} \right] = \text{Log} \left| \frac{a^2+z^2}{z^2} \right| - i\pi$

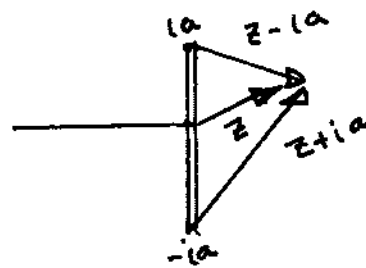
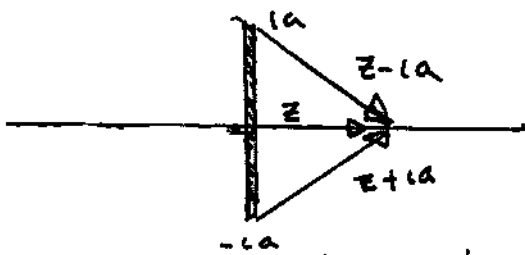

on C_1 $\text{Log} \left[\frac{a^2+z^2}{z^2} \right] + i\pi$

$$\int_{-\infty}^{+\infty} \text{Log} \left[\frac{a^2+x^2}{x^2} \right] \cos(\nu x) dx = - \int_0^a \left(\text{Log} \left| \frac{a^2+z^2}{z^2} \right| + i\pi \right) e^{-\nu y} e^{i y} dy$$

$$+ \int_a^0 \left(\text{Log} \left| \frac{a^2+z^2}{z^2} \right| - i\pi \right) e^{-\nu y} i dy = 0$$

$z = iy$
 on C_1
 and C_2

$$\int_{-\infty}^{+\infty} \text{Log} \left[\frac{a^2+x^2}{x^2} \right] \cos(\nu x) dx = 2\pi \int_0^a e^{-\nu y} dy$$

$$\int_0^{\infty} \text{Log} \left[\frac{a^2+x^2}{x^2} \right] \cos(\nu x) dx = \frac{\pi}{\nu} [1 - e^{-\nu a}] \quad \text{g.e.d.}$$

Sec 6.8

15) $K_0(w) = \frac{1}{2} \int_{-\infty}^{+\infty} \frac{e^{iwx}}{\sqrt{x^2+1}} dx$

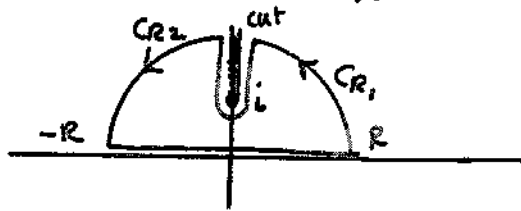

$$\int_{-R}^R \frac{e^{iwx}}{\sqrt{x^2+1}} dx + \int_{C_{R_1}} \frac{e^{iWz}}{(z^2+1)^{1/2}} dz + \int_{y=R}^1 \frac{e^{-Wy}}{(z^2+1)^{1/2}} idy$$

$$+ \int_{y=1}^R \frac{e^{-Wy}}{(z^2+1)^{1/2}} idy + \int_{C_{R_2}} \frac{e^{iWz}}{(z^2+1)^{1/2}} dz = 0$$

rt side of cut
lft side, cut.

On rt side of cut: $(z^2+1)^{1/2} = \sqrt{y^2-1} i$

On left side of cut: $(z^2+1)^{1/2} = -\sqrt{y^2-1} i$

let $R \rightarrow \infty$, integrals on C_{R_1} and $C_{R_2} \rightarrow 0$

Thus $\int_{-\infty}^{+\infty} \frac{e^{iwx}}{\sqrt{x^2+1}} dx + 2 \int_0^1 \frac{e^{-Wy}}{\sqrt{y^2-1}} dy = 0$

$$\int_{-\infty}^{+\infty} \frac{e^{iwx} dx}{\sqrt{x^2+1}} = 2 \int_1^{\infty} \frac{e^{-Wy}}{\sqrt{y^2-1}} dy$$

Divide both sides by 2; this completes proof.

15) SEC 6.8

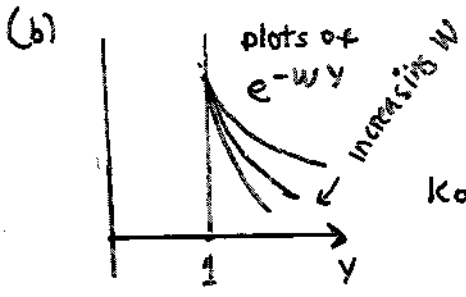

$$k_0(w) = \int_1^{\infty} \frac{e^{-wy}}{\sqrt{y^2-1}} dy = \int_1^{\infty} \frac{e^{-wy}}{\sqrt{y+1} \sqrt{y-1}} dy$$

As w increases, e^{-wy} decreases more and more rapidly with increasing y . Thus the area under the curve $\frac{e^{-wy}}{\sqrt{y+1} \sqrt{y-1}}$; $1 \leq y \leq \infty$, is largely determined

by the behaviour of this function near $y = 1$

This is well approximated by $\frac{e^{-wy}}{\sqrt{2} \sqrt{y-1}}$

Thus $k_0(w) \approx \int_1^{\infty} \frac{e^{-wy}}{\sqrt{2} \sqrt{y-1}} dy$

$$k_0(w) \approx \int_1^{\infty} \frac{e^{-wy}}{\sqrt{2} \sqrt{y-1}} dy, \text{ let } y = t+1$$

$$k_0(w) = \int_0^{\infty} \frac{1}{\sqrt{2}} \frac{1}{\sqrt{t}} e^{-w(t+1)} dt = \frac{e^{-w}}{\sqrt{2}} \int_0^{\infty} \frac{e^{-wt}}{\sqrt{t}} dt$$

d) $x^2 = t, dt = 2x dx = 2\sqrt{t} dx$

$$\int_0^{\infty} \frac{e^{-wt}}{\sqrt{t}} dt = \int_0^{\infty} e^{-wx^2} 2 dx = \frac{\sqrt{\pi}}{\sqrt{w}}$$

Thus $k_0(w) \approx \frac{e^{-w}}{\sqrt{2}} \frac{\sqrt{\pi}}{\sqrt{w}}$

```

Problem 6.8 15(d)
x=linspace(.1,5,100);
y1=besselk(0,x);
y2=sqrt(pi./2*1./x).*exp(-x);
semilogy(x,y1,x,y2, 'r')
    
```

Figure on next pg.

sec 6.8

15 (d) continued

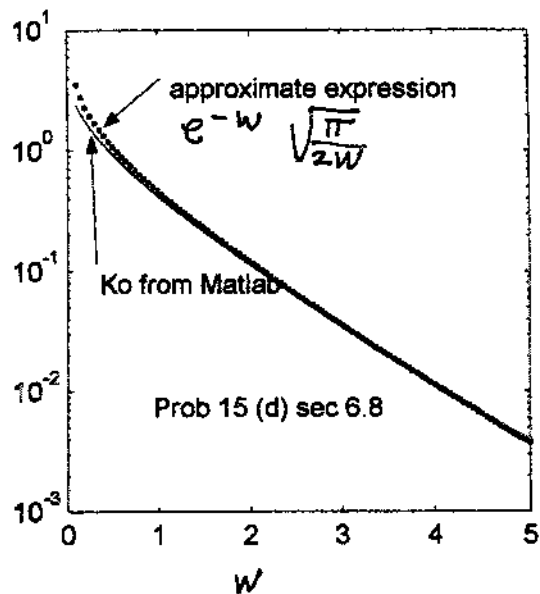

section 6.9

$$\begin{aligned}
 1) \text{ Need } & \frac{1}{2\pi} \int_{-\infty}^{\infty} e^{-a|t|} e^{-j\omega t} dt = \\
 & \frac{1}{2\pi} \int_{-\infty}^0 e^{at} e^{-j\omega t} dt + \frac{1}{2\pi} \int_0^{\infty} e^{-at} e^{-j\omega t} dt \\
 & = \frac{1}{2\pi} \frac{e^{(a-j\omega)t}}{a-j\omega} \Big|_{-\infty}^0 + \frac{1}{2\pi} \frac{e^{(-a-j\omega)t}}{-a-j\omega} \Big|_0^{\infty} \\
 & = \frac{1}{2\pi} \left[\frac{1}{a-j\omega} + \frac{1}{a+j\omega} \right] = \boxed{\frac{1}{2\pi} \frac{2a}{a^2 + \omega^2}}
 \end{aligned}$$

$$\begin{aligned}
 2) \ a) \ F(\omega) &= \frac{1}{2\pi} \int_{-\infty}^{\infty} f(t) e^{-j\omega t} dt = \\
 & \frac{1}{2\pi} \int_{-\infty}^{\infty} f(t) [\cos \omega t - j \sin \omega t] dt = \frac{1}{2\pi} \int_{-\infty}^{\infty} f(t) \cos \omega t dt
 \end{aligned}$$

because $f(t) \sin \omega t$ is an odd func. and its integral = 0. $\therefore F(\omega) = \frac{1}{2\pi} \int_{-\infty}^{\infty} f(t) \cos \omega t dt$ is real.

and $F(\omega) = F(-\omega)$ because $\cos \omega t = \cos(-\omega t)$

$$\begin{aligned}
 b) \text{ From above } \ F(\omega) &= \frac{1}{2\pi} \int_{-\infty}^{\infty} f(t) [\cos \omega t - j \sin \omega t] dt \\
 &= -\frac{j}{2\pi} \int_{-\infty}^{\infty} f(t) \sin \omega t dt \quad \text{because } f(t) \cos \omega t \text{ is}
 \end{aligned}$$

an odd func. and will integrate to zero.

Thus $F(\omega)$ is pure imag. and $F(\omega) = -F(-\omega)$ because $\sin \omega t = -\sin(-\omega t)$.

$$\begin{aligned}
 c) \ F(\omega) &= \frac{1}{2\pi} \int_{-\infty}^{\infty} f(t) [\cos \omega t - j \sin \omega t] dt \\
 \bar{F}(\omega) &= \frac{1}{2\pi} \int_{-\infty}^{\infty} \bar{f}(t) [\cos \omega t + j \sin \omega t] dt = \left\{ \begin{array}{l} \bar{f}(t) = f(t) \\ \text{since } f(t) \\ \text{is real.} \end{array} \right. \\
 &= \frac{1}{2\pi} \int_{-\infty}^{\infty} f(t) [\cos \omega t + j \sin \omega t] dt = \frac{1}{2\pi} \int_{-\infty}^{\infty} f(t) [\cos(-\omega t) - j \sin(-\omega t)] dt \\
 &= F(-\omega) \quad \text{q.e.d.} \quad \text{because } \cos \omega t \text{ is odd} \\
 & \quad \quad \quad \text{and } \sin \omega t \text{ is even}
 \end{aligned}$$

sec 6.9, continued

2(d)

Four. transform of $f(t-\tau)$ is

$$\begin{aligned} & \frac{1}{2\pi} \int_{-\infty}^{\infty} f(t-\tau) e^{-i\omega t} dt \quad \text{let } t' = t - \tau \\ &= \frac{1}{2\pi} \int_{-\infty}^{\infty} f(t') e^{-i\omega(t'+\tau)} dt' = \frac{1}{2\pi} e^{-i\omega\tau} \int_{-\infty}^{\infty} f(t') e^{-i\omega t'} dt' \\ &= e^{-i\omega\tau} F(\omega) \text{ q.e.d.} \end{aligned}$$

$$3) \int_{-\infty}^{+\infty} \frac{e^{i\omega t}}{\omega^2 + a^2} d\omega = 2\pi i \operatorname{Res} \frac{e^{i\omega t}}{\omega^2 + a^2} \Big|_{ai} \quad \text{if } t \geq 0$$

$\omega = \text{complex variable}$ Note

$$= \frac{\pi}{a} e^{-at} \quad \text{if } t \geq 0$$

$$\int_{-\infty}^{+\infty} \frac{e^{i\omega t}}{\omega^2 + a^2} d\omega = -2\pi i \operatorname{Res} \frac{e^{i\omega t}}{\omega^2 + a^2} \Big|_{-ai} \quad \text{if } t \leq 0$$

$$= \frac{\pi}{a} e^{at} \quad \text{if } t \leq 0$$

Thus ans. $\boxed{\frac{\pi}{a} e^{-a|t|}, \text{ all } t}$

4) Assume $t > 0$.

$$\begin{aligned} f(t) &= \int_{-\infty}^{+\infty} \frac{-i e^{i\omega t}}{\omega - ia} d\omega = 2\pi i \operatorname{Res} \left(\frac{-i e^{i\omega t}}{\omega - ia} \right) \Big|_{ai} \\ &= \boxed{2\pi e^{-at} \text{ if } t > 0} \quad \left[\begin{array}{l} \omega = \text{complex var.} \\ \operatorname{Re} \omega = \omega \end{array} \right] \text{ if } t > 0 \end{aligned}$$

$$f(t) = -2\pi i \operatorname{Res} \left[\frac{-i e^{i\omega t}}{\omega - ia} \right] \text{ poles in l.h.p.} = \boxed{0, t < 0}$$

if $t = 0$, $f(t) = \int_{-\infty}^{+\infty} \frac{-i}{\omega - ia} d\omega = \int_{-\infty}^{+\infty} \frac{-i(\omega + ia)}{\omega^2 + a^2} d\omega$

$$= \int_{-\infty}^{+\infty} \frac{-i\omega}{\omega^2 + a^2} d\omega + a \int_{-\infty}^{+\infty} \frac{d\omega}{\omega^2 + a^2} = \boxed{\pi \text{ if } t = 0}$$

" 0

Sec 6.9

$$\int_{-\infty}^{+\infty} \frac{e^{i\omega t} e^{-i\omega b}}{(\omega^2 + a^2)} d\omega = \int_{-\infty}^{+\infty} \frac{e^{i\omega(t-b)}}{\omega^2 + a^2} d\omega$$

Assume $t > b$ [$\omega = \text{complex var.}$ $\text{Re } \omega = \omega$]

$$f(t) = 2\pi i \text{Res} \frac{e^{i\omega(t-b)}}{\omega^2 + a^2} \Big|_{ia} = \frac{\pi}{a} e^{-a(t-b)} \quad t > b$$

Assume $t < b$

$$f(t) = -2\pi i \text{Res} \frac{e^{i\omega(t-b)}}{\omega^2 + a^2} \Big|_{-ia} = \frac{\pi}{a} e^{a(t-b)} \quad t < b$$

Assume $t = b$

$$f = \int_{-\infty}^{+\infty} \frac{1}{\omega^2 + a^2} d\omega = 2\pi i \text{Res} \frac{1}{\omega^2 + a^2} \Big|_{ia} = \frac{\pi}{a}$$

Thus $f(t) = \frac{\pi}{a} e^{-a|t-b|}$ all t

6) $f(t) = 2 \int_{-\infty}^{+\infty} \frac{1}{(\omega - ia)^2} e^{i\omega t} d\omega$. Assume $t > 0$

$$f(t) = 2\pi i \text{Res} \frac{e^{i\omega t}}{(\omega - ia)^2} \Big|_{ia} = \lim_{\omega \rightarrow ia} 2\pi i \frac{d}{d\omega} e^{i\omega t}$$

$$= 4\pi i i t e^{i\omega t} \Big|_{ia} = -4\pi t e^{-at} \quad \text{if } t > 0$$

for $t < 0$, $f(t) = 2 \int_{-\infty}^{+\infty} \frac{e^{i\omega t}}{(\omega - ia)^2} d\omega = -2\pi i \text{Res} \frac{e^{i\omega t}}{(\omega - ia)^2}$

[$\omega = \text{complex variable}$
 $\text{Re } \omega = \omega$]

at poles in lower half plane = 0

if $t = 0$ $f(t) = \int_{-\infty}^{+\infty} \frac{2 d\omega}{(\omega - ia)^2} = 2\pi i \text{Res} \frac{2}{(\omega - ia)^2}$

= 0.

Thus $f(t) = -4\pi t e^{-at} \quad t \geq 0$

$f(t) = 0$ for $t < 0$.

sec 6.9

$$f(t) = \int_{-\infty}^{+\infty} \frac{e^{i\omega t}}{\omega^2 - a^2} d\omega = \int_{-\infty}^{+\infty} \frac{\cos(\omega t) + i \sin(\omega t)}{\omega^2 - a^2} d\omega$$

$$= \int_{-\infty}^{+\infty} \frac{\cos(\omega t)}{\omega^2 - a^2} d\omega, \quad \text{This is an even func. of } \omega.$$

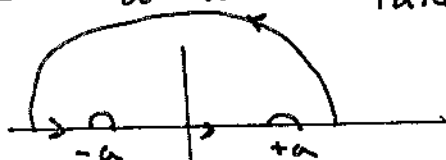

Take $t \geq 0$, $\omega^2 - a^2 = (\omega + a)(\omega - a)$

$$\int_{-\infty}^{+\infty} \frac{e^{i\omega t}}{\omega^2 - a^2} d\omega = 2\pi i \frac{1}{2} \left[\text{Res} \frac{e^{i\omega t}}{\omega^2 - a^2} \Big|_a + \text{Res} \frac{e^{i\omega t}}{\omega^2 - a^2} \Big|_{-a} \right]$$

$$= \pi i \frac{e^{iat}}{2a} + \frac{\pi i e^{-iat}}{-2a} = -\frac{\pi}{a} \sin(at) \quad t \geq 0$$

Since $f(t)$ is an even func. $f(t) = -\frac{\pi}{a} \sin(at)$

for all t . Thus: $f(t) = -\frac{\pi}{a} \sin(at)$, all t

$$f(t) = \int_{-\infty}^{+\infty} \frac{\sin(a\omega)}{\omega} e^{i\omega t} d\omega,$$

$$\sin(a\omega) = \frac{1}{2i} [e^{ia\omega} - e^{-ia\omega}]$$

$$f(t) = I_1 - I_2, \quad I_1 = \int_{-\infty}^{+\infty} \frac{e^{i\omega t} e^{ia\omega}}{2i\omega} d\omega, \quad I_2 = \int_{-\infty}^{+\infty} \frac{e^{i\omega t} e^{-ia\omega}}{2i\omega} d\omega$$

$$I_1 = \int_{-\infty}^{+\infty} \frac{e^{i\omega(at+a)}}{2i\omega} d\omega$$

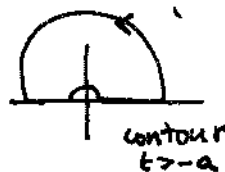

[ω is a complex var.
Re $\omega = \omega$]

Now if $t > -a$, $I_1 = \frac{1}{2} 2\pi i \text{Res} \frac{e^{i\omega(at+a)}}{2i\omega} \quad \omega=0$

$$I_1 = \frac{\pi}{2} \text{ if } t > -a, \quad \text{If } t = -a$$

(continued)
see next page

8 continued

sec 6.9

$$I_1 = \int_{-\infty}^{+\infty} \frac{1}{2i\omega} d\omega = 0 ; \quad \text{If } t < -a :$$

$$I_1 = \int_{-\infty}^{+\infty} \frac{e^{i\omega(a+t)}}{2i\omega} d\omega =$$

$$= -\frac{2\pi i}{2} \text{Res} \frac{e^{i\omega(a+t)}}{2i\omega} = -\pi/2, \quad t < -a.$$

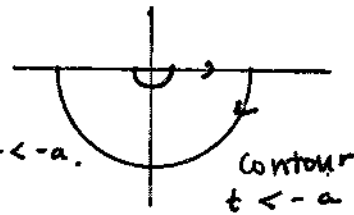

Now $I_2 = \int_{-\infty}^{+\infty} \frac{e^{-i\omega a} e^{i\omega t}}{2i\omega} d\omega$ in a similar way.

$$I_2 = \frac{\pi}{2}, \quad t > a ; \quad I_2 = -\frac{\pi}{2}, \quad t < a ;$$

$$I_2 = 0 \quad t = a ;$$

Thus, for $t \geq a, f(t) = I_1 - I_2 = 0$

for $-a < t < a, f(t) = I_1 - I_2 = \pi$

for $t < -a, f(t) = I_1 - I_2 = 0$

for $t = \pm a, f(t) = 0$

$$9) f(t) = \int_{-\infty}^{+\infty} \frac{e^{i\omega t} \omega(a\omega)}{\omega^2 + b^2} d\omega$$

$$= \int_{-\infty}^{+\infty} \frac{e^{i\omega t} [e^{i\omega a} + e^{-i\omega a}]}{2(\omega^2 + b^2)} d\omega = I_1 + I_2$$

$$I_1 = \int_{-\infty}^{+\infty} \frac{e^{i\omega(t+a)}}{2(\omega^2 + b^2)} d\omega, \quad I_2 = \int_{-\infty}^{+\infty} \frac{e^{i\omega(t-a)}}{2(\omega^2 + b^2)} d\omega$$

$$\text{if } t \geq -a, I_1 = \frac{2\pi i}{2} \text{Res} \frac{e^{i\omega(t+a)}}{\omega^2 + b^2} ; \quad i b$$

$$= \frac{\pi}{2b} e^{-b(t+a)} ;$$

Chap 6, sec 6.9

9) Cont'd for $t \leq -a$,

$$I_1 = \frac{-2\pi i}{2} \text{Res} \frac{e^{i\omega(t+a)}}{\omega^2 + b^2} ; -ib = \frac{\pi}{2b} e^{b(t+a)}$$

Similarly, $I_2 = \int_{-\infty}^{+\infty} \frac{e^{i\omega(t-a)}}{(2)(\omega^2 + b^2)} d\omega = \frac{\pi}{2b} e^{-b(t-a)} \quad t \geq a$

and $I_2 = \frac{\pi}{2b} e^{b(t-a)} \quad t \leq a$

$$f(t) = I_1 + I_2 = \frac{\pi}{b} e^{-bt} \cosh(ab) ; t \geq a$$

$$f(t) = I_1 + I_2 = \frac{\pi}{b} e^{bt} \cosh(ab) ; t \leq -a$$

$$f(t) = I_1 + I_2 = \frac{\pi}{2b} e^{-b(t+a)} + \frac{\pi}{2b} e^{b(t-a)}$$

$$= \frac{\pi e^{-ab}}{b} \left[\frac{e^{-bt} + e^{bt}}{2} \right] = \frac{\pi}{b} e^{-ab} \cosh(bt) ; -a \leq t \leq a$$

Thus $f(t) = \frac{\pi}{b} e^{-b|t|} \cosh(ab)$ for $|t| \geq a$ and $f(t) = \frac{\pi}{b} e^{-ab} \cosh(bt)$ for $|t| \leq a$

$$10) i_0(t) = \frac{w_0}{2\pi} \int_{-\infty}^{+\infty} \frac{e^{i\omega t} d\omega}{(w_0^2 - \omega^2)(r + i\omega L)}$$

$$= \frac{-w_0}{2\pi} \int_{-\infty}^{+\infty} \frac{e^{i\omega t} d\omega}{(\omega^2 - w_0^2)(r + i\omega L)}$$

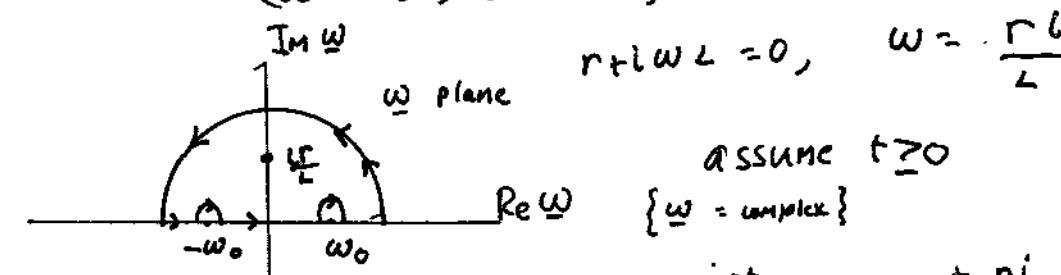

$$= 2\pi i \text{Res} \frac{e^{i\omega t}}{(\omega^2 - w_0^2)(r + i\omega L)} \text{ at } \frac{r}{L}$$

$$+ \pi i \text{Res} \left[\frac{e^{i\omega t}}{(\omega^2 - w_0^2)(r + i\omega L)} \right]_{w_0} + \pi i \text{Res} \left[\frac{e^{i\omega t}}{(\omega^2 - w_0^2)(r + i\omega L)} \right]_{-w_0}$$

Chap 6, Sec 6.9 cont'd

10) cont'd

$$\int_{-\infty}^{+\infty} \frac{e^{i\omega t} d\omega}{(\omega^2 - \omega_0^2)(r + i\omega L)} = \frac{2\pi i e^{-\frac{r}{L}t}}{\left(-\frac{r^2}{L^2} - \omega_0^2\right) i L}$$

$$+ \frac{\pi i e^{i\omega_0 t}}{(2\omega_0)(r + i\omega_0 L)} + \frac{\pi i e^{-i\omega_0 t}}{(-2\omega_0)(r - i\omega_0 L)}$$

$$= \frac{-2\pi L e^{-\frac{r}{L}t}}{r^2 + \omega_0^2 L^2} + \frac{\pi i}{2\omega_0} \left[\frac{e^{i\omega_0 t} (r - i\omega_0 L) - e^{-i\omega_0 t} (r + i\omega_0 L)}{r^2 + \omega_0^2 L^2} \right]$$

to get $L_1(t)$ multiply the above by $\frac{-\omega_0}{2\pi}$.

Thus $L_1(t) = \left[\frac{r \sin(\omega_0 t) - \omega_0 L \cos(\omega_0 t)}{2(r^2 + \omega_0^2 L^2)} \right] + \frac{\omega_0 L e^{-\frac{r}{L}t}}{r^2 + \omega_0^2 L^2} \cdot t \geq 0$

Now assume $t < 0$

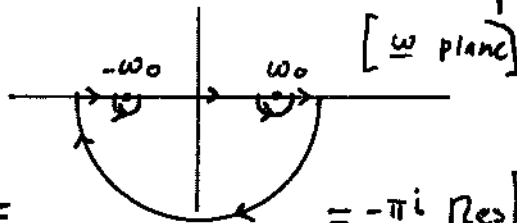

$$\int_{-\infty}^{+\infty} \frac{e^{i\omega t} d\omega}{(\omega^2 - \omega_0^2)(r + i\omega L)} = -\pi i \operatorname{Res} \left[\frac{e^{i\omega t}}{(\omega^2 - \omega_0^2)(r + i\omega L)}, \omega_0 \right]$$

$$- \pi i \operatorname{Res} \left[\frac{e^{i\omega t}}{(\omega^2 - \omega_0^2)(r + i\omega L)}, -\omega_0 \right] = -\pi i e^{i\omega_0 t} \frac{1}{(2\omega_0)(r + i\omega_0 L)} - \pi i e^{-i\omega_0 t} \frac{1}{-2\omega_0(r - i\omega_0 L)}$$

$$= -\frac{\pi i}{2\omega_0} \left[\frac{e^{i\omega_0 t} (r - i\omega_0 L) - e^{-i\omega_0 t} (r + i\omega_0 L)}{r^2 + \omega_0^2 L^2} \right]$$

To get $L_1(t)$, multiply the above by $-\omega_0 / 2\pi$

$$L_1(t) = \frac{\omega_0 L \cos(\omega_0 t) - r \sin(\omega_0 t)}{2(r^2 + \omega_0^2 L^2)}$$

Section 6.9

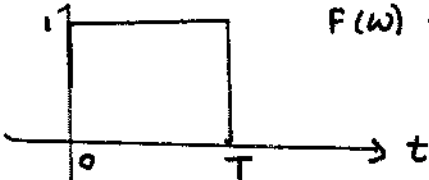
11)  $F(\omega) = \frac{1}{2\pi} \int_0^T e^{-i\omega t} dt$
 $= \frac{1}{2\pi i \omega} [1 - e^{-i\omega T}]$

Verification:

$$f(t) = \int_{-\infty}^{+\infty} \frac{1}{2\pi i \omega} [1 - e^{-i\omega T}] e^{i\omega t} d\omega$$

Assume $t > T$, close contour in u.h.p (Fig 1)

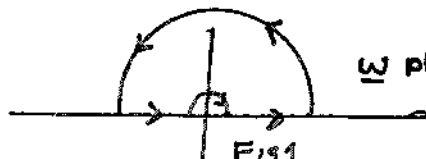

$$f(t) = \frac{2\pi i}{2} \text{Res} \left[\frac{1 - e^{-i\omega T}}{2\pi i \omega}, 0 \right]$$

$$= 0$$

Now assume $0 < t < T$

$$f(t) = \int_{-\infty}^{+\infty} \frac{1}{2\pi i \omega} e^{i\omega t} d\omega - \int_{-\infty}^{+\infty} \frac{e^{i\omega(t-T)}}{2\pi i \omega} d\omega$$

$$= I_1 - I_2 \quad I_1 = \int_{-\infty}^{+\infty} \frac{e^{i\omega t}}{2\pi i \omega} d\omega$$

$$I_2 = \int_{-\infty}^{+\infty} \frac{e^{i\omega(t-T)}}{2\pi i \omega} d\omega$$

Do I_1 , close in u.h.p, use Fig 1, $I_1 = \pi i \text{Res} \frac{e^{i\omega t}}{2\pi i \omega} \Big|_0 = \frac{1}{2}$

Do I_2 , close in l.h.p (Fig 2)

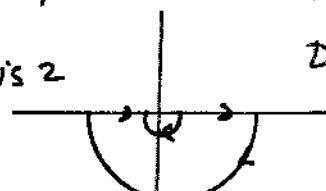

$$I_2 = -\pi i \text{Res} \frac{e^{i\omega(t-T)}}{2\pi i \omega} \Big|_0 = -\frac{1}{2}$$

$$I_1 - I_2 = 1 \quad \text{if } 0 < t < T$$

Now if $t < 0$, close both contours in l.h.p

$$I_1 = -\pi i \text{Res} \frac{e^{i\omega t}}{2\pi i \omega} \Big|_0 = -\frac{1}{2}, \quad I_2 \text{ is still } -\frac{1}{2},$$

$$I_1 - I_2 = 0$$

11) Cont'd

$$f(t) = \int_{-\infty}^{+\infty} \frac{1}{2\pi i \omega} e^{i\omega t} d\omega \quad t=T$$

$$= \int_{-\infty}^{+\infty} \frac{1}{2\pi i \omega} e^{i\omega T} d\omega = \pi i \operatorname{Res} \frac{e^{i\omega T}}{2\pi i \omega} = \frac{1}{2}$$

|| 0 Cauchy P.V.

Similarly, $f(0) = 1/2$.

Thus $f(t) = 1$ for $0 < t < T$, $f(t) = 0$ for $t > T$, $t < 0$ and $f(t) = 1/2$ for $t=0$ or $t=T$

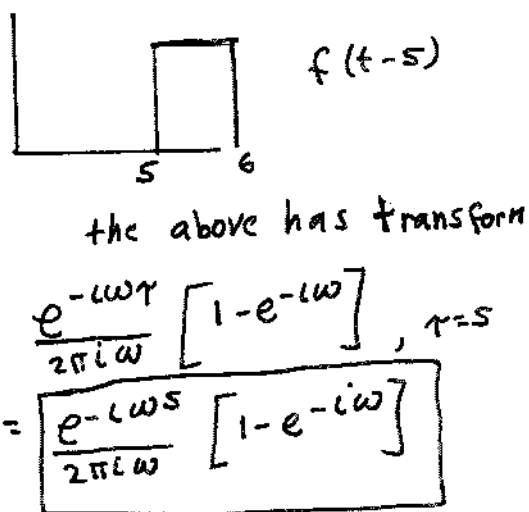
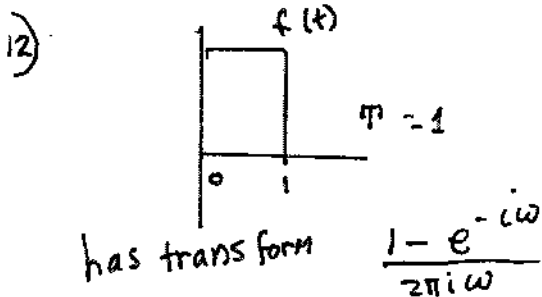

13

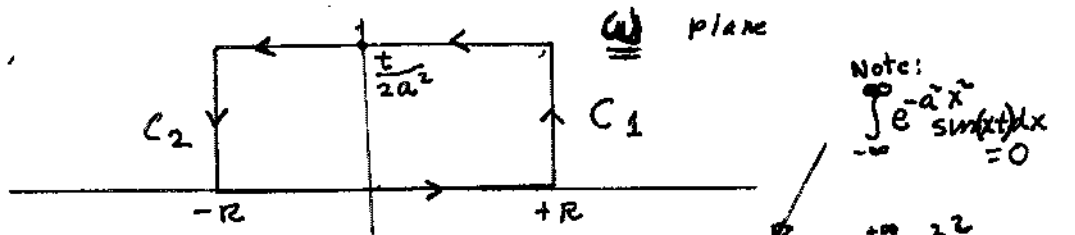

$$f(t) = \int_{-\infty}^{+\infty} e^{-a^2 \omega^2} e^{i\omega t} d\omega = \int_{-\infty}^{+\infty} e^{-a^2 x^2} e^{ixt} dx = \int_{-\infty}^{+\infty} e^{-a^2 x^2} \cos(xt) dx$$

Use x in lieu of ω , consider $\oint e^{-a^2 z^2} dz$ around the above contour.

$$\int_{-R}^R e^{-a^2 x^2} dx + \int_{R}^{t/2a^2} e^{-a^2 z^2} dz + \int_{t/2a^2}^{-R} e^{-a^2 z^2} dz + \int_{-R}^{-R} e^{-a^2 z^2} dz = 0$$

C₁ top of rect.

13) cont'd

Chap 6, sec 6.9

as $R \rightarrow \infty$, integrals on C_1 and $C_2 \rightarrow 0$ on top of rectangle,
 $z = x + i \frac{t}{2a^2}$. Thus, passing to the limit:

$$\int_{-\infty}^{\infty} e^{-a^2 x^2} dx = \int_{-\infty}^{\infty} e^{-a^2 \left[x^2 + \frac{ixt}{a^2} - \frac{t^2}{4a^2} \right]} dx$$

$$e^{-t^2/(4a^2)} \int_{-\infty}^{\infty} e^{-a^2 x^2} dx = \int_{-\infty}^{\infty} e^{-a^2 x^2} e^{-ixt} dx$$

put: $\omega = xt$ - \downarrow $\omega = xt$

Equate real parts, recall $\int_{-\infty}^{\infty} e^{-a^2 x^2} dx = \frac{\sqrt{\pi}}{a}$

$$e^{-t^2/(4a^2)} \frac{\sqrt{\pi}}{a} = \int_{-\infty}^{\infty} e^{-a^2 x^2} \cos(\omega x) dx$$

put $x = \omega$ in the above,

$$1) a) f(t) * g(t) = \int_{-\infty}^{\infty} f(t-\tau) g(\tau) d\tau, \text{ let } \tau' = t - \tau$$

$$= \int_{-\infty}^{\infty} f(\tau') g(t-\tau') d\tau' = \int_{-\infty}^{\infty} g(t-\tau') f(\tau') d\tau' =$$

$g * f$ g.e.d

$$b) \frac{1}{2\pi} \int_{-\infty}^{\infty} \left[\int_{-\infty}^{\infty} f(\tau) g(t-\tau) d\tau \right] e^{-i\omega t} dt \text{ is}$$

the F.T. of $f(t) * g(t)$. Swapping order of the procedures:

$$= \int_{-\infty}^{\infty} f(\tau) \left[\frac{1}{2\pi} \int_{-\infty}^{\infty} g(t-\tau) e^{-i\omega t} dt \right] d\tau$$

\swarrow let $u = t - \tau$

$$= \int_{-\infty}^{\infty} f(\tau) \frac{1}{2\pi} \int_{-\infty}^{\infty} g(u) e^{-i\omega u} e^{-i\omega \tau} du d\tau$$

$$= \int_{-\infty}^{\infty} f(\tau) e^{-i\omega \tau} \left[\frac{1}{2\pi} \int_{-\infty}^{\infty} g(u) e^{-i\omega u} du \right] d\tau =$$

$$= \int_{-\infty}^{\infty} f(\tau) e^{-i\omega \tau} G(\omega) d\tau = G(\omega) 2\pi \frac{1}{2\pi} \int_{-\infty}^{\infty} f(\tau) e^{-i\omega \tau} d\tau$$

$$= 2\pi G(\omega) F(\omega) \quad \text{g.e.d}$$

14 (c)

$$F(\omega) * G(\omega) = \int_{-\infty}^{\infty} F(\omega') G(\omega - \omega') d\omega'$$

inverse transform is

$$\int_{-\infty}^{\infty} \int_{-\infty}^{\infty} F(\omega') G(\omega - \omega') d\omega' e^{i\omega t} d\omega$$

exchange order of the two integrations

$$= \int_{-\infty}^{\infty} F(\omega') \left[\int_{-\infty}^{\infty} G(\omega - \omega') e^{i\omega t} d\omega \right] d\omega' \quad \text{let } u = \omega - \omega'$$

$$= \int_{-\infty}^{\infty} F(\omega') e^{i\omega' t} \left[\int_{-\infty}^{\infty} G(u) e^{i\omega t} du \right] d\omega'$$

$$= \int_{-\infty}^{\infty} F(\omega') e^{i\omega' t} g(t) d\omega' = f(t) g(t) \quad \boxed{\text{f.e.d}}$$

15 a) Inverse Fourier transform of $\frac{1}{(\omega-i)} \frac{1}{\omega-2i}$

$$= \int_{-\infty}^{\infty} \frac{e^{i\omega t}}{(\omega-i)(\omega-2i)} d\omega$$

Assume $t \geq 0$

$$= \frac{2\pi i}{(i-2i)} e^{-t} + \frac{2\pi i}{(2i-i)} e^{-2t} = 2\pi [e^{-2t} - e^{-t}]$$

res $\frac{e^{i\omega t}}{(\omega-i)(\omega-2i)}$ @ $i, 2i$

If $t = 0$ this is still valid, result = 0

Suppose $t < 0$

$$\int_{-\infty}^{\infty} \frac{e^{i\omega t}}{(\omega-i)(\omega-2i)} d\omega = 0$$

close in l.h.p.
poles are in u.h.p.

In summary, the inverse transforms are:

$$2\pi [e^{-2t} - e^{-t}] \quad t \geq 0, \quad \text{else set } 0$$

b) $f(t) = \int_{-\infty}^{\infty} \frac{1}{(\omega-i)} e^{i\omega t} d\omega = 2\pi i e^{-t} \quad t \geq 0, \quad \text{else } 0$

$g(t) = \int_{-\infty}^{\infty} \frac{1}{\omega-2i} e^{i\omega t} d\omega = 2\pi i e^{-2t} \quad t > 0, \quad \text{and } 0 \text{ for } t < 0$

Need $\frac{1}{2\pi} f(t) * g(t) = \frac{1}{2\pi} \int_0^t 2\pi i e^{-\tau} 2\pi i e^{-2(t-\tau)} d\tau$ assume $t \geq 0$

$$= -\frac{4\pi^2}{2\pi} \int_0^t e^{-at} e^{\tau} d\tau = -2\pi e^{-2t} [e^t - 1] = 2\pi [e^{-2t} - e^{-t}] \quad \text{f.e.d}$$

(continued)

Sec 6.9

Prob 15 (b) continued

Recall $f(t) = 0, t < 0, g(t) = 0, t < 0$

$$\therefore \frac{1}{2\pi} f(t) * g(t) = \frac{1}{2\pi} \int_0^t f(\tau) g(t-\tau) d\tau$$

is zero for $t < 0$ which agrees with inverse Fourier transform derived in part (a).

16 (a) Need $\frac{1}{2\pi} \int_{-\infty}^{\infty} \frac{1}{\pi t} e^{-i\omega t} dt$

If $\omega > 0$ close in lower half plane:

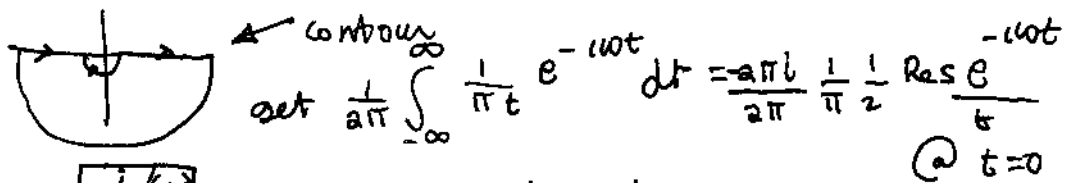

$$\oint_{\text{contour}} \frac{1}{\pi t} e^{-i\omega t} dt = \frac{-2\pi i}{2\pi} \frac{1}{\pi} \frac{1}{2} \text{Res} \frac{e^{-i\omega t}}{t} @ t=0$$

$$= \frac{-i}{2\pi}$$

If $\omega < 0$ close in Uhp and

$$\text{get } \frac{i}{2\pi}$$

If $\omega = 0$ get zero for the Fourier transform of $\frac{1}{\pi t}$ since Cauchy P. Value of $\int_{-\infty}^{\infty} \frac{1}{\pi t} dt = 0$

Thus Fourier transform of

$$b) \int_{-\infty}^{\infty} \frac{-i}{2\pi} \text{sgn}(\omega) e^{i\omega t} d\omega = \int_{-\infty}^{\infty} \frac{-i}{2\pi} \text{sgn}(\omega) \left[\cos \omega t + i \sin \omega t \right] d\omega$$

$$= \frac{-i}{2\pi} \int_{-\infty}^{\infty} \text{sgn}(\omega) \sin \omega t d\omega$$

since $\text{sgn}(\omega) \cos \omega t$ is an odd function

Now $\text{sgn}(\omega) \sin \omega t$ is an even function,

$$\therefore \frac{1}{2\pi} \int_{-\infty}^{\infty} \text{sgn}(\omega) \sin \omega t d\omega = \frac{2}{2\pi} \int_0^{\infty} \sin \omega t d\omega$$

does not converge

$$c) \int_{-\infty}^{\infty} \frac{-i}{2\pi} \text{sgn}(\omega) e^{-\alpha|\omega|} e^{i\omega t} d\omega$$

$$= \int_{-\infty}^{\infty} \frac{-i}{2\pi} \text{sgn}(\omega) e^{-\alpha|\omega|} i \sin \omega t d\omega$$

because $\text{sgn}(\omega) e^{-\alpha|\omega|} \cos \omega t$ is an odd function.

sec 6.9

16) a) continued

$$\begin{aligned} \frac{(-1)^i}{2\pi} \int_{-\infty}^{\infty} \text{sgn } \omega e^{-\alpha|\omega|} \sin \omega t d\omega &= \frac{1}{\pi} \int_0^{\infty} e^{-\alpha\omega} \sin \omega t d\omega \\ &= \frac{1}{\pi} \int_0^{\infty} \text{Im} [e^{-\alpha\omega} e^{i\omega t}] d\omega = \frac{\text{Im}}{\pi} \int_0^{\infty} e^{(-\alpha+it)\omega} d\omega \\ &= \frac{\text{Im}}{\pi} \left[\frac{e^{(-\alpha+it)\omega}}{-\alpha+it} \right]_0^{\infty} = \frac{\text{Im}}{\pi} \left[\frac{1}{\alpha-it} \right] \\ &= \frac{\text{Im}}{\pi} \left[\frac{\alpha+it}{\alpha^2+t^2} \right] = \frac{1}{\pi} \left[\frac{t}{\alpha^2+t^2} \right] \end{aligned}$$

if $\alpha=0^+$ the preceding is $\frac{1}{\pi} \frac{t}{t^2} = \frac{1}{\pi t}$

b) need $\frac{1}{2\pi} \int_{-\infty}^{\infty} \text{sgn } t e^{-\alpha|t|} e^{-i\omega t} dt \quad \lim_{\alpha \rightarrow 0^+}$

$$\begin{aligned} &= \frac{1}{2\pi} \int_{-\infty}^{\infty} \text{sgn } t e^{-\alpha|t|} e^{-i\omega t} dt = \frac{1}{2\pi} \int_0^{\infty} e^{-\alpha t} (-i \sin \omega t) dt = -\frac{2i}{2\pi} \int_0^{\infty} \text{Imag} e^{(-\alpha+i\omega)t} dt \\ &= -\frac{i}{\pi} \text{Imag} \frac{1}{\alpha-i\omega} = -\frac{i}{\pi} \frac{\text{Im}[\alpha+i\omega]}{\alpha^2+\omega^2} = -\frac{i}{\pi} \frac{\omega}{\alpha^2+\omega^2} \quad \text{part } \alpha \rightarrow 0^+ \\ &= -\frac{i}{\pi} \frac{\omega}{\omega^2} = -\frac{i}{\omega\pi} \quad \text{g.e.d} \end{aligned}$$

```

17) % prob 17 sec 6.9      output y =
     syms t w y
     y=fourier(exp(-abs(t)))  2/(1+w^2)  ← (part a)
     ifourier(y)             1)

```

Using result of problem 1 with $a=1$
 we get Fourier transform of $e^{-|t|}$ is $\frac{1}{\pi} \frac{1}{\omega^2+1}$
 If we multiply this by 2π will get
 the Matlab result shown above
 output: $\exp(-x) * \text{Heaviside}(x) + \exp(x) * \text{Heaviside}(-x) = e^{-|x|}$ (part b)

$$\frac{N(t)}{r} + c \frac{dN}{dt} = i(t), \quad \frac{V(\omega)}{r} + i\omega c V = I(\omega)$$

$$\frac{V(\omega)}{I(\omega)} = \frac{1}{\frac{1}{r} + i\omega c} = \boxed{\frac{r}{1 + i r \omega c} = \text{system func}}$$

$$V(\omega) = \left(\frac{r}{1 + i r \omega c} \right) I(\omega), \quad V(\omega) = \frac{r}{1 + i r \omega c} \frac{1}{2\pi i \omega} [1 - e^{-i\omega T}]$$

$$N(t) = \int_{-\infty}^{+\infty} \frac{r}{1 + i r \omega c} \frac{1}{2\pi i \omega} [1 - e^{-i\omega T}] e^{i\omega t} d\omega$$

First assume $t \geq T$. Use contour that closes in uhp. Note that integrand has removable sing. at $\omega=0$.

$$\text{Thus } N(t) = 2\pi i \text{Res}_{\omega = \frac{i}{cr}} \frac{r}{[1 + i(r \cdot \omega c)]} \frac{1}{2\pi i \omega} [1 - e^{-\omega T}] e^{i\omega t} \text{ at } \omega = \frac{i}{cr}$$

prob 18

continued on next page

$$N(t) = \frac{2\pi i r}{rc} \frac{rc}{-2\pi} [1 - e^{-T/rc}] e^{-t/rc}$$

$$N(t) = r e^{-t/rc} [e^{T/rc} - 1] \quad \text{for } t \geq T$$

Now assume $0 < t < T$

$$N(t) = I_1(\omega) - I_2(\omega). \quad I_1(\omega) = \int_{-\infty}^{+\infty} \frac{r}{1+ir\omega c} \frac{1}{2\pi i \omega} e^{i\omega t} d\omega$$

$$I_2(\omega) = \int_{-\infty}^{+\infty} \frac{r}{1+ir\omega c} \frac{e^{i\omega(t-T)}}{2\pi i \omega} d\omega$$

For $I_1(\omega)$ we close contour in u.h.p.

$$I_1(\omega) = 2\pi i \left[\text{Res} \frac{r e^{i\omega t}}{(1+ir\omega c)(2\pi i \omega)}, \omega = \frac{i}{rc} \right]$$

$$+ \pi i \text{Res} \left[\frac{r e^{i\omega t}}{(1+ir\omega c)(2\pi i \omega)}, \omega = 0 \right] = -r e^{-t/rc} + \frac{r}{2}$$

for $I_2(\omega)$ we close in l.h.p.

$$I_2(\omega) = -\frac{1}{2} + 2\pi i \text{Res} \frac{r e^{i\omega(t-T)}}{(1+ir\omega c)(2\pi i \omega)} \Big|_{\omega=0}$$

$$= -\frac{r}{2}. \quad \text{Thus } I_1 - I_2 = -r e^{-t/rc} + r$$

$$\text{Hence } N(t) = r [1 - e^{-t/rc}] \quad \text{for } 0 < t < T$$

For $t \leq 0$,

$$N(t) = \int_{-\infty}^{+\infty} \frac{r}{1+ir\omega c} \frac{1}{2\pi i \omega} [1 - e^{-i\omega T}] e^{i\omega t} d\omega$$

$$= -2\pi i \sum \text{res} \frac{r}{1+ir\omega c} \frac{1}{2\pi i \omega} [1 - e^{-i\omega T}] e^{i\omega t}$$

close contour in l.h.p.
at poles in l.h.p.
[none]

$$= 0$$

$$19) a) F(\omega) = \frac{1}{2\pi} \int_{-\infty}^{+\infty} e^{-i\omega t} \frac{\sin\left[\frac{2\pi t}{T}\right]}{t} dt, \quad \text{let } \omega_0 = \frac{2\pi}{T}$$

$$= \frac{1}{2\pi} \int_{-\infty}^{+\infty} \frac{e^{-i\omega t}}{t} \left[\frac{e^{i\omega_0 t} - e^{-i\omega_0 t}}{2i} \right] dt = \frac{I_1(\omega) - I_2(\omega)}{4\pi i}$$

19) cont'd Chap 6, sec 6.9, cont'd

$$I_1 = \int_{-\infty}^{+\infty} \frac{e^{-i\omega t} e^{i\omega_0 t}}{t} dt, \quad I_2 = \int_{-\infty}^{+\infty} \frac{e^{-i\omega t} e^{-i\omega_0 t}}{t} dt$$

If $\omega > \omega_0$, close contour in l.h.p to get both I_1 and I_2 . Thus: $I_1 = -\pi i \operatorname{Res} \left[\frac{e^{-i\omega t} e^{i\omega_0 t}}{t}; 0 \right] = -\pi i$

$$I_2 = -\pi i \operatorname{Res} \left[\frac{e^{-i\omega t} e^{i\omega_0 t}}{t}; 0 \right] = -\pi i$$

If $-\omega_0 < \omega < \omega_0$, I_2 same as above. To get I_1 , close contour in upper half plane.

$$I_1 = \pi i \operatorname{Res} \left[\frac{e^{-i\omega t} e^{i\omega_0 t}}{t}; 0 \right] = \pi i$$

Finally if $\omega < -\omega_0$, close contours for both I_1 and I_2 in upper half plane. $I_1 = I_2 = \pi i$

Thus: for $|\omega| > \omega_0 = \frac{2\pi}{T}$, $F(\omega) = 0$ and

for $|\omega| < \omega_0$; $F(\omega) = \frac{1}{2}$

(b)

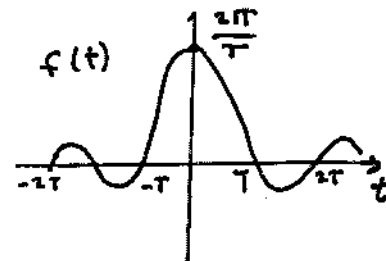
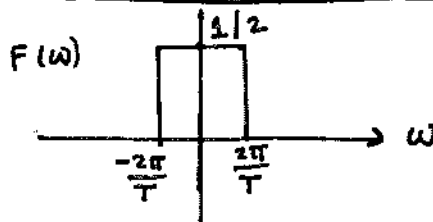

If you increase T , $F(\omega)$ becomes a narrower pulse (or rectangle). Increasing T separates the zero crossings of $f(t)$ further and depresses the value of $f(0)$.

$$20) \int_0^{\infty} \frac{|\sin \frac{2\pi}{T} t|}{t} dt = I_1 + I_2 + \dots = \sum_{n=1}^{\infty} I_n$$

$$\text{where } I_n = \int_{nT-T}^{nT} \frac{|\sin \frac{2\pi t}{T}|}{t} dt$$

$$\text{Now for } n \geq 1 \int_{nT-T}^{nT} \frac{|\sin \frac{2\pi t}{T}|}{t} dt \geq \int_{nT-T}^{nT} \frac{|\sin \frac{2\pi t}{T}|}{nT} dt = \frac{2T}{\pi} \frac{1}{nT}$$

$\therefore I_n \geq \frac{2}{n\pi} > 0$. Now $\sum_{n=1}^{\infty} \frac{2}{n\pi}$ is known to diverge. Thus $\sum_{n=1}^{\infty} I_n$ must diverge, and so must the given integral.

sec 6.9

21 (a) $\frac{\partial^2 y}{\partial x^2} = \frac{1}{c^2} \frac{\partial^2 y}{\partial t^2}$

Take fourier trans. both sides. If $y(x,t)$ has trans. $\bar{y}(\omega, t)$, then $\frac{\partial^2 y}{\partial x^2}$ has transf. $-\omega^2 \bar{y}$.

$$-\omega^2 \bar{y} = \frac{1}{c^2} \int_{-\infty}^{+\infty} \frac{1}{2\pi} e^{-i\omega x} \frac{\partial^2 y}{\partial t^2}(x,t) dx$$

Take $\frac{\partial}{\partial t^2}$ outside integral sign

$$-\omega^2 \bar{y}(\omega, t) = \frac{1}{c^2} \frac{d^2}{dt^2} \bar{y}(\omega, t)$$

$$\text{or } \frac{d^2 \bar{y}}{dt^2} + \omega^2 c^2 \bar{y} = 0$$

(b) Solution of above is

$$A(\omega) \cos(\omega c t) + B(\omega) \sin(\omega c t) = \bar{y}(\omega, t)$$

this is a standard diff. eqn [Linear 2nd order with const. coeffs]

(c) $\bar{y}(\omega, 0) = A(\omega)$ [put $t=0$ in the above]. Thus $A(\omega) = \frac{1}{2\pi} \int_{-\infty}^{+\infty} y(x, t=0) e^{-i\omega x} dx$

$$= \frac{1}{2\pi} \int_{-\infty}^{+\infty} y_0(x) e^{-i\omega x} dx$$

continued on next page

section 6.9, problem 21 cont'd

$$(a) \quad Y(\omega, t) = A(\omega) \cos(\omega c t) + B(\omega) \sin(\omega c t)$$

$$\frac{dY}{dt}(\omega, t) = -\omega c A \sin(\omega c t) + \omega c B \cos(\omega c t)$$

putting $t=0$

$$\frac{dY}{dt}(\omega, 0) = \omega c B \quad B^{(\omega)} = \frac{1}{\omega c} \frac{dY}{dt}(\omega, 0)$$

$$\text{Now } Y(\omega, t) = \frac{1}{2\pi} \int_{-\infty}^{+\infty} y(x, t) e^{-i\omega x} dx$$

$$\frac{dY}{dt}(\omega, 0) = \frac{1}{2\pi} \int_{-\infty}^{+\infty} \left. \frac{dy}{dt} \right|_0 e^{-i\omega x} dx = \frac{1}{2\pi} \int_{-\infty}^{+\infty} N_0(x) e^{-i\omega x} dx$$

$$\text{Thus } B(\omega) = \frac{1}{2\pi \omega c} \int_{-\infty}^{+\infty} N_0(x) e^{-i\omega x} dx$$

$$(e) \quad Y(\omega, t) = A(\omega) \cos(\omega c t) + B \sin(\omega c t) \quad [\text{part b}]$$

$$\text{Thus } y(x, t) = \int_{-\infty}^{+\infty} [A \cos(\omega c t) + B \sin(\omega c t)] e^{i\omega x} d\omega$$

[continued next page]

all continued

(f) $B=0$. Thus $y(x,t) = \int_{-\infty}^{+\infty} A(\omega) \cos(\omega ct) e^{i\omega x} d\omega$

Inverting the Fourier transform:

$$A(\omega) = \frac{1}{2\pi} \int_{-\infty}^{+\infty} \Delta e^{-|x|} e^{-i\omega x} dx$$

Put $e^{-i\omega x} = \cos \omega x - i \sin \omega x$

$$A(\omega) = \frac{1}{2\pi} \int_{-\infty}^{+\infty} \Delta e^{-|x|} \cos(\omega x) dx = \frac{\Delta}{\pi} \int_0^{\infty} e^{-x} \cos(\omega x) dx$$

note: $\int_0^{\infty} e^{-kx} \sin(\omega x) dx = 0$

$$= \frac{\Delta}{\pi} \frac{1}{1+\omega^2} = A(\omega)$$

Thus $y(x,t) = \int_{-\infty}^{+\infty} \frac{\Delta \cos(\omega ct) e^{i\omega x}}{1+\omega^2} d\omega$

$$= \frac{\Delta}{2\pi} \left[\int_{-\infty}^{+\infty} \frac{e^{i\omega[x+ct]}}{1+\omega^2} d\omega + \int_{-\infty}^{+\infty} \frac{e^{i\omega[x-ct]}}{1+\omega^2} d\omega \right]$$

If $x \geq ct$, close both integrals in u.h.p.

$$y = \frac{\Delta}{2\pi} 2\pi i \left[\frac{1}{2i} e^{-[x+ct]} + \frac{1}{2i} e^{-[x-ct]} \right] =$$

$$\Delta e^{-x} \cosh ct \quad \text{for } x \geq ct$$

for $|x| \leq ct$, close the 2nd integral in l.h.p.

$$\text{Thus } y(x,t) = \frac{\Delta}{2\pi} 2\pi i \left[\frac{1}{2i} e^{-(x+ct)} + \frac{1}{2i} e^{x-ct} \right]$$

$$= \Delta e^{-ct} \cosh(x), \quad \text{for } -ct \leq x \leq ct$$

for $x \leq -ct$, will get $\Delta e^x \cosh ct$

To check ans, put $t \rightarrow 0$ in $\Delta e^{-x} \cosh(ct)$

get $y(x,t) = \Delta e^{-x} = y(x,0)$.

Section 6.10

$$1) \frac{1}{\pi} \int_{-\infty}^{\infty} \frac{x}{(x^2+4)} \frac{1}{t-x} dx = \frac{2\pi i}{\pi} \operatorname{Res}_{z=2i} \frac{z}{(z^2+4)(t-z)}, t$$

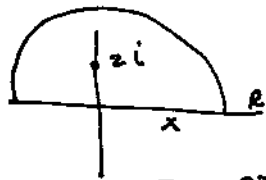

$$+ \pi i \operatorname{Res}_{z=2i} \frac{z}{(z^2+4)(t-z)}, t$$

$$= \frac{2\pi i}{2\pi} \frac{1}{(t-2i)} + \pi i \frac{(-1)^1}{\pi(t^2+4)}$$

$$= \frac{(i)(t+2i)}{t^2+4} - \frac{1t}{t^2+4} = \boxed{\frac{-2}{t^2+4}} = \hat{g}(t)$$

$$g(t) + i \hat{g}(t) = \frac{t}{t^2+4} - \frac{2i}{t^2+4} = \frac{1}{t+2i}$$

Consider $f(z) = \frac{1}{z+2i}$. This satisfies Eq. (6.10-5)

and Theorem 7.

$$\frac{1}{z+2i} = \frac{z-2i}{z^2+4}$$

$$g(x,0) = \frac{x}{x^2+4} = g(x)$$

$$h(x,0) = \frac{-2}{x^2+4} = \hat{g}(x)$$

b) Recovery of $g(t)$ from its Hilbert transform:

$$-\frac{1}{\pi} \int_{-\infty}^{\infty} \left(\frac{-2}{x^2+4} \right) \frac{1}{t-x} dx$$

$$= \frac{2}{\pi} 2\pi i \operatorname{Res}_{z=2i} \frac{1}{(z^2+4)(t-z)}, t + \frac{2}{\pi} \pi i \operatorname{Res}_{z=2i} \frac{1}{(z^2+4)(t-z)}, t$$

$$= \frac{4i}{4i(t-2i)} + 2i \frac{(-1)}{t^2+4} = \frac{t+2i}{t^2+4} - \frac{2i}{t^2+4}$$

$$= \boxed{\frac{t}{t^2+4}} \text{ g.e.d.}$$

$$2) \frac{1}{\pi} \int_{-R}^R \frac{c \operatorname{const}}{t-x} dx = c \lim_{\epsilon \rightarrow 0} \lim_{R \rightarrow \infty} \left[\int_{-R}^{t-\epsilon} \dots + \int_{t+\epsilon}^R \frac{1}{t-x} dx \right] =$$

$$\lim_{\epsilon \rightarrow 0} \lim_{R \rightarrow \infty} c \left[\log \frac{t+R}{\epsilon} + \log \frac{\epsilon}{R-t} \right] = \lim_{R \rightarrow \infty} c \log \left[\frac{R+t}{R-t} \right] = \lim_{R \rightarrow \infty} c \log \left[\frac{1+t/R}{1-t/R} \right] = 0$$

[c = const.]

3) Hilbert transform of $\frac{t \cos t}{t^2+1}$

$$= \frac{1}{\pi} \int_{-\infty}^{\infty} \frac{x \cos x}{(x^2+1)(t-x)} dx = \operatorname{Re} 2\pi i \left[\operatorname{Res} \left[\frac{z e^{iz}}{(z^2+1)(t-z)} ; i \right] \right.$$

$$\left. + \frac{1}{2} \operatorname{Res} \frac{z e^{iz}}{(z^2+1)(t-z)} ; t \right] = \operatorname{Re} 2\pi i \left[\frac{e^{-1}}{(2)(t-i)} - \frac{1}{2} \frac{t e^{it}}{t^2+1} \right]$$

$$= \operatorname{Re} i \left[\frac{e^{-1}(t+i)}{(2)(t^2+1)} - \frac{t e^{it}}{t^2+1} \right] = \boxed{\frac{-e^{-1}}{t^2+1} + \frac{t \sin t}{t^2+1} = \hat{g}(t)}$$

Check: need $-\frac{1}{\pi} \int_{-\infty}^{\infty} \frac{\hat{g}(x)}{(t-x)} dx = -\frac{1}{\pi} \int_{-\infty}^{\infty} \frac{-e^{-1}}{(x^2+1)(t-x)} dx$

$$-\frac{1}{\pi} \int_{-\infty}^{\infty} \frac{x \sin x}{(x^2+1)(t-x)} dx, \text{ Proceeding as above:}$$

$$+\frac{1}{\pi} \int_{-\infty}^{\infty} \frac{e^{-1}}{(x^2+1)(t-x)} dx = \frac{e^{-1}}{\pi} 2\pi i \left[\operatorname{Res} \left[\frac{1}{(x^2+1)(t-x)} ; i \right] + \frac{1}{2} \operatorname{Res} \left[\frac{1}{(x^2+1)(t-x)} ; t \right] \right]$$

$$= \frac{e^{-1} t}{t^2+1}$$

$$\text{Also } -\frac{1}{\pi} \int_{-\infty}^{\infty} \frac{x \sin x}{(x^2+1)(t-x)} dx = -\operatorname{Im} \frac{2\pi i}{\pi} \left[\operatorname{Res} \frac{z e^{iz}}{(z^2+1)(t-z)} ; i \right]$$

$$+ \frac{1}{2} \operatorname{Res} \frac{z e^{iz}}{(z^2+1)(t-z)} ; t \left] = -\operatorname{Im} 2i \left[\frac{e^{-1}}{(2)(t-i)} + \frac{1}{2} \frac{t e^{it}}{(t^2+1)(-1)} \right]$$

$$= \frac{-e^{-1} t}{t^2+1} + \frac{t \cos t}{t^2+1}. \text{ Thus } -\frac{1}{\pi} \int_{-\infty}^{\infty} \frac{\hat{g}(x)}{t-x} dx = \frac{t \cos t}{t^2+1} \text{ as required.}$$

3] continued: sect. 6.10

Note: $g(x) + i\hat{g}(x) = \frac{x \cos x}{x^2+1} + i \frac{[x \sin x - e^{-1}]}{x^2+1}$

Consider $f(z) = \frac{z e^{iz} - i e^{-1}}{z^2+1}$, Note this is analytic

in the upper half plane [removable singularity @ $z=i$].
If put $z=x$ get $\hat{g} + i\hat{g}(x)$. The Theorem 7 is satisfied.

$$4(a) \frac{1}{\pi} \int_{-\infty}^{\infty} \frac{1 - \cos x}{x^2 (t-x)} dx = \operatorname{Re} \frac{1}{\pi} \int_{-\infty}^{\infty} \frac{1 - e^{ix}}{x^2 (t-x)} dx$$

$$= \operatorname{Re} \frac{2\pi i}{\pi} \left[\frac{1}{2} \operatorname{Res} \frac{1 - e^{iz}}{(z^2)(t-z)}, 0 + \frac{1}{2} \operatorname{Res} \frac{1 - e^{iz}}{z^2 (t-z)}, t \right]$$

$$\Rightarrow \operatorname{Re} i \left[\frac{-i}{t} + \frac{1 - e^{it}}{(t^2)(-1)} \right] = \boxed{\frac{1}{t} - \frac{\sin t}{t^2}} = \hat{g}(t)$$

is Hilbert transf of $\frac{1 - \cos t}{t^2}$.

b) Analytic signal $\frac{1 - \cos t}{t^2} + i \left[\frac{1}{t} - \frac{\sin t}{t^2} \right]$

c) $\frac{1 - \cos x}{x^2} + i \left[\frac{1}{x} - \frac{\sin x}{x^2} \right] = \text{analytic signal}$

$$= \frac{1}{x^2} + \frac{i}{x} - \frac{e^{ix}}{x^2}$$

Replace x with z :

$$\boxed{\frac{1}{z^2} + \frac{i}{z} - \frac{e^{iz}}{z^2} = f(z)}$$

analytic continuation
Note: this has removable sing. at origin

Section 6.10

5] First do the Fourier transform of the Hilbert transform of $g(t)$:

$$= \frac{1}{2\pi} \int_{-\infty}^{\infty} \frac{1}{\pi} \int_{-\infty}^{\infty} \frac{g(x)}{t-x} dx e^{-i\omega t} dt$$

We know that the preceding is the Fourier transform of the convolution of $g(t)$ and $\frac{1}{\pi t}$

Now look at the Hilbert transform of the Fourier transform of $g(t)$.

$$\frac{1}{\pi} \int_{-\infty}^{\infty} \frac{1}{\omega - \omega'} \left[\frac{1}{2\pi} \int_{-\infty}^{\infty} g(t) e^{-i\omega' t} dt \right] d\omega'$$

Reverse order of integration:

$$= \frac{1}{2\pi} \int_{-\infty}^{\infty} g(t) \int_{-\infty}^{\infty} \frac{e^{-i\omega' t}}{\omega - \omega'} d\omega' dt$$

let $\psi = \omega - \omega'$ $\omega' = \omega - \psi$, $d\omega' = -d\psi$

Thus have: $\frac{1}{2\pi} \int_{-\infty}^{\infty} g(t) e^{-i\omega t} \int_{-\infty}^{\infty} \frac{e^{i\psi t}}{\psi} d\psi dt$

Can easily verify that $\int_{-\infty}^{\infty} \frac{e^{i\psi t}}{\psi} d\psi = \pi i \operatorname{sgn}(t)$

∴ the Hilbert transform of the Fourier transform of $g(t)$ is: $\frac{i}{2\pi} \int_{-\infty}^{\infty} g(t) e^{-i\omega t} \operatorname{sgn}(t) dt =$ the Fourier transform

of $g(t) i \operatorname{sgn}(t)$. But in general $g(t) i \operatorname{sgn}(t) \neq$

the convolution of $g(t)$ and $\frac{1}{\pi t}$. This completes the proof.

6] Fourier transform of $g(t)$

$$G(\omega) = \frac{1}{2\pi} \int_{-\infty}^{\infty} e^{-i\omega t} \frac{\sin t}{t} dt$$

$$= \frac{1}{2\pi} \int_{-\infty}^{\infty} e^{-i\omega t} \left[\frac{e^{it} - e^{-it}}{2it} \right] dt \quad \text{Evaluate with residues:}$$

$$G(\omega) = \frac{1}{2} \text{ if } |\omega| < 1, \quad G(\omega) = 0 \text{ if } |\omega| > 1, \quad G(\pm 1) = \frac{i}{4}$$

Section 6.10

problem 6, continued

Now take Hilbert transform of $G(\omega)$

$$= \frac{1}{\pi} \int_{-1}^1 \frac{1}{2} \frac{1}{\omega - \omega'} d\omega' \quad (\text{see Example 2, sec. 6.10})$$

Result is $\frac{1}{2\pi} \log \left| \frac{\omega + i}{\omega - i} \right|$ This is the Hilbert transform of the Fourier transform of $g(t)$.

Now take the Hilbert transform of $g(t)$

$$= \frac{1}{\pi} \int_{-\infty}^{\infty} \frac{\sin x}{x(t-x)} dx = \text{Im} \frac{2\pi i}{\pi} \left[\frac{1}{2} \left[\frac{\text{Res } e^{iz}}{(z)(t-z)}, 0 \right] + \frac{1}{2} \left[\frac{\text{Res } e^{iz}}{(z)(t-z)}, i \right] \right] = \text{Im} i \left[\frac{1}{t} - \frac{e^{it}}{t} \right] = \frac{1}{t} - \frac{\cos t}{t} = \hat{g}(t)$$

Now take Fourier transform of $\hat{g}(t)$

$$= \frac{1}{2\pi} \int_{-\infty}^{\infty} \left(\frac{1}{t} - \frac{\cos t}{t} \right) e^{-i\omega t} dt. \text{ This is the Fourier transform of the convolution of } \frac{\sin t}{t} \text{ and } \frac{1}{\pi t}.$$

It must be the product of Fourier transform of $\frac{\sin t}{t}$ and Fourier transform of $\frac{1}{\pi t}$. We know that Fourier transform

of $\frac{\sin t}{t}$ is $1/2$ for $|\omega| < 1$ and zero for $|\omega| > 1$.

$$\text{The Fourier transform of } \frac{1}{\pi t} = \frac{1}{2\pi} \int_{-\infty}^{\infty} \frac{1}{t} e^{-j\omega t} dt = -\frac{j}{2\pi} \text{sgn}(\omega).$$

∴ Fourier transform of Hilbert transform of $g(t)$ is $-\frac{1}{2} \frac{j}{2\pi}$ for $0 < \omega < 1$

and is $\frac{1}{2} \cdot \frac{j}{2\pi}$ for $-1 < \omega < 0$, or same as

$$\frac{-j}{4\pi} \text{sgn}(\omega) \text{ for } -1 < \omega < 1. \text{ It is zero for } |\omega| > 1$$

This result is different from the Hilbert transform of the Fourier transform, as predicted in the previous problem.

Section 6.10 cont'd

7] (a) Need $\frac{1}{2\pi} \int_{-\infty}^{\infty} \frac{t}{t^2+a^2} e^{-\omega t} dt$

Use residue calculus, if $\omega > 0$, close contour in lower half plane

Get $\frac{-2\pi i}{2\pi} \frac{1}{2} e^{-\omega t} \Big|_{t=-ia} = -\frac{\omega}{2} e^{-\omega a}$

If $\omega < 0$ close in upper half plane get $\frac{\omega}{2} e^{\omega a}$

∴ $G(\omega) = -\frac{\omega}{2} e^{-|\omega|a} \text{sgn}(\omega)$

∴ $G(\omega) = -\omega e^{-\omega a} \quad \omega > 0$
and equals zero if $\omega < 0$

b) $g_a(t) = \int_0^{\infty} -i e^{-\omega a} e^{i\omega t} d\omega =$

$\frac{-i e^{-\omega a} e^{i\omega t}}{-a + it} \Big|_0^{\infty} = \frac{\omega}{-a + it} = \frac{\omega(-a - it)}{a^2 + t^2} = \frac{t}{a^2 + t^2} - \frac{ia}{a^2 + t^2}$

∴ analytic signal = $\frac{-a}{a^2 + t^2}$

c) $\frac{1}{\pi} \int_{-\infty}^{\infty} \frac{x}{x^2+a^2} \frac{1}{t-x} dx = \frac{1}{\pi} \left[\frac{2\pi i}{2} \frac{1}{t-ia} + \frac{\pi i t}{t^2+a^2} (t) \right]$

$= i \left[\frac{t+ia}{t^2+a^2} - \frac{t}{t^2+a^2} \right] = \frac{-a}{t^2+a^2}$ same as (b) f.e.d.

8] a) $G_a(\omega) = 2$ for $0 < \omega < 1$
 $G_a(\omega) = 0$ $\omega < 0$
 $G_a(\omega) = 0$, $\omega \geq 1$

Sec 6.10

$$8(b) \quad g(t) + i\hat{g}(t) = \int_0^{\infty} 2e^{i\omega t} d\omega$$

$$= \frac{2}{it} \left[e^{it} - 1 \right] = \frac{2 \sin t}{t} + i \left[\frac{2}{t} - \frac{2 \cos t}{t} \right]$$

$$\therefore g(t) = \frac{2 \sin t}{t} ; \quad \hat{g}(t) = \frac{2}{t} - \frac{2 \cos t}{t}$$

8(c) Take Hilbert transform of $\frac{2 \sin t}{t}$

$$= \frac{1}{\pi} \int_{-\infty}^{\infty} \frac{2 \sin x}{(x)(t-x)} dx = \frac{2}{\pi} \operatorname{Im} \left[\pi i \operatorname{Res}_{\substack{z \\ (z)(t-z)}} \frac{e^{iz}}{(z)(t-z)}, 0 \right]$$

$$+ \pi i \operatorname{Res}_{\substack{z \\ (z)(t-z)}} \frac{e^{iz}}{(z)(t-z)}, t = \frac{2}{\pi} \operatorname{Im} \left[\frac{\pi i}{t} + \frac{\pi i e^{it}}{(t-t)t} \right]$$

$$= \left[\frac{2}{t} - \frac{2 \cos t}{t} \right] = \hat{g}(t)$$

9) Need Hilbert transform of $\frac{-\omega LR}{R^2 + \omega^2 L^2}$

$$= \frac{1}{\pi} \int_{-\infty}^{\infty} \frac{-x LR}{R^2 + x^2 L^2} \frac{1}{(\omega - x)} dx \quad \text{take } R \equiv \Gamma$$

$$= \frac{1}{\pi} \left[2\pi i \operatorname{Res}_{\substack{x \\ R^2 + x^2 L^2}} \frac{-x LR}{R^2 + x^2 L^2} \frac{1}{\omega - x} \Big|_{\frac{LR}{L}} + \pi i \operatorname{Res}_{\substack{x \\ \omega - x}} \frac{-x LR}{R^2 + x^2 L^2} \frac{1}{\omega - x}, \omega \right]$$

$$= \frac{1}{\pi} \left[(2\pi i) \frac{(-LR)}{2L^2} \frac{1}{\omega - \frac{LR}{L}} + \pi i \frac{\omega LR}{R^2 + \omega^2 L^2} \right]$$

$$= \left[\frac{-LR}{\omega L - LR} + \frac{i \omega LR}{R^2 + \omega^2 L^2} \right] = \frac{-LR(\omega L + iR)}{\omega^2 L^2 + R^2} + \frac{i \omega LR}{R^2 + \omega^2 L^2}$$

$$= \frac{R^2}{\omega^2 L^2 + R^2} \quad \text{p.e.d.}$$

SEC 6.10

10] Need to do: $-\frac{1}{\pi} \int_{-\infty}^{\infty} \frac{\omega^2}{\omega^4 - \omega^2 + 1} \frac{1}{\omega - \omega'} d\omega'$

Need to set poles $\omega^2 = \frac{1}{2} \pm \frac{i\sqrt{3}}{2} \therefore \omega^2 = 1 \angle \pm 60^\circ$
 $\omega = 1 \angle 30^\circ, 1 \angle 150^\circ$
 in the upper half plane

$$= -\frac{1}{\pi} 2\pi i \left[\frac{\omega^2}{4\omega'^3 - 2\omega'} \frac{1}{\omega - \omega'} \text{ at } \omega' = 1 \angle 30^\circ \right]$$

$$+ \frac{\omega^2}{4\omega'^3 - 2\omega'} \frac{1}{\omega - \omega'} \text{ at } \omega' = 1 \angle 150^\circ + \frac{-\omega^2/2}{\omega^4 - \omega^2 + 1}$$

$$= -2i \left[\frac{\omega'}{2[2\omega'^2 - 1]} \frac{1}{\omega - \omega'} \text{ at } \omega' = 1 \angle 30^\circ + \frac{\omega'}{2[2\omega'^2 - 1]} \frac{1}{\omega - \omega'} \text{ at } \omega' = 1 \angle 150^\circ \right]$$

$$- \frac{\omega^2/2}{\omega^4 - \omega^2 + 1}$$

$$= -i \left[\frac{1 \angle 30^\circ}{[2 \angle 60^\circ - 1]} \frac{1}{\omega - 1 \angle 30^\circ} + \frac{1 \angle 150^\circ}{[2 \angle 300^\circ - 1]} \frac{1}{\omega - 1 \angle 150^\circ} \right]$$

$$- \frac{\omega^2}{\omega^4 - \omega^2 + 1} = -i \left[\frac{-i\omega}{\omega^2 - \omega - 1} + \frac{-\omega^2}{\omega^4 - \omega^2 + 1} \right]$$

Note $\omega^4 - \omega^2 + 1 = [\omega^2 - (\omega - 1)][\omega^2 + (\omega - 1)]$

$$\therefore \text{ get } -i \left[\frac{-i\omega[\omega^2 + (\omega - 1)] - \omega^2}{\omega^4 - \omega^2 + 1} \right] = -i \left[\frac{-\omega^3 + \omega}{\omega^4 - \omega^2 + 1} \right]$$

$$= \frac{\omega [1 - \omega^2]}{\omega^4 - \omega^2 + 1} \quad \text{q.e.d.}$$

Section 6.10

```
% figure for problem " sec 6.10
clear
x=linspace(-4,4,600);
for jj=1:600
    if abs(x(jj))<=1
        y(jj)=1;
    else y(jj)=0
    end
end

w=hilbert(y);
plot(x,imag(w),x,real(w));

text(-.5,-1,'the Hilbert transform')
text(-2,.5,'the pulse g(t)')
```

Section 6.11

1)

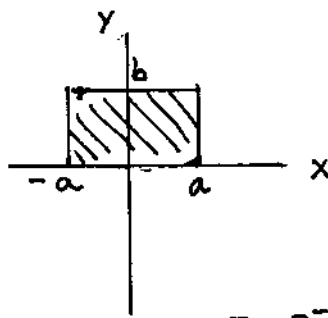

$$|e^{zt}| = |e^{(x+iy)t}|$$

$$= |e^{x t} e^{-y t}| = |e^{x t}| e^{-y t}$$

$$= e^{-y t} \leq 1 \text{ since } t \geq 0$$

and y is positive. $\therefore |e^{zt}| \leq 1$

$$\left| \frac{e^{izt}}{(t+1)^{3/2}} \right| \leq \frac{1}{(t+1)^{3/2}} = M(t), \text{ independent of } z$$

$$\int_0^{\infty} M(t) dt = \int_0^{\infty} \frac{1}{(t+1)^{3/2}} dt = \frac{(t+1)^{-1/2}}{-1/2} \Big|_0^{\infty} \text{ (converges)}$$

\therefore Given integral is uniformly conv.
 $F'(z) = \int_0^{\infty} i t e^{izt} / (t+1)^{3/2} dt$

2)

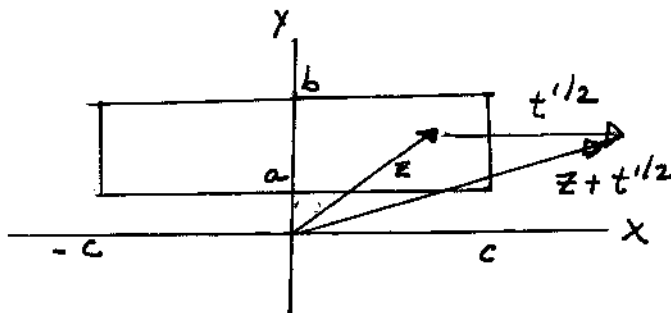

Since $t^{1/2}$ is real $|z + t^{1/2}| \geq a$, where a is the smallest possible value of $\text{Im}(z)$.

$$\frac{1}{|z + t^{1/2}|} \leq \frac{1}{a} \quad \left| \frac{1}{(t^2+1)} \frac{1}{(z + t^{1/2})} \right| \leq \frac{1}{t^2+1} \frac{1}{a} = M(t)$$

$$\int_0^{\infty} M(t) dt = \int_0^{\infty} \frac{dt}{a(t^2+1)} = \frac{\pi}{2a} \text{ (converges)}$$

\therefore given integral is U.C.

$$F'(z) = \int_0^{\infty} \frac{-dt}{(t^2+1)(t^{1/2}+z)^2}$$

section 6.11

3

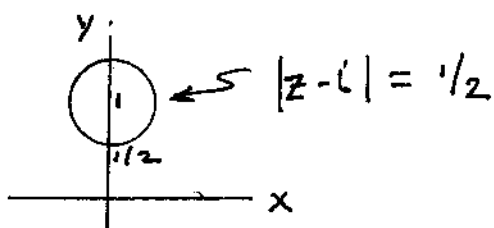

$$e^{izt} = e^{i(x+iy)t}$$

$$= e^{ix} e^{-yt}$$

$$|e^{izt}| = e^{-yt} \leq e^{-1/2} \quad [\text{occurs when } t=1, y=1/2]$$

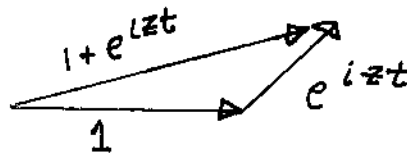

$$|1 + e^{izt}| \geq 1 - |e^{izt}|$$

from triangle inequality

$$|1 + e^{izt}| \geq 1 - e^{-1/2}$$

$$|a+b| \geq |a| - |b| \quad |a| \geq b$$

$$\left| \frac{e^{-t}}{1 + e^{izt}} \right| \leq \frac{e^{-t}}{1 - e^{-1/2}} = M(t)$$

$$\int_0^{\infty} M(t) dt = \frac{e^{-1}}{1 - e^{-1/2}}$$

$$\text{converges } \int_0^{\infty} -t! e^{izt} e^{-t} dt$$

$$\text{so given integral is u.c. } f'(z) = \int_0^{\infty} \frac{-t! e^{izt} e^{-t}}{(1 + e^{izt})^2} dt$$

$$4) \Gamma(n+1) = n! , \quad n=5, \quad 5! = 120$$

$$5) \Gamma(z+1) = z \Gamma(z), \quad \Gamma(3+7i+1) = (3+7i) \Gamma(3+7i)$$

$$= (3+7i)(-0.0044 - i.0037) = \boxed{0.127 - i.0419}$$

$$6) \Gamma(z+2) = (z+1)z \Gamma(z) \quad \Gamma(z) = \frac{\Gamma(z+2)}{(z+1)z}$$

$$\text{put } z = 1+7i, \quad \Gamma(1+7i) = \frac{\Gamma(3+7i)}{(z+1)z}$$

$$= \frac{-0.0044 - i.0037}{(2+7i)(1+7i)} = \boxed{4.8717 \times 10^{-5} + i1.0049 \times 10^{-4}}$$

$$7) \Gamma(z+1) = z \Gamma(z), \quad \Gamma(3/2) = \frac{1}{2} \Gamma(1/2) = \boxed{0.886}$$

$$8) \Gamma(5/2) = 3/2 \Gamma(3/2) = \frac{3}{2} \times \frac{1}{2} \Gamma(1/2) = \boxed{1.3293}$$

$$9) \Gamma(z+2) = (z+1)z \Gamma(z), \quad \Gamma(z) = \frac{\Gamma(z+2)}{(z+1)z}$$

$$z = -1\frac{1}{2}, \quad \Gamma(-1\frac{1}{2}) = \frac{\Gamma(1/2)}{(-1/2)(-1/2)} = \frac{\sqrt{\pi} \cdot 4}{3} = \boxed{2.3633}$$

Section 6.11

$$\begin{aligned}
 10) a) \quad \Gamma(z) &= \int_0^{\infty} t^{z-1} e^{-t} dt = \int_0^{\infty} e^{(z-1)\log t} e^{-t} dt \\
 &= \int_0^{\infty} e^{(x-1+i y)\log t} e^{-t} dt = \int_0^{\infty} e^{(x-1)\log t} e^{i y \log t} e^{-t} dt \\
 &= \int_0^{\infty} \left[e^{(x-1)\log t} \cos(y \log t) + i e^{(x-1)\log t} \sin(y \log t) \right] e^{-t} dt \\
 &= \int_0^{\infty} e^{-t} e^{(x-1)\log t} \cos(y \log t) dt + i \int_0^{\infty} e^{-t} e^{(x-1)\log t} \sin(y \log t) dt
 \end{aligned}$$

$\Gamma(\bar{z})$ is same as above but put $-y$ for y
 Note $\cos(-y \log t) = \cos(y \log t)$, $\sin(-y \log t) = -\sin(y \log t)$.

$$\begin{aligned}
 \therefore \Gamma(\bar{z}) &= \int_0^{\infty} e^{-t} e^{(x-1)\log t} \cos(y \log t) dt \\
 &\quad - i \int_0^{\infty} e^{-t} e^{(x-1)\log t} \sin(y \log t) dt = \bar{\Gamma}(z) \text{ p.e.d.}
 \end{aligned}$$

To show that $\Gamma(z) = \bar{\Gamma}(\bar{z})$ for the analytic continuation, take conj of rt hand side of Eq (6.11-10). Note that $\bar{\Gamma}(z+n) = \Gamma(\bar{z}+n)$ from the integral definition of gamma func. Note too that $\frac{1}{(z+n-1)(z+n-2)\dots z} = \frac{1}{(\bar{z}+n-1)(\bar{z}+n-2)\dots \bar{z}}$. Thus for the analytic continuation we have $\overline{\Gamma(z)} = \Gamma(\bar{z})$

$$\begin{aligned}
 b) \Gamma(z) &= \frac{\Gamma(z+1)}{z}, \quad \Gamma\left(-\frac{1}{2} + \frac{i}{2}\right) = \frac{\Gamma\left(\frac{1}{2} + \frac{i}{2}\right)}{-\frac{1}{2} + \frac{i}{2}} = \frac{.8182 - i.7633}{-\frac{1}{2} + \frac{i}{2}} \\
 &= -1.5815 - i.0549. \text{ Must take conj of the above to get } \Gamma\left(-\frac{1}{2} - \frac{i}{2}\right) \\
 &= -1.5815 + i.0549
 \end{aligned}$$

$$\begin{aligned}
 11) \quad (a) \quad \Gamma(x) &= \int_0^{\infty} t^{x-1} e^{-t} dt = \int_0^{\infty} e^{(x-1)\log t} e^{-t} dt \\
 \Gamma'(x) &= \int_0^{\infty} \frac{d}{dx} e^{(x-1)\log t} e^{-t} dt = \int_0^{\infty} e^{(x-1)\log t} \log t e^{-t} dt \\
 \Gamma''(x) &= \int_0^{\infty} e^{(x-1)\log t} (\log t)^2 e^{-t} dt. \text{ Since} \\
 &\text{the integrand is } \geq 0 \text{ and not identically zero} \\
 &\text{it follows that } \Gamma''(x) > 0 \text{ for } x > 0.
 \end{aligned}$$

b) Because $\Gamma''(x) > 0$, $\Gamma'(x)$ is monotonically increasing for $x > 0$. At a relative minimum $\Gamma'(x) = 0$. If there is another minimum $\Gamma'(x) = 0$. But this contradicts requirement that $\Gamma'(x)$ be increasing.

Section 6.11

12] a) $\Gamma(z) \Gamma(1-z) = \frac{\pi}{\sin(\pi z)}$ and $\Gamma(z+1) = z \Gamma(z)$

Thus $\Gamma(z) = \frac{\Gamma(z+1)}{z}$ or $\frac{\Gamma(1+z) \Gamma(1-z)}{z} = \frac{\pi}{\sin(\pi z)}$

$\Gamma(1+z) \Gamma(1-z) = \frac{\pi z}{\sin(\pi z)}$

b) Let $z = iy$, $\sin(\pi iy) = i \sinh(\pi y)$

$\Gamma(1+iy) \Gamma(1-iy) = \frac{\pi iy}{i \sinh(\pi y)} = \frac{\pi y}{\sinh(\pi y)}$

13] (a) Recall Eq (6.11-10):

$\Gamma(z) = \frac{\Gamma(z+n)}{(z+n-1)(z+n-2)\dots z}$. Let $z = 1/2$

and cross multiply:

$\Gamma(\frac{1}{2}) \left[\frac{1}{2} + (n-1) \right] \left[\frac{1}{2} + (n-2) \right] \dots z = \Gamma(n+1/2)$
 $n \geq 1$

put: $\Gamma(1/2) = \sqrt{\pi}$

b) $\left[\frac{1}{2} + (n-1) \right] \left[\frac{1}{2} + (n-2) \right] \dots \left[\frac{1}{2} + (n-n) \right]$
 $= \frac{1}{2^n} [1+2n-2][1+2n-4] \dots 1$
 $= \frac{1}{2^n} [(2n-1)(2n-3)\dots 1]$ ← there are n terms within brackets
 $= \frac{1}{2^n} \frac{(2n)!}{(2n)(2n-2)(2n-4)\dots 2} = \frac{1}{2^n 2^n} \frac{(2n)!}{(n)(n-1)(n-2)\dots 1}$

$= \frac{(2n)!}{2^{2n} n!}$ $\therefore \Gamma(\frac{1}{2}) \frac{(2n)!}{2^{2n} n!} = \Gamma(n+1/2)$ $n \geq 1$

Notice that this is still valid for $n=0$ since $0!$ is defined as 1.

Section 6.11

14] $\Gamma(z) = \frac{\Gamma(z+n)}{[z+(n-1)][z+(n-2)] \dots z}$ [for $\text{Re } z > -n$] . Let $m = n-1$

$n = m+1$ $\Gamma(z) = \frac{\Gamma(z+m+1)}{(z+m)(z+m-1) \dots z}$ for $\text{Re } z > -m-1$

Residue of $\Gamma(z)$ at $-m =$

$$\lim_{z \rightarrow -m} \frac{(z+m) \Gamma(z+m+1)}{(z+m)(z+m-1) \dots z} = \frac{\Gamma(1)}{(-1)(-2) \dots (-m)} = \frac{1}{(-1)^m m!}$$

$= (-1)^m / m!$ f.e.d.

15] $\Gamma(z) \Gamma(1-z) = \frac{\pi}{\sin(\pi z)}$ $\Gamma(z) = \frac{\pi}{\sin(\pi z) \Gamma(1-z)}$

Residue at $-m$ is

$\lim_{z \rightarrow -m} \frac{(z+m) \pi}{\sin(\pi z) \Gamma(1-z)}$ Use L'Hôpital's rule,

$$= \lim_{z \rightarrow -m} \frac{\pi}{\pi \cos(\pi z) \Gamma(1-z)} = \frac{\pi}{\pi \cos(m\pi) \Gamma(m+1)}$$

$= \frac{1}{(-1)^m m!} = (-1)^m / m!$ f.e.d.

Section 6.11

16] a) $\Gamma(z)\Gamma(1-z) = \frac{\pi}{\sin(\pi z)}$ - let $z = \frac{1}{2} + iy$

$$\Gamma\left(\frac{1}{2} + iy\right)\Gamma\left(\frac{1}{2} - iy\right) = \frac{\pi}{\sin\left[\pi\left[\frac{1}{2} + iy\right]\right]} =$$

$$\frac{\pi}{\cosh[\pi y]}$$

using $\sin(x+iy) = \sin x \cosh y + i \cos x \sinh y$

b) $\Gamma\left(\frac{1}{2} + iy\right)\Gamma\left(\frac{1}{2} - iy\right) = \frac{\pi}{\cosh(\pi y)}$

Now $\overline{\Gamma\left(\frac{1}{2} + iy\right)} = \Gamma\left(\frac{1}{2} - iy\right)$

$$\Gamma\left(\frac{1}{2} + iy\right)\overline{\Gamma\left(\frac{1}{2} + iy\right)} = \frac{\pi}{\cosh(\pi y)}$$

$$\left|\Gamma\left(\frac{1}{2} + iy\right)\right|^2 = \frac{\pi}{\cosh(\pi y)}$$

$$\left|\Gamma\left(\frac{1}{2} + iy\right)\right| = \sqrt{\frac{\pi}{\cosh(\pi y)}} = \sqrt{\frac{2\pi}{e^{\pi y} + e^{-\pi y}}}$$

$$= \sqrt{\frac{2\pi}{e^{\pi y}}} \quad (if \ y \gg 1) = \sqrt{2\pi} e^{-\pi y/2}$$

c) $\Gamma(z)\Gamma(1-z) = \frac{\pi}{\sin \pi z}$

recall $\Gamma(z+1) = z\Gamma(z)$

put $-z$ for z

$$\Gamma(1-z) = -z\Gamma(-z)$$

Use here

continued on next page

16 (c) continued. section 6.11

$$-z \Gamma(z) \Gamma(-z) = \frac{\pi}{\sin(\pi z)}$$

put $z = iy$ $-iy \Gamma(iy) \Gamma(-iy) = \frac{\pi}{\sin(\pi iy)}$

$$-iy \Gamma(iy) \Gamma(-iy) = \frac{\pi}{i \sinh(\pi y)}$$

$$\Gamma(iy) \Gamma(-iy) = \frac{\pi}{y \sinh(\pi y)}$$

recall $\Gamma(-iy) = \bar{\Gamma}(iy)$

$$\Gamma(iy) \bar{\Gamma}(iy) = |\Gamma(iy)|^2 = \frac{\pi}{y \sinh(\pi y)}$$

$$|\Gamma(iy)| = \sqrt{\frac{\pi}{y \sinh(\pi y)}}$$

17

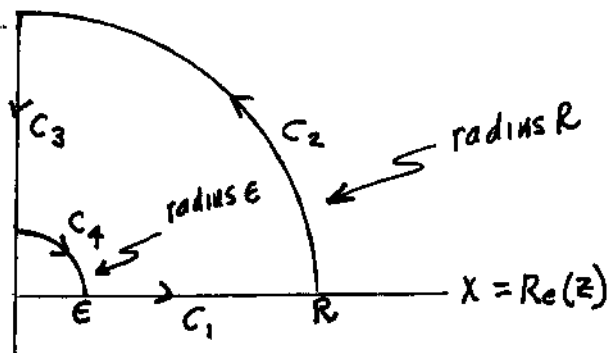

Let C be the entire contour shown above. Now $\int_C \frac{e^{\beta z}}{z^{1-\alpha}} dz = 0$ since we use a branch of $1/z^{1-\alpha}$ that is analytic on and inside C .

$$0 = \int_{C_1} dz + \int_{C_2} \dots dz + \int_{C_3} \dots dz + \int_{C_4} \dots dz$$

$$C_1 \int \frac{e^{\beta z}}{z^{1-\alpha}} dz \stackrel{z=x}{=} \int_{\epsilon}^R \frac{e^{\beta x}}{x^{1-\alpha}} dx$$

$$C_2 \int \frac{e^{\beta z}}{z^{1-\alpha}} dz \stackrel{z=Re^{i\theta}}{=} \int_{\theta=0}^{\pi/2} \frac{e^{\beta [R\cos\theta + iR\sin\theta]}}{R^{1-\alpha} e^{i\theta(1-\alpha)}} R e^{i\theta} d\theta$$

$$C_3 \int \frac{e^{\beta z}}{z^{1-\alpha}} dz \stackrel{z=y}{=} \int_R^{\epsilon} \frac{e^{-\beta y}}{y^{1-\alpha}} i dy$$

$$C_4 \int \frac{e^{\beta z}}{z^{1-\alpha}} dz \stackrel{z=\epsilon e^{i\theta}}{=} \int_{\theta=\pi/2}^0 \frac{e^{\beta (\epsilon \cos\theta + i\epsilon \sin\theta)}}{\epsilon^{1-\alpha} e^{i\theta(1-\alpha)}} \epsilon e^{i\theta} i d\theta$$

We let $\epsilon \rightarrow 0+$, $R \rightarrow \infty$ and show that integrals along C_2 and $C_4 \rightarrow 0$. Begin with C_2

To prove that $\lim_{R \rightarrow \infty} \int_0^{\pi/2} \frac{e^{\beta [R\cos\theta + iR\sin\theta]}}{R^{1-\alpha} e^{i\theta(1-\alpha)}} R e^{i\theta} d\theta = 0$

Use the same argument as is used to prove Theorem 6.6 in sec. 6.6. However now integrate $\theta=0$ to $\theta=\pi/2$, replace R^k in that discussion with $R^{1-\alpha}$, which is permissible because $0 < \alpha < 1$ which means $k > 0$ as required. Replace ν in that discussion with β . Both are positive as required.

Along C_4 , recall $\left| \int_a^b g(\theta) d\theta \right| \leq \int_a^b |g(\theta)| d\theta$ b7a

$$\text{Now } \left| \frac{e^{\beta (\epsilon \cos\theta + i\epsilon \sin\theta)}}{\epsilon^{1-\alpha} e^{i\theta(1-\alpha)}} \epsilon e^{i\theta} i \right| = \epsilon^{\alpha} e^{-\beta \epsilon \sin\theta}$$

$$\int_0^{\pi/2} |g(\theta)| d\theta = \int_0^{\pi/2} \underbrace{\epsilon^{\alpha} e^{-\beta \epsilon \sin\theta}}_{\text{positive} \leq 1} d\theta \leq \int_0^{\pi/2} \epsilon^{\alpha} d\theta = \frac{\pi}{2} \epsilon^{\alpha} \quad 0 < \alpha < 1$$

since $\lim_{\epsilon \rightarrow 0} \frac{\pi}{2} \epsilon^{\alpha} = 0$ it follows that

$$\int_{\theta=0}^{\pi/2} \frac{e^{\beta (\epsilon \cos\theta + i\epsilon \sin\theta)}}{\epsilon^{1-\alpha} e^{i\theta(1-\alpha)}} \epsilon e^{i\theta} i d\theta \rightarrow 0 \quad \text{as } \epsilon \rightarrow 0+$$

17] continued and concluded

Section 6.11

Now consider $\int \dots dz$

$$= -\int_{\epsilon}^R \beta^{\alpha} e^{-\beta y} y^{\alpha-1} dy = -\int_{\epsilon}^R e^{i\frac{\alpha\pi}{2}} e^{-\beta y} y^{\alpha-1} dy$$

let $t = \beta y$

$$\int_{C_3} \dots dz = -\int_{\beta\epsilon}^{\beta R} e^{i\frac{\alpha\pi}{2}} e^{-t} \left(\frac{t}{\beta}\right)^{\alpha-1} \frac{dt}{\beta}$$

In the limit as $\epsilon \rightarrow 0+$, $R = \infty$ the preceding becomes

$$-\int_0^{\infty} e^{-t} \left[\cos \frac{\alpha\pi}{2} + i \sin \frac{\alpha\pi}{2} \right] \frac{t^{\alpha-1}}{\beta^{\alpha}} dt$$

$$= -\frac{\Gamma(\alpha)}{\beta^{\alpha}} \left[\cos \left(\frac{\alpha\pi}{2} \right) + i \sin \left(\frac{\alpha\pi}{2} \right) \right]$$

Now passing to limit $\epsilon \rightarrow 0+$, $R \rightarrow \infty$ along C_1 and adding to integral along C_3 we have:

$$\int_0^{\infty} \frac{e^{-\beta x}}{x^{1-\alpha}} dx - \frac{\Gamma(\alpha)}{\beta^{\alpha}} \left[\cos \left(\frac{\alpha\pi}{2} \right) + i \sin \left(\frac{\alpha\pi}{2} \right) \right] = 0$$

Now rearrange and equate reals on each side, and imaginaries.

$$\int_0^{\infty} \frac{\cos \beta x}{x^{1-\alpha}} dx = \frac{\Gamma(\alpha)}{\beta^{\alpha}} \cos \left(\frac{\alpha\pi}{2} \right)$$

$$\int_0^{\infty} \frac{\sin \beta x}{x^{1-\alpha}} dx = \frac{\Gamma(\alpha)}{\beta^{\alpha}} \sin \left(\frac{\alpha\pi}{2} \right)$$

f.e.d.

section 6.11

18

```
% solution to problem 18, section 6.11
%give gamma function of the complex argument .1+iY
%where Y varies .
clear
global z
Y=linspace(-3,3,100);
Z=.1+i*Y;
Z=Z+1;
%we will compute gamma(z+1),
%then will use gamma(z)=gamma(z+1)/z
m=length(Z);
for k=1:m
    z=Z(k);
    GAM=quad8('gamc',eps,1,.0001)+quad8('gamc',1,20);
    %splitting integration into 2 parts gives better
    %accuracy.Put lower limit as eps, not zero
    %as some matlab versions will not yield 0^complex.
    z=z-1;
    gammaans(k)=GAM/z;
end
r=real(gammaans);xx=imag(gammaans);
plot(Y,abs(gammaans),'LineWidth',1.5);hold on
plot(Y,r);hold on; plot(Y,xx,'LineWidth',1.1);grid
xlabel('y=Imag(z)');ylabel('\Gamma(.1+iy)')
text(.65,1.5,'magnitude');text(-.75,-3,'imag part');
text(-.75,.25,'real part')
title('Figure 6.11-2 \Gamma(.1+iy) vs. y')
```

```
function yy=gamc(t)
```

```
global z
% remember to have global statement in main program.
yy=t.^(z-1).*exp(-t);
```

Sec 6.12

1) $f(z) = z$, $f(z) = 0$ at $z = 0$ zero of order 1
 $f(z)$ has one zero inside C . Thus $N = 1$

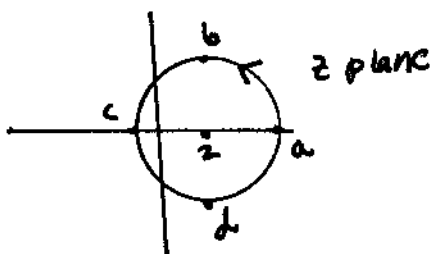

$$W = z$$

$$\Delta_C^{\text{arg}} f(z) = 2\pi$$

$$\frac{2\pi}{2\pi} = 1 = N \text{ as required}$$

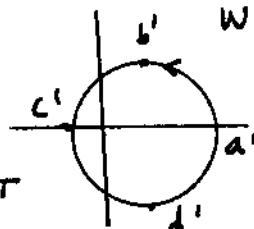

(2) $f(z) = 1/z$ has simple pole at $z = 0$

$$N - P = -1$$

since $P = 1$

$$W = 1/z$$

$$W = f(z)$$

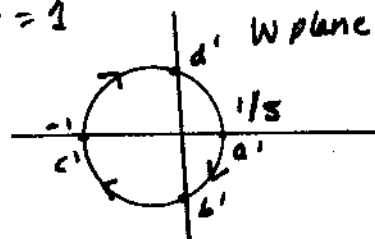
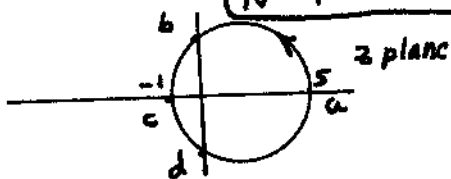

Ch 6,

P. 162

Sec 6.12
 problem 2 cont'd.
 in W plane, $W = f(z)$

$$\frac{\Delta_c \arg f(z)}{2\pi} = \frac{-2\pi}{2\pi} = -1 = -P$$

as
reg'd.

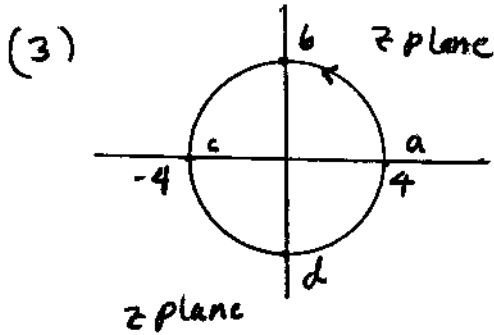

$$f(z) = \frac{z+1}{z}$$

One zero, order 1 at -1
 simple pole at $z=0$

Thus $N - P = 0$

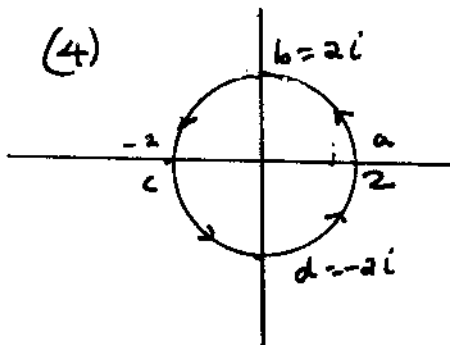
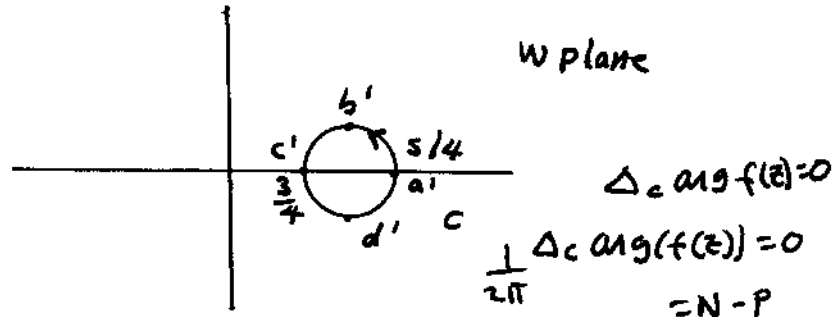

$f(z) = \frac{1}{(z-1)^2}$ has 1 pole
 of 2nd order in c
 thus $N - P = -2$ (No zeros)

$$a' = 1, c' = 19$$

$$b' = -.12 + i.16$$

$$d' = -.12 - i.16$$

$$\Delta_c \arg f(z) = -4\pi$$

$$\frac{-4\pi}{2\pi} = -2 = N - P$$

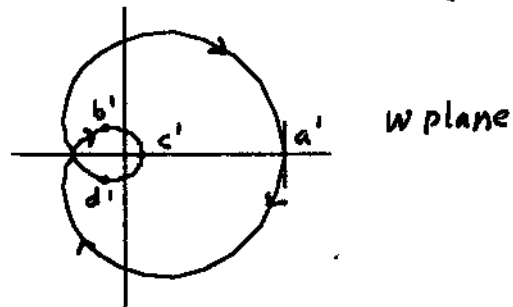

sec 6.12 cont'd

(5) $f(z) = \text{Log } z$, $\text{Log } z = 0$ if $z = 1$
 this is a zero of order 1 since $f'(1) = 1 \neq 0$. No poles.

$N - P = 1$

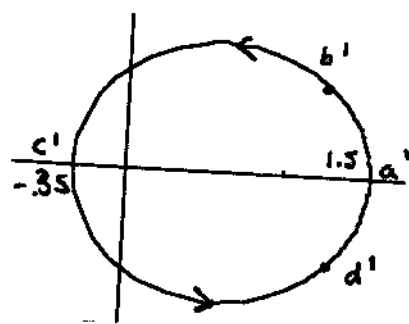
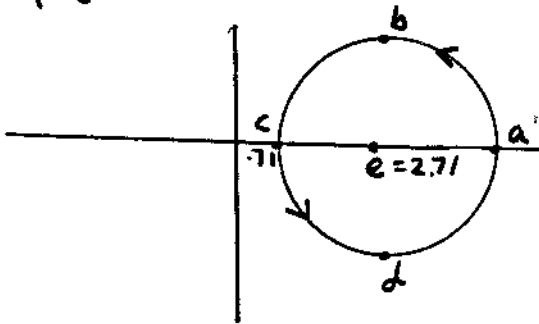

$\Delta \arg f(z) = 2\pi$
 $\frac{\Delta \arg f(z)}{2\pi} = 1 = N - P$

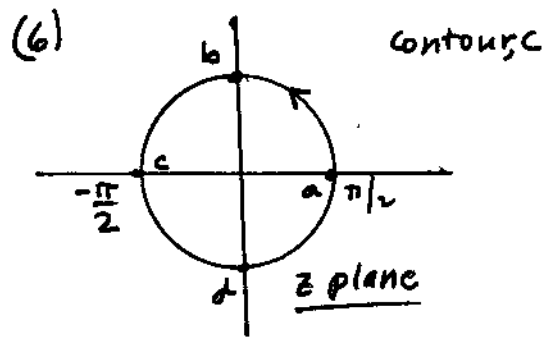

$\sin z$ has no poles
 $\sin z = 0$ inside C at $z = 0$
 $\frac{\sin z}{z}$ is analytic at $z = 0$ (removable singl.)

thus $N - P = 0 - 0 = 0$

$\frac{\arg \Delta_C f(z)}{2\pi} = 0$

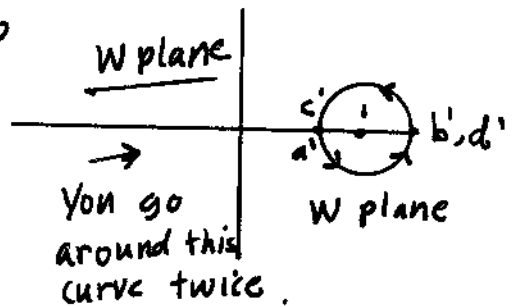

$\Rightarrow f(z) = C_{-p} (z - \alpha)^{-p} + C_{-(p-1)} (z - \alpha)^{-(p-1)} + C_{-(p-2)} \dots$
 Valid for $0 < |z - \alpha| < r$, $C_{-p} \neq 0$

$(z - \alpha)^p f(z) = C_{-p} + C_{-(p-1)}(z - \alpha) + C_{-(p-2)}(z - \alpha)^2 \dots$
 the above right is a convergent power series, converges to an analytic function in a disc, center at $z = \alpha$

7) cont'd

$$g(z) = (z-\alpha)^p f(z) = c_{-p} + c_{-(p-1)}(z-\alpha) + \dots$$

$$f(z) = \frac{g(z)}{(z-\alpha)^p} \quad \text{where } g(z) \text{ is analytic at } z=\alpha$$

$g(\alpha) = c_{-p} \neq 0$

$$f'(z) = \frac{g'(z)}{(z-\alpha)^p} + \frac{g(z)(-p)}{(z-\alpha)^{p+1}}$$

$$\frac{f'(z)}{f(z)} = \frac{g'(z)}{g(z)} - \frac{p}{(z-\alpha)} \quad \begin{array}{l} g(z) \neq 0 \text{ at } z=\alpha \\ g'(z) \text{ is analytic} \\ \text{at } z=\alpha \end{array}$$

Thus $\text{Res} \left[\frac{f'(z)}{f(z)} \right]$ at $z=\alpha$ is $-p$

8) (a) Since $f(z)$ is analytic, and has no poles, $\frac{\Delta_C \arg f(z)}{2\pi} = N_f$. (Princ. of arg).

By same logic: $\frac{\Delta_C [\arg(f+g)]}{2\pi} = N_{f+g} =$
 [since $f+g$ analytic on and inc] number of zeroes of $(f+g)$ inside C

(b) $\arg(f+g) = \arg \left[f \left(1 + \frac{g}{f} \right) \right] = \arg f + \arg \left[1 + \frac{g}{f} \right]$

thus $\Delta \arg(f+g) = \Delta \arg f + \Delta \arg \left[1 + \frac{g}{f} \right]$

$$\frac{\Delta_C \arg(f+g)}{2\pi} = N_{f+g} = \frac{\Delta_C \arg f}{2\pi} + \frac{\Delta_C \arg \left[1 + \frac{g}{f} \right]}{2\pi}$$

(c) ASSUME $1 + \frac{g}{f}$ is neg. real for some z

$$1 + \frac{g}{f} = -a \quad \text{where } a \text{ is real, } a > 0.$$

thus $\frac{g}{f} = -a - 1 \quad |g| = |-a-1| |f|$
 $|g| = |a+1| |f|.$

The preceding implies that $|g| > |f|$, or $\left| \frac{g}{f} \right| > 1$
 which contradicts our assumption $|g/f| < 1$

8) (d) cont'd

$$N_{f+g} = \frac{1}{2\pi} \Delta_C \arg f(z) + \frac{1}{2\pi} \Delta_C \arg \left[1 + \frac{g}{f} \right]$$

But if $\left| \frac{g}{f} \right| < 1$, $\Delta_C \arg \left[1 + \frac{g}{f} \right] = 0$

Thus $N_{f+g} = \frac{1}{2\pi} \Delta_C \arg f(z) = N_f$.

9) (a) $\left| \frac{g(z)}{f(z)} \right| = \frac{|a_{n-1} z^{n-1} + a_{n-2} z^{n-2} + \dots + a_0|}{|a_n| |z|^n}$

$$\leq \frac{|a_{n-1}| |z|^{n-1} + |a_{n-2}| |z|^{n-2} + \dots + |a_0|}{|a_n| |z|^n}$$

put $|z| = r$

$$= \frac{|a_{n-1}| r^{-1} + |a_{n-2}| r^{-2} + \dots + |a_0| r^{-n}}{|a_n|}$$

since $r > 1$

$$< \frac{|a_{n-1}| r^{-1} + |a_{n-2}| r^{-1} + \dots + |a_0| r^{-1}}{|a_n|} \quad \text{[q.e.d.]}$$

[Thus by making r large enough you can insure that: $|g|/|f| < 1$]

(b) $h(z) = f(z) + g(z)$. Now on $|z| = r$

We have $|g| < |f|$ provided (see part a)

that: $\frac{|a_0| + |a_1| r + \dots + |a_{n-1}|}{|a_n| r} < 1$ or if

we choose $r > \frac{|a_0| + |a_1| + \dots + |a_{n-1}|}{|a_n|}$. Now

choosing C as $|z| = r$ we have that

$$N_f = N_{f+g} \quad \text{[number of zeroes of } f+g \text{ inside } C = \text{number of zeroes of } f(z) \text{ inside } C]$$

Now $f = a_n z^n$ and $N_f = n = N_{f+g} = \text{number of zeroes of } a_n z^n + a_{n-1} z^{n-1} + \dots + a_0 \text{ inside } C$

10) On C , $|f(z)| = \left(\frac{3}{2}\right)^4 = 5.0625$

On C $|g(z)| \leq 1 + |z|^3$ (triangle inequality)

$|g(z)| \leq 1 + (1.5)^3 = 4.375$. Since $4.375 < 5.0625$

we have $|g(z)| < |f(z)|$ on C . Thus

$N_{f+g} = N_f$. Number of roots of $z^4=0$ inside C is 4. Thus $z^4+z^3+1=0$ has 4 roots inside C . These are all the roots.

11) $f = 1 + z^3$, on $|z| = 3/4$,

$|f| \geq 1 - |z|^3$ (triangle ineq.),

Thus $|f| \geq .578125$ Now $g = z^4$, $|g| = |z|^4$

$= .3164$. Thus $|f| > |g|$ on C and

$N_{f+g} = N_f$. Now all the zeroes of $f(z) = 1+z^3$ are on the unit circle. None are inside

$|z| = 3/4$. Thus $N_f = 0$ and $N_{f+g} = 0$

Thus $z^4 + z^3 + 1$ has no zeroes inside C ,

12) $\Rightarrow w = [1 \ 1 \ 0 \ 0 \ 1]$

$w =$

\curvearrowright $\begin{matrix} 1 & 1 & 0 & 0 & 1 \\ \text{this represents the polynomial } z^4+z^3+1 \\ \Rightarrow \text{roots}(w) \end{matrix}$

ans =

$$\left. \begin{matrix} -1.0189 + 0.6026i \\ -1.0189 - 0.6026i \\ 0.5189 + 0.6666i \\ 0.5189 - 0.6666i \end{matrix} \right\} \begin{matrix} \text{the 4 roots} \\ \text{(continued next pg.)} \end{matrix}$$

abs(ans)

see. 6.12
prob 12, cont'd

ans =

$\left. \begin{array}{l} 1.1838 \\ 1.1838 \\ 0.8448 \\ 0.8448 \end{array} \right\}$ their magnitudes. Note they all
 satisfy $\frac{3}{4} < |z| < \frac{3}{2}$

13] $f(z) = 3z^2$, $|f| = 3$, $|g| = |e^z| = e^x$

On C , $|g| \leq e$ while $|f| = 3$, Thus
 $|f| > |g|$ $N_{f+g} = N_f$. $N_f = 2$ since
 $3z^2$ has zero of order 2 at $z=0$. Thus
 $3z^2 - e^z = 0$ has 2 roots inside $|z|=1$

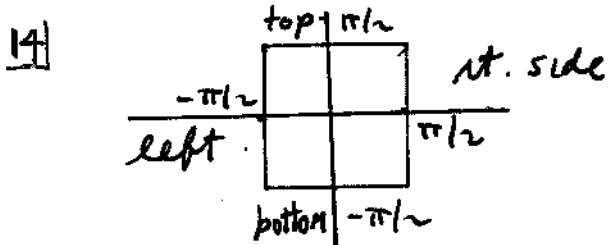

take $f = 5 \sin z$
 $g = -e^z$
 $|g| = |e^z| = e^x$
 $|g| \leq e^{\pi/2} = 4.81$

$|f(z)| = 5 |\sin z| =$
 $5 \sqrt{\sinh^2 y + \sin^2 x}$. On rt. and left
 sides, $|f(z)| = 5 \sqrt{\sinh^2 y + 1} \geq 5$

On top and bottom sides $|f(z)| = 5 \sqrt{\sinh^2 \frac{\pi}{2} + \sin^2 x}$
 $|f(z)| \geq 5 \sinh \frac{\pi}{2} = 11.5$. Thus on C

$|f(z)| \geq 5$ while $|g(z)| \leq 4.81$. Thus $|f| > |g|$

^{and} $N_{f+g} = N_f$. Now $5 \sin z = 0$ has one root
 inside C , at $z=0$ (multiplicity is 1).

(continued)

Sec 6.12, problem 14, continued

Thus $5\sin z - e^z$ has one root. This root must be real, if it were complex, its conjugate would also be a root [since $\sin \bar{z} = \overline{\sin z}$, $e^{\bar{z}} = \overline{e^z}$] and we would have 2 roots inside C .

15(a) Assume a real root. Consider

$f(x) = e^x - 2x$, At $x=3$, $f(x) = e^3 - 6 = 14.1$

$f(3)$ is > 0 . At $x=-3$, $f(x) = e^{-3} + 6 = 2.95$

$f(-3)$ is > 0 . Where is minimum of $f(x)$?

$f'(x) = e^x - 2 = 0$ $x = \log 2$, At the min

$f(x) = 2 - 2 \log 2 = .613$ which is positive. \therefore

for $-3 \leq x \leq 3$ $f(x) = 0$ has no solution. You can also sketch $f(x)$ and arrive at same result

b) $e^{z_1} - 2z_1 = 0$ Now take the conjugates of both sides:

$\overline{(e^{z_1} - 2z_1)} = 0$ $\overline{(e^{z_1})} - 2\bar{z}_1 = 0$

$e^{\bar{z}_1} - 2\bar{z}_1 = 0$ Since $\overline{(e^z)} = e^{\bar{z}}$ $\therefore \bar{z}_1$ is a sol'n.

c)

$w = e^z - 2z$

z	w
0	1.0000
0.5000	0.6487
1.0000	0.7183
1.5000	1.4817
2.0000	3.3891
2.5000	7.1825
3.0000	14.0855
$2.7716 + 1.1481i$	$1.0147 + 12.2815i$
$2.1213 + 2.1213i$	$-8.6067 + 2.8670i$
$1.1481 + 2.7716i$	$-5.2349 - 4.4036i$
$0 + 3.0000i$	$-0.9900 - 5.8589i$
$0 + 2.5000i$	$-0.8011 - 4.4015i$
$0 + 1.5000i$	$0.0707 - 2.0025i$
$0 + 0.5000i$	$0.8776 - 0.5206i$

$3e^{i\pi/8}$
 $3e^{i\pi/4}$
 $3e^{i3\pi/8}$

continued next Pg.

Sec 6.12 prob 15 (c) cont'd

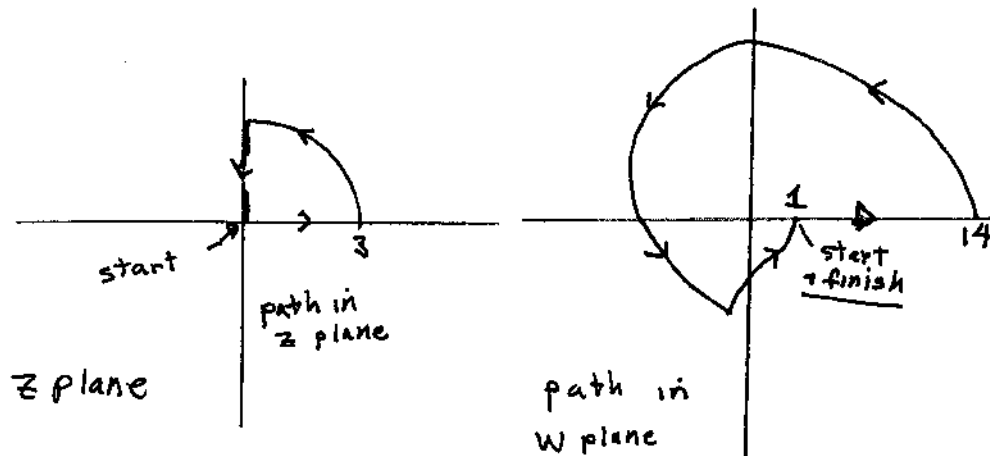

Note that locus in w plane encircles the origin once. $\frac{\Delta \circ \arg f(z)}{2\pi} = 1$ \Rightarrow 1 root, g.e.d. as required

Prob. 16, code for Fig. 6.12-5(b)

```
%sec 6.12 princ of arg
theta=linspace(0,2*pi,100);
thetap=[0 pi/2 pi 3*pi/2]
z=3*exp(i*theta);
zp=3*exp(i*thetap);
w=exp(z)-2*z;
wp=exp(zp)-2*zp;
wrp=real(wp);wip=imag(wp);
wr=real(w);wi=imag(w);
plot(wr,wi,wrp,wip,'o');grid;
```

← places circles on plot at a', b', c', d'

P7

Code for parts (a) and (b)

```
%sec 6.12 princ of arg
% problem 17
```

```
% choose r below to be the radius of the circle, either 2 or 4 as
r=input('r=')
theta=linspace(0,2*pi,100);
```

↙ needed ;

```
z=r*exp(i*theta);
w=exp(z)-sin(z);
wr=real(w);wi=imag(w);
plot(wr,wi);grid;
```

Figures on next pg.

sec 6.12

prob 17

Continued.

17(a)

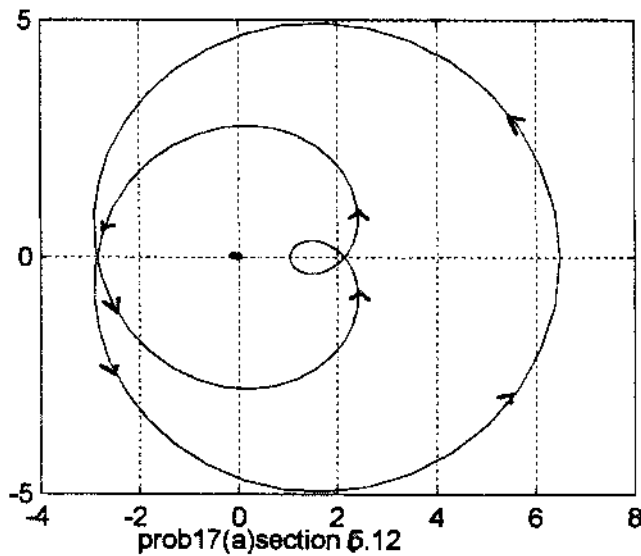

$$\Delta_c \arg f(z) = 4\pi$$

locus of $e^z - \sin z = w$ as z goes once around $|z|=2$.
The origin is encircled twice.

$$\therefore \frac{\Delta_c \arg f(z)}{2\pi} = \frac{4\pi}{2\pi} = 2$$

There are 2 solutions to $e^z - \sin z = 0$ inside $|z|=2$.

17(b) ↓

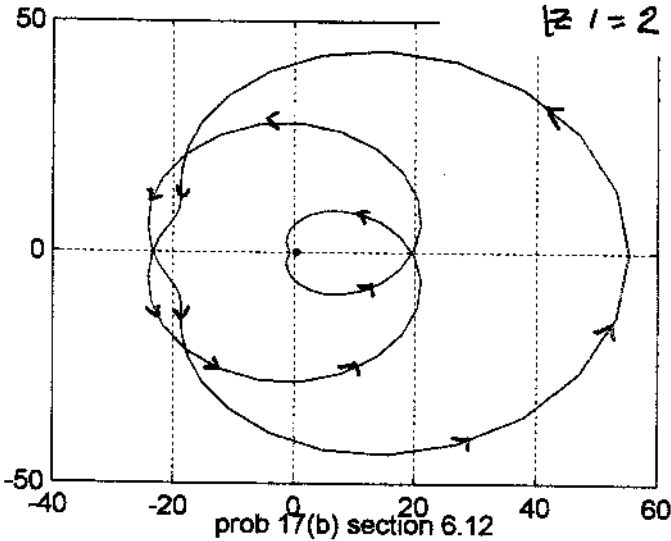

$$\Delta_c \arg f(z) = 6\pi$$

Note that the origin is encircled 3 times.

$$\therefore \frac{\Delta_c \arg f(z)}{2\pi} = \frac{6\pi}{2\pi} = 3$$

There are 3 solutions to $e^z - \sin z = 0$ inside $|z|=4$

7

Laplace Transforms and Stability of Systems

Chap 7, sec 7.1

$$1) \mathcal{L}^{-1} \frac{1}{(s-1)(s+2)} = \text{Res} \frac{e^{st}}{(s-1)(s+2)} \text{ at } 1 +$$

$$\text{Res} \frac{e^{st}}{(s-1)(s+2)} \text{ at } -2 = \boxed{\frac{e^t}{3} + \frac{e^{-2t}}{-3}}$$

$$2) \mathcal{L}^{-1} \frac{s}{(s-a)(s+b)} = \text{Res} \frac{e^{st}s}{(s-a)(s+b)} \Big|_a + \text{Res} \frac{e^{st}s}{(s-a)(s+b)} \Big|_{-b}$$

$$= \frac{e^{at}a}{a+b} + \frac{e^{-bt}(-b)}{-b-a} = \boxed{\frac{1}{a+b} [ae^{at} + be^{-bt}]}$$

$$3) \mathcal{L}^{-1} \frac{1}{(s+a)^2} = \text{Res} \frac{e^{st}}{(s+a)^2} \Big|_{-a} = \lim_{s \rightarrow -a} \frac{d}{ds} e^{st}$$

$$= \boxed{t e^{-at}}$$

$$4) \mathcal{L}^{-1} \frac{s}{(s+a)^2(s+b)} = \sum \text{Res} \frac{s e^{st}}{(s+a)^2(s+b)} \text{ at } -a, -b$$

$$\text{Res at } -a \text{ is } \frac{(e^{st} + s t e^{st})(s+b) - s e^{st}}{(s+b)^2} \Big|_{s=-a}$$

$$\text{Res at } -b \text{ is } \frac{-b e^{-bt}}{(b-a)^2}$$

$$\text{ans. } \boxed{\frac{e^{-at} [b - at + a^2 t] - b e^{-bt}}{(b-a)^2}}$$

$$5) \mathcal{L}^{-1} \frac{1}{s^2 + a^2} = \sum \text{res} \frac{e^{st}}{s^2 + a^2} \Big|_{\pm ai} = \frac{e^{ait}}{2ai}$$

$$+ \frac{e^{-ait}}{-2ai} = \boxed{\frac{\sin at}{a}}$$

Chap 17 Sec 7.1 cont'd

$$6) \mathcal{L}^{-1} \frac{s}{s^2+a^2} = \sum_{\text{res}} \frac{s e^{st}}{s^2+a^2} \Big|_{\pm ai} = \frac{ai e^{ait}}{2ai} + \frac{(-ai) e^{-ait}}{-2ai} = \boxed{\cos at}$$

$$7) \mathcal{L}^{-1} \frac{1}{(s^2+a^2)^2} = \sum_{\text{res}} \frac{e^{st}}{(s^2+a^2)^2} \text{ at } \pm ai$$

$$= \frac{d}{ds} \frac{e^{st}}{(s+ia)^2} \Big|_{ai} + \frac{d}{ds} \frac{e^{st}}{(s-ia)^2} \Big|_{-ai} =$$

$$\frac{t e^{(ia)(-4a^2)} - e^{ita} 4ia}{16a^4} + \frac{t e^{-ita} (-4a^2) + e^{-ita} 4ia}{16a^4}$$

$$= \boxed{\frac{1}{2a^3} \sin at - \frac{1}{2a^2} t \cos at}$$

$$8) \mathcal{L}^{-1} \frac{1}{(s^2+a^2)(s^2+b^2)} = \sum_{\text{res}} \frac{e^{st}}{(s^2+a^2)(s^2+b^2)} \text{ at } \pm ia, \pm ib$$

$$\frac{e^{iat}}{(aia)(b^2-a^2)} + \frac{e^{-iat}}{(-aia)(b^2-a^2)} + \frac{e^{ibt}}{(a^2-b^2)(aib)} + \frac{e^{-ibt}}{(a^2-b^2)(-aib)}$$

$$= \boxed{\frac{\sin(at)}{(a)(b^2-a^2)} + \frac{\sin(bt)}{(b)(a^2-b^2)}}$$

$$9) s^2+s+1=0, s = \frac{-1 \pm i\sqrt{3}}{2}$$

$$\mathcal{L}^{-1} \frac{1}{s^2+s+1} = \sum_{\text{res}} \frac{e^{st}}{s^2+s+1} \text{ at } \frac{-1 \pm i\sqrt{3}}{2}$$

$$= \frac{e^{st}}{2s+1} \Big|_{\frac{-1+i\sqrt{3}}{2}} + \frac{e^{st}}{2s+1} \Big|_{\frac{-1-i\sqrt{3}}{2}} = \boxed{e^{-\frac{t}{2}} \frac{2 \sin\left(\frac{\sqrt{3}}{2} t\right)}{\sqrt{3}}}$$

chap 7, sec 7.1

10) $\mathcal{L}^{-1} \frac{1}{(s+1)^4} = \text{Res} \frac{e^{st}}{(s+1)^4} \Big|_{s=-1}$ 4th order pole

$$= \frac{d^3}{ds^3} e^{st} \Big|_{s=-1} = \frac{t^3}{3!} e^{-t}$$

11) $\mathcal{L}^{-1} \frac{1}{s^n} = \text{Res} \frac{e^{st}}{s^n} \Big|_{s=0} = \frac{d^{n-1}}{ds^{n-1}} e^{st} \Big|_{s=0}$

$$= \frac{t^{n-1}}{(n-1)!}$$

12) % problem 12 in section 7.1
 syms s t
 % part a is below
 laplace(1/sqrt(pi*t))
 % part b is below
 ilaplace(1/s^(1/2)) ;
 pretty(ans)
 syms a real
 % part c is below
 ilaplace (1/(s+a)^2)
 % part d is below recall that gamma(n)=(n-1) !
 syms n positive
 syms n integer
 ilaplace(1/s^n);
 pretty(ans)

13. | Refer to Theorem 10, Chap 6, ^{sec 7.1} Take

$$f(z, t) = f(t) e^{-zt} \quad \text{where } z \equiv s.$$

Need to establish $\int_0^{\infty} f(t) e^{-zt} dt$ is unit conv for z in R where R is: $\alpha \leq x \leq \beta$, $|Im(z)| \leq \delta$. Use Thm 11, Chap 6. Need $M(t)$.

$$\text{Now take } F(z) = \int_0^{\infty} f(z, t) dt = \int_0^{\pi} f(z, t) dt + \int_{\pi}^{\infty} f(z, t) dt.$$

Consider $0 \leq t \leq \pi$. Here $|f(z, t)| = |f(t)| |e^{-zt}| = |f(t)| e^{-xt}$. Note that e^{-xt} decreases monotonically with increasing x . In R , $x \geq \alpha$

$$\circ \circ \quad |f(t)| e^{-xt} \leq |f(t)| e^{-\alpha t} \quad \text{for } z \text{ in } R.$$

$$\text{Now if } \alpha \geq 0, \quad |f(t)| e^{-\alpha t} \leq |f(t)|, \quad 0 \leq t \leq \pi$$

$$\text{If } \alpha \leq 0, \quad |f(t)| e^{-\alpha t} \leq |f(t)| e^{|\alpha| \pi}, \quad 0 \leq t \leq \pi$$

$\circ \circ$ for all z in R , and $0 \leq t \leq \pi$

$$|f(z, t)| \leq |f(t)| e^{|\alpha| \pi} = M(t)$$

Now consider $t \geq \pi$.

$$|f(z, t)| = |f(t)| e^{-xt} \leq k e^{pt} e^{-xt} = k e^{(p-x)t} \quad \text{take as } M(t).$$

Consider $\int_0^{\infty} M(t) dt = \int_0^{\pi} |f(t)| e^{|\alpha| \pi} dt + \int_{\pi}^{\infty} k e^{(p-x)t} dt$. The integral $\int_0^{\pi} |f(t)| e^{|\alpha| \pi} dt$ converges because $|f(t)|$ is continuous.

$$\int_{\pi}^{\infty} k e^{(p-x)t} dt = \frac{k e^{(p-x)\pi}}{x-p} \quad \text{if } x = Re(z) > p \text{ or } Re s > p$$

Since $\int_0^{\infty} M(t) dt$ converges, Theorem 11 is satisfied for $s = z$ in R . This completes proof that $F(z) = F(s)$ is analytic for s in R .

Chap 7, Sec 7.1 cont'd

14) a) $f(t) = \sum_{\text{res}} \frac{p(s)}{Q(s)} e^{st}$ at $s = a_1, a_2, \dots, a_n$

All the poles of $[p/Q]e^{st}$ are simple.

Residue at a_j is $\frac{p(s)}{Q'(s)} e^{st} \Big|_{a_j} = \frac{p(a_j)}{Q'(a_j)} e^{a_j t}$

thus: $f(t) = \sum_{j=1}^n \frac{p(a_j)}{Q'(a_j)} e^{a_j t}$

(b) $P=1, Q=(s-1)(s+2), Q'=(s+2)+s-1=2s+1$

$f(t) = \frac{1}{2s+1} e^{st} \Big|_{s=1} + \frac{1}{2s+1} e^{st} \Big|_{s=-2} = \frac{1}{3} e^t + \frac{e^{-2t}}{-3}$

15) $\mathcal{L} f(t) = F(s) = \int_0^{\infty} f(t) e^{-st} dt$ (by definition)

Now: $\mathcal{L} f(t-\tau) u(t-\tau) = \int_0^{\infty} f(t-\tau) u(t-\tau) e^{-st} dt = \int_{\tau}^{\infty} f(t-\tau) e^{-st} dt$ since $u(t-\tau)=1, t \geq \tau$

let $t' = t - \tau$ in the preceding integral.

$\mathcal{L} f(t-\tau) u(t-\tau) = \int_0^{\infty} f(t') e^{-s(t'+\tau)} dt' = e^{-s\tau} \int_0^{\infty} f(t') e^{-st'} dt' = e^{-s\tau} \mathcal{L} f(t') = e^{-s\tau} F(s)$ q.e.d

16) $\mathcal{L}^{-1} e^{-s\tau} F(s) = u(t-\tau) f(t-\tau)$

thus $\mathcal{L}^{-1} \frac{e^{-2s}}{s^2+1} = u(t-2) \mathcal{L}^{-1} \frac{1}{s^2+1} \Big|_{t \Rightarrow t-2}$

$\mathcal{L}^{-1} \frac{1}{s^2+1} = \sin t$ (probl. 5)

$\therefore \mathcal{L}^{-1} \frac{e^{-2s}}{s^2+1} = \boxed{u(t-2) \sin(t-2)}$

Chap 7 Sec 7.1, Cont'd

17] take $\tau = 1$, Note $\mathcal{L}^{-1} \frac{1}{s} = 1$

Thus $\mathcal{L}^{-1} \frac{e^{-s}}{s} = \boxed{u(t-1)}$

18] Take $\tau = 3$, Now $\mathcal{L}^{-1} \frac{1}{(s^2+1)(s^2+4)} =$

(see problem 8) is $\frac{\sin t}{3} + \frac{\sin 2t}{(2)(-3)}$

Thus $\mathcal{L}^{-1} \frac{e^{-3s}}{(s^2+1)(s^2+4)} = \boxed{u(t-3) \left[\frac{\sin(t-3)}{3} + \frac{\sin 2(t-3)}{-6} \right]}$

19] Take $\tau = a$, From prob. (7) $\mathcal{L}^{-1} \frac{1}{(s^2+b^2)^2} =$

$\frac{1}{2b^3} \sin(bt) - \frac{1}{2b^2} t \cos(bt)$

Thus $\mathcal{L}^{-1} \frac{e^{-as}}{(s^2+b^2)^2} = \boxed{\left[\frac{1}{2b^3} \sin b(t-a) - \frac{1}{2b^2} t \cos b(t-a) \right] u(t-a)}$

20] $F(s) = \int_0^{\infty} f(t) e^{-st} dt = \int_1^{\infty} e^{-st} dt = \frac{e^{-st}}{-s} \Big|_{t=1}^{\infty}$ this

vanishes at upper limit if $\text{Re } s > 0$

Thus $F(s) = e^{-s}/s \quad \text{Re } s > 0$

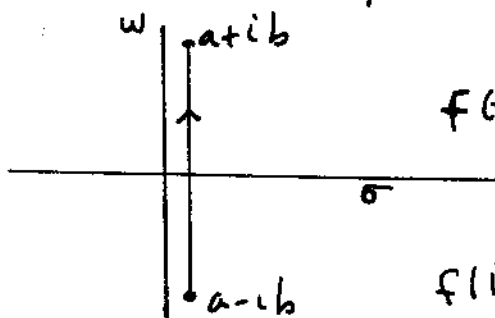

$f(t) = \lim_{b \rightarrow \infty} \frac{1}{2\pi i} \int_{a-ib}^{a+ib} \frac{e^{-s}}{s} e^{st} ds$

$f(1) = \lim_{b \rightarrow \infty} \frac{1}{2\pi i} \int_{a-ib}^{a+ib} \frac{1}{s} ds$

$\lim_{b \rightarrow \infty} \frac{1}{2\pi i} \left[\text{Log} \left[\frac{a+ib}{a-ib} \right] \right] = \frac{1}{2\pi i} \left[\text{Log} \left| \frac{a+ib}{a-ib} \right| + i \text{ars}(a+ib) - i \text{ars}(a-ib) \right]$

chap 7, see 7.1 cont'd

20(b), cont'd $\text{Los} \left| \frac{a+ib}{a-ib} \right| = 0$

$$f(i) = \lim_{b \rightarrow \infty} \left[\frac{\arg(a+ib) - \arg(a-ib)}{2\pi} \right] =$$

$$\frac{\frac{\pi}{2} - (-\frac{\pi}{2})}{2\pi} = \frac{1}{2} \quad \text{q.e.d.}$$

21) a) $f(t) = \int_0^t g(t') dt'$, Note $f(0) = 0$

$\frac{df}{dt} = g(t)$ Fund. Thm. Int. Calculus.

$$\mathcal{L} \frac{df}{dt} = sF(s) - f(0) = sF(s)$$

$$\mathcal{L} g(t) = sF(s) = s \mathcal{L} \int_0^t g(t') dt'$$

Now $\mathcal{L} g(t) = G(s)$

Thus $G(s) = s \mathcal{L} \int_0^t g(t') dt'$, $\frac{G(s)}{s} = \mathcal{L} \int_0^t g(t') dt'$ q.e.d.

(b) $t = \int_0^t 1 dt'$, $\mathcal{L} 1 = \frac{1}{s} \therefore \boxed{\mathcal{L} t = \frac{1}{s^2}}$

$\mathcal{L} t = \frac{1}{s^2}$, $\int_0^t t' dt' = \frac{t^2}{2} \therefore \mathcal{L} \frac{t^2}{2} = \frac{1}{s^3}$

$\int_0^t t'^2 dt' = \frac{t^3}{3}$ $\therefore \frac{1}{2} \mathcal{L} \frac{t^3}{3} = \frac{1}{s^4}$ or $\mathcal{L} t^3 = \frac{3 \cdot 2}{s^4}$

in general $\boxed{\mathcal{L} t^n = \frac{n!}{s^{n+1}}}$ $n \geq 0$

22) $0 = \mathcal{L} \frac{dt}{dt} + \frac{g_0}{c} + \frac{1}{c} \int_0^t \lambda(t') dt' + \lambda(t) R$

Take Laplace transform of both sides

$0 = \mathcal{L} sI + \frac{g_0}{sC} + \frac{I(s)}{sC} + I(s)R$, solve for I

$$I(s) = \frac{-g_0}{C[LS^2 + RS + 1/C]}$$

22 cont'd

Chap 7

Sec 7.1 cont'd

(b) [1]

$$I(s) = \frac{-g_0}{LC \left[s^2 + \frac{R}{L}s + \frac{1}{LC} \right]}$$

$$s^2 + \frac{R}{L}s + \frac{1}{LC} = 0, \quad s_{1,2} = -\frac{R}{2L} \pm \sqrt{\left(\frac{R}{2L}\right)^2 - \frac{1}{LC}}$$

$$\text{if } R > 2\sqrt{\frac{L}{C}}$$

$$\text{thus } i(t) = \sum_{\text{res}} \frac{-g_0 e^{st}}{LC \left[s^2 + \frac{R}{L}s + \frac{1}{LC} \right]} \text{ at } s_1, s_2$$

$$= \frac{-g_0}{LC} \frac{e^{-(R/2L)t}}{\sqrt{\left(\frac{R}{2L}\right)^2 - \frac{1}{LC}}} \sinh \left[\sqrt{\left(\frac{R}{2L}\right)^2 - \frac{1}{LC}} t \right]$$

case

$$(ii) \text{ poles are at } -\frac{R}{2L} \pm i \sqrt{\left(\frac{1}{LC}\right) - \left(\frac{R}{2L}\right)^2} = s_1, s_2$$

$$i(t) = \sum_{\text{res}} \frac{-g_0 e^{st}}{LC \left[s^2 + \frac{R}{L}s + \frac{1}{LC} \right]} \text{ at } s_1, s_2$$

$$= \frac{-g_0}{LC} e^{-(R/2L)t} \frac{\sin \left[\sqrt{\left(\frac{1}{LC}\right) - \left(\frac{R}{2L}\right)^2} t \right]}{\sqrt{\frac{1}{LC} - \left(\frac{R}{2L}\right)^2}}$$

$$\text{case (iii) } s_1 = s_2, \quad R = 2\sqrt{\frac{L}{C}}, \text{ have 2nd order pole at } s = -\frac{R}{2L}.$$

$$I(s) = \frac{-g_0}{(LC) \left[s + \frac{R}{2L} \right]^2}$$

$$i(t) = \text{Res} \frac{-g_0 e^{st}}{(LC) \left[s + \frac{R}{2L} \right]^2}$$

$$i(t) = \frac{-g_0}{LC} t e^{st} \Big|_{s_1} = \frac{-g_0}{LC} t e^{-\frac{R}{2L}t}$$

$$23) [1 + e^{-sT} + e^{-2sT} + e^{-3sT} \dots] = [1 + p + p^2 + p^3 \dots]$$

$$= \text{geometric series } \frac{1}{1-p} \text{ if } |p| < 1 \text{ or } \frac{1}{1-e^{-sT}} \text{ if}$$

$$|e^{-sT}| < 1 \text{ which implies (since } T > 0) \text{ that } \boxed{\text{Re } s > 0}$$

Chap 7 7.1 cont'd

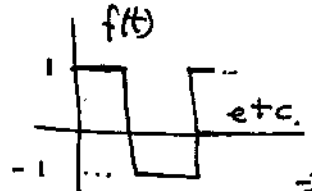
24]  $\mathcal{L} f(t) = \int_0^T e^{-st} dt + \int_{T/2}^T e^{-st} dt$

$= \frac{1 - 2e^{-sT/2} + e^{-sT}}{s}$

$\mathcal{L} f(t) = \frac{1}{s} (1 - e^{-sT/2})^2$, thus $\mathcal{L} g(t) = \frac{(1 - e^{-sT/2})^2}{(s)(1 - e^{-sT})}$

$= \frac{e^{-sT/2} 4 \operatorname{smh}^2 \frac{sT}{4}}{e^{-sT/2} s 2 \operatorname{smh} \frac{sT}{2}} = \frac{1}{s} \tanh \frac{sT}{4}$

note: $\operatorname{smh} \frac{sT}{2} = 2 \operatorname{smh} \frac{sT}{4} \operatorname{cosh} \frac{sT}{4}$

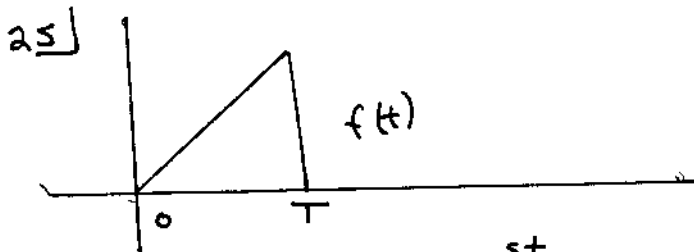

$\mathcal{L} f(t) = \int_0^T \frac{t}{T} e^{-st} dt$ (integrate by parts or use table)

$F(s) = -\frac{e^{-sT}}{s} + \frac{1}{s^2 T} [1 - e^{-sT}]$

Thus: $\mathcal{L} g(t) = \frac{F(s)}{1 - e^{-sT}} = \frac{1}{s^2 T} \frac{1 - e^{-sT}}{1 - e^{-sT}}$

$= \frac{1}{s^2 T} - \frac{e^{-(sT/2)}}{2s \operatorname{smh}(\frac{sT}{2})}$

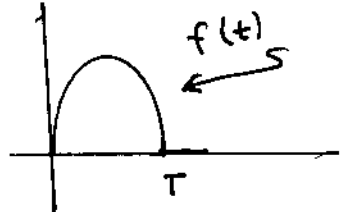
26] 

$\mathcal{L} f(t) = \int_0^T \sin\left[\frac{\pi t}{T}\right] e^{-st} dt$

integrate by parts, or use table
or put $\sin \frac{\pi t}{T} = \frac{e^{i\pi t/T} - e^{-i\pi t/T}}{2i}$

Chap 7 7.1 cont'd

26] cont'd

$$f(t) = \frac{e^{-st} \left[-s \sin\left(\frac{\pi t}{T}\right) - \frac{\pi}{T} \cos\left(\frac{\pi t}{T}\right) \right]}{s^2 + \left(\frac{\pi}{T}\right)^2} \Bigg|_0^T$$

$$= \frac{\pi}{T} \frac{e^{-sT} + 1}{s^2 + \left(\frac{\pi}{T}\right)^2} \quad \text{Thus } \mathcal{L} g(t) =$$

$$\frac{\frac{\pi}{T}}{s^2 + \left(\frac{\pi}{T}\right)^2} \frac{1 + e^{-sT}}{1 - e^{-sT}} = \frac{\pi T}{\pi^2 s^2 + \pi^2} \coth \frac{sT}{2}$$

27] $m_1 \frac{d^2 X_1}{dt^2} = -2kX_1 + kX_2$

$$m_2 \frac{d^2 X_2}{dt^2} = kX_1 - 2kX_2$$

a) Taknis transforms:

$$s^2 X_1(s) - s = -2 X_1(s) + X_2(s)$$

$$2s^2 X_2(s) = X_1(s) - 2X_2(s)$$

(b) From the 2nd equation above, get:

$$X_2 = \frac{X_1}{2(s^2+1)} \quad \text{use this in the first eqn.}$$

$$\text{get } X_1 = \frac{s(s^2+1)}{s^4 + 3s^2 + 3/2}$$

$$\text{which implies } X_2 = \frac{s/2}{s^4 + 3s^2 + 3/2}$$

(c) for poles $s^4 + 3s^2 + 3/2 = 0$

$$s^2 = -\frac{3}{2} \pm \frac{\sqrt{3}}{2}, \quad s = \pm i \sqrt{\frac{3 \pm \sqrt{3}}{2}}_{1,2,3,4}$$

$$X_2(t) = \sum_{\text{res}} \frac{e^{st} s/2}{s^4 + 3s^2 + 3/2} \text{ at } s_{1,2,3,4}$$

Chap 7 7.1 cont'd

27] (c) cont'd

Res at a pole s_j is $\frac{s/2 e^{st}}{4s^2+6s} = \frac{e^{st}}{8s^2+12}$ at s_j

thus $X_2(t) = \frac{e^{i\sqrt{\frac{3+\sqrt{3}}{2}}t}}{-4\sqrt{3}} + \frac{e^{i\sqrt{\frac{3-\sqrt{3}}{2}}t}}{4\sqrt{3}} + \frac{e^{-i\sqrt{\frac{3+\sqrt{3}}{2}}t}}{-4\sqrt{3}} + \frac{e^{-i\sqrt{\frac{3-\sqrt{3}}{2}}t}}{4\sqrt{3}}$

$$= \frac{1}{2\sqrt{3}} \cos\left[\sqrt{\frac{3-\sqrt{3}}{2}}t\right] - \frac{1}{2\sqrt{3}} \cos\left[\sqrt{\frac{3+\sqrt{3}}{2}}t\right] = X_2$$

Now you can get $X_1(t)$ from $\mathcal{L}^{-1} X_1(s)$, but it is easier to use $X_2(t)$ obtained above

note: $m_2 \frac{d^2 X_2}{dt^2} + 2k X_2 = k X_1$, $X_1(t) = 2 \frac{d^2 X_2}{dt^2} + 2 X_2$

Using X_2 obtained above, get:

$$X_1 = \frac{1}{2\sqrt{3}} \left[(-1+\sqrt{3}) \cos\left[\sqrt{\frac{3-\sqrt{3}}{2}}t\right] + (1+\sqrt{3}) \cos\left[\sqrt{\frac{3+\sqrt{3}}{2}}t\right] \right]$$

28] (a) $V_1(s) = R I_1(s) + L_1 s I_1 + M s I_2$

$0 = M s I_1 + R_2 I_2(s) + L_2 s I_2$

$V_1(s) = 1/(s+\alpha)$

(b) $\frac{1}{s+\alpha} = (1+s)I_1 + .5sI_2$

$0 = .5sI_1 + (1+s)I_2$

From 2nd equation: $I_2 = -\frac{.5sI_1}{1+s}$

Use this in 1st equation with $\alpha = 1$

get: $I_1 = \frac{4/3}{s^2 + \frac{8}{3}s + \frac{4}{3}}$

$I_2 = \frac{-(2/3)s}{(1+s)(s^2 + \frac{8}{3}s + \frac{4}{3})}$

chap 7 7.1 cont'd

28 (c) $I_1(s) = \frac{4/3}{s^2 + \frac{8}{3}s + \frac{4}{3}}$. Find poles of

$I_1(s) : s^2 + \frac{8}{3}s + \frac{4}{3} = 0, \quad s_1 = -2, \quad s_2 = -2/3$

$i_1(t) = \sum_{\text{res}} \frac{4/3 e^{st}}{s^2 + \frac{8}{3}s + \frac{4}{3}} \quad \text{at } -2, -2/3$

$= \sum \frac{(4/3)e^{st}}{2s + 8/3} \Big|_{-2 \text{ and } -2/3} = \boxed{e^{-2/3t} - e^{-2t}}$

$i_2(t) = \sum_{\text{res}} \frac{(-2/3)s e^{st}}{(1+s)(s^2 + \frac{8}{3}s + \frac{4}{3})} \quad \text{at } s = -1$
 at -2 and $-2/3$

$= \frac{(-2/3)s}{(1+s)(2s + \frac{8}{3})} e^{st} \Big|_{s=-2} + \frac{(-2/3)s e^{st}}{(1+s)(2s + \frac{8}{3})} \Big|_{s=-2/3}$

$\frac{(-2/3)s e^{st}}{s^2 + \frac{8}{3}s + \frac{4}{3}} \Big|_{s=-1} = \boxed{e^{-2t} + e^{-2/3t} - 2e^{-t} = i_2}$

29 | a) $f(t) = \int_{-\infty}^{+\infty} \frac{1}{2\pi} \int_{-\infty}^{+\infty} f(t') e^{-i\omega t'} dt' e^{i\omega t} d\omega$
 $g(t) e^{-\alpha t} = \int_{-\infty}^{+\infty} \frac{1}{2\pi} \int_{-\infty}^{+\infty} g(t') e^{-\alpha t'} e^{-i\omega t'} dt' e^{i\omega t} d\omega$

since $g(t) = 0$ for $t < 0$ we can change this limit to 0

$g(t) = e^{\alpha t} \int_{-\infty}^{+\infty} \frac{1}{2\pi} \int_0^{\infty} g(t') e^{-\alpha t'} e^{-i\omega t'} dt' e^{i\omega t} d\omega$

$g(t) = \int_{-\infty}^{+\infty} \frac{1}{2\pi} \int_0^{\infty} g(t') e^{-(\alpha + i\omega)t'} dt' e^{(\alpha + i\omega)t} d\omega$

(b) $s = a + iw, ds = i dw, dw = \frac{1}{i} ds$
 as $w \rightarrow \infty, s \rightarrow a + i\infty, ds \rightarrow i dw, ds \rightarrow a - i\infty, s \rightarrow a - i\infty$

$$g(t) = \frac{1}{2\pi i} \int_{a-i\infty}^{a+i\infty} \int_0^\infty g(t') e^{-st'} dt' e^{st} ds$$

(c) $G(s) = \int_0^\infty g(t') e^{-st'} dt'$

thus $g(t) = \frac{1}{2\pi i} \int_{a-i\infty}^{a+i\infty} G(s) e^{st} ds$ e.e.d.

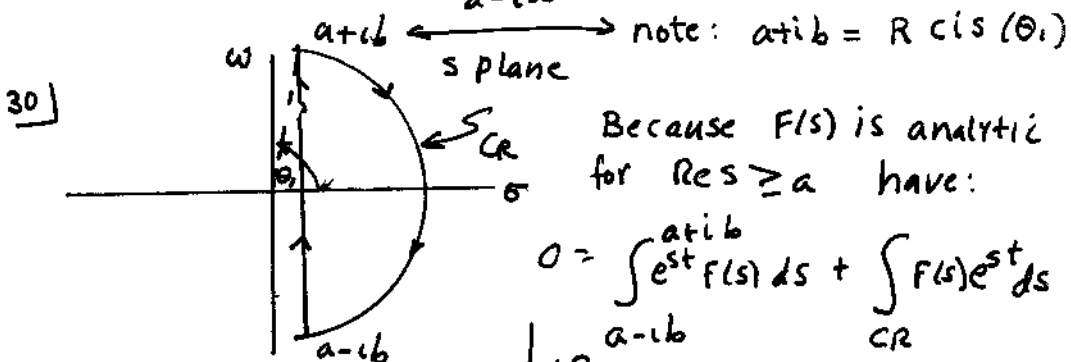

$$0 = \int_{a-ib}^{a+ib} e^{st} F(s) ds + \int_{CR} F(s) e^{st} ds$$

$$\text{Consider } \left| \int_{CR} F(s) e^{st} ds \right| = \left| \int_{-\theta_1}^{+\theta_1} F(R e^{i\theta}) e^{t[R \cos\theta + i R \sin\theta]} R i d\theta \right|$$

$$\leq \int_{-\theta_1}^{\theta_1} |F(R e^{i\theta})| e^{tR \cos\theta} R d\theta = \int_{-\theta_1}^{\theta_1} \frac{m}{R^k} e^{tR \cos\theta} R d\theta$$

$$= 2 \int_0^{\theta_1} \frac{m}{R^{k-1}} e^{tR \cos\theta} d\theta$$

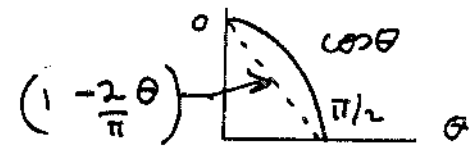

Recall that $0 \leq \theta_1 \leq \pi/2$.

Now $(1 - \frac{2}{\pi} \theta) \leq \cos \theta$

If $0 \leq \theta \leq \frac{\pi}{2}$. Since $t < 0$ have $e^{Rt \cos \theta} \leq e^{Rt(1 - \frac{2}{\pi} \theta)}$

Thus $\left| \int_{CR} F(s) e^{st} ds \right| \leq \frac{2m}{R^{k-1}} \int_0^{\theta_1} e^{tR [1 - \frac{2}{\pi} \theta]} d\theta =$
 $\frac{2m}{R^{k-1}} e^{tR} \int_0^{\theta_1} e^{-\frac{2}{\pi} tR \theta} d\theta = \frac{2m}{R^{k-1}} \frac{e^{tR}}{(-\frac{2}{\pi} tR)} \left[e^{-\frac{2}{\pi} tR \theta_1} - 1 \right]$
 which $\rightarrow 0$ as $R \rightarrow \infty$ since $t < 0$

30 cont'd

Recall that $0 = \frac{1}{2\pi i} \int_{a-ib}^{a+ib} F(s) e^{st} ds + \frac{1}{2\pi i} \int_{CR} F(s) e^{st} ds$

Letting $R \rightarrow \infty$ we have shown that the second integral (i.e. around CR) $\rightarrow 0$

Thus, $0 = \frac{1}{2\pi i} \int_{a-i\infty}^{a+i\infty} F(s) e^{st} ds \quad t < 0$

or $f(t) = 0, t < 0$ as required.

31) $f(t) * g(t) = \int_0^t f(t-\tau) g(\tau) d\tau$

$\mathcal{L} [f(t) * g(t)] = \int_0^\infty \left[\int_0^t f(t-\tau) g(\tau) d\tau \right] e^{-st} dt$

Now $u(t-\tau) = 1$ if $\tau \leq t$
 $= 0$ if $\tau > t$

Thus $f(t-\tau) u(t-\tau) g(\tau) = f(t-\tau) g(\tau)$ if $\tau \leq t$
 $= 0$ if $\tau > t$

$\int_0^t f(t-\tau) g(\tau) d\tau = \int_0^\infty f(t-\tau) g(\tau) u(t-\tau) d\tau$

$\mathcal{L} f(t) * g(t) = \int_0^\infty \left[\int_0^\infty f(t-\tau) g(\tau) u(t-\tau) d\tau \right] e^{-st} dt$

Now do t integration first, τ integration last

$\mathcal{L} f(t) * g(t) = \int_0^\infty \int_0^\infty f(t-\tau) u(t-\tau) e^{-st} dt g(\tau) d\tau$
 $= \int_0^\infty F(s) e^{-s\tau} g(\tau) d\tau = F(s) \underbrace{\int_0^\infty e^{-s\tau} g(\tau) d\tau}_{G(s)}$

Chap 7 7.1 cont'd

32]

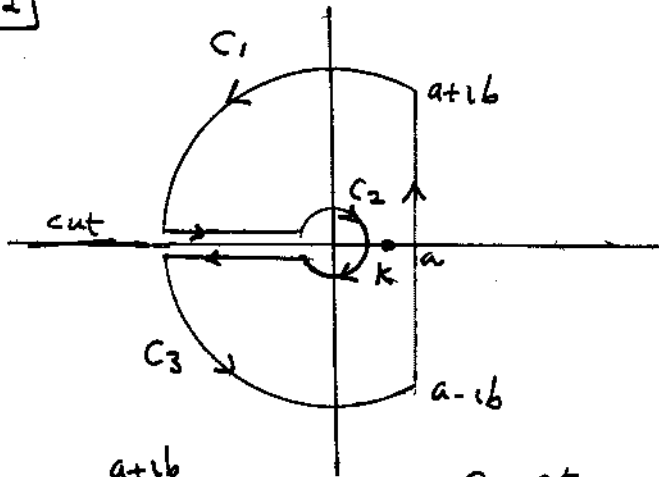

on top of cut:
 $s^{1/2} = i \sqrt{|s|}$

on bottom:
 $s^{1/2} = -i \sqrt{|s|}$

$$\begin{aligned} & \frac{1}{2\pi i} \int_{a-ib}^{a+ib} \frac{e^{st}}{s^{1/2}(s-k)} ds + \frac{1}{2\pi i} \int_{C_1} \frac{e^{st}}{(s^{1/2})(s-k)} ds + \frac{1}{2\pi i} \int_{-R}^{-\epsilon} \frac{e^{\sigma t}}{i \sqrt{|\sigma|} (\sigma-k)} d\sigma \\ & + \frac{1}{2\pi i} \int_{C_2} \frac{e^{st}}{(s^{1/2})(s-k)} ds + \frac{1}{2\pi i} \int_{-\epsilon}^{-R} \frac{e^{\sigma t}}{-i \sqrt{|\sigma|} (\sigma-k)} d\sigma + \frac{1}{2\pi i} \int_{C_3} \frac{e^{st}}{s^{1/2}(s-k)} ds \\ & = \text{Res} \frac{e^{st}}{(s^{1/2})(s-k)} \Big|_k = \frac{e^{kt}}{\sqrt{k}} \end{aligned}$$

Now let $R \rightarrow \infty$, $\epsilon \rightarrow 0+$, argue that integrals on $C_1, C_2, C_3 \rightarrow 0$ for example

$$\left| \int_{C_1} \frac{e^{st}}{(s^{1/2})(s-k)} ds \right| \leq ML \quad \text{where } L \leq \pi R$$

$$\left| \frac{e^{st}}{(s^{1/2})(s-k)} \right| \leq \frac{e^{at}}{\sqrt{R} (R-k)} = M$$

thus $\left| \int_{C_1} \dots ds \right| \leq \frac{e^{at}}{(\sqrt{R})(R-k)} \pi R \rightarrow 0$ as $R \rightarrow \infty$

similar argument on C_3 . Now do integral on C_2 .

$$\left| \int_{C_2} \frac{e^{st}}{s^{1/2}(s-k)} ds \right|_{s=e^{i\theta}\epsilon} \leq ML, \quad L=2\pi\epsilon$$

32) cont'd.

$$\text{on } C_2 \left| \frac{e^{st}}{(s^{1/2})(s-k)} \right| \leq \frac{e^\epsilon}{\sqrt{\epsilon} (k-\epsilon)} = M$$

$$\text{thus } ML = \frac{\rho^\epsilon}{\sqrt{\epsilon} (k-\epsilon)} 2\pi\epsilon \rightarrow 0 \text{ as } \epsilon \rightarrow 0^+$$

thus letting $k \rightarrow \infty$, $\epsilon \rightarrow 0$ [$b \rightarrow \infty$ as $R \rightarrow \infty$]

$$\frac{1}{2\pi i} \int_{a-i\infty}^{a+i\infty} \frac{e^{st}}{(s^{1/2})(s-k)} ds + \frac{1}{2\pi i} \int_{-\infty}^0 \frac{e^{\sigma t}}{i\sqrt{\sigma}(\sigma-k)} d\sigma + \frac{1}{2\pi i} \int_0^{-\infty} \frac{e^{\sigma t}}{-i\sqrt{\sigma}(\sigma-k)} d\sigma = \frac{e^{kt}}{\sqrt{k}}$$

let $u = -\sigma$ in the preceding integrals on σ

$$\frac{1}{2\pi i} \int_{a-i\infty}^{a+i\infty} \frac{e^{st}}{(s^{1/2})(s-k)} ds = \frac{e^{kt}}{\sqrt{k}} - \frac{1}{\pi} \int_0^\infty \frac{e^{-ut}}{\sqrt{u}(u+k)} du$$

the expression on the left is $\mathcal{L}^{-1} \frac{1}{(s^{1/2})(s-k)}$

33)

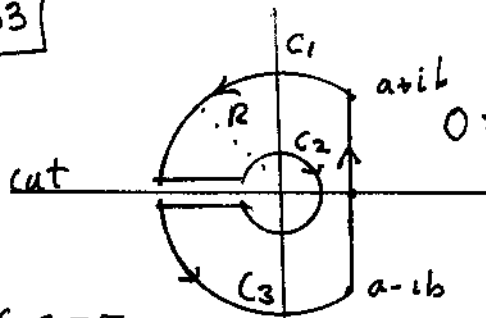

if $s = \sigma$, $\sigma < 0$
 $s^{1/2} = i\sqrt{\sigma}$ on top of cut
 $s^{1/2} = -i\sqrt{\sigma}$ on bottom of cut

$$0 = \frac{1}{2\pi i} \int_{a-ib}^{a+ib} \frac{e^{-bs^{1/2}} e^{st}}{s} ds$$

$$+ \frac{1}{2\pi i} \int_{a-ib}^{-R} \frac{e^{-bs^{1/2}} e^{st}}{s} ds +$$

$$\frac{1}{2\pi i} \int_{-R}^{-\epsilon} \frac{e^{-bi\sqrt{\sigma}} e^{\sigma t}}{\sigma} d\sigma + \frac{1}{2\pi i} \int_{C_2} \frac{e^{-bs^{1/2}} e^{st}}{s} ds$$

$$+ \frac{1}{2\pi i} \int_{-\epsilon}^{-R} \frac{e^{ib\sqrt{\sigma}} e^{\sigma t}}{\sigma} d\sigma + \frac{1}{2\pi i} \int_{C_3} \frac{e^{-bs^{1/2}} e^{st}}{s} ds$$

Sec 7.]

33] cont'd

Since $|e^{-bs^{1/2}}| \leq 1$ on C_1 and C_3 we can argue that as $R \rightarrow \infty$ the integrals along C_1 and C_3 go to zero. We have that $\left| \frac{e^{-bs^{1/2}}}{s} \right| \leq \frac{1}{s}$

for s on C_1 and C_3 and the discussion following theorem 3 applies. Now on C_2 we have:

$$\frac{1}{2\pi i} \int_{C_2} \frac{e^{-bs^{1/2}}}{s} e^{st} ds = \frac{1}{2\pi i} \int_{\theta=\pi}^{-\pi} \left[e^{-b e^{i\theta/2}} \sqrt{e^{i\theta}} \right] \frac{e^{te^{i\theta}}}{e^{i\theta}} d\theta$$

$s = \epsilon e^{i\theta}$

Now let $\epsilon \rightarrow 0+$, and assume you can take this limit under the integral sign, get:

$$\frac{1}{2\pi i} \int_{C_2} \frac{e^{-bs^{1/2}}}{s} e^{st} ds = \frac{1}{2\pi i} \int_{\pi}^{-\pi} i d\theta = -1$$

Thus with $R \rightarrow \infty$, $\epsilon \rightarrow 0+$, have

$$\frac{1}{2\pi i} \int_{a-i\infty}^{a+i\infty} \frac{e^{-bs^{1/2}}}{s} e^{st} ds + \frac{1}{2\pi i} \int_{-\infty}^{\infty} \frac{e^{-b\sqrt{\sigma}} e^{\sigma t} - e^{i b \sqrt{\sigma}} e^{\sigma t}}{\sigma} d\sigma$$

$$-1 = 0$$

let $x = -\sigma$ in integral on σ . Get:

$$\frac{1}{2\pi i} \int_{a-i\infty}^{a+i\infty} \frac{e^{-bs^{1/2}}}{s} e^{st} ds = 1 - \frac{1}{\pi} \int_0^{\infty} \frac{e^{b\sqrt{x}} - e^{-b\sqrt{x}}}{2ix} e^{-xt} dx$$

let side is $\mathcal{L}^{-1} \frac{e^{-bs^{1/2}}}{s}$

$$\text{Thus } \mathcal{L}^{-1} \frac{e^{-bs^{1/2}}}{s} = 1 - \frac{1}{\pi} \int_0^{\infty} \frac{e^{-xt} \sin b\sqrt{x}}{x} dx$$

sec 7.1 cont'd

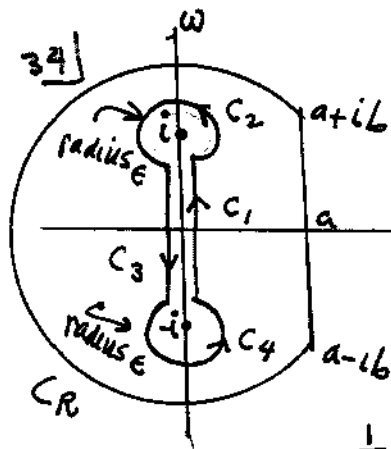

$$\frac{1}{2\pi i} \int_{a-ib}^{a+ib} \frac{e^{st}}{(s^2+1)^{1/2}} ds$$

$$+ \frac{1}{2\pi i} \int_{a-ib}^{a+ib} \frac{e^{st}}{(s^2+1)^{1/2}} ds =$$

$$\frac{1}{2\pi i} \int_{C_1} \frac{e^{st} ds}{(s^2+1)^{1/2}} + \frac{1}{2\pi i} \int_{C_2} \frac{e^{st} ds}{(s^2+1)^{1/2}} + \frac{1}{2\pi i} \int_{C_3} \frac{e^{st} ds}{(s^2+1)^{1/2}} + \frac{1}{2\pi i} \int_{C_4} \frac{e^{st} ds}{(s^2+1)^{1/2}}$$

On C_R : $\left| \frac{1}{s^2+1} \right|^{1/2} \leq \left| \frac{1}{s} \right|^{1/2}$. Thus using the reasoning that lead to theorem 3 we can argue that as $R \rightarrow \infty$ $\int_{C_R} \frac{e^{st}}{(s^2+1)^{1/2}} ds \rightarrow 0$. We can argue that as $\epsilon \rightarrow 0+$, $\int_{C_2} \frac{e^{st} ds}{(s^2+1)^{1/2}} \rightarrow 0$ let $s = \epsilon e^{i\theta}$, $ds = \epsilon e^{i\theta} i d\theta$,

$$\left| \int_{C_2} \frac{e^{st} ds}{(s^2+1)^{1/2}} \right| = \left| \int_{-\pi/2}^{3\pi/2} \frac{e^{t \epsilon e^{i\theta}} \epsilon e^{i\theta} i d\theta}{(1 + \epsilon^2 e^{2i\theta})^{1/2}} \right| \leq$$

ML where $L = 2\pi$ $M = \frac{e^{t\epsilon} \epsilon}{\sqrt{1-\epsilon^2}}$. Note $ML \rightarrow 0$ as $\epsilon \rightarrow 0$

A similar argument applies around C_4 .

On C_1 , $s = i\omega$, $ds = i d\omega$, $(s^2+1)^{1/2} = \sqrt{1-\omega^2}$

On C_3 , $s = -i\omega$, $ds = -i d\omega$, $(s^2+1)^{1/2} = -\sqrt{1-\omega^2}$

$$\frac{1}{2\pi i} \int_{a-ib}^{a+ib} \frac{e^{st}}{(s^2+1)^{1/2}} ds = \int_{\omega=-1}^{\omega=1} \frac{e^{i\omega t} i d\omega}{\sqrt{1-\omega^2}} + \int_{\omega=1}^{-1} \frac{e^{-i\omega t} -i d\omega}{-\sqrt{1-\omega^2}}$$

$$\frac{1}{2\pi i} \int_{a-ib}^{a+ib} \frac{e^{st}}{(s^2+1)^{1/2}} ds = \frac{1}{\pi} \int_{\omega=-1}^{\omega=1} \frac{e^{i\omega t} d\omega}{\sqrt{1-\omega^2}}$$

The left side is $\mathcal{L}^{-1} \left\{ \frac{1}{(s^2+1)^{1/2}} \right\}$

Chap 7, sec 7.1 cont'd

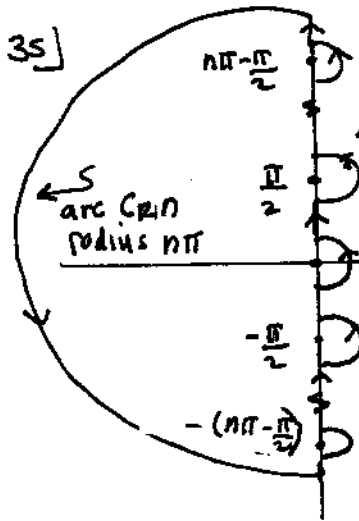

$$\frac{1}{2\pi i} \int_{\text{arc } C_{Rn}} \frac{e^{st}}{s \cosh s} ds + \int_{\text{arc } C_R} \frac{e^{st}}{2\pi i s \cosh s} ds$$

$$= \sum_{\text{residues}} \frac{e^{st}}{s \cosh s} \text{ at}$$

$$s = 0, \pm \frac{\pi i}{2}, \pm \frac{3\pi i}{2}, \dots, \pm \left[\frac{n\pi - \pi}{2} \right] i$$

$n = 1, 2, \dots$

Residue at $s = 0$ is 1

$$\text{residue at } (k\pi - \frac{\pi}{2})i = \frac{e^{it[k\pi - \frac{\pi}{2}]}}{(k\pi - \frac{\pi}{2})i \sinh[k\pi - \frac{\pi}{2}]}$$

$$= \frac{e^{it[k\pi - \frac{\pi}{2}]} - (i(k\pi - \frac{\pi}{2})) \sin[(k\pi - \frac{\pi}{2})]}{(k\pi - \frac{\pi}{2})i \sinh[k\pi - \frac{\pi}{2}]}$$

The sum of the residues

at $i(k\pi - \frac{\pi}{2})$ and $-i(k\pi - \frac{\pi}{2})$ $k = 1, 2, \dots, n$ is:

$$\frac{2 \cos[(2k-1)\pi t/2]}{(2k-1)\pi} \left[\frac{e^{it[k\pi - \frac{\pi}{2}]} - (i(k\pi - \frac{\pi}{2})) \sin[(k\pi - \frac{\pi}{2})]}{(k\pi - \frac{\pi}{2})i \sinh[k\pi - \frac{\pi}{2}]} + \frac{e^{-it[k\pi - \frac{\pi}{2}]} - (-i(k\pi - \frac{\pi}{2})) \sin[-(k\pi - \frac{\pi}{2})]}{(-k\pi + \frac{\pi}{2})i \sinh[-k\pi + \frac{\pi}{2}]} \right]$$

SUM of residues at $\pm i(k\pi - \frac{\pi}{2})$

Thus let $n \rightarrow \infty$. Assuming that $\int_{\text{arc } C_{Rn}} \frac{e^{st}}{2\pi i s \cosh s} ds \rightarrow 0$ as $R \rightarrow \infty$ through the values $n\pi$

we have

$$\frac{1}{2\pi i} \int_{a-i\infty}^{a+i\infty} \frac{e^{st}}{s \cosh s} ds = 1 + \sum_{k=1}^n \frac{4(-1)^k \cos[(2k-1)\pi t/2]}{(2k-1)\pi}$$

$\lim_{n \rightarrow \infty}$

The integral on the left is $\mathcal{L}^{-1} \frac{1}{s \cosh s}$

$$\text{Thus } \mathcal{L}^{-1} \frac{1}{s \cosh s} = 1 + \sum_{n=1}^{\infty} \frac{4(-1)^n \cos[(2n-1)\pi t/2]}{(2n-1)\pi}$$

chap 7, sec 7.1 cont'd

35] cont'd

To complete the proof, must show that

$$\frac{1}{|\cosh s|} \leq 1 \text{ on } C_R n. \quad \text{Now: } |\cosh s|^2 = \cosh^2 \sigma - \sin^2 \omega$$

$$\text{Now if } \sin(n\pi) = 0, \quad |\sin \omega| \leq |n\pi - \omega|$$

$$\text{Thus } \cosh^2 \sigma - \sin^2 \omega \geq \cosh^2 \sigma - (n\pi - \omega)^2$$

$$\cosh^2 \sigma \geq 1 + \sigma^2 \quad \left[\text{from the Maclaurin expansion for } \cosh \sigma \right]$$

$$\text{Thus } |\cosh s|^2 \geq 1 + \sigma^2 - (n\pi - \omega)^2$$

$$|\cosh s|^2 \geq 1 + \sigma^2 - n^2 \pi^2 + 2\omega n\pi - \omega^2$$

$$\text{on arc. } \sigma^2 + \omega^2 = n^2 \pi^2, \quad \sigma^2 = n^2 \pi^2 - \omega^2$$

$$\text{Thus } |\cosh s|^2 \geq 1 - 2\omega^2 + 2\omega n\pi = 1 + 2\omega [n\pi - \omega]$$

Since $0 \leq \omega \leq n\pi$ on the arc, ^[in upper half plane] $n\pi - \omega$ is positive

Thus $|\cosh s|^2 \geq 1$ on the arc and

$\frac{1}{|\cosh s|} \leq 1$ on R_n as required. Thus:
[the preceding argument can be extended into lower half plane].

$$\frac{1}{|\cosh s|} \leq 1 \quad \text{and} \quad \frac{1}{|s| |\cosh s|} \leq \frac{1}{|s|} \quad \text{and}$$

We can use the development leading to theorem 3, to show that our integral on $C_R n \rightarrow 0$ as $n \rightarrow \infty$,

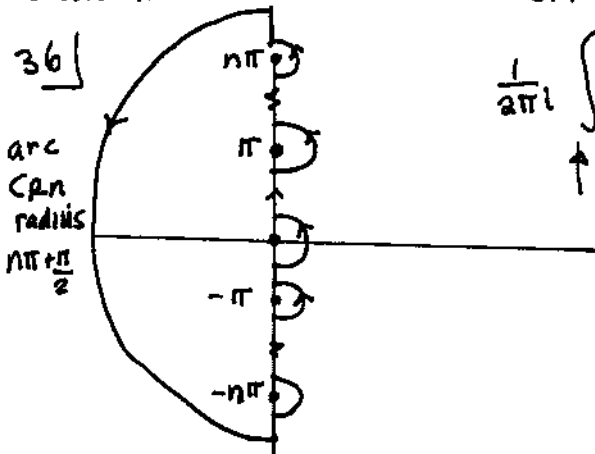

$$\frac{1}{2\pi i} \int \frac{e^{st}}{s \sinh s} ds + \frac{1}{2\pi i} \int_{\text{arc } C_R n} \frac{e^{st}}{s \sinh s} ds$$

$$= \sum \text{residues } \frac{e^{st}}{s \sinh s} \text{ at } s = 0, \pm \pi i, \pm 2\pi i, \dots, \pm n\pi i \quad n = 0, 1, \dots$$

Chap 7, sec 7.1 cont'd

36] Cont'd

The residue of $\frac{e^{st}}{s \sinh s}$ at $s=0$ is t .

Since $\frac{e^{st}}{s \sinh s} = \frac{e^{st}}{s^2 + \frac{s^4}{3!} + \frac{s^6}{5!} \dots} = \frac{e^{st}}{s^2 \left[1 + \frac{s^2}{3!} + \frac{s^4}{5!} \dots \right]}$

(multiply by s^2 , take first deriv and put $s=0$ to get residue).

The residue of $\frac{e^{st}}{s \sinh s}$ at $s = i n \pi$ ($n \neq 0$) is

$\frac{e^{i n \pi t}}{(i n \pi) \cosh(i n \pi)} = \frac{e^{i n \pi t} (-1)^n}{(i n \pi)}$. The sum of the residues at $\pm n \pi i$ is $(-1)^n \left[\frac{e^{i n \pi t} - e^{-i n \pi t}}{(i n \pi)} \right]$
 $= \frac{2}{\pi} \frac{(-1)^n}{n} \sinh(n \pi t)$ [$n=1, 2, \dots$]

Now assuming that $\lim_{n \rightarrow \infty} \frac{1}{2 \pi i} \int_{C_n} \frac{e^{st}}{s \sinh s} ds \rightarrow 0$

we have:

$\frac{1}{2 \pi i} \int_{a-i\infty}^{a+i\infty} \frac{e^{st}}{s \sinh s} ds = t + \sum_{n=1}^{\infty} \frac{2}{\pi} (-1)^n \sinh(n \pi t)$

Proof that $\lim_{n \rightarrow \infty} \frac{1}{2 \pi i} \int_{C_n} \frac{e^{st}}{s \sinh s} ds \rightarrow 0$

Must show that $\left| \frac{1}{s \sinh s} \right| \leq \frac{m}{s^k}$ on C_n . Show this

for the part of C_n in the 2nd quadrant. The argument is easily extended to the third quadrant since

$\left| \frac{1}{s \sinh s} \right| = \left| \frac{1}{\bar{s} \sinh \bar{s}} \right|$.

Now $|\sinh s|^2 = \cosh^2 \sigma - \cos^2 \omega \geq 1 + \sigma^2 - \cos^2 \omega$
 $\geq (1 + \sigma^2) - \left(n \pi + \frac{\pi}{2} - \omega \right)^2$

chap 7, sec 7.1 cont'd

36] cont'd

$$|\sinh s|^2 \geq 1 + \sigma^2 - \left(n\pi + \frac{\pi}{2}\right)^2 + 2\omega \left(n\pi + \frac{\pi}{2}\right) = \omega^2$$

$$\text{On arc } CR_n: \sigma^2 = \left(n\pi + \frac{\pi}{2}\right)^2 - \omega^2$$

$$\text{Thus: } |\sinh s|^2 \geq 1 - 2\omega^2 + 2\omega \left(n\pi + \frac{\pi}{2}\right)$$

$$|\sinh s|^2 \geq \underbrace{1 + 2\omega \left[\left(n\pi + \frac{\pi}{2}\right) - \omega\right]}_{\text{this is } \geq 1} \quad \text{where } 0 \leq \omega \leq n\pi + \frac{\pi}{2}$$

on arc in 2nd quad.

$$\text{thus: } \frac{1}{|\sinh s|} \leq 1 \quad \text{on arc} \quad \text{And } \frac{1}{|s \sinh s|} \leq \frac{1}{|s|}$$

on portion of CR_n in 2nd quadrant. A similar argument applies to portion of CR_n in 3rd quad.

Since $\frac{1}{|s \sinh s|} \leq \frac{1}{|s|}$ we can use argument leading to thm 3 to argue that the integral on $CR_n \rightarrow 0$ as $n \rightarrow \infty$.

$$(b) \int_0^{\infty} \left[t + \frac{2}{\pi} \sum_{n=1}^{\infty} \frac{(-1)^n \sin(n\pi t)}{n} \right] e^{-st} dt = \frac{1}{s \sinh s}$$

[Proved in a] Now let $\frac{\tau}{b} = t$, $dt = \frac{d\tau}{b}$

$$\int_0^{\infty} \left[\frac{\tau}{b} + \frac{2}{\pi} \sum_{n=1}^{\infty} \frac{(-1)^n \sin\left(\frac{n\pi\tau}{b}\right)}{n} \right] e^{-\frac{s}{b}\tau} \frac{d\tau}{b} = \frac{1}{s \sinh s}$$

Let $s' = \frac{s}{b}$, Thus $s = bs'$

$$\int_0^{\infty} \left[\frac{\tau}{b} + \frac{2}{\pi} \sum_{n=1}^{\infty} \frac{(-1)^n \sin\left(\frac{n\pi\tau}{b}\right)}{n} \right] e^{-s'\tau} \frac{d\tau}{b} = \frac{1}{bs' \sinh(bs')}$$

cancel (b') on both sides

$$\int_0^{\infty} \left[\frac{\tau}{b} + \frac{2}{\pi} \sum_{n=1}^{\infty} \frac{(-1)^n \sin\left(\frac{n\pi\tau}{b}\right)}{n} \right] e^{-s'\tau} d\tau = \frac{1}{s' \sinh(bs')}$$

The preceding is the desired result

Chap 7, sec 7.2

1) $\frac{1}{(s)(s^2+1)(s+2)}$ poles at 0, $\pm i$, -2. None in r.h.p. Simple poles on imag. axis \therefore **bounded**

2) $\frac{1}{(s+1)(s^2+3s+2)} = \frac{1}{(s+1)(s+1)(s+2)}$, poles at -1, -2
None in r.h.p. All in left half. \therefore **bounded**

3) $\frac{s}{(s^2+1)(s-2)}$ pole at $s=2$, rt. half plane
Thus **unbounded**

4) $s^4 + s^2 + 1 = 0$, $s^2 = -\frac{1}{2} \pm i\frac{\sqrt{3}}{2} = 1 \angle \pm 120^\circ$

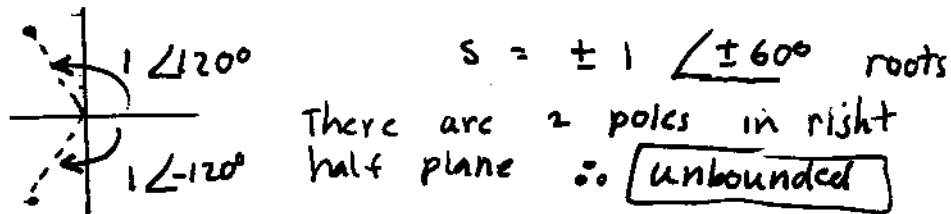

5) $\frac{s-1}{(s^3-1)(s^2+s+1)} = \frac{s-1}{(s-1)(s^2+s+1)(s^2+s+1)} =$

$\frac{1}{(s^2+s+1)^2}$ $s^2+s+1=0$ $s = -\frac{1}{2} \pm i\frac{\sqrt{3}}{2}$

The poles of the given expression are all in left half plane. Thus **bounded**

6) $\frac{s^5-1}{s-1} = s^4+s^3+s^2+s+1$, $\frac{1}{s^4+s^3+s^2+s+1} = \frac{s-1}{s^5-1}$

The expression $\frac{s-1}{s^5-1}$ is analytic at $s=1$

Chap 1 Sec 7.2 continued

6) cont'd

The poles of $\frac{s-1}{s^5-1}$ are the zeroes of

$s^5-1=0$ except $s=1$.

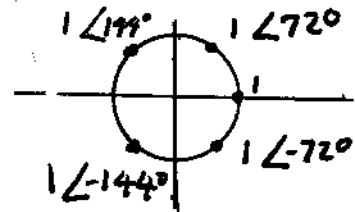

roots of $s^5-1=0$

Thus unbounded There are 2 roots in rt. half plane

7) $s^4 - s^2 - 2 = 0$, $s^2 = \frac{1 \pm 3}{2}$ from quadratic formula,

roots $s = \pm\sqrt{2}$, $s = \pm i$ or $s^2 = 2$ or $s^2 = -1$

Thus: $\frac{s-\sqrt{2}}{s^4-s^2-2} = \frac{1}{(s+\sqrt{2})(s+i)(s-i)}$. No

poles in rt. half plane. Therefore bounded.

8) $s^2 + \beta s + 1 = 0$, let s_1 and s_2 be the 2 roots.
 $s_1, s_2 = -\frac{\beta}{2} \pm \left[\left(\frac{\beta}{2}\right)^2 - 1 \right]^{1/2}$

Consider $\beta \geq 0$. First assume $\beta \geq 2$. Then

$s_1, s_2 = -\frac{\beta}{2} \pm \sqrt{\left(\frac{\beta}{2}\right)^2 - 1}$. Note $\sqrt{\left(\frac{\beta}{2}\right)^2 - 1} < \frac{\beta}{2}$

Thus both roots are negative real. Poles are in left half of s plane. Function is bounded. Now

assume $0 < \beta < 2$. Then $s_1, s_2 = -\frac{\beta}{2} \pm i \sqrt{1 - \left(\frac{\beta}{2}\right)^2}$

This has neg. real part. Thus poles in left half of s plane. Function is bounded. If

$\beta = 0$, poles are on imag. axis and are simple $s = \pm i$. Thus for $\beta \geq 0$ function of t is bounded.

Chap 7 Sec 7.2, cont'd

8) cont'd

Now take $\beta < 0$

$$s_1, s_2 = -\frac{\beta}{2} \pm \left[\left(\frac{\beta}{2} \right)^2 - 1 \right]^{1/2} \quad \text{First assume}$$

$\beta \leq -2$. Thus $\sqrt{\left(\frac{\beta}{2}\right)^2 - 1} \leq \left|\frac{\beta}{2}\right|$ and s_1 and s_2 are both positive real. Poles are in rt. half plane. Function not bounded.

Now assume $\beta < 0$ but $-2 < \beta < 0$.

$s_1, s_2 = -\frac{\beta}{2} \pm i \sqrt{1 - \left(\frac{\beta}{2}\right)^2}$. Both values have positive real parts. Poles are in rt. half of s plane. Function $f(t)$ not bounded.

(b) If $0 < \beta < 2$, $s_1, s_2 = -\frac{\beta}{2} \pm i \sqrt{1 - \left(\frac{\beta}{2}\right)^2}$. Both poles are in left half of s plane. Get decaying oscillations. If $\beta = 0$, $s_1, s_2 = \pm i$.

Get oscillations of fixed amplitude (no growth or decay). If $-2 < \beta < 0$, then $s_1, s_2 = -\frac{\beta}{2} \pm i \sqrt{1 - \frac{\beta^2}{4}}$. Poles in right half of s plane. Get growing oscillations.

Thus. $-2 < \beta < 0$ growing

$0 < \beta < 2$ decaying.

$\beta = 0$, fixed amplitude

- 9) part (i) marginally unstable (poles at $\pm i$, simple)
 part (ii) stable, part (iii) unstable, (poles at ± 2)
 part IV unstable
 part V stable, part VI unstable, 2 poles in r.h.p.
 part VII, marginally unstable, (simple poles on imag. axis)

Sec 7.2

10

```

% problem 10 sec7.2, remove % where needed
% part a
num=[1 1];
den=[1 -10 -5 4 3];
pzmap(num,den)

% part b
num1=[1];
den1=[1 2 1 1 1];
% pzmap(num1,den1)

% part c
num2=[1];
den2=[1 10 36 70 75];
%pzmap(num2,den2)

% part d
num3=[1 1];
den3=[1 10 5 4 3];
% roots(den3)
% pzmap(num3,den3)
    
```

Pole-Zero Map

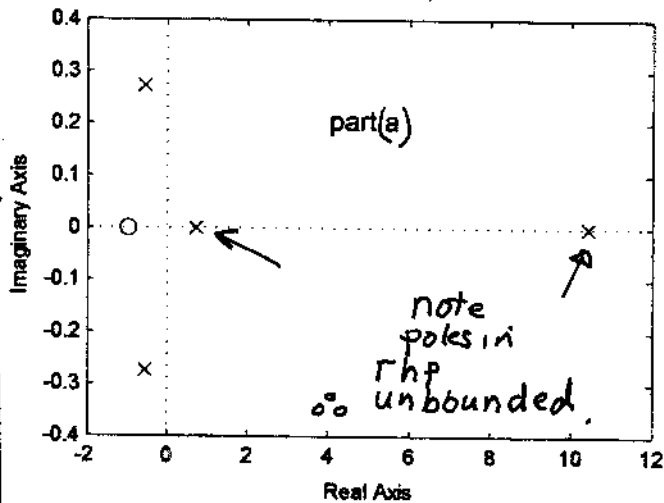

Sec 7.2

10] continued,

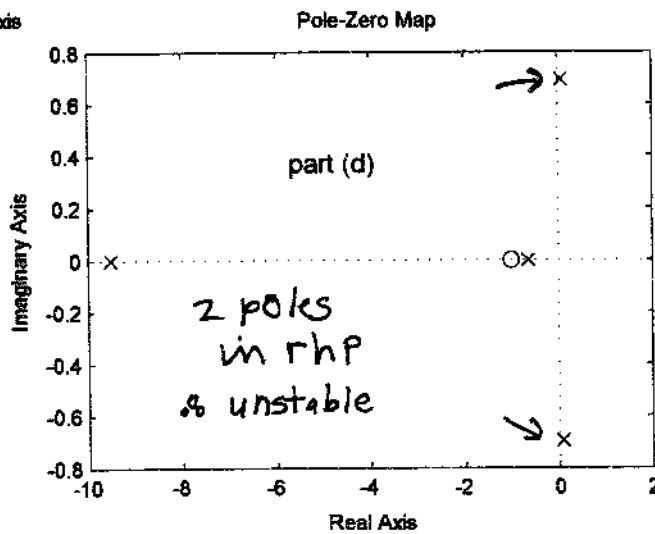
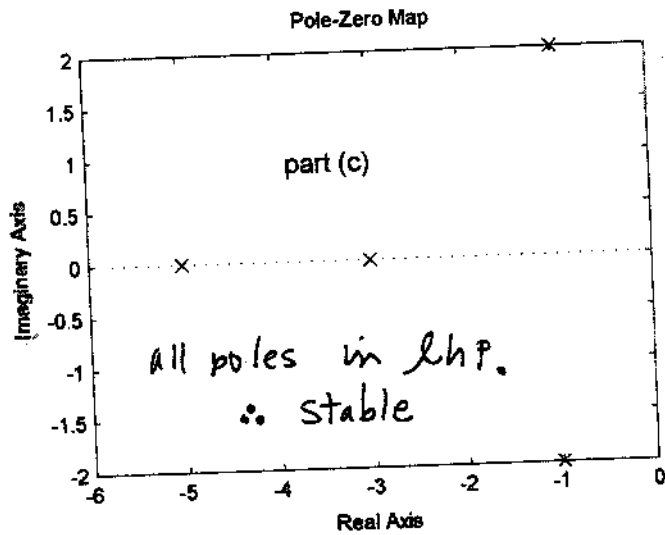
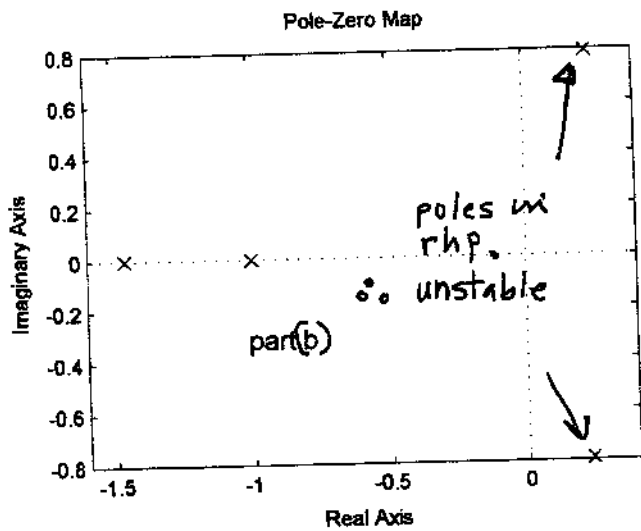

(a) result of using roots ↓

-9.5152
-0.6439
0.0795 + 0.6952i
0.0795 - 0.6952i

in rhp.
∴ unstable

Chap 7, sec 7.2 cont'd

11) Take that $X(s) = \frac{1}{s^2+9}$. Thus

$$x(t) = \sum_{\text{res}} \frac{1}{s^2+9} e^{st} \Big|_{\pm 3i} = \boxed{\frac{1}{3} \sin(3t)}$$

Note $Y(s)$ has poles of 2nd order at $\pm 3i$

12) Take $X(s) = \frac{s}{s^2+1}$, thus $x(t) =$

$$\sum_{\text{res}} \frac{s}{s^2+1} e^{st} \Big|_{\pm i} = \boxed{\cos t} \quad \text{another possibility:}$$

take $x(t) = \mathcal{L}^{-1} \frac{1}{s} = 1$. $Y(s)$ will have pole 2nd order at $s=0$

13) $\mathcal{L} \{y(t)\} = Y(s) = \int_0^{\infty} m x(t-T) U(t-T) e^{-st} dt$

let $t' = t-T$, $Y(s) = \int_0^{\infty} m x(t') U(t') e^{-s(t'+T)} dt'$

$$= m \int_0^{\infty} x(t') e^{-st'} dt' e^{-sT} = e^{-sT} m X(s)$$

b) $Y/X = \boxed{m e^{-sT}}$ transfer func. e^{-sT}

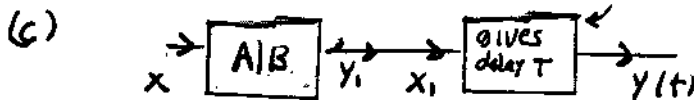

$$\frac{Y_1(s)}{X(s)} = \frac{A}{B}, \quad \frac{Y(s)}{X_1(s)} = e^{-sT} \quad (\text{see part a})$$

$$\frac{Y_1(s)}{X(s)} \cdot \frac{Y(s)}{X_1(s)} = \frac{A}{B} e^{-sT} \quad \text{But } X_1(s) = Y_1(s)$$

$$\text{Thus } \frac{Y(s)}{X(s)} = \frac{A}{B} e^{-sT}$$

(d) The factor e^{-sT} represents a delay of T time units in the output. If the output is bounded, then delaying it will not affect its boundedness.

Chap 7, sec 7.2, continued.

$$14) \quad a) \quad m \frac{d^2 y}{dt^2} + ky + \alpha \frac{dy}{dt} = x(t)$$

Take Laplace Transforms of both sides:

$$s^2 m Y(s) + k Y(s) + \alpha s Y(s) = X(s)$$

$$\frac{Y}{X} = \frac{1}{ms^2 + \alpha s + k}$$

b) Need poles, if $\alpha = 0$, $G = \frac{1}{ms^2 + k}$

$$s^2 = -k/m, \quad s = \pm i \sqrt{\frac{k}{m}} \quad (\text{simple poles}$$

on imag. axis) Marginally unstable.

If $\alpha \neq 0$ $G = \frac{1}{ms^2 + \alpha s + k}$ poles:

$$ms^2 + \alpha s + k = 0 \quad s^2 + \frac{\alpha}{m} s + \frac{k}{m} = 0$$

poles: $s_1, s_2 = -\frac{\alpha}{2m} \pm \left(\left(\frac{\alpha}{2m} \right)^2 - \frac{k}{m} \right)^{1/2}$ Both values, s_1 and s_2 have negative real parts.

Thus $s_1, s_2 = -\frac{\alpha}{2m} \pm \sqrt{\left(\frac{\alpha}{2m} \right)^2 - \frac{k}{m}}$ $\left(\frac{\alpha}{2m} \right) \geq \sqrt{\frac{k}{m}}$

or $s_1, s_2 = -\frac{\alpha}{2m} \pm i \sqrt{\frac{k}{m} - \left(\frac{\alpha}{2m} \right)^2}$ $\left(\frac{\alpha}{2m} \right) < \sqrt{\frac{k}{m}}$

$$15) \quad N_i(t) = N_o(t) + \frac{R}{L} \int_0^t N_o(t') dt'$$

Take Laplace transform of both sides

$$V_i(s) = V_o(s) + \frac{R}{L} \frac{1}{s} V_o(s)$$

$$\frac{V_o}{V_i} = \frac{Ls}{Ls + R}, \quad \text{pole } Ls + R = 0$$

$$s = -\frac{R}{L}$$

If $L > 0, R > 0$ pole is in left half of s plane. system is stable.

Chap 7, sec 7.2

$$16 (a) \quad V(t) = L \frac{di_1}{dt} + \frac{1}{C} \int_0^t (i_1 - i_2) dt$$

$$0 = \frac{1}{C} \int_0^t (i_2 - i_1) dt - L_2 R d$$

Take Laplace Trans forms of both sides, both equations:

$$V(s) = L s I_1 + \frac{1}{sC} [I_1 - I_2]$$

$$0 = \frac{I_2 - I_1}{sC} - I_2(s) R d$$

From the second of these, get:

$$I_2 = I_1 / (1 - sCRd)$$

Use this in the first:

$$V = L s I_1 + \frac{I_1}{sC} - \frac{1}{sC} \frac{I_1}{1 - sCRd}$$

$$V(1 - sCRd) = I_1 (L s)(1 - sCRd) + \frac{I_1}{sC} (1 - sCRd) - \frac{I_1}{sC}$$

$$\frac{I_1}{V} = \frac{1 - sCRd}{(L s)(1 - sCRd) - R d}$$

(b) Find poles: $L s - L C s^2 R d - R d = 0$

or $s^2 - \frac{s}{RdC} + \frac{1}{LC} = 0$ solutions

$$s = \frac{1}{2RdC} \pm \sqrt{\left(\frac{1}{2RdC}\right)^2 - \frac{1}{LC}} \quad \text{if } \frac{1}{2RdC} \geq \frac{1}{\sqrt{LC}}$$

$$\text{or } s = \frac{1}{2RdC} \pm i \sqrt{\frac{1}{LC} - \left(\frac{1}{2RdC}\right)^2} \quad \text{if } \frac{1}{2RdC} \leq \frac{1}{\sqrt{LC}}$$

In either case, the real part of the roots is positive and thus the poles are in the right half of the s plane. \therefore system unstable.

Chap 7 sec 7.2

16 (c)

$$I_1(s) = V(s) G(s)$$

Suppose $\frac{1}{2R_d C} < \frac{1}{\sqrt{LC}}$ or $2R_d C > \sqrt{LC}$
 $R_d > \frac{1}{2} \sqrt{\frac{L}{C}}$

From part (b) this means [poles of $G(s)$] \rightarrow $s = \frac{1}{2R_d C} \pm i \sqrt{\frac{1}{LC} - \left(\frac{1}{2R_d C}\right)^2}$

$$I_1(t) = \sum_{\text{res, poles}} V(s) G(s) e^{st} \quad \text{all poles}$$

which will include terms of form $e^{t \left[\frac{1}{2R_d C} \pm i \sqrt{\frac{1}{LC} - \left(\frac{1}{2R_d C}\right)^2} \right]}$

which are oscillations that grow exponentially in time $\sim e^{t/(2R_d C)} \left(\text{or } \cos \left[\sqrt{\frac{1}{LC} - \left(\frac{1}{2R_d C}\right)^2} t \right] \right)$

Similarly: $\frac{1}{2R_d C} > \frac{1}{\sqrt{LC}}$ [or $R_d < \frac{1}{2} \sqrt{\frac{L}{C}}$] \leftarrow

then from part (b), poles of $G(s)$ are at:

$$s = \frac{1}{2R_d C} \pm \sqrt{\left(\frac{1}{2R_d C}\right)^2 - \frac{1}{LC}}$$

the poles of $G(s)$ are in r.h.p

$$I_1(t) = \sum_{\text{res at poles}} V(s) G(s) e^{st} \quad \text{which leads to}$$

terms of form: $e^{t \left[\frac{1}{2R_d C} \pm \sqrt{\left(\frac{1}{2R_d C}\right)^2 - \frac{1}{LC}} \right]}$

which grow exponentially in time.

sec 7.3

1) $B(s) = s^3 + s^2 + 3s + 16$

$s = i\omega$

$B = u + iV = -\omega^3 - \omega^2 + 3i\omega + 16$

$U = 16 - \omega^2, V = 3\omega - \omega^3 = \omega[3 - \omega^2]$

$U = 0$ if $\omega = \pm 4, V = 0$ if $\omega = 0$ or $\pm\sqrt{3}$

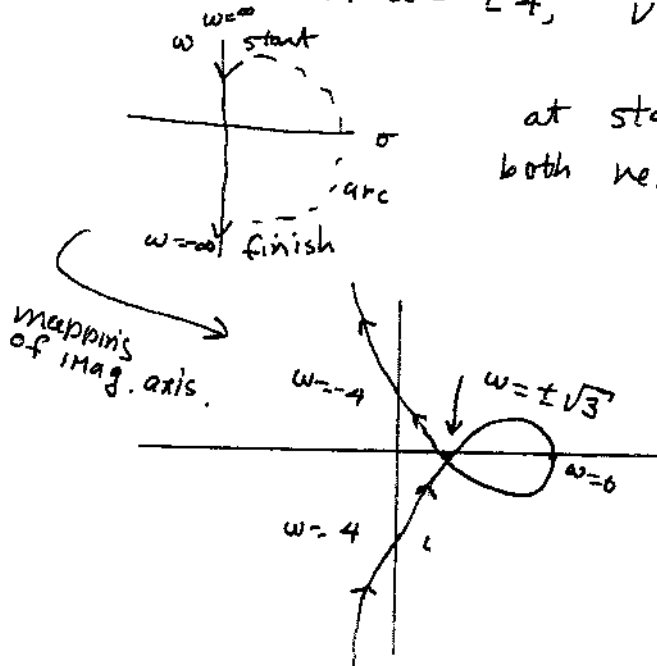

at start U and V are both negative, but $|V| > |U|$

on here $\Delta \arg B(s) = \pi$

on arc $\Delta \arg B(s) = 3\pi$
 cubic poly

so total $\Delta_c \arg B(s) = \pi + 3\pi = 4\pi$

number of zeros in rhp = $\frac{4\pi}{2\pi} = 2$

system is unstable.

Pole-Zero Map

```

% probl in sec 7.3
num=[1 2];
den=[1 1 3 16];
pzmap(num, den)
roots(den)
    
```

Code for parts b and c

```

↓ roots of denom, part (c)
-2.4467
0.7233 + 2.4528i
0.7233 - 2.4528i
    
```

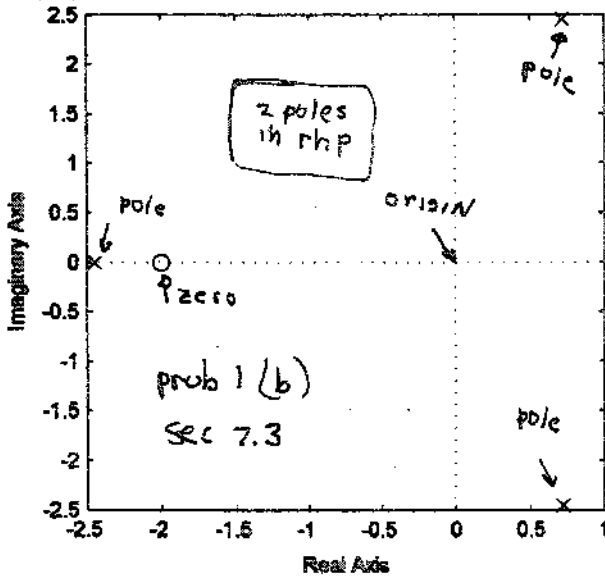

sec 7.3

2) Look at $B(s) = s^4 + s^3 + 3s^2 + 2s + 1$

$s = j\omega$

$B = u + jv = \omega^4 - (j\omega^3 - 3\omega^2 + 2j\omega + 1)$

$u = \omega^4 - 3\omega^2 + 1, \quad v = -\omega^3 + 2\omega$

$u = 0, \quad \omega^4 - 3\omega^2 + 1 = 0$

$\omega^2 = \frac{3 \pm \sqrt{9-4}}{2}$

$v = \omega [2 - \omega^2]$

$v = 0, \quad \omega = 0, \pm\sqrt{2}$

$u = 0$
 $\omega = 1.618$
 $\omega = -1.618$
 $\omega = .618, -.618$

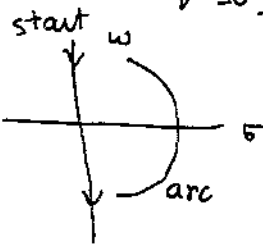

if ω is large and positive
 u is large and positive, v is negative
 and $|u| \gg |v|$

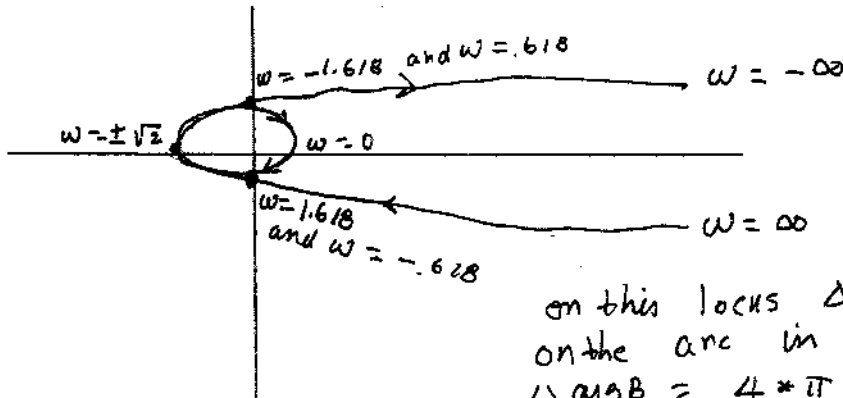

on this locus $\Delta \arg B = -4\pi$
 on the arc in s plane
 $\Delta \arg B = 4 * \pi = 4\pi$

- ∴ total $\Delta_c \arg B(s) = 4\pi - 4\pi = 0$
- ∴ No roots of $B(s) = 0$ in rhp.
- System is stable

```
code for (b) (c)
% prob2 in sec 7.3
num=[1 0 1];
den=[1 1 3 2 1];
pzmap(num,den)
roots(den)
```

-0.1049 + 1.5525i
 -0.1049 - 1.5525i
 -0.3951 + 0.5068i
 -0.3951 - 0.5068i
 roots of
 denomi
 All in l.h.p

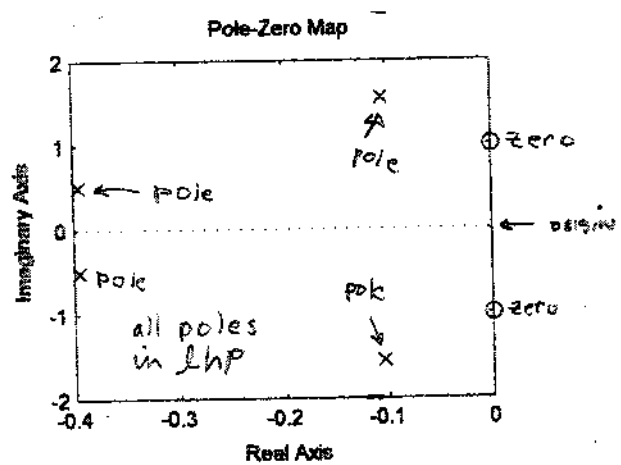

sec 7.3

3

```
% prob3 in sec 7.3  
num=[-1];  
den=[1 4 6 5 2];  
% nyquist(num,den); % use when beta = -1  
num=[-3];  
nyquist(num,den); %use when beta= -3
```

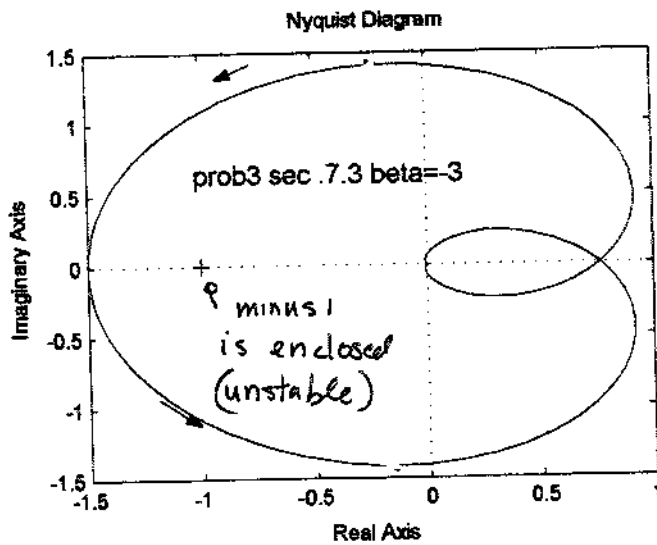
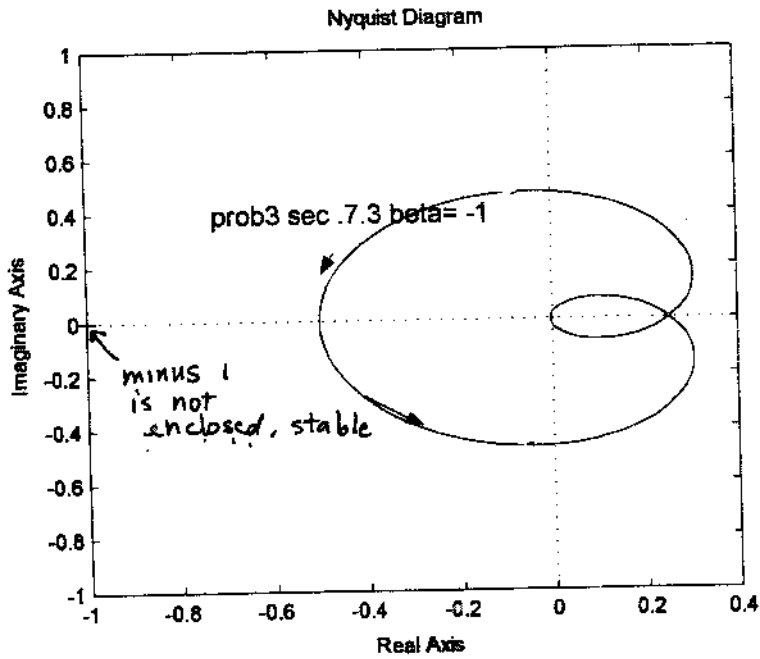

See 7.3

4) a) $(s^2+s+1)(s^2+s+1/2) = s^4 + 2s^3 + \frac{5}{2}s^2 + \frac{3}{2}s + \frac{1}{2}$

```

% prob4 in sec 7.3
num=[1];
den=[1 2 5/2 3/2 1/2];
% nyquist(num,den); ← part a
num=[1 2 5/2 3/2 3/2];
pzmap(num,den) ← part b
% the following is useful data for part (c)
s=i*[0 .1 .2 .3 .4 .5 .6 .7 .8 .9 1 1.5 2 2.5 3 5 7 9 10];
d=1./(s.^4 +2*s.^3 +5/2*s.^2+3/2*s+1/2);
a=[transpose(s) transpose(d)]
    
```

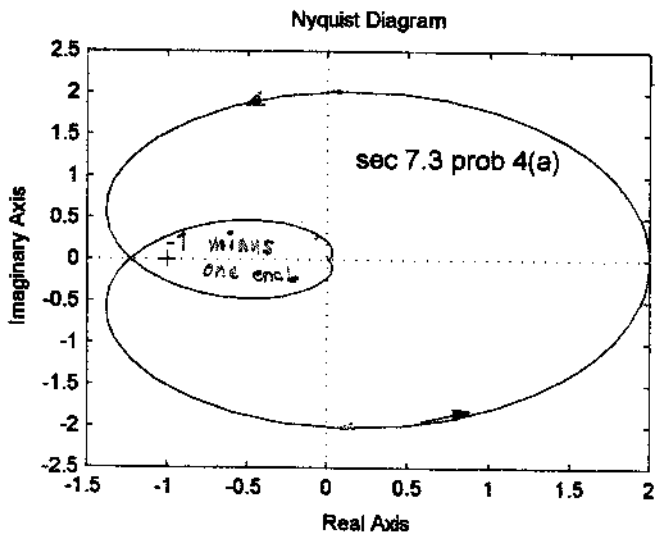

The point -1 is encircled twice.
 ∴ $1+GH$ has 2 zeros in rhp.

b) $1 + GH = 1 + \frac{1}{s^4 + 2s^3 + \frac{5}{2}s^2 + \frac{3}{2}s + \frac{1}{2}}$

$= \frac{s^4 + 2s^3 + \frac{5}{2}s^2 + \frac{3}{2}s + \frac{3}{2}}{s^4 + 2s^3 + \frac{5}{2}s^2 + \frac{3}{2}s + \frac{1}{2}}$

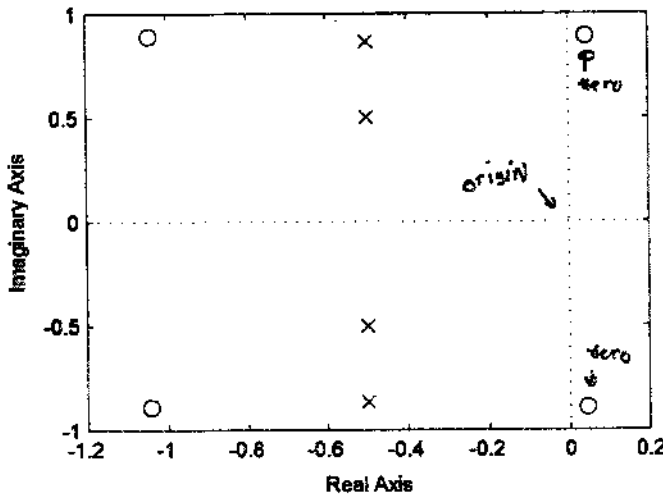

pole zero map of $1+GH$
 note that this has 2 zeros in rhp ∴ unstable

Sec 7.3

4(a)

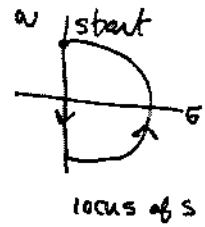
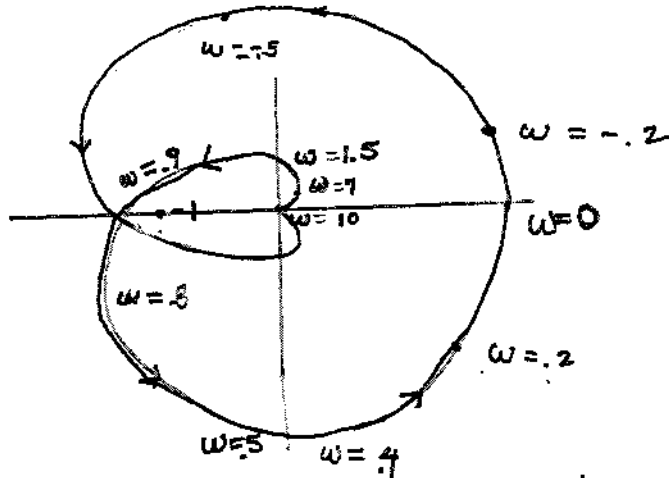

plot of $W = GH$

The point $W = -1$ is enclosed twice. \therefore
 $+GH$ has 2 zeros in rhp.

5(a)

%prob5 sec 7.3

```
% transfer=tf(1,[1 1 1/2],'inputdelay',1);% use for part a
% nyquist(transfer)
```

```
transfer=tf(-1,[1 1 1/2],'inputdelay',1);%use for part b
nyquist(transfer)
```

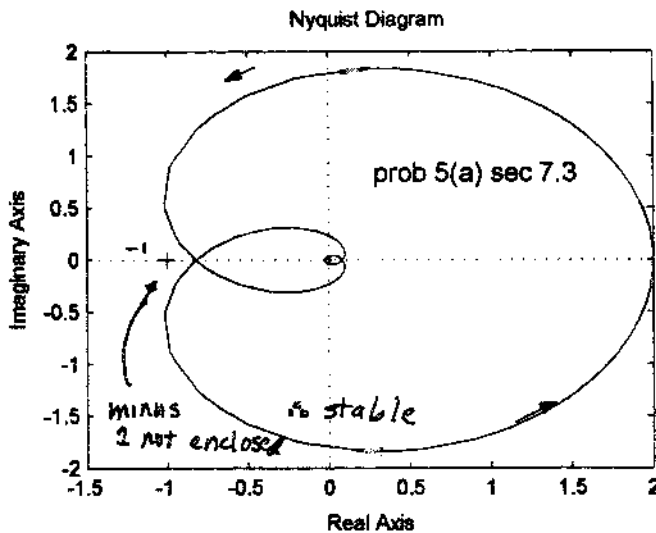

sec 7.3

S (b)

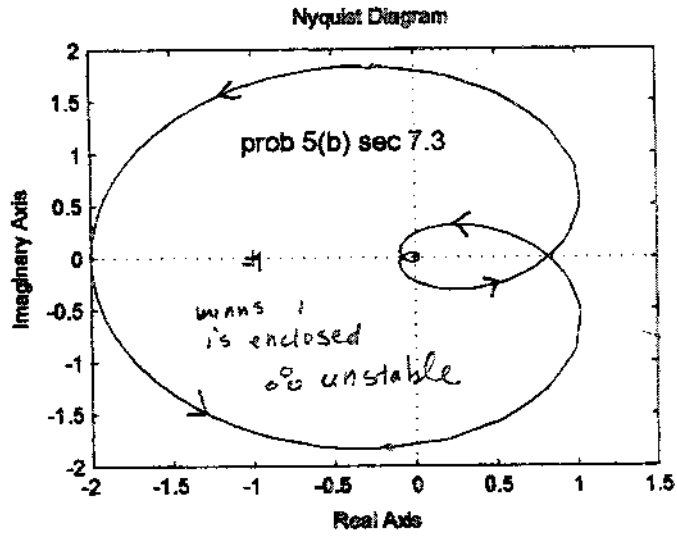

Chap 7, sec 7.4

$$1) \int_{-\infty}^{+\infty} \delta(x) \cos(x-1) dx = \cos(x-1) \Big|_0 = \cos(-1) = \boxed{\cos 1}$$

$$2) \int_{-\infty}^{+\infty} \delta(x) \sin x dx = \sin 0 = 0$$

$$3) \int_{-\infty}^{+\infty} \delta'(x) \sin x dx = -\frac{d}{dx} \sin x \Big|_0 = -\cos 0 = \boxed{-1}$$

$$4) \int_{-\infty}^{+\infty} \delta(x) \left[\frac{1}{x^2+1} + \tan(x+1) \right] dx = \frac{1}{x^2+1} \Big|_0 + \tan(x+1) \Big|_0 \\ = \boxed{1 + \tan 1}$$

$$5) \int_0^{\infty} \delta(x+3) \cos x dx = \boxed{0} \text{ since } -3 \text{ not between limits}$$

$$6) \int_{-\infty}^1 \delta(x+3) \cos x dx = \cos(-3) = \boxed{\cos 3}$$

$$7) \int_0^{10} \delta^{(2)}(x-1) e^{2x} dx = \frac{d^2}{dx^2} e^{2x} \Big|_1 = \boxed{4e^2}$$

$$8) \int_{-3}^3 \delta'(x-1) [\cos(x+1) + \sin(x-1)] dx = \\ -\frac{d}{dx} \cos(x+1) \Big|_1 - \frac{d}{dx} \sin(x-1) \Big|_1 = \boxed{\sin 2 - 1}$$

Chap 7, Sec 7.4 cont'd

$$9) \mathcal{L} \delta(t) + \mathcal{L} \delta'(t-1) = 1 + s e^{-s} \quad (1-t = 1-t)$$

$$\boxed{1 + s e^{-s}}$$

$$10) \mathcal{L} \delta(t-1) \cos 3t = \mathcal{L} \delta(t-1) \cos 3 = \cos 3 \mathcal{L} \delta(t-1) = \boxed{\cos 3 e^{-s}}$$

$$11) \mathcal{L} \delta(t-1) + \mathcal{L} u(t-2) = \boxed{e^{-s} + \frac{e^{-2s}}{s}}$$

12)

Since $u(t-2) = 0$ for $t < 2$ and $\delta(t-1) = 0$, $t \neq 1$, $\delta(t-1) u(t-2) = 0$ and $\mathcal{L} \delta(t-1) u(t-2) = \boxed{0}$

$$13) \delta(t-2) u(t-1) = \delta(t-2), \quad \mathcal{L} \delta(t-2) = \boxed{e^{-2s}}$$

$$14) \sum_{n=0}^{\infty} \delta(t-n\tau) = \delta(t) + \delta(t-\tau) + \delta(t-2\tau) + \delta(t-3\tau) + \delta(t-4\tau) \dots$$

$$\mathcal{L} \delta(t-n\tau) = e^{-sn\tau}$$

$$\text{Thus } \mathcal{L} \sum_{n=0}^{\infty} \delta(t-n\tau) = 1 + e^{-s\tau} + e^{-s2\tau} + e^{-s3\tau} + e^{-s4\tau} + \dots$$

15) Refer to prev. problem

$$\mathcal{L} \sum_{n=0}^{\infty} \delta(t-n\tau) = 1 + e^{-s\tau} + e^{-s2\tau} + e^{-s3\tau} + \dots$$

$$= 1 + (e^{-s\tau})^1 + (e^{-s\tau})^2 + (e^{-s\tau})^3 + \dots$$

$$= \boxed{\frac{1}{1 - e^{-s\tau}}} \quad [\text{sum of geometric series}]$$

Chap 7, sec 7.4, cont'd

16) $\frac{s}{s+1} = \frac{s+1}{s+1} - \frac{1}{s+1} = 1 - \frac{1}{s+1}$
 $\mathcal{L}^{-1} 1 = \delta(t), \quad \mathcal{L}^{-1} \frac{1}{s+1} = \text{Res} \frac{e^{st}}{s+1} \Big|_{-1} = e^{-t}$
 answer: $\delta(t) - e^{-t}$

17) $\frac{s+3}{s-1} \frac{s^2+2s+1}{s^2-3} = \frac{s^2+2s+1}{s-1} = s+3 + \frac{4}{s-1}$
 $\mathcal{L}^{-1} s = \delta'(t), \quad \mathcal{L}^{-1} 3 = 3\delta(t), \quad \mathcal{L}^{-1} \frac{4}{s-1} = 4 \text{Res} \frac{e^{st}}{s-1} = 4e^t$
 answer: $\delta'(t) + 3\delta(t) + 4e^t$

18) $\frac{s^2+s}{s^2+s+2} = \frac{s^2+s+2}{s^2+s+2} - \frac{2}{s^2+s+2} = 1 - \frac{2}{s^2+s+2}$
 $\mathcal{L}^{-1} 1 = \delta(t), \quad \mathcal{L}^{-1} \frac{1}{s^2+s+2} = \sum_{\text{res}} \frac{e^{st}}{s^2+s+2} \text{ at } \left. \begin{array}{l} -\frac{1}{2} + \frac{i\sqrt{7}}{2} \\ -\frac{1}{2} - \frac{i\sqrt{7}}{2} \end{array} \right\} =$
 $= \sum \frac{e^{st}}{2s+1} \text{ at } -\frac{1}{2} \pm \frac{i\sqrt{7}}{2}$
 $\mathcal{L}^{-1} \frac{1}{s^2+s+2} = \frac{e^{-t/2}}{i\sqrt{7}} e^{i\frac{\sqrt{7}}{2}t} + \frac{e^{-t/2}}{-i\sqrt{7}} e^{-i\frac{\sqrt{7}}{2}t}$
 Thus $\mathcal{L}^{-1} 1 - 2 \mathcal{L}^{-1} \frac{1}{s^2+s+2} = \delta(t) - \frac{4e^{-t/2}}{\sqrt{7}} \sin \frac{\sqrt{7}}{2} t$

19) $\frac{s^3}{s^2+s+1} = \frac{(s-1) \frac{s^3}{s^3+s^2+s}}{s^2+s+1} + \frac{1}{s^2+s+1}$
 $\frac{-s^2-s}{-s^2-s-1}$

chap 7 sec 7.4

19) cont'd $\frac{s^3}{s^2+s+1} = s-1 + \frac{1}{s^2+s+1}$

$\mathcal{L}^{-1} s = \delta'(t), \quad \mathcal{L}^{-1}(-1) = -\delta(t)$

$\mathcal{L}^{-1} \frac{1}{s^2+s+1} = \sum_{\text{res}} \frac{e^{st}}{s^2+s+1}$ at $-\frac{1}{2} \pm i \frac{\sqrt{3}}{2}$

$= \sum \frac{e^{st}}{2s+1}$ at $-\frac{1}{2} \pm i \frac{\sqrt{3}}{2} = e^{-t/2} \left[\frac{e^{i\frac{\sqrt{3}}{2}t} - e^{-i\frac{\sqrt{3}}{2}t}}{i\sqrt{3}} \right]$

$= \frac{2e^{-t/2}}{\sqrt{3}} \sin\left[\frac{\sqrt{3}}{2}t\right]$

$\mathcal{L}^{-1} \frac{s^3}{s^2+s+1} = \delta'(t) - \delta(t) + \frac{2}{\sqrt{3}} e^{-t/2} \sin\left[\frac{\sqrt{3}}{2}t\right]$

20] First find $\mathcal{L}^{-1} \frac{s^2}{s^2+s+1}$

$\frac{s^2}{s^2+s+1} = \frac{s^2+s+1}{s^2+s+1} - \frac{(s+1)}{s^2+s+1} = 1 - \frac{(s+1)}{s^2+s+1}$

$\mathcal{L}^{-1} 1 = \delta(t), \quad \mathcal{L}^{-1} \frac{s}{s^2+s+1} = \sum \frac{s}{2s+1} e^{st}$ at $-\frac{1+i\sqrt{3}}{2}$
 $= \left[-\frac{1}{\sqrt{3}} \sin\left[\frac{\sqrt{3}}{2}t\right] + \cos\left[\frac{\sqrt{3}}{2}t\right] \right] e^{-t/2}$

$\mathcal{L}^{-1} \frac{1}{s^2+s+1} = \sum \frac{e^{st}}{2s+1}$ at $-\frac{1+i\sqrt{3}}{2} = \frac{2}{\sqrt{3}} \sin\left[\frac{\sqrt{3}}{2}t\right] e^{-t/2}$

$\mathcal{L}^{-1} 1 - \frac{(s+1)}{s^2+s+1} = \delta(t) - e^{-t/2} \left[\frac{1}{\sqrt{3}} \sin\left[\frac{\sqrt{3}}{2}t\right] + \cos\left[\frac{\sqrt{3}}{2}t\right] \right]$

Chap 7 Sec 7.4

20] cont'd : Now account for e^{-2s}

$$\mathcal{L}^{-1} \frac{s^2}{s^2+s+1} = \delta(t) - e^{-t/2} \left[\frac{1}{\sqrt{3}} \sin \left[\frac{\sqrt{3}}{2} t \right] + \cos \left[\frac{\sqrt{3}}{2} t \right] \right]$$

$$\mathcal{L}^{-1} \frac{s^2 e^{-2s}}{s^2+s+1} =$$

$$= u(t-2) \left[\delta(t-2) - e^{-[t-2]/2} \left[\frac{1}{\sqrt{3}} \sin \left[\frac{\sqrt{3}}{2} (t-2) \right] + \cos \left[\frac{\sqrt{3}}{2} (t-2) \right] \right] \right]$$

21] $LSI + I(s)R = V(s)$

$$I = \frac{V}{LS+R}$$

transfer func. = $\frac{1}{LS+R}$

$$V(s) = 1 \quad (\text{if } v(t) = \delta(t))$$

$$I = \frac{1}{LS+R}$$

$$i(t) = \text{Res} \frac{e^{st}}{LS+R} \text{ at } s = -\frac{R}{L}$$

impulse resp = $\frac{e^{(-R/L)t}}{L}$

22] $\frac{V(s)}{R} + \frac{1}{LS} V(s) = I(s)$

$$V = \frac{I}{\frac{1}{R} + \frac{1}{LS}} = I \frac{LSR}{LS+R}$$

transfer func. = $\frac{LSR}{LS+R}$

if $i(t) = \delta(t)$
 $I(s) = 1$

$$V(s) = \frac{LSR}{LS+R}$$

chap 7 sec 7.4

22) Cont'd

$$\frac{R [Ls]}{Ls+R} = R \left[\frac{Ls+R}{Ls+R} - \frac{R}{Ls+R} \right]$$

$$= R - \frac{R^2}{Ls+R} = V(s)$$

$$v(t) = \mathcal{L}^{-1} R - R^2 \mathcal{L}^{-1} \frac{1}{Ls+R} =$$

$$R \delta(t) - R^2 \text{Res} \frac{e^{st}}{Ls+R} \Big|_{s=-\frac{R}{L}} = \boxed{R \delta(t) - R^2 \frac{e^{-t\frac{R}{L}}}{L}}$$

23) taking Laplace transforms:

$$LsI + \frac{I}{sC} = V(s), \quad I = \frac{V sC}{1+LCS^2}$$

Transfer function, $\frac{sC}{1+LCS^2}$ poles are simple

and are on imaginary axis at $s = \pm i \sqrt{\frac{1}{LC}}$
Thus system marginally unstable. Impulse response:

$$\mathcal{L}^{-1} \frac{sC}{1+LCS^2} = \sum_{\text{res}} \frac{sC}{1+LCS^2} e^{st} \text{ at } \pm \frac{i}{\sqrt{LC}}$$

$$= \sum \frac{sC e^{st}}{2sLC} \text{ at } \pm \frac{i}{\sqrt{LC}} = \boxed{\frac{1}{L} \cos \frac{t}{\sqrt{LC}}}$$

24) $\mathcal{L} g(t) = G(s)$ [Laplace transform of impulse response is transfer func.]

$$Y(s) = X(s) G(s) \quad \text{where } Y(s) = \mathcal{L} y(t)$$

$$\mathcal{L}^{-1} Y(s) = \mathcal{L}^{-1} [X(s) G(s)] = \int_0^t x(t-\tau) g(\tau) d\tau$$

$y(t) = \int_0^t x(t-\tau) g(\tau) d\tau$. Now $x(t-\tau) u(t-\tau) = x(t-\tau)$ for $0 \leq \tau \leq t$, while $x(t-\tau) u(t-\tau) = 0$ if $\tau > t$

Chap 7, sec 7.4

24) cont'd

$$\text{Thus } \int_0^t x(t-\tau)g(\tau)d\tau = \int_0^{\infty} x(t-\tau)u(t-\tau)g(\tau)d\tau$$

(b) From example 5, impulse response:

$$g(t) = \frac{\delta(t)}{R} - \frac{e^{-t/RC}}{R^2C} u(t).$$

$$\text{input: } x(t) = e^{-\alpha t} u(t)$$

$$\text{output: } \int_0^t x(t-\tau)g(\tau)d\tau =$$

$$\int_0^t e^{-\alpha(t-\tau)} u(t-\tau) \left[\frac{\delta(\tau)}{R} - \frac{e^{-\tau/RC}}{R^2C} \right] d\tau$$

[can drop step funcs]

$$= \int_0^t e^{-\alpha(t-\tau)} \frac{\delta(\tau)}{R} d\tau - \int_0^t \frac{e^{-\alpha(t-\tau)} e^{-\tau/RC}}{R^2C} d\tau$$

$$= \frac{e^{-\alpha t}}{R} - \frac{[e^{-t/RC} - e^{-\alpha t}]}{R^2C [\alpha - \frac{1}{RC}]} =$$

$$\frac{e^{-\alpha t}}{R - \frac{1}{\alpha C}} - \frac{e^{-t/RC}}{R^2C [\alpha - \frac{1}{RC}]}$$

Sec 7.4

25

```

% problem 25 section 7.4
syms s t
answer_a=ilaplace(s)
answer_b=ilaplace(s^0)
answer_c=ilaplace((s+1)^3/s)
answer_d=ilaplace((s^3+s+1)/(s^2+s+1));
disp('answer_d')

pretty(answer_d)

```

answer_a =

$$\text{Dirac}(1, t) = \frac{d}{dt} \delta(t)$$

answer_b =

$$\text{Dirac}(t) = \delta(t)$$

answer_c =

$$\text{Dirac}(2, t) + 3 \cdot \text{Dirac}(1, t) + 3 \cdot \text{Dirac}(t) + 1 = \frac{d^2}{dt^2} \delta(t) + 3 \frac{d}{dt} \delta(t) + 3 \delta(t) + 1$$

answer_d

$$\begin{aligned} & \text{Dirac}(1, t) - \text{Dirac}(t) + \exp(-1/2 t) \cos(1/2 \sqrt{3} t) \\ & + \exp(-1/2 t) \sqrt{3} \sin(1/2 \sqrt{3} t) \end{aligned}$$

>>

$$= \frac{d}{dt} \delta(t) - \delta(t) + e^{-t/2} \cos\left[\frac{\sqrt{3}}{2} t\right] + e^{-t/2} \sqrt{3} \sin\left[\frac{\sqrt{3}}{2} t\right]$$

8

Conformal Mapping and Some of Its Applications

sec. 8.2

1) $W = z^2$ is conformal exc. at $z=0$ because
 z^2 is analytic, Note that $(\bar{z})^2 = \overline{(z^2)}$ is not analytic.

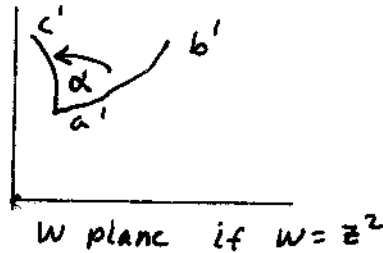
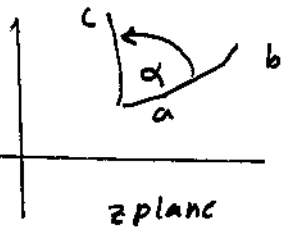

W plane if $W = (\bar{z}^2) = \overline{(z^2)}$
 Note $a'' = \overline{(a')}$, $b'' = \overline{(b')}$ etc.

The magnitude of the angles of intersection is preserved but sense of angle is reversed.

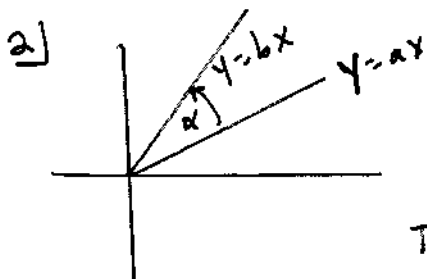

$$u = x^2 - y^2$$

$$v = 2xy$$

$$W = x^2 - b^2x^2, v = 2bx^2$$

Thus $u = x^2 [1 - b^2]$

$v = \frac{2b}{1-b^2} u$ is image of $y = bx$

Similarly $v = \frac{2a}{1-a^2} u$ is image of $y = ax$

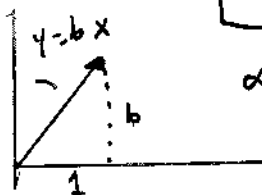

$$\alpha = \tan^{-1} b - \tan^{-1} a = \text{arg}(1+ib) - \text{arg}(1+ia)$$

$$= \text{arg} \left[\frac{1+ib}{1+ia} \right]$$

2) cont'd

Sec 8.2

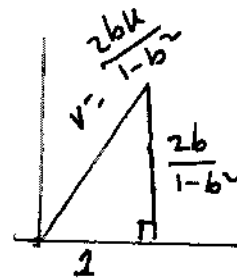
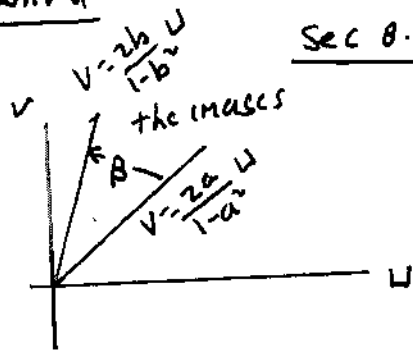

$$\beta = \tan^{-1} \frac{2b}{1-b^2} - \tan^{-1} \frac{2a}{1-a^2} = \arg[(1+ib)^2] - \arg[(1+ia)^2]$$

$$= \arg \left[\frac{(1+ib)^2}{(1+ia)^2} \right] = 2 \arg \left[\frac{1+ib}{1+ia} \right] = 2\alpha$$

angle of intersect = 2α

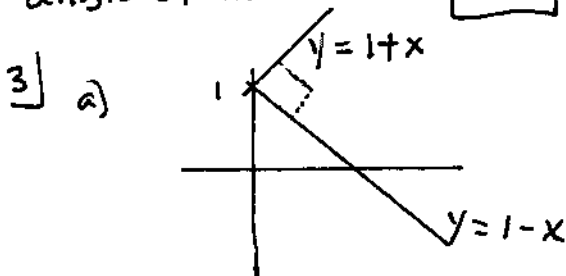

intersect at (0, 1)

slopes are negative reciprocals of each other, ± 1 , so angle of intersection = 90°

(b) First do image of $y=1-x$

$$w = u + iv = x^2 - y^2 + i2xy, \quad u = x^2 - y^2, \quad v = 2xy$$

$$w = x^2 - (1-x)^2, \quad v = 2x(1-x), \quad u = -1 + 2x, \quad v = 2x(1-x)$$

$$x = \frac{u+1}{2}, \quad \text{so } v = \frac{1}{2}(1-u^2). \quad \text{Since } x \geq 0, \quad u \geq -1$$

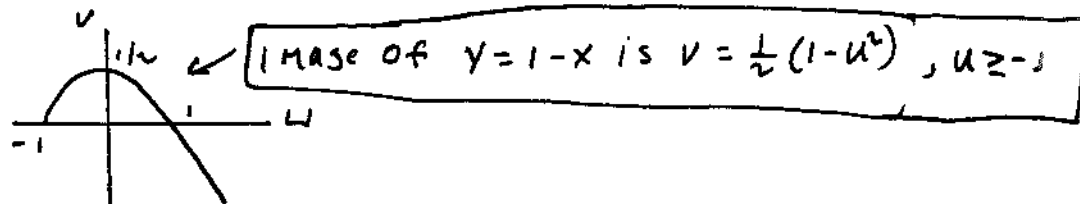

image of $y=1-x$ is $v = \frac{1}{2}(1-u^2), u \geq -1$

Now do image of $y=1+x$

$$u = x^2 - y^2 = x^2 - (1+x)^2, \quad v = 2xy = 2x(1+x)$$

$$u = -1 - 2x, \quad x = \frac{u+1}{-2}, \quad v = \frac{u^2-1}{2} \text{ is image of } y=1+x$$

$u \leq -1$ since $x \geq 0$

Sec 8.2 cont'd

3 (b) cont'd

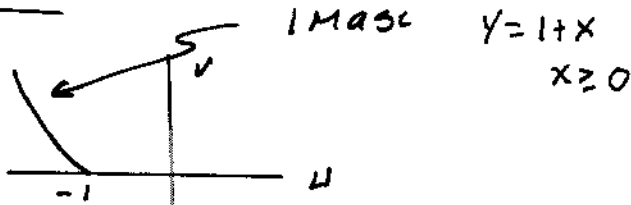

(c) point of intersection, use figures, $u = -1, v = 0$

or $v = \frac{1}{2}(1-u^2) = \frac{1}{2}(u^2-1)$ $u = \pm 1, v = 0$, must

choose $u = -1$

slopes, if $v = \frac{1}{2}(1-u^2)$, $dv = -u du$

$\frac{dv}{du} = -u$, if $v = \frac{1}{2}(-1+u^2)$, $\frac{dv}{du} = u$

slopes are negative reciprocals of each other.

\therefore angle of intersection is still 90°

4] $w = z - \bar{z}$, $dw/dz = 1 + z^{-2}$ $1 + z^{-2} = 0$

$z^2 + 1 = 0$, $z = \pm i$

5] $w = \cos z$, $\frac{dw}{dz} = -\sin z$, $-\sin z = 0$

$z = k\pi, k = 0, \pm 1, \dots$

6] $w = ze^z$, $dw/dz = e^z + ze^z = 0$, $e^z \neq 0$

$\therefore 1+z=0$, $z = -1$

7] $w = \frac{z-i}{z+i}$ $\frac{dw}{dz} = \frac{(z+i) - (z-i)}{(z+i)^2} = \frac{2i}{(z+i)^2}$

$\frac{2i}{(z+i)^2} = 0$ This has no solution in the (finite) complex plane. \therefore No critical points.

8] $w = iz + \text{Log } z$, $dw/dz = i + \frac{1}{z}$ $i + \frac{1}{z} = 0$, $z = i$

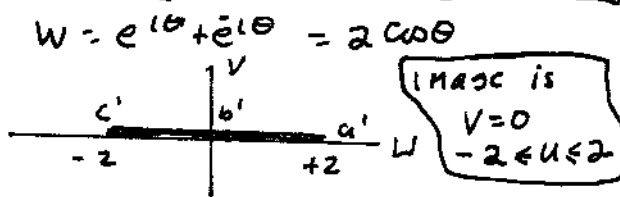
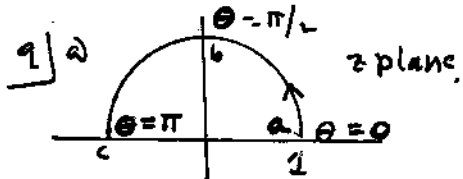

sec 8.2 cont'd

9(b)

$$W = x + \frac{1}{x} = u + iv, \quad v = 0, \quad u = x + \frac{1}{x}$$

As x goes from 1 to ∞ , u goes from 2 to ∞ .

ans. $\boxed{\text{Im } W = 0, \quad 2 \leq \text{Re } W. \quad \text{or } v = 0, \quad u \geq 2}$

9(c) The image curves intersect at 180°

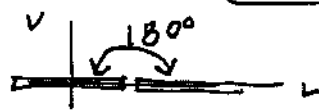
 but the original curves intersect at 90°

The transformation is not conformal at $z = 1$ since

$$\frac{d}{dz} [z + 1/z] = 1 - \frac{1}{z^2} = 0 \quad \text{if } z = 1$$

10. $u + iv = \frac{1}{x + iy}, \quad y = 1$
 $= \frac{1}{x + i} = \frac{(x - i)}{x^2 + 1}$

$$u = \frac{x}{x^2 + 1}, \quad v = \frac{-1}{x^2 + 1}, \quad -\frac{1}{v} = x^2 + 1, \quad -\frac{1}{v} - 1 = x^2$$

$$u = \frac{\sqrt{-\frac{1}{v} - 1}}{-\frac{1}{v}}, \quad u^2 = v^2 \left[-\frac{1}{v} - 1 \right], \quad u^2 + v^2 = -v$$

$u^2 + (v + \frac{1}{2})^2 = (\frac{1}{2})^2$. Circle in the w plane, radius $1/2$, center at $w = -i/2$

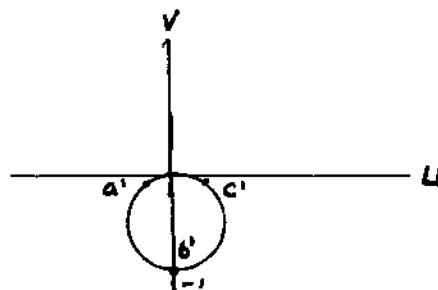
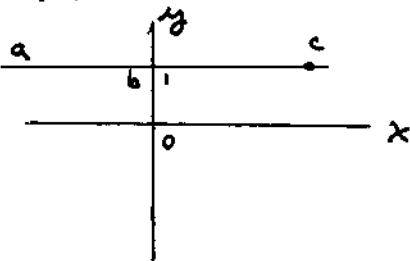

11. $u + iv = \frac{1}{x + iy}, \quad w = \frac{x}{x^2 + y^2}, \quad v = \frac{-y}{x^2 + y^2} = \frac{x - 1}{x^2 + y^2}$

$$\frac{w}{v} = \frac{x}{x - 1}, \quad x = \frac{u}{u - v}, \quad y = 1 - x = \frac{-v}{u - v}, \quad \text{now } w = \frac{x}{x^2 + y^2}$$

(see next pg.)

11) cont'd. $u = \frac{x}{x^2+y^2} = \frac{u}{u-v}$

$$\left(\frac{u}{u-v}\right)^2 + \left(\frac{v}{u-v}\right)^2$$

$$u = \frac{(u-v)u}{u^2+v^2} \Rightarrow (u)(u^2+v^2) = u^2 - uv$$

$$u^2+v^2 = u-v, \quad \left(u - \frac{1}{2}\right)^2 + \left(v + \frac{1}{2}\right)^2 = \frac{1}{2}$$

Circle in w plane, center at $W = \frac{1}{2} - \frac{i}{2}$, radius $\frac{1}{\sqrt{2}}$

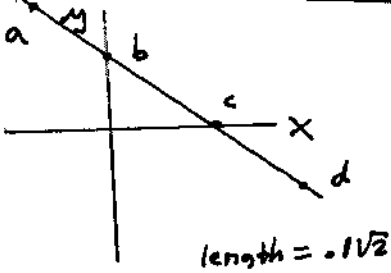

length = $\cdot 1\sqrt{2}$

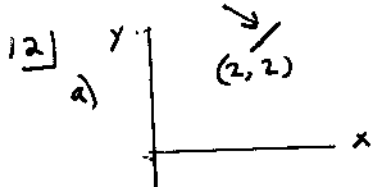
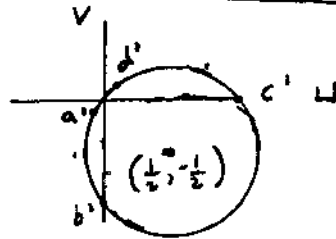

$$w = \text{Log } z, \quad \frac{dw}{dz} = \frac{1}{z} \Big|_{z=2+i2} = \frac{1}{2+i2}$$

$$\left| \frac{dw}{dz} \right| = \frac{1}{2\sqrt{2}} \cdot \text{New length} \approx \frac{1\sqrt{2}}{2\sqrt{2}} = \boxed{.05}$$

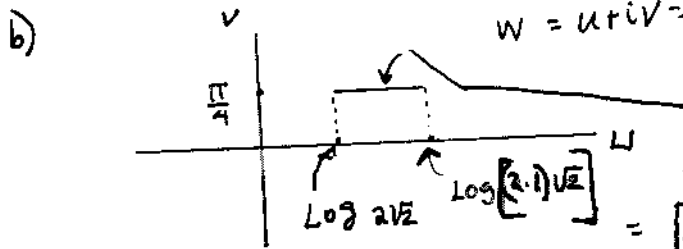

$$w = u+iv = \text{Log } |z| + i \frac{\pi}{4}$$

New length =

$$\text{Log } (2\sqrt{2}) - \text{Log } (2\sqrt{2}) =$$

$$= \boxed{\text{Log } 1.05 \approx .04879}$$

c)

$$\frac{dw}{dz} = \frac{1}{2+i2}, \quad \text{arg } \frac{dw}{dz} = \boxed{-\frac{\pi}{4}}$$

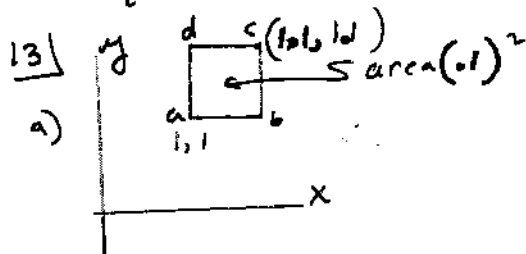

$$w = e^z$$

$$\frac{dw}{dz} = e^z \Big|_{z=1+i} = e e^i$$

$$\left| \frac{dw}{dz} \right| = e$$

$$\text{New area} \approx e^2 \cdot (1)^2 = \boxed{.07389}$$

SEC 8-2 cont'd

13 (b)

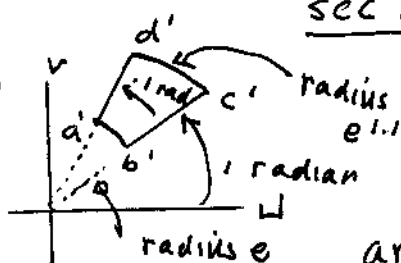

$w = e^z$

$|w| = e^x$

$\arg w = y$

$e^{1.1} \theta = 1.1$

area = $\int_{r=e}^{e^{1.1}} \int_{\theta=0}^1 r d\theta dr = .1 \cdot \left[\frac{(e^{1.1})^2 - (e^1)^2}{2} \right]$

= .081798

SEC. 8.3

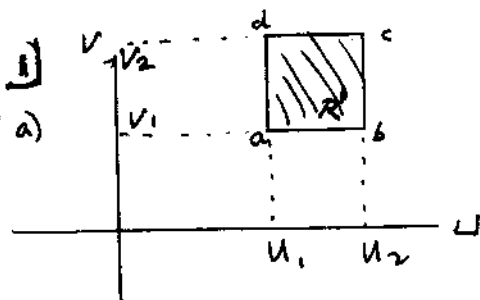

$w = z^2 = u + iv = x^2 - y^2 + i2xy$

$x^2 - y^2 = u, \quad 2xy = v$

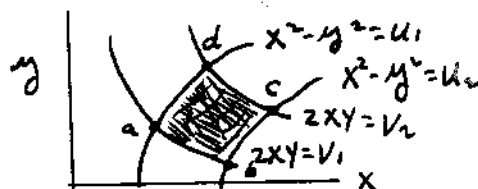

Region R shown shaded.

mappings is one to one.

because $z_1^2 = z_2^2$ is

satisfied in R if and only if $z_1 = z_2$ (the equation $z_1 = -z_2$ cannot be satisfied in R)

Boundaries: $x^2 - y^2 = u_1, x^2 - y^2 = u_2, 2xy = v_1, 2xy = v_2$ all in first quadrant of x, y plane

b) mappings is one to one. Equations of boundaries same as in (a) but are now in third quadrant.

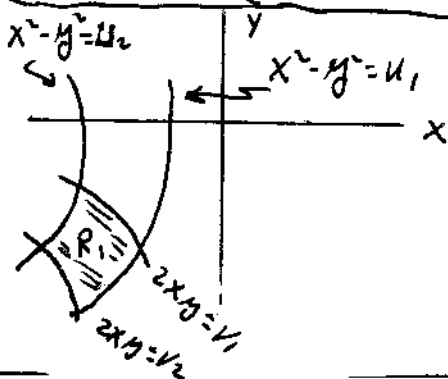

sec 8.3 cont'd

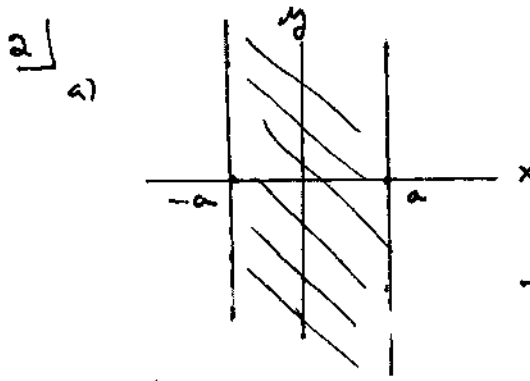

$w = \sin z$
 $u + iv = \sin x \cosh y + i \cos x \sinh y$
 let $x = a$
 $u = \sin a \cosh y, v = \cos a \sinh y$

$\frac{u^2}{\sin^2 a} - \frac{v^2}{\cos^2 a} = 1$

strip is mapped between two branches of the hyperbola described by

$\frac{u^2}{\sin^2 a} - \frac{v^2}{\cos^2 a} = 1$

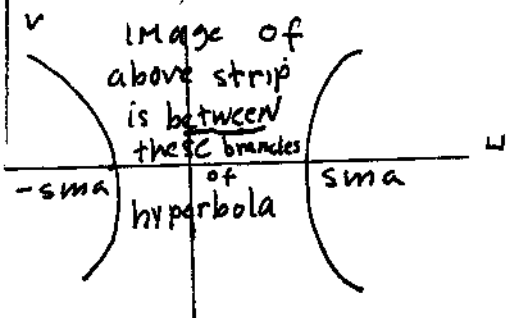

(b) Mapping is one-to-one, let $\sin z_1 = \sin z_2$. Either $z_1 = z_2$ or $\{z_1 - z_2 = 2n\pi \text{ or } z_1 + z_2 = \pi + 2n\pi\}$. Since the strip satisfies: $-\frac{\pi}{2} < \text{Re } z < \frac{\pi}{2}$ the eqn. $\sin z_1 = \sin z_2$ is satisfied only if $z_1 = z_2$

(c) Mapping is not one to one. Consider

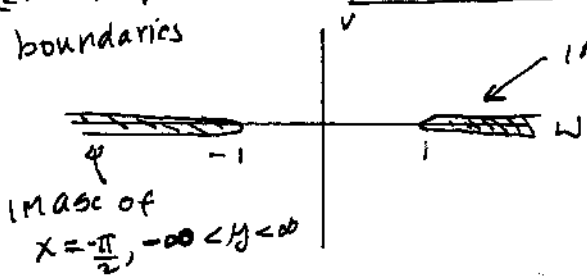

The boundaries of the strip in the x, y plane are folded as shown. Thus $x = \frac{\pi}{2}, y = 1$ and $x = \frac{\pi}{2}, y = -1$ are both mapped to $w = \cosh 1$

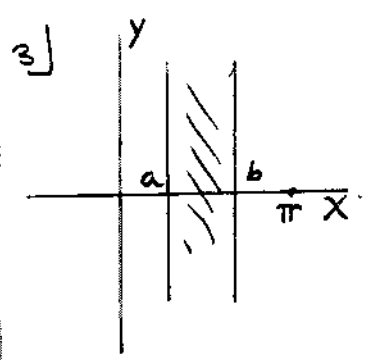

$u + iv = \cos(x + iy)$
 $u = \cos x \cosh y, v = -\sin x \sinh y$
 $\frac{u^2}{\cos^2 a} - \frac{v^2}{\sin^2 a} = 1$

If $x = b$, mapped into

$\frac{u^2}{\cos^2 b} - \frac{v^2}{\sin^2 b} = 1$

Sec 8.3

Cont'd

3 cont'd

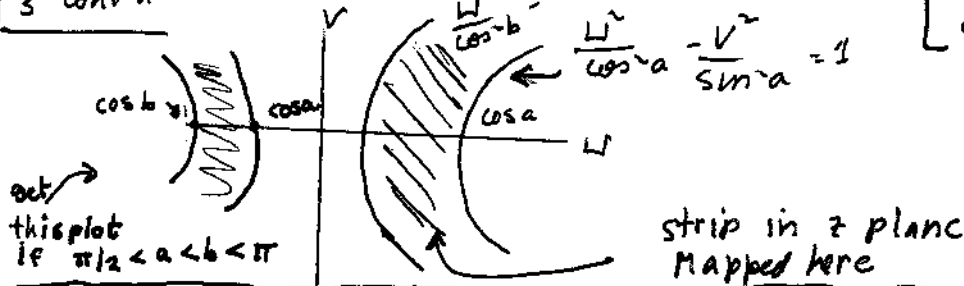

The given region mapped on and between appropriate branches of the hyperbolas:

$$\frac{u^2}{\cos^2 a} - \frac{v^2}{\sin^2 a} = 1 \text{ and } \frac{u^2}{\cos^2 b} - \frac{v^2}{\sin^2 b} = 1$$

Mappings is one to one

Consider $\cos z_1 = \cos z_2$

which $\Rightarrow z_1 = z_2$ or

$$z_1 \pm z_2 = 2n\pi$$

Since the width of the strip in the z plane is $< \pi$ i.e. $0 < \text{Re } z < \pi$, then $\cos z_1 = \cos z_2 \Rightarrow z_1 = z_2$

4] Proceed as in 3] $u = \cos x \cosh y$, $v = \sin x \sinh y$.

If $x=0$, $u = \cosh y$, $v=0$, $-\infty < y < \infty$,

While if $x=\pi$, $v=0$, $u = -\cosh y$, $-\infty < y < \infty$

Boundaries mapped as shown:

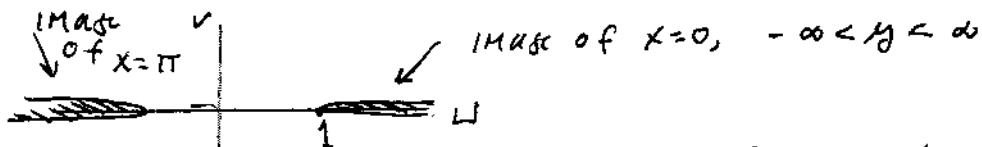

Mappings is not one to one. for example $z=i$ and $z=-i$ are both mapped into $w = \cosh 1$

5] As in previous problems, if $w = \cos z$, then $u = \cos x \cosh y$, $v = -\sin x \sinh y$. Since $y \geq 0$, and $0 \leq x < \pi$, we have $v \leq 0$.



sec 8.3 Cont'd

5) Cont'd

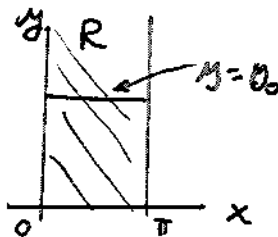
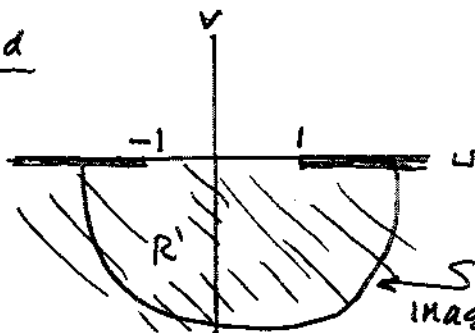

R is mapped onto R', **one to one**.

Image of $y=y_0, 0 \leq x \leq \pi$

$$u = \cos x \cosh y_0, \quad v = -\sin x \sinh y_0$$

$$\frac{u^2}{\cosh^2 y_0} + \frac{v^2}{\sinh^2 y_0} = 1 \quad \text{ellipse} \quad v < 0$$

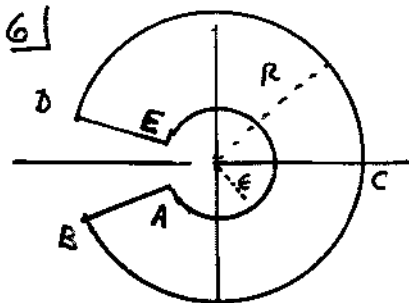

$$w = \text{Log } z = \text{Log}|z| + i \arg z$$

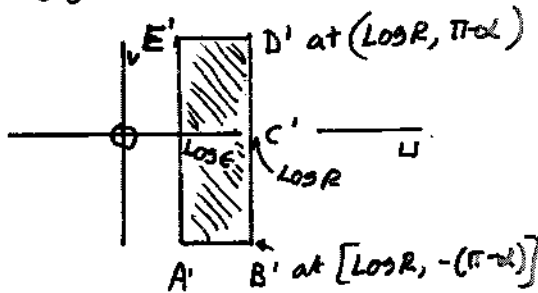

b) **MAPPING is one to one**

If $\text{Log } z_1 = \text{Log } z_2$
then $z_1 = z_2$

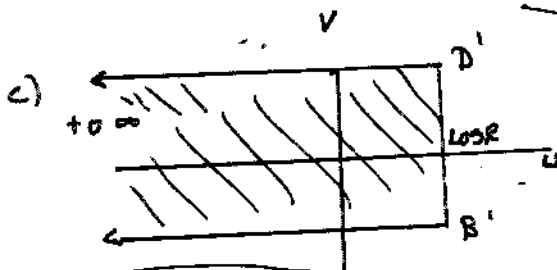

The points A' and E' move to ∞ as shown if $\epsilon \rightarrow 0+$.

Thus you obtain the semi-infinite rectangle

$$u \leq \text{Log } R, \quad -(\pi - \alpha) \leq v \leq (\pi - \alpha)$$

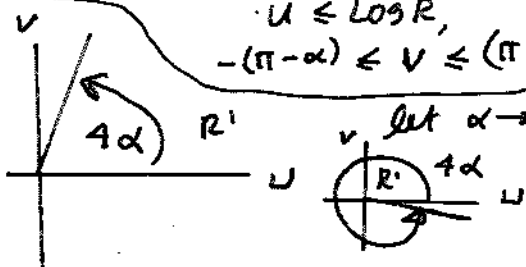
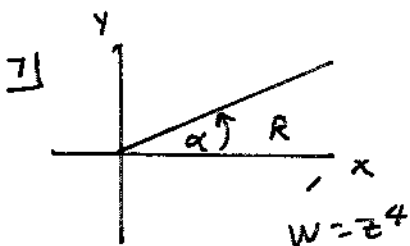

Let $\alpha \rightarrow \pi/2$

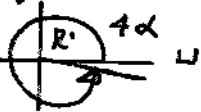

You need $\alpha < \frac{\pi}{2}$

see 8.3 cont'd

$$8) a) \frac{U^2}{\sin^2 x_1} - \frac{V^2}{\cos^2 x_1} = 1, \quad U^2 \cos^2 x_1 - V^2 \sin^2 x_1 = \sin^2 x_1 \cos^2 x_1$$

differentiating implicitly

$$2U dU \cos^2 x_1 - 2V dV \sin^2 x_1 = 0$$

$$\left. \frac{dU}{dV} \right|_1 = \frac{V \sin^2 x_1}{U \cos^2 x_1} \quad \text{slope of hyperbola at intersection}$$

$$\text{ellipse} \quad \frac{U^2}{\cosh^2 \theta_1} + \frac{V^2}{\sinh^2 \theta_1} = 1$$

proceeding as above

$$\left. \frac{dU}{dV} \right|_2 = \frac{-V \cosh^2 \theta_1}{U \sinh^2 \theta_1} \quad \text{slope of ellipse at intersection,}$$

at intersection $U_1 = \sin x_1 \cosh \theta_1, V_1 = \cos x_1 \sinh \theta_1$

$$\text{thus } \left. \frac{dU}{dV} \right|_1 = \frac{\cos x_1 \sinh \theta_1}{\sin x_1 \cosh \theta_1} \frac{\sin^2 x_1}{\cos^2 x_1} \quad \text{slope hyperb.}$$

$$\text{while } \left. \frac{dU}{dV} \right|_2 = - \frac{\cos x_1 \sinh \theta_1}{\sin x_1 \cosh \theta_1} \frac{\cosh^2 \theta_1}{\sinh^2 \theta_1} \quad \text{slope ellipse}$$

Note that these slopes are negative reciprocals of each other. Thus intersection is 90°

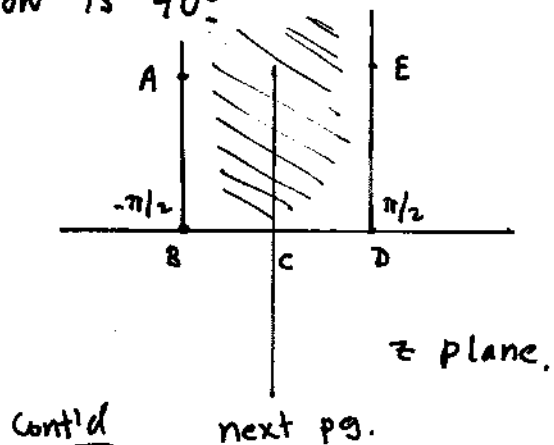
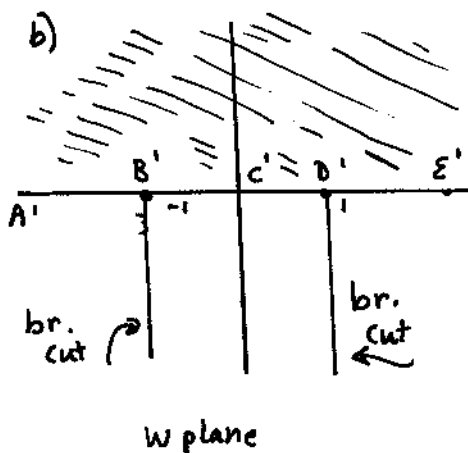

8] cont'd Sec. 8.3 cont'd

Use $z = \sin^{-1} W, z = -i \operatorname{Log} [iW + (1-W^2)^{1/2}]$

Use princ. branch of log. branch cuts for $(1-W^2)^{1/2}$ are at $W = \pm 1$ and extend into lower half of W plane (see prev. pg.)

Checks: $B' = -1 = W, z = -i \operatorname{Log}(-i) = -\frac{\pi}{2} = B$

$C' = 0 = W, z = -i \operatorname{Log} 1 = 0 = C$

$D' = 1 = W, z = -i \operatorname{Log} i = \frac{\pi}{2} = D$

we also use princ. branch of sq. root. func.

If $W = i, z = -i \operatorname{Log} [-1 + \sqrt{2}] \approx i.88$ which is in the strip shown on bottom previous pg.

let $A' = -10, z = -i \operatorname{Log} [-10i + (-99)^{1/2}]$

$= -i \operatorname{Log} [-10i + 9.9498] = -\frac{\pi}{2} + i2.99 = A$

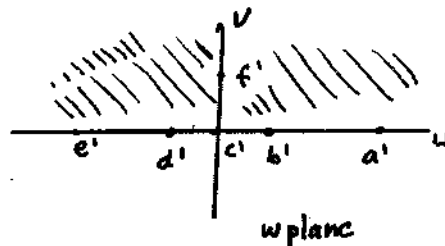
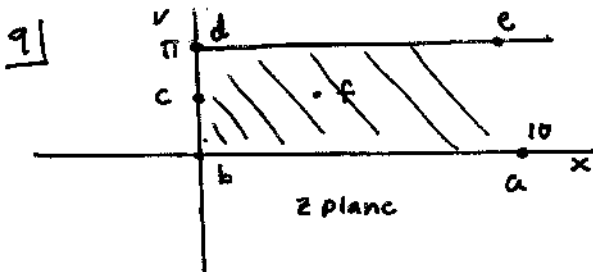

$W = \cosh z, u + iv = \cosh x \times \cos y + i \sinh x \times \sin y$

$u = \cosh x \times \cos y, v = \sinh x \times \sin y$

$a = 10 = \cosh x, \cosh 10 = a', b = 0 = \cosh x, b' = 1$

$c = \frac{\pi}{2} = \sin y, c' = 0, d = \pi, d' = -1; e = 10 + i\pi, e' = -\cosh 10$

$f = 1 + \frac{i\pi}{2}, f' = i \sinh 1$. Image of given region is $\operatorname{Im} W > 0$

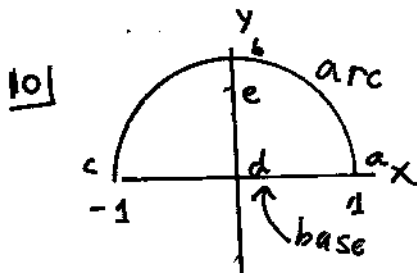

First get image of arc:

$z = e^{i\theta} \quad 0 \leq \theta < \pi$

$W = \left(\frac{e^{i\theta} - 1}{e^{i\theta} + 1} \right)^2 = \left(\frac{e^{i\theta/2} - e^{-i\theta/2}}{e^{i\theta/2} + e^{-i\theta/2}} \right)^2 = \left[\frac{e^{i\theta/2} - e^{-i\theta/2}}{e^{i\theta/2} + e^{-i\theta/2}} \right]^2$

$W = \left[\frac{2i \sin(\theta/2)}{2 \cos(\theta/2)} \right]^2 = -\tan^2 \frac{\theta}{2} = u + iv$. As $\theta \rightarrow 0 \rightarrow \pi$
 $v = 0, u$ goes from 0 to $-\infty$. [next pg.]

10] cont'd

sec 8.3 cont'd

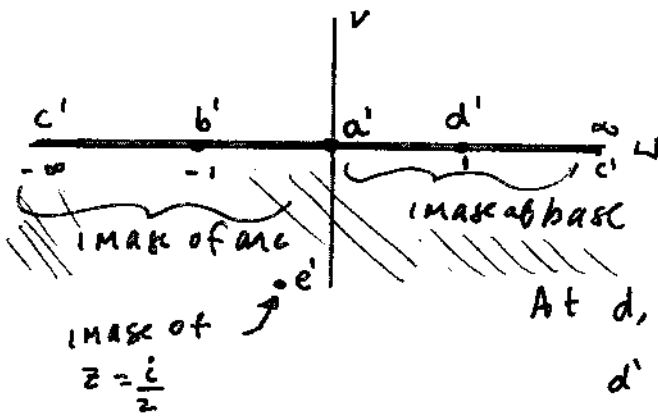

On base, $y=0, z=x$

$$u+iv = \left(\frac{x-1}{x+1}\right)^2$$

$$u = \frac{(x-1)^2}{(x+1)^2}, v=0$$

At d, $y=0, z=0, u=1, v=0$
d' is at $w=1$

As $x \rightarrow -1, u \rightarrow \infty, v=0$

At e, $z = i/2, w = \frac{\left(\frac{i}{2}-1\right)^2}{\left(\frac{i}{2}+1\right)^2} = -2.8 - i.96 = u+iv$

The half disc domain is mapped onto space

$$\boxed{\text{Im}(w) < 0}$$

(b) $w = \frac{(z-1)^2}{(z+1)^2}, w^{1/2} = \frac{z-1}{z+1}, \text{ thus } \boxed{z = \frac{1+w^{1/2}}{1-w^{1/2}}}$

In w plane, branch cut runs from $w=0$ to ∞ through upper half plane. Take $w^{1/2} = -1$ when $w=1$, thus d' [$w=1$] will be mapped to $z=0$

11] There is no contradiction. The wedge being mapped (which contained $z=0$) is not an open set. It is not a domain.

Sec 8.4

i) a) $w = \frac{az+b}{cz+d}, wcz+wd = az+b, wd-b = z(a-wc)$

(b) $w = \frac{\frac{a}{c}[cz+d] + \frac{bc-ad}{c}}{cz+d}$ thus $z = \frac{wd-b}{a-wc}$ q.e.d

$w = \frac{az+ad/c + b-ad/c}{cz+d} = \frac{az+b}{cz+d}$ q.e.d

sec 8.4 cont'd

2) If z_1 lies on the given curve in the x - y plane, then from the given symmetry conditions, \bar{z}_1 is also on this curve. If w_1 is the image of z_1 , (under Eqn 8.4-1) then $w_1 = \frac{az_1+b}{cz_1+d}$. The

image of \bar{z}_1 is $\frac{a\bar{z}_1+b}{c\bar{z}_1+d}$. But this equals

$$\overline{\left(\frac{az_1+b}{cz_1+d}\right)} = \bar{w}_1. \text{ Thus } z_1 \text{ and } \bar{z}_1 \text{ are symmetric}$$

about the x axis and their images w_1 and \bar{w}_1 are symmetric about the u (Real w) axis.

3) Use (8.4-26) $w_1 - w_2 = \frac{(ad-bc)(z_1 - z_2)}{(cz_1+d)(cz_2+d)}$

$$\text{and } w_3 - w_4 = \frac{(ad-bc)(z_3 - z_4)}{(cz_3+d)(cz_4+d)}$$

Dividing: $\frac{w_1 - w_2}{w_3 - w_4} = \frac{z_1 - z_2}{z_3 - z_4} \frac{cz_4+d}{cz_2+d}$

Similarly $\frac{w_3 - w_4}{w_1 - w_2} = \frac{z_3 - z_4}{z_1 - z_2} \frac{cz_2+d}{cz_4+d}$

Multiply together corresponding sides of preceding two eqns. Get:

$$\frac{w_1 - w_2}{w_1 - w_4} \frac{w_3 - w_4}{w_3 - w_2} = \frac{z_1 - z_2}{z_1 - z_4} \frac{z_3 - z_4}{z_3 - z_2} \quad \text{Q.E.D.}$$

4) (a) $z = \frac{az+b}{cz+d}$ thus $az+b = cz^2+d$
or $cz^2 + (d-a)z - b = 0$

Sec 8.4 cont'd

in general

4 (b) Assume $c \neq 0$ $c z^2 + (d-a)z - b = 0$ has [^] two solutions (fundamental theorem of algebra). The two solutions become identical if $(d-a)^2 = -4bc$ (see quadratic formula). Thus if $c \neq 0$ and $(d-a)^2 \neq -4bc$ there are two solutions, while if $c \neq 0$ and $(d-a)^2 = -4bc$ there is one solution (i.e. one fixed pt).

Now assume $c=0$. Then require for fixed pt:
 $(d-a)z - b = 0$. This has just one solution $\frac{b}{d-a}$ unless $d=a$. Now still assume $c=0$, but take $d=a$ then we have no solution to $-b=0$ unless b happens to be zero. Now still assume $c=0$, $d=a$, but take $b=0$. Then $(d-a)z - b = 0$ is satisfied for all z .

$$c) \quad w = \frac{az+b}{cz+d} = \frac{az+b}{d} = \frac{a}{d}z = z$$

$c=0 \quad (b=0)$

The transformation $w=z$ is trivial. Every point in the z plane is mapped into itself.

5] $c + (a-d) - b = 0 \quad c - (a-d) - b = 0$ add these
 $2c - 2b = 0 \implies c = b$, thus $a-d=0$ and $a=d$
 answer: $a=d$ and $b=c$ or $w = \frac{az+b}{bz+a}$

6] $c - (a-d) - b = 0, \quad -c - (a-d) - b = 0$
 add these equations $(d-a)(1+i) - 2b = 0$
 $b = \frac{(1+i)}{2}(d-a)$. Now subtract instead of adding
 $2c - (a-d) + i(a-d) = 0$ and $c = \frac{1}{2}(a-d)(1-i)$. Thus:
 $w = \frac{\frac{a}{2}z + \frac{1}{2}(1+i)(d-a)}{\frac{1}{2}(a-d)(1-i)z + d}$ or $w = \frac{2az + (1+i)(d-a)}{(a-d)(1-i)z + 2d}$ ← ans.

Sec 8.4 cont'd

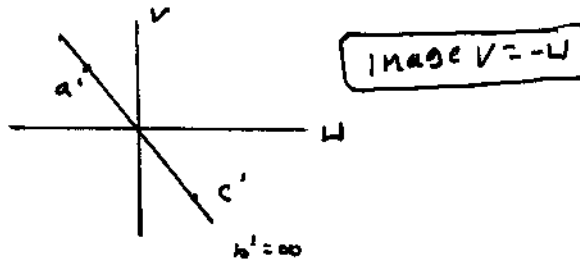
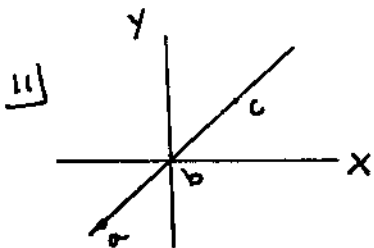
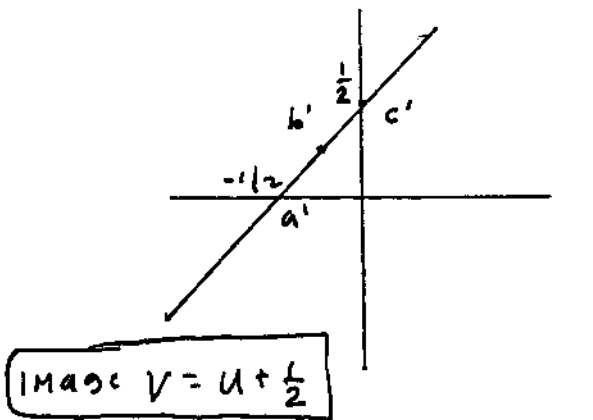
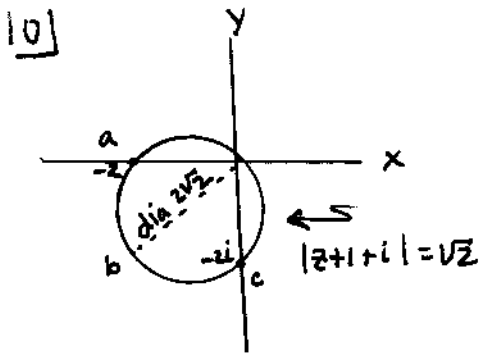
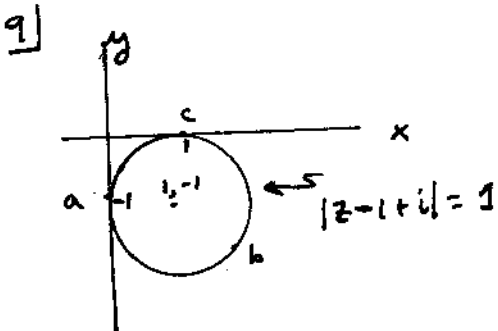
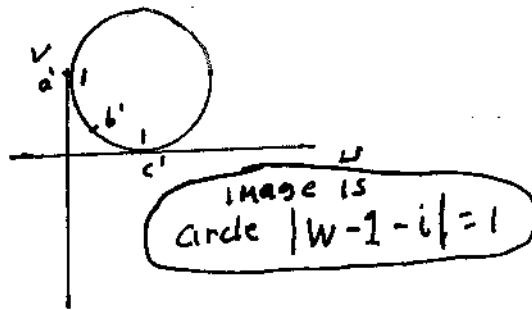
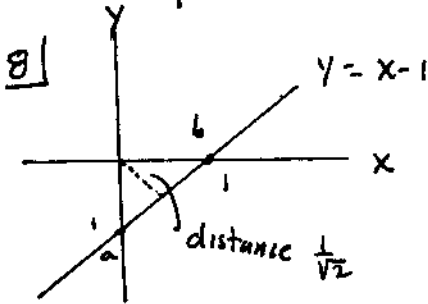
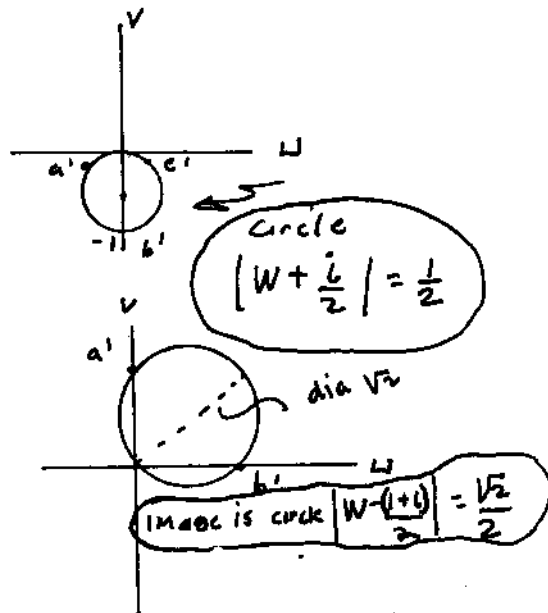
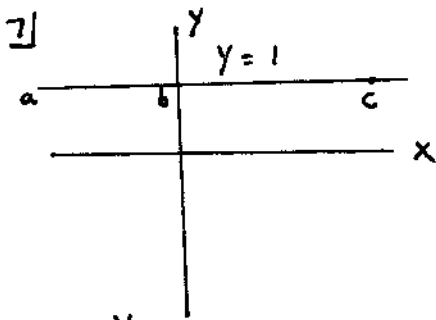

Sec 8.4 Cont'd

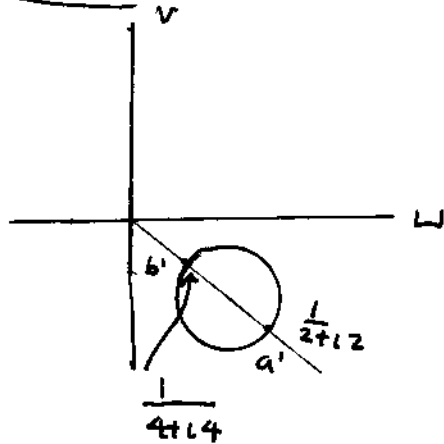
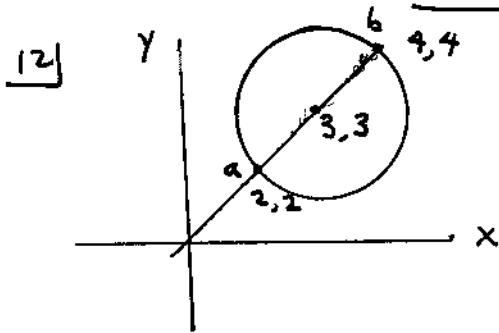

in w, v , plane, radius of

circle is $\frac{1}{2} \left| \frac{1}{2+i2} - \frac{1}{4+i4} \right| = \frac{1}{8\sqrt{2}}$
 center is at $\frac{1}{2} \left(\frac{1}{2+i2} + \frac{1}{4+i4} \right) = \frac{3}{16} (1-i)$

thus answer circle, $\left| w - \frac{3}{16} (1-i) \right| = \frac{1}{8\sqrt{2}}$

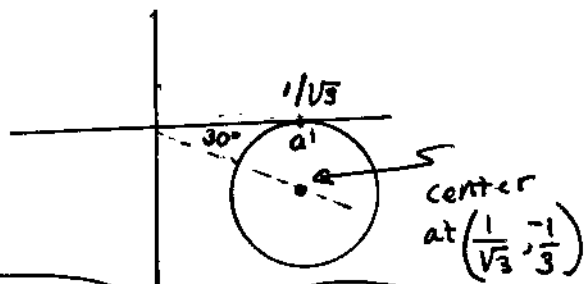
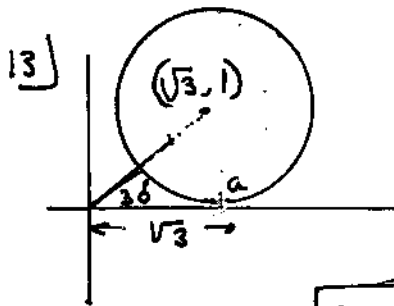
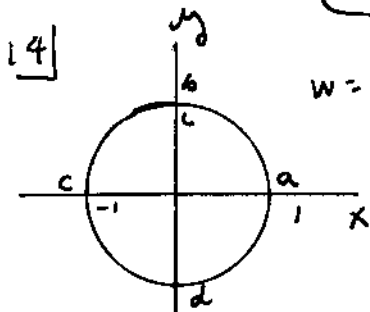

image is circle $\left| w - \left(\frac{1}{\sqrt{3}} - \frac{i}{3} \right) \right| = \frac{1}{3}$



$w = \frac{z+1}{z-1}$

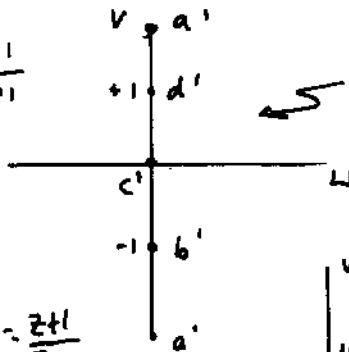
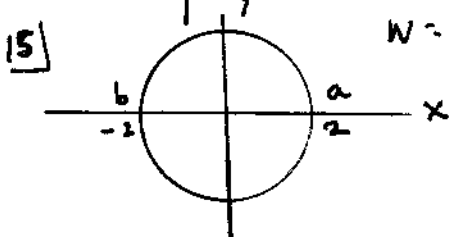
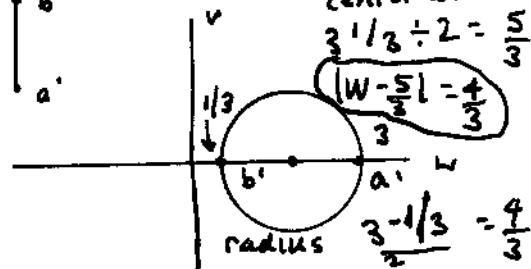

image is line $Re w = 0$



$w = \frac{z+1}{z-1}$



Sec 8.4, cont'd

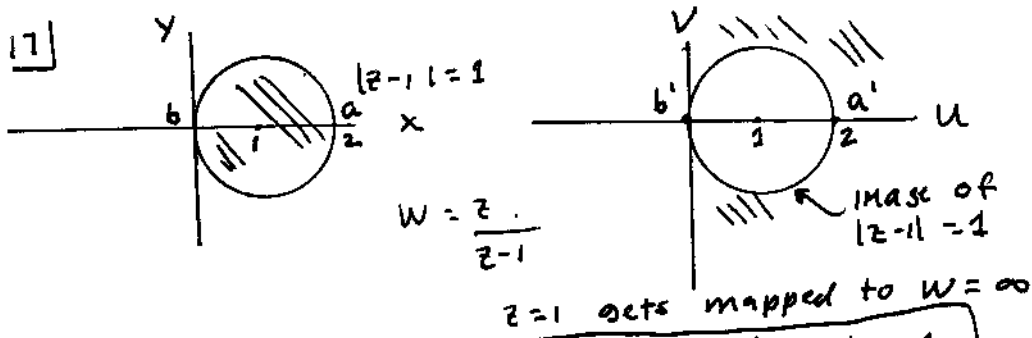
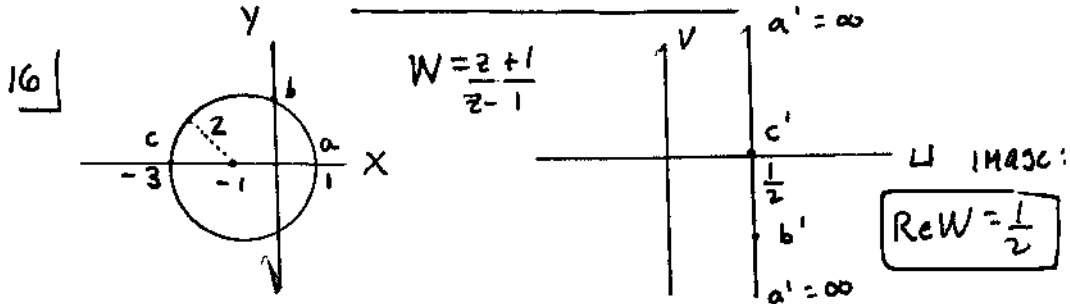

Thus given domain is mapped to $|W-1| > 1$

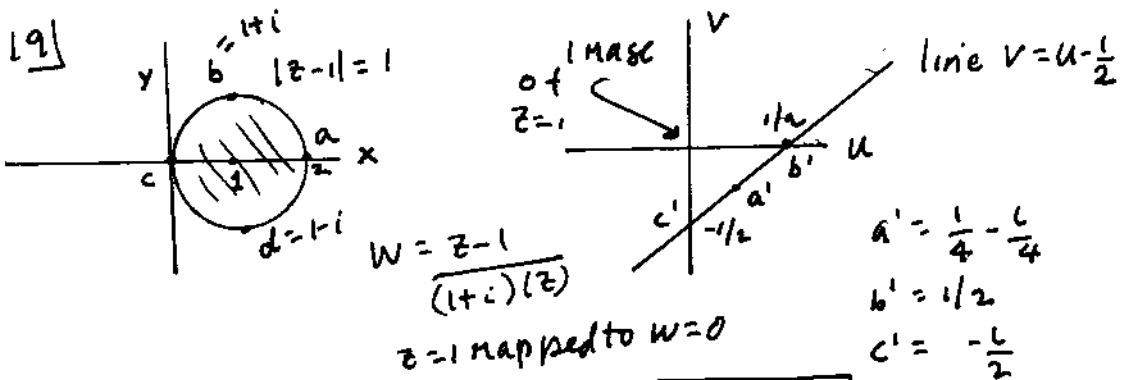
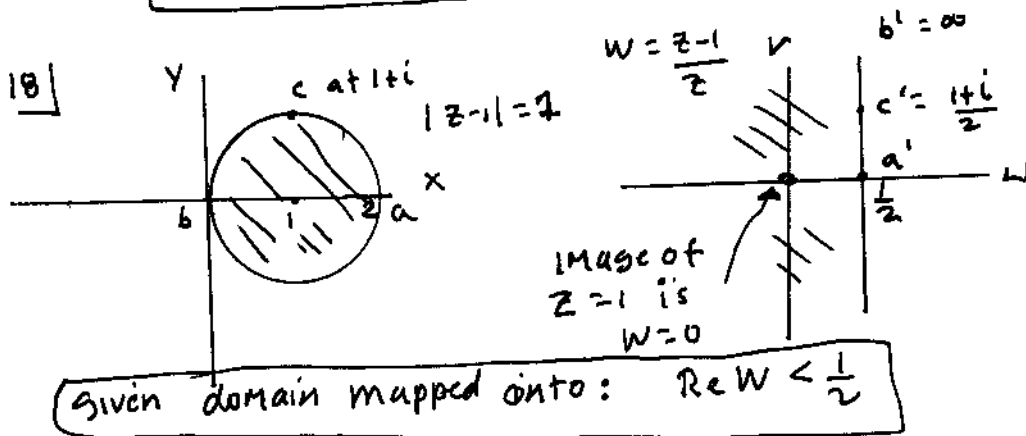

Given domain mapped onto $v > u - \frac{1}{2}$

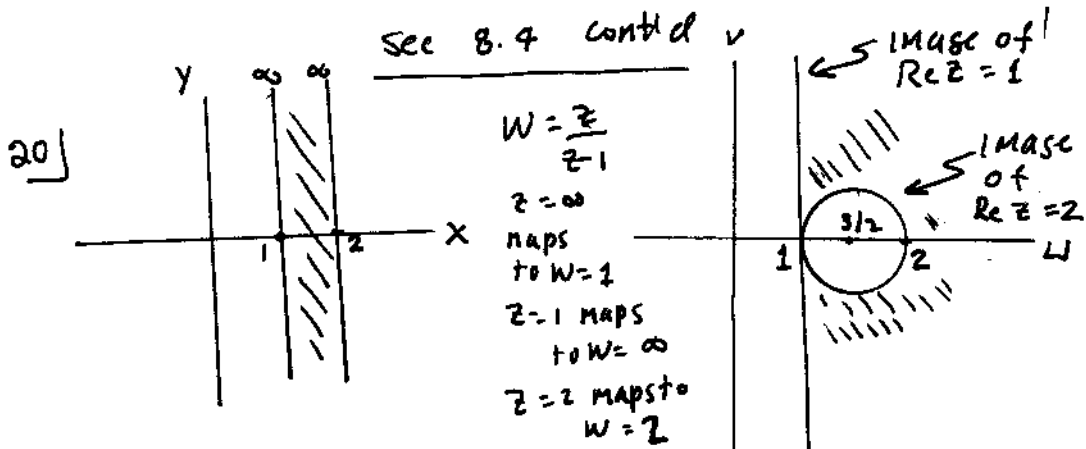
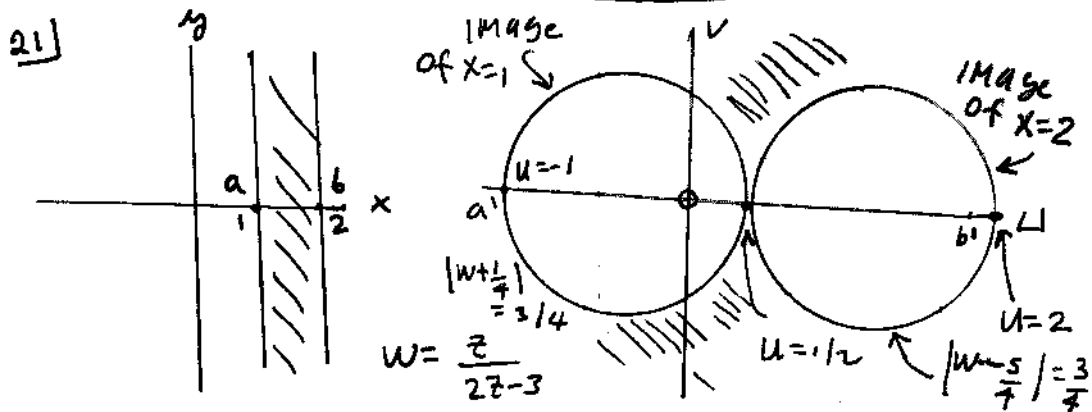
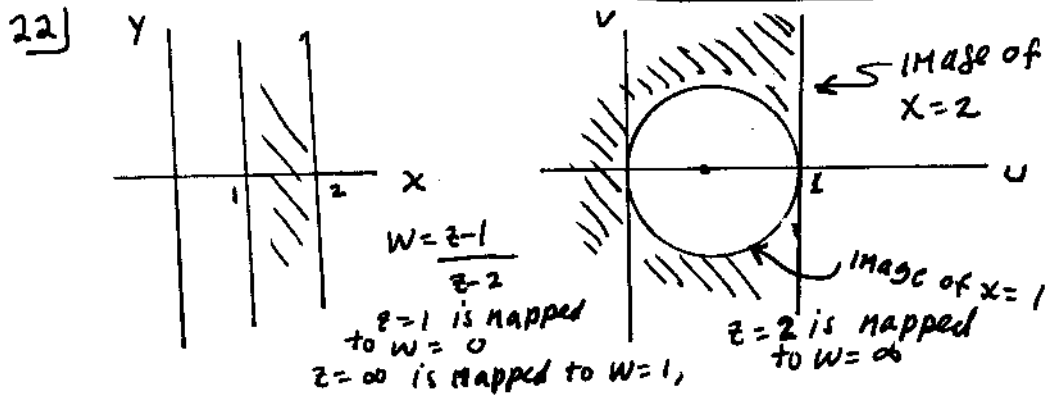

Image of given domain is set of points satisfying both: $\text{Re } W > 1$, and $|W - \frac{3}{2}| > \frac{1}{2}$



$z = \infty$ is mapped to $W = 1/2$; $z = 1$ is mapped to $W = -1$
 $z = 2$ is mapped to $W = 2$

Thus given domain is mapped onto domain satisfying both $|W + \frac{1}{4}| > \frac{3}{4}$ and $|W - \frac{5}{4}| > \frac{3}{4}$



Sec 8.4, cont'd

22) cont'd

Given domain is mapped onto domain satisfying both $\text{Re } W < 1$ and $|W - \frac{1}{2}| > 1$

23) use
$$\frac{(W_1 - W_2)(W_3 - W)}{(W_1 - W)(W_3 - W_2)} = \frac{(z_1 - z_2)(z_3 - z)}{(z_1 - z)(z_3 - z_2)}$$

put $z_1 = 0, z_2 = i, z_3 = -i, W_1 = 1, W_2 = i, W_3 = 2 - i$

get
$$\frac{(1 - i)(2 - i - W)}{(1 - W)(2 - 2i)} = \frac{(-i)(-i - z)}{(-z)(-2i)}$$

Solution:
$$W = (1 + i)z + 1$$

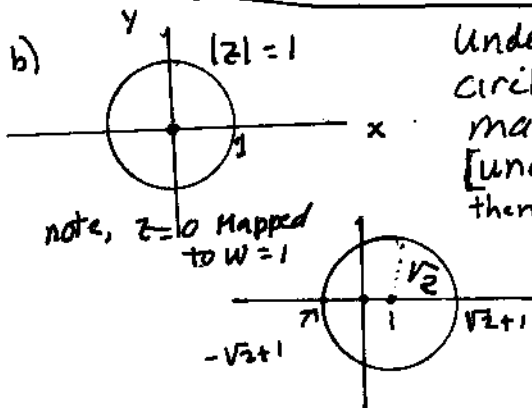

Under the transformation the circle $|z|=1$ has its radius magnified by $|1+i| = \sqrt{2}$. [Under $W = (1+i)z$]. The circle is then displaced one unit to the right.

Image of given domain is $|W-1| < \sqrt{2}$

24) a) Use the formula given in ^{problem} (23) above, but since $W_2 = \infty$, use on left:

$$\Rightarrow \frac{W_3 - W}{(W_1 - W)} = \frac{(1+i)(-i-z)}{(i-z)(-i+1)} = \frac{1-i-W}{1+i-W}$$

Solution:
$$W = \frac{2z}{z+1}$$

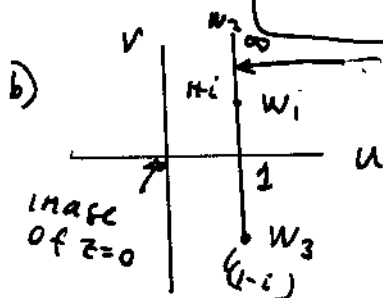

Image of given domain: $\text{Re } W > 1$

sec 8.4 cont'd

25) a) Use formula given in problem 23 but since

$z_1 = \infty$, have:
$$\frac{(w_1 - w_2)(w_3 - w)}{(w_1 - w)(w_2 - w_3)} = \frac{z_3 - z}{z_3 - z_2}$$

Thus:
$$\frac{(1-i)(-i-w)}{(1-w)(-2i)} = \frac{-i-z}{-i-1}$$

Whose solution is
$$w = \frac{z+i-1}{z} = 1 + \frac{i-1}{z}$$

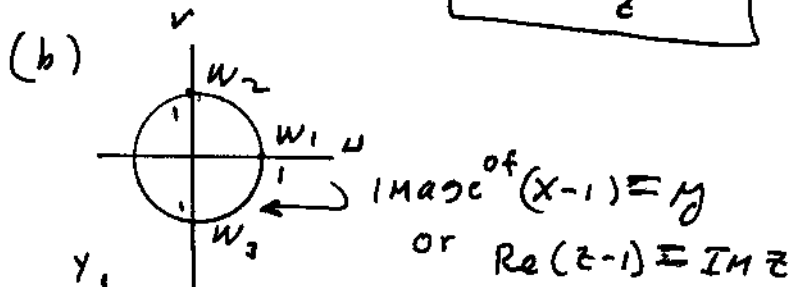

given
Image of ^ domain
 $Re(z-1) > IM z$ is
the domain $|w| < 1$

note: image of $z=0$
is $w = \infty$.

26) a) Use formula given in problem 23, with
 $z_1 = i, z_2 = -i, z_3 = 1; w_1 = 1, w_2 = -1, w_3 = -i$

Get:
$$\frac{(1+i)(-1-w)}{(1-w)(-1+i)} = \frac{(1-i)(1-z)}{(1-z)(1+i)}$$

Solution:
$$w = \frac{i z + 1 - 2i}{z[-2+i] + 1}$$

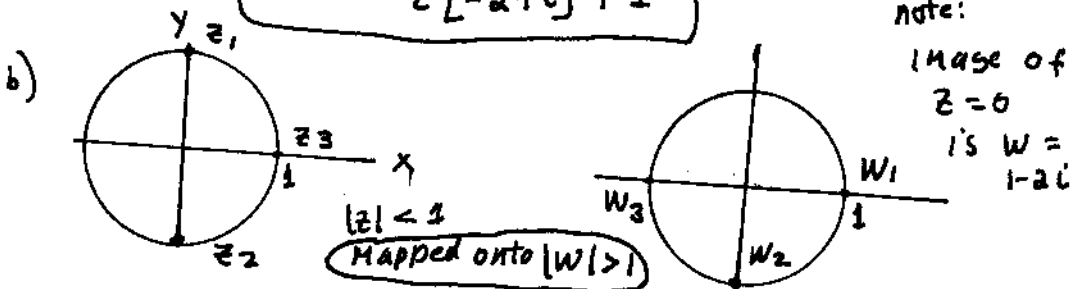

Sec 8.4 Cont'd

27

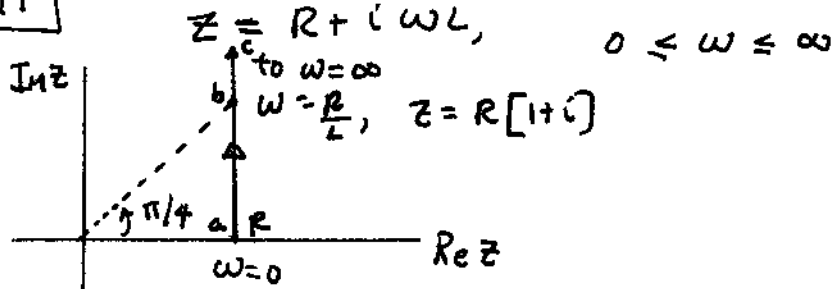

$y = \frac{1}{z}$. Since this is a bilinear transformation, the semi-infinite line shown above must be mapped either into a circular arc or a line segment.

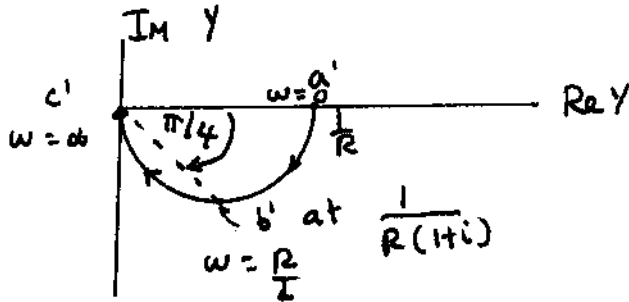

Get semi circle
$y(0) = 1/R$
$y(R/L) = 1/[R(1+i)]$
$y(\infty) = 0$

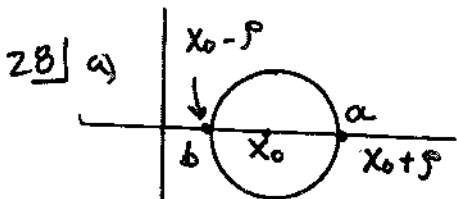

$$a' = \left(\frac{1}{x_0 + p}, 0 \right)$$

$$b' = \left(\frac{1}{x_0 - p}, 0 \right)$$

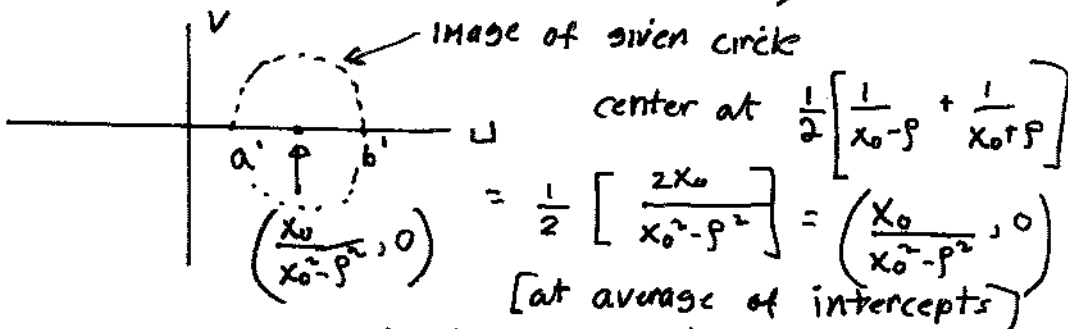

radius is half of distance between a' and b'

$$\frac{1}{2} \left[\frac{2 \cdot p}{|x_0^2 - p^2|} \right] = \frac{p}{|x_0^2 - p^2|}$$

28) cont'd

sec. 8.4 cont'd

(b) No, image of center of orig. circle is $(\frac{1}{x_0}, 0)$ while center of image of orig. circle is: $(\frac{x_0}{x_0^2 - p^2}, 0)$. These not the same since $p > 0$.

(c) In general no, since general bilinear transf. contains an inversion

(d) $|z - z_0| = \rho, W = az + b \quad z = \frac{W - b}{a}$

thus set $|\frac{W - b}{a} - z_0| = \rho$ or $|a| |\frac{W - b}{a} - z_0| = \rho |a|$

or $|a| (\frac{W - b}{a} - z_0) = \rho |a|$ or $|W - b - az_0| = \rho |a|$

The last equation describes a circle in the w plane. Center is at $az_0 + b$, radius $\rho |a|$. g.e.d.

29) $W_1 = \frac{a_1 z + b_1}{c_1 z + d_1}$, use this in the second transformation:

$$W = \frac{a_2 \left[\frac{a_1 z + b_1}{c_1 z + d_1} \right] + b_2}{c_2 \left[\frac{a_1 z + b_1}{c_1 z + d_1} \right] + d_2} = \frac{a_2 [a_1 z + b_1] + b_2 [c_1 z + d_1]}{c_2 [a_1 z + b_1] + d_2 [c_1 z + d_1]}$$

$$= z [a_1 a_2 + b_2 c_1] + a_2 b_1 + b_2 d_1$$

$$\frac{z [a_1 a_2 + b_2 c_1] + a_2 b_1 + b_2 d_1}{c_2 [a_1 z + b_1] + d_2 [c_1 z + d_1]}$$

thus:

$$a = a_1 a_2 + b_2 c_1 \quad \text{and} \quad b = a_2 b_1 + b_2 d_1$$

$$c = a_1 c_2 + c_1 d_2 \quad \text{and} \quad d = b_1 c_2 + d_1 d_2$$

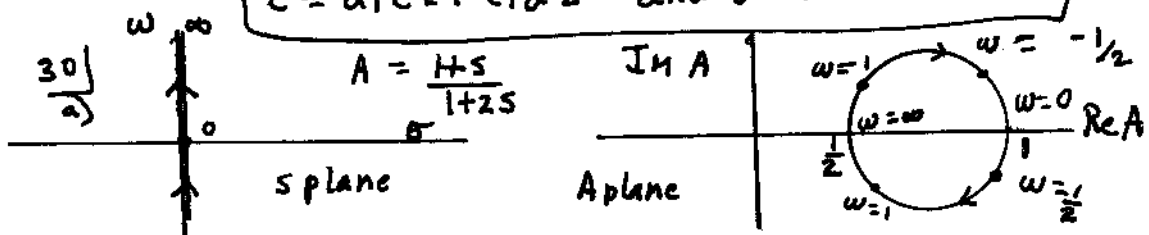

sec 8.4 cont'd

30 a) cont'd The given line is the s plane must be mapped into a circle. If $w=0$

$A=1$, if $w \rightarrow \infty$ $A \rightarrow \frac{1}{2}$

If $s = \pm i$, then $A = .6 \mp i.2$ (when $w=1$)

If $s = \pm \frac{i}{2}$ [or $w = \pm \frac{1}{2}$] then $A = .75 \mp i.25$

Locus, : circle center at (.75, 0) radius .25

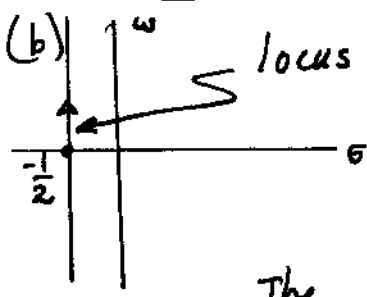

equation: $|A - .75| = 1/4$

$A = \frac{1+s}{1+2s}$. Note that if $s = -\frac{1}{2}$, then $A = \infty$.

The locus in s plane passes thru $s = -1/2$. Thus the locus in the s plane must be transformed into a line (which passes thru $A = \infty$). The locus in the

A plane must also pass thru $A = 1/2$

(when $w = \infty$) Af $s = -\frac{1}{2} \pm i$, $A = \frac{1}{2} \mp \frac{1}{4}i$

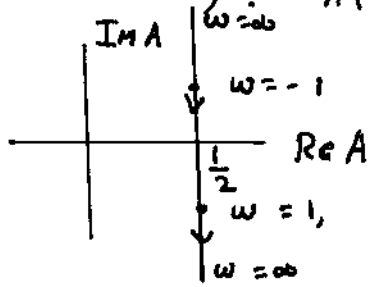

locus in A plane
Re A = 1/2

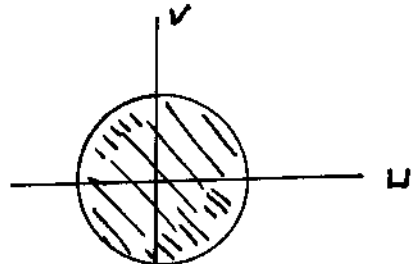
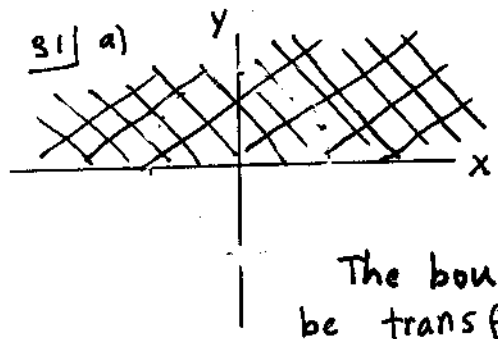

The boundary of $Im z > 0$ must be transformed into the boundary of the disc, i.e. into $|w|=1$
cont'd next pg.

sec 8.4 cont'd

31(a) cont'd As $z \rightarrow \infty$ along the line $y=0$ the corresponding image point in the w plane must continue to lie on $|w|=1$. Thus

$$\lim_{z \rightarrow \infty} \left| \frac{a}{c} \right| \left| \frac{z+b/a}{z+d/c} \right| = \lim_{z \rightarrow \infty} \left| \frac{a}{c} \right| \lim_{z \rightarrow \infty} \left| \frac{z+b/a}{z+d/c} \right|$$

$$= \left| \frac{a}{c} \right| = 1. \text{ Since } \left| \frac{a}{c} \right| = 1, \text{ then } \frac{a}{c} = e^{i\delta} \quad [\delta \text{ is real}]$$

(b) $\left| x + \frac{d}{c} \right| = \left| x + \frac{b}{a} \right|$ setting $x=0$ we

see that $\left| \frac{d}{c} \right| = \left| \frac{b}{a} \right|$.

Now $\left| x + \frac{d}{c} \right| = \left| x + \frac{b}{a} \right| \Rightarrow \left| x + \frac{d}{c} \right|^2 = \left| x + \frac{b}{a} \right|^2$

or $(x + \frac{d}{c})(\bar{x} + \overline{\frac{d}{c}}) = (x + \frac{b}{a})(\bar{x} + \overline{\frac{b}{a}})$

or $|x|^2 + \bar{x} \frac{d}{c} + x \overline{\frac{d}{c}} + \left| \frac{d}{c} \right|^2 = |x|^2 + \bar{x} \frac{b}{a} + x \overline{\frac{b}{a}} + \left| \frac{b}{a} \right|^2$

Since $\left| \frac{d}{c} \right| = \left| \frac{b}{a} \right|$ this reduces to:

$$\bar{x} \frac{d}{c} + x \overline{\frac{d}{c}} = \bar{x} \frac{b}{a} + x \overline{\frac{b}{a}}. \text{ Now } x = \bar{\bar{x}}$$

Thus $x \left[\overline{\frac{d}{c}} + \frac{d}{c} \right] = x \left[\overline{\frac{b}{a}} + \frac{b}{a} \right]$

or $\operatorname{Re} \left[\frac{d}{c} \right] = \operatorname{Re} \left[\frac{b}{a} \right]$. Since $\left| \frac{d}{c} \right| = \left| \frac{b}{a} \right|$ it

follows that either $\operatorname{Im} \left[\frac{d}{c} \right] = \operatorname{Im} \left[\frac{b}{a} \right]$ or

$\operatorname{Im} \left[\frac{d}{c} \right] = -\operatorname{Im} \left[\frac{b}{a} \right]$. Thus either $\frac{d}{c} = \frac{b}{a}$

or $\frac{d}{c} = \overline{\left(\frac{b}{a} \right)}$. But we must discard $\frac{d}{c} = \frac{b}{a}$

otherwise we get $w = e^{i\delta}$ which is of no interest (the w plane gets mapped into a point).

Hence we require $\frac{d}{c} = \overline{\left(\frac{b}{a} \right)}$.

sec 8.4 cont'd

31) cont'd

c) We take $\text{Im } p > 0$ so that the point $z = p$ in the space $\text{Im } z > 0$ will be mapped inside $|W| = 1$. If $\text{Im } p < 0$ then the point $z = p$ in the ^{half}space $\text{Im } z < 0$ will be mapped inside $|W| = 1$, which we don't want. Note that we cannot have $\text{Im } p = 0$, for this implies $\frac{d}{c} = \frac{b}{a}$ as described in (b).

d) If $\text{Im } p < 0$, then the ^{half}space $\text{Im } z < 0$ is mapped onto $|W| < 1$ while the space $\text{Im } z > 0$ is **mapped onto $|W| > 1$.**

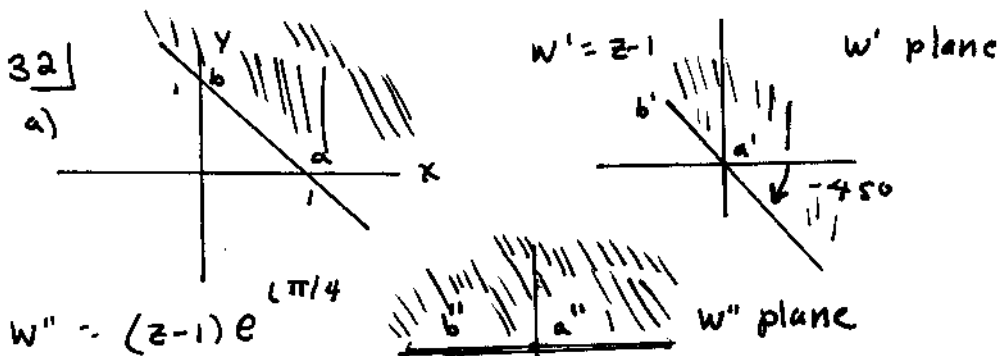

Now use Eqn (8.4-34) with $\gamma = 0$, $p = i$

Use w'' in lieu of z . Thus:

$$W = \frac{(z-1)e^{i\pi/4} - i}{(z-1)e^{i\pi/4} + i}$$

note: there is no unique solution

Check: put $z = 2$, where is this mapped:

$$W = \frac{e^{i\pi/4} - i}{e^{i\pi/4} + i} = -i[\sqrt{2}-1] \text{ which is inside unit circle.}$$

(b) Follow same steps as in (a), use Eqn (8.4-34) but take $p = -i$ (thus $\text{Im } p < 0$).

$$W = \frac{(z-1)e^{i\pi/4} + i}{(z-1)e^{i\pi/4} - i}$$

33

a)

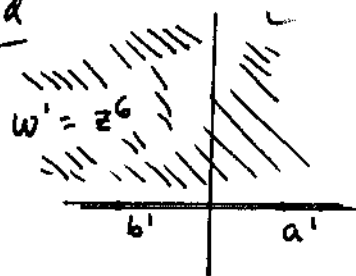
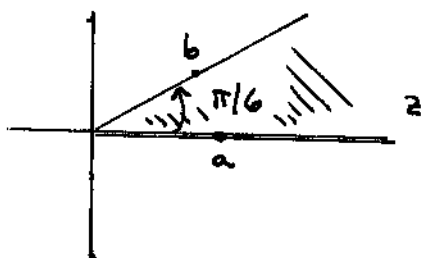

Now use Eqn. (8.4-34), prob. 31 with w' in lieu of z . $\delta=0, \rho=i$

$$W = \frac{z^6 - i}{z^6 + i}$$

(b)

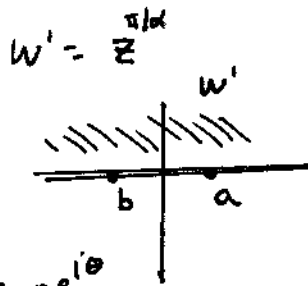
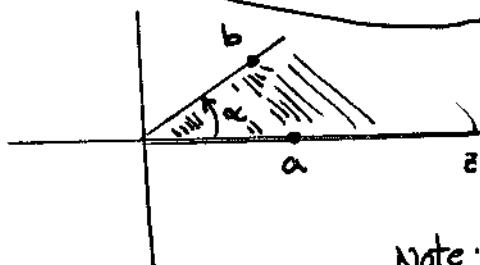

Note: if $z = r e^{i\theta}$
 $0 \leq \theta \leq \alpha$
 then $w' = r^{\pi/\alpha} e^{i \frac{\pi\theta}{\alpha}}$

Now use Eqn (8.4-34) as in a

$$W = \frac{w' - i}{w' + i} = \frac{z^{\pi/\alpha} - i}{z^{\pi/\alpha} + i}$$

34(a) Use bilinear transformation; map from z -plane to w' -plane:

$$\frac{(w_1 - w_2)(w_3 - w')}{(w_1 - w')(w_3 - w_2)} = \frac{(z_1 - z_2)(z_3 - z')}{(z_1 - z')(z_3 - z_2)}$$

Now letting $w_1 \rightarrow \infty$

$$\left(\frac{w_3 - w'}{w_3 - w_2} \right) = 1 - w' = \frac{(2i\sqrt{3})(1-z)}{(i\sqrt{3}-z)(1+i\sqrt{3})}$$

The solution of this is

$$w' = e^{-i 2\pi/3} \frac{(z + i\sqrt{3})}{z - i\sqrt{3}}$$

The arc passing thru $z_1, -1$ and z_2 must be transformed into a straight line segment passing thru ∞ . The arc thru $z_2, 1, z_1$ must be transformed into a line segment passing thru ∞ . The pair of lines must emanate

Sec 8.4 Cont'd

34) a) cont'd

from the image of z_2 , i.e. $w'=0$, and the second line segment just mentioned should pass thru 0 and 1, and thus occupy the non-negative real axis in the w' plane. In Fig 8.4-11(a) the acute angle between the arcs meeting at z_1 must be preserved as α in Fig 8.4-11 (b). (follows from conformal property) From elementary plane geometry we see that $\alpha = 120^\circ = \frac{2\pi}{3}$

see that $\alpha = 120^\circ = \frac{2\pi}{3}$

(b) $w' = e^{-i2\pi/3} \frac{i\sqrt{3}}{-i\sqrt{3}} = e^{i\pi/3}$ This lies inside the wedge. Thus the whole oval maps onto the sector.

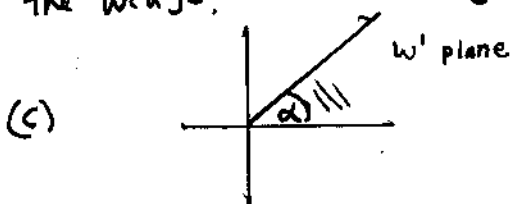

From problem 33, $w = (w')^{\pi/\alpha}$ will map this wedge onto upper half of w plane. Combining this with the transformation of part (a) (where $\alpha = 2\pi/3$)

$$w = \left[e^{-i\frac{2\pi}{3}} \frac{(z+i\sqrt{3})}{z-i\sqrt{3}} \right]^{\frac{\pi}{\frac{2}{3}\pi}} = \left[e^{-i\frac{2\pi}{3}} \right]^{3/2} \left[\frac{z+i\sqrt{3}}{z-i\sqrt{3}} \right]^{3/2}$$

or $w = (-1) \left[\frac{z+i\sqrt{3}}{z-i\sqrt{3}} \right]^{3/2}$

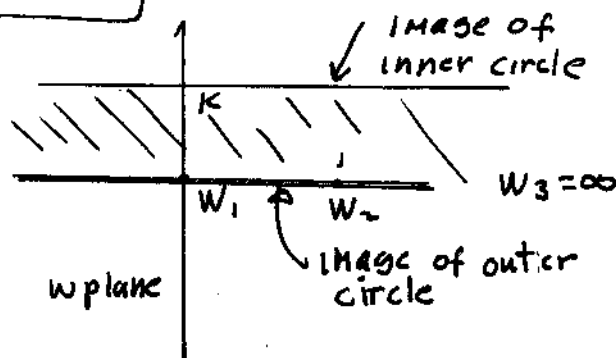
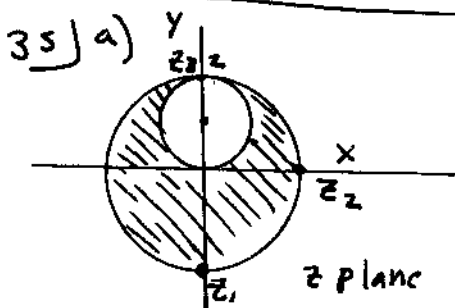

sec 8.4 cont'd

35] cont'd (Refer to bottom, prev. pg.)

Since the two circles intersect at only $z=2i$ their images will intersect only at the image of $z=2i$, namely $w=\infty$. Since their images are 2 lines intersecting only at ∞ , these lines must be parallel.

For the mapping use cross-ratio:

$$\frac{(w_1 - w_2)(w_3 - w)}{(w_1 - w)(w_3 - w_2)} = \frac{(z_1 - z_2)(z_3 - z)}{(z_1 - z)(z_3 - z_2)} = \frac{w_1 - w_2}{w_1 - w}$$

since $w_3 = \infty$

or $\frac{-1}{-w} = \frac{(-2i - 2)(2i - z)}{(-2i - z)(2i - 2)}$ whose solution is:

or $W = \frac{(-i)(z + 2i)}{z - 2i}$

If $z=0, w=i$

thus $K=1$

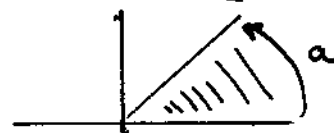
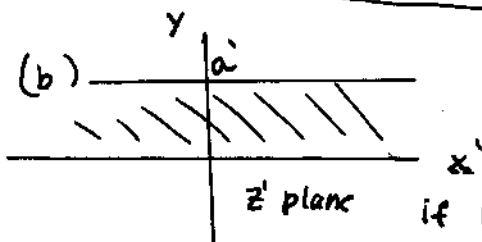

if $w = e^z$ (see example 2, sec 8.3)

In our present situation, $a=1$, we want the wedge on the above right to have angle π

Thus use $W = e^{\pi z'}$ where $z' = -i \frac{(z+2i)}{(z-2i)}$ found in (a). Thus use:

$W = e^{-\pi i (z+2i)/(z-2i)}$

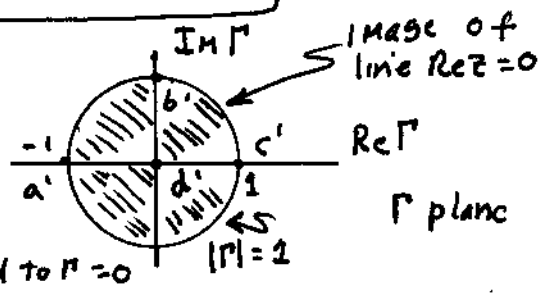
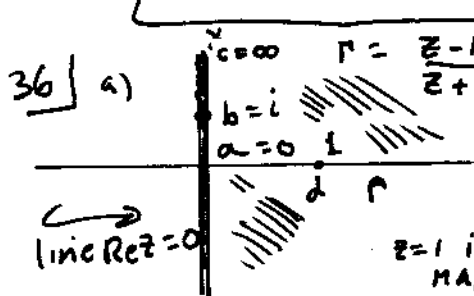

$z=1$ is mapped to $\Gamma=0$

Sec 8.4 cont'd

36) (b) From part (a), image of $r=0$ is $|\Gamma|=1$

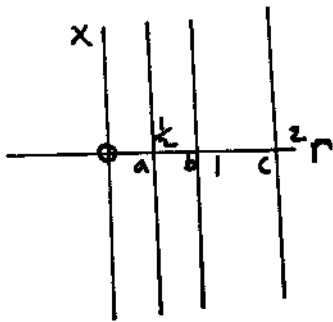

all of these ^{vertical} lines pass thru $z=\infty$. Thus their images all intersect at

$$\Gamma = \frac{z-1}{z+1} \Big|_{z=\infty} = -1$$

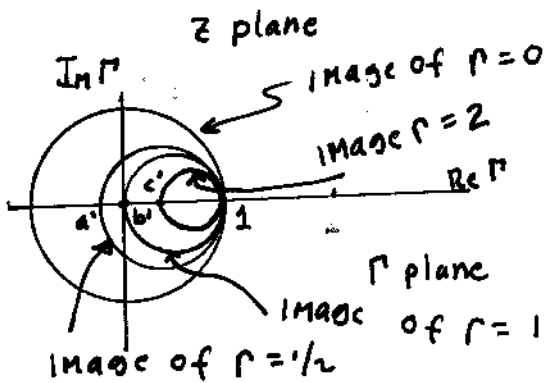

$$a' = \frac{\frac{1}{2}-1}{\frac{1}{2}+1} = -\frac{1}{3}$$

$$b' = \frac{1-1}{1+1} = 0$$

$$c' = \frac{2-1}{2+1} = \frac{1}{3}$$

$r=0$ has image $|\Gamma|=1$
 $r=\frac{1}{2}$ has image $|\Gamma-\frac{1}{3}|=\frac{2}{3}$
 $r=1$ has image $|\Gamma-\frac{1}{2}|=\frac{1}{2}$
 $r=2$ has image $|\Gamma-\frac{2}{3}|=\frac{1}{3}$

(c)

$$\Gamma = \frac{z-1}{z+1}, \quad \Gamma = \frac{r+jx-1}{r+jx+1}, \quad \text{if } x=0, \quad \Gamma = \frac{r-1}{r+1}$$

As r goes from 0 to ∞ , Γ remains real and goes from -1 to 1

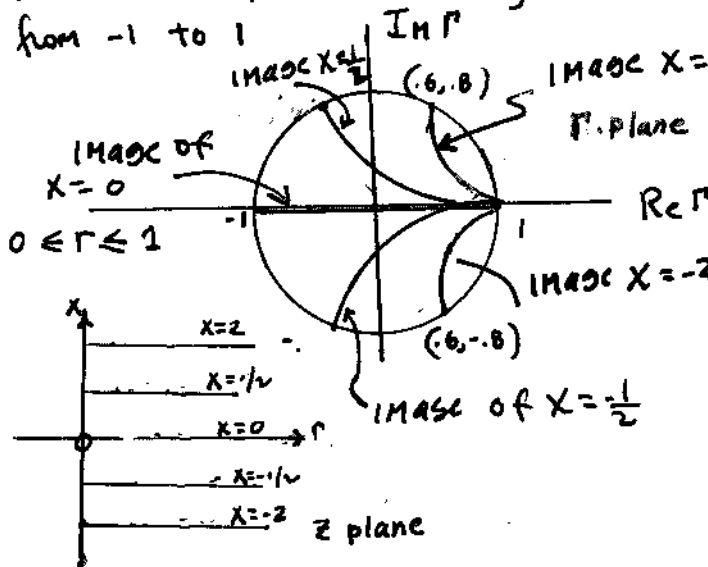

$x=\frac{1}{2}$ is transformed into arc on circle $|\Gamma-1-2i|=2$

The arc connects $-b \pm b i$ with $|\Gamma|=1$

$x=-\frac{1}{2}$ is transformed into the conjugate of the preceding arc

$x=2$ is transformed into arc on $|\Gamma-1-5i|=1/2$

The arc connects $\Gamma=.6 \pm .8i$ with $|\Gamma|=1$

Sec 8.4 cont'd

3.6 (d) Cont'd

$$\Gamma - 1 = \frac{-2}{z+1}$$

Note that $\Gamma = \frac{z-1}{z+1} = 1 - \frac{2}{z+1}$.

$$\boxed{z = \frac{1+\Gamma}{1-\Gamma}}$$

if $z(\Gamma) = \frac{1+\Gamma}{1-\Gamma}$, then $z(-\Gamma) = \frac{1-\Gamma}{1-(-\Gamma)} = \frac{1-\Gamma}{1+\Gamma}$
 thus $z(\Gamma) = 1/z(-\Gamma)$

Sec 8.5

1) a) $\psi = \frac{-100M}{x^2+y^2} = \beta$, $\frac{-100M}{\beta} = x^2+y^2$

$x^2+y^2 + \frac{100M}{\beta} = 0$ compl. square

$x^2 + \left(y + \frac{50}{\beta}\right)^2 = \frac{2500}{\beta^2}$

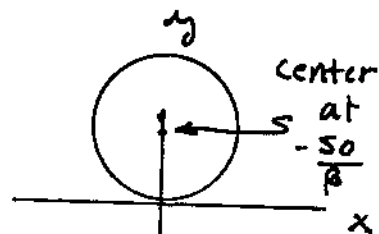

drawings for case $\beta < 0$

(b)

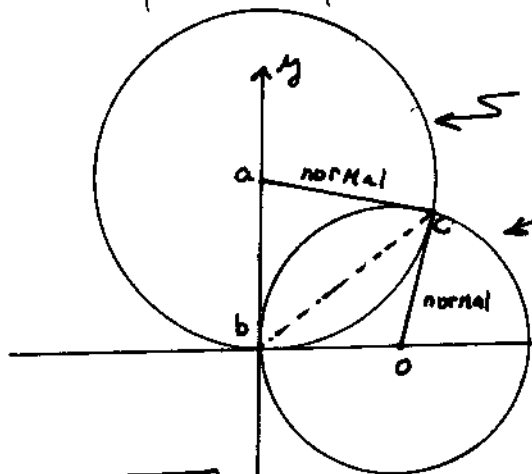

streamline

isotherm

$\angle abo = 90^\circ$

$\angle abc + \angle cbo = 90^\circ$

$\angle abc = \angle acb$ (isosceles Δ)

$\angle cbo = \angle bco$ (" ")

$\angle acb + \angle bco = \angle abc + \angle cbo = 90^\circ$

$\angle acb + \angle bco = \angle aco$

$\angle aco = 90^\circ$

We must show that the normals to each curve intersect at right angles at c

Sec 85. Cont'd

2]

a)

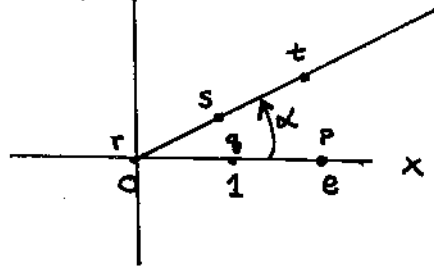

$$u + iv = \text{Log}|z| + i \arg z$$

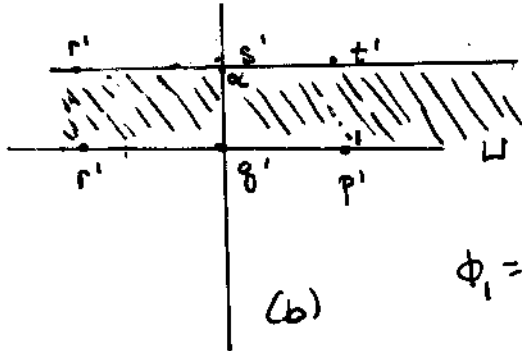

(b)

applying b. conditions

$$\phi_1 = AN + B, \quad \phi_1(0) = T_1 = B$$

$$\phi_1(\alpha) = A\alpha + B$$

Thus

$$\boxed{B = T_1, \quad A = \frac{T_2 - T_1}{\alpha}}$$

c) $\phi_1 = AN + B, \quad N = \arg z = \tan^{-1} \frac{y}{x}$

$$\phi_1 = A \tan^{-1} \frac{y}{x} + B = \frac{T_2 - T_1}{\alpha} \tan^{-1} \frac{y}{x} + B \quad \text{q.e.d.}$$

(d) $\phi_1 = AN + B, \quad \phi_1 = \text{Re } \Phi, \quad A \text{ and } B \text{ are real.}$

thus $\phi_1 = \text{Re} [-iAW + B], \quad W = u + iv$

Thus $\Phi = -iAW + B = -i \left[\frac{T_2 - T_1}{\alpha} \right] W + T_1$

Now put $W = \text{Log } z$

(e) $\Phi = -i \left[\frac{T_2 - T_1}{\alpha} \right] [\text{Log}|z| + i \arg z] + T_1$

$$\phi = \text{Re } \Phi = \frac{T_2 - T_1}{\alpha} \tan^{-1} \frac{y}{x} + T_1, \quad \text{isotherms}$$

are rays on which $\tan^{-1} \frac{y}{x}$ are constant

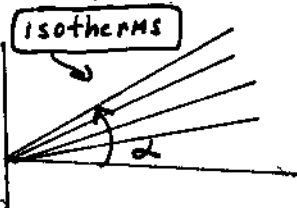

$$\psi = \text{Im } \Phi =$$

$$-\frac{(T_2 - T_1)}{\alpha} \text{Log} \sqrt{x^2 + y^2}$$

rays emanating from (0,0)

Sec 8.5 cont'd

2 (e) cont'd: streamlines are lines on which $\sqrt{x^2+y^2}$ are constant. These are arcs on circles centered at origin.

3] Using $w = -1/z$, we map the given configuration as follows:

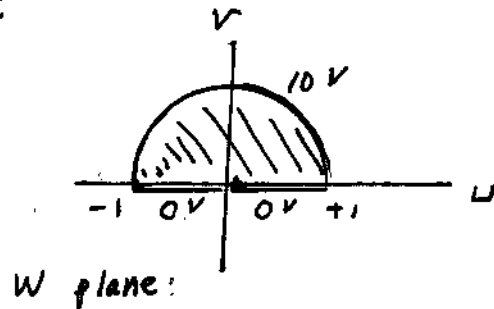
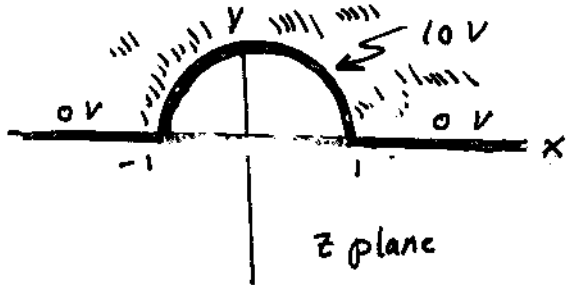

Now use Eq (8.5-21) and Eq (8.5-19) to get potential in config. on the above right. Note that we must swap z and w [See Fig 8.5-4(a) and compare with Fig. on above right]. Thus:

$\Phi_1(w) = \frac{-10i}{\pi} \text{LOS} \left[\frac{1+w}{1-w} \right]^2$ for solution in w plane above

To get $\Phi(z)$ for above left, put $w = -1/z$.

Thus $\Phi(z) = \frac{-10i}{\pi} \left[\text{LOS} \left(\frac{1-1/z}{1+1/z} \right)^2 \right] = \frac{-20i}{\pi} \text{LOS} \left[\frac{z-1}{z+1} \right]$

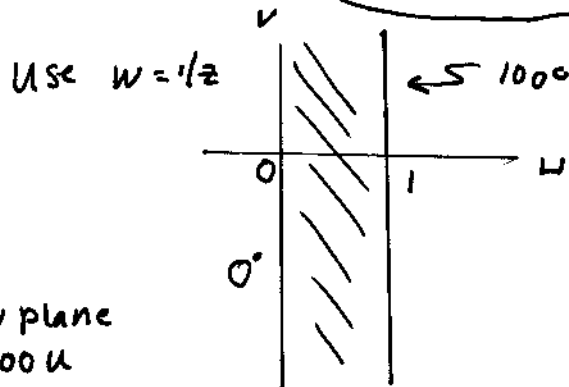
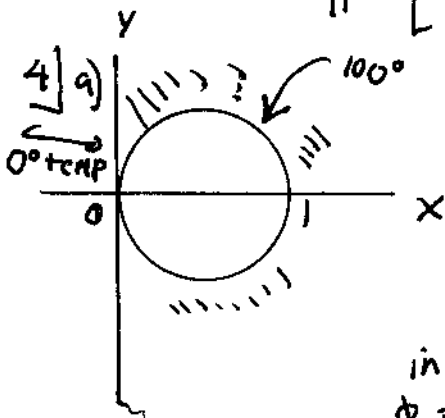

in w plane
 $\Phi = 100u$

Thus $\Phi_1 = 100w$, $w = u+iv$, $\Psi_1 = 100v$

Sec 8.5, cont'd

a) cont'd

$$V = \frac{-y}{x^2+y^2}$$

$$u+iv = \frac{1}{x+iy} = \frac{x-iy}{x^2+y^2}, \quad u = \frac{x}{x^2+y^2}$$

$$\Phi_1 = 100u = \frac{100x}{x^2+y^2} \quad \text{p.e.d.}$$

(b) $\Psi_1 = 100v$, from part (a) $V = \frac{-y}{x^2+y^2}$, $\Psi = \frac{-100y}{x^2+y^2}$

(c) from (a), $\Phi_1 = 100u$, $\Phi(z) = \frac{100}{z}$

$$\begin{aligned} g &= -k \overline{\left(\frac{d\Phi}{dz}\right)} = -k \overline{\left(\frac{-100}{z^2}\right)} = \left(\frac{k}{z^2}\right) 100 = \\ &= 100k \left[\frac{1}{x^2-y^2+i2xy} \right] = \frac{100k}{|z|^4} \frac{x^2-y^2-i2xy}{1} \\ &= 100k \frac{[x^2-y^2+i2xy]}{(x^2+y^2)^2} \end{aligned}$$

5] Use a bilinear transformation.

Using cross-ratio Eqn (8.4-24):

$$\begin{aligned} \frac{(w_1-w_3)(w_2-w_4)}{(w_1-w_4)(w_2-w_3)} &= \frac{(z_1-z_3)(z_2-z_4)}{(z_1-z_4)(z_2-z_3)} = \\ &= (\text{since } z_4 = \infty) = \frac{z_1-z_2}{z_3-z_2} \end{aligned}$$

Thus $z_3 = 0, w_3 = -p; z_2 = H-R, w_2 = -1;$

$z_1 = H+R; w_1 = 1; z_4 = \infty, w_4 = p$

$$\frac{(z_1-z_3)(z_2-z_4)}{(z_1-z_4)(z_2-z_3)} = \frac{z_1 z_2}{z_1 z_3} \quad \text{this can be rearranged to:}$$

$$p^2 - 2p \frac{H}{R} + 1 = 0, \quad p = \frac{H}{R} \pm \sqrt{\frac{H^2}{R^2} - 1}$$

we choose + sign since $p > 1$, thus $p = \frac{H}{R} + \sqrt{\frac{H^2}{R^2} - 1}$

Sec 8.5 cont'd

s) cont'd

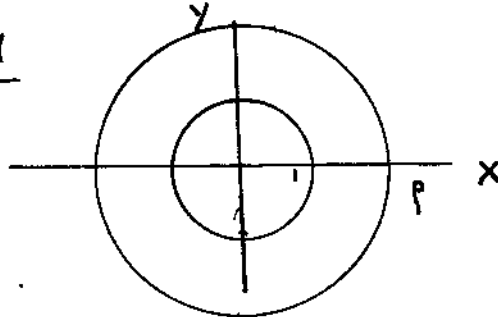

Use Eqn.

$$(8.5-32) \quad C = \frac{2\pi \epsilon}{\text{Log } \rho} = \frac{2\pi \epsilon}{\text{Log} \left[\frac{H}{R} + \sqrt{\frac{H^2}{R^2} - 1} \right]} \quad \text{B.c.d.}$$

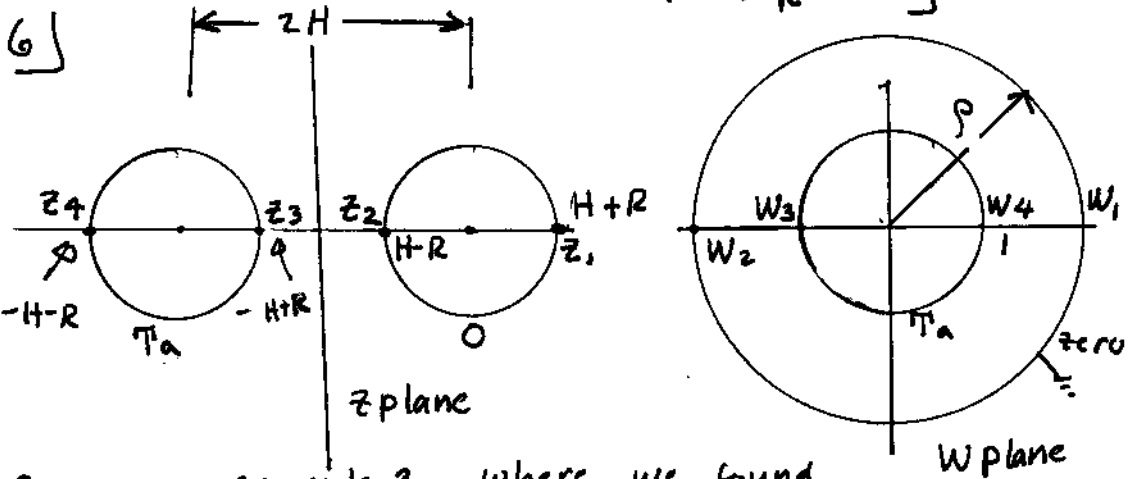

Refer to example 3, where we found that $\rho = \left(\frac{H}{R} + \sqrt{\frac{H^2}{R^2} - 1} \right)^2$. Now use the bilinear transformation, Eq. (8.4-27)

$$\text{Get } \frac{(z\rho)(-1-w)}{(\rho-w)(-1+\rho)} = \frac{(zR)(-H+R-z)}{(H+R-z)(-H+R-(H-R))}$$

Solve for w:

$$w = \frac{-\rho[H+R-z][2H+2R] + R[R-H-z]\rho(1-\rho)}{\rho(H+R-z)(-2H+2R) + (1-\rho)R(R-H-z)} \quad (1)$$

Use Eqn (8.5-30) in the w plane to solve for complex potential on the above right configuration. Thus $\Phi(w) = T_a \frac{\text{Log} [b/w]}{\text{Log} \left(\frac{b}{a} \right)}$

Put $b = \rho, a = 1$

Sec 8.5 cont'd

Sec 8.5 | 6 cont'd

$$\Phi_1(w) = \frac{\tau_a \operatorname{Log} \left[\frac{p}{w} \right]}{\operatorname{Log} p}, \quad \phi(w) = \frac{\tau_a \operatorname{Log} \frac{p}{|w|}}{\operatorname{Log} p} = \operatorname{Re} \Phi$$

$$\phi_1(w) = \frac{\frac{\tau_a}{2} \operatorname{Log} \frac{p^2}{|w|^2}}{\operatorname{Log} p}, \quad \text{Now use eqn(1) on previous pg. put } H=2, R=1$$

Get $w = \frac{z(p^2 - 3p) + p^2 + 5p}{z(3p-1) - 5p - 1}$ Now (see prev. pg.)

$$p = \left(\frac{H}{R} + \sqrt{\frac{H^2}{R^2} - 1} \right)^2 = (2 + \sqrt{3})^2 = 7 + 4\sqrt{3}$$

$$p^2 = 97 + 56\sqrt{3}, \quad 3p = 21 + 12\sqrt{3}, \quad p^2 - 3p = 76 + 44\sqrt{3}$$

$$3p - 1 = 20 + 12\sqrt{3}, \quad 5p + 1 = 36 + 20\sqrt{3}$$

Thus using above eqn. for w:

$$w = \frac{z [76 + 44\sqrt{3}] + 132 + 76\sqrt{3}}{z (20 + 12\sqrt{3}) - 36 - 20\sqrt{3}}$$

put $z = x + iy$

$$|w|^2 = \frac{(x(76 + 44\sqrt{3}) + 132 + 76\sqrt{3})^2 + y^2(76 + 44\sqrt{3})^2}{(x(20 + 12\sqrt{3}) - 36 - 20\sqrt{3})^2 + y^2(20 + 12\sqrt{3})^2}$$

$$\phi_1(w) = \phi(w(x,y)) = \frac{\tau_a}{2} \frac{\operatorname{Log} \frac{p^2}{|w|^2}}{\operatorname{Log} p}$$

where p and $|w|^2$ are given above.

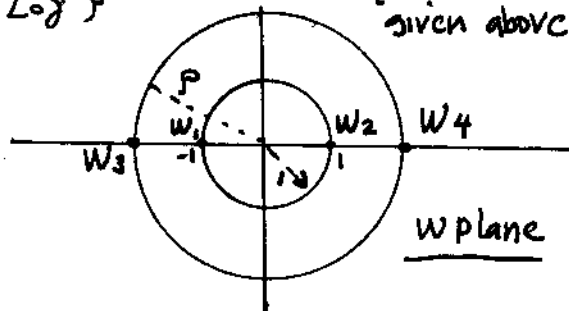
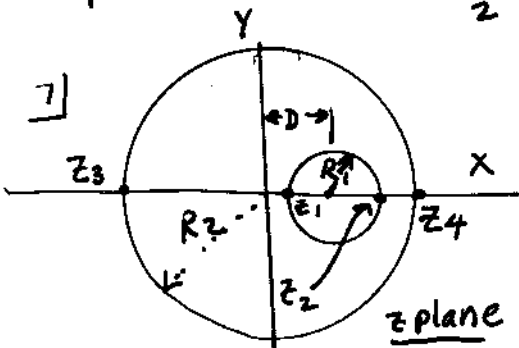

sec 8.5 cont'd

7) cont'd refer to bott. previous pg.

take $w_1 = -1, w_2 = 1, w_3 = -\rho, w_4 = \rho$

$z_1 = D - R_1, z_2 = D + R_1, z_3 = -R_2, z_4 = R_2$

Use bilinear transform. $\frac{(w_1 - w_2)(w_3 - w_4)}{(w_1 - w_4)(w_3 - w_2)} = \frac{(z_1 - z_2)(z_3 - z_4)}{(z_1 - z_4)(z_3 - z_2)}$

Using the above, get

$$\frac{4\rho}{(1+\rho)^2} = \frac{-4R_1R_2}{(D - R_1 - R_2)(R_2 + R_1 + D)}$$

$$\frac{(1+\rho)^2}{\rho} = \frac{(R_1 + R_2)^2 - D^2}{R_1R_2} \quad \text{We can solve the preceding for } \rho$$

$$\rho = \frac{R_1^2 + R_2^2 - D^2}{2R_1R_2} \pm \sqrt{\left(\frac{R_1^2 + R_2^2 - D^2}{2R_1R_2}\right)^2 - 1}$$

The plus sign leads to $\rho > 1$ while minus sign leads to $\rho < 1$. Proof: $D + R_1 < R_2$

$D < R_2 - R_1, D^2 < R_2^2 - 2R_1R_2 + R_1^2$. Thus $R_1^2 + R_2^2 - D^2 > 2R_1R_2$, or $\frac{R_1^2 + R_2^2 - D^2}{2R_1R_2} > 1$

$\rho = P \pm \sqrt{P^2 - 1}, P > 1$, then with plus sign $\rho > 1$.

Now use Eq (8.5-32), $b = \rho, a = 1$.

$$C = \frac{2\pi\epsilon}{\log\left(\frac{b}{a}\right)} = \frac{2\pi\epsilon}{\log\rho} \quad \text{where } \rho \text{ is given above.}$$

(b) Use Eqn (8.5-30) in the w plane, take $b = \rho, a = 1$, thus $\Phi(w) = \frac{\log\left[\frac{\rho}{w}\right]}{\log\rho} = \phi + i\psi$
 $V_a = 1$

$$\phi = \operatorname{Re} \Phi = \frac{\log \frac{\rho}{|w|}}{\log \rho} = \frac{\frac{1}{2} \log \frac{\rho^2}{|w|^2}}{\log \rho}$$

Sec 8.5 cont'd

7) (b) cont'd with $D = R_1 = 1, R_2 = 3$, find from part (a) that $\rho = \frac{3 + \sqrt{5}}{2}$

Using bilinear transformation in (a), but use w and z instead of w_1 and z_1 . Get:

$$\frac{(z) (p+w)}{(1+w)(1+p)} = \frac{(z R_1)(R_2+z)}{(R_1+z-D)(R_1+R_2+D)}$$

Put in values $D = R_1 = 1, R_2 = 3$, solve for w

$$w = \frac{z(4p-1) - 3(p+1)}{3(p+1) + z(p-4)}$$

$$4p-1 = 5 + 2\sqrt{5}, \quad p+1 = \frac{5+\sqrt{5}}{2}, \quad p-4 = \frac{-5+\sqrt{5}}{2}$$

Using these get

$$w = \frac{z(10+4\sqrt{5}) - 3(5+\sqrt{5})}{3(5+\sqrt{5}) + z[-5+\sqrt{5}]}$$

$$|w|^2 = \frac{[(10+4\sqrt{5})x - 3(5+\sqrt{5})]^2 + [(10+4\sqrt{5})y]^2}{[-(5+\sqrt{5})x + 3(5+\sqrt{5})]^2 + [(-5+\sqrt{5})y]^2}$$

$$\phi(w(x,y)) = \frac{1}{2} \log \frac{\rho^2}{|w|^2} = \log \rho$$

$$\rho = \frac{3 + \sqrt{5}}{2}$$

$|w|^2$ given above.

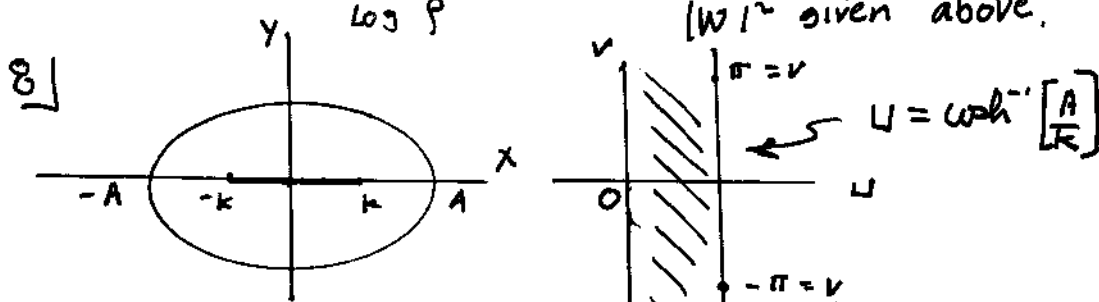

a) $x + iy = k [\cosh u \cos v + i \sinh u \sin v]$

$$x = k \cosh u \cos v, \quad y = k \sinh u \sin v$$

let $u = \cosh^{-1}[A/k], \quad \cosh u = A/k, \quad A = k \cosh u$

$$\sinh u = \sqrt{\cosh^2 u - 1} = \sqrt{A^2/k^2 - 1}$$

Sec 8.5 cont'd

8]

a) cont'd

$$x = k \frac{A}{k} \cos v = A \cos v$$

$$y = k \sqrt{\frac{A^2}{k^2} - 1} \sin v = \sqrt{A^2 - k^2} \sin v$$

As v varies, note that we are always on the ellipse described by $\frac{x^2}{A^2} + \frac{y^2}{A^2 - k^2} = 1$

(since $\sin^2 v + \cos^2 v = 1$). As v goes from $-\pi$ to π the entire ellipse is negotiated since y goes from 0 to $\sqrt{A^2 - k^2}$ to $-\sqrt{A^2 - k^2}$ and back to zero and x goes from A to $-A$ and back to A .

b) Because of the periodic nature of $y = \sqrt{A^2 - k^2} \sin v$ as we move along the line $u = \cosh^{-1} \left(\frac{A}{k} \right)$, $-\infty < v < \infty$ all points are mapped into the elliptical curve found in part a. The mapping is not one-to-one since any segment of length 2π on this line is transformed into the ellipse.

c) $x = k \cosh w \cos v$, $y = k \sinh w \sin v$

if $w=0$, $x = k \cos v$, $y=0$, as v goes from $-\pi$ to π , x goes from $-k$ to k and back to $-k$. The mapping is not one to one, because the line segments $w=0$; $-\pi < v \leq 0$ and $w=0$, $0 \leq v < \pi$ are both transformed into the line $y=0$, $-k < x < k$. The infinite line $w=0$, $-\infty < v < \infty$ is transformed into the line $y=0$, $-k \leq x \leq k$.

d) see next pg.

Sec 8-5 Cont'd

8

(d) Cont'd

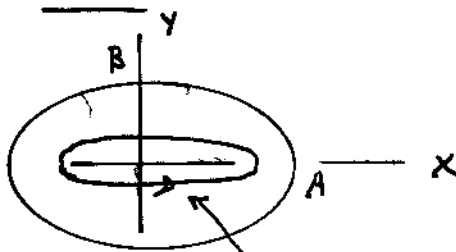

Corresponding path in x-y plane
 $x = K \cosh v, -\pi \leq v \leq \pi$
 $y = K \sinh(\sigma + i)v$

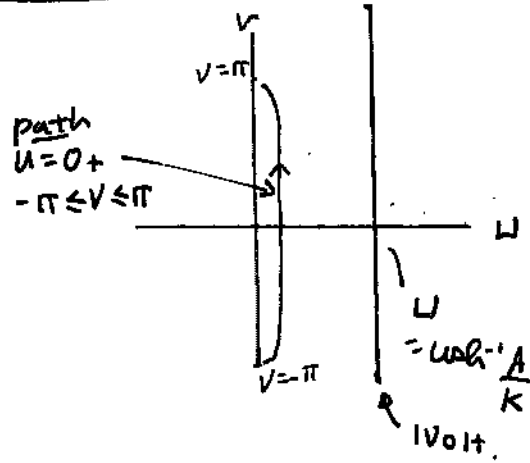

In w plane $\Phi(w) = \frac{u}{\cosh^{-1} \left[\frac{A}{K} \right]}$, thus $\Phi(w) = \frac{w}{\cosh^{-1} \left[\frac{A}{K} \right]}$

$\Psi(w) = \text{Im } \Phi = \frac{v}{\cosh^{-1} \left[\frac{A}{K} \right]}$, $\Delta \Psi$ on path $= -\frac{2\pi}{\cosh^{-1} \left[\frac{A}{K} \right]}$

$C = \epsilon \frac{|\Delta \Psi|}{|\Delta V|}$, ($\Delta V = 1$) see Eq. 8.5-25.

Thus $C = \frac{2\pi\epsilon}{\cosh^{-1} \left(\frac{A}{K} \right)}$ f.e.d.

9] (a)

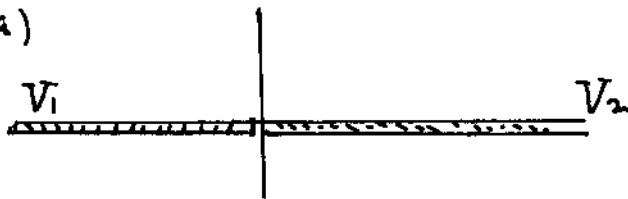

$\Phi(u, v) = A \cos w + B$, on $v=0, u > 0$, $\cos w = 0$

thus $V_2 = B$, on $v=0, u < 0$, $\cos w = \pi$,

thus $V_1 = A * \pi + B = A * \pi + V_2$, $A = \frac{V_1 - V_2}{\pi}$

(b) From sec. 4.7

$$\Phi(x, y) = \frac{y}{\pi} \int_{-\infty}^{+\infty} \frac{\phi(u, 0) du}{(u-x)^2 + y^2} = \frac{y}{\pi} \left[\int_{-\infty}^0 \frac{V_1 du}{(u-x)^2 + y^2} + \int_0^{\infty} \frac{V_2 du}{(u-x)^2 + y^2} \right]$$

sec 8.5 cont'd

q(b) cont'd

$$\phi(x,y) = \frac{y}{\pi} \left[\frac{V_1}{y} \tan^{-1} \frac{u-x}{y} \Big|_{-\infty}^0 + \frac{V_2}{y} \tan^{-1} \frac{u-x}{y} \Big|_0^{\infty} \right]$$

$$\phi(x,y) = \frac{1}{\pi} \left[V_1 \tan^{-1} \left(\frac{-x}{y} \right) + V_1 \frac{\pi}{2} + V_2 \frac{\pi}{2} - V_2 \tan^{-1} \left(\frac{-x}{y} \right) \right]$$

recall that $\tan^{-1} \left(\frac{-x}{y} \right) = -\tan^{-1} \frac{x}{y}$. Also
 $\frac{\pi}{2} - \tan^{-1} \frac{x}{y} = \tan^{-1} \frac{y}{x}$. Use this in the preceding

set $\phi(x,y) = \frac{V_1 - V_2}{\pi} \tan^{-1} \frac{y}{x} + V_2$

or $\phi(u,v) = \frac{V_1 - V_2}{\pi} \tan^{-1} \frac{v}{u} + V_2$, $\tan^{-1} \frac{v}{u} = \text{ang } W$
 this is same answer as obtained in (a).

q(c)

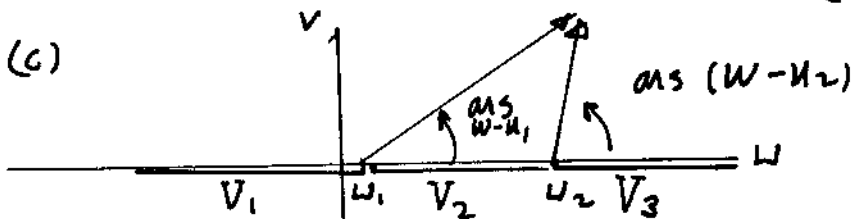

$$\phi(u,v) = A_1 \text{ang}(W-u_1) + A_2 \text{ang}(W-u_2) + B$$

put $\text{ang}(W-u_1) = \text{ang}(W-u_2) = 0$, should get $\phi = V_3$
 thus $B = V_3$.

$$\phi(u,v) = A_1 \text{ang}(W-u_1) + A_2 \text{ang}(W-u_2) + V_3$$

put $\text{ang}(W-u_1) = 0$, $\text{ang}(W-u_2) = \pi$, should get
 $\phi = V_2$. Thus:

$$V_2 = 0 A_1 + \pi A_2 + V_3, \quad A_2 = \frac{V_2 - V_3}{\pi}$$

put $\text{ang}(W-u_2) = \text{ang}(W-u_1) = \pi$. should get $\phi = V_1$

$$V_1 = \pi A_1 + \pi \left[\frac{V_2 - V_3}{\pi} \right] + V_3$$

$$A_1 = \frac{V_1 - V_2}{\pi}$$

q cont'd

Sec 8.5 cont'd

9 (d) from 9 (c), $\phi(u,v) = \frac{V_1 - V_2}{\pi} \arg(w - u_1)$

+ $\frac{V_2 - V_3}{\pi} \arg(w - u_2) + V_3$, put $V_1 = V_3 = 0$; $V_2 = V$

thus $\phi(u,v) = \frac{V}{\pi} \left[\arg[w - i] - \arg[w + i] \right]$

= $\frac{V}{\pi} \operatorname{Re} \left[-i \operatorname{Log} [w - i] + i \operatorname{Log} [w + i] \right]$

= $\operatorname{Re} \left[\frac{-iV}{\pi} \operatorname{Log} \left[\frac{w-i}{w+i} \right] \right]$. The expression in the brackets must be $\Phi(w)$, the complex pot'l.

$\phi(u,v) = \operatorname{Re} \left[\frac{-iV}{\pi} \operatorname{Log} \left[\frac{w-i}{w+i} \right] \right] =$

$\operatorname{Re} \left[\frac{-iV}{\pi} \left[\operatorname{Log} \left| \frac{w-i}{w+i} \right| + i \arg \left[\frac{w-i}{w+i} \right] \right] \right] =$

$\frac{V}{\pi} \arg \left[\frac{u-1+iV}{(u+1)+iV} \right] = \frac{V}{\pi} \arg \left[\frac{(u-1)+iV}{(u+1)+iV} \right] = \frac{V}{\pi} \arg \frac{[(u-1)+iV][u+1-iV]}{(u+1)^2+V^2}$

= $\frac{V}{\pi} \arg \left[\frac{u^2+V^2-1+2iV}{(u+1)^2+V^2} \right] = \frac{V}{\pi} \tan^{-1} \frac{2V}{u^2+V^2-1}$

(e) $\frac{V}{2} = \frac{V}{\pi} \tan^{-1} \frac{2V}{u^2+V^2-1}$

$\tan^{-1} [] = \frac{\pi}{2}$ $\frac{2 \cdot V}{u^2+V^2-1} = \infty$ $\boxed{u^2+V^2=1}$
if $\phi = \frac{V}{2}$

if $\frac{V}{4} = \frac{V}{\pi} \tan^{-1} \left[\frac{2V}{u^2+V^2-1} \right]$, then $\tan^{-1} [] = \frac{\pi}{4}$

or $\frac{2V}{u^2+V^2-1} = 1$ $u^2+V^2-1 = 2V$

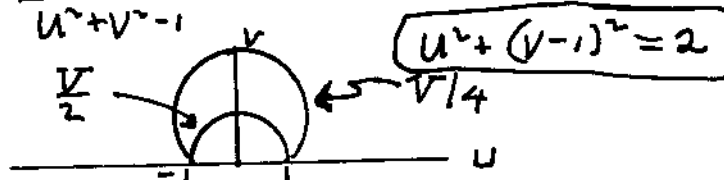

Sec 8.5 cont'd

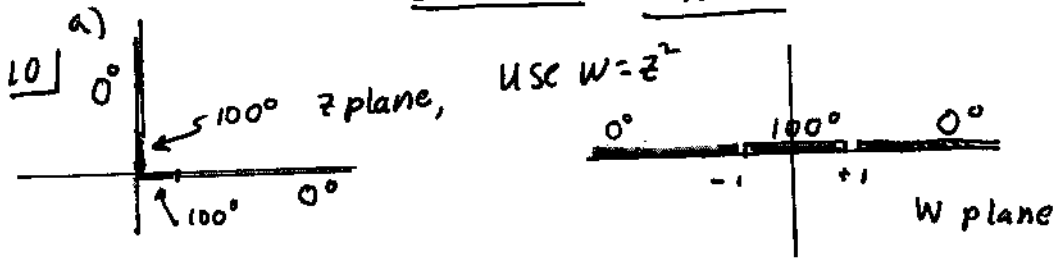

Using result of problem 9, we have that in w plane the complex potential is: $\Phi = \frac{-i}{\pi} 100 \text{Log} \left[\frac{w-1}{w+1} \right]$ where we use 100° in place of the voltage V .

Thus in the z plane: $\Phi = \frac{-i}{\pi} 100 \text{Log} \left[\frac{z^2-1}{z^2+1} \right]$

$$\begin{aligned} \phi(x,y) &= \text{Re} \left[\frac{-i}{\pi} 100 \left[\text{Log} \left| \frac{z^2-1}{z^2+1} \right| + i \text{Arg} \left[\frac{z^2-1}{z^2+1} \right] \right] \right] \\ &= \frac{100}{\pi} \text{Arg} \left[\frac{z^2-1}{z^2+1} \right] = \frac{100}{\pi} \text{Arg} \left[\frac{(z^2-1)(\bar{z}^2+1)}{|z^2+1|^2} \right] \\ &= \frac{100}{\pi} \text{Arg} \left[\frac{(z^2-1)(\bar{z}^2+1)}{|z^2+1|^2} \right] = \frac{100}{\pi} \text{Arg} \left[\frac{|z|^4 + z^2 - \bar{z}^2 - 1}{|z^2+1|^2} \right] \\ &= \frac{100}{\pi} \text{Arg} \left[\frac{(x^2+y^2)^2 - 1 + i2xy}{(x^2+y^2)^2 + 1} \right] = \frac{100}{\pi} \tan^{-1} \left[\frac{4xy}{(x^2+y^2)^2 - 1} \right] \end{aligned}$$

(b) $\phi = \frac{100}{\pi} \tan^{-1} \frac{4xy}{(x^2+y^2)^2 - 1}$

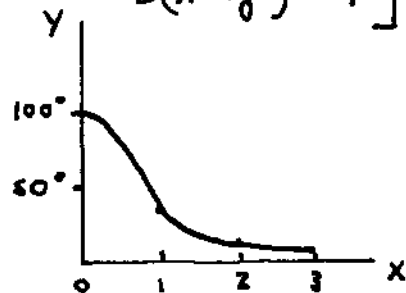

(c) $\psi = \text{Im} \Phi$, Φ given in (a)

$$\begin{aligned} \psi &= \frac{-100}{\pi} \text{Log} \left| \frac{z^2-1}{z^2+1} \right| = \frac{-50}{\pi} \text{Log} \left| \frac{z^2-1}{z^2+1} \right|^2 = \\ &= \frac{-50}{\pi} \text{Log} \left[\frac{(z^2-1)(\bar{z}^2-1)}{(z^2+1)(\bar{z}^2+1)} \right] = \\ &= \frac{-50}{\pi} \text{Log} \left[\frac{(x^2-y^2-1) + i2xy}{(x^2-y^2+1) + i2xy} \right] \frac{(x^2-y^2-1) - i2xy}{(x^2-y^2+1) - i2xy} = \frac{-50}{\pi} \text{Log} \left[\frac{(x^2-y^2-1)^2 + 4x^2y^2}{(x^2-y^2+1)^2 + 4x^2y^2} \right] \end{aligned}$$

sec 8.5 cont'd

10) continued

$$(d) \quad Q_x + iQ_y = -1k \left(\frac{d\Phi}{dz} \right) = -1k \frac{d}{dz} \left(\frac{-i100}{\pi} \operatorname{Log} \left[\frac{z^2-1}{z^2+1} \right] \right)$$

$$= -\frac{100k i}{\pi} \left[\frac{2z}{z^2-1} - \frac{2z}{z^2+1} \right] = -\frac{200k i}{\pi} \left[\frac{x-iy}{(\bar{z})^2-1} - \frac{x-iy}{(\bar{z})^2+1} \right]$$

$$= -\frac{200k i}{\pi} \left[\frac{(x-iy)[z^2-1]}{|\bar{z}^2-1|^2} - \frac{(x-iy)[z^2+1]}{|\bar{z}^2+1|^2} \right]$$

$$Q_x = \text{Real part of the above} = \frac{200k}{\pi} \left[\frac{x^2y+y^3+y}{(x^2-y^2-1)^2+4x^2y^2} - \frac{x^2y+y^3-y}{(x^2-y^2+1)^2+4x^2y^2} \right] = Q_x$$

$$Q_y = \text{Imag part of the above} \quad Q_y = -\frac{200k}{\pi} \left[\frac{x^3+x y^2-x}{(x^2-y^2-1)^2+4x^2y^2} - \frac{x^3+x y^2+x}{(x^2-y^2+1)^2+4x^2y^2} \right] = Q_y$$

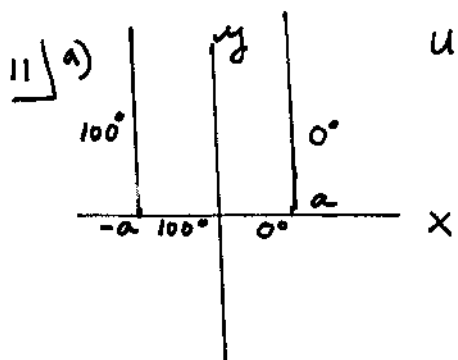

use $w = \sin \left[\frac{\pi z}{2a} \right]$

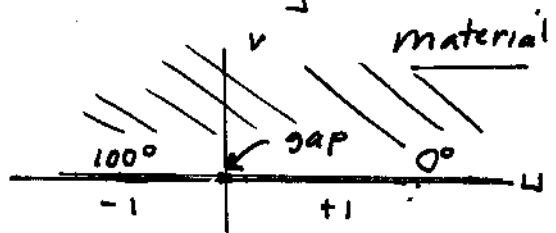

Using result in 9(a) we have in the w plane:

$\phi(u,v) = A \operatorname{arg} w + B$. Since $\phi = 0$ if $\operatorname{arg} w = 0$ we have $B = 0$. $\phi = 100^\circ$ if $\operatorname{arg} w = \pi$, Thus $A = \frac{100}{\pi}$

$$\phi(u,v) = \frac{100}{\pi} \operatorname{arg} w = \frac{100}{\pi} \tan^{-1} \frac{v}{u}$$

$$\text{Now } w = u+iv = \sin \left[\frac{\pi}{2} \left(\frac{x+iy}{a} \right) \right] = \sin \frac{\pi x}{2a} \cosh \left[\frac{\pi y}{2a} \right] + i \cos \left[\frac{\pi x}{2a} \right] \sinh \left[\frac{\pi y}{2a} \right]$$

Sec 8.5 cont'd

11) cont'd Thus $u = \sin \frac{\pi x}{2a} \operatorname{cosh} \left[\frac{\pi y}{2a} \right]$

$v = \cos \left[\frac{\pi x}{2a} \right] \sinh \left[\frac{\pi y}{2a} \right]$

$\phi(u,v) = \frac{100}{\pi} \tan^{-1} \left[\frac{\cos \left[\frac{\pi x}{2a} \right] \sinh \left[\frac{\pi y}{2a} \right]}{\sin \left[\frac{\pi x}{2a} \right] \operatorname{cosh} \left[\frac{\pi y}{2a} \right]} \right]$

or $\phi(x,y) = \frac{100}{\pi} \tan^{-1} \left[\frac{\tanh \left[\frac{\pi y}{2a} \right]}{\tan \left[\frac{\pi x}{2a} \right]} \right]$

b) $\phi \left[x, \frac{a}{10} \right] = \frac{100}{\pi} \tan^{-1} \left[\frac{\tanh \left[\frac{\pi}{20} \right]}{\tan \left[\frac{\pi x}{2a} \right]} \right]$

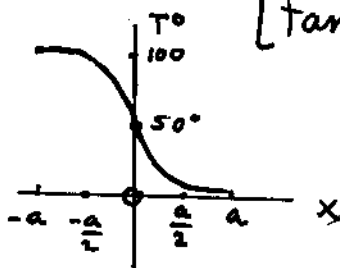

12) a) $w = \cos^{-1} \left[\frac{z}{a} \right] = u + i v, \quad \cos [u + i v] = \frac{z}{a}$

$x + i y = a [\cos u \cosh v - i \sin u \sinh v]$

$x = a \cos u \cosh v, \quad y = -a \sin u \sinh v$

Let $u = 0, -\infty < v < \infty$, then $y = 0, \quad x = a \cosh v$

as v goes from $-\infty$ to ∞ , the line $y = 0, a \leq x < \infty$ is negotiated twice. Now let $u = \pi, -\infty < v < \infty$,

then $y = 0, x = a \cos \pi \cosh v = -a \cosh v$. As v goes from $-\infty$ to ∞ , the line $y = 0, -\infty \leq x \leq -a$ is negotiated twice

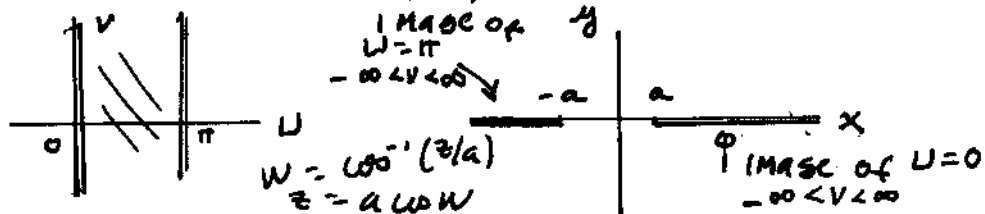

Sec 8.5 Cont'd

12 (b) from a, $x = a \cos w \cosh v$, $y = -a \sin w \sinh v$
 let $u = u_1$ (constant)

$$\text{then } \frac{x^2}{a^2 \cos^2 u_1} - \frac{y^2}{a^2 \sinh^2 u_1} = 1 \quad \left[\text{since } \cosh^2 u - \sinh^2 u = 1 \right]$$

Thus the line $u = u_1$ is transformed into a hyperbola

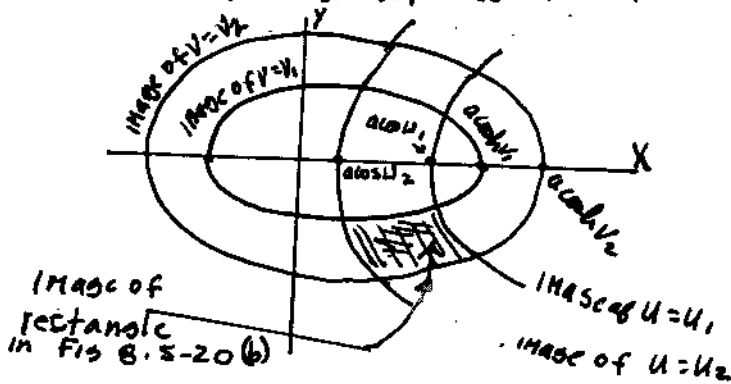

WE ASSUME
 $0 < u_1 < u_2 < \frac{\pi}{2}$
 in figure
 and $0 < v_1 < v_2$

let $v = v_1$

$$x = a \cos w \cosh v_1, \quad y = -a \sin w \sinh v_1$$

$$\text{then } \frac{x^2}{a^2 \cosh^2 v_1} + \frac{y^2}{a^2 \sinh^2 v_1} = 1$$

the image of $v = v_1$ is an ellipse in x, y plane.
 Consider the rectangle shown in Fig 8.5-20 (b)
 ASSUME $0 < u_1 < u_2 < \frac{\pi}{2}$ and $v > 0$. Since $x = a \cos w \cosh v$
 $y = -a \sin w \sinh v$, it follows that points (u, v)
 in this rectangle are mapped by $z = a \cosh w$ into
 the fourth quadrant in the z plane. This image is
 shown shaded above and is bounded by the hyperbolas
 and ellipses shown.

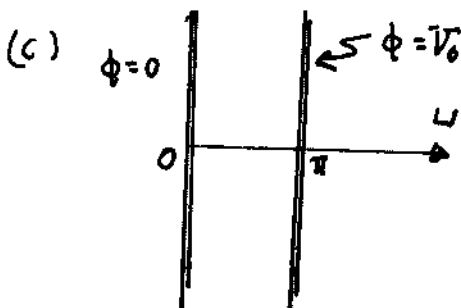

$$\phi = V_0 \frac{u}{\pi}$$

$$\text{thus } \Phi(w) = V_0 \frac{w}{\pi}$$

$$w = \cos^{-1} \left(\frac{z}{a} \right)$$

$$\text{thus } \Phi(z) = \frac{V_0}{\pi} \cos^{-1} \left(\frac{z}{a} \right)$$

12]

continued

Sec 8.5 cont'd

$$(d) \phi = \frac{V_0 u}{\pi}, \quad \text{now } \frac{x^2}{\cos^2 u} - \frac{y^2}{\sin^2 u} = 1$$

$$\text{let } p = \cos^2 u, \quad \text{thus } \sin^2 u = 1-p$$

$$\frac{x^2}{p} - \frac{y^2}{1-p} = 1, \quad x^2(1-p) - y^2 p = (p)(1-p)$$

$$p^2 - p[x^2 + y^2 + 1] + x^2 = 0$$

$$\text{sol'n: } p = \frac{x^2 + y^2 + 1}{2} \pm \sqrt{\left(\frac{x^2 + y^2 + 1}{2}\right)^2 - x^2} = \cos^2 u$$

$$\cos u = \pm \sqrt{\frac{x^2 + y^2 + 1}{2} \pm \sqrt{\left(\frac{x^2 + y^2 + 1}{2}\right)^2 - x^2}}$$

$$u = \cos^{-1} \left[\pm \sqrt{\frac{x^2 + y^2 + 1}{2} \pm \sqrt{\left(\frac{x^2 + y^2 + 1}{2}\right)^2 - x^2}} \right]$$

$$\phi(x, y) = \frac{V_0}{\pi} u, \quad u \text{ given above.}$$

(e) if $x=0$, you are half way between the boundaries carrying the potentials V_0 and 0 respectively, thus $\phi = V_0/2$

Choosing the minus sign we have

$$\phi = \frac{V_0}{\pi} \cos^{-1} \left[\pm \sqrt{\frac{y^2 + 1}{2} - \sqrt{\left(\frac{y^2 + 1}{2}\right)^2 - 0}} \right]$$

$$= \frac{V_0}{\pi} \cos^{-1}(0) = \frac{V_0}{\pi} \times \frac{\pi}{2} = \frac{V_0}{2} \quad \text{q.e.d.}$$

(f) Put $y=0$

$$\phi = \frac{V_0}{\pi} \cos^{-1} \left[\pm \sqrt{\frac{x^2 + 1}{2} - \sqrt{\left(\frac{x^2 + 1}{2}\right)^2 - x^2}} \right]$$

$$= \frac{V_0}{\pi} \cos^{-1} \left[\pm \sqrt{\left(\frac{x^2 + 1}{2}\right) - \left|\frac{x^2 - 1}{2}\right|} \right]$$

if $x > 1$, and you are in quadrants 1 and 4 set:

$$\frac{V_0}{\pi} \cos^{-1}[1] = 0$$

Sec. 8.5, cont'd

12) (f) cont'd. If $x < -1$ and you are in quads.

2 and 3 get $\phi = \frac{V_0}{\pi} \cos^{-1}[-1] = V_0$. There

is no discontinuity as we cross the line $x=0$ since

with $x=0$ we get $\phi = \frac{V_0}{\pi} \cos^{-1} \left[\pm \sqrt{\frac{y^2+1}{2}} - \left(\frac{y^2+1}{2} \right) \right]$

$$= \frac{V_0}{\pi} \cos^{-1}[0] = \frac{V_0}{2}$$

(g) $\phi(z) = \frac{V_0}{\pi} \cos^{-1}(z)$, $E_x + i E_y = \overline{\left(\frac{d\phi}{dz} \right)}$

$$= \frac{V_0}{\pi} \frac{1}{(1-z^2)^{1/2}} = \frac{V_0}{\pi} \frac{1}{(1-z^2)^{1/2}}$$

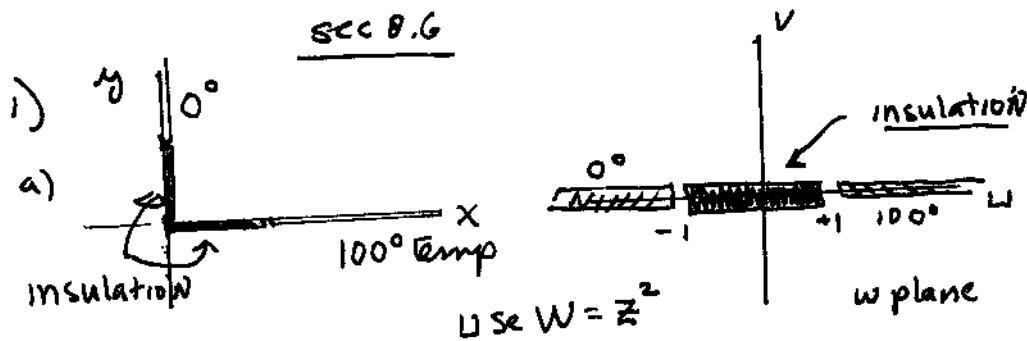

from Example (1) we can solve problem in w plane.

thus $\Phi_1(w) = \frac{100}{\pi} \sin^{-1} w + 50$, But $w = z^2$

thus in z plane, have: $\Phi(z) = \frac{100}{\pi} \sin^{-1}(z^2) + 50$

b) $\Phi(z) = \phi + i\psi = \frac{100}{\pi} \sin^{-1}[z^2] + 50$

let $\alpha + i\beta = \sin^{-1}(z^2)$

thus $\phi = \frac{100}{\pi} \alpha + 50$, so must solve for $\alpha(x,y)$

$$\sin(\alpha + i\beta) = z^2 = x^2 - y^2 + i 2xy$$

$$\sin \alpha \cosh \beta = x^2 - y^2, \quad \cos \alpha \sinh \beta = 2xy$$

Sec 8.6 cont'd

1 (b) cont'd

$$\sin \alpha \cosh \beta = x^2 - y^2, \quad \sqrt{1 - \sin^2 \alpha} \sinh \beta = 2xy$$

Now since $\cosh^2 \beta - \sinh^2 \beta = 1$, have:

$$\frac{(x^2 - y^2)^2}{\sin^2 \alpha} - \frac{4x^2 y^2}{1 - \sin^2 \alpha} = 1, \quad \text{or}$$

$$(x^2 - y^2)^2 (1 - \sin^2 \alpha) - 4x^2 y^2 \sin^2 \alpha = \sin^2 \alpha (1 - \sin^2 \alpha)$$

let $p = \sin^2 \alpha$

$$(x^2 - y^2)^2 (1 - p) - 4x^2 y^2 p = p(1 - p), \quad \text{a quadratic in } p.$$

$$p^2 + p[-1 - (x^2 - y^2)^2 - 4x^2 y^2] + (x^2 - y^2)^2 = 0$$

$$p^2 - 10 \left[1 + (x^2 + y^2)^2 \right] p + (x^2 - y^2)^2 = 0 \quad \text{use quadr. formula.}$$

$$p = \sin^2 \alpha = \frac{1 + (x^2 + y^2)^2 \pm \sqrt{[1 + (x^2 + y^2)^2]^2 - (x^2 - y^2)^2}}{2}$$

$$\alpha = \pm \sin^{-1} \sqrt{\frac{1 + (x^2 + y^2)^2 \pm \sqrt{[1 + (x^2 + y^2)^2]^2 - (x^2 - y^2)^2}}{2}}$$

but recall $\phi = \frac{100}{\pi} \alpha + 50$, α given above

(c) Put $y=0$ in the above

$$\phi = 50 + \frac{100}{\pi} (\pm) \sin^{-1} \left[\sqrt{\frac{1+x^4}{2} \pm \sqrt{\frac{1+2x^4+x^8}{4} - x^4}} \right]$$

$$= 50 + \frac{100}{\pi} (\pm) \sin^{-1} \sqrt{\frac{1+x^4}{2} \pm \sqrt{\frac{(x^4-1)^2}{2}}}$$

$$= 50 + \frac{100}{\pi} (\pm) \sin^{-1} \left[\sqrt{\frac{x^4+1}{2}} \pm \frac{1}{2} (x^4-1) \right]$$

$$\phi = 50 \pm \frac{100}{\pi} \sin^{-1} (x^2)$$

use + sign so that $\phi(x=1) = 100$

$$\phi = \frac{100}{\pi} \sin^{-1} (x^2) + 50$$

choose + sign
if $0 \leq x < 1$
if use minus here,
 ϕ would be constant
and it must vary if $0 \leq x < 1$
 $y=0$

prob 1, sec 8.6 continued

```
%prob 1 C sec 8.6
x=linspace(0,1,100);
y=50+100/pi*asin(x.^2);
plot(x,y)
grid
```

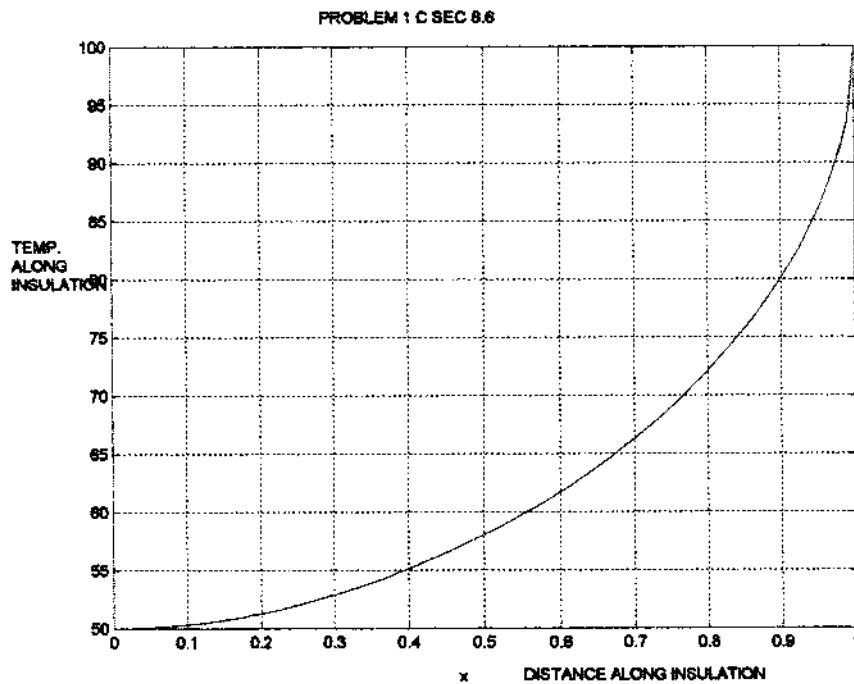

$$\begin{aligned}
 (d) \quad Q_x + i Q_y &= -k \overline{\left(\frac{d\Phi}{dz} \right)} \\
 &= -k \frac{d}{dz} \left[\frac{100}{\pi} \sin^{-1} [z^2] + 50 \right] \\
 &= -k \frac{200}{\pi} \left[\frac{z}{[1-z^2]^{1/2}} \right]
 \end{aligned}$$

sec 8.6 Cont'd

1(e)

$$Q_x + i Q_y = \frac{-200}{\pi} \bar{z} * (1 - z^4)^{-1/2}$$

$$x = 1/2, y = 0, \quad \frac{-200}{\pi} \frac{1}{2} * \left(\frac{15}{16}\right)^{-1/2}$$

thus $Q_x = -32.87; Q_y = 0$ at $(\frac{1}{2}, 0)$

Similarly $Q_x = 0, Q_y = 32.87$ at $2, 0$

$Q_x = 0, Q_y = -32.87$ at $0, 1/2$

$Q_x = -32.87, Q_y = 0$ at $0, 2$

2]

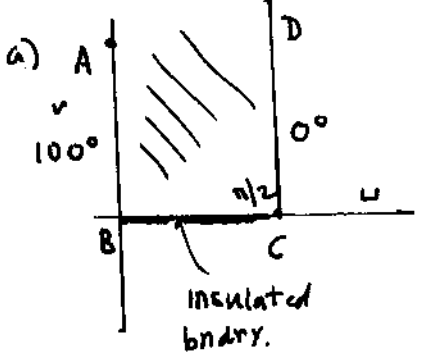

$$z = a \sin w = a [\sin u \cosh v + i \cos u \sinh v]$$

$$x = a \sin u \cosh v$$

$$y = a \cos u \sinh v$$

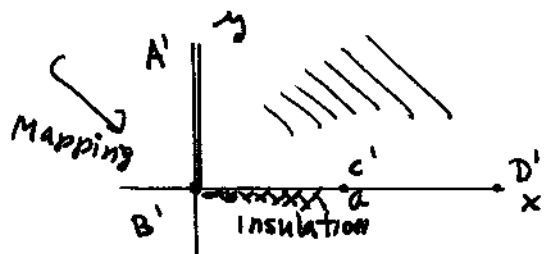

in w plane

$$\phi = au + b \quad \text{where } \phi(0) = 100^\circ$$

$$\text{and } \phi(\pi/2) = 0^\circ$$

thus $a = -\frac{200}{\pi}, b = 100$

$$\phi = -\frac{200}{\pi} u + 100, \quad \bar{\phi}_I = -\frac{200}{\pi} W + 100$$

$$z = a \sin w, \quad w = \sin^{-1}\left(\frac{z}{a}\right), \quad \bar{\phi} = -\frac{200}{\pi} \sin^{-1}\left(\frac{z}{a}\right) + 100$$

b) $\phi = -\frac{200u}{\pi} + 100 = T \therefore u = \frac{\pi}{200} [100 - T]$ for this fixed temperature

Sec 8.6 cont'd

2] (b) cont'd Since $z = a \sin w = x + iy$

$$x = a \sin u \cosh v, \quad y = a \cos u \sinh v$$

Suppose $u = \frac{\pi}{200} [100 - T]$. Then, because $\cosh^2 - \sinh^2 = 1$

We must be on the curve $\frac{x^2}{a^2 \sin^2 u} - \frac{y^2}{a^2 \cos^2 u} = 1$

(c) if $T = 50$, $u = \frac{\pi}{4}$

$$\frac{x^2}{\frac{1}{2}} - \frac{y^2}{\frac{1}{2}} = 1$$

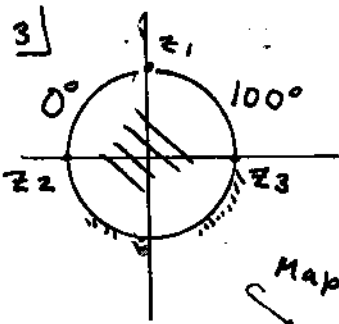
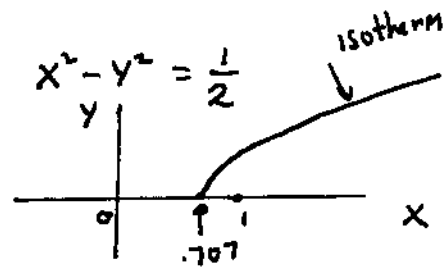

map into w plane
use bilinear trans.

get

take $z_1 = i, w_1 = \infty$
 $z_2 = -1, w_2 = -1$
 $z_3 = 1, w_3 = 1$

$$w = -i \frac{[1+z]}{[z-1]}$$

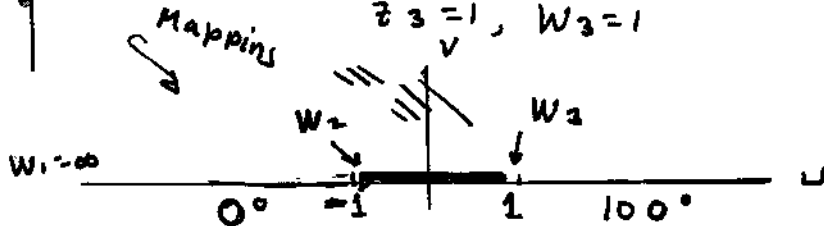

From example 1, solution to the given problem
in w plane is $\Phi(w) = \frac{100}{\pi} \sin^{-1} w + 50$

Now use the transformation found above

$$\Phi(z) = \frac{-100}{\pi} \sin^{-1} \left[\frac{[z+i]}{[z-1]} \right] + 50 \quad \text{q.e.d.}$$

4] (a) $V_u + i V_v = \left(\frac{d\Phi}{dw} \right) = \frac{d}{dw} AW = A$

(b) $\psi = \text{Im} [AW] = AV$ since $w = u + iv$

Sec 8.6 cont'd

4) (b) cont'd $\psi = 0$ on boundary

The locii of $\psi = 0$, $\psi = A$, $\psi = 2A$ are the lines $v = 0$, $v = 1$, $v = 2$ $[-\infty < u < \infty]$ respectively.

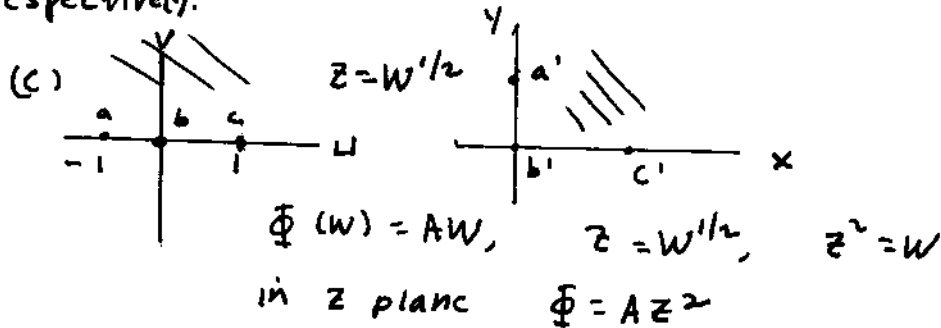

(d) $V_x + iV_y = \overline{\left(\frac{d\Phi}{dz}\right)} = \overline{2Az} = 2A[x - iy]$

$V_x = 2Ax$, $V_y = -2Ay$ speed = $\sqrt{V_x^2 + V_y^2} = 2A\sqrt{x^2 + y^2} = 2A \times \text{distance from corner}$

If $x=0, y>0$, $V_x=0$ while $V_y = -2Ay$ [down along wall] if $y=0, x>0$ $V_x = 2Ax, V_y=0$ flow in pos. x direction

(e) $\Phi = Az^2 = A[x^2 - y^2 + i2xy]$, $\psi = \text{Im } \Phi = 2AXY$

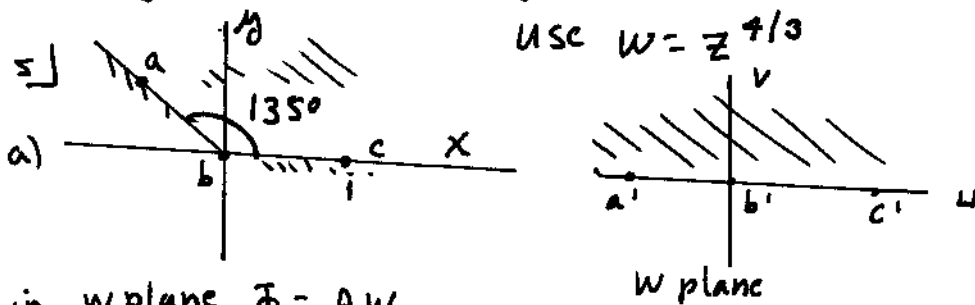

(b) let $z = r \angle \theta$, $\Phi = A r^{4/3} \angle \frac{4}{3}\theta = A r^{4/3} \cos\left[\frac{4\theta}{3}\right] + i A r^{4/3} \sin\left[\frac{4\theta}{3}\right]$
 Thus $\phi = A r^{4/3} \cos\left[\frac{4\theta}{3}\right]$
 $\psi = A r^{4/3} \sin\left[\frac{4\theta}{3}\right]$

sec 8.6 cont'd

5 (c) cont'd

$$0 = A r^{4/3} \sin \frac{4\theta}{3} \quad \text{Thus } \sin \frac{4\theta}{3} = 0$$

$\theta = 0$ or $\theta = \frac{3}{4}\pi$. [other solutions are outside given domain].

$$\psi = A = A r^{4/3} \sin \frac{4\theta}{3}$$

thus $\sin \frac{4\theta}{3} = r^{-4/3}$, $r = \left(\sin \frac{4\theta}{3}\right)^{-3/4}$ locus of $\psi = A$

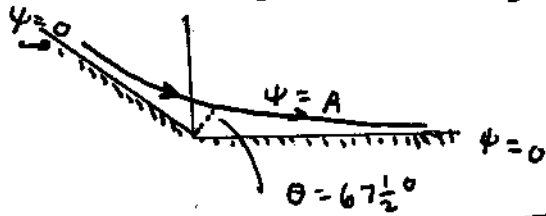

(d)
$$\underline{V} = \frac{d\Phi}{dz} \Big|_{r=1} = \frac{4}{3} A (\bar{z})^{1/3}$$

$$= \frac{4}{3} A r^{1/3} \text{cis} \left[\frac{\theta}{3} \right] = \frac{4}{3} A \sqrt[3]{r} \text{cis} \left(-\frac{\theta}{3} \right)$$

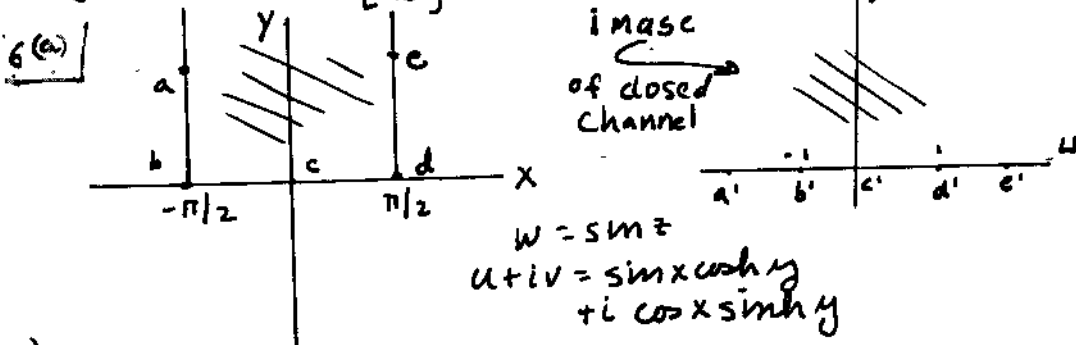

(b) in w plane $\Phi(w) = AW$, $\Phi(z) = A \sin(z)$

[since $w = \sin z$]

$$V_x + iV_y = \overline{\left(\frac{d\Phi}{dz} \right)} = \overline{A \cos(z)} = A \overline{\cos z} =$$

$$A [\cos x \cosh y - i \sin x \sinh y] = A [\cos x \cosh y + i \sin x \sinh y]$$

(c) $V_x = A \cos x \cosh y$, $V_y = A \sin x \sinh y$

Assume $A > 0$.

along left wall $x = -\frac{\pi}{2}$, $y \geq 0$. $V_x = 0$, $V_y = -A \sinh y$

∴ $V_x = 0$, $V_y < 0$. Along right wall: $x = \frac{\pi}{2}$, $V_x = 0$

and $V_y = A \sinh y$, thus, $V_y > 0$. End of channel, $y = 0$, $V_y = 0$
 $V_x = A \cos x > 0$

Sec 8.6 Cont'd

5 (d) $\Phi = A \sin \tau = A \sin x \cosh y + i A \cos x \sinh y$
 $= \phi + i \psi$ $\psi = A \cos x \sinh y$

6 (e) $\psi = 0$, $A \cos x \sinh y = 0$ either $x = \pm \frac{\pi}{2}$ or $y = 0$. Thus $\psi = 0$ corresponds to the walls of the channel.

$\psi = \frac{A}{2}$. $A \cos x \sinh y = A/2$ $\cos x \sinh y = 1/2$
 $y = \sinh^{-1} \left(\frac{0.5}{\cos x} \right)$ locus of $\psi = A/2$,
 locus of $\psi = A$ is $y = \sinh^{-1} \left[\frac{1}{\cos x} \right]$

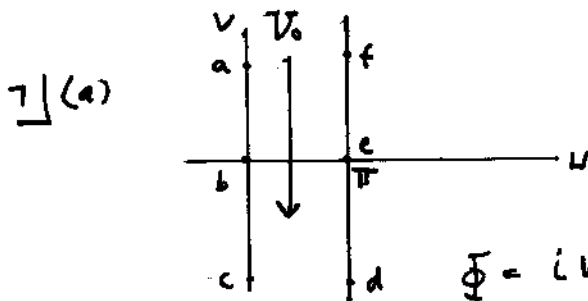
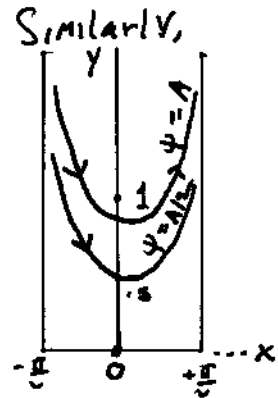

$\Phi = i W V_0 = i [u + iv] V_0$
 $\Phi = \phi + i \psi$ $\phi = -v V_0$
 $\psi = u V_0$

$w = \left(\frac{d\Phi}{dW} \right) = \overline{i V_0} = -i V_0$

thus: flow is down ward,
 streamlines are lines on which $\psi = \text{constant}$,
 $u V_0 = \text{constant}$, $\therefore u = \text{constant}$ describes streamlines.

(b) $x + iy = \omega W \cosh v - i \sin \omega \sinh v$, $x = \omega W \cosh v$
 $y = -\sin \omega \sinh v$
 refer to channel above.

if $u = 0$, $x = \cosh v$, $y = 0$

if $u = \pi$ $x = -\cosh v$, $y = 0$

mapping is as shown:

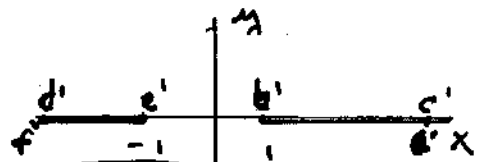

$\Phi = i W V_0$, $w = \cos^{-1} z$, $\Phi = i V_0 \cos^{-1}(z)$

Sec 8.6 Cont'd

7 (c) $\frac{d\Phi}{dz} = \frac{-iV_0}{(1-z^2)^{1/2}} \quad V_x + iV_y = \overline{\left(\frac{d\Phi}{dz}\right)}$

$= iV_0 (1-z^2)^{-1/2}$ Which square root branch should be used? Consider

$w = \cos^{-1}(z) = -i \log [z + i(1-z^2)^{1/2}]$. Put $z=0$

$w = -i \log [(i)(\pm 1)]$. You must choose the positive root so that $z=0$ will have an image inside the given channel, namely at $w = \pi/2$

Thus $V_x + iV_y \Big|_{z=0} = iV_0 (1-z^2)^{-1/2} \Big|_{z=0}$

$= iV_0$. Thus in the center of the aperture $V_x = 0, V_y = V_0$

(d) $\phi + i\psi = iV_0 \cos^{-1}(z)$,

if $y=0, x=1/2, i\psi = iV_0 \cos^{-1}(1/2), \psi = \frac{\pi}{3}V_0$

$\frac{\phi + i\psi}{iV_0} = \cos^{-1} z, \quad z = \cos \left[\frac{\psi}{V_0} - i \frac{\phi}{V_0} \right]$

$x = \cos \frac{\psi}{V_0} \cosh \frac{\phi}{V_0}, \quad y = \sin \frac{\psi}{V_0} \sinh \frac{\phi}{V_0}$

let $\frac{\psi}{V_0} = \frac{\pi}{3}$, thus $\cos \frac{\psi}{V_0} = \frac{1}{2}, \quad \sin \frac{\psi}{V_0} = \frac{\sqrt{3}}{2}$

$x = \frac{1}{2} \cosh \frac{\phi}{V_0}, \quad y = \frac{\sqrt{3}}{2} \sinh \frac{\phi}{V_0}$, Now $\cosh^2 - \sinh^2 = 1$

thus locus: $\frac{x^2}{(\frac{1}{2})^2} - \frac{y^2}{(\frac{\sqrt{3}}{2})^2} = 1$ or $\boxed{x^2 - \frac{1}{3}y^2 = \frac{1}{4}}$ locus

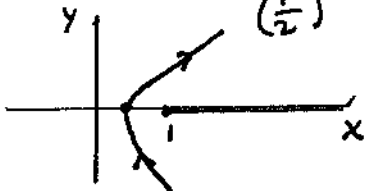

Sec 8.6 Cont'd

$$\gamma(\theta) \quad \vec{v} = \overline{\left(\frac{d\Phi}{dz}\right)} = v_x + i v_y = i \sqrt{V_0} (1-z^2)^{-1/2}$$

if $|z| \gg 1$ $v_x + i v_y \approx i \sqrt{V_0} (-z^2)^{-1/2}$
 $= (i) (\sqrt{V_0}) \frac{(\pm i)}{\bar{z}} = \pm \frac{\sqrt{V_0}}{r} \text{cis}(\theta)$ since $z = r \text{cis} \theta$

Note that $v_y > 0$ for all θ . thus
 if $0 \leq \theta \leq \pi$ we use plus sign above

$$v_x = \frac{\sqrt{V_0}}{r} \cos \theta, \quad v_y = \frac{\sqrt{V_0}}{r} \sin \theta$$

if $\pi \leq \theta \leq 2\pi$ must use minus. thus

$$v_x = -\frac{\sqrt{V_0} \cos \theta}{r}, \quad v_y = -\frac{\sqrt{V_0} \sin \theta}{r}$$

$$\textcircled{a} \quad z = \frac{W}{2} + \left[\frac{W^2}{4} - 1\right]^{1/2}, \quad \left(z - \frac{W}{2}\right) = \left(\frac{W^2}{4} - 1\right)^{1/2}$$

$$z^2 - Wz + \frac{W^2}{4} = \frac{W^2}{4} - 1, \quad z^2 - Wz + 1 = 0$$

$$W = z + z^{-1}$$

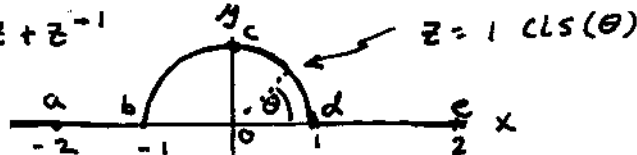

Using $W = z + z^{-1}$ we map the boundary shown

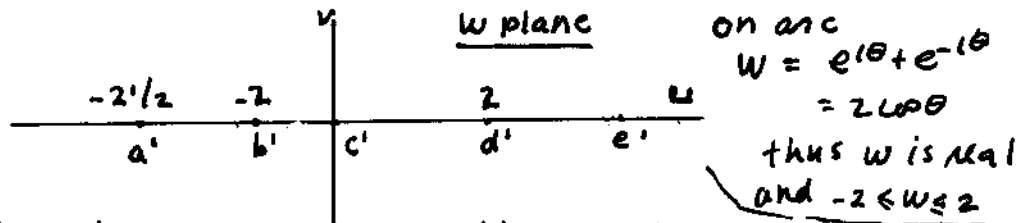

(b) in W plane we will assume uniform flow parallel to the boundary $v=0$.

Thus $\Phi = AW$ since $\vec{v} = \overline{\left(\frac{d\Phi}{dW}\right)} = \bar{A} = A$.

If $A > 0$ this yields a uniform flow to the right. The boundary $v=0$ is a streamline. $A < 0 \Rightarrow$ flow to left.

Sec 8.6 cont'd

8 (b) cont'd since $w = z + z^{-1}$ we have in z plane that $\Phi = A(z + z^{-1})$

(c) $N_z = \overline{\left(\frac{d\Phi}{dz}\right)} = \overline{A\left[1 - \frac{1}{z^2}\right]} = A\left[1 - \frac{1}{(\bar{z})^2}\right]$

Note, if $|z| \gg 1$ $V_x + iV_y \approx A$, thus $V_x = A$, $V_y = 0$, set uniform flow to right.

d) $\Phi = A[z + z^{-1}]$, $z = re^{i\theta}$

$\Phi = A[r e^{i\theta} + r^{-1} e^{-i\theta}]$, $\psi = \text{Im}\Phi = A \sin\theta \left[r - \frac{1}{r}\right]$

On boundary, either $\theta = 0, \pi$, or $r = 1$.
in any case, $\psi = 0$ on boundary.

If $\psi = A$, $\left(r - \frac{1}{r}\right) \sin\theta = 1$ or $r^2 - \frac{r}{\sin\theta} - 1 = 0$

Solve quadratic: $r = \frac{1}{2\sin\theta} \pm \sqrt{\frac{1}{4\sin^2\theta} + 1}$

Use + sign since $r \geq 0$. Thus our curve satisfies

$r = \frac{1}{2\sin\theta} + \sqrt{\frac{1}{4\sin^2\theta} + 1}$

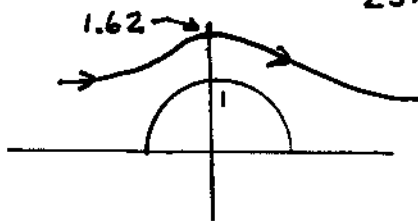

Sec 8.7

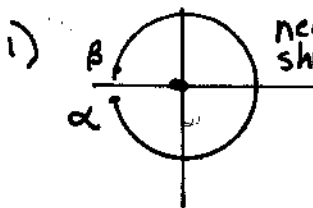

need to show:

$h = K [\psi(\alpha) - \psi(\beta)]$

$\psi = \text{Im} \frac{h}{2\pi K} \text{Log} \left[\frac{c}{z}\right]$

$= \frac{h}{2\pi K} \text{arg} \left[\frac{c}{z}\right] = -\frac{h}{2\pi K} \text{arg } z$

$\psi(\alpha) - \psi(\beta) = -\frac{h}{2\pi K} [-\pi - \pi] = \frac{h}{K}$

$K [\psi(\alpha) - \psi(\beta)] = h$ b.e.d

sec 8.7

1) Cont'd $\phi = \text{Re } \Phi = \text{Re } \frac{h}{2\pi k} \text{Log } \frac{c}{z}$
 $= \frac{h}{2\pi k} \text{Log } \left| \frac{c}{z} \right| = \frac{h}{2\pi k} \text{Log} \left[\frac{b e^{T_0 2\pi k l h}}{|z|} \right]$

If $|z| = b$, $\phi = T_0$ as required

2) (a) $\Phi_1 = -i V_0 \text{Log } z, = -i V_0 [\text{Log}|z| + i \text{arg } z]$
 $\phi = V_0 \text{arg } z = \text{Re } \Phi, \quad \psi = \text{Im } \Phi = -V_0 \text{Log}|z|$
 $|z| = \sqrt{x^2 + y^2}$. Streamlines are circles concentric with vortex axis.

2) (b) $\underline{V} = \left(\frac{d\Phi_1}{dz} \right) = \left(\frac{-i V_0}{z} \right) = \frac{i V_0}{z} = \frac{i V_0}{r} \text{cis } (\theta)$

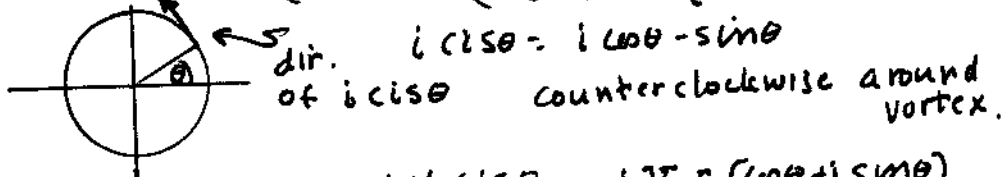

2) (c) $\underline{V} = \frac{i V_0 \text{cis } \theta}{r} = \frac{i V_0 r (\cos \theta + i \sin \theta)}{r^2}$

$\underline{V} = v_x + i v_y, \quad v_x = \frac{-y V_0}{x^2 + y^2}, \quad v_y = \frac{x V_0}{x^2 + y^2}$

Note that $\frac{\partial v_x}{\partial x} + \frac{\partial v_y}{\partial y} = 0$

2) (d) $\psi = \text{Im } \Phi = -V_0 \text{Log}|z|$. ON $|z| = 1, \psi = 0$
 (a streamline).

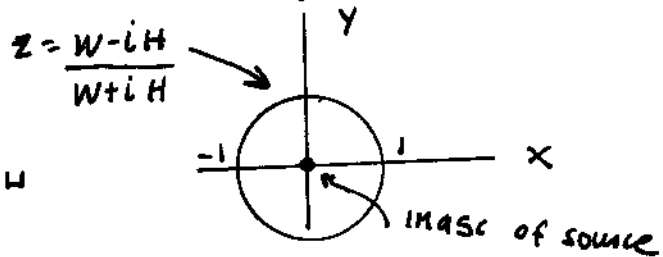
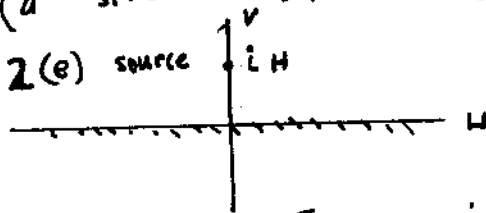

$\Phi_1(z) = -i V_0 \text{Log } z$
 $\Phi(w) = -i V_0 \text{Log} \left[\frac{w - iH}{w + iH} \right]$

$\Phi(w) = -i V_0 [\text{Log}(w - iH) - \text{Log}(w + iH)], \quad \underline{V} = \left(\frac{d\Phi}{dw} \right)$
 $\underline{V} = i V_0 \left[\frac{2iH}{w^2 + H^2} \right] = \frac{2H V_0 [w^2 + H^2]}{(w^2 + H^2)(w^2 + H^2)} = \frac{2H V_0 [u^2 - v^2 + H^2 + 2iuv]}{u^2 + v^2 + 2u^2v^2 + H^2 + 2H^2(u^2 - v^2)}$

Sec 8.7 Cont'd

3) (a)

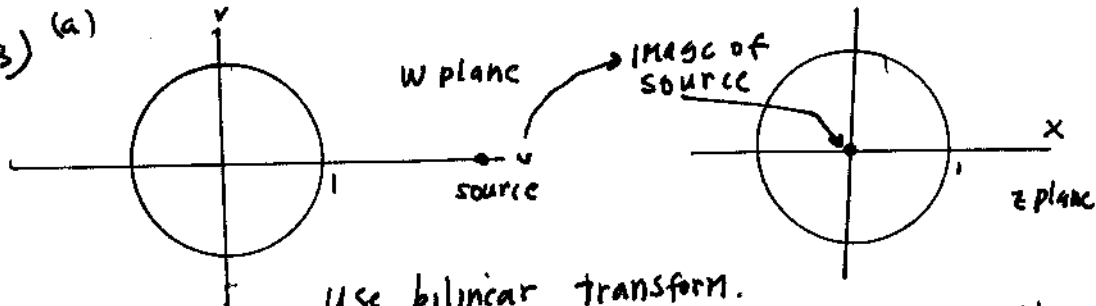

Use bilinear transform.

make fixed points ± 1 , map $w = H$

into $z = 0$. Thus $z = \frac{w-H}{1-wH}$

in z plane: $\Phi(z) = \frac{\rho L}{2\pi\epsilon} \text{Log} \frac{1}{z}$

Thus $\Phi(w) = \frac{\rho}{2\pi\epsilon} \text{Log} \left[\frac{1-wH}{w-H} \right]$

(b) $\phi = \frac{\rho}{2\pi\epsilon} \text{Log} \left| \frac{H \left(\frac{1}{H} - w \right)}{w-H} \right| = \frac{\rho}{4\pi\epsilon} \text{Log} \left[\frac{H^2 \left[\left(\frac{u-1}{H} \right)^2 + v^2 \right]}{(u-H)^2 + v^2} \right]$

$= \text{Log} \frac{5}{2}$. $\frac{\rho}{2\pi\epsilon} = 1$

Thus $(H^2) \frac{\left[\left(\frac{u-1}{H} \right)^2 + v^2 \right]}{(u-H)^2 + v^2} = \left(\frac{5}{2} \right)^2$, put $H=2$

The preceding can be rearranged to yield:

$\left(u - \frac{42}{9} \right)^2 + v^2 = \left(\frac{30}{9} \right)^2$ A circle center at $\left(\frac{42}{9}, 0 \right)$ radius $3\frac{1}{3}$.

4) (a) $\Phi(w) = \frac{G}{2\pi} \left[\text{Log}(w+iH) + \text{Log}(w-iH) \right]$

$= \frac{G}{2\pi} \text{Log}(w^2+H^2) = \frac{G}{2\pi} \text{Log} [u^2-v^2+H^2+i2uV]$

$\psi = \text{Im} \Phi = \frac{G}{2\pi} \text{Arg} [u^2-v^2+H^2+i2uV] =$

$\frac{G}{2\pi} \tan^{-1} \left[\frac{2uV}{u^2-v^2+H^2} \right]$ $v=0 \Rightarrow \psi=0$

(b) $N_z = \left(\frac{d\Phi}{dz} \right) = \frac{G}{2\pi} \left[\frac{1}{(w+iH)} + \frac{1}{(w-iH)} \right]$

Sec 8.7 cont'd

4 (b) cont'd.

$$N = \frac{Q}{2\pi} \left[\frac{1}{u-i(V+H)} + \frac{1}{u-i(V-H)} \right]$$

$$= \frac{Q}{2\pi} \left[\frac{u+i(V+H)}{u^2+(V+H)^2} + \frac{u+i(V-H)}{u^2+(V-H)^2} \right]$$

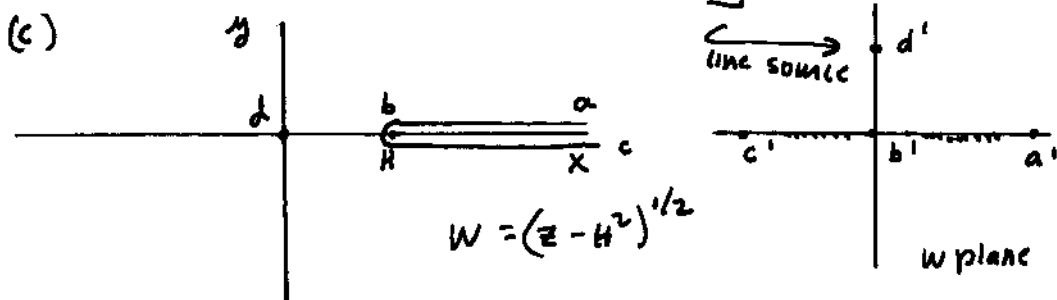

Image of c is the line $\text{Im}W = 0$

The branch cut in z plane is a streamline, so so is the contour c in w plane.

$$W = (z - H^2)^{1/2}, \quad W^2 = z - H^2$$

$$z = W^2 + H^2$$

$$\Phi(z) = \frac{Q}{2\pi} \text{Log} z = \frac{Q}{2\pi} \text{Log} [W^2 + H^2]$$

$$\Phi(W) = \frac{Q}{2\pi} \text{Log} [W^2 + H^2]$$

$$z = \sin W$$

$$x = \sin W \cos h v$$

$$y = \cos W \sinh v$$

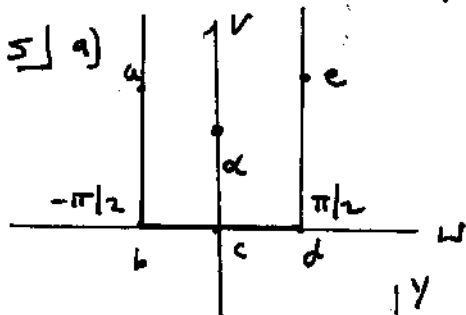

source at $w = id$
maps to $z = i \sinh d$

source at $y = \sinh d$

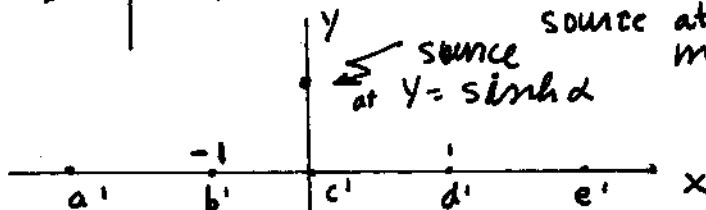

\sin 's images

in z plane:

$$\Phi(z) = \frac{P}{2\pi\epsilon} \left[\text{Log} \frac{1}{z - i \sinh d} - \text{Log} \frac{1}{z + i \sinh d} \right]$$

NOW USE $z = \sin W$

$$\Phi(W) = \frac{P}{2\pi\epsilon} \text{Log} \frac{[\sin W + i \sinh d]}{[\sin W - i \sinh d]}$$

Sec 8.7 cont'd

5) cont'd

(b) Use $z = \sin \left[\frac{\pi w}{2b} \right]$ thus

$$\Phi(w) = \frac{\rho}{2\pi\epsilon} \text{Log} \left[\frac{\sin \left(\frac{\pi w}{2b} \right) + i \sinh \left[\frac{\pi d}{2} \right]}{\sin \left(\frac{\pi w}{2b} \right) - i \sinh \left(\frac{\pi d}{2b} \right)} \right]$$

(c) $\phi = \text{Re } \Phi = \frac{\rho}{4\pi\epsilon} \text{Log} \frac{|\sin w + i \sinh d|^2}{|\sin w - i \sinh d|^2}$

Now $|\sin w + i \sinh d|^2 = (\sin w + i \sinh d)(\overline{\sin w} - i \sinh d)$
 $= |\sin w|^2 + \sinh^2 d + i \sinh d [\overline{\sin w} - \sin w]$
 $= \sin^2 u + \sinh^2 v + \sinh^2 d + 2 \sinh d \cos u \sinh v$
 Similarly: $|\sin w - i \sinh d|^2 = \sin^2 u + \sinh^2 v + \sinh^2 d - 2 \sinh d \cos u \sinh v$
 Use these expressions in ϕ above.

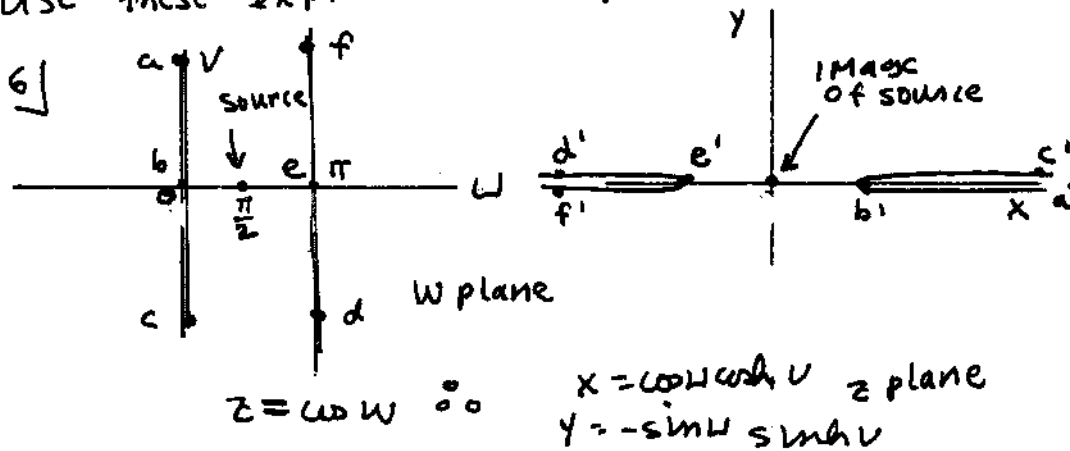

In z plane the source of strength Q creates a complex potential $\Phi_z = \frac{Q}{2\pi} \text{Log } z$. The streamlines are the rays on which $\text{Arg } z$ assumes constant values. Thus the rigid boundaries in z plane correspond to streamlines. $\Phi(w) = (Q/2\pi) \text{Log } \cos w$ in w plane

sec 8.7
cont'd

6(b) cont'd

$$N_{\bar{z}} = \overline{\left(\frac{d\Phi}{dW}\right)} = \frac{G}{2\pi} \overline{\left(\frac{-\sin W}{\cos W}\right)} = -\frac{G}{2\pi} \frac{\overline{(\sin W) \cos W}}{|\cos W|^2}$$

$$= -\frac{G}{2\pi} \frac{(\sin W) \cos W}{\sinh^2 V + \cos^2 U}$$

$$= -\frac{G}{2\pi} \left[\frac{(\sin U \cosh V - i \cos U \sinh V)(\cos U \cosh V - i \sin U \sinh V)}{\sinh^2 V + \cos^2 U} \right]$$

$$= -\frac{G}{4\pi} \left[\frac{\sin 2U - i \sinh 2V}{\sinh^2 V + \cos^2 U} \right]$$

Note:
 $\sin W \cos W = \frac{1}{2} \sin 2W$
 $\sinh V \cosh V = \frac{1}{2} \sinh 2V$

6(c) if $V \gg 1$, $N_{\bar{z}} \approx -\frac{G}{4\pi} \left[\frac{-i \sinh 2V}{\sinh^2 V} \right]$

$$\approx \frac{iG}{4\pi} \left[\frac{[e^{2V} - e^{-2V}]/2}{[e^V - e^{-V}]^2/4} \right] \approx \frac{iG}{2\pi}$$

since, large
 $e^V \gg e^{-V}$
 $e^{2V} \gg e^{-2V}$

thus: $V_u + iV_v = \frac{iG}{2\pi}$, $V_u = 0$, $V_v = \frac{G}{2\pi}$

6(d) $\Phi = \frac{G}{2\pi} \text{Log}[\cos W] = \frac{G}{2\pi} \text{Log} \left[\frac{\cos W \cosh V - i \sin W \sinh V}{1} \right]$

$$\psi = \text{Im} \Phi = -\frac{G}{2\pi} \arg[\cos W \cosh V - i \sin W \sinh V]$$

$$= \frac{G}{2\pi} \tan^{-1} \left[\frac{\sin W \sinh V}{\cos W \cosh V} \right] = -\frac{G}{2\pi} \tan^{-1} [\tan W \tanh V]$$

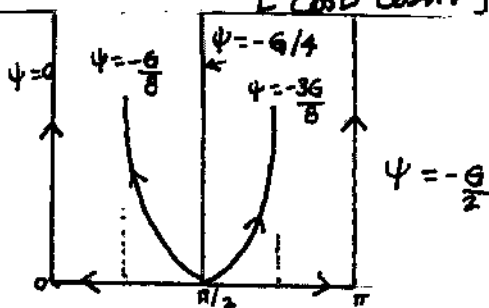

Sec 8.7

Cont'd

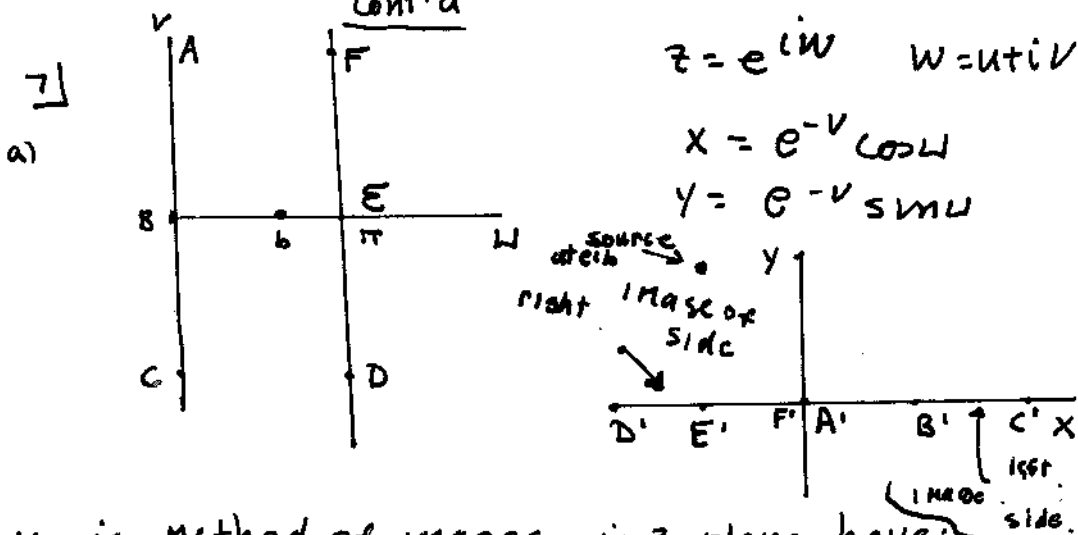

$$z = e^{iw} \quad w = u + iv$$

$$x = e^{-v} \cos u$$

$$y = e^{-v} \sin u$$

Using method of images, in z plane have:

$$\Phi(z) = \frac{h}{2\pi k} \text{Log} \frac{z - e^{-ib}}{z - e^{ib}}, \quad \text{thus } \Phi(w) = \frac{h}{2\pi k} \text{Log} \frac{e^{iw} - e^{-ib}}{e^{iw} - e^{ib}}$$

If right boundary is at $w = \beta$, use, $z = e^{i \frac{\pi w}{\beta}}$

for transformation. Thus

$$\Phi(w) = \frac{h}{2\pi k} \text{Log} \frac{e^{i \frac{\pi w}{\beta}} - e^{-i \frac{\pi b}{\beta}}}{e^{i \frac{\pi w}{\beta}} - e^{i \frac{\pi b}{\beta}}}$$

$$(b) \quad \phi = \frac{h}{4\pi k} \text{Log} \left| \frac{e^{i[u+iv]} - e^{-ib}}{e^{i[u+iv]} - e^{ib}} \right|^2 =$$

$$\frac{h}{4\pi k} \text{Log} \left[\frac{(e^{-v} \cos u - \cos b)^2 + (\sin u e^{-v} + \sin b)^2}{(e^{-v} \cos u - \cos b)^2 + (\sin u e^{-v} - \sin b)^2} \right]$$

$$= \frac{h}{4\pi k} \text{Log} \left[\frac{\cosh v - \cos(u+b)}{\cosh v - \cos(u-b)} \right] \quad \text{If } b = \frac{\pi}{2}, \quad \cos(u+b) = -\sin u$$

$$\cos(u-b) = \sin u$$

$$(c) \quad \Phi = \frac{h}{2\pi k} \text{Log} \left[\frac{e^{iw} + i}{e^{iw} - i} \right] \quad \text{if } b = \pi/2$$

Sec 8.7 cont'd

7(c) cont'd

$$\frac{d\Phi}{dw} = \frac{h}{2\pi k} \left[\frac{i e^{iw}}{e^{iw+1}} - \frac{e^{iw} i}{e^{iw-1}} \right] =$$

$$\frac{h}{2\pi k} \left[\frac{2e^{iw}}{(e^{2w+1})} \right] \cdot \bar{q} = k \left(-\frac{d\Phi}{dw} \right) = -\frac{h}{2\pi} \left[\frac{2e^{iw}}{e^{2w+1}} \right]$$

$$= -\frac{h}{2\pi} \left[\frac{1}{\cos w} \right] = -\frac{h}{2\pi} \left[\frac{1}{\cos u \cosh v + i \sin u \sinh v} \right]$$

$$= -\frac{h}{2\pi} \left[\frac{\cos u \cosh v - i \sin u \sinh v}{\cos^2 u + \sinh^2 v} \right]$$

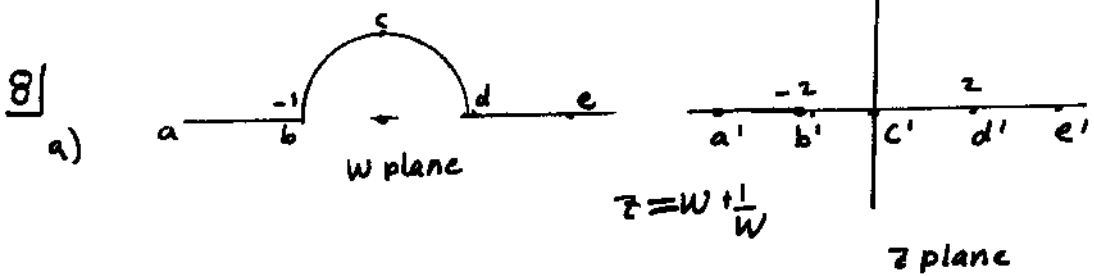

source is now at

$$z = H e^{i\alpha} + \frac{1}{H} e^{-i\alpha}$$

Using method of images, we have in z plane:

$$\Phi(z) = \frac{\rho_L}{2\pi\epsilon} \text{Log} \left[\frac{z - [H e^{-i\alpha} + \frac{1}{H} e^{i\alpha}]}{z - [H e^{i\alpha} + \frac{1}{H} e^{-i\alpha}]} \right]$$

Now use $z = w + 1/w$

$$\text{thus: } \Phi(w) = \frac{\rho_L}{2\pi\epsilon} \text{Log} \left[\frac{(w + \frac{1}{w}) - [H e^{-i\alpha} + \frac{1}{H} e^{i\alpha}]}{(w + \frac{1}{w}) - [H e^{i\alpha} + \frac{1}{H} e^{-i\alpha}]} \right]$$

$$= \frac{\rho_L}{2\pi\epsilon} \text{Log} \left[\frac{(w - \frac{1}{H} e^{i\alpha})(w - H e^{-i\alpha})}{(w - H e^{i\alpha})(w - \frac{1}{H} e^{-i\alpha})} \right]$$

$$(b) \Phi = \frac{\rho_L}{4\pi\epsilon} \text{Log} \left[\frac{|w - \frac{1}{H} e^{i\alpha}|^2 |w - H e^{-i\alpha}|^2}{|w - H e^{i\alpha}|^2 |w - \frac{1}{H} e^{-i\alpha}|^2} \right]$$

put $w = r e^{i\theta}$

sec. 8.7 cont'd

8(b) cont'd

$$\phi = \frac{\rho_2}{4\pi\epsilon} \text{Log} \frac{(re^{i\theta} - \frac{1}{H}e^{i\alpha})(re^{-i\theta} - \frac{1}{H}e^{-i\alpha})(re^{i\theta} - He^{-i\alpha})(re^{-i\theta} - He^{i\alpha})}{(re^{i\theta} - He^{i\alpha})(re^{-i\theta} - He^{-i\alpha})(re^{i\theta} - \frac{1}{H}e^{-i\alpha})(re^{-i\theta} - \frac{1}{H}e^{i\alpha})}$$

$$\phi(r, \theta) = \frac{\rho_2}{4\pi\epsilon} \text{Log} \frac{[r^2 + (\frac{1}{H})^2 - 2r\cos(\theta - \alpha)/H][r^2 + H^2 - 2rH\cos(\theta + \alpha)]}{[r^2 + \frac{1}{H^2} - 2r\cos(\theta + \alpha)/H][r^2 + H^2 - 2rH\cos(\theta - \alpha)]}$$

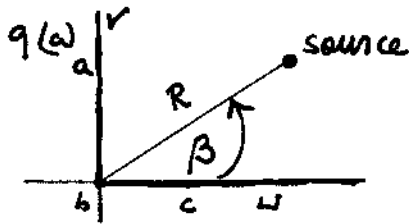

Use $z = w^2$

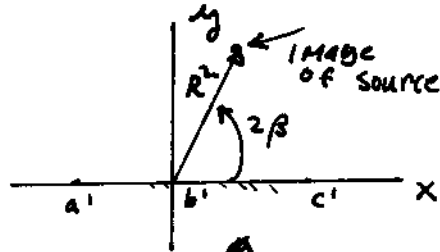

Use method of images here

$$\Phi(z) = \frac{\rho}{2\pi\epsilon} \text{Log} \frac{z - R^2 e^{-i2\beta}}{z - R^2 e^{i2\beta}}$$

Use $z = w^2$
 thus $\Phi(w) = \frac{\rho}{2\pi\epsilon} \text{Log} \left[\frac{w^2 - R^2 e^{-i2\beta}}{w^2 - R^2 e^{i2\beta}} \right], w = re^{i\theta}$

$$\Phi(w) = \frac{\rho}{2\pi\epsilon} \text{Log} \left[\frac{r^2 e^{i2\theta} - R^2 e^{-i2\beta}}{r^2 e^{i2\theta} - R^2 e^{i2\beta}} \right]$$

(b)
$$\phi = \frac{\rho}{4\pi\epsilon} \text{Log} \frac{|r^2 e^{i2\theta} - R^2 e^{-i2\beta}|^2}{|r^2 e^{i2\theta} - R^2 e^{i2\beta}|^2}$$

$$\frac{\rho}{4\pi\epsilon} \text{Log} \left[\frac{(r^2 e^{i2\theta} - R^2 e^{-i2\beta})(r^2 e^{-i2\theta} - R^2 e^{i2\beta})}{(r^2 e^{i2\theta} - R^2 e^{i2\beta})(r^2 e^{-2i\theta} - R^2 e^{-i2\beta})} \right]$$

$$\phi = \frac{\rho}{4\pi\epsilon} \text{Log} \left[\frac{r^4 + R^4 - 2R^2 r^2 \cos 2(\theta + \beta)}{r^4 + R^4 - 2R^2 r^2 \cos 2(\theta - \beta)} \right]$$

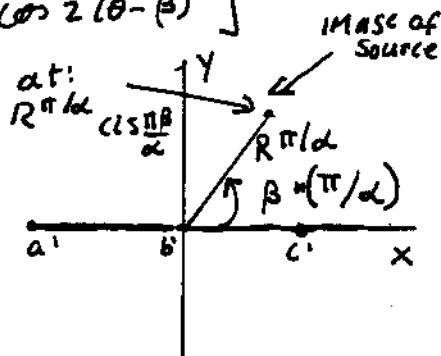
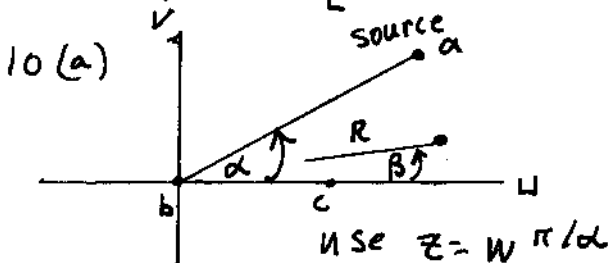

Sec 8.7, cont'd

10 (a) cont'd

use method of images

in z plane, $\Phi(z) = \frac{\rho}{2\pi\epsilon} \text{Log} \left[\frac{z - R^{\pi/\alpha} \text{cis}(-\frac{\pi\beta}{\alpha})}{z - R^{\pi/\alpha} \text{cis}(\frac{\pi\beta}{\alpha})} \right]$

put $z = W^{\pi/\alpha}$, $W = r e^{i\theta}$ $W^{\pi/\alpha} = r^{\pi/\alpha} e^{i\theta\pi/\alpha}$

$$\Phi(W) = \frac{\rho}{2\pi\epsilon} \text{Log} \left[\frac{r^{\pi/\alpha} e^{i\theta\pi/\alpha} - R^{\pi/\alpha} \text{cis}(-\beta\pi/\alpha)}{r^{\pi/\alpha} e^{i\theta\pi/\alpha} - R^{\pi/\alpha} \text{cis}(\frac{\pi\beta}{\alpha})} \right]$$

$$\phi = \frac{\rho}{4\pi\epsilon} \text{Log} \left| \frac{r^{\pi/\alpha} e^{i\theta\pi/\alpha} - R^{\pi/\alpha} \text{cis}(-\frac{\beta\pi}{\alpha})}{r^{\pi/\alpha} e^{i\theta\pi/\alpha} - R^{\pi/\alpha} \text{cis}(\frac{\pi\beta}{\alpha})} \right|^2$$

$$\phi = \frac{\rho}{4\pi\epsilon} \text{Log} \frac{(r^{\pi/\alpha} e^{i\theta\pi/\alpha} - R^{\pi/\alpha} \text{cis}(-\frac{\beta\pi}{\alpha})) (r^{\pi/\alpha} e^{-i\theta\pi/\alpha} - R^{\pi/\alpha} \text{cis}(\frac{\beta\pi}{\alpha}))}{[r^{\pi/\alpha} e^{i\theta\pi/\alpha} - R^{\pi/\alpha} \text{cis}(\frac{\pi\beta}{\alpha})] [r^{\pi/\alpha} e^{-i\theta\pi/\alpha} - R^{\pi/\alpha} \text{cis}(-\frac{\pi\beta}{\alpha})]}$$

$$\phi = \frac{\rho}{4\pi\epsilon} \text{Log} \frac{r^{2\pi/\alpha} + R^{2\pi/\alpha} - 2r^{\pi/\alpha} R^{\pi/\alpha} \cos[(\theta+\beta)\frac{\pi}{\alpha}]}{r^{2\pi/\alpha} + R^{2\pi/\alpha} - 2r^{\pi/\alpha} R^{\pi/\alpha} \cos[(\theta-\beta)\frac{\pi}{\alpha}]}$$

(b) take $\alpha = 2\pi$ in above

$$\phi = \frac{\rho}{4\pi\epsilon} \text{Log} \frac{r + R - 2r^{1/2} R^{1/2} \cos[(\theta+\beta)/2]}{r + R - 2r^{1/2} R^{1/2} \cos[(\theta-\beta)/2]}$$

Sec 8.8

1) Mapping not conformal at these points.

If the transformation were conformal at $W = U_1, W = U_2, \dots, W = U_n$ it would preserve angles for lines intersecting at these points. This transformation, in general, does not preserve such angles. For example (see Fig 8.8-2) angles of π radians are converted into angles of α_1, α_2 , etc radians in the z plane. Note that unless $(\frac{\alpha_j}{\pi} - 1)$ is an integer, $\frac{dz}{dw}$ has a branch point sing. at U_j . Since $\frac{dz}{dw}$ is not analytic at $W = U_j$, $z(w)$ is not analytic at U_j either.

Sec 8.8 cont'd

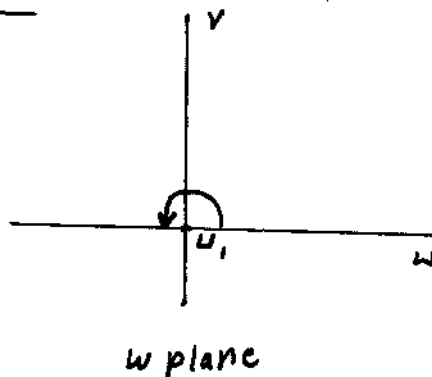
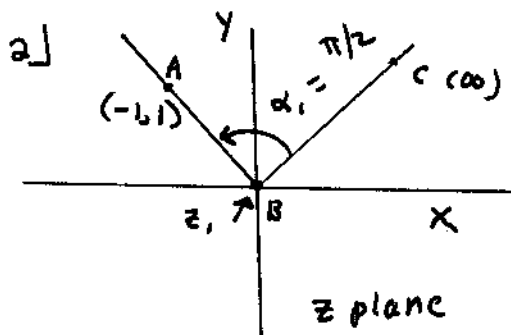

$$\frac{dz}{dw} = A [W - u_1]^{\frac{\alpha_1}{\pi} - 1} = A W^{-1/2}$$

$$z = 2A W^{1/2} + B = A' W^{1/2} + B$$

if $z=0$, $W=0$, so $B=0$. If $z=-1+i$,

$W=-1$. Thus $(-1+i) = A' [-1]^{1/2}$ or

$$A' = \frac{(-1+i)}{[-1]^{1/2}} \quad z = \frac{-1+i}{[-1]^{1/2}} W^{1/2}$$

$$W = \frac{-z^2}{(-1+i)^2} = \frac{-z^2}{-2i} = \frac{-iz^2}{2}$$

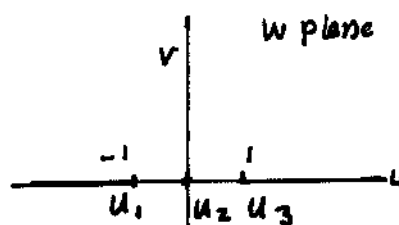
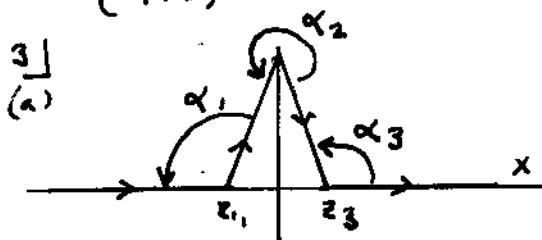

$$\frac{dz}{dw} = A [W+1]^{\frac{\alpha_1}{\pi} - 1} [W]^{\frac{\alpha_2}{\pi} - 1} [W-1]^{\frac{\alpha_3}{\pi} - 1}$$

$$\frac{dz}{dw} = A [W+1]^{-1/2} W [W-1]^{-1/2}$$

$$\frac{dz}{dw} = \frac{AW}{(W^2-1)^{1/2}}, \quad z = A(W^2-1)^{1/2} + B$$

If $W=1=u=0+$, then we require $z=0+$

Thus $B=0$.

We need $z=i$,
 $z^2+1=W^2$

Hence $z=A(W^2-1)^{1/2}$. If $W=u_2=0$

Thus $A=i$. Thus $z=(W^2-1)^{1/2}$

$W=(z^2+1)^{1/2}$. choice of branch requires

sec 8.8 cont'd

3(a) cont'd

that $z_1 = 0^-$ and $z_2 = 0^+$ be on opposite sides of the branch cut. Thus $w = (z^2 + 1)^{1/2} = (z-i)^{1/2} (z+i)^{1/2}$ is defined by a cut connecting i with $-i$ (a straight line segment). If $z = 2i$ we take: $w = i\sqrt{3}$ which lies in upper

half of w plane.

(b) Use mapping $w = (z^2 + 1)^{1/2}$

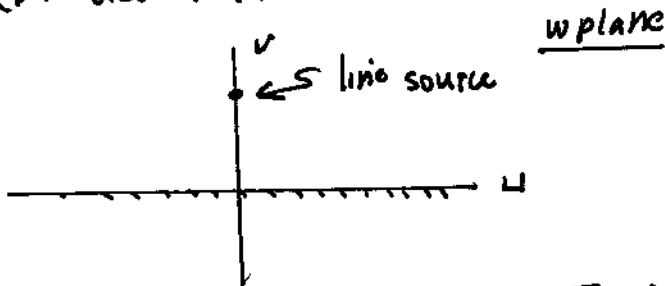

The line source at $z = iH$ is mapped to $w = (-H^2 + 1)^{1/2} = i\sqrt{H^2 - 1}$

Using method of images, get $\Phi(w)$

$$\Phi_1(w) = \frac{\rho}{2\pi\epsilon} \left[\text{Log} \left(\frac{w + i\sqrt{H^2 - 1}}{w - i\sqrt{H^2 - 1}} \right) \right] \text{ Thus in } z \text{ plane}$$

$$\text{have } \Phi(z) = \frac{\rho}{2\pi\epsilon} \text{Log} \left[\frac{(z^2 + 1)^{1/2} + i\sqrt{H^2 - 1}}{(z^2 + 1)^{1/2} - i\sqrt{H^2 - 1}} \right]$$

$$(c) \Phi(0, y) = \frac{1}{2} \text{Log} \left[\frac{(-y^2 + 1)^{1/2} + i}{(-y^2 + 1)^{1/2} - i} \right] =$$

$$\text{Log} \left[\frac{i\sqrt{y^2 - 1} + i}{i\sqrt{y^2 - 1} - i} \right] = \text{Log} \left[\frac{\sqrt{y^2 - 1} + 1}{\sqrt{y^2 - 1} - 1} \right]. \text{ Since } \phi = \text{Re } \Phi$$

$$\phi = \text{Log} \left| \frac{\sqrt{y^2 - 1} + 1}{\sqrt{y^2 - 1} - 1} \right|$$

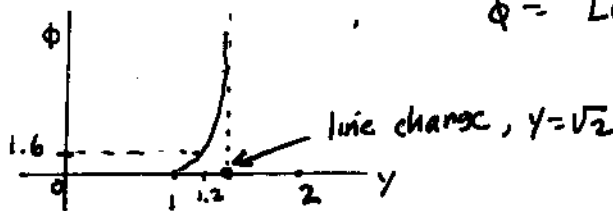

Sec. 8.8 cont'd

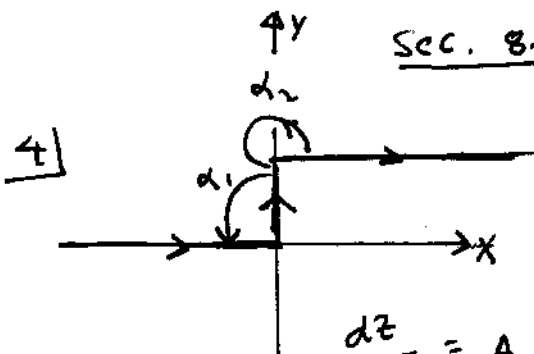

$$\alpha_1 = \pi/2$$

$$\alpha_2 = 3\pi/2$$

$$u_1 = 0, u_2 = 1$$

$$\frac{dz}{dw} = A (W-u_1)^{\frac{\alpha_1}{\pi}-1} (W-u_2)^{\frac{\alpha_2}{\pi}-1}$$

$$\frac{dz}{dw} = A W^{-1/2} (W-1)^{1/2}$$

From tables, set

$$z = \int \frac{dz}{dw} dw = A \left[(W-1)^{1/2} W^{1/2} - \log \left(W^{1/2} + (W-1)^{1/2} \right) \right] + B$$

Now: $\frac{1}{W^{1/2} + (W-1)^{1/2}} = W^{1/2} - (W-1)^{1/2}$

$$\text{Thus } z = A \left[(W-1)^{1/2} W^{1/2} + \log \left(W^{1/2} - (W-1)^{1/2} \right) \right] + B$$

We will now use princ. values of \log , $W^{1/2}$ and $(W-1)^{1/2}$ since they are all analytic in half space $\text{Im } W > 0$.

Since $z = i$ when $W = 1$ we have:

$$i = B, \text{ or } B = \frac{2}{\pi} \text{Log } i$$

Since $z = 0$ when $W = 0$

have: $0 = A \left[\text{Log}(-i) \right] + \frac{2}{\pi} \text{Log } i$ $A = \frac{2}{\pi}$

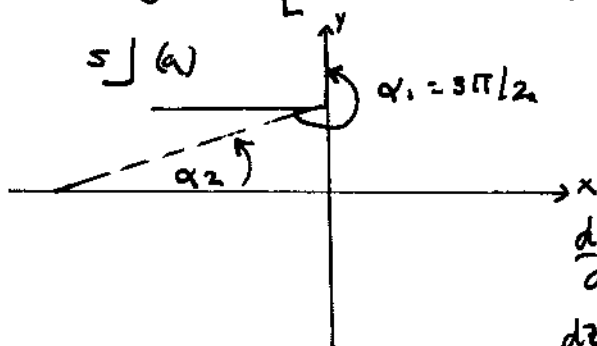

$$\alpha_1 = 3\pi/2$$

$$\alpha_2 = 0$$

$$u_1 = -1$$

$$u_2 = 0$$

$$\frac{dz}{dw} = A [W+1]^{1/2} W^{-1}$$

$$dz = A [W+1]^{1/2} W^{-1} dW$$

From tables: $z = A \left[2(W+1)^{1/2} + \log \frac{(W+1)^{1/2} - 1}{(W+1)^{1/2} + 1} \right] + B$

If $W = -1$, need $z = i$. Use princ. values \log s + sq. rts.

$$i = A \text{Log}(-1) + B \text{ or } B = i(1 - A\pi)$$

Sec. 8.8 cont'd

5) (a) cont'd

$$z = A \left[2(W+1)^{1/2} + \text{Log} \left[\frac{(W+1)^{1/2} - 1}{(W+1)^{1/2} + 1} \right] \right] + i(1 - A\pi)$$

Suppose $V=0, W > 0$ but $u \ll 1$.

Then $(1+W)^{1/2} \approx 1 + \frac{1}{2}W \approx 1 + \frac{1}{2}u$
 [Mac. series expans.]

Thus $z \approx A \left[2 \left[1 + \frac{u}{2} \right] + \text{Log} \left[\frac{u/2}{2+u/2} \right] \right] + i[1 - A\pi]$

if $0 < u \ll 1$, now as $u \rightarrow 0+$ in the preceding we require that $z \rightarrow -\infty + i0$ (see Fig 8.8-10). This can only be satisfied in the preceding if $i[1 - A\pi] = 0$ or $A = 1/\pi$. This completes the proof.

(b) In the w plane, the complex potential satisfies

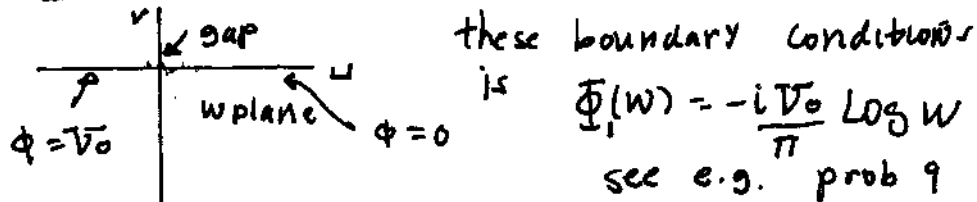

Refer to Eqn (8.8-23). Assume $|z| \gg 1$. sec 8.5

This can happen either if $|w| \gg 1$ or $|w| \ll 1$.

We can eliminate the second possibility $|w| \ll 1$ since it implies that $\text{Re } z < 0$. We want $\text{Re } z > 0$

Thus $|w| \gg 1$ and $z \approx \frac{2}{\pi} (1+w)^{1/2}$, or $z \approx \frac{2}{\pi} w^{1/2}$

Thus if $|z| \gg 1, \text{Re } z > 0, w \approx \frac{\pi^2}{4} z^2$ and

$$\Phi(z) \approx -\frac{iV_0}{\pi} \text{Log} \left[\frac{\pi z}{2} \right]^2 = -\frac{2iV_0}{\pi} \text{Log} \left[\frac{\pi z}{2} \right] = \phi + i\psi$$

Thus $\psi = -\frac{2V_0}{\pi} \text{Log} \left| \frac{\pi z}{2} \right|, \phi = \frac{2V_0}{\pi} \text{Arg} \left[\frac{\pi z}{2} \right] = \frac{2V_0}{\pi} \text{Arg } z$

sketch on next pg.

sec 8.8 Cont'd

5(b) Cont'd

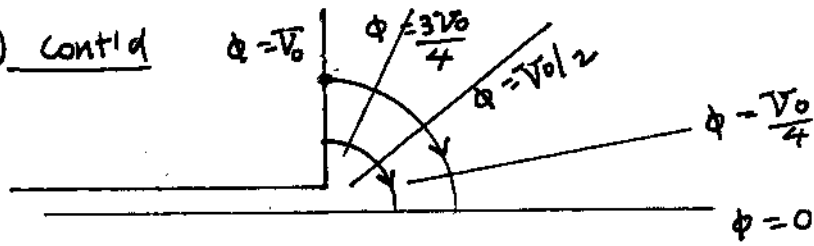

Streamlines marked with arrows

5(c)

See part (b), if $\text{Re } z \ll 1$, we must have $|w| \ll 1$. Thus $\text{Log} \left[\frac{(1+w)^{1/2} - 1}{(1+w)^{1/2} + 1} \right] \approx$

$$\text{Log} \left[\frac{1 + 1/2 w - 1}{1 + 1/2 w + 1} \right] \approx \text{Log} \left[\frac{w}{4} \right]. \quad \text{We drop}$$

$(1+w)^{1/2}$ in comparison with $\text{Log} \left[\frac{w}{4} \right]$

$$\text{Thus } z \approx \frac{1}{\pi} \text{Log} \frac{w}{4}, \quad w \approx 4 e^{\pi z}$$

$$\Phi(w) = \frac{-i V_0}{\pi} \text{Log} w, \quad \Phi(z) \approx \frac{-i V_0}{\pi} \text{Log} 4 e^{\pi z} =$$

$$\frac{-i V_0}{\pi} [\text{Log} 4 + \pi z] = \phi + i \psi, \quad \text{Thus } \phi \approx V_0 y,$$

$$\psi \approx -\frac{V_0}{\pi} [\text{Log} 4 + \pi x] = -V_0 x \quad \text{if } x \ll -1$$

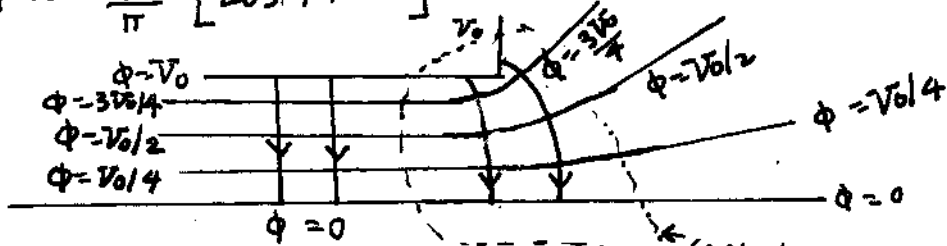

Streamlines have arrows ← conjectured region

6(a)

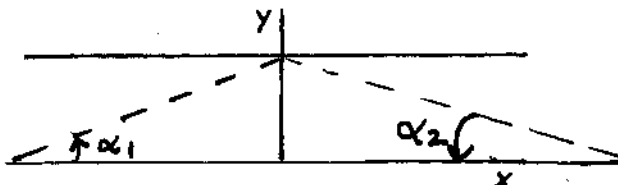

$$\begin{aligned} u_1 &= -1 & \psi_1 &= 0 \\ u_2 &= 1 & \psi_2 &= 0 \end{aligned}$$

$$\begin{aligned} \frac{dz}{dw} &= A [w+1]^{-1} [w-1]^{-1} = \frac{A}{w^2-1} = \frac{A}{2} \left[\frac{1}{w-1} + \frac{1}{w+1} \right] \\ &= A' \left[\frac{1}{w-1} + \frac{1}{w+1} \right] = A' [\text{Log}(w-1) - \text{Log}(w+1)] + B \end{aligned}$$

Sec 8.8 cont'd

6(a) cont'd

$z = A \operatorname{Log} \left[\frac{w-1}{w+1} \right] + B$ We elect to use princ. value of log since it is analytic in $\operatorname{Im} w > 0$.
 Let $v = 0+$ and $u \rightarrow \infty$ through positive values. We require that $z \rightarrow i$. Thus $B = i$.

Let $v = 0+$, and $u \rightarrow 1-$. We require that z be a complex number of form $\infty + i0$.

Now $\operatorname{Log} \left[\frac{w-1}{w+1} \right] \rightarrow i\pi - \infty$ as $w \rightarrow 1-$.

Thus $A \operatorname{Log} \left[\frac{w-1}{w+1} \right] + B \rightarrow A [i\pi - \infty] + i$. Thus require

$A = -\frac{i}{\pi}$. Finally $z = -\frac{i}{\pi} \operatorname{Log} \left[\frac{w-1}{w+1} \right] + i$

(b)

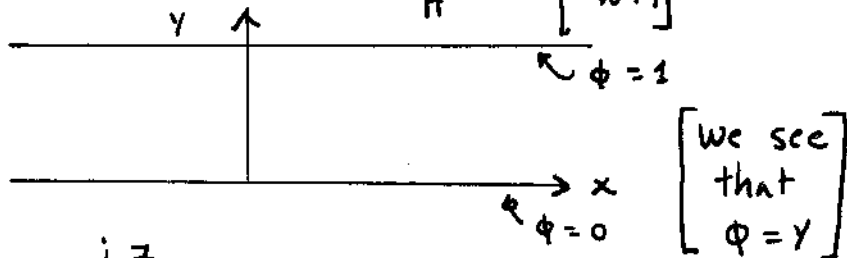

$\Phi(z) = -iz$ Thus in w plane:

$\Phi(w) = -i \left[-\frac{i}{\pi} \operatorname{Log} \left[\frac{w-1}{w+1} \right] + i \right] = 1 + \frac{i}{\pi} \operatorname{Log} \left[\frac{w-1}{w+1} \right]$

$\phi(u,v) = \operatorname{Re} \Phi = 1 + \operatorname{Re} \left[\frac{i}{\pi} \operatorname{Log} \left[\frac{w-1}{w+1} \right] \right] =$

$1 - \frac{1}{\pi} \operatorname{arg} \left[\frac{w-1}{w+1} \right]$. Now $\operatorname{arg} \left[\frac{w-1}{w+1} \right] =$

$\operatorname{arg} \left[\frac{(w-1)(\bar{w}+1)}{|w+1|^2} \right] = \operatorname{arg} [(w-1)(\bar{w}+1)] =$

$= \operatorname{arg} [|w|^2 - 1 + w - \bar{w}] = \tan^{-1} \left[\frac{2v}{u^2 + v^2 - 1} \right]$
 ($w = u+iv$)

Thus $\phi = 1 - \frac{1}{\pi} \tan^{-1} \left[\frac{2v}{u^2 + v^2 - 1} \right]$ where $\left\{ \begin{array}{l} 0 \leq \tan^{-1}(\cdot) \leq \pi \\ \text{where} \end{array} \right\}$

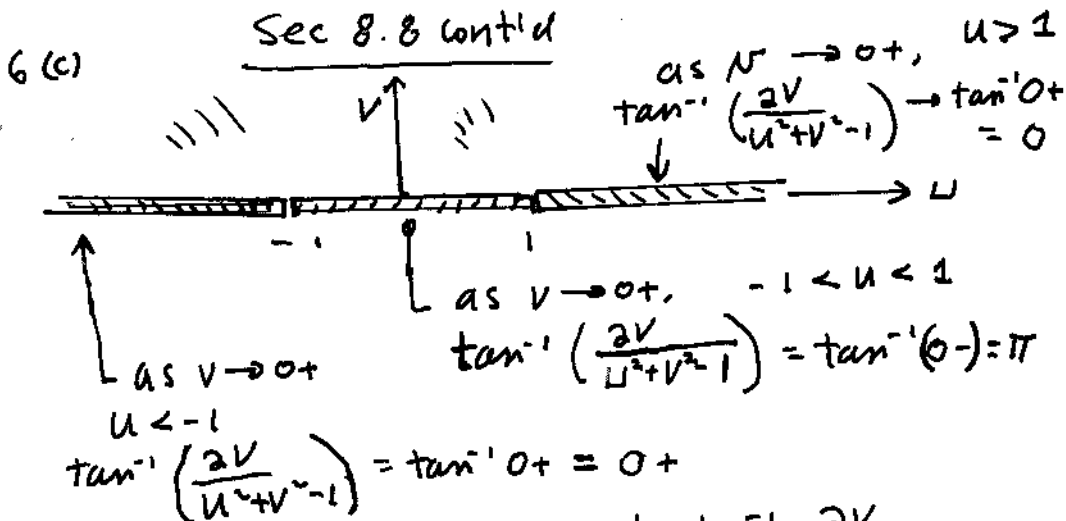

thus: $\phi(u, v) = 1 - \frac{1}{\pi} \tan^{-1} \frac{2v}{u^2+v^2-1}$

Satisfies $\phi = (u, 0+) = 1$ if $|u| > 1$
 $\phi(u, 0+) = 0$ if $|u| < 1$.

7(a)

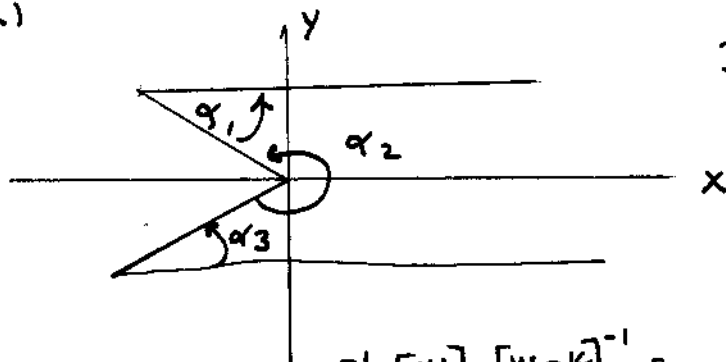

In limit:
 $\alpha_1 = 0$
 $\alpha_2 = -2\pi$
 $\alpha_3 = 0$
 $u_1 = -k$
 $u_2 = 0$
 $u_3 = k$

$$\frac{dz}{dw} = A' [w+k]^{-1} [w] [w-k]^{-1} = \frac{A'w}{w^2-k^2}$$

$$z = A \log(w^2-k^2) + B \quad \text{where } A' = 2A$$

We will use branch of \log with cuts as shown in w plane, and $\log(w^2-k^2)$ real if $v=0, u > k$. Thus $\log(w^2-k^2)$ will be analytic in half plane $\text{Im} w \geq 0$.

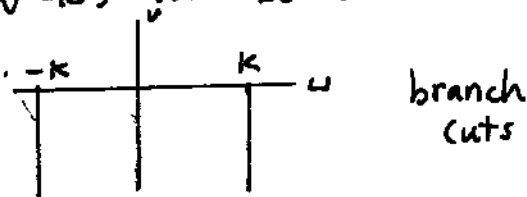

Sec 8.8 Cont'd

7 (a) Cont'd. $z = A \log(W^2 - k^2) + B$

let $A = A_r + i A_i$, $B = B_r + i B_i$

$z = (A_r + i A_i) \log(W^2 - k^2) + B_r + i B_i$

Let $v=0$, $u > 0$, $u \rightarrow \infty$. Requires $z \rightarrow \infty - i$

Thus $A_i = 0$, $B_i = -1$

Now let $v=0$, $u < 0$, $u \rightarrow -\infty$. Requires that $z \rightarrow \infty + i$. Now $z = A_r \log(W^2 - k^2) + B_r - i$

Suppose $u < k$, $v = 0$

$z = A_r \text{Log}|u^2 - k^2| + i 2\pi A_r + B_r - i$

As $u \rightarrow -\infty$ this must yield $\text{Im} z = 1$.

Thus $A_r = \frac{1}{\pi}$. Thus have $z = \frac{1}{\pi} \text{Log}(W^2 - k^2) + B_r - i$

Now if $w=0$ want $z=0$

$0 = \frac{1}{\pi} [\text{Log}(k^2) + i\pi] + B_r - i$. $B_r = -\frac{1}{\pi} \text{Log} k^2$

finally $z = \frac{1}{\pi} \text{Log}(W^2 - k^2) - i - \frac{1}{\pi} \text{Log} k^2$

$z = \frac{1}{\pi} \text{Log} \left[\frac{W^2 - k^2}{k^2} \right] - i$, $(z+i)\pi = \text{Log} \left[\frac{W^2 - k^2}{k^2} \right]$
 $e^{(z+i)\pi} = \frac{W^2 - k^2}{k^2}$, $e^{\pi z} k^2 = W^2 - k^2$

$W^2 = k^2 [1 - e^{\pi z}]$, $w = k [1 - e^{\pi z}]^{1/2}$

Assignment of branch; take cuts so they coincide with boundaries of domain (see e.g. below)

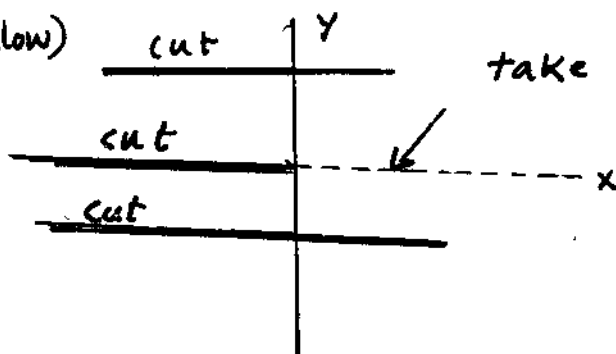

take $w = k [1 - e^{\pi z}]^{1/2}$
 as pos. imaginary
 if $y=0$, $x > 0$.
 Thus this line is
 mapped into upper
 half of w plane.

SEC 8.8 cont'd

7(b)

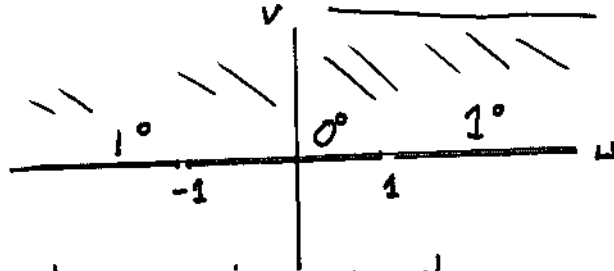

Image of Fig 8.8-12a with boundary conds.

With boundaries as shown, we can find the complex temp. for $v > 0$. This can be obtained from prob 9(c) in sec 8.5 [put $V_1 = V_3 = 1, V_2 = 0$]. Thus we find: $\Phi_1(w) = \frac{i}{\pi} \text{Log} \left[\frac{w-1}{w+1} \right] + 1$

Now $w = [1 - e^{\pi z}]^{1/2}$

Thus $\Phi(z) = \frac{i}{\pi} \text{Log} \left[\frac{[1 - e^{\pi z}]^{1/2} - 1}{[1 - e^{\pi z}]^{1/2} + 1} \right] + 1$

7(c)

Let $x=0, 0 \leq y < 1$

$\Phi(z) = \frac{i}{\pi} \text{Log} \left[\frac{[1 - e^{i\pi y}]^{1/2} - 1}{[1 - e^{i\pi y}]^{1/2} + 1} \right] + 1$

$\phi = \text{Re } \Phi$

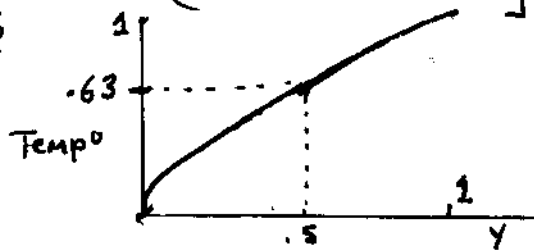

ϕ for $x=0, 0 \leq y \leq 1$

Let $y=0, 0 \leq x \leq 2$

$\phi = \frac{i}{\pi} \text{Log} \left[\frac{[1 - e^{\pi x}]^{1/2} - 1}{[1 - e^{\pi x}]^{1/2} + 1} \right] + 1$

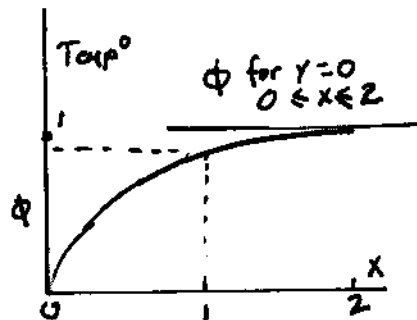

ϕ for $y=0, 0 \leq x \leq 2$

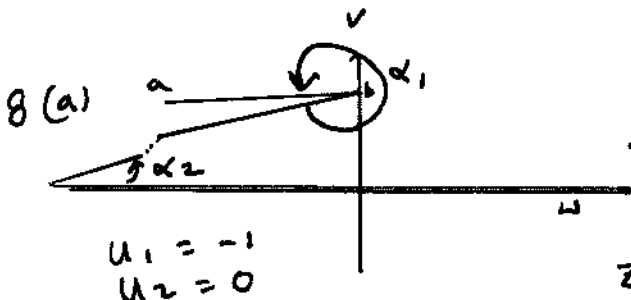

$\frac{dz}{dw} = A(w+1)w^{-1}$
 $= A \left[1 + \frac{1}{w} \right]$

$z = A [w + \text{Log } w] + B$

Sec. 8.8 cont'd

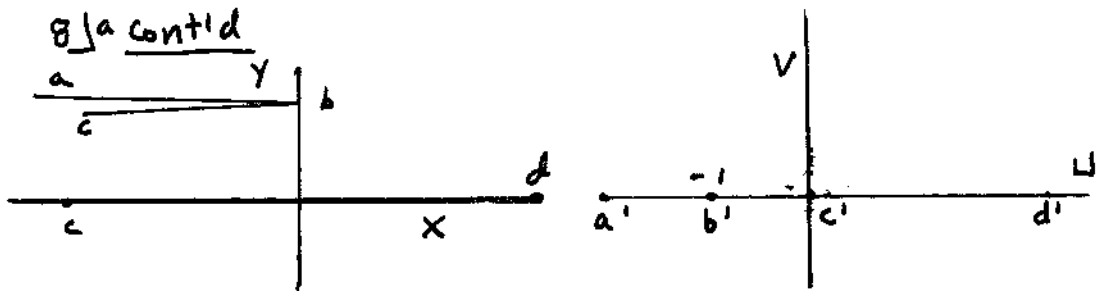

Let $w \rightarrow 0+$ thru pos. real values. You should get $z = -\infty + i0$, z is neg. real.

$z = A [w + i \log w] + B$. Thus A is real. Now let $w = -1$, should get $z = i$, Take: $\log(-1) = i\pi$

$i = A [-1 + i\pi] + B$ Equate Thus A = Real B
reals:

Equate imag. parts

$1 - A\pi = \text{Imag } B$

Now let $w \rightarrow \infty$ through pos. real values.

get $\text{Im } z \rightarrow 0$ in this limit. Since A is known to be real, we see from $z = A [w + i \log w] + B$ that $\text{Imag } B = 0$. Since $1 - A\pi = \text{Imag } B$ we have from above that $A = \frac{1}{\pi}$. Also $B = \frac{1}{\pi} = A$. Finally $z = \frac{1}{\pi} [w + i \log w] + \frac{1}{\pi}$. Take

the principal value for $\log w$, i.e. $\text{Log } w = \log w$.

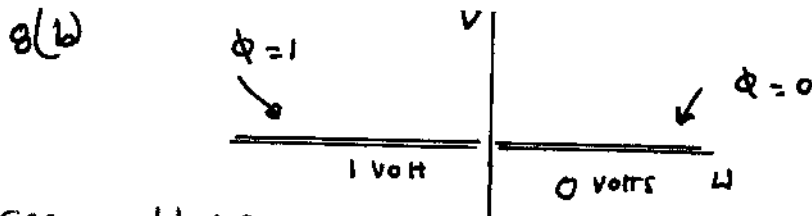

See problem 9, sec 8.5

$\Phi_1 = -\frac{i}{\pi} \text{Log } w$

thus $\phi_1 = \frac{1}{\pi} \arg w$ which satisfies the boundary conditions.

Sec 8.8 cont'd

8(b), cont'd

$$\phi + i\psi = -\frac{L}{\pi} \log w$$

$$L\pi\phi - \pi\psi = \log w, \quad \boxed{e^{L\pi\phi} e^{-\pi\psi} = w}$$

ϕ is the actual potential and must achieve its highest and lowest values on the boundaries. There is no such requirement on ψ .

$$(c) \quad z = \frac{1}{\pi} [w + \log w + 1]$$

$$= \frac{1}{\pi} [e^{L\pi\phi} e^{-\pi\psi} + \log [(e^{L\pi\phi}) e^{-\pi\psi}] + 1]$$

$$= \frac{1}{\pi} [e^{L\pi\phi} e^{-\pi\psi} + L\pi\phi - \pi\psi + 1] = \frac{1}{\pi} [e^{-\pi\psi} (e^{L\pi\phi} + 1) - \pi\psi + 1]$$

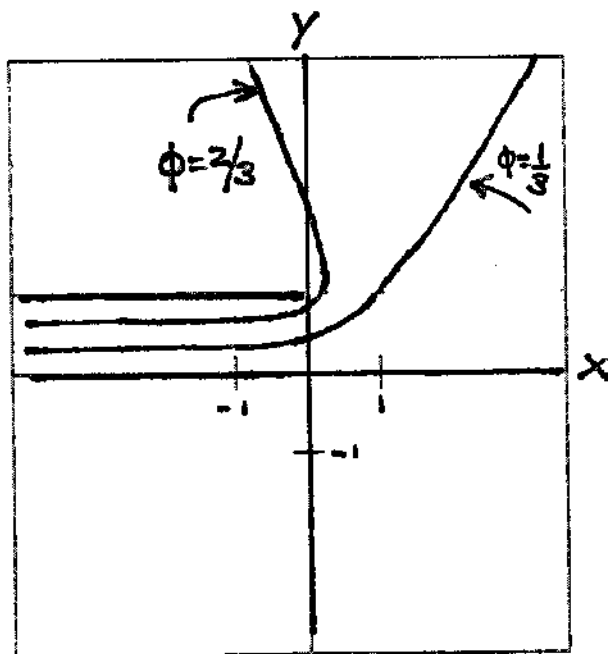

Sec 8.8 Cont'd

Q (c) Cont'd

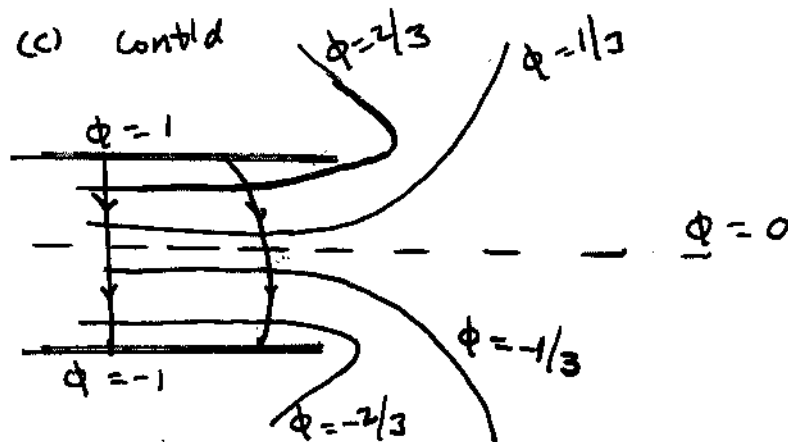

By symmetry the equipotential on which $\phi = 0$ must be the plane $y = 0$ which is half way between the 2 plates. By symmetry the equipotentials corresponding to negative values of voltages must be the mirror images of the equipotentials having the corresponding positive values (as shown in the examples above). The streamlines also exhibit mirror image behaviour, e.g. the behaviour of $\psi = 1, y < 0$ must be the mirror image of the streamline on which $\psi = 1, y > 0$.

finis chap 8

9

**Advanced Topics in Infinite
Series and Products**

sec 9.1

$$\begin{aligned}
 d) \sum_{n=-\infty}^{+\infty} \frac{1}{n^2+a^2} &= -\pi \sum_{\text{residues}} \left[\cot(\pi z) \frac{1}{z^2+a^2} \right] \\
 &= -\pi \left[\frac{\cot(\pi a)}{\sin(\frac{\pi a}{a})} \frac{1}{a^2 a} \right] + \pi \left[\frac{\cot(\frac{i\pi}{a})}{\sin(\frac{-i\pi}{a})} \right] \frac{1}{a^2 a} \quad \text{at } \pm ia \\
 &= \frac{\pi}{2a} \left[\coth(\pi a) \right] + \frac{\pi}{2a} \coth(\pi a) = \frac{\pi}{a} \coth(\pi a)
 \end{aligned}$$

$$\begin{aligned}
 \sum_{n=-\infty}^{+\infty} \frac{1}{n^2+a^2} &= 2 \sum_{n=1}^{\infty} \frac{1}{n^2+a^2} + \frac{1}{a^2} \\
 \sum_{n=1}^{\infty} \frac{1}{n^2+a^2} + \frac{1}{a^2} &= \frac{\pi}{a} \coth \pi a
 \end{aligned}$$

$$\sum_{n=1}^{\infty} \frac{1}{n^2+a^2} = \frac{\pi}{2a} \coth(\pi a) - \frac{1}{2a^2} = \frac{\pi a \coth(\pi a) - 1}{2a^2}$$

$$\sum_{n=0}^{\infty} \frac{1}{n^2+a^2} = \frac{\pi}{2a} \coth(\pi a) + \frac{1}{2a^2} = \frac{1 + \pi a \coth(\pi a)}{2a^2}$$

$$c) \sum_{n=1}^{\infty} \frac{1}{n^2+a^2} = \frac{\pi a \coth(\pi a) - 1}{2a^2}$$

pass to limit $a \rightarrow 0$ on both sides. Take limit under summation sign.

$$\lim_{a \rightarrow 0} \frac{\pi a \frac{\cosh(\pi a)}{\sinh(\pi a)} - 1}{2a^2} = \lim_{a \rightarrow 0} \frac{\pi a \cosh(\pi a) - \sinh(\pi a)}{2a^2 \sinh(\pi a)}$$

$$= \lim_{a \rightarrow 0} \frac{a \pi^2 \sinh(\pi a)}{4 \sinh(\pi a) + 2a\pi \cosh(\pi a)} = \frac{\pi^2 \sinh(\pi a)}{4 \sinh(\pi a) + 2a\pi \cosh(\pi a)}$$

$$\lim_{a \rightarrow 0} \frac{\pi^3 \cosh(\pi a)}{4\pi \cosh(\pi a) + 2\pi \cosh(\pi a) + 2a\pi^2 \sinh(\pi a)} = \frac{\pi^3}{6\pi} = \frac{\pi^2}{6}$$

apply L'Hopital's rule again.

Sec 9.1, Prob 1 cont'd

```

clear
% problem 1 (d) in section 9.1
a=linspace(.0001,20,100);
z=a;
nmax=length(z);
seriesm=10;
while (seriesm<=50)
for kk=1:nmax
    s=0;
    for n=1:seriesm;
        s=1/(n^2+z(kk)^2)+s;
    end
    ya(kk)=pi*pi/6;

    sumz(kk)=s;
end
plot(z,(sumz));
seriesm=seriesm+40;
hold on
end
y1=cosh(pi*z)./sinh(pi*z);
y1=pi*z.*y1-1;
y=y1./(2*z.^2);

plot(z,y,'r',z,ya,'-');grid on
xlabel('a'); ylabel('function and sum of series')
title('problem 1, chap 9, part d')

```

chap 9, sec 9.1 prob 1, cont'd

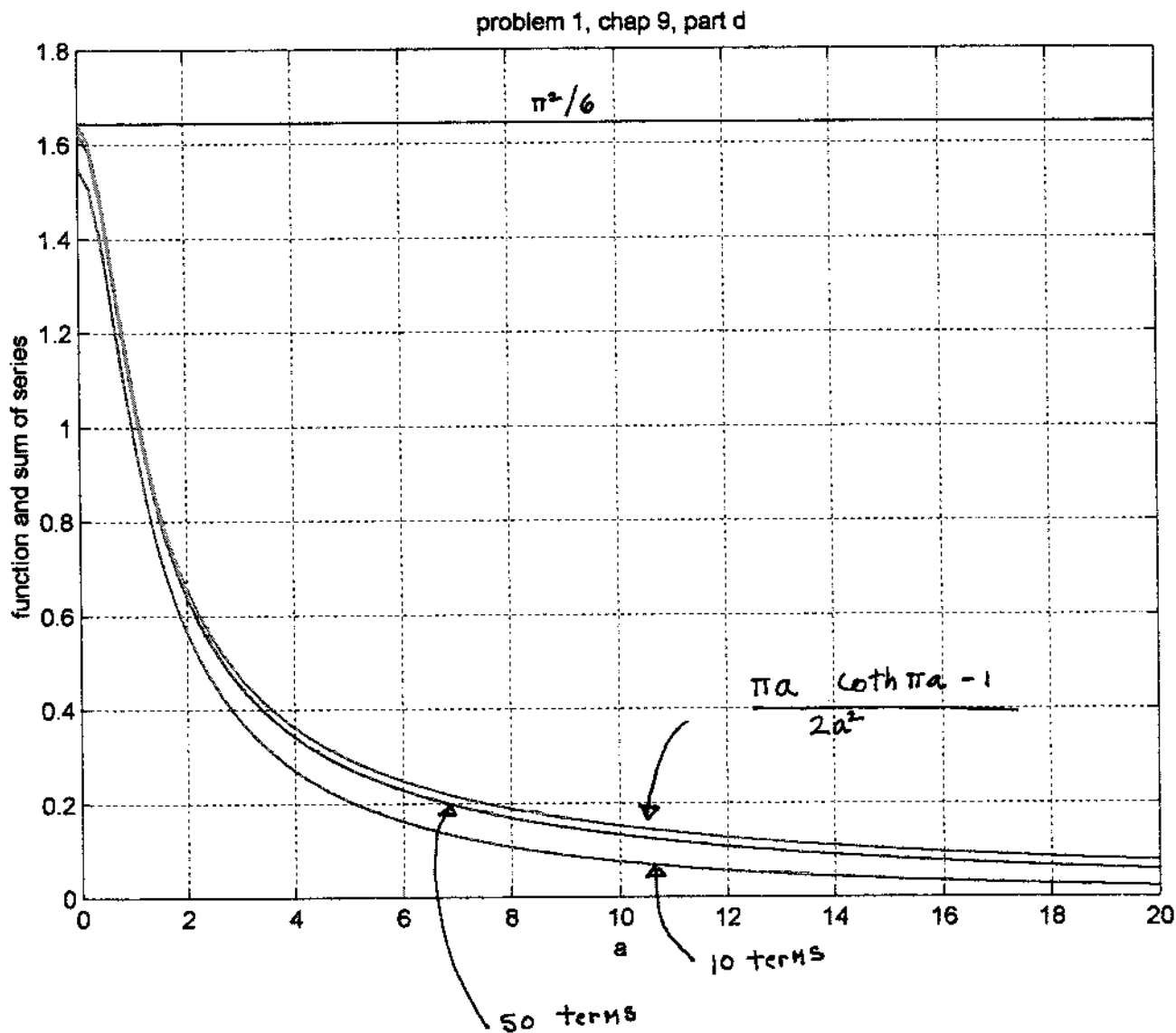

$$\begin{aligned}
2) \quad \sum_{n=-\infty}^{+\infty} \frac{1}{n^2 - i} &= -\pi \sum_{\text{res}} \left[\frac{\cot(\pi z)}{z^2 - i} ; z = \pm \frac{1+i}{\sqrt{2}} \right] \\
&= -\pi \left[\frac{\cot \left[\pi \frac{1+i}{\sqrt{2}} \right]}{2 \left[\frac{1+i}{\sqrt{2}} \right]} + \frac{\cot \left[-\pi \right] \left[\frac{1+i}{\sqrt{2}} \right]}{-2 \left[\frac{1+i}{\sqrt{2}} \right]} \right] \\
&= -\pi \left[\frac{\cot \left[\pi \left[\frac{1+i}{\sqrt{2}} \right] \right]}{\left(\frac{1+i}{\sqrt{2}} \right)} \right] = -\frac{\pi(1-i)}{\sqrt{2}} \cot \left[\pi \frac{1+i}{\sqrt{2}} \right]
\end{aligned}$$

Ch9, p. 4

Section 9.1

2) Cont'd

Use Eqn (3.2-14)

$$\sum_{n=-\infty}^{\infty} \frac{1}{n^2 - i} = \frac{\pi}{\sqrt{2}} [i-1] \left[\frac{\operatorname{sm} \left[\frac{2\pi}{\sqrt{2}} \right] - i \operatorname{sinh} \left[\frac{2\pi}{\sqrt{2}} \right]}{\operatorname{cosh} \left[\frac{2\pi}{\sqrt{2}} \right] - \operatorname{cos} \left[\frac{2\pi}{\sqrt{2}} \right]} \right]$$

$$(b) \sum_{n=-\infty}^{+\infty} \frac{1}{n^2 - i} = \sum_{n=-\infty}^{+\infty} \frac{n^2 + i}{n^4 + 1} =$$

$$2 \sum_{n=0}^{\infty} \frac{n^2}{n^4 + 1} + 2i \sum_{n=0}^{\infty} \frac{1}{n^4 + 1} - i =$$

Now equate real and imag. parts.
Then divide each side by 2,

$$3) (a) \sum_{n=-\infty}^{\infty} \frac{(-1)^n}{n^2 + 1} = -\pi \sum_{\text{res}} \frac{1}{\operatorname{sm}(\pi z)} \frac{1}{z^2 + 1} \text{ at } \pm i$$

$$= -\pi \left[\frac{1}{\operatorname{sm}(i\pi) 2i} + \frac{1}{\operatorname{sm}[-L\pi](-2i)} \right] = \frac{\pi}{\operatorname{smh}(\pi)}$$

$$(b) \sum_{n=-\infty}^{\infty} \frac{(-1)^n}{n^2 + 1} = \frac{\pi}{\operatorname{smh}(\pi)}$$

$$2 \sum_{n=0}^{\infty} \frac{(-1)^n}{n^2 + 1} - 1 = \frac{\pi}{\operatorname{smh}(\pi)}, \quad \sum_{n=0}^{\infty} \frac{(-1)^n}{n^2 + 1} = \frac{\pi}{2 \operatorname{smh}(\pi)} + \frac{1}{2}$$

4)

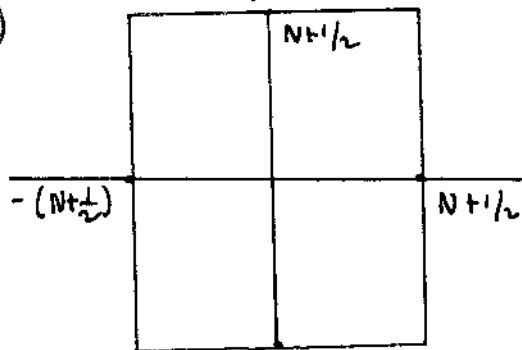

$$\operatorname{sm} \pi z = \operatorname{sm} \pi x \operatorname{cosh} \pi y + i \operatorname{cos} \pi x \operatorname{sinh} \pi y$$

On rt. side, $x = N + \frac{1}{2}$, Thus $|\operatorname{sm} \pi z| = \operatorname{cosh} \pi y$
 $\left| \frac{1}{\operatorname{sm} \pi z} \right| = \frac{1}{\operatorname{cosh} \pi y} \leq 1$

Sec 9.1

4) (a) Cont'd A similar argument applies on left side. On top side: $y = (N + \frac{1}{2})$

$$\text{Now } |\sin \pi z| = |\sin \pi x \cosh \pi y + i \cos(\pi x) \sinh(\pi y)|$$

$$\geq |\sinh \pi y| |\sin \pi x + i \cos(\pi x)| = |\sinh \pi y|$$

$$\left| \frac{1}{\sin \pi z} \right| \leq \frac{1}{\sinh(\pi y)} \leq \frac{1}{\sinh\left[\frac{\pi}{2}\right]}$$

[Since the smallest possible value of y is when $N=0$, $[y = \frac{1}{2}]$] A similar argument applies on the bottom.

$$(b) \int_{C_N} \pi \frac{f(z)}{\sin(\pi z)} dz = 2\pi i \sum_{\substack{\text{residues} \\ \text{poles of } f(z)}} \frac{\pi}{\sin(\pi z)} f(z)$$

$$+ 2\pi i \sum_{\text{res.}} \frac{\pi f(z)}{\sin(\pi z)} \text{ at } z=0, \pm 1, \pm 2, \dots, \pm N$$

$$(c) \text{Res } \frac{\pi f(z)}{\sin \pi z}, n = \frac{\pi f(n)}{\pi \cos(\pi n)} = (-1)^n f(n)$$

$$(d) \left| \int_{C_N} \frac{\pi f(z)}{\sin(\pi z)} dz \right| \leq ML, \quad L = 8\pi(N + \frac{1}{2})$$

$$\left| \frac{\pi f(z)}{\sin \pi z} \right| \leq \frac{\pi M}{|z|^k} \leq \frac{\pi M}{(N + \frac{1}{2})^k} = M$$

$$\text{Note } ML = \frac{8\pi M}{(N + \frac{1}{2})^{k-1}} \rightarrow 0 \text{ as } N \rightarrow \infty$$

Thus, passing to limit $N = \infty$ in equation of part (b) we have:

$$0 = \sum_{\substack{\text{all poles} \\ f(z)}} \frac{\pi}{\sin \pi z} f(z) + \sum_{n=-\infty}^{\infty} (-1)^n f(n)$$

This completes the proof.

sec 9.1

5)
$$\sum_{n=-\infty}^{+\infty} \frac{(-1)^n n^2}{n^4 + a^4} =$$

$$-\pi \sum_{\text{res}} \frac{1}{\sin(\pi z)} \frac{z^2}{z^4 + a^4} \quad \text{at } \left(\pm a \cos \left[\frac{\pm \pi}{4} \right] \right)$$

$$= -\pi \sum \frac{1}{\sin \pi z} \frac{z^2}{4z^3} = -\frac{\pi}{4} \sum \frac{1}{z \sin(\pi z)}$$

let $d = \pi a / \sqrt{2}$ at $z = \pm a \left[\frac{1 \pm i}{\sqrt{2}} \right]$

$$= -\frac{\pi}{4} \left[\frac{2}{(a \left[\frac{1+i}{\sqrt{2}} \right] \sin \pi \left[\frac{1+i}{\sqrt{2}} \right])} + \frac{2}{a \left[\frac{1-i}{\sqrt{2}} \right] \sin \pi \left[\frac{1-i}{\sqrt{2}} \right]} \right] =$$

$$-\pi^2 \text{Real} \left[\frac{1}{(d+id) \sin(d+id)} \right] = -\frac{\pi^2}{2d} \text{Real} \left[\frac{1-i}{\sin(d+id)} \right]$$

$$= -\frac{\pi^2}{2d} \text{Real} \left\{ \frac{(1-i) [\sin d \cosh d - i \cos d \sinh d]}{\sin^2 d + \sinh^2 d} \right\} =$$

$$\frac{\pi^2 [\sin d \cosh d + \cos d \sinh d]}{2d (\sin^2 d + \sinh^2 d)} = \sum_{n=-\infty}^{+\infty} \frac{(-1)^n n^2}{n^4 + a^4}$$

$$\sum_{n=0}^{\infty} \frac{(-1)^n n^2}{n^4 + a^4} = \frac{\pi^2}{4d} \left[\frac{\cos d \sinh d - \sin d \cosh d}{2 \sin^2 d + \sinh^2 d} \right]$$

6) a) On CN we have that $|\cot \pi z| \leq \coth \left(\frac{\pi}{2} \right)$ [Eg 9.1-9]. Now on the contour $|z| \geq N + \frac{1}{2}$, $\left| \frac{1}{z} \right|^2 \leq \left(\frac{1}{N + \frac{1}{2}} \right)^2$

Thus $\left| \frac{\cot(\pi z)}{z^2} \right| \leq \frac{\coth(\pi/2)}{(N + 1/2)^2}$

Sec 9.1

6(b), continued

$$\oint_{C_N} \frac{\pi}{z^2} \cot(\pi z) dz = 2\pi i \operatorname{Res} \left[\frac{\pi \cot(\pi z)}{z^2}; 0 \right]$$

$$+ 2\pi i \sum_{\operatorname{res}} \frac{\pi}{z^2} \frac{\cos \pi z}{\sin \pi z} \quad \text{at } z = \pm 1, \pm 2, \dots, \pm N$$

Now $\operatorname{Res} \frac{\pi}{z^2} \frac{\cos \pi z}{\sin \pi z}$ at $n = \frac{\pi}{n^2} \frac{\cos n\pi}{\pi \cot(n\pi)} = \frac{1}{n^2}$. Thus the residue at n equals the residue at $-n$.

$$\sum_{\operatorname{res}} \frac{\pi}{z^2} \frac{\cos(\pi z)}{\sin \pi z} = 2 \sum_{n=1}^N \frac{1}{n^2}$$

$$\oint_{C_N} \frac{\pi}{z^2} \cot(\pi z) dz = 2\pi i \operatorname{Res} \left[\frac{\pi \cot(\pi z)}{z^2}, 0 \right]$$

$$+ 4\pi i \sum_{n=1}^N \frac{1}{n^2}. \quad [C] \text{ Let } N \rightarrow \infty, \text{ integral on } C_N \text{ goes to zero, use ML inequality.}$$

$$L = 8 \left[N + \frac{1}{2} \right], \quad M = \frac{\coth \pi/2}{(N + 1/2)^2}.$$

[d] By long div.

$$\frac{\cos[\pi z]}{\sin(\pi z) \pi^2 z^2} = (\pi z)^{-3} + (\pi z)^{-1} \left[-\frac{1}{3} \right] \dots$$

$$\text{Thus } \operatorname{Res} \frac{\cot(\pi z)}{z^2} \Big|_0 = -\frac{\pi}{3}.$$

$$(2\pi i) \left[-\frac{\pi}{3} \right] = -4\pi i \sum_{n=1}^{\infty} \frac{1}{n^2}. \quad \text{Divide by } 4\pi i \text{ for result.}$$

sec 9.1

$$7) \oint_{CN} \frac{\pi}{z^2 \sin(\pi z)} dz = 2\pi i \operatorname{Res} \frac{\pi}{z^2 \sin(\pi z)} \Big|_0$$

$$+ 2\pi i \sum \operatorname{Res} \frac{\pi}{z^2 \sin(\pi z)} \text{ at } \pm 1, \pm 2, \dots, \pm N$$

$$\operatorname{Res} \frac{\pi}{z^2 \sin(\pi z)} \text{ at } n = \frac{\pi}{n^2 \pi \cos(n\pi)} = \frac{(-1)^n}{n^2}$$

Note, Res at $n = \operatorname{Res}$ at $-n$.

$$\text{Thus } \oint_{CN} \frac{\pi}{z^2 \sin(\pi z)} dz = 2\pi i \operatorname{Res} \frac{\pi}{z^2 \sin(\pi z)} \Big|_0$$

$$+ 2\pi i * 2 \sum_{n=1}^N \frac{(-1)^n}{n^2} \quad \text{Now let } N \rightarrow \infty.$$

We can argue that $\left| \frac{1}{\sin \pi z} \right| \leq 1$ on C_N

(see solution prob 4), and $\left| \frac{1}{z} \right|^2 \leq \left(\frac{1}{N + \frac{1}{2}} \right)^2$

Use the ML inequality.

$$M = \left| \frac{1}{N + \frac{1}{2}} \right|^2, \quad L = 8\pi \left[N + \frac{1}{2} \right], \quad \int_{C_N} \dots dz = 0 \text{ as } N \rightarrow \infty$$

$$\text{Using long div. } \operatorname{Res} \left[\frac{1}{z^2 (\sin \pi z)} \Big|_0 \right] = \frac{\pi}{3!}$$

Thus passing to the limit $N \rightarrow \infty$

$$0 = \frac{2\pi i \pi^2}{3!} + 2\pi i * 2 \sum_{n=1}^N \frac{(-1)^n}{n^2}$$

$$\sum_{n=1}^N \frac{(-1)^n}{n^2} = \frac{-\pi^2}{2 * 3!} = \frac{-\pi^2}{12}$$

Sec 9.1

$$8) \sum_{n=-\infty}^{\infty} \frac{1}{n^2+a^2} = \frac{\pi}{a} \operatorname{coth}(\pi a)$$

differentiating with respect to (a) we have:

$$\sum_{n=-\infty}^{\infty} \frac{-2a}{(n^2+a^2)^2} = -\frac{\pi}{a^2} \operatorname{coth} \pi a - \frac{\pi^2}{a} \frac{1}{\sinh^2 \pi a}$$

Note $\frac{d}{da} \operatorname{coth} \pi a = \frac{d}{da} \frac{\cosh \pi a}{\sinh \pi a} = \frac{\pi \sinh^2 \pi a - \pi \cosh^2 \pi a}{\sinh^2 \pi a}$

$$= -\frac{\pi}{\sinh^2 \pi a}$$

$$\sum_{n=-\infty}^{\infty} \frac{2}{(n^2+a^2)^2} = \frac{\pi}{a^3} \operatorname{coth} \pi a + \frac{\pi^2}{a^2} \frac{1}{\sinh^2 \pi a}$$

$$b) \sum_{n=0}^{\infty} \frac{1}{(n^2+a^2)^2} = \frac{\pi}{a^3} \operatorname{coth}(\pi a) + \frac{\pi^2}{a^2 \sinh^2 \pi a} - \frac{2}{a^4}$$

c) consider limit of right side as $a \rightarrow 0$

$$\operatorname{coth}(\pi a) = \frac{\cosh(\pi a)}{\sinh(\pi a)} = \frac{1 + \frac{\pi^2 a^2}{2} + \frac{\pi^4 a^4}{24} \dots}{\pi a + \frac{\pi^3 a^3}{30} + \frac{\pi^5 a^5}{42} \dots}$$

$$= \frac{1}{\pi a} + \frac{\pi a}{3} - \frac{\pi^3 a^3}{45} \dots \text{ by long division}$$

$$\frac{1}{\sinh(\pi a)} = \frac{1}{(\pi a) + \frac{(\pi a)^3}{30} + \frac{(\pi a)^5}{42} \dots} = \left[\frac{1}{\pi a} - \frac{\pi a}{6} + \frac{7(\pi a)^3}{360} \dots \right]$$

$$\frac{1}{\sinh^2 \pi a} = \frac{1}{\pi^2 a^2} - \frac{1}{3} + \frac{24(\pi a)^2}{360} - \frac{14(\pi a)^4}{6 \times 360} \dots$$

$$\therefore \frac{\pi}{a^3} \operatorname{coth}(\pi a) + \frac{\pi^2}{a^2 \sinh^2 \pi a} - \frac{2}{a^4} =$$

$$\frac{\pi}{a^3} \left[\frac{1}{\pi a} + \frac{\pi a}{3} - \frac{\pi^3 a^3}{45} \dots \right] + \frac{\pi^2}{a^2} \left[\frac{1}{\pi^2 a^2} - \frac{1}{3} + \frac{1}{15} (\pi a)^2 - \frac{14(\pi a)^4}{6 \times 360} \dots \right] - \frac{2}{a^4}$$

As $a \rightarrow 0$ this tends to

$$-\frac{\pi^4}{45} + \frac{\pi^4}{15} = \frac{2\pi^4}{45}$$

$$\lim_{a \rightarrow 0} \sum_{n=0}^{\infty} \frac{1}{(n^2+a^2)^2} = \frac{2\pi^4}{45}, \text{ now exchange limits on left:}$$

$$\sum_{n=0}^{\infty} \frac{1}{n^4} = \frac{\pi^4}{90} \text{ g.e.d.}$$

9) ^{sec 9.1} Note that $\sum_{n=0}^{\infty} \frac{(-1)^n}{(2n+1)^3} = \frac{1}{2} \sum_{n=-\infty}^{\infty} \frac{(-1)^n}{(2n+1)^3}$

the $n=0$ term and $n=-1$ term are the same
 $n=1$ term and $n=-2$ term are the same
 [etc]

Now use theorem 2

$$\frac{1}{2} \sum_{n=-\infty}^{\infty} \frac{(-1)^n}{(2n+1)^3} = -\frac{\pi}{2} \sum_{\text{res}} \frac{1}{\sin(\pi z)} \frac{1}{(2z+1)^3} \quad \left[\text{at } z = -\frac{1}{2} \right]$$

We have a third order pole at $z = -1/2$.

Compute residue by long div.

Note $\frac{1}{(2z+1)^3} = \frac{1}{8 \left[z + \frac{1}{2} \right]^3}$

Let us expand $\sin(\pi z)$ about $z = -1/2$

Get $\sin(\pi z) = -1 + \frac{\pi^2}{2} \left(z + \frac{1}{2} \right)^2 \dots$

$$-\frac{\pi}{2} \text{Res}_{z=-1/2} \left[\frac{1}{(\sin \pi z)(2z+1)^3} \right] = \text{Res}_{z=-1/2} \left[\frac{-\pi}{16} \frac{1}{\left(-1 + \frac{\pi^2}{2} \left(z + \frac{1}{2} \right)^2 \dots \right) \left(z + \frac{1}{2} \right)^3} \right]$$

$$= \text{Res} \left[\frac{-\pi}{16} \frac{1}{-\left(z + \frac{1}{2} \right)^3 + \frac{\pi^2}{2} \left(z + \frac{1}{2} \right)^5 \dots} \right]$$

do long div $\frac{1}{-\left(z + \frac{1}{2} \right)^3 + \frac{\pi^2}{2} \left(z + \frac{1}{2} \right)^5 \dots} = -\left(z + \frac{1}{2} \right)^{-3} - \frac{\pi^2}{2} \left(z + \frac{1}{2} \right)^{-1} \dots$

$$\therefore \text{Res} \left[\frac{-\pi}{16} \frac{1}{-\left(z + \frac{1}{2} \right)^3 + \frac{\pi^2}{2} \left(z + \frac{1}{2} \right)^5 \dots} \right]_{z=-1/2} = \frac{-\pi}{16} \left(\frac{-\pi^2}{2} \right) = \frac{\pi^3}{32}$$

q.e.d.

section 9.2

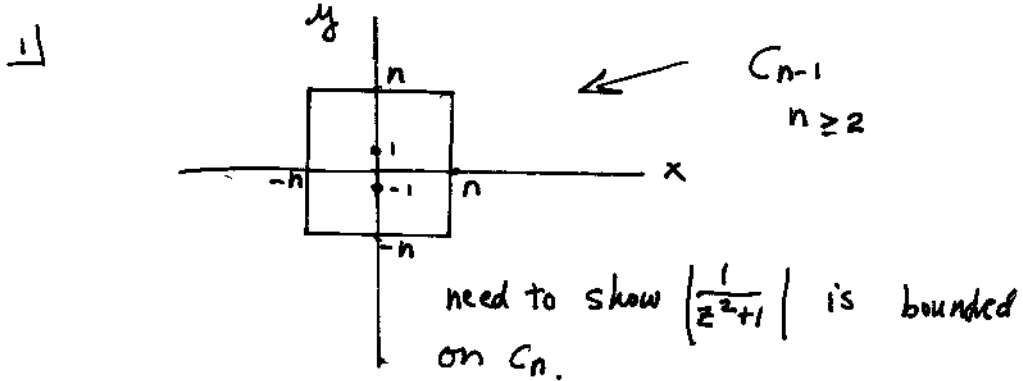

On C_n $\left| \frac{1}{z^2+1} \right| = \frac{1}{|z-i||z+i|} \leq \frac{1}{(n-1)(n-1)} \leq 1$
 since smallest n is 2

Have found bound.

$\frac{1}{z^2+1}$ has simple poles at $z = \pm i$, residues are $\pm 1/2i$

so from the theorem

$$f(z) = \frac{1}{z^2+1} = 1 + \frac{1}{2i} \left[\frac{1}{z-i} + \frac{1}{i} \right] + \frac{-1}{2i} \left[\frac{1}{z+i} + \frac{1}{-i} \right]$$

$$= \frac{1}{2i} \frac{1}{z-i} - \frac{1}{2i} \frac{1}{z+i}$$

From sec 5.5 $\frac{1}{(z-i)(z+i)} = \frac{a}{z-i} + \frac{b}{z+i}$

$1 = a(z+i) + b(z-i)$
 $a = 1/2i, b = -1/2i$ as above

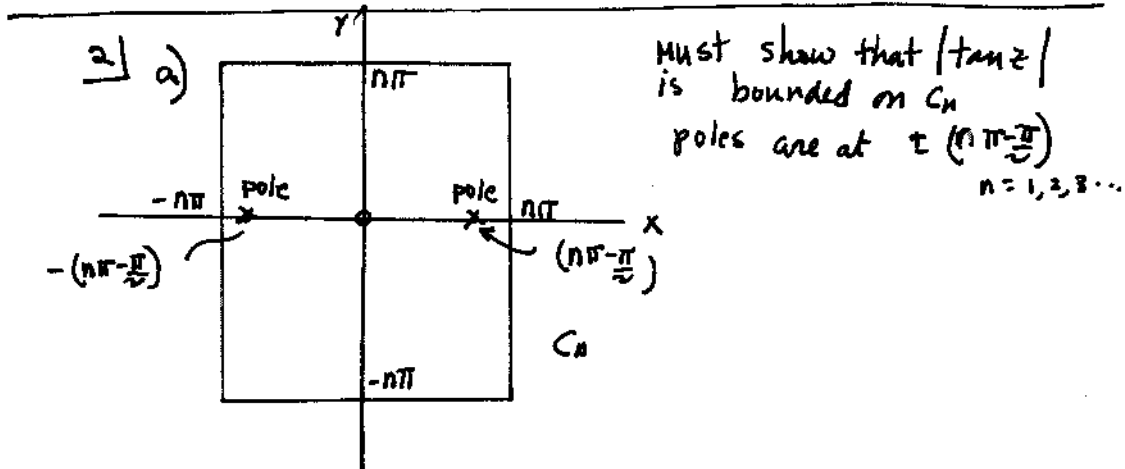

Section 9.2

prob 2, continued:

On right side $|\tan(z)| = \frac{|\sin(n\pi + iy)|}{|\cos(n\pi + iy)|}$
 $= \frac{|\sinh y|}{|\cosh y|} = |\tanh(y)| \leq 1$

and similarly for left of C_n .

on top side of C_n : $|\tan(z)| = \frac{|\sin(x + i n\pi)|}{|\cos(x + i n\pi)|}$
 $= \frac{|\sin x \cosh(n\pi) + i \cos x \sinh(n\pi)|}{|\cos x \cosh(n\pi) - i \sin x \sinh(n\pi)|} \leq \frac{\cosh(n\pi)}{\sinh(n\pi)}$
 $= \frac{1}{\tanh(n\pi)}$ $\tanh(n\pi)$ is monotonic increasing with n

∴ use smallest n for bound

on top: $|\tan(z)| \leq \frac{1}{\tanh \pi}$, works on bottom too.

since $\frac{1}{\tanh \pi} > 1$, on C_n : $|\tan(z)| \leq \frac{1}{\tanh(\pi)}$

$$f(z) = f(0) + \sum_{k=1}^{\infty} b_k \left[\frac{1}{(z-d_k)} + \frac{1}{d_k} \right]$$

$f(0) = 0$
 $d_1 = \pi/2, d_2 = -\pi/2, d_3 = \frac{3\pi}{2}, d_4 = -\frac{3\pi}{2} \dots$
 etc.

residue at $\pm [n\pi - \frac{\pi}{2}]$ $n = 1, 2, 3 \dots$

$$= \frac{\sin(z)}{-\sin(z)} \Big|_{z=\text{pole}} = -1$$

$$f(z) = \left[\frac{-1}{z - \pi/2} + \frac{-1}{(z + \pi/2)} + \frac{-1}{z - \frac{3\pi}{2}} + \frac{-1}{(z + \frac{3\pi}{2})} + \dots \right]$$

$$+ \left[\frac{1}{\frac{\pi}{2}} + \frac{1}{(-\frac{\pi}{2})} + \frac{1}{\frac{3\pi}{2}} + \frac{1}{-\frac{3\pi}{2}} + \dots \right]$$

$$\therefore f(z) = \frac{-2z}{z^2 - \pi^2/4} - \frac{2z}{z^2 - 9\pi^2/4} + \dots \quad \text{p.e.d}$$

$$= \frac{2z}{(\pi/2)^2 - z^2} + \frac{2z}{(3\pi/2)^2 - z^2} + \dots$$

sec 9.2

2 (b)

Take $z = \pi/4$

$$1 = \frac{\pi}{2} \left[\frac{1}{\frac{\pi^2}{4} - \pi^2} + \frac{1}{\frac{9\pi^2}{4} - \pi^2} + \frac{1}{\frac{25\pi^2}{4} - \pi^2} \dots \right]$$

$$\pi = \frac{1}{2} \left[\frac{1}{\frac{3}{16}} + \frac{1}{\frac{35}{16}} + \frac{1}{\frac{99}{16}} \dots \right]$$

$$\frac{\pi}{8} = \left[\frac{1}{3} + \frac{1}{35} + \frac{1}{99} + \dots \right]$$

$$\frac{\pi}{8} = \left[\frac{1}{2^2-1} + \frac{1}{6^2-1} + \frac{1}{10^2-1} + \frac{1}{14^2-1} \dots \right]$$

3] Maclaurin series $\tan z = z + \frac{z^3}{3} + \dots$

Must compare above Maclaurin series with:
 use this

$$\frac{2z}{(\pi/2)^2 - z^2}$$

```
x=linspace(0,1.5,1000);
y1=tan(x);
y3=2*x./((pi/2)^2-x.^2);
plot(x,y1,x,y3);grid;axis([0 2.2 -8 8])
hold on
x=linspace(0,2.2,1000);
y2=x+x.^3/3;
plot(x,y2);axis([0 2.2 -8 8])
hold on
title(' prob 3, sec 9.2 Two Approximations to tan(z)')
xlabel(' z ')
text(1,3.75,'tan(z)');
text(1.8,-4.6,'2z/[(\pi/2)^2-z^2]')
text(1.45,6,'2z/[(\pi/2)^2-z^2]')
text(1.5,2,'z+z^3/3')
text(1.5,-4.25,'tan(z)');
x=linspace(1.6,2.2,1000);
y1=tan(x);
y3=2*x./((pi/2)^2-x.^2);
plot(x,y1,x,y3);grid;axis([0 2.2 -8 8])
grid on
```

miss

Sec 9.2, prob 3,

Two Approximations to $\tan(z)$

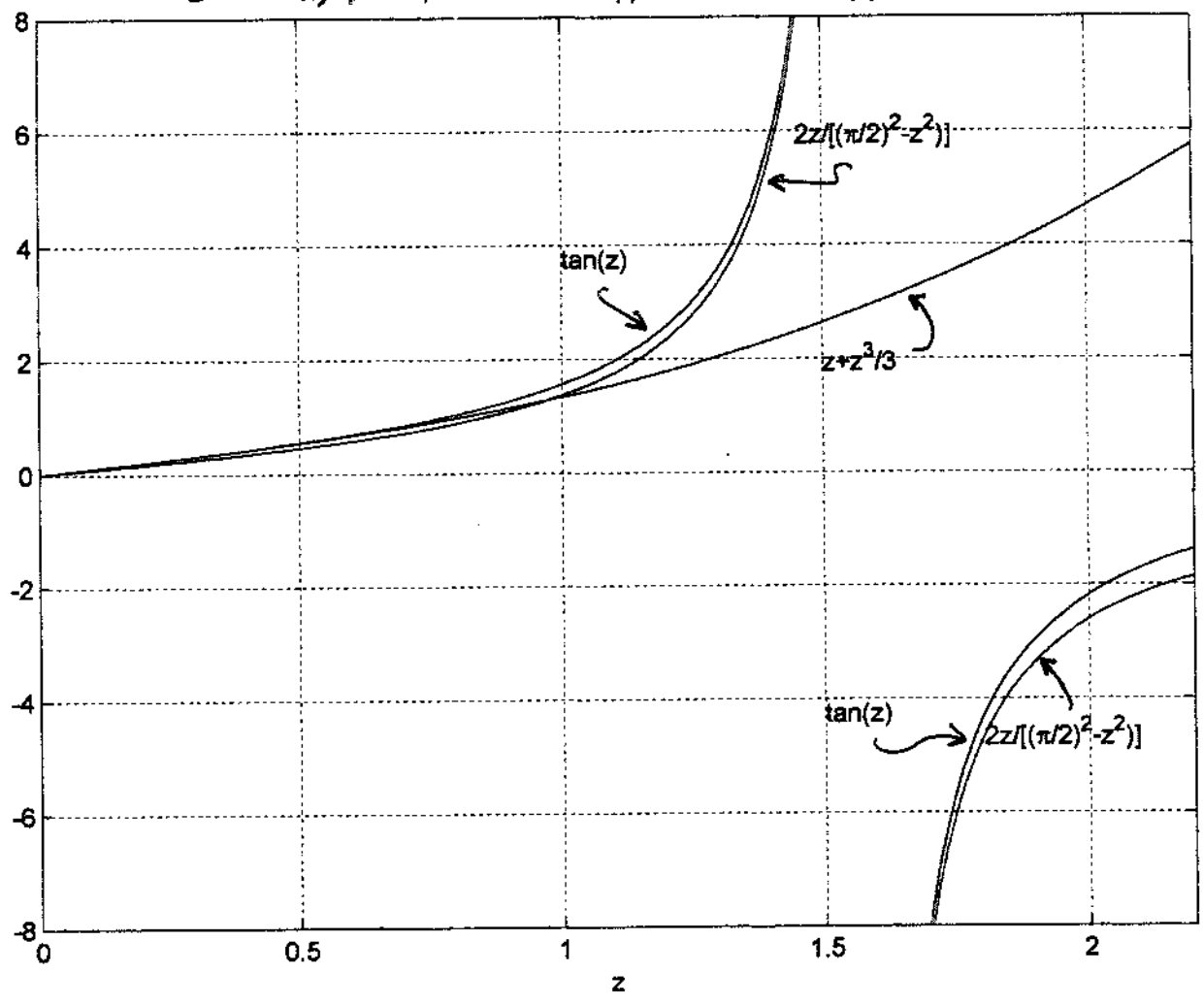

chap 9,

P.15

4) $\cosh(z)$ has zeros at $\pm i\pi/2, \pm i\frac{3\pi}{2}, \dots$

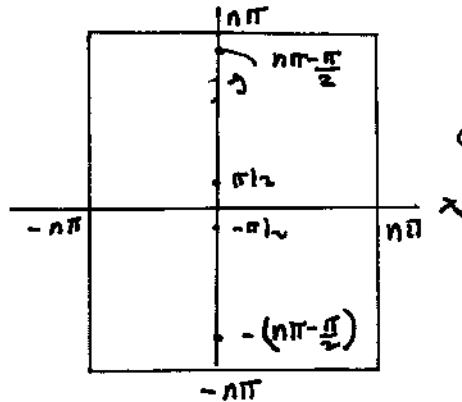

$C_n \quad n \geq 1$

$$\operatorname{sech}(z) = \frac{1}{\cosh z}$$

on right side:

$$\left| \frac{1}{\cosh(z)} \right| = \left| \frac{1}{\cosh(n\pi + iy)} \right|$$

$$= \left| \frac{1}{\cosh(n\pi) \cos y + i \sinh(n\pi) \sin y} \right| \leq \frac{1}{|\sinh(n\pi) \cos y|}$$

$$= \left| \frac{1}{\sinh(n\pi)} \right| \leq \frac{1}{\sinh(\pi)} \quad \text{also holds for left side}$$

on top side:

$$\left| \frac{1}{\cosh(z)} \right| = \left| \frac{1}{\cosh(x) \cos(n\pi) + i \sinh(x) \sin n\pi} \right|$$

$$= \left| \frac{1}{\cosh(x)} \right| \leq 1 \quad \text{also holds for bottom}$$

since $\frac{1}{\sinh(\pi)} < 1$ can say

$$\left| \frac{1}{\cosh(z)} \right| \leq 1 \quad \text{on } C_n$$

$\frac{1}{\cosh z}$ has simple poles at $\pm i\frac{\pi}{2}, \pm i\frac{3\pi}{2}, \dots$

and is analytic at $z=0$

Residue of $\frac{1}{\cosh(z)}$ @ $\pm i(n\pi - \frac{\pi}{2}) = \pm \frac{1}{\sinh i(n\pi - \frac{\pi}{2})}$

prob 4 continued

$$\text{Res } \frac{1}{\cosh z} \pm i \left(n\pi - \frac{\pi}{2} \right) = \frac{1}{\pm i \sin \left(n\pi - \frac{\pi}{2} \right)}$$

$$= \frac{-1}{\pm i \cos(n\pi)} = \frac{\pm i}{\cos(n\pi)} \text{ at } \pm \left[n\pi - \frac{\pi}{2} \right]$$

Thus res. at $i\frac{\pi}{2} = -i$, at $i\frac{3\pi}{2} = +i$

at $\frac{3\pi}{2}i = i$ at $-\frac{3\pi}{2}i = -i$ etc.

Note $1/\cosh z = 1$ @ $z=0$

$$\text{thus } \frac{1}{\cosh z} = 1 + -i \left[\frac{1}{z - i\frac{\pi}{2}} + \frac{1}{i\frac{\pi}{2}} \right]$$

$$+ i \left[\frac{1}{z + i\frac{\pi}{2}} + \frac{1}{-i\frac{\pi}{2}} \right] + i \left[\frac{1}{z - i\frac{3\pi}{2}} + \frac{1}{i\frac{3\pi}{2}} \right]$$

$$- i \left[\frac{1}{z + i\frac{3\pi}{2}} + \frac{1}{-i\frac{3\pi}{2}} \right] \dots$$

expression in brackets = $\frac{\pi}{4}$

$$= 1 - \frac{4}{\pi} \left[1 - \frac{1}{3} + \frac{1}{5} \dots \right] + i \left[\frac{-1}{\left(z - i\frac{\pi}{2}\right)} + \frac{1}{\left(z + i\frac{\pi}{2}\right)} \right]$$

$$+ \left[\frac{1}{z - i\frac{3\pi}{2}} - \frac{1}{\left(z + i\frac{3\pi}{2}\right)} - \left(\frac{1}{z - i\frac{5\pi}{2}} \right) + \frac{1}{z + i\frac{5\pi}{2}} \dots \right]$$

$$= \frac{\pi}{\left(\frac{\pi}{2}\right)^2 + z^2} - \frac{3\pi}{\left(\frac{3\pi}{2}\right)^2 + z^2} + \frac{5\pi}{\left(\frac{5\pi}{2}\right)^2 + z^2} \dots$$

problem 5, next page

sec 9.2
prob 5

S a) From problem 2

$$\tan z = \frac{2z}{\left(\frac{\pi}{2}\right)^2 - z^2} + \frac{2z}{\left(\frac{3\pi}{2}\right)^2 - z^2} + \frac{2z}{\left(\frac{5\pi}{2}\right)^2 - z^2} + \dots$$

Valid $z \neq \pm \frac{\pi}{2}, \pm \frac{3\pi}{2}, \dots$

Replace z with iz , so the result would be valid if $iz \neq \pm \frac{\pi}{2}, \pm \frac{3\pi}{2}, \dots$

or $z \neq \pm \frac{i\pi}{2}, \pm \frac{i3\pi}{2}, \dots$

$$\tan iz = \frac{2iz}{\left(\frac{\pi}{2}\right)^2 + z^2} + \frac{2iz}{\left(\frac{3\pi}{2}\right)^2 + z^2} + \frac{2iz}{\left(\frac{5\pi}{2}\right)^2 + z^2} + \dots$$

$\tan iz = i \tanh z$ [use in above]

$$\text{set } \tanh z = \frac{2z}{\left(\frac{\pi}{2}\right)^2 + z^2} + \frac{2z}{\left(\frac{3\pi}{2}\right)^2 + z^2} + \frac{2z}{\left(\frac{5\pi}{2}\right)^2 + z^2} + \dots$$

S(b) poles of $\tanh z = \frac{\sinh z}{\cosh z}$ are at $\pm i \left(k\pi - \frac{\pi}{2} \right)$
 $k = 1, 2, 3, \dots$

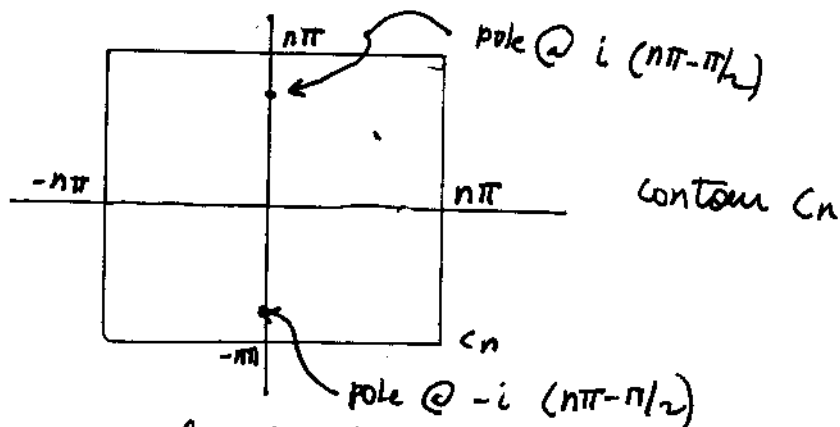

must show $\tanh z$ is bounded on C_n

On right side: $|\tanh z| = \left| \frac{\sinh[n\pi + is]}{\cosh[n\pi + is]} \right|$

5(b) continued
right side,

$$|\tanh z| = \left| \frac{\sinh n\pi \cos y + i \cosh(n\pi) \sin y}{\cosh n\pi \cos y + i \sinh n\pi \sin y} \right|$$

$$\leq \left| \frac{\cosh n\pi \cos y + i \cosh(n\pi) \sin y}{\sinh n\pi \cos y + i \sinh n\pi \sin y} \right|$$

since $\cosh n\pi > \sinh n\pi$ n pos.

$$|\tanh z| \leq \frac{\cosh n\pi}{\sinh n\pi} \leq \frac{\cosh \pi}{\sinh \pi}$$

on right side [use smallest n for bound]

the above also holds on left side too.

Now do top side: On top $z = x + i\pi$

$$|\tanh z| = \frac{|\sinh(x + i\pi)|}{|\cosh(x + i\pi)|} = \frac{|\sinh x \cos \pi + i \cosh x \sin \pi|}{|\cosh x \cos \pi + i \sinh x \sin \pi|}$$

$= |\tanh x| \leq 1$, holds on bottom of C_n too.

Since $\frac{\cosh \pi}{\sinh \pi} > 1$, can say that

$$|\tanh z| \leq \frac{\cosh \pi}{\sinh \pi} \text{ over all contours } C_n$$

Note that $\tanh z$ is analytic @ $z=0$
 $\therefore \tanh z$ meets all the requirements of
 Theorem 3. Applying the theorem:

Residues at $\pm \frac{i\pi}{2}, \pm \frac{i3\pi}{2}, \dots$ etc

$$= \frac{\sinh z}{\sinh z} \Big|_{\text{pole}} = 1. \text{ Now use the Theorem 3}$$

$$\tanh z = \left[\frac{1}{z - i\pi/2} + \frac{1}{i\pi/2} + \frac{1}{z + i\pi/2} + \frac{1}{-i\pi/2} + \frac{1}{z - i3\pi/2} + \frac{1}{i3\pi/2} + \frac{1}{z + i3\pi/2} + \frac{1}{-i3\pi/2} + \dots \right]$$

$$= \frac{2z}{z^2 + \pi^2} + \frac{2z}{z^2 + 9\pi^2} + \dots \quad \text{p.e.d.}$$

sec 9.2

6 (a) $\cot z$ not analytic @ $z=0$
 $\circ\circ$ Theorem 3 not satisfied.

$$b) \frac{\cos z}{\sin z} = \cot z = z \frac{z^{-3} + z^{-5} + \dots}{3!, 5!, \dots} \cdot \frac{z^{-1} - \frac{z}{3} + \dots}{1 - \frac{z^2}{2!} + \frac{z^4}{4!} - \dots}$$

$$\frac{1 - \frac{z^2}{3!}}{3!}$$

$$z^2 \left(-\frac{1}{3} \right)$$

Princ. part of expansion is z^{-1}

$$\cot z - \frac{1}{z} = z^{-1} + (z) \left(-\frac{1}{3} \right) + \dots - \frac{1}{z} = 0$$

lim

$$z \rightarrow 0$$

$\circ\circ$ $\cot z - 1/z$ has a removable singularity

@ $z=0$.

(c) see next page.

prob 6,

(continued)

(c)

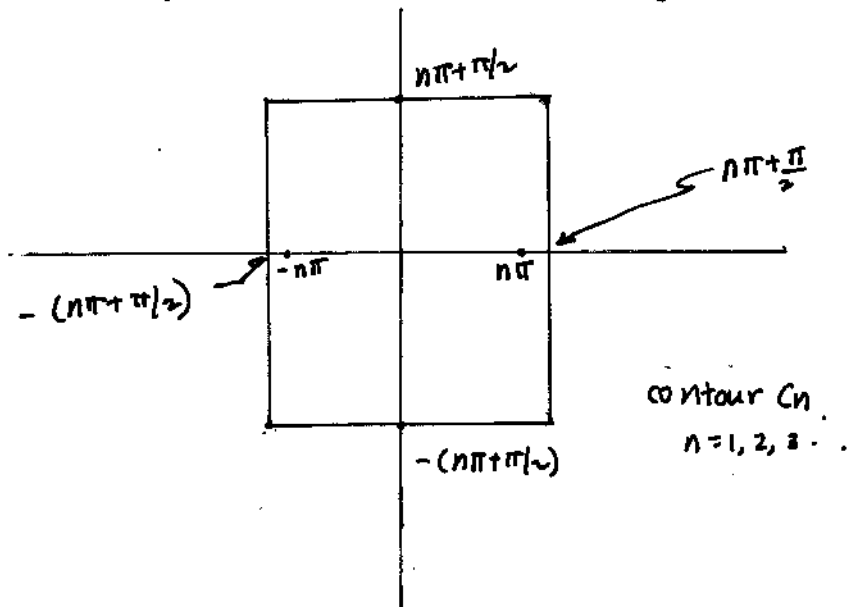

Must find bound on $|\cot(z) - \frac{1}{z}|$ on this contour.

Begin, right side

$$|\cot(z) - \frac{1}{z}| \leq |\cot(z)| + \frac{1}{|z|}$$

$$\leq |\cot(z)| + \frac{1}{n\pi + i\pi/2} = \left| \frac{\cos(n\pi + i\pi/2 + iy)}{\sin(n\pi + i\pi/2 + iy)} \right| + \frac{1}{n\pi + i\pi/2}$$

$$= \left| \frac{\sinh y}{\cosh y} \right| + \frac{1}{n\pi + i\pi/2} \quad \text{Recall } \tanh y \leq 1$$

$\therefore |\cot z - \frac{1}{z}| \leq 1 + \frac{1}{(3\pi/2)}$ on right side.

A similar argument holds on left side

$\therefore |\cot(z) - \frac{1}{z}| \leq 1 + \frac{1}{(3\pi)}$ at + left sides.

Now do top side $|\cot z - \frac{1}{z}| \leq |\cot(z)| + \frac{1}{n\pi + i\pi/2}$

$$\text{On top side } |\cot(z)| = \left| \frac{\cos(x + i(n\pi + \pi/2))}{\sin(x + i(n\pi + \pi/2))} \right| =$$

$$= \frac{|\cos x \cosh(n\pi + \pi/2) - i \sin x \sinh(n\pi + \pi/2)|}{|\sin x \cosh(n\pi + \pi/2) + i \cos x \sinh(n\pi + \pi/2)|} \leq \frac{\cosh(n\pi + \pi/2)}{\sinh(n\pi + \pi/2)}$$

$$\leq \frac{1}{\tanh(3\pi/2)} \quad \text{On top side } |\cot z - \frac{1}{z}| \leq \frac{1}{\tanh(3\pi/2)} + \frac{1}{3\pi/2}$$

sec 9.2

prob 6(c) continued

On bottom side $|\cot(z) - 1/z| \leq \frac{1}{\tanh(3\pi/2)} + \frac{1}{3\pi/2}$

Since $\frac{1}{\tanh(3\pi/2)} \leq 1$ We have as a bound on all 4 sides of C_n : $|\cot(z) - 1/z| \leq 1 + \frac{1}{3\pi/2}$ also.

d) Since $(\cot(z) - 1/z)$ does meet the requirements of theorem 3 we will expand it using partial fractions. Note that $f(z) = 0$ @ $z=0$ [removable sing.]

Need residue at $\pi = \lim_{z \rightarrow \pi} \frac{\cot z}{\cos(z)} = 1$

Same residue at $-\pi$, and $\pm 2\pi, \pm 3\pi$, etc.

$$\begin{aligned} \text{Therefore } \left[\cot z - \frac{1}{z} \right] &= \left[\frac{1}{(z-\pi)} + \frac{1}{\pi} \right] + \left[\frac{1}{z+\pi} + \frac{-1}{\pi} \right] \\ &+ \left[\frac{1}{z-2\pi} + \frac{1}{2\pi} \right] + \left[\frac{1}{z+2\pi} + \frac{-1}{-2\pi} \right] \dots \\ &= \frac{2z}{z^2 - \pi^2} + \frac{2z}{z^2 - 4\pi^2} + \dots \end{aligned}$$

$\therefore \cot z = \frac{1}{z} + \frac{2z}{z^2 - \pi^2} + \frac{2z}{z^2 - 4\pi^2} + \frac{2z}{z^2 - 9\pi^2} \dots$

1] $\frac{1}{\sinh z}$ has simple pole @ $z=0$ \therefore

does not satisfy theorem 3

Consider $\frac{1}{\sinh z} - \frac{1}{z} = \frac{z - \sinh(z)}{z \sinh(z)}$

$$= \frac{z - (z + z^3/3! + \dots)}{z (z + z^3/3! + z^5/5! + \dots)} = \frac{-z^3/3! - z^5/5! - \dots}{z^2 + z^4/2! + \dots} \xrightarrow{\lim_{z \rightarrow 0}} 0$$

$\therefore \frac{1}{\sinh z} - \frac{1}{z}$ has removable sing. at $z=0$

sec 9.2

problem 7 continued.

Use same contour as problem 6
 must show $\frac{1}{\sinh(z)} - \frac{1}{z}$ is bounded on C_n

$$\left| \frac{1}{\sinh z} - \frac{1}{z} \right| \leq \left| \frac{1}{\sinh(z)} \right| + \left| \frac{1}{z} \right| \leq \left| \frac{1}{\sinh(z)} \right| + \frac{1}{(\pi + \frac{\pi}{2})}$$

$$\leq \left| \frac{1}{\sinh(z)} \right| + \frac{2}{3\pi}$$

on right side $\left| \frac{1}{\sinh(z)} \right| = \left| \frac{1}{\sinh(\pi + \frac{\pi}{2} + iy)} \right|$

$$= \left| \frac{1}{\sinh(\pi + \frac{\pi}{2}) \cosh y + i \cosh(\pi + \frac{\pi}{2}) \sinh y} \right| \leq$$

$$\left| \frac{1}{\sinh(\pi + \frac{\pi}{2})} \right| \leq \frac{1}{\sinh(\frac{3\pi}{2})} \quad \text{[using smallest } n \text{]}$$

Same holds for left side.

∴ on right and left $\left| \frac{1}{\sinh z} - \frac{1}{z} \right|$

$$\leq \frac{1}{\sinh(\frac{3\pi}{2})} + \frac{2}{3\pi}$$

on top side of C_n :

$$\left| \frac{1}{\sinh(z)} - \frac{1}{z} \right| \leq \left| \frac{1}{\sinh(z)} \right| + \frac{2}{3\pi} \quad \text{as above}$$

$$\left| \frac{1}{\sinh(z)} \right| = \left| \frac{1}{\sinh(x + i(\pi + \frac{\pi}{2}))} \right| =$$

$$= \left| \frac{1}{\sinh x \cosh(\pi + \frac{\pi}{2}) + i \cosh(x) \sinh(\pi + \frac{\pi}{2})} \right|$$

$$= \left| \frac{1}{\cosh(x)} \right| \leq 1 \quad \text{Thus on top } \left| \frac{1}{\sinh z} - \frac{1}{z} \right| \leq 1 + \frac{2}{3\pi}$$

Same on bottom. Since $1 > \frac{1}{\sinh(\frac{3\pi}{2})}$ on C_n

have: $\left| \frac{1}{\sinh(z)} - \frac{1}{z} \right| \leq 1 + \frac{2}{3\pi}$ on whole contour C_n

Sec 9.2, prob 7, continued

Now $\frac{1}{\sinh(z)} - \frac{1}{z}$ has simple poles at $\pm i\pi$, $\pm 2i\pi$, $\pm 3i\pi$, etc. with residues

$$\frac{1}{\cosh(i\pi)}, \frac{1}{\cosh(-i\pi)}, \frac{1}{\cosh(i2\pi)}, \frac{1}{\cosh(-i2\pi)}, \dots$$

residue at $i\pi = \frac{1}{\cosh(i\pi)} = -1$, residue at $-i\pi = -1$
 residue at $i2\pi = \frac{1}{\cosh(i2\pi)} = 1$, residue at $-i2\pi = 1$, etc.

Thus applying Theorem 3: to $\frac{1}{\sinh z} - \frac{1}{z}$ have

$$\frac{1}{\sinh z} - \frac{1}{z} = (-1) \left[\frac{1}{z-i\pi} + \frac{1}{i\pi} \right] + (-1) \left[\frac{1}{z+i\pi} + \frac{1}{-i\pi} \right]$$

$$+ \left[\frac{1}{z-i2\pi} + \frac{1}{i2\pi} \right] + \left[\frac{1}{z+i2\pi} + \frac{1}{-i2\pi} \right] \dots$$

$$\frac{1}{\sinh z} = \frac{1}{z} - \frac{2z}{z^2 + \pi^2} + \frac{2z}{z^2 + 4\pi^2} - \frac{2z}{z^2 + 9\pi^2} \dots$$

8)

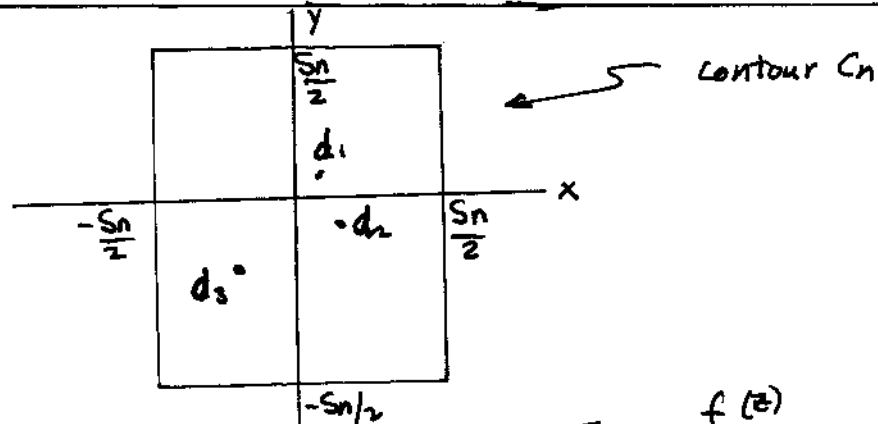

Consider $\frac{1}{2\pi i} \oint_{\text{around } C_n} \frac{f(z)}{z-w} dz = f(w) + \sum_{\text{residues}} \frac{f(z)}{z-w}$
 at enclosed poles d_1, d_2, \dots

What is residue of $\frac{f(z)}{z-w}$ at d_k where $f(z)$ has a second order pole

Section 9.2
problem 8 continued

$$\text{Res } \frac{f(z)}{z-w} \Big|_{d_k} = \lim_{z \rightarrow d_k} \frac{d}{dz} \frac{(z-d_k)^2 f(z)}{(z-w)} \quad \left[\text{since } d_k \text{ is a pole of order 2} \right]$$

$$= \lim_{z \rightarrow d_k} \frac{(z-w) \frac{d}{dz} [(z-d_k)^2 f(z)] - (z-d_k)^2 f(z)}{(z-w)^2}$$

$$= \frac{\text{Res } [f(z), d_k]}{(d_k-w)} - \frac{g_k}{(d_k-w)^2}$$

where $g_k = \lim_{z \rightarrow d_k} (z-d_k)^2 f(z)$ which is the coefficient of $(z-d_k)^{-2}$ in the Laurent expansion of $f(z)$ about d_k [where $f(z)$ has a pole of order 2].

Thus

$$\frac{1}{2\pi i} \oint_{C_n} \frac{f(z)}{z-w} dz = f(w) + \sum_{\text{all enclosed poles } d_1, d_2, \dots} \frac{b_k}{(d_k-w)} - \frac{g_k}{(d_k-w)^2}$$

Now let $w=0$ in the preceding

$$\frac{1}{2\pi i} \oint_{C_n} \frac{f(z)}{z} dz = f(0) + \sum \frac{b_k}{d_k} - \frac{g_k}{d_k^2}$$

Subtract the 2nd integral from the first

$$\frac{w}{2\pi i} \oint \frac{f(z)}{(z-w)(z)} dz = f(w) - f(0) + \sum_k \frac{b_k}{d_k-w} - \frac{b_k}{d_k} - \left[\sum_k \frac{g_k}{(d_k-w)^2} - \frac{g_k}{d_k^2} \right]$$

Let $S_n \rightarrow \infty$, integral on left vanishes

[use ML inequality as in derivation of theorem 3]

Now, in this limit replace w by z . Put $f(z)$

on left, get

$$f(z) = f(w) + \sum_{k=1}^{\infty} \frac{b_k}{z-d_k} + \frac{b_k}{d_k} + \sum_{k=1}^{\infty} \frac{g_k}{(d_k-z)^2} - \frac{g_k}{d_k^2}$$

Note this checks if $z=0$

sec 9.2

9) a)

$$\frac{1}{1 + \sin(z)}$$

is analytic at $z=0$

poles are where $\sin(z) = -1$
 $z = -\frac{\pi}{2}, \frac{3\pi}{2}, -\frac{5\pi}{2}, \frac{7\pi}{2}, \dots$

$$z = (-1)^n \left(n\pi - \frac{\pi}{2} \right) \quad n=1, 2, 3, \dots$$

What is order of zero of $1 + \sin(z)$ at these values of z ? Answer is 2. You

find $1 + \sin(z)$ has vanishing first deriv. but non vanishing second derivative.

Must show that $\left| \frac{1}{1 + \sin(z)} \right|$ is bounded on C_n . Choose C_n same as in example 1.

$$|f(z)| = \left| \frac{1}{1 + \sin(z)} \right| = \left| \frac{1}{1 + \cos\left(z - \frac{\pi}{2}\right)} \right| =$$

$$\frac{1/2}{\left| \cos^2\left(\frac{z}{2} - \frac{\pi}{4}\right) \right|}$$

$$z = x + i n\pi, \text{ on top.}$$

$$|f(z)| = \frac{1/2}{\left| \cos\left(\frac{x + i n\pi}{2} - \frac{\pi}{4}\right) \right|} =$$

$$= \frac{1/2}{\left| \cos\left(\frac{x}{2} - \frac{\pi}{4}\right) \cosh\left[\frac{n\pi}{2}\right] - i \sin\left(\frac{x}{2} - \frac{\pi}{4}\right) \sinh\left(\frac{n\pi}{2}\right) \right|}$$

$$\leq \frac{1/2}{\left| \sinh\frac{n\pi}{2} \right|} \leq \frac{1/2}{\left| \sinh\frac{\pi}{2} \right|} \quad \text{using smallest } n \quad [n=1]$$

Same inequality holds on bottom side.

Section 9.2

9(a) continued, on right side of C_n .

$$z = n\pi + iy.$$

$$|f(z)| = \frac{1/2}{\left| \cos\left(\frac{n\pi + iy}{2} - \frac{\pi}{4}\right) \right|} =$$

$1/2$

$$\frac{1/2}{\left| \cos\left(\frac{n\pi}{2} - \frac{\pi}{4}\right) \cosh\left[\frac{y}{2}\right] - i \sin\left(\frac{n\pi}{2} - \frac{\pi}{4}\right) \sinh\left[\frac{y}{2}\right] \right|}$$

$= 1/2$

$$1/2 \left[\cosh^2 \frac{y}{2} + \sinh^2 \frac{y}{2} \right]^{1/2}$$

since $\left| \cos\left(\frac{n\pi}{2} - \frac{\pi}{4}\right) \right| = \left| \sin\left(\frac{n\pi}{2} - \frac{\pi}{4}\right) \right| = 1/\sqrt{2}$

$$|f(z)| = \left| \frac{1}{1 + 2 \sinh^2(y/2)} \right|^{1/2} \leq 1$$

max when $y=0$

above holds on left side too. Now since

$$\frac{1/2}{\sinh(\pi/2)} \leq 1, \text{ can say } \frac{1}{|1 + \sin z|} \leq 1 \text{ on } C_n.$$

9(b)

Need residues of $\frac{1}{1 + \sin(z)}$ at the poles $(-i)^n \left(n\pi - \frac{\pi}{2}\right)$

Suppose want residue at $z = -\frac{\pi}{2}$

$$\text{Put: } \frac{1}{1 + \sin(z)} = \frac{1}{1 - \cos(z + \pi/2)}$$

$$\frac{1}{1 - \left[1 - \frac{(z + \pi/2)^2}{2!} + \frac{(z + \pi/2)^4}{4!} - \frac{(z + \pi/2)^6}{6!} + \dots \right]} = \frac{1}{\frac{(z + \pi/2)^2}{2!} - \frac{(z + \pi/2)^4}{4!} + \dots}$$

note, you get only even powers of $(z + \pi/2)$ in the Laurent Series Expansion about $-\frac{\pi}{2}$.

Thus coeff of $(z + \frac{\pi}{2})^{-1}$ is zero, residue $\circlearrowleft -\frac{\pi}{2} = 0$

9(b) Continued.

In a similar way, residues at the other poles [located at $\frac{3\pi}{2}, -\frac{5\pi}{2}, \frac{7\pi}{2}, \dots$] is zero

Now need coeff of $(z-d_k)^{-2}$ in Laurent expansions of $\frac{1}{1+\sin(z)}$ about $-\frac{\pi}{2}, \frac{3\pi}{2}, -\frac{5\pi}{2}, \dots$ etc.

Let us get g_1 which is coeff of $(z+\frac{\pi}{2})$ in expansion about $-\frac{\pi}{2}$. Proceeding as above

$$\frac{1}{1+\sin(z)} = \frac{1}{1 - \cos(z+\frac{\pi}{2})} = \frac{1}{\frac{(z+\frac{\pi}{2})^2}{2!} - \frac{(z+\frac{\pi}{2})^4}{4!} + \dots}$$

value not needed

$$2! \left(z+\frac{\pi}{2}\right)^{-2} + (\dots)\left(z+\frac{\pi}{2}\right)^0 + \dots$$

Coeff of $(z+\pi/2)^{-2}$ is $2! = g_1$

Similarly if expand about $(3\pi/2)$ coeff of $(z-\frac{3\pi}{2})^{-2}$ is $2! = g_2$

in general $g_1, g_2, \dots = 2$

Now $f(0) = 1$, thus applying result of previous problem:

$$\frac{1}{1+\sin(z)} = 1 + \frac{2}{(z+\frac{\pi}{2})^2} - \frac{2}{(\frac{\pi}{2})^2} + \frac{2}{(z-\frac{3\pi}{2})^2} - \frac{2}{(\frac{3\pi}{2})^2} + \frac{2}{(z+\frac{5\pi}{2})^2} - \frac{2}{(\frac{5\pi}{2})^2} + \dots$$

$$= 1 + \frac{2}{(z+\frac{\pi}{2})^2} + \frac{2}{(z-\frac{3\pi}{2})^2} + \frac{2}{(z+\frac{5\pi}{2})^2} - \frac{8}{\pi^2} \left[1 + \frac{1}{9} + \frac{1}{25} + \frac{1}{49} \right]$$

9(c) put $z = \pi/2$

$$\frac{1}{2} = 1 + \frac{2}{\pi^2} + \frac{2}{\pi^2} + \frac{2}{(3\pi)^2} + \frac{2}{(3\pi)^2} + \dots - \frac{8}{\pi^2} \left[1 + \frac{1}{9} + \frac{1}{25} + \frac{1}{49} \right]$$

$$0 = \frac{1}{2} + \frac{4}{\pi^2} \left[1 + \frac{1}{3^2} + \frac{1}{5^2} + \dots \right] - \frac{8}{\pi^2} \left[1 + \frac{1}{3^2} + \frac{1}{5^2} + \dots \right]$$

9(b)

Section

9.2

Continued

$$0 = \frac{1}{2} - \frac{4}{\pi^2} \left[1 + \frac{1}{3^2} + \frac{1}{5^2} + \dots \right]$$

$$\text{or } \frac{\pi^2}{8} = \left[1 + \frac{1}{3^2} + \frac{1}{5^2} + \dots \right] \quad \text{q.e.d.}$$

Section 9.3

1) $a_n(z) = z^{2^{n-1}}$

$|a_n(z)| = |z|^{2^{n-1}}$

$\lim_{n \rightarrow \infty} |z|^{2^{n-1}} = 1$ if $|z| = 1$
 $= \infty$ if $|z| > 1$

neither result is zero. \therefore by Thm. 1 infinite product diverges.

2] a) $w_k = 1 + \frac{1}{k}$, $w_k = \frac{k+1}{k}$, n^{th} partial product:

$\left(\frac{1+1}{1}\right) \left(\frac{1+2}{2}\right) \left(\frac{1+3}{3}\right) \dots \left(\frac{1+n}{n}\right) = \frac{n+1}{1} = n+1$, $P_n = n+1$

$\lim_{n \rightarrow \infty} P_n = \infty$, \therefore product diverges.

b) We proved in (a) $\prod_{k=1}^{\infty} \left(1 + \frac{1}{k}\right)$ diverges. \therefore according to Theorem 4, $\sum_{k=1}^{\infty} \log\left(1 + \frac{1}{k}\right)$ diverges. (c) Note $\log\left(1 + \frac{x}{k}\right) \geq \log\left(1 + \frac{1}{k}\right) > 0$

if $x \geq 1$. Both terms are positive. By comparison test for series must have $\sum_{k=1}^{\infty} \log\left(1 + \frac{x}{k}\right)$ diverges. By Thm 4 $\prod_{k=1}^{\infty} \left(1 + \frac{x}{k}\right)$

div. Another approach $\prod_{k=1}^{\infty} \left(1 + \frac{1}{k}\right)$ has n^{th} partial product $P_n = n+1$

Now $\prod_{k=1}^n \left(1 + \frac{x}{k}\right) \geq \prod_{k=1}^n \left(1 + \frac{1}{k}\right) = n+1$. Since $\lim_{n \rightarrow \infty} n+1 = \infty$

$x \geq 1$ it follows that $\lim_{n \rightarrow \infty} \prod_{k=1}^n \left(1 + \frac{x}{k}\right) = \infty$ if $x \geq 1$

3) $\frac{1}{1+1} \cdot \frac{2}{1+2} \cdot \frac{3}{1+3} \dots \frac{(n+1)}{(n+1)} = P_n$

For any term except the first and last the numerator can be cancelled against the denominator of the preceding term while the denominator can be cancelled against the numerator of the following term. Thus we are left with $P_n = \frac{1}{(n+1)}$. Now $\lim_{n \rightarrow \infty} P_n = 0$ which is not permissible for a convergent infinite product. Q.E.D.

prob 4 | Section 9.3
 Can write as $\sum_{k=1}^n \frac{(k)(k+2)}{(k+1)^2}$

n^{th} partial product:

$$\frac{(1)(1+2)}{(1+1)^2} \frac{(2)(2+2)}{(2+1)^2} \dots \frac{(k-1)(k+1)(k)(k+2)(k+1)(k+3)}{k^2 (k+1)^2 (k+2)^2} \dots \frac{(n)(n+2)}{(n+1)^2}$$

k^{th} term

Note the numerator of the k^{th} term can be reduced to unity by cancellation against the denom. of $k+1$ and $(k-1)$ terms. Similarly the denominator of the k^{th} term can be reduced to unity by cancellation against the numerator of $(k+1)$ and $(k-1)$ terms. This does not work for first and last (n^{th} term). The last term reduces to $\frac{n+2}{n+1}$ while the first reduces to $\frac{1}{2}$. Thus $P_n = \frac{1}{2} \frac{n+2}{n+1}$ and $\lim_{n \rightarrow \infty} \frac{1}{2} \frac{n+2}{n+1} = \lim_{n \rightarrow \infty} \frac{1}{2} \frac{1+2/n}{1+1/n} = \boxed{\frac{1}{2}}$

5) $1 - \frac{2}{(k+1)(k+2)} = \frac{k^2+3k}{(k+1)(k+2)} = \frac{(k)(k+3)}{(k+1)(k+2)}$

$$P_n = \left[\frac{(1)(1+3)}{(1+1)(1+2)} \right] \left[\frac{(2)(2+3)}{(2+1)(2+2)} \right] \dots \frac{(k-1)(k+3)(k)(k+2)(k+1)(k+4)}{(k)(k+1)(k+1)(k+2)(k+2)(k+3)} \dots \frac{(n-1)(n+3)(n)(n+2)}{(n)(n+1)(n+1)(n+2)}$$

k^{th} term

cont'd. next pg.

Section 9.3 prob. 5 cont'd
 prob 5, continued

As long as the k^{th} term is not the first nor the last it can be reduced to unity thru cancellation. The first term can be reduced only to $\frac{1}{3}$ while the last reduces to $\frac{n+3}{n+1}$. Thus $P_n = \frac{1}{3} \frac{n+3}{n+1}$
 $= \frac{1}{3} \frac{1+3/n}{1+1/n}$. $\lim_{n \rightarrow \infty} P_n = \frac{1}{3}$ g.e.d.

6. If $e^{nz} = -1$ $e^{nx} e^{iny} = -1$
 $|e^{nx}| = 1$ only possible if $x=0$

[since $n \geq 1$] But we assume $x < 0$
 [or $\text{Re}(z) < 0$] Now apply ratio test to show

that $\sum_{n=1}^{\infty} a_n(z)$ is abs. conv. if $\text{Re}(z) < 0$
 Have $\left| \frac{e^{(n+1)z}}{e^{nz}} \right| = |e^z| = e^x < 1$ since $\text{Re } z < 0$

\therefore ratio test is satisfied and according to Theorem 6 product is abs. conv.

7. We require that no term vanishes in given region R . If $1 = \frac{z^2}{k^2}$
 then $z = \pm k$. But our closed region excludes any integer value for k .

Now use M test. Require $\sum_{k=1}^{\infty} M_k$ converge

Where $\left| \frac{-z^2}{k^2} \right| \leq M_k$. Take $M_k = r^2/k^2$

Where $r \geq \max |z|$ in given region

Note $\sum_{k=1}^{\infty} r^2/k^2 = r^2 \sum_{k=1}^{\infty} 1/k^2$ converges. This establishes uniform convergence \therefore series is abs. conv $\forall \infty$.

section 9.3, problem 8

8] Need $\sum_{n=1}^{\infty} M_n$ is convergent, where $\frac{|z|^n}{n} \leq M_n$.

Take $M_n = r^n/n$. Now $\sum_{n=1}^{\infty} \frac{r^n}{n}$ converges by either ratio test or a comparison test

[Compare with $\sum_{n=1}^{\infty} r^n$]. Using either test need

$0 < r < 1$. Note $\frac{z^n}{n} \neq -1$ if

$|z| \leq r, r < 1$

9] Must show that $\sum_{n=1}^{\infty} \frac{1}{n^z}$ is u. convergent.

in the half space $\operatorname{Re} z \geq 1 + \epsilon$ where $\epsilon > 0$

$$\frac{1}{n^z} = \frac{1}{e^{z \log n}} = \frac{1}{e^{x \log n} e^{iy \log n}}$$

$$\left| \frac{1}{n^z} \right| = \frac{1}{e^{x \log n}} \quad n \geq 1$$

$$\left| \frac{1}{n^z} \right| = \frac{1}{n^x} < \frac{1}{n^{1+\epsilon}} \quad \text{if } x \geq 1 + \epsilon$$

Now $\sum_{n=1}^{\infty} M_n$ is convergent if $M_n = \frac{1}{n^{1+\epsilon}}$

so by n test $\sum_{n=1}^{\infty} \frac{1}{n^z}$ is u.c. if $x \geq 1 + \epsilon$.

Must also show $\frac{1}{n^z} \neq -1$ if $x \geq 1 + \epsilon$

$$\frac{1}{n^z} = \frac{1}{e^{x \log n} e^{iy \log n}} \quad \text{If } n=1 \quad \frac{1}{n^z} = 1 \neq -1$$

$$\text{If } n \geq 2 \quad \left| \frac{1}{n^z} \right| = e^{-x \log n} < 1$$

if x is positive. Thus $\frac{1}{n^z} \neq -1$.

Solution prob 10 , sec 9.3

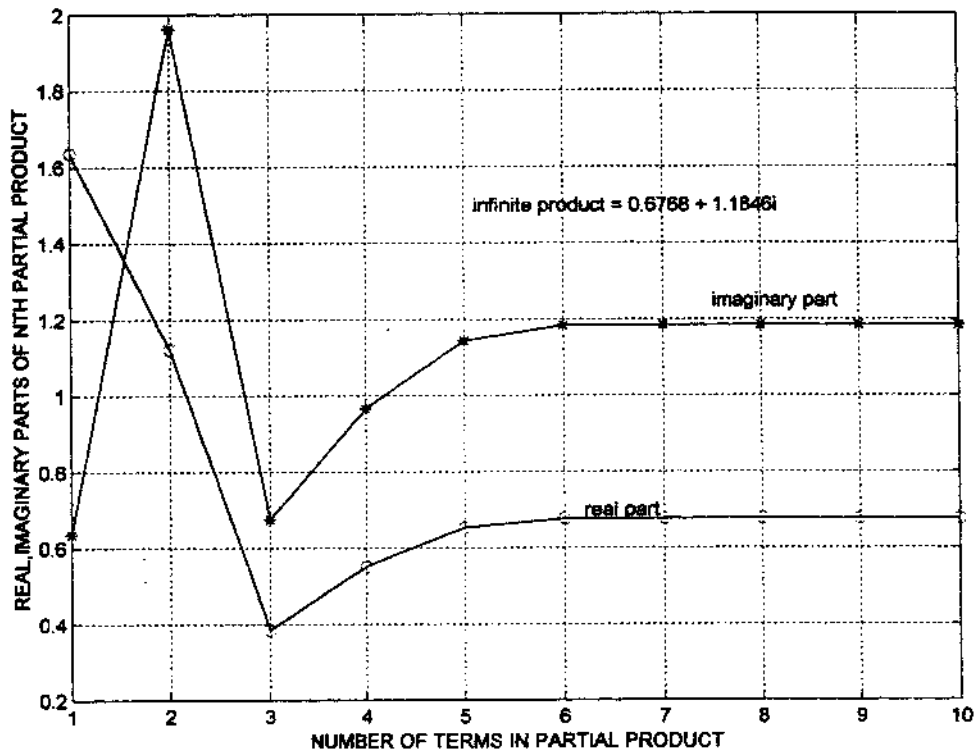

code on next page

ch 9,

p.34

10]

continued ^{sec 9.3}

```

%PROB 10 SEC 9.3
clear
n=10;

zz=.9*exp(i*pi/4);
p(1)=1+zz;v(1)=1;
for k=2:n
    p(k)=(1+zz^(2^(k-1))).*p(k-1);
    v(k)=k;
end

plot(v,real(p),v,imag(p),v,real(p),'o',v,imag(p),'*');
grid;
xlabel('NUMBER OF TERMS IN PARTIAL PRODUCT')
ylabel('REAL,IMAGINARY PARTS OF NTH PARTIAL PRODUCT')
text(7.5,1.25,'imaginary part');
text(6.2,.7,'real part')
infinite_product=1./(1-zz)
text(5.1,1.5,'infinite product = 0.6768 + 1.1846i');
p

```

11) First must show:

$$1+z+z^2+\dots+z^{2^n-1} = \frac{1-z^{2^n}}{1-z} \quad z \neq 1$$

Cross multiply and easily verify that
 $(1+z+z^2+\dots+z^{2^n-1})(1-z) = 1-z^{2^n}$

Thus:

$$(1+z)(1+z^2)(1+z^4)\dots(1+z^{2^{n-1}}) = \frac{1-z^{2^n}}{1-z}$$

Now put $z = e^{i2\theta}$

$$\begin{aligned}
 & (1+e^{i2\theta})(1+e^{i4\theta})(1+e^{i8\theta})\dots(1+e^{i2^n\theta}) \\
 &= \frac{1-e^{i2\theta \cdot 2^n}}{1-e^{i2\theta}} = \frac{e^{i2\theta \cdot 2^n} - 1}{e^{i2\theta} - 1} = \frac{e^{i\theta 2^n}}{e^{i\theta}} \frac{\sin(2^n\theta)}{\sin\theta} \\
 & e^{i\theta 2^{n-1}} e^{i\theta 2^{n-2}} \dots e^{i\theta 2^1} e^{i\theta 2^0} = e^{i\theta(2^n-1)} \frac{\sin(2^n\theta)}{\sin\theta}
 \end{aligned}$$

(continued)

ii) cont'd

Now $1+2+4 \dots 2^{n-1} = \frac{1-2^n}{1-2} = 2^n - 1$
 Thus $e^{i\theta} e^{i2\theta} e^{i4\theta} \dots e^{i2^{n-1}\theta} = e^{i(2^n-1)\theta}$

$$2^n e^{i(2^n-1)\theta} = e^{i\theta(2^n-1)} \frac{\cos \theta + i \sin \theta + \cos(2\theta) + i \sin(2\theta) + \dots + \cos(2^{n-1}\theta) + i \sin(2^{n-1}\theta)}{\cos \theta + i \sin \theta}$$

∴ Divide both sides by $2^n e^{i(2^n-1)\theta}$

12(a)

Using Maclaurin series for $\text{Log}(1+z)$ but replacing z with a_n we have:

$$\text{Log}(1+a_n) = a_n - \frac{a_n^2}{2} + \frac{a_n^3}{3} \dots \quad |a_n| < 1$$

$$\frac{\text{Log}(1+a_n)}{a_n} = 1 - \frac{a_n}{2} + \frac{a_n^2}{3} \dots \quad 0 < |a_n| < 1$$

$$\left| \frac{\text{Log}(1+a_n)}{a_n} - 1 \right| = \left| \frac{a_n}{2} - \frac{a_n^2}{3} + \frac{a_n^3}{4} \dots \right|$$

$$b) \left| \frac{a_n}{2} - \frac{a_n^2}{3} + \frac{a_n^3}{4} \dots \right| \leq \frac{|a_n|}{2} + \frac{|a_n|^2}{3} + \frac{|a_n|^3}{4} \dots$$

Now $\frac{|a_n|^2}{3} \leq \frac{|a_n|^2}{2}$,

follows from triangle inequality.

$$\frac{|a_n|^3}{4} \leq \frac{|a_n|^3}{2} \text{ etc.}$$

Thus $\left| \frac{a_n}{2} - \frac{a_n^2}{3} + \frac{a_n^3}{4} \dots \right| \leq \frac{|a_n|}{2} + \frac{|a_n|^2}{2} + \frac{|a_n|^3}{2} \dots$

Right side of above = $\frac{1}{2} [|a_n| + |a_n|^2 + |a_n|^3 \dots]$

sec 9.3
prob 12, cont'd

If $|a_n| < 1$, recall that infinite series
 $|a_n| + |a_n|^2 + |a_n|^3 \dots = \frac{|a_n|}{1 - |a_n|}$

Since $|a_n| \leq \frac{1}{2}$, we have $\frac{|a_n|}{1 - |a_n|} \leq \frac{1/2}{1/2} = 1$

Summarizing

$$\left| \frac{a_n}{2} - \frac{a_n^2}{3} + \frac{a_n^3}{4} \dots \right| \leq \frac{1}{2} \left[|a_n| + |a_n|^2 + |a_n|^3 \dots \right]$$

$$\leq \frac{1}{2} \quad \text{q.e.d}$$

Thus using result of (a) and the above:

$$\left| \frac{\text{Log}(1+a_n)}{a_n} - 1 \right| \leq 1/2$$

Let $w = \frac{\text{Log}(1+a_n)}{a_n}$

provided n
 large enough
 that $|a_n| < 1/2$
 note, we can relax
 condition $|a_n| \neq 0$

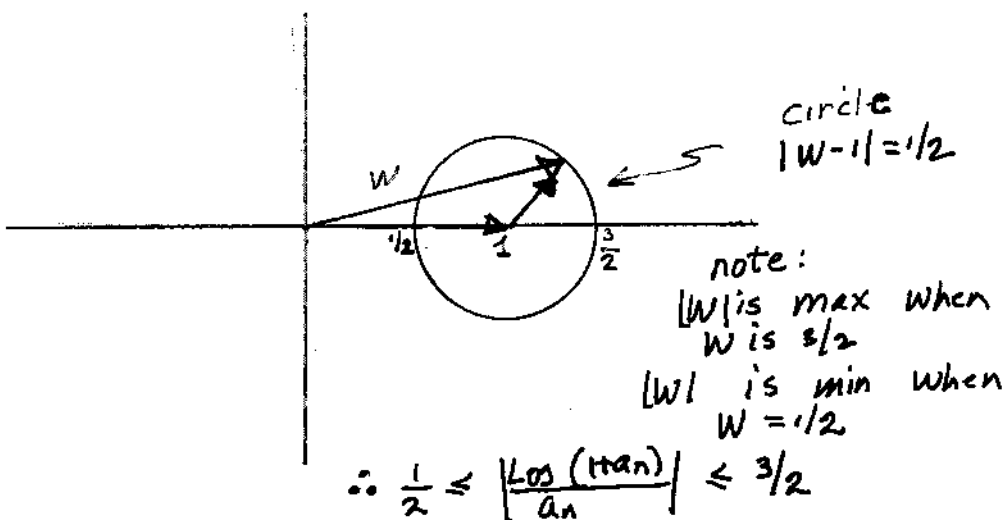

sec 9.3, Prob. 12 continued

$$(d) \quad \text{If} \quad \left| \frac{\text{Log}(1+an)}{a_n} \right| \leq \frac{3}{2}$$

$$|\text{Log}(1+an)| \leq \frac{3}{2}|a_n|$$

Now by assumption $\sum_{n=0}^{\infty} |a_n|$ is convergent.

Thus by comparison test (for real series) $\sum_{n=0}^{\infty} |\text{Log}(1+an)|$ must be convergent.

Thus the convergence of $\sum_{n=0}^{\infty} |a_n|$ is a sufficient condition for the absolute convergence of the series $\sum_{n=0}^{\infty} \text{Log}(1+an)$

$$\text{If} \quad \left| \frac{\text{Log}(1+an)}{a_n} \right| \geq \frac{1}{2}, \quad \left| \text{Log}(1+an) \right| \geq \frac{|a_n|}{2}$$

If $\frac{1}{2} \sum_{n=0}^{\infty} |a_n|$ diverges, then by the comparison test $\sum_{n=0}^{\infty} |\text{Log}(1+an)|$ diverges.

Thus the convergence of $\frac{1}{2} \sum_{n=0}^{\infty} |a_n|$ is a necessary condition for the absolute convergence of $\sum_{n=0}^{\infty} |\text{Log}(1+an)|$

Note: the double inequality: $\frac{|a_n|}{2} \leq |\text{Log}(1+an)| \leq \frac{3}{2}|a_n|$

holds for $n > N$ where N such that $|a_n| \leq \frac{1}{2}$, $n > N$. Thus the preceding comparison tests are strictly only true for $n > N$. However, this is not a problem.

e.g. $\sum_{n=1}^{\infty} \frac{1}{n^2} |\text{Log}(1+an)|$ is conv. [for $n' > N$] because $\sum_{n=0}^{\infty} \frac{1}{n^2} |a_n|$ conv. Now $\sum_{n=0}^{\infty} \frac{1}{n^2} |\text{Log}(1+an)|$ is defined [$n' \neq \infty$] as long as $a_n \neq -1$ [which we must assume]. $\therefore \sum_{n=0}^{\infty} |\text{Log}(1+an)|$ converge if and only if $\sum_{n=0}^{\infty} |a_n|$ converges.

Sec 9.4

1) a) From sec. 5.3 $\text{Log}(1-z) = -z - \frac{z^2}{2} - \frac{z^3}{3} \dots, |z| < 1$

$$\begin{aligned} \text{Log}(1-z) &= -\lim_{n \rightarrow \infty} \sum_{k=1}^n \frac{z^k}{k} \\ \exp \text{Log}(1-z) &= \exp \lim_{n \rightarrow \infty} \sum_{k=1}^n \frac{-z^k}{k} \\ &= \lim_{n \rightarrow \infty} \exp \sum_{k=1}^n \frac{-z^k}{k} = \lim_{n \rightarrow \infty} e^{-z} e^{-z^2/2} \dots e^{-z^n/n} \end{aligned}$$

We can swap the limit because exp is a continuous function and so are terms z, z^2, \dots etc.

$$\begin{aligned} \exp \text{Log}(1-z) &= 1-z \\ \therefore 1-z &= e^{-z} e^{-z^2/2} e^{-z^3/3} \dots \quad \text{q.e.d} \\ &\quad \text{for } |z| < 1 \end{aligned}$$

b) $e^{-z} e^{-z^2/2} e^{-z^3/3} e^{-z^4/4} = .5055$ if $z = 1/2$

$1-z = .5$ difference $\sim \frac{1}{2} \%$

c) Derivation requires that $|z| < 1$
 This is violated for $z=2$ $1-z = -1$ for $z=2$
 right side: $e^{-z} e^{-z^2/2} e^{-z^3/3} \rightarrow 0$

2) a) From eq. (9.4-6)

$$\cos(z') = \prod_{k=1}^{\infty} \left(1 - \frac{z'^2}{\left[\frac{(2k-1)\pi}{2} \right]^2} \right) \text{ for all } z'$$

Let $z' = iz$ where z can have any value

$$\cos(iz) = \cosh z = \prod_{k=1}^{\infty} \left(1 + \frac{z^2}{\left[\frac{(2k-1)\pi}{2} \right]^2} \right) \text{ for all } z$$

Note if any factor on the right $1 + \frac{z^2}{\left[\frac{(2k-1)\pi}{2} \right]^2} = 0$ then must define the right side $\prod_{k=1}^{\infty}$ as zero.

b) Let $g(z) = \cosh(z)$, $g'(z)/g(z) = \tanh z$
 $= \frac{\sinh z}{\cosh z}$ which has poles at $\pm i \left[\frac{n\pi - \pi}{2} \right]$ $n=1, 2, 3, \dots$
 note, $\tanh 0 = 0$, also residue $\tanh z$ @ poles = 1

sec 9.4

2(b) continued.

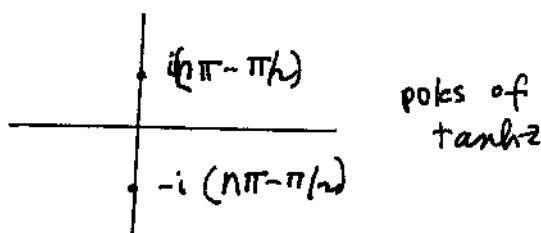

Following Mittag-Leffler Theorem of section 9.2

$$\begin{aligned} \tanh z &= \tanh z \Big|_{z=0} + \left[\frac{1}{z - i(\frac{\pi}{2})} + \frac{1}{z + i(\frac{\pi}{2})} + \frac{1}{z - i(\frac{3\pi}{2})} \right. \\ &+ \frac{1}{z + i(\frac{3\pi}{2})} + \dots + \frac{1}{z - i(n\pi - \frac{\pi}{2})} + \frac{1}{z + i(n\pi - \frac{\pi}{2})} + \dots \\ &\left. + \left[\frac{1}{i(\frac{\pi}{2})} + \frac{1}{i(-\frac{\pi}{2})} + \frac{1}{i(\frac{3\pi}{2})} + \frac{1}{i(-\frac{3\pi}{2})} + \dots \right] \right] \\ &= \frac{2z}{z^2 + (\frac{\pi}{2})^2} + \frac{2z}{z^2 + (\frac{3\pi}{2})^2} + \dots + \frac{2z}{z^2 + (\frac{5\pi}{2})^2} + \dots \\ &= \tanh z \end{aligned}$$

Set $z = z'$ in the preceding, integrate from 0 to z on a path in the complex z' plane. Path does not pass thru any poles in the preceding series of partial fractions.

$$\begin{aligned} \int_0^z \tanh z' dz' &= \int_0^z \frac{d}{dz'} \log \cosh z' dz' \\ &= \int_0^z \left[\frac{2z'}{z'^2 + (\frac{\pi}{2})^2} + \frac{2z'}{z'^2 + (\frac{3\pi}{2})^2} + \dots \right] dz' \end{aligned}$$

$$= \log \cosh(z) = \log \left(1 + \frac{z^2}{(\frac{\pi}{2})^2} \right) + \log \left[1 + \frac{z^2}{(\frac{3\pi}{2})^2} \right] + \dots$$

take $\log 1 = 0$

Now treat both sides as exponents $e^{\log \cosh z} = \cosh z$

$$\cosh z = e^{\left[\log \left(1 + \frac{z^2}{(\frac{\pi}{2})^2} \right) + \log \left(1 + \frac{z^2}{(\frac{3\pi}{2})^2} \right) + \dots \right]}$$

$$\cosh z = \left(1 + \frac{z^2}{(\frac{\pi}{2})^2} \right) \left(1 + \frac{z^2}{(\frac{3\pi}{2})^2} \right) \left(1 + \frac{z^2}{(\frac{5\pi}{2})^2} \right) \dots \leftarrow \text{q.e.d.}$$

Note if $z = \pm i(n\pi - \frac{\pi}{2})$ $n=1, 2, 3$, take the product as zero

3) a) From eqn. (9.4-10)

$$\frac{\text{sm} z'}{z'} = \prod_{k=1}^{\infty} \left(1 - \frac{z'^2}{k^2 \pi^2} \right) \quad \text{valid for all } z' \text{ if take r.h.s} = 0 \text{ if } z' = k\pi$$

let $z = z'$ $\frac{\text{SM}(iz)}{i z} = \prod_{k=1}^{\infty} \left[1 + \frac{z^2}{k^2 \pi^2} \right]$

$\text{sm} iz = i \text{sm} h z$
 $\therefore \text{sm} h(z) = z \prod_{k=1}^{\infty} \left[1 + \frac{z^2}{k^2 \pi^2} \right]$

b) Let $g(z) = \sinh z$. $g'(z)/g(z) = \frac{\cosh z}{\sinh z}$ has simple pole at $z=0$ with residue = 1

$\frac{\cosh z}{\sinh z} - \frac{1}{z}$ is analytic at $z=0$, let $F(z) = \frac{\cosh z}{\sinh z} - \frac{1}{z}$
 Expand $F(z)$ in a series of partial fractions.
 $F(z) = \text{coth} z - \frac{1}{z}$

Use Mittag. Leffler. Poles @ $\pm i\pi, \pm i2\pi, \dots$
 Residue @ each pole is 1.

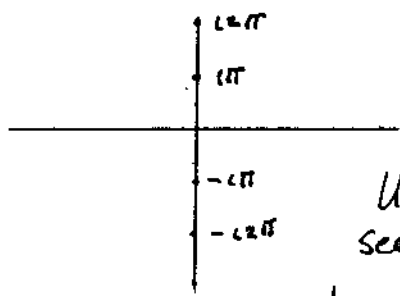

poles of $\text{coth} z - \frac{1}{z}$

Using Mittag-Leffler Theorem of Section 9.2 :

$$\text{coth} z - \frac{1}{z} = \frac{1}{z - i\pi} + \frac{1}{z + i\pi} + \frac{1}{z - i2\pi} + \frac{1}{z + i2\pi} \dots$$

$$\text{coth} z - \frac{1}{z} = \frac{2z}{z^2 + \pi^2} + \frac{2z}{z^2 + 4\pi^2} + \dots$$

Put z' in the above in place of z .

$$\frac{d}{dz'} (\log \text{sm} h z') - \frac{d}{dz'} \log z' = \frac{2z'}{z'^2 + \pi^2} + \frac{2z'}{z'^2 + 4\pi^2} + \frac{2z'}{z'^2 + 9\pi^2} + \dots$$

$$\frac{d}{dz'} \log \left[\frac{\text{sm} h z'}{z'} \right] = \frac{2z'}{z'^2 + \pi^2} + \frac{2z'}{z'^2 + 4\pi^2} + \frac{2z'}{z'^2 + 9\pi^2} + \dots$$

$$\int_0^z \frac{d}{dz'} \left[\log \frac{\text{sm} h z'}{z'} \right] dz' = \int_0^z \left[\frac{2z'}{z'^2 + \pi^2} + \frac{2z'}{z'^2 + 4\pi^2} + \dots \right] dz'$$

along a contour not passing thru any poles.

sec 9.4,

prob 3 (b), continued

$$\log \left[\frac{\sinh z}{z} \right] = \log \left(1 + \frac{z^2}{\pi^2} \right) + \log \left(1 + \frac{z^2}{4\pi^2} \right) + \log \left[1 + \frac{z^2}{9\pi^2} \right] + \dots$$

Treat both sides as exponents of e

$$\frac{\sinh z}{z} = e^{\log \left(1 + \frac{z^2}{\pi^2} \right) + \log \left(1 + \frac{z^2}{4\pi^2} \right) + \log \left(1 + \frac{z^2}{9\pi^2} \right) + \dots}$$
$$= \left(1 + \frac{z^2}{\pi^2} \right) \left(1 + \frac{z^2}{4\pi^2} \right) \left(1 + \frac{z^2}{9\pi^2} \right) \dots$$
$$\sinh z = z \left(1 + \frac{z^2}{\pi^2} \right) \left(1 + \frac{z^2}{4\pi^2} \right) \left(1 + \frac{z^2}{9\pi^2} \right) \dots \text{ q.e.d.}$$

4]

```
%solves prob 4 sec 9.4
clear;
p(1)=4/3;w(1)=pi/2;
for k=2:100;
    p(k)=p(k-1)*(2*k)^2/((2*k-1)*(2*k+1));
    w(k)=pi/2;
    x(k)=k;
end
plot(x,p,x,w);grid;
text(1,1.58,'pi/2')
percent_error=100*(pi/2-p(100))
```

graph on next page

Graph, prob 4, sec 9.4

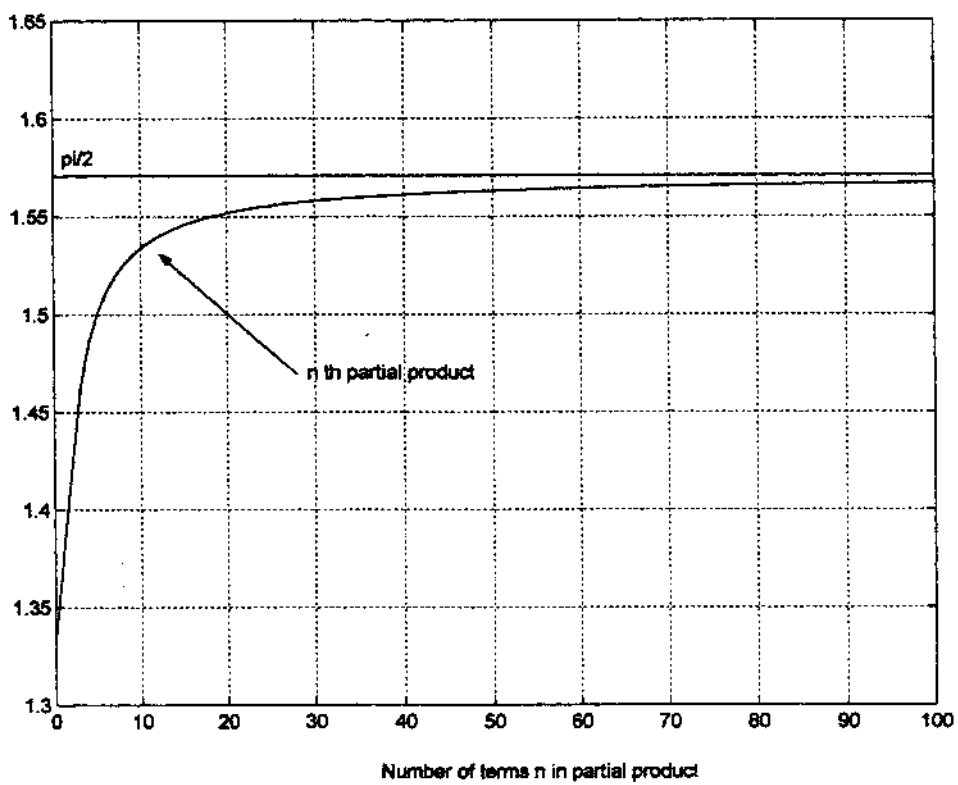

ch. 9,

1

P. 43

Section 9.4

5. If $|z| \leq r$, and $r < \frac{(2n+1)\pi}{2}$
 Then $\frac{(2k-1)\pi}{2} \geq |z|$ if $k \geq (n+1)$

so $|z|^2 - \left[\frac{(2k-1)\pi}{2}\right]^2 \geq \left[\frac{(2k-1)\pi}{2}\right]^2 - |z|^2$
 by a triangle inequality.

$$|z|^2 - \left[\frac{(2k-1)\pi}{2}\right]^2 \geq \left[\frac{(2k-1)\pi}{2}\right]^2 - r^2$$

$$\text{Thus } \left| \frac{2z'}{z^2 - \left[\frac{(2k-1)\pi}{2}\right]^2} \right| \leq \frac{2r}{\left[\frac{(2k-1)\pi}{2}\right]^2 - r^2} = M_k$$

if $k \geq (n+1)$

Now $\sum_{k=(n+1)}^{\infty} M_k$ converges. (can prove this
 with a comparison test): $\int_{n+1}^{\infty} \frac{2r}{\left[\frac{(2x-1)\pi}{2}\right]^2 - r^2} dx$
 converges

Thus, from the M test:
 $\sum_{k=n+1}^{\infty} \frac{2z^k}{z^2 - \left[\frac{(2k-1)\pi}{2}\right]^2}$ is uniformly conv. for $|z| \leq r$

$$6(a) \quad \underbrace{1 - \frac{z^2}{2!} + \frac{z^4}{4!} \dots}_{\text{Series for } \cos z} = \left[1 - \frac{z^2}{(\pi/2)^2}\right] \left[1 - \frac{z^2}{(3\pi/2)^2}\right] \left[1 - \frac{z^2}{(5\pi/2)^2}\right] \dots$$

Series for $\cos z$

Now equate coeffs of z^2

$$-\frac{1}{2} = (-1) \left[\frac{1}{(\pi/2)^2} + \frac{1}{(3\pi/2)^2} + \frac{1}{(5\pi/2)^2} + \dots \right]$$

$$\frac{1}{2} = \frac{4}{\pi^2} \left[1 + \frac{1}{9} + \frac{1}{25} \dots \right]$$

$$\text{or } \frac{\pi^2}{8} = \left[1 + \frac{1}{9} + \frac{1}{25} + \frac{1}{49} + \dots \right]$$

q.e.d.

section 9.4

6(b) continued

$$\frac{\sin z}{z} = \left(1 - \frac{z^2}{\pi^2}\right) \left(1 - \frac{z^2}{4\pi^2}\right) \left(1 - \frac{z^2}{9\pi^2}\right) \dots$$

$$= \frac{z - z^3/30 + z^5/5! - \dots}{z} = 1 - \frac{z^2}{30} + \frac{z^4}{5!} - \dots = \left(\frac{1-z^2}{\pi^2}\right) \left(\frac{1-z^2}{4\pi^2}\right) \left(\frac{1-z^2}{9\pi^2}\right) \dots$$

Equating coeffs of z^2

$$-\frac{1}{30} = -\frac{1}{\pi^2} \left[\frac{1}{1} + \frac{1}{4} + \frac{1}{9} + \dots \right]$$

$$\frac{\pi^2}{6} = \left[1 + \frac{1}{4} + \frac{1}{9} + \frac{1}{16} + \dots \right] \quad \text{g.e.d.}$$

7] $e^\alpha - e^\beta = e^{\frac{\alpha+\beta}{2}z} 2 \sinh \left[\frac{\alpha-\beta}{2}z \right]$

In formula contained in problem 3
replace: z with $\frac{\alpha-\beta}{2}z$ to represent $\sinh[\]$ in the preceding.

Thus $e^\alpha - e^\beta = 2 e^{\frac{\alpha+\beta}{2}z} \frac{(\alpha-\beta)z}{\pi} \prod_{k=1}^{\infty} \left[1 + \frac{\left(\frac{\alpha-\beta}{2}z\right)^2}{k^2 \pi^2} \right]$

$$e^\alpha - e^\beta = (\alpha-\beta) e^{\frac{\alpha+\beta}{2}z} z \prod_{k=1}^{\infty} \left[1 + \frac{(\alpha-\beta)^2 z^2}{4k^2 \pi^2} \right] \quad \text{g.e.d.}$$

8] next pg.

code for prob8, sec 9.4

```
%solves prob 8 sec 9.4
clear all
hold off
z=linspace(0,5,100);
pi2=(pi/2);
p=(1-z.^2/pi2^2);
n=9
for k=2:n
    p=p.*(1-z.^2/((2*k-1)*pi2)^2)

    if k==5 ;
        plot(z,p);axis([-0.01,4.9,-3,3]);hold on;
    end
    if k==7 ;
        plot(z,p);axis([-0.01,4.9,-3,3]);hold on;
    end
    if k==9 ; plot(z,p);axis([-0.01,4.9,-3,3]);
        hold on;
    end
end
end
z4=cos(z);
plot(z,z4);grid on;
```

figure on next page

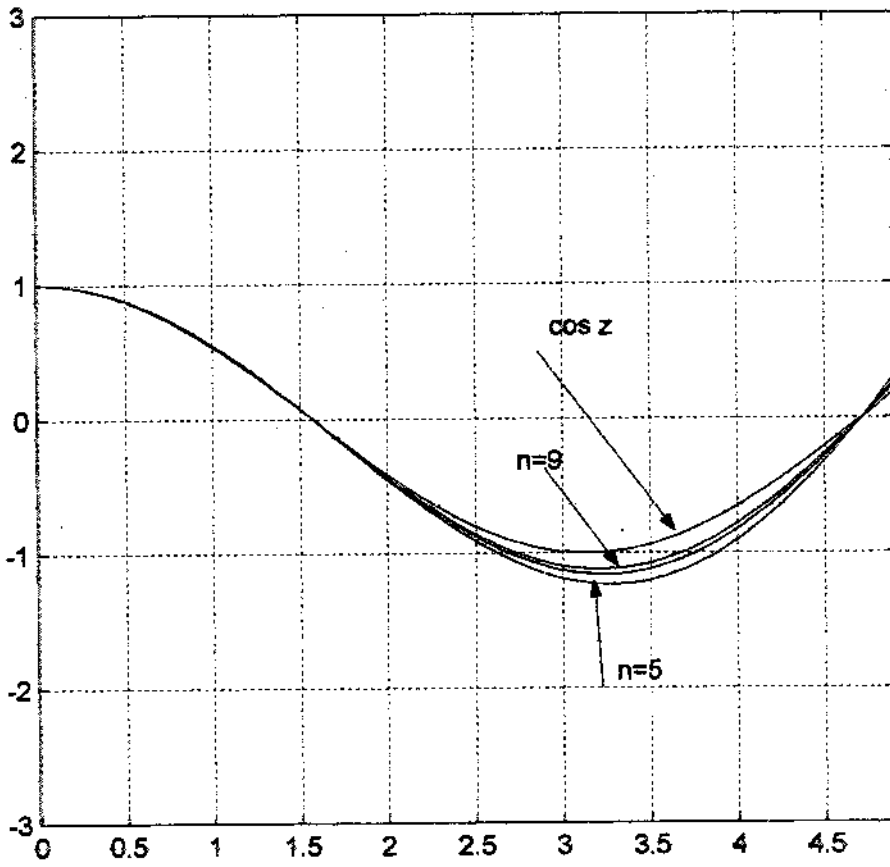

prob 8 sec 9.4

Sec 9.4

Q] Let $g(z) = \cosh z - \cos z$, $\frac{d}{dz} \log g = \frac{g'}{g}$

$\frac{g'(z)}{g(z)} = \frac{\sinh z + \sin z}{\cosh z - \cos z}$ has a simple pole

at $z=0$ because numerator has zero of order 1 and denominator has zero of order 2. Its

residue is $\lim_{z \rightarrow 0} z \frac{\sinh z + \sin z}{\cosh z - \cos z} = z \frac{[z + \dots + z + \dots]}{[1 + \frac{z^2}{2!} - [1 - \frac{z^2}{2!}]]} = 2$

So princ. part of Laur. series expansion about $z=0$ is simply $2/z$, and

$F(z) = \frac{g'}{g} - \frac{2}{z} = \frac{\sinh z + \sin z}{\cosh z - \cos z} - \frac{2}{z}$ is analytic at

$z=0$. Note $\lim_{z \rightarrow 0} F(z) = 0$ as can be found

by putting expression over common denom. and expanding \sinh, \cosh, \sin, \cos in Maclaurin Series.

Where are poles of $F(z)$? They are where $\cosh z - \cos z = 0$ and are simple poles.

$\cosh z = \cos z$

$\cos iz = \cos z, \quad z \pm iz = \pm 2n\pi$
where $n=0, 1, 2, \dots$

$z = \frac{\pm 2n\pi}{1 \pm i} = \pm 2n\pi [1 \pm i] \quad n=0, 1, 2, 3, \dots$

Where we exclude pole at $n=0$ since it is subtracted out with $-2/z$. Must expand $F(z)$

using Mittag-Leff.

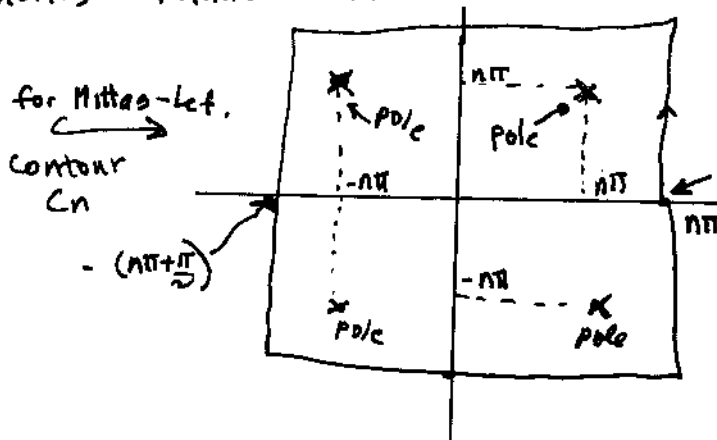

We can show that $|F(z)|$ is bounded on C_n

where bound indep. of n .

[Not given here]

Sec 9.4

Problem 9, continued:

need Res $F(z)$ @ the poles $\pm 2n\pi [1 \pm i]$, $n=0,1,2,\dots$
 Can ignore $-1/z$ because $F(z)$ is analytic at these points. Res $\frac{\sinh z + \sin z}{\cosh z - \cos z}$ @ simple pole

$$= \frac{\sinh z + \sin z}{\sinh z + \sin z} = 1 = \text{Res } F(z)$$

Now apply Mittag-Leffler. Note that the poles inside the contour on previous page are symmetrically placed. The sum of their complex locations for any given n is zero.
 $\therefore \sum \frac{b_k}{a_k} = 0$ [all $b_k = 1$]

$$\frac{\sinh z + \sin z}{\cosh z - \cos z} - \frac{2}{z} =$$

$$\frac{1}{[z - (1+i)\pi]} + \frac{1}{[z - (1-i)\pi]} + \frac{1}{[z + (1+i)\pi]} + \frac{1}{[z + (1-i)\pi]}$$

$$+ \frac{1}{[z - (1+i)2\pi]} + \frac{1}{[z - (1-i)2\pi]} + \frac{1}{[z + (1+i)2\pi]} + \frac{1}{[z + (1-i)2\pi]}$$

+ same as above but put 3π in place of 2π , etc]. Now combine fractions:

$$= \sum_{n=1}^{\infty} \frac{4z^3}{z^4 + 4n^4\pi^4} = \frac{d}{dz} \log[\cosh z - \cos z] - \frac{2}{z}$$

$$\therefore \frac{d}{dz} [\log[\cosh z - \cos z]] = \frac{2}{z} + \sum_{n=1}^{\infty} \frac{4z^3}{z^4 + 4n^4\pi^4}$$

$$\frac{d}{dz} \left[\frac{\log[\cosh z - \cos z]}{z^2} \right] = \sum_{n=1}^{\infty} \frac{4z^3}{z^4 + 4n^4\pi^4}$$

sec 9.4

prob 9, Continuation and conclusion:

$$\frac{d}{dz} \left[\log \frac{\cosh z - \cos z}{z^2} \right] = \sum_{n=1}^{\infty} \frac{d}{dz} \log \left[1 + \frac{z^4}{4(n\pi)^4} \right]$$

Now integrate both side on a path from 0 to z,

Take $\log 1 = 0$ Note $\lim_{z \rightarrow 0} \frac{\cosh z - \cos z}{z^2} = 1$

$$\log \left[\frac{\cosh z - \cos z}{z^2} \right] = \sum_{n=1}^{\infty} \log \left[1 + \frac{z^4}{4n^4\pi^4} \right]$$

exponentiate

$$\frac{\cosh z - \cos z}{z^2} = e^{\log \left[1 + \frac{z^4}{4\pi^4} \right] + \log \left[1 + \frac{z^4}{4 \times 2^4\pi^4} \right] + \dots}$$

$$\begin{aligned} \cosh z - \cos z &= z^2 \left[\left(1 + \frac{z^4}{4\pi^4} \right) \left(1 + \frac{z^4}{4 \times 16\pi^4} \right) \dots \right] \\ &= z^2 \prod_{n=1}^{\infty} \left[1 + \frac{z^4}{4n^4\pi^4} \right] \quad \text{q.e.d.} \end{aligned}$$

Fini's

