

INSTRUCTIONS
for
converting
DRAGON'S LAIR II
to
***AMERICAN LASER
GAMES***
products

American Laser Games
4801 Lincoln Road NE
Albuquerque, NM 87109
Phone: (505) 880-1718
(505) 880-1557 (FAX)

OVERVIEW

This manual provides instructions for converting a “Dragon’s Lair II” game for use with games from American Laser Games. It includes the following;

- * Assumptions about your DRAGON’S LAIR II game
- * Name/phone number of ALG Customer Support if you need assistance
- * Safety notice
- * Step-by-step conversion instructions
 - Adding ALG components to game (computer board/metal box, computer power supply, TAOS PC board, etc.)
 - Installation of ALG wiring harness in game
 - Connections involved with wiring harness
 - Addition of gun(s) to game cabinet
 - Replacing the old top panel with new ALG top panel
 - Comments about cabinet decals
 - Pre-power-up instructions
- * Additional conversion instructions for a 2-player game
- * Tools needed for conversion
- * Drawings provided

INSTRUCTIONS TO CONVERT "DRAGON'S LAIR II" TO AMERICAN LASER GAMES (MAD DOG II, ETC.)

- 1) If you have questions about this installation procedure, PHONE A.L.G. rather than risk damage. It's possible some DRAGON'S LAIR games may be configured slightly differently or have different equipment - check before beginning the conversion process. "Tools Needed" are listed near the end of this paper.

This conversion assumes the following exists on the DRAGON'S LAIR II game:

- 1) A Sony model 1450 Laser Disk Player (LDP).
- 2) A color monitor with an NTSC video input. (rather than RGB inputs).
- 3) The basic physical configuration shown on the "DRAGON'S LAIR II HARNESS LAYOUT" drawing included in this documentation (Coin door, cabinet-mounted/fused/dual/120V AC power receptacle, external AC power switch, monitor isolation transformer)

If questions arise, phone ALG and ask for Dave Fickers, Tim Penner, or Dan Montano. Phone: (505) 880-1718 (voice) or (505) 880-1557 (FAX).

IMPORTANT SAFETY NOTICE

ALG recommends replacing the glass in front of the CRT with 1/4" Plexiglas to prevent injury if a player hits it with the gun.

- 2) Unplug game from wall. Be aware of the ***CRT HIGH VOLTAGE DANGER*** which exists *even after the game is unplugged*
- 3) Unplug the connector from the PC-style power supply to the computer board. Leave intact the 3-position output connector from the PC-style power supply which provides 120VAC to the monitor isolation transformer & the AC plug-in.
- 4) *Facing the rear of the cabinet*, mount the TAOS board to the right side of the cabinet ... to the right of the Laser Disk Player (LDP). The TAOS board should be 2-1/2" from the game cabinet rear edge and 1/2" down from the monitor mounting shelf. Mount the TAOS board with the four #6 x 7/8" self-tapping screws and 1/4" plastic standoffs provided. Orient the board so that the 25-position "D" style connector is towards the top.
- 5) On the underside of the Dragon's Lair II top panel, disconnect the Molex connector to free the top panel wires. This will allow you to remove the top panel which will provide much easier access to the inside of the cabinet. Then remove the Phillips screws which hold the DRAGON'S LAIR top panel to the hinge. Remove and **save both of the red START switches** from the DRAGON'S LAIR II top panel. In a later step, you will replace the old top panel with a new ALG-provided top panel. You should use the old top panel to make a template to transfer the hinge hole spacing & positions to the new top panel.

- 6) Disconnect the existing 25-position serial cable from the LDP to the computer board. Tie back or remove the old serial cable. Connect the 25-position serial cable which was provided as part of the conversion kit to the LDP and leave the other end loose for now. Tighten the cable connector screws to firmly attach the new serial cable to the LDP.
- 7) Disconnect the existing audio cables from the LDP. Tie back or remove.
- 8) Working through the top panel opening, mount the provided power supply left of the coin box..behind the LDP (see the diagram on page 13). Position the power supply so its ON/OFF switch can be reached and operated through the coin door.
- 9) Lay the American Laser Games (ALG) cable harness kit in the game cabinet. See the attached DRAGON'S LAIR II HARNESS LAYOUT drawing for proper cable harness positioning. *Study this drawing* to familiarize yourself with the various connectors & their functions.

Locate the red and black audio cables with RCA style connectors near the laser player. Find where these cables branch off the harness near the laser player. Connect the red and black cables to the similarly colored LDP connectors. (Red is the right channel).

- 10) Locate the other end of the RCA cables. Near there, find a 3-position Molex connector with 2 wires...one gray, the other black. Connect this Molex connector to J103 of the TAOS board. (See page 6 of the ALG manual which shows TAOS board connector locations and functions). J103 is the 12.6 VAC power input for the audio section of the TAOS board.

Next find a 5-position/4-wire (orange/gray/brown/gray) Molex connector near the TAOS board and connect it to J104 of the TAOS board. This is the speakers connection.

Next locate the round, gray, shielded cable from the volume control pot. It has a 5-position/5-wire Molex connector. Connect it to J106 of the TAOS board. This remote pot allows you to control overall (laser audio + gunshot) volume through the coin door opening.

Locate the black RCA-style audio connector labeled LDP-LEFT (J123) near the TAOS board. Connect it to TAOS board J123. This cable provides left-channel audio from the LDP.

Locate the other black RCA-style audio connector labeled COMPUTER AUDIO (J120) near the TAOS board. Connect it to J120 on the TAOS board. This cable provides gunshot audio from the ALG computer board.

Locate the remaining (red) RCA-style audio connector labeled LDP-RIGHT (J121) and connect it to J121 on the TAOS board. This cable provides right-channel audio from the LDP.

- 11) Find a gray-hooded 9-position "D" connector on the harness and connect it to J100 on the TAOS board. It provides COIN signals, START button signals, and the SERVICE button signal.
- 12) Locate and connect a green wire with a forked terminal in the wire harness near the corner of the TAOS board. This is a SAFETY/STATIC ground wire. Connect it to the TAOS board mounting screw labeled CHASSIS GND near J100. See the NEW CABLE HARNESS LAYOUT drawing for the location.

- 13) Locate the black wire pair in the wire harness which comes from the wall-plug transformer. It has a white 2-prong connector on the end of the wire. Insert the white 2-prong connector in J110 on the TAOS board....paying close attention to connector polarity (RED = +) which is also marked on the TAOS board. The wall-plug transformer provides +12VDC **isolated** power to the optoisolator section of the TAOS board.

Connect the two 9-conductor ribbon cables with "D" connectors to J108 and J109 on the TAOS board. The shorter cable connects to J109 and the longer to J108...they are labeled and harness dress-out should prevent misconnection. The J108 cable provides optoisolated gun signals to the ALG computer board. The J109 cable provides optoisolated COIN/START/SERVICE signals to the ALG computer board.

- 14) Locate the SERVICE button mounted on the top of the coin box. Unplug the wires from this switch at the associated Molex connector and remove the original switch and bracket from the top of the coin box.

Locate the ALG metal bracket with a pre-mounted SERVICE switch. Mount the bracket on top of the metal coin box so that the switch can be operated by reaching through the coin door. Locate the bracket vertical face 4-1/2" from the front edge of the coin box. *This location is critical for proper coin door closing.*

Mount the volume control pot in the service bracket hole using the provided nut. *Do not overtighten the nut.*

Locate the orange wire in the harness near the service bracket and connect it to the NORMALLY OPEN lug of the service switch. Connect the black wire to the COMMON lug of the service switch.

- 15) Mount the large, gray, metal EMI box (it contains the Amiga computer board) over the LDP using the four leg brackets provided. First fasten the leg brackets to the EMI box. Then position the EMI box over the LDP with the EMI box cutout towards the rear of the game.

The edge of EMI box with the cutout should be 3" from the face of the LDP. Screw the brackets to the wood floor using four of the #6 x 1/2" self-tapping screws provided.

- 16) Route the two ribbon cables with 9-position "D" connectors through the EMI box cutout. Connect the longer ribbon cable labeled CONSOLE SWITCHES to connector CN1 on the Amiga computer board. CN1 is near the corner of Amiga computer board and is labeled on the board. Connect the other (shorter) ribbon cable labeled GUNS to CN2.

CN1 is the input for COIN/START/SERVICE switches and CN2 is the GUNs input. (See page 6 of the ALG manual which shows connector locations and functions for the Amiga computer board).

Connect the single audio cable with RCA connector to CN3 on the Amiga computer board. This provides gunshot & other sounds to the audio amplifier on the TAOS board.

- 17) Connect the 25-position ALG serial cable to **CN6** on the Amiga computer board. This cable provides computer control of the laser disk player to command the LDP to the proper scenes at the proper times.
- 18) Connect the thick, beige-colored Amiga power supply output cable to CN8 on the Amiga computer board. Page 11 of the ALG manual shows the Amiga power supply connector pinout if you ever need to test the power supply.
- 19) Connect the RCA **VIDEO** cable from the LDP output to the genlock input. The genlock input is the **LEFT** RCA jack when viewing the genlock through the EMI box cutout. See page 6 of the ALG manual for **standard** genlock connections. (Note: Certain genlocks may have a 3-position toggle switch between the two RCA jacks. On these genlocks, the input is the **RIGHT**-hand RCA jack and the 3-position switch should be in the **CENTER** position. The toggle switch, if present, selects among "LDP-ONLY"/"MIXED"/"AMIGA ONLY" video sources.)

Connect one end of the remaining video cable in the conversion kit to the output RCA jack of the genlock. Route and tie-down the cable towards the video input of the monitor. Unplug the existing DRAGON'S LAIR video cable and plug ALG-provided cable into the monitor.
- 20) The cable harness will be routed along the back edge of the shelf on which the LDP is mounted (see the diagram on page 13 of these instructions). The harness should be held in place with several cable-tie mounting blocks. The provided cable-tie mounting blocks have self-adhesive backing, but **MUST** be screwed to the shelf to support the weight/strain of the wire harness.

Use the provided #6 x 1/2" self-tapping screws to firmly attach the cable-tie mounting blocks to the back edge of the LDP shelf. Route the wire harness along the back edge of the shelf from near the TAOS board toward the AC receptacle. Tie-wrap the wire harness to the cable-tie mounting blocks.
- 21) Connect the cable harness GREEN safety/static ground wires to the mounting screws at the foot of EMI box mounting bracket and the LDP mounting bracket. This provides static protection and reduced hum for the LDP and computer.
- 22) Locate the speaker connector on the original DRAGON'S LAIR computer board. It is an 8-position connector at the middle of the rear edge of the Dragon's Lair board. Disconnect the speaker cable from the PC board and plug it into the 8-position Molex header from the cable harness. *Pay attention to the connector orientation to ensure all wires line up through the connector.* This connection routes ALG audio from the TAOS board to the speakers.
- 23) Mount the provided 12.6 VAC transformer to the left side of the cabinet ... between the AC receptacle and the rear edge of the cabinet. Use two of the #6 x 1/2" self-tapping screws provided. Insert the forked terminal of the green SAFETY/HUM ground wire under one of the transformer mounting screws before tightening the screw. Plug the 3 x 4 Molex connector from the transformer into the mating connector of the wire harness. The transformer provides 12.6 VAC power to the audio section of the TAOS board and 6.3 VAC power to the coin door lights.

- 24) Insert the forked terminal of the wire harness green SAFETY/STATIC ground wire under one of the mounting screws of the metal plate under the DRAGON'S LAIR computer board. This provides the SAFETY/HUM ground path for the COIN/AUDIO transformer.
- 25) Dress the ALG wire harness together with the DRAGON'S LAIR harness along the bottom edge of the DRAGON'S LAIR computer board. Route it to the coin door.
- 26) Disconnect the existing 3 x 3 Molex connector of the coin door. Then connect the ALG wire harness 3 x 3 Molex connector to the coin door male connector.
- 27) Locate the loose, gray 24 AWG wire with a crimped-on male pin in the ALG harness near the coin door 3 x 3 Molex connector. Insert this male pin into the coin door 3 x 3 Molex connector at pin 3 (see attached drawing to determine which position is pin 3).
- 28) Locate the gun mounting template on page 16 of these instructions. Use it to center-punch the drill hole locations on the cabinet ... see page 15 for further details on where to drill the holes and mount the gun. **WHEN DRILLING INTO THE CABINET, BE CAREFUL NOT TO DRILL INTO CABLES OR OTHER EQUIPMENT INSIDE THE CABINET.** Drill 3 holes using the 5/16" drill bit and drill a big center hole using the 1-1/2" drill bit. These drill bits are called for in the "Tools Needed" section. After drilling the holes, clean up any wood chips which may have fallen inside the cabinet you want your laser disk to keep working, don't you?
- 29) Mount the gun assembly in the newly drilled holes using the 1/4" bolts, nuts, and washers provided. Connect the green SAFETY/STATIC ground wire ring terminal of the ALG wire harness on one of the 3 gun mounting bolts. Also connect the green wire from the **gun** 9-position "D" connector to the same gun mounting bolt. These ground wires help protect the game electronics against static discharge...for example, from a person walking across carpet then touching the metal gun. You may notice a yellow wire coming from the gun 9-pos. "D" connector. This wire is not needed on this game and should be clipped off or insulated to prevent shorting. It is a duplicate connection for the gun RELOAD signal.
- 30) Mount the gun holster to the cabinet. See the attached drawing of the entire game for preferred mounting location. Drill the 5/16" holster mounting holes. Again, be sure to clean up any wood chips which may have fallen inside the cabinet. Attach the holster to the cabinet using the provided 1/4" bolts, nuts, and washers.
- 31) Connect the female end of the provided 9-pos. "D" connector extension cable into J101 of the TAOS board. Route this cable along the ALG wire harness towards the coin door. Route it OVER the coin door opening to prevent interference with opening/closing of the coin door. Continue routing it towards the gun 9-position "D" connector. Bundle any excess cable length at a convenient location which doesn't interfere with anything else. Use the provided cable-tie mounting blocks and cable-ties to keep the gun extension cable from interfering with other items in the cabinet. Connect the other end of the extension cable to the gun 9-position "D" connector.

- 32) Unplug the original black wires from the coin lights at the bulbs. It is **NECESSARY** to do this because the coin lights will now operate between the secondary and the center-tap of the ALG-provided 12V **AC** transformer rather than between +12V **DC** and ground. The existing DRAGON'S LAIR coin door wiring **MUST** be changed because it has one side of the coin lights tied to ground which would short out the transformer.
- 33) Locate the loose, gray 24 AWG wire with 2 female "push-on" terminals that's near the coin door in the ALG wire harness. Connect these 2 terminals to the coin light male terminals...the terminals where you removed the black wires in the previous step. The new gray wire provides one leg of the 6.3V AC power to the coin lights. The pre-existing yellow wire now carries the other leg of the 6.3V AC power from the COIN_LIGHT/AUDIO transformer.
- 34) Unplug the Laser Disk Player from the AC power receptacle mounted on the side of the cabinet. Plug the 3-way adapter receptacle provided with the conversion kit into the top position of the cabinet-mounted AC power receptacle.
- Plug the wall-mount transformer into the *lower* position of the cabinet-mounted AC power receptacle.
- Plug the cord from the ALG-provided Amiga power supply into one of the 3 positions of the 3-way adapter receptacle.
- Plug the cord from the Laser Disk Player into another of the positions of the 3-way adapter receptacle.
- Plug the cord from the COIN_LIGHT/AUDIO transformer (from the 3 x 4 Molex connector) into the remaining position of the 3-way adapter receptacle.
- 35) Position the top panel metal edging that is near the CRT onto the new ALG top panel. Mark drill locations through the holes in the metal edging. Use a 3/32" drill bit to drill these locations. Do not drill all the way through the new top panel. Fasten the metal edging to the new top panel using the #6 x 1/2" screws provided.
- Position the two right angle latch brackets as shown on the included top panel drawing. *Before drilling holes, compare the bracket locations to the old top panel to ensure that the brackets will fit properly when the top panel is closed.* Drill the holes and use 8 of the #6 x 1/2" screws to fasten the brackets to the new top panel.
- Next mark and drill holes in the new top panel for the hinge. *The location and spacing of these holes is **CRITICAL** for proper fit of the top panel.* Use a strip of paper to make a template of the hole locations on the old top panel. (see the included top panel drawing). Then use this paper template to transfer the hole positions to the new ALG-provided top panel. On one particular game, these holes were 1" from the front edge of the top panel and 3" apart, but this spacing may vary slightly on your game so use the template for position and spacing of the hinge mounting holes. Drill 3/32" holes partway into the new top panel and use the old hinge screws to attach the new top panel to the cabinet hinge.

- 35) (continued) Mount the **salvaged red START switches** from the DRAGON'S LAIR II top panel into the new top panel. Connect the **BLUE wire** in the ALG wire harness to the **NORMALLY OPEN** terminal of the left START switch. Connect the **BLACK wire** in the ALG wire harness to the **COMMON** terminal of this START button. Plug the **PURPLE wire** in the ALG wire harness onto the **NORMALLY OPEN** terminal of the right START switch. Connect the **BLACK wire** in the ALG wire harness to the **COMMON** terminal of this START button.
- 36) Locate the RAM/ROM PC card in the conversion kit. *Make sure that the Amiga power supply is switched OFF*, then plug the RAM/ROM card onto the Amiga computer card inside the metal EMI box (see page 6 of the ALG game manual for an illustration of the Amiga board and the RAM/ROM card).
- 37) You may wish to replace the DRAGON'S LAIR II side decals from the cabinet and replace them with A.L.G. decals. You may choose to cover the old decal. Ordinary contact paper is fairly inexpensive and readily available.

Alternatively, you may wish to remove the DRAGON'S LAIR II decals entirely. Heating the corner of each decal with a heat gun may soften the adhesive and allow you to get a handhold on the decal. You may then be able to peel the decal off since it's fairly thick. Otherwise, you may need to continue using the heat gun to soften the adhesive while peeling the decal off. Remove any remaining adhesive using a cleaner such as "3M Citrus Base NATURAL CLEANER" which comes in an 18-1/2 oz. aerosol can. It has a 3M ID number of 62-4615-4930-5.

Apply the ALG decals where desired on the sides of the cabinet and on the new top panel.

This completes the installation & wiring portion of the conversion process.

- 38) Make sure the power switch of the Amiga power supply is switched on. Also, the power switch of the original DRAGON'S LAIR power supply must be ON to provide 120V AC power to the monitor, Laser Disk Player, and the ALG-provided equipment. Don't forget to plug the game cord into the wall outlet!!

ADDITIONAL STEPS **WHEN CONVERTING A DRAGON'S LAIR GAME TO A** **2-PLAYER ALG GAME**

For a 2-player game, it's only necessary to install and connect a second gun and a second holster to the game. Do the following:

- 1) Drill holes to mount the second gun and holster. Refer to steps 28-30 for details.
- 2) Route the second 9-conductor "D" connector ribbon cable to the left gun. Tie down as appropriate. Connect the female end to TAOS board J102 and the male end to the gun 9-position "D" connector.
- 3) Connect the green SAFETY/STATIC ground wire ring terminal of the ALG wire harness onto one of the 3 gun mounting bolts. Also connect the green wire from the **gun** 9-position "D" connector to the same gun mounting bolt. This helps protect the game electronics against static discharge...from a person walking across carpet for example. You may notice a yellow wire coming from the gun 9-pos. "D" connector. This wire is not needed on this game and should be clipped off or insulated to prevent shorting. It is a duplicate connection for the gun RELOAD signal.
- 4) After completing the above steps, press the SERVICE button and select GAME SETTINGS. Go to the 2nd screen of GAME SETTINGS and adjust the NUMBER OF PLAYERS to 2. Note that the maximum number of lives available in 2-player mode is limited to 3 in **Mad Dog II - The Lost Gold**. (Lives are not applicable to Space Pirates or Who Shot Johnny Rock games). Tickets are disabled in 2-player mode.
- 5) For Mad Dog II-The Lost Gold, note that if either player loses all his (3) lives, then ***neither*** player will "get the gold". This prevents players from using the 2nd gun only to "get through the tough spots" or to shoot Mad Dog. Of course, any player can "get the gold" by using all three guides and shooting Mad Dog three times...once for each guide used.

Notes: For "Space Pirates" or "Who Shot Johnny Rock" games, the START switches should BOTH be wired to the LEFT COIN INPUT (blue wire) and the purple wire becomes a no-connect. The COMMON terminals of both START switches should be tied to a black wire (Isolated Return).

TOOLS NEEDED

Electric drill

1-1/2" drill bit --- (to mount gun)

5/16" drill bit - (to mount gun)

3/32" drill bit - (for top panel screws)

Wire cutters

Screwdriver - Phillips

7/16" open-end wrench -- for mounting gun and holster

Paper for template ... 1 piece 20 inches x 2 inches

ATTACHED DRAWINGS

- * DRAGON'S LAIR II HARNESS LAYOUT
- * Harness connectors - functions & description diagram
- * Cabinet diagram for gun and holster mounting locations
- * GUN HOLES template
- * TOP PANEL drawing showing metal edging, bracket, & hinge hole positions
- * 4 x 3 coin/audio transformer Molex connectors and 3 x 3 coin door Molex

DRAGON'S LAIR II Conversion Kit

Bill of Materials... 3/22/93

SOFTWARE KIT: *(specify game desired)*

- | | |
|--|--------------------|
| (1) RAM/ROM board | (p/o software kit) |
| (1) Laser disk | (p/o software kit) |
| (3) Decals ... sides and top panel (see below) | (p/o software kit) |
| (1) Marquee .. translucent, "Live Action" ALG P/N: 1010078 | (p/o software kit) |
| (1) Marquee .. translucent, title strip | (p/o software kit) |

HARDWARE KIT:

- | | |
|--|------------------|
| (1) A500 board Pre-mount A500 computer board | ALG P/N: 4020001 |
| (1) Genlock and genlock in EMI box | ALG P/N: 4020002 |
| (5) Standoffs using self-adhesive plastic standoffs | ALG P/N: 4010040 |
| (1) Power supply, for Amiga mainboard | ALG P/N: 4020004 |
| (1) TAOS board | ALG P/N: 4020055 |
| +*(1) Gun (Space Pirates) & mtg -"-bolts/nuts/washers (3 ea) | ALG P/N: 4010036 |
| *(3) Bolts 1/4" x 1-1/4" | ALG P/N: 3010004 |
| *(3) Washers, flat, 1/4" | ALG P/N: 1010001 |
| *(3) Nuts, 1/4" | ALG P/N: 2010008 |
| * (1) Holster, for gun and mounting bolt/nuts/washers (2 ea) | ALG P/N: 2010007 |
| *(2) Bolts 1/4" x 1-1/4" | ALG P/N: 3010004 |
| *(2) Washers, flat, 1/4" | ALG P/N: 1010001 |
| *(2) Nuts, 1/4" | ALG P/N: 2010008 |
| (2) Extension cable, 9-cond. "D"-type male/female 6 ft. long | ALG P/N: 1031006 |
| (1) Top panel, particle board with black melamine surface/T-molding edge | ALG P/N: 1010080 |
| (1) Transformer, coin/audio | ALG P/N: 1020005 |
| (1) 3-way 120V AC outlet adapter Radio Shack P/N: 61-2705 | ALG P/N: 1030038 |
| (1) SERVICE switch | ALG P/N: 2030002 |
| (1) Bracket, service switch & volume control | ALG P/N: 2010002 |
| (1) Volume control pot incl. Molex conn. (part of wire harness) | ALG P/N: 1031002 |
| (1) Serial cable, Amiga-to-LDP, 6 ft. long | ALG P/N: 4033000 |
| (4) Spacers, 1/4" plastic -- TAOS bd. mounting | ALG P/N: 1010028 |
| (4) #6 x 3/4" self-tap screws-Phillips - TAOS board mounting | ALG P/N: 1010027 |
| (4) #6 x 1/2" self-tap screws-Phillips - EMI box mounting | ALG P/N: 1010033 |
| (4) #6 x 1/2" self-tap screws-Phillips - wire harness support | " |
| (2) #6 x 1/2" self-tap screws-Phillips - coin/audio transformer | " |
| (2) #6 x 1/2" self-tap screws-Phillips - SERVICE/volume bracket | " |
| (2) #6 x 1/2" self-tap screws-Phillips - Amiga power supply | " |
| (4) #6 x 1/2" self-tap screws-Phillips - Barlock anchoring | " |
| (4) Barlocks - wire harness support | ALG P/N: 2010012 |
| (20) Cable ties, small, for wires at Barlocks | ALG P/N: 2010013 |
| (10) Cable ties, large, (for A500 power supply cable bundling) | ALG P/N: 2010024 |
| (2) Video cables, 3 ft. long with male RCA plugs both ends | ALG P/N: 4030046 |
| LDP-to-genlock & genlock-to-monitor | |
| (1) ALG game manual | ALG P/N: 1010040 |

* The quantity of these items doubles for a 2-player conversion kit

+ A 6-shooter gun is needed for games other than Space Pirates to provide the RELOAD signal. Two guns are needed for dual-player game versions.

DRAGON'S LAIR II Conversion Kit

Bill of Materials... 3/22/93

CABLE HARNESS: includes:

- | | |
|---|-----------------------|
| (1) Wall-plug + 12VDC transformer | ALG P/N: 1020004 |
| (1) Cord, AC, male, 2-conductor, 3 ft length | ALG P/N: 1030039 |
| (1) "D" connector, 9-position, female..console switches | ALG P/N: 4030024 |
| (1) Hood, for 9-position "D" connector | ALG P/N: 4010001 |
| (2) 42" ribbon cables - male/female 9-pos. "D" connector
for GUN and CONSOLE connection between TAOS and Amiga | ALG P/N: 1031013 |
| (1) Dual audio cable (red/black), -- LDP to TAOS
2 ft. long, male RCA plugs both ends | ALG P/N: 4030048 |
| (1) Single audio cable (black) -- Amiga computer to TAOS
4 ft. long, male RCA plugs both ends | ALG P/N: 4030008 |
| (6) Terminals, female "push-on", 1/4" | ALG P/N: 1010021 |
| (2) Terminals, female "push-on", 3/16" | ALG P/N: 1010022 |
| (2) Terminals, "forked", smaller red | ALG P/N: 1010023 |
| (2) Terminals, "forked", larger blue | ALG P/N: 9999999 |
| (2) Terminals, "ring" style | ALG P/N: 1030029 |
| (1) <u>Connector, Molex, 1 x 3 - for TAOS AC power</u> | |
| (1) F-Housing - | ALG P/N: 1010016 |
| (2) F-Sockets - | ALG P/N: 1010020 |
| (1) <u>Connector, Molex, 1 x 5 - for TAOS speaker connections</u> | |
| (1) F-Housing - | ALG P/N: 1010017 |
| (4) F-Sockets - | ALG P/N: 1010020 |
| (1) <u>8-position (1 x 8) Molex connector, male - for speakers</u> | |
| (1) 8-position locking header
(.156" straight with .045" square pin locking header) | Molex P/N: 26-60-4080 |
| (1) <u>9-position (3x3) Molex female connector - for coin switches & lights</u> | |
| (1) Housing -- 3x3 free-hanging receptacle | Molex P/N: 03-09-1094 |
| (4) Sockets -- 18-22 ga brass/tin-plated | Molex P/N: 02-09-1119 |
| (1) Pin (mate) -- 18-22 ga brass/tin-plated pin | Molex P/N: 02-09-2118 |
| (1) <u>12-pos. (3 x 4) Molex connector - for coin/audio transformer connections</u> | |
| (1) F-Housing -- 3x4 free-hanging receptacle | Molex P/N: 03-09-1126 |
| (6) F-Sockets -- 18-22 ga brass/tin-plated sockets | Molex P/N: 02-09-1119 |
| (1) M-Housing -- 3x4 free-hanging plug | Molex P/N: 03-09-2121 |
| (6) M-Pins -- 18-22 ga brass/tin-plated pins | Molex P/N: 02-09-2118 |

Decals:

MD/LG-II	Front.....4540001	Mad Dog I	Left side.....4140001
	Console4540002		Right side.....4140002
	Cabinet4540003		
	25 inch4540004	WSJR	4240001
S.P.	Space Pirates4340001	GG	4440001
	Skull/Bones.....4340002		
	Alien4340003		

Disks (English)

Space Pirates4310001	MD-II/LG..... 4510001	Mad Dog I..... 4110001
Crime Patrol.....4610001	GG..... 4410001	WSJR.....4210001

DRAGON'S LAIR II HARNESS LAYOUT

FRONT OF GAME

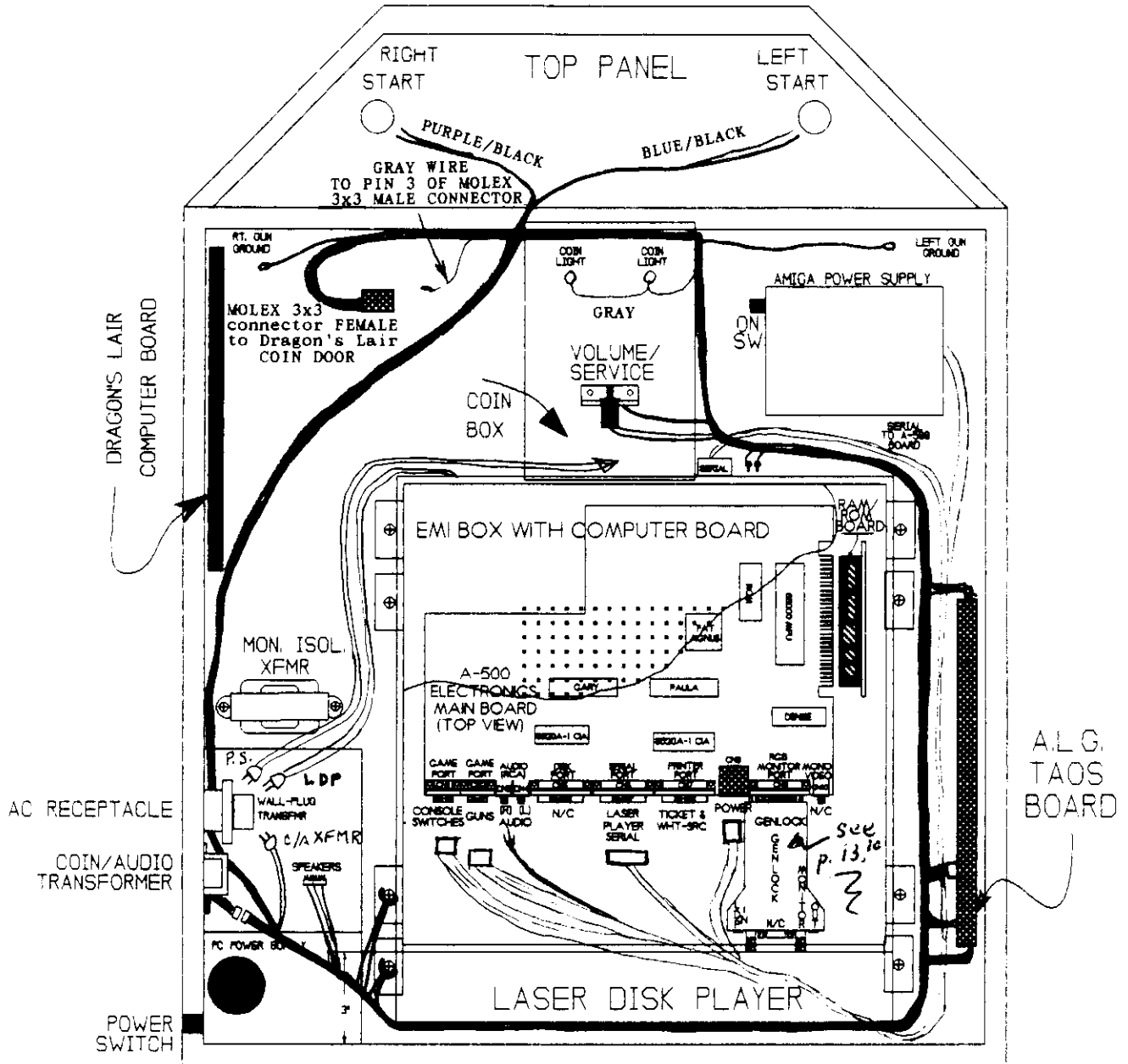

REAR OF GAME

DESIGNED/DRAWN
by
David A. Fickers

13

18-FEB-93

NOT SHOWN HERE
GUN EXTENSION CABLE
GUN & CONNECTOR
VIDEO CABLES
DRAGON'S LAIR HARNESS

ADDENDUM -A-

Information about Rocgen genlock

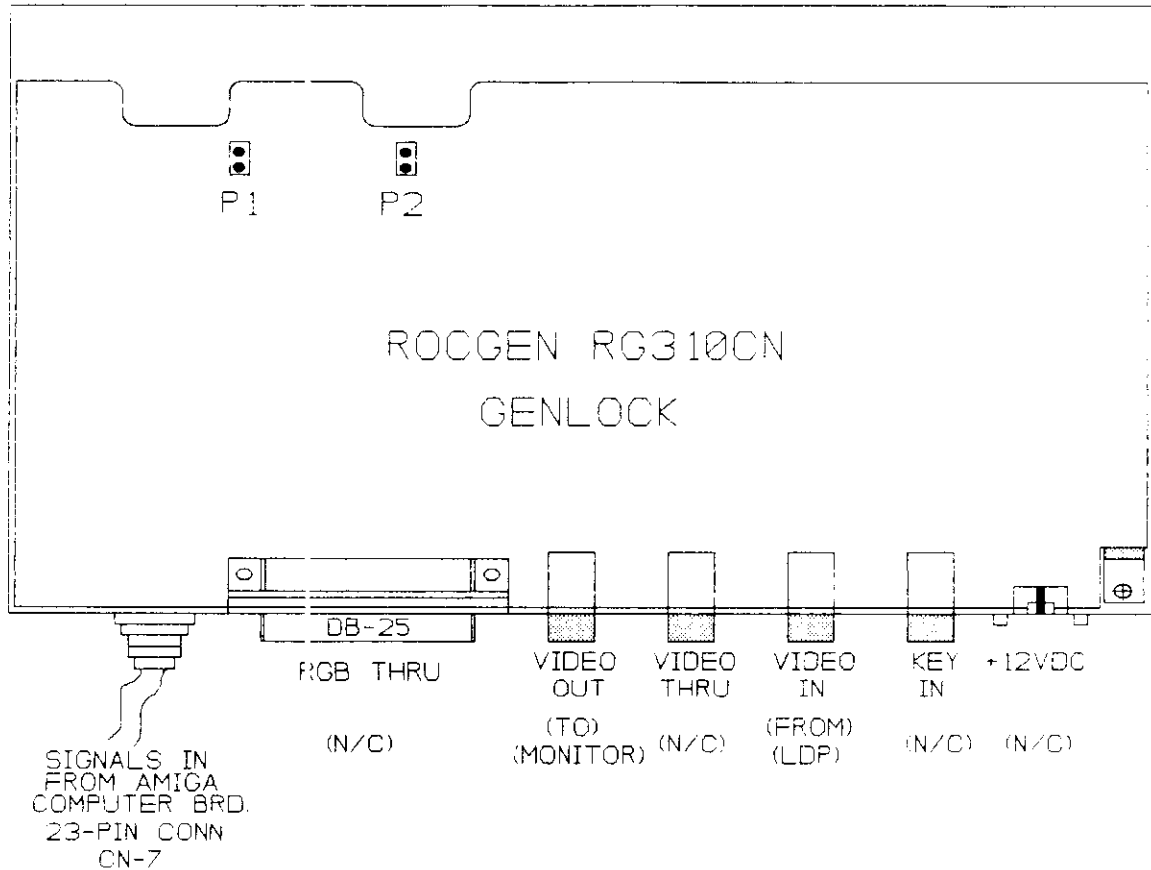

P1 = resistor (plug-in) 1K ohm < P1 value < 5K ohm

P2 = shorting bar

The ROCGEN model RG310CN replaces the genlock style shown in the other drawings. Connectors P1 and P2 shown in the drawing above were originally connected to potentiometers on the top cover and provided DISSOLVE capability for the computer and laser disk video. **Since DISSOLVE capability is not needed with ALG games** and the top cover inhibits mounting of the genlock, it is shipped without a top cover. Therefore, P1 has been replaced with a fixed resistor and P2 has been replaced with a shorting bar.

If P1 is absent or its value is too large, video shadowing of computer generated images (scoring, etc.) will occur. P1 is typically 4.7K ohms but on some units may be 3.3K ohms. P2 should always be a shorting bar.

For further details, contact Roctec Electronics.

ALG "TAOS" BOARD

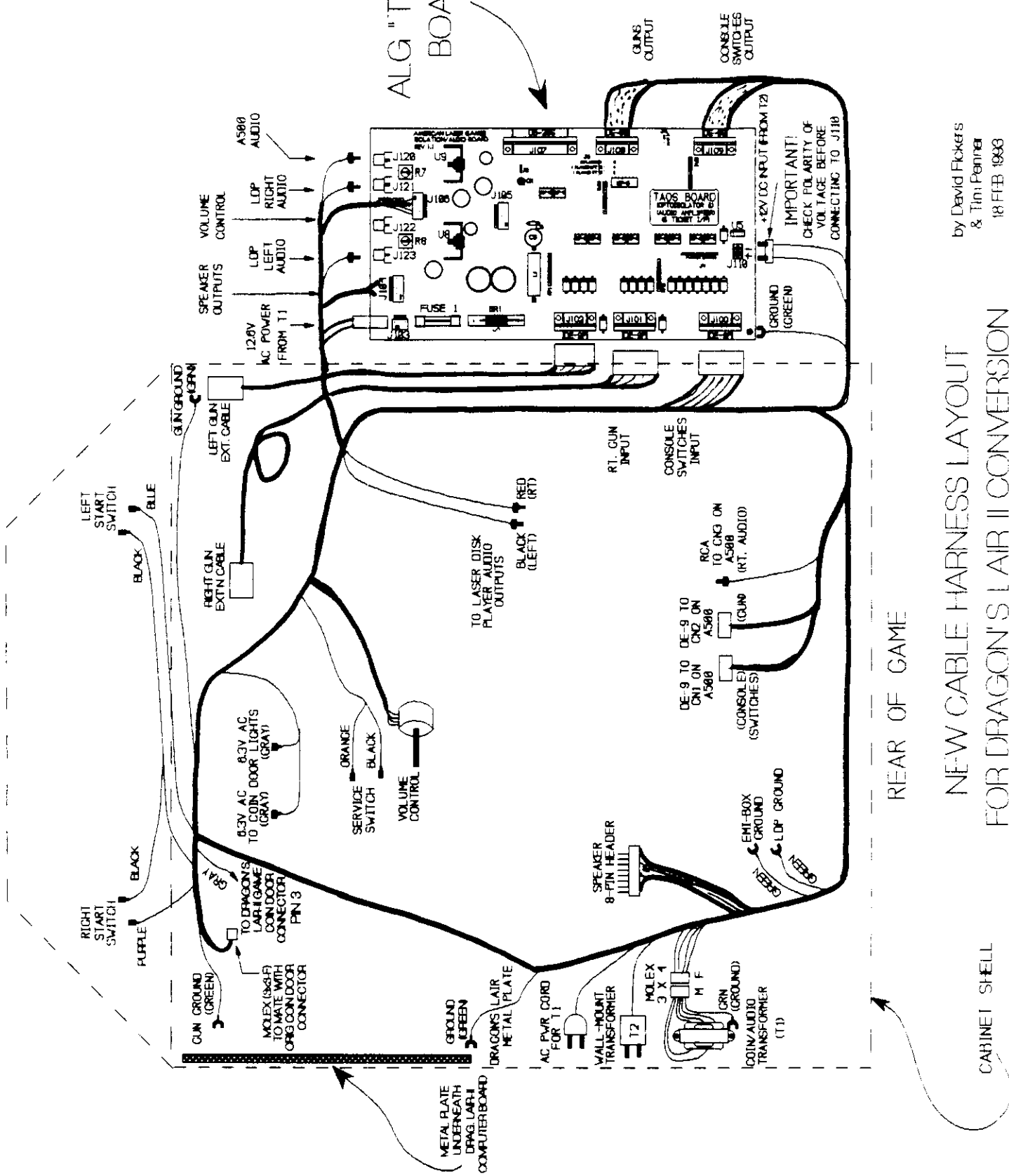

by David Fickers
& Tim Penner
18 FEB 1988

NEW CABLE HARNESS LAYOUT FOR DRAGON'S LAIR II CONVERSION

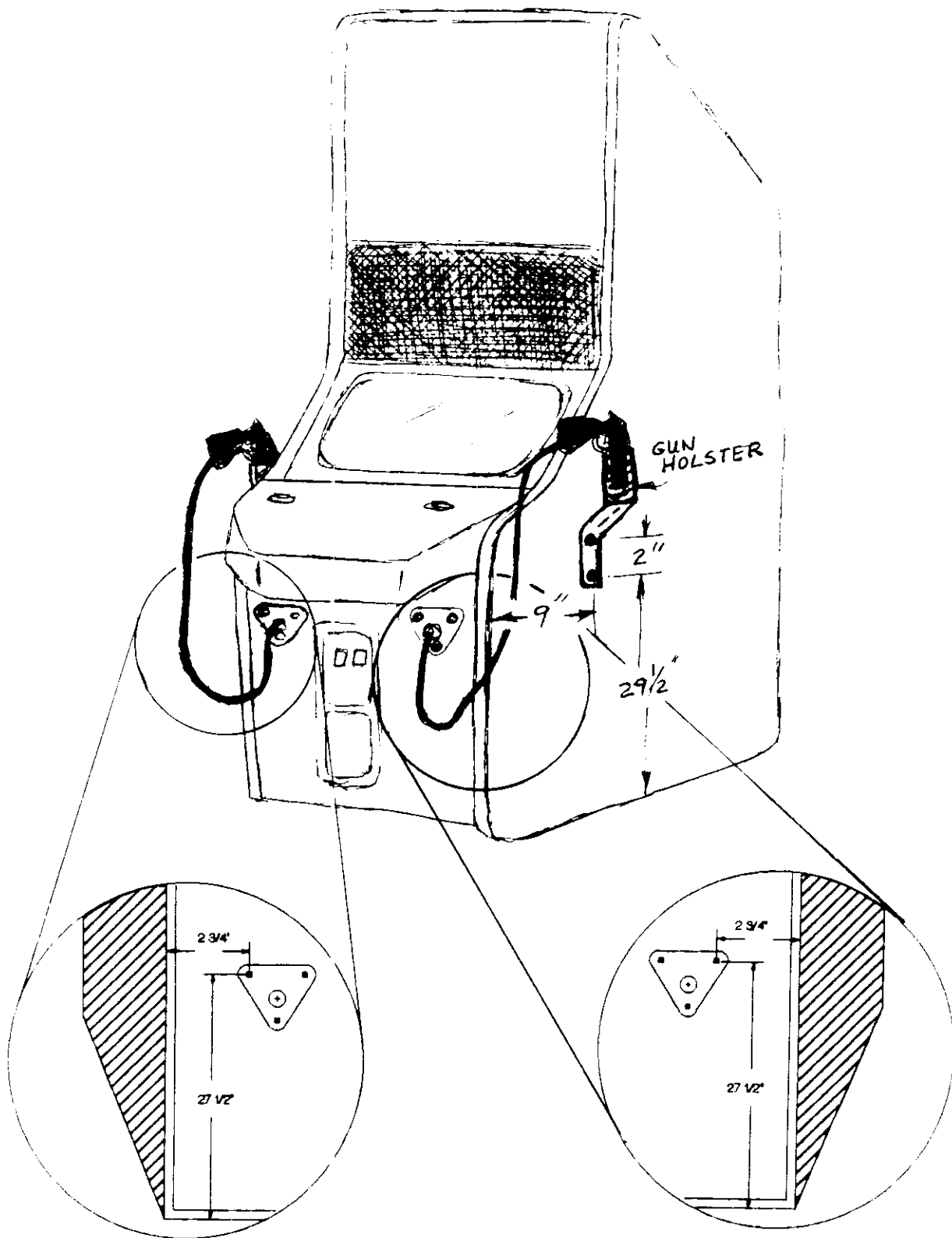

(TOP)

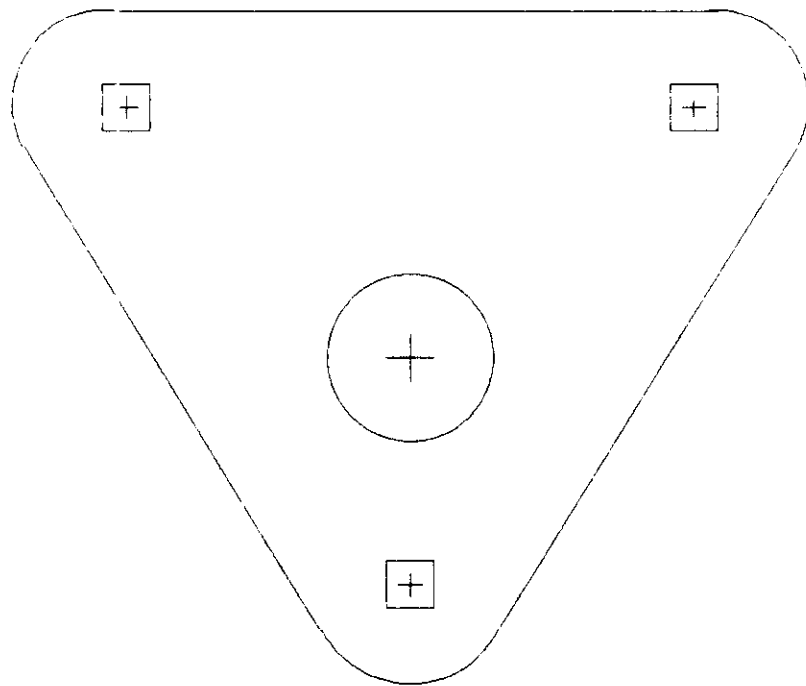

BRACKET, EDGING, & HINGE LOCATIONS
ON NEW TOP PANEL

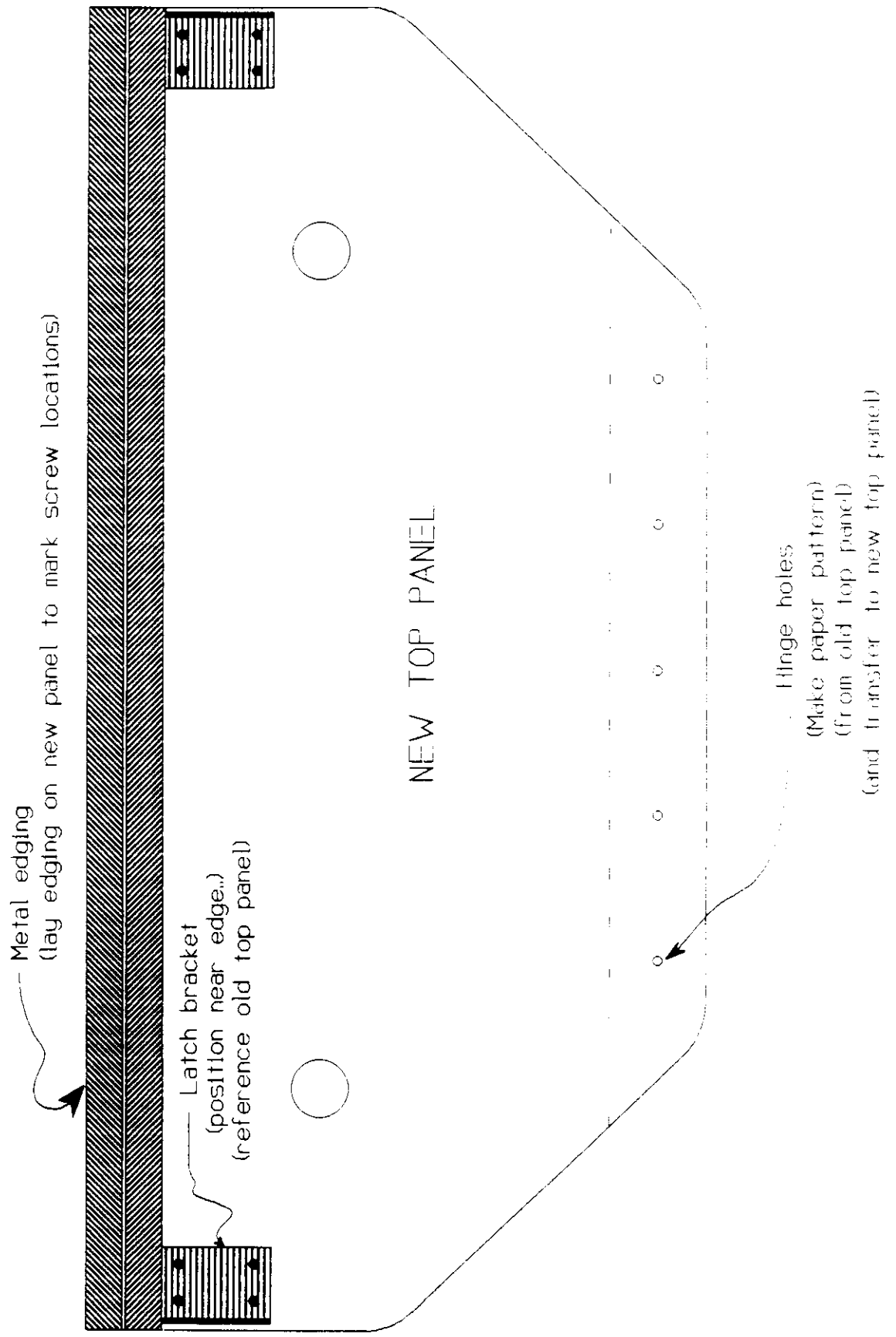

MOLEX CONNECTOR PINOUTS

ALG HARNESS
COIN/AUDIO TRANSFORMER
FEMALE CONNECTOR

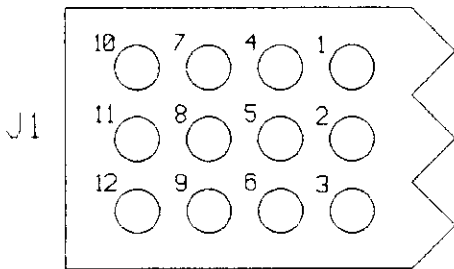

- 1 - AC POWER CORD (WHITE)
- 3 - AC POWER CORD (WHITE)
- 4 - SEC. OF T2 (12.6VAC) (GREY/GREY)
- 5 - C.T. OF T2 (6.3VAC) (WHITE)
- 6 - SEC. OF T2 (12.6VAC) (BLACK)
- 7 - SAFETY/HUM GROUND (GREEN)

FRONT VIEW
(MATING SURFACE)

COIN/AUDIO
TRANSFORMER WIRES
MALE CONNECTOR

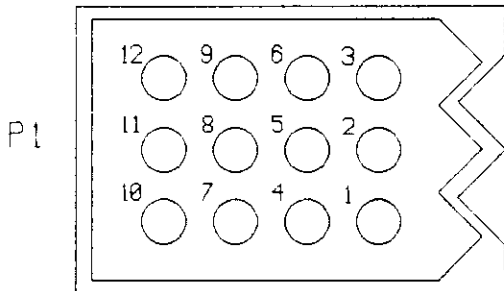

- 1 - AC POWER CORD (BLACK)
- 3 - AC POWER CORD (BLACK)
- 4 - SEC. OF T2 (12.6VAC) (GREEN)
- 5 - C.T. OF T2 (6.3VAC) (GREEN/YELLOW)
- 6 - SEC. OF T2 (12.6VAC) (GREEN)
- 7 - SAFETY/HUM GROUND (GREEN)

FRONT VIEW
(MATING SURFACE)

ALG HARNESS
COIN DOOR
FEMALE CONNECTOR

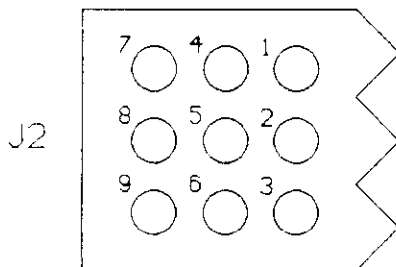

- 1 - COIN SWITCHES (GREEN) (24 AWG)
(ALG "LEFT COIN" INPUT)
- 2 - ISOLATED RETURN (COINS) (BLACK) (24 AWG)
- 3 - 6.3V AC (GRAY) (18 AWG)
- 5 - 6.3V AC (WHITE) (18 AWG)

FRONT VIEW
(MATING SURFACE)