

ESU-2000 Series Product Overview

A Paradigm Shift In Electrosurgery Testing Technology and Capability Is Here

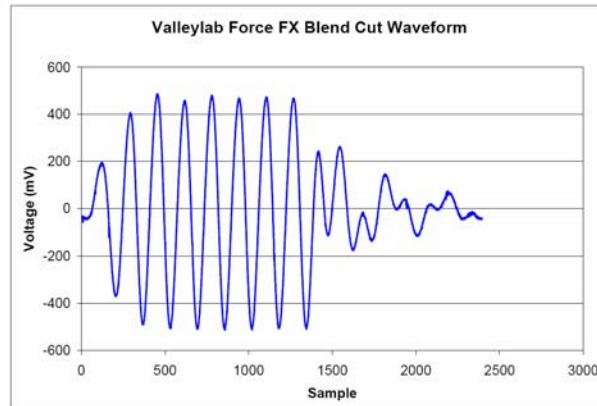

100.0		500.0
mV		Watts
1000	141.4	1.4
mA	mV Pk	CF
Load: 500.0Ω		



0		0.0		Load
mA		Watts		00
DISPLAY		RECO		External
				SETUP



Your current ESU Analyzer just became obsolete – no matter how new it is!

INDEX

The Next Generation in ESU Testing is Finally Here.....	3
Electrosurgery 101 – A Basic Review of Electrosurgery	3
ESU Testing 101 – Some Testing History	7
ESU-2050: Truly Unique in the Market.....	9
ESU-2050: A Replacement for the Discontinued Fluke 8920A Instrument.....	11
ESU-2050: Unprecedented 1% Accuracy in ESU Testing.....	11
ESU-2300: A More Conventional Approach	11
ESU-2400: More High-End Technology to Come.....	11
Common Element: Patent Pending DFA Technology.....	11
Up To 32,768 Data Points!	12
ESU-2050: Precision Load Resistors Are Where Accuracy Starts	13
Product Development In Cooperation with ESU Manufacturers	14
Industry Standard Current Sensing Technology.....	13
Working With The Best In Current Sensing: Pearson Electronics	13
Current Sensing vs. Voltage Measurement	13
Ensuring Quality By Taking Care Of The Details	14
Those Crazy & Exotic Pulsed Waveforms.....	15
ESU-2300: External Load Capabilities – Built In Non-Obsolescence.....	16
ESU-2000 Series PC Utility Software.....	16
One Picture is Worth a Thousand Words – Or Up To 32,768 Data Points.....	16
See The Data You Want – The Way You Want	17
Easy Setup and Operation	18
ESU-2050: Graphical Mode	18
Product Comparison Overview.....	18
One-Stop-Source: We Make It Easy for You.....	19
Conclusion	20
ESU-2050 Product Specifications	21
ESU-2300 Product Specifications	22
Technical References.....	23
About the Author	24

APPENDICES

APPENDIX A Fluke Biomedical 454A Instrument Specifications	26
APPENDIX B Fluke Biomedical RF-303 _{RS} Instrument Specifications	27
APPENDIX C Dale Technology DALE3000 Instrument Specifications.....	31
APPENDIX D Metron QA-ES Instrument Specifications	33
APPENDIX E Valleylab ForceFX Generator Output waveforms	34
APPENDIX F Valleylab Force 2 Generator Output Waveforms	36
APPENDIX G Conmed System 5000 Output Waveforms	38
APPENDIX H (Pearson Electronics Model 411 Data Sheet).....	41
APPENDIX I (Pearson Electronics Model 4100 Data Sheet)	42
APPENDIX J (Vishay Dale NH-250 Data Sheet).....	43
APPENDIX K (Sample Microsoft Excel® Data Export Workbook)	45
APPENDIX L (Tyco Healthcare / Valleylab Recommended Test Procedures).....	46
APPENDIX M (ESU-2000 Series PC Utility Software Screen Shots).....	49
APPENDIX N (History of BC Group International, Inc.).....	52

The Next Generation in ESU Testing is Finally Here

With the introduction of the new BC Biomedical ESU-2000 Series of Electrosurgery (ESU) Analyzers (the ESU-2050 and ESU-2300 instruments)¹, BC Group International, Inc. brings to market, the most exciting and technologically significant advances in electrosurgical testing to come about in well over a decade! The new BC Biomedical ESU-2050 represents an 18-month duration major product design effort in full cooperation with some of the leading electrosurgery generator manufacturers in the worldwide medical device market. The ESU-2050 is the very first instrument of its kind to be introduced, specifically designed for electrosurgery generator testing, with 1% of reading accuracy and a testing methodology that is exactly the same as the one that many medical device manufacturers currently use². The new ESU-2300 is a more conventional “mid-range” ESU analyzer, offering features and functionality above and beyond competitive analyzers in this “mid-range” class. Both analyzers can be easily upgraded in the field via the BC Biomedical Flash Update PC Utility Software in the event of a needed firmware update. Together, these new ESU analyzers from BC Group represent an unprecedented paradigm shift in electrosurgery testing technology, and set a new baseline for the electrosurgery test device industry. The long-awaited next generation in ESU testing has finally arrived!

Electrosurgery 101 – A Basic Review of Electrosurgery³

The following basic review on electrosurgery is derived from technical information obtained from various sources in the public sector, including the Tyco Healthcare/ Valleylab document, *Electrosurgery Self Study Guide*⁴, Copyright September 1999, Tyco Healthcare / Valleylab. This information is intended for basic review purposes of some of the terminology and basic principles of electrosurgery technology.

Electrosurgery generally deals with electrical signal frequencies in the range of approximately 200 kHz to 3.3 MHz (see Figure 1). This is well above the human body’s inherent frequency range of susceptibility to the hazards of microshock.

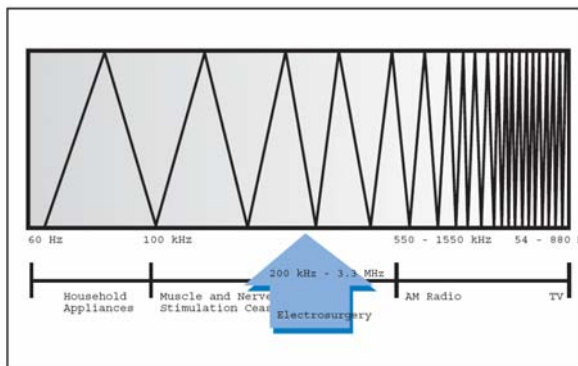

Figure 1
Frequency Spectrum Showing Range of Frequencies for Electrosurgery

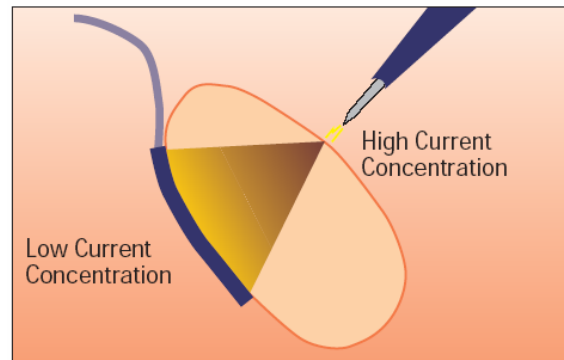

Figure 2
Current Density Differences at Surgical Site vs. Return Path

Electrosurgery works based upon heat generated by the density (see Figure 2) of the high frequency current being passed through human tissue. At the surgical site, the density is typically very high, resulting in high heat and a cutting or coagulating effect. The “return path” for the high frequency current is much larger and consequently much less current density exists at this area, which allows the high frequency energy to safely leave the body without any adverse effects.

There are two basic modes of electrosurgery: bipolar and monopolar. Bipolar surgery (see Figure 3) is accomplished by using two parallel poles in close proximity, where the flow of high frequency current is restricted to the two poles, one being the “source” and the other being the “return path”. A patient return electrode is typically not needed in bipolar electrosurgery applications, and because these two poles are close together, the

¹ Commercial availability scheduled for July/August 2007.

² See Appendix L for specific information regarding Tyco Healthcare / Valleylab recommended test setup procedures and recommended test equipment.

³ Sincere appreciation to Tyco Healthcare / Valleylab for the use of the illustrations in this section. Images and information are based upon the Valleylab publication *Electrosurgery Self-Study Guide*, Copyright September, 1999, Authored by Brenda C. Ulmer, RN, MN, CNOR.

⁴ This Tyco Healthcare / Valleylab publication can be downloaded in PDF format at <http://www.valleylabeducation.org/pages/list-book.html>

voltage level and resulting applied power are lower than in monopolar electro-surgical applications. This results in less localized tissue heating and reduced “charring” of tissue. Bipolar electro-surgery is typically used in neuro-surgical and gynecological procedures, and in other procedures where there is concern due to implanted pacemakers and automatic defibrillators. In general, bipolar electro-surgery is safer than monopolar electro-surgery, and the subsequent risks of high frequency burns at the return electrode site are avoided.

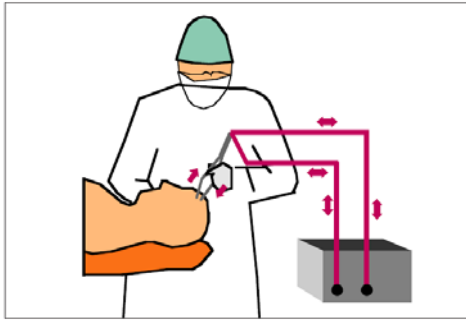

Figure 3
Electrosurgery – Bipolar Mode

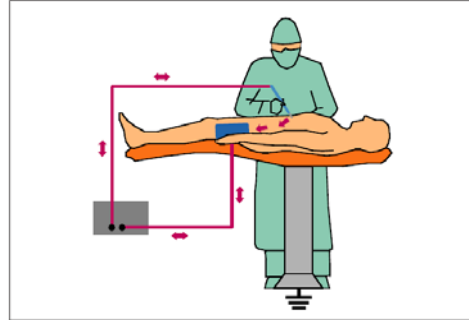

Figure 4
Electrosurgery – Monopolar Mode

Monopolar electro-surgery (see Figure 4) is a more generalized and more frequently used mode. Monopolar electro-surgery utilizes higher voltage levels than bipolar, resulting in higher power delivered at the surgical site. The need for a well prepared and maintained patient electrode site is of paramount concern in monopolar electro-surgical applications, in order to prevent high frequency burns at the patient return electrode site.

The high frequency waveform produced by the electro-surgical generator determines the physiological effect of the application of this energy to the tissue in the body. The **Cut** mode of an electro-surgical generator creates a continuous waveform, as shown in Figure 5. Different degrees of hemostasis (**coagulation**) can be achieved by utilizing varying degrees of “**Blended**” waveforms as shown in Figure 6.

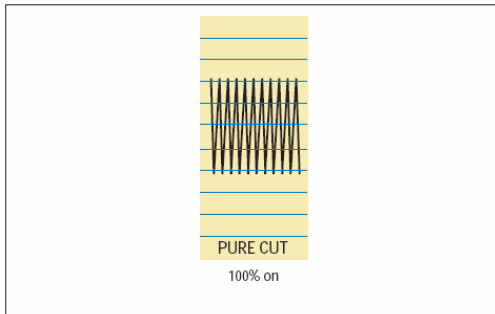

Figure 5
Pure Cut - Pure Sinusoidal Waveform

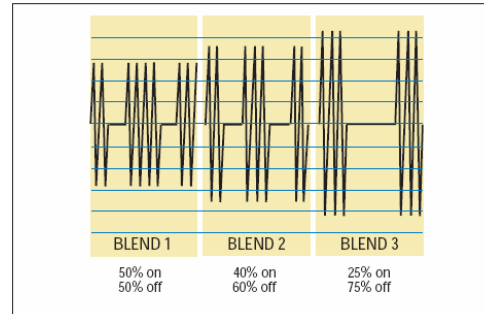

Figure 6
Blended Waveforms

The **Coag** mode (see Figure 7) of an electro-surgical generator creates a waveform with large amplitude but short duration “spikes” to achieve hemostasis (coagulation). The surrounding tissue is heated when the waveform spikes and then cools down (between spikes), producing coagulation of the cells. **Fulguration** is achieved in the **Coag** mode of the electro-surgical generator, with the tip of the surgical “active electrode” held above (but not in contact with) the tissue. Electro-surgical **Desiccation** is achieved in either the **Cut** or **Coag** modes of the generator. The difference between **Desiccation** and **Fulguration** is the tip of the “active electrode” must contact the tissue as in Figure 8 in order to achieve **Desiccation**. The more desired mode to achieve tissue **Desiccation** through direct tissue contact is the **Cut** mode.

Older electro-surgical generators (those produced prior to around 1968) are generally **ground-referenced** devices and must be used with extreme care to avoid unwanted “current division” and possible resulting high frequency burns at this site (or at multiple sites). This is illustrated in Figure 9 below. Current division can occur at any point of contact with an earth grounded point, such as the frame of the surgical table or the outer chassis of another medical device. For the most part, these types of devices are no longer used in surgical procedures, mainly due to advances in electro-surgical generator technology and concerns over safety.

Advances in electrosurgery generator technology brought about the “solid state” generator around 1968. Along with this more reliable and more condensed electronics technology came the introduction of the **isolated-output** electrosurgical generator (see Figure 10 below), thus eliminating the concern over unwanted current diversion and vastly improving patient safety. The outputs of these generators were no longer earth ground-referenced, so even the best electrical ground-referenced contact made to the patient would not present the risk of high frequency burns at alternate sites.

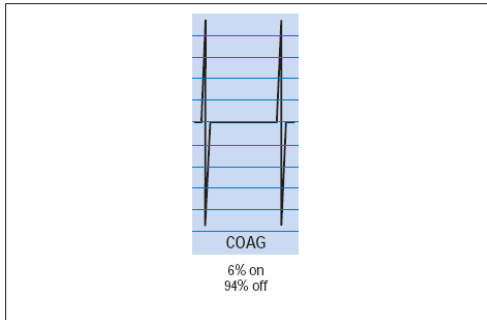

Figure 7
Coagulation Waveform

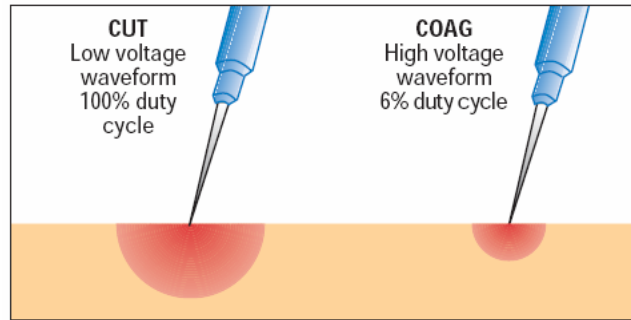

Figure 8
Tissue Penetration: Cut vs. Coag

The shift in concern now focused on the quality of the **patient return electrode** and electrode site, and over the succeeding years, many manufacturers introduced new monitoring techniques designed to constantly measure the integrity of the patient electrode site in order to minimize the possibility of high frequency burns at the patient electrode. The varying technologies introduced by the various electrosurgical generator manufacturers over the years have generically become known in today’s market as the **Contact Quality Monitor (CQM)** function (see Figure 11) of the electrosurgical generator.

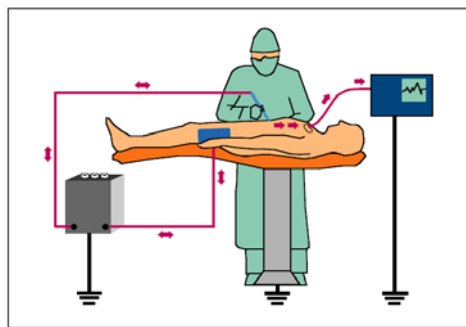

Figure 9
Ground-Referenced Electrosurgical Generator

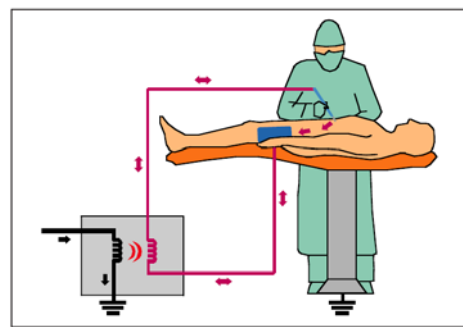

Figure 10
Isolated Output Electrosurgical Generator

In more recent years, there has been a steady stream of advances in electrosurgery generator technology, one of the most significant of which was the introduction by Tyco Healthcare / Valleylab in their Force FX Generator of “**Tissue Response Technology**” in the late 90’s. This technology utilizes a constant feedback loop to the

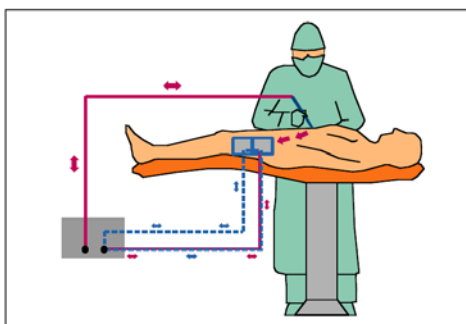

Figure 11
Contact Quality Monitor (CQM) Function

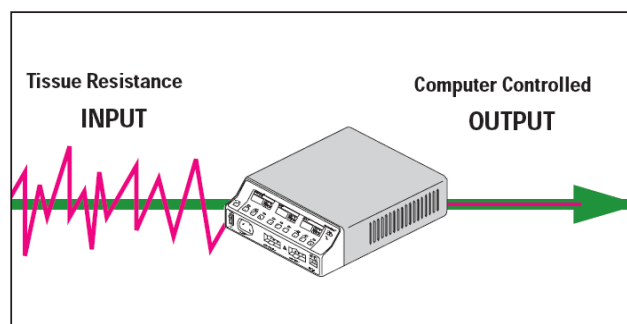

Figure 12
Tyco Healthcare / Valleylab Tissue Response Technology

generator's microprocessor and actually adjusts the power level output of the generator in order to provide relatively constant power delivery (and thus a consistent surgical effect) at the surgical site, regardless of tissue impedance.

Electrosurgery generator improvements continue, with new introductions by leading manufacturers like Tyco Healthcare / Valleylab, Conmed (Electrosurgery Division), Erbe, Bovie, etc. on a regular basis. The need for routine testing and performance verification of these generators has not decreased due to these introductions of new technologies. In fact, there are more features and safeguards to test for proper operation on today's average electrosurgical generator than ever.

Some Common Electrosurgery Terminology

Active Electrode: an electrosurgical instrument or accessory that concentrates the high frequency current at the surgical site, thus enabling the heating effect at the site and producing the desired electrosurgical effect

Blend: an electrosurgical generator output waveform that combines the features of cut and coag waveforms, cutting with various degrees of hemostasis (coagulation)

Contact Quality Monitor (CQM): a system that constantly monitors the impedance of the physical connection between the patient's body and the patient return electrode and interrupts power from the electrosurgical generator if the quality of this connection is compromised electrically

Current Density: the amount of electrical current flow per unit of surface area – as current density increases so does the heating of the tissue in the immediate location

Current Division: high frequency electrical current leaving the intended electrosurgical patient circuit and following an alternate low impedance path of lesser resistance to earth ground, thus introducing the possibility of high frequency burns at the alternate earth ground contact point – typically a concern in ground-reference generators and not isolated output generators.

Coagulation: the clotting of blood or destruction of tissue with no cutting effect – electrosurgical fulguration and desiccation.

Cut Mode: electrosurgical mode that produces a low voltage continuous waveform optimized for tissue cutting

Desiccation: the effect of tissue dehydration and protein denaturation caused by direct contact between the electrosurgical "active electrode" and the tissue

Fulguration: using electrical arcs (sparks) to coagulate tissue, whereby the sparks jump from the electrosurgical "active electrode" across an air gap to the tissue

Ground-Referenced Output: an electrosurgical generator with an output that is electrically referenced to earth ground

Isolated Output: an electrosurgical generator with an output that is not electrically referenced to earth ground

Leakage Current: electrical current that flows along an undesired pathway, usually to earth ground – in an electrosurgical generator, RF leakage current is high frequency current that regains its ground reference and seeks earth ground.

Patient Return Electrode: an electrically conductive plate or pad (also known as the dispersive electrode) that recovers the high frequency current introduced into the patient's body by the "active electrode" during electrosurgery. This electrode minimizes the current density of this return current flow in order to minimize the possibility of high frequency burns at this electrode site.

Radio Frequency (RF): frequencies above 100 kHz that transmit radio signals – the high frequency current utilized in electrosurgery

Tissue Response Technology: the Tyco Healthcare / Valleylab electrosurgical generator technology that continuously measures the impedance/resistance of the tissue in contact with the patient return electrode and automatically adjusts the output of the generator accordingly to achieve a consistent tissue effect.

ESU Testing 101 – Some Testing History

Electrosurgery generator technology has undergone tremendous technological advances over the past decade, but the technology base of ESU analyzers has remained relatively slow-moving over this same time period. The recently discontinued Fluke Biomedical Model 454A dates back to around 1992 or 1993, and until now, represents the culmination of research and development efforts on the behalf of competitive companies in the area of electrosurgery testing. Here is a brief history of ESU testing devices over the past 15 to 20 years. Analyzers are shown in the order of their introduction to the market.

No
Picture
Available

Bio-Tek Instruments RF-301: The very first offering in ESU analyzers by Bio-Tek Instruments. This “passive”⁵ RF thermocouple ammeter type instrument got the job done. There are still quite a few RF-301 instruments in use in the field today. The design was basic and rugged.



Neurodyne Dempsey Model 403A: The Neurodyne Dempsey (which later became Dynatech Nevada Inc.) Model 403A was a very small-sized ESU tester with limited functionality. This was a passive technology device with an RF thermocouple type analog ammeter and a single fixed 500 Ω internal load. Meter range was 0.2 A to 1.0 A / 20 watts to 500 watts. It was the company's first dedicated ESU tester. There are very few of these units left in the market.



Bio-Tek Instruments RF-302: The predecessor to the Bio-Tek RF-303, the RF-302 was a “passive” RF thermocouple ammeter type instrument. This gave an advantage to the RF-302 above other competitive “active” type ESU analyzers available at time. The RF-302 offered a better high frequency range than some competitive “active” units. Bio-Tek Instruments sold quite a few of these units in the market. This instrument is very similar to the BC Biomedical ESU-2000A instrument that is still available today, for those customers who prefer a legacy type RF ammeter “passive” instrument approach to ESU generator testing.



Dynatech Nevada Model 443: The Dynatech Nevada Model 443 was the company's very first “active” type⁶ design in ESU analyzers. Despite it's active internal circuitry and measurement technology, the Model 443 still utilized an analog meter. The Model 443 was discontinued shortly after the introduction of the Model 453A.



Dynatech Nevada Model 453A: The predecessor to the 454A, the Dynatech Nevada Model 453A was probably the very first “Hi-Tech” ESU analyzer on the market. It utilized active technology. Introduced in the mid 1980's, the Model 453A was in production until the introduction of the Dynatech Nevada Model 454A, starting in 1992 or 1993. The 453A had a small LED 7-segment display and was a fairly large instrument weighing well over 15 pounds. There are still many 453A ESU analyzers in use in biomedical departments across the U.S. today.

⁵ Passive technology in an ESU Analyzer refers to an instrument that does not require any external power source and simply meters the RF energy without any electronic signal processing.

⁶ Active technology in an ESU Analyzer refers to an instrument that requires a power supply and has active electronic circuitry including components such as A/D converters. Operational amplifiers, thermal converters, etc.



Dynatech Nevada Model 454A: Until it was recently discontinued by Fluke Biomedical (the Model 454A is no longer listed on the Fluke Biomedical web site and customers report having been informed that the 454A is no longer available from Fluke Biomedical) in favor of the more recent Metron QA-ES (re-branded as the Fluke Biomedical QA-ES effective March 18, 2007), the 454A was probably the most popular and successful ESU analyzer on the market. Originally designed by Dynatech Nevada Inc., the 454A utilized industry standard current sensing technology and offered accuracies of 5% of reading on RMS current and 10% of range on RMS power. For the the past decade, the 454A was considered to be an electrosurgery industry icon, but despite this status in the market, it never really attained any level of actual customer recommendation for any of the leading electrosurgery generator manufacturers. See Appendix A for full specifications on the discontinued Model 454A.



Fluke Biomedical RF-303_{RS}: Originally marketed as the Bio-Tek Instruments RF-303_{RS}, this is the current “mid-range” ESU analyzer offering from Fluke Biomedical. The RF-303_{RS} does not utilize industry standard current sensing technology, but uses simple voltage measurement instead. This product was designed during the period of time that Lionheart Technologies owned and operated Bio-Tek Instruments, DNI Nevada, and Dale Technology. A concurrent companion product to the RF-303_{RS} was originally introduced in 1998 under the DNI Nevada (formerly Dynatech Nevada) brand as the Model 402A. The 402A was later re-branded as the Dale Technology DALE3000 following the acquisition of the biomedical holdings of Lionheart Technologies by Fluke Electronics (Fluke Biomedical) in 1993. Instrument specifications for the Fluke Biomedical (Bio-Tek Instruments) RF-303_{RS}, the DNI Nevada 402A, and the Dale

Technology DALE3000 are (were) essentially identical. Current Fluke Biomedical advertised specifications for the RF-303_{RS} are $\pm 5\%$ of reading or ± 3 watts (whichever is greater) on RMS power and $\pm 2.5\%$ of reading or ± 15 ma (whichever is greater) on RMS current. See Appendix B for full specifications on the RF-303_{RS}.



DNI Nevada Model 402A: The DNI Nevada Model 402A was the “sister product” to the Bio-Tek Model RF-303, introduced concurrently with the RF-303 (see information above under the RF-303_{RS}). Actual design, development, and manufacturing of the 402A and the RF-303 took place at the DNI Nevada Inc. facility in Carson City, NV, under the ownership and management of Lionheart Technologies, Inc. In order to make the two products look sufficiently different, and in order to somehow truly differentiate the two, the 402A was given an RS232 communications port and the RF-303 was given a battery for portable operation. Slightly different enclosures were also chosen, and the 402A was given an LED 7-segment display while the RF-303 was given an LCD 7-segment display. The instrument firmware that operated the 402A and RF-303 was

common between the products, with firmware subroutines that recognized which instrument was being operated by the microprocessor. The RS232 communications port was added to the RF-303 much later in time, following the discontinuance of the 402A. When Fluke Electronics (Fluke Biomedical) acquired the biomedical holdings of Lionheart Technologies in 1993, the DNI Nevada Model 402A was soon after discontinued and re-branded under the Dale Technology brand as the DALE3000.



Dale Technology DALE3000: The DALE3000 existed in the market for less than three-years before it was discontinued. The re-branding of the DNI Nevada Model 402A to the Dale Technology DALE3000 was concurrent with the relocation of the Dale Technology business from its original location in Thornwood, NY to Carson City, NV, in the then-existing Fluke Biomedical manufacturing facilities (the original Dynatech Nevada manufacturing facility and offices) in Carson City, NV. The discontinuance of the DALE3000 was actually fairly close in time to the Fluke acquisition of Metron AS of Trondheim, Norway, which brought the Metron QA-ES “high-end” ESU analyzer to the Fluke Biomedical family of products.



BC Biomedical ESU-2000A: The BC Biomedical ESU-2000A was originally introduced in the year 2000, based upon strong customer demand for a “simple but effective” legacy tester similar to the original Bio-Tek Instruments RF-302. With accuracy of $\pm 2\%$ of full scale on current and power, the ESU-2000A remains popular with customers today. It is still available from BC Group International. Full instrument specifications for the ESU-2000A ESU analyzer can be found on the BC Group International web site at:

<http://testequipmentandtools.com/acatalog/BCBiomedicalESU2000ADatasheet.pdf>.



Fluke Biomedical / Metron QA-ES: The re-branded Metron (Trondheim, Norway) QA-ES is the current “high-end” ESU analyzer offering from Fluke Biomedical, effective March 18, 2007. Originally introduced by Metron AS in Trondheim, Norway, the QA-ES offers accuracy of 2% of reading for RMS current measurements. RMS power reading accuracy is not specified by the manufacturer. The QA-ES does not utilize industry standard current sensing technology. See Appendix D for specifications on the Metron QA-ES version of this analyzer. Fluke Biomedical instrument specifications can be found on the manufacturer’s web site.



BC Biomedical ESU-2050: With commercial availability scheduled for July/August 2007, the new BC Biomedical ESU-2050 represents a paradigm shift in ESU analyzer technology, allowing customers to test their electrosurgical generators in exactly the same way as the electrosurgery manufacturers do! With unprecedented 1% of reading accuracy, the ESU-2050 is the most accurate ESU analyzer on the market, offering advanced level features and functionality such as exporting waveform data sets with up to 32,768 data points to Microsoft Excel® for graphing and analysis. Patent pending DFA® Technology.



BC Biomedical ESU-2300: With commercial availability scheduled for July/August 2007, the new BC Biomedical ESU-2300 is a conventional design “mid-range” ESU analyzer utilizing internal precision load resistors. Unlike other mid-range analyzers on the market, the ESU-2300 utilizes industry standard current sensing technology for improved accuracy and reliability. Like the ESU-2050, the ESU-2300 utilizes patent pending DFA® Technology. The ESU-2300 offers the ability to connect an external load resistor, thus ensuring the availability of the required test load no matter what the value is. External load resistors can be used in additive mode (add the external load resistor value to any of the internal load values) or external only mode (use only the value of the external load resistor).

The release of the new BC Biomedical ESU-2000 Series, including the ESU-2050 and ESU-2300 analyzers represents a paradigm shift in the level of technology offered for electrosurgery generator testing.

ESU-2050: Truly Unique in the Market



From its original product design proposal, the new BC Biomedical ESU-2050 analyzer has been a totally different instrument as compared to the traditional approach to ESU testing. Until now, traditional ESU analyzers have had the following common elements:

- Internal load resistors (typically the most fragile element of the conventional ESU analyzer)
- Accuracy on RMS power typically in the 5% to 10% range
- Accuracy on RMS current typically in the 2% to 5% range
- Crest factor (the ratio of V_{peak} to V_{rms}) limitation typically around 16 or less
- Measurement technique: typically (less costly) voltage measurement with the exception of the 454A which utilized electrosurgical manufacturer industry standard current sensing
- “Active” type instruments typically utilize a thermal converter

The new ESU-2050 is a direct result of extensive collaboration with leading medical device industry electrosurgery generator manufacturers. The ESU-2050 analyzer was designed to be 100% compatible with the following mandates of some of the leading manufacturers in this area:

- Accuracy of 1% (give us a calibration quality instrument that can replace the legacy Fluke Electronics Model 8920A⁷ Digital Wide-Band True RMS Voltmeters currently in widespread use)
- Utilize external high-precision (1%) power resistors widely used in the OEM segment

⁷ The Fluke 8920A was discontinued at the end of 1999 due to “product maturity” and electronic component shortages. For the detailed statement on product discontinuance from Fluke Electronics, simply visit the following url: <http://us.fluke.com/usen/support/safetynote/DiscontinuedProductNotice.htm>.

- Utilize external high-accuracy current sensing transformers of 0.1:1 and 1:1 ratio (typically Pearson Electronics Model 411 and 4100 transformers), thus eliminating the virtual inaccuracies of commercially available analyzers that utilize voltage measurement techniques
- Eliminate internal test load switching relays that add capacitive leakage at RF frequencies and decrease the overall level of instrument accuracy
- Add the ability to capture and store in high resolution, the ESU output waveform
- Supply Crest Factor (CF) capability well in excess of the current industry (competitive instrument) limitation of 16
- Make the new instrument much smaller and lighter, and more resistant to breakage during shipment than the current industry available ESU analyzers
- In summary, give us an instrument that we can use to test the way we have tested our electrosurgery generators over the past 10+ years!

The result of these ongoing collaborative efforts over the past 18 months is the new BC Biomedical ESU-2050 analyzer, with never before seen levels of accuracy and functionality in a commercially available ESU analyzer⁸. Testing with the new ESU-2050 analyzer is remarkable easy, and requires minimal setup, as can be seen in Figure 13 below.

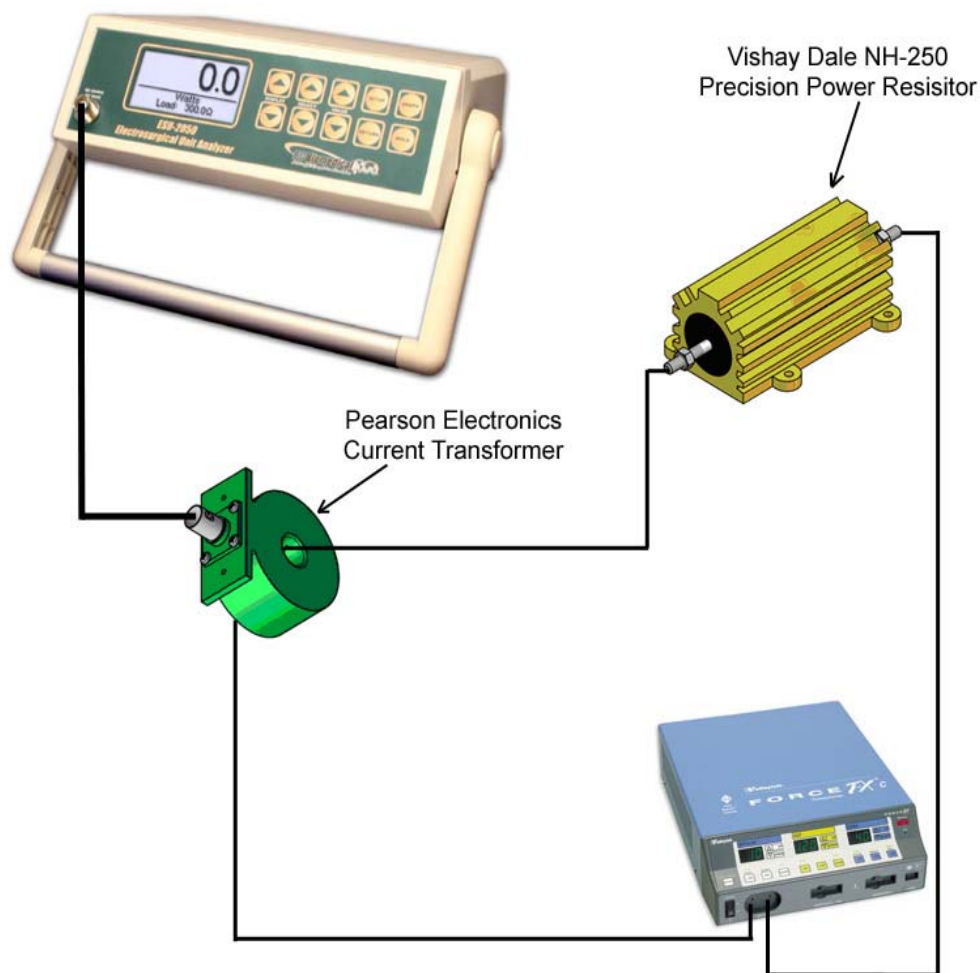

Figure 13

Typical Test Setup Using the ESU-2050 ESU Analyzer – Test the Way ESU OEMs Test Their Products

⁸ See complete product specifications for the ESU-2050 on Page 21.

ESU-2050: A Replacement for the Discontinued Fluke 8920A Instrument



The Fluke Electronics Model 8920A Digital Wide-Band True RMS Voltmeter with BNC Input was widely adopted by electrosurgical generator manufacturers around the world. Fluke Electronics discontinued this instrument and ceased all shipments by the end of 1999, leaving a void in the industry. Since the formal discontinuance of the 8920A, several electrosurgical generator manufacturers have searched for a suitable replacement instrument capable of delivering the same functionality and at the same level of accuracy as the 8920A. But none had been found up to and including the beginning of 2007. The development of the new BC Biomedical ESU-2050 ESU analyzer was by design, intended to provide a suitable replacement for the Fluke Electronics 8920A instruments currently in use by these manufacturers.

ESU-2050: Unprecedented 1% Accuracy In ESU Testing

The accuracy specifications (see ESU-2050 specifications on Page 21) of the new BC Biomedical ESU-2050 ESU analyzer are well beyond any competitive ESU analyzer of the market today, meeting the requirements of even the most demanding electrosurgical manufacturers. The ESU-2050 ESU analyzer allows the customer to test according to the exact same methodology as the electrosurgery generator manufacturers test their own products. This is an industry first! Now these manufacturers will be using the exact same instrumentation for test and measurement that typical electrosurgery generator customers do!

ESU-2300: A More Conventional Approach



For those customers that do not wish to make the quantum leap from conventional ESU testing methodologies to the new ESU-2050 platform, the new BC Biomedical ESU-2300 analyzer offers a more conventional approach to ESU testing. The ESU-2300 utilizes some of the best attributes of the ESU-2050 design:

- Patent pending DFA[®] Technology
- Industry standard current sensing technology via a custom design current transformer designed specifically for the BC Biomedical ESU-2300 by Pearson Electronics
- The latest in microprocessor design, which allows for high speed digital acquisition and “interrogation” of the electrosurgery generator waveform

The ESU-2300 is a mid-range analyzer (similar in price point to the Fluke Biomedical RF-303_{RS}), but offers superior features and accuracy (as result of the implementation of current sensing technology).

ESU-2400: More High-End Technology to Come

Is anything missing from the new BC Biomedical ESU-2000 Series lineup? What about a “high-end” analyzer? The new BC Biomedical ESU-2400 “high-end” ESU analyzer is currently under active development. Stay tuned to BC Group International, Inc. for more to come on the new BC Biomedical ESU-2400.

Common Element: Patent Pending DFA[®] Technology

The common element of all instruments in our new ESU-2000 Series is our patent pending DFA[®] Technology. This technology platform allows the instrument to aggressively digitize the RF signal, analyze its components, and provide highly accurate results. No other ESU analyzer on the market today uses this type of technology platform. Not even the “high-end” competitive instruments offer this advanced level capability!

In fact, most competitive ESU analyzers on the market today utilize thermal technology, where the ESU generator signal is fed into a thermal converter of some kind. This component measures the waveform energy through a temperature change and provides a reading. Most commercially available “active” ESU analyzers have used this technique for many years. The new BC Biomedical ESU-2000 Series of analyzers breaks this “old technology” trend and introduces an exciting new level of ESU measurement technology moving forward!

Up To 32,768 Data Points!

For advanced level users, the number of A/D converter samples used in displaying the electrosurgery generator measurement parameters can be adjusted to any of the following values: 1024, 2048, 4096, 8192, 16,384, 32,768. This setting adjusts the number of A/D converter readings used in each RMS mV computation. A higher setting requires more computation and is slower, but results in a more stable reading. This setting also determines the “resolution” of the stored and exported data sets for the captured electrosurgical generator waveforms. The waveform data sets shown throughout this document and in Appendices E, F, and G all have 32,768 discrete data points.

ESU-2050 & ESU-2300: Precision Load Resistors Are Where Accuracy Starts

If there is another industry standard among manufacturers of electrosurgery generators, it is the precision load resistors that are commonly used in their manufacturing testing, service, and calibration functions. That is why we chose the exact same external load resistors for use with our new BC Biomedical ESU-2050 analyzer: the proven Vishay Dale NH-250 series. See Appendix J for additional information on these precision power resistors.

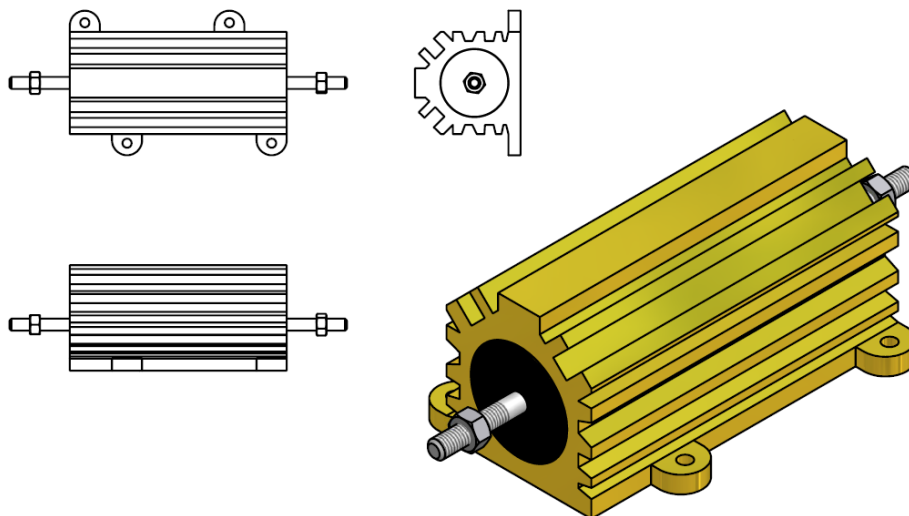

Figure 14

Vishay Dale NH-250 Precision Power Resistors Commonly Used With the ESU-2050

The BC Biomedical ESU-2300 ESU analyzer also uses 1% precision power resistors manufactured by Riedon Inc. (www.riedon.com). These 225-watt rated precision resistors are of a design that is more suitable for use as an internal component, and have a superior accuracy specification compared to some of the resistors used in competitive ESU analyzers.

Product Development In Cooperation with ESU Manufacturers

The product development campaign on the new BC Biomedical ESU-2050 analyzer, and the subsequent design of the more conventional ESU-2300 analyzer has brought us into contact with some of the leading electrosurgical manufacturers in the world market.



As we move forward with ongoing product support and possible enhancements to our ESU-2000 Series of ESU Analyzers, we will remain in contact with these manufacturers.

Industry Standard Current Sensing Technology

Virtually all of the world's leading electrosurgery generator manufacturers use RF current sensing as their standard means of measurement when they test, service, and calibrate their electrosurgical devices. This is why we chose to implement the more costly but more effective current sensing technology in our new ESU-2000 Series products. The simple fact is that current sensing is more accurate and more reliable than voltage measurement when it comes to ESU analyzers. But don't just take our word for it. Ask your favorite electrosurgery manufacturer which technology they approve and use.

Working With The Best In Current Sensing: Pearson Electronics

When it comes to sensing high frequency current flow, Pearson Electronics (www.pearsonelectronics.com) is one of the very best companies in the market today. We chose to utilize their current sensing transformers with both the ESU-2050 and ESU-2300 analyzers.

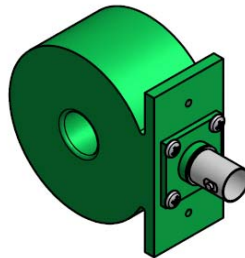

Figure 15

External Current Sensing Toroid Transformer by Pearson Electronics

The BC Biomedical ESU-2050 utilizes an external transformer. The Pearson Model 411 (0.1:1 ratio) and Model 4100 (1:1 ratio) are the specified transformers for use with the ESU-2050. These are the exact same transformers currently used by many major electrosurgery generator manufacturers. Data sheets for these transformers can be seen in Appendices H & I. For customer convenience, these external transformers are available directly from BC Group International, Inc.

The BC Biomedical ESU-2300 utilizes an internal custom designed current transformer manufactured specifically for BC Group International, Inc. by Pearson Electronics.

Current Sensing vs. Voltage Measurement

The simple voltage measurement technique utilized by many competitive ESU analyzers introduces several distinct product attributes as compared to the industry standard current sensing technique:

- reduced manufacturing cost for the test equipment manufacturer
- shorter product development time
- reduced accuracy for the end-user

This is why we chose to utilize the industry standard current sensing methodology in our new BC Biomedical ESU-2050 and ESU-2300 instruments. The manufacturers of these voltage measurement based ESU analyzers realize the shortcomings of this technology, and simply try to explain around them. The following statement is from a User's Manual Update⁹ for a competitive product that utilizes the voltage measurement technique:

1. RF303 Load Issues

The load resistors typically used in ESU analyzers are not "ideal"; they possess some reactive components that are frequency dependent. The RF303 derives applied power by measuring the voltage across the set load and calculating the power (V^2/R). Most other ESU analyzers on the market derive the applied power by measuring the current flowing through a set load and calculating the power ($I^2 \cdot R$). At fundamental frequencies below 500 kHz and regardless of the load setting, the two methods of measurement are comparable. Above 500 kHz, and at the extremes of the loads, the readings displayed by the two methods will differ on opposite sides of the expected value.

As an example, when testing the Conmed™ Excalibur™ Electrosurgical Unit in the monopolar output with the RF303 load set to 50 ohms, the set value on the Conmed will correlate with the displayed value on the RF303. When in the Bipolar mode, the RF303 will display higher than expected values – up to 35% higher. The same test performed on some current measuring analyzers will produce lower than expected values. This is due to the difference in fundamental frequencies between the monopolar and bipolar modes. In this case, the Conmed operates at 500 kHz in monopolar mode and 1 MHz in bipolar mode. When comparing readings measured with a V^2/R device to readings measured with an $I^2 \cdot R$ device, total measurement difference will likely be larger than 35%, due to different methods of deriving power.

This does not mean that the RF303 is malfunctioning or in error. Rather, it reflects the different results the two measurement techniques will produce when the load deviates from the nominal value used in the power calculations. It should be noted that most ESU manufacturers use the current measuring technique to calibrate production units.

Page 1 of 9

The information above is significant in two main areas. First, the explanation clearly indicates that when using the device in question, **the operator should expect measurement errors up to 35% (as compared to the industry standard current sensing technique)!** Secondly, it acknowledges that the **industry accepted normal practice by electrosurgery generator manufacturers is the superior current sensing technique.**

With the discontinuance of the Fluke Biomedical Model 454A, the BC Biomedical ESU-2050 and ESU-2300 ESU analyzers are now the only commercially available analyzers on the market today utilizing industry standard current sensing technology!

Ensuring Quality By Taking Care Of The Details

Sometimes it comes down to the little things that ensure accuracy and a long-lasting life to your ESU analyzer. Things like selecting the right load resistors and relays that switch in and out individual load resistors in the internal load bank can make a big difference. The ESU-2300 utilizes switching relays rated at 10,000 volts (isolation), 3 amps, 7500 volts (switching). The leading competitive "high-end" analyzer on the market utilizes relays that are rated significantly lower than this. The ESU-2300 utilizes internal precision load resistors that are rated at 1% tolerance (DC) with a power dissipation rating of 225 watts. The leading competitive "high-end" ESU

⁹ The complete User Manual Update can be downloaded in PDF format from the manufacturer's web site at the following url:
<http://global.flukebiomedical.com/busen/support/manuals/default.htm>

analyzer on the market utilizes resistors that are rated at 5% tolerance (DC) with a power dissipation rating of only 175 watts. These are just a few of the subtle differences between the new BC Biomedical ESU-2000 Series of ESU analyzers and competitive analyzers on the market today. Don't let the perceived "promise" of a particular brand fool you into making an inferior choice when it comes to selecting your new ESU analyzer, Do your homework before you purchase!

Those Crazy & Exotic Pulsed Waveforms

Conmed and Erbe are two manufacturers that offer electrosurgical generators with pulsed waveforms. Typically, these pulsed waveforms have long single cycle time periods within which a signal is pulsed for a brief period of time. This results in a very low duty cycle waveform that is extremely difficult to measure, let alone measure accurately.

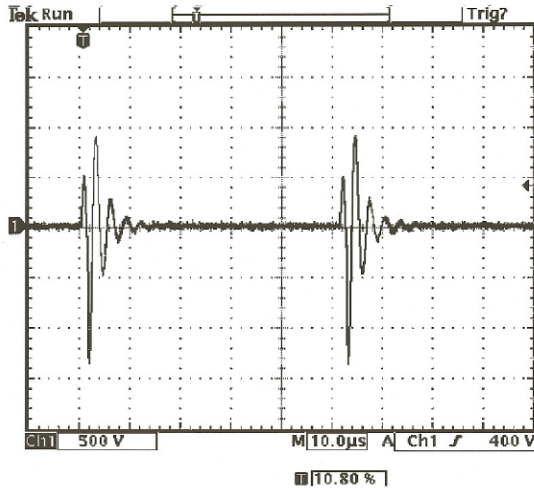

Figure 16
Conmed Spray RF Waveform

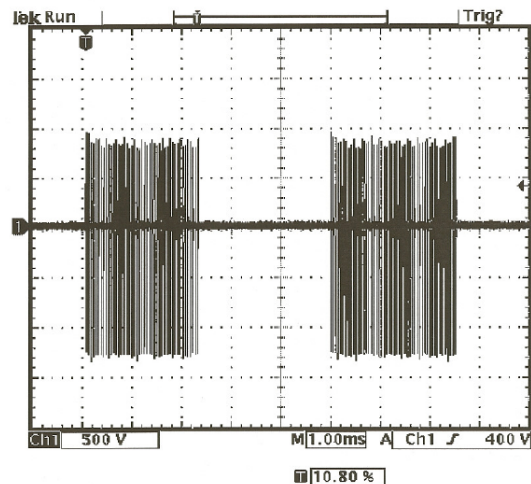

Figure 17
Conmed Spray Pulsed Waveform

Pulse Modes

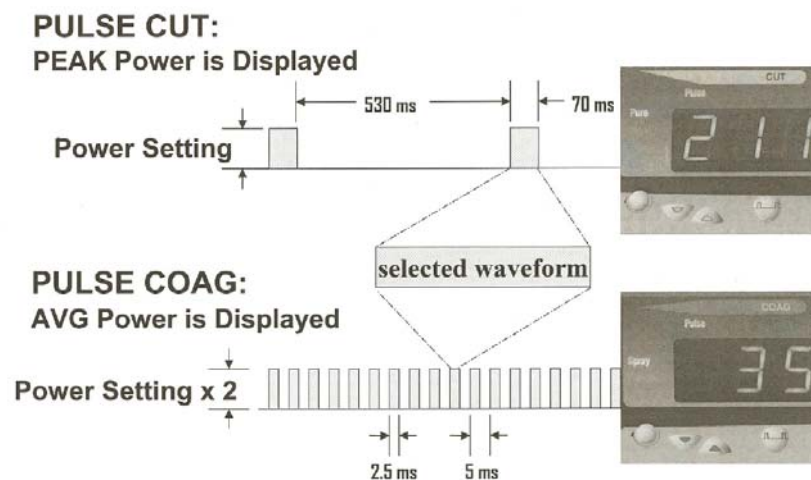

Figure 18
Conmed Pulse Waveform Modes

The BC Biomedical ESU-2050 Analyzer handles these pulsed waveforms easily, and yields accurate results time after time, leaving all competitive units behind, wondering what hit them.

ESU-2300: External Load Capabilities – Built In Non-Obsolescence

The most common shortcoming of any commercially available ESU analyzer is not having the correct load resistor value available for the specific electrosurgery generator to be tested. No matter how many internal loads are designed into a conventional ESU analyzer, you can be sure that one of the electrosurgery generator manufacturers will eventually come along and specify a load that is not in the mix. That's why we designed external load resistor capability into our new ESU-2300 analyzer. Not only does the ESU-2300 allow you to connect an external load, but you have the option of adding this external load value to the internal load selected (additive mode) or simply using the external load for its actual value (external only mode).

Our ESU-2050 relies on external load resistors, so obsolescence due to unavailability of a specific test load is not at all possible.

ESU-2000 Series PC Utility Software

Our BC Biomedical ESU-2000 Series Utility Software enhances the use of your BC Biomedical ESU-2050 and ESU-2300 analyzers. When used with the ESU-2050, the software allows for export of the saved digitized waveforms from the ESU-2050 to an Excel® workbook for further analysis. It also supports remote operation of the ESU-2050 and ESU-2300. See Appendix M for sample screen shots from the utility software.

One Picture is Worth a Thousand Words – Or Up To 32,768 Data Points

We've all heard the old adage that "one picture is worth a thousand words". The new BC Biomedical ESU-2050 analyzer puts some technological reality to this statement for the first time in ESU testing history. Through utilization of the ESU-2000 Series PC Utility Software, now you can export data sets to Microsoft Excel®, with up to 32,768 discrete data points on your electrosurgery generator's output energy waveform. This export function automatically creates an Excel® file that you can name anything you want. No knowledge of Microsoft Excel® is required. The created Excel® file will automatically include all of the measurement data as well as a graphical representation such as the one shown in Figure 19 below. See Appendix K for a sample look at the Excel® file structure.

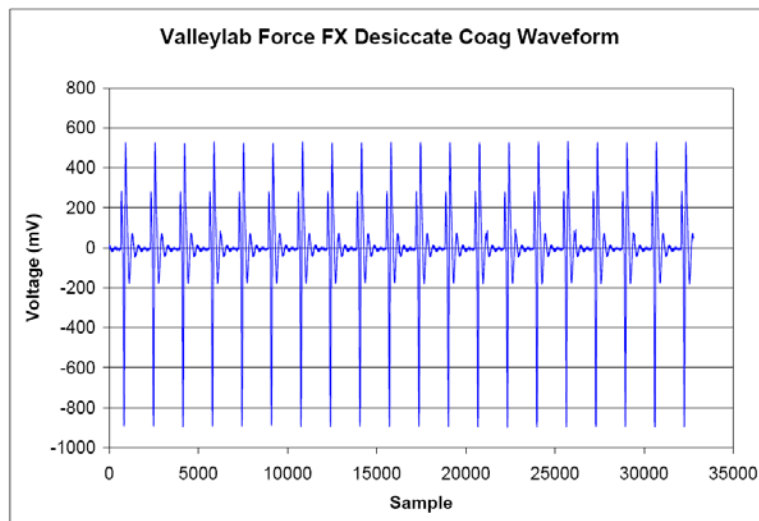

Figure 19

Microsoft Excel® (Automatically Created) Graphical Plot of Exported Electrosurgery Generator Waveform

You can then use the power of Excel® to analyze the data in any way you choose. Once you export the data set to Excel®, you can manipulate this data set to accomplish specific tasks, such as zooming in on a single cycle of a specific waveform. See an example of this capability in the Figure 20 illustration below. This is a user-created "zoomed" waveform based on the exported data.

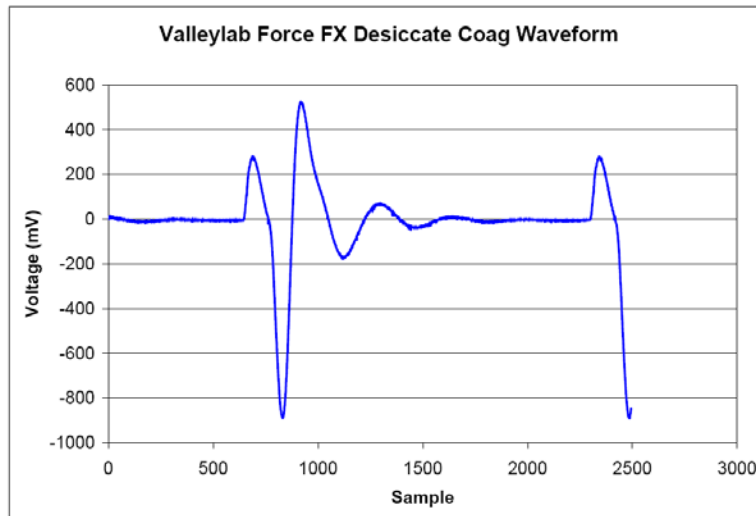

Figure 20

Microsoft Excel Graphical Plot of Exported Electrosurgery Generator Waveform With Zoom Manipulation of the Waveform Cycle

A sample Microsoft Excel[®] exported data set can be viewed in Appendix K. This example illustrates the fundamental structure of the resulting Excel[®] workbook, but has been reduced significantly in size to allow display on a single page. The original Excel[®] workbook contains 32,768 rows of actual measurement data, accompanied by a graph of the displayed data. This Excel[®] workbook is created automatically by the export function of the BC Biomedical ESU-2000 Series PC Utility Software. No knowledge of Excel[®] is required.

See The Data You Want – The Way You Want

Both the BC Biomedical ESU-2050 and ESU-2300 offer the capability of multiple parameter screens for viewing test measurement parameters. The ESU-2050 allows you to select screens with 1 to 5 measurement parameters for display. You can even select which parameters you want displayed in each window of the screen. For user convenience, the value of load resistance is always displayed on the screen. See Figure 21 below.

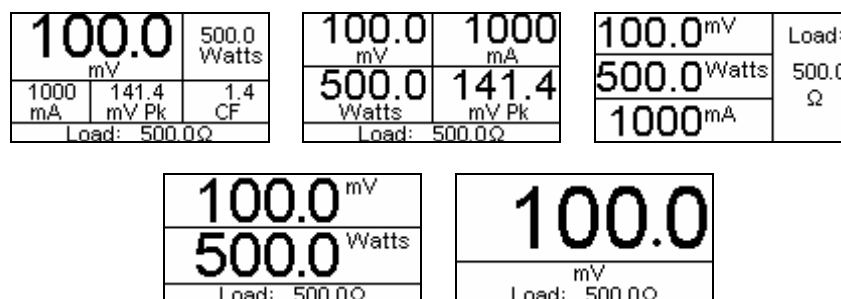

Figure 21

ESU-2050: Display the Number of Measurement Parameters That You Want

The ESU-2300 offers multiple display screens for viewing instrument parameters and setup information. See Figure 22 below for some examples of the wide screen layout of the ESU-2300's LCD display with backlighting.

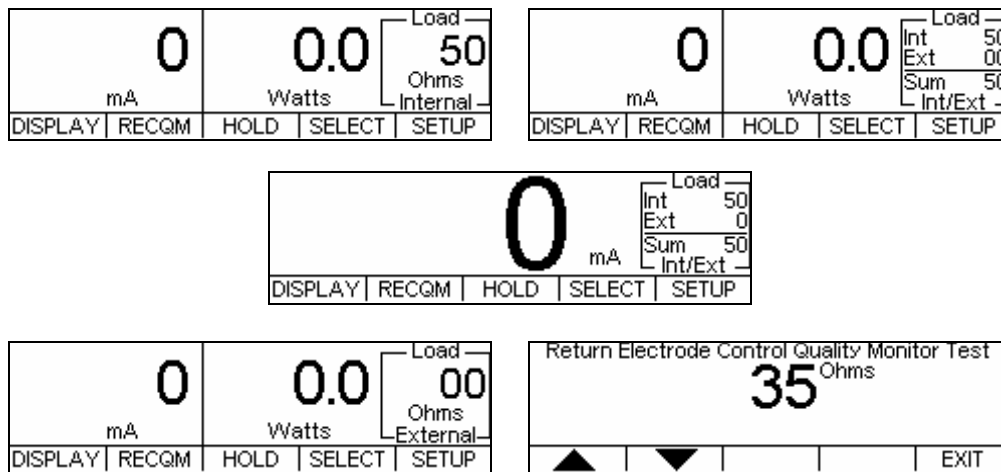

Figure 22

ESU-2300: Multiple Options Are Available for Display of Measurement Parameters

Easy Setup and Operation

The user interface of both the BC Biomedical ESU-2050 and ESU-2300 is extremely intuitive and easy to learn. On-screen selection of test loads and other setup parameters is extremely easy.



Figure 23

The ESU-2050 and ESU-2300 User Interface is Easy to Learn

The “learning curve” for new users of the ESU-2050 and ESU-2300 ESU analyzers is short and both instruments have an extremely intuitive user interface.

ESU-2050: Graphical Mode

The BC Biomedical ESU-2050 offers a graphical mode in which you can easily view the captured electrosurgical generator waveform. You can even zoom in on the waveform for a closer look, and save it to any one of three storage locations. Stored waveforms can have up to 32,768 discrete data points.

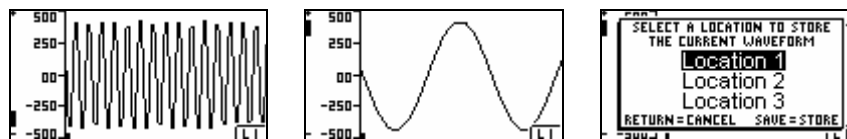

Figure 24

The ESU-2050 Graphical Mode Offers Advanced Capabilities

Up to three captured waveforms can be saved in the ESU-2050 for export to the ESU-2000 Series PC Utility Software at any time.

The ESU-2000 Series PC Utility Software also works with the ESU-2300. See Appendix M for some screen shots of the ESU-2000 Series PC Utility Software in action.

Product Comparison Overview

A brief overview of the BC Biomedical ESU-2000 Series as compared to leading competitive products on today's market is as follows:

Feature / Product	BC Biomedical ESU-2050	BC Biomedical ESU-2300	Fluke Biomedical 454A (Discontinued)	Fluke Biomedical RF303RS	Metron QA-ES & Fluke Biomedical QA-ES
Industry standard current sensing technology	Yes	Yes	Yes	No Voltage Measurement	No Voltage Measurement
High-speed digital waveform processing and analysis	Yes Patent Pending DFA® Technology	Yes Patent Pending DFA® Technology	No	No	No
Store digitized high resolution ESU waveforms	Yes	No	No	No	No
Export ESU waveform data to Microsoft Excel®	Yes	Yes	No	No	No
Internal load resistors	No	Yes	Yes	Yes	Yes
External load resistor capability	Yes	Yes	Yes Proprietary Load Modules Only	No	No
RF Leakage Current Testing	Yes Perform Test Externally using 1:1 Current Transformer	Yes	Yes	Yes	Yes
CQM Testing (Internal)	No Perform Externally per OEM Specifications	Yes	Yes Limited	Yes Limited	Yes Limited
Displayed parameters	Power (watts) Peak Voltage RMS Voltage RMS Current Crest Factor Test Load Ω	Power (watts) RMS Current Test Load Ω	Power (watts) RMS Current Peak to Peak Voltage Crest Factor Test Load Ω	Power (watts) RMS Current Test Load Ω	Power (watts) RMS Current Peak to Peak Voltage Crest Factor
RS232 Communications Port	Yes	Yes	Yes	Yes	Yes
USB Communications Port	Yes	Yes	No	No	No
Battery Operation	No	Yes	No	Yes	No
Pulse waveform compatibility	Yes	No	No	No	No
Accuracy specification for RMS current ¹⁰	1% of Reading	2.5% of Reading	5% of Reading	2.5% of Reading	2% of Reading
Accuracy specification for RMS power ¹¹	1% of Reading	5% of Reading	10% of Reading	5% of Reading	Not Specified
Easy Flash ROM field upgrades via PC	Yes	Yes	No	No	No
First introduced to market (year)	2007	2007	1993	1998	2002
Manufactured In (Country)	USA	USA	USA	USA	Norway
U.S. List Price	\$ 4,495	\$ 3,495	\$ 4,442	\$ 3,439	\$ 4,720

For a more thorough product comparison, please visit www.bcgrouptnl.com/compare.htm and download the product comparison sheet on the ESU-2000 Series in Adobe Acrobat PDF format.

¹⁰ This is an abbreviated specification. See the full specification in the product specifications at the end of this document or in the Appendices.

¹¹ This is an abbreviated specification. See the full specification in the product specifications at the end of this document or in the Appendices.

One-Stop-Source: We Make It Easy for You

BC Group International, Inc. does whatever it takes to make it easy on our customers. Our customers who purchase the ESU-2050 won't have to go shopping elsewhere for their Pearson Electronics current sensing transformers or Vishay Dale NH-250 precision load resistors. BC Group offers these product accessories directly to the customer, without the standard long lead times from the original manufacturers.

Conclusion

At BC Group International, Inc., we would rather spend our time and effort designing and bringing new and innovative products such as the new ESU-2050 and ESU-2300 ESU Analyzers to market under the BC Biomedical brand, than waste it re-branding and re-launching 5 to 10 year old technology base products. Innovative new products are what we are all about; not new photography and product overlays. We'll let those types of "development" efforts up to our competitors. We hold the technology needs of our customers in the highest regard, and we are confident that our ongoing development efforts, in cooperation with some of the medical device industry's most significant players, will be recognized by our customers for what they are – a sincere desire to lead the biomedical test and measurement industry through a continuous launch of exciting new products. Our new BC Biomedical ESU-2050 and ESU-2300 ESU Analyzers are simply the most recent evidence of our real mission. Stay tuned for much more to come!

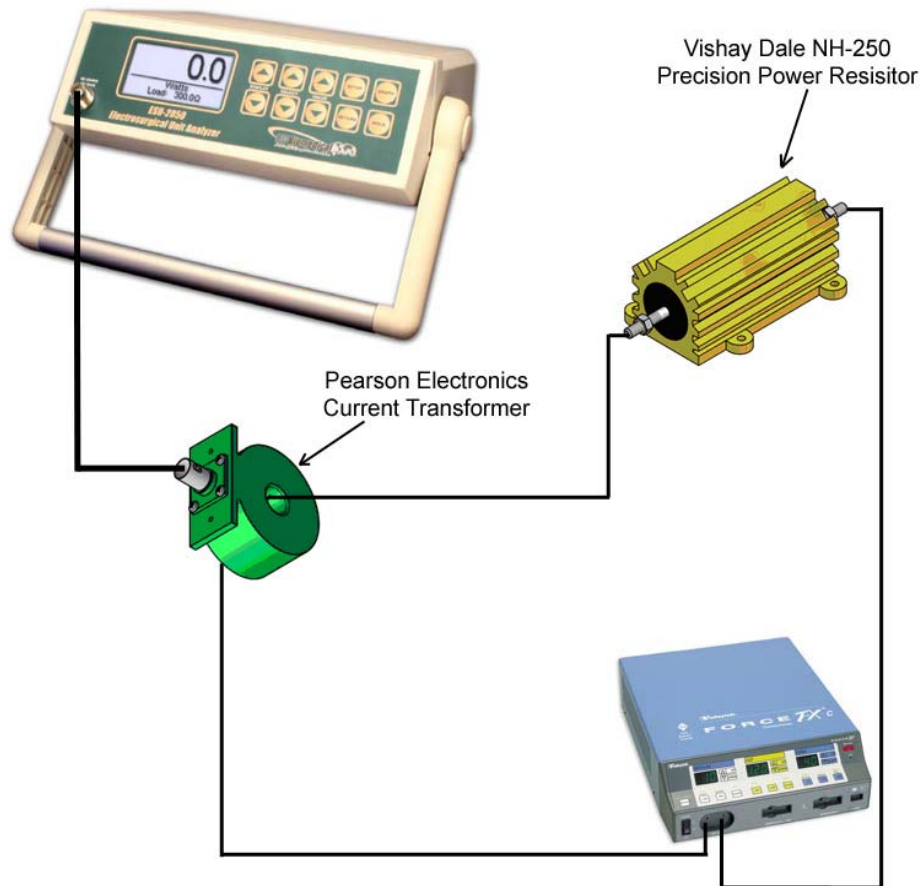

Figure 25

Typical Test Setup Using the ESU-2050 ESU Analyzer – Test the Way ESU OEMs Test Their Products

ESU-2050 Product Specifications¹²

INPUT RANGE

Voltage (RMS):	2.0 – 700.0 mV RMS
Input Resolution:	0.1 mV RMS
Voltage (Peak):	1000.0 mV
Resolution:	0.1 mV
Frequency:	10 kHz – 10 MHz
Accuracy:	0.5 mV, \leq 50 mV 1% of reading, > 50 mV, up to 1 MHz 3% of reading, > 50 mV, 1 to 10 MHz

CALCULATED RANGES

Current (with 0.1:1 CT):	7000 mA RMS
Resolution:	1 mA
Current (with 1:1 CT):	700.0 mA RMS
Resolution:	0.1 mA
Wattage:	999.9 Watts
Resolution:	0.1 Watt
Crest Factor:	1.4 to 500
Resolution:	0.1

INPUT IMPEDANCE

50 Ohms

INPUT COMPATIBILITY

RF Current Transformer (50 ohm):	Pearson Electronics 411 or 4100 (Typical)
RF Current Transformer Attenuation:	0.1:1 or 1:1 User Selectable

OTHER

Display:	LCD Graphical 128 x 64 Pixels with Backlight
Setup Memory:	EEPROM, All Parameters
Memory Retention:	10 Years without Power
Operating Range:	15 to 30 Degrees C
Storage Range:	-40 to 60 Degrees C
Construction:	Enclosure – ABS Plastic Face – Lexan, Back Printed
Size:	3.4" H x 9.1" W x 8.0" D
Weight:	\leq 3 lbs
Connections:	Input: BNC Output: Serial DB-9 or USB
Power Supply Adapter:	6 VDC, Center Positive, 300 mA
Power Consumption:	ON: less than 150 mA OFF: less than 40 ua
Data Storage (Internal):	3 Sets of 32,768 Data Points

¹² Specifications are accurate as of the date of release of this document. Specifications are subject to change without prior notice.

ESU-2300 Product Specifications¹³

Measurement

Method Industry Standard Current Sensing Using RF Current Transformer (Pearson[®] Coil)

Power

Range 1.0 to 400.0 Watts RMS
 Resolution 0.1 Watts
 Accuracy $\pm 5\%$ Reading or ± 3 Watts (whichever is greater)

Current

Range 30 to 2500 mA RMS
 Resolution 1 mA
 Accuracy $\pm 2.5\%$ Reading or ± 15 mA (whichever is greater)

Limits

Bandwidth 10 kHz to 10 MHz
 Crest Factor 1.4 to 500
 Voltage 10,000 Peak

Loads

Main Test Load

Range 50 to 750 Ω
 Resolution 50 Ω
 Accuracy $\pm 1\%$ (DC)
 Duty Cycle 50% (1 minute period)

Auxiliary Test Load

Fixed 200 Ω
 Accuracy $\pm 1\%$ (DC)
 Rating 225 Watts

CQM Test Load

(Contact Quality Monitor test load is an independent variable load)

Range 1 to 500 Ω
 Resolution 1 Ω
 Accuracy $\pm 2\%$

Physical

Enclosure 6.0" x 13.5" x 12.0"

Weight 12.5 lbs

Electrical

Power Supply External Universal Power Supply: 12 VDC Output
 83 to 264 VAC
 Voltage 83 to 264 VAC
 Frequency 47 to 63 Hz
 Battery Sealed Lead Acid
 6 VDC, 7.2 AH

General

Display LCD Graphical 256 x 64 Pixels with Backlight
 Ventilation Internal Fan, variable speed, over-temperature protected, Fan rotor sensor
 Oscilloscope Output Isolated (uncalibrated), BNC Connector
 Setup Memory EEPROM, All Parameters
 Memory Retention 10 Years without Power
 Operating Range 15 to 35 Degrees C
 Storage Range -40 to 60 Degrees C
 Humidity Limit 90% Non-Condensing
 Connections Oscilloscope: BNC
 Communications: USB & RS232 DB-9
 External Loads: 4mm Safety Sockets

¹³ Specifications are accurate as of the date of release of this document. Specifications are subject to change without prior notice.

Technical References

- Tyco Healthcare / Valleylab Electrosurgery Self-Study Guide, Copyright Tyco Healthcare Valleylab, September, 1999 (Author: Brenda C. Ulmer, RN, MN, CNOR)
- Fluke Biomedical / DNI Nevada Model 454A Electrosurgical Analyzer Operating Manual, Copyright Fluke Electronics / Fluke Biomedical
- Fluke Biomedical / Bio-Tek Instruments RF-303 Electrosurgical Analyzer Operator's Manual, Copyright September, 1998 Fluke Electronics / Fluke Biomedical
- Metron QA-ES Operator's Manual, Copyright Fluke Electronics / Fluke Biomedical
- DNI Nevada Model 402A Operating Manual, Copyright Fluke Electronics / Fluke Biomedical
- Dale Technology DALE3000 Instruction Manual, Copyright Fluke Electronics / Fluke Biomedical
- Tyco Healthcare / Valleylab Force 2 Electrosurgical Generator Service Manual, Copyright 2004
- Tyco Healthcare / Valleylab Force FX Electrosurgical Generator Service Manual, Copyright 2006
- Tyco Healthcare / Valleylab LigaSure Vessel Sealing System Service Manual, Copyright 2004
- Electrosurgical Generators: Guide to Performance and Safety Testing (ISBN 09661128-1-4), Copyright Tektran Incorporated (Available for downloading as a PDF at www.tektran.com)
- Principles of Electrosurgery (ISBN 0-9661128-0-6), Copyright Tektran Incorporated (Available for downloading as a PDF at www.tektran.com)
- Understanding Electrosurgery, Bovie / Aaron Medical (Publication # MC-55-049-001 Rev 1), Copyright July, 2003
- Application Note: Electrosurgical Analyzer Primer, Copyright Fluke Electronics / Fluke Biomedical (Available for downloading as a PDF from the Fluke Electronics / Fluke Biomedical website at <http://global.flukebiomedical.com/busen/support/appnotes/default.htm#>)
- ANSI/AAMI HF18-2001 Standard, Electrosurgical Devices

About the Author

Michael R. Erwine has been involved in the medical device industry since 1975, with his roots being in biomedical and clinical engineering. Since January, 2006 Mr. Erwine has been employed by BC Group International, Inc. and is currently fulfilling multiple roles including Strategic Accounts Manager, Worldwide Dealer Network Manager, Product Manager, as well as other functions. He also manages the BC Group International, Inc. Western Regional Office in Carson City, NV. Since 1989, Mr. Erwine has worked for or with (under strategic alliances, marketing partnerships, corporate family structure, etc.), the following major biomedical test and measurement manufacturers and service providers:

- *Spectrum Technologies Inc. (Elysburg, PA)*
- *Dynatech Nevada Inc. (Carson City, NV)*
- *Metron AS (Trondheim, Norway)*
- *Bender GmbH (Grunberg, Germany)*
- *Datrend Systems (Burnaby, Canada)*
- *Lionheart Technologies Inc. (Carson City, NV)*
- *DNI Nevada Inc. (Carson City, NV)*
- *Bio-Tek Instruments Corp. (Burlington, VT)*
- *Ultramedic Ltd (Liverpool, England)*
- *Labatoire Gamida (Eaubonne, France)*
- *Dale Technology Inc. (Thornwood, NY)*
- *Fluke Biomedical Corp. (Carson City, NV)*
- *Fluke Electronics Corp. (Everett, WA)*
- *Metron USA (Grand Rapids, MI)*

During his career track, Mr. Erwine has served in the following capacities, just to name a few:

- *Product Manager*
- *Project Manager*
- *Product Validation Engineer*
- *Commercial Manager*
- *National Sales Manager*
- *International Sales Manager*
- *Strategic Accounts Manager*
- *VP of Sales & Marketing*
- *Executive Vice President*
- *General Manager*

In the electrosurgery testing specialty area, Mr. Erwine has interfaced and worked with major medical device manufacturers such as Tyco Healthcare (Valleylab), Conmed (Electrosurgery Division), Erbe USA, Bovie, etc. While at Dynatech Nevada Inc., Mr. Erwine successfully launched the industry icon Model 454A ESU Analyzer. Following the acquisition of Dynatech Nevada, Inc. by Lionheart Technologies in 1997, Mr. Erwine launched the DNI Nevada Model 402A ESU Analyzer and assisted the Bio-Tek Instruments sales and marketing staff in the launch of their very first “active” ESU testing device in the way of the concurrent Bio-Tek Model RF-303 (currently offered as the Fluke Biomedical RF-303_{RS}).

Mr. Erwine has worked heavily with Tyco Healthcare / Valleylab and Conmed Electrosurgery Division since January, 2006 on the development and functionality of the new BC Biomedical ESU-2050 analyzer, and has also interfaced with Erbe USA, Bovie, Megadyne, and others during the BC Biomedical ESU-2000 Series development project. Mr. Erwine continues to work with all of these medical device manufacturers in his various roles at BC Group International, Inc. The design and functionality of the new BC Biomedical ESU-2000 Series of ESU Analyzers is strongly rooted in these collaborative efforts with some of the same medical device manufacturers with whom Mr. Erwine has historically worked.

If you have questions concerning anything in this document or on the ESU-2000 Series of Electrosurgery Analyzers in general, please feel free to e-mail the author at merwine@bcgroupintl.com.

APPENDICES

All documents and information contained in the following Appendices have been obtained from various sources within the public sector, and do not represent confidential information or trade secrets of any kind. Recognition of ownership and copyright is hereby given to the companies and manufacturers whose product and other types of information are represented here in this document for informational purposes. Original ownership and copyright of this documentation remains with these companies.

APPENDIX A

Fluke Biomedical 454A Instrument Specifications (Source: Fluke Biomedical Model 454A Operating Manual)

454A OPERATING MANUAL

Instrument Specifications

Parameter	Specification/Accuracy
RMS Current	±5.0% of reading (100–2000 mA) ±5.0% of reading (30–100 mA) for Crest Factor <16.0
RMS Power	±10% of range (watts)
Peak-to-Peak Voltage	±10% of reading (0–10 kV)
Crest Factor	±10% of reading ($1.4 \geq CF \leq 15.9$)
Bandwidth	-3 dB (30 Hz–7 MHz)
Load Resistance	50–1550 Ω (50- Ω steps) ±3.0% of selected load (@ dc)
Oscilloscope Output	≈2.5 volt/amp (uncalibrated)
Temperature Range	Operating: 15° to 35°C Storage: 0° to 50°C
Power Requirements	≤0.75 amps, 115 VAC 50/60 Hz 240 VAC 50/60 Hz
Display	4 lines × 42 characters 32 × 256 pixel matrix 0.5" H × 0.5" W numeric font
Case	Aluminum frame with polycarbonate front panel
Weight	7.71 kg (17 lb)
Dimensions	46.36 cm L × 31.75 cm W × 15.24 cm H (18.25" L × 12.50" W × 6.00" H)

APPENDIX B

Fluke Biomedical RF-303_{RS} Instrument Specifications

(Source: Fluke Biomedical RF-303 Operator's Manual)

Instrument Specifications

<u>Parameter</u>	<u>Specification/Accuracy</u>
Modes of Operation	<ul style="list-style-type: none">• Line Powered (Battery Charge and Maintenance Charge)• Battery Operation• Offline (Battery Charge and Maintenance Charge)
Displayed Parameters	<ul style="list-style-type: none">• Power (watts)• HF Current (milliamperes)• Test Load (ohms)
Tests Performed	<ul style="list-style-type: none">• Generator Output• HF Leakage <p>Performs HF leakage tests to IEC 601 2-2, 1289-2, ANSI/AAMI standards: <i>Type BF Test 1</i>—Earth referenced monopolar output <i>Type BF Test 2</i>—Earth referenced monopolar output <i>Type CF / Bipolar</i>—Isolated monopolar or bipolar output</p>
Measurement	<ul style="list-style-type: none">• Technique: Precision high-voltage capacitive attenuator samples applied ESU signal. This directly measured HF voltage and the selected test load resistance value utilized to derive the true RMS values of both current and wattage readings.• HF Power (watts): Resolution: 1 to 400 W / Resolution: 0.1 W

APPENDIX B (Continued)

Fluke Biomedical RF-303_{RS} Instrument Specifications

(Source: Fluke Biomedical RF-303 Operator's Manual)

<u>Parameter</u>	<u>Specification/Accuracy</u>
Measurement (cont'd)	<ul style="list-style-type: none">• Maximum power input: 400 W RMS Accuracy: $\pm 5\%$ of reading or ± 3 watts, whichever is greater.• HF Current Range: 30 to 2500 mA RMS, Resolution: 1 mA Accuracy: $\pm 2.5\%$ of reading or ± 15 mA, whichever is greater.
Bandwidth/ System Response	<ul style="list-style-type: none">• Bandwidth of RMS converter circuit (1% accuracy) Flat response: 10 KHz to 10 MHz -3 dB points: 1 KHz to 20 MHz• System Response (measurement circuitry and selected test load): -3 dB points: 1 KHz to 10 MHz @ 300 ohms
Test Load Section	<ul style="list-style-type: none">• Main Test Load <i>Selections: 15</i> <i>Selection range: 50 to 750 Ω</i> <i>Step size: 50 Ω</i> <i>Duty cycle: 50% @ 400 W (maximum 30 seconds ON during any one-minute period)</i> <i>Resonance impedance variation: ± 0.5 dB maximum (<10 MHz)</i>

APPENDIX B (Continued)

Fluke Biomedical RF-303_{RS} Instrument Specifications

(Source: Fluke Biomedical RF-303 Operator's Manual)

<u>Parameter</u>	<u>Specification/Accuracy</u>
Test Load Section (cont'd)	<ul style="list-style-type: none">• Main Test Load (cont'd)• Accuracy (DC to 500 KHz): $\pm 4\%$ of selected value measured at calibration to $\pm 1\%$ (across the entire operating temperature range)• Auxiliary Leakage Test Load<ul style="list-style-type: none">Fixed: 200 ΩAccuracy: $\pm 4\%$Power rating: 225 W• Input Capacitance (nominal)<ul style="list-style-type: none">Active to Dispersive: 30 pFActive or Dispersive to Earth ground: 40 pF
Battery	<ul style="list-style-type: none">• Type: Sealed lead-acid• Voltage: 12 volts nominal• Capacity: 2.2 A H• Field serviceable: No• Typical time between recharges: 2-hour minimum• Battery cycles: 200• Recharging: Instrument has internal, automatic charger. No external charger required.
Auxiliary Contact Quality Monitor Testing Feature	The main test load section is used to perform a simple Auxiliary Contact Quality Monitor Testing Feature (CQM) operational check.
Display	<ul style="list-style-type: none">• Type: LCD, 7-segment• Display size: 4 full digits• Overall display size: 2.0" x 0.75"

RF303 Operator's Manual

1-5

APPENDIX B (Continued)

Fluke Biomedical RF-303_{RS} Instrument Specifications

(Source: Fluke Biomedical RF-303 Operator's Manual)

<u>Parameter</u>	<u>Specification/Accuracy</u>
Front-Panel Controls/Push buttons	<ul style="list-style-type: none">• <i>Measurement Select</i> (1)• <i>Load Select:</i><ul style="list-style-type: none">Increment test load (+) one stepDecrement test load (-) one step
Top-Panel Input Connections	<ul style="list-style-type: none">• <i>Designations:</i><ul style="list-style-type: none">Generator output-active (1)Generator output-dispersive (2)Signal earth/ground reference (2)Auxiliary HF leakage load (2)• <i>Connector type:</i> 4-mm (0.160") diameter safety sockets• <i>Input voltage limit:</i> 10,000 V peak• <i>Input current limit:</i> 3 amperes RMS• <i>Installation category:</i> II
Side Input Connection	<i>Designation:</i> Signal reference
Oscilloscope Output	<ul style="list-style-type: none">• Transformer coupled output• <i>Scale Factor:</i> uncalibrated• <i>Connector Type:</i> BNC
Calibration Period	Calibration recommended every 12 months.

APPENDIX C

Dale Technology DALE3000 Instrument Specifications (Source: Dale Technology Product Catalog)

ELECTROSURGICAL ANALYZER

DALE3000 Electrosurgical Analyzer

Simple, portable, and digital to satisfy your electrosurgical-unit (ESU) testing needs.

The DALE3000 makes it easy to conduct generator-output, HF-leakage, and CQM tests, allowing you to read the results on a bright LED display. Compatible with both isolated and earth-referenced ESUs, the DALE3000 has fifteen standard test loads to match the requirements of most ESUs. All of the high-frequency (HF) leakage tests, as specified in the current IEC and ANSI/AAMI standards, are easily conducted. The DALE3000 will also verify the basic operation of the dispersive electrode's Contact Quality Monitor (CQM).

Features

- Easy-to-use test instrument
- Performs output, HF-leakage, & CQM tests
- Select watts, current, and test load with a touch of a button
- Main test loads from 50 Ω to 750 Ω (in 50 Ω steps)
- Performs all IEC & ANSI/AAMI HF-leakage tests
- Auxiliary HF-leakage test load
- Large LED, 4-digit numeric display
- Oscilloscope output
- RS232 serial-port interface for test automation

Since the instrument's enclosure is constructed of high-grade plastic, the DALE3000 is lighter than other models.



DALE3000

Also, you are protected from potentially dangerous electrical shock while testing the high-voltage, high-frequency ESU-generator output.

Standard Accessories

- Test leads (4): Active, dispersive, earth reference, CQM
- Two insulated jumpers
- Fuses: Two 3.15 A
- Detachable power-cord set
- Operating manual

Optional Accessories

- Serial cables
- Hard-sided carrying case
- Service Manual

Specifications

Modes of Operation

- Manual
- Remote
- Simplex: Transmits data only
- Duplex: Transmits data and receives control commands

Displayed Parameters

- Power (W)
- RF current (mA)
- Test load (Ω)

Tests Performed

Generator Output

HF/RF Leakage: Performs tests in accordance with IEC 601-2-2, 1289-2, ANSI/AAMI HF-18.

Earth Referenced Leakage (IEC)

- Type BF Test 1
- Type BF Test 2

Isolated Output Leakage (IEC & ANSI/AAMI)

- Type CF/Bipolar Test 3

Contact Quality Monitor (CQM)

Measurement Technique

A precision, high-voltage/high-frequency capacitive divider samples the applied ESU signal. This voltage and the selected test-load-resistance value are utilized to derive the True RMS current and power values of the applied electrosurgical signal.

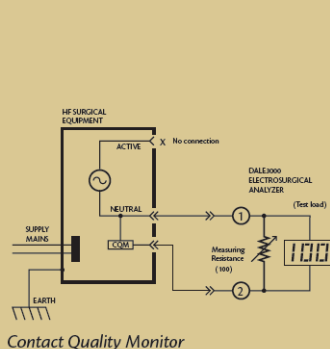

Contact Quality Monitor

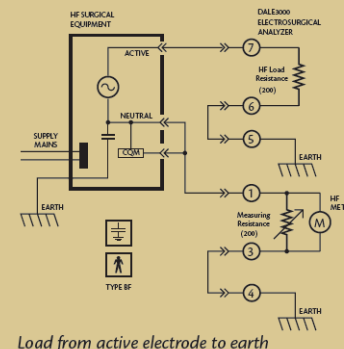

Load from active electrode to earth

APPENDIX C (Continued)

Dale Technology DALE3000 Instrument Specifications (Source: Dale Technology Product Catalog)

ELECTROSURGICAL ANALYZER

RF Measurements

Watts (Resolution)
Range: 0.1 to 400 (± 0.1 W)
Maximum power input: 400 W
Accuracy: $\pm 5\%$ of reading or ± 3 W (whichever is greater)
RF Current (Resolution)
Range: 30 to 2500 mA (± 1 mA)
Accuracy: $\pm 2.5\%$ of reading or ± 15 mA (whichever is greater)

Bandwidth (Measurement Circuitry Only)

Flat response: 10 kHz to 10 MHz
-3dB points: 1 kHz to 20 MHz

System Response (Measurement Circuitry and Test Load Sections)

-3dB points: 1 kHz to 10 MHz @ 300 Ω

Test-Load Section

Selections: 15
Range: 50 Ω to 750 Ω
Step size: 50 Ω
Accuracy: $\pm 4\%$ of selected value
Maximum duty cycle @ 400 W: 50% (period = one minute)

Auxiliary-Leakage Test Load

Fixed: 200 Ω
Accuracy: $\pm 4\%$ rated @ 225 W
Input capacitance at 300 Ω
Active to neutral: 30 pF
Active or neutral to earth ground: 40 pF

Auxiliary Contact-Quality-Monitor (CQM) Test

The main test loads are used to perform a simple operational check of the ESU's CQM feature.

Signal Averaging Mode (SAM)

2 rolling average algorithms to smooth ESU output

Display

4-digit red LED, seven segments

Front-Panel Controls

Measurement select (1): Watts or current
Load select (2): Increment or decrement

Top-Panel Input Connections (7)

Designations:
Generator output-active (1)
generator output dispersive (2)
earth/ground reference (2)
auxiliary HF-leakage load (2)
Connector type: 4 mm (.160") diameter safety sockets (IEC-1010 approved)

Serial Port

Baud rate: 2400 Fixed
Connector type: Male DB9
Modes: Simplex and duplex

Oscilloscope Output (Uncalibrated)

Transformer coupled-output connector type: BNC

Ventilation (Variable Speed Fan)

Over-temperature protection
Blocked-rotor optical sensor/detector

Power Requirements

Operating voltage (frequency): 115/230 VAC (50 Hz/60 Hz)
Maximum input: 60 W
Fuses: 3.15 A (2) user replaceable (external)

Safety Requirements

U.S.A.: UL3101-1
Canada: CAN/CSA C22.2 No. 1010-1 1992
International: EN 61010-1 (1990) (73/23 EEC low-voltage directive)

Electromagnetic Interference and Susceptibility

89/336/EEC Electromagnetic (Amendment 93/68/EEC)
EN 50082-1 Group I
EN 550221 Class A

Environment

Operating temperature: 15 $^{\circ}$ C to 35 $^{\circ}$ C
Storage temperature: 0 $^{\circ}$ C to 50 $^{\circ}$ C
Humidity: <90% non-condensing

Case

High-impact plastic

Dimensions

12" L x 13.5" W x 6" H
(30 cm L x 34 cm W x 15 cm H)

Weight

12 lbs (5.5 kg)

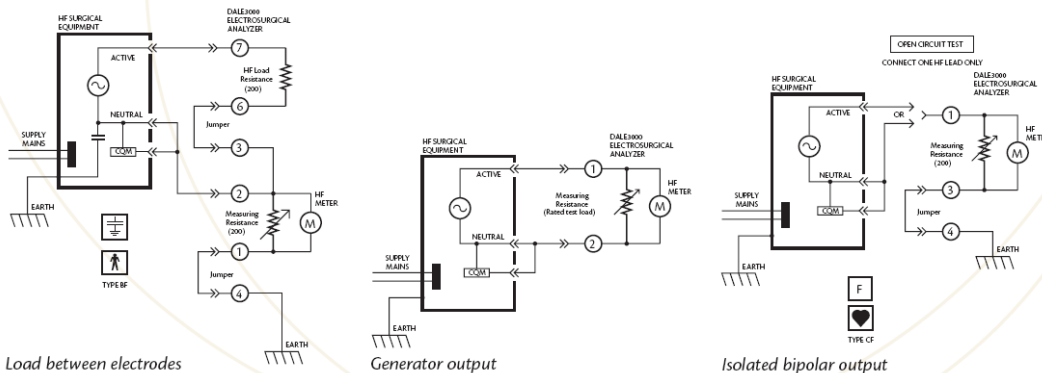

1.800.544.3253 • www.daletech.com

15

APPENDIX D

Metron QA-ES Instrument Specifications (Source: Metron QA-ES Product Data Sheet)

QA-ES MKII Specifications

ESU TESTING	ansur QA-ES OFFERS THE FOLLOWING FEATURES	GENERAL INFORMATION																																																																																																																																																
<p>GENERATOR OUTPUT:</p> <p>CONTINUOUS OPERATION continuous measurement of Power, Current, Peak Voltage and Crest Factor</p> <p>SINGLE OPERATION instant measurement of Power, Current, Peak Voltage and Crest Factor</p> <p>POWER DISTRIBUTION automatic measurement of Power, Current, Peak Voltage and Crest Factor through a user selectable load range</p> <p>RF LEAKAGE current from active, dispersive or bipolar electrodes using one or 2 loads.</p> <p>RECOM - test the "Return Electrode Control Quality Monitoring" using the QA-ES internal loads</p> <p>MODES OF OPERATION: Manual, user-programmable or remote controlled (via RS-232).</p> <p>MEASUREMENT: True RMS value of applied waveform.</p> <p>RMS BANDWIDTH: 30 Hz to 10 MHz (-3 dB).</p> <p>LOW FREQUENCY FILTER: 100 Hz filter to avoid low frequency disturbance/ interference.</p> <p>CURRENT: 20 mA to 2200 mA.</p> <p>CURRENT ACCURACY: 20 - 2200 mA $\pm 2\%$ of reading.</p> <p>LOAD RESISTANCE: 10 - 2500 ohms in step of 25 ohms (@ dc) 2600 - 5200 ohms in step of 100 ohms (@ dc)</p> <p>ADDITIONAL FIXED LOAD: 200 ohms 500 watts maximum.</p> <p>CREST FACTOR: The higher of the two peak voltage measurements is used for computation. RANGE: 1.4 / 16 (V peak / V rms).</p> <p>FOOT SWITCH OUTPUT: The foot switch output triggers the measurement after a programmed delay time. Start test (QA ES) → Foot switch triggers → Delay time (ms) → Start measurement The delay time is between 200 ms and 4000 ms.</p> <p>PEAK TO PEAK VOLTAGE: 0 to 10 kV (closed load only) $\pm 10\%$. Measurement is taken between the active and dispersive electrodes with closed load only</p> <p>OSCILLOSCOPE OUTPUT: 5 Volts/Amps uncalibrated.</p> <p>ISOLATION: 10 kV isolation between MD and enclosure.</p>	<p>REMOTE CONTROL: All functions and tests in QA-ES may be performed from the PC.</p> <p>USER PROGRAMMABLE TEST SEQUENCES: Allows unlimited numbers of test sequences with user-programmable templates and test limits. These tests include Power distribution test, Output test, HF leakage, and RECOM verification.</p> <p>STORAGE AND RECALL: Protocol formats and data may be stored, recalled, printed out or transferred to D-base systems.</p> <p>PRINT OUT:</p> <div style="border: 1px solid black; padding: 5px;"> <p>METRON QA-ES Electrosurgical Analyzer Ver. xxx</p> <p>QA-ES Serial no: _____</p> <p>Establishment: _____</p> <p>Appliance code: _____</p> <p>Serial no: _____</p> <p>Status: _____</p> <p>Group: _____</p> <p>Manufacturer: _____</p> <p>Model: _____</p> <p>Type: _____</p> <p>Location: _____</p> <p>Unit passed test: _____ Unit failed test: _____</p> <p>Comments: _____</p> <p>Date: _____</p> <p>Signature: _____</p> </div> <p>Example of a printout.</p> <table border="1"> <thead> <tr> <th>Test#</th> <th>Mode</th> <th>Delay</th> <th>Load</th> <th>Current</th> <th>Power</th> <th>V_{pk}</th> <th>CF</th> </tr> </thead> <tbody> <tr><td>1</td><td>Power-disp</td><td>300 ms</td><td>10 ohms</td><td>1460 mA</td><td>25 W</td><td>40 V</td><td>1.5</td></tr> <tr><td>2</td><td>Power-disp</td><td>300 ms</td><td>25 ohms</td><td>1212 mA</td><td>49 W</td><td>121 V</td><td>1.9</td></tr> <tr><td>3</td><td>Power-disp</td><td>300 ms</td><td>50 ohms</td><td>1241 mA</td><td>78 W</td><td>174 V</td><td>1.8</td></tr> <tr><td>4</td><td>Power-disp</td><td>300 ms</td><td>75 ohms</td><td>1142 mA</td><td>96 W</td><td>220 V</td><td>1.5</td></tr> <tr><td>5</td><td>Power-disp</td><td>300 ms</td><td>100 ohms</td><td>1028 mA</td><td>107 W</td><td>224 V</td><td>1.8</td></tr> <tr><td>6</td><td>Power-disp</td><td>300 ms</td><td>125 ohms</td><td>901 mA</td><td>119 W</td><td>247 V</td><td>1.5</td></tr> <tr><td>7</td><td>Power-disp</td><td>300 ms</td><td>150 ohms</td><td>805 mA</td><td>124 W</td><td>421 V</td><td>1.7</td></tr> <tr><td>8</td><td>Power-disp</td><td>300 ms</td><td>175 ohms</td><td>720 mA</td><td>129 W</td><td>424 V</td><td>1.5</td></tr> <tr><td>9</td><td>Power-disp</td><td>300 ms</td><td>200 ohms</td><td>777 mA</td><td>133 W</td><td>440 V</td><td>1.5</td></tr> <tr><td>10</td><td>Power-disp</td><td>300 ms</td><td>225 ohms</td><td>736 mA</td><td>124 W</td><td>472 V</td><td>1.5</td></tr> <tr><td>11</td><td>Power-disp</td><td>300 ms</td><td>250 ohms</td><td>694 mA</td><td>122 W</td><td>478 V</td><td>1.4</td></tr> <tr><td>12</td><td>Power-disp</td><td>300 ms</td><td>275 ohms</td><td>656 mA</td><td>120 W</td><td>492 V</td><td>1.4</td></tr> <tr><td>13</td><td>Power-disp</td><td>300 ms</td><td>300 ohms</td><td>610 mA</td><td>114 W</td><td>513 V</td><td>1.5</td></tr> <tr><td>14</td><td>Power-disp</td><td>300 ms</td><td>325 ohms</td><td>568 mA</td><td>116 W</td><td>542 V</td><td>1.5</td></tr> <tr><td>15</td><td>Power-disp</td><td>300 ms</td><td>350 ohms</td><td>509 mA</td><td>114 W</td><td>549 V</td><td>1.4</td></tr> <tr><td>16</td><td>Power-disp</td><td>300 ms</td><td>375 ohms</td><td>463 mA</td><td>113 W</td><td>621 V</td><td>1.5</td></tr> <tr><td>17</td><td>Power-disp</td><td>300 ms</td><td>400 ohms</td><td>529 mA</td><td>112 W</td><td>587 V</td><td>1.4</td></tr> </tbody> </table>	Test#	Mode	Delay	Load	Current	Power	V _{pk}	CF	1	Power-disp	300 ms	10 ohms	1460 mA	25 W	40 V	1.5	2	Power-disp	300 ms	25 ohms	1212 mA	49 W	121 V	1.9	3	Power-disp	300 ms	50 ohms	1241 mA	78 W	174 V	1.8	4	Power-disp	300 ms	75 ohms	1142 mA	96 W	220 V	1.5	5	Power-disp	300 ms	100 ohms	1028 mA	107 W	224 V	1.8	6	Power-disp	300 ms	125 ohms	901 mA	119 W	247 V	1.5	7	Power-disp	300 ms	150 ohms	805 mA	124 W	421 V	1.7	8	Power-disp	300 ms	175 ohms	720 mA	129 W	424 V	1.5	9	Power-disp	300 ms	200 ohms	777 mA	133 W	440 V	1.5	10	Power-disp	300 ms	225 ohms	736 mA	124 W	472 V	1.5	11	Power-disp	300 ms	250 ohms	694 mA	122 W	478 V	1.4	12	Power-disp	300 ms	275 ohms	656 mA	120 W	492 V	1.4	13	Power-disp	300 ms	300 ohms	610 mA	114 W	513 V	1.5	14	Power-disp	300 ms	325 ohms	568 mA	116 W	542 V	1.5	15	Power-disp	300 ms	350 ohms	509 mA	114 W	549 V	1.4	16	Power-disp	300 ms	375 ohms	463 mA	113 W	621 V	1.5	17	Power-disp	300 ms	400 ohms	529 mA	112 W	587 V	1.4	<p>TEMPERATURE REQUIREMENTS: +15°C to +35°C while operating 0°C to +50°C for storage</p> <p>DISPLAY: Type: LCD Alphanumeric format: 8 lines by 40 characters Graphics mode: 240 x 64 pixel matrix. Display control: 5 F-keys, enter, cancel and an encoder.</p> <p>DATA INPUT/OUTPUTS (2): Parallel printer port (1); Bi-directional RS-232C (1) for Computer control</p> <p>POWER: From 115 VAC to 240 VAC, 48/60 Hz</p> <p>HOUSING: Metal case</p> <p>DIMENSIONS: D x W x H: 395 mm x 342 mm x 132 mm</p> <p>WEIGHT: 9.8 kg</p> <p>STANDARD ACCESSORIES: User and Service manual.</p> <p>RECOMMENDED PRINTERS: HP Desk Jet, Canon Bubble Jet or compatible.</p> <p>QA-ES MKII ORDERING INFORMATION</p> <p>Order no: 14010: QA-ES MKII Electrosurgical Analyzer</p> <p>Accessories: 14100: Carrying Case 10500: Carrying Case, ext. printer 14200: ansur QA-ES Plug-In 14201: ansur QA-ES Plug-In, demo 14226: User manual ansur QA-ES Plug-In (CD) 14025: User / Service manual QA-ES (CD) 11451: E-Input Measuring Cable, 2m, black 11452: E-Input Measuring Cable, 2m, red 11481: E-Input Measuring Cable, 5m, black 11482: E-Input Measuring Cable, 5m, red 11471: Grip C, black 11472: Grip C, red</p>
Test#	Mode	Delay	Load	Current	Power	V _{pk}	CF																																																																																																																																											
1	Power-disp	300 ms	10 ohms	1460 mA	25 W	40 V	1.5																																																																																																																																											
2	Power-disp	300 ms	25 ohms	1212 mA	49 W	121 V	1.9																																																																																																																																											
3	Power-disp	300 ms	50 ohms	1241 mA	78 W	174 V	1.8																																																																																																																																											
4	Power-disp	300 ms	75 ohms	1142 mA	96 W	220 V	1.5																																																																																																																																											
5	Power-disp	300 ms	100 ohms	1028 mA	107 W	224 V	1.8																																																																																																																																											
6	Power-disp	300 ms	125 ohms	901 mA	119 W	247 V	1.5																																																																																																																																											
7	Power-disp	300 ms	150 ohms	805 mA	124 W	421 V	1.7																																																																																																																																											
8	Power-disp	300 ms	175 ohms	720 mA	129 W	424 V	1.5																																																																																																																																											
9	Power-disp	300 ms	200 ohms	777 mA	133 W	440 V	1.5																																																																																																																																											
10	Power-disp	300 ms	225 ohms	736 mA	124 W	472 V	1.5																																																																																																																																											
11	Power-disp	300 ms	250 ohms	694 mA	122 W	478 V	1.4																																																																																																																																											
12	Power-disp	300 ms	275 ohms	656 mA	120 W	492 V	1.4																																																																																																																																											
13	Power-disp	300 ms	300 ohms	610 mA	114 W	513 V	1.5																																																																																																																																											
14	Power-disp	300 ms	325 ohms	568 mA	116 W	542 V	1.5																																																																																																																																											
15	Power-disp	300 ms	350 ohms	509 mA	114 W	549 V	1.4																																																																																																																																											
16	Power-disp	300 ms	375 ohms	463 mA	113 W	621 V	1.5																																																																																																																																											
17	Power-disp	300 ms	400 ohms	529 mA	112 W	587 V	1.4																																																																																																																																											

MTD0501.027.13

In the interest of product improvement Metron claims the right to alter specifications without notice.



APPENDIX E

Valleylab Force FX Generator Output Waveforms (Source: BC Biomedical ESU-2000 Series PC Utility Software Excel® File Export¹⁴)

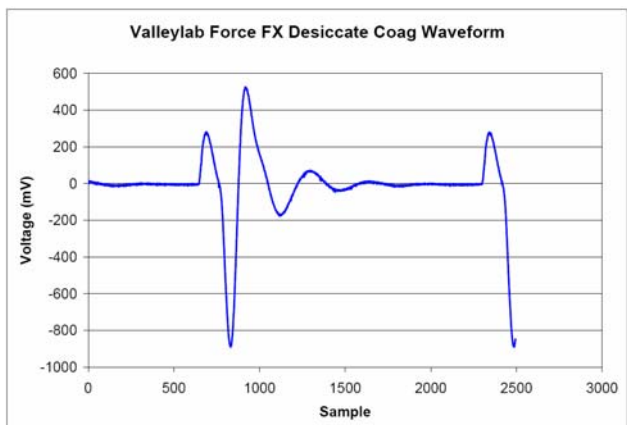
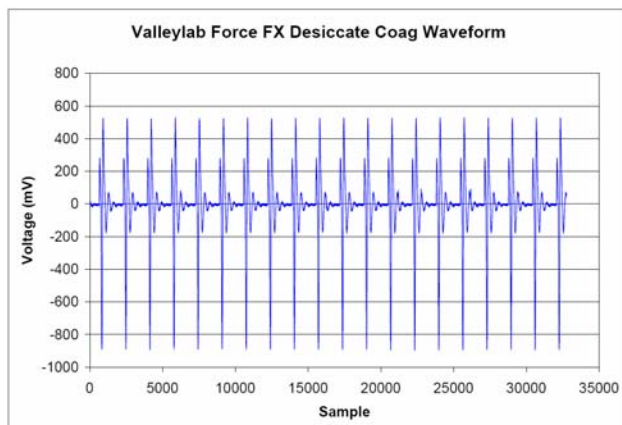
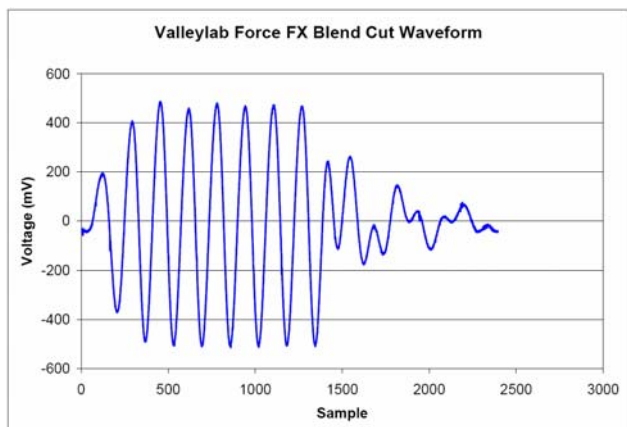
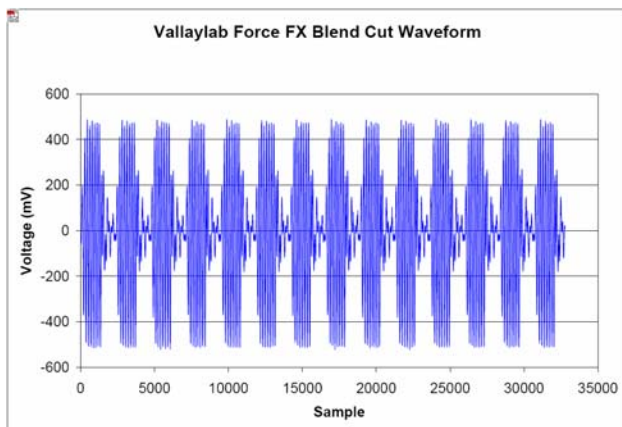
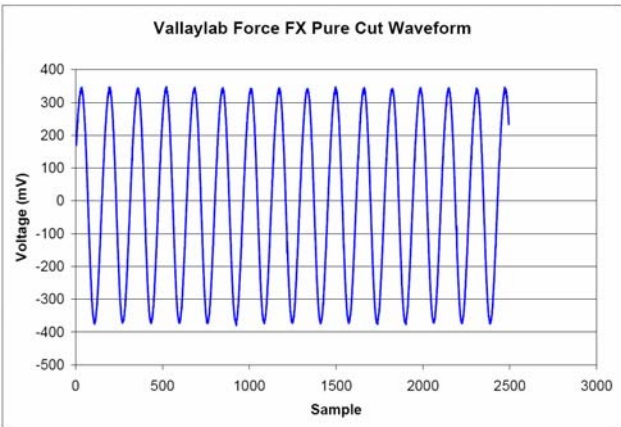
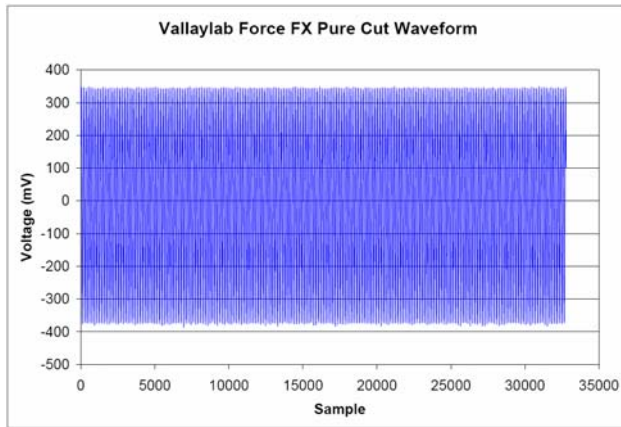

¹⁴ Graphed data shown in the left hand set of illustrations above was automatically created by Excel® as part of the normal data export from the ESU-2000 Series PC Utility Software. No user knowledge of Excel® for graphing purposes is required at this level. The graphs on the right were individually created within Excel® by the user, based upon the data exported from the ESU-2000 Series PC Utility Software.

APPENDIX E (Continued)

Valleylab Force FX Generator Output Waveforms (Source: BC Biomedical ESU-2000 Series PC Utility Software Excel® File Export¹⁵)

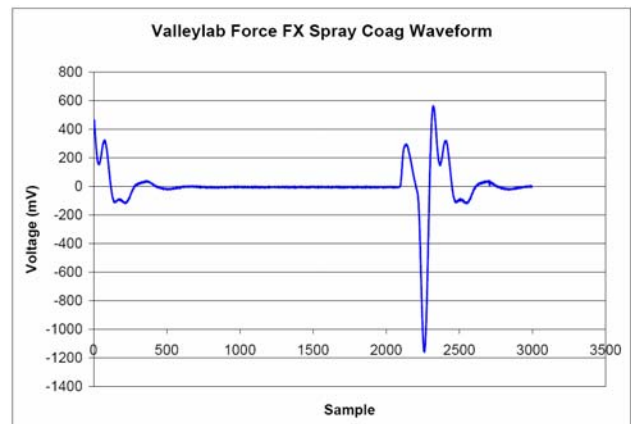
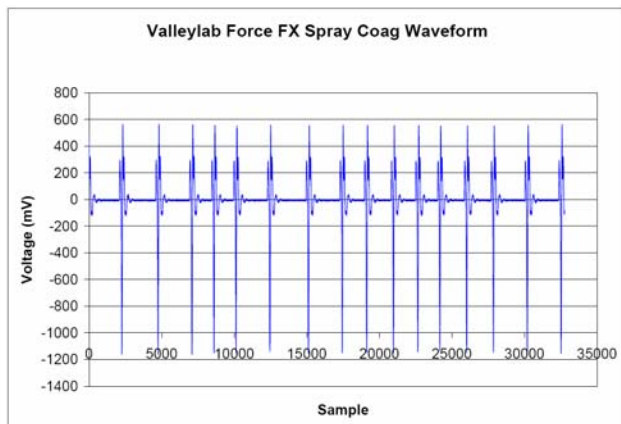
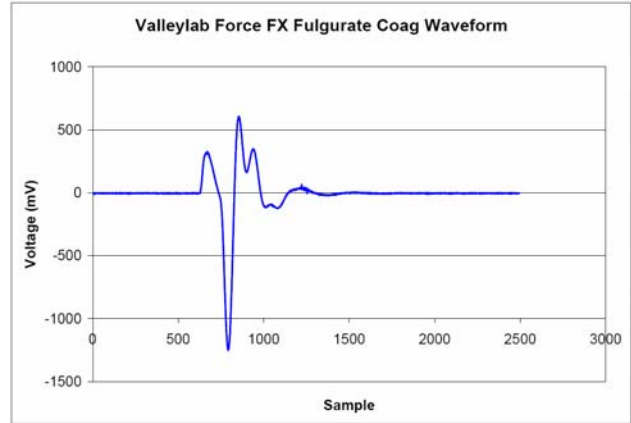
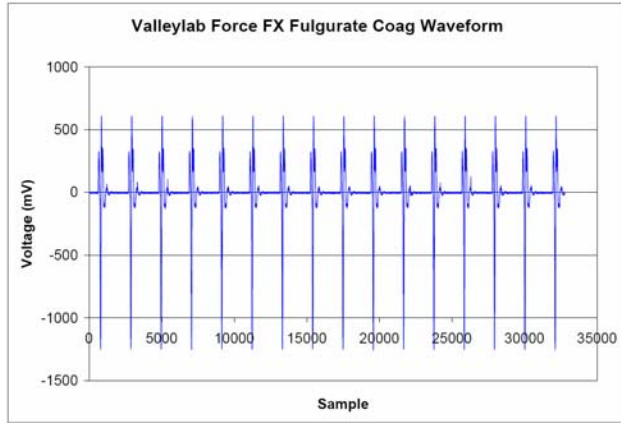

¹⁵ Graphed data shown in the left hand set of illustrations above was automatically created by Excel® as part of the normal data export from the ESU-2000 Series PC Utility Software. No user knowledge of Excel® for graphing purposes is required at this level. The graphs on the right were individually created within Excel® by the user, based upon the data exported from the ESU-2000 Series PC Utility Software.

APPENDIX F

Valleylab Force 2 Generator Output waveforms (Source: BC Biomedical ESU-2000 Series PC Utility Software Excel[®] File Export¹⁶)

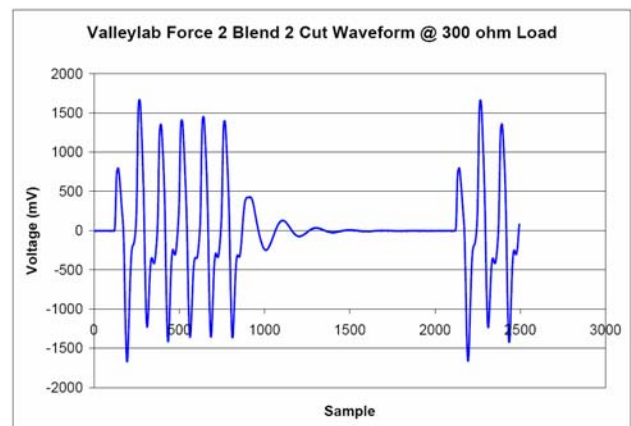
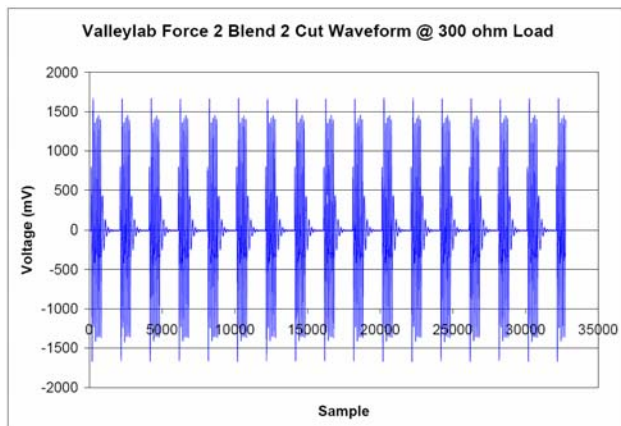
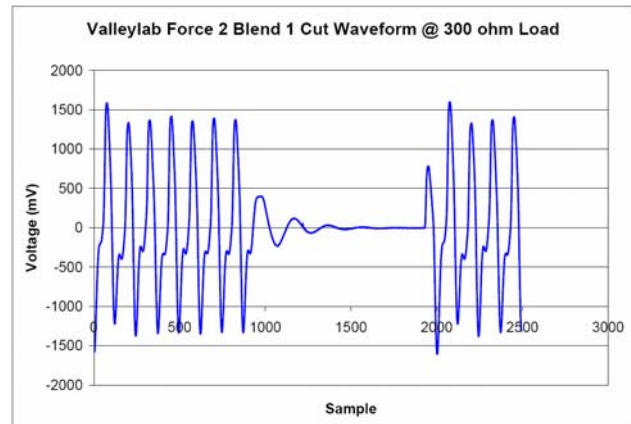
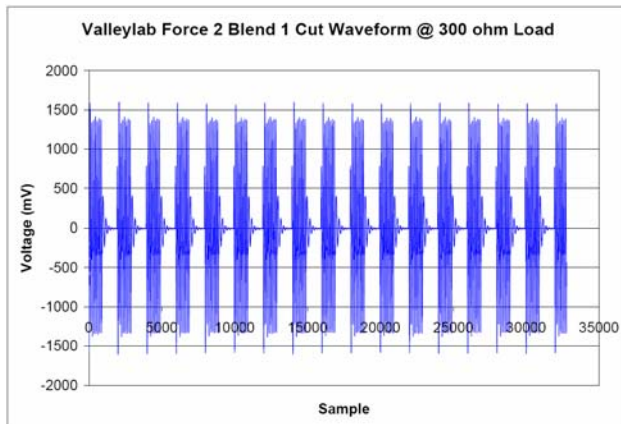
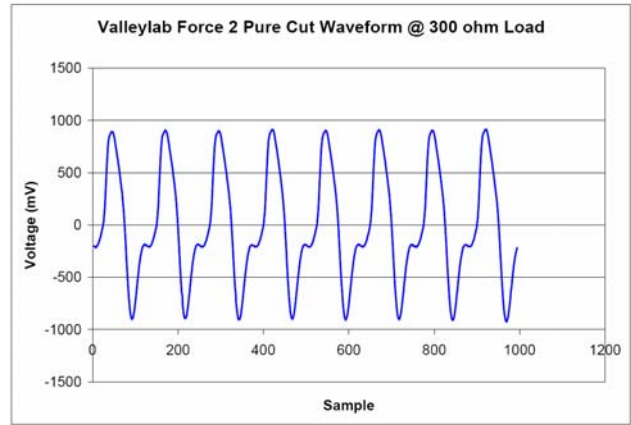
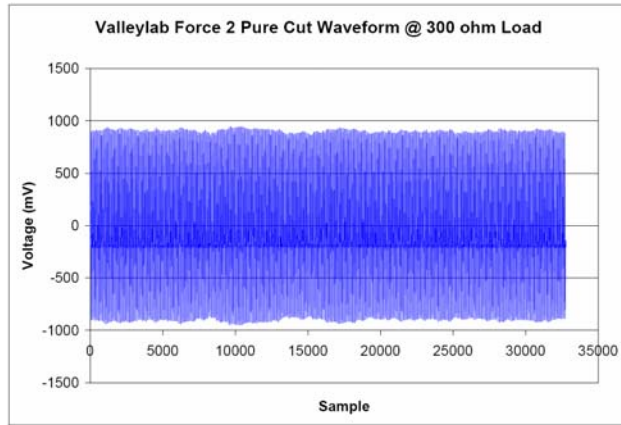

¹⁶ Graphed data shown in the left hand set of illustrations above was automatically created by Excel[®] as part of the normal data export from the ESU-2000 Series PC Utility Software. No user knowledge of Excel[®] for graphing purposes is required at this level. The graphs on the right were individually created within Excel[®] by the user, based upon the data exported from the ESU-2000 Series PC Utility Software.

APPENDIX F (Continued)

Valleylab Force 2 Generator Output waveforms (Source: BC Biomedical ESU-2000 Series PC Utility Software Excel® File Export¹⁷)

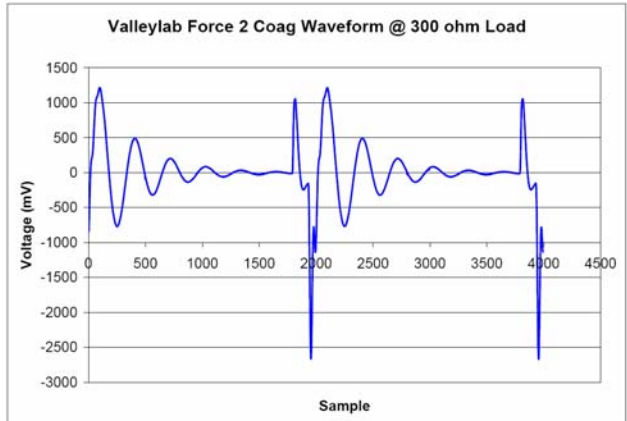
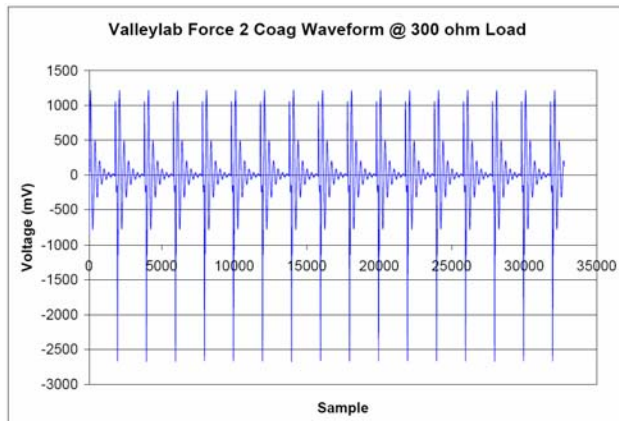
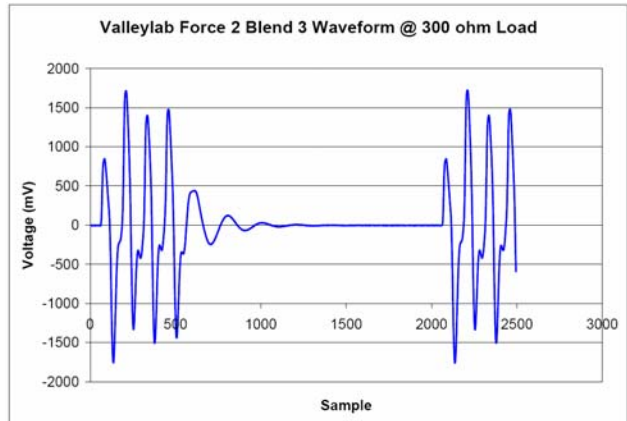
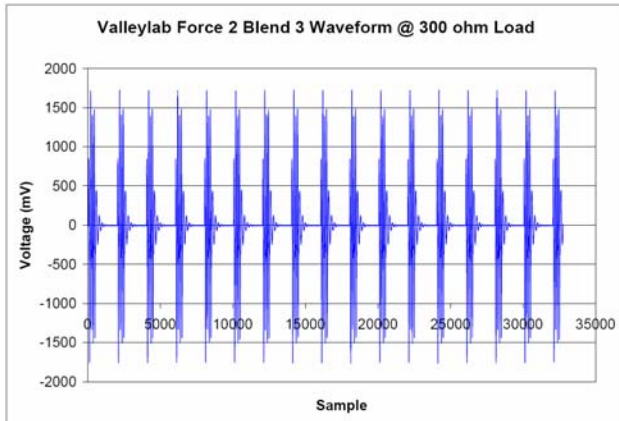

¹⁷ Graphed data shown in the left hand set of illustrations above was automatically created by Excel® as part of the normal data export from the ESU-2000 Series PC Utility Software. No user knowledge of Excel® for graphing purposes is required at this level. The graphs on the right were individually created within Excel® by the user, based upon the data exported from the ESU-2000 Series PC Utility Software.

APPENDIX G

Conmed System 5000 Output Waveforms

(Source: BC Biomedical ESU-2000 Series PC Utility Software Excel® File Export¹⁸)

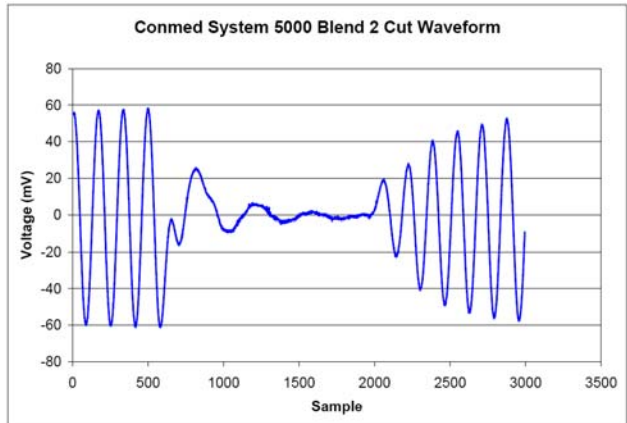
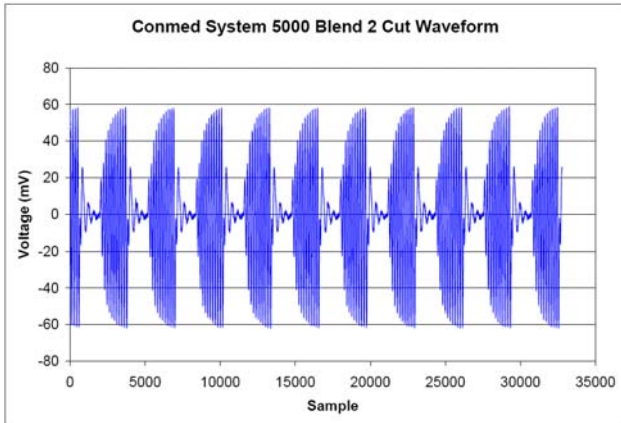
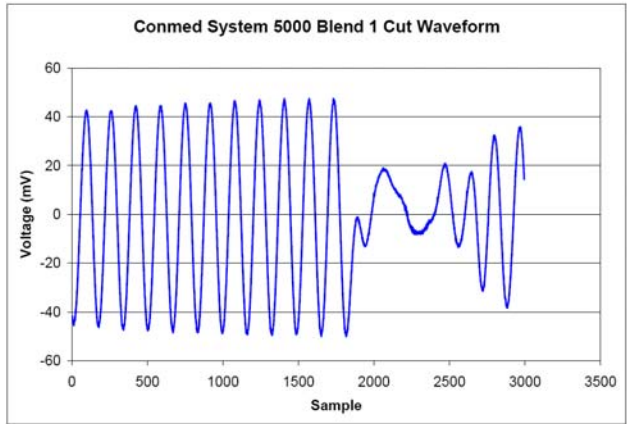
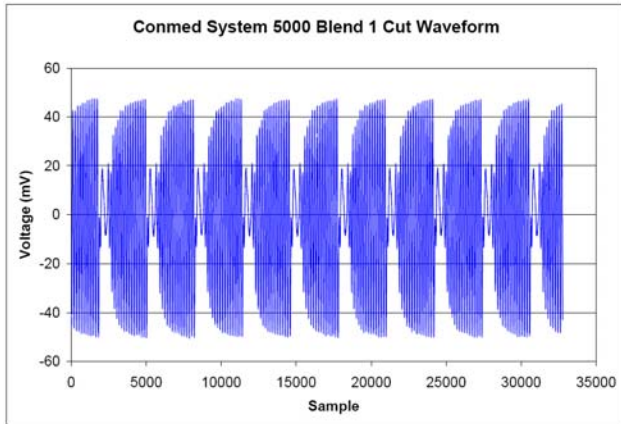
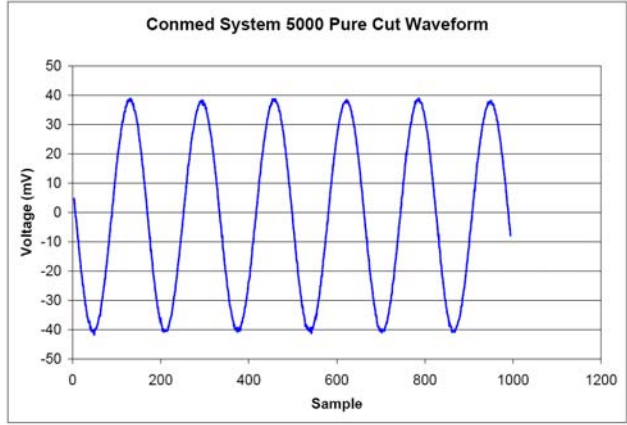
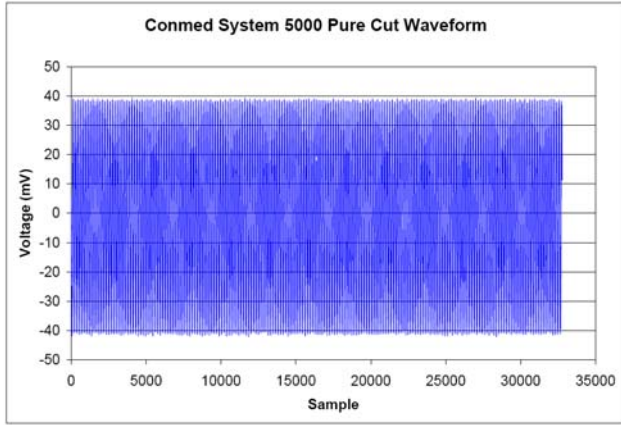

¹⁸ Graphed data shown in the left hand set of illustrations above was automatically created by Excel® as part of the normal data export from the ESU-2000 Series PC Utility Software. No user knowledge of Excel® for graphing purposes is required at this level. The graphs on the right were individually created within Excel® by the user, based upon the data exported from the ESU-2000 Series PC Utility Software.

APPENDIX G (Continued)

Conmed System 5000 Output Waveforms

(Source: BC Biomedical ESU-2000 Series PC Utility Software Excel® File Export¹⁹)

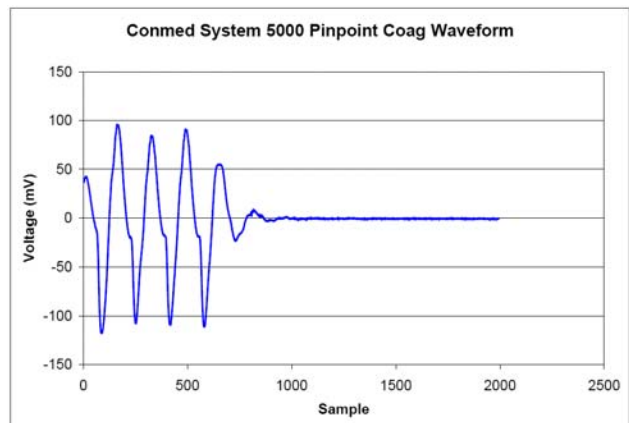
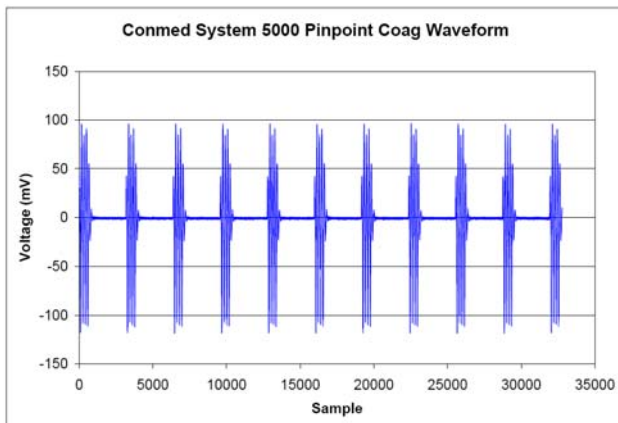
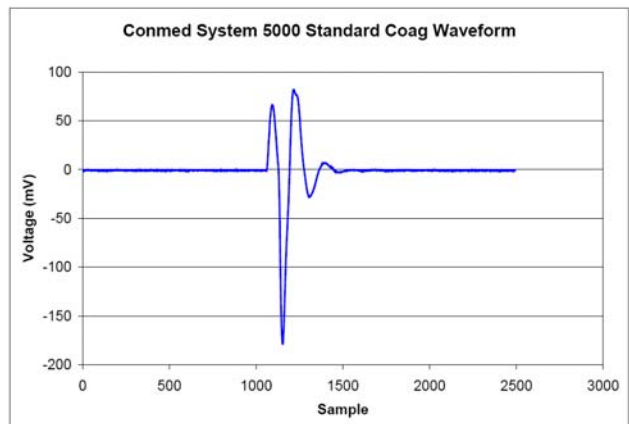
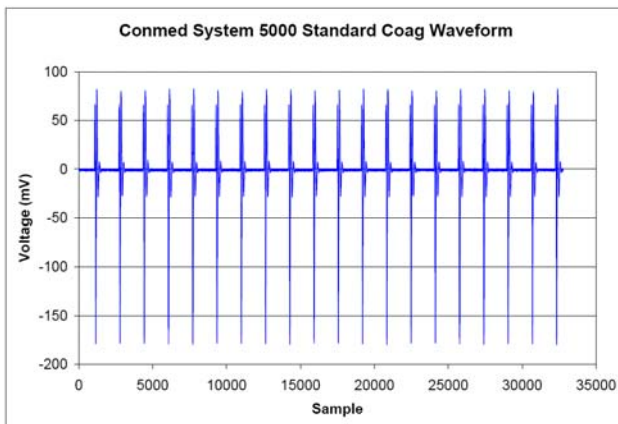
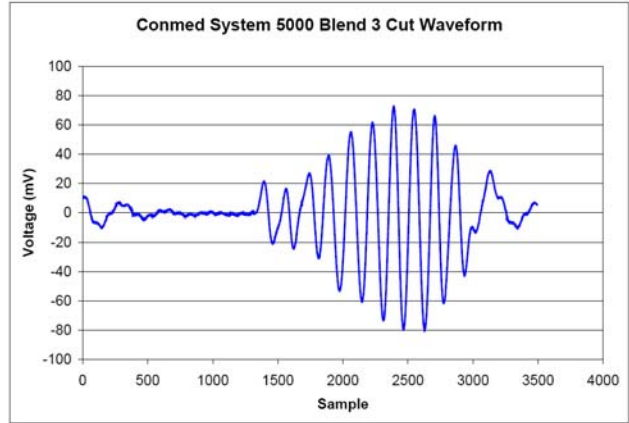
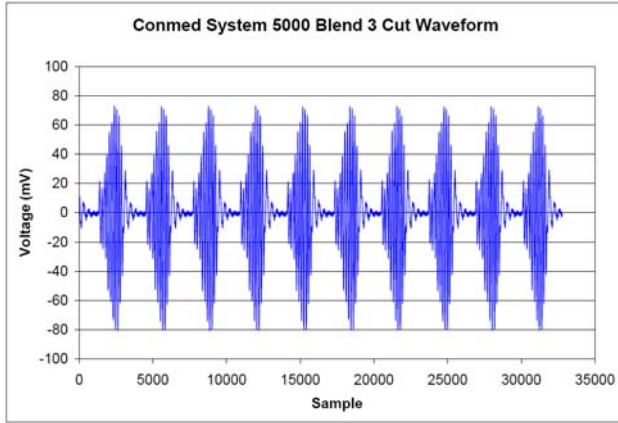

¹⁹ Graphed data shown in the left hand set of illustrations above was automatically created by Excel® as part of the normal data export from the ESU-2000 Series PC Utility Software. No user knowledge of Excel® for graphing purposes is required at this level. The graphs on the right were individually created within Excel® by the user, based upon the data exported from the ESU-2000 Series PC Utility Software.

APPENDIX G (Continued)

Conmed System 5000 Output Waveforms

(Source: BC Biomedical ESU-2000 Series PC Utility Software Excel[®] File Export²⁰)

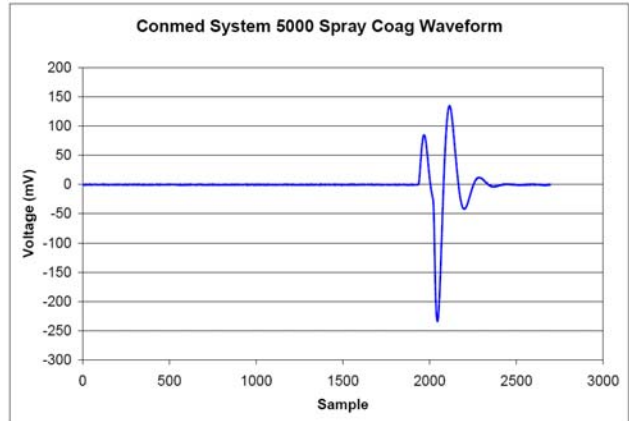
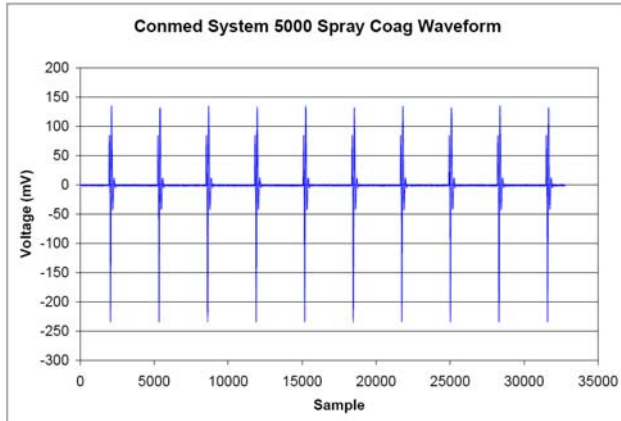

²⁰ Graphed data shown in the left hand set of illustrations above was automatically created by Excel[®] as part of the normal data export from the ESU-2000 Series PC Utility Software. No user knowledge of Excel[®] for graphing purposes is required at this level. The graphs on the right were individually created within Excel[®] by the user, based upon the data exported from the ESU-2000 Series PC Utility Software.

APPENDIX H

Pearson Electronics Model 411 Data Sheet

(Source: www.pearsonelectronics.com)

PEARSON ELECTRONICS, INC.

PEARSON™ CURRENT MONITOR MODEL 411

Sensitivity	0.1 Volt/Ampere +1/-0%
Output resistance	50 Ohms
Maximum peak current	5000 A
Maximum rms current	50 A
Drop rate	0.9 %/millisecond
Useable rise time	20 nanoseconds
Current time product	0.2 Ampere-second max*
Low frequency 3dB point	1 Hz (approximate)
High frequency 3dB point	20 MHz (approximate)
I/f figure	0.6 peak Amperes/Hz
Output connector	BNC (UG-290A/U)
Operating temperature	0 to 65 °C
Weight	8.3 ounces

* Maximum current-time product can be obtained by using core-reset bias as described in the *Application Notes*. 0.06 Ampere-second is typical without bias.

© 2002 Pearson Electronics, Inc. 411.wpd-021011

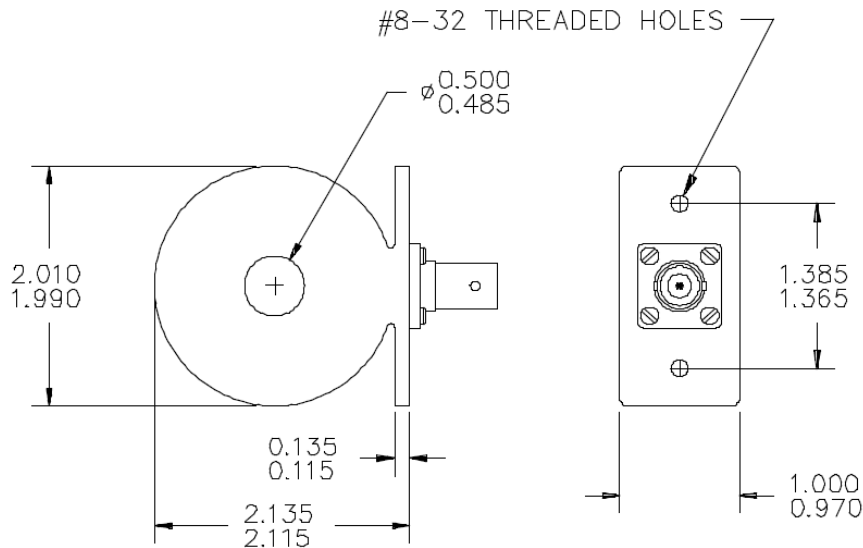

Pearson Electronics, Inc. • 4009 Transport Street • Palo Alto, CA 94303
Telephone 650-494-6444 • FAX 650-494-6716 • www.pearsonelectronics.com

Copyright June, 2007 by BC Group International, Inc.
Author: Michael R. Erwine
Revision 1 – June 13, 2007

APPENDIX I

Pearson Electronics Model 4100 Data Sheet

(Source: www.pearsonelectronics.com)

PEARSON ELECTRONICS, INC.

PEARSON™ CURRENT MONITOR MODEL 4100

Sensitivity	1 Volt/Ampere +1/-0%
Output resistance	50 Ohms
Maximum peak current	500 Amperes
Maximum rms current	5 Amperes
Droop rate	0.09 %/microsecond
Useable rise time	10 nanoseconds
Current time product	0.002 Amp-second max*
Low frequency 3dB point	140 Hz (approximate)
High frequency 3dB point	35 MHz (approximate)
I/f figure	0.006 peak Amperes/Hz
Output connector	BNC (UG-290A/U)
Operating temperature	0 to 65 °C
Weight	8.0 ounces

* Maximum current-time product can be obtained by using core-reset bias as described in the *Application Notes*.
0.0006 Ampere-second is typical without bias.

© 1999 Pearson Electronics, Inc. 4100.SPX_990506

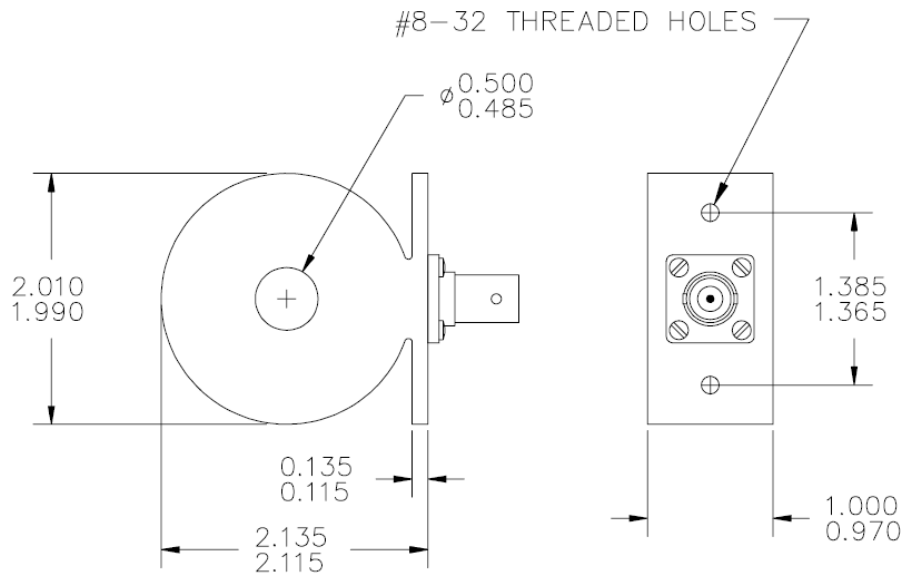

Pearson Electronics, Inc. • 4009 Transport Street • Palo Alto, CA 94303
Telephone 650-494-6444 • FAX 650-494-6716 • www.pearsonelectronics.com

Copyright June, 2007 by BC Group International, Inc.
Author: Michael R. Erwine
Revision 1 – June 13, 2007

APPENDIX J

Vishay Dale NH-250 Data Sheet

(Source: www.vishay.com)



RH, NH

Wirewound Resistors, Military, MIL-PRF-18546 Qualified,
Type RE, Aluminum Housed, Chassis Mount

Vishay Dale

DIMENSIONS

RH-5, -10, -25, -50
NH-5, -10, -25, -50

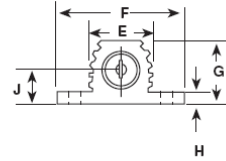
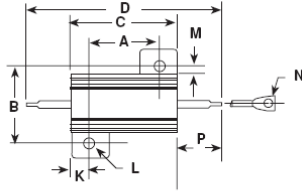

MODEL	DIMENSIONS in inches [millimeters]													
	A	B	C	D	E	F	G	H	J	K	L	M	N	P
RH-5 NH-5	0.444 ± 0.005 ± 0.127	0.490 ± 0.005 ± 0.127	0.600 ± 0.031 ± 0.787	1.125 ± 0.062 ± 1.57	0.334 ± 0.015 ± 0.381	0.646 ± 0.015 ± .381	0.320 ± 0.015 ± 0.381	0.065 ± 0.010 ± 0.254	0.133 ± 0.010 ± 0.254	0.078 ± 0.010 ± 0.254	0.093 ± 0.005 ± 0.127	0.078 ± 0.015 ± .381	0.050 ± 0.005 ± 0.127	0.266 ± 0.062 ± 1.57
RH-10 NH-10	0.562 ± 0.005 ± 0.127	0.625 ± 0.005 ± 0.127	0.750 ± 0.031 ± 0.787	1.375 ± 0.062 ± 1.57	0.420 ± 0.015 ± 0.381	0.800 ± 0.015 ± 0.381	0.390 ± 0.015 ± 0.381	0.075 ± 0.010 ± 0.254	0.165 ± 0.010 ± 0.254	0.093 ± 0.010 ± 0.254	0.094 ± 0.005 ± 0.127	0.102 ± 0.015 ± 0.381	0.085 ± 0.005 ± 0.127	0.312 ± 0.062 ± 1.57
RH-25 NH-25	0.719 ± 0.005 ± 0.127	0.781 ± 0.005 ± 0.127	1.062 ± 0.031 ± 0.787	1.938 ± 0.062 ± 1.57	0.550 ± 0.015 ± .381	1.080 ± 0.015 ± 0.381	0.546 ± 0.015 ± 0.381	0.075 ± 0.010 ± 0.254	0.231 ± 0.010 ± 0.254	0.172 ± 0.010 ± 0.254	0.125 ± 0.005 ± 0.127	0.115 ± 0.015 ± 0.381	0.085 ± 0.005 ± 0.127	0.438 ± 0.062 ± 1.57
RH-50 NH-50	1.562 ± 0.005 ± 0.127	0.844 ± 0.005 ± 0.127	1.968 ± 0.031 ± 0.787	2.781 ± 0.062 ± 1.57	0.630 ± 0.015 ± 0.381	1.140 ± 0.015 ± 0.381	0.610 ± 0.015 ± 0.381	0.088 ± 0.010 ± 0.254	0.260 ± 0.010 ± 0.254	0.196 ± 0.010 ± 0.254	0.125 ± 0.005 ± 0.127	0.107 ± 0.015 ± 0.381	0.085 ± 0.005 ± 0.127	0.438 ± 0.062 ± 1.57

RH-100, NH-100

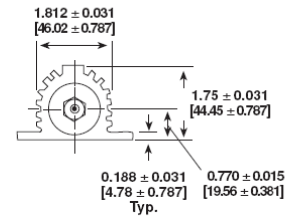
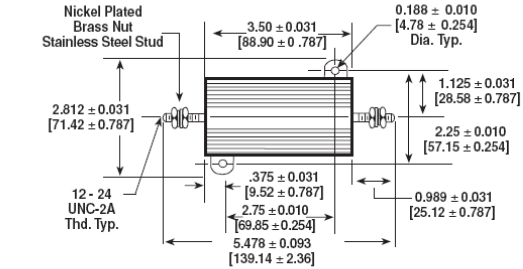

RH-250, NH-250

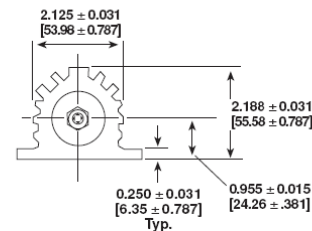
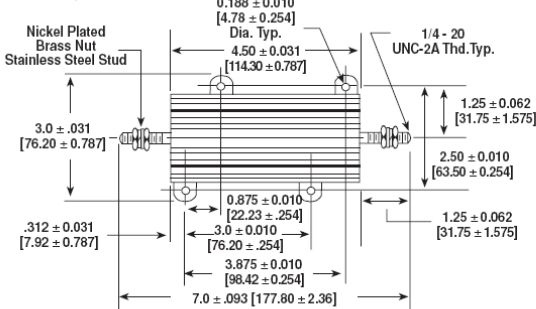

Document Number 30201
Revision 09-Sep-04

For technical questions, contact ww2bresistors@vishay.com

www.vishay.com
123

Copyright June, 2007 by BC Group International, Inc.
Author: Michael R. Erwine
Revision 1 – June 13, 2007

APPENDIX J (Continued)

Vishay Dale NH-250 Data Sheet

(Source: www.vishay.com)

RH, NH

Vishay Dale Wirewound Resistors, Military, MIL-PRF-18546 Qualified, Type RE, Aluminum Housed, Chassis Mount



TECHNICAL SPECIFICATIONS		
PARAMETER	UNIT	RH RESISTOR CHARACTERISTICS
Temperature Coefficient	ppm/°C	± 100 for 0.1Ω to 0.99Ω, ± 50 for 1Ω to 9.9Ω, ± 20 for 10Ω and above
Dielectric Withstanding Voltage	V _{AC}	1000 for RH-5, RH-10 and RH-25, 2000 for RH-50, 4500 for RH-100 and RH-250
Short Time Overload	-	5 x rated power for 5 seconds
Maximum Working Voltage	V	(P X R) ^{1/2}
Insulation Resistance	Ω	10,000 Megohm minimum dry, 1000 Megohm minimum after moisture test
Terminal Strength	lb	5 minimum for RH-5 and RH-10, 10 minimum for all others
Solderability	-	MIL-PRF-18546 Type - Meets requirements of ANSI J-STD-002
Operating Temperature Range	°C	- 55/+ 250

POWER RATING

Vishay RH resistor wattage ratings are based on mounting to the following heat sink:

- RH-5 and RH-10: 4" x 6" x 2" x 0.040" thick aluminum chassis (129 sq. in. surface area)
- RH-25: 5" x 7" x 2" x 0.040" thick aluminum chassis (167 sq. in. surface area)
- RH-50: 12" x 12" x 0.059" thick aluminum panel (291 sq. in. surface area)
- RH-100 and RH-250: 12" x 12" x 0.125" thick aluminum panel (294 sq. in. surface area)

AMBIENT TEMPERATURE DERATING

Derating is required for ambient temperatures above 25°C, see the following graph.

Curves A, B, C apply to operation of unmounted resistors. Curve D applies to all types when mounted to specified heat sink.

A = RH-5 and RH-10 size resistor, unmounted

B = RH-25 size resistor, unmounted

C = RH-50, RH-100 and RH-250 size resistor, unmounted

D = All types mounted to recommended aluminum heat sink

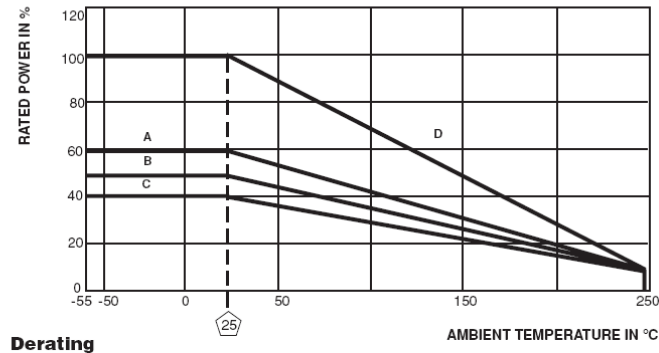

REDUCED HEAT SINK DERATING:

Derating is also required when recommended heat sink area is reduced.

A = RH-5 and RH-10 size resistor

B = RH-25 size resistor

C = RH-50, RH-100 and RH-250 size resistor

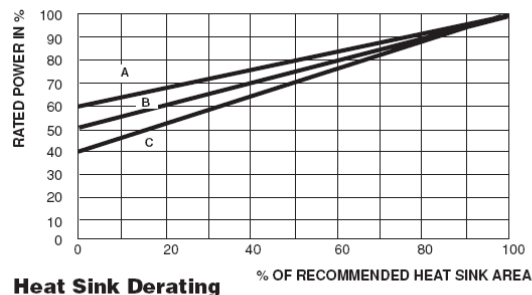

APPENDIX K

Sample Microsoft Excel® Data Export Workbook²¹ (Limited in format to what can be displayed on this page)

ESU-2050 Sampled Data

Date 4/3/2007
Time 12:10:53 PM

Sample	Voltage
1	-6.24609375
2	-3.123046875
3	-5.205078125
4	0
5	-7.287109375
6	-2.08203125
7	-2.08203125
8	-3.123046875
9	-6.24609375
10	-4.1640625
11	-9.369140625
12	-3.123046875
13	-5.205078125
14	-3.123046875
15	-4.1640625
16	-7.287109375
17	-2.08203125
18	-1.041015625
19	-6.24609375
20	-1.041015625
21	-5.205078125
22	-2.08203125
23	-6.24609375
24	-3.123046875
25	-2.08203125
26	-10.41015625
27	-2.08203125
28	-4.1640625
29	-8.328125
30	-1.041015625
31	-5.205078125
32	-6.24609375
33	-3.123046875
34	-6.24609375
35	-6.24609375
36	-7.287109375
37	-2.08203125
38	-3.123046875
39	-5.205078125

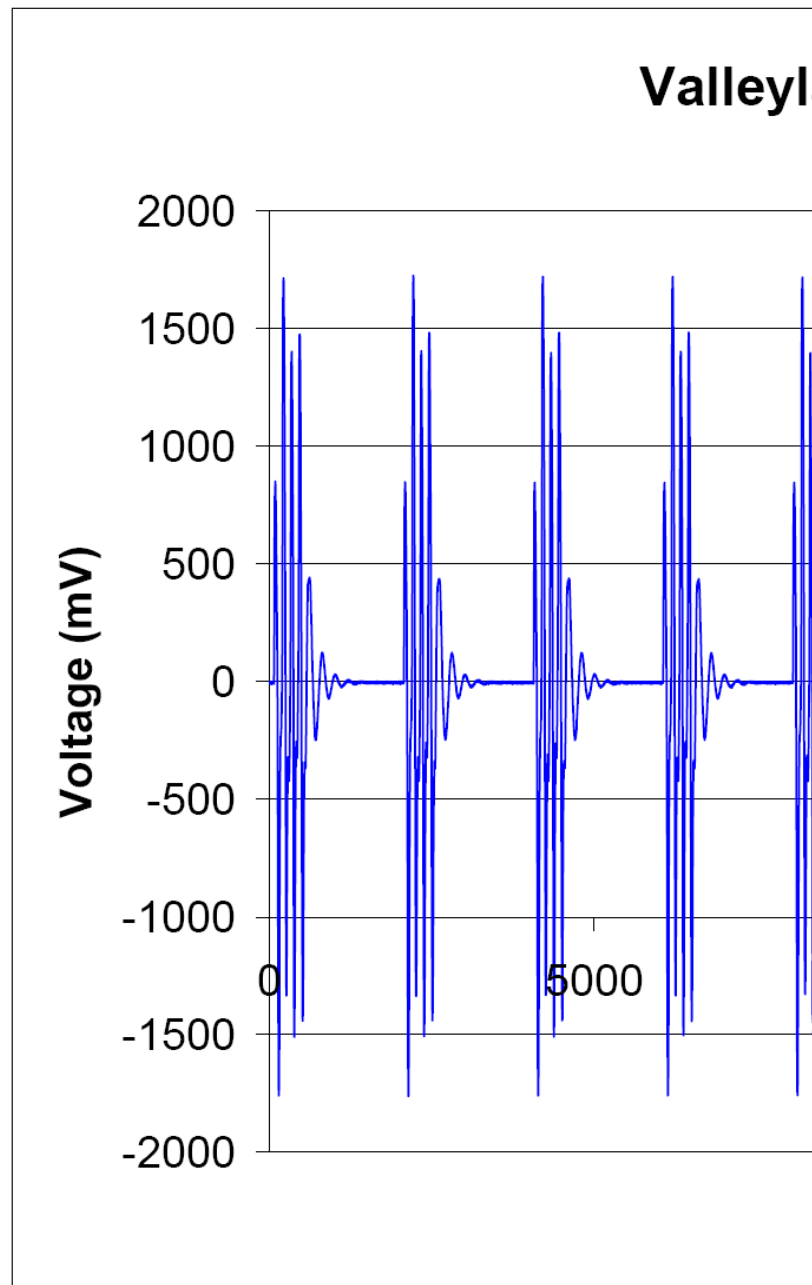

²¹ The illustration above shows the left hand portion of a graph that is automatically created during the data export process from the ESU-2000 PC Utility Software. No knowledge of Excel® is required to get this data and the resulting graph into Excel®. The measurement data shown above is abbreviated for illustration purposes. The actual Excel® spreadsheet created by the data export function contains a total of 32,768 rows of actual measurement data. Excel® file size is approximately 1.5 MB.

APPENDIX L

Valleylab Recommended Test Procedure²² (Source: Valleylab Force 2 Electrosurgical Generator Service Manual)

Recommended Test Equipment

Recommended Test Equipment

You will need the following equipment to perform the checks and calibration described in this section. If you use substitute equipment, it must meet or exceed the specifications of the recommended equipment.

- Tektronix type 465 Oscilloscope, or equivalent, with 50 MHz or greater band width
- Tektronix type P6015A High Voltage Probe
- Tektronix type P6009 100X Probe
- Simpson Model 1339 RMS RF Ammeter, 0-250 mA
- Wattmeter, 0-500 W 300 ohm load and 100 ohm load with reactive phase angle of less than 20 degrees at 500 kHz
- Variable Resistor 0 to 150 ohms
- Fluke Model 8920A True RMS Meter
- Pearson Model 411 Wideband Current Transformer
- Dale NH250 1% Noninductive Load Resistors
- Line Frequency Leakage Current Test Load (1k ohm parallel 0.15 μ F)
- 30 pF \pm 20%, 6kV Ceramic Capacitor.

Power Up Self-Test

Plug the generator into a grounded receptacle (do not use extension cords and/or adapter plugs). Turn the power on using the On/Off switch on the rear panel.

The generator will conduct an internal self test during which a tone sounds, digital displays show "8"s, and indicators illuminate. Ensure that all digit segments, mode, alert, and power indicators illuminate. If any of these indicators do not illuminate, return the generator for service.

In five to seven seconds following the self test, the generator enters the standby mode with the digital displays showing dashes.

Press the **READY** button to place the generator into service. The power setting displays indicate one watt, and the **MONOPOLAR FOOTSWITCH** indicator illuminates.

Maintenance Procedures

²² For their Force 2 Electrosurgical Generator, Valleylab recommends a current sensing test setup utilizing a Pearson Electronics Model 411 current transformer and Dale NH-250 precision resistors. The Fluke 8920A is no longer available and is being replaced with the BC Biomedical ESU-2050.

APPENDIX L (Continued)

Valleylab Recommended Test Procedure²³ (Source: Valleylab Ligasure Vessel Sealing Generator Service Manual)

Testing the Generator

Testing the Generator

Turning on the generator initiates an internal self-test to verify the calibration and the operation of the speaker, all indicators, the displays, and some internal components.

Warning

Use the generator only if the self-test has been completed as described. Otherwise, inaccurate power outputs may result.

To test the generator, follow this procedure:

1. Turn on the generator by pressing the front panel On (I) switch. Verify the following:
 - All visual indicators and displays on the front panel illuminate.
 - Activation tones sound to verify that the speaker is working properly.
2. *If the self-test is successful*, a tone sounds. Verify the following:
 - The macrobipolar and bipolar displays each show a power setting of one watt.
 - The seal display shows one amber bar illuminated.

If the self-test is not successful, an alarm tone sounds. A number may momentarily appear in the bipolar display and, in most cases, the generator shuts down. Note the number and refer to "Responding to System Alarms" in Section 6.

If you removed and/or replaced the battery, alarm number 105 may appear in the bipolar display when you turn on the generator. If this happens, calibrate the generator.

Confirming Outputs

Use this procedure to ensure the accuracy of the generator. Always confirm the output

- After calibrating the generator
- or
- Every six months

Equipment

- Valleylab smart connector adapter (P/N LS 0500) required to confirm RF output
- Valleylab bipolar forceps cord (E0509)
- Current transformer, Pearson 411
- True RMS voltmeter (such as the Fluke 8920 or equivalent)
- 10, 100, 200, 500, and 1000 ohm 1% noninductive power resistors
- Bipolar footswitch

²³ For their Ligasure Vessel Sealing Generator, Valleylab recommends a current sensing test setup utilizing a Pearson Electronics Model 411 current transformer and Dale NH-250 precision resistors. The Fluke 8920A is no longer available and is being replaced with the BC Biomedical ESU-2050.

APPENDIX L (Continued)

Valleylab Recommended Test Procedure²⁴ (Source: Valleylab Force FX-C Electrosurgical Generator Service Manual)

Periodic Safety Check

6. Press the Macro (Macrobipolar) button and repeat step 4.
7. Verify that the generator output for each mode is 315 ± 24 mA rms.
If the output is outside the specified range, calibrate the bipolar output as described in calibration steps 5, 6, 7, and 8. Then repeat this procedure. If the output for one or more modes remains outside the specified range, call the Valleylab Service Center.

Checking the Monopolar Output

Step 1 – Check the Output for the Cut Modes

- A. Verify that the generator successfully completes the self-test as described in *Testing the Generator* in this section.
- B. Connect the test equipment for monopolar output.
 - (1) Connect one test cable to the left jack in the Monopolar 1/CEM Instrument receptacle. Pass the test cable through the current transformer and connect the current transformer to the voltmeter.
 - (2) Use a test cable to short the two pins on the Patient Return Electrode receptacle.
 - (3) Connect the second test cable from the voltmeter to both pins of the Patient Return Electrode receptacle.
 - (4) Connect the 300 ohm resistor across the output jacks at the end of the test cables.
 - (5) Connect the monopolar footswitch to the Monopolar 1 Footswitch receptacle on the rear panel of the generator.
- C. Press the Pure button.
- D. Press the Cut up (Δ) or down (∇) arrow buttons to set the cut power to 75 watts.
- E. Test the monopolar cut output.
 - (1) Press the footswitch cut pedal and, while activating the generator, note the output on the voltmeter.
 - (2) Release the footswitch pedal.
 - (3) Based on the voltmeter setting and the current transformer you are using, calculate and record the output current.
- F. Press the Low cut button and repeat step 1.E.
- G. Press the Blend button and repeat step 1.E.
- H. Verify that the generator output for each mode is 499 ± 38 mA rms.
If the output is outside the specified range, calibrate the monopolar output as described in calibration steps 5, 6, 7, and 8. Then repeat this procedure. If the output for one or more cut modes remains outside the specified range, call the Valleylab Service Center.

²⁴ For their Force FX-C Electrosurgical Generator, Valleylab recommends a current sensing test setup utilizing a Pearson Electronics Model 411 current transformer and Dale NH-250 precision resistors. Measurement procedures are outlined as above. The Fluke 8920A is no longer available and is being replaced with the BC Biomedical ESU-2050.

APPENDIX M

ESU-2000 Series PC Utility Software Screen Shots²⁵

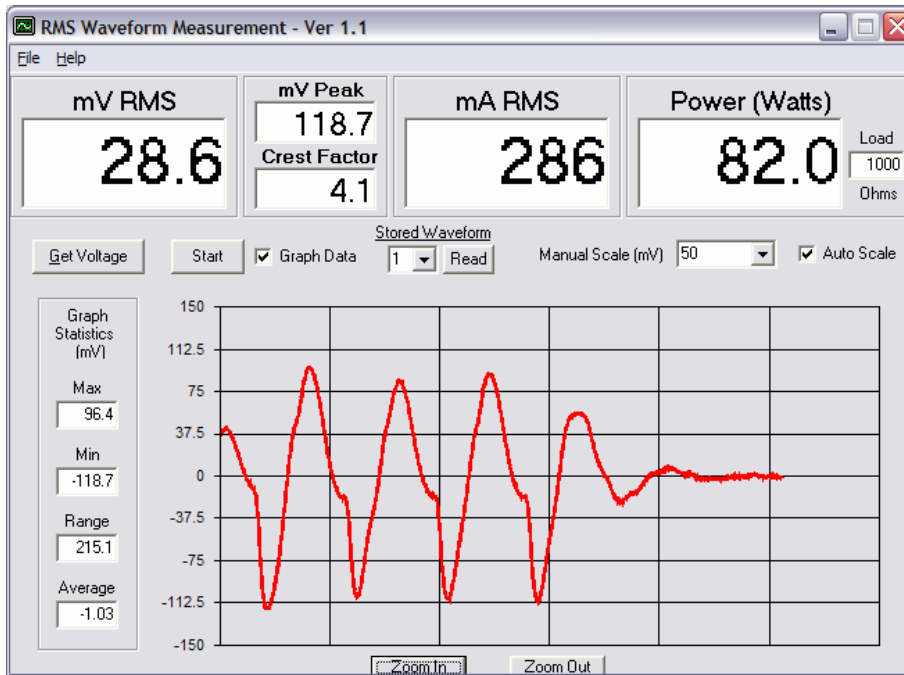
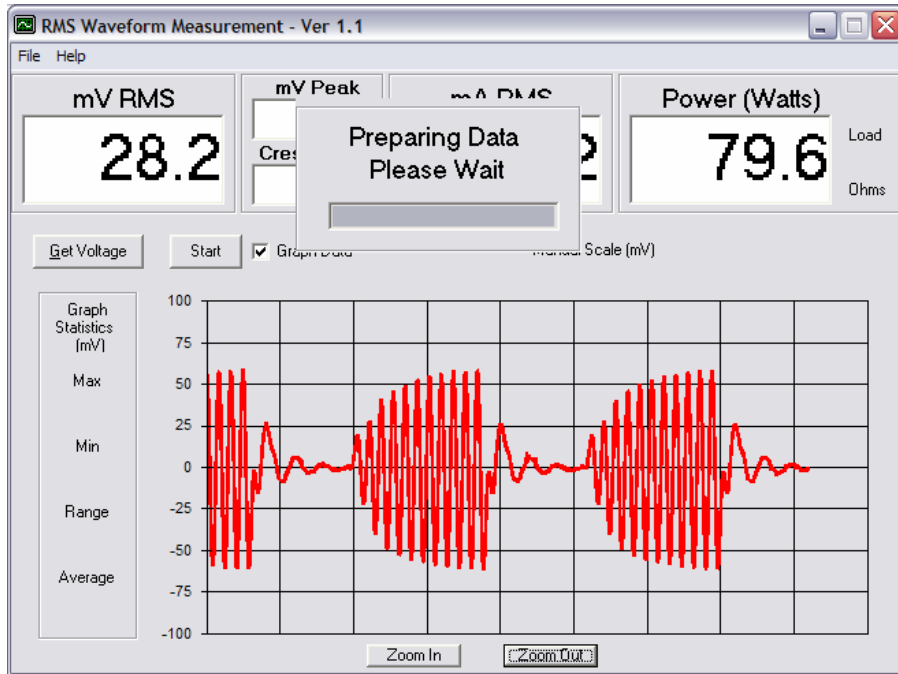

²⁵ Version 1.1 shown – software subject to change with new features and functionality added through routine updates.

APPENDIX M (Continued)

ESU-2000 Series PC Utility Software Screen Shots²⁶

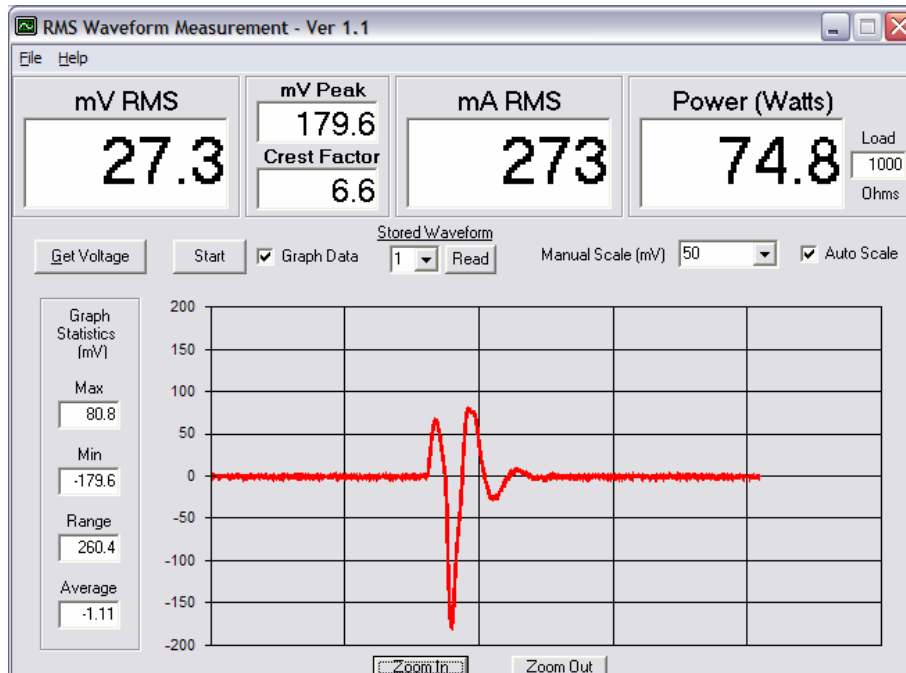
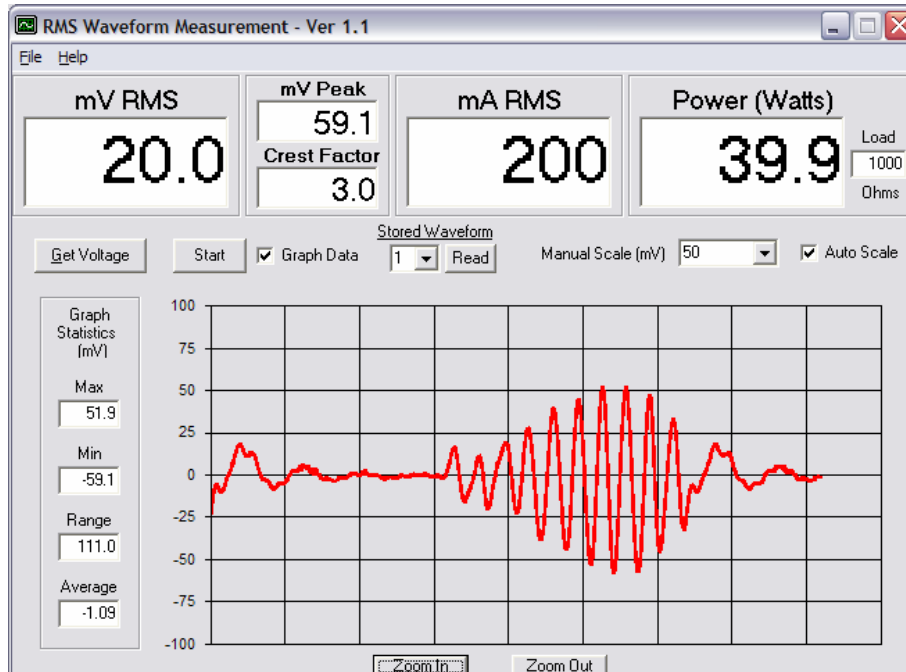

²⁶ Version 1.1 shown – software subject to change with new features and functionality added through routine updates.

APPENDIX M (Continued)

ESU-2000 Series PC Utility Software Screen Shots²⁷

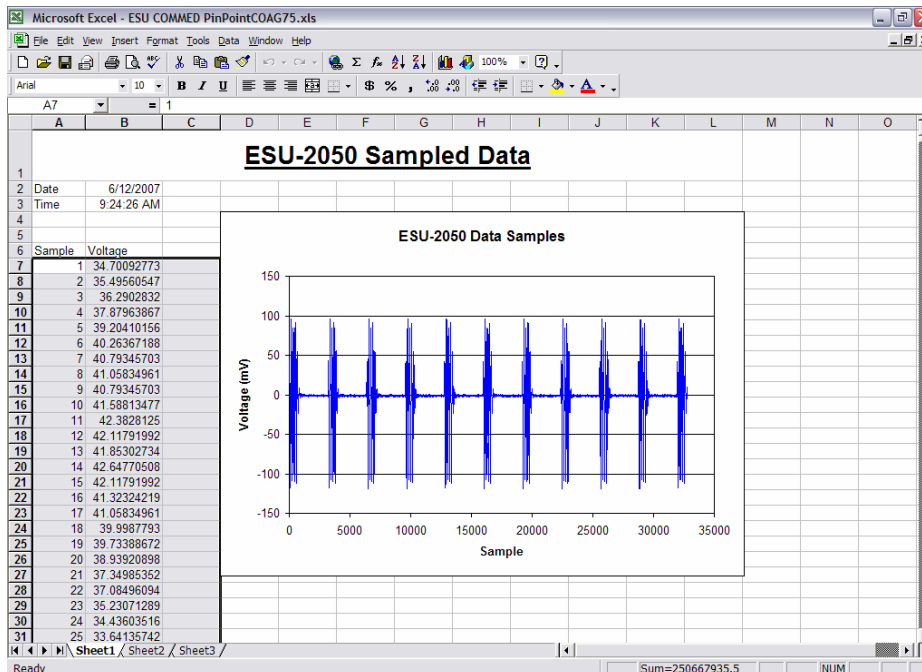
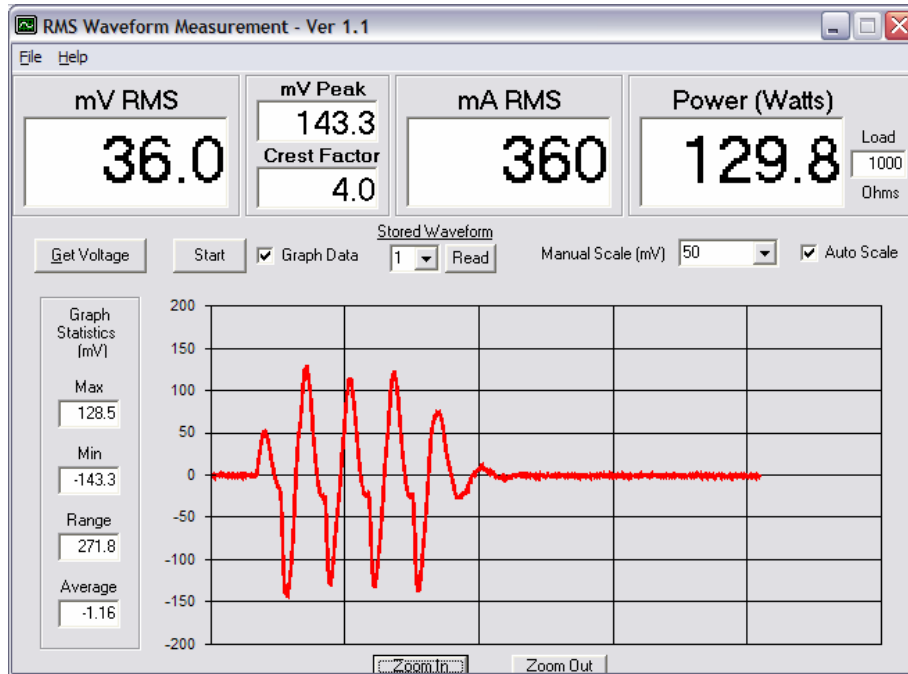

Microsoft Excel[®] File Screen Shot - See Footnote²⁸

²⁷ Version 1.1 shown – software subject to change with new features and functionality added through routine updates.

²⁸ After the ESU waveform is exported from The ESU-2000 Series PC Utility Software to Microsoft Excel[®], this file is automatically created. No user knowledge of Microsoft Excel[®] is required to create this file or the accompanying graph.

APPENDIX N

History of BC Group International, Inc.

BC Group was founded in 1988. The company was formed as a sales and service organization to handle the test equipment needs of the worldwide biomedical engineering community.

Originally, BC Group sold only test equipment manufactured by other companies. Then, in 2000, we began manufacturing our own product line under the now familiar Green and Gold BC Biomedical brand.

In January of 2005, Lloyd Industries, the company that engineered and manufactured most of BC Biomedical brand products, purchased BC Group. This acquisition has allowed our products and services to expand at an even faster pace. BC Group, under the "BC Biomedical" brand, is now the second largest manufacturer of biomedical test and measurement equipment in the world.

Our philosophy with BC Biomedical products runs counter to the current trend of "one-size-fits-all". We offer families of products that provide the users with a choice of models so they can pick the features they need and at a price they can afford.

We are working closely with leading medical device manufacturers worldwide, in the continuing development of new and innovative test and measurement products for the biomedical engineering community. For 2007, our new ESU-2000 Family of Electrosurgery Analyzers and our new ULT-2000 Series of Ultrasound Electrical Leakage Current Testers are just the latest evidence of this important collaboration with medical device manufacturers worldwide. We have a lot more in store for the future, so keep checking our website for the latest additions to the BC Biomedical product line.



Website: www.bcgrouptl.com
E-mail: merwine@bcgrouptl.com

Copyright June, 2007 by BC Group International, Inc.
Author: Michael R. Erwine
Revision 1 – June 13, 2007