

ETSI TS 102 820 V1.2.1 (2005-10)

Technical Specification

Digital Radio Mondiale (DRM); Multiplex Distribution Interface (MDI)

European Broadcasting Union



Union Européenne de Radio-Télévision

EBU·UER



Reference

RTS/JTC-DRM-12

Keywords

broadcasting, digital, DRM, MUX, radio

ETSI

650 Route des Lucioles
F-06921 Sophia Antipolis Cedex - FRANCE

Tel.: +33 4 92 94 42 00 Fax: +33 4 93 65 47 16

Siret N° 348 623 562 00017 - NAF 742 C
Association à but non lucratif enregistrée à la
Sous-Préfecture de Grasse (06) N° 7803/88

Important notice

Individual copies of the present document can be downloaded from:

<http://www.etsi.org>

The present document may be made available in more than one electronic version or in print. In any case of existing or perceived difference in contents between such versions, the reference version is the Portable Document Format (PDF). In case of dispute, the reference shall be the printing on ETSI printers of the PDF version kept on a specific network drive within ETSI Secretariat.

Users of the present document should be aware that the document may be subject to revision or change of status. Information on the current status of this and other ETSI documents is available at

<http://portal.etsi.org/tb/status/status.asp>

If you find errors in the present document, please send your comment to one of the following services:

http://portal.etsi.org/chaicor/ETSI_support.asp

Copyright Notification

No part may be reproduced except as authorized by written permission.
The copyright and the foregoing restriction extend to reproduction in all media.

© European Telecommunications Standards Institute 2005.

© European Broadcasting Union 2005.

All rights reserved.

DECT™, **PLUGTESTS™** and **UMTS™** are Trade Marks of ETSI registered for the benefit of its Members.
TIPHON™ and the **TIPHON logo** are Trade Marks currently being registered by ETSI for the benefit of its Members.
3GPP™ is a Trade Mark of ETSI registered for the benefit of its Members and of the 3GPP Organizational Partners.

Contents

Intellectual Property Rights	4
Foreword.....	4
Introduction	4
1 Scope	6
2 References	6
3 Definitions, symbols, abbreviations and conventions	6
3.1 Definitions	6
3.2 Symbols.....	8
3.3 Abbreviations	8
3.4 Conventions.....	8
4 General description.....	9
4.1 System overview	9
4.2 System architecture	9
4.2.1 TAG items and packets (informative).....	10
5 TAG items	10
5.1 Mandatory TAG items.....	11
5.1.1 Protocol type and revision (*ptr)	12
5.1.2 DRM logical frame count (dlfc)	12
5.1.3 Fast access channel (fac_).....	13
5.1.4 Service description channel (sdc_)	13
5.1.5 Service description channel information (sdc_i).....	14
5.1.6 Robustness mode (robm)	14
5.1.7 Stream <n> (str0, str1, str2 and str3)	15
5.2 Optional TAG items	15
5.2.1 Information (info)	15
5.2.2 Timestamp (tist).....	16
5.3 Revision history.....	16
Annex A (informative): Typical DRM networks	17
Annex B (informative): DRM Timestamps.....	18
B.1 Relationships	18
B.2 Rationale.....	18
Annex C (normative): Physical presentation.....	19
Annex D (normative): MDI switching mechanism.....	20
D.1 Scenario examples.....	20
D.2 MDI Configuration Announcement Packets	21
D.3 Timing diagram example.....	22
History	23

Intellectual Property Rights

IPRs essential or potentially essential to the present document may have been declared to ETSI. The information pertaining to these essential IPRs, if any, is publicly available for **ETSI members and non-members**, and can be found in ETSI SR 000 314: "*Intellectual Property Rights (IPRs); Essential, or potentially Essential, IPRs notified to ETSI in respect of ETSI standards*", which is available from the ETSI Secretariat. Latest updates are available on the ETSI Web server (<http://webapp.etsi.org/IPR/home.asp>).

Pursuant to the ETSI IPR Policy, no investigation, including IPR searches, has been carried out by ETSI. No guarantee can be given as to the existence of other IPRs not referenced in ETSI SR 000 314 (or the updates on the ETSI Web server) which are, or may be, or may become, essential to the present document.

Foreword

This Technical Specification (TS) has been produced by Joint Technical Committee (JTC) Broadcast of the European Broadcasting Union (EBU), Comité Européen de Normalisation ELECTrotechnique (CENELEC) and the European Telecommunications Standards Institute (ETSI).

NOTE: The EBU/ETSI JTC Broadcast was established in 1990 to co-ordinate the drafting of standards in the specific field of broadcasting and related fields. Since 1995 the JTC Broadcast became a tripartite body by including in the Memorandum of Understanding also CENELEC, which is responsible for the standardization of radio and television receivers. The EBU is a professional association of broadcasting organizations whose work includes the co-ordination of its members' activities in the technical, legal, programme-making and programme-exchange domains. The EBU has active members in about 60 countries in the European broadcasting area; its headquarters is in Geneva.

European Broadcasting Union
CH-1218 GRAND SACONNEX (Geneva)
Switzerland
Tel: +41 22 717 21 11
Fax: +41 22 717 24 81

Introduction

The frequency bands used for broadcasting below 30 MHz are:

- Low Frequency (LF) band - from 148,5 kHz to 283,5 kHz, in ITU Region 1 [1] only;
- Medium Frequency (MF) band - from 526,5 kHz to 1 606,5 kHz, in ITU Regions 1 [1] and 3 [1] and from 525 kHz to 1 705 kHz in ITU Region 2 [1];
- High Frequency (HF) bands - a set of individual broadcasting bands in the frequency range 2,3 MHz to 27 MHz, generally available on a Worldwide basis.

These bands offer unique propagation capabilities that permit the achievement of:

- large coverage areas, whose size and location may be dependent upon the time of day, season of the year or period in the (approximately) 11 year sunspot cycle;
- portable and mobile reception with relatively little impairment caused by the environment surrounding the receiver.

There is thus a desire to continue broadcasting in these bands, perhaps especially in the case of international broadcasting where the HF bands offer the only reception possibilities which do not also involve the use of local repeater stations.

However, broadcasting services in these bands:

- use analogue techniques;
- are subject to limited quality;
- are subject to considerable interference as a result of the long-distance propagation mechanisms which prevail in this part of the frequency spectrum and the large number of users.

As a direct result of the above considerations, there is a desire to effect a transfer to digital transmission and reception techniques in order to provide the increase in quality which is needed to retain listeners who, increasingly, have a wide variety of other programme reception media possibilities, usually already offering higher quality and reliability.

In order to meet the need for a digital transmission system suitable for use in all of the bands below 30 MHz, the Digital Radio Mondiale (DRM) consortium was formed in early 1998. The DRM consortium is a non-profit making body which seeks to develop and promote the use of the DRM system worldwide. Its members include broadcasters, network providers, receiver and transmitter manufacturers and research institutes. More information is available from their website (<http://www.drm.org/>).

1 Scope

The present document gives the specification for the link between a Digital Radio Mondiale (DRM) Multiplexer and a DRM Modulator.

2 References

The following documents contain provisions which, through reference in this text, constitute provisions of the present document.

- References are either specific (identified by date of publication and/or edition number or version number) or non-specific.
- For a specific reference, subsequent revisions do not apply.
- For a non-specific reference, the latest version applies.

Referenced documents which are not found to be publicly available in the expected location might be found at <http://docbox.etsi.org/Reference>.

[1] ETSI ES 201 980: "Digital Radio Mondiale (DRM); System Specification".

NOTE: Clause numbers, where quoted, refer to ES 201 980 (V1.2.2).

[2] ETSI TS 102 821: "Digital Radio Mondiale (DRM); Distribution and Communications Protocol (DCP)".

[3] ISO/IEC 10646: "Information technology - Universal Multiple-Octet Coded Character Set (UCS)".

[4] ETSI TS 102 358: "Digital Radio Mondiale (DRM); Specific Restrictions for the use of the Distribution and Communication Protocol (DCP)".

3 Definitions, symbols, abbreviations and conventions

3.1 Definitions

For the purposes of the present document, the following terms and definitions apply:

Alternative Frequency Switching (AFS): feature of the DRM multiplex which allows receivers to automatically re-tune to a frequency offering more reliable reception without a break in the decoded audio

byte: collection of 8-bits

Distribution and Communication Protocol (DCP): transport layer communications protocol providing fragmentation, addressing and/or reliable data transmission over errored channels using a Reed Solomon code to provide Forward Error Correction (FEC)

Fast Access Channel (FAC): channel of the multiplex data stream that contains the information that is necessary to find services and begin to decode the multiplex

Greenwich Mean Time (GMT): historically the standard time for all international applications, now superseded by UTC

Global Position System (GPS): constellation of satellites providing accurate time and position information to receivers

GPS Time: time signal broadcast by the GPS satellites using an epoch of January 6th 1980 with no leap seconds and a "week number" (actually a modulo-604 800 seconds number) that wraps every 1 024 weeks (approximately 19,7 years)

logical frame: contains data of one stream during 400 ms

multiplex frame: logical frames from all streams form a multiplex frame (duration of 400 ms)

NOTE: It is the relevant basis for coding and interleaving.

Main Service Channel (MSC): channel of the multiplex data stream which occupies the major part of the transmission frame and which carries all the digital audio services, together with possible supporting and additional data services

MDI Packet: A TAG: packet containing those TAG Items as defined in TS 102 820

Modified Julian Date (MJD): date format based on the number of days since midnight GMT on 17th November 1858 AD

NOTE: Time can be represented as a fraction of a day, however as MJD is subject to leap seconds, the fractional part corresponding to an SI second is of variable size and hence complex to implement in a fixed width bit-field.

Multi-Frequency Network (MFN): network of transmitters serving a large geographic area using different radio frequencies to achieve improved reliability of reception

NOTE: The transmitters might not be synchronized in time (non-synchronized MFN, see annex A), and so the AFS feature of DRM may not operate correctly.

Service Description Channel (SDC): channel within the multiplex data stream that gives information necessary to decode the services included in the multiplex

NOTE: The SDC also provides additional information to enable a receiver to find alternate sources of the same data.

Single Frequency Network (SFN): network of transmitters sharing the same radio frequency to cover a large area

Synchronized Multi-Frequency Network (SMFN): network of transmitters serving a large geographic area using different radio frequencies to achieve improved reliability of reception

NOTE: The transmitters are synchronized in time to allow the AFS feature of the transmitted signal to operate correctly.

TAG Item: DCP elemental type combining in a single logical data the name, length and value of the data

TAG Name: name field within an individual TAG Item used to identify an individual piece of information

TAG Packet: collection of TAG Items with a header carrying a cohesive and self-contained block of data

TAG Value: payload of a TAG Item

International Atomic Time (literally Temps Atomique International) (TAI): time format counting in standard SI seconds

NOTE: TAI and GPS Time have a constant offset of 19 s.

transmission frame: number of consecutive OFDM symbols (duration of 400 ms), wherein the first OFDM symbol contains the frame synchronization cells

transmission super-frame: three consecutive transmission frames (duration of 1 200 ms), wherein the first OFDM symbols contain the SDC block

Coordinated Universal Time (literally Universel Temps Coordonné) (UTC): time format counting in standard SI seconds with periodic adjustments made by the addition (or removal) of leap seconds to keep the difference between UTC and Astronomical Time less than $\pm 0,9$ s

NOTE: TAI and UTC were defined as having an initial offset of 10 s on January 1st 1972 (TAI prior to this date had a variable fractional offset to UTC as the two times did not use the same definition of the second). As at 25th February 2003 there have been 22 leap seconds, all positive, making TAI = UTC + 32.

3.2 Symbols

For the purposes of the present document, the following symbols apply:

N_x The value "N" is expressed in radix "x". The radix of "x" shall be decimal, thus $2A_{16}$ is the hexadecimal representation of the decimal number 42.

3.3 Abbreviations

For the purposes of the present document, the following abbreviations apply:

AF	Application Framing
AFS	Alternative Frequency Switching
BOOTP	BOOT Protocol
CRC	Cyclic Redundancy Check
DCP	Distribution and Communication Protocol
DHCP	Dynamic Host Configuration Protocol
DRM	Digital Radio Mondiale
FAC	Fast Access Channel
FEC	Forward Error Correction
GMT	Greenwich Mean Time
GPS	Global Positioning System
HF	High Frequency
IP	Internet Protocol
ISO	International Organization for Standardization
LF	Low Frequency
LSb	Least Significant bit
LSB	Least Significant Byte
MDI	Multiplex Distribution Interface
MF	Medium Frequency
MFN	Multi-Frequency Network
MJD	Modified Julian Date
MSb	Most Significant bit
MSB	Most Significant Byte
MSC	Main Service Channel
OFDM	Orthogonal Frequency Division Multiplexing
RF	Radio Frequency
rfu	reserved for future use
SDC	Service Description Channel
SFN	Single Frequency Network
SMFN	Synchronized Multi-Frequency Network
TAG	Tag, Length, Value
TAI	International Atomic Time (Temps Atomique International)
UDP	User Datagram Protocol
UTC	Co-ordinated Universal Time (Universel Temps Coordonnée)

3.4 Conventions

The order of bits and bytes within each description shall use the following notation unless otherwise stated:

- in figures, the bit or byte shown in the left hand position is considered to be first;
- in tables, the bit or byte shown in the left hand position is considered to be first;
- in byte fields, the Most Significant bit (MSb) is considered to be first and denoted by the higher number. For example, the MSb of a single byte is denoted "b₇" and the Least Significant bit (LSb) is denoted "b₀";
- in vectors (mathematical expressions), the bit with the lowest index is considered to be first.

4 General description

4.1 System overview

The Multiplex Distribution Interface carries the description of a complete DRM Multiplex from the equipment generating the data (the DRM Multiplex Generator) to the DRM Modulator in such a way that reliable networks of transmitters (MFN, SMFN and SFN) can be constructed. Typically the DRM Multiplex Generator will be sited at the studio centre, although some systems may locate it at the transmitter or at a third-party multiplex provider. The DRM Modulator will almost invariably be located at the transmitter site, and in many networks, several such sites will combine to form a comprehensive network using one or more RF channels.

4.2 System architecture

The protocol stack provided by the Distribution and Communication Protocols (TS 102 821 [2]) is described in figure 1. As can be seen, the Multiplex Distribution Interface as described in the present document builds upon the DCP stack, defining the TAG Items to be used and the format of the data carried. The result is a collection of TAG Items which can be carried in a single TAG packet and which together contain all the data necessary for the DRM Modulator to produce one logical frame (400 ms) of output. When carrying TAG Items conforming to the present document, a TAG Packet is known as an MDI Packet.

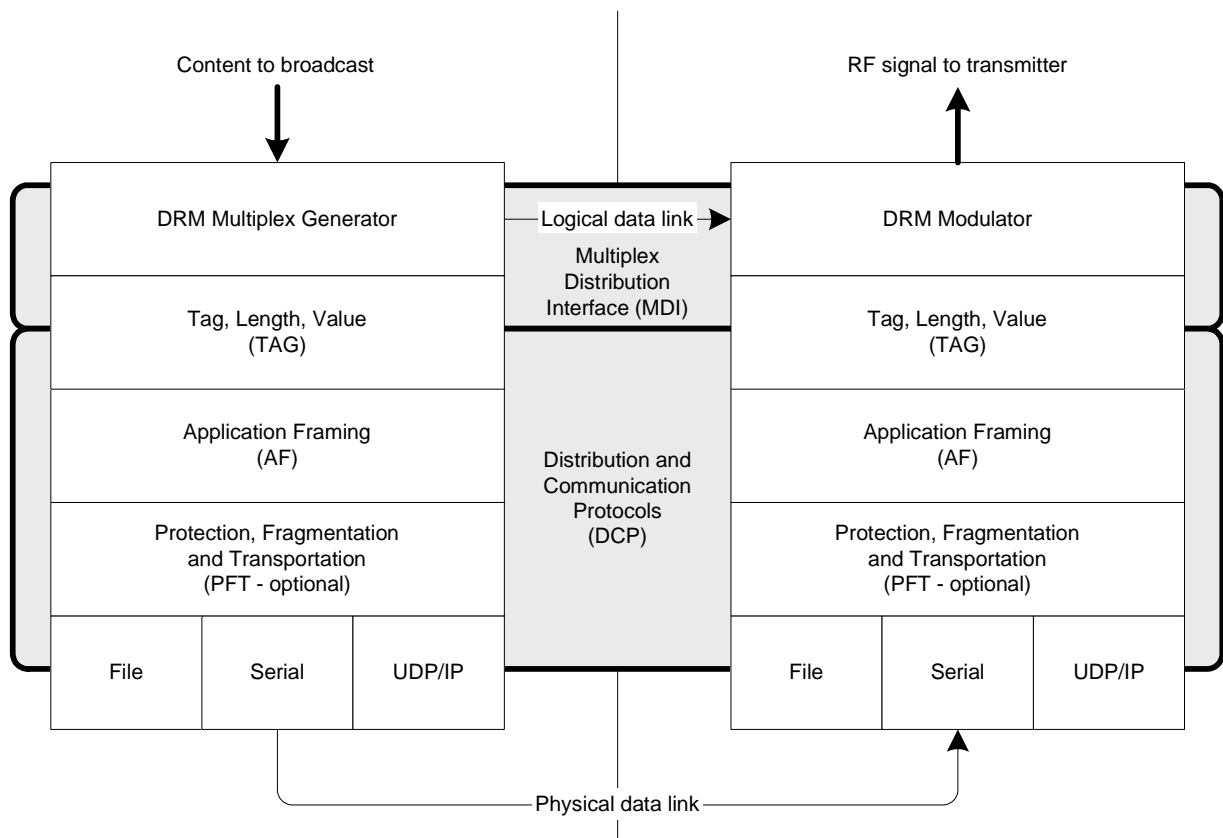

Figure 1: MDI and DCP protocol stack

A detailed description of:

- the DRM broadcast chain and its transmission protocols;
- supported hardware interfaces; and
- mandatory parameters and general restrictions to the general purpose Distribution & Communication Protocol ("DCP") for the use within DRM,

is given in the document TS 102 358 [4].

4.2.1 TAG items and packets (informative)

For ease of reference, the basic structure of a TAG Packet and the TAG Items it contains is described in figure 2. The normative definition is contained in TS 102 821 [2].

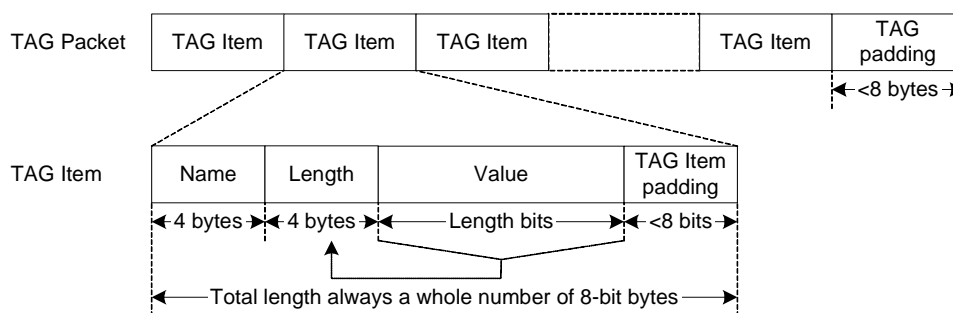

Figure 2: TAG Packets and TAG Item overview

5 TAG items

Each MDI Packet consists of a number of TAG Items where each TAG Item carries a single piece of information. When combined, the TAG Items present in one MDI Packet completely describe one DRM logical frame of 400 ms. Upon reception of an MDI Packet, one DRM transmission frame may be produced, or in combination with two other consecutive MDI Packets (as defined by the "dlfc" TAG item, see clause 5.1.2), a DRM transmission super-frame may be produced.

The FAC, SDC (if present) and MSC data carried within one MDI Packet belong together, and describe one DRM logical frame of 400 ms. For example: When the reconfiguration index after a reconfiguration announcement reaches 0 for the first time, the MSC data of the same MDI Packet is the first MSC data to be configured according to the updated FAC/SDC information.

In the case of short interleaving, the FAC, SDC and MSC from one MDI packet shall be broadcast within the same 400 ms DRM transmission frame (signal on air).

NOTE: Strictly, one frame's worth of MSC data is not confined exactly to one transmission frame even for short interleaving. Instead the first multiplex frame continues into the beginning of the second transmission frame and the second multiplex frame continues into the third transmission frame, because of the presence of the SDC symbols in the first frame. For the purposes of the above explanation the multiplex frame is equated with the transmission frame of the same index, i.e. the frame that carries most of the MSC cells of the multiplex frame.

In case of long interleaving, the DRM transmission frame (signal on air) containing a particular FAC information only carries the first part of the related MSC data of the same DRM logical frame. While the FAC (and optionally the SDC) information of the current DRM logical frame is fully transmitted within one DRM transmission frame of 400 ms, the corresponding MSC data is spread over the current plus the following 4 consecutive DRM transmission frames.

Within a single MDI Packet, each TAG Name shall be unique. No TAG Name may occur multiple times within a single MDI Packet.

Mandatory TAG Items must be supported by every MDI implementation, although not every Mandatory TAG Item will appear in every MDI Packet unless stated in the descriptions below.

The MDI also defines additional TAG Items which may be supported by some implementations - these are known as optional TAG Items and extend the basic MDI implementation. These TAG Items should be ignored without error by equipment not supporting the appropriate feature(s).

Additional proprietary TAG Items may be supported by individual implementations but do not form part of the MDI specification and should be ignored without error by equipment not recognizing the TAG Name. No MDI conformant equipment shall produce or require any additional information other than as described in the present document in order to work according to the DRM System Specification (ES 201 980 [1]).

5.1 Mandatory TAG items

Every DRM MDI implementation shall support the following TAG items.

Table 1: Mandatory TAG items

TAG Name (ASCII)	TAG Length (bits)	TAG Value
*ptr	64	Control TAG Item "Protocol Type and Revision"; see the DCP definition (TS 102 821 [2]) for format and interpretation details.
dlfc	32	DRM logical frame counter: this value identifies a single MDI Packet.
fac_	72	FAC data for one DRM logical frame (64 bits data + 8-bit-CRC). See the DRM System Specification (ES 201 980 [1]) for a full description.
sd_	variable	SDC data block for one DRM logical frame (incl. 16-bit-CRC). See the DRM System Specification (ES 201 980 [1]) for a full description.
sdci	32 (1 stream) 56 (2 streams) 80 (3 streams) 104 (4 streams)	SDC Information contains the complete "Multiplex Description Data Entity - type 0" as described in the DRM System Specification (ES 201 980 [1]).
robm	8	Current robustness mode; Encoding: 0x00 = Mode A; 0x01 = Mode B; 0x02 = Mode C; 0x03 = Mode D.
str0	variable	The data for MSC stream 0 for one DRM logical frame.
str1	variable	The data for MSC stream 1 for one DRM logical frame, if any. If stream 1 is not present in the multiplex, this TAG shall have zero length.
str2	variable	The data for MSC stream 2 for one DRM logical frame, if any. If stream 2 is not present in the multiplex, this TAG shall have zero length. If the length of str1 is zero, the length of str2 must also be zero.
str3	variable	The data for MSC stream 3 for one DRM logical frame, if any. If stream 3 is not present in the multiplex, this TAG shall have zero length. If the length of str2 is zero, the length of str3 must also be zero.

5.1.1 Protocol type and revision (*ptr)

This TAG Item shall be included in every MDI Packet.

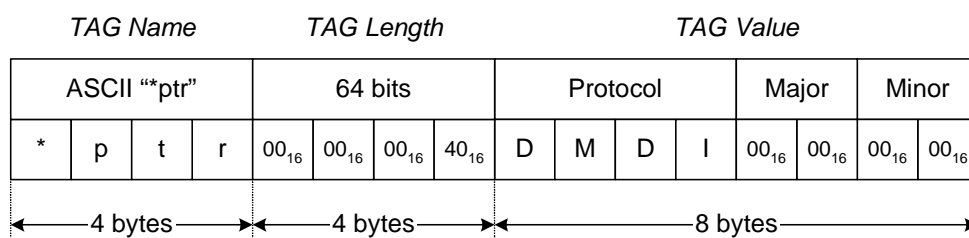

Figure 3: Protocol type and revision

Protocol type: the ASCII string "DMDI" (DRM Multiplex Distribution Interface).

Major revision: Currently 0000₁₆.

Minor revision: Currently 0000₁₆.

For further information on the revision numbering, refer to clause 5.3.

5.1.2 DRM logical frame count (dlfc)

This TAG Item shall be included in every MDI Packet.

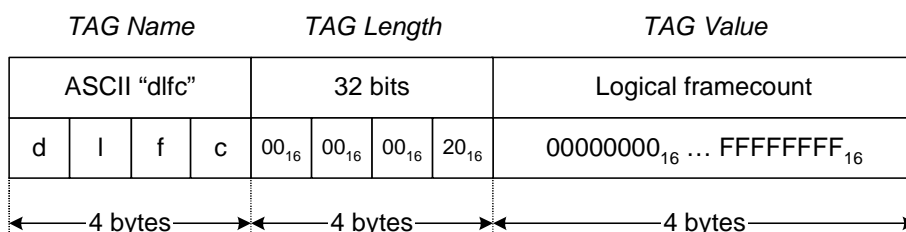

Figure 4: DRM logical frame count

Logical frame count: the value shall be incremented by one by the device generating the MDI Packets for each MDI Packet sent. In the event that the maximum value is reached, the counter shall reset to zero ..., FFFFFFFE₁₆, FFFFFFFF₁₆, 00000000₁₆, 00000001₁₆, The receiver shall not expect or require the first packet received to have a specific value of logical frame count. This value shall be used by the receiver of the MDI Packet to ensure that packets which arrive out-of-order are re-ordered correctly. The logical frame count may also be used to detect lost MDI Packets and, if a suitable link exists, request retransmission of the lost packet.

5.1.3 Fast access channel (fac_)

This TAG Item shall be included in every MDI Packet.

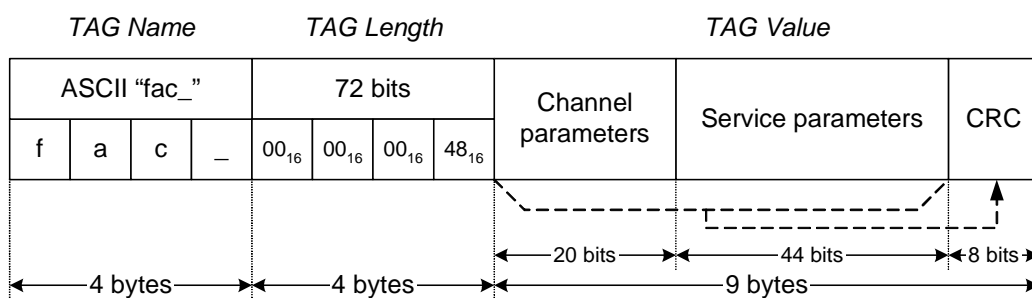

Figure 5: Fast access channel

Channel parameters: as described in ES 201 980 [1], clause 6.3.3.

Service parameters: as described in ES 201 980 [1], clause 6.3.4. The data carried in the Service Parameters shall be repeated according to the FAC repetition rules described in ES 201 980 [1], clause 6.3.6.

CRC: as described in ES 201 980 [1], clause 6.3.5.

5.1.4 Service description channel (sdc_)

This TAG Item shall only be included in the MDI Packet containing the data for the first logical frame in each transmission super-frame. This TAG Item shall not be included in any other MDI Packets.

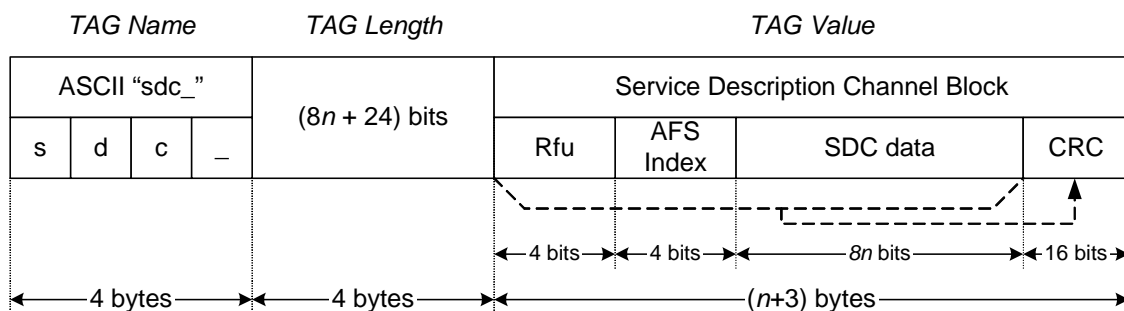

Figure 6: Service description channel

Rfu: these four bits are reserved for future use and shall have the value zero.

AFS index: as described in ES 201 980 [1], clause 6.4.2.

SDC data: as described in ES 201 980 [1], clause 6.4.3.

CRC: as described in ES 201 980 [1], clause 6.4.2.

The value of "n" depends upon the robustness mode, SDC mode and spectrum occupancy of the DRM ensemble as described in ES 201 980 [1], clause 6.4.2 table 61 which lists values in the range 13 to 207.

5.1.5 Service description channel information (sdci)

This TAG Item shall be included in every MDI Packet.

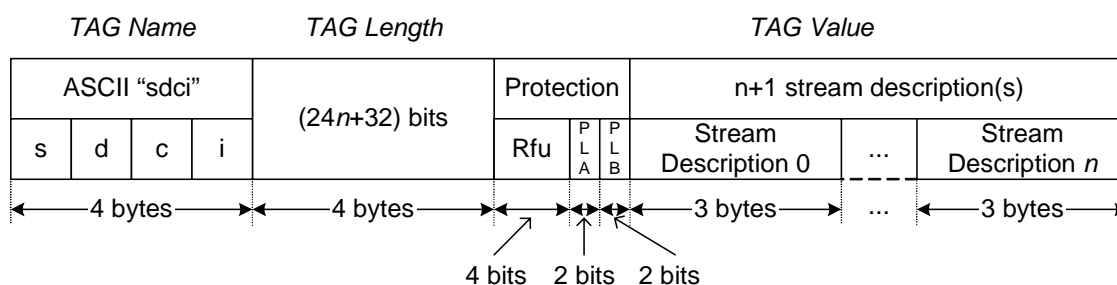

Figure 7: Service description channel information

Rfu: these four bits are reserved for future use and shall have the value zero.

PLA and PLB: the protection level as described in ES 201 980 [1], clause 7.5.1.

Stream Description n: the stream description for an individual MSC stream - see ES 201 980 [1], clause 6.4.3.1. Up to four stream descriptions may be included, the corresponding stream data being carried in the MDI str0, str1, str2 and str3 TAG Items respectively.

5.1.6 Robustness mode (robm)

This TAG Item shall be included in every MDI Packet.

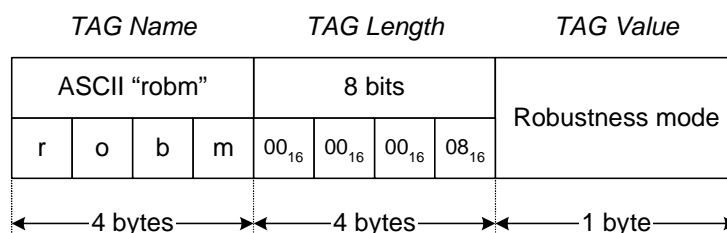

Figure 8: Robustness mode

Robustness mode: the robustness mode to be used encoded as shown in table 2. All other values are reserved for future use.

Table 2: Robustness mode encoding

Value	Robustness
00 ₁₆	Mode A
01 ₁₆	Mode B
02 ₁₆	Mode C
03 ₁₆	Mode D

5.1.7 Stream <n> (str0, str1, str2 and str3)

The str0, str1, str2 and str3 TAG Items shall contain the data for the corresponding DRM stream. If the TAG Length is zero, the TAG Item may be omitted from the MDI Packet.

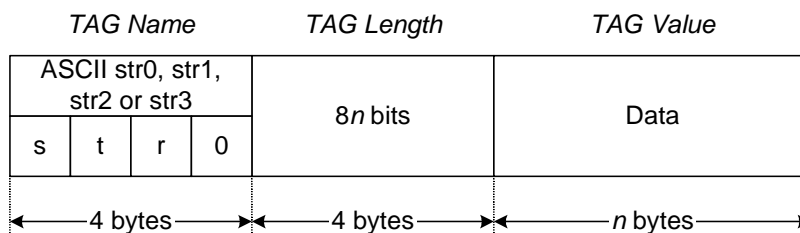

Figure 9: Stream data

Data: the content of one of the streams present in the DRM multiplex.

5.2 Optional TAG items

Every DRM MDI implementation may choose to support the following optional TAG Items. Where one or more of the optional TAG Items are supported, they shall behave as described below. When not supported by an implementation, the presence of these TAG Items shall be ignored.

Table 3: Optional TAG Items

TAG Name (ASCII)	TAG Length (bits)	TAG Value
info	variable	Free-form textual information.
tist	64	This TAG Item specifies the point in time at which the DRM transmission frame should be broadcast.

5.2.1 Information (info)

This TAG Item may be included in any MDI Packet.

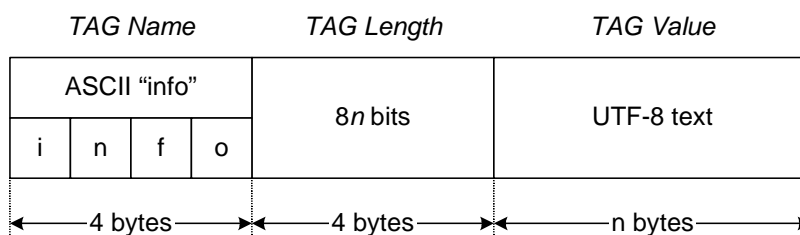

Figure 10: Info TAG item

UTF-8 Text: an arbitrary number of bytes encoding a text string using UTF-8 (ISO/IEC 10646 [3]). No fixed purpose is defined for this string, however it is envisaged that the value may be displayed by a DRM Modulator. This could be used for any purpose, for example to identify the DRM Multiplex or the DRM Multiplexer providing the MDI Packets being processed or to provide warnings, additional information, statistics, etc.

5.2.2 Timestamp (tist)

This TAG Item shall be included in every MDI Packet intended to be broadcast using an SFN or SMFN. It may be included in any other MDI Packet if desired.

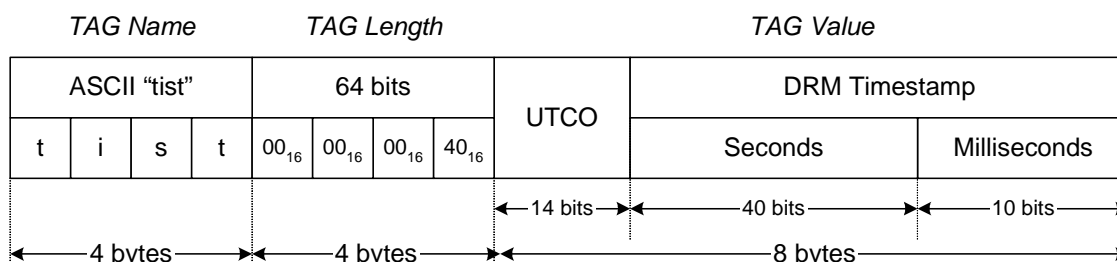

Figure 11: Timestamp

UTC0: the offset (in seconds) between UTC and the Seconds value. The value is expressed as an unsigned 14-bit quantity. As of 2000-01-01 T 00:00:00 UTC, the value shall be zero and shall change as a result of each leap second. The value contained in this field shall have no effect on the time of emission from the modulator.

Seconds: the number of SI seconds since 2000-01-01 T 00:00:00 UTC as an unsigned 40-bit quantity.

Milliseconds: the number of milliseconds ($1/1000^{\text{th}}$ of an SI second) since the time expressed in the Seconds field. The value is expressed as an unsigned 10-bit quantity. The values 1 000 to 1 023 inclusive are reserved for future use.

DRM Timestamp: taken together, the Seconds and Milliseconds values produce the DRM Timestamp value that defines the time at which 50 % of the energy of the first time sample from the IFFT of the first symbol of the DRM transmission frame shall have been radiated on air. Each subsequent MDI packet (as defined by the "dlfc" value, see clause 5.1.2) shall have a timestamp value which increases by 400 ms. The chosen bit-widths allow DRM Timestamp to represent uniquely any date/time from 2 000 AD until approximately 34 800 AD with a resolution of one millisecond. Conversion between DRM Timestamp and other standard time references is outlined in annex B.

NOTE: The binary value of the combined DRM Timestamp field does not increase uniformly due to the modulo-1 000 milliseconds count.

It is the function of the DRM Multiplexer to allow sufficient time when encoding this value to enable the longest transmission path to deliver the data before it is required by the DRM Modulator. All modulators supporting this TAG Item shall provide at least ten seconds of buffering of MDI Packets.

5.3 Revision history

Table 4 contains the history of the TAG Item changes of the MDI Protocol for each new revision.

Table 4: Revision history

Major revision	Minor revision	Date	Changes from previous to new revision
0000 ₁₆	0000 ₁₆	2003-02-04	Initial revision

Changes to the protocol which will allow existing decoders to still function will be represented by an increment of the minor version number only. Any new features added by the change will obviously not need to be supported by older modulators. Existing TAG Items will not be altered except for the definition of bits previously declared *Rfu*. New TAG Items may be added.

Changes to the protocol which will render previous implementations unable to correctly process the new format will be represented by an increment of the major version number. Older implementations should not attempt to decode such MDI packets. Changes may include modification to or removal of existing TAG Item definitions.

Annex A (informative): Typical DRM networks

The following list describes some of the possible options for building SFN/SMFN/MFN networks. The intention is to clarify the use of the "tist" TAG which is only mandatory for SFN or SMFN networks.

- **Single Frequency Networks (SFN):**
 - All DRM transmitters broadcast an identical DRM signal such that they appear at the receiving antenna nominally at the same time and on the same frequency. Such signals received simultaneously by a DRM compliant receiver may increase the reception quality. The DRM timestamp TAG Item tist (together with any locally configured timing offset) is used to ensure that the transmitters are accurately synchronized. The typical timing accuracy required is around 0,5 % of the guard interval for the transmission mode in use, approximately $\pm 13,3 \mu\text{s}$ in mode A, $\pm 26,65 \mu\text{s}$ in modes B and C, $\pm 36,65 \mu\text{s}$ in mode D.
- **Synchronized Multi-Frequency Networks (SMFN):**
 - All DRM transmitters broadcast identical DRM signals such that they appear at the receiving antenna nominally at the same time but on different frequencies. This allows the receiver to exploit the Alternative Frequency Switching (AFS) feature of DRM to seamlessly switch to an alternative frequency. The DRM timestamp TAG Item tist (together with any locally configured timing offset) is used to ensure that the transmitters are accurately synchronized. The typical timing accuracy required is around 1 % of the SDC duration, approximately $533,2 \mu\text{s}$ in modes A and B, $\pm 600,0 \mu\text{s}$ in mode C and $\pm 499,8 \mu\text{s}$ in mode D.
- **Non-synchronized Multi-Frequency Networks (MFN):**
 - All DRM transmitters broadcast similar or identical DRM signals such that they appear at the receiving antenna at slightly different times and on different frequencies. This does not allow the use of the Alternative Frequency Switching (AFS) feature but still allows a non-seamless switch to an alternative frequency. The DRM timestamp TAG Item tist (together with any locally configured timing offset) may be used if desired to achieve synchronization between the transmitters.
- **Single transmitter:**
 - The DRM transmitter is the only one broadcasting the DRM Multiplex. AFS support is not appropriate as there is only one transmitter, however it is possible to non-seamlessly switch to an alternative frequency carrying one or more of the services in the current multiplex.

Annex B (informative): DRM Timestamps

B.1 Relationships

The relationships between UTC, TAI, GPS Time and DRM Timestamp (as defined in clause 5.2.2) are, as at the time of writing (June 2003), as follows:

- $GPS = TAI - 19 \text{ s}$ (constant).
- $UTC = TAI - 32 \text{ s}$ (variable due to leap seconds).
- $UTC = GPS - 13 \text{ s}$ (variable due to leap seconds).
- $UTC = DRM - UTCO$ (constant due to varying value of UTCO).
- $DRM = TAI - 32 \text{ s}$ (constant).
- $DRM = GPS - 13 \text{ s}$ (constant).
- $DRM = UTC + UTCO$ (constant due to varying value of UTCO).

B.2 Rationale

Several other standard time/date encodings are in common use, including MJD, UTC, GPS and TAI. It was agreed that none of these adequately addressed the needs of a DRM system and that it was desirable to define a time format specifically for the DRM Timestamp. The following reasons were given for rejecting other common timebases:

- MJD is subject to leap seconds making the fractional portion very hard to represent in a fixed-point format.
- UTC is subject to leap seconds making the number of seconds in a day variable (86 399 / 86 400 / 86 401).
- GPS Time is subject to "week number wrapping" approximately every 19,7 years.
- UTC, TAI, MJD and GPS Time all have epochs (start dates) partway through the 400-year leap-year cycle.

The DRM Timestamp is not subject to leap seconds but contains sufficient extra information (in the UTCO field) to trivially convert the value to UTC which does include leap-seconds. Conversion to GPS Time and/or TAI is also trivial, simply involving the subtraction of a constant value. The epoch for DRM Time is synchronized with the start of a 400-year leap-year cycle, making leap-year calculations simpler and less error prone.

Annex C (normative): Physical presentation

The DCP (TS 102 821 [2]) allows almost any physical interface to be used.

All MDI applications shall provide a UDP/IP interface using twisted-pair Ethernet (10Base-T or better). The parameters for the IP stack shall be manually configurable. Automatic configuration using DHCP, BOOTP or similar may also be provided.

Optionally RS232 interfaces may be provided.

Further optional interfaces may also be included in later revisions.

A detailed specification of the parameters and hardware of the interface types listed above is provided in TS 102 358 [4].

Annex D (normative): MDI switching mechanism

The mechanism described in this annex shall be implemented by any "MDI Switcher" device (a device supporting MDI Switching functionality, see below).

The mechanism may optionally be implemented by DRM Multiplex Generators (which may state the fact of supporting this feature).

One scenario of MDI distribution might be the transmission of several MDI streams in parallel (e.g. via satellite). This allows a transmitter site to individually order any DRM Modulator to switch among the available sources of MDI input. In this context it might happen that the announcement of a new MDI stream and its configuration is required at the transmitter site, while there is no possibility to provide the full stream content in advance of the actual switch time (e.g. due to bandwidth limitations or just unavailable content).

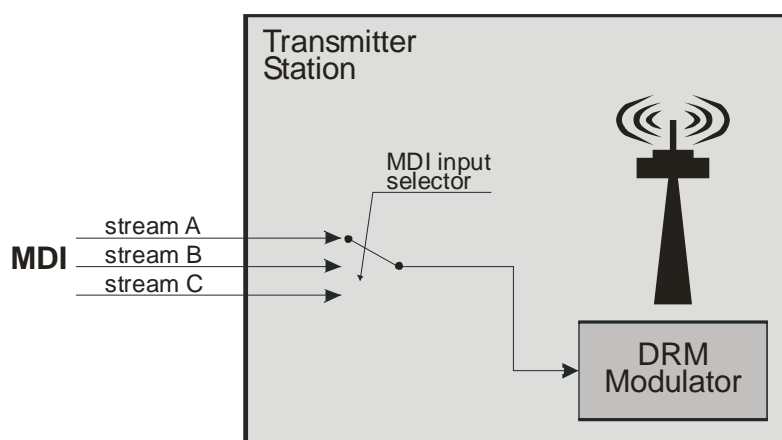

Figure D.1: MDI Switcher setup - local MDI input selection

A DRM Multiplex Generator supporting the "MDI switching mechanism" shall create and send out MDI Packets such that the time value stored in the "tist" timestamp TAG Item indicates a full minute or a multiple of 400 ms increments afterwards. The packets whose timestamps correspond to the full minute (or multiples of 1.2 seconds afterwards) shall contain the first frame of a DRM transmission super frame, i.e. the frame number in the fac_ item shall be zero and SDC information shall be provided in the "sdc_" TAG Item. This allows easy transition between MDI streams originating from different sources.

D.1 Scenario examples

Example 1

A broadcaster provides two MDI streams named A and B via satellite distribution to all its transmitter sites. At a certain point in time, all DRM Modulators currently processing MDI stream A shall switch to MDI stream B.

In this case the broadcaster can provide the correct reconfiguration announcement within MDI stream A in advance for all DRM Modulators currently processing MDI stream A. At the point in time indicated by the reconfiguration signalling, all DRM Modulators currently processing MDI stream A shall switch to MDI stream B. The transmission network capacity occupied by MDI stream A can then be used by a new MDI stream C.

This transition can be done without any additional external configuration information provided by the broadcaster to the transmitter site (except the switch command)!

Example 2

A broadcaster continuously provides two MDI streams named A and B via satellite distribution to all its transmitter sites. The DRM Modulators X and Y are currently processing MDI stream A, while DRM Modulator Z processes MDI stream B. At a certain point in time, only DRM Modulator Y shall switch from MDI stream A to MDI stream B. This can be done fully in accordance with the DRM specification regarding the announcement of configuration changes in advance to the DRM receivers: During the reconfiguration period, an MDI Switcher device (which may be implemented as a stand-alone device) modifies the MDI stream A on the fly to a) signal the reconfiguration and b) signal the future configuration derived from MDI stream B within the SDC.

So during the reconfiguration period (of DRM Modulator Y), DRM Modulator X continues to process the unmodified MDI stream A, while DRM Modulator Z continues to process the unmodified MDI stream B. Only DRM Modulator Y processes a locally modified MDI stream A, containing the announcement for the following reconfiguration to MDI stream B.

This transition can be done without any additional external configuration information provided by the broadcaster to the transmitter site (except the switch command)!

However problems might arise if MDI stream B undergoes a reconfiguration at the same time as the transition from MDI stream A to MDI stream B for DRM Modulator Y shall take place.

Example 3 (MDI configuration announcement)

A broadcaster provides one MDI stream named A via satellite distribution to all its transmitter sites, along with additional non-MDI data. At a certain point in time, some DRM Modulators shall switch from MDI stream A to a newly started MDI stream C (replacing some other stream B or alternatively the non-MDI content on the distribution network). The broadcaster can *not* generally send the required reconfiguration information as part of MDI stream A, since some DRM Modulators shall continue broadcasting MDI stream A!

In this case the broadcaster might choose to start broadcasting MDI stream C some time in advance to the point in time when the switch shall take place, to allow the MDI Switcher devices to create the correct reconfiguration signaling for the DRM Modulators scheduled to switch from MDI stream A to MDI stream C (see example 1).

However, if this option is not available (e.g. due to bandwidth limitations on the distribution network), the broadcaster may also choose to broadcast **MDI Configuration Announcement Packets** for MDI stream C. These Packets contain no MSC data and are therefore very small in size.

Note that an MDI Switcher device must not alter the output MDI stream in case of SFN operation, if only parts of the SFN are altered or discontinued. Otherwise the receivers within the SFN may receive a fully distorted signal for a few seconds (e.g. while some SFN transmitters broadcast the default MDI stream A, while other SFN transmitters broadcast an altered MDI stream A including the reconfiguration announcement to another MDI stream B).

D.2 MDI Configuration Announcement Packets

To support the MDI switching mechanism by pre-signalling the configuration of an upcoming MDI stream, a special version of MDI Packets can be used: "MDI Configuration Announcement Packets".

The TAG Items contained in an MDI Configuration Announcement Packet must comprise all mandatory and may comprise any optional (or proprietary) TAG Item contained in an ordinary MDI Packet (see clause 5), with the following exceptions:

- None of the TAG Items "str0", "str1", "str2" or "str3" must be present. This ensures that an MDI Modulator implementation that is not aware of MDI Configuration Announcement TAG Packets is not confused by such an MDI Configuration Announcement Packet, because it will simply discard it as invalid.
- The "sdc_" TAG Item, which is normally mandatory only in every third MDI Packet, may be contained in any MDI Configuration Announcement TAG Packet, optionally carrying another piece of the total SDC information with every repetition.
- The "dlfc" TAG Item may be omitted. If present, it should be increased with every MDI Configuration Announcement TAG Packet sent and should continue in this sequence during the transition between MDI Configuration Announcement TAG Packets and the following regular MDI Packets.

All **DCP** parameters used for the MDI Configuration Announcement Packets should be identical to the DCP parameters used later for the regular MDI stream.

The number of MDI Configuration Announcement Packets sent in advance of a new MDI stream shall be enough to signal all FAC service parameters of all DRM Services and at least all mandatory SDC information of the new configuration.

MDI Configuration Announcement Packets shall be sent sufficiently in advance to the start of the new (or changed) MDI stream, so that all FAC and SDC information is available to the MDI Switcher before the reconfiguration countdown is scheduled to start.

D.3 Timing diagram example

An example satellite link provides capacity for two parallel MDI streams; the total capacity is first used by logical MDI streams A+B, then A+C (distinguished by their DCP address):

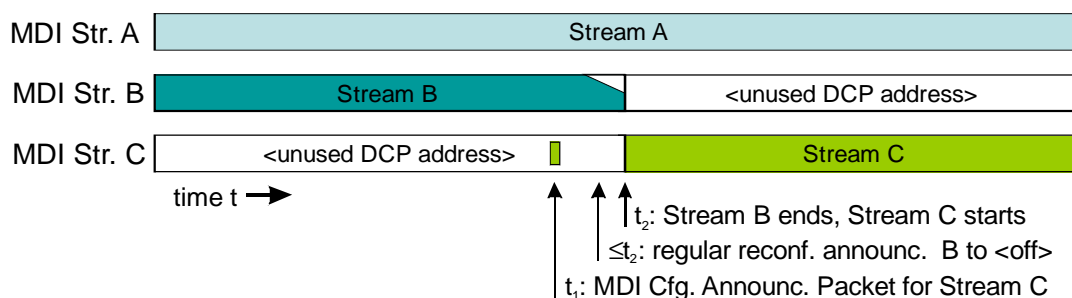

MDI Switcher device creates individual FAC/SDC multiplex reconfiguration announcements per transmitter Tx (, if required):

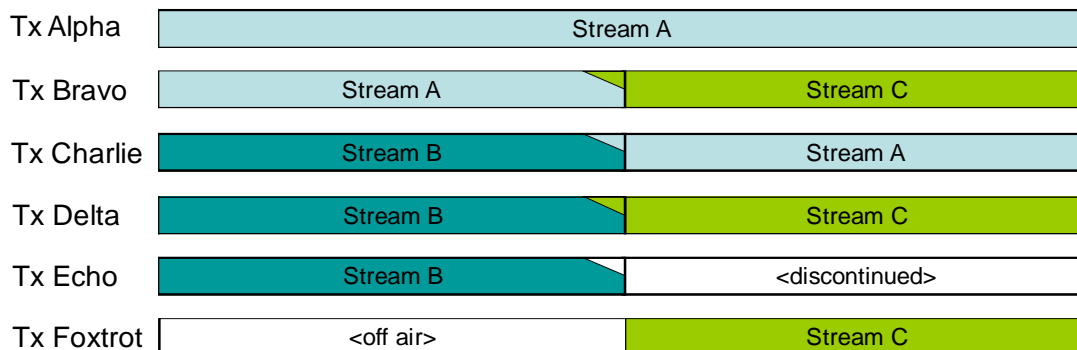

Figure D.2

History

Document history		
V1.1.1	December 2003	Publication
V1.2.1	October 2005	Publication