

**1963**  
POPULAR  
ELECTRONICS

# ELECTRONIC EXPERIMENTER'S HANDBOOK

**\$100**  
(1.25 in Canada  
and elsewhere)

Complete Plans for

**35+ PROJECTS**

**Fun to Build • Fun to Use**

**Stereo/Hi-Fi  
Home & Shop  
Ham Radio  
CB & SWL  
Robot**

Stereo Sweet 16  
(p. 51)

**Bonus Section:**

**How to be an Electronic Technician**



# LAFAYETTE

# RADIO ELECTRONICS

1963 CATALOG No. 630



## FOR '63

### 388 GIANT-SIZED pages



It's New — It's Big — It's Better Than Ever  
*It's From the "World's Hi-Fi & Electronics Shopping Center"*

Here it is . . . the exciting, all-new 1963 Lafayette Catalog. 388 giant-sized pages (the largest in our 42-year history) . . . thousands of different items for the audiophile, experimenter, technician, hobbyist, engineer, student, serviceman . . . fully illustrated . . . hundreds of different manufacturers. It's the "World's Hi-Fi and Electronics Shopping Center" right in a catalog.

#### CHECK THESE OUTSTANDING LAFAYETTE BENEFITS

**SATISFACTION GUARANTEED OR MONEY REFUNDED.** Lafayette's 30-day Free Home Trial lets you try-what-you-buy at home. If you're not completely satisfied, the full purchase price will be refunded.

**LARGEST STOCK SELECTION.** If it's in Electronics or Hi-Fi it's in the Lafayette catalog — Citizens Band; Tape Recorders; Ham and Amateur Equipment; Test Instruments; P.A. Equipment; Radio & TV Tubes, Parts, Antennas; and much more.

**EXCLUSIVE LAFAYETTE KITS.** Easy-to-assemble kits designed by Lafayette engineers for at-home construction. Dollar for dollar the best value for your money today.

**SPECIAL HI-FI SYSTEM PRICES.** Select a hi-fi music system and get Lafayette's special money-saving price.

**24 HOUR SERVICE.** Most orders fully processed within 24 hours after receipt.

**LOWEST PRICES.** You always save more with Lafayette's low, low prices.

**3-IN-1 EASY PAY PLAN.** Choose the plan that suits you best. No money down, up to 24 months to pay.

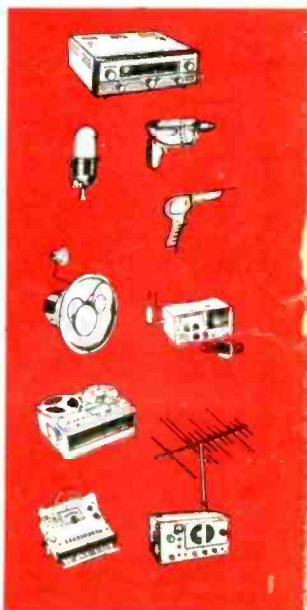

## Detach and Mail the Attached Card for Your FREE CATALOG

# 3 More Big Training Advantages

## DeVRY Tech Exclusive!



WITH TRANSISTORIZED METER . . . PLUS NEW "MODULAR CIRCUITS" TO BUILD AT HOME!

Now Prepare for GOOD JOB OPPORTUNITIES IN ELECTRONICS Faster—with

1. **METER** — Transistorized, Portable, AC-DC Multimeter
2. **SCOPE** — 5-inch New Streamlined Commercial-Type Oscilloscope
3. **ELECTRO-LAB** — For 3-Dimension Circuit Building

To help you get ready F-A-S-T-E-R . . . and THOROUGHLY . . . for good-paying job opportunities in the fast growing Electronics field, DeVry Technical Institute now presents the newest and finest training advantages in its over 30 years of experience. Now . . . AT HOME . . . in your spare time, you prepare with "industry-type" home laboratory equipment. To provide real PRACTICAL EXPERIENCE, you build a quality Transistorized Meter and a 5-inch industrial-type Oscilloscope . . . work with small, 3-dimensional circuits on DeVry's new Design Console . . . use highly instructive home training movies . . . and follow up-to-date lessons with many time-saving fold-out diagram sheets.

Little wonder DeVry men qualify for such fine opportunities in Space-Missile Electronics, Automation, Computer Work, Radio-TV, Industrial Controls, and other fields.

You learn PRACTICAL techniques important in today's Space Age industry, because you build many compact circuits with the streamlined Electro-Lab, using exclusive solderless "modular connectors." You perform over 300 construction and test procedures in all! Your self-built test equipment has function-grouped controls, meter scales color-keyed to the panel markings—much like instruments used on today's jobs. What's so important, the home laboratory and the test equipment are YOURS TO KEEP!



OSCILLOSCOPE

DESIGN CONSOLE



METER

\*Trademark ©

### INDUSTRY NEEDS TRAINED MEN

Through this remarkable 3-way method, DeVry Tech has helped thousands of ambitious men prepare for good jobs or their own profitable full-time or part-time service shops. It is the newest in a long series of PRACTICAL training aids that we have pioneered and developed in more than three decades of experience. Sound interesting? Then see how DeVry Tech may help YOU. Mail the coupon today.

### From RADIO to SPACE-MISSILE ELECTRONICS

DeVry's training goes all the way from radio repair . . . to space missile electronics. That's the range of subjects covered in its programs AT HOME or in its well-equipped training centers in Chicago and Toronto. You learn up-to-date techniques, working with new equipment, modern texts, movies—one of today's finest combinations of training equipment . . . geared for RESULTS!

### EMPLOYMENT SERVICE

When you complete the program, DeVry's efficient Employment Service is ready to help you get started. There is no extra charge—over—for this aid. ACCREDITED MEMBER, NATIONAL HOME STUDY COUNCIL

**DeVRY TECHNICAL INSTITUTE**  
CHICAGO • TORONTO

### MAIL COUPON FOR FREE FACTS

DEVRY TECHNICAL INSTITUTE 2082  
4141 Belmont Ave., Chicago 41, Ill., Dept. EEH-T

Please give me your two free booklets, "Pocket Guide to Real Earnings" and "Electronics in Space Travel"; also include details on how to prepare for a career in Electronics. I am interested in the following opportunity fields (check one or more):

- |  |   |
|--|---|
| <input type="checkbox"/> Space & Missile Electronics | <input type="checkbox"/> Communications         |
| <input type="checkbox"/> Television and Radio        | <input type="checkbox"/> Computers              |
| <input type="checkbox"/> Microwaves                  | <input type="checkbox"/> Broadcasting           |
| <input type="checkbox"/> Radar                       | <input type="checkbox"/> Industrial Electronics |
| <input type="checkbox"/> Automation Electronics      |   |

Name \_\_\_\_\_ Age \_\_\_\_\_

Address \_\_\_\_\_ Apt. \_\_\_\_\_

City \_\_\_\_\_ Zone \_\_\_\_\_ State \_\_\_\_\_

Check here if you face military service.  
Canadian residents: Write DeVry Tech of Canada, Ltd.  
970 Lawrence Avenue West, Toronto 19, Ontario

CIRCLE NO. 9 ON READER SERVICE CARD

←CIRCLE NO. 19 ON READER SERVICE CARD

# 1963 POPULAR ELECTRONICS

# ELECTRONIC EXPERIMENTER'S HANDBOOK

Publisher **PHILLIP T. HEFFERNAN**  
Editor **OLIVER P. FERRELL**  
Managing Editor **JULIAN M. SIENKIEWICZ, WA2CQL**  
Art Editor **JAMES A. ROTH**  
Associate Editors **RICHARD A. FLANAGAN**  
**MARGARET MAGNA**  
Draftsman **ANDRE DUZANT**  
Editorial Consultant **OLIVER READ, W4TWV**  
Advertising Manager **WILLIAM G. McROY, 2W4144**  
Advertising Service Manager **ARDYS C. MORAN**

#### ZIFF-DAVIS PUBLISHING COMPANY

Editorial and Executive Offices (ORegon 9-7200)  
One Park Avenue, New York 16, New York  
William B. Ziff, Chairman of the Board (1946-1953)  
William Ziff, President  
W. Bradford Briggs, Executive Vice President  
Hershel B. Sarbin, Vice President and General Manager  
M. T. Birmingham, Jr., Vice President and Treasurer  
Robert P. Breeding, Circulation Director  
Charles Housman, Financial Vice President  
Stanley R. Greenfield, Vice President  
Midwestern and Circulation Office (WAbash 2-4911)  
434 South Wabash Avenue, Chicago 5, Illinois  
Midwestern Advertising Manager **JAMES WEAKLEY**  
Western Office (CRestview 4-0265)  
9025 Wilshire Boulevard, Beverly Hills, California  
Western Advertising Manager **WILLIAM J. RYAN**  
Foreign Advertising Representative  
D. A. Goodall Ltd., London, England

## 1963 POPULAR ELECTRONICS

# ELECTRONIC EXPERIMENTER'S HANDBOOK



Cover Photo by Bruce Pendleton



**T**HE Editors of **POPULAR ELECTRONICS** look forward to the annual publication of the *ELECTRONIC EXPERIMENTER'S HANDBOOK*. Devoted almost exclusively to "bench-tested" construction projects, each annual edition (this is the seventh) contains our favorites—projects that we know will be fun to build and use.

A few pages in this edition have been assigned to a subject that may at first seem out of place—electronic schools. This particular section has been included because many buyers of the 1963 Edition will be making their first contact with electronics. Some will be curious about following it as a trade or career; and it is to them that we dedicate the vitally interesting material prepared by John D. and Irene Lenk which starts on page 81.

*The Editors*

# SPECIAL OFFER

## FROM COMMAND RECORDS

The primary component in any high fidelity stereo equipment is the record itself. No matter how good all your other components may be, the ultimate excellence of the performance depends on the record. You can get no more from your equipment than the quality and sound of the record being played. It is at this point that Command has no peer. Leading manufacturers of high fidelity stereo equipment use Command recordings not only to demonstrate the full potential of their equipment to the public, but to check their products before they leave the factory. Get the most from your stereo equipment. Discover for yourself how Command helps you enjoy the full potential of stereo sound, sound that is virtually free of all mechanical noises, sweeping in its magnitude, astounding in its clarity.

### Your choice of two special edition COMMAND STEREO SAMPLERS

To give you a sampling of what makes COMMAND the world leader in recorded sound, two special albums have just been released.

These magnificent albums will open your eyes to the broad scope and magnitude of Command recordings . . . will reveal to you the unparalleled technical advances Command engineers have achieved in master-recording on tape and on 35 mm magnetic film.

Here is your opportunity to savor the full range of Command artistry. The POPULAR SAMPLER contains 12 of the most exciting selections from 12 different Command Popular Albums. The CLASSIC SAMPLER contains 8 magnificent selections from 8 different Command Classical Albums.

Unlike many sampler albums, these Command Albums were created to give you full, uninterrupted musical pleasure. There is no sales message . . . no talk. The musical selections in the Popular Albums are complete — not excerpts! In the Classical Album, great care was taken to select complete movements for your greatest possible enjoyment.

### THESE ALBUMS NOT AVAILABLE IN STORES

To obtain your Command Sampler albums, order direct by mailing the coupon. You may select either the Popular Album or the Classical Album for only \$2.98 each. (Command Stereo albums are normally list-priced at \$5.98).

If you wish, you can take advantage of an additional saving by ordering both albums for only \$5.00. Your albums will be shipped postpaid.

You may order as many albums as you wish, but don't delay . . . mail your order today.

**Command RECORDS**  
World leader in recorded sound  
1501 Broadway, New York 36, N. Y.

CIRCLE NO. 6 ON READER SERVICE CARD

### POPULAR SAMPLER



12 Complete  
Selections from 12  
Different Popular  
Command Albums

- HEAT WAVE (Stereo 35/mm)
- MOON RIVER (Great Themes from Hit Films)
- FINALE FROM CAROUSEL (Carousel) Alfred Drake, Roberta Peters
- CHEEK TO CHEEK (Enoch Light and his Orchestra at Carnegie Hall play Irving Berlin)
- GUITAR ESPANOL (Spanish Guitar) Tony Mottola
- LOVE FOR SALE (The Big Band's back in town)
- VIENI VIENI (Rome Revisited)
- FORTY-SECOND STREET (Off Beat Percussion)
- I'M OVER HERE (Something Wonderful) Ray Charles Singers
- CLOSE YOUR EYES (The Persuasive Trombone of Urbie Green)
- THE CRY OF THE WILD GOOSE (Strange Interlude)
- NINA (Roman Guitar)

### CLASSIC SAMPLER



8 Selections  
from the  
Following 8  
Command Classics

- WAGNER — Der Ring Des Nibelungen Steinberg . . . Pittsburgh Symph. Orch.
- BRAHMS — Symphony No. 2 Steinberg . . . Pittsburgh Symph. Orch.
- BERLIOZ — Symphonie Fantastique Vandernoot . . . National Symph. Orch. (Paris).
- BEETHOVEN — Symphony No. 4 Steinberg . . . Pittsburgh Symph. Orch.
- MUSSORGSKY-RAVEL — Pictures At an Exhibition Vandernoot . . . Conservatoire Symph. Orch. (Paris).
- RAVEL — Rapsodie Espagnole Dervaux . . . Colonne Symph. Orch. (Paris).
- SCHUBERT — Symphony No. 3 Steinberg . . . Pittsburgh Symph. Orch.
- RAVEL — Alborada Del Gracioso Dervaux . . . Colonne Symph. Orch. (Paris).

### MAIL COUPON TODAY!

**COMMAND RECORDS, Dept. 63-EE**  
1501 Broadway, N. Y. 36, N. Y.

Please send me the Command Stereo Sampler Albums checked below. I understand Command pays all postage and handling.

- POPULAR SAMPLER @ \$2.98 each  
 CLASSIC SAMPLER @ \$2.98 each  
 \$5 for BOTH

NAME .....

ADDRESS .....

CITY ..... ZONE ..... STATE .....

# Contents

## 1

### Electronics Around the Home 9

*Emily, the Robot—Transistor Power Supply—SENSOR-MATIC—Supersonic Squawker—Electronic Machine Gun—Bigger Bass from Broadcast Sets—Whistle Switch—Idiot Lights Out, Meters In—Banana Plug Splice—Transistorized Power Flash—Capacitor Stabilizes Solar Cell—Radiation Fallout Monitor—Why Tune By Ear?*

## 2

### Hi-Fi and Stereo 47

*Mini-Mono/Stereo—Stereo Sixteen Plus Four—Transistorized Tremolo—Private FM Listening—Printed-Circuit P.A.—Clean Sound from Drainpipe 8—Audio Pack—Starved Circuit Amplifier—Hi-Fi Hints*

## 3

### Electronics Schools 81

*Servicing—Broadcasting—Communications—Industrial—Military—Correspondence Schools—Residence Schools*

## 4

### Communications for the Hobbyist 95

*One for the Road—Loud-Speaking CPO—Simple Sidebander—Gabble Killer—S-9'er—"10-8" De Luxe*

## 5

### Electronics in the Workshop 127

*Signal Monitor—Square-Wave Generator—Spray Can Short Cuts—Transistor Frequency Standard—Vibration Pickups—Imp Sleuth—Automatic Diode Checker—Transistor Tester—Nickel-Cadmium Battery Charger—Pint-Sized Carillon*

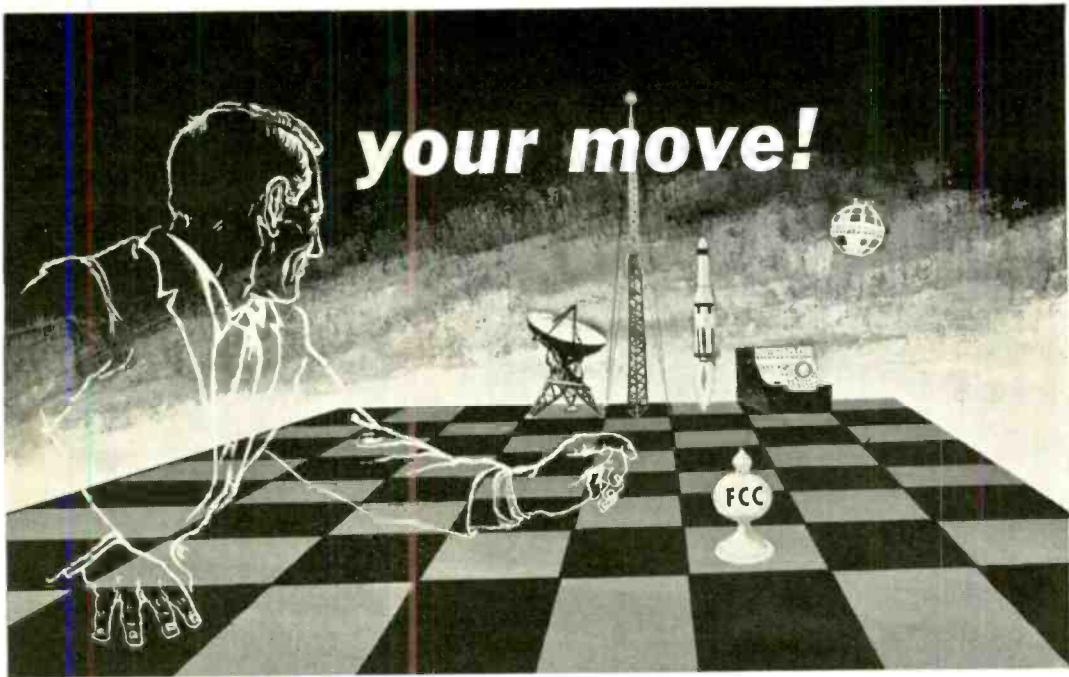

**The move into electronics is your decision. GRANTHAM SCHOOL OF ELECTRONICS makes your move easier . . .**

...easier by teaching you electronics in a logical, step-by-step manner, while preparing you to qualify for your **First Class Commercial FCC License**. This license is a "diploma" issued by the U. S. Government to certify qualified electronics technicians, and is awarded only to those who pass certain technical FCC examinations. We teach you electronics and prepare you to pass these FCC examinations.

Grantham training is **Specialized Training**, endorsed and recommended by many electronics firms throughout the nation, and accredited by the National Home Study Council. We teach you the **how** and **why** of basic electronics, with the necessary math taught as an integral part of the lessons. The

course is thorough, easy to understand, and lays a solid foundation for all types of electronics work—communications electronics, military electronics, computer electronics, automation electronics, broadcasting electronics, and many more.

The time required to prepare for your first class FCC license, an important step toward your goal, is cut to a minimum through quality instruction—either by home study or in resident classes. You learn more electronics in less time because the Grantham Method is engineered with the student in mind. Complete details concerning Grantham training are available free for the asking. Now, it's up to you—it's your move!



**GRANTHAM**  
**SCHOOL OF ELECTRONICS**

**Accredited Member of the National Home Study Council**

1505 N. Western Ave.  
Los Angeles 27, Calif.  
(Phone: MO 7-7727)

408 Marion Street  
Seattle 4, Wash.  
(Phone: MA 2-7227)

3123 Gillham Road  
Kansas City 9, Mo.  
(Phone: JE 1-6320)

821-19th Street, N.W.  
Washington 6, D. C.  
(Phone: ST 3-3614)

**CIRCLE NO. 13 ON READER SERVICE CARD**

[Mail in envelope or paste on postal card]

EH-3

**To: GRANTHAM SCHOOL OF ELECTRONICS**  
NATIONAL HEADQUARTERS OFFICE  
1505 N. Western Ave., Hollywood 27, Calif.

Gentlemen:

Please send me your free booklet telling how I can get my commercial F.C.C. license quickly. I understand there is no obligation and no salesman will call.

Name \_\_\_\_\_ Age \_\_\_\_\_

Address \_\_\_\_\_

City \_\_\_\_\_ State \_\_\_\_\_

I am interested in:  Home Study.  Resident Classes



# NEW!

## INTERNATIONAL

### Model 1500 . . . for the Hobbyist . . .

Now . . . you can be on the air, and operate a two-way radio, without a license. The new International Model 1500 Executive transceiver is certified to fill all FCC Part 15 requirements.

Designed primarily for short range radio communication, you can talk 1 to 10 miles with the Model 1500 depending on the height of the antenna/transmitter. What's more there are no restrictions on working skip or sky-wave signals 1,000 miles or more when a band opening occurs. You can also use CW (code) transmission for maximum distance communicating.

The International Model 1500 transceiver is designed to put the maximum RF power into the antenna. This is accomplished by combining the transmitter and antenna into one unit for rooftop mounting, thus eliminating loss through a transmission line.

The exciter unit remains with the receiver. A receiver preamplifier at the antenna boosts weak signals and helps reception. And in addition, the Model 1500 has a field proven supersensitive receiver with a crystal filter to reduce interference from adjacent channel Class D radio units.

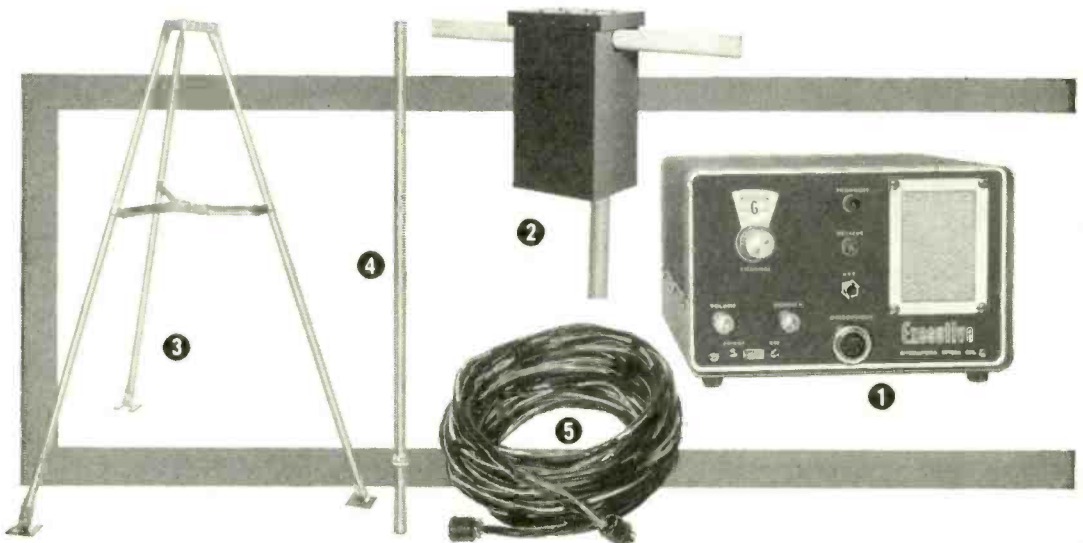



# EXECUTIVE TRANSCEIVER

## *No License Required!*

- Certified for FCC Part 15 communication
- 100 milliwatts input / 60 inch antenna
- 27 mc frequency range
- Operates on phone and cw
- Eight channels . . . all crystal controlled
- 115 vac operation
- Quality components and construction

The Model 1500 is a complete package, ready to go on the air. The package includes: ① receiver/driver complete with 8 sets of crystals, ② transmitter/antenna assembly, ③ antenna mount, ④ 5 foot mast, ⑤ 100 feet of control cable, ⑥ microphone, ⑦ key for (CW).

Model 1500 Transceiver complete . . . . . \$299.50\*

See this exciting new transceiver at your International dealer. You can be on the air tomorrow with International's Model 1500.

\*other models from \$80.00

Write for International's complete catalog of radio crystals and equipment.

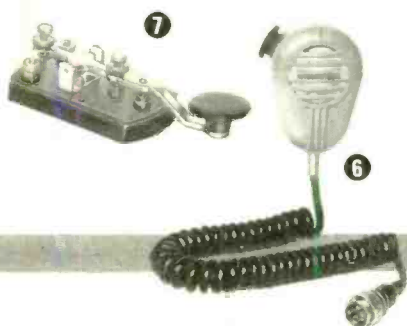

**INTERNATIONAL**  
CRYSTAL MANUFACTURING CO., INC.

18 NORTH LEE • OKLAHOMA CITY, OKLA.

CIRCLE NO. 16 ON READER SERVICE CARD

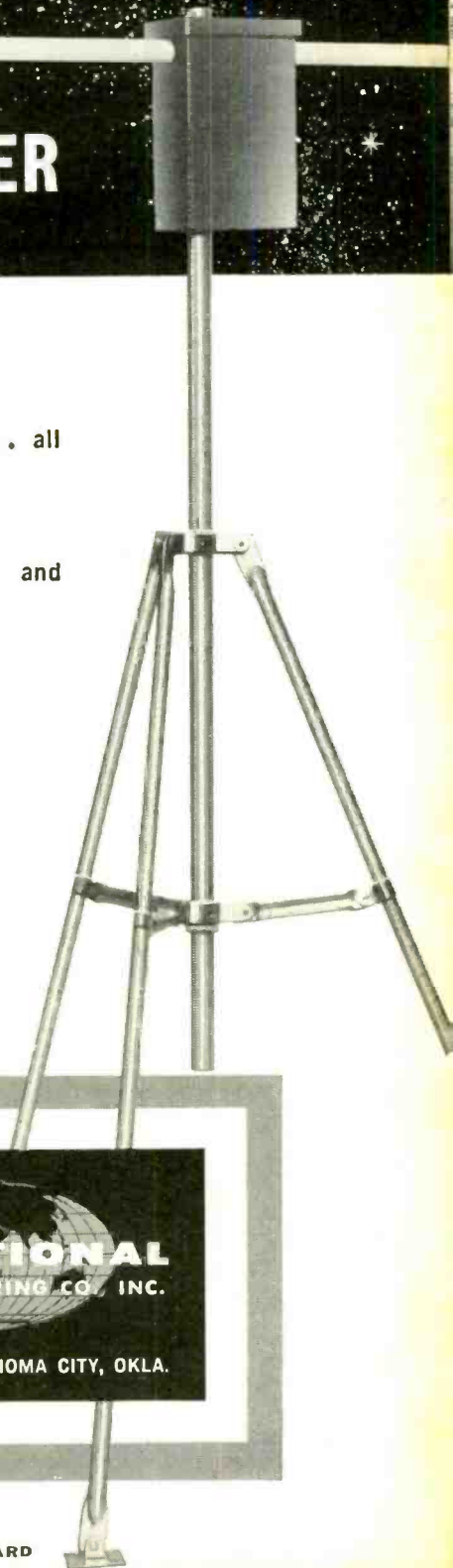

Here's the Newest Electronic Science Kits! They're Powered by the Sun!\*

# PERFORM AMAZING EXPERIMENTS WITH SPACE-AGE SOLAR CELLS

BY INTERNATIONAL RECTIFIER



7 Lab Models...  
up to 75 Experiments!

Exclusive Master Control Panel on every lab. Indicator scope, galvanometer, signal buzzer, power switch, push-button switches.

Labs range in price from \$9.95 to \$39.95

\*IR SOLAR CELLS  
convert light into electricity

Learn Electronic and Photo-Electric Principles. Conduct experiments in Solar Energy, communications, electronic measuring and control systems.

Build "Electric Eye" Circuits for burglar alarms, counters and other light beam systems. Make hot-cold indicators, moisture detectors, etc.

Build Solar Powered Radios, telegraph sets, intercoms, public address systems, even your own fascinating remote control TV commercial killer!

**Build Your Own Solar Powered Radio!**

Be first with a radio powered by the sun. Easy to assemble, no soldering. Choose from 2 kits. Earphone: \$12.95. Speaker: \$19.95.

Get IR Science Kits in Toy, Hobby, and Electronic Parts Stores Today!

LOOK FOR THE  
**IR**  
ON THE PACKAGE

Send for the FREE BOOKLET "Solar Cells for Experimenters"  
Plus IR Catalog with details on Labs and Cells!

DEPT. EEH  
INTERNATIONAL RECTIFIER, EL SEGUNDO, CALIF.

NAME \_\_\_\_\_ AGE \_\_\_\_\_

ADDRESS \_\_\_\_\_

CITY \_\_\_\_\_ ZONE \_\_\_\_\_ STATE \_\_\_\_\_

EDUCATIONAL PRODUCTS DIVISION: INTERNATIONAL RECTIFIER CORPORATION • EL SEGUNDO, CALIFORNIA  
CIRCLE NO. 17 ON READER SERVICE CARD

ELECTRONIC EXPERIMENTER'S HANDBOOK

# Chapter

# 1

## Electronics

## Around the Home

**F**EW hobbies provide as much fun as building electronic gadgets. And every project offers an opportunity for you to learn something more about the fascinating field of electronics.

These projects are a cross-section of the useful things you can build. On the simpler side, the "Electronic Machine Gun" (page 24) will make any 7-year-old boy the envy of his neighborhood. In the more complex area are the "SENSOR-MATIC" (page 16) and the "Whistle Switch" (page 27), both means for controlling electrical devices without manually throwing a switch.

"Emily," a practical working robot (page 10), is already a lady of distinction, having been counted among the distinguished guests on the Jack Paar Show. Very much a challenge, Emily will set any experimenter thinking of ways and means to improve the cause-and-effect relationships in elementary robotonics.

Emily—Robot with One-Track Mind.....	Bernard Dickman	10
Transistor Power Supply.....	Robert B. Kuehn	15
The SENSOR-MATIC.....	Hartwell M. Hughes	16
Supersonic Squawker.....	I. C. Chapel	22
Electronic Machine Gun.....	Martin H. Patrick	24
Bigger Bass from Broadcast Sets.....	R. H. Decker	26
The Whistle Switch.....	Martin J. Luff	27
Idiot Lights Out—Meters In.....	Charles Caringella, W6NJV	31
Banana Plug Splice.....	William E. Bentley	34
Transistorized Power Flash.....	Jim Kyle, K5JKX/6	38
Capacitor Stabilizes Solar Cell.....	Rufus P. Turner	40
Radiation Fallout Monitor.....	R. L. Winklepleck	41
Why Tune By Ear?.....	Rocco J. Carlucci	46

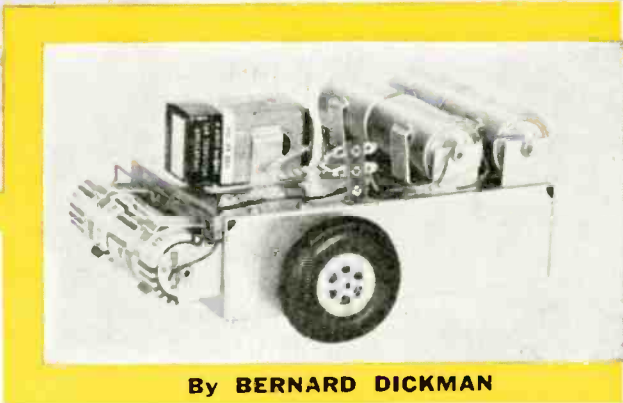
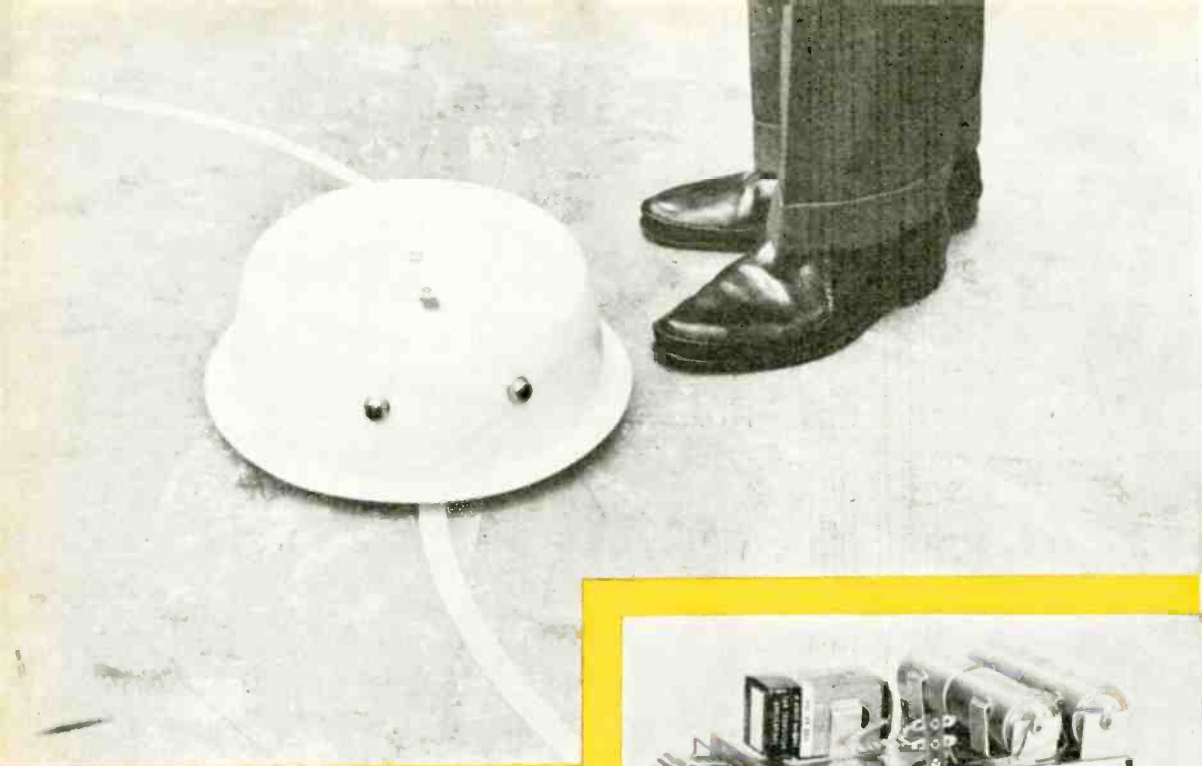

By BERNARD DICKMAN

# Emily...

## The Robot with a One Track Mind

**T**HE strange-looking object following the white line is named "Emily." She may look like a dishpan with eyes, but this "Electro-Mechanical Inebriated Ladybug" is actually an electronic robot of the simplest type. Though equipped with only one "sense organ" (a photocell), two "muscles" (a pair of motors), and a very rudimentary "brain" (a transistor and relay), she's capable of some extremely intelligent (if slightly inebriated) behavior.

The ladies of our own species are often said to have "one-track minds." In Emily's case, however, this is literally true. Set her down on a white line and she'll doggedly follow it, regardless of how many times it twists and turns. Though her weaving gait suggests that she's a little "under the influence," she always reaches the end. This isn't all Emily can do, though; blink a flashlight beam at her and she'll follow *you* to the ends of the earth.

SWITCH POSITION	FUNCTION
OFF	ALL POWER OFF
1	TEST PCI CIRCUIT
2	OPERATE WITH PC1
3	TEST PC2 CIRCUIT
4	OPERATE WITH PC2

Emily's uncomplicated circuit can be further simplified if optional photocell PC1 is omitted. Positions 1 and 2 of S1 would not be needed, and a 3-position switch could be used.

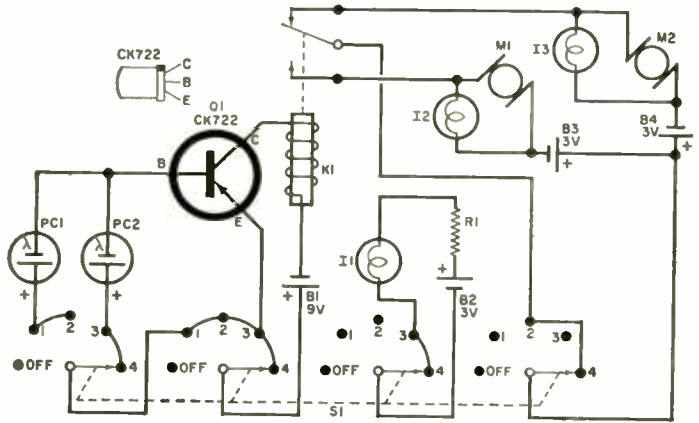

### PARTS LIST

- B1—9-volt battery (RCA VS305 or equivalent)
- B2, B3, B4—3-volt battery; 2 flashlight cells in series (Burgess Type 2 or equivalent)
- I1—2.2-volt, prefocused-type flashlight lamp (G.E. Type 222 or equivalent)
- I2\*, I3\*—Pilot lamp (G.E. Type 48, or equivalent)
- K1—Sensitive relay; 8000-ohm, 0.7-ma. coil; s.p.d.t. contacts (Sigma 26F-8000-CDS/SIL or equivalent)
- M1, M2—Miniature d.c. motor (supplied with gear train kit—see "Hobby-Shop Items" listed below)
- PC1\*, PC2—Selenium photocell (International Rectifier B2M or equivalent)
- Q1—CK722 transistor (Raytheon)

- R1—2.2-ohm, 1/2-watt resistor
- S1—4-pole, 5-position rotary switch (4-pole, 3-position switch if PC1 is not used—see text)
- 1—2" x 7" x 5" aluminum chassis (Bud AC-402 or equivalent)
- 1\*—1 1/4" x 2 3/4" x 2 5/8" miniature aluminum chassis (Bud CB-1623 or equivalent)
- 1—Socket for I1 (Dialco 503 or equivalent)
- 3—Battery holders for B2, B3, and B4 (Keystone 186 or equivalent)
- 1—Battery clip for B1 (Keystone 96 or equivalent)
- Misc.—Terminal strips, wire, hardware, plastic dishpan\*, pilot lamp assemblies for I2 and I3 (if used), etc.
- \*Optional—see text

### Hobby-Shop Items

- 2—Wilson No. 3000 motor and gear train kits—see text
- 2—2 1/2"-diameter, airplane-type wheels (VECO No. 321 or equivalent)
- 1—1"-diameter, airplane-type wheel

- 1—6"-length of stiff wire (diameter to match hub of 1" wheel above)
- Misc.—Epoxy-resin glue (Duro E·POX·E or equivalent) or "heatless" solder (Craftsman Metal-Mend or equivalent)

**How Emily Works.** Emily's uncanny behavior is made possible by a very simple electronic circuit. With switch S1 in position 4, as shown in the schematic diagram, photocell PC2 is connected to the base circuit of transistor Q1. Also, power is fed to the transistor, exciter lamp (I1), and motors M1 and M2 from batteries B1, B2, B3, and B4, respectively.

Exciter lamp I1, a 2.2-volt flashlight bulb, is powered from 3-volt battery B2 and provides illumination for photocell PC2. Though resistor R1 drops the battery voltage a bit, I1 is still operated slightly in excess of its rating. This is done purposely, since the extra light output is needed to insure positive operation of the photocell.

When PC2 is illuminated, a small volt-

age of the two motor and gear train units which drive rear wheels. Assembled from kits, these units were set for reduction ratios of 216 to 1.

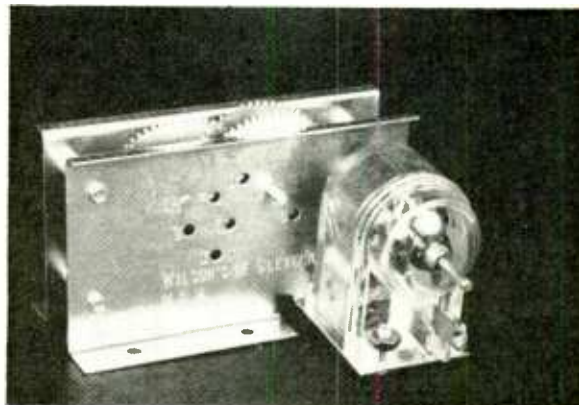

age is generated which biases *Q1*'s base. This causes the collector-emitter resistance of the transistor to drop to a low value, allowing current to pass from *B1* through *K1*'s coil. The energized coil then pulls down the relay armature.

Motors *M1* and *M2*, each of which turns one of Emily's rear wheels, are controlled through the relay's contacts. When the relay coil is not energized, power is fed to *M2*; when it is energized, power is fed to *M1*. The two motors are never powered simultaneously.

Photocell *PC2* and exciter lamp *I1* are mounted on the *M1*, or right, side of the chassis, near the front, as shown in the photos. The lamp, which is of the pre-focused type, is pointed down. If it passes over a white surface, light is reflected back into the photocell and motor *M1* is switched on; if the surface is dark, *M1* is shut off and power is fed to *M2*.

When Emily is placed over a white line on a dark floor, the left-rear wheel (driven by *M2*) will rotate. Pivoting on her single front wheel, she will turn toward the right until *I1* passes over the line, reflecting light into *PC2* and activating *K1*. This, of course, switches power from *M2* to *M1*, and Emily will turn toward her left until *I1* is moved away from the white line and power is switched back to *M2*.

The process is then repeated as described above—the net result being that the robot follows a mildly “drunken” course along the line. Indicator lamps *I2*

and *I3* (optional), wired in parallel with *M1* and *M2*, respectively, are Emily's “eyes”; they blink on and off as she changes direction.

*Position 3* of *S1* is used for test purposes. With the switch set in this position, photocell *PC2*, the transistor, and exciter-lamp circuits are left unchanged—but power for the motors is cut. In this way, the operation of the white-line tracking circuits can be checked without running the motors.

With *S1* in *position 2*, photocell *PC1* is connected to *Q1*'s base circuit in place of *PC2*. This optional photocell is mounted on top of Emily's cover and enables the robot to follow, by means similar to those discussed earlier, a flashlight beam in a darkened room. Power is also fed to the transistor and motor circuits, but exciter lamp *I1*, not needed in this application, is shut off.

*Position 1* of *S1* is used for testing the light-beam following circuit. With *S1* in this position, everything is connected as above, except that the motor circuit is shut off. To cut off all of Emily's power, *S1* is placed in the “off” position.

If the light-beam-following feature is not desired, *PC1* is not needed—nor are switch positions 1 and 2. In this case, Emily may be wired to use a 4-pole, 3-position switch.

**Putting Emily Together.** Begin by assembling the two Wilson No. 3000 motor and gear train kits which will supply the robot's motive power. Following the in-

View of robot's underside with all major components installed. Terminals of *K1* should be prewired, since they are difficult to reach once relay is in place.

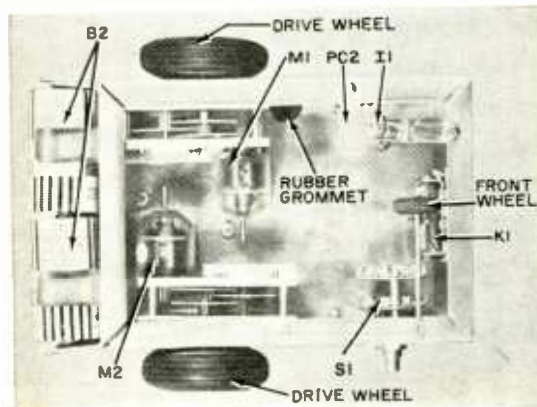

Batteries which power the motors, exciter lamp, and transistor circuit dominate top view. Battery leads are run through the rubber grommet.

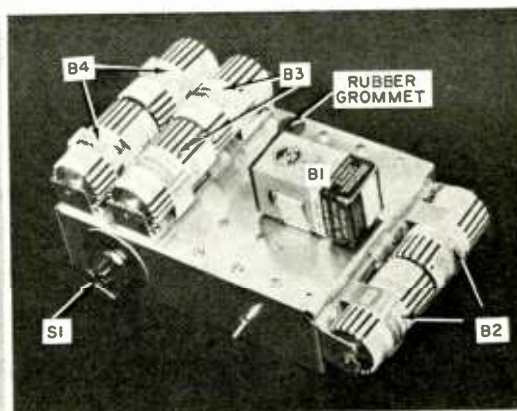

structions supplied with the kits, set up each unit for a reduction ratio of 216 to 1.

These kits are available in most hobby shops; but you can also get them by mail (write Wilson's of Cleveland, 6502 N.W. 16th St., P.O. Box 8995, Fort Lauderdale, Fla., enclosing \$4.00 for each kit). You'll find that more gears are included than you will need, but it's more economical to purchase the kits than to buy the required components individually.

With the power units assembled, the main construction job can begin. Parts placement is not critical, except where specified, but the photographs should be followed as closely as possible.

Mount the power units under the chassis as shown. Each one should be positioned so that its output shaft passes through the chassis lip at a point about 2" from the B2 end of the chassis. Use sheet-metal screws wherever there isn't enough clearance to install a nut for a machine screw.

Relay K1 is installed under the chassis on the end opposite B2. Place it far enough from switch S1 so you won't have difficulty wiring the switch terminals. The terminals of the relay itself are difficult to reach once the unit is fastened in place, so solder leads of the proper length to each one before installation.

The bracket for I1's holder is fastened to the lip of the K1 end of the chassis and positioned 1" from the corner as

shown. Before installing I1 in the holder, wrap the bulb with tape so that only its tip is left unmasked. Then, with I1 in place, bend the bracket down so that the tip of I1 projects only about  $\frac{3}{16}$ " out from the chassis. Photocell PC2, its right-angled mounting bracket carefully bent out straight, is also fastened to the chassis lip and placed so that it centers on, and almost touches, I2.

The leads of transistor Q1 are soldered to a 3-lug terminal strip fastened under one of the mounting nuts for B3's holder. Dropping resistor R1 (not visible in the photographs) is mounted on a 2-lug terminal strip which is located under PC2 and fastened to another of the mounting nuts for B3's holder. Other terminal strips found to be necessary as you proceed with the wiring can be installed as you go along.

Holders for batteries B1, B2, B3, and B4 are mounted as shown in the photos and need no special comment. The leads from these batteries, and from the pilot lights and photocell (if used) on Emily's cover, pass to the underside of the chassis through a  $\frac{3}{8}$ " rubber grommet placed as shown.

This all but completes the mechanical work on the chassis except for the installation of the wheels. The small front wheel is mounted on a length of steel wire, the diameter of which matches its hub. As can be seen in the close-up photograph of this assembly, the wire is bent

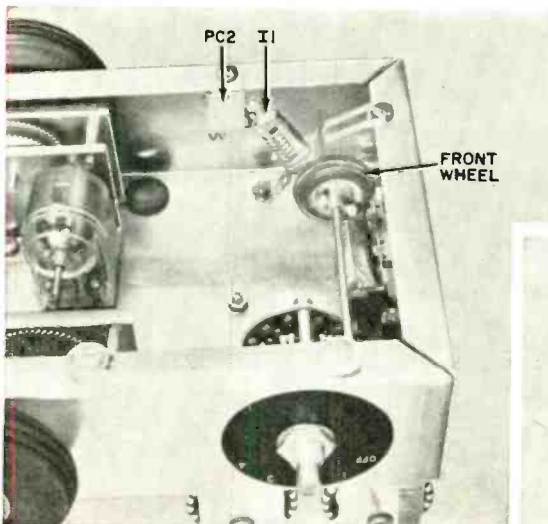

Mounting of PC2, I1, and front wheel can be seen clearly at left. Terminal strip for resistor R1 will be fastened under nut directly below I1. Rear wheels with setscrew pulleys glued on are shown below, as is spare shaft used for centering the hubs. Either epoxy resin or "heatless" solder can be used for gluing.



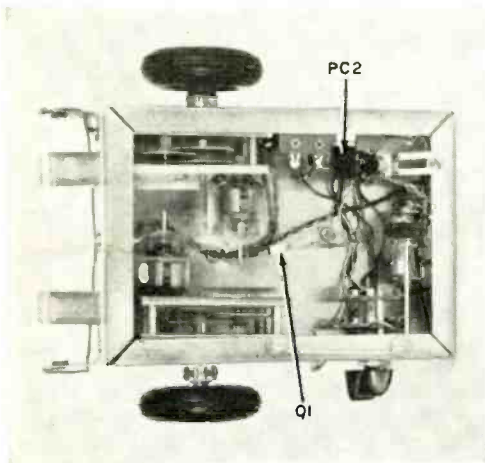

This under-the-chassis view shows the completed wiring. A 3-lug terminal strip is mounted for Q1; connections to PC2 are made via a 2-lug strip.

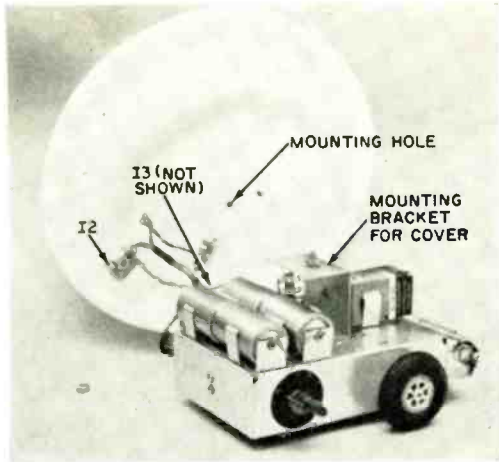

Completed robot with dish-pan cover in background. All the components and wiring associated with the cover are optional (see text).

at a right angle and fastened at two points on the chassis lip with screws and washers.

The driving wheels are mounted on the gearbox output shafts by means of set-screw pulleys (one is supplied with each Wilson kit). These pulleys must be glued to the wheels; either epoxy-resin glue or "heatless" auto body solder will work well (see Parts List).

The hubs of the wheels used in the model were larger in diameter than the  $\frac{3}{32}$ " pulley hubs. In order to center the pulley hubs on the wheel hubs properly, spare  $\frac{3}{32}$ " shafts from the kits were slipped through the latter. In each case the diameter of the shaft, where it passed through the wheel, was built up with masking tape to match the diameter of the hub. The pulley was then slipped over the protruding end of the shaft and glued in place. When the glue dried, the spare shafts were removed and the wheel mounted on the gearbox shafts.

The design for the robot's cover can be as fanciful and imaginative as you wish to make it. The cover used here was made out of a yellow plastic dishpan about  $12\frac{3}{4}$ " in diameter and 4" high. A  $1\frac{1}{4}$ " x  $2\frac{3}{4}$ " x  $2\frac{5}{8}$ " miniature aluminum chassis, its two short ends bolted to Emily and the dishpan, respectively, serves as the mounting bracket.

Photocell PC1 and the pilot lamp assemblies for I1 and I2 are mounted on the cover. A terminal strip installed under PC1's mounting nut connects the short leads of the photocell to the longer ones required to reach the chassis. The photocell and the two pilot lamps, as explained earlier, are optional.

Emily's wiring is not at all critical. All connections are made in normal point-to-point fashion, and no special attention need be paid to lead dress. Just be sure to use a heat sink when soldering Q1's leads and to observe carefully the polarity of battery B1—otherwise, the transistor might be damaged.

**Testing and Operation.** Install batteries B1, B2, B3, and B4 and, if PC1 is used, set switch S1 at position 1. Shine a flashlight on photocell PC1 and check to see that relay K1 pulls in. When you block the light beam with your hand, the relay should return to its normal position. (Look and listen carefully; the relay movement will be slight and will make almost no noise.)

With PC1 illuminated, turn S1 to position 2. This should start motor M1 and illuminate I2. Be sure that the rotation of the wheel is in the proper direction (clockwise when viewed from the side). If the rotation is wrong, reverse either the motor leads or the polarity of battery B3.



Next, shield *PC1* from the light. This should switch power from *M1* and *I2* to *M2* and *I3*. If the rotation of *M2*'s wheel is not *counterclockwise* when viewed from the side, reverse the connections to *M2* or the polarity of battery *B4*.

Now turn *S1* to position 3. This will stop the motor, turn on exciter lamp *I1*, and switch photocell *PC2* to *Q1*'s base circuit in place of *PC1*. Position a white card in front of *I1* so that the beam is reflected back into *PC2* and check to see that *K1* pulls in. Then cover the photocell with your thumb; the relay should return to its normal position.

Finally, move *S1* to position 4 and repeat the tests outlined above. With the photocell illuminated, motor *M1* should turn and *I2* should light. When the photocell is covered, power should be switched from *M1* and *I2* to *M2* and *I3*.

If Emily passes these preliminary tests, you're ready to try her out. Use  $\frac{3}{4}$ " masking tape, or some similar light-colored material, to lay out a patch on the floor (pick out as dark a floor as possible which is not too shiny). The path may curve in as many directions as you wish, but a turn that is too sharp can make Emily "lose her way." A little experimentation will soon show you just how sharp a turn she can take. (Wider tape will let her make sharper turns with less chance of getting lost.)

Center Emily directly over the path and set *S1* to position 4. The robot should travel to the right until she "finds" the path, then follow it to the end. When the end of the path is reached, she'll turn in circles until you shut her off or place her on the path again.

If Emily doesn't work properly at this point, chances are one of two things is wrong. Either motor *M1* is running all the time (*PC2* receiving too much illumination) or motor *M2* is running continually (*PC2* receiving too little illumination).

Should the problem be too much illumination, *PC2* is probably picking up a reflection of *I1*'s beam from the floor. You can make the photocell less sensitive by masking off part of it with black tape (experiment to determine the best area to mask). This tape can be removed when battery *B2* becomes so weak that *I1* no longer gives quite enough illumination to operate the relay, and replaced when a new battery is installed.

On the other hand, if *PC2* is not receiving enough light when it passes over the tape, you may have to make an adjustment in the position of *I1*. Place Emily on a table with the exciter lamp-photocell assembly close to the edge. Lay a white card under the assembly and turn *S1* to position 3. If the beam of *I1* doesn't reflect back into the photocell, bend *I1*'s bracket one way or the other until it does.

Emily can also be used on a white, or light-colored, floor with a dark path. In this case, though, you'll have to start her to the right, instead of the left, of the line.

To make her follow a light beam, turn *S1* to position 2. Then, standing in front of the robot, aim a flashlight (at a shallow angle) to the left of *PC1*. Emily will travel to her right until she reaches the beam, then follow it as if it were a white line.

-30-

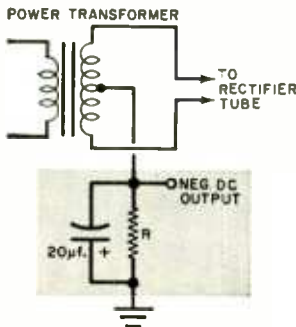

## TRANSISTOR POWER SUPPLY

You won't have to provide a separate power supply for a *pnp*-transistorized device if you're adding it to a piece of equipment possessing a power transformer with a center-tapped high-voltage winding. Just insert the circuit shown in the shaded portion of the diagram in series with the grounded center-tap lead. The output voltage will be negative, as required, and its amount will depend on the load on this transformer winding and the value of resistor *R*. You'll have to determine the latter by experimentation, but 100 ohms is a good place to start. The working voltage of the 20- $\mu$ f. electrolytic capacitor should be at least equal to the output voltage.

—Robert B. Kuehn

Think you'd like

- an inexpensive Burglar Alarm
- an invisible Mystery Switch
- a Doorbell that thinks



## Then build the **SENSOR-MATIC** —a one-tube capacity-operated relay

By **HARTWELL M. HUGHES**

**H**ERE'S a neat little capacity-operated relay that operates from any 117-volt a.c. line. Easy as well as inexpensive to build, the "Sensor-Matic" may well make use of a few of the parts which have been "gathering dust" in your spare-parts box. In addition to operating the usual low-current devices, it will handle small motors and appliances drawing up to 5 amperes. And by substituting a heavy-duty relay for *K2*, even larger currents can be handled.

Parts placement and wiring aren't at all critical, and changes in layout will have little if any effect on operation. While the unit is relatively insensitive—the "intruder" must actually touch the door knob, window frame, floor mat, etc., to "trigger" the relay, this is not a serious drawback.

The Sensor-Matic is built on a 2" x 7" x 5" aluminum chassis, with tube *V1*, transformer *T1*, and binding posts *BP1* and *BP2* mounted on top. The 1-megohm potentiometer *R2* (the sensitivity control) and its associated switch (*S1*) are mounted on one side, and binding posts *BP3*, *BP4*, and *BP5* on one end. Oscillator coil *L1* consists of 60 turns of No. 26 enameled wire, wound on a CTC form (Cambridge Thermionic PLST-2C4L/H) and tapped at the 30th turn.

**Setting It Up.** To place the Sensor-Matic in operation, connect a length of wire or an aluminum or copper plate to *BP1*, and turn sensitivity control *R2* fully counterclockwise (this will put maximum resistance between the grid and cathode of *V1b*).

Next, check to see if the oscillator is

# RCA training at home can be the smartest investment you ever made

Look what you get in the Course in Radio and Electronic Fundamentals

**40 Fascinating THEORY LESSONS**



Containing all the basic principles of radio and electronics in easy-to-understand form.

**40 EXPERIMENT LESSONS**



Each containing absorbing, practical experiments bound together in 20 books.

**40 SERVICE PRACTICES**



Full of practical, time-saving and money-saving servicing tips, bound into 20 books.

**PLUS ALL THIS AT NO EXTRA COST...**

**15 KITS**

to build a Multimeter, AM Receiver and Signal Generator. Kits contain new parts for experiments, integrated so as to demonstrate what you learn in the lessons and to help you develop technical skills. Each kit is fun to put together!

**MULTIMETER**



A sensitive precision measuring instrument you *build* and *use* on the job. Big 4½" meter with 50 micro-amp meter movement. 20,000 ohms-per-volt sensitivity d-c. 6,667 a-c.

**AM RECEIVER**



Have the satisfaction of building your own radio receiver with this high-quality 6-tube superheterodyne set. Big 5" speaker. fine tone!

**SIGNAL GENERATOR**



A "must" for aligning and trouble-shooting receivers. Build it for your own use. 170 KC to 50 MC fundamental frequencies for all radio and TV work.

**LET RCA TRAIN YOU AT HOME**  
 RCA Institutes, one of the leading technical institutes in the United States devoted exclusively to electronics, offers you the finest training-at-home. The very name "RCA" means dependability, integrity, and scientific advance. Practical work with your very first basic lesson. You build and keep prime quality equipment. Pay as you learn. No installment payments necessary. You pay for your next study group only when you order it. And remember, in electronics the more you know the higher you go. Licensed by the University of the State of New York.

**CLASSROOM TRAINING**  
 Classroom training in New York City and Los Angeles. Day and Evening classes start four times a year. In addition, Radio Corporation of America offers a limited number of basic courses in Chicago, Philadelphia, and Cherry Hill, N. J. (near Camden). Indicate your preference on attached card.

**SEND POSTCARD FOR FREE ILLUSTRATED BOOK TODAY!**  
 Check Home Study or Resident School Box



RCA INSTITUTES, INC. A SERVICE OF RADIO CORPORATION OF AMERICA, DEPT. EE-13  
 350 WEST 4TH ST., NEW YORK 14, N. Y. 610 S. MAIN ST., LOS ANGELES 14, CALIF.

The Most Trusted Name in Electronics



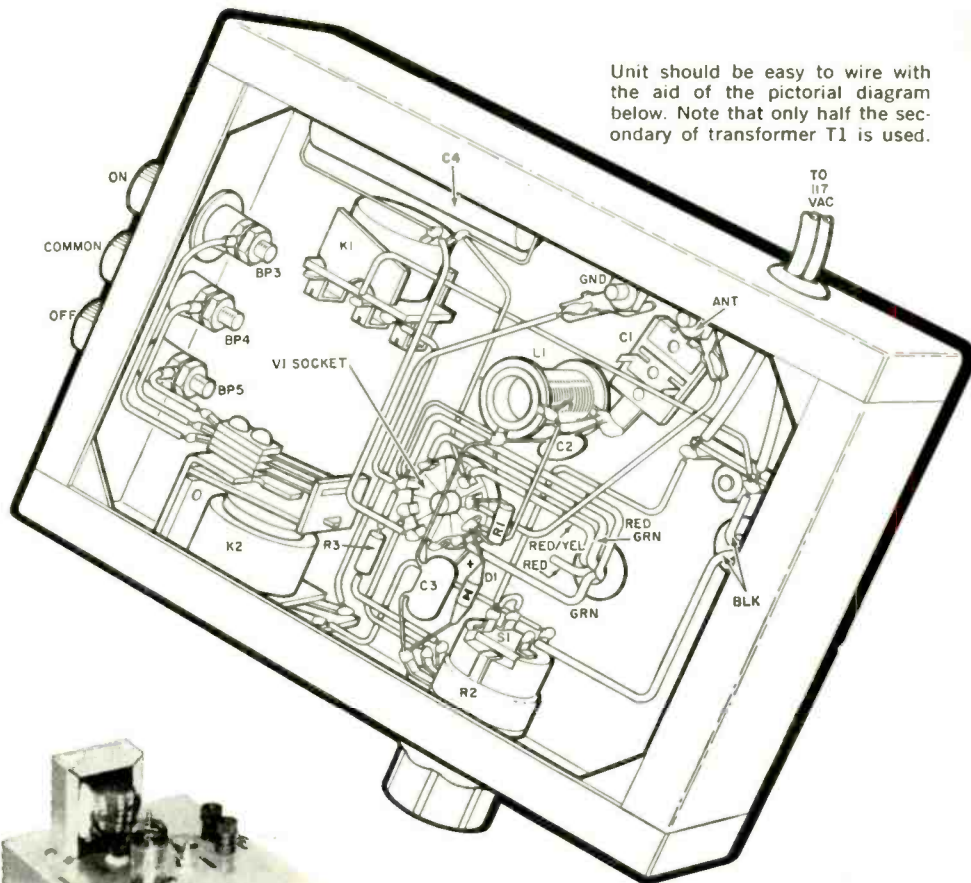

Unit should be easy to wire with the aid of the pictorial diagram below. Note that only half the secondary of transformer T1 is used.



Decals were added to completed relay to identify binding posts and controls.

barely oscillates. The voltage appearing on the cathode of *V1a* is rectified by diode *D1*, filtered by capacitor *C3*, and applied to the grid of *V1b* through potentiometer *R2*. With the proper setting of *R2*, no plate current flows in *V1b*, there is no current through *K1*, the relay contacts are open, and no current can flow through *K2*. This results in an open circuit between *BP4* and *BP5*.

When an external object such as a human being changes the effective load-

ing of the "antenna," the oscillator is thrown out of oscillation. This removes the cutoff bias and causes the plate current to flow in *V1b*, which, in turn, closes the relay contacts and allows current to flow through *K2*. As a result, *BP4* and *BP5* will now constitute a closed circuit, and any device connected between them will be energized.

Capacitor *C4*, incidentally, prevents *K1* from "chattering." Since *K1* is a d.c. relay and its coil is in the plate circuit of *V1b* which operates from an a.c. rather than a d.c. supply, some smoothing is necessary. The optimum value for *C4* may vary from the 1  $\mu$ f. specified: if relay chatter is troublesome, other values should be substituted for *C4* until it is eliminated.

# Supersonic Squawker



By I. C. CHAPEL



## Transistorized noise generator chases away unwelcome guests

**E**VER hear of "lo-fi"? Here it is—transistorized, battery-powered, and frequency-adjustable. What's the purpose of lo-fi? Well, if you've ever been bothered by dog, cat, or bird congregations in your yard—and wanted to shoo them off painlessly—then this lo-fi squawker is the answer to your prayers.

**Construction.** The complete unit is housed in a 3" x 5" x 9" metal cabinet and uses two modular subassemblies. Module A is the relaxation oscillator and module B the transistor oscillator. Both subassemblies and the speaker are mounted on the front panel. The tone control and on/off switch are mounted on the cabinet where they are readily accessible.

Each module is wired on a 2½"-wide phenolic or Bakelite board. All components are mounted on the front sides of the boards except power transistor  $Q_4$ , which is on the back of module B. Parts placement is not important, but the arrangement shown eliminates most crossing of wires. The non-power transistors and other components are mounted to the boards by means of flea clips or copper pins. This method allows easy parts replacement, if necessary.

The upper right-hand and lower left-hand corners of module A should have

eyelets or pins installed for connection to module B. Since the speaker has no provisions for mounting a transformer,  $T_1$  is fastened to the bottom of module B. A simple bracket bolted to the inner bottom of the cabinet holds the batteries in position. Mount tone control  $R_4$  and on-off switch  $S_1$  on top of the cabinet.

**Testing.** After module A is wired according to the diagram, power may be applied. This unit is complete within itself and can be tested without connection to the other circuits. The frequency of the transistor oscillator ( $Q_1$  and  $Q_2$ ) can be changed by variation of  $R_4$  and  $C_4$ . The values given for  $C_1$  and  $R_1$  cause a pulse rate of about 100 per minute in the neon lamp relaxation oscillator.

Module B can be tested without con-

### HOW IT WORKS

Components  $C_1$ ,  $R_1$ ,  $NL_1$  and  $B_1$  comprise a relaxation oscillator that pulses at a rate (approximately 100 per minute) determined by the time constant of  $C_1$  and  $R_1$ . This signal is applied to  $Q_1$  and  $Q_2$ , which operate as an audio oscillator. Potentiometer  $R_4$  controls the frequency of oscillation.

The combined output of the oscillators feeds a driver stage ( $Q_3$ ) which is followed by an inter-stage transformer ( $T_1$ ). This transformer feeds the 2N255 power amplifier ( $Q_4$ ), the output of which is connected to a direct-radiating 20-watt tweeter.

Subassemblies (right) interconnected and ready to be installed in cabinet. Note mounting of power transistor Q4 immediately below transformer on module B.

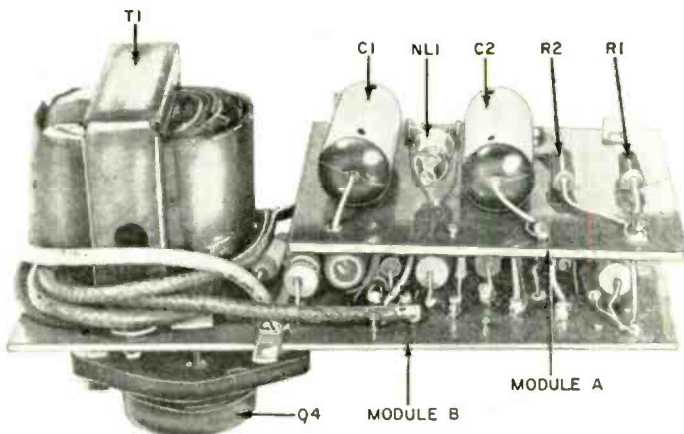

Rear view of cabinet with back panel removed shows relative placement of major components. Use a larger cabinet if you find wiring or assembly too crowded.

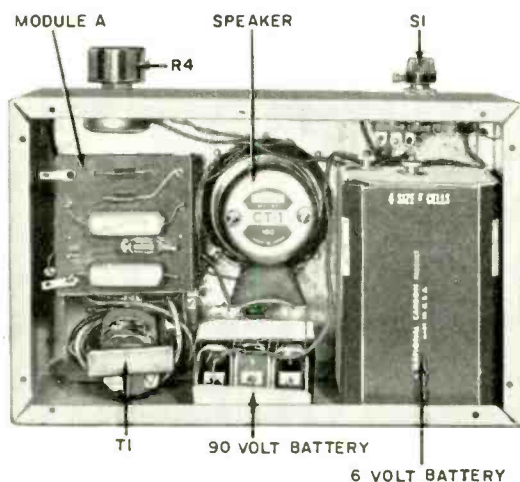

### PARTS LIST

- B1—90-volt battery (three Burgess U20 batteries or equivalent in series)
- B2—6-volt battery (Burgess F-4BP or equivalent)
- C1, C2—.05- $\mu$ f., 600-volt capacitor
- C3—.002- $\mu$ f., 600-volt capacitor
- C4, C5—.001- $\mu$ f., 600-volt capacitor
- NL1—NE-2 neon lamp
- Q1, Q2—CK722 transistor (Raytheon)
- Q3—2N217 transistor (RCA)
- Q4—2N255, 2N234, GE-3, or SYL109 transistor
- R1—10 megohms All resistors
- R2—560,000 ohms  $\frac{1}{4}$ -watt
- R3—3300 ohms
- R4—15,000-ohm potentiometer
- R5—180,000 ohms
- R6—18,000 ohms
- R7—91,000 ohms
- R8—47 ohms
- R9—2700 ohms
- S1—D.p.s.t. toggle or rotary switch
- T1—Interstage transformer: primary 100 ohms. (CT not used); secondary 10 ohms (Stancor T.A-2 or equivalent)
- SPKR—Tweeter speaker with 16-ohm voice coil, 2"-3" diameter
- 1-3" x 5" x 9" metal cabinet

necting it to module A if a 100,000-ohm resistor is connected from the base of Q1 to ground. The power drawn by module B is about 90 ma. at 6 volts. The signal level, measured across the speaker voice coil is approximately 10 db.

-30-

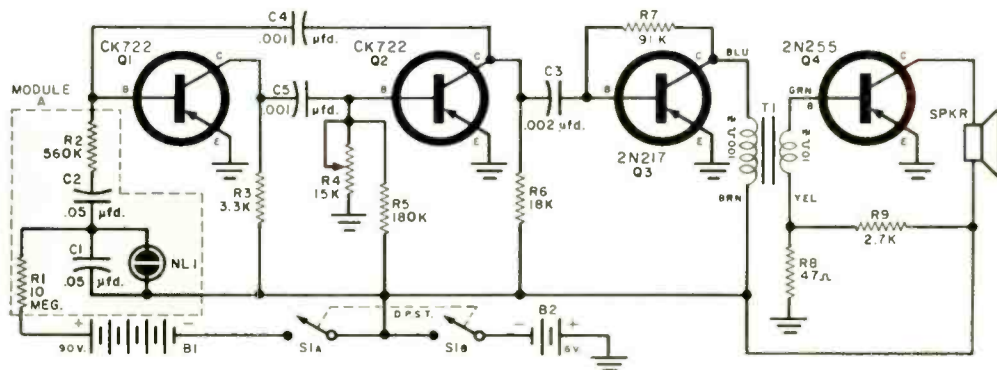

*Transistors provide rat-a-tat-tat sound effects  
for Junior's small artillery*



# ELECTRONIC MACHINE GUN

By MARTIN H. PATRICK

**W**OULD you like to delight your child by making his toy machine gun sound like the real McCoy? You can do the job with a couple of transistors, a discarded door buzzer, and a minimum of other components. Built into any toy machine gun having room enough to house it, the circuit produces a loud "rat-a-tat-tat" which is startlingly like that of a real weapon. For a variety of effects, the pulse rate is adjustable over a wide range.

**The Circuit.** Essentially a direct-coupled amplifier, the circuit uses two complementary transistors ( $Q1$  and  $Q2$ ). Collector-to-base feedback between  $npn$  transistor  $Q2$  and  $pnp$  transistor  $Q1$  is provided through an  $RC$  network consisting of  $R1$ ,  $R2$ , and  $C1$ . The values of the latter components were chosen to make the circuit oscillate, or pulse, at a low rate. Potentiometer  $R2$  allows adjustment of the rate of oscillation.

The coil of a door buzzer serves as the collector load for  $Q2$ , and the buzzer armature is pulled in (with a loud click) and released each time a pulse passes through the system. The buzzer's "breaker" contacts are removed and bypassed so that the coil is always in the circuit regardless of the armature posi-

tion. Power for the device is provided by battery  $B1$  through switch  $S1$ .

**Construction.** Building techniques, of course, will vary with the toy machine gun being adapted. The author elected to construct his gun from some scraps of wood. The photographs and pictorial diagram will serve as a rough guide for anyone wishing to duplicate it.

In the author's model, capacitor  $C1$  and the sockets for transistors  $Q1$  and  $Q2$  are mounted on a  $1'' \times 1\frac{1}{2}''$  piece of perforated board. This board, and the door buzzer, are fastened inside the stock of the gun with machine screws. Potentiometer  $R2$  is mounted so that its stubby shaft passes through the stock.

Switch  $S1$ , which is of the push-button type, is placed just behind the hinged front "trigger," and is depressed each time that the trigger is pulled. (The mechanical arrangement of the trigger in your gun might be such that a lever-operated snap-action switch would work better.) The two flashlight cells making up battery  $B1$  were installed without benefit of a holder, the leads having been soldered on directly.

Again, the author's model is intended only as a guide. Your parts layout may be quite different, depending on the



Layout of the circuit as installed in author's model. Vary it to suit your mounting situation.

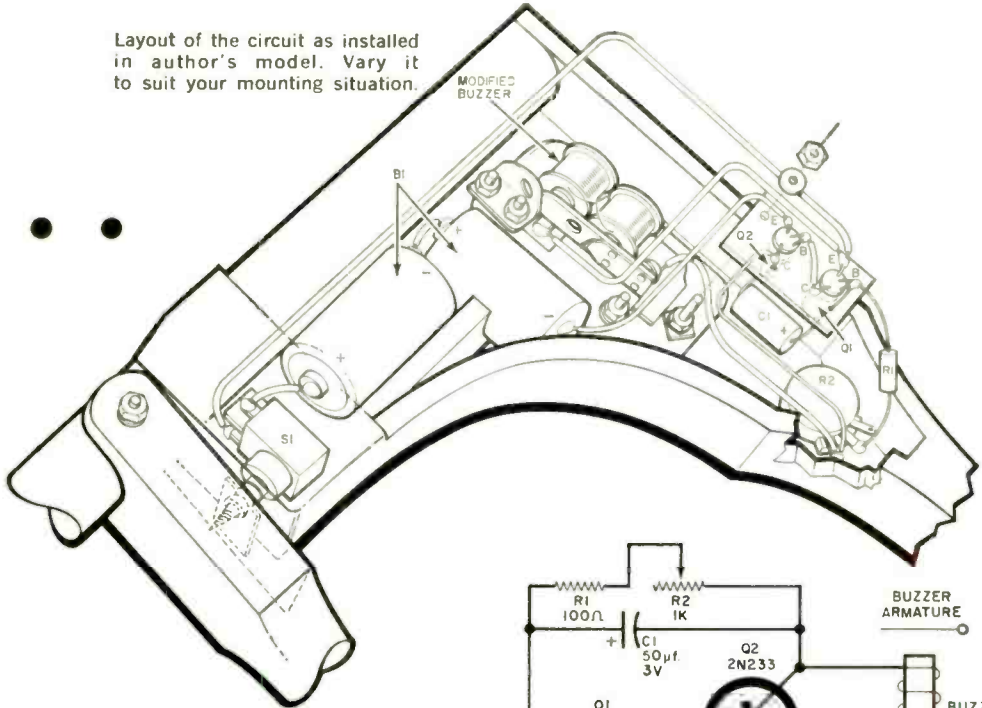

Oscillator circuit is essentially a direct-coupled amplifier; R1, R2, C1 provide the feedback.

A few key dimensions for those who wish to construct a machine gun similar to the author's. Contact paper gives a "marble" effect.

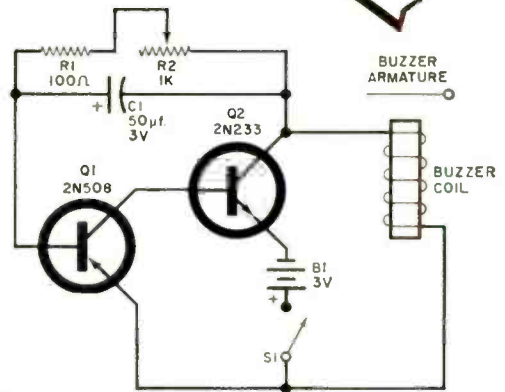
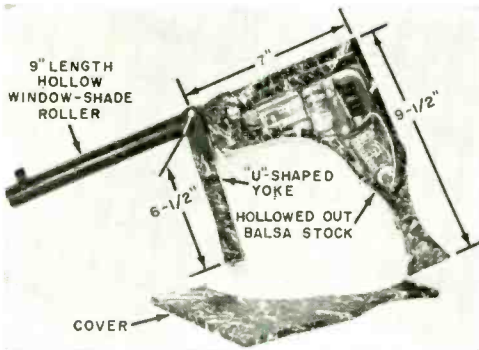

**PARTS LIST**

- B1—Two 1.5-volt flashlight cells in series ( Burgess Type 1 or equivalent)
- C1—50- $\mu$ f., 3-w.v.d.c. electrolytic capacitor
- Q1—2N508 transistor
- Q2—2N233 transistor
- R1—100-ohm,  $\frac{1}{2}$ -watt resistor
- R2—1000-ohm potentiometer, linear taper
- S1—S.p.s.t. push-button or snap-action switch—see text
- 1—Door buzzer, modified—see text
- 1—Toy machine gun or materials for homemade version—see text.
- Misc.—Perforated board, wire, solder, hardware, etc.

mounting space available in the gun you're using. The wiring is not critical and, if it's necessary to separate the components, the longer leads required will not affect the circuit's operation. If your machine gun should be constructed of metal, however, watch out for shorts to the case.

**Buzzer Modifications.** Before installing the buzzer, remember to remove the "breaker" contacts and connect the coil so that it's in the circuit at all times. In addition, to give the modified buzzer a crisp snap-action sound, mount a metal stop behind—and just touching—the armature.



# BIGGER BASS FROM BROADCAST SETS

By R. H. DECKER

**H**ERE is a simple circuit that will enhance the tone of most older a.c./d.c. broadcast receivers. The components were selected to give negative feedback at mid and high audio frequencies, with progressively less feedback at lower frequencies. This results in bass boost plus a reduction in distortion to improve the overall audio quality of the receiver.

The schematic diagram below shows the audio section of a typical receiver, with added components and wiring changes indicated in color. As you have no doubt guessed, *V1* is a twin diode/hi-mu triode employed as a second detector and first audio amplifier stage; *V2* is a beam-power tube employed as the audio power output stage which drives the speaker. Before installing the circuit, remove the chassis from the cabinet and compare the original wiring with the diagram below. If the two circuits differ appreciably, it might be wise not to attempt the modification.

Note that one end of capacitor *C1* is connected to the unbypassed cathode resistor of *V2*. If this resistor is bypassed, i.e., if there is a capacitor connected in parallel with it, the bypass capacitor must be removed in order for the circuit to work properly.

Check the modifications carefully, then re-install the chassis in its cabinet. Turn the radio on and tune in a station with a musical program. You should be pleasantly surprised at the improvement in sound quality.

-50-

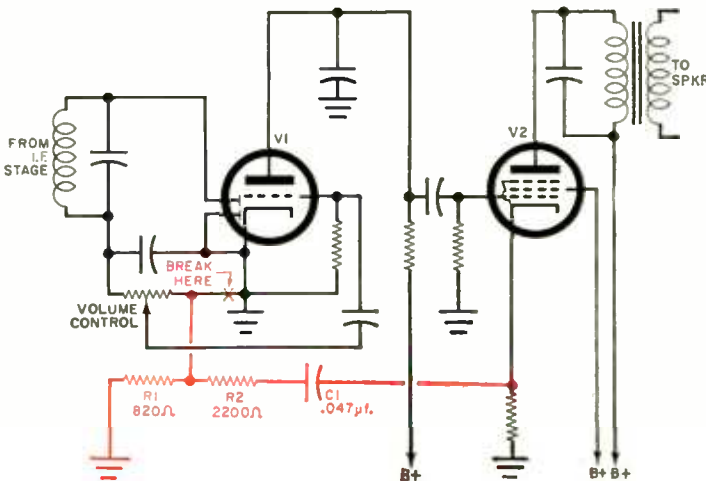

The audio section in most older a.c./d.c. receivers is similar to the circuit shown here; tube *V1* is typically a 12SQ7 or 12AT6, tube *V2* is often a 35L6, 50L6, or 50B5. Although the necessary components can be easily added to older radios, it's usually more difficult installing them in receivers which employ printed-circuit boards.

# THE WHISTLE SWITCH

**A cinch to build,  
this whistle-operated relay  
will turn electrical equipment  
on or off from distances  
up to 100 feet**

**By MARTIN J. LEFF**

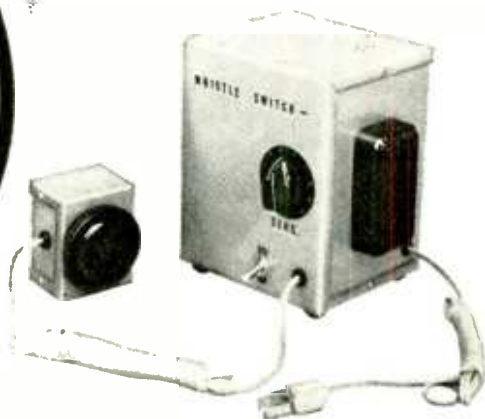

**I**N A LARGE mid-town Manhattan photo studio, the photographer had just finished posing his pretty model. "We're ready to shoot now," he said; "hold it while I switch on the lights." Expecting him to turn and walk to the distant wall switch, the model was understandably startled when he merely put his fingers to his lips and emitted a piercing whistle. But, in instant response to his signal, the great banks of lights overhead flicked on.

The photographer was using a variation of the "Whistle Switch." Responding to a whistle of the "puckered lips" variety, this unit will turn electrical equipment on or off from up to about 15 feet away. The range can be increased to some 50 feet by using a "lips and fingers" whistle, and mechanical whistles—such as the "police" type—will actuate the switch at distances up to about 100 feet.

Definitely more economical than the conventional radio remote-control system, the Whistle Switch costs about \$30.00 to

build—much less than that if you already have some of the parts on hand.

**About the Circuit.** The whistle command is picked up by the carbon microphone (*MIC*) and converted to an electrical pulse. Amplified by transistors *Q1* and *Q2*, the pulse charges capacitor *C4* (which is connected in *Q2*'s collector circuit). Relay *K1*'s coil, connected in parallel with capacitor *C4*, is then energized—and *K1*'s contacts close, connecting the 117-volt line to the coil of latching relay *K2*.

With *K2*'s coil energized, that relay's contacts switch from "off" to "on," or from "on" to "off," depending on which position they were originally in. Then, as soon as the whistle stops, capacitor *C4* discharges, opening *K1*'s contacts and de-energizing *K2*. The contacts of *K2*, however, remained locked in whichever position they were switched to.

Since *K2*'s contacts control the line voltage to outlet *J1*, any device plugged into that outlet will be "whistle-con-

# SWITCH

Begin construction by temporarily fastening the two terminal strips to a board. After wiring as shown at right, remove assembly from board and mount in utility box.

trolled." One whistle will turn it on, the next will turn it off, etc.

The sensitivity of the Whistle Switch is governed by potentiometer *R1*, which acts as a mike gain control. Resistors *R3/R4* and *R6/R7* are voltage dividers, supplying bias for transistors *Q1* and *Q2*, respectively. Coupling capacitors *C1*, *C2*, and *C3* also act (in conjunction with *R1*, *R4*, and *R7*, respectively) as high-pass filters. The filtering action reduces the circuit's response to low-frequency noises (voices, etc.), while having no effect on the response to whistles.

Power for the Whistle Switch comes from the a.c. line via low-voltage transformer *T1* and a rectifying and filtering circuit consisting of diodes *D1* and *D2*, capacitors *C5* and *C6*, and resistor *R9*. Resistor *R8* is a bleeder for the power supply.

**Construction.** All of the components within the dotted box on the schematic diagram are mounted between two 10-lug (none grounded) terminal strips. Begin construction by temporarily screwing these two strips (parallel to each other and 2" apart) to a wooden board. Then wire the components to the strips as shown in the pictorial diagram of the assembly and in the schematic. Install a 6" lead at all points where a wire must run from the assembly to another part of the circuit. These points are lettered "A" through "I" in both the pictorial and schematic diagrams.

The completed terminal strip assembly is removed from the board and mounted under the top of a 6" x 5" x 4" aluminum utility box (see photos). Transistors *Q1* and *Q2*, as used in this circuit, are quite temperature-sensitive. Therefore, they

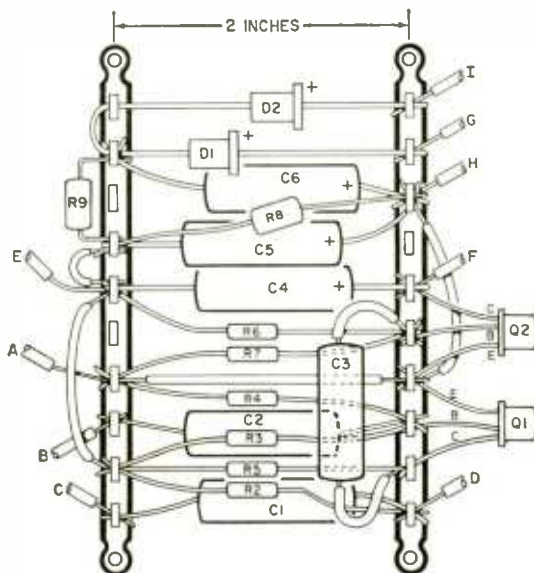

## PARTS LIST

- C1*, *C2*, *C3*—0.1- $\mu$ f., 200-volt paper capacitor
- C4*—2- $\mu$ f., 25-w.v.d.c. electrolytic capacitor
- C5*, *C6*—50- $\mu$ f., 25-w.v.d.c. electrolytic capacitor
- D1*, *D2*—1N1692 diode (General Electric)
- J1*—Surface-mounted duplex outlet (household type)
- K1*—Sensitive relay; 2300-ohm, 4.6-ma. coil (Sigma 11F-2300-G/SIL or equivalent—see text)
- K2*—Ratchet-impulse relay, 115-volt a.c. coil (Potter & Brumfield AP11A or equivalent—see text)
- MIC*—Telephone-type carbon microphone cartridge—see text
- Q1*, *Q2*—2N631 transistor (Raytheon)
- R1*—10,000-ohm potentiometer, linear taper

are snapped into a couple of fuse clips (which act as heat sinks) fastened next to the terminal strip assembly.

Potentiometer *R1*, switch *S1*, and relay *K1* are mounted on the front panel of the utility box. Since one side of the a.c. line will appear on the frame of relay *K1*, the latter must be insulated from ground. The author solved this problem by installing *K1* on a small square of insulating material which, in turn, was fastened to the panel. If you prefer, you can use a Sigma 11F2-2300-G/SIL for *K1* instead of the unit specified in the Parts List; the two relays are identical, except that the former is already mounted on an insulated base.

Mount transformer *T1* and relay *K2* on

the bottom of the box. The transformer is located as far as possible from sensitive relay *K1* so that *K1* won't be affected by the transformer's magnetic field.

The relay specified for *K2* in the Parts List was used primarily because the author happened to have it on hand. It has two sets of s.p.d.t. contacts. One of these was not employed in this application; the other was used as a s.p.s.t. switch. Any similar relay will work in this circuit as long as it has a 117-volt coil and at least one set of s.p.s.t. contacts.

Outlet *J1* is located on one of the sides of the box cover, and both its cord and the line cord enter the box through grommets near the outlet. A similar hole at the bottom of the front panel accepts the cord from the microphone.

To prevent the microphone from picking up noise from relays *K1* and *K2*, it

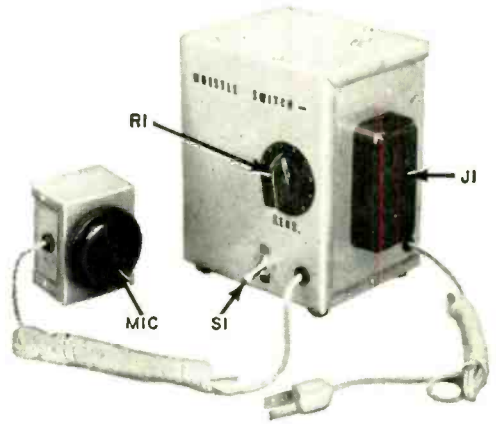

Completed Whistle Switch is shown above. Mike is in separate box to prevent pickup of relay noises.

- R2*—3300 ohms  
*R3*—1 megohm, 5%  
*R4*—10,000 ohms, 5%  
*R5*—10,000 ohms  
*R6*—750,000 ohms, 5%  
*R7*—4300 ohms, 5%  
*R8*—2200 ohms, 1 watt  
*R9*—100 ohms, 2 watts  
*S1*—D.p.s.t. switch  
*T1*—Filament transformer; primary, 117 volts; secondary, 26.5 volts CT @ 0.6 ampere (Thorndarson 21F27 or equivalent)  
 1—6" x 5" x 4" aluminum utility box (Bud CU-2107-A or equivalent)  
 1—2 3/4" x 2 1/8" x 1 1/8" aluminum utility box (Bud CU-2100-A or equivalent)  
 2—10-lug (none grounded) terminal strips (Cinch-Jones 2010 or equivalent)  
 Misc.—Fuse clips, #16 and #22 hookup wire, zip cord, line cord and plug, grommets, etc.
- all 10%, 1/2-watt resistors unless otherwise specified

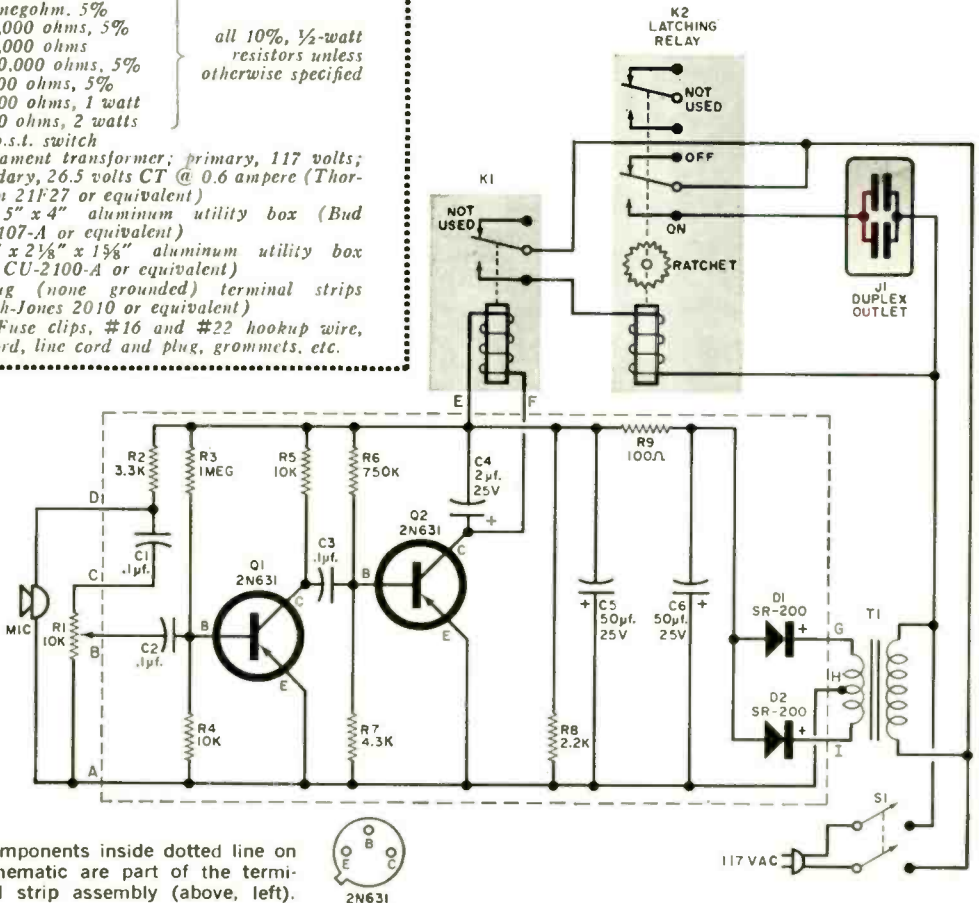

Components inside dotted line on schematic are part of the terminal strip assembly (above, left).



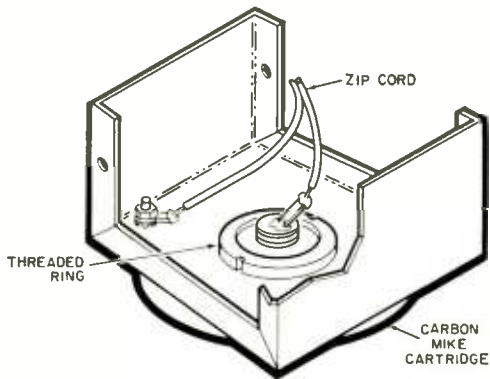

Method of mounting mike on box will vary with type of cartridge employed. Author's installation (see text) is illustrated here.

is mounted in a separate utility box (2 1/4" x 2 1/8" x 1 5/8"). A carbon mike, salvaged from a government-surplus handset, was used by the author. The threaded ring sealing the carbon chamber was removed and re-installed as a retaining ring to hold the microphone in place on the box's front panel (see

drawing). If you use this method of installation, be careful not to spill any of the carbon granules while you have the ring unscrewed.

A 5' zip-cord cable is attached to the microphone and run out of the utility box through a grommeted hole. In the model shown, one lead of the mike cable was grounded to the box because the threaded retaining ring (automatically grounded) also serves as one of the mike contacts.

Now run the mike cord and a heavy-duty line cord into the main box and complete the wiring. Trim each lead from the terminal strip assembly, as you come to it, to an appropriate length. Use #16 hookup wire for the leads running from *S1* to *J1* and the contacts of *K2*. Elsewhere, #22 wire may be used.

**Operation.** Plug the apparatus to be controlled into *J1*, plug the Whistle Switch into the line, and close *S1*. Set the microphone well away from the main unit. The sensitivity control (*R1*) should be adjusted so that the relays just respond to your whistle under actual operating conditions.

Because of manufacturing variations in the transistors, the sensitivity of your unit may vary from that of the author's model. If the sensitivity is too high (relays respond to extraneous noise regardless of the setting of *R1*), increase resistor *R3* to 1.5 megohms. Should the sensitivity be too low (relays don't respond at all), try reducing *R3* to 750,000 ohms.

The power-handling capacity of the Whistle Switch depends primarily on the rating of relay *K2*'s contacts. With the relay specified here, loads up to about 600 watts can be safely controlled. —30—

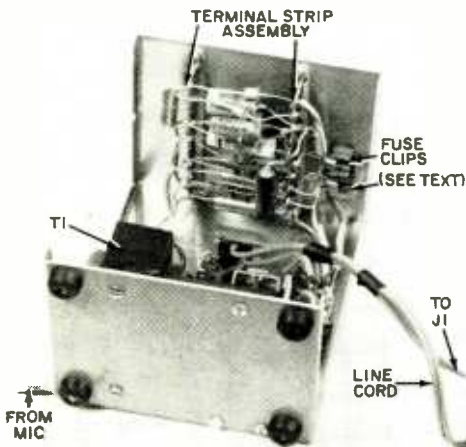

Positioning of terminal strip assembly can be seen in the photo above (note fuse clips used as heat sinks for *Q1* and *Q2*). View at right shows wiring associated with cover.

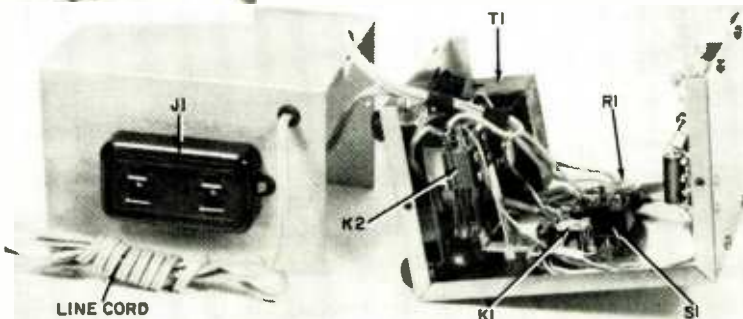

# IDIOT LIGHTS OUT ...METERS IN

*No way to keep tabs on your car's exact engine temperature? Then dump those "idiot lights" and replace them with this all-electronic temperature gauge!*

**By**  
**CHARLES CARINGELLA**  
W6NJV

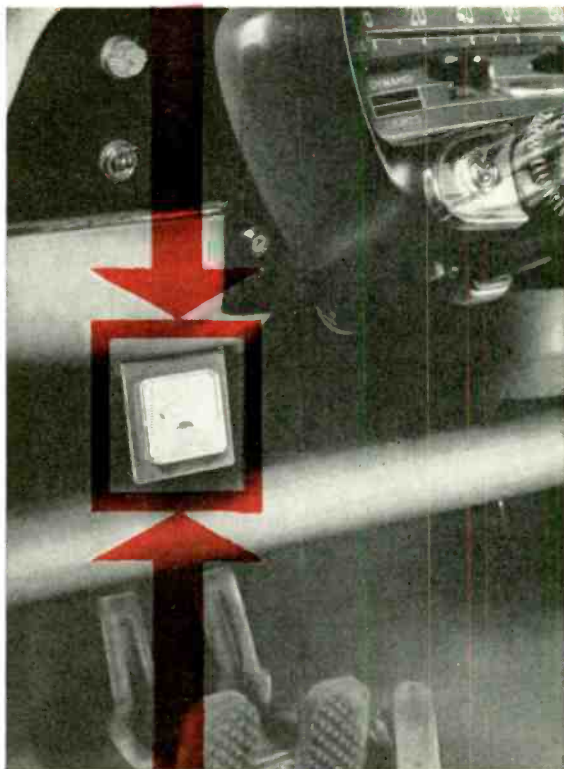

AS you no doubt know, the temperature gauge is one "standard equipment" item that is missing from a good many cars. In fact, a colored light is often the only indication that there's trouble brewing somewhere in the auto's cooling system. And all too often, its warning comes too late.

While canvassing the auto parts houses in search of a suitable temperature gauge for his automobile, the author decided that he wanted a more versatile instrument than the types commonly available. An *electronic* temperature gauge was his solution.

The model shown was designed to operate as "universally" as possible. It will work on either a 6- or 12-volt, positive- or negative-ground system with simple circuit modifications. In addition, it can

be constructed for less than \$10.00—cheap "insurance" against costly auto engine repairs from almost anyone's point of view. And it can be duplicated by virtually anyone without the need for test equipment or tricky adjustments.

There are several advantages in using an *electronic* temperature gauge. First, a single-conductor lead of any length can be run from the sensing unit to the meter assembly. Secondly, its response time is much faster than that of many other gauges—bourdon-tube types, for example. Last of all, any number of sensing units can be switched; this feature should be of value to auto enthusiasts and race-car drivers who would like to monitor cylinder-head and oil temperature as well as water temperature.

The model was carefully temperature-

calibrated, and, as long as the specified components are used, this calibration should be accurate enough for your unit. A meter face has been reproduced as part of this article and need only be traced, cut out, and glued in place.

**About the Device.** The "heart" of the electronic temperature gauge is a thermistor (*RT1*), which serves as the sensing element. Technically speaking, a thermistor is a resistor that has a *negative* temperature coefficient—that is, its resistance decreases tremendously as its temperature rises, and increases markedly as its temperature falls. By contrast, an ordinary resistor has a *positive* temperature coefficient; its resistance increases (although only slightly) as its

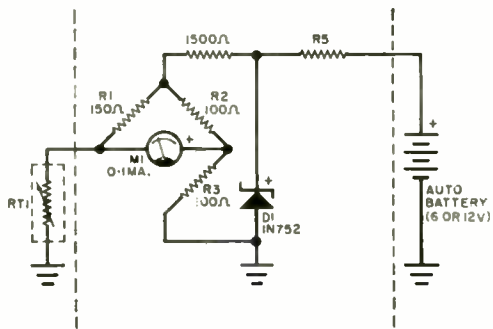

Bridge circuit is heart of electronic temperature gauge. Resistance of thermistor *RT1* varies with temperature, upsetting bridge balance, and causing current flow through meter *M1*.

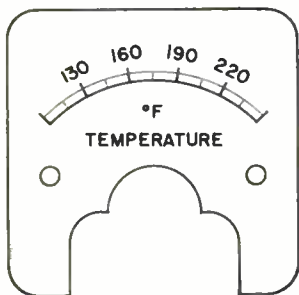

New face for milliammeter can be prepared by simply tracing this drawing.

### PARTS LIST

- D1*—Zener diode, 5.6 volts, 5%, 400 mw. (Texas Instruments 1N752 or equivalent)
- M1*—0.1 ma. miniature d.c. milliammeter (Lafayette TM-400, or equivalent)
- R1*—150 ohms
- R2, R3*—100 ohm. } all resistors 1/2-watt, 5%
- R4*—1500 ohms
- R5*—68 ohms (for 6-volt systems) or 330 ohms (for 12-volt systems)
- RT1*—Thermistor (Fenwal KB2311—available from Allied Radio, 100 N. Western Ave., Chicago 80, Ill., as # 10 E 194)
- 1—Printed-circuit board—see text
- Misc.—Wire, solder, etc.

Plastic cover must be removed from meter to permit installation of new meter face. Rubber cement holds new face securely in place.

temperature rises, and decreases as its temperature falls.

The thermistor is inserted into one leg of a bridge circuit—see the schematic diagram. At some temperature, the resistance of the thermistor is equal to the resistance of resistor *R1*, which is in the opposite leg of the bridge. In this condition, the bridge is balanced and no current flows through the meter.

Whenever the thermistor is heated, however, its resistance drops, causing current to flow through the meter. In order to read temperature rather than current, the meter scale is calibrated directly in degrees Fahrenheit.

The circuit is powered by the automobile battery. Unfortunately, battery voltage is not always constant; furthermore, since the generator is across the battery, its output voltage exceeds the bat-

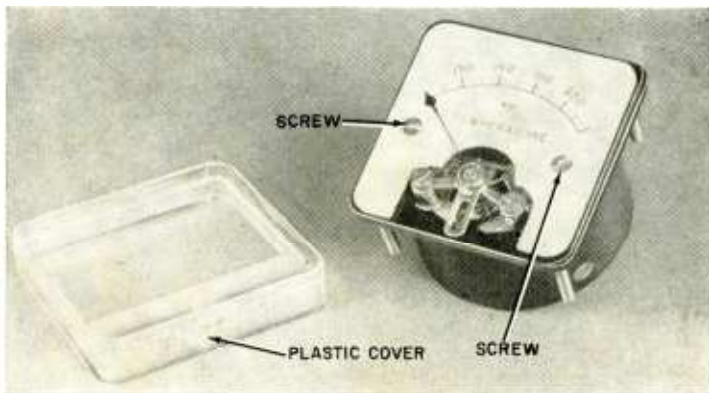



tery voltage during the charging period, and the output of the generator will vary with engine speed.

These voltage fluctuations would naturally disturb the overall accuracy of the instrument, had they not been eliminated with zener diode *D1*, which keeps the voltage applied to the bridge at a constant 5.6 volts d.c. regardless of what the actual battery voltage might be.

**Construction.** Begin construction by carefully removing the plastic cover from the front of the meter. (The cover is held by two snaps on either side and can be pried off with a small knife.) Remove the two screws which hold the meter face (see photo), and carefully slide the face out from under the pointer. (The pointer is extremely delicate, so hands off!)

Cut out the new meter face, including the two holes for the screws. Apply a thin layer of rubber cement to the front of the old meter face and also to the rear of the new one. Join the two together, being careful to align the two screw holes in the process. Then mount the new meter face on the meter movement once again and snap the plastic cover back in place.

The entire circuit, except for the thermistor sensing probe, is constructed on a printed-circuit board.\* (If you wish, a piece of perforated phenolic board can be used in place of the printed-circuit board, with the components mounted exactly as shown. A similar point-to-point wiring arrangement can then be used on the underside of the board.)

The hookup shown in the schematic diagram is for the conventional negative-ground system. If your automobile employs a positive-ground system, reverse the zener diode connection so that the banded end is connected to ground, and reverse the meter connections so that the positive terminal is connected to the junction of resistor *R1* and thermistor *RT1*.

It was decided to monitor the oil temperature, since the author's car is air-cooled rather than water-cooled, and oil

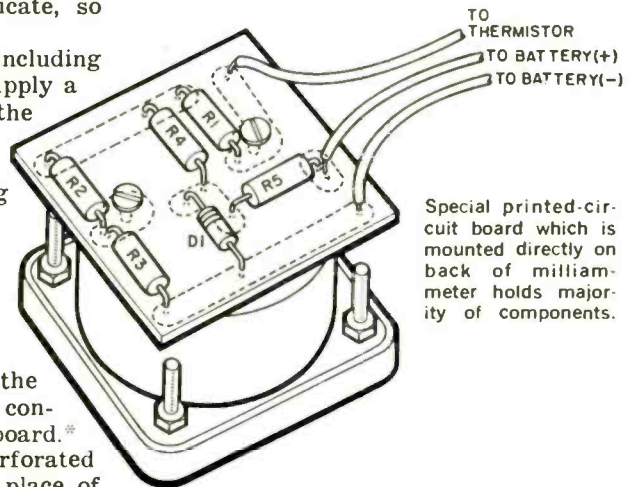
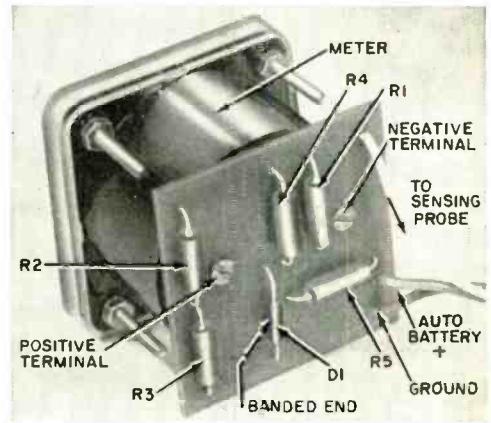

Special printed-circuit board which is mounted directly on back of milliammeter holds majority of components.

Entire meter assembly can be inserted into small right-angle aluminum bracket and bolted to underside of automobile dashboard, as pictured below.

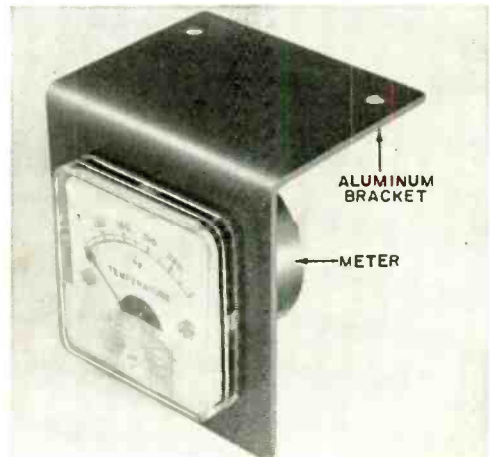

\*The printed-circuit board is available for \$1.00, postpaid, from SESCO, Box 7388, Alta Loma, Calif.

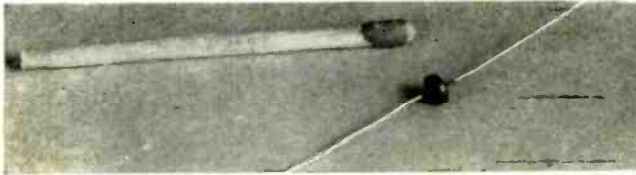

Disc-type thermistor isn't much larger than the head of an ordinary household match, yet it functions as the "sensing unit" for the electronic temperature gauge.

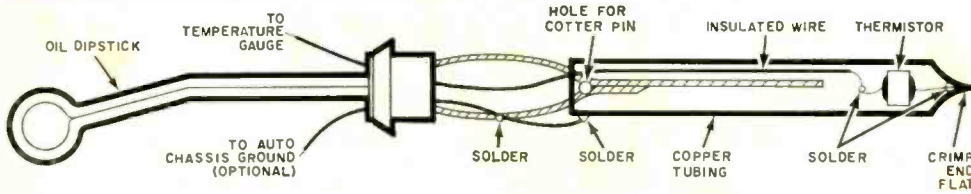

Thermistor can be mounted either in a modified oil dip stick (above) for measuring oil temperature, or in a simple housing (below) for monitoring temperature of cylinder head. See text for details.

temperature is probably a better all-around indication of an engine's cooling efficiency. Accordingly, the thermistor is mounted in a special housing on the oil dip stick and soldered into the end of a piece of copper tubing which is slipped over the dip stick.

One end of the thermistor should be soldered to the copper case, and the other end connected to the lead running to the electronic assembly. A separate ground lead to the auto chassis will probably be required, although the contact between the dip stick and the engine block may be good enough to make such a lead unnecessary. Since the original oil-level markings will have been covered up, it will be necessary to scratch new ones on the outside of the copper tubing.

If it is desired to monitor cylinder-

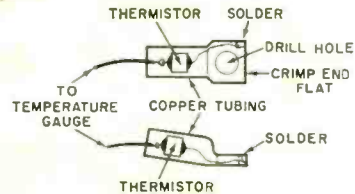

head temperature, a simple housing can be made. The thermistor is mounted in a short piece of copper tubing, with the tubing crimped at one end and flattened along with one of the thermistor leads. The flattened end is drilled so that it can be bolted to the cylinder head.

Take care not to overheat the zener diode when soldering it to the board, and be certain to connect the electronic temperature gauge to the ignition switch so that the gauge is in operation only when the automobile is running. —30—

### BANANA PLUG SPlice

Many experimenters have standardized their test leads by attaching a banana plug to both ends of each one. It's a good



idea, because the hollow end of a standard alligator clip can be easily slipped over one of the plugs. It's not so easy, however, to connect a pair of standard test leads in series unless you have a supply of banana plug splices like the one pictured here (H. H. Smith No. 245 or equivalent). If the local parts dealer doesn't have a stock of these little-known items, you can probably obtain them from your favorite mail-order house.

—William E. Bentley

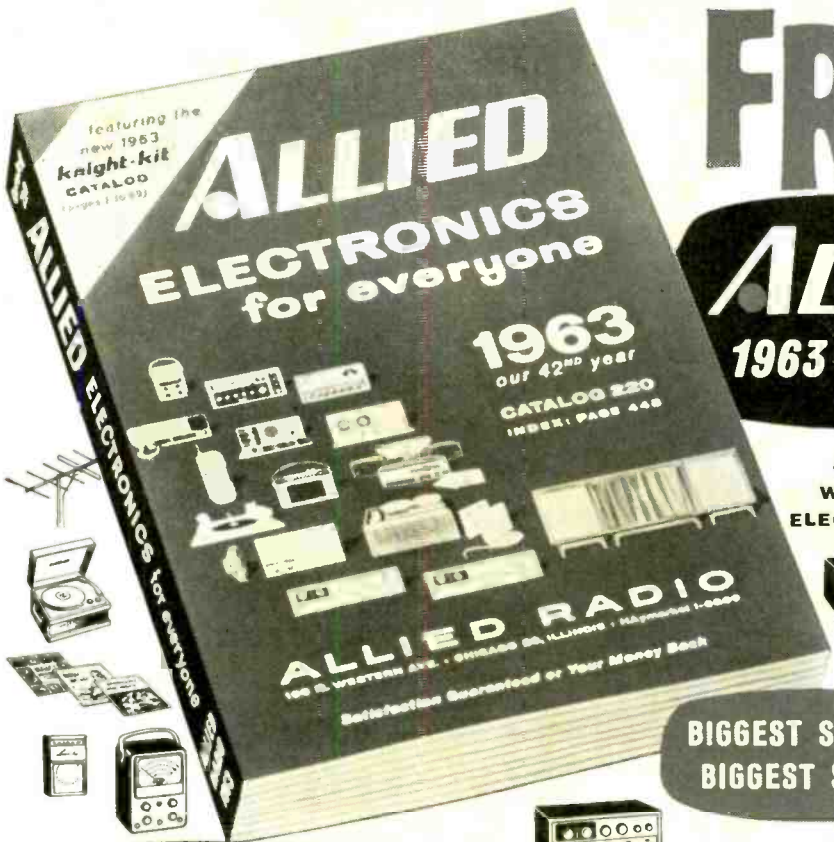

# FREE

# ALLIED

## 1963 CATALOG

**464 PAGES**  
**WORLD'S LARGEST**  
**ELECTRONICS CATALOG**

**BIGGEST SELECTION**  
**BIGGEST SAVINGS!**

see what's new in  
**STEREO HI-FI**

top buys in  
**TAPE RECORDING**

latest values in  
**CITIZENS BAND &  
 SHORTWAVE RADIOS**

exciting build-your-own  
**knight-kits<sup>®</sup>**

**NO MONEY DOWN:** Now! Get More  
 Buying Power with your  
 Allied Credit Fund Plan!

*Satisfaction guaranteed or your money back*

**ALLIED RADIO**  
*The World's Largest Electronic Supply House*

**SAVE MOST ON:**

- Everything in Stereo Hi-Fi
- New All-Transistor Stereo
- KNIGHT<sup>®</sup> Super-Value Hi-Fi
- Tape Recorders & Tape
- Citizens Band 2-Way Radios
- Transistor & FM-AM Radios
- Phonographs & Records
- Ham Station Equipment
- PA Systems, Intercoms
- Latest Test & Lab Instruments
- TV Tubes, Antennas, Accessories
- Parts, Tubes, Transistors, Books, Tools

**ALLIED EXCLUSIVES:**

See special products  
 and values available  
 only from Allied—plus  
 all the famous makes!

**FREE**

**SEND FOR YOUR COPY TODAY!**

ALLIED RADIO, Dept. 76-33-A  
 100 N. Western Ave., Chicago 80, Ill.

Send FREE 1963 ALLIED Catalog

Name \_\_\_\_\_  
PLEASE PRINT

Address \_\_\_\_\_

City \_\_\_\_\_ Zone \_\_\_\_\_ State \_\_\_\_\_

# TRANSISTORIZED

*This transistor-triggered B-C pack*



**H**AVE YOU EVER had a flash bulb misfire when shooting a "once-in-a-lifetime" picture? Flash-bulb failures are all too common, but you can stop them from happening by investing a few hours of your time and about five dollars of your cash in this simple transistorized "Power Flash" unit.

**Why Flash Bulbs Don't Fire.** By far the most common cause of misfiring is lack of current. Most of the older flash guns (and some of the inexpensive modern ones) were designed to fire bulbs by placing them in series, through the camera shutter contacts, with a pair of flashlight batteries. After batteries of this type have been used for a while, however, their internal resistance becomes high enough to make them undependable for delivering the large amounts of current needed to fire a flash bulb.

To overcome this problem, the battery-capacitor ("B-C") flash gun was developed. In these units, a capacitor is slowly charged to about 22 volts, then sud-

Top view of completed "Power Flash" is shown below, left. Underside, with protective cover removed, is shown below, right. The four small screws near the edges of the cardboard (see underside) hold the cover in place. Construction is extremely simple, but be sure to observe polarities of B1 and C1.

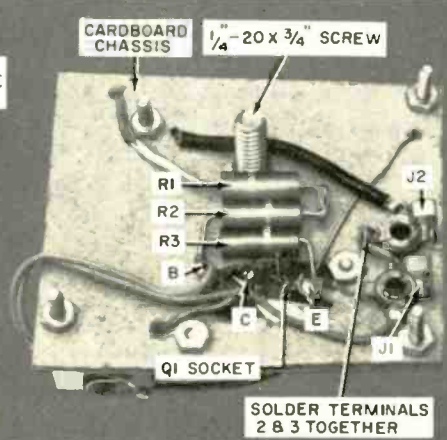
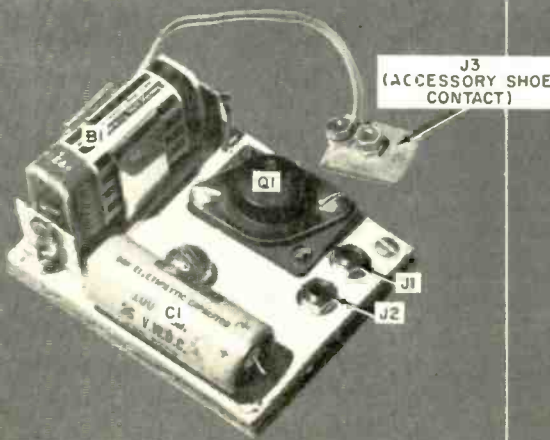

# POWER FLASH

By JIM KYLE, K5JKX/6

*makes flash bulbs fire every time*

denly discharged through the flash bulb when the camera shutter is tripped. Plenty of firing current is assured, even with weak batteries. Just as in the straight battery system, however, all of this current must pass through the delicate shutter contacts. These contacts frequently become pitted after a little use, develop a high resistance, and operate erratically.

The Power Flash described here com-

## PARTS LIST

- B1—Miniature 22½-volt battery (Burgess U15 or equivalent)
- C1—100- $\mu$ f., 25-w.v.d.c. electrolytic capacitor
- J1—Open-circuit phone jack, subminiature type (Switchcraft 41 or equivalent)
- J2—Closed-circuit phone jack, subminiature type (Switchcraft 42A or equivalent)
- J3—Accessory shoe contact (see text)
- Q1—2N307 transistor
- R1, R2, R3—1000-ohm, ½-watt resistor
- 1—Battery holder (Keystone 177, or equivalent)
- Misc.—Perforated board or drafting cardboard, transistor socket—if used, plugs for J1 and J2, hardware, etc.

It's not too much work to wire the Power Flash, as you can see from the pictorial diagram. Extra flash-gun jack can be added, if desired, to left of J2.

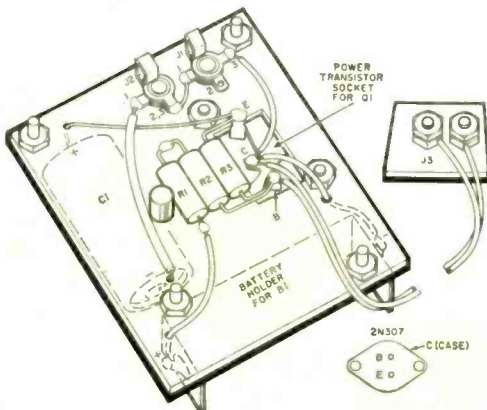

bines a "B-C" unit with a transistorized electronic switch. All of the firing current passes through the transistor, and only about 1/100 of an ampere of control current passes through the shutter contacts. With this device, you can fire up to five flash bulbs at once through 100 feet of extension cord. The author tested it with a shutter which refused to fire a conventional flash gun at even the slowest speeds and was able to obtain perfect synchronization at 1/600 of a second.

**About the Circuit.** The shutter's synchronizing mechanisms is connected to the Power Flash unit via jack J3. When the shutter contacts are open, the base of transistor Q1 receives a positive bias through resistors R1 and R2. The bias prevents current flow between the emitter and collector of the transistor. In this case, Q1 is essentially out of the circuit and capacitor C1 receives a charge through resistors R1, R2, and R3, and the flash bulb connected at jack J1. An additional bulb can be connected, if de-

Schematic diagram of transistorized Power Flash. Transistor Q1 is wired as electronic switch, controlling discharge of C1 through flash-bulb circuit.

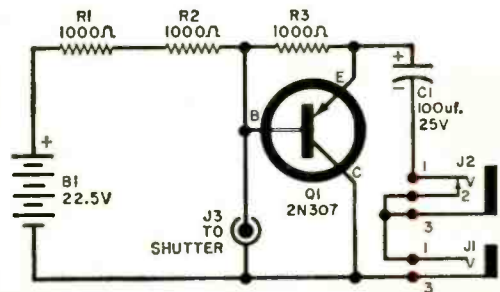

sired, at jack *J2*—but if only one bulb is used, *J2*'s self-shorting contacts remain closed to complete the circuit.

During the charging, not enough current passes through the bulb, or bulbs, to cause firing. When the shutter contacts close, however, *Q1*'s base is placed at collector potential, reducing the resistance between the emitter and collector to less than an ohm. Capacitor *C1* then discharges through the transistor, firing the bulb, or bulbs. The current through the shutter contacts, though, is never more than about 11 ma.

No on-off switch is included since, with no flash bulb connected, the only drain on battery *B1* is *Q1*'s base bias current—something less than 10 microamperes. It's possible, incidentally, to connect one more flash-bulb jack in series with *J1* and *J2*. Make sure that this jack, like *J2*, is of the closed-circuit type so that, if it isn't being used, the circuit will be complete. If only one flash bulb is employed, of course, it should be connected at *J1*.

**Construction.** To keep down both weight and cost, the author built the unit on a chassis made by sandwiching together two 2½" x 3" pieces of heavy drafting cardboard. You might, if you prefer, use sections of perforated phenolic board instead.

Capacitor *C1*, the battery holder, jacks *J1* and *J2*, and transistor *Q1* are mounted on one side of one of the cardboard pieces. Though a transistor socket was used by the author, it's not really necessary. Resistors *R1*, *R2*, and *R3* are installed on the other side, where all of the wiring is carried out.

The second cardboard piece, fastened to the first with four sets of 4-40 screws

and nuts, serves to cover the wiring. A small section is cut out of it to allow clearance for the two jacks; and extra nuts on the fastening screws, located between the two pieces, act as spacers.

A short length of zip cord serves to connect the Power Flash to the camera. On the author's camera, the shutter terminals were located inside the accessory shoe. A small square of cardboard, of the proper dimensions to slide into the shoe, was cut out and two 4-40 screws were mounted on it. The screws were spaced so that their heads would contact the terminals, and the two leads from the zip cord were attached under the nuts on the other side of the cardboard. Your camera may be fitted with a small coaxial jack instead of accessory shoe terminals; if so, pick up a plug to match it at your local camera store.

If you're not planning to mount your camera on a tripod while taking flash pictures, you can fasten the Power Flash to the camera's tripod socket with a ¼"-20 x ¾" screw as the author did. If you prefer not to tie up the tripod socket, an alternate mounting method can easily be worked out.

**Operation.** Just connect the Power Flash unit to your camera, install the battery (being careful to observe the proper polarity), and plug your flash gun into *J1*. The flash gun, of course, should be of the extension type—such as the "Accura Extension Flash" or the "B-C Pocket Flash Extension." It should have no batteries or circuitry of its own.

After a bulb is inserted in the flash-gun socket, capacitor *C1* charges within half a second and the Power Flash is ready for use.

-30-

## CAPACITOR STABILIZES SOLAR CELL

If you're using energy from the sun to power a piece of apparatus, here's a way to keep your solar cell's voltage output more constant. Just connect, in parallel with the cell, a 400- $\mu$ f., 10-w.v.d.c. electrolytic capacitor (Mallory 1040A or equivalent). During periods of illumination, the large capacitor charges to the cell's output voltage. Then, if the light is dimmed (by a cloud passing in front of the sun, for instance), the capacitor slowly discharges through the circuit, maintaining the output voltage near the original level. Don't try

to use this idea with miniaturized equipment, though: the Mallory capacitor specified measures 1½" x 3¾", and the dimensions of equivalent capacitors will be about the same. When connecting the capacitor, be sure to observe the proper polarity.

—Rufus P. Turner

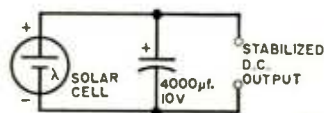

# RADIATION FALLOUT MONITOR

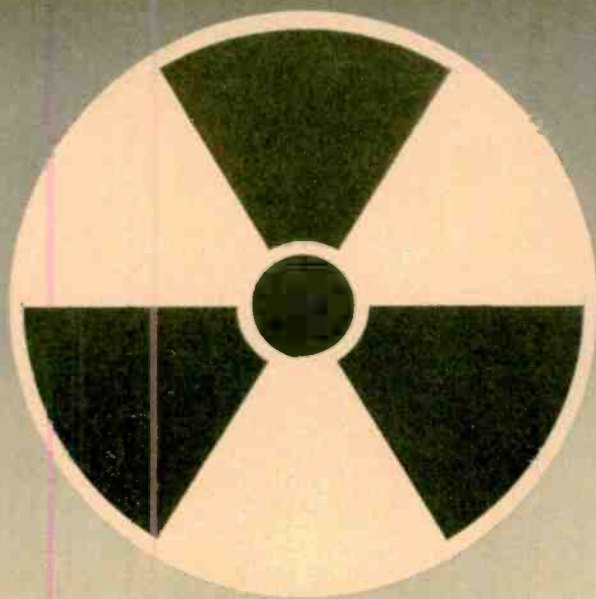

By R. L. WINKLEPLECK

**M**OST OF US in this country," warns a recent Federal Civil Defense Administration booklet, "live within fallout range of some target which it might be important for the enemy to destroy." "Fallout," of course, causes the residual radiation from a nuclear explosion. Consisting of particles of radioactive debris which have been carried into the upper air by the force of the blast, it drops to earth over a wide and only generally predictable area.

The "Radiation Fallout Monitor" described here provides a means for keeping track of the radiation level in your neighborhood. Using one of

# RADIATION FALLOUT MONITOR

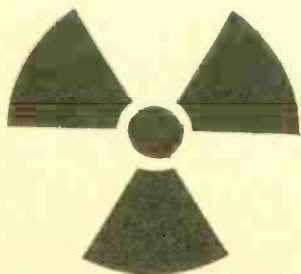
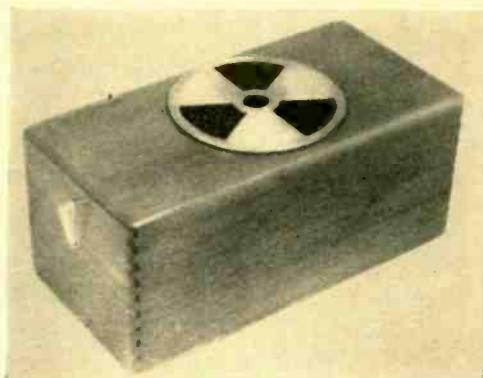

the least expensive Geiger-Mueller tubes available, the unit will give you a good idea of the natural radiation density—and any deviations will be immediately apparent. Using little current, it can be left operating continually to serve as a round-the-clock monitor.

This monitor, however, is to be considered only as an extra household precaution. The most reliable source of emergency information continues to be your local Civil Defense office. They'll know if the radiation from fallout has reached a dangerous level, and will advise you of the necessary protective measures to take.

**About the Circuit.** The approximately 800 volts required for the operation of the Geiger-Mueller tube (*V1*) is developed by a voltage-multiplier circuit consisting of diodes *D1-D6* and capacitors *C1-C6*. Resistor *R1* and capacitor *C7* act as a filter network, and load resistor *R2* tends to prevent excessive voltage fluctuation.

Don't attempt to check the supply voltage with a VOM, incidentally. You won't get a correct reading because even the high resistance of this instrument is enough to cause an overload. A VTVM with a high-voltage probe must be used.

The output of the supply is fed to *V1* through current-limiting resistor *R4*. Ordinarily, this voltage is not enough to cause *V1* to conduct. But when the glass



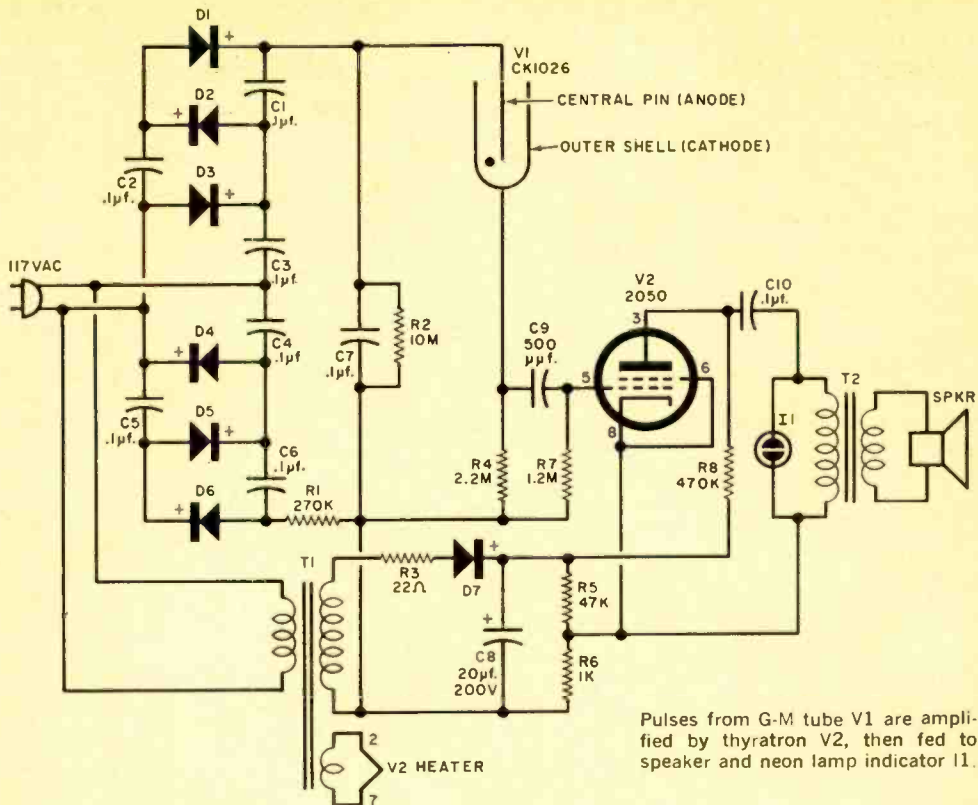

Pulses from G-M tube V1 are amplified by thyatron V2, then fed to speaker and neon lamp indicator I1.

#### PARTS LIST

C1, C2, C3, C4, C5, C6, C10—0.1- $\mu$ f., 400-volt paper capacitor  
 C7—0.1- $\mu$ f., 1000-volt paper capacitor  
 C8—20- $\mu$ f., 200-volt electrolytic capacitor  
 C9—500- $\mu$ f. mica capacitor  
 D1, D2, D3, D4, D5, D6, D7—1N2070 diode (Texas Instruments)  
 I1—NE2 neon lamp  
 R1—270,000 ohms  
 R2—10 megohms  
 R3—22 ohms  
 R4—2.2 megohms  
 R5—47,000 ohms, 1 watt  
 R6—1000 ohms, 2 watts  
 R7—1.2 megohms

all  $\frac{1}{2}$ -watt, 5% resistors unless otherwise specified

R8—470,000 ohms,  $\frac{1}{2}$  watt, 5%  
 SPKR—1 $\frac{1}{8}$ " miniature speaker, 10-ohm voice coil (Lafayette SK-61 or equivalent)  
 T1—Power transformer; primary, 117 volts a.c.; secondaries, 125 volts @ 15 ma., 6.3 volts @ 0.6 amp. (Stancor PS-8415 or equivalent)  
 T2—Miniature output transformer; primary, 2000 ohms; secondary, 8-10 ohms (Lafayette TR-93 or equivalent)  
 V1—CK 1026 Geiger-Mueller tube (Raytheon)  
 V2—2050 thyatron tube  
 1—3 $\frac{1}{4}$ "  $\times$  7 $\frac{1}{4}$ " section of perforated board  
 Misc.—Wooden, plastic, or metal box, screen wire and scrap aluminum for speaker opening, scrap Lucite for I1's window, hardware, etc.

wall of the tube is penetrated by a particle of gamma radiation, the halogen gas inside ionizes for an instant, allowing conduction. This causes a positive pulse of a few volts to appear across R4.

Thyatron tube V2 serves to amplify the pulse. Its plate is supplied with approximately 170 volts by a separate power supply consisting of transformer T1, diode D7, current-limiting resistor R3, and filter capacitor C8. The voltage

is delivered to V2 through load resistor R8, and V2's cathode is biased about 4 volts positive with respect to its control grid by means of voltage-dividing resistors R5 and R6.

With no voltage across R4, the cathode bias prevents the thyatron from conducting. But when a radiation particle causes a positive pulse to appear across that resistor, V2's grid swings positive and conduction occurs. The instantane-

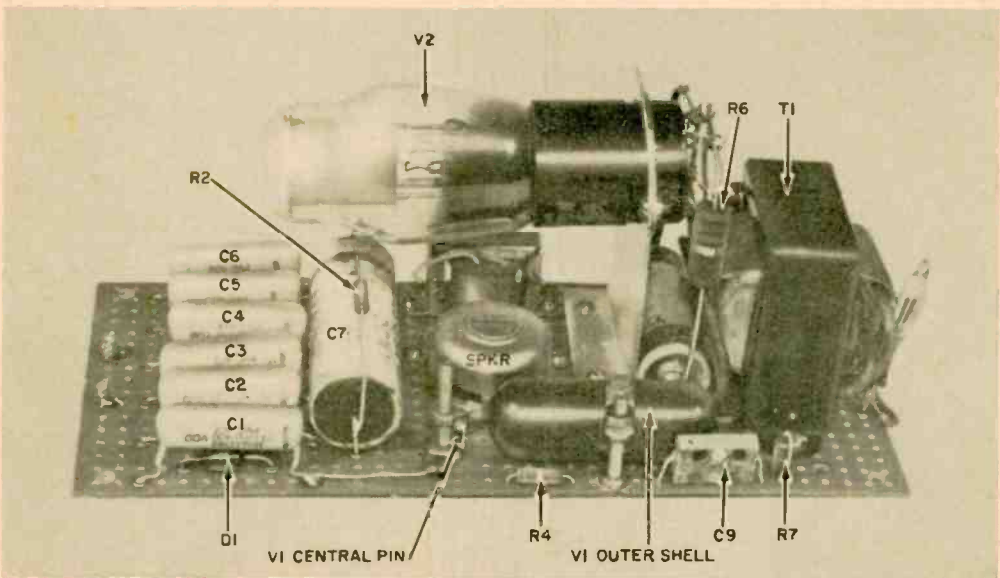
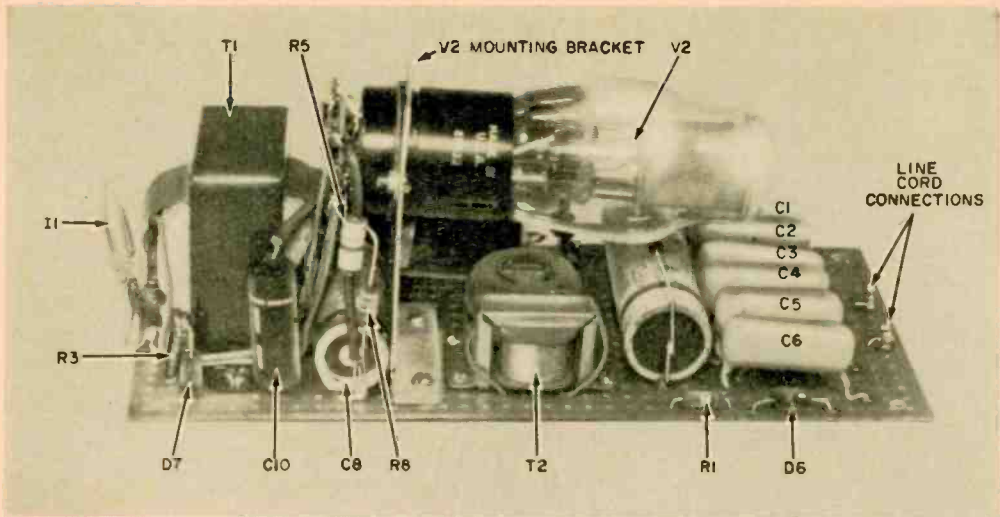

Views of both sides of the perforated board clearly show locations of the major components. Diodes D2, D3, D4, and D5, however, are mounted in the spaces between capacitors C1 and C6 and are not visible. The line connections are made via a pair of metal terminals inserted near C1-C6.

ous voltage drop across *R8*, caused by the current drawn by the conducting thyatron, is fed through capacitor *C10*—ionizing neon lamp *I1*. This gives a visual indication of the presence of the particle and also induces a voltage in the secondary of output transformer *T2*, causing the speaker to click.

Thyatron *V2* would normally continue to conduct, even when the pulse disappears from the control grid. However, the instantaneous voltage drop across *R8*

is large enough to reduce the plate voltage of the thyatron to the point where conduction cannot be maintained. Therefore, the tube cuts off, the load disappears from *R8*, and the plate voltage rises in readiness for the next pulse. This conduction/non-conduction cycle can be repeated a maximum of about 60 times per second.

**Construction.** The circuit is assembled on a 3¼" x 7¼" section of perforated board. All of the components are mounted

# RADIATION FALLOUT MONITOR

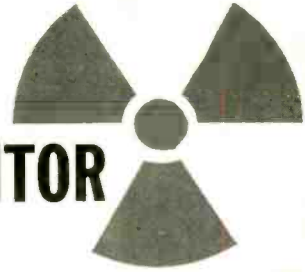

on one side of the board and (in most cases) their leads are passed, through convenient perforations, to the other side. Here, the actual wiring is carried out; make all connections point to point and cover bare leads with spaghetti wherever necessary.

In some cases, the author ran component leads through brass eyelets installed on the board, rather than directly through the perforations. The eyelets make convenient junction points and, if all leads passing through are soldered in place, provide an extra-rigid mounting.

Thyratron V2 is mounted horizontally, its socket being installed on a home-made aluminum "L" bracket. The exact dimensions of the bracket are not important, but see that the socket is raised high enough above the circuit board so that V2 will clear all of the components.

The Geiger-Mueller tube (V1) is held in place by a spring clip mounted on a machine screw and nut which, in turn, are anchored to the board. This clip also serves as a contact to the outer shell, or cathode, of the tube. It's connected into the circuit via a solder lug installed under the screw head.

Tube V1's central pin, or anode, passes through a small hole drilled in another machine screw mounted near the tube. A second solder lug is similarly installed to connect the assembly into the circuit. Run a nut down the screw to make a secure electrical connection with the pin, but make it only finger-tight (this also applies to the nut holding the cathode clip). Excess pressure can easily ruin the tube.

The speaker specified in the Parts List is a bit larger than the one actually used by the author. It makes for a slightly tighter fit on the board, but has the advantage of being provided with its own mounting lugs, and it gives more volume as well. No great change in the relative

component positions shown in the photographs is required.

The author installed his completed circuit board in a wooden box which originally contained "Christmas" after-shave lotion. The speaker opening on top of the box was covered with black screen wire and decorated with the familiar radiation warning symbol (cut from a scrap of sheet aluminum). Flashes from the neon lamp are visible through a piece of Lucite glued into the end of the box near 11.

A set of rubber feet was installed on the box bottom—giving enough clearance for ventilating air to pass through several holes drilled there. An exit for the heated air is provided by the speaker opening.

The housing for the board isn't critical, of course, and you can adapt any metal, plastic, or wooden box which appeals to you. Just be sure to make adequate provisions for ventilation.

*(Continued on page 165)*

Author used shaving-lotion box (shown here with cover off) as a cabinet. Any similar container will serve if adequate ventilation is provided.



# WHY TUNE BY EAR?

By **ROCCO J. CARLUCCI**

*Tricky tuning,  
says this author,  
is strictly  
a matter for meters*



**M**OST EXPERIMENTERS are well aware that the eye is far more "sensitive" than the ear, but a good many fail to put this observation into practice. Take the matter of receiver tuning, for instance—a simple tuning meter can easily be added to almost any AM receiver to make accurate tuning as simple as 1, 2, 3.

Two of the less expensive tuning meters on the market are the Lafayette TM-12 (\$2.95) and the Radio Shack R94L106 (\$2.88). Instructions furnished with the Lafayette meter explain that it should be installed in the cathode circuit of the receiver's last i.f. stage. However, the author installed this meter in a Heath XR-1P transistor portable, only to discover that the variations in current were so small that the meter was insensitive even on the strongest stations.

To remedy this situation, the author connected the meter between the a.v.c. line and a positive reference point provided by the junction of a 100,000- and a 1000-ohm resistor ( $R_1$  and  $R_2$ , respectively, in the diagram above) across the battery. When the receiver is mis-tuned, there is little or no a.v.c. voltage, so the difference in potential across the meter is very small. However, when a station is tuned in, the a.v.c. voltage is greatest, and the difference of potential across the meter is also at a maximum. Naturally, the amount of deflection will vary with the receiver circuit and the value of the divider resistors used, so some juggling of values may be necessary for optimum operation.

-50-

# Chapter

# 2

## Hi-Fi and Stereo

**T**HE world of sound continues to win the interest of an ever-increasing number of experimenters. The projects in this chapter also run the gamut from the simple to the complex, and they're certain to interest both the neophyte and the enthusiast of long standing.

"Private FM Listening" (page 59) shows you how really easy it is to get good sound from even an inexpensive tuner, while the "Starved Circuit Amplifier" (page 75) will give you some idea of the fantastic gain capabilities of the pentode voltage amplifier. A trifle more advanced, the "Mini-Mono/Stereo" (page 48) is a small amplifier which, while not strictly hi-fi, delivers surprisingly good sound from a circuit which is very straightforward and exceedingly tiny.

Probably the greatest opportunity for experimenting with sound lies in speaker enclosures. With the exception of Britain's renowned speaker authority, Mr. G. A. Briggs, next to no one is likely to think of housing a speaker in a drainpipe; yet the "Drainpipe 8" (page 65) is a startling performer. And the "Stereo Sixteen Plus Four" (page 51, and pictured on our cover) is a truly compact stereo speaker system that achieves impressive stereophonic sound by bouncing the waves off the room wall.

Mini-Mono/Stereo .....	Leon A. Wortman, W2LJU	<b>48</b>
Stereo Sixteen Plus Four .....	Jim Kyle	<b>51</b>
Transistorized Tremolo .....	A. E. Donkin, W2EMF	<b>55</b>
Private FM Listening .....	Art Trauffer	<b>59</b>
Printed-Circuit P.A. ....	Forrest H. Frantz, Sr.	<b>61</b>
Clean Sound from Drainpipe 8 .....	David Weems	<b>65</b>
The Audio Pack .....	E. G. Louis	<b>72</b>
Starved Circuit Amplifier .....	Howard Burgess and Karl Anderson	<b>75</b>
Hi-Fi Hints .....		<b>78</b>

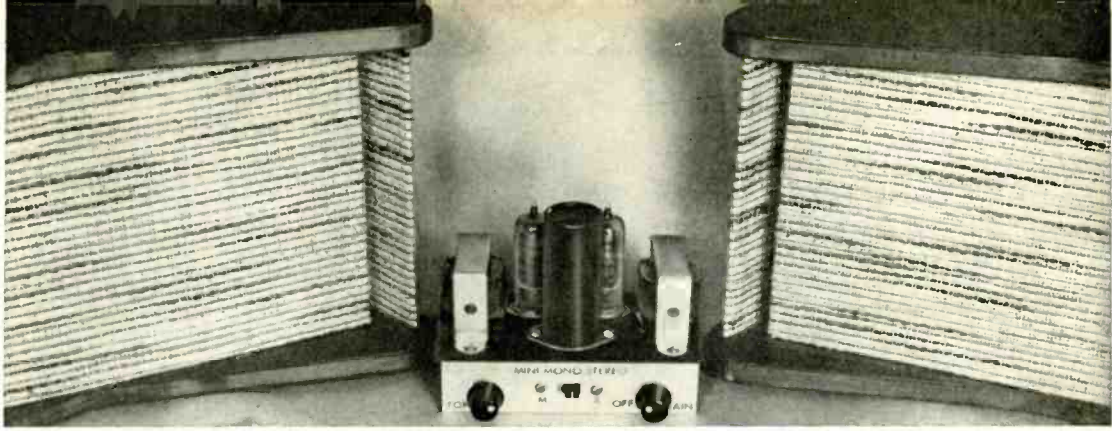

# MINI-MONO/STEREO

*Two dual-purpose tubes and an a.c./d.c. circuit explain this amplifier's miniscule proportions*

By **LEON A. WORTMAN, W2LJU**

**S**AY SOMETHING about "compactness," and most people think of transistorized equipment. But here's a tiny vacuum-tube stereo amplifier that all but puts transistors to shame. It not only offers stereophonic or monophonic operation at the flip of a switch, but (believe it or not!) it packs voltage amplifiers, power amplifiers, tone and volume controls—everything, in fact—on a single 1¼" x 5½" x 3" chassis!

Dubbed the "Mini-Mono/Stereo," this miniaturized amplifier is equipped with two separate channels for stereophonic operation. A flip of the stereo/mono switch, and the two "channels" become a single monophonic "channel," complete with push-pull output.

**Two In One.** As you may have guessed from the appearance of the unit, this novel circuitry is made possible through the use of a dual-purpose tube which actually contains two different assemblies in a single glass envelope. The tube in this case is the 35HB8, which incorporates both a triode voltage amplifier and a pentode power amplifier. A semiconductor contributes to the design, too, since a

tiny silicon diode rectifies the a.c. line.

Power output of the Mini-Mono/Stereo is approximately 1 watt per channel in the stereo hookup and about 1.75 watt in the monophonic mode—more than adequate for most low-level listening. Frequency response is reasonably flat from 50 to 10,000 cycles. All told, considering cost, simplicity, ease of construction, and fidelity, this little amplifier promises considerable satisfaction for the builder and hours of pleasure for the listener.

Block diagrams of amplifier in monophonic (left) and its circuit. In mono operation, tube V2a serves as a

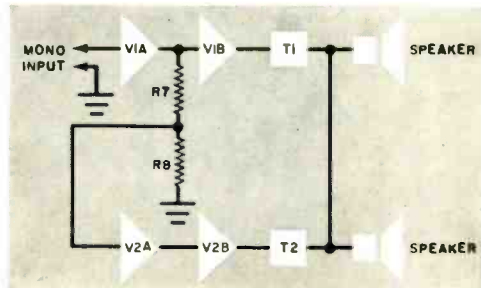

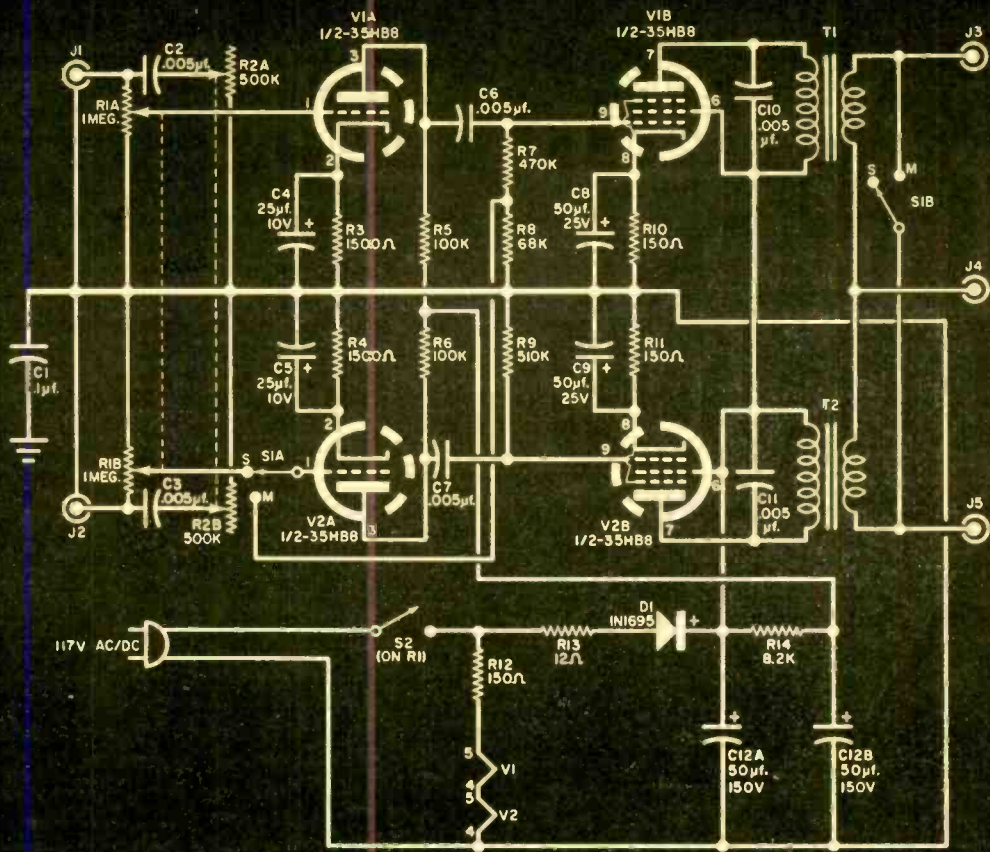

**Stereo and Mono.** The block diagrams show the separate stages and how they are interconnected in both stereo and mono. And reference to the circuit diagram should quickly reveal how the changeover is made from one mode to the other.

When switch *S1* is in the stereo or "S" position, tubes *V1* and *V2* operate as

stereophonic mode (right) should help you understand phase inverter, driving tubes *V1b* and *V2b* in push-pull.

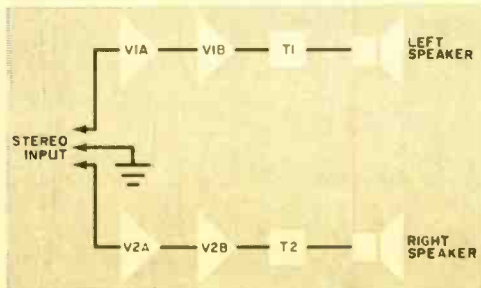

### PARTS LIST

- C1*—0.1- $\mu$ f., 400-volt paper capacitor
- C2, C3, C6, C7, C10, C11*—0.005- $\mu$ f., 400-volt paper capacitor
- C4, C5*—25- $\mu$ f., 10-w.v.d.c. electrolytic capacitor
- C8, C9*—50- $\mu$ f., 25-w.v.d.c. electrolytic capacitor
- C12a/C12b*—Dual 50- $\mu$ f., 150-w.v.d.c. electrolytic capacitor
- D1*—1N1695 diode
- J1, J2*—RCA phono jack
- J3, J4, J5*—Insulated binding post
- R1a/R1b*—Dual 1-megohm potentiometer, audio taper (with s.p.s.t. switch *S2*)
- R2a/R2b*—Dual 500,000-ohm potentiometer, audio taper
- R3, R4*—1500 ohms
- R5, R6*—100,000 ohms
- R7*—470,000 ohms
- R8*—68,000 ohms
- R9*—510,000 ohms
- R10, R11*—150 ohms
- R12*—150 ohms, 25 watts, wire-wound
- R13*—12 ohms, 1 watt
- R14*—8200 ohms, 1 watt
- S1a/S1b*—D.p.d.t. slide switch
- S2*—S.p.s.t. switch (on *R1*)
- T1, T2*—Output transformer: primary, 4000 ohms; secondary, 3.3 ohms (Stancor A3328 or equivalent)
- V1, V2*—3511B8 tube (Sylvania)
- 1—1 $\frac{1}{4}$ " x 5 $\frac{1}{2}$ " x 3" "interlocking" chassis (LMB Type 139 or equivalent)
- Misc.—Tube sockets, knobs, hardware, line cord and plug, wire, busbar, solder, etc.

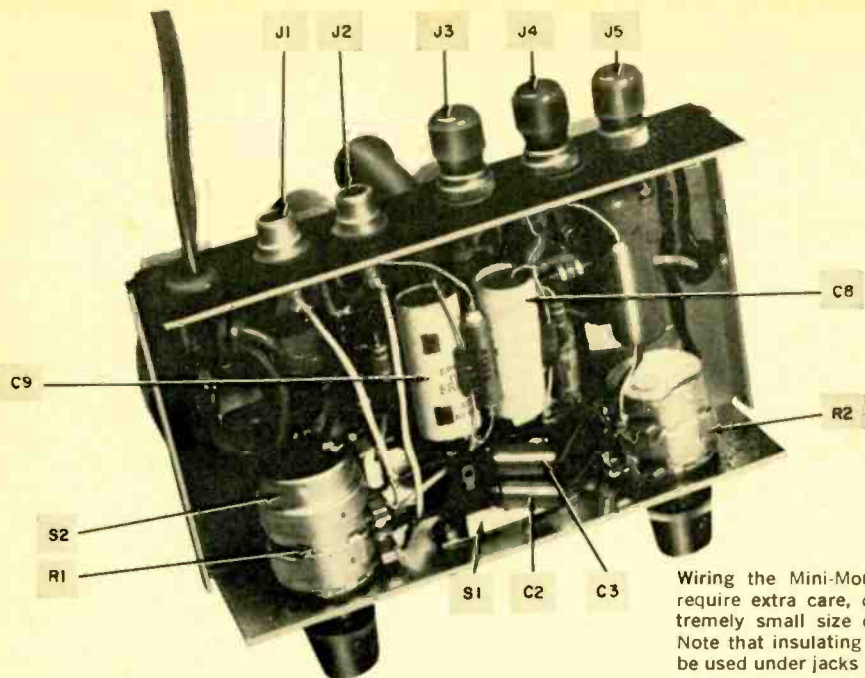

separate amplifiers, each with its own input and output jacks. But throwing *S1* to the mono or "M" position connects the grid of *V2a* to the junction of resistors *R7* and *R8*. Since this pair of resistors functions as a voltage divider, a portion of the audio signal coming from the plate circuit of *V1a* is fed to the grid of *V2a*.

This "sample" is then amplified by *V2a*. Due to the ratio between *R7* and *R8*, the audio voltages appearing at the grids of power amplifiers *V1b* and *V2b* are still approximately equal in amplitude. But because of the phase reversal within *V2a*, they are now 180° out of phase with one another—a condition which is essential for push-pull operation of *V1b* and *V2b*.

The "M" position of *S1* also connects the voice-coil windings of transformers *T1* and *T2* in parallel. Thus, we have *V1a* and *V2a* operating as a voltage amplifier/phase inverter, driving *V1b* and *V2b* functioning as a push-pull power amplifier.

Incidentally, you'll notice that the volume controls for the two separate channels are actuated simultaneously through the use of ganged potentiometers. The same is true of the tone controls; however, the volume and tone controls for *V2a* are automatically dis-

connected from the circuit when the unit is in the monophonic mode.

**Wiring and Phasing.** Since this is an a.c./d.c. circuit, it's important not to connect any of the circuit wiring to the chassis proper. Use a common wire or "busbar" for the "ground" connections instead, and connect a 0.1- $\mu$ f. capacitor (*C1*) from the busbar to the chassis. In addition, be sure to insulate all jacks (*J1* through *J5*) from the chassis with fiber shoulder washers.

Proper phasing of the voice-coil windings of *T1* and *T2* is especially important in the monophonic hookup. Improper phasing may be difficult to detect when the unit is operating as a stereophonic system, but you'll have no difficulty picking up incorrect phasing in the monophonic hookup, since the outputs will tend to cancel each other. To correct this condition, simply reverse the secondary leads of either *T1* or *T2* at the output jacks. (Do *not* reverse the terminations of both transformers—just one!)

Your Mini-Mono/Stereo amplifier is now complete, and you're all set for years of pleasurable listening. Who would have thought a vacuum-tube stereo amplifier with such impressive performance could be so small?



# STEREO SIXTEEN PLUS FOUR

*Sixteen 5" speakers and  
four 2" tweeters deliver  
super-sweet stereo sound  
from a single enclosure*

By JIM KYLE

**D**O STEREO SPEAKERS pose a space problem for you? If so, here's a complete stereo speaker system, housed in a single enclosure measuring less than 2 feet deep and 3 feet wide, which you can build in a single weekend for less than \$50.00. Based on the principles of the "Sweet Sixteen" (see January, 1961, POPULAR ELECTRONICS, p. 55), this speaker system, consisting of sixteen 5" units and four tweeters, reproduces the full audible range with outstanding clarity and definition. What's more, it effectively spreads the stereo effect over the entire room rather than along the conventional "line down the middle."

The only "drawback" (if it is a drawback) to the "Stereo Sixteen" is that it *must* be placed against a wall so that the sound will be reflected into the room. (Its stereo effect disappears when the sound is not reflected, due to the need for greater "spread" between the two

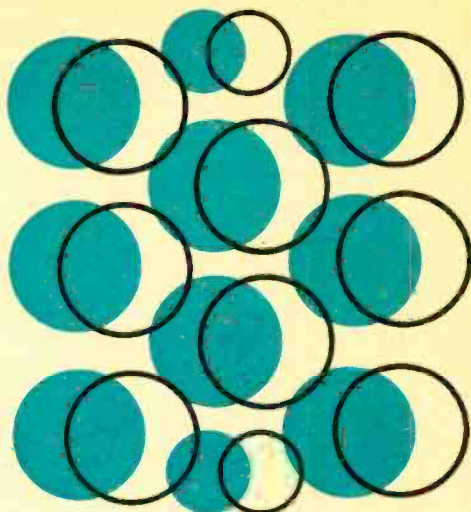

"groups" of speakers.) When reflecting from a wall, however, this system has outperformed a hundred-dollar-plus, factory-assembled system hands down, both in response and separation!

Despite the outcome of this comparison, the "Stereo Sixteen" is admittedly a compromise, since it is designed for maximum performance in limited space. As a result, bass response drops fairly sharply below about 45 cycles, and the high end tapers off rapidly above 14,000 cycles. The reasons for this are that the

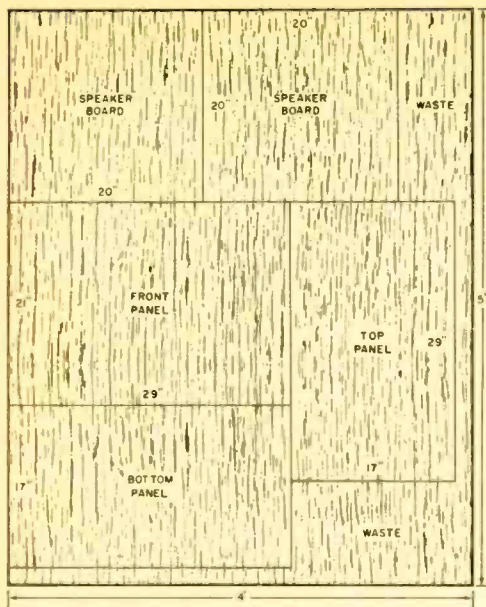

Wire speakers as shown here, paying particular attention to polarities. A 7.5-ohm, 10-watt resistor in series with each speaker array decreases damping and improves bass response.

All major pieces are cut from a single sheet of 4' x 5' plywood, with a minimum of waste. Since the two speaker boards are identical (see dimensions at left), holes can be marked in both panels at once. Speaker system, wired as shown below, has impedance of 8-16 ohms.

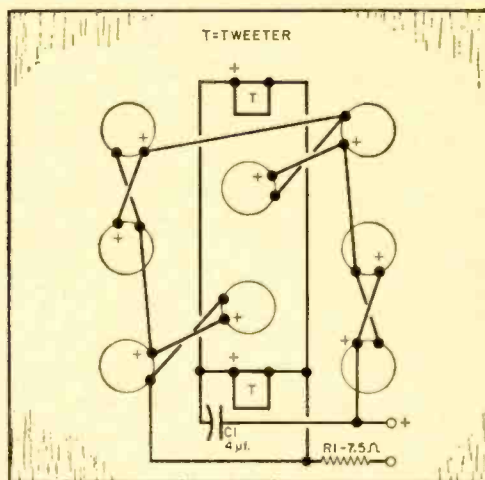

small size limits the bass, while the inexpensive tweeters limit the high end.

Total enclosure volume is less than optimum for even a "Sweet Sixteen" system, and individual speaker quality was deliberately held to the minimum which would produce acceptable results.

Ready to build it? Gather the necessary materials and let's begin.

**Getting Started.** If you have complete confidence in your woodworking ability, you can begin by cutting all pieces to size as shown above. However, if your carpentry skills are no greater than the author's, it's best to measure each new item against the preceding pieces.

The place to start is with the speaker boards: cut them 20" square, and sand the edges to eliminate splinters. Next, take eight 5" speakers and two tweeters and position them on one of the boards, leaving a 2" margin on all four edges to accommodate the 2" x 2" bracing which will be attached later. When you have all 10 speakers positioned on the board, carefully mark through each mounting

hole with a soft lead pencil. Then remove the speakers and put them to one side.

Place the marked speaker board over the other one and drill through both boards at each mounting hole, using a  $\frac{1}{16}$ " drill; this serves the dual purpose of providing screw-starting holes and marking both boards simultaneously. Next, draw lines to connect opposite mounting holes so as to locate the center of each individual speaker, and insure that each speaker will be concentric with its hole in the final board.

When all speaker centers have been marked, you're ready to mark and cut the speaker holes. A saber-saw or power jig-saw is best for cutting the large holes, while the  $1\frac{1}{2}$ " holes for the tweeters are best cut with either a hole saw or an adjustable circle cutter in a power drill.

After you have cut all 20" square holes, take one of the 20" 2 x 2's and attach it firmly to one edge of one speaker board, using at least three wood screws; this will be the back brace. Next, attach the other speaker board to the adjacent

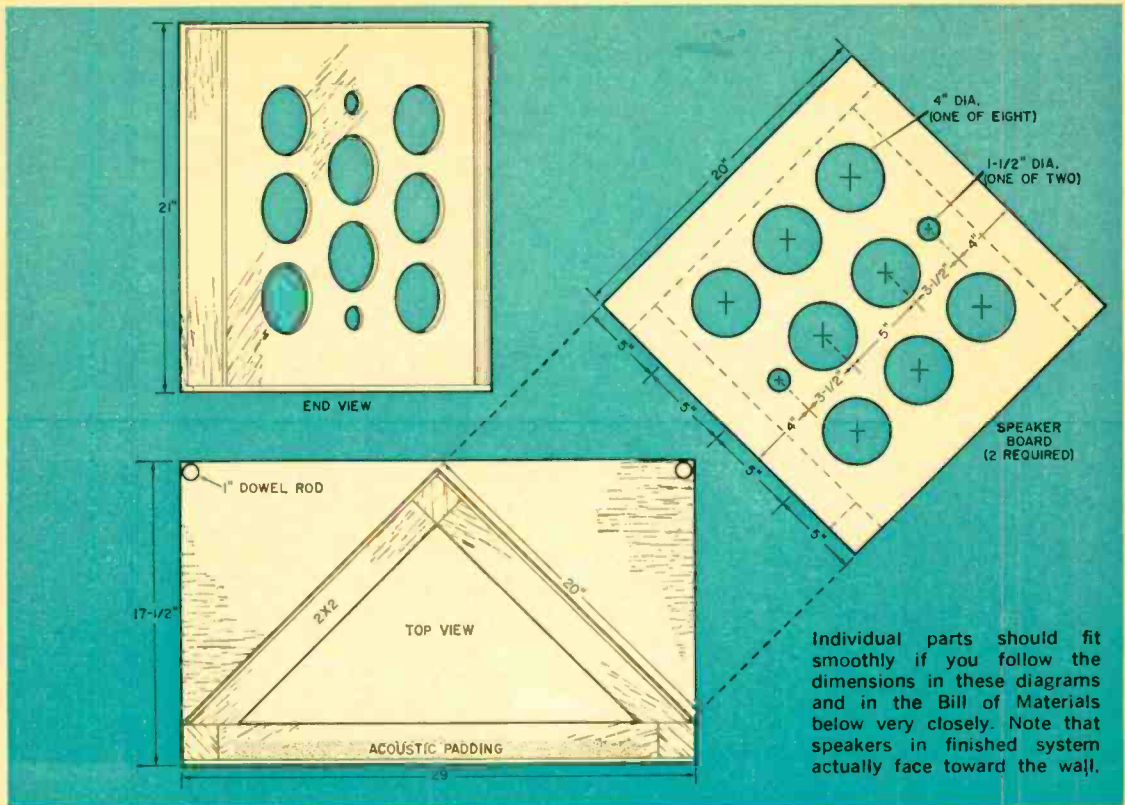

Individual parts should fit smoothly if you follow the dimensions in these diagrams and in the Bill of Materials below very closely. Note that speakers in finished system actually face toward the wall.

edge of the 2 x 2 to form a right-angled corner.

At this point, you're ready to mark the top and bottom panels for cutting. Place a length of 2 x 2 along what will be the 29" edge of one of the panels. Position the speaker-board assembly on the panel against this temporary spacer, and check to see that the 17" depth allows the panel to overhang approximately 1/2" beyond the back brace at this point; if it does not, make the panel deeper or shallower until it does. Mark the cutting lines square with the edges, and cut both the top and the bottom panels the same size. Then sand the cut edges lightly to remove splinters.

**Wiring the Speakers.** Remove the speaker boards from the back brace and attach all the speakers to them. (No. 6 x 1/2" sheet-metal screws are excellent for mounting the speakers, since they hold more firmly in the plywood than most other types.) After all the speakers are attached to the boards, wire them as shown on the previous page.

#### BILL OF MATERIALS

- 1—4' x 5' sheet of 1/2" plywood, cut into:
  - 2—20" x 20" sheets (speaker boards)
  - 2—17" x 29" sheets (top and bottom panels)
  - 1—21" x 29" sheet (front panel)
- 2—8' lengths of 2 x 2 framing stock, cut into:
  - 4—18" lengths
  - 3—20" lengths
  - 2—25" lengths
- 2—20" x 1" diameter dowel rods
- 72—No. 8 x 1" flat-head wood screws
- 80—No. 6 x 1/2" sheet-metal screws
- 16\*—5" speakers (Quam 5A15, Lafayette SK-26, Olson S-336, or equivalent)
- 4\*—2" tweeters (Oaktron 3C8T, Jensen P-35VAH, or equivalent)
- 2—4- $\mu$ f. capacitors (non-polarized electrolytic or paper)
- 2—7.5-ohm, 10-watt resistors
- 1 Sq. yd. acoustic padding (or 6 papier-mache egg cartons—see text)
- Misc.—Wire staples or thumbtacks, wire, solder

\*A complete set of speakers for the "Stereo Sixteen Plus Four" is available from Radio Shack Corp., 730 Commonwealth Ave., Boston 17, Mass. Catalog No. 40K50SX028, the "kit" is priced at \$24.00, plus postage.

When wiring, make certain that the speakers are correctly phased—i.e., that they are so connected that the cones all move in the same direction at the same

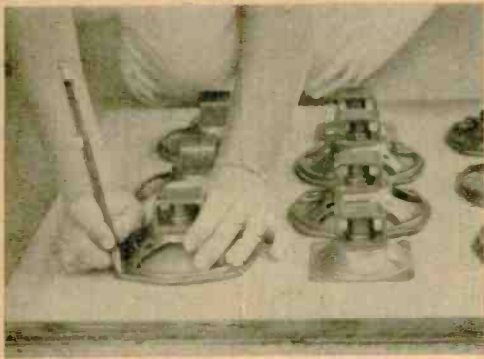

Begin construction by placing speakers on speaker boards and marking through each mounting hole with a soft pencil.



After speaker mounting holes have been marked, the next step is to mark and cut holes for the speakers themselves.



time. If all the speakers are of identical make, simply connect right-hand to right-hand terminals and left-hand to left-hand terminals. Alternatively, if speakers of mixed manufacture are used, check each one with a flashlight cell and mark "+" on the terminal which makes the cone move *out* when it's positive.

**Putting It Together.** With the wiring completed, reattach the speaker boards to the back brace and add the upper and lower braces (18" 2 x 2's), using at least three wood screws per brace and ignoring the overhang at the front. Next, position the speaker-board assembly on the bottom panel as you did when marking the bottom panel for cutting. The overhang of the braces will prevent use of the 2 x 2 spacer, but it must be allowed for.

Now, at the top of the speaker-board assembly, align a straightedge with the front edges of the speaker boards. Mark the upper braces for cutting off the overhang, and cut along the markings. After cutting, turn the speaker-board assembly over on the panel and repeat the procedure for the lower braces. (With the upper overhang removed, the 2 x 2 spacer can be used when aligning the assembly on the bottom panel the second time.)

Take the remaining 29"-wide piece of plywood and attach a 20" 2 x 2 to one of the narrow edges, allowing the panel to overhang the lower edge of the 2 x 2 by

*(Continued on page 162)*

Speakers (left) are easy to wire—see diagram on page 52—but proper phasing is of utmost importance.

Rear view of basic unit, showing relative positions of speakers for each channel. Acoustic padding or an egg-carton "diffuser" should be attached to the inside front panel before it is screwed in place.



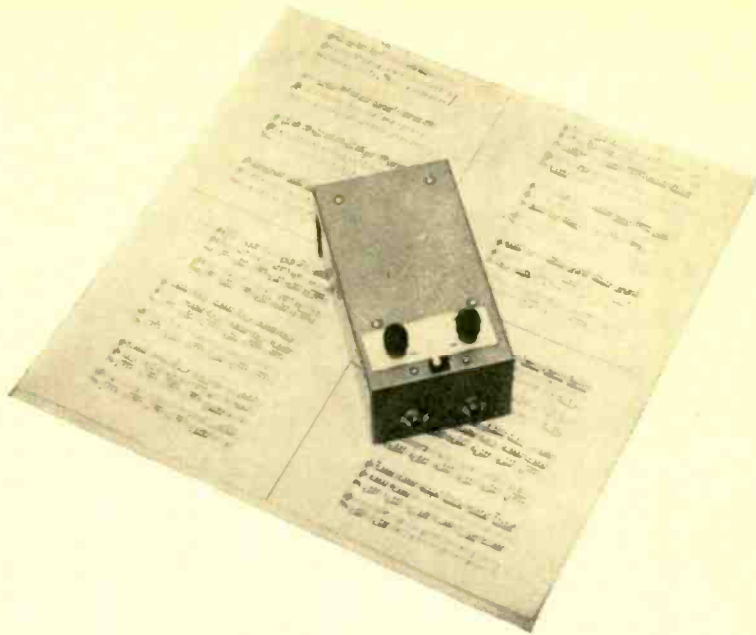

# TRANSISTORIZED TREMOLO

. . . adds "color" to musical instruments

By A. E. DONKIN, W2EMF

**G**OT A MUSICIAN in the family? You can delight him (or her) and your friends by constructing this little electronic tremolo. Reasonably easy to build, it makes a perfect addition to an electric guitar. Add a suitable mike, and you can use it with almost any musical instrument.

Like other tremolos, this device produces a "throbbing" effect on the sound of an electric musical instrument which is played "through" it. Unlike some versions, however, this circuit is transistorized and battery-operated, with several resultant advantages.

For one thing, the number of components is reduced; and so, too, is the cost. In addition, the unit is small enough and light enough to be attached

directly to the musical instrument; this means that it can be readily controlled by the musician himself. Finally, the battery power supply substantially reduces the possibility of hum in the amplifying system.

**About the Circuit.** The transistorized tremolo is connected between the output of an electric musical instrument and an audio amplifier. It functions by varying the amplitude of the electrical signal from the musical instrument at a rate of about 5 to 15 times per second.

In the circuit shown here, transistor *Q1* is connected as an amplifier and is biased to draw very little collector current. To match the impedance of a magnetic instrument pickup, its input impedance has been increased by leaving

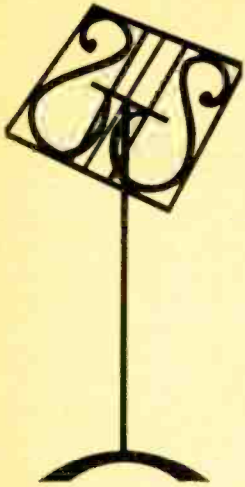

# TREMLO

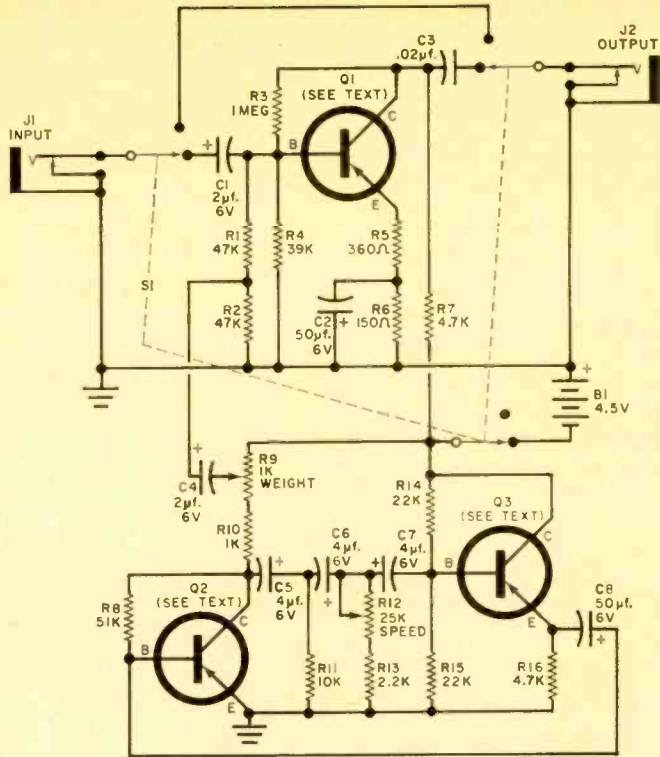

Most components in the tremolo circuit are mounted on a piece of Vectorbord, with only the battery holder, jacks, potentiometers, and switch installed on the metal chassis itself (see photo at right). Although potentiometer R12 controls the "speed" or frequency, substituting other values for R11 will alter the basic frequency, as explained in text.

a portion of the emitter resistor unbypassed (R5).

Since transistor Q1 is operated in the low-current region, its gain varies rapidly with changes in collector current. A low-frequency (5- to 15-cycle) signal is superimposed on the d.c. bias for this stage via resistors R1 and R2, causing the collector current (and hence the gain) to vary.

Transistors Q2 and Q3 operate as a phase shift oscillator to generate the 5- to 15-cycle signal. Transistor Q2 is a common-emitter amplifier supplying the phase shift network, and Q3 is an emitter follower to adjust impedances and provide positive feedback. The frequency of the phase shift oscillator is adjusted

by varying one "leg" of the phase shift network (potentiometer R12); the depth or "weight" is controlled by adjusting potentiometer R9.

**Construction.** Layout of the transistorized tremolo isn't critical, but it's still a good idea to follow the author's parts placement as nearly as possible. A 2<sup>7</sup>/<sub>16</sub>" x 3<sup>1</sup>/<sub>2</sub>" piece of Vectorbord facilitates mounting the smaller components, and Vector terminals can be used as tie-points where needed.

Potentiometers R9 and R12, jacks J1 and J2, switch S1, and the battery holder should be mounted in the utility box first, leaving as much room as possible for the Vectorbord assembly (be sure to allow enough clearance to insert and re-

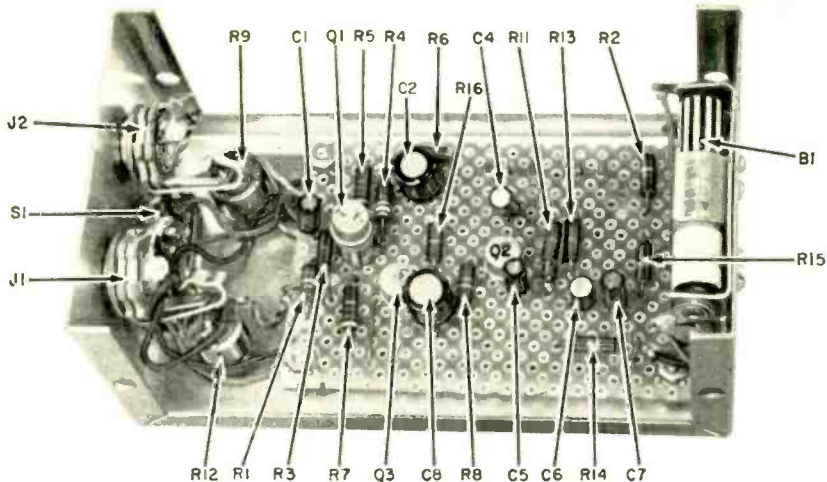

### PARTS LIST

*B1—4.5-volt battery (three Burgess Type 7 "slim" penlight cells in series or equivalent)*  
*C1, C4—2- $\mu$ f., 6-w.v.d.c. miniature electrolytic capacitor*  
*C2, C8—50- $\mu$ f., 6-w.v.d.c. miniature electrolytic capacitor*  
*C3—0.02- $\mu$ f. miniature paper capacitor*  
*C5, C6, C7—4- $\mu$ f., 6-w.v.d.c. miniature electrolytic capacitor*  
*J1, J2—Phone jack, shorting type*  
*Q1, Q2, Q3—Audio transistors, pup type (Lafayette SP-239 or equivalent)*  
*R1, R2—47,000 ohms*  
*R3—1 megohm*  
*R4—39,000 ohms*  
*R5—360 ohms, 5%*  
*R6—150 ohms*  
*R7, R16—4700 ohms*  
*R8—51,000 ohms, 5%*

*All resistors  
 $\frac{1}{2}$  watt, 10%,  
 unless otherwise noted*

*R9—1000-ohm miniature potentiometer, linear taper*  
*R10—1000 ohms*  
*R11—10,000 ohms*  
*R12—25,000-ohm miniature potentiometer, linear taper*  
*R13—2200 ohms*  
*R14, R15—22,000 ohms*  
*S1—3-pole, double-throw slide switch (Lafayette SW-94, with one section unused, or equivalent)*  
*1—5 $\frac{1}{4}$ " x 3" x 2 $\frac{1}{8}$ " aluminum utility box (Bud CU-2106-A or equivalent)*  
*3—Battery holders (Keystone Type 137 or equivalent)*  
*1—2 $\frac{1}{16}$ " x 3 $\frac{1}{2}$ " piece of Type 85G24EP Vectorbord*  
*Misc.—Type T28 Vector push-in terminals, miniature knobs for R9 and R12, wire, solder, hardware, etc.*

move the batteries). The Vectorbord should then be cut and drilled, after which the other components can be mounted.

Although the transistors in the author's model are of the "2 for 98 cents" variety, they function quite satisfactorily. For optimum results, the transistors should be interchanged in the circuit, and Q1 selected for lowest noise (Q2 and Q3 aren't particularly critical). If the transistors are installed in either sockets or Vector terminals, they can be "selected" after the Vectorbord assembly has been wired into the Minibox.

When wiring, be sure to "heat sink" the transistor leads with a pair of long-nose pliers. You may want to use the

same treatment for the electrolytic capacitors, just to be on the safe side; in addition, the polarities of the electrolytics must be observed.

After the wiring is completed, the Vectorbord should be fastened to the top of the box with  $\frac{1}{4}$ " spacers, and the leads from it to the balance of the circuit soldered in place.

**Check-Out and Operation.** The unit is ready for testing. Install the batteries, again observing polarity, and turn the unit on. To check for oscillation of Q2 and Q3, simply measure the collector voltage of Q2 or the emitter voltage of Q3. A rapid fluctuation indicates that the oscillator is operating properly.

Now insert the tremolo between the

# TREMOLO

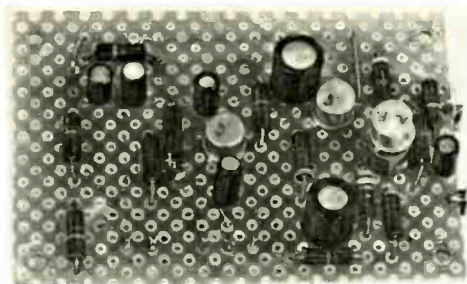
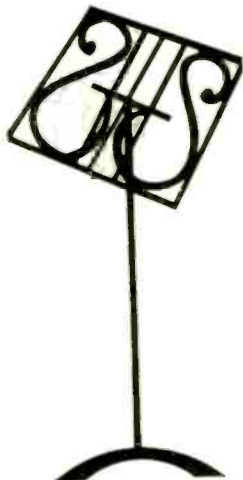

Here's how the Vectorbord subassembly should look when it's ready to be installed in the chassis box.



Hooking up the transistorized tremolo is simplicity itself—just plug the electric guitar or other musical instrument into jack J1 on the tremolo and connect an audio amplifier and speaker to jack J2.

output from the musical instrument and the input to your amplifier, as shown. The “weight” control,  $R9$ , should be adjusted until a “throbbing” is noticeable in the amplifier output; don’t advance the “weight” control too far or you may cause a “thumping” sound in the

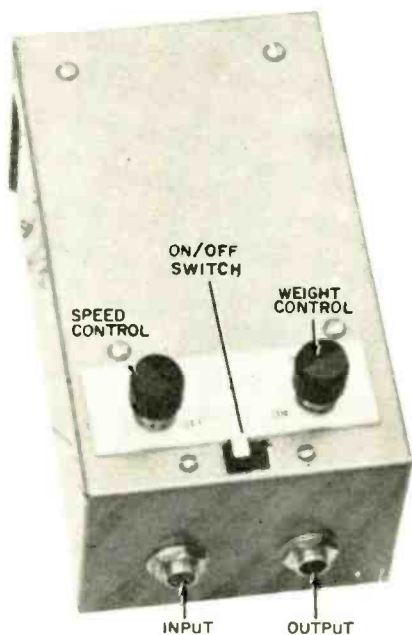

The transistorized tremolo, all wired up and ready for use. See text for details on adjusting speed and weight controls.

speaker. The “speed” control,  $R12$ , governs the rate of tremolo and should be adjusted to suit your taste.

If desired, the range of adjustment of the “speed” control can be modified by adding a resistor in parallel with  $R11$ , since reducing the effective value of  $R11$  will increase the speed. In the author’s model,  $R11$  was paralleled with a 1000-ohm resistor for an effective value of about 900 ohms.

**Possible Troubles and Cures.** The simplicity of the circuit is some insurance against trouble. If the components and wiring seem to be okay, lack of oscillation may be due to low  $\beta$  in  $Q2$  or  $Q3$ , although the requirements for this portion of the circuit aren’t very exacting.

“Thumping” can be reduced by experimenting with smaller values for capacitor  $C3$ . The final value for this component depends to some extent on the amplifier you happen to use, but don’t reduce the capacitance too much or you’ll cut out most of the low frequencies.

Since the amplifier stage ( $Q1$ ) is operated at low collector current, the amplitude of the input signal is limited, and large signals will cause distortion. Even so, most guitar pickups won’t overload  $Q1$ . But if distortion does occur, you should be able to correct it by reducing the output level of the instrument and increasing the gain of the amplifier accordingly. -30-





By ART TRAUFFER

## Private FM Listening

*Inexpensive tuner and high-quality earphones deliver topnotch "fi"*

**F**OR private FM listening, you can't beat an FM tuner and a pair of high-quality earphones. With a simple setup such as this, you can listen to your favorite types of music as late as you please without disturbing others. Then, too, you can enjoy FM programming while you're saving up for a high-quality amplifier and speaker. And you'll still have the phones for private listening later on.

There are two types of earphones on the market suitable for FM listening purposes. One is the low-impedance type that uses voice coils and diaphragms or cones, just like dynamic speakers. The

other is the crystal-type transducer with its cones connected to crystals. Although both of these types are capable of low distortion and wide-range response, do not expect quality reproduction with common magnetic phones that have flat metal disc diaphragms.

The photo below shows a pair of high-quality crystal earphones (Brush-Clevite) connected directly to an FM tuner. Since crystal phones have high impedance, they match the tuner output without the use of a transformer or an impedance-matching amplifier. There is no danger of shock while wearing the

An FM tuner, such as the Granco T-300 shown here, can be fed directly to a pair of high-quality crystal earphones for private listening. Although the Granco tuner does not have a power transformer, capacitors feed output to phones and thus prevent danger of electric shock.

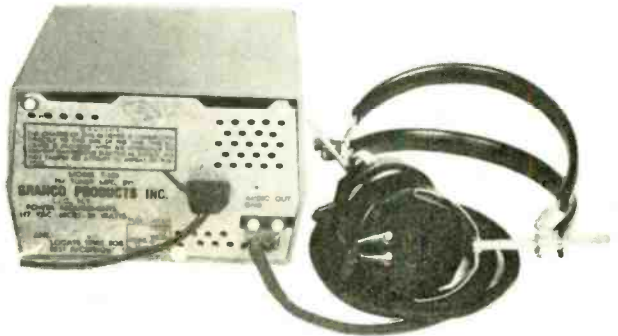

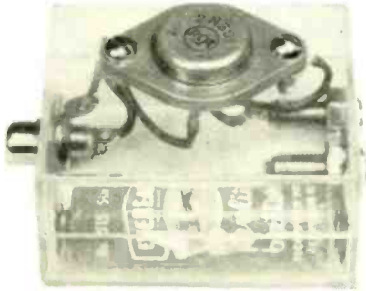

One-transistor amplifier actually operates as an impedance-matching device to couple high-impedance output of tuner to low impedance of earphones. Construction details are shown in open view (right).

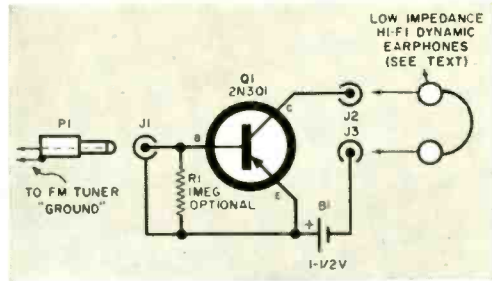

Schematic diagram of one-transistor impedance-matching amplifier. Resistor R1 is optional and may be omitted, depending on output circuit of tuner.

phones because the tuner manufacturer has isolated the output terminals from the chassis with blocking capacitors.

The photo on p. 59, top, shows a music lover listening to FM with high-quality low-impedance dynamic earphones (Lafayette F-767). The small plastic box contains a simple amplifier which matches the low impedance of the phones to the high impedance of the FM tuner output and provides a small amount of amplification at the same time. Although an audio output transformer having a high-impedance primary and low-impedance secondary could be used to match the dynamic phones to the FM tuner, the transformer would have to be a high-quality unit to give hi-fi results.

Complete construction details for an impedance-matching amplifier are shown in the photos and diagram on this page. The author used round-type phono cartridge clips for the pins on the 2N301

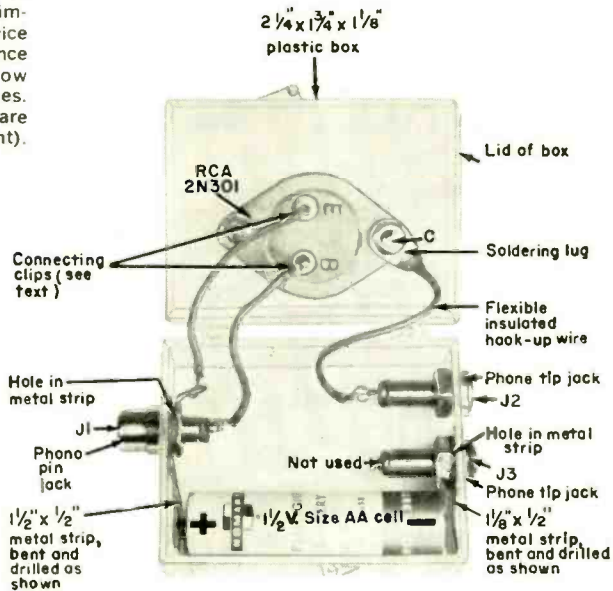

transistor. All holes in the plastic box were made by reaming with the point of a small knife blade and filing with a small rat-tail file. Note that the metal-strip battery clips also serve as connectors between the battery and jacks; phone tip jack J3 should be an all-metal type.

Besides the Lafayette F-767 dynamic phones mentioned above, quality dynamic headsets are made by such companies as Allied Radio (Knight), Jensen, Koss, Permoflux, Roanwell, Superex, and Telex. But whether you choose crystal or dynamic phones, you can be assured of first-class private FM listening.

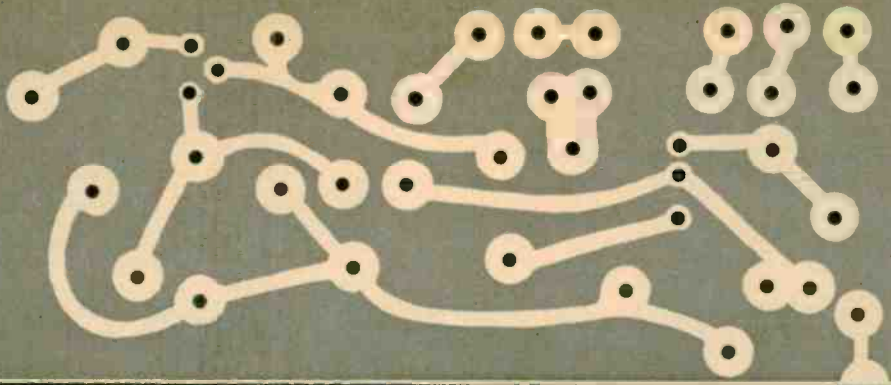

# PRINTED-CIRCUIT P.A.



*Transistorized miniature public-address amplifier operates on 12 volts*

By **FORREST H. FRANTZ, Sr.**

**L**OOKING FOR a compact public-address amplifier that will operate from your car battery? Here's one that's fully transistorized, light in weight, and completely portable. Yet it packs punch enough to deliver about 3 watts from a 12-volt battery and about 1 watt from a 6-volt battery. Since it was designed for operation from 12 volts, use of this voltage naturally results in the best performance.

In addition to being battery-operated, this amplifier has several other outstanding features. Due in part to a special printed-circuit board, it's both attractive and professional looking. It measures a compact 3" x 5" x 7" and incorporates separate "mixable" inputs for microphone and phono or tuner. And its output transformer matches any 8-ohm speaker or series/parallel combination of speakers totaling 8 ohms.

The amplifier contains only four transistors and is relatively easy to construct. Once assembled, you'll find that it's ideal for use at pic-

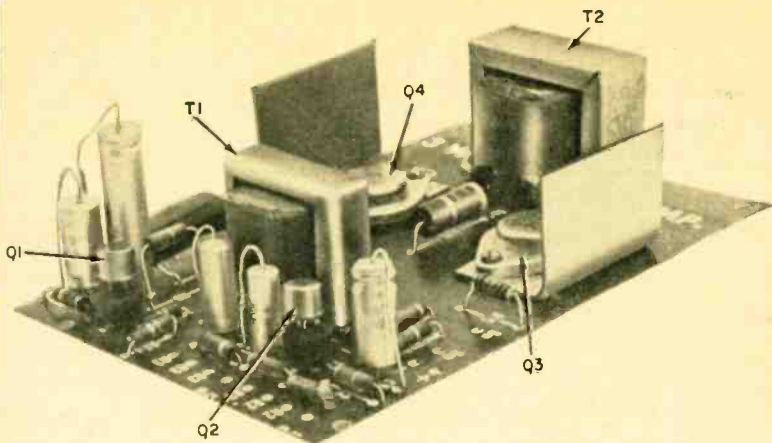
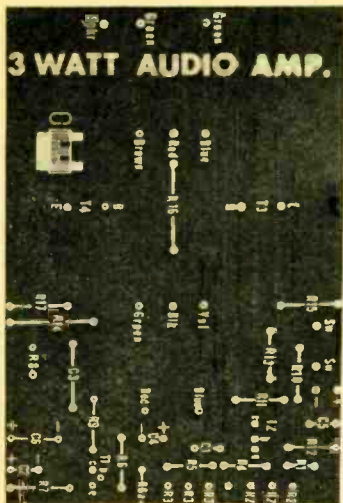
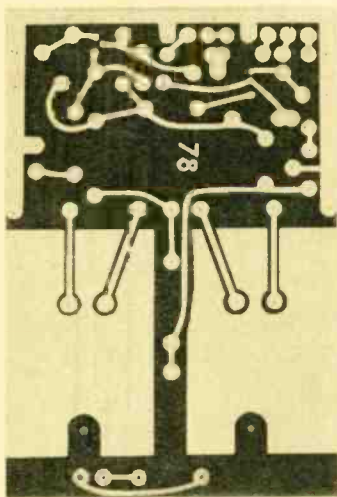

Fig. 1. You'll find construction a "snap" if you use the special printed-circuit board. Heat sinks for power transistors Q3 and Q4 can be cut out from an old aluminum chassis.



tics and other outdoor activities, or it can be permanently installed in an auto or a truck. It can also function indoors with a battery eliminator for a.c. operation, or it can be operated from a spare car battery or even a number of flashlight batteries connected in a series/parallel arrangement.

**Construction.** The major portion of the circuit is constructed on a printed-circuit board.\* This type of construction insures that the components will be held secure-

ly in place and makes the amplifier a "toughie" that can take rough treatment. Figures 1 and 3 show the completed circuit-board wiring except for capacitor C7, which is connected to the etched side of the board after all other components have been mounted.

Begin construction by cutting and drilling the heat sinks for power transistors Q3 and Q4. Then set the heat sinks aside for the moment, and mount transformers T1 and T2 on the circuit board with  $\frac{1}{2}$ " 6-32 machine screws.

Now proceed with the wiring, cutting component leads to length and soldering connections as you come to them. Use a hot, clean soldering iron or gun and rosin-core solder. Apply heat only for as long a time as necessary, and don't forget to use a heat sink when soldering the transistor leads. As you can see from Fig. 1, all electrolytic capacitors should be mounted vertically.

When you've completed the wiring up to and including the primary of T1, you're ready to mount Q3 and Q4 on the heat sinks. Be careful not to let the emitter and base leads short to the heat sinks, and mark the respective leads on the sinks to avoid foul-ups with the transistor connections.

Now mount the heat sinks containing the transistors on the circuit board. Note

\*A special printed-circuit board has been designed for this amplifier and is available from Irving Electronics Co., P.O. Box 9222, San Antonio 4, Texas. Designated as Catalog No. 78, it sells for \$2.75, postpaid. Since illustrations of both sides of the board appear here, you should have no trouble making one of your own if you prefer.

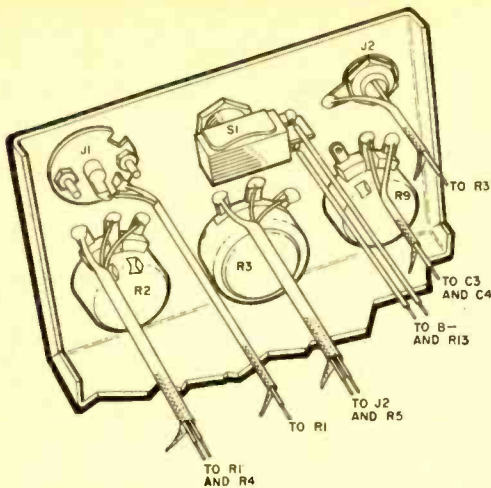

Fig. 2. Jacks and controls are all mounted on front panel, independent of the amplifier chassis. Jack J2 should match the microphone selected.

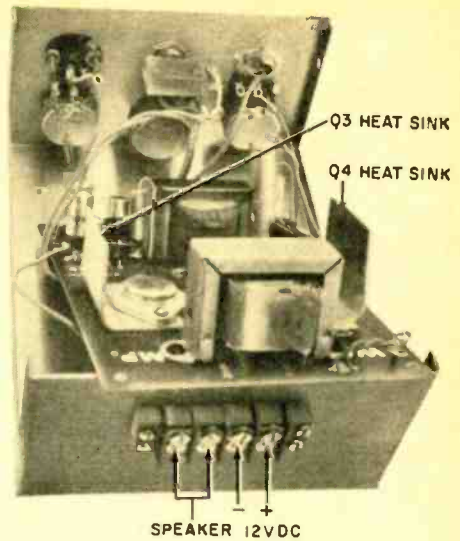

Fig. 3. Completed circuit board, ready to be installed in aluminum case.

that the screws should again be about  $\frac{1}{2}$ " long, since longer screws may short to the case. With this part of the wiring completed, set the circuit board aside for later installation in the metal case.

Next, drill one end of the case for the controls shown in Fig. 2. Mark the hole positions with a punch, then use a  $\frac{1}{16}$ " drill to make "starter" holes. You can enlarge the holes with a  $\frac{1}{8}$ " drill and cut them to the required size. Place a block of wood under the metal when drilling.

After the drilling is completed, cut the shafts of potentiometers  $R2$ ,  $R3$ , and  $R9$  to a length of  $\frac{3}{8}$ " beyond the mounting bushing. (It's best to place the portion of the shaft which is to be discarded in a vise and cut with a hacksaw.) Then mount  $R2$ ,  $R3$ ,  $R9$ ,  $J1$ ,  $J2$ , and  $S1$  on the front of the case. Place a lock washer between each of the controls and the case to prevent the controls from slipping.

The position of the hex nut on the mounting bushing of  $S1$  should be adjusted so that only enough of the bushing protrudes from the front of the case to allow the switch plate and nut to fit on the bushing. The battery and speaker terminal strip (see Fig. 3) can now be mounted on the rear of the case.

Next, wire up the front panel controls (phono jack  $J1$ , microphone jack  $J2$ ,

phono volume control  $R2$ , microphone volume control  $R3$ , tone control  $R9$ , and on/off switch  $S1$ ), exactly as shown in Fig. 2. This done, drill four holes in the top of the case to match the four mounting holes at the extreme edges of the circuit board. Four 1" screws and four  $\frac{1}{2}$ " spacers will be required to mount the circuit board in the case.

Smear Duco cement over each screw to hold the screws and nuts securely in place, and position the circuit board in the case. Fasten the board to the case, then wire in the input cables, grounding the shields to the ground bus which runs around the edge of the board. To complete the wiring, connect  $S1$  and the battery and speaker terminals.

**Testing.** Before you test the amplifier, be certain that there are no short circuits between the circuit board and the bottom of the case. Then connect an 8-ohm speaker to the speaker terminals, and a low-impedance microphone (100 to 2000 ohms should be satisfactory) to the mike input (or a crystal phono pickup to the phono jack).

Connect the amplifier to a 12-volt battery or battery eliminator, turn  $S1$  on, and test. If you don't get satisfactory operation, turn the amplifier off and recheck your wiring. Incidentally, if the microphone and speaker are close enough

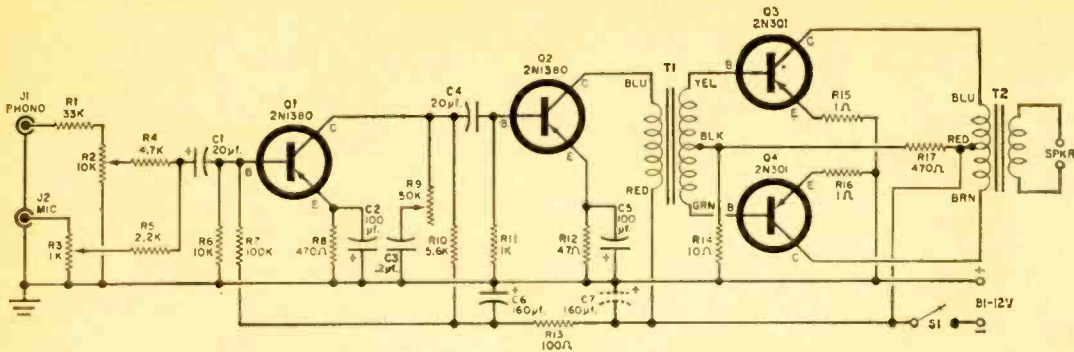
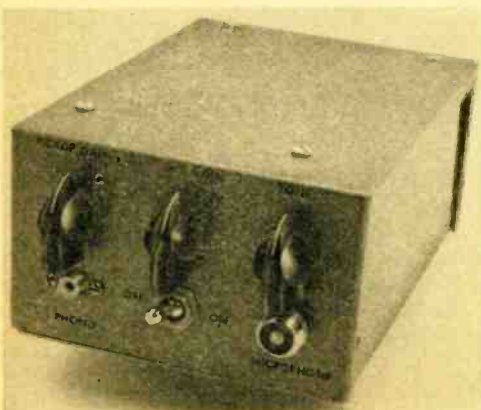

Fig. 4. Schematic diagram of amplifier. Capacitor C7 (shown dotted) mounts on underside of board; like other electrolytics, it should be rated at 15 w.v.d.c.

### PARTS LIST

- |  |  |
|--|--|
| B1—12-volt battery—see text  | R10—5600 ohms  |
| C1, C4—20- $\mu$ f., 15-w.v.d.c. miniature electrolytic capacitor      | R11—1000 ohms  |
| C2, C5—100- $\mu$ f., 15-w.v.d.c. miniature electrolytic capacitor     | R12—47 ohms  |
| C3—0.2 or 0.22- $\mu$ f. ceramic capacitor (Sprague 5C9 or equivalent) | R13—100 ohms   |
| C6, C7—160- $\mu$ f., 15-w.v.d.c. miniature electrolytic capacitor     | R14—10 ohms, 2 watts   |
| J1—RCA phono jack  | R15, R16—1 ohm   |
| J2—Microphone jack (to match microphone used)                          | R17—470 ohms, 2 watts  |
| Q1, Q2—2N1380 transistor (Texas Instruments)                           | S1—S.p.s.t. toggle switch (Cutler-Hammer 8280-K16 or equivalent)                                     |
| Q3, Q4—2N301 transistor (RCA)  | T1—Driver transformer; primary, 100 ohms; secondary, 200 ohms CT (Thordarson TR-65 or equivalent)    |
| R1—33,000 ohms   | T2—Output transformer; primary, 20 ohms CT; secondary, 8 ohms (Stancor TA-12 or equivalent)          |
| R2—10,000-ohm miniature volume control (Lafayette VC-34 or equivalent) | 1—4" x 5 $\frac{7}{8}$ " printed-circuit board—see text  |
| R3—1000-ohm miniature volume control (Lafayette VC-32 or equivalent)   | 1—7" x 5" x 3" aluminum utility box (Bud CU-2108A or equivalent)                                     |
| R4—4700 ohms   | 1—4-lug barrier terminal strip (Cinch-Jones 4-140 or equivalent with 4-140 adapter solder terminals) |
| R5—2200 ohms   | 1—Switch plate (Cutler-Hammer 827-228F3 or equivalent)   |
| R6—10,000 ohms   | 2—Transistor heat sinks  |
| R7—100,000 ohms  | Misc.—Knobs, wire, solder, speakers, microphone, nameplates, etc.                                    |
| R8—470 ohms  |  |
| R9—50,000-ohm miniature volume control (Lafayette VC-36 or equivalent) |  |

Fig. 5. All decked out and rarin' to go, the amplifier needs only a microphone, a speaker, and a power source to operate.



to each other, "squealing" may result. Such acoustic feedback is normal and is not an indication of trouble.

This amplifier is designed to operate with a high-impedance (i.e., crystal) phono pickup and a low-impedance microphone; if desired, a tuner can be connected to the phono input instead.

The Electro-Voice Model 623 microphone (pictured with the amplifier and the E-V Type PA15 paging speaker on page 61) works well, but any other mike with an impedance in the range of 100 to 2000 ohms will suffice. It's also possible to use a crystal microphone if it's plugged into the phono jack, but volume will generally be low with this arrangement.

(Continued on page 158)

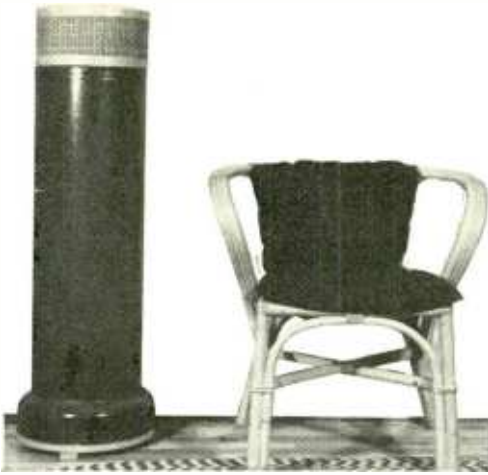

**Want to build a low-cost,  
vibration-free speaker system?  
Just take a single 8" speaker,  
house it in (of all things!)  
a 3-foot section of sewer pipe,  
then sit back and enjoy . . .**

## Clean sound from the

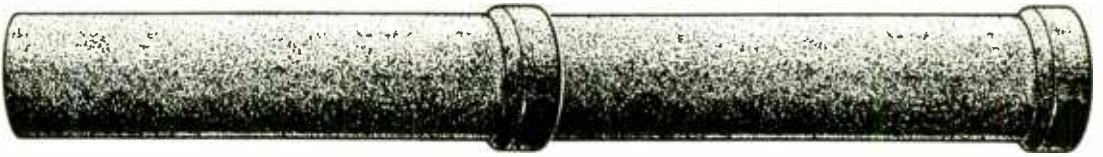

# DRAINPIPE 8

**F**ROM the many articles and books written by G.A. Briggs, Britain's famed authority on speakers, it is evident that he seeks the kind of solidity in speaker enclosures ordinarily found in his country's Rolls-Royce cars. When I first read of Mr. Briggs' sand-filled and brick baffles, I admired his thoroughness and uncompromising dedication to the art. However, still the victim of old habits, I then went out and bought some plywood.

The plywood made a very good "box," but the thought of Mr. Briggs' inflexible brick "walls" continued to obsess me. Every time I sat before a fireplace or crouched over the coals of a brick barbecue, I wondered how a hi-fi speaker would sound in them. I thought the fireplace idea had some merit, but stereo came in, and there just didn't seem to be many houses with twin fireplaces!

Considering how much I had been impressed with the possibilities of brick, it's remarkable how long I overlooked a good substitute—sewer pipe! After I

**By DAVID WEEMS**

got over the initial "shock" of my idea (a sewer pipe is a rather unlikely candidate for a speaker baffle, needless to say), I visited a local lumberyard. Sewer pipes were there all right, not displayed as prominently as the plywood, but definitely available.

The pipes, for your information, come in two kinds: smooth tile, and a rough concrete that they almost pay you to haul out. I chose the tile. And here, after some paper work, a number of trials, and quite a few errors, is the result—a speaker enclosure to satisfy even the proverbial "purist," and at a cost of less than \$10.00.

**Materials and Dimensions.** After experimenting with two sizes of pipe and various speakers, I fixed the inside diameter of the pipe at 10 inches, which happens to be a standard dimension. The "Drainpipe 8" was designed to accommo-

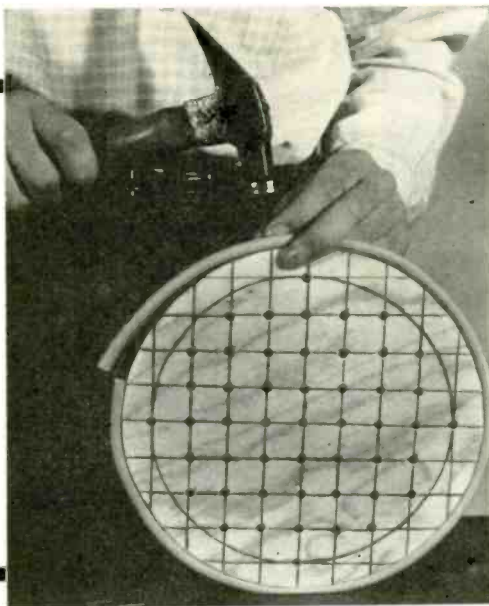

date an 8" speaker, so don't try to squeeze in a 10-incher—you'd probably be disappointed. And in case you're eyeing the dimensions and wondering if the internal volume is sufficient (as I did at first), don't give it a second thought. In spite of its small physical size, this enclosure *sounds* "big!"

Materials should be no problem. For the pipe, check with the nearest lumberyards or, if they don't have any, with distributors of plumbing supplies. The polyurethane foam plastic can be obtained from many sources, but I got mine from an upholstery supplier for only \$1.25. The "Art Foam" that serves as gasket material is carried by many "dime" stores. Picking up the other materials should be routine procedure.

The dimensions for the various parts are listed in the Bill of Materials, but you may have to make minor changes due to variations in the pipe.

**Marking and Cutting.** A good fit can be insured by using the pipe as a pattern for marking out Parts *A* and *C* (the "end plugs" for the pipe—see photo at left, above, and the drawings on page 68). Although Part *D* (the plywood ring which forms the top) doesn't have to fit the pipe, it's best to make it perfectly round with a diameter equal to that of Part *C*.

Part *B*, the acoustic filter, should then

be marked on a radius of  $4\frac{7}{8}$ " from the center of Part *D*. If you don't have a saw that makes its own opening, you can drill a small hole just inside the boundary line for Part *B* and plug the hole later. The acoustic filter, incidentally, is purposely cut smaller than the pipe's inside diameter. This allows the weather stripping to make the snug fit required to prevent unwanted air leakage and hold the part firmly in position.

After Part *B* has been cut from Part *D*, mark out the pattern for the 49 quarter-inch holes in Part *B* by first drawing two diameters at right angles to each other. Then draw lines parallel to each diameter at 1" intervals. Finally, using a 4" radius, draw another circle and drill at each cross-point that lies inside the circle or touches its boundary. When the weather stripping is attached, the filter can be placed into position in the pipe.

The base (Part *A*) should be prepared as shown; the 4"-diameter hole in its center serves as the bass-reflex port. For extra solidity, the short lengths of  $\frac{3}{4}$ " x  $1\frac{1}{2}$ " material (Part *E*) should be screwed as well as glued in place.

Note that the pieces used on the top of the base are set on edge to act as "ribs" or stiffeners as well as to locate the pipe on its base. They may have to be trimmed slightly with some kinds of



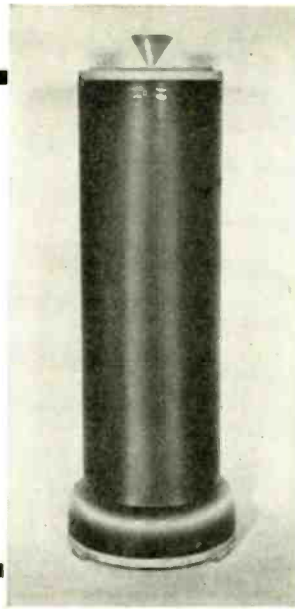
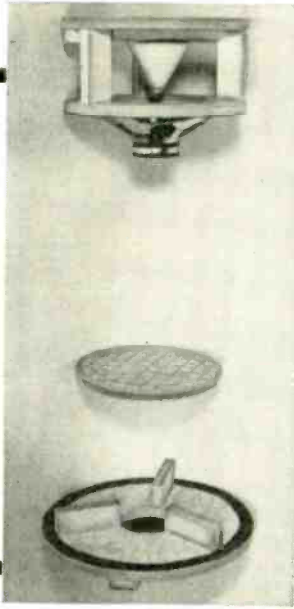

Because it requires a minimum of woodworking skills, the "Drainpipe 8" should be a pleasure to build.

To insure a proper fit for the top and bottom end plugs for the pipe, it's best to use the pipe as a pattern (see photo at far left); the acoustic filter, Part B, should then be prepared exactly as described in text. Photos on this page show (1) various parts, minus pipe, as they appear in relation to one another, and (2) an open-top model without the top ring.

pipe, so check the fit before you mount them permanently. The bottom "feet" are turned on their sides to provide  $\frac{3}{4}$ " clearance from the floor and spaced equally between each top rib; the edge and bottom of the base can be painted to match the color of the tile if you wish.

There is no mandatory plan for the top of the enclosure as there is for the bottom. After Part C has been cut out, you are ready to finish off the top as you like. For best results, you should use some kind of treble diffuser, such as the funnel shown in the photos.

**Treble Diffuser.** The simplest plan is to mount a 3" or 4" funnel on a narrow strip of wood over the speaker. This is done by cutting off the funnel neck at the bottom of its conical section, and screwing the funnel in place with a wood screw and a washer large enough to prevent the head of the screw from going through the funnel neck. Then mix enough plaster of Paris to fill the funnel. If you wish, you can also use some plaster of Paris to fill in any chips or unevenness in the pipe.

To improve the appearance of the enclosure, the ring (Part D) may be used, with the area between Parts C and D as well as the opening in Part D covered with grille cloth and trimmed with "wood tape." Part D is held at the correct

height by three of the nine pieces of  $\frac{3}{4}$ " x  $1\frac{1}{2}$ " material specified in the Bill of Materials.

A round piece of grille cloth may be cut and tacked under the ring (Part D), and a piece of the  $\frac{3}{4}$ " x  $1\frac{1}{2}$ " wood about 11" long (Part F) glued and screwed across the bottom of Part D. The funnel, in this case, can be fastened to the cross-piece with small nails in a position that will place it over the center of the speaker, or over the tweeter if you use a coaxial speaker.

It's possible that some kinds of pipe will require more than a 36" length of grille cloth. Of course, if the enclosure is to be set in a corner or against a wall, a slight gap will be no problem. But if all sides are to be visible, you may either have to buy a longer strip of grille cloth or use a vertical strip of wood tape to camouflage the gap.

Wood tape is very easily attached around the top ring (Part D) and the speaker board (Part C) because of its almost paper thinness and complete flexibility; small brads and glue should do the job nicely.

**Finishing Touches.** Before final assembly, the "Art Foam" which serves as a gasket for the speaker board (Part C) and the base (Part A) will have to be cut and glued in place. In the case of

## BILL OF MATERIALS

- 1—"3' section" (actually 38" long) of 10"-i.d. sewer pipe, concrete or glazed tile
- 1—15" x 42" sheet of 3/4" plywood (for Parts A, B, C, and D)
- 9—1 1/2" x 4 1/2" pieces of 3/4" pine (for parts labeled E)
- 1—1 1/2" x 11" piece of 3/4" pine (for funnel holder F)
- 1—22" x 30" sheet of 1" polyurethane foam plastic (for lining above filter)
- 1—15" x 30" sheet of 1" polyurethane foam plastic (for lining below filter)
- 1—12" x 36" sheet of 1/8" foam plastic, known as "Art Foam" (for gaskets)
- 1—3' length of vinyl-covered foam plastic weather-stripping (for filter gasket)
- 1—5 1/2" x 36" length of grille cloth (for side grille)
- 1—11"-diameter round piece of grille cloth (for top grille)
- 1—Package of "wood tape" (for top trim)
- 1—4" or 5" plastic funnel (for treble diffuser)
- 1—Small lead swivel casting sinker or other conical plug (for use with funnel)
- 1—8" PA1 speaker
- Misc.—Plaster of Paris, glue, wood screws, tacks, brads, additional material for padding, etc. (see text)

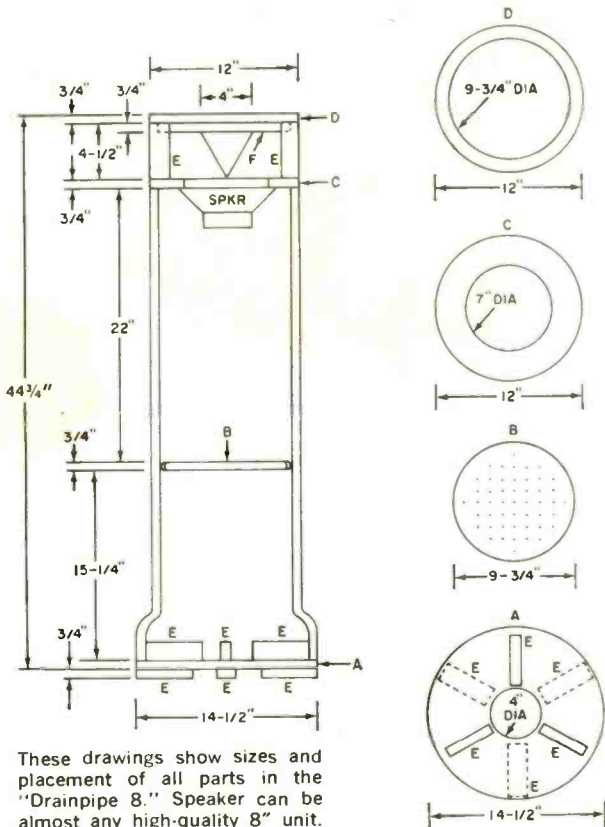

the speaker board, the art foam may be cut to the same diameter as the board and first glued to the entire surface, then trimmed away from the speaker opening. Used this way, it forms an extra gasket for the speaker itself as well as a gasket between the pipe and the board.

The walls of the pipe should be lined with the polyurethane foam plastic both above and below the acoustic filter; it isn't necessary to use glue here unless desired. When the glue has dried on the gasket material, set the pipe on its base, mount your speaker, and you're ready to listen.

A mismatch between your speaker and the enclosure is unlikely, because most good 8" speakers have similar fundamental resonances. If a mismatch should occur, however, there is an easy cure. Simply fill the entire pipe, above and below the filter, with some kind of padding. This will cut down on the efficiency somewhat, of course, but it will also

broaden the "Q" or tuning of the enclosure. Another solution is to tune the pipe as you would any bass-reflex enclosure by covering part of the hole in the base.

Actually, the shape of any enclosure will affect the sound, and the "Drainpipe 8" is no different than any other enclosure in this respect. The acoustic filter does much to eliminate any effects of the round "organ pipe" shape, which in itself is admittedly not ideal. Some people will prefer more padding—just remember to use the minimum amount of padding (except for the walls) that will remove peaks in the response, and you won't suffer any unnecessary loss in efficiency.

Bouquets and superlatives for this neat little system are hardly called for if you keep one fact in mind. Once you get used to listening to this vibration-free setup—as I have, you'll never again be satisfied with makeshift wooden "boxes."

# FREE

## ALL NEW 1963 B-A CATALOG

THE OUTSTANDING  
**\$\$\$ SAVING**  
BUYING GUIDE  
FOR EVERYTHING  
IN RADIO, TV,  
ELECTRONICS  
FOR 35 YEARS

MAIL  
**THIS CARD**  
OR THE COUPON  
BELOW

30  
PAGES OF  
BARGAINS  
NOT IN ANY  
OTHER  
CATALOG

100's of  
NEW ITEMS  
LISTED FOR  
FIRST TIME

SAVE  
UPTO 50%  
ON B-A  
SELECTED  
KITS

Send for this big book now and see for yourself the amazing money-saving prices on the latest of everything in Electronics. From parts and tubes to complete Hi-Fi systems, you'll get the most for every dollar when you order from this Giant catalog.

B-A has hundreds of items not listed in any other catalog—and all at unbelievable low prices. You'll find page-after-page of • Tools • Kits • Tape Recorders • Phonos • LP Records • Radios • Ham Equipment • Public Address and Intercoms • TV Antennas and Tubes • Photographic Equipment and Film . . . all backed by B-A's money-back guarantee and rushed to you by the fast efficient service developed by over 35 years of mail order experience. You can buy on B-A's Easy Terms—No money down and up to 24 months to pay if you desire.

HI-FI  
& STEREO  
COMPONENTS  
AND  
SYSTEMS

226 . . . PHONE Baltimore 1-1155

1963  
ANNUAL CATALOG  
621



RADIO-TV  
ELECTRONICS

STEIN-APPLEBEE CO. 1012-14 MCGEE ST., KANSAS CITY 6, MO.

TOP  
VALUES  
IN POWER  
& HAND  
TOOLS

### BURSTEIN-APPLEBEE CO.

Dept. 21, 1012 McGee, Kansas City 6, Mo.

Rush me the FREE 1963 B-A Catalog.

Name \_\_\_\_\_

Address \_\_\_\_\_

City \_\_\_\_\_ Zone \_\_\_\_\_ State \_\_\_\_\_



# THE AUDIO PACK

By E. G. LOUIS

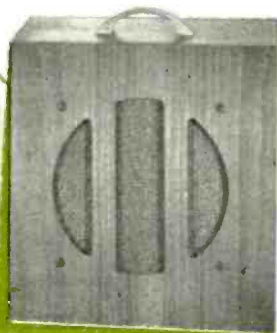

*You'll use this portable sound system for everything from a phono to a junior-sized p.a. amplifier*

**WHETHER** you're an advanced electronics hobbyist or just past the "novice" stage, you should enjoy building and using this multi-purpose audio system. It's completely self-contained—the transistorized amplifier and battery power supply are mounted in the same case that houses the speaker.

The "Audio Pack" has a high-impedance input and adequate output power for schoolrooms, clubs, or homes. You'll find it useful for p.a. work, as a booster amplifier for small radios, as part of a record-playing setup, or for amplifying the sound of musical instruments. It can even be pressed into service as an audio signal tracer or as a test amplifier for checking crystal phono cartridges and mikes.

**Construction.** The three-stage transistorized amplifier is assembled on a small metal chassis measuring approximately 1" x 4" x 2". Follow the general layout shown in the photographs when mounting the components.

A small "L"-shaped bracket (measuring approximately 1" x 1", with a  $\frac{3}{4}$ " mounting lip) is used as a heat sink for power transistor Q3. Be sure that the holes for the base and emitter pins are large enough to prevent shorts.

A lockwasher-type ground lug is placed under one of Q3's mounting nuts to serve as the collector terminal. Since the entire bracket is

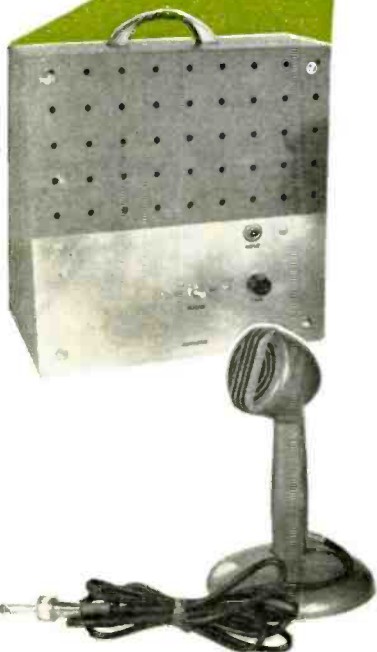

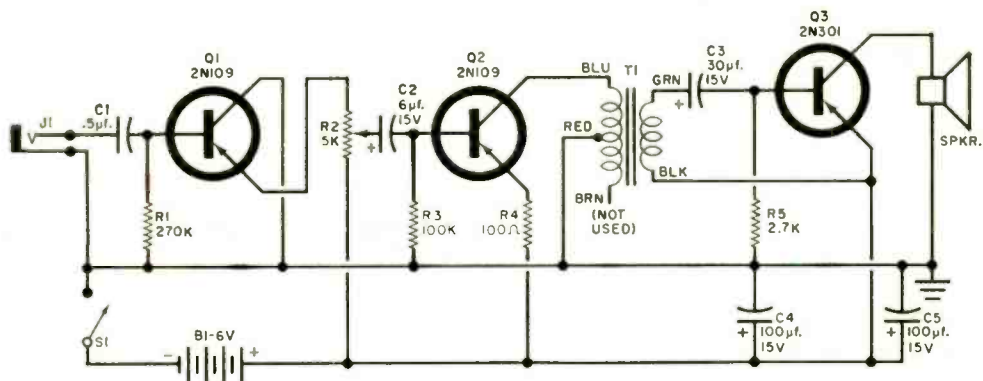

Schematic diagram of three-stage transistorized amplifier. If desired, power output can be doubled by replacing 6-volt battery B1 with a 12-volt unit, as explained in text.

at collector potential, it must be insulated from the main chassis with fiber washers. Check with an ohmmeter to be sure that there is no continuity between the bracket and the chassis.

In carrying out the wiring, all leads should be kept as short and direct as possible. Make the connections to Q3's base and emitter pins via small clips (these can be obtained by breaking up a used 7- or 9-pin miniature tube socket). Since the PM speaker, battery B1, and jack J1 are external to the chassis, it's necessary to provide leads to reach them. Make the battery and speaker leads 10" to 12" long; the lead to the jack should be a 4" to 6" length of shielded cable.

**Final Assembly.** A standard sloping-front wall baffle, of the proper size to house the speaker, is used as a combination cabinet and carrying case. Rubber

feet are mounted at the wide end—normally the top—of the baffle, and a small metal handle is attached to the narrow end.

The PM speaker, an 8" to 12" unit, is mounted using ornamental-head machine screws. Battery B1 is wedged into the case at a slight angle and secured in position with a small "L" bracket. The two-piece back consists of a section of ¼" perforated hardboard with a smaller panel of aluminum bolted to it—the hardboard provides a stiff, solid back without muffling the speaker, while the aluminum panel adds a decorative touch and provides an electrical shield for the amplifier's input.

Holes should be drilled in the aluminum/hardboard panel for switch S1, potentiometer R2, and jack J1. The mounting nuts for S1 and R2 could be used to hold the amplifier in place on the

Standard wall baffle houses amplifier, speaker, and battery; perforated hardboard serves as back for baffle and supports amplifier and jack J1 as well as operating controls S1 and R2.

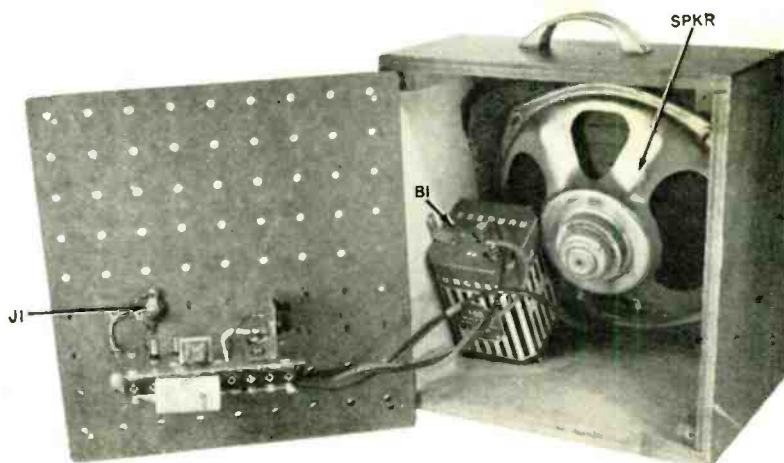

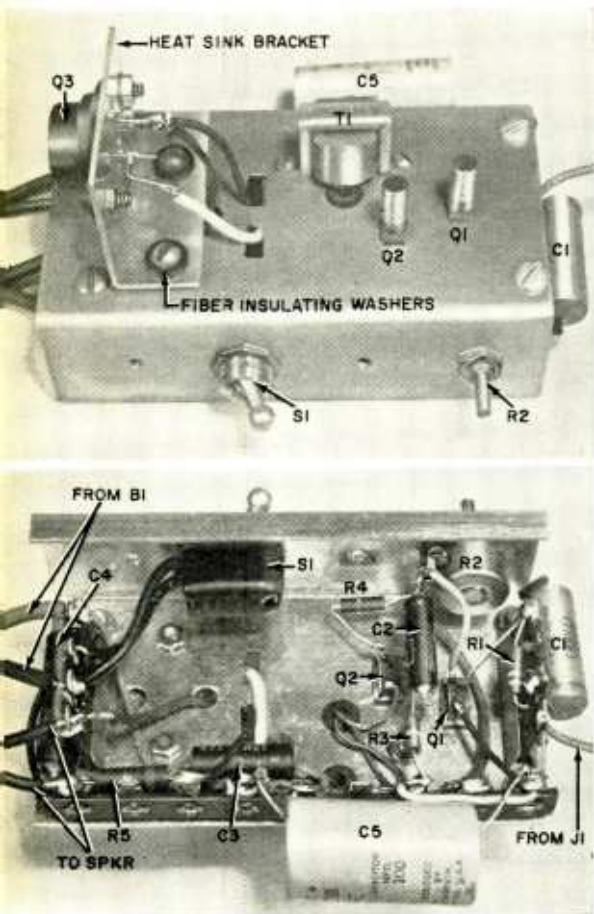

Top and bottom views of amplifier chassis. Note use of fiber washers to insulate chassis from heat sink for Q3.

#### PARTS LIST

- B1—6-volt lantern battery (Burgess F4H or equivalent)
- C1—0.5- $\mu$ l., 200-volt paper capacitor
- C2—6  $\mu$ l. } 15-w.v.d.c. electro-
- C3—30  $\mu$ l. } lytic capacitors
- C4, C5—100  $\mu$ l.
- J1—Open-circuit phone jack
- Q1, Q2—2N109 transistor
- Q3—2N301 transistor
- R1—270,000-ohm,  $\frac{1}{2}$ -watt resistor
- R2—5000-ohm potentiometer, audio-taper
- R3—100,000-ohm,  $\frac{1}{2}$ -watt resistor
- R4—100-ohm,  $\frac{1}{2}$ -watt resistor
- R5—2700-ohm, 1-watt resistor
- S1—S.p.s.t. toggle switch
- SPKR—8" to 12" PM speaker, 3.2-ohm voice coil
- T1—Transistor transformer; primary, 500 ohms
- CT; secondary, 8 ohms (Argonne AR-164 or equivalent)
- 1—1" x  $4\frac{1}{8}$ " x  $2\frac{3}{4}$ " miniature aluminum chassis (Bud CB-1626 or equivalent)
- 1—Wall baffle to fit speaker
- Misc.—Perforated hardboard, sheet aluminum, carrying handle, rubber feet, transistor sockets, terminal strips, etc.

#### HOW IT WORKS

The "Audio Pack" is a self-contained audio amplifying system using a 3-stage transistor amplifier. Signals applied to input jack *J1* are coupled through capacitor *C1*, to the base of transistor *Q1*. This transistor is connected in a common collector (emitter-follower) circuit which provides a high input impedance. Base bias for *Q1* is furnished by resistor *R1*, and gain control potentiometer *R2* serves as the emitter load.

From *R2*, the signal is coupled to the base of driver transistor *Q2* through capacitor *C2*. Resistor *R3* supplies *Q2*'s base bias, and resistor *R4* introduces a small amount of degenerative feedback to improve the frequency response and reduce distortion. Half of transformer *T1*'s primary winding is the collector load for *Q2*; the other half is not used.

Transformer *T1* matches *Q2*'s comparatively high output impedance to *Q3*'s low input impedance. From *T1*, the signal is coupled—through capacitor *C3*—to the base-emitter circuit of *Q3*. Base bias for *Q3* is taken from resistor *R5*, and the speaker serves as the collector load. No output transformer is required, since the output impedance of *Q3* is low enough to be comparable to the impedance of the voice coil winding of the speaker.

Power for the unit is supplied by 6-volt battery *B1*, and bypass capacitors *C4* and *C5* prevent possible interstage coupling through *B1* or through the circuit wiring. In this way, the possibility of oscillation and squealing is reduced and distortion is kept to a minimum.

panel, but the author secured it with a couple of sheet-metal screws. When the amplifier has been mounted, install and wire *J1* and connect the leads to the battery and speaker.

Your "Audio Pack" is now complete, and it remains only to fasten the back panel to the baffle with wood screws.

**Operation.** To use the Audio Pack, just plug the mike, phono cartridge, or what have you into *J1*, snap on *S1*, and you're in business. Volume is set to the desired level with *R2*.

To avoid acoustic feedback when working with a microphone, speak in a slightly louder than normal voice, keep the mike close to your mouth, and turn the volume up only as far as required. It's also necessary to keep the microphone and speaker as far apart as possible.

The "Audio Pack," as described above, delivers a healthy fraction of a watt. Should more power be desired, it can be obtained with a 12-volt supply; simply use two 6-volt lantern batteries (wired in series) instead of one. No circuit changes are necessary, and power output will be increased to a little over a watt. The instrument's weight and cost of operation, of course, will be increased as well.

—30—

# STARVED CIRCUIT AMPLIFIER



**Oversized load resistor reduces both plate voltage and current, yet gives gain of almost 2000 times**

By **HOWARD BURGESS**  
and  
**KARL ANDERSON**

**H**AVE you ever put an amplifier on a starvation diet? It's almost unbelievable how much gain an ordinary tube can turn out when it gets really "hungry." Special circuits, sometimes known as "starved circuits" because of their very low plate voltages, have been designed for just this purpose and are among the oddities of electronics.

Few other types of amplifier circuits can do so much with so few parts. For example, a two-tube audio amplifier using "starved" circuitry can give voltage gains in excess of 50,000 with only 4 resistors and 2 capacitors; this probably qualifies it as one of today's best bargains. The little starved-circuit amplifier to be described here will give you a good idea of what can be done.

**Theory.** Those who like to know the "why" before they build should start by



Completed unit has high gain and good frequency response, an unbeatable combination for almost any application.

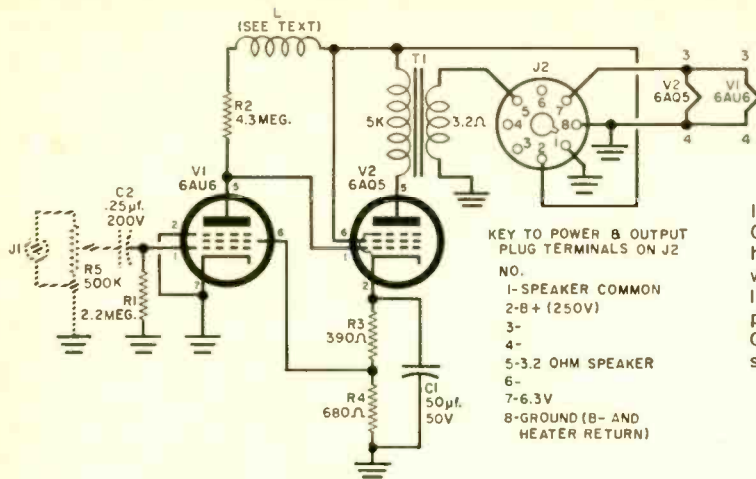

KEY TO POWER & OUTPUT  
PLUG TERMINALS ON J2

NO.  
1- SPEAKER COMMON  
2-B+ (250V)  
3-  
4-  
5-3.2 OHM SPEAKER  
6-  
7-6.3V  
8-GROUND (B- AND  
HEATER RETURN)

Inductor "L" in "Starved Circuit Amplifier" extends high-frequency response which would otherwise be limited by extra-large plate-load resistor R2. Optional gain control is shown in the shaded area.

### PARTS LIST

- C1—50- $\mu$ f., 50-w.v.d.c. electrolytic capacitor  
C2—0.25- $\mu$ f., 200-volt paper capacitor  
J1—Phono jack  
L—20 to 50  $\mu$ h. inductor—see text  
R1—2.2-megohm,  $\frac{1}{2}$ -watt resistor  
R2—4.3-megohm,  $\frac{1}{2}$ -watt resistor  
R3—390-ohm, 1-watt resistor  
R4—680-ohm, 1-watt resistor  
R5—500,000-ohm potentiometer, audio taper  
T1—Output transformer; primary, 5000 ohms; secondary, 3.2 ohms (Knight 62G064 or equivalent)  
V1—6AU6 tube  
V2—6AQ5 tube  
1—5 $\frac{1}{4}$ " x 3" x 2 $\frac{1}{8}$ " aluminum box (Bud CU-3006A or equivalent)  
Misc.—Hardware, tube sockets, etc.

15 volts, however, the gain may go up to well over 2000 under the right circuit conditions.

One of the secrets of achieving this high gain is the use of a very large plate resistor. The signal voltage developed across a 10-megohm plate resistor, for instance, becomes quite high for even a very small plate current.

Starved circuits should not be confused with circuits using 12-volt plate tubes, by the way. The gain of a true starved circuit depends on the use of several hundred volts dropped across the plate load resistor.

**The Circuit.** The schematic diagram shows the extreme simplicity which can be designed into a starved-circuit amplifier. Almost any of the common tubes can be used if slight changes in circuit values are made; some tubes, of course, will give more gain than others. Two

looking at the data sheets for a 6AU6 pentode. This tube gives a gain of about 300 with a 250-volt plate supply; and if the voltage is reduced to 100, the gain may fall as low as 110. If the screen and plate voltages are reduced to about

Two possible applications for starved circuit amplifier: modulating low-powered transmitter (left, below); and amplifying output of small crystal receiver (right).

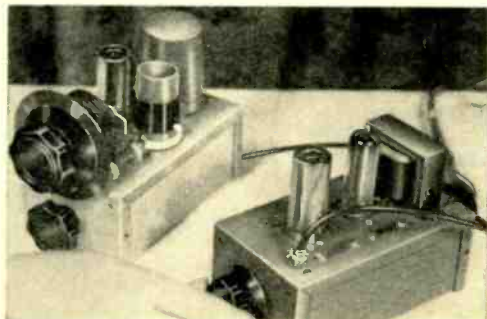
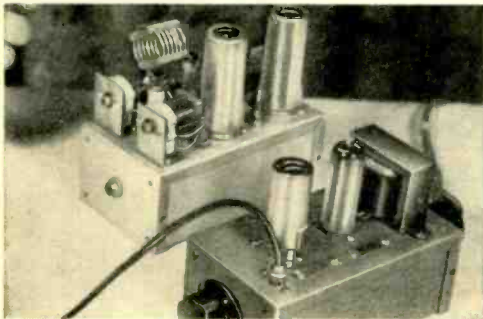



very common types are used here—the 6AU6 pentode (*V1*) and the 6AQ5 beam power audio tube (*V2*).

One of the main points of interest in this circuit is the direct coupling from the plate of the 6AU6 to the control grid of the 6AQ5. It is possible to eliminate the usual coupling capacitor and grid resistor because the plate of *V1* is only about 17 volts above ground. The grid of *V2* has a comfortable value of negative bias—even though it is tied to the plate of *V1*—because *V2*'s cathode is about 32 volts above ground.

It was found by experiment that *V1* works very well with about 20 volts on its screen. This voltage could have

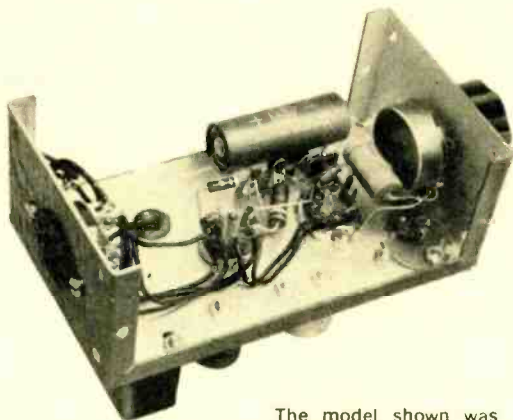

The model shown was constructed in a fairly large box, with standard-sized components. Your version can be smaller, if you wish.

been taken from the plate supply, in the ordinary way, with a dropping resistor and bypass capacitor. Instead, however, the screen grid is tied to a point on the cathode resistance of *V2* about 20 volts above ground—so no bypass capacitor is needed for the screen grid.

The schematic diagram shows two fixed resistors (*R3* and *R4*) with a total value of 1070 ohms in the cathode circuit of *V2*. If you like to experiment however, you might replace these resistors with a 1000-ohm, 2-watt potentiometer. The screen grid of *V1* could be connected to the slider arm. Adjusting this arm would vary the value of the screen voltage on *V1*, which in turn could be used to control the amount of plate current in *V2*.

Control grid bias for *V1* is furnished by the so-called "contact" potential which is developed across resistor *R1*. This allows the cathode of *V1* to be grounded, eliminating another resistor and bypass capacitor which are usually necessary.

Potentiometer *R5* and capacitor *C2* constitute an optional gain control circuit; there must be a capacitor here even if the gain control circuit is not used, in order to avoid loss of bias on *V1*.

We have now "thrown away" almost as many resistors and capacitors as we have kept. With fewer components, the amplifier circuit is easier to manipulate. It would be no problem now for the experimentally minded builder to alter the characteristics of the unit with a few simple resistor changes.

**Frequency Response.** Of course, no amplifier offers everything, and starved circuit units are no exception. Though these amplifiers are long on gain, they are somewhat short on high-frequency response.

In this particular circuit, the gain is between 25,000 and 30,000, but the upper frequency limit is between 2500 and 3000 cycles—without inductor *L*. However, thanks to this inductor, the high-frequency response of this amplifier is equivalent to that of amplifiers costing much more. The proper value of this inductance will depend on the amount of stray capacitance in your particular amplifier, but it will probably fall somewhere between 20 and 50  $\mu$ h.

The upper frequency limit of the amplifier can also be increased by reducing the resistance of *R2*, though the gain will suffer. Since direct coupling is used between the tubes, about the only limits to the *low-frequency* response are the sizes of *C1* and *C2* and the characteristics of the output transformer (*T1*).

**Uses.** The starved-circuit amplifier can be used as a very sensitive signal tracer or voice amplifier. It has sufficient gain to operate from a low-level microphone and can serve as a low-power modulator, a driver for a higher power modulator, or an intercom amplifier. Since the circuit is adaptable to miniaturization, many other uses will suggest themselves. And the minimum of construction involved won't upset anybody's time or parts budget. —30—

# hi-fi HINTS

## RELIABLE PHONO PLUGS

Coax antenna cable makes better phono cables than most of the flimsy stuff on the market. Try making your next set out of Amphenol Type RG-58A/U cable. First prepare the cable by stripping back the outer insulation  $1\frac{1}{2}$ ". Clip off about  $1\frac{1}{8}$ " of the braid and  $1\frac{1}{16}$ " of the center insulation, and wrap five or six turns of #20 wire around the braid to prevent fraying. Then slip on the phono plug and solder the center conductor. Point the phono plug toward the floor and allow solder to flow around the wire wrapping so that it will be securely attached to the phono plug. Finally, cut off the excess solder from the center conductor and clean the soldered connections with solvent.

—Paul Galluzzi

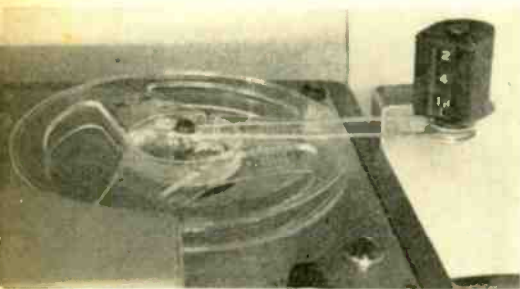
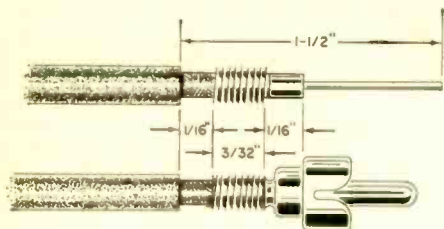

## TAPE COUNTER

If your tape recorder lacks a counter, you can easily attach one without tearing up the insides of the recorder. Check the catalog of your favorite electronics parts house for three- to seven-digit counters that are pulley-driven. Fabricate a simple bracket to mount the counter to the side of the recorder near the takeup reel. Then attach the counter to the hub of the takeup reel with a rubber band, and away you go.

—Fred Blechman

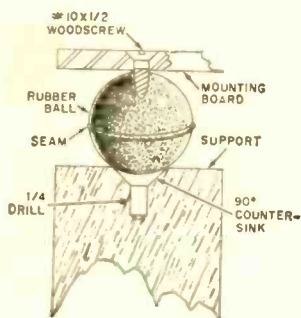

## TURNTABLE MOUNTING

You can make your own shockproof turntable mounting with four dime-store rubber balls—look for very soft rubber balls with a diameter of about  $1\frac{1}{4}$ ". Pierce the top of each ball with a sharp instrument and hold the ball in place by filling the screw threads with glue. Countersink small recesses in the turntable support— $\frac{5}{8}$ " deep will do nicely—being sure that they line up with the balls attached to the turntable board. Let the four balls rest in the countersunk holes, and your turntable will be vibration-proof.

—Rudolf Bohm



## PROTECTIVE COVERING

Your local hardware, building or lumber supply dealer can sell you Visqueen plastic film for protective storage of hi-fi, CB, or ham gear. This flexible plastic sheeting is only two or three cents per square foot and comes in various thicknesses (.004" being the most popular). It will also be useful as a transparent dust cover in many spots around the home.

—George Cunningham

# WATCH FOR THE PUBLICATION THAT COVERS THE ENTIRE FIELD OF COMMUNICATIONS—THE 1963 COMMUNICATIONS HANDBOOK

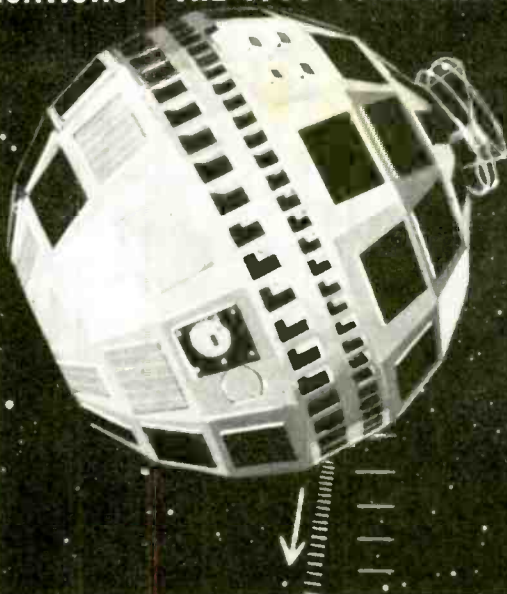

*Here's the most complete and helpful handbook ever published in the communications field! Four big sections—each one illustrated with graphs, charts and tables—filled with all brand-new material and inside information for*

## THE CB'ER

How to Get a License  
The Ten-Code  
Designing a Station  
Operating Practices  
Setting Up a Mobile  
CB in Civil Defense  
Joining a CB Club  
Latest USA and Canadian  
license requirements

## THE HAM RADIO OPERATOR

The Choice of a Ham License  
Studying the Code  
How and Why of the FCC Tests  
Setting up a Station  
QSL Bureaus Around the World  
Listing of Certificates and Awards  
Why CB'ers Switch to Ham Radio

## THE SWL

Getting started in SWL'ing  
What Equipment to Buy or Build  
How To Report and Get QSL Cards  
Frequencies and Time Zone Tables  
International Postal Rates  
Station Lists, Where to Buy  
How to Identify Different Radio Signals  
Time Signals and Weather Broadcasts  
Equipment Suggestions

## BUSINESS RADIO SERVICE

Who Qualifies For a License  
How it Differs From CB  
Equipment Required  
List of Industrial Associations  
Operating Practices  
The Future of Business Radio  
Manufacturers Directory

*All in all, you'll get 164 pages of comprehensive information on every phase of communications for only \$1.00. The 1963 COMMUNICATIONS HANDBOOK is on sale in March, but you can reserve your copy now with this coupon.*



Retail Sales Division  
Ziff-Davis Publishing Co.—Dept. BT  
One Park Avenue, New York 16, N.Y.

EEH3

Please send me a copy of the 1963 COMMUNICATIONS HANDBOOK. I enclose \$1.00, the cost of the HANDBOOK, plus 10¢ to cover mailing and handling charges.

NAME

ADDRESS

CITY

ZONE  STATE

(add 3% sales tax if N.Y.C. resident)

# What Job Do You Want In Electronics?

Whatever it is, Cleveland Institute can help you get it!

Yes, whatever your goal is in Electronics, there's a Cleveland Institute program to help you reach it *quickly* and *economically*. Here's how: Each CIE program concentrates on electronics theory as applied to the solution of practical, everyday problems. Result . . . as a Cleveland Institute student you will not only learn electronics but *develop the ability to*

*use it!* This ability makes you eligible for any of the thousands of challenging, high-paying jobs in Electronics. Before you turn this page, select a program to suit your career objective. Then, mark your selection on the coupon below and mail it to us *today*. We will send you the complete details . . . without obligation . . . if you will act NOW!

## Electronics Technology



A comprehensive program covering Automation, Communications, Computers, Industrial Controls, Television, Transistors, and preparation for a 1st Class FCC License.

## First Class FCC License



If you want a 1st Class FCC ticket quickly, this streamlined program will do the trick and enable you to maintain and service all types of transmitting equipment.

## Industrial Electronics & Automation

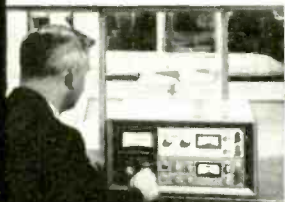

This exciting program includes many important subjects as Computers, Electronic Heating and Welding, Industrial Controls, Servomechanisms, and Solid State Devices.

## Electronic Communications



Mobile Radio, Microwave, and 2nd Class FCC preparation are just a few of the topics covered in this "compact" program . . . Carrier Telephony too, if you so desire.

## Broadcast Engineering



Here's an excellent studio engineering program which will get you a 1st Class FCC License and teach you all about Program Transmission and Broadcast Transmitters.

## Mail Coupon TODAY For FREE Catalog

### Cleveland Institute of Electronics

1776 E. 17th St., Dept. PE99  
Cleveland 14, Ohio

Please send FREE Career Information prepared to help me get ahead in Electronics, without further obligation.

#### CHECK AREA OF MOST INTEREST —

- |   |  |
|---|--|
| <input type="checkbox"/> Electronics Technology | <input type="checkbox"/> First-Class FCC License   |
| <input type="checkbox"/> Industrial Electronics | <input type="checkbox"/> Electronic Communications |
| <input type="checkbox"/> Broadcast Engineering  | <input type="checkbox"/> _____<br>other            |

Your present occupation \_\_\_\_\_

Name \_\_\_\_\_ Age \_\_\_\_\_  
(please print)

Address \_\_\_\_\_

City \_\_\_\_\_ Zone \_\_\_\_\_ State \_\_\_\_\_

PE-99

## Cleveland Institute of Electronics

1776 E. 17th St., Dept. PE99  
Cleveland 14, Ohio



Accredited Member



Chapter

# 3

## ELECTRONICS SCHOOLS the key to your future

By JOHN D. & IRENE LENK

“THE Electronics Age . . . Outer Space . . . FCC License . . . Color TV . . . Earn While You Learn . . . Radio Astronomy . . . B.S.E.E. Degree . . . Technical Writing . . . Big Pay . . . Computer Specialist . . .” Any of these sound familiar? If so, it’s likely that you’ve been reading some of the advertisements for electronics training schools. If you’ve paid any attention to these ads, you know that they point to an almost unlimited future in the field of electronics. They indicate that there are thousands of job openings today, with many thousands more to come in the years ahead.

But what are the facts? Is the picture really this bright? Can *you* step into a rewarding career by spending the next year or so at intensive study? The answer is unquestionably, “Yes.” Why? To find out all about electronics schools and the status of the professional electronics

technician today, we've poured through reams of government and independent manpower surveys. We've questioned dozens of schools, and we've interviewed leaders of the electronics industry. Despite a certain confusion in terminology (there are at least four different descriptions of an "electronics technician"), certain facts are quite clear.

The electronics field is expanding at a fantastic rate, and the advertisements tell only part of the story. If all of the schools operated all of their training facilities at full blast, they would still have difficulty in filling present job openings. And they wouldn't even make a fair-sized dent in the potential jobs due to open up within the next few years.

You will need training and more training to qualify for the newer developments in electronics. There has never been any room for the "screwdriver-and-pliers mechanic" in the electronics field. The half-trained or "self-taught" man is equally lost. There is only one way to enter or to advance yourself in the electronics industry. You must study a planned program under the direction of qualified instructors. And that's where electronics schools come in.

There is an electronics school to fit every specific need and every pocket-book. Our survey shows that there are at least 240 schools in the United States offering some form of electronics training. Over 50 of these provide home-study courses. Another 150 schools have evening classes. This means that there is really no excuse for someone who wants to enter the electronics field, but feels that he has no chance because he lacks training.

So where does this leave you? Let's say that you're wise enough to realize the value of electronics training. But which school and which course will be best for you? Your first step is to decide which particular branch of electronics you want to enter. Then find out the qualifications (and rewards) for this specialization. Next, determine what training the various schools have to offer, and how they operate. This will tell you which school will "phase in" with your particular needs.

For purposes of the survey, we defined an electronics technician as "anyone whose job duties demand a basic knowl-

edge of electronics, as well as specific knowledge of a particular electronics field, but who is not a graduate engineer." With this in mind, we arbitrarily divided the entire electronics field into five sections. Actually, some sections overlap others. But each section has certain characteristics that make it stand out from the rest.

## SERVICING

**A**LTHOUGH not the largest and not necessarily the most rewarding, radio and television repair is still the best known phase of electronics. Today, there are nearly 50 million TV sets in the United States, not to mention the millions of radios, hi-fi systems, phonographs, and tape recorders. All of these devices, needless to say, will require touch-up and repair at some time in their lives. This means 100,000 jobs in home electronics servicing at present, with an estimated increase of 15% per year over the next seven years.

Even in large metropolitan areas where the TV repair business is most competitive, a trained repairman can earn from \$6000 to \$10,000 per year. However, to make the top end of this pay scale, a repairman must be thoroughly trained in more than one specialty—color TV, for example, is a subject that is almost impossible to master without professional training. And while the radio/TV repair field offers the greatest opportunity for self-employment, complete training in all phases of home electronics is of utmost importance to the man who is seriously planning to enter this end of the business.

## BROADCASTING

**T**O SOME, radio and television broadcasting is the most glamorous phase of electronics. With just a little imagination, you can visualize yourself as technical director on some network variety show, taking your coffee break with Dinah Shore. In reality, however, most cameramen, technical directors, sound men, and so on are not in the business for its glamour. Our survey shows that starting salaries in this field are in the \$6000-per-year bracket, with top technical personnel receiving \$14,000—and

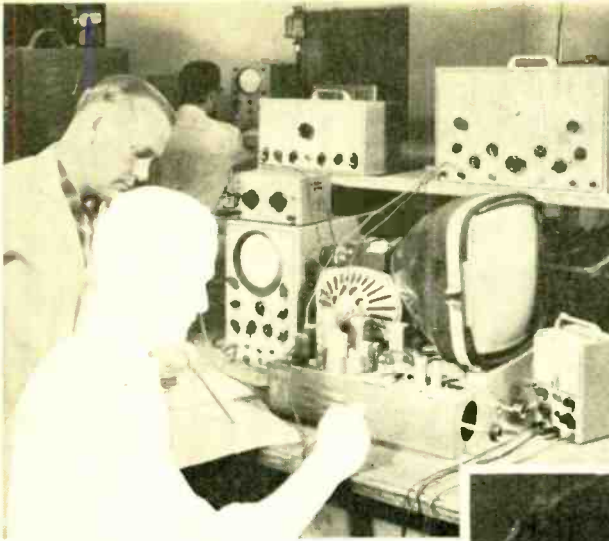

UPI

these figures are for a 40-hour, "full-coffee-break" week!

To some degree, this relatively high pay scale is the result of the rapid expansion in the field. Take TV as an example. In 1952, there were about 100 TV stations. Today, there are roughly 500 such stations, and the supply of trained personnel has never quite matched the demand.

The most important consideration for training in this field is the fact that you must hold a first-class radiotelephone license for just about any position. So most schools now include license preparation as part of their courses.



About 60% of the technicians working in this field are employed by service companies who install and maintain equipment on a contract basis. Another 10% are employed by state and municipal governments as civil service employees. The remaining 30% is divided between employees of the merchant marine, airlines, telephone companies, and individual technicians who operate their own service companies.

Although actual earnings will depend upon the individual, the average is quite high. For example, a typical mobile radio service maintenance contract pays about \$100 per month. It's quite possible for a trained technician to maintain eight to ten such mobile stations single-handedly, while some individuals are now covering as many as 15 stations by themselves.

Besides a first-class radiotelephone license, the person interested in communications must have *practical experience* with communications equipment. And this is the snag. Since you are not permitted by law to use or operate such equipment without a license, or without being under the direct supervision of a licensed operator, your chances of bypassing formal electronics training and breaking directly into the communica-

## COMMUNICATIONS

**M**OBILE and communications radio is another branch of electronics that has expanded into a big business overnight. Ten years ago, there were about 100,000 licensed communications stations in use. These included stations for police and fire departments, airlines, the merchant marine, pipelines, telephone companies, taxicabs, railroads, trucking firms, delivery services, and so on. Today, there are over a million such stations on the air, and the number is growing constantly.

tions field are just about non-existent. Fortunately, most electronics training schools already include mobile radio courses (sometimes called communications courses) as part of their programs.

## INDUSTRIAL

**T**HE TERM "industrial electronics" is just about as broad as the term "electronics technician." For that reason, it has been next to impossible to pin down exact figures as to the number of people employed in this field. It is even more difficult to predict the future needs of this vast and rapidly growing branch of electronics.

For example, there are about 3300 computers and electronic processing machines now in use (excluding those operated by the military). The estimated non-military potential is for 50,000 to 60,000 such machines and this figure assumes no increase in our population! While a widespread use of this equipment may wipe out armies of semi-skilled clerical help, it will create even greater needs for trained electronics technicians.

Using the present figure of 8 to 10 technicians for each computer operating on a 24-hour basis, we will need over one-half million technicians to maintain our future electronic processing systems alone. And this is only part of the picture. Our term "industrial electronics" includes automation, all non-military research and development, medical electronics, closed-circuit TV, railroad control, materials control, and several other minor fields or specializations.

To qualify as an industrial electronics technician, you must have intensive training in both the basics of electronics, and in one or more specialized fields. Assume that you now have a good working knowledge of basic electronics. Further assume that you want to enter the field of automation—say at the Ford Motor Company, which has an automated factory producing motor blocks.

To qualify as an operator or maintenance technician for the electronics nerve center which controls this factory, you must be trained in all aspects of electronics automation. Because these automation techniques are so advanced and so far removed from the every-day

branches of electronics, a specialized course at an electronics school is almost the only way to acquire the necessary skills.

The rewards in industrial electronics are understandably high. Our survey shows that starting salaries for graduates of electronics schools are in the area of \$6500 a year. And we have recorded many examples of industrial electronics personnel earning in the very pleasant neighborhood of \$20,000. Despite what you may think, these men are not graduate engineers. But they are graduates of advanced level trade schools or, in most cases, of technical institutes.

## MILITARY

**A**LTHOUGH there are no precise figures available, it has been reliably estimated that about half the electronics technicians working in the U.S. are connected directly or indirectly with the military. And while we will not deal extensively with military personnel in this series, it can be said that a graduate of an electronics training school who enters one of the armed services will have a 300% better chance of promotion than the untrained recruit.

For every military technician, there are five or six civilian technicians to back up the man behind the gun. Several thousand of these technicians work directly for the services, or as liaison men between the services and the equipment manufacturers. Generally known as field engineers, they maintain and repair radar, sonar, and guided-missile equipment, solve technical problems, or instruct service personnel. Such men enjoy officer status, receive generous travel and "per diem" allowances, and draw salaries in the range of \$7000 to \$11,000 a year.

At one time, the field specialist came largely from the ranks of graduate electrical and electronics engineers. But this has been changed by the rapid post-World War II expansion. Today, less than 20% of the field engineers are college graduates. The remaining 80% are recruited directly from the electronics schools of the advanced trade or technical institute level.

The great bulk of military electronics



technicians are employed by firms which manufacture electronic equipment. These people work as engineering aides, research and development laboratory technicians, quality-control specialists, production-line trouble-shooters, and technical writers, to name a few classifications. Significantly, there are over 1000 such electronics manufacturing firms in the United States.

To solve the shortage of electronics personnel, some companies will even hire you, then send you to a training school at their expense! Most firms are not in a position to do this, however, so they must rely on new graduates to fill their needs. It goes without saying that if you are already trained, the electronics manufacturing firms will welcome you with open arms.

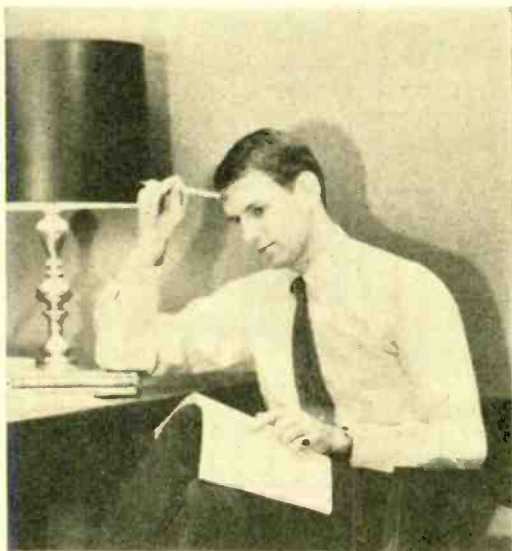

## CORRESPONDENCE SCHOOLS

**G**ETTING AHEAD in electronics makes some type of formal electronics training almost a necessity. But whether you decide to take this training at home from a correspondence school—or away from home at a residence school—depends on individual circumstances and preferences. Since “home-study” schools have proven extremely popular over the years, let’s take a close look

at how this type of school operates.

Almost all correspondence schools divide their home-study courses into a number of individual lessons. In actual practice, each lesson is a separate booklet devoted to a specific subject—modulation, time constants, electron tubes, and so on. In fact, by carefully grouping the training material, a student can easily build up a reference library in which almost any subject can be readily located.

Usually, each booklet opens with an introduction and then goes into the subject in detail. Each booklet ordinarily includes all necessary diagrams and exercises, as well as a summary of the material covered. Sometimes, too, each booklet contains a glossary of new terms to be learned in that particular lesson.

The average electronics home-study course will have 60, 80, or even more lessons, depending upon the particular electronics field covered. In each case, the first 40 or so lessons will cover basic electronics and elementary mathematics. The remaining lessons will be devoted to a particular subject—TV servicing, FCC license preparation, etc., or perhaps even to specialized subjects such as TV cameras, servomechanisms, and computer logic.

In the case of a Technical Institute or Advanced Trade School, a home-study course will probably be divided into 80 or 100 lessons. In addition, each lesson will be broader in scope and quite a bit more “meaty” than those from an “ordinary” correspondence school.

**How Long Will It Take?** As with most home-study schooling, the time required to complete any given course is pretty much up to you. A good rule of thumb, however, is one lesson per week, or 8 to 10 hours per lesson—whichever fits your situation. Thus, a full 100-lesson course from an Advanced Trade School or Technical Institute will take you the better part of two years to complete.

Some schools impose a time limit (usually about three years) for completion of their courses. They reason that either the course is too difficult or that you’re not applying yourself if you can’t complete a “1½-” or “2-year” course in three years.

Even so, most schools recognize that each student is an individual, with in-

Electronic kits form a part of many correspondence school courses. Kits help you to become familiar with many basic circuits and give you an opportunity to build and test a wide variety of electronic equipment. All will prove very useful to you, especially the test instrument kits which you will probably need later in your professional career.



dividual capabilities and circumstances. However, a student who regularly turns in one lesson every two or three weeks is considered a much better prospect than one who intermittently keeps up with a one-a-week average schedule and then falls badly behind. In other words, if you can show steady progress and are doing good work, most schools will allow you to take additional time.

**Will I Get Any "Extras"?** At one extreme, you might receive nothing but basic lesson material and the corresponding examinations. At the other extreme, you could receive the parts for a 21-inch TV set (which you can assemble and fit into your own cabinet) along with a fairly complete set of test equipment in kit form (which you can also build and later use in your work). Generally, the more you receive in the way of "extras," the more you will pay.

Some schools supplement their basic lesson material with such training devices as motion picture films. The counterpart of classroom lectures, such films are loaned to you during the course, along with a hand-operated silent projector and a viewing screen. This type of extra training aid is the exception, however—in most cases, the "extras" consist of slide rules, reference books, electronics dictionaries, tips on turning your new-found skills into spare-time cash, and so on.

As far as kits are concerned, some home-study schools supply them and some do not. Those schools which don't furnish kits—about 50% or more—offer several reasons for their stand. They feel that the prime purpose of kit construction is for the student to acquire mechanical skills, to become familiar with the physical appearance of electronics parts, and to "learn by doing." Students

of the advanced schools (particularly the Technical Institutes) are ordinarily already working in electronics or have at least been exposed to basic shop practices, so kits might serve only to slow them down. Other schools state flatly that they omit kits to reduce the cost of training.

If you decide that kits are a necessary part of your home-study course, you'll find that there is a vast difference in both their quantity and quality. In general, the shorter courses supply fewer kits, and the less expensive courses supply kits of lower quality. But this isn't always so. Some schools have gone "all-out" in their kit programs, particularly those which provide test equipment in the form of kits. Such schools assume that you will make use of test instruments in your professional career.

**What Will I Need?** If you select a non-kit type of home-study course, you can get by with a minimum of equipment. About all you'll need is a few pencils, possibly a slide rule, a ream or two of scratch paper, and (if worse comes to worst) several gallons of black coffee!

The situation is a little different if your study course includes kits. First, you'll need adequate work space (a conventional workbench is best) and a source of electric power. Most kits require 117 volts a.c. (at least for the soldering gun), even though they may be battery-operated. This may seem a minor

## ADVANTAGES OF HOME STUDY

You set your own pace. You neither fall behind, nor are you held back by a "class average" schedule.

You can repeat the study material. In residence-school training, you receive a class lecture or a demonstration only once. If you miss it or fail to understand it, you've more or less had it. With home study, you can read the lessons any number of times. And you can keep the lesson material after you have completed the course.

You receive more personal attention. No other student shares the time of your instructors with you. An instructor at a residence school can answer just so many questions after each lecture or demonstration. A home-study instructor answers all of your questions, and in writing. Thus, you retain the answers for future use.

You have less problems with temporary interruptions in study. You can't interrupt in-residence training more than a day or two without missing vital lectures and demonstrations (or examinations). Therefore, no matter what the reason, residence schools cannot tolerate your being absent for any length of time. They must drop you, or put you back. Home-study courses can be far more lenient in this respect.

The hidden factor of personal application. By its very nature, home study develops your ability to analyze and extract information, as well as to strengthen your sense of responsibility and initiative. Electronics technicians, even though they do not intend working for themselves, must be "self starters." Anyone who can satisfactorily complete a home-study course in electronics need have no worry about his initiative.

point, but some schools have reported cases where students in remote areas or foreign countries have had to skip key portions of their training because of inadequate or otherwise unsuitable power sources!

Next comes the problem of tools and test equipment. Some schools supply common hand tools, some make tool kits available at reduced cost, and some expect you to dig up your own. Tools present no great problem, since most are inexpensive and readily available. Unfortunately, this isn't true of test equipment, at least as far as cost is concerned. And since a number of schools specify that you must have certain items of test equipment to complete kit training, this is a point to watch when selecting a home-study course.

**What About Exams?** The majority of home-study courses in electronics provide an examination with each lesson. One exception is where the lessons are supplied in groups of two, three, or five, in which case there will be an examination for each group. A very small number of schools require examinations at periodic intervals during the course as well as a final examination.

Those Technical Institutes which grant an A.S.E.E. degree for home study require that you sit for a final exam at the school or for a "proctored" exam somewhere nearer your home. (A proctored examination is one supervised by a rep-

resentative of the school or by an instructor so designated.)

It's not that the Technical Institutes don't trust you; in fact, they won't even allow you to take the final exam until they feel you're qualified! However, the accrediting agency (usually the State Board of Education) will not permit the institutes to grant an A.S.E.E. degree without a supervised final exam.

Home-study course examinations are almost always "open-book." But since the lessons and examinations are written in such a way that you can't "match up" the questions and answers, you must do more than merely memorize facts. In short, you must understand the principles you have learned to get the right answers; simply memorizing facts isn't enough!

When the course includes kits, most schools require that you also submit examination papers on various stages of kit construction. In this way, your instructor can check your practical knowledge and tell whether you are developing the necessary manual skills.

For example, assume that you have constructed a simple ohmmeter kit. You might then be asked to make up a network of resistors, to measure the resistance at various test points in the network, and to write up the test results. By carefully studying your answers, the instructor can tell: (1) if the ohmmeter was constructed properly, (2) if the re-

sistor network was arranged as indicated, and (3) if you performed the tests correctly. If you've "goofed" somewhere along the line, you'll hear about it. So it's not just a matter of putting home-study kits together and making them work.

**And If I Fail?** At this point you may be wondering, "What happens if I flunk one or more of the exams?" Although each of the schools has its own particular procedure for "problem" students, it usually goes something like this.

Your instructor sends you a new examination paper (the schools have several dozen examinations for each lesson), and a letter explaining why you failed. He will then recommend that you re-study the lesson, and he may point out certain areas on which to concentrate. If you fail this second examination, the instructor will again supply you with a new one and sufficient written comment to point out your weaknesses.

A third failure will bring one of two things. Some schools will permit you to take the examination any number of times, although you'll receive no additional lessons until you pass. Other schools set a limit on the number of failures. If you exceed the limit, they tactfully request that you drop the course. If you're in the early stages of training, the schools will quite often refund all or most of your money; if you're toward the end of the course, they will pro-rate the refund.

**Personal Contact.** In any type of home-study course, there is the obvious drawback of the student not having personal contact with his instructors in the classroom. This situation is particularly critical in the study of electronics, or at least far more critical than with comparable studies—say accounting or law.

All of the schools recognize this drawback, and each school has developed its own methods for bridging the "in-person" gap. In general, the methods boil down to (1) clear, straightforward lesson material, and (2) personal attention for each student.

The lesson material is written and illustrated in such a manner that the average student should be able to grasp the subject *without further help* from an instructor. Naturally, the schools aren't going to force you to "go it alone," but they do try to prepare their material so that you can digest it without the aid of an instructor.

Most texts are written in two steps: first, by an expert in the particular field the lesson covers, then by an editorial specialist to make sure that the lesson is clear and readily understandable. All of the material is heavily supplemented with drawings, diagrams, and photographs to clarify or stress particular points.

Each examination sent in by a student is personally evaluated, corrected, and graded by individual instructors who are experts in their particular fields. Incorrect answers are noted, and special com-

## DISADVANTAGES OF HOME STUDY

**The lack of training and supervision in manual skills.** A professional electronics technician must be able to assemble, wire, and solder electronic equipment in a workman-like manner. The only way you can learn this is by actually doing it. Unless you have worked in the field, you'll likely need training and supervision to acquire the skills. Even with a home-study course that supplies kits, there is no instructor to inspect your practical shop work in person. It's true that home kit experiments and test results will tell the instructor that you have wired a particular kit correctly, but they won't show if you have produced a good wiring job.

**The lack of personal contact with instructors.** There are some people who must be shown how a thing is done, or how it works, to fully grasp a new subject. Once they understand the subject, they have no trouble in remem-

bering, or in putting the knowledge to work. If you are one of those people, home study may prove difficult.

**The lack of practical experience in specialized fields.** Some specialized electronics fields require on-the-job type training before a technician is qualified to fill a position—such as operator of a radar set or a TV camera. Until a person has actually operated these devices, no amount of theoretical study will enable him to make full use of them.

**Lack of academic credit.** As of this writing, it is not possible to obtain a B.S.E.E. degree solely through home-study training. Also, it is quite difficult to obtain an A.S.E.E. degree without some resident work. If a degree is your immediate goal, you may as well plan on spending months, if not years, at resident training.



ments are made, showing the proper approach to the problem. The instructors rarely give you the correct answers; instead, they make you "dig" to find the solution on the basis of their comments.

There are times when even a *correct* answer will draw comment from an instructor. This is so when the instructor feels that you have stumbled onto the right answer without really understanding the subject. Since you are always encouraged to ask questions, and these questions bring a prompt, complete answer in writing, there is no excuse for having anything but a full grasp of the subject.

It is interesting to note that the way in which examinations are handled and graded by the instructor is also a good measure of the course's overall quality. If the examination is essentially a "copy" exercise, tests only what you have learned, and could be graded by a clerk (or a machine), its quality is likely not "top-drawer."

A good examination should help you understand the lesson, help you learn more, and require an expert to grade. In general, the more you have to analyze and write out, and the more hand-written comments you receive back, the better the course.

**What Will It Cost?** The question "How much does an electronics home-study course cost?" is in the same category

Periodic examinations are the rule for most home-study courses.

The majority of these exams are "open-book" and are designed to gauge your knowledge of electronic principles rather than specific facts.

When completed, the exams are mailed to your school's home office where your instructor carefully checks them and grades you on your progress.

as "How long is a piece of string?" As a very rough rule of thumb, however, each lesson will cost somewhere between \$2.50 and \$5.00. Thus, a 60-lesson TV servicing course might cost \$150.00, while a 100-lesson Advanced Trade School course could cost \$500.00.

The reason for this difference in cost is *quality*. If the lessons are better prepared and more comprehensive, the kits are of better quality, and you receive more personal attention from top-grade instructors, the cost per lesson is naturally going to be higher than for a course which gets by with the minimum.

But all this does not necessarily mean that the minimum-cost courses provide inferior instruction. To a large extent, what is "good" or "bad" here depends on *what you need* in the way of training. Only you can be the proper judge of that.

**How Will I Pay?** Although individual schools vary, there are primarily three basic payment plans available. First, if you are prepared to pay cash in advance for the entire course, most schools will allow a discount.

The next and most popular plan is to pay for the lessons more or less as you get them. After making an initial down-payment, you receive a group of lessons. When you are about half-way through this group, you make another payment, and receive a second group. In this way, you always have lessons on hand. The schools which offer this type of pay-as-you-go plan also supply their kits in essentially the same manner.

The third plan involves a contract whereby you make an initial down-payment and fixed monthly payments, no matter how many or few lessons you use.

The pay-for-each-lesson type of course is usually easier to discontinue or interrupt than the monthly contract arrangement. Otherwise, the plans are about the same and are a matter of choice.

## RESIDENCE SCHOOLS

**N**OW THAT we've looked at the inner workings of electronics *home-study* schools—what subjects are covered, how these subjects are taught, the approximate cost of the courses, and so on—let's cover the same ground for electronics "*residence*" schools. These are schools which you attend in person.

As you might expect, the number of hours a week in class, how this time is spent, the amount of homework, the subjects covered, and (most important) the total length of the training will vary with the particular school.

At most residence schools, you will spend between 20 and 30 hours a week in class as part of a full-time electronics training course. In general, the schools which provide less in-class training make up the difference with additional homework, but some amount of homework will be required with any training course. Usually, the schools expect you to devote a total of about 40 hours a week to your study. Thus, a 6-hour-a-day, 5-day-a-week course will also involve an extra 10 hours a week of home study.

You must put in about 9 hours a week

of classroom work for the average part-time or evening course, and you will spend at least 9 hours a week at homework. (Such courses usually operate on a 3-hour-a-night, 3-night-a-week basis.)

If you take a TV Servicing, Communications, or Advanced Trade School type of course, you will spend about 50% of your time in classroom lectures, the other 50% in the shop or laboratory. The Technical Institutes follow the lead of most Universities, and devote about 2 hours to lectures for each hour of laboratory work.

**Total Length of Course.** The average TV servicing course will run approximately 9 months of full-time day study, while a corresponding communications course will take 9 months to a year for completion. An advanced trade school course, which includes TV servicing and communications as well as specialized study in other fields of electronics, will usually require at least 1½ years of full-time training. The full technical institute courses run from 2 years to 27 months; usually, they are comprised of 8 or 9 quarters, with each quarter being 12 or 13 weeks in length.

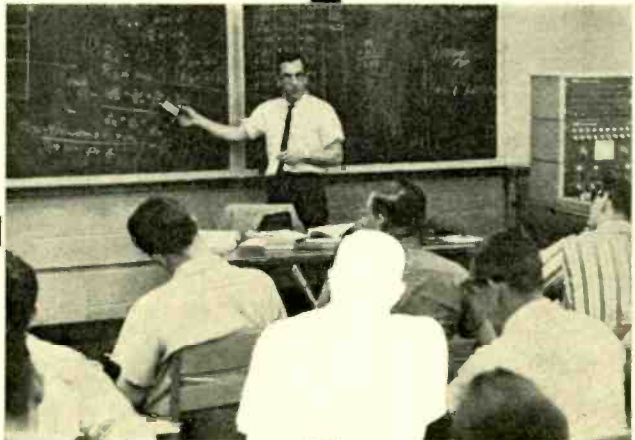
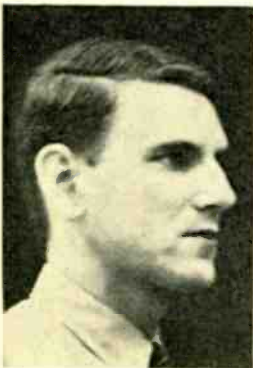

In general, those schools which provide equivalent courses for evening classes allow more time for you to complete the training. Thus, an evening course in TV servicing will take at least 1½ years to complete.

Our survey shows that the evening training is identical with that provided for full-time day classes, except in the case of technical institutes and universities. Most evening classes at technical institutes cover about 75% to 90% of the day class material. Then, if you want to go on toward a full B.S.E.E. degree, you must put in 3 to 6 months of residence work.

A comparison of evening and day-time residence courses can be summed up like this. If you want a TV servicing, communications, or advanced trade school course, you can have the training either during the day or in the evening, but evening study will naturally be spread over a much longer period of time. The chief advantage of evening work is that

it permits you to complete the course and perhaps obtain a degree without a long interruption in your regular employment.

If you want a technical institute course with a degree, you had best attend "full-time," or at least plan to squeeze in a few months of full-time resident training at the end of the line. And if you are after a B.S.E.E. degree, those few months of study are going to expand into at least a year.

**Examinations.** Unlike home-study schools, residence schools rarely require an examination at the end of each lesson. Instead, you take an examination after completing study of each *subject*.

In general, the TV servicing, communications, and advanced trade schools form a new class every month or 6 weeks. Such a class stays together for the duration of the entire course, and each month or 6 weeks the class moves on to study a new subject. For example, your first month of study might cover applied sci-

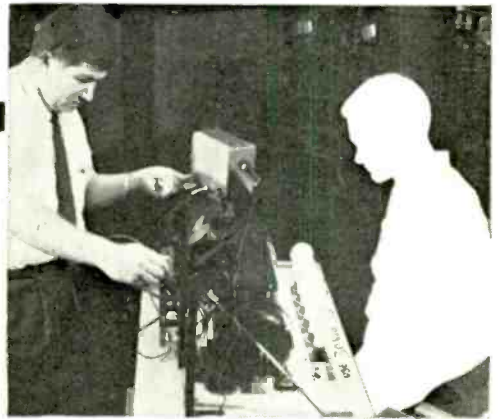
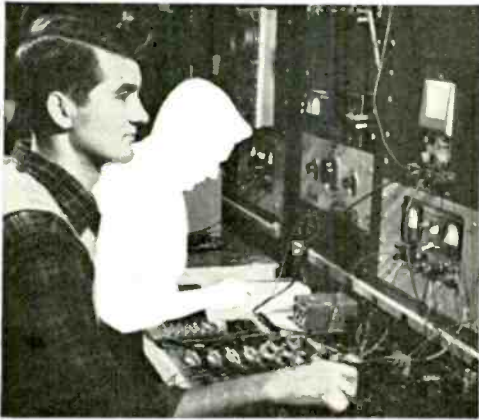

ence; the next month, electricity and magnetism; the third month, radio principles; and so on, through 9 to 18 months.

Each week, you are given a "brush up" or "preview" examination covering the past week's study. If you show any signs of weakness, the instructors bring them to your attention. Then there is a final class examination covering the entire subject. If you pass this final exam satisfactorily, you move on with your class to the next subject.

The technical institutes follow essentially the same plan, except that final examinations are usually given at the end of each quarter, as are university examinations. A few technical institutes also require that you pass a "master" examination before granting a degree.

Each school has its own particular method of presenting examinations. Today, a number of residence schools follow the practice of "open-book" examinations, as in home-study courses. Naturally, the questions are worded so that you can't simply "match up" answers.

In most cases, the questions are problems to be solved, with the answers to be written out in essay form. And you're actually encouraged to read through the reference material as well as your own lecture notes while you're solving the problems. The theory here is that this method tends to duplicate circumstances you will encounter in your future work.

Other schools still hold to the idea that you must understand and *remember* what you have learned. Their examinations are written and presented accordingly.

**Checking Your Progress.** Since resident training involves considerable shop and laboratory work, your progress in these areas is also carefully monitored. Although the schools usually do not present formal examinations on shop or laboratory work, you must show the instructors that you have learned the practical side of electronics and that you are acquiring the necessary manual skills.

For example, in any course you will learn basic shop practices (wiring, soldering, etc.). And you will probably be expected to construct simple (or even complex) electronic devices.

After you build a device, the instructor will check it out for proper operation and look over your workmanship. If your work is not up to standard (even

though the unit operates), the instructor will point out the defects. If you have done an exceptionally sloppy job, you may have to build the entire project over again.

Again, the instructor may want to check your ability to use an oscilloscope. After instruction, you will be assigned to measure various waveforms under the watchful eye of the instructor. If you fail to use the 'scope properly, the instructor will have you repeat the measurements until he is certain that you understand what you are doing.

**A Second Try.** Now we come to the favorite question, "What happens if I flunk?" If you fail to pass a monthly subject examination in a TV servicing, communications, or advanced trade school, you will usually be asked to repeat the entire month's study.

Sometimes, too, the schools will permit you to take a special examination on the month's work if they feel that you might pass with a second try. They realize that you may have been suffering from "examination jitters," or that there may have been extenuating circumstances, such as absence from class due to illness, personal problems, etc.

But if they feel that you simply don't understand the material, they will probably want you to repeat it in another class. A second failure generally brings a request that you discontinue the course (although some schools have allowed students to repeat a particular subject three or four times, in rare instances).

The technical institutes and universities usually employ the standard grading system for examinations: A, excellent; B, good; C, average; D, poor, but passing; F, failure. You can pass any given subject with a D, but you must maintain a C average to receive a degree.

**Shop and Laboratory Training.** Personalized shop and laboratory training is the strong point of in-residence electronics study, whether you go during the day or in the evening. And residence schools pride themselves on the quantity and quality of their laboratory equipment.

A school specializing in TV servicing will have at least one completely equipped TV service shop, while a communications school will duplicate a typical TV and radio broadcasting studio.

(Continued on page 150)



These men are getting practical training in **NEW Shop-Labs of**

# ELECTRICITY

# COYNE

## ELECTRONICS

### ON REAL

Motors—Generators  
—Switchboards—  
Controls—Modern  
Appliances—  
Automatic  
Electronic  
Control Units

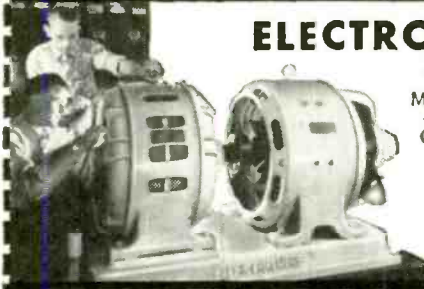

# TELEVISION

## RADIO ELECTRONICS

### ON REAL

TV Receivers—  
Black and White  
and Color  
AM-FM and  
Auto Radios  
Transistors  
Printed Circuits  
Test Equipment



in Chicago—prepare for today's **TOP OPPORTUNITY FIELD**. Train on real full-size equipment at **COYNE** where thousands of successful men have trained for over 60 years—largest, oldest, best equipped school of its kind. Professional and experienced instructors show you how, then do practical jobs yourself. No previous experience or advanced education needed. Employment Service to Graduates.

**START NOW—PAY LATER**—Liberal Finance and Payment Plans. Part-time employment help for students. **GET FREE BOOK**—"Guide to Careers" which describes all training offered in **ELECTRICITY** and **TELEVISION-RADIO ELECTRONICS**—no obligation; **NO SALESMAN WILL CALL**.

Coyne Electrical School, 1501 W. Congress Parkway  
Chartered Not For Profit • Chicago 7, Dept. 23-V

## MAIL COUPON OR WRITE TO ADDRESS BELOW

**COYNE ELECTRICAL SCHOOL**  
Dept. 23-V—New Coyne Building  
1501 W. Congress Pkwy., Chicago 7, Ill.  
Send **BIG FREE** book and details of all the training you offer.

Name \_\_\_\_\_  
Address \_\_\_\_\_  
City \_\_\_\_\_ State \_\_\_\_\_



**COYNE offers**  
**LOW COST**

# TELEVISION

## RADIO - COLOR TV

Training in  
Spare Time **AT HOME**



The future is **YOURS** in **TELEVISION!**  
A fabulous field—good pay—fascinating work—a prosperous future in a good job, or independence in your own business!

Coyne brings you **MODERN-QUALITY** Television Home Training; training designed to meet **Coyn**e standards at truly lowest cost—you pay for training only—**no costly "put together kits."** Not an old Radio Course with Television "tacked on." Here is **MODERN TELEVISION TRAINING** including **Radio, UHF and Color TV**. No Radio background or previous experience needed. Personal guidance by Coyne Staff. **Practical Job Guides** to show you how to do actual servicing jobs—**make money early** in course. Free Lifetime Employment Service to Graduates.

Send Coupon or write to address below  
for **Free Book**

and full details,  
including easy  
Payment Plan.  
**No obligation, no  
salesman will call.**



## COYNE Television

### Home Training Division

Dept. 23-H1, New Coyne Building  
1501 W. Congress Pkwy., Chicago 7, Ill.

Send **Free Book** and details on how I can get Coyne Quality Television Home Training at **low cost and easy terms.**

Name \_\_\_\_\_  
Address \_\_\_\_\_  
City \_\_\_\_\_ State \_\_\_\_\_

# COYNE

## ELECTRICAL SCHOOL

CHARTERED AS AN EDUCATIONAL INSTITUTION  
NOT FOR PROFIT

1501 W. Congress Parkway • Chicago 7, Dept. 23-H1



**B. W. COOKE, Jr., President**  
Coyne—the Institution behind this training—the largest, oldest, best equipped residential school of its kind. Founded 1899.

# *the hallicrafters touch*

makes the big difference  
in kit performance!



Ultimate performance of the kits you build depends on the excellence of their original design. Design excellence depends on experience and creativity. In over 30 years of amateur equipment engineering, the Hallicrafters laboratories have piled up more experience and more important engineering "firsts" than any other manufacturer by a country mile. It makes sense to team up your skill with the communications know-how of the leader.

## HT-40K TRANSMITTER KIT, \$89.95

- **FEATURES:** Excellent CW performance as well as AM. Full band switching, 80 through 6 meters. Easy tune-up and crisp, professional styling. Unit is fully metered, TVI filtered.
- **SPECIFICATIONS:** Maximum DC power input: 75 watts. Power output in excess of 35 watts CW, 30 watts peak AM phone. (Slightly less on 6 meters.) Frequency bands: 80, 40, 20, 15, 10 and 6 meters.
- **FRONT PANEL:** Function (AC off, tune, standby, AM, CW); Band Selector (80, 40, 20, 15, 10, 6); Drive Control; Plate Tuning, Plate Loading, Crystal-VFO; Grid Current; Meter; AC Indicator Light; RF Output.
- **REAR CHASSIS:** Microphone gain; antenna co-ax connector; remote control terminals; AC power cord.

S-119K

## General Coverage Receiver Kit, \$39.95



Three-band, superheterodyne receiver for AM plus short wave coverage from 2.0-16.5 Mc. Planetary drive tuning; transformer-operated. Built-in speaker, headset provision. 3 tubes.

the new ideas  
in communications  
are born at

**hallicrafters**



## SX-140K RECEIVER KIT, \$114.95

- **FEATURES:** Complete coverage of all amateur bands 80 through 6 meters, with extremely high sensitivity and sharp selectivity. Unit has RF stage; S-meter; antenna trimmer; and XTAL calibrator. Tuning ratio is 25 to 1.
- **CONTROLS:** Tuning; Antenna Trimmer; Cal. Reset; Function (AC off, standby, AM, CW-SSB); Band Selector; Cal. on/off; RF Gain; Auto. Noise Limiter on/off; Selectivity/BFO; Audio Gain; Phone Jack; S-meter Adj.

**P.S.** All three units are available fully wired and tested. SX-140, \$139.95, HT-40, \$109.95, S-119, \$49.95.

*Send for Complete Specifications*

Hallicrafters, Dept. 5-A

5th & Kostner Aves., Chicago 24, Illinois

Gentlemen: Please send immediately latest technical information on kits indicated:

HT-40K  SX-140K  S-119K

Name \_\_\_\_\_

Address \_\_\_\_\_

City \_\_\_\_\_ State \_\_\_\_\_

# Chapter

# 4

## Communications for the Hobbyist

**O**NE of the greatest pleasures for the electronics hobbyist comes from the satisfaction of having built a piece of equipment designed to fill some specific need. All of the projects in this chapter are intended for the "communications hobbyist"—the ham, the CB'er, the SWL. And all are unique in the sense that they provide one or more special "extras"—features that raise them far above the ordinary units of their type.

The "Loud-Speaking CPO," for example (page 100), employs a minimum of components, yet it's powerful enough to be heard dozens of feet away. Far more specialized in function, the "Gabble Killer" (page 109) is an uncommonly good device that does exactly what its title suggests—"kill" much of the meaningless "gabble" that pervades the Citizens Band.

Another unique project, "One for the Road" (page 96), is a tiny auxiliary receiver that tunes the little-known 122—144 mc. VHF band; it can either be used by itself (with headphones), or you can feed its output into the audio section of your car radio for full speaker volume. "The S-9'er" (page 116) employs an unusual circuit to improve the sensitivity and selectivity of any communications receiver tuning from 5 to 20 mc.

One for the Road.....	Howard F. Burgess, W5WGF	96
Loud-Speaking CPO.....	Michael S. Robbins	100
The Simple Sidebander.....	Hartland B. Smith, W8VVD	101
The Gabble Killer.....	Hartland B. Smith, W8VVD/19W1375	109
The S-9'er.....	James G. Lee, W6VAT	116
The "10-8" De Luxe.....	Hartland B. Smith, W8VVD	121

# ONE FOR THE ROAD

*Auxiliary receiver tunes 122—144 mc.,  
operates from any 12-volt car battery*

By **HOWARD F. BURGESS**, W5WGF



**S**OME EXCITING LISTENING is to be had in the VHF regions—signals from airplanes en route, emergency operations at airports, Civil Air Patrol missions, even local hamfests lurk in these frequencies, literally waiting to be pulled in. Unfortunately, though, most of the VHF “events” seem to take place just when you don’t have a VHF receiver handy!

Of course, the obvious way to be prepared for a “find” on the VHF airwaves is to carry a VHF receiver in your car at all times. There’s nothing very original about this idea, and it may even sound somewhat impractical. But it is just what we would like to suggest: “One For The Road” . . . and only the road; a VHF receiver so small that it can get lost in the glove compartment and so inexpensive that you can toss it into the car and forget it until you need it!

Although the unit shown here is the extreme in simplicity, it covers the 122-144 mc. range and is more than capable of satisfying the curiosity of the occasional VHF “eavesdropper.” In addition, it can do a creditable job as an auxiliary receiver in times of emergency.

Since it uses one of the tubes designed for “hybrid” car radios, the need for vibrators or high-voltage power supplies is eliminated—the only power required to operate this receiver is 12 volts d.c. Thus, not only are costs and circuit complications reduced, but installation is as quick

as 1-2-3. In fact, all you have to do to install this receiver is plug it into your cigarette lighter!

**About the Circuit.** As you may have already noted, the 12EC8 tube in the set consists of a triode and a pentode in the same envelope. Fortunately, the tube’s triode section will oscillate at frequencies up to 200 mc. or more with plate voltages as low as 6 volts! And the same characteristics that make it a good VHF oscillator also make it a good superregenerative detector.

A single tube in a superregenerative circuit can often equal a full-sized communications receiver in sensitivity. However, one of the unfortunate features of the “superregen” is its tendency to radiate interference on the channel being received. In this receiver, the power input to the detector is in the vicinity of 300 microwatts or less, so radiation should be of little concern.

With the triode section of the tube used as a detector, the pentode section is still available as a stage of audio amplification. However, in the circuit shown in Fig. 1, the pentode is triode-connected and serves as a cathode follower. This hookup gives very good results, since it isolates the detector and its load very nicely.

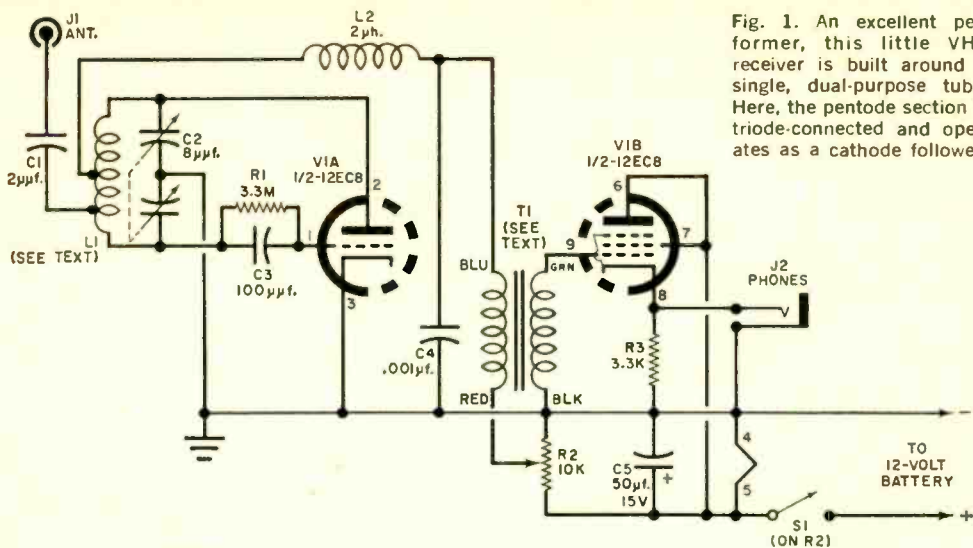

Fig. 1. An excellent performer, this little VHF receiver is built around a single, dual-purpose tube. Here, the pentode section is triode-connected and operates as a cathode follower.

### PARTS LIST

- C1—2- $\mu$ f. mica or ceramic capacitor
- C2—8- $\mu$ f. midget variable capacitor, "butterfly" type (E. F. Johnson 160-208 or equivalent)
- C3—100- $\mu$ f. mica capacitor
- C4—0.001- $\mu$ f. ceramic capacitor
- C5—50- $\mu$ f., 15-w.v.d.c. electrolytic capacitor
- J1—Banana jack
- J2—Miniature phone jack, non-shorting type (insulated type required for circuit in Fig. 2)
- L1—Antenna coil (5 turns of #16 wire,  $\frac{3}{8}$ " in diameter, spaced  $\frac{1}{2}$ " long, tapped at center and 1 turn from end)
- L2—2- $\mu$ h. r.f. choke or 24 turns of #30 enameled wire close-wound on and connected in parallel

- with a 2-megohm,  $\frac{1}{2}$ -watt resistor
- R1—3.3-megohm,  $\frac{1}{2}$ -watt resistor
- R2—10,000-ohm miniature potentiometer, linear taper, with s.p.s.t. switch S1
- R3—3300-ohm,  $\frac{1}{2}$ -watt resistor
- S1—S.p.s.t. switch (on R2)
- T1—Miniature interstage transformer, at least 1:3 turns ratio—see text
- V1a/V1b—12EC8 tube
- 1—4" x 2" x 2 $\frac{3}{4}$ " aluminum utility box (Bud CU-2115-A or equivalent)
- Misc.—Mica-filled 9-pin socket for V1, telescoping antenna, scrap aluminum for shelf, wire, solder, earphones, etc.

The alternate circuit of Fig. 2 shows how the pentode section can be used as a conventional audio amplifier. Naturally, this configuration has more gain than the previous circuit, but it does require that the output jack be insulated. However, the added voltage gain will be appreciated in many cases, especially if you intend to do most of your listening with headphones.

Construction. If full speaker volume is your goal, then your best bet is to build the circuit of Fig. 1 and feed its output into the audio section of your car radio. Alternatively, with the 4" x 2" x 2 $\frac{3}{4}$ " case suggested, there's still room enough for the serious experimenter to include a power transistor to drive a speaker.

Several versions of the receiver have been built, and they have all worked—even with substitute parts and some pretty "haywire" hookups! With the construction and circuit as simple as

they are, the photos and drawings should just about tell the complete story.

In the author's case, the small interstage transformer (T1) came from his spare-parts box, but any miniature plate-to-grid coupling transformer with a turns ratio of 1:3 or more will work (the Argonne Type AR-155 is a good choice). A standard size interstage transformer can

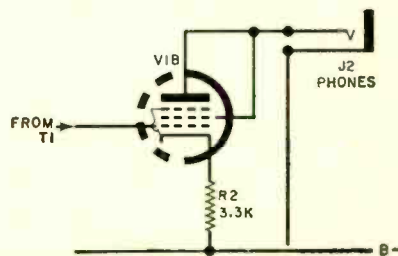
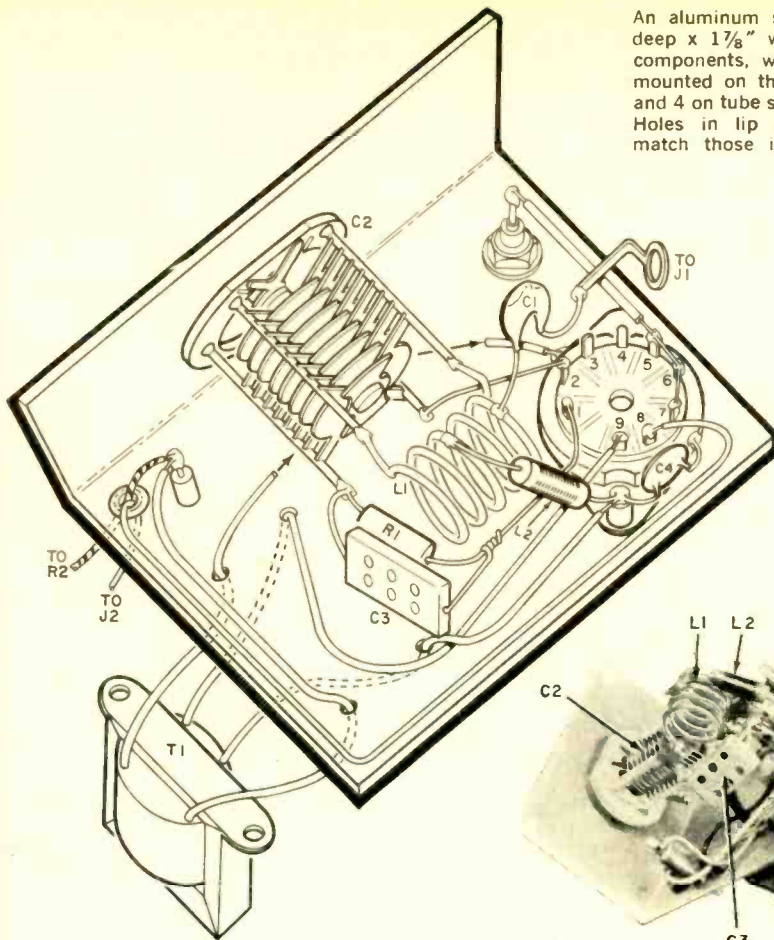
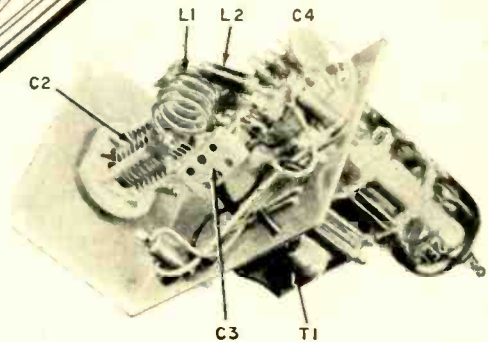

Fig. 2. Placing the phones in the plate lead increases overall gain.



An aluminum shelf (left), about  $2\frac{1}{4}$ " deep x  $1\frac{7}{8}$ " wide, holds most of the components, with tuning capacitor C2 mounted on the shelf's 1" lip; pins 3 and 4 on tube socket must be grounded. Holes in lip of shelf (below) must match those in front panel of case.



be used with quite a saving in cost if the receiver is spread out on a larger chassis.

All of the parts except regeneration control *R2* and capacitor *C5* should be mounted on a small aluminum shelf. As long as you keep the leads from capacitor *C2* to socket pins 1 and 2 as short as possible, placement of the other components isn't especially critical. For best results, however, coil *L1* should be kept at least  $\frac{1}{4}$ " away from such large parts as transformer *T1* or the chassis itself.

**Adjustment and Operation.** After the receiver is wired, it can be tested by "clipping" it across a 12-volt car battery for a trial run—just make sure that the ground lead on the receiver is connected to the negative lead on the battery. Plug a pair of phones into the phone jack and advance the regeneration control until you hear the familiar

smooth rushing sound of the superregenerative detector.

If the signals are strong enough, a 12" section of a telescoping antenna inside your car should be sufficient. The same antenna will do for weaker signals if you hold the receiver out of a window, but for best results you should mount a good VHF antenna on the outside of your car.

Very little "trimming" or adjusting will be required, although in some cases it may be necessary to vary the location of the point where antenna coupling capacitor *C1* is tapped onto the tuning coil in order to get the detector to oscillate. It's a good idea to make this connection at the grid end of the coil as a start. Then, if the detector refuses to oscillate even with the regeneration control at maximum, move the tap one turn closer to the center of the coil.

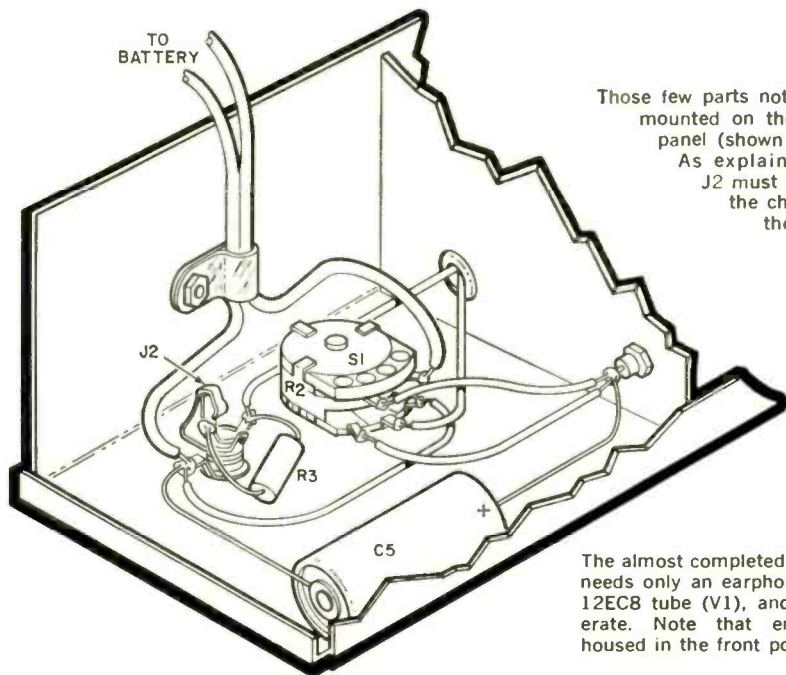

Those few parts not on the shelf are mounted on the receiver's front panel (shown here face down). As explained in text, jack J2 must be insulated from the chassis if you build the circuit in Fig. 2.

The almost completed unit shown below needs only an earphone, an antenna, a 12EC8 tube (V1), and a battery to operate. Note that entire receiver is housed in the front portion of the case.

The ideal method of checking the frequency range covered by the receiver is to feed in signals of known frequencies from a signal generator. Lacking a signal generator, the range can be checked with an absorption-type wavemeter or a grid dip meter, since the detector is of the oscillating type. And, even if you don't have either of these instruments, it's always possible just to tune in "known" stations and use the dial settings as marker points. Some "squeezing" or "pulling" of the coil may be required in order to get the set to tune the intended range.

If speaker operation is desired, it should be an easy trick to feed the output of the circuit in Fig. 1 into the audio portion of your car radio, as mentioned earlier. Just be certain that you have a coupling capacitor at the input to the amplifier in order to keep the small amount of d.c. at the output jack from being fed into the audio amplifier.

Since a superregenerative detector also produces frequencies just above the audible range, an amplifier capable of passing these frequencies—a hi-fi unit, for

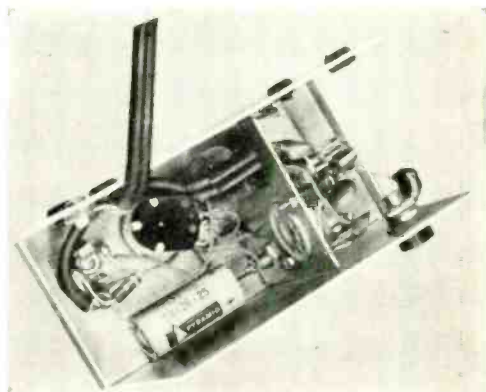

example—may be inclined to "howl" when connected to the receiver. This noise can usually be stopped by placing a 0.01- $\mu$ f. capacitor across the output of the circuit in Fig. 1.

**Ready to Go.** However you use this little receiver, you'll find that it boasts a sensitivity equal to that of units costing many times as much. On the other hand, the output of a single tube with less than a milliamperes of plate current can't give more than medium headset volume when used by itself, so don't expect the impossible. As we said before, this is an auxiliary receiver—just "One For The Road."

CIRCUITS for code-practice oscillators aren't exactly a "dime a dozen," but there are certainly more than enough to go around. The circuit shown here has a number of points in its favor, chief of which is the fact that it's LOUD. And remarkably enough, it supplies room-level volume using only seven components, plus a key and a speaker.

As you can see from the schematic diagram, the circuit is an oscillator/switch similar to that found in many incandescent lamp flashers. Since the 2N322 transistor (*Q2*) functions as a "switch," the audio tone is not a pure sine wave. Nevertheless, the unit *sounds* good, and a sacrifice in waveform is a very small

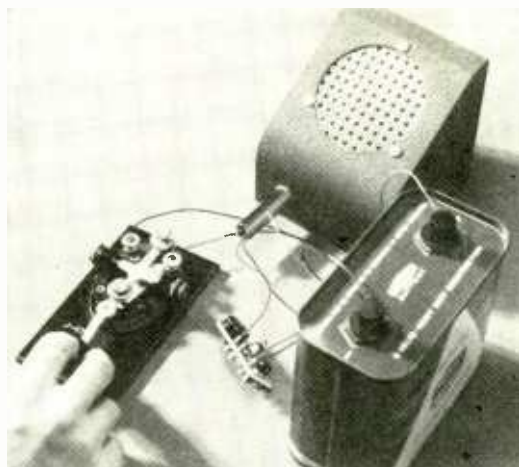

## Loud-Speaking CPO

By MICHAEL S. ROBBINS

*Simple code practice oscillator delivers "really big" sound*

price to pay for the increased volume.

The frequency can be controlled by varying the setting of potentiometer *R2*, and it can also be altered by changing the value of capacitor *C1*. Don't make *C1* too large, though, or transistor *Q2* will draw excessive current.

The author assembled his oscillator on a small piece of perforated "Vectorbord" (see photo below, right). This material is especially easy to work with, since it requires no drilling and permits connections to be made both above and below the "chassis."

Either a 6-volt lantern battery or four flashlight cells in series will power the unit. And while virtually any PM speaker will do, the author obtained best results with a 4", 45-ohm intercom speaker.

No fantastic claims are made for this little device—other than that it's small, inexpensive, and LOUD! —

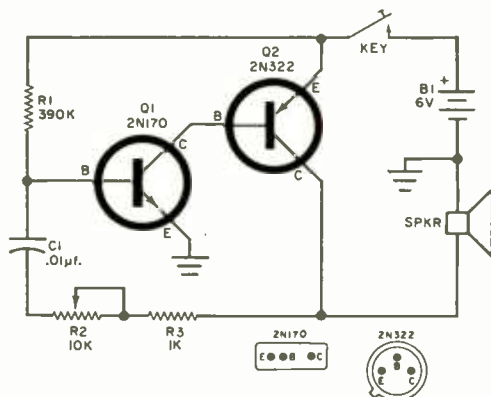

### PARTS LIST

- B1—6-volt battery—see text
- C1—0.01- $\mu$ f., 200-volt paper capacitor
- Q1—2N170 transistor (General Electric)
- Q2—2N322 transistor (General Electric)
- R1—390,000-ohm,  $\frac{1}{2}$ -watt resistor
- R2—10,000-ohm potentiometer, linear taper
- R3—1000-ohm,  $\frac{1}{2}$ -watt resistor
- S—45-ohm PM speaker—see text
- Misc.—Transistor sockets, wire, solder, knob, phenolic board, key, etc.

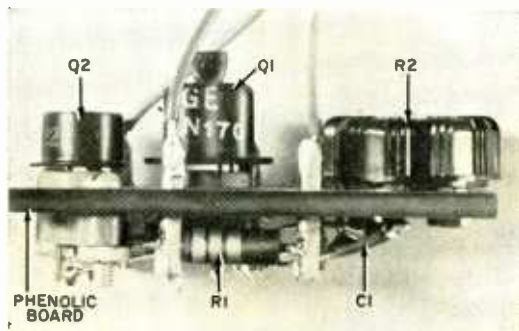





# THE SIMPLE SIDEBANDER

*Bargain phone package for the ham*

By HARTLAND B. SMITH, W8VVD

**H**ERE'S a rig that proves you don't have to build complicated circuits or spend a great deal of cash in order to experiment with sideband transmission. Surprising as it may seem, the "Simple Sidebender" needs only three tubes to produce a 40- or 75-meter signal with "talk power" better than that of the average 25-watt AM phone transmitter.

How can this unit be so simple and inexpensive when the usual sideband rig is loaded with tubes and carries a purse-

flattening price tag? The answer lies in the fact that it generates a *double-sideband suppressed-carrier* signal.

The "double-sideband" signal occupies twice the spectrum space of the more common "single-sideband" signal and, on a selective ham receiver, is about half an "S"-unit weaker. With these minor exceptions, DSB and SSB are equivalent. Over the air, they sound almost identical, and receiver adjustment is the same for either mode of transmission. As a

Completed transmitter (left), with companion power supply, is a neat-looking rig.

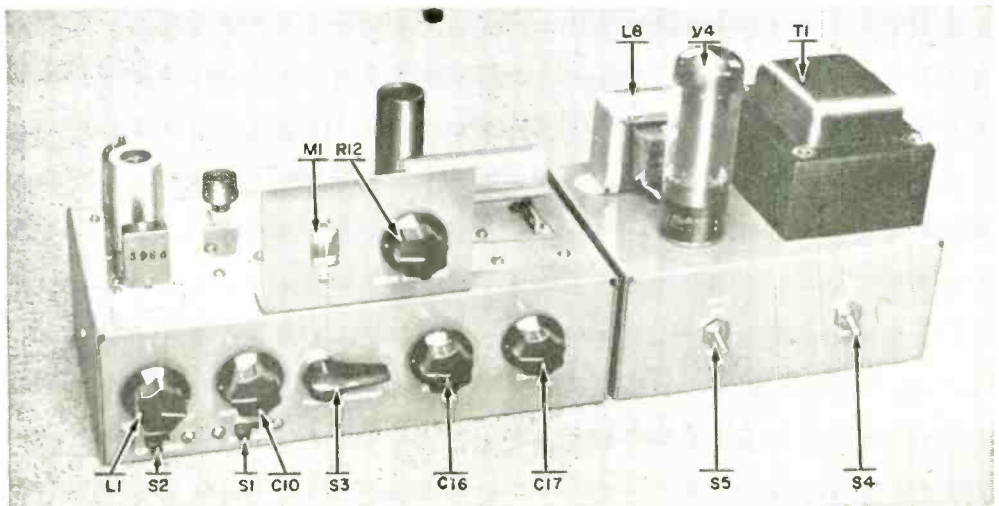

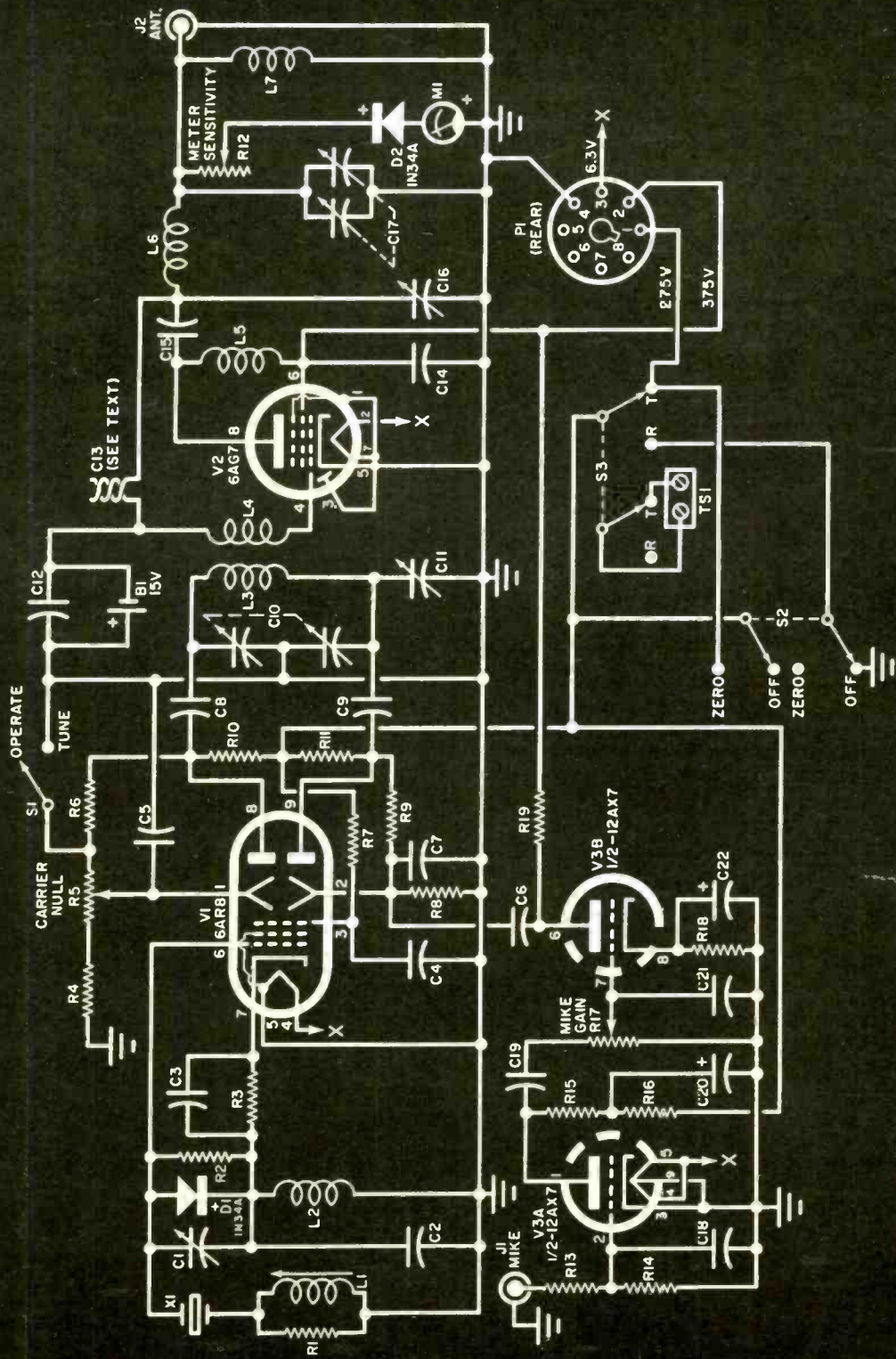

matter of fact, very few people contacted with the Simple Sidebander have noticed the extra sideband.

**Construction.** First prepare coils *L1*, *L3*, *L4*, and *L6*. These coils should be constructed for the specific band on which the transmitter is to operate (40 or 75 meters), and complete specifications will be found in the Parts List.

In building the transmitter proper, follow the parts layout illustrated in the photographs as closely as possible. Since the area around tubes *V1* and *V3* is rather crowded, wire as much of this portion of the transmitter as you can before installing either coil *L1* or capacitor *C10*.

Orient *V1*'s socket with pins 8 and 9 nearest *C10*. Put ground lugs under both mounting nuts and place a 1-lug terminal strip on the side wall of the chassis near the socket; it should be positioned about  $\frac{3}{8}$ " down from the chassis top. This tie point supports the junction of resistors *R7*, *R10*, and *R11* and the B-plus line. Be sure, incidentally, that you ground heater pin 5, rather than heater pin 4, on *V1*; pin 5 not only carries heater current, but is also internally connected to a shield and focus electrode.

Orient *V3*'s socket with pin 2 nearest jack *J1*, and put a ground lug under the mounting screw nearest potentiometer *R17*. A 4-lug (one grounded) terminal strip, mounted between terminal strip *TS1* and jack *J1* on the rear wall of the chassis, serves as a support for the capacitors and resistors associated with *V3*. Locate capacitor *C6* well away from *J1* in order to prevent feedback from the plate of *V3b* to the grid of *V3a*.

Fasten a 1-lug terminal strip under the crystal-socket mounting nut nearest

*C10* and put a ground lug under the other nut. Use this terminal strip to make the junction between choke *L2*, capacitors *C1*, *C2*, and *C3*, diode *D1*, and resistors *R2* and *R3*. Connect the other end of choke *L2* to the ground lug, keeping the choke close to the chassis where it won't interfere with the later installation of *L1*. Support *C1* on  $1\frac{1}{2}$ " leads so that it, too, will be positioned out of *L1*'s way.

Coil *L1* is mounted in a  $\frac{3}{8}$ " hole drilled in the front panel. Push the coil through this hole until the ears spring out to hold it in place. Turn the coil adjusting screw as far counterclockwise as you can. Next, cut a piece of scrap brass volume control shafting to a length of exactly  $\frac{3}{8}$ " and drill out its center with a  $\frac{1}{8}$ " bit. The shafting is then pushed over the coil adjusting screw and sweat-soldered in place. A conventional knob can now be installed over the shafting. For smooth operation, lubricate the threads of the coil adjusting screw with heavy oil or grease.

Remove and discard the mica trimmers on the sides of capacitors *C10* and *C17* before installation. It's necessary to mount *C10* about  $1\frac{1}{8}$ " back from the front panel, so this capacitor must be provided with an appropriate extension shaft.

A 2-terminal tie point located midway between *C10* and *C16* supports coil *L4*. Slip coil *L3* inside *L4*, being careful to prevent shorts between the turns of the two coils. After soldering  $1\frac{1}{4}$ " leads to battery *B1*, connect it between the *C12* end of *L4* and ground (positive lead grounded).

Mount *V2*'s socket with terminals 3 and 4 nearest the rear wall of the chassis. Install ground lugs close to terminals 1, 3, 5, and 7. Very short leads are used for the connections between the socket and the lugs. The power cable enters the chassis through a grommet-lined hole in the rear wall above the socket and terminates at a nearby 4-lug (one grounded) terminal strip.

A couple of 1-lug terminal strips support coil *L6* above the chassis. Leads to the coil pass through  $\frac{1}{4}$ " holes drilled near the terminal strips and lined with grommets. An "L"-shaped bracket, the front dimensions of which are  $2\frac{3}{4}$ " x 4", is fabricated from scrap aluminum to



"Simple Sidebander" employs 12AX7 speech amplifier, 6AR8 oscillator/modulator, and 6AG7 linear amplifier. Oscillator frequency can be shifted over a small range by adjusting slug of *L1*.

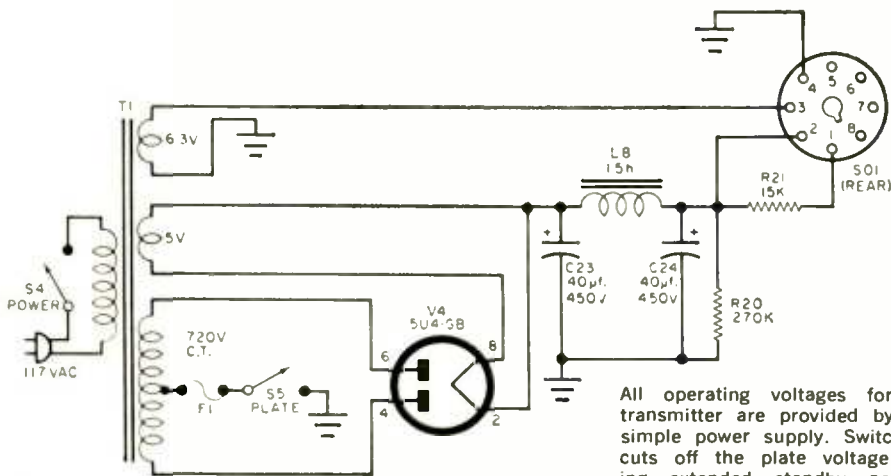

All operating voltages for the transmitter are provided by this simple power supply. Switch S5 cuts off the plate voltage during extended standby periods.

### PARTS LIST FOR TRANSMITTER AND POWER SUPPLY

- B1—15-volt battery (Burgess U10 or equivalent)  
 C1, C11—3-30  $\mu$ f, mica trimmer capacitor  
 C2, C21—150- $\mu$ f, mica capacitor  
 C3, C5, C15—0.01- $\mu$ f., 1000-volt ceramic disc capacitor  
 C4, C7, C12, C19—0.001- $\mu$ f., 1000-volt ceramic disc capacitor  
 C6—0.1- $\mu$ f., 600-volt paper capacitor  
 C8, C9, C14—0.0047- $\mu$ f., 1000-volt ceramic disc capacitor  
 C10, C17—2-gang variable capacitor, 467.8  $\mu$ f. per section (Allied Radio 61 L 059 or equiv.)  
 C13—Two  $3\frac{1}{2}$ " lengths of insulated hookup wire twisted tightly together—see text  
 C16—140- $\mu$ f. variable capacitor (Bud 1856 or equivalent)  
 C18—100- $\mu$ f., 1000-volt ceramic disc capacitor  
 C20—12- $\mu$ f., 450-w.v.d.c. electrolytic capacitor  
 C22—10- $\mu$ f., 25-w.v.d.c. electrolytic capacitor  
 C23, C24—40- $\mu$ f., 450-w.v.d.c. electrolytic capacitor
- D1, D2—1N34A diode  
 F1— $\frac{1}{4}$ -ampere, 3AG fuse  
 J1—Chassis-type mike receptacle (Amphenol 75-PCM or equivalent)  
 J2—Chassis-type coax receptacle (Amphenol 83-1R or equivalent)
- L1—For 75 meters: 68 turns of #32 enameled wire close-wound on Supercx C-3 coil form (Form available from Radio Shack Corp., 730 Commonwealth Ave., Boston 17, Mass.)  
 For 40 meters: 25 turns of #32 enameled wire close-wound on Supercx C-3 coil form
- L2, L5, L7—2.5-millihenry, 250-ma. r.f. choke (Millen 34103 or equivalent)
- L3—For 75 meters: 34 turns of #24 tinned wire,  $\frac{3}{4}$ " in diameter, spaced 32 turns per inch (cut from B&W 3012 "Miniductor" stock)  
 For 40 meters: Same as above, but 22 turns
- L4—For 75 meters: 50 turns of #24 tinned wire, 1" in diameter, spaced 32 turns per inch (cut from B&W 3016 "Miniductor" stock)  
 For 40 meters: Same as above, but 34 turns
- L6—For 75 meters: 48 turns of #20 tinned wire, 1" in diameter, spaced 16 turns per inch (cut from B&W #3015 "Miniductor" stock)  
 For 40 meters: Same as above, but 24 turns
- L8—1.5-henry, 200-ma., filter choke (Stancor C2327 or equivalent)

- M1—Miniature "AM-Tuning" type meter (Lafayette TM-12 or equivalent)  
 P1—Octal plug, cable type (Amphenol 86-PM8 or equivalent)
- R1, R13—150,000-ohm,  $\frac{1}{2}$ -watt resistor  
 R2—470,000-ohm,  $\frac{1}{2}$ -watt resistor  
 R3—330-ohm,  $\frac{1}{2}$ -watt resistor  
 R4, R8, R10, R11, R19—56,000-ohm, 1-watt resistor  
 R5—25,000-ohm potentiometer, linear taper  
 R6—100,000-ohm, 1-watt resistor  
 R7—33,000-ohm,  $\frac{1}{2}$ -watt resistor  
 R9—120,000-ohm, 1-watt resistor  
 R12—100,000-ohm potentiometer, linear taper  
 R14—2.2-megohm,  $\frac{1}{2}$ -watt resistor  
 R15, R16—75,000-ohm,  $\frac{1}{2}$ -watt resistor  
 R17—500,000-ohm potentiometer, audio taper  
 R18—1000-ohm,  $\frac{1}{2}$ -watt resistor  
 R20—270,000-ohm, 2-watt resistor  
 R21—15,000-ohm, 10-watt resistor
- S1—S.p.s.t. slide switch  
 S2—D.p.d.t. slide switch  
 S3—D.p.d.t. spring-return switch (Centralab 1464 or equivalent)
- S4, S5—S.p.s.t. toggle switch  
 S01—Octal socket (Amphenol 78SS or equivalent)
- T1—Power transformer; primary, 117 volts; secondaries, 720 volts CT @ 120 ma., 5 volts @ 3 amperes, 6.3 volts @ 3.5 amperes (Stancor PM-8410 with center tap of 6.3-volt winding unused, or equivalent)
- TS1—2-lug, screw-type terminal strip
- V1—6AR8 tube  
 V2—6AG7 tube  
 V3—12AX7 tube  
 V4—5U4-GB tube
- X1—Quartz transmitting crystal, ground for operating frequency
- 1—3" x 10" x 5" aluminum chassis for transmitter (Bud AC-404 or equivalent)  
 1—3" x 7" x 5" aluminum chassis for power supply (Bud AC-429 or equivalent)
- 2—Octal sockets for V2 and V4  
 1—9-pin miniature tube socket  
 1—9-pin miniature tube socket with  $2\frac{3}{4}$ " shield
- Misc.—Extension shaft for C10, crystal socket, ceramic or crystal mike, grommets, knobs, holder for F1, assorted terminal strips, etc.

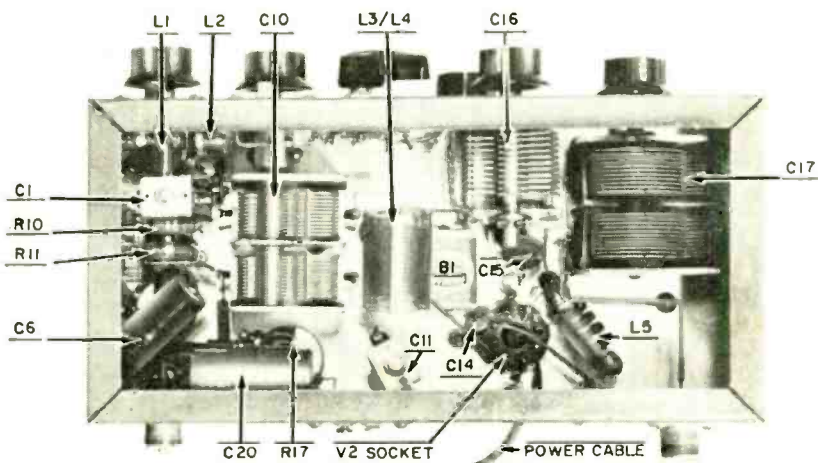
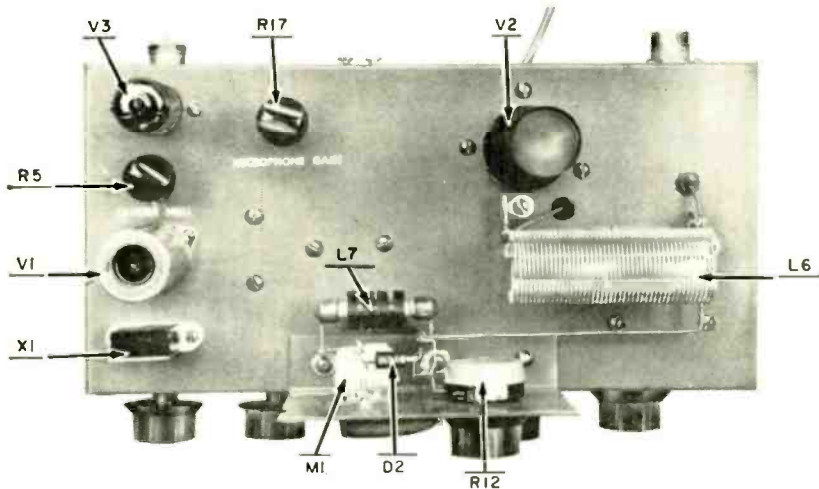

Views of top and bottom of transmitter chassis (above) show locations of most of the major components. Photograph below illustrates placement of parts on the back panel.

support meter *M1* and potentiometer *R12*. Choke *L7* is connected between a 1-lug terminal strip near *R12* and a ground lug fastened under one of the bracket mounting screws.

The construction of the Simple Side-bander's power supply is not critical and needs no special comment. Just follow the schematic diagram and use the photograph as a guide for the parts layout.

**Adjustments.** Meter *M1*, the r.f. output indicator, is the only instrument needed to make all tests and adjustments. When *R12*, the meter sensitivity control, is set at minimum resistance, even a slight

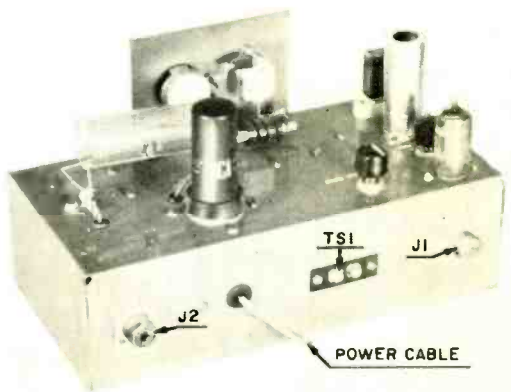



## Simple Sidebander

amount of unsuppressed carrier will deflect *M1*'s needle. By increasing the resistance of *R12*, the sensitivity can be set at a point where the full transmitter output can be safely handled. From time to time during the tune-up process, you'll find it necessary to adjust *R12* in order to keep *M1*'s needle near mid-scale, the position where changes in output are most easily noted.

To ready the transmitter for testing, set *R12* and *R17* for minimum resistance and gain, respectively, set *C1* and *C11* for maximum capacitance, and turn *L1*'s adjustment control fully counterclockwise. Then switch *S1* to "Tune" and *S2* to "Off," and connect the coaxial feedline from a dipole antenna to *J2*.

Now turn on *S4* and, after a 1-minute warm-up, turn on *S5* and depress the push-to-transmit switch (*S3*). Holding *S3* down, tune *C10*, *C16*, and *C17* for maximum indication on *M1*. As the tuning progresses, you will undoubtedly have to increase the resistance of *R12* to prevent the meter needle from going off scale.

With *C10*, *C16*, and *C17* tuned, throw *S1* to the "Operate" position and, continuing to hold down *S3*, set *R5* for minimum carrier output (minimum deflection of *M1*). Then reduce the capacity of *C1* and again adjust *R5* for minimum deflection. Continue the process until *R5* can be set at a position where there is little or no reading on meter *M1*.

To achieve this degree of carrier suppression, you will probably have to reduce the capacity of *C1* to a point where the crystal just goes into oscillation whenever *S3* is pushed. A reduction in the capacity of *C11* may also help to cut down the amount of residual carrier. If you should discover that minimum carrier occurs when the arm of potentiometer *R5* is at the *R4* end, reduce *R4* to 33,000 ohms. If the minimum occurs at the *R6* end, increase *R4* to 82,000 ohms.

To check for correct neutralization of *V2*, leave *S1* and *S2* at their previous settings, remove both the crystal and antenna, and set *R12* at maximum sensitivity. With *S3* depressed, no combination of the settings of *C10*, *C16*, and *C17* should produce a reading on *M1*.

If *M1*'s needle moves off zero during the test, change the capacity of *C13* by untwisting the wires a bit. Should this fail to help, replace the capacitor with one made from longer wires twisted together over a greater distance. Changing the position of *C13* relative to *C16* will also affect the neutralization.

During the above operations, play it safe! Disconnect the a.c. plug and discharge the filter capacitors before you make an underchassis adjustment.

**Operation.** You're ready to go on the air. Plug in the crystal, reconnect the antenna, connect a ceramic or crystal mike at *J1*, and wire any external receiver-muting or antenna-changeover relays to *TS1*.

As before, peak *C10*, *C16*, and *C17* for maximum output, and null the carrier with *R5*. Then, while whistling loudly into the mike, advance *R17* until maximum r.f. output is obtained. Next, set *R12* for a full-scale reading on *M1* and stop whistling. Finally, adjust *R17* to the point where *M1* "kicks" up to a maximum of half-scale as you speak in a normal tone.

Now call CQ or, if you hear someone near your frequency with whom you'd like to chat, set *S2* to "Zero" and zero-beat the desired station by adjusting *L1*.

While operated at the author's southern Michigan QTH, the Simple Sidebander provided many solid-copy 75-meter QSO's with stations in Wisconsin, Illinois, Indiana, Ohio, and Kentucky. Even though its output drops a bit on 40 meters, the unit does an excellent job locally and has produced a number of 1000-mile contacts. It can't be adapted for 20, 15, or 10 meters, however. -30-



## The **GABBLE KILLER**

By **HARTLAND B. SMITH**, W8VVD/19W1375

*Nerves jangled by QRM? This selective calling system will silence your CB base receiver until the mobile unit calls in*

**A**RE YOU one of the many CB'ers who are rapidly going mad listening to the squawks, squeaks, and channel chatter emanating from their base station receivers? Then here's the answer to your prayers. The pretty CB operator above is triggering the "Gabble Killer," an easily constructed tone-selective calling system described on the following pages. Though the base station receiver is turned on awaiting her call, not a peep will come out of it—till she presses the button.

This turns on both her transmitter and a tone generator connected to the rig's mike circuit. The resulting tone-modulated signal is intercepted by the base station receiver, which is operating with its speaker disconnected. A resonant-reed relay, activated by the signal, restores the speaker connection. So if you, too, are fed up with hearing about Uncle Herman's lumbago or Aunt Suzy's favorite recipe, and the ear-shattering noise on 11 meters, read on and build—the Gabble Killer!

*(Continued on next page)*

# THE TONE GENERATOR



Tone generator parts are "poured" into small utility box. There's little wasted space, but you should have no trouble if you follow the author's layout.

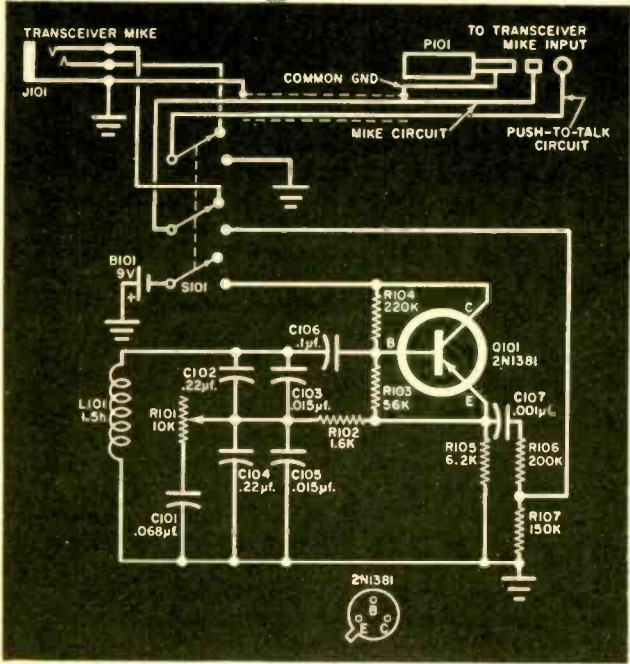
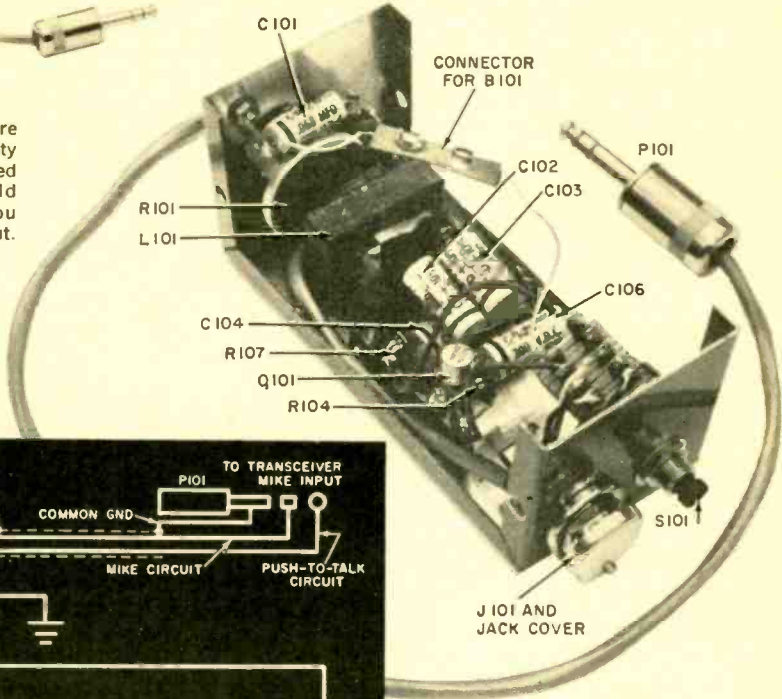

Schematic of tone generator circuit shows phone jack at J101, phone plug at P101. Connectors actually used should match those on your mobile transmitter.

**Building the Tone Generator.** All of the tone generator components are fitted into a 5" x 2 1/4" x 2 1/4" aluminum utility box as shown in the photo and pictorial diagram. Since paper capacitors are unstable when subjected to the temperature extremes encountered during mobile operation, don't attempt to substitute them

for the Mylar units specified in the Parts List. The heavy-duty potentiometer specified for R101<sup>20</sup> was also chosen for its sta-

*\*To avoid confusion, three-digit numbers have been assigned to each component in this system. The parts used in the tone generator have numbers beginning with "10," while the first two digits of the parts used in the audio-actuated relay circuit are "20."*



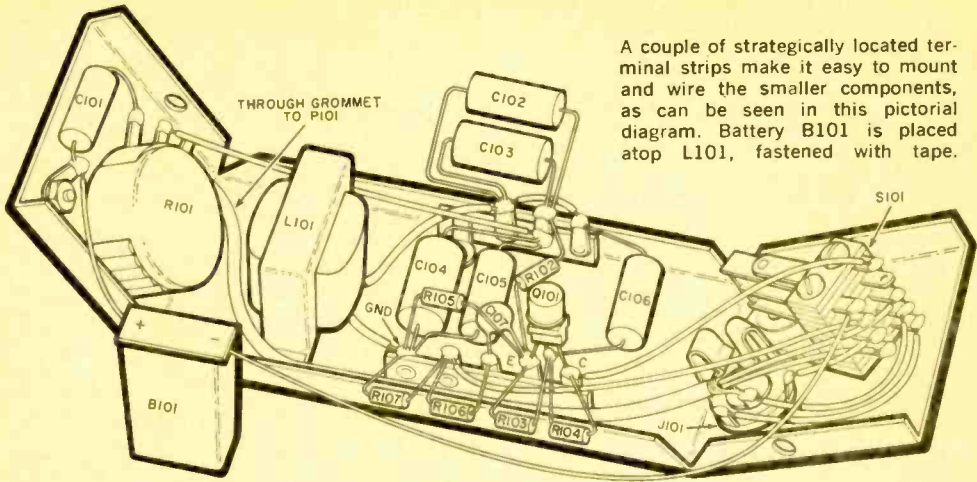

A couple of strategically located terminal strips make it easy to mount and wire the smaller components, as can be seen in this pictorial diagram. Battery B101 is placed atop L101, fastened with tape.

### PARTS FOR TONE GENERATOR CIRCUIT

- B101—9-volt battery (Burgess 2U6 or equivalent)
- C101—0.068  $\mu$ f.
- C102, C104—0.22  $\mu$ f.—see text
- C103, C105—0.015  $\mu$ f.—see text
- C106—0.1  $\mu$ f.
- C107—0.001- $\mu$ f. ceramic capacitor
- J101—3-conductor, open-circuit phone jack—see text
- L101—1.5-henry, 10-ma. choke; d.c. resistance, 95 ohms (Thordarson 26C40)
- P101—3-conductor phone plug—see text
- Q101—2N1381 transistor
- R101—10,000-ohm, 2-watt potentiometer—

all 200-volt Mylar capacitors

screwdriver-controlled, with shaft lock (Claro-stat Type 53C2 or equivalent)

- R102—1600 ohms
- R103—56,000 ohms
- R104—220,000 ohms
- R105—6200 ohms
- R106—200,000 ohms
- R107—150,000 ohms

all 1/2-watt resistors

- S101—3-pole, double-throw, push-button switch (Switchcraft 1009 or equivalent—see text)
- 1—5"x2 1/4"x2 1/4" aluminum utility box (Bud CU-2104-A or equivalent)
- Misc.—Transistor socket, shielded cable, rubber grommet, terminal strips, battery plug, etc.

bility during wide temperature changes. It's important, too, that you make no substitution for the recommended choke (L101); if you do, the tone produced by your unit may not be of the proper frequency.

A 3-conductor, open-circuit phone jack is shown for J101, which accepts the transceiver mike plug. Similarly, a 3-conductor phone plug is shown for P101, which plugs into the transceiver's mike input jack. The units actually used for J101 and P101, however, depend on the type of mike jack employed on your transceiver. If, on the other hand, your mike is permanently wired to the transceiver, you'll want to install a plug system so that you can remove the tone generator when required.

Regardless of what type of plug and jack you use, be sure that the "Common Gnd.," "Mike Circuit," and "Push-to-Talk" leads (see schematic diagram of

tone generator) are wired to match the appropriate connections in your mike and transceiver. The wiring shown is typical for most transceivers using 3-conductor jacks. If your rig has no provision for "push-to-talk" operation, the wiring associated with the top set of contacts on S101 will not apply, and you can use a d.p.d.t. switch instead.

Most of the tone generator components can be mounted as illustrated and permanently soldered in place. Capacitors C104 and C105, however, should be only temporarily installed until final adjustment is complete.

Battery B101 is placed atop L101, where it is held in place with plastic tape. It's wise to use a battery plug rather than soldering directly to the terminals. The battery can then be disconnected during preliminary adjustments, preventing accidental short circuits.

(Continued on next page)



# THE RELAY CIRCUIT

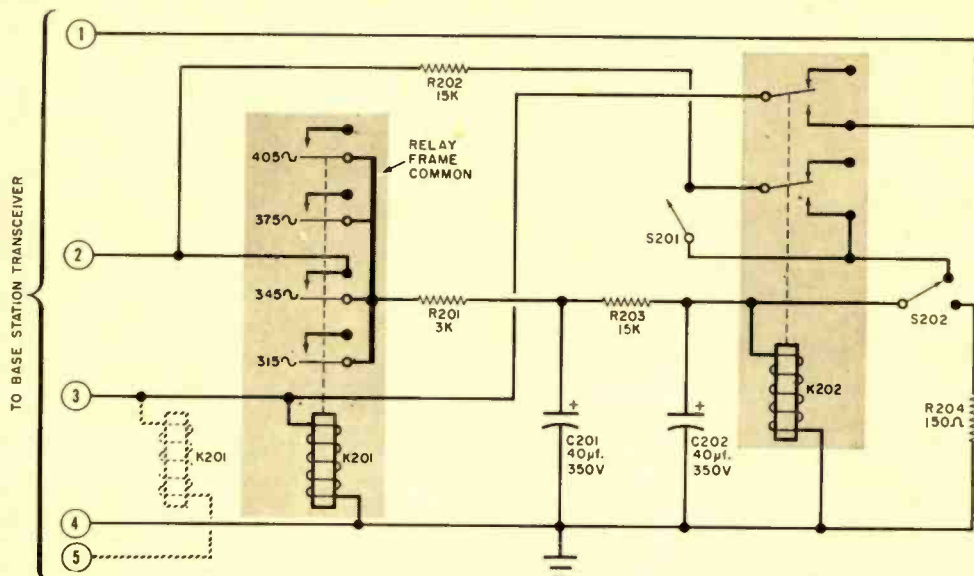

Schematic of relay circuit. One reed of K201 is in use, others are in reserve to change signaling tone if necessary. Dotted section shows alternate wiring for K201 coil (see text).

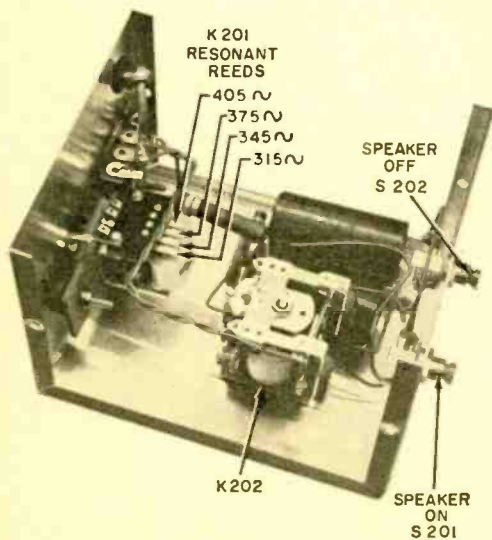

Parts placement for the relay unit is not critical, and there's plenty of mounting room. But be sure to insulate the frame of K201 from the box.

**Building the Relay Circuit.** The components for the base-station relay circuit are mounted in a 6" x 5" x 4" aluminum utility box. Since the frame of relay K201 is at a high potential when the contacts are closed, the relay cannot be fastened directly to the box. Instead, mount it on a 1" x 3/4" piece of Masonite. A solder lug should be installed under one of the mounting screws; this lug will serve as the terminal for one relay contact.

Fasten the Masonite to one of the end walls of the box with machine screws and nuts. A couple of rubber grommets slipped over the screws, between the Masonite and the chassis, will act as spacers and sound deadeners. The rest of the mechanical work needs no comment, and the photos and pictorial diagram of the relay circuit will serve as a guide.

When you're making the connections to the contacts of K201, connect R201 to the solder lug previously installed. The

Leads between base receiver and relay circuit are marked with circled numbers here; the numbers are keyed to schematic at left and those on next page. Author needed only four leads to make hookup.

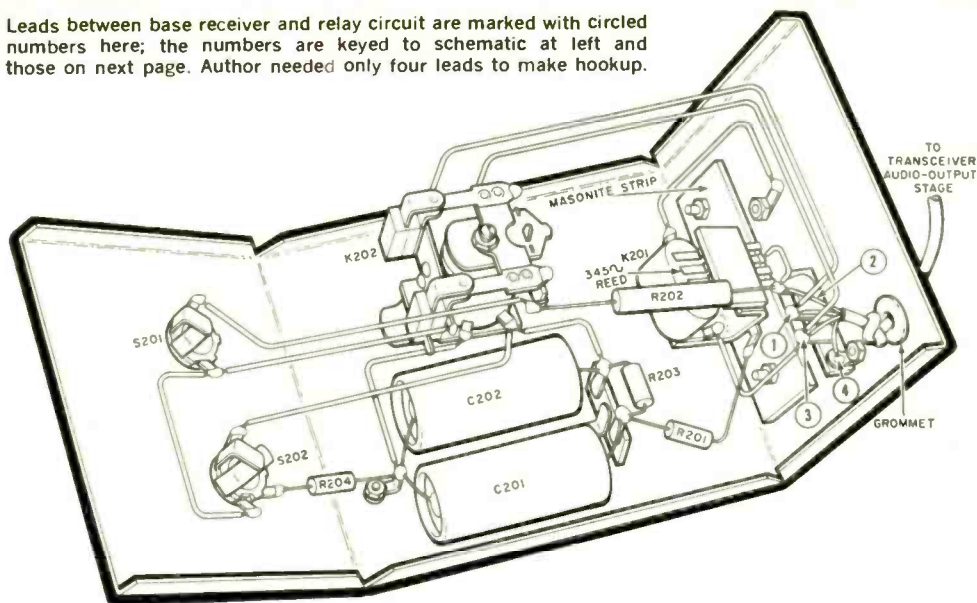

### PARTS FOR RELAY CIRCUIT

C201, C202—40- $\mu$ f., 350-w.v.d.c. electrolytic capacitor

K201§—Resonant reed relay (Bramco No. 511A-00035)

K202—10,000-ohm, 4.5-ma. plate relay; d.p.d.t. contacts (Potter & Brumfield Type LM11 or equivalent)

§A special relay designed for this project available from Bramco, College & South Sts., Piqua, Ohio, for \$9.75 postpaid.

R201—3000-ohm, 1-watt resistor

R202—15,000-ohm, 2-watt resistor

R203—15,000-ohm, 1-watt resistor

R204—150-ohm,  $\frac{1}{2}$ -watt resistor

S201—S.p.s.t., normally-open, push-button switch

S202—S.p.d.t. push-button switch

1—6" x 5" x 4" aluminum utility box (Bud CU-2107-A or equivalent)

Misc.—Color-coded cable, rubber grommets, terminal strips, Masonite to mount K201, etc.

connections from lead 2 of the cable interconnecting the transceiver and relay circuit and from R202 are made to the terminal corresponding to the 345-cycle (next-to-longest) reed.\* Don't hook up K201's coil, however, or install the interconnecting cable, until you've read the following paragraphs.

**Installation.** Insert the tone generator's plug (P101) into the mike jack on your mobile transceiver, and plug the mike into J101. That's all there is to the mobile installation.

Now remove the base station transceiver from its cabinet and examine the audio output stage. One lead from the output transformer's secondary should be connected directly to the speaker. Break this lead as shown in the sample output

stage schematics (which appear on the next page). The other output transformer lead will either be grounded (see sample schematic "A") or connected to the "Send-Receive" switch (see sample schematic "B").

If the lead is grounded, run a 4-conductor cable between the relay circuit and the receiver. The cable is wired as shown in the pictorial and schematic of the relay circuit and in output stage schematic "A." Corresponding points on the pictorial and schematics are labeled with identical, circled numbers. Ignore the dotted section of the schematic diagram of the relay circuit. Now wire in the coil of K201, still ignoring the dotted section of the diagram.

If the lead is not grounded, but connects to the "Send-Receive" switch, you'll have to use a 5-conductor cable. Wire in the coil of K201 according to the dotted section of the relay circuit schematic; connect the cable according to

\*Relay K201 also contains three other reeds, tuned to three other frequencies. You can switch to one of these (see section on "Changing the Signaling Tone" on page 115) in the event of interference from another station using this calling system.

## HOW THE SYSTEM WORKS

The tone generator connects to the mobile transceiver's mike input jack via plug *P101*, and the mike plugs into jack *J101*. When switch *S101* is in the normal position (shown), the transceiver operates as usual. With *S101* depressed, however, power from battery *B101* is applied to the tone generating circuit, the output of the circuit is fed (via coupling capacitor *C107* and voltage-dividing resistors *R106* and *R107*) to the input of the transceiver, and the transceiver's "push-to-talk" circuit is activated. The net result is that a 345-cycle tone is broadcast by the transceiver.

A modified Colpitts oscillator, the tone-generating circuit is designed around transistor *Q101*. Base bias for *Q101* is taken from the junction of voltage-dividing resistors *R104* and *R103*, and the oscillator's output is developed across emitter-load resistor *R105*. The feedback necessary to maintain oscillation is provided by a network consisting of resistor *R102*, the tuned circuit formed by *C102-C105* and choke *L101*, and coupling capacitor *C106*. Capacitors *C102* and *C103*, as well as *C104* and *C105*, are in parallel because it is difficult to obtain stock capacitors having exactly the required values. Potentiometer *R101*, with its series capacitor (*C101*), is used to make small adjustments in the frequency of the generated tone.

An audio-actuated relay circuit is connected to the base station transceiver via the leads marked with circled numbers (see schematic of relay circuit and sample schematics of transceiver audio output stages). When a call from the mobile unit is expected, the transceiver is turned on and set to receive on the proper frequency. Though the receiver is operating, no sound is heard because one of the leads between the speaker and the output transformer is disconnected.

The mobile operator activates the base station receiver by holding the tone generator button (*S101*) closed for about four seconds. The resulting 345-cycle tone is picked up by the receiver and fed, via leads 3 and 4 (or 3 and 5—see "Installation" section), to the coil of resonant-reed relay *K201*. A vigorous vibration is then set up in a small metal reed, tuned to 345 cycles and located in the relay. This closes a circuit which allows *B+* voltage to flow, via lead 2, from the transceiver to a delay network (resistors *R201* and *R203* and capacitors *C201* and *C202*). After an interval of about three seconds (necessary to prevent activation of the receiver by a random tone), capacitors *C201* and *C202* charge enough to close relay *K202*. One set of contacts on *K202* restores the broken speaker/output transformer connection via leads 1 and 3; the other set holds *K202* closed by bypassing the contacts of *K201*, allowing *B+* voltage to flow (through dropping resistor *R202*) directly to *K202*'s coil.

When communication with the mobile unit is ended, the base station operator presses push-button switch *S202*. This action breaks the holding-current path to relay *K202*, the relay contacts open, the receiver is silenced, and capacitors *C201* and *C202* are discharged (through resistor *R204* and the coil of *K202*) to await the next signal. For manual activation of the receiver in the absence of a tone signal, push-button switch *S201* is wired in parallel with *K202*'s "holding" contacts. It's necessary only to press the button momentarily to lock *K202* in a closed position.

this schematic and to output stage schematic "B."

Whether you use a 4- or a 5-wire cable, run it through a ventilation louver or other convenient opening in the transceiver cabinet before making the connections.

**Adjustment.** Switch on the base station transceiver, setting the volume control to its normal level and disabling the squelch. After a 1-minute warmup, push

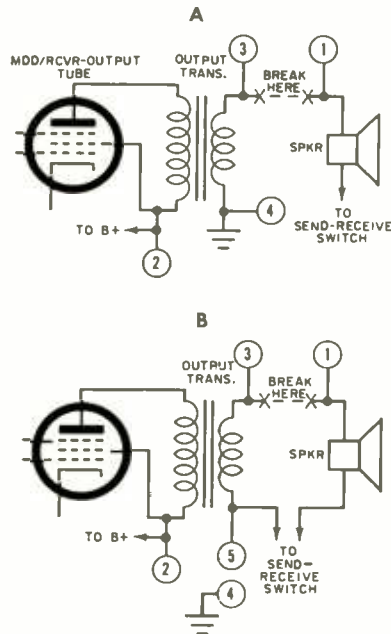

Sample schematics of wiring you may encounter in audio output stage of base transceiver. Type "A" requires only four wires to the relay circuit; "B" needs five.

switch *S201*. Relay *K202* should now snap closed, and the usual background hiss should come from the speaker. If the relay fails to operate, try reducing the spring tension on its armature. Should the transceiver power supply furnish less than 200 volts to lead 2 of the interconnecting cable, you may also have to reduce the value of *R202* to about 10,000 ohms.

With the relay closed, push switch *S202*; this should open it, silencing the speaker, in about half a second (the time required to discharge *C201* and *C202*). Now switch on the speaker by pushing *S201*, and you're ready to proceed with the next step.

Temporarily set up the mobile rig next to the base station transceiver, switching it to the base station's channel. Next, depress *S101* on the tone generator (if your mobile unit has no push-to-talk circuit, you'll also have to flip its "Transmit-Receive" switch to "Transmit"). You should now hear a tone in the base station speaker.

Vary the frequency of the tone, using potentiometer *R101*. At the same time, keep your eye on *K201*'s 345-cycle reed. It should be possible to find a setting of *R101* which will throw the reed into lively vibration. If not, the tone generator's frequency range isn't quite right; adding an 0.068- $\mu$ f. capacitor (Mylar!) in parallel with *C104* and *C105* will probably clear up the trouble. Once you obtain the proper vibration, permanently solder *C104*, *C105*, and the extra capacitor (if used) in place.

At this point, push *S202* to release *K202*. Now push *S101* again; the 345-cycle reed should vibrate and, after a 2- or 3-second delay, *K202* should snap closed. You'll again be able to hear the audio tone in the base station speaker. When you let go of *S101*, the tone should stop and the receiver should continue to function normally until *S202* is actuated.

If *K202* closes less than 2 seconds after *K201* starts to buzz, increase the value of *R201*; if the delay is greater than 3 seconds, reduce the value. Some delay is necessary in order to keep heterodynes and other spurious noises from accidentally switching on the receiver speaker.

As a final check, have an assistant drive the mobile unit 4 or 5 miles away from your base. Try out the system again, making sure that it still functions dependably. It might be necessary to touch up the setting of *R101*.

The tone generator can now be fastened permanently on or near the mobile transceiver. But if the generator, over a period of time, drifts so far off frequency that *K101* fails to operate, try another 2N1381 transistor at *Q101*. Now and then, one encounters a transistor which is extremely sensitive to temperature variations.

The selective calling system, as described, works only from mobile to base station. The average CB'er enjoys listening to activity on the band as he drives along the highway, so there is no need

## FREQUENCY CONVERSION CHART

Reed Frequency	Capacitor Values Required	
	C102, C104	C103, C105
315 cps*	.22 $\mu$ f.	.047 $\mu$ f.
345 cps	.22 $\mu$ f.	.015 $\mu$ f.
375 cps	.1 $\mu$ f.	.1 $\mu$ f.
405 cps**	.15 $\mu$ f.	.022 $\mu$ f.

\*Longest reed

\*\*Shortest reed

to immunize his receiver against signals not meant for him. Any reader who wants selective calling in both directions, however, can readily combine a tone generator and relay circuit in a single package. He can then install one of these dual units at each end of the line.

**Changing the Signaling Tone.** As CB interference increases and more selective calling systems are installed, you may discover that a nearby station is using a signaling tone identical in frequency with yours. If this happens, you can readily shift to one of the three other reeds on *K201*.

It will be necessary also, of course, to change the frequency of the tone generator. This can be done by changing the values of *C102-C105*; a table of values for these capacitors, corresponding to each of the four reeds, will be found at the top of this page. As before, you may have to make slight variations in capacitance to produce exactly the right frequency.

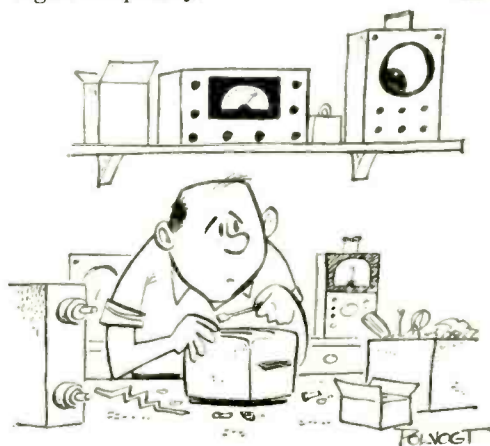



## THE S-9'er

By JAMES G. LEE, W6VAT

*From 15 to 60 meters, this short-wave preselector will vastly improve sensitivity and selectivity*

“WOW! What black magic did you use to get those rare QSL's?” one SWL asked his buddy in amazement. “I've never really been sure I've heard those guys through all the QRM.”

“No black magic,” replied the second, “just that little black box sitting on top of my receiver.”

The “black box” referred to by the second SWL was the *S-9'er*, an unusual type of preselector. If your receiver has no r.f. stage, this unit can increase its sensitivity and image rejection to the point where you, too, will have a better chance of hearing and receiving QSL's from those rare DX stations. Covering 5 to 20 megacycles, the *S-9'er* is also useful to hams who do much of their operating in the 40- or 20-meter bands.

**About the Circuit.** The *S-9'er* is designed to be inserted in series with the line between the antenna and the receiver. With *S1 Out* (see schematic on p. 120), the preselector is bypassed and the antenna connected directly to the receiver.

When *S1* is in the *In* position, however, the antenna is switched to the preselector's input and the output of the preselector is connected to the receiver's antenna terminal.

In the latter case, the r.f. signals entering input jack *J1* from the antenna pass through coil *L1*, which is a movable link coupled to coil *L2*; this adjustable coupling allows the use of a variety of antennas. Coil *L2* is tuned by a dual variable capacitor (*C1*) in such a way that, for any setting of *C1*, the L/C combination resonates at two frequencies at once. In this way, the ranges of 5-12 and 11-20 megacycles are tuned simultaneously—eliminating the need for a bandswitch or for separate plug-in coils.

From the tuned circuit, the selected signals pass to the grid of triode *V1a*, which is connected as a neutralized r.f. amplifier. Capacitors *C2* and *C3* adjust the degree of neutralization; when the neutralization is reduced below a certain

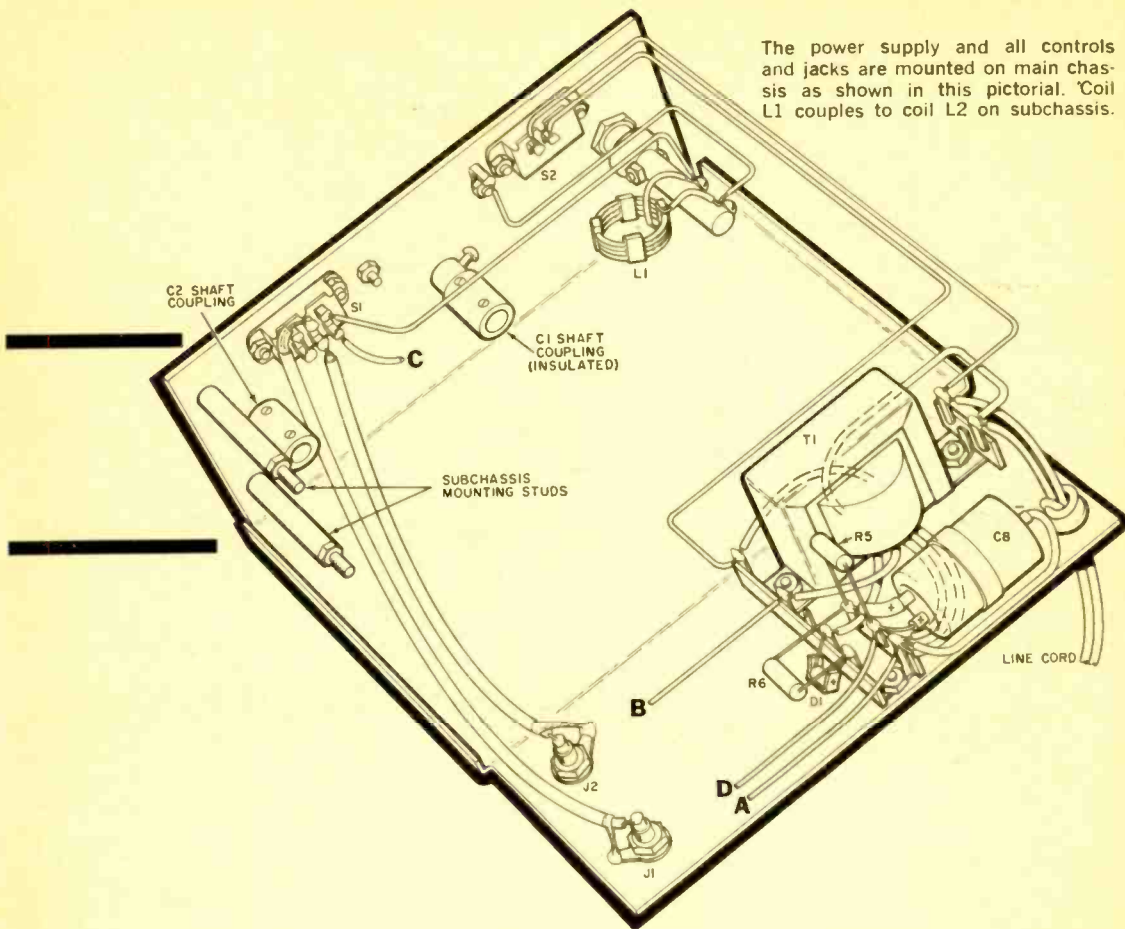

The power supply and all controls and jacks are mounted on main chassis as shown in this pictorial. Coil L1 couples to coil L2 on subchassis.

point, *V1a* oscillates (regenerates) due to increased interelectrode coupling. The regeneration, carefully controlled, is used to increase the sensitivity and gain of the amplification stage, and the selectivity of the tuned circuit.

The amplified signal passes, through triode *V1b*, to output jack *J2* and is fed to the receiver. Triode *V1b* is connected as a cathode follower and contributes no further amplification. It serves, rather, to isolate the neutralized r.f. amplifier from the load of the receiver and connecting cable.

Power for the preselector comes from a built-in supply utilizing a silicon diode in a half-wave circuit.

**Construction.** A 7" x 5" x 3" chassis box houses the preselector. The controls,

power supply, and input and output jacks are mounted on the chassis itself, while the r.f. section is built on a separate subchassis. Construction details are shown in the photographs and pictorial diagrams and should be followed fairly closely.

Begin by mounting the main tuning dial at the center of the front panel, then install slide switches *S1* and *S2*. When the above front-panel components are in place, the power transformer, filter capacitor, tie points, line-cord grommet, and input and output jacks are mounted on the rear wall.

At this point, the line cord should be installed and the power-supply circuit wired. When the wiring is complete, temporarily install a 10,000-ohm, 1-watt

Pictorial diagram of r.f. section subchassis. Leads lettered "A" through "D" connect to similarly lettered leads on pictorial of main chassis.

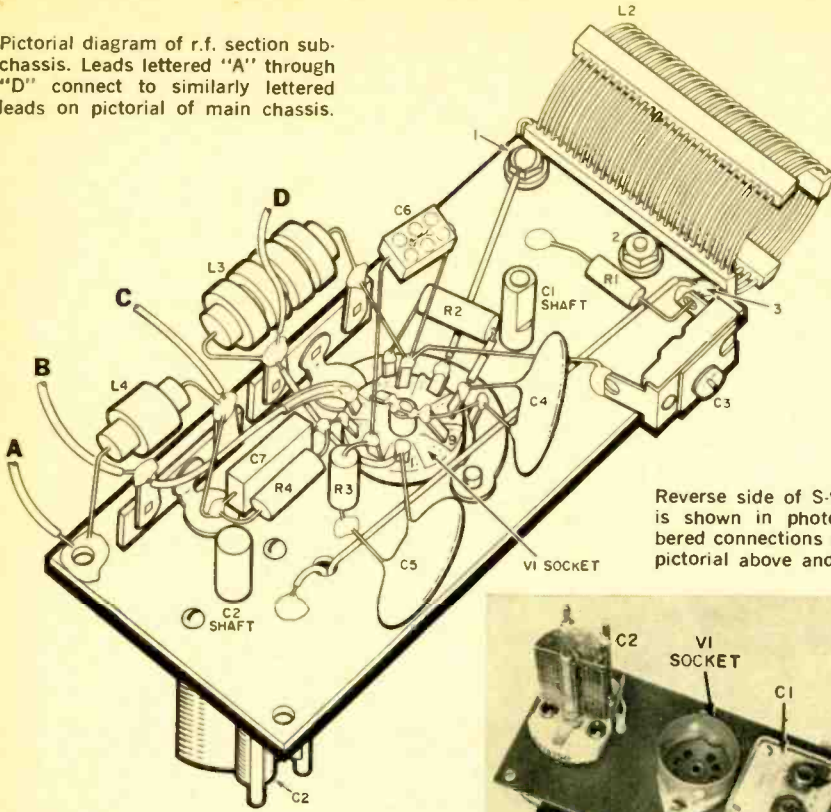

Reverse side of S-9'er subchassis is shown in photo below. Numbered connections match those on pictorial above and on schematic.

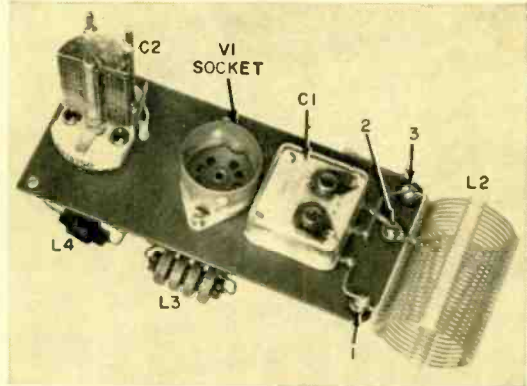

load resistor from the junction of  $C8a$  and  $R5$  to ground. Plug in the line cord, switch on  $S2$ , and measure the voltage across the load resistor. It should be at least 100 volts.

When the power supply has been checked out, wire the input and output jacks to switch  $S1$  using RG-58/U coaxial cable. The main chassis is now set aside for the time being and construction begun on the r.f. section.

The r.f. section is built on a  $2'' \times 4\frac{1}{2}''$  Bakelite board which is copper-clad on one side. This type of board is intended for printed-circuit work, and is used here merely to simplify construction. The material is easy to drill and grounds can be soldered directly to the copper—allowing the use of short leads.

All three major components—capacitors  $C1$  and  $C2$  and the socket for  $V1$ —mount along the center line of the board. The tube socket is mounted in the exact center of the board; capacitor  $C1$  is mounted  $1\frac{1}{8}''$  in from one end and positioned so that its lugs point away from the tube socket; capacitor  $C2$  is placed  $\frac{5}{8}''$  in from the other end of the board. The shafts of the capacitors and the bottom of the tube socket should pass through to the copper-clad side of the board. Capacitor  $C1$ 's shaft must be isolated from ground, so be sure to make the hole through which it will pass large enough to avoid shorts to the copper.

The connections (labeled 1, 2, and 3 on the schematic) to coil  $L2$  are made via three terminals (labeled with cor-



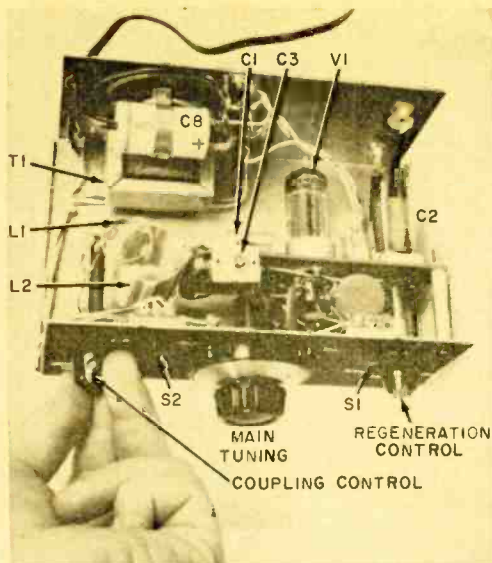

The relationship between the main chassis and sub-chassis can be seen in this photo of the completely assembled S-9'er. Main tuning and regeneration controls are coupled to shafts of C1 and C2 respectively.

#### PARTS LIST

- C1—195- $\mu$ f. and 87- $\mu$ f. two-gang midget variable capacitor (Lafayette MS-270 or equivalent)
- C2—140- $\mu$ f. miniature variable capacitor (Hammarlund APC-140 or equivalent)
- C3—30- $\mu$ f. trimmer capacitor
- C4, C5—0.02- $\mu$ f., 600-volt ceramic disc capacitor
- C6—270- $\mu$ f. silvered-mica capacitor
- C7—0.001- $\mu$ f. silvered-mica capacitor
- C8—20/20- $\mu$ f., 150-v.d.c. electrolytic capacitor
- D1—Silicon diode, at least 25 ma., 350 P.I.V. r.m.s.
- J1, J2—Phono jack, RCA-type
- L1—4 turns of B&W 3011 Miniductor coil stock, or equivalent ( $\frac{3}{4}$ "-diameter, 16 turns per inch)
- L2—28 turns of B&W 3015 Miniductor coil stock, or equivalent (1"-diameter, 16 turns per inch) tapped at 10 turns from "cold" end
- L3, L4—1-mh. r.f. choke
- R1, R3—100,000-ohm,  $\frac{1}{2}$ -watt resistor
- R2, R4—68-ohm,  $\frac{1}{2}$ -watt resistor
- R5—1000-ohm, 2-watt resistor
- R6—39-ohm, 1-watt resistor
- S1—D.p.d.t. slide switch
- S2—S.p.s.t. slide switch
- T1—Power transformer: primary, 117 volts; secondaries, 125 volts @ 15 ma., 6.3 volts @ 0.6 amp. (Stancor PS-8415 or equivalent)
- V1—6CG7 tube
- 1—7" x 5" x 3" chassis box (LMB 145 or equivalent)
- 1—2" x 4 $\frac{1}{2}$ " Bakelite board, copper-clad on one side (Lafayette MS-513 or equivalent)
- 1—2"-diameter vernier dial
- Misc.—Knobs, shaft bushing, shaft couplings, tube socket, wire, hardware, line cord and plug, tie points, RG-58 U coax, etc.

responding numbers on the pictorial diagram and photo of the r.f. section) mounted on the end of the board nearest C1. Each terminal consists of a 4-40 x  $\frac{1}{4}$ " screw and nut insulated from ground by means of shoulder washers. The screw heads should be located on the unclad side of the board. Install terminals 1 and 3 at the corners of the board as shown in the pictorial. Terminal 2 is mounted about  $\frac{3}{4}$ " from terminal 3; place two solder lugs under its screw and do not tighten it.

Now cut coil L2 from the B&W Miniductor stock, leaving the leads extra long. The coil is then placed against the end of the board on which the terminals are mounted; one lead is soldered into the screw-slot of terminal 1, the other into that of terminal 3. Use the excess lead lengths to make connections to capacitor C1. One of the lugs on terminal 2 is soldered to L2 at a point 10 turns up from the terminal 3 end of the coil, the other is soldered to the appropriate lug on C2. Terminal 2 may now be tightened and, to insure good electrical continuity, the two lugs should be soldered to the screw.

The two tie points are mounted on the copper-clad side of the board as shown on the pictorial diagram. Fasten the tie point nearest V1 under one of the tube-socket mounting screws. The other tie point may be soldered directly to the copper. This all but completes the mechanical work on the r.f. section, but before beginning the wiring you should drill a small hole in the chassis, near the terminals of C2, to accommodate the leads to that component.

All wiring is point-to-point, and the grounds can be soldered directly to the copper. To make some of the ground connections, the author used a semi-circular ground-lug strip which was supplied with the tube socket; it's not necessary to employ such a strip, however. All further connections to L2 and C1, incidentally, are made via leads soldered directly to the nuts of terminals 1 and 3. Leads A, B, C, and D are connected to the main chassis as shown in the two pictorials. Make leads A, B, and D 8" long; lead C should be about 3" long.

The r.f. section is mounted on the front panel of the main chassis by means of two studs spaced 1 $\frac{1}{2}$ " from the panel;

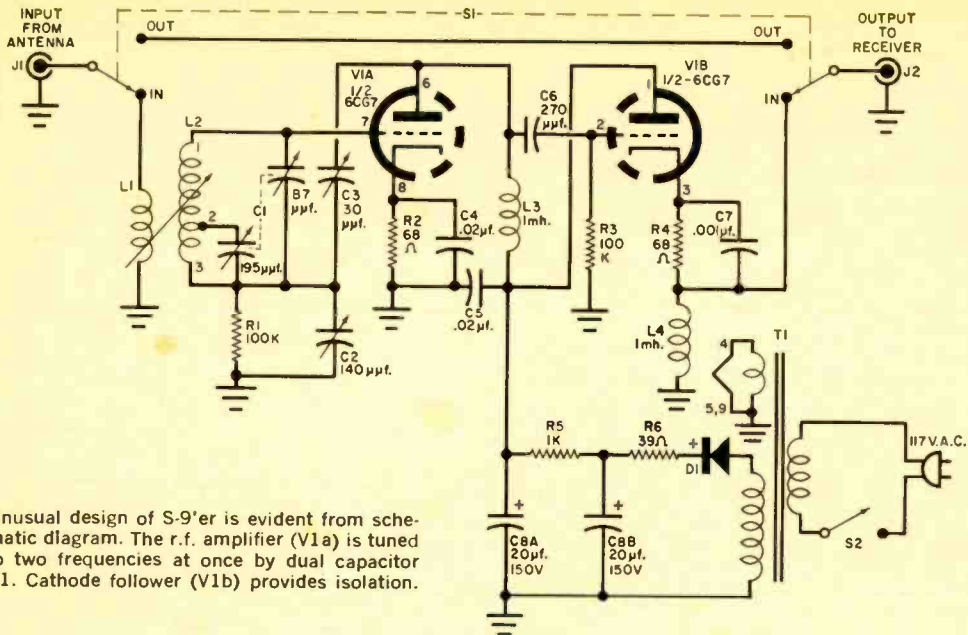

Unusual design of S-9'er is evident from schematic diagram. The r.f. amplifier (V1a) is tuned to two frequencies at once by dual capacitor C1. Cathode follower (V1b) provides isolation.

additional support is given by the insulated coupling between the shaft of *C1* and the tuning dial. After the r.f. section is mounted, connect the free ends of leads *A, B, C*, and *D*. Then drill a hole in the front panel to line up with *C2*'s shaft (use a piece of paper to catch any metal shavings which might fall onto the subchassis). Attach an extension to the shaft to bring it out through the front panel, and install a pointer knob.

The last item to be put together is the variable antenna coupling. Drill a  $\frac{3}{8}$ " hole, positioned symmetrically with respect to the hole for *C2*'s shaft, on the other side of the tuning dial. Install a  $\frac{1}{4}$ " shaft bushing in the hole, then cut a  $2\frac{1}{2}$ " length of  $\frac{1}{4}$ " Bakelite rod. Three holes for #4 screws should be drilled in the rod—the first is located  $\frac{1}{8}$ " from an end; the second,  $\frac{1}{2}$ " further in; and the third, 1" in from the other end. Cut coil *L1* from B&W Miniductor stock, making the leads about  $1\frac{3}{8}$ " long, and slide a  $\frac{3}{4}$ " length of spaghetti over each lead. The lead ends are secured under #4 sheet-metal screws installed in the first two holes; about  $\frac{3}{8}$ " of each lead is left protruding for use in making connections to the coil.

Run a 4-40 nut up to the head of a 4-40 x  $\frac{1}{2}$ " screw and insert the screw

through the remaining hole. This screw is secured in place with another 4-40 nut, and a  $\frac{3}{8}$ " grommet is slipped over the undrilled end of the shaft. Slide the same shaft-end through the bushing in the panel; push it in so that the grommet is slightly compressed between the screw and the bushing, and install a pointer knob on the shaft.

The leads of coil *L1* are bent so that the coil penetrates a turn or two into *L2* at the maximum coupling position; the plastic structural bars of both *L1* and *L2* may have to be filed down a bit in order to make this possible. Be sure that the coils do not short together at any point in the adjustment range. Solder leads to each of the coil wires, running one to *S1* and the other to a ground lug secured under one of the tuning dial nuts. Make a final check of all the connections, and you're ready to try out the S-9'er.

**Adjustment and Operation.** Attach your antenna, receiver antenna terminal, and ground to the input and output jacks of the S-9'er (see schematic); be sure to use coaxial cable between the output jack and the receiver. The chassis cover should be left off temporarily. Switch both the receiver and the S-9'er on and  
(Continued on page 126)

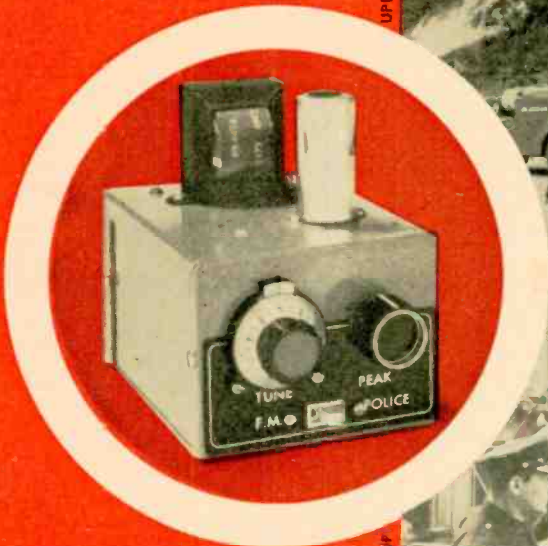

By  
**HARTLAND B. SMITH**  
W8VVD

# The "10-8" DE LUXE

*Eavesdrop on the news  
while it's happening—  
with a converter that pulls in everything  
from police cruisers to cabs and fire engines*

**A**LTHOUGH a good many SWL's are unaware of it, one of the busiest portions of the radio spectrum extends from 150.8 to 162 mc. This band is literally alive with police and fire calls, mobile telephone conversations, and the voices of taxicab dispatchers! Public utilities employ this segment of the ether to keep in touch with their repair crews. And, in coastal areas, even steamships can be heard on these frequencies.

Attached to a standard FM receiver or

tuner, the 10-8 converter enables you to eavesdrop on all this exciting activity. If you're the kind of fellow who enjoys "keeping up with the news" while it's happening, you'll undoubtedly want to try your hand at building this little gadget. Costing less than \$20.00, it can provide you with many hours of fascinating entertainment.

Why is the converter dubbed the 10-8? Because "10-8" in the "10" system used by the police means "in service"—



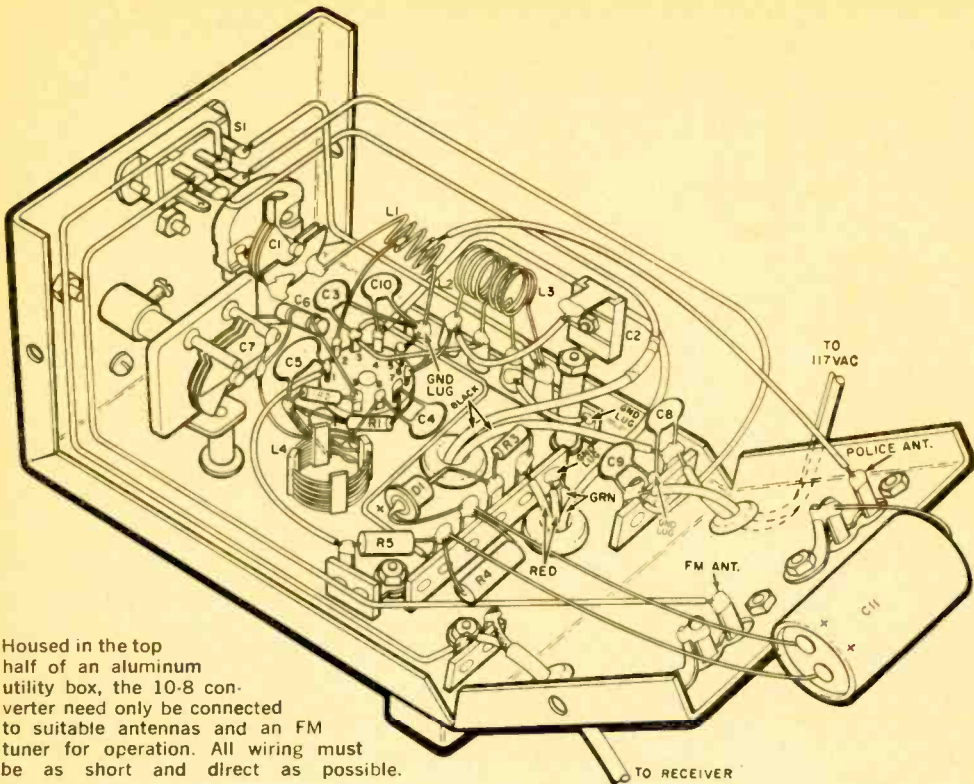

Housed in the top half of an aluminum utility box, the 10-8 converter need only be connected to suitable antennas and an FM tuner for operation. All wiring must be as short and direct as possible.

which is just what your 10-8 will be most of the time.

**Construction.** The top half of a 5" x 4" x 3" aluminum utility box supports all of the parts. Component placement should closely follow that of the original, since changes in layout may adversely affect the circuit's performance.

Capacitor *C7*, a Hammarlund HF-15 variable driven by a small vernier dial, is supported on a 1/2" metal spacer held in place with a 6-32 machine screw. The dial should be set so that it reads 10 when the capacitor's plates are completely unmeshed.

The other tuning capacitor, *C1*, can be any small variable with a maximum capacity between 10 and 15  $\mu\text{f}$ . Mount it on the front panel and orient it so that the stator lugs are positioned as illustrated. A capacitor taken from the author's spare-parts box was used in the prototype. However, if you don't happen to have such a unit on hand, a second HF-15 can be used at this point.

The socket for *V1* should be mounted

with pins 1 and 9 pointing toward the center of the chassis and pins 4 and 5 near the edge. One mounting lug of a four-lug terminal strip is held by the tube-socket mounting nut near pins 4 and 5. The other mounting lug on the terminal strip is fastened to the chassis with a 1 1/4" 6-32 screw, and this same screw also holds *C2* atop a 1" metal spacer. Make certain that the movable plate of this capacitor is the one which is grounded to the spacer.

Another four-lug terminal strip, held by *T1*'s mounting nuts, provides support for *D1*, *R3*, *R4*, and one end of *R5*; a single-lug tie point acts as a convenient terminal for the other end of *R5*. In addition, a couple of two-lug, screw-type terminal strips are mounted on the rear of the chassis and serve as antenna connectors. One terminal of each strip is grounded to the chassis.

Grommets should be placed in two holes in the top of the chassis through which the transformer leads pass. Two other grommets at the rear of the chassis

Circuit of 10-8 employs a 6EA8 mixer/oscillator to convert incoming signals to 108 mc. Switch S1A selects police or FM antenna.

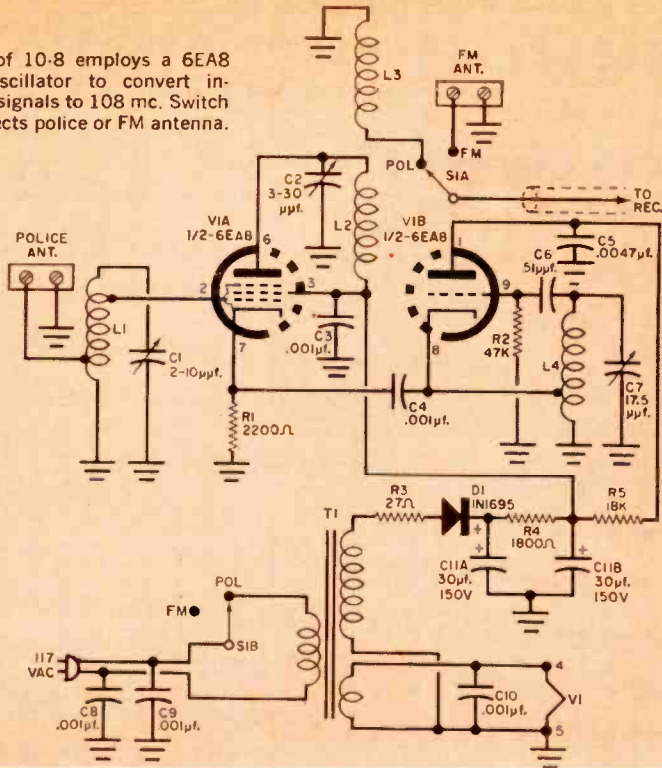

#### PARTS LIST

- C1—2 - 10  $\mu\text{f}$ . midget variable capacitor—see text  
 C2—3 - 30  $\mu\text{f}$ . mica trimmer capacitor  
 C3, C4, C8, C9, C10—.001- $\mu\text{f}$ ., 600-volt disc capacitor  
 C5—0.0047- $\mu\text{f}$ ., 600-volt disc capacitor  
 C6—51- $\mu\text{f}$ . tubular ceramic capacitor, zero temperature coefficient  
 C7—2.8 - 17.5  $\mu\text{f}$ . midget variable capacitor (Hammarlund HF-15 or equivalent)  
 C11—30/30- $\mu\text{f}$ . 150-w.v.d.c. electrolytic capacitor  
 D1—1N1695 diode  
 L1—Five turns of #20 tinned solid copper wire,  $\frac{1}{4}$ " in diameter, spaced 4 times the diameter of the wire and tapped  $1\frac{1}{2}$  turns from each end, with  $\frac{3}{8}$ " leads—see text  
 L2—Four turns of #20 Nyclad wire,  $\frac{3}{8}$ " in diameter, close-wound, with  $\frac{3}{8}$ " leads—see text  
 L3—Three turns of #20 Nyclad wire,  $\frac{3}{8}$ " in diameter, close-wound, with  $\frac{3}{8}$ " leads—see text  
 L4—Six turns of #20 tinned solid copper wire, spaced the diameter of the wire,  $\frac{3}{8}$ " in diameter, tapped 3 turns from the ground end, with  $\frac{3}{8}$ " lead at ground end, 1" lead at grid end—see text  
 R1—2200-ohm,  $\frac{1}{2}$ -watt resistor  
 R2—47,000-ohm,  $\frac{1}{2}$ -watt resistor  
 R3—27-ohm,  $\frac{1}{2}$ -watt resistor  
 R4—1800-ohm, 1-watt resistor  
 R5—18,000-ohm, 1-watt resistor  
 S1—D.p.d.t. slide switch  
 T1—Power transformer; primary, 117 volts a.c.; secondaries, 125 volts @ 15 ma. and 6.3 volts @ 0.6 amp. (Stancor PS-8415 or equivalent)  
 V1—6EA8 tube  
 1—Nine-pin miniature tube socket, shield base (Amphenol 59-407 or equivalent)  
 1—Miniature tube shield for above (Amphenol 5-408 or equivalent)  
 1—5" x 4" x 3" aluminum utility box (Bud CU-2105A or equivalent)  
 1—36-mm. ( $1\frac{1}{2}$ " vernier dial (Lafayette F-348 or equivalent)  
 1—15" length of RG-122/U coaxial cable  
 Misc.—Screws, grommets, knobs, terminal strips, ground lugs, etc.

protect the a.c. power cord and the coaxial lead which runs between the FM receiver and the 10-8. Four more grommets, inserted in holes drilled at each corner of the bottom cover, serve as

protective feet for the device. Additional holes include those for C1 and C7 as well as one in the side of the cover to provide access for adjusting C2.

Wind the coils exactly as specified in

## THE "10" SIGNALS

The APCO "10" signals were developed by the Associated Police Communication Officers, Inc., to reduce the content of police messages to a codified form. Listed below are the "10" signals most often heard on the air, together with their meanings.

- 10-1 Receiving poorly—move to better location.
- 10-2 Receiving well.
- 10-3 Stop transmitting.
- 10-4 Acknowledgment (OK).
- 10-5 Relay message.
- 10-6 Busy.
- 10-7 Out of service.
- 10-8 In service, subject to call.
- 10-9 Repeat, conditions bad.
- 10-10 Out of service—subject to call.
- 10-11 Talking too rapidly.
- 10-12 Officials or visitors present.
- 10-13 Advise weather and road conditions.
- 10-14 Convoy or escort.
- 10-15 We have prisoner in custody.
- 10-16 Procure prisoner at \_\_\_\_\_.
- 10-17 Procure papers at \_\_\_\_\_.
- 10-18 Complete present assignment as quickly as possible.
- 10-19 Return to your station.
- 10-20 What is your location?
- 10-21 Call this station by telephone.
- 10-23 Stand by.
- 10-24 Trouble at station—unwelcome visitors—all units in vicinity report at once.
- 10-29 Check for wanted.
- 10-31 Is lie detector available?
- 10-32 Is drunkometer available?
- 10-33 Emergency traffic at this station.
- 10-34 Clear for local dispatch?
- 10-35 Confidential information.
- 10-36 Correct time?
- 10-37 Operator on duty?
- 10-38 Station report satisfactory.
- 10-40 Advise if Officer \_\_\_\_\_ is available for radio call.
- 10-60 What is next message number?
- 10-63 Net is directed.
- 10-64 Net clear.
- 10-67 Stations \_\_\_\_\_ carry this message.
- 10-68 Repeat dispatch.
- 10-70 Net message.
- 10-71 Proceed with traffic in sequence.
- 10-83 Have Officer number \_\_\_\_\_ call this station by telephone.
- 10-92 Your quality poor—transmitter apparently out of adjustment.
- 10-97 Arrived at scene.
- 10-98 Finished with last assignment.
- 10-99 Unable to receive your signals.

*All municipal, county, and state police; special emergency; forestry; fire department; local government, and highway maintenance radio stations appear in the "Official Registry of Public Safety Radio Systems." Available from Communication Engineering, Box 629, Mineola, N. Y., for \$6.00. The book lists frequencies, call-signs, locations, and number of mobile units.*

the Parts List. Strip the insulation from a short length of No. 20 tinned solid hookup wire to make *L1*, and solder this coil between the terminal strip mounting lug near the tube socket and the closest stator terminal of *C1*. Next, run a bare 1" lead from pin 2 of *V1* to a point 1½ turns from the "capacitor" end of *L1*. Finally, solder a 5½"-long insulated wire between the ungrounded end of the police antenna terminal strip and a point 1½ turns from the opposite end of the coil.

Nyclad wire (No. 20), with its tough, chip-resistant coating, is recommended for both *L2* and *L3*; be certain to scrape the insulation carefully from the leads at the ends of these coils. Note that coil *L2* is supported by the 4-lug terminal strip's two insulated lugs nearest the tube socket. A ¾" length of bare wire runs from pin 6 of *V1* to the near end of *L2*; a 2¼" wire is also soldered to this end of *L2* and then run to the fixed plate of *C2*. A wire soldered to tube pin 3 is connected to the opposite end of *L2*.

Coil *L3* is fastened to the two insulated lugs nearest *C2*. A short insulated wire runs from the end of *L3* next to *L2* to the grounded terminal strip mounting lug near *C2*. A 6¼"-long insulated wire is then run from the other end of *L3* to the "Police" terminal of *S1a*.

Before installing *L4*, solder a ¾" piece of bare wire to the third turn from the bottom end of the coil. More room will be available for making this tap if you bend the second and fourth turns inward by pushing on them with a screwdriver. Place the coil between the ground lug near pin 9 of *V1* and the adjacent stator lug of *C7*. The wire from the tap at turn 3 can now be soldered to tube pin 8.

Finally, trim the leads of *C6* to ½". One end of this capacitor is soldered to pin 9 of the tube; the opposite end is wrapped around and soldered to the lead of *L4* which connects to *C7*.

**Alignment.** With power applied to the 10-8 and the bottom cover removed, there are a number of exposed high-voltage points in the converter which are apt to shock the unwary. Therefore, it's wise to "play it safe" and put on a pair of gloves before making the following adjustments.

First, connect a 150-mc. antenna to the "police" antenna terminal strip and an

FM antenna to the FM antenna strip. Run the output cable from the 10-8 to the antenna terminals of the FM set, and temporarily solder a 1" wire between pins 5 and 7 of V1.

Next, set the FM receiver dial at 108 mc. and C7 at maximum capacity, then adjust C2 for the loudest hiss in the receiver's speaker. Spread the turns of L2 slightly if maximum noise occurs with C2 wide open. Bend L3 back and forth with respect to L2 until you determine the position which results in the greatest background noise.

Remove and discard the wire between pins 5 and 7, then tune C7 from maximum to minimum capacity. As you do this, you should hear several signals which are harmonics of the variable oscillator. If no signals are evident, V1b is not oscillating—try increasing the plate voltage by reducing R5 to approximately 4000 ohms. If this fails to start the oscillator, look for a defective component or a wrong connection. Another check is to tune the FM receiver to 94 mc. and see if the second harmonic of V1b can be heard; this should occur when the plates of C7 are about half-meshed.

Once you have the oscillator perking, tune the vernier dial back and forth in search of police calls and other v.h.f. transmissions. When you come across a signal, peak C1 for maximum volume. Since this particular adjustment is rather broad, a slight touch-up will suffice when tuning from one end of the band to the other. If C1 must be fully meshed for best reception, squeeze the turns of L1 closer together. If optimum results are obtained with C1 at minimum capacity, open up the coil a bit.

Mobile telephone and taxicab dispatcher signals should be picked up with the vernier dial set somewhere between 3 and 5. Likewise, police calls should come in between 5 and 7. If you can receive no mobile phones, but police calls are found between 1 and 3 on the dial, add a turn to the top of L4. On the other hand, if mobile phones are heard around 7 or 8, remove a turn from the coil.

**Performance.** Naturally, the performance of the converter depends to a large extent on the quality of the antenna installation. At an average location, mobile stations will come through at distances up to about five miles. Base stations,

especially the higher powered ones, will be audible for at least 20 miles.

Be sure to log the dial settings of the various services you hear so that you can retune to them in the future. And always set the FM dial to exactly 108 mc.

## HOW IT WORKS

Many police, fire, public utility, and maritime mobile stations operate between 150.8 and 162 mc. The 10-8 makes it possible to tune in these signals on an ordinary FM radio.

A 155-mc. police call, for example, arrives at the antenna, drops down the feedline, and finally reaches coil L1. Since L1 and capacitor C1 form a resonant circuit that can be tuned to 155 mc., a 155-mc. voltage can be built up across this LC combination and applied to the grid of V1a.

Tube V1b is a variable-frequency oscillator which, in this case, is tuned to 47 mc. The 47-mc. output of V1b is fed to the cathode of V1a via capacitor C4. Because V1a is a non-linear device, the 47-mc. energy combines in the tube with the 155-mc. police signal to produce two new frequencies. These new frequencies, or "beats," are equal to the sum of and the difference between 47 and 155 mc.

The sum (202 mc.) and the difference (108 mc.), as well as the 47- and 155-mc. signals, are all present at the plate of V1a. Only one of these, the 108-mc. signal, is desired. Consequently, coil L2 and capacitor C2 are resonated to this particular frequency. Coil L3, which is inductively coupled to L2, picks up 108-mc. energy and feeds it, via switch S1a and the coaxial cable, to the input of the FM receiver. The 155-mc. police signal will now be heard when the FM set is tuned to 108 mc.

To eavesdrop on a mobile telephone conversation at 152 mc., C1 is peaked to this new frequency and capacitor C7 reset for an oscillator frequency of 44 mc. The FM set need not be retuned, because the difference between 152 and 44 is again 108.

Power to operate the 10-8 is supplied by a small isolation transformer, T1, and a silicon rectifier, D1. When normal broadcast reception is desired, S1 is thrown to the FM position. This action shuts down the power supply, disconnects the converter from the FM set, and connects an FM antenna to the input of the receiver.

when using the 10-8—failure to do so will nullify your loggings.

The 10-8 is designed to receive one or two stations well—not for continuous tuning. Readers who live close to a TV transmitter on Channel 2 may pick up its audio signal in the middle of the band and its raw a.c. video carrier at 8 or 9 on the dial. Two or three unmodulated carriers may also be noted as you tune across the band. In the unlikely event that one of these signals falls on the frequency of a desired station, simply shift the FM dial to 107.5 mc.; this will "move" the offending carrier so that it will no longer be troublesome.

-50-

# FREE Catalog

OF THE WORLD'S FINEST  
ELECTRONIC GOV'T  
SURPLUS BARGAINS



## DC SUPPLIES

Operate from 115 volts 60 cycles: are complete with Transformer, Rectifier, Capacitor, Switch, Line Cord, Pilot Light, Line Fuse, etc. Indicated ratings are for load conditions

**DUAL OUTPUT 12 14 or 24/28 VDC @ 6 amps**  
Size: 7 x 6 1/2 x 13" - Wt. 17 lbs. - STK #PS-12/24

VDC6A  
KIT of Parts ..... \$20.00  
Wired Complete ..... \$24.95

**OUTPUT 12/14 VDC @ 4 A. Size: 5 1/2 x 9 1/2 x 5" - Wt.: 15 lbs. - STK #PS-12VDC6A:**  
KIT of Parts ..... \$14.00  
Wired Complete ..... \$18.95

**OUTPUT 24/28 VDC @ 4 A. Size: 5 1/2 x 9 1/2 x 5" - Wt.: 12 lbs. - STK #PS-24VDC4A:**  
KIT of Parts ..... \$13.00  
Wired Complete ..... \$17.95

**OUTPUT 12/14 VDC @ 4 A. Size: 5 1/2 x 9 1/2 x 5" - Wt.: 12 lbs. - STK #PS-12VDC4A:**  
Wired Complete ..... \$14.95

KIT of Parts ..... \$10.00  
Address Dept. EH-3—Prices F.O.B., Lima, Ohio—25% Deposit on all C.O.D. Orders. **FOR CATALOG!**



## FAIR RADIO SALES

2133 ELIDA RD. • Box 1105 • LIMA, OHIO

### FAIR RADIO SALES

Dept. EH-3—P. O. Box 1105—Lima, Ohio—U.S.A.

NAME: .....

ADDRESS: .....

CITY: ..... STATE: .....

CIRCLE NO. 12 ON READER SERVICE CARD

# 108

## ELECTRONIC KITS

- STEREO & MONO HI-FI
- TEST INSTRUMENTS
- HAM GEAR
- CITIZENS TRANSCEIVERS
- WALKIE-TALKIES
- TRANSISTOR RADIO

- All easy-to-build — with complete, step-by-step, beginner-tested pictorial instructions
- All tremendously economical — cost 50% less than comparable wired units
- All professional quality — uncompromisingly engineered



Mail coupon today

EICO Electronic Instrument Co., Inc.  
3300 Northern Blvd., L.I.C. 1, N.Y.  
Please send FREE catalog and name of neighborhood dealer.

Name \_\_\_\_\_

Address \_\_\_\_\_

City \_\_\_\_\_ Zone \_\_\_\_\_ State \_\_\_\_\_

EEH-63

CIRCLE NO. 10 ON READER SERVICE CARD

## The S-9'er

(Continued from page 120)

set the coupling for maximum, the regeneration control (*C2*) for maximum capacity, and switch *S1* to *Out*.

Tune in a signal on the receiver at about 6 mc. and set *S1* to *In*. Adjust capacitor *C1* (main tuning) for maximum signal volume, then slowly decouple coils *L1* and *L2* (keeping capacitor *C1* peaked up) until, once again, you've reached the point of maximum volume. If regeneration occurs while you're adjusting the coupling, slowly vary the capacity of *C3* until it stops. Now decrease the capacity of *C2* until regeneration occurs, then back off slowly, keeping the coupling and main tuning peaked up, until the signal is loudest. This optimum point, ideally, should not be far from the minimum-capacity setting of *C2*; if *C2*'s setting is much higher, it will be necessary to increase the capacity of *C3*.

Check the operation of the unit over several other frequencies within its range, making sure that all controls operate smoothly and that regeneration can be stopped, even with the coupling at minimum. Then install the cover—and your S-9'er is all set to go.

You'll find, incidentally, that it's best not to set the regeneration too high—or settings will require frequent changing as you tune a band. Though the controls do interact to some extent, a little practice will soon enable you to make adjustments quickly. —50—



"He either got an income tax refund or his Novice permit!"



# Chapter

# 5

## Electronics in the Workshop

**T**HESSE projects include a number of devices which will be of value around your workshop. "The Signal Monitor" (page 128) combines a field strength meter and an audio monitor in one package and belongs in every ham shack. But the bulk of the devices described here are more properly classed as "test equipment."

Audio enthusiasts will be interested in such devices as the "Simple Square-Wave Generator" (page 131) and "The Imp Sleuth" (page 141), the latter being a simple bridge circuit which provides a reasonably accurate indication of speaker and output transformer impedances. "Solid-staters" will want to build both the "Experimenter's Transistor Tester" (page 144) and the "Automatic Diode Checker" (page 143), while the "Nickel-Cadmium Battery Charger" (page 145) will be of appreciable value to anyone using these longer-lived cells.

Some of the devices, such as the "Pint-Sized Carillon" (page 148), are just plain fun. One of these "tinklers" hooked up to your hi-fi system is sure to impress friends and neighbors alike.

The Signal Monitor.....	Thomas M. Browning	<b>128</b>
Simple Square-Wave Generator.....	C. E. Miller	<b>131</b>
Spray Can Short Cuts.....	Ken Murray	<b>134</b>
Transistor Frequency Standard.....	Donald L. Stoner, W6TNS and Lester A. Earnshaw, ZL1AAX	<b>137</b>
Vibration Pickups.....	Lou Garner	<b>139</b>
The Imp Sleuth.....	Anthony Troiano	<b>141</b>
Automatic Diode Checker.....	Keith Sueker	<b>143</b>
Experimenter's Transistor Tester.....	Charles Caringella, W6NJV	<b>144</b>
Nickel-Cadium Battery Charger.....	Herbert Friedman, W2ZLF	<b>145</b>
Pint-Sized Carillon.....	Art Trauffer	<b>148</b>

# THE SIGNAL MONITOR

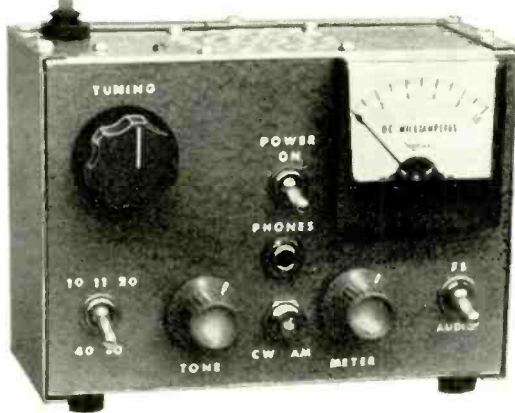

By **THOMAS M. BROWNING**

*This combined field-strength meter and AM/CW monitor is self-powered, covers frequencies from 80 to 10 meters*

**O**NCE you've put together this handy field-strength and audio monitor, you'll never have to guess about the tuning of your transmitter or wonder how good your signal sounds "on the air." Actually a simple, self-powered receiver, the instrument needs no connection to your rig. Just place it in, or near your shack, extend the short whip antenna, and you're ready to go.

The Signal Monitor covers the frequencies from 80 to 10 meters (including the Citizens Band). When operating as a field-strength meter, it provides a visual indication of the transmitter's r.f. output. When it's set for audio monitoring, you can check the quality of your AM or CW signal using either the built-in speaker or a pair of headphones.

**Construction.** All of the components, except for the battery holder, are mounted on the main section of a 7" x 5" x 3" aluminum utility box;

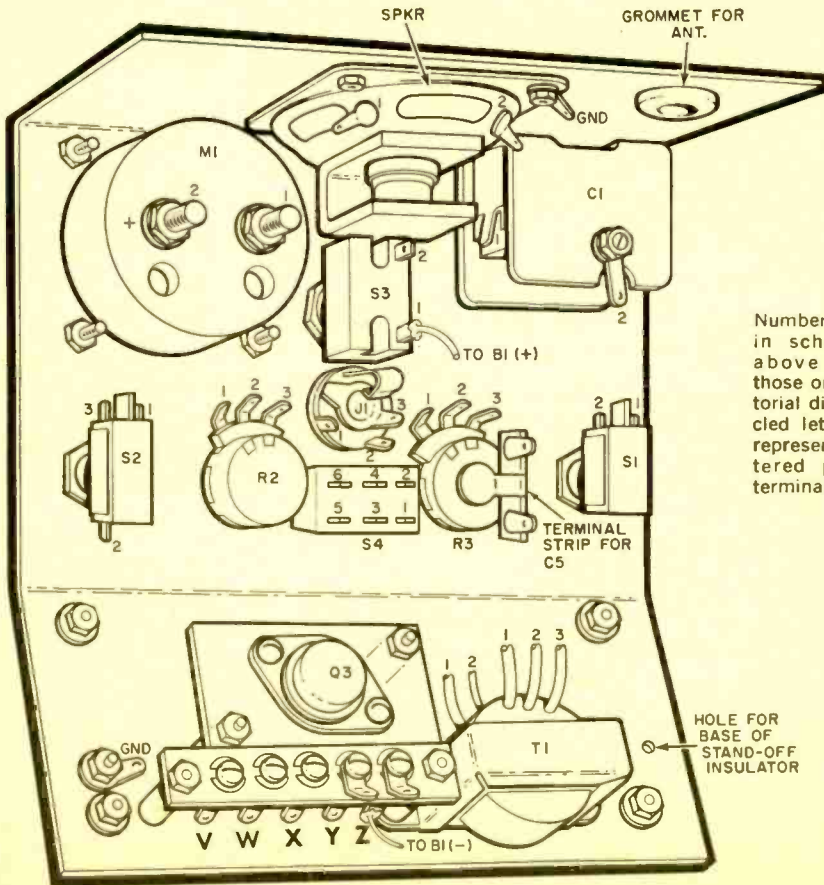
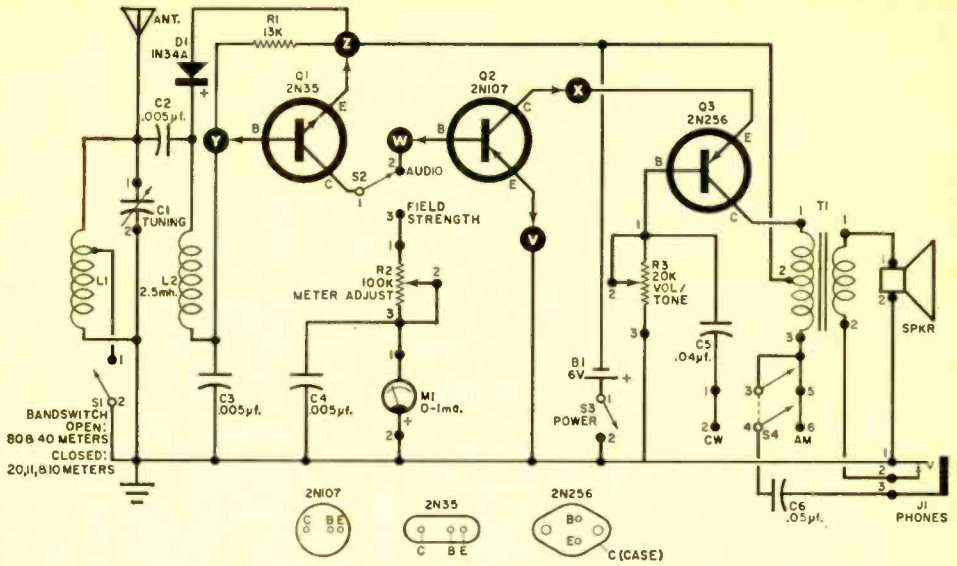

Numbers on connections in schematic diagram above correspond to those on terminals in pictorial diagram at left. Circled letters in schematic represent similarly lettered points on 5-lug terminal strip (see text).

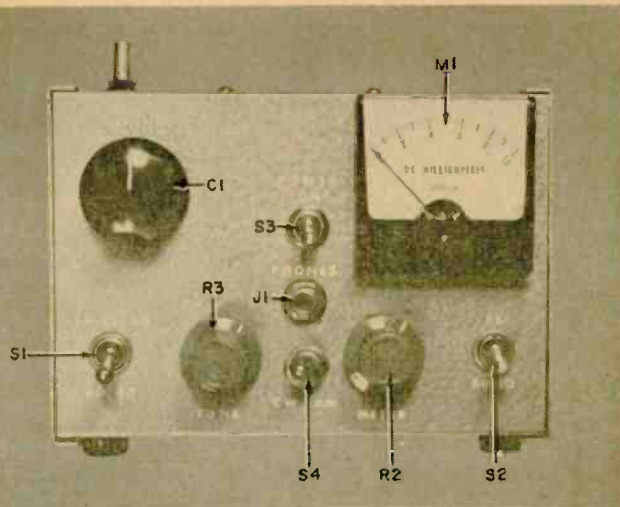
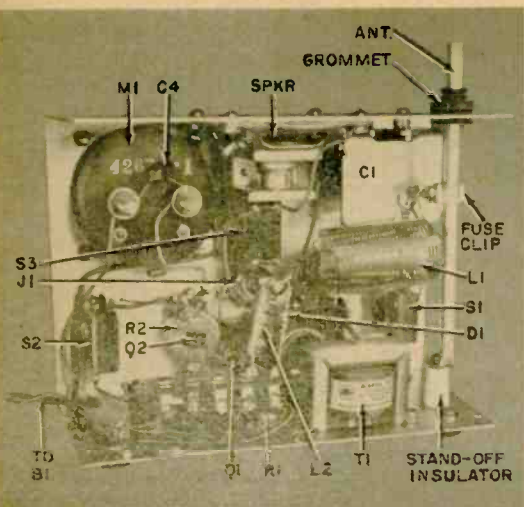

Interior of completely wired Signal Monitor is seen at left; battery B1 is located in the box cover (not shown). At right is view of front panel, showing placement of the various controls.

#### PARTS LIST

B1—6-volt battery (4 Burgess Type "Z" pen-light cells in series, or equivalent)  
 C1—365- $\mu$ f. variable capacitor (Lafayette MS-214 or equivalent)  
 C2, C3, C4—0.005  $\mu$ f. } all ceramic disc capacitors, at least 25 volts  
 C5—0.04  $\mu$ f.  
 C6—0.05  $\mu$ f.  
 D1—1N34A diode  
 J1—Closed-circuit phone jack  
 L1—28 turns cut from B&W 3015 (1"-diameter, 16 turns-per-inch) Miniductor coil stock, tapped at  $5\frac{1}{4}$  turns  
 L2—2.5-mh. r.f. choke  
 M1—0-1 ma. d.c. milliammeter (Simpson Model 1227 or equivalent)  
 Q1—2N35 transistor (Sylvania)  
 Q2—2N107 transistor (G.E.)  
 Q3—2N256 transistor (CBS or Sylvania)

R1—13,000-ohm,  $\frac{1}{2}$ -watt resistor  
 R2—100,000-ohm potentiometer, linear-taper (CTS-IRC Q11-128 or equivalent)  
 R3—20,000-ohm potentiometer, linear-taper  
 S1, S3—S.p.s.t. switch  
 S2—S.p.d.t. switch  
 S4—D.p.d.t. switch  
 SPKR—2 $\frac{1}{2}$ " speaker, 3.2-ohm voice coil (Quam 25A07 or equivalent)  
 T1—Output transformer: primary, 15,000 ohms CT; secondary, 4 ohms (Stancor A-3881 or equivalent)  
 1—7" x 5" x 3" aluminum utility box (Bud CU-2108A or equivalent)  
 Misc.—Battery holder, 5-lug screw-type terminal strip, 2-lug terminal strip, knobs, fuse clip for antenna connection, stand-off insulator, rubber feet, rubber grommet, etc.

the holder is installed on the box cover. Though there's little waste space, you should have no trouble duplicating the parts layout shown in the photographs and pictorial diagram.

When mounting the parts, remember that both the case of transistor Q3 and the frame of jack J1 must be insulated from ground. Transistor Q3 is installed on a small square of Lucite (about  $1\frac{1}{4}$ " x 2") which is fastened to the box on a pair of  $\frac{3}{8}$ " spacers. The mounting hole for J1 is drilled slightly oversize and "sandwiched" between a pair of fiber insulating washers.

The antenna, which extends about 34" above the top of the box when open, can

be cut from an old set of TV "rabbit ears." Pass its base into the box through a grommet-lined hole (see photograph at left, above), and secure it in place with a stand-off insulator. Connections can be made via a 3AG fuse clip snapped onto the bottom portion of the antenna at some convenient spot.

To simplify wiring, the terminals and leads of the components shown on the pictorial diagram are keyed, by matching numbers, to the corresponding connections on the schematic diagram. Since all the major chassis-mounted parts appear on the pictorial, it should be easy to "fill in" the others as you go along. Just  
 (Continued on page 166)

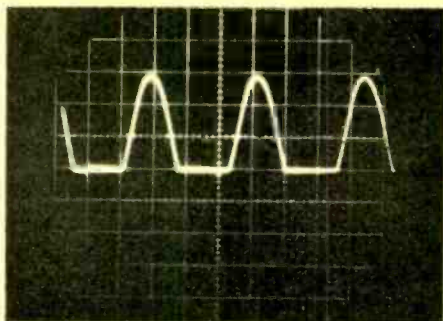

A

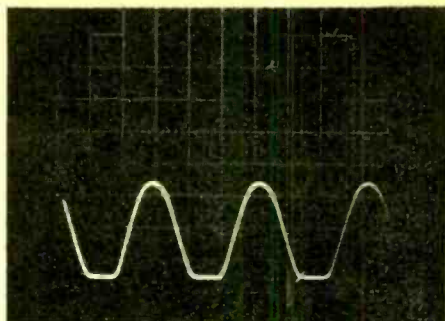

B

Waveforms obtained from unit. (A) is the voltage across R1. (B) to (E) show the effect of increasing the input amplitude at 60 cycles (see p. 132). The waveform at (D) is about what would be expected at 6.3 volts input. (F) is the output waveform obtained when an audio oscillator set at approximately 500 cycles is substituted for the 6.3-volt heater transformer. An audio oscillator output voltage on the order of 5 to 10 volts is required for proper clipping.

# Simple Square-Wave Generator

By C. E. MILLER, General Radio Co.

*Construction of ultra-simple clipper that employs contact potential to produce square waves. Only two resistors, a tube, and a transformer are required*

UNTIL the Second World War the use of square waves in testing electronic equipment was limited almost entirely to laboratories and commercial manufacturers. Since that time there has been a growing recognition of the value of tests involving nonsinusoidal waveforms. Most square-wave generators are characterized by complex circuits, waveform distortion, or high cost. A limiter-type sine-wave clipper gives good results with a simple

Fig. 1. Open-circuit contact potential of 6H6 as the heater voltage is increased.

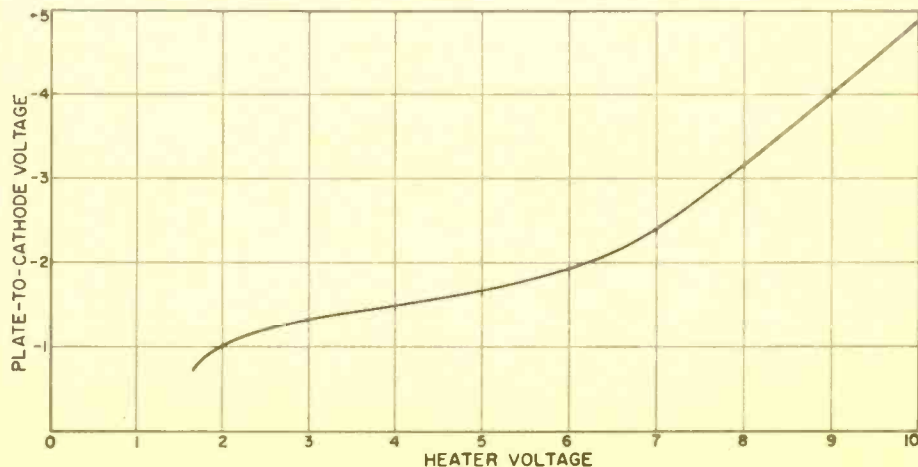

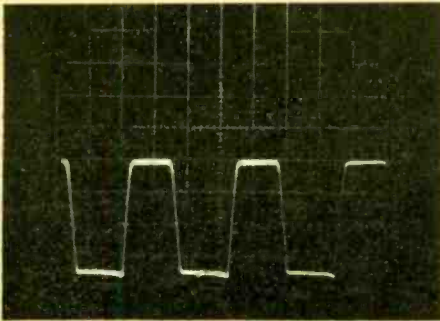

C

Because of the manner in which these traces were photographed off the screen of the oscilloscope used, the waveforms shown here appear as though the oscilloscope sweeps from right to left as would occur in a mirror-image of the actual waveforms.

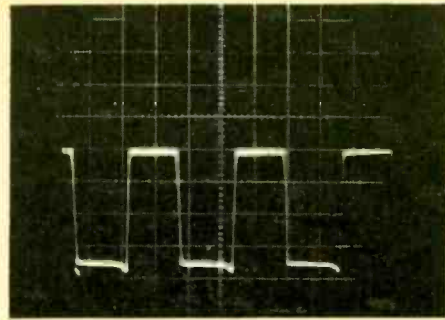

D

circuit, but usually requires an additional power supply, batteries that must be replaced, or expensive zener diodes.

The device to be described is very simple, yet has few of the disadvantages of other types of square-wave generators.

**Theory of Operation.** The circuit of the square-wave generator is shown in Fig. 2, although its operation is not too obvious from this schematic. A sinusoidal input voltage is applied between point "A" and ground and a square-wave output voltage appears between point "B" and ground. Unlike a conventional sine-wave clipper, this circuit requires no external bias voltage. Instead, the circuit generates its own "bias" voltage, which is then chopped by the input voltage.

The "bias" voltage in the circuit is developed by the Edison Effect in *V1b*. When the temperature of a material is raised, the random motion of its free

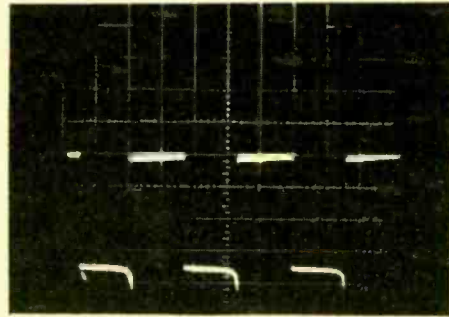

E

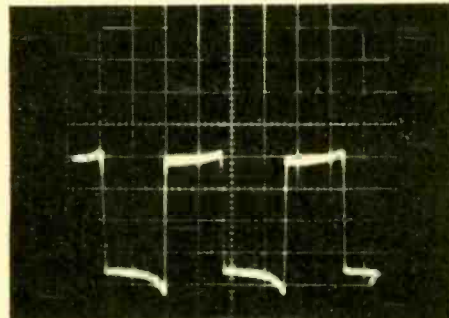

F

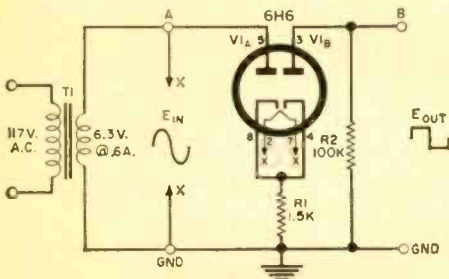

Fig. 2. Schematic of a unit using a twin-diode. If a twin-triode is used, the control grids should be tied to the cathodes.

electrons is increased. In vacuum tubes, the cathode material is heated to a point where some free electrons are actually "boiled" from its surface. These electrons form a space charge (or space cloud) about the cathode. With no external voltage applied between the plate and cathode, the space charge forces many of the electrons on the outer boundary toward the plate, giving it a negative charge. The cathode becomes positive because of its loss of electrons.

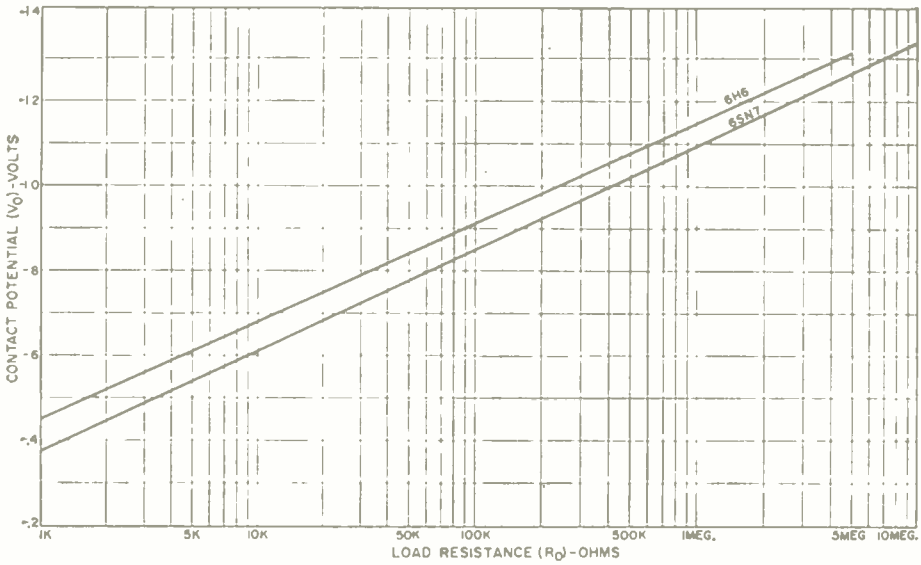

Fig. 3. Effect of circuit loading on 6H6 and 6SN7 tubes operating at normal heater voltage.

This process continues until the plate becomes sufficiently negative with respect to the cathode to repel space-charge electrons back to the plate-to-cathode region. The magnitude of this plate-to-cathode voltage, sometimes referred to as contact potential, depends principally upon the

composition of the cathode material and the temperature to which it is heated. Fig. 1 shows the effect of increasing the heater voltage.

If the external circuit between the cathode and plate of *V1b* is closed, as it  
(Continued on page 160)

Author used 6.3-volt secondary winding of a Stancor PS-8415 power transformer to deliver sine-wave signal to the clipper. The under-chassis view shows the simplicity of the construction.

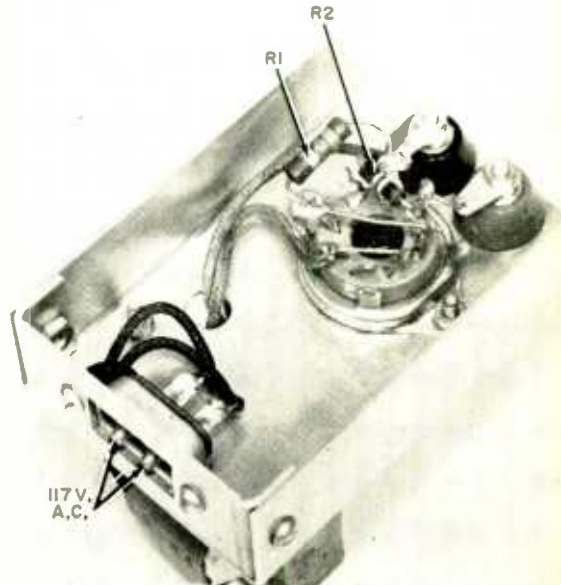
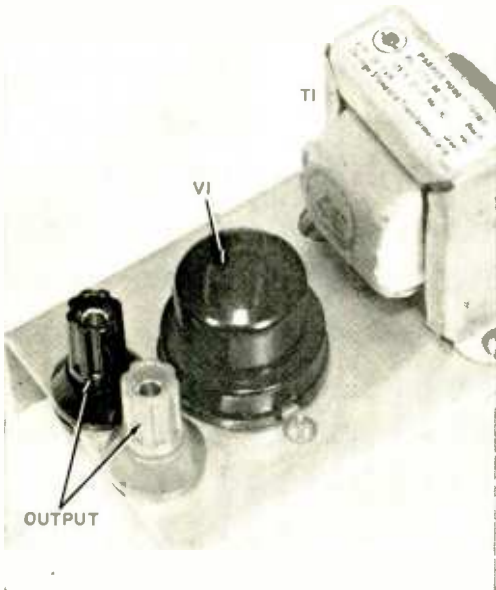

# SPRAY CAN SHORT CUTS



By KEN MURRAY



**2** Handle-and-trigger assembly removed from an old coffee maker enables you to hold and aim a spray can in "pistol-fashion."

**1** Attach a coat hook to a spray can with a rubber band and you can hang it anywhere. Cap can be wedged between bottom of hook and side of can.

**E**LECTRONIC EXPERIMENTERS are being bombarded with pressurized spray cans containing everything from clear acrylic and enamel to non-arc, non-short coatings. Even penetrating oil and a fire extinguisher for the workbench are now packaged in pressurized cans. In fact, about the only other "tool" the modern experimenter needs to clean and degrease, prime, prevent rust, eliminate static, and perform a host of other operations is a fingertip.

Helpful though they are, spray cans can never be as handy as they might be unless you know some of the inside tricks for using them. Here are a few "short cuts" to help you make the most of all the various spray cans now on the market.

**Clean Nozzles.** One thing many of these pressurized products have in common is the need to keep their nozzles clean. As

their labels command: "When finished spraying, invert can and press trigger to remove excess from tube and spray head." Otherwise, they will clog.

When you happen to use a burst of acrylic or print-coat a dozen times during the day, there'll be a generous amount of waste if you clean the feed tube and head each time—you may waste as much as half the pressure in a can that way. A good trick is to plaster a piece of masking tape over the nozzle after using it. The tape will stop evaporation, and you can clean out the feed tube, as directed on the label, at the end of the day.

**Can Hook.** If you don't have a satisfactory place to set a spray can when it's not in use, hang it from a ladder rung or a nail. Just cut the screw point from a wire coat hook, turn it upside down, and fasten it to the side of the spray can with a heavy rubber band (see Fig. 1).





**4** An accessory spray head (below) produces a "splatter-type" finish for old cabinets, enclosures, panels.



**3** All you really need is a pencil to learn how much liquid is left in spray can.



**5** Any rotary device, such as the electric drill shown here, can be a big help in spraying small parts evenly.

As a bonus feature, the lower end of the hook will make a handy clip for the can's dust cap.

**Handle and Trigger.** With the addition of a longer metal band to fit the spray can, the handle from a glass coffee maker can provide a comfortable hand grip. The trigger shown in Fig. 2 is a semi-circular piece cut from  $\frac{3}{16}$ " tempered Masonite. Bolt or rivet it to one side of the handle, and add a bolt near the end to depress the spray-can release.

**How Much in the Can?** If you can distinguish one tone from another, you can easily and quickly estimate how much liquid remains in a spray can. All you do is grasp a wooden pencil firmly, then lightly tap the can with the rubber eraser from top to bottom, as shown in Fig. 3. With a little practice, you'll find that the sound of the tapping changes pitch when the eraser passes the level of the liquid

inside the can. As a test, try tapping the side of a partly filled can of water.

**Spatter Head.** An old cabinet can be given a new look with the "spatter" treatment. Simply replace the regular spray head on a can of enamel with another that spatters instead of sprays—see Fig. 4. When spatter painting, hold the can about three feet from the work. Newspapers or a drop cloth should be draped around the article being painted to protect the area which surrounds it.

**Rotate for Even Spraying.** A short burst from a spray can will coat small parts evenly and give them a professional finish if they are being rotated by a slow- or medium-speed drill (see Fig. 5). You can refinish split-shaft knobs, for example, by using a split bolt for the spindle. Cover the chuck and shaft of the drill with a paper sleeve and a piece of masking tape.

# Here's how you can receive the next 6 months of **POPULAR ELECTRONICS** Free...

as part of this special  
introductory offer:  
**18 months for only \$3.85!**

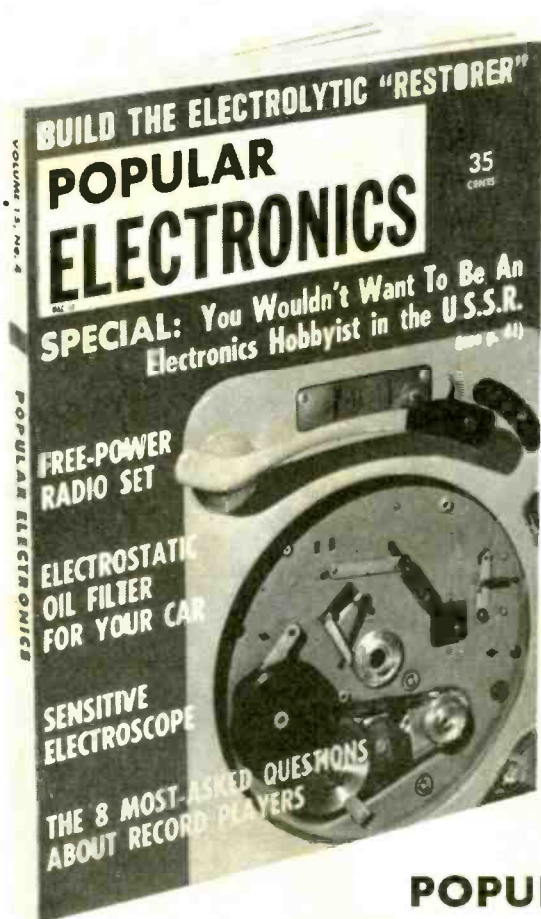

The regular subscription rate for 1 year (12 issues) of POPULAR ELECTRONICS is \$4. However, you can receive 18 project-packed issues for *less* than the regular price of 12—actually giving you 6 EXTRA ISSUES AT NO EXTRA COST!

If you like to take a set of diagrams and photos, a paragraph or two of clear directions, some simple tools, and build a practical, exciting electronics project—*then this offer is for you.*

During the next year and a half, POPULAR ELECTRONICS will bring you more than 270 projects—each one in complete detail, with exclusive "pictorial diagrams" that guide each step, complete parts lists, and clear instructions. Experts who have designed and built these projects will show you how to construct or assemble such valuable devices as hi-fi components and enclosures, money-saving test equipment, tape recorder gear, electronic games and computers, photo aids, radio apparatus, short wave receivers and antenna systems, solar powered and transistorized equipment—and much more.

POPULAR ELECTRONICS also reviews every major electronic kit released, gives full specifications, and the experts' opinions.

Just fill in the card opposite this page and mail it today. Or, if someone has already used the card, write to:

## **POPULAR ELECTRONICS**

Dept. 6921

434 S. Wabash Ave.

Chicago 5, Ill.

# Transistor Frequency Standard

By DONALD L. STONER, W6TNS and LESTER A. EARNSHAW, ZL1AAX

## Design of a one-transistor calibrator that generates 100-kc. marks at frequencies up through 30 megacycles

A NUMBER of publications have described several transistor communications receivers but none, to date, has included a frequency standard for spotting band edges—or if they have, the authors have missed such an article. Actually, the design of a device to generate 100-kc. interval marks up to 30 mc. pre-

sents some pretty knotty design problems.

One principal reason is that a transistor oscillator has far less output than its tube counterpart. Harmonics from a tube standard can be considerably attenuated and still be audible on 10 meters.

Harmonics from a transistor 100-kc. oscillator are heard with difficulty, if at all, on the 10-meter band. Consider that 28 mc. is the 280th harmonic of the fundamental and a crystal oscillator is not normally high in harmonic output. To increase the harmonic content, it becomes necessary to distort the oscillator waveshape in one way or another and then, with the aid of a suitable circuit, accentuate the harmonics that are desired.

**Theory of Operation.** The frequency standard shown in Fig. 1 is just such a circuit. It may be redrawn as shown in Fig. 2(A). Reduced to this form it will be immediately apparent that the circuit is nothing more than a transistor version of the simple Colpitts oscillator. Capacitor *C1*, in Fig. 2(A), is made up of both the variable padder and the base/emitter junction capacity. The latter may be quite high—as much as 1000  $\mu\text{f}$ .—with some transistors. Capacitor *C2* in Fig. 2(A) includes the collector-to-ground capacitance of the transistor. These two capacitors form a divider across the crystal. The small capacitor in series with the crystal effectively reduces shunt capacity which would otherwise tune the crystal to a frequency somewhat lower than 100 kc.

Distortion of the envelope is created by the non-linear transfer characteris-

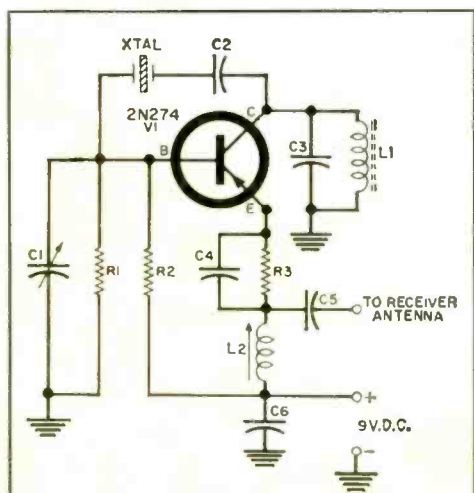
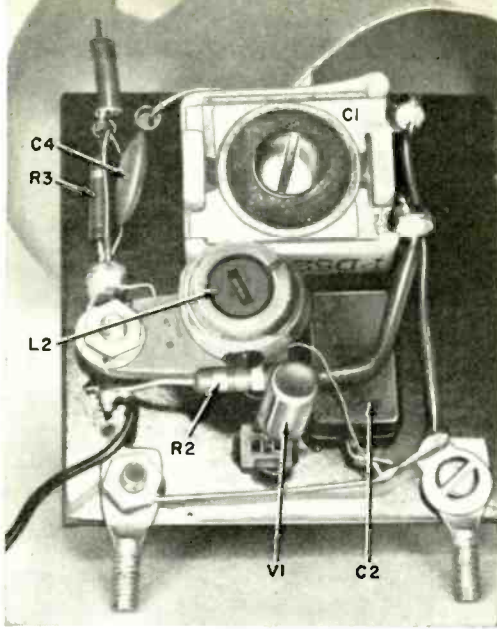
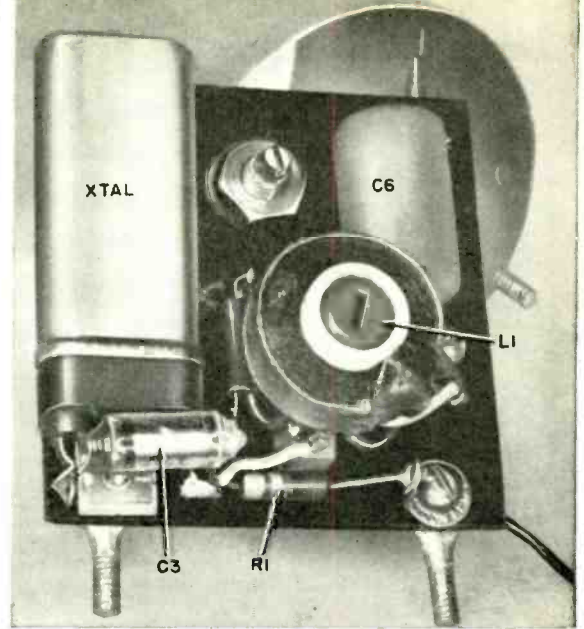

Fig. 1. Circuit diagram of the standard.

- R1—39,000-ohm,  $\frac{1}{2}$ -watt resistor
- R2—10,000-ohm,  $\frac{1}{2}$ -watt resistor
- R3—1000-ohm,  $\frac{1}{2}$ -watt resistor
- C1—60-600  $\mu\text{f}$ . padder capacitor
- C2—47  $\mu\text{f}$ . mica capacitor
- C3—500  $\mu\text{f}$ . paper capacitor
- C4—.02  $\mu\text{f}$ . disc ceramic capacitor
- C5—5.6  $\mu\text{f}$ . ceramic capacitor
- C6—.02  $\mu\text{f}$ . paper capacitor
- L1—10 mh. choke—see text
- L2—90 turns of #36 enameled wire, scramble-wound on  $\frac{3}{8}$ " slug-tuned form
- Xtal.—100 kc. crystal
- V1—2N274 transistor



Circuit is mounted in coil shield can shown in the background.



The crystal side of the Micarta circuit board used by authors.

tics of the transistor and harmonics are thereby produced.

Coil  $L2$ , in connection with the emitter capacity of the transistor, forms a tuned circuit which is resonated to the center of the 80-meter band. Thus, harmonics between 3.5 and 30 mc. are emphasized and output, even on 10 meters, is more than adequate.

**Construction.** There is nothing difficult about the construction of the frequency standard. A small piece of phenolic board makes an excellent chassis as can be seen in the photographs. The suggested construction size is 2" x 2". To prevent radiation of unwanted harmonics between 100 kc. and 3.5 mc., the entire unit may be placed in a discarded coil can of the type popular in broadcast receivers many years ago.

Inductance  $L1$  may be a choke with a minimum of 10 millihenrys inductance. The coil shown in the photographs was a winding from a discarded ARC-5, 85-kc. i.f. transformer. To increase its inductance, a powdered-iron slug was cemented inside the form.

**Adjustment.** Transistors other than the one specified in the parts list may require different values for  $C1$  and  $C2$ . The crystal is normally "pulled" to frequency by carefully adjusting the padder,  $C1$ , while

listening to a harmonic beating with WWV. Coil  $L2$  should then be adjusted for maximum output with the oscillator connected to the receiver antenna terminal and the dial set to 3.7 mc. Coil  $L2$  (Continued on page 161)

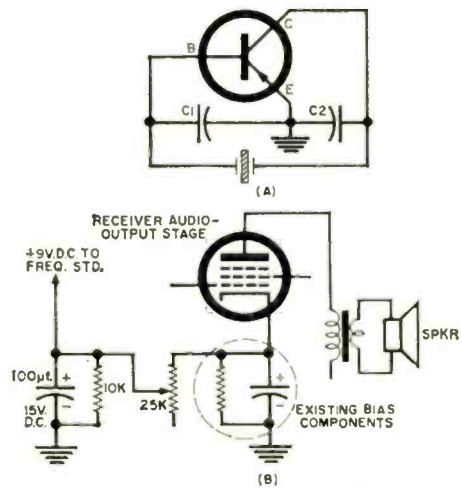

Fig 2. (A) The circuit may be redrawn to show a Colpitts-like oscillator configuration. (B) Novel method of obtaining +9 volts from an existing receiver. A portion of the audio output stage cathode bias voltage is used. Filter capacitor keeps audio signals from being fed to circuit.

**V**IBRATION PICKUPS are devices that change mechanical vibrations into electrical signals. Their action is similar to that of a microphone's when it converts sound (air vibrations) into a.c. signals. They can pick up a heartbeat, "listen" through a wall, or help track down a noise source.

Commercially available vibration pickups are generally in the \$100-and-up price range. However, all it takes to make a pair of pickups yourself is an interesting evening's work and a modest investment in components.

There are two types you can build—high-impedance and low-impedance units. The high-impedance pickup is most sensi-

drying, cut a circular hole in the case for the cap to pass through.

The cap does several jobs: it acts as a direct mechanical coupling between the vibrating object and the speaker's cone; it loads the speaker, peaking the low-frequency response and lessening its tendency to act as a microphone; and finally, it provides a smooth, non-scratching pickup surface. Vibrations are carried by the cap to the cone, thus moving the voice coil. The coil, vibrating in a magnetic field, generates an a.c. signal.

When using the low-impedance pickup, let the cap lightly touch the vibrating object and press the button. The output signal can be fed to either the high- or

## Track down squeaks, clinks, and thuds with...

# VIBRATION PICKUPS

By **LOU GARNER**

tive in the mid-audio frequency range, while the low-impedance unit responds best to lower audio frequencies.

**Low-Impedance Pickup.** A modified permanent-magnet, 45-ohm, intercom-type loudspeaker mounted in a metal case makes up the low-impedance pickup (see illustrations on next page). Also in the case is a normally closed push-button switch; unless depressed, it effectively shorts out the speaker and thus prevents harsh noises when setting up the unit.

Cement a light plastic "cap" to the cone of the speaker. The cap's exact size is not critical, but it must fit on the rigid portion of the speaker's cone, and it must be large enough to project through a hole in the metal case. (The author used a cap from a "blister pack" of 45-rpm record adapters.) While the cement is

low-impedance input of an audio amplifier. Feed the amplifier's output to another speaker, a pair of headphones, a voltmeter, an oscilloscope, or a combination of these instruments.

Although most high-gain audio amplifiers (hi-fi, p.a., signal tracer, etc.) are suitable for amplifying the pickup's signals, they are not suitable for listening to heartbeats. For this purpose, you'll need a direct-coupled scope as the amplifier and indicator, and you will have to lower the scope's sweep rate. Many better-quality scopes have a set of terminals on the front panel for an external capacitor to lower the sweep frequency—one cycle might be a good starting point.

**High-Impedance Pickup.** The high-impedance unit is simply a high-output crystal phonograph cartridge mounted



High-impedance pickup at right consists of phono cartridge mounted in plastic case. Above, unit is shown detecting vibration in fan base.

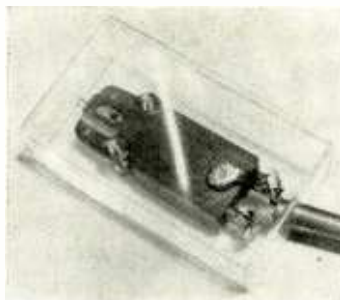

Low-impedance pickup, made from small 45-ohm speaker, uses plastic "cap" for mechanical coupling. The switch mounts on top of case.



in a small plastic case (see photographs at the left).

Drill mounting holes carefully so you won't crack the case. (The holes could be made with a hot nail, but you would have to trim away the excess raised plastic rim around the hole.) Use a length of shielded microphone cable with a suitable plug on one end to connect the pickup to an audio amplifier's high-impedance input.

When the high-impedance pickup is held against an object, any vibrations are carried to the cartridge case. The crystal bends with the movements of the case, and because of its piezo-electric properties, generates an electrical signal corresponding to these vibrations. The audio amplifier boosts the strength of this signal sufficiently to enable it to be listened to over a speaker or with earphones or to be observed on a scope. Noises in machinery or in cars are best detected with the high-impedance unit.

You can use your home-made pickups to listen to the "tick" of a watch, to locate a scraping noise in a machine, to check the effectiveness of shock-mounting a motor, or to find that squeak in the rear seat of your car. And you'll probably "pick up" other ideas as you go along.

-30-

## PARTS LIST

- P1*—Connector to match amplifier's input jack  
*S1*—S.p.s.t., normally-closed, push-button switch (Switchcraft 102 or equivalent)  
*Cap*—Light plastic cap (see text)  
*SPKR.*— $3\frac{1}{2}$ " P.M. speaker, 45-ohm voice coil (Quam 3A070T or equivalent)  
 1—5" x 4" x 3" aluminum chassis box (Bud CU-2105-A or equivalent)  
 1—36" length of shielded microphone cable  
*Misc.*—Household cement, screws, nuts, etc.

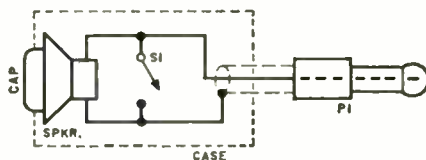

Schematic diagram and parts list for low-impedance pickup. Switch S1 is normally closed.

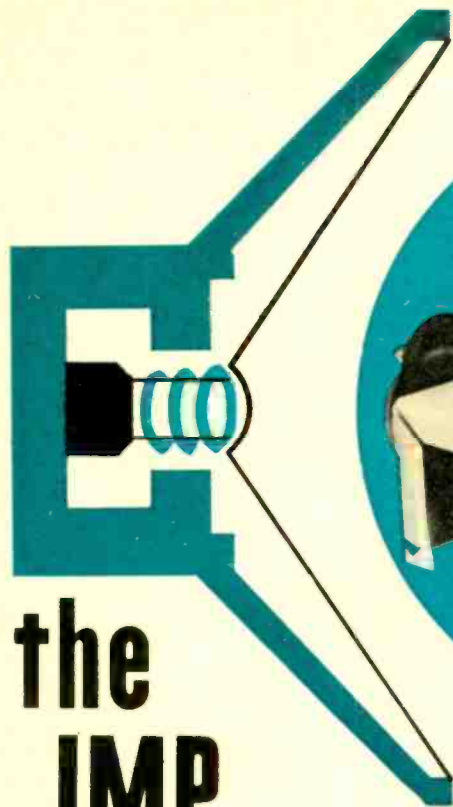

# the IMP SLEUTH

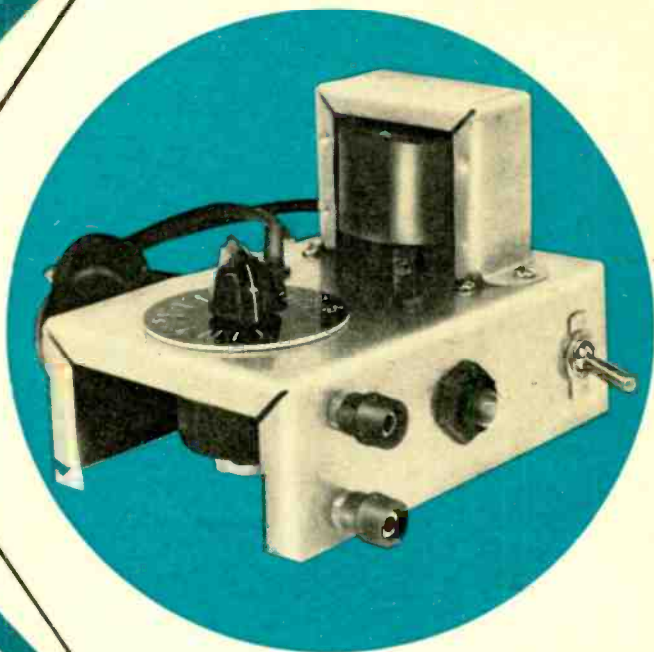

*Measure speaker voice coil  
impedance with bridge circuit*

By ANTHONY TROIANO\*

**M**ATCHING IMPEDANCES, as every hi-fi fan knows, is mighty important. But what can you do about those spare speakers around the house that carry no indication of what their impedances might be?

While you *could* simply measure the d.c. resistance of the speaker voice coils and assume that their impedances were roughly equal to these values, this would hardly solve the problem. A voice coil's impedance is *not* the same as its d.c. resistance and can actually be as much as ten times as large.

Speaker impedances, as you may already be aware, are usually measured at around 800 cycles with an a.c. bridge.

But such equipment is costly and ordinarily found only in laboratories. The "Imp Sleuth" described here is intended as a simple and inexpensive substitute.

Easily constructed from readily available parts, the "Imp Sleuth" utilizes the 60-cycle frequency of the a.c. line. While not the equal of its more elaborate counterparts, it can be used to obtain a fairly close approximation of speaker and even transformer impedances in the range from 0 to 25 ohms.

**Construction and Calibration.** Building the "Imp Sleuth" should be a snap, if you follow the schematic diagram closely and use the photos as a guide.

Although a Stancor Type P6465 or equivalent is specified for transformer T1 in the Parts List, this component can

\*Semiconductor and Materials Division,  
Radio Corporation of America, Somerville, N.J.

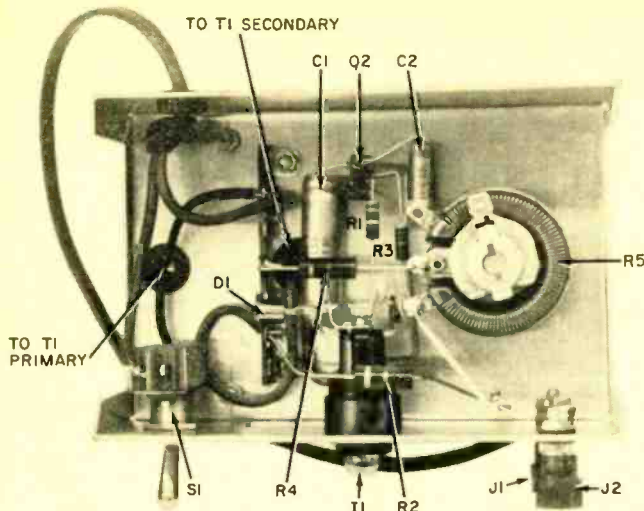

Bottom view of the "Imp Sleuth," showing location of most major components. Transistor Q1 is directly beneath indicator lamp I1 and therefore is not visible.

Schematic diagram of this inexpensive impedance-measuring device. Polarities of capacitors and diode must be observed; potentiometer R5 can be wire-wound.

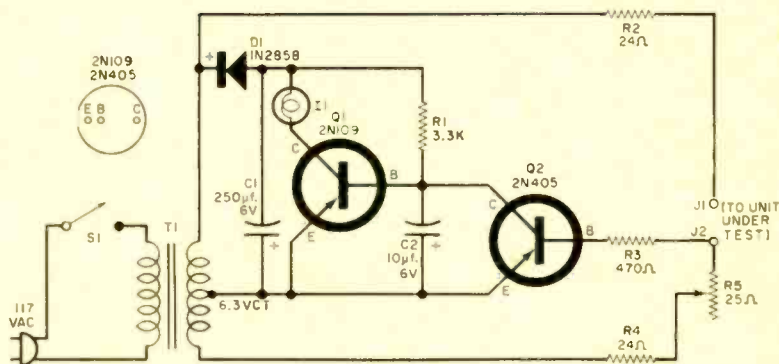

### PARTS LIST

- C1—250- $\mu$ f., 6-w.v.d.c. electrolytic capacitor
- C2—10- $\mu$ f., 6-w.v.d.c. electrolytic capacitor
- D1—1N2858 diode
- I1—Type 49 miniature lamp
- J1, J2—Insulated binding post
- Q1—2N109 transistor (RCA)
- Q2—2N405 transistor (RCA)
- R1—3300-ohm,  $\frac{1}{2}$ -watt resistor, 10% tolerance
- R2, R4—24-ohm, 1-watt resistor, 5% tolerance
- R3—470-ohm,  $\frac{1}{2}$ -watt resistor, 10% tolerance
- R5—25-ohm, 2-watt potentiometer, linear taper
- S1—S.p.s.t. toggle switch
- T1—Filament transformer: primary, 117 volts a.c.; secondary, 6.3 volts CT @ 0.5 amp. or more (Stancor P6465 or equivalent—see text)
- 1—2" x 4 $\frac{1}{2}$ " x 3 $\frac{1}{4}$ " open-end aluminum chassis (Bud CB-1625 or equivalent)
- Misc.—Mounting assembly for I1, switchplate for S1, pointer knob and dial for R5, sockets for Q1 and Q2, grommets, line cord and plug, wire, hardware, solder, etc.

have almost any current rating as long as it is center-tapped. When wiring, be sure that you connect the positive leads of electrolytic capacitors C1 and C2 to this center tap, and make certain that

you hook up diode D1 exactly as shown.

To calibrate the unit, simply place an ohmmeter across jacks J1 and J2. Rotate the pointer knob on R5 from minimum to maximum setting, and mark the various resistances indicated on the ohmmeter directly on the dial plate.

If an ohmmeter isn't available, you can calibrate the "Imp Sleuth" by an alternate method. Connect resistors of known value (in the range of 0 to 25 ohms) across jacks J1 and J2, then rotate the knob on R5 and mark the position at which indicator lamp I1 shows maximum brightness. Only three or four points need be marked; other values can be determined by extrapolation.

**Applications.** To measure the impedance of a speaker, connect its voice coil to jacks J1 and J2, and rotate the knob on R5 until indicator lamp I1 reaches maximum brightness. The impedance can  
(Continued on page 168)



# AUTOMATIC DIODE CHECKER



... for silicon power rectifiers

By **KEITH SUEKER**

Manager, Product Planning  
Semiconductor Div., Westinghouse Electric Corp.

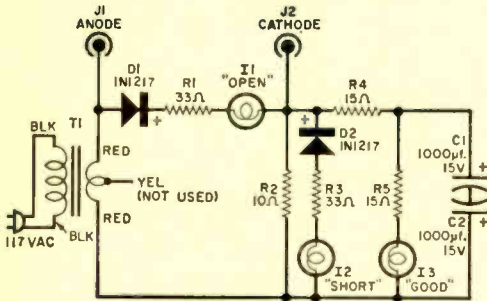

## PARTS LIST

- C1, C2—1000- $\mu$ f., 15-w.v.d.c. electrolytic capacitor
- D1, D2—1N1217 diode (Westinghouse)
- I1, I2, I3—#49 pilot lamp
- J1, J2—Combination binding post and banana jack; one red, one black
- R1, R3—33-ohm, 1-watt resistor
- R2—10-ohm, 5-watt resistor
- R4, R5—15-ohm, 1-watt resistor
- T1—Filament transformer; primary, 117 volts; secondary, 6.3 volts @ 1.2 amp (Stancor P6134 with secondary CT unused, or equivalent)
- 1—5 $\frac{1}{4}$ " x 3" x 2 $\frac{1}{8}$ " aluminum utility box (Bud CU-2106-A or equivalent)
- Misc.—Pilot lamp assemblies for I1, I2, I3, test leads, terminal strips, line cord, etc.

WITH the increasingly widespread use of silicon diode power-supply rectifiers, experimenters and servicemen alike find it handy to have a means for quickly checking them. This little unit was designed to do just that; all you have to do is plug it in and connect the suspected diode across its test jacks. Then, depending on which of the three pilot lamps lights up, you'll have an immediate indication of the condition and polarity of the suspected unit. The automatic checker will handle any silicon rectifier rated at 250 ma.—or greater—average current.

**Construction.** The checker is built in a 5 $\frac{1}{4}$ " x 3" x 2 $\frac{1}{8}$ " aluminum utility box. Parts layout and wiring are not critical; use the photos on page 157 as a guide.

In some cases, the author used two paralleled resistors to make up a resistance value specified in the Parts List. This was done only to take advantage of the contents of his spare-parts box, however. All of the specified resist-

(Continued on page 156)

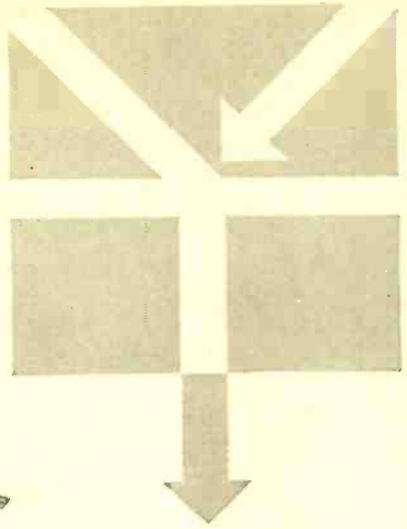
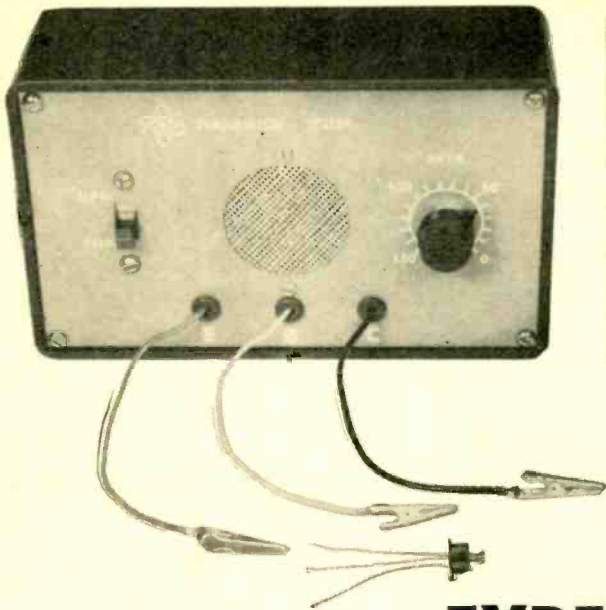

# EXPERIMENTER'S TRANSISTOR TESTER . . . checks 'em all

By CHARLES CARINGELLA, W6NJV

**A**N inexpensive, yet reliable and accurate transistor tester is something no experimenter should be without. There are plenty of testers on the market, of course—including some sophisticated laboratory models costing hundreds of dollars, but most of them aren't intended for the average experimenter. Why? Because when you're constructing equipment from P.E. articles or even when you're breadboarding an original idea of your own, you usually have only one concern—is your transistor *good* or *bad*?

The tester described here greatly simplifies the testing problem by eliminating most of the tests you probably have no interest in. Furthermore, it offers several distinct advantages of its own. First, and most important, this tester will check most transistors *in* as well as *out* of the circuit. What's more, it's capable of testing all types of transistors, including power, low-level audio, and even r.f. types. And finally, it uses only a handful of parts, and can easily be built in a single evening for \$5.00 or so.

**About the Circuit.** As you can see from the schematic (on page 155) the transistor under test becomes part of an audio oscillator circuit when it's hooked

up to the tester. If your transistor is "good," an audio tone will be heard in the speaker. If your transistor is "bad," no tone will be heard.

The feedback to produce oscillation is provided between the transistor's collector and base by transformer *T1*, with the amount of feedback determined by the setting of "*Beta*" control *R3*. This control, incidentally, is calibrated from 0-150 in units which correspond approximately to the small-signal current gain (*beta*) of the transistor.

In actual operation, the control is ro-  
(Continued on page 154)

# NICKEL-CADMIUM BATTERY CHARGER

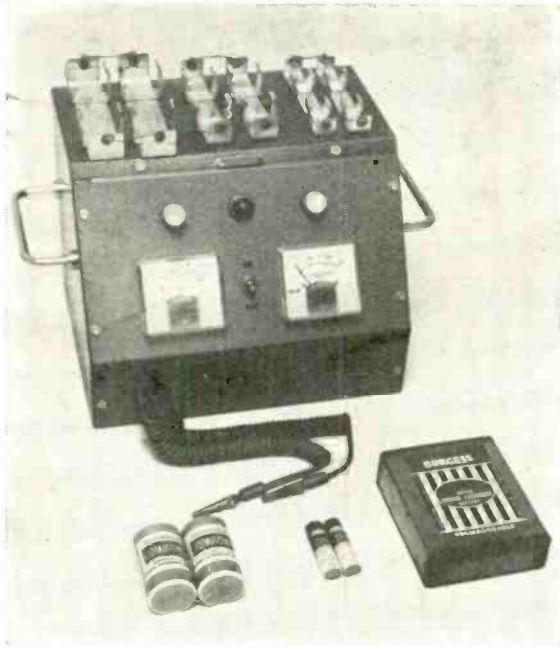

*Heavy-duty charger  
with two  
output circuits  
extends life  
and usefulness  
of N-C batteries*

By **HERBERT FRIEDMAN, W2ZLF**

**W**ITH everything from transistor radios to children's toys being powered by batteries these days, even the average family is apt to spend a sizable amount of money each year on battery replacements. Accordingly, the nickel-cadmium battery (once practical only for large-scale industrial use) is now finding its way into many homes and workshops. Though they represent a high initial investment, most nickel-cadmium batteries can be recharged considerably more than a thousand times. In addition, these batteries are virtually leakproof and are now available in a variety of popular sizes.

After making the switch to nickel-cadmium batteries, the author soon found

himself using several different types—each having a different charging-current requirement. The battery charger described here was designed to meet all present needs and to anticipate any which might come up in the future. It has two fully adjustable outputs—one delivering a maximum of 500 ma., the other a maximum of 150 ma. These outputs can be used individually or simultaneously; they'll charge most nickel-cadmium batteries from the smallest flashlight types to the largest sizes employed as power supplies for electronic flash guns.

**Construction.** For neatness of appearance and ease in reading the meters, the unit is housed in a 8" x 10 $\frac{1}{16}$ " x 8"

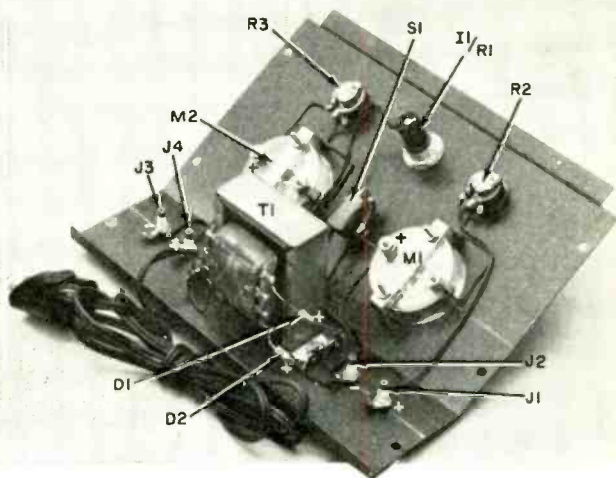
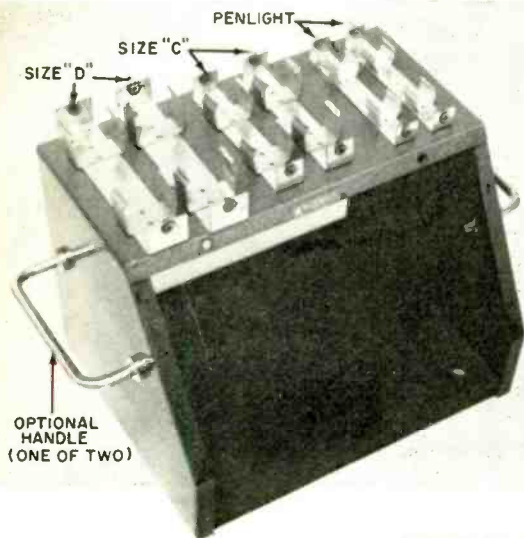

Holders for three sizes of nickel-cadmium cells are mounted on top of cabinet (above, left), but all charging-circuit components are installed on the front panel (above, right). Jacks J1-J4 must be of the insulated type.

sloping-panel cabinet. All of the components in the charging circuit are mounted on the panel itself, and a series of holders for the batteries to be charged is installed on the cabinet top.

There's no permanent electrical connection between the battery holders and the charging circuit, incidentally. The holders are wired to the charger, as needed, via leads plugged into J1-J2 and/or J3-J4.

You can get a good idea of the parts layout from the photographs and pictorial diagram. Notice that the two current-control potentiometers (R2 and R3) have been mounted *above* the meters, so that any heat generated by the controls will not damage the plastic meter cases. Notice also that, contrary to usual practice, T1's center tap is not grounded. This prevents unwanted contact between the battery holders and the charging circuit. Jacks J2 and J3 therefore, like jacks J1 and J4, should be of the insulated type.

The pilot-light assembly specified in the Parts List has current-limiting resistor R1 built in. If you use an assembly without this built-in resistor, R1 must be installed externally.

The choice of the battery holders to be mounted on top of the cabinet is up to you. Six double holders were used by

the author: two for "D" cells, two for "C" cells, and two for penlight cells. Each pair of holders was wired in series so that, depending on the placement of the leads, two or four cells of any type could be charged at once. Batteries with clip or screw terminals, of course, can be connected directly to the test leads and need no holders.

To make the charger easier to carry, you can, if you wish, install a pair of handles on the sides of the cabinet. Finally, provide yourself with two sets of output leads, and you're ready to go. The output leads pictured here were made from coiled-cord test leads and will not easily become tangled with other equipment on the bench.

**Using the Charger.** First determine the charging rate for the battery to be charged. This figure is often printed on the battery case; if it is not, the manufacturer will supply it. Charging rates are usually given in terms of current to be applied for 14 or 16 hours. Some manufacturers also specify a "rapid charge" rate, involving a larger amount of current applied for a shorter period of time.

Try not to use a "rapid charge" unless you are desperate for battery power, and never use it unless you are certain of the exact recommended rate. Too high

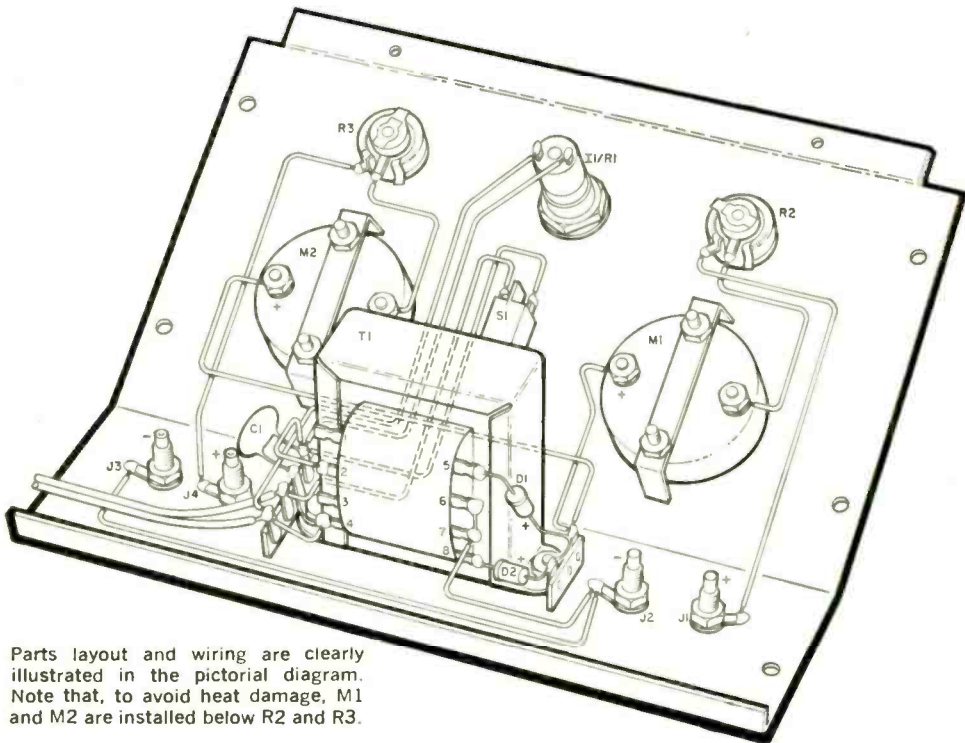

Parts layout and wiring are clearly illustrated in the pictorial diagram. Note that, to avoid heat damage, M1 and M2 are installed below R2 and R3.

a charging rate can build up enough pressure to burst the battery case. Some nickel-cadmium batteries now have built-in safety valves to relieve this pressure, but once the valve releases, the battery is ruined.

When you've determined the proper charging rate, place the battery, or batteries, in the appropriate holder(s) and connect the charger output leads. The positive lead goes to the positive battery terminal, the negative lead to the negative terminal. If the battery has termi-

nals to which the output leads can be directly connected, as already mentioned, it's not necessary to use a holder. Groups of batteries to be charged simultaneously should be placed in series, so that each battery gets the same current.

If the charging rate is under 150 ma., use either output (jacks J1-J2 or J3-J4). If it's more than 150 ma., use only J1-J2.

Before turning on the charger, set the current-control potentiometer to be used (R2 and/or R3) at minimum current. Then flick on switch S1 and set the con-

#### PARTS LIST

- C1—0.005- $\mu$ f., 500-volt ceramic capacitor
- D1, D2—Silicon diode, at least 0.75 amp., 100 PIV
- F1, F2—0.5-amp., 3AG fuse (in line plug)
- I1—NE-51 neon lamp
- J1, J2, J3, J4—Insulated tip jack (two red, two black)
- M1—0-500 ma. panel meter (EMIICO RF-2 $\frac{1}{4}$ C Series or equivalent)
- M2—0-150 ma. panel meter (EMIICO RF-2 $\frac{1}{4}$ C Series or equivalent)
- R1—56,000-ohm,  $\frac{1}{8}$ -watt resistor (supplied in pilot light assembly listed at right)
- R2—100-ohm wire-wound potentiometer, at least

- 6 watts (Ohmite Type 0112 or equivalent)
- R3—250-ohm wire-wound potentiometer, at least 2 watts (CTS Type 252 or equivalent)
- S1—S.p.s.t. toggle switch
- T1—Filament transformer: primary, 117 volts; secondary, 24 volts CT @ 1.0 amp. (Triad F-45X or equivalent—see How It Works)
- 1—Pilot light assembly for I1 (Dialco 95408X-931 or equivalent)
- 1—8" x 10 $\frac{1}{16}$ " x 8" sloping-panel cabinet (Bud C-158811G or equivalent)
- Misc.—Knobs for R2 and R3, test leads, line cord with fused plug, terminal strips, battery holders, cabinet handles, etc.

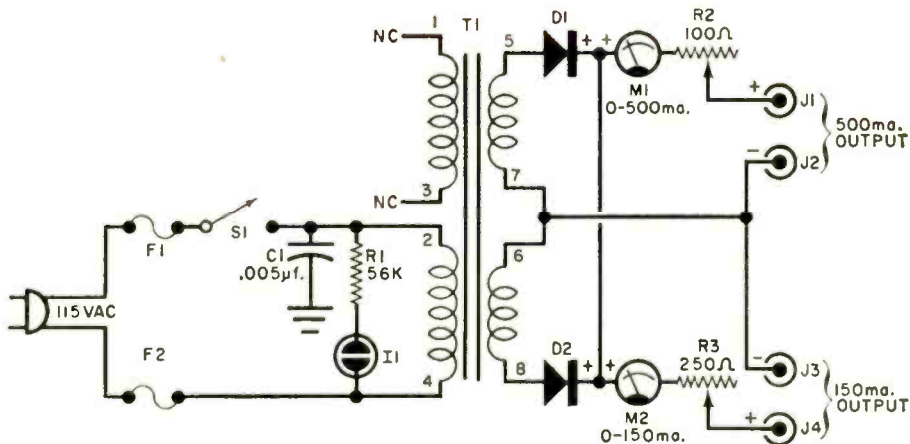

Two diodes are used as a full-wave rectifier, but T1's center tap, contrary to usual procedure, is not grounded. Both d.c. outputs can handle up to 500 ma.; however, one output is limited to 150 ma., which is more than adequate to handle almost all of the battery types experimenters use.

#### HOW IT WORKS

Power transformer *T1*'s secondary is connected to a standard, full-wave rectifier (diodes *D1* and *D2*). The resulting d.c. (12 volts) is available either at jacks *J1* and *J2* (the 500-ma. output) or jacks *J3* and *J4* (the 150-ma. output). Current taken from the former output passes through meter *M1* (0-500 ma.) and potentiometer *R2*; current taken from the latter passes through meter *M2* (0-150 ma.) and potentiometer *R3*.

For transformer *T1*, the author used an industrial control model (Stancor P-6377) which he had in his spare-parts box. This transformer has

a 115/230-volt primary and two 12-volt secondaries: it was wired (see schematic and pictorial diagram) for a 115-volt input and a 24-volt CT output. Such an elaborate unit is not really necessary, and the simpler, lighter-duty transformer specified in the Parts List will work just as well. It's similar to the P-6377 in style, but has wire leads instead of the numbered terminals shown.

The charger is protected by two fuses (*F1* and *F2*) located in the line plug. Switch *S1* controls the power, and neon bulb *I1* (with limiting resistor *R1*) acts as a pilot light.

control for the proper charging current. Leave the battery, or batteries, on charge for the recommended amount of time, and that's all there is to it.

To insure maximum life, a nickel-cadmium battery should be recycled three or

four times a year. Recycling simply means allowing the battery to become completely discharged before recharging it. This procedure arrests internal "plating," which would reduce the battery's efficiency.

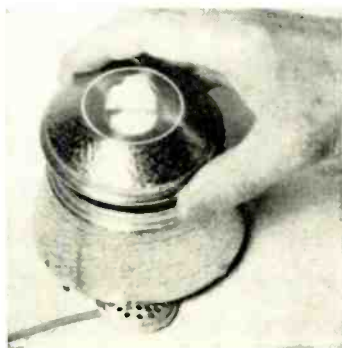

#### PINT-SIZED CARILLON

The tinkling of a music box will have a carillon-like effect if played through your hi-fi system. All you need to pick up the sound is a low-priced crystal microphone (Lafayette MS-108 or equivalent) placed under the unit. Most hi-fi amplifiers aren't equipped with a mike input, but a magnetic phono or tape-head input will provide plenty of gain. The bass boost from the phono or tape equalization circuit shouldn't affect the essentially high frequency sound of the music box. However, if too much mechanical noise is picked up, try experimenting with the position of the mike.

—Art Trauffer

# BREAK THROUGH TO HIGHER PAY

# in ELECTRONICS

# TV-RADIO

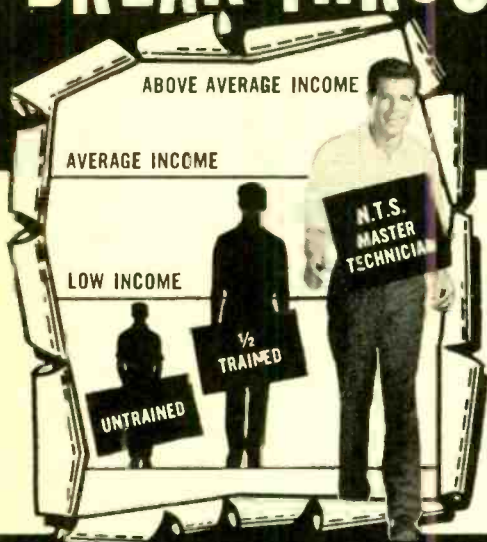

**START NOW!** Break through the Earning Barrier that stops half-trained men. N.T.S. "All-Phase" training prepares you — at home in spare time — for a high-paying CAREER in Electronics — TV — Radio as a MASTER TECHNICIAN. One Master Course at One Low Tuition trains you for unlimited opportunities in All Phases: Servicing, Communications, Preparation, F.C.C. License, Broadcasting, Manufacturing, Automation, Radar and Micro-Waves, Missile and Rocket Projects.

A more rewarding job... a secure future... a richer, fuller life can be yours! As an N.T.S. MASTER TECHNICIAN you can go straight to the top in industry... or in your own profitable business.

You work on actual job projects

## SUCCEED IN MANY HIGH-PAYING JOBS LIKE THESE...

- TV-Radio Sales, Service and Repair
- Profitable Business of Your Own
- Communications Technician — F.C.C. License
- Hi-Fi, Stereo & Sound Recording Specialist
- TV-Radio Broadcasting Operator
- Technician in Computers & Missiles
- Electronics Field Engineer
- Specialist in Microwaves & Servomechanisms
- Expert Troubleshooter
- All-Phase Master Technician

## 19 BIG KITS YOURS TO KEEP

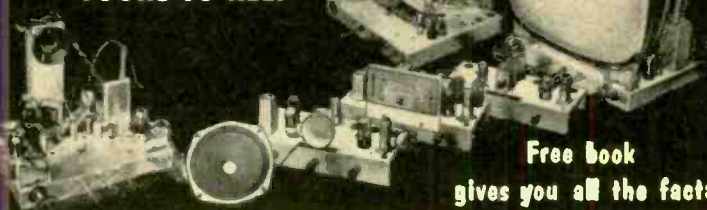

Free book gives you all the facts

## NATIONAL TECHNICAL SCHOOLS

WORLD-WIDE TRAINING SINCE 1905

4000 SO. FIGUEROA ST., LOS ANGELES 37, CALIF., U. S. A.  
Write Dept. R5A-33



### RESIDENT TRAINING AT LOS ANGELES

If you wish to take your training in our Resident School at Los Angeles, the world's TV capital, start NOW in our big, modern Shops, Labs, and Radio-TV Studios. Here you work with latest Electronic equipment—professionally installed—finest, most complete facilities offered by any school. Expert friendly instructors. Personal attention. Graduate Employment Service. Help in finding home near school—and part time job while you learn.

WRITE FOR SPECIAL RESIDENT SCHOOL CATALOG AND INFORMATION



ACCREDITED MEMBER  
... the only nationally recognized accrediting agency for private home study schools.

N.T.S. Shop-Tested HOME TRAINING is **Better, More Complete, Lower Cost**... and it is your key to the most fascinating, opportunity-filled industry today!

### YOU LEARN QUICKLY AND EASILY THE N.T.S. SHOP-TESTED WAY

You get lessons, manuals, job projects, unlimited consultation, graduate advisory service.

You build a Short Wave-Long Wave Superhet Receiver, plus a large-screen TV set from the ground up, with parts we send you at no addi-

tional cost. You also get a Professional Multimeter for your practical job projects.

### EARN AS YOU LEARN... WE SHOW YOU HOW!

Many students pay for entire tuition — and earn much more — with spare time work they perform while training. You can do the same... we show you how.

**SEND FOR INFORMATION NOW... TODAY! IT COSTS YOU NOTHING TO INVESTIGATE.**

### N.T.S. HOME TRAINING is

- Classroom Developed
- Lab-Studio Planned
- Shop-Tested
- Industry-Approved
- Specifically Designed for Home Study

### ACTUAL LESSON



**MAIL COUPON NOW** for **FREE BOOK** and **ACTUAL LESSON**

## NATIONAL TECHNICAL SCHOOLS

WORLD-WIDE TRAINING SINCE 1905

Mail Now To  
National Technical Schools, Dept. R5A-33  
4000 S. Figueroa St., Los Angeles 37, Calif.

Please rush **FREE** Electronics-TV-Radio "Opportunity" Book and Actual Lesson. No Salesman will call.

Name \_\_\_\_\_ Age \_\_\_\_\_

Address \_\_\_\_\_

City \_\_\_\_\_ Zone \_\_\_\_\_ State \_\_\_\_\_

Check here if interested ONLY in Resident training at Los Angeles.  
VETERANS: Give date of discharge.

**NO OBLIGATION!  
NO SALESMAN WILL CALL**

## SURPLUS BARGAINS SURPLUS BARGAINS

BC-733 RADIO RCVR, converts to FM rcvr, w/conv sheet	\$7.00
BC-453 Q'5r RCVR, 190-550 kc, xInt cond.	12.75
IBM MEMORY PLANE, 200 bit plane \$5.00; 8,000 bit plane	15.00
NIKE BATTERY, charged, 12. volt 6 amp hr	2.00
IBM COMPUTER sub-assembly w/wired memory plane	2.75
IBM COMPUTER sub-assembly, over 100 parts	1.00
TELESCOPE, PANORAMIC TYPE, rotates 360°, 3 power	7.50
17 FT GIANT BALLOON, aluminum coated, weighs 25 lbs.	4.50
PRINTED CIRCUIT copper laminated board, 4 x 10 inch	8/1.00
SNIPERSCOPE as used on military rifles, ready to use	150.00
GEIGER COUNTER KIT, with 900 volt power supply	9.50
MINIATURE MOTOR, operates from 1.5 volt btry.	.50
AIRCRAFT AMPLIFIER with conv. sheet for phone patch	1.25
TRANSISTORS, 15 gen. purpose PNP	1.25
EARPHONE, single phone, 1,000 ohm	.35
SNIPERSCOPE IR VIEWER TUBE #6032, with spec sheet	7.50
DISC CAPACITORS, 100 mixed with ratings marked	1.00
ALNICO HI-POWER magnets, bag of 4	1.00
PERISCOPE PRISMS, optical glass 5 Inches long.	1.00
SOUND POWER PHONES w/100 ft wire	2.00
RESISTORS, carbon, with ratings, bag of 100	1.00
TELESCOPE, M-7 elbow scope 8 power, xInt cond.	12.50
LM FREQ. METER w/orig calib book	49.00
TELETYPE PERF. PAPER 11/16 inch wide, case 40 rolls	5.00
TELESCOPE, ZOOM FOCUS 10-20 power, govt cost \$700.	25.00
IBM COMPUTER plug-in assembly w/6 transistors, diodes, toroids, resistors, tantalum cond, a bonanza of parts	2.00
28 VOLT DC POWER SUPPLY 4 AMPS, unused govt cost \$300, operates from regular 115 volt house power.	12.50
REMOTE CONTROL, #TDZ, unused, gadgeteers delight, tel. dial, 3 selsyn indicator meters, switches, parts galore, Govt cost \$200 each.	6.00
SUN BATTERY, make electricity from sunlight. Solar bank kit of 5 cells w/book 13 experiments.	1.50
SEXTANT, late model #5851 automatic averag. Exint w/book	12.50

Above is only a small selection from our giant 70 page illustrated catalog of govt surplus material. Send 10c handling cost for catalog.

**JOHN MESHNA JR.**  
19 Allerton Street, Lynn, Mass.

CIRCLE NO. 31 ON READER SERVICE CARD

## Electronics Schools

(Continued from page 92)

In all cases, the schools use this laboratory and shop equipment to reproduce actual industrial and commercial situations, giving you the opportunity to "learn by doing."

Although the shop and laboratory programs vary with each school, all schools follow a general pattern of demonstration and lecture on a group or class basis, followed by individual instruction. When your class progresses to a particular shop or laboratory, each item of equipment is fully explained in class lectures and demonstrations. The instructors describe what the equipment is for, how it operates, and how it is used. Sometimes, these lectures are supplemented with various technical films.

After the theoretical discussion and practical demonstration at the class level, each student, or group of two or three students, will perform experiments using the particular item of equipment. This gives each student an opportunity to "get the feel" of test equipment. Once you've completed these courses, you should be able to recognize all standard types of test instruments, and use them without fumbling over the knobs or connecting an ohmmeter across a high-voltage source!

**Tools and Equipment.** Normally, you will not be required to provide any tools or test equipment for residence training. Most schools lend you a complete kit of tools (and sometimes simple test equipment, such as an ohmmeter) for the duration of the course. There is no additional charge, unless the tools or equipment are damaged or missing when it's time for you to return them.

Some schools recommend that you purchase your own set of tools and will provide tool kits at reduced cost. Other schools make standard test equipment available to students at discount prices. In general, reference texts, slide rules, and similar items are also supplied at reduced cost. Occasionally, a school will recommend that you buy special reference texts.

(Continued on page 152)





## FREE — world's biggest electronic kit catalog

### Fastest growing hobby of the space age — Heathkits!

Explore this most rewarding of "do-it-yourself" ideas. Heath combines fine components and latest engineering techniques with complete check-by-step instructions to provide quality electronic kits with guaranteed performance specifications. Choose stereo/hi-fi, marine gear, ham radio, test & lab instruments, educational courses, home, hobby & auto items. It's fun, it's easy, and you save up to 50% . . . by buying direct and by assembling your own Heathkit.



- Please send my FREE copy of the 100 page 1963 Heathkit catalog describing over 250 electronic kits.

Name \_\_\_\_\_

Address \_\_\_\_\_

City \_\_\_\_\_ Zone \_\_\_\_\_ State \_\_\_\_\_

**HEATH COMPANY**  
Benton Harbor 10, Michigan

## ADVANTAGES OF RESIDENT SCHOOLS

You have personal contact with your instructors. There are those who say a picture is worth 1000 words, but a demonstration is often worth 10,000 words. If you are one of these people, residence training is your best bet. In other words, if you have difficulty in learning a manual skill (such as soldering, operating test equipment, etc.) until you have seen someone else do it, or if it gives you more confidence to have an expert at your shoulder to check your work, you should definitely choose residence training.

You'll find companionship with others in the same status. At best, a thorough study of electronics is a long, hard road. Some people prefer to make this "trip" with others. You may be able to gain a better understanding of a subject if you can discuss the problems with other students in the same situation. Most residence schools encourage this type of group discussion, as well as group activities outside of class.

You'll see major electronics installations firsthand. Practically all resident-type electronics schools conduct class field trips to local manufacturing concerns, TV shops, broadcast studios, and research laboratories. This gives the students an opportunity to see professional technicians at work and to see today's electronics equipment in use.

A wider range of equipment is available. It's quite obvious that a home-study school is not going to ship you a complete working model of a shipboard or aircraft radar. Nor are they going to install a full-scale electronic computer in your home. But both of these units (or units of the same complexity) are available at the laboratories of various technical institutes. It would even be difficult for a home-study course to supply all of the equipment found in the average TV service type of residence school. So if you want exposure to specialized equipment, it would be best for you to consider resident training.

**What About Cost?** As is the case with home-study courses, all in-residence electronics training courses do not cost the same amount. The best "yardstick" to cost is that you will pay between 75 cents and \$1.00 for each classroom hour of residence training. Thus, a 9-month

TV servicing course (1080 hours, based on 36 weeks at 30 hours a week) will cost between \$750.00 and \$1000.00.

Except for the length of training, the difference in cost often reflects the quality and scope of the program.

If you can pay for a course in cash at

# ELECTRONIC SURPLUS BARGAINS SAVE UP TO 90%

### RCA 6032 IMAGE-CONVERTER TUBE

Combined with suitable optical systems, this 3-electrode tube permits viewing of scene with infrared radiation. Scene to be viewed is imaged by optical objective upon semi-transparent photocathode. Spectral resp., S-1; good response up to about 1200A. Max. ratings, absolute. grid #2, 20,000VDC or peak AC. grid #1, 2700 VDC. \$9.95 ppd.



### NICKEL CADMIUM BATTERY 1.2 VOLTS

Rechargeable thousands of times. Alkaline storage battery sintered-plate. Flat voltage curve during discharge. Will hold charge for long period of time. High discharge rate up to 50 amps. Spill-proof, may be used in any position. Approx. 6-ampere-hour capacity. Dimensions: 6" high; 2" wide; 1/2" thick. Approx. wt.: 6 oz. Uses potassium hydroxide (30% Electrolite). \$1.95



### SILICON RECTIFIERS

All rectifiers listed at maximum peak inverse voltage ratings; approximate forward voltage drop, 1.5 volts.

1N1446	.075	amp.	100 volts	.50
1N1447	.075	amp.	200 volts	.60
1N1448	.075	amp.	300 volts	.75
1N1449	.075	amp.	400 volts	.85
1N1450	.5	amp.	100 volts	1.00
1N1451	.5	amp.	200 volts	1.25
1N1452	.5	amp.	300 volts	1.50
1N1453	.5	amp.	400 volts	2.00
1N1454	.25	amp.	100 volts	3.00
1N1455	.25	amp.	200 volts	3.50
1N1456	.25	amp.	300 volts	4.50
1N1458	.35	amp.	100 volts	3.50
1N1459	.35	amp.	200 volts	4.00
1N05P7	.50	amp.	50 volts	6.00
1N1462	.50	amp.	100 volts	7.00
1N1466	.75	amp.	100 volts	10.00
1N1467	.75	amp.	200 volts	11.00
1N1468	.75	amp.	300 volts	12.50
1N05V7	1.50	amp.	50 volts	16.50
1N1474	1.50	amp.	100 volts	17.00

### NT-6 WILLARD 6-VOLT STORAGE BATTERY

Rated 2.4 amp hr. Approx. dimensions: 3 1/2" x 1 1/4" w. x 2 1/2" h. Weight: 1 lb. 3 oz. (plastic case) Dry-charged. \$2.50

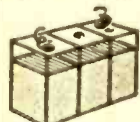

### SIGMA; EXTRA-SENSITIVE PRECISION RELAY—SERIES; SF

Extremely precise, rugged DC general purpose sensitive relay. Balanced armature, single-pole, double-throw. Suitable for wide range of adjustments. Dimensions: 1 3/4" x 1 1/16" x 1 1/4" high. Weight: 4 1/4 oz. 15F-10,000S: 10,000 coil ohms. Operates 1.0 ma DC \$4.95  
5F-16,000-S: 16,000 coil ohms. Operates 0.5 ma DC \$5.95



### POTTER & BRUMFIELD RELAY

#SM5LS SPDT 8,000 ohm 1 1/4" dia. x 1 1/4" long. Approx. weight 1 oz. Hermetically sealed. Standard 7-pin miniature base. \$2.00



### POWER TRANSFORMER

Output: 12, 24, 36 volts. Input: 100 volts, 60 cycles, single-phase. Will handle 2 1/2 amps. Steel case is hermetically sealed. 3 1/2" x 2 3/4" x 4 1/4". Wt.: 3 1/2 pounds. \$2.95



### MINOR SWITCH

10-position, 3-pole with stopper coil and reset coil 6-12 volts D.C. off-normal non-bridging wiper approx. dimensions: 4" long x 4 1/2" high x 1 1/8" wide, weight: 1 lb. \$9.95



### DIRECT-READING MAGNETIC COMPASS

Full-floating card, compensating magnets, and dial light avail. In 6- or 12-v. bulb. Luminous dial. Mfgd. by Bendix-Pioneer. 3 3/4" x 3 3/4" x 3 3/4". 1 1/2 lbs. \$8.50 postpaid.



### X-BAND POWER LEVEL TEST SET, TS-36/AP

Brand new, in original packing, with accessories. Measures 10 to 30 dbm. 8700-9500 mc. \$14.95



All prices FOB Pasadena unless otherwise noted. No COD's.

## C & H SALES CO.

2176 E. Colorado St., Pasadena, Calif.  
MUrray 1-7393

## DISADVANTAGES OF RESIDENT SCHOOLS

School is a "full-time job." This is the most obvious drawback to in-residence training. Unless you plan to take an evening course, you must spend about 25 hours a week in class, and devote a few more hours to homework. This routine is extremely difficult when added to another 40 hours on a full-time job. Even if you are working only part time and can get along on the reduced income, you'll find that the strain will show up after a few months.

**Schedules must be maintained.** Unlike home study, you must keep up with the "class average" in residence-type work. If you're slow in learning or you find the subject difficult, you will always be under pressure. If you're fast, you may become impatient and will probably become bored. Even if you're "average," you will have to scramble to catch up if you happen to miss a few classes.

**Study is difficult to interrupt.** Because you must keep up with the class, residence schools can't tolerate frequent or long interruptions in training, no matter what the cause. This means

that illness or personal problems can easily throw you off. Most residence schools will drop you back a class after a prolonged absence. Or, they could ask you to prove (by special examination) that the interruption did not affect your standing. If these interruptions are frequent, the school may ask you to discontinue the training until you have placed your affairs in order.

**Study material is not repeated.** Except in very rare cases, lectures, class demonstrations, and examinations cannot be repeated for individual students. If you miss something of importance, you'll just have to get along without it. Even more significant, if you don't understand a particular point, you will have a very limited opportunity to question the instructor on an individual basis. Obviously, an instructor with 20 or 30 students cannot handle more than about one question per student. On the other hand, you can read each home-study lesson as many times as necessary. Likewise, your home-study instructor will answer all questions, and in writing.

the beginning of it, you will receive a substantial discount on the overall price. However, the technical institutes and other schools offering long courses do

not expect you to plunk down \$2000.00 or more.

A great number of schools arrange for weekly (about \$25.00), monthly (about

**VACUUM TUBE VOLT METER KIT (6-INCH METER)—** RMS and p. to p. scale. Input imped. 12.2 megs. Professional performance and appearance. Kit: **\$31.95**  
Assembled: **\$44.95**



**"CUSTOM 70" TV SET KIT—**Excellent sensitivity. Transformer power supply; 3 stages of IF. Includes slimline cabinet, 19 inch picture tube—everything. NOT a portable. Kit Price: **\$135.00**

**TRANSISTOR RADIO KIT—**Superb tone and sensitivity. No delicate printed circuits. Attractive, durable case. All U.S. made parts. Kit: **\$25.50**



**5-INCH WIDE BAND OSCILLOSCOPE KIT—**For black-white, color, AM-FM and electronic applications. High intensity trace. Extremely stable sync. Advanced design. Kit: **\$89.50**  
Assembled: **\$139.50**

## Get your FREE 1963 CATALOG from CONAR

It's full of exciting new electronic kits of highest quality. Many items available in both kit or assembled form. Home entertainment items that make perfect family gifts or test instruments for the technician who appreciates quality and high performance. Tools, too, to make your work easier, faster. And you'll like the reasonable prices and convenient payment plans which make CONAR Kits easy to own. Mail coupon for new 1963 Catalog now.

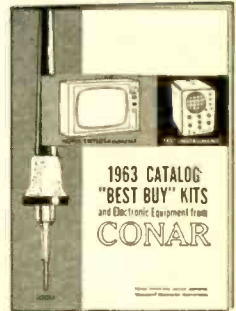

# CONAR

division of  
NATIONAL RADIO  
INSTITUTE

**Mail this Coupon**

**GUARANTEE**  
Parts and performance guaranteed by NRI—nearly 50 years of pioneering in Electronics.

CONAR  
3939 Wisconsin Ave., N.W.  
Washington 16, D.C.

AQ3C

Send me your new 1963 CONAR KIT CATALOG

Name

Address

City  Zone  State

\$100.00), or quarterly (about \$250.00) pay-as-you-go installments after you have made an initial down-payment. Usually, this type of plan allows you to discontinue the course at any time.

A number of schools offer a contract plan in which you make an initial down-payment, and fixed monthly payments until the total price is paid, no matter

how long the course takes. They usually offer this as an alternative to the pay-as-you-go plan, and at a substantially reduced cost. But you are under obligation to pay for the course, whether you finish it or not. You can definitely save money this way, but you should understand the contract and make sure of your future plans before you sign it. -30-

## Transistor Tester

(Continued from page 144)

tated from the 150 position toward the zero point until the audio tone is heard. The point at which the oscillation just begins is the approximate transistor *beta* or  $h_{FE}$ —probably the most meaningful of the various parameters, since it determines the gain which can be expected from the transistor.

The tester is powered by two penlight cells in series, and switch *S1* reverses battery polarity so that both *pnp* and *nnp* types can be tested. If the type of transistor is unknown, it can be quickly determined by

switching between the *pnp* and *nnp* positions and rotating the *beta* control until oscillation is heard. And regardless of the position of switch *S1*, there's no danger of burning out a transistor, since the voltages are comfortably low and the tester's circuit includes current-limiting resistors.

**Putting It Together.** The tester is housed in a small Bakelite instrument case, with all components mounted on the front

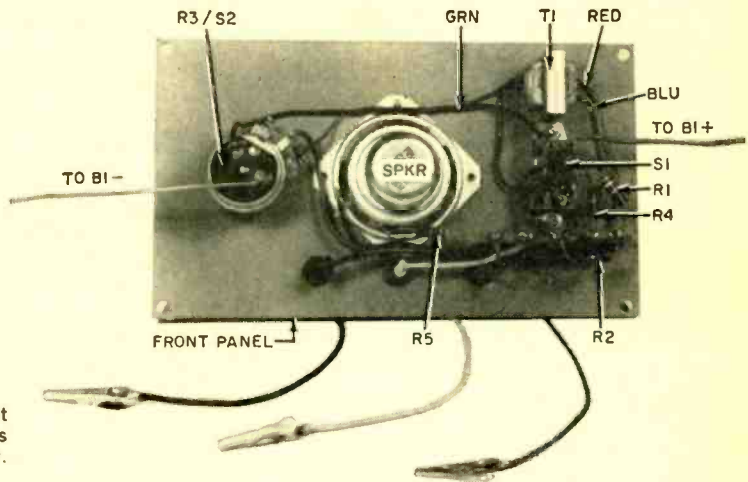

Bakelite front panel holds most of tester's parts. Three leads at bottom connect to transistor.

## EXPERIMENTERS • AMATEURS • HOBBYISTS

Once again... brand new vacuum tubes at our inventory reduction prices. Send only indicated price; we will forward your assortments via insured parcel post. Just pay postman the postage plus small COD charge.



- 10 tubes, all different, including 3" electrostatic CRT \$ 2.22
- 15 tubes, all different, including 5" electromagnetic CRT 3.33
- 20 tubes, all different, including 5" electrostatic CRT 4.44
- 30, including 3" electrostatic and 7" electromagnetic CRTs 5.55

Order all of these assortments for just \$13.95 and we will include transmitting tubes for VHF and UHF. Giant jumbo surprise! 100 tubes including 3, 5, 7, and 12 inch CRTs for only \$24.95; shipped by Express only.



JOE PALMER  
ELECTRONICS

P.O. BOX 6188 CCC  
SACRAMENTO, CALIFORNIA

WRITE TODAY FOR FREE CATALOG

CIRCLE NO. 24 ON READER SERVICE CARD

ELECTRONIC EXPERIMENTER'S HANDBOOK

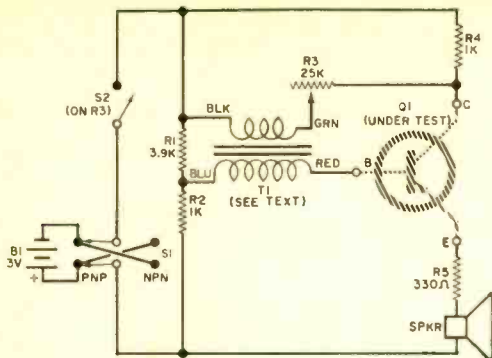

### PARTS LIST

- B1—3-volt battery (two Burgess Type Z flashlight cells or equivalent in series)
- R1—3900 ohms All resistors
- R2, R4—1000 ohms ½ watt
- R3—25,000-ohm potentiometer, linear taper, with switch S2
- R5—330 ohms
- S1—D.p.d.t. slide switch
- S2—S.p.s.t. switch (part of R3)
- T1—Transformer output transformer; primary, 5000 ohms; secondary, 100 ohms (Argonne AR-111)
- 1—1½" PM speaker, 10-ohm voice coil (Lafayette SK-61 or equivalent)
- 1—6¼" x 3¾" x 2" Bakelite case (Lafayette MS-216 or equivalent)
- 1—Bakelite front panel for above (Lafayette MS-217 or equivalent)
- Misc.—Miniature alligator clips, rubber grommets, grille cloth, knob, wire, solder, etc.

panel. Three short leads of hookup wire are brought out the front panel, and miniature alligator clips are soldered to the ends of the leads for connection to the transistor's emitter, base, and collector leads. This arrangement enables you to check any type of transistor, regardless of its actual mechanical configuration.

In the author's model, the batteries comprising B1 were soldered directly into the circuit, having first been inserted into a block of Styrofoam which was notched to the battery size and glued to the case; if you wish, battery holders may be employed instead. Decals were used to label the front panel, and the numerals around the beta control were spaced evenly throughout the 270 degrees, with 15 divisions overall.

Incidentally, the phasing of the windings on transformer T1 must be exactly as indicated for oscillation to occur. Since the transformer leads are identified by colored wires, all you have to do is follow the connections shown in the schematic diagram.

## UNUSUAL BARGAINS



### BUILD YOUR OWN INFRARED DETECTOR SEE IN TOTAL DARKNESS

Use IP25A Infrared Image Tube to convert infrared rays to visible image. You see everything—even in total darkness. Approx. 5,000 volts, 4¼" long x 1½" diam. New tubes—environment cost about \$150 ea. Tested before shipment. Complete directions. Stock No. 70-127-GD \$9.95 Postpaid Also available later model Farnsworth Tube #6032 or RCA Tube #1676. Potential approx. 30,000 volts, 4½" long, 2" dia. at weld point. Stock No. 70-160-GD \$12.50 Postpaid



### MAT ALARM—NEW SIGNALING DEVICE FOR HOMES, STORES AND OFFICES

Mat Alarm and Signaling Device, 3/32" thick x 17" x 22". Detects presence of anyone entering home, store or office. May be used as burglar alarm, entrance alarm, door illumination for private homes, etc. Placed under rugs, etc., at entrances or below windows. 5 lbs. pressure actuates low-voltage bell, buzzer, or electric bulb. Switching elements electronically sealed. Transformer to step down voltage. Bell or other alarm device may be obtained locally.

Stock No. 70-591-GD CONSTANT SIGNALING DROP RELAY OPTIONAL \$10.75 Postpaid  
Stock No. 40-592-GD \$12.50 Postpaid



### INSTANT ELECTRICITY with SUPER-POWER WET CELL BATTERY

Packs power galore, yet weighs only 15 grams. Learn about and/or demonstrate electro-chemistry, run small electric motors, etc., with this fascinating postage-stamp sized battery. For one-time use. Activated by adding brine. Stores indefinitely. 1.1V per cell. Stock No. 40-590-GD Set \$2.00 Postpaid \$2.00 Postpaid

ORDER BY STOCK NO.—SEND CHECK OR M. O.—Money-Back Guarantee. EDMUND SCIENTIFIC CO., BARRINGTON, NEW JERSEY

## MAIL COUPON FOR FREE CATALOG "GD"

164 Pages—1000's of Bargains!

EDMUND SCIENTIFIC CO., Barrington, N. J.

Please rush Free Giant Catalog-GD

Name.....

Address.....

City..... Zone..... State.....



CIRCLE NO. 11 ON READER SERVICE CARD

## PART KITS FOR HANDBOOK PROJECTS

The 10-8 Deluxe.....	\$19.25
Sensor-Matic.....	29.25
Idiot Lights Out—Meters In....	13.50
The Signal Monitor.....	34.50
Mini-Mono/Stereo.....	28.35
The Imp Sleuth.....	14.35
Automatic Diode Checker.....	14.95
Radiation Fallout Monitor.....	30.75

SEND CHECK OR MONEY ORDER  
PARCEL POST PAID IN U.S.A.

Part Kits for Other Electronic  
Projects can be Supplied

R. H. ELECTRONICS CO.  
P.O. Box 13236  
Houston 19, Texas

CIRCLE NO. 32 ON READER SERVICE CARD

# EARN YOUR DEGREE in ELECTRONICS ENGINEERING at home

Our A.S.E.E. degree is recognized the world over by personnel men in the electronics industry. Our graduates are always in demand.

College level HOME STUDY courses—taught so that you can easily understand them. Continue your education. . . . Earn more in the highly paid electronics industry.

Learn about Missiles, Computers, Transistors, Automation, complete electronics.

Over 27,000 graduates now employed by industry. Resident school also available at our Chicago Campus.—Founded 1934.

Send for our FREE course catalog.

## AMERICAN INSTITUTE OF ENGINEERING & TECHNOLOGY

1137-1139 West Fullerton Pkwy.—Chicago 14, Illinois

CIRCLE NO. 2 ON READER SERVICE CARD

### INTRODUCTORY OFFER

# FREE! DOUBLE BONUS!

**BONUS #1** **\$50.00** WORTH OF RADIO-TV PARTS!!!  
Include 25¢ for handling

**BONUS #2** **\$1** POLY PAK OF YOUR CHOICE LISTED BELOW

**BOTH FREE WITH EVERY \$10.00 ORDER**

#### WORLD FAMOUS POLY PAK KITS—BRAND NEW PARTS

- |   |   |
|---|---|
| <input type="checkbox"/> 10 ELECTROLYTICS, 5mf to 1000mf to 450 VDC . . . \$1                                 | <input type="checkbox"/> 10 TRANSISTOR SET. CK-722a, 2N35a . . . \$1                |
| <input type="checkbox"/> 100 CERAMIC CONDENSERS, ER5, NP0s, 100p, worth \$30 . . . \$1                        | <input type="checkbox"/> 60 KNOBS, asst sizes, colors, push & screw . . . \$1       |
| <input type="checkbox"/> 30 WORLDS' SMALLEST RESISTORS, 1% tol. . . \$1                                       | <input type="checkbox"/> 20 MICROSWITCHES, by GE, 115VAC, SPDBreak . . . \$1        |
| <input type="checkbox"/> 60 CARBON RESISTORS, 1/2-2W, 100ohm to 50 meg . . . \$1                              | <input type="checkbox"/> 8 TRANSISTOR SOCKETS, with metal flange, PNP-NPN . . . \$1 |
| <input type="checkbox"/> 25 POWER RESISTORS, 5-50W, 100ohms to 10K . . . \$1                                  | <input type="checkbox"/> 60 SOCKETS, receptacles, plugs, tubs, gvr, audio . . . \$1 |
| <input type="checkbox"/> 15 NPN TRANSISTORS, "Gold Bonders" hobby, must asst types to 2 Amp . . . \$1         | <input type="checkbox"/> 50 TERMINAL STRIPS, 1 to 12 lug types, \$5 val . . . \$1   |
| <input type="checkbox"/> 15 TOP HAT RECTIFIERS, silicon, 10, 750 projects . . . \$1                           | <input type="checkbox"/> 10 RCA PLUG N JACK SETS, 1000, amp, tuners . . . \$1       |
| <input type="checkbox"/> 10 SUBMINI DIODES, germanium 1N34, 1N48 . . . \$1                                    | <input type="checkbox"/> 50 COILS-N-CHOKES, rf, lf, osc, peaking, etc. . . \$1      |
| <input type="checkbox"/> 525 RADIO-TV HOBBY SURPRISE kits, worth \$15 . . . \$1                               | <input type="checkbox"/> 1000PC HARDWARE KIT, radio-TV-hobby, electronics . . . \$1 |
| <input type="checkbox"/> 10 TWO AMP SILICON RECTIFIERS, stud & axial 1 1/2, like sensitive projects . . . \$1 | <input type="checkbox"/> 10 TRANSISTOR ELECTROLYTICS, 3 to 20 mf . . . \$1          |
| <input type="checkbox"/> 15 SWITCHES, rotary, micro, 115vac, worth \$15 . . . \$1                             | <input type="checkbox"/> 30 DISC CONDENSERS, 27mf to .01mf to 1KV . . . \$1         |
| <input type="checkbox"/> 35 TWO WATT TRANSFORMERS, AB, IRC, var, val . . . \$1                                | <input type="checkbox"/> 60 MICA CONDENSERS, 20 vals to .01mf to 1KV . . . \$1      |
| <input type="checkbox"/> 10 VOLUME CONTROLS, 10 popular types to 1meg . . . \$1                               | <input type="checkbox"/> 30 SILVER MICA CONDENSERS, 1 & 5% types . . . \$1          |
| <input type="checkbox"/> 30 PRECISION RESISTORS 1/2, 1, 2, 5W, 1% . . . \$1                                   | <input type="checkbox"/> 60 TUBULAR CONDENSERS, 20 vals to .5mf to 1KV . . . \$1    |
| <input type="checkbox"/> 10 CK-722 TRANSFORMERS, by Raytheon, PNP . . . \$1                                   | <input type="checkbox"/> 4 PHILCO 100 MEGA-CYCLE TRANSISTOR, PNP . . . \$1          |
- Include postage, asst wt per pak 1-lb, 10¢ for "1983 Flyer"

## POLY PAKS

P.O. Box 942H  
So. Lynnfield, Mass.

CIRCLE NO. 26 ON READER SERVICE CARD

## Automatic Diode Checker

(Continued from page 143)

ances are standard and appropriate single resistors are available.

While carrying out the construction, be sure to observe carefully the polarities of *D1*, *D2*, *C1*, and *C2*. Also check to see that no leads or connections are shorted to the cover (you may want to line the sides of the cover with wide adhesive tape).

**Operation.** No line switch is provided because the current drawn by the checker when it is not in use is negligible, and it can be left running continuously.

To check a diode, connect it across jacks *J1* and *J2*. If only *I1* lights, the diode is open; if only *I2* lights, it's shorted; if only *I3* lights, it's good. Should all three indicators light, the

### HOW IT WORKS

Transformer *T1* provides the 6.3-volt a.c. source needed to operate the checking circuit. With no connection across test jacks *J1* and *J2* (or with an open-circuit diode connected), d.c. current flows through diode *D1*, resistors *R1* and *R2*, and "open" indicator *I1* on the positive half-cycles. Indicator *I1* then lights up, but no current flows through *I2* because of reverse-connected diode *D2*, and the voltage drop across *R2* is too small to allow *I3* to light.

If a good diode is connected across *J1* and *J2* according to the polarity labeled on the jacks, *D1*, *R1*, and *I1* will be shorted out on the positive half-cycles and *D1* will be open on the negative half-cycles; therefore *I1* will not light. And, once again, no current will flow through *I2* because of reverse-connected diode *D2*. But now enough d.c. voltage appears across *R2* to charge capacitor *C1* to the point where "good" indicator *I3* will light (the voltage applied to capacitor *C2* is in reverse polarity, so *C2* acts as a short circuit and does not charge).

If a shorted diode is connected across the jacks, *D1*, *R1*, and *I1* will be shorted out—so *I1* will remain dark. But the voltage across *R2* is now a.c. and neither *C1* nor *C2* will charge. Instead, these capacitors act as a low-reactance shunt across *I3* and resistor *R3*, and *I3* also remains dark. Diode *D2*, however, conducts on the negative half-cycles and passes enough current to light "short" indicator *I2*.

If a good diode is connected across *J1* and *J2* with polarity opposite to that labeled on the jacks, a d.c. voltage will appear across *R2* (with the upper end of the resistor negative) on negative half-cycles. Diode *D2* will then conduct, lighting *I2*. Capacitor *C2* also charges up enough to light *I3* (capacitor *C1* has voltage of reverse polarity applied to it and acts as a short circuit). On the positive half-cycles, the situation is the same as the open-circuit case first discussed; d.c. current flows through diode *D1*, resistors *R1* and *R2*, and "open" indicator *I1*—illuminating the latter.

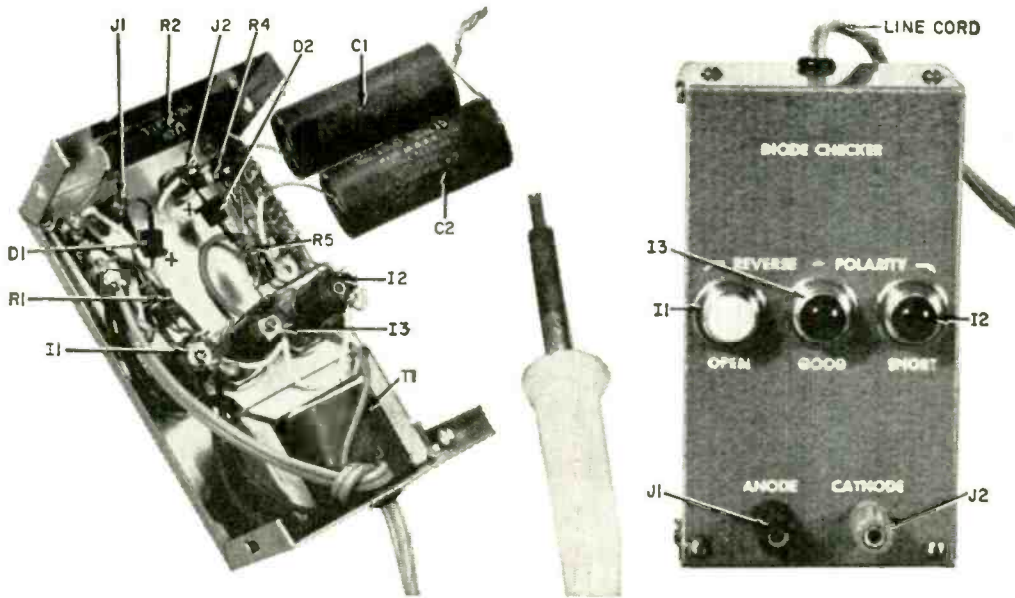

Photographs of diode checker's interior and front panel reveal construction details. Capacitors C1 and C2 (see photo at left) have been partially disconnected and moved aside for a better view.

diode is good, but connected in reverse

at less than 250 ma. average current. If you do, you stand a good chance of burning out the diode.

Never use the checker on a diode rated

-30-

# Weller® Heavy Duty Soldering Kit

Features a professional DUAL HEAT gun. Two trigger positions let you switch instantly to low 240-watt or high 325-watt heat to suit the job. By using high heat only when necessary, you prolong tip life. Heat and spotlight come on instantly when trigger is pulled. Included: Soldering tip. Smoothing tip. Cutting tip. Tip-changing wrench. Solder. Instructions. Plus break-proof plastic case which can be used as a lunch, fishing tackle or tool box. Model D-550PK.



*For quick, easy soldering  
and scores of household repairs*

WELLER ELECTRIC CORP. EASTON, PA.

# FREE CAREER BOOKLET

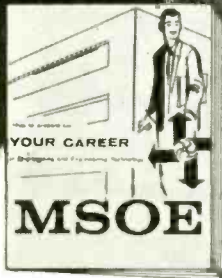

To guide you to a  
successful future in

## ELECTRONICS RADIO-TV COMPUTERS ELECTRICAL ENGINEERING

This interesting pictorial booklet tells you how you can prepare for a dynamic career as an Electrical Engineer or Engineering Technician in many exciting, growing fields:

MISSILES • AVIONICS • AUTOMATION  
SALES • DEVELOPMENT  
ELECTRICAL POWER • ROCKETRY  
RADAR • RESEARCH

Get all the facts about job opportunities, length of study, courses offered, degrees you can earn, scholarships, part-time work — as well as pictures of the Milwaukee School of Engineering's educational and recreational facilities. No obligation — it's yours free.

**MILWAUKEE SCHOOL OF ENGINEERING**

### MAIL COUPON TODAY!

Milwaukee School of Engineering  
Dept. EEH-63, 1025 N. Milwaukee St., Milwaukee, Wis.  
Please send FREE "Your Career" booklet  
I'm interested in  
 Electronics     Radio-TV     Computers  
 Electrical Engineering     Mechanical Engineering

Name \_\_\_\_\_ Age \_\_\_\_\_

Address \_\_\_\_\_

City \_\_\_\_\_ Zone \_\_\_\_\_ State \_\_\_\_\_

I'm eligible for veterans education benefits.

Discharge date \_\_\_\_\_ MS-117

CIRCLE NO. 20 ON READER SERVICE CARD

## Printed-Circuit P.A.

(Continued from page 64)

**Installation Tips.** The appearance of the amplifier can be improved by placing suitable nameplates on the front and back panels. Since the on/off switch is already identified, placing *Phono* and *Mike* on the respective jacks and volume controls and *Tone* on the tone control will take care of labeling the front panel. *Plus* and *Minus* as well as *Speaker* labels may be fastened to the back of the amplifier to identify these terminals.

If the amplifier is to be installed permanently or semi-permanently in a car or truck, some additional fittings will have to be fastened to the amplifier case. Since the requirements will vary considerably with each individual installation, you're pretty much on your own. However, a few tips may be helpful.

For a semi-permanent installation, power can be secured from the cigarette lighter outlet, and the amplifier can be placed in the glove compartment. For a permanent installation, a set of angle brackets (available at most hardware stores) attached to the case will permit easy under-the-dash mounting.

If you want to use the amplifier inside or move it about a good bit, attach rubber feet to minimize chances of scratching table tops.



"Is this EICO? I think I've found an error..."

ELECTRONIC EXPERIMENTER'S HANDBOOK



# BUILD 10-20 RADIO

CIRCUITS AT HOME  
with the Deluxe

PROGRESSIVE RADIO "EDU-KIT"®

only  
**\$14.95**  
up

Reg. U. S.  
Pat. Off.



Training Electronics Technicians Since 1946

**A Practical Home Radio Course**

**Now Includes**

- \* RECEIVERS
- \* TRANSMITTERS
- \* SQ. WAVE GENERATOR
- \* SIGNAL TRACER
- \* AMPLIFIER
- \* SIGNAL INJECTOR
- \* CODE OSCILLATOR

- \* No Knowledge of Radio Necessary
- \* No Additional Parts or Tools Needed
- \* EXCELLENT BACKGROUND FOR TV
- \* SCHOOL INQUIRIES INVITED
- \* Sold In 79 Countries

**YOU DON'T HAVE TO SPEND  
HUNDREDS OF DOLLARS FOR A RADIO COURSE**

The "Edu-Kit" offers you an outstanding PRACTICAL HOME RADIO COURSE at a rock-bottom price. Our Kit is designed to train Radio & Electronics Technicians, making use of the most modern methods of home training. You will learn radio theory, construction practice and servicing. THIS IS A COMPLETE RADIO COURSE IN EVERY DETAIL.

You will learn how to build radios, using regular schematics; how to wire and solder in a professional manner; how to service radios. You will work with the standard type of punched metal chassis as well as the latest development of Printed Circuit chassis.

You will learn the basic principles of radio. You will construct, study and work with RF and AF amplifiers and oscillators, detectors, rectifiers, test equipment. You will learn and practice radio, using the Progressive Code Oscillator. You will learn and practice trouble-shooting, using the Progressive Signal Tracer, Progressive Signal Injector, Progressive Dynamic Radio & Electronics Tester, Square Wave Generator and the accompanying instructional material.

You will receive training for the Novice, Technician and General Classes of F.C.C. Radio Amateur Licenses. You will build Receiver, Transmitter, Square Wave Generator, Code Oscillator, Signal Tracer and Signal injector circuits, and learn how to operate them. You will receive an excellent background for television, Hi-Fi and Electronics.

Absolutely no previous knowledge of radio or science is required. The "Edu-Kit" is the product of many years of teaching and engineering experience. The "Edu-Kit" will provide you with a basic education in Electronics and Radio, worth many times the low price you pay. The Signal Tracer alone is worth more than the price of the kit.

## THE KIT FOR EVERYONE

You do not need the slightest background in radio or science. Whether you are interested in Radio & Electronics because you want an interesting hobby, a well paying business or a job with a future, you will find the "Edu-Kit" a worthwhile investment. Many thousands of individuals of all

ages and backgrounds have successfully used the "Edu-Kit" in more than 79 countries of the world. The "Edu-Kit" has been carefully designed, step by step, so that you cannot make a mistake. The "Edu-Kit" allows you to teach yourself at your own rate. No instructor is necessary.

## PROGRESSIVE TEACHING METHOD

The Progressive Radio "Edu-Kit" is the foremost educational radio kit in the world, and is universally accepted as the standard in the field of electronics training. The "Edu-Kit" uses the modern educational principle of "Learn by Doing." Therefore you construct, learn schematics, study theory, practice trouble shooting—all in a closely integrated program designed to provide an easily-learned, thorough and interesting background in radio.

You begin by examining the various radio parts of the "Edu-Kit." You then learn the function, theory and wiring of these parts. Then you build a simple radio. With this first set you will enjoy listening to regular broadcast stations, learn theory, practice testing and trouble-shooting. Then you build a more advanced radio, learn more advanced theory and techniques. Gradually, in a progressive manner, and at your own rate, you will find yourself constructing more advanced multi-tube radio circuits, and doing work like a professional Radio Technician.

Included in the "Edu-Kit" course are Receiver, Transmitter, Code Oscillator, Signal Tracer, Square Wave Generator and Signal injector Circuits. These are not unprofessional "breadboard" experiments, but genuine radio circuits, constructed by means of professional wiring and soldering on metal chassis, plus the new method of radio construction known as "Printed Circuitry." These circuits operate on your regular AC or DC house current.

## THE "EDU-KIT" IS COMPLETE

You will receive all parts and instructions necessary to build several different radio and electronics circuits, each guaranteed to operate. Our Kits contain tubes, tube sockets, variable, electrolytic, mica, ceramic and paper dielectric condensers, resistors, tie strips, hardware, tubing, punched metal chassis, instruction Manuals, hook-up wire, solder, selenium rectifiers, coils, volume controls and switches, etc.

In addition, you receive Printed Circuit materials, including Printed Circuit chassis, special tube sockets, hardware and instructions. You also receive a useful set of tools, a professional electric soldering iron, and a self-powered Dynamic Radio and Electronics Tester. The "Edu-Kit" also includes Code Instructions and the Progressive Code Oscillator, in addition to F.C.C.-type Questions and Answers for Radio Amateur License training. You will also receive lessons for servicing with the Progressive Signal Tracer and the Progressive Signal Injector, High Fidelity Guide and Quiz Book. You receive Membership in Radio-TV Club. Free Consultation Service, Certificate of Merit and Discount Privileges. You receive all parts, tools, instructions, etc. Everything is yours to keep.

## FREE EXTRAS

### • SET OF TOOLS

- SOLDERING IRON
- ELECTRONICS TESTER
- PLIERS-CUTTERS
- ALIGNMENT TOOL
- WRENCH SET
- VALUABLE DISCOUNT CARD
- CERTIFICATE OF MERIT
- TESTER INSTRUCTION MANUAL
- HIGH FIDELITY GUIDE & QUIZZES
- TELEVISION BOOK
- TROUBLE-SHOOTING BOOK
- MEMBERSHIP IN RADIO-TV CLUB
- CONSULTATION SERVICE
- FCC AMATEUR LICENSE TRAINING
- PRINTED CIRCUITRY

## SERVICING LESSONS

You will learn trouble-shooting and servicing in a progressive manner. You will practice repairs on the sets that you construct. You will learn symptoms and causes of trouble in home, portable and car radios. You will learn how to use the professional Signal Tracer, the unique Signal Injector and the dynamic Radio & Electronics Tester. While you are learning in this practical way, you will be able to do many a repair job for your friends and neighbors, and charge fees which will far exceed the price of the "Edu-Kit." Our Consultation Service will help you with any technical problems you may have.

## FROM OUR MAIL BAG

J. Stataitis, of 25 Poplar Pl., Waterbury, Conn., writes: "I have regaled several sets for my friends, and made money. The "Edu-Kit" paid for itself. I was ready to spend \$240 for a Course, but I found your ad and sent for your Kit."

Ben Valerio, P. O. Box 21, Magna, Utah, writes: "The Edu-Kits are wonderful. Here I am sending you the questions and also the answers for them. I have been in Radio for the last seven years, but like to work with Radio Kits, and like to build Radio Testing Equipment. I enjoyed every minute I worked with the different kits; the Signal Tracer works fine. Also like to let you know that I feel proud of becoming a member of your Radio-TV Club."

Robert L. Shurr, 1534 Monroe Ave., Huntington, W. Va.: "Thought I would drop you a few lines to say that I received my Edu-Kit, and was really amazed that such a bargain can be had at such a low price. I have already started repairing radio and phonographs. My friends were really surprised to see me get into the swing of it so quickly. The Trouble-Shooting Tester that comes with the kit is really swell, and finds the trouble, if there is any to be found."

Choose From These Popular

"Edu-Kit" Models

#10A: 10 Circuits \$14.95

#15A: 15 Circuits \$19.95

#16A: 16 Circuits

(includes Printed Circuitry) \$22.95

#20A: 20 Circuits (includes Printed Circuitry and 4 Advanced Circuits) \$26.95

## UNCONDITIONAL MONEY-BACK GUARANTEE

ORDER DIRECT FROM AD—RECEIVE FREE BONUS  
RESISTOR AND CONDENSER KITS WORTH \$7

- MODEL desired \_\_\_\_\_ Price \_\_\_\_\_
- Send "Edu-Kit" postpaid; I enclose remittance in full.
  - Send "Edu-Kit" C.O.D. I will pay postage.
  - Send me FREE additional information describing "Edu-Kits."

Name \_\_\_\_\_

Address \_\_\_\_\_

## PROGRESSIVE "EDU-KITS" INC.

1186 Broadway, Dept. 507RR, Hewlett, N. Y.



**Olson** **SURPLUS**  
 — Name Brands  
**BARGAINS**

Send for the amazing Olson, value packed, Electronic Catalogs today! You will find SURPLUS and NAME BRAND Bargains in CB, Amplifiers, FM-AM Tuners, Speakers, Phonographs, Telephones, Antennas, Transistors, Wire, Tubes, Tools — and hundreds of other money-saving items. Catalogs will be mailed FREE every 6 weeks for one full year.

**MAIL TODAY!**

MAIL TO: **OLSON ELECTRONICS, INC.**  
 905 S. Forge St., Akron 8, Ohio

NAME \_\_\_\_\_

ADDRESS \_\_\_\_\_

CITY \_\_\_\_\_ ZONE \_\_\_\_\_ STATE \_\_\_\_\_

CIRCLE NO. 23 ON READER SERVICE CARD

Interested in a space age electronics career?

**THINK**

Before  
 you  
 select  
 a  
 technical  
 school

For a free copy of this folder write:

**Penn Technical Institute**  
 5440 Penn Ave., Pittsburgh, Pa.  
 Phone 441-3502

CIRCLE NO. 25 ON READER SERVICE CARD

**Square-Wave Generator**

(Continued from page 133)

is by  $R1$  and  $R2$  in Fig. 2, for example, the contact potential causes a current to flow as though there were a battery in the circuit. Thus, some of the energy required to heat the cathode in normal operation is also utilized to provide a d.c. source in the circuit. If the negative plate-to-cathode potential is increased substantially by means of an external negative voltage applied to the plate, current in  $V1b$  will cease to flow.

A sine-wave signal applied at point "A" is rectified by  $V1a$  and appears across  $R1$  with respect to ground. On negative input peaks, no current flows through  $R1$ . On positive input peaks, the full input voltage developed across  $R1$  causes the cathode of  $V1b$  to go positive with respect to ground. Hence,  $V1b$  is biased off by positive peaks of the input signal, while during negative peaks the Edison Effect previously described takes place. If  $R1$  (required only to provide a chopping signal from the input voltage) is made small compared with  $R2$ , almost all of the contact potential appears at "B" with respect to ground when  $V1b$  conducts. As the output is taken only across  $R2$ , the output consists of the chopped contact potential exclusively.

If the peak value of the input voltage equals the contact potential, the output voltage resembles the output of a half-wave rectifier circuit without a filter. Increasing the amplitude of the input signal considerably reduces the rise and decay times of the output waveforms. This is clearly illustrated in the oscillograms.

**Description of Unit.** One advantage of this circuit is that almost any thermionic-emission type of vacuum tube can be used. Also, the same voltage can be used for both heater supply and input voltage. Although a twin-diode was used by the author, twin triodes may be used equally well. When triodes are used, the control grids should be tied to the cathode for best results.

As with any source, output amplitude decreases as the output load increases. In this case, the total load is  $R2$  plus the

device under test, connected between point "B" and ground. The effect of this loading on the output voltage is shown in Fig. 3. If maximum output is desired,  $R_2$  should be from 1 to 10 megohms. The principal load is then only that provided by the input circuit of the device under test. Changes in this impedance will cause relatively large changes in the output amplitude. If it is desired that the output voltage remain essentially constant with changes in load impedance,  $R_2$  may be made relatively small. Then the total parallel resistance presented by  $R_2$  and the changing load impedance will be essentially constant.

The photographs illustrate a unit built around a 6H6 twin-diode. The transformer provides both the heater voltage and the input drive signal, making it a completely independent unit with a 60-cycle square-wave output. For operation at other frequencies, the input signal may be obtained from any sine-wave generator with a 5- to 10-volt output. -30-

### Transistor Frequency Standard

(Continued from page 138)

should show a definite, although broad, peak. If necessary, add or remove turns as indicated by the position of the iron-core slug. The adjustment of  $L_2$  may result in a small frequency shift and the setting of  $C_1$  should again be checked with WWV after adjusting the coil  $L_2$ .

Current drawn from a 9-volt battery will be around 1.5 ma. There will be a small frequency variation when the supply voltage is changed and it should be held as constant as possible.

The transistor frequency standard may also be used in vacuum-tube communications receivers if kept isolated from heat-producing components. A novel system of obtaining the supply voltage, without resorting to batteries, is shown in Fig. 2(B). A voltage divider, consisting of a 10,000-ohm resistor and 25,000-ohm potentiometer, is placed across the cathode-bias voltage (usually between 10 and 15 volts) and the potentiometer is adjusted for 9 volts. A filter capacitor smooths out any audio variations. -30-

## CHRISTY'S MOST COMPLETE COURSE!

Christy's complete course covers every phase of this exciting new subject. You get comprehensive training, starting with your first lesson. You learn Radar, Sonar, Television (Color TV too!), Radio and Electronics in CTS's COMPLETE course.

Christy Shop Method Home Training makes you a more valuable and desirable technician, assures you of more money, faster progress and greater success. Practical step-by-step training makes everything interesting and easy to learn.

### 19 Training Kits Sent

you learn in months what used to take years, to learn.

### 3 Free Books

give you complete information as to how you too can get started in this fascinating new field.

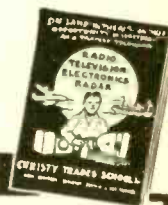

## MAIL COUPON

CHRISTY TRADES SCHOOL Dept. T-118  
3214 West Lawrence Ave., Chicago 25, Ill.

Send me without cost or obligation two FREE lessons, new 24 page illustrated book and Pay Later Form.

Name \_\_\_\_\_ Age \_\_\_\_\_

Address \_\_\_\_\_

City \_\_\_\_\_ Zone \_\_\_\_\_ State \_\_\_\_\_

Save Money **RAD-TEL'S QUALITY BRAND NEW TUBES**

**NOT USED**

**UP TO 75% OFF / 1 YEAR GUARANTEE**  
**1 DAY SERVICE ■ OVER 500 TYPES IN STOCK**

Qty.	Type	Price	Qty.	Type	Price	Qty.	Type	Price	Qty.	Type	Price
024	75	—	BY3	.46	—	6RG5	1.12	—	12AD6	.87	—
1AX2	.82	—	3AB4	.46	—	6R07	1.00	—	12AD5	.80	—
1Q3	75	—	6AC7	.74	—	6R08	.70	—	12AT5	.50	—
1C3	75	—	6AF4	1.01	—	6R2L	.55	—	12AT7	.78	—
1RS	75	—	6AG5	.70	—	6R2	1.03	—	12B07	.61	—
1U4	72	—	6AM4	.81	—	6CA	.95	—	12AV8	.81	—
1U5	.65	—	6AN8	.70	—	6CB	.55	—	12BA4	.57	—
1X2	.87	—	6AL8	.87	—	6CD5	1.51	—	12AR7	.83	—
30W4	84	—	6AM8	.78	—	6CC7	.41	—	12BA6	.50	—
3CY3	70	—	6AN9	.93	—	6CC8	.40	—	12BL6	.52	—
3AU6	.54	—	6AD5	.52	—	6CL8	.79	—	12BH7	.77	—
3AV5	.62	—	6AS5	.60	—	6CV5	.70	—	12BL6	.56	—
3BC5	.83	—	6AT8	.86	—	6DQ6	1.10	—	12R06	1.15	—
3BU8	75	—	6AM4	.85	—	6D7C	.53	—	12R77	.77	—
3BZ6	.56	—	6AV6	.52	—	6EAB	.75	—	12D08	1.04	—
3CB6	.84	—	6AU8	.87	—	6E6	.71	—	12S1CT	.89	—
3DT8	.34	—	6AV8	.41	—	6E6	.82	—	12S1CT	.85	—
304	.93	—	6AW8	.70	—	6E6	1.04	—	12S1P	.87	—
4BC0	1.05	—	6AZ4	.64	—	6E4	.32	—	12B07CT	.89	—
4DQ7	1.01	—	6B8	.50	—	6E7	.45	—	18AU4	.87	—
4R27	1.84	—	6BC5	.41	—	6E7	.85	—	25R06	1.17	—
5AT8	.81	—	6B8	.50	—	6E7	.83	—	25D6	1.32	—
5BK7	.86	—	6BM8	.68	—	6E7C	.84	—	25L8	.82	—
5C4	.81	—	6B9	.68	—	6E7	.81	—	25W4	.64	—
5CL8	.74	—	6B9	.68	—	6E7	.80	—	39Z5	.60	—
5G6	.72	—	6B9	.68	—	6E7	.80	—	50C5	.82	—
5U4	.60	—	6BL7	1.05	—	6E7	.85	—	50L6	.81	—
50B	.84	—	6BN4	.82	—	7AU7	.85	—			

NAME \_\_\_\_\_  
 ADDRESS \_\_\_\_\_  
 CITY \_\_\_\_\_ STATE \_\_\_\_\_

Free

SEND FOR TROUBLE SHOOTING GUIDE ■ SEND FOR NEW TUBE & PARTS CATALOG

**RAD-TEL TUBE CO.**

DEPT. EM-1 55 CHAMBERS STREET, NEWARK 5, NEW JERSEY

TERMS: 25% deposit must accompany all orders. Balance C.O.D. Orders under \$5; add \$1 handling charge plus postage. Orders over \$5; plus postage. Approx. 8 tubes per 1 lb. Subject to prior sale. No C.O.D.'s outside continental USA.

CIRCLE NO. 28 ON READER SERVICE CARD

**SAVE Time & Worry!**  
**BUILD "POP" TRONICS**

**HANDBOOK Projects And Others With**

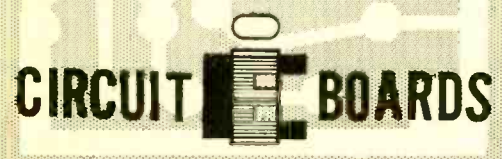

**CIRCUIT BOARDS**  
**Simple - Easy**  
**Send For FREE Catalog**

**IRVING ELECTRONICS CO.**  
 417 OWYER - SAN ANTONIO 4, TEXAS - POST OFFICE BOX 3222  
 CIRCLE NO. 18 ON READER SERVICE CARD

**Stereo Sixteen Plus Four**

(Continued from page 54)

the thickness of the bottom panel. Position the panel at the front of the enclosure, with the bottom edge flush with the surface of the bottom panel, and mark the other edges for cutting. After the front panel is cut and edge-sanded, attach the remaining 20" 2 x 2 to the other narrow edge and the two 25" 2 x 2's to the top and bottom edges.

**Pad or Diffuse.** The acoustic padding is attached to the inside of the front panel with either thumbtacks or a staple gun; if desired, an inexpensive substitute for acoustic padding can be made from six egg cartons of the *papier-mâché* variety. Simply tack the bottom halves of the egg cartons to the inside of the panel.

To attach the front panel to the enclosure, position it in place and drill through the front edges of the speaker-board panels for a No. 8 x 1" wood screw (three screws per panel), drilling through the panel at an angle so as to go into the front-corner-brace 2 x 2 straight. In addition, attach the top and bottom panels to the front-edge braces with four screws per panel, and, if you haven't already done so, tie the top and bottom down to the upper and lower speaker-board braces with two screws per brace.

The rear corner supports are attached by a single wood screw run into each end of each dowel, through the top and bottom panels, and pulled up tight. This done, the electro-acoustical part of the system is now complete, and you can give it its test run.

**Finishing the System.** If you keep in mind that both sides and the back must be acoustically open to let the sound out without restriction, the "sky's the limit" on finishing.

The original system was finished in an Oriental motif, with solid gloss black top, ebony and brass legs, and a mosaic Masonite front-panel overlay. This results in a striking piece of furniture, but a simple "wrap-around" of grille cloth (hard-weave drapery fabric does as well and is less expensive) will also look extremely professional.

# LATEST SAMS BOOKS FOR EVERYONE IN ELECTRONICS



## USE THIS HANDY ORDER FORM

- ABC's of Electronics.** Unique approach to a clear understanding of the basic principles; fully explains theory and application in terms of everyday concepts familiar to anyone. Order **ELW-1**, only..... \$1.95
- How To Read Schematic Diagrams.** Not only shows you how to read and interpret diagrams, but analyzes each component, its construction and the effect it has on the circuit. Order **RSD-1**, only..... \$1.50
- Electronics for the Beginner.** Introduces you to electronics through the basics of constructing fascinating, practical devices, all using transistor circuits. Order **BHJ-1**, only..... \$3.95
- Sams International Code Training System.** Fastest method ever devised for learning to send and receive code! Amazing system includes full text plus 7" LP record sides. Order **CTG-1**, only..... \$6.95
- Having Fun With Transistors.** THF-1..... \$2.50
- Radio Receiver Servicing.** RS-2..... 2.95
- Electronic Games & Toys You Can Build.** EGT-1..... 2.50
- Modern Dictionary of Electronics.** DIC-1..... 6.95
- So You Want To Be A Ham.** HAM-2..... 2.95
- TV Servicing Guide.** SGS-1..... 2.00
- ABC's of Short Wave Listening.** SWL-1..... 1.95
- ABC's of Citizens Band Radio.** ACR-1..... 2.95
- Basic Electronics Series: Amplifier Circuits.** BEA-1..... 2.95
- Basic Electronics Series: Oscillator Circuits.** BEO-1..... 2.95
- Basic Electronics Series: Det. & Rect. Circuits.** BED-1..... 2.95
- Basic Electronics Series: Transistor Circuits.** BET-1..... 2.95
- Basic Electronics Series—4 Volumes**..... 9.95
- Electronic Experiments & Projects.** ESE-1..... 2.50
- Understanding Capacitors & Their Uses.** CAP-1..... 1.95
- CB Radio Antenna Handbook.** CAH-1..... 2.50
- Air Conditioning Install. & Maint.** ACM-1..... 3.95
- 101 Ways To Use Your VOM & VTVM.** TEM-3..... 2.00
- 101 Ways To Use Your Oscilloscope.** TEM-2..... 2.50
- ABC's of Trans. stars.** TRA-1..... 1.25
- Citizens Band Radio Handbook.** CBH-1..... 2.95
- ABC's of Electronic Organs.** ECO-1..... 1.95
- Electronics Math Simplified.** MAT-1..... 4.95
- ABC's of Computers.** ABC-1..... 1.95
- ABC's of Ham Radio.** HAP-1..... 1.50
- Electronic Servicing For the Beginner.** BSJ-1..... 2.95
- Electric Motor and Generator Repair.** MGR-1..... 4.95
- Automotive Electronics Test Equipment.** AEL-1..... 2.50
- How To Repair Small Appliances.** APP-1..... 2.50
- ABC's of Computer Programming.** CPL-1..... 1.95
- Electronic Musical Instrument Handbook.** EMI-1..... 2.50

**FREE!** Ask for the Sams Booklist, describing over 200 important books.

**FREE!** Index to Photofact, world's finest circuit data on 53,000 TV & radio models.

**HOWARD W. SAMS & CO., INC.**

Order from any Electronic Parts Distributor, or mail to Howard W. Sams & Co., Inc., Dept. A-153 4300 W. 62nd St., Indianapolis 6, Ind.

Send books checked above. \$ \_\_\_\_\_ enclosed.

Send FREE Booklist.  Send Photofact Index

Name \_\_\_\_\_

Address \_\_\_\_\_

City \_\_\_\_\_ Zone \_\_\_\_\_ State \_\_\_\_\_

IN CANADA: A. C. Simmonds & Sons, Ltd., Toronto 7

**CIRCLE NO. 33 ON READER SERVICE CARD**

1963 Edition

# ATR

## PRODUCTS FOR MODERN LIVING



**ATR PLUG-IN TYPE PORTABLE INVERTERS**

A.C. HOUSEHOLD ELECTRICITY  
Anywhere... in your own car!

- Operates Standard A.C. Record Players
  - Dictating Machines
  - Small Radios
  - Electric Shavers
  - Heating Pads, etc.
- In your own car or boat!

**MODELS**  
6-RMF (6 volts) 60 to 80 watts. Shipping weight 12 lbs. DEALER NET PRICE \$33.00  
12T-RME (12 volts) 90 to 125 watts. Shipping weight 12 lbs. DEALER NET PRICE \$33.00  
\*Additional Models Available

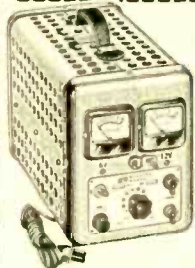

**ATR "A" Battery ELIMINATOR**

For Demonstrating and Testing Auto Radios—TRANSISTOR or VIBRATOR OPERATED!

Designed for testing D.C. Electrical Apparatus on Regular A.C. Lines—Equipped with Full-Wave Dry Disc-Type Rectifier, assuring noiseless, interference-free operation and extreme long life and reliability.

**MAY ALSO BE USED AS A BATTERY CHARGER**  
MODEL 610C-ELIF... 6 volts at 10 amps, or 12 volts at 6 amps. Shipping weight 22 lbs. DEALER NET PRICE \$49.95  
MODEL 620C-ELIT... 6 volts at 20 amps, or 12 volts at 10 amps. Shipping weight 33 lbs. DEALER NET PRICE \$66.95



**ATR UNIVERSAL KARADIO**

**MODEL 600 SERIES**

Easily installed in-dash or under-dash. Amplifier power-supply chassis may be separated from tuner chassis for installation flexibility and easy servicing. Utilizes 6-tube super heterodyne circuit (2 dual-purpose tubes) with 8-tube performance... pulls in those distant stations with good tone and volume. Supplied with separate 5" x 7" speaker which is installed in original automobile speaker compartment for high fidelity performance. Neutral gray-tan baked enamel finish. Over-all size 4" deep x 6 1/2" wide x 2" high. Tuner Chassis: with Amplifier Chassis. 2 3/4" deep x 6 1/2" wide x 3 3/4" high. Shipping weight 7 lbs. **WILL OUTPERFORM MOST SETS!**  
Model 612—12 volt Dealer Net Price \$31.96  
Model 606—6 volt Dealer Net Price \$31.96

**ATR TRUCK KARADIO**

Excellent Tone, Volume, and Sensitivity!

Compact, yet powerful. Fits all trucks, station wagons, most cars and boats. Just drill a 3/8 inch hole in roof and suspend the one-piece unit (aerial, chassis and speaker) in minutes. Watertight mounting assembly holds antenna upright. Yoke-type bracket lets you tilt radio to any angle.

Extra-sensitive radio has 6 tubes (2 double-purpose), over 6-2e Aincio 5 P14 speaker for full rich tone. Big, easy-to-read illuminated dial. Fingertip tuning control. Volume and tone controls. 33-in. stainless steel antenna. Neutral gray-tan enameled metal cabinet. 7 x 6 1/2 x 4 in. high over-all. Shipping weight 10 1/2 lbs.

Model TR-1279—12A for 12V Dealer Net Price \$41.96  
Model TR-1279—6A for 6V Dealer Net Price \$41.96

**ATR ELECTRONICS, INC.**

Formerly: American Television & Radio Co.

**ATR**

Quality Products Since 1931

ST. PAUL 1, MINNESOTA—U.S.A.

**CIRCLE NO. 3 ON READER SERVICE CARD**

163

NOW YOU CAN  
BUILD A FINE  
*Schober Organ*

FOR ONLY  
**\$550**



You can assemble this new Schober Spinet Organ for \$550 — or half the cost of comparable instruments you have seen in stores. The job is simplicity itself because clear, detailed step-by-step instructions tell you exactly what to do. And you can assemble it in as little as 50 hours.

You will experience the thrill and satisfaction of watching a beautiful musical instrument take shape under your hands. The new Schober Electronic Spinet sounds just like a big concert-size organ — with two keyboards, thirteen pedals and magnificent pipe organ tone. Yet it's small enough (only 38 inches wide) to fit into the most limited living space.

You can learn to play your spinet with astounding ease. From the very first day you will transform simple tunes into deeply satisfying musical experiences. Then, for the rest of your life, you will realize one of life's rarest pleasures — the joy of creating your own music.

For free details on all Schober Organs, mail the coupon now. No salesman will call.

THE *Schober Organ* CORPORATION

43 West 61st Street, New York 23, N. Y.

Also available in Canada and Australia.

**MAIL THIS COUPON TODAY**

The Schober Organ Corporation, Dept. EH-2  
43 West 61st Street, New York 23, N. Y.

Please send me FREE booklet and other literature on the Schober Organs.

Please send me the Hi-Fi demonstration record. I enclose \$2 which is refundable when I order my first kit.

Name .....

Address .....

City ..... Zone ..... State .....

**CIRCLE NO. 29 ON READER SERVICE CARD**

# NEW DOUBLE DUTY TOOL SETS

Compact, convertible sets do more jobs with fewer tools, save bench space, lighten the service kit. Remarkable piggyback "torque amplifier" handle slips over pocket tool handles to give the grip, reach, and power of standard drivers. Slim, trim see-thru plastic case fits pocket, has flat base for use as bench stand.

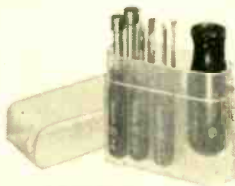

### PS-7 SET

2 nutdrivers ( $\frac{1}{4}$ " and  $\frac{3}{16}$ "),  
2 slot tip screwdrivers  
( $\frac{3}{16}$ " and  $\frac{5}{32}$ "), 2 Phillips  
screwdrivers (#0 and #1),  
all  $3\frac{1}{2}$ " pocket size . . .  
plus 1" x  $3\frac{1}{4}$ " hollow  
handle and case.



### PS-120 SET

10 color coded,  $3\frac{1}{4}$ "  
pocket size nutdrivers  
( $\frac{3}{32}$ " thru  $\frac{3}{16}$ ") . . .  
plus 1" x  $3\frac{1}{4}$ " hollow  
handle and case.

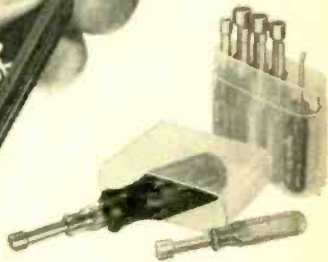

WRITE FOR LITERATURE

# XCELITE

XCELITE, INC. • 54 BANK ST., ORCHARD PARK, N. Y.

Canada: Charles W. Pointon, Ltd., Toronto, Ont.

**CIRCLE NO. 39 ON READER SERVICE CARD**

ELECTRONIC EXPERIMENTER'S HANDBOOK

## Radiation Fallout Monitor

(Continued from page 45)

**Operation.** First of all, remember that this is not a precision instrument. Nor will it respond to extremely high levels of radiation (about 60 counts per second, as mentioned earlier, is the maximum). For this reason, it's not suitable for use in locating areas of heavy contamination during emergencies. What it will do is provide an approximate indication of the normal level of background radiation in your area, giving positive evidence when the count varies excessively.

To operate the device, just plug it into the line. (No on-off switch is provided because the current drain is so low that the unit can be left running continually.) After the thyatron heater has warmed up, the instrument will begin to respond to background radiation. This activity will be sporadic—there may be no pulses for several seconds, then several at once.

To get an idea of the counts per min-

ute at any given time, always make your observations over a period of several minutes and take an average. The author has measured rates ranging from a low of 30 counts per minute to a high (during a period of fallout from the Russian bomb tests) of over 100. In the P.E. editorial offices, when this article was prepared for publication, the instrument registered about 15 counts per minute.

Small variations in the rate are not significant (they may be due, in part, to variations in line voltage). But if the radiation level begins to drive  $V_2$  at a frequency close to its maximum ability to respond, chances are that something unusual has occurred.

If you find your instrument counting at a very high frequency, don't be immediately concerned about radiation injury (even luminous watch dials, when placed close to  $V_1$ , will produce quite high rates). You'd better check your radio, though, to see if there's anything going on. We hope that a radiation emergency situation will never arise, but if it does, instructions will be broadcast (via Conelrad) over 640 or 1240 kc. -50-

**TV-RADIO Servicemen or Beginners...**

Send for *Coyne's*  
7-Volume Job-Training Set  
on 7-Day **FREE TRIAL!**



The First  
Practical  
TV-RADIO-  
ELECTRONICS  
Shop  
Library!

**Answers ALL Servicing Problems QUICKLY . . .  
Makes You Worth More On The Job!**

Put money-making, time-saving TV-RADIO-ELECTRONICS know-how at your fingertips—examine Coyne's all-new 7-Volume TV-RADIO-ELECTRONICS Reference Set for 7 days at our expense! Shows you the way to easier TV-Radio repair—time saving, practical working knowledge that helps you get the BIG money. How to install, service and align ALL radio and TV sets, even color TV, VHF, FM and transistorized equipment. Step photo-instruction shows you what makes equipment "tick." No complicated math or theory—just practical facts you can put to use immediately right in the shop, or for ready reference at home. Over 3000 pages; 1200 diagrams; 10,000 facts!

**SEND NO MONEY!** Just mail coupon for 7-Volume TV-Radio Set on 7-Day FREE TRIAL! We'll include the FREE BOOK below. If you keep the set, pay only \$3 in 7 days and \$3 per month until \$27.25 plus postage is paid. Cash price only \$24.95. Or return set at our expense in 7 days and owe nothing. Either way, the FREE BOOK is yours to keep. Offer limited, so act NOW!

**"LEARNED MORE FROM THEM THAN FROM 5 YEARS WORK!"**

"Learned more from your first two volumes than from 5 years work."

—Guy Bliss, New York

"Swell set for either the serviceman or the beginner. Every service bench should have one."—Melvin Mesbruch, Iowa.

### FREE DIAGRAM WORK!

We'll send you this big book, "150 Radio-Television Picture Patterns and Diagrams Explained" ABSOLUTELY FREE just for examining Coyne's 7-Volume Shop Library on 7-Day FREE TRIAL! Shows how to cut servicing time by reading picture-patterns, plus schematic diagrams for many TV and radio sets. Yours FREE whether you keep the 7-Volume Set or not! Mail coupon TODAY!



**Like Having An Electronics Expert Right At Your Side!**

**VOL. 1—EVERYTHING ON TV-RADIO PRINCIPLES!** 300 pages of practical explanations; hundreds of illustrations.

**VOL. 2—EVERYTHING ON TV-RADIO-FM RECEIVERS;** 403 pages; fully illustrated.

**VOL. 3—EVERYTHING ON TV-RADIO CIRCUITS!** 336 pages; hundreds of illustrations, circuit diagrams.

**VOL. 4—EVERYTHING ON SERVICING INSTRUMENTS!** How they work, how to use them. 368 pages; illustrated.

**VOL. 5—EVERYTHING ON TV TROUBLESHOOTING!** Covers all types of sets. 437 pages; illustrations, diagrams.

**VOL. 6—TV CYCLOPEDIA!** Quick and concise answers to TV problems in alphabetical order, including UHF, Color TV and Transistors; 868 pages.

**VOL. 7—TRANSISTOR CIRCUIT HANDBOOK!** Practical Reference covering Transistor Applications; over 200 Circuit Diagrams; 410 pages.

BOOKS HAVE BRIGHT, VINYL CLOTH WASHABLE COVERS

**FREE BOOK—FREE TRIAL COUPON!**

Educational Book Publishing Division  
COYNE ELECTRICAL SCHOOL

1455 W. Congress Parkway, Dept. 13-EM, Chicago 7, Ill.

Yes! Send me COYNE'S 7-Volume Applied Practical TV-RADIO-ELECTRONICS Set for 7-Days FREE TRIAL per offer. Include "Patterns & Diagrams" book FREE!

Name \_\_\_\_\_ Age \_\_\_\_\_

Address \_\_\_\_\_

City \_\_\_\_\_ Zone \_\_\_\_\_ State \_\_\_\_\_

Check here if you want Set sent C.O.D. Coyne pays postage on C.O.D. and cash orders. 7-Day Money-Back Guarantee.

**Coyne**

Educational Book Publishing Division  
**ELECTRICAL SCHOOL**

1455 W. Congress Parkway, Dept. 13-EM, Chicago 7, Illinois

**CIRCLE NO. 8 ON READER SERVICE CARD**

## The Signal Monitor

(Continued from page 130)

try to keep all wiring associated with capacitor *C1* and coil *L1* very short.

Coil *L1* and transistors *Q1* and *Q2* are supported only by their own leads. Transistor *Q1*'s base and emitter leads, and all of the leads from *Q2*, are wired into the circuit by means of a 5-lug, screw-type terminal strip. The lugs on this strip are lettered "V" through "Z" on the pictorial diagram and represented by identically lettered circles on the schematic diagram. All leads to the latter circles are connected to the appropriate terminals on the strip. The leads ending in arrows are fastened under the screw; the plain ones are soldered to the lug.

**About the Circuit.** The signal from the transmitter is picked up by the monitor's whip antenna (*ANT*), tuned by *L1/C1*, and rectified by diode *D1*. Switch *S1*, which shorts out part of *L1* when closed, acts as a band selector. Passing from *D1*

to transistor *Q1*, the signal is amplified and fed to switch *S2*.

When *S2* is in the "Field Strength" position, meter *M1* is connected to *Q1*'s output through "Meter Adjust" potentiometer *R2*. The meter then provides a visual indication of the relative signal strength. With *S2* in the "Audio" position, *Q1*'s output is fed to the base of transistor *Q2* and further amplified by *Q2* and *Q3*. The output of *Q3* is coupled either to the speaker or to a set of headphones plugged into *J1*.

If a CW signal is being monitored, switch *S4* is flipped to the "CW" position. This introduces collector-to-base feedback in *Q3*, providing a BFO action, and potentiometer *R3* acts as a combined volume and "pitch" control. For AM monitoring, *S4* is set at "AM," disabling the feedback; in this case, *R3* acts only as a volume control.

Power for the unit comes entirely from 6-volt battery *B1* and is controlled by "Power" switch *S3*.

**Operation.** Turn on "Power" switch *S3*, extend the antenna, and set "Band-  
(Continued on page 168)

### "Do-It-Yourself" TUBE CHECKER

At 1/5 The Original Cost!  
Shipped Railway Express, F.O.B. **\$36.95**  
Pays for itself in one month or less! Ideal for supermarkets & drug stores. Completely reconditioned, these machines have up-to-date charts. Hinged back & locked compartment that stores up to 300 tubes.

**ONE YEAR GUARANTEED TV PICTURE TUBES**  
Priced As Low As 49¢ Per Inch! Here are just a few spectacular sample prices!

10BP4 \$ 4.99 17BP4 \$19.95  
12LP4 \$ 7.19 19AP4 \$15.75  
14BP4 \$ 8.25 21EP4 \$16.95  
16EP4 \$ 8.95 21AMP4 \$22.95  
17BP4 \$ 9.95 21CEP4 \$28.95

**NOTE: No Duds Required On Any Of The Above Tube Types**  
Attention! All picture tubes sold by Nation-Wide contain only new parts except for the glass envelope which is reused and has been closely inspected prior to manufacture to insure clear and perfect picture! All picture tubes shipped F.O.B. Send For Nation-Wide's Complete Picture Tube List Dept. CL

### TV CONSOLES

Complete from knob to back cover! No burned out picture tubes or transformer! Satisfaction guaranteed or your money back! Shipped Railway Express, F.O.B.

10" 12" 14" 16" 17" 19" 20" 21" \$7.95 (as is) \$15.95 (as is)

Free Postage On All Orders, 25¢ Handling Charge On Orders Under \$5.00! Deposit Of 25¢ On C.O.D.'s, Canadian and Foreign, please send approximate postage. If you're not satisfied, we will return your money within 5 days.

### THANKS AMERICA!

Your terrific response overwhelmed us! Please be patient on your orders!

- Brand New
- Factory Seconds
- Used Tubes

**\$27.**  
per  
**HUNDRED**

For all type

**TUBES**

**NATION-WIDE TUBE CO.**

Nation-Wide Bldg., Harrison, N.J.

HUMboldt 4-9848

Dept. EEN3

### 1-YEAR GUARANTEE ON ALL TUBES!

Before shipping, each order of tubes is scientifically tested by Nation-Wide's own quality-control department! All shorted and low-emission tubes are immediately destroyed! You receive only top quality, long-life. *Hitback and set tested tubes!*

Individualy boxed. Code dated! Brand

0Z4	6AH4GT	6F6GT	12RA6
1A7GT	6AR6	6GH8	12BE6
180GT	6AK5	6BG6	12BH7/A
116GT	6AL5	6BE6	12BL7
11L6	6AM8/A	616A	12BQ6
1N6GT	6AN8/A	6BK7	12BY7/A
1R7	6AQ5/A	6BK7	12CA5
1T4	6AS5	6L6	12CU6
1U4	6AT6	6A/B/C	12CS5
1U5	6AT8/A	684	12CC5
1V2	6AU	6SA7	12D4/A
2A7	6C7/A	68L7	12DB5
2R4	6AUGT	68L7GT	12DQ6
2CT5	6AU8/A	68N7	12E7/A
3AU6	6AUS	6A/B	12DT8
3BC6	6AV6GA	6SQ7	12E6GT
3BN6	6AV6	6T4	12G7GT
3BR8	6AW8/A	6TR/A	12G7GT
3BZ6	6AX4	6U5/6G5	12SA7
3CB6	6TA/B	6UR/A	12SK7
3CS6	6AX5GT	6V3A	12SN7GT
3DK6	6BA6	6V6GT	12SQ7
3DT6	6BC6	6W4GT/A	12V6GT
3EQ6T	6BC8	6W6GT	12V6GT
3E4	6BE6	6X4	12V7
3V4	6BG6G/A	6X6GT	13DE7
4BQ7A	6BH6	6XB/A	13DR7
4BS8	6BI6	744/XNL	14G7
4BZ6	6BK2	7A5	14I6
6CB6	6BK7/A	7A7	14G7
6C8	6BK7	7L6	17AX4GT
6AN8	6C7/A	7A7	17CS
6AQ5	6BQ5	7BE	19A4
6AS8	6BQ5	7BT	6TA
6AT8	6BQ6	7C5	19BG6
6BK7A	6C1	7B6	19G7
6BR8	6BQ7/A	7N7	19T4
6C8	6BU8	8A8/A	20BQ6
6CL8A	6BY6	8C10	25C10
6C7	6R27	8C7	6A/B
6C4	6C4	8CX8	25CU6
6CB6/A	9AU7	25L6GT	25L6GT
6C5	10DZ7	25W4GT	25Z6GT
6A/B	6CD6G/A	12A6GT	25Z6GT
6C8	6CG7	12AB5	35C5
6V4G	6CM7	12AD5	35L6GT
6Y8	6CQ8	12AT6	36W4
6Y8GT	6CU5	12AT7	35Y4
6WGT	6CUB	12A7	35Z6GT
6AB4	61E4	12AX7	50A5
6AC7	6DQ6	12AZ7	50B5
6AG5	6A/B	12AV5	50C5
6AF	6DT7	12AX4	50E16
4/A	6E8	6TA/B	50L6GT
	6E8R	12B6	70L7GT

Partial listing—  
send for free complete tube listing.  
**FREE SURPRISE BONUS ON  
ORDERS OF \$5 OR MORE!**

CIRCLE NO. 21 ON READER SERVICE CARD



# ELECTRONICS MARKET PLACE

## FOR SALE

**CBERS**, Amateurs, Speech clipper-kit complete \$17.85! Dual Conversion adapter-kit all parts, schematic, pictorial. Hear only the channel you tune. HE-15, A, B; TR-800, 910, B; etc. HE-20, A, B, C; Mark VII; 770, 1, 2; Messenger; GW-10 etc. \$15.50 with tubes \$17.50 or \$5.00 deposit plus C.O.D. Free literature. Dept. "Y", BAINBRIDGE RADIO ELECTRONICS, 2839 Briggs Ave., New York 58, N. Y.

**BEFORE** You Buy Receiving Tubes, Test Equipment, Hi-Fi Components, Kits, Parts, etc. . . . send for your Giant Free Zalytron Current Catalog, featuring all Standard Brand Tubes all Brand New Premium Individually Boxed, One Year Guarantee—all at Biggest Discounts in America! We serve professional servicemen, hobbyists, experimenters, engineers, technicians. Why Pay More? ZALYTRON TUBE CORP., 461 Jericho Turnpike, Mineola, N. Y.

**WORLD** Radio-TV Handbook latest edition with call signs, frequencies, and programs all short wave broadcasting stations \$3.25. GILFER, Box 239, Park Ridge, N. J.

**CBERS**, HAMS, SWL'S 3.5-30 Megacycle Preselector kit, \$18.98. "Audio-Aid-All" Clipper-filter kit, \$10.99. All band vertical, \$16.95. Postpaid! Free catalog! HOLSTROM ASSOCIATES, Box 8640, Sacramento 22, California.

**DIAGRAMS** for repairing Radios \$1.00. Television \$2.00. Give make, model. DIAGRAMS, Box 672A, Hartford 1, Conn.

**HIFI** amplifiers, tuners, radios, TV's. Free Electronic Catalog. GM PHOTOELECTRONICS, 623 Gay, Knoxville, Tennessee.

**ELECTRONIC** Surplus "Great Buys" 10¢. FERTIK'S, 9TH Tioga, Phila. 40, Pa.

**TRANSISTOR** Ignition Coil—Instructions. Special \$8.50 Kits Available. ANDERSON ENGINEERING, Wrentham, Mass.

**PRINTED** Circuit Boards, Complete Etching Supplies \$5 p.p. HAMKITS, Cranford, N. J.

**FCC** Warning Decal Against Unauthorized Use. Mobile (2x3) 35¢ 4/1.00 Base (3x4) 65¢ 2/1.00. CB, Box 457, Encino, California.

**CB** Transmitters \$5.99. Other bargains, send 10¢ for list. VANGUARD, 190-48 99th Ave., Hollis 23, N. Y.

**NEW** Surplus Electronic Components. Free Catalog On Request. JRB SURPLUS SALES CO., P.O. Box E, Pismo Beach, California.

**CONVERT** any television to sensitive, big-screen oscilloscope. No electronic experience necessary. Only minor changes needed. Inexpensive. Clearly illustrated plans \$2.00. RELCO ELECTRONICS, Box 10563, Houston 18, Texas.

**TREE** Telegraph, any distance. Detector Plan, \$1. SENSITRON SYSTEM, Box 1126, St. Augustine, Florida.

**14** Weather Instrument Plans \$2. SACO PRESS, Box 2513D, South Bend, Indiana.

**ROCKETEERS**. Supplies, Fuel Chemicals, Ignition Materials. Illustrated Catalog 25¢. CENTRAL ROCKET COMPANY, 89E Waupaca, Wis.

## EDUCATIONAL OPPORTUNITIES

**ENGINEERING** And Art Degrees earned through home study. Electronics, Mechanical, Liberal Arts, Major Accounting. When writing specify course desired. PACIFIC INTERNATIONAL COLLEGE OF ARTS & SCIENCES, primarily a correspondence school. Resident classes also available. 5719-X Santa Monica Blvd., Hollywood 38, California.

**MONMOUTH RADIO ELECTRONICS INSTITUTE**, Evening Classes on Electronics, Radio, Television, and Mathematics. 814 Cookman Avenue, Asbury Park, New Jersey.

**LEARN** while asleep, hypnotize with your recorder, phonograph. Details free. RESEARCH ASSOCIATION, Box 24-ZB, Olympia, Washington.

## WANTED

**WANT** Pre-1920 Wireless Equipment, Callbooks, Magazines, Personal Collection. W4AA, Box 72, Concord, N. C.

**WANTED:** Quicksilver, Platinum, Silver, Gold. Ores Analyzed. Free Circular. MERCURY TERMINAL, Norwood, Massachusetts.

## QSL, SWL, WPE, CARDS

**QSL** Cards. Low Prices. Free Samples. DEBBELER PRINTING, 1309-M North 38th Street, Milwaukee 8, Wis.

**CREATIVE** QSL Cards—Free, new catalog and samples. Personal attention given. WILKINS CREATIVE PRINTING, P.O. Box 1064-6, Atascadero, California.

## REPAIRS and SERVICING

**ELECTRIC** motor repairing simplified! Free booklet! MODERN, Box 8573, Kansas City 14, Mo.

**LOUDSPEAKERS** reconed. Any Make. Price List. JAMAC, 8845 N.E. Sandy, Portland, Oregon.

## FOR INVENTORS

**INVENTORS:** Save time and money. Prepare and File Your own patent application. Our complete "Patent Kit" makes it easy. Includes detailed instructions and all necessary material. Only \$12.95. Money back guarantee. Don't delay. Send check or money order today to INVENTORS SERVICE, INC., Box 88, Benjamin Franklin Station, Washington, D. C.

## HELP WANTED

**AIRCRAFT** RADIO TECHNICIAN. Excellent opportunity with well-known Midwestern aviation firm for man of higher-than-average intelligence. Must have heavy background in aircraft radio installation and maintenance. Pleasant and stable personality. Highest salary offered. All Inquiries held in confidence. Box 101, Electronic Experimenters Handbook, One Park Avenue, New York 16, N. Y.

## BUSINESS OPPORTUNITIES

**BUY DIRECT FROM FACTORIES!** Appliances, Cameras, Watches. Free Details! CAMP COMPANY, 436EA Bloomfield Avenue, Verona, New Jersey.

## MISCELLANEOUS

**AUTHORS!** Learn how to have your book published, promoted, distributed. Free booklet "ZD-1". Vantage, 120 West 31 St., New York 1.

**SWISS** Musical Electrical Movements \$6.75. SPIELMAN, 131 West 42nd, New York 36.

**QUALITY** Engraving. New Catalogue 10¢ (refunded). ERROL ENGRAVING, Hampden Street, Westfield, Mass.

# ELECTRONIC EXPERIMENTER'S HANDBOOK

## Advertisers Index

CIRCLE NO.	ADVERTISER	PAGE NO.
3	ATR Electronics .....	163
1	Allied Radio .....	35, 36, 37
2	American Institute of Engineering & Technology	156
4	Burstein-Applebee Co. ....	69, 70, 71
5	C & H Sales Co. ....	152
34	Christy Trades School .....	161
35	Cleveland Institute of Electronics .....	80
6	Command Records .....	3
36	Conar .....	153
7	Coyne Electrical School .....	93
8	Coyne Electrical School .....	165
9	DeVry Technical Institute .....	1
10	EICO Electronic Instr., Co. Inc. ....	126
11	Edmund Scientific Co. ....	155
12	Fair Radio Sales .....	126
13	Grantham School of Electronics .....	5
14	Hallicrafters .....	94
15	Heath Company .....	151
16	International Crystal Manufacturing Co., Inc.	6, 7
17	International Rectifier Corp. ....	8
18	Irving Electronics Co. ....	162
19	Lafayette Radio .....	Second Cover
31	Meshna Jr., John .....	150
20	Milwaukee School of Engineering .....	158
37	National Radio Institute .....	Third, Fourth Covers
21	Nation-Wide Tube Co. ....	166
22	National Technical Schools .....	149
23	Olson Electronics, Inc. ....	160
24	Palmer Electronics, Joe .....	154
25	Penn Technical Institute .....	160
26	Poly Paks .....	156
27	Progressive 'Edu-Kits' Inc. ....	159
38	RCA Institutes, Inc. ....	17, 18, 19
32	R H Electronics .....	155
28	Rad-Tel Tube Co. ....	162
33	Sams Co., Inc., Howard W. ....	163
29	Schober Organ Corporation, The .....	164
30	Weller Electric Corp. ....	157
39	Xcelite, Inc. ....	164

switch" *S1* to the bands you desire.

If you're going to measure field strength, throw switch *S2* to the "Field Strength" position and rotate "Meter Adjust" potentiometer *R2* fully clockwise. Turn on your transmitter and peak capacitor *C1* for maximum indication on *M1*. Should the meter go off scale, turn potentiometer *R2* counterclockwise to reduce the reading. The results of any adjustments made on the transmitter can now be readily seen on *M1*.

To monitor AM or CW, set *S2* to the "Audio" position and turn *S4* to either "AM" or "CW." With *S4* in the "AM" position, potentiometer *R3* will act as a volume control; with the switch set for "CW," *R3* will act as a combined volume and "pitch" control. Headphones may be plugged into *J1* (disconnecting the speaker) at any time, and can be used to avoid feedback through the transmitter mike, in situations where there isn't enough gain to operate the speaker, etc.

When working close to the transmitter, the instrument may become overloaded by too much signal. If so, shorten the antenna and/or detune *C1*. -30-

### The Imp Sleuth

*(Continued from page 142)*

then be read directly from the scale.

The bridge can also be used to measure the impedance of output transformers designed to match speakers in the range of 0 to 25 ohms. For example, you may have an output transformer of unknown primary impedance which you want to use with an 8-ohm speaker. To find its impedance, connect jacks *J1* and *J2* of the "Imp Sleuth" to the secondary (speaker side) of the transformer, and a resistor of some known value across its primary.

If the impedance read on the bridge is less than 8 ohms, the primary impedance is greater than the value of the resistor, and vice versa. Given two or three tries, you should be able to find a resistor which will indicate approximately 8 ohms on the "Imp Sleuth." The value of this resistor is the primary impedance of the transformer. -30-

# WHERE You Train is as Important As Your Decision to Train



Electronics is a growing and expanding industry. That's why so many ambitious men are training for careers in this exciting field. They recognize the opportunities to fill in interesting and important positions. But *where* a man trains and *how* the school

of his choice teaches the many fields of Electronics—Automation, Radio-Television . . . how it encourages him to reach his goals and realize his ambitions . . . is most important to his success.

This is a fast changing world. A school offering Electronics courses must keep pace. That's why NRI—with nearly 50 years of specialized experience—now offers eight choices of training. Select the course of most interest to you and receive the kind of home-study training that prepares you for a *specialized career*. NRI's large staff of specialists is always on the job keeping your course material up-to-date . . . helping you earn your way while you train . . . assisting you with job placement. In short, NRI is qualified to help you grow.

## Special Training Equipment Included



The NRI "learn-by practice" method is the time-proved way to better pay. It makes training easier, faster, better. Most NRI courses include—at *no extra cost*—special training equipment to give shop and laboratory experience in your own home. All equipment is yours to keep.

Projects you build, experiments you perform, make NRI lessons come to life. Complex subjects take on real meaning. You measure voltage and current in circuits you build yourself. You use a Vacuum Tube Voltmeter which you construct. Later on, you progress to more involved experiments. If you like working with your hands, you'll enjoy learning Electronics with NRI.

## Oldest and largest School of its kind

NRI training of the 60's is based on nearly half a century of experience gained from training thousands of men like yourself for new careers. NRI has earned the confidence of students, graduates and the Electronics industry. They all recognize NRI training material as an outstanding educational value. And as the oldest and largest Radio-Television-Electronics home-study school, NRI can supply training at reasonable cost. Mail the postage-free card today for facts on the school, on opportunities in Electronics, on monthly payment plans and special Trial Enrollment Offer. NRI TRAINING, Washington 16, D. C.

## JOIN THE THOUSANDS WHO TRAINED AT HOME FOR NEW CAREERS WITH NRI



"I want to thank NRI for making it all possible," says Robert L. L'Heureux of Needham, Mass., who sought our job consultant's advice in making applications and is now an assistant Field Engineer in the DATAmatic Div. of Minneapolis-Honeywell, working on data systems.

"I have gone ahead financially ever since I enrolled with NRI," writes Gerald W. Kallies, now a chief Instrument Technician of Rio Algom Nordic cerenium mines and part-time TV engineer for CKSO-TV, Elliott Lake, Ont. He enrolled with NRI on finishing high school.



His own full-time Radio-TV shop has brought steadily rising income to Harlin C. Robertson of Oroville, Calif. In addition to employing a full-time technician, two NRI students work for him part-time. He remarks about NRI training, "I think it's tops!"

# NOW 8 NRI COURSES

SEE OTHER SIDE

FIRST CLASS  
PERMIT  
NO. 20-R  
(Sec. 349, P.L. & R.)  
Washington, D.C.



BUSINESS REPLY MAIL

NO POSTAGE STAMP NECESSARY IF MAILED IN THE UNITED STATES

POSTAGE WILL BE PAID BY



3939 Wisconsin Avenue  
Washington 16, D.C.



BACKED BY NEARLY 50 YEARS  
EXPERIENCE TRAINING MEN  
FOR SUCCESS BY HOME STUDY



# NOW 8 WAYS to Assure Advancement or Turn Your Hobby Into a New Career

No matter how much or how little education you have, one of NRI's eight career-training home-study courses can help you toward a better future in the great and growing fields of Automation-Electronics, Radio-Television. There has never been a time when ambitious men with specialized Electronics know-how were as much in demand as today. Industries, businesses, government, the military all need men with practical Electronics training to install, operate, service and supervise equipment. Automation continues to eliminate jobs for unskilled labor as fast as *skilled technicians* are available to run Electronically-controlled machines.

## YOU TRAIN AT HOME WITH THE LEADER

Good jobs await Communications technicians, since broadcasting now means more than entertainment; becoming an essential in trucks, cars, trains, planes, ships, etc. In the home, Color TV has come of age along with FM stereo multiplexing and increasing popularity of Hi-fi; television and radio means more opportunities for Service Technicians in spare time or full time businesses of their own. NRI training has been tailored to meet present and future needs of Electronics, Communications and Servicing. Check the field of most interest to you and mail the postage-free card now. NRI TRAINING, Washington 16, D. C.

### SEE OTHER SIDE

CUT OUT AND MAIL CARD NOW!

**FREE 64-PAGE CATALOG**

No stamp necessary  
NRI pays postage

NRI Training  
Washington 16, D. C.

3 AE 2

The Amazing  
Field of  
Electronics



Please send your catalog. I am interested in training checked below. (No salesman will call.)

- |  |  |
|--|--|
| <input type="checkbox"/> Industrial Electronics  | <input type="checkbox"/> Mobile Communications   |
| <input type="checkbox"/> Radio-TV Servicing      | <input type="checkbox"/> Marine Communications   |
| <input type="checkbox"/> Complete Communications | <input type="checkbox"/> Aviation Communications |
| <input type="checkbox"/> FCC License             | <input type="checkbox"/> Math for Electronics    |

Name \_\_\_\_\_ Age \_\_\_\_\_  
(Please Print)

Address \_\_\_\_\_

City \_\_\_\_\_ Zone \_\_\_\_\_ State \_\_\_\_\_

ACCREDITED MEMBER NATIONAL HOME STUDY COUNCIL

- 1 INDUSTRIAL-MILITARY ELECTRONICS**  
Learn Principles, Practices, Maintenance of Electronic equipment used today in business, industry, defense. Covers Electronic controls and measurement, computers, servos, telemetry, multiplexing, many other subjects.
- 2 RADIO AND TELEVISION SERVICING**  
Learn to service and maintain AM-FM Radios, TV sets, Stereo Hi-fi, PA systems, etc. A profitable, interesting field for part-time or full time business of your own.
- 3 COMPLETE COMMUNICATIONS**  
A comprehensive training course for men seeking careers operating and maintaining transmitting equipment in Radio-TV Broadcasting or mobile, marine, aviation communications. Prepares you for FCC License.
- 4 FCC LICENSE**  
Prepares you quickly for First Class License exams. Every communications station must have one or more FCC-licensed operators. Also valuable for Service Technicians. You train at home.
- 5 MOBILE COMMUNICATIONS**  
Training in installation and maintenance of mobile equipment and associated base stations like those used by fire and police, taxi companies, etc. Prepares you for First Class FCC License exams.
- 6 MARINE COMMUNICATIONS**  
Shipboard transmitting equipment, direction finders, depth indicators, radar are all covered in this course. You prepare for your First Class Radiotelephone License with Radar Endorsement.
- 7 AVIATION COMMUNICATIONS**  
For men who want careers working with and around planes. Covers direction finders, ranges, markers, loran, shoran, radar, landing systems, transmitters. Prepares you for FCC License exams.
- 8 MATH FOR ELECTRONICS**  
From basic arithmetic review to graphs and electronic formulas in one complete "short course" package of five carefully prepared texts. Quick, complete and low in cost.

CUT OUT AND MAIL  
POSTAGE-FREE CARD

**SPRING EDITION**

**\$125**

**1965**  
**POPULAR**  
**ELECTRONICS**

**ELECTRONIC**

**EXPERIMENTER'S**

**HANDBOOK**

**HOW TO BUILD**

**VHF, SWL, & HAM BAND RECEIVERS • HI-FI  
SPEAKER SYSTEMS • SCIENCE FAIR PROJECTS  
PHOTOELECTRIC ALARM • TEST EQUIPMENT**

**AUTOMOTIVE  
ELECTRONIC  
PROJECTS**

**IMPROVING  
TV RECEPTION**

**MAKE YOUR  
OWN 0-5000  
RPM TACH FROM  
SIMPLIFIED PLANS**

**(see page 11)**

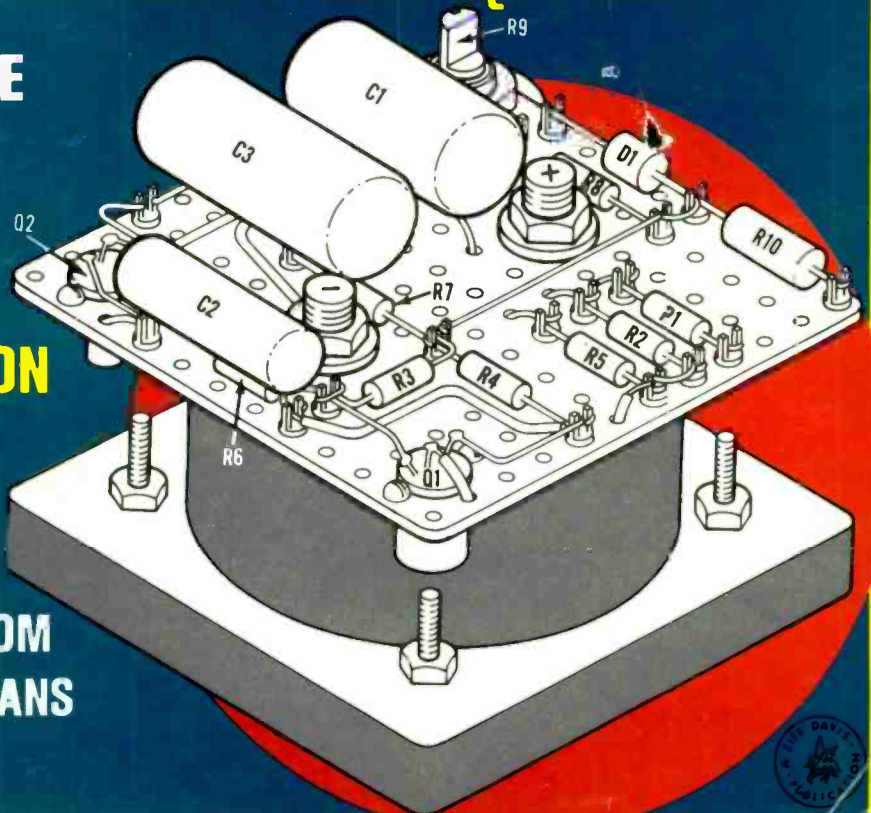

# LAFAYETTE RADIO ELECTRONICS

# FREE!

1965 CATALOG  
No. 650

Now — Over 500 Pages!

Featuring Everything  
in Electronics for

- Home
- Industry
- Laboratory

from the  
"World's Hi-Fi &  
Electronics Center"



It's all in the new,  
1965 Lafayette Catalog.  
Detach and Mail the Card  
for Your FREE Copy!

or write—

Lafayette Radio Electronics, Dept. ET-5  
P.O. Box 10, Syosset, L. I., N. Y. 11791

See the Largest Selection in Our 44-Year History:

**STEREO HI-FI** . . . there's a complete selection of stereo hi-fi equipment at Lafayette. All famous brands plus Lafayette's own top-rated components. All at Lafayette's low, low prices too.

**CITIZENS BAND** . . . Lafayette still leads the field in transceivers, Walkie-Talkie and accessories. And the price is always right at Lafayette.

**TAPE RECORDERS** . . . from portable recorders to complete decks—you'll find the right recorder at the right price at Lafayette.

**HAM GEAR** . . . for receivers, transmitters, as well as the smallest accessory, amateurs everywhere make Lafayette their headquarters for all their gear.

Want More? There's Test Equipment, Radios, Tools, Books, TV and Radio Tubes and Parts, Auto Accessories, Cabinets, Drafting Supplies, Intercoms.

**AND** Marine Equipment, Cameras, Optical Goods, Musical Instruments, P.A. Equipment, TV Sets, and Much More.

**BUY ON TIME** . . . Use Lafayette's famous Easy-Pay Credit Plan—up to 24 Months to Pay.

CIRCLE NO. 22 ON READER SERVICE CARD

- 5 in. Oscilloscope 1
- Transistorized Meter 2
- Modern Lessons 3

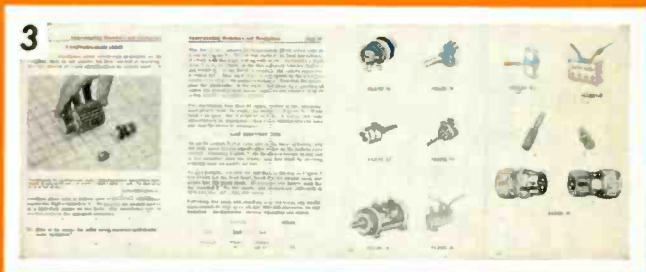

*AT SEA*  
*ON LAND*  
*In the Air!*



**TRAINING FILM**

You also get the loan of a motion picture projector and 16 reels of film to help you learn quickly, remember more.

## Job Opportunities continue to increase for the Electronics Technician

Electronics is a multi-billion dollar industry, growing rapidly, calling for well-trained technicians, offering many good-paying opportunities. DeVry prepares you at home — or in its well-equipped training centers — for Radio, Television, Communications, Missiles, Computers, Radar, Control Systems, etc.

DeVry sends the type of materials you need for learning electronics at home. You build and keep (1) a modern 5-inch oscilloscope and (2) a portable transistorized meter. Use these on the job or to make money as you learn. You work 300 construction and test procedures with our exclusive "Electro-Lab". Modern lessons (No. 3 above) with their handy foldout diagrams help to speed your progress.

Let us put our more than 30 years of "know-how" behind you today to help you prepare for a lot of brighter, more prosperous tomorrows. Send coupon for 2 FREE booklets today.

Accredited Member of National Home Study Council

**FREE!**  
**Send For 2**  
**Booklets Today!**

**EMPLOYMENT SERVICE**

All DeVry graduates can receive the help of our highly effective employment service without additional cost.

## DeVry Technical Institute

Chicago • Toronto  
4141 Belmont Avenue  
Chicago, Illinois 60641



**DeVry TECHNICAL INSTITUTE**  
4141 Belmont Ave., Chicago, Ill. 60641 Dept. EEM-1-V

Please give me your two free booklets, "Pocket Guide to Real Earnings," and "Electronics in Space Travel"; also include details on how to prepare for a career in Electronics. I am interested in the following opportunity fields (check one or more):

- Space & Missile Electronics
- Television and Radio
- Microwaves
- Radar
- Automation Electronics
- Communications
- Computers
- Broadcasting
- Industrial Electronics
- Electronic Control

Name \_\_\_\_\_ Age \_\_\_\_\_

Address \_\_\_\_\_ PLEASE PRINT \_\_\_\_\_ Apt. \_\_\_\_\_

City \_\_\_\_\_ Zone \_\_\_\_\_ State \_\_\_\_\_

Check here if you are under 16 years of age  
Canadian residents: Write DeVry Tech of Canada, Ltd.  
970 Lawrence Avenue West, Toronto 19, Ontario

2093

CIRCLE NO. 11 ON READER SERVICE CARD



# hallicrafters quality is the BIG NEWS in TEST INSTRUMENT KITS

. . . and hallicrafters engineered quality means outstanding specifications and performance . . . plus simplified construction!



NEW "Fail-Proof" soldering terminal strips simplify making of positive connections.

NEW assembly ease. Mechanical parts are riveted to the chassis at the factory.



## CAPACITANCE DECADE Kit HD-1

Ideal for experimental and service work requiring precision capacitors. Sixteen commercial slide switches give total variability in 100 pf steps. Uses silve. mica capacitors and long lasting stable defilm capacitors. Range .0001 to 1.0 mfd in four decades. Price \$14.95



## RESISTOR DECADE Kit HD-2

Use to substitute known-value precision resistors in a circuit. Resistors are one-watt. 10%. Twenty-eight commercial slide switches give total variability in 1-ohm steps. Range: 1 ohm to 10 megohms in seven decades. Price \$14.95



## CONDENSER TESTER Kit HC-1

Handy service bench instrument for checking unknown condenser and resistor values under operating conditions. Has precision tuning eye for easy operation. Four capacitance ranges: 10 mmf to 2,000 mfd. Three resistance ranges: 0.5 ohm to 5 megohms. Price \$29.95



## R.F. GENERATOR Kit HG-1

Generates frequencies from 50 kc. to 55 Mc. in six steps. Calibrated harmonics in two steps from 55 Mc. to 220 Mc. Low frequency range exceptionally stable. Accuracy 1½% of the reading. R.F. output .1-volt. Bandswitch assembly pre-wired and calibrated. Price \$29.95



## 5-INCH OSCILLOSCOPE Kit HO-1

A perfect scope for servicing color TV sets. Has full 5 Mc. bandwidth. Tube is 5 UPI. One-volt peak-to-peak source attenuator permits voltage measurements over range of 10,000 to 1. Retrace blanking amplifier provided. Phasing is continuously variable from 0 to 140°. Has two axis (beam) modulation. Price \$84.95



## VACUUM TUBE VOLT MILLIAMMETER Kit HM-1

Has an exclusive built-in milliammeter circuit, available at the turn of a switch. Illuminated meter and separate front panel On-Off switch. Has seven AC, DC voltage ranges, from 1.5 to 1500; seven ohmmeter ranges, 0 to 1,000 megohms; and six milliammeter ranges, 1.5 to 500. Price \$29.95



## BATTERY ELIMINATOR Kit HP-1

Reliable source of 6- or 12-volt DC power for servicing car radios, including transistor and "hybrid." AC ripple less than .25%; exceptionally low. Voltage ranges 0-8 volts and 0-16 volts. Also use as battery charger. Has voltage and current panel meters. Price \$49.95

Look for  
this display



at your Authorized  
Hallicrafters Kit  
Headquarters!



# hallicrafters Master Kits

For FREE Catalog, write Dept. 5-A, 5th & Kostner Aves., Chicago 24, Ill.  
Export: International Div., Hallicrafters. Canada: Gould Sales Company, Montreal, P. Q.

CIRCLE NO. 17 ON READER SERVICE CARD



# 1965 POPULAR ELECTRONICS ELECTRONIC EXPERIMENTER'S HANDBOOK

SPRING EDITION

**PHILLIP T. HEFFERNAN** Publisher  
**OLIVER P. FERRELL** Editor  
**JAMES A. ROTH** Art Editor  
**MARGARET MAGNA** Associate Editor  
**ANDRE DUZANT** Technical Illustrator  
**NINA CHIRKO** Editorial Assistant  
**PATTI MORGAN** Editorial Assistant  
**LAWRENCE SPORN** Advertising Sales Manager  
**ARDYS C. MORAN** Advertising Service Manager

#### ZIFF-DAVIS PUBLISHING COMPANY

Editorial and Executive Offices (212 ORegon 9-7200)  
One Park Avenue, New York, New York 10016  
William B. Ziff, Chairman of the Board (1946-1953)  
William Ziff, President  
W. Bradford Briggs, Executive Vice President  
Hershel B. Sarbin, Vice President and General Manager  
Philip Sine, Treasurer  
Walter S. Mills, Jr., Circulation Director  
Stanley R. Greenfield, Vice President  
Phillip T. Heffernan, Vice President

New York Office (212 ORegon 9-7200)  
One Park Avenue, New York, New York 10016  
Eastern Advertising Manager, RICHARD J. HALPERN

Midwestern Office (312 WAbash 2-4911)  
434 South Wabash Avenue, Chicago, Illinois 60605  
Midwestern Advertising Manager, JAMES WEAKLEY

Western Office (213 CRestview 4-0265)  
9025 Wilshire Boulevard, Beverly Hills, California 90211  
Western Advertising Manager, BUD DEAN



1965 POPULAR ELECTRONICS ELECTRONIC  
EXPERIMENTER'S  
HANDBOOK

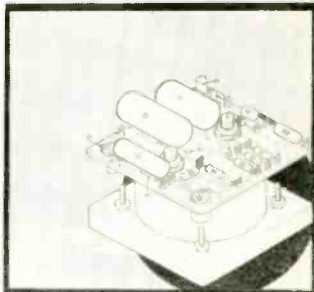

**T**HIS is the Ninth Annual Edition of the ELECTRONIC EXPERIMENTER'S HANDBOOK. If you looked closely at the cover, you will have noted that we said "Spring Edition." Yes, in response to hundreds of requests, the EXPERIMENTER'S HANDBOOK will be issued twice in 1965—the usual Spring Edition, and a brand-new "Fall Edition." We are also pleased to announce that projects will appear in both editions that are new and not reprints from POPULAR ELECTRONICS. As in the past, your Editors have taken great pains to double-check all circuit diagrams and parts listings. We believe them to be as correct as possible at time of printing. We hope you enjoy the projects described herein and that you will look forward to the Fall Edition.

THE EDITORS

1965 ELECTRONIC EXPERIMENTER'S HANDBOOK, Spring Edition, published by the Ziff-Davis Publishing Company, One Park Avenue, New York, New York 10016. Also publishers of Popular Electronics, Electronics World, HiFi/Stereo Review, Communications Handbook, Tape Recorder Annual, Stereo/Hi-Fi Directory. Copyright © 1965 by Ziff-Davis Publishing Company. All rights reserved.

# CHECK JOHNSON FIRST!

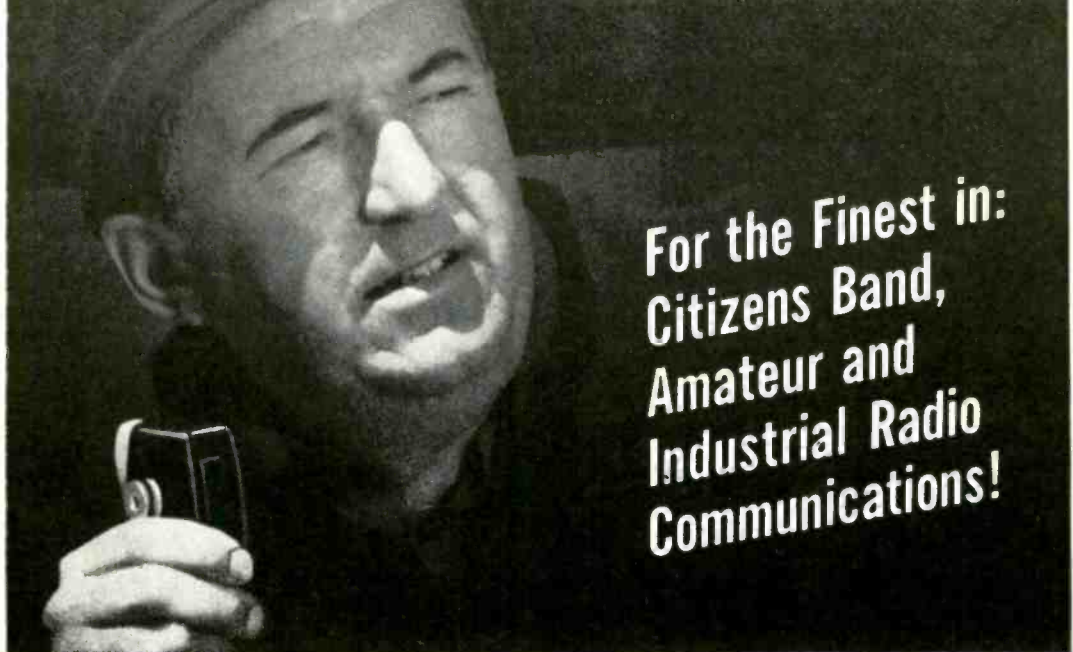

For the Finest in:  
Citizens Band,  
Amateur and  
Industrial Radio  
Communications!

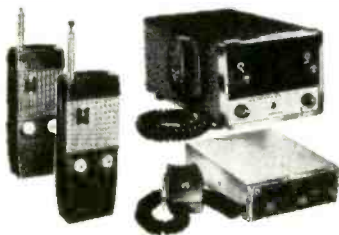

**Nation's most popular, most complete Citizens Band line!** Everything you ever wanted for CB — from compact, hand-held "Personal Messengers" to the tiny, new all-transistor "Messenger III"! Information-packed, full-color 8-page brochure gives you all the details—see your distributor or use the coupon below.

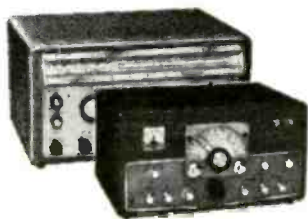

**Viking Amateur Equipment opens the door to world-wide adventure!** Excellent value, solid performance, and an unmatched reputation for reliability—that's why novice and experienced amateurs check Johnson first! Complete, 20-page amateur catalog gives you all the dope on these world famous transmitters and station accessories.

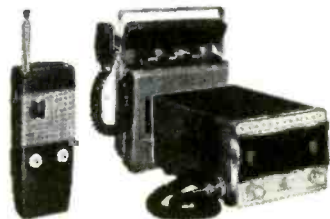

**"Messenger" Industrial Radio for a fully integrated system!** Priced within easy reach of any business, here's the line that offers everything from hand-held units and portable field pack to a choice of base station and mobile equipment for use in 25 to 50 megacycle range! Complete descriptive literature available from your distributor, or use coupon.



## E. F. JOHNSON COMPANY

2503 10th Ave. S.W. • Waseca, Minnesota 56093

Please rush me the following literature:

- 4-Color "Messenger" Citizens Radio Literature  20-Page Amateur Equipment Catalog  20-Page Booklet "All About Two-Way Radio"  4-Color "Messenger" Industrial Radio Literature

NAME \_\_\_\_\_

ADDRESS \_\_\_\_\_

CITY \_\_\_\_\_ STATE \_\_\_\_\_ ZIP \_\_\_\_\_

**SEND  
COUPON  
TODAY!**

Indicate the material you wish to receive—for detailed information, see your Johnson distributor!

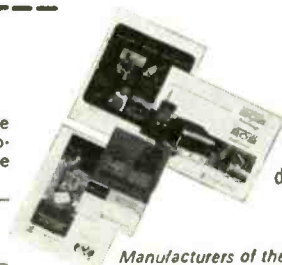

*Manufacturers of the world's most widely used personal communications transmitters*

**CIRCLE NO. 21 ON READER SERVICE CARD**

**ELECTRONIC EXPERIMENTER'S HANDBOOK**

# CONTENTS

## **1** Electronics Around the Home **7**

*Cloud Sentinel—X-Line Tachometer—Cheater Cord De Luxe—X-Line Charger—Automatic Safety Flasher—Exterminate TV Sync-Bug Interference—Pickup Pranks—Boost Box—Telephone Beeper—TV's Best Guarded Secret—Coming or Going—Largo to Presto Metronome—"Loud-Hailer" for the Telephone—Car Battery Saver*

## **2** Hi-Fi and Stereo **57**

*Reflectoflex Speaker Enclosure—Phono Fillips—Resistive Load for Hi-Fi Test—Another Ceramic Tile Enclosure—Audio Aids—Stereo Indicator*

## **3** Communications for the Hobbyist **77**

*VHF Listener—SSB Product Detector—Crystal Super Calibrator—2-Tube Superhet for 80 Meters—The WXCVR—R.F. Coil Frequency Finder—Code Bander—Selected Projects from W9EGQ—The Identio-Minder—2-Meter Simple Superhet*

## **4** Electronics in the Workshop **121**

*Bargains by the Bagful—Handy EP Pack—The Squealer—Meterless VTVM—Electronic Stop Watch—C Bridge—VHF Grid-Dip Meter—Best of Tips and Techniques*

# VOLTAGE PROBLEMS?

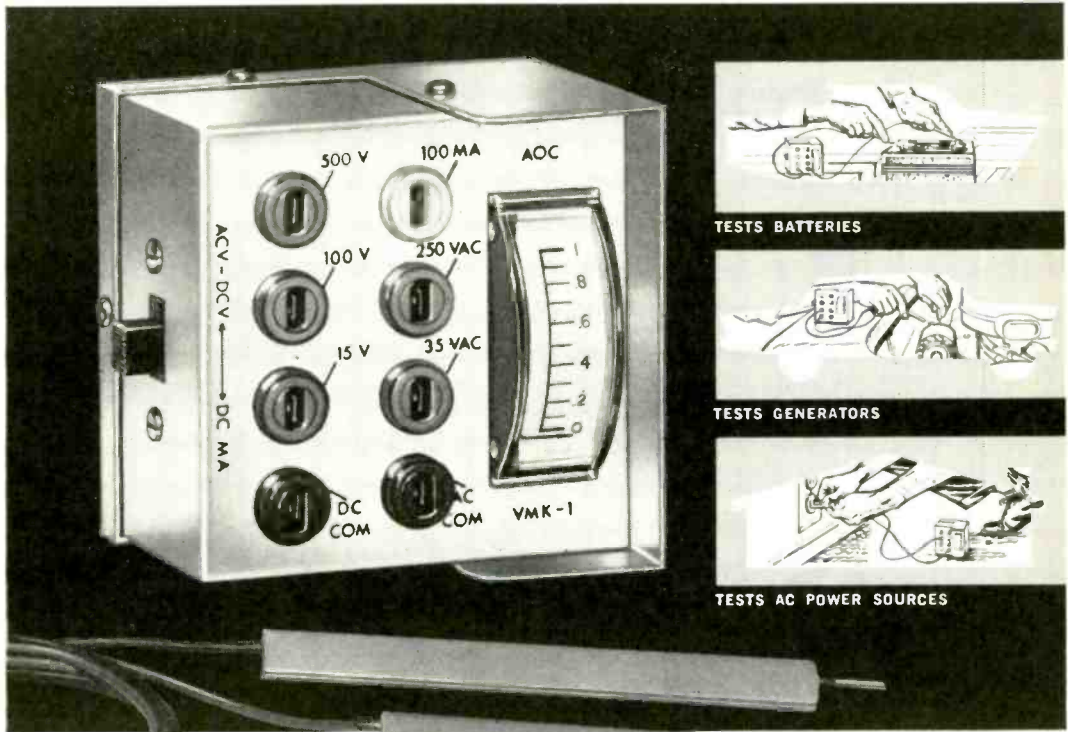

IT'S EASY TO CHECK WITH INTERNATIONAL'S

## AOC VMK-1 VOLTMETER

This compact test instrument will measure DC voltages from 0 to 500 volts, AC voltages from 0 to 250 volts, DC milliamperes from 0 to 100 milliamperes. Accuracy within  $\pm 10$  percent. Dimensions: 3" x 3" x 2"

- Tests batteries
- Tests generators
- Tests AC power sources

Use the VMK-1 voltmeter aboard your boat, at home, in your workshop, office or car. Prevent

expensive equipment failure due to improper voltages. Handy as a screwdriver. It takes only a short time to assemble the kit from easy to understand instructions.

- Designed by International
- High quality components
- Economically priced

Order your AOC VMK-1 Voltmeter today!

Kit, complete with test probes..... **\$7.95**

Wired, complete with test probes..... **9.95**

Write Today For Our Free Catalog!

MANUFACTURERS OF  
PRECISION MADE CRYSTALS  
AND EQUIPMENT

**INTERNATIONAL**  
CRYSTAL MANUFACTURING CO., INC.

18 NORTH LEE • OKLAHOMA CITY, OKLA.

CIRCLE NO. 19 ON READER SERVICE CARD

ELECTRONIC EXPERIMENTER'S HANDBOOK

# Chapter

## **ELECTRONICS**

### **AROUND the HOME**



**E**LECTRONIC gadgets or devices that you can build for use around your home are practically limitless. In this chapter, your Editors have offered a sampling that is sure to attract your interest and attention. Automotive electronics is represented by four projects, including a precision tachometer with a 0-5000 or 0-6000 rpm range; a battery charger that thinks for itself; a "Car Battery Saver"—just in case you (or someone in the family) has a tendency to walk off and leave the headlights burning; and a simple "Safety Flasher."

Everyone with a portable TV set should read Lew Harlow's story on rabbit-ear antennas, and SWL's, CB'ers, or hams bugged by TV sync interference should find Bill Orr's ideas on suppression of value.

The remaining projects include some telephone attachments, a metronome, a science fair project, and a photoelectric alarm that actually tells which way a person is moving when the light beam is broken.



The Cloud Sentinel.....	H. E. Sanders, W4CWK	<b>8</b>
X-Line Tachometer.....	Charles Caringella, W6NJV	<b>11</b>
Cheater Cord DeLuxe.....	James A. Fred	<b>16</b>
X-Line Charger.....	Oliver P. Ferrell	<b>21</b>
Automatic Safety Flasher.....	Lou Garner	<b>26</b>
Exterminate TV Sync-Bug Interference.....	William I. Orr, W6SAI	<b>28</b>
Pickup Pranks.....	Fred Blechman, K6UGT	<b>30</b>
Boost Box.....	Art Trauffer	<b>32</b>
Telephone Beeper.....	Fred Blechman, K6UGT	<b>34</b>
TV's Best Guarded Secret.....	Lewis A. Harlow	<b>39</b>
Coming or Going.....	Arthur J. Davison	<b>41</b>
Largo to Presto Metronome.....	John F. Cleary	<b>47</b>
"Loud-Hailer" for the Telephone.....	Donald L. Wilcox	<b>50</b>
Car Battery Saver.....	R. C. Apperson, Jr.	<b>53</b>

# THE CLOUD SENTINEL

*Watch far-off flashes of lightning, small storm discharges, and fair weather currents as they animate the meter needle*

**B**OLTS OF LIGHTNING have frightened, puzzled, and fascinated mankind from the beginning of recorded time. These bright, intense flashes of electricity between clouds and earth, or between concentrations of opposite polarity within clouds, may pass average currents as high as 30,000 amperes. Not so familiar as visible and audible discharges, however, are the infinite number of unspectacular discharges which pass varying and continuous currents so small that even sensitive microammeters have difficulty detecting them.

These tiny currents, which pass through any conductor rising above the earth's surface, flow during both fair weather and foul. With a device that shows the direction of current flow and the amount and rapidity of the changes constantly taking place, it is possible to predict the approach of a storm, and to "see" far-off flashes of lightning as they occur. Day-to-day observations can be correlated with weather conditions for a science fair project, or just to satisfy your curiosity.

"The Cloud Sentinel" is a simple, easy-to-build device which you can use

By H. E. SANDERS, W4CWX

## PARTS LIST

- B1—Size AA dry cell
- B2—Size D dry cell (two required)
- M1—0-50  $\mu$ z. meter (Lafayette TM-200, \$4.95)
- Q1—Pnp transistor (G.E. 2N508 or 2N107)
- R1—1.5-megohm, 1/2-watt resistor
- R2, R5—2200-ohm, 1/2-watt resistor
- R3—10,000-ohm potentiometer, log taper
- R4—500-ohm potentiometer, linear taper
- S1—5-p.s.t. snap-action switch
- S2—5-p.s.t. slide switch
- S3—2-pole, 2-position reverb switch
- 1—Battery holder for AA cell (Keystone #139 or equivalent)
- 1—Battery holder for two D cells (Keystone #176 or equivalent)
- 1—Transistor socket
- 1—3" x 4" x 5" Minibox (Bud CU-3005A)
- Misc.—2" x 2 1/2" component mounting board, plastic pill box cap, knobs, wire, bracket, rubber feet, solder, hardware, panel decals

### Antenna Ground System

- 1—36'-50" length of #12 insulated solid copper wire
- 1—36'-90" length of microphone cable (Belden #8201)
- 1—3' length of #14 galvanized ground or guy wire
- 1—10'-10" antenna mast
- 1—6' length of 1/2" galvanized steel pipe
- Misc.—Wood plug to fit in top of mast, screws, solder, mast platform, guy wire, insulators (as necessary)

to detect cloud-earth currents as low as several hundredths of one microampere as they pass through your antenna-ground system.

**How It Works.** The Cloud Sentinel is essentially a basic d.c. current amplifier circuit which has been expanded to include a meter shunt to allow the operator to reduce amplification as a storm approaches and electrical activity increases. Another switch permits reversing the polarity of the input in the event of cloud-earth polarity reversals.

Transistor Q1, resistors R2 and R5, potentiometer R4, switch S2, and battery B2 form the d.c. current amplifier, with meter M1 and shunt potentiometer R3 providing current indications. On the author's unit, a current amplification of 30 is obtained with R3 in "off" position. With R3 in the "on" position there is no noticeable meter movement. Various in-between settings allow the operator to choose any desired amplification factor.

Switch S3 connects the antenna and ground to the transistor's base and emitter with a choice of polarities. With S3 in its neutral position, the antenna is connected directly to ground. Switch S1,

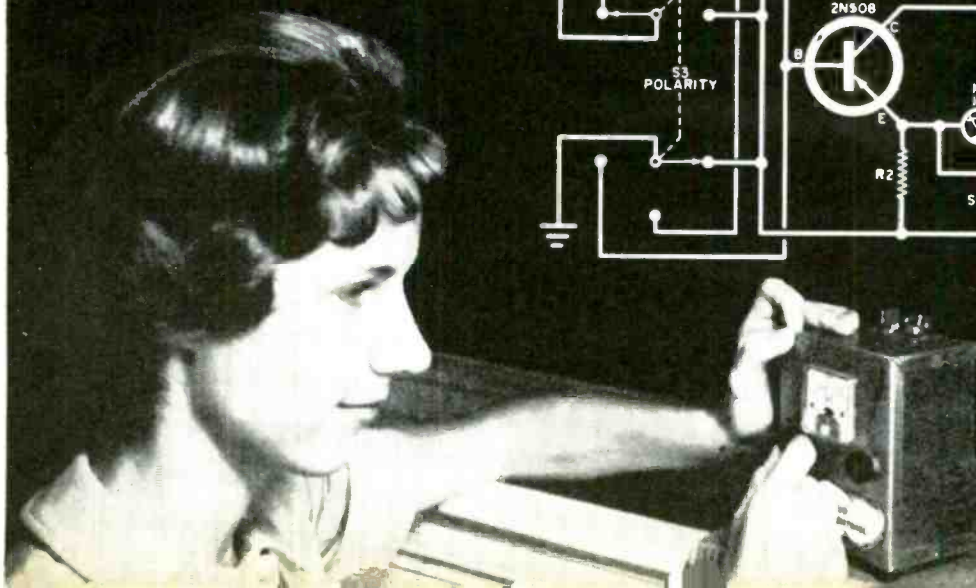
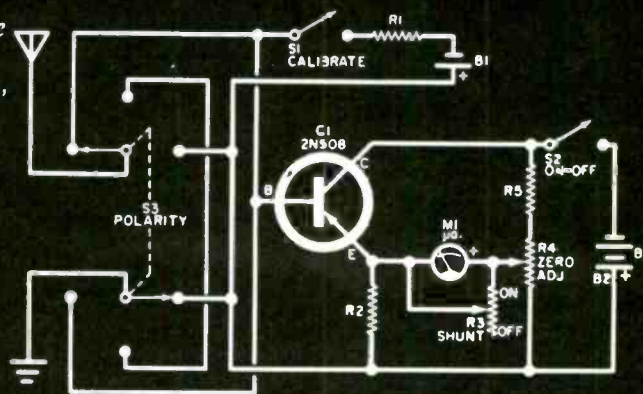



Completed Cloud Sentinel is shown above, the parts layout at the right. Parts values and arrangement are not at all critical; principal requirement is sensitive meter. (The new Lafayette catalog number for the TM-200 specified in the Parts List is 99 G 5060.) At the far right is a photo of antenna used by the author (see text). Use #14 bare copper wire for spikes, insulated wire for the lead-in taped to mast.

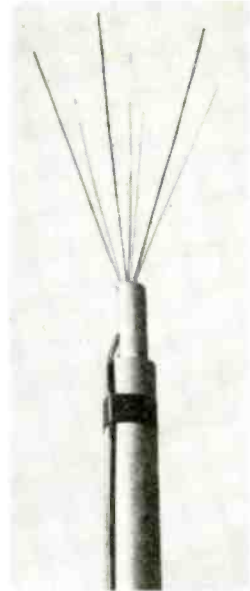
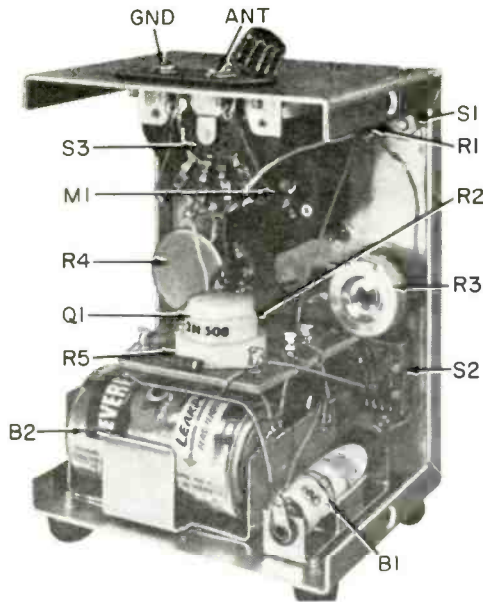

$Q1$ ,  $R2$ ,  $R5$ , and several tie points, and is attached to the front panel with a  $\frac{1}{2}$ " x  $\frac{1}{2}$ " x 2" bracket. Battery holders for  $B1$  and  $B2$  are screwed to the bottom of the box with  $\frac{1}{4}$ " space above them to provide clearance for wiring the transistor. Mechanical details, parts layout, and lead dress are not critical, and may be altered as desired.

Although not absolutely essential, it is a good idea to surround the transistor with a thermal barrier. For the proto-

resistor  $R1$ , and battery  $B1$  provide a known current of one microampere to the amplifier for calibration purposes.

**Construction.** The prototype Cloud Sentinel was built into a 3" x 4" x 5" Mini-box which provided ample space for easy assembly with the miniature meter and batteries specified. The on-off switch ( $S2$ ), meter  $M1$ , and potentiometers  $R3$  and  $R4$  are mounted on the front panel, and the antenna-ground terminal board and polarity-reversing switch,  $S3$ , are fitted on the top. The calibrate switch,  $S1$ , is a microswitch mounted behind the front panel at the left top corner, and is actuated through a hole in the top of the unit.

A small 2" x 2½" piece of component mounting board is used as a chassis for

type, papier-mâché was made by soaking newspaper in water. A plastic pill box lid was filled loosely with this mixture and pressed down over  $Q1$ .

**Parts Substitutions.** Resistance values specified for the Cloud Sentinel may be altered within reason. The author satisfactorily used a large surplus 50-0-50 microammeter in a breadboard version of the Sentinel, which eliminated the need for polarity-reversing switch  $S3$ . A multi-position switch and a series of resistors in place of  $R3$  would permit the operator to switch from one known amplification to another and eliminate the need for the calibration circuit. With minor resistance changes which can be worked out by the reader, up to 6 volts  
(Continued on page 159)



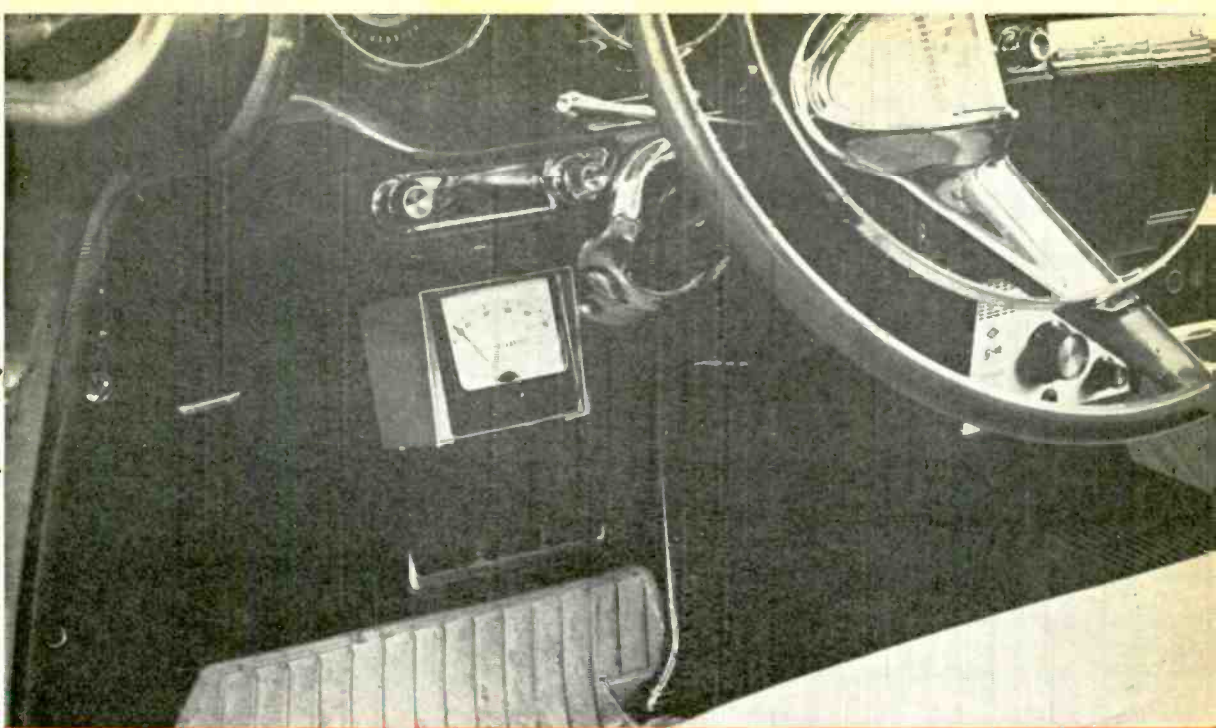

COVER STORY

# - Line Tachometer

Pre-packaged low-cost semiconductors offer opportunity to build linear-scale, high-accuracy tach for automotive or marine use

By CHARLES CARINGELLA, W6NJV

**M**OUNTED under the dashboard in the photo above is a tachometer that would make any hot-rod enthusiast green with envy. The circuit and some of the semiconductors were taken from General Electric Company's new "Experimenter Line" of control devices which come complete with schematics. These devices consist of zener diodes, transistors, reed switches, etc., and the "Line" is available throughout the United States. The tach described here uses two of the packaged devices. The remaining tach components can be purchased at prices ranging from about \$20 to a high of \$30.

**How It Works.** The tachometer input terminals are connected directly across the distributor breaker points. While the points are closed during the dwell time, the base of transistor Q1 is at ground potential. Since the Q1 emitter is biased positive through resistors R3 and R6, Q1 is held cut off, with its collector about 8 volts positive to ground. When the breaker points open, the inductive kick from the coil primary drives the tach input sharply pos-

# X-Line Tachometer

itive. Reduced by the input network ( $R1$ ,  $C1$ ,  $R2$ , and  $R5$ ) to a safe value, this positive-going impulse turns  $Q1$  on, dropping its collector to about ground potential.

This negative-going pulse is coupled through  $C2$  to base 2 of  $Q2$ , which was held cut off until this time by positive bias through  $R7$ . The duration of the negative pulse at base  $B2$  is very short, since it exists only while  $C2$  is charging through  $R7$ . Transistor  $Q2$  is turned on by the short negative pulse, and becomes a short-circuit path to ground through which  $C3$  discharges. The discharge current from  $C3$  through base  $B1$  holds  $Q2$  on until the discharge is completed, regardless of the return of base 2 to a positive bias condition.

When  $C3$  has fully discharged,  $Q2$

No effort has been made to draw up a new scale for the X-Line tachometer since many builders may not use this meter. The scale is perfectly linear, with 100 equal to 1000 rpm, 200 to 2000 rpm, etc.

again cuts off, and  $C3$  charges through  $R8$  and  $R9$ . Since the voltage at the plus end of  $R8$  is held at 8.2 volts by zener diode  $D1$ , the amount of current that flows each time  $C3$  is recharged is always the same. Since  $C3$  is recharged once each time the breaker points open, the average current through the meter is directly proportional to engine speed, despite changes in point dwell time and other factors. The required capacitance value for  $C3$  for different types of marine and automobile engines is given in the small table near the top of page 14.

**Construction.** Probably the easiest way to construct the X-Line Tach is to mount all components on a  $3\frac{1}{4}'' \times 3\frac{1}{4}''$  piece of Vectorbord. Component layout is not critical, however; the close-up view on

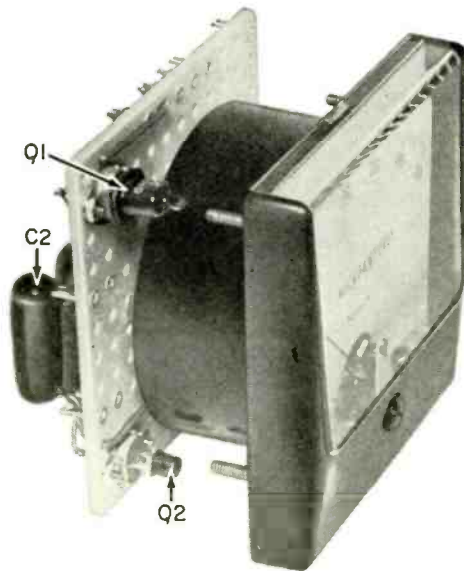
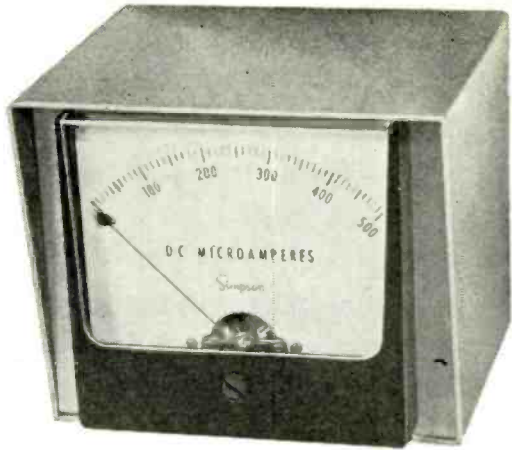

the next page can be followed with assurance that everything will fit properly.

Regardless of the meter used on your tach, prepare to mount the Vectorbord on the meter terminals; use push-in terminals to hold the components rigidly in place. Both transistors are seated in sockets and calibration potentiometer  $R9$  is attached to the Vectorbord in one corner. Only three wires need exit from the metal cabinet—or two if the metal frame of the cabinet is grounded to the metal of the dashboard.

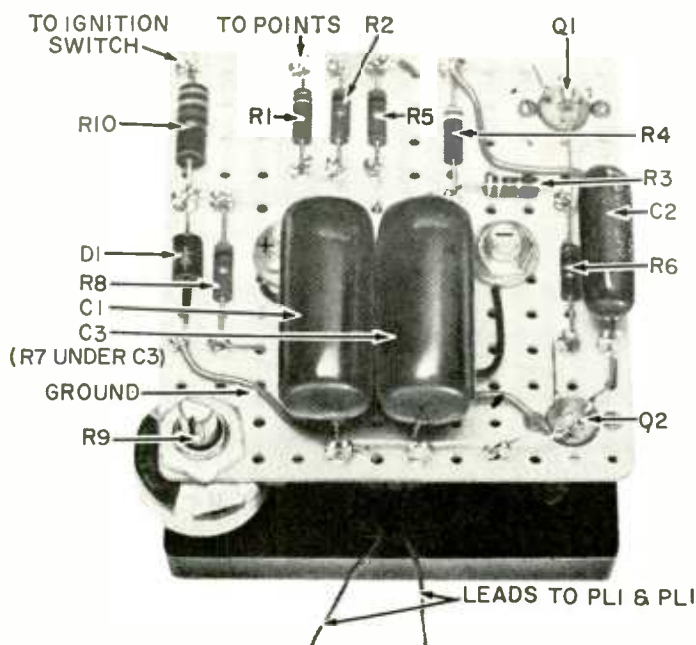

All components can be conveniently mounted on a small piece of Vectorbord. Push-in terminals (22 required) are used as tie points. Vectorbord is attached to terminal posts of 500- $\mu$ a. meter.

Two miniature 6-volt bulbs—wired in series—are cemented to the back of the plastic meter face, providing nighttime illumination of dial. A dropping resistor (not shown) cuts down on brightness.

The most expensive item in the X-Line Tach can be the 0-500  $\mu$ a. meter. To verify the linearity and accuracy of the circuit design, a high-quality Simpson Model 1327C meter was used in the author's prototype. While this meter has many admirable features, a substantial saving can be made by shopping around for meters costing \$7-\$8 less. An additional saving can be made by eliminating the special cabinet and mounting the meter—and Vectorbord—on a solid sheet of plain aluminum.

**Meter Illumination.** For convenience while driving at night, the meter used in this prototype has been provided with illumination by mounting two small lamps along the bottom edge of the meter scale. Similar illuminating methods can be devised using the same parts (I1, I2, and R11) with different meters.

If the Simpson meter is used, pry off the meter front cover with a penknife or thin screwdriver blade. Use epoxy cement to attach the lamp sockets to the plastic meter face (see photo). Then wire the two lamps in series—they are rated at 200 ma. and 6 volts—bringing thin wire connecting leads out through a small hole in the rear of the meter.

Resistor R11 is used to cut down on

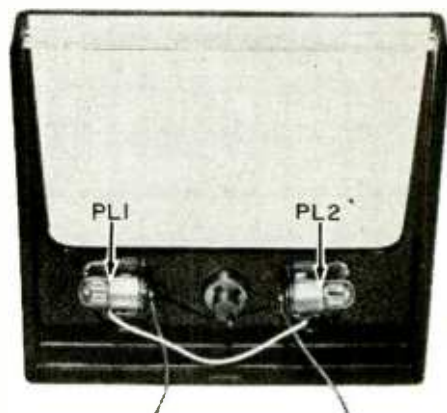

the brilliance of the bulbs. It is not visible in any of the illustrations, but is soldered to the ground lug on the Vectorbord between D1 and R9. If you want to adjust the brilliance with the car's dashboard control, there is no reason why the lead from I1 cannot go to the dashboard rheostat.

**Calibration.** The range of the X-Line Tach can be set between 0-4500 and 0-7000 rpm by adjustment of R9. Practically all pre-1964 Detroit cars are covered in the range of 0-5000 rpm. This range has the advantage of not requir-

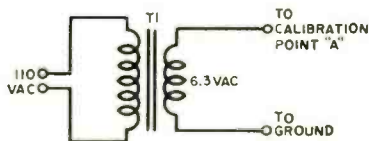
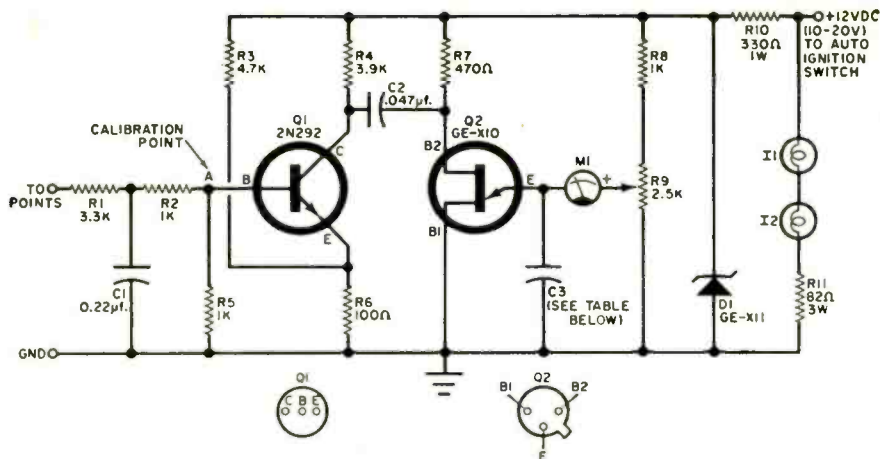

	No. of Cylinders		
	4	6	8
C3 in $\mu\text{f.}$ for 2-cycle engine	0.33	0.22	0.15
C3 in $\mu\text{f.}$ for 4-cycle engine	0.68	0.47	0.33

In this circuit capacitor C3 is discharged through unijunction transistor Q2. Charging up C3 depends upon the type of engine (2- or 4-cycle) and the number of cylinders. Select a value for C3 from the table above to match the engine. Calibration is accomplished by connecting 6.3 volts a.c. between ground and point "A". Potentiometer R9 is adjusted so that a reading of 900 rpm is obtained. The scale is linear; only one calibration point is needed.

### PARTS LIST

- C1—0.22- $\mu\text{f.}$  Mylar capacitor
  - C2—0.047- $\mu\text{f.}$  Mylar capacitor
  - C3—See table above
  - D1—8.2-volt, 1-watt zener diode (General Electric X-11 Kit)
  - I1, I2—No. 328 midget bulb (G.E. or equivalent)
  - M1—500-microampere d.c. meter—see text
  - Q1—2N292 transistor (G.E. or equivalent)
  - Q2—Unijunction transistor (G.E. X-10 Kit)
  - R1—3300 ohms
  - R2, R5, R8—1000 ohms
  - R3—4700 ohms
  - R4—3900 ohms
  - R6—100 ohms
  - R7—470 ohms
  - R9—2500-ohm potentiometer
  - R10—330 ohms, 1 watt
  - R11—82 ohms, 3 watts
  - T1—6.3-volt filament transformer
- Misc.—Cabinet (LMB "Glamor" Type W-2A used), transistor sockets, Vectorbord, push-in Vector terminals, wire, solder, etc.

All resistors  
1/2 watt unless  
otherwise  
stated

"A" at the junction of R2 and R5. Adjust R9 to read 900 rpm, and the remainder of the linear scale will fall into line.

Calibration can also be done at your local service station or garage by tying the X-Line Tach in parallel with a tachometer of known accuracy.

The X-Line Tachometer was used for several months in conjunction with a special transistorized ignition system which appeared in the June, 1963, issue of POPULAR ELECTRONICS. It had no adverse effect on the transistor system. The X-Line Tach can be mounted under the dash (as per the lead photo) or on the steering column. Use a worm drive hose clamp (available at most garages) to hold the cabinet securely. —30—

ing a new meter scale—if a 0-500  $\mu\text{a.}$  meter is employed.

In any case, the linearity of this circuit is such that calibration need only be established at one point. The circuit above illustrates a simple bench method (provided a 12-volt d.c. supply is available). The output of the filament transformer is connected to calibration point

*NOTE: The unijunction transistor is mainly responsible for the accuracy of the X-Line Tach. Once turned on by the negative pulse at B2, conduction through the emitter to the base 1 path maintains itself, regardless of the recovery of base 2, insuring a uniform time period for charging and discharging C3.*



# SONALERT®

## WHERE TO BUY SONALERT

Standard Model is SC-628, 6-28  
VDC. \$4.95. AC Models are also  
available.

ALLIED ELECTRONICS  
Chicago—Western Ave. only  
ARROW ELECTRONIC COMPANY  
Norwalk, Conn.  
W. H. BINTZ COMPANY  
Salt Lake City, Utah  
BUSACKER ELECTRONIC  
EQUIPMENT CO., INC.  
Houston, Texas  
H. L. DALIS, INC.  
Long Island City, N. Y.  
DEECO  
Cedar Rapids, Iowa  
DeMAMBRO ELECTRONICS  
Boston & Worcester, Mass.  
Providence, R. I.  
Manchester, N. H.  
ELECTRICAL SUPPLIES, INC.  
Hartford, Conn.  
ELECTRONIC PARTS CO., INC.  
Albuquerque, N. Mex.  
ELECTRONIC SUPPLY, INC.  
Huntington, W. Va.  
ELECTRONIC WHOLESALERS, INC.  
Baltimore, Md.  
Melbourne, Fla.  
Winston-Salem, N. C.  
Washington, D. C.  
ELMAR ELECTRONICS  
Oakland, Calif.  
ESSEX ELECTRONICS, INC.  
Syracuse, N. Y.  
GOPHER ELECTRONICS CO.  
St. Paul, Minn.  
GRAHAM ELECTRONICS SUPPLY, INC.  
Indianapolis, Ind.  
GRAYBAR ELECTRIC CO., INC.  
New England  
Newark, N. J.  
HUGHES-PETERS, INC.  
Columbus & Cincinnati, Ohio  
M-G ELECTRONICS &  
EQUIPMENT CO., INC.  
Huntsville, Ala.  
NEWARK ELECTRONICS CORP.  
Chicago, Ill.  
Inglewood, Calif.  
Denver, Colo.  
Detroit, Mich.  
PHILA. ELECTRONICS, INC.  
Philadelphia, Pa.  
PIONEER-STANDARD  
ELECTRONICS, INC.  
Cleveland, Ohio  
RADIO PARTS CO., INC.  
Milwaukee, Wis.  
SREPCO, INC.  
Dayton, Ohio  
R. V. WEATHERFORD CO.  
Glendale, Calif.

lowest powered signal in the world

— AND SO READILY ADAPTABLE TO A  
NUMBER OF INTERESTING, USEFUL  
PROJECTS YOU CAN BUILD YOURSELF.  
THIS UNIQUE SOLID-STATE DEVICE  
REPRESENTS A BREAKTHROUGH IN  
THE SIGNAL-WARNING FIELD. HIGHLY  
EFFICIENT, IT NEEDS BUT 3 MILLIAMPS  
OF CURRENT TO DELIVER AN AUDIBLE  
OUTPUT SIGNAL OF 65 DECIBELS.

## SEND FOR NEW PROJECTS BOOKLET



Recently released, this highly-readable 24-page booklet contains ideas, descriptions, schematic drawings, parts lists, and construction hints for the use of Sonalert in a number of applications. It was written especially for Hams, Hobbyists, and Experimenters . . . as well as for Professional Design Engineers.

*Sample projects include: Sun or Battery Powered CPO . . . Moisture Detector . . . Doorway Annunciator . . . and various Fail-Safe Alarms.*

Send 50 cents — coins, check, or stamps — with your name and address to: Department EH-1, Electropac Inc., Peterborough, New Hampshire. You'll receive your copy of the 24 page Sonalert Projects Booklet by return mail.



Sonalert Is A Product Of  
**ELECTROPAC INC., PETERBOROUGH, N.H.**  
A Subsidiary of Computer Control Company

# Cheater Cord De Luxe

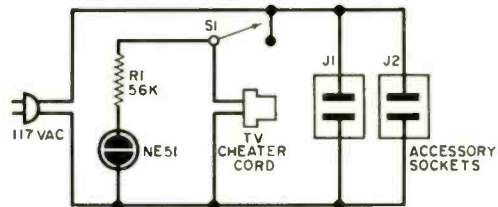
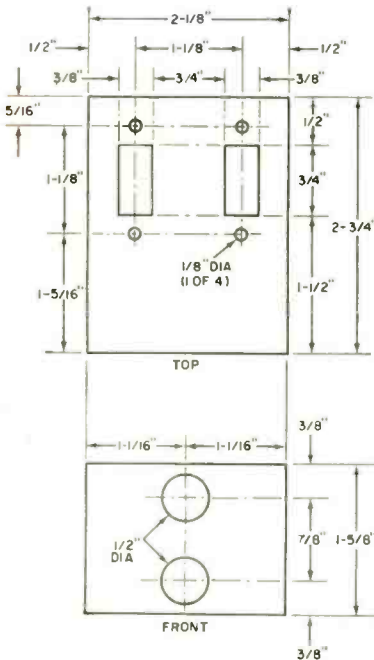

If your junk box doesn't contain the parts for the indicator light, buy a preassembled unit. Extra bright neon bulbs are available in most radio stores for a few cents more.

Chassis cutouts and drilling notations are based on use of Premier PMC-1000 utility box.

**T**HE FAMILIAR TV interlock, which disconnects your set from the a.c. line when you take the back off, can be a nuisance when it comes to servicing. Assuming that you have a "cheater cord," you often have to scramble around to find a place to plug it in. And you also have to find an outlet for, say, a soldering iron and a VTVM. If you're tired of stringing extension cords all over the room, here's a gadget that will make the job easier. The "Cheater Cord De Luxe" supplies the TV set with power and has a safety pilot light to indicate when it's on. Two accessory sockets (*J1* and *J2*), not controlled by the switch (*S1*), take care of your trouble-shooting equipment.

The Cheater Cord De Luxe can be constructed in an aluminum box measuring 2 3/4"x2 1/8"x1 5/8" (Premier PMC-1000). You'll need two a.c. accessory sockets (chassis mount), s.p.s.t. toggle switch, a.c. line cord, and the business end of a TV cheater cord. The indicator lamp can either be purchased preassembled (Dialco 95408) or made up from junk box parts using an NE-51 and a 56,000-ohm resistor (*R1*). Keep in mind that the box will be connected to the 117-volt a.c. line and carefully insulate all connections.

—James A. Fred

# Master Electronics faster with RCA Home Training

NEW, EASY WAY TO BEGIN WITH "AUTOTEXT" PROGRAMMED INSTRUCTION  
HERE'S WHAT YOU GET!

**40** fascinating  
THEORY LESSONS.



Here are all the basic principles of radio and electronics in easy-to-understand language, fully illustrated!

**40** exciting  
EXPERIMENT LESSONS.



Each contains hundreds of absorbing, experiments and construction techniques to help you learn easier!

**40** complete  
SERVICE PRACTICES.



Filled with practical, time-saving, money-saving servicing tips to use throughout your training!

PLUS ALL THIS AT NO EXTRA COST...

**15 KITS!**

to build a Multimeter, AM Receiver and Signal Generator. Kits contain new parts for experiments, integrated so as to demonstrate what you learn in the lessons and to help you develop technical skills. Each kit is fun to put together! Compare what RCA gives you with any other school!



### MULTIMETER

A sensitive precision measuring instrument you build and use on the job. Big 4½" meter with 50 micro-amp meter movement. 20,000 ohms-per-volt sensitivity d-c, 6,667 a-c.

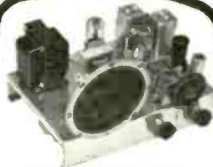

### AM RECEIVER

Have the satisfaction of building your own AM radio with this high quality 6-tube superheterodyne set. Big 5" speaker, fine tone!



### SIGNAL GENERATOR

A "must" for aligning and trouble-shooting receivers. Build it for your own use. 170 KC to 50 MC fundamental frequencies for all radio and TV work.

Begin your training the faster, easier way with new "Autotext" programmed instruction. You learn almost automatically—and go on to advanced training sooner than you ever thought possible! Practical work with the very first lesson. Liberal Tuition Plan. Pay only as you learn. No long term contracts to sign! No monthly installments required!

Complete selection of Home Training Courses to choose from: TV Servicing • Color TV • Transistors • Communications Electronics • FCC License Preparation • Mobile Communications • Automation Electronics • Digital Techniques • Nuclear Instrumentation • Automatic Controls • Industrial Applications • Drafting • Computer Programming.

### CLASSROOM TRAINING ALSO AVAILABLE

RCA Institutes Resident School in New York City offers training that will prepare you to work in rewarding positions in fields such as automation, communications, television, computers, and other industrial and advanced electronic applications. You are eligible even if you haven't completed high school. Check Classroom training and information will be rushed to you.

**Send postcard for free illustrated book today!**  
**Specify home training or classroom training!**

**RCA INSTITUTES, INC.,** Dept. EE-15  
350 West 4th St., New York 14, N. Y.



**THE MOST TRUSTED NAME  
IN ELECTRONICS**

CIRCLE NO. 33 ON READER SERVICE CARD

# FREE!...Send Today



**World's  
Largest  
Electronic  
Kit  
Catalog**

**Save 50% on:  
Electronic Organs  
Color TV  
Stereo/Hi-Fi  
Shortwave  
Automotive  
Amateur Radio  
Citizen's Band  
Education  
Photography  
Lab & Test  
Marine**

## Over 250 Easy-To-Build Kits

Over 250 ways to add better quality and more fun to your hobby or profession . . . and save up to 50%! Convenient time-payment plan. Free help from our technical correspondents. Find out why Heath is the world's largest manufacturer of quality electronic kits. Send for your FREE 1965 Heathkit Catalog now!

**HEATHKIT**  
**HEATH COMPANY, Dept. 110-2**  
Benton Harbor, Michigan 49023  
In Canada: Daystrom, Ltd., Cooksville, Ontario

Please send Free 1965 Heathkit Catalog.

Name \_\_\_\_\_ (Please Print)

Address \_\_\_\_\_

City \_\_\_\_\_ State \_\_\_\_\_ Zip \_\_\_\_\_

Prices & specifications subject to change without notice.

CL-202

**CIRCLE NO. 18 ON READER SERVICE CARD**

**ELECTRONIC EXPERIMENTER'S HANDBOOK**



# X-LINE CHARGER

**Advanced design using silicon-controlled rectifiers permits automatic operation**

**T**HE DEMANDS upon the lead-acid battery in the American automobile are ever-increasing. In wintertime, the ampere-hour capacity is reduced by freezing temperatures. Summertime woes include more frequent short trips, more use of radio equipment, and last—but not least—the electrical requirements of air conditioning. Recharging the battery with a typical generator setup is usually not enough for year-round trouble-free battery performance.

Electronics experimenters are aware of the good and bad things about battery chargers. Low-cost, low-amperage chargers selling for around \$5 are sometimes helpful—if you want to wait five to ten times as long as necessary for the battery to recharge. Higher-amperage chargers (3-6 amps) are better built, but must be watched

**By OLIVER P. FERRELL**  
Editor

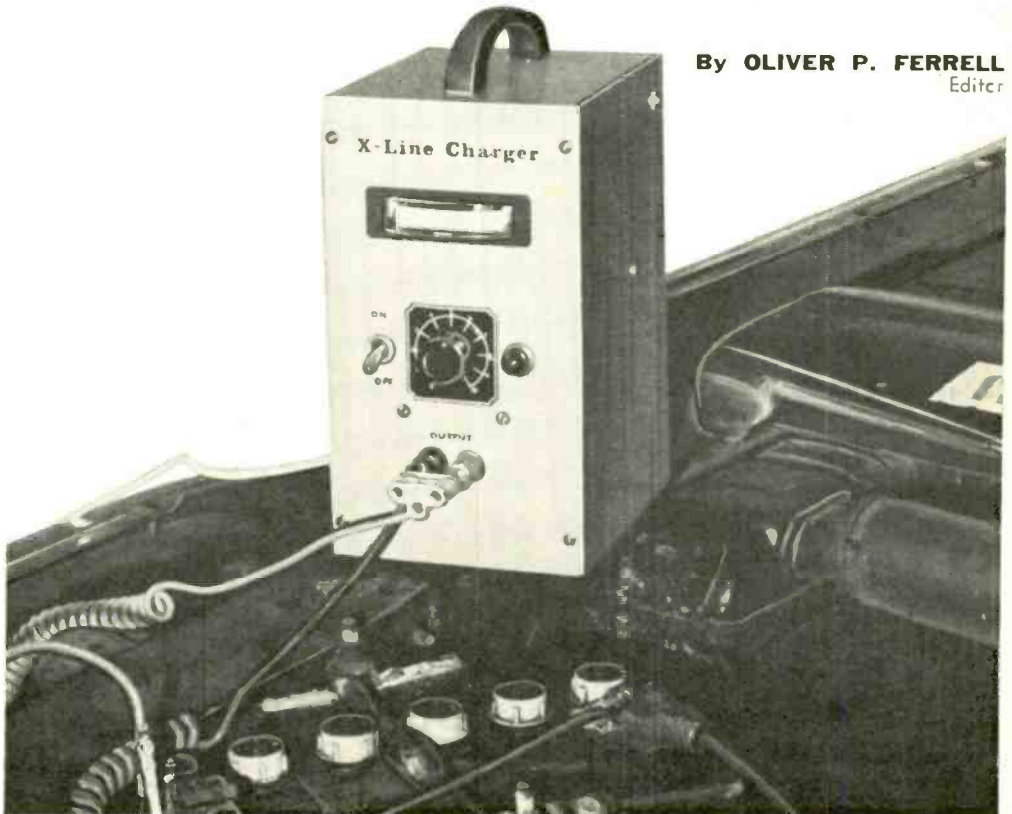

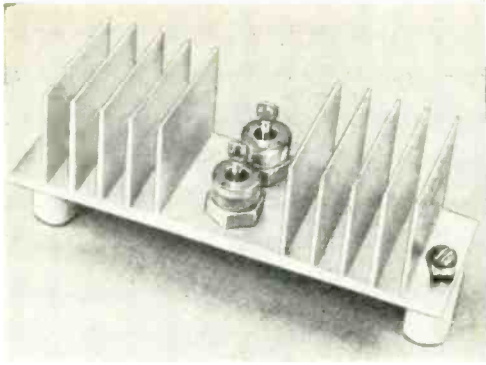

High-amperage silicon rectifiers D1 and D2 are mounted side by side on a Delco heat sink. Steatite stand-off insulators electrically isolate heat sink from metal cabinet.

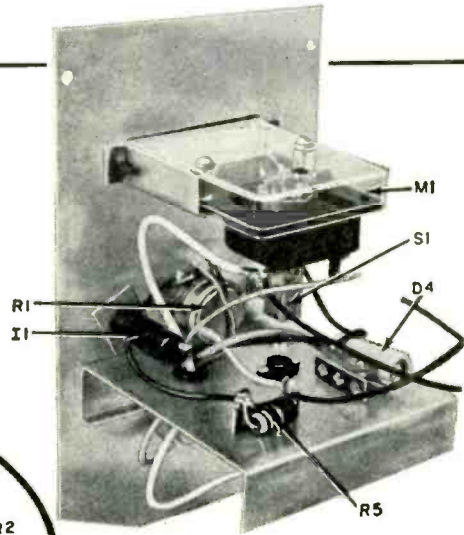
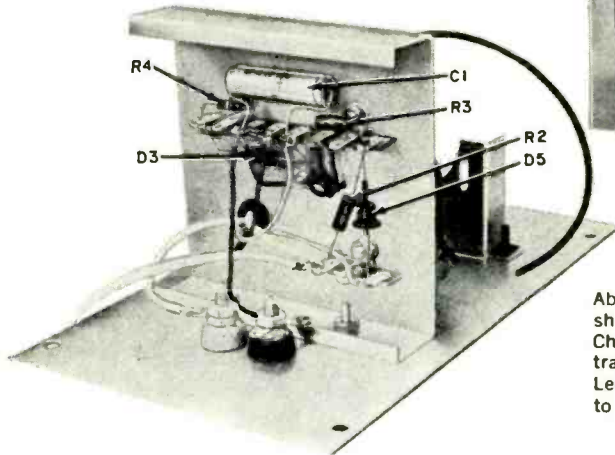

Above and below open-end chassis views show location of various components. Chassis is assembled after heat sinks and transformer have been attached to box. Leave sufficient wire length for connection to a.c. line, transformer, and heat sinks.

closely since only the most expensive models have provisions to eliminate the hazards of overcharging. Leave a high-amperage charger connected to the battery for too long and either the electrolyte boils away, or the plates start to warp.

If you have been plagued with any of the above problems, you need the "X-Line Charger." This is an all-electronic gadget that is set up once for your optimum battery charge. It need never be set again. When connected to the car battery, it senses the battery's condition. If it is low and needs a charge, the X-Line Charger automatically goes into operation. As the charge level comes up, the charging rate goes down. When the preset level has been reached, the X-Line

Charger automatically turns itself off.

No relays are used in the circuit of the X-Line Charger; instead, it is built around silicon-controlled rectifiers now offered at moderate prices by the General Electric Company. These SCR's—and other semiconductors—are sold in numerous radio stores as the GE "Experimenter Line."

The basic circuit of the charger was obtained from the GE "Hobby Manual." Cost of building this project will vary between \$25 and \$45—depending upon refinements and whether or not the charging rate is metered.

**How It Works.** The circuit surrounding transformer *T1* and rectifiers *D1* and *D2* is that of a full-wave rectifier. Connected to the primary of *T1* is a fuse, switch, neon pilot light indicator, and Thyrector (*F1*, *S1*, *I1*, and *D4*, respec-

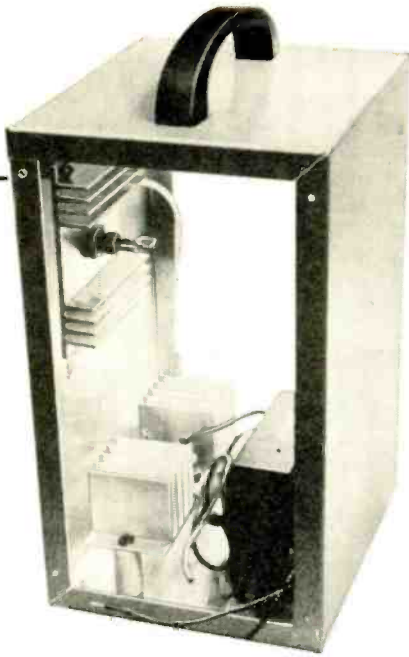

Transformer is bolted to bottom of box. Rectifier heat sink is at left and heat sink for SCR1 is attached to the side.

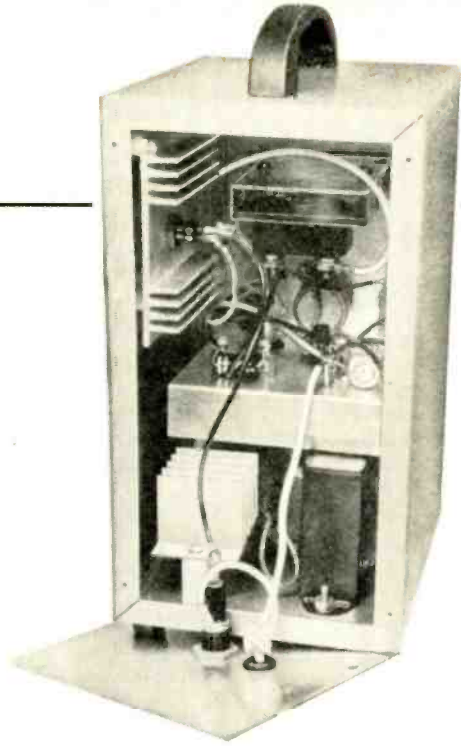

Prior to attaching the back panel, the completed X-Line Charger looks like this.

tively). Any one—or all—of these components may be eliminated from your working model—depending upon the conditions under which your X-Line Charger will be operating. Thyrector *D4* is a special semiconductor consisting of two selenium diodes mounted back to back. Rated at 120 volts, *D4* protects the solid-state rectifiers in the charger from harmful a.c. power line surges.

Heavy-duty *SCR1* is operated as a switch in series with the battery and rectifiers. A positive-voltage gating signal to turn on *SCR1* comes from *SCR2* through *R3* and *D5*. The gating signal to turn on and off light-duty *SCR2* is established by the battery voltage according to the setting of *R1* and the charge held by capacitor *C1*. As the battery voltage rises and the charge of *C1* increases, zener diode *D3* conducts, turning on *SCR2*. Since *R2*, *R3*, and *SCR2* are all in series, a voltage divider is formed; and when current flows through this circuit, the gate of *SCR1* cannot receive a positive signal and is therefore turned

off—preventing further battery charging.

**Construction.** All components can be made to fit comfortably into a 6" x 9" x 5" box. A Premier gray hammertone Model PAC-695 suited these requirements. Four rubber feet were attached to one 6" x 5" end of the box. A metal handle salvaged from the junk box was affixed to the opposite end. The box now rests so that both the front and rear panels (9" x 5") are removable.

A drawing of the cutout dimensions for a front panel is shown on the next page. Sufficient room is left near the top of the panel to mount any 0-10 ampere meter, although the cutout shown is for an edgewise Simpson Model 1502 meter.

Mounted in the three holes below the meter are *S1*, *R1*, and *I1* (from left to right). Near the bottom are two holes on  $\frac{3}{4}$ " centers for heavy-duty binding posts. Attached to the front panel is a small open-end chassis used to mount some of the small components. Transformer *T1* is bolted to the bottom of the

Front panel dimensions are those of a Premier PAC-695 aluminum box. An oblong cutout near top of panel is for an edge-wise Simpson meter. Any round or square meter can be mounted in this position by adjusting the necessary cutout size. See text for data on three holes directly below meter. Holes near bottom are for heavy-duty output lead binding posts.

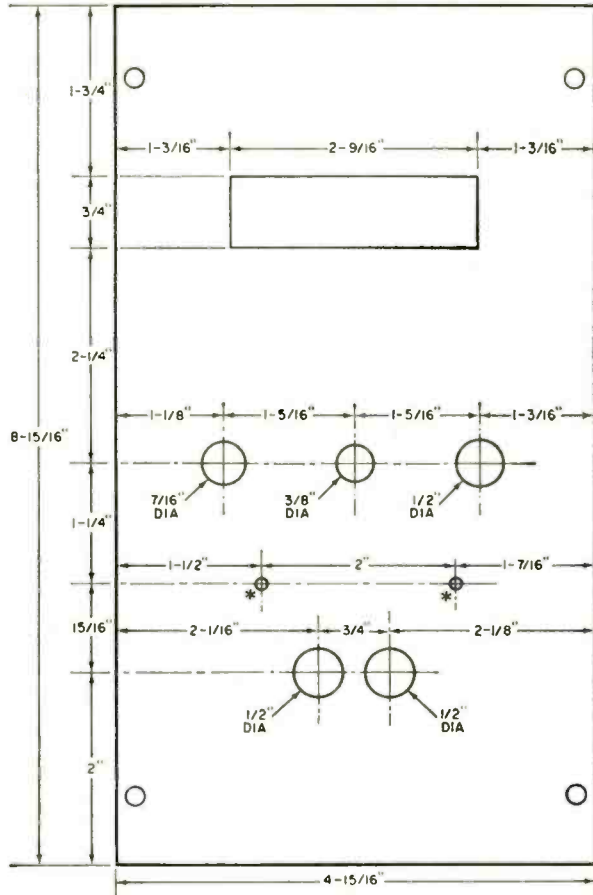

Small open-end chassis holds socket for SCR2 and other miscellaneous components. Hole in lower right corner is grommeted to pass leads above and below chassis deck. Two holes in lip align with holes in panel for rigidity when assembly is complete.

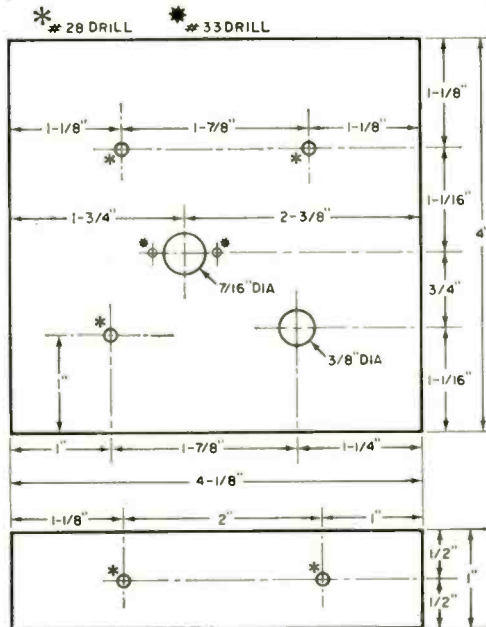

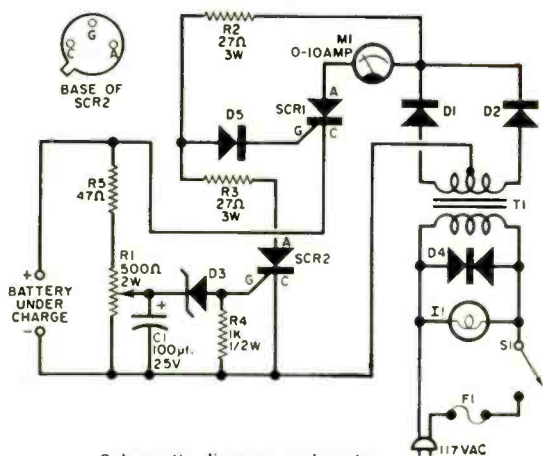

Schematic diagram and parts list for the X-Line Charger.

- C1*—100- $\mu$ f., 25-volt capacitor
- D1, D2*—15-amp., 50-volt silicon rectifier (GE X-4 Kit)
- D3*—8.2-volt, 1-watt zener diode (GE X-11 Kit)
- D4*—Transient voltage suppressor (GE Thyrector Type 6RS20SP4B4)
- D5*—100-volt, 600-ma. silicon rectifier (GE Type 1N1692 or equivalent)
- F1*—2-amp. fuse
- I1*—120-volt neon indicator light (Calrad N.P.L. or equivalent)
- M1*—0-10 amp. meter (Simpson 1502 or equiv.)
- R1*—500-ohm, 2-watt linear scale potentiometer (Ohmite CU-5011 or equivalent)
- R2, R3*—27-ohm, 3-watt resistor
- R4*—1000-ohm, 1/2-watt resistor
- R5*—47-ohm, 2-watt resistor
- S1*—S.p.s.t. toggle switch
- SCR1*—Silicon-controlled rectifier (GE X-3 Kit)
- SCR2*—Silicon-controlled rectifier (GE X-5 Kit)
- T1*—Power transformer: primary, 117 volts a.c.; secondary, 24 volts, CT (Triad F41X or equivalent)
- Misc.—Cabinet (Premier PAC-695), heat sinks, handle, rubber feet, binding posts, stand-off insulators, fuse holder, line cord, etc.



X-Line Charger has clean-cut appearance. Although not visible in photos, two screened  $\frac{3}{4}$ " holes are cut in the bottom and back panel for ventilation.

box with 8-32 machine screws and bolts.

Two heat sinks are required for the mounting of *D1-D2* and *SCR1*. Almost any sink of reasonable size can be used

at these points. The sink retaining *D1-D2* is electrically isolated from the box by Steatite stand-off insulators. Cathode connection to *D1-D2* is made to a soldering lug that also serves to hold the sink to the insulator. An insulator manufactured by E. F. Johnson (Type 501) works well in this application. Controlled rectifier *SCR1* is electrically isolated from its heat sink, but it is also held away from the aluminum box with stand-off insulators (Type 500). A lead is soldered to the anode before mounting the sink to the box wall.

Wiring of the X-Line Charger is not difficult as long as the polarities of the diodes and SCR's are observed. Details on mounting and wiring *SCR1* are included in the GE "Experimenter Line" X-3 package.

**Operation.** After double-checking your wiring, bench-test your X-Line Charger by inserting a high-wattage, very low ohm wire-wound resistor across the output terminals. Read the output amperage—a 3-ohm resistor should give a reading of about 4 amperes.

Now make sure your car battery is fully charged by measuring the specific gravity. Connect the charger to the battery and rotate *R1* until the meter reads zero. Turn on the bright headlights and see if the charger operates. Turn off the headlights and the charging rate should slowly taper off and gradually return the meter to a zero reading.

# Build This Automatic

**This caution light turns itself on at dusk and off at dawn**



THE HOME OWNER will find many uses for this automatically operating safety flasher. It can warn of an open ditch or hole, attract the attention of a taxi driver or doctor arriving at night, or serve as a beacon to point the way for after-dinner guests. And you can take it on trips as a safety accessory in case of highway breakdowns.

The handy part about this flasher is that it may be left unattended. As sky lighting decreases, it is sensed by photocell *PC1*, and the flasher automatically goes into operation. When the photocell is again illuminated, *Q1* is biased to cut-off by the action of *PC1*, causing the flasher to stop operating.

**Construction.** The safety flasher is easily assembled from inexpensive components and housed in a standard aluminum box. The 6-volt battery drain is so low that the battery can be attached to the flasher through plug *PL1*, eliminating an on-off switch. The battery plug

If other transistors are substituted for *Q1* and *Q2*, different values of *R2* and *R3* may be needed.

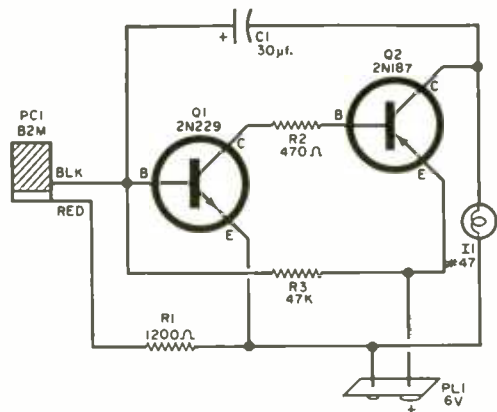

# Safety Flasher

By LOU GARNER

is affixed to the edge of a small perforated Bakelite subchassis. This insulated chassis holds all of the components. The transistor sockets are wedged into place through holes cut in the Bakelite and the leads are arranged to support the rest of the circuit.

Neither lead dress nor layout is critical. The transistors could be wedged into the Bakelite chassis and the leads permanently soldered into place. However, if you do this, be sure to use a heat sink to prevent accidental heat damage. Regardless of the layout used, cut a hole in the aluminum box to permit light to shine on *PC1*.

**Modifications.** Some builders may prefer to construct a larger unit with four flashlight D cells in series. This design would require an on-off switch, since without it the flasher would turn itself on when stored in darkness. The unit shown here can be stored just by unplugging the battery.

Experiment with the value of *R3* for optimum performance, or, as an alternative, use a 100,000-ohm potentiometer in place of this bias resistor. The flashing rate can be adjusted by changing the value of *C1*; use smaller values for a faster rate. Keep in mind that the light will not appear as bright as a continuously lit bulb—the flasher applies current to the bulb in short pulses and the light output is accordingly somewhat lower.

## PARTS LIST

- C1*—30- $\mu$ f., 10-volt electrolytic capacitor
- I1*—#47 pilot lamp
- PC1*—B2M photocell (International Rectifier)
- PL1*—Battery plug for Burgess F4P1 battery
- Q1*—2N229 npn transistor (Sylvania)
- Q2*—2N187 pnp transistor (General Electric)
- R1*—1200-ohm,  $\frac{1}{2}$ -watt resistor
- R2*—470-ohm,  $\frac{1}{2}$ -watt resistor
- R3*—47,000-ohm,  $\frac{1}{2}$ -watt resistor
- Misc.—Small aluminum box, clearance light assembly and bracket, transistor sockets, lantern-type battery (Burgess F4P1), Bakelite chassis—see text, screws and nuts, wire, solder, etc.

Don't forget the hole in the chassis to let in daylight on the B2M self-generating photocell.

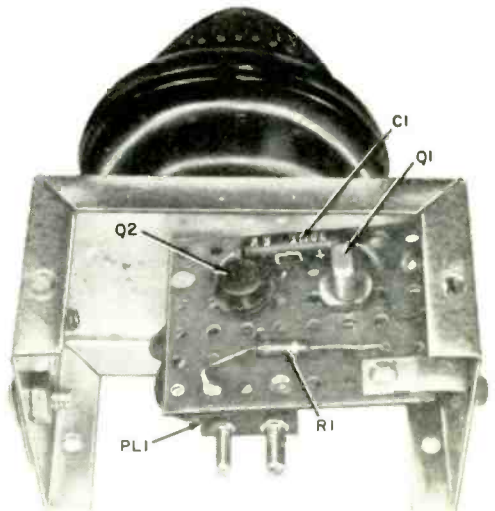
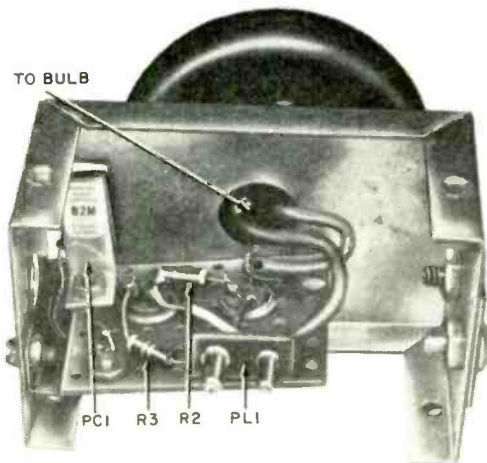

# EXTERMINATE TV

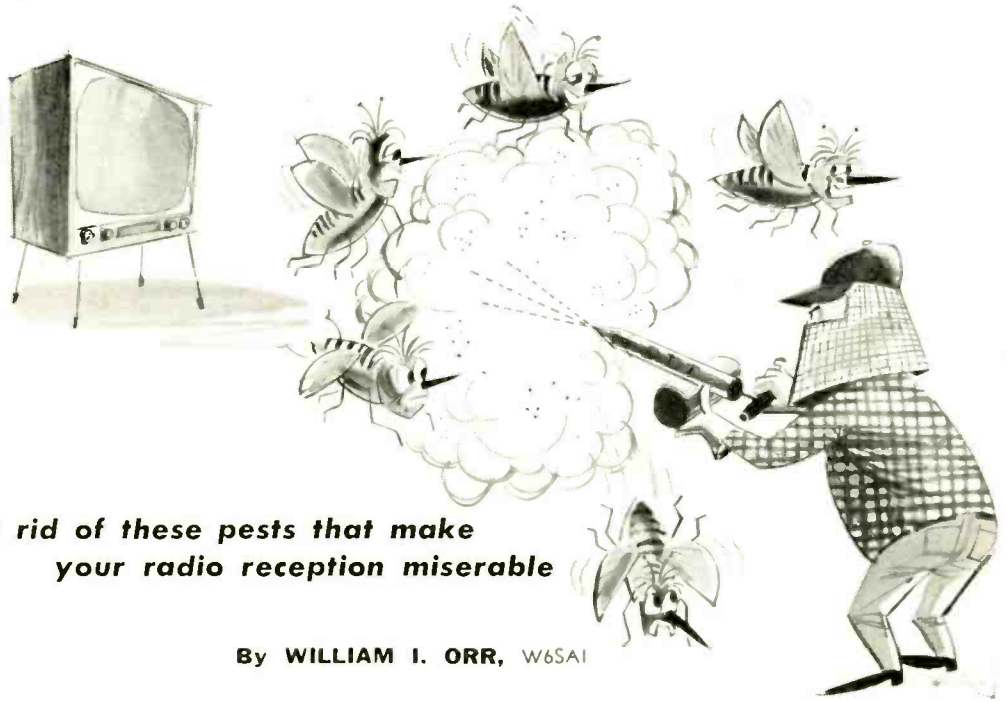

**Get rid of these pests that make  
your radio reception miserable**

By WILLIAM I. ORR, W6SAI

**A**RE YOU plagued by TV "sync-bugs?" Many amateurs and SWL's hear this persistent nuisance, which is threatening to make a shambles of the radio spectrum, as rough, unstable signals found at close points across the dials of their short-wave receivers.

Sync-bugs creep across the bands with a slow, measured tread, uncanny in their instinct for squatting directly atop the signal you're trying to listen to. The broadcast listener hears them in the form of "birdies" and "whistles" across the dial that turn Toscanini and Fabian into a cacophony of howls and catcalls.

Where do these "insects" come from? The truth of the matter is that they are generated by a nearby TV set (which is probably operating quite normally). The 15 kc. horizontal oscillator, which possesses about as much stability as a hundred-foot antenna mast made of "two-by-four's," generates powerful pulses of energy rich in harmonics which can be radiated for hundreds of yards. You can identify the sync-bugs by the fact that they appear every 15 kc. across

the dial; check to see if it's your TV set you're hearing by turning it on and off.

**TV Set Radiation.** Sync-bugs can reach your receiver in three different ways: they can be radiated by the TV lead-in and antenna system, they can travel down the power cord and into the a.c. line to be "piped" to your receiver, or they can be radiated directly by the wiring of the TV set. Since you can't eliminate the *source* of the radiation (without, that is, eliminating your TV viewing), the answer is to prevent the interference from being radiated beyond the immediate vicinity of the set.

The first step is to effectively trap the sync-bugs that are radiated by the antenna system of the television receiver. This can be accomplished by shunting the radiations to ground (the chassis) while permitting the TV signals to pass down the antenna to the set without appreciable attenuation. A simple linear trap made of a length of 300-ohm TV "ribbon" lead-in affixed to the antenna terminals will do the job.

To make the trap, cut a length of



# SYNC-BUG INTERFERENCE

300-ohm line 25" long. Strip 1½" of insulation from each end and tin the leads; twist the wires at one end together. Connect a .01  $\mu$ f. capacitor between the twisted ends of the stub and TV chassis ground, as shown in Fig. 1.

When you're dealing with antennas and tuned stubs, much of the work has to be "cut and try." Sometimes one problem is solved only to have another crop up. Check to see if all channels are coming in properly after you have hooked up the stub. If all but one or possibly two channels work well, you may want to add a low-loss switch to disconnect the stub when viewing the troublesome channel.

**Wiring and Power Line Problems.** The next step is to prevent unwanted sync-bugs from reaching your receiver via the a.c. cord of the TV set and the house wiring. To block this exit from the set, two .01  $\mu$ f., 1000-volt ceramic capacitors are placed across the a.c. line to ground at the point where the line leaves the TV chassis. With most TV sets, the power connection is made through a simple interlock mounted at the rear. It may be possible to solder the capacitor leads to the back of the plug pins (see Fig. 2), or a bit of insulation can be removed from the power wires and the leads soldered to them. Tape the wires securely. Solder or bolt the other two capacitor leads to the chassis.

Radiation is especially apt to take place from the wires running from the chassis to the socket of the picture tube. The cure for this problem is a simple shield made from heavy aluminum foil, such as "Reynolds Wrap." Form the wires into a bundle, and wrap them with a covering of electrical tape. Trim the foil to size and carefully wrap it over the tape. Smooth the foil and form the rough edges back on themselves until the wires are substantially shielded. *Do not shield the high voltage lead going to the bulb of the picture tube.* Finally, wrap several turns of wire around the foil, twist it tight, and connect the other end to the chassis.

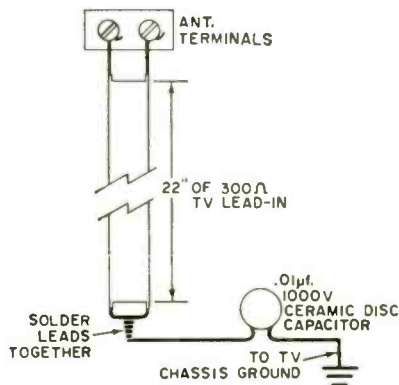

Fig. 1. Simple trap for eliminating sync-bugs from antenna system consists of 22" of TV lead-in and a .01  $\mu$ f. bypass capacitor.

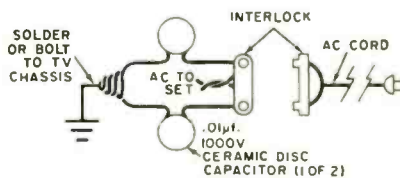

Fig. 2. Radiation into power line can be cured by bypassing to ground (the chassis) both sides of the a.c. line with capacitors.

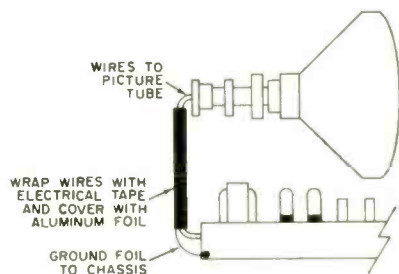

Fig. 3. To stop the set's wiring from radiating, shield the wires running from the chassis to the picture tube socket; see text.

The results of all this? In the author's case, the sync-bugs almost vanished, going from S9 to S3 in strength on 80 meters. On an a.c.-d.c. receiver, the sync-bugs had almost obliterated a local station; after "exterminating" them, they were unnoticeable.

# PICKUP

**It's a combination  
recording pickup,  
oscillator, and  
tachometer—for  
less than \$2!**



Two types of pickups are shown above. To couple to a radio, simply place a pickup in the strong inductive field of the speaker or the audio output transformer.

**O**NE OF THE MOST fascinating and useful electronic gadgets in existence consists, quite simply, of several thousand turns of fine wire enclosed in a small plastic shell. Its price is low—under \$2. What is this miracle item? As the illustrations reveal, it's the telephone pickup.

This flexible pickup can be used to make "clean" tape recordings from your radio or phonograph without any wiring changes or other alterations, to construct an inexpensive meter-readout tachometer, or an audible code-practice oscillator.

Two types of pickups are shown in the photographs—one is the flat, rectangular type which can be placed on top of a unit or under a telephone (Lafayette Radio 28 G 0901 at \$1.95 is one of these). The other kind of pickup is in the form of a small cylinder with a suction cup attached to one end (Allied Radio 58R297 at \$1.50).

**Basic Uses.** When a pickup is mounted on a receiver end of a telephone handset (or, if it's the flat type, placed underneath), it picks up the telephone signals by induction. The output of the pickup depends on the strength of the

inductive field it is in, and is quite low when used to pick up telephone conversations. However, almost any amplifier or tape recorder has sufficient gain to produce a good output. (Be sure to check federal, state, and telephone company regulations before *recording* telephone conversations; in many cases, it is illegal.)

The impedance of the pickup is several thousand ohms, and it can be connected directly to a hi-fi amplifier or simple transistor amplifier for group listening to long-distance family calls or business "conference" calls. The Lafayette Radio 99 G 9042 transistor amplifier (\$4.95) will provide sufficient gain with the pickup (100 mw.) to drive a speaker. If you have a tape recorder with a "monitor" function, it can also be used.

**Tape Recording Techniques.** Since the pickup is really nothing more than an "inductive sensor," why not use it to "sense" the inductive field of a speaker coil? This is very easy to do: The speaker field is so strong that it's not even necessary for the pickup to be in close proximity—the speaker grille of a radio or phonograph is usually close enough.

# PRANKS

By Fred Blechman, K6UGT

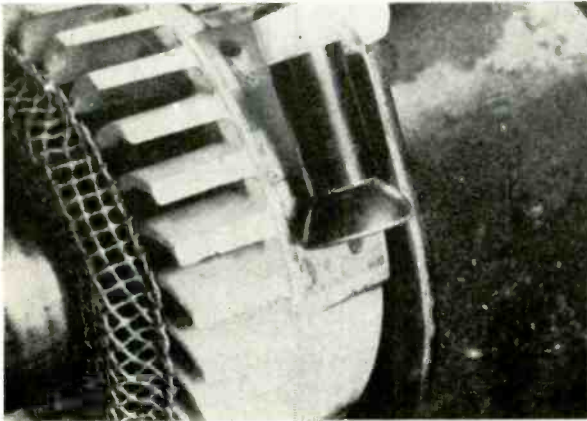

A tachometer based on a pickup is easy to construct following the information in the text. Either the relative or—with calibration—actual rpm can be read.

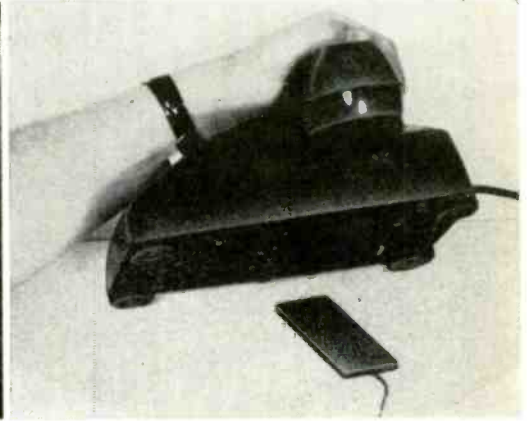

Flat type pickups can be placed under a telephone as above. By connecting the pickup to an amplifier, you can monitor family, business conference calls.

Just place the pickup against the speaker grille, plug the cable into the microphone jack of the recorder, and adjust speaker and recorder volume as desired. Unlike a microphone, the pickup will not record speaker distortion and room noise; this setup also allows you to monitor while recording.

**The "Induc-Tach."** It is very often desirable to know the speed of a motor or engine. "Go-Kart," quarter-midget racer, and hot-rod competitors, for example, need a means of determining whether a given engine modification results in higher engine speed or acceleration. The pickup, especially with magneto-operated engines, provides a simple, inexpensive way to read relative engine rpm, and, with a little extra trouble, can be calibrated to read actual rpm.

The photo above shows a pickup attached to a lawn mower magneto engine in such a position that the magnets on the flywheel pass by the pickup on each revolution. Relative rpm can be read by connecting a diode rectifier, potentiometer, and 0-1 ma. meter as shown in the schematic. The reading will depend on meter sensitivity, magnet strength, pickup proximity and orientation, rpm,

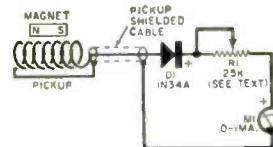

A circuit for reading relative rpm is shown at the left. A signal is picked up from rotating magnets on the engine or the motor.

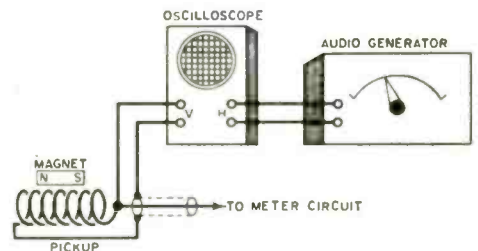

A pickup tachometer can be calibrated with an oscilloscope and audio generator. With a bit of work, a meter scale can be drawn which shows actual rpm.

and the value of the potentiometer ( $R1$ ).

For slow speeds and small magnets,  $R1$  may not be needed. If required,  $R1$  should be adjusted to full scale at maximum rpm; it can be replaced with a fixed,  $\frac{1}{2}$ -watt resistor if desired.

For spark engines or motors, it is necessary to place a magnet on the shaft  
(Continued on page 156)

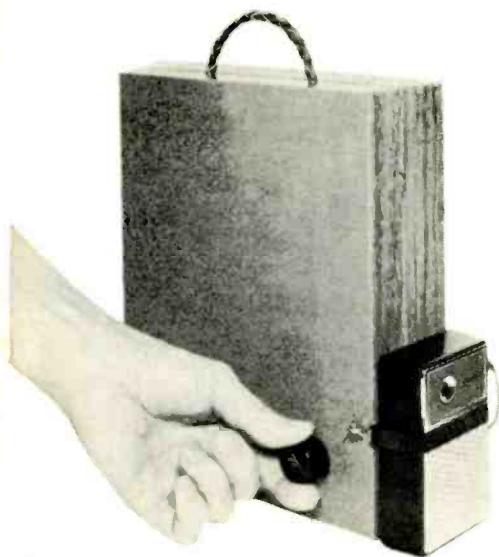

# BOOST BOX

**Get better tone  
and more sensitivity from  
your six-transistor  
pocket radio receiver**

**D**O you want more sound and greater sensitivity from your pocket transistor radio? Here is a simple and relatively inexpensive way to get both.

As shown in the photos, a 6" PM speaker is mounted in a homemade wood and compo-board baffle box measuring 10" x 8" x 3". Approximately 80 feet of #26 wire is close-wound around the outside of the box and, when connected across a 365-pf. variable capacitor, gives you a tunable loop.

In operation, your small transistor radio is clamped to the outside of the box so that the receiver's loopstick antenna parallels the loop on the box. First, tune in a weak distant station and then turn the radio and box in the direction of the station for the loudest signal. Next, tune the large loop for maximum boost. And finally, plug the 6" speaker into the radio's jack (the earphone jack).

If you want to use a larger box, wind fewer loop turns; for a smaller box, wind more. The right number of turns for the 365-pf. capacitor can best be determined by experiment.

The "clamp" used to hold the transistor radio to the side of the box is easy to make and can be fastened with tacks or staples. Some transistor radios have their loopsticks mounted vertically; if this is the case with yours, design the holder so that the radio mounts horizontally on its side.

When not being used as a booster, your "box" can serve as a test-bench speaker or an extension radio speaker. Or, if you connect a 1N34A germanium diode and a pair of high-impedance headphones in series across the variable capacitor, you'll have a crystal set for tuning in local stations—or a hi-fi tuner for AM. You can probably think of other uses as well.

**By ART TRAUFFER**

THE WRITER USED DIME STORE BRAIDED LEATHER FOR HANDLE, PASSED THROUGH TWO HOLES AND TACKED TO INSIDE OF WOOD BOX

WOOD BOX IS 10" HIGH, 8" WIDE, 3" DEEP

MINIATURE PLUG AND 75-OHM TWIN-LEAD CONNECTS TO 2-TERMINAL STRIP

ONE END OF ELASTIC BAND IS TACKED TO INSIDE OF FRAME

ENDS OF LOOP PASS THROUGH SMALL HOLES TO LUGS ON VARIABLE CAPACITOR

365 PF VARIABLE CAPACITOR

2-TERMINAL STRIP MOUNTED WITH TWO SMALL METAL ANGLES SCREW-FASTENED TO INSIDE OF FRAME

6" PM SPEAKER MOUNTED OVER 5 1/4" HOLE IN PANEL

MOUNT SPEAKER WITH FOUR 8-32 BY 1/2" FLAT-HEAD MACHINE SCREWS, WITH NUTS TO FIT COUNTERSINK HOLES ON FRONT OF PANEL

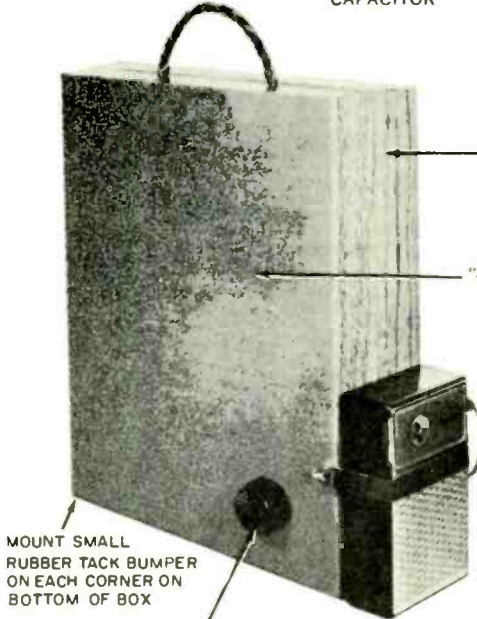

LOOP ANTENNA IS 20 TURNS OF #26 ENAMELLED COTTON-COVERED COPPER WIRE WOUND AROUND OUTSIDE OF BOX AND COVERED WITH BROWN "CONTACT" PLASTIC MATERIAL

"GRILLE CLOTH" IS BROWN LADIES HANDKERCHIEF COVERING ENTIRE FRONT

MOUNT SMALL RUBBER TACK BUMPER ON EACH CORNER ON BOTTOM OF BOX

TUNING KNOB

SMALL SCREW-EYE

HOOK BENT FROM SMALL FINISHING NAIL

STRIPS OF "NON-SKID" UNDER-THE-RUG RUBBER MATERIAL CEMENTED TO SIDE OF BOX

6" LENGTH OF 1/2" WIDE ELASTIC BAND

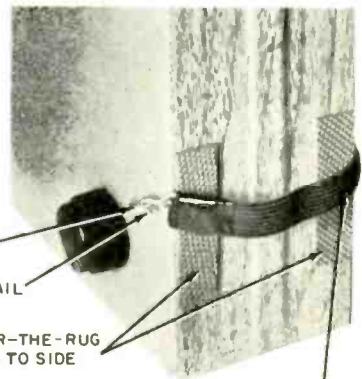



## Build a Telephone Beeper

The law says you must put an audible tone on the line when you record a phone call—here's an inexpensive gadget that does the trick for you

By **FRED BLECHMAN**, K6UGT

SINCE the introduction of inexpensive tape recorders and inductive pickups, the practice of recording telephone conversations has become widespread. In business or private life, it often saves the day for people who can't take shorthand, permitting them to transcribe the important facts of the conversation at their own pace later on. But there's a catch: An FCC Order issued May 20, 1948, directed that an audible tone signal must be sent over the line at least once every 15 seconds on calls that cross a state or national boundary when a conversation is being recorded. Not long thereafter, most telephone companies filed new tariff regulations with the Public Service Commissions of the various states, imposing the same requirement for calls within state boundaries. And when these regulations were approved, they acquired the force of law.

You can equip yourself to comply with this requirement by building the "Telephone Beeper." The outlay is modest (around \$8.00), and the unit is small, self-contained, and requires no electrical connection to the telephone. This latter point is of some importance, since telephone companies are understandably touchy about having unauthorized devices connected to their equipment.

Many tone signal units in commercially available equipment are

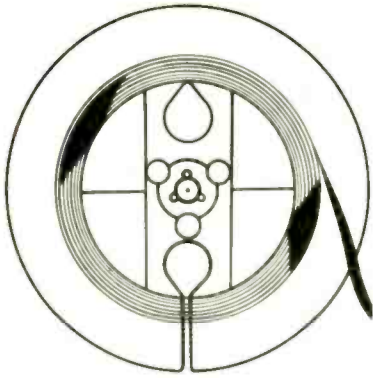

Induction pickup for recorder is attached to earpiece. Clip holds Telephone Beeper to mouthpiece as shown.



inductively coupled to the telephone earpiece. This usually results in a very loud BEEP on the recording, but a rather low-level tone at the other party's end. In fact, to make the tone audible at the distant end, it may be necessary to raise the beep to such a level that some incoming words are smothered on the recording.

In addition, it's easy to forget to turn off some units, since only the position of the power switch indicates the "on" or "off" condition of the tone signaler.

**What the "Beeper" Does.** The Telephone Beeper overcomes all of the above disadvantages neatly and simply. The tone signal itself is an audible "beep" emitted from a miniature loudspeaker positioned so that the sound enters the telephone transmitter (microphone) acoustically, along with the voice of the user. Thus, there's no need for any electrical coupling or connection to the phone.

The signal is also coupled to the recording pickup on the earpiece via the sidetone path provided between mouthpiece and earpiece within the telephone circuit itself. It is this sidetone circuit that allows you to hear your voice in the earpiece when you speak, and of course it carries the sound of the Beeper just as well. Because of this arrangement, the Beeper is recorded at about the same

level as it is heard at the other end of the line.

As for forgetting to shut off the unit, its continued beeping after you've hung up the phone will be an unailing reminder to you to do so.

The photograph on page 34 shows how the Beeper is mounted and used. The device contains an oscillator, speaker, and a timing circuit, along with two 9-volt transistor batteries for power. It is held in position adjacent to the mouthpiece by a retaining clip made of piano wire. It does not interfere with normal use of the telephone, and may be left permanently in place.

**How It Works.** The simple circuit that generates and times the beeps is shown in the schematic on the next page. Transistor  $Q1$  is a unijunction type, which is energized by the two 9-volt batteries in series. When switch  $S1$  is closed, capacitors  $C1$  and  $C2$  are charged through resistor  $R1$ . When the voltage at the emitter of  $Q1$  reaches a certain value,  $C1$  and  $C2$  discharge through resistors  $R4$  and  $R5$ , and the emitter-base 1 junction of  $Q1$ . The resulting positive voltage at the junction of  $R4$  and  $R5$  provides conductive bias for oscillator transistor  $Q2$ . Feedback for oscillation is obtained through the center-tapped primary of transformer  $T1$ , which also couples the oscillator output to the speaker. Variable

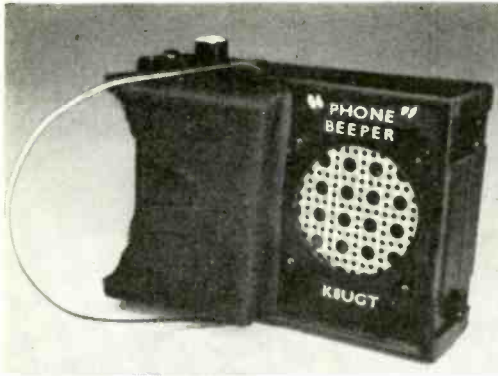

Contoured block of sponge material fits phone shape, secures Beeper in position.

Parts placement isn't critical. Author's layout shown here permits easy assembly.

Simplicity of basic circuit is clear in schematic. Only critical parts are T1, Q1.

resistor  $R2$  controls the oscillation frequency.

This circuit is somewhat critical, so you must use the parts specified for transformer  $T1$  and transistor  $Q1$ . Transistor  $Q2$  may be just about any inexpensive *pnp* germanium transistor (CK722, 2N107, etc.) since adjustment of  $R2$  will compensate for any difference between specific transistors. Potentiometer  $R2$  is the smallest unit available.

(Continued on page 162)

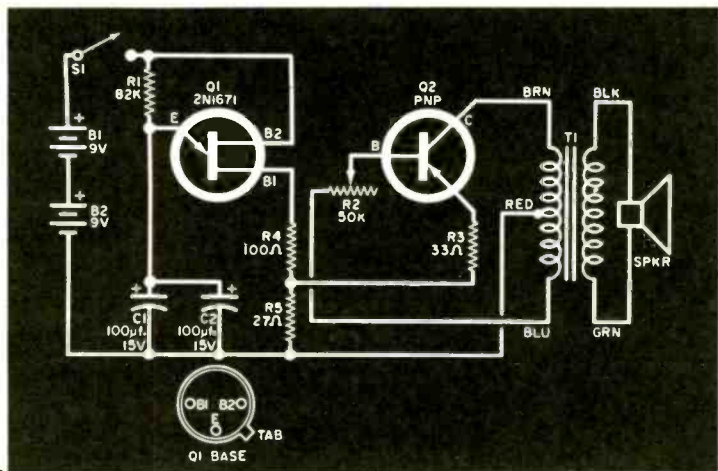
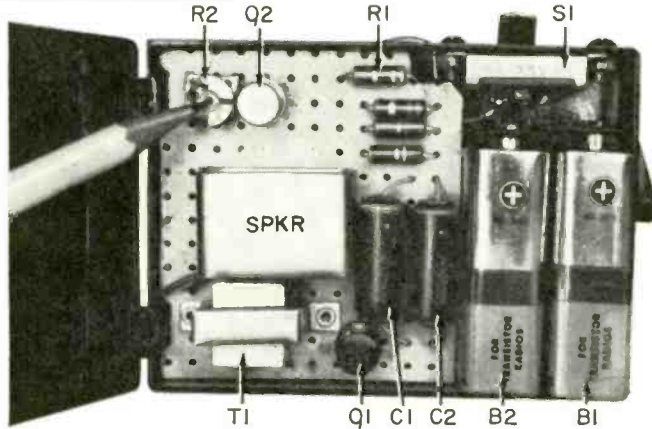

**PARTS LIST**

- B1, B2—9-volt transistor radio battery
- C1, C2—100- $\mu$ f., 15-volt miniature electrolytic
- Q1\*—GE 2N1671 unijunction transistor
- Q2—CK722 or 2N107 *pnp* germanium transistor
- R1—82,000 ohms
- R2—50,000-ohm subminiature potentiometer (Lafayette 99-6142); alternate, 10,000-ohm unit (Lafayette 99-6144)
- R3—33 ohms { all resistors
- R4—100 ohms { fixed,
- R5—27 ohms { 1/2-watt carbon

- S1—S.p.s.t. slide switch
- T1\*—Output transformer (Lafayette 99-6123 or Philmore ST-32)
- I—Induction type pickup (Lafayette 99-6197)
- SPKR—1 1/2"-diameter speaker (Lafayette 99-6035)
- Misc.—Case (author used plastic box 3 3/4" x 2 3/4" x 1 1/4"), perforated aluminum for grille, stiff wire for clip, foam rubber, battery terminals, etc.
- \*Do not substitute for these parts



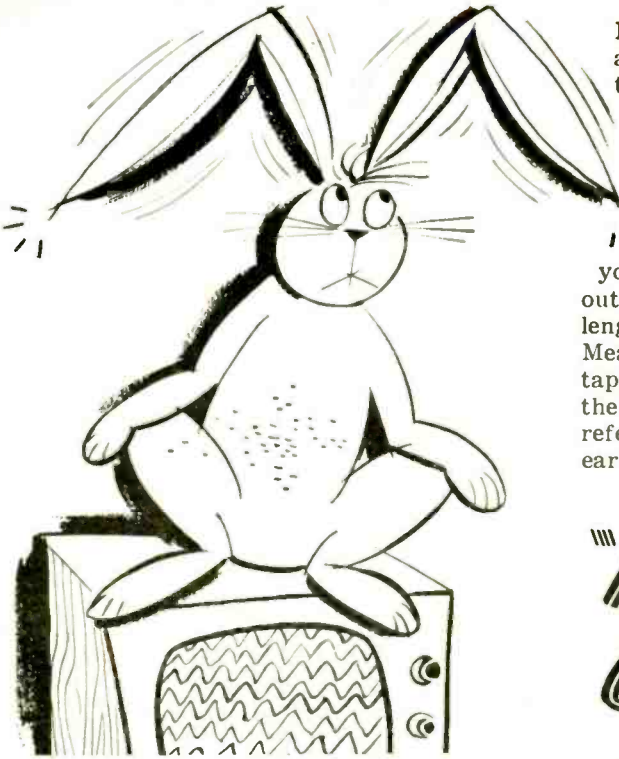

WHEN you took your original rabbit ears out of the box in which they came to you, it's almost certain that you did *not* find adequate instructions for their use. All of the manufacturers of rabbit ears, having built a very fine product, seem to have agreed that you must learn about it the hard way. So, they tell you nothing, or next to nothing, and your only recourse is to regard the adjustment of your ears as another of the "pleasant" mysteries of television.

Perhaps you have decided, after much experimenting, that you get best results with a long ear pointed at Chillicothe, Ohio, and a short ear pointed at the moon. Now this is all wrong—for several dull scientific reasons which can quickly be passed by. However, since the manipulation of rabbit ears is quite critical, producing either (and usually unexpectedly) a shocking improvement or degeneration in picture quality, a few helpful comments are in order.

As on the rabbit, the ears should be the same length, and if you need utmost sensitivity from your antenna, this length should be changed every time you switch channels.

In the chart on the next page is the answer to TV's best guarded secret—the *electronically* right length for rabbit ears. Measurements to a small fraction of an inch may seem like lint-picking if you're entirely happy about the picture quality you are getting by adjusting your ears "esthetically." If, however, you're fighting to get a good picture out of a troublesome channel, exact-length rabbit ears will improve things. Measure with a steel tape or that cloth tape in the sewing basket, starting where the ears come out of the base. Small reference scratches can be made on each ear with a file so that you can quickly

## TV'S BEST GUARDED SECRET—

By LEWIS A. HARLOW

retune them for best results on any channel.

**Wide or Narrow Ears?** There's a catch to the problem of adjusting rabbit ears. They do not do their best when pointed up in a wide or tight V—they should be extended out to the sides! Unfortunately, this introduces a situation which is socially impractical, and one which has an element of danger. An unsuspecting guest may back into a rabbit ear point and impale himself upon it.

What happens, you ask, when rabbit ears are turned up into a V position? How long should they be? The arithmetic for this can get very complicated because everything changes a little every time you change the angle of the V.

In general, when using rabbit ears in this unscientific position, they should be slightly longer (maybe 10 percent) than the exact figures given for horizontal ears in the chart. They should be as

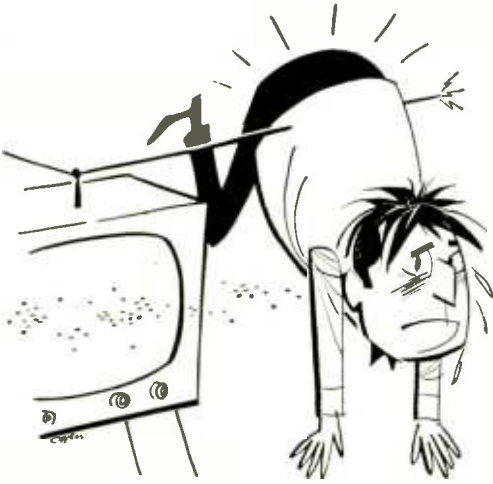

widely spread as possible, and, of course, they should be the same length as one another.

**Different Types of Ears.** In addition to the ordinary, garden-variety rabbit ears, other types available include exact replacements for those built into portable TV sets (sold through electronics supply houses), and at least a dozen models that include a switching arrangement in addition to the basic adjustment of the ears. These switches, which perform a variety of matching and orienting functions, may have as few as three positions or as many as twelve, depending, seemingly, upon whim.

If the switch positions correspond to Channels 2-13, fine. If, however, the positions are numbered 1-12 or, as in



one case, 1-9 followed by A, B, and C, the contribution of the switch is far more subtle, and the best position can be found only by "cut-and-try."

**Guaranteed Method.** Here is a three-step experiment that will guarantee absolute maximum performance with switches. Before starting, adjust the ears to exact length, and provide room to swing them around. It is necessary to carry out the steps in the order indicated, since you are dealing with three variables which are inter-related; if your method lacks scientific orderliness, your results will be confusing.

*Step One:* Set the rabbit ears selector switch to its lowest position.

*Step Two:* Swing the ears in a circle to get the best picture. You are trying to do two unrelated things—strengthen the incoming signal and, secondly, eliminate "ghosts." If the main signal is strong enough so that the rabbit ears

Channel	Inches	Channel	Inches
2	50 $\frac{7}{8}$	8	15 $\frac{1}{2}$
3	45 $\frac{7}{8}$	9	15
4	41 $\frac{3}{4}$	10	14 $\frac{1}{2}$
5	36 $\frac{3}{8}$	11	14 $\frac{1}{8}$
6	33 $\frac{3}{4}$	12	13 $\frac{5}{8}$
7	16	13	13 $\frac{1}{4}$

do not need to be positioned critically, the ears can then be set to reject ghosts. A compromise may be necessary.

*Step Three:* After obtaining the best possible results with the above steps, adjust the TV set's fine tuning control. Now move the selector switch on the rabbit ears to its next position, and repeat Steps Two and Three. And so on, *ad nauseam.*

**What About UHF?** The standard or domestic rabbit ears (13 $\frac{1}{4}$ " minimum to 50 $\frac{7}{8}$ " maximum) are too long for fully efficient signal collection from the ultra-high-frequency stations using Channels 14 to 83. Baby rabbit ears should be about 6 $\frac{1}{2}$ " in repose and about 12" fully extended. So far, this miniature size is not available. You can experiment, though, with your regular ears, which will do a fairly efficient job at *double* these lengths. Twenty-four inches is about right for Channel 14, and fully contracted, your rabbit ears can almost reach the resonance of Channel 83. —30—



# COMING or GOING

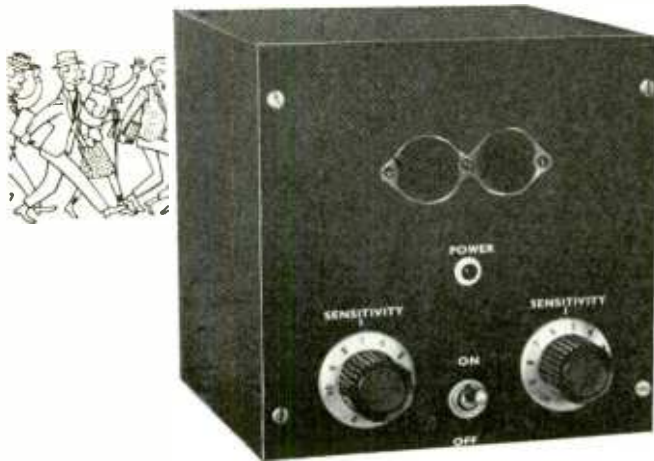

By **ARTHUR J. DAVISON**

*This photoelectric sensing device not only tells you when something is passing in front of it—the gadget will also indicate whether that something is . . . coming or going!*

**M**OST “CUSTOMER-ANNOUNCING” SYSTEMS do a fine job of letting a storekeeper know when someone has passed through his shop door. But suppose the storekeeper’s working in back when the signal sounds. Does the clerk in front need help with another customer—or has the original customer gone *out* the door?

This interesting photoelectric device will solve the problem very nicely. Employing twin photocell-and-relay systems, it unfailingly announces the direction of movement of any person or object breaking an associated light beam. You can use it to actuate separate “in” and “out” lamps, a buzzer and bell combination, or whatever else your imagination suggests.

**Construction.** The components are mounted in a 6” x 6” x 6” utility box having a built-in chassis. Parts placement is illustrated in the photos and diagrams but (except for photocells *PC1* and *PC2*) isn’t critical and

If the schematic diagram of the "sensor" looks a trifle complicated, keep in mind that one side of the circuit is simply a "mirror image" of the other side (two separate circuits are required to indicate both "coming" and "going"). The numbers from 1 to 11 on this diagram correspond to similar numbers on the two pictorials.

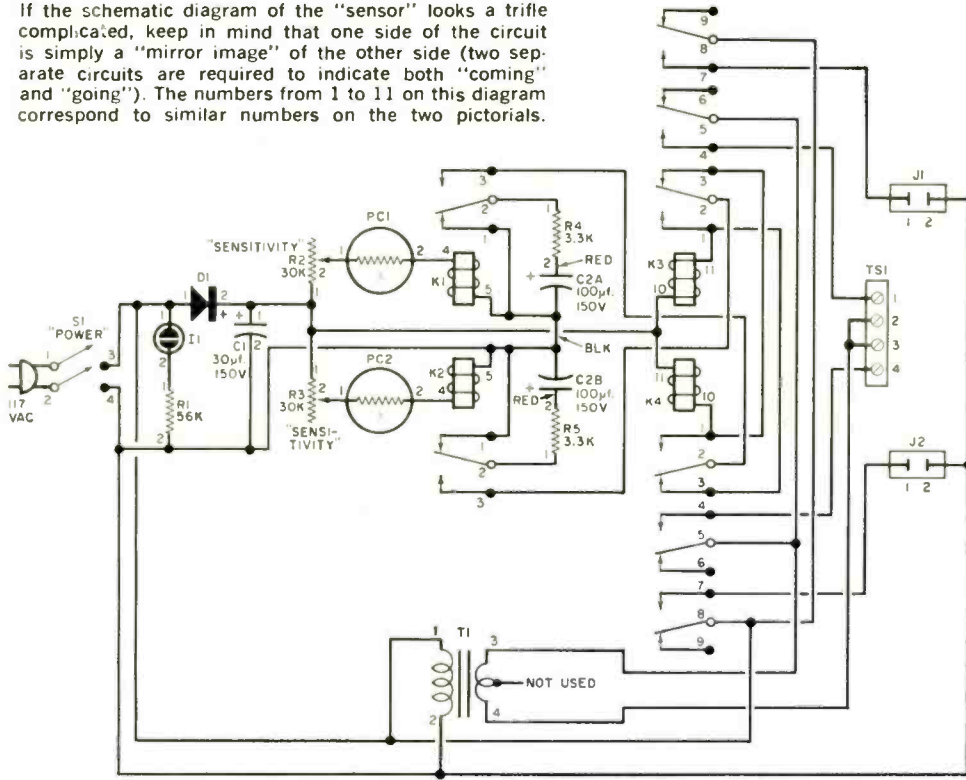

can be varied to suit your own taste.

For the sake of clarity, most of the wiring has been eliminated from the pictorials. The leads or terminals of all important components, however, are keyed to the schematic diagram by means of matching numbers.

When carrying out the wiring, no special care need be taken with the lead dress; all leads may be routed in the most convenient manner. Install rubber grommets as shown in the pictorials to pass wires through the chassis.

Photocells *PC1* and *PC2* are installed on the box's front panel as shown on page 44. In order to prevent stray light from affecting the photocells, they are set back in 2¼" "wells" made from 9-pin tube shields. These wells are set far enough apart (1¼") so that *PC1* and *PC2* will operate independently.

Note that the shields are press-fitted over shield bases (see Parts List) which have been pushed through holes in the panel. The circular lip at the top of each

shield is first sawed off, and slots are cut to clear the shield-retaining bosses on the base. The opening at the other end is slightly enlarged with pliers so that it will fit the casing of the photocell snugly.

The spacing of the pin terminals on the photocells specified for *PC1* and *PC2* is such that any pair of opposite contacts on a 9-pin tube socket will slip over them. This type of socket, then, is used to make the connections to the photocells.

**Setup and Adjustment.** First provide yourself with a suitable light source. A 6-volt, lantern-type flashlight—among other things—will do the job. If you use such a flashlight, a 6-volt filament transformer can be installed in place of the battery. But be sure that the flashlight's reflector is made of metal rather than plastic. It's possible that transformer heat might warp some plastics.

Aim the light beam so that it crosses the doorway and strikes *PC1* and *PC2*—making sure that the two photocells are

Underside of chassis should look like this before bulk of wiring is put in place. Lead dress is not at all critical, and rubber grommets can be used wherever necessary to pass wires through the chassis. The number "2" on jacks J1 and J2 refers to screw heads.

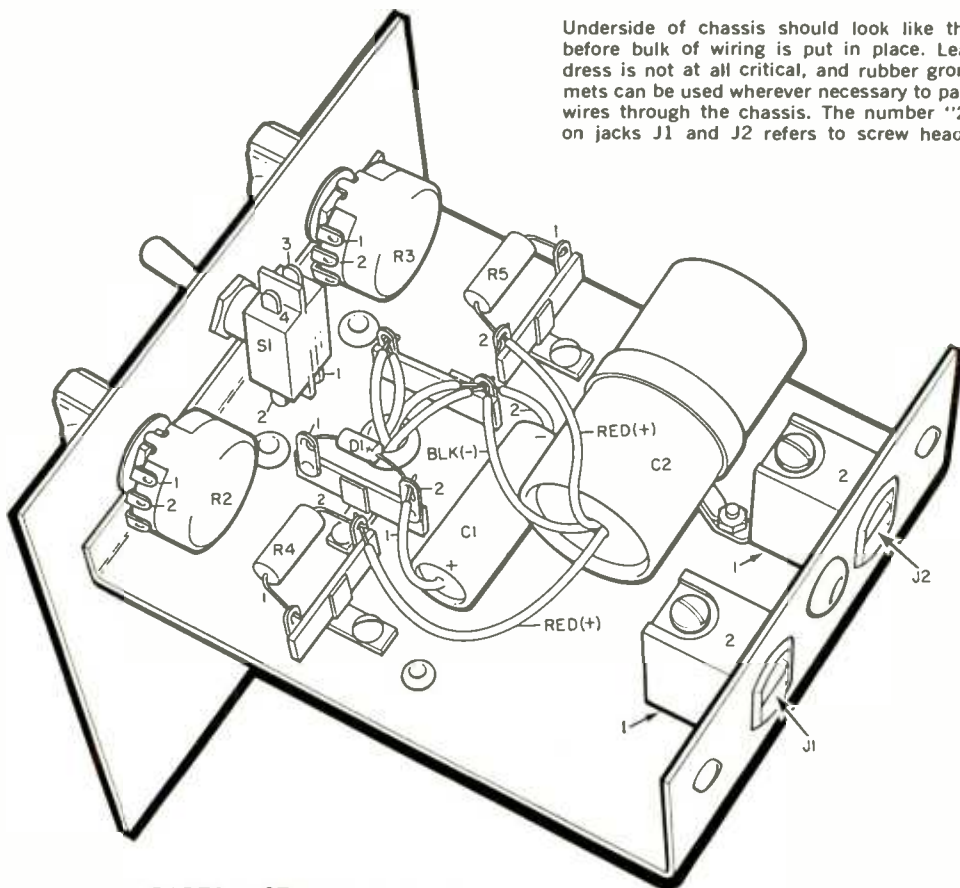

#### ---PARTS LIST---

- C1*—30- $\mu$ ., 150-volt electrolytic capacitor  
*C2*—Dual 100- $\mu$ ., 150-volt electrolytic capacitor  
*D1*—400-P1V, 750-ma. silicon diode  
*I1*—NE-51 neon lamp  
*J1, J2*—Chassis-mounting a.c. outlet  
*K1, K2*—5000-ohm plate relay, s.p.d.t. contacts (Potter & Brumfield Series LB-5 or equivalent)  
*K3, K4*—5000-ohm plate relay, 3-p.d.t. contacts (Guardian "Universal 200" Series; 200-5000 D coil, 200-M5 contact assembly with one pole unused—or equivalent)  
*PC1, PC2*—Heavy-duty cadmium photocell (Lajayette 99 G 6316 or equivalent)  
*R1*—56,000-ohm,  $\frac{1}{2}$ -watt resistor  
*R2, R3*—30,000-ohm potentiometer  
*R4, R5*—3300-ohm, 2-watt resistor  
*S1*—D.p.s.t. toggle switch  
*T1*—Filament transformer; primary, 117 volts; secondary, 6.3 volts @ 1.0 amp. (Knight 62 G 030 or equivalent)  
*TS1*—4-terminal, barrier-type terminal strip (Cinch-Jones 4-140 or equivalent)  
 1—6" x 6" x 6" utility case with  $4\frac{7}{8}$ " x  $5\frac{7}{8}$ " x  $1\frac{3}{4}$ " chassis (Premier CA-1405 or equivalent)  
 2—Shield bases for 9-pin miniature tube socket (Cinch-Jones 9SB1 or equivalent)  
 2— $2\frac{3}{8}$ " shields for 9-pin miniature tube (Cinch-Jones 9SJ3-1 or equivalent)  
 2—9-pin miniature tube sockets  
 Misc.—Line cord and plug, rubber grommets, terminal strips, hardware, wire, etc.

illuminated with equal intensity. Then turn on "power" switch *S1*. Neon power indicator *I1* should now glow.

Move both "sensitivity" controls (*R2* and *R3*) to their maximum-resistance positions. Then turn them in the opposite direction until the relays they control (*K1* and *K2*, respectively) pull in—and continue for another quarter-turn. These settings should be about right, but in the first few hours of operation there may be resistance changes in the photocells calling for further reduction in the resistances of *R2* and *R3*.

Now all you have to do is connect the signaling devices. If the photocell unit is placed so that people on the way in will darken *PC1* first, connect the "in" signals to *J1* and/or terminals 1 and 2 of *TS1*. The "out" signals are connected to *J2* and/or terminals 3 and 4 of *TS1*. If people coming in will darken *PC2* first,

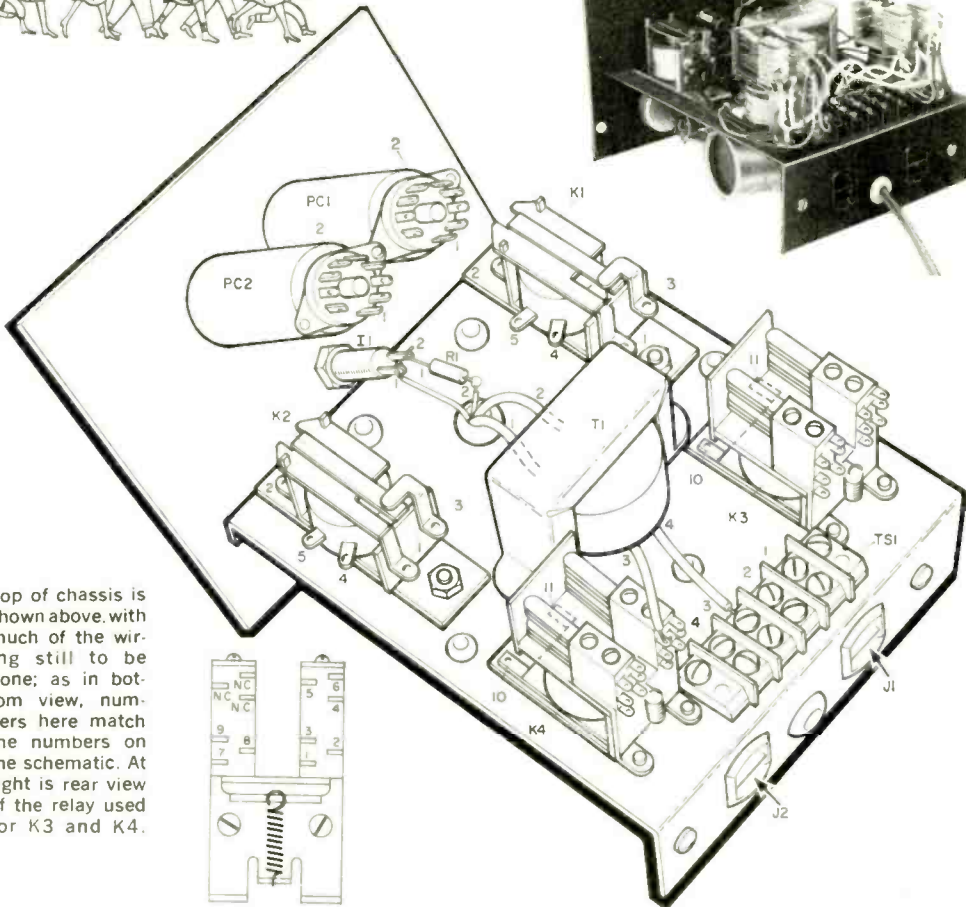
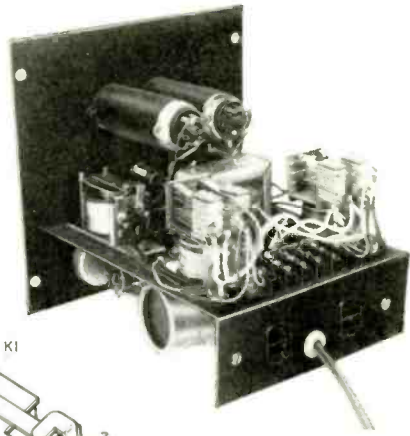

Top of chassis is shown above, with much of the wiring still to be done; as in bottom view, numbers here match the numbers on the schematic. At right is rear view of the relay used for K3 and K4.

When installing PC1 and PC2, prepare identical modified tube shields for both 1" holes. Remove and discard internal spring before cutting out slots; coat insides of bases and shields with flat black paint to reduce glare.

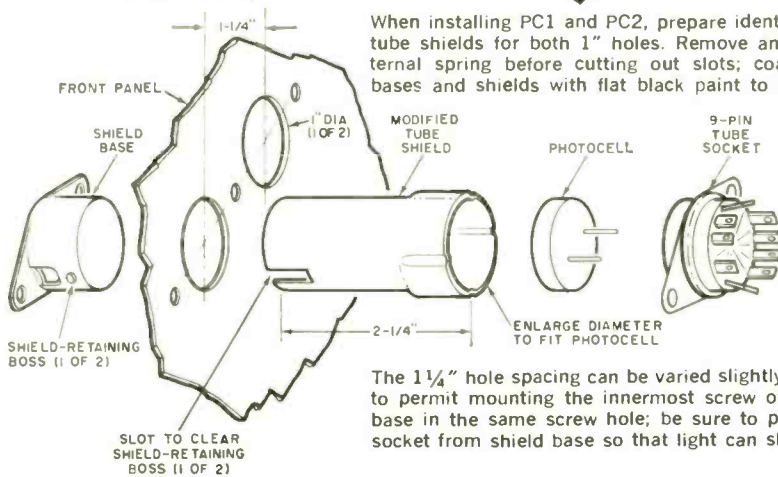

The 1 1/4" hole spacing can be varied slightly if necessary to permit mounting the innermost screw of each shield base in the same screw hole; be sure to push out tube socket from shield base so that light can shine through.



**-HOW IT WORKS-**

The a.c. line voltage is rectified by diode *D1* to furnish d.c. for relays *K1-K4*, and capacitor *C1* filters this d.c. voltage well enough to prevent chattering. The coils of relays *K1* and *K2* are each connected, across the d.c. supply, in series with a "sensitivity control" and photocell (*R2* and *PC1*, *R3* and *PC2*).

As long as a light beam strikes the photocells, their resistances remain low, and *R2* and *R3* can be adjusted to pass enough current to pull in *K1* and *K2*, respectively. But if either *PC1* or *PC2* is darkened, its resistance will immediately increase, and the current flow will decrease enough to drop out the appropriate relay.

The photocells are so placed that a person walking by them, depending on whether he's coming or going, will darken *PC1* or *PC2* first. If *PC1* is darkened first, *K1* drops out and contacts 2 and 3 of that relay close. This connects capacitor *C2a* and resistor *R4* (through contacts 2 and 3 of *K4*) in series with the coil of *K3* and the d.c. supply.

Current from the supply flows through *K3*'s coil and *R4* to charge *C2a*, and the charging current pulls in *K3*. Since contacts 4 and 5 of *K3* have now closed, the 6.3-volt secondary of transformer *T1* is connected across terminals 1 and 2 of terminal strip *TS1*. In addition, contacts 7 and 8 of *K3* make the a.c. line voltage available across outlet *J1*.

Though contacts 1 and 2 of *K3* also close, this accomplishes nothing until photocell *PC2* is darkened. Then *K2* drops out, closing its contacts 2 and 3. Accordingly, charging current for capacitor *C2b* flows (via contacts 1 and 2 of *K3*) through resistor *R5* and the coil of *K3*—helping to keep the latter relay pulled in.

If the photocells remain darkened, the charging currents for *C2a* and *C2b* will keep *K3* pulled in for about 3 seconds. Therefore, any electrical signaling devices connected to *J1* or to terminals 1 and 2 of *TS1* will operate for that length of time. Should light hit the photocells before the three seconds are up (as is usual), *K1* and *K2* will pull in—dropping out *K3* and cutting off the prior signals. Note that capacitors *C2a* and *C2b* discharge through resistors *R4* and *R5*, respectively—readying themselves for the next cycle—when *K1* and *K2* pull in.

Should *PC2* be darkened first, the reverse situation occurs. Relay *K2* drops out and *K4* is pulled in by charging current for *C2b*. Then as *PC1* is darkened, *K1* drops out—adding the charging current for *C2a* to that already flowing through *K4*'s coil. The result is that 6 volts appears across terminals 3 and 4 of *TS1* and 117 volts appears across *J2*. As before, these signal voltages remain available for about 3 seconds—but will be cut off earlier if light strikes the photocells.

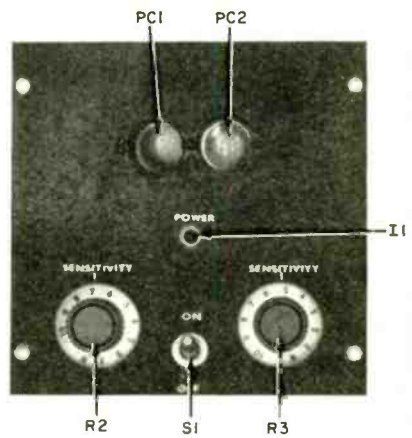

Front panel of the "sensor" is extremely symmetrical, with photocells, pilot lamp, and sensitivity controls arranged in a neatly balanced fashion.

then simply reverse these connections.

Remember that outlets *J1* and *J2* are for signaling devices (such as illuminated "In" and "Out" signs) which operate on 117 volts. Six-volt devices (such as bells, buzzers, etc.) should be connected to *TS1*.

And there you have it! Chances are you'll stumble across all kinds of interesting applications for this novel alarm. For example, let's say you want to count the number of objects—people, cars, or what have you—passing in one direction only; you just plug a suitable counter into either *J1* or *J2* (depending on whether you want to count them "coming" or "going"), and your problem is solved. Or you can use the gadget to trigger a tape recorder, set up so that it will give one greeting to people coming in and a different message to those going out. Regardless of your specific requirements, one thing is certain: thanks to this little photoelectric "sensor," you'll never again have to wonder whether someone is *coming or going!*

# You probably thought top quality electronic test instruments were too expensive...didn't you?

*Well, they're not when you build them with money-saving RCA kits*

You've known right along that you can save money on electronic test instruments by building from kits.

But you may have shied away from kits because you thought they involved complicated calibration or adjustment problems. Forget it!

RCA kits are inexpensive, of course, but they're also easy to build. Build them right and they'll give you the best performance you can buy in their price range.

What's better about RCA test instrument kits?

**Ease of assembly is one thing.** Parts are clearly identified. Each assembly diagram appears on the same page as the step-by-step instructions for that section of assembly. There's no need to refer back constantly to other pages, which consumes time and increases the chance of error.

**Ease of alignment is another thing.** Each kit contains complete instructions for accurate calibration or alignment of the instrument. Where necessary, precision calibrating resistors are provided for this purpose.

**What does it mean?** It means that with RCA kits you can get a professional V-O-M or VTVM for as little as \$29.95\*. Or you can get a good oscilloscope (one of the most useful—but normally one of the most expensive—test instruments) for only \$79.50\*.

Specialized instruments such as an AC VTVM or an RF Signal Generator, are also available as kits for far less than they would cost otherwise. In every case, RCA kits, when completed, are identical with RCA factory assembled instruments.

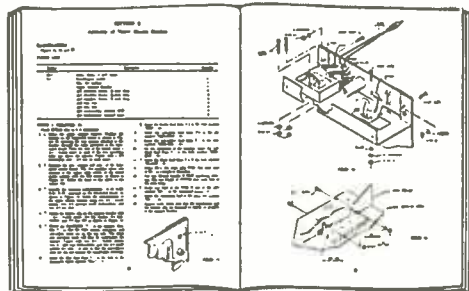

Each sub-assembly is described in a separate section with illustrations applying to that sub-assembly available at a glance. No cross referencing necessary.

## LOOK WHAT'S AVAILABLE TO YOU IN KIT FORM:



RCA VOLT-OHM-MYST®. The most popular VTVM on the market. WV-77E(K). Kit price: \$29.95\*



RCA SENIOR VOLT-OHM-MYST. A professional VTVM. WV-98C(K). Kit price: \$57.95\*



RCA VOLT-OHM-MILLIAMMETER. One of most useful instruments. WV-38A(K). Kit price: \$29.95\*



RCA 3-INCH OSCILLOSCOPE. Compact, lightweight, portable. WO-33A(K). Kit price: \$79.95\*



RCA HIGH-SENSITIVITY AC VTVM. Doubles as audio pre-amplifier. WV-76A(K). Kit price: \$57.95\*



RCA RF SIGNAL GENERATOR. For audio and TV servicing. WR-50A(K). Kit price: \$39.95\*

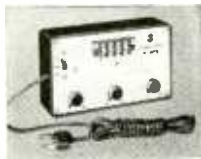

RCA TV BIAS SUPPLY. For RF, IF alignment in TV sets. WG-307B(K). Kit price: \$11.95\*

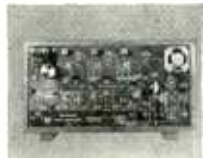

RCA TRANSISTOR-RADIO DYNAMIC DEMONSTRATOR. For schools. WE-93A(K). Kit price: \$39.95\*



RCA V-O-M DYNAMIC OEMONSTRATOR. A working V-O-M. WE-95A(K). Kit price: \$37.95\*

See them all—and get full technical specifications for each—at your local Authorized RCA Test Equipment Distributor. Or write for information to: Commercial Engineering, Section 141W, RCA ELECTRONIC COMPONENTS AND DEVICES, HARRISON, N. J.

\*Optional Distributor Retail Price. All prices are subject to change without notice. Prices may be higher in Alaska, Hawaii and the West.



The Most Trusted Name in Electronics

RCA ELECTRONIC COMPONENTS AND DEVICES, HARRISON, N. J.

CIRCLE NO. 32 ON READER SERVICE CARD





# Largo to Presto Metronome

**Single-transistor  
metronome operates  
from house current**

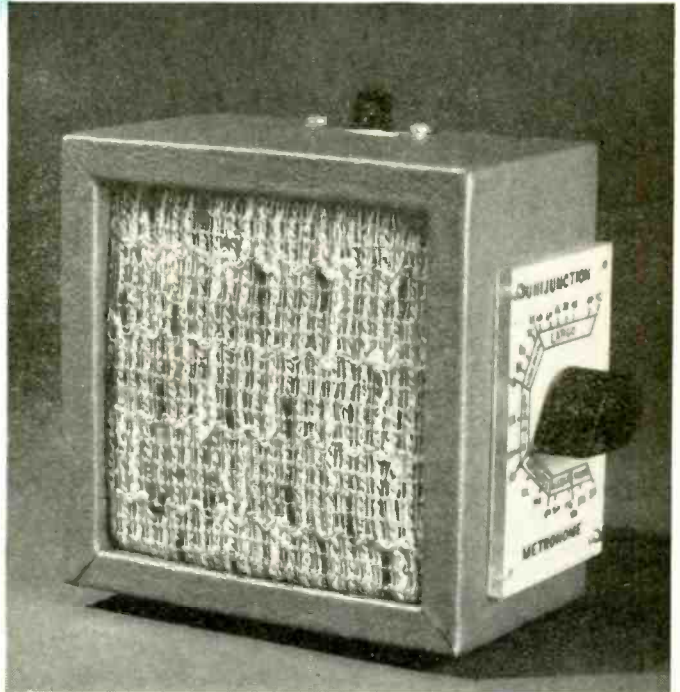

By JOHN F. CLEARY\*

A METRONOME can be any contrivance for marking time as an aid to musical study and performance. The metronome to be described here is one of the simpler electronic "contrivances" in that it uses the unique unijunction transistor to generate precision timing pulses. In fact, this is the only transistor used—or for that matter needed—in order to generate a distinct "metronomic tick" at the loudspeaker. An advantage of using the unijunction, or UJT as it is often called, is that the

loudspeaker can be driven directly. No output transformer is needed.

The circuit can be powered either by a transformerless supply as shown or by a battery. Beat rate is adjustable from below 42 beats per minute, a low *largo*, to slightly over 208 beats per minute, a high *presto*. Both limits can be extended simply by changing the emitter component values.

Circuit operation centers around the 2N2160 (you can substitute a 2N2646 if you wish) in a basic unijunction transistor relaxation circuit. Applying voltage across  $R_3$ ,  $R_4$ ,  $R_5$ , and  $C_2$  allows  $C_2$  to charge. Since at the beginning of the operating cycle the unijunction emit-

\*Applications Engineering, Semiconductor Products Dept., General Electric Company

# METRONOME

ter is reverse-biased and therefore non-conducting, a high impedance exists across  $C2$ . As  $C2$  continues to charge, the emitter voltage increases exponentially and approaches the supply voltage level. At a point determined by the uni-junction and called the "emitter peak point voltage," the emitter becomes forward-biased and presents a low impedance across  $C2$ , causing it to "dump" its charge into base 1 ( $B1$ ) through the speaker voice coil. This results in a distinct "tick" from the speaker.

"Rate" pot  $R4$  provides for a slow or fast beat rate by controlling the charging time of  $C2$ . Frequency is thus determined by the combination of  $R4$ ,  $C2$ , and the supply voltage across the UJT. Resistor  $R3$  is selected to set the high beat rate limit while  $R5$  sets the low limit. By using a log-taper potentiometer for  $R4$ , a well-proportioned "rate" scale can be adjusted to any range desired. The photograph on page 47 shows a typical 42-208 beats-per-minute metronome scale spread over almost the total  $270^\circ$  range of  $R4$ . The number of beats for the various tempi employed as calibration for the author's metronome are as follows:

BEATS/MINUTE	TEMPO	BEATS/MINUTE	TEMPO
42-69	Largo	125-154	Andante
69-98	Larghetto	154-180	Allegro
98-125	Adagio	180-208	Presto

Four 1N1692 silicon rectifiers in a bridge-rectifier configuration and a 100- $\mu$ f. filter capacitor make up the power supply. Fed directly from the a.c. line, this arrangement supplies the required 25 volts at 4 ma. with sufficient regulation for good metronome stability. Resistors  $R1$  and  $R2$  act as voltage-dropping resistors and add some degree of safety by limiting the total current drain to approximately 5 ma. under direct short-circuit conditions. By housing the circuit in an insulated box, additional protection is obtained against electric shock.

Naturally, other power supply ar-

rangements can be used. A 22½-volt battery can replace the supply shown. Lower voltages can be used with decreased output and increased calibration error; in fact the UJT will continue to operate with as low as 3 volts applied in many instances.

**Construction.** The photos show how the unit is constructed with the exception of the line resistors and three of the 1N1692 rectifiers, which are all hidden behind the speaker "U" frame. Two rectifiers are located on either side of the perforated insulation board for ease of mounting and wiring. The back of the speaker frame, as shown, protrudes through the square hole cut from the board and rides on the surrounding lip of the speaker frame. After cutting the board to size (slightly smaller than the over-all speaker measurement), measuring and cutting out the center opening, and mounting all components, the completed board is slipped onto the speaker frame and secured in place with contact cement. The bracket-supported  $R4$  is then soldered to the speaker frame for increased rigidity, as can be seen in the photo showing the inside view of the unit.

A square of grille cloth and a square of aluminum window screening are cut about 1" larger than the speaker frame. Place the grille cloth on a flat surface, the screen on top of it, and the speaker—cone down—on top of the screen. By wrapping the excess material around the edge of the speaker frame, the cone will be protected from damage. This method of covering the speaker requires no hardware and is self-supporting.

The cabinet shown is made from ¾" plywood and measures 2½" deep x 4½" square. The back is cut from ¼" hardboard and is glued in place. A shaft hole about ¾" in diameter—large enough to accommodate the shaft and allow the completed unit to be placed in the box snugly—is then carefully drilled in the side of the box. An additional power switch hole is made in the top of the cabinet and a power-line cord hole in the back.

In the photo showing the internal view of the metronome, note the two threaded holes located on the back of the speaker "U" frame. Two additional holes are carefully drilled in the cabinet

## PARTS LIST

*C1*—100- $\mu$ f., 50-volt miniature electrolytic capacitor

*C2*—10- $\mu$ f., 25-volt miniature electrolytic capacitor

*D1, D2, D3, D4*—1N1692 silicon diode

*Q1*—2N2160 or 2N2646 unijunction transistor

*R1, R2*—12,000-ohm,  $\frac{1}{2}$ -watt resistor

*R3*—22,000-ohm,  $\frac{1}{2}$ -watt resistor

*R4*—150,000-ohm potentiometer

*R5*—430,000-ohm,  $\frac{1}{2}$ -watt resistor

*R6*—330-ohm,  $\frac{1}{2}$ -watt resistor

*S1*—S.p.s.t. switch

*Misc.*—Small speaker and cabinet—see text, perforated phenolic board, flea clips, a.c. cap, wire, solder, etc.

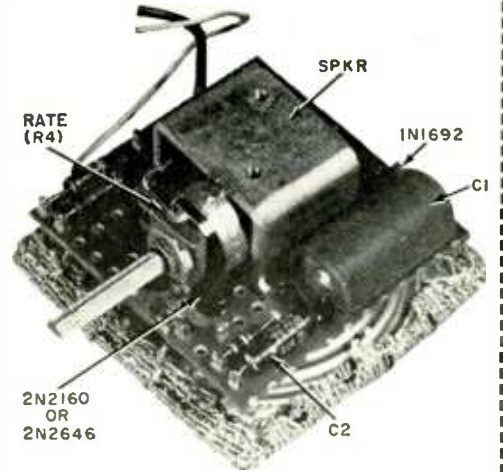

Components of the metronome are mounted on a perforated circuit board. The speaker is a square-framed 3 $\frac{1}{2}$ " Utah SP358 3-4 ohm unit containing a 1-ounce magnet. Any speaker can be used, however; the higher its efficiency, the louder the tick.

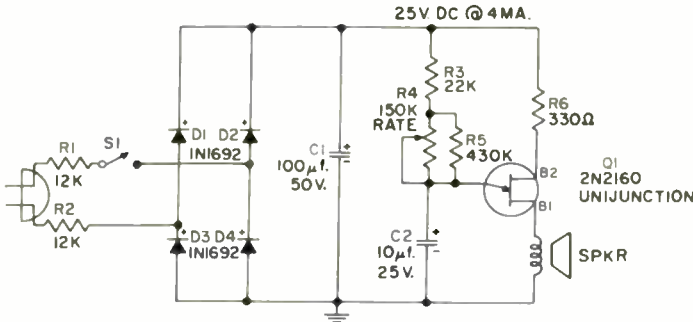

back to match these holes which are then used to hold the speaker securely in place.

Should a battery be used to power the unit rather than a permanent power supply, cabinet dimensions must be changed accordingly. Since wiring is in no way critical, any type of cabinet or component arrangement can be employed.

**Calibration.** Fairly accurate rate calibration will result by counting "ticks" against time. Using a stopwatch or a wristwatch sweep second hand, counting the number of ticks per 15 seconds and multiplying by 4 to obtain the "beat rate" per minute, will result in accurate dial calibration. This method works well for slow to medium beat rates but is

more difficult at the faster rates. A second method is to compare the uncalibrated metronome with a calibrated metronome of known accuracy. Both methods are sufficiently accurate for musical purposes.

Should a louder "tick" be desired, the unijunction metronome will easily drive an audio amplifier. By replacing the loudspeaker with a 20- or 30-ohm resistor, positive driving pulses may be taken from base 1 (B1). Negative pulses can be taken directly from base 2 (B2) simultaneously, if needed.

Pulse rate can be changed widely simply by replacing *R4* and *C2*. Two to three minutes, and more, are possible between pulses.

**Beef up the sound of your  
phone bell and put it  
where you can hear it when  
you're out at the barbecue  
pit or in the garage**

**D**ID YOU ever miss an important telephone call because you were working outdoors or in the garage, or lounging on the patio or porch, where you couldn't hear the bell? Most of us have had this frustrating experience at least once or twice. One way to avoid it is to have the phone company install a loud outside bell. This is fine, *if* you need the outside bell all year round, and *if* it won't disturb the neighbors, and *if* you're always in an area where the bell can be heard readily.

But that's a lot of "ifs," which for many families just don't add up to placement of an order with the phone company. Nevertheless, when the lady of our house was heard to remark to a friend, "We heard *Radio Australia* last

## **"LOUD-HAILER" for the TELEPHONE**

By **DONALD L. WILCOX**



You can duplicate the author's layout by following the parts placement shown here. Holes in chassis allow bell sound to reach bracket-mounted microphone.

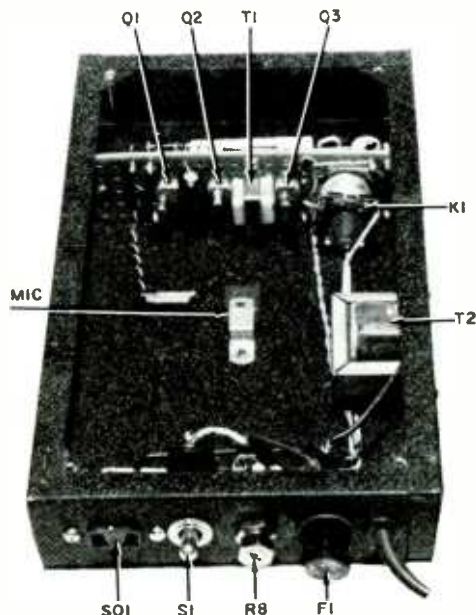

night on the short-wave set, but we can't hear the phone ring out at the barbecue pit," it was clear that something had to be done. It was, and the alternative solution to the remote telephone signal problem described here is the result.

It involves no monthly service charge at any time—let alone for those months when you don't need the bell, doesn't require any connection to telephone company equipment, permits you to put the bell where you need it, and allows you to relocate it at any time without inconvenience. Furthermore, you can build the "Loud-Hailer" in a couple of evenings, at a nominal cost of about \$18.00, even using all new parts, and you can probably halve that by raiding the trusty junk box.

**How It Works.** The Loud-Hailer is a simple device, made up essentially of a microphone, audio amplifier, and a relay, energized by a small power supply that plugs into the house a.c. line. With the unit in operation, the sound of the telephone bell is picked up by a microphone, the output from which is amplified to a level capable of closing a relay. The remote bell is energized by a.c. from the line, applied through contacts of the relay. The remote bell can be mounted outside the house at any suitable point, or moved about from garden to garage to pool, wherever its extension cord will reach.

A look at the schematic diagram will clarify details of the circuit function. The first two transistors, *Q1* and *Q2*, operate as Class A amplifiers, boosting the microwatt output of the microphone to a level great enough to drive transistor *Q3*, which operates as a Class B power detector.

With no sound at the microphone, *Q3* is practically cut off, since there is no

base current; and the emitter-to-collector current is therefore no more than a few microamperes leakage. When the phone bell rings, the amplified microphone signal drives the base of *Q3* negative once each cycle, causing the *Q3* collector current to flow in a series of d.c. pulses. This output, smoothed by capacitor *C6*, energizes relay *K1*, applying a.c. power to the remote bell.

**Construction.** Since the circuit is extremely non-critical, parts placement and other mechanical details can be varied to suit the constructor's preference. In the author's unit, most of the circuit parts are mounted on a strip of Vectorbord, as shown in the photograph. The controls are grouped at one end of the metal box. The microphone is mounted in the middle of the box, facing a group of drilled holes which permit easy entry for the sound of the phone bell. Wiring is simple and straightforward, and requires only the normal caution about use of a heat sink when soldering transistor leads.

**Operation.** In use, the Loud-Hailer is placed under the phone with the controls at the rear, so the cords to the a.c. line and the remote bell can be dressed out of the way. This brings the microphone of the Loud-Hailer directly under the bell of the usual desk-type telephone

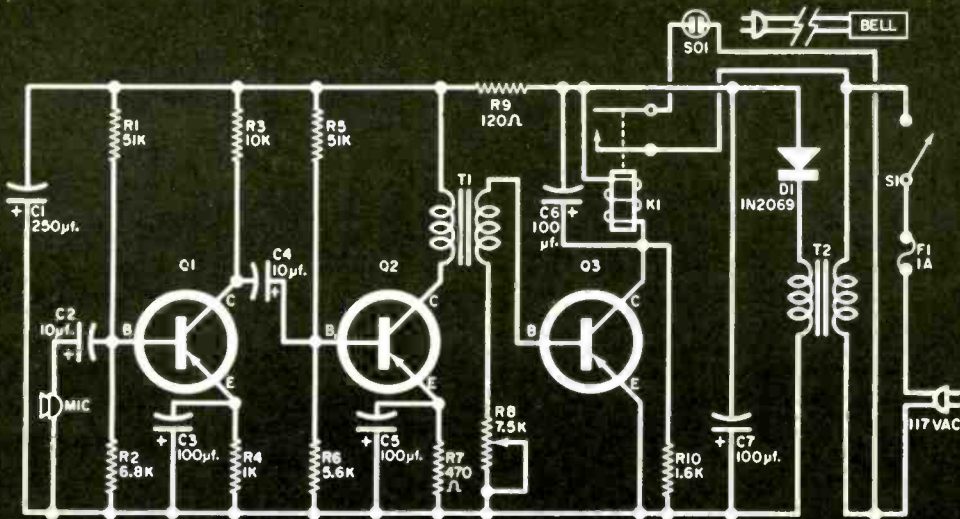

Schematic diagram shows basic simplicity of the Loud-Hailer circuit.

**PARTS LIST**

- C1—50-µf., 12-volt electrolytic capacitor
- C2, C4—10-µf., 6-volt electrolytic capacitor
- C3, C5—100 µf., 6 volt electrolytic capacitor
- C6, C7—100-µf., 15-volt electrolytic capacitor
- D1—1N2069 silicon diode
- K1—S.p.s.t. relay, 6-volt, 335-ohm coil (Potter & Bruhnfield RS5D or equivalent)
- Q1, Q2, Q3—2N1274 germanium transistor
- R1, R5—51,000 ohms
- R2—6800 ohms
- R3—10,000 ohms
- R4—1000 ohms
- R6—5600 ohms
- R7—470 ohms
- R8—7500-ohm potentiometer, with shaft lock
- R9—120 ohms

All resistors  
1/2-watt carbon  
unless other-  
wise specified

- R10—1600 ohms
- S1—S.p.s.t. toggle switch
- SO1—A.c. convenience outlet socket
- T1—Transistor driver transformer, 10,000-ohm primary, 2000-ohm secondary (Lafayette 99 G 6126 or equivalent)
- T2—Filament transformer, 6.3-volt secondary (Lafayette 33 G 3702 or equivalent)
- 1—Alarm-type bell, 115-volt a.c. (Lafayette 99 G 9023 or equivalent)
- 1—5½" x 9½" x 1½" pan-type chassis
- 1—600-ohm dynamic microphone (Lafayette 99 G 4527 or equivalent)
- Misc.—Vectorbord, fuse holder, transistor sockets, solder, wire, hardware, etc.

**TYPICAL D.C. VOLTAGES**

	Q1	Q2	Q3
Ve	-0.90	-0.75	0
Vb	-1.00	-0.85	0
Vc	-1.30	-10.00	-9.6

All voltages are measured to + side of C7 with high-impedance voltmeter, no input signal to microphone.

where sound pickup will be strongest.

The extension cord leading to the remote bell is plugged into a.c. outlet SO1, and gain control potentiometer R8 is adjusted so that an incoming ring causes reliable ringing of the remote bell. This setting can be tested by asking one of your neighbors to dial your number. When correct operation has been obtained, locate the remote bell where you'll be sure to hear it when it rings.

If you want to use the Loud-Hailer only occasionally, and in different locations, such as the garden, attic, garage, or barbecue pit, you may want to keep the extension cord free, to be rerouted as necessary. However, if you intend to use the Loud-Hailer for just one or two remote locations, you may prefer to install permanent remote lines and outlets. Either way, you'll stop missing those important calls.

# CAR BATTERY SAVER

By R. C. APPERSON, JR.



Never again will your wife leave the lights on and kill the battery—this little “computerized” gadget makes forgetting an impossibility

**O**NE MISERABLE RAINY MORNING, we climbed into our car and headed to work, picking up riders along the way. In order to let fellow drivers know we were on the highway, the headlights were flicked on, and conversation engulfed the group. The rest of the drive was just sufficient to let the stimulating conversation sweep all thoughts of headlights from the driver's mind. Once in the company parking lot, the ignition switch was quickly cut off, and all passengers made a mad, splashing dash for the front door. Two high candle-power lamps remained on, doing no useful work, but sapping those ampere-hours from the car's battery. The weather was clear when quitting time rolled around. All loaded aboard the car, and—urrr, urrr—then nothing. The language that followed was much stronger than the battery, and a vow was made to find a way to remedy the problem. Here is the device that has eliminated many

trips to the battery charger; it's yours for a very few dollars and a little time.

**How It Works.** As in computer logic circuitry, certain conditions must be present before the device generates a signal. When the stage is set properly, the little gadget comes alive with a raucous 100-cycle squawk that won't allow you to leave your lights on. In fact, when this thing sounds off, you'll wish for a second that you never heard of headlights!

The signal is generated only when the headlights are on and the ignition is off. If the ignition is on, nothing happens. Headlight and ignition voltages cause no disturbance either, but the removal of the ignition voltage if headlight voltage is applied starts the action. A look at the circuit will explain why.

### Computer Logic: The Battery Saver

The circuit used in this project follows computer logic to an extent. The desired action does not fit either "AND" or "OR" gate conditions. "AND" gates operate with both inputs present, and "OR" gates with either one input or the other. The design of the Car Battery Saver is similar to that of an "INHIBIT" gate, to use computer terminology. When the headlights are left on, there is an output unless the ignition is also on. The output is in the form of a raucous warning signal that emanates from the loudspeaker. It doesn't let you forget the lights! If the ignition switch is on, the output is "INHIBITED."

**INHIBIT Gate, Generator.** If you have a resistor and capacitor in series with a car battery, the capacitor will charge through the resistor to the full battery potential. If you have a resistor and capacitor connected in series and then to sources of like potential (both to the positive terminal of the car battery, for example), the capacitor cannot charge as no current flows from the battery. This, basically, is the INHIBIT principle.

How do we apply this in the car? We

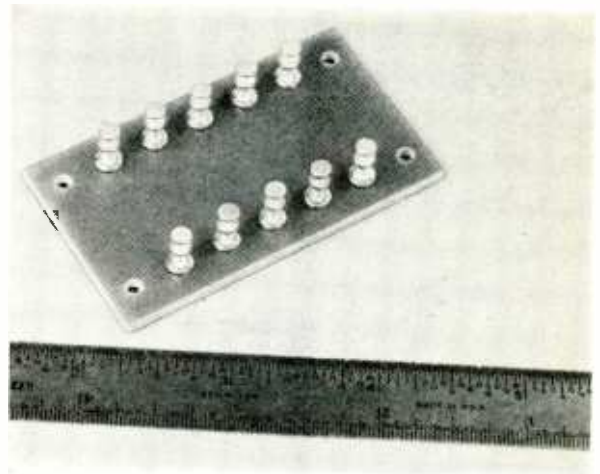

Terminal board was used for the prototype, but layout is noncritical; terminal strips can be used.

have two controls that switch voltages from the same source. Let the headlight voltage be the supply, and the ignition the hold-off signal. Since a reference point is required for the supply, a resistor is placed between the normally-grounded circuit element and the ground. The ignition voltage is dropped across it. Only one-half watt is dissipated as hold-off power. This is a negligible load to a battery being charged by a generator.

The signal generator itself is simple. It is a unijunction relaxation oscillator delivering pulsed energy to a speaker at a 100-cycle rate as determined by the  $R1$ ,  $C1$  time constant.

Unijunction  $Q1$  does not conduct until  $C1$  charges through  $R1$  to a potential determined by the unijunction characteristics and the supply voltage. When this potential is reached, the emitter allows  $C1$  to discharge into base number 1. This turns on the unijunction and a current pulse is drawn through the speaker, producing an audible tone.

Protective resistance for the unijunction is provided by  $R2$ , and  $R3$  is the resistor logic. Obviously,  $C1$  won't charge if a voltage at the top of  $R3$  is equal to the voltage at the top of  $R1$ . When the voltage at the top of  $R3$  disappears,  $C1$  charges, and the circuit emits the warning.

The "Battery Saver" is flexible. Move the location of  $R3$  and the battery saver



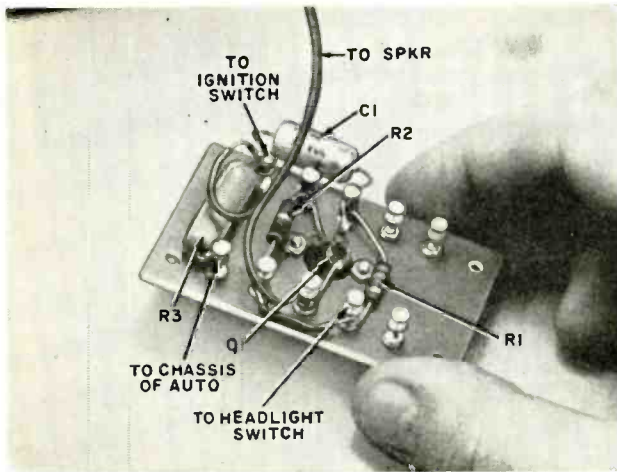

Parts placement is clearly shown above. Connection to the automobile is done as described in the text.

system will operate on a car with either positive or negative ground. Voltage is not critical either. The only difference between a 6- and 12-volt system is a slight volume decrease with the lower voltage.

**Building The Unit.** Any small container large enough to house the speaker will make a suitable cabinet for the unit. Circuit layout and wiring is not at all critical, but the author's layout is shown for your convenience. Three leads are brought from inside the cabinet which go to the ignition, headlights, and auto chassis ground. The speaker is attached to the case after holes are drilled in the box to let the sound out. Small screws mount the speaker to the cabinet. The speaker terminals also serve as tie points for one base lead and the negative side of the capacitor. The hold-off resistor and the lead that goes to the ignition connect to this capacitor lead. Care must be exercised when soldering to the unjunction, and a heat sink should be used; remember, *it's a transistor.*

(Continued on page 153)

#### PARTS LIST

C1—20- $\mu$ f., 25-d.c.w.v. electrolytic capacitor  
 Q1—2N2160 unijunction transistor  
 R1—1500-ohm,  $\frac{1}{2}$ -watt resistor  
 R2—91-ohm,  $\frac{1}{2}$ -watt resistor  
 R3—270-ohm, 2-watt resistor  
 1—Miniature speaker, 8 ohms  
 1—Minibox or other housing  
 Misc.—Terminal strips or board, wire, etc.

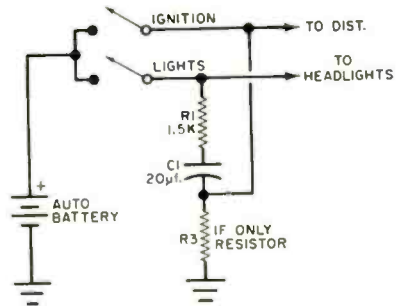

Basic INHIBIT circuit is integrated into auto electrical system as above. This drawing is for illustration only; actually, C1, R2, and R3 are in Battery Saver.

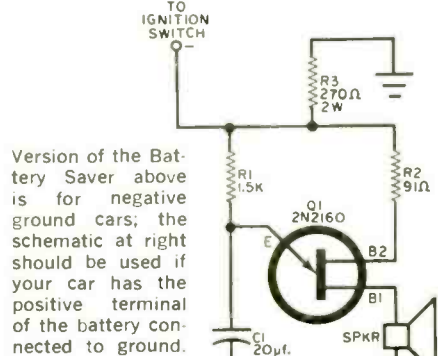
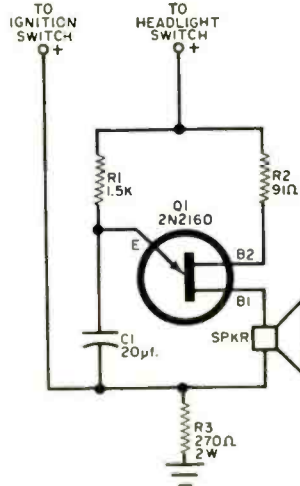

Version of the Battery Saver above is for negative ground cars; the schematic at right should be used if your car has the positive terminal of the battery connected to ground.

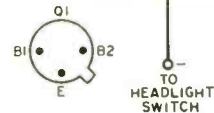

# SCOTT'S TOP RATED LT-110 FM STEREO TUNER KIT NOW AT A NEW LOW PRICE ... \$139.95

"... 1.88 uv sensitivity by a home alignment procedure  
without instruments ... an exceptional feat..."

*Electronics Illustrated*



Here's terrific news for you kit builders! Now, the famous Scott LT-110 tuner kit ... top rated by every audio expert ... built by thousands of hi fi enthusiasts ... is available in handsome new styling at a truly modest price.

Look at the outstanding features of this superbly engineered tuner. It includes a heavily silver-plated front end ... prewired and tested in Scott's engineering laboratories. The critical multiplex section is also pre-wired and tested with the most advanced multiplex equipment available. Among the LT-110B's many extras: Stereo Separation in excess of 30 db, Sonic Monitor stereo indicator, 60 db Signal-to-Noise ratio, sensitive tuning meter.

Here's what the technical editor of *Electronics Illustrated* said about the LT-110: "If you have hesitated to go into stereo FM because of imagined complexities and highly technical skills and knowledge that might be required, fear no more. The LT-110 shows you how to enjoy stereo FM the easy way."



**LK-72B 80-Watt Stereo Amplifier Kit.** This popular amplifier kit delivers enough power to drive any speaker system, and at an outstanding price. Complete range of control features includes switched front panel headphone output, complete recording facilities, and provision for driving a third or center channel loud-speaker system without additional amplification. Only \$149.95.



**LK-48B 48-Watt Complete Stereo Amplifier Kit.** Here's more than enough power for most music systems, and two great new features: Switched front panel headphone output for private listening, and powered center channel output to drive extension speakers. 13 front panel controls. Complete tape facilities. Includes all-aluminum chassis and DC-operated heaters for lowest hum. Only \$129.95.

## IMPORTANT FREE OFFER FROM SCOTT



Please send me your new 20-page full-color 1965 Stereo Guide and complete catalog. Include complete information on new consoles by Scott ... component quality in beautiful, hand-finished cabinets.

Name .....

Address .....

City ..... Zone ..... State .....



H. H. SCOTT, INC. 521-00  
111 Powdermill Road, Maynard, Mass.

Export: Scott International, 111 Powdermill Road, Maynard, Mass. Canada: Atlas Radio Corp., 50 Wingold Ave., Toronto. Cable HIFI  
Price slightly higher West of Rockies. Subject to change without notice.

**CIRCLE NO. 35 ON READER SERVICE CARD**

# Chapter



# Hi-Fi and STEREO

**Hi-Fi** speaker enclosures remain a favorite construction project of the died-in-the-wool audiophile. Once again, the **ELECTRONIC EXPERIMENTER'S HANDBOOK** has utilized the services of Dave Weems to design something out of the ordinary. This year Dave has come up with an enclosure made from a rectangular block of ceramic tile; with the addition of baffling and high-frequency diffusers, Dave has constructed a low-cost stereo system capable of reproducing surprisingly good sound. Author and designer Jim Reid has attacked the enclosure problem from a different angle and describes a clean-cut conventional hi-fi system.

Just in case you don't want to part with that stereo tuner which lacks a multiplex indicator, Chuck Caringella has designed a transistorized gadget to fill the bill. Hi-Fi buffs can regale you with stories about the misadventures of FM multiplex—especially stereo transmissions that are not really broadcast in stereo. An indicator is the only positive way of knowing if an FM station has the necessary multiplex pilot carriers in operation.



Reflectoflex Speaker Enclosure.....	James D. Reid	58
Phono Fillips.....	Art Trauffer	62
Resistive Load for Hi-Fi Test.....	Walter Temcor	64
Another Ceramic Tile Enclosure.....	David B. Weems	67
Audio Aids.....		72
Stereo Indicator.....	Charles Caringella	73

Build the

# reflectoflex

## REFLECTOFLEX

### SPEAKER ENCLOSURE

By JAMES D. REID

*Fill the entire room with realistic, bright, hi-fi sound using this practical reflected-sound system*

WHEN STEREO HI-FI first became popular, the ardent audiophile who wanted to show off his gleaming new equipment and fancy speakers would first carefully position a chair at "stereo center" and then ask you to sit down. Needless to say, the illusion—provided by recordings of locomotives, brass bands, and bouncing Ping-pong balls—was amazing, and seemed too good to be true. □ Music lovers quickly recognized that this extravagant separation of channels was, indeed, too good to be true, and as the stereo hi-fi art matured, a number of solutions to the problem, all of which eliminated the "stereo seat," came along. □ One method of getting rid of the center "gap" between the two channels is, of course, to use a center speaker. Another less expensive, simpler method, the one recommended here, is to use two speaker systems having good dispersion—systems that radiate the sound in all directions rather than in a narrow beam. The "Reflectoflex" speaker enclosure which you can easily build—one for monophonic use and two for stereo—is such a system. □ By aiming the speaker upward and "spraying" the sound off the inclined lid (or adjacent walls and ceiling if the lid is not used), it achieves a high degree of dispersion. The result is hi-fi sound with an airiness, an openness that must be heard to be appreciated. □ Some care should be taken in selecting a speaker for this cabinet. Because more high-frequency energy is absorbed when the sound is reflected rather than directed at the listener, a coaxial speaker with a highly efficient tweeter is recommended. Even so, some treble boost at the amplifier may be desirable. □ An alternative would be to use a woofer or full-range speaker with a separate horn tweeter and the crossover network recommended by the manufacturer. The tweeter could



Light, airy sound fills the room when it's dispersed by reflection from cabinet lid (as above). Two enclosures can be constructed for use with stereo setup.

be mounted between the hoies shown for the "brilliance" control and the port.

**Ports and Port Sizes.** Whether or not you need a port depends on the free-air resonance of the speaker you use. If a low resonant frequency speaker (below 35 cps) is available, the port is not cut, and the Reflectoflex is then a sealed box or "infinite baffle" system. If the resonant point is higher, the speaker is positioned off-center on the speaker mounting board, and a circular port cut to match the resonance of the cabinet to that of the speaker (the bass reflex principle).

If the cone resonance of the speaker is 50 cps, the port should be  $5\frac{1}{2}$  inches in diameter; for a resonance of 45 cps,  $4\frac{1}{2}$  inches; for 40 cps,  $3\frac{1}{2}$  inches. The manufacturer of the speaker should be able to furnish information as to its free-air resonance point.

Building the Reflectoflex involves little more than making a rigid box from sheets of  $\frac{3}{4}$ " plywood or Novoply as

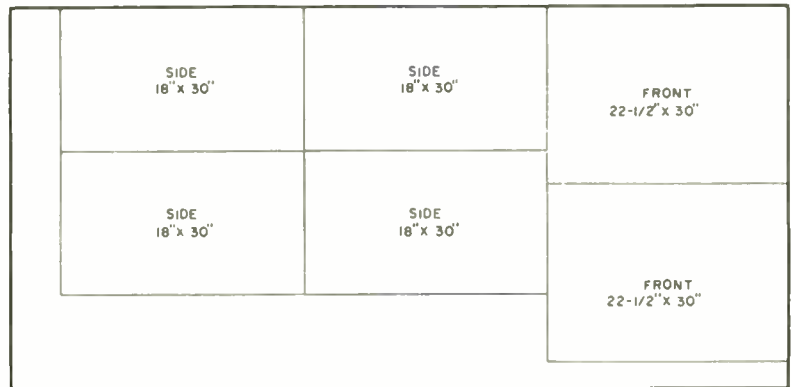

All sections for two enclosures can be cut from two 4' x 8' sheets of plywood as shown at right. Ordinary, interior grade plywood can be used instead of the veneered type. Other materials include hardwood strips for inside bracing and outside trim, a piano hinge, glue, and wood screws.

4' x 8' PLYWOOD HARDWOOD VENEER  
(2 REQ.)

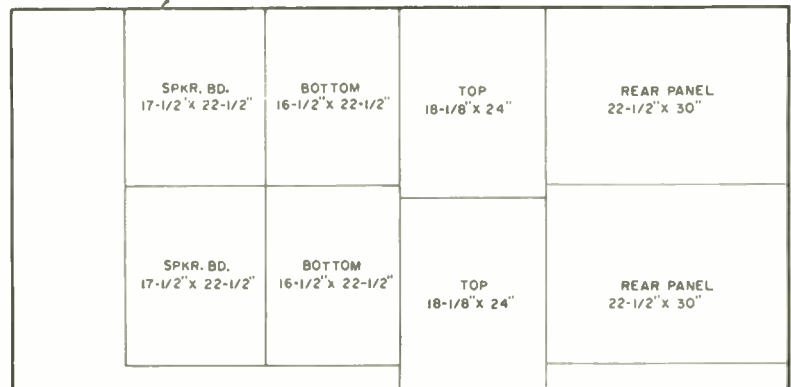

shown in the drawings below. The author used hardwood surfaced plywood for good appearance. Hardwood cleats (strips), 1" x 1", are glued and screwed to the side panels, and the front and rear panels secured to them with glue and 1½" #8 screws countersunk from the outside. The resulting holes are covered with 1" x 1½" strips of hardwood. If a port is used, staple a 2" layer of fiberglass padding to the interior surfaces. If built as an infinite baffle (no port), fill the enclosure with large (12" to a side) pieces of fiberglass, leaving room for the speaker magnet assembly.

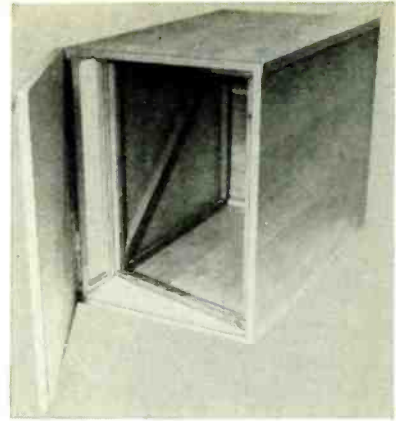

Interior view of Reflectoflex enclosure.

The enclosure lid is attached to the rear panel with a 22" length of brass piano hinge, and is held open with a simple prop made from a ½"-square piece of hardwood rounded at one end. Shallow holes drilled in the underside of the lid provide for alternate positions so that the lid can be adjusted for best sound reflection. The lid should be given a

"hard" finish, several coats of shellac, varnish, etc., or a thin sheet of metal should be attached to the underside of the lid to increase its sound reflecting properties.

The speaker board is beveled at front

Interior panel details for the enclosure are shown below. The control hole is for a "brilliance" control if used. The 1" x 1" cleats are hardwood strips used for bracing, and are glued and screwed from the inside. The front and rear panels are set in between the two side panels, and screwed from the front and back. The screw holes can be filled or covered with hardwood strips.

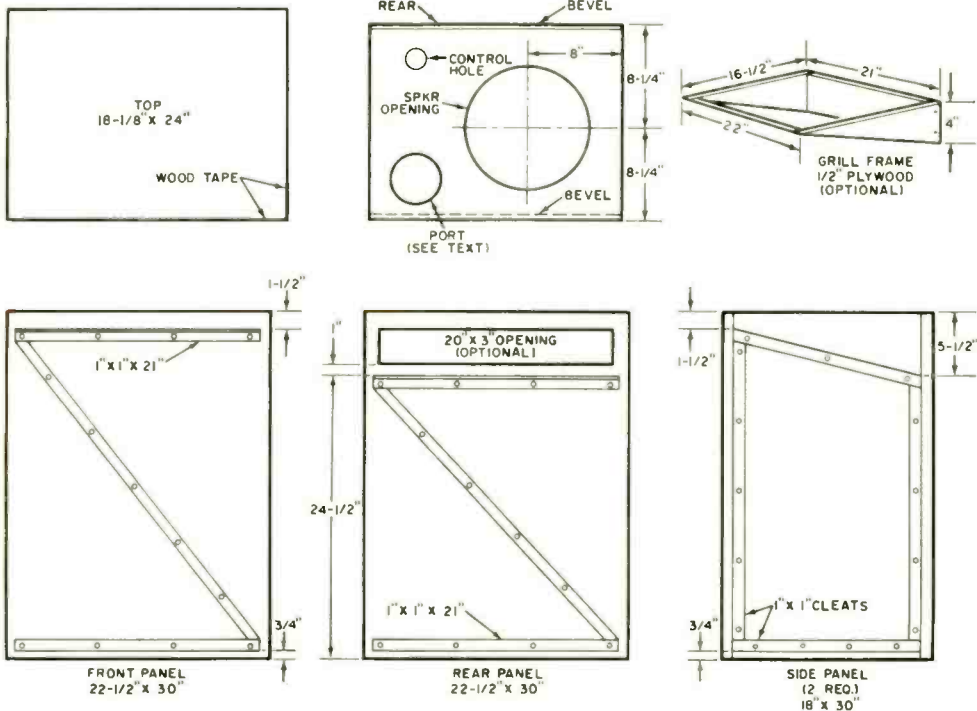

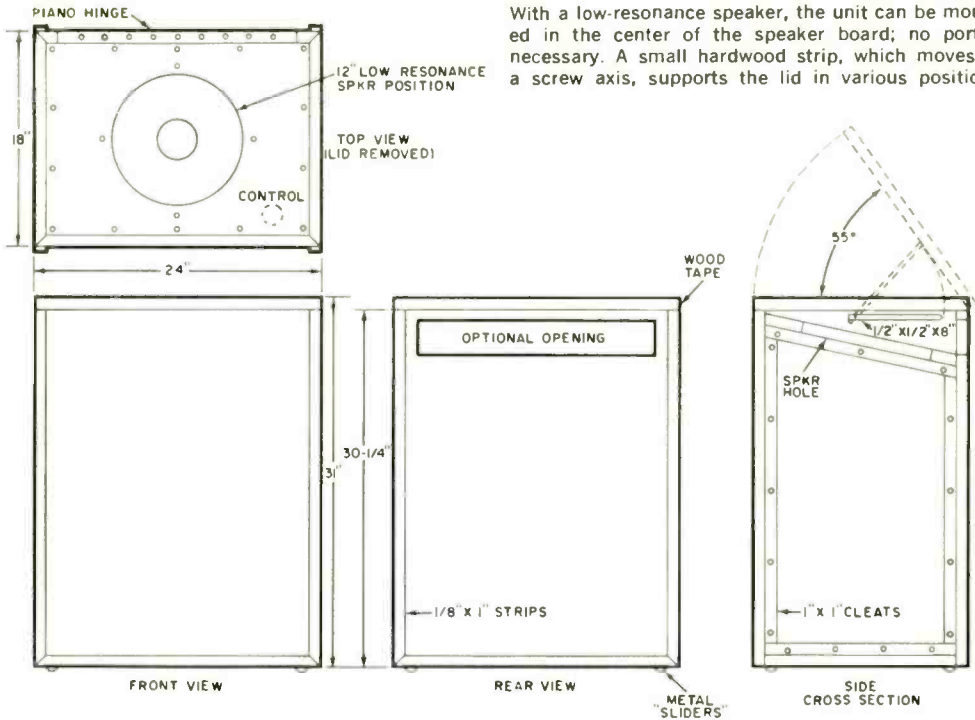

With a low-resonance speaker, the unit can be mounted in the center of the speaker board; no port is necessary. A small hardwood strip, which moves on a screw axis, supports the lid in various positions.

and rear, and the underside lined with a strip of sponge rubber to provide an airtight joint when screwed in place. While a grille is not needed, the speaker can be attractively covered and protected by stapling a grille cloth to a simple frame that fits into the top (see drawing on the preceding page). The com-

pleted frame simply rests on the speaker mounting board and is easily removed.

Enclosure with speaker board in position.



The Reflectoflex, or a pair of them, can be used in upright position, or on the side; the bottom of one unit can be butted against the bottom of another if two units are used with sides down. As previously noted, it is quite possible to use the walls or ceiling as reflecting surfaces instead of the enclosure lid. Simply position the enclosure or enclosures for best results.

The wire from the amplifier enters the cabinet through a hole in the bottom or rear panel if you choose to use the cabinet on its side. Metal "sliders" are fastened to the bottom; alternatively, a simple rectangular base can be built from left-over plywood to lift the enclosure off the floor.

**Finishing.** The author used stain and several coats of varnish over hardwood veneer plywood to produce professional-looking cabinets. Even ordinary plywood can be quite pleasing to the eye, however, if care is taken in finishing it. In any case, your Reflectoflex enclosure can be counted on to provide a definite improvement in the realism of your living room "concert hall."

**Got an inexpensive record player that's gathering dust? Here are five easy ways to cure five common problems**

# PHONO 1 Phillips

## 1

**QUICK CHECK FOR RECORD PLAYERS—**When a teen-ager's record player goes bad, it's the cartridge or amplifier 99 per cent of the time. Before going to the trouble of taking the player apart, simply turn it on, adjust volume to maximum, grasp a screwdriver blade, and touch it to the lugs of the cartridge. A loud a.c. hum at one lug indicates the amplifier is working; if the hum is weak or absent, take the player apart. Good hum indicates a new cartridge, but you can double-check by disconnecting the amplifier leads and connecting a high-impedance magnetic earphone. A good, clear signal when you play a record shows that the cartridge is O.K. Note: Do NOT make these tests while standing on a damp basement floor, or while touching a "ground" such as a radiator.



## 2

**SIMPLE TURNTABLE TIMING—**A stroboscopic disc and a fluorescent lamp, if you happen to have them handy, will tell you if your turntable is fast or slow, but not by how much. The photo shows a simple, exact, timing method. Place a strip of paper between a record and the turntable, allowing a little to stick out so it will brush against your finger tip. In this way, you can feel and count each revolution for one minute while watching the second hand of a watch or clock. An accurate count gives you exact turntable rpm. You might also be interested to find out how much the drag of the record player pickup arm reduces the speed of the turntable. Count the rpm's again with the pickup arm in place on the record, and compare.





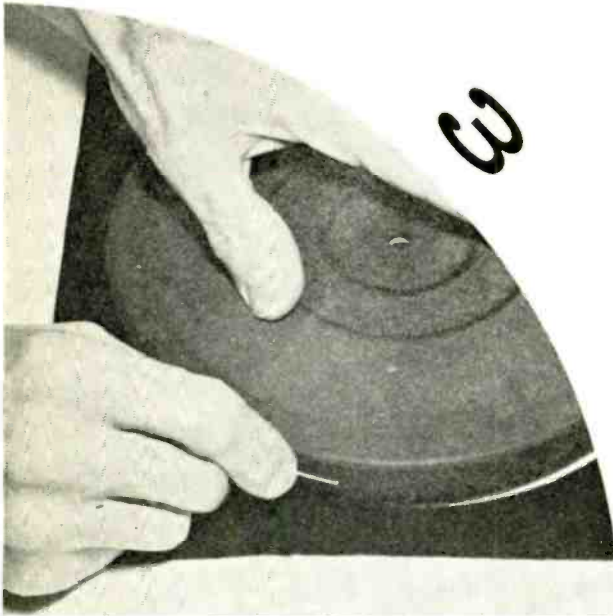

3

3

**NEW FELT FOR PHONOS**—When the flocking on top of low-priced phono turntables wears off, it's a good idea to glue on a disc of felt or other material. Such a covering improves appearance and makes things easier on your records at the same time. Having turntables reflocked is more expensive, and small particles of fiber will sometimes adhere to your records. As shown in the photo, remove the turntable (in most cases it's held in place by a "C" washer that fits in a groove on the shaft), lay it over the felt, and cut around the edge with a razor blade. Before removing the turntable, mark the center of the felt disc by inserting a sharp, pointed instrument through the center hole. Punch out a  $\frac{1}{4}$ "-diameter hole in the felt for the center shaft. Spread glue (LePage's wood glue, Goodyear Pliobond, or a similar adhesive) over the turntable and position the new felt disc.



4

4

**A "SAVE" FOR CENTERING DISCS**—The recess in the center of some turntables is so low that plastic 45-rpm centering discs don't come up high enough to engage the center hole of 45-rpm records. Note in the photo that the top surface of the centering disc is about flush with the top surface of the record. The problem is easily solved by buying another plastic disc (about 25 cents), and cementing it on top of the old one, but the method used here was to grab a  $1\frac{3}{8}$ "-O.D. iron washer from the junk box (a rubber washer can also be used) and cement it to the bottom of the centering disc. The thickness of the washer was enough to raise the disc to the required height.

5

**IMPROVING WORN BEARINGS**—After long use, the turntable shaft and bearing become worn and dry, and the turntable teeters due to increased play. This situation can be improved by disassembling (see drawing) and cleaning the shaft and bearing with gasoline. A coating of Vaseline on the shaft will both reduce play and lubricate it.

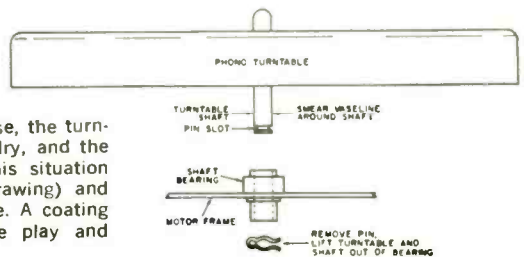

# RESISTIVE LOAD

*If you're tired of using makeshift resistive loads when testing audio amplifier projects, this adjustable unit is for you. The cost is low, and it can be built in two hours*

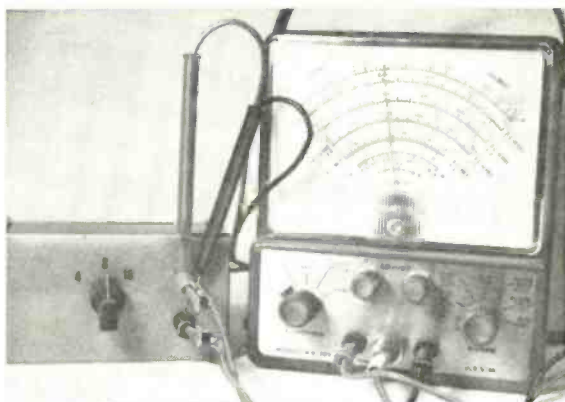

When testing hi-fi amplifiers, a load of the rated resistive impedance that will not shatter the eardrums is a must. Such a test load should also have a negligible reactance over the frequency range of interest, and should be capable of dissipating a reasonable amount of power, at least for short periods. Most of us go along for years haywiring the test load with clip leads, which short out or let go while we're setting the bias or adjusting the feedback, with disastrous results.

The writer finally got fed up with haywire and makeshifts and built this adjustable load unit, which you can duplicate quickly at nominal cost. It is so simple that it can be wired merely by following the schematic diagram and the pictures, without special construction data. Power-handling ability is 15 watts on the 4-ohm, 30 watts on the 8-ohm, and 40 watts on the 16-ohm switch position, if adequate ventilation is provided. Higher-wattage resistors can be used if desired, but will require a larger box and better ventilation.

As a bonus, use of the load permits you to read power output by connecting your VTVM or wide-band multimeter across the load, and choosing the appropriate a.c. scale. Just read the voltage and convert it to watts by means of the graph. The dashed lines show sample measurements of 6.0 volts across the 4-ohm load and 9.0 volts across the 16-ohm load. And if you're worried by the inductance of wire-wound resistors, forget it. Up to well above 100 kc., the inductance of even the 16-ohm resistor is negligible.

# FOR HI-FI TEST

By WALTER TEMCOR

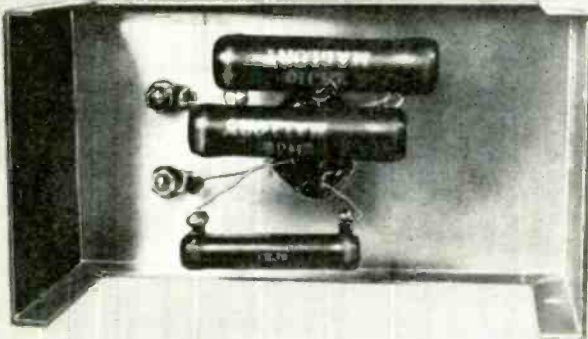

Resistors making up the adjustable load are mounted directly on the switch terminals for wiring ease.

Straightedge and voltmeter are all you need to read watts output from power graph.

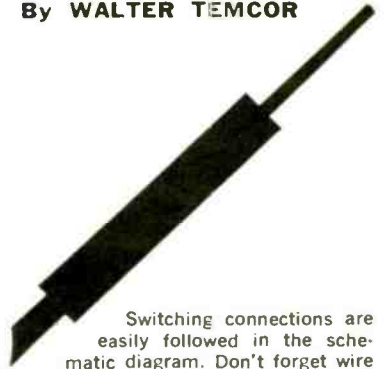
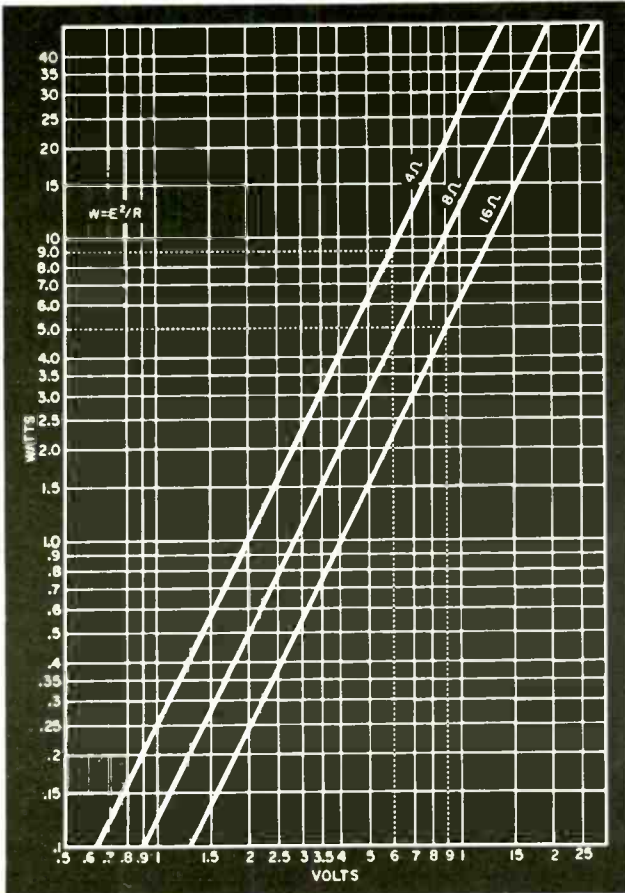

Switching connections are easily followed in the schematic diagram. Don't forget wire lead between S1b and S1c arms.

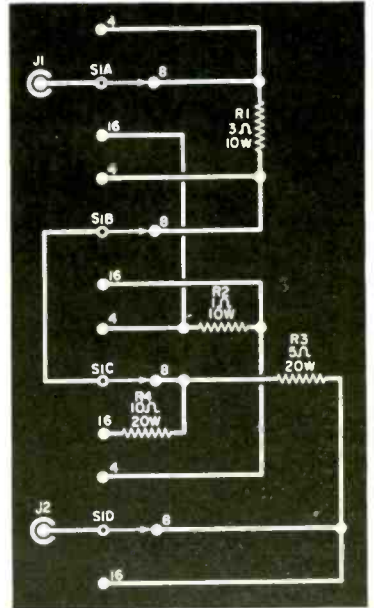

## PARTS LIST

- R1—3-ohm, 10-watt wire-wound resistor (Mallory 111J3 or equivalent)
- R2—1-ohm, 10-watt wire-wound resistor (Mallory 111J1 or equivalent)
- R3—5-ohm, 20-watt wire-wound resistor (Mallory 211J5 or equivalent)
- R4—10-ohm, 20-watt wire-wound resistor (Mallory 211J10 or equivalent)
- S1—3-position, 4-pole rotary switch (Lafayette 99-6156 or equivalent)
- 2—Binding posts
- 1—5¼" x 3" x 2¼" aluminum box (Premier PMC 1006 or equivalent)
- 1—Pointer knob
- Misc.—Hookup wire, solder, etc.

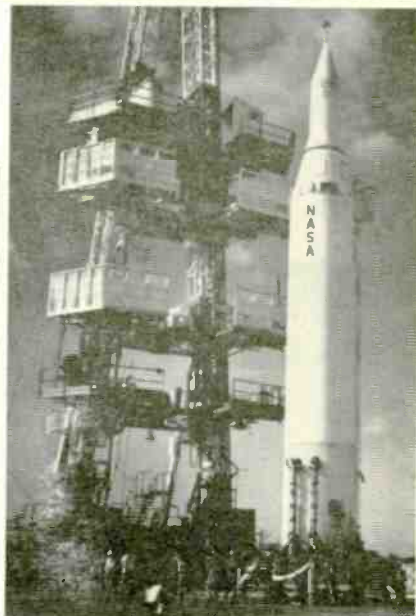
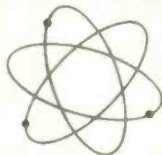
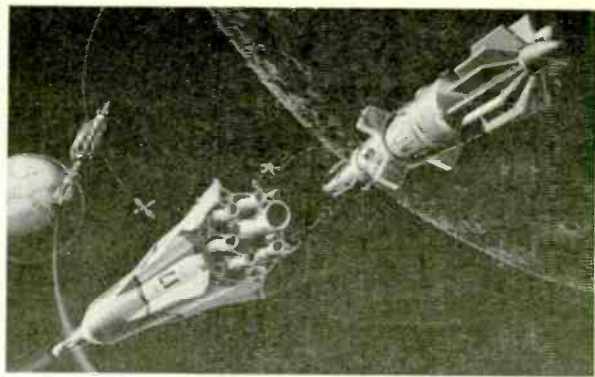

**High pay...exciting, steady work...the great feeling of doing something important. It's all yours with a job in electronics.**

Look around. There's never been anything to match the career opportunities you'll find in electronics. In government, in industry . . . thousands of good, high-paying jobs —just waiting for the right men to fill them. **AND YOU CAN HAVE ONE OF THESE JOBS.** Regardless of what you're doing today . . . a Cleveland Institute Training Program will give you the necessary electronics skills and knowledge. You'll learn all about Transistors, Communications, Aerospace Electronics. What's more, you'll learn quickly and economically . . . at home, in your spare time. Why wait? There will never be a better time to get started. Send the coupon for complete details.

There's no cost . . . no obligation. Do it now.

## Cleveland Institute of Electronics



1776 E. 17th St., Dept. EM-1 Cleveland, Ohio 44114

Accredited Member

**CIRCLE NO. 8 ON READER SERVICE CARD**

### Mail Coupon TODAY For FREE Catalog

#### Cleveland Institute of Electronics

1776 E. 17th St., Dept. EM-1  
Cleveland, Ohio 44114

Please send me your FREE catalog,  
"How to Succeed in Electronics".  
I am over 17 years of age and inter-  
ested in (check one):

#### How to Succeed in Electronics

- |   |  |
|---|--|
| <input type="checkbox"/> Electronics Technology | <input type="checkbox"/> First Class FCC License   |
| <input type="checkbox"/> Industrial Electronics | <input type="checkbox"/> Electronic Communications |
| <input type="checkbox"/> Broadcast Engineering  | <input type="checkbox"/> Advanced Engineering      |

Your present occupation \_\_\_\_\_

Name \_\_\_\_\_ Age \_\_\_\_\_  
(please print)

Address \_\_\_\_\_ County \_\_\_\_\_

City \_\_\_\_\_ State \_\_\_\_\_ Zip \_\_\_\_\_

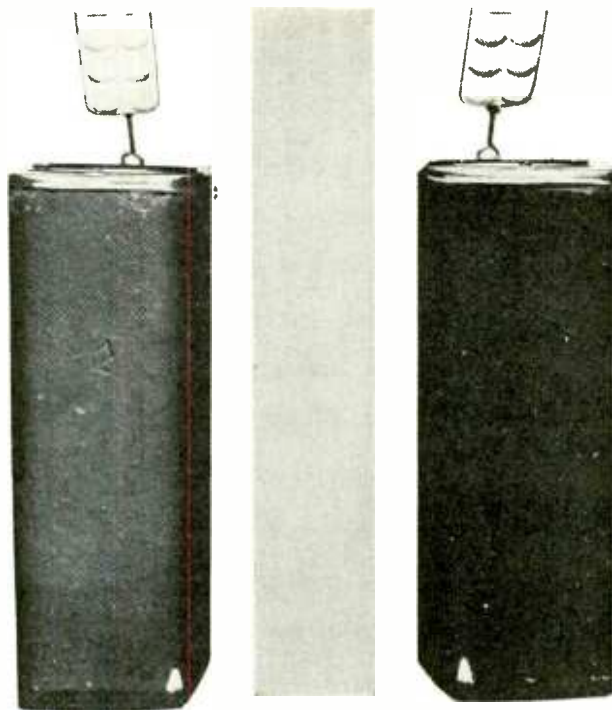

## ANOTHER CERAMIC TILE ENCLOSURE

*A ducted-port bass reflex for 8" speakers, this system is nonvibrant, inexpensive, and exceedingly compact*

By **DAVID B. WEEMS**

**S**OME speaker enclosures are small, some enormous; some are cheap, some cost dearly. But all speaker enclosures fall into one of two categories—good or bad. Actually, it makes little sense to house a good speaker in a poor enclosure, no matter whether the reason is to save money, space, or both. On the other hand, with a quality enclosure that also happens to be low in cost, the savings can be applied on a better speaker, or on other components.

In the stereo age the space problem is usually with us, so we can always hope for something compact. The system described here is compact, yet it sacrifices little in quality. What's more, each basic

enclosure costs only about \$6.00, so two enclosures for a stereo setup would run you only about \$12.00. Soundwise, almost all the advantages of this enclosure stem from its tile construction.

**Tile for Density?** The important argument for the use of tile can be found in any complete "Density of Materials" chart. For example, the chart published in Briggs' *Sound Reproduction*<sup>1</sup> lists plywood, the usual material for speaker enclosures, at a density of 0.67. This is admittedly rather good, at least when compared with other forms of wood

<sup>1</sup>Sound Reproduction, by G. A. Briggs, Third Edition, p. 102

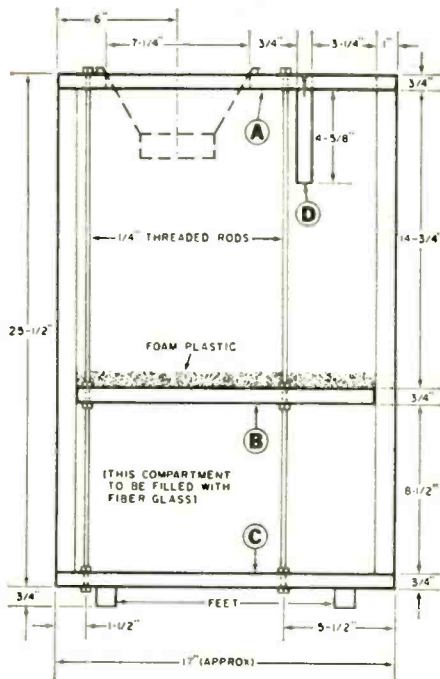
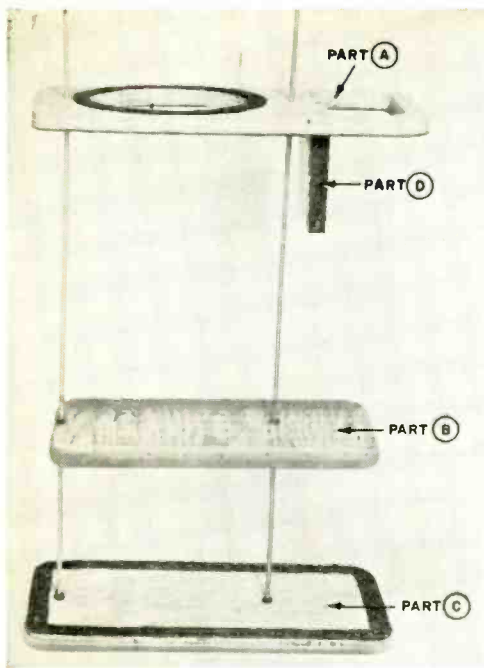

General design of enclosure is evident in photo and drawing above. Parts A and C form top and bottom, respectively, and are held securely in place against tile by two threaded bolts. Gaskets made from  $\frac{1}{8}$ " foam plastic insure airtight fit between plywood parts and the ceramic tile.

(walnut, for example, is only 0.56). But tile boasts a figure of 2.0, or just about three times that of plywood. In addition, the tile used here has a thickness of a full inch, compared to the usual  $\frac{3}{4}$ " for plywood.

To quote Mr. Briggs again, "All will agree on the necessity of overcoming vibration and resonance at low frequencies, and this is achieved by adequate density." When Mr. Briggs says "All," he surely means all hi-fi and stereo fans who are conscious of what true bass sounds like. People still talk about the beautiful "tone" of a wooden cabinet, forgetting that the speaker system isn't a musical instrument, but a reproducer of an endless variety of instruments and tones. Any energy used up in panel vibrations is lost so far as true bass response is concerned. Even worse, it comes back to us in the form of hang-over.

The speaker system shown here uses some plywood, but only at the ends. Furthermore, the plywood end pieces are

held securely by two threaded rods, which adds considerably to their rigidity. The bulk of the enclosure is made of non-vibrating tile, sold by lumber yards as "flue tile."

**Port with Padding.** The basic design of this system is simply a ducted port bass reflex, and any good 8" speaker can be used. The only unusual feature is the resonant chamber at the bottom which cancels out a tendency toward a peak or boom at one point in the bass range. Most compact enclosures show such a peak, and the elimination of this peak is probably more important than precise matching of port and speaker.

Best results are obtained with this chamber completely but loosely filled with fiberglass. Several materials were tested, and fiberglass was found to work best. Cotton batting was almost as good, but rug padding and foam plastic were less effective. Interestingly enough, a change of material was evident in the impedance curve of the speaker as well as in the actual sound of the system.

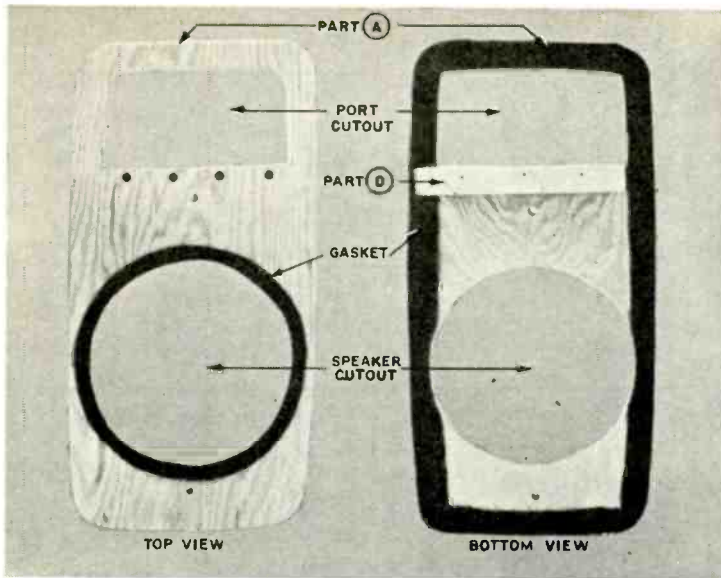

Top and bottom views of Part A appear at left; drawings of Parts D, A, and C have been reproduced below. Parts A and C are identical, with the exception that Part C requires no port or speaker cutouts. Gasket surrounding speaker cutout on top of Part A is for speaker flange which is on top of (rather than underneath) Part A in the finished enclosure.

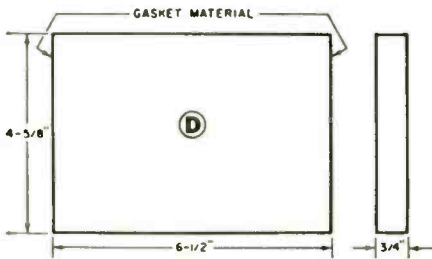

The kind of padding you use in the speaker compartment is another matter. Here personal taste is the best guide. Fiberglass will probably give you the most level response, but the sound will be "livelier" with foam plastic. However, fiberglass could damage some speakers if it is placed too close to them. If you do choose to use it, you'll be wise to cover it with cheesecloth.

**Building the Enclosure.** This is a rather easy system to construct if you take a few precautions. The plywood parts can be marked out by using each tile as a pattern. Of course, you should label each part, not only as to location, but as to which side is "up" and which is "down." This is necessary because some tiles are asymmetrical. Reverse the speaker board, for example, and it may fit like a left shoe on a right foot.

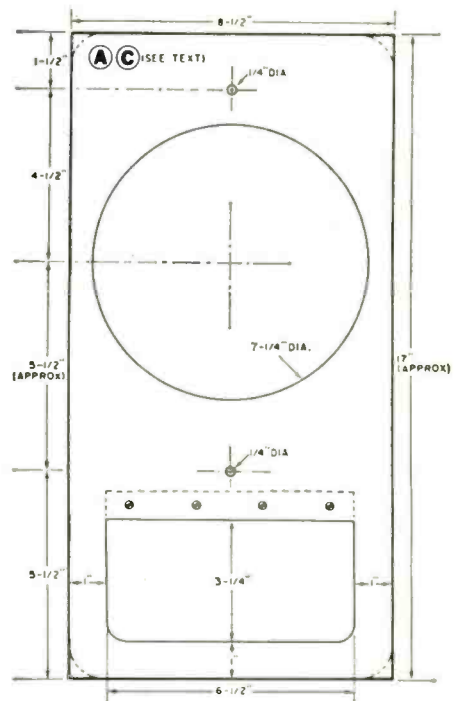

When the parts are sawed to fit and the gasket materials are glued in place, you can begin putting the enclosure together. Note that a  $\frac{1}{8}$ " foam plastic gasket is used to insure a tight fit between the top and bottom boards (Parts

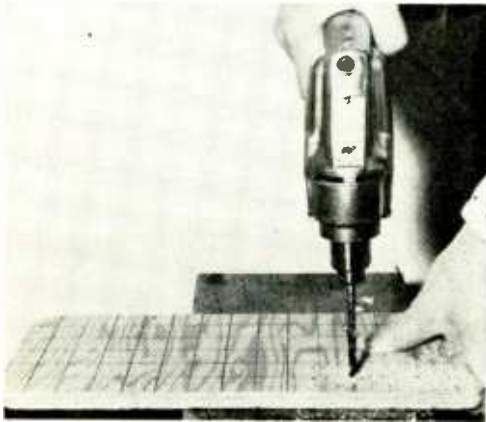
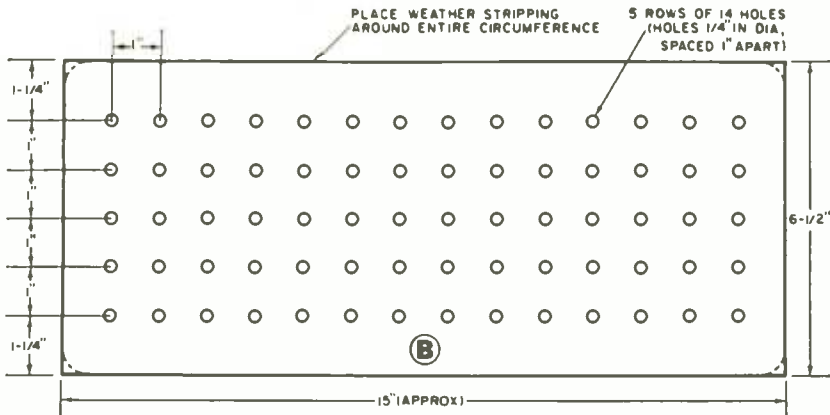

Partition (Part B) must be drilled as shown here before mounting; you'll also have to drill two holes for rods (see photo and drawing on page 68).

A and C) and the tile, between the speaker and Part A, and between the sides of Part D and the tile itself. Weather stripping is best for gasketing the partition (Part B).

Drill the holes for the threaded rod in the top speaker board (Part A) as shown on p. 69. Then, using the speaker board as a pattern, drill holes for the rods in the bottom (Part C) and middle partition (Part B). One way to properly locate the holes in the partition is to place it just inside the tile and lay the top or bottom over it. The duct wall (Part D) can now be glued and screwed to the speaker board.

Next, locate the partition (Part B) 9 1/2" from one end of the two rods by running nuts down tightly on each side and using bolt-and-nut sealant or lock washers. Now add a nut to each rod at the end, turning it on far enough to allow the bottom board (Part C) to go in place. Use a washer under the nut on the bottom side, and tighten both nuts securely on each rod, again using sealant.

The assembly can now be slid into the bottom of the tile, but don't forget to fill the space between the bottom and the partition (Part B) with fiberglass. Then line the top of the partition with foam plastic, and pad the walls around the speaker. Drop the speaker board down over the threaded rods and add a

### BILL OF MATERIALS

- 1—24" length of 8 1/2" x 17" flue or fireplace tile for basic enclosure (this is called "18-inch tile" by some dealers)
- 1—18" x 24" sheet of 3/4" fir plywood (for Parts A, B, and C)
- 1—4 5/8" x 6 1/2" sheet of 3/4" wood (for Part D)
- 2—36" lengths of 1/4" threaded steel rods
- 10—1/4" hex nuts
- 4—1/4" washers
- 1—4" length of weather stripping, foam plastic or foam rubber (for edges of Part B)
- 1—12" x 36" sheet of 1/8" "Art Foam" foam plastic (for gaskets on Parts A, C, and D)
- 1—36" length of 1/2" to 1" foam plastic (dampening material for top of Part B and speaker compartment walls—see text)
- 1—8" P.M. hi-fi speaker
- Misc.—Wood and machine screws, nuts, fiberglass, glue, grille cloth, etc.

#### Optional (see text)

- 1—8 1/2" x 17" sheet of 1/4" fir plywood (for mask)
- 1—Plastic egg tray
- 1—3/16" x 4" eye bolt
- 1—Cable strap
- Window screen wire (for mask)



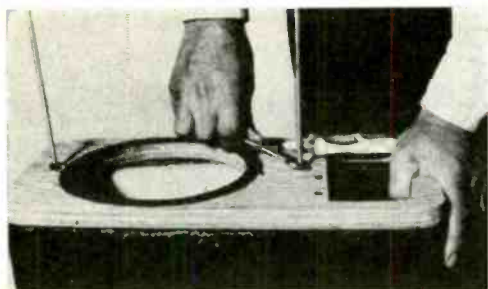

Top (Part A) and bottom (Part C) are the two pieces of "bread" in this flue tile "sandwich." A hacksaw can be used to trim off protruding portion of the threaded rods after the nuts have been tightened securely.

washer and a nut from the top. Tighten the nut as firmly as possible, but don't overdo the job—you may strip the threads if you use a long wrench and apply too much force.

**Placement Possibilities.** There are many ways of using this system, depending upon the space you have available. One builder succeeded in stowing away the flue tile enclosures in room corners and placing small tweeter baffles on table tops. With the tiles more or less out of view, there was no decorating problem.

Perhaps the next best solution, with regard to saving space, is that shown at right. The enclosures lie on edge with the speakers toward the upper front. This is especially useful if you must keep the enclosure as low as possible but don't want to go to the woofer/tweeter arrangement.

The projections of the speaker and the bolts on the speaker board require setting the grille cloth out a short distance from the board. One practical way of solving this problem is with a "mask." The mask is made from  $\frac{1}{4}$ " plywood with cutouts for the speaker and bolts. To stiffen the grille cloth and protect the speakers, wire can be glued to the mask and the edges trimmed to fit with old scissors. Then the grille cloth can be folded over the edge of the mask and

Plastic egg-tray treble diffuser (in photo below) aids in dispersing the "high's" throughout listening room.

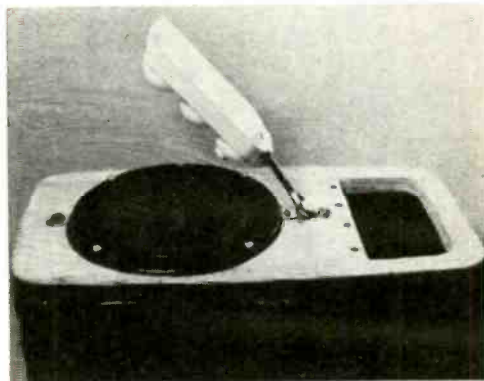

If space is really at a premium, the enclosure can be placed between two pieces of furniture, as it is here.

glued in place. Finally, to hide the edge of the speaker board, a coat of paint can be applied (ideally to match the color of the tile).

Some purists may object to having the high frequencies produced from a point about a foot above the floor. If you happen to like your highs "elevated," the enclosure can be stood on end with the speaker facing up and some kind of  
(Continued on page 158)

# Audio Aids

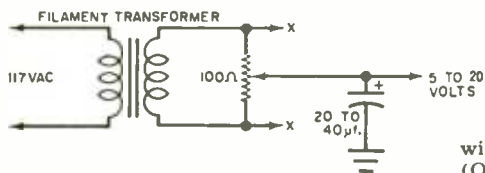

## POSITIVE BIASED HEATERS

If you're experimenting with high-gain pre-amp stages, hum and noise problems can be considerably reduced by means of the "positive heater bias" trick used by audio engineers. Don't connect the transformer heater winding to ground. Instead, wire a 100-ohm, 10-watt (Ohmite Dividohm) adjustable resistor across the heater winding, and run a lead from the tap to a source of 5-to-20 volt positive bias, such as a tap on a voltage divider from the B-plus line to ground. Bypass the tap with a 20-40  $\mu\text{f}$ . electrolytic capacitor, and adjust the tap point for minimum hum. You'll be surprised at the improvement.

—Kenneth Bohn



## SPORTS CAR MIKE STAND

Do you have a friend with a taste for sports cars as well as ham radio or tape recordings? Tell him to make one of the mike stands shown at left. Sears-Roebuck sells a rubber-tired wheel (recently catalogued as #8732 and selling for \$1.49) that makes an ideal base. A regular Atlas AD-8 extension tube is used to support the mike. Since the AD-8 has threads on both ends of the tube, saw off those that will be closest to the wheel. To fit the AD-8 to the hub of the wheel, force-fit a 4" wood dowel into the AD-8 tube, leaving half the length to pass through the hub. Snug the dowel into the hub and cement in place with epoxy resin.

—Art Trauffer

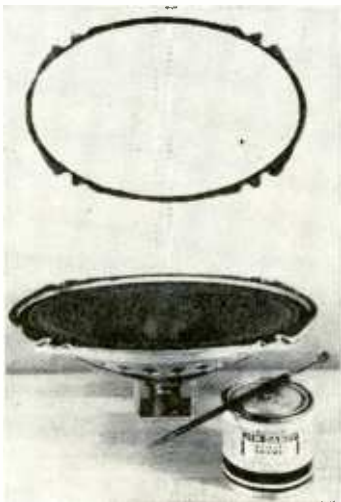

## RECORD DUST REMOVAL

When your hi-fi stereo records get dusty (from lint, hair, cigarette ashes, etc.), there is a simple way to clean them. Go into the kitchen and "borrow" your wife's box of thin-sheet Saran Wrap plastic. Tear off sheet about 6" wide and crinkle it in your fingers while holding it about 1" above the record. Start the turntable and let it revolve slowly. The static electricity generated in the Saran Wrap will attract almost all of the loose dirt and dust.

—Phil Manley

## OVAL SPEAKER CUTOUT

There's no trick to accurately cutting out a circular speaker opening using the intersecting line method—but an oval or elliptical speaker is something else again. The following practice is somewhat obvious, but maybe you've forgotten about it. Turn the speaker up and carefully paint the cardboard gasket—black is a good color. Press the gasket against the baffle and you have an outline of the speaker opening that can be used as a sawing line. (See photo.) The paint won't hurt the cardboard gasket, but be sure to let it dry before mounting—it might otherwise hold the speaker gasket permanently in place!

—Carl Dunant

# Build a STEREO INDICATOR

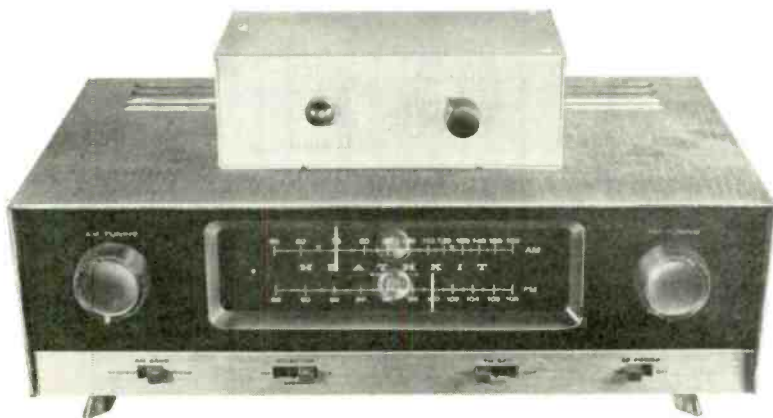

*Stereo multiplex FM programs are becoming more and more common. This indicator lets you know when you have tuned in a stereo transmission*

By CHARLES CARINGELLA

A STEREO INDICATOR of some sort (usually a panel lamp) is now a standard feature of most commercial multiplex adapters and FM-multiplex receivers. Such an indicator helps the user find FM-stereo signals when tuning, and eliminates any doubt as to whether the transmission is stereo or not.

If your equipment does not have one of these stereo indicators, don't despair; the low-cost unit described here can be added to any multiplex adapter or FM receiver. In fact, the transistorized device can easily be tucked away inside most multiplex adapter or FM receiver enclosures. Or, if desired, the unit can be built into a separate enclosure as shown.

**How It Works.** The transmitted stereo signal contains, along with other modulation components, a 19-kc. pilot sub-carrier. The multiplex information, in-

cluding the 19-kc. signal, appears at the output of the FM receiver. This 19-kc. signal is constant in amplitude and, when present, constitutes the signal that turns on the stereo indicator light.

Multiplex signal output from the FM tuner is fed into jack *J1* (see Fig. 1) and then out again through jack *J2* to the multiplex adapter. If your FM tuner has a built-in multiplex circuit, then it is only necessary to bring out one shielded line from the tuner to *J1*, the input of the indicator circuit. This will necessitate an internal connection in the tuner at the detector output, or at the input of the multiplex circuit in the receiver.

The tuned circuit made up of coil *L1* and capacitor *C1* resonates at 19 kc. This allows only the 19-kc. signal to pass, and all the other components present in the complete multiplex signal are greatly attenuated. The 19-kc. signal is

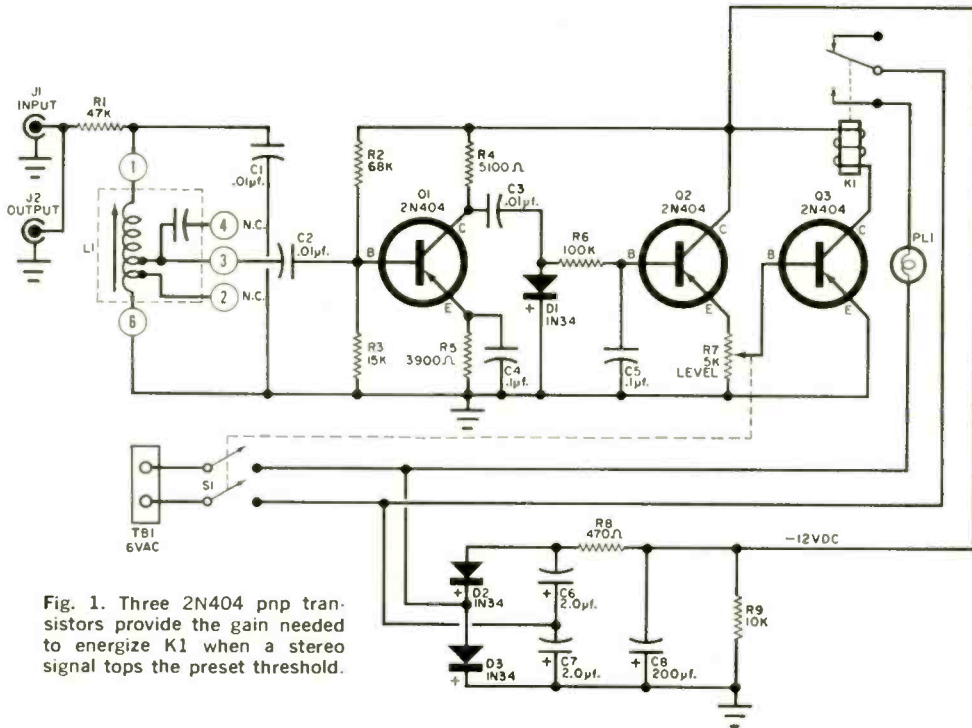

Fig. 1. Three 2N404 pnp transistors provide the gain needed to energize K1 when a stereo signal tops the preset threshold.

then amplified by transistor  $Q_1$ , which is a conventional Class A amplifier.

The amplified 19-kc. signal is then rectified by diode  $D_1$ , and the output is smoothed by resistor  $R_6$  and capacitor  $C_5$ . Transistors  $Q_2$  and  $Q_3$  amplify this d.c. signal, and the final output controls a sensitive relay ( $K_1$ ). The relay controls a pilot lamp ( $PL$ ), which is lighted whenever the 19-kc. signal is present.

The only primary power required for the unit is 6-volt a.c. **CAUTION!** The source of this 6-volt supply must *not* be grounded! The voltage can be taken from the power transformer of the tuner, multiplex adapter, or hi-fi amplifier *only* if the winding supplying the 6-volt a.c. is *known* to be ungrounded. If you can't be perfectly sure that it is, use a separate, small, 6-volt filament transformer for power. This precaution is necessary because of the voltage doubler circuit in the power supply of the indicator unit.

The 6-volt a.c. is applied directly to the voltage doubler circuit, and through normally open contacts of  $K_1$  to the indicator lamp. The output of the voltage doubler circuit is smoothed by resistor



Fig. 2. In the self-contained unit, all connections are made on the rear panel. The name "Multiplex" refers to a function that no longer applies.

$R_8$  and capacitor  $C_8$ , and provides about 12 volts d.c. negative to ground across bleeder  $R_9$ . Since the total current drain is only about 3 ma., inexpensive 1N34 (or equivalent) diodes are satisfactory as rectifiers.

**Construction and Adjustment.** The entire circuit is constructed on a piece of 6" x 3" Vectorbord. The placement of parts is not critical; however, the layout shown in Figs. 3 and 4 will provide a handy guide. The relay is mounted on the Vectorbord also, since the arma-  
(Continued on page 164)

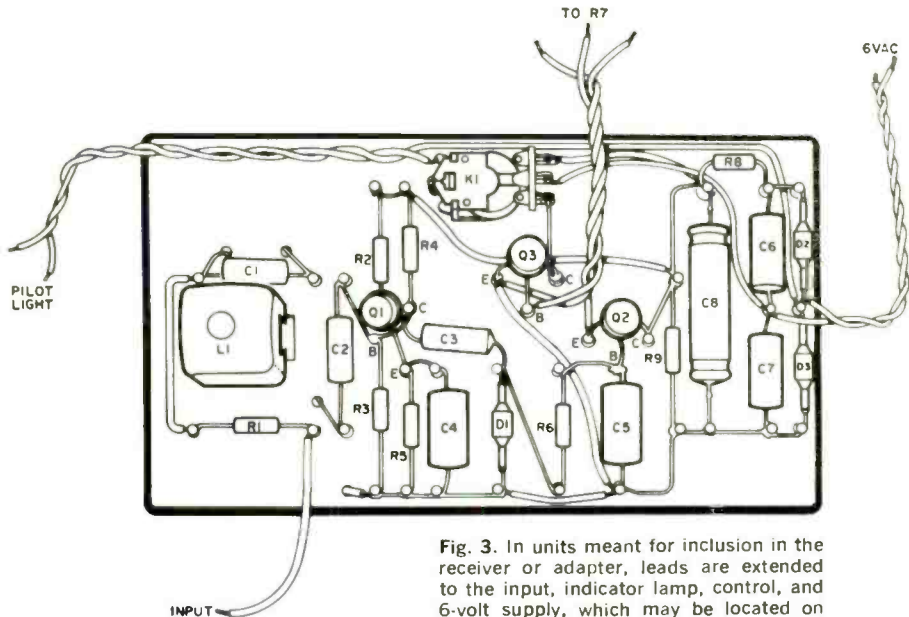

Fig. 3. In units meant for inclusion in the receiver or adapter, leads are extended to the input, indicator lamp, control, and 6-volt supply, which may be located on the main receiving unit, or control panel.

#### PARTS LIST

C1, C2, C3—0.01- $\mu$ f., 200-volt d.c., paper capacitor  
 C4, C5—0.1- $\mu$ f., 200-volt d.c., paper capacitor  
 C6, C7—2- $\mu$ f., 15-volt d.c., electrolytic capacitor  
 C8—200- $\mu$ f., 15-volt d.c., electrolytic capacitor  
 D1, D2, D3—1N34 germanium diode (or equivalent)  
 I1—G.E. #47 6-volt lamp (or equivalent)  
 J1, J2—Phono jack  
 K1—Relay, 5,000-ohm coil (Lafayette 99-6091 or equivalent)  
 LI—19-kc. multiplex coil (Miller 1354)  
 Q1, Q2, Q3—GE 2N404 transistor (or equiv.)  
 R1—47,000 ohms

R2—68,000 ohms  
 R3—15,000 ohms  
 R4—5,100 ohms  
 R5—3,900 ohms  
 R6—100,000 ohms  
 R7—5000-ohm potentiometer, linear taper, with d.p.s.t. switch S1  
 R8—470 ohms  
 R9—10,000 ohms  
 S1—D.p.s.t. switch (part of R7)  
 1—6" x 3" Vectorbord  
 1—6 $\frac{1}{4}$ " x 3 $\frac{3}{8}$ " x 2 $\frac{1}{8}$ " aluminum box chassis  
 Misc.—Pilot lamp socket assembly, knob, 2-lug terminal board

All resistors  
 $\frac{1}{2}$  watt.  $\pm$  10%

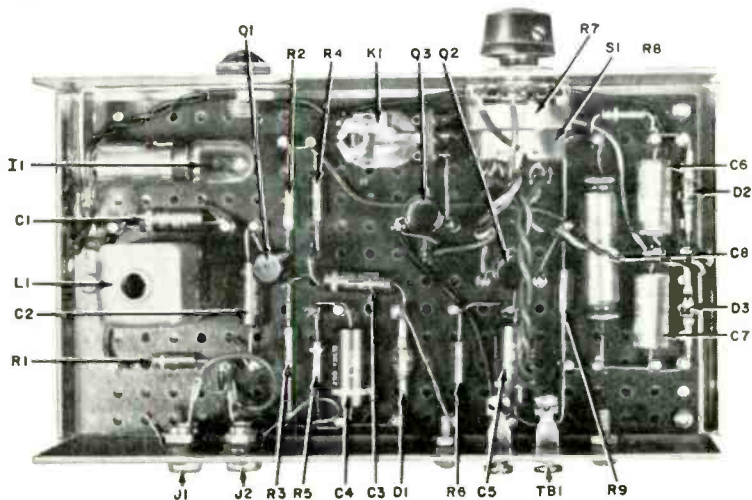

Fig. 4. The layout of parts lends itself to ease of assembly and trouble-shooting. Make sure you do not ground the relay while you're mounting or wiring it.

# BUILD YOUR OWN RADIO

**CIRCUITS AT HOME**  
with the Deluxe

only  
**\$26.95**

## PROGRESSIVE RADIO "EDU-KIT"®

### A Practical Home Radio Course

#### Now Includes

- ★ 12 RECEIVERS
- ★ 3 TRANSMITTERS
- ★ SQ. WAVE GENERATOR
- ★ SIGNAL TRACER
- ★ AMPLIFIER
- ★ SIGNAL INJECTOR
- ★ CODE OSCILLATOR

- ★ No Knowledge of Radio Necessary
- ★ No Additional Parts or Tools Needed
- ★ EXCELLENT BACKGROUND FOR TV
- ★ SCHOOL INQUIRIES INVITED
- ★ Sold in 79 Countries



Reg. U. S. Pat. Off.

Training Electronics Technicians Since 1946

### FREE EXTRAS

#### • SET OF TOOLS

- SOLDERING IRON
- ELECTRONICS TESTER
- PLIERS-CUTTERS
- VALUABLE DISCOUNT CARD
- CERTIFICATE OF MERIT
- TESTER INSTRUCTION MANUAL
- HIGH FIDELITY GUIDE & QUIZ
- TELEVISION BOOK & RADIO TROUBLE-SHOOTING BOOK
- MEMBERSHIP IN RADIO-TV CLUB: CONSULTATION SERVICE & FCC AMATEUR LICENSE TRAINING
- PRINTED CIRCUITRY

### SERVICING LESSONS

You will learn trouble-shooting and servicing in a progressive manner. You will practice repairs on the sets that you construct. You will learn symptoms and causes of trouble in home, portable and car radios. You will learn how to use the professional Signal Tracer, the unique Signal Injector and the dynamic Radio & Electronics Tester. While you are learning in this practical way, you will be able to do many a repair job for your friends and neighbors, and charge fees which will far exceed the price of the "Edu-Kit." Our Consultation Service will help you with any technical problems you may have.

### FROM OUR MAIL BAG

J. Statkalis, of 25 Poplar Pl., Waterbury, Conn., writes: "I have repaired several sets for my friends, and made money. The "Edu-Kit" paid for itself. I was ready to spend \$240 for a Course, but I found your ad and sent for your Kit."

Ben Valerio, P. O. Box 21, Magna, Utah: "The Edu-Kits are wonderful. Here I am sending you the questions and also the answers for them. I have been in Radio for the last seven years, but like to work with Radio Kits, and like to build Radio Testing Equipment. I enjoyed every minute I worked with the different kits; the Signal Tracer works fine. Also you know that I feel proud of becoming a member of your Radio-TV Club."

Robert L. Snuff, 1534 Monroe Ave., Huntington, W. Va.: "Thought I would drop you a few lines to say that I received my Edu-Kit, and was really amazed that such a bargain can be had at such a low price. I have already started repairing radios and Phonographs. My friends were really surprised to see me get into the swing of it so quickly. The Trouble-shooting Tester that comes with the Kit is really swell, and finds the trouble, if there is any to be found."

**YOU DON'T HAVE TO SPEND HUNDREDS OF DOLLARS FOR A RADIO COURSE**

The "Edu-Kit" offers you an outstanding PRACTICAL HOME RADIO COURSE at a rock-bottom price. It is designed to train Radio & Electronics Technicians, making use of the most modern methods of home training. You will learn radio theory, construction practice and servicing. THIS IS A COMPLETE RADIO COURSE IN EVERY DETAIL. You will learn how to build radios, using regular schematics; how to wire and solder in a professional manner; how to service radios. You will work with the standard type of punched metal chassis as well as the latest development of Printed Circuit chassis.

You will learn the basic principles of radio. You will construct, study and work with RF and AF amplifiers and oscillators, detectors, radio or science is required. The "Edu-Kit" will provide you with a basic education in Electronics and Radio, worth many times the low price you pay. The Signal Tracer alone is worth more than the price of the kit.

You will receive training for the Novice, Technician and General Classes of F.C.C. Radio Amateur License. You will build Receiver, Transmitter, Square Wave Generator, Code Oscillator, Signal Tracer and Signal Injector circuits, and learn how to operate them. You will receive an excellent background for television, Hi-Fi and Electronics. "Edu-Kit" is the product of many years of teaching and engineering experience. The "Edu-Kit" will provide you with a basic education in Electronics and Radio, worth many times the low price you pay. The Signal Tracer alone is worth more than the price of the kit.

### THE KIT FOR EVERYONE

You do not need the slightest background in radio or science. Whether you are interested in Radio & Electronics because you want an interesting hobby, a well paying business or a job with a future, you will find the "Edu-Kit" a worth-while investment. Many thousands of individuals of all

ages and backgrounds have successfully used the "Edu-Kit" in more than 79 countries of the world. The "Edu-Kit" has been carefully designed, step by step, so that you cannot make a mistake. The "Edu-Kit" allows you to teach yourself at your own rate. No instructor is necessary.

### PROGRESSIVE TEACHING METHOD

The Progressive Radio "Edu-Kit" is the foremost educational radio kit in the world, and is universally accepted as the standard in the field of electronics training. The "Edu-Kit" uses the modern educational principle of "Learn by Doing." Therefore you construct, learn schematics, study theory, practice trouble shooting—all in a closely integrated program designed to provide an easily-learned, thorough and interesting background in radio. You begin by examining the various radio parts of the "Edu-Kit." You then learn the function, theory and wiring of these parts. Then you build a simple radio. With this first set you will enjoy listening to regular broadcast stations, learn theory, practice testing and trouble shooting. Then you build a more advanced radio, learn more advanced theory and techniques. Gradually, in a progressive manner, and at your own rate, you will find yourself constructing more advanced multi-tube radio circuits, and doing work like a professional Radio Technician.

Included in the "Edu-Kit" course are Receiver, Transmitter, Code Oscillator, Signal Tracer, Square Wave Generator and Signal Injector Circuits. These are not unprofessional "breadboard" experiments, but genuine radio circuits, constructed by means of professional wiring and soldering on metal chassis, plus the new method of radio construction known as "Printed Circuitry." These circuits operate on your regular AC or DC house current.

### THE "EDU-KIT" IS COMPLETE

You will receive all parts and instructions necessary to build twenty different radio and electronics circuits, each guaranteed to operate. Our Kits contain tubes, tube sockets, variable, electro, mica, ceramic and paper dielectric condensers, resistors, tie strips, hardware, tubing, Punched metal chassis, Instruction Manuals, hook-up wire, solder, selenium rectifiers, coils, volume controls and switches, etc. In addition, you receive Printed Circuit materials, including Printed Circuit chassis, special tube sockets, hardware and instructions. You also receive a useful set of tools, a professional electric soldering iron, and a self-powered Dynamic Radio and Electronics Tester. The "Edu-Kit" also includes Code Instructions and the Progressive Code Oscillator, in addition to F.C.C. Radio Amateur License training. You will also receive lessons for servicing with the Progressive Signal Tracer and the Progressive Signal Injector, a High Fidelity Guide and a Quiz Book. You receive Membership in Radio-TV Club, Free Consultation Service, Certificate of Merit and Discount Privileges. You receive all parts, tools, instructions, etc. Everything is yours to keep.

### PRINTED CIRCUITRY

At no increase in price, the "Edu-Kit" now includes Printed Circuitry. You build a Printed Circuit Signal Injector, a unique servicing instrument that can detect many Radio and TV troubles. This revolutionary new technique of radio construction is now becoming popular in commercial radio and TV sets.

A Printed Circuit is a special insulated chassis on which has been deposited a conducting material which takes the place of wiring. The various parts are merely plugged in and soldered to terminals.

Printed Circuitry is the basis of modern Automation Electronics. A knowledge of this subject is a necessity today for anyone interested in Electronics.

### UNCONDITIONAL MONEY-BACK GUARANTEE

#### ORDER FROM AD—RECEIVE FREE BONUS RADIO & TV PARTS JACKPOT WORTH \$15

- Send "Edu-Kit" postpaid. I enclose full payment of \$26.95.
- Send "Edu-Kit" C.O.D. I will pay \$26.95 plus postage.
- Rush me FREE descriptive literature concerning "Edu-Kit."

Name.....

Address.....

### PROGRESSIVE "EDU-KITS" INC.

(ATT: S. GOODMAN, M.S. IN ED., PRES.)  
1186 Broadway, Dept. 509RR, Hewlett, N. Y.

CIRCLE NO. 31 ON READER SERVICE CARD

# Chapter

# 3

## COMMUNICATIONS for the HOBBYIST

ONE of our ELECTRONIC EXPERIMENTER'S HANDBOOK contributors has a knack of developing very workable but simple receivers. He is Charlie Green, and in this issue your Editors direct your attention to his 80-meter and 2-meter ham band superhets. Another receiver sure to attract its share of attention is the "VHF Listener"—a superregenerative unit incorporating a squelch circuit. Hams and SWL's will find the outboard accessories (the "SSB Product Detector," "Code Bander," weather station converter, etc.) excellent construction projects for one of those quiet weekends. If you don't have a 100-kc. calibrator, we urge you to seriously consider the special printed circuit board and circuit developed by author Scheidel; this transistorized unit produces harmonics that are perfectly readable well into the VHF part of the spectrum.

---

VHF Listener.....	Walt Henry	78
SSB Product Detector.....	R. M. Mendelson, W2OKO	84
Crystal Super Calibrator.....	R. A. Scheidel	87
2-Tube Superhet for 80 Meters.....	Charles Green, W3IKH	91
The WXCVR.....	Hartland B. Smith, W8VVD	95
R.F. Coil Frequency-Finder.....	Leon A. Wortman	98
The Code Bander.....	Hartland B. Smith, W8VVD	101
Selected Projects from W9EGQ.....	Herb S. Brier, W9EGQ	105
The Idento-Minder.....	Hartland B. Smith, W8VVD	113
2-Meter Simple Superhet.....	Charles Green, W3IKH	116



**T**HERE'S a large and growing group made up of SWL's and other radio enthusiasts who like to eavesdrop on the goings-on in the 30-54 mc. and 108-148 mc. bands, but who find the receiver problem a tough one. A good commercial receiver for a part of this region of the VHF spectrum can cost from one-tenth to one-third of a kilo-buck, a non-trivial sum for most of us.

In addition, home construction of a good superhet, such as the "VHF Adventurer" (POPULAR ELECTRONICS, October, 1963) requires a rather uncommon amount of test gear and experience. The usual alternative, the very simple superregen receiver, has serious shortcomings. It tends to be unstable, seldom gives equally good results all across its tuning range, causes interference in other receivers, and hisses like a nest of angry copperheads when there's no signal input.

If these obstacles have kept you from the VHF listening ranks in the past, the "VHF Listener" is the answer to your prayers. For sensitivity, simplicity, and low cost, the superregen circuit has been retained, but with modifications that cure its major ills.

The actual unit described here covers the 108-130 mc. aircraft communications band, but the basic circuit can be built to cover other bands between 10 and 170 mc. with very little change other than the use of different values of inductance and capacitance in the tuned circuits. Required departures from the values used in the unit are given later in this

article for similar receivers to cover the Citizens Band and 2-meter ham band.

**About The Circuit.** Signals picked up by the extendible whip antenna are applied via  $C2$  to a tap on  $L1$ , shown in Fig. 1. Capacitor  $C1$  resonates  $L1$  at the center of the band covered, and once set, does not need retuning. Coil  $L2$  is a single turn of wire which acts as a low-impedance secondary to  $L1$ , to match  $Q1$ 's input impedance.

Transistor  $Q1$  is the r.f. amplifier, operating in a grounded-base circuit. Power is shunt-fed to the collector via  $L3$ , which has relatively high impedance across the band covered. Resistors  $R1$ ,  $R2$ , and  $R3$  set  $Q1$ 's operating bias.

The  $Q1$  output is applied to the  $Q2$  detector stage via  $C5$ , shown in Fig. 2. Tuning capacitor  $C6$  and coil  $L4$  make up the oscillator tuned circuit which is connected to the  $Q2$  collector. Capacitor  $C7$  is the feedback path for superregeneration. The 60-kc. quench frequency is determined mainly by the values of  $C8$ ,  $C9$ , and resistor  $R7$ .

This detector differs from most superregens by providing, in addition to the audio signal, a d.c. output proportional to the r.f. input. This d.c. component controls the squelch circuit, which silences the set when there is no input.

The audio signal and d.c. squelch control voltage are taken from the detector through a filter made up of  $C10$ ,  $C11$ , and  $R8$ . This prevents the 60-kc. quench frequency from reaching and overloading the audio amplifier input.

The squelch circuit is a d.c. amplifier



# VHF LISTENER

**There's exciting listening in the VHF bands. Here's a potent transistor receiver that will let you in on it for under \$30**

By **WALT HENRY**

that controls diode *D1*, which acts as a gate. The audio signal reaches *D1* via *C13*, but cannot pass through when the diode is reverse-biased. When a signal is received, the d.c. level at the junction of *L4* and *R4* rises. This rise is amplified through *Q3* and *Q4*, overcoming the reverse bias on the *D1* diode gate. This permits the audio signal to pass to the audio amplifier input. If the incoming r.f. signal is cut off, *D1* is again reverse-biased by the voltage at the junction of *R17* and *R18*, and the detector hiss cannot pass through.

The audio amplifier shown in Fig. 5

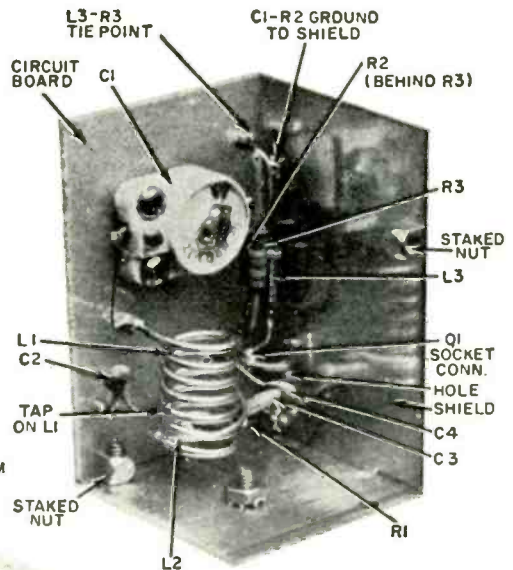
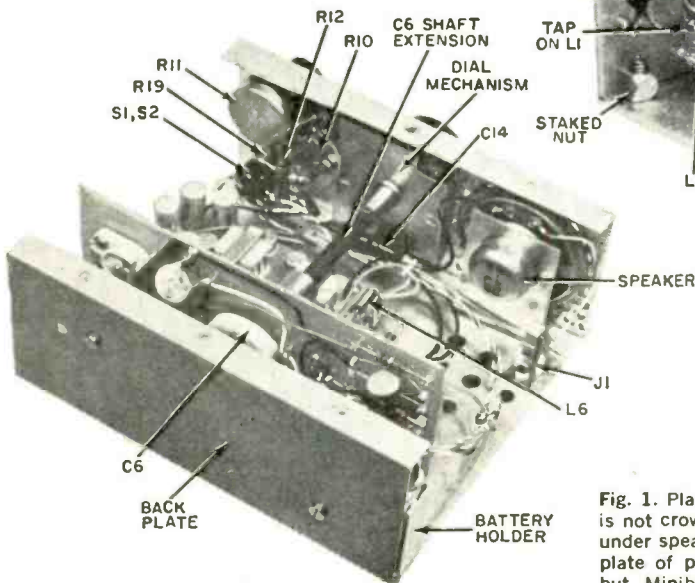

Fig. 2. Follow layout of *Q1* r.f. stage closely. Ground ends of *L1* and *L2* are soldered to circuit board tie point (hidden behind coils) and *C3-R1* junction.

Fig. 1. Placement of major parts is not crowded. Holes in chassis under speaker are optional. Back plate of prototype is removable but Minibox assembly is O.K.

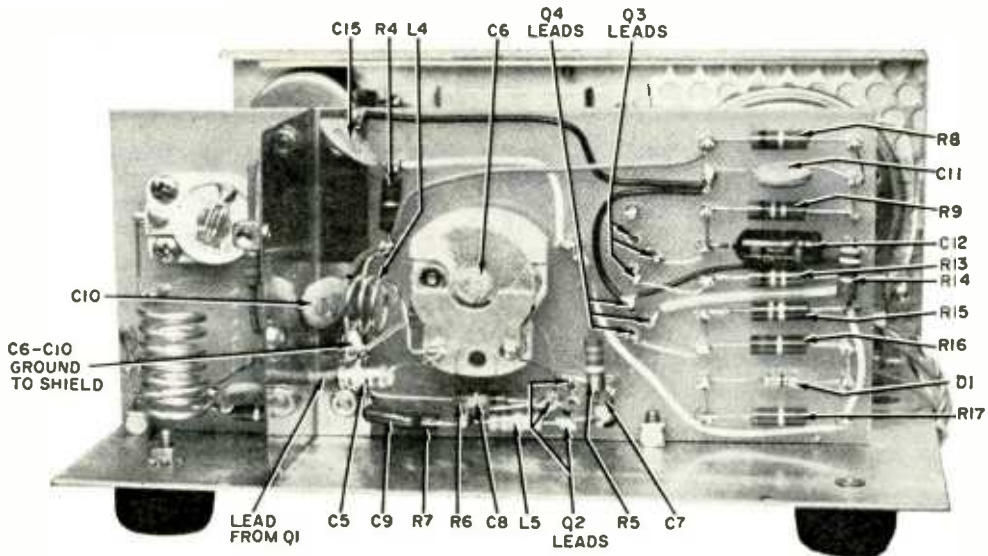

Fig. 3. Signal from Q1 stage left of shield is coupled to detector by wire through hole in shield. R.f. and squelch circuit transistors mount in sockets on front face of circuit board.

was made by the author, but the manufactured units given in the Parts List are equally good, and require less work.

Separate batteries are used to power the r.f. and audio sections. Use of a single battery tends to cause some motor-boating due to interaction between the squelch circuit and the audio amplifier when the battery internal impedance increases with age and use.

**Construction.** The mechanical construction of the author's unit includes staked nuts for holding the circuit board and shield in the case. These are not readily available to most home constructors, but the small angle brackets sold in the "five-and-ten-cent" stores will serve just as well. Alternatively, short lengths of aluminum or brass angle bracket can be used with either self-tapping or machine screws.

The r.f. and squelch circuits are assembled on a  $2\frac{1}{2}$ " x  $5\frac{1}{2}$ " piece of insulated circuit board. The author used a non-perforated board and drilled  $1/16$ " holes for small push-in terminals for solder connections. However, a piece of pre-punched Vectorbord and the "flea-clip" terminals made for it are ideal, and are called for in the Parts List.

The only part of the circuit that must be laid out with care is the r.f. amplifier shown in Fig. 2. Such a grounded-base amplifier stage works very well at VHF,

but is inherently slightly regenerative and may tend to oscillate if leads are not kept short and direct. The 2N1517 transistor has an internal shield which should be grounded. This may be done by connecting the shield lead directly to ground, or by connecting it to the base lead, which is, in turn, effectively grounded by C4. The metal shield between r.f. and detector stages provides a convenient ground for both.

The detector stage may be laid out almost any convenient way as long as the leads are kept reasonably short, as shown in Fig. 3. During construction, omit R5 temporarily, as its optimum value will be determined by experiment. It probably will be approximately 22,000 ohms. The shield lead of Q2 can be wired to ground, but this step is not vital.

In case you have some high-frequency transistors in the spare parts box, any of the following types will work quite well in either the r.f. or the detector stage. Tested examples include Philco's 2N502, 2N1742, 2N1743, and 2N1744, the Amperex 2N2084, and Texas Instruments' 2N797. Silicon npn types 2N743 and 2N744 will also give excellent performance. If npn transistors are used in your version of the "Listener," however, the polarities of B1, C12, C14, and D1 must be reversed, R6 must be 3300 ohms, and Q3 and Q4 must be interchanged.

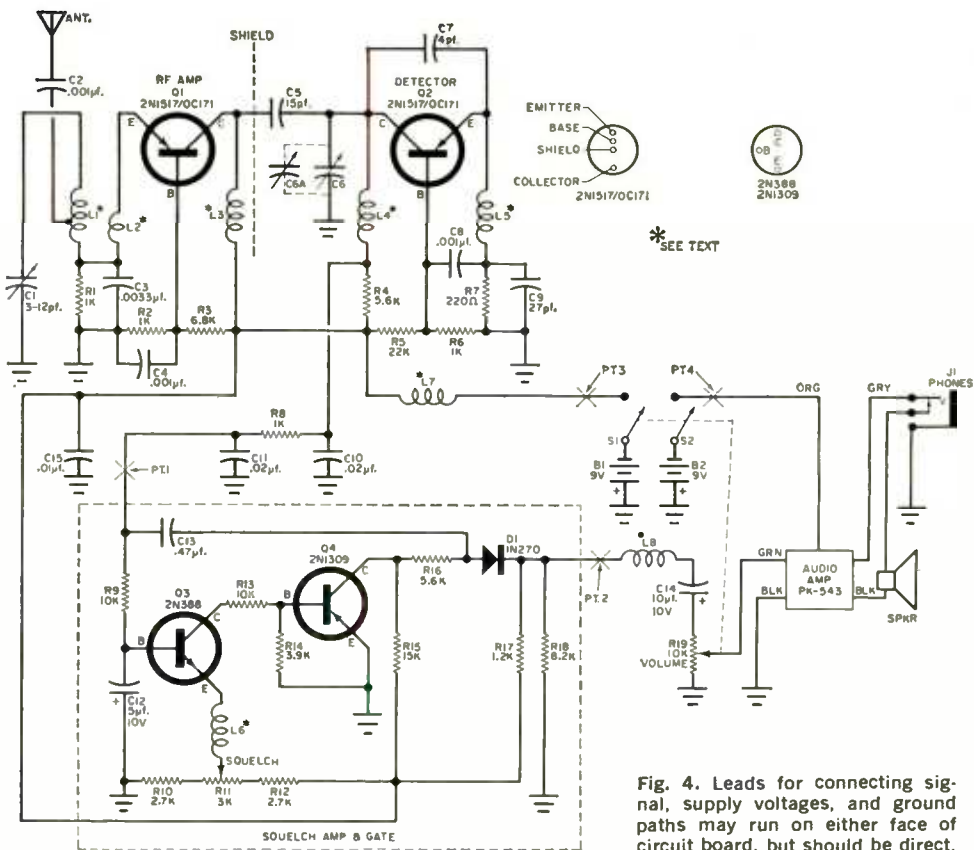

Fig. 4. Leads for connecting signal, supply voltages, and ground paths may run on either face of circuit board, but should be direct.

## PARTS LIST

B1—9-volt manganese transistor battery (Burgess 2MN6 or equivalent)  
 B2—9-volt transistor battery (Eveready 216 or equivalent)  
 C1—3-12 pf. ceramic trimmer capacitor  
 C2, C4, C8—0.001- $\mu$ f., 100-volt disc cer. cap.  
 C3—0.0033- $\mu$ f., 100-volt disc cer. capacitor  
 C5—15-pf. tubular ceramic capacitor  
 C6—2.8-17 pf. variable capacitor (Hammarlund APC-15B or equivalent, modified as per text)  
 C7—4-pf. tubular ceramic capacitor  
 C9—27-pf. silver mica capacitor  
 C10, C11—0.02- $\mu$ f., 100-volt disc cer. capacitor  
 C12—5- $\mu$ f., 10-volt electrolytic capacitor  
 C13—0.47- $\mu$ f., 100-volt tubular paper capacitor  
 C14—10- $\mu$ f., 10-volt electrolytic capacitor  
 C15—0.01- $\mu$ f., 100-volt disc cer. capacitor  
 D1—1N270 germanium diode  
 J1—Subminiature phone jack, shorting type  
 L1, L2, L4—See text  
 L3, L5, L6, L7, L8—4.7  $\mu$ h.—see text  
 Q1, Q2—2N1517/OC171 Amperex transistor (available from Newark Electronics Corp., 223 W. Madison St., Chicago, Ill., stock nr. 21FX2612—see text)  
 Q3—2N388 germanium transistor  
 Q4—2N1309 germanium transistor  
 R1, R2, R6, R8—1000 ohms  
 R3—6800 ohms  
 R4, R16—5600 ohms

R5—See text  
 R7—220 ohms  
 R9, R13—10,000 ohms  
 R10, R12—2700 ohms  
 R11—3000-ohm potentiometer (IRC Q11-112 or equivalent)  
 R14—3900 ohms  
 R15—15,000 ohms  
 R17—1200 ohms  
 R18—8200 ohms  
 R19—10,000-ohm potentiometer, with switch (Mallory U-20, with US-27, or equivalent)  
 S1, S2—D.p.s.t. switch, on R19 (Mallory US-27 or equivalent)  
 1—7" x 5" x 3" Minibox (Bud 80P350 or equivalent)  
 1—Transistor audio amplifier (Lafayette 99-9039 or equivalent)  
 1—Vernier dial mechanism (Lafayette 99-2516 or equivalent)  
 1—Shaft coupler (Lafayette 32-6412 or equiv.)  
 1—Extension shaft (Lafayette 32-6409 or equiv.)  
 1—Telescoping whip antenna (Lafayette 99-3005 or equivalent)  
 1—2-inch speaker (Lafayette 99-6036 or equiv.)  
 1—2½" x 5½" preperforated Vectorbord  
 Misc.—3-lug terminal strip, hookup and coil winding wire, transistor sockets, knobs, screws, etc.  
 Note: For CB, R7 is 680 ohms, C5 is 51 pf., C7 is 10 pf., C9 is 62 pf., Q2 is a 2N370

# VHF LISTENER

The specified tuning capacitor (*C6*) should be modified for use in the 108-132 mc. aircraft or 2-meter amateur bands. Remove all but one of the rotor plates, and all but two of the stator plates, the rotor plate meshing between the two remaining stator plates.

Coil *L1* is made by winding  $6\frac{1}{2}$  turns of #14 tinned copper wire on a  $\frac{1}{2}$ " rod, spaced  $\frac{3}{4}$ " long. After removing the forming rod, solder the tap at a point  $2\frac{1}{2}$  turns from the ground end of *L1*.

Coil *L2* is  $\frac{3}{4}$  of a full turn of #18 around the ground end of *L1*. It should be grounded at the same point as *L1*, but should not contact *L1* elsewhere. Coil *L4* is 3 turns of #18 wound on a  $\frac{3}{8}$ " rod, in a  $\frac{1}{4}$ " length.

For the Citizens Band, *L1* requires 23 turns of #28 enameled copper wire on a J. W. Miller 20A000RBI form, tapped 8 turns from the ground end. Coil *L2* is  $2\frac{1}{2}$  turns of the same wire close-wound over the ground end of *L1*. Coil *L4* is 17 turns of the same wire on the same type of coil form. Change *Q2* to a 2N370.

Chokes *L3* and *L5* are 23- $\mu$ h. units, Miller 9310-44 or equivalent, and *L6*, *L7*, and *L8* are omitted. Also, *C6a* must be added in parallel with *C6*, which is not modified for the Citizens Band.

If you decide to build the unit for the 2-meter band, simply use one less turn in making both *L1* and *L4*, and tap *L1* two turns from the ground end. Also reduce the value of *C7* from 4 pf. to 3 pf.

R.f. chokes *L3*, *L5*, *L6*, *L7*, and *L8* may be commercial 4.7- $\mu$ h. units, but cheaper ones that work just as well can be made by winding 36-gauge copper wire on one-megohm resistors. Wind the turns closely and cover the full length of a half-watt resistor. Strip the enamel off the ends of the wire with fine sandpaper, wind around the resistor leads, and solder. Note that different choke values are required for the Citizens Band.

Layout is not important in the squelch circuitry, but the construction shown in Fig. 3 is compact and neat. If you are leaving out the squelch feature, omit all circuitry in the dotted rectangle on the schematic, and connect point 1 directly

to point 2. Also connect point 3 directly to point 4 and eliminate battery *B1* and switch *S1*.

The color coding on the schematic is for some Lafayette 99-9039 preassembled audio amplifiers. They come with two orange leads which are meant to be connected to a volume control on-off switch. Since a different arrangement is used, cut off the orange lead running to one of the (now disconnected) battery leads and leave the other one intact. Save the battery clip for connecting to the battery leads later on. The other needed battery clip may be salvaged from a worn-out battery of the same type.

The phone jack is connected so that the speaker is turned off when the phones are plugged in.

The case shown in the photographs was handmade in an effort to give the "Listener" a professional appearance. However, the Minibox specified in the Parts List is quite satisfactory, and saves much work.

The dial is a 2" aluminum disc cut from sheet material, but heavy artist's board or stiff sheet plastic is equally good. If you use metal, sand the surface with very fine sandpaper and put the calibration marks on with India ink. A light priming coat of clear Krylon spray will make the ink flow on perfectly. After the ink has dried, spray several coats on the dial to protect the markings.

**Testing and Calibration.** Temporarily connect a 0.1- $\mu$ f. capacitor between point 1 and 2 on the schematic. This will bypass the squelch circuit while the detector is being tested. Connect a 10,000-ohm resistor in series with a 100,000-ohm potentiometer and temporarily substitute this combination for bias resistor *R5*. Attach the fixed resistor end of the combination to the base of *Q2*. Turn *C6* to minimum capacitance and connect the antenna. With the audio volume turned up full, vary the 100,000-ohm test bias potentiometer. At some point a loud hiss will indicate correct detector operation.

With the temporary bias potentiometer still in place, calibrate the dial. If a grid dip meter is used, keep the signal

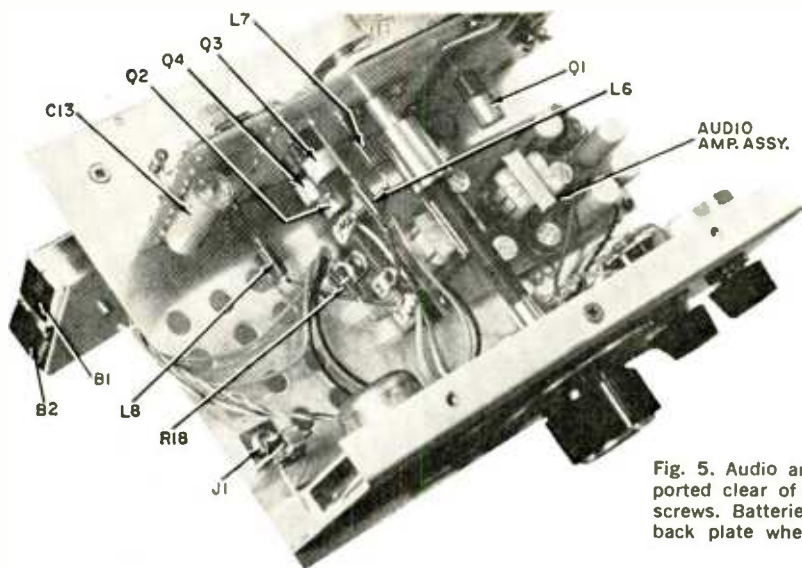

Fig. 5. Audio amplifier board is supported clear of chassis on four long screws. Batteries in holder attach to back plate when unit is assembled.

weak by keeping dipper and Listener well separated. With a generator, a short antenna plugged into the output may be needed. When the signal source is tuned to the detector frequency, the audio hiss will drop noticeably in volume. The frequency range tuned by the detector may be adjusted by squeezing or stretching  $L_4$  slightly to change its inductance. You may also need to readjust the bias on  $Q_2$  with the temporary bias potentiometer. For the Citizens Band version, set the frequency range covered by adjusting  $L_4$  and  $C_{6a}$  in alternate steps.

Tune near the center of the band, and adjust antenna capacitor  $C_1$  for loudest volume (or lowest hiss level if your signal source is not modulated). It will not be necessary to change this setting when tuning other parts of the band.

Now measure the total resistance of the temporary resistor-potentiometer bias combination, and install a fixed resistor ( $R_5$ ) of the nearest standard value. The optimum value for  $R_5$  depends slightly on the voltage of battery  $B_1$ , and the detector may fail to operate near the high end of the band when the voltage of an aging battery begins to drop.

If this happens with a relatively fresh battery, lower the value of  $R_5$  slightly. The current drain on both batteries is only about 5 ma., so they will give many hours of service. A manganese-alkaline battery such as the Burgess 2MN6 is ideal for  $B_1$  since it holds an almost con-

stant voltage until the end of its long life.

When the detector is working satisfactorily, remove the temporary capacitor between points 1 and 2. With squelch control  $R_{11}$  fully counterclockwise, the detector hiss should be heard. When fully clockwise, the audio output should be silent. Check squelch operation over the entire tuning range. If it does not operate properly over the full range, a slight adjustment in the value of  $R_{12}$  may be necessary.

For most sensitive receiver operation, the squelch control should be set as close as possible to the turn-on point. If the receiver is left on for extended periods of time, check the squelch setting periodically.

Thanks to the relatively broad tuned circuits of the Listener, tuning to a given channel is not critical. Also, the broad tuning and very low warm-up drift make the set stay "put" on a selected channel without constant retuning.

If you have built the unit for the aircraft band, here's a word of caution. Even though the r.f. stage cuts detector radiation to a relatively low value, very sensitive aircraft receivers may still pick it up and experience troublesome interference when they are very close. For this reason you should never operate the VHF Listener while in a commercial airliner, or closer than several hundred feet to a control tower or airport. —□—

# SSB PRODUCT DETECTOR

By R. M. MENDELSON, W2OKO

## Compact nuvistor detector unravels SSB signals

**N**UVISTORS have been described in r.f. converter and preamplifier circuits but little has been published about other uses for this component in amateur radio, especially where small size is paramount.

An excellent application for the RCA 6CW4 nuvistor is in a miniature product detector that can be added to any communications receiver—commercial, home-built, or surplus. The size of conventional tubes has often made it difficult to construct an adapter small enough to fit into a compact chassis.

**Advantages of Product Detector.** When a conventional diode detector is used for single-sideband reception, the beat-frequency oscillator must also be used to supply the carrier. Under these conditions, distortion usually results. It is necessary to reduce the r.f. signal in-

put to the detector and raise the audio gain all the way to help reduce this distortion. The beat-frequency-oscillator injection voltage must also be changed from that used for continuous-wave reception. In lower-priced receivers, running the audio at full gain often introduces hum. The receiver a.v.c. cannot be used, but rather the r.f. gain must be continuously adjusted manually according to the strength of each signal received. In a multistation round table, this adjustment is quite a chore. Many of the weaker signals may be lost altogether.

The best solution to the problem of good single-sideband reception is the use of the product detector, so named because the output voltage equals the algebraic product of the input signal and the local oscillator voltages. It al-

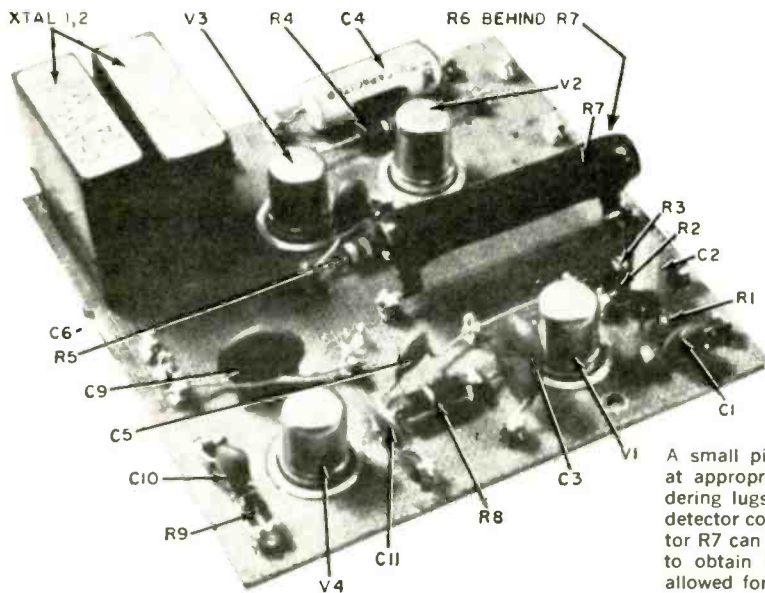

A small piece of fiberboard drilled at appropriate spots for Alden soldering lugs was used to mount the detector components. Ten-watt resistor R7 can be a fixed or a slider type to obtain the 110 volts maximum allowed for proper 6CW4 operation.

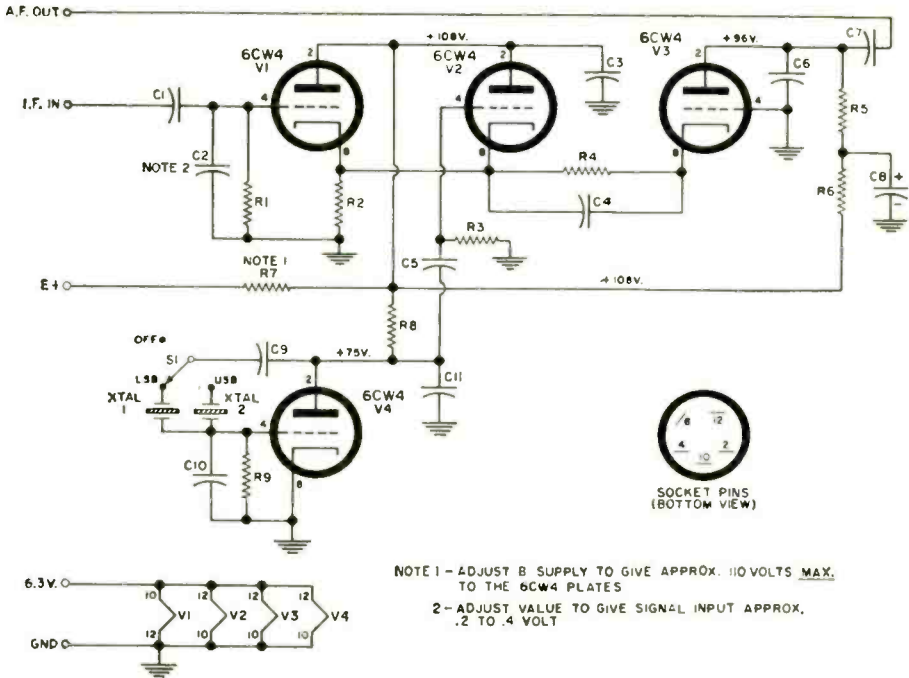

A product detector is an absolute necessity for good SSB reception. This uncomplicated circuit features a crystal-controlled BFO.

**PARTS LIST**

- C1, C10—10-pf. disc ceramic capacitor
- C2—82-pf. disc ceramic capacitor
- C3, C9—0.01- $\mu$ f. disc ceramic capacitor
- C4, C7—0.02- $\mu$ f. plastic tubular capacitor
- C5—100-pf. disc ceramic capacitor
- C6—1000-pf. disc ceramic capacitor
- C8—20- $\mu$ f., 250-volt electrolytic capacitor
- C11—250-pf. disc ceramic capacitor
- R1—500,000-ohm, 1/2-watt resistor
- R2—820-ohm, 1/2-watt resistor
- R3—82,000-ohm, 1/2-watt resistor
- R4—680-ohm, 1/2-watt resistor
- R5—47,000-ohm, 1/2-watt resistor
- R6—1000-ohm, 1/2-watt resistor
- R7—10,000-ohm, 10-watt wire-wound resistor
- R8—10,000-ohm, 1/2-watt resistor
- R9—120,000-ohm, 1/2-watt resistor
- S1—3-position selector switch
- V1, V2, V3, V4—6CW4 triode (RCA)
- Xtal 1, Xtal 2—See accompanying table

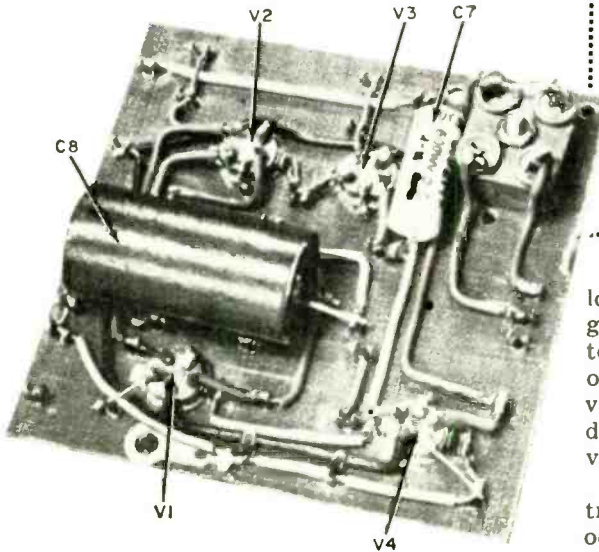

Bottom view of the circuit board shows the various interconnections.

lows operation of the r.f. control at full gain with use of the receiver a.v.c., distortion-free reception, and a low value of beat-frequency-oscillator insertion voltage for good reception. The product detector will also greatly improve conventional code reception.

The circuit itself consists of three triodes (V1, V2, and V3). The first triode is a cathode-follower for coupling the signal from the i.f. stage of the receiver to V3, which serves as a mixer

# SSB PRODUCT DETECTOR

stage. Triode *V2* is a cathode coupler between the local oscillator (*V4*) and mixer tube *V3*. In the mixer, the received signal and the local oscillator heterodyne to produce the audio output. The undesired heterodynes are filtered out of this stage, leaving a clean audio signal not dependent on the strength of the input signal.

In the unit described here, the local oscillator is crystal-controlled to overcome the problems of stability that would be encountered from the beat-frequency-oscillator stage of the many different ham receivers. It also provides the proper injection voltage; thus, even low-priced receivers can be used for single-sideband reception without trouble in keeping tuned to a station.

The nuvistor product detector shown in the photos uses four 6CW4 nuvistors and yet is only  $3\frac{1}{2}$ " square by  $2\frac{1}{4}$ " high. If it were not for the crystals, the total height would be only half as much. The nuvistor model works as well as the older models using conventional tubes, but is less than one-quarter the size. All power is obtained from the receiver; only 0.52 ampere at 6.3 volts and approximately 15 ma. at around 100 volts are required.

**Construction.** In constructing the circuit, a piece of fiberboard is used with mounting lugs for all components. To eliminate wiring errors, Alden No. 651T

resort, conventional solder lugs can be screwed to the board; the particular type of lug is not important, nor is the exact layout.

Mounting of the nuvistor sockets requires a little care because the sockets are too small to be bolted on and must be held to the mounting board by two bent lugs. It is best to drill a  $\frac{3}{16}$ "-diameter hole and then hand-file two notches for the lugs. At least one lug on each socket must be soldered to the ground lead to insure a ground for the nuvistor shell when it is plugged in.

The switch used to select the desired crystal is best mounted on the receiver panel, but should not be too far from the terminals. The choice of crystal frequencies is set by the receiver's i.f. One crystal should be above and one below the center frequency of the i.f. by about 1.5 kc. For the common 455-kc. i.f., surplus crystals for channel 45 and channel 329 are suitable. Other i.f. frequencies and their proper surplus crystals are shown in the accompanying table.

**Operation.** With no tuned circuits, potentiometers, or other adjustable components, this product detector is ready to operate as soon as it is wired up. The only precaution necessary is not to exceed the 6CW4's maximum plate-voltage rating of 110 volts. Actually, the detector works best at about 90 volts, and various values of *R7* can be tried after the unit is in operation.

In some receivers, the value of capacitor *C2* may have to be changed to prevent application of too strong an input signal. The value should be adjusted to provide an input signal of between 0.2 and 0.4 volt at the grid of *V1*. With the oscillator disabled by removal of *V4*, no audio signal should be heard leaking through the cathode-followers.

Sideband is here to stay. Let's convert those receivers over to receive it properly and at the same time get better continuous-wave and radioteletype-writer reception. —30—

Receiver I.F. (kc.)	Upper Sideband Crystal (kc.)	Lower Sideband Crystal (kc.)
455	453.7 (Ch. 45)	456.9 (Ch. 329)
915	913.5 (Ch. 87.7)	916.7 (Ch. 88)
500	498.1 (Ch. 69)	501.8 (Ch. 71)
456	451.166 (Ch. 327)	457.4 (Ch. 47)
1600	1598.5	1601.5

lugs have been used in the model, but in their absence several preperforated boards and lugs are available in the ham market as substitutes. As a last



# CRYSTAL SUPER CALIBRATOR

By R. A. SCHEIDEL

*Like port and starboard channel buoys for the navigator, crystal calibrator harmonics mark the band edges for hams and others*

**N**EXT TO MONEY, hardly anything serves certain needs of the ham, the SWL, and the set builder better than a good crystal calibrator. For the ham, those stable signals precisely 100 kc. apart mark the band edges of most of the amateur bands with an accuracy that removes the gnawing fear of an unwanted FCC QSL for out-of-band operation. For the SWL, the rather sketchy calibration of many short-wave receiver dials no longer causes such exasperating difficulties when trying to identify an unknown station. And the set builder and experimenter can calibrate the dial of the new receiver, oscillator, or other tunable device with some assurance that the figures they put down on the scale mean something definite.

Crystal calibrator kits are available from several companies, and many receivers feature a plug-in socket for a calibrator, or have a calibrator built in at the factory. Even so, the unit described here has several solid advantages that more than justify its moderate cost and the time required to build it.

First of all, the "super" calibrator is small, rugged, and can be constructed as a completely self-contained unit if you wish. This makes it a natural choice for field day, portable, or mobile use. It also means you don't need to cut into other equipment to steal power, although of course you can power the unit

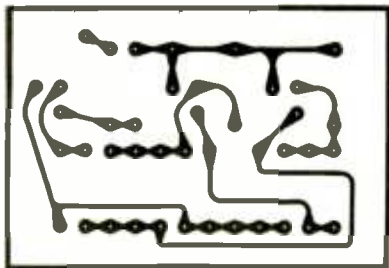

this way if you choose, and a circuit for this construction scheme is provided. Next, crystal current is very low, even if you elect to use the highest battery voltage the design permits, and all other sources of thermal frequency drift are weak. For these reasons, stability is significantly better than is usual for units not operating in a temperature-controlled oven.

Third, the super calibrator is so easy to build, thanks to a high-quality printed-circuit board, that you can choose just about any final assembly form that suits your own needs. This can range from building the unit into an existing receiver to making it the basis for an elaborate home lab signal source, with additional multivibrators to provide outputs at multiples and sub-multiples of the basic 100-kc. frequency. Because of the "foolproofness" of the design, constructors are encouraged to adapt the unit to their own requirements, although the version described here can be duplicated exactly if desired. And even for this completely self-contained model, certain optional choices are given in the Parts List.

And as the final clincher, the super calibrator provides usable harmonic output to well beyond 100 mc., thanks to an output amplifier stage of optimum design. This last feature alone should perk up the interest of 6-meter hams, and DX'ers who comb the mobile bands above 30 mc., for this is where many calibrators get feeble, and receiver gain also begins to droop.

**How It Works.** The oscillating circuit of the super calibrator is essentially a multivibrator, with the crystal connected in the feedback path from the collector of transistor  $Q2$  to the base of transistor  $Q1$ . The crystal operates in this circuit at its series-resonant frequency; that is,



Where accurate frequency check points are a must, as when checking a BC-221 at 100-kc. points, the super calibrator speeds and eases the operation.

it presents a relatively low series impedance at 100 kc., and a relatively high impedance at all other frequencies near 100 kc. As a result, the circuit made up of  $Q1$ ,  $Q2$ , and associated resistors and capacitors oscillates at 100 kc., since this is the only frequency at which there can be enough positive feedback to sustain oscillation. The exact frequency of oscillation can be adjusted over a small range by means of padder capacitor  $C4$ , making it possible to adjust the calibrator to zero beat (of a harmonic) with WWV, or another standard frequency signal source.

The base of output transistor  $Q3$  is coupled to the collector of  $Q2$  by capacitor  $C1$ . Transistor  $Q3$  is an *nnp* type (2N835), and is capable of being switched from cutoff to fully conducting condition in about 10 nanoseconds. This high switching speed is just another way of saying that it can handle very high frequencies.

Since the input waveform from the oscillator circuit is substantially a 100-kc. square wave,  $Q3$  amplifies this wave and all harmonics to at least 100 mc.,

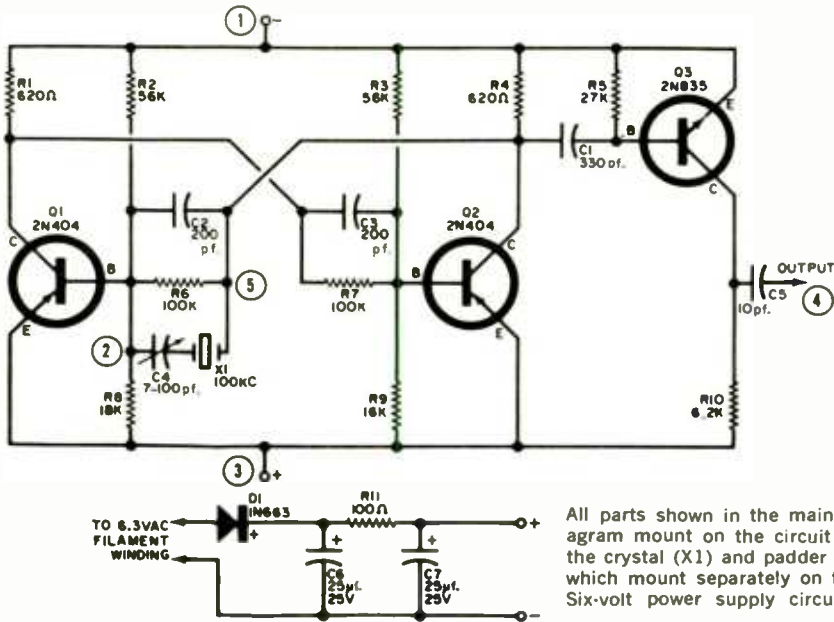

All parts shown in the main schematic diagram mount on the circuit board, except the crystal (X1) and padder capacitor (C4) which mount separately on the box cover. Six-volt power supply circuit is optional.

### PARTS LIST

B1\*—1.5-volt to 10-volt battery to supply 4- to 12-ma. drain—see text  
 C1—330-pf. silver mica capacitor, voltage rating not important  
 C2, C3—200-pf. silver mica capacitor, voltage rating not important  
 C4—7-to-100 pf. air dielectric variable capacitor, ceramic insulation (alternate for easier fine adjustment; 7-to-24 pf. size)  
 C5—10-pf. silver mica capacitor, voltage rating not important  
 J1\*—Crystal jack, to suit 100-kc. crystal used—see text  
 Q1, Q2—2N404 pnp transistor  
 Q3—2N835 npn transistor  
 R1, R4—620 ohms  
 R2, R3—56,000 ohms

R5—27,000 ohms } all resistors  
 R6, R7—100,000 ohms } carbon, 1/2 watt  
 R8—18,000 ohms  
 R9—16,000 ohms  
 R10—6200 ohms  
 S1\*—Any small on-off switch—see text  
 X1—100-kc. standard type crystal (Petersen Z-6A or equivalent)  
 1—Printed circuit board (available from R. A. Scheidel, 22 W. Elm, Fremont, Mich., \$3.00, three-week delivery)  
 1—Small aluminum box (4" x 4" x 2" used here)  
 Misc.—Binding post (BP1) or pin jack for outputs, screws and spacers for mounting board, hookup wire, solder, rubber feet for box, etc.

\*Not shown in schematic, constructor's option

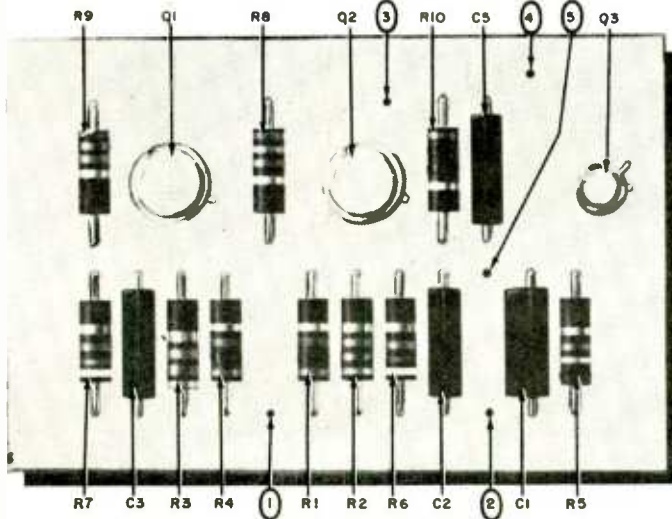

- ① POWER CONNECTION (-)
- ② PADDER CONNECTION
- ③ POWER CONNECTION (+)
- ④ OUTPUT CONNECTION
- ⑤ CRYSTAL CONNECTION

Parts placement is set by circuit board layout. Note orientation of the transistor locating lugs when inserting leads in circuit board openings.

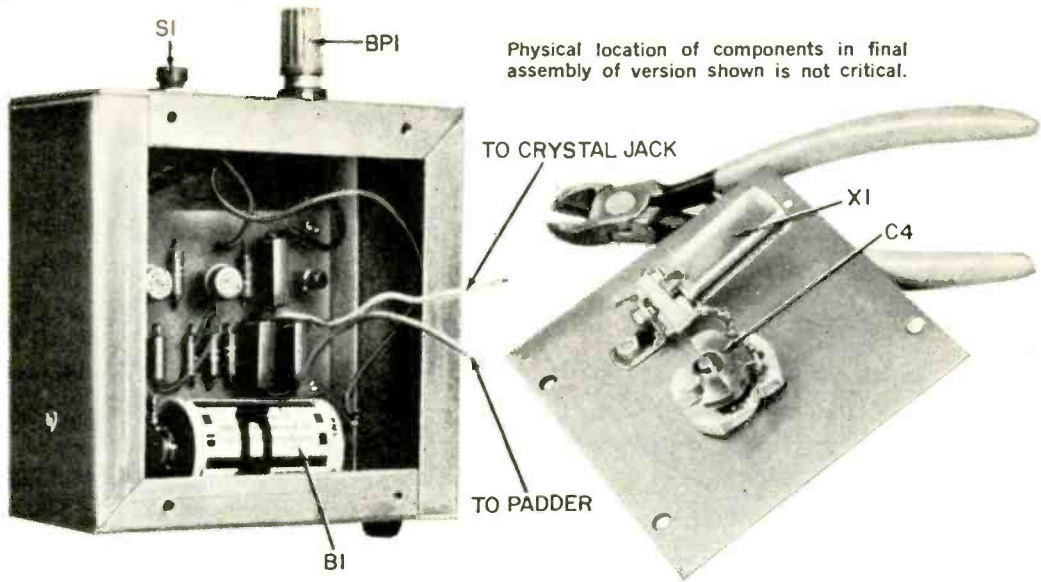

Physical location of components in final assembly of version shown is not critical.

and delivers the amplified version to the output terminal through *C5*. The output stage is of relatively low impedance, so that moderate loading such as by the input circuit of a receiver under test will not seriously reduce the output or alter the unit's frequency stability.

**Construction.** The type of box chosen to enclose the unit does not affect the construction greatly, since almost all of the parts are mounted on the printed-circuit board. However, the type of switch chosen, and the type and size of the battery used to power the unit do affect the choice of the box, so it is well to select these components before you buy the box.

If you choose to duplicate the construction illustrated, begin by drilling holes for 4 x 32 machine screws in the three corners of the printed-circuit board that are clear of printed conductors. By drilling before the parts are mounted on the board, the chance of damaging anything is greatly reduced. With the holes in the board drilled, use the board as a template to locate the mounting holes to be drilled in one of the box covers. In doing this, be sure to spot the holes so the board will clear the lip of the box when it is mounted on the cover, noting that the board will be supported far enough from the cover to allow ample clearance for the solder side.

With this done, mount the padder ca-

pacitor, *C4*, and the crystal jack (if one is used) on the other box cover, as shown in the illustration. The crystal can be soldered into the circuit if desired, but most constructors may prefer to mount a ceramic crystal jack as shown, and insure the crystal against accidental removal due to jarring by securing a rubber band around the holder and crystal can.

Mount the output binding post and the on-off switch on one side of the box frame, and the battery holder on the opposite side.

Wire the circuit parts on the printed-circuit board in the positions shown. Use normal care in soldering, and be sure to use a heat sink (such as a copper alligator clip or pair of long-nose pliers) when soldering the transistor leads.

When all parts have been soldered in place and the ends of the leads have been trimmed close to the solder surface, connect five pieces of insulated hookup wire to the points on the board numbered 1 through 5 in the photograph showing the mounted parts. If you use a different color for each wire, it will help prevent errors when you make the final hookup. Leave these wires long enough to permit completion of the wiring when the board and other components are mounted in their final positions.

At this point you can either "go for  
(Continued on page 151)

# 2-TUBE SUPERHET FOR 80 METERS



The 80-meter band remains a perennial favorite. Here's a receiver that will let you in on the fun with little outlay of hours and dollars

By CHARLES GREEN, W3IKH

**H**ERE'S a simple, easy-to-build receiver for the 80-meter band that can do a real job for the novice, or as a standby receiver for the experienced old-timer. Costing less than \$30 to build, even with all-new parts, it uses only two tubes in a superhet circuit, yet provides remarkable sensitivity and fully adequate headphone output, thanks to a regenerative second detector.

Use of regeneration with panel control also makes the receiver usable on either phone or c.w. signals, and the built-in power supply makes it unnecessary to "steal" power from other sets in the shack. Sharp-eyed EEH readers will note a family resemblance to the 6-meter superhet which appeared in the 1964 HANDBOOK and the 2-meter superhet in this edition. This is far from accidental, for the basic circuit is sound, and lends itself to construction by experimenters not blessed with a shop full of test equipment.

**ABOUT THE CIRCUIT.** Eighty-meter signals from the antenna enter via jack J2, and are fed to the fixed-tuned circuit made up of L1 and C1, and to the grid

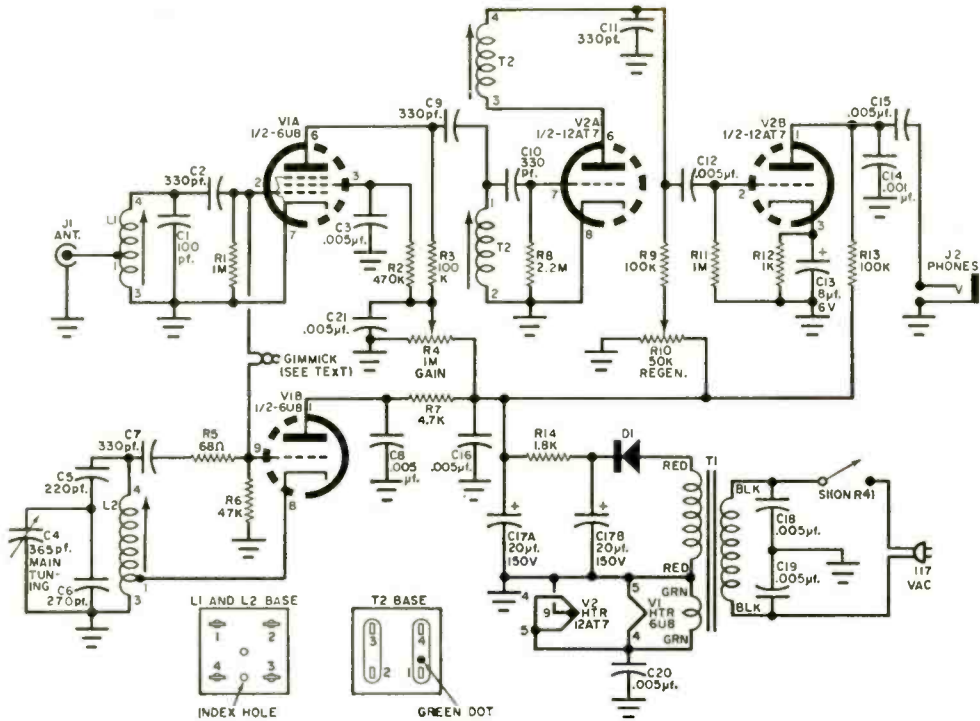

Values of capacitors C5 and C6 affect the bandspread. Reducing the value of C5 increases the arc of the dial occupied by the 80-meter band; increasing C5 reduces the bandspread.

Point-to-point wiring permits mounting most small parts on lugs of major parts as shown.

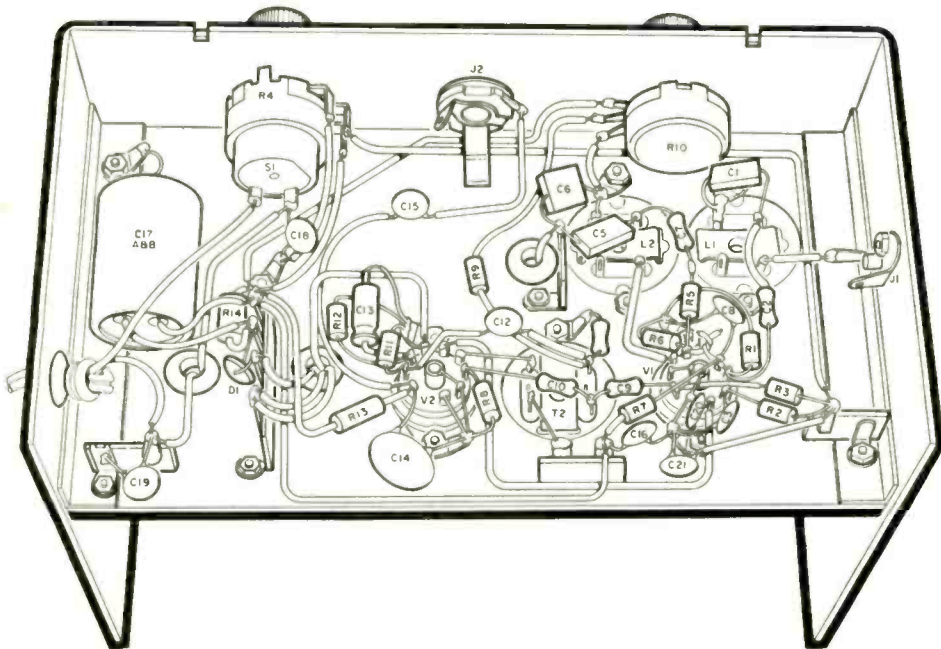

## PARTS LIST

- C1*—100-pf., 500-volt silver mica capacitor  
*C2, C7, C9, C10, C11*—330-pf., 600-volt ceramic tubular capacitor  
*C3, C8, C12, C15, C16, C18, C19, C20, C21*—0.005- $\mu$ f., 600-volt ceramic disc capacitor  
*C4*—365-pf. variable tuning capacitor (Lafayette 32-1103 or equivalent)  
*C5*—220-pf., 500-volt silver mica capacitor  
*C6*—270-pf., 500-volt silver mica capacitor  
*C13*—8- $\mu$ f., 6-volt miniature electrolytic capacitor  
*C14*—0.001- $\mu$ f., 600-volt ceramic disc capacitor  
*C17*—Dual 20- $\mu$ f., 150-volt electrolytic capacitor  
*D1*—400-PIV, 450-ma. silicon rectifier (International Rectifier Type 5E4 or equivalent)  
*J1*—Phono jack, chassis type  
*J2*—Earphone jack (to match your phones)  
*L1*—Antenna coil (Stancor RTC-8762 or equivalent)  
*L2*—Oscillator coil (Stancor RTC-8764 or equivalent)  
*R1, R11*—1 megohm  
*R2*—470,000 ohms  
*R3, R9, R13*—100,000 ohms  
*R4*—1-megohm linear taper potentiometer (with switch *S1*)  
*R5*—68 ohms  
*R6*—47,000 ohms  
*R7*—4700 ohms  
*R10*—50,000-ohm linear taper potentiometer  
*R12*—1000 ohms  
*R14*—1800-ohm, 2-watt, 10% carbon resistor  
*S1*—S.p.s.t. switch (part of *R4*)  
*T1*—Power transformer: primary, 117 volts, a.c.; secondary 1, 125 volts, 15 ma.; secondary 2, 6.3 volts, 0.6 ampere (Knight 61G410 or equivalent)  
*T2*—455-kc. slug-tuned i.f. amplifier input transformer (Meissner 16-6758 or equivalent)  
*V1*—6U8A tube  
*V2*—12AT7 tube  
 1—Dial (Eddystone #598)  
 1—Shaft coupling (National TX-10)  
 1—8" x 6" x 4½" aluminum utility box (LMB 146 or equivalent)  
 1—8" x 4¾" aluminum sheet (for chassis shelf)  
 Misc.—"K Tran" mounting plates (Miller 181 or equivalent), tube sockets, angle brackets, grommets, terminal strips, knobs, ⅜" metal spacers, line cord and plug, wire, etc.)

} All fixed resistors  
 } ½ watt, 10% carbon unless otherwise noted

of mixer tube *V1a*. Main tuning capacitor *C4* is connected in parallel with *C6*, and the combination is in series with *C5* to make up the total capacity that tunes oscillator coil *L2*. This arrangement gives a good spread of the 80-meter band over practically the whole dial arc.

The "gimmick" capacitor made of two twisted insulated wires couples the output of oscillator *V1b* to the grid of *V1a*, and the resultant 455-kc. difference-frequency signals are connected by *C9* from the plate of *V1a* to *T2*. *GAIN* control *R4* varies the conversion gain of the mixer stage so the signal will not overload *V2a*, the detector stage. Coil *T2* is fixed-tuned by its adjustable core to 455 kc., and *REGEN* control *R10* varies the regenerative action of the detector stage.

The detected audio signals are fed through capacitor *C12* to *V2b* and amplified. Capacitor *C15* couples the amplified signals to phone jack *J2*. Power transformer *T1*, rectifier *D1*, and the filter circuit made up of resistor *R14* and capacitor *C17* provide the operating voltages for the receiver.

**Construction.** A metal 8" x 6" x 4½" utility box and a 8" x 4¾" chassis shelf of aluminum sheet are used to house the components. The chassis shelf is mounted by a pair of angle brackets 10¾" from the base of the utility box.

The parts placement shown in the photographs is fairly critical, especially in the mixer-oscillator circuits of *V1*. Begin construction by mounting the chassis shelf and components as indicated.

Coils *L1* and *L2* are supplied with

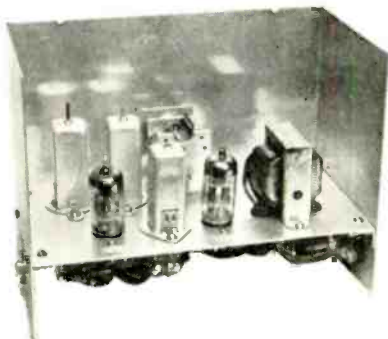

Position of tuning capacitor *C4* is shown above. Other major parts placement is given at right.

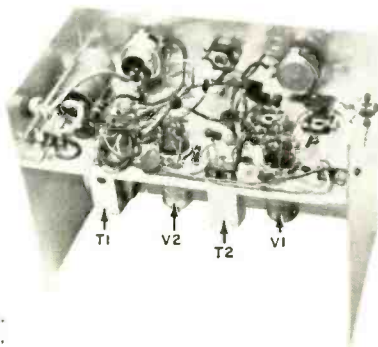

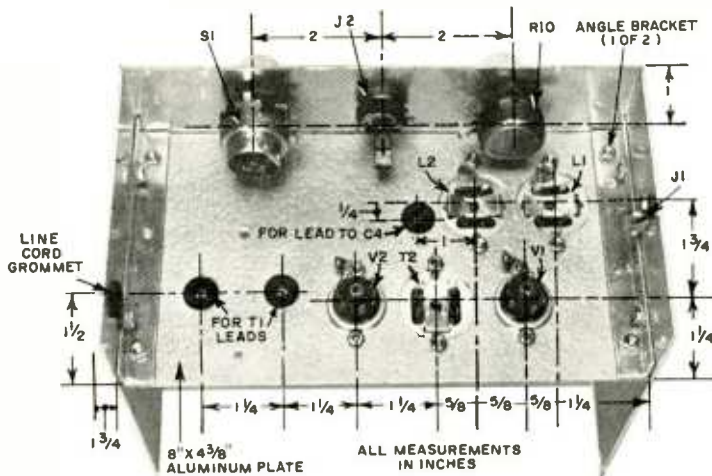

Dimensions and orientation of parts should be followed closely to duplicate the author's results. All holes should be deburred before final assembly.

mounting clips only. The author used "K Tran" mounting plates, similar to the plate supplied with  $T2$ . If these mounting plates cannot be procured, duplicates of the  $T2$  plate can be made or spaced holes can be drilled in the chassis to mount the coils by their clips.

Short pieces of insulated sleeving should be placed over the coil terminals of  $L1$  and  $T2$  to prevent accidental shorting to the chassis, since the plates are not an exact fit and also may move a bit. The author enlarged the shield can clip holes to fit "K Tran" type mounting clips, but the clips supplied with the coils can be used as well.

Two 6-32 machine screws with spacers made of seven metal washers for each were used to mount tuning capacitor  $C4$  to the chassis. The spacing of the tuning capacitor, the shaft coupling, and the vernier dial must be fairly accurate, so use care in mounting these parts.

After wiring the mixer-oscillator stages of  $V1$ , form the "gimmick" capacitor by soldering two short pieces of insulated wire to pins 2 and 7 of  $V1$  and twisting the ends together two turns.

Make sure that you drill a series of holes in the back of the rear box cover, to provide a means of ventilation for the receiver.

**Testing and Calibration.** After the construction is finished, adjust the bottom iron core of coil  $T2$  all the way out, as far as it will go. This is necessary to limit the maximum regenerative feedback of the circuit of  $V2a$ . Install the

tubes and connect the receiver to the a.c. line. Insert a pair of high-impedance earphones into  $J2$ , and warm up the receiver for a while.

Then turn up the *REGEN* control until you hear the typical regenerative hiss. Set the *TUNING* control to full capacity and the *GAIN* about midway. Connect a signal generator or other source with an output of 3.5 mc. to  $J1$ . Loosen the locking nut on the slug of coil  $L2$  and rotate the tuning slug downwards until it is almost flush with the nut; then adjust the slug upwards until you hear the test signal, and tighten the locking nut. In a pinch, you can use a signal you know is at the low end of the 80-meter band for this adjustment.

Disconnect the signal generator and connect a 15' insulated wire to  $J1$ . Loosely couple the signal generator to the wire by twisting a small piece of insulated wire around it and connecting the end to the signal generator. Reset the signal generator to 3.75 mc., and rotate the *TUNING* control until the signal is heard. Loosen the locking nut on the slug of coil  $L1$  and adjust the slug for maximum signal, decreasing the *GAIN* control as necessary to prevent overloading the detector. Now reset the generator to 3.5 mc., and proceed with the calibration of the dial. The author calibrated the dial every 10 kc. to 4 mc.

A transmitter VFO or GDO can also be used for alignment and calibration. If no equipment is available, set the tun-

(Continued on page 161)



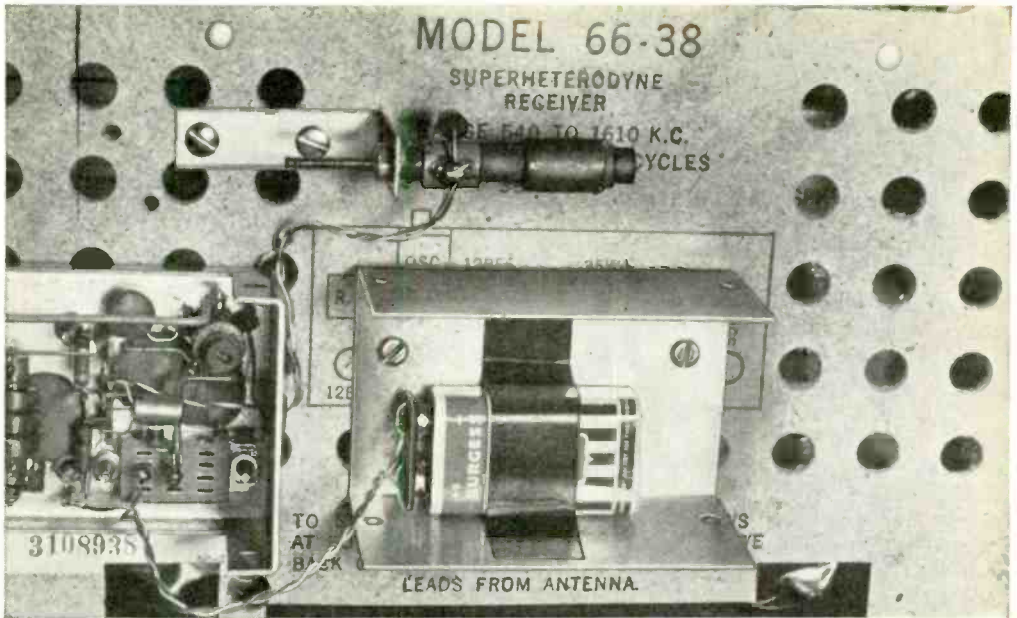

# THE WXCVR

If weather is important to you in your work or leisure, get the best information Uncle Sam can provide by tuning in the airline forecasts. The WXCVR lets you do it the easy way.

By HARTLAND B. SMITH, W8VVD

**T** IRED of being rained out at ball games, drowned out at picnics, and snowed in on trips? Thanks to the Federal Aviation Authority's continuously repeated weathercasts, you can now usually avoid disappointing and inconvenient happenings of this kind.

Twenty-four hours a day, seven days a week, the stations listed in the accompanying table transmit up-to-the-minute taped forecasts, and report the current temperature, humidity, barometric pressure, wind velocity and direction for major cities within a radius of several hundred miles. A few moments of eavesdropping on these transmissions will not only inform you of what to expect, locally, within the next twelve hours, but will also give you an excellent idea of

the state of the weather in surrounding areas and neighboring states. Armed with this data, you'll be able to do a better job of planning both recreational and business activities.

These aeronautical weathercasts are transmitted in the low-frequency aviation band between 200 and 400 kc., and therefore cannot be picked up by ordinary broadcast-band or short-wave receivers. However, the WXCVR (radioesefor "weather-receiver") described here provides an inexpensive answer to this reception problem. It converts low-frequency weather signals to an unused channel near the middle of the broadcast band for easy detection by any home or portable radio. Costing less than \$7, the device can be assembled in a single eve-

ning and will receive FAA stations as far as 250 miles away.

**How It Works.** As an example, suppose you want to hear the Denver forecast transmitted on 379 kc. Radio energy at this frequency intercepted by the antenna causes r.f. current to flow through coil *L1* and the primary of transformer *T1*. Inductive coupling between the transformer windings induces a signal in the secondary of *T1* which, together with the combined capacities of *CA* and *C2*, forms a parallel circuit resonant at 379 kc. From the tap on *T1*, the signal flows through the feedback winding of *L2* and is then applied, via *C1*, to the base of transistor *Q1*.

When switch *S1* is closed, *Q1* operates as an oscillating detector, due to positive feedback through oscillator coil *L2*. The exact frequency of oscillation is determined by the capacity of *C4* and the setting of *L2*'s variable slug. In this case, oscillation at 1529 kc. is desired.

The 379-kc. and 1529-kc. signals present at *Q1*'s base are mixed in the transistor to produce additional signals at the sum of the two frequencies, 1908 kc., and the difference frequency, 1150 kc. Loopstick *L3* and capacitor *C3* are resonated at 1150 kc. Direct connection between converter and broadcast receiver is normally unnecessary, since the strong 1150-kc. field surrounding *L3* can be readily picked up by the receiver's loop antenna.

The high impedance of *L1* to frequen-



Completed WXCVR is neat and compact.



cies above 1 mc. minimizes such unwanted signals before they reach the base of *Q1*, where they might cause interference to a desired weathercast.

**Construction.** All parts, with the exception of *C3*, *L3* and *B1* are housed inside the cover of a 3¼" x 2½" x 1¾" Minibox. Miniature components and a simple circuit result in plenty of working space inside the box, despite the small size. Parts layout is not critical although it is best to follow, in a general way, the arrangement shown.

Most capacitor and resistor leads go either to the coil and switch terminals, or to ground lugs. A three-terminal miniature insulated tie strip mounted near the center of the cover supports *Q1* and its associated components. When

### FAA AUTOMATIC RADIO WEATHER BROADCASTS

Locality	Kc.	Locality	Kc.	Locality	Kc.	Locality	Kc.
Albuquerque, N. M.	230	Duluth, Minn.	379	Millinocket, Me.	344	Redmond, Ore.	368
Amarillo, Tex.	251	Elmira, N. Y.	375	Milwaukee, Wis.	242	Roanoke, Va.	371
Atlanta, Ga.	266	El Paso, Tex.	242	Minneapolis, Minn.	266	Rock Springs, Wyo.	290
Big Spring, Tex.	326	Elko, Nev.	391	Missoula, Mont.	308	St. Louis, Mo.	338
Billings, Mont.	400	Ft. Worth, Tex.	365	Newark, N. J.	379	San Antonio, Tex.	254
Birmingham, Ala.	224	Fresno, Calif.	344	New Orleans, La.	338	S. Ste. Marie, Mich.	400
Blythe, Calif.	251	Garden City, Kans.	257	North Platte, Nebr.	224	Seattle, Wash.	260
Boise, Idaho	359	Great Falls, Mont.	371	Oakland, Calif.	362	Spartanburg, S. C.	248
Boston, Mass.	382	Houghton, Mich.	227	Oklahoma City, Okla.	350	Spokane, Wash.	365
Bozeman, Mont.	329	Houston, Tex.	332	Ogden, Utah	263	Tampa, Fla.	388
Burlington, Vt.	263	Idaho Falls, Idaho	350	Omaha, Nebr.	320	Texarkana, Ark.	329
Casper, Wyo.	229	Indianapolis, Ind.	266	Pendleton, Ore.	341	Toponah, Nev.	221
Charleston, S. C.	329	Jacksonville, Fla.	344	Pensacola, Fla.	326	Traverse City, Mich.	365
Chicago, Ill.	350	Kansas City, Mo.	359	Pittsburgh, Pa.	254	Trinidad, Colo.	329
Cincinnati, Ohio	335	Knoxville, Tenn.	257	Portland, Ore.	332	Tucson, Ariz.	338
Cleveland, Ohio	344	Las Vegas, Nev.	206	Raleigh, N. C.	350	Tulsa, Okla.	245
Delta, Utah	212	Los Angeles, Calif.	332	Rapid City, S. D.	254	Washington, D. C.	332
Denver, Colo.	379	Miami, Fla.	365	Red Bluff, Calif.	338	Wichita, Kans.	332
Detroit, Mich.	388	Miles City, Mont.	320			Winslow, Ariz.	266

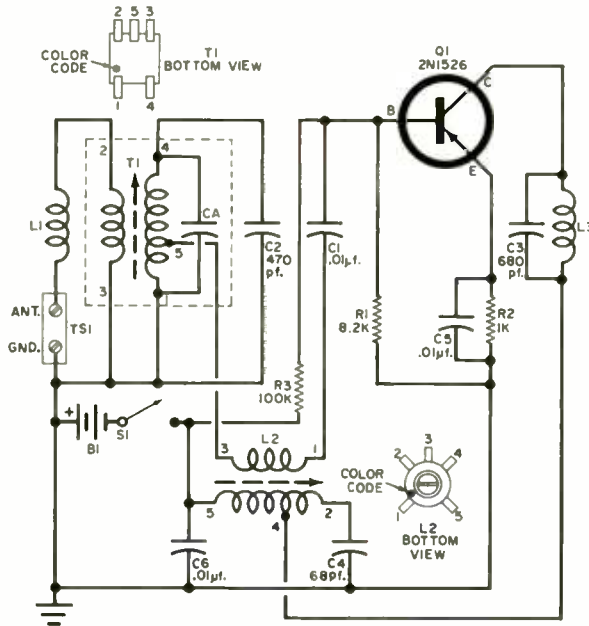

## PARTS LIST

- B1—9-volt transistor battery  
 C1, C5, C6—0.01- $\mu$ f. ceramic disc capacitor  
 C2—470-pf. ceramic capacitor  
 C3—680-pf. ceramic capacitor  
 C4—68-pf. ceramic capacitor  
 L1—1-mh. r.f. choke (National R-50 or equivalent)  
 L2—455-kc. transistor oscillator coil (Miller 2020)  
 L3—Suprex Vari-Loopstick (or Meissner 14-9015 coil)  
 Q1—2N1526 transistor  
 R1—8200 ohms } All resistors  
 R2—1000 ohms }  $\frac{1}{2}$ -watt,  
 R3—100,000 ohms } 10% carbon  
 S1—S.p.s.t. slide switch  
 T1\*—455-kc. transistor input i.f. transformer (Miller 2041)  
 TS1—Antenna-ground terminal strip  
 1—3 $\frac{1}{4}$ " x 2 $\frac{1}{8}$ " x 1 $\frac{5}{8}$ " aluminum box (Bud CU-2101-A or equivalent)  
 Misc.—3-terminal miniature tie strip, battery connector, 4-36 machine screws and nuts, wire, solder, etc.

\*Capacitor CA shown on the schematic diagram inside the shield can of T1 is part of the manufactured T1 assembly

One-transistor converter circuit of WXCVR is simple and easy to get into operation.

Parts placement is uncritical, but layout shown leaves room for easy assembly and wiring.

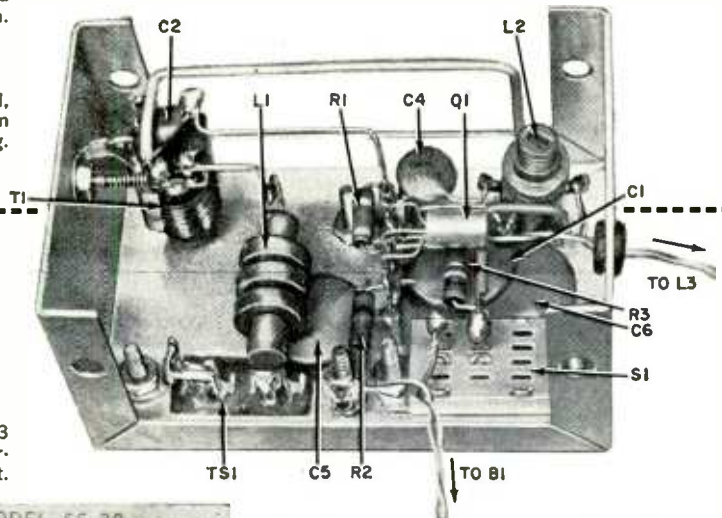

Find optimum position for L3 before mounting WXCVR permanently on back of BC set.

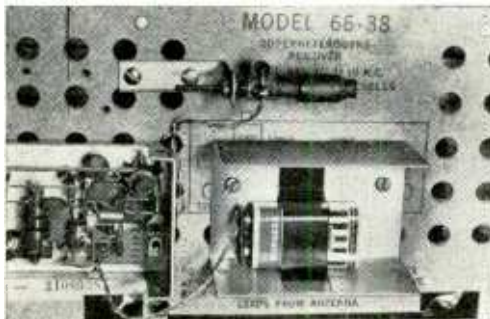

soldering the transistor in place, be sure to use a heat sink between the iron and the transistor body. A copper alligator clip or long-nosed pliers will do the job.

Carefully remove and discard the square aluminum can surrounding T1. Position the transformer as shown. Make certain that the slot in its tuning slug is directly behind the  $\frac{3}{16}$ " "RF" tuning hole. Solder terminal 3 to a  
 (Continued on page 154)

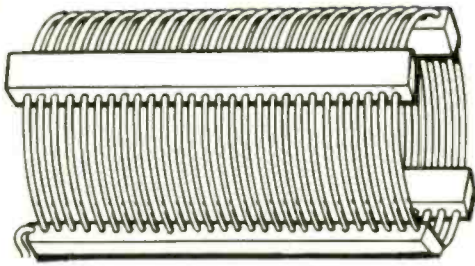

# R.F. Coil

**No more hit-or-miss coil**

**W**HILE there's nothing wrong with the time-honored cut-and-try technique of winding coils for a receiver or transmitter, you can save yourself a lot of time and trouble by building this simple "R.F. Coil Frequency-Finder" for use with an external signal source such as an r.f. signal generator, a VFO, or a grid dipper.

The design of the unit is straightforward. The unknown coil is connected in parallel with  $C2$ , a midget 140-pf. variable capacitor, through  $J2$  and  $J3$ . The only power required is the r.f. furnished by the signal source through  $J1-C1$ . When the coil and  $C2$  resonate with the external r.f. source, energy is absorbed by the circuit and rectified by  $D1$ , giving a reading on the 50- or 100- $\mu$ a. meter,  $M1$ .

**Construction.** Cut a hole for  $M1$  near one end of the  $2\frac{1}{4}$ " x  $2\frac{1}{4}$ " x 4" Minibox.

Drill a hole to mount  $C2$  close to the other end of the box. Locate holes for the coil jacks,  $J2$  and  $J3$ , in the end of the box near  $C2$ . Terminal  $J1$  is mounted at the opposite end near the meter. Both  $J1$  and  $J2$  must be insulated from the metal box. Wiring is done point-to-point, keeping leads as short as possible; use a heat sink when soldering  $D1$ .

Although a 100- $\mu$ a. meter was used in the author's model, a 50- $\mu$ a. movement will give better sensitivity (although possibly at greater cost). In any case, a miniature meter of the relatively inexpensive imported variety should prove perfectly satisfactory.

Install a knob with a pointer on  $C2$ 's shaft, and calibrate  $C2$ , marking the minimum point ( $C2$  fully open) 10 pf. and the maximum point 150 pf. ( $C2$  fully closed). From these two points, estimate the 75- and 100-pf. points

External r.f. source—signal generator or VFO—is the only power required to operate the unit.

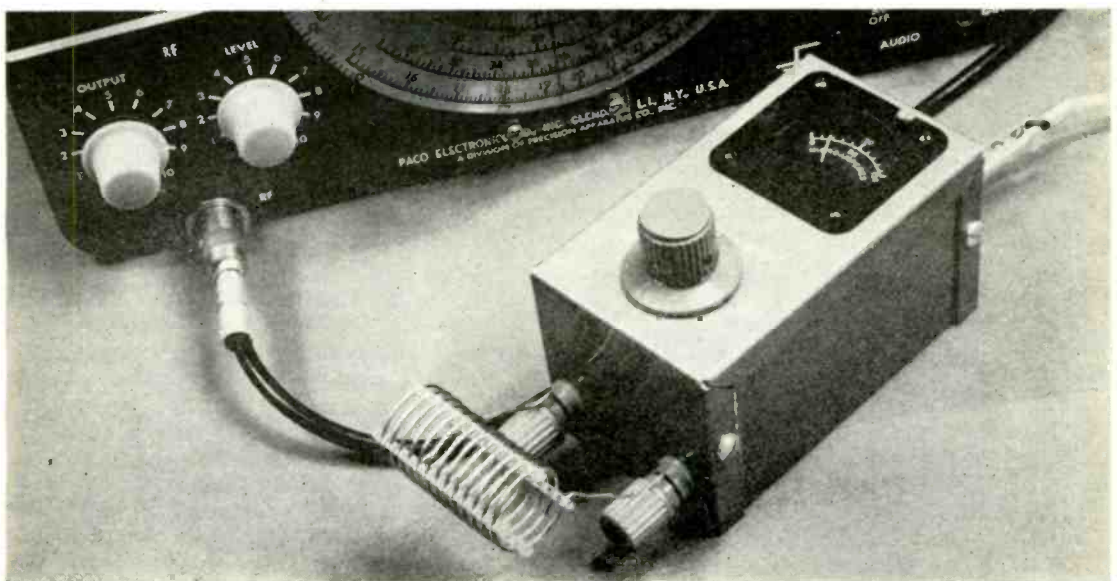

# Frequency-Finder

winding—all it takes is a meter, a few parts, and r.f. source

By LEON A. WORTMAN

and mark them on the panel. Decals, if available, will make a professional-looking scale. The markings (slightly greater than  $C2$ 's maximum and minimum capacities to compensate for the unit's internal capacity) will be only roughly accurate, but quite adequate in this application.

**Operation.** To use the Frequency-Finder with an r.f. generator, simply connect the center conductor of the output cable to  $J1$ , leaving the shield unconnected. Connect the unknown coil to  $J2$ - $J3$ , keeping leads as short as possible. If the coil is to be used with a capacitor of any type, set  $C2$  to that value; otherwise, at minimum.

Sweep across the desired frequency range with the r.f. signal generator until you find the resonant point indicated by a maximum reading on  $M1$ . The resonant frequency of the coil and  $C2$  can then

be read directly on the dial of the r.f. generator. Keep the output low, consistent with a readable indication on  $M1$ . A VFO can be used in the same manner. If the r.f. source is poorly calibrated, you can double-check by tuning its signal in on an accurate receiver.

To use the Frequency-Finder with a grid-dip oscillator, plug the appropriate coil into the dipper, set it in the oscillating mode, and bring it to within a few inches of the unknown coil. Adjust the tuning dial of the grid dipper for peak indication on  $M1$ . Read the resonant frequency from the dial of the grid dipper, ignoring, for this test, the dipper's own meter and sensitivity control.

**Other Uses.** Another method of using the Frequency-Finder is to set the r.f. source at a predetermined frequency, and adjust  $C2$  to determine how much capacitance is required to make the unknown coil resonate.

The value of a small capacitor can be estimated with the unit. Connect a coil to  $J2$ - $J3$ , set  $C2$  at 150 pf., and tune the r.f. source for maximum indication. Connect the unknown capacitor in parallel with the coil at  $J2$ - $J3$ , and reset  $C2$  for maximum indication. The value of the unknown capacitor is approximately equal to the maximum value of  $C2$  (150 pf.) minus the new setting of  $C2$  that restores  $M1$  to maximum reading.

Coils are easy to add to, or subtract from, if you use the Frequency-Finder first—try it.

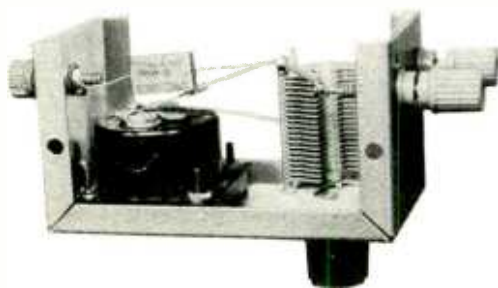

Frequency-Finder is mounted in small Minibox; all wiring is done point-to-point to keep leads short.

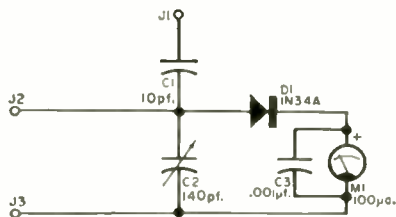

## PARTS LIST

- C1—10-pf. mica or ceramic capacitor
- C2—140-pf. midget variable capacitor
- C3—0.001- $\mu$ f. ceramic disc capacitor
- D1—1N34A diode or equivalent
- J1, J2, J3—Insulated binding posts or jacks
- M1—50 or 100  $\mu$ a. d.c. microammeter
- 1—2 $\frac{1}{4}$ " x 2 $\frac{1}{4}$ " x 4" aluminum box
- 1—Knob with pointer

# Electronics Enthusiasts!

Take a great big discount  
on a subscription to

# POPULAR ELECTRONICS!

**18** exciting **\$3.85**  
months only

At the regular subscription rate these same 18 issues would cost all of \$6.00! BUT NOT FOR YOU. Your low price is \$3.85—a saving of \$2.15.

Every month POPULAR ELECTRONICS brings you a wealth of fascinating features aimed especially at experimenters and do-it-yourselfers like yourself. (Just glance to the right for a sample!)

You'll enjoy being right on top of the fast-growing world of electronics with up-to-the-minute new product reports, lab tests, buying guides, and electronics breakthroughs you want to know about. Plenty of articles on hi-fi, money-saving test equipment, tape recorders, electronic games, computers, photo-aids, short wave receivers, antenna systems, solar powered and transistorized equipment—and much more.

Construction projects galore! Clear-as-crystal diagrams guide you each step of the way through fun-to-build projects you can put together in just a few hours...for pennies! Turn friends green with envy by building a super hi-fi rig they couldn't match in the stores for hundreds of dollars! Or throw together a fool-proof photoelectric burglar alarm to protect your home and loved ones...or a remote control switch that actually turns lights on and off when you whistle a bar of your favorite tune!

Pit yourself against the experts in monthly Electronics Quizzes. And see if you're enough of a Sherlock to beat Carl and Jerry to the solution of crimes it takes electronics know-how to solve!

POPULAR ELECTRONICS is definitely for men like YOU. Take advantage of this special Discount Offer to readers of the Experimenter's Handbook. Just complete and mail the card facing this page. Or, if someone has already used the card, write to:  
POPULAR ELECTRONICS, Dept. 4066,  
Portland Place, Boulder, Colorado 80301



## EXCLUSIVE HAM, SW & CB ARTICLES IN POPULAR ELECTRONICS

### Amateur Radio and SWL

Make Your Signal Reports More Accurate  
Safety in the Ham Station  
Amateur License Fees and ARRL Petitions  
Take Advantage of Changing Propagation  
Conditions  
Operating Another Ham's Station  
Calling All SWL DX'ers  
DX Awards  
English-Language Newscasts to North  
America  
Radio Marathon Broadcasts Truth  
To Cuba  
Satellites on the Air  
Short-Wave Broadcast Predictions  
Short-Wave Report  
North American Alliance of SWL Clubs  
Welcome to the SWL Newcomer  
Sure Cure for Ham/CB Mobile Noise

### Citizens Band Radio

"DSRC," New CB Features  
Equipment Buyer's Guide  
Transmitters and Transceivers  
Station Accessories  
Antennas  
Microphones  
Hand-Held Transceivers  
FCC Report  
On the Citizens Band  
Sure Cure for Ham/CB Mobile Noise  
Vibrator Hash, Wipe Out

### Build-It-Yourself

Antenna, 40-Meter, for Small Room  
Antenna Adapter, Power Line  
Code Bander  
Crystal Super Calibrator  
Double-Duty EICO 772  
Hula-Hoop—a Ham or CB Antenna  
Idento-Minder  
Q-Multiplier, Nuvistor  
Screen Modulator, One-Tube  
Transmitter Crystal Switch, Plug-in  
2-Meter Simple Superhet

# THE CODE BANDER



*This stable "front-end" BFO makes CW and SSB sets out of marginal receivers*

By HARTLAND B. SMITH, W8VVD

Despite the well-deserved popularity of c.w. and single-sideband among radio amateurs, both modes of operation—and especially sideband (SSB)—can create some annoying problems on the receiving end. They can't be copied on a receiver which lacks a beat frequency oscillator (BFO). Without some means for generating a stable local carrier (the function of a BFO), the prospective Novice finds it impossible to practice code reception, and the curious SWL has a hard time deciphering sideband QSO's. Furthermore, many inexpensive or elderly ham receivers, even when equipped with BFO's, drift so badly that the operator must constantly retune to keep from losing the desired signal.

Luckily, there is now a simple answer to these problems—an amazingly stable, simple gadget called the "Code Bander." This easily constructed receiver accessory will enable you to copy code and sideband on any receiver

# THE CODE BANDER

that covers the amateur frequencies. If you're presently DX'ing with a broadcast/short-wave combination that lacks a BFO, or if you're struggling along with a simple regenerative set or a communications receiver that drifts badly, this useful little device will greatly improve your receiving capabilities.

**How It Works.** Unlike ordinary BFO's, the Code Bander does not operate at the receiver's intermediate frequency. Instead, it produces r.f. energy on or near the frequency of the desired station. It will turn a quacking sideband signal into easily understood AM phone, and will

also supply a beat note for effective code reception. Designed for connection to the set's antenna terminals, it can be installed without tearing into your receiver's vitals.

The Code Bander contains two inexpensive transistors: *Q1*, which serves as a highly stable oscillator, and *Q2*, which acts as an r.f. amplifier. The oscillator can be tuned to any frequency in the 3.5 to 4 mc. amateur band by adjusting the coarse tuning capacitor, *C2*. Vernier capacitor *C1* provides the extreme bandspread required to accurately zero on a specific signal.

Both the fundamental and harmonics of the oscillator frequency are present at jack *J1*. Thus, the Code Bander can be used not only on 80 meters, but on 40,

## PARTS LIST

- B1*—9-volt transistor battery (Burgess 2U6 or equivalent)
- C1*—15-pf. variable capacitor (Hammarlund IIF-15-X or equivalent)
- C2*—140-pf. variable capacitor (Hammarlund MC-140-S or equivalent)
- C3*—39-pf. NPO ceramic capacitor (Centralab TCZ-39 or equivalent)
- C4*, *C5*—560-pf. silver mica capacitor (Elmenco CM-20-D-561J or equivalent)
- C6*, *C7*, *C9*—0.0047- $\mu$ f. disc capacitor
- C8*—2-pf. tubular ceramic capacitor (Eric CC20-CK-020C or equivalent)
- C10*—30-pf. disc ceramic capacitor (Centralab DD-300 or equivalent)
- J1*—Shielded phono jack
- L1*—22 turns of Barker and Williamson 3011 coil stock tapped 2 turns and 15 turns from the ground end

- Q1*, *Q2*—2N1180 transistor
- R1*—1500 ohms
- R2*—47,000 ohms
- R3*—270,000 ohms
- R4*—6800 ohms
- R5*—560 ohms
- R6*—100,000 ohms
- R7*—10,000 ohms
- R8*—470 ohms
- R9*—5000-ohm potentiometer with switch *S1*
- RFC*—2.5-mh. r.f. choke
- S1*—S.p.d.t. switch (part of *R9*)
- 2—Transistor sockets
- 1—3" x 5" x 4" aluminum utility cabinet (Bud AL-1028-H.G. or equivalent)
- 1—3" x 3 1/4" x 1 1/2" (approx.) aluminum chassis
- 1—Transistor battery connector—see text
- Misc.—One- and two-terminal tie strips, solder lugs, wire, hardware, knobs, etc.

Transistor *Q1* is a highly stable oscillator, and *Q2* acts as an r.f. amplifier. The unit's fundamental frequency range is 3.5 to 4 mc.

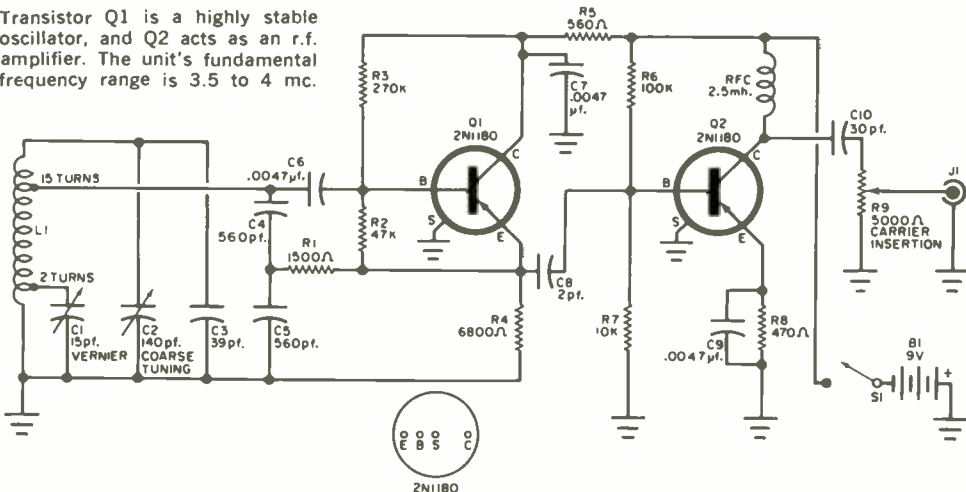



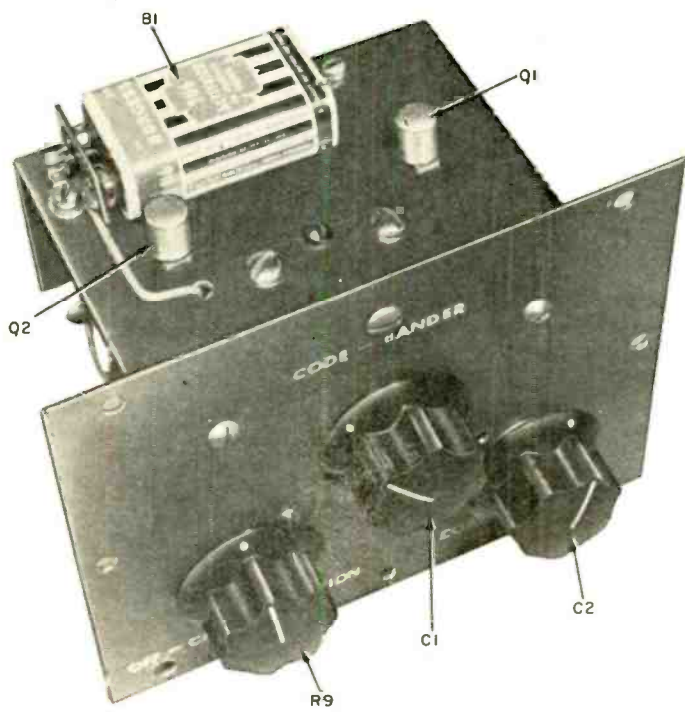

This top and front view of the Code Bander shows the general mechanical arrangement with the small chassis mounted to the front panel. Note that the transistors and battery are mounted on top of the chassis.

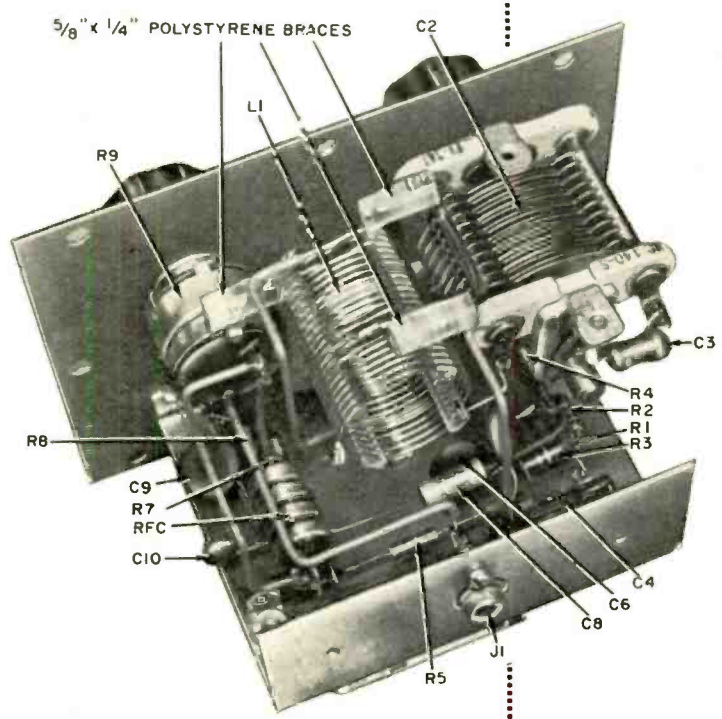

The small parts are mounted under the chassis, and tuning capacitors and insertion control to the front panel. Solid support for L1 is provided by cementing pieces of polystyrene rod in the places shown.

20, and 15 as well. Control *R9* adjusts the output so that optimum balance between the received signal and locally generated carrier can be achieved.

Oscillator stability is enhanced by tapping the base connection of *Q1* down from the top of *L1*, and by using high capacity at *C4* and *C5* to swamp out capacitance changes in *Q1*. A very low value coupling capacitor, *C8*, minimizes instability resulting from amplifier loading.

**Construction.** Putting the Code Bander together will be easier if you install *C1*, *C2*, *C3*, *L1*, and *R9* after wiring the other parts. A one-terminal tie strip supports the junction of *R5*, *R6*, and the r.f. choke (*RFC*). A two-terminal strip supports *C4* and one end of *C5*.

Most chassis grounds are made to solder lugs located under the nuts which

#### SINGLE SIDEBAND

Single sideband (SSB) is basically a way of reducing the bandwidth an AM signal occupies, and increasing its effectiveness per watt of power radiated. A conventional AM signal has 66 percent of the power in the carrier and 16 percent in each sideband when 100 percent modulated. An SSB signal has all the radiated power in one sideband. Since a carrier of the correct frequency and amplitude is required for recovery of the modulation signal at the receiving end, it must be supplied in the receiver. The Code Bander is a low-cost device for providing this carrier to receivers lacking an adequate BFO or any BFO whatsoever for receiving both c.w. and SSB.

hold the chassis to the front panel. Exceptions are the grounded end of *C5* which goes to the ground terminal of *J1*, and the cold ends of *L1* and *R9* which go to a lug bolted to the front panel midway between *R9* and *C1*. (The head of this bolt is visible in the top photo on page 103 behind *R9*'s knob.) Trim resistor and capacitor leads so they are just long enough to connect to the terminals.

The connector for *B1* was salvaged from the top of a discarded 9-volt transistor battery. Solder one terminal of this connector to a ground lug and run a wire from the other terminal, through a hole in the chassis, to switch *S1* (a part of *R9*). Since the drain is less than 2 ma., the battery will last indefinitely.

**Mechanical Stability.** A number of precautions must be observed to insure

ruggedness. Beef up the 3" x 5" x 4" aluminum utility cabinet by installing extra sheet metal screws around the edges of both front and rear panels. Most components are mounted on a small aluminum chassis which is bolted to the front panel and, after installation in the cabinet, fastened to the rear panel with two sheet metal screws.

Solid support must be provided for *L1*. Cut three  $\frac{5}{8}$ " lengths of  $\frac{1}{4}$ "-diameter polystyrene rod and cement them between the coil and the bodies of *C2* and *R9*. These plastic braces are visible in the bottom photo on page 103.

**Code Bander Operation.** To copy c.w., tune the receiver until you come across the familiar thump and hiss which denotes a code signal. Turn *R9* to mid-range, and adjust *C2* until the Code Bander's carrier beats against the signal to produce a whistle each time code is sent. You can vary the pitch of the beat note by tuning *C1*. Finally, adjust *R9* for the best ratio between the signal and the locally generated carrier.

If *R9* is set too high, the c.w. station will be smothered. On the other hand, to low a setting of the injection control will cause the beat note to weaken or disappear entirely.

**Copying Sideband.** For sideband reception, tune the receiver until the incoming garbled speech is loudest. If you're using a regenerative set, turn down its regeneration to drop the detector out of oscillation. Run *C2* back and forth until the local carrier can be heard on top of the incoming signal. Slowly tune *C1* for normal sounding speech. Set *R9* just above the point where the signal tends to distort.

Although at first glance these instructions may appear complicated, once you're accustomed to operating the Code Bander, you'll find it easy to quickly tune in either a c.w. or sideband signal. If there is too much output with *R9* at minimum, connect a twisted wire gimmick in the lead to the receiver (a gimmick is two short pieces of insulated wire twisted together to form a small capacitance). The gimmick arrangement may be needed with some receivers on 80 meters.

One final tip: if *Q1* should refuse to oscillate, move the base tap on *L1* up a turn or two.

# SELECTED PROJECTS

from  W9EGQ

## ONE-TUBE SCREEN MODULATOR

The simple modulator shown here will convert any of the currently available, low-power c.w. transmitters into low-power phone transmitters. Referring to the diagram, the signal from the microphone is amplified in the pentode section of the 6EA8 tube and drives the triode section as the modulator, which is choke-coupled to the r.f. amplifier tube's screen circuit. Operating the modulator at a higher voltage than the screen assures adequate audio modulation voltage without excessive distortion. Resistor *R6* across the coupling "choke" (the primary of transformer *T1*) helps to pre-

sent a relatively constant load to the modulator during the entire modulation cycle, thereby improving audio quality. It also eliminated an audio squeal that developed when the gain control was advanced too far.

**Construction.** A 2 1/4" x 2 1/4" x 5" aluminum box easily accommodates the modulator. Following the general parts layout shown on the next page will keep the input and output separated and minimize feedback problems. Modulation "choke" *T1* is the primary winding of a small, replacement-type, speaker output transformer (Stancor A-3856).

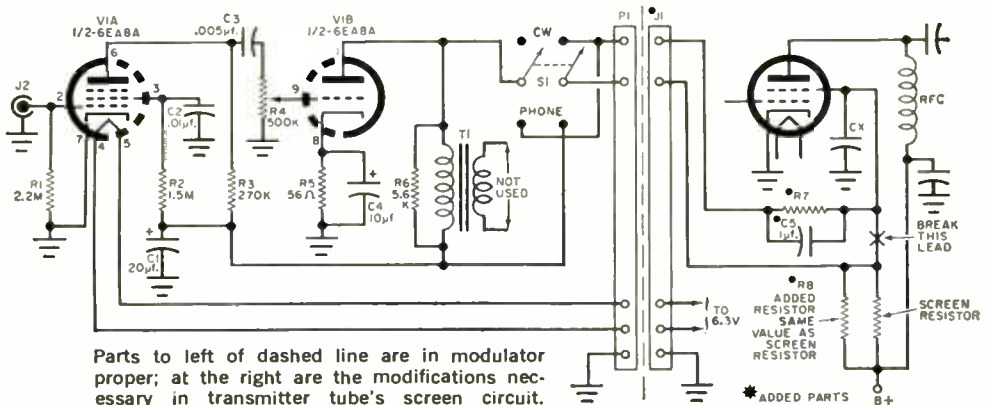

Parts to left of dashed line are in modulator proper; at the right are the modifications necessary in transmitter tube's screen circuit.

### PARTS LIST

- C1*—20- $\mu$ f., 450-volt electrolytic capacitor
- C2*—0.01- $\mu$ f., 600-volt ceramic capacitor
- C3*—0.005- $\mu$ f., 600-volt ceramic capacitor
- C4*—10- $\mu$ f., 10-volt electrolytic capacitor
- C5*\*—1- $\mu$ f., 200-volt paper capacitor
- J1*\*—Accessory socket on transmitter
- J2*—Single-contact microphone connector (Amphenol 75PC1M or equivalent)
- P1*—Plug to match accessory socket on transmitter
- R1*—2.2-megohm, 1/2-watt resistor
- R2*—1.5-megohm, 1/2-watt resistor
- R3*—270,000-ohm, 1/2-watt resistor
- R4*—500,000-ohm potentiometer with audio taper
- R5*—56-ohm, 1/2-watt resistor
- R6*—5600-ohm, 1-watt resistor

- R7*\*—2-watt resistor having one-half the resistance value of r.f. amplifier screen-dropping resistor
- R8*\*—2-watt resistor equal in value to original screen resistor
- S1*—D.p.d.t. toggle or slide switch
- T1*—Modulation choke; primary winding of 4-watt, replacement-type speaker output transformer (Stancor A-3856 or equivalent)
- V1*—6EA8A triode-tetrode vacuum tube
- 1—2 1/4" x 2 1/4" x 5" aluminum box
- Misc.—High-impedance crystal or ceramic microphone, 5-conductor cable, tube socket and shield, hardware, etc.

\*Components installed in transmitter proper

Simple screen modulator converts low power c.w. into phone transmitter.

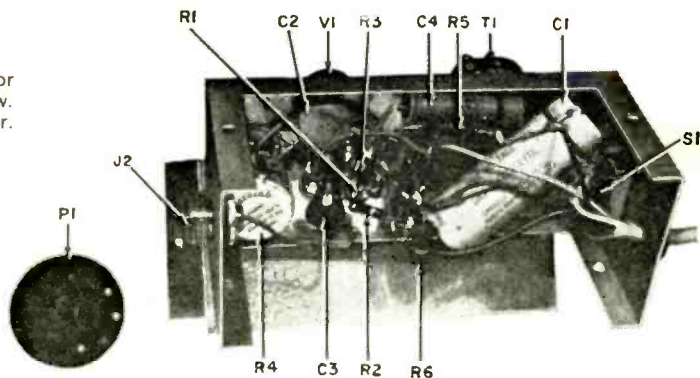

Refer to your transmitter instruction manual and the diagram (on the previous page) while carrying out the following steps. If necessary, it is an easy matter to add an accessory socket at a convenient spot on the rear chassis lip of the transmitter to accommodate the modulator plug. You'll need five terminals.

Disconnect the screen-dropping resistor from the r.f. amplifier tube's terminal and connect a 1-watt resistor ( $R7$ ) of half the resistance of the screen resistor between the tube socket screen terminal and the accessory socket; also connect capacitor  $C5$  across the resistor. Connect the free end of the screen resistor to another terminal on the accessory; at the same time, connect another resistor of the same value across the screen resistor. Check the value of screen bypass capacitor  $Cx$ ; if it is greater than .002  $\mu$ f., replace it with a .002- $\mu$ f., 1200-volt mica or ceramic unit. (You might check the operation of the transmitter on phone before making this change. If the quality is not too bassy and the modulation percentage is adequate, do not disturb

the original screen bypass capacitor, no matter what its value is.) Also connect a pair of wires from the transmitter's 6.3-volt heater circuit to the accessory socket, and ground its fifth terminal to the transmitter chassis. Finally, wire the plug from the modulator to match these connections, and insert the plug in the socket.

**Operation.** Tune up the transmitter in the normal manner with switch  $S1$  in the c.w. position. Then put the switch in the phone position; this should cause the amplifier plate current to drop approximately 50 per cent. Now, advance the audio gain control ( $R4$ ) while talking into the microphone until the amplifier plate current increases slightly on voice peaks.

You can check your phone quality and depth of modulation by listening to your signal on your own receiver using headphones. Short the receiver's antenna input terminals to reduce the strength of the incoming signal. Careful adjustment of the r.f. amplifier's grid current and possible experimental adjustment of  $R7$  will produce the best-sounding signal.

### PLUG-IN TRANSMITTER CRYSTAL SWITCH

A sharp Novice operator soon recognizes the advantages of changing his transmitter crystal to get out from under a strong interfering signal, or to move closer in frequency to a station he wishes to work. Unfortunately, even when the crystal socket is mounted on the transmitter front panel, it is not always easy to change crystals in a hurry, and when the crystal socket is recessed inside the transmitter, it is practically

impossible. But by adding crystal switching to your transmitter, you can change crystals effortlessly.

The plug-in unit in the photograph at right will accommodate up to eight crystals, and by using the larger box specified in the Parts List and adding four more crystal sockets, 12 crystals can be accommodated.

**Construction.** Clearances are quite limited (unless you decide to mount the

crystal sockets externally); therefore, be extra careful to mount switch *S1* in the *exact* center of the box. Position the sockets flush with the rear of the box, and space them about  $\frac{9}{16}$ " apart, center to center. The  $\frac{1}{8}$ " mounting holes are  $\frac{13}{32}$ " apart, and the  $\frac{9}{16}$ " holes to accommodate the crystal holder prongs are centered  $\frac{5}{16}$ " from the adjacent mounting hole. Place an extra panel nut on the switch bushing before mounting the selector switch; adjust this nut to position the switch wafer between terminals on the crystal sockets.

**Wiring.** Connect together the front terminals of all crystal sockets, and connect the rear terminal of each socket to the corresponding fixed terminal of the selector switch. Use a length of standard 300-ohm TV *lead-in* for the connection to plug *P1*. Solder one conductor to the common crystal socket terminals, and connect the other con-

ductor to the terminal for the switch rotor. Make the lead long enough to permit you to insert plug *P1* into the transmitter crystal socket when the unit is conveniently placed near the transmitter. Don't make the lead excessively long, however. Although length is not critical, too long a lead might make the transmitter operate erratically.

**Operation.** Transmitter operation should remain essentially the same except for the added convenience of crystal switching. In addition, if you tune the transmitter to a frequency near the center of the 80-, 40-, or 15-meter Novice bands, it probably won't be necessary to retune the buffer and final stages of the transmitter to operate on any other frequency within that Novice band. However, for best keying with some crystals, you may wish to touch up the oscillator tuning.

(Continued on next page)

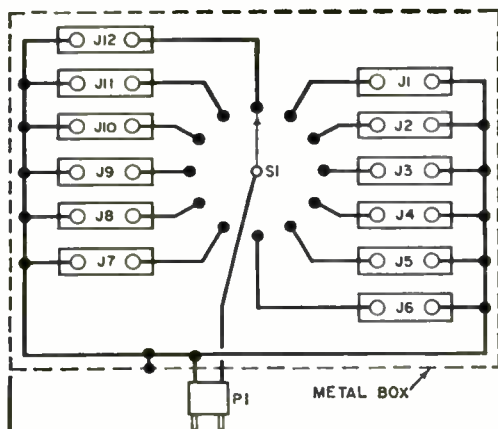

## PARTS LIST

*J1-J12*—Jacks for FT-243 type crystal holders, 0.487" pin spacing, 0.095" dia. pins (Millen #33102 or equivalent)

*P1*—2-terminal plug (Mosley #301 or equivalent)

*S1*—Multi-position, s.p., ceramic rotary switch (Centralab PA-2000 or equivalent)

*Box*—For 8-crystal unit:  $1\frac{5}{8}$ " x  $2\frac{1}{4}$ " x  $2\frac{3}{4}$ " aluminum (Bud CU-2100A or equivalent); for 12-crystal unit:  $1\frac{5}{8}$ " x  $2\frac{1}{8}$ " x 4" aluminum (Bud CU-2102A or equivalent)

*Misc.*—18" length of 300-ohm TV lead-in. 4-32 round-head machine screws  $\frac{5}{8}$ " long, etc.

Changing frequency with crystal control is easy with this multi-position switch. Plug *P1* must be inserted in transmitter crystal jack in position that grounds common crystal lead.

Two crystal jacks were left out of the unit shown to clarify the construction details.

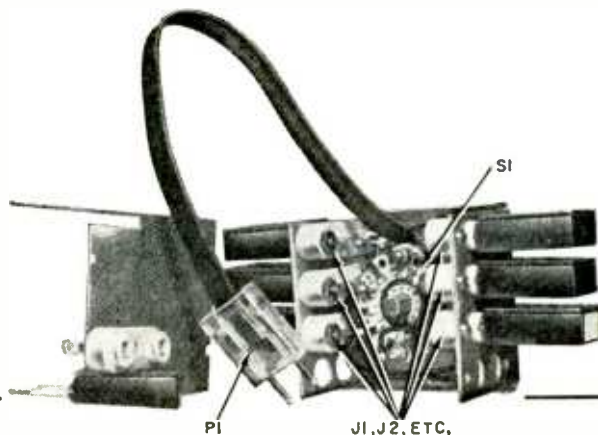

*P1* *J1, J2, ETC.*

**Warning.** The distributed capacitances, etc., of the crystal switch may change the actual oscillating frequency of some crystals as much as 100 cycles or so from their marked values. This possibil-

ity is of no importance for normal Novice operation, but it is illegal for a CB operator to make any changes that will affect the output frequency. Therefore, the switch is not suitable for CB use.

### ZENER DIODE NOISE LIMITERS

When you are listening to weak c.w. or SSB signals on your receiver, do strong signals appearing suddenly on the same frequency really blast your eardrums? When you use your receiver to monitor your c.w. sending, are you constantly running the audio gain control up and down? Does your receiver's noise limiter work properly for AM phone reception, but become useless for c.w. and SSB? Maybe a couple of inexpensive zener diodes in one of the circuits shown here can solve your problems.

**Simple Limiter.** Figure 1 is a simplified and modernized version of the "Headphone 'Ear Saver'" originally described in POPULAR ELECTRONICS in July, 1961. At low signal levels, the two zener diodes (Z1 and Z2) act like a very high resistance, and the circuit performs normally. But when a signal voltage exceeds the zener breakdown voltage rating of the diodes, they act like a virtual short circuit. As a result, strong noise and signal peaks are effectively clipped down to size.

The two zener diodes connected back to back are required to clip the positive and negative peaks of the a.c. signal equally, and their voltage rating determines the clipping level. For a fairly

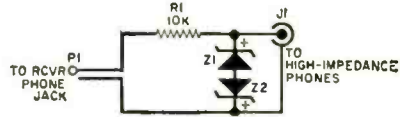

Fig. 1. Simple "ear saver" noise limiter should be inserted between the receiver phone jack and a pair of headphones.

#### PARTS LIST

- J1—Single-circuit phone jack
- P1—Phone plug
- R1— $\frac{1}{2}$ -watt, 10,000-ohm resistor
- Z1, Z2—6.8-volt, 400-mw. zener diode (Motorola 1N957 or equivalent—see text)
- Misc.—Short length of insulated wire, insulated tie point, hookup wire, small box, etc.

loud signal in the phones, 6.8-volt zener diodes (such as the Motorola 1N957 specified in the Parts List) are recommended; for a moderate signal level, try 3.3-volt units (such as the Motorola 1N746).

The "ear saver" can be built in any small box that may be available. When you wire the diodes, join the two negative leads (or the two positive leads)

#### PARTS LIST

- R1—500,000-ohm to 1-megohm potentiometer—see text
- S1—S.p.s.t. switch
- Z1, Z2—6.8-volt, 400-mw. zener diode (Motorola 1N957 or equivalent)
- Misc.—Short length of shielded hookup wire

Fig. 2. To add more versatile noise limiter to a communications receiver, just make the changes shown in these "before" and "after" circuit diagrams.

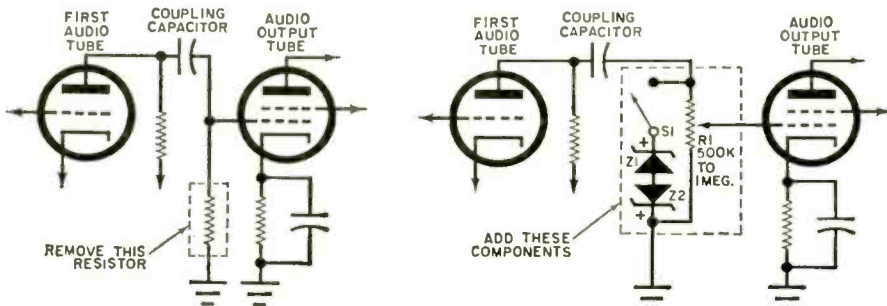

together, and connect the two remaining leads across phone jack *J1*. To prevent heat damage to the diodes while soldering, grasp their leads between the diode body and the connection with long-nose pliers.

**Versatile Limiter.** The limiter of Fig. 2 works on AM, c.w., and SSB signals. Its installation requires replacing the 470,000-ohm to 1-megohm fixed resistor normally connected between the receiver's output tube control grid and ground (consult your receiver's instruction manual to identify the resistor) with a small potentiometer (*R1*) of the same resistance connected as shown. The zener diodes are connected across the potentiometer through s.p.s.t. switch *S1*. If you use shielded leads, the components can

be grouped together at any convenient point on the receiver chassis.

After you finish wiring this unit, close switch *S1* and set potentiometer *R1* to an arbitrary position—say, half scale. Then slowly advance the regular receiver audio volume control to the point where further increase causes *no* further increase in volume from your loudspeaker or phones; simultaneously adjust *R1* for the desired output level.

When these adjustments have been made, no signal or noise pulse can exceed this preset level unless switch *S1* is opened or potentiometer *R1* is readjusted. (With the switch open and the potentiometer turned to the maximum-signal position, the receiver will perform exactly as before.)

### PI-NETWORK TANK CIRCUIT

Have you ever tried to visualize what modern band-switching amateur transmitters would be like if the universally used *pi*-network tank circuit had never been developed? Without it, they certainly would be bulkier, more complicated and more expensive. In addition, they would probably be slightly more difficult to tune; and—other things being equal—their emitted signals would contain just a bit more undesired harmonic energy.

**Original Arrangement.** Probably the first use of the *pi*-network in amateur transmitters was described in the article "A Universal Antenna Coupling System for Modern Transmitters," by Arthur A. Collins, W9CXX, in *QST*, February, 1934, page 15. Art claimed that the new circuit (see top diagram on the next page) would feed power into virtually any antenna, with increased transmitter efficiency and decreased harmonic output.

For some months after the publication of the article, almost every ham seemed to be building a "Collins Coupler," and they were loading up all sorts of unlikely metallic articles like bedsprings and window screens as antennas. But after its novelty wore off, the Collins Coupler was soon forgotten by the average ham.

Some time later, Frank C. Jones, W6AJF, described a low-power, portable transmitter which used a *pi*-network

combination output tank circuit and antenna-matching network in the *Jones Amateur Radio Handbook*, the predecessor of the *Radio Handbook*. W6AJF's circuit (see bottom diagram on next page) was identical to that used in many transmitters today.

In spite of its claimed advantages, however, the *pi*-net tank circuit did not gain much popularity up to the start of World War II. But during the war practically every ham was involved in defense electronics work, or was in the Armed Services, and many were directly concerned with mobile and portable communications transmitters. Such equipment was more useful if it could feed r.f. energy into almost any random length of wire in an emergency. It also had to be light and compact, without sacrificing efficiency and reliability. Many of these military transmitters used *pi*-network output tank circuits.

As a result of their wartime experience, these hams came home convinced that an amateur transmitter, even the "full-gallon" size, did not have to be a rack-and-panel monster, forever condemned to inhabit the attic or basement. The idea of the compact, table-top-cabinet transmitter caught on strongly, stimulated by the early appearance in surplus of the Collins-designed AN/ART-13 and similar transmitters. And the *pi*-network speedily took over as *the* final

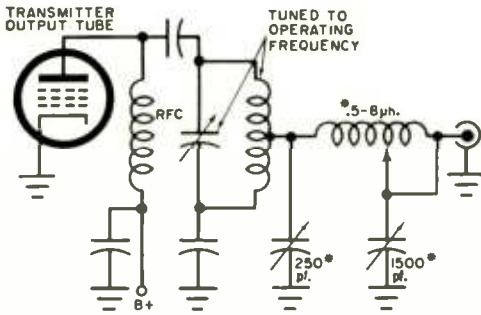

The diagram above shows how the classic pi-network circuit was first used in amateur transmitters in conjunction with a parallel-tuned tank circuit as an antenna-matching network. The modern, simplified arrangement below employs a pi-network combination plate tank circuit and antenna-matching network.

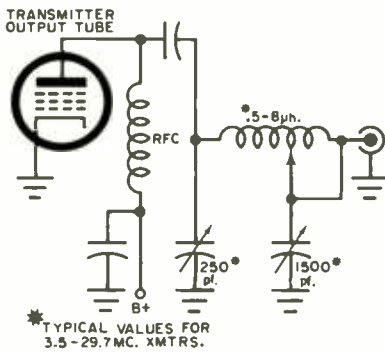

tank circuit, for no other configuration known could be made so compact for the amount of power handled, and still provide front-panel bandswitching, harmonic suppression, reasonable efficiency, and the ability to drive a considerable range of load impedances.

**De-Bugging the Pi-Network.** Unfortunately, the performance of many trans-

mitters did little to bolster the reputation of the *pi*-network. While many users had no trouble, others battled high harmonic output, and replaced numerous final tank components. Some technical Sherlocking soon pinned down the trouble. A lot of transmitter designers, both amateur and professional, had gone overboard in claiming that the *pi*-net was able to drive any and all impedances, and people expected far too much of it. Theory was one thing, but in practical equipment results were far better when the standard *pi*-network was not required to feed loads greater than 100 ohms or so.

Oddly enough, the Collins Radio Company, whose president, Art Collins, first brought the *pi*-network to the attention of radio amateurs as a "wide-range" coupler, was among the first to recognize the practical limitations of the circuit. Consequently, all post-WW-II Collins amateur transmitters have been designed to work into nominal 50- to 75-ohm loads and are not guaranteed to give satisfactory results with appreciably different load impedances.

Some manufacturers were a little slow to restrict the range of load impedances they claimed that their transmitters would match. However, most of today's amateur transmitters are designed to work into 50- to 75-ohm loads (with the exception of some low-power beginners' transmitters). All of those we have had the opportunity of testing—which has been most of them—work well when fed into their rated load impedance.

Thus, after a sometimes painful "growing-up" period, the *pi*-network transmitter output tank circuit finally redeemed its early promise.

## NUVISTOR Q-MULTIPLIER

Regular readers of "News and Views" in POPULAR ELECTRONICS have undoubtedly noticed that many equipment descriptions go something like "He uses a 'you-name-it' receiver, plus a Q-multiplier for additional selectivity." A Q-multiplier is a regenerative circuit connected to the i.f. amplifier of a superheterodyne receiver to modify its selectivity characteristics. The simple Q-multiplier described here, which utilizes a nuvistor, will increase the ability of

an inexpensive communications receiver to separate signals up to 10 times.

**Construction Notes.** The frequency range of the Q-multiplier must match the receiver intermediate frequency; therefore, part values are included in the parts list for units to operate in both the 455-kc. and 1600-kc. i.f. ranges. The unit is built in a 5" x 2 1/4" x 2 1/4" aluminum utility box; the small size of the nuvistor permits uncrowded construction. Although parts placement is not critical, the gen-



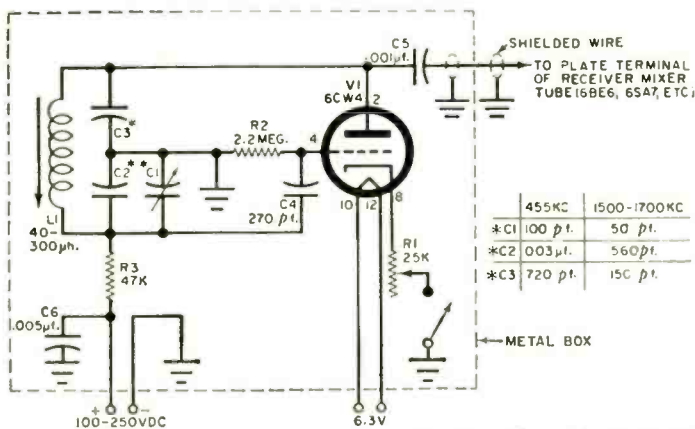

As with other Q-multipliers, the nuvistor version makes use of controlled regeneration to boost selectivity.

Construction in the type of box shown permits parts layout for good electronic function and easy assembly.

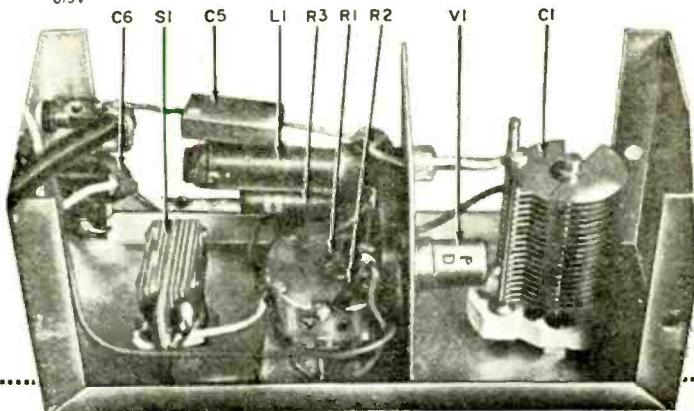

#### PARTS LIST

- \*C1—100-pf. (50pf.) midget variable capacitor
- \*C2—0.003-μf. (560-pf.) mica or silver mica capacitor
- \*C3—720-pf. (150-pf.) mica or silver mica capacitor
- C4—270-pf. mica or paper capacitor
- C5—0.001-μf. mica or paper capacitor
- C6—0.005-μf. mica or paper capacitor
- L1—40-300 μh. slug-tuned coil (Miller #2002 ferrite rod loop antenna or equivalent)
- R1—25,000-ohm potentiometer, linear taper
- R2—2.2-megohm, 1/2-watt resistor

- R3—47,000-ohm, 1/2-watt resistor
- P1—Single-contact "phono" plug or equivalent
- S1—S.p.s.t. switch
- V1—6CW4 nuvistor
- 1—2 3/4" x 2 1/4" x 5" aluminum box (Bud #2104A or equivalent)
- Misc.—Insulated tie points, shielded wire (RG-59U or equivalent), etc.

\*First values are given for 455-kc. i.f. amplifiers; values in parentheses are for i.f.'s in the 1600-kc. range.

eral arrangement shown in the photograph is recommended.

Refer to your receiver instruction manual in connection with the following step. The 6.3 volts at 0.135 amperes and 100-250 volts, d.c., at a few milliamperes required to power the Q-multiplier can be obtained from the receiver's accessory socket (if it has one), or from a convenient spot in the receiver, such as the heater and screen terminals of the output tube socket. The power may also be obtained from a small external power supply. In fact, with an a.c./d.c. type of receiver, an external supply is required;

a Q-multiplier may not give completely satisfactory results on c.w., however, when used with inexpensive a.c./d.c. receivers.

Install a shielded wire between the plate terminal of the receiver's mixer tube (6BE6, 6SA7, etc.) and a connector on the rear of the receiver chassis or to an unused terminal on the receiver accessory socket, to accommodate the output terminal (P1) of the Q-multiplier. After the lead is installed, tune in a steady signal on the receiver, and carefully retune the primary winding of the first i.f. transformer for maximum signal

strength. This must be done to compensate for the capacity added to the primary tuned circuit of the i.f. transformer by the shielded lead.

Then plug in the Q-multiplier, adjust capacitor *C1* and resistor *R1*, and adjust coil slug *L1* for maximum signal strength. Retard control *R1* as necessary during this operation to prevent the Q-multiplier from breaking into sustained oscillation (indicated by a steady

squeal from the loudspeaker or by the receiver suddenly going dead). Also, the value of resistor *R3* may be increased or decreased if necessary to give resistor *R1* full control.

**Operation.** In operation, receiver selectivity is maximum when resistor *R1* is adjusted just below the oscillation point. Capacitor *C1* acts as a vernier tuning control, permitting the desired signal to be picked out of a mess of interference.

## 40-METER ANTENNA FOR SMALL ROOF

Are you one of those people who claim that they don't have room on the roof for an efficient transmitting antenna? Actually, if you have an outside TV antenna, you probably do have room for an effective 40-meter (7-mc.) antenna which will also work on 15 meters. The secret is to use a pair of the TV antenna guy wires as the radiating portion of an "inverted-V" transmitting antenna as shown in the diagram.

Let's work out the details for installing a 40-meter dipole which has an overall length of approximately 66 feet on a 20' x 40' roof—a *very* small roof, incidentally. You'll need a few "egg" type strain insulators (approximately 1<sup>3</sup>/<sub>4</sub>" x 3/4") and some 50-ohm coaxial feedline to do the job. Use RG-8/U coaxial cable if you can; RG-58/U will be okay if the length is not excessive.

**Design Details.** Assuming that the TV antenna is mounted in the center of the roof, we first determine the distance from its base to the corners of the roof, where the guy wires are undoubtedly anchored.

Using the Pythagorean theorem (*the square of the hypotenuse of a right triangle is equal to the sum of the squares of the other two sides, or  $Z^2 = X^2 + Y^2$* ), and substituting the distances from the TV antenna base to one side and to the front (or back) of the roof in the formula, we come up with  $10^2 + 20^2 = 500$ . From a table of roots and squares in a high-school math book, the square root of 500 is something over 22 feet.

Allowing a foot at each end of the dipole for insulators means that approximately 34 feet will be required to accommodate each half of the antenna. Substituting 34 feet for *Z* and 22 feet

for *X* in the formula gives:  $500 + Y^2 = 1152$ . Solving for *Y*, we get *Y* = 26 feet, approximately. Consequently, the apex of the "V" will have to be 26 feet  
(Continued on page 163)

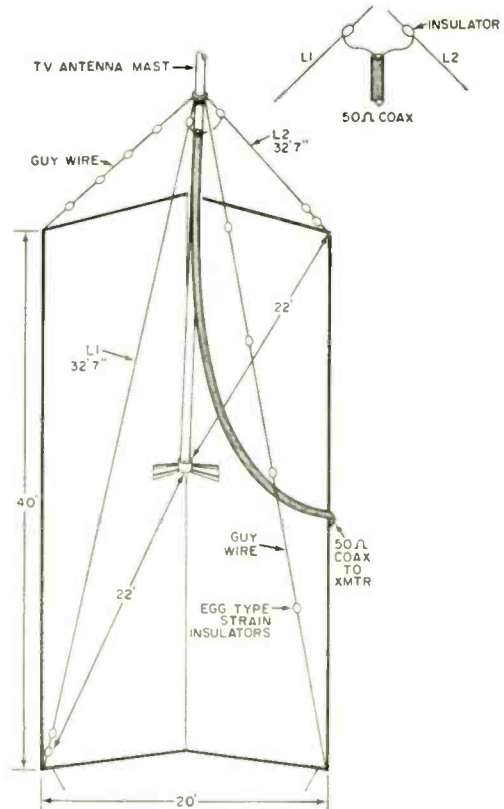

Where roof space is at a minimum, a pair of guy wires supporting a TV antenna installation can be used as the radiating portions of a 7-mc. (and 21-mc.) "inverted-V" transmitting antenna.

**H**OW ABOUT IT, OM, what precautions have you taken to make sure you comply with the FCC's ten-minute identification rule? Do you rely on the tumbling sand grains of an egg timer to alert you for an ID? Or have you placed your faith in one of those gadgets that ticks like a time bomb and, every now and then, gives out with a nerve-shattering bong—provided you go to the trouble of resetting it every ten minutes. Probably you trust to luck and memory to stay legal.

The "Idento-Minder" overcomes the inconvenience of

# THE IDENTO- MINDER



***Ten-minute ID's? You'll  
never forget with a  
gadget for the ham shack  
that times QSO's***

**By HARTLAND B. SMITH, W8VVD**

other timing gadgets, and the uncertainty of depending on memory. Housed in a 3" x 4" x 5" Minibox, it tells you not only when to identify, but also lets you know at a glance how many minutes have elapsed since the previous ID has been given. Its quiet electric movement requires no winding, and its flashing neon indicator, while an effective reminder, will neither startle nor annoy you with unnecessary in-shack QRM.

The heart of the Idento-Minder is a small synchronous timing motor that drives a 3½"-diameter disc at a speed

# THE IDENTO-MINDER

of 1/10th rpm. At ten-minute intervals, a 9/16" hole, cut 1/2" from the edge of the disc, uncovers a blinking neon bulb to alert the operator in time for proper station identification.

**The Blinker Circuit.** A relaxation oscillator circuit is formed by *R1*, *D1*, *C1*, and *I1*. When the direct current passed by *D1* charges *C1* to the bulb's striking voltage, *I1* lights up and discharges the capacitor. As soon as the capacitor voltage drops to a low level, the bulb goes out and remains extinguished until *C1* recharges. The amount of resistance at *R1* governs capacitor *C1*'s charging time. The higher the resistance, the longer the intervals between flashes. When a 470,000-ohm resistor is employed, the neon bulb blinks approximately four times per second.

Although synchronous timing motors are listed in many radio catalogs and bargain bulletins, you undoubtedly *won't*

be able to find one rated at exactly 1/10th rpm. The solution to this problem is to use a pulley and belt arrangement like that shown in the photos below to achieve the proper disc speed.

**Making the Pulleys.** The motor in the prototype is a 1/4th-rpm type which requires a pulley diameter ratio of 1:2.5. A suitable motor pulley was fashioned from a 1/2" length of 1/2"-diameter polystyrene rod. After cutting a fairly deep groove around the rod with a small rat-tail file, the pulley was drilled at the center and pressed on the motor shaft.

A larger pulley, slightly more than 1" in diameter, was then scroll-sawed from a piece of 1/4" plywood and also grooved with a file. After drilling a 1/4" hole at its center, the wooden pulley was pushed onto the shaft of the 1/4" panel bearing assembly visible in the first two photos and fastened in place with epoxy cement. An ordinary rubber band serves as the belt which transfers power from one pulley to the other.

The exact pulley diameters you use will, of course, depend on the speed of your particular motor. The motor suggested in the Parts List, for example, turns at only 1/15th rpm. Therefore, it requires a 1/2" disc pulley and a 3/4" motor pulley to bring the disc speed up

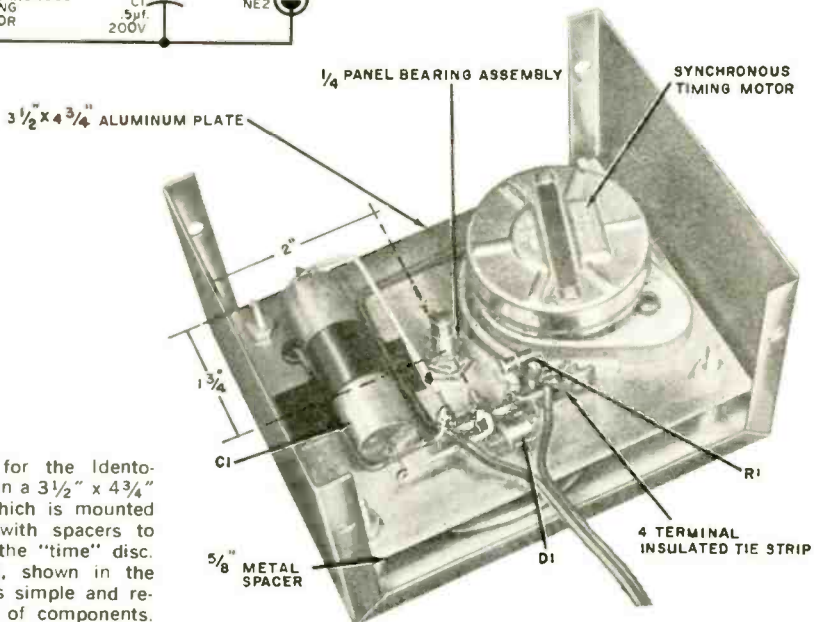
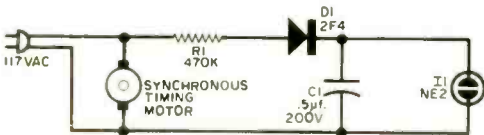

All of the parts for the Idento-Minder are bolted on a 3 1/2" x 4 3/4" aluminum panel which is mounted inside a Minibox with spacers to permit rotation of the "time" disc. The blinker circuit, shown in the schematic above, is simple and requires a minimum of components.

together is used to couple the output of oscillator *V1a* to the grid of *V1b*. The oscillator frequency is basically set by trimmer capacitor *C3* and *L1*. This frequency is variable from about 138 to 142 mc., tuning 6 mc. below the desired signal, which establishes the correct 6-mc. i.f. frequency.

The i.f. output of mixer *V1b* is coupled by *C9* to the tuned circuit of the second detector, which consists of *L3* and *C10*. This circuit is adjusted to 6 mc. by means of the tuning slug in *L3*. The *REGEN* control, potentiometer *R6*, adjusts the screen voltage of *V2*, to control the superregenerative action of the detector stage.

To prevent overdriving the grid of *V3* with the quench frequency output of *V2*, *R8* and *C14* are connected as a low-pass filter section. The detected audio output from *V2* passes via *R8* and *C15* to *GAIN* control *R9*, from which the signal is applied to the grid of *V3*. The amplified output of *V3* is coupled through output transformer *T1* to closed circuit jack *J2* and the loudspeaker. Plugging in a set of headphones disconnects the speaker and provides output to the phones through *C18*.

Power transformer *T2*, rectifier diode *D1*, and the filter made up of *R11* and *C19* provide the necessary B+ voltages.

**Construction.** An 8" x 6" x 4½" aluminum utility box is used as the receiver cabinet. The chassis shelf is made from

an 8" x 4½" aluminum sheet. Two pieces of aluminum angle support the chassis shelf about 1¼" from the bottom of the cabinet.

The parts layout is shown in Figs. 2, 4, and 5, and, as we said before, the placement of parts and wiring must be closely followed, as in all VHF devices.

Tuning capacitor *C2* is mounted on three ⅜" metal spacers. A solder lug is screwed to a tapped hole in the frame of *C2*, and soldered to the free end of a second solder lug, which is held to the chassis shelf by one of the screws that secures the socket of *V1*. This provides a short ground path for *C2*, and helps to stiffen the structure mechanically, which improves stability.

A "K-Tran" type of mounting plate was used to mount 6-mc. coil *L3*. Since it is not an exact fit for the Stancor coil specified, care must be taken to avoid shorting the coil terminals. Use short lengths of sleeving over the coil leads or, alternatively, drill holes in the chassis and mount *L3* by its spring clips.

A 3" square of perforated aluminum is used as the speaker grille, and a 1" bracket held by the lower left-hand speaker mounting screw aids in supporting the chassis. The small pointer cemented to the back of the outer tuning knob can be made of stiff cardboard or white plastic. The dial calibration is inked on heavy bond paper and taped to the panel.

Fig. 1. Schematically, the 2-meter set closely resembles the 6-meter unit.

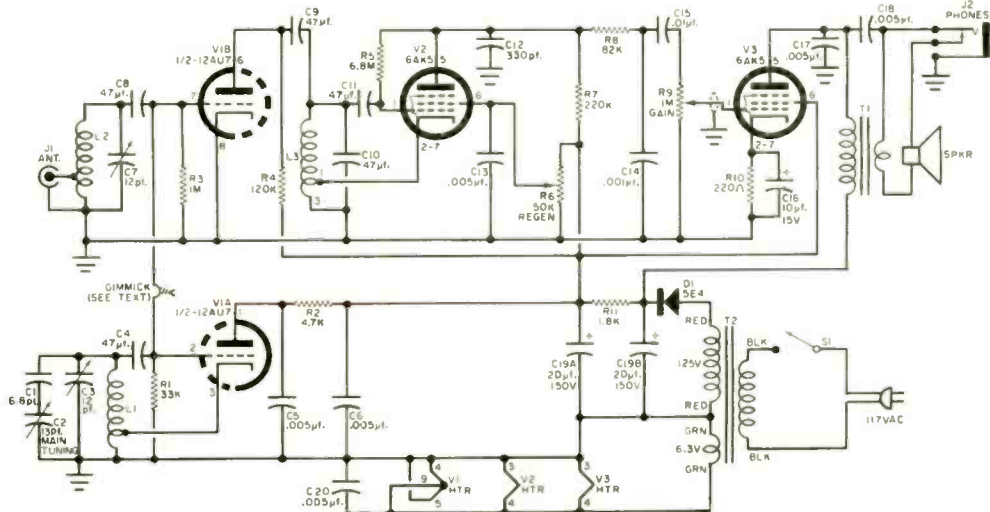

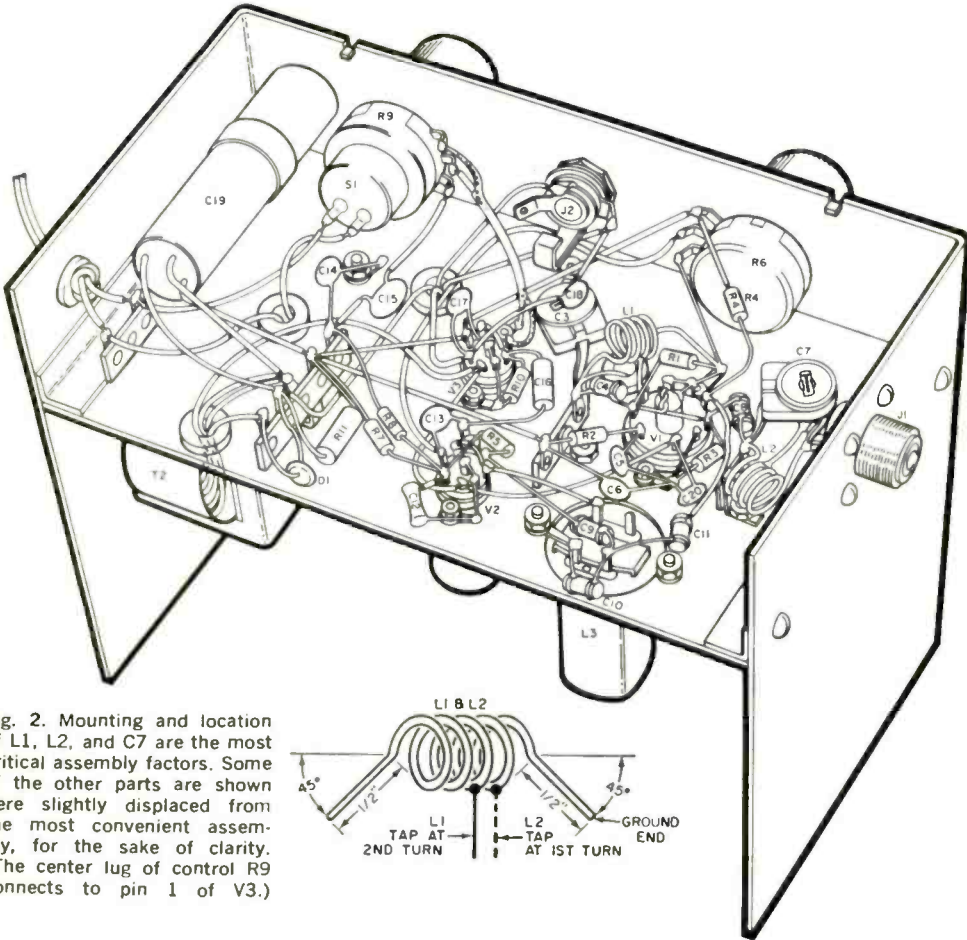
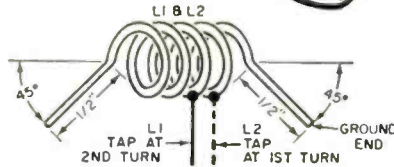

Fig. 2. Mounting and location of L1, L2, and C7 are the most critical assembly factors. Some of the other parts are shown here slightly displaced from the most convenient assembly, for the sake of clarity. (The center lug of control R9 connects to pin 1 of V3.)



### PARTS LIST

- |  |   |  |
|--|---|--|
| C1—6.8-pf., 600-volt, NPO ceramic tubular capacitor (5-pf. and 2-pf. units wired in parallel)  | R1—33,000 ohms  | } All resistors<br>1/2-watt, 10% unless<br>otherwise specified |
| C2—13-pf. variable capacitor, with vernier shaft and dual knob assembly (Lafayette 32-0919, 18-79, and 18-77—\$1.95)                                 | R2—4700 ohms  |  |
| C3, C7—12-pf., NPO ceramic trimmer capacitor   | R3—1 megohm   |  |
| C4, C8, C9, C10, C11—47- $\mu$ f., 600-volt ceramic disc capacitor   | R4—120,000 ohms   |  |
| C5, C6, C13, C17, C18, C20—0.005- $\mu$ f., 600-volt ceramic disc capacitor  | R5—6.8 megohms  |  |
| C12—330-pf., 600-volt ceramic tubular  | R6—50,000-ohm carbon potentiometer  |  |
| C14—0.001- $\mu$ f., 600-volt ceramic disc capacitor   | R7—220,000 ohms   |  |
| C15—0.01- $\mu$ f., 600-volt ceramic disc capacitor  | R8—82,000 ohms  |  |
| C16—10- $\mu$ f., 15-volt miniature electrolytic   | R9—1-megohm carbon potentiometer (with S1)  |  |
| C19—Dual 20- $\mu$ f., 150-volt electrolytic capacitor   | R10—220 ohms  |  |
| D1—400 PIV, 450-ma. silicon rectifier (International Rectifier Corp. 5E4 or equivalent)  | R11—1800 ohms, 2 watts  |  |
| J1—Chassis mounting type coaxial receptacle (Amphenol 83-1R or equivalent)   | S1—S.p.s.t. switch (on R9)  |  |
| J2—Closed circuit phone jack   | SPKR—3.2-ohm, 3" speaker (Utah SP3A or equivalent)  |  |
| L1—4 turns of #16 tinned copper wire, wound 1/2" long on 1/4" diameter; tap at second turn from ground end, leave 1/2" leads at 45° angle—see Fig. 2 | T1—Output transformer; primary, 10,000 ohms; secondary, 4 ohms (Stancor A3879 or equiv.)  |  |
| L2—Same as L1 but tap at first turn from ground end—see Fig. 2   | T2—Power transformer; primary, 117 volts; secondaries, 125 volts @ 15 ma., 6.3 volts @ 0.6 amp. (Stancor PS-8415 or equivalent)   |  |
| L3—Oscillator coil (Stancor RTC 8764)  | V1—12AU7A tube  |  |
|  | V2, V3—6AK5 tube  |  |
|  | 1—8" x 6" x 4 1/2" aluminum utility box (LMB 146 or equivalent)   |  |
|  | 1—8" x 4 3/8" aluminum plate (for chassis shelf)  |  |
|  | Misc.—Line cord and plug, "K-Tran" mounting plate (for L3), tube sockets, aluminum angle stock, grommets, terminal strips, knobs, perforated aluminum for speaker grill, #16 bus wire, insulated hookup wire, shielded wire, etc. |  |

to 1/10th rpm. If you use a motor with a different speed, vary the pulley size accordingly.

All of the parts for the Idento-Minder are mounted on the 3 1/2" x 4 3/4" aluminum plate. Approximate the parts layout, and then drill holes for the timing motor, the panel bearing assembly, and the four-terminal tie strip. Drill four mounting holes for the bolts with spacers which hold the panel to the front of the Minibox. While you're at it, drill a hole 9/16" in diameter centered 13/16" from the top of the front panel of the Minibox for the "time" window, and another hole (line with a grommet) in the back for the a.c. line cord.

**Assembly.** Mount all of the components on the aluminum panel. The tie strip supports *D1*, *R1*, and the leads of *C1*. You can prevent the capacitor from flopping around inside the case by taping it tightly to the panel as shown in the first photo.

After fabricating and installing the pulleys, cut a 3 1/2"-diameter disc from stiff cardboard or other suitable material, and make a 9/16" hole centered 1/2"

from the edge for the warning light to shine through. Spray the disc with black paint and apply equally-spaced number decals. To install it, simply cement it to the disc pulley.

To finish the job, insert bolts through the front of the Minibox, slip 5/8" metal spacers over them to provide clearance between the panel and the box for the rotating disc, and bolt the panel in place. Screw on the back of the Minibox, and you're ready to go.

Install the Idento-Minder where it will be in your line of vision when you're on the air. Don't worry about having to watch the little gadget like a hawk, however, since its flashing neon indicator is so insistent that you'll have a difficult time ignoring it, even when your eyes are focused on an object as much as 90 degrees away from it. Due to the disc's slow rotation, the bulb is visible for almost a minute as the hole passes by, and you're bound to notice the winking light. The numbers also keep you alert because they indicate how many minutes have gone by since the previous ID. —30—

**PARTS LIST**

- C1*—0.5- $\mu$ f., 200-volt paper capacitor
- D1*—200-ma., 400-PIV silicon rectifier (Sarkes Tarzian 2F4 or equivalent)
- I1*—NE-2 neon bulb
- R1*—470,000-ohm, 1/2-watt resistor
- M*—120-volt, 60-cycle synchronous timing motor (Allied Radio, 78B-497, \$2.40)
- P*—1/2" disc pulley for use with above motor—see text

- 1—3/4" motor pulley for use with above motor—see text
- 1—3" x 4" x 5" Minibox (Bud CU-2105-A)
- 1—3 1/2" x 4 3/4" aluminum plate
- 1—1/4" panel bearing assembly
- 4—5/8" spacers for #6 machine screws
- Misc.—Decals, 4-terminal tie strip, hookup wire, hardware, 3 1/2" cardboard disc, black spray paint

Pulleys are mounted on front of inside panel and coupled with a rubber band. Mount bulb *I1* as shown.

Glue the 3 1/2" disc to the large pulley, and position bulb *I1* so it shines through the "ten minute" hole.

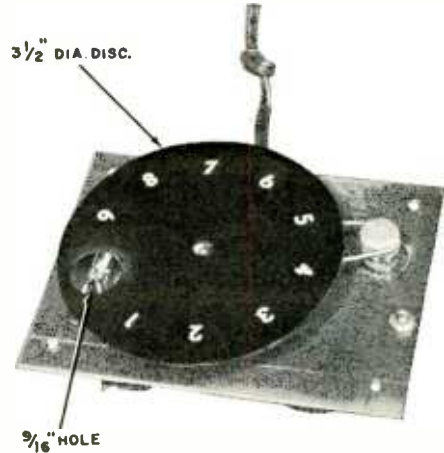
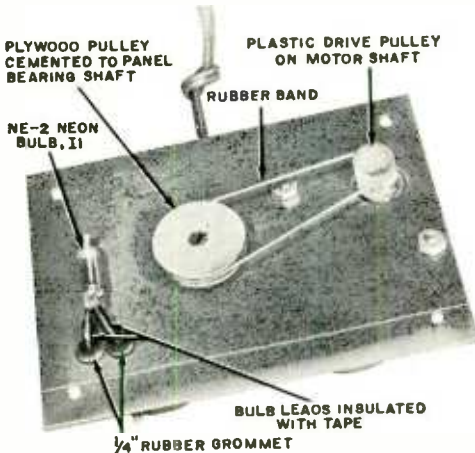

Need a receiver for the 2-meter amateur band? You can build this sensitive unit easily, at low cost.



# 2-METER SIMPLE SUPERHET

By CHARLES GREEN, W3IKH

READERS RESPONDED to the appeal of the "Simple Superhet for 6" (1964 ELECTRONIC EXPERIMENTER'S HANDBOOK) so well that a 2-meter version was quickly assembled. It covers the 144- to 148-mc. amateur band, with enough overlap at the band ends to include MARS and CAP frequencies. Three tubes are used to provide a superhet-type front end and a superregenerative second detector, as in the 6-meter version. This combination provides exceptional performance, considering the number of tubes and the overall simplicity of the circuit.

Most details of design and construction closely follow those of the 6-meter model, with a utility box again serving as the cabinet, which also contains the built-in speaker and power supply. The construction is straightforward and free of tricky assembly problems, so with the careful wiring and attention to detail that all VHF circuits require, you should have little trouble getting it going.

**About the Circuit.** The coaxial line from the antenna connects to jack *J1*, which is connected internally to the tuned input circuit, made up of *C7* and *L2*. This circuit is adjusted to peak broadly at 145 mc. by means of trimmer capacitor *C7*. The 2-meter signals are coupled to the grid of mixer *V1b* via *C8*.

A "gimmick" capacitor made by twisting two lengths of insulated wire



The connection from *L1* to *C1* is made by means of a piece of #16 bus wire, which passes through a grommeted hole in the chassis. The "gimmick" capacitor is formed by soldering two short pieces of insulated hookup wire to pins 2 and 7 of *V1*'s socket, and twisting them together. Trim the pair with your diagonal cutters to leave about two complete twists.

Several  $\frac{3}{8}$ " holes drilled in the back of the cabinet cover will provide ventilation. In addition, two accurately placed holes in the bottom are required to permit adjustment of trimmers *C3* and *C7* with the cover on.

(Continued on page 157)

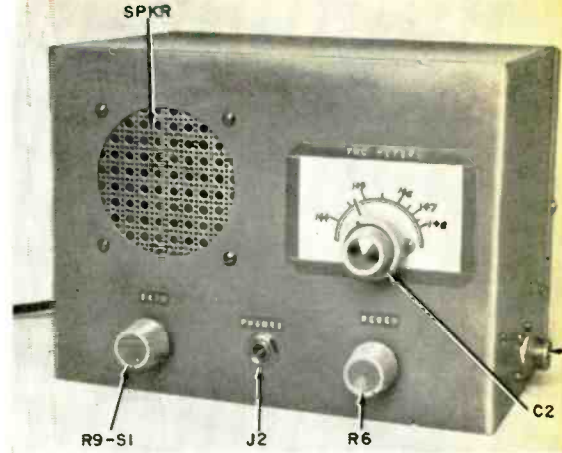

Fig. 3. Panel controls are straightforward and functional, for ease and efficiency of operation.

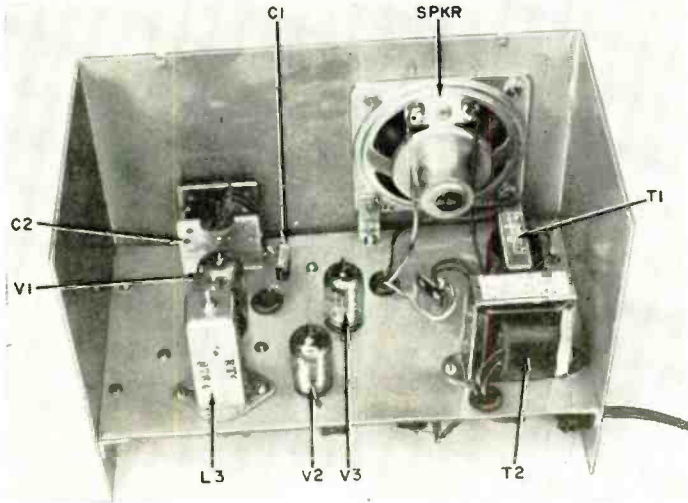

Fig. 4. Rigidity in the mounting of *C1* and *C2* is important for good tuning stability. This top view shows their relationship.

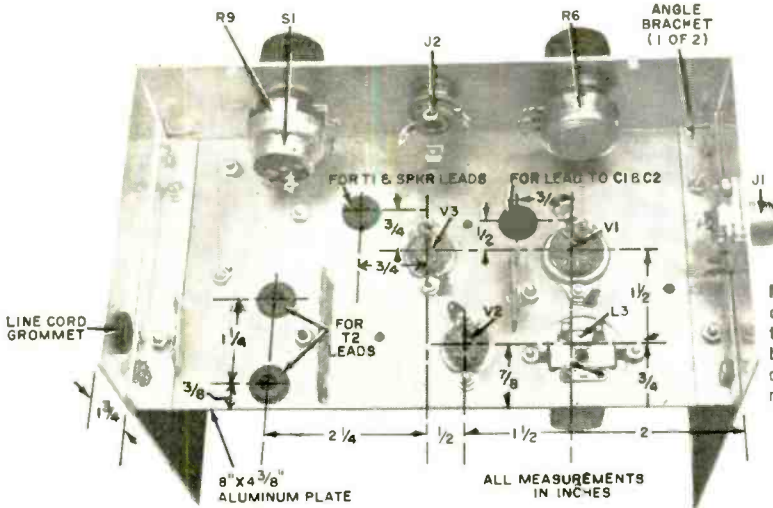

Fig. 5. The spacing and dimensions in this bottom view are important because of the very high operating frequency, and must be followed closely.

## Pacific

electronic organs  
are available  
by mail,  
completely  
assembled, or in  
build-it-yourself  
kits —  
the first with  
pre-wired chassis.



Avoid dealer profits. Buy directly from the manufacturer. Pacific has easy-to-play theatre-style "horseshoe" consoles; all-transistorized circuitry; built-in reverberation, sustain, percussion, vibrato; and complete organ voicing. Several models available.

## Pacific ORGANS

a division of Electric Organ Arts  
597 N. Lake Ave. / Pasadena, California

Write Dept. E11B for additional information.  
CIRCLE NO. 4 ON READER SERVICE CARD

**actionCITI-FONE SS**

Microphone Preamp • "Dual" Function Panel Meter • Pulse Tuned AM • Delta Tuning • Scratch Immune • Selector

**FULL 23 CHANNEL**

Compact 8" x 11" x 4 1/2" • Ready to Operate • Double Tuned IF's • Noise Immune • Illuminated Meter and Channel Selector

AC/DC Power Supply • Triple Tuned RF

WRITE OR PHONE TODAY FOR COMPLETE INFORMATION  
COMPLETE **\$169.50**



MULTI-ELM COMPANY

21470 COOLIDGE HIGHWAY OAK PARK 37, MICH.

Name \_\_\_\_\_

Address \_\_\_\_\_

City \_\_\_\_\_ Zone \_\_\_\_\_ State \_\_\_\_\_

CIRCLE NO. 25 ON READER SERVICE CARD

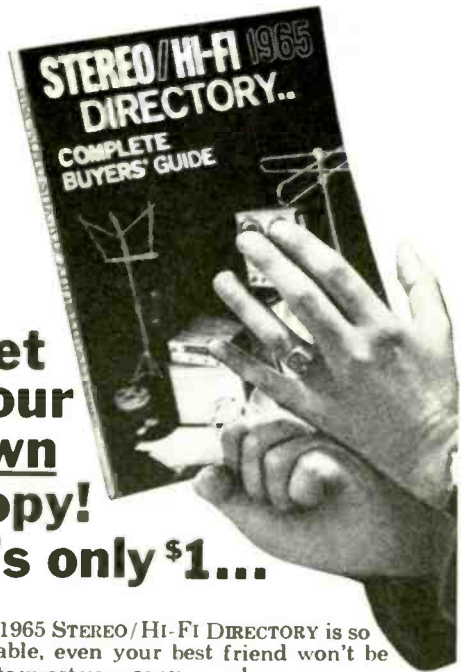

## Get your own copy! It's only \$1...

The 1965 STEREO/HI-FI DIRECTORY is so valuable, even your best friend won't be able to wrest your copy away!

In 180 photo-packed pages, you get authoritative prices and performance data on over 2,000 components from 170 manufacturers!

This all-new Buyer's Guide gives you vital statistics on *speakers, tuners, receivers, turntables, changers, cartridges*—on every hi-fi component manufactured today! Use it to compare similar items, dollar-for-dollar, feature-for-feature, *before you buy*, and avoid excessive prices, disappointment, and costly mistakes!

The 1965 STEREO/HI-FI DIRECTORY also contains...an up-to-the-minute listing of every hi-fi dealer in the country...and a complete run-down of all the FM stereo multiplex stations in the U.S. and Canada!

But most important — if you want to get top value on every hi-fi component you buy during the next twelve months...

### SEND JUST \$1 NOW FOR YOUR COPY OF THE 1965 STEREO/HI-FI DIRECTORY

FILL IN AND MAIL THIS COUPON RIGHT NOW!

Ziff-Davis Service Division • Dept. S.H.  
589 Broadway • New York, N.Y. 10012

Send me a copy of the New, up-to-date 1965 STEREO/HIFI DIRECTORY! My dollar (plus 15¢ for shipping and handling; 25¢ outside U.S.A.) is enclosed.

name \_\_\_\_\_ please print

address \_\_\_\_\_

city \_\_\_\_\_ state \_\_\_\_\_ zip code \_\_\_\_\_

EEH-1

# Chapter



# ELECTRONICS for the WORKSHOP

**S**ELECTING material for this chapter always presents a bit of a problem for your Editors. We solve this problem by introducing test equipment that is unusual and not readily available in kit form, or gadgets that can only have a special place in your workshop. The "Electronic Stop Watch" is a good case in point; connected to a 6-digit readout, the stop watch is accurate to a tenth of a second—and because it is all-electronic, it can be remotely controlled and a total of 27 hours can be timed! The "Grid-Dip Meter," "C Bridge," and the "Meterless VTVM" are all low-cost construction projects for the fellow whose workshop budget is at a low ebb.

"Bargains by the Bagful" is a report on the current practice of selling resistors and capacitors sight unseen. You can stockpile your lab or workshop, but be cautious—some bargains are not what they seem.



Bargains by the Bagful.....	Oliver P. Ferrell	122
Handy EP Pack.....	E. G. Louis	126
The Squealer.....	Frank A. Parker	127
Meterless VTVM.....	William J. Millard	131
Electronic Stop Watch.....	Fred Blechman, K6UGT	137
C Bridge.....	Frank A. Parker	141
VHF Grid-Dip Meter.....	E. H. Marriner, W6BLZ	143
The Best of Tips and Techniques.....		146

# BARGAINS

---



---

## BY THE BAGFUL

*With a few careful purchases, you can stockpile many of the resistors and capacitors you'll need for project building*

By OLIVER P. FERRELL, Editor

EVERY radio parts store worth its salt these days offers a variety of "poly" bags full of capacitors, resistors, potentiometers, transistors, diodes—everything but the kitchen sink. Mail-order catalogs and flyers are full of assortment offers and several companies specialize in selling nothing but bags of various radio components.

The editorial staff has spent several months quietly investigating poly bag assortments of resistors and capacitors. These two categories of *bargain bags* will be discussed here.

First of all, why buy assortments at all? Inveterate electronic project builders are well aware that there are numerous ways and means of cutting project costs.

The so-called "junk box" of re-usable parts is one method. A second is stocking up resistors and capacitors obtained in poly bag assortments. As opposed to buying each resistor or capacitor in a project individually, a stockpile can shave these costs by 70-80 per cent.

We found that poly bag assortments included everything from floor sweepings of some unknown manufacturer to carefully packaged, top-quality merchandise. The buyer has no recourse (*caveat emptor*) but to accept what the poly bag contains without question. The only firm guideline that we could uncover as to the possible worth of a bargain bag is to know with whom you are dealing. Mail-order companies with business reputa-

These are a few of the different types of capacitors (mica, ceramic, molded paper, etc.) culled from poly bag assortments. The two mica capacitors with eyelet leads are over 15 years old. They are not color-coded; values are hot-stamped on bodies of the capacitors.

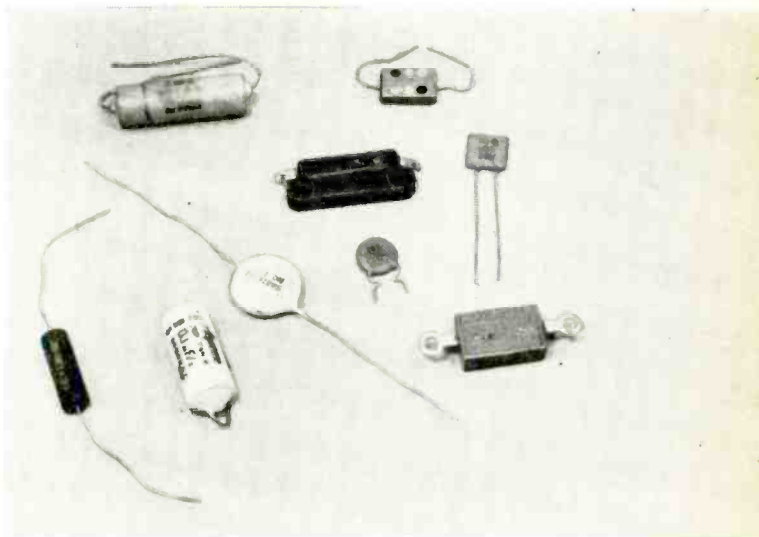

In disposing of these tubular ceramics, no effort was made to even separate them from an adhesive strip. Obviously, they are all the same value.

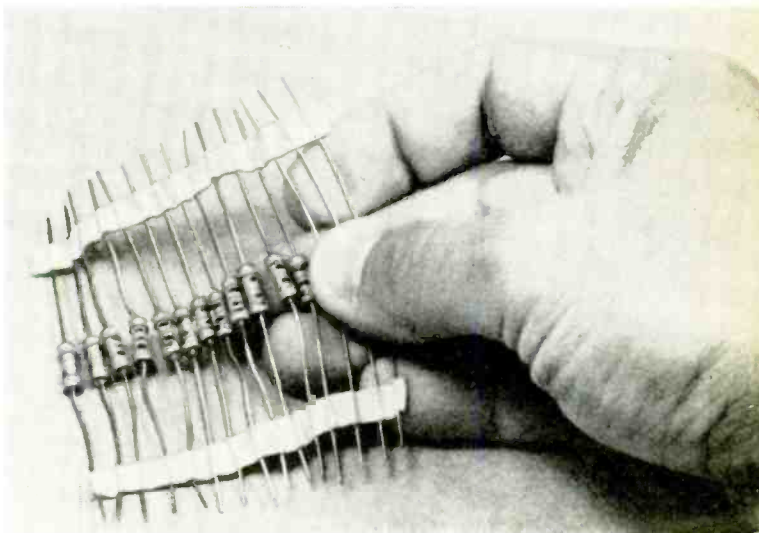

tions at stake and speciality houses dealing in bargain bags will nine times out of ten sell exactly what they advertise.

The same cannot be said for at least one-third of surplus or distress equipment mail-order houses, or most of the inhabitants of "radio row" stores in major metropolitan areas. The latter stores—specializing in a walk-in-off-the-street trade—offer very tempting bargains that are difficult to resist. But, resist them you should, even though the investment is almost always under \$2. Often as not, you'll be glad you did.

**Bargains, Bargains, Bargains?** As examples of "radio row" transactions, here are two instances that occurred during our poly bag hunts in lower Manhattan. In one store a sign proclaimed drastic price reductions in resistor assortments from \$1.98 to \$1.49 to a new final "low-low" of 99¢—an irresistible bargain. A sealed box (poly bag inside) was purchased and from its weight appeared to be packed. It was—with 481 resistors of the same value!

A second store offered precision wire-wound and carbon-film resistors—30 for \$1.29. The count was correct and we

This was our prize purchase. All 481 resistors are of the same value although the exterior wrapping of this assortment said it contained 100 different resistors.

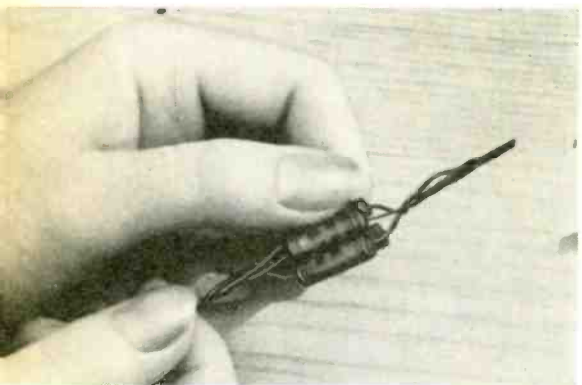
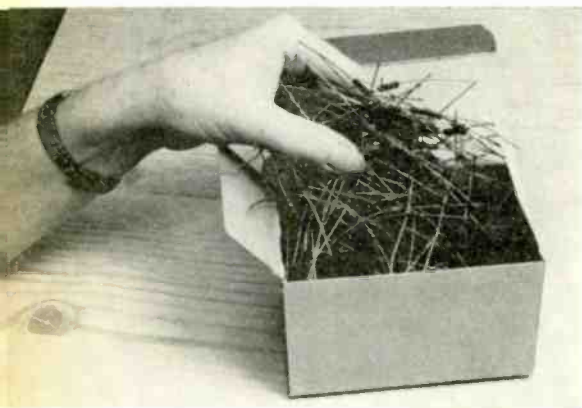

In the politest terms, these four resistors can be called "floor sweepings." Twisting the leads together was done by a technician, eliminating the chance that the resistors would be new stock.

found values ranging from a low of 100 ohms to a high of 3.32 megohms. However, four of the 30 resistors were unmarked and if you can describe a more worthless electronic item than an unmarked "precision" resistor we'd like to hear about it.

Purchases via mail order from any of the five top distributors, plus one speciality mail-order house, were satisfactory. With few exceptions, the components were clean, well-marked, of fairly recent manufacture and of good quality. A sampling of capacitors indicated that only one out of a possible 50 would be

### "BAD" ASSORTMENT

#### 25 Mica Capacitors for 89¢

4	3.7 $\mu\text{f.}$	2	68 $\mu\text{f.}$
1	7.5 $\mu\text{f.}$	1	680 $\mu\text{f.}$
1	25 $\mu\text{f.}$	1	800 $\mu\text{f.}$
3	27 $\mu\text{f.}$	2	900 $\mu\text{f.}$
8	60 $\mu\text{f.}$	2	1000 $\mu\text{f.}$

Although far from obsolete, this assortment clearly established that mica capacitors are "on their way out." Capacitors from five different manufacturers were represented and all showed distinct signs of aging. Seven capacitors had pre-World War II color coding (nearly invisible) and two of the 27- $\mu\text{f.}$  capacitors were unmarked. This was a local (New York City) purchase.

### "EXCELLENT" ASSORTMENT

#### 50 Tubular Capacitors for 98¢

19	0.001 $\mu\text{f.}$ , 60 w.v.d.c.
6	0.0015 $\mu\text{f.}$ , 600 w.v.d.c.
1	0.0018 $\mu\text{f.}$ , 400 w.v.d.c.
6	0.002 $\mu\text{f.}$ , 150 w.v.d.c.
6	0.002 $\mu\text{f.}$ , 400 w.v.d.c.
1	0.0022 $\mu\text{f.}$ , 400 w.v.d.c.
1	0.0022 $\mu\text{f.}$ , 600 w.v.d.c.
4	0.0027 $\mu\text{f.}$ , 600 w.v.d.c.
1	0.003 $\mu\text{f.}$ , 400 w.v.d.c.
5	0.005 $\mu\text{f.}$ , 200 w.v.d.c.
1	0.007 $\mu\text{f.}$ , 600 w.v.d.c.
2	0.01 $\mu\text{f.}$ , 100 w.v.d.c.
1	0.01 $\mu\text{f.}$ , 600 w.v.d.c.
1	0.015 $\mu\text{f.}$ , 200 w.v.d.c.
2	0.1 $\mu\text{f.}$ , 200 w.v.d.c.
1	0.2 $\mu\text{f.}$ , 400 w.v.d.c.
1	0.5 $\mu\text{f.}$ , 600 w.v.d.c.

This mail-order assortment contained 59 capacitors instead of the advertised 50. All were in good shape, although obviously "over-runs" from TV set manufacturers. All were clearly imprinted, and all tested "good."

leaky, shorted or open on being tested.

Some of the problems that *do* beset bargain capacitors, especially those purchased from doubtful sources, are old, obsolete or indistinguishable color codes and markings. Fortunately, these troubles do not usually affect resistors. Our sampling showed that only one out of every 90 resistors would either be open or have indiscernible markings.

On the other hand, precision resistors are *always* a poor buy in poly bag assortments. The offerings are generally over-production runs of highly irregular values used in test equipment manufac-

### "BAD" ASSORTMENT

#### 50 Resistors for 99¢

2 0.33 ohm, 1/2 watt	1 7500 ohm, 1 watt
3 3.3 ohm, 1/2 watt	1 8200 ohm, 1/2 watt
1 15 ohm, 1/2 watt	2 8200 ohm, 3 watt*
2 180 ohm, 1/2 watt	2 10,000 ohm, 1 watt
2 390 ohm, 2 watt*	1 10,500 ohm,
1 470 ohm, 3 watt*	precision
1 560 ohm, 1 watt	1 18,000 ohm, 2 watt
1 680 ohm, 1 watt*	1 68,000 ohm, 2 watt,
1 820 ohm, 1/4 watt,	20%
20%	1 75,000 ohm,
2 910 ohm, 1/2 watt,	1/2 watt
5%	2 44,000 ohm, 2 watt
1 2700 ohm, 1 watt	2 330,000 ohm,
1 4700 ohm, 1 watt	1 watt
1 4700 ohm, 4 watt*	1 750,000 ohm,
3 4700 ohm, 2 watt	1 watt, 5%
1 6800 ohm, 1/4 watt,	1 1.2 meg., 1 watt
20%	1 2.2 meg., 1 watt
2 6800 ohm, 1/2 watt	2 20.0 meg., 1/2 watt
1 6800 ohm, 1 watt	

At first glance—while the resistors were still in the poly bag—this looked like a promising purchase. Unfortunately, the assortment was more of a hodge-podge containing all wattage values from 1/4 to 4 watts. Particularly bad in this assortment was the absence of values in the range of 75,000 to 330,000 ohms. All resistors identified by the asterisk had no color code. This was a "radio row" purchase.

ture. Wattages are rarely indicated (perhaps on one unit out of ten) and you take a chance in using a precision resistor in any circuit that draws more than a watt. Also, the need for precision resistors in everyday electronic experimenting is unbelievably small.

**What To Buy.** There are several rules-of-thumb in buying poly bags. If you can see the bags be sure that component leads are uncut and have not been shortened for use in printed circuit wiring. In the case of resistors, check that the one-half-watters have either a silver or gold tolerance color-coding band. Also, ancient 2-watt resistors were much longer and thinner than present-day units—they are not a good buy.

Capacitors must be watched carefully, although the signs of age are more obvious (see p. 123) than with resistors. Ceramic disc capacitors should be checked for signs of poor dipping—the colored ceramic insulation does not cover all of the capacitor body. Units of this type are "seconds" and are not safe to use.

### "EXCELLENT" ASSORTMENT

#### 40 Disc Ceramic Capacitors for \$1

2 12.0 μmf.	3 100 μmf.
1 15.0 μmf.	1 120 μmf.
1 18.0 μmf.	7 470 μmf.
3 22 μmf.	1 390 μmf. (1.5 kv.)
3 27 μmf.	1 680 μmf.
2 33 μmf.	4 1000 μmf.
1 39 μmf.	2 0.005 μf.
2 47 μmf.	6 0.01 μf.
1 56 μmf.	3 0.02 μf. (1.6 kv.)
2 68 μmf.	1 0.05 μf. (25 v.)
1 82 μmf. (2 kv.)	1 0.047 μf. (50 v.)

Even though this assortment contained a few "seconds" there was a surplus of nine extra capacitors—plus an unusual 27/27 μmf. duoceramic not listed above. The distribution of values was remarkable in this poly bag—note the volume of most-used values (470 and 1000 μmf.).

In the great welter of assortments, special "buys," and "good deals," the average buyer of poly bags has reason to be hopelessly confused when it comes to determining just what he's getting for his money. As this article was being written, the following average prices (cents-per-unit) were computed from our survey.

#### Resistors:

Top-grade 1/2-watt	.....	.03
Second grade 1/2-watt	.....	.015
1- and 2-watt	.....	.035
3-watt, or higher (carbon)	.....	.05
3-watt, or higher (w.w.)	.....	.08
Precision	.....	.07

#### Capacitors:

Ceramic discs	.....	.03
Ceramic tubulars	.....	.02
Top-grade mica	.....	.03
Second grade mica	.....	.02
Paper or molded	.....	.035

The experimenter will find that an \$8-\$10 investment in poly bag resistor and capacitor assortments will be money well spent. We suggest that the following components be purchased as a start: two good 1/2-watt resistor assortments, one good 1-watt resistor assortment, one ceramic disc assortment, and two bags of mica or molded capacitors. Unless you need them for some specific purpose, defer buying precision resistors or electrolytic capacitors until a later date. However, if you expect to try out transistor circuits, a good assortment of high-capacitance, low-voltage electrolytics can be added to the above list. -50-

# Handy EP Pack

*Like to breadboard tube circuits? Here's an Experimenter's Power pack that makes it easy*



By E. G. LOUIS

ONE OF THE BIG REASONS transistor circuits are popular with experimenters is that the only power supply required is a small battery. Tubes can do a number of jobs better than transistors, however, and if you take an hour or two to assemble this simple supply, your power problems for one- and two-tube circuits will be ended.

Since the EP Pack is a medium-voltage supply, a rather elegant filter section can be used without straining the budget; in any case, the junk box should provide numerous substitutions. Transformer T1 (Merit P-3046 or equivalent) delivers 150 volts at 25 ma., and 6.3 volts at 0.5 ampere. A half-wave rectifier circuit is used with a 50-ma., 300-PIV (or better) silicon rectifier (D1). Resistor R1—1 watt will suffice—prevents surge damage to D1 as C1 charges. The filter capacitors (C1, C2, C3) are all in one multi-section can, and should be rated at 250 w.v.d.c. Use an 8-henry choke for L1 (Stancor C1355). The only other parts required are a small chassis, tie points, a s.p.s.t. toggle switch, and a three-terminal, screw-type terminal strip.

Mount the major components, placing the capacitor can so that it is not in direct contact with the heat-producing transformer. Also, some degree of separation between the choke and transformer should be maintained to prevent hum coupling. The wiring under the chassis is connected to standard tie points. Be sure to observe capacitor and rectifier polarities; use a heat sink when wiring the rectifier.

If the supply will not be connected to a constant load, add a bleeder resistor (60,000 ohms, 2 watts) between terminals 1 and 3 (the B-plus and ground terminals). If isolated filament output is desired, a four-screw terminal strip can be used—five screws if the filament winding of the transformer employed has a center tap. A neon pilot lamp can be connected across T1's primary, and another optional feature would be a 1/2- or 1-amp fuse connected in one leg of the primary.

-30-

Simple power supply for experimenting with tube circuits is cinch to build, and can usually be put together with junk box materials. If you use a higher voltage transformer, you must rate other components accordingly.

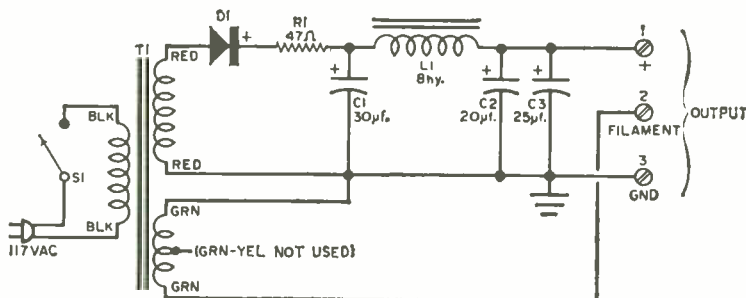



# THE

# SQUEALER

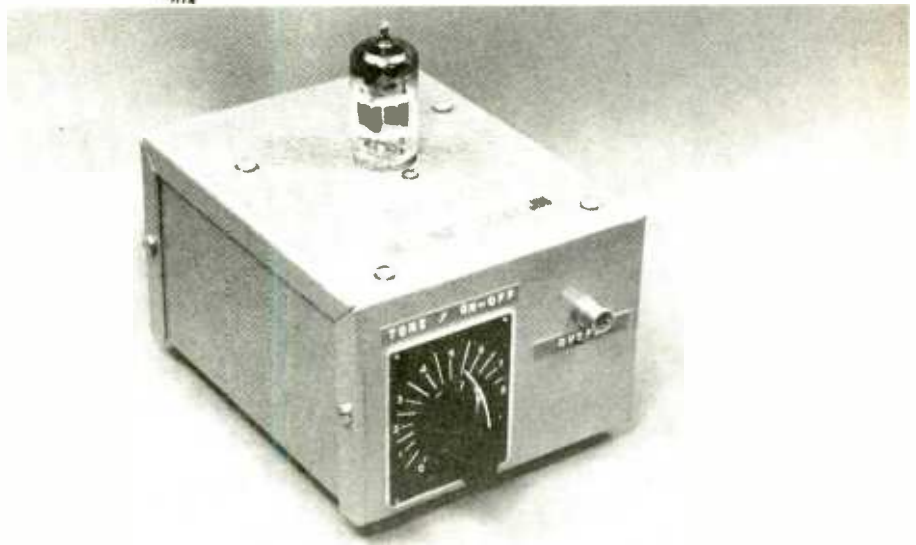

By FRANK A. PARKER

*Another starved current circuit application—an audio oscillator*

AMAZING AS IT SOUNDS, this starved circuit vacuum-tube audio-note generator has a plate supply of only 5 volts! What's more, the 100-microampere plate current drain beats many transistor circuits. In a unit similar to the "Starved Circuit Amplifier" which appeared in the 1963 ELECTRONIC EXPERIMENTER'S HANDBOOK, the single 12AT7 dual-triode does not need the usual high-voltage plate supply transformer. Plate voltage is taken off the same 6.3-volt winding used for the tube's heater. In the author's model, plate voltage was reduced to an unbelievable 3 volts before the *Squealer* was silenced.

The output of this easy-to-build unit can be varied from 20 cycles to

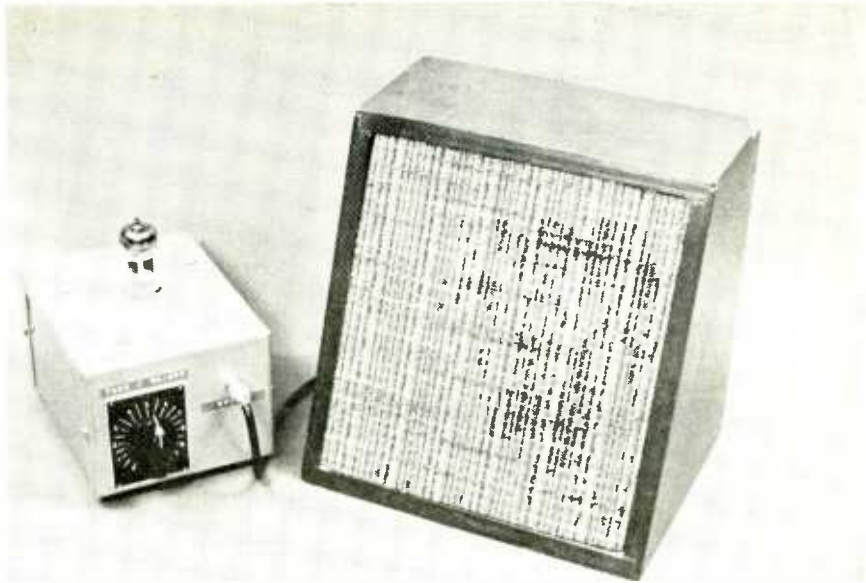

Coupled to a 3-transistor amplifier in the speaker enclosure, the Squealer had a resounding wallop. If the Squealer's output circuit were broken with a telegraph key, this arrangement could be used for code practice.

about 12,000 cycles with a single control. Audio output voltage is high enough to drive any hi-fi amplifier to full volume. The *Squealer* makes a fine auxiliary audio source in the shack. And, in emergencies, or for mobile use, it can run from a 6-volt battery.

**About the Circuit.** The *Squealer* uses dual triode *V1* in a modified multivibrator oscillator circuit. Coupling between stages is through the cathode connection, resistor *R2* being common to both triodes. Feedback is maintained by capacitor *C1*, which together with potentiometer *R3* determines the *Squealer's* audio output frequency. The upper frequency limit can be pushed to 15,000 cps or higher by decreasing capacitor *C1* to about 0.01  $\mu\text{f.}$  or lower. Resistor *R1* serves as a plate load for *V1a*; audio output is tapped off the same plate via capacitor *C2*.

The *Squealer* is isolated from the power line by filament transformer *T1*. The same transformer is also used in a standard half-wave rectifier circuit with diode *D1* and RC filter *C3*, *C4*, *R5*. Resistor *R4* protects *D1* against current surges. For battery operation, a 6-volt d.c. source is connected between point *A* and ground. Useful output can be obtained with a d.c. source as low as 3 or 4 volts operating *V1's* plate and heater.

Experimenters will realize how this circuit differs from the previously mentioned "Starved Circuit Amplifier." The latter circuit produced a high signal gain through the use of a 4.3-megohm plate load resistor. Furthermore, the gain could only be obtained by forcing a voltage drop of several hundred volts across the plate load resistor. This circuit is "starved" in a different sense—deriving its voltage from the heater line (6 vs. 250 volts) and feeding through a small plate load resistor (47,000 ohms vs. 4.3 megohms). The effects are largely the same, however.

**Construction.** The *Squealer* fits neatly in a 5" x 4" x 3" aluminum box. Parts placement is not critical but layout might well follow the author's setup for easiest assembly.

All parts are mounted on the cover half of the box. The tube is mounted topside in the center of the box. If desired, the filament transformer can also be mounted on top of the box but the author chose to mount it at one end as shown.

Most of the resistors and capacitors and the diode are soldered to a pair of 9-lug terminal strips (visible in the photo at right) on either side of the tube socket. Potentiometer *R3* and audio output jack *J1* are mounted on the end of

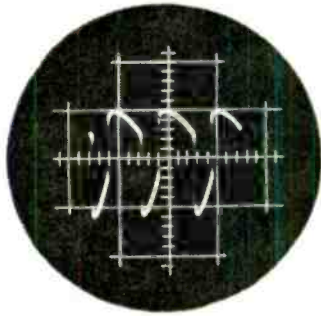

Waveform of the audio note generated by the Squealer is not a true sine wave. As the diagram at right illustrates, plate voltage is taken from half-wave rectified heater supply.

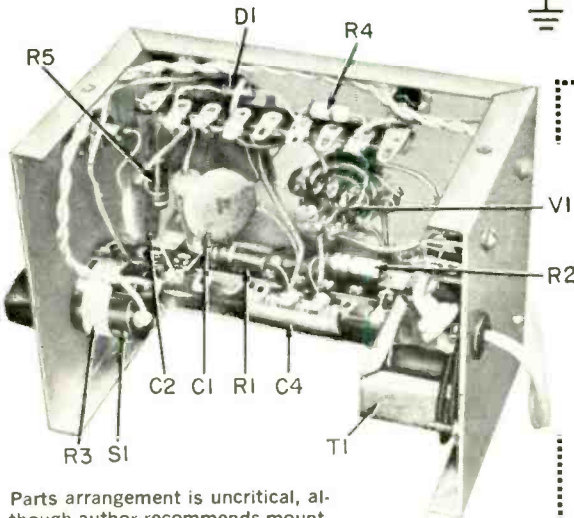
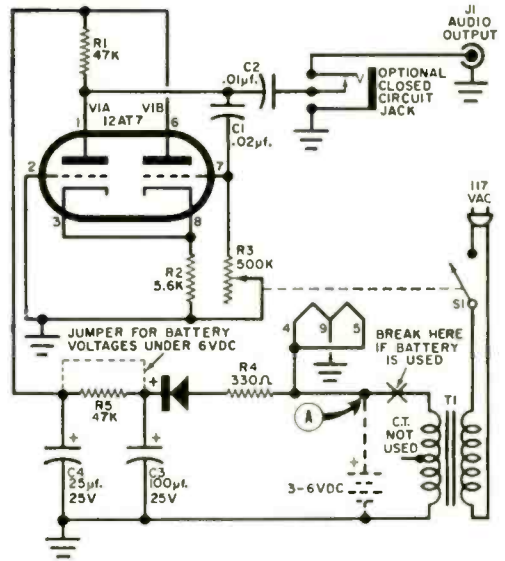

Parts arrangement is uncritical, although author recommends mounting most of the components in outside wraparound of aluminum box.

#### PARTS LIST

- C1—0.02- $\mu$ f., 200-volt disc capacitor
- C2—0.01- $\mu$ f., 200-volt disc capacitor
- C3—100- $\mu$ f., 25-volt electrolytic capacitor
- C4—25- $\mu$ f., 25-volt electrolytic capacitor
- D1—Silicon diode, 50 PIV, 100 ma., or higher
- J1—RCA-type phono jack
- R1, R5—47,000-ohm,  $\frac{1}{2}$ -watt resistor
- R2—5600-ohm,  $\frac{1}{2}$ -watt resistor
- R3—500,000-ohm potentiometer (with switch S1)
- R4—330-ohm,  $\frac{1}{2}$ -watt resistor
- S1—S.p.s.t. volume control switch (ganged with R3)
- T1—Filament transformer: primary, 117 volts a.c.; CT secondary, 6.3 volts @ 0.6 ampere. CT not used (Stancor P6465 or equivalent)
- V1—12AT7 tube
- 1—5" x 4" x 3" aluminum box
- Misc.—9-pin miniature tube socket, terminal strips, knob, dial plate, hardware, wire, solder, etc.

the box opposite the transformer. Since no pilot lamp is employed, a dial plate is used with the potentiometer as an on-off indicator and to spot the different output frequencies.

**Operation.** The *Squealer* works fine with both crystal and medium- to high-impedance dynamic headphones. If it is to be used for code practice, a closed-circuit telephone key jack can be optionally inserted between capacitor C2 and output jack J1. As an audio source for hi-fi amplifiers, an ordinary shielded

cable terminated with a pair of RCA-type phono plugs will do.

If desired, the *Squealer* can be operated from a 6-volt battery. Simply connect the battery between point A and ground as shown on the schematic. Be sure to disconnect the 6.3-volt secondary of T1 before connecting the battery since the transformer winding represents a d.c. short for the battery. To increase the audio output with supply voltages under 6 volts, short out resistor R5 with a wire jumper.



**TWICE AS MANY PROJECTS  
...TWICE AS MUCH FUN!**

**In September, 1965**

**For the first time, ever,**

**POPULAR ELECTRONICS**

**will publish a Fall Edition of**

**ELECTRONIC EXPERIMENTER'S HANDBOOK**

**...the second one this year!**

(THE REGULAR PRICE WILL BE \$1.25 PLUS POSTAGE FOR MAIL ORDERS!)

**BUT, AS A PREFERRED READER, YOU  
ARE INVITED TO RESERVE A COPY  
IN ADVANCE, AT THE VERY SPECIAL  
PRE-PUBLICATION PRICE  
OF JUST \$1—POSTPAID.**

**YOUR ORDER WILL BE  
CONFIRMED PROMPTLY!**

**164**  
more pages  
of challenging  
electronics projects  
and experiments—  
for fun... for profit  
...for YOU!

This special offer to EEH readers  
cannot be repeated, so don't miss out!  
Fill in and mail the Reservation

Coupon today!

Ziff-Davis Service Division • Dept. EH2-P  
589 Broadway • New York, N.Y. 10012

My dollar is enclosed. Reserve my copy of the  
Fall Edition of Electronic Experimenter's Hand-  
book and mail it to me from first-off-press cop-  
ies in September, 1965, postpaid.

name \_\_\_\_\_

address \_\_\_\_\_

city \_\_\_\_\_ state \_\_\_\_\_ zip code \_\_\_\_\_

**(PAYMENT MUST BE ENCLOSED WITH ORDER.)**

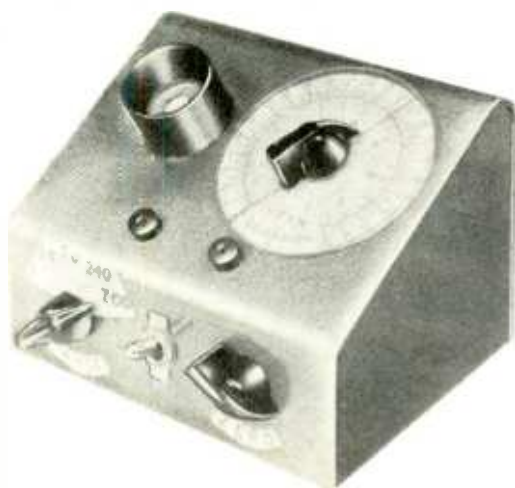

---

# meterless vtvm

By WILLIAM J. MILLARD

When you need a high-impedance voltmeter, you usually need it bad—this one uses no meter, and twelve bucks buys the parts

**T**HE trusty multimeter is generally the first measuring instrument bought for the average home workshop, and often it's the *only* one the experimenter's budget will permit. But what do you do when the voltage to be measured is in a very high impedance circuit? Even if the multimeter is one of the fairly expensive sort having a 20,000-ohm-per-volt movement, the input impedance on a low-voltage range, say 3 volts full scale, is only 60,000 ohms. If you're trying to measure the bias on the oscillator grid of a mixer, or in a low-level audio stage having a 5-megohm (or higher) grid resistor, the multimeter looks pretty much like a dead short circuit to the voltage being measured. In such cases you either give up (unthinkable!), buy a vacuum-tube voltmeter ("unfunda-ble"), or rummage in your junk box and build the "Meterless VTVM."

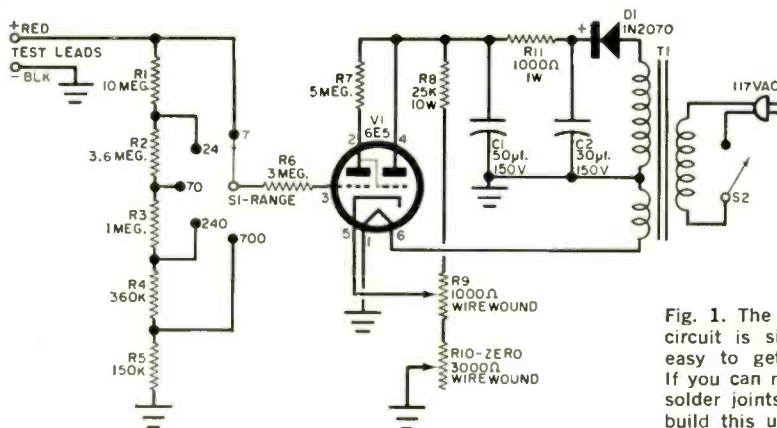
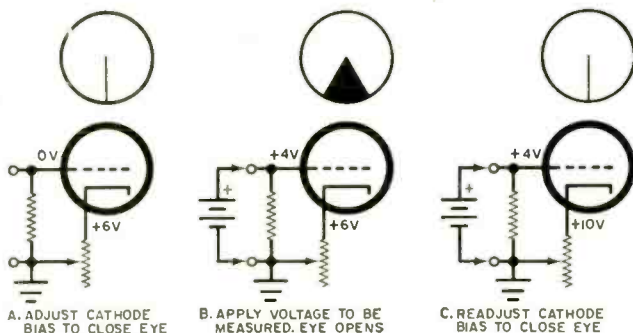

Fig. 1. The slide-back circuit is simple and easy to get working. If you can make good solder joints, you can build this useful unit.



### PARTS LIST

C1—50- $\mu$ f., 150-volt electrolytic capacitor  
 C2—30- $\mu$ f., 150-volt electrolytic capacitor  
 D1—1N2070, 400-PIV silicon diode  
 R1—10 megohms  
 R2—3.6 megohms  
 R3—1.0 megohm  
 R4—360,000 ohms  
 R5—150,000 ohms  
 R6—3.0 megohms  
 R7—5.0 megohms  
 R8—25,000-ohm, 10-watt, wire-wound resistor  
 R9—1000-ohm, linear taper, wire-wound potentiometer

R10—3000-ohm, wire-wound potentiometer  
 R11—1000-ohm, 1-watt carbon resistor  
 S1—Single-pole, 5-position rotary switch  
 S2—S.p.s.t. toggle switch  
 T1—Power transformer; 125 volts @ 15 ma., 6.3 volts @ 0.6 ampere (Stancor PS-8415 or equivalent)  
 V1—6E5 electron-ray indicator tube  
 1—Aluminum box, sloping front (Bud AC-1612 or equivalent), or constructor's choice  
 Misc.—6-prong tube socket, line cord and plug, red and black pin jacks (one each), test prods, solder, hookup wire, hardware, etc.

It's true that the Meterless VTVM won't measure resistance or current, except by indirect methods, but the multimeter can still take care of those chores as before. And the Meterless VTVM will provide a bonus "instrument." You can use it when you're measuring a voltage that may suddenly take a drastic jump as you make adjustments, thereby avoiding the risk of wrapping the pointer of your multimeter around the stop pin! The repair of this all-too-common laboratory ailment (known as Technician Goofitis) will deflate your piggy bank by

at least \$10, and it can cost more. Such transient voltage jumps are taken in stride by the Meterless VTVM.

How do you measure voltage without a meter? By reviving a voltmeter circuit so old and out of use that it has probably been forgotten by many old-timers . . . and maybe never learned by newcomers to the electronics field. It's called the slide-back voltmeter circuit, and it originated back in the 1930's. It doesn't require a meter (although one can be used, of course), because all that is needed is a means of indicating when

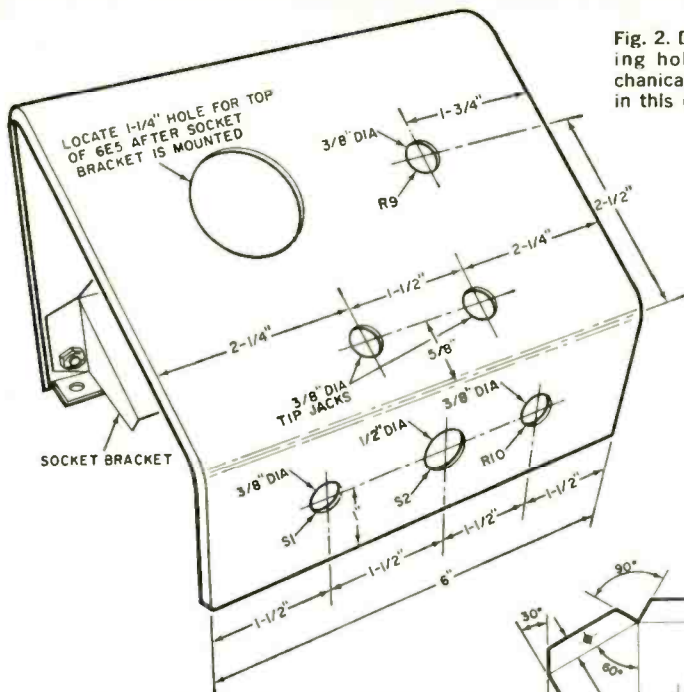

Fig. 2. Details of the mounting holes and other mechanical work are shown in this dimensioned sketch.

two voltages have been adjusted to be equal, and a tuning indicator ("magic eye") tube can do that very nicely.

Years ago these miniature cathode-ray tubes were used by the thousands as tuning indicators in broadcast and other receivers. Today, they're still used widely in the less costly tape recorders. Naturally a lot of them are lurking in the junk box waiting to be put into service again, and if you don't have one on hand, the cost of a new one is far below that of a respectable meter.

A 6U5/6G5 may be substituted for the 6E5 tube specified if an additional 1000-ohm resistor is put in series with the lead from the arm of *R10* to ground. The 6U5/6G5 will sharpen up the "tuning" of the VTVM.

**How It Works.** Take a look at the schematic diagram in Fig. 1. If you set the arm of potentiometer *R9* to the low-voltage end of the resistance element, and adjust potentiometer *R10* to bias *V1* so that the "eye" just closes, as in Fig. 1(A), application of a d.c. voltage to the input leads will cause the eye to open again—see Fig. 1(B). Now, by readjusting the bias by means of potentiometer *R9*, you can cause the eye to just close again, as in Fig. 1(C). And if you calibrate the position of the arm of *R9* on

Fig. 3. Cut the sheet metal for the bracket as shown before bending to final shape.

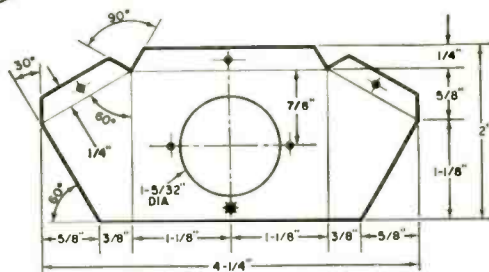

● MOUNT TUBE SOCKET SO THAT PIN 5 IS AT THIS POINT. SHADOW WILL THEN BE AT 6 O'CLOCK WHEN TUBE IS INSERTED.

a suitable dial scale, you can read off the unknown voltage as quickly as the eye-closing adjustment can be made.

How do you calibrate the scale of *R9*? By applying known voltages, such as from combinations of batteries, or by measuring voltages in low-impedance circuits simultaneously with your multimeter and the Meterless VTVM.

Since the range of measurement potentiometer *R9* is limited, the switchable voltage divider network has been included to extend the usefulness of the circuit to higher voltages. For stable operation and ease of calibration, *R9* must be a linear taper wire-wound potentiometer, if you want the voltage scale to be uniform. The 1000-ohm value used by the writer provides a good spread of the dial markings without requiring too many steps of the range switch, but other values can be used to suit the individual constructor's needs. Use of 5% tolerance resistors adds little to the cost of

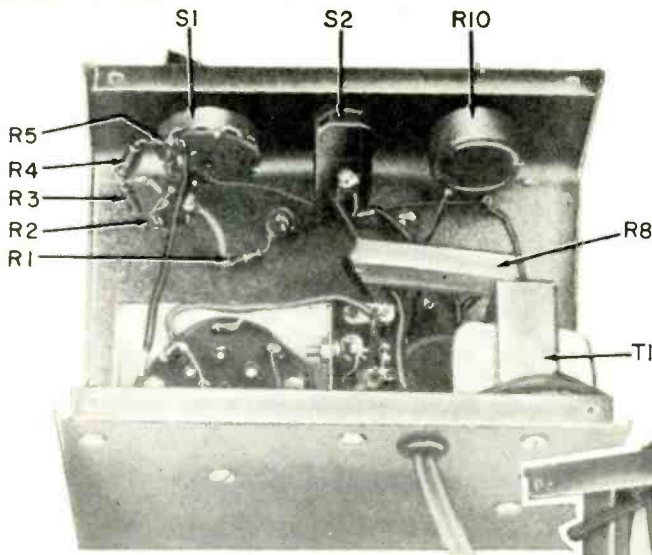

Layout and wiring are not critical, but assembly is easier if the order given in the text is followed.

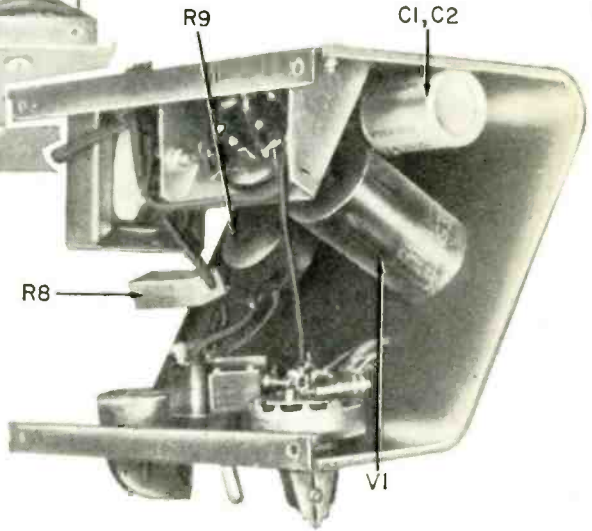

the unit, and provides better accuracy and ease of calibration.

**Construction.** Since the box used to house the writer's unit has no chassis, all controls and associated parts are mounted on the sloping front panel, as shown above. Solder resistors *R1* through *R5* to the terminals of the range switch before you mount it. It's also a good idea to mount *R9*, *R10*, *S1*, *S2*, and the test prod jacks before installing the transformer and indicator tube.

For details of the angle bracket used to support the socket of *V1*, see Fig. 3. When the socket is in place, you can determine the exact location of the 1¼" hole in the front panel for the eye end of the tube. Cut this hole and cement a piece of blackened cardboard mailing tube around it as a light shield.

Fasten the filter capacitor to the rear surface of the box by means of the machine screw in the center hole of the tube socket bracket. A three-lug terminal strip on the side of the tube bracket supports diode *D1* and resistor *R11*. Resistors *R6* and *R7* (not indicated in the photos) are supported by the tube base lugs to which they are soldered.

**Calibration.** When you have completed and checked the wiring, switch the unit on and let it warm up until the eye pattern stabilizes. Set range switch *S1* to the lowest range and turn *R9* counter-clockwise so that the arm is at the end nearest to *R10*. This is zero volts on all

ranges. Then short the test leads together and adjust the zero setting control (*R10*) so that the eye of tube *V1* just closes.

Now fasten a piece of paper under the knob of *R9* with Scotch tape, for use as a temporary scale. Apply a known voltage such as from a single flashlight cell, and adjust *R9* until the eye is just closed again. Mark the temporary scale accordingly. Continue with other voltages until the low range is calibrated.

This scale will hold for ranges three and five if you multiply the scale markings by 10 and 100, respectively. Ranges two and four are calibrated in the same way, after which you have only to transfer the temporary markings to a permanent scale for mounting under the knob.

Want to use your unit for a.c. also? Just add a 0.002- to 0.005- $\mu$ f., 200-volt capacitor from pin 2 of *V1* to ground, and you're in business.



*Split-second timing is vital in dozens of operations from firing moon rockets to checking hot rod performance at the local drag strip. Equip yourself to make highly accurate time checks by building the . . .*

# ELECTRONIC STOP WATCH

By FRED BLECHMAN, K6GCT

**F**OR YEARS the standard device for accurate elapsed time measurement in sporting events and industrial processes has been the hand-held stop watch. This works well for many purposes, but it has its shortcomings and limitations. For one thing, it can't very well be operated remotely, and most models are limited to a total elapsed time of fifteen minutes, when the hands are again on zero. And you do have to remember to wind it, of course.

Also, pricing a good jeweled-movement stop watch capable of tenth-second accuracy at the local jeweler's will probably get you a quotation of \$25.00 or more.

For less than \$21.00 you can build this electronic stop watch that will time events in seconds and tenths, up to a total of more than 27 hours, yet can be reset to zero in seconds. Readout is entirely in Arabic numerals, with no unnumbered dial marks to interpret, and remote control can be added for about \$4.00, with safe isolation of the control circuit from the power line.

You can time almost any kind of race or

sporting event, and scores of other things like free-flight model airplane endurance flights, photographic time exposures or developing processes, phone call duration, lab experiments, and . . . but the list of potential uses is endless.

**How It Works.** The heart of the electronic stop watch is a 600-rpm synchronous motor. The shaft speed of this motor is directly controlled by the *frequency* of the 60-cps a.c. line voltage (not the voltage), which is maintained by the utility company to an accuracy of 0.1 of 1 per cent, or better. At 600 rpm, the motor shaft makes 10 revolutions per second. A plastic cam mounted on the shaft opens and closes a snap-action switch ten times per second. Each switch closure advances an electronic counter one digit, indicating the lapse of 0.1 second.

Since the counter has six digits, 99,999.9 seconds can be counted without interruption—a total of 27.77+ hours. The control switch has a standby position (marked *STDBY*) between the *OFF* and *TIME* positions. In this position, the motor is started and allowed to get up to full synchronous speed, which requires about one second. If this were not done, the timing during the first second would be slow, causing a serious error in measuring duration of events that last no more than a few seconds.

Note also that when the switch is

moved from *TIME* to *STDBY* at the end of a timing operation, the motor continues to run, and the unit remains in readiness for the next timing operation.

With the switch at *STDBY*, the timer can also be controlled from a remote point (if you elect to include this feature) by merely closing a switch to initiate a timing period and opening it at the termination. This can be done either manually or automatically by the mechanism of the operation being timed, such as the rise of a starting gate. Since the remote line carries only the current needed to close a relay, it is not necessary to shield it, and it can have several ohms resistance without affecting operation.

The pilot lamp provides a visual alerting signal to let the user know that the unit is standing by, or actually counting. In a noisy environment (such as a drag strip), the muted clicking of the leaf switch can't be heard when the unit is at *STDBY*.

**Construction.** For correct electromechanical operation, three of the component parts are critical. The motor must be a 600-rpm unit of the *synchronous* type, and it must have sufficient torque to operate the switch. The smallest, lightest, and least expensive motor filling these requirements, and having the added advantage of ready availability, is specified in the Parts List.

Fig. 1. The author's layout of parts is compact, and can be followed easily.

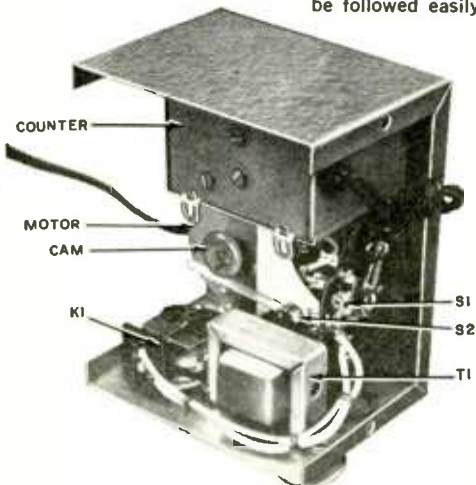

BINDING POSTS

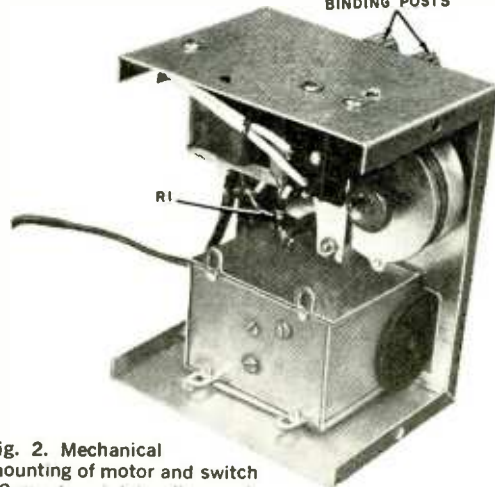

Fig. 2. Mechanical mounting of motor and switch S2 must maintain alignment.

In order to use the motor called for, the operating force required by the snap-action switch must be very small. The switch specified requires an operating force of only four grams, and comes with the necessary leaf actuator already attached.

The 6-digit electrically operated counter has a built-in full-wave bridge rectifier circuit, which serves two important purposes. It converts a.c. line current to d.c., which is required by the counter actuating coil for operation at the ten-counts-per-second rate used. It also provides a conductive path across the coil terminals to dissipate the transient voltage generated when the actuating voltage is interrupted by action of the motor-driven switch. If you want to substitute another counter for the one specified, it *must* have a similar bridge rectifier circuit.

The layout of the author's unit is shown in Figs. 1 and 2. Since wiring is not critical, the layout can be altered to suit the constructor's preferences. However, good mechanical positioning and rigidity between the motor shaft and the snap-action switch is very important. The necessary mechanical relationship between these parts is shown in Fig. 3.

The control switch may be a rotary type if desired, but the lever switch specified allows more precise start-stop

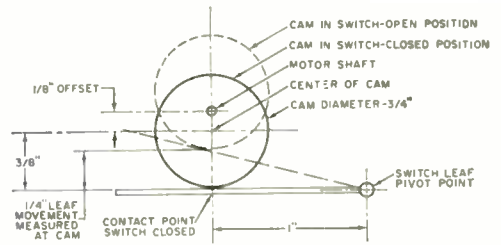

Fig. 3. Dimensions shown must be followed closely to insure correct cam and switch action.

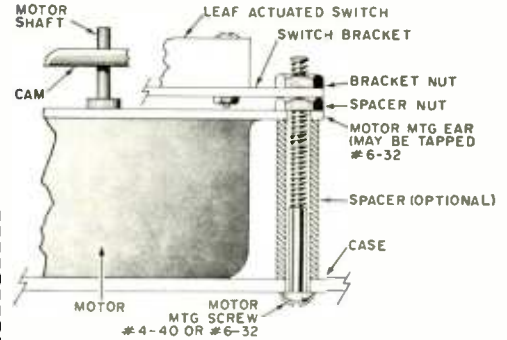
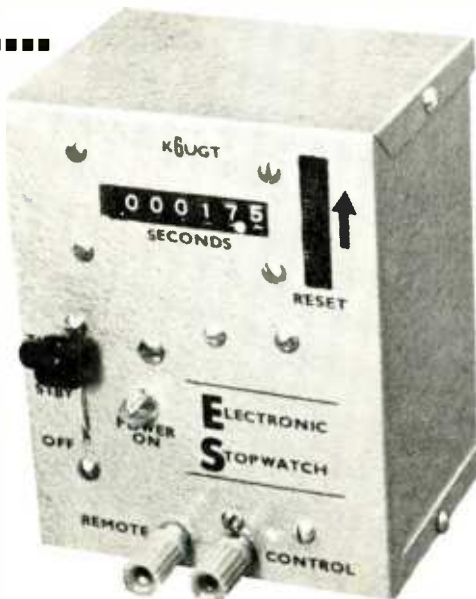

Fig. 4. Use of spacer tube and nut will avoid risk of bending motor case and misaligning cam.

control. Another alternative would be to use a push-button switch as a means for starting and stopping the actual timing function, with the lever switch controlling the off and standby conditions. If a push-on, push-off type of switch is used, the Electronic Stop Watch will require less relearning on the part of users who are familiar with the ordinary mechanical stop watch.

The counter specified comes with a removable escutcheon plate that allows additional mounting flexibility; it was not used in the author's unit. In quiet surroundings, the counter is a bit noisy when it is running. If the sound is undesirable, insulate the counter from the panel with soft rubber grommets, and wrap the counter with a layer of styrofoam or foam rubber.

The filament transformer, relay, and REMOTE CONTROL terminals are optional parts, necessary only if you want to use the remote control feature. The



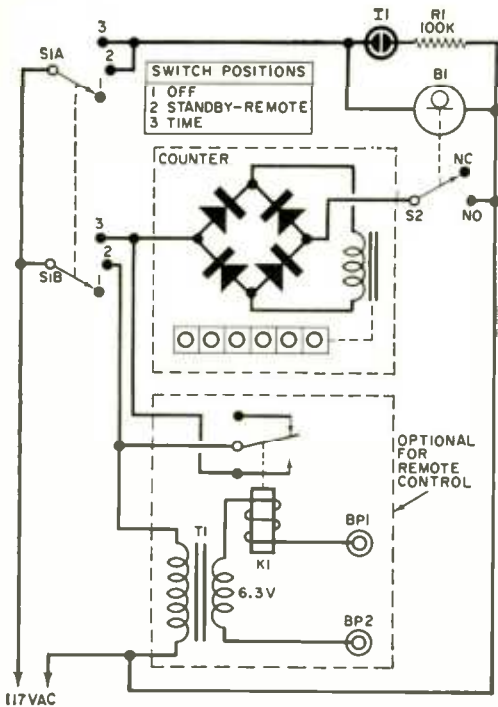

Fig. 5. Wiring is not critical but it must be kept clear of the cam and snap-action switch.

#### PARTS LIST

B1\*—600-rpm, 20-inch/ounce synchronous motor (Synchro Model 630, Herbach & Radman, 1204 Arch St., Philadelphia 7, Pa., Stock No. H1-26, \$4.95)

B1—NE-2 neon panel lamp

R1—100,000-ohm, ¼-watt carbon resistor

S1—2-pole, 3-position lever switch, non-short-circuiting (Centralab PA-7001 or equivalent)

S2\*—Miniature snap-action switch, with integral leaf (Acro 2(CMD1-2AXX-A24)

1\*—117-volt a.c., 6-digit type counter (Lafayette 99-9511)

1—5" x 4" x 3" aluminum utility box (Premier P.M.C.1005 or equivalent)

Misc.—Line cord and plug, panel marking decals, sheet metal screws, machine screws and nuts, terminal strip

#### Optional for Remote Control

BP1, BP2—Insulated binding post

K1—6.3-volt a.c. relay (Advance GHA-1C-6AC or equivalent)

T1—6.3 volt, 0.75-ampere heater transformer

\*Do not substitute for these parts. Equivalent items may be used for all other parts.

parts are small, and can be added to the basic unit without difficulty. However, be sure to insulate the terminals and the contacts of relay *K1* from the box, if a metal box is used.

The motor may be mounted in any position. The four motor mounting ears can be tapped for 6-32 screws, or 4-40 screws and nuts may be used. Take care not to overtighten the screws as the thin motor case is easily bent. Spacers of aluminum or brass tubing can be used as mounting standoffs, as shown in Fig. 4, if desired.

The cam consists of a heavy plastic button with a 1/16" hole drilled 1/8" off center. It should make a gentle force-fit on the motor shaft. Cement it permanently in position with epoxy or a similar strong adhesive.

Make a simple sheet-metal bracket to hold the snap-action switch in the required position with respect to the cam, as shown in Figs. 3 and 4. If you make elongated holes in the bracket, they will permit some adjustment of the cam-to-leaf spacing. Don't stray too far from the dimensions shown, or the motor may be stalled by excessive friction or mechanical interference.

Follow the schematic diagram of Fig. 5 when you are ready to wire the unit. There are no critical points, but it is advisable to mechanically anchor the wiring so that it cannot interfere with operation of the motor and snap-action switch.

**Operation.** The control switch is set to *STDBY* when timing operations are to be started. The motor reaches synchronous speed in about one second, and a rapid, quiet clicking of the snap-action switch will be heard. To start a timing operation, flip the control switch to *TIME* and leave it there until the event nears the finish. At the exact finish, flip the switch back to the *STDBY* position, and read the time in seconds and tenths of a second. To operate from a remote point, leave the unit in *STDBY*, close the remote switch to start, and open it to stop the timing operation. When the time has been read off, the counter is reset to zero by a few strokes on the thumb wheel.

The author's unit has timed events ranging from sprint races to recording time of long-play tapes, but you can undoubtedly come up with plenty of uses not mentioned here.

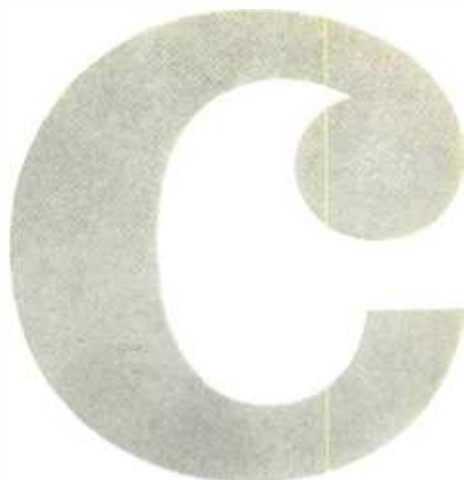

# BRIDGE

By FRANK A. PARKER

**Having trouble reading the markings on your junk box capacitors? The C Bridge will enable you to measure them more accurately than the maker marked them.**

**M**OST OF US have many capacitors gathering dust in the junk box because the markings can't be read. It's easy to measure the values of the unknowns if you have access to a capacitance bridge, but most such instruments come high, due to the wide range, sensitivity, and accuracy that must be provided in a laboratory instrument.

For those who can't afford so much frosting on their technical cake, the "C Bridge" will do the job very well. And you can make the accuracy high enough to yield far closer values than the maker puts on ordinary bypass and coupling capacitors. Best of all, since no sensitive null detector is built in, you can construct the C Bridge for about \$12.00, even if you buy all new parts. If your

junk box contains a few of the common parts needed, you can easily cut that cost in half.

**How It Works.** Any bridge works by comparing the signal voltage across the unknown part with the same signal across an adjustable known part that is accurately calibrated. The C Bridge is no exception, but by using a null indicator that you already have on hand, and making the a.c. line provide the bridge signal, a lot of the cost of the precision lab bridge is avoided.

The bridge circuit consists of potentiometer  $R2$ , the "known" capacitor selected by switch  $S1$ , and the unknown capacitor connected between binding posts  $BP1$  and  $BP2$ . Notice that  $R2$  actually forms two arms of the bridge

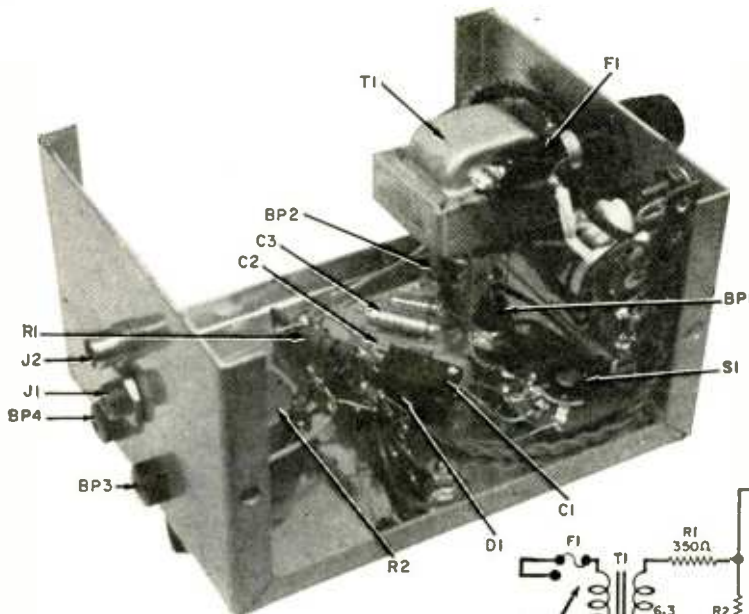

Label positions of range switch S1 "x.01," "x1.0," and "x 10.0." Use capacitors of known value singly and in parallel combinations to calibrate your C Bridge. By borrowing or buying a few 5% capacitors, you can give your scales greater accuracy.

#### -PARTS LIST-

- BP1, BP2—Universal binding post (one black, one red)  
 BP3, BP4—Insulated pin jack (one black, one red)  
 C1—0.001- $\mu$ f., 200-volt silver mica capacitor—see text  
 C2—0.1- $\mu$ f., 200-volt Mylar or paper capacitor—see text  
 C3—10- $\mu$ f., 25-volt electrolytic capacitor—see text  
 D1—750-ma., 400-PIV silicon diode  
 F1— $\frac{3}{8}$ -ampere, 250-volt type 3AG fuse  
 J1—Open-circuit phone jack  
 J2—Phono jack, RCA type  
 R1—350-ohm,  $\frac{1}{4}$ -watt carbon resistor  
 R2—10,000-ohm, linear taper, carbon element potentiometer (Ohmite CMU-1031 or equivalent)  
 S1—Single-pole, 3-position rotary switch  
 S2—S.p.s.t. toggle switch  
 T1—6.3-volt, 0.6-ampere filament transformer  
 I—5" x 4" x 3" aluminum utility box  
 Misc.—Hardware, knobs, terminal strips, wire, solder, etc.  
 Note: Four 0.0001- $\mu$ f. and four 0.01- $\mu$ f. capacitors for use in calibration may be required if capacitors of known value are not at hand

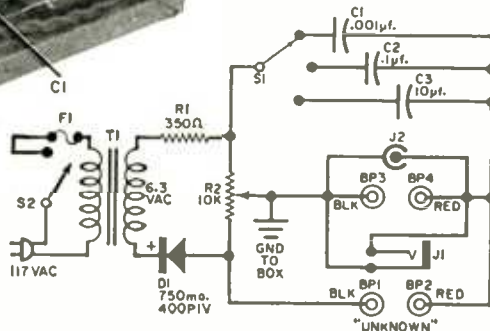

reason for not using the 60-cycle line frequency from the 6.3-volt secondary of transformer T1 is that many inexpensive earphones don't reproduce a 60-cycle signal very well.)

The signal voltage across the known and unknown capacitors in series will be divided according to their relative capacities. By adjusting the arm of potentiometer R2, a point will be found where the voltage is the same as the voltage at BP4, the common point of the known and unknown capacities. In a pair of headphones plugged into J1, this will be heard as a "null" point, at which the signal disappears. Once the dial scale of the potentiometer is calibrated, the value of the unknown capacitor can be read from the scale as fast as you find the null point.

**Construction.** All parts of the circuit mount in the cover portion of the box. There is nothing electronically critical about the parts layout, but potentiometer R2 should be located so that the calibrated scale can be made relatively large and easy to read. The writer's lay-

(Continued on page 152)

# VHF GRID-DIP METER

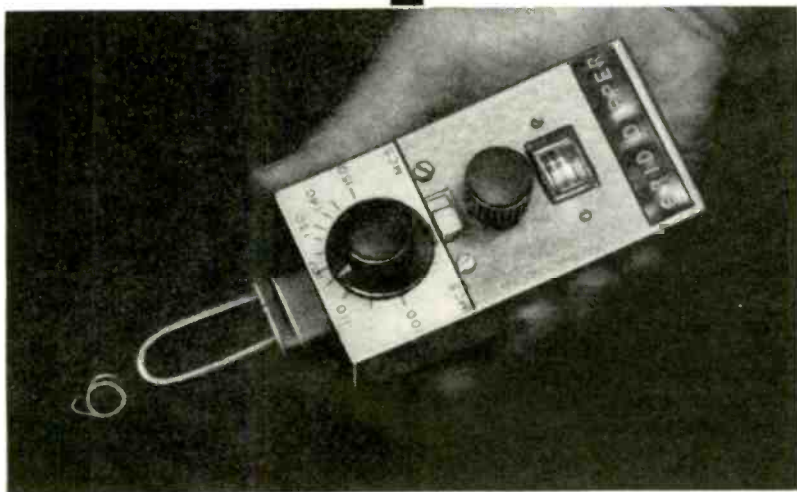

Going to build some gear for working the VHF bands? VHF project construction can be a real pleasure if you build this gadget first—cost is under \$10 with all-new parts, and it's a one-evening job

By E. H. MARRINER, W6BLZ

**M**OST OF US would like to build equipment for the VHF part of the spectrum, but find ourselves blocked by lack of a suitable instrument for adjusting tuned circuits to the desired frequency. A good VHF signal generator will do the job, but its cost will cause sharp, shooting pains in the region of the wallet.

The author found a way around this snag with a transistor version of the familiar "grid-dip" oscillator, which, though grid-less, works on the same basic principle.

**About the Circuit.** The VHF Grid-Dip Meter is a simple, self-excited oscillator, with a diode and microammeter so connected as to give a reading proportional to the emitter-to-base r.f. current. When the tuned collector tank circuit consisting of  $L1$  and  $C1$  is coupled to an external tuned circuit that is resonant at the frequency of oscillation, there is a sharp dip in the meter indication, similar to the dip in grid current of the tube version.

**Construction.** The VHF Grid-Dip Meter is assembled in an aluminum utility box

with all parts mounted on the flanged half. This provides complete enclosure and shielding when the box halves are mated, but also permits easy access when a battery change is needed (which isn't often, incidentally).

As in all VHF devices, placement of parts and length of leads is important. Take particular pains to center the hole for tuning capacitor  $C1$   $\frac{3}{4}$ " from the end of the box, measured on the outside. Take equal care to center the coil socket in the end of the box  $\frac{3}{8}$ " back from the front panel surface (outside measure). If you use the specified part for  $C1$ , and make the coil as described below, calibration of your unit will closely follow that shown on the dial of the author's unit.

Mount the coil socket, tuning capacitor  $C1$ , switch  $S1$ , potentiometer  $R2$ , and meter  $M1$  first, since lugs on these parts support many of the other parts.

Note that  $S1$  is held in place by an internally threaded insulated terminal and a binding head machine screw at each end. Wire the small parts according to the pictorial diagram. Be sure to use a heat sink every time you heat a transistor lead, either by soldering to it or its supporting lug; a small wad of wet facial tissue gripped around the lead with a small alligator clip is good.

Note that capacitor  $C6$  is not shown in the pictorial. In practice, the capacity to ground through the ceramic standoff supporting the junction of  $R1$  and  $R4$  at one end of  $S1$  was enough for proper operation in the author's unit. If you use a different insulated terminal, better play safe by using  $C6$ , as shown in the schematic. It may be wired from the hot end of the standoff terminal to the ground lug.

The sawed-off base of an FT-243 crystal holder serves as the base for  $L1$ , the tuning "coil," which is actually a loop of  $\pm 16$  solid copper wire. Make the loop  $\frac{1}{2}$ " wide, with parallel sides, and trim the length to just 2" long from the end of the base pins to the end of the loop. Cover the exposed portion with sleeving of Teflon or polyethylene before soldering to the base pins.

**Adjustment.** Plug in the coil and set switch  $S1$  to the "on" position. The meter should read up-scale at once, and the amount of the deflection should be con-

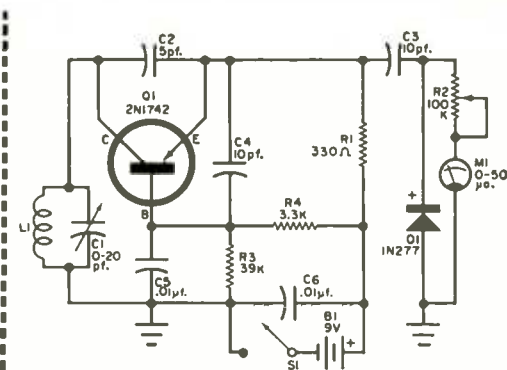

#### PARTS LIST

- B1—9-volt transistor battery (RCA VS 323 or equivalent)
- C1—4- to 20-pf. variable capacitor (E. F. Johnson Type 20M11)
- C2—5-pf. NPO tubular ceramic capacitor
- C3—10-pf. silver mica capacitor
- C4—10-pf. NPO tubular ceramic capacitor
- C5, C6—0.01-µf. disc ceramic capacitor
- D1—1N277 VHF semiconductor diode
- L1—VHF tuning inductor—see text
- M1—99-5026 50-µa. tuning meter (Lafayette Radio Electronics, 111 Jericho Turnpike, Syosset, L.I., N.Y.)
- Q1—2N1742 VHF transistor
- R1—330-ohm,  $\frac{1}{2}$ -watt carbon resistor
- R2—50,000-ohm, linear-taper miniature potentiometer
- R3—39,000-ohm,  $\frac{1}{2}$ -watt carbon resistor
- R4—3300-ohm,  $\frac{1}{2}$ -watt carbon resistor
- S1—S.p.s.t. slide switch (Lafayette 99-6189 or equivalent)
- 1—4" x 2 $\frac{1}{4}$ " x 2 $\frac{1}{4}$ " aluminum utility box (LMB J-875 or equivalent)
- Misc.—#16 solid copper wire (for L1), hookup wire, ceramic standoffs—see text, etc.

trollable with potentiometer  $R2$ . If this is not so, check for a wiring error, or defective transistor or diode.

Calibration near the low end of the range can be checked against an FM receiver. Tune in an FM station on a channel above 100 mc., hold the grid-dip unit loop close and parallel to one wire of the twin-lead at the FM receiver antenna posts, and tune the dipper slowly through its range. Near full engagement of capacitor  $C1$ , the output of the meter will be heard interfering with the FM station tuned in. Tune the meter exactly to the FM station signal, and mark the dial with the corresponding frequency. Do the same for other stations of known frequency that your receiver covers. Bear in mind that if your dipper tunes to an FM station on, say, 100.9 mc. with  $C1$  almost fully meshed, it can't be far from 150 mc. with  $C1$  fully unmeshed, if



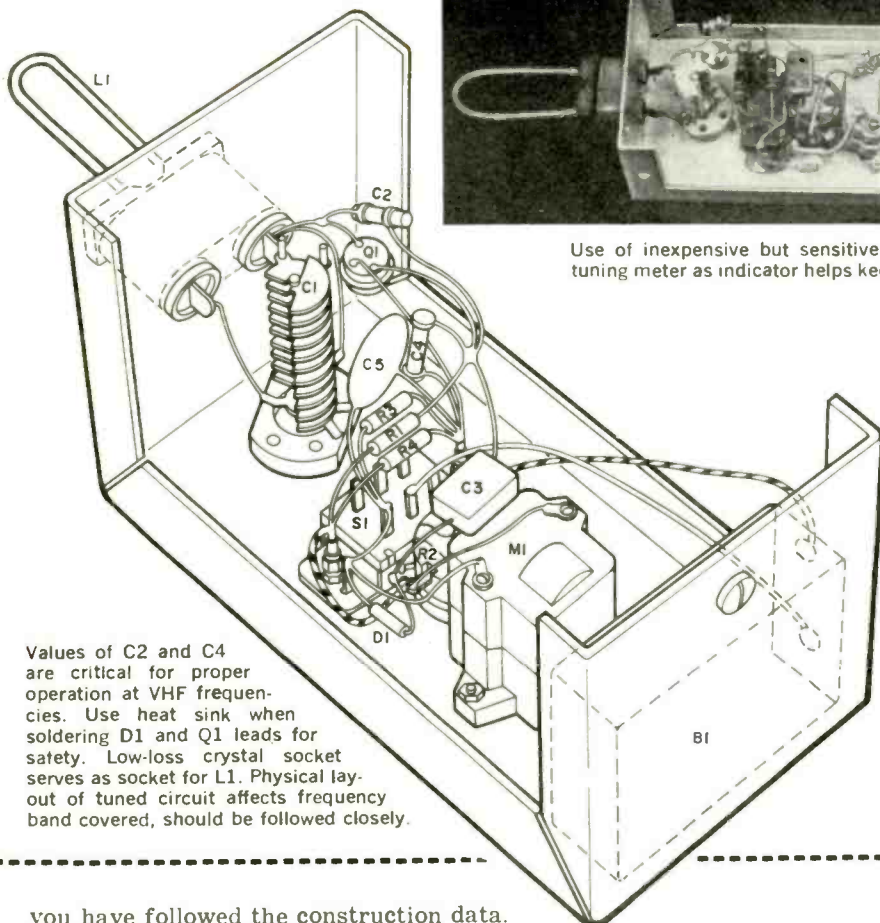

Use of inexpensive but sensitive uncalibrated tuning meter as indicator helps keep cost down.

Values of C2 and C4 are critical for proper operation at VHF frequencies. Use heat sink when soldering D1 and Q1 leads for safety. Low-loss crystal socket serves as socket for L1. Physical layout of tuned circuit affects frequency band covered, should be followed closely.

you have followed the construction data. If you are a 2-meter ham (or have a pal who is), check the dipper against the receiver calibration, and so on.

**Operation.** Once calibrated, your VHF Grid-Dip Meter serves both as a signal source and means for determining the resonant frequency of tuned circuits in its range. Want to trap out a local FM station on 106.9 mc. so you can receive that distant station on 107.3 mc.? A trap series-resonant at 106.9 mc. across the receiver input will do the job. A short length of small coil stock of the "Airdux" kind and a low-value trimmer capacitor (15- to 20-pf. max.) will do.

Connect the coil and trimmer directly (no extra leads) in parallel with each other. Couple the loop of the dipper to the trap circuit by holding it near the end of the coil, and watch the meter while tuning the dipper slowly through

its range. At the resonant frequency of the trap, the meter will show a sharp dip. Be sure to adjust R2 as needed to keep the meter indicating nearly full scale, so the dip will show clearly.

When the dip is found, reduce the coupling between the dipper loop and the trap circuit, and carefully find the center of the dip; read the resonant frequency of the trap from the dipper dial. Tune the trap trimmer over its range to resonate the trap at 106.9 mc. if possible. If necessary, trim the coil value, and try again, until you hit the frequency of the unwanted station. Now reconnect the trap coil and capacitor in series across the FM receiver input, and make final adjustment for minimum signal from the unwanted station. ~~50~~



# The Best of

# TIPS & TECHNIQUES

## HANDLES FOR MINIBOXES

Good-looking, sturdy handles for units built into Miniboxes can be made with pieces of 300-ohm TV twin-lead. Determine how long the handle should be, cut the twin-lead to length, and punch a small hole at each end through the center of the insulation. Fasten

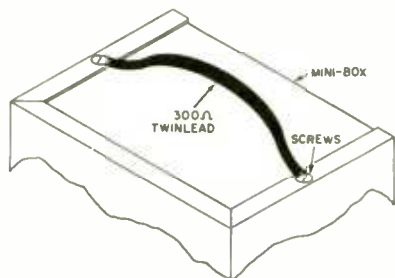

the handle in place with two of the screws that hold the box together. If the unit is rather heavy, a stronger handle can be made by cutting the twin-lead a bit longer than needed, stripping off some insulation at each end, and twisting and soldering the two conductors together. —*Jay Prager*

## CHANGING PANEL DECALS WITHOUT TEARS

Ever wish you could change some of those decals you put on the panels of your home-brewed electronic masterpieces? It happens to all of us when we modify a unit, or think of a better name. If this is your problem,



place a strip of fresh cellophane tape over the decal and stick it down well, leaving one end free. Then remove the old decal by pulling the tape directly out and away from the panel. It may take two or three pieces of tape to remove stubborn old decals completely. —*Stanley E. Bammel*

## WIRE STRIPPER FOR PLASTIC INSULATION

A handy wire stripper for plastic-insulated hookup wire can be made from a strip of sheet copper with a V-shaped slot in one end as shown in the photograph at right. Bolt the copper in place and allow the iron to heat. The insulation to be removed is laid in the "V" and rotated. The heat will make a clean break in the insulation and permit it to be easily removed by simply sliding it off the wire.

—*Milton F. Dickfoss*

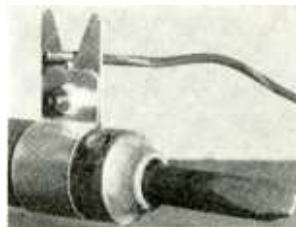

## PLUG-IN CONNECTOR FOR 300-OHM TWIN-LEAD

Connectors for 300-ohm ribbon transmission line can be bought at reasonable cost, but there are plenty of times when you need one right away, and the shop shelf is bare. If you have a spare crystal holder of the FT-243

variety, the problem is easily solved. If the crystal is still in the holder, disassemble the unit and remove it. Heat each pin with the soldering iron and shake



or blow out excess solder. Use a file to cut a groove in the Bakelite portion of the holder just wide and deep enough to fit snugly over the twin-lead you are using. Next, strip the conductors of the twin-lead back  $\frac{1}{8}$ " to  $\frac{3}{8}$ ", clean and pre-tin them. Push them fully home in the crystal holder pins, solder, and reassemble the holder. Any standard crystal socket serves as a female connector on the receiver chassis.

—*Waldo T. Boyd*

## EMERGENCY OR SPECIAL SCREWDRIVERS

If you carry a screwdriver to fit every width and length of screw-slot you encounter, you'll find that they can crowd other items out of the tool box. Here's a way to obtain those special sizes you need without having them bulge over the sides of your tool kit. Cut some short driver blades from  $\frac{1}{16}$ "

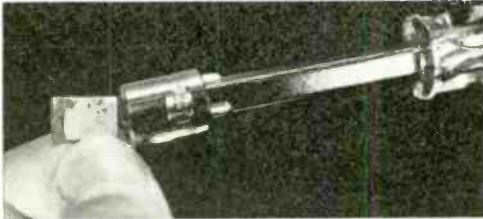

steel and grind the opposite edges parallel so that each blade is a snug push-fit in one of your hex-nut drivers. Then grind the end to leave  $\frac{1}{8}$ " to  $\frac{3}{16}$ " projecting. Finally grind the tip to the thickness you need for those special narrow or broad screw-slots.

—Ken Murray

## EXTRA "LAMP HANDEE"

Here's an old trick, but one so useful that it's worthwhile rehashing. It's easy to see into those dark chassis corners if you have a spare Ungar "Standard Line" soldering iron. This is the common type of iron that comes equipped with several screw-on heating units of different wattages. The thread is the same as that for the base of a standard 7-watt decorative light bulb. For less eye strain, all you have to do is to screw one of these bulbs into the soldering iron, in place of a heating unit.

—Steve Brant, K8VII

## ANOTHER KIND OF THIRD HAND

If you're suffering from the same old problem of not having enough hands to hold a component, a soldering iron, and a roll of



1965 Spring Edition

# PRODUCTS FOR MODERN LIVING

**ATR PLUG-IN TYPE PORTABLE INVERTERS\***

**A.C. HOUSEHOLD ELECTRICITY**  
Anywhere . . . in your own car!

Operates Standard A.C.

- Record Players
- Dictating Machines
- Small Radios
- Electric Shavers
- Heating Pads, etc.

**MODELS**

6-RMF (6 volts) 60 to 80 watts. Shipping weight 12 lbs. DEALER NET PRICE. . . . . \$36.50

12T-RME (12 volts) 90 to 125 watts. Shipping weight 12 lbs. DEALER NET PRICE. . . . . \$36.50

\*Additional Models Available

---

**ATR "A" BATTERY ELIMINATOR**

For Demonstrating and Testing Auto Radios—TRANSISTOR or VIBRATOR OPERATED!

Designed for testing D.C. Electrical Apparatus on Regular A.C. Lines—Equipped with Full-Wave Dry Disc-Type Rectifier, assuring noiseless, interference-free operation and extreme long life and reliability.

**MAY ALSO BE USED AS A BATTERY CHARGER**

MODEL 610C-ELIF . . . 6 volts at 10 amps. or 12 volts at 6 amps. Shipping weight 22 lbs. . . . . \$55.00

DEALER NET PRICE . . . . . \$55.00

MODEL 620C-ELIT . . . 6 volts at 20 amps. or 12 volts at 10 amps. Shipping weight 33 lbs. . . . . \$73.50

DEALER NET PRICE . . . . . \$73.50

---

**ATR ALL-TRANSISTOR MODEL 707**

# Karadio

**SUGGESTED RETAIL PRICE \$29<sup>95</sup>**

. . . for those who want the finest! Check the features of this all-new, all-transistor Model 707 Karadio by ATR . . . features galore that make sales easier, keep users happier! Compare . . . and without hesitation place your order NOW for the new all-transistor ATR Karadio.

Neutral Gray-Tan baked enamel finish. Overall size approximately 5½" deep x 6½" wide x 2" high. Shipping Weight 5 lbs.

SEE YOUR ELECTRONIC PARTS DISTRIBUTOR WRITE FACTORY FOR FREE LITERATURE . . .

**ATR ELECTRONICS, INC.**  
Formerly: American Television & Radio Co.

**ATR** Quality Products Since 1931  
ST. PAUL 1, MINNESOTA—U.S.A.

**CIRCLE NO. 1 ON READER SERVICE CARD**

147

# FREE CAREER BOOKLET



To guide you to a successful future in

## ELECTRONICS RADIO-TV COMPUTERS ELECTRICAL ENGINEERING

This interesting pictorial booklet tells you how you can prepare for a dynamic career as an Electrical Engineer or Engineering Technician in many exciting, growing fields:

**MISSILES • AVIONICS • AUTOMATION  
SALES • DEVELOPMENT  
ELECTRICAL POWER • ROCKETRY  
RADAR • RESEARCH**

Get all the facts about job opportunities, length of study, courses offered, degrees you can earn, scholarships, part-time work — as well as pictures of the Milwaukee School of Engineering's educational and recreational facilities. No obligation — it's yours free.

### MILWAUKEE SCHOOL OF ENGINEERING

#### MAIL COUPON TODAY!

**Milwaukee School of Engineering**  
Dept. EX-65, 1025 N. Milwaukee St., Milwaukee, Wis.  
Please send FREE "Your Career" booklet  
I'm interested in  
 Electronics     Radio-TV     Computers  
 Electrical Engineering     Mechanical Engineering

Name..... Age.....

PLEASE PRINT

Address.....

City..... Zone..... State.....

I'm eligible for veterans education benefits.

Discharge date..... MS-117

CIRCLE NO. 39 ON READER SERVICE CARD

solder (unless, of course, you use your teeth!), try this idea. Slip a small rubber grommet over the end of a pair of needle-nose pliers and use them to hold the component. This "third hand" can also be used when you solder transistors, diodes or other small parts requiring a heat sink.

—Charles Caringella

#### RIBBON REELS BECOME SOLDERING IRON STANDS

Worn-out typewriter ribbons should be discarded, of course, but you might want to keep the reels they come on. You can make handy holders for soldering irons from this

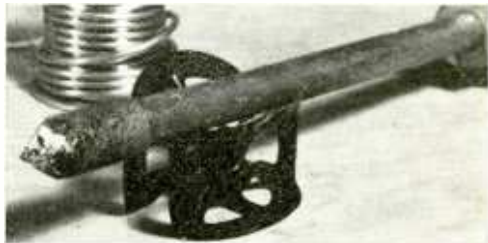

type of reel. All you have to do is bend the reel to resemble the one shown in the photo.

—Wayne Floyd

#### ERASER CLEANS CIRCUIT BOARDS

If you've ever faced the problem of having the foil separate from a printed-circuit board when you attempt to solder it, this tip is for you. Before you start, carefully clean the copper foil by rubbing it with a typewriter eraser like that shown. The eraser has the correct amount of abrasive, and removes oxidation and dirt so that

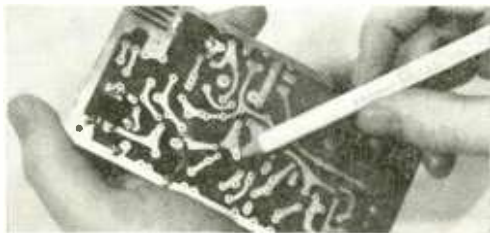

joints can be rapidly tinned and soldered. Incidentally, this technique is recommended by NASA for high-reliability soldering of satellite components.

—Kent A. Mitchell, W3WTO

#### IDENTIFYING TRANSISTOR TYPES

Painted-on transistor type-numbers often wear off with repeated handling, and many transistors, especially those of the general-

purpose variety sold to experimenters, are not marked at all. If you do a lot of bread-boarding of circuits, you'll save yourself considerable time and trouble by scratching type numbers and/or other data such as "a.f." or "r.f.," and "pnp" or "npn," on the outside of each transistor case with a sharp instrument. —Stanley E. Bammel

**IMPROVING COMFORT OF TAP WRENCH HANDLE**



The ordinary tap wrench can be pretty wearing on the hands when many holes must be tapped in hard or tough metal. In a pinch, slide a pair of large rubber battery clip sleeves over the two halves of the wrench handle, as shown. They can be taped or tied in place if desired, and will

help prevent the development of blisters when a lot of tapping must be done.

—Jerome Cunningham

**SLEEVE PROTECTS AGAINST DRILLING DAMAGE**

If you find it necessary to drill holes in delicate pieces of electronic equipment, protect them from damage by using a piece of polystyrene tubing over the bit as shown in the photo. The tubing, which can be

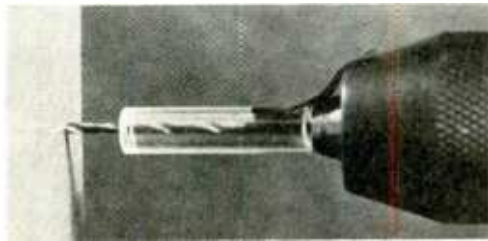

taped to the drill chuck to hold it in place, will keep the bit from plunging through the hole when the metal gives way, and then striking and damaging delicate components on the other side of the panel.

—Stanley E. Bammel

**BATTERY CLAMP SERVES AS SELF-GRIPPING PLIERS**

A large battery clamp can be a handy tool for turning TV lead-in stand-off insulators; as a bonus, it will hang onto the stand-off if you have to let go. Such a clamp can also help in turning wing-nuts and thumbscrews, and in getting those pesky caps off

now there are **3** time & tool-saving double duty sets

New PS88 all-screwdriver set rounds out Xcelite's popular, compact convertible tool set line. Handy midgets do double duty when slipped into remarkable hollow "piggyback" torque amplifier handle which provides the grip, reach and power of standard drivers. Each set in a slim, trim, see-thru plastic pocket case, also usable as a bench stand.



**PS88**  
5 slot tip,  
3 Phillips  
screwdrivers

**PS7**  
2 slot tip,  
2 Phillips  
screwdrivers,  
2 nutdrivers



**PS120**  
10 color  
coded nutdrivers



XCELITE INC. • 54 BANK ST., ORCHARD PARK, N. Y.  
Please send free literature N563.

name \_\_\_\_\_  
address \_\_\_\_\_  
city \_\_\_\_\_ state & zone \_\_\_\_\_

CIRCLE NO. 38 ON READER SERVICE CARD

# FREE

## GIANT NEW 1965 CATALOG

**B-A**  
SINCE 1937  
RADIO TV ELECTRONICS  
1705 Grand City

100% OF BARGAINS NOT IN ANY OTHER CATALOG

EVERYTHING IN HI-FI AND STEREO

TOP VALUES IN POWER & HAND TOOLS

100's OF BIG PAGES CRAMMED WITH SAVINGS

TUBES, PARTS ETC. AT LOWEST PRICES

SAVE UP TO 50% ON CHOICE KITS

### BURSTEIN-APPLEBEE CO.

Dept. 459, 1012 McGee St., Kansas City 6, Mo.

Rush me FREE 1965 B-A Catalog

Name .....

Address .....

City ..... State .....

SEND FOR IT TODAY

FREE

CIRCLE NO. 6 ON READER SERVICE CARD

Interested in a space age electronics career?

# THINK

Before  
you  
select  
a  
technical  
school

For a free copy of this folder write:

**Penn Technical Institute**  
5440 Penn Ave., Pittsburgh, Pa.  
Phone 441-3502

CIRCLE NO. 29 ON READER SERVICE CARD



bottles of coil dope and speaker cement. And as a "third hand" for holding together two parts to be soldered, it's hard to beat.

—Joseph Carroll

### FLUORESCENT STARTER REPAIR

The starters in fluorescent light fixtures seldom outlive the fluorescent tubes. This is almost invariably due to the failure of the poor-grade capacitor used in the starter. When the starter goes, the tube blinks on and off, or doesn't light at all. To repair the starter, open its case by bending back the lugs holding the aluminum shell to the

fiber base. Clip out the paper-foil capacitor and discard it. Substitute a 600-volt, .01- $\mu$ f. ceramic disc capacitor for the original capacitor if the



light uses a 15-20 watt fluorescent tube. For a light using a 30-40 watt tube, install a .005- $\mu$ f., 600-volt ceramic disc capacitor. Then reassemble the starter, making sure that the capacitor leads do not short to the aluminum shell.

—Bert Isbell, K5IBZ

### FOOT PADS FOR HEADPHONES

Nothing beats a pair of ordinary, inexpensive magnetic headphones for general utility use, but they can become very uncomfortable if you wear them for any length of time. If copying code or trying to snag rare s.w. stations is your meat, get a couple of foam rubber callus cushions to attach to your headphones. Although these pads are intended to ease foot problems, they'll do a good job on your ears, too!



—John A. Comstock

## Crystal Super Calibrator

(Continued from page 90)

broke," and complete the final assembly, or you can hook everything up on the bench with clip leads and make sure it works before assembling the unit in the box. If it doesn't oscillate, recheck everything, particularly the transistors.

When you're ready, mount the circuit board on the inside of the prepared box cover, taking care to space it clear of the cover with quarter-inch spacers, or with extra nuts on the mounting screws. Put the cover on, and complete the wiring to the battery, on-off switch, and the output binding post. Last, connect the two wires going to the crystal and padder capacitor, put on the second cover, and you're ready to fire up.

**Adjustment.** To adjust for zero beat with WWV, tune in the 10-mc. transmission (or the 5-mc. signal if you can't hear the 10-mc. signal at your location). Couple the output of the calibrator to

the receiver antenna, either directly or through a small capacitor, and fully mesh the padder capacitor plates. Then back off on the padder slowly, listening as the beat note gets lower, until zero beat is reached.

When the frequency difference between the calibrator harmonic and the standard signal gets down to a few cycles, a regular oscillation of the receiver signal strength meter will be seen. This indication is more sensitive than the audible one, and permits adjustment to within one cycle per second or better! If you adjust your calibrator this carefully, the harmonic will be within 15 cycles of the correct frequency, even at 150 mc!

Bear in mind that, while the unit will function with a 1.5-volt, one-cell battery supply, it will also operate on higher voltages (safely to at least 10 volts), and will give commensurately greater output, at some small sacrifice in thermal stability. And you can even use an a.c. power supply running off the receiver heater circuit, as shown in the schematic, if the few milliamperes of battery drain worry you. —30—

# TELEX

## FOR QUALITY

The quality of Telex headsets has become well known to hams over the last twenty-five years. Here are three Telex headsets that deliver the kind of top grade performance that hams expect from Telex—



**MAGNA-TWIN**

For absolute maximum intelligibility under difficult QRM conditions... Super-comfort foam cushions... Rugged, moisture-proof magnetic drivers give broad response, excellent sensitivity... Sturdy construction of high impact plastic.



**TELESET**

Lightweight, economy version of the famous Magna-Twin... High performance, shock-proof Magna-Twin drivers... Designed especially for ham requirements.



**MONOSET**

Feather-light at 1.2 oz... Eliminates headset fatigue... Sound from replaceable driver is fed directly into your ears through adjustable tone arms... Telex quality construction assures reliability.

Write for descriptive literature today.



**TELEX** / Acoustic Products  
COMMUNICATIONS ACCESSORIES

3054 Excelsior Blvd. • Minneapolis 16, Minn.

CIRCLE NO. 40 ON READER SERVICE CARD

## C Bridge

(Continued from page 142)

out is convenient, but need not be followed exactly.

First drill and deburr all the holes needed for mounting the parts. Note that in the unit shown the transformer, line fuse, and a neon pilot lamp (optional) are all mounted in one end of the box, with all connections for the null detector at the opposite end. One of the two terminal strips is mounted near the center of the box lid, and supports *D1*, *R1*, and the common ends of capacitors *C1*, *C2*, and *C3*. Use a heat sink when soldering *D1*.

Standard capacitors *C1* and *C2* can be bought in 10%, 5%, 2%, or even 1% tolerance. The 5% tolerance is recommended for *C1* as the best compromise in price and accuracy. For *C2*, the saving for the 10% tolerance may be enough to be worthwhile. Capacitor *C3* is actually made up of two small 25-w.v.d.c.

electrolytics in parallel. This was necessary in order to bring *C3* to within the desired 5% accuracy, since ordinary electrolytics are not made to close tolerances. The writer found that two Sprague Type TE capacitors marked 6 and 2  $\mu$ f. totaled 10  $\mu$ f. when paralleled.

An optional neon pilot lamp was included in the writer's unit. If you wish to add this feature, connect a plastic-encased NE-2A (or similar) neon lamp in series with a 200,000-ohm, 1/2-watt carbon resistor across the primary of transformer *T1*.

**Calibration.** The C Bridge is calibrated by connecting known values of capacitance across the "unknown" binding posts, adjusting potentiometer *R2* to the null point, and marking the position of the knob pointer with the value of the known capacitor. To do this, connect the null detector by plugging it into the appropriate jacks (*J1*, *J2*, or *BP3* and *BP4*), and plug the C bridge into the a.c. line.

You can use high-impedance phones, a VTVM, or best of all, an amplifying type a.c. VTVM as null detector. -50-

# "MOVING OUT SALE" N.Y. PORT OF AUTHORITY TAKING OVER 13 BLOCKS FOR TRADE CENTER & WE'RE IN IT!

We must unload 3 BULGING WAREHOUSES . . . at the GREATEST PRICE SLASH in Electronic History!

**FREE \$1 BUY WITH EVERY 10 YOU ORDER** Only applies to \$11 Buys **FREE GIFT WITH EVERY ORDER**

- |   |  |  |   |
|---|--|--|---|
| <ul style="list-style-type: none"> <li><input type="checkbox"/> 1000-ASST. HARDWARE KIT \$1<br/><small>screws, nuts, washers, rivets, etc.</small></li> <li><input type="checkbox"/> 1000-ASSORTED RIVETS \$1<br/><small>most useful selected sizes</small></li> <li><input type="checkbox"/> 1000-ASSORTED WASHERS \$1<br/><small>most useful selected sizes</small></li> <li><input type="checkbox"/> TELEPHONE RECORDING DEVICE \$1<br/><small>simply utilize it under telephone</small></li> <li><input type="checkbox"/> UNIVERSAL 5" PM SPEAKER \$1<br/><small>Alnico 5 magnet, quality tone</small></li> <li><input type="checkbox"/> UNIVERSAL 4" PM SPEAKER \$1<br/><small>Alnico 5 magnet, quality tone</small></li> <li><input type="checkbox"/> ELECTROSTATIC 3" TWEETER SPEAKER \$1<br/><small>for PM, III-PI, etc.</small></li> <li><input type="checkbox"/> 5-1-F. COIL TRANSFORMERS \$1<br/><small>sub-min for Transistor Radios</small></li> <li><input type="checkbox"/> 5 - AUDIO OUTPUT TRANSFORM \$1<br/><small>sub-min for Trans Radios</small></li> <li><input type="checkbox"/> 4-TOGGLE SWITCHES \$1<br/><small>SPST, DPST, DPST, DPDT</small></li> <li><input type="checkbox"/> 15-ASST. ROTARY SWITCHES \$1<br/><small>all popular types \$20 value</small></li> <li><input type="checkbox"/> CLEAN UP THE KITCHEN "JACKPOT" \$1<br/><small>11g deal only one to a customer</small></li> <li><input type="checkbox"/> 100-BRASS FANSTOCK CLIPS \$1<br/><small>popular type &amp; size, plated</small></li> <li><input type="checkbox"/> 10-ASST DUAL CONTROLS \$1<br/><small>for Radio, TV, Hi-Fi, Stereo, etc.</small></li> </ul> | <ul style="list-style-type: none"> <li><input type="checkbox"/> 3 AMPHENOL CO-AX CONNECTORS \$1<br/><small>30-239, PL-239, M-339 or asst</small></li> <li><input type="checkbox"/> 100-MIXED DEAL "JACKPOT" \$1<br/><small>Condensers, Resistors, Surpluses</small></li> <li><input type="checkbox"/> 100-MINIATURE ZIP CORD \$1<br/><small>2 conductor, serves EUI uses</small></li> <li><input type="checkbox"/> 100-ASST. RADIO KNOBS \$1<br/><small>all selected popular types</small></li> <li><input type="checkbox"/> 100-RADIO &amp; TV SOCKETS \$1<br/><small>all type 7 pin, 8 pin, 9 pin, etc</small></li> <li><input type="checkbox"/> 100-ASST. TERMINAL STRIPS \$1<br/><small>all types, 1-lug to 6-lug</small></li> <li><input type="checkbox"/> 100 - ASST 1/4 WATT RESISTORS \$1<br/><small>choir, ohmages, some 5%.</small></li> <li><input type="checkbox"/> 100 - ASSORTED 1/2 WATT RESISTORS \$1<br/><small>some in 5%</small></li> <li><input type="checkbox"/> 70 - ASSORTED 1 WATT RESISTORS \$1<br/><small>some in 5%</small></li> <li><input type="checkbox"/> 35 - ASSORTED 2 WATT RESISTORS \$1<br/><small>some in 5%</small></li> <li><input type="checkbox"/> 50-PRECISION RESISTORS \$1<br/><small>asst. list price \$50 less 98%</small></li> <li><input type="checkbox"/> 20 - ASSORTED WIREWOUND RESISTORS, 5, 10, 20 watt \$1</li> <li><input type="checkbox"/> 6 - ASST. SELENIUM RECTIFIERS \$1<br/><small>95ma, 100ma, 300ma, etc.</small></li> <li><input type="checkbox"/> 25 - SYLVANIA HEAT SINKS \$1<br/><small>for Transistors, etc.</small></li> <li><input type="checkbox"/> 50-ASSORTED MILAR CONDENSERS \$1<br/><small>Popular types, .001 to .47</small></li> <li><input type="checkbox"/> 20-BENDIX CONDENSERS \$1<br/><small>107-201118 \$1.5 value</small></li> <li><input type="checkbox"/> 100-ASST. CERAMIC CONDENSERS \$1<br/><small>some in 5%</small></li> </ul> | <ul style="list-style-type: none"> <li><input type="checkbox"/> 1-WESTINGHOUSE TV TUNER \$1<br/><small>4 line, brand new (test tubes)</small></li> <li><input type="checkbox"/> \$15.00 TELEVISION PARTS \$1<br/><small>"JACKPOT" best buy ever</small></li> <li><input type="checkbox"/> 4 - TV ALIGNMENT TOOLS \$1<br/><small>most useful assortment</small></li> <li><input type="checkbox"/> \$15.00 RADIO PARTS "JACKPOT" \$1<br/><small>handy assortment</small></li> <li><input type="checkbox"/> 50-RCA LUCITE RADIO KNOBS \$1<br/><small>Pigular type w indicator pointer</small></li> <li><input type="checkbox"/> 300-ASST. 1/2 W RESISTORS \$1<br/><small>Top Brand, Short leads, excellent</small></li> <li><input type="checkbox"/> 300-ASST MOLDED CONDENSERS \$1<br/><small>Top Brand, Short leads, excellent</small></li> <li><input type="checkbox"/> 50 - STRIPS ASSORTED SPA. GHETTI \$1<br/><small>handy sizes</small></li> <li><input type="checkbox"/> 100-ASSORTED RUBBER GROMMETS \$1<br/><small>METS best sizes</small></li> <li><input type="checkbox"/> 10 - SURE-GRIP ALLIGATOR CLIPS \$1<br/><small>2" plated</small></li> <li><input type="checkbox"/> 10 - SETS PHONO PLUGS &amp; PIN JACKS \$1<br/><small>RCA type</small></li> <li><input type="checkbox"/> 10 SETS - DELUXE PLUGS &amp; JACKS \$1<br/><small>asst. for many purposes</small></li> <li><input type="checkbox"/> 20-ASSORTED TV COILS \$1<br/><small>I.P. video, sound, ratio, etc.</small></li> <li><input type="checkbox"/> 40-ASSORTED TV KNOBS \$1<br/><small>all standard types, \$40 value</small></li> <li><input type="checkbox"/> 4 - 50' SPOOLS HOOK-UP WIRE \$1<br/><small>4 different colors</small></li> <li><input type="checkbox"/> 7 - ASST. TV ELECTROLYTIC CONDENSERS \$1<br/><small>popular selection</small></li> </ul> | <ul style="list-style-type: none"> <li><input type="checkbox"/> \$200 SONOTONE HEARING AID \$5<br/><small>Complete less Earpiece &amp; Batteries</small></li> <li><input type="checkbox"/> 20-11T SELENIUM RECTIFIERS \$1<br/><small>95ma for Radios, Motors, Chargers, Transistors, Experiment, etc</small></li> <li><input type="checkbox"/> 6-IBM COMPUTER SECTIONS \$1<br/><small>loaded with Transistors, Condensers, Diodes, Resistors, Etc.</small></li> <li><input type="checkbox"/> 60NANZA "JACKPOT" not gold, not oil, but a wealth of Electronic Items—Money-Back-guarantee \$5</li> <li><input type="checkbox"/> 15-GE 6NE-2 TUBES \$1<br/><small>Neon Glow Lamp for 101 uses</small></li> <li><input type="checkbox"/> 50-GE-E FLASHLIGHT BULBS \$1<br/><small>2PR-9, 2.7 volts</small></li> <li><input type="checkbox"/> 2-GE PIECES OF EQUIPMENT \$1<br/><small>Stacked with over 200 useful parts</small></li> <li><input type="checkbox"/> G.E. TV POWER TRANSFORMER \$4<br/><small>250ma, 30V/300V, 6.3-9A, 5V-3A</small></li> <li><input type="checkbox"/> 10-SNAP HOOK &amp; CABLE RIG \$1<br/><small>for test, car, handy for 101 uses</small></li> <li><input type="checkbox"/> CRYSTAL LAMP MICROPHONE \$1<br/><small>high impedance, 200-10000 eps</small></li> <li><input type="checkbox"/> 10-A ASSORTED TUBES \$1<br/><small>Radio, Television and Industrial</small></li> <li><input type="checkbox"/> 10-SYLVANIA 1U4 TUBES \$1<br/><small>brand new Jan., individual partons also serves as 1E4</small></li> <li><input type="checkbox"/> ALL AMERICAN TUBE KIT \$2<br/><small>Top Standard Brand — 128A6, 12NE6, 12AV6, 50C5, 35W4</small></li> <li><input type="checkbox"/> 3 - TOP BRAND 35W4 TUBES \$1</li> <li><input type="checkbox"/> CHAPT ZU DI MIZTIA "JACKPOT" \$1<br/><small>double your money back if not completely satisfied</small></li> </ul> |
|---|--|--|---|

HANDY WAY TO ORDER: Pencil mark or write amounts wanted in each box. Enclose with check or money order, add extra for shipping.

**BROOKS RADIO & TV CORP., 84 Vesey St., Dept. B, New York 7, N.Y.** TELEPHONE COlumbia 7-2359

CIRCLE NO. 5 ON READER SERVICE CARD



## Car Battery Saver

(Continued from page 55)

**Mounting the Battery Saver.** After determining the polarity of your car's electrical system, choosing the proper circuit and constructing the Battery Saver, the last step is to mount it in the car and hook it up. One self-tapping screw will secure the case in any location you choose. When it is in place, connect the ground lead under a bolt on the dash or to any metal that is in common potential with the frame of the car. Connect the ignition wire to the cold accessory side of the ignition switch. This is the terminal normally used for a radio or other accessories. Turn on the ignition as a test; nothing should happen. Connect the other lead to the headlight switch on the side that goes to the

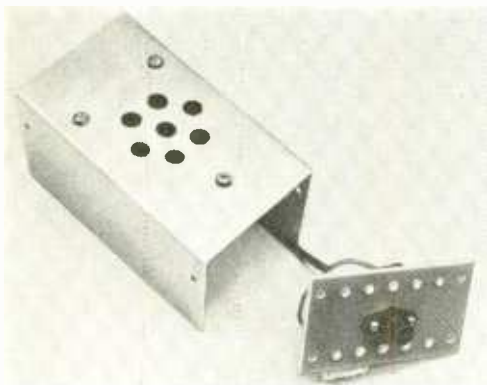

You can mount finished unit in almost anything, even plastic soap dish. This one fits in Minibox.

headlights, or again, the "cold" side of the switch. With the switch off, no voltage should be measured. Then, with the ignition switch on, turn on the headlights. Still nothing should occur. However, when you turn off the ignition with the headlights on, your Battery Saver will come to life with a loud blat.

You have built, tested and installed a device that will save you considerable trouble. Of course, the acid test comes when you trade cars. Which do you pull out first: the Battery Saver or those new tires?

-30-

## LATEST SAMS BOOKS FOR EVERYONE IN ELECTRONICS

### Use This Handy Order Form

- Electronic Gadgets for Your Car.** Practical projects for building a tachometer, transistorized battery checker/charger, handbrake protector, other automotive electronic devices. Order CAR-1, only. \$2.95
- CB Radio Construction Projects.** Complete details for building S-meter, portable antenna, pocket monitor receiver, selective call system, SWR meter, modulation monitor, etc. Order CBG-1, only. \$2.50
- Hi-Fi Projects for the Hobbyist.** Improve your present hi-fi system—build low-cost rumble filter, noise filter, hi-gain antenna, transistorized mike preamp, FM tuner, tape recorder, etc. Order HFF-1, only. \$2.50
- Amateur Radio Construction Projects.** Shows how to build 40-80 meter novice transmitter; 30-watt, 15, 40, 80 meter transmitter; crystal-controlled converters, and other ham gear. Order ARP-1, only. \$2.50
- ABC's of Electronics. ELW-1..... \$1.95
- How to Read Schematic Diagrams. RSD-1..... 1.50
- Electronics For the Beginner. BHJ-1..... 3.95
- Having Fun With Transistors. THF-1..... 2.50
- Radio Receiver Servicing. RS-2..... 2.95
- Transistor Ignition Systems Handbook. IGS-1..... 2.50
- Garage Door Openers. GDO-1..... 2.95
- Modern Dictionary of Electronics. DIC-2..... 6.95
- So You Want To Be a Ham. HAM-3..... 2.95
- TV Servicing Guide. SGS-1..... 2.00
- ABC's of Hi-Fi and Stereo. HSF-1..... 1.95
- ABC's of Short-Wave Listening. SWL-1..... 1.95
- ABC's of Citizens Band Radio. ACR-1..... 1.95
- Electronic Games & Toys You Can Build. EGT-1..... 2.50
- Science Projects in Electronics. SPJ-1..... 2.95
- Practical Projects in Radio Electronics. RSM-1..... 4.95
- Science Projects in Electricity. SPE-1..... 2.95
- Computer Circuit Projects You Can Build. BOC-1..... 2.95
- Tape Recorders—How They Work. TRW-2..... 3.95
- Electronic Experiments & Projects. ESE-1..... 2.50
- ABC's of Transistors. TRA-1..... 1.25
- ABC's of Electronic Organs. ECO-1..... 1.95
- ABC's of Ham Radio. HAP-2..... 1.95
- ABC's of Computers. ABC-1..... 1.95
- Electronic Servicing For the Beginner. BSJ-1..... 2.95
- ABC's of Television Servicing. STA-1..... 1.95
- Short-Wave Listeners Guide. SLG-1..... 1.25
- How to Repair Small Appliances. APP-1..... 2.50
- Know Your VOM-VTVM. KVM-1..... 2.50
- Automotive Electronics Test Equipment. AEL-1..... 2.50
- ABC's of Electronic Test Equipment. STE-1..... 1.95
- 101 Ways to Use Your Oscilloscope. TEM-2..... 2.50
- Electronic Musical Instrument Handbook. EMI-1..... 2.50
- Citizens Band Radio Handbook. CBH-2..... 2.95
- Sams International Code Training System. CTG-1..... 6.95
- Handbook of Electronic Tables & Formulas. HTF-2..... 3.95
- Electronics Math Simplified. 2 Vols. MAT-20..... 7.95
- Tube Substitution Guide. TUB-8..... 1.50
- Understanding Electronic Components. UEC-1..... 2.95
- Understanding Electronic Circuits. UEW-1..... 2.95



**FREE!** Ask for the Sams Booklist, describing over 300 important books.

**FREE!** Index to Photofact, world's finest circuit data on 58,000 TV & radio models.

**HOWARD W. SAMS & CO., INC.**

Order from any Electronic Parts Distributor, or mail to Howard W. Sams & Co., Inc., Dept. EX-1 4300 W. 62nd St., Indianapolis, Ind. 46206

Send books checked above. \$ \_\_\_\_\_ enclosed.

Send FREE Booklist  Send Photofact Index

Name \_\_\_\_\_

Address \_\_\_\_\_

City \_\_\_\_\_ State \_\_\_\_\_ Zip \_\_\_\_\_

IN CANADA: A. C. Simmonds & Sons, Ltd., Toronto 7

**CIRCLE NO. 34 ON READER SERVICE CARD**

# SAVE Time & Worry!

## BUILD "POP" TRONICS

### HANDBOOK Projects And Others With



### CIRCUIT BOARDS

## Simple - Easy Send For FREE Catalog

### IRVING ELECTRONICS CO.

417 DWYER - SAN ANTONIO 4, TEXAS - POST OFFICE BOX 9222  
CIRCLE NO. 20 ON READER SERVICE CARD

### RAY JEFFERSON CITIZENS BAND

MODEL 7000 L

## 1-WATT 2-WAY RADIO



on sale at McGEE

at 1/2 original price

Reg \$99.50 **\$49.95**  
for  
**2 for \$99.50**

Send remittance with your order plus \$1.00 for packing and postage—send 25% deposit with C.O.D. orders.

Ray Jefferson 1 watt 27 Mc C.B. walkie-talkies for channel 6, made to sell at \$99.50. McGEE's sale price is only \$49.95 each—2 for the original price of one, or \$99.50. Add \$1.35 for a regular "AAA" size cells if you want batteries.

Features—8 transistors, crystal controlled superbet receiver with 1 micro volt sensitivity. Transmitter is crystal controlled with 1 watt power to the final. Furnished with channel 6 crystal. Other channel crystals at \$3.00 per pair extra.

Net weight is a little over 3 lbs. Textured plastic case is 11" long by 3 1/2" by 5 1/4". Telescoping antenna and external antenna neck, speaker and mike are built in. A fabulous value. Each set is new, factory cartoned with factory warranties. A regular C.B. license is required.

Write for McGEE's 1965 catalog—sent free—176 pages of bargains in Hi-Fi Speakers—Tape Recorders—Radio and TV parts

**McGEE RADIO CO.**

1901-A McGee St., Kansas City 8, Missouri

CIRCLE NO. 23 ON READER SERVICE CARD

## The WXCVR

(Continued from page 97)

ground lug bolted on the left end of the cover. Run a fairly heavy, solid wire from terminal 1 to the grounded mounting foot of the 3-lug tie strip. Use similar wire for the balance of *T1*'s connections to insure adequate support for the transformer. A study of the illustrations will reveal how the rest of the components are mounted and wired.

**Antenna Tips.** Don't skimp on the sky-wire if you want topnotch performance from the WXCVR, for long wavelengths need long antennas. Within 50 miles of an FAA station, a 25' antenna will probably be sufficient. However, if you want to reach out for distance, put up at least 50 feet of wire, and install the antenna as high in the air as possible.

For best results, use a cold water pipe or a rod driven into moist earth for the ground connection. If you can't conveniently do this, simulate a ground by connecting 20 or 30 feet of wire to the ground terminal of *TS1*. Put this wire on the floor under a rug, or run it along the baseboard.

**Adjustment.** After temporarily taping *L3* to the case of the radio the WXCVR is to work with, adjust the slug until "4" of the slug screw extends outside the coil form. Should the receiver have no built-in loop, but, instead, require an external antenna, wrap a couple of turns of insulated wire around *L3*, strip the opposite end of the wire, and connect it to the radio's antenna terminal.

Add 1150 kc. to the frequency of your nearest FAA station as listed in the table. Tune the receiver to the sum of the two frequencies, which will lie somewhere between 1350 and 1550 kc. With antenna, ground and battery connected to the WXCVR, and *S1* switched on, slowly adjust the slug of *L2* until the carrier generated by *Q1* is heard in the radio. If you hear more than one carrier during this adjustment, pick the strongest.

Now retune the receiver dial to 1150 kc. If a strong broadcast station occupies this spot, move over to 1140 kc. or 1160 kc. Adjust the slugs of *T1* and

*L3* for maximum noise, hiss, or static. With ordinary luck, you will already be hearing the weathercaster's voice. If not, slowly move *L2*'s slug back and forth until you encounter the desired signal. Touch up *T1* and *L3* for maximum volume.

As you align the converter, you will probably hear what sound like slow speed code stations. These are airways and marine beacons, many of which operate on the low frequencies. You will also hear a Morse code identification signal under the voice of the weathercaster. Tweak the receiver dial slightly to accentuate the voice and discriminate against the beacon tone.

If you want to explore the band from 200 to 400 kc., slowly tune *L2*'s slug through its adjustment range. As you discover interesting signals, repeak *T1* for best reception.

**Final Installation.** With adjustment on the desired FAA station completed, machine screws can be used to fasten the rear cover of the converter to the back of the receiver. Fasten *L3* in place after finding the position which provides

maximum signal transfer to the receiver's loop. To avoid the danger of shock when working with an a.c.-d.c. set, be sure that the converter's mounting screws and other parts do not make contact with any metal parts of the receiver. Apply plastic electrical tape to all screws that protrude from the receiver's case.

Readers located beyond the range of an automatic weathercaster need not despair. Similar information is transmitted at half-hour intervals on many other low-frequency channels. A complete list of all FAA radio facilities is contained in the *Airman's Guide*, available for about 75 cents (the price varies) from the Superintendent of Documents, Government Printing Office, Washington 25, D. C.; since a new issue is published every two weeks, you may be able to wangle a copy for free at the local airport. The station list is also given in *Weather Services For Pilots*, also available from the Superintendent of Documents (for 10 cents), but this pamphlet is not so frequently updated as the *Airman's Guide*. -30-



**Electro-Voice**  
SETTING NEW STANDARDS IN SOUND

# FREE! HOW TO IMPROVE YOUR TWO-WAY RADIO!

The right communications microphone may *double* the talk power of even the finest transmitters! Learn how unwanted noise can be eliminated—reliability improved—intelligibility increased by proper microphone selection.

Write for our helpful free booklet today!

ELECTRO-VOICE, INC., Dept. 152EH  
Buchanan, Michigan 49107

Please send the free E-V booklet on choosing communications microphones. I am interested in the following areas of two-way radio:  Amateur  Aviation  CB  Business.

NAME \_\_\_\_\_

COMPANY \_\_\_\_\_

ADDRESS \_\_\_\_\_

CITY \_\_\_\_\_ STATE \_\_\_\_\_

CIRCLE NO. 41 ON READER SERVICE CARD

**"TAB" \* SCR'S \* TRANSISTORS \* DIODES!!!**  
Full Leads, Factory Tested & Guaranteed U.S.A. Mfg.

PNP (HiPower) 15amp Round TO36 Pchlet  
2N441 442, 277, 278, D501 up to  
2N2907, 2N2908, 2N2909, 2N2910  
2N2911, 2N2912, 2N2913, 2N2914  
2N2915, 2N2916, 2N2917, 2N2918  
2N2919, 2N2920, 2N2921, 2N2922  
2N2923, 2N2924, 2N2925, 2N2926  
2N2927, 2N2928, 2N2929, 2N2930  
2N2931, 2N2932, 2N2933, 2N2934  
2N2935, 2N2936, 2N2937, 2N2938  
2N2939, 2N2940, 2N2941, 2N2942  
2N2943, 2N2944, 2N2945, 2N2946  
2N2947, 2N2948, 2N2949, 2N2950  
2N2951, 2N2952, 2N2953, 2N2954  
2N2955, 2N2956, 2N2957, 2N2958  
2N2959, 2N2960, 2N2961, 2N2962  
2N2963, 2N2964, 2N2965, 2N2966  
2N2967, 2N2968, 2N2969, 2N2970  
2N2971, 2N2972, 2N2973, 2N2974  
2N2975, 2N2976, 2N2977, 2N2978  
2N2979, 2N2980, 2N2981, 2N2982  
2N2983, 2N2984, 2N2985, 2N2986  
2N2987, 2N2988, 2N2989, 2N2990  
2N2991, 2N2992, 2N2993, 2N2994  
2N2995, 2N2996, 2N2997, 2N2998  
2N2999, 3N1, 3N2, 3N3, 3N4, 3N5  
3N6, 3N7, 3N8, 3N9, 3N10, 3N11  
3N12, 3N13, 3N14, 3N15, 3N16  
3N17, 3N18, 3N19, 3N20, 3N21  
3N22, 3N23, 3N24, 3N25, 3N26  
3N27, 3N28, 3N29, 3N30, 3N31  
3N32, 3N33, 3N34, 3N35, 3N36  
3N37, 3N38, 3N39, 3N40, 3N41  
3N42, 3N43, 3N44, 3N45, 3N46  
3N47, 3N48, 3N49, 3N50, 3N51  
3N52, 3N53, 3N54, 3N55, 3N56  
3N57, 3N58, 3N59, 3N60, 3N61  
3N62, 3N63, 3N64, 3N65, 3N66  
3N67, 3N68, 3N69, 3N70, 3N71  
3N72, 3N73, 3N74, 3N75, 3N76  
3N77, 3N78, 3N79, 3N80, 3N81  
3N82, 3N83, 3N84, 3N85, 3N86  
3N87, 3N88, 3N89, 3N90, 3N91  
3N92, 3N93, 3N94, 3N95, 3N96  
3N97, 3N98, 3N99, 4N1, 4N2, 4N3  
4N4, 4N5, 4N6, 4N7, 4N8, 4N9, 4N10  
4N11, 4N12, 4N13, 4N14, 4N15  
4N16, 4N17, 4N18, 4N19, 4N20  
4N21, 4N22, 4N23, 4N24, 4N25  
4N26, 4N27, 4N28, 4N29, 4N30  
4N31, 4N32, 4N33, 4N34, 4N35  
4N36, 4N37, 4N38, 4N39, 4N40  
4N41, 4N42, 4N43, 4N44, 4N45  
4N46, 4N47, 4N48, 4N49, 4N50  
4N51, 4N52, 4N53, 4N54, 4N55  
4N56, 4N57, 4N58, 4N59, 4N60  
4N61, 4N62, 4N63, 4N64, 4N65  
4N66, 4N67, 4N68, 4N69, 4N70  
4N71, 4N72, 4N73, 4N74, 4N75  
4N76, 4N77, 4N78, 4N79, 4N80  
4N81, 4N82, 4N83, 4N84, 4N85  
4N86, 4N87, 4N88, 4N89, 4N90  
4N91, 4N92, 4N93, 4N94, 4N95  
4N96, 4N97, 4N98, 4N99, 5N1  
5N2, 5N3, 5N4, 5N5, 5N6, 5N7  
5N8, 5N9, 5N10, 5N11, 5N12  
5N13, 5N14, 5N15, 5N16, 5N17  
5N18, 5N19, 5N20, 5N21, 5N22  
5N23, 5N24, 5N25, 5N26, 5N27  
5N28, 5N29, 5N30, 5N31, 5N32  
5N33, 5N34, 5N35, 5N36, 5N37  
5N38, 5N39, 5N40, 5N41, 5N42  
5N43, 5N44, 5N45, 5N46, 5N47  
5N48, 5N49, 5N50, 5N51, 5N52  
5N53, 5N54, 5N55, 5N56, 5N57  
5N58, 5N59, 5N60, 5N61, 5N62  
5N63, 5N64, 5N65, 5N66, 5N67  
5N68, 5N69, 5N70, 5N71, 5N72  
5N73, 5N74, 5N75, 5N76, 5N77  
5N78, 5N79, 5N80, 5N81, 5N82  
5N83, 5N84, 5N85, 5N86, 5N87  
5N88, 5N89, 5N90, 5N91, 5N92  
5N93, 5N94, 5N95, 5N96, 5N97  
5N98, 5N99, 6N1, 6N2, 6N3, 6N4  
6N5, 6N6, 6N7, 6N8, 6N9, 6N10  
6N11, 6N12, 6N13, 6N14, 6N15  
6N16, 6N17, 6N18, 6N19, 6N20  
6N21, 6N22, 6N23, 6N24, 6N25  
6N26, 6N27, 6N28, 6N29, 6N30  
6N31, 6N32, 6N33, 6N34, 6N35  
6N36, 6N37, 6N38, 6N39, 6N40  
6N41, 6N42, 6N43, 6N44, 6N45  
6N46, 6N47, 6N48, 6N49, 6N50  
6N51, 6N52, 6N53, 6N54, 6N55  
6N56, 6N57, 6N58, 6N59, 6N60  
6N61, 6N62, 6N63, 6N64, 6N65  
6N66, 6N67, 6N68, 6N69, 6N70  
6N71, 6N72, 6N73, 6N74, 6N75  
6N76, 6N77, 6N78, 6N79, 6N80  
6N81, 6N82, 6N83, 6N84, 6N85  
6N86, 6N87, 6N88, 6N89, 6N90  
6N91, 6N92, 6N93, 6N94, 6N95  
6N96, 6N97, 6N98, 6N99, 7N1  
7N2, 7N3, 7N4, 7N5, 7N6, 7N7  
7N8, 7N9, 7N10, 7N11, 7N12  
7N13, 7N14, 7N15, 7N16, 7N17  
7N18, 7N19, 7N20, 7N21, 7N22  
7N23, 7N24, 7N25, 7N26, 7N27  
7N28, 7N29, 7N30, 7N31, 7N32  
7N33, 7N34, 7N35, 7N36, 7N37  
7N38, 7N39, 7N40, 7N41, 7N42  
7N43, 7N44, 7N45, 7N46, 7N47  
7N48, 7N49, 7N50, 7N51, 7N52  
7N53, 7N54, 7N55, 7N56, 7N57  
7N58, 7N59, 7N60, 7N61, 7N62  
7N63, 7N64, 7N65, 7N66, 7N67  
7N68, 7N69, 7N70, 7N71, 7N72  
7N73, 7N74, 7N75, 7N76, 7N77  
7N78, 7N79, 7N80, 7N81, 7N82  
7N83, 7N84, 7N85, 7N86, 7N87  
7N88, 7N89, 7N90, 7N91, 7N92  
7N93, 7N94, 7N95, 7N96, 7N97  
7N98, 7N99, 8N1, 8N2, 8N3, 8N4  
8N5, 8N6, 8N7, 8N8, 8N9, 8N10  
8N11, 8N12, 8N13, 8N14, 8N15  
8N16, 8N17, 8N18, 8N19, 8N20  
8N21, 8N22, 8N23, 8N24, 8N25  
8N26, 8N27, 8N28, 8N29, 8N30  
8N31, 8N32, 8N33, 8N34, 8N35  
8N36, 8N37, 8N38, 8N39, 8N40  
8N41, 8N42, 8N43, 8N44, 8N45  
8N46, 8N47, 8N48, 8N49, 8N50  
8N51, 8N52, 8N53, 8N54, 8N55  
8N56, 8N57, 8N58, 8N59, 8N60  
8N61, 8N62, 8N63, 8N64, 8N65  
8N66, 8N67, 8N68, 8N69, 8N70  
8N71, 8N72, 8N73, 8N74, 8N75  
8N76, 8N77, 8N78, 8N79, 8N80  
8N81, 8N82, 8N83, 8N84, 8N85  
8N86, 8N87, 8N88, 8N89, 8N90  
8N91, 8N92, 8N93, 8N94, 8N95  
8N96, 8N97, 8N98, 8N99, 9N1  
9N2, 9N3, 9N4, 9N5, 9N6, 9N7  
9N8, 9N9, 9N10, 9N11, 9N12  
9N13, 9N14, 9N15, 9N16, 9N17  
9N18, 9N19, 9N20, 9N21, 9N22  
9N23, 9N24, 9N25, 9N26, 9N27  
9N28, 9N29, 9N30, 9N31, 9N32  
9N33, 9N34, 9N35, 9N36, 9N37  
9N38, 9N39, 9N40, 9N41, 9N42  
9N43, 9N44, 9N45, 9N46, 9N47  
9N48, 9N49, 9N50, 9N51, 9N52  
9N53, 9N54, 9N55, 9N56, 9N57  
9N58, 9N59, 9N60, 9N61, 9N62  
9N63, 9N64, 9N65, 9N66, 9N67  
9N68, 9N69, 9N70, 9N71, 9N72  
9N73, 9N74, 9N75, 9N76, 9N77  
9N78, 9N79, 9N80, 9N81, 9N82  
9N83, 9N84, 9N85, 9N86, 9N87  
9N88, 9N89, 9N90, 9N91, 9N92  
9N93, 9N94, 9N95, 9N96, 9N97  
9N98, 9N99, 10N1, 10N2, 10N3  
10N4, 10N5, 10N6, 10N7, 10N8  
10N9, 10N10, 10N11, 10N12, 10N13  
10N14, 10N15, 10N16, 10N17, 10N18  
10N19, 10N20, 10N21, 10N22, 10N23  
10N24, 10N25, 10N26, 10N27, 10N28  
10N29, 10N30, 10N31, 10N32, 10N33  
10N34, 10N35, 10N36, 10N37, 10N38  
10N39, 10N40, 10N41, 10N42, 10N43  
10N44, 10N45, 10N46, 10N47, 10N48  
10N49, 10N50, 10N51, 10N52, 10N53  
10N54, 10N55, 10N56, 10N57, 10N58  
10N59, 10N60, 10N61, 10N62, 10N63  
10N64, 10N65, 10N66, 10N67, 10N68  
10N69, 10N70, 10N71, 10N72, 10N73  
10N74, 10N75, 10N76, 10N77, 10N78  
10N79, 10N80, 10N81, 10N82, 10N83  
10N84, 10N85, 10N86, 10N87, 10N88  
10N89, 10N90, 10N91, 10N92, 10N93  
10N94, 10N95, 10N96, 10N97, 10N98  
10N99, 11N1, 11N2, 11N3, 11N4  
11N5, 11N6, 11N7, 11N8, 11N9, 11N10  
11N11, 11N12, 11N13, 11N14, 11N15  
11N16, 11N17, 11N18, 11N19, 11N20  
11N21, 11N22, 11N23, 11N24, 11N25  
11N26, 11N27, 11N28, 11N29, 11N30  
11N31, 11N32, 11N33, 11N34, 11N35  
11N36, 11N37, 11N38, 11N39, 11N40  
11N41, 11N42, 11N43, 11N44, 11N45  
11N46, 11N47, 11N48, 11N49, 11N50  
11N51, 11N52, 11N53, 11N54, 11N55  
11N56, 11N57, 11N58, 11N59, 11N60  
11N61, 11N62, 11N63, 11N64, 11N65  
11N66, 11N67, 11N68, 11N69, 11N70  
11N71, 11N72, 11N73, 11N74, 11N75  
11N76, 11N77, 11N78, 11N79, 11N80  
11N81, 11N82, 11N83, 11N84, 11N85  
11N86, 11N87, 11N88, 11N89, 11N90  
11N91, 11N92, 11N93, 11N94, 11N95  
11N96, 11N97, 11N98, 11N99, 12N1  
12N2, 12N3, 12N4, 12N5, 12N6, 12N7  
12N8, 12N9, 12N10, 12N11, 12N12  
12N13, 12N14, 12N15, 12N16, 12N17  
12N18, 12N19, 12N20, 12N21, 12N22  
12N23, 12N24, 12N25, 12N26, 12N27  
12N28, 12N29, 12N30, 12N31, 12N32  
12N33, 12N34, 12N35, 12N36, 12N37  
12N38, 12N39, 12N40, 12N41, 12N42  
12N43, 12N44, 12N45, 12N46, 12N47  
12N48, 12N49, 12N50, 12N51, 12N52  
12N53, 12N54, 12N55, 12N56, 12N57  
12N58, 12N59, 12N60, 12N61, 12N62  
12N63, 12N64, 12N65, 12N66, 12N67  
12N68, 12N69, 12N70, 12N71, 12N72  
12N73, 12N74, 12N75, 12N76, 12N77  
12N78, 12N79, 12N80, 12N81, 12N82  
12N83, 12N84, 12N85, 12N86, 12N87  
12N88, 12N89, 12N90, 12N91, 12N92  
12N93, 12N94, 12N95, 12N96, 12N97  
12N98, 12N99, 13N1, 13N2, 13N3  
13N4, 13N5, 13N6, 13N7, 13N8, 13N9  
13N10, 13N11, 13N12, 13N13, 13N14  
13N15, 13N16, 13N17, 13N18, 13N19  
13N20, 13N21, 13N22, 13N23, 13N24  
13N25, 13N26, 13N27, 13N28, 13N29  
13N30, 13N31, 13N32, 13N33, 13N34  
13N35, 13N36, 13N37, 13N38, 13N39  
13N40, 13N41, 13N42, 13N43, 13N44  
13N45, 13N46, 13N47, 13N48, 13N49  
13N50, 13N51, 13N52, 13N53, 13N54  
13N55, 13N56, 13N57, 13N58, 13N59  
13N60, 13N61, 13N62, 13N63, 13N64  
13N65, 13N66, 13N67, 13N68, 13N69  
13N70, 13N71, 13N72, 13N73, 13N74  
13N75, 13N76, 13N77, 13N78, 13N79  
13N80, 13N81, 13N82, 13N83, 13N84  
13N85, 13N86, 13N87, 13N88, 13N89  
13N90, 13N91, 13N92, 13N93, 13N94  
13N95, 13N96, 13N97, 13N98, 13N99  
14N1, 14N2, 14N3, 14N4, 14N5, 14N6  
14N7, 14N8, 14N9, 14N10, 14N11, 14N12  
14N13, 14N14, 14N15, 14N16, 14N17  
14N18, 14N19, 14N20, 14N21, 14N22  
14N23, 14N24, 14N25, 14N26, 14N27  
14N28, 14N29, 14N30, 14N31, 14N32  
14N33, 14N34, 14N35, 14N36, 14N37  
14N38, 14N39, 14N40, 14N41, 14N42  
14N43, 14N44, 14N45, 14N46, 14N47  
14N48, 14N49, 14N50, 14N51, 14N52  
14N53, 14N54, 14N55, 14N56, 14N57  
14N58, 14N59, 14N60, 14N61, 14N62  
14N63, 14N64, 14N65, 14N66, 14N67  
14N68, 14N69, 14N70, 14N71, 14N72  
14N73, 14N74, 14N75, 14N76, 14N77  
14N78, 14N79, 14N80, 14N81, 14N82  
14N83, 14N84, 14N85, 14N86, 14N87  
14N88, 14N89, 14N90, 14N91, 14N92  
14N93, 14N94, 14N95, 14N96, 14N97  
14N98, 14N99, 15N1, 15N2, 15N3  
15N4, 15N5, 15N6, 15N7, 15N8, 15N9  
15N10, 15N11, 15N12, 15N13, 15N14  
15N15, 15N16, 15N17, 15N18, 15N19  
15N20, 15N21, 15N22, 15N23, 15N24  
15N25, 15N26, 15N27, 15N28, 15N29  
15N30, 15N31, 15N32, 15N33, 15N34  
15N35, 15N36, 15N37, 15N38, 15N39  
15N40, 15N41, 15N42, 15N43, 15N44  
15N45, 15N46, 15N47, 15N48, 15N49  
15N50, 15N51, 15N52, 15N53, 15N54  
15N55, 15N56, 15N57, 15N58, 15N59  
15N60, 15N61, 15N62, 15N63, 15N64  
15N65, 15N66, 15N67, 15N68, 15N69  
15N70, 15N71, 15N72, 15N73, 15N74  
15N75, 15N76, 15N77, 15N78, 15N79  
15N80, 15N81, 15N82, 15N83, 15N84  
15N85, 15N86, 15N87, 15N88, 15N89  
15N90, 15N91, 15N92, 15N93, 15N94  
15N95, 15N96, 15N97, 15N98, 15N99  
16N1, 16N2, 16N3, 16N4, 16N5, 16N6  
16N7, 16N8, 16N9, 16N10, 16N11, 16N12  
16N13, 16N14, 16N15, 16N16, 16N17  
16N18, 16N19, 16N20, 16N21, 16N22  
16N23, 16N24, 16N25, 16N26, 16N27  
16N28, 16N29, 16N30, 16N31, 16N32  
16N33, 16N34, 16N35, 16N36, 16N37  
16N38, 16N39, 16N40, 16N41, 16N42  
16N43, 16N44, 16N45, 16N46, 16N47  
16N48, 16N49, 16N50, 16N51, 16N52  
16N53, 16N54, 16N55, 16N56, 16N57  
16N58, 16N59, 16N60, 16N61, 16N62  
16N63, 16N64, 16N65, 16N66, 16N67  
16N68, 16N69, 16N70, 16N71, 16N72  
16N73, 16N74, 16N75, 16N76, 16N77  
16N78, 16N79, 16N80, 16N81, 16N82  
16N83, 16N84, 16N85, 16N86, 16N87  
16N88, 16N89, 16N90, 16N91, 16N92  
16N93, 16N94, 16N95, 16N96, 16N97  
16N98, 16N99, 17N1, 17N2, 17N3  
17N4, 17N5, 17N6, 17N7, 17N8, 17N9  
17N10, 17N11, 17N12, 17N13, 17N14  
17N15, 17N16, 17N17, 17N18, 17N19  
17N20, 17N21, 17N22, 17N23, 17N24  
17N25, 17N26, 17N27, 17N28, 17N29  
17N30, 17N31, 17N32, 17N33, 17N34  
17N35, 17N36, 17N37, 17N38, 17N39  
17N40, 17N41, 17N42, 17N43, 17N44  
17N45, 17N46, 17N47, 17N48, 17N49  
17N50, 17N51, 17N52, 17N53, 17N54  
17N55, 17N56, 17N57, 17N58, 17N59  
17N60, 17N61, 17N62, 17N63, 17N64  
17N65, 17N66, 17N67, 17N68, 17N69  
17N70, 17N71, 17N72, 17N73, 17N74  
17N75, 17N76, 17N77, 17N78, 17N79  
17N80, 17N81, 17N82, 17N83, 17N84  
17N85, 17N86, 17N87, 17N88, 17N89  
17N90, 17N91, 17N92, 17N93, 17N94  
17N95, 17N96, 17N97, 17N98, 17N99  
18N1, 18N2, 18N3, 18N4, 18N5, 18N6  
18N7, 18N8, 18N9, 18N10, 18N11, 18N12  
18N13, 18N14, 18N15, 18N16, 18N17  
18N18, 18N19, 18N20, 18N21, 18N22  
18N23, 18N24, 18N25, 18N26, 18N27  
18N28, 18N29, 18N30, 18N31, 18N32  
18N33, 18N34, 18N35, 18N36, 18N37  
18N38, 18N39, 18N40, 18N41, 18N42  
18N43, 18N44, 18N45, 18N46, 18N47  
18N48, 18N49, 18N50, 18N51, 18N52  
18N53, 18N54, 18N55, 18N56, 18N57  
18N58, 18N59, 18N60, 18N61, 18N62  
18N63, 18N64, 18N65, 18N66, 18N67  
18N68, 18N69, 18N70, 18N71, 18N72  
18N73, 18N74, 18N75, 18N76, 18N77  
18N78, 18N79, 18N80, 18N81, 18N82  
18N83, 18N84, 18N85, 18N86, 18N87  
18N88, 18N89, 18N90, 18N91, 18N92  
18N93, 18N94, 18N95, 18N96, 18N97  
18N98, 18N99, 19N1, 19N2, 19N3  
19N4, 19N5, 19N6, 19N7, 19N8, 19N9  
19N10, 19N11, 19N12, 19N13, 19N14  
19N15, 19N16, 19N17, 19N18, 19N19  
19N20, 19N21, 19N22, 19N23, 19N24  
19N25, 19N26, 19N27, 19N28, 19N29  
19N30, 19N31, 19N32, 19N33, 19N34  
19N35, 19N36, 19N37, 19N38, 19N39  
19N40, 19N41, 19N42, 19N43, 19N44  
19N45, 19N46, 19N47, 19N48, 19N49  
19N50, 19N51, 19N52, 19N53, 19N54  
19N55, 19N56, 19N57, 19N58, 19N59  
19N60, 19N61, 19N62, 19N63, 19N64  
19N65, 19N66, 19N67, 19N68, 19N69  
19N70, 19N71, 19N72, 19N73, 19N74  
19N75, 19N76, 19N77, 19N78, 19N79  
19N80, 19N81, 19N82, 19N83, 19N84  
19N85, 19N86, 19N87, 19N88, 19N89  
19N90, 19N91, 19N92, 19N93, 19N94  
19N95, 19N96, 19N97, 19N98, 19N99  
20N1, 20N2, 20N3, 20N4, 20N5, 20N6  
20N7, 20N8, 20N9, 20N10, 20N11, 20N12  
20N13, 20N14, 20N15, 20N16, 20N17  
20N18, 20N19, 20N20, 20N21, 20N22  
20N23, 20N24, 20N25, 20N26, 20N27  
20N28, 20N29, 20N30, 20N31, 20N32  
20N33, 20N34, 20N35, 20N36, 20N37  
20N38, 20N39, 20N40, 20N41, 20N42  
20N43, 20N44, 20N45, 20N46, 20N47  
20N48, 20N49, 20N50, 20N51, 20N52  
20N53, 20N54, 20N55, 20N56, 20N57  
20N58, 20N59, 20N60, 20N61, 20N62  
20N63, 20N64, 20N65, 20N66, 20N67  
20N68, 20N69, 20N70, 20N71, 20N72  
20N73, 20N74, 20N75, 20N76, 20N77  
20N78, 20N79, 20N80,

## 2-Meter Simple Superhet

(Continued from page 119)

As with any other construction job, it is important to do all cutting, drilling, and deburring before beginning assembly. You'll probably find it easier to wire the tuned circuits connecting to *V1* before wiring the other stages.

**Testing and Calibration.** When assembly and wiring is completed, carefully check all connections against Figs. 3 and 5 before firing up. That done, plug into the a.c. line, turn on the set, and allow a 10-minute warm-up. Set the *GAIN* control to maximum and increase the *REGEN* control setting until you hear the typical superregenerative detector hiss from the speaker.

Before aligning the front end to cover the 2-meter amateur band, it's necessary to align the second detector to the 6-mc. i.f. channel. First, make an approximate adjustment of *L3* by turning the slug screw until about  $\frac{1}{4}$ " is exposed above the lock nut on the can. If you have a generator that will provide a 6-mc. signal, apply it to the coax antenna input, back off the *REGEN* control until the hiss just disappears, and adjust the slug in *L3* for maximum output from the speaker. This puts the detector circuit on 6 mc.

To align the front end when no generator covering the 2-meter band is available, set trimmers *C3* and *C7* to about half capacity, and main tuning capacitor *C2* at a little more than half capacity. Connect a good 2-meter antenna to *J1*, and adjust oscillator trimmer *C3* until 2-meter amateur signals are heard. On a medium strength ham signal, adjust *C7* for maximum gain.

If you have a generator covering 2 meters, connect it to *J1* and set it to give a modulated signal at 145 mc. Turn up the *REGEN* control until you hear the hiss, and adjust *C3* with a nonmetallic screwdriver until you hear the generator signal.

Finally, adjust *C7* for maximum signal output while rocking the main tuning capacitor slightly. This adjustment is necessary because changing *C3* affects the oscillator frequency.

—30—

# You've got to SEE it to BELIEVE it!

instant lettering<sup>®</sup>

dry transfer

## MARKING KITS for ELECTRONIC EQUIPMENT



"Instant Lettering" marking kits bring you all the necessary elements for completely marking electronic equipment, drawings, prototypes, schematics, etc. in a fast new easy-to-use form.

Words, letters, numerals, switch patterns, arcs, etc. are printed on a special transparent carrier film. Rubbing over one of these elements with a ballpoint pen releases it from the carrier film and adheres it to your working surface.

"Instant Lettering" words and patterns transfer to almost any surface including glass, plastic, metal . . . even cracked finished metal. Now you can quickly mark all panels, even especially calibrated two-color meter dials, tap switches, panel nomenclatures, pilot light jewels, sub-assemblies, circuit boards, etc. Reproduction quality "Instant Lettering" transfers are clean and sharp, leave no background haze or film, make prototypes look like finished production equipment and give all equipment and drawings a professional look.

### TITLES FOR ELECTRONIC EQUIPMENT

This set contains hundreds of preprinted titles researched to give you up to 95% of all electronic marking. For labeling, marking, titling all electronic control panels, drawings, prototypes, etc.

No. 958 — BLACK.....\$4.95    No. 959 — WHITE.....\$4.95

### TERMINAL & CHASSIS MARKING KIT

Contains all the necessary letters, letter combinations and numerals for marking chassis, printed circuit and terminal boards, rotating components, etc.

No. 966 — BLACK.....\$4.95    No. 967 — WHITE.....\$4.95

### METER & DIAL MARKING KIT

Arcs, dial patterns, lines, wedges, graduation lines, switch symbols, alphabets and numerals in black, white and red for marking standard and special rotary tap switches, potentiometers and prototype and especially calibrated meter dials. Colors provide contrast on scales and switches simplifying usage of complex instruments.

No. 968 — METER & DIAL MARKING KIT.....\$4.95

WRITE FOR FREE SAMPLE AND COMPLETE DETAILS

## THE DATAK CORPORATION

63 · 71st St. · Dept. 634 · Guttenberg, N. J.

CIRCLE NO. 10 ON READER SERVICE CARD

## SILICON RECTIFIER SALE

IMMEDIATE DELIVERY  
FULLY GUARANTEED NEWEST TYPE  
AMERICAN MADE FULLY TESTED  
HIGHEST QUALITY

750 MA-SILICON "TOP-HAT" DIODES

LOW LEAKAGE FULL LEAD LENGTH

PIV/RMS	PIV/RMS	PIV/RMS	PIV/RMS
50/35 .05 ea	100/70 .09 ea	200/140 .12 ea	300/210 .16 ea
400/280 .20 ea	500/350 .24 ea	600/420 .32 ea	700/490 .40 ea
800/560 .46 ea	900/630 .55 ea	1000/700 .70 ea	1100/770 .75 ea

ALL TESTS AC & DC & FWD & LOAD  
SILICON POWER DIODE STUDS

D.C. AMPS	50 PIV 35 RMS	100 PIV 70 RMS	150 PIV 105 RMS	200 PIV 140 RMS
3	.12	.18	.22	.30
12	.45	.65	.75	.90
35	.90	1.18	1.50	1.70
50	1.60	1.90	2.30	2.80
100	1.75	2.15	2.55	3.15

D.C. AMPS	300 PIV 210 RMS	400 PIV 280 RMS	500 PIV 350 RMS	600 PIV 450 RMS
3	.40	.45	.55	.65
12	1.10	1.35	1.50	1.70
35	2.35	2.55	3.00	3.50
50	3.50	4.20	5.25	7.00
100	3.75	4.60	5.65	8.00

"SCR" SILICON CONTROLLED RECTIFIERS "SCR"

PRV	7 AMP	16 AMP	25 AMP	PRV	7 AMP	16 AMP	25 AMP
25	.50	.85	1.20	250	2.30	2.65	3.10
50	.85	1.20	1.40	300	2.60	3.00	3.40
100	1.35	1.80	2.20	400	3.00	3.40	4.15
150	1.60	2.10	2.65	500	3.75	4.25	4.75
200	1.75	2.40	2.90	600	4.00	5.00	5.25

Money Back Guarantee. \$2.00 min. order. Orders F.O.B. NYC. Include check or money order ship. charges plus. C.O.D. orders 25% down.

**WARREN ELECTRONIC COMPONENTS**  
230 MERCER ST., BOX EH, N.Y. 10012 N.Y. OR-3-2620

CIRCLE NO. 37 ON READER SERVICE CARD

## Ceramic Tile Enclosure

(Continued from page 71)

treble diffuser added. One method that works well is an inverted plastic funnel (as used in the "Drainpipe 8" enclosure—see the 1963 ELECTRONIC EXPERIMENTER'S HANDBOOK).

**Egg Tray Diffuser.** Another type of diffuser, shown on p. 71, has the advantage of being adjustable, and the multiple convex surfaces insure wide diffusion. It is made from half of a plastic refrigerator egg tray (sold in dime stores for about 29 cents), an eye bolt, and a strap that electricians use for fastening down electrical cables.

The egg tray is cut in half and a hole drilled in the remaining end to match the size of the eye bolt. A nut is then placed on each side of the plastic tray end to clamp it in place; again, sealant is called for.

The small strap will have to be drilled out on one side to allow it to fit the 1/4" threaded rod as shown. If you're planning to use this diffuser, the strap should be installed at the time the speaker board is tightened, substituting it for the washer. After the diffuser is mounted, a screw should be put on the other end of the strap.

If you use this diffuser, you may want to "dress up" the system. Decorator bur-lap or even grille cloth can be glued directly to the outside of the tile. Alternatively, a light frame could carry the grille cloth up around the diffuser and hide it, or a frame could be built around the entire system which could then be encased in grille cloth.

The Word Is "Crisp." Not everyone will like this speaker system. One listener, for example, said he preferred his own, because it was more "mellow." But it's wise to be suspicious of that word. "Mellow" usually suggests hangover, and this in turn means transient distortion. A poorly braced cabinet can produce it in great quantities.

"Crisp" is the word for the kind of bass produced by this little enclosure. If you like your bass crisp and you aren't flush with either space or money, this system is for you!



# BIG MONEY IN THE 4 CORNERS OF THE WORLD!

in TELEVISION, RADIO,  
ELECTRONICS, RADAR, SONAR

ONLY CHRISTY OFFERS  
COMPLETE TRAINING!

Investigate the Christy Complete Course. Why be satisfied with less? CTS Shop Method, Home Training makes learning easy. You learn by working with actual equipment. You receive Comprehensive training from the start. Can EARN AS YOU LEARN. You become qualified to open your own Electronics Repair business or to gain high pay as a TV, Radio, Electronics, etc. Technician.

**19 TRAINING KITS INCLUDED!**  
You receive a Multi-Tester, Oscillator, Signal Tracer, Oscilloscope, Signal Generator, Electronic Timer, Regenerative Radio, 24" TV set (optional) and other valuable testing equipment. **FREE BOOK** and **TWO FREE LESSONS** yours for the asking! No obligation.

**CHRISTY TRADES SCHOOL**

3214 W. Lawrence Ave.  
Dept. T-318 Chicago 60625



Send for 3  
FREE  
BOOKS



CHRISTY TRADES SCHOOL, Dept. T-318  
3214 W. Lawrence Ave., Chicago 60625  
Please send me the 3 FREE BOOKS and Special Form for  
PAYING LATER from EARNINGS MADE WHILE LEARNING.

NAME ..... AGE .....

ADDRESS .....

CITY .....ZONE.....STATE.....

CIRCLE NO. 7 ON READER SERVICE CARD

## The Cloud Sentinel

(Continued from page 10)

can be used to power the amplifier and thereby increase amplification.

You can experiment with different values of  $R_2$ ,  $R_5$ , and possibly  $R_4$  for even better results. Because current drain on  $B_2$  is only about 3 ma., smaller batteries can be substituted for  $B_2$ . Possible transistor substitutions include experimenter's *pnp* types such as the 2N107. All switches can readily be changed, as can potentiometer types and values.

**Antenna-Ground System.** The antenna shown in the photograph on page 10 is made with seven 10" lengths of #14 bare copper wire filed to points at the top, and soldered together at the bottom. The wires are fitted into a hollow oiled block of wood which insulates them from the mast and supports them so that they point upward. Connect a length of #14 insulated copper wire to this assembly, and bring it down the antenna mast to

the base, taping it to the mast at suitable intervals.

A 6' length of  $\frac{1}{2}$ " galvanized steel pipe driven into the ground near the base serves as a ground. Use microphone cable to connect the antenna and ground to the Cloud Sentinel, soldering the antenna lead to the center conductor. Connect galvanized ground wire to the ground pipe, and then to the base of the antenna mast; solder the braid of the microphone cable to this wire.

Be sure that these connections are electrically and mechanically sturdy, then bury the length of microphone cable leading away from the mast in a trench at least 10" deep for a minimum distance of 30 feet. Finally, bring the end of the cable above ground and connect it to the Sentinel.

**Calibration and Use.** To calibrate the Sentinel, turn it on, rotate  $R_4$  until the meter is zeroed for ambient temperature, close  $S_1$ , and adjust  $R_3$  until the desired amplification factor is shown on  $M_1$ . Connect the antenna and ground and throw  $S_3$  to *ANT*. If the meter reads down-scale, throw  $S_3$  to the *GND* posi-

# YOUR NEW COPY IS WAITING



**FREE!** For fun and pride in assembly, for long years of pleasure and performance, for new adventures in creative electronics mail the coupon below and get Conar's brand new catalog of quality do-it-yourself and assembled kits and equipment. Read about items from TV set kits to transistor radios . . . from VTVM's to scopes . . . from tube testers to tools. And every item in the Conar catalog is backed by a no-nonsense, no-loopholes, money-back guarantee! See for yourself why Conar, a division of National Radio Institute, is about the fastest growing entry in the quality kit and equipment business.

# CONAR

**MAIL THIS COUPON NOW**

CONAR

AQ5C

3939 Wisconsin Ave., Washington 16, D.C.

Please send me your new catalog.

Name \_\_\_\_\_

Address \_\_\_\_\_

City \_\_\_\_\_ State \_\_\_\_\_ Z-Code \_\_\_\_\_

CIRCLE NO. 9 ON READER SERVICE CARD

## GIANT CB SALE!!!

HALLMARK TRANSCEIVER (Reg. \$150.00) SALE \$99.50  
 GLOBE STAR TRANSCEIVER (Reg. \$159.95) SALE \$99.50  
 HY-GAIN 3-ELEMENT BEAM (CB-100)..... SALE \$15.99  
 CB WALKIE-TALKIES (3 trans.) 2 for \$19.95  
 GROUND PLANE ANTENNA SALE \$ 7.99  
 HALLMARK CB TESTER (Reg. \$50.00) . . . SALE \$39.95

CB CRYSTALS (.002% Tol.) EACH \$ 1.79  
 (Specify Make, Model, Channel) 12 or more at EACH \$ 1.69

TRIUMPH 10 TRANSISTOR WALKIE-TALKIE SALE \$29.95

RG58U FOAM COAXIAL CABLE 100 feet for \$ 4.95  
 RG8U FOAM COAXIAL CABLE 100 feet for \$ 9.95  
 RG8U EXTRA-FLEX FOAM COAXIAL CABLE 100 feet for \$14.95  
 ROTOR CABLE—4 conductor—  
 (plastic jacket) 100 feet for \$ 2.49

MOBILE NOISE SUPPRESSION KIT (15 pc) SALE \$ 4.99

MOBILE ANT. BUMPER MOUNT  
 (BM-1) (Chrome) SALE \$ 3.99

CITIZENS BAND COUPLER (Solid State).....SALE \$ 3.99

CHANNEL SELECTOR—12 POSITION SALE \$ 3.99

SUPER-MAGNETIC MICROPHONE HOLDER SALE 89¢

VIBRATOR ELIMINATOR—TRANSISTORIZED SALE \$ 4.99

SWR BRIDGE & FIELD STRENGTH

METER (Reg \$15) SALE \$ 9.89

CDR ANTENNA ROTATOR—Model AR-22 ONLY \$31.31

FREE with AR-22 Rotator: 150 ft. of ROTOR CABLE—FREE

SEND FOR GROVE'S FREE  
 1965 CATALOG OF TERRIFIC CB VALUES!!!

Send check or money order; include postage, excess re-  
 funded. Min. order: \$5.00—50¢ serv chg under \$10.00  
 50% deposit on COD's.

**GROVE ELECTRONIC SUPPLY  
 COMPANY**

4107 W. Belmont Ave. Chicago, Ill. 60641

CIRCLE NO. 16 ON READER SERVICE CARD

## KNOW-IT ALL

Its easy to be an authority on tape when you have a copy of Hi Fi/Stereo Review's 1965 Tape Recorder Annual handy. The special articles featured in this 132 page factbook including now to choose a recorder—tips on making better tapes—selecting the right recording tape—how to edit tape—recording live stereo in the home—copying records onto tape—the truth about bargain tape—and much more are just a few of the 23 complete features!

Expert tips by the dozens on equipment—making better tapes—editing—copying—sound on everything you need to know about tape recording.

Plus . . . a complete directory of stereo tape recorders! Over 100 photos—complete data on 230 models from 33 different manufacturers! All the model numbers, specifications, dimensions and prices!

Published for the first time, the 1965 Tape Recorder is an indispensable guide for everyone who wants better performance and better versatility from his tape recorder. For your copy, send \$1 plus 15¢ for shipping and handling (25¢ for orders outside the U.S.A.) to Ziff-Davis Service Division, Dept. TR, 589 Broadway, New York, N.Y. 10012.

tion. During use it will be noted that the meter will frequently deflect down-scale—this shows a temporary reversal of current flow in the antenna-ground circuit and is in no way unusual.

In operation, it will be found that as an electrical storm approaches the meter pointer will wander—aimlessly at first, then rather animatedly as the storm nears. If the storm is at a distance of 15 miles or more, it will normally be impossible to hear the thunder, but the meter will show lightning discharges as fast drops in readings following rather slower build-ups.

As the storm approaches, the pattern continues, but it will be necessary to shunt the meter because peak currents of several microamperes will flow. Typical lightning flashes will be read as increasingly rapid rises in current followed by very sharp drops—possibly necessitating reversing the ANT-GND polarity. With some experience, it will be possible for the operator to predict quite accurately both the instant and intensity of each stroke.

Another interesting phenomenon which will be noted is that variations in the temperature of the surrounding air alter the no-signal (zero) position of the meter—up-scale for warmer, down-scale for colder. Temperatures can change very quickly during thunderstorms, and for this reason, zero and calibration should be checked every few minutes.

The Cloud Sentinel can also be used in clear weather to measure what are known as "fair weather currents." During thunderstorms you will note that electron movement is normally from air to antenna to ground. In fine weather, a reverse flow will be registered, but at considerably reduced readings and with the possible need for extended antenna height.

**Safety Precautions.** The Sentinel is considerably safer than most installations using an antenna. However, the following rules should be observed for absolute safety:

(1) Limit antenna height to 20 feet for monitoring local thunderstorm activity.

(2) Locate the antenna mast near a building or other tall object so that the antenna is within the object's "cone of protection."



(3) Lead the microphone cable away from the antenna by burying it in a covered trench at least 10" deep and 30" long.

(4) Operate the Sentinel indoors—in a house, garage, or dry shed.

(5) Should lightning begin striking within two miles of your operating position, suspend operations until the storm passes out of this range.

(6) Ground the base of the antenna mast to the nearby ground.

At first glance it may seem that the above precautions go to molycoddling extremes. This may be true, but it is strongly recommended that they be observed—they could possibly save your life!

Although parts for the Sentinel catalog at about \$13 (including \$4.95 for the meter), judicious use of junk box parts and substitutions can cut this total down considerably. The completed unit can also be used as a sensitive laboratory instrument for measuring tiny currents. The amplifier will prove to be quite linear for all factors of amplification if the meter has been accurately zeroed and calibrated prior to use.

## Two-Tube Superhet

(Continued from page 94)

ing slug screw of L1 to 1/2" above the shield can, and the slug screw of L2 3/8" above the shield can; this should bring the adjustments in the vicinity of 80 meters, and you can readjust on received signals.

A ground connection will probably improve reception, and is also advisable if you use C18 and C19 across the power transformer primary, as otherwise the chassis will be slightly "hot" to ground. If you have no trouble with line noise or transmitter r.f. into the receiver, C18 and C19 can be omitted. The author used a hank of stranded insulated wire about 20 feet long as an antenna and an inexpensive imported type of crystal headset (Lafayette 99-2550 or equivalent) for reception.

The c.w. signals are received with the detector REGEN control set just above

In '64 over 6,000 readers asked for Poly Paks

# FREE! DOUBLE BONUS!

BONUS #1  BONUS #2

**\$25.00** Worth of Radio-TV PLUS **\$1** POLY PAK OF YOUR CHOICE LISTED BELOW

Include 25¢ for handling parts!!!

**BOTH FREE WITH EVERY \$10.00 ORDER**

## New! 'PANCAKE' Transistors

IN THE NEW TO46	Like	W.	VCB*	HFE	MC	SALE
<b>MICRO CASES</b>	<input type="checkbox"/> 2N706	.4	20	20	200	\$1.00
Planars	<input type="checkbox"/> 2N708	.36	20	30	480	1.00
• Silicon Epitaxial	<input type="checkbox"/> 2N807	.5	60	120*	80	1.00
• Only 1/16" High	<input type="checkbox"/> 2N995**	.36	15	140*	100	1.00
• 70% off retail	<input type="checkbox"/> 2N996**	.36	12	100*	120	1.00
• Gold novar leads	<input type="checkbox"/> 2N1613	.8	50	120*	80	1.00
	<input type="checkbox"/> 2N1893	.8	100	120*	70	1.00
	<input type="checkbox"/> 2N2049	.8	50	300*	85	1.00
	<input type="checkbox"/> 2N2645	.5	50	300*	85	1.00
	<input type="checkbox"/> 2N2695**	.36	25	139*	100	1.00

\*Maximums \*\*PNP's



## WORLD FAMOUS POLY PAK KITS—BRAND NEW PARTS

<input type="checkbox"/> INFRA-RED RAY PHOTO detector-transducer	\$1	<input type="checkbox"/> 40 PRECISION RESIS-TORS, 1/2, 1, 2W, 1%.	\$1
<input type="checkbox"/> 2—500-MC "MESA" Transistors, nnp TO18	\$1	<input type="checkbox"/> 30 POWER RESISTORS.	\$1
<input type="checkbox"/> INFRA-RED RAY PARA-BOLIC reflector "n" filter.	\$1	<input type="checkbox"/> 10 VOLU-ME CONTROLS to ast. all-glass too.	\$1
<input type="checkbox"/> 3—25W 2N255 TRANSIS-TORS or equal TO3 case.	\$1	<input type="checkbox"/> 50 RADIO "n" TV KNOBS	\$1
<input type="checkbox"/> 60 TUBULAR COND'S to .5mf to 1KV	\$1	<input type="checkbox"/> 10 TRANSISTOR ELEC-TROLYTICS, 10-to-100 mf.	\$1
<input type="checkbox"/> 3 TEXAS 20-WATT, 2N1038, 39, 40 transistor.	\$1	<input type="checkbox"/> 50'S SUPRAC-E, wide radio-n-T, ast.	\$1

## HI-FI SPECIAL! 4" SQ. ELECTROSTATIC TWEETER

Made by Lorenz, ITT, for Grundig. Never before offered. A natural for hi-fi enthusiasts. Buy 2 for stereo. Illustration 70. **\$1.49 ea.**

semibale tweeter in stock. Includes hookup  2 for 2.50

<input type="checkbox"/> 50 COILS "n" CHOKES, r.f., use, peaking, etc.	\$1	<input type="checkbox"/> 15 NPN TRANSISTORS	\$1
<input type="checkbox"/> 35 TWO WATTERS, Allen Bradley, IRC, 100	\$1	<input type="checkbox"/> 4—20W TRANSISTORS	\$1
<input type="checkbox"/> 40 DISC CONDENSERS, 2500pf to .001uf, 10KV	\$1	<input type="checkbox"/> 15 PRINTED CIRCUIT	\$1
<input type="checkbox"/> 60 TUBE SOCKETS, aluga, receptacles, etc.	\$1	<input type="checkbox"/> 40 WORLD'S SMALLEST	\$1
<input type="checkbox"/> 10 PANEL SWITCHES, milers, rotary, variable	\$1	<input type="checkbox"/> 100 PRINTED CIRCUIT	\$1
<input type="checkbox"/> 4 RAYTHEON CK721 transistors, new alum case nnp.	\$1	<input type="checkbox"/> 2 "MESA" 2N498 4-watt	\$1
<input type="checkbox"/> 25 GERMANIUM "n" SILICON Diodes, 1N281, etc.	\$1	<input type="checkbox"/> 4 SYLVANIA 2N35 transistors, nnp, TO22	\$1
<input type="checkbox"/> 5 GENERAL ELECTRIC 2N107 nnp transistors	\$1	<input type="checkbox"/> 2—25-AMP SILICON	\$1
<input type="checkbox"/> 75 HALF WATTERS, ast. and 1/2 ton	\$1	<input type="checkbox"/> STUD rectifiers	\$1
<input type="checkbox"/> 10 RAYTHEON CK 722 transistors, nnp	\$1	<input type="checkbox"/> 6 TRANSISTOR RADIO	\$1
		<input type="checkbox"/> 10 RCA PHONO PLUGS, n-Jack Sets, tunra-amps.	\$1

## 3-TRANSISTOR AUDIO AMPLIFIER **1.95**

<input type="checkbox"/> 4 2N336 NPN SILICON transistors	\$1	<input type="checkbox"/> 4—2N43 POWER OUTPUT	\$1
<input type="checkbox"/> 30 TRANSISTORS TO5 case, untested	\$1	<input type="checkbox"/> 15 PRINTED CIRCUIT	\$1
<input type="checkbox"/> 4 GENERAL ELECTRIC 2N130 nnp transistors, r.f., etc.	\$1	<input type="checkbox"/> 10 HEARING AID SIZE	\$1
<input type="checkbox"/> 3 2N341 TRANSISTORS, nnp, silicon, 1/2 Watt	\$1	<input type="checkbox"/> 25 TOP HAT RECTI-FIERS, 750ml, untested	\$1
<input type="checkbox"/> 1—20-Watt 2N1647 silicon nnp MESA	\$1	<input type="checkbox"/> 14N29 ZENER	\$1
<input type="checkbox"/> 60 HI-Q RESISTORS, 1/2, 1, 2 watts, to 1 meg, 5% too	\$1	<input type="checkbox"/> 15 TEXAS SWITCHING	\$1
<input type="checkbox"/> 50 TERMINAL STRIPS, 1 to 8 lugs, ast.	\$1	<input type="checkbox"/> 30 SPRAGUE "YELLOW"	\$1
<input type="checkbox"/> 35 SILVER MICA con-densers, 1/8 to .01uf, 10KV	\$1	<input type="checkbox"/> 6 SYLVANIA one amp 400V	\$1
<input type="checkbox"/> 60 CERAMIC condensers, 100pf to .001uf	\$1	<input type="checkbox"/> 10 2-AMP POWER REC-TIFIERS, ast 50-40V	\$1
<input type="checkbox"/> 4 TRANSISTOR trans-formers, worth \$25	\$1	<input type="checkbox"/> 3 50-WATT 50-36	\$1
<input type="checkbox"/> 5 SUN BATTERIES, to 15 volt sensitive oral	\$1	<input type="checkbox"/> GOLD, stud transistors	\$1
<input type="checkbox"/> 15 PNP TRANSISTORS, ast. types "n" styles	\$1	<input type="checkbox"/> 10 10-WATT POWER	\$1
		<input type="checkbox"/> 10 PHILCO 30 MC	\$1
		<input type="checkbox"/> Transistors, untested	\$1

## Transistor Sale 1000\* GAIN TRANSISTORS

100 for \$2.50	Silicon nnp Planar Similar to 2N998	<b>1.49</b>
All types, shapes, RF, IS, switching, audil, power, untested, TO5, TO22, cases, etc.	*Minimum	
	<input type="checkbox"/> PHOTO TRANSISTORS NPN SILICON PLANAR	
	Sensitivity: 3ua p/ft. candle. TO18. 2N986	<b>2.98</b>

FREE! 1965 catalog. Orders: include postage, avg. wt. per pak 1 lb.

# POLY PAKS

P.O. Box 942-EH  
So. Lynnfield, Mass.

CIRCLE NO. 30 ON READER SERVICE CARD



**WORLD'S FINEST  
ERSIN  
MULTICORE  
5-CORE SOLDER**

**NEW EASY  
DISPENSER  
PAK ONLY 50¢**

BUY IT AT RADIO-TV PARTS STORES  
MULTICORE SALES CORP. PORT WASHINGTON, N. Y.

CIRCLE NO. 26 ON READER SERVICE CARD



**FREE Catalog**  
OF THE WORLD'S FINEST  
GOV'T. SURPLUS  
ELECTRONIC BARGAINS

**HUNDREDS and HUNDREDS**  
OF TOP QUALITY SURPLUS ITEMS  
TO CHOOSE FROM:

ANTENNAS  
AMPLIFIERS  
RECEIVERS  
TRANSMITTERS  
GENERATORS  
OSCILLOSCOPES  
DYNAMOTORS  
INDICATORS  
CONVERTERS  
TRANSFORMERS  
POWER SUPPLIES  
TEST EQUIPMENT  
CONTROL BOXES  
MICROPHONES

TIMERS, TELEPHONES,  
MOTORS, FILTERS, BLOWERS, CHOKES, HEADSETS, CABLE,  
SELSYNS, SWITCHES, KEYERS, HANDSETS, METERS—Etc., Etc.

SEND FOR FREE CATALOG! Dept. EH-5

**FAIR RADIO SALES**  
2133 ELIDA RD. • P.O. Box 1105 • LIMA, OHIO

CIRCLE NO. 14 ON READER SERVICE CARD

the point of oscillation and the *GAIN* control low enough to prevent detector overloading. Phone signals are received by setting the *REGEN* control just below the point of oscillation. With a little trial and error, you'll find you can hear just about any signal on the band that anyone else can hear, and without straining your ears, either. —30—

### Telephone Beeper

(Continued from page 38)

Any standard potentiometer will do if the box you use has room for it. (If the adjustment of *R2* is too touchy, use alternate 10,000-ohm unit specified.)

The time interval between beeps is controlled mainly by the relative values of capacitors *C1* and *C2*, and resistor *R1*. Increase the resistance of *R1* if the interval is too short, decrease *R1*'s resistance if the interval is too long. If "chirp" is evident, readjust *R2*.

The speaker specified in the Parts List will fit in the plastic box used by the author. If a larger enclosure is used, any 3.2-ohm speaker will be satisfactory.

**Construction.** The construction of the Beeper may be varied to suit the builder, and wiring placement is not at all critical. The author used a perforated board, with components on top and point-to-point wiring and jumpers underneath. A cutout in the board accommodates the speaker frame. A single screw and spacer support the circuit board in the box. Small holes may be drilled in the box in the area of the speaker, or (as in the author's unit) a piece of perforated aluminum can serve as a grille to cover a cutout opening. The speaker itself is supported by four screws.

A simple retainer clip fashioned from  $\frac{1}{16}$ "-diameter piano or coat-hanger wire is formed to fit around the mouthpiece of the particular telephone you intend to use (since the size of the mouthpiece is different for different-style handsets). A piece of foam rubber or plastic may be shaped with a razor blade to form a cradle for the mouthpiece, as well as to provide a "spring" force holding the phone snugly against the wire clip.

which fits into the mouthpiece groove. The ends of the wire clip fit into small holes in the side of the box.

Switch *S1* is mounted with two screws, and wired to two battery connectors (which may be salvaged from discarded 9-volt batteries) in series. The batteries can be wedged into position by the circuit board, or held in the box with a bracket or cement. Spray-painting the box after assembly will improve the appearance, and title decals will add the finishing touch.

**Operation.** When the Beeper is in use, the first beep will be heard about 30 seconds after the switch is turned on. Thereafter the beeps will be heard at approximately 15-second intervals. To test the Beeper, temporarily connect a 10,000-ohm resistor across *R1*; this should increase the beep rate. Current drain is only about 2½ ma., so the batteries should last over 200 operating hours with normal intermittent phone use.

If you regularly record telephone conversations of technical discussions, business transactions, long-distance family calls or for any other purpose, the Telephone Beeper will be a useful accessory to remind the party at the other end that he is being recorded, and may also prevent you from being charged with unlawful recording. The investment is small, the inconvenience slight, the result worthwhile.

-30-

### 40-Meter Antenna

(Continued from page 112)

higher than the ends to fit in the available space. If your TV antenna mast is not high enough for the purpose, you can add a length of mast to it above the TV antenna.

**Modifying the Guy Wires.** Insert an egg-type strain insulator (which is stronger than ordinary antenna insulators) in the pair of guy wires where they are fastened to the mast. Then determine the exact length of each half of the antenna (*L1* and *L2* in the diagram) for the desired frequency with the formula:  $Length_{ft.} = 234 / Freq_{mc.}$

## SURPLUS BARGAINS SURPLUS BARGAINS

ENLARGER LENS f3.5 to f16, govt. cost \$53.00	<b>\$3.50</b>
LAPEL MIKE, xtl, w/cord & plug	1.35
PHONE, hearing aid type, w/cord & plug	.60
GEIGER COUNTER tube w/schem.	1.25
THROAT MIKE, from Air Force	.50
MIKE BUTTONS, carbon, min. size	<b>4/1.00</b>
SOLAR CELL KIT, 5 cells with book	1.50
IBM FERRITE toroidal cores (memory)	<b>200/1.00</b>
MAT TRANSISTORS, hi-freq	<b>5/1.00</b>
POLARIZING FILTER (Polaroid) 6x6 inch	<b>2/1.00</b>
2N174 POWER TRANSISTOR 15 amp 80 volt	1.50
RELAY, DPDT 1.5 volt operation	1.00
RADIOSONDE xmtr w/tubes, new	1.25
MINE DETECTOR PRS-3, military, un- used, w/book, & btrys, finds treasure	<b>45.00</b>
SCOPE TUBE (CRT) 3AP1, new	1.00
SOUND POWER PHONE (2) w/100 ft wire	2.00
MINIATURE MOTOR 1.5 volt operation	.50
CADMIUM PHOTO CELL, make counter, nite liter	1.00
COMPUTER plug-in boards, good for parts source. Each w/transistors, re- sistors, etc.	<b>6/1.00</b>
REED SWITCH w/magnet, make burglar alarm	1.00
SNIPERSCOPE TUBE 6032 w/specs, see in dark	<b>6.50</b>
OPTICAL PRISM— pocket rainbow, new	.60
TOGGLE SWITCHES	<b>4/1.00</b>
SIGMA	1.50
4F RELAY	1.50
SILICON DIODES 750 ma, 500 PIV	<b>5/1.00</b>
INFRA-RED DETECTOR	1.25
USA PERISCOPE PRISM 5 inch long	1.00
IR FILTER 5½ in. dia.	1.75
RDZ Military receiver. 200-400 mc, channel, 115 volt. Cost \$2,500 NEW	<b>125.00</b>
SILICON DIODES 2 amp 1,000 PIV	1.00
M-3 SNIPERSCOPE INFRA-RED see in dark	<b>225.00</b>

ALL MATERIAL FOB LYNN, MASS.

Above is a small selection of choice surplus from our large 72 page illustrated catalog. Send 20¢ production & handling cost for catalog.

**JOHN MESHNA JR.**  
19 Allerton St., Lynn, Mass.

CIRCLE NO. 24 ON READER SERVICE CARD

## EARN YOUR DEGREE in ELECTRONICS ENGINEERING at home

Our A.S.E.E. degree is recognized the world over by personnel men in the electronics industry. Our graduates are always in demand.

College level HOME STUDY courses—taught so that you can easily understand them. Continue your education. . . . Earn more in the highly paid electronics industry.

Learn about Missiles, Computers, Transistors, Automation, complete electronics.

Over 27,000 graduates now employed by industry. Resident school also available at our Chicago Campus.—Founded 1934.

Send for our FREE course catalog.

**AMERICAN INSTITUTE OF  
ENGINEERING & TECHNOLOGY**

1137-1139 West Fullerton Pkwy.—Chicago 14, Illinois

CIRCLE NO. 3 ON READER SERVICE CARD

# Olson

\* FREE

Fill in coupon for a FREE One Year Subscription to OLSON ELECTRONICS' Fantastic Value Packed Catalog—Unheard of LOW, LOW PRICES on Brand Name Speakers, Changers, Tubes, Tools, Stereo Amps, Tuners, CB, and other Values. Credit plan available.

NAME \_\_\_\_\_  
ADDRESS \_\_\_\_\_  
CITY \_\_\_\_\_ ZONE \_\_\_\_\_ STATE \_\_\_\_\_

If you have a friend interested in electronics send his name and address for a FREE subscription also.

**OLSON ELECTRONICS  
INCORPORATED**

318 S. Forge Street Akron, Ohio 44308

CIRCLE NO. 28 ON READER SERVICE CARD

which works out to 32' 7" for 7.175 mc., the center of the 40-meter Novice band. Both  $L1$  and  $L2$  should be cut to this length if you want to operate around this frequency.

Now measure off the desired lengths from the center insulators and insert another strain insulator at each measured point. If your transmitter power is much over 100 watts, it might be wise to use two strain insulators in series at these points for increased insulation.

Finally, solder the inner conductor of your coaxial feedline to one side of the antenna at the apex and the outer shield to the other side. Tightly tape the end of the cable to keep moisture out of it, and drop the cable down the pole, along the roof, and into the radio room.

Don't worry about the guy wires not being copper; they will radiate okay. But you might insert strain insulators in the unused guy wires at 10' intervals for slightly improved results. -30-

### Stereo Indicator

(Continued from page 75)

ture is connected to the frame, and in the case of the stereo indicator, it's necessary to keep it off ground.

Connect a multimeter or VTVM across diode  $D1$ , and tune in a stereo signal. A negative potential of about 0.5 volt d.c. will appear across the diode with respect to ground. If no stereo signal is available at the time, a 19-kc. signal from the audio oscillator can serve as the input. Set the audio oscillator to provide a signal of 0.5 to 1.0 volt or so, and tune coil  $L1$  for maximum voltage across  $D1$ . The input sensitivity of the stereo indicator is about 0.03 volt r.m.s. at 19 kc.

Potentiometer  $R7$  is a level or threshold control. Adjust it to set the threshold high enough to light the lamp when a moderate level FM stereo signal is being received, but not so high that the unit trips on inter-station noise. Stronger bursts of noise between stations will trip the relay. However, careful adjustment of  $R7$  will eliminate most of the trouble from this source. -30-

# CLASSIFIED MARKET PLACE

## FOR SALE

**RESISTORS**, newest type metal-film, Copper Circuit Board, Capacitors, Barrier Terminal Blocks, Farnsworth Electronic Components, 88 Berkeley St., Rochester, N.Y.

**CRYSTALS**—Navy 100Kc Units \$2.95. Electronicraft, Box 13, Binghamton, N.Y. 13902.

**SURPLUS QUARTZ** Crystals 500,000 Available. Lists 10¢. Quaker-Electronics, Hunlock Creek, Pa.

**TRANSISTORIZED** buried or concealed pipe, cable finders. Free information. Relco-D4, Box 10563, Houston 18, Texas.

**CANADIANS**—Giant Surplus Bargain Packed Catalogs. Electronics. Hi-Fi, Shortwave, Amateur, Citizens Radio. Rush \$1.00 (Refunded). ETCO. Dept. Z, 464 McGill, Montreal, Canada.

**PRINTED CIRCUIT** Boards. Hams, Experimenters. Catalog 10¢. P/M Electronics, Box 6288, Seattle, Wash. 98188.

**EXPERIMENTERS' CATALOG**—TV Camera Parts, Transistors, Tubes, Diodes. Relays. Transformers. Spera Electronics, 37-10 33rd Street, Long Island City, New York.

## HIGH FIDELITY

**ARISTOCRAT** of **SPEAKER SYSTEMS** for perfectionists. "Designing the Ducted Port Bass Reflex Enclosure", \$1.00. How to double the bass output of any loudspeaker. Formulas, charts, trade secrets. Also free literature on guaranteed basic speaker systems, unbelievable prices. ESW Speaker Systems, 1602 Alta, Wichita, Kansas 67216.

## TREASURE FINDERS

**NEW** Supersensitive transistor locators detect buried gold, silver, coins. Kits, assembled models. \$19.95 up. Underwater models available. Free catalog. Relco-A45, Box 10563, Houston 18, Texas.

## EQUIPMENT

**FREE** Electronics Catalog. Tremendous bargains. Electro-labs, Department C-510RR, Hewlett, N.Y. 11557.

## PLANS AND KITS

**WE SELL CONSTRUCTION PLANS:** \$35 Color TV, \$40 Automatic Telephone Answering Machine, \$50 TV Camera, \$50 Ultrasonic Dishwasher, \$15 Bell System Type Speakerphone, TV Recorder, Private Eye Tail Transmitter, \$10 Legal Telephone Connector, Electronic Tranquilizer, Transistorized Teletype; Plans \$4.75 each. Free Super Hobby Catalog. Don Britton Enterprises, 7906 Santa Monica Blvd., Hollywood, Calif. 90046.

## BOOKS

**15¢ BOOKS** 7 for \$1.00 Postpaid. Catalog send stamp. M & M Books, 536 Tracy, Peoria, Ill. 61603.

## RADIO-TV

**CONVERT** any television to sensitive, big-screen oscilloscope. Only minor changes required. No electronic experience necessary. Illustrated plans, \$2.00. Relco-A45, Box 10563, Houston 18, Texas.

## CLUBS

**ELECTRONIC EXPERIMENTERS' CLUB.** Projects. Bargains, Benefits. Join NOW! Information Box 5332A, Inglewood, Calif. 90310.

## BUSINESS OPPORTUNITIES

**SIMPLE**, pleasant mailorder can net \$12,000 year. Write Rutward 2682, Bryant, Columbia Station, Ohio.

**SELL CB EQUIPMENT**—Dealerships available to aggressive people who can sell Citizens Band Radio full or part time. Knox Electronic, Dept. ES5, Galesburg, Ill. 61401.

## INSTRUCTION

**FREE** Career Guide to success in Electronics, Automation. Practical "job oriented" home study training. Beginners, intermediate advanced college level. Tuition refund surety. Since 1931. Write Central Technical Institute, Dept. 16015, 1655 Wyandotte, Kansas City, Mo. 64108.

**LEARN** Morse International Code Alphabet in Half Hour. Mail \$2.00 check or money order for Laminated, Pocket-Size, Fifty Word Mnemonic to: MNEMONICS ASSOCIATES, 56 Grand Street, White Plains, New York.

## TAPE & RECORDERS

**TAPE-MATES** MAKES AVAILABLE TO YOU—ALL 4-TRACK STEREO TAPES—ALL LABELS—POSTPAID TO YOUR DOOR—AT TREMENDOUS SAVINGS. FOR FREE BROCHURE WRITE TAPE-MATES CLUB, 5280 P. W. PICO BLVD., LOS ANGELES, CALIF. 90019.

## MISCELLANEOUS

**FREE 'HIT' SONG** gift for you, friends. Send names, addresses: Nordyke Songs, 6000-3A Sunset, Hollywood, Calif. 90028.

**INCREDIBLY COOL-SMOKING PIPE** Unique air-cooled stem makes the difference, removes hot moisture and tars. You agree or money returned. Inquire and receive free pipe cleaners. Write: Monarch Pipes, Dept. N, Box 1431, Tulsa, Oklahoma.

**HORSE RACE COMPUTER.** Dial time for each horse. Any distance, Any track. 42 Distances, 91 Tracks listed. Fascinating, Exciting, Fun. \$5.00 Delivered. Lehtonen Computerizer, 914 Pulaski Hwy., Joppa, Md. 21085.

# UNUSUAL BARGAINS



## BUILD YOUR OWN INFRARED DETECTOR SEE IN TOTAL DARKNESS

Use 1P25A Infrared Image Tube to convert infrared rays to visible image. You see everything—even in total darkness. Approx. 5,000 volts. 4 1/4" long x 1 3/8" diam. New tubes—government cost about \$150 ea. Tested before shipment. Complete directions.

Stock No. 70.127-GD ..... \$9.95 Postpaid  
Also available later model Farnsworth Tube #6032 or RCA Tube #6676. Potential approx. 20,000 volts. 4 1/2" long. 2" diam. at widest point.  
Stock No. 70.160-GD ..... \$12.50 Postpaid

## SOLVE PROBLEMS! TELL FORTUNES! PLAY GAMES! NEW WORKING MODEL DIGITAL COMPUTER ACTUAL MINIATURE VERSION OF GIANT ELECTRONIC BRAINS

Fascinating new see-through model computer actually solves problems, teaches computer fundamentals. Adds, subtracts, multiplies, divides, complements, carries, memorizes, counts, compares, sequences. Attractively colored, rigid plastic parts easily assembled. 12" x 3 1/2" x 4 3/4" Incl. step-by-step assembly diagrams, 32-page instruction book covering operation, computer language (binary systems), programming, problems and 15 experiments.  
Stock No. 70.683-GD ..... \$5.00 Postpaid



## Make Your Own Astronomical Telescope

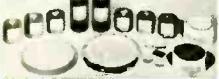

## GRIND YOUR OWN MIRROR

Kits contain mirror blank, tool, abrasives, diagonal mirror and eyepiece lenses. You build instruments ranging in value from \$75.00 to hundreds of dollars.

Stock No.	Diam.	Mirror Thickness	Price
70.003-GD	4 1/4"	3/4"	\$ 7.50 Ppd.
70.004-GD	6"	1"	11.95 Ppd.
70.005-GD	8"	1 1/2"	19.50 Ppd.
70.006-GD	10"	1 3/4"	30.75 f.o.b.
70.007-GD	12 1/2"	2 1/8"	59.95 Barrington

## SCIENCE TREASURE CHESTS

For Boys—Girls—Adults

Science Treasure Chest—Extra-powerful magnets, polarizing filters, compass, one-way-mirror, film, prism, diffraction gratings, and lots of other items for hundreds of thrilling experiments, plus a Ten-Lens Kit for making telescopes, microscopes, etc. Full instructions included.  
Stock no. 70.342-GD ..... \$5.00 Postpaid



## SCIENCE TREASURE CHEST DELUXE

Everything in Chest above plus exciting additional items, for more advanced experiments including crystal-growing kit, electric motor, molecular model set, first-surface mirrors and lots more.  
Stock No. 70.343-GD ..... \$10.00 Postpaid

## STEREO-MICROSCOPE TERRIFIC BUY! AMERICAN MADE!

Up to 3" Working Distance  
Wide 3 Dimensional Field

Used in production, in research or at home; for inspections, examinations, counting, checking, assembling. 2 sets of objectives on rotating turret. Standard pair of wide field 10X Kellner Eyepieces give you 23 power and 40 power clear, sharp, erect image. Helical rack and pinion focusing. Interpupillary distance adjustable. So good we'll SHIP on 10-DAY FREE TRIAL.  
Order Stock No. 85.056-GD ..... full price \$99.50 F.O.B.



## GOOSENECK INSPECTION MAGNIFIER

For Workshop—Lab—Office

Large 4" glass lens mounted in chrome plated brass for extensive use, on 12" long, flexible gooseneck. New, unique ball swivel provides trouble-free movement in any direction. Weighted metal grey finish base.

Stock No. 70.241-GD ..... \$7.00 Postpaid

Order by Stock No.—Send Check or M.O.—Money-Back Guarantee  
**EDMUND SCIENTIFIC CO., Barrington, New Jersey**

## MAIL COUPON for FREE CATALOG "GD"

Completely New 1965 Edition. 148 pages.  
Nearly 4000 Bargains.

EDMUND SCIENTIFIC CO., Barrington, N. J.  
Please rush Free Giant Catalog-GD

Name.....  
Address.....  
City.....Zone.....State.....



CIRCLE NO. 12 ON READER SERVICE CARD

# ELECTRONIC EXPERIMENTER'S HANDBOOK SPRING 1965

READER SERVICE NO. ADVERTISER PAGE NO.

1	ATR Electronics, Inc	147
2	Allied Radio	35, 36
3	American Institute of Engineering & Technology	164
5	Brooks Radio & TV Corp	152
6	Burstein-Applebee Co	150
7	Christy Trades School	158
8	Cleveland Institute of Electronics	66
9	Conar	159
10	Datak Corporation, The	157
11	DeVry Technical Institute	1
12	Edmund Scientific Co	166
13	Electro-Voice, Inc	155
14	Electropac Inc	15
14	Fair Radio Sales	162
15	Grantham School of Electronics	156
16	Grove Electronic Supply Company	160
17	Hallcrafters	2
18	Heath Company	20
19	International Crystal Mfg. Co., Inc	6
20	Irving Electronics Co	154
21	Johnson Company, E.F.	4
22	Lafayette Radio Electronics	SECOND COVER
23	McGee Radio Co	154
24	Meshna Jr., John	163
39	Milwaukee School of Engineering	148
25	Multi-Elmac Company	120
26	Multicore Sales Corp	162
27	National Radio Institute	THIRD, FOURTH COVERS
28	Olson Electronics Incorporated	164
4	Pacific Organs	120
29	Penn Technical Institute	150
30	Poly Paks	161
31	Progressive "Edu-Kits" Inc	76
32	RCA Electronic Components and Devices	46
33	RCA Institutes, Inc	17, 18, 19
34	Sams & Co., Inc., Howard W	153
35	Scott, Inc., H.H.	56
36	"TAB"	156
40	Telex/Acoustic Products	151
37	Warren Electronic Components	158
38	Xcelite Inc	149

CIRCLE NO. 27 ON READER SERVICE CARD  
ELECTRONIC EXPERIMENTER'S HANDBOOK

# BUILD, EXPERIMENT, EXPLORE, DISCOVER WITH NRI CUSTOM-DESIGNED TRAINING KITS



## BUILD YOUR OWN PHONE/CODE TRANSMITTER

This is just one of seven training kits programmed into NRI's Complete Communications course. You get actual practice in building your own crystal-controlled, phone/code transmitter and putting it on the air. You experiment with modulation, "clamping" circuits, key filters, other aspects of commercial transmitter operation. Can be put on the air simply by attaching an antenna and complies with FCC regulations. As with all NRI training kits, you get the most modern features and parts.



## BUILD ACTUAL ANALOG COMPUTER CIRCUITS

Industry, business offices, the government and military all need trained Electronics Technicians. NRI's Industrial Electronics course prepares you. You progress through 10 carefully designed training kits, topping off your practical experience phase of training by experimenting with feedback control systems, analog computers and digital computer elements. You actually solve problems on this analog computer you build yourself. This is the *practical*, fast way to a good paying, career position.

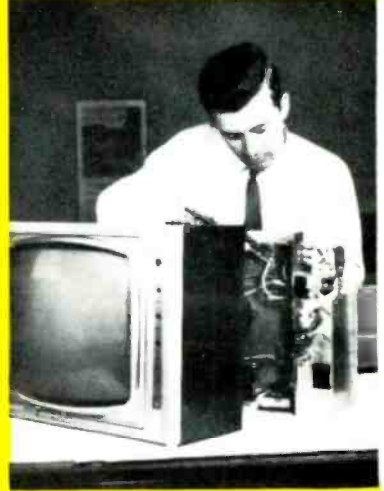

## BUILD A CUSTOM-ENGINEERED TELEVISION RECEIVER

Want to earn \$3 to \$5 an hour in spare time? Want your own part-time or full-time business? In Radio-TV Servicing you learn to install, maintain, service radios, TV sets, hi-fi and stereo, other home Electronics equipment. In your training are eight training kits, including this complete, modern, slim-line TV receiver. You build it yourself, become familiar with components and circuits, learn servicing procedures . . . and earn extra money as you train. National Radio Institute, Washington, D.C.

**SEE OTHER SIDE** ▶

Join the Thousands Who  
Gained Success with NRI



"I am Frequency Coordinator for the 11th Naval District. The course was priceless." J. J. JENKINS, San Diego, Calif.



"Many thanks to NRI. I hold FCC license, am master control engineer with KXIB-TV." R.L. WOOD, Fargo, N.D.



"I am a Senior Engineering Aide. Without NRI I would still be working in a factory at a lower standard of living." D.F. CONRAD, Reseda, Calif.



FIRST CLASS  
PERMIT  
NO. 20-R  
Washington, D.C.

## BUSINESS REPLY MAIL

NO POSTAGE STAMP NECESSARY IF MAILED IN THE UNITED STATES

POSTAGE WILL BE PAID BY

**NATIONAL RADIO INSTITUTE**

**3939 Wisconsin Avenue**

**Washington, D.C. 20016**





**GET FAST START WITH NEW ACHIEVEMENT KIT**

Delivered to your door—everything you need to make a significant start in the Electronics field of your choice. An outstanding, logical way to introduce you to home-study training. It includes your first set of lesson texts and all the "classroom tools" you need. No other school has anything like the new NRI Achievement Kit.



**ELECTRONICS COMES ALIVE WITH NRI TRAINING KITS**

Nothing is as effective as learning by doing . . . and NRI pioneered the "home lab" technique of training. NRI invites comparison with training equipment offered by any other school. Begin NOW this exciting program of practical learning. Make the skills of the finest Electronic Technicians your own. Mail card below.



**"BITE SIZE" TEXTS PROGRAM YOUR TRAINING**

Certainly, lesson texts are necessary. NRI's programmed texts are as simple, direct and well illustrated as 50 years of teaching experience can make them. They are carefully programmed with NRI training kits to make the things you read about come alive. You experience all the excitement of original discovery.

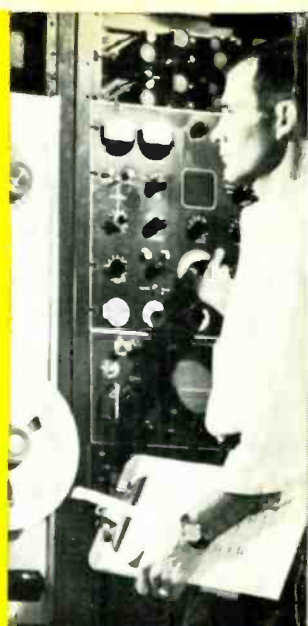

**HOBBY? CAREER? MAIL CARD NOW TO NRI**

Whatever your need . . . whatever your education . . . there's an NRI training plan to fit your requirements. Choose from three major courses or select one of seven special courses in particular Electronics subjects. Check the postage-free card below, fill in and mail. National Radio Institute, Washington, D.C.

**DISCOVER THE EASE AND EXCITEMENT OF LEARNING ELECTRONICS THE NRI WAY**

**SEE OTHER SIDE**

National Radio Institute, Electronics Div.  
Washington, D.C. 20016

13-015

Please send me your catalog. I have checked the field(s) of most interest to me. (No salesman will call.)

- |  |   |
|--|---|
| <input type="checkbox"/> TV-Radio Servicing      | <input type="checkbox"/> Basic Electronics          |
| <input type="checkbox"/> Industrial Electronics  | <input type="checkbox"/> Electronics for Automation |
| <input type="checkbox"/> Complete Communications | <input type="checkbox"/> Aviation Communications    |
| <input type="checkbox"/> FCC License             | <input type="checkbox"/> Marine Communications      |
| <input type="checkbox"/> Math for Electronics    | <input type="checkbox"/> Mobile Communications      |

Name \_\_\_\_\_ Age \_\_\_\_\_

Address \_\_\_\_\_

City \_\_\_\_\_ State \_\_\_\_\_ Zip Code \_\_\_\_\_

Accredited Member National Home Study Council



**PICK THE TRAINING PLAN OF YOUR CHOICE AND MAIL CARD FOR FREE CATALOG**



**OUR 50TH YEAR OF LEADERSHIP IN ELECTRONICS TRAINING**



1966

POPULAR  
ELECTRONICS

# ELECTRONIC EXPERIMENTER'S HANDBOOK

SPRING EDITION

\$1.25

**100%  
CONSTRUCTION  
PROJECT  
ISSUE**

**AUDIO & HI-FI  
RADIO CONTROL  
HAM RADIO  
TEST EQUIPMENT  
AUTOMOTIVE  
HOUSEHOLD GADGETS  
GAMES  
PHOTOGRAPHY**

**BUILD  
ELECTRONIC FLASH**

(uses either house  
current or batteries)

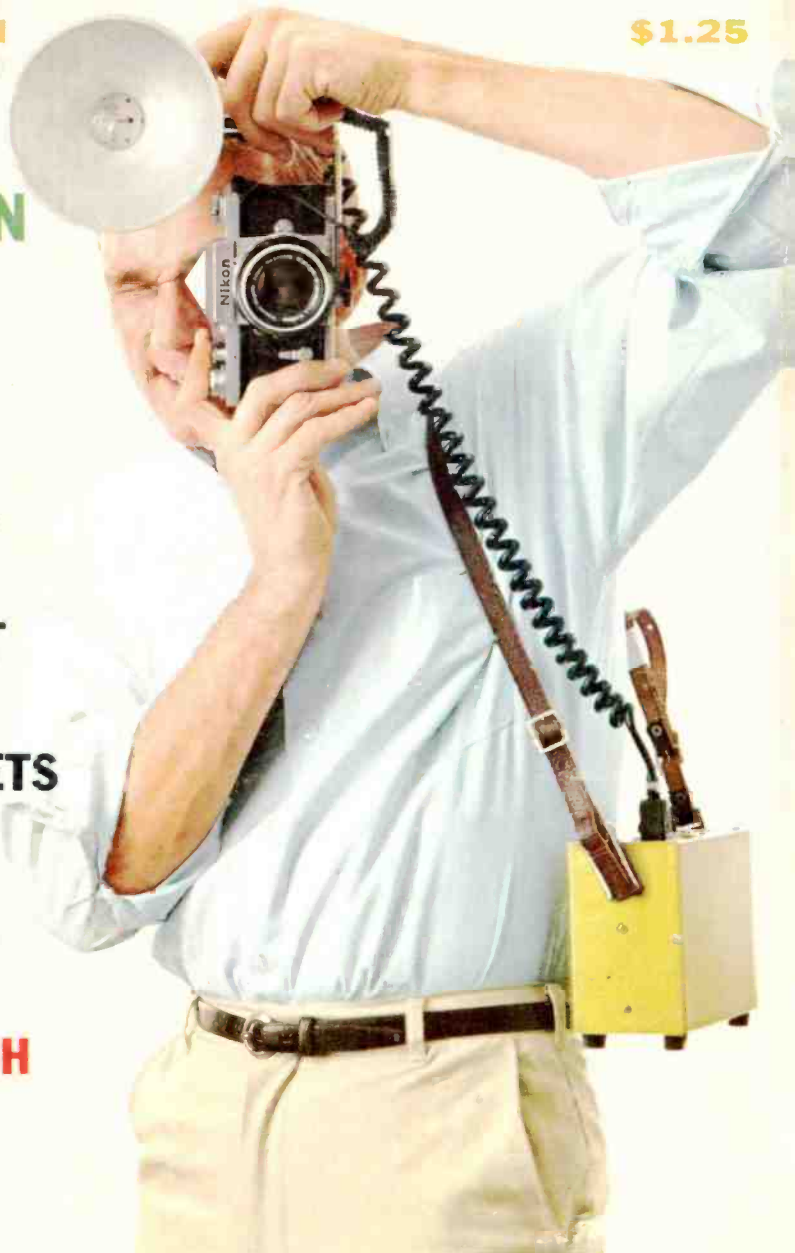

# BETTER THAN EVER!

Mail the Card Today for Your **FREE** Catalog

No Money Down • Easy Pay Terms

**1966**  
CATALOG NO.  
**660**

Live Better Electronically With

# LAFAYETTE RADIO ELECTRONICS

Over 500 Pages

# FREE!



- TV Tubes and Parts
- Electronic Parts
- Test Equipment
- Citizens Band
- Tools
- Ham Gear
- Stereo Hi-Fi
- Tape Recorders
- Walkie-Talkies
- Auto Accessories

Featuring Everything in Electronics for

• HOME • INDUSTRY • LABORATORY

from the

**"World's Hi-Fi & Electronics Center"**

LAFAYETTE'S MAIL ORDER &  
LONG ISLAND  
SALES CENTER



111 Jericho Turnpike  
Syosset, Long Island, New York

**OTHER LOCATIONS**

NEW YORK—45th St.  
71 West 45 St.  
BROOKLYN, NEW YORK  
2265 Bedford Avenue  
NEW YORK, NEW YORK  
17 Union Square W.  
(cor. 15 St.)  
JAMAICA, NEW YORK  
165-08 Liberty Avenue  
SCARSDALE, NEW YORK  
691 Central Avenue  
BRONX, NEW YORK  
542 E. Fordham Road

MT. RAINIER/  
HYATTSVILLE, MD.  
3191 Queens Chapel Road  
NEWARK, NEW JERSEY  
24 Central Avenue  
PLAINFIELD, NEW JERSEY  
139 West 2 Street  
PARAMUS, NEW JERSEY  
182 Route 17  
BOSTON, MASS.  
584 Commonwealth Avenue  
NATICK, MASS.  
1400 Worcester Street

LAFAYETTE Radio ELECTRONICS  
Dept. EHB-6, P.O. Box 10  
Syosset, L.I., N.Y. 11791

Send  
FREE Lafayette  
Catalog

Name \_\_\_\_\_

Address \_\_\_\_\_

City \_\_\_\_\_ State \_\_\_\_\_

Zip \_\_\_\_\_

(Please Give Your Zip Code No.)

CIRCLE NO. 12 ON READER SERVICE CARD

# Your ticket to a high-pay job in electronics

**AN FCC LICENSE  
issued by the  
UNITED STATES  
GOVERNMENT**

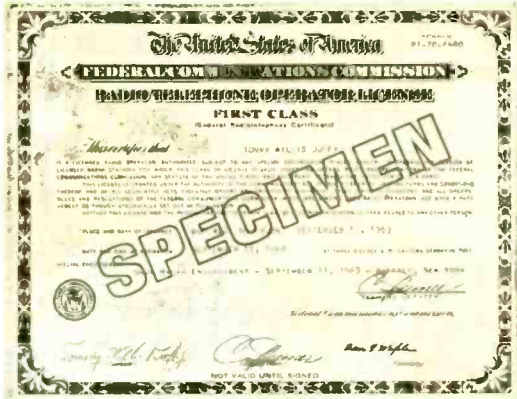

**These men will tell you how to get it!**



**Matt Stuczynski, Senior Transmitter Operator, Radio Station WBOE.**

"The Commercial FCC License is a 'must' for a career in broadcasting. I took CIE's Home Study Electronics Course and, thanks to their 'Auto-Programmed' teaching method, passed the 1st Class FCC License Exam on my first try! I now have a good job in studio operation, transmitting, proof of performance, equipment servicing."



**Chuck Hawkins, Chief Radio Technician, Division 12, Ohio Dept. of Highways.**

"My Cleveland Institute Course enabled me to pass both the 2nd and 1st Class License Exams on my first attempt . . . even though I'd had no other electronics training. I'm now in charge of Division Communications and we service 119 mobile units and six base stations. It's an interesting, challenging and extremely rewarding job."



**Glenn Horning, Local Equipment Supervisor, Western Reserve Telephone Company.**

"I owe my 2nd Class FCC License to Cleveland Institute. Their FCC License Program really teaches you theory and fundamentals . . . is particularly strong on transistors, mobile radio, troubleshooting and math. Our Company has 10 other men enrolled with CIE and it's going to help every one of them just like it helped me."

How about you? If lack of an FCC License is holding you back, it's time you looked into Cleveland Institute of Electronics Home Study. All you have to do is send us the coupon . . . and in a few days, you'll have the complete story. And remember . . . Cleveland Institute backs their programs with this exclusive, money-back warranty: "A CIE License Course will quickly prepare you for a Commercial FCC License exam. If you complete the course but fail to pass the exam on your first attempt, CIE will refund all tuition."

**Get started now. Send coupon for free booklet "How To Get an FCC License." There's no obligation.**

**Cleveland Institute  
of Electronics**

1776 E. 17th St., Dept. EH-2 • Cleveland, Ohio 44114



**Cleveland Institute  
of Electronics**  
1776 E. 17th St., Dept. EH-2  
Cleveland, Ohio 44114

**HOW TO GET A  
COMMERCIAL  
FCC LICENSE**



Yes! I want to know how to get a Commercial FCC License. Please send me your FREE booklet . . . without obligation.

My Occupation is \_\_\_\_\_

Name \_\_\_\_\_ Age \_\_\_\_\_

Address \_\_\_\_\_ County \_\_\_\_\_

City \_\_\_\_\_ State \_\_\_\_\_ Zip \_\_\_\_\_

A leader in Electronics Training . . . since 1934

**CIRCLE NO. 5 ON READER SERVICE CARD**

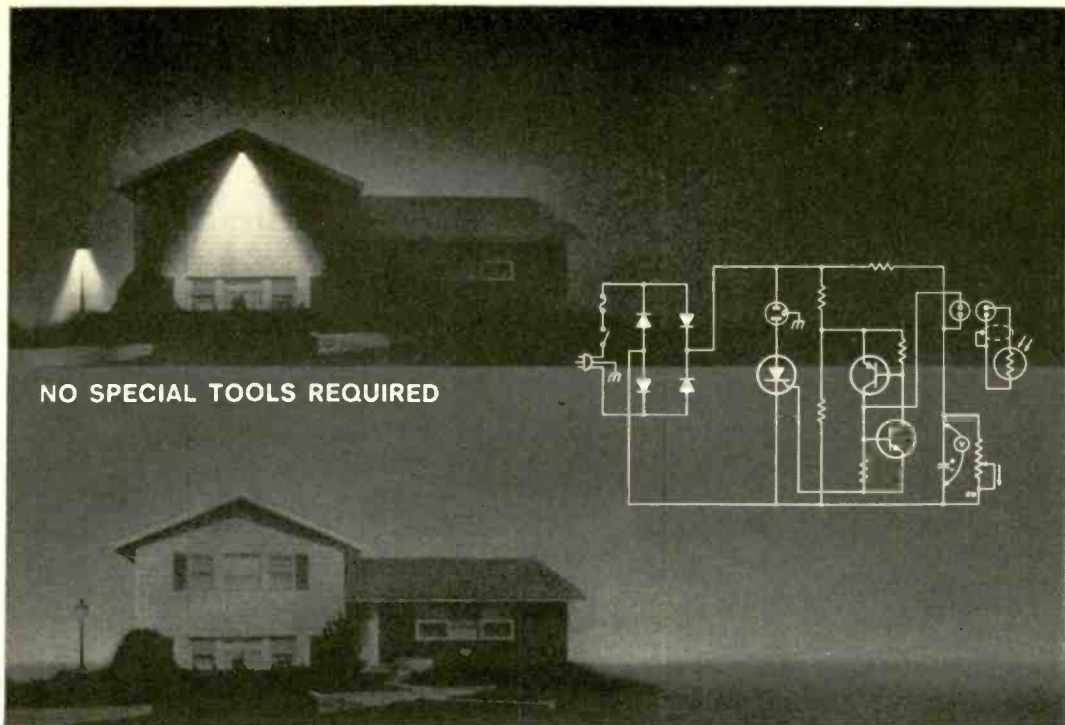

**NO SPECIAL TOOLS REQUIRED**

## LIGHT UP THE NIGHT With RCA's EXPERIMENTER'S KIT

### Build Your Own Light-Operated Switch for Dozens of Applications Around the House

Just let your imagination soar—and you'll trigger your own application ideas for any of the 14 control circuits you can build with only three RCA Experimenter's Kits. For instance, you can build a light-operated switch for a garage light, a yard or path light, or even an advertising sign that can be activated with lights from an approaching automobile! You can also build a model race car speed control, an electronic heat control and other interesting circuits with hundreds of applications. All these circuits with easy-to-follow directions are described in the RCA Experimenter's Manual, KM-70, available from your RCA Semiconductor Distributor.

### HERE IS WHAT YOU NEED...

- RCA Basic Experimenter's Kit (KD2105). Containing one silicon controlled-rectifier; two transistors; five rectifiers.
- RCA Experimenter's Manual (KM-70). 80 pages profusely illustrated: 14 circuits—how they operate and how to build them.
- RCA Add-On Light Sensor Kit (KD2106). Containing one photocell for light-operated circuits.
- RCA Add-On Heat Sensor Kit (KD2110). Containing three thermistors for different temperature ranges; special solder for heat control circuits.
- Readily available passive components and hardware.

### HERE IS WHAT YOU CAN MAKE...

1. Electronic Timer. 2. Electronic Time Delay Switch.
3. Electronic Flasher. 4. Battery Charger (12 Volts).
5. Battery Charger (6 Volts). 6. Model Race Car and Railroad Speed Control. 7. Light-Operated Switch (Turn-On).
8. Light-Operated Switch (Turn-Off). 9. Electronic Heat Control (Turn-On). 10. Electronic Heat Control (Turn-Off).
11. Overload Switch. 12. Electronic Synchronous Switch.
13. Universal Motor Speed Control. 14. Lamp Dimmer.



If you want to build one circuit or all 14, check with your RCA Distributor where kits and RCA Experimenter's Manual are on display. He'll be glad to help you select the kit or kits for the solid-state circuit you have in mind. Do it today!

AVAILABLE FROM YOUR RCA SEMICONDUCTOR DISTRIBUTOR

RCA Electronic Components and Devices, Harrison, N. J.



**The Most Trusted Name in Electronics**

**CIRCLE NO. 19 ON READER SERVICE CARD**

ELECTRONIC EXPERIMENTER'S HANDBOOK

# SPRING EDITION 1966 POPULAR ELECTRONICS ELECTRONICS EXPERIMENTER'S HANDBOOK

**PHILLIP T. HEFFERNAN**  
Publisher

**OLIVER P. FERRELL**  
Editor

**ROBERT CORNELL**  
Managing Editor

**JOHN D. DRUMMOND**  
Technical Editor

**WILLIAM GALBREATH**  
Art Editor

**MARGARET MAGNA**  
Associate Editor

**CHRISTOPHER SHERIDAN**  
Associate Editor

**ANDRE DUZANT**  
Technical Illustrator

**NINA KALAWSKY**  
Editorial Assistant

**PATTI MORGAN**  
Editorial Assistant

**LAWRENCE SPORN**  
Advertising Sales Manager

**ARDYS C. MORAN**  
Advertising Service Manager

## ZIFF-DAVIS PUBLISHING COMPANY

Editorial and Executive Offices (212 O'Regan 9-7200)

One Park Avenue, New York, New York 10016

William B. Ziff, Chairman of the Board (1946-1953)

William Ziff, President

W. Bradford Briggs, Executive Vice President

Hershel B. Sorbin, Vice President and General Manager

Phillip Sine, Financial Vice President

Walter S. Mills, Jr., Vice President, Circulation

Stanley R. Greenfield, Vice President, Marketing

Phillip T. Heffernan, Vice President

Frank Pamerantz, Vice President, Creative Services

Arthur W. Butzow, Vice President, Production

New York Office (212 O'Regan 9-7200)

One Park Avenue, New York, New York 10016

Eastern Advertising Manager, RICHARD J. HALPERN

Midwestern Office (312-726-0892)

307 North Michigan Avenue, Chicago, Illinois 60601

Midwestern Advertising Manager, JAMES WEAKLEY

Western Office (213 CRestview 4-0265)

9025 Wilshire Boulevard, Beverly Hills, California 90211

Western Advertising Manager, BUD DEAN

Circulation Office

One Park Avenue

New York, New York 10016



1966 ELECTRONIC EXPERIMENTER'S HANDBOOK, Spring Edition, published by the Ziff-Davis Publishing Company, One Park Avenue, New York, New York 10016. Also publishers of Popular Electronics, Electronics World, HiFi/Stereo Review, Communications Handbook, Tape Recorder Annual, Stereo/Hi-Fi Directory, Electronics Installation and Servicing Handbook.

*If you have read the past 10 issues of the ELECTRONIC EXPERIMENTER'S HANDBOOK, you will be aware of two significant things. First, the phenomenal interest in electronics continues unabated and two editions of the HANDBOOK are being published each year. Secondly, at the request of our avid readers, this edition has been devoted solely to construction projects—34 of them. Each project has been carefully checked by the author, and in most instances the project itself tested by the staff of the HANDBOOK. At a rate of 3½ cents per project, this Spring Edition is one of the best bargains you can find in electronics magazines or handbooks.*

*Due to the season of the year, our Science Fair chapter has been replaced in this edition by a chapter on Radio Control. Several Science Fair projects are now scheduled for the Fall Edition that will go on sale in October 1966.*

*The cover of this edition features a universally powered electronic flash. This flash has been designed to incorporate as many safety features as possible. The circuit is straightforward, and it is expected that many readers will study this flash to gain some idea of how electronic flash guns operate. Your Editors were impressed by the performance of this flash and believe that nothing like it has ever appeared in print before.*

—THE EDITORS

# When you want QUALITY 2-way radio-check Johnson first!



Look to Johnson for the most versatile, most reliable 2-way radio equipment available today! For personal or business use, choose from a broad CB equipment line... compact, hand-held Personal Messengers; portable field packs; and popular-priced tube-type or all solid-state transceivers for base station or mobile applications. For demanding business applications, Johnson's Business/Industrial 2-way radio line offers a true systems approach for communications in depth!



*most complete line...*

**MESSENGER<sup>®</sup>**

**Check Johnson  
First! Put a  
"Messenger" to  
work for you!**



**JOHNSON<sup>®</sup>**

**E. F. JOHNSON COMPANY**  
2501 Tenth Ave. S.W. • Waseca, Minnesota 56093

*Please rush me full details on:*

- Citizens Radio Equipment       Business/Industrial Radio Equipment

NAME \_\_\_\_\_

ADDRESS \_\_\_\_\_

CITY \_\_\_\_\_ STATE \_\_\_\_\_ ZIP \_\_\_\_\_

CIRCLE NO. 29 ON READER SERVICE CARD

**SPRING EDITION**  
1966  
POPULAR ELECTRONICS  
**ELECTRONICS**  
**EXPERIMENTER'S**  
HANDBOOK  
**CONTENTS**

**1**  
**USEFUL**  
**HOUSEHOLD**  
**PROJECTS**

**7**  
*Electronic Flash—D.C.-Operated Fluorescent Light  
—Transistorized Capacitor Discharge Ignition  
System—Wireless Re-Broadcaster—Electric Fence  
Charger—Simple Dwell Meter—Tachometer &  
Engine Idle Speed Calibrator—Self-Regulating  
Lighting Controller—Strobelight Slave—Electronic  
Coin Tosser—Dymwatt*

**2**  
**AUDIO**  
**STEREO**  
**HI-FI**  
**PROJECTS**

**55**  
*Transistor FM Multiplexer—Mr. Thurax' Magic  
Box—Slim Twosome—Bargain Page Amplifier—  
Stereo Bal*

**3**  
**RADIO**  
**CONTROL**  
**PROJECTS**

**79**  
*Miniature R/Ceiver—R/C Transmitter*

**4**  
**COMMUNI-**  
**CATIONS**  
**SWL**  
**CB**  
**HAM**

**89**  
*Paragon 144—Miniature I.F. Module Super-  
heterodyne Pocket Receiver—Compact BCB DX  
Antennas—2 Halos Stacked for 2 Meters—144-Mc.  
Swiss Quad Antenna—Marine Band Wavemeter  
—Simple Auto Light Minder*

**5**  
**TEST**  
**EQUIPMENT**  
**PROJECTS**

**109**  
*Miniature VTVM—Master Control SCR Switching  
Center—Simple Simon Voltage Calibrators—Put  
Your Best Meter Face Forward—Experimenter's  
L Bridge—Transistor Replacement Technique—  
Exalted Pot—Four-Way Oscillator—Case of the  
Aluminum Ally—Best of Tips & Techniques*

**ELECTRONICS**  
**MARKET**  
**PLACE**

**149**

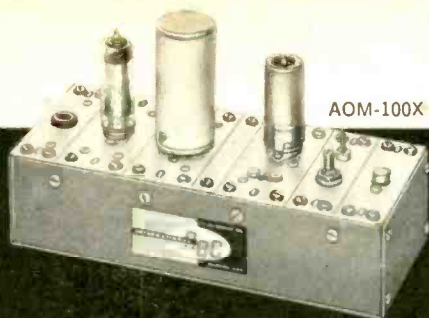

AOM-100X



AOM-200 Series

# INTERNATIONAL AOC MULTIVIBRATORS...



AOM-100 Series

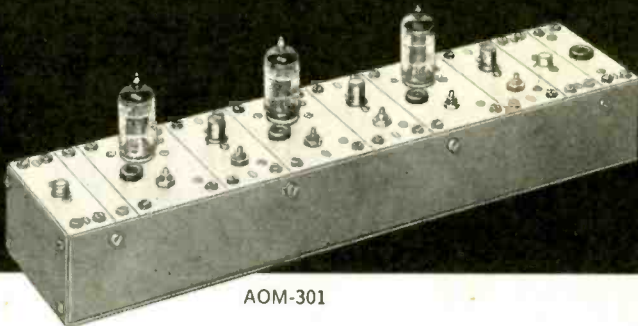

AOM-301

- FREQUENCY MEASURING ■ BAND MARKERS
- GENERATING ACCURATE TIMING PULSES

AOC Multivibrators are free running saw-tooth oscillators designed to lock on a stabilized signal source for division of 10.

Multivibrator units may be obtained in a number of combinations or single units. Each multivibrator has isolation amplifier to stabilize lock. Complete series allows 1,000 kc crystal to produce a 1 cycle per second pulse. Both 1,000 kc and 100 kc crystal oscillator units are available.

Crystal oscillators AOM-100X and AOM-1000X provide a stabilized signal source to drive the multivibrator chain. Each oscillator has regulator tube and crystal oven to insure maximum stability. Short term stability, 1 part in 10<sup>6</sup>.

UNIT	DESCRIPTION	PRICE
AOM-101	100 kc.....	\$19.95
AOM-102	10 kc.....	19.95
AOM-103	1 kc.....	19.95
AOM-104	100 cps.....	19.95
AOM-105	10 cps.....	19.95
AOM-106	1 cps.....	19.95
AOM-201	100 kc and 10 kc.....	35.00
AOM-202	10 kc and 1 kc.....	35.00
AOM-301	100 cps, 10 cps, 1 cps.....	49.50
AOM-100X	100 kc oscillator.....	32.50
AOM-1000X	1,000 kc oscillator.....	32.50

Shipping weight: 5 lbs. each

**FREE!** SEND FOR NEW 60 PAGE INTERNATIONAL CATALOG



**CRYSTAL MFG. CO., INC.**

18 NO. LEE · OKLA. CITY, OKLA. 73102

CIRCLE NO. 30 ON READER SERVICE CARD

ELECTRONIC EXPERIMENTER'S HANDBOOK



# CHAPTER

1

## USEFUL HOUSEHOLD PROJECTS

*In this Spring 1966 Edition of the ELECTRONIC EXPERIMENTER'S HANDBOOK, a 3-part emphasis has been placed on "Household" projects. Two of the projects are strictly photographic—including one of the few published stories on the home construction of an electronic flash. This particular story was especially prepared for the Spring '66 EEH, and nothing like it has appeared in print before. The second photographic story concerns a very capable strobe or electronic flash slave unit.*

*Automotive electronics takes up a sizable share of this chapter with projects like the POPULAR ELECTRONICS capacitive discharge ignition system (page 19); a simple dwell meter (page 36); a novel engine idle calibrator (page 39); and a 12-volt d.c.-operated fluorescent lamp (page 16).*

*There are a number of distinctive home projects, and your family will be impressed by the electronic "versatility" of the "Lighting Controller" (page 41) or the "Dymwatt" (page 50). Just for fun and games, investigate the "Coin Tosser" (page 46). Last, but not least, is the "Fence Charger," a project frequently requested by the thousands of EEH readers.*

8	ELECTRONIC FLASH .....	Charles Caringella
16	D.C.-OPERATED FLUORESCENT LIGHT .....	Ben Richards
19	TRANSISTORIZED CAPACITOR DISCHARGE IGNITION SYSTEM .....	Murray Gellman
25	WIRELESS RE-BROADCASTER .....	Ken Dobler
29	ELECTRIC FENCE CHARGER .....	Lyman E. Greenlee
36	SIMPLE DWELL METER .....	T. C. Penn
39	TACHOMETER AND ENGINE IDLE SPEED CALIBRATOR .....	James S. Shreve
41	SELF-REGULATING LIGHTING CONTROLLER .....	Edward P. Nawracaj and Fred Forman
43	STROBELIGHT SLAVE .....	W. F. Gephart
46	ELECTRONIC COIN TOSSER .....	Woodrow Pope
50	THE DYMWATT .....	Don Lancaster



By CHARLES CARINGELLA

**T**HE electronic flash, or speedlight, is a basic necessity for the serious-minded amateur and professional photographer. If you have an interest in photography—as well as electronics—you will find this construction project of considerable interest.

Very few build-it-yourself articles on electronic flash units have appeared in print. There have been two reasons for this absence of construction projects: (1) the performance of a unit was not commensurate with the building cost, and (2) the unit was unsafe. The project described below easily overpowers both of these objections. Its performance

is equal to that of professional speedlights costing more money; and if the builder carefully follows the construction and wiring instructions, this unit is as safe as any flash now sold in a photography store.

**How the Circuit Works.** The schematic diagram of the shoulder pack is shown in Fig. 1. Basically, the circuit consists of an a.c./d.c. power supply that charges a photoflash storage capacitor.

A special feature of the main power transformer,  $T_2$ , is dual primary windings: one for a.c. and the other for d.c. operation. The a.c. winding is connected to the 117-volt a.c. line when power

# ELECTRONIC FLASH

*Universally powered photoflash can be constructed from these carefully engineered detailed plans*

switch *S1* is in the "AG" position. A second transformer, *T1*, operates in conjunction with the center-tapped winding of *T2*, as part of a simple d.c.-to-d.c. converter. Transistors *Q1* and *Q2* serve as the converter's switching transistors.

while *T1* provides the necessary feedback for oscillator action. A 6-volt battery, *B1*, powers the d.c.-d.c. converter section and is switched into the circuit when switch *S1* is in the "DC" position.

High-voltage a.c. appears across the secondary of *T2* when *S1* is in either the "AC" or "DC" position. Neon glow lamp *I1* indicates the presence of high voltage across the secondary. This lamp serves a dual purpose. It not only indicates the presence of high voltage, but it indirectly indicates the condition of battery *B1*. The lamp glow diminishes as the batteries get weaker.

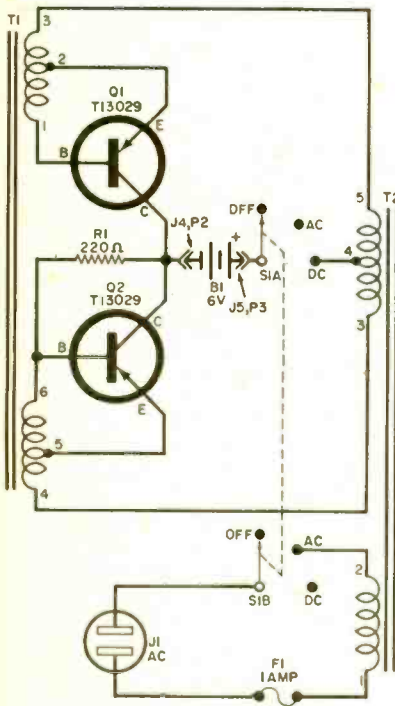

Fig. 1. The shoulder pack is the power supply for the electronic flash. A transistorized d.c. to d.c. converter boosts the battery voltage to the value necessary to charge flash capacitor *C2*. On house current the pack operates like a simple voltage doubler circuit.

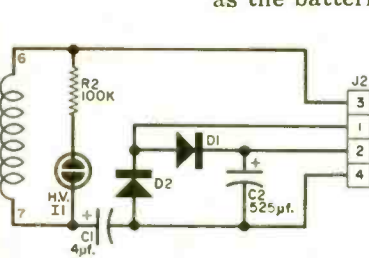
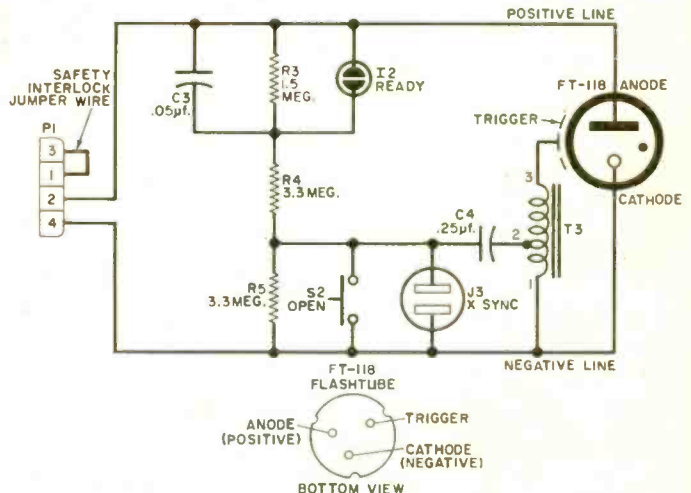

Fig. 2. This is the circuit of the flash head. Operation of all these two diagrams is explained in text.



The secondary output voltage of  $T2$  is about 200 volts a.c. Diodes  $D1$  and  $D2$ , along with capacitors  $C1$  and  $C2$ , form a voltage doubler network, which rectifies and doubles the secondary output voltage. Photoflash capacitor  $C2$  charges to almost 450 volts d.c. The energy stored in  $C2$  is used to flash the flash-tube.

One of the connections from the secondary of  $T2$  (pin 6) is routed through the power jack,  $J2$ , and back to the input of the voltage doubler network. A jumper wire, located between pins 1 and 3 of  $P1$ , completes the circuit when  $P1$  is plugged into  $J2$ . This arrangement serves as a safety interlock to keep  $C2$  from being charged when  $P1$  is disconnected.

A schematic diagram of the flash head is given in Fig. 2. When  $C2$  is charged, the full d.c. voltage appears across the flashtube. The flashtube, however, is designed not to flash (due to its "hold-off" voltage rating) until a high-voltage pulse is applied to the trigger electrode.

The high-voltage pulse is derived from  $C4$  and  $T3$ . Capacitor  $C4$  is charged through the divider network consisting of  $R3$ ,  $R4$ , and  $R5$ . One side of  $C4$  is also connected to the camera shutter contacts via  $J3$ . When the shutter contacts close,  $C4$  is discharged and the pulse is stepped up by  $T3$  to a peak value of approximately 6000 volts.

The 6000-volt pulse is applied to the

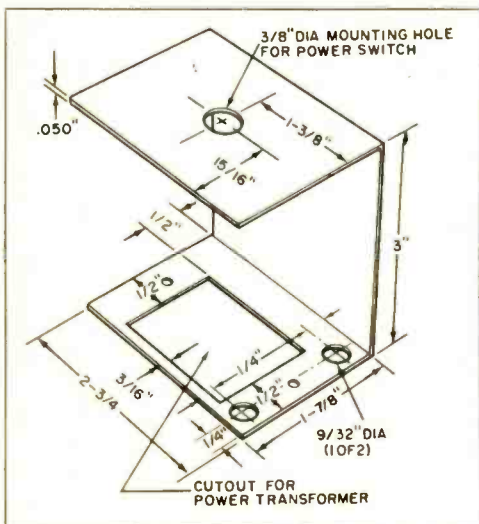

Fig. 3. Only a part of the necessary metal work is shown in this drawing of the power supply sub-chassis. Read the text on the facing page for details.

trigger electrode of the flashtube. Once the pulse is applied, the gas within the flashtube is immediately ionized, making it highly conductive. The photoflash capacitor,  $C2$ , then discharges all of its energy into the flashtube, causing the brilliant flash of light.

## PARTS LIST

- $B1$ —Four D-size batteries—see text
- $C1$ —4- $\mu$ f., 450-volt electrolytic capacitor
- $C2$ —525- $\mu$ f. 450-volt electrolytic capacitor (Cornell-Dubilier FWSN-10001 or Aerovox FF-2)\*
- $C3$ —0.05- $\mu$ f. 400-volt paper capacitor
- $C4$ —0.25- $\mu$ f. 400-volt capacitor
- $D1$ ,  $D2$ —1N547 rectifier\*
- $F1$ —1-ampere fuse, type 3AG
- $I1$ ,  $I2$ —NE-51 neon lamp
- $J1$ —Chassis-mounting a.c. male receptacle, with recessed shell (Amphenol 61-M10 or equivalent)
- $J2$ —Four-contact, chassis-mounting socket (Cinch-Jones S-304 or equivalent)
- $J3$ —Rectangular chassis-mounting a.c. female socket (Cinch-Jones SR2 or equivalent)
- $J4$ ,  $J5$ —Tip jack (one red, one black)
- $P1$ —Four-contact plug with cable clamp (Cinch-Jones P-304 or equivalent)
- $P2$ ,  $P3$ —Phone tip plug
- $Q1$ ,  $Q2$ —Germanium power transistor (Texas Instruments TI5029 or equivalent)\*
- $R1$ —220-ohm, 1-watt resistor
- $R2$ —100,000-ohm,  $\frac{1}{2}$ -watt resistor
- $R3$ —1.5-megohm,  $\frac{1}{2}$ -watt resistor
- $R4$ ,  $R5$ —3.3-megohm,  $\frac{1}{2}$ -watt resistor
- $S1$ —Double-pole, 3-position, single-section miniature phenolic rotary switch (Centralab PA-1003 or equivalent)
- $S2$ —Miniature normally-open push-button switch (Grahill 23-1 or equivalent)
- $T1$ —Inverter transformer (UTC PF-6)\*\*
- $T2$ —AC/DC photoflash power transformer (UTC PF-5)\*\*
- $T3$ —Trigger transformer (UTC PF-7)\*\*
- 1—General Electric FT-118 flashtube (available from photo stores)\*
- 1—Reflector, type 165-P-157 (Weber Brass Co., 3344 Payne Ave., Cleveland, Ohio, \$4 post-paid)\*
- 1—2 $\frac{3}{4}$ " x 2 $\frac{1}{2}$ " x 2 $\frac{3}{4}$ " aluminum chassis box (LMB 100 or equivalent)
- 1—7" x 5" x 3" aluminum chassis box (LMB 145, or equivalent)
- 2—Dual battery holders for D cells (Keystone 176 or equivalent)
- 2—Transistor mounting kits (Motorola MK-15, or equivalent)\*
- 1—Fuse holder (Russ I1KP, or equivalent)
- 1—Pilot light holder for NE-51 lamp
- 1—Coiled cable, three-conductor, with one conductor not used, extends from 10" to 4 $\frac{1}{2}$ " (Belden 8495 or equivalent)
- 1—6" x 2 $\frac{3}{4}$ " strip of 0.050"-thick aluminum
- Misc.—Rubber feet (4),  $\frac{3}{8}$ " grommets (2), solder, screws, etc.

\*A kit of parts containing these components is available from Caringella Electronics, Box 327, Upland, Calif. 91786, for \$26 (\$6 below cost of parts if purchased separately). Shipping weight, 3 lb. California residents must add 4% sales tax. The reflector collar may be purchased separately for \$2.00.

\*\*These transformers, if not available locally, can be obtained from Harvey Radio, 103 West 43 St., New York, N.Y. 10036, for approximately \$17.25, plus shipping cost.

The "Ready" light is neon glow lamp *I2*. The "Ready" light blinks on and off when the photoflash capacitor has sufficient charge to flash the flashtube. This value can be anywhere from 400 to 450 volts d.c. A simple relaxation oscillator circuit (*C3* and *R3*) causes *I2* to blink

at a rate proportional to the charge on *C2*. The greater the voltage, the faster the rate.

Switch *S2* is in parallel with the shutter contacts. It can be used to "open" or "flash" the circuit. You can test the flash with it at any time without operating the camera shutter.

**Construction.** Before beginning construction, round up all the needed components. You can save more than \$6 by ordering a kit of parts rather than buying some of the parts separately. The kit consists of photoflash capacitor *C2*, diodes *D1* and *D2*, transistors *Q1* and *Q2*—plus their mounting kits, the FT-118 flashtube, plus reflector and collar.

Begin construction of the electronic flash with the power supply subchassis. This subassembly chassis is partially detailed in Fig. 3. Besides the holes shown in this drawing, holes must be drilled in the 2 1/4" x 3" face to mount the transistors and their sockets. Because of differences in size of switches, hardware, and other components, the holes for mounting *Q1* and *Q2* have not been drawn. However, once you have all the

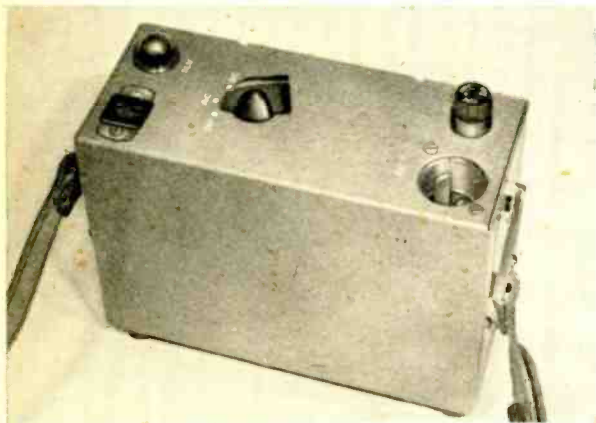

In this top view of the electronic flash shoulder pack, note the location of the jacks, pilot light, fuse holder and switch *S1*. Compare this photo with the drawing below to orient component location.

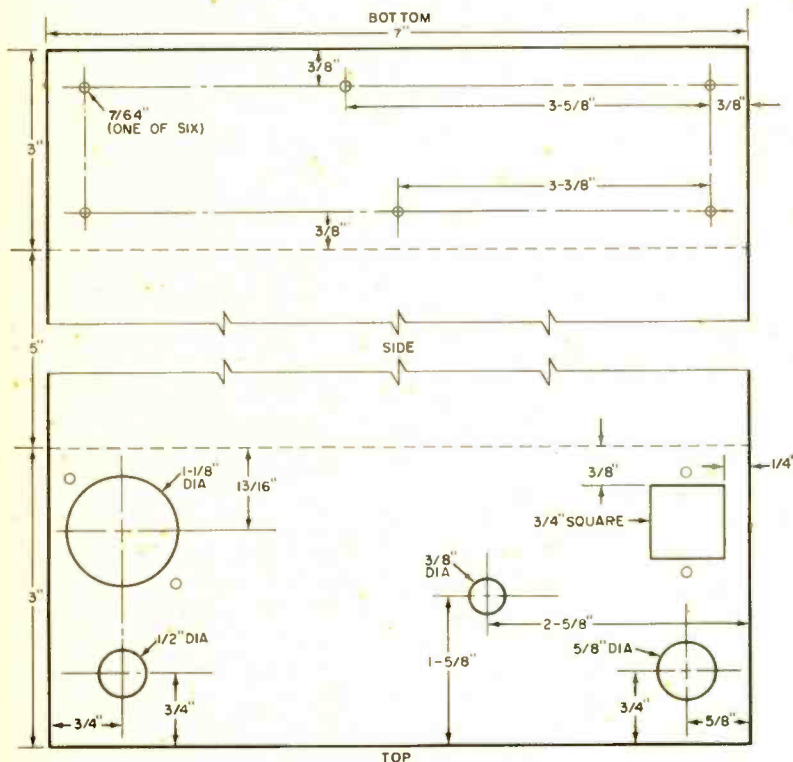

Fig. 4. The power supply or shoulder pack was built in a LMB box—a type commonly available in the west, but somewhat rare on the east coast. The dimensions for metal working shown here are predicated on the use of the LMB 145 box. If it is unattainable, the builder should pick out the closest substitute and adjust the metal working measurements accordingly.



# ELECTRONICS

WHERE CAN YOU EQUAL THIS OPPORTUNITY

TO EARN A GOOD PAYING JOB IN A FAST GROWING FIELD?

DeVRY'S "BIG 3" AIDS TO PROGRESS ARE DESIGNED TO SPEED YOU QUICKLY TO A REAL FUTURE IN ELECTRONICS

## 1. EFFECTIVE TRAINING!

Learn AT HOME in spare time, or day or evening in one of our RESIDENT SCHOOLS.

## 2. INDUSTRY RECOGNITION!

DeVry programs, prepared with industry's help, are "JOB-AIMED."

## 3. EMPLOYMENT SERVICE!

for ALL graduates through our contacts with many large, respected companies across North America.

ELECTRONICS is one field that spells OPPORTUNITY in big capital letters for many men 18 to 45. This widespread but FAST GROWING field offers trained men some of today's finest, good-paying job opportunities — or a chance to start a profitable servicing shop!

Even if you don't have previous technical experience or an advanced education, DeVry's "BIG 3" aids to progress may very well be YOUR stepping stones to a BETTER FUTURE. You can learn at home in your spare time, while keeping your present job. Or, in a day or evening program in our U.S. or Canadian resident school, you can develop the very skills needed to make wonderful progress. We even work to get resident students part-time jobs to help with tuition or living expenses, if necessary!

Regardless of how you complete your educational program with DeVry, you can count on industry-recognized, effective training aimed directly at providing on-the-job-type "know-how." This is followed by actual EMPLOYMENT SERVICE to help you get started in Electronics. Or, if you are in the field already, remember that a DeVry recommendation has meant plenty of ADDED DOLLARS in income to many who made themselves more valuable to employers.

See for yourself how you, too, may prepare for the INCOME, the PRESTIGE and the FINE FUTURE that goes with the title of Electronics Technician. Mail the coupon NOW for facts without obligation.

WE PREPARE YOU NOT FOR ONE JOB BUT FOR JOBS IN MANY DIVISIONS OF THE FASCINATING FIELD OF ELECTRONICS



MOVIES, TEXTS AND EQUIPMENT HELP YOU LEARN FASTER



DeVry includes training movies AT HOME, "programmed" texts and many shipments of Electronic parts — to help you learn quickly, remember more.

FREE

Send coupon for these two (actual booklets NOW!



MAIL COUPON TODAY!

### DeVRY TECHNICAL INSTITUTE

4141 Belmont Avenue, Chicago, Ill. 60641 Dept. EEH-1-W  
Please give me your two free booklets, "Pocket Guide to Real Earnings," and "Electronics in Space Travel"; also include details on how to prepare for a career in Electronics. I am interested in the following opportunity fields (check one or more):

- |  |   |
|--|---|
| <input type="checkbox"/> Space & Missile Electronics | <input type="checkbox"/> Communications         |
| <input type="checkbox"/> Television and Radio        | <input type="checkbox"/> Computers              |
| <input type="checkbox"/> Microwaves                  | <input type="checkbox"/> Broadcasting           |
| <input type="checkbox"/> Radar                       | <input type="checkbox"/> Industrial Electronics |
| <input type="checkbox"/> Automation Electronics      | <input type="checkbox"/> Electronic Control     |

Name \_\_\_\_\_ Age \_\_\_\_\_

Address \_\_\_\_\_ Apt. \_\_\_\_\_

City \_\_\_\_\_ State \_\_\_\_\_ Zip \_\_\_\_\_ Code \_\_\_\_\_

Check here if you are under 16 years of age.

HOME STUDY AND RESIDENT SCHOOL TRAINING  
AVAILABLE IN CANADA

2101

## DeVry Technical Institute

4141 Belmont Avenue  
Chicago, Illinois 60641

Accredited Member of National Home Study Council

CIRCLE NO. 7 ON READER SERVICE CARD

dangle free; they will be connected later. Now set the subchassis aside and go to work on the main chassis.

Use Fig. 4 as a guide to cut out and drill the main chassis, but check the actual component fit before you do any sheet metal work. Mount *J1*, *F1*, *I1*, *J2*, and *C2*.

Before mounting *C2*, attach two 11" lengths of good insulated wire to its terminals. To avoid damage, observe polarity; make the positive wire red, and the negative wire black. Run these two wires around the subassembly to *J2*. Be sure that the wires and the capacitor terminals do not short to the chassis or any other components or hardware. For safety's sake, tuck these wires between the chassis and *C2* and *T2*. (*Caution: Do not touch C2's terminals or its leads, even with the power disconnected, unless you are absolutely certain there is no voltage present. The only way you can be sure is to place a jumper across C2's terminals.*)

Secure the subassembly to the main chassis by first removing the nut that holds *S1* in place, pass *S1*'s shaft through the opening in the chassis, position the subassembly as shown in the photographs, and replace the nut. A  $\frac{3}{8}$ " flat washer placed under the nut protects the chassis against wrench marks and adds to the professional look.

Solder the 10" black lead from terminal 1 on *T2* to *F1* and the other 10" black lead to *J1*. Now add a wire between the remaining terminals of *F1* and *J1* to complete the 117-volt a.c. input circuit. The rest of the wiring is straightforward—just make certain that you observe polarity of the capacitors, diodes and the batteries, and that all connections are soldered and well insulated.

The four D cell batteries are retained in holders bolted to the sides of the chassis cover. Here again, you should gauge the location of the battery holders to be sure they clear the components on the chassis when the cover is screwed into place. Wire the holders so that all the batteries are in series. Solder 10" lengths of red and black hookup wire to the positive and negative battery output terminals respectively. Connect appropriate colored tip plugs (*P3* and *P2*) to the other end of these leads.

**The Flash Head.** Figure 5 details the metal work necessary to assemble the flash head. The dimensions shown are reasonably critical—especially if you intend to make a carbon copy of the unit shown here.

Resistors *R3*, *R4*, and *R5*, and capacitor *C3* are mounted on a Cinch-Jones 2006 terminal strip before the strip is installed. Looking at the strip from the top down (in the photograph of the flash head), mount *C3* and *R3* between terminals 1 and 3; *R4* between terminals 3 and 4; and *R5* between terminals 4 and 6. Clip off terminal 5 for the extra room needed to slip the lead from the photo-flash trigger pin to terminal 3 of *T3*.

There is no socket for *I2*, just short flexible leads soldered to the base of the bulb and to terminals 1 and 3 of the tie point strip. The location and wiring of the other components (Fig. 2) is obvious once the terminal strip has been installed. The flashtube and its wafer base is fitted into the neck of the reflector and crimped into place.

Mounting the reflector to the box can be accomplished in two ways: it can be attached with three or four small right-

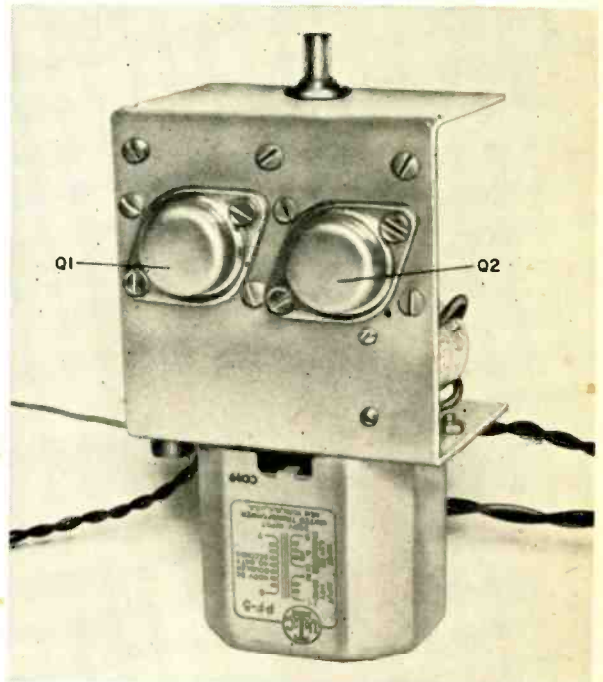

Completed power supply subchassis should look like this. Holes to mount the transistors and transformer *T1* are not detailed in Fig. 3 but are shown here.



angle brackets, or with a retaining collar similar to that shown in Fig. 6. This collar can be machined from plastic or aluminum, and fastened to the small box with four  $\frac{1}{4}$ - $\frac{1}{40}$  x  $\frac{1}{4}$ " machine screws. The neck of the reflector is inserted into the collar and protrudes about  $\frac{1}{4}$ " into the box. A setscrew on the collar holds the reflector in place.

Connections are made to the flashtube by soldering directly to its pins. Avoid excessive use of solder flux to prevent high-voltage leakage paths. The lead from the trigger electrode to T3 must be short and very well insulated (it carries more than 6000 volts). The coiled cable with P1 connected to it is routed through a grommet in the box. (Use a restraining clamp to prevent the cable from slipping out of the box.)

**Operating Information.** The "Ready" light (I2) will start blinking when the charge on C2 has reached about 425 volts. If the batteries are fresh and the power supply is running, C2 will continue to charge to about 450 volts. This charge can be held by C2 for 10-15 minutes, and during this period the photographer should have the power supply switched off. This is a good habit to learn as it will add many flashes to the life of your D cells. Of course, if recycling is important, leave the power supply running.

The blinking rate of the "Ready" light is determined by the charge on C2. At maximum charge, the blinking rate should be about 30-40 flashes per second. As the voltage on C2 drops, the blinking rate will also drop until it reaches 4-6 flashes per second. Don't shoot when the blinking rate is less than 4 flashes.

The choice of the kind of D cell determines the recycling time in the d.c. mode of operation. The author evalu-

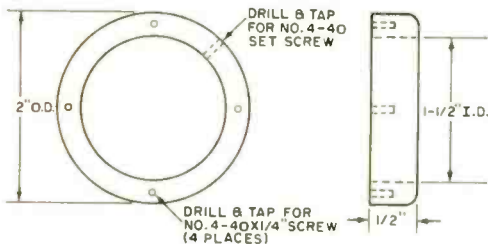
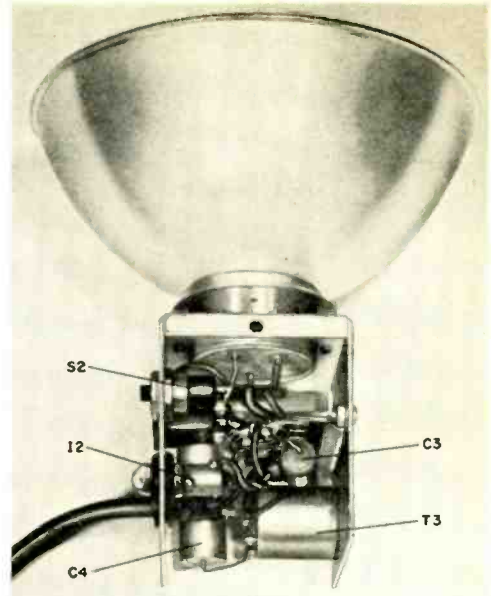

Fig. 6. This is the collar made to hold the flash reflector to the flash head box. The author has available a collar machined of aluminum for \$2.00.



Inside view of flash head shows location of some components. Connections to the flash tube are all soldered in place. Insulation of the lead to the trigger lead is important—it carries 6000 volts!

ated three types of D cells and arrived at the following conclusions.

**Ordinary D cells:** Average 40 flashes before becoming useless. Average recycling time was 40 seconds with fresh batteries and 60-70 seconds near the end of battery life.

**Alkaline D cells:** Tested were the Eveready E95 and Burgess AL-2. Average of 60 flashes and a recycling time of 12 seconds with fresh batteries and 20 seconds near the end of useful battery life.

**Nickel-Cadmium D cells:** Tested were the Eveready N57 and Burgess CD10. These excellent batteries recycle in 5-7 seconds until discharged. The user should expect to get at least 300 flashes per battery charge (not per set of batteries).

It is possible to recharge regular and alkaline D cells to extend useful life before it's necessary to throw them away. The nickel-cadmium battery is quite expensive, but this is all in initial cost since under average conditions you can recharge these batteries over 100 times. One set of nickel-cadmium batteries should last for many years.

(Continued on page 134)

# D.C.-OPERATED FLUORESCENT LIGHT



By **BEN RICHARDS**

Portable  
emergency light  
doubles as  
luminescence  
detector

**M**ADE TO ORDER for wherever a portable light is needed, this battery-operated fluorescent light will find favor with sportsmen, hobbyists, and rock collectors alike. The light works off a 12-volt battery and uses a 6-watt tube. By substituting a "black light" for the white tube, rock hunters can use it to locate mineral specimens.

Since the light can be used in many different ways, construction should be tailored to satisfy your needs. For instance, those rock hunters may find it

desirable to enclose the unit in a light-tight box with a tray and viewing hood to permit daylight sorting of rocks. Motorists will find it advantageous to use a cigarette lighter type of plug to obtain a quick power connection in the event of an emergency. Sportsmen and campers may want to add a watertight battery compartment to the unit to hold a lantern-type battery.

**How It Works.** Operating fluorescent lamps from d.c. usually presents a problem: the supply voltage must be higher than the "striking" voltage of the lamp and power is wasted in the resistive ballast which must be used to limit lamp current. Not so if an efficient transistorized inverter steps up low voltage d.c. to high voltage and high frequency a.c.—a simple series capacitor can then serve as a reactance-type current limiter. The circuit used here produces more than half again as much light output as an incandescent bulb drawing the same battery power, a feature which campers and boaters who are concerned with conserving their batteries will appreciate.

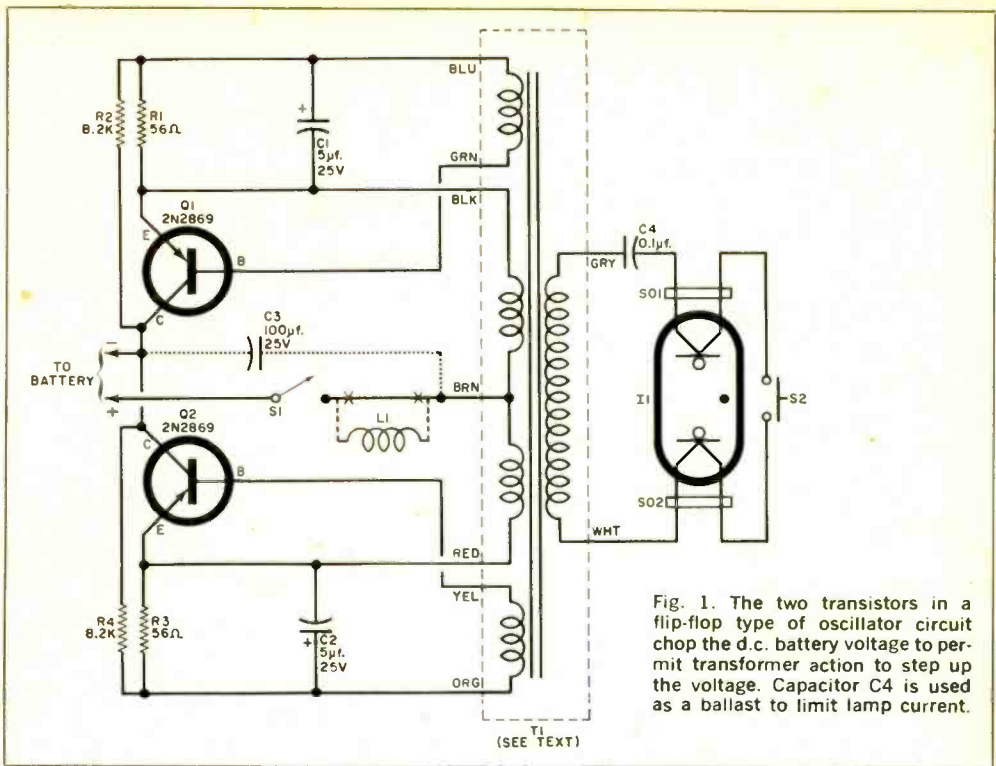

Fig. 1. The two transistors in a flip-flop type of oscillator circuit chop the d.c. battery voltage to permit transformer action to step up the voltage. Capacitor C4 is used as a ballast to limit lamp current.

The circuit, shown in Fig. 1, incorporates two transistors and a saturable core transformer with feedback windings to produce an audio oscillation at a frequency determined primarily by the transformer. The a.c. output voltage is connected to the fluorescent lamp (I1) through capacitor C4, which serves to limit load current.

The type of lamp employed has filaments at both ends of the tube to "pre-heat" the gas in order to facilitate lamp ignition. Note that the function of S2 is to allow current to flow through both filaments as long as it is closed. The hot filaments heat and ionize the gas in the lamp, so that current can flow through the gas from one end of the lamp to the other. The hotter the gas, the more current that can flow; the more current that flows, the hotter the gas becomes. The external current limiter prevents "run-away" and destruction of the lamp and other circuit components.

Capacitor C3 and coil L1 are optional and are used to cut down radio interference. If you do not use C3 and L1, con-

### PARTS LIST

- C1, C2—5- $\mu$ f., 25-volt capacitor
- C3—100- $\mu$ f., 25-volt electrolytic capacitor—optional
- C4—0.1- $\mu$ f., 10%, 600-volt tubular capacitor (Sprague 6PS-P10 or equivalent)
- I1—6-watt fluorescent lamp (Sylvania F6T5/CW cool white or F6T5/BL black light, or equivalent)
- L1—45 turns of #15 enameled wire, two layers wound evenly on  $\frac{3}{4}$ "-O.D. dowel—optional
- Q1, Q2—2N2869 transistor
- R1, R3—56-ohm,  $\frac{1}{2}$ -watt resistor
- R2, R4—8200-ohm,  $\frac{1}{2}$ -watt resistor
- S1—S.p.s.t. switch
- S2—Momentary-contact, push-to-close switch
- SO1, SO2—Miniature two-pin fluorescent lamp socket (GE 95X276 or equivalent)
- T1—Type EC-0104-1P saturable transformer (available from Milwaukee Electromagnetics, P. O. Box 4476, Milwaukee, Wis. 53207, for \$5.60 postpaid)
- Misc.—Wood parts, aluminum, celluloid shield

nect the switch directly to the brown lead on T1. Do not connect the brown lead to the negative side of the battery. A 2- or 3-ampere fuse can be placed in series with the switch. However, the fuse may not act fast enough to protect the transistors if you apply too much voltage or fail to observe polarity.

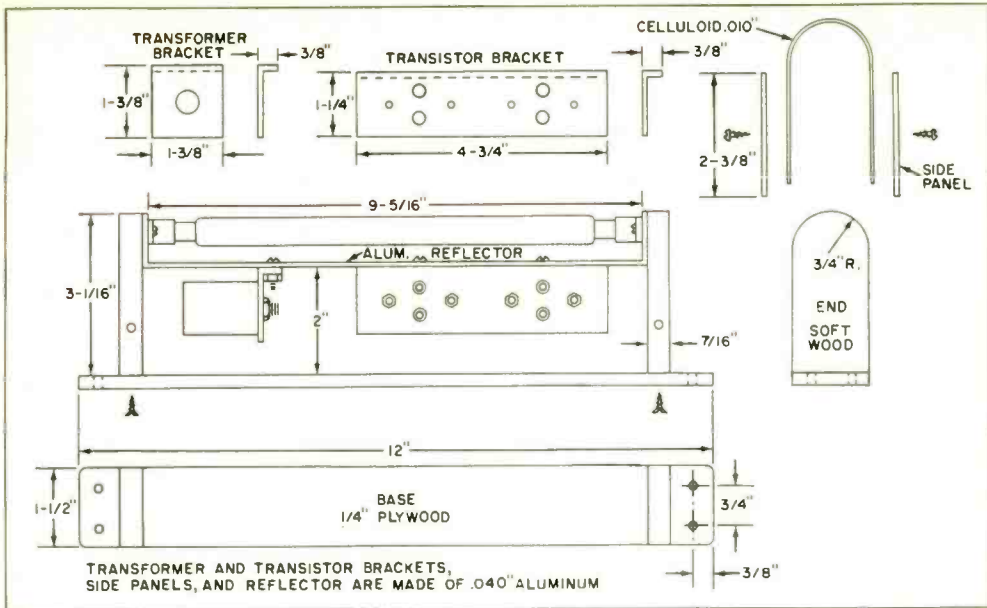

Fig. 2. Celluloid shield forms a window and insulates the side panels from the aluminum chassis. The unit can be fastened to a container built to hold two 6-volt lantern-type batteries connected in series.

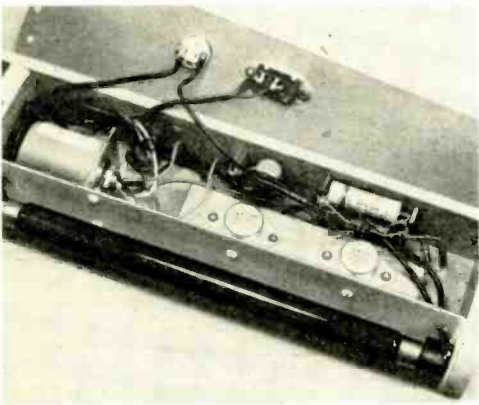

Fig. 3. Layout is not critical, but space transistors as far apart as possible to dissipate the heat.

**Construction.** Assemble the base, ends, aluminum reflector, and sockets as shown in Fig. 2. Note that the same screws hold the lamp sockets and reflector to the soft wood ends. The transistors are mounted on an aluminum bracket which in turn is mounted on the reflector. The transformer is mounted on another bracket and attached to the reflector in the same manner. The on-off switch and starter button can be installed on either aluminum side panel. Most of the com-

ponents are connected between terminal strips mounted on the wood base.

Connections to the two transistors can be made by soldering directly to the pins. Care must be exercised not to damage the transistors with excessive heat; use a pair of long-nose pliers as a heat sink when soldering. Transistor layout is not critical, but they should be spaced as far apart as possible to allow for dissipation of heat when in operation.

If the small amount of audible noise from the unit is disturbing, pack some foam rubber, styrofoam, or other acoustic absorbent material around the transformer. When installing the celluloid (or plastic) shield, be sure it insulates the aluminum side panels from the reflector in order to isolate and completely enclose the electrical circuit.

**Testing and Use.** If you are sure of your wiring and supply voltage polarity, turn the unit on and depress the starter button for a few seconds. The lamp should operate with normal brilliance if battery voltage is about 12 volts. Current drawn should be around 0.9 ampere. The circuit should work on 9 to 15 volts with lamp brightness corresponding to voltage; higher voltage levels tend to shorten lamp life. -30-

# TRANSISTORIZED CAPACITOR DISCHARGE IGNITION SYSTEM

By MURRAY GELLMAN



*Put more spark into your gasoline engine to enhance performance*

**I**NCREASED gas mileage, quicker starting even in cold weather, longer life for breaker points and spark plugs, more power at high speed, and less ignition interference on ham and CB rigs are claimed for the transistorized Capacitor Discharge Ignition System. A one-two punch has been delivered to conventional ignition systems, and it's beginning to look as though they will be replaced by electronic systems in the very near future.

The first blow was struck with the introduction of the transistor system. The transistor system relieves the breaker points from having to carry all the current in the ignition coil's primary circuit, but still depends upon a large magnetic field around the ignition coil. The size of the field, among other things, depends upon the amount of time available between sparks. This time is shorter at higher engine speeds and it is quite normal for the high voltage to fall off at the higher speeds.

Until the transistor was put to work, a practical limit on the amount of current that could flow through the primary circuit to build up the magnetic field was determined by the size of breaker points. In order for the points to handle more current, larger points are needed, but there is a practical limit to point size. The transistor ignition system eliminates the points as a stumbling block so far

as current is concerned, although breaker points still have to be in good condition and properly timed.

More than enough current is now available to the coil. But the regular coil wasn't designed to take much more current, so a new coil became desirable, one with a higher turns ratio, that is, one that would take all the current from the transistor in the amount of time between sparks. The drawback now is that the same high current is drawn at slow speeds and while starting. The battery has all it can do to satisfy the starter motor and chances are when you need it most, like on a cold winter morning, you'll be looking for a battery booster.

Several things have been done to overcome this effect: use of ballast resistor jumpers when starting, relays to connect the battery more directly to the coil, etc. But even before the designers had a chance to fully eliminate the bugs in the original transistor ignition system, the second blow was struck. Another system was brought out for public consideration and use: the transistorized capacitor discharge ignition system which uses the original ignition coil and associated equipment. It draws very little current, and makes cold-weather starting much easier.

The capacitor discharge system, by no means a newcomer, was originally a thyatron operated device; it now takes

on a completely new look and promises to become the new standard in a very short time. This transistorized capacitor discharge ignition system has a transistor power supply and a capacitor to fire the ignition coil. As there is never any d.c. on the ignition coil, the coil works more effectively, and remains much cooler in the system. A negative-ground, 12-volt system is described here.

**Construction.** Assembly of the entire ignition system can be accomplished in less than half an hour. A printed circuit

board, made of G 10 (fiberglass impregnated) material and heavy copper foil, simplifies the construction considerably.

The most important parts required are the SCR (*Q3*) and the transistor transformer (*T1*). This transformer is a special type, and can be purchased directly from SYDMUR (P. O. Box 25A, Midwood Station, Brooklyn, N. Y., 11230) for \$14.95. The SCR can be purchased locally. SYDMUR claims their SCR's are pretested and exceed manufacturer's specifications. A special selection of

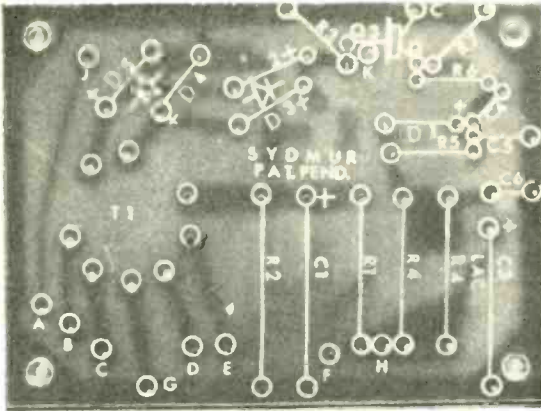
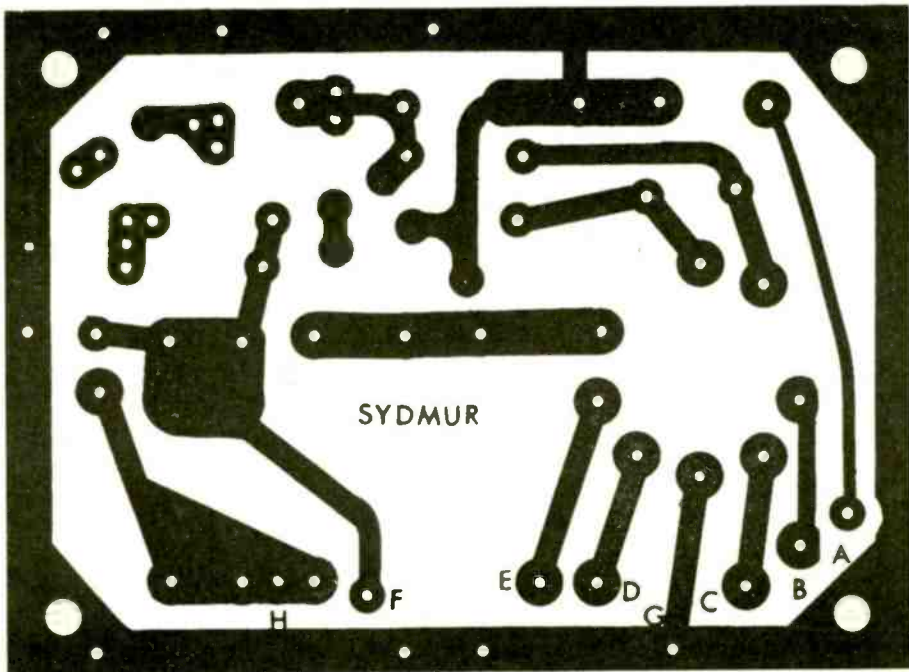

Fig. 1. Component side of circuit board (left) shows parts location and orientation. SYDMUR kit has all components color-coded, and the appropriate colors marked on the board to speed assembly. Actual size photo of board (below) will help you make your own. Do not change alignment of conductor paths.



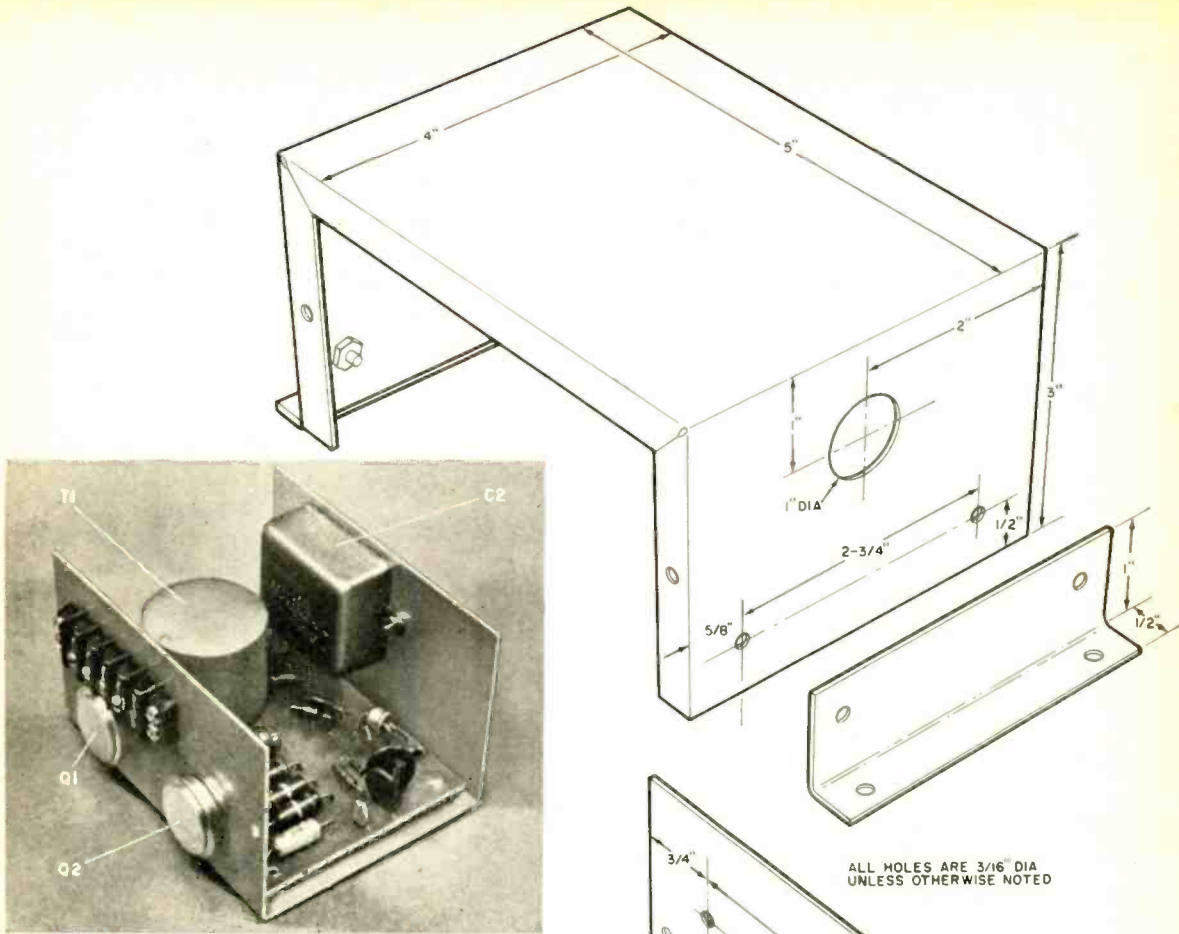
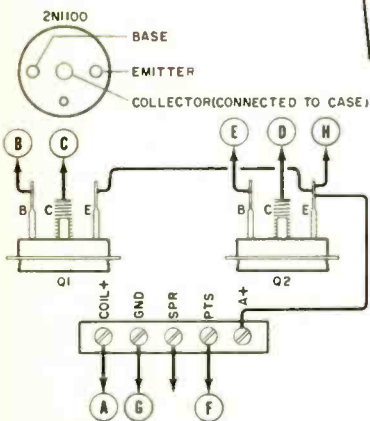
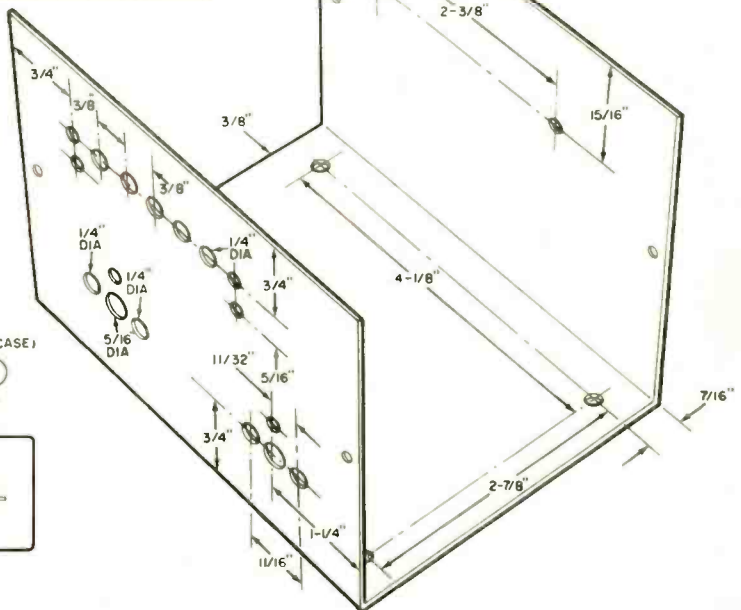

Fig. 2. Locate and drill all holes accurately. Large 1" hole is for screened air vent. Size and spacing of holes for terminal strip can vary. Mounting sequence is: Q1, Q2, terminal strip, completed board, and bathtub capacitor. Transistors must not touch the cabinet.



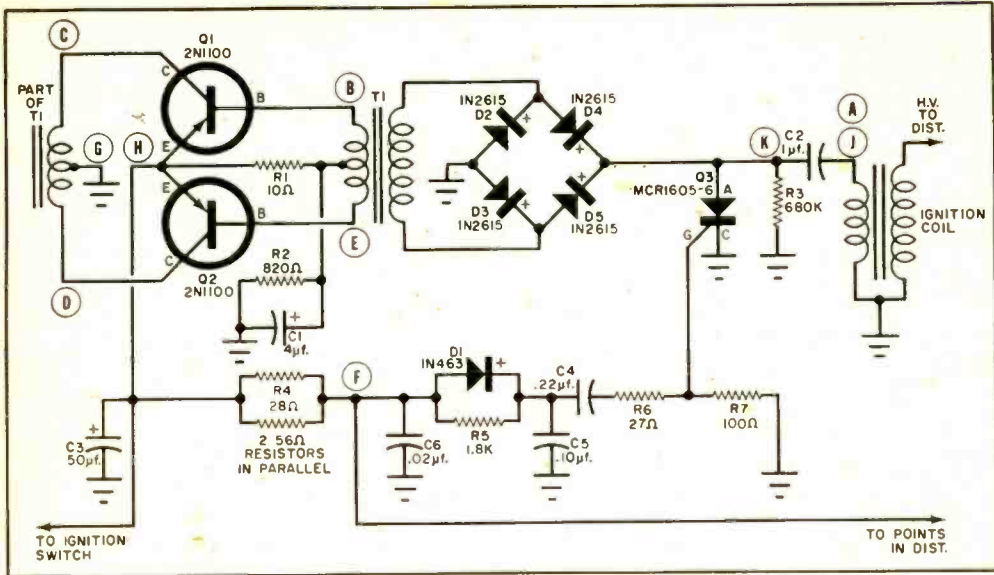

Fig. 3. Transistors Q1 and Q2 "chop" the battery input to enable T1 to step up the voltage, which is then rectified and used to charge C2. The potential stored in C2 is then "dumped" into the ignition coil.

SCR's is made to insure optimum performance; they are priced at \$7.45 each, including a heat sink. The other parts are not critical, and they can be obtained from your local parts dealer.

Should you decide to make your own printed circuit board, follow the actual size and layout as shown in Fig. 1. Do not change any lines, or false triggering of the SCR can result.

First install all the components on the printed circuit board or other suitable chassis, and put it aside. Use rosin core solder and observe polarity of all diodes. Next, prepare the cabinet as shown in Fig. 2 and mount the transistors and terminal strip. Do not mount the bathtub capacitor until the circuit board has been put in place.

When installing the transistors, coat both sides of a mica insulator with silicon grease to act as a heat conductor and electrical insulator between the transistors and the cabinet. Line up the holes of the mica insulator with the holes in the cabinet. Next, insert the transistors (they can fit only one way). Then place a fiber washer over each transistor bolt, and follow with a metal washer and solder lug. Bolt the entire assembly into place.

Be certain that the transistor pins do not touch the metal cabinet. Use an

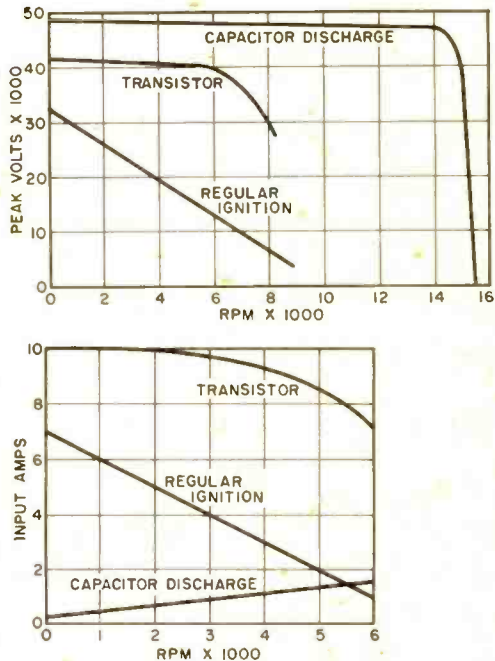

Fig. 4. Capacitor discharge system has highest voltage output and lowest current drain at road speeds.

ohmmeter to check this out. Connect one lead to the cabinet and the other to the transistor case and then to the pins. If there is a reading on the ohmmeter, recenter the transistor.



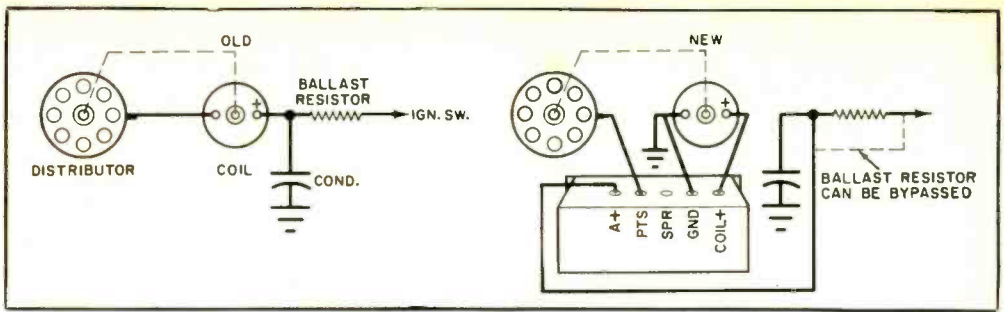

Fig. 5. Simple wiring change needed to install capacitor discharge system. To get the most out of the new installation, points, plugs, coil, wire, and distributor cap should be clean and in good condition.

### PARTS LIST

- C1—4- $\mu$ f., 50-volt electrolytic capacitor
- C2—1- $\mu$ f., 600-volt bathtub capacitor
- C3—50- $\mu$ f., 25-volt electrolytic capacitor
- C4—0.22- $\mu$ f., 25-volt ceramic capacitor
- C5—0.1- $\mu$ f., 100-volt ceramic capacitor
- C6—0.02- $\mu$ f., 150-volt ceramic capacitor
- D1—1N463 silicon diode
- D2, D3, D4, D5—1N2615 silicon diode (SYDMUR ER61A\*)
- Q1, Q2—2N1100 power transistor
- Q3—Motorola MCR1605-6 silicon-controlled rectifier (SYDMUR SCR 1268 with heat sink)
- R1—10-ohm, 2-watt resistor
- R2—820-ohm, 1-watt resistor
- R3—680,000-ohm,  $\frac{1}{2}$ -watt resistor
- R4—28-ohm resistor (two 56-ohm, 2-watt resistors in parallel)
- R5—1800-ohm,  $\frac{1}{2}$ -watt resistor
- R6—27-ohm,  $\frac{1}{2}$ -watt resistor
- R7—100-ohm,  $\frac{1}{2}$ -watt resistor
- T1—SYDMUR SPC-4 special transformer\*
- 1—3" x 4" x 5" cabinet
- Misc.—1" wire-screen snap-in plug, 5-terminal barrier-type terminal strip, circuit board, 4  $\frac{3}{16}$ " spacers, machine screws, terminals, etc.

\*The following parts are available from SYDMUR, P.O. Box 25A, Midwood Station, Brooklyn, N.Y.: ER61A @ \$1.80; transformer T1, \$14.95 (T1 is a proprietary product of SYDMUR... no coil winding information available); SCR 1268, \$7.45; complete kit including a specially made cabinet, \$44.50; and a completely wired unit, \$60.00. A positive ground system at \$47.50, and a 6-volt system at \$44.50 are available completely wired (not in kit form).

Mount the board into place with machine screws and be sure that there is enough clearance on all sides and top and bottom to prevent short circuits. Connect a wire from point C (next to T1) to the collector and a wire from point B to the base of Q1. Connect a wire from point D to the collector; a wire from point E to the base; and a wire from point H to the emitter of Q2. The emitters of both transistors should be connected together and to the A+ terminal on the terminal strip. Finally,

connect a wire from point A on the board to the Coil+ terminal on the strip; a wire from point G to the GND terminal; and a wire from point F to the PTS terminal.

**How It Works.** When the ignition switch is turned on, the battery voltage is applied to the emitters of Q1 and Q2. (See Fig. 3.) Transistors Q1 and Q2 are forward-biased through the resistive divider (R1 and R2). Usually, whichever transistor has the most gain will conduct first. First one transistor conducts, and then the other, in a flip-flop manner. This form of oscillation repeats itself regularly and continuously; transformer action steps up the voltage to about 375 volts, which is then rectified by the full-wave bridge (D2, D3, D4 and D5).

The d.c. voltage output from the bridge rectifier then charges capacitor C2. Capacitor C2 stores this d.c. energy until the SCR (Q3) conducts. Resistor R3 improves regulation and acts as a bleeder to discharge C2 when the ignition switch is turned off.

When the points in the distributor are closed, the SCR (Q3) is an open circuit across the power supply. Also, when the points are closed, R4 allows about 500 ma. of current to flow across the points to help keep them clean. When the points open, current flow through R4, D1, C4, R6 and R7 causes a positive pulse to be applied to the gate of Q3, which then flips into conductivity very rapidly (approximately 1 microsecond), discharging C2 through the primary of the ignition coil.

Notice that the voltage impressed across the primary is on the order of 375 volts and not the usual 6 or 12 volts. The ignition coil can now produce a

much hotter and "faster" spark. Actually, "faster" spark simply means a steeper slope (rise time) of the spark's waveform as it would appear on an oscilloscope. It is this very short rise time, inherent in a capacitor discharge system, that makes it possible to fire fouled and defective spark plugs. Another important gain is the fact that the coil does not have to draw current while the breaker points are closed to build up a large magnetic field as in conventional ignition systems.

At high engine speeds in conventional systems, not enough time is available to build up the magnetic field to maximum, and so there is a very definite drop in voltage, as shown in Fig. 4. Note that in this capacitor discharge system there is essentially no drop in voltage up to 15,000 rpm. Since engine speeds rarely exceed 5000 rpm, there is no drop in voltage over the entire range of usable engine speeds.

At the instant  $Q3$  conducts, it also shorts out the power supply, forcing the power transistors ( $Q1$  and  $Q2$ ) into a quiescent state. The transformer ( $T1$ ) is specially designed to prevent high transients and self-oscillation of the power transistors when  $Q3$  conducts. After  $C2$  discharges through the coil and  $Q3$ , the ignition coil—because of a flywheel type of action and its sinusoidal type of response—sets up a reverse current which develops a negative voltage on the anode of  $Q3$  and positively halts conduction. The SCR would normally shut off as the anode voltage approached zero. Polarity of the bridge rectifier happens to be just right to remove any residual negative voltage and to keep it within safe limits.

As soon as  $Q3$  stops conducting, the power supply turns on. By this time the same sinusoidal action of the ignition coil is now heading in the other direction and tends to aid the power supply in charging up  $C2$ , further reducing the charging time. All this is accomplished in less than 300 microseconds.

To prevent the SCR from conducting on point bounce or high impulse noise, the voltage on  $C4$  and  $C5$  back-biases  $D1$  and bleeds off through  $R5$  at a slower rate than the charge time (about 0.5 millisecond). Capacitor  $C6$  helps to pre-

vent any high-frequency noise that may create r.f. interference from getting out of the ignition system.

Note that the original coil is used and that the unit will perform on a battery voltage range from 9 to 16 volts.

**Checking It Out.** Before installing the system, you may want to satisfy yourself that all is in working order. The system can be tested if there is an ignition coil and a 12-volt battery available. Follow the installation instructions.

Care must be exercised when connecting the coil. A wire from the high voltage output should be gapped a maximum of 1" from the minus side of the ignition coil. There is a possibility of breaking down the internal insulation of the ignition coil if you omit this load.

Instead of using the breaker points, a wire can be connected from the *GND* terminal and brushed along the *PTS* terminal on the strip. Do not touch the ignition coil or high voltage lead while you are making this test, or you might get a nasty jolt.

**Installation.** Mount the unit close to the ignition coil, but as far as possible from the manifold. Remove all wires from the ignition coil. Also remove any capacitors if they are attached to the coil. Reconnect the wire or wires and the capacitor (if any) that were on the coil's plus terminal, to the *A+* terminal on the unit. Connect a wire from the *COIL +* on the unit to the *+* on the ignition coil. See Fig. 5.

Now connect a wire from the engine ground (the coil's clamp can serve as a ground) to the other side of the ignition coil—and to the *GND* terminal on the unit. Connect the wire from the terminal on the distributor to the *PTS* terminal on the unit. Be sure all connections are tight and well insulated, and do not let wires or metal touch the transistors.

It is advisable to install a new set of breaker points, and to clean the distributor head and the rest of the ignition system. Follow the car manufacturer's recommendations as to timing and gapping of points. If the spark plugs are shot, they'll work, but it is better to begin with your best foot forward.

When you turn the ignition switch on, a slight hum will be heard from the unit. Start the engine.

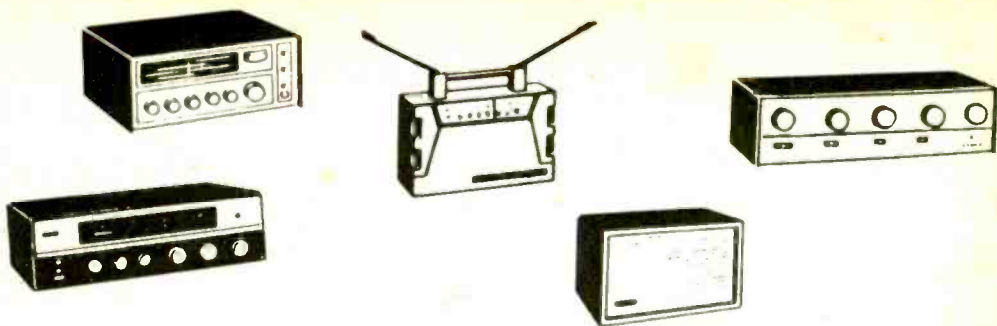

# Wireless Re-Broadcaster



**Broadcast music or sound from your  
hi-fi, FM tuner, or TV set to  
every AM radio in the house—all it  
takes is a simple one-tube unit**

**By KEN DOBLER**

**R**EBROADCAST anything that comes out of a loudspeaker. You can get FM programs on all the AM radios in your home. Television sound and music from your tape recorder or phonograph can be heard on the kitchen radio. Your portable transistor radio can become another listening end of a paging or intercom system. You can remote-monitor your CB, amateur or short-wave receiver on any AM radio within range of the Wireless Re-Broadcaster (*WRB*). The *WRB* can be attached to the speaker leads of any program source (*PS*).

The speakers at the *PS* can be switched off or left on while you are rebroadcasting. When the *WRB* is shut off, the

*PS* is not affected in any way and will function in a normal manner. The *WRB* is also equipped with a *Modulation* level control and a visual *Level* indicator to handle the high-level signals taken directly from loudspeaker leads, and can function properly over a wide range of input signal strengths.

The circuitry is easy to understand and easy to put together. Parts are standard, few in number, and readily available. Use only enough antenna length to transmit a signal to your own sets. Part 15 of the FCC regulations and a neighbor's complaint can put an end to your rebroadcasting days if you cause interference. So keep it down and find a spot

# Wireless Re-Broadcaster

Unique use of "S"-type fuse clip is shown below: it's soldered directly to the chassis and holds neon lamp I1. Grommets protect wires at various feedthrough points. Lamp I2, also grommet-held, can be moved up or down to line up with opening in front panel.

## PARTS LIST

C1a/C1b—40- $\mu$ f., 150-volt, and 20- $\mu$ f., 25-volt dual electrolytic capacitor  
 C2—0.047- $\mu$ f., 200-volt capacitor  
 C3—150-pf. ceramic disc capacitor  
 C4, C5, C6—400-pf., 400-volt capacitor  
 D1—1N3254 diode or equivalent  
 F1—3-ampere fuse (optional)  
 I1—NE-2 neon lamp  
 I2—NE-51 neon lamp  
 L1—Oscillator coil (Miller 71-OSC. or equivalent)  
 R1, R6—100,000-ohm,  $\frac{1}{2}$ -watt resistor  
 R2—10,000-ohm,  $\frac{1}{2}$ -watt resistor

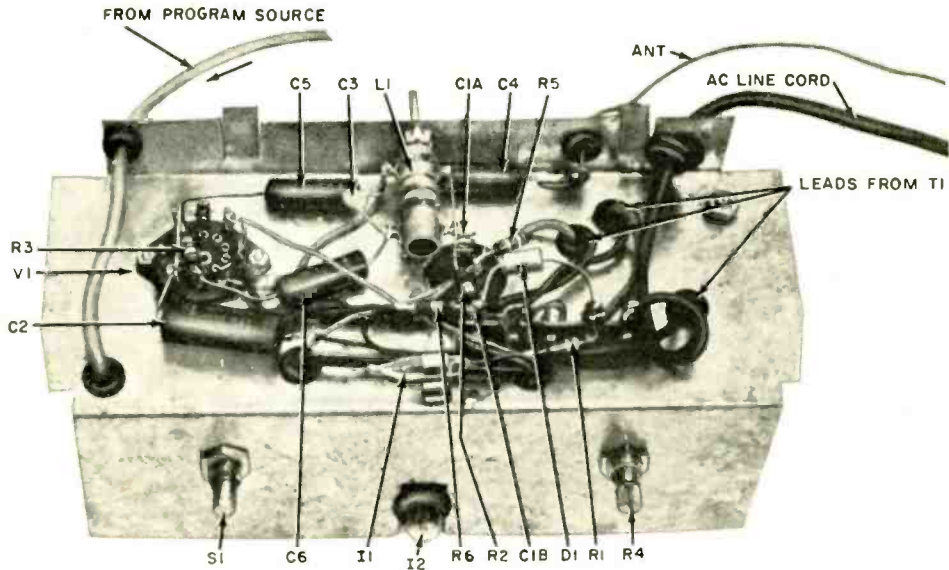

on the band that doesn't conflict with a regular broadcast program.

A dual-triode vacuum tube (12AT7) is used as an oscillator and series modulator. A series modulator can be recognized by the fact that the plate voltage supply is in series with the modulator and modulated tubes. The unit is powered by a half-wave power supply isolated from the a.c. line by *T1*.

**Construction.** A wooden cabinet (8" x 4" x 4") can be made and stained to match existing furniture. The chassis is fabricated from a piece of sheet metal cut and bent to the proper shape. A separate chassis pan and front panel could be put together instead.

Cut a notch rather than a hole in the front panel for the neon lamp modulation *Level* indicator. The outer groove of the grommet holding the lamp can now act as a runway to grip the sides of the slot. The lamp can then be moved

up or down to line up with an opening in the cabinet. Lettering on the cabinet's Masonite front panel can be done with a  $\frac{1}{8}$ " plastic lettering guide over a strip of gold writing foil.

Wiring is not critical; just check all connections before turning on the power. An "S"-shaped fuse clip makes a convenient holder for the neon "off-on" indicator. Solder the clip directly to the chassis, so that it is upright and the upper opening faces the front. Insert the lamp into the upper opening.

Keep the antenna lead down to 10 feet to avoid difficulty with FCC regulations.

**How It Works.** Signals taken from the speaker circuit of a *PS* are fed to the *Modulation* level control, potentiometer *R4*, through switch *S1b* and *S1c*. More or less signal (depending upon the control setting) is passed to the cathode of the modulation portion of the tube (*V1b*). Triode section *V1b* is hooked up as a



quency. Varying the adjustment of coil *L1* will enable you to select a quiet spot on the AM broadcast band.

The generated radio frequency in tube section *V1a* is amplitude-modulated by the signals from section *V1b* and then "piped" into the atmosphere by the antenna. Capacitor *C4* serves as an antenna coupler.

The modulation *Level* indicator circuit is also very simple. In the presence of an audio signal, plate voltage of triode section *V1b* varies with the applied signal. As the cathode goes more negative, the tube conducts more and plate voltage goes down; as the signal goes more positive, the tube conducts less and plate voltage goes up. Neon lamp *I2* "looks" at this varying plate voltage through capacitor *C2*. Resistor *R6* is a current limiter. When plate voltage goes down, the voltage across *I2* increases and "fires," provided that the applied signal is of the proper level. The lamp should flicker on and off in "step" with the program. Too high a volume level will cause the lamp to stay on, even during very low signal passages.

Transformer *T1* provides heater voltage to the tube as well as an isolated line voltage to the rectifier. Actually it is stepped down a bit from 117 volts to 110 volts. While the exact voltage is not critical, it is best not to deviate too much. Neon lamp *I1*, across the secondary of transformer *T1*, serves as a pilot light.

The B+ developed by half-wave rectifier *D1* and the filter components (resistor *R2* and capacitor *C1a*) is fed to the plate of tube *V1a* through the top half of coil *L1*. Both tube sections act as a dynamic voltage divider between

B+ and ground. The exact distribution of voltage depends upon the way each section conducts.

**Installation.** To connect the *WRB* to the *PS*, follow the schematic diagram. Connect line 3 to one side of the speaker. Open the lead going to the other side of the speaker at any convenient point and connect line 1 to the end closest to the output transformer, and line 2 to the end nearest the speaker. This completes the project, except for setting the frequency of the *WRB*.

Turn on the *PS* and an AM radio. If you are working alone, place the AM radio, the *PS*, and the *WRB* close to each other to cut down the leg work. Set the selector switch in the *Both* position and the *Modulation* level control in the fully counterclockwise position on the *WRB*. Turn up the program on the *PS* to a moderate volume level and advance the *Modulation* level control on the *WRB* until the *Level* indicator flashes in "step" with the program. Tune the radio to a clear spot on the dial and adjust the oscillator coil on the back of the *WRB* until the signal is heard in the radio. If you don't get the signal on one end of the band, try the other end.

When the selector switch is in the *Off* position, the *PS* operates normally. In the *Both* position, the *PS* operates normally and the *WRB* transmits the program. In the *Remote* position, the speakers at the *PS* are cut off, but the *WRB* continues to transmit the signals from the speaker line.

The *Modulation* level control need only be used when the selector switch is in the *Both* position. Its main function is to limit the amount of signal sent to the broadcaster when the *PS* volume level is high. In the *Remote* position, the *Modulation* level control should normally be turned fully counterclockwise and the *PS* volume adjusted for proper level.

Since too much bass can cause distortion, it is better to keep the bass control at a minimum setting during preliminary adjustments and then advance it for the most pleasing tone.

After becoming familiar with the operation of the controls and the best setting for your AM radio, you will find the *WRB* easy to operate, mystifying to friends, and loads of fun.

-30-

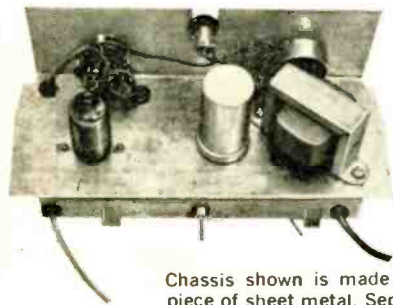

Chassis shown is made from one piece of sheet metal. Separate pan and front piece could be employed. Tabs on apron act as backstops.

# ELECTRIC



## FENCE CHARGER

*Marauder monitor curbs canine capers. Stop garden invasions and garbage can inspections at four o'clock in the morning*

By LYMAN E. GREENLEE

**K**EEP your disposition from going to the dogs by charging up a few things. You can build a small fence charger that will deliver a wallop big enough to make any self-respecting dog or cat think twice before investigating the contents of your garbage can a second time. The punch is a high-voltage shock of short duration and is harmless to man or beast. Cost of construction is low—you may already have most of the parts on hand.

**How It Works.** A small isolation transformer (*T1*) isolates the fence charger from the house power line for safety, as shown in the schematic diagram. A  $\frac{1}{8}$ -ampere "slow-blow" fuse carries the small normal load of the charger and also withstands the initial current surge which may occur when the unit is first turned on. This is normal for equipment having capacitor input filtering in the power supply.

Capacitors draw relatively large current as they go from 0-to-operating voltage levels. The output from the transformer secondary goes through a current limiting resistor (*R1*) to the silicon rectifier (*D1*). Resistor *R1* protects the rectifier from starting current surges. The rectifier's pulsating d.c. output is smoothed by capacitors *C1* and *C2* and by resistor *R3*. The NE-2 neon light (*I1*) serves as a pilot light—it not only shows whether

# ELECTRIC FENCE CHARGER

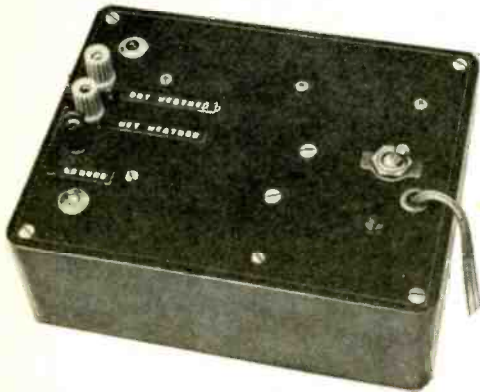

Small unit teaches hounds to behave.  
Short duration pulses are harmless.

Note that this transformer was originally intended for audio output work and is used in the reverse manner in this project. Therefore, what was originally the primary winding is now the secondary.

Capacitor *C3* serves the same purpose as the capacitor across the points in a conventional automobile ignition system. It overcomes the inertial effects of the current, minimizes arcing across the points, and takes on a charge which series-aids the voltage from the power supply when the contacts close.

The second neon light (*I2*) connected across the secondary of *T2* flashes momentarily with each pulse applied to the fence if all is well. Resistors *R4* and *R5* are current limiters for *I2*. The spark gap protects the transformer against damage from internal arcing and also from electrostatic or lightning charges that might be picked up on a long length of fence wire connected to the charger.

The shock pulse generated is completely safe due to its short duration. Any possibility of a dangerous or lethal voltage being applied to the fence because of component failure is remote. Transformer *T2* can pass only a small current and is isolated from the house power line. The B+ component is "chopped up" by the relay. If the relay contacts stick open or closed, no high voltage can be developed on the fence. Should transformer *T1*, diode *D1*, or capacitors *C1*, *C2*, and *C4* short, the fuse would probably blow or resistor *R1* would burn out. In any event, there would still be no high voltage on the fence.

**Construction.** The charger should be built in a Bakelite or plastic box, or at least on an insulated board, as shown in the illustrations. Provide a good ground connection for terminal *BP1*. All parts are mounted on the cover. Keep in mind the 2¼" space between the cover and the bottom of the case when

the charger is on or off, it also tells you if the B+ power supply is working up to this point in the circuit. Resistor *R2* limits the amount of current that can be passed by the neon light. Output from this half-wave rectifier power supply is approximately 140 volts.

The relay coil (*K1*) is a normally-closed s.p.s.t. type with a coil resistance of from 3000 to 8000 ohms. Upon application of power, the relay tends to become energized almost immediately and to open the circuit through itself and transformer *T2*. Since enough time must be allowed for the current to build up, and, in turn, for the magnetic field to go to maximum in transformer *T2*, capacitor *C4* is used to hold the relay armature down for about one second. Timing depends upon the values of the capacitor and the coil resistance, as well as the characteristics of the relay. Spring tension on the relay armature can be changed to increase or decrease the on-off time. Relays with coil resistance varying from 1000 to 10,000 ohms have been tried by the author and all of them have worked. Variations in hold-down time ranged from about 0.1 to 3 seconds.

When the relay points open, current ceases to flow through *T2*, the magnetic field collapses and induces a voltage across what is now the transformer's secondary winding, and the voltage appears at terminals *BP1* to *BP3*. The quicker the magnetic field collapses and the higher the turns ratio of the transformer, the higher the voltage produced.



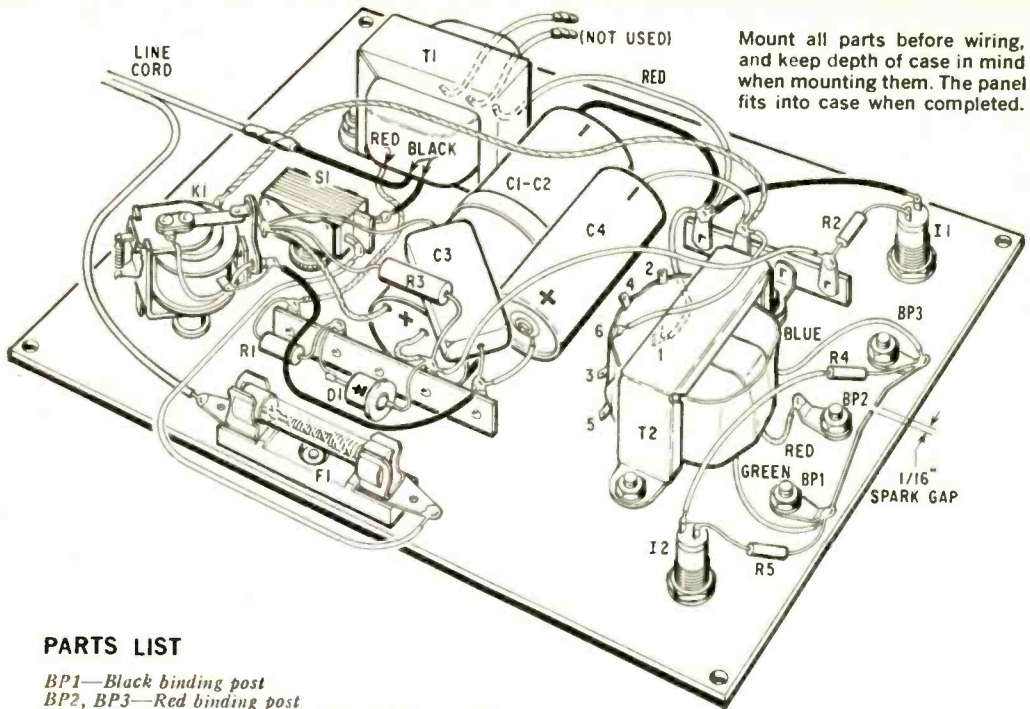

### PARTS LIST

- BP1—Black binding post
- BP2, BP3—Red binding post
- C1, C2—40-40  $\mu$ f., 150-volt dual electrolytic capacitor
- C3—0.05- $\mu$ f., 600-volt mica capacitor
- C4—40- $\mu$ f., 150-volt electrolytic capacitor
- D1—1N1763, 400-PIV, 500-ma. silicon rectifier
- F1— $\frac{1}{8}$ -amp. "slow-blow" fuse
- I1, I2—NE-2 neon light
- K1—S.p.s.t., normally-closed relay with 5000-ohm coil (Potter & Brumfield LB5 or equivalent)
- R1—100-ohm, 1-watt resistor
- R2—100,000-ohm,  $\frac{1}{2}$ -watt resistor
- R3—1000-ohm, 1-watt resistor
- R4, R5—2.2-megohm,  $\frac{1}{2}$ -watt resistor
- S1—S.p.s.t. toggle switch
- T1—Isolation transformer: primary, 117 volts; secondary, 125 volts @ 15 ma. (Stancor PS8415 or equivalent)

- T2—4-watt universal output transformer (Allied Radio 62 G 023 or equivalent)
- I—2 5/32" x 5 9/32" x 6 13/16" Bakelite instrument case and cover
- Misc.—Line cord,  $\frac{3}{8}$ " grommets, fuse holder, 4-terminal strip, neon-light sockets, hookup wire, machine screws and nuts, etc.

**NOTE:** A complete kit of parts with drilled and finished box, ready for easy assembly, is available from Mobil Electronics, Inc., 3023 Mounds Rd., P. O. Box 1132, Anderson, Ind., for \$21.95; postpaid.

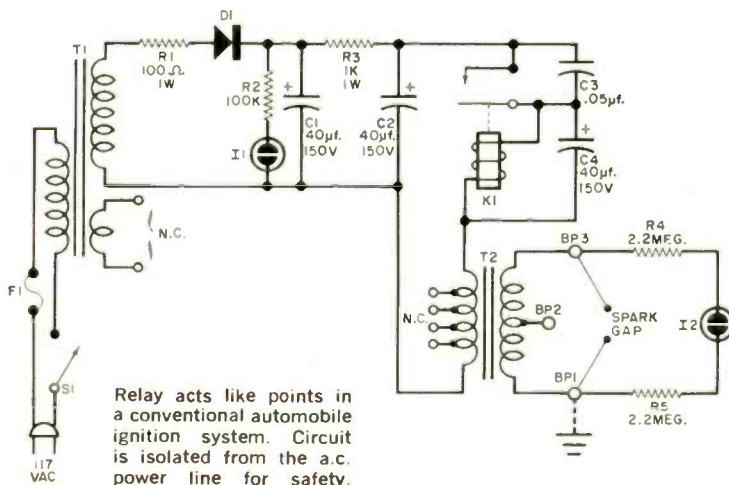

Relay acts like points in a conventional automobile ignition system. Circuit is isolated from the a.c. power line for safety.

# ELECTRIC FENCE CHARGER

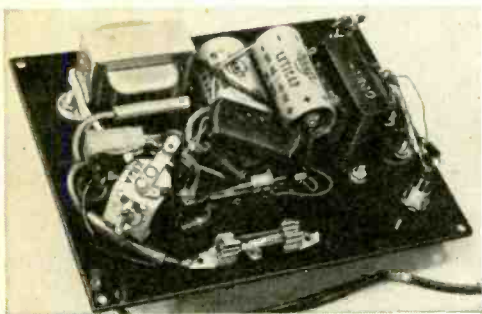

Spring tension on normally-closed relay should provide good contact. Tighten to increase "on" time.

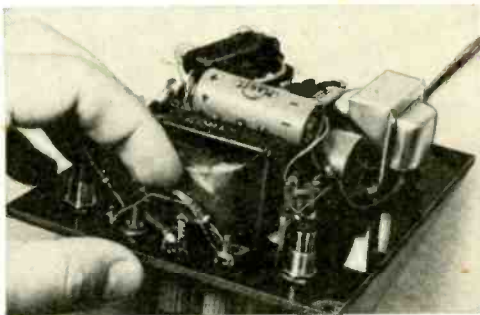

Spark gap protects the transformer. Adjust size to prevent continual firing with no load attached.

mounting the various parts. The cover has to fit into the case when the instrument is completed.

Prearrange the parts in the cover, as shown in the photos, and mark the position of the various mounting holes. All parts should be mounted before wiring. The 6-volt filament wires from the isolation transformer are not used; the ends of these wires should be taped and folded around the transformer and tucked out of the way.

The output transformer has a series of taps for impedance matching. Locate the two outer ends of the tapped winding and wire them into the circuit. One way to identify the outer ends is to use an ohmmeter. Select the two terminals that have the most resistance between them.

The high-voltage side of the output transformer has three insulated wires which may be colored red for the center tap, blue for one end, and brown or green for the other end of the winding. Connect the brown or green wire to the black binding post (*BP1*), the red wire to the middle red binding post (*BP2*), and the blue wire to the end red binding post (*BP3*).

You can construct a spark gap by soldering a fairly stiff wire about 2" long to each lug on the outer binding posts. Shape the two wires so that their ends are about  $\frac{1}{16}$ " apart and suspended in air away from other terminals and cabinet, as shown in the pictorial.

Check the wiring when completed. If you're satisfied with it, place the cover

in the case, plug in the unit, and flip the switch. If all is well, the relay will start pulsing. Don't screw down the cover until you have checked the spark gap to see that it is not firing. Normally the gap should be just big enough to prevent no more than occasional arcing. You may also want to vary the armature tension by adjusting the spring to get the right timing cycle. Spring tension should be strong enough to insure a good contact when the relay trips out. The relay should stay closed for about 0.1 second.

**Operation.** Connect the black binding post to a suitable ground connection, and connect the fence to be charged to one of the red binding posts. Use the middle binding post for wet weather and the outer one for dry weather. On a dry day a higher voltage is needed to force current through dry ground. In wet weather a high voltage could be a disadvantage because the current would tend to leak across the insulators. The higher the voltage, the higher the leakage. When the ground is wet, a low voltage is just as effective. Approximately half the voltage and twice the amperage is available from the black and middle red post. Maximum high voltage is obtained from the black and outer red post.

To test for leakage in the fence circuit, connect a NE-2 neon light in series with the fence and the red binding post being used. The higher the intensity of the flashes, the greater the leakage. To

*(Continued on page 145)*

# SOMEONE SHOULD DEVELOP AN EASY WAY TO LEARN ELECTRONICS AT HOME

## RCA INSTITUTES DID!

RCA introduces new CAREER PROGRAMS—beginning with the student-proved "AUTOTEXT" Programmed Instruction Method—the faster, easier way to learn. You start to learn the field of your choice immediately. No previous training or experience needed.

Pick the career of your choice—and RCA Institutes will do the rest! RCA's new, revolutionary "Career Programs" help you go directly to the career you want! You waste no time learning things you'll never use on your job! Each Career Program is designed to get you into the kind of job you want in the fastest, easiest possible way!

### SEPARATE COURSES

In addition, in order to meet specific needs, RCA Institutes offers a wide variety of separate courses which may be taken independently of the above Career Programs, on all subjects from Electronics Fundamentals to Computer Programming. Complete information about these courses will be sent with your other materials.

CHOOSE A CAREER PROGRAM NOW  
your first step to the job of your choice!

- Television Servicing
- Telecommunications
- FCC License Preparation
- Automation Electronics
- Automatic Controls
- Digital Techniques
- Industrial Electronics
- Nuclear Instrumentation
- Solid State Electronics
- Electronics Drafting

### RCA INSTITUTES BONUS EXTRAS

Only RCA Institutes offers you a Liberal Tuition Plan, one of the most economical ways to learn. Plus, you get top quality equipment in all kits furnished to you with your courses—yours to keep and use on the job. And now, RCA's NEW PROGRAMMED ELECTRONIC BREADBOARD GIVES YOU LIMITLESS EXPERIMENTATION—scientific laboratory procedures

right in your own home! You build a working signal generator, AM Receiver, Multimeter, Oscilloscope, and other valuable equipment—ALL AS A PART OF YOUR COURSE! Get the facts today!

Classroom Training Also Available. Day and Evening Classes are available to you in New York City at RCA Institutes Resident School. You may be admitted without any previous technical training; prep courses are available if you haven't completed high school. Coeducational classes start four times a year.

SEND ATTACHED POSTCARD TODAY FOR COMPLETE INFORMATION. NO OBLIGATION. NO SALESMAN WILL CALL. FREE BOOK INCLUDED. CHECK HOME STUDY OR CLASSROOM TRAINING.

**RCA INSTITUTES, INC.**, Dept. EF-26

A Service of the Radio Corporation of America  
350 West 4th St., New York City 10014



The Most Trusted Name in Electronics

# SIMPLE DWELL METER

By T. C. PENN

*Best possible gasoline engine performance results from a combination of many ingredients—not least of which is the dwell angle*

THE use of a dwell meter to adjust the spacing of the breaker points of an automobile is well known to mechanics and is now becoming familiar to the "do-it-yourself'er." Several transistor circuits of varying complexity have been published for dwell meters. In view of these previously published circuits, a circuit as simple as the one to be described here might well be viewed with skepticism. But in addition to justifying the simpler circuit on the basis that it has been used successfully for the past two years, it will be shown that this dwell meter is even more accurate than some of the circuits that have been published in the past.

Before touching on the details, some discussion of what a dwell meter can and cannot do might be worthwhile. For example, a dwell meter will not insure "up to 20% more horsepower" nor "up to 5 more miles per gallon of gas." A dwell meter by itself is useful only in adjusting the breaker-point gap in the distrib-

utor. It is very useful with modern engines which provide for such adjustment while the distributor cap remains in place. A dwell meter is also useful in checking the breaker point condition of older engines since it replaces the function of a gap gauge.

Each time the cam lobe of the distributor pushes open the breaker points, a spark plug ignites. Changing the dwell angle (during which the points remain closed) changes the point spacing and obviously changes the angle the cam makes when the points first open. In other words, it should be appreciated that any adjustment of the breaker-point gap requires that the engine be re-timed.

The mechanical-electrical characteristics of most single breaker point ignition systems are chosen to hold the points closed (dwell) twice as long as they are open. The dwell duty cycle is therefore two-thirds and that is really all that needs to be remembered regardless of

Fig. 1. Examination of voltage swing at the ignition with an oscilloscope would reveal a waveform similar to that at right. The very large swing (or transient) is due to the resonance of the ignition coil as "tuned" by the capacitor across the breaker points. Dwell time, or dwell angle, is the amount of time in angular degrees that the points are closed.

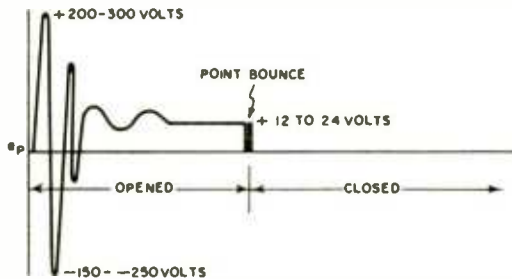

(A)

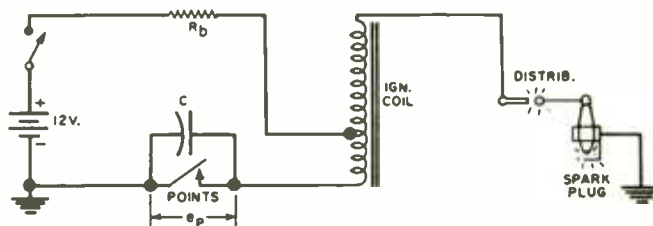

(B)



in the primary of the ignition coil does not reach its proper amplitude at high speeds. This causes the ignition coil voltage to decrease. In addition, the breaker points are thrown open so wide that severe contact bounce results when they close. If the dwell angle is too large, the points are not opened wide enough and arcing will take place across the points, resulting in decreased point life and low voltage.

**How It Works.** The dwell meter to be described is based on the same principle as that illustrated by the old electronics riddle. "An electrical black box has three terminals accessible for an ohmmeter check. Terminals 1 and 2 read open circuit, both terminals 2 and 3 as well as 1 and 3 give a half-scale reading on *all* ranges. What is in the box?" The usual answer is a vibrator or chopper. The duty cycle of the chopper is

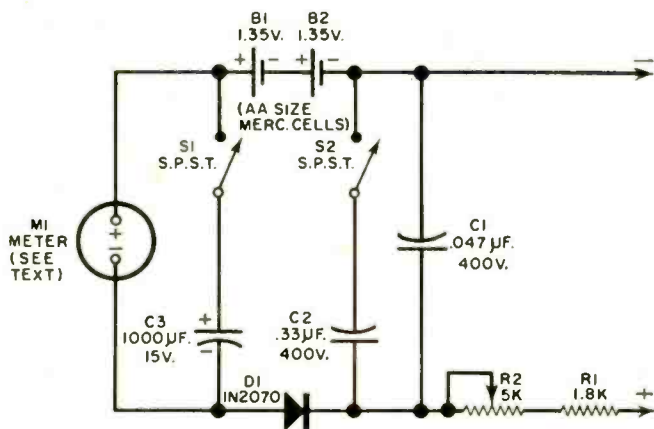

Fig. 2. Simplicity is the key word in the design of this dwell meter. "Plus" lead goes to "hot" or plus terminal of the ignition coil in negative ground systems. This circuit has provisions to measure dwell angle when the ignition coil cannot be reached. See text for details.

the number of cylinders. Not every model of every car has been checked, so you are encouraged to check the specs of your own car.

An eight-cylinder engine has a timing cam which turns  $45^\circ$  between the successive firings of spark plugs. The nominal dwell angle is two-thirds of this angle, or  $30^\circ$ . In a six-cylinder engine, the timing cam rotates  $60^\circ$  between ignition times, and thus the nominal dwell angle is  $40^\circ$ . A tolerance of  $\pm 5\%$  is quite acceptable.

Faulty dwell settings produce undesired results, as might be expected. If the dwell angle is too small, the current

50%, so the meter reads halfway between open and short circuit.

Unfortunately, the voltage waveform appearing across the breaker points of an automobile is not quite as ideal as a chopper. Figure 1 illustrates a typical waveform of the point voltage in a negative-ground system. (For positive-ground systems the waveform is inverted.) Note the large magnitude transients caused by resonance of the coil with capacitor *C* across the points. If one is tempted to use a clipper or a Schmitt trigger to produce a rectangular pulse of the same length as the open time, the negative transient will momentarily turn off the

clipper or reverse the Schmitt trigger. The shaped waveform will therefore not be representative of the open time of the points.

Figure 2 is a schematic of the dwell meter. When the meter is connected across the points of an automobile, the internal batteries drive the meter to full-scale as long as the points remain closed. As the points open, the 200- to 300-volt positive spike is unable to produce current flow through the meter due to the diode. At the same time the  $RC$  product chosen is such that the subsequent negative voltage spikes are also unable to cause current to flow through the meter. When the points again close,  $C1$  is discharged through  $R1$  and  $R2$  via the points. The internal batteries again drive the meter toward full-scale. The meter reads linearly in duty cycle, 0 being points fully open, and 100% deflection, fully closed. A linear angular scale may be added for dwell if preferred, although two-thirds full-scale is the nominal dwell reading, as mentioned previously. Inasmuch as almost any meter movement up to 10 ma. is suitable for this application (a 2" Weston 500- $\mu$ a. meter with internal resistance of 235 ohms was used by the author), the following rules of thumb are included for the constructor:

(1) Choose a battery voltage which requires a limiting resistance ( $R1$  plus  $R2$ ) that is at least ten times larger than the internal resistance of the meter.

(2) Choose  $C1$  so that the product of the limiting resistance (in ohms)  $\times$   $C1$  (in  $\mu$ f.) is approximately 250.

(3) Choose  $C2$  approximately eight times larger than  $C1$ .

If these rules are followed, the dwell meter can be used with reliability over a wide speed range and not just at idle speed where dwell adjustments are being made. This permits checking for "point bounce" and "floating." Capacitors  $C2$  and  $C3$  have been included to facilitate adjusting the points of automobiles not having external access to a point-adjusting screw.

**Operation.** To use the dwell meter on an automobile engine with negative ground, having external access to the points, the following instructions apply:

(1) Switch out  $C2$  and  $C3$ .

(2) Connect the "plus" lead of the

dwell meter to the junction of the ignition-coil primary and the points. This terminal is readily available on the ignition coil.

(3) Connect the "minus" lead to a ground.

(4) Turn on ignition switch without starting. If the points are closed, the dwell meter will read up-scale. If points are open, momentarily crank engine until points stay closed.

(5) With ignition switch still on and the points closed, adjust  $R2$  for exactly full-scale deflection.

(6) Start engine and read dwell meter directly for duty cycle (or add degree scale if preferred).

(7) Set the point-adjusting screw for two-thirds full-scale (6.7 if your meter reads 10 full-scale).

(8) Reset engine timing.

These instructions are also applicable for positive-ground ignition systems by merely reversing the meter leads.

For engines not having external access to the points, the following instructions apply:

(1) Switch in  $C2$ .

Perform steps 2, 3, 4, and 5 as before with due regard to polarity of ground.

(6) Remove center wire (high tension) from distributor and place on or near a ground away from the carburetor. This minimizes chance of coil damage due to internal arcing.

(7) Remove distributor cap and rotor.

(8) Crank engine with starter and read dwell while cranking. (If necessary, meter may be damped by switching in  $C3$ .) Stop, adjust points, crank again until satisfied.

(9) Reassemble distributor, insert high-tension wire, and time engine.

This dwell meter is very handy for checking point condition of any car by simply clipping the meter in, calibrating, then starting the engine. It has been used with satisfaction by several persons in the past two years on engines with 4-, 6-, and 8-cylinders; one of these autos had a transistor ignition system.

A chassis box was chosen for the housing with the switches mounted for one-hand operation as shown in the photo. The meter shown is a readily available surplus unit. Leads should be unplugged when not in use to conserve batteries, or a power switch could be added. -30-

# TACHOMETER & ENGINE IDLE SPEED CALIBRATOR

By JAMES S. SHREVE

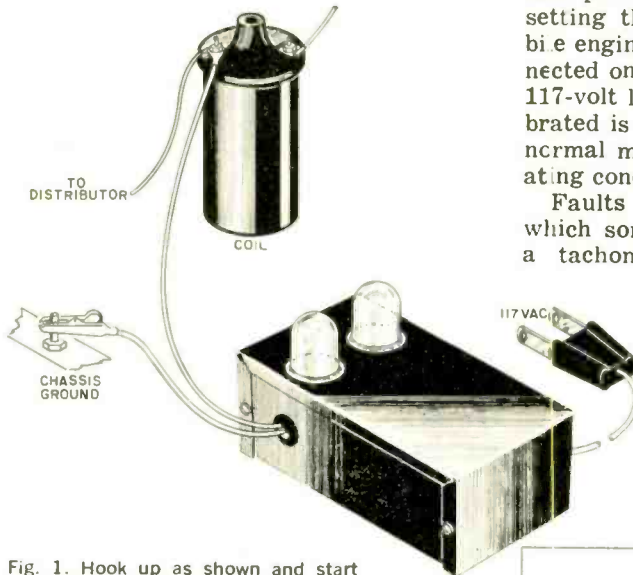
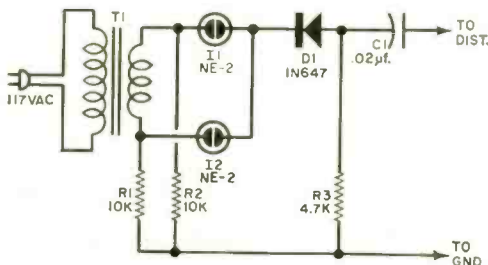

Fig. 1. Hook up as shown and start the engine; both lights will flash. At sync speeds, only one stays on.

Fig. 2. Pulses from the ignition coil are keyed to the 60-cycle a.c. power line and cause the neon lamps to blink out a calibration signal.



*Low cost, easy-to-make  
tester calibrates tachometers  
under actual conditions  
without any other equipment*

**T**HIS simple circuit enables you to calibrate automobile tachometers and check their accuracy. In many cases it also provides an independent means for setting the idle speed of your automobile engine. In use, the calibrator is connected only to the engine and a 60-cycle, 117-volt line. The tachometer to be calibrated is connected to the engine in the normal manner to establish actual operating conditions.

Faults leading to improper readings, which sometimes escape detection when a tachometer is bench-tested instead of tested in the car, have no place to hide. For this reason, the calibrator described here is especially good for testing accuracy of new tachometer designs.

**How It Works.** The calibrator has two neon lamps which alternately flash on and off

## PARTS LIST

C1—0.02- $\mu$ f, 600-volt capacitor  
D1—1N647 diode rectifier  
I1, I2—NE-2 neon lamp  
R1, R2—10,000-ohm,  $\frac{1}{2}$ -watt resistor  
R3—4700-ohm,  $\frac{1}{2}$ -watt resistor  
T1—24-volt transformer (Burstein-Applebee stock No. 18B506 or equivalent)  
1—5 $\frac{1}{4}$ " x 3" x 2 $\frac{1}{8}$ " metal case  
Misc.—A.c. line cord, 5- or 6-point terminal strip, two grommets, two alligator clips, and two neon lamp sockets

when the unit is properly connected to the car and the a.c. power line. The rate of flash diminishes as the engine speed approaches either 450 rpm or 900 rpm for an 8-cylinder car, or 600 rpm or 1200 rpm for a 6-cylinder car. When each lamp flashes about once per second, engine speed is off by only 1.7%.

As the engine reaches exactly one of the test speeds given above, one of the lamps will stay on and the other will stay off.

Figure 1 shows the hookup to the car and Fig. 2 is a schematic diagram of the calibrator. The principle of operation is rather simple: the whole idea is based on a coincidence of pulses from the distributor and the 60-cycle a.c. line voltage.

The ringing voltage produced in the primary circuit when the ignition points open passes through *C1* and appears across *R3*. Every positive swing of the ringing voltage passes through diode *D1* and attempts to ignite the neon lamps (in some cases the lamps do go on from ignition pulses only). At the same time, the voltage from the secondary winding of *T1* is also applied to the neon lamps. Therefore, at any given instant the potential across the neon lamps will be increased or decreased by *T1*.

While the potential across one lamp is increased, the potential across the other lamp is decreased by the same amount. The "favored" lamp fires at intervals or continues to fire and the other lamp is either extinguished at intervals or remains off. The speed of the alternate on-and-off action varies with the degree of out-of-sync conditions between the two comparison voltages.

When the distributor pulses are syn-

chronized with the 60-cycle line, only one lamp is favored each time and appears to remain on all the time. Its partner never receives adequate voltage to fire; and thus it remains off all the time. A slight change in engine speed, either faster or slower, will again result in first one lamp, then the other, being in the favored position.

The lower of the two sync points for a given engine takes place when one ignition pulse occurs for every two cycles of line current. The higher sync point shows up when one ignition pulse occurs for every cycle.

The calibrator will not work when primary circuit pulses are too low, too high, or of very short duration. Short duration pulses are found in transistor and capacitor ignition systems, but not in the conventional ignition system. High and low voltage pulses normally will not have to be reckoned with in an ignition system that is operating properly. If the pulse is too low, the neon lamps will not ignite; if the pulse is too high, the lamps will not shut off.

**Construction.** Layout of parts is not critical. A terminal strip supports all of the components except the transformer. It is desirable, if space permits, to install the calibrator in the tachometer's housing. Otherwise, a small metal or plastic cabinet can be used. The neon

*(Continued on page 148)*

Fig. 3. Allow enough room for neon lamp sockets to clear terminal strip when meshing both halves of the box. Lay out parts in any convenient manner. Neon lamps can be mounted in grommets or sockets.

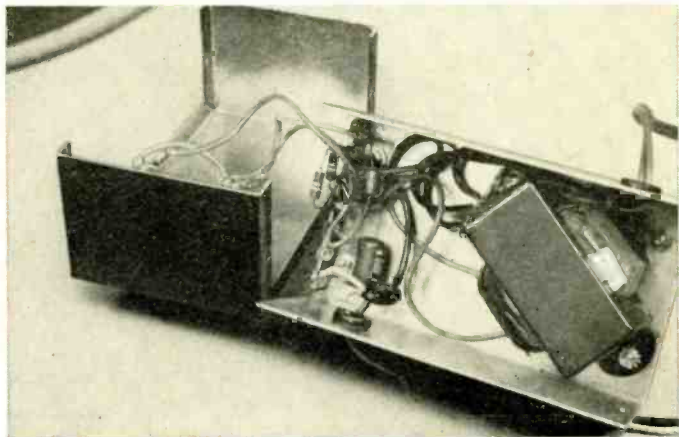
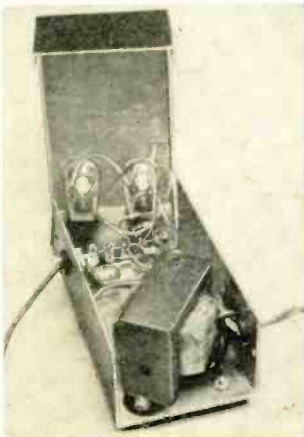



# Self-Regulating Lighting Controller

**Get even light even when  
day changes to night—  
build this automatic device**

**By EDWARD P. NAWRACAJ  
and  
FRED FORMAN**

**T**URN off the lights and the regulated lamp goes on. Turn on the lights and the regulated lamp goes off. Let the overall ambient illumination vary between daytime and nighttime, and the regulated lamp will vary in intensity in the opposite way. The lighting controller "wants to see" the same amount of light regardless of how bright or dim the day or night, and will automatically compensate for varying levels of illumination. You can establish an average round-the-clock light level limited only by the power-handling capabilities of the controller.

**How It Works.** Photoconductive cells *PC1* and *PC2* are in series with resistors *R1* and *R2* respectively, and form simple voltage dividers to apply triggering voltages to the gates of silicon-controlled rectifiers *SCR1* and *SCR2*. When the ambient light level is low, the resistance of the photoconductive cells is high. Proportionally higher voltages are developed across the cells and applied to the appropriate SCR gate.

The SCR's fire when the gates and anodes are sufficiently positive with respect to the cathodes. The higher the

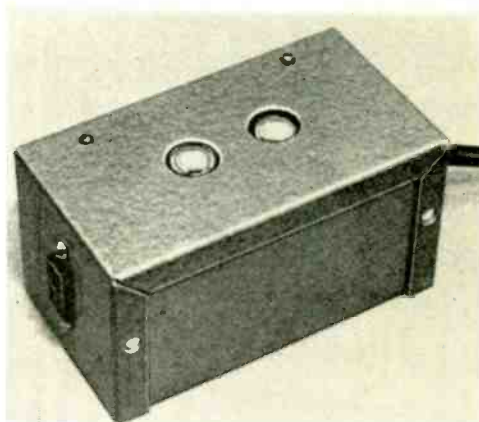

Point the "eyes" away from direct light to automatically compensate for varying ambient light levels.

Simplicity of construction is the keynote of the controller. Only four components are on the chassis.

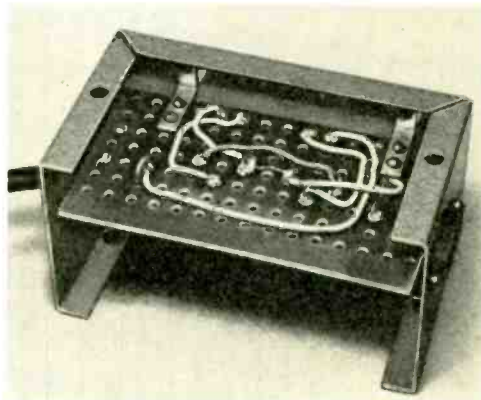

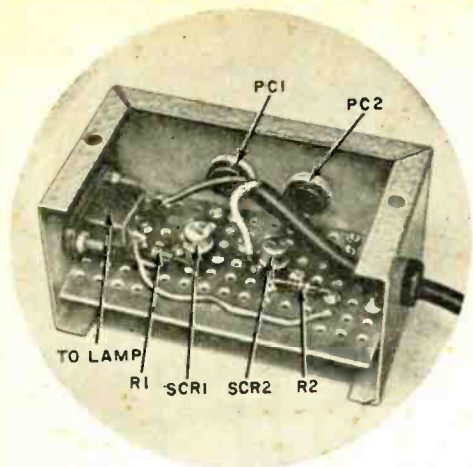

The two SCR's can be connected directly to the board and soldered into the circuit, or plugged into appropriate sockets. Avoid overheating the SCR's when soldering.

positive voltages, the sooner the SCR's conduct, and the longer they stay on. The longer the SCR's stay on, the brighter the regulated lamp.

Once the SCR's conduct, the gates have no further control and conduction takes place until the anode voltage is removed or reduced below the holding point. This happens each time the 60-cycle line voltage reverses. When the line voltage reverses, the SCR that was on—or conducting—switches off, and the SCR that was off switches on. When ambient light levels increase, the resistance of the cells decrease, and so down goes the amount of control voltage applied to the gates of the SCR's.

The 22,000-ohm resistors establish a preset range of overall operation. Variable controls of about 50,000 or 75,000 ohms can be substituted to shift the range to satisfy most requirements.

**Construction.** Any available box—even a cigar box—can be used to house the controller. There is nothing critical about construction or location of the parts. Only four parts (the SCR's and resistors) are mounted on a perforated phenolic board used as a chassis. The cells are mounted on the case, as is the regulated lamp's socket.

Aim the cells away from any direct light, including the regulated lamp, in order to get them to respond to ambient

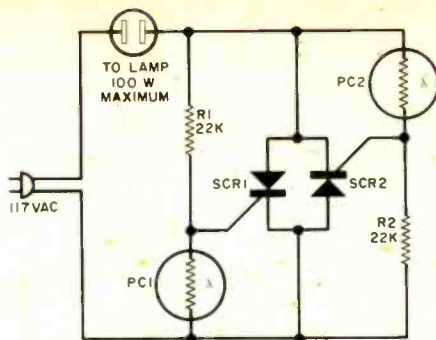

Brilliance of regulated lamp depends on how long each SCR is on.

conditions. The regulated lamp will flicker on and off if you point it at the photocells. Differences in parts values, due to normal commercially accepted tolerances, may cause one photocell to do more work or be more responsive than the other. To prevent this possibility, you should use matching components.

The SCR's used by the author are RCA 2N3228's, costing less than \$2 each (Motorola MCR 1304-4's and Texas Instruments TI 3012's will also work. The photocells are Clairex CI 505's at about \$3 each (the Lafayette 99 G 6322 at 99 cents will serve as well). Resistors *R1* and *R2* are 22,000-ohm, 1/2-watt units. A 4" x 2 1/4" x 2 1/4" metal box and other miscellaneous small hardware are also needed.

The 2N3228, without a heat sink, has a 1.57-ampere maximum rating when it is conducting for half the time, as is the case when the controlled lamp is full on. With less than half conduction time, greater current-handling ability is possible. With a suitable heat sink, the same SCR can safely handle up to 3.2 amperes or about 375 watts of power.

**Other Uses.** Many other applications are possible for the controller. It can be used to activate a relay which, in turn, would switch on or off other types of loads, such as alarm devices, appliances, and motor-driven machinery. Larger lamp loads could also be turned on or off by such a relay.

When the controller is used in this manner, however, it becomes a simple on/off triggering device, and you will not get varying and intermediate levels of illumination from the lamp. —30—

# STROBELIGHT SLAVE

By W. F. GEPHART

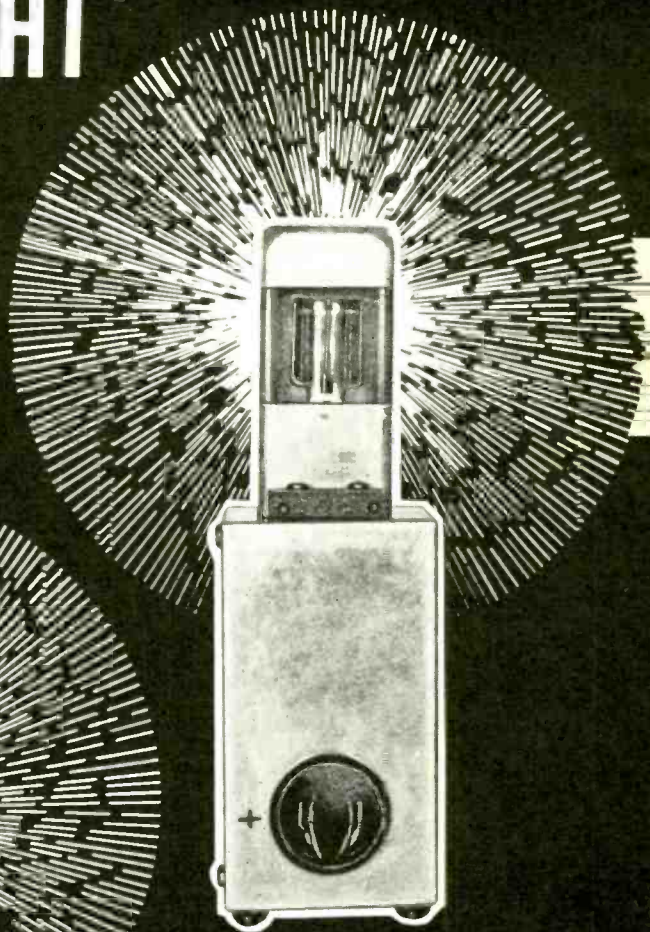

Convert any electronic flash unit to a cordless, reliable, light-actuated slave with an easy-to-build adapter

**H**OW OFTEN have you wished you had more convenient and better flash units to provide fill-in light for photographs of large groups, sports events, or in other critical spots where the light is unfavorable? When you talk about "better," chances are you mean electronic strobe units with their reliability, quick recycling time, and (in recent years) relatively low cost. When it comes to convenience, a prime requisite is the elimination of awkward, hazardous, unreliable cables.

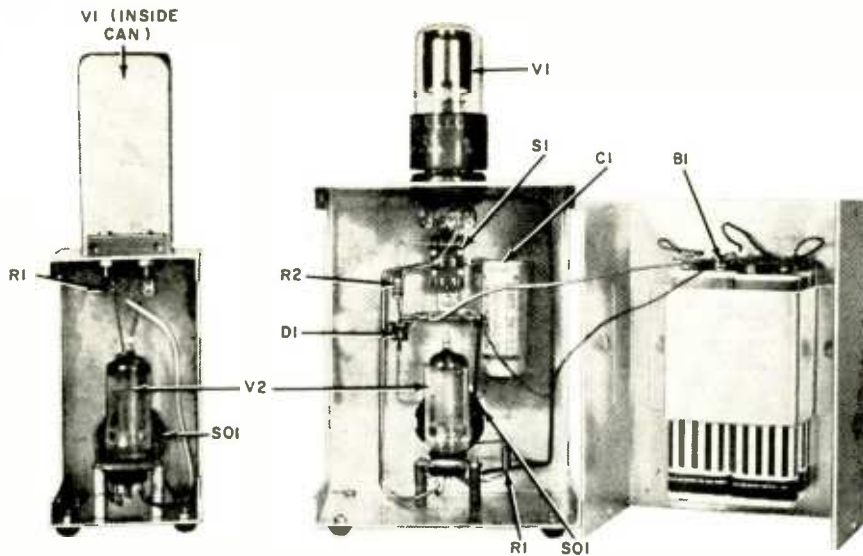

### PARTS LIST

- B1—180 volts (four Burgess U-30 45-volt batteries or equivalent)*  
*C1—20- $\mu$ f., 250-volt electrolytic capacitor*  
*D1—1N539 silicon diode or equivalent*  
*R1—10-megohm,  $\frac{1}{2}$ -watt resistor\**  
*R2—680,000-ohm,  $\frac{1}{2}$ -watt resistor*  
*S1—D.p.d.t. slide switch*  
*SO1—Panel-mounting female receptacle, a.c. type (Amphenol 61-F or equivalent)\**  
*V1—929 phototube\**  
*V2—5823 gas triode\**  
*I—(ctal socket\**  
*I—7-pin miniature socket\**  
*I—2 $\frac{1}{4}$ " x 2 $\frac{1}{4}$ " x 4" aluminum box\* for basic unit, or 3" x 4" x 5" box for booster unit*  
*Misc.—Shield can\* for V1, 1" spacers\* for mounting V2, 6-32 hardware\*, terminal strip, scrap aluminum for battery retainer, battery terminals, rubber feet\*, wire\*, solder\*.*  
 \*Only the parts marked with an asterisk are used in the basic Strobelight Slave.

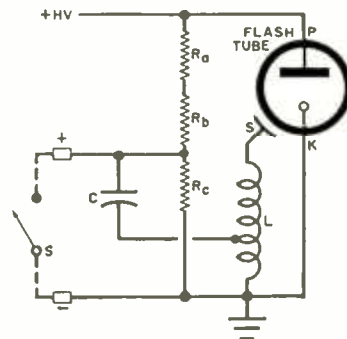

Fig. 1. Shutter discharges capacitor through coil to fire typical strobe.

In addition to the inherent problems cables present, different strobe units cannot always be wired together—in some cases damage may result. Even if the units are similar and designed for parallel operation, polarities must be carefully observed.

What the foregoing list of factors adds up to is the "Strobelight Slave," a simple adapter, described here in two versions, which can be used to convert any electronic flash into a light-operated slave unit. With the slave, the strobelight can be remotely located, responding instantly to the flash from the master strobe fired by the camera shutter.

**Typical Strobe Operation.** Figure 1 shows the firing arrangement used in most electronic flash units. High volt-

age is applied to the flash tube between its plate and cathode, while the starter anode is connected to ignition coil *L*. Capacitor *C* is charged to a certain percentage of the high voltage through the voltage divider consisting of *R<sub>a</sub>*, *R<sub>b</sub>*, and *R<sub>c</sub>*. When the shutter contacts (*S*) close, the capacitor discharges through the lower part of the coil, inducing a very high voltage in the upper part, and causing the flash tube to fire.

**Basic Slave Circuit.** A look at the Strobelight Slave Circuit shown in Fig. 2 reveals how it works. The 5823 (*V2*), a gas-filled triode, operates as a switch. At least 150 volts must be applied between the plate (pin 1) and the cathode (pin 7 or pin 3). No conduction occurs until a certain voltage appears on *V1*'s

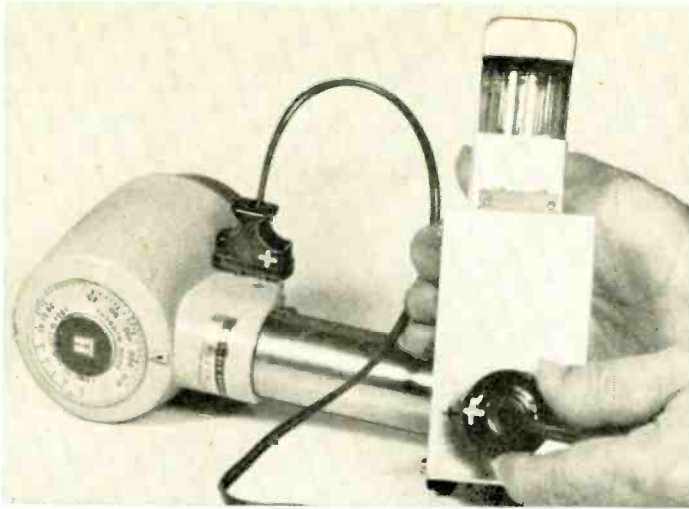

Basic Strobelight Slave is shown connected to strobe with a cord terminating in plugs on both ends. Both plugs and the sockets on the strobe unit and either slave unit should be marked with plus signs to avoid damage from cross-polarizing units.

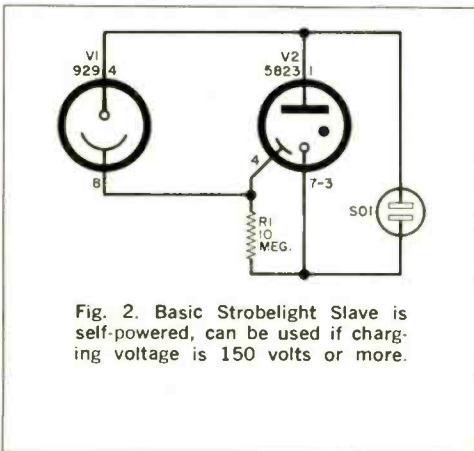

Fig. 2. Basic Strobelight Slave is self-powered, can be used if charging voltage is 150 volts or more.

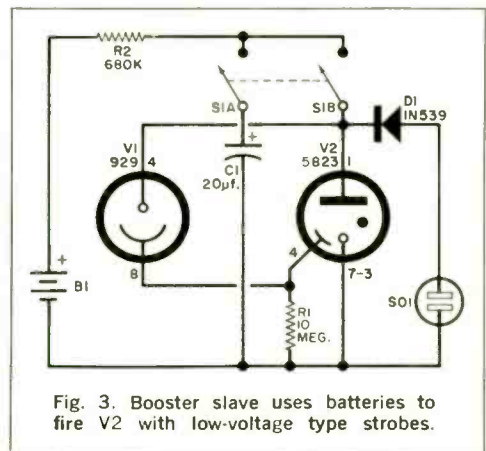

Fig. 3. Booster slave uses batteries to fire V2 with low-voltage type strobes.

starter anode (pin 4). When this happens, the tube then fires, and conducts to such an extent that the plate and cathode are literally shorted. Of course, this condition causes the remote strobe unit plugged into *SO1* to flash.

The trigger voltage for *V2* is generated by *V1*, a 929 phototube, in response to the light from the master strobelight. The basic Strobelight Slave shown in Fig. 2 is, therefore, completely self-powered, and may be used with any strobe having a shutter capacitor charging voltage of at least 150 volts.

**Booster Slave.** The second version of the Strobelight Slave shown in Fig. 3 provides supplemental voltage for the slave trigger tube when the capacitor charging voltage of the strobe is less

than 150 volts. Here, *B1* is used to charge *C1* through *R2*. This insures that the full battery voltage is available to fire *V2* when light strikes *V1*, since, when fully charged, *C1* bolsters the current capacity of *B1*. Diode *D1* isolates the internal slave voltage from the strobe unit, but permits current to flow in a forward direction when *V2* fires, firing the strobe connected to *SO1*.

The second version of the Strobelight Slave also includes switch *S1* to cut *B1* out of the circuit when the slave is used with units having high shutter contact charging voltages—normally *S1* is on only when used with units having low charging voltages. However, when a strobe unit has a charging voltage over  
(Continued on page 147)

# TRUE YES HEADS BLACK WIN GREEN

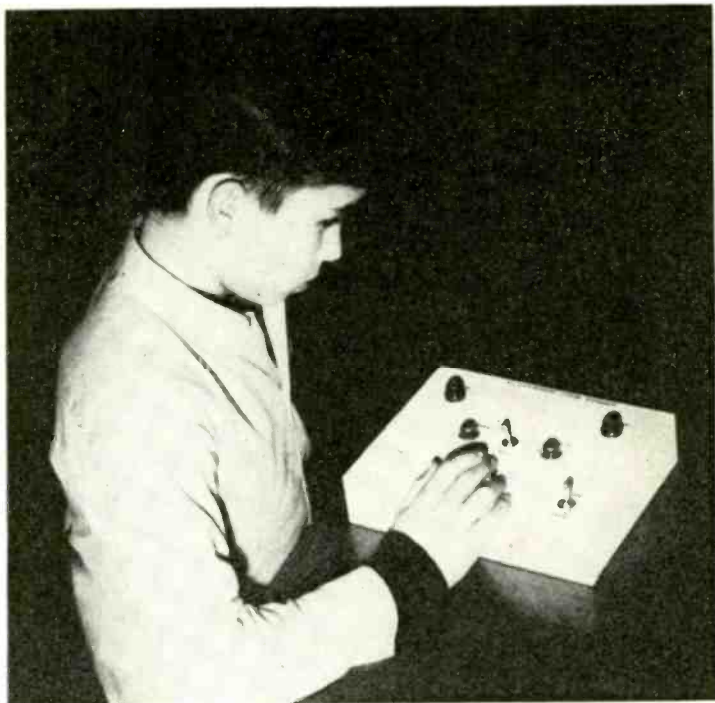

**H**ERE'S a clever computer-type gadget that will provide hours of fun for "youngsters" of all ages, and at the same time teach basic computer logic. A good science fair project, the "Electronic Coin Tosser" simulates electronically the toss of a coin. The probability of the *HEADS* lamp lighting is 50:50. That is, if the game is played one hundred times, the heads will come up approximately fifty times.

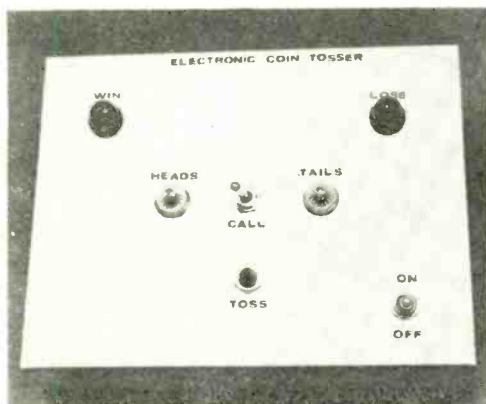

CALL switch leaning towards HEADS allows WIN lamp to light if electronic flip-flop stops on heads. Press TOSS button to match wits with the "brain."

To play the game, turn the power switch on and allow time for the lights to quit blinking. Now make your call by throwing the *CALL* toggle toward *HEADS* or *TAILS*. Toss the coin by pressing the *TOSS* button momentarily. The lamps begin to blink, and increase in speed; suddenly the blinking stops; and just as suddenly you win or lose, for the *HEADS* or *TAILS* lamp goes on, and so does the appropriate *WIN* or *LOSE* lamp.

**Theory of Operation.** A computer-type logic diagram for the game is shown in Fig. 1. Like a double-throw switch, the flip-flop circuit places a signal first on one side, then on the other. Looking at the switch or the flip-flop circuit at any given instant, you will find that when there is an *on* condition on one side there is an *off* condition on the other, and vice versa. Actually, any binary type of indication can be programmed, such as 1 and 0; on and off, plus and minus, hot and cold, black and white, heads and tails, etc.

In this project, the readout is *HEADS* and *TAILS*, and *WIN* and *LOSE*. If the flip-flop in our game stops on heads, the *HEADS* output will be a 1 and the

# ELECTRONIC COIN TOSSER

By **WOODROW POPE**

Design Engineer  
Collins Radio Co.

**FALSE**  
**NO**  
**TAILS**  
**WHITE**  
**LOSE**  
**RED**

*TAILS* output will be a 0. These signals as well as the signals from the *CALL* heads and tails switch are fed to a series of logic gates. There are four *AND* gates (*G1, G2, G3, G4*) and 2 *OR* gates (*G5, G6*). Each gate has provisions for two input signals and one output signal. The output signal depends upon the input signal.

To simplify matters, consider heads to be 1 and tails to be 0 when heads are called. When tails are called, tails become a 1 and heads a 0. The *AND* gate requires a 1 on both inputs to give a 1 on the output; a 1 and a 0, or a 0 and a 0, on the inputs gives a 0 on the output. An *OR* gate requires a 1 on either input to give a 1 on the output; a 0 and a 0 on the inputs give a 0 on the output.

In order to light the *WIN* lamp, a logic 1 on its input is needed. This means the *OR* gate (*G5*) must have a logic 1 on at least one of its inputs. To reach this condition, one of the *AND* gates must have logic 1's on both its inputs.

Assume heads is called. This puts a logic 1 on input #1 of gate *G1* and gate *G4*. It also puts a logic 0 on input #1 of gate *G2* and on input #2 of gate *G3*

(logic 0 means tails was not called). Also assume that the flip-flop circuit stops on heads, putting out a 1 on the heads output and a 0 on the tails output.

So now we have: a 1 on inputs #1 and #2 of gate *G1*, and it puts out a 1; and both inputs of gate *G2* have 0's, and it puts out a 0. Gate *G5* now has a 1 on input #1 and a 0 on input #2 and so it puts out a 1, and causes the *WIN* lamp to light. What about gates

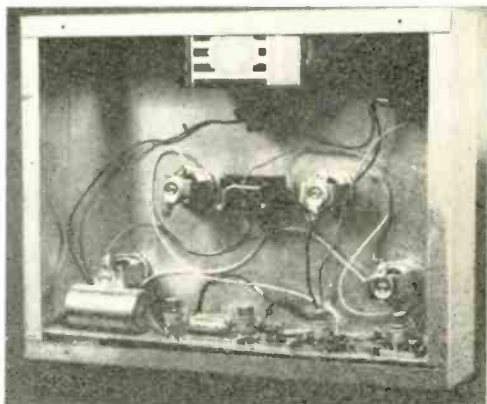

Rear view of Electronic Coin Tosser shows simplicity of wiring and assembly. Battery can be held in place with a dash of glue, or a suitable bracket.

$G3$  and  $G4$ ? Gate  $G3$  has a 1 on input #1 and a 0 on input #2, so its output is a 0. Gate  $G4$  has a 1 on input #1 and a 0 on input #2, so it too puts out a 0. Gate  $G6$  has 0's on both inputs, so its output is 0 and the *LOSE* lamp does not light. Try your hand at the three other possible combinations.

**How It Works.** The circuit consists of an astable and a bistable multivibrator, as shown in Fig. 2. The astable multivibrator looks like an ordinary collector-coupled circuit except that the two bias resistors ( $R3$  and  $R4$ ) are connected to a 150- $\mu$ f. capacitor ( $C1$ ). When the *TOSS* button ( $S1$ ) is closed,  $C1$  takes on a

charge from  $B1$  through  $R1$  and applies this voltage to  $R3$  and  $R4$  and allows the astable multivibrator to oscillate. Oscillations continue until the voltage across  $C1$  falls below the level required to forward-bias  $Q1$  and  $Q2$ .

The output from the collector of  $Q2$  is fed to the inputs of the bistable multivibrator through  $C4$  and  $C5$ . The signal at this point is in the form of a square wave and triggers the bistable multivibrator ( $Q3$  and  $Q4$ ). In the absence of an input signal, either  $Q3$  or  $Q4$  is conducting all the time. When  $Q3$  conducts,  $Q4$  is off,  $I3$  is on, and  $I4$  is off. When  $Q4$  conducts,  $Q3$  is off,  $I3$  is off, and  $I4$

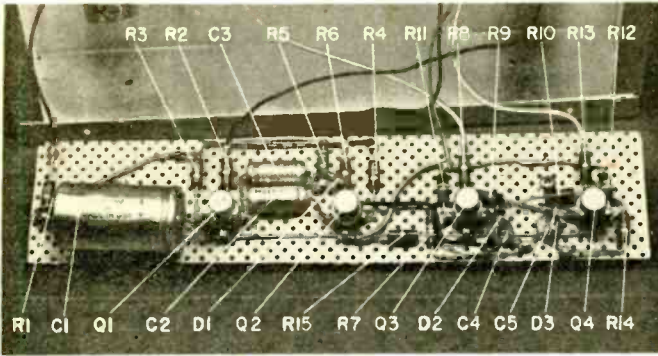

All components are mounted on Vectorbord with push-in terminals. Use of transistor sockets eliminates possible soldering heat damage to the transistors. Entire assembly can be secured to the cabinet by a machine screw and nut at each end. Use suitable standoffs to keep the bottoms of the push-in terminals from touching the cabinet.

Fig. 1. Computer logic diagram shows action required to light *WIN* or *LOSE* lamps. Selection of heads with the *CALL* switch places a 1 on input #1 of  $G1$  and  $G4$ . If the flip-flop oscillator stops on heads, it places a 1 on the inputs of  $G2$  and  $G3$ . All other inputs on  $G1$  through  $G4$  have a 0. Since  $G1$  is the only gate with a 1 on both inputs, its output is a 1. AND gates have an output of 1 when both inputs are 1. OR gates ( $G5$  and  $G6$ ) require at least a 1 on either of the inputs to signal a 1 on the output. A 1 output from an OR gate is needed to light the *WIN* or *LOSE* lamps. Since  $G5$  has a 1 on one of its inputs, its output is 1 and the *WIN* lamp lights. See text and try your hand at logic.

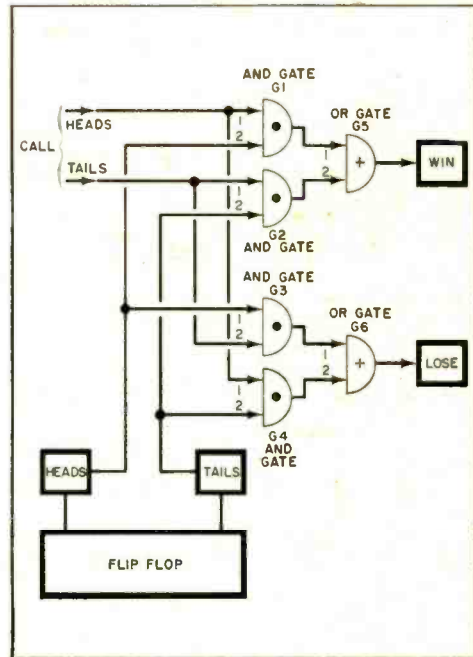



is on. In the presence of an input signal,  $Q3$  and  $Q4$  cycle on and off continuously. When the input signal is removed, the circuit reverts back to one of its two possible stable states.

Switch  $S3$  connects  $I1$  and  $I2$  in series with the appropriate circuit. When the call is heads,  $I1$  is in series with  $I3$  and

$I2$  is in series with  $I4$ . If tails is called, the series connections are interchanged;  $I1$  and  $I4$  are in series, and  $I2$  and  $I3$  are in series. If the manual selection of heads or tails coincides with the random electronic selection of heads or tails, the  $WIN$  light ( $I1$ ) goes on; otherwise the  $LOSE$  light ( $I2$ ) lights up.

**Construction.** A 2" x 7" x 9" aluminum chassis is used to hold the game. The circuit is built on a piece of 1 3/4" x 8" Vectorbord using push-in terminals.

Layout is not critical but care should be taken when soldering diodes and transistor leads so that they do not become overheated. Polarity of diodes and electrolytic capacitors must be observed. Transistor sockets are convenient to use and eliminate the possibility of ruining a transistor with a soldering iron.

A d.p.s.t. switch ( $S2$ ) is used as an on/off switch, but a s.p.s.t. unit will do just as well. Connect the positive side of the battery directly to the lead serving as ground.

The chassis is finished with flat white paint and lettered with rub-on decals. Lenses for the  $WIN$  and  $LOSE$  lamps are colored green and red respectively.  $HEADS$  and  $TAILS$  lens color could be either amber or white.

### PARTS LIST

$B1$ —9-volt battery (Burgess 2N6 or equivalent)  
 $C1$ —150- $\mu$ f., 100-volt d.c. electrolytic capacitor  
 (d.c.w.v. could be as low as 10 volts)  
 $C2, C3$ —7- $\mu$ f., 50-volt d.c. electrolytic capacitor  
 $C4, C5$ —0.002- $\mu$ f. ceramic capacitor  
 $D1, D2, D3$ —1N34A diode  
 $I1, I2, I3, I4$ —#49 lamp  
 $Q1, Q2, Q3, Q4$ —2N404 transistor  
 $R1$ —680 ohms  
 $R2, R6$ —1000 ohms  
 $R3, R4$ —6800 ohms  
 $R5$ —3300 ohms  
 $R7, R14$ —10,000 ohms  
 $R8, R13$ —68 ohms  
 $R9, R10$ —1200 ohms  
 $R11, R12$ —100,000 ohms  
 $R15$ —15 ohms  
 $S1$ —Normally open push-button switch  
 $S2$ —D.p.s.t. toggle switch (s.p.s.t. may be used)  
 $S3$ —D.p.d.t. toggle switch  
 1—2"x7"x9" aluminum chassis  
 4—Lamp holders with lenses; 1 red, 1 green, and 2 amber  
 Misc.—1 3/4"x8" Vectorbord and push-in terminals, or equivalent, to hold components; four transistor sockets (optional); battery connector terminals; and wire

all resistors  
1/2-watt carbon,  
 $\pm 10\%$

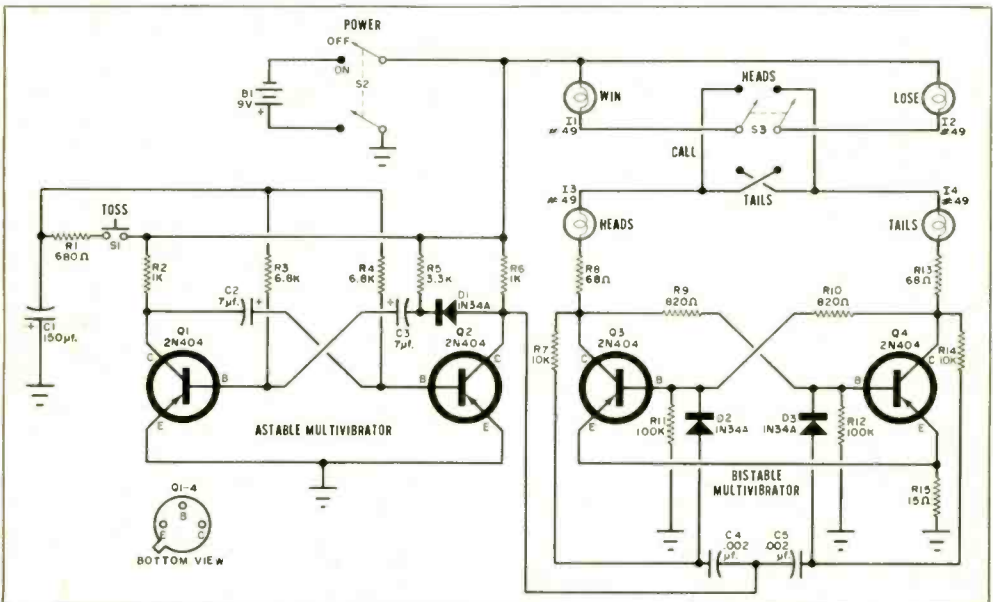

Fig. 2. Bistable multivibrator flip-flops from heads to tails only when the astable multivibrator is in action. Position of  $S3$  and electronic selection of heads or tails determines the win or lose indication.



# THE DYMWATT

By DON LANCASTER

**Build a full-wave motor speed control and light dimmer with new Triac semiconductor and four other components**

**M**EEET the "Dymwatt." It's a no-nonsense light dimmer and power-tool speed control that provides up to 600 watts of 117-volt a.c. with a symmetrical waveform and full-range, variable power output. The circuit uses only five electronic parts and fits in the palm of your hand.

With the Dymwatt, you can get precise control of incandescent lights, photo-floods, soldering guns and irons, and electric drills. It will also control any motor rated up to  $\frac{1}{2}$  horsepower and equipped with brushes—including most, but not all, sanders, fans, and electric mixers. The only things this control can't handle are fluorescent lights and induction motors—but neither can most of the ordinary power controls.

The two special parts in the circuit, *Q1* and *D1*, price out at \$4.65 and \$1.02 respectively. This puts the Dymwatt's cost at less than \$6 if you've got a volume control, a box, and two stock capacitors.

The "Triac." Older control designs call for SCR's. A single SCR provides

a half-range type of control, as between half and full brightness, or between zero and half brightness. To provide full-wave, full-range control, you have to add parts—usually a second SCR, a single mechanically switched diode, or a full-wave bridge rectifier.

The "Triac" is a new semiconductor which makes possible full-wave control without the need for all the extra components. The electrical equivalent of SCR's back to back, it operates equally well in both current directions, and with either a positive or negative gate pulse!

Two of the Triac's three leads (*T1* and *T2*) are connected in series with the load. The third connection is the gate lead (*G*). (The designations *T1* and *T2* simply mean terminal 1 and terminal 2. Designations of anode and cathode, unfortunately, cannot apply in this case. An equivalent set of components for the Triac would contain seven transistors and several resistors.)

A small signal pulse can trigger the Triac so that it will fire just like a thyatron, and switch on full or partial

power to the load. Conduction stops when the current through the load circuit drops to zero. This happens every time the a.c. voltage goes through zero. It also happens when the load is removed, or the circuit is opened.

**How It Works.** Current through potentiometer  $R1$  (see Fig. 1) charges capacitor  $C1$  up to 30 volts, which is the breakdown voltage of the special pulse diode ( $D1$ ). At 30 volts, the pulse diode "snaps" on and delivers a pulse to the Triac gate. The Triac then turns on, allows full current flow through the load, and shorts out the  $R1$ ,  $C1$  circuit. Diode  $D1$  keeps conducting until  $C1$  is discharged, and then turns off. The Triac continues to conduct until the a.c. line voltage alternates and goes through a zero.

The larger  $R1$  is, the longer it takes to charge  $C1$  and the longer it takes to turn on the Triac. The fact that the Triac shuts off at the end of each  $\frac{1}{2}$  cycle of line voltage, plus the delayed start of conduction, reduces the conduction time and the effective voltage (r.m.s.) accordingly. Thus, it becomes apparent that increasing or decreasing

the value of  $R1$  controls the r.m.s. voltage. See Fig. 2.

If  $R1$  is nearly zero in value,  $C1$  charges very rapidly, and nearly full power reaches the load. If  $R1$  is very large in value,  $C1$  never reaches 30 volts within the 60-cycle swing. With each alternation of voltage,  $C1$  starts to charge in the other direction. Under this condition, gate pulses cannot be



Finished Dymwatt can be plugged into one opening of a duplex receptacle without obstructing the other. You have a choice of using the controlled or noncontrolled outlet. Cost of this full-wave unit is less than that of commercially available half-wave controllers.

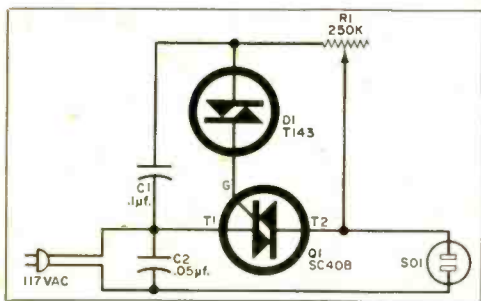
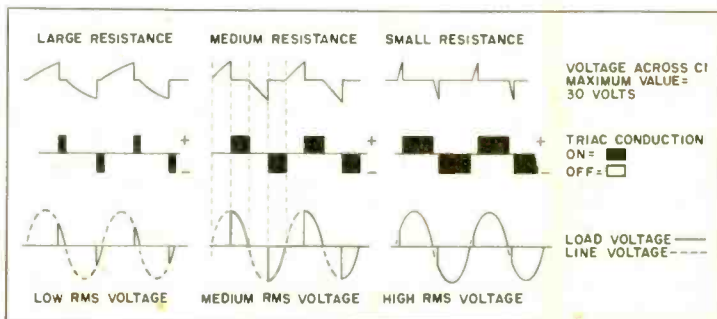

Fig. 1. The Triac (Q1) will conduct in either direction. A positive or negative gate pulse can trigger conduction and control r.m.s. output voltage.



The heat sink on the inside of the case and the dial plate on the outside are held in place by a rivet (hidden by the capacitor) and the potentiometer nut.

Fig. 2. When  $C1$  reaches 30 volts,  $D1$  conducts and triggers  $Q1$ . The sooner the gate pulse is developed with respect to the 60-cycle line voltage, the higher the effective output voltage. With little or no resistance in the circuit, the output is maximum. As the resistance increases, the output decreases. If the resistance is made high enough, the output is 0.



produced and the Triac remains cut off. By making *R1* variable, it is possible to adjust for maximum or minimum power output.

Capacitor *C2* is directly across the line to prevent any high-frequency pulse, which might be set up by the fast switching action of the Triac, from radiating down the power line and becoming a source of radio interference.

**Construction.** The Triac should be mounted on an aluminum heat sink. A  $\frac{1}{8}$ "-thick piece of aluminum will do the trick. Bend it in a vise or small brake and then drill the holes. Use insulated mounting hardware and silicone grease to mount the Triac, as shown in Fig. 3. The Triac *must* be electrically insulated from the heat sink. Test the setup with

(Continued on page 144)

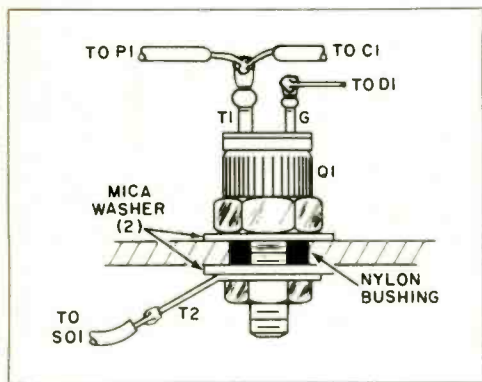

Fig. 3. Silicone grease, two mica washers, and a nylon bushing are used to mount Triac on heat sink to get thermal conduction without electrical contact.

### PARTS LIST

- C1*—0.1- $\mu$ f., 600-volt capacitor
- C2*—0.05- $\mu$ f., 600-volt capacitor
- D1*—Texas Instruments TI-43 bilateral trigger diode
- P1*—A.c. plug (Amphenol 61-M or equivalent)
- Q1*—General Electric SC 40B Triac
- R1*—250,000-ohm carbon potentiometer, linear taper
- SO1*—A.c. socket (Amphenol 61-F or equivalent)
- 1— $2\frac{1}{4}$ " x  $2\frac{1}{4}$ " x 4" case, and cover
- Misc.—Silicone grease, knob,  $\frac{1}{8}$ " "Pop" rivets, spaghetti, solder, wire, nameplate, and  $\frac{1}{4}$ " solderless terminal,  $2\frac{1}{4}$ " x  $1\frac{1}{8}$ " x  $\frac{1}{8}$ " piece of aluminum, etc.

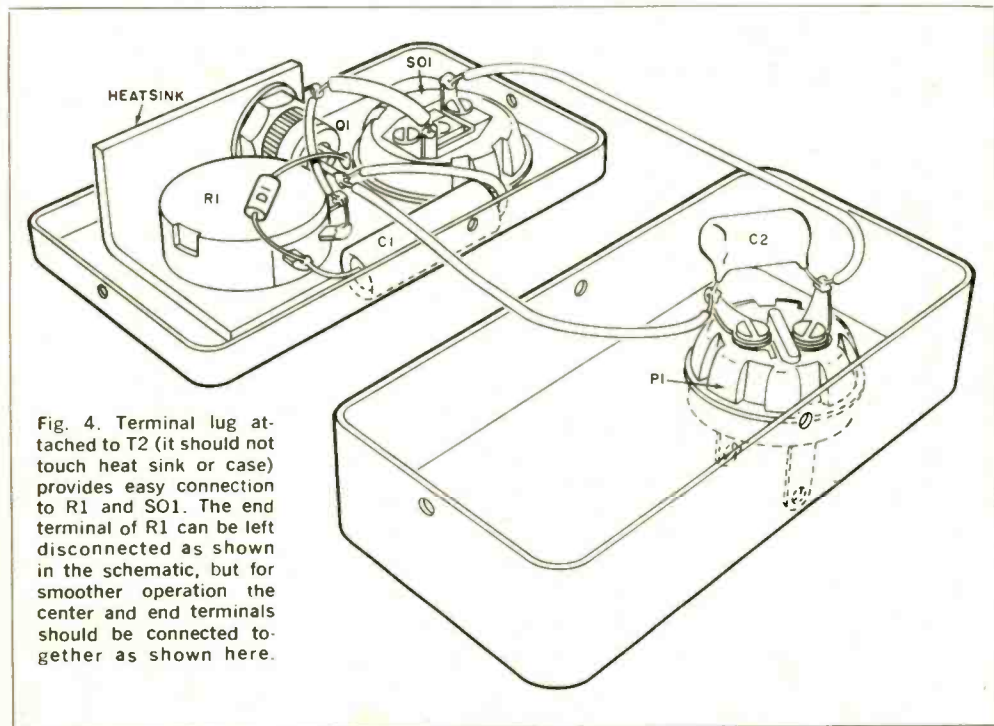
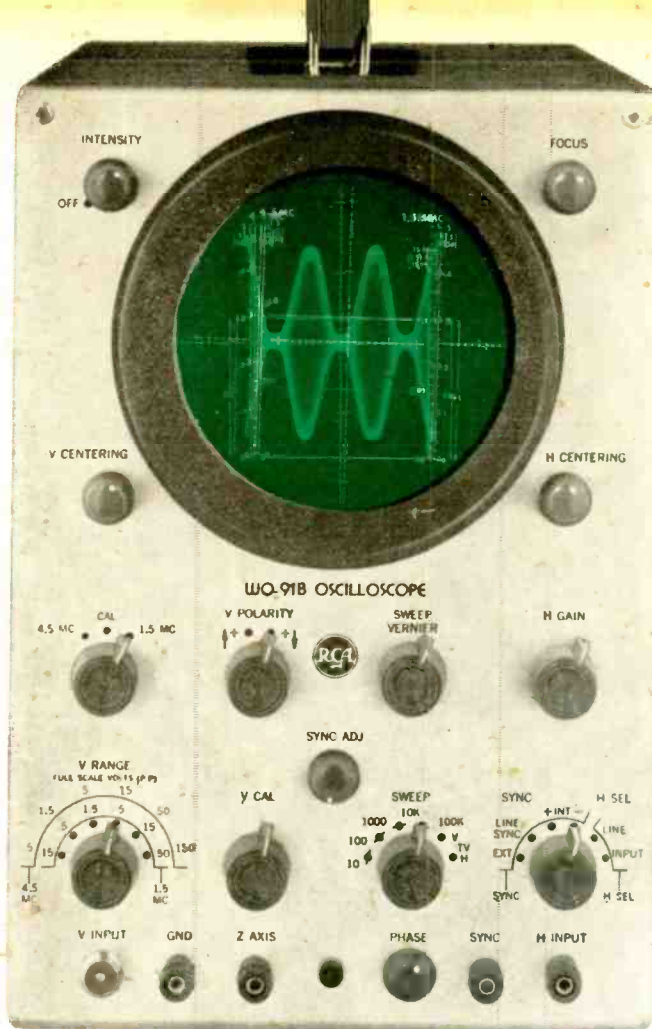

Fig. 4. Terminal lug attached to T2 (it should not touch heat sink or case) provides easy connection to R1 and SO1. The end terminal of R1 can be left disconnected as shown in the schematic, but for smoother operation the center and end terminals should be connected together as shown here.



**The famous RCA 5-inch scope  
NOW WITH MORE FEATURES  
TO SIMPLIFY YOUR JOB**

Here's the latest model of the famous **RCA 5-inch scope: the NEW WO-91B**

- Provision for connecting signals directly to the vertical deflection plates of the CRT. Permits observation of high frequency RF waveforms, such as trapezoidal and wave-envelope modulation patterns.

- Two-stage sync separator simplifies checking of TV horizontal and vertical sweep synchronization... provides exceptionally solid lock-in action on composite TV signals.

- Choice of wide-band or high-sensitivity, narrow-band display.

- Complete with RCA WG-300B Direct/Low Cap. Probe and Cable.

- Optional at slight extra cost: RCA WG-354A slip-on capacitance-type voltage-divider probe that extends the range of the scope to permit observation of signal pulse amplitudes up to 5000 volts. RCA WG-302A slip-on RF/IF/VF signal tracing probe for RF applications from 100 Kc to 250 Mc.

- WO-91B Scope: **\$249.50\***
- WG-354A Probe: **\$ 7.50\***
- WG-302A Probe: **\$ 8.20\***

Ask to see it at your Authorized RCA Test Equipment Distributor.

\*Optional distributor resale price. All prices subject to change without notice. Prices may be slightly higher in Alaska, Hawaii and the West.

RCA Electronic Components and Devices, Harrison, N.J.



**The Most Trusted Name in Electronics**

# BUILD YOUR OWN RADIO

**CIRCUITS AT HOME**  
with the New Improved

only \$29.95

## PROGRESSIVE RADIO "EDU-KIT"®

A Practical Home Radio Course

Now Includes

- ★ 12 RECEIVERS
- ★ 3 TRANSMITTERS
- ★ SQ. WAVE GENERATOR
- ★ SIGNAL TRACER
- ★ AMPLIFIER
- ★ SIGNAL INJECTOR
- ★ CODE OSCILLATOR

- ★ No Knowledge of Radio Necessary
- ★ No Additional Parts or Tools Needed
- ★ EXCELLENT BACKGROUND FOR TV
- ★ SCHOOL INQUIRIES INVITED
- ★ Sold in 79 Countries

**YOU DON'T HAVE TO SPEND  
HUNDREDS OF DOLLARS FOR A RADIO COURSE**

The "Edu-Kit" offers you an outstanding PRACTICAL HOME RADIO COURSE at a rock-bottom price. Our Kit is designed to train Radio & Electronics Technicians, making use of the most modern methods of home training. You will learn radio theory, construction practice and servicing. THIS IS A COMPLETE RADIO COURSE IN EVERY DETAIL.

You will learn how to build radios, using regular schematics; how to wire and solder in a professional manner; how to service radios. You will work with the standard type of punched metal chassis as well as the latest development of Printed Circuit Chassis. You will learn the basic principles of radio. You will construct, study and work with RF and AF amplifiers and oscillators, detectors, rectifiers, test equipment. You will learn and practice code using the Progressive Code Oscillator. You will learn and practice trouble shooting using the Progressive Signal Tracer, Progressive Signal Injector, Progressive Dynamic Radio & Electronics Tester, Square Wave Generator and the accompanying instructional material.

You will receive training for the Novice, Technician and General Classes of F.C.C. Radio Amateur Licenses. You will build Receiver, Transmitter, Square Wave Generator, Code Oscillator, Signal Tracer and Signal Injector circuits, and learn how to operate them. You will receive an excellent background for television, Hi-Fi and Electronics.

Absolutely no previous knowledge of radio or science is required. The "Edu-Kit" is the product of many years of teaching and engineering experience. The "Edu-Kit" will provide you with education in Electronics and Radio, worth many times the low price you pay. The Signal Tracer alone is worth more than the price of the kit.

### THE KIT FOR EVERYONE

You do not need the slightest background in radio or science. Whether you are interested in radio & electronics because you want an interesting hobby, a well paying business or a job with a future, you will find the "Edu-Kit" a worth-while investment. Many thousands of individuals of all

ages and backgrounds have successfully used the "Edu-Kit" in more than 79 countries of the world. The "Edu-Kit" has been carefully designed, step by step, so that you cannot make a mistake. The "Edu-Kit" allows you to teach yourself at your own rate. No instructor is necessary.

### PROGRESSIVE TEACHING METHOD

The Progressive Radio "Edu-Kit" is the foremost educational radio kit in the world, and is universally accepted as the standard in the field of electronics training. The "Edu-Kit" uses the modern educational principle of "Learn by Doing." Therefore you construct, learn schematics, study theory, practice trouble shooting—all in a closely integrated program designed to provide an easily-learned, thorough and interesting background in radio.

You begin by examining the various radio parts of the "Edu-Kit." You then learn the function, theory and wiring of these parts. Then you build a simple radio. With this first set you will enjoy listening to regular broadcast stations, learn theory, practice testing and trouble shooting. Then you build a more advanced radio, learn more advanced theory and technique gradually, in a progressive manner, and at your own rate, you will find yourself constructing more advanced multi-tube radio circuits, and doing work like a professional Radio Technician.

Included in the "Edu-Kit" course are Receiver, Transmitter, Code Oscillator, Signal Tracer, Square Wave Generator and Signal Injector Circuits. These are not unprofessional "breadboard" experiments, but genuine radio circuits, constructed by means of professional wiring and soldering on metal chassis. Plus the new method of radio construction known as "Printed Circuitry." These circuits operate on your regular AC or DC house current.

### THE "EDU-KIT" IS COMPLETE

You will receive all parts and instructions necessary to build twenty different radio and electronics circuits, each guaranteed to operate. Our Kits contain tubes, tube sockets, variable, electrolytic, mica, ceramic and paper dielectric condensers, resistors, tie strips, hardware, tubing, punched metal chassis, Instruction Manuals, hook-up wire, solder, selenium rectifiers, coils, volume controls and switches, etc.

In addition, you receive Printed Circuit materials, including Printed Circuit chassis, special tube sockets, hardware and instructions. You also receive a useful set of tools, a professional electric soldering iron, and a self-powered Dynamic Radio and Electronics Tester. The "Edu-Kit" also includes Code Instructions and the Progressive Code Oscillator. In addition to F.C.C. Radio Amateur License training. You will also receive lessons for servicing with the Progressive Signal Tracer and the Progressive Signal Injector, a High Fidelity Guide and a Song Book. You receive Membership in Radio-TV Club, Free Consultation Service, Certificate of Merit and Discount Privileges. You receive all parts, tools, instructions, etc. Everything is yours to keep.

### PRINTED CIRCUITRY

At no increase in price, the "Edu-Kit" now includes Printed Circuitry. You build a Printed Circuit Signal Injector, a unique servicing instrument that can detect many Radio and TV troubles. This revolutionary new technique of radio construction is now becoming popular in commercial radio and TV sets.

A Printed Circuit is a special insulated chassis on which has been deposited a conducting material which takes the place of wiring. The various parts are merely plugged in and soldered to terminals.

Printed Circuitry is the basis of modern Automation Electronics. A knowledge of this subject is a necessity today for anyone interested in Electronics.

### UNCONDITIONAL MONEY-BACK GUARANTEE

**ORDER FROM AD—RECEIVE FREE BONUS  
RADIO & TV PARTS JACKPOT WORTH \$15**

- Send "Edu-Kit" postpaid. I enclose full payment of \$26.95.
- Send "Edu-Kit" C.O.D. I will pay \$26.95 plus postage.
- Rush me FREE descriptive literature concerning "Edu-Kit."

Name.....

Address.....

### PROGRESSIVE "EDU-KITS" INC.

1186 Broadway, Dept. 512RR Hewlett, N. Y. 11557

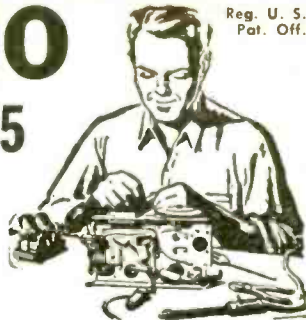

Reg. U. S.  
Pat. Off.

Training Electronics Technicians Since 1946

### FREE EXTRAS

#### ● SET OF TOOLS

- SOLDERING IRON
- ELECTRONICS TESTER
- PLIERS-CUTTERS
- VALUABLE DISCOUNT CARD
- CERTIFICATE OF MERIT
- TESTER INSTRUCTION MANUAL
- HIGH FIDELITY GUIDE ● QUIZZES
- TELEVISION BOOK ● RADIO TROUBLE-SHOOTING BOOK
- MEMBERSHIP IN RADIO-TV CLUB: CONSULTATION SERVICE ● FCC AMATEUR LICENSE TRAINING
- PRINTED CIRCUITRY

### SERVICING LESSONS

You will learn trouble-shooting and servicing in a progressive manner. You will practice repairs on the sets that you construct. You will learn symptoms and causes of trouble in home, portable and car radios. You will learn how to use the professional Signal Tracer, the unique Signal Injector and the dynamic Radio & Electronics Tester. While you are learning in this practical way, you will be able to do many a repair job for your friends and neighbors, and charge which will far exceed the price of the "Edu-Kit." Our Consultation Service will help you with any technical problems you may have.

### FROM OUR MAIL BAG

J. Statatilis, of 25 Poplar Pl., Waterbury, Conn., writes: "I have repaired several sets for my friends, and made money. The "Edu-Kit" paid for itself. I was ready to spend \$240 for a course, but I found your ad and sent for your Kit."

Ben Vaterlo, P. O. Box 21, Magna, Utah: "The Edu-Kits are wonderful. Here I am sending you the questions and also the answers for them. I have been in Radio for the last seven years, but like to work with Radio Kits, and like to build Radio Testing Equipment. I enjoyed every minute I worked with the different kits: the Signal Tracer works fine. Also like to let you know that I feel proud of becoming a member of your Radio-TV Club."

Robert L. Shuff, 1534 Monroe Ave., Huntington, W. Va.: "Thought I would drop you a few lines to say that I received my Edu-Kit, and was really amazed that such a bargain can be had at such a low price. I have already started repairing radios and phonographs. My friends were really surprised to see me get into the swing of it so quickly. The Trouble-Shooting Tester that comes with the Kit is really swell, and finds the trouble. If there is any to be found."

# CHAPTER

2

## AUDIO STEREO HI-FI PROJECTS

*Diversity is the key word for this chapter, and all the projects have been selected for maximum reader interest. There are two unusual speaker enclosures, a multiplex adapter, a small public address or intercom amplifier, and a handy stereo balance indicator.*

*Both of the major electronics construction project stories involve the use of printed circuit boards. Both authors sell these boards at very reasonable prices and both projects have been exhaustively tested by the ELECTRONIC EXPERIMENTER'S HANDBOOK staff. It is the consensus of staff opinion that use of the printed circuit boards absolutely insures easy reproduction of the projects by the home builder and virtually eliminates faulty performance. Sufficient detail has been provided in both articles to enable the do-it-yourselfer with printed circuit board etching facilities to make his own.*

*Our favorite speaker enclosure designer has returned (Dave Weems has had enclosure designs in each of the last six issues of the HANDBOOK) with a modernized version of a bass reflex patented many years ago. From all reports, the sound from this design is most pleasant and the bass well-rounded.*

56	TRANSISTOR FM MULTIPLEXER .....	O. D. Carlson
61	MR. THURAS' MAGIC BOX .....	David B. Weems
66	THE SLIM TWOSOME .....	Harold Hufnagel
71	THE BARGAIN PAGE AMPLIFIER .....	Daniel Meyer
76	STEREO BAL .....	Dave Gordon

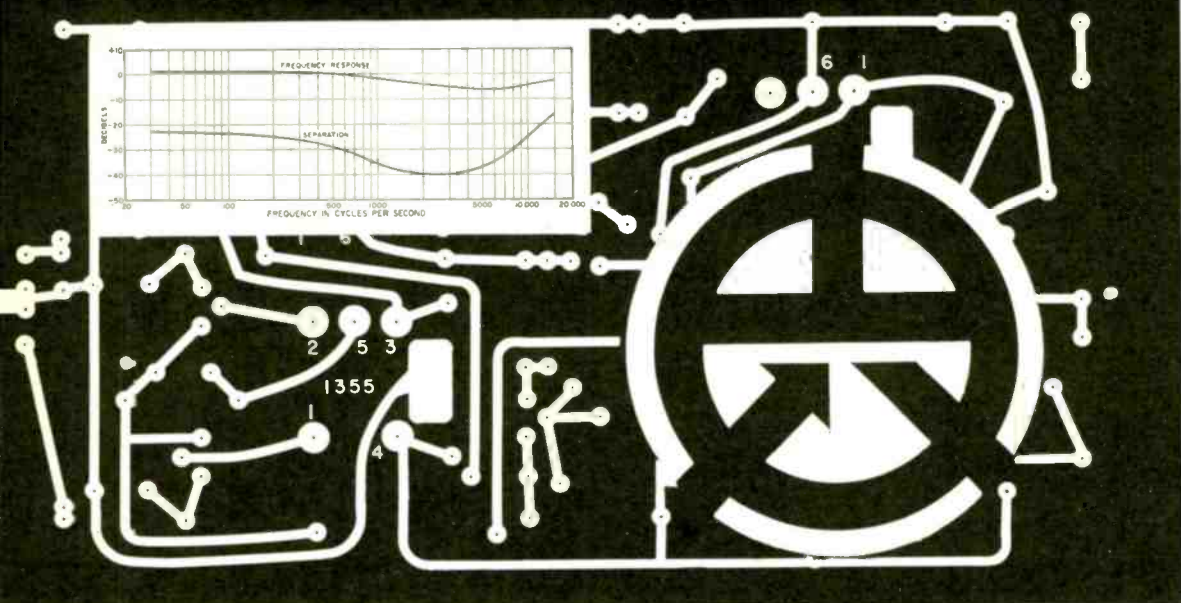

# TRANSISTOR FM MULTIPLEXER

By O.D. CARLSON

Double your pleasure from your hi-fi FM tuner or radio with an automatic switchless FM stereo adapter and stereo indicator

**M**ANY tried and true mono tuners can die a premature death because their owners want stereo reception. However, the addition of a suitable multiplex adapter can prolong the tuner's life. The Transistor FM Multiplexer is a quality, high-fidelity component utilizing a widely accepted time-sharing concept to reconstitute stereo programs in the home. The adapter features a stereo indicator to show when a stereo program is coming through, a switchless stereo-to-mono capability, and a separation of 25 to 30 db across the audio band.

Audio passing through this time-sharing type of multiplexer is not subjected to the nonlinear phase distortion of bandpass filters, as is the case with some matrix-type adapters. Both mono

and stereo programs are played through the adapter and electronically switched back and forth, from left to right, at a 38-kc. rate, without any discernible depreciation of quality. Stereo, when it is present, comes out like magic.

**How It Works.** Signals from an FM tuner are fed to the base of *Q1*. (See Fig. 1.) The 19-kc. pilot component in the stereo multiplexed signal is filtered out in the emitter tank circuit (*T1* and *C3*). All remaining signals are amplified and fed through the 67-kc. filter (*T3*) to an emitter follower (*Q2*). The audio signal is then fed to the collectors of switching transistors *Q5* and *Q6*.

As these transistors are switched on and off, the signal appears first at one emitter and then at the other at a



38-kc. rate. If this switching rate is precisely synchronized with the 19-kc. pilot signal of a stereo station, the left and right components of a stereo program are separated and recovered.

From the switching transistors, the signal passes through the appropriate de-emphasis networks ( $C14$ ,  $R16$ ,  $C15$  and  $C16$ ,  $R17$ ,  $C17$ ). Standard 75-microsecond de-emphasis is employed, effectively filtering out any 38-kc. signal that may be introduced by the switching action. For that matter, all frequencies greater than 20 kc. are reduced or eliminated by the de-emphasis network. This is fine for the audio signals going to the loudspeakers, but no good for the signals from the tuner to the multiplexer. The multiplexer has to see the total stereo signal, which also has components greater than 20 kc. and so the signal take-off point in the tuner is *before* the de-em-

phasis network but *after* the detector.

Returning to the emitter tank circuit of  $Q1$  in the multiplexer, the 19-kc. pilot signal is fed to two identical amplifiers ( $Q3$  and  $Q7$ ). Transistor  $Q3$  amplifies the signal to synchronize the 19-kc. oscillator ( $Q4$ ). The collector tank circuit of this transistor is tuned to the second harmonic of the amplified 19-kc. pilot signal and passes a 38-kc. signal to the switching transistors via  $T4$ .

To see how the stereo indicator works, let us go back again to the emitter tank circuit of  $Q1$  and follow the signal path through  $Q7$ . The amplified 19-kc. pilot signal from  $Q7$  is rectified by  $D1$ , providing a negative-going signal to the base of  $Q8$ , and causing it to conduct and illuminate  $I1$ . Since the pilot signal is present only on multiplexed broadcasts, the lamp will go on when the receiver is tuned to an operating stereo

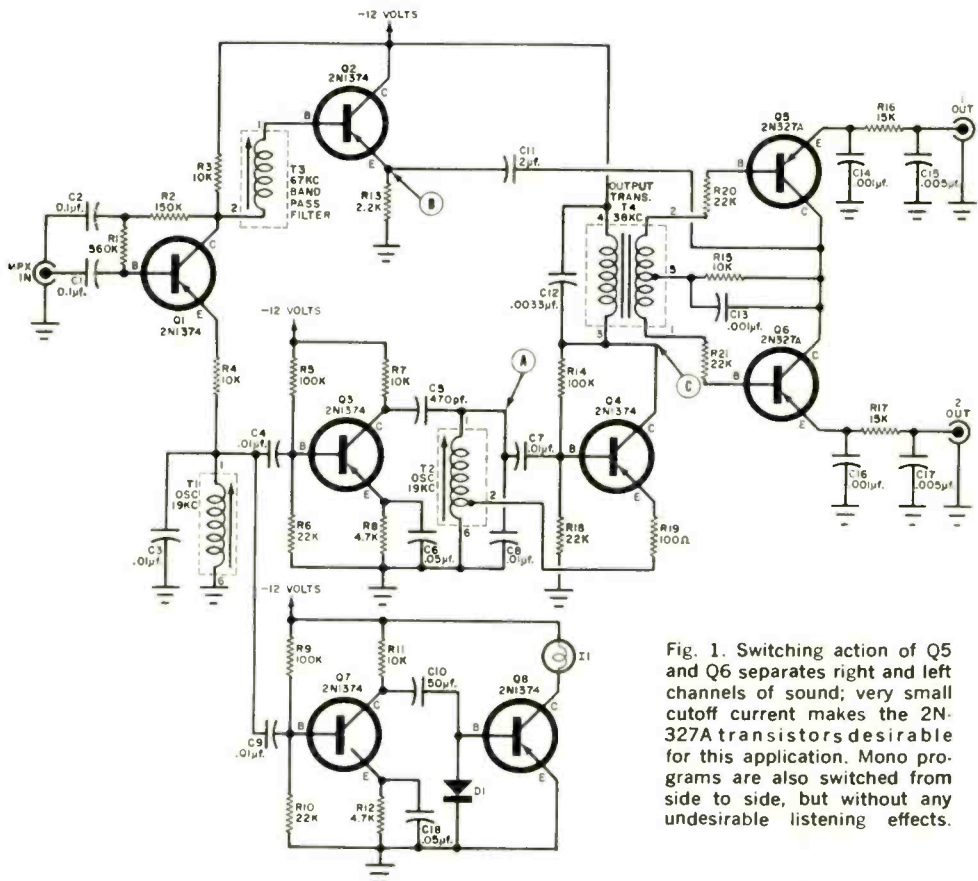

Fig. 1. Switching action of  $Q5$  and  $Q6$  separates right and left channels of sound; very small cutoff current makes the 2N-327A transistors desirable for this application. Mono programs are also switched from side to side, but without any undesirable listening effects.

station. Pilot signal input levels of less than 0.2 volt are sufficient to operate the lamp driver circuit.

**Construction.** A printed wiring board can be made from the full-scale drawing. However, you can use any other conventional wiring technique and type of chassis. A 6" x 3" undrilled phenolic circuit board containing all internal wiring is available from the author. (See Parts List.)

First, mount the transformers; connect only one spade-type projection on each transformer can to ground, and cut off the other one. Resistors, capacitors, and interconnecting leads for power and indicator lamp follow in just this order. Bend the lead ends slightly to hold them in place and then solder. You can cut off excessive lead lengths either before or after soldering, depending upon which

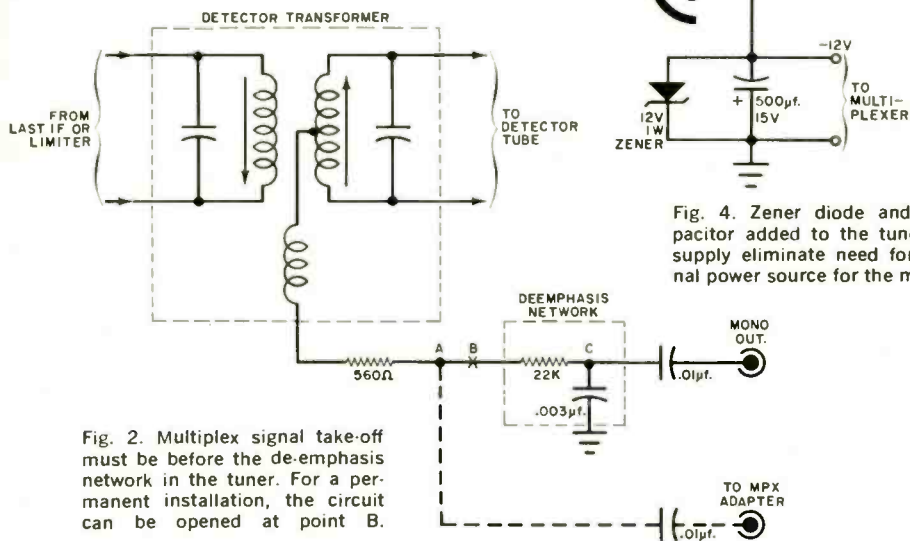

Fig. 2. Multiplex signal take-off must be before the de-emphasis network in the tuner. For a permanent installation, the circuit can be opened at point B.

is easier for you. For best results, do a neat soldering and wiring job and avoid lifting the foil with excessive heat and pressure.

Leave the installation of the transistors and the diode for last. If a transistor socket is used for  $Q_1$ , the oscillator can be easily disconnected during alignment of the adapter simply by removing the transistor. All other semiconductors are soldered directly to the circuit board. Allow approximately  $\frac{3}{8}$ " of air space above the board for clamping a heat sink to each transistor lead as it is soldered.

Fig. 3. A cathode follower circuit serves to match the low-impedance input of the multiplexer and at the same time prevents excessive loading of the detector stage. Adapter input signals should not exceed 0.5 volt.

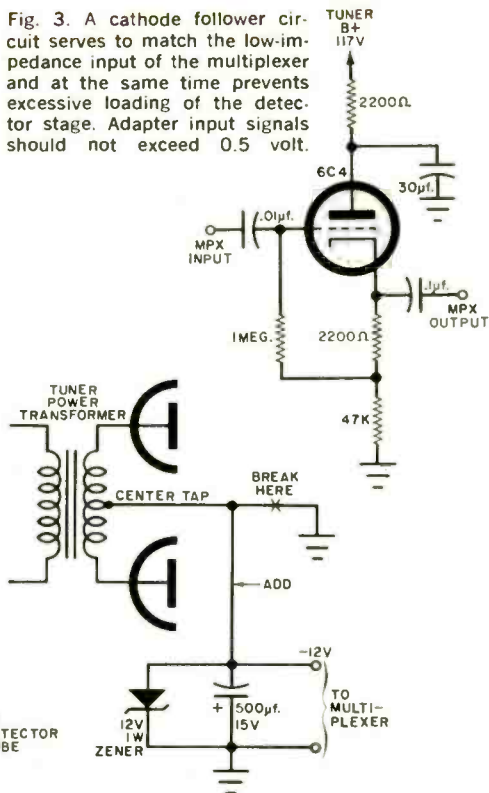

Fig. 4. Zener diode and filter capacitor added to the tuner's power supply eliminate need for an external power source for the multiplexer.

**Connection to FM Tuner.** Reception of stereo FM programs places more stringent requirements on a tuner and its antenna than for mono broadcasts. Greater bandwidth and sensitivity is needed for stereo receivers. The extra bandwidth allows for the standard spread of mono signal frequencies plus the stereo signal frequencies. The need for increased sensitivity is evident from the fact that a portion of a given stereo radio station's overall signal strength contains stereo signals. The main channel, therefore has less than maximum power.



# FM MULTIPLEXER

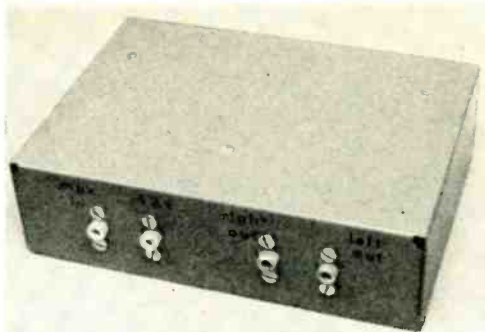
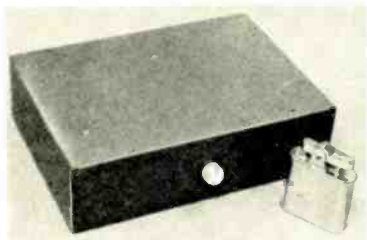

Fig. 7. Indicator lamp on front of cabinet goes on when stereo signals are tuned in. Electronic switching eliminates all external controls.

Tuners having a cathode follower output tube are easily modified to supply proper stereo signals, since this type of circuit already has a low output impedance. All you have to do is hook up the multiplexer in front of the de-emphasis network, as shown in Fig. 2. For a permanent installation, disconnect the de-emphasis network in the tuner (usually an 0.001- or 0.003- $\mu$ f. capacitor on the output end of the 68,000- or 22,000-ohm resistor which is attached to the grid of the first stage after the detector), and turn the tuner's volume control to maximum (if it affects the signal take-off point).

Volume is not adjusted at this point in the system unless the signal to the

multiplexer is in excess of 0.5 volt, because reduction here could diminish the 19-kc. pilot signal needed for the oscillator and other circuits in the adapter. On the other hand, excessive signal strength will cause distortion. About 0.3 volt makes the unit work just fine.

Since the multiplexer is used for both mono and stereo programs, de-emphasis of all signals is reinserted in the multiplexer.

Tuners not equipped with multiplex outputs are generally not satisfactory for stereo reception due to narrow bandwidth and sometimes lack of sensitivity, but with certain modifications and a good antenna can be made to work. In a

*(Continued on page 137)*

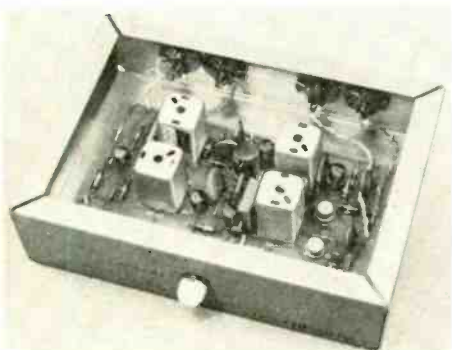
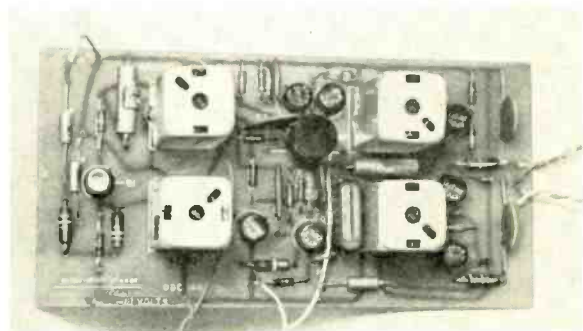
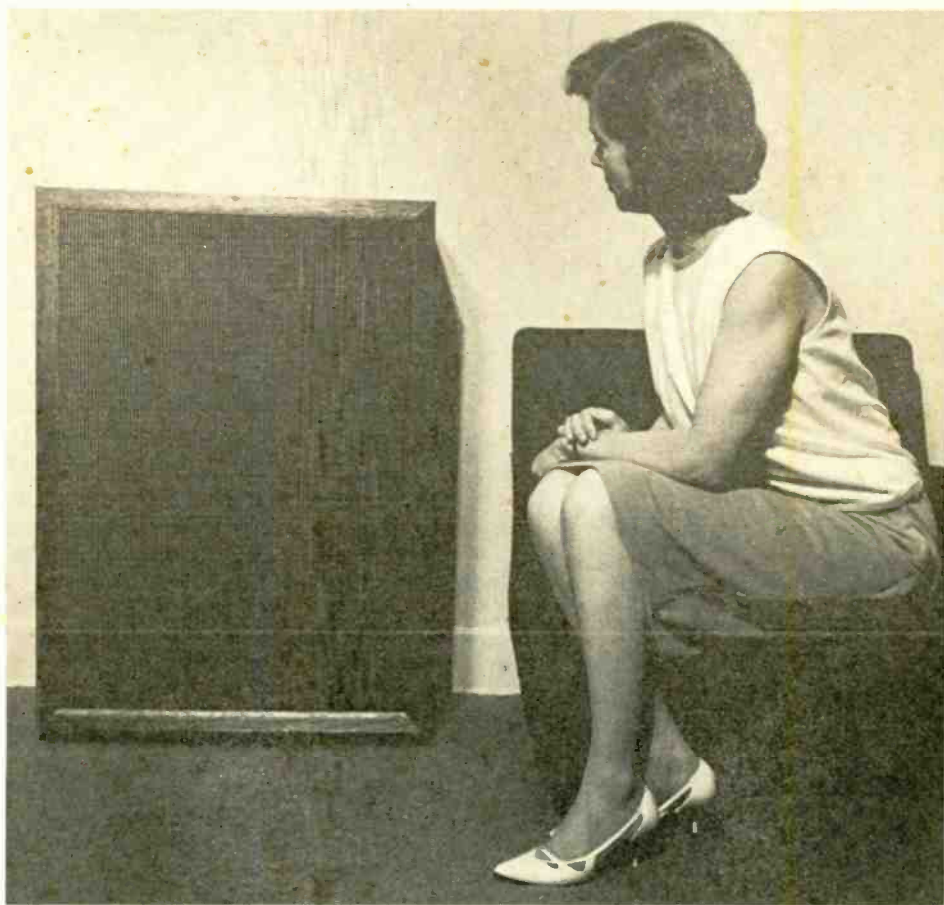

Fig. 9. A printed circuit board or any other standard wiring technique can be used. All components are mounted on one side. Keep transistors about  $\frac{1}{4}$ " above the board, or install in sockets.

Fig. 8. Twisted leads are used as self-shielded conductors. The lead acting as a shield is connected only to the ground foil on the board. A bare wire connects the ground side of the jacks to a single ground point on the circuit board.



# MR. THURAS' MAGIC BOX



By DAVID B. WEEMS

*The distributed port bass reflex was invented 35 years ago; with a modern-day hi-fi speaker, it sounds better than ever*

**M**Y INTRODUCTION TO HI-FI occurred about 15 years ago when I heard a speaker in a bass reflex enclosure. I was so impressed I bought some plywood and started building bass reflex cabinets, finally owning more boxes than I had speakers to fit. A few years later, I learned about the use of ducts or "tunnels," which permitted a reduction of enclosure volume for a given resonant frequency. Since just about all commer-

cial cabinets of the era had only single ports, the ducted port was apparently a new development of vague and mysterious origin.

Another variation in the bass reflex cabinets of the '50's was the "distributed port," consisting of several small holes drilled in the face of the baffle to replace the single large hole. The proponents of the distributed port claimed that a smoother hi-fi response

resulted from the resistive force that the multiple small holes exerted on the flow of air through them.

Then the stereo age arrived, and the need for double speaker systems created a demand for compact enclosures. We began to hear less about distributed ports and more about the ducted port, which now finally had its day. Those pioneers of the 1950's who had advocated them were simply ahead of their time.

Recently I became curious about the origin of the bass reflex. I knew that its invention by A. L. Thuras of Bell Telephone Laboratories had probably had greater influence on high-fidelity speaker systems than any other development, but details on just what he invented seemed non-existent. Finally after a fruitless search in hi-fi books and several libraries, I sent 25 cents to the

U. S. Patent Office and received a copy of Patent No. 1,869,178, "A Sound Translating Device."

I eagerly examined the drawings, expecting to find the typical boxed-in speaker with a rectangular port below it in the front panel. To my surprise there was instead a series of short pipes surrounding the speaker. Not only did Thuras invent the bass reflex, but a "distributed duct" bass reflex. But the real shocker came when I looked at the patent filing date: August 15, 1930!

The more I studied the patent specifications, the more intriguing they became. The enclosure had esthetic drawbacks, such as a square face and a volume of more than 9 cubic feet, but I was convinced that the original design had unusual merit if only it could be matched to present-day speakers. Finally I decided to try, and here is the result—a smooth-operating "sound translating device" of the highest order. It is designed to operate with the University "Mustang" series of speakers.

**Construction.** The box itself is conventional. You may make minor changes in construction, but you should not change the inside dimensions. If you make any significant volume changes, good luck, but don't expect to predict a match for any particular speaker or resonant frequency from the published bass reflex charts you might have on hand. Those charts apply to single ports or ducts and are not valid for the multiple pipe baffle. I found this out when the indicated pipe length proved to be too short.

Except for the cardboard tubes, the materials are conventional and readily available. You can probably find tubes of the diameter listed at a neighborhood furniture store or rug dealer, but if the store is a small one, you may have to ask the owner to reserve one or two for you. My nearest furniture store had two empty tubes twelve feet long standing in a corner waiting for the trash collector. If you can't find tubes with the same inside diameter, you may have to use larger ones, changing the number of tubes to maintain approximately the same cross-sectional area. Or you can cut square openings and fabricate plywood ducts with inside dimensions of  $1\frac{9}{16}$ " x  $1\frac{9}{16}$ ".

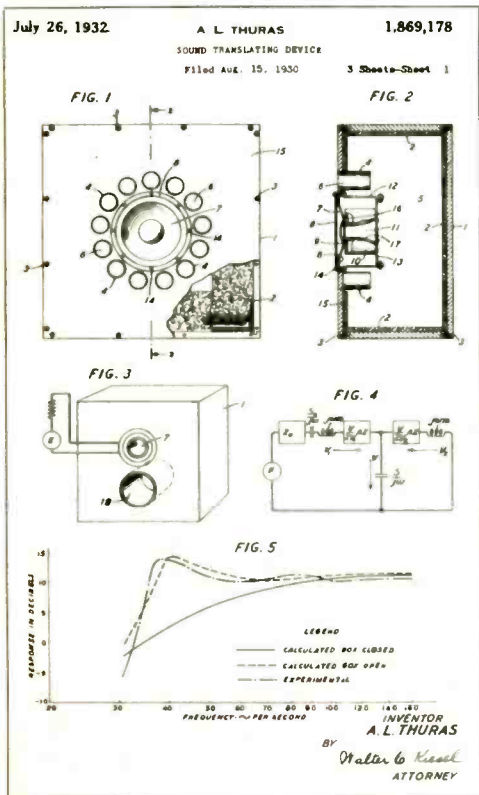

A. L. Thuras filed a patent application for this distributed port enclosure on August 15, 1930, and assigned the patent rights to the Bell Telephone Company. He called it a "Sound Translating Device."

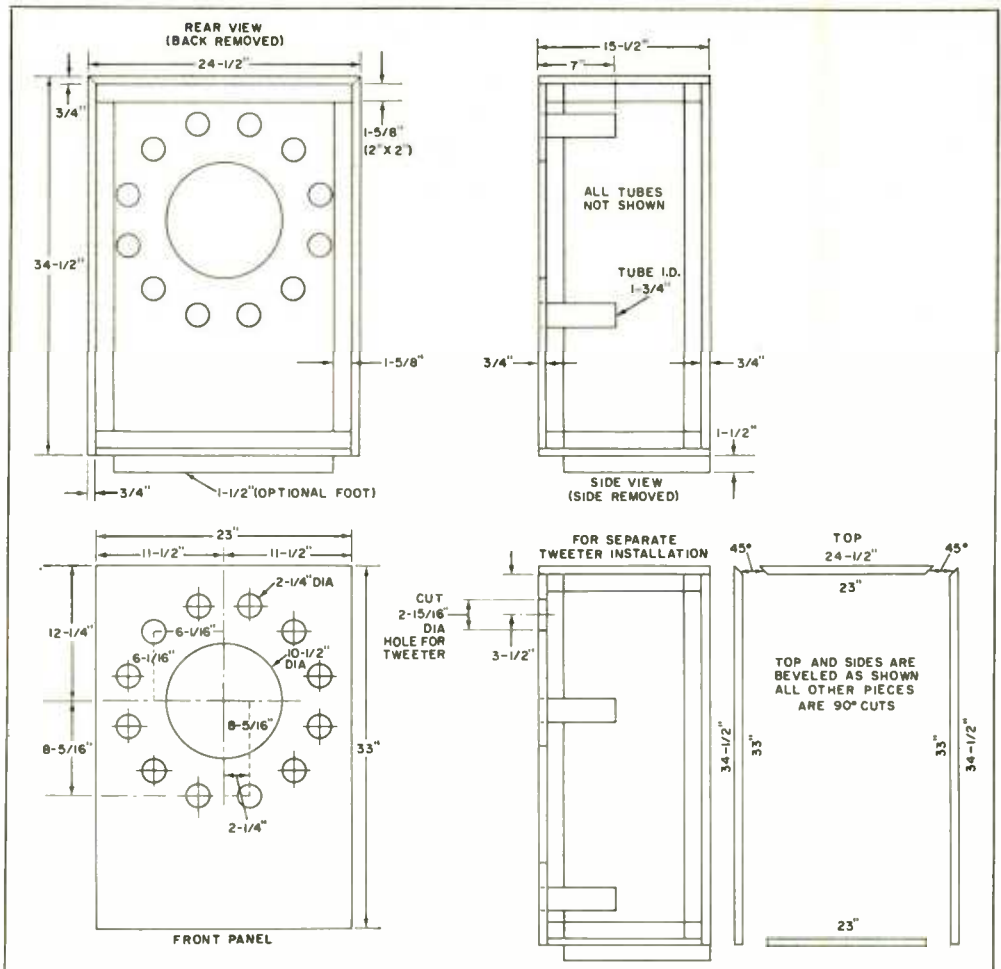

Outline drawings above show the general arrangement to use in building a duplicate of A. L. Thuras' distributed port reflex. A University "Mustang" speaker was tested in this enclosure and sounded fine. If more highs are desired because of room acoustics, mount a separate tweeter as shown at the lower right.

### BILL OF MATERIALS

- Cut from 3/4" plywood:
- 2—23" x 33" pieces for front and back panels
  - 2—15 1/2" x 34 1/2" pieces for sides
  - 1—15 1/2" x 24 1/2" piece for top
  - 1—15 1/2" x 23" piece for bottom
- Cut from fir or pine 2 x 2's (actually 1 5/8" x 1 5/8"):
- 4—10 3/4" pieces for corner cleats
  - 4—23" pieces for top and bottom cleats
  - 4—30" pieces (approx.—cut to fit) for side cleats
- 12—2 1/4"-o.d., 1 3/4"-i.d., 7"-long pieces of cardboard mailing tubes for pipes
- 1—6-1/16" x 6-1/16" piece of cardboard or wood for pattern board
- 1—2 1/4" x 8-5/16" piece of cardboard or wood for pattern board
- Misc.—7 doz. #9 x 2" flat-head wood screws (see text), glue, grille cloth, trim, legs—if desired

The first step after cutting out the parts is to screw and glue the braces or cleats to the top and bottom. The sides are then fastened to the top and bottom, using glue and screws through the corner braces into the sides. It is then possible to cut the side cleats, which serve as anchors for the front and back, to fit exactly. Incidentally, if your lumber dealer does not have pre-cut 2 x 2's, he may supply you with pieces that have been ripped from 2 x 4's. In that case the dimensions may be slightly different and require longer or shorter screws. Be sure to check the screw length.

The only part of the design which re-



Centers for port holes are marked out using two pattern boards. Dimensions of the boards are given in the Bill of Materials. How they are used is described below.

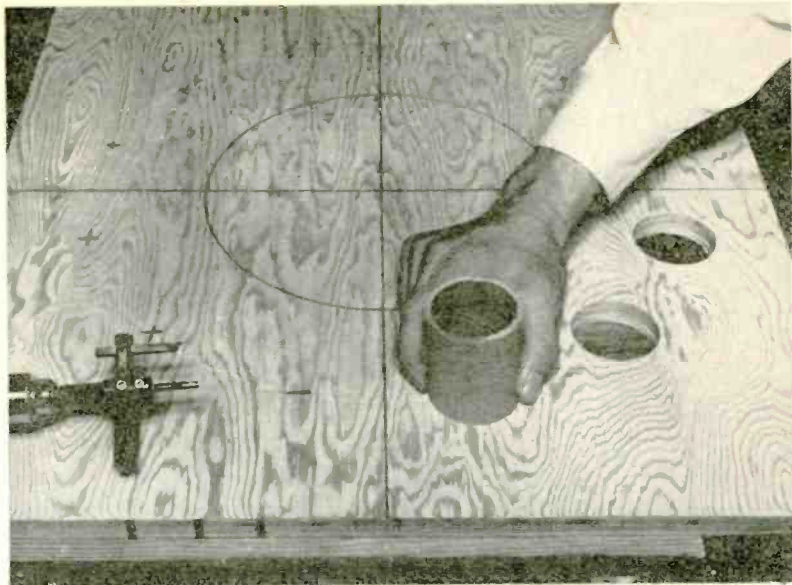

Bore the port holes using a heavy-duty "fly" or circle cutter with a low-speed electric drill. An Arco hole saw can be employed if the diameter of the saw matches the outside diameter of the cardboard tubes.

quires careful planning and measuring is the front baffle. I found that "pattern boards" made from scraps of plywood greatly simplified the location of the 12 holes for the pipes. First locate and draw the circle for the speaker cutout; then divide the circle into quadrants, extending the lines to the edges of the board. The middle hole in each quadrant can then be located by positioning the  $6\frac{1}{16}$ "-square pattern board with one corner at the center of the circle and the sides bounded by the quadrant lines as shown in the photo. The other two holes in each quadrant are located by positioning the other pattern board with the longer side first on one quadrant line, then the other, keeping a corner at the circle's center (see photo).

The holes can be easily cut with a circle cutter and a large portable drill. It's possible to cut them with a small high speed drill, but such an operation is hazardous. Keep a firm control on the drill at all times and a safe distance between it and your knees or feet. Cut some sample holes in waste plywood first and check for a tight fit with a piece of tubing. When the cutting of the port holes and speaker opening is completed, glue the 7-inch tubes in place so that

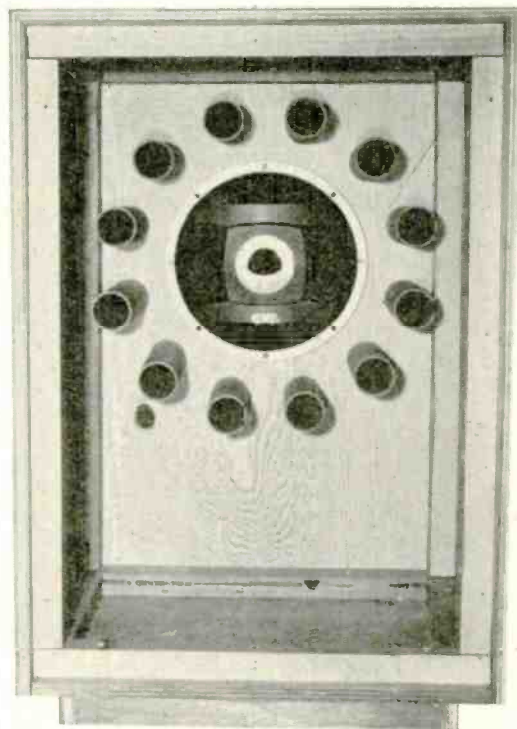

This rear view of the speaker enclosure does not show the cheesecloth and cotton batting used to dampen boomy resonances. See text on next page.



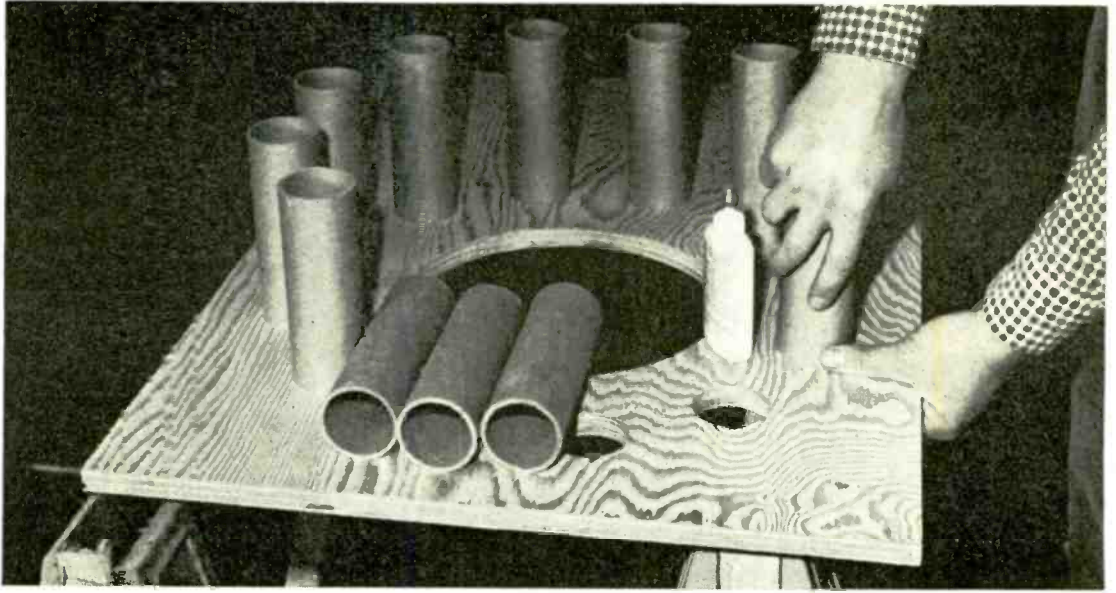

The cardboard tubes should fit snugly into the port holes. The length of the tubes recommended for use with a University "Mustang" speaker is 7 inches. Glue each of the tubes in place so that the end of the tube is exactly flush with the front panel.

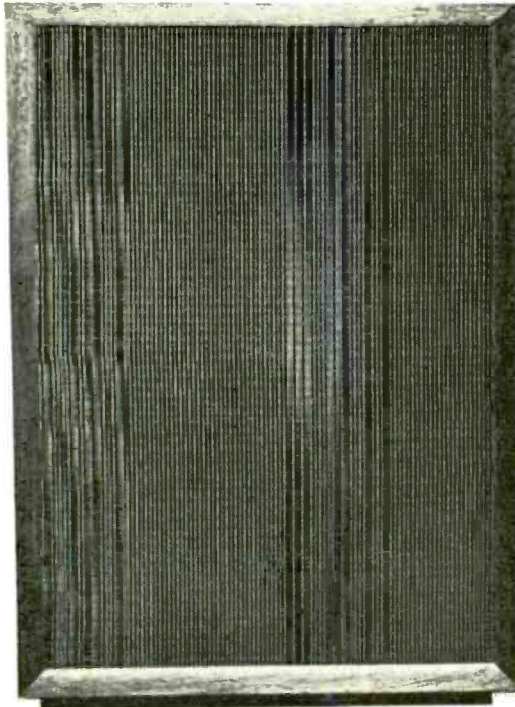

Ordinary plastic grille cloth is carefully tacked to the front of the enclosure. Mitered strip of molding covers the tacks and frayed ends of the cloth.

the end of each tube is flush with the front of the board. Mount the board, and you are ready to finish the cabinet.

Don't forget to use padding on at least the top, one side, and back—more if you wish. The pipes offer a convenient anchor for a particularly effective placement of padding. I made a "doughnut" of heavy cotton batting sandwiched between layers of cheesecloth and cut openings in the cheesecloth for the pipes; this suspends the sheet of batting just in back of the speaker without totally enclosing the speaker and putting a pressure compartment around it.

**Variations.** For a full-range speaker such as the University M-12T or M-12D, construct the enclosure as shown here. If you want to use a separate woofer-tweeter arrangement such as the M-12 "Mustang" woofer plus the T-202 super tweeter, the front panel can be inverted with the woofer and pipes in the lower part and a tweeter opening cut near the top. If you substitute other speakers, the bass resonance of the speaker should be similar to that of the "Mustang" series, or about 40-50 cycles.

If you build this enclosure, you can honestly tell your friends that it's 35 years ahead of its time.

# THE SLIM

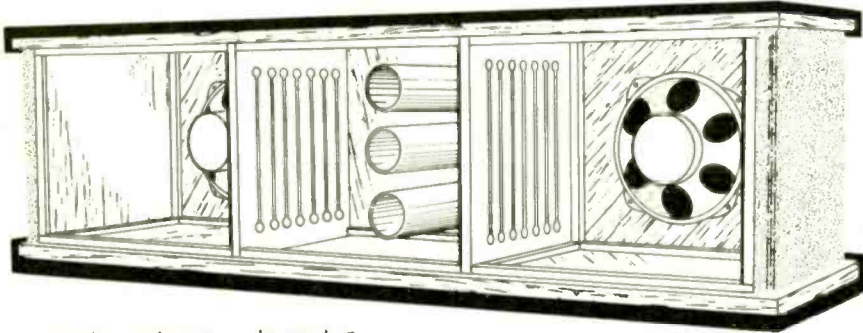

Two-speaker enclosure can be used on its side as above, or on end as seen below. Novel filters (the slotted boards) and ports furnish bass boost.

# TWOSOME

**For big bass from a small box, try this unique enclosure using center decompression chamber**

By HAROLD HUFNAGEL

**W**ANT to know how to pack good, strong bass, as well as clear, sparkling highs, into a speaker cabinet measuring just 10" x 10" x 36"? Interested in economy? Would you like to have a speaker system that can proudly take its place among your living room furniture, or on a convenient bookshelf? If your answer is "yes" to these questions, "The Slim Twosome" is for you.

A combination of filters and a decompression chamber increase air column length and enhance bass response without detracting from the highs. Two full-range 6" speakers pumping in phase can move as much air as a larger speaker. The filters dampen speaker action without a build-up of excessive back pressure. The ports relieve the cabinet of internal pressures and, when properly tuned, can improve bass response, as in a bass-reflex enclosure.

**Construction.** Ordinary  $\frac{1}{2}$ " plywood can be used for the front, back, sides, and ends. However, you may choose—as did the author—to use hardwood or veneered plywood for the "sides" (top and bottom if the cabinet is laid flat). The remaining exposed surfaces are covered with grille cloth.

First cut the two 10" x 36" side panels, taking care not to mar the outside surfaces. The cleats used to hold the

*(Continued on page 70)*

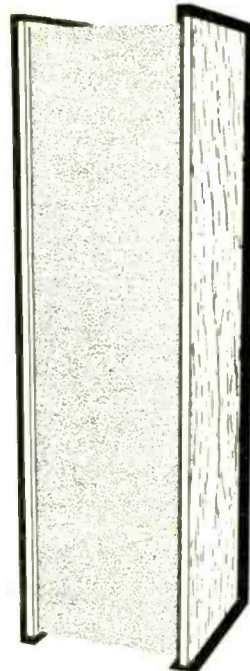

# FREE CATALOG.

250 "Do-It-Yourself"  
Electronic Kits At  
Up To 50% Savings

**WHY BUILD HEATHKIT ELECTRONICS?** A desire for top-quality products at 50% savings, to be sure. But it goes beyond that. The reason people choose Heathkit is pride. Not just the pride of owning something new, but something a bit better that you have created yourself! From watching your Heathkit grow and take shape from your own efforts. It's a labor of love and a lot of fun. The large pictorial diagrams and simple, step-by-step instructions make it easy. And when you finish and turn it on you'll know that unique self-satisfaction that comes with "do-it-yourself." You will have joined the millions of people, from ages 11 to 79, people with no special electronic skills or knowledge, who successfully build Heathkits. People like you! Give it a try. Your FREE Heathkit catalog is waiting for you now.

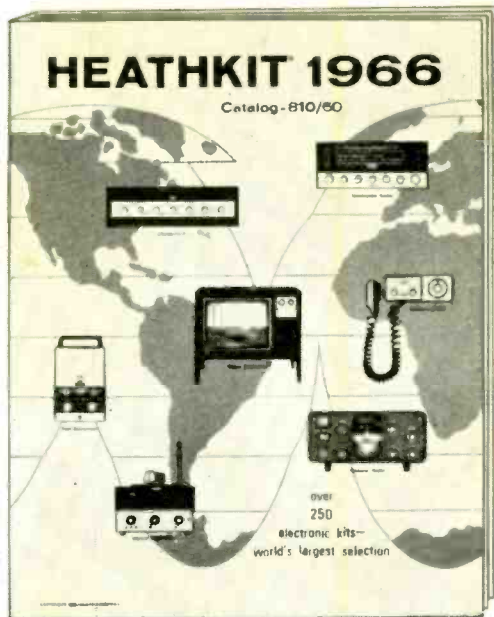

## World's Largest Selection Of Electronic Kits



**NEW** Low Price On Heathkit  
21" Color TV . . . Only \$375.00



**NEW** Transistor FM Stereo  
Tuner That Assembles In 6  
Hours Or Less . . . Only \$49.95



**NEW** Low Prices On  
Many Heathkit Stereo/Hi-Fi  
Components



**NEW** Deluxe Shortwave  
Radio . . . Only \$84.95



**NEW** 23-Channel, 5-Watt  
All-Transistor CB Transceiver . . .  
Only \$89.95

- ★ See The Vast Selection Of Portable And Table Model AM, FM and Shortwave Radios
- ★ See The Famous Heathkit/Thomas Transistor Electronic Organs
- ★ See A Complete Selection Of Home & Hobby Items . . . Intercoms, Garage Door Opener, Automotive Kits, Tools, Color TV Sets
- ★ See All Heathkit Stereo/Hi-Fi Components . . . Tuners, Amplifiers, Speakers, Turntables, Cartridges, Furniture
- ★ See The Full Complement Of Heath Marine Electronics
- ★ See The Complete Line Of Citizen's Band Radio Gear . . . Transceivers, Walkie-Talkies, Accessories
- ★ See The Wide Selection Of Heath Educational Kits For Home Or Classroom Study
- ★ See The World's Largest Line Of Amateur Radio Gear
- ★ See The Full Line Of Heathkit Lab & Test Instruments For Home Workshop, Industrial & Educational Use



**MAIL  
COUPON  
FOR YOUR  
FREE  
COPY** ▶

**HEATH COMPANY, Dept. 110-1**  
Benton Harbor, Michigan 49023  
In Canada: Daystrom, Ltd., Cooksville, Ontario

Please send FREE 1966 Heathkit Catalog

Name \_\_\_\_\_

Address \_\_\_\_\_

City \_\_\_\_\_ State \_\_\_\_\_ Zip \_\_\_\_\_

Prices & specifications subject to change without notice. CL-215



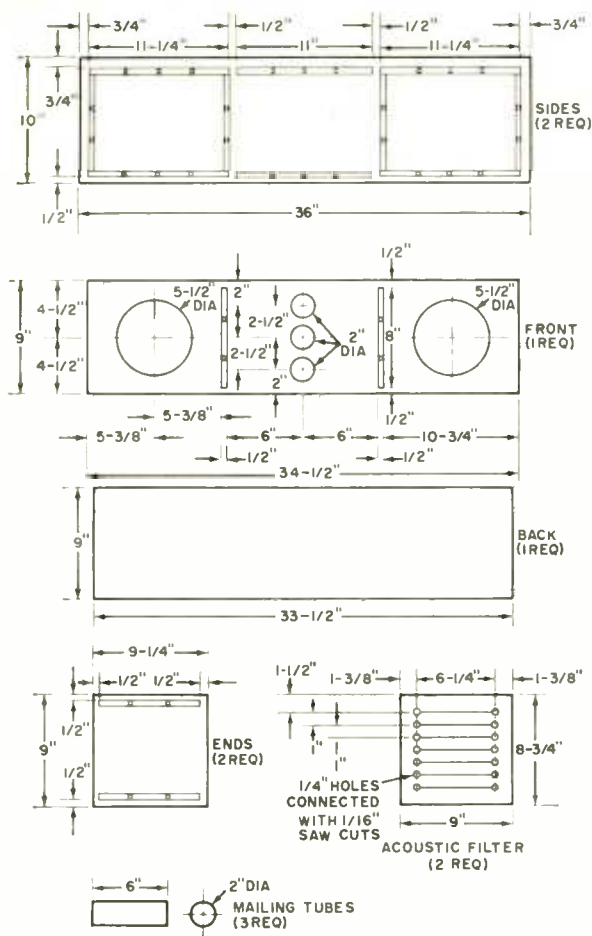

Construction of enclosure is detailed at left. All panels can be made from  $\frac{1}{2}$ " plywood, with  $\frac{1}{2}$ "-square stock making up the cleats. Cut all pieces exactly to size; place cleats as shown for easy assembly.

tween the cleats as shown, and firmly screw them to the adjacent cleats to prevent any vibration.

**Final Assembly.** The ports are made of three 6" pieces of mailing tube 2" in diameter. First give them several coats of shellac, then glue them in place, filling any openings around them with sawdust and glue. Line the speaker chambers with a  $\frac{3}{4}$ " layer of acoustic padding on the ends, sides, and the back panel area that will cover the speaker chambers; no padding is placed on the filters or in the decompression chamber.

The front and ends of the author's cabinet were finished by covering them with grille cloth after the bare wood was painted flat black so that shadows would not show through the cloth. The side panels can be finished to your liking.

If plywood is used for the sides, you can finish the edges very easily by covering them with "flexible wood trim" available from most lumberyards. The trim is simply glued in place with contact cement. Fit grille cloth between the sides, stapling it to the rear edge of the ends and near the edges around the front. Gold cording or molding will conceal the staples.

While the exact type of speakers you choose for your "Slim Twosome" is not overly critical, be sure to get wide-range types such as the Lafayette Radio 99 R 0028, priced at \$6.25. There are other similar units which can be used.

Install the speakers, and wire them to a terminal strip on the rear panel, taking care to connect them both in the same phase—i.e., so both cones move in or out together. Small both in terms of size and the investment required, "The Slim Twosome" can be counted on to give big listening pleasure.

enclosure sections together are made of  $\frac{1}{2}$ "-square stock. Cut enough pieces of the right length for the two sides, and place them exactly as shown in the detail construction drawings above. Secure them in place with glue and screws. Cut the front, back, and ends from ordinary plywood, and fasten cleats to the front and ends as shown.

The end pieces are glued and screwed to the cleats on the side pieces using  $\frac{3}{4}$ " flat-head #6 wood screws. Drill holes for the screws through the ends, countersinking the holes  $\frac{1}{8}$ " so the screw heads will be below the outside surface of the enclosure. (Note: The cleats on the end pieces are later used to mount the front and back.)

Glue and screw the front in place, countersinking screw holes as before. After drilling and cutting the filter slots in the filters, slide them in place be-

**I**F YOU are like most electronics experimenters, you spend considerable time browsing through catalogs and flyers from parts dealers and distributors. Also, if you're like the author, those tempting packages of bargain-priced transistors are just too much to resist. Sometimes we get stung, but this amplifier has proven to be an extraordinary exception—the push-pull power output transistors are commonly available TO-3 (diamond shape) types that can be purchased surplus from Poly-Paks, TAB, Transistors Unlimited, etc. The following transistors will all work well in this circuit: 2N250, 2N251, 2N256, 2N276, 2N301, 2N553, and 2N1046.

All of these transistors will give you a power output of about 3 watts without excessive distortion. (If you feel that improved performance above 10,000 cycles is necessary, use 2N1046 transistors at Q4 and Q5.) Don't forget to check the leakage of surplus transistors. Some, but not all, transistors sold for bargain prices are "seconds" and will not give you the maximum possible performance from this amplifier.

The "Bargain Page Amplifier" is a versatile little package of audio power. It may be operated from either a positive- or negative-ground 12-volt automotive supply. It can be used as a mobile public address system, modulator,

# THE BARGAIN PAGE AMPLIFIER

*All-purpose transistorized  
printed circuit board  
amplifier has 3-watt output  
over an audio range  
of 30 to 20,000 cycles*

By DANIEL MEYER



Amplifier schematic; the terminals shown with dotted lines indicate connections only—they are not actually on PC board.

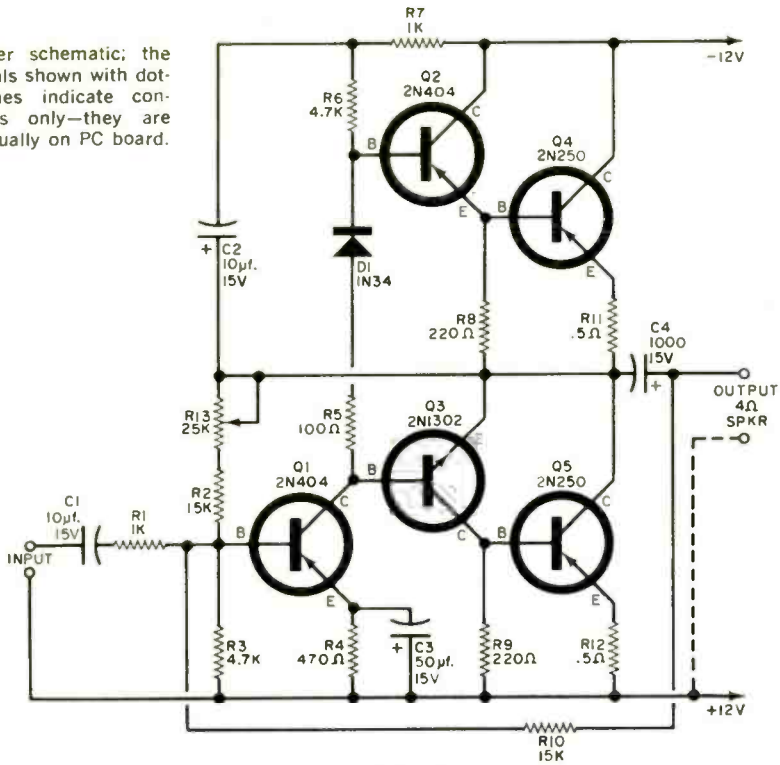

#### PARTS LIST

C1, C2—10- $\mu$ f., 15-volt electrolytic capacitor  
 C3—50- $\mu$ f., 15-volt electrolytic capacitor  
 C4—1000- $\mu$ f., 12-volt electrolytic capacitor  
 D1—1N34A germanium diode (or equivalent)  
 Q1, Q3—2N404 transistor (or equiv.—see text)  
 Q2—2N1302 transistor (or equivalent—see text)  
 Q4, Q5—2N250 transistor (or equivalent)  
 R1, R7—1000 ohms  
 R2—27,000 ohms  
 R3, R6—4700 ohms  
 R4—470 ohms  
 R5—100 ohms  
 R8, R9—220 ohms  
 R10—15,000 ohms  
 R11, R12—0.5-ohm (wind 15" length of #36 magnet wire on a 1/2-watt, 10,000-ohm resistor to shunt internal resistance)  
 R13—25,000 ohm trimmer potentiometer

All resistors  
 1/2 watt

Misc.—Circuit board available from DEMCO, 430 Redcliff Drive, San Antonio, Texas 78216 for \$2.50 (epoxy glass) or \$2 (phenolic base); solder, wire, batteries, cabinet, etc.

#### Optional Power Supply

C5—500- $\mu$ f., 12-volt electrolytic capacitor  
 C6—1000- $\mu$ f., 12-volt electrolytic capacitor  
 D2, D3—50-PIV @ 1-amp. silicon diode (Mallory S-50 or equivalent)  
 D4—1N3022 zener diode, 12 volts at 1 watt (Texas Instruments)  
 Q6—2N256 transistor (or equivalent)  
 R11—100-ohm, 1/2-watt resistor  
 S1—S.p.s.t. toggle switch  
 T1—Filament transformer; primary, 117 volts a.c.; secondary, 24 volts a.c. CT

or audio amplifier. The amplifier makes a neat, practical audio system for use with a low-cost portable phonograph. The setup for such a project can be very simple—a pair of 6-volt lantern batteries, plus the amplifier tucked away in the back of a speaker baffle.

Because this unit has a wide frequency response, it can be used with wide-range speakers in a hi-fi system.

**How It Works.** The output transistors, Q4 and Q5, although in series with the 12-volt power supply, look like push-

pull amplifiers to an audio signal. These two transistors are slightly forward-biased to minimize distortion at low volume levels. With no signal input, Q4 and Q5 draw about 15 ma. At full volume output with this circuit, the output transistors will draw up to 400 ma. The mode of operation is Class AB<sub>2</sub>; transistor Q4 can be thought of as amplifying the negative portion of the audio signal and Q5 as amplifying the positive portion.

Transistor Q2 is a phase inverter as

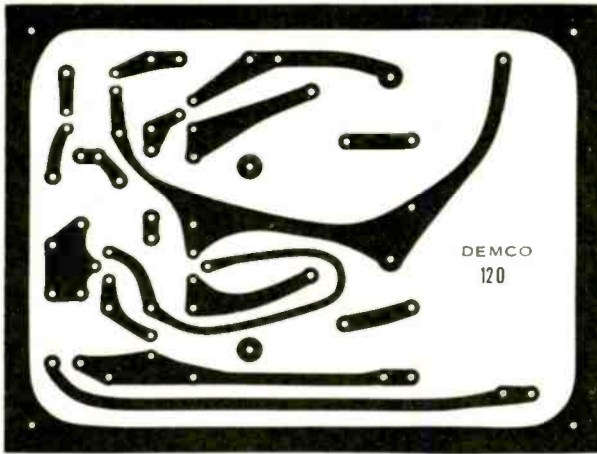

Using template above, you can etch your own circuit board—or you can get one from DEMCO (see photograph below). The address is given in the Parts List at left.

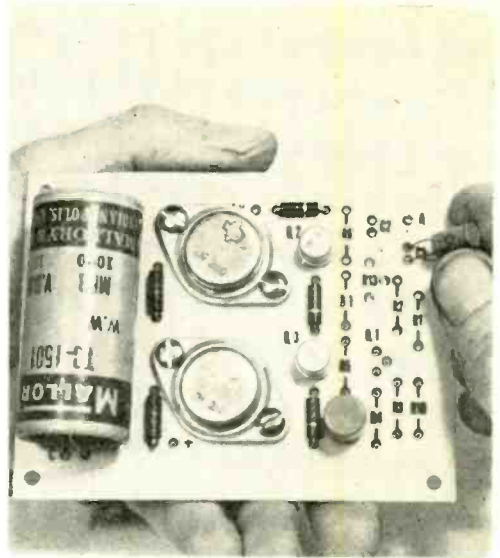

Using dirt-cheap transistors, this amplifier can produce 3 watts without a heat sink by running the power output transistors far below their maximum rating.

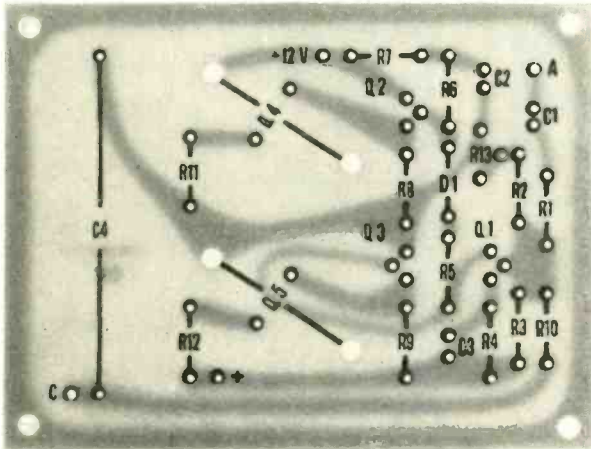

well as a low-impedance driver amplifier. Transistor *Q3* performs a similar function sans the phase inversion. Voltage amplification to drive these two transistors is provided by *Q1*. The collector of *Q1* is fed directly to the base of *Q2* and through *D1* and *R5* to the base of *Q3*.

Diode *D1* performs two functions: it provides slight forward bias (with *R5*) and also acts as a temperature compensator. The voltage drop across the diode decreases as the temperature of the

whole amplifier increases. This counteracts the thermal runaway possibilities of this type of circuit.

Both d.c. and a.c. feedback are used between the output and input transistors. Resistor *R2* provides a d.c. path and capacitor *C4* an a.c. path. Feedback lowers distortion, improves stability, and broadens the frequency response. Total feedback is about 20 db.

**Construction.** A printed circuit board on which to build this amplifier is available from the author at a modest charge. Construction time is thereby reduced to less than one hour and the chances of wiring errors or unwanted feedback are eliminated completely. A board can be made in your own workshop following the layout shown above. Point-to-point wiring with Vectorbord<sup>®</sup> and push-in terminals can be used if care is exer-

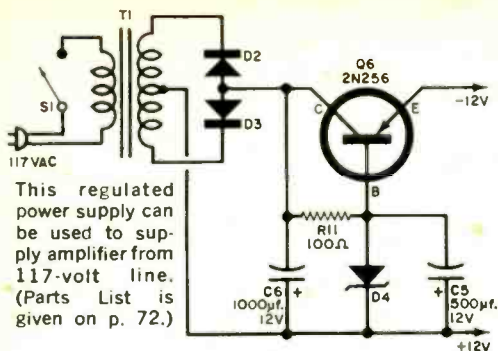

This regulated power supply can be used to supply amplifier from 117-volt line. (Parts List is given on p. 72.)

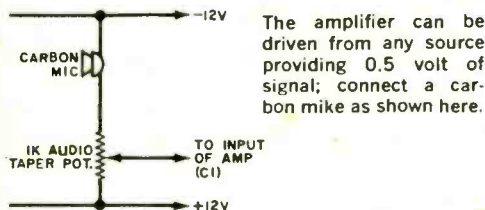

The amplifier can be driven from any source providing 0.5 volt of signal; connect a carbon mike as shown here.

Check your power transistors for leakage with the simple circuit at right. A zero reading, or more than 1 ma. of leakage current, indicates that the transistors will not work in the amplifier.

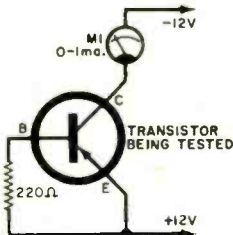

cised to reduce the possibility of the wiring introducing feedback.

You can make a number of possible substitutions at  $Q1$ ,  $Q2$ , and  $Q3$ . Each must have at least a 12-volt breakdown ( $V_{ce0}$  in the RCA *Transistor Manual*), and in the case of  $Q2$  and  $Q3$ , a current gain of 50 or more. Transistors  $Q4$  and  $Q5$  are equivalent to 2N1038-1 transistors manufactured by Texas Instruments and selling for about \$3 apiece.

**Testing and Installation.** Before installing your bargain transistors, it is a good idea to test them for excessive leakage using the circuit shown above. If the meter reading is either zero or over 1 ma., the transistor should not be used in this amplifier. Transistors with leakage currents of between 0.1 and 0.8 ma. are O.K.

After assembling the amplifier and installing the transistors, connect a 0-100 milliammeter in series with the battery or power supply and the amplifier. Current drain should be from 20 to 50 ma. with no signal input. If the drain ex-

ceeds 50 ma., reduce the value of  $R5$  to 47 or 68 ohms. On the other hand, if the current drain is below 20 ma., increase  $R5$  to 120 or 150 ohms.

Emitter stabilizing resistors  $R11$  and  $R12$  reduce the chances of thermal runaway of  $Q4$  and  $Q5$ . These very low ohm resistors are wound from 15" lengths of #36 magnet wire on the body of a 1/2-watt resistor with a value of 10,000 ohms or greater. Solder the ends of the magnet wire to the resistor leads so that the length of wire shunts the internal resistance.

Another test to improve the fidelity of your "Bargain Page Amplifier" may be performed after it is assembled. Couple the amplifier to a 1000-cycle audio input source and a 4-ohm resistive output load. Also connect the input of an oscilloscope across the output and drive the amplifier from the 1000-cycle source until sine-wave clipping occurs. If the clipping is not symmetrical on the positive and negative portions of the waveform. Adjust  $R13$  for symmetrical clipping. If no signal generator or oscilloscope is available, adjust  $R13$  to obtain a 6-volt reading at the collector terminal of output transistor  $Q5$ .

**Using the Amplifier.** The printed circuit board may be mounted on metal or insulated standoffs and bolted to an appropriate size chassis. The small size of the amplifier and the modest power requirements make it suitable for many applications. If a power supply for 117-volt a.c. operation is not available, a power supply with zener diode regulation can be built using the parts and circuit shown at the top of this page.

The power output of the "Bargain Page Amplifier" will depend upon the speaker impedance—even though the amplifier can be used with any 4-, 8-, or 16-ohm voice coil speaker. However, the amplifier is a good match for a 4-ohm speaker. If an 8-ohm speaker is used, the maximum power output will only be 1.5 watts; and with a 16-ohm speaker, the output will be 0.75 watt maximum. Of course, you can always parallel two 8-ohm speakers for optimum output.

**WARNING:** Do not short the output connections. Do not submit the amplifier to sine-wave inputs of 10 kc. or more for over two seconds.



# What most people don't know about hi-fi kits could fill a book.

## This one. (And it's free!)

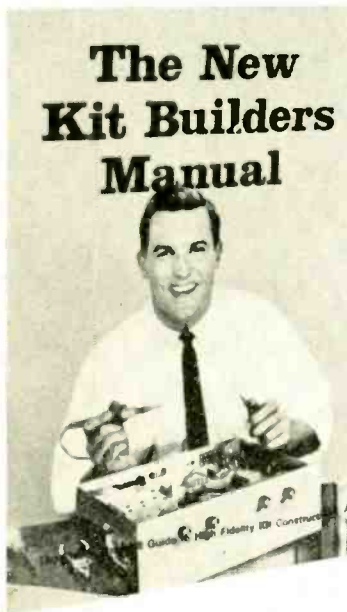

**FREE! \$1.50 VALUE! 32 PAGES!** *The New Kit Builder's Manual* is a completely new version of the authoritative Fisher guide to high-fidelity kit construction. It is new in format, twice as long in content, and contains detailed specifications of all Fisher StrataKits. Here is an introduction to kit building presented in a manner so nontechnical and lucid, even your wife will understand it. Included are comprehensive, illustrated articles on every phase of assembly, wiring and soldering. *The New Kit Builder's Manual* is the handiest tool a do-it-yourself audiophile can have: the first thing you need before investing in stereo amplifier, tuner or loudspeaker kits.

Mail this coupon today for your *free* copy of *The New Kit Builder's Manual!*

Fisher Radio Corporation 825  
11-35 45th Road, Long Island City, N.Y. 11101

Please send me *The New Kit Builder's Manual* without charge or obligation.

Name \_\_\_\_\_

Address \_\_\_\_\_

City \_\_\_\_\_

State \_\_\_\_\_

OVERSEAS RESIDENTS PLEASE WRITE TO FISHER RADIO INTERNATIONAL, INC., LONG ISLAND CITY, N.Y. 11101.

## The Fisher

CIRCLE NO. 10 ON READER SERVICE CARD



# BUILD A STEREO BAL

By DAVE GORDON

Balance  
stereo speakers  
and find  
multiplex  
broadcasts  
with \$4 indicator

**T**HE Stereo Bal is designed to solve two common hi-fi/stereo problems. The first concerns system balance. Unless your stereo speakers are fed a balanced diet of power—the same amount to each speaker—you'll get off-center sound, and musical instruments will be reproduced either with incorrect perspective or incorrect volume.

The second problem that the Stereo Bal will solve involves FM-stereo broadcasts. Very few of the early FM-stereo tuners or receivers had built-in indicators to tell you whether or not the station being received was broadcasting in stereo. And even fewer of the multiplex adapters that converted standard FM tuners to stereo were equipped with stereo indicators.

What was needed was a simple, inexpensive (under \$4), and practically fool-proof gadget that could do both those jobs—and that is how the P.E. Stereo Bal came to be.

**How It Works.** To achieve stereo reproduction, there obviously must be a difference between the signals fed to the two speakers. Let's call the signal fed to the right speaker "A" and the signal fed to the left speaker "B." Any differ-

ence between the two signals represents the stereo information and is usually referred to as the "difference" signal or the A-B signal.

If an a.c. voltmeter were connected to the speaker terminals of a stereo amplifier (from the 16-ohm tap of one to the 16-ohm tap of the other), the meter would read no voltage as long as the same signal *at the same strength* appeared across the two 16-ohm terminals. However, as soon as there was any difference between the signals coming out of the amplifiers, the meter would respond.

That explains where the difference signal comes from, but how do we use it in the Stereo Bal? Instead of an expensive, easily damaged meter, we use a step-up transformer (*T1*) to soup up the very small difference voltage sufficiently to light a neon lamp.

**Construction.** An inexpensive type of transformer that proved ideal for the soup-up job is one that normally serves as an input transformer for tube intercoms. Transformer *T1* is connected with its high-impedance side to the neon lamp. Control *R1* adjusts the sensitivity of the Stereo Bal in accordance with the loudness of the program being played.

Depending upon the type of neon-lamp pilot assembly used for *I1*, you may find that resistor *R2* is already built into the assembly and hence need not be added. As an inexpensive alternative to using a pilot-lamp assembly, you can make a socketless mounting by press-fitting an NE-2 lamp into a rubber grommet. In that case, simply solder *R2* to one lead of the lamp. Do not use an NE-51 as this lamp is quite fragile.

Parts layout is not critical. In fact, the Stereo Bal's few components can be mounted on a panel rather than in the small metal box shown in the model. The sole precaution that might be

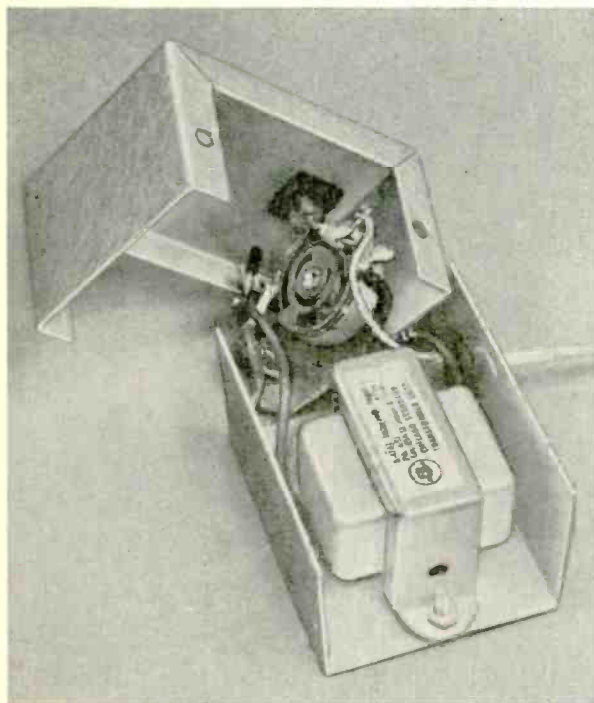
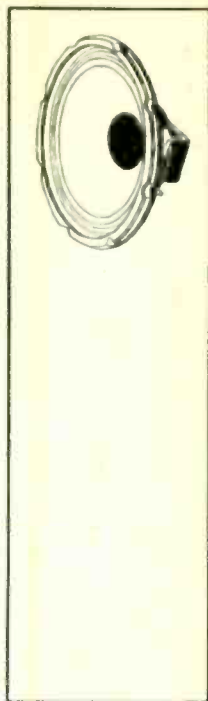

It's a tight fit, but all of the Stereo Bal components can be squeezed into a miniature aluminum box. Although the author used a small wire wound potentiometer for R1, a carbon unit could be employed.

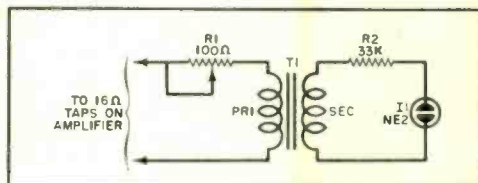

The Stereo Bal is fed from the 16-ohm output taps of each amplifier. There's no common ground return.

#### PARTS LIST

- I1—NE-2 neon lamp or neon-lamp pilot assembly—see text
- R1—75- or 100-ohm potentiometer (taper and value not critical)
- R2—33,000- or 47,000-ohm, 1/2-watt resistor—see text
- T1—Intercom input transformer, voice coil to grid (Stancor A-4744 or Thordarson 20A04)
- 1—Cabinet (Premier PMC-1000)
- Misc.—Two-conductor speaker wire to reach from Stereo Bal to amplifier, hardware, etc.

necessary is to avoid mounting *T1* too close to a power transformer or phono motor.

The leads from the Stereo Bal should be connected to the highest impedance speaker taps on your amplifier irrespective of which taps the speakers are connected to. If you are using two separate  
(Continued on page 133)



## Why We Make the Model 211 Available Now

Although there are many stereo test records on the market today, most critical checks on existing test records have to be made with expensive test equipment.

Realizing this, HiFi/STEREO REVIEW decided to produce a record that allows you to check your stereo rig, accurately and completely, just by listening! A record that would be precise enough for technicians to use in the laboratory—and versatile enough for you to use in your home.

The result: the HiFi/STEREO REVIEW Model 211 Stereo Test Record!

## Stereo Checks That Can Be Made With the Model 211

- ✓ Frequency response — a direct check of eighteen sections of the frequency spectrum, from 20 to 20,000 cps.
- ✓ Pickup tracking — the most sensitive tests ever available to the amateur for checking cartridge, stylus, and tone arm.
- ✓ Hum and rumble — foolproof tests that help you evaluate the actual audible levels of rumble and hum in your system.
- ✓ Flutter—a test to check whether your turntable's flutter is low, moderate, or high.
- ✓ Channel balance — two white-noise signals that allow you to match your system's stereo channels for level and tonal characteristics.
- ✓ Separation—an ingenious means of checking the stereo separation at seven different parts of the musical spectrum—from mid-bass to high treble.

- ALSO:** ✓ Stereo Spread  
 ✓ Speaker Phasing  
 ✓ Channel Identification

## PLUS SUPER FIDELITY MUSIC!

The non-test side of this record consists of music recorded directly on the master disc, without going through the usual tape process. It's a superb demonstration of flawless recording technique. A demonstration that will amaze and entertain you and your friends.

# NOW...GET THE FINEST STEREO TEST RECORD ever produced for just ...\$4.98

## Featuring Tests Never Before Available To The Hobbyist

### UNIQUE FEATURES OF HiFi/STEREO REVIEW'S MODEL 211 STEREO TEST RECORD

- Warble tones to minimize the distorting effects of room acoustics when making frequency-response checks.
- White-noise signals to allow the stereo channels to be matched in level and in tonal characteristics.
- Four specially designed tests to check distortion in stereo cartridges.
- Open-air recording of moving snare drums to minimize reverberation when checking stereo spread.

## All Tests Can Be Made By Ear

HiFi/STEREO REVIEW'S Model 211 Stereo Test Record will give you immediate answers to all of the questions you have about your stereo system. It's the most complete test record of its kind—contains the widest range of check-points ever included on one test disc! And you need no expensive test equipment. All checks can be made by ear!

*Note to professionals: The Model 211 can be used as a highly efficient design and measurement tool. Recorded levels, frequencies, etc. have been controlled to very close tolerances — affording accurate numerical evaluation when used with test instruments.*

## DON'T MISS OUT—ORDER NOW

The Model 211 Stereo Test Record is a disc that has set the new standard for stereo test recording. There is an overwhelming demand for this record and orders will be filled by POPULAR ELECTRONICS promptly upon receipt. At the low price of \$4.98, this is a value you won't want to miss. Make sure you fill in and mail the coupon together with your check (\$4.98 per record) today.

### FILL IN AND MAIL TODAY!

Stereo Test Record N  
 Popular Electronics—Dept. SD  
 One Park Ave., New York 16, N.Y.

Please send me \_\_\_\_\_ test records at \$4.98 each. My check (or money order) for \$\_\_\_\_\_ is enclosed. I understand that you will pay the postage. (Orders from outside the U.S.A. add 50c to partially defray postage and handling costs.) N.Y.C. residents please add 5% sales tax. N.Y. State residents 2% sales tax.

Name \_\_\_\_\_ (Please Print)

Address \_\_\_\_\_

City \_\_\_\_\_ Zone \_\_\_\_\_ State \_\_\_\_\_

Sorry—No charges or C.O.D. orders! EEH-66

# CHAPTER

3

## RADIO CONTROL PROJECTS

*The two articles in this chapter were written to take the mystery out of radio control circuitry. Both the transmitter and receiver are transistorized and have been designed for printed circuit board construction. Your editors believe that use of printed circuit boards is mandatory to insure faultless operation.*

*Construction of these two projects will give the builder a good idea of how radio control works and will probably suggest many uses for it other than models or garage door openers.*

*In the Fall 1966 issue of this HANDBOOK, your Editors will present several Science Fair projects instead of R/C projects.*

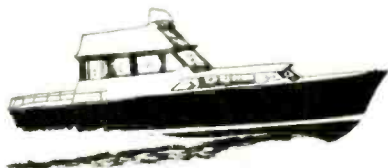
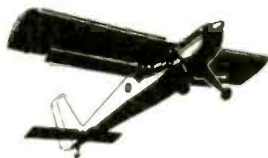

## BUILD A MINIATURE R/CEIVER

By DANIEL MEYER

**You can control models and other gadgets on land, at sea, or in the air, with this 1½-ounce, three-transistor receiver**

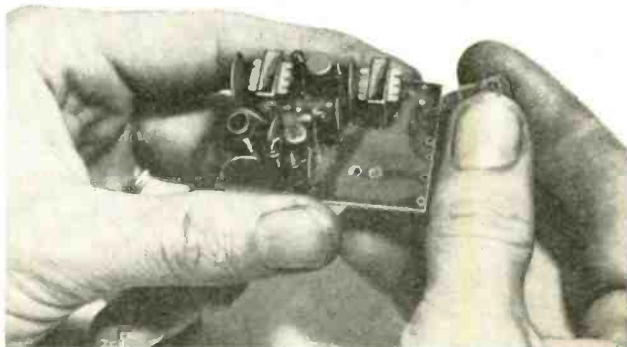

**L**ESS THAN half the size of a package of cigarettes, this lightweight, three-transistor radio-control receiver can be used in cars, boats, and in the home. It's suitable for remote operation of toys, models, garage doors, or any other control application you might have. The receiver circuitry contains a sensitive superregenerative detector, a tone-modulated selector, and a relay in the output. Its small size is made possible by the use of transistors and a printed circuit board—which allows quick assembly of components.

The R/Ceiver is operated by a 600- to 800-cycle tone-modulated carrier on the 27-mc. remote-control channels. This type of operation makes it possible to use the rather broad tuning superregenerative detector without interference problems. Voice modulation even on the same channel will almost never energize the receiver relay. A continuous tone in the proper frequency range must be received before the relay will operate.

The sensitive relay is isolated from the receiver circuits and can be connected to anything you want to control as long as the 0.5-amp., 50-volt rating of the relay contacts is not exceeded.

**How It Works.** Transistor *Q1* acts as a superregenerative detector, which oscillates at a frequency determined by tuned circuit *L1* and *C4*. Oscillation is quenched (cut off) at an ultrasonic rate, which is determined by the values of the base bias and emitter resistors and their associated bypass capacitors (*R2*,

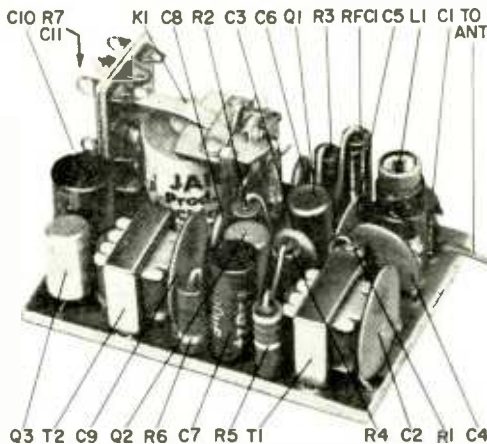

Printed circuit board permits upended parts layout to provide a compact layout with adequate space for all components. Photo is actual size. Resistor *R7* and capacitor *C11* are shown in detail drawing below.

*R3*, *C3* and *C6*). Capacitor *C5*, connected to the emitter and collector of *Q1*, provides the feedback needed to sustain oscillation.

The antenna is loosely coupled to the tuned circuit by *C1*. The loose coupling reduces antenna loading effects on the tuned circuit. Capacitor *C2* filters out the r.f. carrier and quench signals, and leaves just the detected tone modulation across the primary of *T1*.

The tone signal is transformer-coupled to the base of audio amplifier *Q2*. Transformer *T2* delivers the signal from the collector of *Q2* to the base of *Q3*. Transistor *Q3* conducts in the presence of



Flexible wire connected between the external components and relay board will prevent breakage due to vibration. Shock-mount unit with foam rubber.

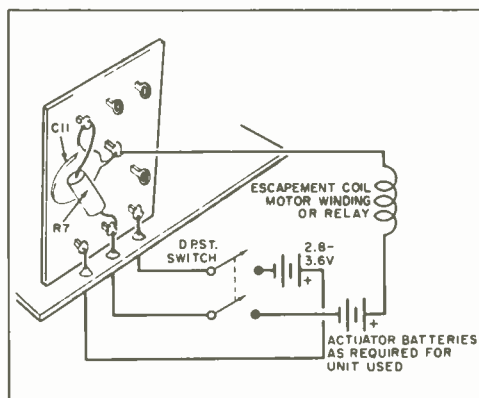

Detail drawing shows location and connection of *R7* and *C11*, as well as how to hook up external circuit. Do not exceed current rating of relay contacts.

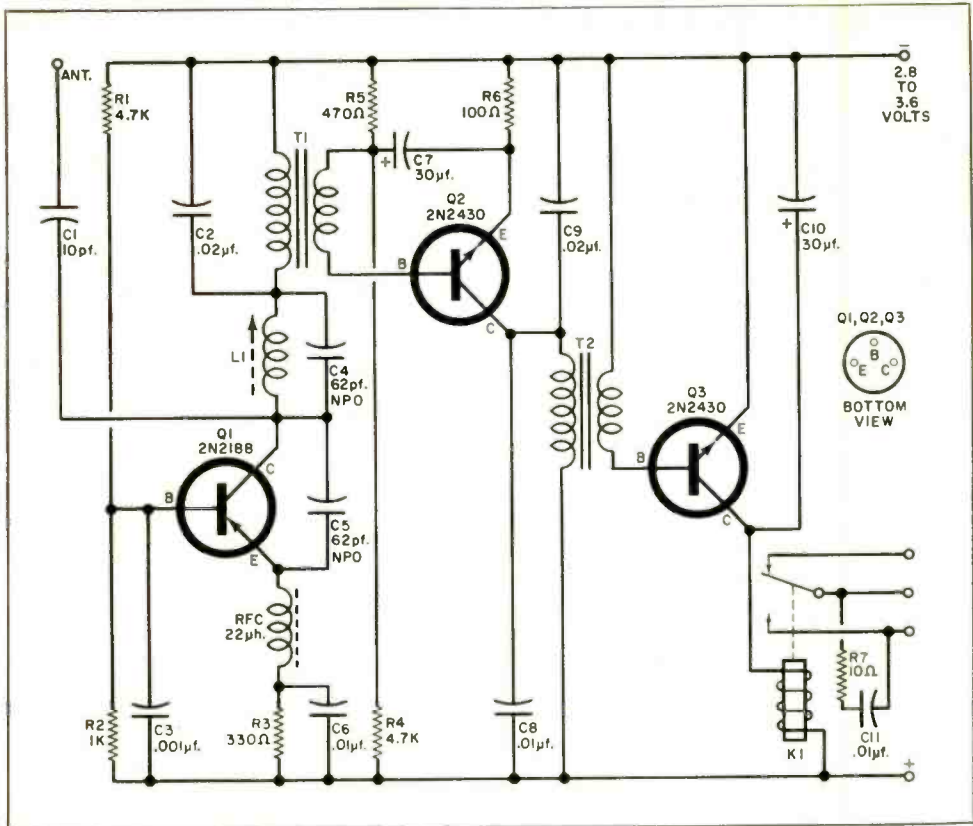

Transistor Q1 is part of a sensitive superregenerative detector which demodulates a tone-modulated control signal. The tone burst only is then amplified by Q2 and passed on to Q3 to activate the relay.

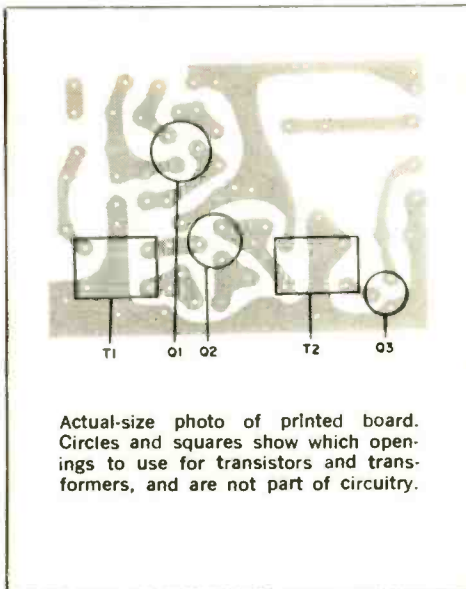

Actual-size photo of printed board. Circles and squares show which openings to use for transistors and transformers, and are not part of circuitry.

## PARTS LIST

- C1—10-pf. ceramic capacitor
- C2, C9—0.02-μf., 50-volt ceramic capacitor
- C3—0.001-μf. ceramic capacitor
- C4, C5—62-pf., NPO ceramic capacitor
- C6, C8, C11—0.01-μf., 50-volt ceramic capacitor
- C7, C10—30-μf., 15-volt electrolytic capacitor
- K1—100-ohm sensitive relay (Jaico Products Co., Chicago, or equivalent)\*
- L1—7¼ turns of #26 enameled wire on 0.20"-diameter coil form, with powdered iron tuning core\*
- Q1—2N2188 transistor
- Q2, Q3—2N2430 transistor
- R1, R4—4700-ohm, ½-watt resistor
- R2—1000-ohm, ½-watt resistor
- R3—330-ohm, ½-watt resistor
- R5—470-ohm, ½-watt resistor
- R6—100-ohm, ½-watt resistor
- R7—10-ohm, ⅛-watt resistor
- RFC1—22-μh. r.f. choke\*
- T1, T2—Miniature interstage transformer: primary, 10,000 ohms; secondary, 2000 ohms\*
- 1—Printed circuit board\*

\*A set of parts consisting of a predrilled printed circuit board, T1, T2, L1, RFC1, and K1 is available for \$9 pp. from Daniel Meyer, Box 16041, San Antonio, Texas 78216

the tone signal, specifically the positive half cycles, and energizes the relay (*K1*).

**Construction.** Use of a printed circuit fiberglass board makes the receiver very rugged and compact, and easy to build. Start construction by mounting the transformers. Be careful not to pull the leads out of the transformers or to cut the wires when stripping the insulation. The blue and red leads are the primary side and should be installed in the transformer lead holes next to *C2* and *C9*. Bend the tabs on the transformer brackets to grip the board.

Next, install the tuning coil (*L1*) and the r.f. choke (*RFC1*). Do not use too much force on the coil, to avoid pulling the lugs out of the coil form. Install the three transistors, making sure that the leads are in the correct holes. Basing for all three transistors is shown on the schematic. Some transistors have a red dot next to the collector lead.

Now install the capacitors and observe polarity, particularly for *C7* and *C10*. Install the resistors and mount the relay. The relay coil is connected to the holes in the board with short pieces of bare wire.

Bend all component leads to grip the board, and trim. Solder all connections and avoid bridging adjacent conductors.

The antenna lead can be any piece of wire 18 inches or longer. Use of lightweight wire on the order of No. 26 AWG to interconnect the receiver to external components will keep the wiring bundle small and flexible and better able to withstand vibration. Mount the receiver in a small plastic box to prevent dust from getting into the relay.

Almost any type of actuator used with this receiver will require an arc suppression network to protect the relay contacts. This network consists simply of a 10-ohm resistor (*R7*) and a 0.01- $\mu$ f. capacitor (*C11*) across the relay points.

**Using the R/Ceiver.** If the R/Ceiver is to be used in a model airplane, it should be shock-mounted with foam or rubber material. There are many types of actuators available for use in model airplanes, cars and boats. Airborne actuators are usually of the rubber-band powered escapement type and are light in weight. Motor-driven types are generally used in cars or boats where more

power is needed and weight is not a problem.

Self-neutralizing types of actuators provide alternate right and left control. Compound types provide right-side control on the first burst of tone signal, left with the second, and motor control with the third. This makes it unnecessary to remember what the last control position is. You just press the transmitter key once for right, twice for left, or three times for motor. The mechanism cycles back to neutral when the tone signal stops.

If the R/Ceiver is to be used for garage door operation or some other application requiring maximum security, cut down the size of the antenna. The receiver should not be allowed to pick up any signals that are weaker than your own weakest signal. You can make this adjustment by transmitting a signal at maximum range, then trimming the antenna and increasing the relay spring tension until the receiver will just operate.

**Final Adjustments.** The receiver needs 2.8 to 3.6 volts to operate. Two standard 1.5-volt cells in series can be used. (A separate power supply should be employed for the device being controlled.)

To check out the receiver, connect the batteries and put a weak signal on the air from your transmitter, or from a signal generator tuned to the proper frequency. The signal is amplitude (600- to 800-cycle) tone-modulated at a frequency within the range of 26.995 to 27.255 mc., in conformance with proper Class C operation. Modulation should be at least 85%.

Tune *L1* until the relay pulls in. Use a fiber or plastic-tip tuning tool to avoid loading and detuning effects. As you rotate the core into the coil, count the number of turns from the point where the relay first pulled in to the point where the relay drops out. Back up the core to a mid position, half the number of turns you counted.

It is very important to use a weak signal when tuning. If the signal is too strong, the tuning range will seem to be very broad, and it will be hard to find the best core setting. An alternate method of tuning is to connect a high-impedance phone across the secondary of *T2* and tune for the loudest tone. -50-



# R/C TRANSMITTER

By DANIEL MEYER

*Transmitter sends  
tone-modulated  
signals up to 1 mile  
to energize  
miniature R/Ceiver*



**T**HIS TRANSMITTER is designed to operate with the miniature R/Ceiver described on pages 79-82. It can also activate any other receiver using tone-modulated signals in the Citizens Band, and can be operated without a license under Part 15.205 of the FCC Regulations. Transmitter output is approximately 90 milliwatts, more than enough to control a model up to one mile, line of sight, with the proper receiver.

The unit is powered by a 9-volt battery, and up to 20 hours of operation can be had with a No. 276 Eveready battery or equivalent. Weight of the complete transmitter including battery is a trifle over 1½ pounds. Cost of parts should not be more than \$10 to \$12.

**Construction.** Thanks to the availability of a special printed circuit board and pre-wound coils, construction is easy. The parts are mounted in the positions indicated by the part numbers printed on the top side of the printed circuit board. (See Figs. 1 and 2.)

The primary side of coil *L1*, indicated by a red dot, should be installed next to capacitor *C2*. Coil *L2*'s connections are between point *B* and *RFC1*. When installing the coils, be careful not to apply too much pressure on the lugs. Work

the lugs into the holes slowly, by rocking the form as it is pushed down. Rough handling can break the lugs loose from the coil form base.

After all parts are installed, bend the leads flush to the foil side of the board and cut them off so that they do not bridge any gaps between conductors. Solder the leads to the etched foil with a 25- to 50-watt iron. Use only rosin-core solder. Heat the lead being soldered and the foil at the same time and let the solder flow onto the connection. Avoid excess heat: it can cause the foil to separate from the board.

Drill out all the openings in the metal cabinet as shown in Fig. 4. Use a file to square off the opening for the switch. And use a wooden block behind the metal to prevent distorting the case when drilling or filing. The prototype transmitter is covered with a white self-adhesive vinyl plastic sheet.

Mount the rubber feet, switches, threaded spacers and antenna post as shown in Fig. 4. The antenna post is an 8-32 x 1/2" panhead machine screw. It should be installed with a fiber shoulder washer on one side and a flat fiber washer on the other side of the metal

to insulate the antenna from the case. Don't forget the solder lug between the head of the antenna screw and the fiber washer. Then wire in the battery clip and other leads.

Mount the circuit board on the two threaded spacers with 6-32 x 1/4" machine screws as shown in Fig. 5. Connect the wires from the antenna, switches, and battery to points A, B, C and D as indicated on the board.

**How It Works.** Transistor Q1 acts as a crystal-controlled oscillator operating on the channel determined by the crystal. Coil L1 and capacitor C2 form a resonant circuit at the crystal frequency. The crystal provides a feedback path from the collector to the base of Q1. Resistors R1 and R2 establish the bias at the base of Q1. Capacitors C1 and C3 bypass r.f., as shown in Fig. 6.

The output stage (Q2) operates as a Class C amplifier. The base is link-coupled by L1, and resistor R4 limits the current through Q2 to a safe value. Collector voltage is obtained by way of T1 and the r.f. choke. The tuned output stage consists of L2 and stray antenna capacitance connected in series; this has a bearing on antenna resonance.

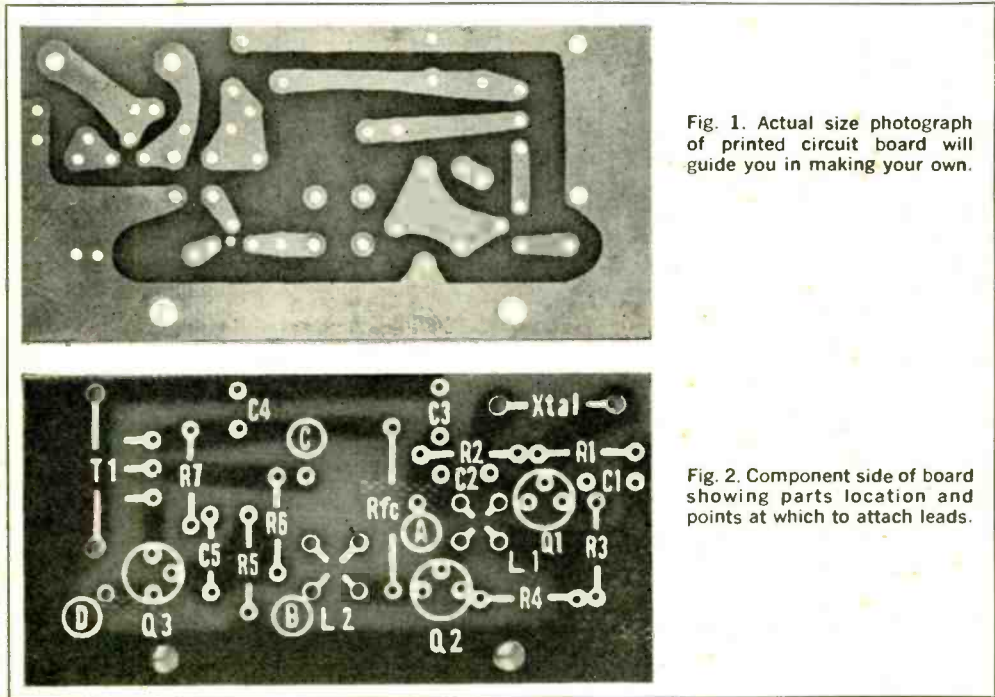

Fig. 1. Actual size photograph of printed circuit board will guide you in making your own.

Fig. 2. Component side of board showing parts location and points at which to attach leads.

The tone generator stage (*Q3*) is an audio power oscillator. The auto-transformer (*T1*) provides feedback to the transistor base by way of *R7* and *C5*. Capacitor *C4* acts as an r.f. bypass. The emitter of *Q3* is connected to the *Tone* switch. Closing this switch completes the emitter circuit and operates the tone oscillator.

**Tuning the Transmitter.** The transmitter can be tuned with a field strength

meter, or if one is not available, with a tuning meter you can easily make. The circuit is shown in Fig. 7.

The field strength meter can be loosely coupled to the transmitter circuit, while the less sensitive tuning meter would have to be connected to the antenna. You may or may not get a reading on the meter when the transmitter is turned on for the first time. If no reading is noted, turn the core in coil *L1* until you do get a maximum reading. Use a non-metallic tuning tool to make adjustments.

If everything is working normally, the output should reach a maximum and then suddenly drop to zero as you rotate the core. When this happens, return the core to a point a bit less than maximum. If you attempt to peak the oscillator, it will probably refuse to start after the power is turned off and then turned on. Then tune coil *L2* for maximum output.

All adjustments should be made while you are holding the case. Your body is part of the antenna circuit on this type of transmitter and adjustments must be made under in-use conditions.

After adjusting the coils, press switch *S2*. If the meter reading drops slightly

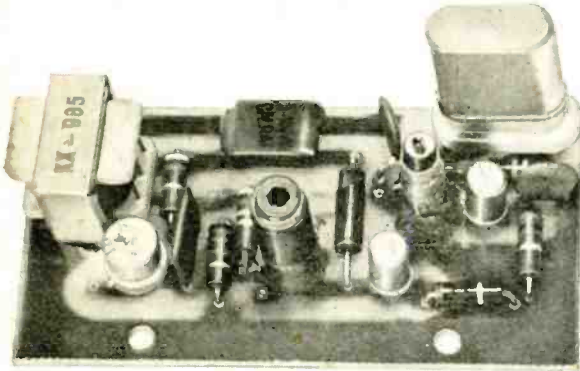

Fig. 3. Parts mounted on board, including crystal holder. Leave  $1/16''$  air space under transistors. Connect leads to board before installing in cabinet.

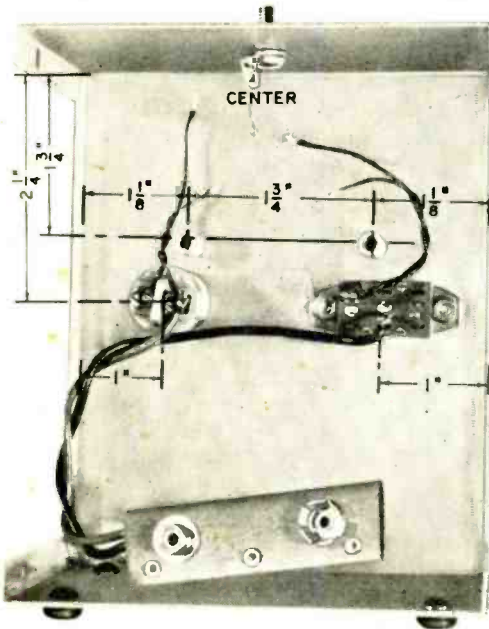

Fig. 4. Prepare cabinet and mount parts as shown before installing completed board. Note terminal located between screw and washer on antenna post.

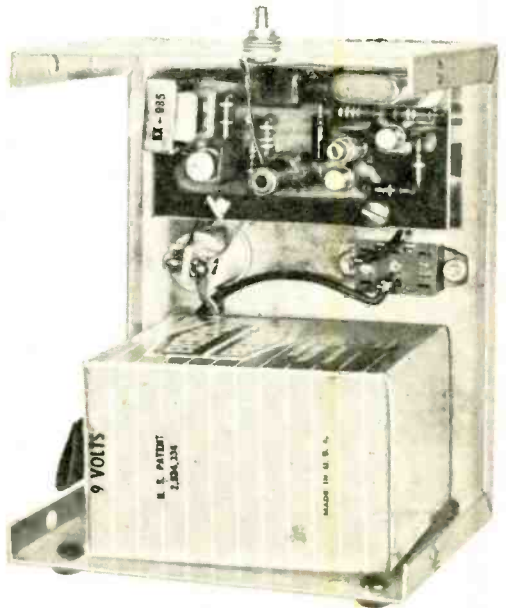

Fig. 5. After installing the board and battery, cement a piece of  $1/2''$ -thick foam rubber to the inside of the cover to hold the battery in place.

**THE MOST COMPLETE  
AND UP-TO-DATE GUIDE  
TO THE EXCITING WORLD  
OF SPECIALIZED RADIO  
COMMUNICATIONS!**

ONLY \$1.25



**4  
FACT-PACKED SECTIONS**

**Short Wave Listening  
Amateur Radio  
Citizens Radio Service  
Business Radio Service**

**148 PAGES . . .**

All-new and better than ever, the 1966 COMMUNICATIONS HANDBOOK brings you exclusive information on such vital subjects as getting started in SWL—buying equipment and station reporting; establishing your CB station, public service activities; ham license applications procedures, learning the code; typical business radio installations . . .

PLUS a special nation-wide listing of 250 amateur radio clubs offering code and theory courses and a roster of 400 CB clubs—both lists available nowhere else!

. . . and much, much more. Everything you need to know about your specialty is covered by a leading authority in the field—from basic instruction for the beginner through the most advanced data and techniques.

Complete with charts, tables and illustrations galore, it's a big, valuable "encyclopedia" of communications information you'll use all year long.

Just what you've been looking for? Then clip the handy coupon below and send for your copy today!



**GET THE EXQUISITE  
LEATHERFLEX-<sup>®</sup>  
BOUND EDITION**  
*for just \$3 POSTPAID!*

The 1966 COMMUNICATIONS HANDBOOK is now available in an attractive, gold-embossed, Leatherflex-bound edition—a superb addition to your library of permanent reference books. This deluxe volume will be mailed to your home, **postpaid**, for just \$3.00, when you check the appropriate box on the order form.

Ziff-Davis Service Division • Dept. CH  
589 Broadway • N.Y., N.Y. 10012  
**YES!** Send me a copy of the 1966 COMMUNICATIONS HANDBOOK, as checked below:

- \$1.25 enclosed, plus 15¢ for shipping and handling. Send me the regular edition. (\$1.50 for orders outside the U.S.A.)
- \$3.00 enclosed. Send me the Deluxe Leatherflex-bound edition, **postpaid**. (\$3.75 for orders outside the U.S.A.) Allow three additional weeks for delivery.

NAME \_\_\_\_\_ EEH 66

ADDRESS \_\_\_\_\_

CITY \_\_\_\_\_ STATE \_\_\_\_\_ ZIP CODE \_\_\_\_\_

**PAYMENT MUST BE ENCLOSED WITH ORDER.**

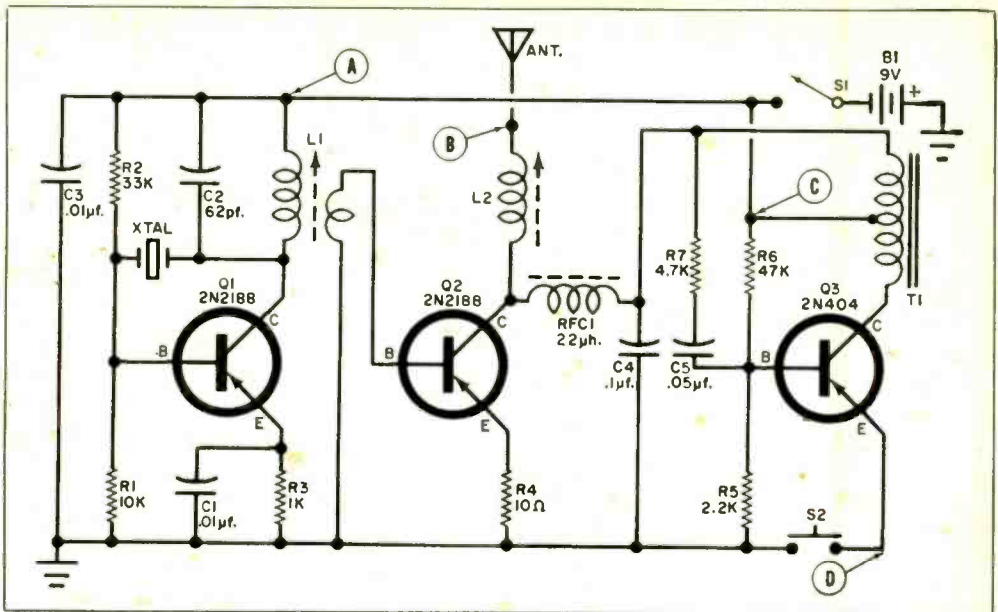

Fig. 6. Signals from the crystal-controlled oscillator (Q1) are modulated by tone generator (Q3) and boosted by the amplifier (Q2) for transmission.

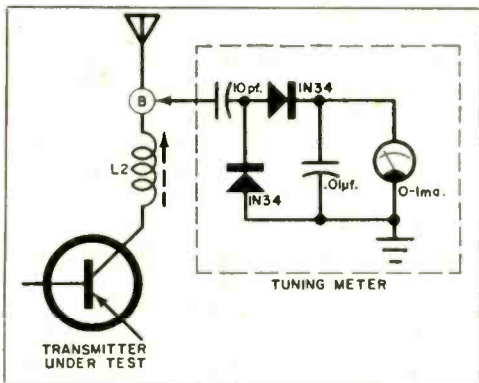

Fig. 7. Tuning meter can be easily made to align and check transmitter. Loosely couple or attach the meter to the antenna to get a usable reading.

the audio oscillator is probably working. This can be confirmed with a CB receiver if one is available.

**Operation.** Extend the antenna all the way, turn on the switch, and press the *Tone* button. Reduced antenna length will reduce the output. Check the battery periodically. If the battery voltage drops below 8 volts with the transmitter and the tone oscillator on, replace the battery.

### PARTS LIST

- B1—9-volt battery (Eveready 276 or equivalent)
- C1, C3—0.01-µf., 50-volt ceramic capacitor
- C2—62-pf., NPO ceramic capacitor
- C4—0.1-µf., 50-volt ceramic capacitor
- C5—0.05-µf., 50-volt ceramic capacitor
- L1—Oscillator coil: primary, 12 turns of #26 magnet wire on 3/16" coil form with tuning core (Lafayette 34 G 8772 or equivalent); secondary, 3 turns of #26 magnet wire, bifilar wound, starting with third primary winding from the bottom end of the coil form and working down\*
- L2—Tuned output coil: 25 turns of #26 magnet wire on 1/4" coil form with tuning core (Lafayette 34 G 8952 or equivalent)\*
- Q1, Q2—2N2188 transistor
- Q3—2N404 transistor
- R1—10,000 ohms
- R2—33,000 ohms
- R3—1,000 ohms
- R4—10 ohms
- R5—2,200 ohms
- R6—47,000 ohms
- R7—4,700 ohms
- RFC1—22-µh. r.f. choke\*
- S1—S.p.s.t. slide switch
- S2—Normally open push-button switch
- T1—1,600-ohm, center-tapped autotransformer\*\*
- Xtal—Third-overtone Citizens Band type crystal, 0.005% tolerance (any frequency within specified band)
- 1—52" telescoping whip antenna (Lafayette 99 G 3008 or equivalent)
- 1—3" x 4" x 5" aluminum box (Bud 2105 or equivalent)
- 1—Printed circuit board\*

All resistors  
1/2 watt, ± 10%

\*A set of parts consisting of the printed circuit board, T1, RFC1, and wound coils L1 and L2 is available from Daniel Meyer, Box 16041, San Antonio, Texas 78216 for \$5.00.

\*\*Available separately from Daniel Meyer for \$1.00.

# Hy-gain COMMUNICATIONS ANTENNAS

... where all **BIG** signals come from!

## High Frequency Antennas For 10 Thru 80 Meters

Anywhere in the world you want to talk, there's a Hy-Gain antenna designed to provide you with maximum performance from your Amateur Radio equipment. Automatic Band Switching Verticals—Duo-Beams—Tri-Bander Beams—Multi-Band Trap Doublets—Famous "Topper" Mobile Whips PLUS many, many more ranging from standard ground planes to the incomparable DX "Long John" optimum spaced beams for the Ham who wants the whole world at his fingertips. All pictured and described in Hy-Gain's FREE 16-page Catalog No. 200

## VHF Antennas For 6 and 2 Meters

For maximum performance across town or using moon bounce, Hy-Gain VHF antennas will deliver the strongest signals for you. Gain Ground Planes—Gain Stacked Jay-Poles—Mono-Band Beams—Base Station and Mobile Halos—Duo-Band Beams—Duo-Band Mobile Whips—and, a host of others. All pictured and completely described in Hy-Gain's FREE 16-page Catalog No. 100.

## Base Station and Mobile Antennas for CITIZENS BAND

**Fabulous New Directional Duo-Beams**—Deliver up to 120 watts "Talk Power"—Effectively block off signals from the side and back—Rotate to concentrate maximum power with pinpoint accuracy 360° on the compass—Guaranteed to out-perform any other base station antenna for Citizens Band. Three models to choose from...all pictured and fully described with important comparison data in Hy-Gain's FREE Catalog No. 13.

**World Famous CLR2**—Delivers all-directional "Talk-Power" of 12.55 watts—Keeps you constantly alert to signals from all directions surrounding your station—Has  $\frac{3}{8}$  wavelength radiator acknowledged as essential for maximum efficiency—Guaranteed to out-perform any other all-directional antenna for Citizens Band. Completely described with important comparison data in Hy-Gain's FREE Catalog No. 16.

**Pace Setting Mobile "Toppers"**—Roof Mounts, Trunk Mounts, Fender Mounts, Cowl Mounts, Marine Mounts, AM-CB combinations. All models guaranteed to out-perform any other mobile antenna of comparable length and mount. Each model pictured and fully described with important comparison data in Hy-Gain's FREE Catalog No. 15.

## Short Wave Listener Antennas

Precision engineered and tuned antennas designed to provide maximum short wave listening enjoyment on all of the popular bands from 1.8 thru 30 mc. Two popular models to choose from for world-wide performance...one for outdoor or attic installation...one for window sill or portable applications where space is a factor. Both models completely described in Hy-Gain's FREE Catalog No. 20.



**Hy-gain ELECTRONICS CORPORATION**  
8575 N.E. Highway 6 — Lincoln, Nebraska 68501

Rush the following literature to me:

- HF Catalog No. 200     "Topper" Catalog No. 15     CLR2 Catalog No. 16  
 Duo-Beam Catalog No. 13     VHF Catalog No. 100     SWL Catalog No. 20

NAME \_\_\_\_\_

ADDRESS \_\_\_\_\_

CITY \_\_\_\_\_

STATE \_\_\_\_\_

ZIP \_\_\_\_\_

### SEND COUPON TODAY

Indicate the material you wish to receive—or, contact your Hy-Gain distributor!

*The World's Largest  
Manufacturer of  
Communications Antennas*

# CHAPTER

4

## COMMUNICATIONS SWL CB HAM

*There's a very definite 2-meter ham band tone to this chapter. It is by no means accidental; rather, it was arranged by intent so that the article describing W8VVD's 144-mc. transmitter would be supplemented by suitable ideas on antennas.*

*For local work, try the "Stacked Halos" (page 103). For modest DX'ing, the "Swiss Quad" (page 104), a distant relative of the famous Cubical Quad, is worth an afternoon's construction. Another ham, W6FPO, presents some very interesting experimental broadcast-band DX'ing antennas (page 101).*

*The avid builder who likes to "roll his own" should try the "Miniature Receiver" (page 97) built around the J.W. Miller ceramic i.f. module. The "Auto Light Minder" was slipped into this chapter at the last moment—simply to fill out the page; it really belongs under the Chapter 1 heading.*

90	THE PARAGON 144 .....	Hartland B. Smith, W8VVD
97	MINIATURE I.F. MODULE SUPERHETERODYNE POCKET RECEIVER .....	Charles Caringella
101	COMPACT BCB DX ANTENNAS .....	F. J. Bauer, Jr., W6FPO
103	2 HALOS STACKED FOR 2 METERS .....	Bob Sargent, WA066I
104	144-MC. SWISS QUAD ANTENNA .....	Herbert S. Brier, W9EGQ
106	MARINE BAND WAVEMETER .....	E. H. Marriner, W6BLZ
107	SIMPLE AUTO LIGHT MINDER .....	R. L. Winklepleck

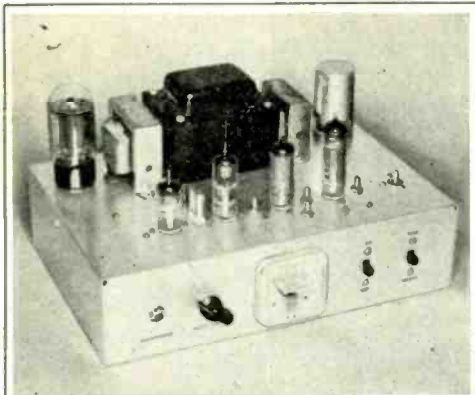

## BUILD THE PARAGON 144

Would you like to  
put a truly effective phone  
signal on 2 meters?  
Here's a little rig that's  
ideally suited for  
Novice, Technician, or General

By HARTLAND B. SMITH, W8VVD

WHETHER you're a Novice weary of pounding brass, a Technician fed up with 6-meter TVI complaints, or a General tired of ear-shattering QRM, there's an answer to your problem: 2-meter phone. Even if you don't live in an area where there's much 2-meter activity, it will pay you to keep a 2-meter rig on the shelf just to take advantage of VHF band openings, and possibly the satellite repeater capabilities of OSCAR III and other ham satellites to follow.

As long as you're going to give 2 meters a whirl, you'll want a transmitter that radiates a truly effective signal. The "Paragon 144," rated at 20 watts input on AM phone, has been designed to do just that. Thanks to its relatively simple circuitry, straightforward parts layout and ease of adjustment, any

reader who can drill, file, saw and solder will have little difficulty in putting it on the air.

**The Circuit.** Referring to the schematic on page 93, *V1a*, a triode oscillator, utilizes third-overtone crystals cut for about 36 mc. Pentode *V1b* doubles the oscillator frequency to around 72 mc.; *V2* serves as a second doubler, boosting the frequency to 144 mc. An Amperex 6360 twin-tetrode, *V3*, is used as a self-neutralized push-pull final power amplifier.

Audio from the microphone is amplified by *V4a* and *V4b* and is then applied to the grid of the Class A Heising modulator, *V5*. An ordinary filter choke, rather than an expensive modulation transformer, superimposes audio from the modulator onto the d.c. power fed to the final amplifier.

An 0-5 ma. meter (*M1*) may be clipped across a number of different shunt resistors to indicate final plate current, final grid current, and the plate currents of either the first or second doubler. (These test points are indicated on the schematic as "TP1," "TP2" etc.) Silicon diodes *D1* through *D6* serve as power supply rectifiers.

**Chassis Preparation.** Long leads and haphazard parts placement cannot be tolerated in a 2-meter transmitter: carefully follow the layout diagrammed in Fig. 1 and Fig. 2. The 3" x 8" x 12" chassis should be of aluminum rather than steel—aluminum is easier to work and exhibits better conductivity than steel.

Before mounting the tube sockets, study Fig. 3 to make certain the pins are correctly oriented. The rotor of *C13* is hot with r.f., so it cannot be fastened directly to the chassis. Cut a 3/4" x 1 1/4" piece of insulation from a sheet of 1/16" polystyrene or Bakelite. Mount *C13* in a hole drilled at the center of the insulator and then fasten the insulator to the chassis as shown in Fig. 7. Make certain the 3/8" nut on the threaded shaft bushing of *C13* clears the edges of the 1/2" chassis hole (see Fig. 5) through which it protrudes.

**Wiring.** Wire the heaters first. Cut the green-yellow transformer wire to a length of about an inch and tape the end to prevent it from shorting against another wire or component. Ground one green wire to the mounting foot of the 4-



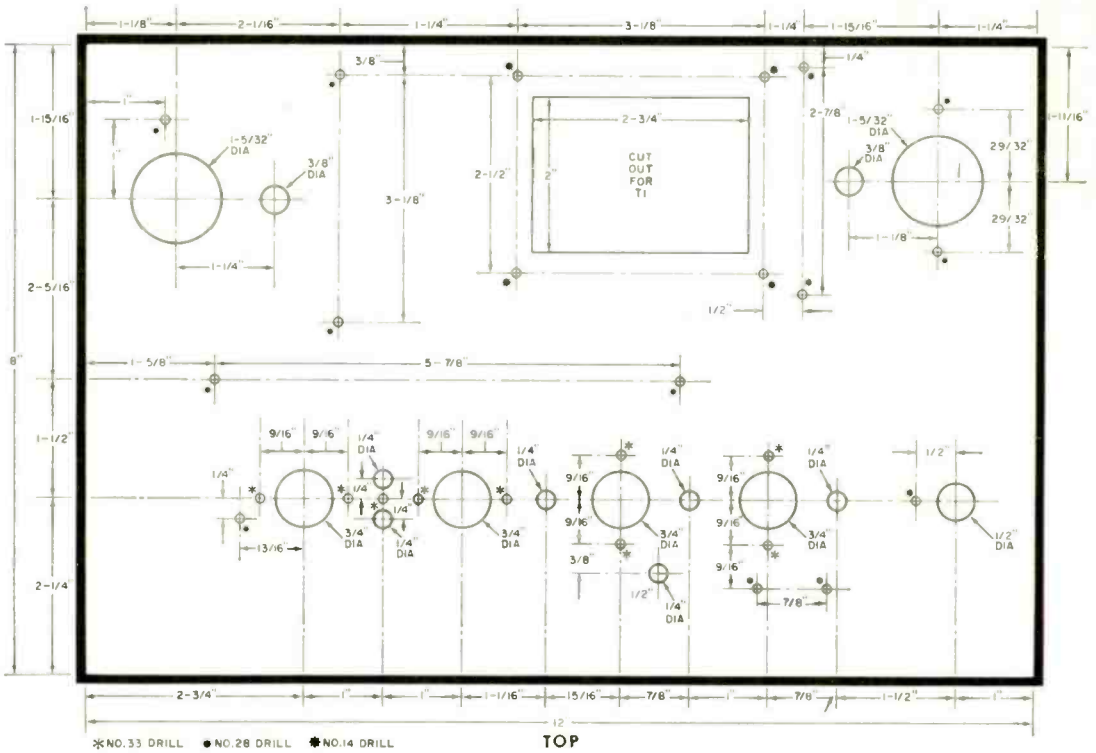

Fig. 1. Diagram shows cutouts, mounting holes in top of chassis. At front, from left to right, are V4, V1, V2, V3. Large hole at top left is for mounting V5; opposite are cutouts for T1 and for capacitor C25.

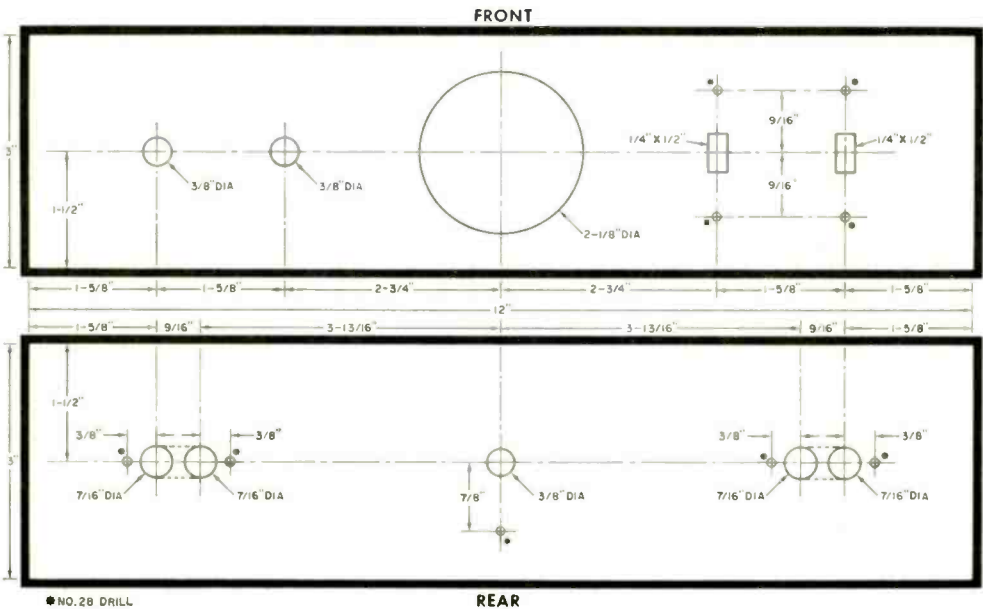

Fig. 2. Cutouts in front panel are (left to right) for mike jack, audio gain control, meter, on-off switch, and send-receive switch. Those on the rear are for mounting TS1, the a.c. line cord, and TS2.

## PARTS LIST

- C1—10-pf., 1000-volt NPO ceramic disc capacitor (Sprague Series 10TCC, Type Q10, or equivalent)  
 C2, C4, C6, C8, C10, C21, C22, C23, C24—0.001- $\mu$ f., 1000-volt ceramic disc capacitor  
 C3, C7—25-pf., 1000-volt NPO ceramic disc capacitor (Sprague Series 10TCC, Type Q25, or equiv.)  
 C5—8-7.18 pf. miniature variable capacitor (E. F. Johnson Type 160-104 or equivalent)  
 C9—14.2-2.3 pf. miniature variable capacitor (E. F. Johnson Type 160-107 or equivalent)  
 C11, C12—8-2.2 pf. miniature variable butterfly capacitor (E. F. Johnson Type 160-208 or equiv.)  
 C13—32.3 pf. miniature variable capacitor (E. F. Johnson Type 160-130 or equivalent)  
 C14—16- $\mu$ f., 150-volt electrolytic capacitor  
 C15, C16, C17, C18, C19, C20, C28, C30—0.01- $\mu$ f., 1000-volt disc ceramic capacitor  
 C25—40/40/20- $\mu$ f., 450/450/25-volt electrolytic  
 C26, C29—150-pf., 1000-volt disc ceramic capacitor  
 C27—10/10- $\mu$ f., 450/450-volt electrolytic capacitor  
 D1, D2, D3, D4, D5, D6—750-ma., 400-PIV silicon diode (Lafayette Radio 19G5001 or equivalent)  
 J1—Standard open-circuit phone jack  
 L1—11 turns of #20 bare wire, spaced diameter of wire, on a  $\frac{3}{8}$ " x  $1\frac{1}{8}$ " phenolic slug-tuned coil form (J. W. Miller 21A000RBI coil form, available from Allied Electronics, Stock No. 63G909, @ 64 cents)  
 L2—4 turns of #20 tinned wire,  $\frac{1}{2}$ " diameter, turns spaced  $\frac{1}{8}$ ";  $\frac{1}{2}$ " leads  
 L3—4 turns of #20 tinned wire,  $\frac{1}{2}$ " diameter, turns spaced  $\frac{1}{8}$ "; 1" leads; coil tapped one turn from C9 end  
 L4—2 turns of #20 tinned wire,  $\frac{1}{2}$ " diameter, turns spaced  $\frac{1}{8}$ "; 1" leads; coil tapped at midpoint  
 L5—6 turns of #12 bare wire,  $\frac{1}{2}$ " diameter, turns spaced  $\frac{1}{8}$ ";  $\frac{3}{4}$ " leads;  $\frac{1}{2}$ " space at center of coil for insertion of L6; coil tapped at midpoint  
 L6—2 turns of #12 bare wire,  $\frac{1}{2}$ " diameter, turns spaced  $\frac{1}{8}$ "; 1" leads  
 L7—2.3-h., 150-ma. filter choke (Allied Radio 61G482 or equivalent)  
 L8—3-h., 150-ma. filter choke (Allied Radio 61G483 or equivalent)  
 M1—0-5 ma. d.c. panel meter (Emico RF 2 $\frac{1}{4}$ C)  
 R1—39,000-ohm resistor  
 R2—100,000-ohm, 1-watt resistor  
 R3—100,000-ohm resistor

- R4, R7—68,000-ohm, 1-watt resistor  
 R5, R8—82-ohm resistor  
 R6—47,000-ohm resistor  
 R9—15,000-ohm resistor  
 R10—1500-ohm resistor  
 R11—56,000-ohm, 1-watt resistor  
 R12—20,000-ohm, 1-watt resistor  
 R13—39-ohm resistor  
 R14—1000-ohm, 20-watt resistor  
 R15, R16, R17, R18, R19, R20—220,000-ohm resistor  
 R21—100-ohm, 20-watt resistor  
 R22—270,000-ohm, 2-watt resistor  
 R23, R27—120,000-ohm resistor  
 R24—2.2-megohm resistor  
 R25, R31—330,000-ohm resistor  
 R26—500,000-ohm potentiometer  
 R28, R30—8200-ohm resistor  
 R29—1000-ohm resistor  
 R32—150,000-ohm resistor  
 R33—200-ohm, 10-watt resistor  
 RFC1, RFC2—1.8- $\mu$ h. r.f. choke (Ohmite Z-144)  
 S1—S.p.s.t. slide switch  
 S2—D.p.d.t. slide switch  
 T1—Power transformer: secondaries, 650 volts @ 150 ma., center-tapped; 6.3 volts @ 5 amp; 5 volts @ 3 amp  
 TS1, TS2—2-screw terminal strip  
 V1—6AU8A vacuum tube  
 V2—5763 vacuum tube  
 V3—Amperex 6360 or 6360A vacuum tube  
 V4—12AX7A vacuum tube  
 V5—6L6GC vacuum tube  
 Xtal—Third overtone crystal for a frequency between 36 and 37 mc. (36.250 mc. to 36.750 mc. for Technicians and Novices)  
 1—Crystal socket  
 4—9-prong miniature tube socket  
 11—Octal tube socket  
 11—Tie strips: 4 one-terminal, 1 two-terminal, 1 three-terminal, 5 four-terminal strips  
 1— $\frac{3}{4}$ " x  $1\frac{1}{4}$ " piece of 1/16" polystyrene  
 1— $1\frac{1}{4}$ " x  $2\frac{1}{4}$ " metal shield for 6360—see text  
 1—3" x 8" x 12" aluminum chassis (Bud AC-424)  
 Misc.—#20 solid hookup wire, #12 bare wire, piece of 300-ohm twin lead, a.c. line cord and plug, pointer knob,  $\frac{3}{8}$ " grommets, ground lugs, 4-36 and 6-32 machine screws and nuts, solder, decals, fine stranded wire and clips for meter leads

All resistors  $\frac{1}{2}$ -watt, 10%, unless otherwise specified

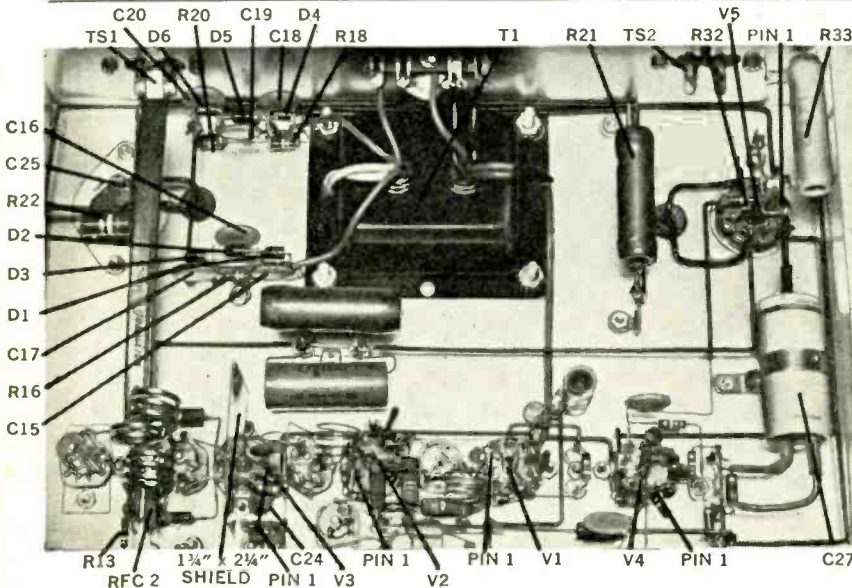

Fig. 3. An overall view of the chassis bottom looking from front to back. In building unit, it is essential that tube sockets be oriented as shown and coils positioned correctly.

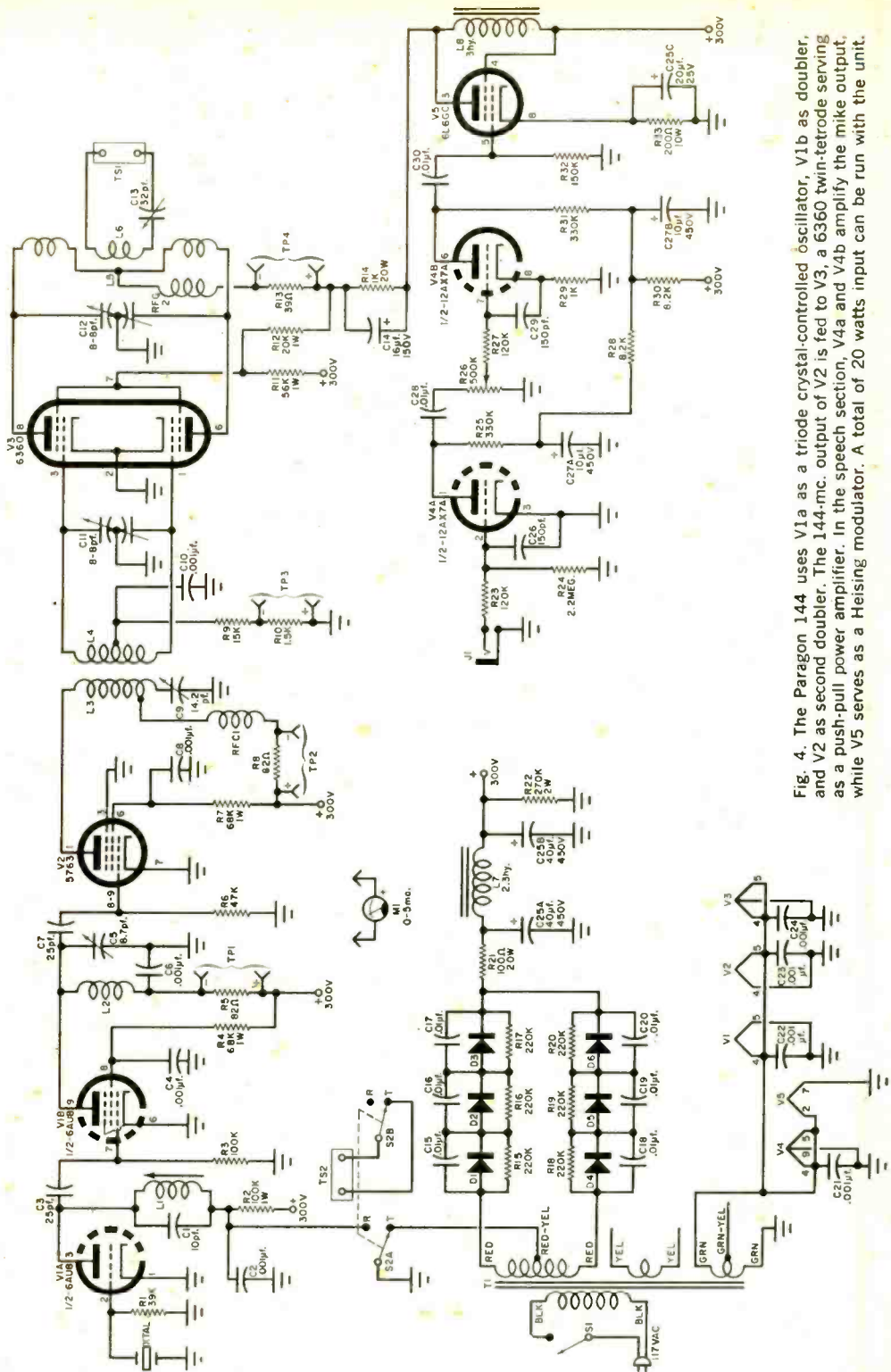

Fig. 4. The Paragon 144 uses V1a as a triode crystal-controlled oscillator, V1b as doubler, and V2 as second doubler. The 144-mc. output of V2 is fed to V3, a 6360 twin-tetrode serving as a push-pull power amplifier. In the speech section, V4a and V4b amplify the mike output, while V5 serves as a Heising modulator. A total of 20 watts input can be run with the unit.

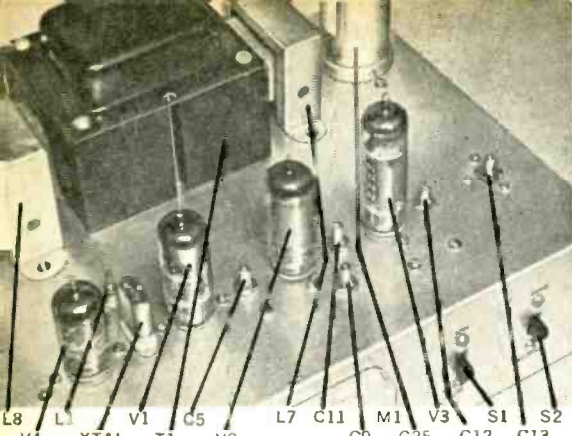

Fig. 5 (top). View of chassis top shows location of r.f. coils and capacitors, as well as other major components. Text describes how to tune up stages.

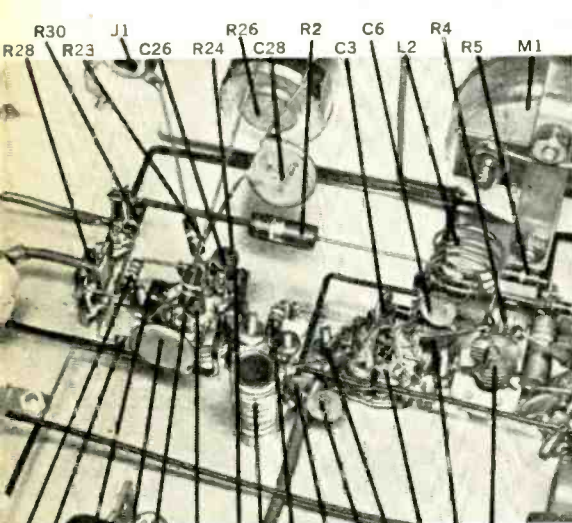

Fig. 6 (center). Photo of left side of chassis, as viewed from bottom, shows sockets of  $V1$  and  $V4$  and associated components; also note  $J1$ ,  $R26$ , and  $M1$ .

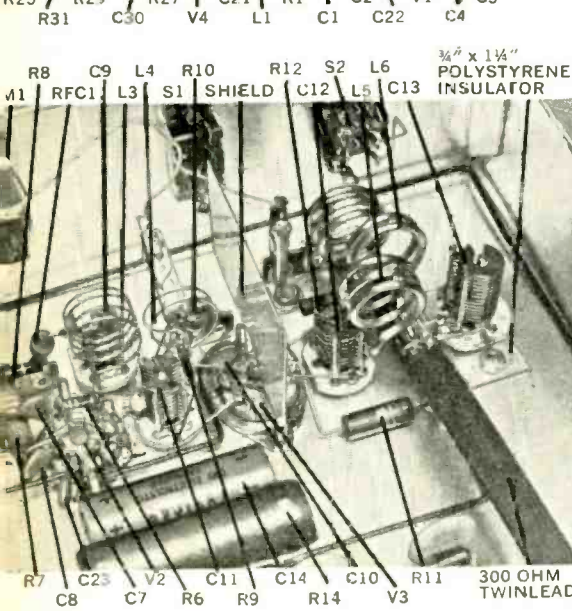

Fig. 7 (bottom). Right side of chassis (from below) shows shield across 6360 socket, polystyrene insulator used to mount  $C13$ . Note coils  $L3$ ,  $L4$ ,  $L5$ ,  $L6$ .

lug terminal strip on the rear edge of the chassis (see Fig. 3). Run the other green wire to pin 4 of  $V1$ . Connect one branch of the heater line to pin 5 of  $V2$ , and then to pins 4 and 5 of  $V3$ . Run the other branch first to pins 4 and 5 of  $V4$ , and then to pin 2 of  $V5$ . Cut off and tape the yellow transformer wires.

The long wires going to  $S1$  and  $S2$ , as well as those carrying d.c. to various parts of the circuit, should be kept out of the way by running them along the chassis edge. Be sure to observe correct polarity when wiring in diodes  $D1$  through  $D6$ , and the electrolytic capacitors (including  $C14$ ).

Solder all chassis connections associated with  $V1$ ,  $V2$ ,  $V3$ , and  $V4$  directly to the socket mounting flanges. Run each ground lead from the specified pin to the nearest point on the flange. Ground the metal center post of each miniature socket. Shorten the leads of the 0.001- $\mu\text{f}$ . bypass capacitors until they barely reach the appropriate terminals and the socket flanges.

Wind all coils, except  $L5$  and  $L6$ , with No. 20 solid tinned wire obtained by stripping insulation from the hookup wire you are using. Space the winding of  $L1$  (wound on a slug-tuned coil form) sufficiently to prevent the turns from shorting against one another. Coat the finished coil with polystyrene cement.

Use a penlight cell as a temporary winding form for the balance of the coils. After each has been completed, stretch it lengthwise until the turns are spaced  $\frac{1}{8}$ " apart.

Solder one end of *L2* to *C5*'s stator support rod nearest *V1* (see Fig. 6). The opposite end of this coil goes to the nearest terminal of a 4-lug tie strip located directly behind *M1*. Capacitor *C6* and *R5* also go to this same terminal, as shown in Fig. 6. Connect the ground end of *C6* to the rotor lug of *C5*. Solder one end of *L3* to a stator support rod on *C9* (see Fig. 7). The opposite end of this coil goes to pin 1 of *V2*. Attach *RFC1* to the coil, one turn from *C9*. Connect *L4* to the stator lugs of *C11*, rather than to the stator rods. The ends of *L5*, on the other hand, go to the rods, rather than to the lugs, of *C12*. Both the grid and plate leads of *V3* run to the stator lugs of *C11* and *C12*.

A few words of explanation will clear up any confusion which may exist as a result of the foregoing discussion of lugs and rods. Each miniature variable capacitor used in the Paragon 144 has small solder lugs for making electrical connections to both the rotor and stator plates. In those cases where it is impractical to utilize the stator lugs, connections can be made to the stator support rods which extend about  $\frac{3}{16}$ " beyond the rear of the capacitors.

To prevent self-oscillation, the input and output circuits of *V3* must be shielded from each other. Suitable material may be obtained from a well-tinned vacuum-type coffee can. Make the shield  $1\frac{3}{4}$ " x  $2\frac{1}{4}$ ". Scrape the paint off the printed label side of the tin and solder the shield to the center post and terminal 9 of *V3*'s socket. Cut a small notch in it to clear terminals 4 and 5. The shield's position is illustrated in Figs. 3 and 7.

Solder *L6* to the two center lugs of a 4-lug terminal strip. Install 300-ohm twin-lead between the terminal strip and *TS1*. Solder a 5" length of stranded hookup wire to each terminal of *M1*; attach miniature alligator clips to the free ends of these wires.

Note that *R23*, *C26*, *R27*, and *C29* filter out r.f. energy which might otherwise be rectified by the first two audio amplifier stages and cause annoying r.f. feedback to develop in the modulator section of the transmitter. These capacitors and resistors will function effectively only if they are installed in the proper manner. Cut one lead of each resistor to a length of  $\frac{1}{4}$ ". Connect the

short lead of *R23* to pin 2, *V4a*, and the long lead to *J1*. The short lead of *R27* goes to pin 7 of *V4b*, while the long one goes to the center terminal of *R26*. Trim the leads of *C26* and *C29* to  $\frac{1}{4}$ ". Capacitor *C26* goes between pins 2 and 3 of *V4a*. Connect *C29* to pins 7 and 8 of *V4b*.

**Adjustment.** First carefully check the completed transmitter for wiring errors, then plug in a 36-mc. crystal, *V1*, *V4*, and *V5*. Connect *M1* across *R5* (*TP1*), and plug in the a.c. cord. Set *R26* for minimum gain and turn the slug of *L1* fully counterclockwise when viewed from the top of the chassis. Throw *S1* to "On," and, after a one-minute warm-up, throw *S2* to "Send." If the crystal is oscillating, the meter needle will rise to about 1. As you screw the coil slug clockwise, the reading will slowly drop to about 0.8, and then suddenly jump to approximately 1.5 when the crystal goes out of oscillation.

If the meter reads 1.5 at all settings of *L1*, the crystal is not oscillating. Check for either a wiring error associated with *V1*, or too many turns on *L1*. When you finally have *V1* working properly, set *L1* for a meter reading between 0.9 and 1. Flick *S2* up and down several times to make sure the crystal starts up readily.

During the following tune-up procedure, refer to the chart on page 96 when you want to know the actual value of current indicated by *M1* as it is clipped across the different shunt resistors.

Disconnect the a.c. plug and connect the meter leads across *R8* (*TP2*). (Caution! Never touch the meter leads without first removing the a.c. plug from the wall socket!) When changing the leads to a different test point, make certain the clips do not short against other components. Always keep them as far as possible from the coils and tuning capacitors.

Replace the a.c. plug and insert *V2* in its socket. After warm-up, throw *S2* to "Send." As you tune *C5*, the meter indication should vary between about 1.6 and 2.4. Set *C5* for the lowest meter reading, cut the power, and turn the chassis over and examine it. If *C5*'s plates are somewhere between minimum and maximum capacity, *L2* has the proper inductance.

## CURRENT MEASUREMENTS

Test Point and Measurement	Typical Reading	Multiply By	Actual Current
TP1—V1b plate current	.9	20	18 ma.
TP2—V2 plate current	1.6	20	32 ma.
TP3—V3 grid current	1.6	2	3.2 ma.
TP4—V3 plate current	2.3	40	92 ma.

*Note: Variations of  $\pm 15\%$  are normal*

Measurements shown in chart are made by clipping leads from M1 across appropriate test points. After initial tune-up, meter can be connected permanently across TP4 for monitoring final plate current.

If minimum current occurs at minimum capacity, less inductance is needed. If full capacity is required for a current dip, the inductance is too small. Squeeze the turns together to increase the inductance, or pull them apart to lower it. If there is no current change as *C5* is tuned, recheck the wiring associated with *V1b* and *V2*.

The next step is to move the meter clips to *R10* and connect a 15-watt light bulb across *TS1*. Plug in *V3*. Turn the power on and tune *C9* and *C11* for the highest meter indication. It should be in the neighborhood of 2 if *L3* and *L4* have been correctly wound and installed. If the highest reading is obtained with either *C9* or *C11* at the extremes of their ranges, stretch or squeeze the coils as suggested in the previous paragraph.

Slowly tune *C12* and *C13* until the light bulb glows most brightly. Use a nonmetallic screwdriver on *C13*. Now, adjust *L1* counterclockwise until the meter drops to approximately 1.6.

After pulling out the power plug, connect the meter clips across *R13* (*TP4*). Re-install the plug and experiment with various settings of *C12* and *C13*, and the position of *L6* with respect to *L5*. In this way, you'll become thoroughly familiar with how these adjustments affect transmitter output as indicated by the meter needle and bulb brightness.

Plug a crystal or ceramic microphone into *J1*. Advance *R26* until the meter needle flickers very slightly and the bulb intensity increases noticeably as you speak into the mike. Do not raise the

gain beyond this level. More audio will merely result in excessive distortion and a broad signal.

The transmitter is now ready to go on the air. Connect a 300-ohm feedline between *TS1* and a good 2-meter beam antenna. Adjust *C12* and *C13* so that the meter reads between 2 and 2.5 at resonance dip. This indicates an input power of between 16 and 20 watts.

**Tips On Operation.** Most 2-meter operators use crystal-controlled rigs and tend to stick to a single frequency. However, if you decide to purchase a number of crystals in order to hop around the band, it will pay you to put knobs on *C12* and *C13* so you won't have to hunt up a screwdriver to *QSY*.

You can ignore the other adjustments when changing crystals if you stagger-tune them. To do this, set *L1* and *C9* for a meter indication of 1.5 with your lowest frequency crystal in the socket. For this tuning operation, the meter is connected across *R10* (*TP3*). Peak *C5* and *C11* for a 1.5 reading with your highest frequency crystal, and from then on, just retune *C12* and *C13* slightly when you change frequency.

Once you have the transmitter working properly, the meter clips can be connected permanently across *R13* to permit you to monitor plate current during each transmission. The antenna change-over and receiver muting relays in your shack may be controlled by *S2b*, thereby providing you with one switch operation. Access to *S2b* is provided by *TS2*.

**Results.** When the prototype was first put on the air, it produced 18 QSO's from 20 calls, a 90 percent batting average. Comments received over the air were uniformly complimentary with regard to signal strength and audio quality.

If you live in relatively flat country and use a 6- to 8-element beam mounted 40 or so feet in the air, the Paragon 144 will provide consistently strong signals at a distance of about 30 miles. Usable signals can be expected up to 40 or more miles under normal day-to-day conditions. A higher tower and larger antenna, or a hill-top location, will stretch these figures significantly. However, when skip conditions are good, you'll be able to work 300 miles and beyond, even with a low-gain, chimney-mounted antenna array.

-30-

# Miniature I.F. Module Superheterodyne Pocket Receiver

By CHARLES CARINGELLA

*Modern electronics module concept gets more elements into less space and greatly reduces number of tie points. Two i.f. amplifiers and detector take up only 0.375 cubic inch.*

**R**OUND-THE-CLOCK listening pleasure will be your reward for doing a good building job on this modern transistor superheterodyne broadcast-band radio. It is a complete unit and can be put into your pocket. It can also give your phonograph or tape recorder the ability to sound off with broadcast-band programs. No test or alignment equipment is needed to construct the radio.

A pre-aligned i.f. amplifier module only  $1\frac{1}{2}'' \times \frac{1}{2}'' \times \frac{1}{2}''$  in size speeds construction and simplifies wiring. The module contains 24 parts including a ceramic filter, two transistors, two transformers and a diode detector.



Fig. 1. Variable capacitors C1a and C1b are held in place by machine screws. The antenna loopstick can be cemented to the case, or just allowed to "float" in place.

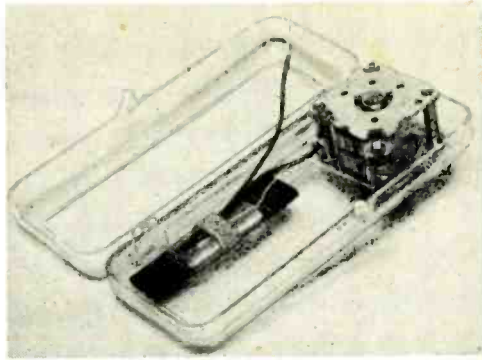

Except for the antenna loopstick, variable capacitor and phono jack, all components including the i.f. module are mounted on a small board, measuring just  $2\frac{7}{8}$ " x  $1\frac{9}{16}$ ", as shown in Fig. 2. This is not a printed circuit. All the components are hand-wired.

**How It Works.** Transistor Q1 serves as an r.f. amplifier, local oscillator and mixer. (See Fig. 4.) The input circuit, consisting of a variable capacitor (C1a) and an antenna ferrite loopstick (L1), tunes the broadcast band. Local oscillator coil L2 is tuned by variable capacitor C1b to a frequency that is always 455 kc. above the frequency of the incoming signal. Capacitors C1a and C1b are ganged.

The incoming r.f. signal and the local oscillator signal are mixed in transistor Q1. Sum and difference frequencies as well as the r.f. and oscillator signals appear at the output of Q1. The miniature i.f. transformer (L3) is tuned to 455 kc., and allows only the difference frequency to pass on to the next stage. The primary of L3 is part of the collector load circuit of Q1; the tap on this winding is not used.

The next two i.f. stages are in the module, as is the detector stage, as shown in Fig. 6. Bandwidth is fairly narrow, thanks to the ceramic filter between pin 2 and the 390-ohm resistor, but not narrow enough to prevent good reception of music. The bandwidth is about 8 kc. at -6 db. It is therefore possible to obtain good selectivity. The 455-kc. i.f. signal is amplified by each of the two pre-tuned transistor stages and then demodulated by the crystal diode detector. The audio signal goes through a low-pass filter to pin 7 and then to the top of the volume control, potentiometer R6. From the

volume control the signal is fed directly to an earphone jack. Additional transistor stages can be added, if desired, to drive a loudspeaker. A patch cord could be used to connect the radio earphone jack to the input of a tape recorder or phonograph. A feedback loop from the detector to the base of the first transistor in the module provides a.v.c. action. Overall gain of the i.f. module is about 55 db.

A loudspeaker is usually preferred, but there are several advantages to using an earphone: fewer transistors are needed, battery life is longer because power consumption is lower, and you can listen without disturbing anybody. An earphone can also provide exceptionally good fidelity—bass notes, which can not be reproduced by a small speaker, can be heard in an earphone, because the earphone is directly coupled to the ear and does not have to move a large vol-

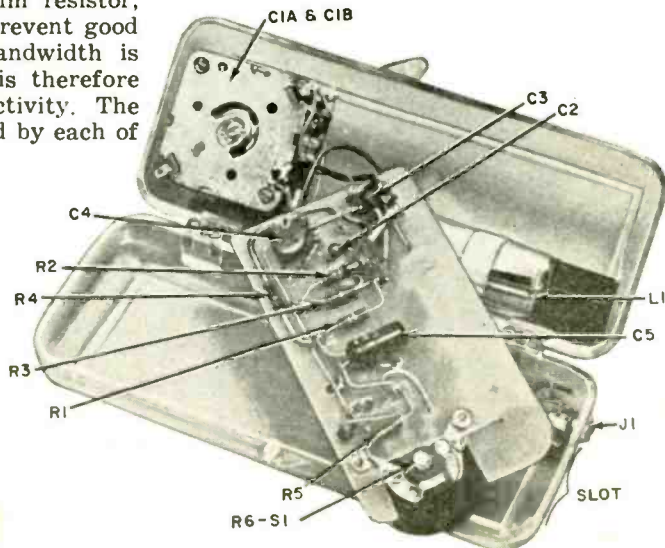

Fig. 2. Bottom view of the circuit board. Notch permits volume control to work without undue stress. The slot in the case allows volume control knob to turn freely.



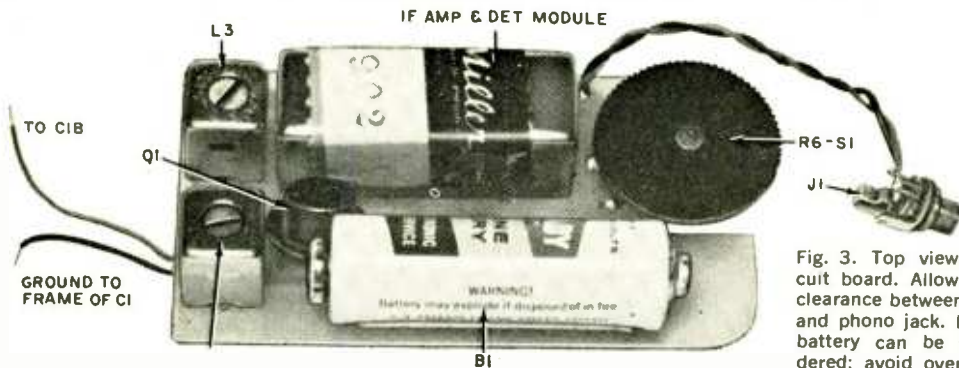

Fig. 3. Top view of circuit board. Allow enough clearance between battery and phono jack. Leads to battery can be spot-soldered; avoid overheating.

### PARTS LIST

- B1—6- to 9-volt transistor radio battery (NEDA 1606 or equivalent)
- C1a/C1b—Miniature 2-gang variable capacitor; 117.1-pf. r.f. section, and 74.4-pf. osc. section
- C2—0.02  $\mu$ f., 3 volts } miniature ceramic
- C3—0.01  $\mu$ f., 3 volts } disc capacitors
- C4—0.05  $\mu$ f., 10 volts }
- C5—10- $\mu$ f., 12-volt electrolytic capacitor
- J1—Phono jack, subminiature type
- L1—Ferrite antenna loopstick (Miller 2010 or equivalent)
- L2—Oscillator coil, miniature (Miller 2065 or equivalent)
- L3—I.f. transformer, miniature (Miller 8901 or equivalent)\*

- Q1—2N1087 transistor
- R1—15,000 ohms
- R2—10,000 ohms
- R3—1500 ohms
- R4, R5—1000 ohms
- R6—5000-ohm potentiometer with s.p.s.t. switch (Lafayette 99 G 6019 or equivalent)
- S1—S.p.s.t. switch (on R6)
- I—i.f. amplifier module (Miller 8902)\*
- 1—2 $\frac{1}{8}$ " x 1 $\frac{9}{16}$ " phenolic or laminated board
- 1—3000- to 7000-ohm dynamic carphone
- 1—4 $\frac{1}{4}$ " x 1 $\frac{3}{4}$ " x 1" plastic box

\*The Miller 8902 module and the Miller 8901 transformer are available together as the 8903

Fig. 4. Optional 0-1 ma. meter at point X serves as tuning indicator. Superhet circuit can give AM broadcast "voice" to tape recorder or record player.

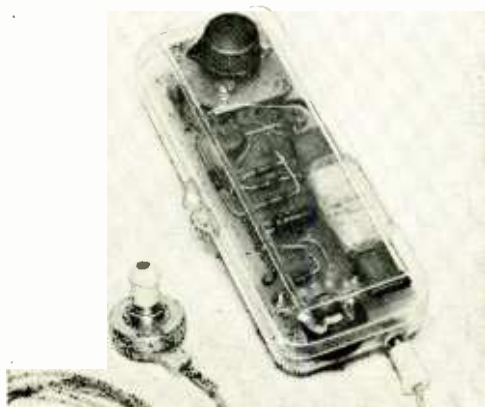
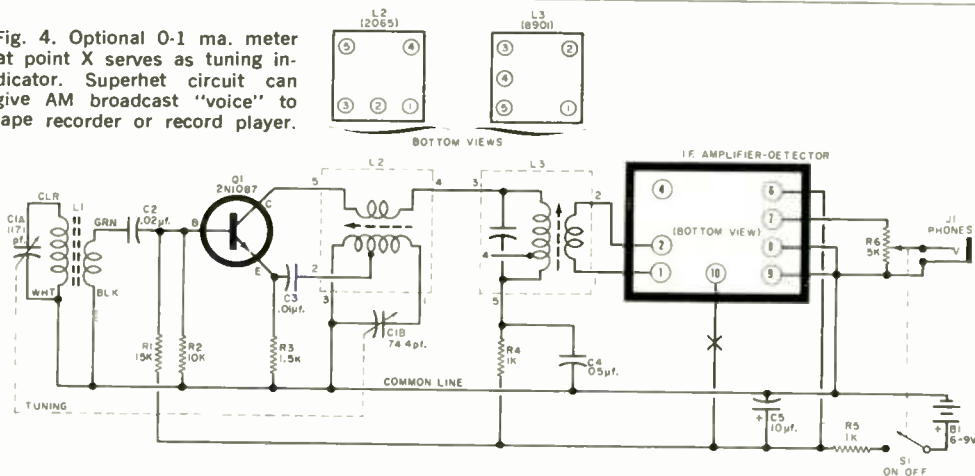

Fig. 5. Tuning dial can be mounted under knob on finished radio. High-impedance earphone provides good audio frequency response.

ume of air as a loudspeaker does. Earphone impedance should be anywhere from 3000 to 7000 ohms. Do not use a low-impedance phone, as it will load down the output circuit excessively.

If you wish, you can add a tuning meter to the circuit. Insert a 0-1 milli-ampere meter in series with the lead going to terminal 10 on the i.f. module.

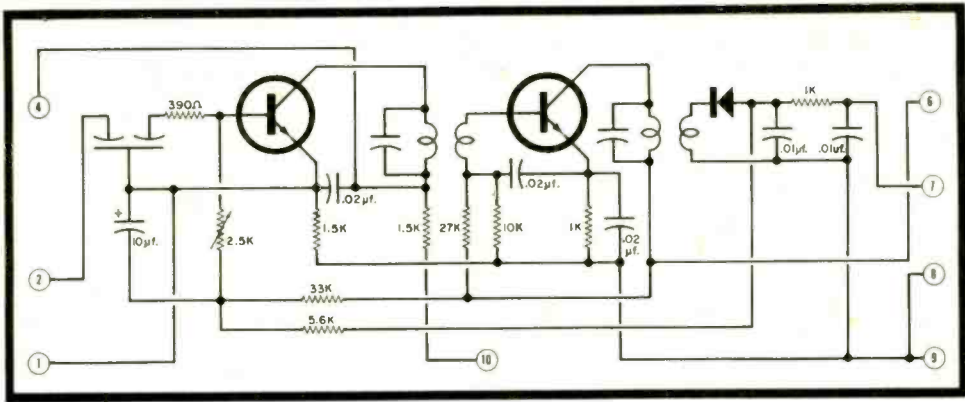
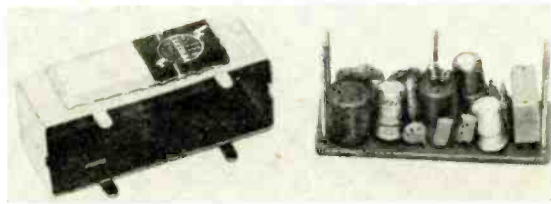

Fig. 6. Miniature i.f. strip is pre-aligned and pre-packaged. A detector stage is also included. A ceramic filter limits i.f. response to improve receiver selectivity without damaging audio quality. Overall gain is 55 db and output is sufficient to direct-drive an earphone. Bandwidth is 8 kc. at -6 db. Photo at right shows how actual components were fitted into can.



(See point X in Fig. 4.) The radio draws only 3 milliamperes.

**Construction.** The completed broadcast radio is shown in Fig. 5. It was built to fit into a small plastic box, which is readily available. You can choose any size box, as long as all the parts fit and are arranged in an orderly manner—the best thing to do is follow the photographs. Do not use a metal case. A shielded antenna usually develops into a situation of apparent radio silence.

Mount *C1* directly to the case. *L1* can be held in place by a dab of cement or just allowed to “float.” The black and white wires from *L1* are soldered directly to the capacitor frame. The clear wire is soldered to *C1a*, the capacitor with a greater number of plates. The green lead is attached to *C2* on the circuit board later.

The circuit board assembly is shown in Figs. 2 and 3. Parts location is not critical, but here again it is best to follow the layout as shown. Keep the leads short and avoid overheating the transistors when soldering. Notch out the board to allow the volume control (*R6*) to be mounted without undue stress or strain. Enough of the knob should protrude so that it can be easily reached when the assembly is finally placed into the case.

A  $\frac{3}{4}$ " x  $\frac{1}{8}$ " slot is cut out on the side of the case to allow the knob to stick out about  $\frac{1}{16}$ ".

Connect all the metal cans to a common ground line. This line is also connected to the frame of the variable capacitor. Short leads can be soldered directly to the battery. Next to the slot in the case, install the miniature phono jack.

Position the board in the case when completed. Connect the green wire to *C2* and two wires from the volume control to the phono jack.

**Alignment.** If all is well with your radio, you will hear background noise or, hopefully, a radio station or two when you first turn it on. The alignment and peaking adjustments are made from off-the-air signals. All you need is a non-metallic screwdriver. Do not force any of the screws or slugs; they should turn easily. Try to get any station and adjust *L3* for maximum. In the absence of a station, adjust for maximum noise.

Rotate the knob until the plates are almost fully meshed. This is the low end of the broadcast band. With the aid of another radio, as a “standard,” locate a station at the lowest end of the band. Adjust the slug in oscillator coil *L2* until  
(Continued on page 138)

**T**RADITIONALLY, the rule applied to broadcast-band antennas has been "the longer the better." While this rule still holds, it is also true that when antenna length is already short compared to the wavelength of the signal being received (as is the case with most practical BCB antennas), a further reduction in length, within certain limits, has little effect on antenna efficiency.

Almost any single wire antenna of random length will give good results when used with one of the antenna couplers which were described in the 1965 Fall Edition of the *ELECTRONIC EXPERIMENTER'S HANDBOOK* ("Soup Up That AM Broadcast Receiver"). In the author's case, tests made with a 100-foot horizontal, a 50-foot horizontal, and a 33-foot vertical antenna showed little difference in performance when DX'ing the BCB with a medium-priced communications receiver.

**"Loaded" Whip.** Since most antennas for BCB reception are "short" anyway, why not "load" the antenna with an inductance above its center for greater efficiency? To try this idea, the author used a 9-foot whip mounted on a pole with a 24-foot down-lead making up the rest of a 33-foot vertical. An adjustable ferrite antenna coil was connected at the base of the whip as shown in Fig. 1, and the base of the antenna grounded. A transistor radio held near the antenna wire was used to resonate the antenna. The radio was tuned to a weak station at the high-frequency end of the band, and the coil slug adjusted for maximum volume.

To tune such an antenna across the broadcast band and also couple it to the receiver, one of the antenna couplers featured in the article mentioned above should be used, and is shown in Fig. 1 within the dotted lines. The capacitor used in the tuner is a 100-pf. mica unit, and the coil is simply another ferrite antenna coil. Tests with the loaded whip showed a very worthwhile improvement in signal strength—WMAQ, Chicago (670 kc.), for example, was three "S" units higher in Los Angeles with the loading coil in the circuit.

**Loop Antenna Cuts QRM.** What about adjacent-channel DX? If the strength of strong local stations can be reduced somewhat, it becomes possible to copy

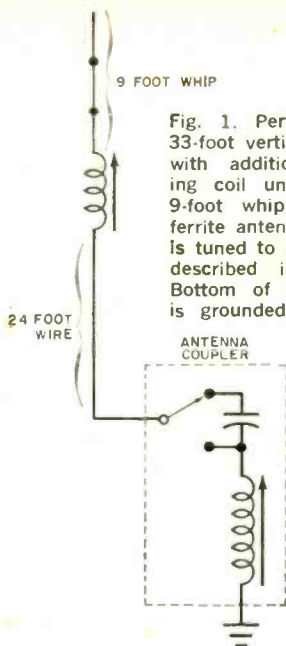

Fig. 1. Performance of 33-foot vertical improves with addition of loading coil under topmost 9-foot whip. Coil is a ferrite antenna type, and is tuned to resonance as described in the text. Bottom of 24-foot wire is grounded for tuning.

## Compact BCB DX Antennas

**Attention to antenna design helps dig out those buried BC stations**

By **F. J. BAUER, JR.,** W6FPO

Fig. 2. Variable-tuned loop antenna permits nulling of strong signals so weak signals can be copied.

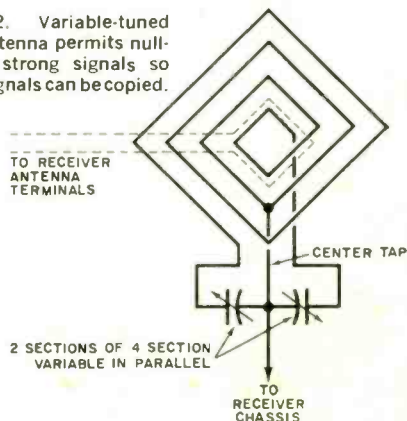

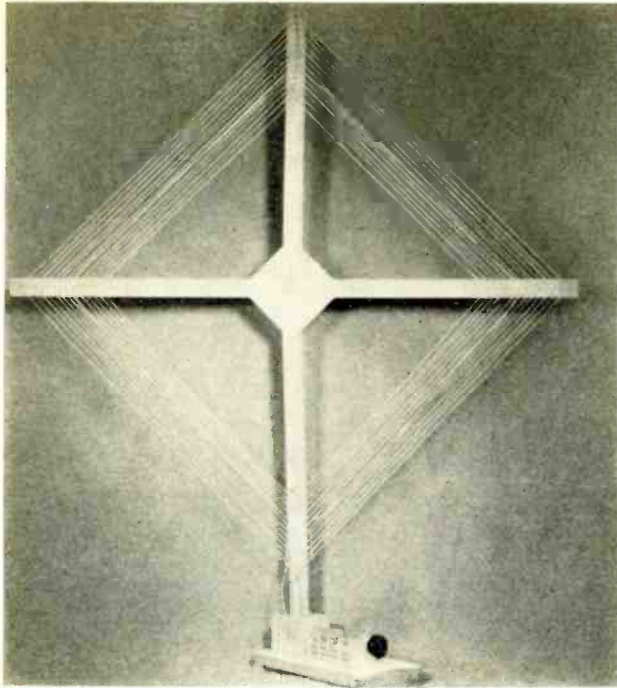

Crossarms of loop are made with  $\frac{1}{4}$ " x  $1\frac{1}{2}$ " x 44" plywood strips—the vertical arm in one piece and the horizontal in two pieces. Join the three strips together with 6"-square pieces of plywood nailed and glued on each side of the joint. In the author's unit, the loop was mounted in a wooden block fastened to the base holding the tuning capacitor. The loop itself, which is wound 1" from the ends of the arms, is supported with wire brads. The one-turn coupling coil is wound on the back of the arms opposite the center turn of the loop and as close to it as possible. Three connections are made to the receiver as shown in the diagram on p. 101, two to the antenna terminals and one to the chassis. Note: do not ground the loop to the chassis of an a.c.-d.c. radio due to the shock hazard which might result.

stations in the background. Wave traps were tried but were of little use. In some instances the trap acted more like an antenna than a trap, and merely aggravated the interference problem.

A loop antenna was considered next. If properly built, it would have reasonably good signal pickup and a sharp null at right angles to the plane of the loop. Its directional characteristics would make it possible to null out, to some extent, strong ground-wave signals from local stations.

Although the author's loop looks like a throwback to the 1920's, it performs better than expected. In Los Angeles, for example, it is possible to reduce the signal of a powerful local, KMPC on 710 kc., to receive Chicago, WGN on 720 kc., with little or no interference. After playing around with this circuit for a while, you will often be able to separate and identify distant stations on the *same* frequency by rotating the loop antenna for a null on one of the signals.

**Loop Construction.** At its largest, the loop measures 42" across, and consists of 13 turns of stranded wire spaced  $\frac{1}{2}$ " apart. Construct the crossarms of the loop as described in the caption above.

To couple the loop to the receiver, wind a separate one-turn coupling coil on the back of the cross-arms opposite the center turn and as close to it as possible.

The best way to tune the loop is with a salvaged four-section variable capacitor of the type used in older receivers. When you pair the sections by connecting them in parallel, the effective maximum capacity of the two resulting sections is well over 600 pf. A similar arrangement can be worked out by gangging two double-section TRF variable capacitors, which are readily available from most electronic parts houses.

Connect the capacitor sections as shown in Fig. 2, and make the three connections to the receiver (to the antenna terminals and ground). With the center tap disconnected, turn the loop for *minimum* signal on a strong local station. Next, place the center tap at approximately the center of the loop, and tune the variable for *maximum* signal. Adjust the tap for minimum signal, and, again, tune the capacitor for maximum. The variable capacitor is retuned as you tune across the broadcast band.

You'll be surprised at the improvement in your BCB DX score!

# 2 Halos Stacked for 2 Meters

**Easy-to-build high-gain antenna for fixed or mobile use**

By **BOB SARGENT**, WAØ661

Right: Coaxial "T" connection ties the transmission line to both halos. Gamma match faces same way and is adjusted for minimum SWR.

Below: Cut slot just wide enough to accommodate halos. Mount pole so that the bottom halo is as high above the ground as possible.

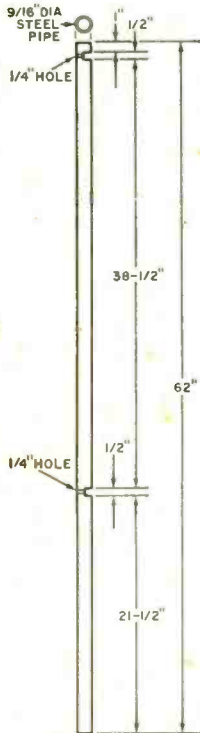

**HALO ANTENNAS** are like  $\frac{1}{2}$ -wavelength dipoles in many ways. They are cut to the same size, they are horizontally polarized, and they can be stacked for additional gain. However, the bidirectional characteristic of the dipole changes to an omnidirectional pattern when the dipole is curved to form a halo.

Horizontally polarized antennas favor horizontally polarized signals and are less susceptible to ignition noise and vertically polarized waveforms. Gain of a halo over a  $\frac{1}{4}$  wavelength vertical Marconi type is usually about 8 db. A gain of 12 db can be expected from a two-halo stack.

At 2 meters a stacked halo arrangement becomes manageable and suitable for mobile work, since the higher frequencies make it possible to employ smaller size antenna elements. The om-  
(Continued on page 143)

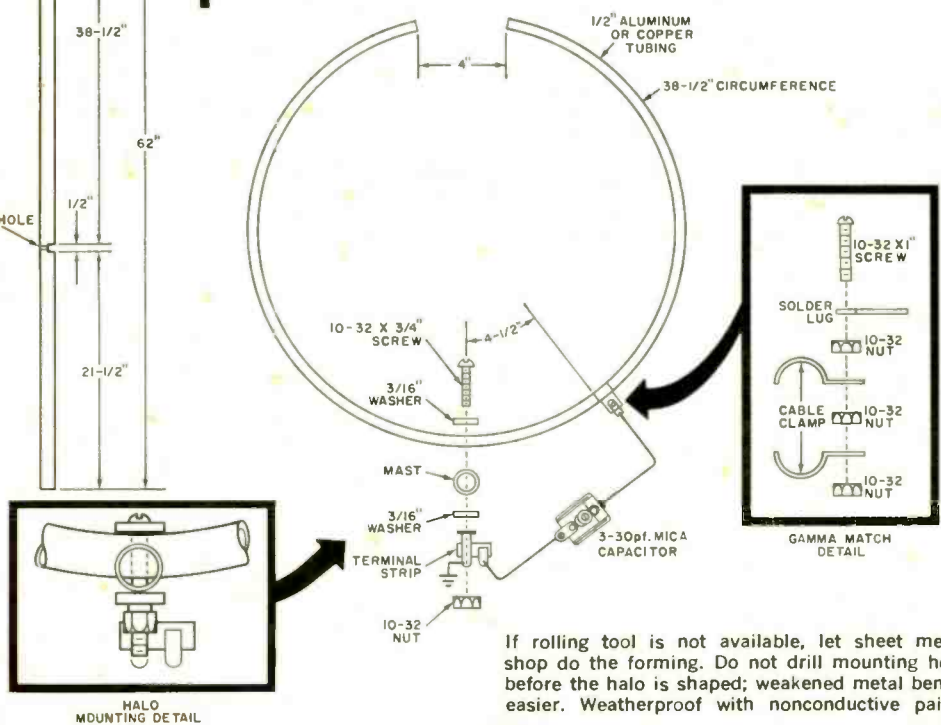

If rolling tool is not available, let sheet metal shop do the forming. Do not drill mounting hole before the halo is shaped; weakened metal bends easier. Weatherproof with nonconductive paint.

# BUILD A 144-MC. Swiss Quad ANTENNA

By HERBERT S. BRIER, W9EGQ

*All-metal, 2-meter  
cubical quad uses new ideas  
proposed by HB9CV—  
front-to-back and front-to-side  
ratios are over 25 db*

ALTHOUGH the "Cubical Quad" directional antenna has several obvious advantages, including high gain and economy of construction, the mechanical strength to cope with high winds is not an outstanding feature of the Quad constructed of bamboo and wire. The *all-metal* "Swiss Quad" described in "Across the Ham Bands" in the April, 1965, issue of POPULAR ELECTRONICS (page 74) has generated great interest among the ham fraternity.

The Swiss Quad retains the electrical advantages of the usual Quad, but adds strength and durability. A 144-mc. Swiss Quad can be built in a few hours at a cost of less than \$4.00. It will give a real *hop* to your signals.

**Design.** If the centers of the horizontal members of a two-element Quad are pushed in until they touch, they may be joined—both electrically and mechanically—to the central support pipe. If the horizontal members are metal tubing, the

Quad becomes a self-supporting structure without an auxiliary framework.

Coupling the centers of the horizontal members of the Quad together and to the support pipe is permissible, because these points are at zero r.f. potential. But, because a portion of the elements are partially bent back upon themselves, the overall dimensions of the antenna should be approximately 10% greater than for a conventional Quad cut for the same frequency.

The designer of the Swiss Quad, Rudolf Baumgartner, HB9CV, accommodated this increased size by adding to both the horizontal and vertical dimensions. I have found, however, that there is no significant difference in results if either the horizontal or vertical dimensions are kept the same as in a conventional Quad, and the other dimensions are increased sufficiently to restore resonance at the desired frequency.

**Construction.** The 144-mc. Swiss Quad is made of copper wire and tubing which is available in hardware and plumbing supply houses. To build a duplicate of my Swiss Quad, first straighten the  $\frac{3}{16}$ " copper tubing by rolling it on a flat surface while tapping it lightly with a wooden mallet. Cut off four 21" lengths.

Now take the hard-drawn  $\frac{1}{2}$ "-diameter copper tubing and drill a  $\frac{13}{64}$ " hole a half inch from the top end. Line up the drill so that the bit passes through the diameter of the tubing and comes out on the opposite wall. Drill another pair of  $\frac{13}{64}$ " holes 22" below the first pair in the same manner. Then rotate the tubing a quarter turn, and drill a third pair of  $\frac{13}{64}$ " holes  $\frac{3}{4}$ " from the top end and at right angles to the first pair; and drill a fourth pair 22" below the third pair. Finally, drill a  $\frac{9}{64}$ " hole a half inch below the bottom  $\frac{13}{64}$ " hole and in line with the first and second pairs.

Mount the standoff insulator in the  $\frac{9}{64}$ " hole on the supporting rod. Place a solder lug under and on top of the insulator. You may have to do a bit of juggling to line up the screw through the  $\frac{9}{64}$ " hole from the inside to catch the insulator, but it can be done.

Slide the four pieces of  $\frac{3}{16}$ " tubing through the  $\frac{13}{64}$ " holes, and position them so that they all extend 10" from the center of the  $\frac{1}{2}$ " supporting rod to one side and 11" from the center to the

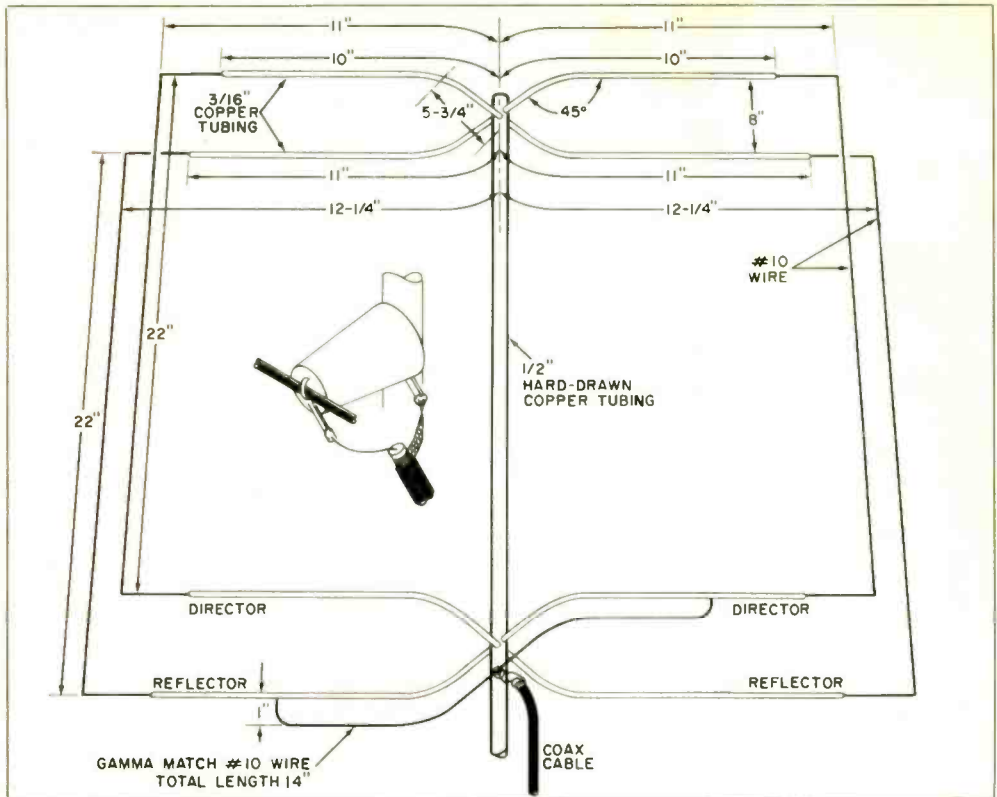

You can build a Swiss Quad in a few hours using readily available copper wire and tubing. The mast can be any convenient length. Sweat elements to the support pole with a heavy soldering iron or butane torch.

#### BILL OF MATERIALS

- 1—7' length of 3/16" copper tubing
- 1—3' length of 1/2" hard-drawn copper tubing
- 1—12' length of #10 plastic-insulated copper wire
- 1—5/8" cone-type standoff insulator (E. F. Johnson #135-501 or equivalent)
- 2—Solder lugs

other side. Solder them in place, using a husky soldering iron (250 watts or larger) or a small torch.

Measure 5 3/4" from the center of the supporting rod along the 3/16" tubing, and bend the 3/16" tubing horizontally 45° so that the end sections of each adjacent 10" and 11" length are parallel and spaced eight inches apart. It is not necessary that the bends be sharp; slightly rounded corners are preferred.

Remove the plastic insulation from a 14" length of #10 wire which serves as the *gamma* matching rod. The rod is approximately 12" long and soldered at

each end to the radiating elements; it is spaced an inch away from the elements. Do not solder the ends of the *gamma* rod until you have had an opportunity to adjust it, as described below. Cinch the solder lug on top of the standoff insulator around the center of the *gamma* rod, and solder it and the center conductor of the 50-ohm (nominal) coaxial feed line to the *gamma* rod. Solder the cable shield to the other solder lug.

Slice the insulation off the remainder of the #10 wire, and cut four 30" lengths. Four inches from each end of these lengths, bend the wire at right angles to form shallow U's 22" wide. Slip the ends of these U's into the corresponding top and bottom 3/16" copper tubing to the dimensions shown in the drawing.

**Adjustment.** Place an SWR bridge in the coax line and feed a small amount of r.f. into the line. Slide the wire U's  
(Continued on page 136)

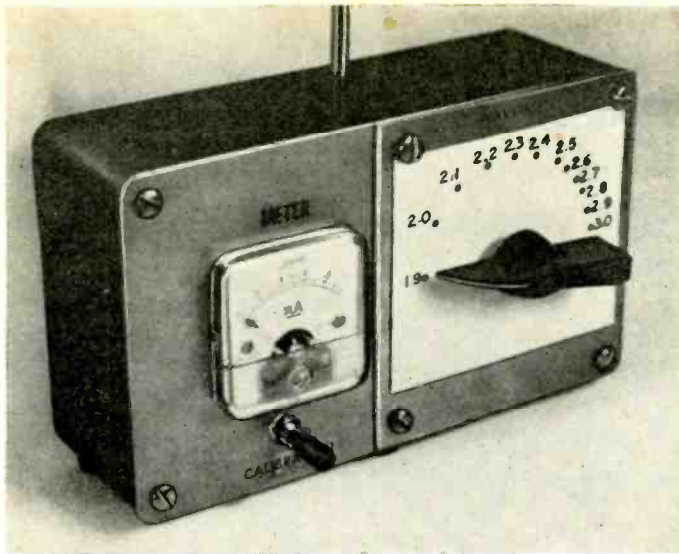

# MARINE BAND WAVE- METER

By E. H. MARRINER,  
W6BLZ

This little unit  
keeps tabs  
on your signal

**S**SMALL boat owners, fishermen, technicians, and others who own, use, or service and install marine band radio equipment will want to duplicate this simple wavemeter designed for monitoring and tuning up shipboard transmitters in the 2-3 mc. range. The unit does not use any batteries, and can be left on to monitor transmitter output and insure that it is set to the proper channel.

**How It Works.** To simplify matters, the wavemeter was constructed inside a small plastic box; in most cases, enough r.f. energy will be picked up by the internal coil to operate the device. If not,

the rod antenna specified in the Parts List can be added to the unit.

The bottom four turns of coil *L1* act as a coupling between the tuned circuit, consisting of *C1*, *C2*, and *L1*, and diode *D1*. The coupling coil prevents overloading of the tuned circuit so that the main dial (*C2*) tunes sharply and accurately. The r.f. is rectified by *D1*, and the resulting d.c. current indicated by *M1* (the meter can be made more or less sensitive by adjusting *R1*).

**Construction.** A small plastic instrument case (Lafayette 19 G 2001 or similar) was used to house the meter; an

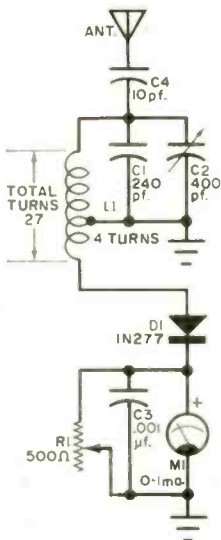

Wavemeter is simply tuned circuit coupled to rectifier-meter circuit by bottom four turns of coil. Circuit tunes sharply to indicate frequency of transmitter.

As shown below, all components are mounted on front panel of wavemeter. Connections to the optional external antenna are not shown here; simply add a 10-pf. coupling capacitor and wire the antenna to the stator of *C2*. The top end of the coil must be mounted on an insulator as shown. Calibrate the wavemeter as described in text, using accurate generator.

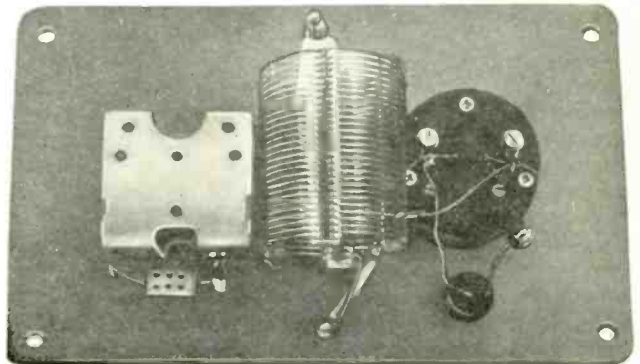



aluminum cover was made for the box. As shown in the photos, all of the components are mounted on this aluminum cover; *C2* at right; the coil in the center with the above-ground end fastened to an insulator; and the meter at left. Potentiometer *R1* is just below *M1*.

It is necessary that the coil be of the dimensions specified in the Parts List, tapped at four turns, and that a 240-pf. capacitor be placed across the variable and not some other value. This will insure that the wavemeter covers the correct range.

**Calibration.** After the wavemeter has been assembled, it can be tested and calibrated by placing it near some r.f. source in the 2-3 mc. band. One of the best methods is to use the radiophone set itself, a crystal oscillator, a grid dip oscillator, or other signal generator of known accuracy. If the meter should read backwards, reverse either the diode or the meter.

A rough dial can be made by placing a piece of paper under *C2*'s knob, and marking off frequencies in pencil. You can then ink in a finished dial and install it on the wavemeter; it should look much like that shown in the photo. A piece of clear plastic mounted over the dial will keep it clean and free from smudges.

As mentioned earlier, you can use the unit for peaking your transmitter, as well as for monitoring, if you have a commercial FCC license. For monitoring only, you can bolt the wavemeter to a bulkhead wall to keep an eye on transmitter output. A log of readings from day to day will serve as an indication that your antenna is radiating as it should be.

-50-

### PARTS LIST

- C1*—240-pf. silver mica capacitor
- C2*—400-pf. variable capacitor
- C3*—0.001-pf. ceramic disc capacitor
- C4*—10-pf. ceramic or mica capacitor
- D1*—1N277 silicon diode
- L1*—27 turns of  $\approx 12$  to  $\approx 18$  wire, 1 $\frac{1}{4}$ " diameter form, 16 turns per inch, tapped at 4 turns (B & W Miniductor  $\approx 3019$  or equivalent)
- M1*—0-1 ma. meter
- R1*—500-ohm potentiometer
- 1—2" x 3 $\frac{3}{4}$ " x 6 $\frac{1}{4}$ " plastic box
- 1—Extension antenna—optional (Lafayette 09 G 4001 @ 59 cents or equivalent)
- Misc.—Wire, solder, mounting insulator for coil, aluminum sheet, pointer knob, etc.

# SIMPLE AUTO LIGHT MINDER



Both *R1* and *D1* can be mounted under buzzer cover.

**I**T'S EASY to forget that your headlights are still on—easier still to forget the parking lights if you turn them on while driving on a rainy or foggy day.

You can eliminate the whole memory problem entirely by building this simple Auto Light Minder that requires only three components—a 10-ohm, 1-watt resistor, the cheapest silicon diode rectifier you can locate (the author used a 1N2069), and an inexpensive code practice buzzer. The recti-

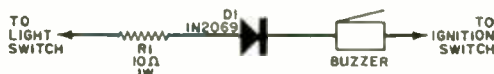

Light Minder uses three components; *R1* is omitted in 6-volt cars, leads reversed for positive ground.

fier and resistor can be mounted under the buzzer cover for compactness.

Connect one lead of the Light Minder to the light switch, and the other to the ignition switch as shown in the diagram. The correct terminals can be identified by observing which ones show a voltage to ground when the switches are operated (avoid the accessory lead on the ignition switch, however). When the lights and ignition are both off, both sides of the buzzer are at ground potential and there is no sound. Likewise, when both lights and ignition are on, there is no potential difference.

Diode *D1* blocks current flow with the lights off and ignition on, but with the lights on and ignition off, one side of the buzzer is grounded through the low-resistance ignition system, *D1* is forward-biased by the battery, and the buzzer sounds.

Eliminate *R1* for 6-volt cars, and reverse the light and ignition leads for positive ground cars.

—R. L. Winklepleck

# A PUBLISHING FIRST

... THE ONLY COMPLETE GUIDE FOR SERVICEMEN AND HOBBYISTS TO EVERY MAJOR PHASE OF CONSUMER ELECTRONICS SERVICING!



For the progressive serviceman who wants to find out how to service better and faster... how to expand his business by handling a wider variety of electronics equipment —

For the "do-it-yourself" hobbyist who wants to save hundreds of dollars by installing and repairing his own equipment —

The 1966 ELECTRONICS INSTALLATION & SERVICING HANDBOOK has arrived! The only comprehensive and authoritative guide to every major phase of consumer electronics servicing. There's nothing like it anywhere!

A handy, on-the-bench reference volume containing 128 pages—over 150 illustrations, charts and tables—on how to spot, analyze and correct trouble... quickly, efficiently and economically!

Complete, in-depth coverage of: the fundamentals of servicing • servicing b/w & color TV • AM-FM household radios • stereo/hi-fi • CB equipment • intercoms and PA systems • antennas • transistorized ignition systems.

Hundreds of money-saving techniques and shortcuts. Every up-to-date method and procedure. All in easy-to-understand language for the novice... yet thorough enough to answer the professional's most complex question!

You'd have to purchase several expensive manuals to equal this kind of incisive, all-inclusive coverage. But now you get it all in the 1966 ELECTRONICS INSTALLATION & SERVICING HANDBOOK. A small investment that will pay for itself many times over with just one practical application. **only \$1.25**

GET THE EXQUISITE  
LEATHERFLEX-BOUND EDITION  
for just \$3 POSTPAID!

The 1966 ELECTRONICS INSTALLATION & SERVICING HANDBOOK is also available in an attractive, gold-embossed, Leatherflex-bound edition — a superb addition to your library of permanent reference books. This deluxe volume will be mailed to your home, **postpaid**, for just \$3.00, when you check the appropriate box on the order form.



**--- FILL IN, CLIP & MAIL THIS FORM TODAY! ---**

Ziff-Davis Service Division • Dept. 18  
589 Broadway • New York, N.Y. 10012

**YES!** Send me a copy of the 1966 ELECTRONICS INSTALLATION & SERVICING HANDBOOK, as checked below:

\$1.25 enclosed, plus 15¢ for shipping and handling. Send me the regular edition. (\$1.50 for orders outside the U.S.A.)

\$3.00 enclosed. Send me the DeLuxe Leatherflex-bound edition, postpaid. (\$3.75 for orders outside the U.S.A.) Allow three additional weeks for delivery.

name \_\_\_\_\_ please print \_\_\_\_\_ EEH-66

address \_\_\_\_\_

city \_\_\_\_\_ state \_\_\_\_\_ zip code \_\_\_\_\_

**--- PAYMENT MUST BE ENCLOSED WITH ORDER. ---**

# CHAPTER

## 5 TEST EQUIPMENT PROJECTS

A test equipment construction project should be an exceptional item—something not commonly available as a kit. Such projects can be used in conjunction with existing test equipment to extend the usefulness of such equipment or to adapt present testing gear to new applications. This philosophy has been expounded in previous editions of the *ELECTRONIC EXPERIMENTER'S HANDBOOK* and is continued in this one.

The article titles below are largely self-explanatory, and only one requires any comment. Don Lancaster's "Meter Face" story should be one of those articles you immediately read from start to finish. The surplus markets are still loaded with excellent meter buys—meters which would cost three or four times as much if purchased retail. The only thing wrong with a surplus meter is the scale—it generally has some military significance, but nothing whatsoever to do with the milliamps or volts you want to measure. The article tells you how to change the scale and achieve a professional appearance.

This chapter ends with some "Tips and Techniques" from *POPULAR ELECTRONICS*.

110	MINIATURE VTVM .....	Ryder Wilson
113	MASTER CONTROL SCR SWITCHING CENTER .....	Harold Reed
116	SIMPLE SIMON VOLTAGE CALIBRATORS .....	Fred Chapman
117	PUT YOUR BEST METER FACE FORWARD .....	Don Lancaster
119	EXPERIMENTER'S L BRIDGE .....	Charles Green, W3IKH
122	TRANSISTOR REPLACEMENT TECHNIQUE .....	Roy E. Pafenberg, W4WKM
123	THE EXALTED POT .....	Forrest H. Frantz, Sr.
125	FOUR-WAY OSCILLATOR .....	L. E. Byfield, K9ADD
126	THE CASE OF THE ALUMINUM ALLY .....	Homer L. Davidson
127	THE BEST OF TIPS AND TECHNIQUES .....	



**Unit measures voltage in a.g.c., grid bias, oscillator and other high-impedance circuits without loading**

By **RYDER WILSON**

ONE of the most useful test instruments in the electronics enthusiast's workshop is the vacuum-tube voltmeter. The VTVM enables the experimenter to measure small voltages accurately, especially in high-impedance grid bias, a.g.c., detector and oscillator circuits. Unlike the 1000- or 20,000-ohms-per-volt voltmeters which present different resistances on different ranges, the miniature VTVM to be described here has a constant resistance of 10 megohms on all ranges.

The miniature VTVM is a low-cost construction project and operates economically on batteries. It can measure

d.c. voltages in five or six ranges, depending on whether a 5- or 6-point switch is used. Up to 500 volts can be measured directly; audio, r.f. and other a.c. voltages can also be measured with the demodulator probes. The miniature unit is completely self-contained in a 5" x 4" x 3" metal utility box and has a large, easy-to-read, reasonably-priced, 50- $\mu$ a. meter movement.

**How It Works.** A CK6088 subminiature beam-power-pentode vacuum tube (*V1*) is "triode"-operated in a d.c. bridge circuit. The quiescent voltage drop across resistor *R8* is balanced out by applying just enough bucking voltage to zero the meter. You simply adjust potentiometer *R11* for a zero meter reading. Potenti-

## MINIATURE VTVM

ometer *R9* serves as a current limiter and calibrator for the meter circuit.

A positive d.c. voltage applied to the grid of tube *V1* through resistor *R7* causes a proportional up-scale deflection. The more positive the grid, the more the tube conducts and the greater the voltage drop across resistor *R8*. The greater the voltage drop, the greater the deflection of the meter. The rotary switch (*S1*) specified in the Parts List selects one of the five voltage ranges from 5 to 500 volts. Precision  $\pm 5\%$  resistors are used in the input voltage divider network. The VTVM's accuracy is dependent upon the selection of the proper value of resistors, as well as the quality of the meter movement.

If you can get a 6-position, single-circuit switch that will fit, you can wire the input voltage divider as shown in Fig. 3, to get a very desirable 1-volt range. Actually, no change in the arrangement of the resistors in this circuit would have to be made to accommodate the 6-position switch. Jack *J1* would be connected to the first contact which would become the position for the 1-volt range. All other positions would

follow in the same consecutive order as in the 5-position switch.

Because of its d.c. operation, the miniature VTVM is relatively stable and free of drift. It does not require constant resetting of the zero control.

**Construction.** The interior view of the VTVM shows the layout of the various components. The tube (V1) is held in place by a cable clamp. The circuit board is mounted on the meter terminals. Resistors R7, R8, R9 and filament battery B2 are mounted on the board. Resistors R1 through R6 are mounted, turret style, directly on S1. (See Fig. 6.)

Position the meter as close as possible to the top of the case to allow room for the range selector switch and panel markings. Zero-adjust control R11 and tube V1 are then positioned to avoid interference with other components. Place battery B1 on the bottom of the case and hold it in position with a suitable friction clip.

The d.c. probe shown with the meter is made from a 2' length of 52-ohm coaxial cable and a test prod connected to the center conductor. An alligator clip and a short length of insulated wire are connected to the shield inside the probe handle. In use, the test prod point is connected to the positive side and the alligator clip to the negative side of the voltage to be measured.

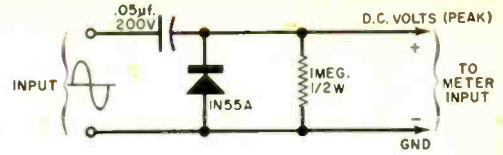

Fig. 2. Demodulator probe measures low a.c. peak voltages. Capacitance of probe leads acts as filter.

**Calibration.** Any known source of voltage can be used to calibrate the VTVM. A simple setup is shown in Fig. 5. However, before turning the instrument on, check for mechanical zero of the VTVM's meter. Next, set the range-selector switch to the 5-volt scale and adjust zero control R11 until the switch just clicks on. The meter will probably read about 1.25 volts. Continue turning R11 slowly, clockwise, until the meter reads zero. Do this with the probe connected to the meter and the alligator clip on the test prod's point, to prevent readings of stray voltages.

Adjust the 1000-ohm potentiometer on the calibrator rig to 5 volts, and apply the probe. Adjust calibrating potentiometer R9 for full-scale deflection (the 5-volt mark on the VTVM). By successively reducing the input voltage to 4, 3, 2 and 1 volt, linearity of the meter can be compared with the meter in the test circuit. A slight nonlinearity may be observed as the input voltage is decreased, with an approximate error of  $\pm 0.1$  volt at the low end of the scale.

Fig. 1. The voltage drop across the cathode resistor is in proportion to voltage being measured. The more positive the applied voltage to the grid, the greater the voltage on the resistor.

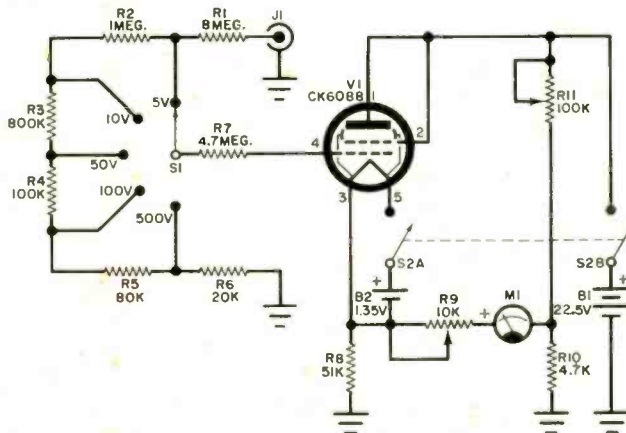
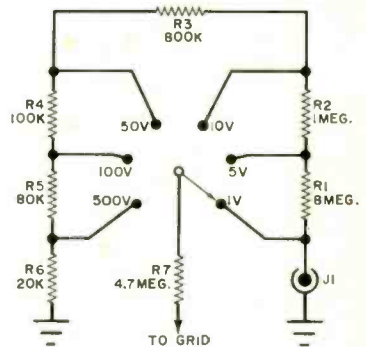

Fig. 3. Alternate hookup of voltage divider provides extra 0- to 1-volt range.



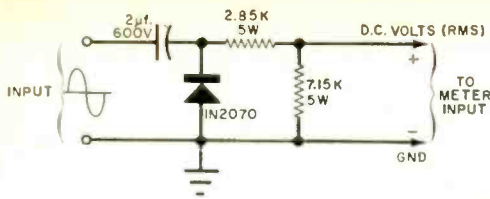

Fig. 4. Divider in demodulator probe delivers about 70% of peak voltage to meter circuit to enable direct readout of r.m.s. voltages.

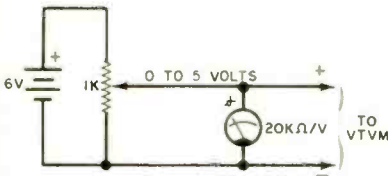

Fig. 5. Variable voltage divider circuit used to calibrate the miniature VTVM.

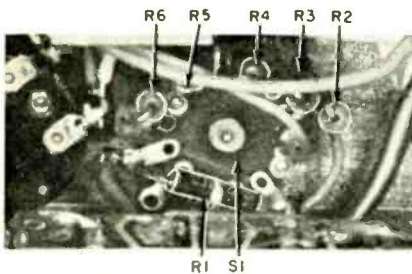
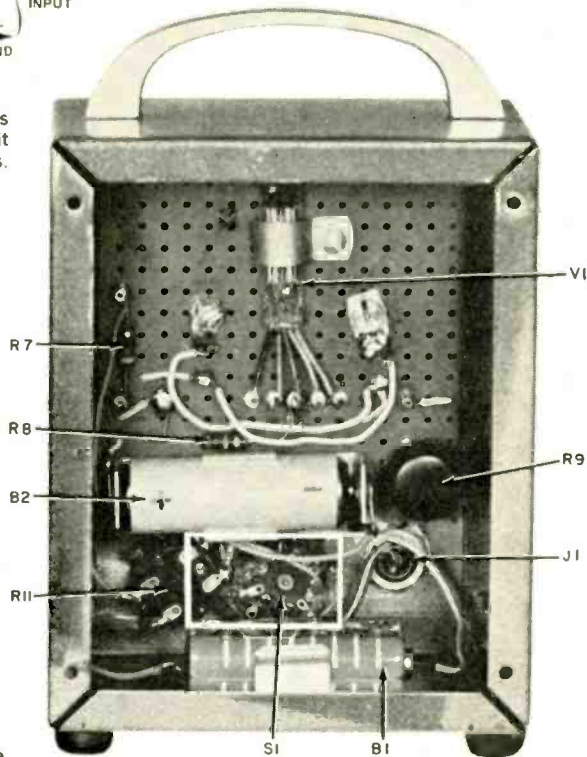

Fig. 6. Preassembly the resistors and the switch in "turret" fashion before mounting.

### PARTS LIST

- B1—22.5-volt battery (NEDA No. 215)
  - B2—1.35-volt mercury cell battery (Mallory RM-12R or equivalent)
  - J1—Single-contact, male, panel-mounted mike connector
  - M1—0-50 microammeter (Lafayette 99 G 5042 or equivalent)
  - R1—8-megohm,  $\frac{1}{2}$ -watt resistor\* (selected from 8.2-megohm stock)
  - R2—1-megohm,  $\frac{1}{2}$ -watt resistor\*
  - R3—800,000-ohm,  $\frac{1}{2}$ -watt resistor\* (selected from 820,000-ohm stock)
  - R4—100,000-ohm,  $\frac{1}{2}$ -watt resistor\*
  - R5—80,000-ohm,  $\frac{1}{2}$ -watt resistor\* (selected from 82,000-ohm stock)
  - R6—20,000-ohm,  $\frac{1}{2}$ -watt resistor\*
  - R7—4.7-megohm,  $\frac{1}{2}$ -watt resistor
  - R8—51,000-ohm,  $\frac{1}{2}$ -watt resistor
  - R9—10,000-ohm miniature potentiometer
  - R10—4700-ohm,  $\frac{1}{2}$ -watt resistor\*
  - R11—100,000-ohm miniature potentiometer with d.p.s.t. switch (S2)
  - S1—2-circuit, 5-position switch (Lafayette 99 G 6164 or equivalent; use only 1 circuit)
  - S2—D.p.s.t. switch (on R11)
  - V1—CK6088 vacuum tube
  - 1—5" x 4" x 3" metal utility box
  - Misc.—Probe tip, wire, battery clamps, etc.
- \*Resistors are  $\pm 5\%$  or better

Fig. 7. Position meter as high as possible in case. Mount circuit board directly to back of meter.



If a greater error occurs, it could be due to a poor tube, or nonlinearity of the calibrator meter.

Use the same procedure only to check the VTVM on the other voltage scales. Actually, this is not necessary; once one scale is calibrated, all the other scales take their proper relative position. Significant errors on the other ranges would be due to employing wrong values (one or more) for resistors R1 through R6. When the calibration is completed, the meter is ready for use.

Higher voltages applied to the tube's grid, beyond a certain point, have less and less effect on tube current, and at saturation have none. The meter cannot be subjected to "burn-out" currents no matter how high the voltage being tested or how low the selected voltage range on the meter. But don't poke the unit into a 16,000-volt circuit without a suitable high-voltage probe!



# BUILD THE MASTER CONTROL SCR SWITCHING CENTER

You can control equipment from a remote or local position with automatic or manual go—no-go type switch, photocell, or sensor

By **HAROLD REED**

**T**HE silicon-controlled rectifier (SCR) is one of the most recently introduced types of semiconductors presently performing electronic miracles. It works like a high-current on/off switch, yet has no moving parts. Many devices, such as electric light dimmers and motor speed controllers, are already taking advantage of the SCR. As the demand for new semiconductors builds up, prices come down. They have already done so to a considerable extent. The SCR used in the Switching Center is a 2N2323 and costs less

than \$3.50, which is below the cost of many vacuum tubes.

The Switching Center can be used as the heart of burglar alarms, fire alarms, photographic control equipment, door openers, motor driven controls, etc. Control can be automatic or manual, local or remote, and can be triggered by Microswitches, magnetic reed or thermal switches, photocells, etc. The switches can be used in combination, say a magnetic reed switch to close the controller and a Microswitch to open it.

The controller is extremely sensitive; a photoconductive cell connected directly to its binding posts can actuate the relay just by "seeing" a lit match 12 inches away.

**How It Works.** Like a thyatron, the SCR (*Q1*) conducts when the anode is sufficiently positive with respect to the cathode. Under normal operating conditions the anode voltage is not high enough to start conduction, but is high enough to maintain current flow once it starts. The gate on the SCR performs the same function as the grid of the thyatron. When a small positive voltage is applied to the gate, the SCR fires (provided that the correct anode-to-cathode voltage is also present).

Thereafter, the gate has no control and cannot stop current flow. The only way to extinguish the SCR is to remove or reduce the anode-to-cathode voltage below the holding point. When current flow is stopped and plate voltage is restored, the gate once again is in a position to exercise control.

Relay *K1* has a four-pole, double-throw switch to provide numerous control applications. If desired, a s.p.d.t. relay can be used and is noted in the Parts List for your convenience. Both relays have a 2500-ohm coil.

The relay is energized when d.c. flows through the circuit consisting of *T1*, *D1*, *K1* and *Q1*. About 25 volts a.c. from *T1* is rectified by *D1*, filtered by *C1* and applied to *K1* and *Q1*. The d.c. control voltage applied to *Q1*'s gate is developed by the voltage divider action of *R2* and *R3*. Diode *D2* stabilizes relay action and cuts down the high inductive kick from the relay coil when the unit is switched off. Excessive voltage peaks could damage *Q1*.

In the nonconducting state, *Q1* ex-

A positive voltage at the gate of the SCR causes it to conduct and close the relay; to stop conduction, a negative pulse is applied to the anode.

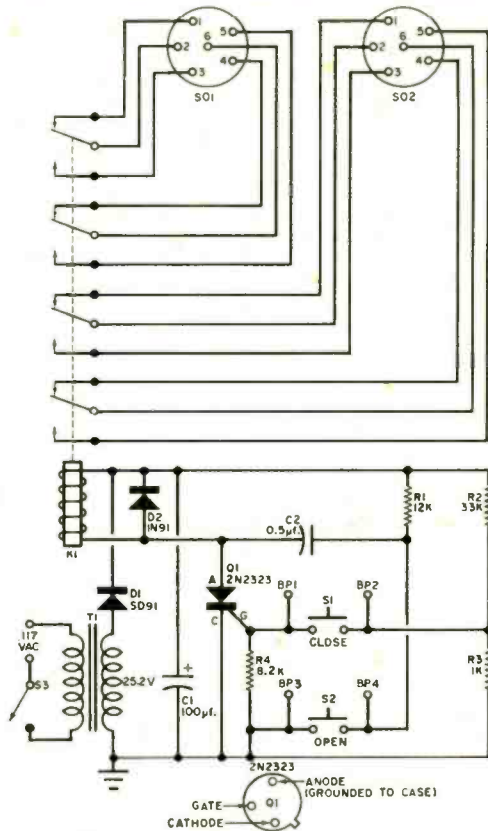

## PARTS LIST

- BP1* to *BP4*—5-way binding post (Lafayette 32 G 6430C or equivalent)  
*C1*—100- $\mu$ ., 50-volt capacitor  
*C2*—0.5- $\mu$ ., 200-volt capacitor  
*D1*—Silicon diode (International Rectifier SD91 or equivalent)  
*D2*—Germanium diode (General Electric 1N91)

hibits a very high internal resistance and only a very small leakage current flows; thus, *Q1*'s anode voltage is approximately equal to the d.c. supply voltage. Since this voltage is below the rated peak forward voltage of *Q1*, it will not trigger.

Under this circumstance, all it takes to fire *Q1* is a small positive d.c. pulse applied to *Q1*'s gate. As mentioned before, this comes from the junction of *R2* and *R3* via *S1*. Switch *S1* may be manually controlled or paralleled by any external switching devices attached to *BP1* and *BP2*. Internal resistance of *Q1*



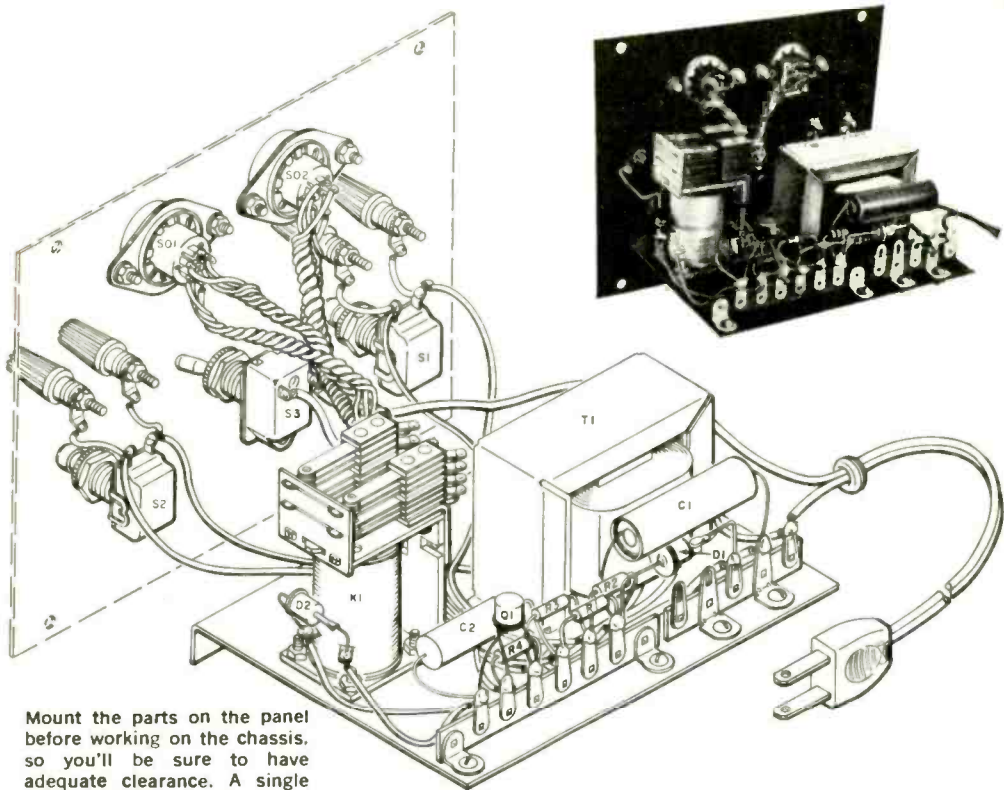

Mount the parts on the panel before working on the chassis, so you'll be sure to have adequate clearance. A single terminal strip can be substituted for sockets SO1 and SO2.

- K1*—Relay, 4-p.d.t. or s.p.d.t., 2500-ohm coil (Potter & Brumfield GB17D or GB5D or equivalent)  
*Q1*—2N2323 silicon-controlled rectifier  
*R1*—12,000 ohms  
*R2*—33,000 ohms  
*R3*—1000 ohms  
*R4*—8200 ohms

} 1/2-watt resistors

- S1, S2*—S.p.s.t. push-button switch (Lafayette 99 G 6218 or equivalent)  
*S3*—S.p.s.t. on-off switch  
*SO1, SO2*—6-pin miniature socket  
*T1*—Power transformer: primary, 117 volts; secondary, 25.2 volts (Siancor P-6469 or equivalent)  
 1—4" x 5" x 6" steel cabinet (Bud C-1797)

becomes extremely low when it conducts and practically all of the d.c. supply voltage appears across *K1*. The relay closes and works any appropriate device plugged into *SO1* or *SO2*.

Once *Q1* fires, it remains in this condition, keeping *K1* closed regardless of any further switching attempts by the gate. To extinguish *Q1* and open the relay, the voltage developed across *C2* through *R1* is discharged across *Q1* by closing *S2* or by a bridging action of an external control switch. The charge on *C2* momentarily counteracts the voltage across *Q1* enough to stop conduction.

**Construction.** The unit shown in the photos is built in a 4" x 5" x 6" box which has a self-contained chassis attached to the front panel. All parts are easy to obtain and inexpensive. Transformer *T1* and relay *K1* are mounted on the chassis; smaller parts are soldered to terminal strips. Switches *S1* and *S2*, the binding posts, and power switch *S3* are attached to the front panel.

Two 6-contact sockets to extend the relay contactors to a convenient outlet are also mounted on the front panel. Any type of connector or terminal strip could be used for this purpose.

# Simple Simon Voltage Calibrators

By FRED CHAPMAN

Fig. 1. Simple calibrator at right requires only a handful of 10% resistors and banana jacks. Best accuracy can be had by selecting resistors with a good meter or bridge.

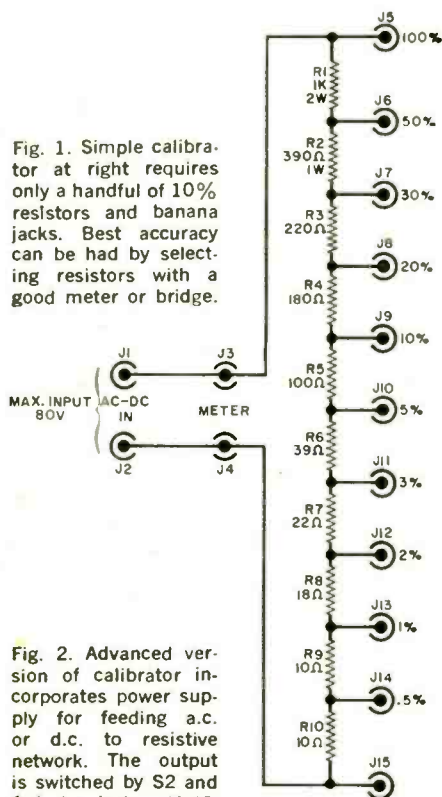
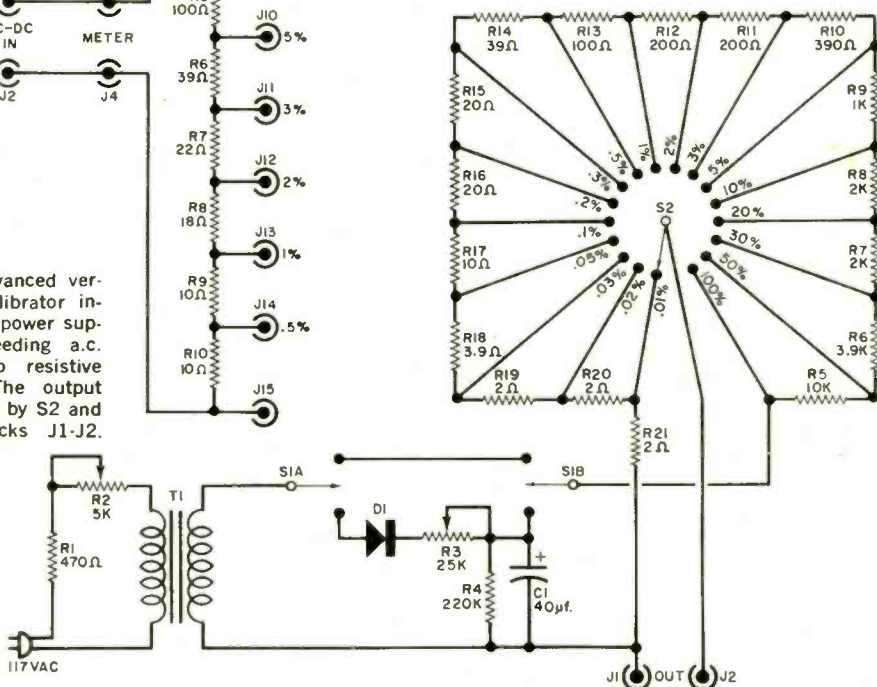

Fig. 2. Advanced version of calibrator incorporates power supply for feeding a.c. or d.c. to resistive network. The output is switched by S2 and fed to jacks J1-J2.



INTERESTED in a versatile voltage-step calibrator that has, literally, hundreds of uses? While designing a wide-range VTVM the author found a need for some means of feeding calibrated millivolt signals to the meter. The answer was a simple voltage divider, whipped up around a handful of 10% resistors as shown in Fig. 1.

Jacks J1 through J15 are banana jacks, and the resistors are 1/2-watt units unless otherwise specified. A separate pair of jacks (J3 and J4) accommodates the meter, while the voltage output is taken between the bottom jack (J15) and the jack at the desired percentage level. If you want to work with higher voltage levels, it will be necessary to increase the wattage rating of most of the components.

Figure 2 shows a grown-up version of the calibrator that you might want to put together. Note the provision for a.c. or d.c. voltages from 0.1 mv. to 1 volt with a 1-volt input; for a 6-volt input, the steps will range from 0.6 mv. to 6 volts. You simply multiply the input voltage by the percentage indication at the desired position of switch S2.

Transformer T1 is a 6.3-volt filament  
(Continued on page 142)

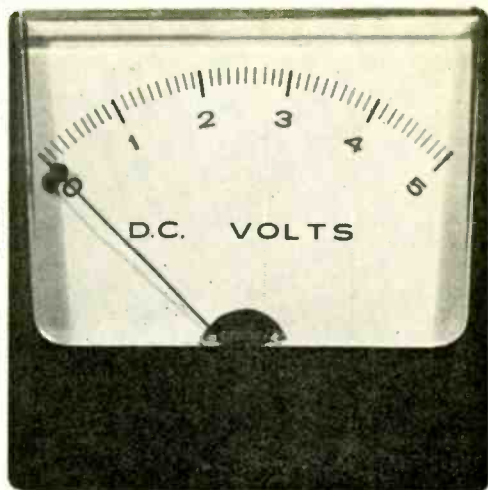
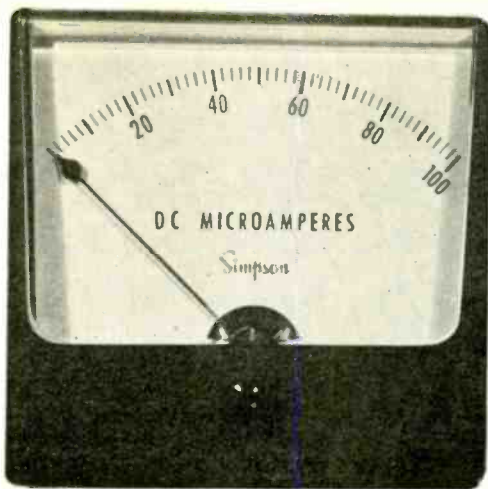

# PUT YOUR BEST METER FACE FORWARD

Before and After. Can you determine which of the meter faces above is homemade and which is the manufacturer's original? The only tip-off is the trademark under the title.

*You can make professional-looking scales  
with little effort and a small investment*

By **DON LANCASTER**

**W**ANT to change the scale of that panel meter sitting in your junk box? Or how about that surplus bargain, an 0-50 d.c. microammeter . . . calibrated as 0-75 MR/HR/FT<sup>3</sup> or something equally mysterious? Help stamp out sloppy meter faces! Get rid of wrong scales! You don't have to be an artist—all you need is \$2.15 and some time. You'll wind up with a meter face as good as the factory original, and to your exact specifications. And each duplicate face will cost just 15 cents.

What's the catch? You simply work five times life size. In this king-size world, mistakes are few and far between, and easily corrected. Any misalignment that might creep in gets reduced 5:1 in the final reproduction. You use all prefab letters and numerals—no ink and no mess. A nearby

photolithography firm then gives you the required reduction.

**Measurements.** The first step in making a new meter face is to carefully remove the *original*, and make all the measurements shown in Fig. 1. Multiply each one by five (except *c*, the scale angle), and record the results. Dimension *a* is the distance in inches between the pivot point or center and mounting screw; *b* the distance between the pivot point and title; *c* the scale angle in degrees; *d* the numeral radius in inches; *e* the lower division radius; *f* the middle division radius; and *g* the upper division radius.

Decide what the full-scale reading of the new meter scale will be, and choose a reasonable number of major divisions. Every major division, or every other one,

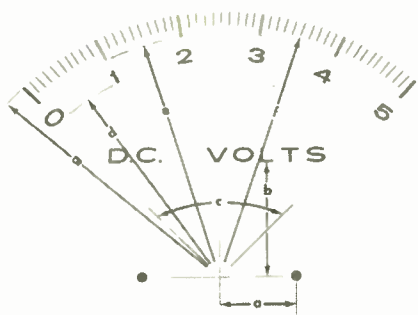

Fig. 1. Carefully measure dimensions "a" through "g" on original meter face and multiply by five. All measurements are in inches except the angle "c," which is measured in degrees with a protractor.

Fig 2. Materials you need for making a new face include instant transfer letters, a beam compass,  $\frac{3}{8}$ " printed circuit dots,  $\frac{1}{8}$ "- and  $\frac{1}{16}$ "-wide black printed circuit tape, and white illustration board.

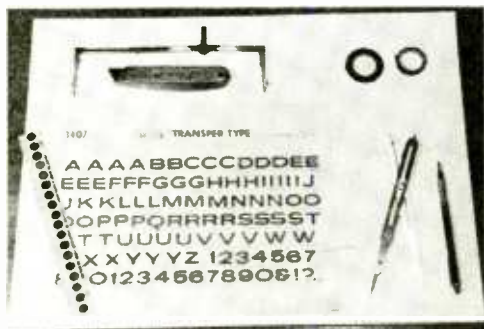
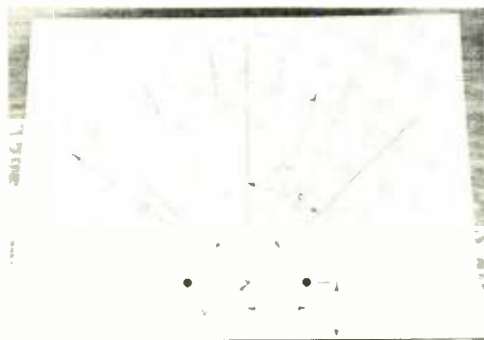

Fig. 3. The new meter face is drawn lightly in pencil on a piece of illustration board working five times up. First draw vertical center line, then add a horizontal base line 2" up from bottom of board.



should have a number below it. Limit the numbered divisions to between five and eight to make the meter easy to read. The number of minor divisions should be around 50. Each minor division should correspond to some reasonable increment, say one, two, or five of the full-scale units.

**Materials and Layout.** Go to the art store and buy a sheet of  $\frac{1}{2}$ "-high instant transfer letters and numerals. You can also pick up a 15" x 20" sheet of white illustration board, although white cardboard or painted plywood will do. (For a meter face larger than 3 $\frac{1}{2}$ ", get a 20" x 30" illustration board.)

Lay out the new face as in Fig. 3, keeping all pencil lines very light so they can be easily erased. Start with a vertical center line and add a horizontal line 2" up from the bottom; use a square to insure that these two lines are perpendicular. The point where the two lines cross is the pivot point of the meter, and the basis of all the measurements detailed in Fig. 1.

Carefully and accurately locate the meter mounting holes with two  $\frac{3}{8}$ "-diameter dots (black printed circuit dots are ideal for this). Using a beam compass (or a pencil and some string), swing the arcs corresponding to the tops and bottoms of the minor divisions. Using a large protractor, locate the zero and full-scale points.

Next, with dividers (or just a ruler), lay out all the major division marks on the  
(Continued on page 146)

Fig. 4. High-contrast photolith negative (top) is a 5:1 reduction of art work. After negative is made, it is a simple matter to get photographic contact prints (below). Mount new face as described in text.

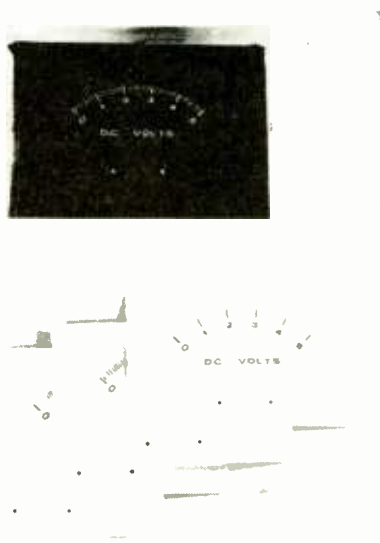

# EXPERIMENTER'S

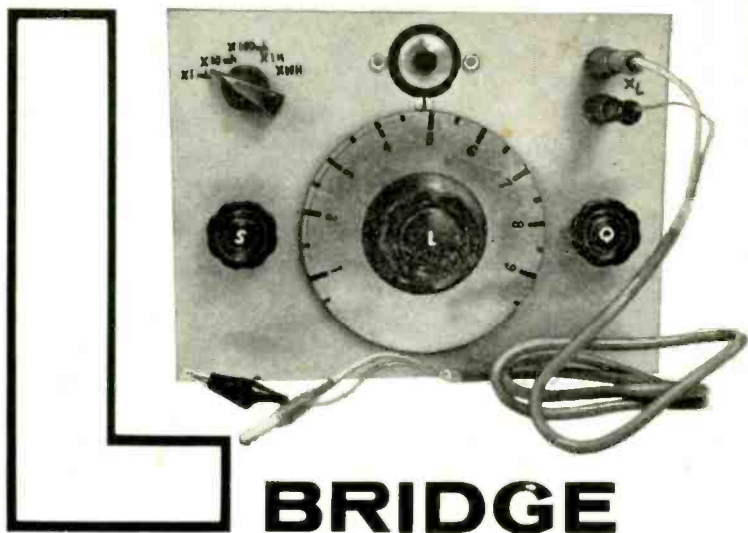

***Build this multi-range inductance tester to find unknown values of r.f., i.f., audio and filter coils and chokes***

By CHARLES GREEN, W3IKH

**I**NDUCTANCE measurements are not difficult to make, but they can fool you, especially if you have been using just an ohmmeter. A few shorted turns won't make enough of a difference to show up in a simple resistance test, yet it takes only one shorted turn to ruin a coil or choke. At times you may wish to know only if a part is good or bad. At other times you may be looking for a specific value. Either way, the "L Bridge" is a worthwhile addition to your line-up of test equipment.

In all fairness to the ohmmeter test method, it does quickly indicate open windings, shorts to iron cores and frames, and shorts between two different coils wound in close contact with each other, such as primary and secondary transformer windings. It can also spot relatively large changes in a coil's re-

sistance, but it does all this under d.c. conditions. Most of the coils we use have to function in an a.c. circuit of one type or another.

An obvious improvement, then, would be to break away from d.c. and go to an a.c. procedure, applying an a.c. signal to an unknown inductance and determining its value by its performance in the test circuit. The easiest, cheapest way to do this is to employ a Maxwell bridge which uses an a.c. signal to measure inductance in terms of resistance and capacitance. The "Experimenter's L Bridge" is just such a unit with the ability to measure inductance values from about 1 mh to 100 h (100,000 mh) in five ranges.

**How It Works.** The test signal from the 1 kc. oscillator, the pentode section of V3b, is amplified by the triode sec-

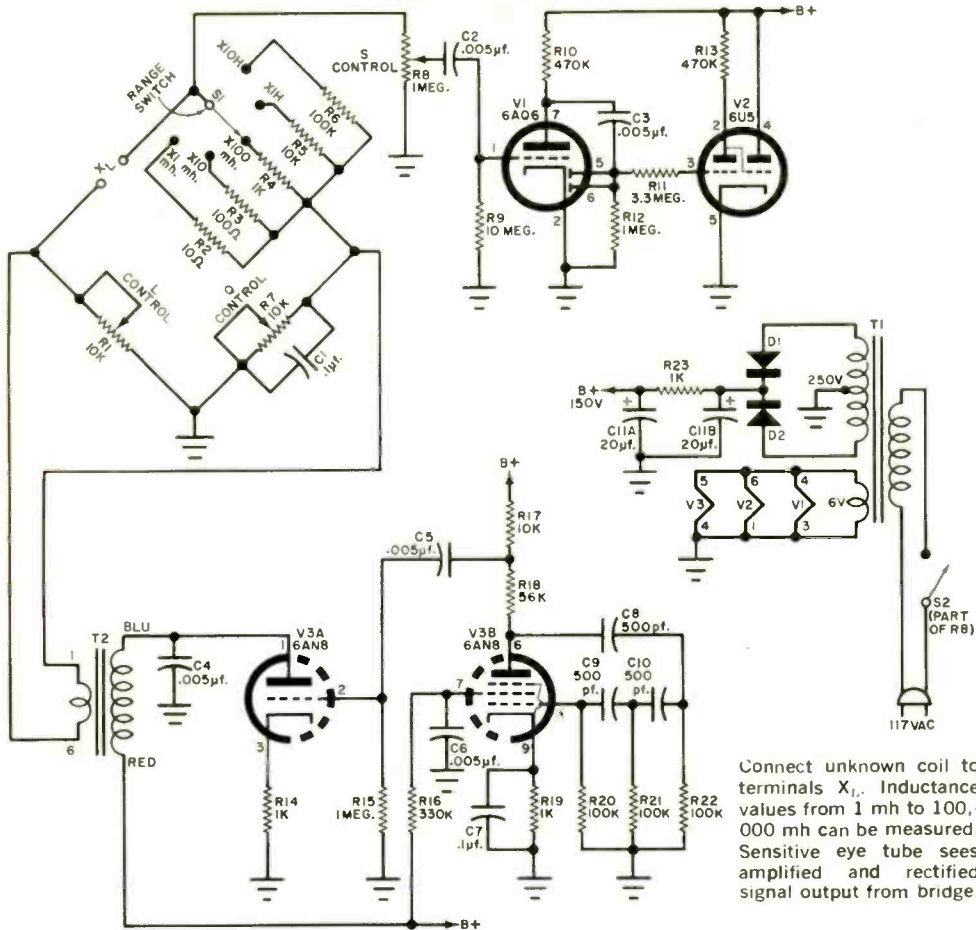

Connect unknown coil to terminals X<sub>1</sub>. Inductance values from 1 mh to 100,000 mh can be measured. Sensitive eye tube sees amplified and rectified signal output from bridge.

## PARTS LIST

- |  |  |
|--|--|
| C1, C7—0.1- $\mu$ f., 100-volt capacitor. $\pm 10\%$             | R8—1.0-megohm potentiometer with S1  |
| C2-C6—0.005- $\mu$ f., 600-volt ceramic capacitor                | R9—10 megohms  |
| C8, C9, C10—500-pf., 1000-volt ceramic capacitor. $\pm 10\%$     | R10, R13—470,000 ohms  |
| C11—20-20 $\mu$ f., 150-volts-per-section electrolytic capacitor | R11—3.3 megohms  |
| R1—10,000-ohm wire-wound potentiometer, linear taper             | R12, R15—1 megohm  |
| R2—10 ohms   | R14, R19—1000 ohms   |
| R3—100 ohms  | R16—330,000 ohms   |
| R4—1000 ohms   | R17—10,000 ohms  |
| R5—10,000 ohms   | R18—56,000 ohms  |
| R6—100,000 ohms  | R20, R21, R22—100,000-ohm. $\frac{1}{2}$ -watt resistor, $\pm 10\%$                |
| R7—10,000-ohm potentiometer                                      | R23—1000-ohm, 2-watt resistor  |
|  | D1, D2—65-ma., 130-volt a.c. input, selenium rectifier (ITT 1234AII or equivalent) |

tion (V3a) and is then transformer coupled by T2 to the bridge. One leg of the bridge takes the inductor under test (X<sub>1</sub>). A direct-reading inductance-calibrated dial on the L control R1 in conjunction with the Q control R7 is used to balance the bridge. The sensitive tuning eye shows degree of balance. The S control R8 feeds more or less signal into

tube V1 and enables the eye to "look" into large or small signals without overloading the eye circuit. Range switch S1 places any one of five resistors in the S1, R2-R6 leg. The C1, R7 leg consists of a 0.1- $\mu$ f. capacitor paralleled by the Q control. The Q control balances out the resistance of the coil under test while the capacitor sets up a phase con-

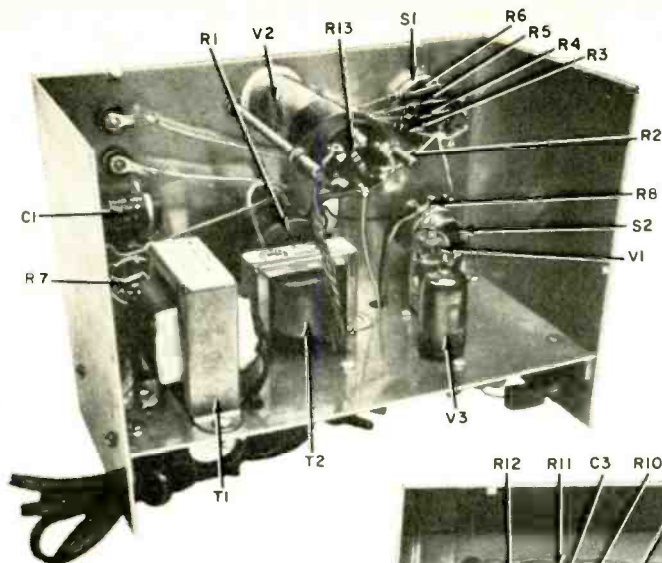

Install T1 and T2 at right angles to each other to minimize 60-cycle hum in the circuit. Leave room between V2 and R1 for L dial and screw head index.

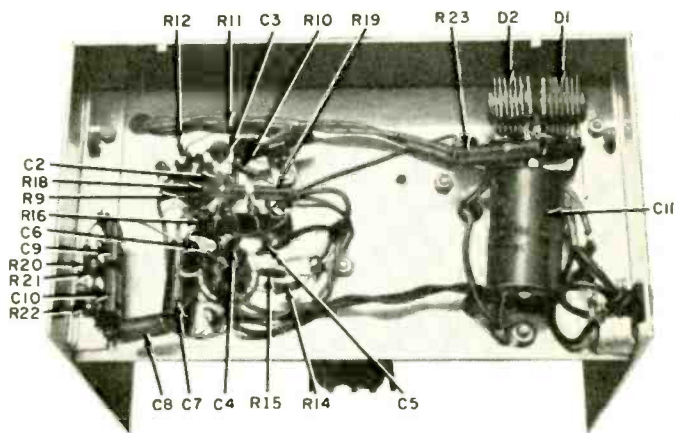

Easy construction: angle brackets support flat chassis plate. Keep leads short for R20-R22 and C8-C10, in the oscillator circuit. Other wiring is not critical.

S1—1-pole, 5-position rotary switch  
 S2—S.p.s.t. switch (part of R3)  
 T1—Power transformer: primary, 117 volts; secondaries, 250 volts, CT @ 25 ma., and 6.3 volts @ 1 amp (Stancor PS 8416 or equivalent)  
 T2—Universal output transformer (Merit A-2902 or equivalent)  
 V1—6AQ6 tube  
 V2—6U5 tube  
 V3—6AN8 tube  
 1—4½" x 6" x 8" utility box (LMB #146)  
 1—4¾" x 8" chassis, sheet aluminum  
 Misc.—Two 8-32x4" threaded rods, wire, etc.

dition to cancel the effects of lagging current caused by the coil. When reactance and resistance conditions across the  $X_L$  leg and the S1, R2-R6 leg balance conditions across the R1 leg and the C1, R7 leg, no signal will appear at R8.

When the bridge is not in balance, a voltage appears across R8. It is amplified by V1, then coupled to the diode

section of the same tube through C3, then rectified and direct-coupled to V2. The voltage is negative going and tends to close the eye. When the bridge is balanced, the tuning eye is wide open because the rectified voltage is then at a minimum. The values selected make it possible for each 1000-ohm division on the dial to indicate another *mh* on the lowest range. The five ranges are *x1 mh*, *x10 mh*, *x100 mh*, *x1 h*, and *x10 h*, as resistors from R2 to R6 are switched in respectively.

The 6AN8 oscillator (V3b) has an RC phase shift network consisting of R20, C9, R21, C10, R22 and C8 connected between plate and grid and forms a 180° shift in phase at 1 kc. It provides the positive feedback needed to maintain  
 (Continued on page 135)

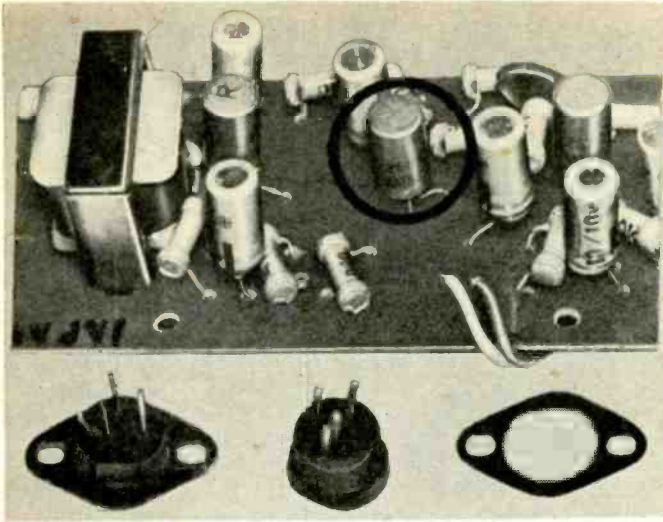

The first step is to isolate the bad transistor (circled), clip it out, and clean the solder out of the holes in the printed circuit board. Replace it on the board with an inexpensive imported transistor socket with the metal mounting ring and extra pin removed.

**T**RANSISTOR REPLACEMENT in commercially wired gear has always been a tricky business. Not only do you have to find the bad transistor and wrestle it out of the circuit board, but you have the problem of finding a replacement transistor that will work as well as the original. This latter step can get a bit sticky if you can't identify the original transistor, or if the circuit involved is a bit critical and refuses to work with just any replacement you happen to have in the junk box.

If trial and error substitution is the only answer, you can save yourself time, trouble, and a damaged circuit board by installing an inexpensive transistor socket. Since most of these sockets are equipped with four contacts, remove the contact that does not mate with the drilling pattern of the circuit board, and carefully work the remaining pins into the holes in the board. Solder the pins to the foil, and insert a substitute transistor in the socket.

When you find a suitable replacement transistor that performs to perfection, you can either leave it installed in the socket, or remove the socket and solder the transistor to the circuit board.

—Roy E. Pafenberg, W4WKM

## Transistor Replacement Technique

*Why solder in a doubtful replacement when this trick allows a variety of substitutes?*

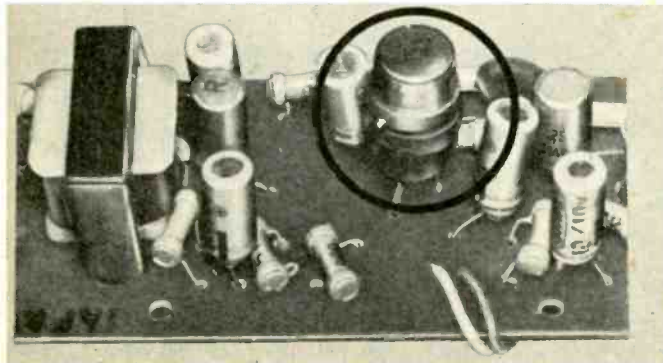

To install the socket, carefully push the leads through the holes in the board, making sure that the orientation matches that of the bad transistor. Plug in a substitute, and you're back in business.



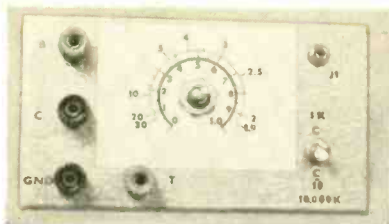

Knob is removed to show scale in photo at left. Jack J1 is for signal generator input; terminal posts serve as test points and outputs.

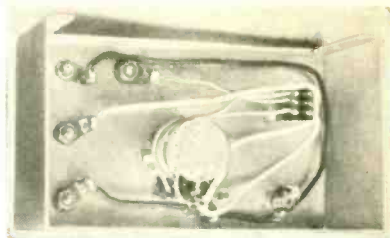

## THE EXALTED POT

*Sometimes even the simplest of electronic gadgets can save you countless hours of needless effort*

By **FORREST H. FRANTZ, Sr.**

**T**HE VERSATILE "Exalted Pot" is so simple you'll wonder why you didn't think of it yourself. All that's required to build the unit are two ganged potentiometers, a d.p.d.t. switch, assorted connectors, and a small aluminum box.

You can use it as a 1000-ohm and a 10,000-ohm resistance adjustable divider, as a substitution adjustable resistor for any value up to 10,000 ohms, or as a substitute volume control in transistor circuits. In combination with a VTVM and an audio signal generator, you can even use it for measuring capacity and inductance.

**Construction Details.** The unit is housed in a 2½" x 3" x 5¼" Minibox. The dual potentiometer (R1-R2) is made by using a 10,000-ohm linear unit (IRC-CTS Q11-116) and an add-on multi-section (IRC-CTS M11-108) which is a linear 1000-ohm unit. After cutting the shaft of R2 (the 10,000-ohm unit), attach R1 to the back of R2, but be careful that the wiper arm finger of R1 is properly seated in the wiper slot of R2 before bending the tabs and sealing the units together.

Now attach this ganged pot to the Minibox cover, and place the knob on the shaft, repositioning the potentiometer as necessary to maintain the same overshoot at each end of rotation.

Terminal posts B, C, T and GND are available from Lafayette Radio in a kit of 10 pieces (MS-566), and each requires a ⅜" hole. The GND post is grounded to the Minibox, but the other

three are insulated with fiber washers. Subminiature phone jack J1 is a Lafayette 99 G 9905, and needs a ¼" hole also. Switch S1 is a d.p.d.t. miniature toggle switch and requires a ¼" hole. Mount all components and wire them as shown in the diagram on the next page.

**Calibration.** The "Exalted Pot" dial scale can be calibrated by measuring resistance at various knob settings with an ohmmeter of known accuracy. The inner scale will be calibrated from zero at one extreme to 1.0 at the other, and interpreted to mean 1000 ohms full scale or 10,000 ohms full scale, depending on the setting of switch S1.

The outer (capacity) scale is calibrated from 1.9 to 30μf. These capaci-

If you have an audio signal generator and a VTVM you can use the "Exalted Pot" to determine capacitor values fairly accurately. The unit will also perform many other functions as described in text.

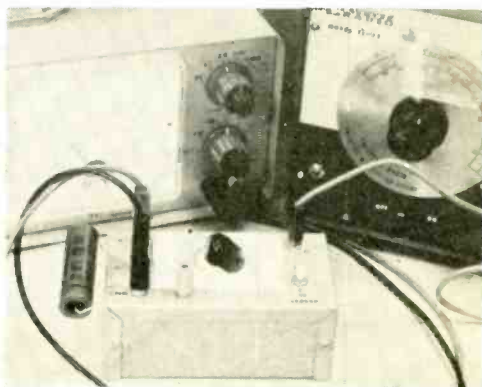

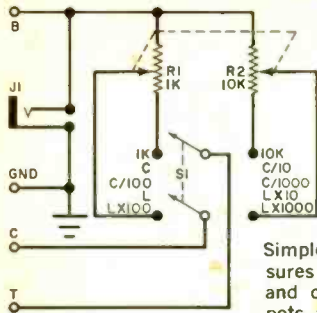

Simple instrument measures values of coils and capacitors. Adjust pots to match voltage across unknown parts.

RESISTANCE SCALE CALIBRATIONS		
Mark Scale	S1 at 1K (ohms)	S1 at 10K (ohms)
0	0	0
1	100	1000
2	200	2000
3	300	3000
4	400	4000
5	500	5000
6	600	6000
7	700	7000
8	800	8000
9	900	9000
10	1000	10000

tor markings actually correspond to capacitive reactance at a test frequency of 100 cycles. Potentiometers *R1* and *R2*, as well as the test frequencies of 100 and 10,000 cycles, were selected to provide a wide range of measurements without having to resort to many scales. Capacitance values of 0.0019 to 30  $\mu\text{f}$ . can be measured.

While not shown in the photo, the dial can also be calibrated to read values of inductance. For the values of the re-

sistors and frequencies selected, the instrument's range is from 1 mh. to 15 h. (15,000 mh.).

First calibrate the resistance scale. Set *S1* in the 1K position. Rotate the control and mark the dial at each 100-ohm point. Do this carefully and use a good ohmmeter to measure the resistance as you proceed around the dial. No further calibration is needed for resistance. The other range is essentially now cali-

(Continued on page 139)

CAPACITANCE SCALE CALIBRATIONS					
Mark Scale	Resistance (ohms)	100-cycle signal		10,000-cycle signal	
		S1 at C ( $\mu\text{f}$ .)	S1 at C/10 ( $\mu\text{f}$ .)	S1 at C/100 ( $\mu\text{f}$ .)	S1 at C/1000 ( $\mu\text{f}$ .)
1.9	836	1.9	0.19	0.019	0.0019
2	800	2	0.2	0.02	0.002
2.5	640	2.5	0.25	0.025	0.0025
3	530	3	0.3	0.03	0.003
4	400	4	0.4	0.04	0.004
5	320	5	0.5	0.05	0.005
7.5	212	7.5	0.75	0.075	0.0075
10	160	10	1	0.1	0.01
15	106	15	1.5	0.15	0.015
20	80	20	2	0.2	0.02
30	53	30	3	0.3	0.03

INDUCTANCE SCALE CALIBRATIONS					
Mark Scale	Resistance (ohms)	10,000-cycle signal		100-cycle signal	
		S1 at L (mh.)	S1 at Lx10 (mh.)	S1 at Lx100 (h.)	S1 at Lx1000 (h.)
1	62.8	1	10	0.1	1
2	125.6	2	20	0.2	2
3	188.4	3	30	0.3	3
4	251.2	4	40	0.4	4
5	314	5	50	0.5	5
6	376.8	6	60	0.6	6
7	439.6	7	70	0.7	7
8	502.4	8	80	0.8	8
9	565.2	9	90	0.9	9
10	628	10	100	1	10
11	690.8	11	110	1.1	11
12	753.6	12	120	1.2	12
13	816.4	13	130	1.3	13
14	879.2	14	140	1.4	14
15	942	15	150	1.5	15



# Four-Way Oscillator

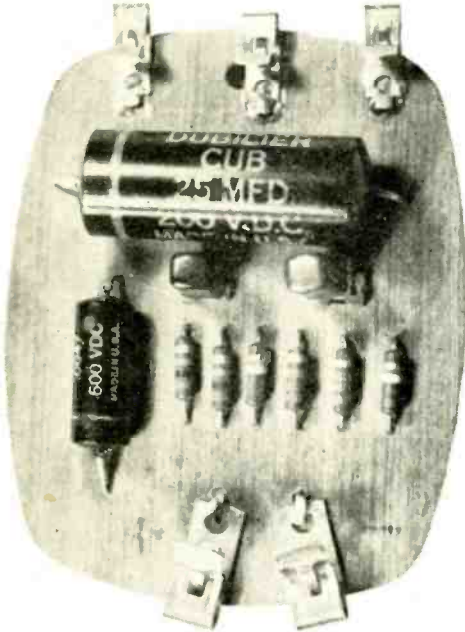

Almost nothing is critical about this one—parts values may be varied to give different frequencies and waveforms. CK722's were used for Q1 and Q2.

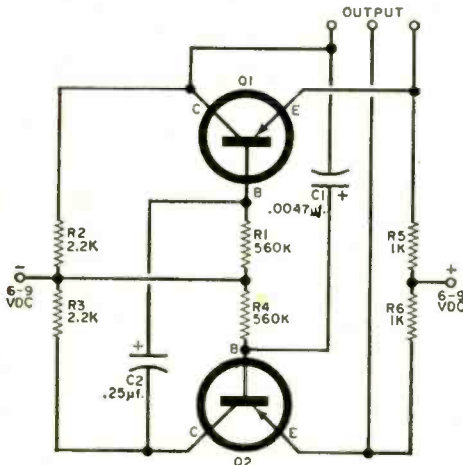

**I**F YOU'D like to try your hand at a very intriguing, easy to build, inexpensive transistor project, the "Four-Way Oscillator" is for you. It generates square waves comparable in quality to those produced by a commercial audio square-wave generator, and at least several other waveforms of different frequencies, shapes and strengths. The unit can also serve as a CPO, a grid dipper modulator, or as a go-no-go transistor tester.

A quick look at the schematic tells the story—the Four-Way Oscillator is actually a simplified free-running multivibrator, unusual in that only ten components are required. With the parts values shown, square-wave output of about 800 cps can be taken from the first two terminals at the top. Varying the value of  $C1$  will change the output frequency. Taking the output from different combinations of terminals will give different waveforms and different frequencies. Actually, output can be taken from almost any point in the circuit—it's fascinating to experiment while watching a 'scope or while monitoring the signals with a pair of headphones.

The Four-Way Oscillator makes an excellent tester for small-signal *npn* transistors. Defective units—including those with excessive leakage—will simply not work when used to replace either  $Q1$  or  $Q2$ —CK722's in the author's unit. Power supply voltage is not critical, but better square-wave linearity was obtained with 9 volts than with 6. The value of  $C2$  can be made considerably smaller without affecting the circuit; changing resistor values will change the waveforms obtainable.

To keep the cost down, the author's unit was built on a small chip of Formica (kitchen cabinet dealers use them for samples, and they should be available for the asking) measuring  $2\frac{1}{4} \times 3$ ". Holes were drilled to accommodate component leads, transistor sockets, and Fahnestock clips for battery leads and output terminals.

The oscillator makes a handy addition to any test bench.

—L. E. Byfield, K9ADD

# THE CASE OF THE ALUMINUM ALLY

THE PLASTIC CASES used in the construction of low-cost multi-testers such as the VOM have brought into existence a new breed of electronics experimenter—the “cracked-case VOM carrier.” Replacement cases simply aren’t available. The solution to the situation? Just call on your aluminum ally, the utility chassis box, to house the useful remains of your VOM.

Going about it is quite easy. First, examine the damaged case. In most instances, the plastic box itself is the damaged part; if it is, discard the box. If the front plastic piece which holds the meter, switch, and pin jacks is also damaged, carefully cement this piece with a good-quality epoxy resin.

Now select an aluminum chassis box about  $\frac{1}{2}$ " larger in each dimension than the original meter case. *Measure* a hole in the cover of the case that will pass the parts mounted on the VOM, leaving a good margin of safety. But remember, if you cut too large a hole, you’ll have to start all over again with a new box.

Once the VOM face fits neatly in its

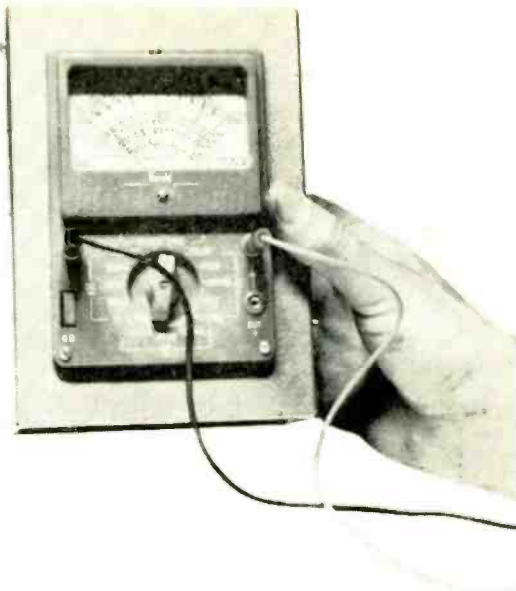

new case, secure it in place. The author’s VOM had pre-drilled holes which permitted the use of  $\frac{1}{2}$ "-long screws and nuts to bolt the meter face to the case. Do *not* drill any holes in the delicate plastic VOM face. Instead, resort to epoxy resin cement—you’ll have to wait from 4 to 12 hours for the cement to take hold.

Before fitting on the rear cover of the chassis box, weigh the assembly in your hand. If the VOM lacks “heft,” you may want to bolt down an old audio or power transformer in the bottom of the case to prevent it from tipping over while in use. —Homer L. Davidson

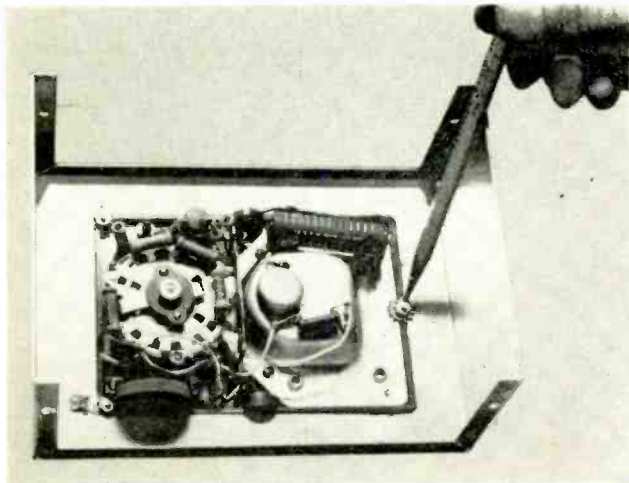

You can cut the VOM mounting hole in the aluminum box face by using the tried-and-true method of drilling many holes edge to edge, knocking out the unwanted center piece, and filing the rough edges smooth. But the job will be much quicker and easier with a square chassis punch or an Adel hand “nibbling” tool. Author took advantage of existing holes in VOM to secure it to the front panel of the “aluminum ally.”

# THE BEST OF TIPS & TECHNIQUES

## SNAP LEADS FOR WORKBENCH POWER SUPPLY

A standard transistor battery can be used as a power supply for experimental projects as well as for equipment tests on the workbench by attaching a pair of snap leads to the battery and the equipment. To make

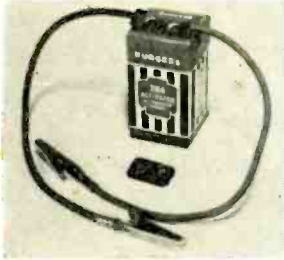

your own connector leads, salvage the terminals from a discarded type 2N6 battery or equivalent, or get a pair from your dealer. If the terminals are mounted on a terminal strip, cut the strip in half to enable them to fit on any size battery using this type of terminal. Connect the terminals to two wires, preferably one red and one black to indicate polarity. The wires should be flexible and durable. Finally, connect an insulated alligator clip to the other end of each wire.

—Luis Vicens

## PEG-BOARD TOOL HOLDERS MADE FROM SCRAP MATERIALS

Peg-board tool holders can be made from readily available scrap materials, such as a convenient length of angle iron or aluminum. Along one side of the metal, drill a series of holes or slots to hold the tools. On the other side, fashion two peg-board hooks

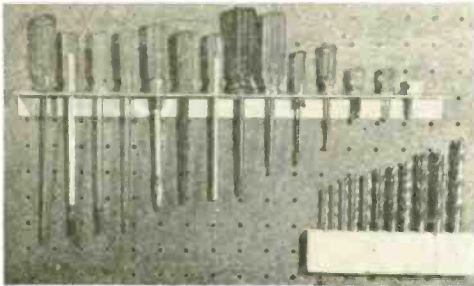

by hacksawing two slots about  $\frac{1}{4}$ " apart approximately 2" in from each end and bend to shape. These newly formed hooks should be spaced to line up with the peg-

board holes. For an easy fit, use a file or grindstone to round off the edges and reduce the diameter of the hooks if necessary. A scrap block of wood can also be utilized as a tool holder, as shown in the photo.

—Carleton A. Phillips

## SIMPLE GDO MODULATOR FITS INTO PHONE PLUG

Do you need a modulator for your grid dipper? The circuit below is that of a simple neon lamp oscillator with an output from 200 to 1000 cycles. Resistor  $R1$  can be increased or decreased to compensate for any variation in B-plus. Coupling is accomplished through  $C2$ , whose reactance is negligible at these frequencies. Resistor  $R2$

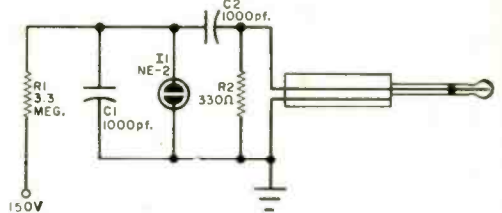

controls the amount of modulation, and can be adjusted to give a pleasant sound. (A 1000-ohm potentiometer could be used instead of a fixed resistor.) The entire circuit can be built into a PL-55 phone plug. A suitable socket should be mounted on the front or rear of the GDO case and connected to a convenient B-plus point on the GDO power supply. The B-plus lead from the modulator can then be conveniently connected. If the PL-55 won't fit into your GDO, mount a suitable plug on any small container—such as a 35-mm. film container—that will hold the modulator parts.

—David W. Beaty, K7MNC

## SPEED UP KIT ASSEMBLY WITH A SEAFOOD PARTS TRAY

The next time you buy frozen seafood at the supermarket, look closely at the package. Some of this frozen food—notably fish cakes and patties, and such delicacies as flounder stuffed with crab meat—are packed in plastic trays like the one in the photo (on p. 128). The trays have 4 compartments, each of which is just the right size for small components such as resistors, capaci-

# 1 PENNY SALE! NEW for '66

- Money-Back Guar
- ZENERS GLASS—EPOXY .6 for \$1 12 for 1.01
  - GERMANIUM DIODES 25 for \$1 50 for 1.01
  - TOP HAT RECTIFIERS .25 for \$1 50 for 1.01
  - TRANSISTORS . . . . .30 for \$1 60 for 1.01
  - DISC CONDENSERS . .30 for \$1 60 for 1.01
  - MICRODIODES RECTFS 50 for \$1 100 for 1.01
  - EPOXY RECTIFIERS 25 for \$1 50 for 1.01
  - 30-MC TRANSISTORS 4 for \$1 8 for 1.01
  - 40-WATT TRANSISTORS 2 for \$1 4 for 1.01
  - 20-WATT TRANSISTORS .3 for \$1 6 for 1.01
  - PRECISION RESISTORS 30 for \$1 60 for 1.01
  - RESISTORS, 1/2W . . . . .50 for \$1 100 for 1.01
  - 2-6 AMP RECTIFIERS . . . . .8 for \$1 16 for 1.01

**HIGH POWER \$1**  1AMP  3AMP  1000 for PIV  RECTIFIERS \$1

PNP 100Watt/15 Amp HI Power  
TO36 Case! 2N441, 442, 277,  
278, DS501 up to 50 Volts ea.

<input type="checkbox"/> TRANSISTORS Supplied		SILICON SCRS CONTROLLED RECTIFIERS	
<b>100 for \$2.98</b> with		PRV 7 16 25	
Power, Audio, RF, untested PLANARS		AMP AMP AMP	
<b>750 MIL TOP HAT</b>		50 <input type="checkbox"/> 48 <input type="checkbox"/> 70 <input type="checkbox"/> .90	
PIV	Sale PIV	100 <input type="checkbox"/> 70 <input type="checkbox"/> 1.20 <input type="checkbox"/> 1.50	
50 <input type="checkbox"/>	5¢	200 <input type="checkbox"/> 1.05 <input type="checkbox"/> 1.70 <input type="checkbox"/> 2.10	
100 <input type="checkbox"/>	7¢ 600 <input type="checkbox"/>	300 <input type="checkbox"/> 1.60 <input type="checkbox"/> 2.20 <input type="checkbox"/> 2.70	
200 <input type="checkbox"/>	9¢ 800 <input type="checkbox"/>	400 <input type="checkbox"/> 2.10 <input type="checkbox"/> 2.70 <input type="checkbox"/> 3.00	
400 <input type="checkbox"/>	13¢ 1000 <input type="checkbox"/>	500 <input type="checkbox"/> 2.80 <input type="checkbox"/> 3.30 <input type="checkbox"/> 3.80	
		600 <input type="checkbox"/> 3.00 <input type="checkbox"/> 3.90 <input type="checkbox"/> 4.30	

TERMS: include postage,  CATALOG 10¢ \$2.00 min. order

**POLY PAKS** P.O. BOX 942 H  
50 LYNNFIELD, MASS.

CIRCLE NO. 17 ON READER SERVICE CARD

# FREE

## GIANT NEW CATALOG

### BURST-APPLEBEE CO.

Dept. EEM, 1012 McGee, Kansas City, Mo. 64106

Rush me FREE 1966 B-A Catalog.

Name

Address

City  State

Please be sure to show your Zip No.

**SEND FOR IT TODAY**  
**FREE**

CIRCLE NO. 2 ON READER SERVICE CARD

tors, nuts, bolts, etc. A couple of these trays can vastly speed up kit assembly—you simply sort parts into compartments before you begin. The tray illustrated here

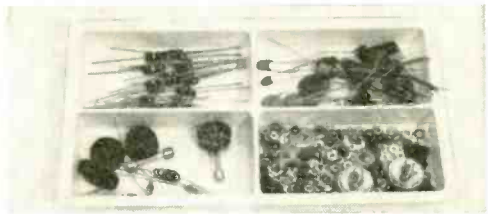

is used by National Food Marketers, Inc., Blue Anchor, N.J., and carries the "Home Spot" registered trademark.

—W. B. Stevenson

### TUNE THE TRAP WITH YOUR TRANSMITTER

In the absence of a signal generator, tunable traps designed to operate within the frequency range of an available transmitter can be tuned accurately with the aid of a field strength meter and the transmitter. Simply connect one side of the trap to a short length of wire and the other side to a field strength meter, set the transmitter on the desired frequency, and tune the trap for a null reading. Watch your signal strength, keeping it down to a minimum, and rock the trap adjustment to be sure you are at the bottom of the response curve.

—Richard Mollentine

### CUT CLIP CLUTTER WITH SHOWER CURTAIN RINGS

You can rack up assorted test clips on one or more shower curtain rings and keep them handy on the tool-board behind your workbench. A ring can be hung on any

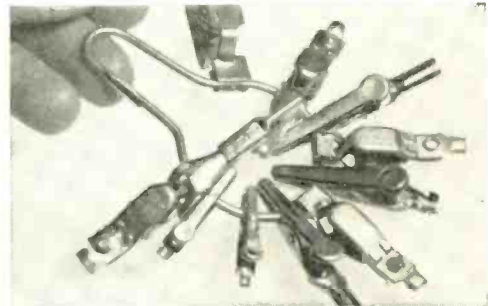

convenient nail or hook. If kept in the tool box, the racked-up clips are not likely to go astray or get mixed up with other hardware, tools, and miscellaneous parts.

—John A. Comstock

## ERSATZ PRESS-TO-DO-SOMETHING SWITCH

The next time you are stuck for a press-to-do-something / release-to-do-something-else type of switch, and all you have is a slide switch, fashion a small piece of springy metal into a "V" shape, drill a hole in it to accommodate the machine screw on the

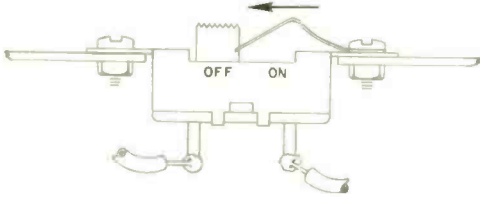

appropriate side of the slide switch, and mount it as shown. Cut or file a small notch in the slide handle to keep the spring in place. A normally open or normally closed switch can be improvised as required.

—A. Rosenblum

## GROMMET-TIRED TRANSISTORS PREVENT SHORT CIRCUITS

Grommets can be used to protect lead-mounted transistors against vibration and short circuits. You simply fit a grommet over a transistor in much the same way as

you would fit a tire over a wheel. This technique will also permit you to leave longer leads on the component and provide a little more protection against heat damage from the soldering iron. Use of a

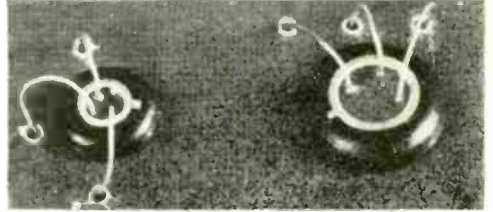

grommet may slightly increase operating temperatures, but ordinarily will not create a problem in small current circuits. A 3/16"-i.d. grommet is suitable for the smaller TO-18 transistor case and a 1/4"-i.d. unit can be stretched to fit over the larger TO-5 container.

—Don Lancaster

## PLASTIC DRAIN TRAYS IDEAL FOR PROJECT BREADBOARDING

Plastic cutlery drainage trays stolen from the kitchen make breadboarding experimental circuits easier and quicker. The holes will accommodate all the nuts and bolts and other hardware you need. Hook-up wire can be conveniently threaded

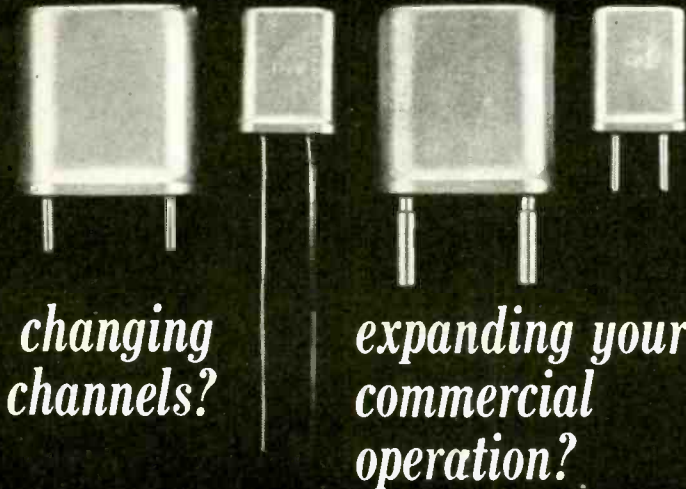

*changing channels?*

*expanding your commercial operation?*

STOCKED IN DEPTH BY LOCAL & MAIL ORDER DISTRIBUTORS

CTS Knights, Inc. has the right crystal for all CB applications.

CTS Golden Line CB crystals are manufactured to the same exacting specifications as military units ... an accuracy of  $\pm .003\%$  of frequency. Crystals are hermetically sealed and are unaffected by wide temperature extremes. All crystals are made from virgin quartz ... only "first cuts" are used.



**CTS KNIGHTS, INC.**

(Formerly the James Knights Company)  
**SANDWICH, ILLINOIS**

a subsidiary of CTS Corporation, Elkhart, Indiana



CIRCLE NO. 3 ON READER SERVICE CARD

# FREE

from your distr./dealer . . . **TRANSISTOR SELECT-A-SPEC** (\$3.95 retail) . . . the only complete specs and substitution book . . . **FREE** with the purchase of three or more **TECHPRESS** books. Stock your library now. Take coupon to distr./dealer; or send to **TECHPRESS, INC.** Brownsburg, Ind., adding 25c for postage.

Please RUSH more information. My distr. dealer doesn't stock **TECHPRESS** Publications.

For my **FREE TRANSISTOR SELECT-A-SPEC** I choose the following:

- Radar—Principles and Practices . . . . . \$1.95
- Semiconductor Circuits Handbook Vol. 1 . . . . . \$2.95
- Semiconductor Circuits Handbook Vol. 2 . . . . . \$1.95
- Selected Semiconductor Circuits . . . . . \$1.25
- Transistor Specifications & Substitution Handbook . . . . . \$1.95
- Diode Select-A-Spec . . . . . \$2.95
- Receiving Tube Specifications and Substitutions . . . . . \$1.95

**TECHPRESS, INC.** Brownsburg, Indiana 46112

Name \_\_\_\_\_  
Address \_\_\_\_\_  
City and State \_\_\_\_\_

## LEARN ELECTRONICS AT HOME IN YOUR SPARE TIME

It is fun to learn when you can set your own pace. Whether you want a beginner's course that teaches the basic fundamentals of solid state and tube electronics, or an advanced course that will equip you to move up the ladder in your chosen field of electronics, you can select just the courses you want to take . . . and take those courses at your own speed.

**EARN MORE**, learn about Missiles, Computers, Transistors, Automation, Printed Circuits.

Over 30,000 graduates now employed by industry. Resident school also available at our Chicago Campus.—Founded in 1934.

Send for our **FREE** course catalog.

**AMERICAN INSTITUTE OF  
ENGINEERING & TECHNOLOGY**

1137-1139 W. Fullerton Parkway—Chicago, Illinois 60614

CIRCLE NO. 1 ON READER SERVICE CARD

through the holes and run on both sides of the tray. You can easily cut larger holes for controls and tube sockets with a pocket

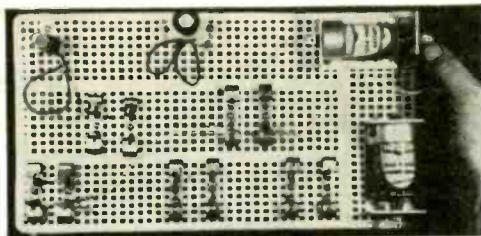

knife. The sides of the tray are deep enough to provide sufficient clearance for many components. —Margie V. Erickson

### CHEATER CORD CONNECTS PROJECTS CONVENIENTLY, SAFELY

Do the line cords on your experimental circuits keep getting shorter? Each time you "borrow" a cord from one project to use on a newer circuit, the number of cordless old



projects grows larger, and you wind up with a shoe-box full of three-inch line cords. One simple solution to the problem is to install a cheater cord

connector on everything you build. In addition, a certain margin of safety can be derived from the use of a cheater cord. If something happens that requires a quick disconnect, a tug on the line cord will cut off the power. —Don Lancaster

### CATWHISKER DETECTOR ECHOES YESTERYEAR

For a nostalgic return to the pioneering days of radio, try your hand at making a catwhisker crystal detector. Carefully break the glass of either a new or discarded 1N34A germanium diode and keep the cathode end containing the little wafer of germanium. Solder the lead to a Fahnestock clip and screw the clip to a small wood base. When soldering the crystal, grip the lead with

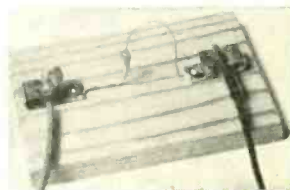

a pair of pliers (which acts as a heat sink). Also solder a 2" length of thin, stiff wire to another Fahnestock clip and fasten



this clip to the base as shown. File the free end of the wire to a point and bend it to contact the crystal. You can use this catwhisker detector in your favorite circuit and have fun finding the most sensitive spots.

—Art Trauffer

### MAKE YOUR OWN PLUG-IN CAPACITORS

When building new equipment from scratch, you can make your own plug-in capacitors if space on the chassis permits. They will simplify replacement should it become necessary. First salvage the bases from old octal tube sockets, carefully removing all the old glass and cement. A hot soldering iron will clear the tube pins, and you can rewire the base to accommodate your capacitor. Just be careful to note the pin numbers and the correct polarity. With an octal socket wired to hold the plug-in capacitor, you can change capacitors without soldering or de-soldering—as easily as tubes.



—James V. Conklin

### RESISTOR STORAGE BLOCK

A handy way to keep resistors ready for instant use is to build a storage block for them. Three rows of holes drilled in the block will allow three resistors of each value to be stored; the hole spacing should be the same as the line spacing of the typewriter used for the identification slip which

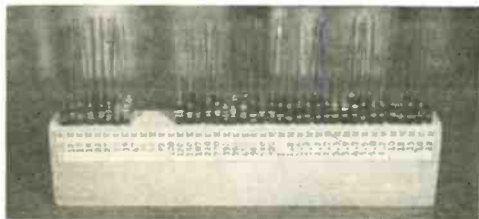

is cemented to the side of the block. Six lines to the inch is just right for 1/2-watt resistors, and double or triple spacing can be used for 1-watt or 2-watt resistor blocks. Drill the holes 1 5/8" deep using a 5/64" drill. You may want to apply a coat of clear lacquer or varnish to the resistor value slip to keep it clean.

—Thomas H. Charters

1966 Spring Edition



*Your copy is waiting*  
**The do-it-yourselfer's  
newest catalog**

Here's your new catalog of quality electronic kits and assembled equipment . . . your shopping guide for TV set kits, transistor radios, voltmeters, scopes, tube testers, ham gear, PA systems, and a host of other carefully engineered products. Every item in the Conar catalog is backed by a no-loopholes, money-back guarantee. It's not the biggest catalog, but once you shop its pages you'll agree it's among the best. For years of pleasurable performance, for fun and pride in assembly, mail the coupon. Discover why Conar, a division of National Radio Institute, is just about the fastest growing name in the kit and equipment business.

# CONAR

**MAIL NOW!**

CONAR

BQ6C

3939 Wisconsin Avenue, Washington, D.C. 20016

Please send me your new catalog.

Name \_\_\_\_\_

Address \_\_\_\_\_

City \_\_\_\_\_ State \_\_\_\_\_ Z-code \_\_\_\_\_

CIRCLE NO. 4 ON READER SERVICE CARD

# HALF-PRICE

on a subscription to

# POPULAR ELECTRONICS!

**18** exciting months **\$3<sup>00</sup>** only

At the regular subscription rate these same 18 issues would cost all of \$6.00! BUT NOT FOR YOU. Your cost is only \$3.00—HALF-PRICE!

Every month POPULAR ELECTRONICS brings you a wealth of fascinating features aimed especially at experimenters and do-it-yourselfers like yourself. (Just glance to the right for a sample!)

You'll enjoy being right on top of the fast-growing world of electronics with up-to-the-minute new product reports, lab tests, buying guides, and electronics breakthroughs you want to know about. Plenty of articles on hi-fi, money-saving test equipment, tape recorders, electronic games, computers, photo-aids, short wave receivers, antenna systems, solar powered and transistorized equipment—and much more.

Construction projects galore! Clear-as-crystal diagrams guide you each step of the way through fun-to-build projects you can put together in just a few hours...for pennies! Turn friends green with envy by building a super hi-fi rig they couldn't match in the stores for hundreds of dollars! Or throw together a fool-proof photoelectric burglar alarm to protect your home and loved ones...or a remote control switch that actually turns lights on and off when you whistle a bar of your favorite tune!

POPULAR ELECTRONICS is definitely for men like YOU. Take advantage of this HALF-PRICE OFFER to readers of the Experimenter's Handbook. Just complete and mail the card facing this page. Or, if someone has already used the card, write to: POPULAR ELECTRONICS, Dept. 4086, Portland Place, Boulder, Colorado 80311



## EXCLUSIVE HAM, SW & CB ARTICLES IN POPULAR ELECTRONICS

### Amateur Radio and SWL

Make Your Signal Reports More Accurate  
Safety in the Ham Station  
Amateur License Fees and ARRL Petitions  
Take Advantage of Changing Propagation Conditions

Operating Another Ham's Station  
Calling All SWL DX'ers  
DX Awards  
English-Language Newscasts to North America

Radio Marathon Broadcasts Truth To Cuba

Satellites on the Air  
Short-Wave Broadcast Predictions  
Short-Wave Report  
North American Alliance of SWL Clubs  
Welcome to the SWL Newcomer  
Sure Cure for Ham/CB Mobile Noise

### Citizens Band Radio

"DSRC," New CB Features  
Equipment Buyer's Guide  
Transmitters and Transceivers  
Station Accessories  
Antennas  
Microphones  
Hand-Held Transceivers  
FCC Report  
On the Citizens Band  
Sure Cure for Ham/CB Mobile Noise  
Vibrator Hash, Wipe Out

### Build-It-Yourself

Antenna, 40-Meter, for Small Roof  
Antenna Adapter, Power Line  
Code Bander  
Crystal Super Calibrator  
Double-Duty EICO 772  
Hula-Hoop—a Ham or CB Antenna  
Idento-Minder  
Q-Multiplier, Nuvistor  
Screen Modulator, One-Tube  
Transmitter Crystal Switch, Plug-in  
2-Meter Simple Superhet

## Build a Stereo Bal

(Continued from page 77)

amplifiers, it may be necessary to run a lead between the two amplifier chassis. However, don't run the lead unless it appears that the Stereo Bal won't work without it.

**How to Use the Stereo Bal: As an FM Stereo Indicator and Output Balance.** With the tuner switched to mono, tune in a known mono station. Set the amplifier balance control to center or normal balance. Tune in a station and adjust the tuner's two output controls (if your tuner has output controls) for minimum flickering of the Stereo Bal's lamp. (When there is a separate output control for each channel of your stereo tuner, the best technique is to turn one control about 9/10 full up and then adjust the other control for balance.) Now switch the tuner to stereo and the bulb should flicker only on stereo program material; the brightness and duration of the flicker will depend upon the amount of stereo separation in the program material. It may also be possible to use the lamp's flickering to adjust the stereo separation of those tuners that have a control for that purpose.

**For Phono and Overall System Balance.** If you have a stereo preamplifier and stereo power amplifiers with input level controls, set the preamplifier for mono and center the preamp's balance control. Play a record and adjust the power amplifier's two input level controls using the same technique as given above to balance the tuner's outputs. If the power amplifier doesn't have input level controls, simply adjust the preamp's balance control for minimum lamp flicker. Incidentally, whenever there are both power amplifier input level controls and tuner output or other program source level controls to be balanced, the power amplifier should always be adjusted first.

While the Stereo-Bal works well in most stereo systems, it may not respond too well when used with certain high-efficiency speakers. Some sensitivity has been sacrificed for simplicity and economy.



**PERMANENT PROTECTION!**

## POPULAR ELECTRONICS

Deluxe Magazine Files that hold a full year's copies!

Designed to keep your periodicals orderly and easy to refer to. These durable files guard against soiling, tearing, wear or misplacement of issues. They look, feel like leather and are washable! 23kt. gold lettering and exquisite 2-color binding make them highly-decorative additions to your bookshelves.

**Shipped POSTPAID! FULLY GUARANTEED!**

**Only \$3.50 each—3 for \$10, 6 for \$19!**

Jesse Jones Box Corp., Box 5120, Dept. PE  
Philadelphia 41, Pa.

Please send me:

TITLE	QTY.	BLACK BACKING/ MAROON SIDES	MAROON BACKING/ BLACK SIDES
Popular Electronics	_____	<input type="checkbox"/>	<input type="checkbox"/>
_____	_____	(Other publications shipped in colors available.)	
_____	_____		

Total amount enclosed \$ \_\_\_\_\_

name \_\_\_\_\_

address \_\_\_\_\_

city \_\_\_\_\_ state \_\_\_\_\_ zip code \_\_\_\_\_

(Payment Must Accompany Order)

**Because you've got to SEE it to BELIEVE it... we will send you a FREE sample!**

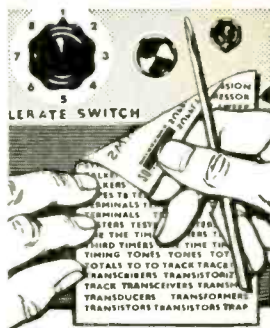

*instant lettering*

## DATAMARK

— the easy new way to label your projects!

Just rub over the pre-printed words or symbols with a ballpoint pen and they transfer to any surface — looks like finest printing! Label control panels, meter dials, letter on anything!

LOOK FOR *instant lettering*

**DATAMARK SETS**... only \$1.25 each

— at leading electronic distributors

**DATAMARK SETS AVAILABLE FOR:**

- Amateur Radio, CB
  - Audio, Hi-Fi, TV
  - Experimenter Home Intercom
  - Industrial Test Equipment
  - Switch & Dial Markings
  - Alphabets & Numerals in 1/8", 1/4" and 1/2"
- each set has black, white, and gold  
SEND FOR FREE SAMPLE

**THE DATAK CORPORATION**

85 HIGHLAND AVENUE • PASSAIC, N. J. 07055  
CIRCLE NO. 6 ON READER SERVICE CARD



## A treasury of SOUND advice.

SELECTING THE RIGHT RECORDER ■ SOUND EFFECTS ■ ACCESSORIES ■ RECORDING LIVE STEREO AT HOME ■ TAPE EDITING ■ PORTABLES ■ VIDEO RECORDERS

It's easy to be an authority on tape with a copy of HiFi/Stereo Review's 1966 TAPE RECORDER ANNUAL handy.

This fact-filled volume contains over 130 pages, more than 20 complete features, covering every aspect of tape recording. You get expert tips by the dozens, on equipment—making better tapes—editing—copying—sound—on everything you want and need to know about tape recording.

Plus a complete directory of the latest monaural and stereo recorders—the only complete buyer's guide available in the tape recorder field!

Over 100 photos—full data on 220 models from 30 different manufacturers! All the model numbers, specifications, dimensions and prices... every vital statistic you need to compare the newest recorders and select the finest one in your price range.

The 1966 TAPE RECORDER ANNUAL is an indispensable guide for everyone who wants better performance, greater versatility and a lot more fun from his tape recorder... month after month... tape after tape!

**GET THE DELUXE  
GOLD-EMBOSSED LEATHERFLEX EDITION**  
...for just \$3.00 POSTPAID!



Ziff-Davis Service Division • Dept. TR  
589 Broadway • New York, N.Y. 10012

Send me a copy of the 1966 TAPE RECORDER ANNUAL, as checked below:

\$1.25 enclosed, plus 15¢ for shipping and handling. Send me the regular edition. (\$1.50 for orders outside the U.S.A.)

\$3.00 enclosed. Send me the DeLuxe Leatherflex-bound edition, postpaid. \$3.75 for orders outside the U.S.A.) Allow three additional weeks for delivery.

name \_\_\_\_\_ please print EEH-66

address \_\_\_\_\_

city \_\_\_\_\_ state \_\_\_\_\_ zip code \_\_\_\_\_

PAYMENT MUST BE ENCLOSED WITH ORDER.

## Electronic Flash

(Continued from page 15)

Using the Electronic Flash. There are four things you should consider when using the electronic flash: camera sync, shutter speed, guide number and type of film.

Your camera must have X sync to work properly with this flash. A few cameras have F sync (5-millisecond delay) or the more common M sync (20-25 millisecond delay). Neither of these sync settings can be used with an electronic flash. Shutter speed is related to sync, but only because most quality focal plane shutter cameras have a  $\frac{1}{50}$ -second X sync speed. Generally speaking, a good focal shutter plane camera is useful up to  $\frac{1}{125}$  second. Some of the more modern shutters (metal leaves) can be used at any shutter speed, up to  $\frac{1}{500}$  or  $\frac{1}{1000}$  second.

Film exposure with different types of film using the electronic flash is calculated from a guide number in the same fashion as with ordinary flash bulbs. You can define guide number as the lamp-to-subject distance times the F-stop. The guide number changes with each ASA film rating. There is no filter factor or color correction factor for the electronic flash.

You can determine the guide number for your electronic flash and your most frequently used films in the following fashion:

(1) Load the camera and connect the flash. Set your model exactly 10 feet in front of the lens and be sure the flash reflector is centered on the model.

(2) Be sure that the Ready light is blinking before you take a picture.

(3) To determine the guide numbers (usually 40 for Kodachrome II, and 150 for plus-X film), take a picture at all openings ( $f/4$  through  $f/22$ ) with your model holding a lettered card calling out the film type and f-stop without changing distance or shutter speed. Develop the film and examine the pictures for best exposure. If the best exposure is say at  $f/4$ , your guide number is 40 ( $f/4 \times 10$  feet).

(4) The guide number remains the

same when the flash gun is operated on batteries or house current.

Once the guide number for the film you will most likely use has been established, you will be on the way to much better indoor (or even outdoor) photography.

-30-

### Experimenter's L Bridge

(Continued from page 121)

oscillation. To minimize loading effects on the oscillator, the signal is taken from the junction of *R17* and *R18*. The output transformer delivers approximately 4 volts to the bridge circuit, which varies with the range setting. The lower mh ranges place a heavier load on the output transformer and cause a drop in voltage. The power supply is a conventional full-wave rectifier circuit.

**Construction.** A 4 $\frac{3}{8}$ " x 8" chassis plate is held in place by two angle brackets about 1 $\frac{1}{2}$ " from the bottom of a 4 $\frac{1}{2}$ " x 6" x 8" utility box. The tuning

eye socket is secured to the front panel by two 8-32 x 4" rods. A single-terminal lug for the other ends of the five resistors attached to the range switch is mounted on the rod nearest the switch. Connect the circuit leads to *R7* so that the resistance increases as the control is rotated clockwise. (Note: do not connect the *L* control (*R1*) until calibration is completed.)

The *L* dial is a 4" metal disc; a cardboard or plastic dial can also be used. A sheet metal screw positioned below the tuning eye and just above the dial and with the slot in a vertical position serves as an indicator. Paint or ink in the slot on the screw head to make it easy to see. Drill several rows of  $\frac{1}{4}$ " or  $\frac{3}{8}$ " holes in the rear panel to allow for ventilation. Wiring is not critical, but keep the leads short in the phase shift network of *V3b*. Terminals *X<sub>L</sub>* should be insulated from the front panel.

**Calibration.** An ohmmeter or multimeter with an 0-10,000-ohm range is needed for calibration. Rotate the still-disconnected *L* control to the full counterclockwise position. Connect the ohm-



## FREE! HOW TO IMPROVE YOUR TWO-WAY RADIO!

The right communications microphone may double the talk power of even the finest transmitters! Learn how unwanted noise can be eliminated—reliability improved—intelligibility increased by proper microphone selection.

Write for our helpful free booklet today!

ELECTRO-VOICE, INC., Dept. 262EH  
Buchanan, Michigan 49107

Please send the free E-V booklet on choosing communications microphones. I am interested in the following areas of two-way radio:  Amateur  Aviation  CB  Business.

NAME \_\_\_\_\_

COMPANY \_\_\_\_\_

ADDRESS \_\_\_\_\_

CITY \_\_\_\_\_ STATE \_\_\_\_\_

**Electro-Voice**

SETTING NEW STANDARDS IN SOUND

CIRCLE NO. 9 ON READER SERVICE CARD

# NOW! FAMOUS SYDMUR TRANSISTORIZED

## Capacitor Discharge Ignition System

as described in June 1965 Popular ELECTRONICS Page 43



# SAVE MONEY

## on GAS! COILS! SPARK PLUGS! TUNE-UPS!

### Give your CAR, TRUCK or BOAT more PEP than when NEW!

You're going to be amazed at the performance of your car, truck or boat! More spark in your gasoline engine means substantially improved performance. You START regardless of weather! You get MORE MILEAGE with MORE POWER at high speeds! And you'll drive 40,000 miles before your engine will need a tune-up!

This is the Famous Sydmur System that was the subject of a special article in Popular Electronics, June and Oct., 1965. Engineered to last, all parts thoroughly pre-tested with specially designed power transformer. Fiberglass printed circuit board, color coded for easy assembly. Functions perfectly at temperatures below freezing or with highest engine temperatures. Built to Mil. Specs. Eliminates ballast resistor and condenser. Weighs less than 2 lbs. Small, 3 x 4 x 5".

KIT - Guaranteed One Full Year, Neg. Grd.,  
6 or 12 V .....\$44.50  
KIT-Positive Ground, 6 or 12 V .....\$47.50  
ASSEMBLED-GUARANTEED TWO FULL YEARS  
6 or 12 V .....\$60.00

Send Check or M.O. or ask for FREE literature - TODAY!

**SYDMUR ELECTRONIC SPECIALTIES**

P.O. BOX 25B, Midwood Station, Brooklyn, N.Y. 11230

**CIRCLE NO. 24 ON READER SERVICE CARD**

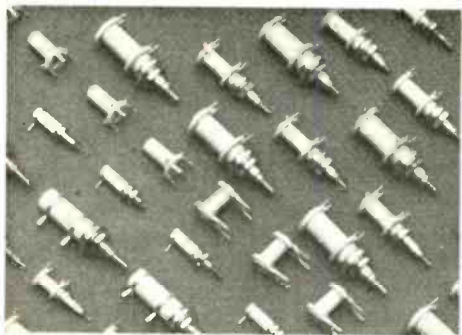

## Ceramic Coil Forms In Stock/In Depth

Ceramic coil forms in .205", .260", .375" and .500" diameters are now stocked in depth for applications in frequency ranges between 50 kc and 300 mc. Bushing mounted forms with fiberglass collars for high "Q"/low loss applications are available in 2-terminal and 4-terminal configurations.

Write for 20-page Coil Form catalog.

### J. W. MILLER CO.

5917 So. Main St. Los Angeles, Calif. 90003

NOW GET FACTORY PRICES IN QUANTITIES  
TO 750 FROM YOUR LOCAL DISTRIBUTOR



**CIRCLE NO. 32 ON READER SERVICE CARD**

meter to the center and right terminals, looking at the control from the rear, the terminals pointed downward. The meter should indicate approximately zero resistance. Now rotate the *L* control clockwise and mark the dial at every 500-ohm point. Number the 1000-ohm positions. Use alternate long and short lines for easier reading, placing the long lines opposite the 1000-ohm points.

Disconnect the meter and hook up the same two terminals of the *L* control to the circuit. The left terminal should be connected to the center terminal for better control action.

**Operation.** Set the *S* and *Q* controls about midway and allow your newly made inductance bridge to warm up for a few minutes. Connect the coil to be tested to the binding posts and set the range switch to an appropriate range. Adjust the *S* control until the tuning eye is almost closed. Slowly rotate the *L* dial while watching the tuning eye for a sharp change from minimum to maximum and back to minimum again.

Adjust both the *L* and the *Q* control for maximum opening. Rock the controls to pinpoint the settings. Then rotate the *S* control clockwise to increase tuning eye sensitivity. The shadow will narrow. Again readjust the *L* and *Q* controls for maximum eye opening. The *L*-dial calibration mark multiplied by the range-switch setting indicates the inductance value.

When filter and audio chokes are measured, begin with the *Q* control at the full clockwise position. It will probably have to stay there. Several bridge balance indications may be found with low value r.f. chokes. Use the one with the largest amount of eye opening.

Accuracy of the bridge is determined by the precision of the components used and the *L* dial calibrations.

-30-

## Swiss Quad Antenna

(Continued from page 105)

in and out to obtain the lowest possible SWR. Move the U's no more than a quarter inch at a time, and keep the ratio between the "director" and "reflector" dimensions constant.

After the SWR is reduced to a minimum by adjusting the U's, vary the length of the *gamma* for a possible further reduction in SWR. It should be a simple matter to reduce the SWR to well below 1.2:1. These adjustments can be made in any reasonably clear space, as long as there is a separation of five feet or more between the antenna and the nearest large object. Be sure to solder all joints and connections.

**Results.** The front-to-back ratio of the Swiss Quad is about 25 db; its front-to-side ratio is over 35 db. In operation, a moderately strong signal from the front of the antenna will disappear off the back and sides. Indicated gain is a minimum of a solid 6 db over a reference dipole antenna. For its size and cost, the "Swiss Quad" is an excellent performer. By the way, it radiates a horizontally polarized signal.

-30-

### Transistor FM Multiplexer

(Continued from page 60)

strong signal area, tuner sensitivity is usually not a problem. Some tuners have high-impedance detector circuits which are not suitable for connecting directly to the relatively low impedance transistor circuit in the FM multiplexer. The circuit shown in Fig. 3 can be added to a tuner not equipped with a cathode follower.

Power requirements for the multiplexer are -12 to -17 volts at approximately 25 ma. for stereo, and 11 ma. for mono operation. Less current is needed for mono reception because, in this mode, the stereo indicator lamp is normally off. Various power supplies can be used, but one simple way to get power is to draw it from the tuner's supply as shown in Fig. 4.

The response and separation curves on page 56 were derived from a quality report by Hirsch-Houck Laboratories.

**Alignment and Operation.** Alignment is begun by removing *Q4* from its socket to kill the 19-kc. oscillator and make it easier to follow the 19-kc. input signal. (See Fig. 1.) Feed into the input jack a 19-kc., 1/4-volt signal, and tune *T1* and

# compact sets

## SPEED DRIVING OF BRISTOL AND ALLEN HEX TYPE SCREWS



No. 99PS-60  
Bristol Multiple Spline Type  
Screwdriver Set

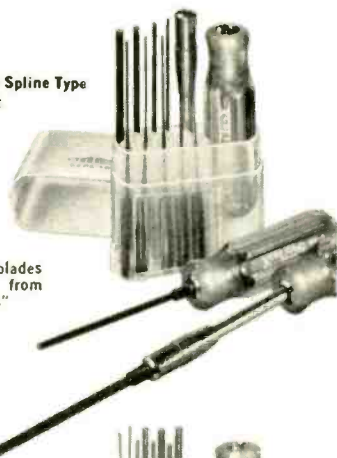

4 and 6-flute blades  
with diameters from  
.048" thru .183"



No. 99PS-40 Allen Hex  
Type Screwdriver Set



Hex diameters  
from .050" thru 3/16"

Compact, interchangeable blade, Xcelite sets permit quick selection of the right tool for the job. With greater reach than conventional keys, these handy blade and handle combinations make it easier to get at deep set or awkwardly placed socket screws, simplify close quarter work.

Each set contains 9 precision formed, alloy steel, 4" blades; 4" extension; shockproof, breakproof, amber plastic (UL) handle with exclusive, positive locking device.

Sturdy, see-thru plastic cases fit pocket, have flat bases for use as bench stands.



XCELITE INC. • 54 BANK ST., ORCHARD PARK, N. Y.  
Send Bulletin N365 on 99PS-60 and 99PS-40 sets.

name \_\_\_\_\_  
address \_\_\_\_\_  
city \_\_\_\_\_ state & zone \_\_\_\_\_

CIRCLE NO. 27 ON READER SERVICE CARD



Enjoy it.

The Lively Sound of the Mustang—University's newest and liveliest line of slim profile speakers. Enjoy more-than-you-pay-for top performance. Send for University's "Guide To Component Stereo High Fidelity"—It's Free.

**UNIVERSITY SOUND**  
A DIVISION OF ETV SING ALITE, INC.  
Desk Y634 Box 1056  
Oklahoma City, Oklahoma



Name \_\_\_\_\_  
Address \_\_\_\_\_  
City \_\_\_\_\_  
State \_\_\_\_\_ Zip \_\_\_\_\_

CIRCLE NO. 26 ON READER SERVICE CARD

## GIGANTIC CB SALE!!!

SONAR Mod. FS-23 (Reg. \$299.95)	SALE \$239.95
SONAR Mod. "G" (Reg. \$229.95)	SALE \$179.95
SONAR Mod. "E" (Reg. \$179.95)	SALE \$139.95
PACE 71 CB Set (Reg. \$169.00)	SALE \$149.95
EICO SENTINEL 23 (Reg. \$169.95)	SALE \$149.95
HALLMARK BANNER model 85	
CB Set with AM Radio	SALE \$ 99.95
MIDLAND Walkie Talkie (11 trans)	SALE \$ 29.95
MIDLAND Walkie Talkie (Mod. 13-103)	PAIR \$ 15.99
ROSS WALKIE TALKIE (11 transistor)	SALE \$ 29.95
+2 TURNER MICROPHONE	SALE \$ 26.99
NEW-TRONICS PRO-27	
Base Antenna (Reg. \$32.95)	SALE \$ 27.95
CB Crystal Activity Checker	SALE \$ 22.95
COMMAND CB CRYSTALS (.002%)	EACH \$ 1.79
(Specify Make, Model, Channel) 12 or more at	EACH \$ 1.69

### MIDLAND AM/FM AUTO RADIO (transistorized)

Works on 6V or 12V DC; Tone Control;

Push button; Built-in Speaker;

w/mounting bkt. EACH \$49.99

ROSS 6 transistor AM Radio SALE \$ 3.99

ROSS 9 trans AM/FM Pocket Radio SALE \$15.95

KX Car Reverberation Unit (Reg. \$26.95) SALE \$19.95

Trumpet Horn Speaker (5" round—paging) SALE \$ 6.99

SN-3 Mobile Noise Suppressor Kit (15 pc) SALE \$ 4.99

DEALERS! Write for quantity prices on your letterhead!

SEND FOR BIG FREE GROVE 1966 CATALOG!

Send check or money order, include postage, excess refunded. Minimum order \$5.00—50¢ service charge under \$10.00. 50% deposit on COD's.

GROVE ELECTRONIC SUPPLY COMPANY

4107 W. Belmont Ave. Chicago, Ill. 60641

CIRCLE NO. 11 ON READER SERVICE CARD

T2 for maximum indication on a scope or VTVM attached to point A. The indicator lamp should light. Be careful not to overload the circuits with too strong an input signal.

Next, with the generator still set on 19 kc., replace Q4, and tune T4 while looking with a scope at point C for the largest 38-kc. signal. Then reset the generator to 67 kc. and tune T3 for minimum signal at point B. If a signal generator is not used, leave T3 at its factory setting—unless you are bothered by a whistle when tuned to a station broadcasting both stereo and SCA signals; in this case, tune T3 to eliminate the whistle.

Now, connect the multiplexer into a hi-fi system and tune in a stereo station. The indicator lamp will go on when a stereo program is coming through. Because of the sensitivity of the indicator lamp and bandpass characteristics of the lamp circuit, the lamp will light on interstation hiss and will flicker occasionally on high-frequency modulation in a mono program. If this should happen, ignore it, as it does not create any confusion once you know about it.

If possible, tune in a station known to broadcast portions of its program on one channel only, and during such a broadcast retune T4 very carefully to reduce the audio output from the unused channel to an absolute minimum. Decrease the volume level of the in-use channel and raise the volume of the unused channel to get the best possible setting for this critical adjustment.

Now all you need is a pair of slippers, a pipe, an easy chair, and a stereo FM disc jockey who shares your taste. —50—

## Module Pocket Receiver

(Continued from page 100)

this station is heard at maximum level. Now find a station at the high end of the band on the standard radio. Rotate the knob until the plates are fully open.

(Note: whether the plates should be fully open or less than fully open depends upon the actual position on the dial occupied by the station. The same



is true for the position of the plates and the radio station at the low end of the band. If the standard radio has, say, 10% rotation from maximum, adjust the radio you have just built to 10% from maximum in a similar manner. Unless you are working with a pre-marked tuning dial, the exact position of the variable capacitors is not critical, so long as you can tune in all the stations.)

When the plates are fully open, the trimmer capacitors on *C1a* and *C1b* have their maximum effect. Adjust the trimmer on *C1b* until the station on the upper end of the band comes in, then adjust the trimmer on *C1a* for maximum volume.

Now go back to the low end of the band and repeat the entire procedure. "Rock" and peak all the adjustments. You can align the set in less than five minutes. If desired, either the case or a small dial mounted under the tuning knob can be marked to show the location of the stations in your area.

As the volume level goes up during the alignment procedure, reduce the level with the volume control to enable you to more easily detect variations in signal level.

### Exalted Pot

(Continued from page 124)

brated also, because both pots are of the linear type. Simply switch *S1* to *10K* and multiply readings by 1000. With *S1* in the *1K* position, you would of course multiply the readings by 100.

To calibrate a capacitance scale, find the capacitance value and mark the appropriate resistance point. At 836 ohms, mark 1.9; at 800 ohms, mark 2; etc. No further calibration for capacitance is required. The other three ranges of capacitance fall into line because the controls are linear. With a 100-cycle test signal, the *C* or *C/10* scale applies, depending on *S1*'s position. With a 10,000-cycle signal, the ranges become *C/100* and *C/1000*. Simply flip *S1* to the desired range. Consult the calibration charts on page 124 as you work.

An inductance scale is calibrated simi-

## POPULAR SAMS BOOKS FOR EVERYONE IN ELECTRONICS

### Use This Handy Order Form

- Transistor Etched-Circuit Projects.** Includes easy-to-use negatives; clip them out and follow instructions to build 30 fascinating projects. Packed with building fun; highly instructive. Order **TCK-1**, only . . . \$2.95
- Second-Class Radiotelephone License Handbook.** New 3rd edition; complete study course for elements I, II, III of latest FCC exams; helps earn license you need for two-way radio work. Order **QAN-2**, only . . . \$3.95
- Hi-Fi Projects for the Hobbyist.** Improve your present hi-fi system—build 20 low-cost projects, including rumble filter, noise filter, hi-gain antenna, transistorized mike preamp, FM tuner, etc. Order **HFF-1**, only . . . \$2.50
- Solar Cell & Photocell Experimenters' Guide.** Complete handbook on theory, construction and applications. Describes easy-to-build projects using photocells, photodiodes, phototransistors. Order **PTL-1** . . . \$2.95
- Color-TV Servicing Made Easy.** **CSL-1** . . . \$2.95
- ABC's of Modern Radio.** **ARS-2** . . . 1.95
- Tape Recorders—How They Work.** **TRW-2** . . . 3.95
- Color-TV Trouble Clues.** **COL-1** . . . 1.95
- ABC's of Computers.** **ABC-1** . . . 1.95
- How to Read Schematic Diagrams.** **RSD-1** . . . 1.50
- ABC's of Tape Recording.** **TAP-2** . . . 1.50
- Color-TV Servicing Guide.** **SGC-1** . . . 3.95
- ABC's of Lasers and Masers.** **LAL-2** . . . 1.95
- ABC's of Computer Programming.** **CPL-1** . . . 1.95
- Build Proximity Detectors & Metal Locators.** **PDS-1** . . . 2.50
- TV Servicing Guide.** **SGS-1** . . . 2.00
- ABC's of Hi-Fi and Stereo.** **HSF-1** . . . 1.95
- 101 Ways to Use Your Oscilloscope.** **TEM-2** . . . 2.50
- Citizens Band Radio Handbook.** **CBH-2** . . . 2.95
- How to Repair Small Appliances.** **APP-1** . . . 2.50
- 101 Ways to Use Your VOM and VTVM.** **TEM-3** . . . 2.00
- ABC's of Electronic Organs.** **ECO-1** . . . 1.95
- ABC's of Transistors.** **TRA-1** . . . 1.25
- ABC's of Ham Radio.** **HAP-2** . . . 1.95
- Handbook of Electronic Tables & Formulas.** **HTF-2** . . . 3.95
- ABC's of Citizens Band Radio.** **ACR-1** . . . 1.95
- Troubleshooting With the Oscilloscope.** **TOS-1** . . . 2.50
- Short-Wave Listeners Guide.** **SLG-1** . . . 1.25
- Modern Dictionary of Electronics.** **DIC-2** . . . 6.95
- Transistor Ignition Systems Handbook.** **IGS-2** . . . 2.95
- Science Projects in Electricity.** **SPE-1** . . . 2.95
- So You Want To Be a Ham.** **HAM-3** . . . 2.95
- Electronics For the Beginner.** **BHJ-1** . . . 3.95
- Electronic Gadgets for Your Car.** **CAR-1** . . . 2.95
- ABC's of Electronics.** **ELW-1** . . . 1.95
- Having Fun With Transistors.** **THF-1** . . . 2.50
- ABC's of Short-Wave Listening.** **SWL-1** . . . 1.95
- Electronic Games & Toys You Can Build.** **EGT-1** . . . 2.50
- Electronics Experiments & Projects.** **ESE-1** . . . 2.50
- Computer Circuit Projects You Can Build.** **BOC-1** . . . 2.95
- Radio Receiver Servicing.** **RS-2** . . . 2.95
- Tube Substitution Guide.** **TUB-2** . . . 1.50
- Sams Photofact Guide to TV Troubles.** **PFG-1** . . . 2.95
- Science Projects in Electronics.** **SPJ-1** . . . 2.95



**FREE!** Ask for the Sams Book Catalog, describing over 300 important books.

**FREE!** Index to Photofact, world's finest service data on 68,000 TV & radio models.

**HOWARD W. SAMS & CO., INC.**

Order from any Electronic Parts Distributor, or mail to Howard W. Sams & Co., Inc., Dept. EX-2 4300 W. 62nd St., Indianapolis, Ind. 46206

Send books checked above. \$ \_\_\_\_\_ enclosed.

Send FREE Booklist  Send Photofact Index

Name \_\_\_\_\_

Address \_\_\_\_\_

City \_\_\_\_\_ State \_\_\_\_\_ Zip \_\_\_\_\_

CIRCLE NO. 22 ON READER SERVICE CARD

# Olson

\* **FREE**

\*  
Fill in coupon for a **FREE** One Year Subscription to **OLSON ELECTRONICS'** Fantastic Value Packed Catalog—Unheard of **LOW, LOW PRICES** on Brand Name Speakers, Changers, Tubes, Tools, Stereo Amps, Tuners, CB, and other Values. Credit plan available.

NAME \_\_\_\_\_  
ADDRESS \_\_\_\_\_  
CITY \_\_\_\_\_ ZONE \_\_\_\_\_ STATE \_\_\_\_\_

If you have a friend interested in electronics send his name and address for a **FREE** subscription also.

**OLSON ELECTRONICS**  
INCORPORATED

451 S. Forge Street Akron, Ohio 44308

CIRCLE NO. 16 ON READER SERVICE CARD



**WORLD'S FINEST**  
**ERSIN**  
**MULTICORE**  
**5-CORE SOLDER**

**NEW EASY**  
**DISPENSER**  
**PAK** ONLY **69c**

BUY IT AT RADIO-TV PARTS STORES

MULTICORE SALES CORP., WESTBURY, N.Y. 11591

CIRCLE NO. 15 ON READER SERVICE CARD

larly. At 62.8 ohms, mark 1; at 125.6 ohms, mark 2; etc. Refer to the first two columns in the calibration table. Here again, because the controls are linear, the other ranges do not require further calibration. With a test signal of 10,000 cycles, and with *S1* at position *L*, you can read 1 to 15 mh. directly. With *S1* in the *Lx10* position, multiply readings by 10 and read 10 to 150 mh. The ranges at 100 cycles are: *Lx100* for readings from 0.1 to 1.5 henrys, and *Lx1000* for values from 1 to 15 henrys.

**Operation.** Connect the generator output to jack *J1* and the unknown component to terminals *C* and *Gnd*. Connect your VTVM first to *C* and *Gnd*, and then to *B* and *C*. Adjust the knob to obtain the same voltage readings. When the voltages are equal, the scale can be read. Keep in mind that the applicable scale depends upon using the correct test frequency and position of the range switch. Also remember that electrolytic capacitors are polarized and are designed for d.c. operation—you may not be able to determine their values with this technique.

To use the "Exalted Pot" as a variable resistor, terminals *B* and *C* are employed. For 0-1000 ohms, set *S1* to the *1K* position. For 0-10,000 ohms, set *S1* to the *10K* side.

To operate the unit as a low-current voltage divider, apply the voltage to terminals *B* and *T*. Take the divided voltage from terminals *B* and *C*. Either the 1000-ohm or 10,000-ohm potentiometer can be used depending upon the position of *S1*. Do not exceed the ½-watt rating of *R1* and *R2*. -30-

## Simple Voltage Calibrators

(Continued from page 116)

type rated at 0.6 ampere, *D1* is a silicon diode rated at 50 PIV, 100 ma., or better, *S1* is a d.p.d.t. unit, and *S2* is a single-pole, 17-position rotary switch. Potentiometer *R2* serves both as an a.c. and a d.c. voltage adjuster, while *R3* controls only the applied d.c. voltage. Resistor *R1* insures a certain amount of mini-

mum resistance in the circuit to protect the diode against current surge. Electrolytic capacitor *C1* can have a working voltage rating of 150 volts or as low as 20 volts.

A voltmeter at the output jacks can be used to set up the desired input voltage on the 100% range. All the other positions will, without further adjustment, provide the indicated voltage steps; accuracy is limited only by the initial meter reading and the variations in values of the resistors. Both the meter reading and output voltage are taken from *J1* and *J2*.

One precaution to observe when taking voltage readings is to avoid the loading effect of a low ohms-per-volt meter. A simple check on the accuracy of your reading on the 100% level is to measure the voltage on the next lower step, which is the 50% level, and then multiply your reading by 2. If the answer is the same, you are on firm ground; otherwise, you should accept the reading on the lower scale as being the more accurate one.

## 2 Halos for 2 Meters

(Continued from page 103)

nidirectional pattern of the stacked halos is particularly desirable for net control stations and for automobiles facing in different directions.

**Construction.** The two halos are spaced  $\frac{1}{2}$  wavelength apart, horizontally leveled and oriented in the same direction. See the diagram on page 103 for actual dimensions.

Carefully form the halos to prevent flat spots, kinks and just plain out-of-roundness. There are machines for this purpose and for a small fee you can get a sheet metal shop to form the halos.

Bolt the halos securely to the mast cutouts as shown in the halo mounting detail diagram. Do not tighten enough to distort the mast or halo tubing, and use lock washers. Connect the halos to each other with 52-ohm coaxial cable. Stranded internal conductor transmission line is preferable to the solid conductor type to reduce breakage from vibration.

## Surplus Bargains Surplus Bargains

**ANALOG OUTPUT** electronic timer. 2 electric motors, one with gear train driving precision pot., the other for re-set. One rev. per 8 hours, output on precision pot. Made for Veeder Root. .... \$1.50

**RUNNING TIME METER** indicates total running time to 9999.99 hours. Use it for time-in-use of motors, oil burners, machines, etc. Operates from 115 volt AC 60 cycle. .... \$4.50

**CANADIAN AIR FORCE** carbon mike noise cancelling, made by Electro Voice. Unused ..... \$1.25

**MARINE-POLICE-FIRE CONVERTERS.** 3 models 2-3 mc, 30-50 mc, 100-200 mc. Simple to use with any car radio. Build it yourself kit with instructions \$5.00 any model. Completely built, ready to use \$15.00 any model.

**T-45 US AIR FORCE LIP MIKE**, unused. .... .75

**PHOTOCONDUCTIVE** cell by Clairex, all glass sealed, new small style, 500 series. New. .... 1.50

**USA OPTICAL PRISM**, 5 inches, used on Army Tanks. .... \$1.00

**POWER SUPPLY KIT, 6-12-24 volts DC 6 amps from 115 volt 60 cycle AC.** Easy to build, with transformer. Operate surplus equipment, plating, battery charging, etc. .... \$12.00

**FIELD EFFECT TRANSISTORS (FET)** w/shaet \$1.50 ea.

4- \$5.00

**40" TELEPHOTO LENS** f8, w/iris & shutter ..... \$50.00

**IBM MEMORY, WIRED PLANES**, First class cond w/specs. 1,000 bit ..... \$10.00; 4096 bit ..... \$12.50; 8192 bit ..... \$15.00; 16,384 bit ..... \$35.00

**US SNIPERSCOPE M-3**, infra red, ready to use. .... \$225.00

**SNIPERSCOPE IR CONVERTER** tube #6032 w/specs. .... \$6.50

**GYRO, 28 VOLT DC drive.** Excellent for marine auto-pilot experimentation, etc. Electric Cage & Uncage, electric drive positioning, pot with 4 take-offs. \$8.75

**INFRA-RED FILTER** 5 inch, use with your light ..... \$ 1.75

**INFRA-RED SENSOR DETECTOR**, brand new ..... \$ 1.25

**US NAVY INFRA RED VIEWER**, optical device ..... \$12.00

**SOLAR CELLS**, electricity from the sun. Assortment with experimentation instruction book. .... \$ 1.50

**The above sampling represent but a very few of the hundreds of unusual surplus items listed in our illustrated catalog. All offered at a fraction of original cost. We believe this is the most interesting catalog of its type in the world. Send 25¢ and get yours.**

All material listed above sold FOB Lynn, Mass. (you pay shipping)

**JOHN MESHNA JR.**

19 Allerton St., Lynn, Mass.

CIRCLE NO. 31 ON READER SERVICE CARD



New 96-page book gives  
step-by-step instructions for

# 50 SIMPLE ELECTRONIC PROJECTS

You Can Build NOW!

How would you like to make a sun-powered radio, or a walkie-talkie, an intercom, a broadcast station, a burglar alarm, a code transmitter, or any one of 50 exciting, easy-to-build projects? It's simple — the Semitronics way.

- Easy-to-build projects described in simple language with clear diagrams.
- No technical background needed — just pliers, screwdriver and soldering iron.
- All parts inexpensive, re-usable for many projects

**IDEAL FOR BEGINNERS OF ALL AGES**

With the new Semitronics handbook "Electronic Projects," any student, beginner or hobbyist can have the fun and excitement of building electronic projects that work — even if you never worked with electronics before. Semitronics makes it simple with this illustrated handbook, and easy-to-find parts, all available at low cost from your dealer's Semitronics Electronics Center.

### THE FUN WAY TO LEARN

This educational science program provides an exciting and fascinating introduction to electronics and the space age. Students will find the Semitronics program especially appealing, as they learn new facts in a practical, enjoyable way. Try your first project now — just for the fun of it.

**ELECTRONIC  
PROJECTS**  
50 Exciting, Easy-to-Build Projects  
You Can Build Tomorrow!



LOOK for the Semitronics Electronics  
Center at Your Local Dealer  
OR SEND \$2 for your Projects Book  
(Includes postage and handling)  
TO:

EH-1

**Semitronics Corp.**  
265 Canal Street, New York, N. Y. 10013

Enclosed is \$\_\_\_\_\_ send me  
\_\_\_\_\_ copies of the Semitron 50-Projects Book postpaid.

Name \_\_\_\_\_

Address \_\_\_\_\_

City/State \_\_\_\_\_

Zip \_\_\_\_\_

CIRCLE NO. 28 ON READER SERVICE CARD

Two lengths of cable, each about 21" long, connect the halos. The center conductor on one end of each cable is attached to the terminal connected to the small mica capacitor on each halo. Connect each outer shield to the adjacent ground terminal. The other end of each cable is terminated in a PL-259 or equivalent type coaxial connector and screwed into an appropriate coaxial "T" fitting. The transmission line from the antenna to the transmitter is also screwed into this fitting.

**Gamma Match.** To construct the gamma match, install a clamp on each halo at a point  $4\frac{1}{2}$ " to the right of center. The gamma match on each halo should be located on the same side of the mast.

The capacitors should be shielded from the weather. As a matter of fact, a coat of acrylic paint over the entire antenna and fittings will protect it from the elements. The wire forming the gamma match should follow the outside curvature of the halo. About #13 AWG tinned copper bus wire will do. Place nothing within the center of the halo.

An easy way to tune the antenna is with the aid of an SWR meter or field strength meter. Another method is to connect the halos to a receiver and adjust the gamma match for maximum volume or reading of an "S" meter if available. -30-

## The Dymwatt

(Continued from page 52)

an ohmmeter to be sure there is no electrical connection.

An aluminum case will help the heat sink do its work. Do not use a smaller box than the one specified—it might get too hot to touch and could damage the Triac. The case used by the author remains relatively cool for all but the heaviest power loads; above 400 watts it becomes noticeably warm.

See Fig. 4 for parts layout. The heat sink on the inside and a dial plate on the outside of the case are held in place with a "Pop" rivet and the mounting nut of the potentiometer. Avoid overheating either Q1 or D1 when you are

soldering. If you wish, a NE-83 neon lamp can be substituted for D1 to reduce cost, but it will also reduce the control range.

As long as the Dymwatt is used within its ratings and only for its intended types of loads, it is capable of long life and trouble-free service.

-30-

### Electric Fence Charger

(Continued from page 32)

find out if the fence is being charged, connect the neon tester between the ground and the fence. The higher the intensity of the flash, the greater the charge. To minimize the possibility of shock, first connect the tester's lead to ground.

To keep a garbage can from being raided, place a small sheet of thin plastic material (the kind that plastic bags are made of) under the can. The plastic sheet should be just large enough to insulate the garbage can from the ground.

If the can is to be placed on a dry cement or gravel walk, first lay down a piece of metal screen, about 2' x 2', to serve as a ground. It should be big enough so that a dog will have to stand on it when he reaches out a paw for the can. Cover the screen with a piece of cardboard, then place the sheet of plastic over the cardboard, and then place the can over this "sandwich." The cardboard keeps the screen from puncturing or tearing the plastic. Both the cardboard and the piece of plastic are just a little bit bigger than the can but not big enough to prevent the dog from standing on the bare screen.

Run an insulated wire from the garbage can to the red post on the charger, and either a bare or insulated wire from the ground to the black binding post. (Better turn off the charger before the garbage collector arrives, or he may decide to take you in along with the garbage.)

One shock per invader should be enough. You will probably see some of the most surprised pooches you ever saw in your life.

-30-

# What can you expect from an automatic turntable under \$70?



**The most  
(If it's a  
Dual)**

□ At \$69.50, the Dual 1010 Auto/Standard Turntable is more than an outstanding value . . . it's a remarkable engineering achievement. □ Because "it delivers essentially the same performance as the Dual 1009, but at a considerably lower price," reports Julian Hirsch in HiFi/Stereo Review. □ As for the 1010's wow, flutter and rumble, The American Record Guide rates them "specifications for a fine manual turntable, but not for a low price automatic." □ Not surprising. For the 1010 offers the same Continuous-Pole motor and precision engineering (though fewer features) as the widely acclaimed Dual 1009. □ Tracking is flawless as low as 2 grams, with 1/2 gram click stops so precise, no stylus gauge is needed. □ Plus automatic and manual start with either the single play or changer spindle. □ Clearly, there's only one medium-price turntable for the discriminating audiophile . . . and your franchised United Audio dealer will be glad to show you the many reasons why.

**united  
audio Dual**

535 MADISON AVE. NEW YORK, N. Y. 10022

CIRCLE NO. 25 ON READER SERVICE CARD



## Dollar-st-r-e-t-c-h-e-r ...1966 edition!

If you're in the market for photography equipment and you want to get the most for your money, send for the 1966 PHOTOGRAPHY DIRECTORY & BUYING GUIDE right now!

Then just sit back and be as choosy as you like!

You'll have access to over a thousand different items—with complete, point-by-point information on manufacturer, model number, size, special characteristics and price.

And the 1966 edition of this big, valuable factbook is more comprehensive than ever before. A large, new 8½" x 11" format now brings you virtually every category of photo gear you want to know about... 160 pages of all the latest equipment!

Expert tips on how to buy and what to look for in... still cameras, flash equipment, meters, lenses, movie cameras, projectors, super-8, titlers, editors, slide equipment, tape recorders, enlargers, films, filters... and more!

The 1966 PHOTOGRAPHY DIRECTORY & BUYING GUIDE has been compiled by the editors of POPULAR PHOTOGRAPHY. That means authoritative, precise information. Dollar-stretching data that will help you select the best equipment in your price range, consistently, all through the next twelve months!

This year, play it smart. Shop before you buy, confidently, with the 1966 PHOTOGRAPHY DIRECTORY & BUYING GUIDE.

**First Time Ever Offered! A DELUXE,  
GOLD-EMBOSSED LEATHERFLEX-BOUND  
EDITION ... just \$3.00 postpaid.**



Ziff-Davis Service Division  
Dept. PD, 589 Broadway • N.Y., N.Y. 10012

YES! Send me a copy of the 1966 PHOTOGRAPHY DIRECTORY & BUYING GUIDE, as checked below:

- \$1.25 enclosed, plus 15¢ for shipping and handling. Send me the regular edition. (\$1.50 for orders outside the U.S.A.)
- \$3.00 enclosed. Send me the DeLuxe Leatherflex-bound edition, postpaid. (\$3.75 for orders outside the U.S.A.) Allow three additional weeks for delivery.

name \_\_\_\_\_

address \_\_\_\_\_

EEH-66

city \_\_\_\_\_

state \_\_\_\_\_

zip code \_\_\_\_\_

**PAYMENT MUST BE ENCLOSED WITH ORDER.**

## Best Meter Face Forward

(Continued from page 118)

top arc. Then lay out each minor division by dividing each major division into a suitable number of parts. Guide lines are drawn through each of these division points, aimed radially toward the meter pivot point. Add the actual scale markings using 1/8"-wide black printed circuit tape for the major divisions, and 1/16"-wide tape for the minor ones. Carefully cut the tape squarely across each arc with a razor blade or a sharp knife.

Transfer the scale numerals into place, being very careful about centering. Note that the center of a 20 is exactly between the "2" and "0," while the center of a 10 is just inside the "0." The center of each numeral group should exactly correspond to the axis of that major division. The title baseline is drawn parallel to the original baseline, and the title pressed into place. To center the title, add up all the space required for each letter and space, and then start the lettering *half* this distance away from the centerline.

**Nonlinear Scales.** Nonlinear scales require more thought. If the scale is clearly defined mathematically, the scale divisions may be determined by suitable algebra or geometry. An ohmmeter scale is started with infinity and ends with a zero at full scale. The exact center of the scale is equal to  $R$ , the internal resistance of the ohmmeter;  $2R$  is located one-third of the way up the scale;  $3R$  is one-fourth,  $4R$  is one-fifth of the way up the scale, etc. For a 1-10 log scale, lightly lay out a linear 0-10 scale. Divisions for each log point are then placed on the log of each desired number. This means the 1 goes at 0, the 2 at 3.01, the 3 at 4.77, etc. Decibel scales work in much the same manner.

**Photolith Negatives.** Most towns have at least one photolithographer who can make a 5:1 reduction of your art work in the form of a photographic negative. The cost of this service is about \$1.00. Don't go to an ordinary photographer, as it will cost much more, and the film used will not have nearly the contrast ratio that lithography film has (the negative is either perfectly transparent or else jet black). Take the negative to a photo store and have semigloss contact prints made; the cost of each print should be about 15 cents.

To mount a new meter face, cut the print to size, align it carefully, and cement it with rubber cement to the *back* of the original meter face. If you ever need the original again, you'll have it handy. **30**

## Strobelight Slave

(Continued from page 45)

150 and less than 180, turning *S1* on will make the slave more sensitive to low light levels without danger of damaging the strobe.

**Construction.** To determine which Strobelight Slave you should build, turn on the strobe you intend to use with it, and carefully measure the d.c. voltage across the contacts of the shutter socket when the "ready" light comes on. While you're at it, observe the polarity of the voltage at the shutter socket, and permanently mark the positive contact with a plus sign.

The assembly of both slave units is simple and straightforward; the basic Strobelight Slave is housed in a 2¼" x 2¼" x 4" box, while a 3" x 4" x 5" box is used for the booster model. Simply mount the parts as shown in the photographs, using spacers to hold *V2*'s socket away from the bottom of the box. With the booster slave, be sure to mount the parts so that the batteries can be secured in the back of the case; a battery retaining strap can be made from scrap aluminum.

Make a shield can with a window in it for *V1* to minimize triggering of the slave by stray light. A tube shield or cover from an old i.f. transformer can be used for this purpose. For some applications, however, it may be desirable to remove the shield to obtain greater sensitivity.

Both versions of the Strobelight Slave are designed to work without any modifications to the strobe unit itself. Just make sure that the connecting cord between the two is properly polarized by marking a plus sign on the positive contact of the socket on the strobe and the positive contact of the socket on the slave. In Figs. 2 and 3, the positive contact of *SO1* is the upper one, and is connected to *V2* or *D1* respectively. *Damage may result to one or both units if the cord is incorrectly polarized.*

The basic slave shown in Fig. 2 can be built for about \$6, and the booster slave for about \$16, the primary increase being in the cost of the batteries. —50—



## Zip through Scott's new solid state FM stereo tuner kit in one afternoon

Four to six hours! That's all you need to zip through Scott's new LT-112 FM stereo tuner kit. Start after lunch . . . enjoy superb stereo at dinner. ■ Scott solid state circuitry is the key to the LT-112's superior performance. Costly silicon transistors give performance unapproached by any other kit on the market. The LT-112 is kit-brother to Scott's best-selling 312 solid state stereo tuner, of which Audio said, ". . . one of the finest tuners anywhere." ■ Your LT-112 arrives with all critical circuitry pre-wired, pre-tested, pre-aligned, and mounted on heavy-duty printed circuit boards. Scott's exclusive life-size, full-color construction book details every step . . . makes perfect wiring almost automatic. ■ You'd never believe a kit so easy to build could be so packed with features. Built into the LT-112 is a new Scott invention . . . the Tri-modulation meter, used for a Signal Strength Indicator, Zero Center Indicator, and Alignment Meter. ■ See your Scott dealer today, and pick up an LT-112 tuner kit . . . \$179.95 plus one enjoyable afternoon will net you a lifetime of listening pleasure.

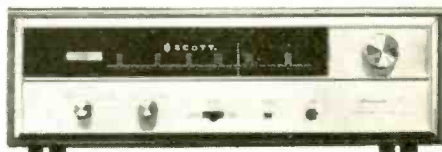

For complete information on Scott's kits & components write:  
H. H. Scott, Inc., 111 Powdermill Road,  
Maynard, Mass. Dept. 521-1

Export: Scott International, Maynard, Mass. Cable HIFI.  
Prices slightly higher west of Rockies. Prices and specifications subject to change without notice.

CIRCLE NO. 23 ON READER SERVICE CARD

**if you  
snap with  
this...**

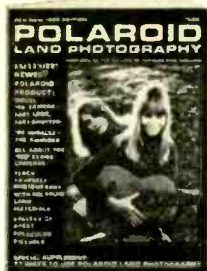

**it's a  
snap with  
this!**

## 1966 POLAROID LAND PHOTOGRAPHY

If you own a Polaroid Land camera, or are in the market for one, sign up now for the most important "excursion" of your picture-taking career. An exciting tour through the miraculous world of "instant" pictures.

Your guide is the all-new 1966 edition of POLAROID LAND PHOTOGRAPHY — the only comprehensive and up-to-date handbook on the subject. The one knowledgeable guide that delivers the skill and know-how for the most rewarding Polaroid Land photographs you've ever taken!

Your tour begins the moment you open your copy... with a detailed inspection of the complete line of Polaroid Land cameras, accessories and film... next, a valuable course in photography basics... an important discussion on Polacolor... followed by 77 fascinating uses for Polaroid Land photography.

**PLUS—gallery after gallery of masterful, enchanting Polaroid Land photographs—including 16 pages in glorious color.**

All in all, 116 fact-and-photo-packed pages of the most extensive, authoritative, important-to-you information available. **Sign up today.** Just clip the coupon below and return it with your remittance. **\$1.25**

**ALSO AVAILABLE—AN EXQUISITE LEATHERFLEX-BOUND EDITION FOR JUST \$3 POSTPAID!**

Ziff-Davis Service Division • Dept. PLP  
589 Broadway • New York, N.Y. 10012

**YES! Send me a copy of the 1966 POLAROID LAND PHOTOGRAPHY, as checked below:**

\$1.25 enclosed, plus 15¢ for shipping and handling. Send me the regular edition. (\$1.50 for orders outside the U.S.A.)

\$3.00 enclosed. Send me the Deluxe Leatherflex-bound edition, postpaid. (\$3.75 for orders outside the U.S.A.) Allow three additional weeks for delivery.

name \_\_\_\_\_ please print EEH-66  
address \_\_\_\_\_  
city \_\_\_\_\_ state \_\_\_\_\_ zip code \_\_\_\_\_

**--- PAYMENT MUST BE ENCLOSED WITH ORDER. ---**

## Tachometer Calibrator

(Continued from page 40)

lamps can be mounted in grommet-lined holes on the front of the case, or in regular small sockets.

Substitutions of components can be made. However, two things should be kept in mind: (1) the peak inverse voltage rating of the diode must be at least 300 volts and (2) the transformer voltage should be well over any possible difference in firing voltage of the two neon lamps, but not so high as to fire the lamps unaided by the ignition pulses. Transformer voltage on the order of 24 volts works very well.

**Operation.** To calibrate the tachometer, connect the newly made calibrator as shown in Fig. 1, one wire going to any convenient chassis ground and the other going to the coil's terminal which is connected to the distributor points. Plug the power cord into any 117-volt, 60-cycle a.c. outlet.

Start the car, and adjust the motor speed until the lamps indicate synchronism. Note the tachometer reading, then adjust the motor speed until the lamps indicate synchronism for the second point, and again note the tachometer reading. You now have two accurate calibration points for the tachometer. The difference between each reading and the corresponding true figures (450 and 900 rpm for an 8-cylinder engine and 600 and 1200 rpm for a 6-cylinder job) is the tachometer error.

No trouble should be encountered in identifying the two points of synchronization. The lower speed is a slow idle, and the upper speed is much faster than idle. As either point is approached from either a higher or lower engine speed, the blinking rate of the lamps will slow down, indicating that you are approaching the calibration speed.

In the event your car specifications show that one of the calibration speeds is the proper idling speed, the calibrator can be used to set the idle adjustment without the aid of a tachometer. Many V-8's with automatic transmission idle at 450 rpm when the transmission is in Drive and the parking brake is on. —30—



# ELECTRONICS MARKET PLACE

## FOR SALE

**JAPAN & Hong Kong Electronics Directory.** Products, components, supplies. 50 firms—just \$1.00. Ippano Kaisha Ltd., Box 6266, Spokane, Washington 99207.

**LOWEST Prices Electronic Parts.** Confidential Catalog Free. **KNAPP**, 3174-EHB 8th Ave. S.W., Largo, Fla.

**CALEMCO**—The diversified line of transformers. Box 585, San Fernando, Calif.

**IT'S SUPERCALIFRAGILISTICEXPIALIDOCIOUS.** Free information on Kit-of-the-Month Club and new catalog of etched circuit boards and radio books. Many exclusive items. Leader Enterprises, Box 44718KI, Los Angeles 90044.

**RECTIFIERS & TRANSISTORS**—Send for catalog of semi-conductors and other components, 10¢. Electronic Components Co., P. O. Box 2902, Baton Rouge, La.

**TRANSISTORCOM AMPLIFIER KIT \$2.95 ppd.** Manufacturers surplus. Complete with switch & PC board. Assembles in 1 hour. Detailed instructions, multi-remotes. Assembled—tested \$1.00 extra. **DART ELECTRONIC DEVICES**, BOX 214, JERICHO, N.Y.

**REGULATED POWER SUPPLY**—Twin Outputs 0-22 Volts At 1 Amp. Ideal for Transistors! Write Parrish Electronics, Box 1785, Melbourne, Florida.

**GIANT TESLA COIL—FORTY-INCH SPARKS!** Complete plans, photo \$5.00. Details 30¢. Huntington Electronics, Inc., Dept. G, Box 9 Huntington Station, Shelton, Conn. 06484.

## PLANS AND KITS

**PLANS** for building computer circuits and catalog of Inexpensive computer modules, 10¢. Diotran, Box 112, Somerville, Mass. 02145.

## TUBES

**ELECTRONIC TUBES—LARGEST STOCK IN USA. ELECTRONIC COMPONENTS AND EQUIPMENT. WRITE FOR "BARRY GREEN SHEET" CATALOG. SEND 10¢.** Barry Electronics, 512 Broadway, N.Y.C., N.Y. 10012. (We also buy unused tubes, and good commercial equipment. Write details.)

## MAGNETS

**MAGNETS.** Alnico, ceramic, flexible, assemblies. What you want, we have. Maryland Magnets, 5412L Gist, Baltimore, Maryland 21215.

## EMPLOYMENT INFORMATION

**GET a Government Job**—pass any Examination, Free details. W.P. Parrish Co., 6118 East 52nd St. North, Kansas City, Mo. 64119.

## INVENTORS

**INVENTIONS WANTED.** All Types. Global Marketing Service, 2420V 77th, Oakland, Calif.

1966 Spring Edition

## INSTRUCTION

**ENGINEERING** and Art Degrees earned through home study, Electronics, Mechanical, Liberal Arts. When writing specify course desired. Pacific International College of Arts & Sciences, primarily a correspondence school. Resident classes also available. 5507-C Santa Monica Blvd., Hollywood, Calif. 90038.

**ENGINEERING MATHEMATICS, TRANSISTOR ELECTRONICS.** Pay as you learn. Satisfaction guaranteed. Free brochure. Indiana Home Study, Dept. EH1, Box 1189 Panama City, Fla.

## BUSINESS OPPORTUNITIES

**ELECTROPLATING** Equipment, Supplies, Instructions. Home workshop and Industrial. DC Power Units from 10 Amps. to 3,000 Amps. Transformers, Meters, Rectifiers. 100 Amps., \$29.50. Send \$1.00 (Refundable) for Formulas, Equipment Guide, Catalog & Schematic. HBS, Dept 8, 3543 East 16th Street, Los Angeles, Calif. 90023.

**INCREASE YOUR BUSINESS OPPORTUNITIES** by featuring a low cost, highly productive classified ad in any or all Ziff-Davis electronics magazines or annuals. The steady growth of each publication's classified advertising section serves to indicate that advertisers are getting results—results that only active electronics enthusiasts can produce. For complete details concerning classified advertising in any Ziff-Davis publication write: Hal Cymes, Classified Advertising Manager, Ziff-Davis Publishing Company, One Park Avenue, New York, New York 10016.

## BOOKS

**GIANSINCERE'S** Life, Loves, Compendium Edition. \$5.00. Serially, \$1.00. Details. Ivory Tower Journal, 444-Z, Fort Lee, N.J. 07024.

## MAGIC TRICKS

**WORLD'S** finest Professional Magic, Tricks, Jokers, Puzzles. Giant illustrated Catalog. (164 Pages) Only 10¢. Vick Lawton's Magic, 4018Z N.E. Fifth Ave., Ft. Lauderdale, Fla.

## CLUBS

**COUPON BOOK**, special offers from various firms. Latest Membership Benefit of Electronic Experimenters' Club. Dues \$2.00. Further Information FREE. Box 5332N, Inglewood, Calif. 90310.

## RUBBER STAMPS

**RUBBER ADDRESS STAMP \$1.00.** Signature \$2.88. Catalog. Jackson Stamps, 1433 Winnemac, Chicago, Ill. 60640.

## MUSICAL INSTRUMENTS

**SWISS MUSICAL MOVEMENTS.** Electrical-Mechanical. Spielman, 131 West 42nd, New York 10036.

# UNUSUAL BARGAINS

## Bargain! 3" Astronomical Telescope



See the stars, moon, phases of Venus, planets close up! 60 to 180 power—famous Mt. Palomar reflecting type. Unusual Buy! Equipped with Equatorial mount; finder telescope; hardwood tripod. Included FREE: "STAR CHART"; 272-page HANDBOOK OF HEAVENS"; "HOW TO USE YOUR TELESCOPE" book. Stock No. 85,050-GD .....\$29.95 postpd.  
3/4" Reflecting Telescope—up to 255 Power.

All-metal pedestal mount.  
Stock No. 85,105-GD .....\$79.50 F.O.B.

**Superb 6" Reflector Telescope**  
Up to 578 Power. Equatorial mount and Pedestal Base.  
Stock No. 85,086-GD .....\$199.50 F.O.B.

## Brand New, Quick-Charge, Industrial Surplus NICKEL-CADMIUM BATTERY

### Unparalleled Values

For the first time a 6-volt, light-weight nickel-cadmium battery in stainless steel, strap type casing, 4-amp hour capacity. Almost unlimited life—dozens of discharge-charge cycles with minute deterioration—charges fully in approx. 1 hr. with Edmund charger kit. Just a few drops of water per year provide full maintenance. Hundreds of uses for hobbyists, amateur photographers, campers, model builders, etc. Unequaled for rechargeable lanterns; cycle scooters, and boat lights; portable fluorescent and ultra-violet lights; electronic flash units. Battery requires minimum of electrolyte; is sealed to prevent loss; delivers nearly 100% of output at below freezing temperatures compared to 50% by lead-acid batteries. No corrosive fumes under any state of recharge. Can't be damaged by accidental charge in reverse (but not recommended). Stud type terminals on top 1 1/2" apart, marked for polarity; 6/32 thread, nuts and lock-washers, 9"x2 1/4", Wt. approx. 2 lbs.

Stock No. 70,776-GD .....\$15.00 Ppd.

**CHARGER KIT FOR 6-VOLT BATTERY.** Charges in approx. 1 hr. Shuts off automatically, attaches to Stock No. 70,766 Battery case. Includes transformer, ballast resistors, charger circuit board, mounting hardware, 8-ft. cord, plug switch, assembly instructions.  
Stock No. 79,807-GD .....\$8.00 Ppd.

**ONE 1.2 VOLT NICKEL-CADMIUM CELL**  
Stock No. 40,798-GD .....\$3.95 Ppd.

## Binocular-to-Camera Holder

Will Fit Any Camera

Bring distant objects 7 times nearer with a 35mm camera. 7x50 binocular and our NEW CAMERA-TO-BINOCULAR HOLDER. Ideal for long range photos of wildlife, ships, people, planes, etc. Camera and binocular attach easily. Use any binocular or monocular—any camera, still or movie. Take color or black and white shots. Attractive gray chrome and bright chrome finish. 10" long. Full directions for taking telephotos.



Stock No. 70,223-GD .....\$11.50 Postpaid

## GRADUATED MECHANICAL STAGE

Easily Attaches to Microscope

Eliminates awkward handling when slide must be moved. Has 30 mm. front to back and 50 mm. left to right excursions. Fixed verniers read to 0.1 mm. Dual control knobs horizontally positioned, conveniently located on right. Slide holder with adjustable arm and spring clip accepts large and small glass slides, max. opening 3 1/2". Metal unit finished in black and chrome. Microscope stage easily drilled to attach with two locating pins and thumb screw; turn thumb screw for simple removal.  
Stock No. 30,058-GD in wooden case .....\$31.50 postpaid



## NEW! STATIC ELECTRICITY GENERATOR

Sturdy, Improved Model

See a thrilling spark display as you set off a miniature bolt of lightning. Sturdily made—stands 14" high. Two 9" plastic discs rotate in opposite directions. Metal collector brushes pick up the static electricity, store it in the Leyden jar type condenser until discharged by the jumping spark. 24 page illustrated booklet included.  
Order Stock No. 70,070-GD .....\$12.95 Postpaid



Order by Stock No.—Send Check or M.O.—Money-Back Guarantee  
**EDMUND SCIENTIFIC CO., Barrington, New Jersey**

## MAIL COUPON for FREE CATALOG "GD"

EDMUND SCIENTIFIC CO., Barrington, N.J.  
Completely New 1966 Edition, 148 pages  
Nearly 4000 Bargains.  
Please rush Free Giant Catalog-GD

Name.....  
Address.....  
City..... Zone..... State.....



CIRCLE NO. 8 ON READER SERVICE CARD

# ELECTRONIC EXPERIMENTER'S HANDBOOK SPRING 1966

READER SERVICE NO. ADVERTISER PAGE NO.

1	American Institute of Engineering & Technology	130
2	Burstein-Applebee Co	128
3	CTS Knights, Inc	129
4	Conar	131
5	Cleveland Institute of Electronics	1
6	Datak Corporation, The	133
7	DeVry Technical Institute	13
8	Edmund Scientific Co	150
9	Electro-Voice, Inc	135
10	Fisher Radio Corporation	75
11	Grove Electronic Supply Company	138
13	Heath Company	69
14	Hi-Gain Electronics Corporation	88
30	International Crystal Mfg. Co., Inc	6
29	Johnson Company, E.F.	4
12	Lafayette Radio Electronics	SECOND COVER
31	Meshna Jr., John	143
32	Miller Co., J.W.	136
15	Multicore Sales Corp	140
	National Radio Institute	THIRD, FOURTH COVERS
16	Olson Electronics Incorporated	140
17	Poly Paks	128
18	Progressive "Edu-Kits" Inc	54
19	RCA Electronic Components and Devices	2
20	RCA Electronic Components and Devices	53
21	RCA Institutes, Inc	35
22	Sams & Co., Inc., Howard W	139
23	Scott, Inc., H.H.	147
28	Semitronics Corp	144
24	Sydmur Electronic Specialties	136
	TechPress Publications	130
25	United Audio	145
26	University Sound	138
27	Xcelite, Inc	137

# BUILD, EXPERIMENT, EXPLORE, DISCOVER WITH NRI CUSTOM-DESIGNED TRAINING KITS



## BUILD YOUR OWN PHONE/CODE TRANSMITTER

This is just one of seven training kits programmed into NRI's Complete Communications course. You get actual practice in building your own crystal-controlled, phone/code transmitter and putting it on the air. You experiment with modulation, "clamping" circuits, key filters, other aspects of commercial transmitter operation. Can be put on the air simply by attaching an antenna and complies with FCC regulations. As with all NRI training kits, you get the most modern features and parts.

## BUILD ACTUAL ANALOG COMPUTER CIRCUITS

Industry, business offices, the government and military all need trained Electronics Technicians. NRI's Industrial Electronics course prepares you. You progress through 10 carefully designed training kits, topping off your practical experience phase of training by experimenting with feedback control systems, analog computers and digital computer elements. You actually solve problems on this analog computer you build yourself. This is the *practical*, fast way to a good paying, career position.

## BUILD A CUSTOM-ENGINEERED TELEVISION RECEIVER

Want to earn \$3 to \$5 an hour in spare time? Want your own part-time or full-time business? In Radio-TV Servicing you learn to install, maintain, service radios, TV sets, hi-fi and stereo, other home Electronics equipment. In your training are eight training kits, including this complete, modern, slim-line TV receiver. You build it yourself, become familiar with components and circuits, learn servicing procedures . . . and earn extra money as you train. National Radio Institute, Washington, D.C.

### Join the Thousands Who Gained Success with NRI



"I am Frequency Coordinator for the 11th Naval District. The course was priceless." J. J. JENKINS, San Diego, Calif.



"Many thanks to NRI. I hold FCC License, am master control engineer with KXIB-TV." R. L. WOOD, Fargo, N.D.



"I am a Senior Engineering Aide. Without NRI I would still be working in a factory at a lower standard of living." D. F. CONRAD, Reseda, Calif.



**SEE OTHER SIDE** ▶

FIRST CLASS  
PERMIT  
NO. 20-R  
Washington, D.C.

### BUSINESS REPLY MAIL

NO POSTAGE STAMP NECESSARY IF MAILED IN THE UNITED STATES

POSTAGE WILL BE PAID BY

**NATIONAL RADIO INSTITUTE**

**3939 Wisconsin Avenue**

**Washington, D.C. 20016**



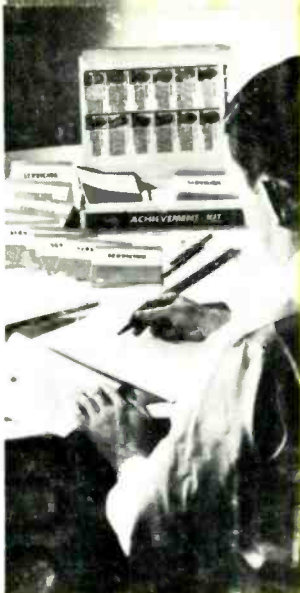

### GET FAST START WITH NEW ACHIEVEMENT KIT

Delivered to your door—everything you need to make a significant start in the Electronics field of your choice. An outstanding, logical way to introduce you to home-study training. It includes your first set of lesson texts and all the "classroom tools" you need. No other school has anything like the new NRI Achievement Kit.



### ELECTRONICS COMES ALIVE WITH NRI TRAINING KITS

Nothing is as effective as learning by doing . . . and NRI pioneered the "home lab" technique of training. NRI invites comparison with training equipment offered by any other school. Begin NOW this exciting program of practical learning. Make the skills of the finest Electronic Technicians your own. Mail card below.



### "BITE SIZE" TEXTS PROGRAM YOUR TRAINING

Certainly, lesson texts are necessary. NRI's programmed texts are as simple, direct and well illustrated as 50 years of teaching experience can make them. They are carefully programmed with NRI training kits to make the things you read about come alive. You experience all the excitement of original discovery.



### HOBBY? CAREER? MAIL CARD NOW TO NRI

Whatever your need . . . whatever your education . . . there's an NRI training plan to fit your requirements. Choose from three major courses or select one of seven special courses in particular Electronics subjects. Check the postage-free card below, fill in and mail. National Radio Institute, Washington, D.C.

## DISCOVER THE EASE AND EXCITEMENT OF LEARNING ELECTRONICS THE NRI WAY

### SEE OTHER SIDE

National Radio Institute, Electronics Div.  
Washington, D.C. 20016

13-026

Please send me your catalog. I have checked the field(s) of most interest to me. (No salesman will call.)

- |  |   |
|--|---|
| <input type="checkbox"/> TV-Radio Servicing      | <input type="checkbox"/> Basic Electronics          |
| <input type="checkbox"/> Industrial Electronics  | <input type="checkbox"/> Electronics for Automation |
| <input type="checkbox"/> Complete Communications | <input type="checkbox"/> Aviation Communications    |
| <input type="checkbox"/> FCC License             | <input type="checkbox"/> Marine Communications      |
| <input type="checkbox"/> Math for Electronics    | <input type="checkbox"/> Mobile Communications      |

Name \_\_\_\_\_ Age \_\_\_\_\_

Address \_\_\_\_\_

City \_\_\_\_\_ State \_\_\_\_\_ Zip Code \_\_\_\_\_

Accredited Member National Home Study Council



**PICK THE TRAINING PLAN OF YOUR CHOICE AND MAIL CARD FOR FREE CATALOG**



**OUR 50TH YEAR OF LEADERSHIP IN ELECTRONICS TRAINING**