

Service
Service
Service



Service Manual



TABLE OF CONTENTS

	Page
Location of pc boards & Version variations	1-2
Technical Specifications	1-3
Measurement setup	1-4
Service Aids, Safety Instruction, etc.	1-5
Instruction for use: Overseas version excerpt	2-1
Additional features	2-10
Disassembly Instructions & Service positions	3-1
Service Test Programs	3-4
Set Block diagram	4
Set Wiring diagram	5
Front Board	6
Tuner Board: ECO5 Sys	7B
Tuner 95	7D
AV Board	8
DVD Module	9
3CDC-LC Module	10
Power 5 DVD Module	11
Set Mechanical Exploded view & parts list	12



© Copyright 2000 Philips Consumer Electronics B.V. Eindhoven, The Netherlands
 All rights reserved. No part of this publication may be reproduced, stored in a retrieval system or transmitted, in any form or by any means, electronic, mechanical, photocopying, or otherwise without the prior permission of Philips.

Published by KC 0026 Service Audio Printed in The Netherlands Subject to modification

3139 785 22300

PCS 103 795



PHILIPS

LOCATION OF PC BOARDS

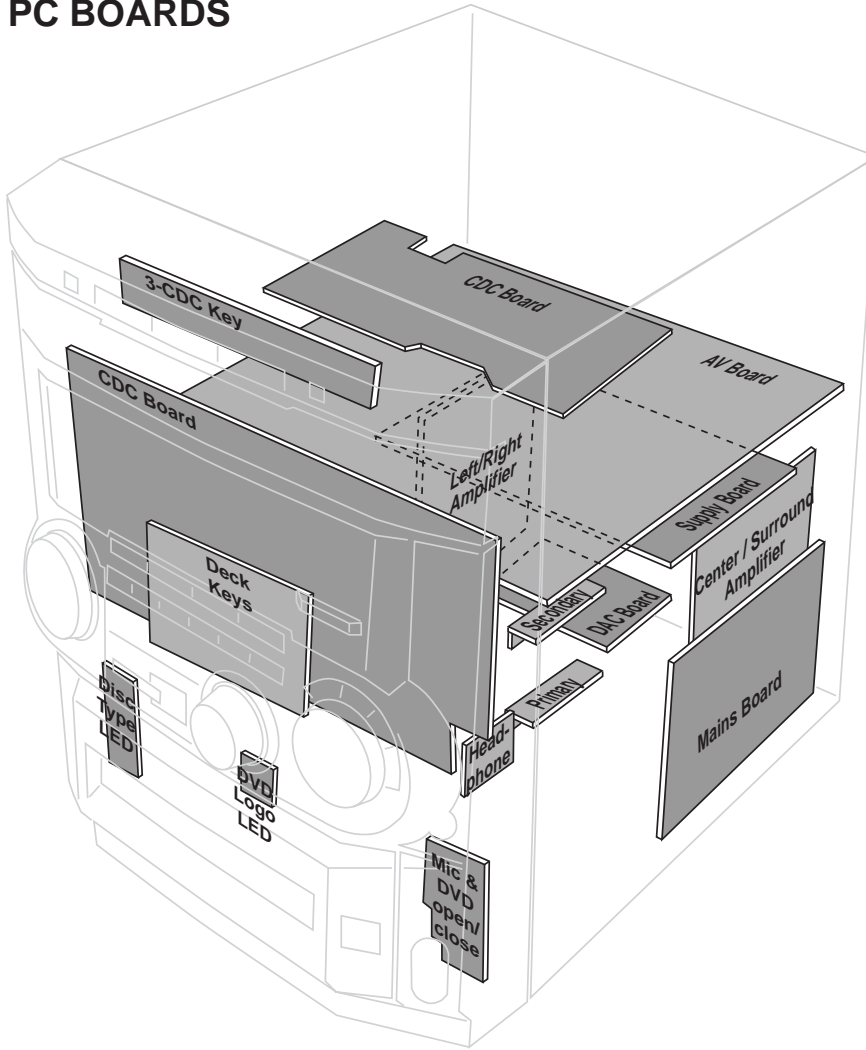

VERSION VARIATIONS:

Type /Versions:	FW-D5								
	/21	/21M	/22	/30	/37				
Features & Board in used:									
Karaoke	x	x							
News			x						
RDS			x						
CD Text			x						
Low Power Standby (No display)			x		x				
Voltage Selector	x	x							
Aux / CDR Input	x	x	x	x	x				
Digital Output	x	x	x	x	x				
Headphone Socket	x	x	x	x	x				
Line Output	x	x	x	x	x				
Subwoofer Output	x	x	x	x	x				
Surround Output	x	x	x	x	x				
S-Video Output	x	x	x	x	x				
SCART connector			x						
Remote Control RC2516/01			x	x	x				
Remote Control RC2567/01	x	x							
Tuner board - ECO5 Sys	x	x		x	x				
Tuner board - Tuner 95			x						

SPECIFICATIONS**GENERAL:**

Mains voltage : 110-127V/220-240V Switchable for /21/21M
 120V for /37
 220V for /33
 220-230V for /22
 230-240V for /30

Mains frequency : 50/60Hz

Power consumption Active : < 230W
 < 280W for /37
 Standby : < 22W
 Low Power Standby : < 2W

Clock accuracy : < 4 seconds per day

Dimension centre unit : 265 x 310 x 390mm

TUNER:**FM**

Tuning range : 87.5-108MHz

Grid : 50kHz
 100kHz for /37

IF frequency : 10.7MHz \pm 25kHz

Aerial input : 75 Ω coaxial
 300 Ω click fit for /37

Sensitivity at 26dB S/N : < 7 μ V

Selectivity at 600kHz bandwidth : > 25dB

Image rejection : > 25dB [> 75dB]

Distortion at RF=1mV, dev. 75kHz : < 3%

-3dB Limiting point : < 8 μ V

Crosstalk at RF=1mV, dev. 40kHz : > 18dB

MW

Tuning range : 531-1602kHz
 530-1700kHz for /21/37

Grid : 9kHz
 10kHz for /21/37

IF frequency : 450kHz \pm 1kHz

Aerial input : Frame aerial

Sensitivity at 26dB S/N : < 4.0mV/M

Selectivity at 18kHz bandwidth : > 18dB

IF rejection : > 45dB

Image rejection : > 28dB

Distortion at RF=50mV, m=80% : < 5%

LW

Tuning range : 153-279kHz

Grid : 3kHz

IF frequency : 450kHz \pm 1kHz

Aerial input : Frame aerial

Sensitivity at 26dB S/N : [< 7.0mV/M]

Selectivity at 18kHz bandwidth : [> 22dB]

IF rejection : [> 26dB]

Image rejection : [> 35dB]

Distortion at RF=50mV, m=80% : [< 5%]

AMPLIFIER:

Output power Left/Right : 2 x 50W FTC ¹⁾ @ 6 Ω
 2 x 50W RMS ²⁾ @ 6 Ω /37
 Center : 1 x 50W @ 6 Ω
 Surround : 2 x 5W @ 6 Ω

Frequency response within \pm 3dB : 20Hz-20kHz

Dynamic Bass Boost : Beat, Punch, Blast, DBB Off ³⁾

Digital Sound Control : Optimal, Classic, Techno, Vocal,
 Rock, Jazz ³⁾

Personal Control : 6 presets

VEC Control : Hall, Club, Disco, Concert, Arcade ³⁾

Input sensitivity
 Aux/CDR in : 500mV \pm 2dB at 1k Ω
 Mic : {2.5mV \pm 2dB} at 600 Ω

Output sensitivity
 Line out : 1.0V \pm 2dB at 22k Ω
 Surround out : 750mV \pm 2dB at 22k Ω
 Sub-woofer : 1.5V \pm 2dB at 22k Ω
 Headphone : 15mW \pm 2dB at 32 Ω
 Digital Out : IEC958 for CDDA / LPCM
 IEC1937 for MPEG1, MPEG2 and AC-3
 DTS

COMPACT DISC:

Measurement done at output conn. of the CDC module.

Frequency response within \pm 1.5dB: 20Hz - 20kHz

Output level (in Vrms) : 550mV, Z_{out} = 100 Ω

Signal/Noise ratio (A-weighted) : > 76dBA

Distortion at 1kHz : < 0.02%

Channel unbalance : < \pm 1dB

Channel separation at 1kHz : > 60dB

De-emphasis : 0 or 15/50 mS (Switched by subcode
 on the disc)

DVD PLAYER:

Playback system : DVD-Video, Video CD, CD (CD-R &
 CD-RW)

Video (CVBS) output ⁴⁾ : 1Vp-p \pm 0.1V

S-Video output ⁴⁾ : Y level : 1Vp-p \pm 0.1V
 C level : 300mV +1/-4dB

[...] Values indicated are for "Tuner 95 Board" only

{...} Values indicated are for Karaoke version only

¹⁾ \pm 1dB, 60Hz - 12,5kHz, 10% THD

²⁾ \pm 1dB, 1kHz, 10% THD

³⁾ Frequency response in each setting is software controlled.

⁴⁾ Output terminated with 75 Ω

MEASUREMENT SETUP

Tuner FM

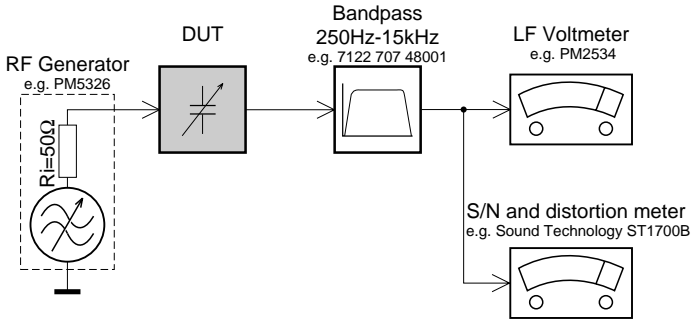

Use a bandpass filter to eliminate hum (50Hz, 100Hz) and disturbance from the pilotone (19kHz, 38kHz).

Tuner AM (MW,LW)

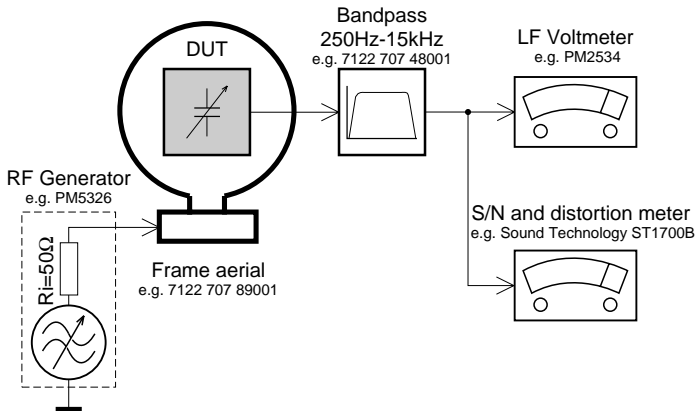

To avoid atmospheric interference all AM-measurements have to be carried out in a Faraday's cage.
Use a bandpass filter (or at least a high pass filter with 250Hz) to eliminate hum (50Hz, 100Hz).

CD

Use Audio Signal Disc SBC429 4822 397 30184
(replaces test disc 3)

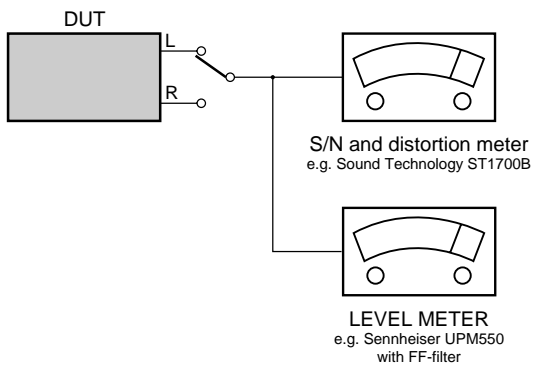

Recorder

Use Universal Test Cassette **CrO2** SBC419 4822 397 30069
or Universal Test Cassette **Fe** SBC420 4822 397 30071

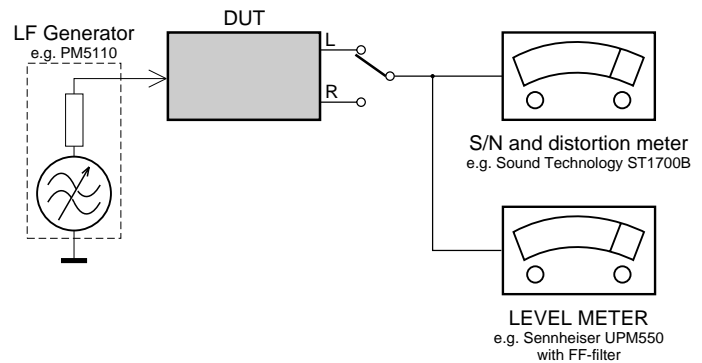

SERVICE AIDS

Service Tools:

Universal Torx driver holder	4822 395 91019
Torx bit T10 150mm	4822 395 50456
Torx driver set T6 - T20	4822 395 50145
Torx driver T10 extended	4822 395 50423

Cassette:

SBC419 Test cassette CrO2	4822 397 30069
SBC420 Test cassette Fe	4822 397 30071
MTT150 Dolby level 200nWb/M	4822 397 30271

Compact Disc:

SBC426/426A Test disc 5 + 5A	4822 397 30096
SBC442 Audio Burn-in Test disc 1kHz	4822 397 30155
SBC429 Audio Signals disc	4822 397 30184
Dolby Pro-logic Test Disc	4822 395 10216

ESD Equipment:

Anti-static table mat - large 1200x650x1.25mm ...	4822 466 10953
Anti-static table mat - small 600x650x1.25mm	4822 466 10958
Anti-static wristband	4822 395 10223
Connector box (1M Ω)	4822 320 11307
Extension cable	
(to connect wristband to conn. box)	4822 320 11305
Connecting cable	
(to connect table mat to conn. box)	4822 320 11306
Earth cable (to connect product to mat or box)	4822 320 11308
Complete kit ESD3	
(combining all above products)	4822 320 10671
Wristband tester	4822 344 13999

HANDLING CHIP COMPONENTS

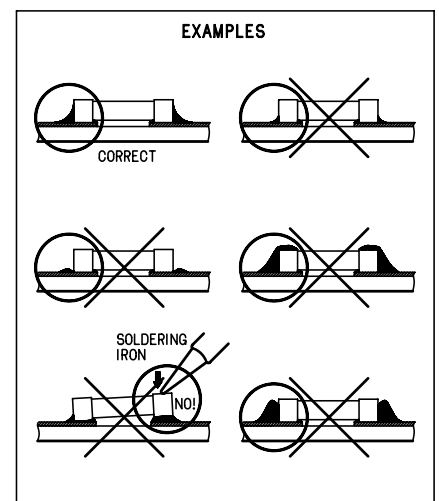
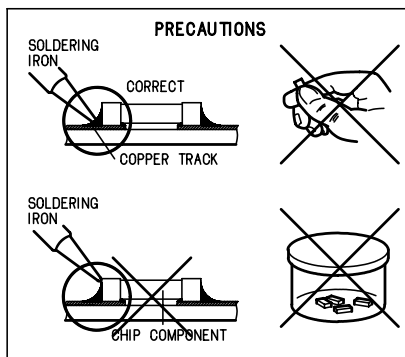
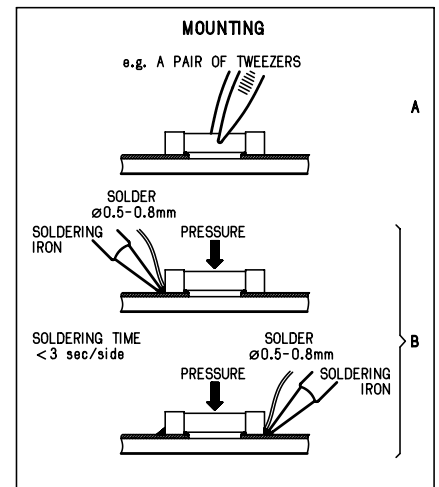
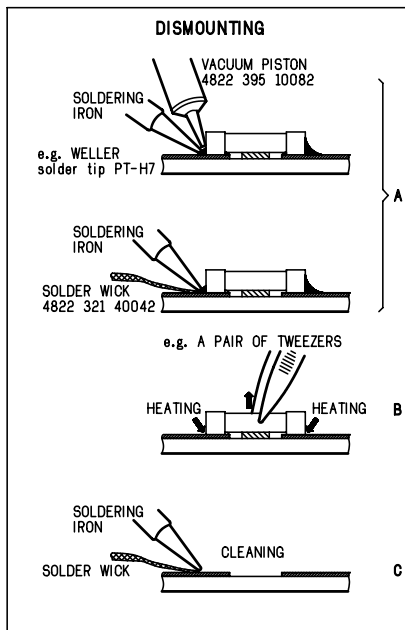
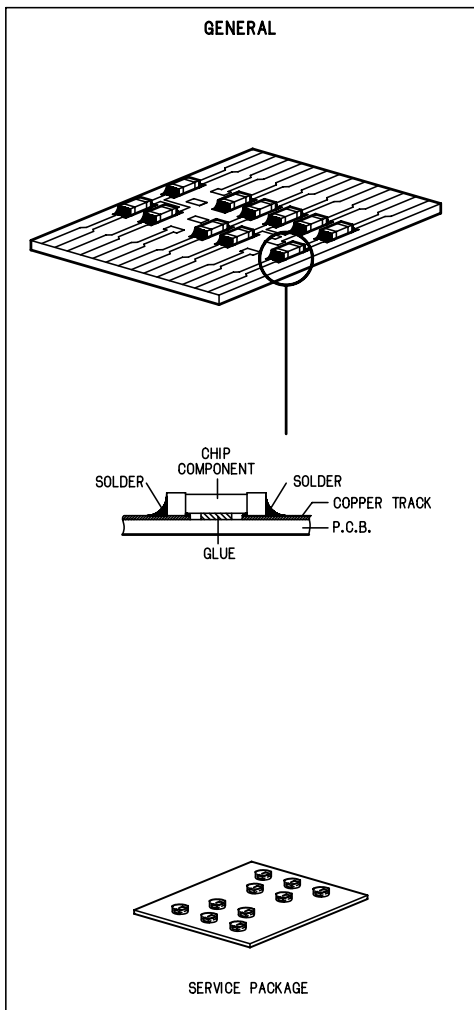

(GB) WARNING

All ICs and many other semi-conductors are susceptible to electrostatic discharges (ESD). Careless handling during repair can reduce life drastically.

When repairing, make sure that you are connected with the same potential as the mass of the set via a wrist wrap with resistance.

Keep components and tools also at this potential.

ESD**(NL) WAARSCHUWING**

Alle IC's en vele andere halfgeleiders zijn gevoelig voor electrostatische ontladingen (ESD).

Onzorgvuldig behandelen tijdens reparatie kan de levensduur drastisch doen verminderen.

Zorg ervoor dat u tijdens reparatie via een polsband met weerstand verbonden bent met hetzelfde potentiaal als de massa van het apparaat.

Houd componenten en hulpmiddelen ook op ditzelfde potentiaal.

(F) ATTENTION

Tous les IC et beaucoup d'autres semi-conducteurs sont sensibles aux décharges statiques (ESD).

Leur longévité pourrait être considérablement écourtée par le fait qu'aucune précaution n'est prise à leur manipulation.

Lors de réparations, s'assurer de bien être relié au même potentiel que la masse de l'appareil et enfilez le bracelet serti d'une résistance de sécurité.

Veiller à ce que les composants ainsi que les outils que l'on utilise soient également à ce potentiel.

(D) WARNUNG

Alle ICs und viele andere Halbleiter sind empfindlich gegenüber elektrostatischen Entladungen (ESD).

Unvorsichtige Behandlung im Reparaturfall kann die Lebensdauer drastisch reduzieren.

Veranlassen Sie, dass Sie im Reparaturfall über ein Pulsarmband mit Widerstand verbunden sind mit dem gleichen Potential wie die Masse des Gerätes.

Bauteile und Hilfsmittel auch auf dieses gleiche Potential halten.

(I) AVVERTIMENTO

Tutti IC e parecchi semi-conduttori sono sensibili alle scariche statiche (ESD).

La loro longevità potrebbe essere fortemente ridotta in caso di non osservazione della più grande cauzione alla loro manipolazione.

Durante le riparazioni occorre quindi essere collegato allo stesso potenziale che quello della massa dell'apparecchio tramite un braccialetto a resistenza.

Assicurarsi che i componenti e anche gli utensili con quali si lavora siano anche a questo potenziale.

(GB)

Safety regulations require that the set be restored to its original condition and that parts which are identical with those specified, be used.

"Pour votre sécurité, ces documents doivent être utilisés par des spécialistes agréés, seuls habilités à réparer votre appareil en panne".

(NL)

Veiligheidsbepalingen vereisen, dat het apparaat bij reparatie in zijn oorspronkelijke toestand wordt teruggebracht en dat onderdelen, identiek aan de gespecificeerde, worden toegepast.

(F)

Les normes de sécurité exigent que l'appareil soit remis à l'état d'origine et que soient utilisées les pièces de rechange identiques à celles spécifiées.

(D)

Bei jeder Reparatur sind die geltenden Sicherheitsvorschriften zu beachten. Der Originalzustand des Geräts darf nicht verändert werden; für Reparaturen sind Original-Ersatzteile zu verwenden.

(I)

Le norme di sicurezza esigono che l'apparecchio venga rimesso nelle condizioni originali e che siano utilizzati i pezzi di ricambio identici a quelli specificati.

**(GB) Warning !**

Invisible laser radiation when open.
Avoid direct exposure to beam.

(S) Varning !

Osynlig laserstrålning när apparaten är öppen och spärren är urkopplad. Betrakta ej strålen.

(SF) Varoitus !

Avatussa laitteessa ja suojalukituksen ohitettaessa olet alttiina näkymättömälle laserisäteilylle. Älä katso säteeseen!

(DK) Advarse !

Usynlig laserstråling ved åbning når sikkerhedsafbrydere er ude af funktion. Undgå udsættelse for stråling.

GENERAL INFORMATION

IMPORTANT:
PLEASE NOTE THAT THE VOLTAGE SELECTOR LOCATED AT THE REAR OF THIS SYSTEM IS PRESET AT 220V FROM THE FACTORY. FOR COUNTRIES THAT OPERATE AT 110V, PLEASE ADJUST TO 110V BEFORE YOU SWITCH ON THE SYSTEM.

General Information

- The typeplate (which contains the serial number) is located at the rear of the system.
- Recording is permissible if copyright or other rights of third parties are not infringed.

Environmental Information

All unnecessary packaging has been omitted. We have tried to make the packaging easy to separate into three materials: cardboard (box), polystyrene foam (buffer) and polyethylene (bags, protective foam sheet).

Your system consists of materials which can be recycled and reused if disassembled by a specialized company. Please observe the local regulations regarding the disposal of packaging materials, exhausted batteries and old equipment.

Accessories (Supplied)

- Remote control
- Batteries (two AA size) for remote control
- AM loop antenna
- FM wire antenna
- AC power cord
- For model FW-D5 only
- CS-05 speaker package (includes one pair of surround speakers and one centre speaker)
- CVBS cable cinch

SAFETY INFORMATION

Safety Information

- Before operating the system, check that the operating voltage indicated on the typeplate (or the voltage indication beside the voltage selector) of your system is identical with the voltage of your local power supply. If not, please consult your dealer. The typeplate is located at the rear of your system.
- When the system is switched on, do not move it around.
- Place the system on a solid base (e.g. a cabinet).
- Place the system in a location with adequate ventilation to prevent internal heat build-up in your system. Allow at least 10 cm (4 inches) clearance from the rear and the top of the unit and 5 cm (2 inches) from each side.
- Do not place the system on soft carpet that will cover the ventilation hole at the bottom.
- Do not expose the system to excessive moisture, rain, sand or heat sources.
- Under no circumstances should you repair the system yourself, as this will invalidate the warranty!

- If the system is brought directly from a cold to a warm location, or is placed in a very damp room, moisture may condense on the lens of the CD/DVD unit inside the system. Should this occur, the player will not operate normally. Leave the power on for about one hour with no disc in the system until normal playback is possible.
- Electrostatic discharge may cause unexpected problems. See whether these problems disappear if you unplug the AC power cord and plug it in again after a few seconds.
- **To disconnect the system from the power supply completely, remove the AC power plug from the wall socket.**

English

PREPARATION

Rear Connections

English

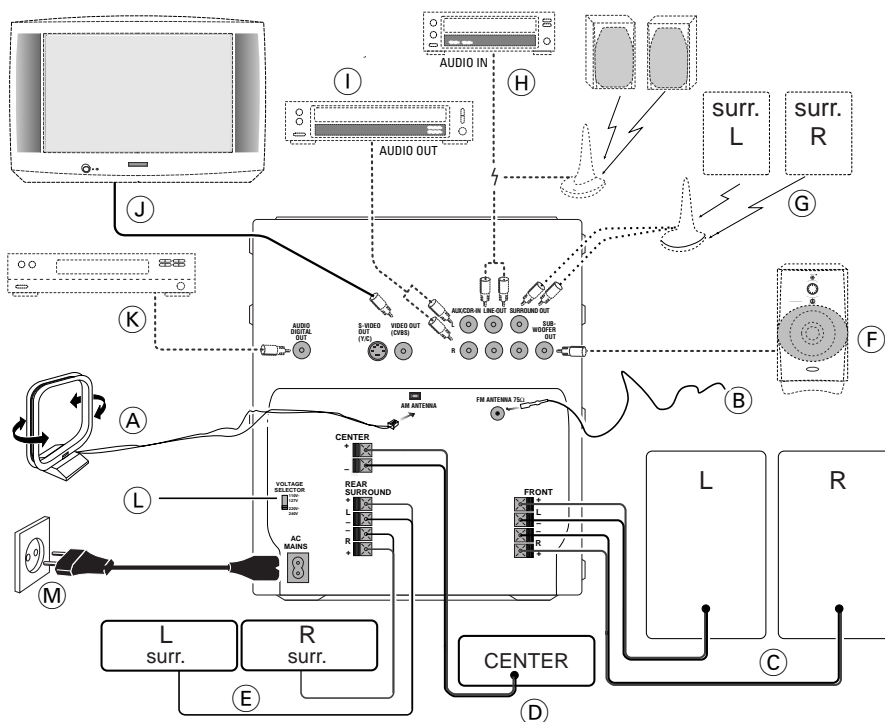

A AM Loop Antenna Connection

Connect the supplied loop antenna to the AM ANTENNA terminal. Place the AM loop antenna far away from the system and adjust its position for the best reception.

B FM Wire Antenna Connection

Connect the supplied FM wire antenna to the FM ANTENNA 75 Ω terminal. Adjust the position of the FM antenna for the best reception.

Outdoor Antenna

For better FM stereo reception connect an outdoor FM antenna to the FM ANTENNA 75 Ω terminal using a 75 Ω coaxial wire.

C Speakers Connection

- Connect the right speaker to Front terminal R, with the coloured wire to + and the black wire to -.
- Connect the left speaker to Front terminal L, with the coloured wire to + and the black wire to -.
- Clip the stripped portion of the speaker wire as shown.

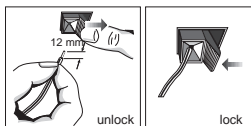
**CAUTION:**

- For optimal sound performance, it is recommended to use the supplied speakers.
- Do not connect more than one speaker to any one pair of + / - speaker terminals.
- Do not connect speakers with impedance lower than the speakers supplied. Please refer to the SPECIFICATIONS section of this manual.

D Centre Speaker Connection (for model FW-D5 only)

Connect the black (non-marked) wires to the black CENTER terminal and the blue (marked wires) to the blue CENTER terminal.

E Rear Surround Speakers' Connection (for model FW-D5 only)

Connect the black (non-marked) wires to the black REAR SURROUND terminals and the coloured (marked) wires to the grey REAR SURROUND terminals.

F Subwoofer Out Connection

Connect the optional active subwoofer to the SUBWOOFER OUT terminal. The subwoofer reproduces just the low bass sound effect (e.g. explosions, the rumble of spaceships, etc.). Be sure to follow the instructions supplied with the subwoofer.

G Wireless Surround Out Connection (for model FW-D5 only)

You may connect the transmitter of the wireless rear speakers (not supplied) to the SURROUND OUT terminal.

Note:

- Availability of a wireless transmitter and its peripherals are subjected to the approval of local authorities. Please check with the respective local safety or approving authority.

H Line Out Connection (wireless ready)

You can connect the audio left and right LINE OUT terminals to a optional CD Recorder's ANALOGUE IN terminals. This allows you to record in an analogue format.

You can also install additional optional front active speakers away from the system (e.g. in another room) to reduce the inconvenience of running long speaker wires across rooms. You can place as many remote speakers as you like provided they operate at the same radio frequency. Connect the wireless radio frequency transmitter to the LINE OUT terminals. Place the active speakers at your preferred location. Be sure to follow the instructions supplied with the active speakers.

I Connecting other equipment to your system

You can connect the audio left and right OUT terminals of a TV, VCR, Laser Disc player, DVD player or CD Recorder to the AUX/CDR IN terminals at the rear of the system.

PREPARATION

J Video Out Connection

Connect the VIDEO OUT (CVBS) terminal at the rear of the system to the TV or VCR VIDEO IN terminal for viewing or recording.

Note:

- You can also choose to connect the S-VIDEO OUT (Y/C) terminal at the rear of the system to the S-VIDEO IN of the TV using an optional S-VIDEO cable.

K Audio Digital Out Connection

You can record the digital sound from the CD/DVD, through this output, on any audio equipment with digital input (e.g. CD Recorder, Digital Audio Tape (DAT) deck, Digital to Analogue Converter and Digital Signal Processor).

Connect one end of the cinch cable (not supplied) to the DIGITAL OUT socket and the other end to the audio equipment's digital input. When connecting the cinch cable, make sure it is fully inserted.

L Adjusting the Operating Voltage (not available for all versions)

Before connecting the AC power cord to a wall outlet, make sure that the voltage selector at the rear of the system is set to the local power line voltage. If not, reset the selector before connecting to the wall outlet.

M AC Power Supply

After all other connections have been made, connect the AC power cord to the system and to the wall outlet.

Inserting batteries into the Remote Control

- Insert the batteries (Type R06 or AA) into the remote control as shown in the battery compartment.

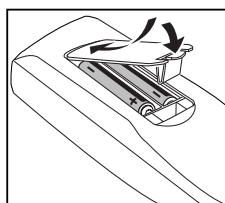

- To avoid damage from possible battery leakage, remove dead batteries or batteries that will not be used for a long time. For replacement, use type R06 or AA batteries.

- 18 PROGRAM (FTS- Favourite track selection)**
for DVD/VCD/CD
– to programme disc tracks.
for TUNER
– to programme preset radio stations.
for CLOCK (on the system only)
– to select 12 or 24 hour in clock setting mode.
- 19 DVD-VIDEO DISC TRAY**
- 20 OPEN/CLOSE ▲**
– to open or close the DVD-VIDEO tray.
- 21 MIC LEVEL (not available for all versions)**
– to adjust the mixing level for karaoke in DVD mode only.
- 22 MIC (not available for all versions)**
– to connect microphone jack.
- 23 PLAYBACK MODE**
– to view the selected playback mode : DVD, VCD or CD.
- 24 DVD MENU**
– to access the DVD disc menu.
- 25 OK**
– to confirm the selection.
- 26 AXIS (◀▶▲▼)**
– to select the direction of cursor movement : up/down or left/right. (on the remote control only)
– to select movement of cursor: left, right, up or down.
- 27 DVD JOG**
– to move the cursor up/down or left/right. You must select the AXIS movement direction first.
- 28 SCAN**
for DVD
– to playback the first 10 seconds of each chapter within a title.
for VCD/CD
– to playback the first 10 seconds of each track.
- 29 A - B (in DVD mode only)**
– to playback a certain scene or passage of a disc repeatedly.
– to repeat playback a Chapter/Index, Title/Track or Disc.
- 30 PBC (PLAYBACK CONTROL)**
– to switch on or off PBC mode (for VCD version 2.0 only).
- 31 RETURN**
– to return to the previous MENU level during playback.
- 32 REPEAT (in CD mode only)**
– to repeat a disc track, a disc, or all available discs.
- 33 OSD MENU (ON SCREEN DISPLAY)**
– to switch on or off the on screen display on the TV screen.
- 34 ECHO - / + (not available for all versions)**
– to adjust the echo level for karaoke.
- 35 AUDIO**
– to select different audio languages available in the DVD disc.
- 36 TIMER**
– to switch on or off the timer.
- 37 KARAOKE (not available for all versions)**
– to switch the Karaoke features ON/OFF mode.
- 38 KEY CONTROL - / + (not available for all versions)**
– to adjust the key to suit your vocal range.
- 39 SHUFFLE**
– to play all the available discs and their tracks in random order.
- 40 DIGIT 0 - 9**
(numbers consisting more than two figures must be keyed in within 2 seconds.)
for DVD/VCD/CD
– to key in a disc title or track for playback or programming.
for VCD with PBC on only
– to select a track.
for TUNER
– to key in a preset radio station.
- 41 ⏻**
– to switch the system to standby mode.

Notes for remote control:

- First select the source you wish to control by pressing one of the source select keys on the remote control (e.g. DVD, TUNER, etc.).
- Then select the desired function (▶, ◀, ▲, ▼, etc.).

OPERATING THE SYSTEM

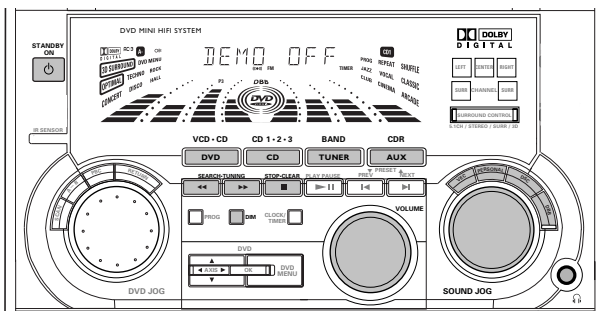
**Important:**

Before you operate the system, complete the preparation procedures.

Demonstration mode

The system has a demonstration mode that shows the various features offered by the system. **When the system is switched on for the first time, the demonstration mode will start automatically.**

Notes:

- During the demonstration, if you press any source (or standby-on) button, the system will switch to the respective mode (or standby).
- When the system is switched to standby mode, the demonstration will resume 5 seconds later.

To stop the demonstration mode

- Press and hold **■** (on the system only) for **5 seconds** when the system is in demonstration mode.
 - The demonstration will stop.
 - "DEMO OFF" will be displayed.
 - The system will switch to standby mode.

Notes:

- When the system is switched on from the main power outlet, the CD carousel tray may open and close again to initialize the set.
- Even though the AC power cord is removed from and reconnected to the wall socket, the demonstration will remain off until it is switched on again.

To start the demonstration mode

- Press and hold **■** (on the system only) for **5 seconds** when the system is in standby mode.
 - The demonstration will begin.

Easy Set

EASY SET allows you to store all available radio stations automatically.

- Press and hold **STANDBY ON** (on the system only) for **5 seconds**, when the system is in standby or demonstration mode.
 - "EASY SET" will be displayed, and followed by "TUNER" and then "AUTO".
 - EASY SET will start searching for all radio on FM band and then followed by radio stations on MW band.
 - All available radio stations with sufficient signal strength will be stored. Up to 40 presets may be stored.

Notes:

- EASY SET will start with the FM band, if there are still presets available, the system will continue to store the MW band.
- When EASY SET is used, all previously stored radio stations will be replaced.
- The last preset radio station will appear on the display when EASY SET is completed.

Switching the system ON

- Press **DVD, CD, TUNER** or **AUX**.

You can also switch on the system by pressing any one of the CD DIRECT PLAY buttons.

Switching the system to standby mode

- Press **STANDBY ON** or **⏻** on the remote control.
 - The system will switch to standby mode.

Selecting the Source

- Press the desired source selection button: **DVD, CD, TUNER** or **AUX**.
 - The display indicates the selected source.

Note:

- For an external source, make sure you have connected the audio left and right OUT terminals of the external equipment (TV, VCR, Laser Disc player, DVD player or CD Recorder) to the AUX/CDR IN terminals.

Dim mode

You can select the desired brightness for the display.

- Press **DIM** to select DIM 1, DIM 2, DIM 3 or DIM OFF display mode.
 - The **DIM** appears on the display.
 - "DIM 1", "DIM 2", "DIM 3" or "DIM OFF" will be displayed depending on the mode selected.

DIM OFF - normal brightness with Spectrum Analyser On**DIM 1 - normal brightness with Spectrum Analyser Off****DIM 2 - half brightness with Spectrum Analyser On****DIM 3 - half brightness with Spectrum Analyser Off and all LEDs on the system will be switched off.****Volume Control**

Adjust **VOLUME** to increase or decrease the sound level.

For Personal Listening

Connect the headphones plug to the socket at the front of the system. The speakers will be muted.

Sound Control

For Optimal sound listening, you can only select one of the following sound controls at a time : VEC, PERSONAL or DSC .

VIRTUAL ENVIRONMENT CONTROL (VEC)

The VEC feature enables you to adjust the system to select a type of environment.

- 1 Press to select the **VEC** feature.
- 2 Adjust the **JOG** to select the desired VEC setting : HALL, CLUB, DISCO, CINEMA, CONCERT or ARCADE.
 - The selected environment is encircled.
 - "HALL, CLUB, DISCO, CINEMA, CONCERT or ARCADE" will be displayed.

PERSONAL SOUND

You can store up to 6 personal settings.

- 1 Press to select the **PERSONAL** feature.
- 2 Adjust the **JOG** to select the desired Personal setting.
 - The selected personal setting number will appear on the display.
 - If no name has been stored previously, "PERSONAL X" will be displayed. "X" is the setting number.

Personal Setting

You can adjust the personal setting to your desired level with the JOG control.

- 1 Press and hold **PERSONAL** for about **5 seconds** to switch on the personal setting mode.
 - "SELECT PRESET NUMBER" will be displayed.
- 2 Adjust the **JOG** to select the desired preset number for personal setting and press **▶▶** to confirm the selection.
 - "ADAPT LOW FREQ LEVEL" will be displayed.
- 3 Adjust the **JOG** to select the desired Spectrum Analyser band level for low frequency.
 - The level will increase or decrease between +3 and -3.
- 4 Press **▶▶** to confirm the selection.
 - "ADAPT MID FREQ LEVEL" will be displayed, followed by "ADAPT HIGH FREQ LEVEL".

OPERATING THE SYSTEM

- Repeat **step 3 - 4** to select the desired middle and high frequencies of the Spectrum Analyser band levels.
- 5 You can edit the name for the personal setting.
 - The first character of the setting name will be flashing.
- 6 Adjust the **JOG** to select the desired letter, number or symbol.
 - "A to Z", "0 to 9" or "*, -, +, \, /, _".
- 7 Press **▶▶** to confirm the selection.
 - The next character for editing will be flashing.
- Repeat **steps 6 - 7** to store up to 10 characters.
- 8 To store the setting, press **PERSONAL** again.
- **Before storing the setting, you can press ◀◀ to retrace the steps.**
- **To exit without storing the setting, press ■ .**

Notes:

- During personal setting, if no button is pressed within 90 seconds, the system will exit personal setting mode automatically.
- It is not possible to adjust the DBB level during personal setting, "USE JOG" will be displayed.

DIGITAL SOUND CONTROL (DSC)

The DSC feature enables you to adjust the system to suit your type of music.

- 1 Press to select the **DSC** feature.
- 2 Adjust the **JOG** to select the desired DSC setting : OPTIMAL, CLASSIC, TECHNO, VOCAL, ROCK or JAZZ.
 - The selected digital sound is encircled.
 - "OPTIMAL, CLASSIC, TECHNO, VOCAL, ROCK or JAZZ" will be displayed.

Note:

- For a neutral setting, select CLASSIC.

DYNAMIC BASS BOOST (DBB)

There are three DBB settings to enhance the bass response.

- Press **DBB** briefly to select a bass boost level.
 - The DBB button will be lit.
 - "BEAT", "PUNCH" or "BLAST" will be displayed.

To switch off DBB

- Press **DBB** briefly until "DBB OFF" is displayed.

Note:

- Some CDs might be recorded in high modulation, which causes a distortion at high volume. If this occurs, switch off DBB or reduce the volume.

Automatic DSC-DBB / VEC-DBB selection

The best DBB setting is generated automatically for each DSC or VEC selection. You can manually select the DBB setting that best suits your listening environment.

General Information

- Digital video discs provide perfect digital, studio-quality pictures; three dimensional digital; multi-channel audio; story sequences screened from your choice of camera angle; sound tracks in as many as eight languages; and up to 32 subtitles if available on disc.
- DVD-Video uses state-of-the-art MPEG2 data compression technology to register an entire movie on the single 5-inch disc. DVD's variable bitrate compression, running up to 9.8 Mb/second, captures even the most complex pictures in their original quality.
- The crystal-clear digital pictures have a horizontal resolution of over 500 lines, with 720 pixels (picture elements) to each line. This resolution is more than double that of VHS, superior to Laser Disc, and entirely comparable with digital masters made in recording studios.
- In addition to the DVD-Video discs, you will be able to play all Video CDs and Audio CDs (including finalised CD Recordable and CD Rewritable).

DVD-Video

You will recognise DVD-Video discs by the logo shown at right. Depending on the material on the disc (a movie, video clips, a drama series, etc.) the disc may have one or more Titles. Each Title may have one or more Chapters. To make playback easy and convenient, your player lets you select Titles and Chapters.



Video CD

You will recognise Video CDs by the logo shown at right. Depending on the material on the disc (a movie, video clips, a drama series, etc.) the disc may have one or more tracks. Tracks may have one or more indexes, as indicated on the disc case. To make playback easy and convenient, your player lets you select tracks and indexes.

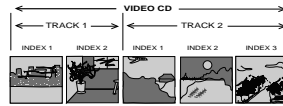

Audio CD

Audio CDs contain music tracks only. You will recognise CDs by their logo which is shown at right. You can play them in conventional style through a stereo system, using the keys on the remote control and/or front panel, or via the TV using the On-Screen Display (OSD).



DVD-VIDEO

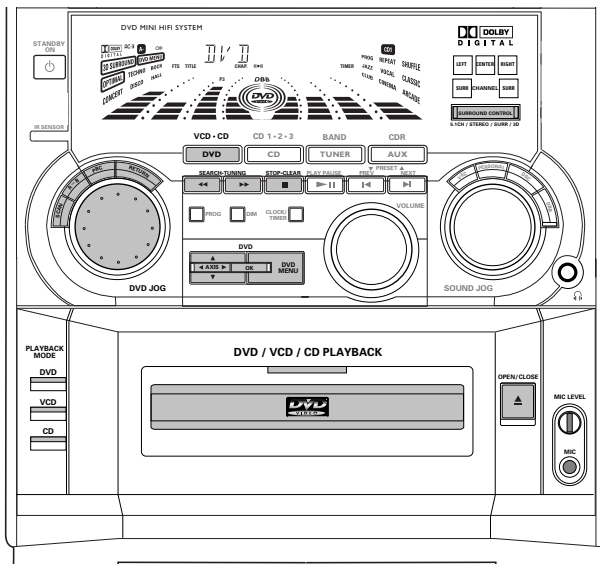

Surround Setup (for FW-D5 DVD operation only)

Multichannel sound

MULTICHANNEL SOUND gives you a completely new listening sensation. You will have the feeling of being in the middle of the action, because sound is coming from everywhere around you. Look for discs with the **DOLBY DIGITAL** **MPEG** **MultiChannel** Mark which indicates the material is encoded for multichannel surround sound.

Notice that DVDs do not always carry full multichannel surround. To be sure that a disc is multichannel encoded, consult your dealer.

Most ordinary stereo tapes and discs can be replayed using surround sound settings with good results. If the reproduction is distorted in surround mode, switch to normal stereo mode.

The availability of the various surround sound modes described depends on the number of speakers used and the incoming sound information.

Setting up the Multichannel system

You must set up the system properly in order to enjoy the MULTICHANNEL to the fullest. First, connect the speakers.

5-Speaker Connection

- **Front speakers:** Connect the front speakers to the **FRONT** terminals.
- **Centre speaker:** Connect the centre speaker to the **CENTER** terminals.
- **Rear (surround) speakers:** Connect either the wired rear surround speakers or a pair of wireless rear speakers (not supplied) to the **SURROUND OUT** terminals.

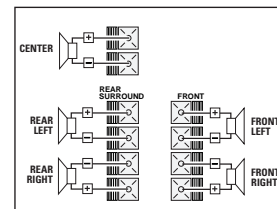

Positioning the Speakers

To get the best surround sound effect, place the speakers as follows.

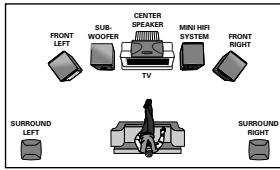

Front Left and Right Speakers

For the best sound, place the Left and Right speakers at an angle of approximately 45 degrees to the listener. If the speakers' magnetic field affects the television picture, increase the distance between the TV and the speakers.

Centre Speaker

For the best sound, place the centre speaker at the same height as the left and right speakers. Place the centre speaker directly above or beneath the television.

Rear (surround) Speakers

The surround speakers should be placed at normal listening ear level or mounted on the wall at the back of the room. Most important, experiment when placing the surround speakers in order to obtain the best sound.

Switching Surround Control Sound

You can switch through the different surround modes. Note that the possibilities are related to speaker setup as defined.

- Press **SURROUND CONTROL** (or **SURR** on the remote control) to select : MULTICHANNEL, STEREO, SURROUND or 3D SURROUND mode.
→ The message "DOLBY DIGITAL AC3 5.1 CHANNEL, STEREO, SURROUND" or "3D SURROUND" will be displayed.

Multichannel (5.1)

In addition to SURROUND, the surround mode used will be displayed. AC3 must be available on the source material.



Stereo

All sound is reproduced and played through the front left and right speakers. This enables standard stereo reproduction.



Surround

This surround mode enables normal surround sound reproduction with two speakers. Depending on the source material, Dolby Pro Logic or MPEG is reproduced (for connection to another Dolby Pro Logic decoder).



3D Surround

The sound of the rear channel is simulated by the front left and right speakers.



Note:

- Always refer to OSD when selecting surround control sound. When in stop mode, the player will not display the correct surround selection.

DVD-VIDEO

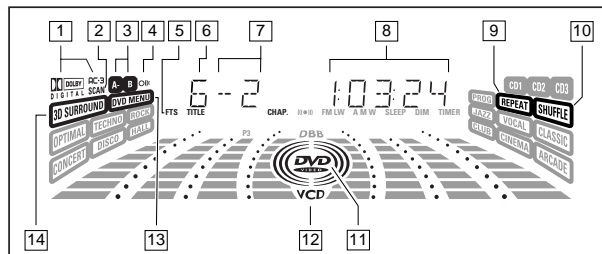

On Screen Display information

DISPLAY indications

- 1** (for model FW-D5 only)
- AC-3 active
- 2** **SCAN**
- SCAN active
- 3** **A-B**
- Repeat A-B active
- 4** (flashing)
- Remote control active (flashing)
- 5** **FTS**
- Favourite Track Selection active

- 6** **5**
- DVD TITLE number
- 7** **--2**
- DVD CHAPTER number
- 8** **1:03:24**
- TRACK/TOTAL TIME in hours, minutes and seconds
- 9** **REPEAT**
- REPEAT active
- 10** **SHUFFLE**
- SHUFFLE active
- 11** **DVD**
- DVD disc inserted
- 12** **VCD**
- (Video)CD disc inserted
- 13** **DVD MENU**
- DVD MENU active
- 14** **3D SURROUND** (for model FW-D5 only)
- 3D SURROUND active

Menu bar/Status window

The status window displays the current status of the player and appears with the first part of the menu bar. (You must activate this in the Features Menu, see Personal Preferences for details).

General



- Angle
- Child Lock On
- Child Safe
- Resume
- Action prohibited

Temporary feedback field icons

- Scan
- Repeat All
- Repeat Title
- Repeat Track
- Repeat Chapter
- Shuffle
- Shuffle Repeat
- Repeat A to end
- Repeat A-B

Default screen

The default screen is displayed when the player is in STOP mode. It may contain a 'Status Window' and a 'Temporary Feedback Field'. This screen gives information concerning prohibited actions, playback modes, available angles, etc.



Preparation

NTSC/PAL Setting

Before viewing the DVD or VCD, ensure that the PAL or NTSC setting of the system matches your TV set.

- 1 Before connecting the system to the power source, press and hold **DVD** and **◀** (on the system only). While holding **DVD** and **◀**, plug in the power cord.
- 2 After PAL or NTSC appears on the display, release **DVD** and **◀** at the same time.
 - The PAL or NTSC that appears on the display indicates the current setting.
- To change the setting, press **▶** within **3 seconds**.
 - After selected, the set will automatically switch to the last NTSC or PAL setting everytime the DVD or VCD source is selected.

Turning On the power

- 1 Switch on the TV and select the video in channel to which you connected your DVD-Video player.
- 2 Press **DVD**.
 - The player display lights and the "Initial Setup" screen appears.

The 'Initial Setup' will only appear the **very first time** you turn on the player. In 'Initial Setup', you may have to set your personal preferences for some of the player's most relevant items. See 'Initial Setup'.

Initial Setup

Manual Operation

After switching on the player for the **very first time**, the 'Initial Setup Screen' will appear.

The menu for the first item to be set is displayed and the first option is highlighted.

- 1 Use the **▲** or **▼** keys to go through the options in the menu.
 - The icon of the selected option will be highlighted.
- 2 Press **OK** to confirm your selection and to go to the next menu.

Automatic setting

When settings will be taken from your TV or Home Cinema system, the message 'Auto configuring in process' will appear. Menus for which no settings are available will be displayed. They have to be set manually.

Notes:

- Preferences have to be set in the order in which the item menus will appear on the screen.
- The 'Initial Setup' screen will only disappear after the settings for the last item have been confirmed.
- If any keys other than **▲** or **▼** or **OK** are pressed, **A** will appear on the screen.
- If the player is switched off while setting personal preferences, all preferences have to be set again after switching the player on again.

The following items may have to be set in INITIAL SETUP:

Menu language

The On Screen Menus will be displayed in the language you choose. You can choose from different languages.

Audio language

The sound will be in the language you choose if it is available on the disc in play. If the language you select is not available, speech will revert to the first spoken language on the disc. You can choose from different languages.

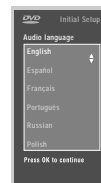

Subtitle language

The subtitles will be in the language you choose if it is available on the disc in play. If the language you select is not available, subtitles will revert to the first subtitle language on the disc. You can choose from different languages.

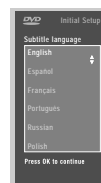

DVD-VIDEO

TV Shape

If you have a wide screen (16:9) TV, select 16:9.

If you have a regular (4:3) TV, select 4:3. If you have a 4:3 TV, you can also select between:

Letterbox for a 'wide-screen' picture with black bars top and bottom, or Pan Scan, for a full-height picture with the sides trimmed. If a disc has Pan Scan, the picture then moves (scans) horizontally to keep the main action on the screen.

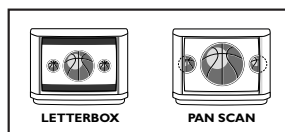

Country

Select your country. This also is used as input for the 'Parental Control' feature. (see 'Access Control')

Note:

- All these items may have to be set during 'Initial Setup'. After that, they can always be changed in the Personal Preferences Menu.

OSD Menu

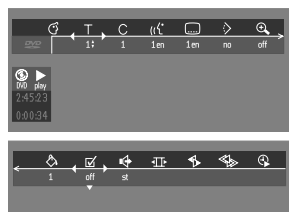

A number of operations can be carried out via the menu bar on the screen. The following functions are available via the menu bar:

- V Personal preference
- W Title/Track
- X Chapter/Index
- Y Audio language
- Z Subtitle language
- } Angle
- a Zoom
- c FTS-Video
- d Sound
- e Picture by Picture
- f Slow motion
- g Fast motion
- h Time search

- The menu bar can be accessed by pressing any of the following keys on the remote control: **OSD MENU** and **AUDIO**.
- The various items can be selected by pressing the **OSD MENU** button, then the **▼** or **▲** keys or by pressing the relevant keys on the remote control.
- Pressing **OSD MENU** while the menu bar is displayed will clear the menu bar from the screen.
- When selecting an item in the menu bar, the selected item will be highlighted and the appropriate cursor keys to operate this item will be displayed below the icon.
- < or > indicates that more items are available at the left/right of the menu bar. Press **◀** or **▶** to select these items.

Personal preferences

You can set your personal preferences for some of the player features: PICTURE, SOUND, LANGUAGE and FEATURE.

General operation:

- 1 Press **OSD MENU** on the remote control.
- 2 Select **V** in the menu bar.
 - The Personal Preferences menu appears.
- Use the **◀** or **▶** / **▲** or **▼** keys (or **DVD JOG**) to toggle through the menus, sub menus and submenu options.
 - When a menu item is selected, the cursor keys (on the remote control) to operate the item are displayed next to the item.
- 3 Press **OK** to confirm and return to the main menu.

Note:

- The DVD JOG can only move within one direction at a time, either up/down or left/right. Press **AXIS** on the system to select the movement direction before using DVD JOG.

The following items can be adapted:

Picture

- **TV Shape**
See 'Initial Setup'
- **Black level shift (NTSC only)**
Adapts the colour dynamics to obtain richer contrasts. Select ON or OFF.

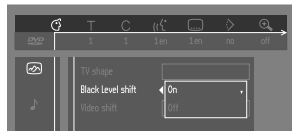

- **Video shift**

The factory centres the video on your screen. Use this setting to personalize the position of the picture on your TV by scrolling it to the left or right.

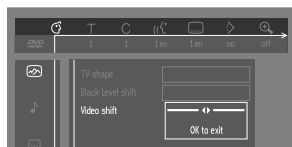

Sound

- **Digital output**
Factory setting: ALL. This means that both coaxial and optical outputs are switched on. If you are not connecting equipment with a digital input, change the setting to OFF. If your equipment doesn't include a digital multi-channel decoder, set the digital output to PCM (Pulse Code Modulation). Both coaxial and optical outputs are switched on.
- **Analogue output**
Select Stereo, Surround, 3D Sound or Multichannel.

Note:

- After selecting the desired Analogue Output, if the message appeared on the TV OSD and the system display screen do not match with the setting, press SURROUND CONTROL (or SURR on the remote control) until the selected setting reached.
- **Night Mode**
Optimises the dynamics of the sound with low volume playback.

- **Karaoke vocal** (not available for all versions)

Put this setting to ON only when a multi-channel karaoke DVD is being played. The karaoke channels on the disc will then be mixed into a normal stereo sound.

- **Speaker**

Allows you to select speaker settings, volume balance and delay time and to test the speaker settings. Speaker settings are only active on the Analogue Multi-Channel Output (see Appendix - page 30).

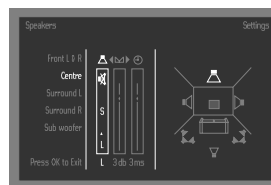

Language

Select the required Menu, Audio and Subtitle language. See 'Initial Setup'. Audio language and Subtitle language can also be adapted via the Menu bar on the screen.

Features

- **Access Control**
Access Control contains the following features:
Child Lock... When Child Lock is set to ON, a 4-digit code needs to be entered in order to play discs.
Parental control... Allows the conditional presentation of DVDs containing Parental Control information. (see 'Access Control')
- **Status Window**
Displays the current status of the player and is displayed with the menu bar. When disc playback is stopped, it is displayed with the 'Temporary Feedback Field' in the default screen.
Factory setting is ON. Select OFF to suppress display of the Status Window.
- **Low power Standby** (not applicable for this model)
- **PBC (Playback Control)**
The PBC can be set to ON or OFF (only applicable for Video CD playback).

DVD-VIDEO

Access control; child lock (DVD and VCD)

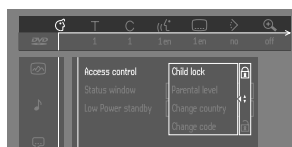

Activating/deactivating the child lock

- 1 When disc playback is stopped, select ACCESS CONTROL in the features menu using the ▲ or ▼ keys.
- 2 Enter a 4-digit code of your own choice.
- 3 Enter the code a second time.
- 4 Move to Child lock using the ▲ or ▼ keys.
- 5 Move to LOCK/UNLOCK icons using the ► key.
- 6 Select LOCK icon using the ▲ or ▼ keys.
- 7 Press OK or ◀ to confirm, then press ◀ again to exit the menu.
→ Now unauthorised discs will not be played unless the 4-digit code is entered.
- 8 Select UNLOCK icon to deactivate the Child Lock.

Note:

- Confirmation of the 4-digit code is necessary when the code is entered for the very first time, changed or cancelled.

Authorising discs

- Insert the disc. See 'Loading disc'.
→ The 'child protect' screen will appear.

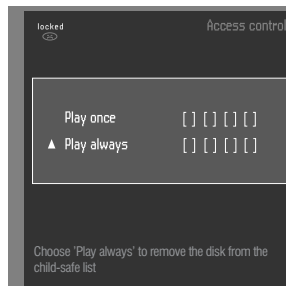

You will be asked to enter your secret code for 'Play Once' or 'Play Always.' If you select 'Play Once', the disc can be played as long as it is in the player and the player is ON. If you select 'Play Always', the disc will become child safe (authorised) and can always be played, even if the Child Lock is set to ON.

Notes:

- The player memory maintains a list of 50 authorised ('Child safe') disc titles. A disc will be placed in the list when 'Play Always' is selected in the 'child protect' screen. Each time a 'child safe' disc is played, it will be placed on top of the list. When the list is full and a new disc is added, the last disc in the list will be removed from the list.

- Double sided DVDs may have a different ID for each side. In order to make the disc 'child safe', each side has to be authorised.
- Multi-volume VCDs may have a different ID for each volume. In order to make the complete set 'child safe', each volume has to be authorised.

DeAuthorising discs

- Insert the disc. See 'Loading disc'.
→ Playback starts automatically.
- Press ■ while { is visible.
→ The I will appear and the disc is now deauthorised.

Access control; Parental control (DVD-Video only)

Movies on DVDs may contain scenes not suitable for children. Therefore, disc may contain 'Parental Control' information which applies to the complete disc or to certain scenes on the disc. These scenes are rated from 1 to 8, and alternative, more suitable scenes are available on the disc. Ratings are country dependent. The 'Parental Control' feature allows you to prevent discs from being played by your children or to have certain discs played with alternative scenes.

Activating/Deactivating Parental Control

- 1 When disc playback is stopped, select ACCESS CONTROL in the Features menu using the ▲ or ▼ keys.
- 2 Enter your 4-digit code. If necessary, enter the code a second time.



- 3 Move to Parental Control using the ▲ or ▼ keys.



- 4 Move to VALUE ADJUSTMENT (1-8) using the ► key.
- 5 Then use the ▲ or ▼ keys or the digit keys (0-9) on the remote control to select a rating from 1 to 8 for the disc inserted.

Rating 0 (displayed as '—'): Parental Control is not activated. The Disc will be played in full.

Ratings 1 to 8:

The disc contains scenes not suitable for children. If you set a rating for the player, all scenes with the same rating or lower will be played. Higher rated scenes will not be played unless an alternative is available on the disc. The alternative must have the same rating or a lower one. If no suitable alternative is found, play will stop and the 4-digit code has to be entered.

- 6 Press **OK** or **◀** to confirm, then press **◀** again to exit the menu.

Country

- 1 When disc playback is stopped, select **ACCESS CONTROL** in the Features menu using the **▲** or **▼** keys.
- 2 Enter the 4-digit code.
- 3 Move to **CHANGE COUNTRY** using the **▼** key.
- 4 Press the **▶** key.
- 5 Select a country using **▲** or **▼**.
- 6 Press **OK** or **◀** to confirm, then press **◀** again to exit the menu.

Changing the 4-digit code

- 1 When disc playback is stopped, select **ACCESS CONTROL** in the Features menu using the **▲** or **▼** keys.
- 2 Enter the old code.
- 3 Move to **CHANGE CODE** using the **▼** key.
- 4 Press the **▶** key.
- 5 Enter the new 4-digit code.
- 6 Enter the code a second time and reconfirm by pressing **OK**.
- 7 Press **◀** to exit the menu.

Note:

– If you forget your 4 digit code, it can be cancelled by pressing 9 four times in the 'Access Control' dialog. You can then enter a new code (twice!) as described above.

Parental Control Disclaimer

This DVD player features the PARENTAL CONTROL system which is intended to activate when playing DVD discs made with certain software coding. This is according to technical standards adopted by the set maker and disc content industries.

Please note that the PARENTAL CONTROL system will not operate if the DVD disc does not have the appropriate software coding. Also note that at the time of release of this DVD player, certain aspects of the said technical standards had not been fully settled among the set maker and the disc content industries.

On this basis, Philips cannot warrant functioning of the PARENTAL CONTROL system and disclaims any liability of unintended watching of disc content.

If in doubt, please check the system with the disc before you allow children access or apply to the relevant disc publisher for more information.

Operation**Loading discs**

- 1 Press **OPEN/CLOSE ▲** on the front of the player. The disc tray opens.
- 2 Load your chosen disc in the tray, label side up (also when a double sided DVD is inserted). Make sure it is sitting properly in the correct recess.
- 3 Gently push the tray, or press **OPEN/CLOSE ▲** to close the tray.
 - "REPEAT" appears in the status window and on the player display, and playback starts automatically.

Notes:

- If 'Child Lock' is set to ON and the disc inserted is not in the 'child safe' list (not authorised), the 4-digit code must be entered and/or the disc must be authorised. (see 'Access Control')
- The DVD tray will open or close only when the system is in DVD mode.

Playing a DVD**Playing a title**

- 1 After inserting the disc and closing the tray, playback starts automatically.
 - The status window and the display show the type of disc loaded, as well as information about the disc's contents and playing time.
- The disc may invite you to select an item from a menu. If the selections are numbered, press the appropriate numerical key; if not, use the **◀** or **▶** / **▲** or **▼** keys to highlight your selection, then press **OK**.
 - The currently playing title and chapter number are shown in the menu bar and display.
 - The elapsed playing time is shown in the status window and the display.
- For model FW-D5 only - If required, you can use the **SURROUND CONTROL (or SURR on the remote control)** key to select Multichannel, Stereo, Surround or 3D-Surround. Play may stop at the end of the Title, and the player may return to the DVD menu. To go on to the next title, press **▶**.
- 2 To stop play at any other time, press **■**.
 - The default screen will appear, giving information about the current status of the player.

DVD-VIDEO

- You can RESUME play from the point at which you stopped play. Press **▶** (PLAY); when you see the RESUME icon **▶** on the screen, press **▶** (PLAY) again.
 - The RESUME feature applies not only to the disc in the player, but also to the last four discs you have played. Simply reload the disc, press **▶** (PLAY); when you see the RESUME icon **▶** on the screen, press **▶** (PLAY) again.

Note:

– Since it is usual for DVD movies to be released at different times in different regions of the world, all players have region codes. Discs can have an optional region code. If you load a disc of a different region code into your player, you will see the region code notice on the screen. The disc will not play and should be removed from the player.

Playing a VCD**Playing a disc**

- 1 After inserting the disc and closing the tray, playback starts automatically.
 - The status window and the display show the type of disc loaded, as well as information about the disc's contents and playing time.
- The disc may invite you to select an item from a menu. If the selections are numbered.
 - The currently playing track number is shown in the menu bar and the display. The elapsed playing time is shown in the status window and the display.
- For model FW-D5 only - If required, you can use the **SURROUND CONTROL (or SURR on the remote control)** key to select Multichannel, Stereo, Surround or 3D-Surround.
- 2 To stop play at any time, press **■**.
 - The default screen will then appear.
- You can RESUME play from the point at which you stopped play. Press **▶** (PLAY); when you see the RESUME icon **▶** on the screen, press **▶** (PLAY) again.
 - The RESUME feature applies not only to the disc in the player, but also to the last four discs you have played. Simply reload the disc, press **▶** (PLAY); when you see the RESUME icon **▶** on the screen, press **▶** (PLAY) again.

Note:

- When PBC mode is switched on, RESUME play is not available.

General features**Note:**

- Unless stated otherwise, all operations described are based on remote control operation. A number of operations can also be carried out via the menu bar on the screen.

Moving to another title/TRACK

When a disc has more than one title or track (which you can see from both the menu bar and the display), you can move to another title/track as follows:

- 1 Select **W (TITLE/TRACK)** in the menu bar.
- 2 Press **▶** briefly during play to select the next title/track.
- Press **◀** briefly during play to return to the beginning of the current title/track. Press **◀** briefly again to step back to the previous title/track.
- 3 To exit, press **◀** or **▶**.

Moving to another chapter/index

When a title has more than one chapter or a track has more than one index (which you can see from the display and on the menu bar), move to another chapter/index as follows:

- 1 Select **X (CHAPTER/INDEX)** in the menu bar.
- 2 Press **▶** briefly during play to select the next chapter/index.
- Press **◀** briefly during play to return to the beginning of the current chapter/index. Press **◀** twice briefly to step back to the previous chapter/index.
- To go directly to any chapter or index, enter the number using the **digit keys (0-9)**.
- 3 To exit, press **◀** or **▶**.

Note:

- If the number has more than one digit, press the keys in rapid succession.

Still Picture and Frame-by-frame playback

- 1 Select **e** (PICTURE BY PICTURE) in the menu bar.
- 2 Use the **▼** key to enter the picture by picture menu.
→ The player will go into PAUSE mode.
- 3 Use the cursor keys **◀** or **▶** to select the previous or next picture frame.
- 4 To exit Picture by picture mode, press **▶** (PLAY) or **▲** on the remote control.

Search

- 1 Select **g** (FAST MOTION) in the menu bar.
- 2 Use the **▼** keys to enter the Fast Motion menu.
- 3 Use the **◀** or **▶** keys to select the required speed: **-32**, **-8** or **-4** (backward), or **+4**, **+8**, **+32** (forward).
- 4 Select **1** to play at normal speed again.
- 5 To exit Fast Motion mode, press **▶** (PLAY) or **▲** on the remote control.

To search forward or backward through different speeds, you can also hold down **◀◀** or **▶▶**.

Repeat A-B

To repeat a sequence in a title:

- Press Repeat **A-B** at your chosen starting point;
→ **A-** appears briefly on the screen.
- Press Repeat **A-B** again at your chosen end point;
→ **A-B** repeat appears briefly on the display, and the repeat sequence begins.
- To exit the sequence, press Repeat **A-B**.

Scan

Plays the first 10 seconds of each chapter/index on the disc.

- Press **SCAN**.
- To continue play at your chosen chapter/index, press **SCAN** again or press **▶** (PLAY) on the remote control.

Shuffle**DVDs**

This shuffles the playing order of chapters within a title, if the title has more than one chapter.

- Press **SHUFFLE** during play.
→ **SHUFFLE** appears on the screen for about two seconds.
- To return to normal play, press **SHUFFLE** again.

VCDs

This shuffles the playing order of the tracks, if the disc has more than one track.

- Press **SHUFFLE** during play.
→ **SHUFFLE** appears on the screen for about two seconds.
- To return to normal play, press **SHUFFLE** again.

Time search

The Time Search function allows you to start playing at any chosen time on the disc.

- 1 Select **h** (TIME SEARCH) in the menu bar.
- 2 Press **▼**.
→ The player will go into PAUSE mode.
→ A time edit box appears on the screen, showing the elapsed playing time of the current disc.
- 3 Use the **digit keys (0-9)** to enter the required start time. Enter hours, minutes and seconds from right to left in the box.
→ Each time an item has been entered, the next item will be highlighted.
- 4 Press **OK** to confirm the start time.
→ The time edit box will disappear and play starts from the selected time position on the disc.

Zoom

The Zoom function allows you to enlarge the video image and to pan through the enlarged image.

- 1 Select **a** (ZOOM) in the menu bar.
- 2 Press **▲** or **▼** to activate the ZOOM function and select the required zoom factor: **1.33** or **2** or **4**.
→ The player will go into PAUSE mode.
→ The selected zoom factor appears below the Zoom icon in the menu bar and 'Press OK to pan' appears below the menu bar.
→ The picture will change accordingly.
- 3 Press **OK** to confirm the selection.
→ The panning icons appear on the screen: **◀** or **▶** / **▲** or **▼** and **OK**.
- 4 Use the **◀** or **▶** / **▲** or **▼** keys to pan across the screen.
- 5 When **OK** is pressed only the zoomed picture will be shown on the screen.
- 6 If you wish to zoom at any moment, press **a** (ZOOM) and select the required zoom factor as described above.
- 7 To exit Zoom mode, press **▶** (PLAY), **■** or **OSD MENU**.
→ If you press **▶** (PLAY), playback will resume.

DVD-VIDEO

FTS-Video

- The FTS-Video function allows you to store your favourite titles and chapters (DVD) and favourite tracks and indexes (VCD) for a particular disc in the player memory.
- Each FTS programme can contain 20 items (titles, chapters).
- Each time an FTS programme is played it will be placed on top of the list. When the list is full and a new programme is added, the last programme in the list will be removed from the list.
- The selections can be played at any time.
- For VCD, FTS programme is not available whenever PBC mode is switched on.

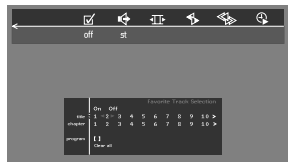
**Storing a FTS-Video Program**

- 1 In STOP mode, select FTS-Video **c** in the menu bar.
- 2 Press **▼** to open the menu.
→ The FTS-Video menu appears.
- 3 Press **◀** or **▶** or **FTS** to select **ON** or **OFF**.

Storing titles/tracks

- 1 Press **▼** to select **TITLES/TRACK**.
- 2 Use **◀** or **▶** to select the required title/track.
- 3 Press **OK** if you wish to store the entire title/track.
→ The title/track number will be added to the list of selections.

Storing chapters/indexes

- 1 Press **▼** on the selected title/track number.
→ The title/track number will be marked and the highlight moves to the first available chapter/index number for this title/track.
- 2 Use **◀** or **▶** to select the required chapter/index number.
- 3 Press **OK** to confirm the selection.
→ The title-chapter/track-index selection will be added to the list of selections.
- 4 Press **OSD MENU** to exit the FTS-Video **c** menu.

Erasing a FTS-Video Program

- 1 In STOP mode, select FTS-Video **c** in the menu bar.
- 2 Use **▼** to select **PROGRAM**.
- 3 Use **◀** or **▶** to select the required selection number.
- 4 Press **OK** to erase the selection.
- 5 Press **OSD MENU** to exit.

If you wish to erase all selections:

- 1 In STOP mode, select FTS-Video **c** in the menu bar.
- 2 Use **▼** to select **CLEAR ALL**.
- 3 Press **OK**.
→ All selections will now be erased.
- 4 Press **OSD MENU** to exit.

Special DVD-features

Checking the contents of DVD : Menus
For titles and chapters, selection menus may be included on the disc. The DVD's menu feature allows you to make selections from these menus.

- Press the appropriate **digit keys (0-9)**; or use the **◀** or **▶** / **▲** or **▼** keys to highlight your selection, then press **OK**.

Title menus

- 1 Press **DVD MENU**.
→ If the current title has a menu, the menu will appear on the screen. If no menu is present in the title, the disc menu will be displayed.
- 2 The menu can list camera angles, spoken language and subtitle options, and chapters for the title.
- 3 To remove the title menu, press **DVD MENU** again.

Disc menu

- 1 Select **W** (TITLE/TRACK) in the menu bar, then press **DVD MENU**.
→ The disc menu is displayed.
- To remove the disc menu, select **W** (TITLE/TRACK) in the menu bar, then press **DVD MENU** again.

Camera Angle

If the disc contains sequences recorded from different camera angles, the angle icon appears, showing the number of available angles and the angle being shown currently. You can then change the camera angle if you wish.

- 1 Select **}** (ANGLE) in the menu bar.
- 2 Use the **▲** or **▼** keys to select the required angle in the angle icon.
→ After a small delay, play changes to the selected angle. The angle icon remains displayed until multiple angles are no longer available.

**Changing the audio language**

- 1 Select **Y** (AUDIO) in the menu bar or press **AUDIO** on the remote control.
- 2 Press **▲** or **▼** repeatedly to see the different languages.



Subtitles

- 1 Select **Z** (SUBTITLE) in the menu bar.
- 2 Press **▲** or **▼** repeatedly to see the different subtitles.

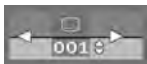

Special VCD-Features

Playback Control (PBC)

When PBC ON

- 1 Press **PBC** to switch on PBC mode.
- 2 Load a Video CD with PBC and press **▶** (PLAY).
→ The **PBC** menu appears on the TV screen.
- 3 Go through the menu with the keys indicated on the TV screen until your chosen passage starts to play. If a PBC menu consists of a list of titles, you can select a title directly.
- 3 Enter your choice with the **digit keys (0-9)**.
- 4 Press **RETURN** to go back to the previous menu.

When PBC OFF

- 1 Press **PBC** to switch off PBC mode.
- 2 Playback will resume when press **▶** (PLAY).
→ The PBC menu does not appear on the TV screen.

Note:

– When **PBC** menu consists of more than one page, use **◀** or **▶** keys to go through the pages.

Playing an audio CD

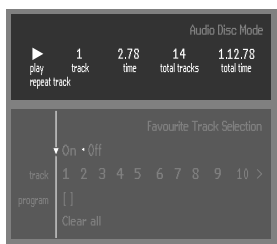

- 1 After loading the disc, playback starts automatically.
- If the TV is on, the Audio CD screen appears.
→ The number of tracks and the total playing time will be shown on the screen and on the player display.
→ During play, the current track number and its elapsed playing time will be shown on the screen and on the player display.
- 2 Playback will stop at the end of the disc.
- To stop play at any other time, press **■**.

Pause

- Press **II** during play.
- To return to play, press **▶** (PLAY).

Moving to another track

- Press **▶** briefly during play to go to the next track.
- Press **◀** briefly during play to return to the beginning of the current track. Press **◀** briefly again to step back to the previous track.
- To go directly to any track, enter the track number using the **digit keys (0-9)**.

Shuffle

- Press **SHUFFLE** during play.
→ The order of the tracks is changed.
- To return to normal play, press **SHUFFLE** again.

Repeat A-B

- To repeat a sequence:
- Press Repeat **A-B** at your chosen starting point;
→ **A** appears briefly on the player display.
 - Press Repeat **A-B** again at your chosen end point;
→ **A-B** appears briefly on the display, and the sequence begins to play repeatedly.
 - To exit the sequence, press Repeat **A-B** again.

Scan

Plays the first 10 seconds of each track on the disc.

- Press **SCAN**.
- To continue play at your chosen track, press **SCAN** again or press **▶** (PLAY).

FTS (Favourite Track Selection)

- The FTS feature allows you to store your favourite tracks for a particular disc in the player memory.
- Each FTS programme can contain 20 tracks.
- Each time an FTS programme is played it will be placed on top of the list. When the list is full and a new programme is added, the last programme in the list will be removed from the list.
- The selections can be played at any time.

DVD-VIDEO

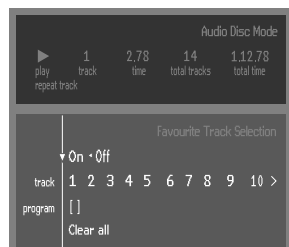

Storing an FTS Program

- 1 Load a disc and stop playback.
- 2 Use **▼** to go to the list of available tracks.
- 3 Use **◀** or **▶** to select tracks from the list. To go directly to any track, enter the track number using the **digit keys (0-9)**.
- 4 Store each track by pressing **OK**.
→ The track numbers will be added to the list of selected tracks.
→ The number of tracks and the playing time of the programme will be shown on the screen and the player display.

When your FTS Program is complete, press **▶** (PLAY) to start play, or **■** to go back to Stop mode. In either case, the FTS Program will be automatically memorised.

Switching FTS ON/OFF

- 1 Use **▲** or **▼** to move to the top.
- 2 Use **◀** or **▶** to select either ON or OFF.

Erasing a track from an FTS-programme

- 1 Use **▼** to go to the list of selected tracks in programme.
- 2 Use **◀** or **▶** to select the track number you wish to erase.
- 3 Press **OK**.
→ The track number will be erased from the list of selected tracks.

Erasing the complete programme

- Use **▼** to select **CLEAR ALL** and press **OK**.
→ The complete FTS programme for the disc will be erased.

Appendix

6 Channel settings

Front speakers

- L (Large): When the front speakers can reproduce low frequency signals below 120Hz
- S (Small): When the front speakers cannot produce low frequency signals below 120Hz

Centre speaker*

- L (Large): When the centre speaker can reproduce low frequency signals below 120Hz
- S (Small): When the centre speaker cannot produce low frequency signals below 120Hz
- Off: When the centre speaker is not connected.

Surround speakers

- L (Large): When the surround speakers can reproduce low frequency signals below 120Hz
- S (Small): When the surround speakers cannot produce low frequency signals below 120Hz
- Off: When the surround speakers are not connected.

Subwoofer

- On: When you connect a subwoofer
- Off: When the subwoofer is not connected.

* You can use your TV as centre speaker. When centre speaker is turned on, the audio L/R as well as the audio from the scart will contain the centre speaker audio.

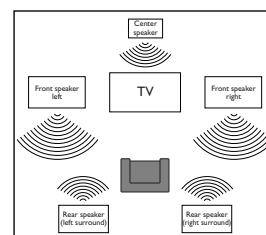

Delay times

The DVD player is set to reproduce correctly synchronised Digital Surround Sound in a listening area where the surround speakers are about 150cm nearer to the listening position than the front speakers, and the centre speaker is in line with the front speakers. To adjust for other listening area arrangements, certain delay times required.

Setting up Karaoke (in DVD mode only)

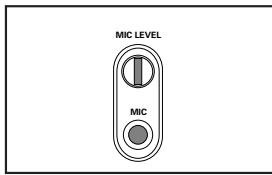

(not available for all versions)

- 1 Load a karaoke disc into the player.
- 2 Set the **MIC LEVEL** control to the minimum level to prevent acoustic feedback (e.g. loud howling sound) before connecting the microphone.
- 3 Connect a microphone to **MIC** socket.
- 4 Press **▶** (PLAY) to start playback.
- 5 Press **KARAOKE** on the remote control to switch on the Karaoke mode.
- 6 Karaoke menu bar appears.
 - Move to the function you want to change using **▲** or **▼** keys then use **◀** or **▶** keys to scroll to your preferred option.



- 7 Adjust the **MIC LEVEL** control.
- 8 Adjust **ECHO** **-/+** (j) to the level you desire.
- 9 Adjust **KEY CONTROL** **-/+** (k) to change the key of your vocal range.
- 10 Select the different **MODE SELECTION** | you desire. (see *Karaoke General Features*).
- 11 Shift to **VOCAL m** to fade out the original vocal from a karaoke disc. When you start singing or talking through the microphone, the original vocal will fade out automatically.
- 12 Shift to **VOCAL CANCEL** to cancel out the original vocal from the sound.
- 13 Press **KARAOKE** button to exit the menu screen.

General features

Karaoke ON/OFF (i)

- To switch karaoke features ON/OFF mode.

Echo -/+ (j)

- Can be adjusted in the range of {0.....+7}.

Key Control -/+ (k)

- Can be adjusted in the range of {-70.....+7}.

Mode Selection (l)

- Works correctly only on karaoke disc.
- Only two channels are available.
- For VCD Karaoke disc,
 - Selection between L+R / L / R
 - L+R - Left + Right
 - L - Left
 - R - Right
- For DVD Karaoke disc,
 - Selection between M1 / M2 / V1 / V2
 - M1 - All channels
 - M2 - Music channels only
 - V1 - Vocal 1 output
 - V2 - Vocal 2 output

Note:

- In the karaoke disc, karaoke L, R, M1, M2, V1, V2 are recorded. In some discs, the M1, M2, V1, V2 may not be recorded in the disc.

Vocal (m)

- Available options for vocal are:
 - ON - normal mode, all music and vocals are played.
 - CANCEL - cancel original vocals.
 - FADE - removes original vocals when you start singing through the microphone.

CD

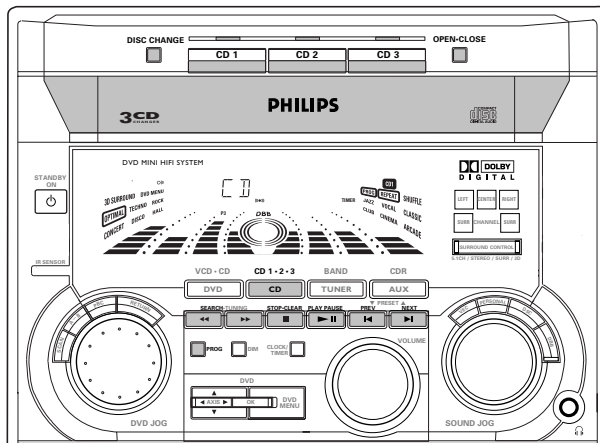

Warning!

- 1) This system is designed for conventional CDs. Do not use any accessories such as disc stabilizer rings or CD treatment sheets, etc., which may damage the CD mechanism.
- 2) Do not load more than one disc into each tray.
- 3) When the CD carousel tray is loaded with CDs, do not turn over or shake the system. This may jam the changer.

You may load three discs in the CD carousel tray for continuous playback without interruption.

Discs for playback

This system can play all digital audio CD, finalised digital audio CD-Recordable and finalised digital audio CD-Rewritable format discs.



Loading the CD Changer

- 1 Press **▶** (PLAY) to select CD mode.
- 2 Press **OPEN•CLOSE**.
 - The CD carousel tray slides out.
- 3 Load a CD with the printed side up in the right tray.
 - You can load another disc in the left tray.
 - To load the third disc, press the **DISC CHANGE** button.
 - The CD carousel will rotate until the empty tray is ready for loading.
- 4 Press **OPEN•CLOSE** to close the CD carousel tray.
 - The total number of tracks and the playing time of the selected disc appear on the display.

Note:

- To ensure good system performance, wait until the CD changer completely reads the disc(s) before proceeding.

CD Direct Play

- You can play a CD directly by pressing the **CD 1**, **CD 2** or **CD 3** button. The CD player will stop at the end of playback of the selected disc.
 - A lit button indicates that a disc is loaded in the disc tray.
 - The selected disc is encircled.

Playing a CD

- 1 Press **▶** (PLAY) to start playback.
 - The disc tray, track number and elapsed playing time of the current track appear on the display.
 - To interrupt playback, press **||**.
 - The playing time flashes.
 - To resume playback, press **▶** (PLAY) again.
- 2 To stop playback, press **■**.

Notes:

- All the available discs will play once, then stop.
- When the CD has stopped playing, the system will switch to standby mode after 30 minutes if no button is pressed.

Disc Change

You can change the outer two discs while the third inner disc is stopped or is playing.

- 1 Press **DISC CHANGE**.
→ The CD carousel tray slides out.
- 2 Replace the discs in the left and right disc trays.
 - If you wish to change the inner disc during playback, press **DISC CHANGE** again.
→ "DISC CHANGE" will be displayed.
→ The CD will stop playing.
→ The CD carousel tray will close to retrieve the inner CD then open again with the inner CD accessible.
- 3 Press **OPEN•CLOSE** to close the CD carousel tray.

Selecting a desired track

Selecting a desired track when playback is stopped

- 1 Press **◀** or **▶** (or **Digit 0-9** on the remote control) until the desired track appears on the display.
- 2 Press **▶** (PLAY) to start playback.
→ The selected track number and elapsed playing time appear on the display.

Selecting a desired track during playback

- Press **◀** or **▶** (or **Digit 0-9** on the remote control) until the desired track appears on the display.
→ The selected track number and elapsed playing time appear on the display.
- If you press **◀** once it will skip to the beginning of the current track and play the track again.

Note:

- Pressing **◀** during shuffling can only skip to the beginning of the current track.

Searching for a particular passage during playback

- Press and hold **◀◀** or **▶▶** until the desired passage is located.
→ The volume will be reduced.
- Play returns to normal when **◀◀** or **▶▶** is released.

Programming Tracks

Programming tracks of a loaded CD is possible when playback is stopped. The display will indicate the total tracks stored in the programme. Up to 40 tracks can be stored in the memory in any order. When 40 tracks are stored and you attempt to store another track, the display will show "PROGRAM FULL".

- 1 Load the desired discs in the disc trays.
- 2 Press **PROG** to start programming.
→ The **PROG** starts flashing.
- 3 Press the **CD** (CD 1•2•3) or **CD 1/2/3** button to select the disc.
- 4 Press **◀** or **▶** (or **Digit 0-9** on the remote control) to select the desired track.
- 5 Press **PROG** to store the track.
- Repeat steps **3** to **5** to store other discs and tracks.
- 6 Press **■** once to end programming.
→ The total number of tracks programmed and total playing time appear on the display.

Notes:

- If the total playing time is more than "99:59" or if one of the programmed tracks has a number greater than 30, then "- : - : -" appears on the display instead of the total playing time.

- If the system is reading the disc, programming is not possible, "REMAIN5" will be displayed and followed by "DISC X" "X" is the current read disc number.
- During programming, if no button is pressed within 20 seconds, the system will exit programme mode automatically.

Reviewing the programme

Reviewing of the programme is possible only when playback is stopped.

- 1 Press **◀** or **▶** repeatedly to review the programmed tracks.
- 2 Press **■** once to exit review mode.

Playing the programme

- 1 Press **▶** (PLAY) to start programme playback.
→ "PLAY PROGRAM" will be displayed.
→ The track number and elapsed playing time of the current track will appear on the display.
- If you press **REPEAT** during programme playback, the current track or all programmed tracks will be played repeatedly.
→ "TRACK" or "PROGRAM" will be displayed.
→ The **REPEAT** and **PROG** appear on the display.

33

CD

- 2 Press **■** to stop programme playback.

Notes:

- If you press any of the **CD DIRECT PLAY** buttons, the system will play the selected disc or track and the stored programme will be ignored temporarily. The **PROG** display also will disappear temporarily from the display. It will reappear when playback of the selected disc ends.
- **REPEAT DISC** mode is not available when programme playback begins.

Erasing the programme (when playback is stopped)

- Press **■**.
→ "PROGRAM CLEARED" will be displayed.

Note:

- The programme will be erased when the system is disconnected from the power supply or when the CD carousel tray is opened.

Shuffle (only on remote control)

In shuffle mode, the system plays all the available discs and their tracks in random order. Shuffle may be used also when tracks are programmed.

To shuffle all the discs and tracks

- 1 Press **SHUFFLE**.
→ "SHUFFLE" will be displayed.
→ The **SHUFFLE**, the disc and the track selected at random appear on the display.
- The discs and the tracks will be played in random order until you press **■**.
- If you press **REPEAT** during shuffling, the current track or all available discs will be played repeatedly.
→ "TRACK" or "ALL DISC" will be displayed.
→ The **REPEAT** and **SHUFFLE** appear on the display.
- 2 Press **SHUFFLE** again to resume normal playback.
→ The **SHUFFLE** disappears from the display.

Note:

- **REPEAT DISC** mode is not available when shuffle is selected.

Repeat (only on remote control)

You can play the current track, a disc or all available discs repeatedly.

- 1 Press **REPEAT** on the remote control to select the various repeat modes.
→ "TRACK", "DISC", "ALL DISC" or "OFF" will be displayed.
→ The **REPEAT** appears on the display.
- The selected track, selected disc or all available discs will now be played repeatedly until you press **■**.
- 2 Press **REPEAT** until the "OFF" mode is displayed to resume normal playback.
→ The **REPEAT** disappears from the display.

Notes:

- **REPEAT DISC** mode is not available during programme play or shuffle mode.
- You can also repeat shuffling a programme.
→ "TRACK" or "PROGRAM" will be displayed.
→ The **REPEAT**, **PROG** and **SHUFFLE** appear on the display.

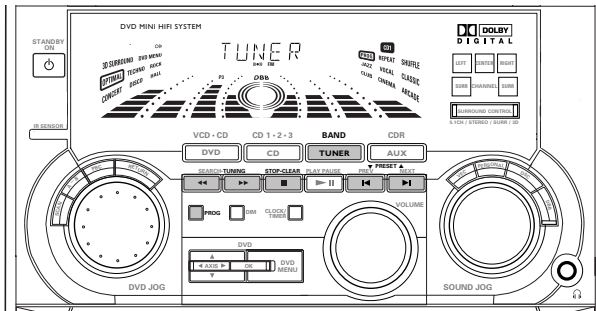

Note:

- For 'EASY SET' feature, please refer to page 14.

Tuning to radio stations

- 1 Press **TUNER (BAND)** to select TUNER mode.
→ "TUNER" will be displayed.
A few seconds later, the current radio frequency will be displayed.
- 2 Press **TUNER (BAND)** again to select the desired waveband : FM or MW.
- 3 Press **◀▶** for more than one second, then release.
→ The display will show "SEARCH" until a radio station with sufficient signal strength is found.

- Repeat this procedure until the desired radio station is reached.
- To tune to a weak radio station, briefly press **◀▶** repeatedly until the display shows the desired frequency and/or when the best reception has been obtained.

Storing Preset Stations

You can store up to 40 radio stations in the memory. When a preset radio station is selected, the preset number appears next to the frequency on the display.

Automatic programming

- 1 Press **TUNER (BAND)**.
- 2 Press **PROG** for more than one second.
→ The **PROG** starts flashing and "AUTO" will be displayed.
→ The system will search for every available radio station in the FM waveband first, then search the MW waveband.
→ All available radio stations will be stored automatically. The frequency and preset number will be displayed briefly.
→ The system will stop searching when all the available radio stations are stored or when the memory for 40 preset radio stations is used.
→ The system will remain tuned to the last stored preset radio station.

Notes:

- You can cancel the automatic programming by pressing **PROG** or **■** (on the system only).

- If you want to reserve a section of preset numbers, for example preset numbers 1 to 9, select preset 10 before starting automatic programming, only the preset numbers 10 to 40 will be programmed.

Manual programming

- 1 Press **TUNER (BAND)**.
- 2 Press **TUNER (BAND)** again to select the desired waveband : FM or MW.
- 3 Press **PROG** for less than one second.
→ The **PROG** starts flashing.
→ The next available preset number will be displayed for selection.
- 4 Press **◀▶** to tune to the desired frequency.
• If you wish to store the radio station to another preset number, press **◀▶** (or **Digit 0-9** on the remote control) to select the desired preset number.
- 5 Press **PROG** again.
→ The **PROG** disappears and the radio station will be stored.
• Repeat **steps 3 – 5** to store other preset radio stations.

Notes:

- When 40 radio stations are stored and you attempt to store another radio station, the display will show "PROGRAM FULL". If you want to change an existing preset number, repeat steps 3 – 5.

TUNER

English

- You can cancel manual programming by pressing **■** (on the system only).
- During programming, if no button is pressed within 20 seconds, the system will exit programme mode automatically.

Tuning to Preset Radio Stations

- Press **◀▶** (or **Digit 0-9** on the remote control) to select the desired preset number.
→ The preset number, radio frequency, and waveband appear on the display.

Changing the MW tuning grid

(not available for all versions)

The frequency step can be changed if necessary. In North and South America, the frequency step between adjacent channels in the MW band is 10 kHz. In other parts of the world, it is 9 kHz. The frequency step preset in the factory is 9 kHz.

For MW band

To change from 9 kHz to 10 kHz or vice versa

Changing of tuning grid will erase all previously stored preset stations.

- 1 Disconnect the system from the AC power supply (pull out the AC power cord).
- 2 Press **TUNER** and **TUNING ▶▶** depressed while reconnecting the system to the AC power supply.
→ Display will show "GRID 9" or "GRID 10".

Notes:

- GRID 9 indicates that the tuning grid is in step of 9 kHz in MW band. GRID 10 indicates that the tuning grid is in step of 10 kHz in MW band.
- FM tuning grid will also be changed from 50 kHz to 100 kHz or vice versa. All preset radio stations will also be erased.

AUX/CDR

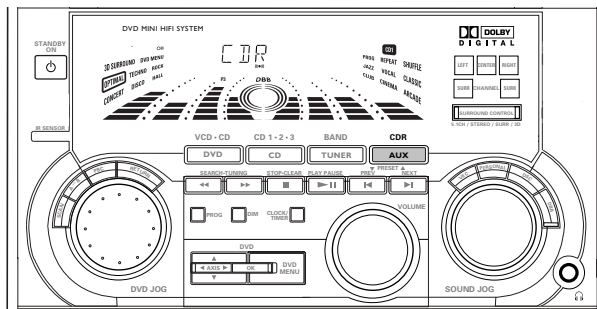

Selecting External Equipment

If you have connected the audio out terminals of the external equipment (TV, VCR, Laser Disc player, DVD player, or CD Recorder) to the AUX/CDR IN terminals, you can hear the enhanced sound from the system.

- 1 Press **AUX** (CDR) to select the CDR mode.
→ "CDR" will be displayed.
- 2 Press **AUX** (CDR) again to select external (normal AUX) mode.
→ "AUX" will be displayed.

Notes:

- There are two Auxiliary modes:
 - i. the normal AUX mode.
 - ii. the CDR mode, where the LINE OUT of this mini system is muted. You will not be able to record or listen to the sound from the LINE OUT.
- You are advised not to listen to and record from the same source simultaneously.
- All the sound control features (e.g. DSC, DBB, etc.) are available for selection.

CLOCK

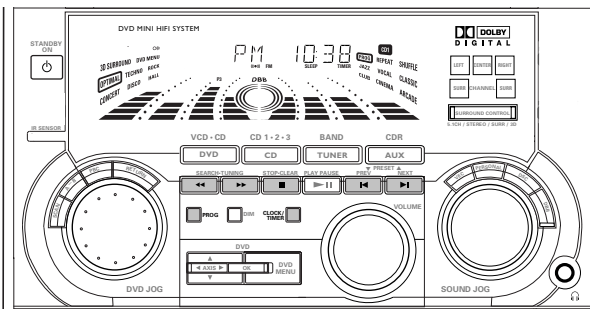

View Clock

You can view the clock (if it is set) if the system is in Standby mode or when any sound source is selected (CD, TUNER, etc.). The clock will be displayed for about seven seconds.

- Press **CLOCK/TIMER** briefly.
→ "PM 10:38" or "22:38" (the current time) will be displayed depending on whether you have selected 12- or 24-hour mode.
→ "----:--" will be displayed if the clock is not set.

Clock Setting

The clock can be set in either 12- or 24-hour mode, e.g. "PM 12:00" or "00:00". Before setting the clock, you must be in the View Clock mode.

- 1 Press **CLOCK/TIMER** to select clock mode.
- 2 Press **PROG** (on the system only) to select 12- and 24- hour mode.
→ If 12-hour mode is selected, "PM 12:00" starts flashing.
→ If 24-hour mode is selected, "00:00" starts flashing.
- 3 Set the hour with **◀◀** or **▶▶** on the system.
- 4 Set the minute with **◀** or **▶** on the system.

TIMER

- 5 Press **CLOCK/TIMER** again to store the setting.
→ The clock starts.
- To exit without storing the setting, press **■** on the system.

Notes:

- During clock setting, if no button is pressed within 90 seconds, the system will exit clock setting mode automatically.
- When a power interruption occurs, the clock setting is erased.

Timer Setting

- The system can switch on to CD or TUNER mode automatically at a preset time. It can serve as an alarm to wake you up.
- Before setting the timer, make sure the clock is set correctly.
- The timer will always be switched on once it is set.
- **The volume of the timer will increase from the minimum level until the volume level before the set is switched to standby mode.**

- 1 Press and hold **CLOCK/TIMER** for more than **2 seconds** to select timer mode.
→ "PM 12:00" or "00:00" or the last timer setting starts flashing depending on whether you have selected 12- or 24-hour mode.
→ The **TIMER** starts flashing.
→ The selected source is lit while other available sources are flashing.
- 2 Press **CD** or **TUNER** to select the desired source.
• Before selecting CD, make sure a CD is loaded in the CD tray.
- 3 Press **◀◀** or **▶▶** on the system to set the hour for the timer to start.
- 4 Press **◀** or **▶** on the system to set the minute for the timer to start.

- 5 Press **CLOCK/TIMER** to store the start time.
→ The timer is now set.
→ The **TIMER** remains on the display.
- At the preset time, the timer will be activated.
→ The selected source will be played.

Notes:

- During timer setting, if no button is pressed within 90 seconds, the system will exit timer setting mode automatically.
- If the source selected is TUNER, the last tuned frequency will be switched on.
- If the source selected is CD, playback will begin with the first track of the selected disc or programme. If the CD trays are empty, TUNER will be selected instead.

To switch off the TIMER

- Press **TIMER** on the remote control.
→ The timer is now switched off.
→ The display will show "CANCEL" and the **TIMER** disappears.

To start the TIMER again (for the same preset time and source)

- Press **TIMER** on the remote control.
→ The timer is now on.
→ The **TIMER** appears on the display.

MAINTENANCE

English

Maintenance

Cleaning the Cabinet

- Use a soft cloth slightly moistened with a mild detergent solution. Do not use a solution containing alcohol, spirits, ammonia or abrasives.

Cleaning Discs

- When a disc becomes dirty, clean it with a cleaning cloth. Wipe the disc from the centre out.
- Do not use solvents such as benzene, thinner, commercially available cleaners, or antistatic spray intended for analogue records.



Cleaning the disc lens

- After prolonged use, dirt or dust may accumulate at the disc lens. To ensure good playback quality, clean the disc lens with Philips CD Lens Cleaner or any commercially available cleaner. Follow the instructions supplied with cleaner.

TROUBLESHOOTING

Warning! Under no circumstances should you try to repair the set yourself as this will invalidate the guarantee. Do not open the set as there is a risk of electric shock.

- If a fault occurs, check the points listed below before taking the system for repair.
- Should any problems persist after you have made these checks, consult your nearest dealer or service centre.

DVD-Video Player Operation

Distorted picture or no colour with player menu.

- The disc format does not match your TV's video signal (PAL/NTSC).
 - *Replace a recommended disc (refer to the instruction of this manual).*
- The system setting is not correct.
 - *Make sure the NTSC/PAL setting at the player matches the video signal of your television (see NTSC/PAL setting).*
- Check the disc for fingerprints.
 - *Clean with a soft cloth, wiping from centre to edge.*
 - *Sometimes a small amount of picture distortion may appear, this is not malfunction.*

No return to start-up screen when disc is removed.

- Check to see if the programme requires another disc to be loaded.
 - *Reload a disc.*
 - *Reset by switching the player off, then on again.*

Player does not respond to all operating commands during playback.

- Operations are not permitted by the disc.
 - *Refer to the instruction of the disc.*

No audio at digital output.

- The digital connections are not properly connected or connected wrongly.
 - *Check the digital connections.*
- Incorrect digital output settings.
 - *Check the settings menu to make sure the digital output is set to ALL or PCM.*
 - *Check if the audio format of the selected audio language matches the receiver capabilities.*

No picture on TV screen.

- The video cable is not connected.
 - *Connect the cable between the system and TV.*

TROUBLESHOOTING

English

CD Player Operation

"NO DISC" is displayed.

- The disc is inserted upside down.
 - *Place disc with printed side up.*
- Moisture condensation at the lens.
 - *Wait until lens has adjusted to normal room temperature.*
- There is no disc in the CD tray.
 - *Insert a disc.*
- The disc is dirty, badly scratched or warped.
 - *Clean or replace the disc.*
 - The disc lens is dirty or dusty.
 - *See section under Maintenance (page 40).*

"DISC NOT FINALIZED" is displayed.

- The CD-RW or CD-R disc is not properly recorded for use with a standard CD player.
 - *Read the instruction booklet of your CD-Rewritable or CD-Recorder on how to finalise a recording.*
- The CD is badly scratched or dirty.
 - *Replace or clean CD.*

Radio Reception

Poor radio reception.

- The signal is too weak.
 - *Adjust the antenna.*
 - *Connect an external antenna for better reception.*
- The TV or VCR is too closed to the stereo system.
 - *Separate the stereo system from the TV or VCR.*

Cannot tune to radio station.

- Wrong tuning grid.
 - *Switch to the correct tuning grid.*

General

System does not react when any button is pressed.

- Electrostatic discharge.
 - *Press STANDBY ON to switch the system off. Remove the AC power plug from the wall outlet, then reconnect the power plug and switch on the system again.*

No or poor sound.

- Volume is not turned up.
 - *Adjust VOLUME.*
- The headphones are connected.
 - *Disconnect the headphones.*

- Speakers are not connected or are connected wrongly.
 - *Check that the speakers are connected correctly.*
 - *Make sure the stripped speaker wire is clamped.*

Reversed left and right sound.

- Speakers are connected wrongly.
 - *Check the speaker connections and location.*

Lack of bass sound or apparently imprecise physical location of musical instruments.

- Speakers are connected wrongly.
 - *Check the speaker connection for proper phasing, coloured/black wires to coloured/black terminals.*

Remote control has no effect on the system.

- Wrong source is selected.
 - *Select the source (CD, TUNER, etc.) before pressing the function button (▶, ◀, ►, etc.).*
- The distance to the system is too large.
 - *Reduce the distance.*
- Batteries are inserted incorrectly.
 - *Insert the batteries with their polarities (+/- signs) as indicated.*
- Batteries are exhausted.
 - *Replace the batteries.*

Timer is not working.

- Clock is not set.
 - *Set the clock.*
- Timer is not switched on.
 - *Press TIMER to switch on the timer.*

Clock setting is erased.

- There was a power failure.
 - *Reset the clock.*

System displays features automatically; buttons flash continuously.

- Demonstration mode is switched on.
 - *Press and hold ■ (on the system) for five seconds to switch off the demonstration.*

There is a howling sound at the external source.

- You hear feedback when you are listening in AUX mode.
 - *Press AUX to select CDR mode.*

All lighted buttons are not lit.

- Display is switched on in DIM 3 mode.
 - *Press DIM until DIM OFF display mode is shown.*

ADDITIONAL FEATURES FOR OTHER VERSIONS

OPERATING THE SYSTEM

Easy Set

EASY SET allows you to store all available radio stations and RDS stations automatically.

- Press and hold **STANDBY ON** (on the system only) for **5 seconds**; when the system is in standby or demonstration mode.
 - "EASY SET" will be displayed, and followed by "TUNER" and then "AUTO".
 - EASY SET will start searching for all RDS radio stations with sufficient signal strength and then followed by radio stations on FM, MW and LW band respectively. Weak RDS radio stations may be stored in later presets.
 - All available RDS and radio stations with sufficient signal strength will be stored. Up to 40 presets may be stored.
- The system will proceed to set the RDS time automatically with the stored RDS preset station.
 - If no RDS station is available in the first preset station, the programme will exit automatically.
 - After a radio station is found, "EASY SET" will be displayed and followed by "TIME".
 - When searching RDS time;
 - "SEARCH RDS TIME" will be displayed.

→ When RDS time is read, "RDS TIME" will be displayed. The current time will be displayed for 2 seconds and stored automatically.

Notes:

- EASY SET will start with the RDS station, if there are still presets available, it will continue to store the FM, MW and LW bands respectively.
- When EASY SET is used, all previously stored radio stations will be replaced.
- The last preset radio station or the first available RDS station will appear on the display when EASY SET is completed.
- If RDS station does not transmit RDS time within 90 seconds, the programme will exit automatically and the display will show "NO RDS TIME".

Switching the system to power save mode (when Demonstration mode is disabled)

- Press **POWER SAVE** to switch to energy saving mode (< 2 watts).
 - "LOW POWER STANDBY ON" will be displayed, after which the display screen goes blank.
 - The low power STANDBY ON LED will be lit.

Note:

- if the demonstration mode has not been disabled, it will resume 5 seconds later.

CD / TUNER

CD Text

It will enable you to know which album and its track you are selecting or playing on specially encoded CD.

- Press **RDS/CD TEXT**.
 - At stop mode**
 - The title of album or total playing time will be displayed.
 - During Playback**
 - The title of album, track title or elapsed time will be displayed.
- If the album and track title are not known.
 - "NO TEXT ON DISC" will be displayed.

- **RADIO TEXT (RT)**: text messages appear in the display.

When you have tuned to a RDS station, the RDS logo and the radio station name will appear on the display:

- The display normally shows the radio station name if available. By repeatedly pressing **RDS/CD TEXT** button you can change the type of display information:
 - The display shows in turn:
STATION NAME →
PROGRAMME TYPE → RADIO TEXT → TUNED FREQUENCY → STATION NAME ...

Note:

- When you press the RDS/CD TEXT button and the display shows "NO RDS", it indicates that either the tuned station is not transmitting RDS signal or it is a non RDS station.

Receiving RDS Radio Station

RDS (Radio Data System) is a broadcasting service that allows FM stations to send additional information along with the regular FM radio signal. This additional information can contain:

- **STATION NAME**: The radio station name is displayed.
- **PROGRAMME TYPE**: The following programme types exist and can be received by your tuner: News, Affairs, Info, Sport, Educate, Drama, Culture, Science, Varied, Pop M, Rock M, M.O.R. (middle of the road music), Light M, Classics, Other M, No type.

RDS Clock

Some RDS station may be transmitting a real clock time at an interval of every minute.

Setting the time with RDS clock

- Press **CLOCK/TIMER**.
 - "--:--" or current time appears on the display.
- Press **CLOCK/TIMER** once more to enter clock setting mode.

TUNER

→ "00:00" or current time starts flashing.

- Press **RDS/CD TEXT**.
 - The message "SEARCH RDS TIME" will be displayed.
 - If the station does not transmit RDS clock, "NO RDS TIME" will be displayed.
 - When the RDS clock is read, "RDS TIME" will be displayed. The current clock time is displayed for 2 seconds and will be stored automatically.
 - If within 90 seconds, the RDS time is not detected, "NO RDS TIME" will be displayed.

Note:

- Some RDS station may be transmitting a real time clock at a minute interval. The accuracy of the transmitted time depends on the transmitting RDS station.

NEWS/TA (Traffic Announcement)

(only available in Radio Station with RDS)

You can activate NEWS or TA function in Standby, Demonstration or any source mode except Tuner mode. Once the News Programme Type (for NEWS function) or Traffic Announcement data (for TA function) is detected in any of the selected RDS

stations, it will switch to TUNER mode automatically.

NEWS/TA key toggles in the following sequence :

NEWS → TA → OFF → NEWS

To start NEWS or TA function

- Press **NEWS/TA** to select NEWS function.
 - The **NEWS** and "NEWS" will be displayed.
- If you want to select TA function, press **NEWS/TA** again.
 - The **TA** and "TA" will be displayed.
- When NEWS or TA is selected;
 - It will scan stations stored in the first 5 preset and wait for the News Programme Type / Traffic Announcement data to be available in any of these RDS stations. During the search :
 - The current source activity will remain uninterrupted.
 - If no RDS station is found in the first 5 presets, the NEWS/TA function will be switched off. The display will show "NO RDS NEWS" or "NO RDS TA" and **NEWS** or **TA** will disappear from the display.
 - When NEWS/TA transmission is detected, the system will switch to Tuner mode.
 - The **NEWS** or **TA** starts flashing.

To cancel NEWS or TA function

- Press **NEWS/TA** until the **NEWS** or **TA** disappears and "TR OFF" is displayed.

Notes:

- If you are listening to a non RDS TUNER radio station and should you decide to hear NEWS or TA, first select other source (e.g. CD, DVD or AUX), then press NEWS/TA.
- Before using the NEWS or TA feature, ensure that the first 5 presets are RDS stations.
- The NEWS/TA works only once for each activation.
- During News bulletin or Traffic Announcement, you can press any available source or Tuner function keys to cancel NEWS/TA function and execute the relevant source mode.
- If set is switched to Tuner source, the NEWS/TA function will be cancelled, "NEWS OFF" or "TA OFF" will be displayed immediately after the "TUNER" message.

SLEEP TIMER

Sleep (only on remote control)

This feature allows you to select a length of time after which the system will switch to the standby mode automatically.

- Press **SLEEP** on the remote control repeatedly to select a period of time.
 - The selections are as follows (time in minutes):
60 → 45 → 30 → 15 → OFF → 60 ...
 - "SLEEP xx" or "OFF" will be displayed. "xx" is the time in minutes.
- When you reach the desired length of time, stop pressing the **SLEEP** button.
 - After this amount of time passes, the system will switch to the standby mode.

To switch off the Sleep Timer

- Press **SLEEP** repeatedly until "OFF" is displayed, or press the **STANDBY ON** button.

DISMANTLING INSTRUCTIONS

1. Open DVD Tray / Removal of Cover DVD Tray manually

Note: Steps a) and b) are meant strictly for sets with a jammed tray that cannot be open via the Open/Close button.

- a) With a Torx screw driver, make a marking of about 5.5cm from the tip as shown below.

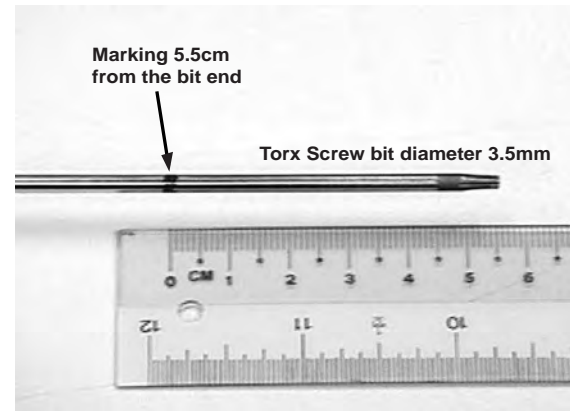

Figure 1

- b) Insert the tip of the screw driver into the slot S1 provide at the bottom of the Cabinet Front.

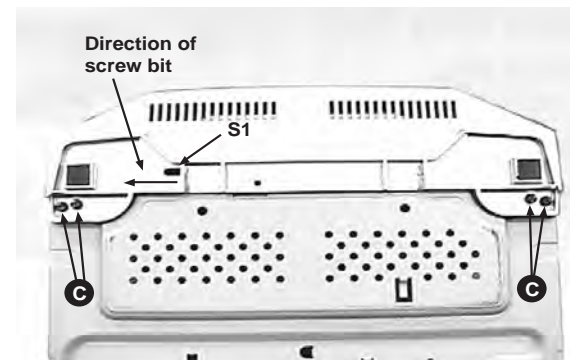

Figure 2

Keep the marking just outside the slot & rotate the screw driver upwards lightly as shown below.

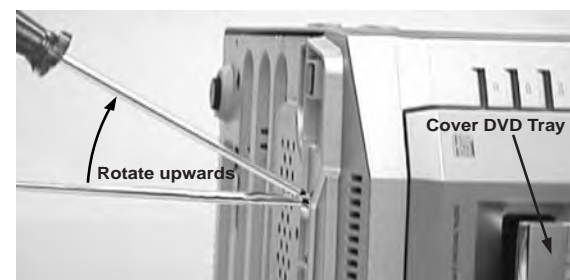

Figure 3

The DVD Tray should jerked outwards slightly. This process is a simulation of pushing the white lever on the DVD Module inwards (see Figure 4).

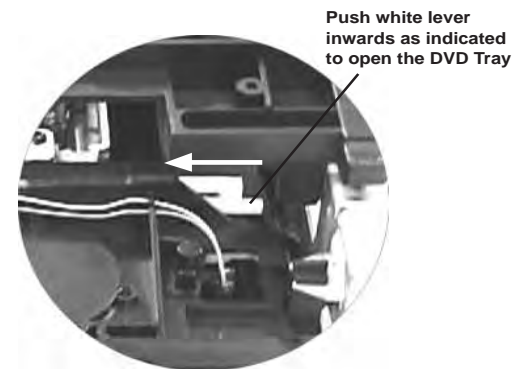

Figure 4

Note: This procedure is best done with the set laying on its side as shown, but when there is any jammed or foreign material in the tray it has to be done with the set placed upright at the edge of the table or work bench.

- c) Pull the tray out and the Cover DVD Tray (pos 160) or any jammed disc can be removed. The Cover DVD Tray is removed as shown below.

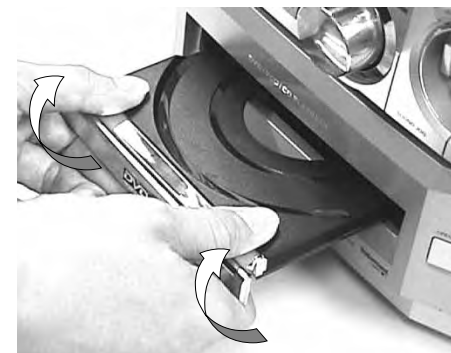

Figure 5

2. Removal of the Jog Shuttle & Volume knobs

- a) Insert a strong string into the slot between the Jog Sound knob (pos 135) and Ring Ornamental (pos 144). Looped it 1,5 turns securely around the Jog Sound knob and pulled it out as shown in fig. 6
- b) Do likewise for the Jog DVD knob (pos 135) and Volume knob (pos 139).



Figure 6

3. Open the CDC Tray / Removal of Cover CDC Tray & CDC module manually

- a) Loosen 16 screws to remove the Cabinet Cover (pos 259).
 - 5 screws on each side
 - 6 screws on the rear
- b) Slide out the CDC Tray as shown by using a finger or a flat screw driver to turn the gear towards the front and remove the Cover Tray CDC assembly (pos 106 & 107) as shown below.

- c) Loosen 2 screws A on the front as shown below.



Figure 8

- d) Loosen 2 screws B at the Rear and remove the CDC Module (pos 1104) as shown below.

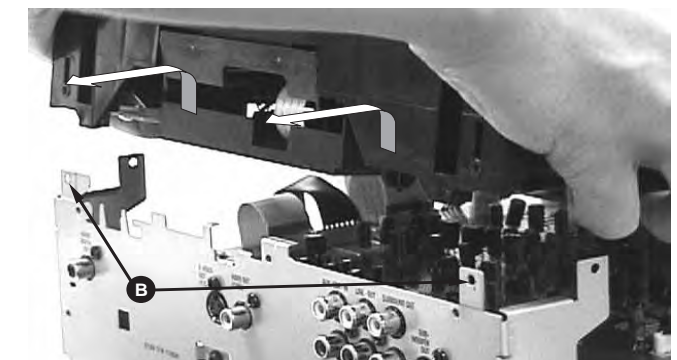

Figure 9

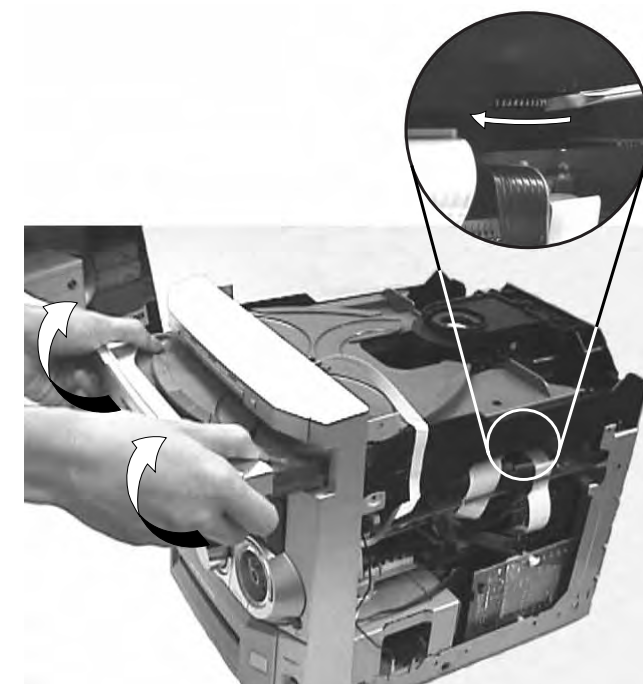

Figure 7

4. Dismantling the Front Panel Assembly

- a) Loosen 4 screws C at the bottom of the Cabinet Front as shown below.

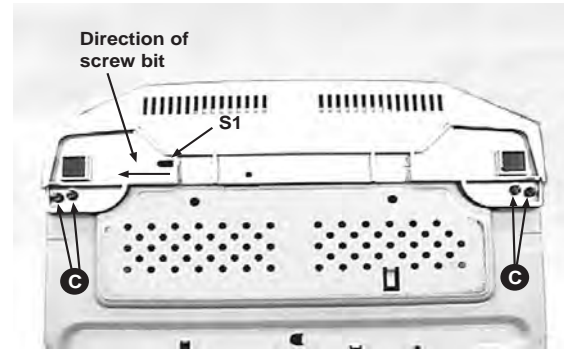

Figure 2

- b) Release the Bar Tuner (pos 263) from the Plate Front (pos 254) as shown below while pushing the Front Panel assembly towards the front.

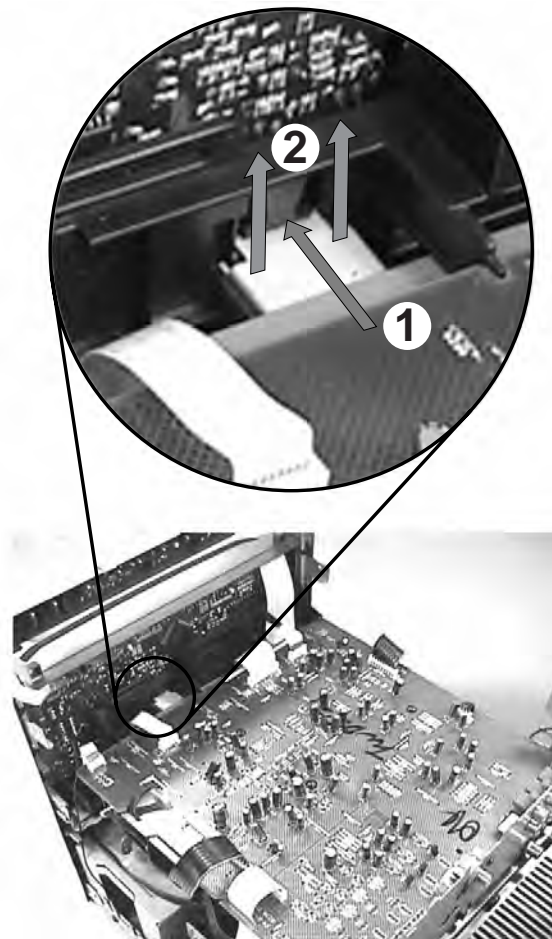

Figure 10

Note: It may be necessary to release screws S (see figure 16) if the flex cables to the front are too tight.

- c) Loosen 5 screws J to remove the Plate Front (pos 254) and 4 more screws K to remove the Front μ Processor Board (pos 1102-A) as shown below.

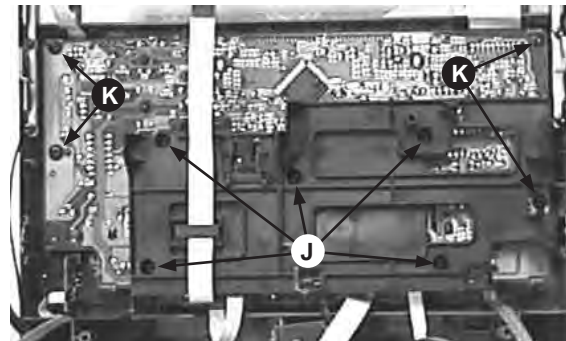

Figure 11

- d) Loosen 7 screws L to remove the Deck Key Board as shown below.

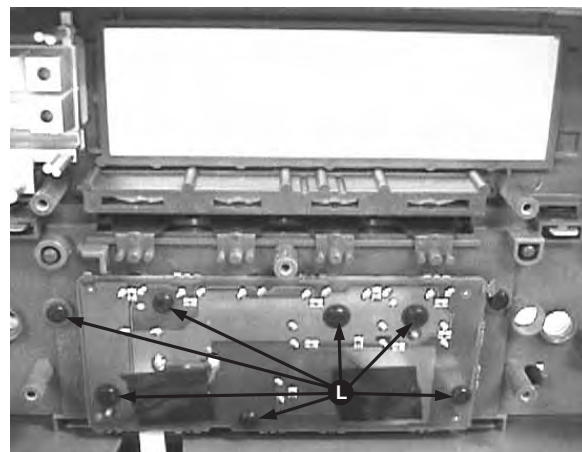

Figure 12

- e) Loosen 3 screws M & 6 catches C4 to remove the Front Cover Ornamental assembly (pos 145 + all button controls) as shown below.

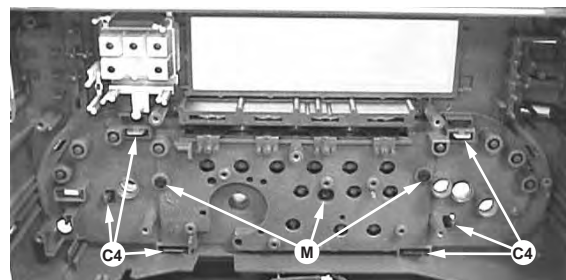

Figure 13

5. Dismantling the AV Board / Mains Transformer / Tuner Module / Plate Rear / Power 5 DVD Module

- a) Loosen 6 screws D at the rear as shown below.

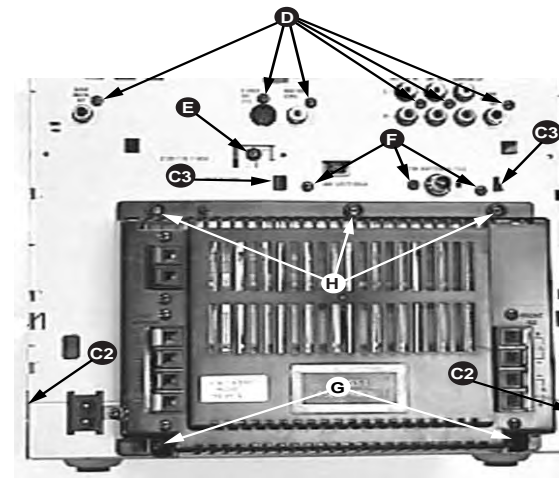

Figure 14

- b) Loosen 3 screws I on the AV Board (pos 1101) and release 2 catches C1 to remove the Board as shown below.

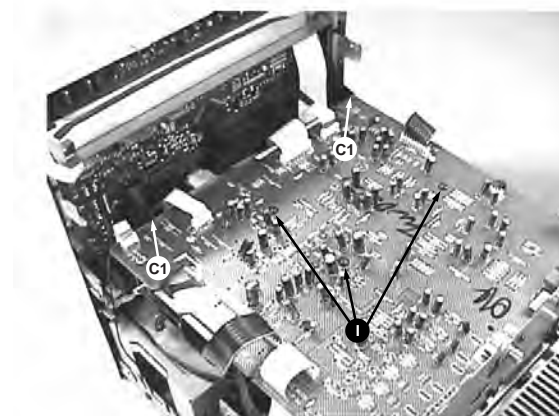

Figure 15

- c) Loosen 1 screw E and remove the Bar Tuner (pos 263) by uncatching it from the Plate Front (pos 254) as shown in fig. 10.

- d) Loosen 4 screws P to remove the Mains Transformer (pos 5280) as shown in figure 16.

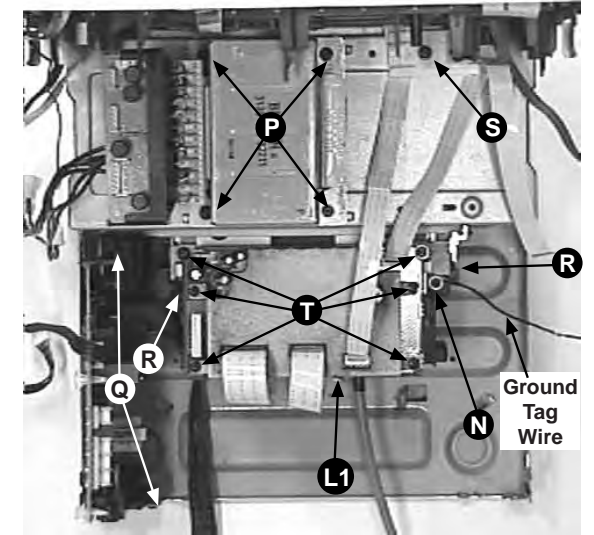

Figure 16

- e) Loosen 3 screws F and 2 catches C3 to remove the Tuner Module (pos 257 & 1100) as shown in figure 14

- f) Loosen 3 screws H, 2 screws G and releasing 2 catches C2 (see figure 14), it is also possible to remove the Plate Rear (pos 234) and Tuner Module together by skipping step e).

- g) Loosen 1 screw N to release the grounding tag wire and the Power 5 Module can be removed by pulling out of the 2 catches H1 (see figure 17).

6. Dismantling the Rear Panel / AV Board / Tuner Module as a complete assembly

- Loosen 2 screws G on the Rear as shown in figure 14.
- Release the Bar Tuner (pos 263) from the Plate Front (pos 254) as shown in figure 10.
- Release the 2 catches C2 on both sides of the Rear Panel (see figure 14), pull the complete Rear Panel assembly backwards slightly and lift it out of the Plate Bottom (pos 236).
- Remove 1 screw N mounting the ground tag wire, Shield EMC DAC (pos 205) and Bracket Mound DVD (pos 197) to Plate Bottom (pos 236) will free the assembly completely (see figure 16).

Note: During re-assembly of this Rear Panel assembly it is very important that the Power 5 DVD Module's bracket be slotted back into the 2 hooks H1 (see figure 17) on the Bottom Plate and there should be no gap between the Module's Rucksack (pos 1103-47) and the Plate Rear (pos 234) as shown in figure 18.

It may be easier to dismantle the Power 5 DVD Module from the Rear Panel (pos 234) and re-assemble this Module to the Bottom Plate first followed by the rest of the Rear Panel assembly.

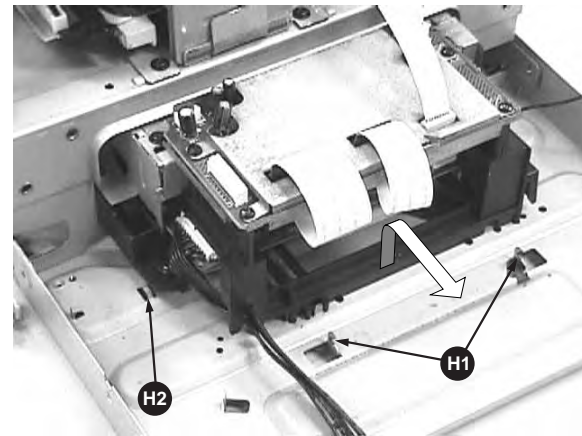

Figure 17



Figure 18

7. Dismantling of DVD / DAC Module

- Remove the Cover DVD Tray (See point 1)
- Dismantle the Rear Panel Assembly. (See point 6)
- Loosen 2 screws Q and unhook H2 (see figure 16 & 17) to remove the Mains Board (pos 1106-A) so that the Standby Transformer will not obstruct the sliding movement of the DVD / DAC Module assembly.

Note: Due to Standby Transformer size variation, the removal of Mains Board may not be required in some version.

- Loosen 2 screws R (see figure 16), lift the rear portion of the DVD Module / DAC Module slightly to clear the stopper and slide it out towards the rear as shown figure 17.
- Loosen 6 screws T (see figure 16) to separate the DAC Module.
- Release the lug L1 by twisting and bend open the Shield EMC DAC cover (pos 205) to remove the DAC Board (pos 1102-C).

Note: Do not bend the Shield EMC DAC cover beyond 45°, otherwise the hinges may be broken.

- Loosen 5 screws U to separate the DVD module from the Bracket Mound DVD (pos 197) as shown in figure 18.

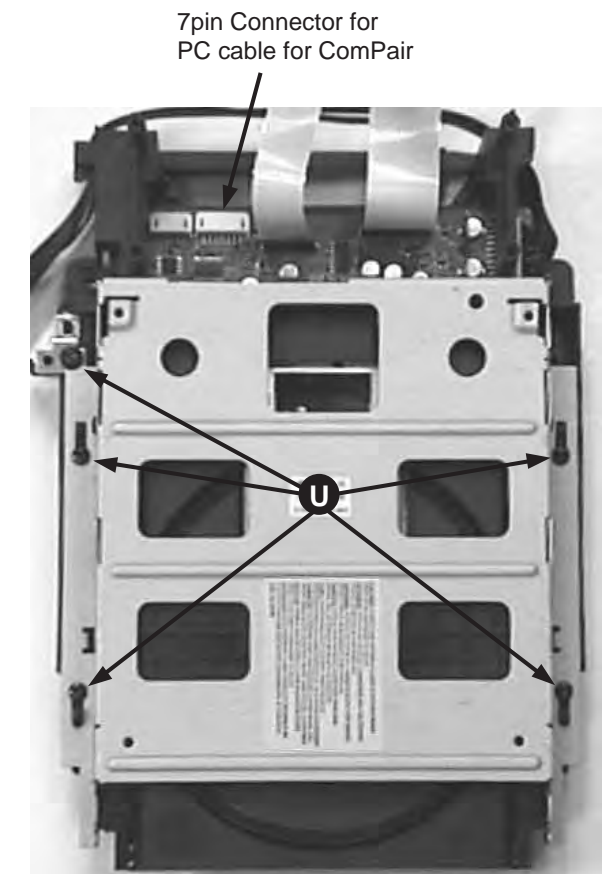

Figure 18

Repair hints on the Left/Right Loudspeaker Box

- Remove the Cloth Frame assembly.
- Pull out the 4 Grommet & loosen the 4 screws under the Grommet mounting location to remove the Woofer Ring.
- To reach the Tweeter forced open the Front Panel Assembly from the wooden LS Box with the help of a minus screw driver.

Note: This procedure is not recommended because of high risk that the LS Box will be damaged.

Service pos A - 3CDC-LC Module

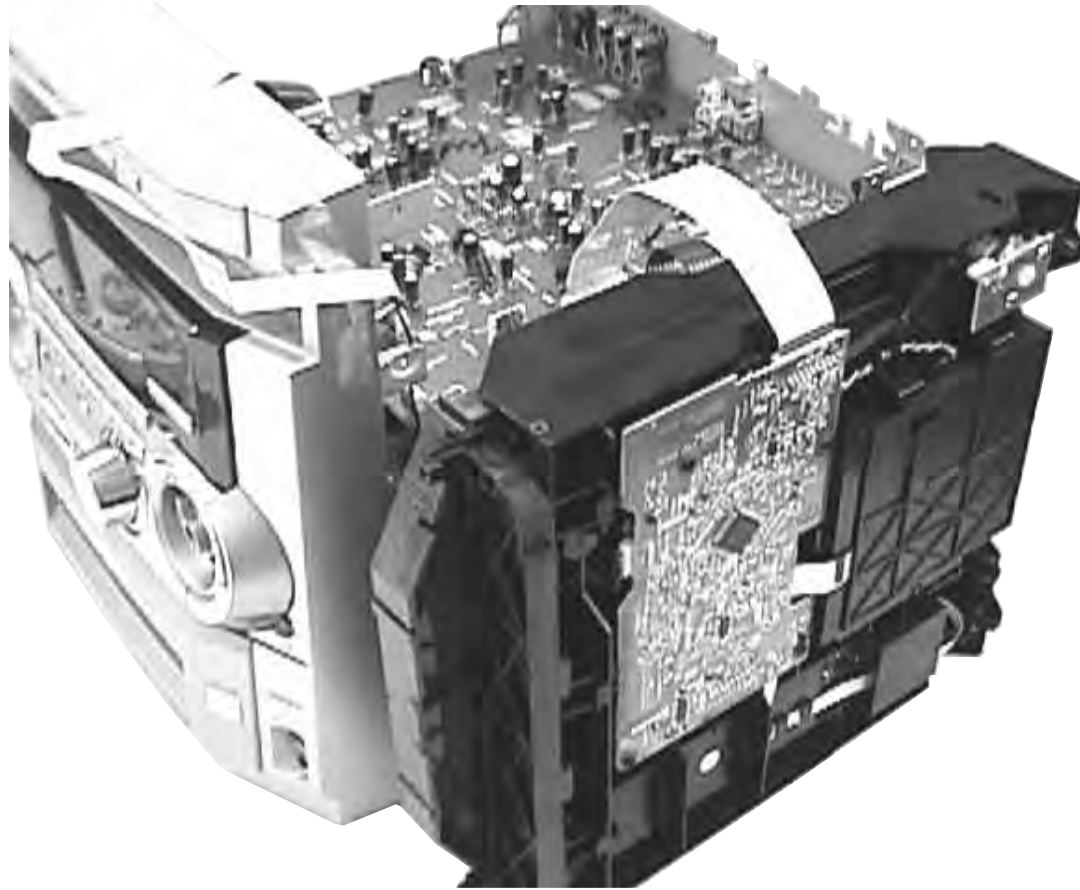

Service pos C - Front Board

Note: The following cables should be disconnected to achieve this Service position:

- 1) Conn. 1510 / 1523 to 3CDC-LC module

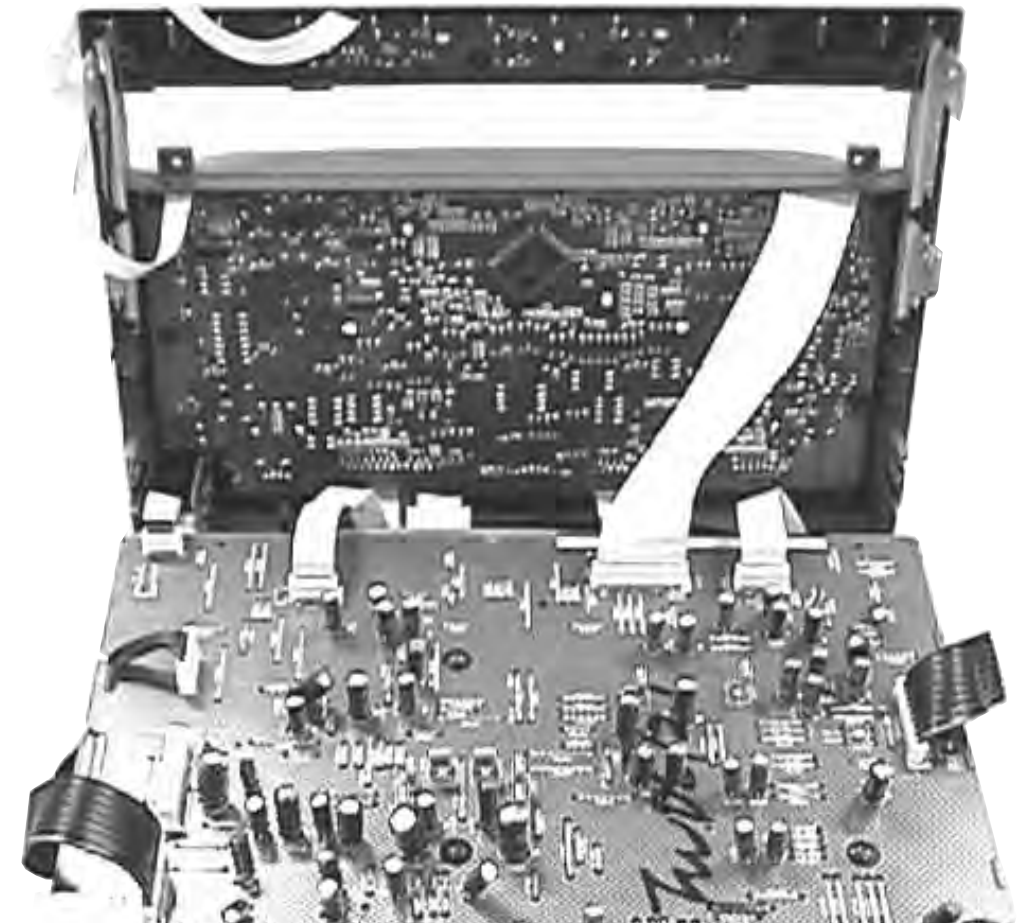

Service pos B - AV Board / Tuner Board

Note: The following cables from the AV board should be disconnected to achieve this Service position:

- 1) Conn. 1517 to DAC board conn. 1905
(there will not be any signal in AV circuit part 3 because of this disconnection)
- 2) Ground pin 1504
- 3) Conn. 1510 / 1523 to 3CDC-LC module
- 4) Conn. 1528 to Headphone 1702
- 5) Conn. 1529 / 1511 to Front 1476 / 1474

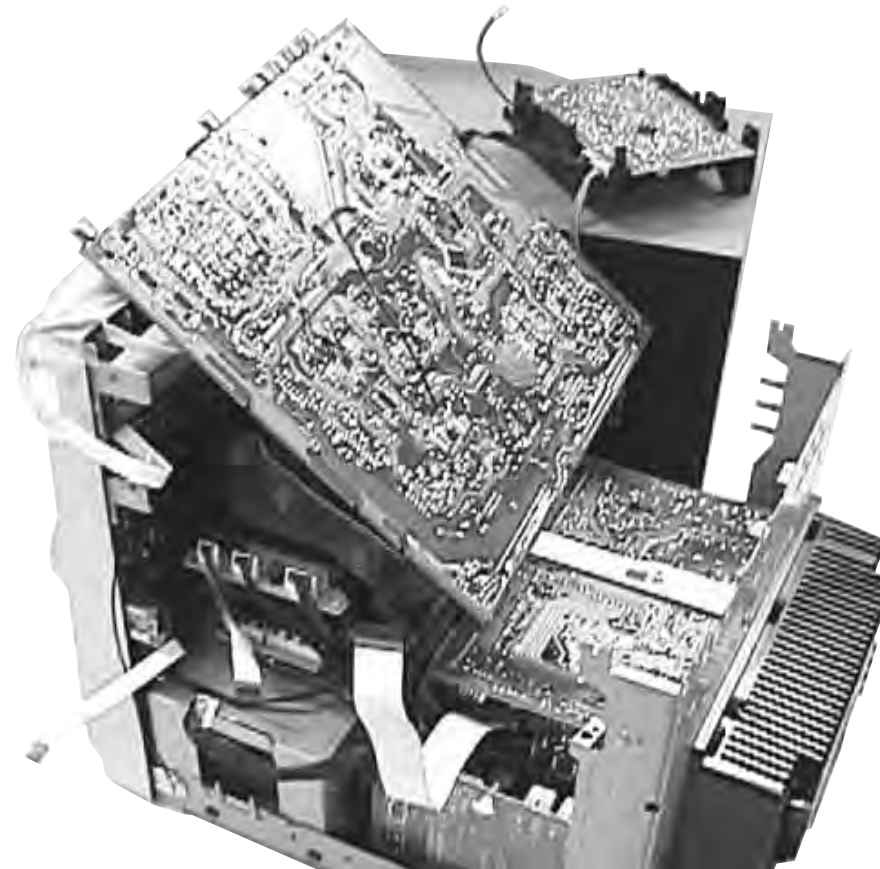

Service pos D - DAC Board

Note: The following cables should be disconnected to achieve this Service position:

From AV board

- 1) conn. 1510 / 1523 to 3CDC-LC module
- 2) conn. 1528 to Headphone 1702
- 3) conn. 1529 / 1511 to Front conn. 1476 / 1474 (if necessary)
- 4) conn 1517 to DAC board conn. 1905
(there will not be any signal in AV circuit part 3 because of this disconnection)

From Tuner board:

- 1) conn. 1121 / 1126 to Front conn. 44 / 43.

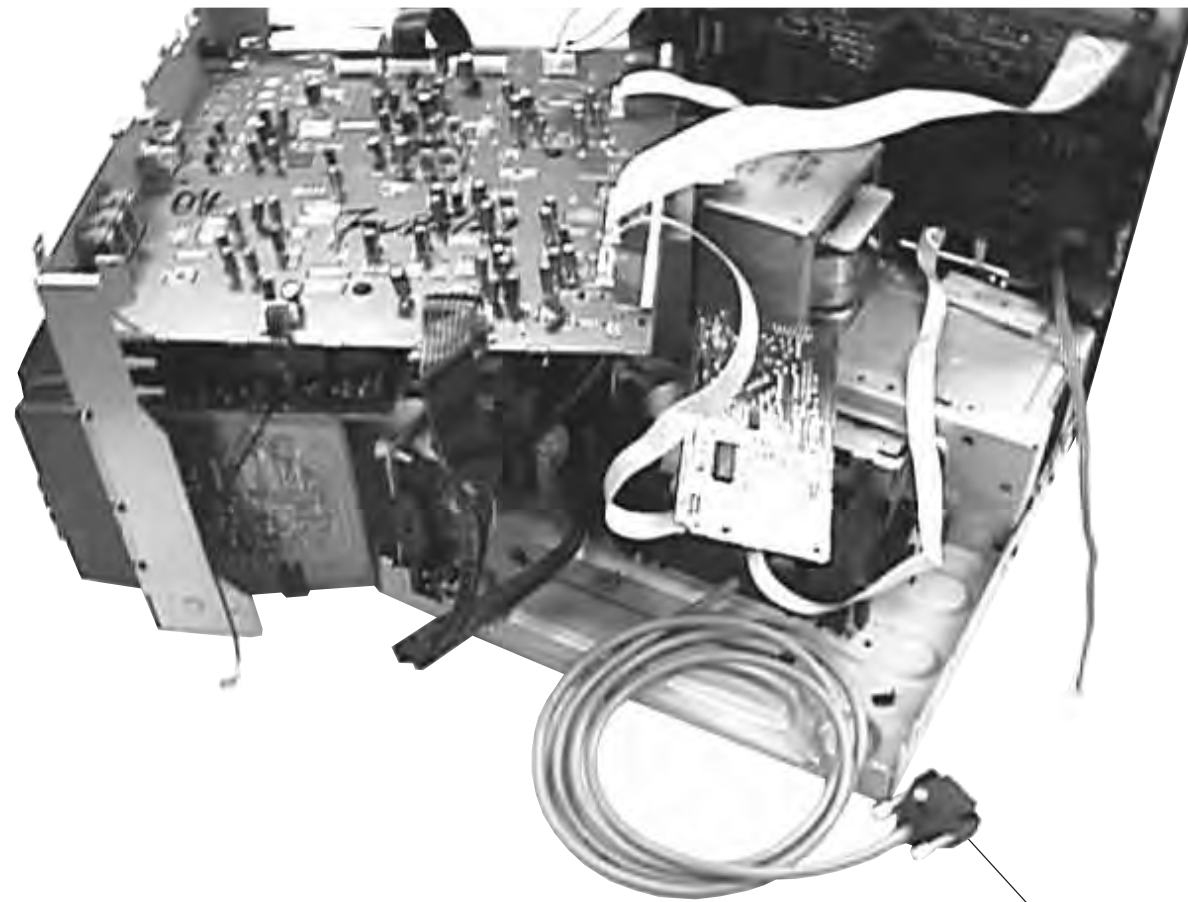

Connecting cable for PC
(ComPair connection)

Service pos E - AV Board / Supply & Amplifiers Board

Note: The following cables should be disconnected to achieve this Service position:

From AV board

- 1) conn. 1510 / 1523 to 3CDC-LC module
- 2) conn. 1528 to Headphone conn. 1702
- 3) conn. 21 to Tuner conn 1124
- 4) conn 1529 / 1511 to Front conn.1476 / 1474
- 5) conn 1517 to DAC board conn. 1905
(there will not be any signal in AV circuit part 3 because of this disconnection)

From Tuner board:

- 1) conn. 1121 / 1126 to Front conn. 44 / 43.

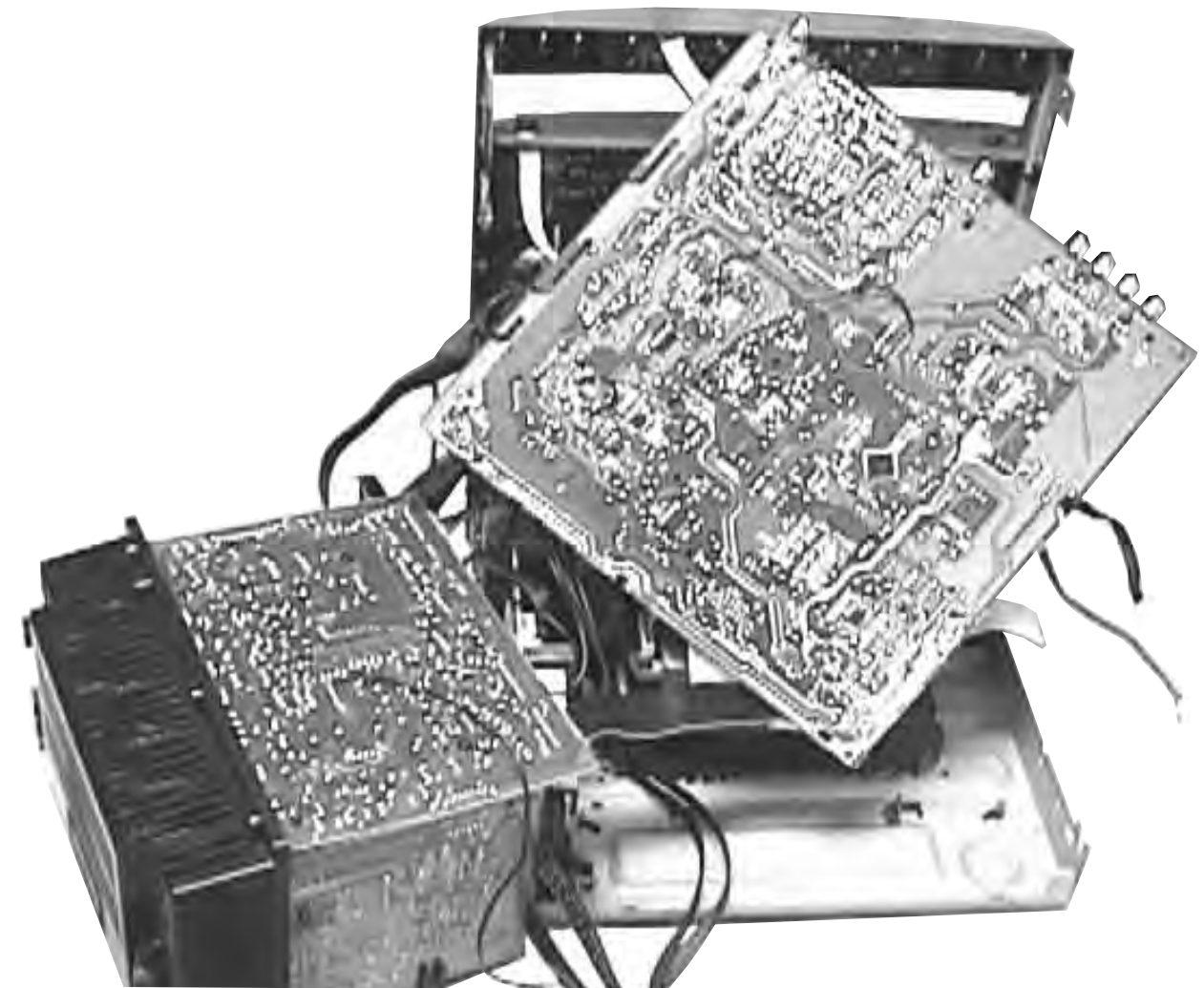

SERVICE TEST PROGRAM

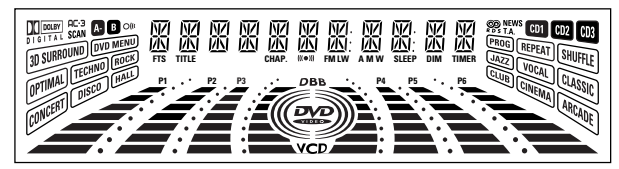
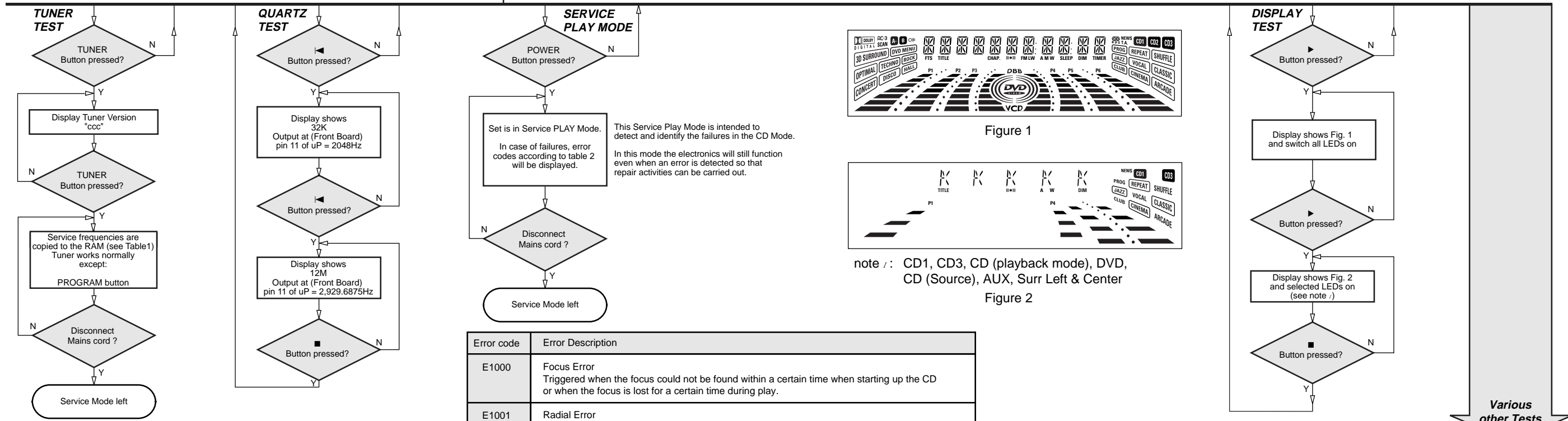
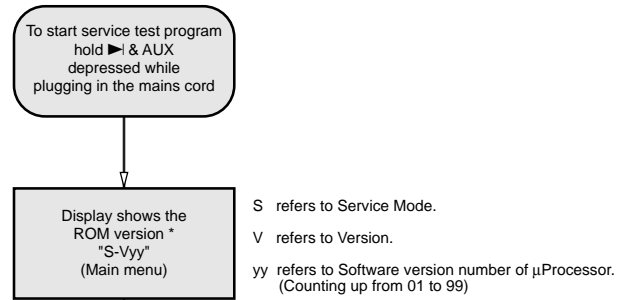

Figure 1

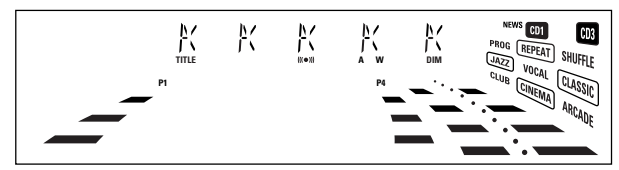

Figure 2

note : CD1, CD3, CD (playback mode), DVD, CD (Source), AUX, Surr Left & Center

PRESET	Europe "EUR"	Oversea "OSE"	USA "USA"
1	87.5MHz	87.5MHz	87.5MHz
2	108MHz	108MHz	108MHz
3	531kHz	531/530kHz*	530kHz
4	1602kHz	1602/1700kHz*	1700kHz
5	558kHz	558/560kHz*	560kHz
6	1494kHz	1494/1500kHz*	1500kHz
7	153kHz	87.5/98MHz*	98MHz
8	279kHz	87.5MHz	87.5MHz
9	198kHz	87.5MHz	87.5MHz
10	87.5MHz	98MHz	87.5MHz
11	87.5MHz	98/87.5MHz*	87.5MHz

Table 1

* Note: Depending on the selected grid frequency (9 or 10kHz). By holding the TUNER and **▶▶** buttons depressed while switching on the Mains supply, the tuning grid frequency is toggled between 9kHz and 10kHz for the "OSC" version.

Error code	Error Description
E1000	Focus Error Triggered when the focus could not be found within a certain time when starting up the CD or when the focus is lost for a certain time during play.
E1001	Radial Error Triggered when the radial servo is off-track for a certain time during play.
E1002	Sledge In Error The sledge did not reach its inner position (inner-switch is still close) before approximately 6 Sec. have passed by. Inner-switch or sledge motor problem.
E1003	Sledge Out Error The sledge did not come out of its inner position (inner-switch is still open) before approximately 250 mSec. have passed by. Inner-switch or sledge motor problem.
E1005	Jump-offtrack error Triggered in normal play when the jump destination could not be found within a certain time. When this error occurred, software will try to recover by initiating the jump command again. If it is recoverable, the disc will continue to play.
E1006	Subcode Error Triggered when a new subcode was missing for a certain time during play.
E1007	PLL Error The Phase Lock Loop could not lock within a certain time.
E1008	Turntable Motor Error Generated when the CD could not reached 75% of speed during startup within a certain time. Discmotor problem.
E1020	Focus Search Error The focus point has not been found within a certain time.
E1070	The carousel switch is not open within certain time. This can happen when either the switch is defective and closed all the time, or when the carousel is blocked when located exactly at a disc position.
E1071	The carousel position switch did not close within a certain time. This can happen when the switch is defective and never closes electrically, or when the carousel is blocked in between two disc positions. The time-out is approximately 5 Sec.
E1079	The drawer could not enter the inside position is opening again. This can be caused because the drawer is blocked by something and cannot go fully inside, or the drawer switch is defective and does not close.

Table 2

TEST	Activated with	ACTION
EEPROM TEST	▶▶ ■ to Exit	A test pattern will be sent to the EEPROM. "PASS" is displayed if the μ Processor read back the test pattern correctly, otherwise "ERROR" will be displayed.
EEPROM FORMAT	◀◀	Load default data (including Virgin Mode). Display shows "NEW" for 1 second. Caution! All presets from the customer will be lost!!
ENCODER TEST	Volume Knob or Jog Shuttle knob	Display shows value for 2 seconds. Values increases or decreases in steps of 1 until 0 (Min.) or 40 (Max.) is reached.
DVD DEALER & PLAYER TEST		Please refer to Chapter 9.
LEAVE SERVICE TESTPROGRAM	Disconnect mains cord	

Various other Tests

SET BLOCK DIAGRAM

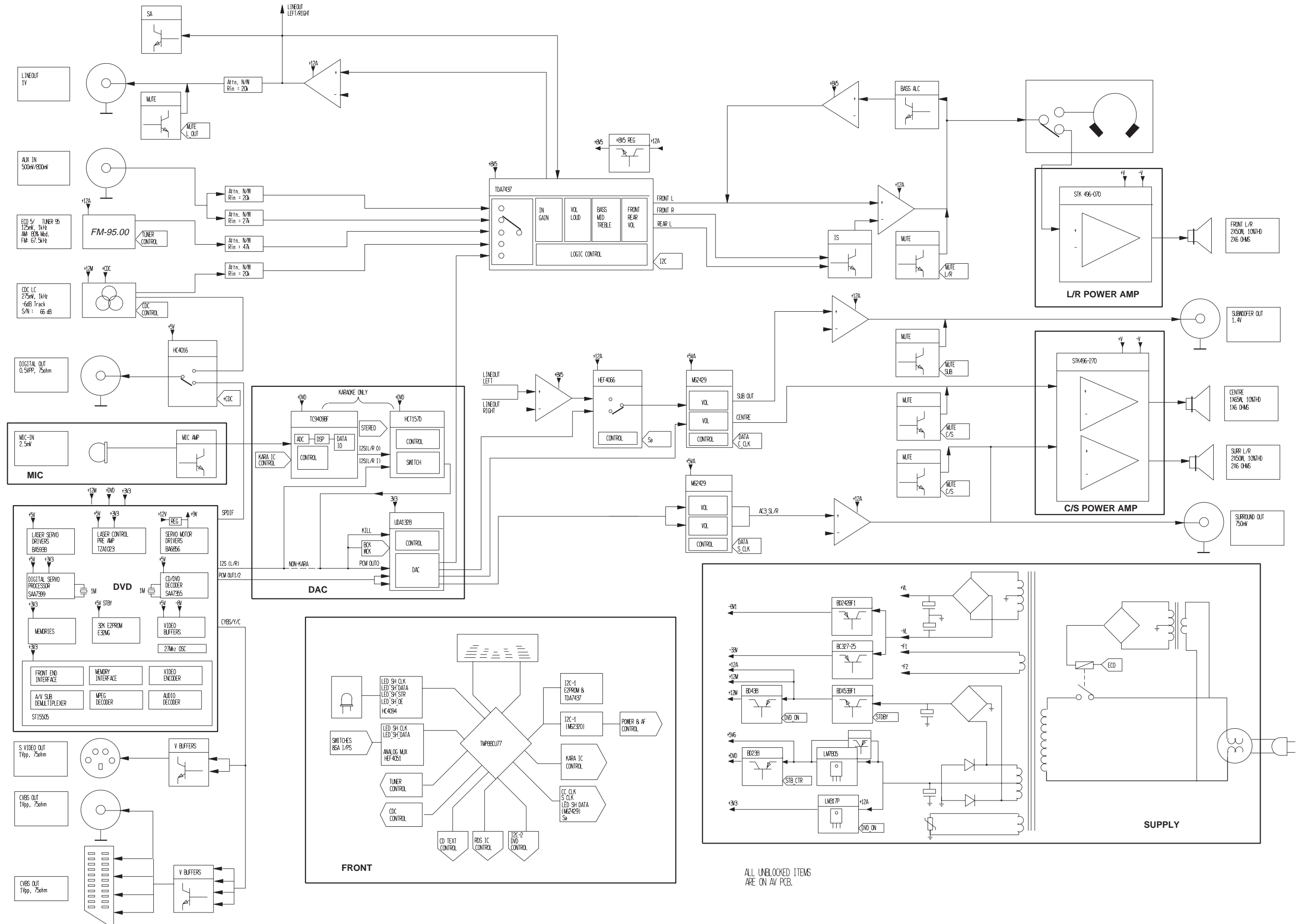

ALL UNLOCKED ITEMS ARE ON AV PCB.

SET GROUND WIRING DIAGRAM

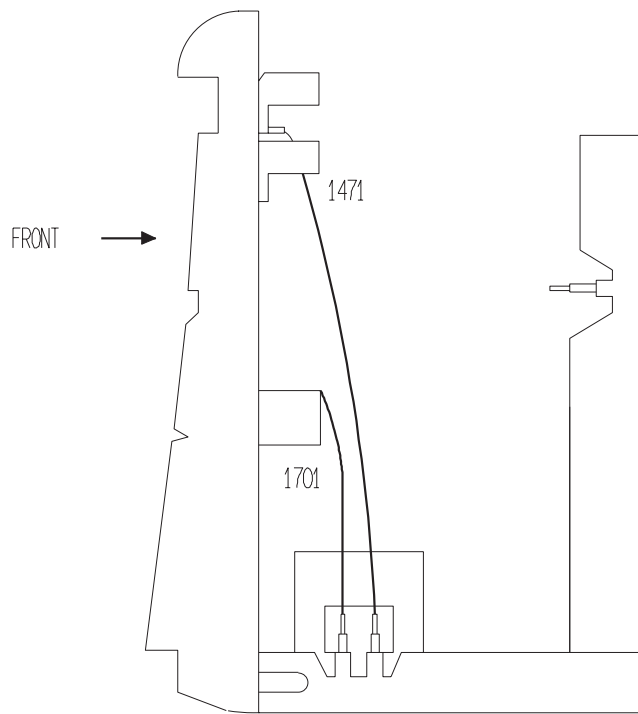

SIDE VIEW OF RIGHT SIDE OF SET

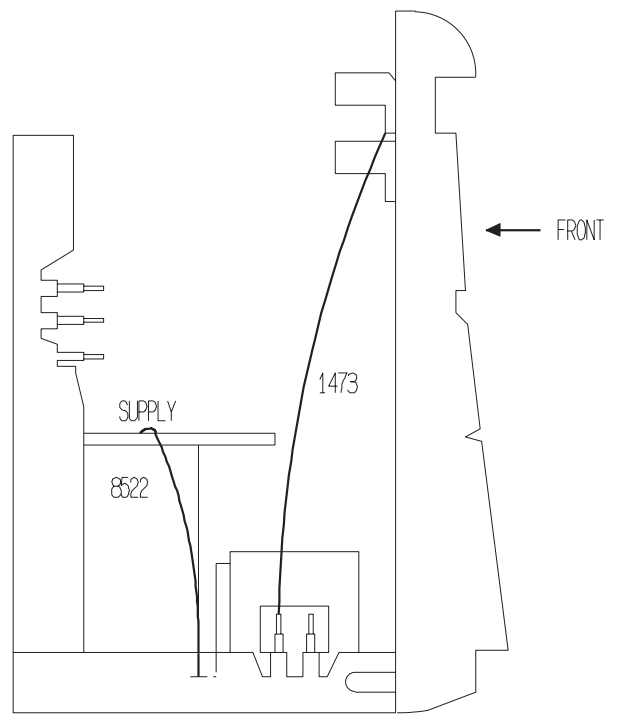

SIDE VIEW OF LEFT SIDE OF SET

ITEM	FROM	TO
1471	MIDDDLE SCREW OF CDC RIGHT BRACKET	LUG AT BOTTOM PLATE
1473	MIDDLE SCREW OF CDC LEFT BRACKET	LUG AT BOTTOM PLATE
1701	HEADPHONE PCB	LUG AT BOTTOM PLATE
8522	STAR PT OF SUPPLY PCB	DAC SHIELD & SCREW TO BOTTOM PLATE

BLANK PAGE

DO NOT PRINT

FRONT BOARD

TABLE OF CONTENTS

FTD display pin connection 6-1
 Deck Key part - Layouts & Circuit diagram 6-2
 DVD Logo LED part - Layout & Circuit diagram 6-2
 Key CDC part - Layouts & Circuit diagram 6-3
 Headphone part - Layouts & Circuit diagram 6-3
 Front Board - Circuit diagram 6-4
 Front Board - Component and Chip layouts 6-5
 DAC part - Layouts & Circuit diagram 6-6
 Microphone & DVD Open/Close part - Layouts & Circuit diagram 6-7
 Disc Type LED part - Layout & Circuit diagram 6-7
 Electrical parts list 6-8

FTD DISPLAY PIN CONNECTIONS

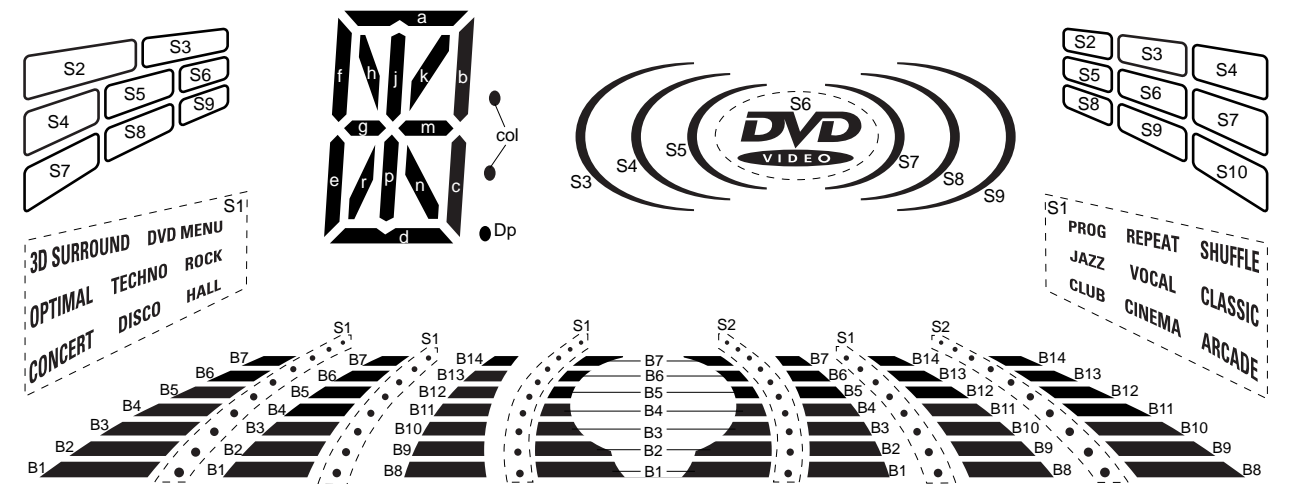
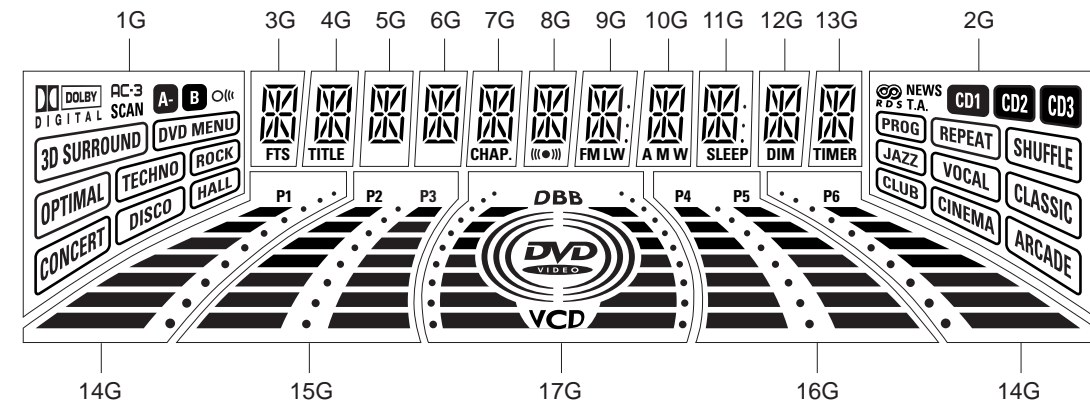

	1G	2G	3G	4G	5G	6G	7G	8G	9G	10G	11G	12G	13G	14G	15G	16G	17G
P1	DOLBY DIGITAL	NEWS RDS T.A.	a	a	a	a	a	a	a	a	a	a	a	B1	B1	B1	B1
P2	AC-3	NEWS	h	h	h	h	h	h	h	h	h	h	h	B2	B2	B2	B2
P3	SCAN	T.A.	j, p	j, p	j, p	j, p	j, p	j, p	j, p	j, p	j, p	j, p	j, p	B3	B3	B3	B3
P4	A-	CD1	k	k	k	k	k	k	k	k	k	k	k	B4	B4	B4	B4
P5	B	CD2	b	b	b	b	b	b	b	b	b	b	b	B5	B5	B5	B5
P6	OK	CD3	f	f	f	f	f	f	f	f	f	f	f	B6	B6	B6	B6
P7	S2	S2	m	m	m	m	m	m	m	m	m	m	m	B7	B7	B7	B7
P8	S3	S3	g	g	g	g	g	g	g	g	g	g	g	P1	P2	P4	S1
P9	S4	S4	c	c	c	c	c	c	c	c	c	c	c	S1	S1	S1	S2
P10	S5	S5	e	e	e	e	e	e	e	e	e	e	e	B8	B8	B8	S3
P11	S6	S6	r	r	r	r	r	r	r	r	r	r	r	B9	B9	B9	S4
P12	S7	S7	n	n	n	n	n	n	n	n	n	n	n	B10	B10	B10	S5
P13	S8	S8	d	d	d	d	d	d	d	d	d	d	d	B11	B11	B11	S7
P14	S9	S9	FTS	TITLE	-	-	CHAP.	((•))	FM	A	SLEEP	DIM	TIMER	B12	B12	B12	S8
P15	S1	S10	-	-	-	-	-	-	LW	M	-	-	-	B13	B13	B13	S9
P16	-	S1	-	-	-	-	-	-	col	W	col	-	-	B14	B14	B14	DBB
P17	-	-	-	-	-	-	-	-	Dp	-	Dp	-	-	P6	P3	P5	S6
P18	-	-	-	-	-	-	-	-	-	-	-	-	-	S2	-	-	VCD

DECK KEY BOARD - COMPONENT LAYOUT

1421 A3 1423 A2 1425 A1 1427 A1 1429 A2 1431 A1 1435 A3 9421 A3
 1422 A3 1424 A2 1426 A1 1428 A1 1430 A1 1432 A2 1436 A3

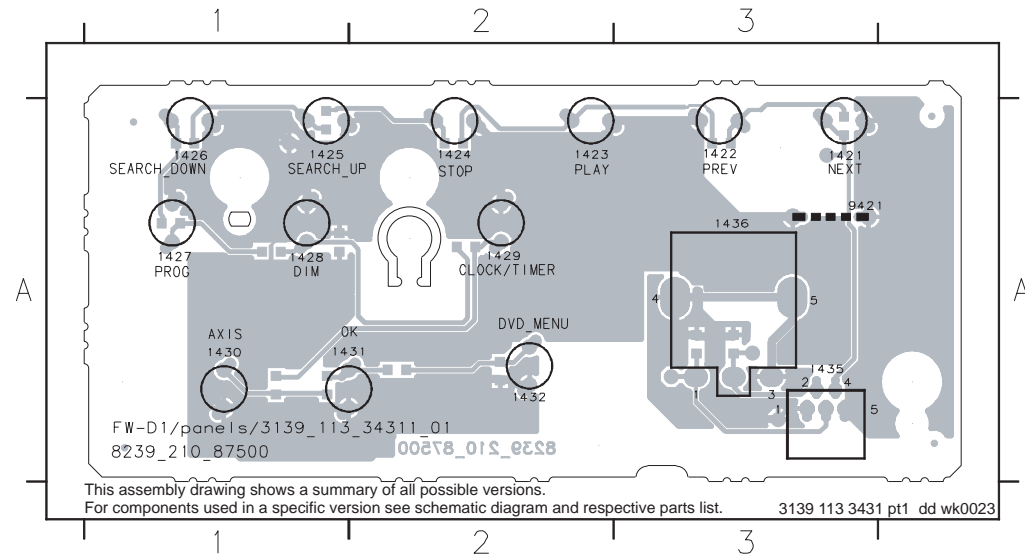

DECK KEY BOARD - CHIP LAYOUT

2421 A2 2426 A1 3422 A1 3424 A3 3426 A3 3428 A2 3430 A3 4422 A3
 2425 A1 3421 A1 3423 A2 3425 A3 3427 A3 3429 A3 3431 A2

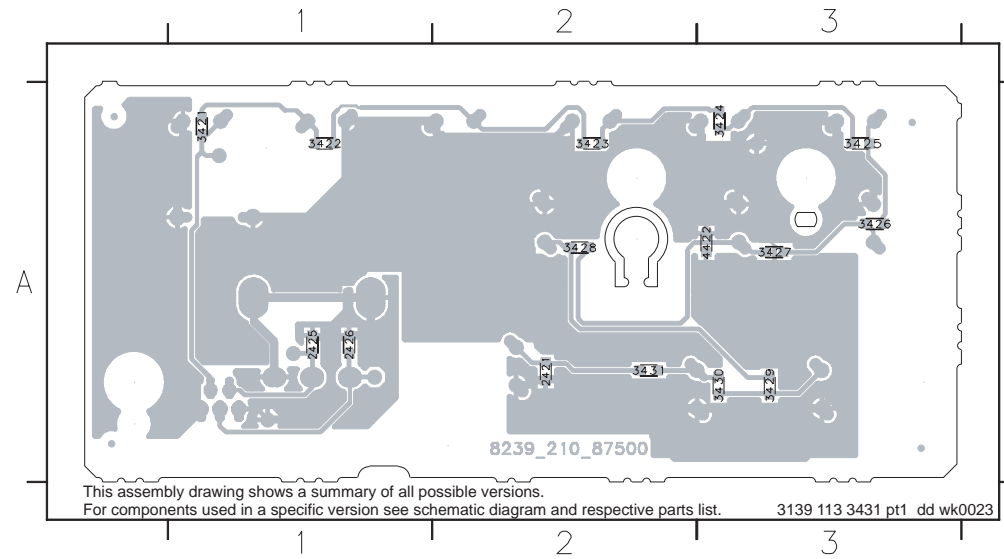

DVD LOGO LED BOARD - COMPONENT LAYOUT

1415 A1 6415 A1

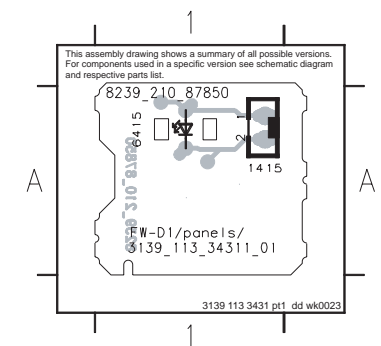

DECK KEY PART - CIRCUIT DIAGRAM

1421 A3 1423 A4 1425 A5 1427 A5 1429 A6 1431 A7 1435 A1 2421 A8 2426 C4 3422 A4 3424 A4 3426 A5 3428 A6 3430 A7
 1422 A3 1424 A4 1426 A5 1428 A6 1430 A7 1432 A8 1436 C3 2425 C4 3421 A3 3423 A4 3425 A5 3427 A6 3429 A7 3431 A7

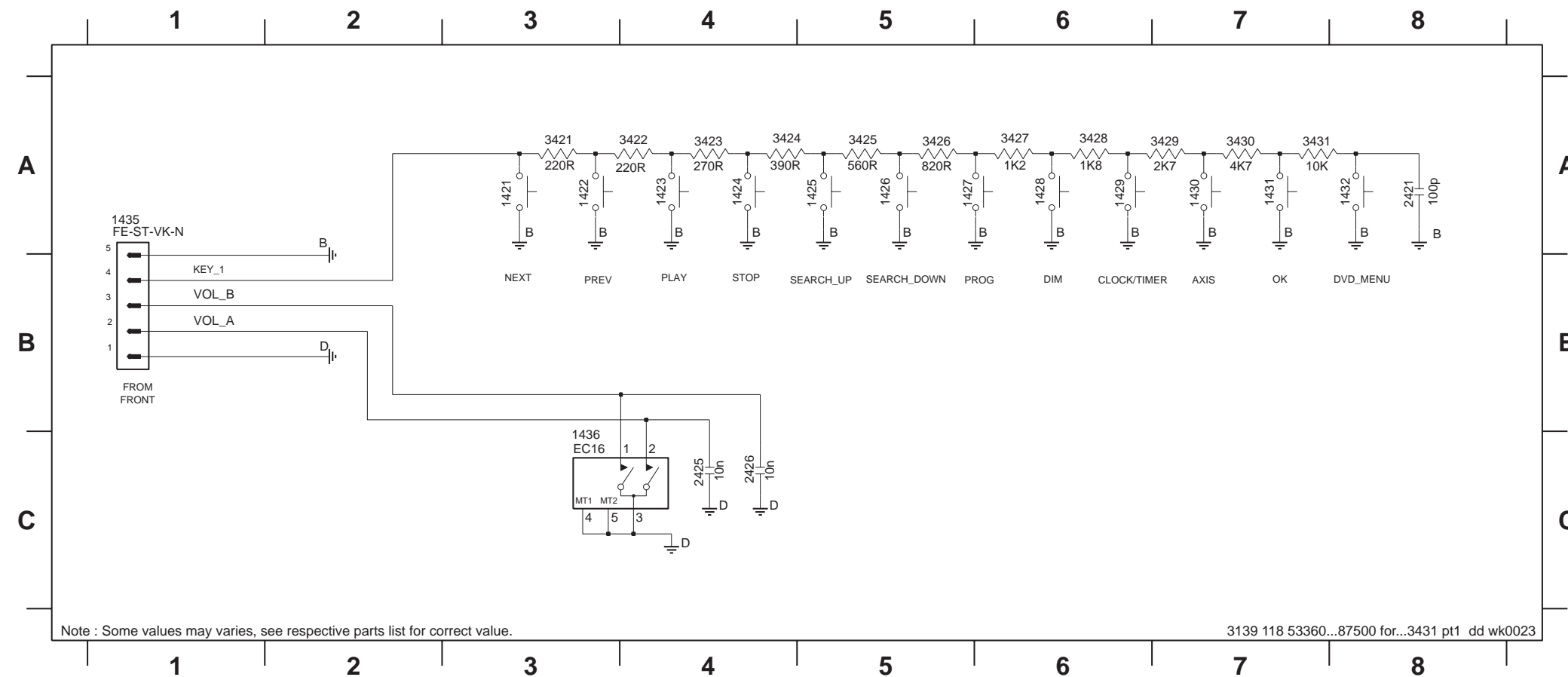

DVD LOGO LED PART - CIRCUIT DIAGRAM

1415 A2 6415 A1

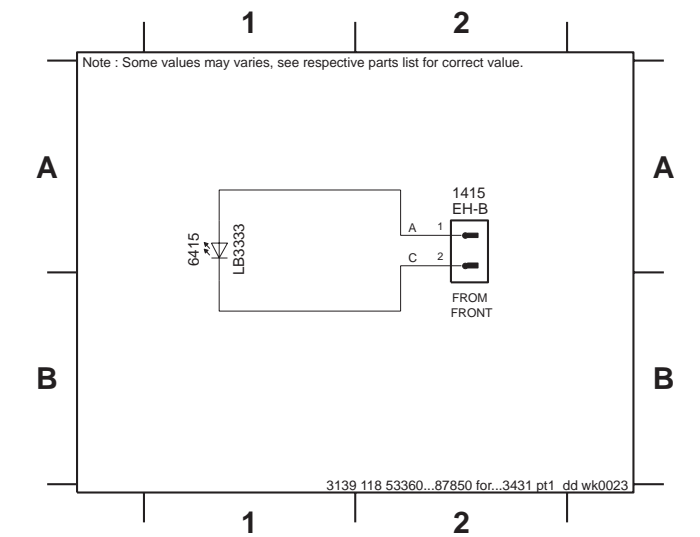

KEY CDC BOARD - COMPONENT LAYOUT

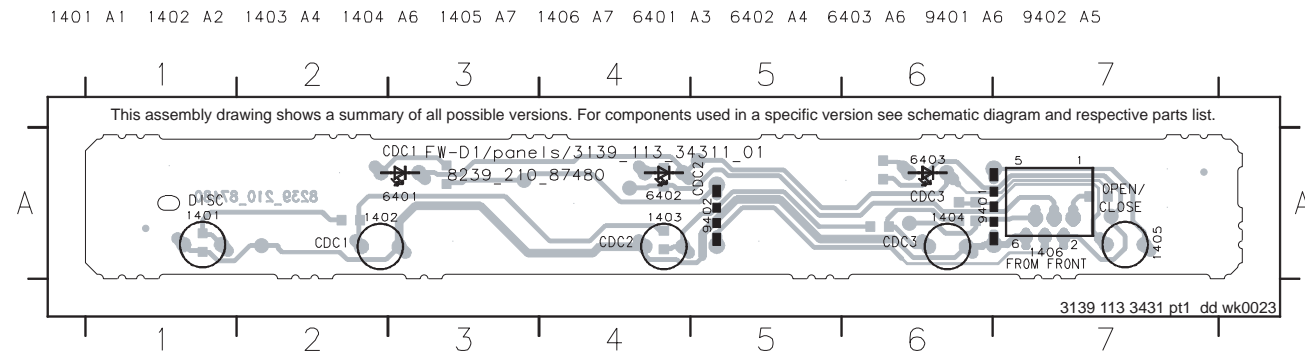

KEY CDC BOARD - CHIP LAYOUT

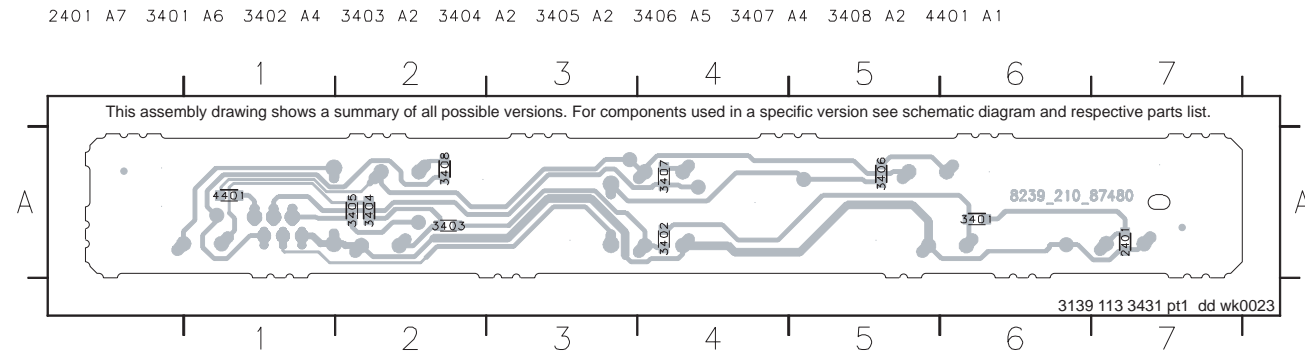

KEY CDC PART - CIRCUIT DIAGRAM

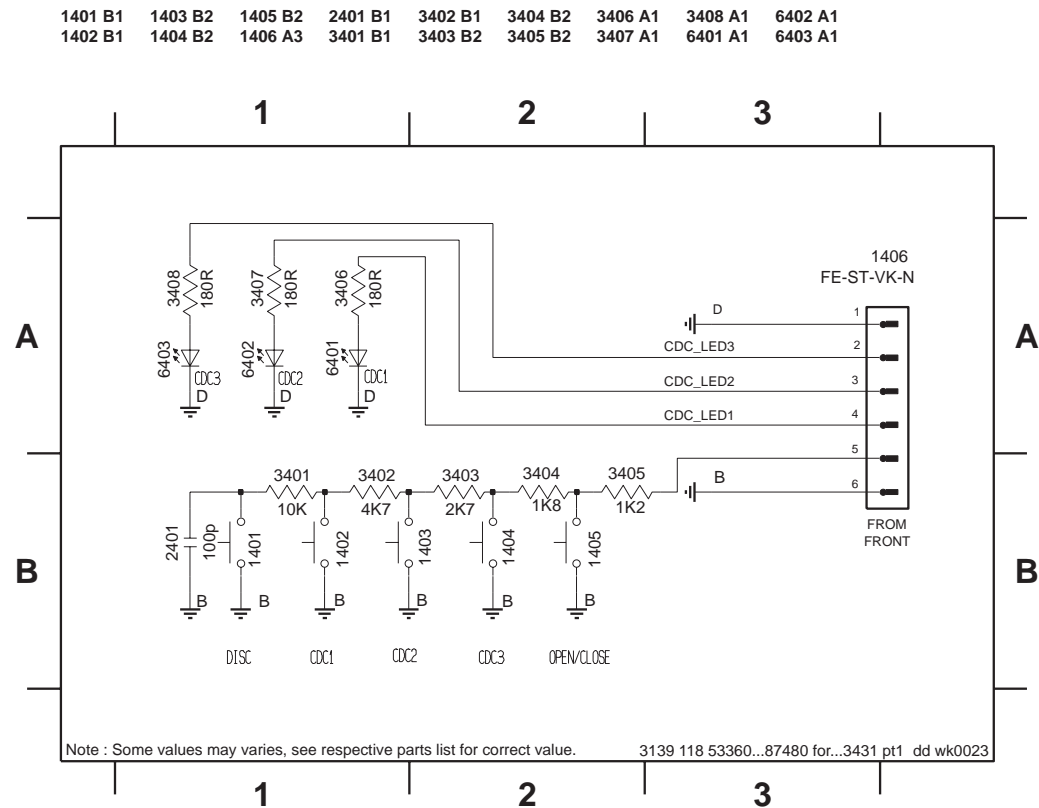

HEADPHONE BOARD - COMPONENT LAYOUT

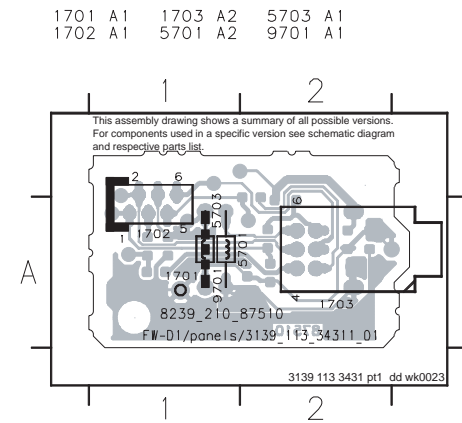

HEADPHONE BOARD - CHIP LAYOUT

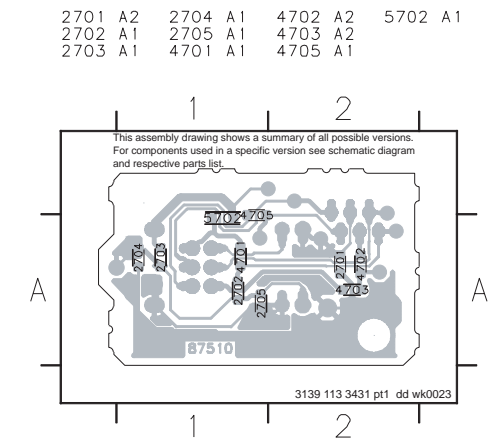

HEADPHONE PART - CIRCUIT DIAGRAM

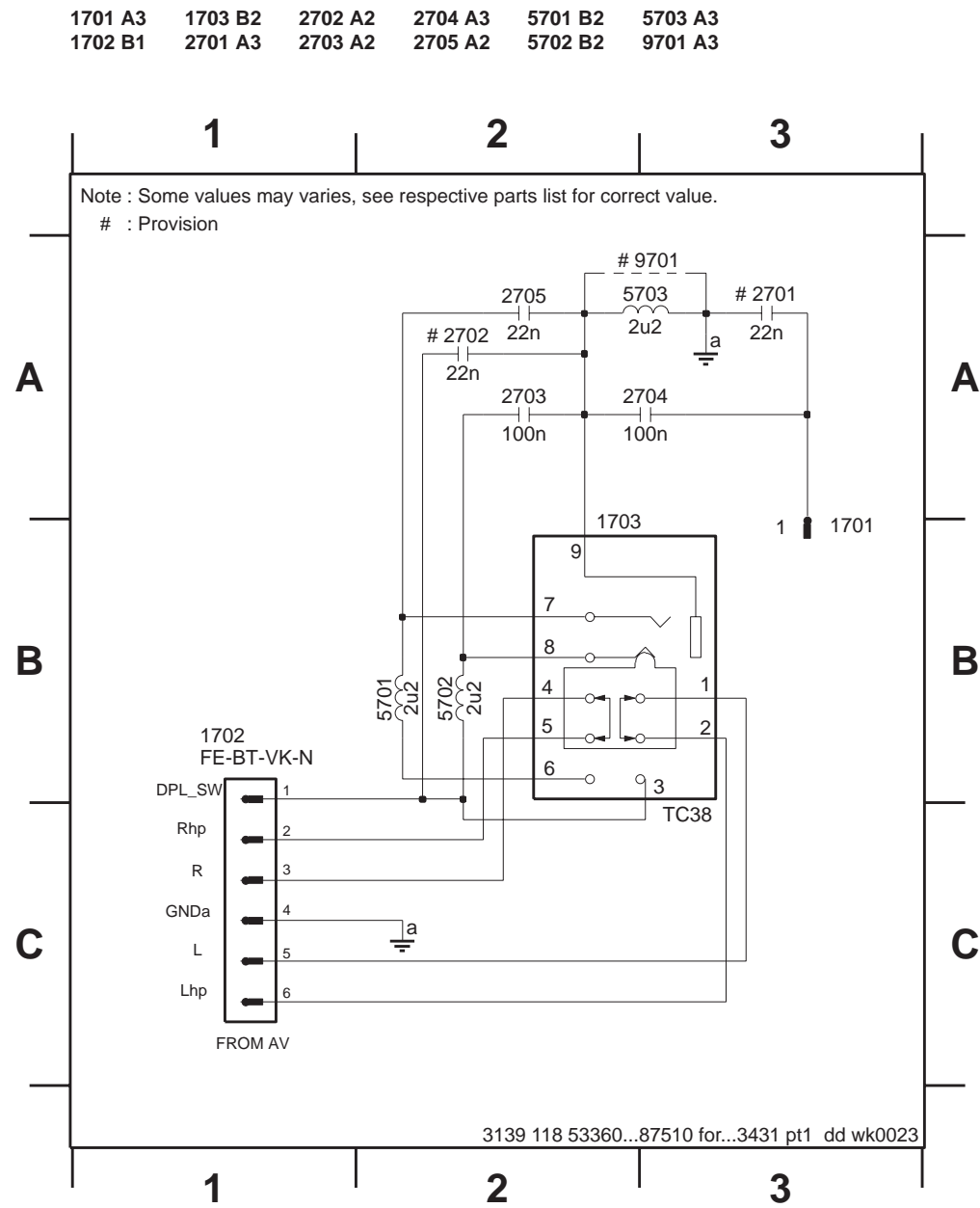

FRONT BOARD - CIRCUIT DIAGRAM

- 41 H1 1445 H5 1458 L10 1470 G19 1479 J13 2448 E9 2461 J12 2470 L2 2480 D5 2493 A3 2508 J8 2520 A19 3441 F12 3449 F12 3457 F13 3465 F13 3474 E14 3482 D14 3490 D14 3498 D13 3506 D13 3516 D12 3524 D9 3533 H1 3542 H2 3552 I2 3560 J3 3568 B8 3576 B2 3586 G6 3594 H5 3603 D6 3616 E2 3624 J9 3636 K13 3646 E17 3664 A17 3672 A5 3695 F16 3703 H16 5442 E11 6441 E5 6454 E2 6471 H9 7445 J2 7457 A19
- 42 A4 1446 H4 1459 L12 1471 B18 2441 E8 2449 E9 2462 J13 2471 J4 2482 C6 2501 I9 2509 J12 2522 A20 3442 F12 3450 F12 3458 F13 3466 F14 3475 E14 3483 D14 3491 D14 3499 D13 3509 D12 3517 D12 3525 F10 3534 J11 3543 J13 3553 I2 3561 I2 3569 A7 3577 B3 3587 G5 3595 H4 3605 E5 3617 E2 3625 J8 3637 K13 3647 E17 3665 A18 3675 C14 3696 G17 3704 H16 5443 D8 6442 E5 6455 D2 6472 I9 7448 E9 7458 A20
- 43 I1 1447 H4 1461 G6 1472 G19 2442 E9 2450 E11 2463 L11 2472 J5 2483 D4 2502 I9 2511 J17 2524 C20 3443 F12 3451 F12 3459 F13 3467 F14 3476 E14 3484 D14 3492 D14 3500 D13 3510 D12 3518 D12 3526 F10 3535 B3 3544 H15 3554 J2 3562 J4 3570 A2 3578 B2 3588 G5 3596 H4 3606 D5 3618 E2 3626 I9 3640 C18 3648 E17 3666 A19 3676 C14 3697 G17 4691 A2 5444 C15 6443 D5 6457 A7 6473 J9 7449 J11 7459 C20
- 44 I1 1448 H3 1462 G6 1473 H19 2443 C14 2451 E10 2464 L11 2473 K1 2488 L13 2503 H9 2512 H17 2531 C16 3444 F12 3452 F13 3460 F13 3468 F14 3477 E14 3485 D14 3493 D13 3501 D13 3511 D12 3519 C9 3527 F10 3536 J4 3545 H14 3555 I3 3563 J5 3571 A2 3579 B3 3589 G4 3597 H3 3607 E5 3619 D2 3627 I9 3641 C18 3649 E17 3667 A20 3677 C14 3698 C8 4692 A2 5445 F15 6444 D5 6458 A6 6474 J9 7451 B7 7459 F18
- 1441 H6 1449 H3 1464 G5 1474 A1 2444 F15 2455 H10 2466 J3 2474 K1 2489 L13 2504 I9 2513 J17 2532 C17 3445 F12 3453 F13 3461 F13 3470 E14 3478 E14 3486 D14 3494 D13 3502 D13 3512 D12 3520 C9 3528 F10 3537 J4 3546 H14 3556 I3 3564 K6 3572 A2 3582 H6 3590 G4 3598 H3 3608 D5 3620 H9 3628 J9 3642 C17 3650 E17 3668 C20 3691 E18 3699 C8 4693 J16 5446 F14 6445 E5 6459 A5 7441 D14 7452 B5 7492 C8
- 1442 H6 1450 H2 1465 G4 1475 D1 2445 F14 2456 J11 2467 J3 2475 K1 2490 B2 2505 J9 2514 A16 2533 D10 3446 F12 3454 F13 3462 F13 3471 E14 3479 D14 3487 D14 3495 D13 3503 D13 3513 D12 3521 D9 3529 G10 3538 H14 3547 K11 3557 I2 3565 L6 3573 A2 3583 G6 3591 H6 3599 H3 3609 E5 3621 I9 3629 I8 3643 D17 3655 H7 3669 B6 3692 F16 3700 C10 4694 K16 5448 H4 6451 E2 6460 J12 7442 I13 7454 A16 7493 C10
- 1443 HS 1451 H2 1466 G4 1476 A1 2447 J11 2468 J3 2476 L1 2491 B2 2506 I8 2516 I7 2534 L17 3447 F12 3455 F13 3463 F13 3472 E14 3480 D14 3488 A7 3496 D13 3504 D13 3514 D12 3522 D9 3531 A3 3539 I5 3548 K11 3558 L6 3566 J3 3574 A2 3584 H6 3592 H6 3600 H2 3610 D4 3622 J9 3630 I8 3644 C16 3656 H7 3670 A5 3693 F16 3701 C11 4695 J12 5450 J5 6452 E2 6461 L16 7443 D5 7455 A17
- 1444 HS 1457 A11 1467 G4 1478 F1 2447 E10 2458 I15 2469 J2 2477 J6 2492 A3 2507 I8 2518 A18 2591 E18 3448 F12 3456 F13 3464 F13 3473 E14 3481 D14 3489 A6 3497 D13 3505 D13 3515 D12 3523 D9 3532 E9 3541 I2 3551 I2 3559 L6 3567 J4 3575 B2 3585 G6 3593 H5 3601 H2 3615 E2 3623 H9 3631 J8 3645 D18 3663 A16 3671 A5 3694 F17 3702 G17 5441 E10 5451 J4 6453 E2 6463 C15 7444 C3 7456 A18

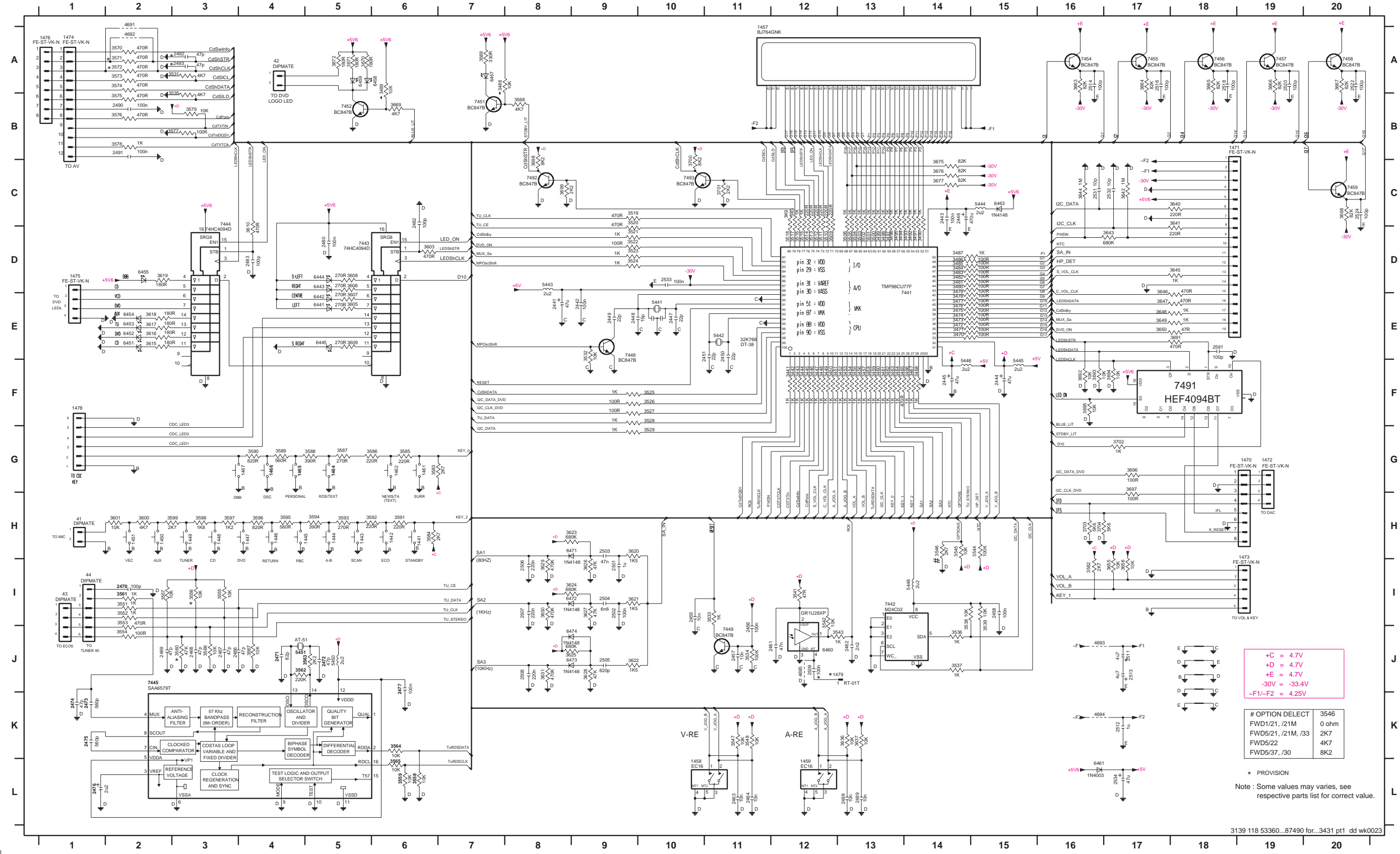

+C	= 4.7V
+D	= 4.7V
+E	= 4.7V
-30V	= -33.4V
-F1/-F2	= 4.25V

# OPTION SELECT	3546
FWD1/21, /21M	0 ohm
FWD5/22, /21M, /33	2K7
FWD5/22	4K7
FWD5/37, /30	8K2

* PROVISION
 Note : Some values may varies, see respective parts list for correct value.

DIGITAL ANALOG CONVERTOR (DAC) BOARD - COMPONENT LAYOUT

1901 B3	1909 A1	2939 A1	9903 B1	9909 B2	9914 B2	9920 A3	9925 B3	9930 B3
1903 B2	1931 B3	2940 A2	9904 B1	9910 B2	9916 B2	9921 A3	9926 B3	9931 B3
1904 B2	2923 A3	2946 A1	9906 B1	9911 B2	9917 B2	9922 B3	9927 B3	9932 B2
1905 B1	2927 B3	9901 A2	9907 B1	9912 B2	9918 A2	9923 B3	9928 B3	9933 A3
1908 A3	2931 A1	9902 B1	9908 B1	9913 B2	9919 A2	9924 B3	9929 B3	9934 B3

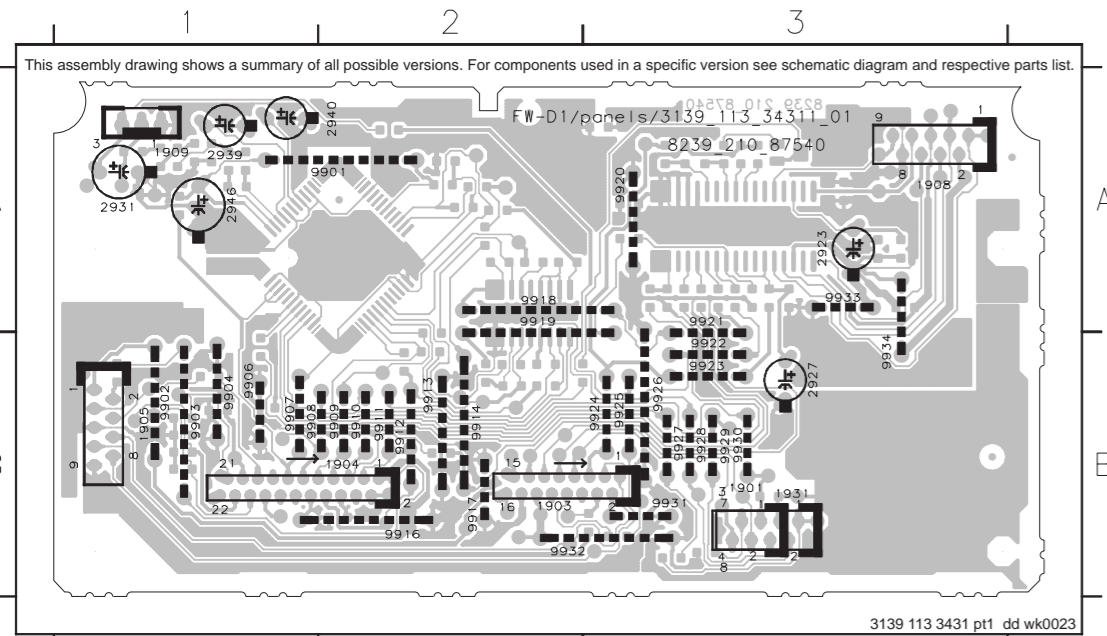

DIGITAL ANALOG CONVERTOR (DAC) BOARD - CHIP LAYOUT

2921 A1	2935 A3	3917 A1	3933 A3	3949 B3	4913 A1	4941 A2	4949 B1	4957 B3	7932 A2
2922 A1	2936 A2	3918 A1	3934 A3	3950 B3	4931 A2	4942 B2	4950 B1	4958 B3	
2924 A1	2937 A2	3919 A1	3935 A3	4607 A1	4932 B2	4943 B2	4951 B1	4959 A1	
2925 A1	2938 B3	3921 A1	3936 B2	4905 A1	4933 B2	4944 B2	4952 A1	5901 B3	
2926 A1	2941 A2	3924 A1	3937 B2	4906 A1	4934 A1	4945 B3	4953 B2	5902 B3	
2932 A3	2947 A2	3925 A1	3938 A2	4910 A1	4935 B1	4946 B2	4954 B2	7903 A1	
2933 A3	3915 A1	3931 A2	3947 A3	4911 A1	4936 A1	4947 B2	4955 A1	7904 A1	
2934 A3	3916 A1	3932 A3	3948 B3	4912 A2	4940 A2	4948 B1	4956 A2	7931 A2	

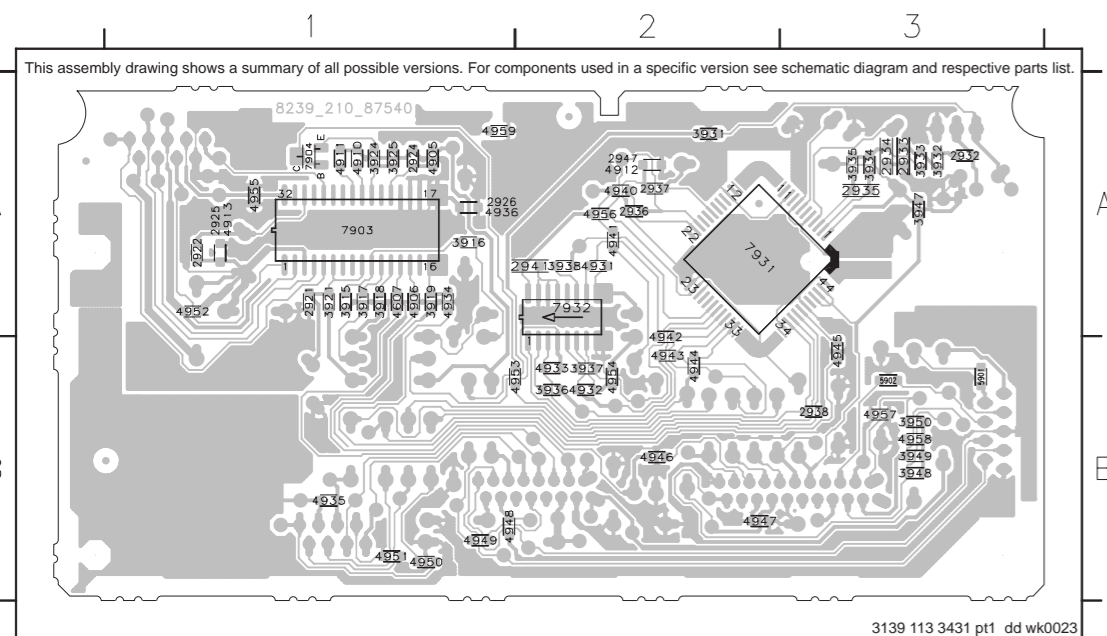

DIGITAL ANALOG CONVERTOR (DAC) PART - CIRCUIT DIAGRAM

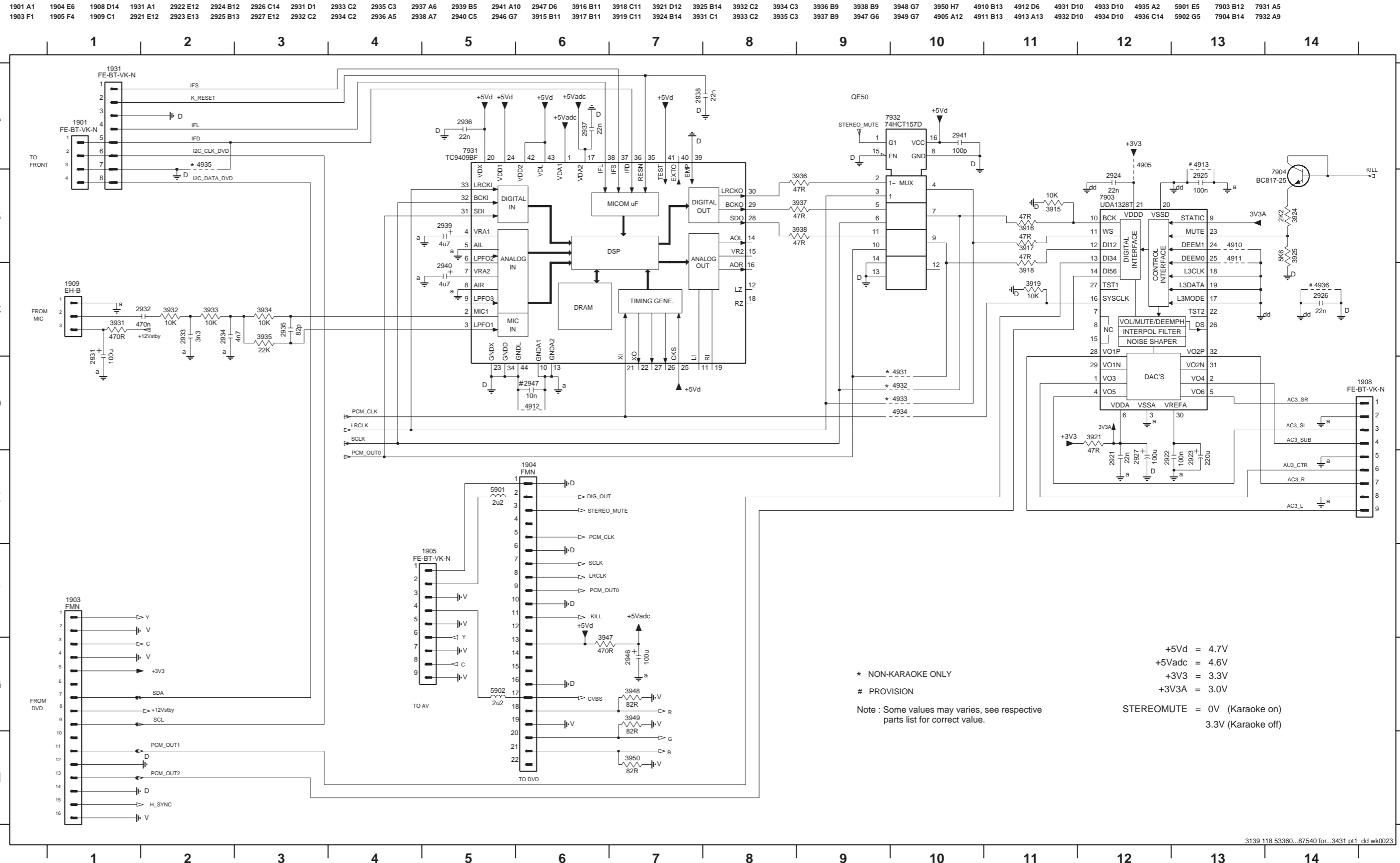

* NON-KARAOKE ONLY
 # PROVISION
 Note : Some values may varies, see respective parts list for correct value.

STEREOMUTE = 0V (Karaoke on)
 3.3V (Karaoke off)

MIC. & DVD OPEN/CLOSE BOARD - COMPONENT LAYOUT

82 A1 1803 A2 1805 A2 2814 A2 3812 A2 9801 A1
1801 A2 1804 A1 2802 A2 2815 A1 5803 A2 9802 A2

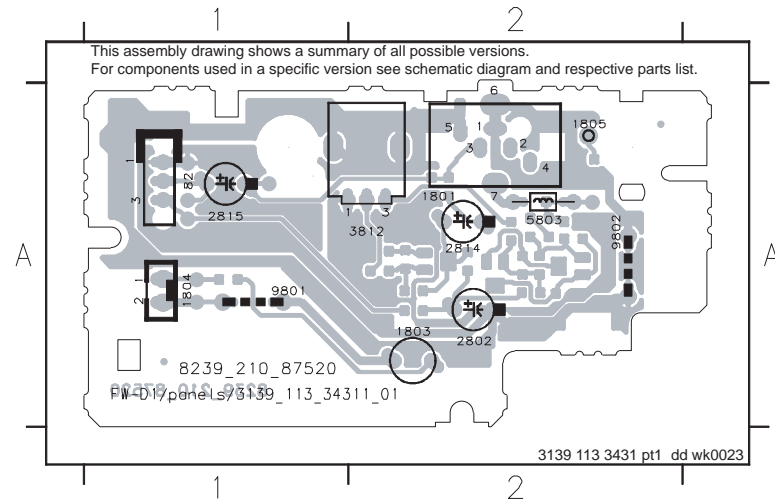

MIC. & DVD OPEN/CLOSE BOARD - CHIP LAYOUT

2803 A1 2812 A1 3803 A1 3807 A1 3815 A1 7803 A1
2804 A1 2813 A1 3804 A1 3808 A1 3816 A1 7804 A1
2805 A1 2818 A1 3805 A1 3813 A1 3817 A2 7806 A1
2806 A1 3802 A1 3806 A1 3814 A1 4801 A1

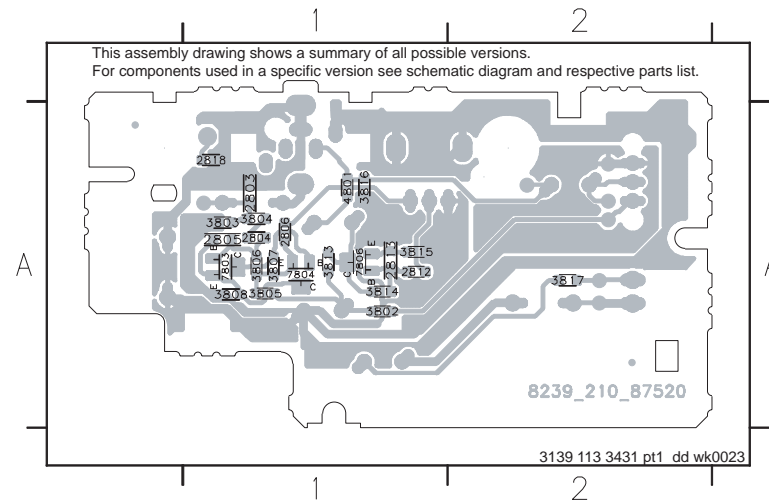

MIC. & DVD OPEN/CLOSE PART - CIRCUIT DIAGRAM

82 B9 1803 D8 1805 C1 2803 B2 2805 B4 2812 B6 2814 B7 2818 C1 3803 C3 3805 A5 3807 B5 3812 B6 3814 B7 3816 B8 5803 B1 7804 B5
1801 B1 1804 D9 2802 A4 2804 B4 2806 B5 2813 B6 2815 B8 3802 B8 3804 B3 3806 B4 3808 C5 3813 B7 3815 C7 3817 D8 7803 B5 7806 B7

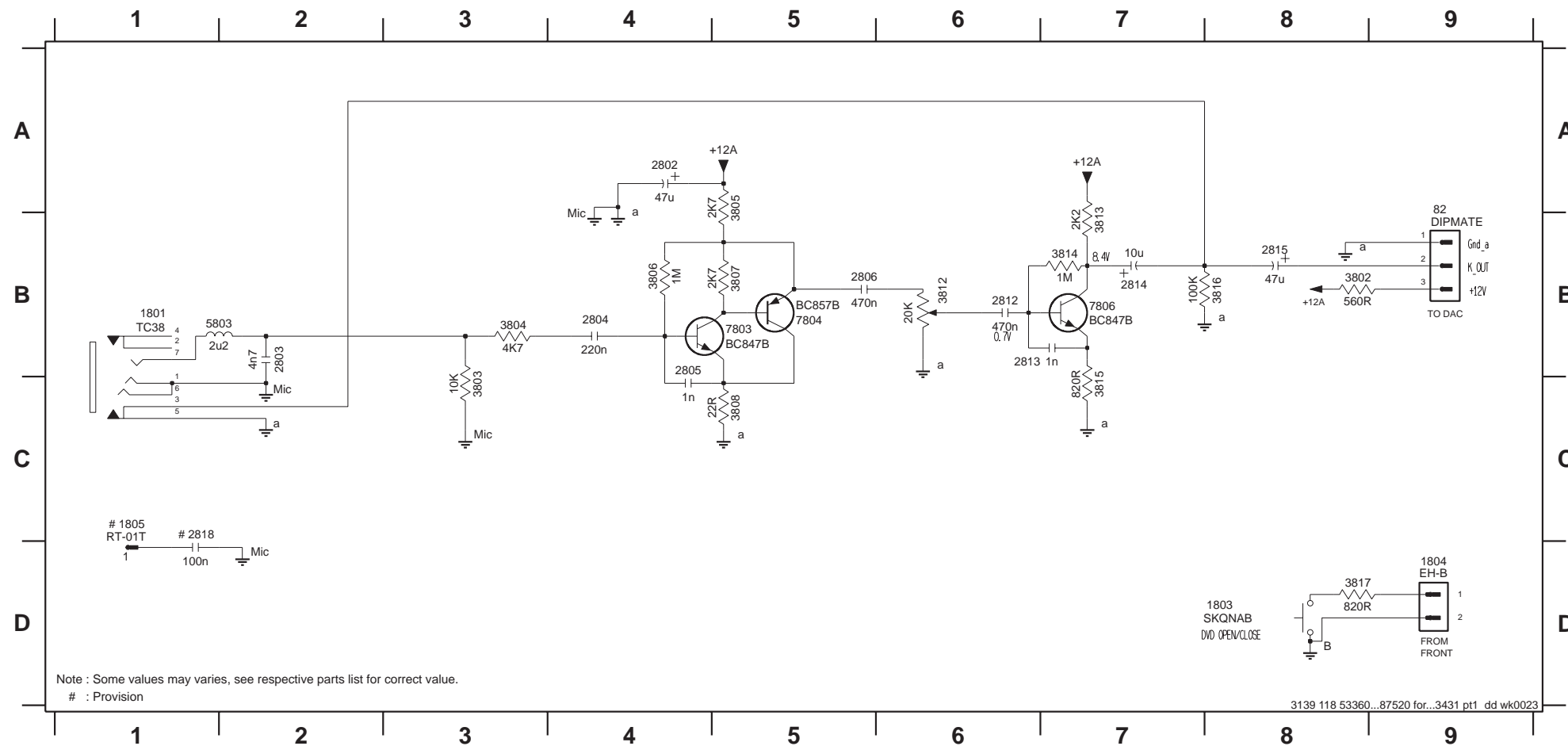

DISC TYPE LED BOARD - COMPONENT LAYOUT

1411 A2 6411 A2 6412 A2 6413 A1

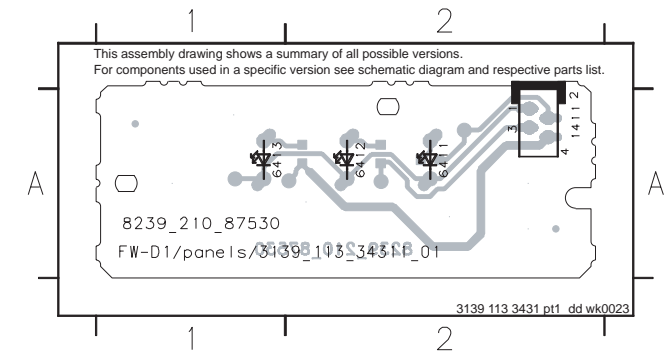

DISC TYPE LED BOARD - CHIP LAYOUT

3411 A1 3412 A1 3413 A1

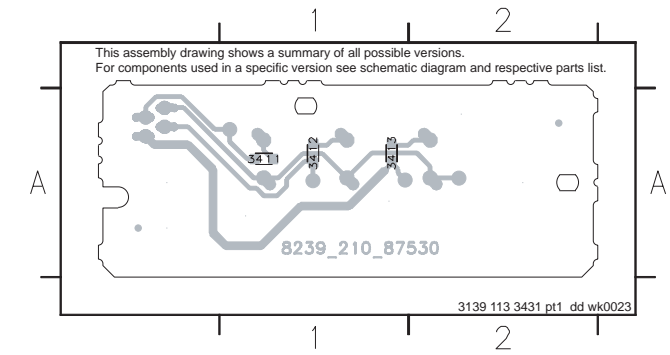

DISC TYPE LED PART - CIRCUIT DIAGRAM

1411 A2 3411 B1 3412 B2 3413 B2 6411 B1 6412 B2 6413 B2

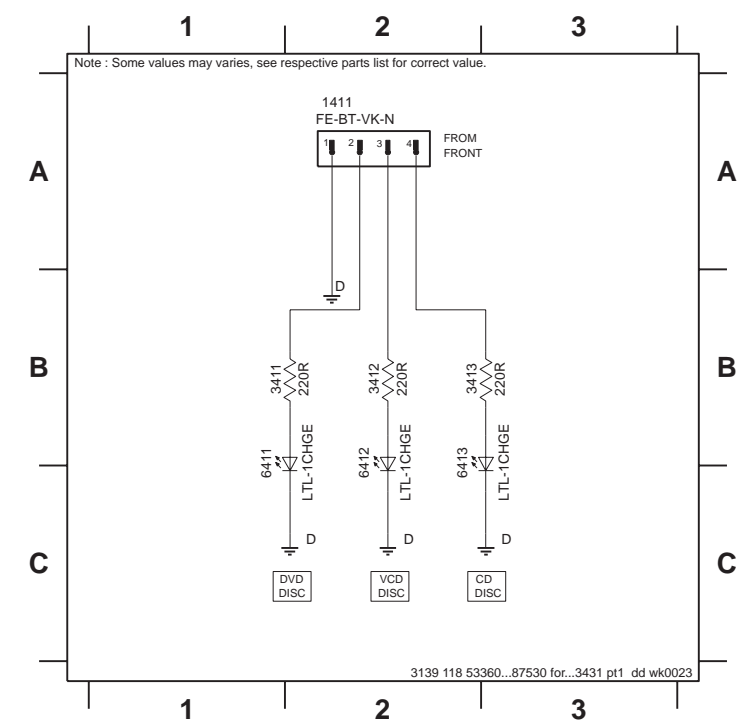

ELECTRICAL PARTS LIST - FRONT BOARD

MISCELLANEOUS

1401	4822 276 13775	Tact Switch	1801	2422 026 05059	Microphone Socket
1402	4822 276 13775	Tact Switch	1803	4822 276 13775	Tact Switch
1403	4822 276 13775	Tact Switch	1901	4822 267 10733	Flex Connector 4P
1404	4822 276 13775	Tact Switch	1903	2422 025 16525	Flex Connector 16P
1405	4822 276 13775	Tact Switch	1904	2422 025 16526	Flex Connector 22P
1406	4822 265 11207	Flex Connector 6P	1905	2422 025 14518	Flex Connector 9P
1411	4822 267 10733	Flex Connector 4P	1908	2422 025 14518	Flex Connector 9P
1421	4822 276 13775	Tact Switch	1931	4822 265 11515	Flex Connector 8P
1422	4822 276 13775	Tact Switch			
1423	4822 276 13775	Tact Switch			
1424	4822 276 13775	Tact Switch			
1425	4822 276 13775	Tact Switch			
1426	4822 276 13775	Tact Switch			
1427	4822 276 13775	Tact Switch			
1428	4822 276 13775	Tact Switch			
1429	4822 276 13775	Tact Switch			
1430	4822 276 13775	Tact Switch			
1431	4822 276 13775	Tact Switch			
1432	4822 276 13775	Tact Switch			
1435	4822 267 10958	Flex Connector 5P			
1436	2422 129 16348	Rotary Encoder 24P			
1441	4822 276 13775	Tact Switch			
1442	4822 276 13775	Tact Switch			
1443	4822 276 13775	Tact Switch			
1444	4822 276 13775	Tact Switch			
1445	4822 276 13775	Tact Switch			
1446	4822 276 13775	Tact Switch			
1447	4822 276 13775	Tact Switch			
1448	4822 276 13775	Tact Switch			
1449	4822 276 13775	Tact Switch			
1450	4822 276 13775	Tact Switch			
1451	4822 276 13775	Tact Switch			
1457	3139 110 52380	FTD Display			
1458	2422 129 16385	Rotary Encoder 12P			
1459	2422 129 16385	Rotary Encoder 12P			
1461	4822 276 13775	Tact Switch			
1462	4822 276 13775	Tact Switch			
1464	4822 276 13775	Tact Switch			
1465	4822 276 13775	Tact Switch			
1466	4822 276 13775	Tact Switch			
1467	4822 276 13775	Tact Switch			
1470	4822 265 11535	Flex Connector 8P			
1471	4822 265 11545	Flex Connector 19P			
1472	4822 265 11183	Flex Connector 4P			
1473	4822 267 10958	Flex Connector 5P			
1474	4822 267 51453	Flex Connector 12P			
1475	4822 265 11183	Flex Connector 4P			
1476	4822 265 11535	Flex Connector 8P			
1478	4822 265 11207	Flex Connector 6P			
1702	4822 267 10731	Flex Connector 6P			
1703	4822 265 11529	Headphone Socket			

CAPACITORS

2401	5322 122 32531	100pF 5% 50V
2421	5322 122 32531	100pF 5% 50V
2425	4822 122 33177	10nF 20% 50V
2426	4822 122 33177	10nF 20% 50V
2441	4822 124 80483	47µF 20% 6,3V
2442	4822 126 14585	100nF 10% 50V
2443	4822 126 14585	100nF 10% 50V
2444	4822 124 80483	47µF 20% 6,3V
2445	4822 124 80483	47µF 20% 6,3V
2446	4822 124 80195	470µF 20% 10V
2447	5322 122 32658	22pF 5% 50V
2448	4822 126 13486	15pF 2% 63V
2449	5322 122 32658	22pF 5% 50V
2450	5322 122 32658	22pF 5% 50V
2451	5322 122 32658	22pF 5% 50V
2455	4822 122 33177	10nF 20% 50V
2456	4822 126 14585	100nF 10% 50V
2457	4822 122 33177	10nF 20% 50V
2458	4822 126 14585	100nF 10% 50V
2461	4822 126 13751	47nF 10% 63V
2462	4822 122 33127	2,2nF 10% 63V
2463	4822 122 33177	10nF 20% 50V
2464	4822 122 33177	10nF 20% 50V
2466	4822 126 13692	47pF 1% 63V
2467	4822 126 13692	47pF 1% 63V
2468	4822 126 13692	47pF 1% 63V
2469	4822 126 13692	47pF 1% 63V
2470	5322 122 32531	100pF 5% 50V
2471	4822 126 13695	82pF 1% 63V
2472	4822 126 13692	47pF 1% 63V
2473	4822 122 33173	560pF 10% 50V
2474	4822 126 13692	47pF 1% 63V
2475	4822 122 33173	560pF 10% 50V
2476	4822 124 22652	2,2µF 20% 50V
2477	4822 126 14585	100nF 10% 50V
2480	4822 126 14585	100nF 10% 50V
2482	5322 122 32531	100pF 5% 50V
2483	5322 122 32531	100pF 5% 50V
2488	4822 122 33177	10nF 20% 50V
2489	4822 122 33177	10nF 20% 50V
2490	4822 126 14585	100nF 10% 50V

ELECTRICAL PARTS LIST - FRONT BOARD

2491	4822 126 14585	100nF 10% 50V	2939	4822 124 40769	4,7µF 20% 100V
2501	4822 126 14043	1µF +80/-20% 16V	2940	4822 124 40769	4,7µF 20% 100V
2502	4822 126 14585	100nF 10% 50V	2941	5322 122 32531	100pF 5% 50V
2503	4822 126 13751	47nF 10% 63V	2946	4822 124 40207	100µF 20% 25V
2504	5322 122 31866	6,8nF 10% 63V			
2505	4822 122 33806	820pF 10% 63V			
2506	4822 126 14076	220nF +80/-20% 25V			
2507	4822 126 14076	220nF +80/-20% 25V			
2508	4822 126 14076	220nF +80/-20% 25V			
2511	4822 124 12032	4,7µF 20% 50V			
2512	4822 126 14043	1µF +80/-20% 16V			
2513	4822 124 12032	4,7µF 20% 50V			
2514	5322 122 32531	100pF 5% 50V			
2516	5322 122 32531	100pF 5% 50V			
2518	5322 122 32531	100pF 5% 50V			
2520	5322 122 32531	100pF 5% 50V			
2522	5322 122 32531	100pF 5% 50V			
2524	5322 122 32531	100pF 5% 50V			
2531	5322 122 32448	10pF 5% 63V			
2532	5322 122 32448	10pF 5% 63V			
2533	4822 126 13838	100nF +80/-20% 50V			
2534	4822 124 40433	47µF 20% 25V			
2591	5322 122 32531	100pF 5% 50V			
2702	5322 122 32654	22nF 10% 63V			
2703	4822 126 14585	100nF 10% 50V			
2704	4822 126 14585	100nF 10% 50V			
2705	5322 122 32654	22nF 10% 63V			
2802	4822 124 40433	47µF 20% 25V			
2803	5322 126 10223	4,7nF 10% 63V			
2804	4822 126 14076	220nF +80/-20% 25V			
2805	5322 122 31647	1nF 10% 63V			
2806	4822 126 13482	470nF +80/-20% 16V			
2812	4822 126 13482	470nF +80/-20% 16V			
2813	5322 122 31647	1nF 10% 63V			
2814	4822 124 21732	10µF 20% 25V			
2815	4822 124 80231	47µF 20% 16V			
2921	5322 122 32654	22nF 10% 63V			
2922	4822 126 14585	100nF 10% 50V			
2923	4822 124 11912	220µF 20% 6,3V			
2924	5322 122 32654	22nF 10% 63V			
2925	4822 126 14585	100nF 10% 50V			
2926	5322 122 32654	22nF 10% 63V			
2927	4822 124 41584	100µF 20% 10V			
2931	4822 124 40207	100µF 20% 25V			
2932	4822 126 13482	470nF +80/-20% 16V			
2933	4822 122 33891	3,3nF 10% 63V			
2934	5322 126 10223	4,7nF 10% 63V			
2935	4822 126 13695	82pF 1% 63V			
2936	5322 122 32654	22nF 10% 63V			
2937	5322 122 32654	22nF 10% 63V			
2938	5322 122 32654	22nF 10% 63V			

RESISTORS

3401	4822 117 10833	10k 1% 0,1W
3402	4822 051 20472	4k7 5% 0,1W
3403	4822 117 12955	2k7 1% 0,1W
3404	4822 051 20182	1k8 5% 0,1W
3405	4822 051 20122	1k2 5% 0,1W
3406	4822 117 11448	180R 1% 0,1W
3407	4822 117 11448	180R 1% 0,1W
3408	4822 117 11448	180R 1% 0,1W
3411	4822 117 11503	220R 1% 0,1W
3412	4822 117 11503	220R 1% 0,1W
3413	4822 117 11503	220R 1% 0,1W
3421	4822 117 11503	220R 1% 0,1W
3422	4822 117 11503	220R 1% 0,1W
3423	4822 117 11504	270R 1% 0,1W
3424	4822 051 20391	390R 5% 0,1W
3425	4822 051 20561	560R 5% 0,1W
3426	4822 117 11454	820R 1% 0,1W
3427	4822 051 20122	1k2 5% 0,1W
3428	4822 051 20182	1k8 5% 0,1W
3429	4822 117 12955	2k7 1% 0,1W
3430	4822 051 20472	4k7 5% 0,1W
3431	4822 117 10833	10k 1% 0,1W
3441	4822 051 10102	1k 2% 0,25W
3442	4822 051 10102	1k 2% 0,25W
3443	4822 051 10102	1k 2% 0,25W
3444	4822 051 10102	1k 2% 0,25W
3445	4822 051 10102	1k 2% 0,25W
3446	4822 051 10102	1k 2% 0,25W
3447	4822 051 10102	1k 2% 0,25W
3448	4822 051 10102	1k 2% 0,25W
3449	4822 051 10102	1k 2% 0,25W
3450	4822 051 10102	1k 2% 0,25W
3451	4822 051 10102	1k 2% 0,25W
3452	4822 051 10102	1k 2% 0,25W
3453	4822 051 10102	1k 2% 0,25W
3454	4822 051 10102	1k 2% 0,25W
3455	4822 051 10102	1k 2% 0,25W
3456	4822 051 10102	1k 2% 0,25W
3457	4822 051 10102	1k 2% 0,25W
3458	4822 051 10102	1k 2% 0,25W
3459	4822 051 10102	1k 2% 0,25W
3460	4822 051 10102	1k 2% 0,25W
3461	4822 051 10102	1k 2% 0,25W
3462	4822 051 10102	1k 2% 0,25W
3463	4822 051 10102	1k 2% 0,25W

ELECTRICAL PARTS LIST - FRONT BOARD

RESISTORS

3464	4822 051 10102	1k 2% 0,25W	3518	4822 051 20392	3k9 5% 0,1W
3465	4822 051 20471	470R 5% 0,1W	3519	4822 051 20471	470R 5% 0,1W
3466	4822 051 10102	1k 2% 0,25W	3520	4822 051 20471	470R 5% 0,1W
3467	4822 051 10102	1k 2% 0,25W	3521	4822 051 10102	1k 2% 0,25W
3468	4822 051 10102	1k 2% 0,25W	3522	4822 051 20101	100R 5% 0,1W
3470	4822 051 20101	100R 5% 0,1W	3523	4822 051 10102	1k 2% 0,25W
3471	4822 051 20101	100R 5% 0,1W	3524	4822 051 10102	1k 2% 0,25W
3472	4822 051 20101	100R 5% 0,1W	3525	4822 051 10102	1k 2% 0,25W
3473	4822 051 20101	100R 5% 0,1W	3526	4822 051 20101	100R 5% 0,1W
3474	4822 051 20101	100R 5% 0,1W	3527	4822 051 20101	100R 5% 0,1W
3475	4822 051 20101	100R 5% 0,1W	3528	4822 051 10102	1k 2% 0,25W
3476	4822 051 20101	100R 5% 0,1W	3529	4822 051 10102	1k 2% 0,25W
3477	4822 051 20101	100R 5% 0,1W	3531	4822 051 20472	4k7 5% 0,1W
3478	4822 051 20101	100R 5% 0,1W	3532	4822 117 10833	10k 1% 0,1W
3479	4822 051 20101	100R 5% 0,1W	3533	4822 051 10102	1k 2% 0,25W
3480	4822 051 20101	100R 5% 0,1W	3534	4822 117 10837	100k 1% 0,1W
3481	4822 051 20101	100R 5% 0,1W	3535	4822 051 20472	4k7 5% 0,1W
3482	4822 051 20101	100R 5% 0,1W	3536	4822 051 10102	1k 2% 0,25W
3483	4822 051 20101	100R 5% 0,1W	3537	4822 051 10102	1k 2% 0,25W
3484	4822 051 20101	100R 5% 0,1W	3538	4822 117 10833	10k 1% 0,1W
3485	4822 051 20101	100R 5% 0,1W	3539	4822 117 10833	10k 1% 0,1W
3486	4822 051 20101	100R 5% 0,1W	3541	4822 051 20479	47R 5% 0,1W
3487	4822 051 10102	1k 2% 0,25W	3542	4822 117 10833	10k 1% 0,1W
3490	4822 051 10102	1k 2% 0,25W	3543	4822 051 10102	1k 2% 0,25W
3491	4822 051 10102	1k 2% 0,25W	3544	4822 117 10837	100k 1% 0,1W
3492	4822 051 10102	1k 2% 0,25W	3545	4822 117 10833	10k 1% 0,1W
3493	4822 051 10102	1k 2% 0,25W	3546	4822 117 12955	2k7 1% 0,1W /21/21M
3494	4822 051 10102	1k 2% 0,25W	3546	4822 051 20472	4k7 5% 0,1W /22
3495	4822 051 10102	1k 2% 0,25W	3546	4822 051 20822	8k2 5% 0,1W /30/37
3496	4822 051 10102	1k 2% 0,25W	3547	4822 117 10833	10k 1% 0,1W
3497	4822 051 10102	1k 2% 0,25W	3548	4822 117 10833	10k 1% 0,1W
3498	4822 051 10102	1k 2% 0,25W	3551	4822 051 10102	1k 2% 0,25W
3499	4822 051 10102	1k 2% 0,25W	3552	4822 051 10102	1k 2% 0,25W
3500	4822 051 10102	1k 2% 0,25W	3553	4822 051 20471	470R 5% 0,1W
3501	4822 051 10102	1k 2% 0,25W	3554	4822 051 20101	100R 5% 0,1W
3502	4822 051 10102	1k 2% 0,25W	3555	4822 117 10833	10k 1% 0,1W
3503	4822 051 10102	1k 2% 0,25W	3557	4822 117 10833	10k 1% 0,1W
3504	4822 051 10102	1k 2% 0,25W	3558	4822 117 10833	10k 1% 0,1W
3505	4822 051 10102	1k 2% 0,25W	3559	4822 117 10833	10k 1% 0,1W
3506	4822 051 10102	1k 2% 0,25W	3561	4822 051 10102	1k 2% 0,25W
3509	4822 117 11503	220R 1% 0,1W	3562	4822 117 13579	220k 1% 0,1W
3510	4822 117 11503	220R 1% 0,1W	3563	4822 117 11449	2k2 5% 0,1W
3511	4822 117 11503	220R 1% 0,1W	3564	4822 117 10833	10k 1% 0,1W
3512	4822 117 11503	220R 1% 0,1W	3565	4822 117 10833	10k 1% 0,1W
3513	4822 051 10102	1k 2% 0,25W	3566	4822 117 10833	10k 1% 0,1W
3513	4822 117 11503	220R 1% 0,1W /21/21M	3567	4822 117 10833	10k 1% 0,1W
3514	4822 051 10102	1k 2% 0,25W	3568	4822 051 20472	4k7 5% 0,1W
3514	4822 117 11503	220R 1% 0,1W /21/21M	3569	4822 117 13577	330R 1% 1,25W
3515	4822 051 10102	1k 2% 0,25W	3570	4822 051 20471	470R 5% 0,1W
3516	4822 051 10102	1k 2% 0,25W	3573	4822 051 20471	470R 5% 0,1W
3517	4822 051 20392	3k9 5% 0,1W	3574	4822 051 20471	470R 5% 0,1W

ELECTRICAL PARTS LIST - FRONT BOARD

3575	4822 051 20471	470R 5% 0,1W	3640	4822 117 11503	220R 1% 0,1W
3576	4822 051 20471	470R 5% 0,1W	3641	4822 117 11503	220R 1% 0,1W
3577	4822 117 10837	100k 1% 0,1W	3642	4822 051 20105	1M 5% 0,1W
3578	4822 051 10102	1k 2% 0,25W	3643	4822 051 20684	680k 5% 0,1W
3579	4822 117 10833	10k 1% 0,1W	3644	4822 051 20105	1M 5% 0,1W
3582	4822 117 12955	2k7 1% 0,1W	3645	4822 051 10102	1k 2% 0,25W
3583	4822 117 12955	2k7 1% 0,1W	3646	4822 051 20471	470R 5% 0,1W
3584	4822 117 12955	2k7 1% 0,1W	3647	4822 051 20471	470R 5% 0,1W
3585	4822 117 11503	220R 1% 0,1W	3648	4822 051 10102	1k 2% 0,25W
3586	4822 117 11503	220R 1% 0,1W	3649	4822 051 10102	1k 2% 0,25W
3587	4822 117 11504	270R 1% 0,1W	3650	4822 051 20479	47R 5% 0,1W
3588	4822 051 20391	390R 5% 0,1W	3655	4822 117 10833	10k 1% 0,1W
3589	4822 051 20561	560R 5% 0,1W	3656	4822 117 10833	10k 1% 0,1W
3590	4822 117 11454	820R 1% 0,1W	3663	4822 117 11149	82k 1% 0,1W
3591	4822 117 11503	220R 1% 0,1W	3664	4822 117 11149	82k 1% 0,1W
3592	4822 117 11503	220R 1% 0,1W	3665	4822 117 11149	82k 1% 0,1W
3593	4822 117 11504	270R 1% 0,1W	3666	4822 117 11149	82k 1% 0,1W
3594	4822 051 20391	390R 5% 0,1W	3667	4822 117 11149	82k 1% 0,1W
3595	4822 051 20561	560R 5% 0,1W	3668	4822 117 11149	82k 1% 0,1W
3596	4822 117 11454	820R 1% 0,1W	3669	4822 051 20472	4k7 5% 0,1W
3597	4822 051 20122	1k2 5% 0,1W	3670	4822 117 11448	180R 1% 0,1W
3598	4822 051 20182	1k8 5% 0,1W	3671	4822 117 11448	180R 1% 0,1W
3599	4822 117 12955	2k7 1% 0,1W	3672	4822 117 11448	180R 1% 0,1W
3600	4822 051 20472	4k7 5% 0,1W	3675	4822 117 11149	82k 1% 0,1W
3601	4822 117 10833	10k 1% 0,1W	3676	4822 117 11149	82k 1% 0,1W
3603	4822 051 20471	470R 5% 0,1W	3677	4822 117 11149	82k 1% 0,1W
3605	4822 117 11504	270R 1% 0,1W	3691	4822 051 20471	470R 5% 0,1W
3606	4822 117 11504	270R 1% 0,1W	3692	4822 117 10833	10k 1% 0,1W
3607	4822 117 11504	270R 1% 0,1W	3693	4822 117 10833	10k 1% 0,1W
3608	4822 117 11504	270R 1% 0,1W	3694	4822 117 10833	10k 1% 0,1W
3609	4822 117 11504	270R 1% 0,1W	3695	4822 117 10833	10k 1% 0,1W
3610	4822 051 20471	470R 5% 0,1W	3696	4822 051 20101	100R 5% 0,1W
3615	4822 117 11448	180R 1% 0,1W	3697	4822 051 20101	100R 5% 0,1W
3616	4822 116 52213	180R 5% 0,5W	3698	4822 051 20822	8k2 5% 0,1W
3617	4822 117 11448	180R 1% 0,1W	3699	4822 117 11449	2k2 5% 0,1W
3618	4822 117 11448	180R 1% 0,1W	3700	4822 051 20822	8k2 5% 0,1W
3619	4822 117 11448	180R 1% 0,1W	3701	4822 117 11449	2k2 5% 0,1W
3620	4822 117 11139	1k5 1% 0,1W	3702	4822 051 10102	1k 2% 0,25W
3621	4822 117 11139	1k5 1% 0,1W	3703	4822 117 10833	10k 1% 0,1W
3622	4822 117 11139	1k5 1% 0,1W	3704	4822 117 10833	10k 1% 0,1W
3623	4822 051 20684	680k 5% 0,1W	3802	4822 051 20561	560R 5% 0,1W
3624	4822 051 20684	680k 5% 0,1W	3803	4822 117 10833	10k 1% 0,1W
3625	4822 051 20684	680k 5% 0,1W	3804	4822 051 20472	4k7 5% 0,1W
3626	4822 117 10834	47k 1% 0,1W	3805	4822 117 12955	2k7 1% 0,1W
3627	4822 117 10834	47k 1% 0,1W	3806	4822 051 20105	1M 5% 0,1W
3628	4822 117 10834	47k 1% 0,1W	3807	4822 117 12955	2k7 1% 0,1W
3629	4822 051 20474	470k 5% 0,1W	3808	4822 051 20229	22R 5% 0,1W
3630	4822 051 20474	470k 5% 0,1W	3812	2120 366 90292	POTM CAR LOG 20k
3631	4822 051 20474	470k 5% 0,1W	3813	4822 117 12955	2k7 1% 0,1W
3636	4822 117 10833	10k 1% 0,1W	3814	4822 051 20105	1M 5% 0,1W
3637	4822 117 10833	10k 1% 0,1W	3815	4822 117 11454	820R 1% 0,1W

ELECTRICAL PARTS LIST - FRONT BOARD**RESISTORS**

3816	4822 117 10837	100k 1% 0,1W	4468	4822 051 20008	OR Jumper 0805
3817	4822 117 11454	820R 1% 0,1W	4469	4822 051 20008	OR Jumper 0805
3915	4822 117 10833	10k 1% 0,1W	4470	4822 051 20008	OR Jumper 0805
3916	4822 051 20479	47R 5% 0,1W	4471	4822 051 20008	OR Jumper 0805
3917	4822 051 20479	47R 5% 0,1W	4472	4822 051 20008	OR Jumper 0805
3918	4822 051 20479	47R 5% 0,1W	4473	4822 051 20008	OR Jumper 0805
3919	4822 117 10833	10k 1% 0,1W	4474	4822 051 20008	OR Jumper 0805
3921	4822 051 20479	47R 5% 0,1W	4475	4822 051 20008	OR Jumper 0805
3924	4822 117 11449	2k2 5% 0,1W	4476	4822 051 20008	OR Jumper 0805
3925	4822 051 20562	5k6 5% 0,1W	4477	4822 051 20008	OR Jumper 0805
3931	4822 051 20471	470R 5% 0,1W	4478	4822 051 20008	OR Jumper 0805
3932	4822 117 10833	10k 1% 0,1W	4479	4822 051 20008	OR Jumper 0805
3933	4822 117 10833	10k 1% 0,1W	4480	4822 051 20008	OR Jumper 0805
3934	4822 117 10833	10k 1% 0,1W	4481	4822 051 20008	OR Jumper 0805
3935	4822 051 20223	22k 5% 0,1W	4482	4822 051 20008	OR Jumper 0805
3936	4822 051 20479	47R 5% 0,1W	4483	4822 051 20008	OR Jumper 0805
3937	4822 051 20479	47R 5% 0,1W	4484	4822 051 20008	OR Jumper 0805
3938	4822 051 20479	47R 5% 0,1W	4485	4822 051 20008	OR Jumper 0805
3947	4822 051 20471	470R 5% 0,1W	4486	4822 051 20008	OR Jumper 0805
3948	4822 051 20829	82R 5% 0,1W	4490	4822 051 20008	OR Jumper 0805
3949	4822 051 20829	82R 5% 0,1W	4491	4822 051 20008	OR Jumper 0805
3950	4822 051 20829	82R 5% 0,1W	4492	4822 051 20008	OR Jumper 0805
4401	4822 051 20008	OR Jumper 0805	4494	4822 051 20008	OR Jumper 0805
4422	4822 051 20008	OR Jumper 0805	4607	4822 051 20008	OR Jumper 0805
4441	4822 051 20008	OR Jumper 0805	4691	4822 051 20008	OR Jumper 0805
4442	4822 051 20008	OR Jumper 0805	4692	4822 051 20008	OR Jumper 0805
4443	4822 051 20008	OR Jumper 0805	4693	4822 051 20008	OR Jumper 0805
4444	4822 051 20008	OR Jumper 0805	4694	4822 051 20008	OR Jumper 0805
4445	4822 051 20008	OR Jumper 0805	4695	4822 051 20008	OR Jumper 0805
4446	4822 051 20008	OR Jumper 0805	4701	4822 051 20008	OR Jumper 0805
4447	4822 051 20008	OR Jumper 0805	4702	4822 051 20008	OR Jumper 0805
4448	4822 051 20008	OR Jumper 0805	4703	4822 051 20008	OR Jumper 0805
4449	4822 051 20008	OR Jumper 0805	4705	4822 051 20008	OR Jumper 0805
4450	4822 051 20008	OR Jumper 0805	4801	4822 051 20008	OR Jumper 0805
4451	4822 051 20008	OR Jumper 0805	4905	4822 051 20008	OR Jumper 0805
4452	4822 051 20008	OR Jumper 0805	4906	4822 051 20008	OR Jumper 0805
4453	4822 051 20008	OR Jumper 0805	4910	4822 051 20008	OR Jumper 0805
4454	4822 051 20008	OR Jumper 0805	4911	4822 051 20008	OR Jumper 0805
4455	4822 051 20008	OR Jumper 0805	4912	4822 051 20008	OR Jumper 0805
4456	4822 051 20008	OR Jumper 0805	4931	4822 051 20008	OR Jumper 0805
4457	4822 051 20008	OR Jumper 0805	4932	4822 051 20008	OR Jumper 0805
4458	4822 051 20008	OR Jumper 0805	4933	4822 051 20008	OR Jumper 0805
4459	4822 051 20008	OR Jumper 0805	4934	4822 051 20008	OR Jumper 0805
4460	4822 051 20008	OR Jumper 0805	4935	4822 051 20008	OR Jumper 0805
4461	4822 051 20008	OR Jumper 0805	4940	4822 051 20008	OR Jumper 0805
4462	4822 051 20008	OR Jumper 0805	4941	4822 051 20008	OR Jumper 0805
4463	4822 051 20008	OR Jumper 0805	4942	4822 051 20008	OR Jumper 0805
4464	4822 051 20008	OR Jumper 0805	4943	4822 051 20008	OR Jumper 0805
4465	4822 051 20008	OR Jumper 0805	4944	4822 051 20008	OR Jumper 0805
4466	4822 051 20008	OR Jumper 0805	4945	4822 051 20008	OR Jumper 0805
4467	4822 051 20008	OR Jumper 0805	4946	4822 051 20008	OR Jumper 0805

ELECTRICAL PARTS LIST - FRONT BOARD

4947	4822 051 20008	OR Jumper 0805
4948	4822 051 20008	OR Jumper 0805
4949	4822 051 20008	OR Jumper 0805
4950	4822 051 20008	OR Jumper 0805
4951	4822 051 20008	OR Jumper 0805
4952	4822 051 20008	OR Jumper 0805
4953	4822 051 20008	OR Jumper 0805
4954	4822 051 20008	OR Jumper 0805
4955	4822 051 20008	OR Jumper 0805
4956	4822 051 20008	OR Jumper 0805
4957	4822 051 20008	OR Jumper 0805

COILS & FILTERS

5441	5322 242 73686	RES CER 12MHz
5442	2422 543 01069	RES XTL 32kHz768
5443	4822 157 62552	Coil 2,2µH 5%
5444	4822 157 62552	Coil 2,2µH 5%
5445	4822 157 62552	Coil 2,2µH 5%
5446	4822 157 62552	Coil 2,2µH 5%
5448	4822 157 62552	Coil 2,2µH 5%
5450	4822 157 62552	Coil 2,2µH 5%
5451	4822 242 72195	QUARZ 4,332MHz
5701	4822 157 62552	Coil 2,2µH 5%
5702	4822 157 10586	Coil 2,2µH 10%
5703	4822 157 62552	Coil 2,2µH 5%
5803	4822 157 62552	Coil 2,2µH 5%
5901	4822 157 10586	Coil 2,2µH 10%
5902	4822 157 10586	Coil 2,2µH 10%

DIODES

6401	4822 130 10791	LTL-1CHGE
6402	4822 130 10791	LTL-1CHGE
6403	4822 130 10791	LTL-1CHGE
6411	4822 130 10791	LTL-1CHGE
6412	4822 130 10791	LTL-1CHGE
6413	4822 130 10791	LTL-1CHGE
6415	9322 153 37676	LB3333RT-E7898
6441	9322 153 38676	LO3336UV-E7898
6442	9322 153 38676	LO3336UV-E7898
6443	9322 153 38676	LO3336UV-E7898
6444	9322 153 38676	LO3336UV-E7898
6445	9322 153 38676	LO3336UV-E7898
6451	4822 130 10791	LTL-1CHGE
6452	4822 130 10791	LTL-1CHGE
6453	4822 130 10791	LTL-1CHGE
6454	4822 130 10791	LTL-1CHGE
6455	4822 130 11589	LTL-1CHAE
6457	4822 130 82978	LTL-1CHPE
6458	9322 153 53676	LED VS LB5416
6459	9322 153 53676	LED VS LB5416
6460	4822 130 10165	GR1U28XP

6461	4822 130 31878	1N4003G
6463	4822 130 30621	1N4148
6471	4822 130 30621	1N4148
6472	4822 130 30621	1N4148
6473	4822 130 30621	1N4148
6474	4822 130 30621	1N4148

TRANSISTORS & INTEGRATED CIRCUITS

7441	3139 110 52370	TMP88CU77 - 'D51S52371'
7442	9322 145 26668	M24C02-WMN6
7443	4822 209 15449	74HC4094D
7444	4822 209 15449	74HC4094D
7445	4822 209 31981	SAA6579T/V1
7448	5322 130 60159	BC847B
7449	5322 130 60159	BC847B
7451	5322 130 60159	BC847B
7452	5322 130 60159	BC847B
7454	5322 130 60159	BC847B
7455	5322 130 60159	BC847B
7456	5322 130 60159	BC847B
7457	5322 130 60159	BC847B
7458	5322 130 60159	BC847B
7459	5322 130 60159	BC847B
7491	5322 209 11306	HEF4094BT
7492	5322 130 60159	BC847B
7493	5322 130 60159	BC847B
7803	5322 130 60159	BC847B
7804	4822 130 60373	BC857B
7806	5322 130 60159	BC847B
7903	4822 209 17423	UDA1328T/N1
7904	4822 130 42804	BC817-25
7931	4822 209 15973	TC9409BF
7932	9337 137 50653	74HCT157D

Note : Only the parts mentioned in this list are normal service spare parts.

BLOCKDIAGRAM

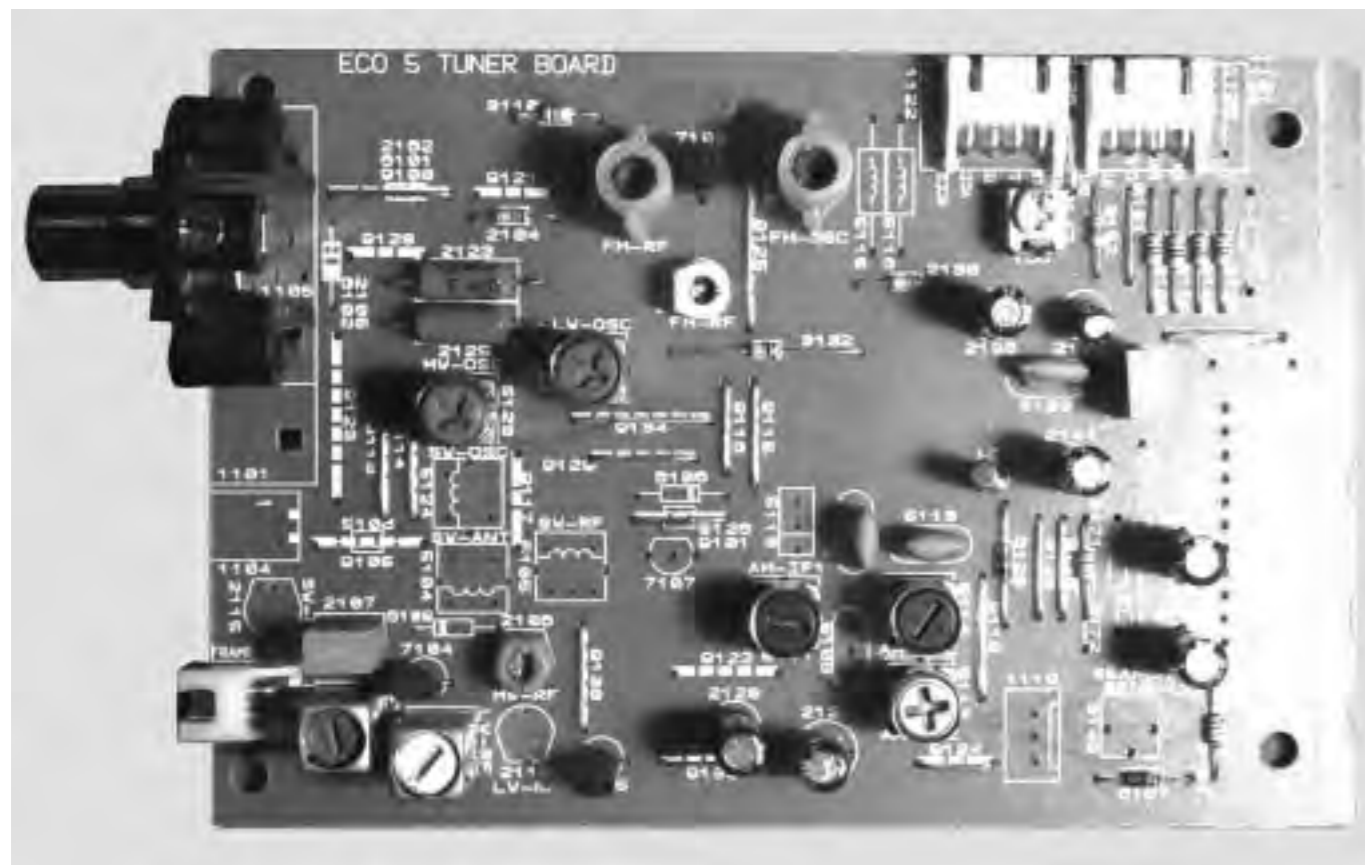

TUNER BOARD ECO5

TABLE OF CONTENTS

Blockdiagram7B-1
 Adjustant table7B-2
 Component layout7B-2
 Circuit diagram7B-3
 Partslist7B-4

TUNER BOARD ECO 5 systems

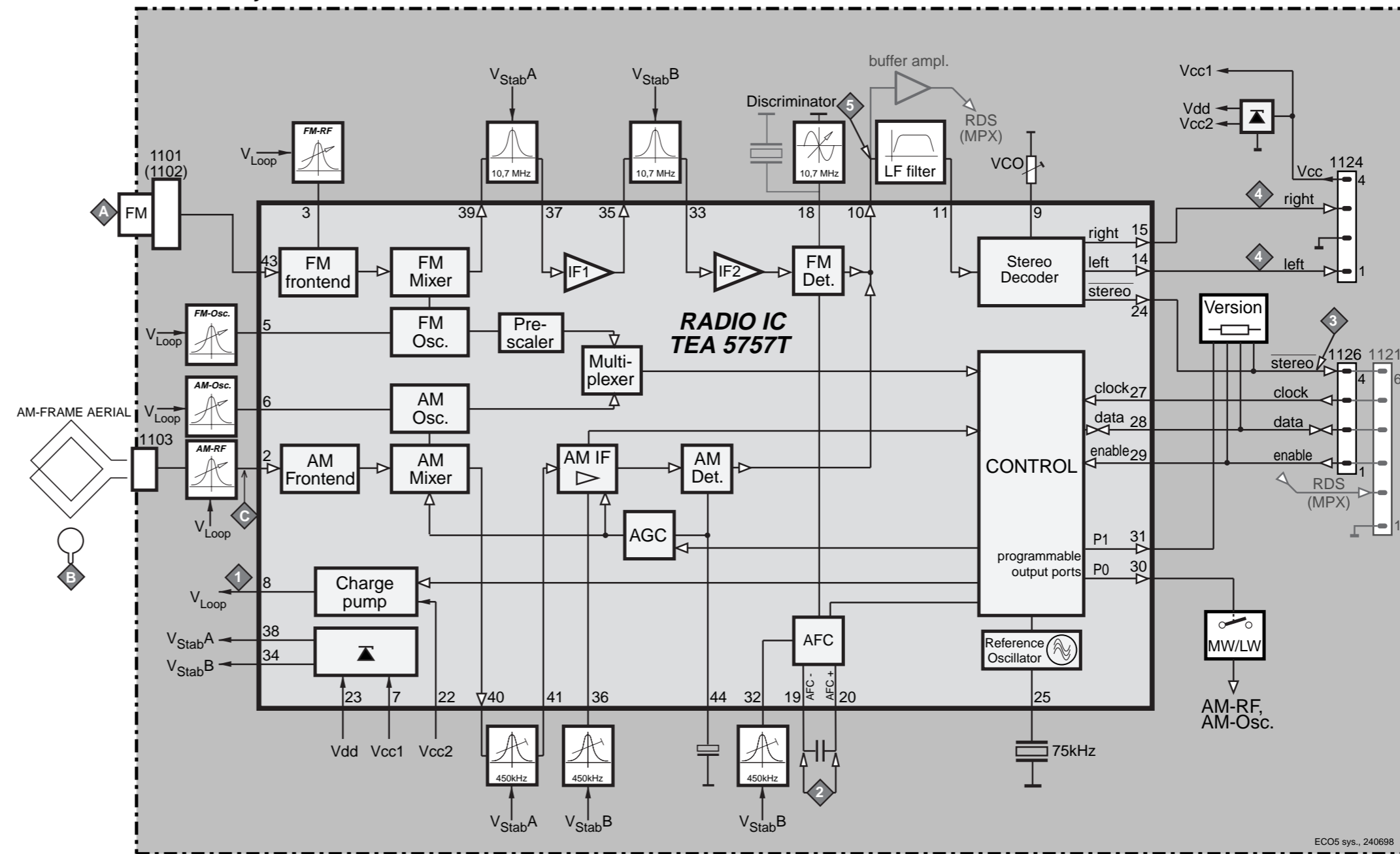

1101 A1	2106 C2	2137 C5	3149 C5	3173 A5	5114 C4	5130 A3	7104 C2	9117 B2	9129 B3
1102 A1	2107 C2	2138 A5	3152 A5	5102 C2	5115 A4	5131 A3	7105 C3	9118 B4	9130 C3
1103 C1	2110 C2	2144 B5	3154 C5	5103 C2	5116 A4	6101 A2	7107 B3	9119 C4	9131 A5
1104 B1	2115 C1	2148 B4	3157 B5	5104 C2	5119 B5	6102 A1	7119 C4	9120 B4	9133 C3
1105 A1	2123 A2	2155 A3	3158 A5	5105 B2	5120 B4	6103 A1	9100 A2	9121 A2	9134 B3
1119 C5	2125 A2	2162 A2	3159 A5	5106 B2	5121 B4	6104 A2	9101 B3	9122 C3	9136 A5
1120 A5	2128 C3	3105 B3	3160 A5	5109 B4	5122 B3	6106 B3	9105 B2	9123 B1	9137 A5
1130 B5	2129 C4	3110 A2	3161 A5	5110 B4	5123 B2	6107 C5	9111 C2	9124 C4	
1131 B5	2130 A4	3132 B3	3170 C5	5111 C3	5124 B2	6109 C2	9113 B2	9125 A3	
2104 A2	2133 A4	3142 A4	3171 C5	5112 C4	5126 B3	6120 C4	9114 B2	9126 B5	
2105 A1	2135 B5	3147 B5	3172 C5	5113 B3	5127 B4	7102 A3	9115 B3	9128 A2	

2101 C4	2118 B4	2139 B2	2153 C3	2166 B2	3112 A3	3123 A3	3143 C2	3175 A2	4105 B3	4153 B4	6105 A4	7120 B4
2102 C4	2119 B4	2141 B1	2154 C3	2167 B2	3113 A2	3125 A3	3144 C2	3176 C2	4106 B4	4154 C3	6110 A4	7121 B3
2103 C3	2120 B4	2142 B1	2156 C4	2168 B1	3114 A3	3126 B3	3145 C2	3177 A1	4107 C4	4155 A4	6111 B4	7122 B4
2108 A4	2122 B3	2143 A1	2157 B4	3101 C3	3115 A3	3127 B3	3146 A1	3178 A1	4108 B4	4156 A2	6130 C2	7123 B4
2109 A4	2124 A5	2145 C1	2158 B4	3102 C3	3116 A3	3128 B3	3148 A1	3179 A1	4109 A3	4157 B3	6131 C3	7124 C4
2111 A2	2126 C2	2146 C1	2159 C2	3103 C3	3117 B4	3133 B4	3153 C2	3180 A4	4110 A3	4158 C2	7101 B2	7125 A1
2112 B5	2127 C2	2147 C1	2160 C4	3104 B3	3118 B3	3134 B4	3155 A2	3181 C3	4111 C1	4159 A2	7103 C2	
2113 A4	2131 C2	2149 B2	2161 A3	3106 C4	3119 A3	3136 B4	3156 A1	4101 A4	4120 C2	4160 A1	7106 A3	
2114 A4	2132 C1	2150 B2	2163 A2	3108 A4	3120 B4	3137 B4	3167 C2	4102 A4	4150 B2	4161 A1	7108 A3	
2116 B3	2134 C1	2151 C2	2164 B1	3109 A4	3121 A3	3140 B2	3168 B3	4103 C2	4151 B3	4162 C1	7109 A3	
2117 A3	2136 B1	2152 C3	2165 B3	3111 A3	3122 B3	3141 C2	3169 B2	4104 A2	4152 B3	4163 C1	7111 A1	

TUNER ADJUSTMENT TABLE (ECO5 FM/MW- and FM/MW/LW - versions with AM-frame aerial)

Waverange	Input frequency	Input	Tuned to	Adjust	Output	Scope/Voltmeter
VARICAP ALIGNMENT						
FM 87.5 - 108MHz (65.81 - 74, 87.5 - 108MHz)			108MHz	5130		8V ±0.2V
			87.5MHz (65.81MHz)	check		4.3V ±0.5V (1.2V ±0.5V)
MW FM/AM-version, 10kHz grid 530 - 1700kHz			1700kHz	5123		8V ±0.2V
			530kHz	check		1.1V ±0.4V
FM/MW-version, 9kHz grid 531 - 1602kHz			1602kHz	5123	1	6.9V ±0.2V
			531kHz	check		1.1V ±0.4V
LW	153 - 279kHz		279kHz	5122		8V ±0.2V
			153kHz	check		1.1V ±0.4V
MW FM/MW/LW-version, 9kHz grid 531 - 1602kHz			1602kHz	5123		8V ±0.2V
			531kHz	check		1.1V ±0.4V
FM IF						
FM	10.7MHz, 50mV continuous wave	F	IC 7101 21 shortcircuit to block AFC	5119	2	0 ± 3 mV DC
FM RF						
FM 87.5 - 108MHz (65.81 - 74, 87.5 - 108MHz)	108MHz	A		2155	4	MAX
	87.5MHz (65.81MHz)	mod=1kHz Δf=±22.5kHz		5131		
VCO						
FM	98MHz, 1mV continuous wave	A		98MHz	3	152kHz ±1kHz ¹⁾
AM IF						
MW	450kHz connect pin 6 of IC 7101 (AM Osc.) with short wire to ground (pin 4)	C	IC 7101 36 100nF	5111	4	symmetric
		C	IC 7101 40 100nF see remark 2)	5112		
AM AFC		C		5114	2	0 ± 2 mV DC
AM RF³⁾						
MW⁴⁾ FM/MW/LW- and FM/MW-version (9kHz grid) 531 - 1602kHz	1494kHz	B		1494kHz	2106	4
	558kHz			558kHz	5102	
LW	198kHz			198kHz	5103	
MW FM/AM-version, 10kHz grid 530 - 1700kHz	1500kHz	Δf = ±30kHz V _{RF} as low as possible		1500kHz	2106	4
	560kHz			560kHz	5102	

Use service test program. By selecting the TUNER TEST test frequencies will be stored as preset frequencies automatically.

1) If sensitivity of frequency counter is too low adjust to max. channel separation (input signal: stereo left 90% + 9%, adjust output on right channel to minimum)

2) RC network serves for damping the IF-filter while adjusting the other one.

3) For AM RF adjustments the original frame antenna has to be used!

4) MW has to be aligned before LW.

Repeat

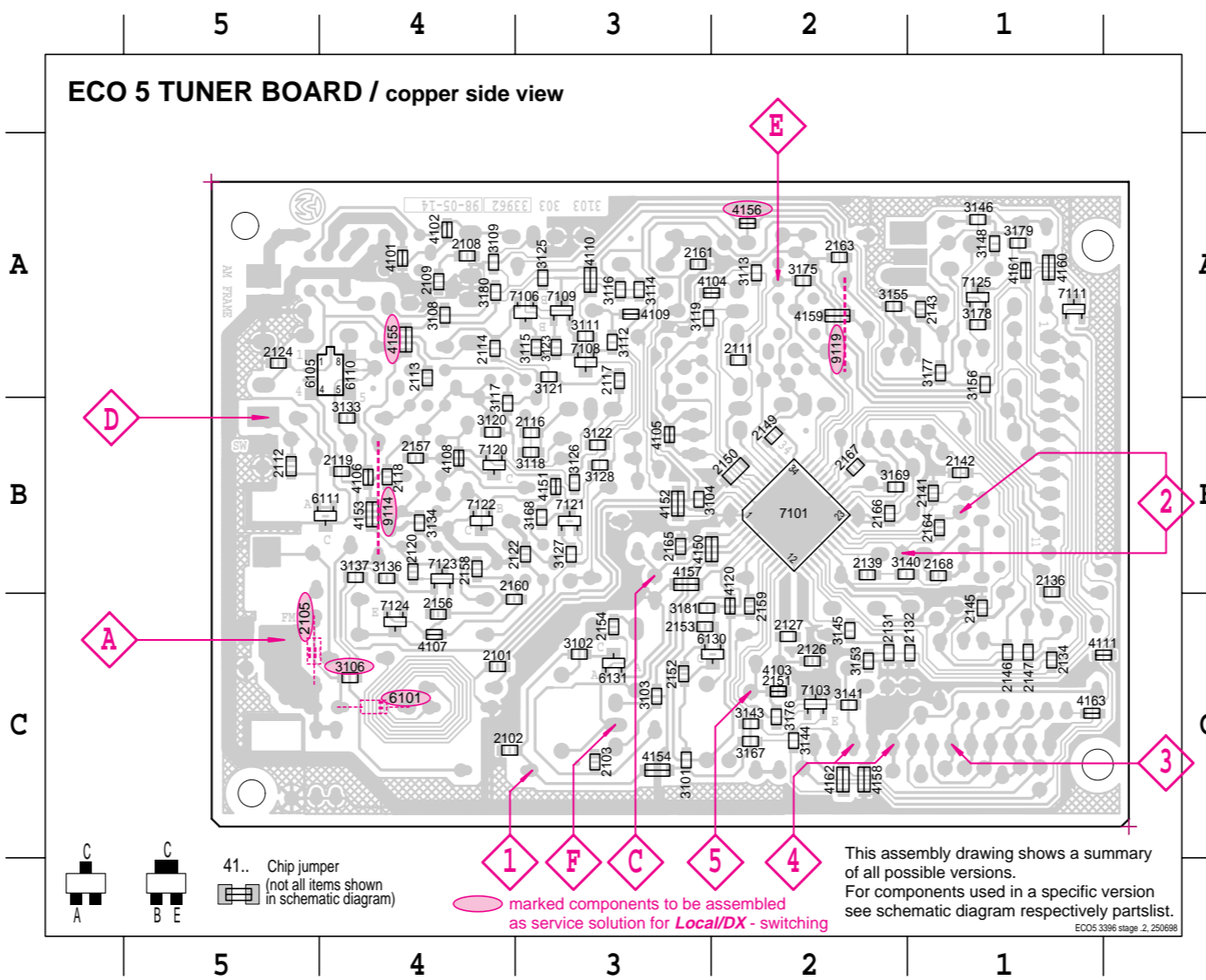
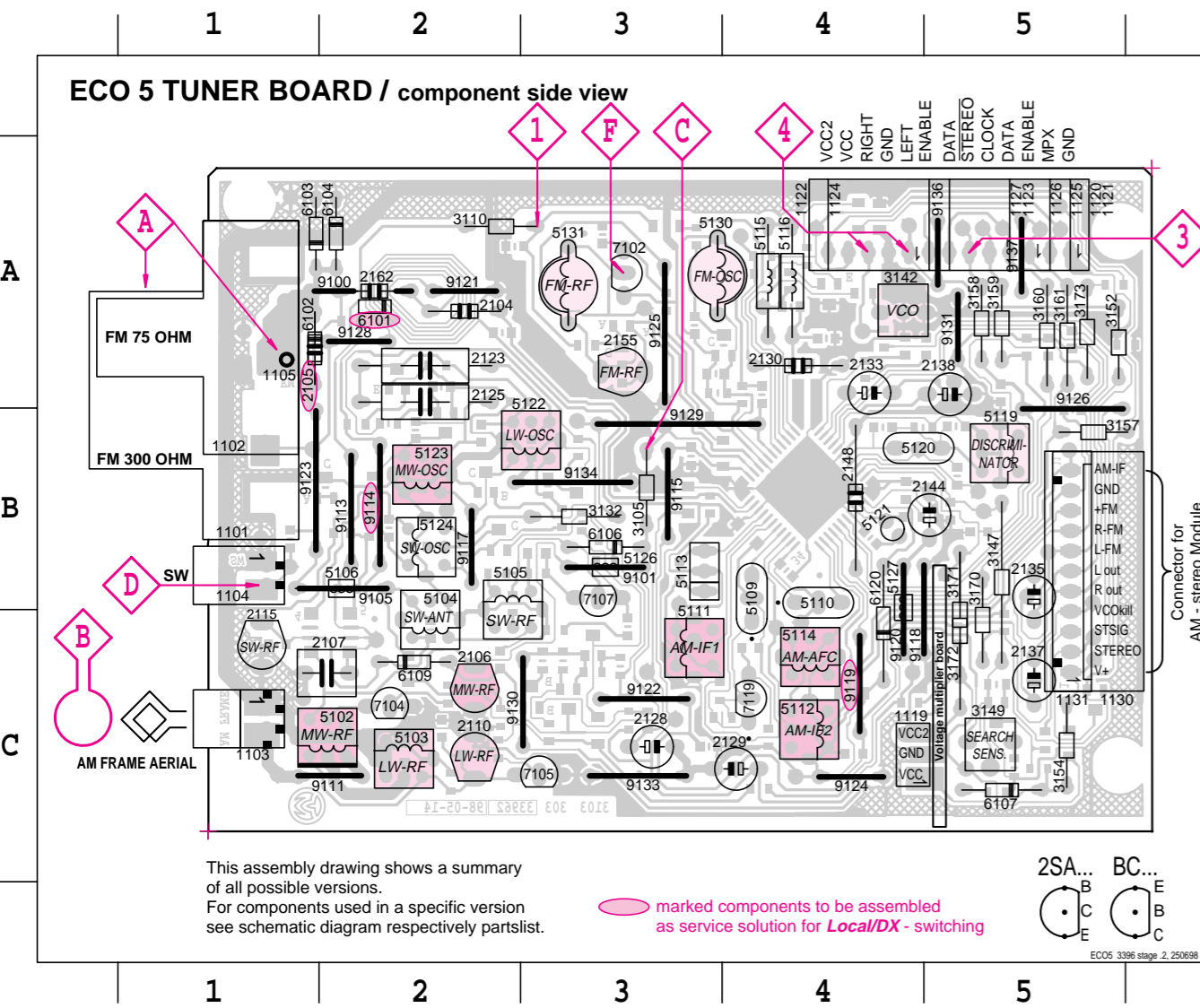

ELECTRICAL PARTS LIST - ECO5 TUNER BOARD

MISCELLANEOUS

1101	4822 267 31505	Antenna Socket 300R
1102	4822 267 10283	Antenna Socket Coax IEC 75R

CAPACITORS

2101	5322 122 32531	100pF 5% 50V	
2101	4822 126 13692	47pF 1% 63V	for USA
2102	4822 122 33177	10nF 20% 50V	
2103	5322 122 34123	1nF 10% 50V	
2104	4822 122 33195	100pF 10% 50V	
2106	4822 125 50355	Trimmer 4-20pF	for LW version
2106	4822 125 60101	Trimmer 3-11pF 100V	
2107	4822 121 51319	1μF 10% 63V	
2108	5322 122 32531	100pF 5% 50V	for LW version
2109	5322 122 32448	10pF 5% 50V	for LW version
2120	4822 126 13691	27pF 1% 63V	for LW version
2120	5322 122 32658	22pF 5% 50V	
2122	4822 122 33891	3,3nF 10% 63V	for LW version
2125	4822 121 51381	560pF 5% 400V	
2126	5322 122 31863	330pF 5% 50V	
2127	4822 126 13473	220nF +80/-20% 50V	
2128	4822 124 41579	10μF 20% 50V	
2129	4822 124 41584	100μF 20% 10V	
2130	4822 126 11585	22nF+80/- 20% 25V	
2131	4822 122 33325	470nF 16V	
2132	4822 122 33325	470nF 16V	
2131	4822 126 13482	470nF +80/- 20% 16V	
2132	4822 126 13482	470nF +80/- 20% 16V	
2133	4822 124 40242	1μF 20% 63V	
2134	4822 126 13188	15nF 5% 63V	
2134	5322 122 32654	22nF 10% 63V	for USA
2135	4822 124 40746	0,22μF 20% 63V	
2136	4822 126 13188	15nF 5% 63V	
2136	5322 122 32654	22nF 10% 63V	for USA
2137	4822 124 40746	0,22μF 20% 63V	
2138	4822 124 41576	2,2μF 20% 50V	
2139	4822 126 14236	50V 15pF 5%	
2140	4822 121 51252	470nF 5% 63V	
2141	4822 126 10002	100nF 20% 25V	
2142	4822 126 10002	100nF 20% 25V	
2143	4822 126 13473	220nF +80/-20% 50V	
2144	4822 124 40242	1μF 20% 63V	
2145	4822 122 33575	220pF 5% 50V	
2146	4822 122 33575	220pF 5% 50V	
2147	4822 122 33575	220pF 5% 50V	
2148	4822 126 11585	22nF+80/- 20% 25V	
2149	5322 122 32654	22nF 10% 63V	
2150	4822 122 31947	100nF 20% 63V	
2152	5322 116 80853	560pF 5% 63V	for East. Europe
2152	4822 126 12105	33nF 5% 63V	
2153	4822 122 32139	12pF 2% 63V	for East. Europe
2153	4822 122 32504	15pF 2% 63V	
2155	4822 125 60101	Trimmer 3-11pF 100V	

2158	5322 122 32448	10pF 5% 50V	for LW version
2159	5322 122 32659	33pF 5% 50V	
2160	5322 122 32654	22nF 10% 63V	
2161	4822 126 10002	100nF 20% 25V	
2163	4822 126 10002	100nF 20% 25V	
2164	4822 126 13482	470nF +80/- 20% 16V	
2165	4822 126 10002	100nF 20% 25V	
2166	5322 122 34123	1nF 10% 50V	
2167	4822 122 32139	12pF 2% 63V	
2168	4822 126 13695	82pF 1% 63V	

RESISTORS

3101	4822 051 20562	5k6 5% 0,1W	for East. Europe
3101	4822 051 20333	33k 5% 0,1W	
3102	4822 051 20104	100k 5% 0,1W	
3103	4822 117 10965	18k 1% 0,1W	
3104	4822 117 11448	180R 1% 0,1W	
3105	4822 116 83872	220R 5% 0,5W	
3108	4822 117 11449	2k2 1% 0,1W	for LW version
3109	4822 051 20472	4k7 5% 0,1W	for LW version
3110	4822 116 52195	47R 5% 0,5W	
3120	4822 051 20008	0R Jumper 0805	
3123	4822 051 20472	4k7 5% 0,1W	for LW version
3125	4822 117 10833	10k 1% 0,1W	for LW version
3128	4822 117 11449	2k2 1% 0,1W	for LW version
3132	4822 116 52195	47R 5% 0,5W	
3134	4822 051 20223	22k 5% 0,1W	
3137	4822 051 20223	22k 5% 0,1W	for LW version
3140	4822 051 20008	0R Jumper 0805	
3140	4822 117 10353	5120=CDA10.7MG40K 150R 1% 0,1W	
3141	4822 051 20563	5120=CDA10.7MG61KA 56k 5% 0,1W	
3142	4822 100 11163	Trimmer 100k 30% 0,1W	
3143	4822 051 20223	22k 5% 0,1W	for RDS version
3144	4822 051 10102	1k 2% 0,25W	for RDS version
3145	4822 117 11449	2k2 1% 0,1W	
3146	4822 051 20229	22R 5% 0,1W	
3152	4822 116 83883	470R 5% 0,5W	
3153	4822 051 20471	470R 5% 0,1W	
3154	4822 116 83868	150R 5% 0,5W	
3155	4822 051 20471	470R 5% 0,1W	
3156	4822 051 20104	100k 5% 0,1W	for /21/30/33 only
3157	4822 116 52234	100k 5% 0,5W	for East. Europe
3158	4822 116 83883	470R 5% 0,5W	
3159	4822 116 83883	470R 5% 0,5W	
3160	4822 116 83883	470R 5% 0,5W	
3161	4822 116 83883	470R 5% 0,5W	
3167	4822 117 11503	220R 1% 0,1W	
3169	4822 051 20154	150k 5% 0,1W	
3170	4822 116 52234	100k 5% 0,5W	
3171	4822 116 52219	330R 5% 0,5W	

ELECTRICAL PARTS LIST - ECO5 TUNER BOARD

3176	4822 051 10102	1k 2% 0,25W	for RDS version
3180	4822 051 20223	22k 5% 0,1W	for LW version
4101	4822 051 20008	0R Jumper 0805	for 2-Band only
4102	4822 051 20008	0R Jumper 0805	for 2-Band only
4103	4822 051 20008	0R Jumper 0805	
4104	4822 051 20008	0R Jumper 0805	
4105	4822 051 20008	0R Jumper 0805	
4106	4822 051 20008	0R Jumper 0805	
4108	4822 051 20008	0R Jumper 0805	
4111	4822 051 20008	0R Jumper 0805	
4120	4822 051 20008	0R Jumper 0805	
4150	4822 051 10008	0R Jumper 1206	
4151	4822 051 20008	0R Jumper 0805	
4152	4822 051 10008	0R Jumper 1206	
4153	4822 051 10008	0R Jumper 1206	
4154	4822 051 10008	0R Jumper 1206	
4155	4822 051 10008	0R Jumper 1206	
4156	4822 051 20008	0R Jumper 0805	
4157	4822 051 10008	0R Jumper 1206	
4158	4822 051 10008	0R Jumper 1206	
4159	4822 051 10008	0R Jumper 1206	
4162	4822 051 10008	0R Jumper 1206	

COILS & FILTERS

5102	4822 157 71634	MW RF Coil	
5103	4822 157 71635	LW RF Coil	for LW version
5109	4822 242 70665	Ceram Filter 10,7MHz	
5110	4822 242 70665	Ceram Filter 10,7MHz	
5111	4822 158 60511	AM-IF Filter 450kHz	
5112	4822 157 70302	AM-IF Filter 450kHz	
5114	4822 157 70302	AM-IF Filter 450kHz	
5119	4822 157 11443	Discriminator 10,7MHz	
5120	4822 242 82065	Cer. Disc. 10,7MG40K	
5120	4822 242 10251	Cer. Disc.10,7MG61KA-TF21	
5121	4822 242 10261	Quartz 75kHz	
5122	4822 157 60517	Osc. Coil LW	for LW version
5123	4822 157 60517	Osc. Coil MW	
5130	4822 156 30947	RF-Coil 1.5T	
5131	4822 156 30947	RF-Coil 1.5T	

DIODES

6103	4822 130 30621	1N4148	
6104	4822 130 30621	1N4148	
6105	4822 130 83075	HN1V02H-B	
6106	4822 130 30621	1N4148	
6107	4822 130 34488	BZX79-B11	
6120	4822 130 30621	1N4148	not for /21/30/33
6130	4822 130 82833	1SV228	
6131	4822 130 82833	1SV228	

TRANSISTORS & INTEGRATED CIRCUITS

7101	4822 209 90924	TEA5757H/V1	
------	----------------	-------------	--

7102	4822 130 60093	2SA838B	
7103	4822 130 42513	BC858C	for RDS version
7104	5322 130 44779	BC338-40	for LW version
7105	5322 130 44779	BC338-40	for LW version
7109	5322 130 41983	BC858B	for LW version
7111	5322 130 42136	BC848C	
7122	5322 130 42136	BC848C	for LW version
7124	5322 130 42136	BC848C	for LW version

Note: Only the parts mentioned in this list are normal service spare parts.

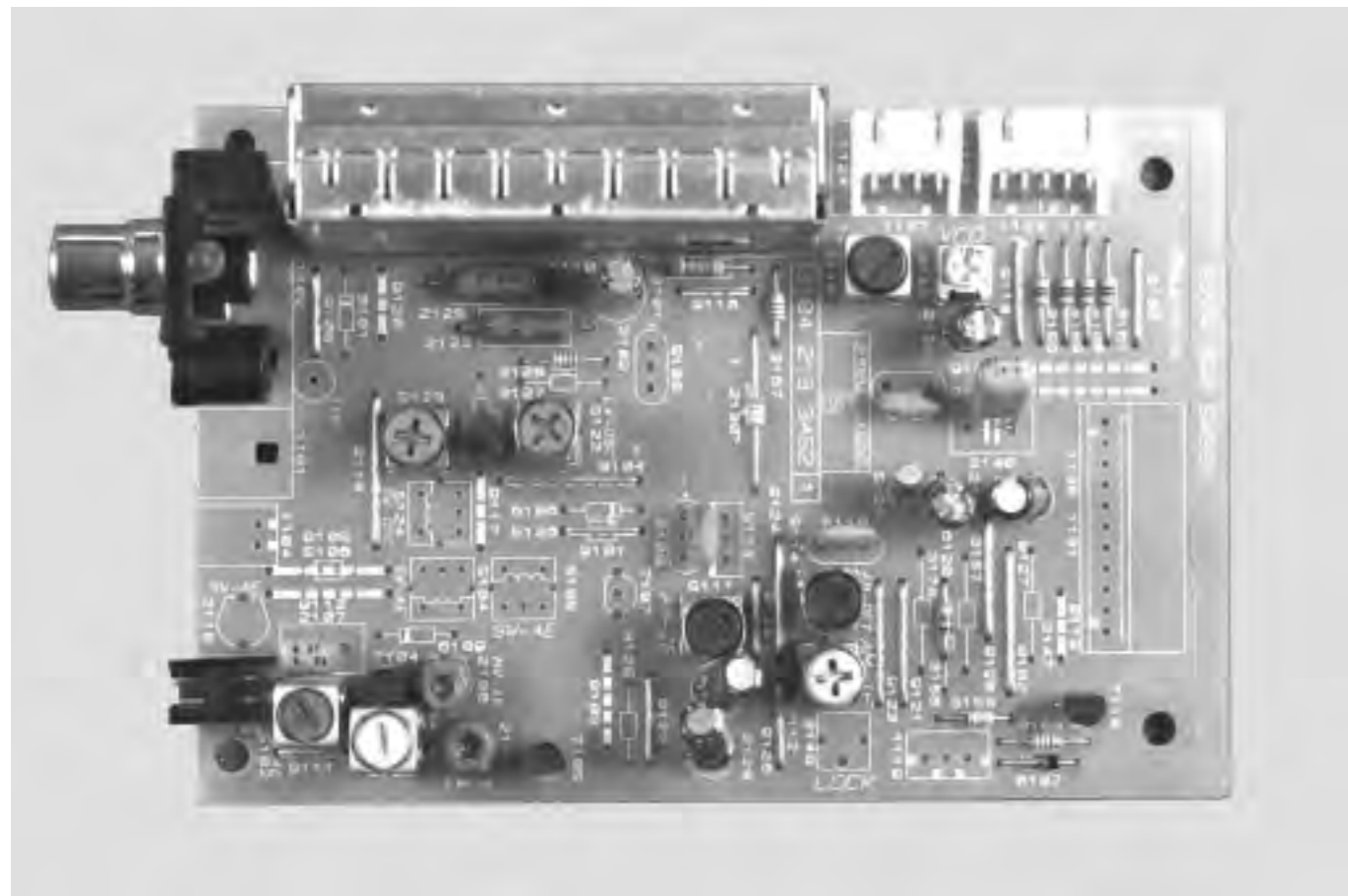

TUNER 95 BOARD

BLOCKDIAGRAM

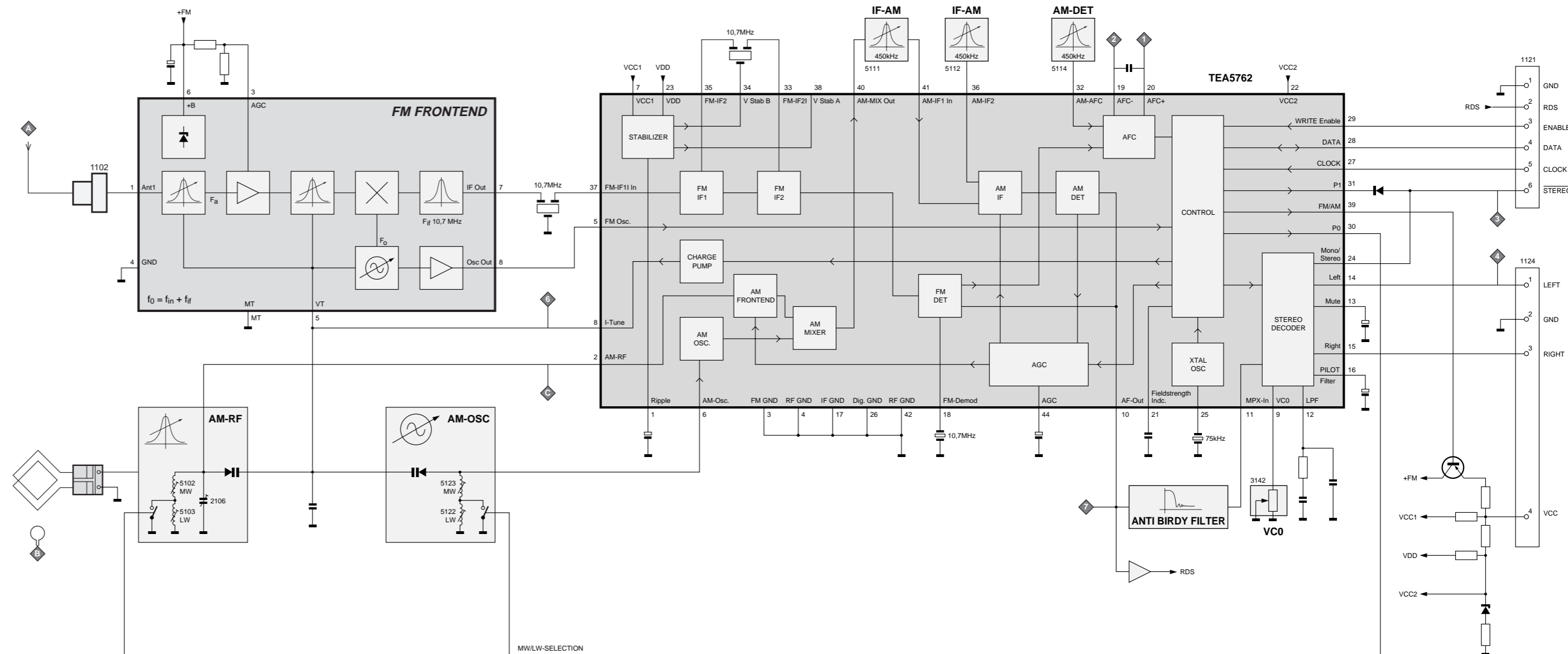

TABLE OF CONTENTS

- Blockdiagram7D-1
- Adjustmant table7D-2
- Component layout.....7D-2
- Circuit diagram.....7D-3
- Partslist7D-4

1102	F4	2107	C4	2128	C7	2136	G10	2144	E10	2160	E9	3120	D6	3132	E5	3143	G8	3153	G9	3163	F8	3176	D9	3188	G11	5111	C8	6106	E7	7110	D11	9108	G11	9121	D9
1103	C4	2108	C6	2129	C8	2137	E11	2145	G11	2161	E9	3123	E4	3134	E5	3144	H9	3154	C10	3164	C11	3177	F7	3192	D8	5112	C9	6107	B10	7122	F7	9111	C4	9123	D9
1110	G7	2109	C5	2130	F8	2138	E10	2147	G11	2162	C11	3124	E5	3137	G5	3145	F9	3155	C10	3165	D8	3178	B8	3197	C7	5114	D8	6120	D10	7124	G6	9114	E5	9125	D8
1121	H11	2120	F5	2131	F9	2139	E8	2148	E9	3103	H6	3125	C7	3138	D9	3146	B10	3158	G11	3167	F8	3181	D8	5102	C4	5115	G9	7101	E9	9100	F4	9115	C8	9126	C8
1124	H9	2122	E6	2132	F9	2140	F10	2150	F8	3104	G6	3128	F6	3139	F8	3147	H9	3159	G11	3169	D5	3183	E7	5103	C5	5121	E9	7103	G9	9101	E7	9116	G8		
1126	G10	2123	F6	2133	F10	2141	E10	2151	F9	3107	G7	3129	E6	3140	H8	3150	C11	3160	G11	3171	D11	3184	E7	5107	F10	5122	E7	7104	D5	9102	D10	9118	G10		
2102	G7	2125	G6	2134	G10	2142	E9	2152	F9	3108	C6	3130	E6	3141	G9	3151	C10	3161	G11	3172	F7	3185	E7	5109	D7	5123	E5	7105	B6	9104	E6	9119	G7		
2106	C5	2127	F9	2135	G11	2143	C10	2158	D10	3109	B7	3131	C6	3142	G10	3152	G9	3162	D9	3173	F7	3186	G8	5110	E9	6105	D4	7109	C6	9107	F11	9120	D10		

TUNER 95 bis Adjustment Table (FM, MW, LW with Frame antenna)

Waverange	Input frequency	Input	Set tuned to	Adjust	Output	Scope / Voltmeter
VARICAP ALIGNMENT						
FM (50)	87.5 - 108 MHz		108 MHz	check		7 ... 9V
			87.5 MHz	check		1.3 ... 2V
MW (9)	531 - 1602 kHz		1602 kHz	5123	◇ 6	8.3V ± 0.2V
			531 kHz	check		1V ± 0.4V
LW (3)	153 - 279 kHz		279 kHz	5122		8.3V ± 0.2V
			153 kHz	check		1V ± 0.4V
FM - DETECTION						
FM	98 MHz 1mV continuous wave <i>short pin 21 (IC7101) to ground</i>	◇ A	98 MHz	5107	◇ 1 ◇ 2	0mV ± 3mV
FM - VCO						
FM	98 MHz 1 mV continuous wave	◇ A	98 MHz	3142	◇ 3	152kHz ± 1 kHz
DISTORTION						
FM	98 MHz 1 mV 90 % L + 9 % pilot mod = 1kHz	◇ A	98MHz	mixcoil inside Tuner 1110	◇ 4	Distortion minimum
AM - IF						
MW	450kHz Δf = 10kHz Low as possible Swept signal	◇ C	MW	5111	◇ 7	symmetrical and max. height
	450kHz continuous wave			5112		
				5114	◇ 1 ◇ 2	0mV ± 2mV
AM - RF						
MW	558kHz Mod = 1kHz 30 % AM 1494 kHz	◇ B	558kHz	5102	◇ 7	MAX
			1494kHz	2106		
LW	198kHz mod = 1kHz 30 % AM	*	198kHz	5103		MAX

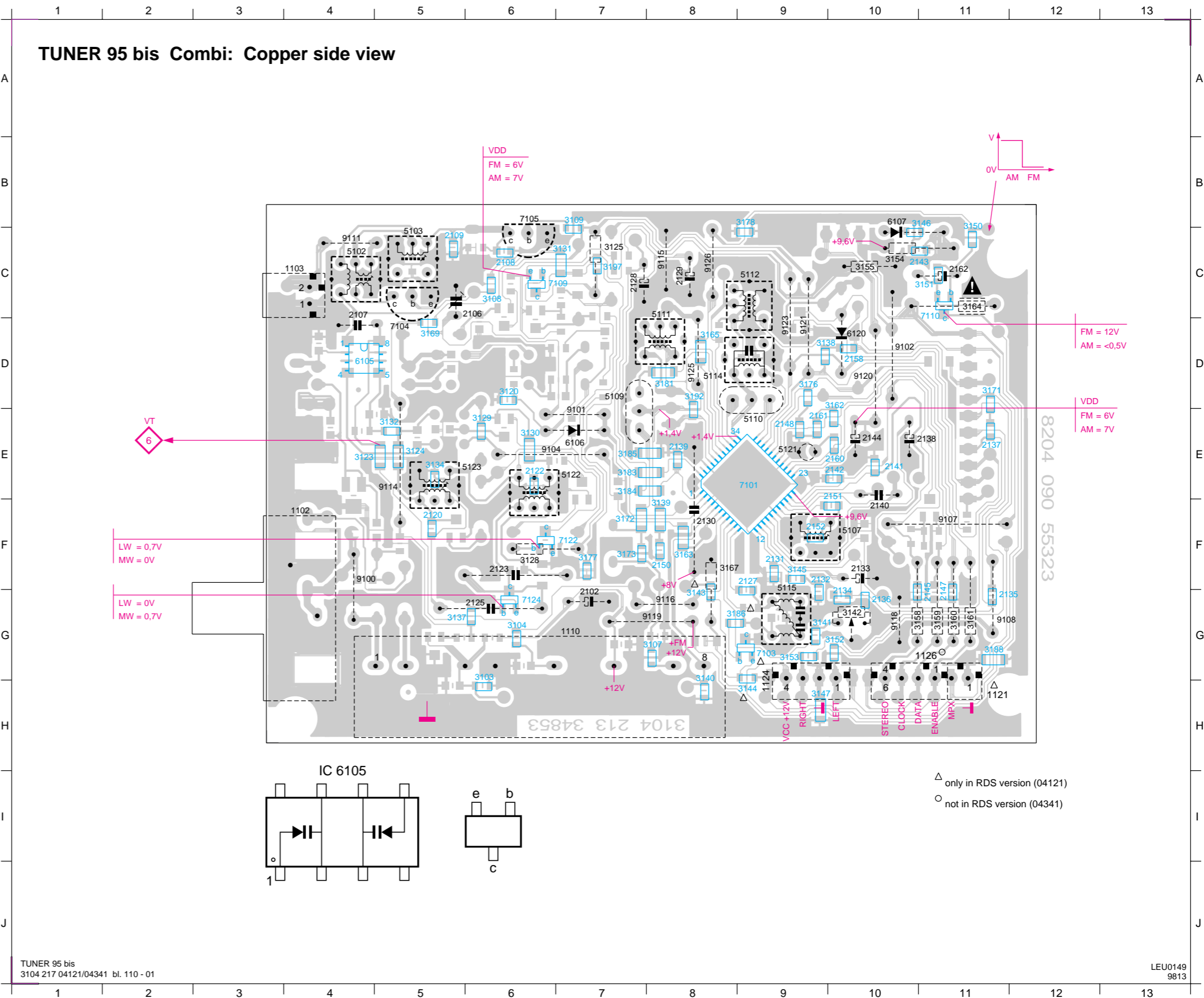

* Signal send via a frame antenna
(..) = tuning grid in kHz
↑ repeat

adjtable for 3104 217 04121/04341

1102	D1	1124	F21	2107	J6	2122	M7	2128	I13	2132	I17	2136	H19	2140	C14	2144	K20	2150	C6	2160	I15	3104	G4	3120	H5	3128	L9	3132	J7	3141	I16	3145	I17	3151	I20	3155	J20	3161	D19	3167	I20	3177	M10	3184	I8	3192	C12	5107	J12	5112	C12	5122	L7	6106	H5	7103	K17	7110	I19
1103	G2	1126	E20	2108	L2	2123	L7	2129	I8	2133	G18	2137	G19	2141	H15	2145	E19	2151	H12	2161	I15	3107	C6	3123	I6	3129	K8	3134	L6	3142	I16	3146	L20	3152	F20	3158	E19	3162	I15	3169	L5	3178	N20	3185	I13	3197	L11	5109	B6	5114	C13	5123	K7	6107	K20	7104	J2	7122	L9
1110	D4	2102	C2	2109	L3	2125	L7	2130	J20	2134	G19	2138	H18	2142	K19	2147	E19	2152	I11	2162	H20	3108	J1	3124	K7	3130	K8	3137	L5	3143	K17	3150	H19	3154	J20	3160	D19	3164	I20	3173	B6	3183	I13	3188	M20	5103	L4	5111	C11	5121	I15	6105a	I5	6120	E17	7105	K2	7124	L6
1121	C21	2106	J4	2120	K7	2127	H16	2131	I17	2135	F19	2139	I7	2143	K20	2148	E19	2158	L18	3103	G3	3109	K1	3125	L11	3131	M10	3140	F7	3144	K17	3150	H19	3154	J20	3160	D19	3164	I20	3173	B6	3183	I13	3188	M20	5103	L4	5111	C11	5121	I15	6105b	I6	7101	C15	7109	L10		

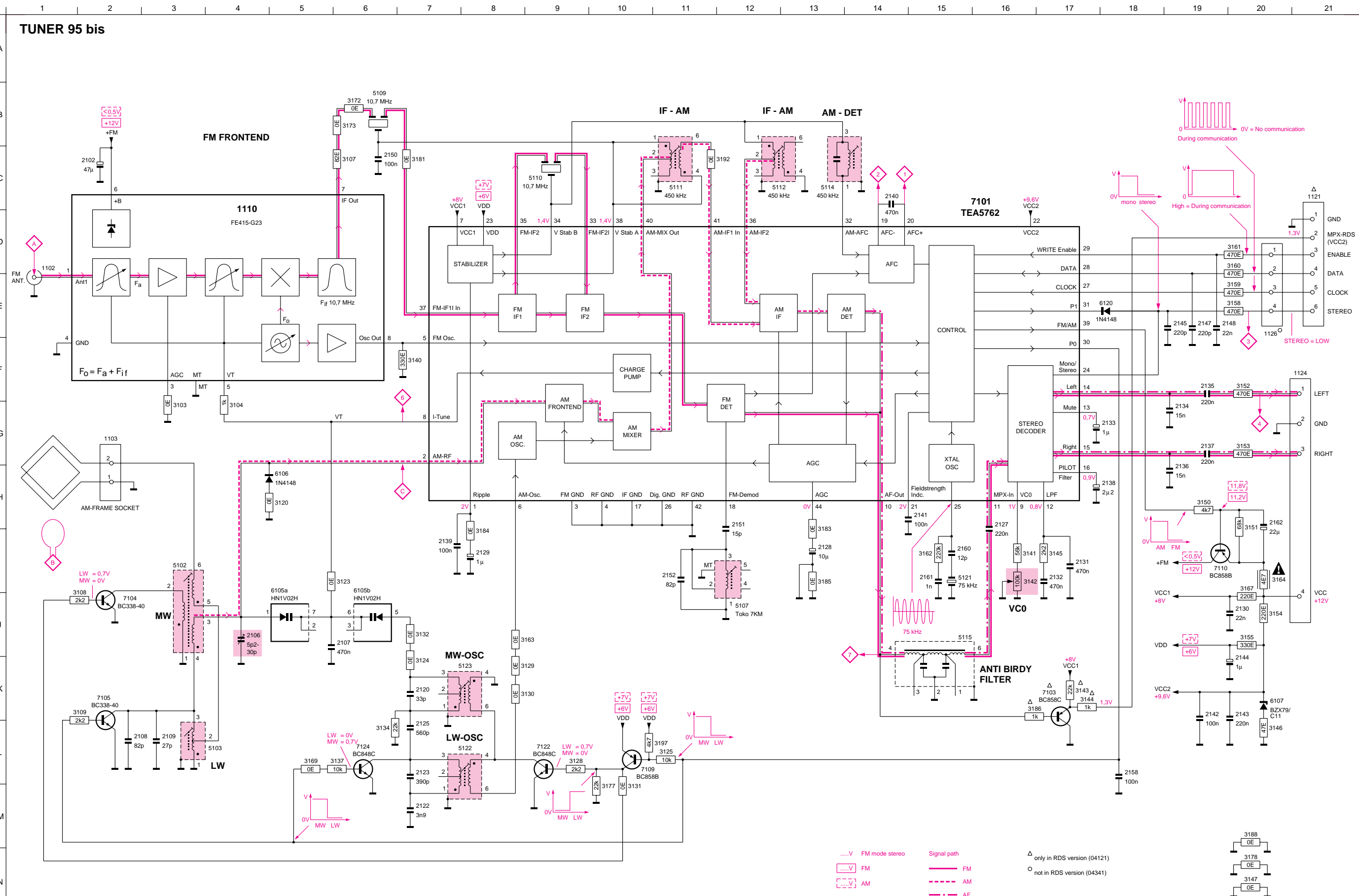

ELECTRICAL PARTS LIST - TUNER 95 BOARD**MISCELLANEOUS**

1102	4822 267 10283	Socket Coaxial IEC 75R
1103	4822 265 31184	JST Connector 2 pin
1110	4822 210 10739	Frontend Assembly FE415-G23

CAPACITORS

2102	4822 124 40433	47µF 20% 25V
2106	4822 125 60102	Trimmer 5,2-30pF 100V
2107	4822 121 51252	470nF 5% 63V
2108	4822 126 13695	82pF 1% 63V
2109	4822 126 13691	27pF 1% 63V
2120	5322 122 32659	33pF 5% 50V
2122	5322 126 10465	3,9nF 10% 50V
2123	4822 121 10766	390pF 1% 630V
2125	4822 121 10578	560pF 1% 630V
2127	4822 122 32927	220nF +80/-20% 50V
2128	4822 124 41579	10µF 20% 50V
2129	4822 124 40242	1µF 20% 63V
2130	4822 126 11585	22nF +80/-20% 25V
2131	4822 122 33325	470nF 16V
2132	4822 122 33325	470nF 16V
2133	4822 124 40242	1µF 20% 63V
2134	4822 126 13188	15nF 5% 63V
2135	4822 122 32927	220nF +80/-20% 50V
2136	4822 126 13188	15nF 5% 63V
2137	4822 122 32927	220nF +80/-20% 50V
2138	4822 124 41576	2,2µF 20% 50V
2139	4822 126 10002	100nF 20% 25V
2140	4822 121 51252	470nF 5% 63V
2141	4822 122 31947	100nF 20% 63V
2142	4822 122 31947	100nF 20% 63V
2143	4822 122 32927	220nF +80/-20% 50V
2144	4822 124 40242	1µF 20% 63V
2145	4822 122 33575	220pF 5% 50V
2147	4822 122 33575	220pF 5% 50V
2148	4822 122 33809	22nF 20% 50V
2150	4822 122 31947	100nF 20% 63V
2151	4822 126 14236	15pF 5% 50V
2152	4822 126 13695	82pF 1% 63V
2158	4822 122 31947	100nF 20% 63V
2160	4822 122 32139	12pF 2% 63V
2161	5322 122 34123	1nF 10% 50V
2162	4822 124 81151	22µF 50V

RESISTORS

3103	4822 051 20008	0R Jumper 0805
3104	4822 051 10102	1k 2% 0,25W
3107	4822 051 20829	82R 5% 0,1W
3108	4822 117 11449	2k2 1% 0,1W
3109	4822 117 11449	2k2 1% 0,1W
3120	4822 051 20008	0R Jumper 0805
3123	4822 051 10008	0R Jumper 1206
3124	4822 051 10008	0R Jumper 1206

3125	4822 116 83864	10k 5% 0,5W
3128	4822 116 52256	2k2 5% 0,5W
3129	4822 051 20008	0R Jumper 0805
3130	4822 051 10008	0R Jumper 1206
3131	4822 051 10008	0R Jumper 1206
3132	4822 051 20008	0R Jumper 0805
3134	4822 051 20223	22k 5% 0,1W
3137	4822 117 10833	10k 1% 0,1W
3138	4822 051 20008	0R Jumper 0805
3139	4822 051 10008	0R Jumper 1206
3140	4822 051 20331	330R 5% 0,1W
3141	4822 117 11148	56k 1% 0,1W
3142	4822 100 11163	Trimmer 100k 30% 0,1W
3143	4822 051 20223	22k 5% 0,1W
3144	4822 051 10102	1k 2% 0,25W
3145	4822 117 11449	2k2 1% 0,1W
3146	4822 051 20479	47R 5% 0,1W
3147	4822 051 10008	0R Jumper 1206
3150	4822 051 20472	4k7 5% 0,1W
3151	4822 051 20683	68k 5% 0,1W
3152	4822 051 20471	470R 5% 0,1W
3153	4822 051 20471	470R 5% 0,1W
3154	4822 116 83872	220R 5% 0,5W
3155	4822 116 52219	330R 5% 0,5W
3158	4822 116 83883	470R 5% 0,5W
3159	4822 116 83883	470R 5% 0,5W
3160	4822 116 83883	470R 5% 0,5W
3161	4822 116 83883	470R 5% 0,5W
3162	4822 117 13579	220k 1% 0,1W
3163	4822 051 10008	0R Jumper 1206
3164	4822 052 10478	△ 4R7 5% 0,33W
3165	4822 051 10008	0R Jumper 1206
3167	4822 116 83872	220R 5% 0,5W
3169	4822 051 20008	0R Jumper 0805
3171	4822 051 20008	0R Jumper 0805
3172	4822 051 10008	0R Jumper 1206
3173	4822 051 20008	0R Jumper 0805
3176	4822 051 20008	0R Jumper 0805
3177	4822 051 20223	22k 5% 0,1W
3178	4822 051 10008	0R Jumper 1206
3181	4822 051 10008	0R Jumper 1206
3183	4822 051 10008	0R Jumper 1206
3184	4822 051 10008	0R Jumper 1206
3185	4822 051 10008	0R Jumper 1206
3186	4822 051 10102	1k 2% 0,25W
3188	4822 051 10008	0R Jumper 1206
3192	4822 051 20008	0R Jumper 0805
3197	4822 051 20472	4k7 5% 0,1W

COILS & FILTERS

5102	4822 157 71634	MW Aerial
5103	4822 157 71635	LW Aerial

ELECTRICAL PARTS LIST - TUNER 95 BOARD

5107	4822 157 11443	FM Discriminator 10,7MHz
5109	4822 157 71639	Ceram Filter 10,7MHz
5110	4822 242 70665	Ceram Filter 10,7MHz
5111	4822 158 60511	AM-IF Filter 450kHz
5112	4822 157 70302	AM-IF Filter 450kHz
5114	4822 157 70302	AM_IF Filter 450kHz
5115	4822 157 71636	Anti-Birdy Filter
5121	4822 242 10261	X'tal Resonator 75kHz
5122	4822 157 60517	RF Coil AM
5123	4822 157 60517	RF Coil AM

DIODES

6105	4822 130 83075	HN1V02H-B
6106	4822 130 30621	1N4148
6107	4822 130 34488	BZX79-C11
6120	4822 130 30621	1N4148

TRANSISTORS & INTEGRATED CIRCUITS

7101	4822 209 90315	TEA5762H/V1
7103	4822 130 42513	BC858C
7104	5322 130 44779	BC338-40
7105	5322 130 44779	BC338-40
7109	5322 130 41983	BC858B
7110	5322 130 41983	BC858B
7122	5322 130 42136	BC848C
7124	5322 130 42136	BC848C

Note : Only the parts mentioned in this list are normal service spare parts.

NOTE :

AV BOARD

TABLE OF CONTENTS

AV Board - Chip Layout 8-2
AV Board - Component Layout 8-3
AV Board - Circuit Diagram (Part 1) 8-4
AV Board - Circuit Diagram (Part 2) 8-5
AV Board - Circuit Diagram (Part 3) 8-6
Electrical parts list 8-7

AV BOARD - COMPONENT LAYOUT

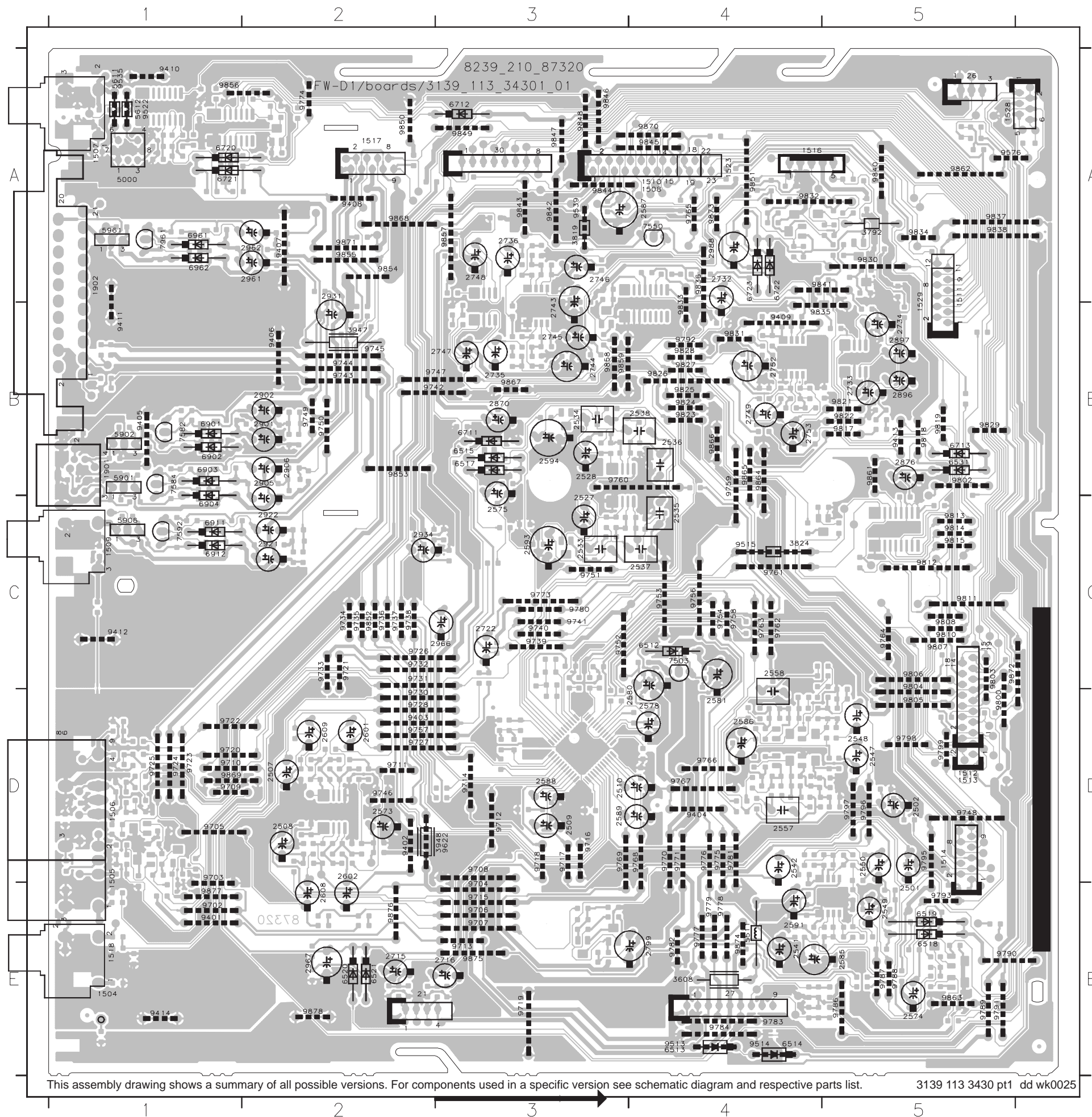

21	E2	6512	C4	9763	C4
26	A5	6513	C4	9764	C5
27	E4	6514	F4	9765	A4
30	A3	6515	B3	9766	D4
1504	E1	6517	B3	9767	D4
1505	D1	6518	F4	9768	D4
1506	D1	6519	F4	9769	D3
1507	A1	6520	F4	9770	D4
1508	A4	6521	B3	9771	D4
1509	C1	6531	B3	9773	C3
1510	A4	6711	A3	9774	A2
1511	A5	6712	A3	9775	D4
1512	D5	6713	B5	9776	E4
1513	D5	6720	A1	9777	E4
1514	D5	6721	A1	9778	E4
1516	A4	6722	A4	9779	E4
1517	A2	6723	A4	9780	C3
1518	E1	6901	B1	9781	B1
1523	A4	6902	B1	9782	F4
1528	A5	6903	B1	9783	F4
1529	B5	6904	C1	9784	F4
1901	B1	6911	C1	9786	E6
1902	A1	6912	C1	9787	E6
2501	E5	6961	A1	9788	E6
2502	D5	6962	A1	9789	E6
2507	D2	7503	C4	9790	E6
2508	D2	7550	A4	9791	E6
2509	D3	7582	B1	9792	B1
2510	D3	7584	B1	9793	E6
2527	C3	7592	C1	9795	E6
2528	B3	7961	A1	9796	E6
2533	C3	9401	E1	9797	D5
2534	B3	9402	D2	9798	D5
2535	C4	9403	D2	9799	D5
2536	B4	9404	D4	9800	D5
2537	C4	9405	B1	9802	B5
2538	B4	9406	B2	9803	C5
2541	E4	9407	A2	9804	C5
2542	D4	9408	A2	9805	D5
2547	D5	9409	B4	9806	C5
2548	E5	9410	A1	9807	C5
2549	E5	9411	B1	9808	C5
2550	D5	9412	C1	9810	C5
2557	D4	9413	B1	9811	C5
2558	C4	9414	F1	9812	C5
2573	D2	9513	F4	9813	C5
2574	E5	9514	F4	9814	C5
2575	C3	9515	C4	9815	C5
2578	D4	9522	A1	9817	B1
2580	D4	9535	A1	9818	B5
2581	D4	9539	A3	9819	B5
2585	E5	9576	A5	9821	B5
2586	D4	9622	D3	9822	B5
2587	A4	9702	E1	9823	B4
2588	D3	9703	D1	9824	B4
2589	D3	9704	F3	9825	B4
2591	E4	9705	F3	9826	B4
2593	C3	9706	F3	9827	B4
2594	B3	9707	D3	9828	B4
2601	D2	9708	D3	9829	B5
2602	D2	9709	D1	9830	A5
2608	E2	9710	D1	9831	B4
2609	D2	9711	D2	9832	A4
2715	E2	9712	D3	9833	B4
2716	E3	9713	D3	9834	A5
2722	C3	9714	D3	9835	B4
2732	A4	9715	F3	9836	A4
2733	B5	9716	D3	9837	A5
2734	B5	9717	D3	9838	A5
2735	B3	9718	D3	9840	A5
2736	A3	9719	F3	9841	A5
2743	B3	9720	D1	9842	A3
2744	B3	9721	C2	9843	A3
2745	B3	9722	D1	9844	A3
2746	A3	9723	D1	9845	A4
2747	B3	9724	D1	9846	A3
2748	A3	9725	D1	9847	A3
2749	B4	9726	C2	9848	A3
2752	B4	9727	D2	9849	A3
2753	B4	9728	D2	9850	A2
2799	E4	9730	D2	9851	A4
2870	B3	9731	C2	9852	C2
2876	B5	9732	C2	9853	B2
2896	B5	9733	C2	9854	A2
2897	B5	9734	C2	9855	A2
2901	B2	9735	C2	9856	A1
2902	B2	9736	C2	9857	A3
2905	B2	9737	C2	9858	B3
2906	B2	9738	C2	9859	B3
2921	C2	9739	C3	9861	B5
2922	C2	9740	C3	9862	A5
2931	A2	9741	C3	9863	E5
2934	C2	9742	B2	9864	B4
2961	A2	9743	B2	9865	B4
2962	A2	9744	B2	9866	B4
2966	C3	9745	B2	9867	B3
2967	E2	9746	D2	9868	A2
2988	A4	9747	B3	9869	D1
3608	E4	9748	D5	9870	A4
3792	A5	9749	B2	9871	A2
3819	A3	9750	B2	9872	C5
3824	C4	9751	C3	9873	A4
3947	B2	9752	C3	9874	E4
3948	D3	9753	C4	9875	E3
5000	A1	9754	C4	9876	E2
5511	E4	9756	C4	9877	E1
5611	A1	9757	D2	9878	E2
5612	A1	9758	C4		
5901	B1	9759	B4		
5902	B1	9760	B3		
5906	C1	9761	C4		
5961	A1	9762	C4		

AV BOARD - CIRCUIT DIAGRAM (PART 1)

21 E2	2501 E4	2509 D8	2519 D9	2527 B9	2535 B10	2543 B17	2551 D19	2559 D14	2567 B15	2575 H15	2583 D11	2591 F18	2602 H7	2612 H3	2625 C7	2720 C4	2986 F4	3507 E4	3515 A10	3523 C10	3531 B17	3539 B18	3547 F19	3555 C14	3563 D15	3571 D15	3579 E13	3588 G14	3599 C19	3611 H4	3619 B7	3627 H5	3715 B3	3983 B21	4911 F19	6517 H14	7503 G11	7511 B19	7522 H4
27 F21	2502 F4	2510 G8	2520 G9	2528 I8	2536 I9	2544 F17	2552 D19	2560 F14	2568 E15	2576 F11	2584 D10	2592 F18	2603 C7	2613 H3	2626 I7	2721 B2	2987 J17	3508 F4	3516 H9	3524 H10	3532 F17	3540 E18	3548 G19	3556 F14	3564 F15	3572 F15	3580 F13	3589 H14	3600 B19	3612 H4	3620 H7	3630 J7	3716 C3	3984 C20	4912 J17	6518 G15	7504 G13	7514 A C17	7529 H5
1504 F1	2503 E5	2511 C8	2521 D9	2529 B10	2537 B11	2545 B17	2553 F19	2561 D15	2569 C15	2577 F12	2585 J14	2593 C10	2604 I7	2614 H4	2628 F1	2934 F5	3501 E4	3509 C8	3517 B10	3525 A11	3533 C17	3541 B19	3549 F16	3557 B14	3565 C15	3573 D14	3581 E11	3592 H13	3605 E20	3613 C7	3621 H6	3631 B7	3717 B4	4911 C7	6519 G15	7505 C14	7514 B E17	9513 J11	
1505-B H2	2504 G5	2512 G8	2522 G9	2530 H8	2538 H9	2546 E17	2554 G19	2562 F15	2570 F15	2578 G12	2586 J15	2594 H10	2605 B6	2615 G4	2715 E3	2986 E5	3502 F4	3510 G8	3518 I9	3526 J9	3534 E17	3542 E19	3550 F16	3558 E14	3566 F15	3574 F14	3582 E12	3593 H13	3606 E20	3614 H7	3622 H5	3633 J16	3718 C4	4912 G7	6520 B20	7506 F14	7515 A10	9514 J11	
1505-C C2	2505 D4	2513 D8	2523 C9	2531 C17	2539 C13	2547 C16	2555 E13	2563 C14	2571 C15	2579 G10	2587 J11	2595 E20	2606 H6	2616 H1	2716 F3	2987 C20	3503 E4	3511 B9	3519 B11	3527 C13	3535 C17	3543 D18	3551 F16	3559 C14	3567 C16	3575 E14	3583 E12	3594 J13	3607 C11	3615 C6	3623 C6	3711 E2	3980 F5	4912 H11	6521 B20	7507 D15	7516 I9	9516 E20	
1506-A I2	2506 E4	2514 G8	2524 G9	2532 E17	2540 G13	2548 E16	2556 E13	2564 E14	2572 F15	2580 H10	2588 E6	2597 E21	2607 I6	2617 H4	2717 B3	2983 E3	3504 G4	3512 I8	3520 I9	3528 G13	3536 E17	3544 D18	3552 F16	3560 F14	3568 E15	3576 G14	3584 E12	3595 H13	3608 F17	3616 I7	3624 I6	3712 F2	3951 E5	4912 H6	6513 J11	7501 D6	7508 F15	7517-A C6	
1506-B B2	2507 D7	2515 D8	2525 B9	2533 B10	2541 B16	2549 B18	2557 D14	2565 C14	2573 J13	2581 H11	2589 F6	2598 B19	2608 I5	2618 D1	2718 C3	2984 F3	3505 D4	3513 B10	3521 C9	3529 B17	3537 C17	3545 F19	3553 C14	3561 C15	3569 C15	3577 E13	3585 G11	3596 J13	3609 H3	3617 B6	3625 B7	3713 E3	3958 D5	4912 J11	6514 J11	7502-A B10	7509 C18	7517-B I6	
1528 D21	2508 G7	2516 G8	2526 I8	2534 H9	2542 F16	2550 E18	2558 F14	2566 F14	2574 C19	2582 H11	2590 E6	2601 C7	2609 C5	2619 D1	2719 B4	2985 D4	3506 F4	3514 I8	3522 H9	3530 E17	3538 E17	3546 G19	3554 E14	3562 E15	3570 E15	3578 E13	3586 H15	3597 J15	3610 H3	3618 H6	3626 J7	3714 F3	3959 F5	4912 H6	6515 G14	7502-B H8	7509 D18	7521 G4	

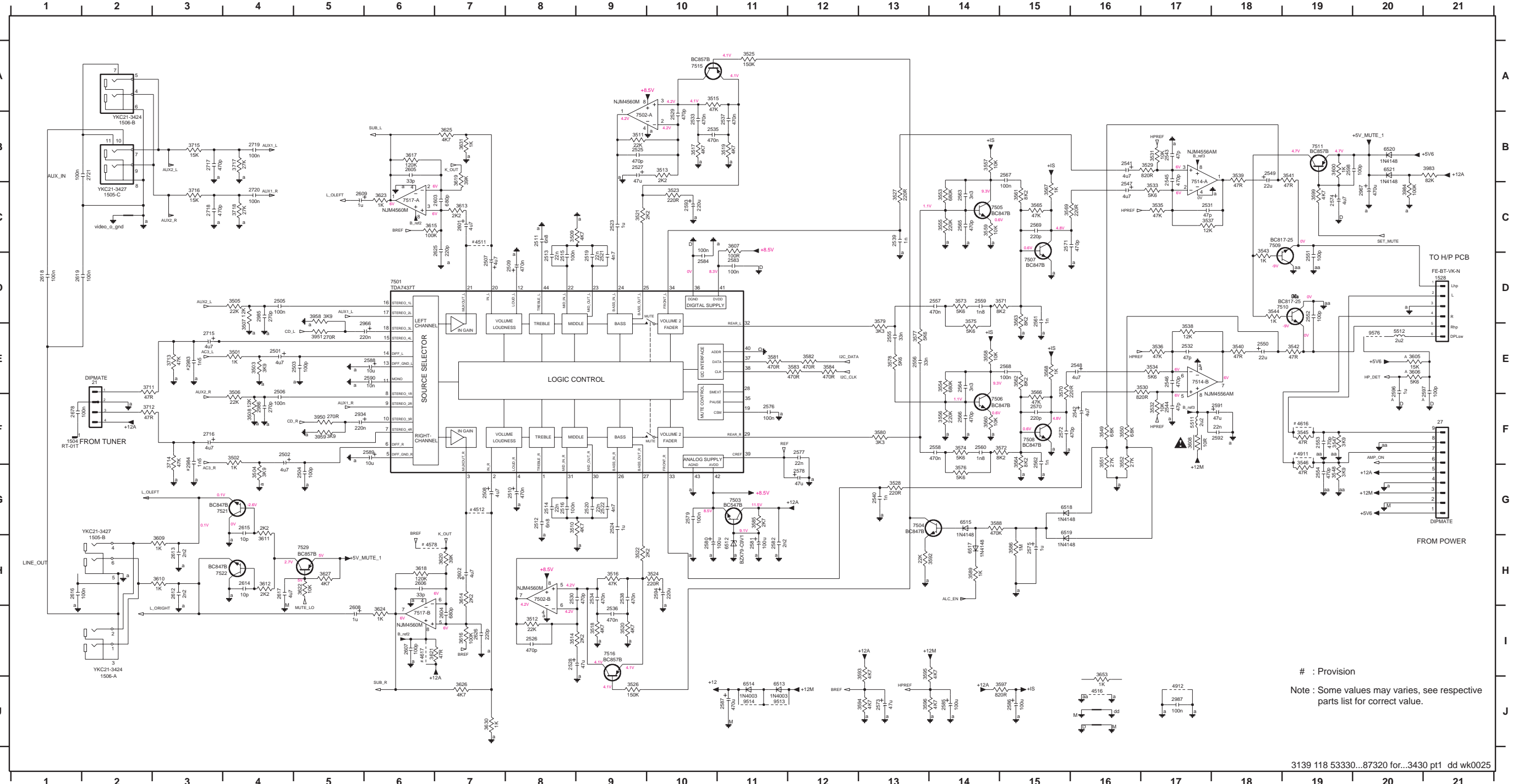

3139 118 53330...87320 for...3430 pt1 dd wk0025

AV BOARD - CIRCUIT DIAGRAM (PART 2)

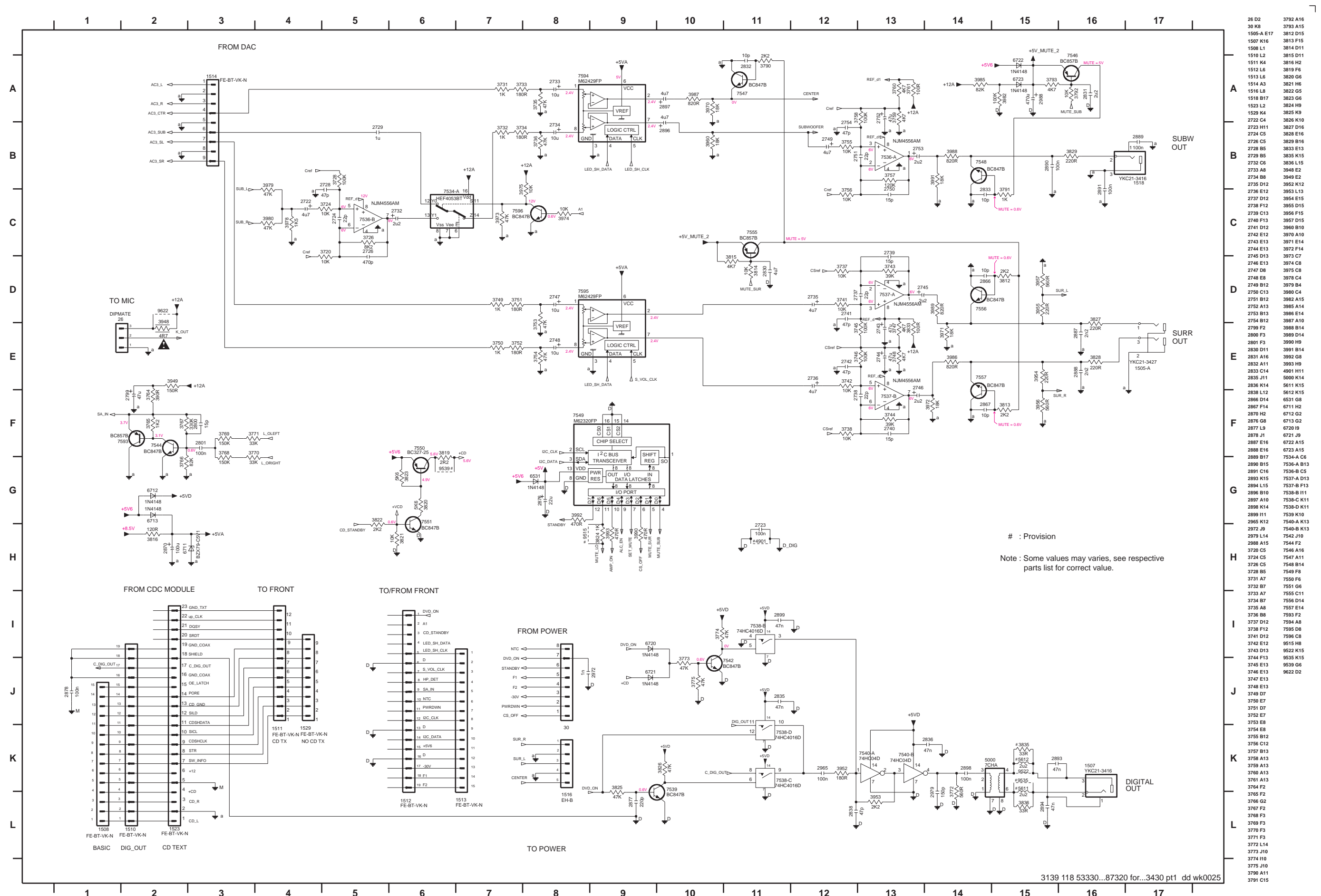

- 26 D2
- 30 K8
- 1505-A E17
- 1507 K16
- 1508 L1
- 1510 L2
- 1511 K4
- 1512 L8
- 1513 L6
- 1514 A3
- 1516 L8
- 1518 B17
- 1523 L2
- 1529 K4
- 2722 C4
- 2723 H11
- 2724 C5
- 2728 B5
- 2729 B5
- 2732 C6
- 2733 A8
- 2734 B8
- 2735 D12
- 2736 E12
- 2737 D12
- 2738 F12
- 2739 C13
- 2740 F13
- 2741 D12
- 2742 E12
- 2743 E13
- 2744 E13
- 2745 D13
- 2746 E13
- 2747 D8
- 2748 E8
- 2749 B12
- 2750 C13
- 2751 B12
- 2752 A13
- 2753 B13
- 2754 B12
- 2759 F2
- 2800 F3
- 2801 F3
- 2830 D11
- 2831 A16
- 2832 A11
- 2833 C14
- 2835 J11
- 2836 K14
- 2838 L13
- 2866 D14
- 2867 F14
- 2870 H2
- 2876 G8
- 2877 L9
- 2878 J9
- 2887 E16
- 2888 E16
- 2889 B17
- 2890 B15
- 2891 C16
- 2894 L15
- 2896 B10
- 2897 A10
- 2898 K14
- 2899 H11
- 2965 K12
- 3732 J9
- 3737 A7
- 3738 A7
- 3739 B7
- 3738 A8
- 3737 D12
- 3738 F12
- 3741 D12
- 3742 E12
- 3743 D13
- 3744 F13
- 3745 E13
- 3746 E13
- 3747 E13
- 3748 E13
- 3749 D7
- 3750 E7
- 3751 D7
- 3753 E7
- 3753 E8
- 3754 E8
- 3755 B12
- 3756 C12
- 3757 B13
- 3758 A13
- 3760 A13
- 3761 A13
- 3764 F2
- 3765 F2
- 3766 G2
- 3767 F2
- 3768 F3
- 3769 F3
- 3770 F3
- 3771 F3
- 3772 L14
- 3773 J10
- 3774 H10
- 3775 J10
- 3790 A11
- 3791 C15
- 3792 A16
- 3793 A15
- 3812 D15
- 3813 F15
- 3814 D11
- 3815 D11
- 3816 H2
- 3819 F6
- 3820 G14
- 3821 H6
- 3822 G5
- 3823 G6
- 3824 H9
- 3825 K9
- 3826 K10
- 3827 D16
- 3828 E16
- 3829 B16
- 3833 E13
- 3835 K15
- 3836 L15
- 3848 E2
- 3949 E2
- 3952 K12
- 3953 L13
- 3954 E15
- 3955 D15
- 3956 F15
- 3957 D15
- 3960 B10
- 3970 A10
- 3971 E14
- 3972 F14
- 3973 C7
- 3974 G8
- 3975 C8
- 3978 C4
- 3979 B4
- 3980 C4
- 3982 A15
- 3985 A14
- 3986 E14
- 3987 A10
- 3988 F14
- 3989 D14
- 3990 H9
- 3991 B14
- 3992 G8
- 3993 H9
- 4901 H11
- 5000 K14
- 5611 K15
- 5612 H8
- 6531 G8
- 6711 H2
- 6712 G2
- 6713 G2
- 6720 H9
- 6721 J9
- 6722 A15
- 7534-A C5
- 7536-A B13
- 7536-B C5
- 7537-A D13
- 7537-B F13
- 7538-B K11
- 7538-C K11
- 7538-D K11
- 7539 K10
- 7540-A K13
- 7540-B K13
- 7542 J10
- 7544 F2
- 7546 A16
- 7547 A11
- 7548 B14
- 7549 F8
- 7550 F6
- 7551 G6
- 7555 C11
- 7556 D14
- 7557 E14
- 7593 F2
- 7594 A8
- 7595 D8
- 7596 C8
- 9515 H8
- 9516 K15
- 9535 K15
- 9539 G6
- 9622 D2

AV BOARD - CIRCUIT DIAGRAM (PART 3)

1509 G12	1978 F6	2901 C6	2905 A7	2921 G2	2925 C11	2930 B11	2935 G12	2964 F10	2973 B7	2978 A6	3852 B7	3903 C7	3907 D8	3911 A9	3936 G3	3940 G4	3946 D11	3963 E9	3967 F8	4904 G1	4962 F10	5902 D9	5963 G1	6902 D8	6912 H4	7582 C8	7592 G4
1517 F3	2775 C6	2902 C6	2906 A7	2922 G2	2926 D11	2931 D2	2961 E7	2968 G1	2974 B6	2980 A12	3857 H2	3904 C8	3908 A7	3912 B8	3937 F3	3941 G4	3947 C2	3964 E7	3981 F7	4906 G5	4963 A6	5906 H5	5964 A6	6903 A8	6961 E8	7583 B8	7961 F9
1901 A12	2776 D6	2903 D8	2907 B9	2923 H4	2927 B12	2932 D2	2962 F7	2969 H2	2976 E6	2981 A12	3901 C7	3905 D7	3909 A8	3913 A9	3938 G3	3942 G4	3961 E8	3965 F8	4902 H12	4907 D9	4964 C6	5961 F10	5965 C6	6904 B9	6962 F9	7584 A9	7962 F8
1902 C12	2777 D5	2904 D9	2908 B10	2924 H5	2929 B11	2933 H12	2963 F8	2970 H1	2977 F6	3851 D6	3902 C7	3906 C8	3910 A8	3914 B9	3939 H3	3945 C11	3962 E8	3966 F9	4903 F6	4908 A10	5901 B10	5962 F6	6901 C7	6911 G3	7581 D7	7591 G3	

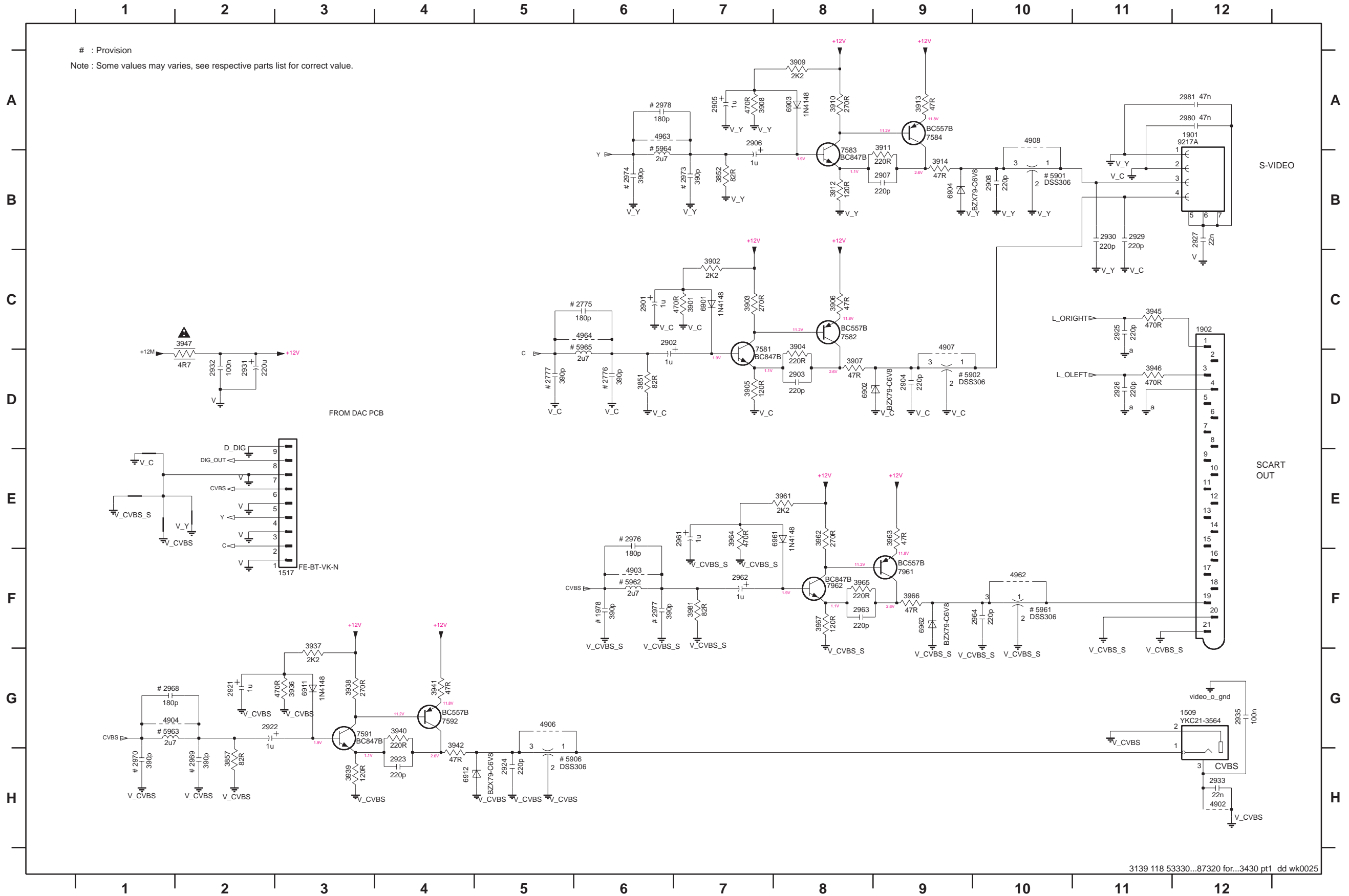

ELECTRICAL PARTS LIST - AV BOARD

MISCELLANEOUS

1505	4822 267 31449	Cinch Socket - Aux-in/Line-out/ Surround Out
1507	4822 267 31729	Cinch Socket - Audio Digital Out
1509	4822 267 31996	Cinch Socket - Video Out (CVBS)
1510	4822 265 11553	Flex Connector 19P
1511	4822 267 10732	Flex Connector 12P
1512	4822 265 11553	Flex Connector 19P
1514	2422 025 14518	Flex Connector 9P
1517	2422 025 14518	Flex Connector 9P
1518	4822 267 31729	Cinch Socket - Sub-Woofer Out
1523	4822 267 10757	Flex Connector 23P
1528	4822 267 10731	Flex Connector 6P
1529	4822 265 11515	Flex Connector 8P
1901	4822 267 10994	S-Video Out Socket
1902	2422 025 12352	Scart Connector

CAPACITORS

2501	4822 124 40769	4,7μF 20% 100V
2502	4822 124 40769	4,7μF 20% 100V
2503	5322 122 32531	100pF 5% 50V
2504	5322 122 32531	100pF 5% 50V
2505	4822 126 14585	100nF 10% 50V
2506	4822 126 14585	100nF 10% 50V
2507	4822 124 40769	4,7μF 20% 100V
2508	4822 124 40769	4,7μF 20% 100V
2509	4822 124 41407	0,47μF 20% 63V
2510	4822 124 41407	0,47μF 20% 63V
2511	5322 122 31866	6,8nF 10% 63V
2512	5322 122 31866	6,8nF 10% 63V
2513	5322 122 32654	22nF 10% 63V
2514	5322 122 32654	22nF 10% 63V
2515	4822 126 13838	100nF +80/-20% 50V
2516	4822 126 13838	100nF +80/-20% 50V
2519	5322 122 32654	22nF 10% 63V
2520	5322 122 32654	22nF 10% 63V
2521	5322 126 10223	4,7nF 10% 63V
2522	5322 126 10223	4,7nF 10% 63V
2523	4822 126 14043	1μF +80/-20% 16V
2524	4822 126 14043	1μF +80/-20% 16V
2525	5322 122 32268	470pF 10% 50V
2526	5322 122 32268	470pF 10% 50V
2527	4822 124 40433	47μF 20% 25V
2528	4822 124 40433	47μF 20% 25V
2529	5322 122 34099	470pF 10% 63V
2530	5322 122 34099	470pF 10% 63V
2531	4822 126 13692	47pF 1% 63V
2532	4822 126 13692	47pF 1% 63V
2533	4822 121 51252	470nF 5% 63V
2534	4822 121 51252	470nF 5% 63V
2535	4822 121 51252	470nF 5% 63V
2536	4822 121 51252	470nF 5% 63V
2537	4822 121 51252	470nF 5% 63V

2538	4822 121 51252	470nF 5% 63V
2539	5322 122 31647	1nF 10% 63V
2540	5322 122 31647	1nF 10% 63V
2541	4822 124 40769	4,7μF 20% 100V
2542	4822 124 40769	4,7μF 20% 100V
2543	4822 126 13692	47pF 1% 63V
2544	4822 126 13692	47pF 1% 63V
2545	5322 122 34099	470pF 10% 63V
2546	5322 122 34099	470pF 10% 63V
2547	4822 124 40769	4,7μF 20% 100V
2548	4822 124 40769	4,7μF 20% 100V
2549	4822 124 81151	22μF 50V
2550	4822 124 81151	22μF 50V
2551	5322 122 32531	100pF 5% 50V
2552	5322 122 32531	100pF 5% 50V
2553	5322 122 34099	470pF 10% 63V
2554	5322 122 34099	470pF 10% 63V
2555	4822 126 12105	33nF 5% 50V
2556	4822 126 12105	33nF 5% 50V
2557	4822 121 51252	470nF 5% 63V
2558	4822 121 51252	470nF 5% 63V
2559	4822 126 10847	1,8nF 10% 63V
2560	4822 126 10847	1,8nF 10% 63V
2561	5322 122 31647	1nF 10% 63V
2562	5322 122 31647	1nF 10% 63V
2563	4822 122 33891	3,3nF 10% 63V
2564	4822 122 33891	3,3nF 10% 63V
2565	5322 122 34099	470pF 10% 63V
2566	5322 122 34099	470pF 10% 63V
2567	4822 126 14585	100nF 10% 50V
2568	4822 126 14585	100nF 10% 50V
2569	4822 122 33575	220pF 5% 63V
2570	4822 122 33575	220pF 5% 63V
2571	5322 122 34099	470pF 10% 63V
2572	5322 122 34099	470pF 10% 63V
2573	4822 124 40433	47μF 20% 25V
2574	4822 124 40769	4,7μF 20% 100V
2575	4822 124 21913	1μF 20% 63V
2576	4822 126 14585	100nF 10% 50V
2577	5322 122 32654	22nF 10% 63V
2578	4822 124 40433	47μF 20% 25V
2579	4822 126 14585	100nF 10% 50V
2580	4822 124 40207	100μF 20% 25V
2581	4822 124 40207	100μF 20% 25V
2582	4822 122 33127	2,2nF 10% 63V
2583	4822 126 13838	100nF +80/-20% 50V
2584	4822 126 14585	100nF 10% 50V
2585	4822 124 40207	100μF 20% 25V
2586	4822 124 40207	100μF 20% 25V
2587	4822 124 80791	470μF 20% 16V
2588	4822 124 40248	10μF 20% 63V
2589	4822 124 40248	10μF 20% 63V

ELECTRICAL PARTS LIST - AV BOARD

2590	5322 122 34098	10nF 10% 63V
2591	4822 124 40433	47μF 20% 25V
2592	5322 122 32654	22nF 10% 63V
2593	4822 124 80144	220μF 20% 25V
2594	4822 124 80144	220μF 20% 25V
2596	4822 126 14043	1μF +80/-20% 16V
2597	5322 122 32531	100pF 5% 50V
2598	5322 122 32531	100pF 5% 50V
2601	4822 124 40769	4,7μF 20% 100V
2602	4822 124 40769	4,7μF 20% 100V
2603	4822 122 32535	680pF 10% 63V
2604	4822 122 32535	680pF 10% 63V
2605	5322 122 32659	33pF 5% 50V
2606	5322 122 32659	33pF 5% 50V
2607	5322 122 32531	100pF 5% 50V
2608	4822 124 21913	1μF 20% 63V
2609	4822 124 21913	1μF 20% 63V
2612	4822 122 33127	2,2nF 10% 63V
2613	4822 122 33127	2,2nF 10% 63V
2614	5322 122 32448	10pF 5% 63V
2615	5322 122 32448	10pF 5% 63V
2616	4822 126 14585	100nF 10% 50V
2617	2020 552 96305	4,7μF +80/-20% 10V
2618	4822 126 13838	100nF +80/-20% 50V
2619	4822 126 13838	100nF +80/-20% 50V
2625	4822 122 33575	220pF 5% 63V
2626	4822 122 33575	220pF 5% 63V
2678	4822 126 14585	100nF 10% 50V
2715	4822 124 40769	4,7μF 20% 100V
2716	4822 124 40769	4,7μF 20% 100V
2717	5322 122 34099	470pF 10% 63V
2718	5322 122 34099	470pF 10% 63V
2719	4822 126 13838	100nF +80/-20% 50V
2720	4822 126 13838	100nF +80/-20% 50V
2721	4822 126 13838	100nF +80/-20% 50V
2722	4822 124 40769	4,7μF 20% 100V
2723	4822 126 13838	100nF +80/-20% 50V
2724	5322 122 32658	22pF 5% 50V
2726	5322 122 34099	470pF 10% 63V
2728	4822 126 13692	47pF 1% 63V
2729	4822 126 14043	1μF +80/-20% 16V
2732	4822 124 22652	2,2μF 20% 50V
2733	4822 124 40248	10μF 20% 63V
2734	4822 124 40248	10μF 20% 63V
2735	4822 124 40769	4,7μF 20% 100V
2736	4822 124 40769	4,7μF 20% 100V
2737	5322 122 32658	22pF 5% 50V
2738	5322 122 32658	22pF 5% 50V
2739	4822 126 13486	15pF 2% 63V
2740	4822 126 13486	15pF 2% 63V
2741	4822 126 13692	47pF 1% 63V
2742	4822 126 13692	47pF 1% 63V
2743	4822 124 41751	47μF 20% 50V
2744	4822 124 41751	47μF 20% 50V
2745	4822 124 22652	2,2μF 20% 50V
2746	4822 124 22652	2,2μF 20% 50V
2747	4822 124 40248	10μF 20% 63V
2748	4822 124 40248	10μF 20% 63V
2749	4822 124 40769	4,7μF 20% 100V
2750	4822 126 13486	15pF 2% 63V
2751	5322 122 32658	22pF 5% 50V
2752	4822 124 41751	47μF 20% 50V
2753	4822 124 22652	2,2μF 20% 50V
2754	4822 126 13692	47pF 1% 63V
2799	4822 124 41751	47μF 20% 50V
2800	4822 126 13486	15pF 2% 63V
2801	4822 126 14585	100nF 10% 50V
2830	2020 552 96305	4,7μF +80/-20% 10V
2831	2020 552 96305	4,7μF +80/-20% 10V
2832	5322 122 32448	10pF 5% 63V
2833	5322 122 32448	10pF 5% 63V
2835	4822 126 13751	47nF 10% 63V
2836	4822 126 13751	47nF 10% 63V
2838	4822 126 13692	47pF 1% 63V
2866	5322 122 32448	10pF 5% 63V
2867	5322 122 32448	10pF 5% 63V
2870	4822 124 41584	100μF 20% 10V
2876	4822 126 14585	100nF 10% 50V
2876	4822 124 81151	22μF 50V /22
2877	4822 122 33575	220pF 5% 63V
2878	4822 126 13838	100nF +80/-20% 50V
2887	4822 122 33127	2,2nF 10% 63V
2888	4822 122 33127	2,2nF 10% 63V
2889	4822 126 14585	100nF 10% 50V
2890	4822 126 14585	100nF 10% 50V
2891	4822 126 13838	100nF +80/-20% 50V
2893	4822 126 13751	47nF 10% 63V
2894	4822 126 13751	47nF 10% 63V
2896	4822 124 40769	4,7μF 20% 100V
2897	4822 124 40769	4,7μF 20% 100V
2898	4822 126 13838	100nF +80/-20% 50V
2899	4822 126 13751	47nF 10% 63V
2901	4822 124 21913	1μF 20% 63V
2902	4822 124 21913	1μF 20% 63V
2903	4822 122 33575	220pF 5% 63V
2904	4822 122 33575	220pF 5% 63V
2905	4822 124 21913	1μF 20% 63V
2906	4822 124 21913	1μF 20% 63V
2907	4822 122 33575	220pF 5% 63V
2908	4822 122 33575	220pF 5% 63V
2921	4822 124 21913	1μF 20% 63V
2922	4822 124 21913	1μF 20% 63V
2923	4822 122 33575	220pF 5% 63V
2924	4822 122 33575	220pF 5% 63V

ELECTRICAL PARTS LIST - AV BOARD

CAPACITORS

2925	4822 122 33575	220pF 5% 63V
2926	4822 122 33575	220pF 5% 63V
2927	5322 122 32654	22nF 10% 63V
2929	4822 122 33575	220pF 5% 63V
2930	4822 122 33575	220pF 5% 63V
2931	4822 124 80144	220µF 20% 25V
2932	4822 126 13838	100nF +80/-20% 50V
2933	5322 122 32654	22nF 10% 63V
2934	4822 124 40746	0,22µF 20% 63V
2935	4822 126 13838	100nF +80/-20% 50V
2961	4822 124 21913	1µF 20% 63V
2962	4822 124 21913	1µF 20% 63V
2963	4822 122 33575	220pF 5% 63V
2964	4822 122 33575	220pF 5% 63V
2965	4822 126 13838	100nF +80/-20% 50V
2966	4822 124 40746	0,22µF 20% 63V
2967	4822 124 81044	470µF 20% 6,3V
2972	5322 126 10511	1nF 5% 50V
2979	5322 122 33538	150pF 2% 63V
2980	4822 126 13751	47nF 10% 63V
2981	4822 126 13751	47nF 10% 63V
2985	4822 122 33216	270pF 5% 50V
2986	4822 122 33216	270pF 5% 50V
2987	4822 126 13838	100nF +80/-20% 50V
2988	4822 124 81044	470µF 20% 6,3V

RESISTORS

3501	4822 051 10102	1k 2% 0,25W
3502	4822 051 10102	1k 2% 0,25W
3503	4822 051 20392	3k9 5% 0,1W
3504	4822 051 20392	3k9 5% 0,1W
3505	4822 051 20223	22k 5% 0,1W
3506	4822 051 20223	22k 5% 0,1W
3507	4822 117 11383	12k 1% 0,1W
3508	4822 117 11383	12k 1% 0,1W
3509	4822 051 20472	4k7 5% 0,1W
3510	4822 051 20472	4k7 5% 0,1W
3511	4822 051 20223	22k 5% 0,1W
3512	4822 051 20223	22k 5% 0,1W
3513	4822 117 11449	2k2 5% 0,1W
3514	4822 117 11449	2k2 5% 0,1W
3515	4822 117 10834	47k 1% 0,1W
3516	4822 117 10834	47k 1% 0,1W
3517	4822 051 20472	4k7 5% 0,1W
3518	4822 051 20472	4k7 5% 0,1W
3519	4822 051 20472	4k7 5% 0,1W
3520	4822 051 20472	4k7 5% 0,1W
3521	4822 117 11449	2k2 5% 0,1W
3522	4822 117 11449	2k2 5% 0,1W
3523	4822 117 11503	220R 1% 0,1W
3524	4822 117 11503	220R 1% 0,1W
3525	4822 051 20154	150k 5% 0,1W

3526	4822 051 20154	150k 5% 0,1W
3527	4822 117 11503	220R 1% 0,1W
3528	4822 117 11503	220R 1% 0,1W
3529	4822 117 11454	820R 1% 0,1W
3530	4822 117 11454	820R 1% 0,1W
3531	4822 117 10833	10k 1% 0,1W
3532	4822 117 10833	10k 1% 0,1W
3533	4822 051 20562	5k6 5% 0,1W
3534	4822 051 20562	5k6 5% 0,1W
3535	4822 117 10834	47k 1% 0,1W
3536	4822 117 10834	47k 1% 0,1W
3537	4822 117 11383	12k 1% 0,1W
3538	4822 117 11383	12k 1% 0,1W
3539	4822 051 20479	47R 5% 0,1W
3540	4822 051 20479	47R 5% 0,1W
3541	4822 051 20479	47R 5% 0,1W
3542	4822 051 20479	47R 5% 0,1W
3543	4822 051 10102	1k 2% 0,25W
3544	4822 051 10102	1k 2% 0,25W
3545	4822 051 20479	47R 5% 0,1W
3546	4822 051 20479	47R 5% 0,1W
3547	4822 051 20392	3k9 5% 0,1W
3548	4822 051 20392	3k9 5% 0,1W
3549	4822 051 20683	68k 5% 0,1W
3550	4822 051 20683	68k 5% 0,1W
3551	4822 051 20273	27k 5% 0,1W
3552	4822 051 20273	27k 5% 0,1W
3553	4822 051 20684	680k 5% 0,1W
3554	4822 051 20684	680k 5% 0,1W
3555	4822 117 13579	220k 1% 0,1W
3556	4822 117 13579	220k 1% 0,1W
3557	4822 117 10833	10k 1% 0,1W
3558	4822 117 10833	10k 1% 0,1W
3559	4822 117 10833	10k 1% 0,1W
3560	4822 117 10833	10k 1% 0,1W
3561	4822 051 20822	8k2 5% 0,1W
3562	4822 051 20822	8k2 5% 0,1W
3563	4822 051 20822	8k2 5% 0,1W
3564	4822 051 20822	8k2 5% 0,1W
3565	4822 117 10834	47k 1% 0,1W
3566	4822 117 10834	47k 1% 0,1W
3567	4822 051 10102	1k 2% 0,25W
3568	4822 051 10102	1k 2% 0,25W
3569	4822 117 11503	220R 1% 0,1W
3570	4822 117 11503	220R 1% 0,1W
3571	4822 051 20822	8k2 5% 0,1W
3572	4822 051 20822	8k2 5% 0,1W
3573	4822 051 20562	5k6 5% 0,1W
3574	4822 051 20562	5k6 5% 0,1W
3575	4822 051 20562	5k6 5% 0,1W
3576	4822 051 20562	5k6 5% 0,1W
3577	4822 051 20562	5k6 5% 0,1W

ELECTRICAL PARTS LIST - AV BOARD

3578	4822 051 20562	5k6 5% 0,1W
3579	4822 051 20332	3k3 5% 0,1W
3580	4822 051 20332	3k3 5% 0,1W
3581	4822 051 20471	470R 5% 0,1W
3582	4822 051 20471	470R 5% 0,1W
3583	4822 051 20471	470R 5% 0,1W
3584	4822 051 20471	470R 5% 0,1W
3585	4822 117 12955	2k7 1% 0,1W
3586	4822 051 20105	1M 5% 0,1W
3588	4822 051 20474	470k 5% 0,1W
3589	4822 051 10102	1k 2% 0,25W
3592	4822 051 20223	22k 5% 0,1W
3593	4822 051 20472	4k7 5% 0,1W
3594	4822 051 20472	4k7 5% 0,1W
3595	4822 051 20472	4k7 5% 0,1W
3596	4822 051 20472	4k7 5% 0,1W
3597	4822 117 11454	820R 1% 0,1W
3599	4822 051 20472	4k7 5% 0,1W
3600	4822 051 10102	1k 2% 0,25W
3605	4822 116 83933	15k 1% 0,1W
3606	4822 051 20562	5k6 5% 0,1W
3607	4822 051 20101	100R 5% 0,1W
3608	4822 052 10109	△ 10R 5% 0,33W
3609	4822 051 10102	1k 2% 0,25W
3610	4822 051 10102	1k 2% 0,25W
3611	4822 117 11449	2k2 5% 0,1W
3612	4822 117 11449	2k2 5% 0,1W
3613	4822 117 11449	2k2 5% 0,1W
3614	4822 117 11449	2k2 5% 0,1W
3615	4822 117 10837	100k 1% 0,1W
3616	4822 117 10837	100k 1% 0,1W
3617	4822 051 20124	120k 5% 0,1W
3618	4822 051 20124	120k 5% 0,1W
3619	4822 051 20393	39k 5% 0,1W
3620	4822 051 20393	39k 5% 0,1W
3621	4822 051 20479	47R 5% 0,1W
3622	4822 117 10833	10k 1% 0,1W
3623	4822 051 10102	1k 2% 0,25W
3624	4822 051 10102	1k 2% 0,25W
3625	4822 051 20472	4k7 5% 0,1W
3626	4822 051 20472	4k7 5% 0,1W
3627	4822 051 20472	4k7 5% 0,1W
3630	4822 051 10102	1k 2% 0,25W
3631	4822 051 10102	1k 2% 0,25W
3653	4822 051 10102	1k 2% 0,25W
3711	4822 051 20479	47R 5% 0,1W
3712	4822 051 20479	47R 5% 0,1W
3713	4822 117 10834	47k 1% 0,1W
3714	4822 117 10834	47k 1% 0,1W
3715	4822 116 83933	15k 1% 0,1W
3716	4822 116 83933	15k 1% 0,1W
3717	4822 051 20273	27k 5% 0,1W

3718	4822 051 20273	27k 5% 0,1W
3720	4822 117 10833	10k 1% 0,1W
3724	4822 117 10833	10k 1% 0,1W
3726	4822 051 20822	8k2 5% 0,1W
3728	4822 117 10837	100k 1% 0,1W
3731	4822 051 10102	1k 2% 0,25W
3732	4822 051 10102	1k 2% 0,25W
3733	4822 117 11448	180R 1% 0,1W
3734	4822 117 11448	180R 1% 0,1W
3735	4822 117 10834	47k 1% 0,1W
3736	4822 117 10834	47k 1% 0,1W
3737	4822 117 10833	10k 1% 0,1W
3738	4822 117 10833	10k 1% 0,1W
3741	4822 117 10833	10k 1% 0,1W
3742	4822 117 10833	10k 1% 0,1W
3743	4822 051 20393	39k 5% 0,1W
3744	4822 051 20393	39k 5% 0,1W
3745	4822 117 10837	100k 1% 0,1W
3746	4822 117 10837	100k 1% 0,1W
3747	4822 051 20472	4k7 5% 0,1W
3748	4822 051 20472	4k7 5% 0,1W
3749	4822 051 10102	1k 2% 0,25W
3750	4822 051 10102	1k 2% 0,25W
3751	4822 117 11448	180R 1% 0,1W
3752	4822 117 11448	180R 1% 0,1W
3753	4822 117 10834	47k 1% 0,1W
3754	4822 117 10834	47k 1% 0,1W
3755	4822 117 10833	10k 1% 0,1W
3756	4822 117 10833	10k 1% 0,1W
3757	4822 051 20124	120k 5% 0,1W
3758	4822 117 10837	100k 1% 0,1W
3759	4822 051 20472	4k7 5% 0,1W
3760	4822 116 52283	4k7 5% 0,5W
3760	4822 051 20472	4k7 5% 0,1W /22
3761	4822 051 20101	100R 5% 0,1W
3764	4822 051 20391	390R 5% 0,1W
3765	4822 051 20122	1k2 5% 0,1W
3766	4822 117 11149	82k 1% 0,1W
3767	4822 051 20334	330k 5% 0,1W
3768	4822 051 20154	150k 5% 0,1W
3769	4822 051 20154	150k 5% 0,1W
3770	4822 051 20333	33k 5% 0,1W
3771	4822 051 20333	33k 5% 0,1W
3772	4822 051 20561	560R 5% 0,1W
3773	4822 117 10834	47k 1% 0,1W
3774	4822 117 10834	47k 1% 0,1W
3775	4822 117 10834	47k 1% 0,1W
3790	4822 117 11449	2k2 5% 0,1W
3791	4822 117 11449	2k2 5% 0,1W
3791	4822 051 10102	1k 2% 0,25W /22
3792	4822 050 21003	10k 1% 0,6W
3793	4822 051 20472	4k7 5% 0,1W

ELECTRICAL PARTS LIST - AV BOARD

RESISTORS

3812	4822 117 11449	2k2 5% 0,1W	3952	4822 117 11448	180R 1% 0,1W
3813	4822 117 11449	2k2 5% 0,1W	3953	4822 117 11449	2k2 5% 0,1W
3814	4822 117 10833	10k 1% 0,1W	3954	4822 051 10102	1k 2% 0,25W
3815	4822 051 20472	4k7 5% 0,1W	3954	4822 117 11503	220R 1% 0,1W /22
3816	4822 051 20121	120R 5% 0,1W	3955	4822 051 10102	1k 2% 0,25W
3819	4822 116 81154	2R2 5% 0,5W	3955	4822 117 11503	220R 1% 0,1W /22
3820	4822 051 20562	5k6 5% 0,1W	3956	4822 051 20561	560R 5% 0,1W
3821	4822 117 10833	10k 1% 0,1W	3957	4822 051 20561	560R 5% 0,1W
3822	4822 117 11449	2k2 5% 0,1W	3958	4822 051 20392	3k9 5% 0,1W
3823	4822 051 20562	5k6 5% 0,1W	3959	4822 051 20392	3k9 5% 0,1W
3824	4822 050 11002	1k 1% 0,4W	3960	4822 117 10965	18k 1% 0,1W
3825	4822 117 10834	47k 1% 0,1W	3961	4822 117 11449	2k2 5% 0,1W
3826	4822 117 10834	47k 1% 0,1W	3962	4822 117 11504	270R 1% 0,1W
3827	4822 051 10102	1k 2% 0,25W	3963	4822 051 20479	47R 5% 0,1W
3827	4822 117 11503	220R 1% 0,1W /22	3964	4822 051 20471	470R 5% 0,1W
3828	4822 051 10102	1k 2% 0,25W	3965	4822 117 11503	220R 1% 0,1W
3828	4822 117 11503	220R 1% 0,1W /22	3966	4822 051 20479	47R 5% 0,1W
3829	4822 051 10102	1k 2% 0,25W	3967	4822 051 20121	120R 5% 0,1W
3829	4822 117 11503	220R 1% 0,1W /22	3970	4822 117 10965	18k 1% 0,1W
3833	4822 051 20101	100R 5% 0,1W	3971	4822 117 10965	18k 1% 0,1W
3836	4822 051 20339	33R 5% 0,1W	3972	4822 117 10965	18k 1% 0,1W
3851	4822 051 20829	82R 5% 0,1W	3973	4822 117 10834	47k 1% 0,1W
3852	4822 051 20829	82R 5% 0,1W	3974	4822 117 10833	10k 1% 0,1W
3857	4822 051 20829	82R 5% 0,1W	3975	4822 117 10833	10k 1% 0,1W
3901	4822 051 20471	470R 5% 0,1W	3978	4822 117 11139	1k5 1% 0,1W
3902	4822 117 11449	2k2 5% 0,1W	3979	4822 117 10834	47k 1% 0,1W
3903	4822 117 11504	270R 1% 0,1W	3980	4822 117 10834	47k 1% 0,1W
3904	4822 117 11503	220R 1% 0,1W	3982	4822 117 10837	100k 1% 0,1W
3905	4822 051 20121	120R 5% 0,1W	3983	4822 117 11149	82k 1% 0,1W
3906	4822 051 20479	47R 5% 0,1W	3984	4822 117 10837	100k 1% 0,1W
3907	4822 051 20479	47R 5% 0,1W	3985	4822 117 11149	82k 1% 0,1W
3908	4822 051 20471	470R 5% 0,1W	3986	4822 117 11454	820R 1% 0,1W
3909	4822 117 11449	2k2 5% 0,1W	3987	4822 117 11454	820R 1% 0,1W
3910	4822 117 11504	270R 1% 0,1W	3988	4822 117 11454	820R 1% 0,1W
3911	4822 117 11503	220R 1% 0,1W	3989	4822 117 11454	820R 1% 0,1W
3912	4822 051 20121	120R 5% 0,1W	3990	4822 051 20471	470R 5% 0,1W
3913	4822 051 20479	47R 5% 0,1W	3991	4822 117 10965	18k 1% 0,1W
3914	4822 051 20479	47R 5% 0,1W	3992	4822 051 20471	470R 5% 0,1W
3936	4822 051 20471	470R 5% 0,1W	3993	4822 051 20471	470R 5% 0,1W
3937	4822 117 11449	2k2 5% 0,1W	4401	4822 051 20008	0R Jumper 0805
3938	4822 117 11504	270R 1% 0,1W	4402	4822 051 20008	0R Jumper 0805
3939	4822 051 20121	120R 5% 0,1W	4403	4822 051 20008	0R Jumper 0805
3940	4822 117 11503	220R 1% 0,1W	4404	4822 051 20008	0R Jumper 0805
3941	4822 051 20479	47R 5% 0,1W	4405	4822 051 20008	0R Jumper 0805
3942	4822 051 20479	47R 5% 0,1W	4406	4822 051 20008	0R Jumper 0805
3945	4822 051 20471	470R 5% 0,1W	4407	4822 051 20008	0R Jumper 0805
3946	4822 051 20471	470R 5% 0,1W	4408	4822 051 20008	0R Jumper 0805
3947	4822 052 10478 Δ	4R7 5% 0,33W	4409	4822 051 20008	0R Jumper 0805
3948	4822 052 10478 Δ	4R7 5% 0,33W	4410	4822 051 20008	0R Jumper 0805
3949	4822 117 10353	150R 1% 0,1W	4411	4822 051 20008	0R Jumper 0805
3950	4822 117 11504	270R 1% 0,1W	4412	4822 051 20008	0R Jumper 0805
3951	4822 117 11504	270R 1% 0,1W	4413	4822 051 20008	0R Jumper 0805

ELECTRICAL PARTS LIST - AV BOARD

4516	4822 051 20008	0R Jumper 0805	4717	4822 051 20008	0R Jumper 0805
4578	4822 051 20008	0R Jumper 0805	4718	4822 051 20008	0R Jumper 0805
4650	4822 051 20008	0R Jumper 0805	4720	4822 051 20008	0R Jumper 0805
4651	4822 051 20008	0R Jumper 0805	4721	4822 051 20008	0R Jumper 0805
4652	4822 051 20008	0R Jumper 0805	4722	4822 051 20008	0R Jumper 0805
4653	4822 051 20008	0R Jumper 0805	4723	4822 051 20008	0R Jumper 0805
4654	4822 051 20008	0R Jumper 0805	4724	4822 051 20008	0R Jumper 0805
4655	4822 051 20008	0R Jumper 0805	4725	4822 051 20008	0R Jumper 0805
4656	4822 051 20008	0R Jumper 0805	4726	4822 051 20008	0R Jumper 0805
4658	4822 051 20008	0R Jumper 0805	4727	4822 051 20008	0R Jumper 0805
4659	4822 051 20008	0R Jumper 0805	4902	4822 051 20008	0R Jumper 0805
4669	4822 051 20008	0R Jumper 0805	4903	4822 051 20008	0R Jumper 0805
4670	4822 051 20008	0R Jumper 0805	4904	4822 051 20008	0R Jumper 0805
4671	4822 051 20008	0R Jumper 0805	4906	4822 051 20008	0R Jumper 0805
4672	4822 051 20008	0R Jumper 0805	4907	4822 051 20008	0R Jumper 0805
4673	4822 051 20008	0R Jumper 0805	4908	4822 051 20008	0R Jumper 0805
4674	4822 051 20008	0R Jumper 0805	4912	4822 051 20008	0R Jumper 0805
4675	4822 051 20008	0R Jumper 0805	4913	4822 051 20008	0R Jumper 0805
4676	4822 051 20008	0R Jumper 0805	4914	4822 051 20008	0R Jumper 0805
4677	4822 051 20008	0R Jumper 0805	4962	4822 051 20008	0R Jumper 0805
4678	4822 051 20008	0R Jumper 0805	4963	4822 051 20008	0R Jumper 0805
4679	4822 051 20008	0R Jumper 0805	4964	4822 051 20008	0R Jumper 0805
4680	4822 051 20008	0R Jumper 0805	4965	4822 051 20008	0R Jumper 0805
4681	4822 051 20008	0R Jumper 0805	4966	4822 051 20008	0R Jumper 0805
4683	4822 051 20008	0R Jumper 0805	4967	4822 051 20008	0R Jumper 0805
4684	4822 051 20008	0R Jumper 0805			
4685	4822 051 20008	0R Jumper 0805			
4688	4822 051 20008	0R Jumper 0805			
4689	4822 051 20008	0R Jumper 0805			
4690	4822 051 20008	0R Jumper 0805			
4691	4822 051 20008	0R Jumper 0805			
4692	4822 051 20008	0R Jumper 0805			
4693	4822 051 20008	0R Jumper 0805			
4694	4822 051 20008	0R Jumper 0805			
4695	4822 051 20008	0R Jumper 0805			
4696	4822 051 20008	0R Jumper 0805			
4697	4822 051 20008	0R Jumper 0805			
4698	4822 051 20008	0R Jumper 0805			
4700	4822 051 20008	0R Jumper 0805			
4704	4822 051 20008	0R Jumper 0805			
4705	4822 051 20008	0R Jumper 0805			
4706	4822 051 20008	0R Jumper 0805			
4707	4822 051 20008	0R Jumper 0805			
4708	4822 051 20008	0R Jumper 0805			
4709	4822 051 20008	0R Jumper 0805			
4710	4822 051 20008	0R Jumper 0805			
4711	4822 051 20008	0R Jumper 0805			
4712	4822 051 20008	0R Jumper 0805			
4713	4822 051 20008	0R Jumper 0805			
4714	4822 051 20008	0R Jumper 0805			
4715	4822 051 20008	0R Jumper 0805			
4716	4822 051 20008	0R Jumper 0805			

COILS & FILTERS

5000	4822 157 70601	Coil 100 μ H 10%
5511	4822 157 62552	Coil 2,2 μ H 5%
5512	4822 157 10586	Coil 2,2 μ H 10%

DIODES

6512	4822 130 30862	BZX79-C9V1
6513	4822 130 31878	1N4003G
6514	4822 130 31878	1N4003G
6515	4822 130 30621	1N4148
6517	4822 130 30621	1N4148
6518	4822 130 30621	1N4148
6519	4822 130 30621	1N4148
6520	4822 130 30621	1N4148
6521	4822 130 30621	1N4148
6531	4822 130 30621	1N4148
6711	4822 130 34233	BZX79-C5V1
6712	4822 130 30621	1N4148
6713	4822 130 30621	1N4148
6720	4822 130 30621	1N4148
6721	4822 130 30621	1N4148
6722	4822 130 30621	1N4148
6723	4822 130 30621	1N4148
6901	4822 130 30621	1N4148
6902	4822 130 34278	BZX79-C6V8
6903	4822 130 30621	1N4148

ELECTRICAL PARTS LIST - AV BOARD**DIODES**

6904	4822 130 34278	BZX79-C6V8	7961	4822 130 44568	BC557B
6911	4822 130 30621	1N4148	7962	5322 130 60159	BC847B
6912	4822 130 34278	BZX79-C6V8			
6961	4822 130 30621	1N4148			
6962	4822 130 34278	BZX79-C6V8			

Note : Only the parts mentioned in this list are normal service spare parts.

TRANSISTORS & INTEGRATED CIRCUITS

7501	4822 209 17386	TDA7437T
7502	4822 209 83357	NJM4560M
7503	4822 130 40959	BC547B
7504	5322 130 60159	BC847B
7505	5322 130 60159	BC847B
7506	5322 130 60159	BC847B
7507	5322 130 60159	BC847B
7508	5322 130 60159	BC847B
7509	4822 130 42804	BC817-25
7510	4822 130 42804	BC817-25
7511	4822 130 60373	BC857B
7514	4822 209 31378	NJM4556AM
7515	4822 130 60373	BC857B
7516	4822 130 60373	BC857B
7517	4822 209 83357	NJM4560M
7521	5322 130 60159	BC847B
7522	5322 130 60159	BC847B
7529	4822 130 60373	BC857B
7534	5322 209 14481	HEF4053BT
7536	4822 209 31378	NJM4556AM
7537	4822 209 31378	NJM4556AM
7538	4822 209 16262	74HC4016D
7539	5322 130 60159	BC847B
7540	9337 142 60653	74HC04D
7542	5322 130 60159	BC847B
7544	5322 130 60159	BC847B
7546	4822 130 60373	BC857B
7547	5322 130 60159	BC847B
7548	5322 130 60159	BC847B
7549	4822 209 17345	M62320FP
7550	4822 130 41246	BC327-25
7551	5322 130 60159	BC847B
7555	4822 130 60373	BC857B
7556	5322 130 60159	BC847B
7557	5322 130 60159	BC847B
7581	5322 130 60159	BC847B
7582	4822 130 44568	BC557B
7583	5322 130 60159	BC847B
7584	4822 130 44568	BC557B
7591	5322 130 60159	BC847B
7592	4822 130 44568	BC557B
7593	4822 130 60373	BC857B
7594	4822 209 17349	M62429FP
7595	4822 209 17349	M62429FP
7596	5322 130 60159	BC847B

DVD Module

TABLE OF CONTENTS

Diagnostic Software:

Dealer Script	9-2
Player Script	9-3
Interactive Tests	9-4
Error Log & Bits	9-6
Loop Test	9-7
Servicing DVD module & Mono board	9-8
Reset of Virgin Mode	9-8

1. DEALER SCRIPT

Purpose of Dealer Script

The dealer script can give a diagnosis on a standalone DVD player; no other equipment is needed to perform a number of hardware tests to check if the DVD player is faulty. The diagnosis is simply a “error” or “pass” message; no indication is given of faulty hardware modules. Only tests within the scope of the diagnostic software will be executed hence only faults within this scope can be detected.

Contents of Dealer Script

The dealer script executes all diagnostic nuclei that do not need any user interaction and are meaningful on a standalone DVD player.

The nuclei called in the dealer script are the following (the number after each nucleus name corresponds with the number being on the local display when the nucleus is executed during the dealer script):

Nucleus		Description
VideoColSetupComm	9	Check the I2C interface with the RGB video processor on the Audio/Video board (only for DVD players with RGB video processor).
VideoScartSwComm	8	Checks the I2C interface with the scart switch on the Audio/Video board
PapChksFl	7	Calculate and verify checksum of FLASH memory
PapDramWrR	6	Pattern test of all locations in the DRAM(s)
PapI2cDisp	5	Checks the I2C interface with the slave processor on the display PCB
PapS2bEcho	4	Checks the I2C interface to the basic engine
PapI2cNvram	3	Checks the I2C interface with the NVRAM
PapNvramWrR	2	Pattern test of all locations in the NVRAM
CompSdramWrR	1	Pattern test of all locations in the SDRAM(s)

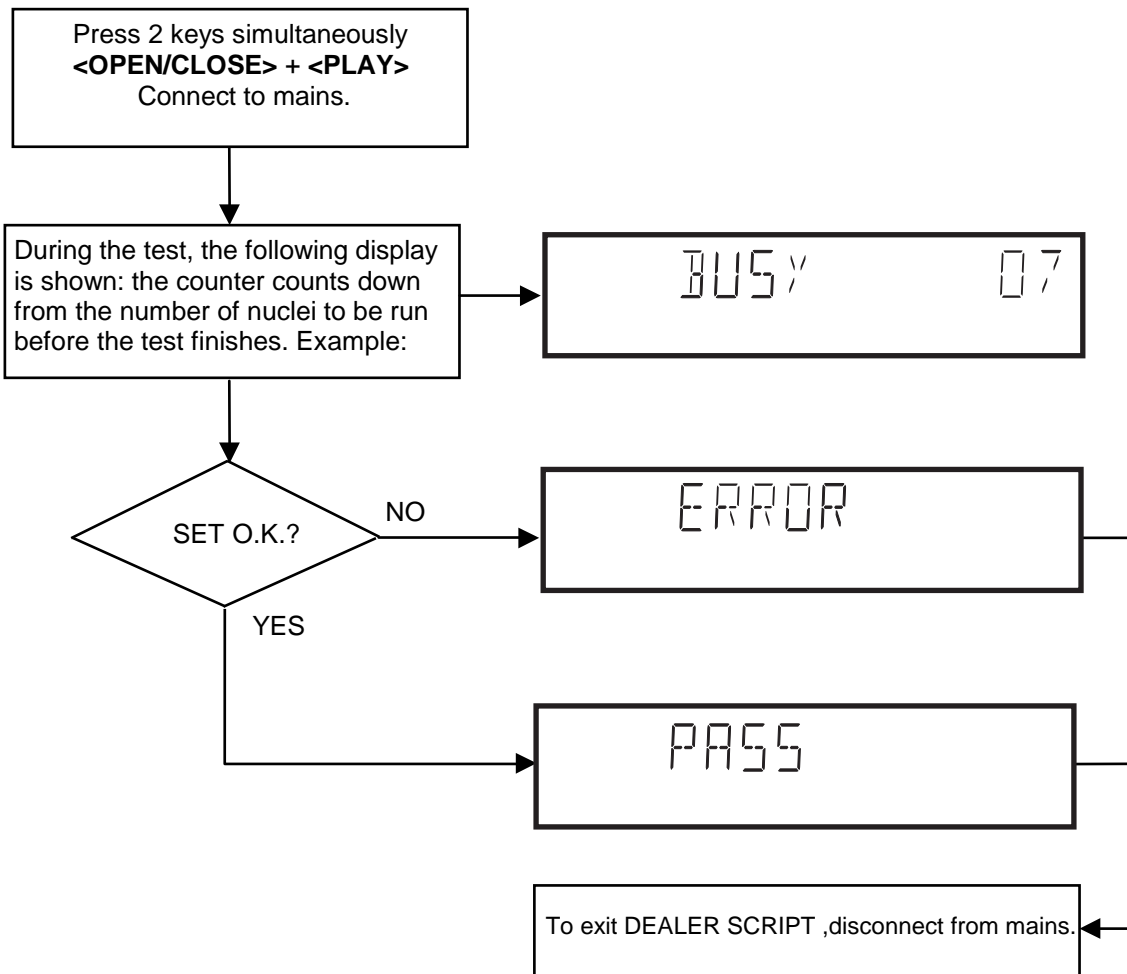

2. PLAYER SCRIPT

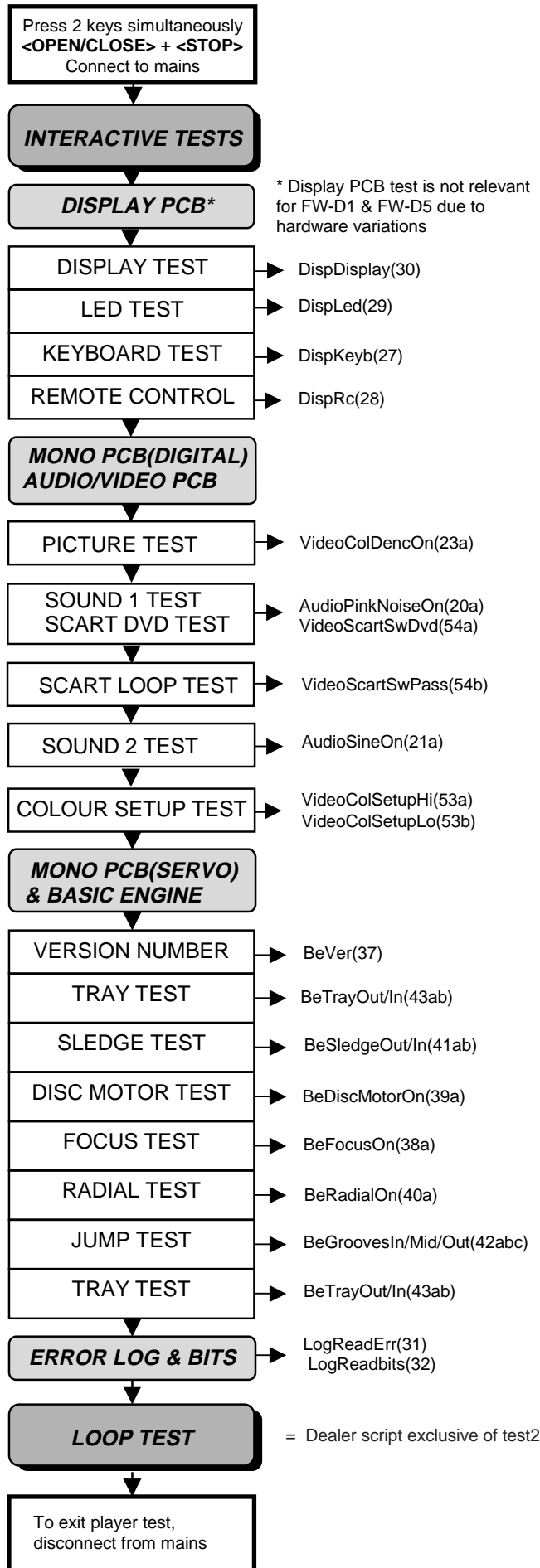

Purpose of Player Script

The Player script will give the opportunity to perform a test that will determine which of the DVD player's modules are faulty, to read the error log and error bits and to perform an endurance loop test.

To successfully perform the tests, the DVD player must be connected to a TV set to check the output of a number of nuclei. For DVDv2B a multi-channel amplifier, a set of 6 boxes and an external video source are necessary to test. To be able to check results of certain nuclei, the player script expects some interaction of the user (i.e. to approve a test picture or a test sound). Some nuclei (e.g. nuclei that test functionality of the Basic Engine module) require that the DVD player itself is opened, to enable the user to observe moving parts and approve their movement visually.

Only tests within the scope of the diagnostic software will be executed hence only faults within this scope can be detected.

Contents of Player Script

The player script contains all nuclei that are useful on a DVD player that is connected to a TV-set and help to determine which module of the DVD player is faulty, as well as to read out the contents of the error logs.

Structure of Player Script

The player script consists of a set of nuclei testing the three hardware modules in the DVD player: the Display PCB*, the Digital PCB and the Basic Engine.

***Note: Display PCB tests are not relevant to FW-D1 & FW-D5 sets**

Nuclei run by the player test need some user interaction; in the next paragraph this interaction is described. The player test is done in two phases:

1. Interactive tests:

This part of the player test depends strongly on user interaction and input to determine nucleus results and to progress through the full test. Reading the error log and error bits information can be useful to determine any errors that occurred recently during normal operation of the DVD player.
2. The loop test will perform the same nuclei as the dealer test, but it will loop through the list of nuclei indefinitely.

3. INTERACTIVE TESTS

3.1 DISPLAY PCB*

***Note:** *The tests on this Display PCB are not relevant to FW-D1 and FW-D5 families.*

DISPLAY TEST & LED TEST

Press 2 times the NEXT key to skip the Display and LED test.

KEYBOARD TEST

The display shows:



TB--

Press the NEXT key for more than 1 second, the display will change to:

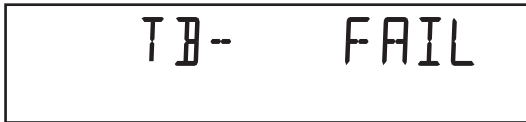

TB-- FAIL

Press NEXT key to proceed to the next test.

REMOTE CONTROL TEST

The display shows:



RC--

Press the NEXT key for more than 1 second, the display will change to:



RC-- FAIL

Press NEXT key to proceed to the next test.

3.2 MONO PCB DIGITAL PART

PICTURE TEST

This test is performed by sending a predefined picture (colour bar) to the TV screen (nucleus VideoColDencOn) and asking the user for confirmation. The display will show the following message:



APP PIC-1

By pressing PLAY the user confirms the test, pressing PREV will indicate the picture was invisible or incorrect. Pressing NEXT will proceed to the next test

SOUND 1 & SCART DVD TEST

The first soundtest is performed by starting a pink noise

sound that needs confirmation from the user (nucleus AudioPinkNoiseOn); the display will show the following message very shortly:



APP SND-1

This sound will only be audible from version cut3.1 of Sti5505 (item7503 on mono board) onwards. After starting up sound 1, SCART loop-trough will be simultaneously active during this test. SCART loop-trough will be measured with the aid of an external video source.

When entering the SCART loop-trough, the local display indicates:



SCART DVD

On the TV screen a colour bar (generated by nucleus VideoColDencOn) is visual and the internally generated pinknoise is audible. By pressing PLAY the user confirms the test, pressing PREV will indicate the sound was inaudible or incorrect. Pressing NEXT will proceed to the next test; if the user presses NEXT without pressing PLAY or PREV first, the result of this test will be TRUE (sound ok).

By pressing the NEXT button there will be switched over to the external source, this must become now visible on the TV screen (using the SCART). The local display indicates:



SCART LOOP

The internally generated colour bar is still available on the CVBS and Y/C outputs. And the pinknoise-signal is still available on the cinch audio outputs. By pressing the PREV button, the internal generated colour bar becomes visual again. The test can be left by pressing the NEXT key for more than one second.

SOUND 2 TEST

The second soundtest is performed by producing a sine sound (nucleusAudioSineOn). The signal can be stopped by pressing the STOP-key. The display will show the following message:



APP SND-2

By pressing PLAY the user confirms the test, pressing PREV will indicate that something went wrong. Pressing NEXT will proceed to the next; if the user presses NEXT without pressing PLAY or PREV first, the result of this test will be TRUE (sound ok).

3.3 BASIC ENGINE

VERSION NUMBER

In the basic engine tests, the version number of the Basic Engine will be shown first, as the following example:



By pressing the NEXT key, the Basic Engine tests are started.

TRAY TEST

First, the tray is tested. The purpose of this test is also to give the user the opportunity to put a disc in the tray of the DVD player. Some tests on the Basic Engine require that a disc (e.g. DVD MPTD test disc) is present in the player. At the end of the Basic Engine tests this tray test will be repeated solely to enable the user to remove the disc in the tray. The local display will look as follows:



By pressing PLAY the user can toggle the position of the tray. Note that this test will not contribute to the test result of the Basic Engine. Pressing NEXT will proceed to the next test, after the tray has been closed (by the software) if it was open.

SLEDGE TEST(visual test)

The second Basic Engine test tests the sledge; the user can move the sledge as many times as desired by using PLAY (nucleus BeSledgeOut) and PREV (nucleus BeSledgeIn). Pressing NEXT on the local keyboard proceeds to the next test. Note that this test will not contribute to the test result of the Basic Engine. The local display will look as follows during the sledge test:



DISC MOTOR TEST(visual test)

The third Basic Engine test tests the disc motor (nucleus BeDiscMotorOn); the local display looks as follows:



By pressing PLAY the user confirms that the disc motor is running; pressing PREV indicates the disc motor does not work. Pressing NEXT proceeds to the next test, after a reset of the disc motor (nucleus BeDiscMotorOff). If the user presses NEXT before pressing PLAY or PREV, the result of

this test will be TRUE (disc motor is running).

FOCUS TEST(visual test)

The fourth Basic Engine test tests the focusing; first focusing is turned on by calling nucleus BeFocusOn. The display will look as follows:



By pressing PLAY the user confirms that the focusing was successful; pressing PREV indicates a focusing failure. Pressing NEXT proceeds to the next test after a reset of the focussing (nucleus BeFocusOff); if NEXT is pressed before PLAY or PREV, the result of this test will be TRUE (focus successful).

RADIAL TEST(visual & listening test)

The fifth Basic Engine test tests the radial functionality (nucleus BeRadialOn); the local display looks as follows:



By pressing PLAY the user confirms that the radial function worked; pressing PREV indicates the function does not work. Pressing NEXT proceeds to the next test, after a reset of the radial (nucleus BeRadialOff). If the user presses NEXT before pressing PLAY or PREV, the result of this test will be TRUE (radial successful).

JUMP TEST(listening test)

The sixth and last Basic Engine test tests the jumping by calling nuclei BeGroovesIn, BeGroovesMid and BeGroovesOut. During this test, the local display looks as follows:



The user can switch between the three different types of groove settings by pressing PLAY (forward to next nucleus in the list In-Mid-Out) or PREV (backward in the list In-Mid-Out). This is done in a cyclic manner; note that this test will not contribute to the test result of the Basic Engine. Pressing NEXT proceeds to the next test, after the disc motor has been shut off with a call to nucleus BeDiscMotorOff.

TRAY TEST

As a last action for the Basic Engine tests, the tray test is repeated. The local display will look as follows:



This test is meant to give the user the opportunity to remove the disc in the tray. The tray position can be toggled using the PLAY key. The tray will be closed (by the software, if it is open) before proceeding to the next test when the user presses the NEXT key.

3.4 ERROR LOG & BITS**ERROR LOG**

Reading the error log and error bits information can be useful to determine any errors that occurred recently during normal operation of the DVD player. Reading the error log is done by nucleus LogReadErr. The display during the errorlog readout looks as follows :

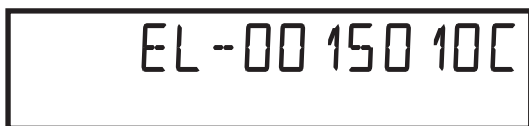

By pressing PLAY or PREV the user can move forward or backward (respectively) through the logged error codes. The highlighted number indicates which errorcode is currently on display (in the example above, errorcode number 4 is displayed). If "0000" is displayed at all positions, the error log is empty. Display of the logged errors is done in a cyclic manner. The errorcode with the lowest highlighted number is the most recent.

By pressing NEXT on the local keyboard, the user can proceed to the next test.

ERROR BITS

Reading the error bits is done by nucleus LogReadBits. The display during the errorbits readout looks as follows:

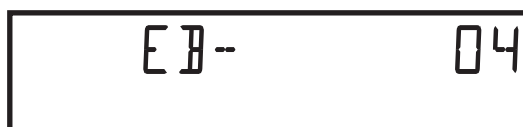

Only the set errorbits will be shown by their (decimal) number. Refer to the appropriate documentation for the explanation of each bit number. If the display only shows "EB-0", no error bits were set.

By pressing NEXT the user can continue to the next test.

	Read Error LOG in player script	Read error bits in player script
Basic engine errors	Value:	Value:
Command to the Basic Engine not allowed in this state or unknown command	150101	8
Parameter(s) from the command to the Basic Engine is not valid	150102	7
Sledge could not be moved to the inner home position	150103	6
Focus failure	150104	5
Turntable motor could not be reached within timeout	150105	4
Radial servo could get on track on the disc	150106	3
PLL could not lock in the accessing or tracking state	150107	2
Subcode or sector information could not be read	150108	1
requested subcode could not be found	150109	16
Tray could not be closed or opened completely	15010A	15
TOC could not be read within timeout	15010B	14
The requested seek on the disc could not be executed	15010C	13
A requested lead is not on the disc	15010D	12
A non existing burst cutting area is requested	15010E	11
S2b communication error	1501F0	10
S2b communication error	1501F1	9
S2b communication error	1501F3	24
S2b communication error	1501F4	23
S2b communication error	1501F5	22
Digital PWB errors		
Communication error with the Sti 5505	90000	32
Communication error with the Sti 5505	90001	31
Display processor errors		
Communication error with the display processor	190000	40

3.5 LOOP TEST

At the start of the loop test, the display will show the result of the interactive player test:



The left side of the display contains a 3-digit code, which can have a value between 000 and 111. these values are to be interpreted as follows:

Display Value	Indication for each module		
	Basic Engine	Mono PCB	Display PCB
000	ok	ok	ok
001	ok	ok	faulty
010	ok	faulty	ok
011	ok	faulty	faulty
100	faulty	ok	ok
101	faulty	ok	faulty
110	faulty	faulty	ok
111	faulty	faulty	faulty

The loop test will perform the same nuclei as the dealer test, but it will loop through the list of nuclei indefinitely.

The display of the DVD player will show not only the 3-digits indicating the correctly/faulty modules and the last found error code, but also a loop counter indicating how many times the loop has been gone through.

Note: Only faults within the scope of the diagnostic software are detected.

Example:

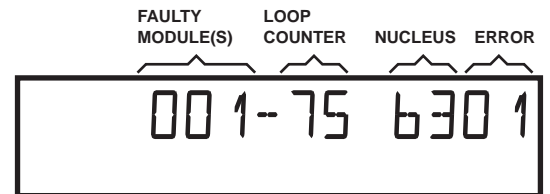

The 2-digit after the hyphen indicates the number of times the loop test has been performed.

The following 4-digits show the last error that was found while running the loop test. The first 2 digits of this code indicate which nucleus resulted in a fault and the next 2 digits refer to the faultcode within that nucleus.

For further explanation of the error code, see list of error codes on below.

ERROR CODES LOOP TEST

ERROR CODE	NUCLEUS NUMBER	ERROR DESCRIPTION
0601	6	Calculated checksum of FLASH is not correct
0901	9	The DVD DRAM is faulty
1101	11	I2C bus busy before start
1102		NVRAM access time-out
1103		No NVRAM Acknowledge
1104		NVRAM reply time-out
1201	12	I2C bus busy
1202		I2C bus not working
1203		Slave controller not responding
1204		Slave response is not correct
1301	13	Parity error from basic engine to serial
1302		Parity error from serial to basic engine
1303		No communication between serial and basic engine
1304		Communication time-out error
1601	16	The SDRAM is faulty
5201	52	I2c bus busy
5202		I2c bus not working
5203		Colour setup controller not responding
5204		Colour setup controller response not correct
5401	54	I2c bus busy
5402		I2c bus not working
5403		Scart switch controller not responding
5404		Scart switch controller response not correct

SERVICING THE DVD MODULE AND MONO BOARD

For repair on the DVD module (Basic Engine and the mono board), refer to Service Document:
2nd line Service Manual DVD-Monoboard 3122 785 10045

Reprogramming of Mono Board

Caution

This information is confidential and may not be distributed. Only a qualified service person should reprogram the mono board.

After replacement/repair of the mono board, the customer settings and also the region code may be lost. Reprogramming of the mono board will put the player back in the state in which it has left the factory, i.e. with the default settings and the allowed region code.

Reprogramming is limited to 25 times.

When the counter reaches 25, reprogramming is not possible anymore.

Reprogramming will be done by way of the remote control.

Put the player in stop mode, no disc loaded.

Press the following keys on the remote control:

<PLAY> followed by numerical keys **<1> <5> <9>**

The display shows: “- - - - -”

Press now successively the following keys :

for FW-D1/21 : **<0><4><4> <0><0><0> <0><0><0> <0><0><0> Latam**

for FW-D1/21M : **<0><4><2> <0><0><0> <0><0><0> <0><0><0> AP**

for FW-D1/33 : **<0><4><2> <0><0><0> <0><0><0> <0><0><0> AP**

for FW-D5/21 : **<0><1><4> <0><0><0> <0><0><0> <0><0><0> Latam**

for FW-D5/21M : **<0><0><5> <0><0><0> <0><0><0> <0><0><0> AP**

for FW-D5/22 : **<0><0><1> <0><0><0> <0><0><0> <0><0><0> Europe**

for FW-D5/30 : **<0><1><2> <0><0><0> <0><0><0> <0><0><0> AP**

for FW-D5/33 : **<0><0><5> <0><0><0> <0><0><0> <0><0><0> AP**

for FW-D5/37 : **<0><0><4> <0><0><0> <0><0><0> <0><0><0> US**

Press **<PLAY>** again.

The TV screen will become BLUE during a short time to confirm that the digital board has been reprogrammed, then the set goes to standby mode.

RESET OF VIRGIN MODE

After the player has been powered up for test by the dealer, it would have gone through the Virgin Mode. It is possible to reset the settings made during that mode before the delivery of player to the customer.

This is done by executing the Eeprom Format while in the Service Test Program (see page 3-6)

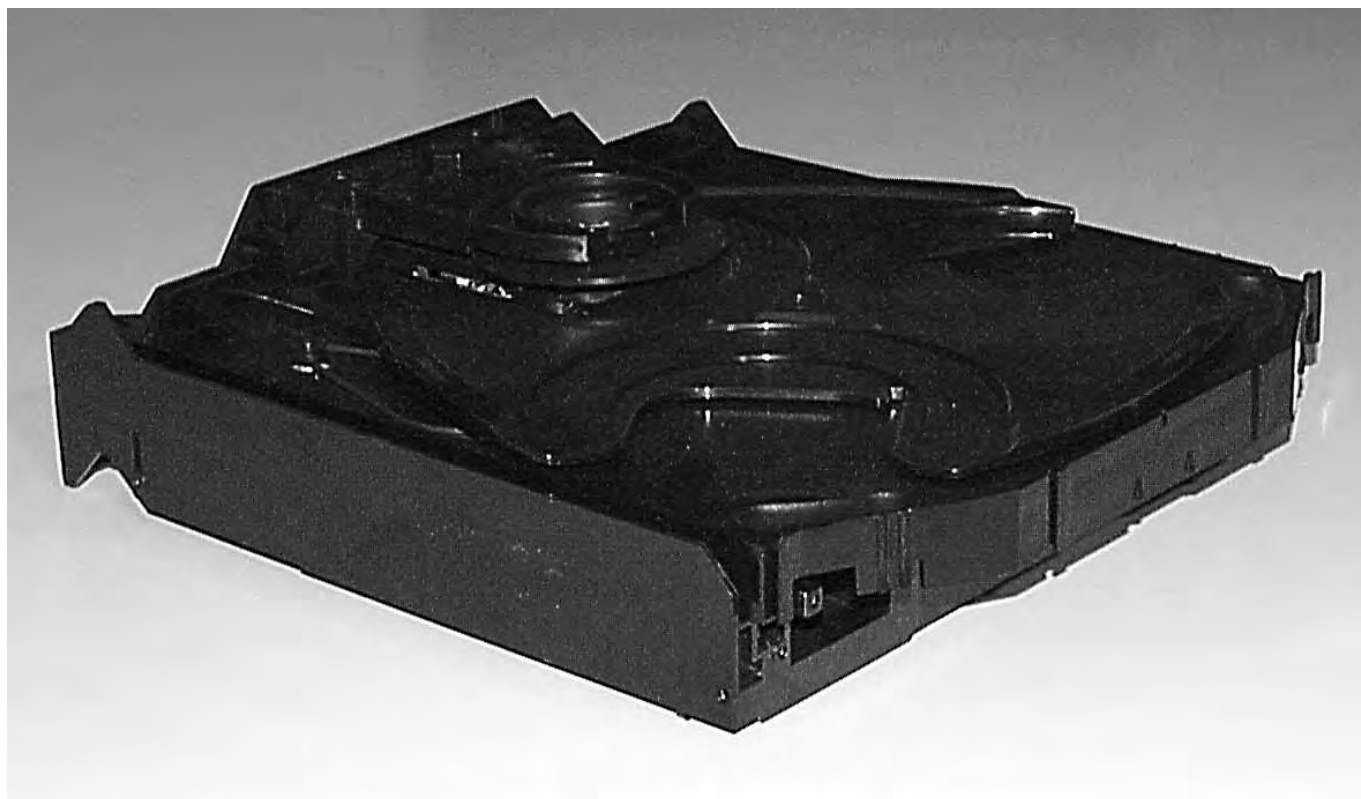

3CDC-LC

(3 Disc Carrousel Changer)

TABLE OF CONTENTS

Servicing Hints	10-2
Wiring	10-4
Blockdiagram	10-5
Component Layout Main Board	10-6
Circuit Diagram part1	10-7
Component Layout Main Board	10-8
Circuit Diagram part2	10-9
Exploded View	10-10
Partslist	10-12



WARNING

CHARGED CAPACITORS ON THE SERVO BOARD MAY DAMAGE THE CD DRIVE ELECTRONICS WHEN CONNECTING A NEW CDM MECHANISM. THAT'S WHY, BESIDES THE SAFETY MEASURES LIKE

- **SWITCH OFF POWER SUPPLY**
- **ESD PROTECTION**

ADDITIONAL ACTIONS MUST BE TAKEN BY THE REPAIR TECHNICIAN.

The following steps have to be done when replacing the CD mechanism:

1. Disconnect CD drive flexfoil from old CD drive
2. Connect paperclip to CD drive flexfoil to short-circuit flexfoil (fig.1)
3. Remove old CD drive
4. Remove short-circuit from flexfoil
5. Connect flexfoil to new CD drive
6. Position new CD drive in its studs
7. Remove short-circuit from Laserunit

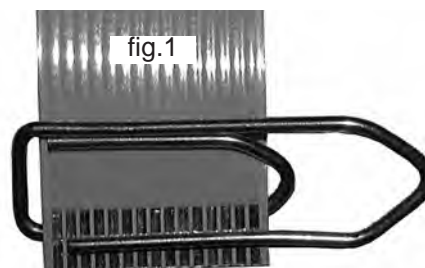

Attention: The laser diode of this CD drive is protected against ESD by a solder joint which shortcircuits the laserdiode to ground.
For proper functionality of the CD drive this solder joint must be removed **after** connection the drive to the set.

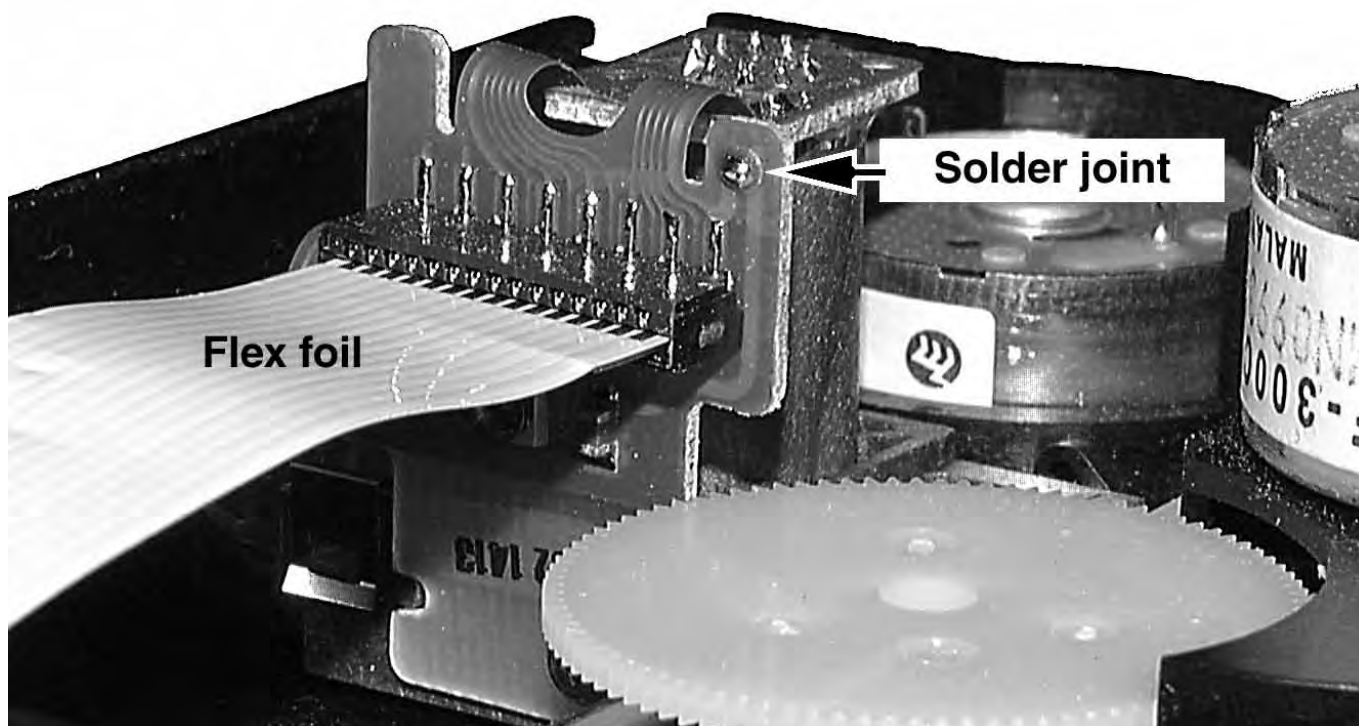

Service Position

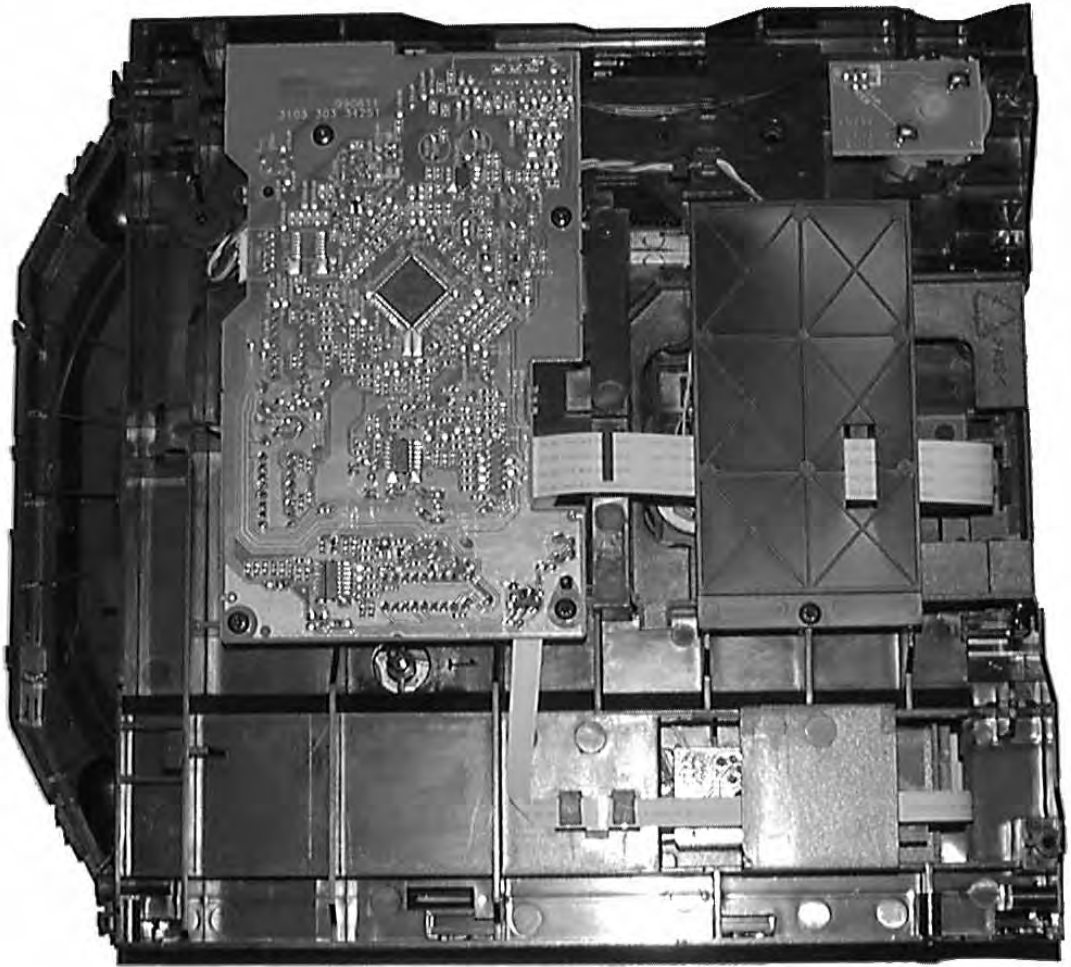

Wiring

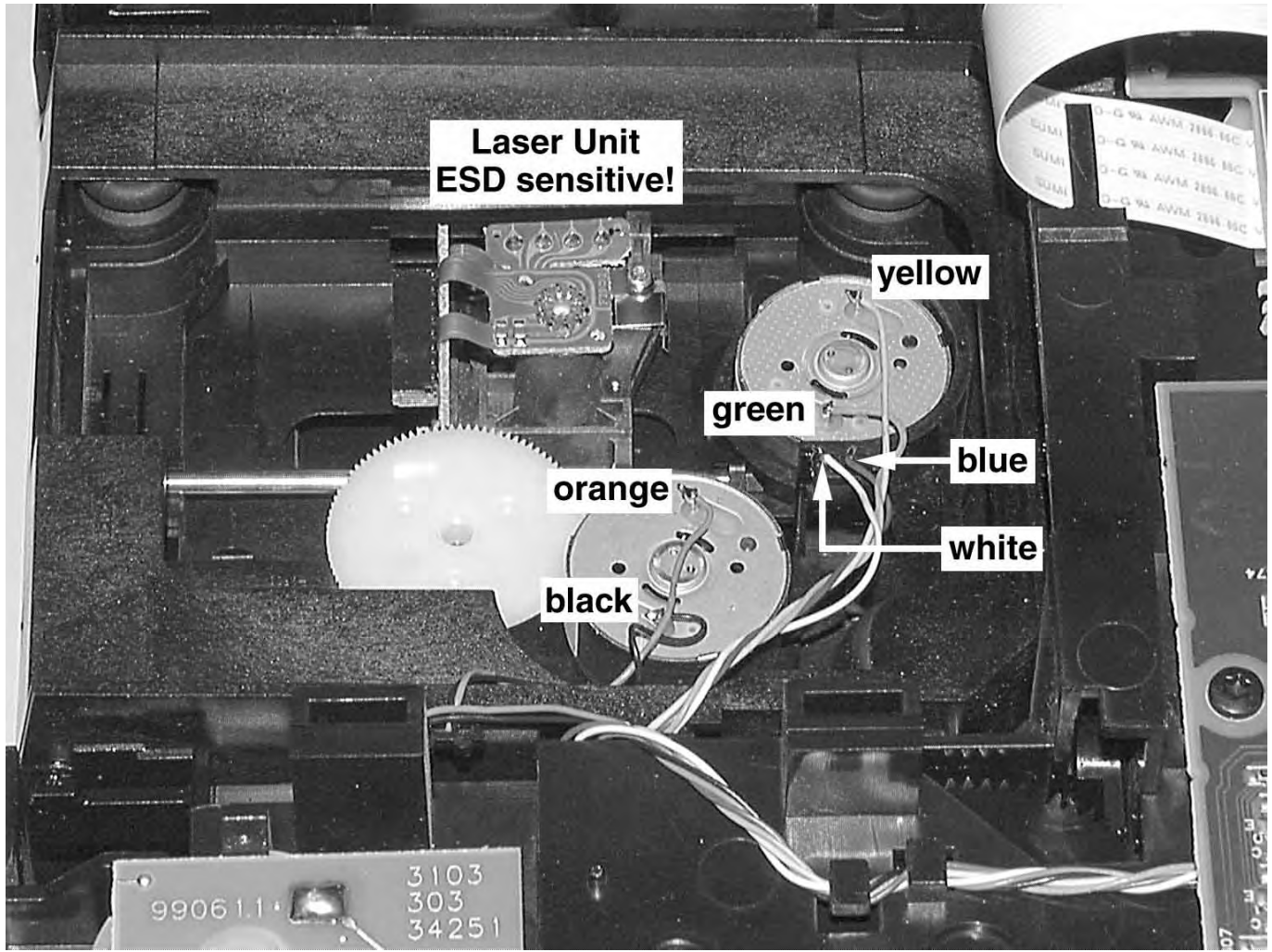

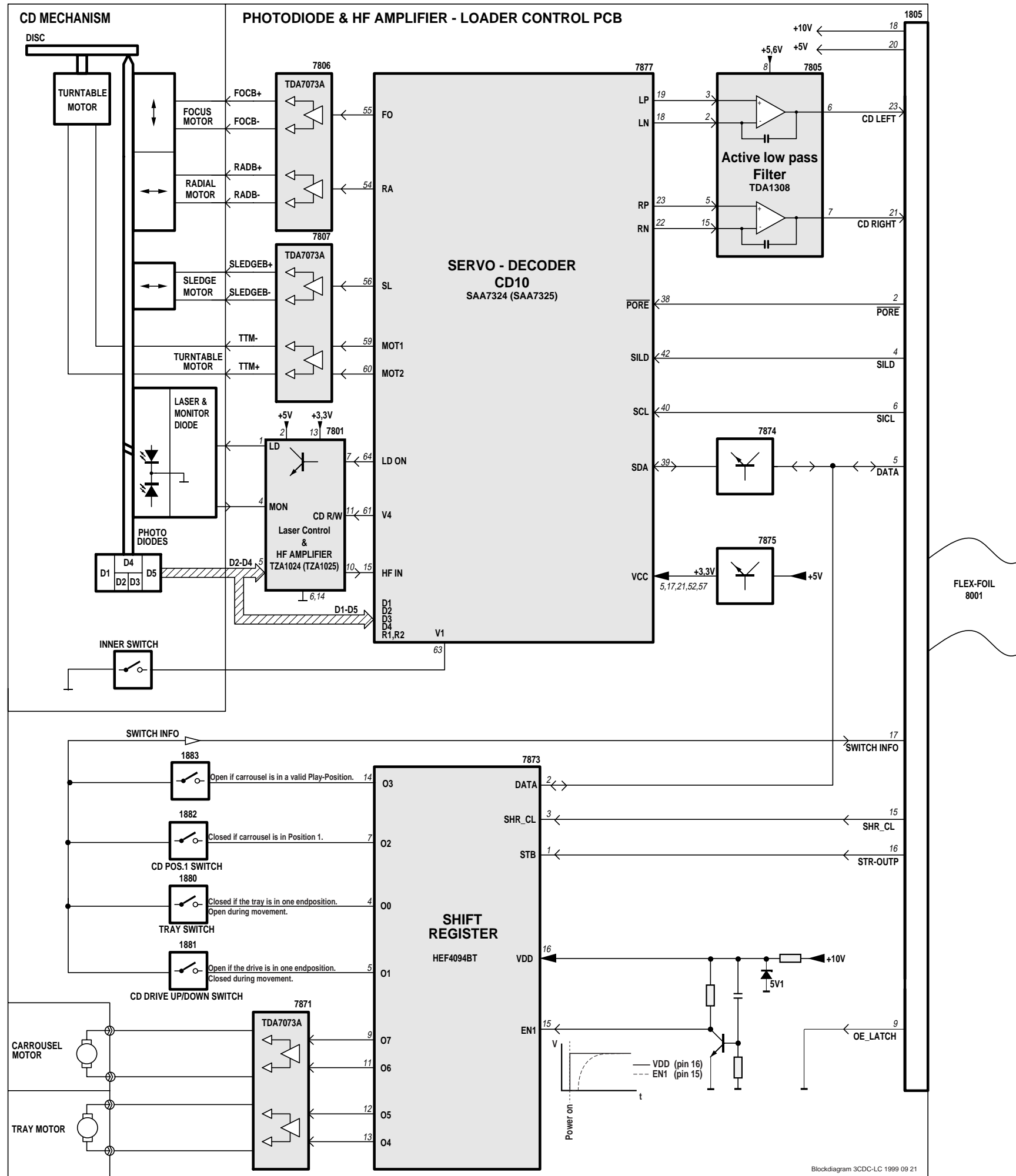

Blockdiagram 3CDC-LC 1999 09 21

3CDC-LC Mainboard Copperside view

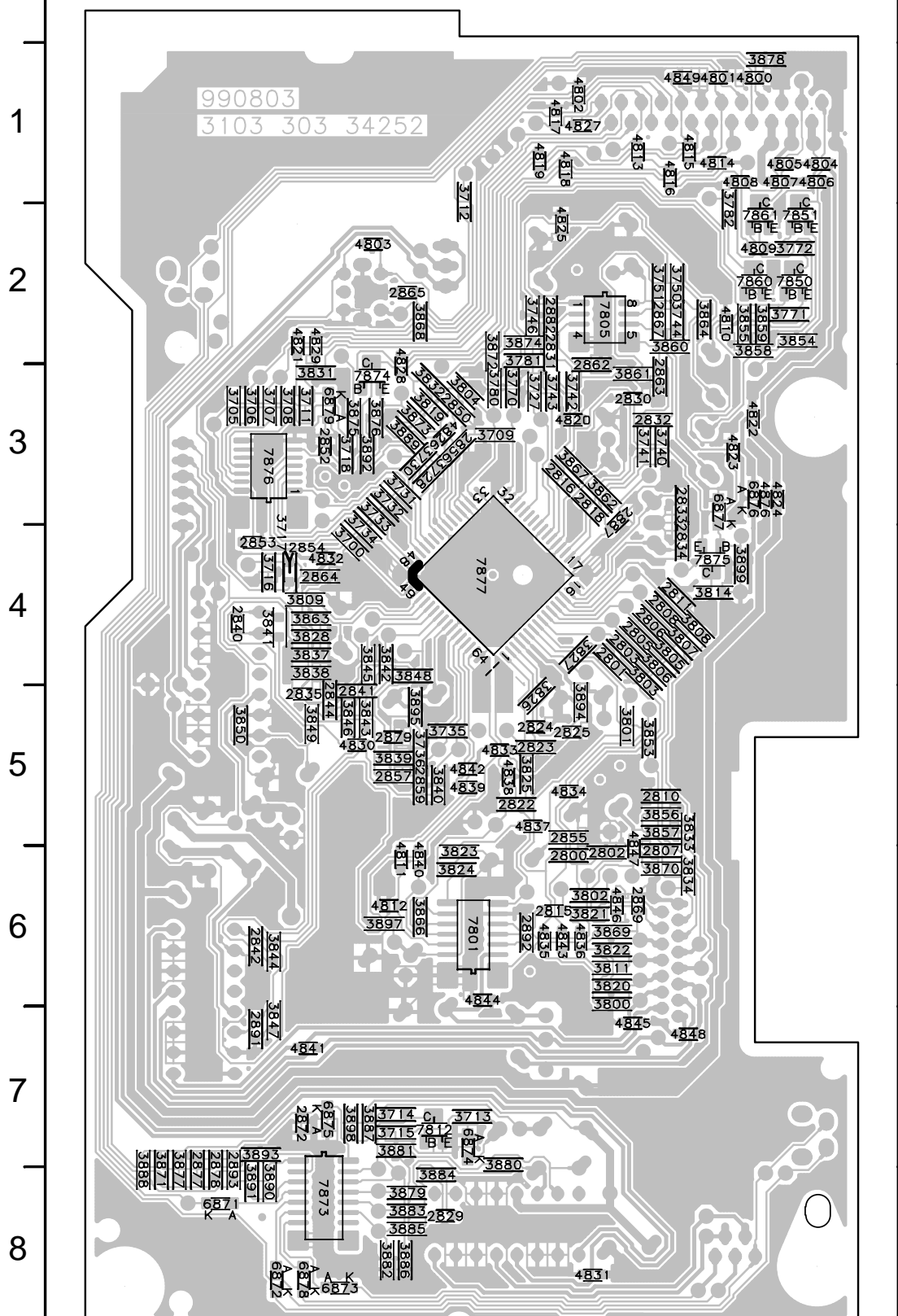

Mapping

Copperside			Componentside
2800	B6	3770	C3
2801	B4	3771	A2
2802	B6	3772	A2
2803	B4	3780	C3
2805	B4	3781	C2
2806	B4	3782	A2
2807	B6	3800	B6
2808	B4	3801	B5
2810	B5	3802	B6
2811	B4	3803	B4
2815	C6	3804	C3
2816	C3	3805	B4
2818	B3	3806	B4
2822	C5	3807	B4
2823	C5	3808	B4
2824	C5	3809	D4
2825	B5	3811	B6
2829	C8	3814	B4
2830	B3	3819	C3
2831	C2	3820	B6
2832	B3	3821	B6
2833	B3	3822	B6
2834	B4	3823	C6
2835	D5	3824	C6
2840	E4	3825	C5
2841	D5	3826	C5
2842	D6	3827	B4
2844	D5	3828	D4
2850	C3	3831	D3
2852	D3	3832	C3
2853	D4	3833	B5
2854	D4	3834	B6
2855	B5	3837	D4
2856	C3	3838	D4
2857	D5	3839	D5
2859	C5	3840	C5
2862	B3	3841	D4
2863	B3	3842	D4
2864	D4	3843	D5
2865	C2	3844	D6
2867	B2	3845	D4
2869	B6	3846	D5
2872	D7	3847	D7
2877	E8	3848	C4
2878	E8	3849	D5
2879	D5	3850	E5
2882	C2	3853	B5
2887	B3	3854	A2
2891	D7	3855	A2
2892	C6	3856	B5
2893	E8	3857	B5
3700	E4	3858	A2
3705	F3	3859	A2
3706	D3	3860	B2
3707	D3	3861	B3
3708	D3	3862	B3
3709	C3	3863	D4
3711	D3	3864	B2
3712	C1	3866	C6
3713	C7	3867	B3
3714	D7	3868	C2
3715	D7	3869	B6
3716	D4	3870	B6
3717	D4	3871	E8
3718	D3	3872	C2
3728	C3	3874	C2
3730	C3	3875	D3
3731	D3	3876	D3
3732	D3	3877	E8
3733	D3	3878	A1
3734	D4	3879	C8
3735	C5	3880	C7
3736	C5	3881	D7
3740	B3	3882	D8
3741	B3	3883	C8
3742	B3	3884	C8
3743	C3	3885	C8
3744	B2	3886	D8
3746	C2	3887	D7
3750	B2	3888	E8
3889	D3	3890	D8
3891	D8	3892	D3
3893	D7	3894	B5
3895	C5	3897	D6
3898	D7	3899	A4
4800	A1	4801	B1
4802	B1	4803	D2
4804	A1	4805	A1
4806	A1	4807	A1
4808	A1	4809	A2
4810	B2	4811	D6
4812	D6	4813	B1
4814	B1	4815	B1
4816	B1	4817	C1
4818	C1	4819	C1
4820	B3	4821	D2
4822	A3	4823	A3
4824	A3	4825	C2
4826	C2	4827	B1
4828	D3	4829	D2
4830	D5	4831	B8
4832	D4	4833	C5
4834	B5	4835	C6
4836	B6	4837	C5
4838	C5	4839	C5
4840	C6	4841	D7
4842	C5	4843	C6
4844	C6	4845	B7
4846	B6	4847	B6
4848	B7	4849	B1
4876	A3	4877	A3
4878	D8	4879	D3
7801	C6	7805	B2
7812	C7	7850	A2
7851	A2	7860	A2
7861	A2	7866	A2
7873	D8	7874	D3
7875	B4	7876	D3
7877	C4		

3CDC-LC Mainboard Componentside view

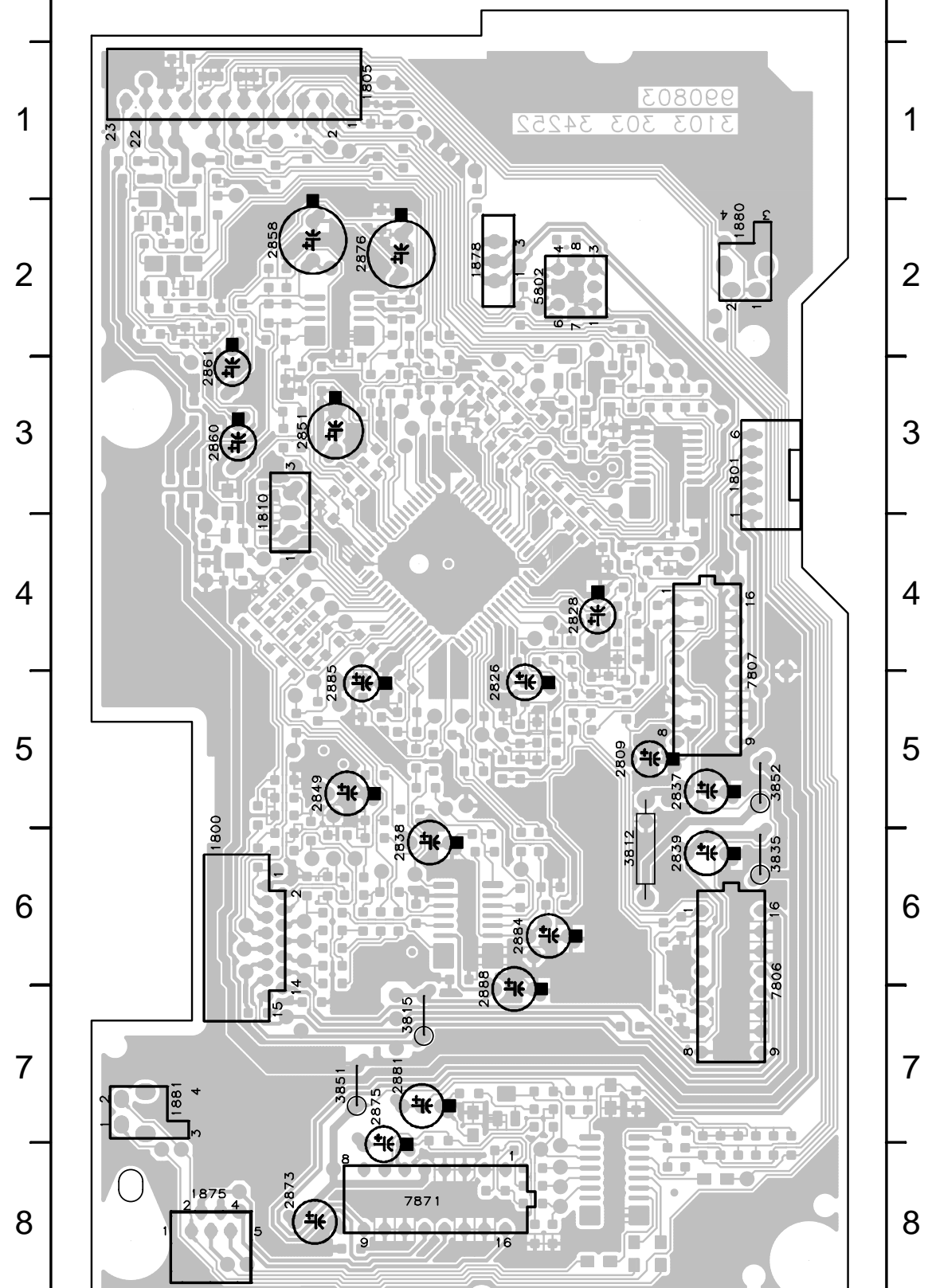

1800 D1	2802 C4	2808 A5	2816 B12	2825 F9	2835 F7	2841 F5	2851 B11	2869 D3	2888 E5	3728 E14	3802 C4	3807 A4	3819 D14	3824 D8	3832 D15	3838 F7	3843 E5	3848 H6	3856 C1	3867 B11	3892 E15	4812 F8	MP713 C5	MP730 B5	MP800 E3	MP814 F2	MP819 G9	MP829 B3	MP841 F6	MP846 G1	MP851 E2	MP859 F10	MP873 H4	MP883 E5
1801 G1	2803 C5	2809 H4	2818 B11	2826 G12	2837 H4	2842 F5	2855 B4	2879 H5	2891 F4	3735 G6	3803 C4	3808 A4	3820 D3	3825 F9	3833 A4	3839 H6	3844 F5	3849 H5	3857 C2	3869 D3	3894 E9	7801 E7	MP715 C5	MP731 B13	MP802 B15	MP815 C3	MP820 F8	MP837 E3	MP842 H6	MP847 G2	MP852 F2	MP860 C2	MP875 G13	MP884 E5
1810 C10	2805 B5	2810 A4	2822 F9	2828 G13	2838 E8	2844 F5	2856 D15	2884 E8	2892 D5	3736 H6	3804 C14	3811 B4	3821 D3	3826 F9	3834 A4	3840 G5	3845 F5	3850 H5	3858 B10	3870 E3	7806 G4	MP716 A5	MP743 D2	MP809 E10	MP816 A3	MP821 D15	MP838 G6	MP843 F6	MP848 E2	MP853 F2	MP861 E8	MP877 E4	MP883 F10	
2800 C4	2806 B5	2811 A5	2823 F10	2833 C10	2839 F4	2849 C1	2857 H5	2885 F9	3709 C14	3800 C4	3805 B4	3812 H4	3822 D3	3827 E10	3835 F5	3841 G5	3846 F5	3852 H5	3863 H13	3873 D14	3897 E7	7807 H4	MP717 A5	MP744 E2	MP812 F2	MP817 A3	MP827 B10	MP839 G6	MP844 E9	MP849 F2	MP855 E10	MP870 D8	MP878 B13	MP895 E14
2801 C5	2807 A4	2815 D5	2824 F10	2834 C10	2840 G4	2850 D14	2859 G5	2887 B10	3727 B12	3801 C4	3806 B4	3815 E5	3823 D8	3828 G10	3837 F7	3842 E5	3847 F5	3853 E9	3866 D8	3889 D15	4811 F8	7877 D12	MP729 B5	MP745 E2	MP813 C3	MP818 D3	MP828 G9	MP840 E6	MP845 F4	MP850 F2	MP858 F9	MP872 C15	MP879 B11	MP896 B12

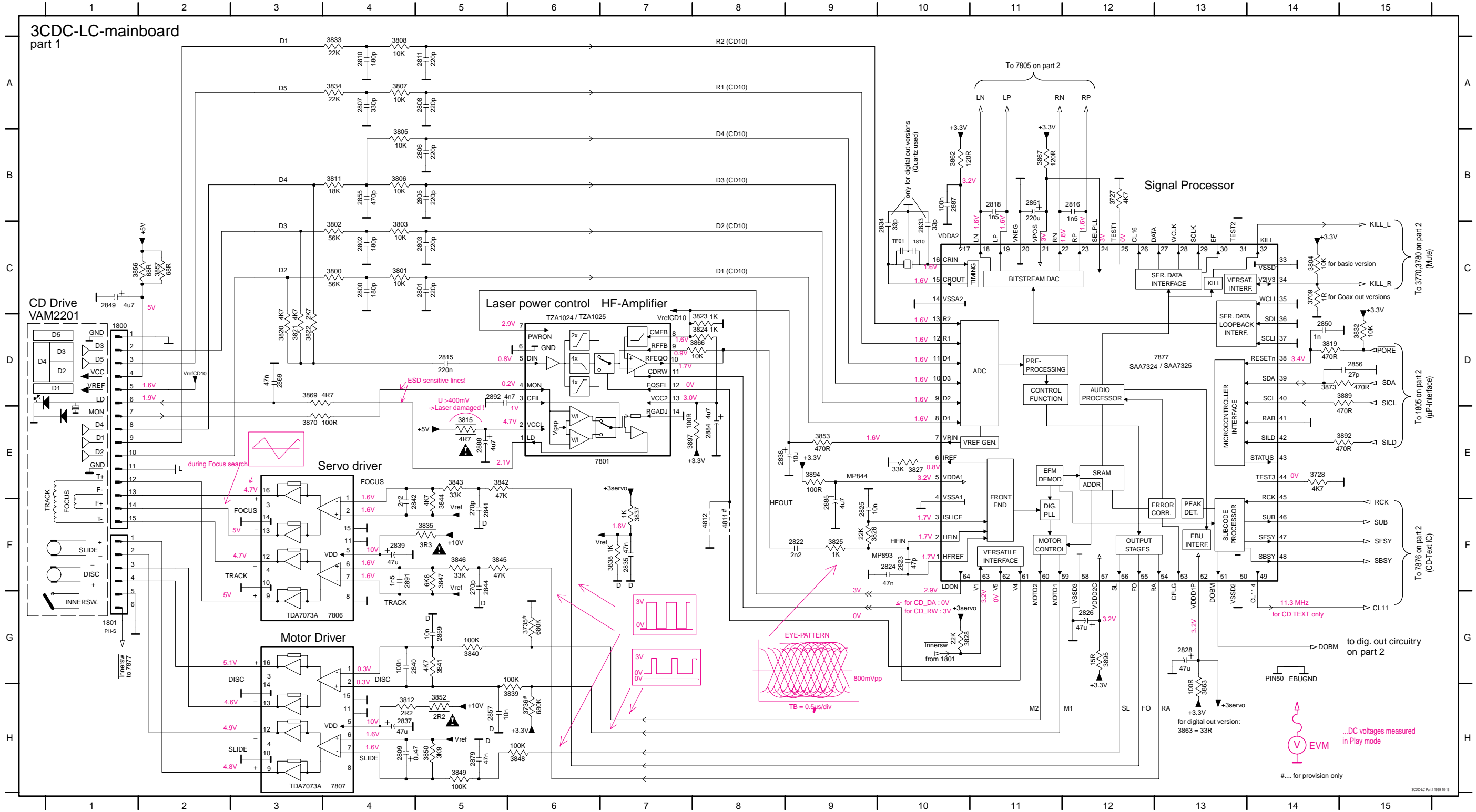

1805 D15	2830 B10	2858 A10	2865 C4	2877 F11	3705 G4	3713 F8	3730 G2	3741 A7	3751 C7	3782 B12	3855 B11	3868 C4	3877 F12	3883 D6	3890 F11	4813 G14	6872 E8	6878 E8	7851 A13	7875 C12	MP725 D8	MP803 F10	MP810 F13	MP830 A9	MP856 E14	MP867 E8	MP882 G2	MP891 B5
1875 D2	2831 B9	2860 A10	2867 A9	2878 F11	3706 G4	3714 F8	3731 G2	3742 B7	3770 A11	3809 B2	3858 A11	3871 F12	3878 E12	3884 D6	3891 F11	4827 G14	6873 E8	6879 G4	7860 B12	7876 G3	MP726 D8	MP804 G14	MP811 F13	MP832 G9	MP857 B13	MP868 F8	MP886 G3	MP892 B5
1878 D2	2832 A8	2861 B10	2872 G10	2881 F8	3707 G4	3715 G8	3732 G2	3743 A7	3771 A12	3814 C12	3859 B11	3872 B13	3879 D7	3885 C6	3893 F11	4849 G13	6874 F7	7805-A A10	7861 B13	MP721 C8	MP740 H14	MP805 E13	MP822 E3	MP833 F13	MP862 G13	MP869 C12	MP887 H5	MP897 D12
1880 E8	2852 H2	2862 B9	2873 D6	2882 B10	3708 G4	3716 B3	3733 G2	3744 A9	3772 A12	3814 C12	3860 B8	3874 B13	3880 E6	3886 E7	3898 F6	4876 C13	6875 F6	7805-B A9	7871 C5	MP722 E8	MP741 G14	MP806 F13	MP823 D3	MP834 G14	MP863 C11	MP871 D6	MP888 G5	MP898 D13
1881 E8	2853 F4	2863 B8	2875 E6	2893 F12	3711 G5	3717 B3	3734 G2	3746 B10	3780 B11	3851 D6	3861 B8	3875 C12	3881 E7	3887 D6	3899 D12	5802 B4	6876 C13	7812 G8	7873 C9	MP723 C8	MP742 G14	MP807 F14	MP824 D4	MP835 F14	MP865 D11	MP874 D12	MP889 G5	MP899 E14
2829 D6	2854 B3	2864 B3	2876 C8	3700 H2	3712 B4	3718 G3	3740 A7	3750 B7	3781 B12	3854 A11	3864 A7	3876 C11	3882 C7	3888 F12	4803 B4	6871 E8	6877 D12	7850 A12	7874 C12	MP724 D8	MP801 D12	MP808 E13	MP825 D4	MP854 A13	MP866 E8	MP881 G2	MP890 B3	

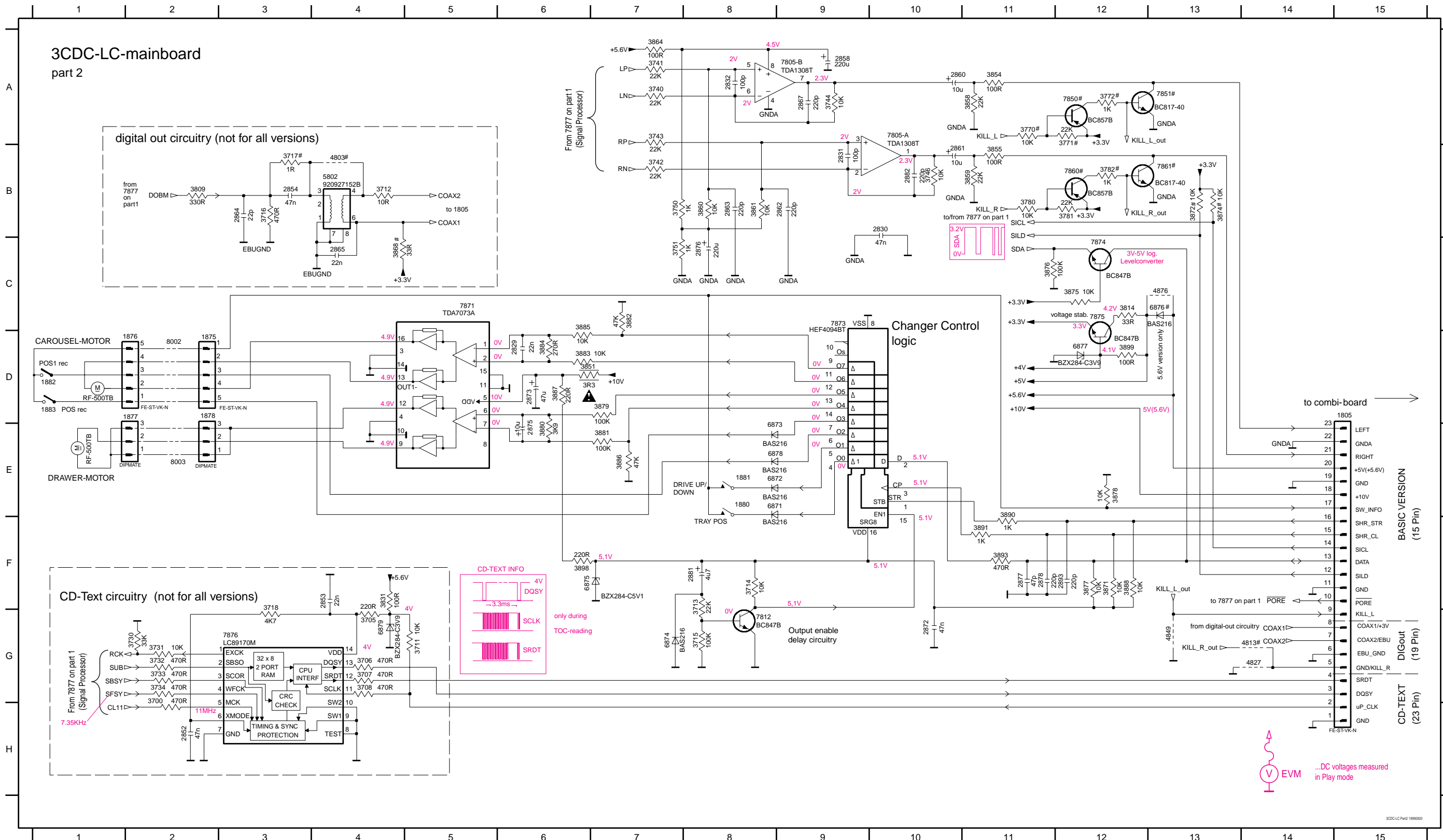

EXPLODED VIEW (3CDC-LC MODULE)

Mechanical Parts List - 3CDC-LC Module

21	314011758650	CLAMPER ASSY-VAM
30	310330466560	SUPPORT
31	482252910431	DAMPER - RUBBER (25DEG)
32	482252910431	DAMPER - RUBBER (25DEG)
33	310330406970	WASHER
35	482269110772	VAM2201/01
41	310330466480	FRAME
42	310330466540	BRACKET-GUIDING
43	310330106460	SPRING-GUIDING
44	310330406890	GEAR-3
45	310330406980	NAIL
46	310330406880	GEAR-2
47	310330466530	BRACKET-LOAD
48	310330406910	CAM
49	310330466510	GUIDING
51	310330406900	GEAR-4
52	310330406870	GEAR-1
53	310330406960	PULLEY-FRAME
54	310330466910	DRIVING-BELT-DRAWER
55	482236110753	MOTOR ASSY
56	482250212548	SCREW M2,6X2,9
57	310330468890	COVER-VAM
59	482246612146	RUBBER

Notes: Only the parts mentioned in this list are normal service spare parts.

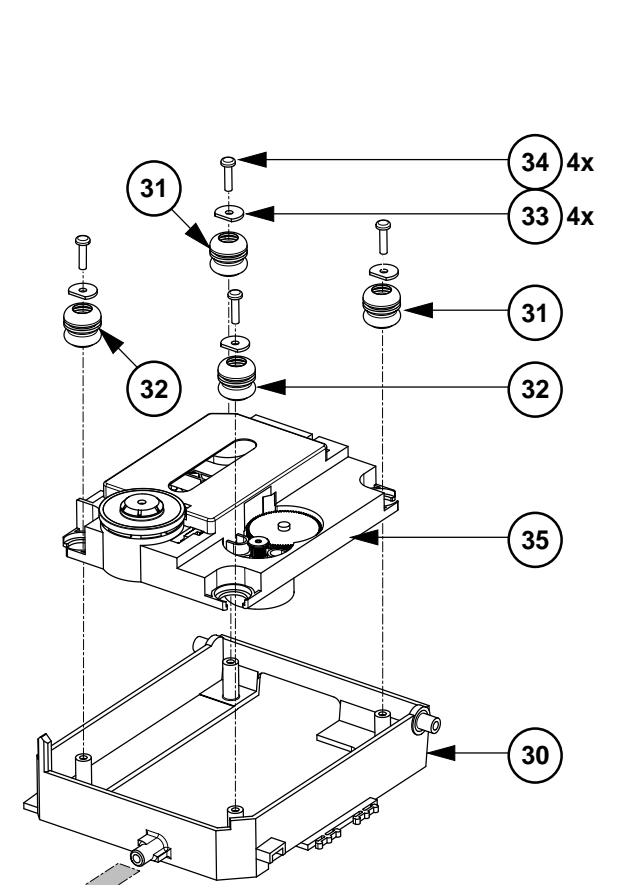
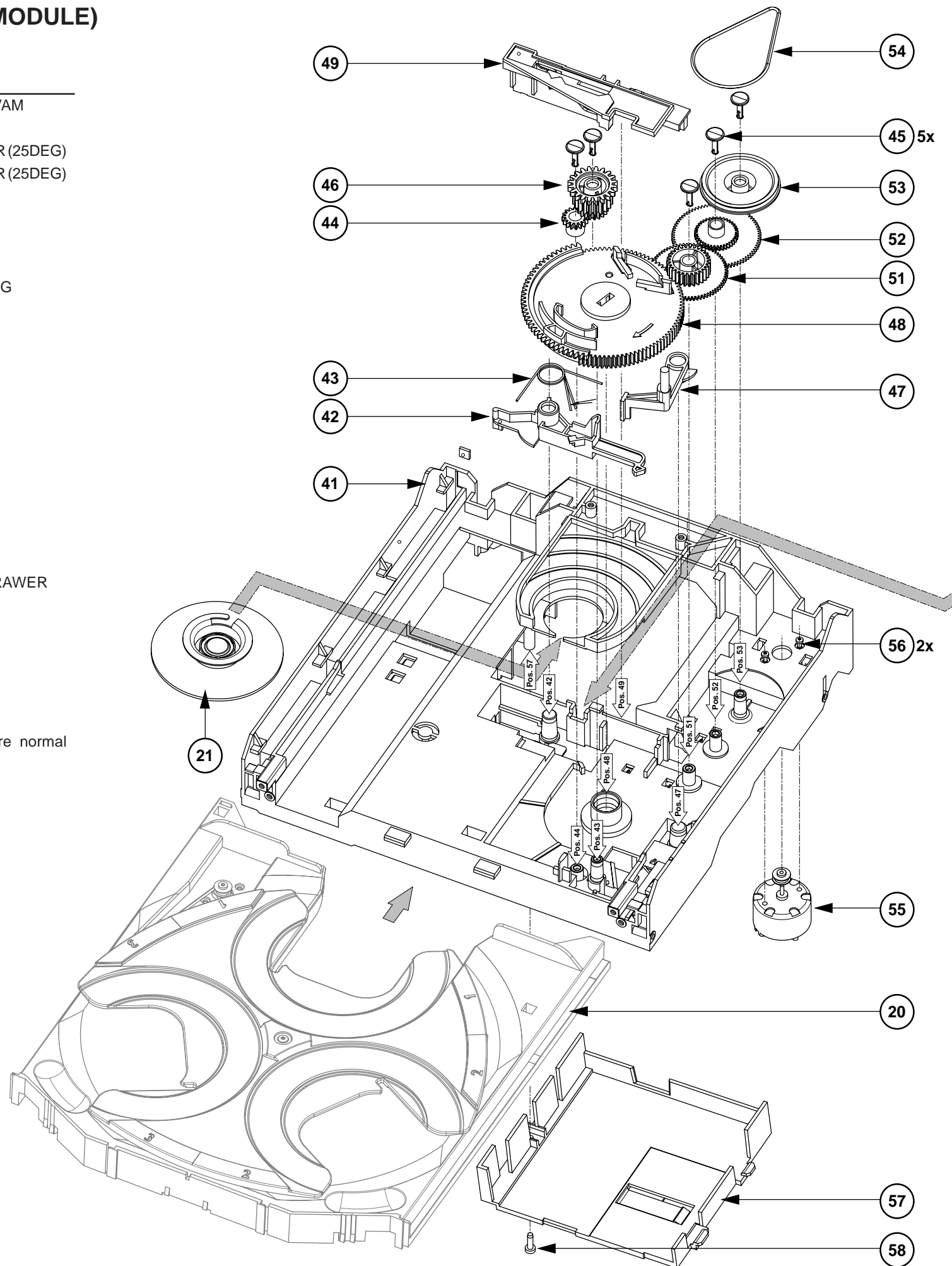

Mechanical Parts list - Drawer Top & Bottom view

20	3103 304 66500	DRAWER
21	3103 304 66490	CARROUSELL
22	3103 304 06860	PULLEY-DRAWER
23	3103 304 06850	ECCENTRIC
24	3103 304 06980	NAIL
25	3103 304 66850	DRIVING-BELT
27	3103 304 07100	BUSH DRAWER
29	3103 304 66550	BRACKET-DISC
30	3103 304 66520	TUMBLER
31	3103 301 06470	SPRING-DISC
32	3103 304 06920	CONTROL-DISC
33	3103 304 06970	WASHER
34	3103 304 06870	GEAR-1
37	4822 361 10753	MOTOR ASSY

Notes: Only the parts mentioned in this list are normal service spare parts.

Drawer bottom view

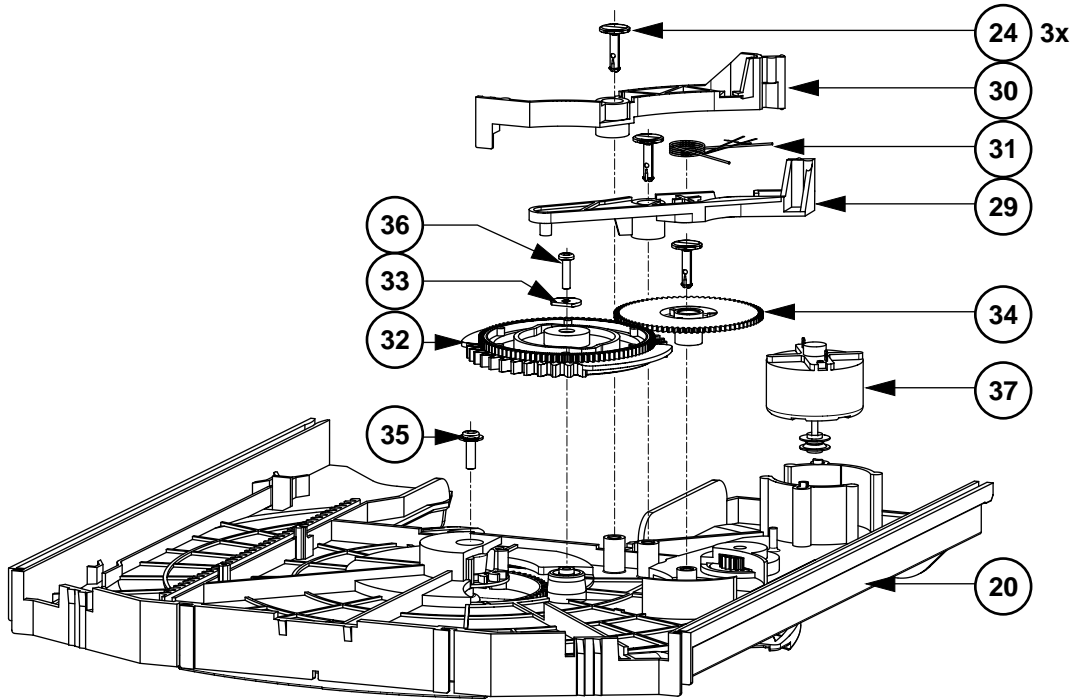

Drawer top view

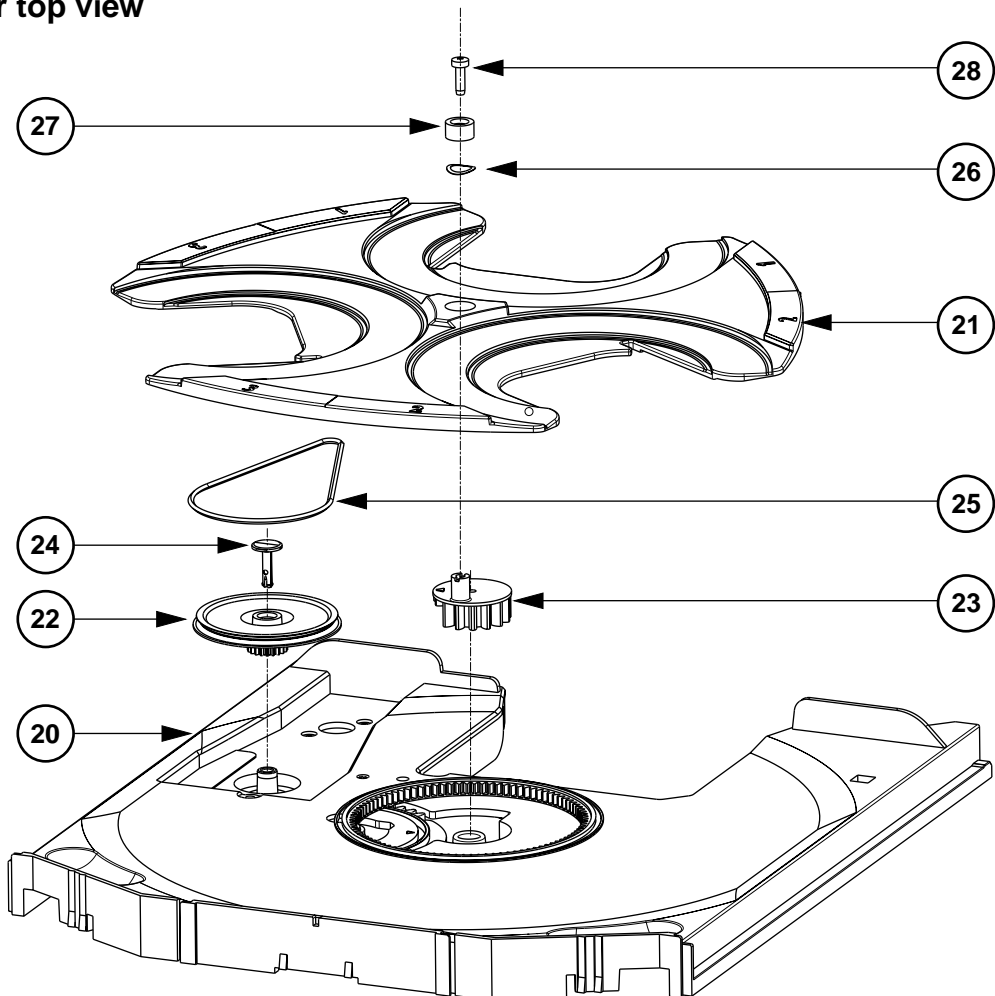

ELECTRICAL PARTS LIST - 3CDC-LC MODULE**MISCELLANEOUS**

1800	482226510925	Flex Foil Connector 15P
1805	482226510979	Flex Foil Connector 15P
1805	482226511545	Flex Foil Connector 19P
1805	482226511182	Flex Foil Connector 23P
1810	482224210849	RES XTL 8MHz4672
1810	482224273557	RES CER 8MHz467
1875	482226710958	Flex Foil Connector 5P
1876	242202508332	Flex Foil Connector 5P
1880	482227613503	Switch
1881	482227613503	Switch
1882	482227613503	Switch
1883	482227613503	Switch
8002	310330891990	Flex Foil 5P 200mm
8005	310330891980	Flex Foil 15P 170mm

CAPACITORS

2800	482212610326	180pF 5% 63V
2801	482212233575	220pF 5% 63V
2802	482212610326	180pF 5% 63V
2803	482212233575	220pF 5% 63V
2805	482212233575	220pF 5% 63V
2806	482212233575	220pF 5% 63V
2807	532212231863	330pF 5% 63V
2808	482212233575	220pF 5% 63V
2809	532212441948	470nF 20% 50V
2810	482212610326	180pF 5% 63V
2811	482212233575	220pF 5% 63V
2815	482212614076	220nF +80/-20% 25V
2816	482212613344	1,5nF 5% 63V
2818	482212613344	1,5nF 5% 63V
2822	222286115222	2,2nF 5% 50V
2823	482212613692	47pF 1% 63V
2824	482212613751	47nF 10% 63V
2825	482212233177	10nF 20% 50V
2826	482212412362	47μF 20% 4V
2828	482212412362	47μF 20% 4V
2829	532212232654	22nF 10% 63V
2830	482212613751	47nF 10% 63V
2831	532212232531	100pF 5% 50V
2832	532212232531	100pF 5% 50V
2833	532212232659	33pF 5% 50V
2834	532212232659	33pF 5% 50V
2835	482212613751	47nF 10% 63V
2837	482212440433	47μF 20% 25V
2838	482212440248	10μF 20% 63V
2839	482212440433	47μF 20% 25V
2840	482212614585	100nF 10% 50V
2841	482212233216	270pF 5% 50V
2842	482212233127	2,2nF 10% 63V
2844	482212233216	270pF 5% 50V
2849	482212440769	4,7μF 20% 100V
2850	532212231647	1nF 10% 63V

2851	482212442383	220μF 20% 4V
2852	482212613751	47nF 10% 63V
2853	532212232654	22nF 10% 63V
2854	482212613751	47nF 10% 63V
2855	532212234099	470pF 10% 63V
2856	482212613691	27pF 1% 63V
2857	482212233177	10nF 20% 50V
2858	482212412245	220μF 20%
2859	482212233177	10nF 20% 50V
2860	482212411947	10μF 20% 16V
2861	482212411947	10μF 20% 16V
2862	482212233575	220pF 5% 63V
2863	482212233575	220pF 5% 63V
2864	532212232658	22pF 5% 50V
2865	532212232654	22nF 10% 63V
2867	482212233575	220pF 5% 63V
2869	482212613751	47nF 10% 63V
2872	482212613751	47nF 10% 63V
2873	482212480231	47μF 20% 16V
2875	482212411947	10μF 20% 16V
2876	482212412245	220μF 20%
2877	482212613692	47pF 1% 63V
2878	482212233575	220pF 5% 63V
2879	482212613751	47nF 10% 63V
2881	482212440769	4,7μF 20% 100V
2882	482212233575	220pF 5% 63V
2884	482212440769	4,7μF 20% 100V
2885	482212440769	4,7μF 20% 100V
2887	482212614585	100nF 10% 50V
2888	482212440769	4,7μF 20% 100V
2891	532212231865	1,5nF 10% 63V
2892	532212610223	4,7nF 10% 63V
2893	482212233575	220pF 5% 63V

RESISTORS

3700	482205120471	470R 5% 0,1W
3705	482211711503	220R 1% 0,1W
3706	482205120471	470R 5% 0,1W
3707	482205120471	470R 5% 0,1W
3708	482205120471	470R 5% 0,1W
3709	482205120108	1R 5% 0,1W
3711	482211710833	10k 1% 0,1W
3712	482205120109	10R 5% 0,1W
3713	482205120223	22k 5% 0,1W
3714	482211710833	10k 1% 0,1W
3715	482211710837	100k 1% 0,1W
3716	482205120471	470R 5% 0,1W
3718	482205120472	4k7 5% 0,1W
3727	482205120472	4k7 5% 0,1W
3728	482205120472	4k7 5% 0,1W
3730	482205120333	33k 5% 0,1W
3731	482211710833	10k 1% 0,1W

ELECTRICAL PARTS LIST - 3CDC-LC MODULE**RESISTORS**

3732	482205120471	470R 5% 0,1W	3850	482205120392	3k9 5% 0,1W
3733	482205120471	470R 5% 0,1W	3851	482205210338	△ 3R3 5% 0,33W
3734	482205120471	470R 5% 0,1W	3852	482205210228	△ 2R2 5% 0,33W
3740	482205120223	22k 5% 0,1W	3853	482205120471	470R 5% 0,1W
3741	482205120223	22k 5% 0,1W	3854	482205120101	100R 5% 0,1W
3742	482205120223	22k 5% 0,1W	3855	482205120101	100R 5% 0,1W
3743	482205120223	22k 5% 0,1W	3856	482211712521	68R 1% 0,1W
3744	482211710833	10k 1% 0,1W	3857	482211712521	68R 1% 0,1W
3746	482211710833	10k 1% 0,1W	3858	482205120223	22k 5% 0,1W
3750	482205110102	1k 2% 0,25W	3859	482205120223	22k 5% 0,1W
3751	482205110102	1k 2% 0,25W	3860	482211710833	10k 1% 0,1W
3800	482211711148	56k 1% 0,1W	3861	482211710833	10k 1% 0,1W
3801	482211710833	10k 1% 0,1W	3862	482205120121	120R 5% 0,1W
3802	482211711148	56k 1% 0,1W	3863	482205120101	100R 5% 0,1W
3803	482211710833	10k 1% 0,1W	3863	482205120339	33R 5% 0,1W
3804	482211710833	10k 1% 0,1W	3864	482205120101	100R 5% 0,1W
3805	482211710833	10k 1% 0,1W	3866	482211710833	10k 1% 0,1W
3806	482211710833	10k 1% 0,1W	3867	482205120121	120R 5% 0,1W
3807	482211710833	10k 1% 0,1W	3869	482205120478	4R7 5% 0,1W
3808	482211710833	10k 1% 0,1W	3870	482205120101	100R 5% 0,1W
3809	482211713577	330R 1% 1,25W	3871	482211710833	10k 1% 0,1W
3811	482211710965	18k 1% 0,1W	3873	482205120471	470R 5% 0,1W
3812	482205310228	2R2 5% 1W	3875	482211710833	10k 1% 0,1W
3814	482205120339	33R 5% 0,1W	3876	482211710837	100k 1% 0,1W
3815	482205210478	△ 4R7 5% 0,33W	3877	482211710833	10k 1% 0,1W
3819	482205120471	470R 5% 0,1W	3878	482211710833	10k 1% 0,1W
3820	482205120472	4k7 5% 0,1W	3879	482211710837	100k 1% 0,1W
3821	482205120472	4k7 5% 0,1W	3880	482205120392	3k9 5% 0,1W
3822	482211712955	2k7 1% 0,1W	3881	482211710837	100k 1% 0,1W
3823	482205110102	1k 2% 0,25W	3882	482211710834	47k 1% 0,1W
3824	482205110102	1k 2% 0,25W	3883	482211710833	10k 1% 0,1W
3825	482205110102	1k 2% 0,25W	3884	482211711504	270R 1% 0,1W
3826	482205120223	22k 5% 0,1W	3885	482211710833	10k 1% 0,1W
3827	482205120333	33k 5% 0,1W	3886	482211710834	47k 1% 0,1W
3828	482205120223	22k 5% 0,1W	3887	482211711503	220R 1% 0,1W
3831	482205120101	100R 5% 0,1W	3888	482211710833	10k 1% 0,1W
3832	482211710833	10k 1% 0,1W	3889	482205120471	470R 5% 0,1W
3833	482205120223	22k 5% 0,1W	3890	482205110102	1k 2% 0,25W
3834	482205120223	22k 5% 0,1W	3891	482205110102	1k 2% 0,25W
3835	482205210338	△ 3R3 5% 0,33W	3892	482205120471	470R 5% 0,1W
3837	482205110102	1k 2% 0,25W	3893	482205120471	470R 5% 0,1W
3838	482205110102	1k 2% 0,25W	3894	482205120101	100R 5% 0,1W
3839	482211710837	100k 1% 0,1W	3895	482205120159	15R 5% 0,1W
3840	482211710837	100k 1% 0,1W	3897	482205120101	100R 5% 0,1W
3841	482205120472	4k7 5% 0,1W	3898	482211711503	220R 1% 0,1W
3842	482211710834	47k 1% 0,1W	3899	482205120101	100R 5% 0,1W
3843	482205120333	33k 5% 0,1W	4800	482205120008	0R Jumper 0805
3844	482205120472	4k7 5% 0,1W	4801	482205120008	0R Jumper 0805
3845	482211710834	47k 1% 0,1W	4802	482205120008	0R Jumper 0805
3846	482205120333	33k 5% 0,1W	4804	482205120008	0R Jumper 0805
3847	482211711507	6k8 1% 0,1W	4805	482205120008	0R Jumper 0805
3848	482211710837	100k 1% 0,1W	4806	482205120008	0R Jumper 0805
3849	482211710837	100k 1% 0,1W	4807	482205120008	0R Jumper 0805

ELECTRICAL PARTS LIST - 3CDC-LC MODULE

RESISTORS

4808	482205120008	0R Jumper 0805	7805	482220933165	TDA1308T/N1
4810	482205120008	0R Jumper 0805	7806	482220932852	TDA7073A/N2
4812	482205120008	0R Jumper 0805	7807	482220932852	TDA7073A/N2
4817	482205120008	0R Jumper 0805	7812	482213060511	BC847B
4818	482205120008	0R Jumper 0805	7871	482220932852	TDA7073A/N2
4819	482205120008	0R Jumper 0805	7873	532220911306	HEF4094BT
4820	482205120008	0R Jumper 0805	7874	482213060511	BC847B
4821	482205120008	0R Jumper 0805	7875	482213060511	BC847B
4822	482205120008	0R Jumper 0805	7876	482220916143	LC89170M
4823	482205120008	0R Jumper 0805	7877	482220917324	SAA7325H
4824	482205120008	0R Jumper 0805			
4825	482205120008	0R Jumper 0805			
4826	482205120008	0R Jumper 0805			
4827	482205120008	0R Jumper 0805			
4828	482205120008	0R Jumper 0805			
4830	482205120008	0R Jumper 0805			
4831	482205120008	0R Jumper 0805			
4832	482205120008	0R Jumper 0805			
4833	482205120008	0R Jumper 0805			
4834	482205120008	0R Jumper 0805			
4835	482205120008	0R Jumper 0805			
4836	482205120008	0R Jumper 0805			
4837	482205120008	0R Jumper 0805			
4838	482205120008	0R Jumper 0805			
4839	482205120008	0R Jumper 0805			
4840	482205120008	0R Jumper 0805			
4841	482205120008	0R Jumper 0805			
4842	482205120008	0R Jumper 0805			
4843	482205120008	0R Jumper 0805			
4844	482205120008	0R Jumper 0805			
4845	482205120008	0R Jumper 0805			
4846	482205120008	0R Jumper 0805			
4847	482205120008	0R Jumper 0805			
4848	482205120008	0R Jumper 0805			
4849	482205120008	0R Jumper 0805			
4876	482205120008	0R Jumper 0805			

Note: Only the parts mentioned in this list are normal service spare parts.

COILS & FILTERS

5802	482215631058	100 μ H
------	--------------	-------------

DIODES

6871	482213083757	BAS216
6872	482213083757	BAS216
6873	482213083757	BAS216
6874	482213083757	BAS216
6875	482213011383	BZX284-C5V1
6877	482213011366	BZX284-C3V9
6878	482213083757	BAS216
6879	482213011366	BZX284-C3V9

TRANSISTORS & INTEGRATED CIRCUITS

7801	935262236118	IC SM TZA1025T/V2
------	--------------	-------------------

NOTES

POWER 5 DVD Module

(Include Mains Board)

TABLE OF CONTENTS

Wiring Diagram	11-2
Mains Board - Component Layout & Circuit Diagram ...	11-3
Supply part - Component Layout	11-4
Supply part - Circuit Diagram	11-5
L/R Amplifier part - Component Layout	11-6
L/R Amplifier part - Circuit Diagram	11-7
C/S Amplifier part - Component Layout	11-8
C/S Amplifier part - Circuit Diagram	11-9
Exploded View	11-10
Electrical parts list.....	11-11

MAINS BOARD - COMPONENT VIEW

Interconnection Board

primary side

- 8901 E 5
- 8902 D 5
- 9920 E 4
- 9921 E 4
- 9922 E 4
- 9923 D 4
- 9924 D 4
- 9925 D 4
- trf3 E 4
- trf4 E 4
- trf5 E 4
- trf6 D 4
- trf7 D 4
- trf8 D 4

secondary side

- 1911 A 5
- 1912 B 5
- 1913 C 5
- 1914 A 5
- 1920 A 4
- 1921 A 4
- 1922 A 4
- 1923 B 5
- 1924 C 4
- 1925 C 4
- 3920 B 4
- 9927 A 5
- 9928 A 5
- 9930 B 4
- 9931 A 4
- 9932 A 4
- 9933 A 4
- 9934 A 4
- 9935 B 4
- 9936 B 4
- 9937 B 4
- 9938 B 4
- 9939 C 4
- 9940 C 4
- 9941 C 4
- 9942 C 4

Mains Board

- 27 B 1
- 1901 E 3
- 1902 E 2
- 1903 C 2
- 1904 B 2
- 1905 C 3
- 1906 C 1
- 1907 E 1
- 1909 D 1
- 1910 C 1
- 2902 A 3
- 2903 A 2
- 2904 A 2
- 2905 A 1
- 2906 B 1
- 3901 B 1
- 3902 A 2
- 3903 A 1
- 3904 B 1
- 3905 A 1
- 3906 A 1
- 3907 E 3
- 3908 C 2
- 5901 D 3
- 5902 D 3
- 5903 B 2
- 5905 C 1
- 6900 B 1
- 6901 A 3
- 6902 A 2
- 6903 A 3
- 6904 A 2
- 6905 A 2
- 6906 A 2
- 6908 B 1
- 6909 B 1
- 6910 B 1
- 6911 B 1
- 6912 B 1
- 7901 A 1
- 7902 B 1
- 8904 D 1
- 8905 C 1
- 9900 B 1
- 9901 D 3
- 9902 D 3
- 9903 C 3
- 9904 D 2
- 9905 C 1
- 9906 E 1
- 9907 B 3
- 9908 A 2
- 9909 A 2
- 9910 B 1
- 9911 A 1
- 9912 A 1
- 9913 A 2
- 9914 A 2
- 9915 D 2
- 9916 D 2
- 9917 D 1
- 9918 C 3
- 9919 C 3
- 9926 C 2
- 9929 B 2

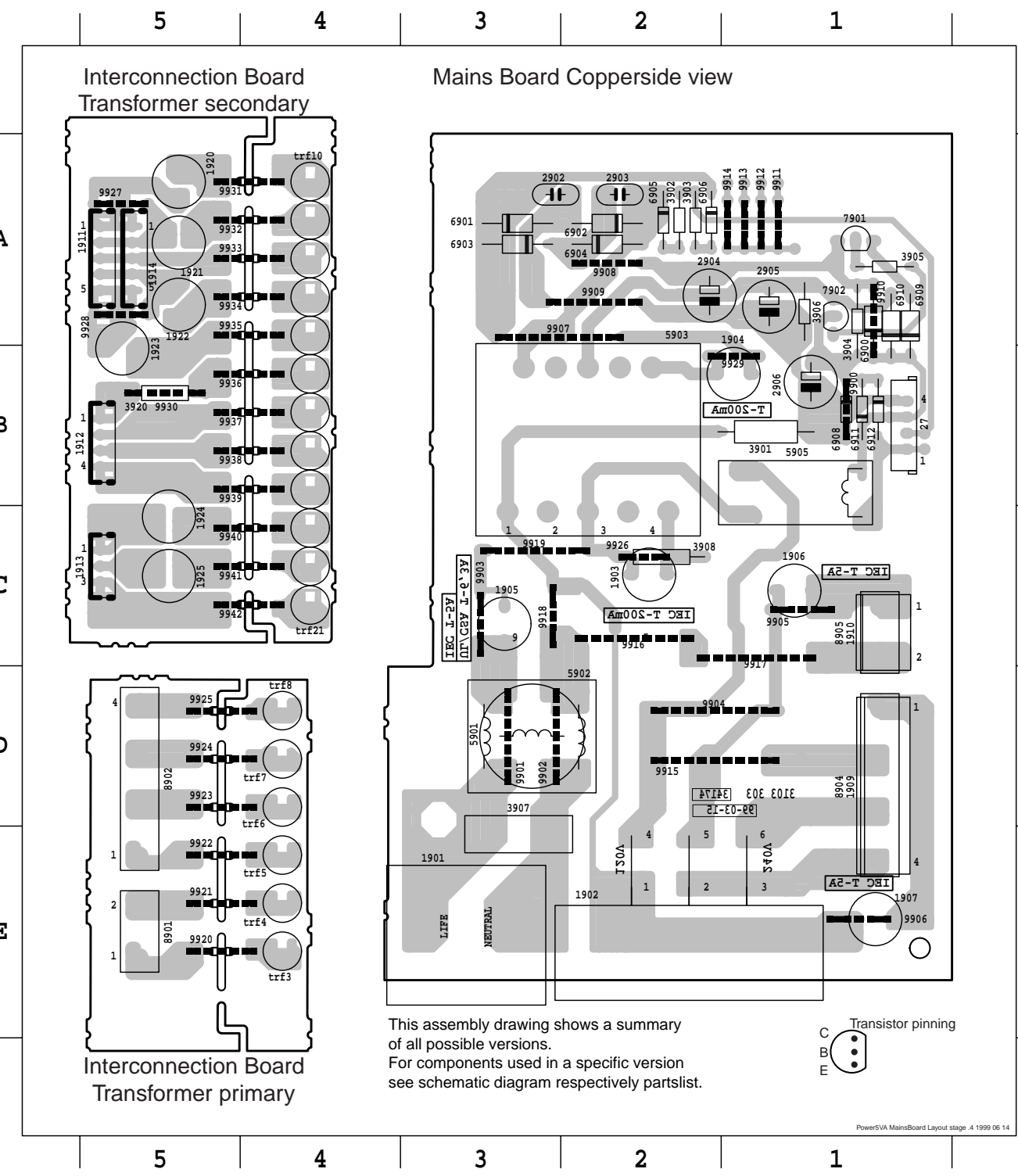

MAINS BOARD - CIRCUIT DIAGRAM

- 27 J13
- 1901 A 1
- 1903 L4
- 1905 A 3
- 1906 C 6
- 1907 C 6
- 1913 H13
- 1914 A13
- 1920 A12
- 1921 A12
- 1922 B12
- 1923 C12
- 1924 H12
- 1925 I12
- 2904 N 7
- 2905 N 6
- 2906 N 7
- 2907 N 3
- 2908 K 5
- 2909 K 6
- 3903 K 6
- 3904 M 7
- 3905 M 8
- 3906 N 5
- 3907 B 1
- 3908 L 4
- 3909 L 4
- 5905 A 4
- 5906 L 5
- 5907 L 6
- 5908 L 5
- 5909 L 9
- 6904 M 6
- 6905 L 5
- 6906 L 5
- 6908 N 8
- 6909 L 9
- 6910 N 9
- 6911 K10
- 6912 K11
- 6913 K11
- 6914 L 6
- 6915 L 6
- 6916 L 6
- 6917 L 6
- 6918 L 6
- 6919 L 6
- 6920 B 2
- 6921 L 6
- 6922 L 6
- 6923 L 6
- 6924 L 6
- 6925 L 6
- 6926 L 6
- 6927 L 6
- 6928 L 6
- 6929 L 6
- 6930 L 6
- 6931 L 6
- 6932 L 6
- 6933 L 6
- 6934 L 6
- 6935 L 6
- 6936 L 6
- 6937 L 6
- 6938 L 6
- 6939 L 6
- 6940 L 6
- 6941 L 6
- 6942 L 6
- 6943 L 6
- 6944 L 6
- 6945 L 6
- 6946 L 6
- 6947 L 6
- 6948 L 6
- 6949 L 6
- 6950 L 6
- 6951 L 6
- 6952 L 6
- 6953 L 6
- 6954 L 6
- 6955 L 6
- 6956 L 6
- 6957 L 6
- 6958 L 6
- 6959 L 6
- 6960 L 6
- 6961 L 6
- 6962 L 6
- 6963 L 6
- 6964 L 6
- 6965 L 6
- 6966 L 6
- 6967 L 6
- 6968 L 6
- 6969 L 6
- 6970 L 6
- 6971 L 6
- 6972 L 6
- 6973 L 6
- 6974 L 6
- 6975 L 6
- 6976 L 6
- 6977 L 6
- 6978 L 6
- 6979 L 6
- 6980 L 6
- 6981 L 6
- 6982 L 6
- 6983 L 6
- 6984 L 6
- 6985 L 6
- 6986 L 6
- 6987 L 6
- 6988 L 6
- 6989 L 6
- 6990 L 6
- 6991 L 6
- 6992 L 6
- 6993 L 6
- 6994 L 6
- 6995 L 6
- 6996 L 6
- 6997 L 6
- 6998 L 6
- 6999 L 6
- 7000 L 6
- 7001 L 6
- 7002 L 6
- 7003 L 6
- 7004 L 6
- 7005 L 6
- 7006 L 6
- 7007 L 6
- 7008 L 6
- 7009 L 6
- 7010 L 6
- 7011 L 6
- 7012 L 6
- 7013 L 6
- 7014 L 6
- 7015 L 6
- 7016 L 6
- 7017 L 6
- 7018 L 6
- 7019 L 6
- 7020 L 6
- 7021 L 6
- 7022 L 6
- 7023 L 6
- 7024 L 6
- 7025 L 6
- 7026 L 6
- 7027 L 6
- 7028 L 6
- 7029 L 6
- 7030 L 6
- 7031 L 6
- 7032 L 6
- 7033 L 6
- 7034 L 6
- 7035 L 6
- 7036 L 6
- 7037 L 6
- 7038 L 6
- 7039 L 6
- 7040 L 6
- 7041 L 6
- 7042 L 6
- 7043 L 6
- 7044 L 6
- 7045 L 6
- 7046 L 6
- 7047 L 6
- 7048 L 6
- 7049 L 6
- 7050 L 6
- 7051 L 6
- 7052 L 6
- 7053 L 6
- 7054 L 6
- 7055 L 6
- 7056 L 6
- 7057 L 6
- 7058 L 6
- 7059 L 6
- 7060 L 6
- 7061 L 6
- 7062 L 6
- 7063 L 6
- 7064 L 6
- 7065 L 6
- 7066 L 6
- 7067 L 6
- 7068 L 6
- 7069 L 6
- 7070 L 6
- 7071 L 6
- 7072 L 6
- 7073 L 6
- 7074 L 6
- 7075 L 6
- 7076 L 6
- 7077 L 6
- 7078 L 6
- 7079 L 6
- 7080 L 6
- 7081 L 6
- 7082 L 6
- 7083 L 6
- 7084 L 6
- 7085 L 6
- 7086 L 6
- 7087 L 6
- 7088 L 6
- 7089 L 6
- 7090 L 6
- 7091 L 6
- 7092 L 6
- 7093 L 6
- 7094 L 6
- 7095 L 6
- 7096 L 6
- 7097 L 6
- 7098 L 6
- 7099 L 6
- 7100 L 6
- 7101 L 6
- 7102 L 6
- 7103 L 6
- 7104 L 6
- 7105 L 6
- 7106 L 6
- 7107 L 6
- 7108 L 6
- 7109 L 6
- 7110 L 6
- 7111 L 6
- 7112 L 6
- 7113 L 6
- 7114 L 6
- 7115 L 6
- 7116 L 6
- 7117 L 6
- 7118 L 6
- 7119 L 6
- 7120 L 6
- 7121 L 6
- 7122 L 6
- 7123 L 6
- 7124 L 6
- 7125 L 6
- 7126 L 6
- 7127 L 6
- 7128 L 6
- 7129 L 6
- 7130 L 6
- 7131 L 6
- 7132 L 6
- 7133 L 6
- 7134 L 6
- 7135 L 6
- 7136 L 6
- 7137 L 6
- 7138 L 6
- 7139 L 6
- 7140 L 6
- 7141 L 6
- 7142 L 6
- 7143 L 6
- 7144 L 6
- 7145 L 6
- 7146 L 6
- 7147 L 6
- 7148 L 6
- 7149 L 6
- 7150 L 6
- 7151 L 6
- 7152 L 6
- 7153 L 6
- 7154 L 6
- 7155 L 6
- 7156 L 6
- 7157 L 6
- 7158 L 6
- 7159 L 6
- 7160 L 6
- 7161 L 6
- 7162 L 6
- 7163 L 6
- 7164 L 6
- 7165 L 6
- 7166 L 6
- 7167 L 6
- 7168 L 6
- 7169 L 6
- 7170 L 6
- 7171 L 6
- 7172 L 6
- 7173 L 6
- 7174 L 6
- 7175 L 6
- 7176 L 6
- 7177 L 6
- 7178 L 6
- 7179 L 6
- 7180 L 6
- 7181 L 6
- 7182 L 6
- 7183 L 6
- 7184 L 6
- 7185 L 6
- 7186 L 6
- 7187 L 6
- 7188 L 6
- 7189 L 6
- 7190 L 6
- 7191 L 6
- 7192 L 6
- 7193 L 6
- 7194 L 6
- 7195 L 6
- 7196 L 6
- 7197 L 6
- 7198 L 6
- 7199 L 6
- 7200 L 6

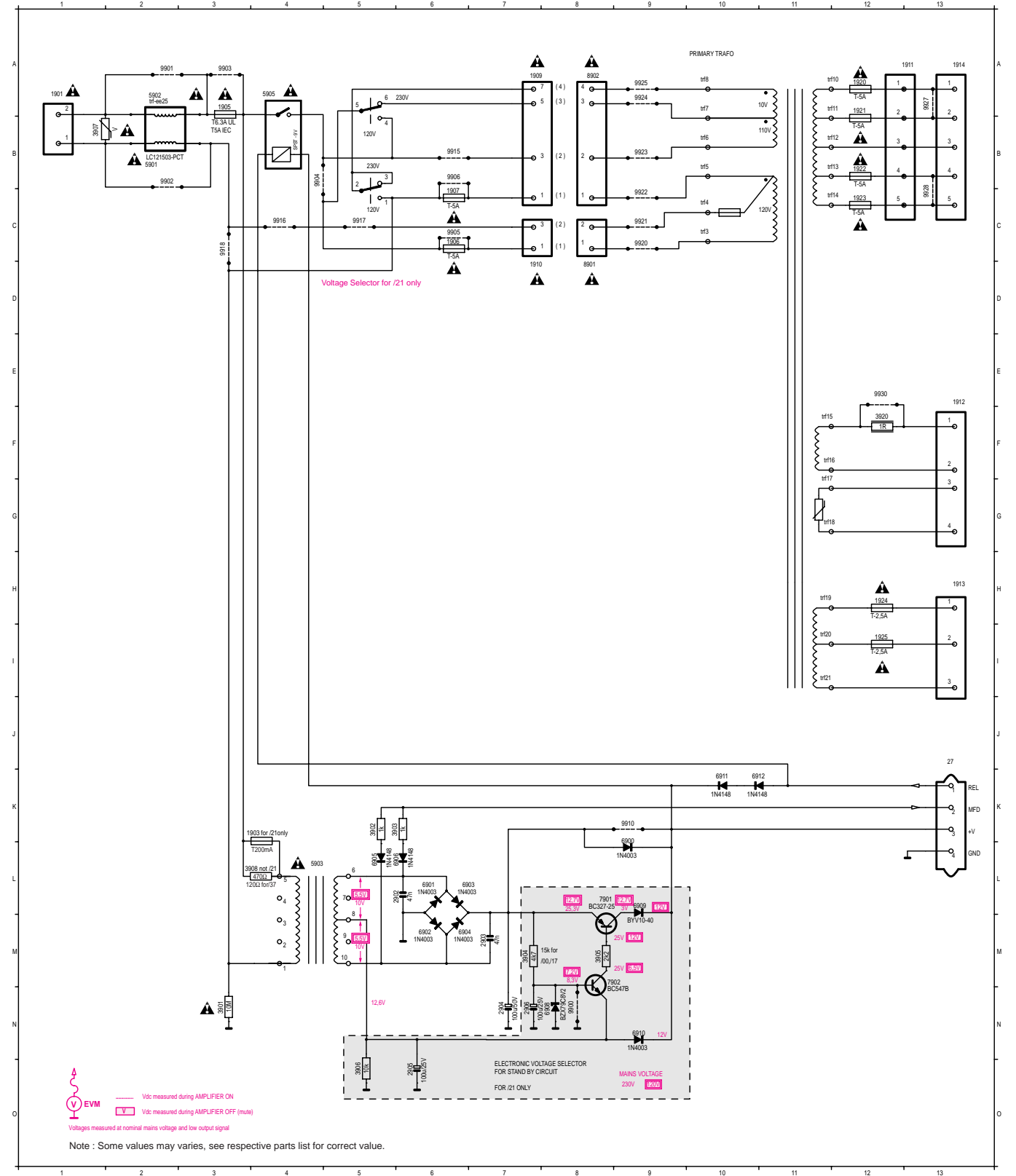

SUPPLY PART - CIRCUIT DIAGRAM

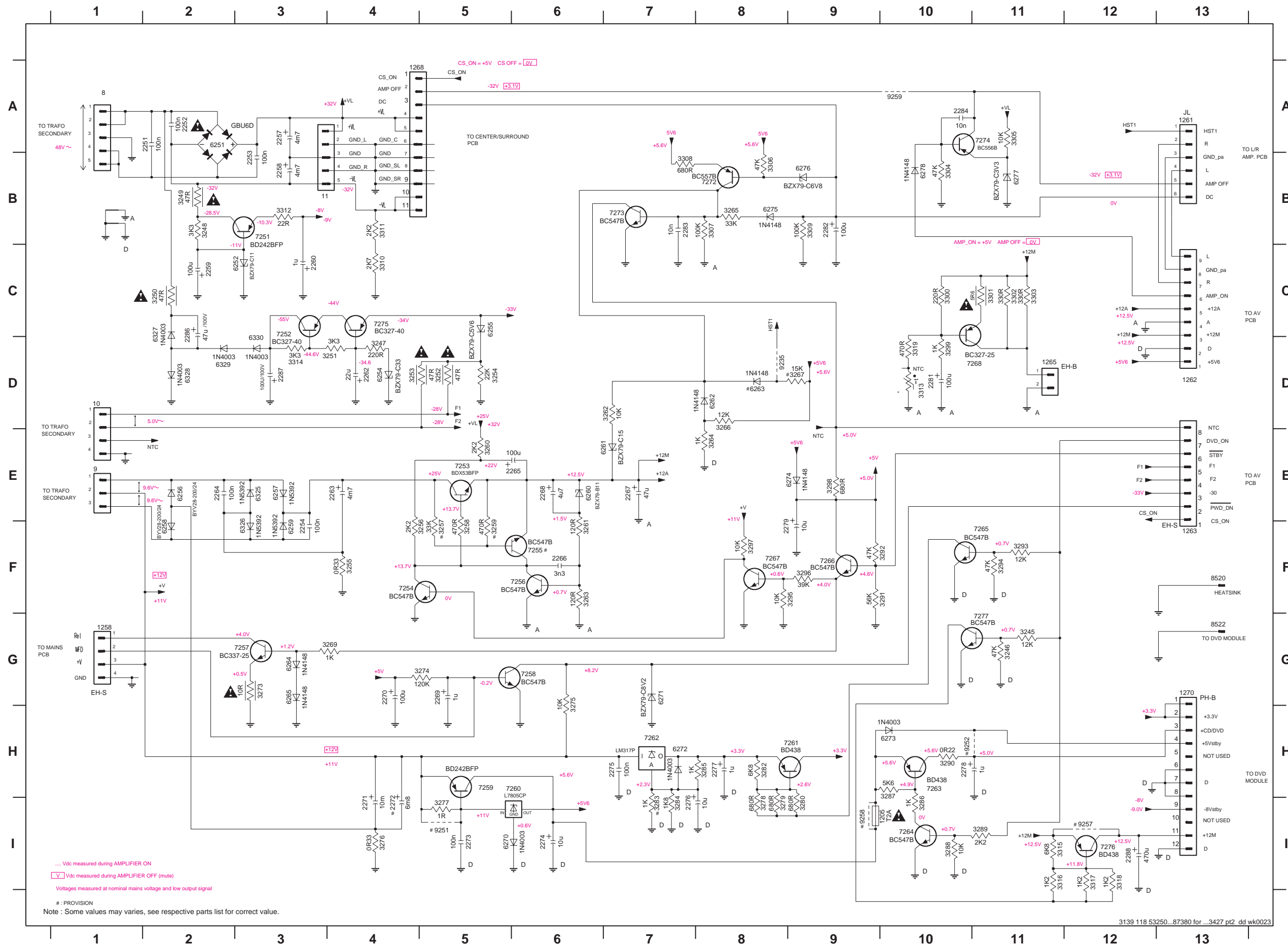

- 8 A1
- 9 E1
- 10 D1
- 11 B4
- 1205 H10
- 1258 G1
- 1261 A13
- 1262 D13
- 1263 F13
- 1265 D11
- 1268 A4
- 1270 G13
- 2251 A2
- 2252 A2
- 2253 B3
- 2254 F3
- 2257 A3
- 2258 B3
- 2259 C2
- 2260 C3
- 2262 D4
- 2263 E4
- 2264 E2
- 2265 E6
- 2266 F6
- 2268 E6
- 2269 G5
- 2270 G4
- 2271 I4
- 2272 I4
- 2273 I5
- 2274 I6
- 2275 H7
- 2276 I7
- 2277 H8
- 2278 H10
- 2279 F9
- 2281 D10
- 2282 B9
- 2283 B7
- 2284 A10
- 2286 C2
- 2287 D3
- 2288 I12
- 3245 G11
- 3246 G11
- 3247 D4
- 3248 B2
- 3249 B2
- 3250 C2
- 3251 D4
- 3252 D5
- 3253 D4
- 3254 D5
- 3255 F4
- 3256 F5
- 3257 F5
- 3258 F5
- 3259 F5
- 3260 E5
- 3261 F6
- 3262 D7
- 3263 F6
- 3264 E8
- 3265 B8
- 3266 D8
- 3267 D9
- 3269 G4
- 3273 G3
- 3274 G5
- 3275 G6
- 3276 I4
- 3277 I5
- 3278 I8
- 3279 I8
- 3280 I9
- 3282 H8
- 3283 I7
- 3284 I7
- 3285 H8
- 3286 H10
- 3288 H10
- 3289 I11
- 3290 H10
- 3291 F10
- 3292 F10
- 3293 F11
- 3294 F11
- 3295 F9
- 3296 F9
- 3297 F8
- 3298 E9
- 3299 D10
- 3300 C10
- 3301 C11
- 3302 C11
- 3303 C11
- 3304 B10
- 3305 A11
- 3306 B8
- 3307 B8
- 3308 B7
- 3309 B9
- 3310 C4
- 3311 B4
- 3312 B3
- 3313 D10
- 3314 D3
- 3315 H1
- 3316 H1
- 3317 H2
- 3318 H2
- 3319 D10
- 6251 A2
- 6252 C3
- 6254 D4
- 6255 C5
- 6256 E2
- 6257 E3
- 6258 F2
- 6259 F3
- 6260 E6
- 6261 E7
- 6262 D8
- 6263 D8
- 6264 G3
- 6265 G3
- 6270 I5
- 6271 G7
- 6272 H10
- 6273 H10
- 6274 E9
- 6275 B8
- 6276 B9
- 6277 B11
- 6278 B10
- 6325 E3
- 6326 F3
- 6327 C2
- 6328 D2
- 6329 D3
- 7251 B3
- 7252 C3
- 7253 E5
- 7254 F4
- 7255 F6
- 7256 F6
- 7257 G3
- 7258 G6
- 7259 H5
- 7260 H6
- 7261 H8
- 7262 H7
- 7263 H10
- 7264 H10
- 7265 F11
- 7266 F9
- 7267 F8
- 7268 D10
- 7272 B8
- 7273 B7
- 7274 A11
- 7275 C4
- 7276 I2
- 7277 G11
- 8520 F13
- 8520 F13
- 8522 G13
- 9251 I5
- 9252 H10
- 9257 I12
- 9258 I9
- 9259 A10

3139 118 53250...87380 for ...3427 pt2 dd wk0023

LEFT/RIGHT AMPLIFIER PART - COMPONENT VIEW

3 A2	2329 B2	2344 A1	3323 B2	3334 C4	3345 A2	3356 B1	3367 B3	7324 A1	9310 A4	9327 B3
1321 B4	2330 C2	2345 A2	3324 C2	3335 A4	3346 A2	3357 B1	5000 B4	7325 A1	9311 B4	9328 C3
1325 A2	2331 B2	2346 B1	3325 B3	3336 B4	3347 A2	3358 B1	5001 C4	7329 B3	9312 A3	
2320 B2	2332 C3	2347 B2	3326 C3	3337 A4	3348 A2	3359 B2	6320 A1	9301 A1	9313 A3	
2321 B2	2337 B4	2348 B2	3327 B2	3338 C4	3349 C3	3360 B1	6321 A4	9302 A1	9314 A3	
2322 C2	2338 B4	2349 A3	3328 C3	3339 A4	3350 B2	3361 C4	6322 C4	9303 A1	9315 A3	
2323 B3	2339 B4	2350 A3	3329 B2	3340 B4	3351 C2	3362 B4	6323 B1	9304 B2	9321 B3	
2324 C2	2340 C4	2351 B3	3330 C3	3341 A2	3352 B1	3363 B4	7320 C2	9305 C2	9323 A4	
2326 C3	2341 B3	3320 B1	3331 B4	3342 A1	3353 B1	3364 B4	7321 B1	9306 B3	9324 C4	
2327 B3	2342 B3	3321 A1	3332 C4	3343 A2	3354 B1	3365 A4	7322 B1	9307 A3	9325 A4	
2328 C3	2343 C4	3322 A1	3333 B4	3344 A2	3355 C1	3366 C3	7323 B2	9308 A3	9326 B4	

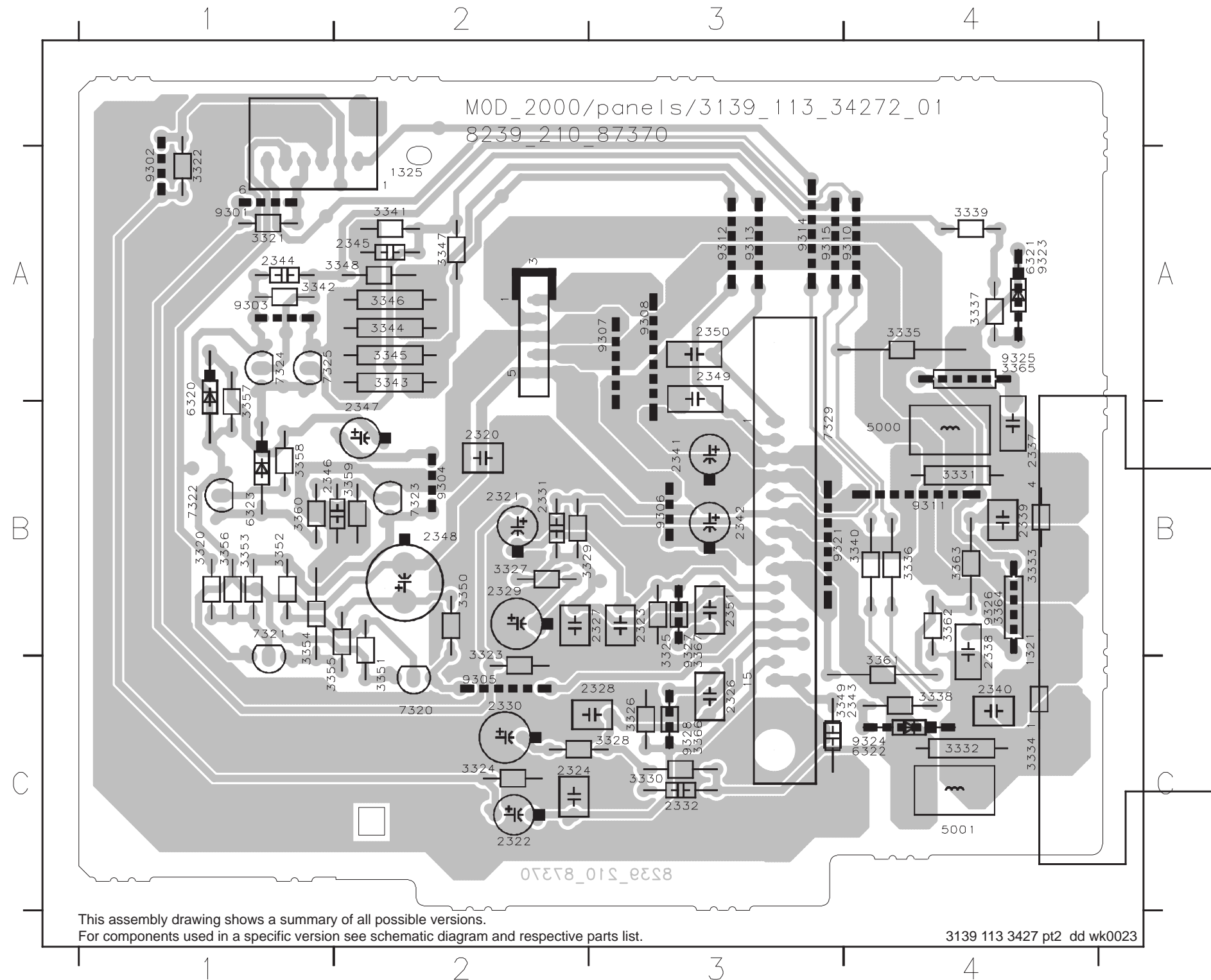

CENTER/SURROUND AMPLIFIER PART - COMPONENT VIEW

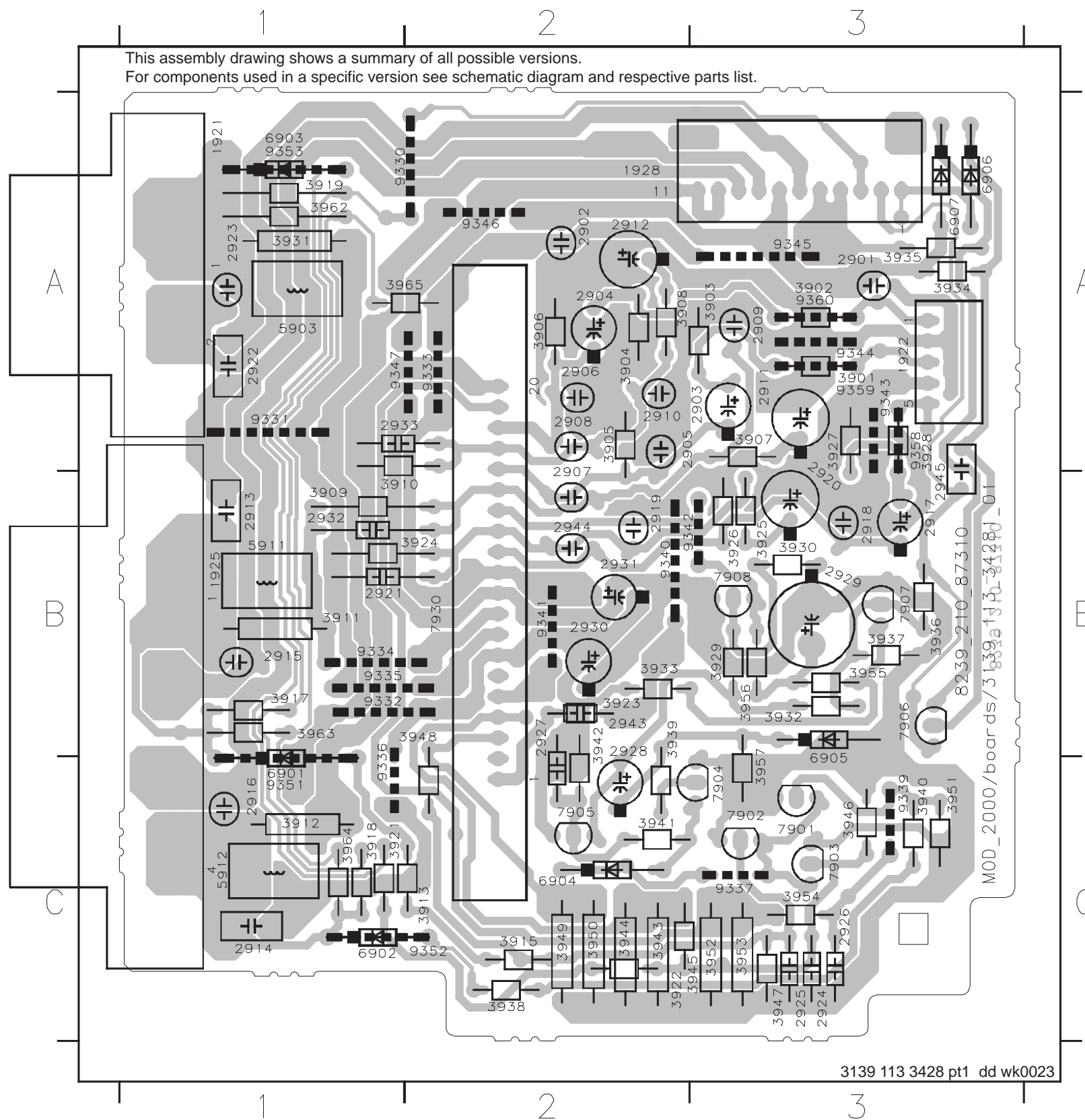

1921	A1	3924	B2	9333	A2
1922	A3	3925	B3	9334	B1
1925	B1	3926	B3	9335	B1
1928	A2	3927	A3	9336	C1
2901	A3	3928	A3	9337	C3
2902	A2	3929	B3	9339	C3
2903	A3	3930	B3	9340	B2
2904	A2	3931	A1	9341	B2
2905	A2	3932	B3	9342	B2
2906	A2	3933	B2	9343	A3
2907	B2	3934	A3	9344	A3
2908	A2	3935	A3	9345	A3
2909	A3	3936	B3	9346	A2
2910	A2	3937	B3	9347	A1
2911	A3	3938	C2	9351	C1
2912	A2	3939	B2	9352	C2
2913	B1	3940	C3	9353	A1
2914	C1	3941	C2	9358	A3
2915	B1	3942	B2	9359	A3
2916	C1	3943	C2	9360	A3
2917	B3	3944	C2		
2918	B3	3945	C3		
2919	B2	3946	C3		
2920	B3	3947	C3		
2921	B1	3948	B2		
2922	A1	3949	C2		
2923	A1	3950	C2		
2924	C3	3951	C3		
2925	C3	3952	C3		
2926	C3	3953	C3		
2927	B2	3954	C3		
2928	B2	3955	B3		
2929	B3	3956	B3		
2930	B2	3957	C3		
2931	B2	3962	A1		
2932	B1	3963	B1		
2933	A1	3964	C1		
2943	B2	3965	A1		
2944	B2	5903	A1		
2945	B3	5911	B1		
3901	A3	5912	C1		
3902	A3	6901	C1		
3903	A3	6902	C1		
3904	A2	6903	A1		
3905	A2	6904	C2		
3906	A2	6905	C3		
3907	A3	6906	A3		
3908	A2	6907	A3		
3909	B1	7901	C3		
3910	B1	7902	C3		
3911	B1	7903	C3		
3912	C1	7904	C3		
3913	C2	7905	C2		
3915	C2	7906	B3		
3917	B1	7907	B3		
3918	C1	7908	B3		
3919	A1	7930	B2		
3921	C1	9330	A1		
3922	C2	9331	A1		
3923	B2	9332	B1		

CENTER/SURROUND AMPLIFIER PART - CIRCUIT DIAGRAM

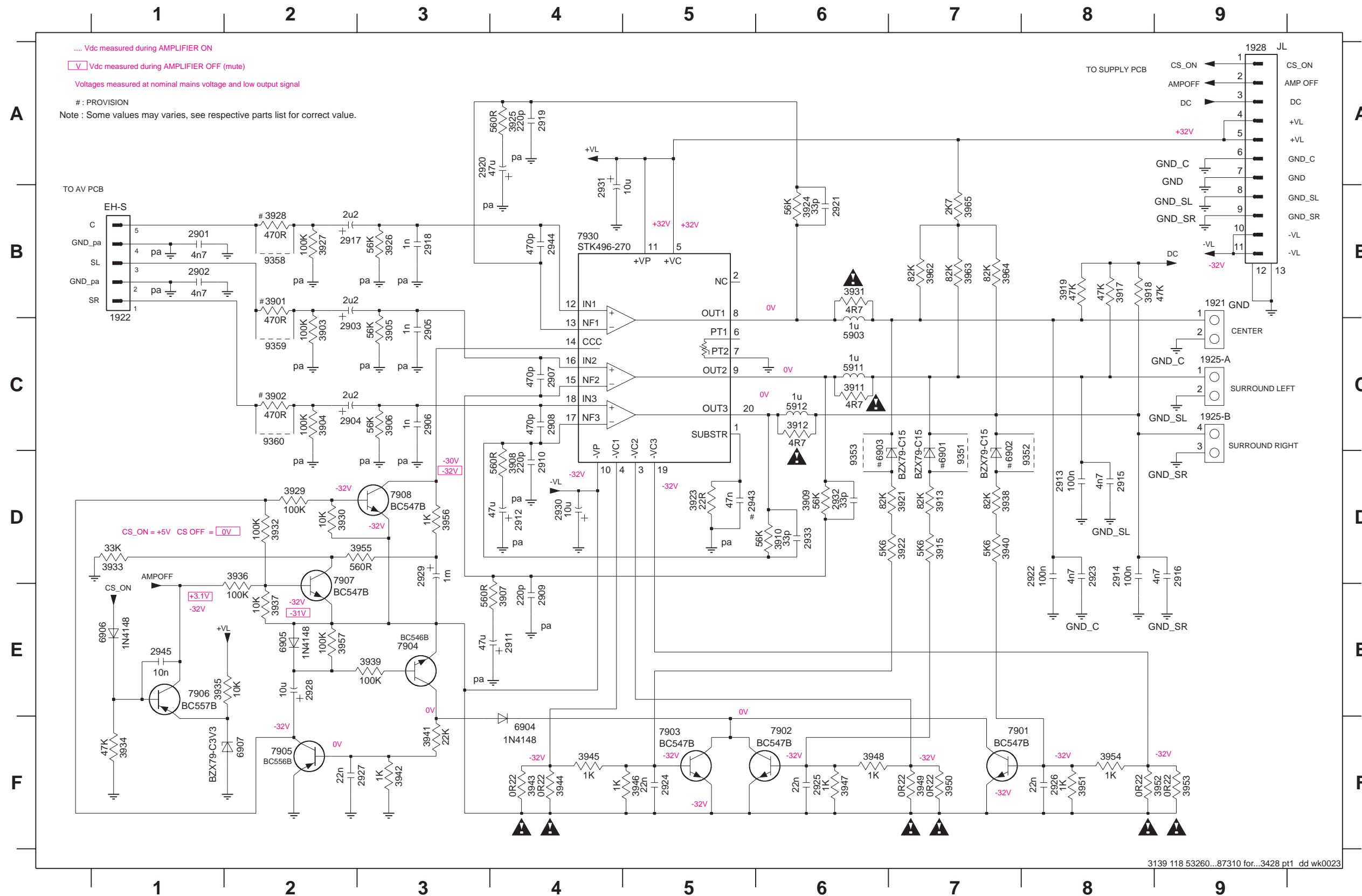

- 1921 B9
- 1922 B1
- 1925-A C9
- 1925-B C9
- 1928 A9
- 2901 B1
- 2902 B1
- 2903 C2
- 2904 C2
- 2905 C3
- 2906 C3
- 2907 C4
- 2908 C4
- 2909 E4
- 2910 D4
- 2911 E4
- 2912 D4
- 2913 D8
- 2914 D8
- 2915 D8
- 2916 D9
- 2917 B2
- 2918 B3
- 2919 A4
- 2920 A3
- 2921 B6
- 2922 D8
- 2923 D8
- 2924 F5
- 2925 F6
- 2926 F8
- 2927 F3
- 2928 E2
- 2929 D3
- 2930 D4
- 2931 B4
- 2932 D6
- 2933 D6
- 2943 D5
- 2944 B4
- 2945 E1
- 3901 B2
- 3902 C2
- 3903 C2
- 3904 C2
- 3905 C3
- 3906 C3
- 3907 E4
- 3908 D4
- 3909 D6
- 3910 D6
- 3911 C6
- 3912 C6
- 3913 D7
- 3915 D7
- 3917 B8
- 3918 B8
- 3919 B8
- 3921 D7
- 3922 D7
- 3923 D5
- 3924 B6
- 3925 A4
- 3926 B3
- 3927 B2
- 3928 B2
- 3929 D2
- 3930 D2
- 3931 B6
- 3932 D2
- 3933 D1
- 3934 F1
- 3935 E1
- 3936 D2
- 3937 E2
- 3938 D7
- 3939 E3
- 3940 D7
- 3941 F3
- 3942 F3
- 3943 F4
- 3944 F4
- 3945 F4
- 3946 F5
- 3947 F6
- 3948 F6
- 3949 F7
- 3950 F7
- 3951 F8
- 3952 F9
- 3953 F9
- 3954 F8
- 3955 D3
- 3956 D3
- 3957 E2
- 3962 B7
- 3963 B7
- 3964 B7
- 3965 B7
- 5903 C6
- 5911 C6
- 5912 C6
- 6901 D7
- 6902 D7
- 6903 C6
- 6904 F4
- 6905 E2
- 6906 E1
- 6907 F2
- 7901 F8
- 7902 F6
- 7903 F5
- 7904 E3
- 7905 F2
- 7906 E1
- 7907 D2
- 7908 D3
- 7909 B4
- 9351 D7
- 9352 D8
- 9353 D6
- 9358 B2
- 9359 C2
- 9360 C2

3139 118 53260...87310 for...3428 pt1 dd wk0023

EXPLODED VIEW

Mechanical parts

0047	3103 304 69030	Rucksack P5-DVD (L/R & C/S)
1241	4822 361 11161	Fan KD1206PTS3

Note: Only the parts mentioned in this list are normal service spare parts.

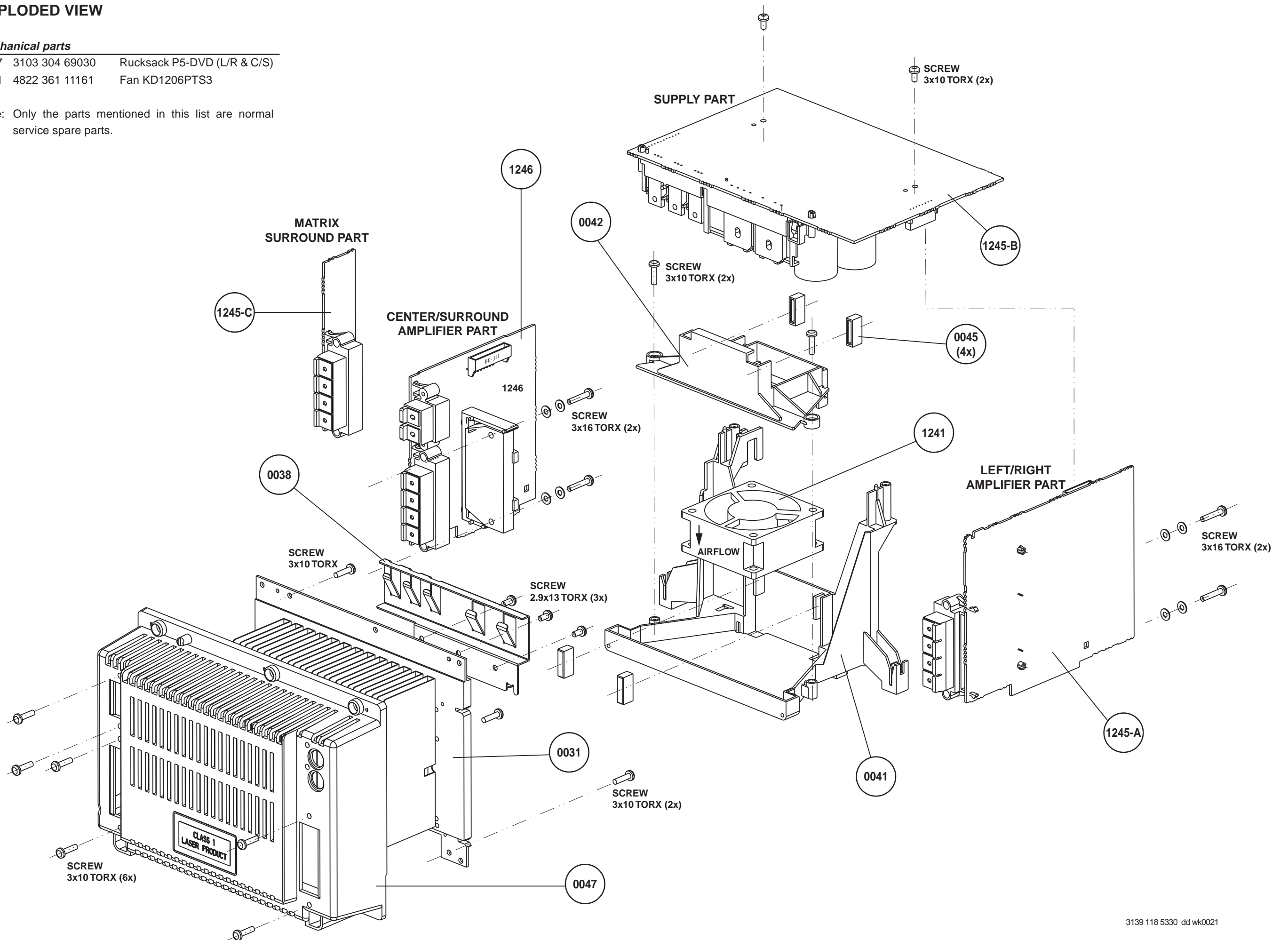

ELECTRICAL PARTS LIST - MAINS BOARD

MISCELLANEOUS

1901	4822 265 31015	△ Mains Socket
1901#	2422 030 00328	△ Mains Socket
1902*	4822 272 10269	△ Voltage Selector
1903*	4822 071 52001	△ Fuse T200mA 250V IEC
1905^	4822 071 55002	△ Fuse T5A 250V IEC
1905#	4822 252 51123	△ Fuse T6,3A 250V UL
1906*	4822 071 55002	△ Fuse T5A 250V IEC
1907*	4822 071 55002	△ Fuse T5A 250V IEC
1909*	4822 267 10728	△ Primary Connector 4P
1910	4822 265 20723	△ Primary Connector 2P
1920	4822 071 55002	△ Fuse T5A 250V IEC
1923	4822 071 55002	△ Fuse T5A 250V IEC
1924	4822 071 52502	△ Fuse T2,5A 250V IEC
1925	4822 071 52502	△ Fuse T2,5A 250V IEC

CAPACITORS

2902	4822 121 43526	47nF 5% 250V
2903	4822 121 43526	47nF 5% 250V
2904*	4822 124 40255	100µF 20% 63V
2905*	4822 124 40207	100µF 20% 25V

RESISTORS

3901#	4822 053 21106	△ 10M 5% 0,5W
3902	4822 050 11002	1k 1% 0,4W
3903	4822 050 11002	1k 1% 0,4W
3904*	4822 116 52283	4k7 5% 0,5W
3904**	4822 116 52244	15k 5% 0,5W
3905*	4822 116 52256	2k2 5% 0,5W
3906*	4822 050 21003	10k 1% 0,6W
3908^	4822 053 10471	470R 5% 1W
3908#	4822 053 10121	120R 5% 1W
3920*	4822 052 10108	△ 1R 5% 0,33W

COILS & FILTERS

5901^	4822 157 11832	△ 400µH 3A
5902*	4822 157 11628	△ Mains Choke
5903*	4822 146 11144	△ Standby Transformer
5903^	4822 146 11143	△ Standby Transformer
5903#	4822 146 11142	△ Standby Transformer
5905	4822 280 10382	△ Relay 1P

DIODES

6900**	4822 130 31878	1N4003G
6901	4822 130 31878	1N4003G
6902	4822 130 31878	1N4003G
6903	4822 130 31878	1N4003G
6904	4822 130 31878	1N4003G
6905	4822 130 30621	1N4148
6906	4822 130 30621	1N4148
6908*	4822 130 34382	BZX79-C8V2
6909*	4822 130 32245	BYV10-40
6910*	4822 130 31878	1N4003G

6911	4822 130 30621	1N4148
6912	4822 130 30621	1N4148

TRANSISTORS & INTEGRATED CIRCUITS

7901*	4822 130 41246	BC327-25
7902*	4822 130 40959	BC547B

* For /21/21M only

** Not for /21/21M

^ For /22/30 only

For /37 only

Note : Only the parts mentioned in this list are normal service spare parts.

ELECTRICAL PARTS LIST - SUPPLY & LEFT/RIGHT AMPLIFIER BOARD

MISCELLANEOUS

1205	4822 071 52002	△ Fuse T2A 250V IEC
1321	4822 267 31176	L/R Loudspeaker Terminal

CAPACITORS

2251	5322 121 42578	100nF 5% 250V
2252	5322 121 42578	100nF 5% 250V
2253	5322 121 42578	100nF 5% 250V
2254	5322 121 42578	100nF 5% 250V
2257	4822 124 80415	4700µF 20% 50V
2258	4822 124 80415	4700µF 20% 50V
2259	4822 124 40255	100µF 20% 63V
2260	4822 124 21913	1µF 20% 63V
2262	4822 124 81151	22µF 50V
2263	4822 124 80563	4700µF 20% 35V
2264	5322 121 42578	100nF 5% 250V
2265	4822 124 40255	100µF 20% 63V
2266	4822 122 10577	3,3nF 10% 16V
2267	4822 124 40433	47µF 20% 25V
2268	4822 124 40769	4,7µF 20% 100V
2269	4822 124 21913	1µF 20% 63V
2270	4822 124 41584	100µF 20% 10V
2271	2020 012 93745	10000µF 20% 16V
2273	4822 126 12882	100nF +80/-20% 50V
2274	4822 124 40248	10µF 20% 63V
2275	4822 126 12882	100nF +80/-20% 50V
2276	4822 124 11947	10µF 20% 16V
2277	4822 124 21913	1µF 20% 63V
2278	4822 124 21913	1µF 20% 63V
2279	4822 124 40248	10µF 20% 63V
2281	4822 124 40207	100µF 20% 25V
2282	4822 124 41584	100µF 20% 10V
2283	4822 121 51387	10nF 20% 16V
2284	4822 122 30043	10nF 80% 63V
2286	2020 012 93594	47µF 20% 100V
2287	2020 012 93741	100µF 20% 100V
2288	4822 124 11767	470µF 20% 25V
2320	5322 122 32261	4,7nF 10% 100V
2321	4822 124 22652	2,2µF 20% 50V
2322	4822 124 22652	2,2µF 20% 50V
2323	5322 122 32331	1nF 10% 100V
2324	5322 122 32331	1nF 10% 100V
2326	5322 122 32818	2,2nF 10% 100V
2329	4822 124 41751	47µF 20% 50V
2330	4822 124 41751	47µF 20% 50V
2331	4822 122 10465	4,7pF 10% 50V
2332	4822 122 10465	4,7pF 10% 50V
2337	5322 121 42386	100nF 5% 63V
2338	5322 121 42386	100nF 5% 63V
2339	5322 122 32261	4,7nF 10% 100V
2340	5322 122 32261	4,7nF 10% 100V
2341	4822 124 40248	10µF 20% 63V
2342	4822 124 40248	10µF 20% 63V

2344	4822 126 11585	22nF +80/-20% 25V
2345	4822 126 11585	22nF +80/-20% 25V
2346	4822 126 11585	22nF +80/-20% 25V
2347	4822 124 40248	10µF 20% 63V
2348	4822 124 81144	1000µF 16V
2349	5322 121 42386	100nF 5% 63V
2350	5322 121 42386	100nF 5% 63V
2351	5322 122 32818	2,2nF 10% 100V

RESISTORS

3245	4822 116 52238	12k 5% 0,5W
3246	4822 116 83884	47k 5% 0,5W
3247	4822 116 83872	220R 5% 0,5W
3248	4822 116 52269	3k3 5% 0,5W
3249	4822 052 10479	△ 47R 5% 0,33W
3250	4822 052 10479	△ 47R 5% 0,33W
3251	4822 116 52269	3k3 5% 0,5W
3252	4822 052 10479	△ 47R 5% 0,33W
3253	4822 052 10479	△ 47R 5% 0,33W
3254	4822 116 52257	22k 5% 0,5W
3255	4822 117 11342	0R33 5% 2W
3256	4822 116 52256	2k2 5% 0,5W
3258	4822 116 83883	470R 5% 0,5W
3260	4822 116 52256	2k2 5% 0,5W
3261	4822 116 52206	120R 5% 0,5W
3262	4822 050 21003	10k 1% 0,6W
3263	4822 116 52206	120R 5% 0,5W
3264	4822 050 11002	1k 1% 0,4W
3265	4822 050 23303	33k 1% 0,6W
3266	4822 116 52238	12k 5% 0,5W
3269	4822 050 11002	1k 1% 0,4W
3273	4822 052 10109	△ 10R 5% 0,33W
3274	4822 116 52239	120k 5% 0,5W
3275	4822 050 21003	10k 1% 0,6W
3276	4822 117 11342	0R33 5% 2W
3277	4822 116 80176	1R 5% 0,5W
3278	4822 116 52228	680R 5% 0,5W
3279	4822 116 52228	680R 5% 0,5W
3280	4822 116 52228	680R 5% 0,5W
3282	4822 116 83961	6k8 5%
3284	4822 116 52249	1k8 5% 0,5W
3285	4822 050 11002	1k 1% 0,4W
3286	4822 050 11002	1k 1% 0,4W
3287	4822 116 52289	5k6 5% 0,5W
3288	4822 050 21003	10k 1% 0,6W
3289	4822 116 52256	2k2 5% 0,5W
3290	4822 117 11744	0R22 5% 1W
3291	4822 116 52291	56k 5% 0,5W
3292	4822 116 83884	47k 5% 0,5W
3293	4822 116 52238	12k 5% 0,5W
3294	4822 116 83884	47k 5% 0,5W
3295	4822 050 21003	10k 1% 0,6W

ELECTRICAL PARTS LIST - SUPPLY & LEFT/RIGHT AMPLIFIER BOARD**RESISTORS**

3296	4822 116 83882	39k 5% 0,5W
3297	4822 050 21003	10k 1% 0,6W
3298	4822 116 52228	680R 5% 0,5W
3299	4822 050 11002	1k 1% 0,4W
3300	4822 116 83872	220R 5% 0,5W
3301	4822 052 10568	△ 5R60 5% 0,33W
3302	4822 116 52219	330R 5% 0,5W
3303	4822 116 52219	330R 5% 0,5W
3304	4822 116 83884	47k 5% 0,5W
3305	4822 050 21003	10k 1% 0,6W
3306	4822 116 83884	47k 5% 0,5W
3307	4822 116 52234	100k 5% 0,5W
3308	4822 116 52228	680R 5% 0,5W
3309	4822 116 52234	100k 5% 0,5W
3310	4822 116 52263	2k7 5% 0,5W
3311	4822 116 52256	2k2 5% 0,5W
3312	4822 116 52186	22R 5% 0,5W
3313	4822 117 12063	NTC DC 5W 10k 5%
3314	4822 116 52269	3k3 5% 0,5W
3315	4822 116 83961	6k8 5%
3316	4822 116 52207	1k2 5% 0,5W
3317	4822 116 52207	1k2 5% 0,5W
3318	4822 116 52207	1k2 5% 0,5W
3319	4822 116 83883	470R 5% 0,5W
3320	4822 116 52234	100k 5% 0,5W
3321	4822 116 52238	12k 5% 0,5W
3322	4822 116 52238	12k 5% 0,5W
3323	4822 116 52207	1k2 5% 0,5W
3324	4822 116 52207	1k2 5% 0,5W
3325	4822 116 52291	56k 5% 0,5W
3326	4822 116 52291	56k 5% 0,5W
3327	4822 116 52228	680R 5% 0,5W
3328	4822 116 52228	680R 5% 0,5W
3329	4822 116 52291	56k 5% 0,5W
3330	4822 116 52291	56k 5% 0,5W
3331	4822 053 10478	△ 4R7 5% 1W
3332	4822 053 10478	△ 4R7 5% 1W
3333	4822 050 21003	10k 1% 0,6W
3334	4822 050 21003	10k 1% 0,6W
3335	4822 116 83884	47k 5% 0,5W
3336	4822 116 83884	47k 5% 0,5W
3337	4822 116 52304	82k 5% 0,5W
3338	4822 116 52304	82k 5% 0,5W
3339	4822 116 52289	5k6 5% 0,5W
3340	4822 116 52289	5k6 5% 0,5W
3341	4822 050 11002	1k 1% 0,4W
3342	4822 050 11002	1k 1% 0,4W
3343	4822 117 11744	△ 0R22 5% 1W
3344	4822 117 11744	△ 0R22 5% 1W
3345	4822 117 11744	△ 0R22 5% 1W
3346	4822 117 11744	△ 0R22 5% 1W
3347	4822 050 11002	1k 1% 0,4W

3348	4822 050 11002	1k 1% 0,4W
3349	4822 116 52186	22R 5% 0,5W
3350	4822 050 11002	1k 1% 0,4W
3351	4822 050 21003	10k 1% 0,6W
3352	4822 116 52234	100k 5% 0,5W
3353	4822 116 52234	100k 5% 0,5W
3354	4822 050 23303	33k 1% 0,6W
3355	4822 116 52226	560R 5% 0,5W
3356	4822 050 21003	10k 1% 0,6W
3357	4822 116 52234	100k 5% 0,5W
3358	4822 116 52234	100k 5% 0,5W
3359	4822 050 11002	1k 1% 0,4W
3360	4822 116 52257	22k 5% 0,5W
3361	4822 116 52263	2k7 5% 0,5W
3362	4822 116 52304	82k 5% 0,5W
3363	4822 116 52304	82k 5% 0,5W
3366	4822 116 83883	470R 5% 0,5W
3367	4822 116 83883	470R 5% 0,5W

COILS & FILTERS

5000	4822 157 62255	Coil 18,5 Turns
5001	4822 157 62255	Coil 18,5 Turns

DIODES

6251	4822 130 10944	△ GBU6D
6252	9337 129 20673	BZX79-C11
6254	3198 010 53390	BZX79-B33
6255	4822 130 34173	BZX79-C5V6
6256	9340 550 66112	BYV28-200/24
6257	5322 130 80686	1N5392
6258	9340 550 66112	BYV28-200/24
6259	5322 130 80686	1N5392
6260	9331 668 80133	BZX79-B11
6261	4822 130 34281	BZX79-C15
6262	4822 130 30621	1N4148
6264	4822 130 30621	1N4148
6265	4822 130 30621	1N4148
6270	4822 130 31878	1N4003G
6271	4822 130 34382	BZX79-C8V2
6272	4822 130 31878	1N4003G
6273	4822 130 31878	1N4003G
6274	4822 130 30621	1N4148
6275	4822 130 30621	1N4148
6276	4822 130 34278	BZX79-C6V8
6277	5322 130 31504	BZX79-C3V3
6278	4822 130 30621	1N4148
6320	4822 130 30621	1N4148
6323	4822 130 30621	1N4148
6325	5322 130 80686	1N5392
6326	5322 130 80686	1N5392
6327	4822 130 31878	1N4003G
6328	4822 130 31878	1N4003G

ELECTRICAL PARTS LIST - SUPPLY & LEFT/RIGHT AMPLIFIER BOARD

6329	4822 130 31878	1N4003G
6330	4822 130 31878	1N4003G

TRANSISTORS & INTEGRATED CIRCUITS

7251	9322 139 22687	BD242BFP
7252	4822 130 41327	BC327-40
7253	9322 139 23687	BDX53BFP
7254	4822 130 40959	BC547B
7256	4822 130 40959	BC547B
7257	4822 130 40981	BC337-25
7258	4822 130 40959	BC547B
7259	9322 139 22687	BD242BFP
7260	4822 209 31841	L7805CP
7261	4822 130 40995	BD438
7262	4822 209 81351	LM317P
7263	4822 130 40995	BD438
7264	4822 130 40959	BC547B
7265	4822 130 40959	BC547B
7266	4822 130 40959	BC547B
7267	4822 130 40959	BC547B
7268	4822 130 41246	BC327-25
7272	4822 130 44568	BC557B
7273	4822 130 40959	BC547B
7274	4822 130 41691	BC556B
7275	4822 130 41327	BC327-40
7276	4822 130 40995	BD438
7277	4822 130 40959	BC547B
7320	4822 130 40959	BC547B
7321	4822 130 40959	BC547B
7322	4822 130 44461	BC546B
7323	4822 130 41691	BC556B
7324	4822 130 40959	BC547B
7325	4822 130 40959	BC547B
7329	9322 148 56682	STK496-070C

Note : Only the parts mentioned in this list are normal service spare parts.

ELECTRICAL PARTS LIST - CENTER/SURROUND AMPLIFIER BOARD**MISCELLANEOUS**

1921	4822 265 10464	Center Speaker Terminal
1925	4822 265 10912	Surround Speaker Terminal

CAPACITORS

2901	5322 122 32261	4,7nF 10% 100V
2902	5322 122 32261	4,7nF 10% 100V
2903	4822 124 22652	2,2µF 20% 50V
2904	4822 124 22652	2,2µF 20% 50V
2905	5322 122 32331	1nF 10% 100V
2906	5322 122 32331	1nF 10% 100V
2907	5322 122 32311	470pF 10% 100V
2908	5322 122 32311	470pF 10% 100V
2909	5322 122 32334	220pF 10% 100V
2910	5322 122 32334	220pF 10% 100V
2911	4822 124 41751	47µF 20% 50V
2912	4822 124 41751	47µF 20% 50V
2913	5322 121 42386	100nF 5% 63V
2914	5322 121 42386	100nF 5% 63V
2915	5322 122 32261	4,7nF 10% 100V
2916	5322 122 32261	4,7nF 10% 100V
2917	4822 124 22652	2,2µF 20% 50V
2918	5322 122 32331	1nF 10% 100V
2919	5322 122 32334	220pF 10% 100V
2920	4822 124 41751	47µF 20% 50V
2921	4822 122 33069	33pF 5% 50V
2922	5322 121 42386	100nF 5% 63V
2923	5322 122 32261	4,7nF 10% 100V
2924	4822 126 11585	22nF +80/-20% 25V
2925	4822 126 11585	22nF +80/-20% 25V
2926	4822 126 11585	22nF +80/-20% 25V
2927	4822 126 11585	22nF +80/-20% 25V
2928	4822 124 40248	10µF 20% 63V
2929	4822 124 81144	1000µF 16V
2930	4822 124 40248	10µF 20% 63V
2931	4822 124 40248	10µF 20% 63V
2932	4822 122 33069	33pF 5% 50V
2933	4822 122 33069	33pF 5% 50V
2944	5322 122 32311	470pF 10% 100V
2945	4822 122 30043	10nF 80% 63V

RESISTORS

3903	4822 116 52234	100k 5% 0,5W
3904	4822 116 52234	100k 5% 0,5W
3905	4822 116 52291	56k 5% 0,5W
3906	4822 116 52291	56k 5% 0,5W
3907	4822 116 52226	560R 5% 0,5W
3908	4822 116 52226	560R 5% 0,5W
3909	4822 116 52291	56k 5% 0,5W
3910	4822 116 52291	56k 5% 0,5W
3911	4822 053 10478	△ 4R7 5% 1W
3912	4822 053 10478	△ 4R7 5% 1W
3913	4822 116 52304	82k 5% 0,5W

3915	4822 116 52289	5k6 5% 0,5W
3917	4822 116 83884	47k 5% 0,5W
3918	4822 116 83884	47k 5% 0,5W
3919	4822 116 83884	47k 5% 0,5W
3921	4822 116 52304	82k 5% 0,5W
3922	4822 116 52289	5k6 5% 0,5W
3923	4822 116 52186	22R 5% 0,5W
3924	4822 116 52291	56k 5% 0,5W
3925	4822 116 52226	560R 5% 0,5W
3926	4822 116 52291	56k 5% 0,5W
3927	4822 116 52234	100k 5% 0,5W
3929	4822 116 52234	100k 5% 0,5W
3930	4822 050 21003	10k 1% 0,6W
3931	4822 053 10478	△ 4R7 5% 1W
3932	4822 116 52234	100k 5% 0,5W
3933	4822 050 23303	33k 1% 0,6W
3934	4822 116 83884	47k 5% 0,5W
3935	4822 050 21003	10k 1% 0,6W
3936	4822 116 52234	100k 5% 0,5W
3937	4822 050 21003	10k 1% 0,6W
3938	4822 116 52304	82k 5% 0,5W
3939	4822 116 52234	100k 5% 0,5W
3940	4822 116 52289	5k6 5% 0,5W
3941	4822 116 52257	22k 5% 0,5W
3942	4822 050 11002	1k 1% 0,4W
3943	4822 117 11744	△ 0R22 5% 1W
3944	4822 117 11744	△ 0R22 5% 1W
3945	4822 050 11002	1k 1% 0,4W
3946	4822 050 11002	1k 1% 0,4W
3947	4822 050 11002	1k 1% 0,4W
3948	4822 050 11002	1k 1% 0,4W
3949	4822 117 11744	△ 0R22 5% 1W
3950	4822 117 11744	△ 0R22 5% 1W
3951	4822 050 11002	1k 1% 0,4W
3952	4822 117 11744	△ 0R22 5% 1W
3953	4822 117 11744	△ 0R22 5% 1W
3954	4822 050 11002	1k 1% 0,4W
3955	4822 116 52226	560R 5% 0,5W
3956	4822 050 11002	1k 1% 0,4W
3957	4822 116 52234	100k 5% 0,5W
3962	4822 116 52304	82k 5% 0,5W
3963	4822 116 52304	82k 5% 0,5W
3964	4822 116 52304	82k 5% 0,5W
3965	4822 116 52263	2k7 5% 0,5W

COILS & FILTERS

5903	4822 157 62255	Coil 18,5 Turns
5911	4822 157 62255	Coil 18,5 Turns
5912	4822 157 62255	Coil 18,5 Turns

DIODES

6904	4822 130 30621	1N4148
------	----------------	--------

ELECTRICAL PARTS LIST - CENTER/SURROUND AMPLIFIER BOARD

DIODES

6905	4822 130 30621	1N4148
6906	4822 130 30621	1N4148
6907	5322 130 31504	BZX79-C3V3

TRANSISTORS & INTEGRATED CIRCUITS

7901	4822 130 40959	BC547B
7902	4822 130 40959	BC547B
7903	4822 130 40959	BC547B
7904	4822 130 44461	BC546B
7905	4822 130 41691	BC556B
7906	4822 130 44568	BC557B
7907	4822 130 40959	BC547B
7908	4822 130 40959	BC547B
7930	4822 209 17447	STK496-270

Note : Only the parts mentioned in this list are normal service spare parts.

EXPLODED VIEW - MAIN UNIT

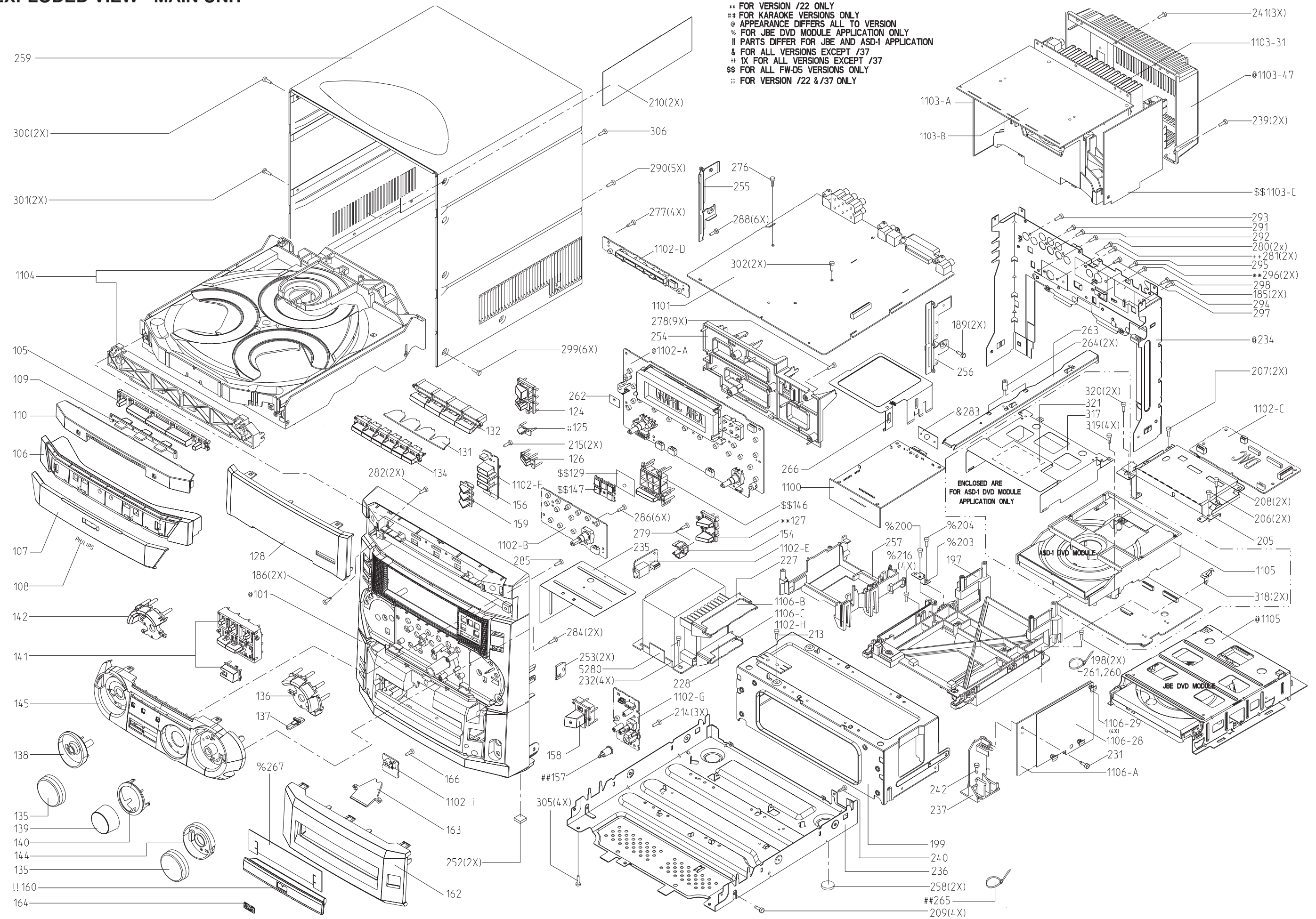

MECHANICAL & ACCESSORIES PARTS LIST - MAIN UNIT

0101	3139 118 11820	Cabinet Front /21/21M	0356	3139 228 84540	Remote Control RC2516/01
0101	3139 118 11790	Cabinet Front /22	0383	4822 320 11642	Cinch Cable 1.7m
0101	3139 118 13850	Cabinet Front /30	0384	4822 303 50082	AM Frame Aerial
0101	3139 118 11680	Cabinet Front /37	0385	4822 321 10249	△ Mains Cord
0105	3139 118 12110	Button Set CDC Select	0385	4822 321 10954	△ Mains Cord /30
0106	3139 118 11070	Cover Tray CDC	0385	4822 321 11466	△ Mains Cord /37
0107	3139 118 11080	Cover Ornament CDC Tray	0386	4822 263 21092	△ Adapter Plug /21
0108	4822 454 13408	Badge, Philips	0387	3139 115 20050	Instruct. For Use /21/21M/30
0110	3139 118 12100	Cover Ornament CDC	0387	3139 115 20030	Instruct. For Use /22
0124	3139 118 11420	Button Power /21/21M/30	0387	3139 116 19770	Instruct. For Use /37
0124	3139 118 11090	Button Power /22/37	1106-29	4822 466 93148	Spacer 5mm
0126	3139 114 69060	Window IR	1673	3139 110 34800	Flex Cable 19pin 18cm BD
0127	3139 118 11410	Button RDS/News /22	1673	3139 110 34790	Flex Cable 23pin 18cm BD
0128	3139 118 12590	Window Display	1680	4822 320 12713	Flex Cable 6pin 34cm AD
0128	3139 118 11690	Window Display /37	1681	3139 110 33960	Flex Cable 4pin 12cm BD
0131	3139 114 68810	Lightguide Source Select	1682	3139 110 34750	Flex Cable 5pin 8cm AD
0132	3139 118 12150	Button Set Source Select	1683	3139 110 34920	Flex Cable 8pin 28cm BD
0134	3139 118 11140	Button Set Control	1683	3139 110 34780	Flex Cable 4pin 28cm BD
0135	3139 118 11110	Knob Jog Rotary	1684	3139 110 34560	Flex Cable 19pin 28cm BD
0136	3139 118 11740	Button Set Jog Sound	1685	3139 110 34740	Flex Cable 8pin 18cm AD
0138	3139 114 70220	Lightguide Jog DVD Rotary	1685	3139 110 34730	Flex Cable 12pin 18cm AD
0139	3139 118 11710	Knob Volume Rotary	1686	4822 320 12702	Flex Cable 6pin 14cm BD
0140	3139 118 11720	Ring Ornament Volume	1691	3139 110 34760	Flex Cable 9pin 28cm BD
0141	3139 118 11770	Button Set DVD Control	1692	3139 110 34870	Flex Cable 9pin 22cm BD
0142	3139 118 11730	Button Set Jog DVD	1693	3139 110 34810	Flex Cable 16pin 14cm
0144	3139 118 11170	Ring Ornament Jog Sound	1694	3139 110 34820	Flex Cable 22pin 14cm
0145	3139 118 11750	Cover Ornament Control	5280	3139 118 32210	△ Mains Transformer /21/21M
0146	3139 118 12170	Button Set DPL	5280	3139 118 32220	△ Mains Transformer /22/30
0157	3139 118 11810	Knob Karaoke /21/21M	5280	3139 118 32200	△ Mains Transformer /37
0158	3139 118 11780	Button Open/Close DVD			
0160	3139 118 11800	Cover Tray DVD			
0162	3139 118 11760	Cover Ornament Front			
0164	3139 240 00010	DVD Logo			
0210	3139 113 10570	Felt Cloth 0.2x160x53mm			
0252	4822 462 40683	Foot Rubber (SQ)			
0258	4822 462 40683	Foot Rubber (SQ)			
0259	3139 114 69230	Cabinet Rear			
0259	3139 114 71450	Cabinet Rear /37			
0283	3139 114 70330	Plate FM Socket			
0350	3139 118 77820	Left/Right LS Box			
	9965 000 05697	Center Box			
	9965 000 05698	Surround Box			
0351	4822 303 50063	FM Aerial			
0351	4822 320 11094	FM Aerial Wire /37			
0356	3139 228 85410	Remote Control RC2567/01			

Left/Right Loudspeaker Box breakdown

9965 000 05538	Wire Assy w/Elco 2,2µF 50V
9965 000 05539	Woofer D5,25" 6R 50W Black
9965 000 04255	Tweeter D2,5" 8R 10W
9965 000 04256	Woofer Ring
9965 000 03233	Grommet
9965 000 04260	Cloth Frame Assembly

Note: Only the part mentioned in this list are normal service spare parts.

SCREW LISTS - MAIN UNIT

166	D3 x 12	280	D3 x 12
185	D3 x 12	281	D3 x 12
186	D3 x 25	282	D3 x 12
189	D3 x 12	284	D3 x 12
198	M3 x 16	285	D3 x 16
200	D3 x 12	286	D3 x 12
204	M3 x 16	288	D3 x 12
206	M3 x 6	290	M3 x 10
207	D3 x 16	291	D3 x 12
208	M3 x 6	292	D3 x 12
209	M3 x 6	293	D3 x 12
213	M3 x 6	294	D3 x 12
214	D3 x 12	295	D3 x 12
215	D3 x 12	297	M3 x 10
216	D3 x 12	298	M3 x 10
231	D3 x 12	299	M3 x 10
232	M3 x 10	300	M3 x 10
239	M3 x 10	301	M3 x 10
240	D3 x 12	302	D3 x 16
241	M3 x 10	305	M3 x 10
242	M3 x 10	306	M3 x 10
276	D3 x 12		
277	D3 x 12		
278	D3 x 12		
279	D3 x 12		

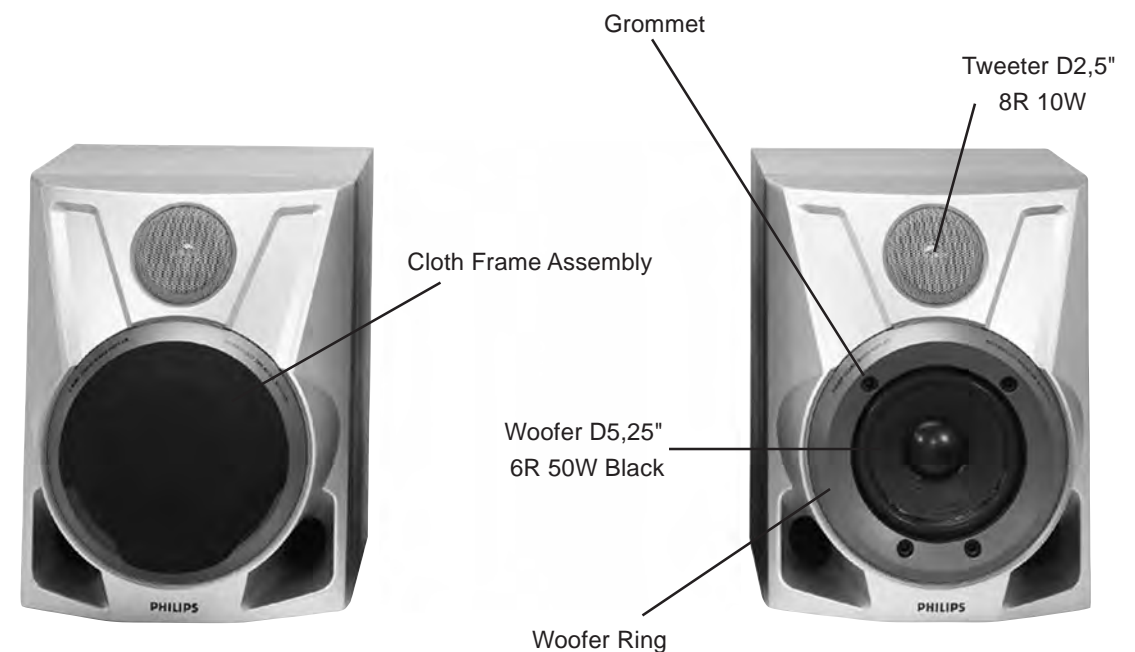

Note: The screw D3 x 10 for Woofer Ring is below the Grommet