

Fogo 180

Moderno

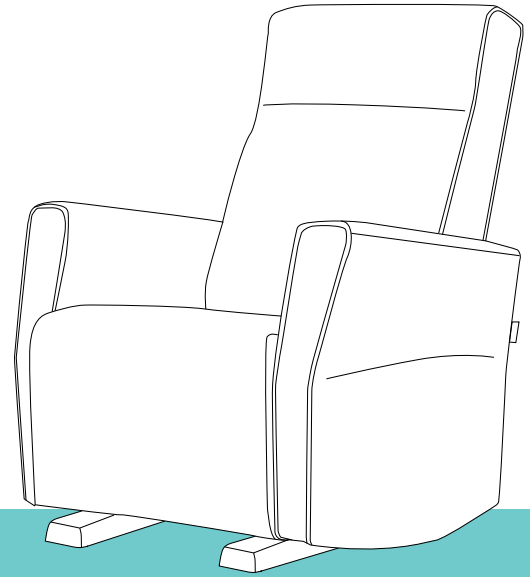

Product code summary

180 101 79 5211*

*For reference only

1

Model

180 101
180 P01

Technogel® option

180 T01
180 G01

2

Finish

All finishes
except Walnut*



3

Cover

All fabrics*
C.O.M. yardage
requirement: 5

*See complete color chart in the general information document

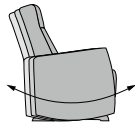
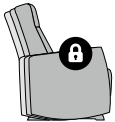
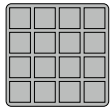
Glider options

	Contrast piping	 Glide	 Multiposition lock	 Technogel®	 Lumbar pillow
180 101		●	●		
180 P01	●	●	●		
180 T01		●	●	●	
180 G01	●	●	●	●	
99306*					●

*Indicate the lumbar pillow code followed by your cover choice number

Features and benefits

- Available with contrasting piping for a modern look
- Ergonomic design perfectly adapted to nursing ones baby
- Long and smooth gliding motion for ultimate relaxation
- Optional integrated Technogel® padding for next level comfort
- Available in a variety of fabrics to cater to everyone's taste
- Made in Canada by our skilled craftsmen

Technogel®

- Unique comfort on the market
- Eliminates body pressure for joint relief
- Absorbs and disperses body heat
- Exclusive partnership with Dutailier



Dimensions

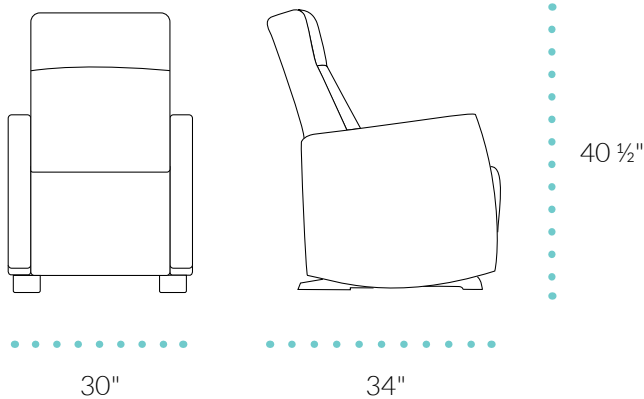

Additional Information

Box: 30 ¾"W x 34"D x 31"H

Volume: 18.6 ft³ / 0.53 m³

Weight: 75 lb / 34 kg

Not UPSable

Frame

Base: Maple

Legs: Hardwood

Finish: Stain, sealer and lacquer

Cushion

Polyester fiber and polyurethane foam

Density: 2.2 lb/ft²

Compression: 35 lb/ft²

Seat and back decking: No-sag spring

Technogel® seating option

Available with contrast piping

Technogel®

Odorless, non-toxic and hypoallergenic

100% polyurethane

Made in Italy

Mechanism

Ball-bearings with metal swing arms

Exclusive Dutailier mechanism

Gliding ottoman 183

Moderno

Product code summary

183 190 79 5211*

*For reference only

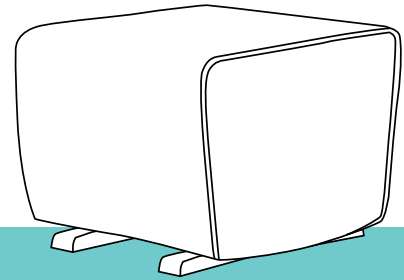

1

Model

183 190
183 P90

2

Finish

All finishes
except Walnut*

3

Cover

All fabrics*
C.O.M. yardage
requirement: 1.5

*See complete color chart in the general information document

Ottoman dimensions

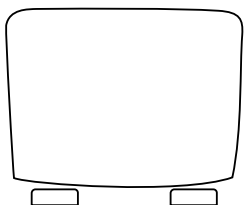

19"

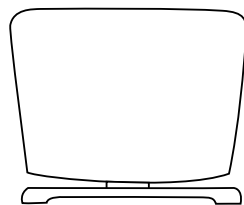

19 1/2"



15 3/4"

Additional Information

Box: 20 1/2"W x 20 3/8"D x 17 1/2"H

Volume: 4.2 ft³ / 0.12 m³

Weight: 21 lb / 9.5 kg

Not UPSable