

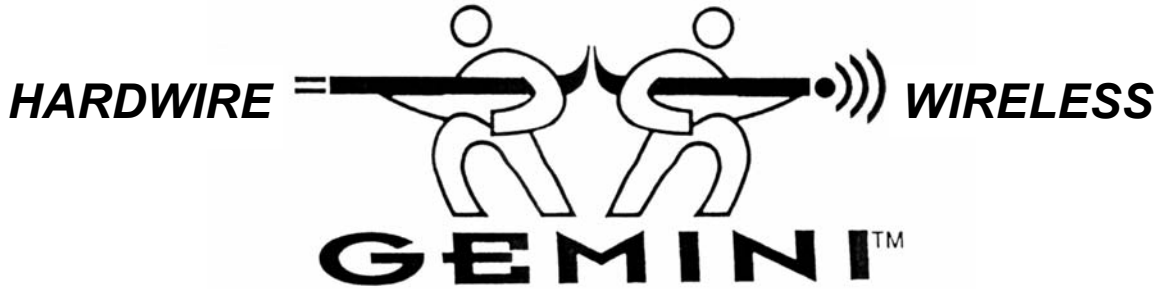

# PROGRAMMING INSTRUCTIONS



## GEM-P1632 CONTROL PANEL/COMMUNICATOR

Programming the GEM-P1632 Control Panel with the "Classic" GEM-RP1CAe2 Keypad and the "K Series" GEM-K1CA Keypad

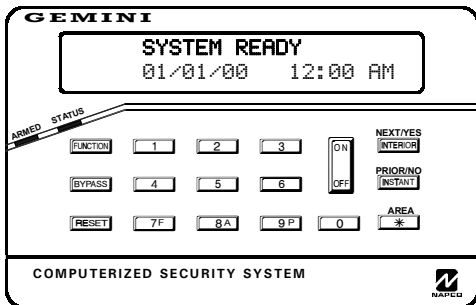

"Classic" GEM-RP1CAe2

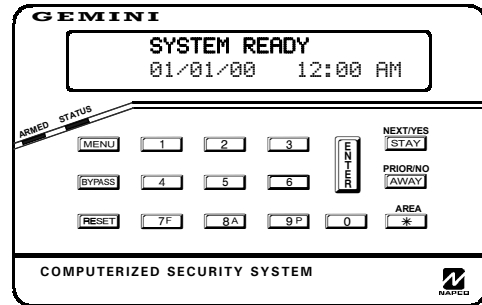

"K Series" GEM-K1CA

### Quick Start (for "Classic" GEM-RP1CAe2)

1. Refer to the wiring diagram, connect Siren, Aux. Power, PGM Output, Remote Bus, Earth ground, Zone and Telephone wiring. NOTE: See Installation Instructions (WI994).
2. Connect AC power first and then the battery.
3. Configure the keypad (see page 34).
4. Access the Easy Menu Driven (Dealer Program) Mode:

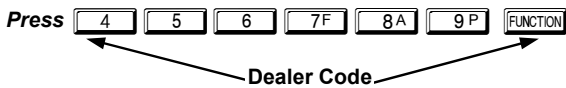

Press NO (**INSTANT**) until "ACTIVATE PROGRAM Y/N" appears on the keypad display.

Press YES (**INTERIOR**) to Enter Dealer Program Mode. Go to page 5.

### Quick Start (for "K-Series" GEM-K1CA)

1. Refer to the wiring diagram, connect Siren, Aux. Power, PGM Output, Remote Bus, Earth ground, Zone and Telephone wiring. NOTE: See Installation Instructions (WI994).
2. Connect AC power first and then the battery.
3. Configure the keypad (see page 34).
4. Access the Easy Menu Driven (Dealer Program) Mode:

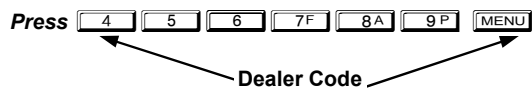

Press NO (**AWAY**) until "ACTIVATE PROGRAM Y/N" appears on the keypad display.

Press YES (**STAY**) to Enter Dealer Program Mode. Go to page 5.







**THIS MANUAL INCLUDES FEATURES WHICH ARE ONLY AVAILABLE IN CONTROL PANEL FIRMWARE VERSION 10 OR LATER.**

**IMPORTANT NOTE**

This manual supports the keypad programming of the GEM-P1632 control panel with the NAPCO "classic" GEM-RP1CAe2 keypad as well as the GEM-K1CA "K Series" keypad. The new "K Series" GEM-K1CA model offers the new STAY and AWAY buttons with simplified functionality, along with the new MENU and ENTER buttons.

While the instructions in this manual are depicted using the GEM-K1CA keypad, the manual applies to both the "classic" and the "K Series" keypads.

**Program Mode** is the same for both keypads--**only the button names have changed**, as follows:

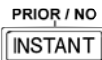
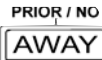
- The  button and the  button operate identically (in Program Mode) for both keypads.
- The  button and the  button operate identically (in Program Mode) for both keypads.
- The  button and the  button operate identically (in Program Mode) for both keypads. The words "NEXT/YES button" are used in this manual.
- The  button and the  button operate identically (in Program Mode) for both keypads. The words "PRIOR/NO button" are used in this manual.

**CHANGES FROM PREVIOUS EDITION**

The following changes have been made to this manual (WI897G) since the previous edition (WI897F).

- Removed the following entries from the index: Change Pulse Output to Cadence, Enable Chirp on RF Arming, Enable Transmitter Telco 1, Enable Transmitter Telco 3, Select Bell Output on RF Arming.
- Page 4, top, "Downloading From a Computer", the following sentence was added: "Unattended downloading from a computer is not allowed for Fire Alarm or UL installations."
- Page 6, "Panel Zone Doubling", the second sentence was modified and now reads, "The 16 zones will remain EOL terminated zones...".
- Pages 4, 5, and 7, the "50mS Loop Response Zones" entries now contain the following notation: "**Note:** 750mS is required for Loop Response time in UL installations."
- Page 7, the "Auto Bypass Re-entry Zones" entry was modified: "Not Evaluated by UL" notation was added.
- Page 8, the "Enter User Codes" entry was modified, and now states to "enter a code from 3 to 6 digits."
- In the Area Options/Explanation chart at the top of page 9, the following information was added: "Ambush: Allows user code to send Ambush signal to Central Station".
- Top of page 16, under the heading, "Output Timeouts", the following reference was added: "Not UL listed for Commercial Installations".
- Page 18, Address 0720, bit 7 (Change Pulse Output to Temporal Output) was modified with the following notation: "This feature must be programmed in Fire Alarm applications."
- Page 29, Table 4: The following notation was added: "Keypad Tamper must be enabled in UL installations."
- Page 18--All references to 0720-Bit 6--"Enable PGM2 Chirp on Keyfob Arming" name changed to "Chirp Output on Keyfob Arm/Disarm".
- Page 18--All references to 0722-Bit 0--"Automatic Interior Bypass" name changed to "Automatic Interior Bypass/Easy Exit".
- Page 18--All references to 0721-Bit 7--"Enable Bell Output on Keyfob Arming" name changed to "Select Alarm Output for Keyfob Chirp".



**NAPCO Security Systems, Inc.**  
333 Bayview Avenue, Amityville, New York 11701  
For Sales and Repairs, call toll free: (800) 645-9445  
For direct line to Technical Service, call toll free: (800) 645-9440  
Internet: <http://www.napcosecurity.com>

# TABLE OF CONTENTS

<b>SYSTEM PROGRAMMING OPTIONS .....</b>	<b>4</b>	<i>System Delays &amp; Timeouts (Addr 0711, 0715-0717)..</i>	<i>15</i>
<b>INTRODUCTION.....</b>	<b>4</b>	<i>System Output Timeouts (Addr 0710, 0712-0714) .....</i>	<i>16</i>
<b>DOWNLOADING FROM A COMPUTER .....</b>	<b>4</b>	<i>Download/Callback Opt. (Addr 1183, 0236-0255) .....</i>	<i>16</i>
<b>EASY MENU DRIVEN PROGRAM MODE .....</b>	<b>5</b>	<i>Pager Format Options (Addr 0256 &amp; 0257) .....</i>	<i>16</i>
<b>Dealer Program - Preliminary Information.....</b>	<b>5</b>	<i>Syst. Opt. &amp; Ambush Code (Addr 0460-0485 &amp; 1054) .....</i>	<i>17</i>
<b>Accessing Dealer Program Mode.....</b>	<b>5</b>	<i>System Options (Addr 0718-0722, 1060-1062) .....</i>	<i>18</i>
<b>Customizing a Default Program .....</b>	<b>5</b>	<i>CS Receiver Opt. (Addr 0170-0235) .....</i>	<i>19</i>
<b>GEM-RP1CAe2/GEM-K1CA Easy Program Menu</b>	<b>6</b>	<i>CS Subscriber Reporting Opt. (Addr 0259-0350) .....</i>	<i>20</i>
<b>Total Number of Zones in Area 1 .....</b>	<b>6</b>	<i>CS Zn Reporting Opt. (Addr 0358-0389 &amp; 0391-0394) .....</i>	<i>21</i>
<b>Panel Zone Doubling.....</b>	<b>6</b>	<i>CS User Reporting Opt. (Addr 0440-0459).....</i>	<i>22</i>
<b>Fire Zones in Area 1 .....</b>	<b>6</b>	<i>EZM Group &amp; Area Arming Opt. (Addr 0737-0744) ....</i>	<i>23</i>
<b>2-Wire Fire Zones in Area 1 .....</b>	<b>6</b>	<i>Area Bell Control Options (Addr 0745-0749) .....</i>	<i>24</i>
<b>Local or Central Station Reporting System .....</b>	<b>6</b>	<i>Keypad Options (Addr 0723-0736) .....</i>	<i>25</i>
<b>Exit/Entry Zones in Area 1.....</b>	<b>6</b>	<i>Zones 1-16 Options (Addr 0490-0595) .....</i>	<i>26</i>
<b>Interior Zones in Area 1 .....</b>	<b>6</b>	<i>Zones 17-32 Options (Addr 0601-0705) .....</i>	<i>27</i>
<b>24 Hour Zones in Area 1 .....</b>	<b>6</b>	<i>External Relay Control (Addr 0750-0829).....</i>	<i>28</i>
<b>Chime Zones in Area 1.....</b>	<b>7</b>	<i>RF Rcvrs. &amp; Sup. Timers (Addr 1038-1053 &amp; 1180)...</i>	<i>30</i>
<b>Chime 2 Zones in Area 1.....</b>	<b>7</b>	<i>Clear Program Features (Addr 1197 &amp; 1198) .....</i>	<i>31</i>
<b>Exit/Entry2 Zones in Area 1.....</b>	<b>7</b>	<b>USER PROGRAM MODE.....</b>	<b>31</b>
<b>50 mS Loop Response Zones.....</b>	<b>7</b>	<b>Preliminary Information .....</b>	<b>31</b>
<b>Aux Output Activated on Alarm Zones .....</b>	<b>7</b>	<b>Accessing User Program Mode .....</b>	<b>32</b>
<b>Sensor Watch Zones.....</b>	<b>7</b>	<b>User Codes .....</b>	<b>32</b>
<b>Keypad Sounder On Alarm Zones.....</b>	<b>7</b>	<b>Zone Descriptions .....</b>	<b>33</b>
<b>Auto Bypass Re-entry Zones.....</b>	<b>7</b>	<b>Date.....</b>	<b>33</b>
<b>Enable No EOLR Zones.....</b>	<b>7</b>	<b>Time .....</b>	<b>33</b>
<b>Enable Telco Line Fault Test?.....</b>	<b>7</b>	<b>KEYPAD CONFIGURATION MODE .....</b>	<b>34</b>
<b>Enable Burg Output Chirp on KeyFob? .....</b>	<b>8</b>	<b>Keypad Installation.....</b>	<b>34</b>
<b>Enable SIA CP-01 Features? .....</b>	<b>8</b>	<b>Configuring the Keypads.....</b>	<b>34</b>
<b>Number of Keypads in Area 1 .....</b>	<b>8</b>	<b>EASY MENU PROGRAMMING WORKSHEETS .....</b>	<b>36</b>
<b>Central Station Receiver 1 Telephone Number... ..</b>	<b>8</b>	<b>ALPHABETICAL INDEX .....</b>	<b>39</b>
<b>Central Station Receiver 1 Account Number.....</b>	<b>8</b>	<b>ADDRESS NUMBER INDEX.....</b>	<b>42</b>
<b>Central Station Receiver 1 Format .....</b>	<b>8</b>	<b>GEM-P1632 WIRING DIAGRAM .....</b>	<b>48</b>
<b>Enter User Codes .....</b>	<b>8</b>		
<b>RF Transmitter Points.....</b>	<b>9</b>		
<b>Key Fob Transmitters as Arm/Disarm &amp; Control De-                 vices.....</b>	<b>9</b>		
<b>Key Fob Transmitters as Zone Input Devices ....</b>	<b>10</b>		
<b>Enter Zone Descriptions.....</b>	<b>10</b>		
<b>Enter Date .....</b>	<b>10</b>		
<b>Enter Time .....</b>	<b>10</b>		
<b>Dealer Code .....</b>	<b>10</b>		
<b>Clear Dealer Program.....</b>	<b>10</b>		
<b>Cold Start.....</b>	<b>10</b>		
<b>DIRECT ADDRESS PROGRAM MODE .....</b>	<b>11</b>		
<b>Direct Address Overview.....</b>	<b>11</b>		
<b>Address Mode Displays.....</b>	<b>11</b>		
<b>Binary (Bit) Format.....</b>	<b>11</b>		
<b>Decimal Format.....</b>	<b>12</b>		
<b>Hexadecimal Format.....</b>	<b>13</b>		
<b>Programming Conventions Used in this Manual .....</b>	<b>14</b>		
<b>System Delays &amp; Timeouts (Addr 0000-0002, 1059 &amp;     1179) .....</b>	<b>15</b>		

Refer to accompanying GEM-P1632 Installation Instructions (WI808) for installation information.



# SYSTEM PROGRAMMING OPTIONS

## INTRODUCTION

The GEM-P1632 control panel may be programmed by various means, each of which will be covered in detail in the sections that follow. Keypad displays shown are for a GEM-RP1CAe2/K1CA (version 8 keypad), the recommended keypad for programming. For Programming Instructions with the GEM-RP2ASe2/GEM-K2AS, GEM-RP3DGTL/GEM-K3DGTL and the GEM-RP4RFC/GEM-K4RF series, see W11148.

✓ **Downloading From a Computer.** This is the preferred method of programming. The panel may be downloaded from (or uploaded to) an IBM PC-compatible computer, either locally or remotely. Napco's PCD3000 Quickloader software features context-sensitive help screens as well as an error-checking utility that prevents programming of incompatible or conflicting data to ensure proper panel operation. **Note:** Unattended downloading from a computer is not allowed for Fire Alarm or UL installations.

✓ **Easy Menu-Driven Program (Dealer Program) Mode - Keypad Programming.** The Easy Menu-Driven Program Mode allows keypad programming of number of zones in area 1, panel zone doubling, number of fire zones (both 4-wire and 2-wire), local or Central Station reporting, number of exit/entry zones, number of interior zones, number of 24 hour zones, number of chime zones, Chime 2 zones, Exit/Entry2 zones, 50ms loop response zones (**Note: 750mS is required for Loop Response time in UL installations**), aux output activated on alarm zones, sensor watch zones, keypad sounder on alarm zones, auto bypass re-entry zones, EOLR zones, number of keypads in area 1, Central Station telephone number, Central Station account number, Central Station receiver format, User Codes, RF transmitter points, RF keyfob transmitters, zone descriptions, date/time, dealer code, Telco line fault test, Burg output chirp on keyfob, keypad time/date display, enable CP-01 programming, and clear dealer program/cold start. For new panels, a custom default program may be created at the keypad. A menu-driven utility prompts the installer to configure the system. Further detailed customization is accomplished in the Direct Address Program Mode.

✓ **Direct Address (Dealer Program) Program Mode - Keypad Programming.** The Direct Address Program Mode is an extension of the Dealer Program Mode wherein data is entered at the keypad by location. This mode is accessed from the Easy Menu Driven Program Mode by pressing the  button at any time.

✓ **User Program Mode - Keypad Programming.** The User Program Mode is intended for authorized users and is limited to keypad programming of User Codes, Time, Date and Zone Descriptions.



## DOWNLOADING FROM A COMPUTER

The control-panel program may be downloaded from the computer by any of the following methods.

### Local Downloading

(**Note:** This procedure should be used after installation, after peripheral devices are connected).



For direct high-speed data transfer to the control panel from a desktop computer, connect the download jack (JP2) on the panel to the LOCAL jack (J3) on the Napco PCI2000/3000 computer interface using the supplied 6-conductor cable. (Refer to PCI2000/3000 Installation Instructions W1443 for wiring diagram and procedures).

Similarly, a high-speed local download may be made in the field using a notebook or laptop computer. Connect JP2 on the control panel to a Napco PCI-MINI computer interface using the 6-conductor cable supplied. (Refer to PCI-MINI Installation Instructions W1767).

### Remote Downloading

(Also see PCI2000/3000 Installation Instructions W1443). **Note:** Unattended downloading from a computer is not allowed for Fire Alarm or UL installations.

### Function Mode

















Start by establishing a telco connection between the computer operator and the installer. During this procedure, voice contact will be lost, therefore both the installer and the computer operator should be familiar with the operation. When a steady high-pitched tone is heard at the site phone, access the "ACTIVATE DOWNLOAD" Function (see Keypad Programming Modes), then press the  or  button or the **NEXT/YES** button; the site phone will go dead. Hang up the phone and wait for a call from the central station confirming a successful download.

### Callback Method

An installed, unattended panel may be programmed or reprogrammed remotely using the Callback-Method Download feature of the PCD3000 software. Remote downloading requires a modem compatible with the PCI2000/3000. Upon answering the call from the computer, the panel will verify the Download Security Code and, if confirmed, will establish a connection. If a Callback Number is programmed into the panel, the panel will automatically disconnect and call the computer at this number before establishing a connection.







# EASY MENU DRIVEN PROGRAM MODE

## DEALER PROGRAM - PRELIMINARY INFORMATION

-  Only Keypad #1 may be used for both Dealer and User programming, however this keypad may be located in any area.
-  The Default Dealer Code is      . Use this code to enter the Dealer Program Mode to program a custom Dealer Code, which replaces the Default Dealer Code. If you clear your Dealer Code, use the Default Dealer Code once again to enter programming.
-  After entering codes or data, press the save  button. Data will not be stored into memory unless  is pressed.
-  If the keypad is in the Program Mode and no activity is detected for longer than 4 minutes, a steady tone will sound.
-  Silence the sounder by the  button to continue, or by pressing the  button to exit.
-  A panel that has been COLD STARTED (Address Location 1198) performs identically to a new panel.
-  When programming a Multiple Area System, Direct Address Programming Mode must be used to complete the program.

**KEYPAD #1:** For ease of programming, it is recommended that a GEM-RP1CAe2 or GEM-K1CA be used as Keypad #1. (Regardless of which keypad is selected, all *new* keypads are configured as Keypad #1 out of the box). If a GEM-RP2ASe2/GEM-K2AS is used, see WI 1148.



## ACCESSING DEALER PROGRAM MODE

**1. Press**       

↙ Dealer Code (Default = 456789) ↘

**2. Press PRIOR/NO button until "ACTIVATE PROGRAM Y/N" appears on LCD screen.**

**3. Press NEXT/YES button to Enter Dealer Program Mode.**



**4. Press**   **to Exit Dealer Program Mode when finished.**

## CUSTOMIZING A DEFAULT PROGRAM

For new panels, you can design a default program that will best suit your application. Using this procedure, you will configure the panel for:

- Number of Zones in Area 1
- Panel Zone Doubling
- Fire Zones in Area 1
- 2-Wire Fire Zones in Area 1
- Local or Central Station Reporting System
- Exit/Entry Zones in Area 1
- Interior Zones in Area 1
- 24 Hour Zones in Area 1
- Chime Zones in Area 1
- Chime 2 Zones in Area 1
- Exit/Entry2 Zones in Area 1
- 50mS Loop Response Zones (Note: 750mS is required for Loop Response time in UL installations).
- Aux Output Activated on Alarm Zones
- Sensor Watch Zones
- Keypad Sounder on Alarm Zones
- Auto Bypass re-entry Zones
- Enable no EOLR Zones
- Number of Keypads in Area 1
- Central Station Receiver 1 Tel. Number
- Central Station Receiver 1 Account Number
- Central Station Receiver 1 Format
- Enter User Codes
- RF Transmitter Points
- Quick Method
- Key Fob Transmitters
- Enter Zone Descriptions
- Enter Date
- Enter Time
- Dealer Code
- Enable Telco Line Fault Test
- Enable Burg Output Chirp on Keyfob
- Enable Keypad Time/Date Display
- Enable CP-01 Programming
- Clear Dealer Program
- Cold Start

This procedure will automatically set up system keypads, EZMs, wireless transmitters, etc. After your basic default program has been loaded, you may alter it as necessary in the Direct Address Program Mode.

**NEW PANELS:** The custom default program may be created for new panels only. Once the panel has been programmed by any means, the number zones will be suppressed and cannot be changed. Should it be necessary to create a new custom default program, (a) from the Dealer Program Mode, press the  button to enter the Direct Address Program Mode; (b) access Location 1197 (Clear Program); (c) press the  button and start over.



## GEM-RP1CAe2/GEM-K1CA Keypad Easy Program Menu

To create a custom program using the GEM-RP1CAe2/GEM-K1CA keypad, simply answer the following questions and record your information on the *Easy Menu Programming Worksheet*. In each of the following steps, press **MENU** to set cursor, the NEXT/YES button to go forwards, the PRIOR/NO button to go backwards, **SAVE** to save and **RESET** twice to exit at any time.

#of Zns in Area1  
Enter # Zones XX

(Direct Entry)

### Total Number of Zones in Area 1 (New Program Only)

- Enter the total number of zones to be programmed for Area 1.
- Valid entries are from 01 to 32. Directly enter the total number of zones, including leading zeros.
- The system is based on groups of 4 zones each (after the first 8 zones), and will automatically round up to the next group of 4. For example, if you enter 18, it will automatically convert this to 20 zones. Press **SAVE** to save. Press the NEXT/YES button to proceed.

EZ Zone Doubling  
Enabled? Y/N

(Press YES or NO)

### Panel Zone Doubling (New Program Only)

- To double the number of hardwired panel zones from 8 to 16, press YES.
- If Panel Zone doubling is not desired, press the PRIOR/NO button.
- The 16 zones will remain EOL terminated zones, requiring Normally Closed devices only.
- Refer to Wiring Diagram and Installation Instructions for wiring instructions

Fire Zones  
Enter Zone # \*\*

(Direct Entry)

### Fire Zones in Area 1 (New Program Only)

- Enter the zone number of any Fire Zones (including 2-wire, 4-wire or wireless).
- Valid entries are from 01 to 32.
- Directly enter each zone number, including leading zeros, and press **SAVE** to save, and then repeat for any additional zone(s). Press the NEXT/YES button to proceed.

2-Wire Fire Zns  
Enter Zone # \*\*

(Direct Entry)

### 2-Wire Fire Zones in Area 1 (New Program Only)

- Enter the zone number of any Fire Zone (from previous question) to be used with 2-wire smoke detectors.
- Valid entries are 07 and 08. Directly enter each zone number, including leading zeros.
- Press **SAVE** to save, and repeat for any additional zone(s); press NEXT to proceed.

**NOTE:** Only zones which have been designated as Fire Zones can be programmed as 2 Wire Fire zones. JP3 must be set to "2-WF" position for 2-wire fire. (refer to Installation Instructions).

Report All Zones  
To Central? Y/N

(Press YES or NO)

### Local or Central Station Reporting System (New Program Only)

Press the NEXT/YES button for all zones to report; press the PRIOR/NO button for local system

Exit/Entry Zones  
Enter Zone # XX

(Direct Entry)

### Exit/Entry Zones in Area 1 (New Program Only)

- Enter the zone numbers of zones to be used as Exit/Entry zones.
- Valid entries are from 01 to 32. Directly enter each zone number, including leading zeros.
- Press **SAVE** to save and repeat for any additional zone(s); press the NEXT/YES button to proceed.

**NOTE:** Exit/Entry Entry time of 30 seconds will automatically be programmed.

Interior Zones  
Enter Zone # XX

(Direct Entry)

### Interior Zones in Area 1 (New Program Only)

- Enter the zone numbers to be used as Interior Zones.
- Valid entries are from 01 to 32. Directly enter each zone number, including leading zeros.
- Press **SAVE** to save and then repeat for any additional zone(s).
- Press the NEXT/YES button to proceed.
- All Interior zones will also be automatically programmed as "Exit/Entry Follower" and as "Power Up Delay" zones.

24 Hour Zones  
Enter Zone # \*\*

(Direct Entry)

### 24 Hour Zones in Area 1 (New Program Only)

- Enter the zone numbers of zones to be used as 24 Hour zones.
- Valid entries are from 01 to 32. Directly enter each zone number, including leading zeros.
- Press **SAVE** to save and repeat for any additional zone(s); press the NEXT/YES button to proceed.

**NOTE:** 24 Hour Zones will automatically be programmed as audible (Burg Output).

```
Chime Zones
Enter Zone # **
```

(Direct Entry)

**Chime Zones in Area 1 (New Program Only)**

- Enter the zone numbers which are to be used as Chime Zones.
- Valid entries are from 01 to 32. Directly enter each zone number, including leading zeros.
- Press  to save and then repeat for any additional zone(s), press the NEXT/YES button to proceed.

**NOTE:** A chime time of 2 seconds will be automatically programmed.

```
Chime 2 Zones
Enter Zone # **
```

(Direct Entry)

**Chime 2 Zones in Area 1 (New Program Only)**

- Enter the zone numbers which are to be used as Chime 2 Zones.
- Valid entries are from 01 to 32. Directly enter each zone number, including leading zeros.
- Press  to save and then repeat for any additional zone(s), Press the NEXT/YES button to proceed.

**NOTE:** A chime time of 2 seconds will be automatically programmed.

Chime 2 zones give a distinct pulsating tone when zone is faulted.

```
Exit/Entry2 Zones
Enter Zone # **
```

(Direct Entry)

**Exit/Entry2 Zones in Area 1 (New Program Only)**

- Enter the zone numbers of zones to be used as Exit/Entry zones.
- Valid entries are from 01 to 32. Directly enter each zone number, including leading zeros.
- Press  to save and repeat for any additional zone(s); press the NEXT/YES button to proceed.

**NOTE:** An Exit/Entry 2 Entry Time of 30 seconds will automatically be programmed.

```
50mS Loop Zones
Enter Zone # **
```

(Direct Entry)

**50 mS Loop Response Zones (New Program Only) Note: 750mS is required for Loop Response time in UL installations.**

- Enter the zone numbers of zones to be have a 50mS loop response.
- Valid entries are from 01 to 08. Directly enter each zone number, including leading zeros.
- Press  to save and then repeat for any additional zone(s), Press the NEXT/YES button to proceed.

**Note:** Only panel zones 01-08 can be programmed for Quick Loop Response. All other zones can be programmed via their respective EZM's (hardware).

```
Aux Output Zones
Enter Zone # **
```

(Direct Entry)

**Aux Output Activated on Alarm Zones (New Program Only)**

- Enter the zone numbers of zones to activate the PGM2 upon alarm.
- Valid entries are from 01 to 32. Directly enter each zone number, including leading zeros.
- Press  to save and then repeat for any additional zone(s), Press the NEXT/YES button to proceed.

**NOTE:** A PGM2 Timeout of 15 minutes will automatically be programmed.

```
Sensor Watch Zns
Enter Zone # **
```

(Direct Entry)

**Sensor Watch Zones (New Program Only)**

- Enter the zone numbers of zones to be Sensor Watch zones.
- Valid entries are from 01 to 32. Directly enter each zone number, including leading zeros.
- Press  to save and then repeat for any additional zone(s), Press the NEXT/YES button to proceed.

**NOTE:** A Sensor Watch Time of 24 hours will automatically be programmed.

```
KP Sndr Alrm Zns
Enter Zone # **
```

(Direct Entry)

**Keypad Sounder On Alarm Zones (New Program Only)**

- Enter the zone numbers of all zones to activate the Keypad Sounder upon alarm.
- Valid entries are from 01 to 32. Directly enter each zone number, including leading zeros.
- Press  to save and then repeat for any additional zone(s), Press the NEXT/YES button to proceed.

```
Auto Byp REnt Zn
Enter Zone # **
```

(Direct Entry)

**Auto Bypass Re-entry Zones (New Program Only) (Not Evaluated by UL)**

- Enter the zone numbers of zones to be Auto Bypass Re-entry zones.
- Valid entries are from 01 to 32. Directly enter each zone number, including leading zeros.
- Press  to save and then repeat for any additional zone(s), Press the NEXT/YES button to proceed.
- Auto Bypass Re-entry Zones allow the system to be armed with the zone faulted but come back into the system (armed) when the zone is subsequently closed.

```
Enable No EOLR
Zones Y/N
```

(Press YES or NO)

**Enable No EOLR Zones (New Program Only)**

- Press YES to program all zones except 24 Hr & fire zones for No End Of Line Resistor. Press NO to continue.
- Do not program this feature for UL Installations.

```
Enable Telco
Line Test? Y/N
```

(Press YES or NO)

**Enable Telco Line Fault Test?**

- Press YES to enable Telco Line Fault Test.
- Press NO to continue. **NOTE: If enabled, a Telco Line Fault Test Delay of 60 sec. will automatically be programmed.**



**Enable Burg Out Chirp?** Y/N

(Press YES or NO)

**Enable SIA CP-01?** Y/N

(Press YES or NO)

**# Area 1 Keypads**  
Enter # KPs 01

(Direct Entry)

**Central Phone #**

(Direct Entry)

**Central Station Account #** (\_\_\_\_)

(Direct Entry)

**See WI for Info Rcvr Format** (0)

(Direct Entry)

**Enter user code**  
U01 123 - 9-

User# User Code Area 1 Area 2

**Enable Burg Output Chirp on KeyFob?**

- Press the NEXT/YES button to enable Burg Output Chirp on KeyFob Arm / Disarm.
- Press the PRIOR/NO button to continue.

**NOTE:** The Burg Output will chirp once on Keyfob Arm and twice on Keyfob Disarm.

**Enable SIA CP-01 Features?**

- Press the NEXT/YES button to enable.
- Press the PRIOR/NO button to continue.

The SIA CP-01 Features are designed to reduce the incidence of false alarms. **NOTE:** Do not enable unless reporting, otherwise system trouble *Fail to Communicate* may occur.

**Number of Keypads in Area 1**

- Enter the total number of Keypads to be installed in Area 1.
- Valid entries are from 01 to 07. Directly enter the number of keypads, including leading zeros. Press to save. Press the NEXT/YES button to proceed.

**NOTE:** Area 2 keypads must be assigned in Direct Address Programming. See Keypad Options.

**Central Station Receiver 1 Telephone Number**

- Enter telephone number of up to 16 digits.
- Press through for digits 1–9; for a zero and for a blank (\*).
- Press through for letters B–F, respectively.
- Pre-Dial Delay = “D” ( ); Dial-Tone Detection = “E” ( ).
- Press to save and press the NEXT/YES button to proceed.

**NOTE:** Central Station Receiver 2 and 3 Telephone Numbers must be entered in Direct Address Programming. See CS Receiver Options.

**Central Station Receiver 1 Account Number**

- Enter an account number of up to four digits.
- Press through for digits 0–9, and for a blank (\*).
- Press to save and press the NEXT/YES button to proceed.

**NOTE:** Central Station Receiver 2 and 3 Account Numbers must be entered in Direct Address Programming. See CS Reporting Options.

**Central Station Receiver 1 Format**

- From the table at the right enter the receiver format.
- Press through , and for blank (\*).
- Press through for letters B–E.
- Press to save and press the NEXT/YES button to proceed.

DATA ENTRY	CS RECEIVER 1 FORMAT
• (blank)	Ademco Slow, Silent Knight Slow
2	Radionics Fast
3	Silent Knight Fast
4	Radionics, DCI, Franklin Slow
5	Universal High Speed
B	SIA
C	Ademco Point ID
E	Pager

**Enter User Codes** (Press to set cursor.)

For default program, enter up to 32 User Codes, with Area 1 and Area 2 Options.

- Press the () button once to set the cursor to the User Code.
- Press through to enter a code from 3 to 6 digits, leave blank (\*) any trailing boxes.
- Press to set the cursor to the Area 1 Options Level. Refer to the table below for available options. For Area 2 Options, press the () button once again.

• If “Enable Global Ambush Code” (Address 0720) is enabled and “Global Ambush Code” (Address 1054) is **not** left blank (\*), *do not* program the first two digits of ANY User Code the same as the “Global Ambush Code”.

• Press to save. **Note:** Duplicate User Codes are not allowed; therefore a duplicate Code entered in the LCD Window will erase when is pressed. To proceed to the next User Code, press () to set the cursor to the User Number and change it using the number buttons. Press the NEXT/YES button to proceed.

USER OPTIONS				
USER CODE (UP TO 6 DIGITS)	AREA 1 OPTIONS	AREA 2 OPTIONS		

USER AREA OPTIONS		
DATA ENTRIES		OPTION ENABLED
L	R	
blank(*)	blank	Disabled
blank(*)	1	Arm/Disarm
blank(*)	2	Arm Only
blank(*)	3	Service
blank(*)	4	Access
blank(*)	5	Ambush
blank(*)	Add 8	* User Program

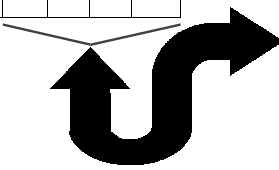



**Example:** Program a code of “2222” for user 02, with area 1 options of “Arm/Disarm” and “User Program”. Enter “2222” for a user code, “• (blank) 9” for area 1 options and “• (blank) • (blank)” for area 2 options.



AREA OPTIONS	EXPLANATION
Disabled	User Code not active in this area.
Arm/Disarm	Allows User Code to arm/disarm this area.
Arm Only	Prevents User Code from disarming this area.
Service	A Service Code has restricted arm/disarm rights; if an area is armed with a Service Code, a "MONITOR ON" appears on the GEM-RP2ASe2 keypad and the area can be disarmed with any valid User Code, including a Service Code. If the area is armed with OTHER than a Service Code,
Ambush	Allows user code to send Ambush signal to Central Station.
Access	This is normally used to activate a door strike while an area is disarmed. Also program "Access Control on PGM2. Output" (Address 0719) and "PGM2 Output Access Control Timeout" (Address 0711).
* User Program	User Program Option is enabled for Keypad 1 only, wherever it is connected (Area 1 or Area 2). To enable User Program Option for any user add 8 to the data entry for Area Option (see example). Then, User Programming can be performed only at Keypad 1 by a user code with user program enabled.

Related User Options: "Enable Global Ambush Code" (Address 0720), "Global Ambush Code" (Address 1054) & "Enable Managers Mode" (Address 0719).

**CHANGING OR CANCELING A CODE:** To change any code, merely program over the existing code as described above and press  to save. Similarly, to cancel a code, blank out each number of the code and press  to save.

ZN#	XMIT#+CS	P
Zn01-	000000:	0-0





Zone # Xmitter Check Point  
Mapped to ID Sum #









### RF Transmitter Points (Press to set cursor.)

For each transmitter enter: (For wireless systems only. Also see Quick Method, which follows)

- The **zone number** (01–32) to which the transmitter will be mapped.
- The **6-digit RF ID #** and **1-digit checksum number** printed on the transmitter and box,
- The **point number** (1–2); enter "9" for unsupervised (all points).
- Press  to save and NEXT/YES button to proceed when all transmitters have been entered.

**NOTE:** When programming the ID Code number, "0" through "9" =  through  ; A =

  ; B =   ;

C =   ; D =   ; E =   and "F" =  .

ZN#	XMIT#+CS	P
Zn01-	000000:	0-0

**Quick Method.** If a receiver is already installed in the panel, transmitter wireless points can be programmed automatically ("enrolled") using the following procedure. **NOTE:** The transmitter point will be enrolled only if the signal strength is 3 or greater.

1. Enter the zone number to which the transmitter point will be mapped.
2. Press  to enter the Enroll Mode. The red and green LEDs on the keypad will flash and the window will display as shown at left.
3. Open the loop of the point that is to be programmed (GEM-TRANS2 only).
4. Install the transmitter battery. The keypad will beep to indicate that the point has been successfully enrolled. Multi-point transmitters can be mapped to successive zones simultaneously.

ZN#	XMIT#+CS	P
ZN01-	ENROLL:	A--

*Example. A 2-point transmitter has the RF ID number 287613:1. Map point 1 to Zone 6 and point 2 to Zone 9.*

1. Enter the Enroll mode as described above.
2. Enter Zone "06".
3. Open point-1 loop.
4. Install the battery. The keypad will beep once to indicate that one point has been programmed. (Transmitter 287613:1, point

1 will be mapped to Zone 6).

5. Enter Zone "09".
6. Close point-1 loop and open point-2 loop.
7. Remove the transmitter battery, then re-install it. The keypad will beep once to indicate that one point has been programmed. (Transmitter 287613:1, point 2 is mapped to Zone 9).

**KEY FOB ZONE ASSIGNMENT:** Key fobs can also be assigned to zones to allow multiple wireless panic buttons on one alarm system, each reporting to a central station, a pager or having a description on the keypad that describes the person holding the key fob, the location where the person holding the key fob is stationed, or the special purpose of the key fob button being depressed. See the next page on Key Fob Transmitters as Zone Input Devices.















KF A	XMIT#+CS	OP
01-0	000000:	0 00

KF Area Xmitter Check Aux  
# # ID Sum 1&2

### Key Fob Transmitters as Arm/Disarm & Control Devices (Press to set cursor).

Key fobs can be programmed as "Arm/Disarm" devices using their On/Off buttons (refer to WI752). For each Key Fob Transmitter, enter:

- The **Key Fob Transmitter number** (01–8).
- The **area number** to which transmitter is assigned (0 to disable keyfob, 1 or 2).
- The **6-digit RF ID #** and **1-digit checksum number** printed on the transmitter and box,
- The **Aux 1 Option** (see key fob aux 1 & aux 2 options).
- The **Aux 2 Option** (see key fob aux 1 & aux 2 options).
- Press  to save and NEXT/YES button to proceed when all key fobs have been entered.

**NOTE:** When programming the ID Code number, "0" through "9" =  through  ; A =   ; B =   ;  
C =   ; D =   ; E =   and "F" =  .



### Key Fob Transmitters as Zone Input Devices

(Refer to display above: press the PRIOR button to go backwards).

Each of the 4 key fob buttons can be assigned to a zone. For example, On button = point 1; Off button = point 2; A1 = point 3; A2 = point 4. Up to 32 key fobs (using 1 button) or 16 key fobs (using 2 buttons) or 8 key fobs (using all 4 buttons) or any combination up to a maximum of 32 controlled zones can be assigned, providing multiple wireless panic buttons on a system, each reporting to a Central Station or a pager and/or annunciating on a keypad the key fob zone number with a description. To assign a key fob to a zone: program the key fob as you would a transmitter, entering the key fob's ID code, check sum and point number at the appropriate zone. The "Quick Method" is not allowed. The zone may be hardwired to an electrical sensor as well as assigned to a key fob (either one will activate the zone alarm output). **NOTE:** If assigning a key fob to a zone, the "ON/OFF" buttons on the key fob will no longer arm/disarm the system. The key fob is converted to a "panic only" device.

DATA ENTRY	AUX 1/AUX 2 OPTIONS
0	None
1	Relay Group 1 Toggle
2	Relay Group 2 Toggle
9	Keypad Panic
A	Keypad Aux.
B	Instant
C	PGM2 Output Toggle
D	Access on PGM2 Output
E	Arm STAY
F	Interior Button

01-

(Direct Entry)

#### Enter Zone Descriptions

- Press **1** and **2** to place the cursor and; press **3** and **6** to select the character.
- For each zone, enter a description of up to two lines.
- Press **ENTER** to save each description.

- To proceed to the next description, place the cursor under the Zone Number (e.g. "01") and change the Zone Number using **3** and **6**. Program new description as above.
- **NOTE:** Zone Descriptions can only be entered through the GEM-RP1CAe2 Keypad or by using the Napco Quickloader Software. See Easy Menu Programming Worksheet for available zone description characters.

Enter Date  
( / / )

(Direct Entry)

#### Enter Date (Press **MENU** to set cursor).

- Enter the current date in the format MM/DD/YY. (MM = month, DD = day and YY = year.
- Press **ENTER** to save. Press the NEXT/YES button to proceed.

Enter Time  
( : )

(Direct Entry)

#### Enter Time (Press **MENU** to set cursor.)

- Enter the current time in format HH:MMA/P, where HH=hours (01-12); MM=minutes (00-59).
- Select AM or PM by pressing any number button.
- Press **ENTER** to save. Press the NEXT/YES button to proceed.

Dealer Code  
456789

#### Dealer Code

- Directly enter the Dealer Code (default = 456789), using **0** through **9P** buttons.
- Press **ENTER** to save.

DEALER CODE  
RE-ENTER

- Re-enter the Dealer Code to verify the previous code.
- Press **ENTER** to save.
- Press the NEXT/YES button to proceed.

**EXIT DEALER PROGRAM MODE:** This completes the custom default program. Press **RESET** to enter the Direct Address Program Mode for further programming or press **RESET** once again to end all programming and resume normal keypad operation.

**CLEAR PROGRAM:** Should it be necessary to create a new custom default program, (a) from the Dealer Program Mode, press **RESET** to enter the Address Program Mode; (b) access Location 1197 (Clear Program) or 1198 (Cold Start); (c) press **ENTER** and then (d) press **RESET** to exit the Dealer Program Mode. A "SYSTEM TROUBLE/E09-00 SERVICE" will occur. Press **RESET** to silence the keypad.

1197 XX H

#### Clear Dealer Program (Erases Dealer Program)

Use this feature to erase the Panel Program, while maintaining Scheduled Data and Zone Descriptions. Access address 1197 and press **ENTER**. Data entry is not allowed. **NOTE:** Enter Easy Menu Driven Program Mode to reprogram system.

1198 XX H

#### Cold Start (Erases Entire Program)

This erases all programmed data (Dealer Program, Zone Description Data and Schedules). Access address 1198 and press **ENTER**. Data entry is not allowed. **NOTE:** Some features (schedules) can only be programmed again with the Downloading Software.

# DIRECT ADDRESS PROGRAM MODE

## DIRECT ADDRESS OVERVIEW

Direct Address Programming allows you to go directly to the address locations (up to 1198) and change the data entries manually in order to customize your control panel options. Whereas the Easy Menu Program Mode guides you through limited selections to get you started, **Direct Address Program Mode** allows you to change all options directly. It consists of up to 1198 address locations each with data entry locations as shown in the following diagram (below left). The data entry location accepts data in one of three formats: Binary, Decimal and Hexadecimal (explained below in "Address Mode Displays"). The following diagram (below right) illustrates a *Decimal* format data entry location (using a GEM-RP1CAe2 keypad).

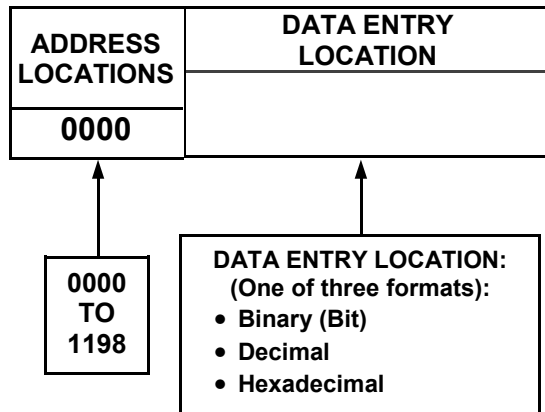

GEM-RP1CAe2 Keypad Display Example

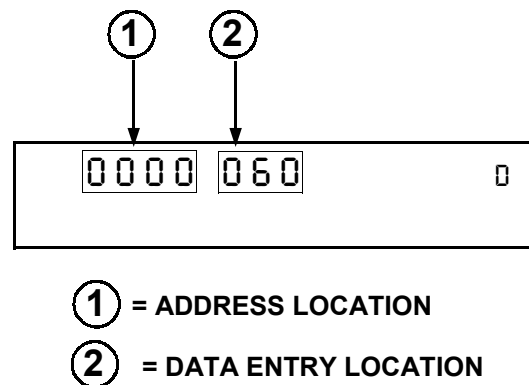

## ADDRESS MODE DISPLAYS

There are three types of address displays when programming in Direct Entry Program Mode, as follows:

### A) Binary (Bit) Format

Settings (such as Zone Features) display and accept data in "number" format. For example, Zone Features are turned on by the pressing of keypad buttons 1 through 8, with the activated Zone(s) displaying the corresponding decimal digit (replacing deactivated zones which are signified by dashes).

**EXAMPLE: BIT Format with the GEM-RP1CAe2:** Program Zones 2, 4, 5 and 7 as *Exit/Entry Follower* Zones.

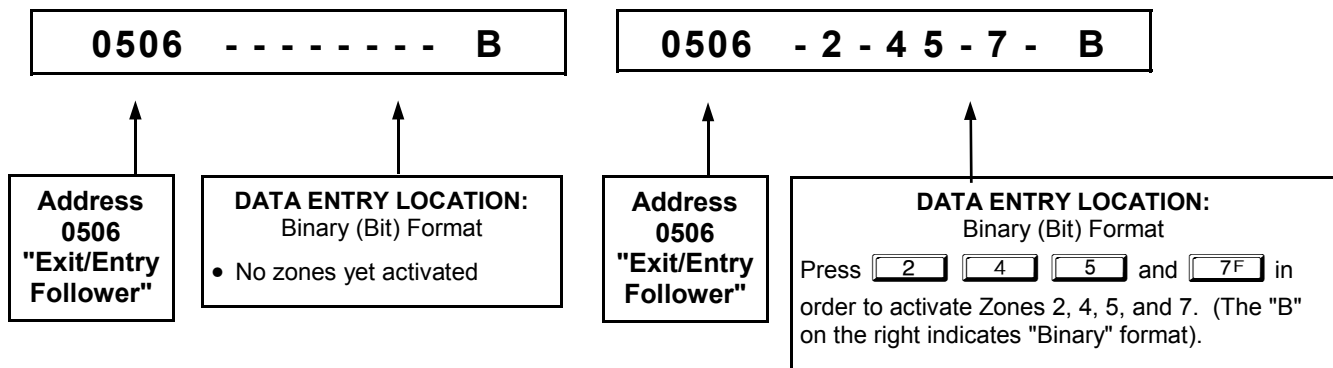

### DETERMINE THE DATA ENTRIES

1. Referring to ZONE FEATURES in the Programming Worksheets that follow, the Exit/Entry Follower for Zones 1 through 8 are located at address 0506.

ZONE FEATURES	ADDR	ZONES 1 → 8								ADDR	ZONES 9 → 16							
		Z1	Z2	Z3	Z4	Z5	Z6	Z7	Z8		Z9	Z10	Z11	Z12	Z13	Z14	Z15	Z16
		1	2	3	4	5	6	7	8		1	2	3	4	5	6	7	8
Exit/Entry Follower	0506						6	7	8	0561								

**PROGRAM THE DATA ENTRIES**

1. Enter the panel's Dealer Security Code, then press **[MENU]**.
2. Answer NO to all questions until "ACTIVATE PROGRAM Y/N" is displayed; then press YES. **NOTE:** If you pass "ACTIVATE PROGRAM", scroll backward using **[BYPASS]**.
3. Press **[RESET]** to enter the Address Program Mode. Address "0000" will display.
4. Press **[0]** **[5]** **[0]** **[6]** to access Address 0506. *The existing data will display and the cursor will advance to the data field.*
5. Press **[6]** **[7F]** **[8A]**. The numbers 6,7 and 8 will appear on the keypad display indicating the zones activated.
6. Press **[ENTER]** to save. Address 0506 is now programmed with "6,7,8".
7. Enter another 4-digit address to continue programming or press **[RESET]** to exit and resume normal keypad operation.

**B) Decimal Format**

Settings (such as Entry and Exit Delay) display and accept data in decimal format, as a 3 digit number. Data is entered directly, by pressing keys 0 – 9, with the cursor automatically moving to the right upon each key press.

**EXAMPLE: DECIMAL Format with the GEM-RP1CAe2:** Program *Abort Delay* to be 15 seconds.

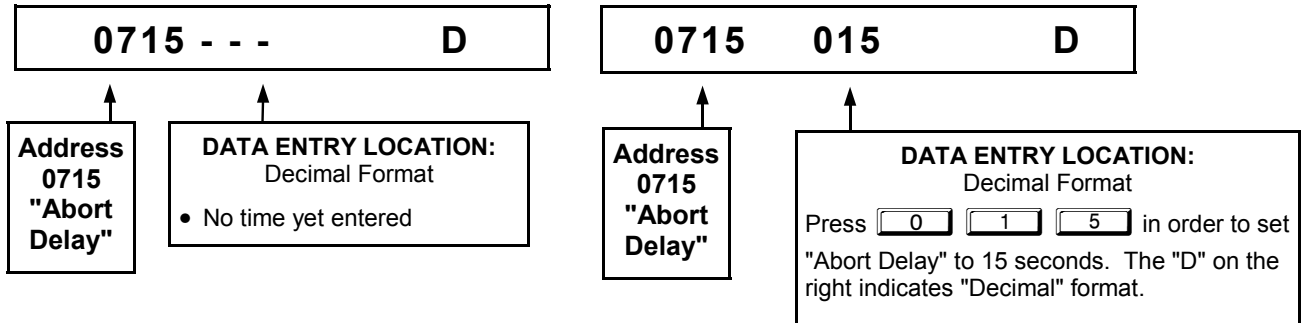

**DETERMINE THE DATA ENTRIES**

1. Referring to SYSTEM DELAYS & TIMEOUTS in the Programming Worksheets that follow, the Abort Delay is located at address 0715:

ABORT DELAY (sec.)	ADDRESS 0715		

[Default = 0 sec. = blank (\*)]

**PROGRAM THE DATA ENTRIES**



1. Enter the panel's Dealer Security Code, then press **[MENU]**.
2. Answer NO to all questions until "ACTIVATE PROGRAM Y/N" is displayed; then press YES. **NOTE:** If you pass "ACTIVATE PROGRAM", scroll backward using **[BYPASS]**.
3. Press **[RESET]** to enter the Address Program Mode. Address "0000" will display.
4. Press **[0]** **[7F]** **[1]** **[5]** to access Address 0715. *The existing data will display and the cursor will*

advance to the data field.

5. Press   . The numbers 015 will appear on the keypad display indicating the number of seconds entered.
6. Press  to save. Address 0715 is now programmed with a 15-second Abort Delay.
7. Enter another 4-digit address to continue programming or press  to exit and resume normal keypad operation.

### C) Hexadecimal Format

Data such as Report Codes displays and accepts data by means of a Hexadecimal display. Data is entered directly, by pressing keys 1 – 9,   for zero, and   through   for hex B through F (11-15), with the cursor automatically moving to the right upon key press. See table below.

HEXADECIMAL ENTRIES					
ENTRY TOTAL	PRESS 	KEYPAD DISPLAYS	ENTRY TOTAL	PRESS 	KEYPAD DISPLAYS
blank	<input type="text" value="0"/>	•	8	<input type="text" value="8A"/>	8
1	<input type="text" value="1"/>	1	9	<input type="text" value="9P"/>	9
2	<input type="text" value="2"/>	2	10	<input type="text" value="*"/> <input type="text" value="0"/>	0
3	<input type="text" value="3"/>	3	11	<input type="text" value="*"/> <input type="text" value="1"/>	B
4	<input type="text" value="4"/>	4	12	<input type="text" value="*"/> <input type="text" value="2"/>	C
5	<input type="text" value="5"/>	5	13	<input type="text" value="*"/> <input type="text" value="3"/>	D
6	<input type="text" value="6"/>	6	14	<input type="text" value="*"/> <input type="text" value="4"/>	E
7	<input type="text" value="7F"/>	7	15	<input type="text" value="*"/> <input type="text" value="5"/>	F

**EXAMPLE: HEXADECIMAL Format with the GEM-RP1CAe2:** Program *Chime Timeout* to be 2 seconds.

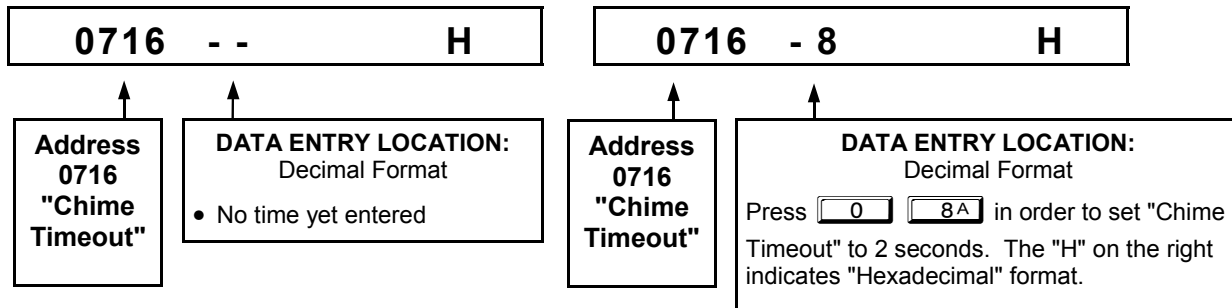

#### DETERMINE THE DATA ENTRIES

1. Referring to SYSTEM DELAYS & TIMEOUTS in the Programming Worksheets that follow, the Chime Timeout is located at address 0716. In the "**Chime Timeout Options**" table, the data entries needed to assign a timeout of 2 seconds are "blank" and "8".

CHIME TIMEOUT ( $\frac{1}{4}$ sec.)	ADDRESS 0716

[Default = 2  $\frac{1}{4}$ sec. =  $\frac{1}{2}$  sec.]

CHIME TIMEOUT OPTIONS		
DATA ENTRIES		TIMEOUT
LEFT	RIGHT	
blank (*)	blank (*)	0 x $\frac{1}{4}$ sec. = 0 sec.
blank (*)	2	2 x $\frac{1}{4}$ sec. = $\frac{1}{2}$ sec.
blank (*)	3	3 x $\frac{1}{4}$ sec. = $\frac{3}{4}$ sec.
blank (*)	4	4 x $\frac{1}{4}$ sec. = 1 sec.
blank (*)	5	5 x $\frac{1}{4}$ sec. = 1.25 sec.
blank (*)	6	6 x $\frac{1}{4}$ sec. = 1.5 sec.
blank (*)	7	7 x $\frac{1}{4}$ sec. = 1.75 sec.
blank (*)	8	8 x $\frac{1}{4}$ sec. = 2 sec.
F	F	255 x $\frac{1}{4}$ sec. = 63.25

← 2 seconds

**PROGRAM THE DATA ENTRIES**

1. Enter the panel's Dealer Security Code, then press **[MENU]**.
2. Answer NO to all questions until "ACTIVATE PROGRAM Y/N" is displayed; then press YES. **NOTE:** If you pass "ACTIVATE PROGRAM", scroll backward using **[BYPASS]**.
3. Press **[RESET]** to enter the Address Program Mode. Address "0000" will display.
4. Press **[0]** **[7F]** **[1]** **[6]** to access Address 0716. *The existing data will display and the cursor will advance to the data field.*
5. Since you wish the timeout to be for 2 seconds (and 8 multiplied by ¼ second equals 2 seconds), press **[0]** **[8A]**. The numbers 08 will appear on the keypad display indicating the number of seconds entered.
6. Press **[SAVE]** to save. Address 0715 is now programmed with a 2-second chime.
7. Enter another 4-digit address to continue programming or press **[RESET]** to exit and resume normal keypad operation.

**PROGRAMMING CONVENTIONS USED IN THIS MANUAL**

The Keypad Programming Worksheets in the back are provided as an address-programming reference to help the installer modify his custom default program or to make minor field alterations to an existing panel program. It is recommended that the panel be uploaded to NAPCO's PCD-Windows software following any keypad programming and that the PCD-Windows's error-check feature be utilized to reduce the possibility of programming omissions or conflicts.

Keep the Keypad Programming Worksheets on file for future reference.

**General Programming Steps**

1. Contact the central station to ascertain receiver format, data format, event codes, subscriber numbers and telephone number(s).
2. Select the desired features by circling  the respective "address" boxes. Refer to the Programming Options and Worksheets for guidance in selecting the "data" to be entered into those boxes.
3. Program the data entered in the boxes on the worksheets into the respective addresses. The display will show the entry numerically, but if hexadecimal format will display "0" for the number 10, and letters "B", "C", "D", "E", and "F" for the numbers 11 through 15, respectively. To program a 10, press **[\*]** **[0]**. To program 11 through 15, press **[\*]** **[1]** through **[\*]** **[5]**, respectively.

The displays will appear after a brief delay.

- Use **[MENU]** to toggle the cursor between the 4-digit address field and the data entry locations.
- Enter the address directly using the number buttons.
- The contents of the address will be read automatically, along with the feature name and programming information. The cursor will advance to the data field. Enter the required data directly using the number buttons.
- IMPORTANT:** Press **[SAVE]** or **[ON]** to save the contents of each address.

**EXIT DIRECT ADDRESS PROGRAM MODE:** When done, press **[RESET]** to exit and resume normal keypad operation.

## SYSTEM DELAYS & TIMEOUTS (ADDRESS 0000 TO 0002, 0711, 0715 & 1059)

<b>EXIT DELAY</b>	<b>ADDRESS 0000</b>		
(sec.)			

[Default = 060]

<b>ENTRY DELAY 1</b>	<b>ADDRESS 0001</b>		
(sec.)			

[Default = 030]

<b>ENTRY DELAY 2</b>	<b>ADDRESS 0002</b>		
(sec.)			

[Default = 030]

<b>PGM2 Output Access Cntrl Timeout (sec.)</b>	<b>ADDRESS 0711</b>		

[Default = 0 sec. = blank (\*)]

<b>ABORT DELAY</b>	<b>ADDRESS 0715</b>		
(sec.)			

[Default = 030]

 Select delay/timeout (0-255 sec.) from the table shown.

**EXIT/ENTRY DELAYS:** Apply only to zones programmed with the following options "Exit/Entry 1, Exit/Entry 2, Exit/Entry Follower". For UL Installations, the maximum exit delay is 60 seconds and the maximum entry delay is 45 seconds. **NOTE:** Sensor Watch Time Options are similar to above table, except in hours.

 Press  or  to save.

<b>Sensor Watch Time</b>	<b>ADDRESS 1059</b>		
(Hrs.)			

[Default = 024]

Maximum Program Time		
Address	Units	Max Prog Time
1179	VERSION 10 - MIN VERSION 9A - SEC	VERSION 10 - 254 MIN VERSION 9A - 254 SEC

<b>Report Cancel Window</b>	<b>ADDRESS 1179</b>		
(min.)			

[Default = 0 sec. = blank (\*)]  
See **Maximum Program Time**  
table (at left)

**WARNING:** Timers have uncertainty of +/-1 sec, so a "time" of 1 second may actually timeout IMMEDIATELY.

## SYSTEM DELAYS & TIMEOUTS (ADDRESS 0716 & 0717)

<b>CHIME TIMEOUT</b>	<b>ADDRESS 0716</b>		
(¼sec.)			

[Default = 008 x ¼ sec. = 2 sec.]

<b>AC Fail Report Delay</b>	<b>ADDRESS 0717</b>		
(min.)			

[Default = 060]

**DEFAULTS:** The defaults shown on this page and on the following pages are automatically set after exiting the Easy Menu Driven Mode.

 1. Enter delay/timeout in corresponding address locations above.

**Note:** All entries for address 0716 are in quarter seconds (.25 seconds).  
Therefore, the default of 008 results in a 2 second timeout.

 2. Press  or  to save.

## SYSTEM OUTPUT TIMEOUTS (ADDRESS 0710, 0712, 0713 & 0714)

PGM2 Output	ADDRESS 0710		
Timeout (min.)			

[Default = 0 min. = blank (\*)]

Alarm Output	ADDRESS 0712		
Timeout (min.)			

[Default = 015]

Pulse Alarm Output	ADDRESS 0713		
Timeout (min.)			

[Default = 015]

PGM1 Output	ADDRESS 0714		
Timeout (min.)			

[Default = 0 min. = blank (\*)]

DATA ENTRIES	DELAY/TIMEOUT
blank (*)	0 min.
1	1 min.
2	2 min.
3	3 min.
4	4 min.
5	5 min.
6	6 min.
16	16 min.
↓	↓
255	255 min.

1. Select delay/timeout (0-255 min.) from the table shown.
2. Enter in corresponding address locations above.
3. Press or to save.

**OUTPUT TIMEOUTS:** If a timeout of "0 min." is selected, then the output will remain active (ON) until the system is reset or disarmed. For UL Residential Installations, the minimum timeout is 4 minutes. Not UL listed for Commercial Installations.

## DOWNLOAD/CALLBACK OPTIONS (ADDRESS 1183 & 0236-0255)

No. Rings Before Pickup	ADDRESS 1183		

[Default = 015]

**NUMBER OF RINGS BEFORE PICKUP:** Enter the number of rings before automatic pickup by the control panel when downloading from a computer (see Glossary at the back for more information).

1. Enter digit only.
2. Valid entries are: 03-15. **NOTE:** Default is 15 Rings.
3. Press or to save.

Callback Telephone	ADDRESS 0236-0255 (RIGHT DIGITS 1-20)																				
(Digits 1-20)	0236	0237	0238	0239	0240	0241	0242	0243	0244	0245	0246	0247	0248	0249	0250	0251	0252	0253	0254	0255	

[Default = blank (\*) for all digits 1-20]

**CALLBACK TELEPHONE NUMBER:** Enter telephone number to be used when downloading from a computer (see Glossary at the back for more information).

1. Enter digit only.
2. Enter up to 20 digits from left to right. **NOTE:** Leave trailing boxes blank (\*).
3. Valid entries are: 1-9, B = , C = , D = 3 sec. pause, E = Wait for dial tone, F = ignore location.
4. Press or to save.

## PAGER FORMAT OPTIONS (ADDRESS 0256 & 0257)

Leading Digits for Pager Format (1st Digit)	ADDRESS 0256
Leading Digits for Pager Format (2nd Digit)	ADDRESS 0257

[Default = blank (\*) blank (\*)]

**LEADING DIGITS FOR PAGER FORMAT:** In Pager Format reporting, the message typically begins with "00". However, for some pager services, this will cause the Pager's Voice Mail feature to activate. This option allows you to program these digits to any number desired. A typical Pager report is "003 22 1234", where 3 is the Event, 22 is the zone, and 1234 is the Subscriber ID number. For example, if the Leading Digits are programmed as "98", the Pager report will now appear as "983 22 1234". **NOTE:** See CS Receiver Options to select Pager Format.

1. Enter in 1st and 2nd Leading Digits as shown.
2. Valid entries are: 0-9. Press or to save.



## SYSTEM OPTIONS (ADDRESS 0460-0485 & 1054)

SYSTEM RESPONSE ACTIVATED BY GLOBAL EVENT/TROUBLE	ADDR	GLOBAL SYSTEM EVENT/TROUBLE							
		TEST TIMER	TELCO FAILURE	RF RCVR. TROUBLE	MEMORY FAILURE	LOW BATTERY	AC FAIL	EZM TAMPER	Bell Superv
		1	2	3	4	5	6	7	8
Alarm Output	0460								
Pulsed Alarm Output	0461								
PGM1 Output	0462								
PGM2 Output	0463								
Report Event Telco 1	0464								
Report Restore Telco 1	0465								
Report Event Telco 3	0468								
Report Restore Telco 3	0469								

[Default = blank (\*) from address 0460-0469]. **Note:** If *Test Timer* is enabled (above), *Digital Dialer Test* is also enabled.

SYSTEM RESPONSE ACTIVATED BY AREA 1 EVENT/TROUBLE	ADDR	AREA 1 SYSTEM EVENT/TROUBLE							
		AMBUSH	KEYPAD PANIC	KEYPAD FIRE	KEYPAD AUX. *	KEYPAD TAMPER	FAIL TO OPEN	FAIL TO CLOSE	Keyfob Low Batt
		1	2	3	4	5	6	7	8
Pulsed Alarm Output	0470								
Alarm Output	0471								
PGM1 Output	0472								
PGM2 Output	0474								
Report Event Telco 1	0475								
Report Event Telco 3	0477								



[Default = blank (\*) from address 0470-0477] \* NOTE: Keypad Aux. is not to be selected for UL Installations.

SYSTEM RESPONSE ACTIVATED BY AREA 2 EVENT/TROUBLE	ADDR	AREA 2 SYSTEM EVENT/TROUBLE							
		AMBUSH	KEYPAD PANIC	KEYPAD FIRE	KEYPAD AUX. *	KEYPAD TAMPER	FAIL TO OPEN	FAIL TO CLOSE	Keyfob Low Batt
		1	2	3	4	5	6	7	8
Pulsed Alarm Output	0478								
Alarm Output	0479								
PGM1 Output	0480								
PGM2 Output	0482								
Report Event Telco 1	0483								
Report Event Telco 3	0485								

[Default = blank (\*) blank (\*) from address 0478-0485] \* NOTE: Keypad Aux. is not to be selected for UL Installations.

 1. Select the desired option entering the option number (1-8) for each digit.



 2. Enter corresponding option number in address location.

 **NOTE:** Dark shaded data value box shows option not available. Press  or  to save.

Global Ambush Code	ADDRESS 1054	
	1st digit	2nd digit

[Default = blank (\*) blank (\*)]

**GLOBAL AMBUSH CODE:** It is the 2-digits entered immediately prior to the regular disarm code. If "Enable Global Ambush Code" (Address 0720) is selected and Address 1054 is left blank (\*), then the 2-digit Global Ambush Code is "99". If "Enable Global Ambush Code" is selected and Address 1054 is **not** left blank (\*), then the 2-digit Global Ambush Code is the two digits entered in address 1054.

 Enter in address location (both 1st and 2nd digits); valid entries are 1-9. 3. Press  or  to save.

## SYSTEM OPTIONS (ADDRESS 0718-0722, 1060-1062)

0718 System Options		
Default		Option
OFF	1	Opening Report Only after Alarm Report
OFF	2	Closing Report Only on Conditional Close
OFF	3	Incl. Sel./Grp. Bypass in Cond. Close /Status
OFF	4	Status Report
OFF	5	Reserved
OFF	6	Enable AutoArm if not closed at end of Window
OFF	7	Enable Time/Date KP Display
OFF	8	Disable Zone Fault Scrolling

0720 System Options		
Default		Option
OFF	1	Interior Normally Bypassed
OFF	2	Enable Global Ambush Code ***
OFF	3	Reset Day Zone with Arm/Disarm Only
OFF	4	Enable Residential Fire
OFF	5	Disable Keypad Function Mode Download
OFF	6	Disable Callback Download
OFF	7	Chirp Output on Keyfob Arm/Disarm
OFF	8	Change Pulse Output to Temporal Output <sup>§</sup>

<sup>§</sup>This feature must be programmed in Fire Alarm applications.

0722 System Options		
Default		Option
OFF	1	Automatic Interior Bypass/Easy Exit
OFF	2	Veri-phone Zones Trip PGM2 Output
OFF	3	Veri-phone Audio Priority Over Alarms
OFF	4	Resound on Wireless Smoke Low Battery
OFF	5	Don't Clear PGM2 Output with Disarm
OFF	6	Disable 2nd Call Ans. Machine Override
OFF	7	RESERVED
OFF	8	RESERVED

0719 System Options		
Default		Option
OFF	1	Auto Bell Test on Arming
OFF	2	Auto Reset after Burglary Output Timeout
OFF	3	Suppress Bypass Reminder when Armed
OFF	4	Enable Local Alarm on First Zone AND Trip
OFF	5	Access Control on PGM2 Output
OFF	6	Maintained Keyswitch Arming
OFF	7	Enable Manager's Mode
OFF	8	Disable Keypad Instant Mode

0721 System Options		
Default*		Option
OFF*	1	Enable Zone Doubling (Zones 9-16)
OFF*	2	Wireless Trouble Activates Telco 1
OFF*	3	Wireless Trouble Activates Telco 3
OFF*	4	Enable Alarm Output on Telco Fail only when Armed
OFF*	5	Line-Fault Test only when Armed**
OFF*	6	Enable Line-Fault Test**
OFF*	7	Inhibit System Trouble Audible at Keypad †
OFF*	8	Select Alarm Output for Keypad Chirp

† NOTE: Not for UL Installations.



1060 System Options		
Default		Option
OFF	1	Enable Keypad Set Time/Date Message
OFF	2	Enable Cancel Report to Telco 3
OFF	3	Disable [ON/OFF] as Easy Exit
OFF	4	Enable GEM-PRINT Module
OFF	5	RESERVED
OFF	6	RESERVED
OFF	7	Disable System Trouble Audible Timeout
OFF	8	RESERVED

1061 Lug E15 Output Mode	
DATA ENTRIES	OPTION
blank (*)	Armed
4	Armed Area 1 Away

**ADDRESS 1061: LUG E15 OUTPUT MODE**

Select the options available from the table above.

1. Enter digit only.

2. Valid entries are "blank (\*)" or "4". Press  or  to save.

\*NOTE: Address 0721: Default depends on Easy Menu Question "EZ ZONE DOUBLING? Y/N". If yes, then [Default = 1]. If no, then [Default = blank (\*)].

\*\*NOTE: To select "Line-Fault Test only when Armed", you must also select "Enable Line-Fault Test" at address 0721.

\*\*\* NOTE: If "Enable Global Ambush Code" in Address 0720 is selected, then program the 2-digit "Global Ambush Code" in Address 1054. If Address 1054 is left blank (\*), then, the 2-digit "Global Ambush Code" will be "99".

1062 System Options		
Default		Option
OFF	1	Exit Time Restart
OFF	2	Sound Alarm On Exit Error
OFF	3	Rpt Exit Err/Recent Close
OFF	4	Enable CP-01 Limits
OFF	5	Digital Dialer Rpt Enter /Exit Test Mode
OFF	6	Disable Call Waiting on 1st Attempt
OFF	7	RESERVED
OFF	8	RESERVED

# CS RECEIVER OPTIONS (ADDRESS 0170-0191, 0192-0213, 0214-0235)

<b>CS Receiver 1</b>	<b>ADDRESS 0170</b>	
Format		

<b>CS Receiver 2</b>	<b>ADDRESS 0192</b>	
Format		

<b>CS Receiver 3</b>	<b>ADDRESS 0214</b>	
Format		

DATA ENTRY	CS RECEIVER 1 FORMAT
blank (*)	Ademco Slow, Silent Knight Slow
2	Radionics Fast
3	Silent Knight Fast
4	Radionics, DCI, Franklin Slow
5	Universal High Speed
B	SIA
C	Ademco Point ID
E	Pager *

Default for CS Receiver 1 Format depends on Easy Menu Question "RCVR FORMAT". [Default = \*(blank) \* (blank)] for CS Receivers 2 and 3 Formats.

**CS RECEIVER FORMATS:** Up to 3 CS Formats may be programmed.

1. Select the desired CS Receiver Format from the table shown.
2. Enter the corresponding digit in the address location for each CS Receiver. **NOTE:** Dark shaded data value box shows option not available. Press [Enter] or [ON/OFF] to save.

**NOTE:** \* See Pager Format Options to program Leading Digits for Pager Format.

0171 CS Receiver Options		
Default		Option
OFF	1	1400Hz Handshake/Kissoff *
OFF	2	2300Hz Handshake/Kissoff *
OFF	3	Enable Zone Number on Pulse Alarm
OFF	4	Single Digit Only
OFF	5	Sum Check
OFF	6	3/1 with Extended Restores
OFF	7	RESERVED
OFF	8	RESERVED

0193 CS Receiver 2 Options		
Default		Option
OFF	1	1400Hz Handshake/Kissoff *
OFF	2	2300Hz Handshake/Kissoff *
OFF	3	Enable Zone Number on Pulse Alarm
OFF	4	Single Digit Only
OFF	5	Sum Check
OFF	6	3/1 with Extended Restores
OFF	7	RESERVED
OFF	8	RESERVED

0215 CS Receiver 3 Options		
Default		Option
OFF	1	1400Hz Handshake/Kissoff *
OFF	2	2300Hz Handshake/Kissoff *
OFF	3	Enable Zone Number on Pulse Alarm
OFF	4	Single Digit Only
OFF	5	Sum Check
OFF	6	3/1 with Extended Restores
OFF	7	RESERVED
OFF	8	RESERVED

**CS RECEIVER OPTIONS:**

Select options for any of the three CS Receivers.

1. Select the desired option entering the option number (1-8) for each digit.
2. Enter corresponding option number in address location.

**NOTE:** Dark shaded data value box shows option not available. Press [Enter] or [ON/OFF] to save.

**\*NOTE:** If both are selected, 1400Hz has priority over 2300Hz.

<b>CS Receiver 1</b>	<b>ADDRESS 0172-0191 (RIGHT DIGITS 1-20)</b>																			
Telephone number	0172	0173	0174	0175	0176	0177	0178	0179	0180	0181	0182	0183	0184	0185	0186	0187	0188	0189	0190	0191
(Digits 1-20)																				

Default for CS Receiver 1 Telephone Number depends on Easy Menu Question "CENTRAL PHONE #".

<b>CS Receiver 2</b>	<b>ADDRESS 0194-0213 (RIGHT DIGITS 1-20)</b>																			
Telephone Number	0194	0195	0196	0197	0198	0199	0200	0201	0202	0203	0204	0205	0206	0207	0208	0209	0210	0211	0212	0213
(Digits 1-20)																				

[Default = blank (\*)] across digits 1-20 for CS Receiver Telephone Numbers 2 and 3.

<b>CS Receiver 3</b>	<b>ADDRESS 0216-0235 (RIGHT DIGITS 1-20)</b>																			
Telephone Number	0216	0217	0218	0219	0220	0221	0222	0223	0224	0225	0226	0227	0228	0229	0230	0231	0232	0233	0234	0235
(Digits 1-20)																				

**CS RECEIVER TELEPHONE NUMBERS:** Enter telephone numbers for any of the three CS Receivers (Telco 1, 2 & 3).

1. Enter digit only.
2. Enter up to 20 digits from left to right. **NOTE:** Leave trailing boxes blank (\*). Press [Enter] or [ON/OFF] to save.
3. Valid entries are: 1-9, B = [\*] button, C = [#] button, D = 3 sec. pause, E = Wait for dial tone, F = ignore location



# CS SUBSCRIBER ID & SYSTEM REPORTING OPTIONS (ADDRESS 0259-0350)

Direct Address Program Mode

CS Telco 1 Subscriber Opening/ Closing ID Number (Area 1)	ADDRESS 0259-0262 (RIGHT DIGITS 1-4)			
	0259	0260	0261	0262

CS Telco 1 Subscriber Opening/ Closing ID Number (Area 2)	ADDRESS 0263-0266 (RIGHT DIGITS 1-4)			
	0263	0264	0265	0266

CS Telco 1 Subscriber Event ID Number (Area 1)	ADDRESS 0267-0270 (RIGHT DIGITS 1-4)			
	0267	0268	0269	0270

CS Telco 1 Subscriber Event ID Number (Area 2)	ADDRESS 0271-0274 (RIGHT DIGITS 1-4)			
	0271	0272	0273	0274

CS Telco 1 Subscriber Event ID Number (System)	ADDRESS 0275-0278 (RIGHT DIGITS 1-4)			
	0275	0276	0277	0278

CS Telco 2 Subscriber Opening/ Closing ID Number (Area 1)	ADDRESS 0279-0282 (RIGHT DIGITS 1-4)			
	0279	0280	0281	0282

CS Telco 2 Subscriber Opening/ Closing ID Number (Area 2)	ADDRESS 0283-0286 (RIGHT DIGITS 1-4)			
	0283	0284	0285	0286

CS Telco 2 Subscriber Event ID Number (Area 1)	ADDRESS 0287-0290 (RIGHT DIGITS 1-4)			
	0287	0288	0289	0290

CS Telco 2 Subscriber Event ID Number (Area 2)	ADDRESS 0291-0294 (RIGHT DIGITS 1-4)			
	0291	0292	0293	0294

CS Telco 2 Subscriber Event ID Number (System)	ADDRESS 0295-0298 (RIGHT DIGITS 1-4)			
	0295	0296	0297	0298

CS Telco 3 Subscriber Opening/ Closing ID Number (Area 1)	ADDRESS 0299-0302 (RIGHT DIGITS 1-4)			
	0299	0300	0301	0302

CS Telco 3 Subscriber Opening/ Closing ID Number (Area 2)	ADDRESS 0303-0306 (RIGHT DIGITS 1-4)			
	0303	0304	0305	0306

CS Telco 3 Subscriber Event ID Number (Area 1)	ADDRESS 0307-0310 (RIGHT DIGITS 1-4)			
	0307	0308	0309	0310

CS Telco 3 Subscriber Event ID Number (Area 2)	ADDRESS 0311-0314 (RIGHT DIGITS 1-4)			
	0311	0312	0313	0314

CS Telco 3 Subscriber Event ID Number (System)	ADDRESS 0315-0318 (RIGHT DIGITS 1-4)			
	0315	0316	0317	0318

Default for CS Telco 1 Subscriber Event ID Number (Area 1) depends on Easy Menu Question "ACCOUNT #". [Default = blank (\*) blank (\*) blank (\*) blank (\*)] for all other ID Numbers.

**CS TELCO SUBSCRIBER ID NUMBERS:** Enter the Subscriber Opening/Closing and Event ID Numbers for any of the 3 CS Receivers.

1. Enter 3 or 4 digits (depending on the CS receiver format) for each subscriber number from left to right.

**NOTE:** Leave trailing boxes blank (\*).

2. Valid entries are: 1-9, 0 and B-F. **NOTE:** A is not permitted. Press [Enter] or ON/OFF to save.

CS SYSTEM REPORTING CODES	ADDRESS 0319-0332		
		ADDR	
Alarm Restore	blank (*)	0319	
Trouble	blank (*)	0320	
Trouble Restore	blank (*)	0321	
Xmitter Low Battery	blank (*)	0322	
Xmitter Supervision	blank (*)	0323	
Xmitter Tamper	blank (*)	0324	
RESERVED	blank (*)	0325	blank (*)
Opening	blank (*)	0326	
Closing	blank (*)	0327	
Opening after Alarm	blank (*)	0328	
Conditional Close	blank (*)	0329	
Cancel	blank (*)	0330	
Test Timer	blank (*)	0332	

CS SYSTEM REPORTING CODES	ADDRESS 0333-0350		
		ADDR	
Telco Fail		0333	
RF Rec. Trouble		0334	
Memory Fail		0335	
Low Battery		0336	
Panel AC Fail		0337	
EZM Tamper		0338	
Alarm Output Superv.		0339	
Ambush		0340	
Panic		0341	
Fire		0342	
Auxiliary *		0343	
Tamper		0344	
Fail to Open		0345	
Fail to Close		0346	
Keyfob Low Battery		0347	
Exit Error		0348	
Recent Close		0349	
Fault Find		0350	

**CS SYSTEM REPORTING CODES:**

1. Enter in corresponding address location (left and right digits).



**NOTE:** Left digit is the first digit and right digit is the second digit in a two digit CS receiver format.

2. Valid entries are: 1-9, 0 and B-F.

**NOTE:** A is not permitted.

3. To disable a code leave boxes blank (\*).

**NOTE:** Dark shaded data value box shows option not available.

4. Press  or  to save.

\* **NOTE:** Keypad Aux. is not to be selected for UL Installations.

[Default = blank (\*) blank (\*) from address 0319-0332]  
[Default = blank (\*) blank (\*) from address 0333-0350]

## CS ZONE REPORTING OPTIONS (ADDRESS 0358-0389)

ADDRESS 0358-0365							
CONTROL PANEL ZONES REPORT CODE							
ZONE 1	ZONE 2	ZONE 3	ZONE 4	ZONE 5	ZONE 6	ZONE 7	ZONE 8
0358	0359	0360	0361	0362	0363	0364	0365

ADDRESS 0366-0369			
ZONES REPORT CODE			
ZONE 9	ZONE 10	ZONE 11	ZONE 12
0366	0367	0368	0369

ADDRESS 0370-0373			
ZONES REPORT CODE			
ZONE 13	ZONE 14	ZONE 15	ZONE 16
0370	0371	0372	0373

ADDRESS 0374-0377			
ZONES REPORT CODE			
ZONE 17	ZONE 18	ZONE 19	ZONE 20
0374	0375	0376	0377

ADDRESS 0378-0381			
ZONES REPORT CODE			
ZONE 21	ZONE 22	ZONE 23	ZONE 24
0378	0379	0380	0381

ADDRESS 0382-0385			
ZONES REPORT CODE			
ZONE 25	ZONE 26	ZONE 27	ZONE 28
0382	0383	0384	0385

ADDRESS 0386-0389			
ZONES REPORT CODE			
ZONE 29	ZONE 30	ZONE 31	ZONE 32
0386	0387	0388	0389

Default for Group Zone Report Codes depends on Easy Menu Question "RCVR. FORMAT".

ZONE REPORT CODE OPTIONS	
DATA ENTRIES	

**NOTE:** If "Zone Doubling" (Address 0721) is **not** enabled, then Zones 1-8 are included in the control panel and Zones 9-32 are EZM Zones. If "Zone Doubling" is enabled, then Zones 1-16 are included in the control panel and Zones 17-32 are EZM Zones. See Address 0737-0742 to enable "EZM Zone Groups".

DATA ENTRIES LEFT	MODEM CODE
1	Fire
2	Panic
3	Burglary
4	Hold up
7	Gas Alarm
8	Heat Alarm
0	Auxiliary Alarm
B	24 Hour Auxiliary

**PULSE EVENT CODE** will be the first digit of the 2 digit reporting code. The second digit will be the second digit of the reporting zone. For example, for zone 9 (address 0366), if the right digit is "3", then the reporting code is "39". For example, for zone 15 (address 0372), if the right digit is "4", then the reporting code is "45".

**MODEM CODES** determine the zone types reported for the following formats: SIA and ADEMCO Point ID.

1. Select the desired Modem Code for each zone from the table shown.

2. Press  or  to save.

## CS AREA & SYSTEM REPORTING OPTIONS (ADDRESS 0391, 0392 & 0394)

AREA	LEFT DATA VALUES (CIRCLE  )
AREA 1	1
RESERVED	2
RESERVED	4
RESERVED	8

DISABLE OPENING REPORTS	
ADDRESS 0391	
LEFT DIGIT (SUM OF DATA VALUES)	RIGHT DIGIT
	blank (*)

[Default = blank (\*) blank (\*)]

AREA	LEFT DATA VALUES (CIRCLE  )
AREA 1	1
RESERVED	2
RESERVED	4
RESERVED	8

DISABLE CLOSING REPORTS	
ADDRESS 0392	
LEFT DIGIT (SUM OF DATA VALUES)	RIGHT DIGIT
	blank (*)

[Default = blank (\*) blank (\*)]

0394	CS System Report Options	
Default	Option	Option
OFF	1	Backup Report on Telco 2
OFF	2	Touch-tone Dialing Only *
OFF	3	Touch-tone Dialing w/Rotary Backup *
OFF	4	RESERVED
OFF	5	Cancel Next Test Timer on any Report
OFF	6	Disable Wait for Silence
OFF	7	Disable Wait for Handshake
OFF	8	Disable Auto Dial Tone Detect

**CS AREA & SYSTEM REPORTING OPTIONS:**

1. Select the desired option entering the option number (1-8) for each digit.
2. Enter corresponding option number in address location.

**NOTE:** Dark shaded data value box shows option not available.

3. Press  or  to save.

**\* NOTE:** If neither Touch-tone Dialing nor Touch-tone w/Rotary Backup is selected, then system defaults automatically to Rotary Dialing. Leave blank (\*) to select Rotary Dialing.



## CS USER REPORTING OPTIONS (ADDRESS 0440-0459)

Enable Users to Report Opening and Closings	ADDR	USERS 1 → 8								ADDR	USERS 9 → 16							
		U1	U2	U3	U4	U5	U6	U7	U8		U9	U10	U11	U12	U13	U14	U15	U16
		1	2	3	4	5	6	7	8		1	2	3	4	5	6	7	8
Enable Opening Report, Telco 1	0440									0441								
Enable Closing Report, Telco 1	0445									0446								
Enable Opening Report, Telco 3	0450									0451								
Enable Closing Report, Telco 3	0455									0456								

Enable Users to Report Opening and Closings	ADDR	USERS 17 → 24								ADDR	USERS 25 → 32							
		U17	U18	U19	U20	U21	U22	U23	U24		U25	U26	U27	U28	U29	U30	U31	U32
		1	2	3	4	5	6	7	8		1	2	3	4	5	6	7	8
Enable Opening Report, Telco 1	0442									0443								
Enable Closing Report, Telco 1	0447									0448								
Enable Opening Report, Telco 3	0452									0453								
Enable Closing Report, Telco 3	0457									0458								

Enable Users to Report Opening and Closings	ADDR	USERS 33 → 36								ADDR	USERS 37 → 44							
		U33	U34	U35	U36	U37	U38	U39	U40		U41	U42	U43	U44				
		1	2	3	4	5	6	7	8		1	2	3	4				
Enable Opening Report, Telco 1	0444									0445								
Enable Closing Report, Telco 1	0449									0450								
Enable Opening Report, Telco 3	0454									0455								
Enable Closing Report, Telco 3	0459									0460								

User 33 = Auto Arming/Disarming  
 User 34 = Quickloader Arming/Disarming  
 User 35 = Easy Arming (Opening not applicable)  
 User 36 = Keyswitch Arming  
**NOTE:** These opening events will report as the user number shown. Also, Keyfobs 1-8 (see Easy Menu Program Driven Mode) will report as Users 25-32, respectively.

**CS USER REPORTING OPTIONS:** [Default = blank (\*) from address 0440-0459]

1. Select the desired option entering the option number (1-8) for each digit.
2. At the keypad, enter corresponding option number in address location.

**NOTE:** Dark shaded data value box shows option not available.

3. Press or to save.

## EZM GROUP OPTIONS (ADDRESS 0737-0742)

<b>EZM Group 1</b>
<b>ADDRESS 0737</b>

<b>EZM Group 2</b>
<b>ADDRESS 0738</b>

<b>EZM Group 3</b>
<b>ADDRESS 0739</b>

<b>EZM Group 4</b>
<b>ADDRESS 0740</b>

<b>EZM Group 5</b>
<b>ADDRESS 0741</b>

<b>EZM Group 6</b>
<b>ADDRESS 0742</b>

Default depends on Easy Menu Question “# OF ZNS IN AREA 1 ENTER # ZONES” and “EZ ZONE DOUBLING? Y/N”. For example, if 32 Zones are used and Zone Doubling is **not** enabled, then all 6 Groups will be automatically enabled. If 32 Zones are used and Zone Doubling is enabled, then only Groups 1-4 will be automatically enabled.

**NOTE:** If “Zone Doubling” (Address 0721) is **not** enabled, then Zones 1-8 are included in the control panel and Zones 9-32 (Groups 1-6) are EZM Zones. If “Zone Doubling” is enabled, then Zones 1-16 are included in the control panel and Zones 17-32 (Groups 1-4) are EZM Zones (and Groups 5 and 6 must not be used).

EZM TYPE	
DATA ENTRIES	OPTION
blank (*)	Not used (No EZM)
1	4-Zone EZM

EZM GROUP	ZONES COVERED	
	NORMAL	DOUBLED
1	9-12	17-20
2	13-16	21-24
3	17-20	25-28
4	21-24	29-32
5	25-28	
6	29-32	

**EZM GROUP OPTIONS:** Up to 6 Groups of 4 Zones each may be programmed depending on the number of Zones used and which EZM modules are connected. Each Group represents 4 Zones.

 1. Select EZM type from the table shown.

 2. Enter either blank (\*) or "1" in corresponding address locations above.

**NOTE:** Dark shaded data value box shows option not available.

 3. Press  or  to save.

## AREA ARMING OPTIONS (ADDRESS 0743 & 0744)

<b>Priority Arming Area 1</b>	<b>ADDRESS 0743</b>

[Default = blank (\*)]

<b>Priority Arming Area 2</b>	<b>ADDRESS 0744</b>

[Default = blank (\*)]

**PRIORITY AREA ARMING:**

 1. Select option from the table shown.

 2. Enter either blank() or "1" in corresponding address location.

**NOTE:** Dark shaded data value box shows option not available.

 3. Press  or  to save.

PRIORITY ARMING/AREA 1	
DATA ENTRIES	OPTION
blank (*)	Not Used
1	Enabled

PRIORITY ARMING/AREA 2	
DATA ENTRIES	OPTION
blank (*)	Not Used
1	Enabled

## AREA BELL CONTROL OPTIONS (ADDRESS 0745-0747 & 0749)

0745 Burglary Output Turns Off upon Disarm		
Default		Option: <b>Disarming Area 1:</b>
ON	1	Area 1 Burg Output Silenced
OFF	2	Area 2 Burg Output Silenced
	3	RESERVED
	4	RESERVED
Default		Option: <b>Disarming Area 2:</b>
OFF	5	Area 1 Burg Output Silenced
OFF	6	Area 2 Burg Output Silenced
	7	RESERVED
	8	RESERVED

0746 Pulsed Burg Output Turns Off upon Disarm		
Default		Option: <b>Disarming Area 1:</b>
ON	1	Area 1 Pulsed Burg Output Silenced
OFF	2	Area 2 Pulsed Burg Output Silenced
	3	RESERVED
	4	RESERVED
Default		Option: <b>Disarming Area 2:</b>
OFF	5	Area 1 Pulsed Burg Output Silenced
OFF	6	Area 2 Pulsed Burg Output Silenced
	7	RESERVED
	8	RESERVED

0747 PGM1 Output Turns Off upon Disarm		
Default		Option: <b>Disarming Area 1:</b>
OFF	1	Area 1 PGM1 Output Silenced
OFF	2	Area 2 PGM1 Output Silenced
	3	RESERVED
	4	RESERVED
Default		Option: <b>Disarming Area 2:</b>
OFF	5	Area 1 PGM1 Output Silenced
OFF	6	Area 2 PGM1 Output Silenced
	7	RESERVED
	8	RESERVED

0749 PGM2 Output Turns Off upon Disarm		
Default		Option: <b>Disarming Area 1:</b>
OFF	1	Area 1 PGM2 Output Silenced
OFF	2	Area 2 PGM2 Output Silenced
	3	RESERVED
	4	RESERVED
Default		Option: <b>Disarming Area 2:</b>
OFF	5	Area 1 PGM2 Output Silenced
OFF	6	Area 2 PGM2 Output Silenced
	7	RESERVED
	8	RESERVED

Direct Address Program Mode

**OUTPUT TURNS OFF UPON DISARM:**



Select options for any of the 4 Outputs.

By default, the ability to turn off an output upon disarm is not allowed.

For example, the ability to silence an Area 1 or Area 2 output via an Area 1 keypad is not enabled by default. To enable selected area output control, enter the number (1,2,5,6) accordingly.

For example, if you wish to grant an Area 1 keypad the ability to turn off an Area 2 PGM2 output, enter "2" in Address 0749.

 Enter digit in address location.

**NOTE:** Dark shaded data value box shows option not available. Press  or  to save.





## KEYPAD OPTIONS (ADDRESS 0723-0736)

Enable Keypad Type & Activation	ADDR	Enable Keypad Type	Keypad Area Assignment
		Blank (•) = Burg Keypad 2 = Wizard * <small>* Not for UL Installations.</small>	Blank (•) = Disabled 1 = Area 1 2 = Area 2
Keypad 1	0723		
Keypad 2	0724		
Keypad 3	0725		
Keypad 4	0726		
Keypad 5	0727		
Keypad 6	0728		
Keypad 7	0729		

**KEYPAD TYPE:** Up to 7 keypads may be programmed, if they are connected.



**NOTE:** See Keypad Configuration Mode. By default from the factory, each keypad is configured as number 1.

1. Select keypad type for each keypad from the tables shown.
2. Enter data in corresponding address locations.
3. Press  or  to save.

Enable Keypad Options	ADDR	Enable Keypad Options							
		Keypad Fire	Keypad Aux.*	Keypad Panic	RSRVD	Ambush	Easy Arming	Panel Access	RSRVD
		1	2	3	4	5	6	7	8
Keypad 1 Options	0730								
Keypad 2 Options	0731								
Keypad 3 Options	0732								
Keypad 4 Options	0733								
Keypad 5 Options	0734								
Keypad 6 Options	0735								
Keypad 7 Options	0736								

[Default = blank (•) from address 0730-0736] \* NOTE: Keypad Aux. is not to be selected for UL Installations.

**ENABLE KEYPAD OPTIONS:** Select options for any of the 7 keypads.

-  1. Select the desired option entering the option number (1-8) for each digit.
-  2. At the keypad, enter corresponding option number in address location.

**NOTE:** Dark shaded data value box shows option not available.

-  3. Press  or  to save.

## ZONE OPTIONS - ZONES 1 TO 16 (ADDRESS 0490-0595)

ZONE OPTIONS	ADDR	ZONES 1 → 8								ADDR	ZONES 9 → 16							
		Z1	Z2	Z3	Z4	Z5	Z6	Z7	Z8		Z9	Z10	Z11	Z12	Z13	Z14	Z15	Z16
		1	2	3	4	5	6	7	8		1	2	3	4	5	6	7	8
50ms Loop Response (A)	0490									0545								
☛ Priority	0491									0546								
☛ Priority with Bypass	0492									0547								
☛ Auto-Bypass	0493									0548								
☛ Selective Bypass	0494									0549								
☛ Keyswitch Arming	0495									0550								
☛ Auto-Bypass Re-entry	0496									0551								
☛ Pre-Alarm Warning	0497									0552								
☛ Never Arm	0498									0553								
☛ 24-Hour Zone	0499									0554								
☛ Alarm Output	0500									0555								
☛ Pulsed Alarm Output	0501									0556								
☛ PGM1 Output	0502									0557								
☛ PGM2 Output	0503									0558								
☛ Entry/Exit 1	0504									0559								
☛ Entry/Exit 2	0505									0560								
☛ Exit/Entry Follower	0506									0561								
☛★ Auto Reset	0507									0562								
☛★ Swinger Shutdown	0508									0563								
☛ Chime	0509									0564								
☛ Abort Delay	0510									0565								
☛ Power-up Delay	0511									0566								
☛ Day Zone Open	0512									0567								
☛ Day Zone Short	0513									0568								
☛ Alarm on Day Zone	0514									0569								
☛ Alarm Telco 1	0515									0570								
☛ Alarm Restore 1	0516									0571								
☛ Trouble Telco 1	0517									0572								
☛ Trouble Restore 1	0518									0573								
☛ Alarm Telco 3	0519									0574								
☛ Alarm Restore 3	0520									0575								
☛ Trouble Telco 3	0521									0576								
☛ Trouble Restore 3	0522									0577								
☛ No EOL Resistor	0523									0578								
☛ Trouble on Open	0524									0579								
☛ Trouble on Short	0525									0580								
☛ Zone Area 1	0526									0581								
☛ Zone Area 2	0527									0582								
☛ Interior (Stay) Bypass	0528									0583								
☛ Keypad Sounder on Alarm	0529									0584								
☛ 2-Wire Smoke Detectors (B)	0530									0585								
☛ Fire (C)	0531									0586								
☛ Fire Alarm Verification (C)	0532									0587								
☛ RESERVED	0533									0588								
☛ Zone ANDing Group 1	0534									0589								
☛ Zone ANDing Group 2	0535									0590								
☛ Zone ANDing Group 3	0536									0591								
☛ Zone ANDing Group 4	0537									0592								
☛ Sensor Watch	0538									0593								
☛ RESERVED	0539									0594								
☛ Chime 2	0540									0595								

☛ When the Easy Program Menu is used, these features are enabled by default.

★ Enabled when "Enable SIA CP-01 Features?" is activated (Answer "Yes" in the EZ Programming Menu).

★ Disabled when "Enable SIA CP-01 Features?" is activated (Answer "Yes" in the EZ Programming Menu). Disable Auto-Reset on non-fire zones for SIA CP-01 installations.

**ZONE OPTIONS:** Select zone options for any zone.

☛ 1. Select the desired zone option by entering the option number (1-8) for each selected zone.

☛ 2. Enter corresponding option number in address location.

**NOTE:** Dark shaded data value box shows option not available. Press [Enter] or ON/OFF] to save

## ZONE OPTIONS - ZONES 17 TO 32 (ADDRESS 0601-0705)

ZONE FEATURES	ADDR	ZONES 17 → 24								ADDR	ZONES 25 → 32							
		Z17	Z18	Z19	Z20	Z21	Z22	Z23	Z24		Z25	Z26	Z27	Z28	Z29	Z30	Z31	Z32
		1	2	3	4	5	6	7	8		1	2	3	4	5	6	7	8
† Priority	0601									0656								
† Priority with Bypass	0602									0657								
† Auto-Bypass	0603									0658								
† Selective Bypass	0604									0659								
† Keyswitch Arming	0605									0660								
† Auto-Bypass Re-entry	0606									0661								
† Pre-Alarm Warning	0607									0662								
† Never Arm	0608									0663								
† 24-Hour Zone	0609									0664								
† Alarm Output	0610									0665								
† Pulsed Alarm Output	0611									0666								
† PGM1 Output	0612									0667								
† PGM2 Output	0613									0668								
† Entry/Exit 1	0614									0669								
† Entry/Exit 2	0615									0670								
† Exit/Entry Follower	0616									0671								
†★ Auto Reset	0617									0672								
†★ Swinger Shutdown	0618									0673								
† Chime	0619									0674								
† Abort Delay	0620									0675								
† Power-up Delay	0621									0676								
† Day Zone Open	0622									0677								
† Day Zone Short	0623									0678								
† Alarm on Day Zone	0624									0679								
† Alarm Telco 1	0625									0680								
† Alarm Restore 1	0626									0681								
† Trouble Telco 1	0627									0682								
† Trouble Restore 1	0628									0683								
† Alarm Telco 3	0629									0684								
† Alarm Restore 3	0630									0685								
† Trouble Telco 3	0631									0686								
† Trouble Restore 3	0632									0687								
† No EOL Resistor	0633									0688								
† Trouble on Open	0634									0689								
† Trouble on Short	0635									0690								
† Zone Area 1	0636									0691								
† Zone Area 2	0637									0692								
† Interior (Stay) Bypass	0638									0693								
† Keypad Sounder on Alarm	0639									0694								
† Fire (C)	0641									0696								
† Fire Alarm Verification (C)	0642									0697								
† Zone ANDing Group 1	0644									0699								
† Zone ANDing Group 2	0645									0700								
† Zone ANDing Group 3	0646									0701								
† Zone ANDing Group 4	0647									0702								
† Sensor Watch	0648									0703								
RESERVED	0649									0704								
† Chime 2	0650									0705								

† When the Easy Program Menu is used, these features are enabled by default.

† Enabled when "Enable SIA CP-01 Features?" is activated (Answer "Yes" in the EZ Programming Menu).

★ Disabled when "Enable SIA CP-01 Features?" is activated (Answer "Yes" in the EZ Programming Menu). Disable Auto-Reset on non-fire zones for SIA CP-01 installations.

**NOTES:** (A) 50ms Loop Response only available for zones 1-8. If Zone Doubling is enabled, Zones 9-16 will follow the loop response programming for Zones 1-8. For all other Zones, loop response is determined by jumpers on the GEM-EZM8 and/or keypad configuration on the GEM-RP1CAe2 or GEM-K1CA.  
 (B) 2-wire Smoke Detectors only available for zones 7 & 8.  
 (C) If Fire Alarm Verification is selected, then Fire must also be selected.

**DEFAULTS:** The zone options indicated are automatically set after exiting the Easy Menu Driven Mode.

- Priority, Selective Bypass, Alarm Output, Auto Reset, Swinger Shutdown and Zone Area 1 are enabled for the total number of zones entered in "\*\*\* OF ZONES IN AREA ENTER # ZONES".
- Alarm Telco 1 is enabled for the zone number(s) entered in "REPORT ALL ZONES TO CENTRAL ZONES? Y/N".
- Entry/Exit 1 and Chime are enabled for the zone number(s) entered in "ENTRY/EXIT ZONES ENTER ZONE #".
- Exit/Entry Follower and Interior Bypass are enabled for the zone number(s) entered in "INTERIOR ZONES ENTER ZONE #".
- Pulse Alarm Output is enabled for the zone number(s) entered in "FIRE ZONES ENTER ZONE #" or "2-WIRE FIRE ZNS ENTER ZONE #".
- Fire is enabled for the zone number(s) entered in "FIRE ZONES ENTER ZONE #".
- 2-Wire Smoke Detector is enabled for the zone number(s) entered in "2-WIRE FIRE ZNS ENTER ZONE #".



## EXTERNAL RELAY CONTROL (ADDRESS 0750-0829)

ADDRESS 0750-0754 (RELAY EVENT 1)				
0750	0751	0752	0753	0754
RELAY #	AREA	TIMEOUT	EVENT ID	COND.

ADDRESS 0755-0759 (RELAY EVENT 2)				
0755	0756	0757	0758	0759
RELAY #	AREA	TIMEOUT	EVENT ID	COND.

ADDRESS 0760-0764 (RELAY EVENT 3)				
0760	0761	0762	0763	0764
RELAY #	AREA	TIMEOUT	EVENT ID	COND.

ADDRESS 0765-0769 (RELAY EVENT 4)				
0765	0766	0767	0768	0769
RELAY #	AREA	TIMEOUT	EVENT ID	COND.

ADDRESS 0770-0774 (RELAY EVENT 5)				
0770	0771	0772	0773	0774
RELAY #	AREA	TIMEOUT	EVENT ID	COND.

ADDRESS 0775-0779 (RELAY EVENT 6)				
0775	0776	0777	0778	0779
RELAY #	AREA	TIMEOUT	EVENT ID	COND.

ADDRESS 0780-0784 (RELAY EVENT 7)				
0780	0781	0782	0783	0784
RELAY #	AREA	TIMEOUT	EVENT ID	COND.

ADDRESS 0785-0789 (RELAY EVENT 8)				
0785	0786	0787	0788	0789
RELAY #	AREA	TIMEOUT	EVENT ID	COND.

ADDRESS 0790-0794 (RELAY EVENT 9)				
0790	0791	0792	0793	0794
RELAY #	AREA	TIMEOUT	EVENT ID	COND.

ADDRESS 0795-0799 (RELAY EVENT 10)				
0795	0796	0797	0798	0799
RELAY #	AREA	TIMEOUT	EVENT ID	COND.

ADDRESS 0800-0804 (RELAY EVENT 11)				
0800	0801	0802	0803	0804
RELAY #	AREA	TIMEOUT	EVENT ID	COND.

ADDRESS 0805-0809 (RELAY EVENT 12)				
0805	0806	0807	0808	0809
RELAY #	AREA	TIMEOUT	EVENT ID	COND.

ADDRESS 0810-0814 (RELAY EVENT 13)				
0810	0811	0812	0813	0814
RELAY #	AREA	TIMEOUT	EVENT ID	COND.

ADDRESS 0815-0819 (RELAY EVENT 14)				
0815	0816	0817	0818	0819
RELAY #	AREA	TIMEOUT	EVENT ID	COND.

ADDRESS 0820-0824 (RELAY EVENT 15)				
0820	0821	0822	0823	0824
RELAY #	AREA	TIMEOUT	EVENT ID	COND.

ADDRESS 0825-0829 (RELAY EVENT 16)				
0825	0826	0827	0828	0829
RELAY #	AREA	TIMEOUT	EVENT ID	COND.

RELAY EVENT OPTIONS				
RELAY #	AREA	TIMEOUT	EVENT ID	COND.
See Step 1 below	See Step 2 below	See Step 3 below	See Step 4 below	See Step 5 below

[Default = blank (\*) from address 0750-0829].

To program, follow the 5 steps below.

### STEP 1

**RELAY # OPTIONS:** The GEM-P1632 supports 8 external relays from Relay Module RM3008. Multiple events may be "mapped" to each relay, up to a maximum of 16 events.

Select the **relay number** from **Table 1** (next page); enter in corresponding address location.

### STEP 2

**AREA OPTIONS:** Each relay event can be assigned to Area 1, Area 2 or both Area 1 and Area 2.

Select the **area** from **Table 2** (on next page); enter in corresponding address location.

### STEP 3

**TIMEOUTS:** Each relay event can be assigned a timeout depending on Alarm Type option.

If Alarm Type is selected for timeout in minutes or seconds, enter the 3-digit **timeout duration** in corresponding address location. To choose seconds or minutes, see step 5A below. 254 is maximum entry.

### STEP 4

**EVENT ID CODES:** Each relay event can be assigned any of the available event IDs from **Table 4**.

Select 2-digit **Event ID** from **Table 4** (on next page); enter in corresponding address locations (left and right digit).

### STEP 5

**RELAY EVENT CONDITION OPTIONS:** Each relay event can be assigned an alarm type; and an activation condition; also, select a timeout type for each. Enter 5A in left area, enter 5B in right area.

5A. Select **Alarm Type** and **Timeout Type** from **Table 5A** (on next page); enter in corresponding left address location.

5B. Select **Activation Conditions** from **Table 5B** (on next page); enter in corresponding right address location.

Continued

RELAY EVENT OPTIONS				
RELAY #	AREA	TIMEOUT	EVENT ID	COND.
See Table 1 below	See Table 2 below	Enter a Time period, in seconds or minutes	See Table 4 below	See Tables 5A & 5B below

**Table 1**

DATA ENTRY	RELAY #
blank (*)	NONE
1	1
2	2
3	3
4	4
5	5
6	6
7	7
8	8

**Table 2**

DATA ENTRY	TURN OFF ON AREA DISARM
blank (*)	NONE
1	Area 1
2	Area 2
3	Area 1 & Area 2

**Table 4**

EVENT ID CODES		
DATA ENTRIES		OPTION
LEFT	RIGHT	
blank (*)	blank (*)	Area 1 Arm
blank (*)	1	Area 2 Arm
blank (*)	8	Zone 1
blank (*)	9	Zone 2
blank (*)	0	Zone 3
blank (*)	B	Zone 4
blank (*)	C	Zone 5
blank (*)	D	Zone 6
blank (*)	E	Zone 7
blank (*)	F	Zone 8
1	blank (*)	Zone 9
1	1	Zone 10
1	2	Zone 11
1	3	Zone 12
1	4	Zone 13
1	5	Zone 14
1	6	Zone 15
1	7	Zone 16
1	8	Zone 17
1	9	Zone 18
1	0	Zone 19
1	B	Zone 20
1	C	Zone 21
1	D	Zone 22
1	E	Zone 23
1	F	Zone 24
2	blank (*)	Zone 25
2	1	Zone 26
2	2	Zone 27
2	3	Zone 28
2	4	Zone 29
2	5	Zone 30
2	6	Zone 31
2	7	Zone 32

**Table 4 (cont'd)**

EVENT ID CODES		
DATA ENTRIES		OPTION
LEFT	RIGHT	
3	blank (*)	Area 1 KP Ambush
3	1	Area 1 KP Panic
3	2	Area 1 KP Fire
3	3	Area 1 KP Aux *
3	4	Area 1 KP Tamper
3	5	Area 1 Fail to Open
3	6	Area 1 Fail to Close
3	8	Area 2 KP Ambush
3	9	Area 2 KP Panic
3	0	Area 2 KP Fire
3	B	Area 2 KP Aux *
3	C	Area 2 KP Tamper
3	D	Area 2 Fail to Open
3	E	Area 2 Fail to Close
4	blank (*)	Test Timer
4	3	Memory Fail
4	4	Low Battery
4	5	AC Fail
4	6	EZM Tamper
4	7	Alarm Supervisory
4	D	RF Receiver Trouble (Tamper/Fail)
4	E	Wireless TX Tamper
4	F	Wireless TX Trouble (LB/Supervisory)
C	8	Area 1 Arming AWAY
C	9	Area 2 Arming AWAY
D	blank (*)	Keypad Fail
D	1	EZM Fail
D	2	Quickloader Device Control
D	5	General System Alarm
D	8	Area 1 General System Alarm
D	9	Area 2 General System Alarm
F	blank (*)	Relay Control Group 1
F	1	Relay Control Group 2
F	8	Entry Relay Area 1
F	9	Entry Relay Area 2

**Table 5A**

RELAY EVENT ALARM TYPE OPTIONS		
LEFT DATA ENTRIES	ALARM TYPE	TIMEOUT TYPE
blank (*)	Burglary	Minutes
1	Fire	Minutes
4	Day Zone	Minutes
8	Burglary	Seconds
9	Fire	Seconds
C	Day Zone	Seconds

**Table 5B**

RELAY EVENT ACTIVATION CONDITIONS	
RIGHT DATA ENTRIES	OPTIONS
1	Alarm
2	Restore
3	Trouble
4	Trouble Restore
5	Follow Zone

\* NOTE: Keypad Auxiliary is not to be selected for UL Installations.  
 NOTE: Keypad Tamper must be enabled in UL installations.

Direct Address Program Mode



## RF RECEIVER & SUPERVISORY TIMER OPTIONS (ADDRESS 1038-1053 & 1180)

Number of RF Receivers	ADDRESS 1180	
	LEFT DIGIT	RIGHT DIGIT
	blank (*)	

DATA ENTRIES	RF RECEIVER(S)
blank (*)	None
1	1
2	2

**RF RECEIVERS:** Up to 2 RF Receivers may be programmed. **NOTE:** This adds wireless capability to the system, increasing up to 16 the number of zones.

1. Select the number of receivers from the table shown.

2. Enter number in address location shown.

3. Press  or  to save.

Default for Number of Receivers depends on Easy Menu Question for RF Transmitters.

**RF SUPERVISORY TIMERS:** RF Supervisory Timers may be programmed for each type of transmitter used. A transmitter will send a transmission every time it is tripped, when there is NO activity, the transmitter sends a status transmission about once an hour. If the receiver does NOT receive ANY signal (a trip or a status) from a transmitter in the time specified for transmitter type, a system trouble "WIRELESS TROUBLE/EDY-NN SERVICE" will be displayed at the keypad.

1. Select timer delay from the table shown. Timers are programmed in increments of 30 minutes each. Valid entries are [3] through [F] (90 minutes-450 minutes).

2. Enter in corresponding address locations below.

3. Press  or  to save.

RF SUPERVISORY TIMER	RF TRANSMITTER	ADDR	RF SUPERVISORY DELAY TIME (Select timer delay from the table at right)
Type 0	Window/Door, 2 Pt.	1038	
Type 1	Window/Door, 2 Pt.	1039	
Type 2	Window/Door, 2 Pt.	1040	
Type 3	Window/Door, 2 Pt.	1041	
Type 4	Window/Door, 4 Pt.	1042	
Type 5	PIR	1043	
Type 6	PIR	1044	
Type 7	Smoke Detector	1045	
Type 8	Smoke Detector	1046	
Type 9	Keyfob	1047	
Type A	Dual Tech.	1048	
Type B	Keyfob	1049	
Type C	Window/Door, 4 Pt.	1050	
Type D	PIR	1051	
Type E	Smoke Detector	1052	
Type F	Napco Glass Break	1053	

RF SUPERVISORY TIMERS	
DATA ENTRIES	DELAY
3	90 min.
4	120 min.
5	150 min.
6	180 min.
7	210 min.
8	240 min.
9	270 min.
0	300 min.
B	330 min.
C	360 min.
D	390 min.
E	420 min.
F	450 min.

[Default = blank (\*) from address 1046-1053]. Default = 8 (240 minutes)

**NOTE:** These timers apply only to Supervised RF Transmitters (see RF Transmitters in Easy Menu Driven Mode Programming).

**CLEAR PROGRAM OPTIONS (ADDRESS 1197 & 1198)**

1197 XX

H

**Clear Dealer Program (Erases Dealer Program)**

This erases the dealer program. Use this feature to start a customized default program. Program Data and System Status Memory is erased where Scheduled Data and Zone Descriptions are maintained.

Access address 1197, then press . Data entry is not allowed.

**NOTE:** Enter Easy Menu Driven Program Mode to program system again.

1198 XX

H

**Cold Start (Erases Entire Program)**



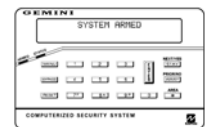

This erases the entire program including Dealer Program by erasing Program Data, Zone Description Data and System Status Data (similar to a new panel).

Access address 1198, then press . Data entry is not allowed.



**NOTE:** Some features (schedules) can only be programmed again with the Downloading Software.

**USER PROGRAM MODE****PRELIMINARY INFORMATION**

The User Program Mode is covered in detail in the operating instructions for the keypad in use.

-  Only Keypad #1 may be used for programming, however this keypad may be located in any area.
-  The Program Mode cannot be accessed while the communicator is transmitting except during the first three minutes after power-up.
-  After entering codes or data, press the save  button. *Data will not be stored into memory unless this button is pressed.*
-  If the keypad is in the Program Mode and no activity is detected for longer than 4 minutes, a steady tone will sound.

**NOTE:** For ease of programming, it is recommended that a GEM K1CA (or GEM-RP1CAe2) be used as Keypad #1. A new GEM-K1CA and a new GEM-RP1CAe2 are automatically configured as Keypad #1. See Keypad Configuration Mode.

-  Press the  button to silence the sounder and exit the User Program Mode.

If a GEM-RP2ASe2/GEM-K2AS keypad is used, configure address jumpers as Keypad #1 (See W11148).



## ACCESSING USER PROGRAM MODE

**1. Press**

**2. Press** **Until "ACTIVATE PROGRAM Y/N" appears on LCD screen.**

**3. Press** **To Enter User Program Mode**

**4. Press** **To Exit User Program Mode when finished**

## USER CODES

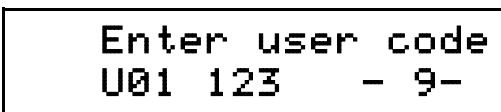

GEM-K1CAe2 Keypad (Direct Entry)

Up to 32 User Codes may be programmed.  
**NOTE:** In this mode, only the code is programmable; the accompanying Area Options must be programmed in the Dealer Program Mode (see page 8).

Use the button to place the cursor over the User Number.

Enter a User Number (01-8) using the number buttons. The cursor will then advance to the User Code and read the existing code, if any.

Enter the new User Code using the number buttons (0-9). If an old code is displayed, program over it. To erase the digit at the cursor, press .

Press the button to save the code in memory.

Repeat this procedure for each user. To proceed to Zone-Description programming, press the NEXT button or the PRIOR button.

**To Program User Codes**

1. Set Cursor Position using the .
2. Enter 2-digit User Number (01-32) directly using number buttons (0-9).
3. Enter Code (1-6 digits) directly using number buttons (0-9).
4. Press the button to save each code.

**NOTE:** Press button to clear character at cursor.  
 To continue press or .

Programming User Codes with GEM-K1CAe2 Keypad





## ZONE DESCRIPTIONS (GEM-RP1CAE2 / GEM-K1CA KEYPADS)

01-

Enter an identifying description for each zone. Buttons **1** and **2** set the cursor position; buttons **3** and **6** scroll numbers, letters, punctuation marks, etc.

 Position the cursor over the displayed Zone Number (i.e., "01") using buttons **1** and **2**.

 Change the Zone Number using buttons **3** and **6**.

 Position the cursor over the first character of the description field. Advancing the cursor between characters, program a description of up to two lines for the new zone using buttons **3** and **6**.

### To Program Zone Descriptions

1. Set the Cursor Position using buttons **1** and **2**.
2. Select characters for zone description using buttons **3** and **6**.
3. Press the  button to save each descriptor.

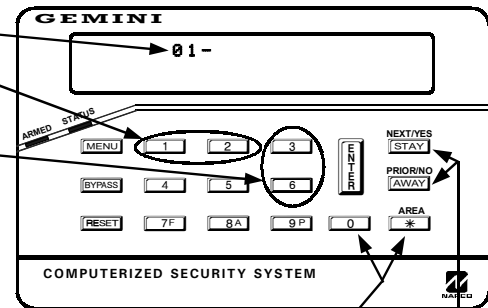

**NOTE:** Press **\*** **0** button to clear character at cursor.  
To continue press **STAY** or **AWAY** button.

### Programming Zone Descriptions

Press  to save. Advance to the next zone as in Steps 1 and 2 above and repeat this procedure until all zones have been programmed. After programming the user codes, press the NEXT button to proceed.

Enter Date

( / / )

(Direct Entry)

**Enter Date** (Press the  button to set cursor.)

Enter the current date in the format MM/DD/YY, where MM = the month (01-12); DD=the day (01-31); and YY=the year. Press  to save. Press NEXT button to proceed.

Enter Time

( : )

(Direct Entry)

**Enter Time** (Press the  button to set cursor.)

Enter the current time in the format HH:MMA/P, where HH=hours (01-12); MM=minutes (00-59). Select Am or Pm by pressing any number button, then press  once again to save.

**NOTE:** To enter the date and time, GEM-RP1CAe2/GEM-K1CA keypad (version 6 or greater) must be used and "Enable Keypad Time/Date Display" (Address 0718) must be enabled.

# KEYPAD CONFIGURATION MODE

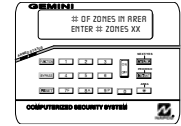

This section will focus on configuring the GEM-RP1CAe2/GEM-K1CA Keypads. If there is more than one keypad in the system, *only Keypad No. 1 may be used for programming.*

## KEYPAD INSTALLATION

Several types of keypads may be used with the GEM-P1632: the GEM-RP1CAe2/GEM-K1CA, the GEM-RP2ASe2/GEM-K2AS, the GEM-RP3DGTL/GEM-K3DGTL, and the GEM-RP4RFC/GEM-K4RF series (see WI1148). Each must be assigned an address number (1–7) and each requires its own configuration procedure (see CONFIGURING THE KEYPADS, which follows, and DIRECT ADDRESS KEYPAD AREA OPTIONS). At least 1 keypad must be used; only 1 is required for a single-area Commercial Burglary installation.

**GEM-RP1CAe2/GEM-K1CA** - is a 2-line combination fire/burglary/access keypad capable of supporting 4 EZM zones and a PGM output. The GEM-RP1CAe2 or GEM-K1CA is recommended for use as Keypad #1. See "Important Note" on page 2 for more information regarding the buttons on the GEM-RP1CAe2/GEM-K1CA keypads.

## CONFIGURING THE KEYPADS

A total of up to 7 keypads may be connected to the panel. GEM-RP1CAe2/GEM-K1CA, GEM-RP2ASe2/GEM-K2AS, GEM-RP3DGTL/GEM-K3DGTL, and GEM-RP4RFC/GEM-K4RF series keypads may be intermixed but require different configuration procedures, as described below and in WI1148.

### Configuring the GEM-RP1CAe2/GEM-K1CA Keypad

Each GEM-RP1CAe2/GEM-K1CA keypad must be configured for (a) keypad tactile beep; (b) entry sounder; (c) keypad address; (d) compatibility number; (e) EZM address; and (f) zone response.

#### To enter the Keypad Configuration Mode:

1. Move jumper JP1 (located in the center of the control panel board) from Pins 1-2 (top two) to Pins 2-3 (bottom two). **NOTE:** See Wiring Diagram on page 48.
2. After about 15 seconds, the display will read "XX OUT OF SYSTEM", where XX indicates the keypad address.
3. Press **1** **1** **1** **2** **3** **MENU** and proceed as follows. (Repeat the following procedure for all keypads).



### Keypad Tactile Beep

Upon entering the Keypad Configuration Mode, "KEYPAD BEEP ON" will be displayed, indicating that the tactile beep, which sounds when any button is pressed, is on. To turn off the tactile beep, press the **1** button (the **1** button will toggle the tactile beep on and off). Press **MENU** to continue or press **RESET** to exit.



### Entry Sounder

To turn off the keypad entry sounder during entry time, press **1** (the **1** button will toggle the entry sounder on and off). Press **MENU** to continue or press **RESET** to exit.



### Keypad Address

If more than one keypad is installed, each must be assigned a unique keypad address (that is, no two keypads may be numbered alike):

☞ Keypads must be numbered consecutively (missing numbers are not permitted)

☞ Only Keypad No. 1 may be used for programming.

To assign the keypad number, proceed as follows:

1. Enter the assigned keypad number 01–07, then press **1** to save. A valid number will be acknowledged by a short beep; an invalid number will be rejected by a long beep.
2. Press **MENU** to continue or press **RESET** to exit.

New Compat # 0000
----------------------

**Compatibility Number (Not Applicable)**

THIS FEATURE IS NOT COMPATIBLE WITH THE GEM-P1632 CONTROL PANEL.

Press the **MENU** button to continue or press the **RESET** button to exit.

EZM Address 01
-------------------

**EZM Address**

The keypad's internal EZM (Expansion Zone Module) may be utilized to provide four additional wired zones. Whether used alone or in conjunction with optional GEM-EZM series modules or other keypad EZMs, it must be assigned a unique address (or Group number, see Keypad Programming Workbook) similar to its keypad address. If no other EZMs are to be used,

designate the keypad as Group "01" at the "EZM ADDRESS 00" display. In multiple-EZM systems, enter an assigned group number "01" through "06". (Each EZM must have a unique assigned group number, starting with "01" and proceeding consecutively.) Press the **MENU** button to continue or press the **RESET** button to exit.

Zone Response 00
---------------------

**Zone Response**

The normal loop response of each keypad expansion zone is 750mS, however the response time of any zone can be reduced to 50mS as follows.

1. Of the following, circle the number(s) in parentheses associated with the zone(s) to be changed: Zone 1=(1); Zone 2=(2); Zone 3=(4); Zone 4=(8)
2. Add up the circled numbers.

3. At the keypad, enter the sum as a two-digit number "01" through "15" on the display, then press **ENTER**.

**Example.** Change Zones 2, 3 and 4 to 50mS response.

1. Circle numbers for Zones 2, 3 and 4: (2), (4) and (8).
2. Add up the circled numbers:  $2 + 4 + 8 = 14$ .
3. Enter "14" at the keypad, then press the **ENTER** button.

Press the **MENU** button to continue or press the **RESET** button to exit.

**Program Control Message (Not Applicable)**

Program Control Message # ?
--------------------------------

THIS FEATURE IS NOT COMPATIBLE WITH THE GEM-P1632 CONTROL PANEL.

Press the **MENU** button to continue (the display will loop back through selections, for changes) or press the **RESET** button to exit the Keypad Configuration Mode (display will read "01 OUT OF SYSTEM"). Then replace Jumper JP1 across Pins 1-2 (top two).

# EASY MENU PROGRAMMING WORKSHEET - 1 OF 3

<b>Name:</b>	<b>Address:</b>
<b>Account Number:</b>	<b>Installer:</b>

**Area 1: # of Zones (1-32) =**   **Zone Doubling?:** Yes  No  **Area 1: # of Keypads (1-8) =**

**NOTE:** Area 2 Zones and Keypads are selected in Direct Address Mode. See Zone Options and Keypad Options.

**Enter Fire Zones (1-32):** \_\_\_\_\_ **2-Wire Fire Zones?:** Zone 7 Yes  No  Zone 8 Yes  No

**Enter Entry/Exit Zones (1-32):** \_\_\_\_\_ **Enter Interior Zones (1-32):** \_\_\_\_\_

**Report all Zones to Central?:** Yes  No

**Central Station Receiver 1 Telephone Number:**

**Central Station Receiver 1 Account Number:**

**Central Station Receiver 1 Format:**

- |  |   |
|--|---|
| <input type="checkbox"/> blank (*) = Ademco Slow, Silent Knight Slow<br><input type="checkbox"/> 2 = Radionics Fast<br><input type="checkbox"/> 3 = Silent Knight Fast<br><input type="checkbox"/> 4 = Radionics, DCI, Franklin Slow | <input type="checkbox"/> 5 = Universal High Speed<br><input type="checkbox"/> B = SIA<br><input type="checkbox"/> C = Ademco Point ID<br><input type="checkbox"/> E = Pager |
|--|---|

**User Codes:**

USER #	CODE (up to 6 digits)	AREA 1 OPTIONS	AREA 2 OPTIONS
1			
2			
3			
4			
5			
6			
7			
8			
9			
10			
11			
12			
13			
14			
15			
16			

USER #	CODE (up to 6 digits)	AREA 1 OPTIONS	AREA 2 OPTIONS
17			
18			
19			
20			
21			
22			
23			
24			
25			
26			
27			
28			
29			
30			
31			
32			

# EASY MENU PROGRAMMING WORKSHEET - 2 OF 3

## RF Transmitter Points:

XMTR #	ZONE #	RF ID (printed on xmtr box)					CHECK SUM	POINT #
1								
2								
3								
4								
5								
6								
7								
8								
9								
10								
11								
12								
13								
14								
15								
16								

XMTR #	ZONE #	RF ID (printed on xmtr box)					CHECK SUM	POINT #
17								
18								
19								
20								
21								
22								
23								
24								
25								
26								
27								
28								
29								
30								
31								
32								

## Key Fob Transmitters:

KEY FOB #	Area	RF ID (printed on xmtr box)					CHECK SUM	OPTION 1	OPTION 2
1									
2									
3									
4									
5									
6									
7									
8									

# EASY MENU PROGRAMMING WORKSHEET - 3 OF 3

Zone Descriptions (GEM-RP1CAe2 Keypads Only):

ZN #	CHARACTERS AVAILABLE (See below)																												
	1	2	3	4	5	6	7	8	9	10	11	12	13	14	15	16	17	18	19	20	21	22	23	24	25	26	27	28	29
1																													
2																													
3																													
4																													
5																													
6																													
7																													
8																													
9																													
10																													
11																													
12																													
13																													
14																													
15																													
16																													
17																													
18																													
19																													
20																													
21																													
22																													
23																													
24																													
25																													
26																													
27																													
28																													
29																													
30																													
31																													
32																													

**Characters Available for Zone Descriptions**  
 !@#\$%^&\*()\_+!|{|}[]`.,.<>?  
 1234567890  
 abcdefghijklmnopqrstuvwxyz  
 ABCDEFGHIJKLMNOPQRSTUVWXYZ

Dealer Code:

**ALPHABETICAL INDEX**

PROGRAMMING OPTION	PROGRAM MODE	ADDRESS LOCATION	PAGE
24-Hour Zone (Enable Zone)	Direct Address	0499, 0554, 0609, 0664	26-27
3/1 with Extended Restores	Direct Address	0171, 0193 & 0215	19
50ms Loop Response (A) (Enable Zone)	Direct Address	0490	26
Abort Delay (Enable Zone)	Direct Address	0510, 0565, 0620, 0675	26-27
Abort Delay (Time)	Direct Address	0715	15
Abort Delay Limit Enable	Direct Address	1062	18
AC Fail Report Delay (Time)	Direct Address	0717	15
Access Control on PGM2 Output	Direct Address	0719	18
Alarm on Day Zone (Enable Zone)	Direct Address	0514, 0569, 0624, 0679	26-27
Alarm Output (Enable Zone)	Direct Address	0500, 0555, 0610, 0665	26-27
Alarm Output Timeout	Direct Address	0712	16
Alarm Restore 1 (Enable Zone)	Direct Address	0516, 0571, 0626, 0681	26-27
Alarm Restore 3 (Enable Zone)	Direct Address	0520, 0575, 0630, 0685	26-27
Alarm Telco 1 (Enable Zone)	Direct Address	0515, 0570, 0625, 0680	26-27
Alarm Telco 3 (Enable Zone)	Direct Address	0519, 0574, 0629, 0684	26-27
AREA (PRIORITY) ARMING OPTIONS	Direct Addresses	0743 & 0744	23
Area Bell Control Options	Direct Address	745-747, 749	24
Auto Bell Test on Arming	Direct Address	0719	18
Auto Reset (Enable Zone)	Direct Address	0507, 0562, 0617, 0672	26-27
Auto Reset after Burglary Output Timeout	Direct Address	0719	18
Auto-Bypass (Enable Zone)	Direct Address	0493, 0548, 0603, 0658	26-27
Auto-Bypass Re-entry (Enable Zone)	Direct Address	0496, 0551, 0606, 0661	26-27
Automatic Interior Bypass/Easy Exit	Direct Address	0722	18
Backup Reporting on Telco 2	Direct Address	0394	21
Burglary Output Turns Off upon Disarm	Direct Address	0745	24
Callback Telephone Number	Direct Address	0236-0255	16
Cancel Next Test Timer on any Report	Direct Address	0394	21
Cancel Report Code	Direct Address	0330	20
Change Pulse Output to Temporal Output	Direct Address	0720	18
Chime (Enable Zone)	Direct Address	0509, 0564, 0619, 0674	26-27
Chime 2 (Enable Zone)	Direct Address	0540, 0595, 0650, 0705	26-27
Chime Timeout	Direct Address	0716	15
Chirp Output on Keyfob Arm/Disarm	Direct Address	0720	18
Clear Dealer Program	Direct Address	1197	31
Closing Report Only on Conditional Close	Direct Address	0718	18
Cold Start	Direct Address	1198	31
CS AREA & SYSTEM REPORTING OPTIONS	Direct Addresses	0391, 0392 & 0394	21
CS Receiver 1, 2 & 3 Formats	Direct Address	0170, 0192 & 0214	19
CS Receiver 1, 2 & 3 Telephone Numbers	Direct Address	0172-0191, 0194-0213 & 0216-0235	19
CS RECEIVER OPTIONS	Direct Addresses	0170-0191, 0192-0213, 0214-0235	19
CS SUBSCRIBER ID & SYSTEM REPORTING OPTIONS	Direct Addresses	0259-0350	20
CS SYSTEM REPORTING CODES	Direct Addresses	0319-0332, 0333-0350	20
CS Telco 1, 2 & 3 Subscriber Event ID Numbers (Area 1)	Direct Address	0227-0270, 0287-0290 & 0307-0310	20
CS Telco 1, 2 & 3 Subscriber Event ID Numbers (Area 2)	Direct Address	0271-0274, 0291-0294 & 0311-0314	20
CS Telco 1, 2 & 3 Subscriber Event ID Numbers (System)	Direct Address	0275-0278, 0295-0298 & 0315-0318	20
CS Telco 1, 2 & 3 Subscriber Opening/Closing ID Numbers (Area 1)	Direct Address	0259-0262, 0279-0282 & 0299-0302	20
CS Telco 1, 2 & 3 Subscriber Opening/Closing ID Numbers (Area 2)	Direct Address	0263-0266, 0291-0294 & 0303-0306	20
CS USER REPORTING OPTIONS	Direct Addresses	0440-0459	22
CS ZONE REPORTING OPTIONS	Direct Addresses	0358-0389	21
Day Zone Open (Enable Zone)	Direct Address	0512, 0567, 0622, 0677	26-27
Day Zone Short (Enable Zone)	Direct Address	0513, 0568, 0623, 0678	26-27
Dealer Code	Easy Menu Driven	N/A	5
Digital Dialer Report Enter/Exit Test Mode	Direct Address	1062	18
Disable [ON/OFF] as Easy Exit	Direct Address	1060	18
Disable Auto Cancel on Disarm	Direct Address	1060	18
Disable Auto Dial Tone Detect	Direct Address	0394	21
Disable Call Waiting on 1 <sup>st</sup> Attempt	Direct Address	1062	18
Disable Callback Download	Direct Address	0720	18
Disable Closing Reports	Direct Address	0392	21
Disable Function Mode Download	Direct Address	0720	18
Disable Keypad Function Mode Download	Direct Address	0720	18
Disable Keypad Instant Mode	Direct Address	0719	18
Disable Opening Reports	Direct Address	0391	21
Disable Second Call Ans. Machine Override	Direct Address	0722	18
Disable System Trouble Audible Timeout	Direct Address	1060	18
Disable Wait for Handshake	Direct Address	0394	21
Disable Wait for Silence	Direct Address	0394	21
Disable Zone Fault Scrolling	Direct Address	0718	18
DOWNLOAD/CALLBACK OPTIONS	Direct Addresses	1183 & 0236-0255	16
Enable Alarm Output on Telco Fail only when Armed	Direct Address	0721	18
Enable AutoArm if not closed at end of Window	Direct Address	0718	18



# ALPHABETICAL INDEX (CONT'D)

PROGRAMMING OPTION	PROGRAM MODE	ADDRESS LOCATION	PAGE
Enable Cancel Report to Telco 3	Direct Address	1060	18
Enable CP-01 Limits	Direct Address	1062	18
Enable EZM Group	Direct Address	0737-0742	23
Enable GEM-PRINT Module	Direct Address	1060	18
Enable Global Ambush Code	Direct Address	0720	18
Enable Keypad Set Time/Date Message	Direct Address	1060	18
Enable Line-Fault Test	Direct Address	0721	18
Enable Local Alarm on First Zone AND Trip	Direct Address	0719	18
Enable Manager's Mode	Direct Address	0719	18
Enable Residential Fire	Direct Address	0720	18
Enable Stay/Away Keypad	Direct Address	1060	18
Enable Time/Date KP Display	Direct Address	0718	18
Enable Zone Doubling	Direct Address	0721	18
Enable Zone Number on Pulse Alarm	Direct Address	0171, 0193 & 0215	19
Entry Delay 1 (Time)	Direct Address	0001	15
Entry Delay 2 (Time)	Direct Address	0002	15
Entry/Exit 1 (Enable Zone)	Direct Address	0504, 0559, 0614, 0669	26-27
Entry/Exit 2 (Enable Zone)	Direct Address	0505, 0560, 0615, 0670	26-27
Exit Delay (Time)	Direct Address	0000	15
Exit Time Restart	Direct Address	1062	18
Exit/Entry Follower (Enable Zone)	Direct Address	0506, 0561, 0616, 0671	26-27
External Relay Control	Direct Address	750-829	28-29
EXTERNAL RELAY CONTROL	Direct Addresses	0750-0829	28-29
EZM GROUP OPTIONS	Direct Addresses	0737-0742	23
Fire (C) (Enable Zone)	Direct Address	0531, 0586, 0641, 0696	26-27
Fire Alarm Verification (C) (Enable Zone)	Direct Address	0532, 0587, 0642, 0697	26-27
Global Ambush Code	Direct Address	1054	17
Incl. Sel./Grp. Bypass in Cond. Close /Status	Direct Address	0718	18
Include Select/Group Bypass in Conditional Close/Status	Direct Address	0718	18
Inhibit System Trouble Audible at Keypad	Direct Address	0721	18
Interior (Stay) Bypass (Enable Zone)	Direct Address	0528, 0583, 0638, 0693	26-27
Interior Normally Bypassed	Direct Address	0720	18
Key fob Transmitters	Easy Menu Driven	N/A	9
Keypad Options	Direct Address	0723-0736, 1055-1058	25
Keypad Sounder on Alarm (Enable Zone)	Direct Address	0529, 0584, 0639, 0694	26-27
KEYPAD TYPE OPTIONS	Direct Addresses	0723-0736	25
Keyswitch Arming (Enable Zone)	Direct Address	0495, 0550, 0605, 0660	26-27
Leading Digits for Pager Format	Direct Address	0256 & 0257	16
Line-Fault Test only when Armed	Direct Address	0721	18
Maintained Keyswitch Arming	Direct Address	0719	18
Modem Codes (CS ZONE REPORTING)	Direct Addresses	0358-0389	21
Never Arm (Enable Zone)	Direct Address	0498, 0553, 0608, 0663	26-27
No EOL Resistor (Enable Zone)	Direct Address	0523, 0578, 0633, 0688	26-27
Number of Rings before Pickup	Direct Address	1183	16
Opening Report Only after Alarm Report	Direct Address	0718	18
OUTPUT TURNS OFF UPON DISARM	Direct Addresses	0745-0749	24
PAGER FORMAT OPTIONS	Direct Addresses	0256 & 0257	16
PGM1 Output (Enable Zone)	Direct Address	0502, 0557, 0612, 0667	26-27
PGM1 Output Timeout	Direct Address	0714	16
PGM1 Output Turns Off upon Disarm	Direct Address	0747	24
PGM2 Output (Enable Zone)	Direct Address	0503, 0558, 0613, 0668	26-27
PGM2 Output Access Control Timeout	Direct Address	0711	15
PGM2 Output Chirp on Key fob Arming	Direct Address	0722	18
PGM2 Output Timeout	Direct Address	0710	16
PGM2 Output Turns Off upon Disarm	Direct Address	0749	24
PGM2, Don't Clear Output with Arm/Disarm	Direct Address	0722	18
Power-up Delay (Enable Zone)	Direct Address	0511, 0566, 0621, 0676	26-27
Pre-Alarm Warning (Enable Zone)	Direct Address	0497, 0552, 0607, 0662	26-27
Priority (Enable Zone)	Direct Address	0491, 0546, 0601, 0656	26-27
PRIORITY AREA ARMING OPTIONS	Direct Addresses	0743 & 0744	23
Priority with Bypass (Enable Zone)	Direct Address	0492, 0547, 0602, 0657	26-27
Pulse Event Codes (CS ZONE REPORTING)	Direct Addresses	0358-0389	21
Pulsed Alarm Output (Enable Zone)	Direct Address	0501, 0556, 0611, 0666	26-27



**ALPHABETICAL INDEX (CONT'D)**

PROGRAMMING OPTION	PROGRAM MODE	ADDRESS LOCATION	PAGE
Pulsed Alarm Output Timeout	Direct Address	0713	16
Pulsed Burg Output Turns Off upon Disarm	Direct Address	0746	24
Report Cancel Window	Direct Address	1179	15
Report Exit Error/Recent Close	Direct Address	1062	18
Reset Day Zone with Arm/Disarm Only	Direct Address	0720	18
<b>RF RECEIVER &amp; SUPERVISORY TIMER OPTIONS</b>	<b>Direct Addresses</b>	<b>1038-1053 &amp; 1180</b>	<b>30</b>
RF Transmitter Points	Easy Menu Driven	N/A	9
Select Alarm Output for Keyfob Chirp	Direct Address	0721	18
Selective Bypass (Enable Zone)	Direct Address	0494, 0549, 0604, 0659	26-27
Sensor Watch (Enable Zone)	Direct Address	0538, 0593, 0648, 0703	26-27
Sensor Watch Time	Direct Address	1059	15
Sound Alarm On Exit Error	Direct Address	1062	18
Status Report	Direct Address	0718	18
Sum check	Direct Address	0171, 0193 & 0215	19
Suppress Bypass Reminder when Armed	Direct Address	0719	18
Swinger Shutdown (Enable Zone)	Direct Address	0508, 0563, 0618, 0673	26-27
<b>SYSTEM DELAYS &amp; TIMEOUTS</b>	<b>Direct Addresses</b>	<b>0000-0002, 0711, 0715, 1059, 0716, 0717</b>	<b>15</b>
<b>SYSTEM OPTIONS</b>	<b>Direct Addresses</b>	<b>0718-0722, 1060-1062</b>	<b>18</b>
<b>SYSTEM OUTPUT TIMEOUTS</b>	<b>Direct Addresses</b>	<b>0710, 0712, 0713 &amp; 0714</b>	<b>16</b>
<b>SYSTEM RESPONSE ACTIVATED BY AREA 1 EVENT/TROUBLE</b>	<b>Direct Addresses</b>	<b>0470-0477</b>	<b>17</b>
<b>SYSTEM RESPONSE ACTIVATED BY AREA 2 EVENT/TROUBLE</b>	<b>Direct Addresses</b>	<b>0478-0485</b>	<b>17</b>
<b>SYSTEM RESPONSE ACTIVATED BY GLOBAL EVENT/TROUBLE</b>	<b>Direct Addresses</b>	<b>0460-0469</b>	<b>17</b>
Test Timer	Direct Address	0332	20
Touch-tone Dialing w/Rotary Backup	Direct Address	0394	21
Trouble on Open (Enable Zone)	Direct Address	0524, 0579, 0634, 0689	26-27
Trouble on Short (Enable Zone)	Direct Address	0525, 0580, 0635, 0690	26-27
Trouble Restore 1 (Enable Zone)	Direct Address	0518, 0573, 0628, 0683	26-27
Trouble Restore 3 (Enable Zone)	Direct Address	0522, 0577, 0632, 0687	26-27
Trouble Telco 1 (Enable Zone)	Direct Address	0517, 0572, 0627, 0682	26-27
Trouble Telco 3 (Enable Zone)	Direct Address	0521, 0576, 0631, 0686	26-27
User Codes	Easy Menu Driven	N/A	8
User Opening/Closing Telco 1 & 3 (Users 00-32 & 97-99)	Direct Address	0430-0449	22
Veri-phone Audio Priority Over Alarms	Direct Address	0722	18
Veriphone Zones trip PGM2 Output	Direct Address	0722	18
Wireless Trouble Activates Telco 1	Direct Address	0721	18
Wireless Trouble Activates Telco 3	Direct Address	0721	18
Zone ANDing Group 1 (Enable Zone)	Direct Address	0534, 0589, 0644, 0699	26-27
Zone ANDing Group 2 (Enable Zone)	Direct Address	0535, 0590, 0645, 0700	26-27
Zone ANDing Group 3 (Enable Zone)	Direct Address	0536, 0591, 0646, 0701	26-27
Zone ANDing Group 4 (Enable Zone)	Direct Address	0537, 0592, 0647, 0702	26-27
Zone Area 1 (Enable Zone)	Direct Address	0526, 0581, 0636, 0691	26-27
Zone Area 2 (Enable Zone)	Direct Address	0637, 0692	27
Zone Descriptors	Easy Menu Driven	N/A	9
Zones Report Code (Zones 1-32)	Direct Address	0358-0389	21

# ADDRESS NUMBER INDEX

ADDRESS	OPTION	PAGE
0000	Exit Delay (Time)	15
0000-0002	SYSTEM DELAYS & TIMEOUTS	15
0001	Entry Delay 1 (Time)	15
0002	Entry Delay 2 (Time)	15
0170	CS Receiver 1, 2 & 3 Formats	19
0170-0191	CS RECEIVER OPTIONS	19
0171	3/1 with Extended Restores	19
0171	Enable Zone Number on Pulse Alarm	19
0171	Sum check	19
0172-0191	CS Receiver 1, 2 & 3 Telephone Numbers	19
0192	CS Receiver 1, 2 & 3 Formats	19
0192-0213	CS RECEIVER OPTIONS	19
0193	3/1 with Extended Restores	19
0193	Enable Zone Number on Pulse Alarm	19
0193	Sum check	19
0194-0213	CS Receiver 1, 2 & 3 Telephone Numbers	19
0214	CS Receiver 1, 2 & 3 Formats	19
0214-0235	CS RECEIVER OPTIONS	19
0215	3/1 with Extended Restores	19
0215	Enable Zone Number on Pulse Alarm	19
0215	Sum check	19
0216-0235	CS Receiver 1, 2 & 3 Telephone Numbers	19
0227-0270	CS Telco 1, 2 & 3 Subscriber Event ID Numbers (Area 1)	20
0236-0255	Callback Telephone Number	16
0236-0255	DOWNLOAD/CALLBACK OPTIONS	16
0256	Leading Digits for Pager Format	16
0256	PAGER FORMAT OPTIONS	16
0257	Leading Digits for Pager Format	16
0257	PAGER FORMAT OPTIONS	16
0259-0262	CS Telco 1, 2 & 3 Subscriber Opening/Closing ID Numbers (Area 1)	20
0259-0350	CS SUBSCRIBER ID & SYSTEM REPORTING OPTIONS	20
0263-0266	CS Telco 1, 2 & 3 Subscriber Opening/Closing ID Numbers (Area 2)	20
0271-0274	CS Telco 1, 2 & 3 Subscriber Event ID Numbers (Area 2)	20
0275-0278	CS Telco 1, 2 & 3 Subscriber Event ID Numbers (System)	20
0279-0282	CS Telco 1, 2 & 3 Subscriber Opening/Closing ID Numbers (Area 1)	20
0287-0290	CS Telco 1, 2 & 3 Subscriber Event ID Numbers (Area 1)	20
0291-0294	CS Telco 1, 2 & 3 Subscriber Event ID Numbers (Area 2)	20
0291-0294	CS Telco 1, 2 & 3 Subscriber Opening/Closing ID Numbers (Area 2)	20
0295-0298	CS Telco 1, 2 & 3 Subscriber Event ID Numbers (System)	20
0299-0302	CS Telco 1, 2 & 3 Subscriber Opening/Closing ID Numbers (Area 1)	20
0303-0306	CS Telco 1, 2 & 3 Subscriber Opening/Closing ID Numbers (Area 2)	20
0307-0310	CS Telco 1, 2 & 3 Subscriber Event ID Numbers (Area 1)	20
0311-0314	CS Telco 1, 2 & 3 Subscriber Event ID Numbers (Area 2)	20
0315-0318	CS Telco 1, 2 & 3 Subscriber Event ID Numbers (System)	20
0319-0332	CS SYSTEM REPORTING CODES	20
0330	Cancel Report Code	20
0332	Test Timer	20
0333-0350	CS SYSTEM REPORTING CODES	20
0358-0389	CS ZONE REPORTING OPTIONS	21
0358-0389	Modem Codes (CS ZONE REPORTING)	21
0358-0389	Pulse Event Codes (CS ZONE REPORTING)	21
0358-0389	Zones Report Code (Zones 1-32)	21
0391	Disable Opening Reports	21
0391	CS AREA & SYSTEM REPORTING OPTIONS	21
0392	Disable Closing Reports	21
0392	CS AREA & SYSTEM REPORTING OPTIONS	21
0394	Backup Reporting on Telco 2	21
0394	Cancel Next Test Timer on any Report	21
0394	Disable Wait for Handshake	21
0394	Disable Wait for Silence	21
0394	Touch-tone Dialing w/Rotary Backup	21
0394	CS AREA & SYSTEM REPORTING OPTIONS	21
0394	Disable Auto Dial Tone Detect	21
0430-0449	User Opening/Closing Telco 1 & 3 (Users 00-32 & 97-99)	22
0440-0459	CS USER REPORTING OPTIONS	22
0460-0469	SYSTEM RESPONSE ACTIVATED BY GLOBAL EVENT/TROUBLE	17
0470-0477	SYSTEM RESPONSE ACTIVATED BY AREA 1 EVENT/TROUBLE	17
0478-0485	SYSTEM RESPONSE ACTIVATED BY AREA 2 EVENT/TROUBLE	17
0490	50ms Loop Response (A) (Enable Zone)	26

**ADDRESS NUMBER INDEX (CONT'D)**

<b>ADDRESS</b>	<b>OPTION</b>	<b>PAGE</b>
0491	Priority (Enable Zone)	26-27
0492	Priority with Bypass (Enable Zone)	26-27
0493	Auto-Bypass (Enable Zone)	26-27
0494	Selective Bypass (Enable Zone)	26-27
0495	Keyswitch Arming (Enable Zone)	26-27
0496	Auto-Bypass Re-entry (Enable Zone)	26-27
0497	Pre-Alarm Warning (Enable Zone)	26-27
0498	Never Arm (Enable Zone)	26-27
0499	24-Hour Zone (Enable Zone)	26-27
0500	Alarm Output (Enable Zone)	26-27
0501	Pulsed Alarm Output (Enable Zone)	26-27
0502	PGM1 Output (Enable Zone)	26-27
0503	PGM2 Output (Enable Zone)	26-27
0504	Entry/Exit 1 (Enable Zone)	26-27
0505	Entry/Exit 2 (Enable Zone)	26-27
0506	Exit/Entry Follower (Enable Zone)	26-27
0507	Auto Reset (Enable Zone)	26-27
0508	Swinger Shutdown (Enable Zone)	26-27
0509	Chime (Enable Zone)	26-27
0510	Abort Delay (Enable Zone)	26-27
0511	Power-up Delay (Enable Zone)	26-27
0512	Day Zone Open (Enable Zone)	26-27
0513	Day Zone Short (Enable Zone)	26-27
0514	Alarm on Day Zone (Enable Zone)	26-27
0515	Alarm Telco 1 (Enable Zone)	26-27
0516	Alarm Restore 1 (Enable Zone)	26-27
0517	Trouble Telco 1 (Enable Zone)	26-27
0518	Trouble Restore 1 (Enable Zone)	26-27
0519	Alarm Telco 3 (Enable Zone)	26-27
0520	Alarm Restore 3 (Enable Zone)	26-27
0521	Trouble Telco 3 (Enable Zone)	26-27
0522	Trouble Restore 3 (Enable Zone)	26-27
0523	No EOL Resistor (Enable Zone)	26-27
0524	Trouble on Open (Enable Zone)	26-27
0525	Trouble on Short (Enable Zone)	26-27
0526	Zone Area 1 (Enable Zone)	26-27
0528	Interior (Stay) Bypass (Enable Zone)	26-27
0529	Keypad Sounder on Alarm (Enable Zone)	26-27
0531	Fire (C) (Enable Zone)	26-27
0532	Fire Alarm Verification (C) (Enable Zone)	26-27
0534	Zone ANDing Group 1 (Enable Zone)	26-27
0535	Zone ANDing Group 2 (Enable Zone)	26-27
0536	Zone ANDing Group 3 (Enable Zone)	26-27
0537	Zone ANDing Group 4 (Enable Zone)	26-27
0538	Sensor Watch (Enable Zone)	26-27
0540	Chime 2 (Enable Zone)	26-27
0546	Priority (Enable Zone)	26-27
0547	Priority with Bypass (Enable Zone)	26-27
0548	Auto-Bypass (Enable Zone)	26-27
0549	Selective Bypass (Enable Zone)	26-27
0550	Keyswitch Arming (Enable Zone)	26-27
0551	Auto-Bypass Re-entry (Enable Zone)	26-27
0552	Pre-Alarm Warning (Enable Zone)	26-27
0553	Never Arm (Enable Zone)	26-27
0554	24-Hour Zone (Enable Zone)	26-27
0555	Alarm Output (Enable Zone)	26-27
0556	Pulsed Alarm Output (Enable Zone)	26-27
0557	PGM1 Output (Enable Zone)	26-27
0558	PGM2 Output (Enable Zone)	26-27
0559	Entry/Exit 1 (Enable Zone)	26-27
0560	Entry/Exit 2 (Enable Zone)	26-27
0561	Exit/Entry Follower (Enable Zone)	26-27
0562	Auto Reset (Enable Zone)	26-27
0563	Swinger Shutdown (Enable Zone)	26-27
0564	Chime (Enable Zone)	26-27

# ADDRESS NUMBER INDEX (CONT'D)

ADDRESS	OPTION	PAGE
0565	Abort Delay (Enable Zone)	26-27
0566	Power-up Delay (Enable Zone)	26-27
0567	Day Zone Open (Enable Zone)	26-27
0568	Day Zone Short (Enable Zone)	26-27
0569	Alarm on Day Zone (Enable Zone)	26-27
0570	Alarm Telco 1 (Enable Zone)	26-27
0571	Alarm Restore 1 (Enable Zone)	26-27
0572	Trouble Telco 1 (Enable Zone)	26-27
0573	Trouble Restore 1 (Enable Zone)	26-27
0574	Alarm Telco 3 (Enable Zone)	26-27
0575	Alarm Restore 3 (Enable Zone)	26-27
0576	Trouble Telco 3 (Enable Zone)	26-27
0577	Trouble Restore 3 (Enable Zone)	26-27
0578	No EOL Resistor (Enable Zone)	26-27
0579	Trouble on Open (Enable Zone)	26-27
0580	Trouble on Short (Enable Zone)	26-27
0581	Zone Area 1 (Enable Zone)	26-27
0583	Interior (Stay) Bypass (Enable Zone)	26-27
0584	Keypad Sounder on Alarm (Enable Zone)	26-27
0586	Fire (C) (Enable Zone)	26-27
0587	Fire Alarm Verification (C) (Enable Zone)	26-27
0589	Zone ANDing Group 1 (Enable Zone)	26-27
0590	Zone ANDing Group 2 (Enable Zone)	26-27
0591	Zone ANDing Group 3 (Enable Zone)	26-27
0592	Zone ANDing Group 4 (Enable Zone)	26-27
0593	Sensor Watch (Enable Zone)	26-27
0595	Chime 2 (Enable Zone)	26-27
0601	Priority (Enable Zone)	26-27
0602	Priority with Bypass (Enable Zone)	26-27
0603	Auto-Bypass (Enable Zone)	26-27
0604	Selective Bypass (Enable Zone)	26-27
0605	Keyswitch Arming (Enable Zone)	26-27
0606	Auto-Bypass Re-entry (Enable Zone)	26-27
0607	Pre-Alarm Warning (Enable Zone)	26-27
0608	Never Arm (Enable Zone)	26-27
0609	24-Hour Zone (Enable Zone)	26-27
0610	Alarm Output (Enable Zone)	26-27
0611	Pulsed Alarm Output (Enable Zone)	26-27
0612	PGM1 Output (Enable Zone)	26-27
0613	PGM2 Output (Enable Zone)	26-27
0614	Entry/Exit 1 (Enable Zone)	26-27
0615	Entry/Exit 2 (Enable Zone)	26-27
0616	Exit/Entry Follower (Enable Zone)	26-27
0617	Auto Reset (Enable Zone)	26-27
0618	Swinger Shutdown (Enable Zone)	26-27
0619	Chime (Enable Zone)	26-27
0620	Abort Delay (Enable Zone)	26-27
0621	Power-up Delay (Enable Zone)	26-27
0622	Day Zone Open (Enable Zone)	26-27
0623	Day Zone Short (Enable Zone)	26-27
0624	Alarm on Day Zone (Enable Zone)	26-27
0625	Alarm Telco 1 (Enable Zone)	26-27
0626	Alarm Restore 1 (Enable Zone)	26-27
0627	Trouble Telco 1 (Enable Zone)	26-27
0628	Trouble Restore 1 (Enable Zone)	26-27
0629	Alarm Telco 3 (Enable Zone)	26-27
0630	Alarm Restore 3 (Enable Zone)	26-27
0631	Trouble Telco 3 (Enable Zone)	26-27
0632	Trouble Restore 3 (Enable Zone)	26-27
0633	No EOL Resistor (Enable Zone)	26-27
0634	Trouble on Open (Enable Zone)	26-27
0635	Trouble on Short (Enable Zone)	26-27
0636	Zone Area 1 (Enable Zone)	26-27
0637	Zone Area 2 (Enable Zone)	27

**ADDRESS NUMBER INDEX (CONT'D)**

ADDRESS	OPTION	PAGE
0638	Interior (Stay) Bypass (Enable Zone)	26-27
0639	Keypad Sounder on Alarm (Enable Zone)	26-27
0641	Fire (C) (Enable Zone)	26-27
0642	Fire Alarm Verification (C) (Enable Zone)	26-27
0644	Zone ANDing Group 1 (Enable Zone)	26-27
0645	Zone ANDing Group 2 (Enable Zone)	26-27
0646	Zone ANDing Group 3 (Enable Zone)	26-27
0647	Zone ANDing Group 4 (Enable Zone)	26-27
0648	Sensor Watch (Enable Zone)	26-27
0650	Chime 2 (Enable Zone)	26-27
0656	Priority (Enable Zone)	26-27
0657	Priority with Bypass (Enable Zone)	26-27
0658	Auto-Bypass (Enable Zone)	26-27
0659	Selective Bypass (Enable Zone)	26-27
0660	Keyswitch Arming (Enable Zone)	26-27
0661	Auto-Bypass Re-entry (Enable Zone)	26-27
0662	Pre-Alarm Warning (Enable Zone)	26-27
0663	Never Arm (Enable Zone)	26-27
0664	24-Hour Zone (Enable Zone)	26-27
0665	Alarm Output (Enable Zone)	26-27
0666	Pulsed Alarm Output (Enable Zone)	26-27
0667	PGM1 Output (Enable Zone)	26-27
0668	PGM2 Output (Enable Zone)	26-27
0669	Entry/Exit 1 (Enable Zone)	26-27
0670	Entry/Exit 2 (Enable Zone)	26-27
0671	Exit/Entry Follower (Enable Zone)	26-27
0672	Auto Reset (Enable Zone)	26-27
0673	Swinger Shutdown (Enable Zone)	26-27
0674	Chime (Enable Zone)	26-27
0675	Abort Delay (Enable Zone)	26-27
0676	Power-up Delay (Enable Zone)	26-27
0677	Day Zone Open (Enable Zone)	26-27
0678	Day Zone Short (Enable Zone)	26-27
0679	Alarm on Day Zone (Enable Zone)	26-27
0680	Alarm Telco 1 (Enable Zone)	26-27
0681	Alarm Restore 1 (Enable Zone)	26-27
0682	Trouble Telco 1 (Enable Zone)	26-27
0683	Trouble Restore 1 (Enable Zone)	26-27
0684	Alarm Telco 3 (Enable Zone)	26-27
0685	Alarm Restore 3 (Enable Zone)	26-27
0686	Trouble Telco 3 (Enable Zone)	26-27
0687	Trouble Restore 3 (Enable Zone)	26-27
0688	No EOL Resistor (Enable Zone)	26-27
0689	Trouble on Open (Enable Zone)	26-27
0690	Trouble on Short (Enable Zone)	26-27
0691	Zone Area 1 (Enable Zone)	26-27
0692	Zone Area 2 (Enable Zone)	27
0693	Interior (Stay) Bypass (Enable Zone)	26-27
0694	Keypad Sounder on Alarm (Enable Zone)	26-27
0696	Fire (C) (Enable Zone)	26-27
0697	Fire Alarm Verification (C) (Enable Zone)	26-27
0699	Zone ANDing Group 1 (Enable Zone)	26-27
0700	Zone ANDing Group 2 (Enable Zone)	26-27
0701	Zone ANDing Group 3 (Enable Zone)	26-27
0702	Zone ANDing Group 4 (Enable Zone)	26-27
0703	Sensor Watch (Enable Zone)	26-27
0705	Chime 2 (Enable Zone)	26-27
0710	PGM2 Output Timeout	16
0710	SYSTEM OUTPUT TIMEOUTS	16
0711	PGM2 Output Access Control Timeout	15
0711	SYSTEM DELAYS & TIMEOUTS	15
0712	Alarm Output Timeout	16
0712	SYSTEM OUTPUT TIMEOUTS	16
0713	Pulsed Alarm Output Timeout	16

# ADDRESS NUMBER INDEX (CONT'D)

ADDRESS	OPTION	PAGE
0713	SYSTEM OUTPUT TIMEOUTS	16
0714	PGM1 Output Timeout	16
0714	SYSTEM OUTPUT TIMEOUTS	16
0715	Abort Delay (Time)	15
0715	SYSTEM DELAYS & TIMEOUTS	15
0716	Chime Timeout	15
0716	SYSTEM DELAYS & TIMEOUTS	15
0717	AC Fail Report Delay (Time)	15
0717	SYSTEM DELAYS & TIMEOUTS	15
0718	Closing Report Only on Conditional Close	18
0718	Disable Zone Fault Scrolling	18
0718	Enable AutoArm if not closed at end of Window	18
0718	Enable Time/Date KP Display	18
0718	Incl. Sel./Grp. Bypass in Cond. Close /Status	18
0718	Include Select/Group Bypass in Conditional Close/Status	18
0718	Opening Report Only after Alarm Report	18
0718	Status Report	18
0718-0722	SYSTEM OPTIONS	18
0719	Access Control on PGM2 Output	18
0719	Auto Bell Test on Arming	18
0719	Auto Reset after Burglary Output Timeout	18
0719	Disable Keypad Instant Mode	18
0719	Enable Manager's Mode	18
0719	Enable Local Alarm on First Zone AND Trip	18
0719	Maintained Keyswitch Arming	18
0719	Suppress Bypass Reminder when Armed	18
0720	Change Pulse Output to Temporal Output	18
0720	Disable Callback Download	18
0720	Disable Keypad Function Mode Download	18
0720	Enable Global Ambush Code	18
0720	Chirp Output on Keyfob Arm/Disarm	18
0720	Enable Residential Fire	18
0720	Interior Normally Bypassed	18
0720	Reset Day Zone with Arm/Disarm Only	18
0721	Enable Alarm Output on Telco Fail only when Armed	18
0721	Select Alarm Output for Keyfob Chirp	18
0721	Enable Line-Fault Test	18
0721	Enable Zone Doubling	18
0721	Inhibit System Trouble Audible at Keypad	18
0721	Line-Fault Test only when Armed	18
0721	Wireless Trouble Activates Telco 1	18
0721	Wireless Trouble Activates Telco 3	18
0722	Automatic Interior Bypass/Easy Exit	18
0722	PGM2 Output Chirp on Key fob Arming	18
0722	PGM2, Don't Clear Output with Arm/Disarm	18
0722	Disable 2nd Call Ans. Machine Override	18
0722	Veri-phone Audio Priority Over Alarms	18
0722	Veriphone Zones trip PGM2 Output	18
0723-0736	Keypad Options	25
0737-0742	Enable EZM Group	23
0743	AREA (PRIORITY) ARMING OPTIONS	23
0743	PRIORITY AREA ARMING OPTIONS	23
0744	AREA (PRIORITY) ARMING OPTIONS	23
0744	PRIORITY AREA ARMING OPTIONS	23
0745	Burglary Output Turns Off upon Disarm	24
0745-0747	Area Bell Control Options	24
0745-0749	OUTPUT TURNS OFF UPON DISARM	24
0746	Pulsed Burg Output Turns Off upon Disarm	24
0747	PGM1 Output Turns Off upon Disarm	24

**ADDRESS NUMBER INDEX (CONT'D)**

<u>ADDRESS</u>	<u>OPTION</u>	<u>PAGE</u>
0749	PGM2 Output Turns Off upon Disarm	24
0749	Area Bell Control Options	24
0750-0829	EXTERNAL RELAY CONTROL	28-29
1038-1053	RF RECEIVER & SUPERVISORY TIMER OPTIONS	30
1054	Global Ambush Code	17
1055-1058	Keypad Options	25
1059	Sensor Watch Time	15
1059	SYSTEM DELAYS & TIMEOUTS	15
1060	Disable [ON/OFF] as Easy Exit	18
1060	Disable Auto Cancel on Disarm	18
1060	Disable System Trouble Audible Timeout	18
1060	Enable Cancel Report to Telco 3	18
1060	Enable GEM-PRINT Module	18
1060	Enable Keypad Set Time/Date Message	18
1060	Enable Stay/Away Keypad	18
1060-1062	SYSTEM OPTIONS	18
1062	Abort Delay Limit Enable	18
1062	Disable Call Waiting on 1 <sup>st</sup> Attempt	18
1062	Enable CP-01 Limits	18
1062	Exit Time Restart	18
1062	Digital Dialer Report Enter/Exit Test Mode	18
1062	Report Exit Error/Recent Close	18
1062	Sound Alarm On Exit Error	18
1179	Report Cancel Window	15
1180	RF RECEIVER & SUPERVISORY TIMER OPTIONS	30
1183	DOWNLOAD/CALLBACK OPTIONS	16
1183	Number of Rings before Pickup	16
1197	Clear Dealer Program	31
1198	Cold Start	31

# GEM-P1632 WIRING DIAGRAM

## GEM-P1632 Wiring Diagram

NAPCO SECURITY SYSTEMS, INC.  
AMITYVILLE, N.Y. 11701



### GEM-P1632 WIRING DIAGRAM

(REFER TO OPERATION AND INSTALLATION INSTRUCTIONS W1808)  
RESIDENTIAL AND COMMERCIAL BURGLARY \*\*

16.5V TRANSFORMER	STANDBY BATTERY	COMBINED STANDBY CURRENT	ALARM CURRENT	STANDBY CURRENT	STANDBY TIME
40VA/50VA	7AH	650mA	2.0A	2.0A	4 HOURS
20VA*	4AH	500mA	2.0A	2.0A	4 HOURS
20VA*	7AH	500mA	2.0A	2.0A	6 HOURS

16.5V TRANSFORMER	COMBINED STANDBY CURRENT	ALARM CURRENT	STANDBY CURRENT	STANDBY TIME
40VA/50VA	120mA	520mA(1)	520mA(1)	24 HOURS
20VA*	360mA	280mA(1)	280mA(1)	24 HOURS
20VA*	120mA	360mA(1)	360mA(1)	24 HOURS
20VA*	360mA	120mA(1)	120mA(1)	24 HOURS

(1) ALARM CURRENT CAN BE INCREASED BY REDUCING STANDBY CURRENT BY THE SAME AMOUNT.  
\*\* COMMERCIAL BURGLARY IS NOT PRESENTLY EVALUATED BY UL.

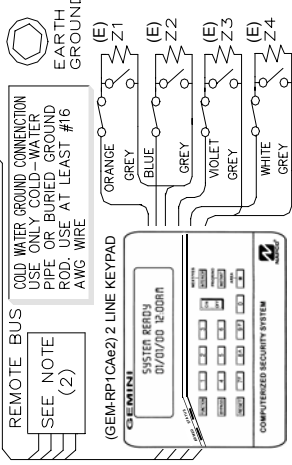
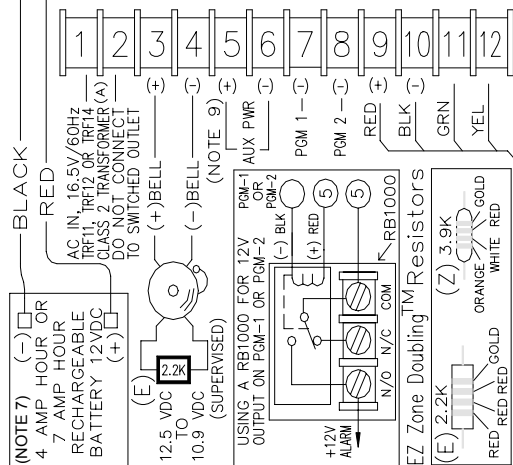

THIS UNIT INCLUDES AN ALARM VERIFICATION FEATURE WHICH WILL RESULT IN A DELAY OF THE SYSTEM ALARM SIGNAL FROM THE INDICATED CIRCUITS. THE TOTAL DELAY (CONTROL UNIT PLUS SMOKE DETECTORS) SHALL NOT EXCEED 60 SECONDS. NO OTHER SMOKE DETECTORS SHALL BE CONNECTED TO THESE CIRCUITS UNLESS APPROVED BY THE LOCAL AUTHORITY HAVING JURISDICTION. CIRCUIT CONTROL UNIT SMOKE DETECTORS ZONES DELAY-SEC.

MODEL DELAY-SEC.

THE DELAY (POWER UP) (STARTUP) TIME MARKED ON THE INSTALLATION WIRING DIAGRAM OF THE SMOKE DETECTOR OR ON THE INSTALLED SMOKE DETECTOR(S) IS TO BE USED.

- NOTES:**
- ALARM CURRENT CAN BE INCREASED BY REDUCING STANDBY CURRENT BY THE SAME AMOUNT.
  - THE FOLLOWING DEVICES MAY BE PLACED ON THE REMOTE BUS: GEM-RP1CAE2, GEM-RP2ASE2, GEM-RP2ASE2, GEM-EVA1, WIZARD2, GEM-K1CA, GEM-K2AS AND GEM-K3DGTL.
  - REFER TO W1808 FOR U.L. LISTINGS
  - COMBINED STANDBY CURRENT = KEYPAD CURRENT + AUX CURRENT + FIRE POWER + PGM1 AND PGM2 CURRENT.
  - UNIT INTENDED TO BE MOUNTED VERTICAL ON WALL.
  - REFER TO W1808 FOR COMPATIBLE TWO WIRE SMOKE DETECTORS. DO NOT MIX DIFFERENT MODELS.
  - RECOMMENDED BATTERIES YUASA NP4-12 OR NP7-12. BATTERY SHOULD BE REPLACED EVERY 5 YEARS.
  - THIS PANEL SHALL BE CHECKED BY A QUALIFIED TECHNICIAN AT LEAST ONCE EVERY 3 YEARS.
  - AUX POWER AND FIRE POWER VOLTAGE RATING: 12.5 VDC TO 11.7 VDC. THE PANEL WILL DISREGARD INPUTS FROM ALL SENSORS WHEN VOLTAGE DROPS BELOW 8.5V.
  - A.C. MUST BE DISCONNECTED WHEN PERFORMING WEEKLY TESTS.
  - THIS PANEL ONLY SUPPORTS ONE SMOKE DETECTOR IN ALARM FOR EACH ZONE.
  - DISABLE AUTO-RESET ON NON-FIRE ZONES FOR SIA CP-01 INSTALLATIONS.

This equipment should be installed in accordance with Chapter 2 of the National Fire Alarm Code, ANSI/NFPA 72-1996 (National Fire Protection Association Batterymarch Park, Quincy, MA 02269), and local codes. Information describing proper installation, operation, testing, maintenance, evacuation planning, and repair service is to be provided with this equipment. UL Listed Limited Energy Cable is required.

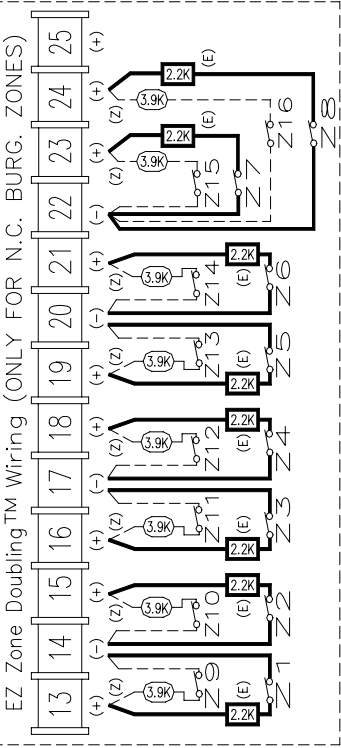
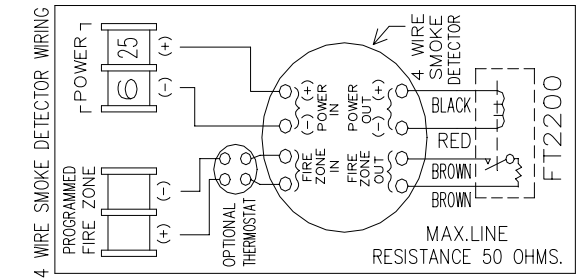
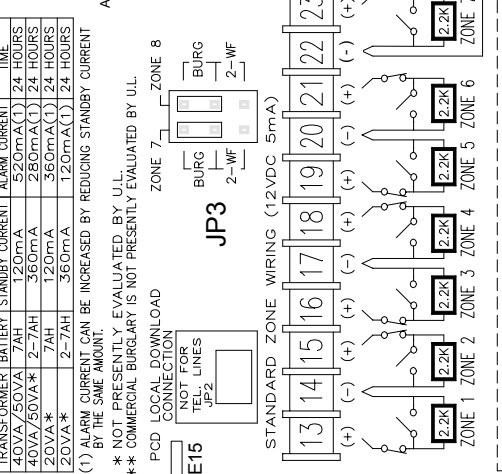
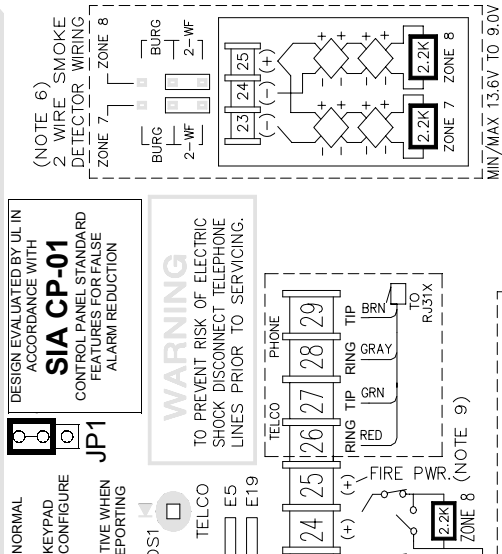

- NOTES:**
- ALARM CURRENT CAN BE INCREASED BY REDUCING STANDBY CURRENT BY THE SAME AMOUNT.
  - THE FOLLOWING DEVICES MAY BE PLACED ON THE REMOTE BUS: GEM-RP1CAE2, GEM-RP2ASE2, GEM-EVA1, WIZARD2, GEM-K1CA, GEM-K2AS AND GEM-K3DGTL.
  - REFER TO W1808 FOR U.L. LISTINGS
  - COMBINED STANDBY CURRENT = KEYPAD CURRENT + AUX CURRENT + FIRE POWER + PGM1 AND PGM2 CURRENT.
  - UNIT INTENDED TO BE MOUNTED VERTICAL ON WALL.
  - REFER TO W1808 FOR COMPATIBLE TWO WIRE SMOKE DETECTORS. DO NOT MIX DIFFERENT MODELS.
  - RECOMMENDED BATTERIES YUASA NP4-12 OR NP7-12. BATTERY SHOULD BE REPLACED EVERY 5 YEARS.
  - THIS PANEL SHALL BE CHECKED BY A QUALIFIED TECHNICIAN AT LEAST ONCE EVERY 3 YEARS.
  - AUX POWER AND FIRE POWER VOLTAGE RATING: 12.5 VDC TO 11.7 VDC. THE PANEL WILL DISREGARD INPUTS FROM ALL SENSORS WHEN VOLTAGE DROPS BELOW 8.5V.
  - A.C. MUST BE DISCONNECTED WHEN PERFORMING WEEKLY TESTS.
  - THIS PANEL ONLY SUPPORTS ONE SMOKE DETECTOR IN ALARM FOR EACH ZONE.
  - DISABLE AUTO-RESET ON NON-FIRE ZONES FOR SIA CP-01 INSTALLATIONS.

LA1469C

