



# INSTALLATION INSTRUCTIONS



**GEMINI™**

## GEM-P9600 CONTROL PANEL/COMMUNICATOR

For use with "Classic" keypads (GEM-RP1CAe2, GEM-RP2ASe2, GEM-RP3DGTL and GEM-RP4RFC/GEM-RP4C) and with "K Series" keypads (GEM-K1CA, GEM-K2AS, GEM-K3DGTL, and GEM-K4RF/GEM-K4)

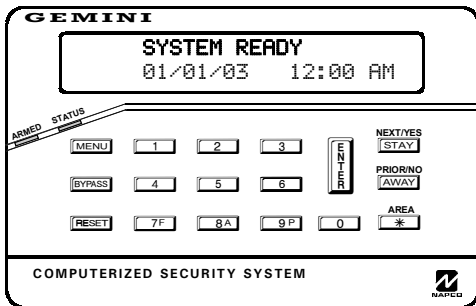

"K Series" GEM-K1CA

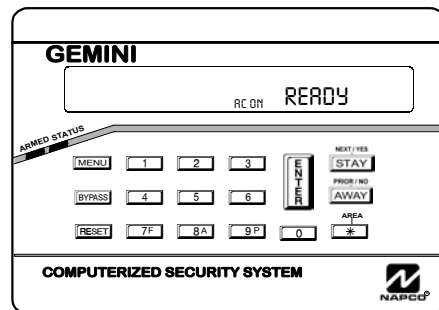

"K Series" GEM-K2AS

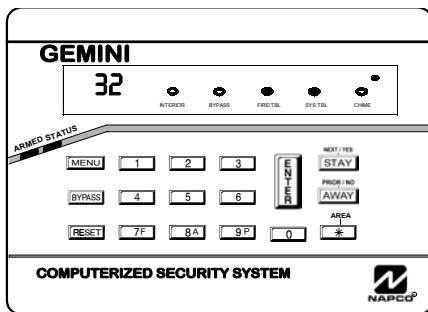

"K Series" GEM-K3DGTL

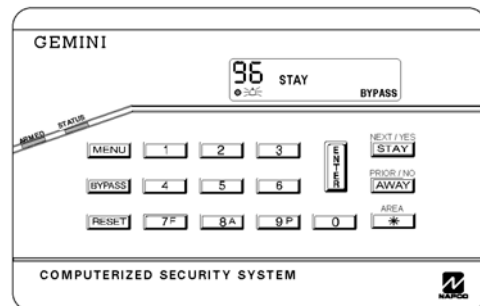

"K Series" GEM-K4 / K4RF

**THIS MANUAL INCLUDES FEATURES WHICH ARE ONLY AVAILABLE IN CONTROL PANEL FIRMWARE VERSION 20 OR LATER.**

**CHANGES FROM PREVIOUS EDITION**

The following changes have been made to this manual (WI742D) since the last edition (WI742C).

Changes to the following existing Glossary entries:

Abort Delay  
Access Control; Access Control (Panel Access) on PGM2 Output; PGM2 Output Access Control Time; Panel Access  
Ambush (Keypad Ambush); Ambush Codes; Enable Global Ambush  
Automatic Interior Bypass  
Callback-Method Download  
Answering Machine Pickup Without Line Seizure  
Disable Callback Download  
Disable Second Call Answering Machine Override  
Disable Answering Machine Download  
Disable Function-Mode Download  
Easy Exit  
Exit Urgency Annunciation  
Number of Rings Before Pickup  
Initiation Report  
Exit Urgency Annunciation  
Panic Zone  
Power-Up Delay  
Second Call Answering Machine Override  
Swinger Shutdown  
Zone ANDing, Groups 1-4; Enable Local Alarm on First Zone "AND" Trip

Additions to the Glossary:

Pages 61-62 includes added new CP-01 Quick Reference Chart detailing SIA CP-01 False Alarm Reduction Requirements.  
Pages 63-64 includes Factory Default Description.  
Page 37 includes added "Digital Dialer Report Enter/Exit Test Mode" in Glossary.  
Page 37 includes added "Disable Call Waiting on 1<sup>st</sup> Attempt" in Glossary.  
Page 38 includes added "Enable Bell Output on Keyfob Arming" in Glossary.  
Page 38 includes added "Enable CP-01 Limits" in Glossary.  
Page 33 includes added "Aux. Output Chirp on Keyfob Arm/Disarm" in Glossary.  
Page 39 includes added "Exit Time Restart" in Glossary.  
Page 41 includes added "Keypad Digital Dialer Test" in Glossary.  
Page 45 includes added "Report Digital Dialer Exit Error/Recent Closing" in Glossary.  
Page 47 includes added "Sound Alarm On Exit Error" in Glossary.  
Page 49 includes added "Time and Date Message Option" in Glossary.

Page 7, RESIDENTIAL BURGLARY & COMMERCIAL BURGLARY chart, "Not Evaluated by UL" warning removed.

Page 8, the **M278** Line-Reversal Module and the **Veri-Phone** Two-Way Module accessories reference an asterisk (\*) in that they have not yet been evaluated by UL.

Page 8, reference to the Security Industry Association (SIA) False Alarm Reduction Standard CP-01 added.

Page 9, "Summary of UL Requirements" modified to specify that the system be serviced once every year.

Page 11, Wireless Systems--modified notation to specify that they are not evaluated by UL for commercial applications.

Page 12, UL Commercial Burglary Installations, the notation "Pending" removed.

Page 14 in the SIREN/BELL BURG/FIRE ALARM OUTPUT section, the following statement added: "In NFPA Household Fire Installations, only a single siren or bell can be used on this bell circuit."

The glossary definition, "Exit Urgency Annunciation" was modified as follows: the first sentence, "When armed Stay, Silent Exit is evoked and time is doubled (120 seconds by default)" was removed.

The glossary definition, "No EOL Resistor" includes the following notation: "**Note:** Do not program for UL installations".

The glossary definition, "Panic Zone..." now reads "Panics", and the following sentence added: "Tamper must be enabled on the keypad".

**Cross Zoning.** the chart on Page 62, the following notation was added: the Cross Zone set time = one (1) minute.

**NOTE:** Upon entering program mode, the keypad display will flash the control panel firmware version, followed by the keypad firmware version: GEM-RP1CAe2: [2006], GEM-RP2ASe2: [205b], GEM-RP3DGTL: [20/1C]







**NAPCO Security Systems, Inc.**  
333 Bayview Avenue, Amityville, New York 11701  
For Sales and Repairs, call toll free: (800) 645-9445  
For direct line to Technical Service, call toll free: (800) 645-9440  
Internet: <http://www.napcosecurity.com>

### IMPORTANT NOTE

This manual supports the keypad programming of the GEM-P9600 control panel with the NAPCO "classic" GEM-RP1CAe2, GEM-RP2ASe2, GEM-RP3DGTL and GEM-RP4RFC/GEM-RP4C keypads as well as the GEM-K1CA, GEM-K2AS, GEM-K3DGTL, and GEM-K4RF/K4 "K Series" keypads. The new "K Series" models offer the new STAY and AWAY buttons with simplified functionality, along with the new MENU and ENTER buttons.

While the instructions in this manual are depicted using the GEM-K1CA and GEM-K2AS keypads, the manual applies to both the "classic" and the "K Series" keypads.

**Program Mode** is the same for both keypads--**only the button names have changed**, as follows:

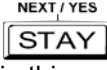
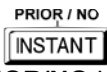
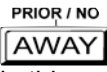
- The  button and the  button operate identically (in Program Mode) for both keypads.
- The  button and the  button operate identically (in Program Mode) for both keypads.
- The  button and the  button operate identically (in Program Mode) for both keypads. The words "NEXT/YES button" are used in this manual.
- The  button and the  button operate identically (in Program Mode) for both keypads. The words "PRIOR/NO button" are used in this manual.

# TABLE OF CONTENTS

<b>CHANGES FROM PREVIOUS EDITION .....</b>	<b>2</b>	4-Wire Smoke Detectors .....	17
<b>IMPORTANT NOTE.....</b>	<b>3</b>	2-Wire Smoke Detectors .....	17
<b>INTRODUCTION.....</b>	<b>5</b>	Telephone Lines.....	18
General Description .....	5	<b>KEYPAD CONFIGURATION MODE.....</b>	<b>19</b>
Features .....	5	Keypad Installation.....	19
Specifications.....	7	Configuring the Keypads.....	19
Ordering Information .....	7	<b>BASIC OPERATION.....</b>	<b>22</b>
Summary Of UL Requirements .....	9	User Codes & Zone Descriptions.....	22
<b>INSTALLATION.....</b>	<b>10</b>	Arming and Disarming the System.....	23
Mounting .....	10	Bypassing Zones.....	25
Wiring.....	11	Alarm Indication .....	26
Wireless Systems.....	11	Function Mode .....	26
Typical Residential Fire Installation.....	11	Keypad Messages.....	30
Typical Partitioned Installation .....	11	<b>GLOSSARY .....</b>	<b>31</b>
UL Commercial-Burglary Installations.....	12	<b>STANDBY-BATTERY CALCULATION WORKSHEET</b>	<b>53</b>
Testing The System .....	13	<b>WIRING LEGEND.....</b>	<b>54</b>
<b>WIRING CONNECTIONS .....</b>	<b>14</b>	<b>KEYPAD PROGRAMMING MODES.....</b>	<b>55</b>
Battery.....	14	<b>GEM-P9600 WIRING DIAGRAM.....</b>	<b>60</b>
Transformer.....	14	<b>CP-01 QUICK REFERENCE CHART-SIA .....</b>	<b>61-62</b>
Siren/Bell Output.....	14	<b>FACTORY DEFAULT DESCRIPTION .....</b>	<b>63</b>
Auxiliary Alarm Output .....	14	<b>STATEMENT FOR CANADIAN MODELS (DOC).....</b>	<b>64</b>
Remote Bus .....	15	<b>FCC STATEMENT.....</b>	<b>65</b>
Earth Ground.....	15	<b>LIMITED WARRANTY.....</b>	<b>68</b>
Auxiliary Power .....	15		
Reset Output.....	16		
Basic Zone Configuration.....	16		
Expanded Zone Configuration .....	16		

Refer to accompanying GEM-P9600 Programming Instructions (WI777 and WI1185) for programming information.

**NOTE: THESE INSTRUCTIONS ARE INTENDED AND WRITTEN FOR PROFESSIONAL INSTALLATION PERSONNEL HAVING SUITABLE TRAINING, EXPERIENCE AND INSTALLATION EQUIPMENT. IT IS RECOMMENDED THAT AFTER PROGRAMMING, THE ERROR CHECK UTILITY OF THE PCD3000 (OR PCD-WINDOWS) DOWNLOADER SOFTWARE BE USED TO VERIFY THAT THE CONTROL PANEL PROGRAM CONTAINS NO ERRORS OR CONFLICTS WHICH MAY INHIBIT ITS INTENDED OPERATION.**

# INTRODUCTION

## GENERAL DESCRIPTION

NAPCO's Gemini GEM-P9600 is a state-of-the-art microcomputer-based burglary and residential fire alarm control panel of modular design. Integrally an 8-zone panel, it will support up to 96 zones with optional zone expansion modules, wireless receiver modules and/or GEM-RP1CAe2/GEM-K1CA Keypads. Each panel includes an integral digital communicator.

The control panel features programmable area partitioning. That is, the system may be divided into up to 8 discrete multiple-zone areas, each allowing access by only those users programmed for their respective area.

Opening Suppression and Closing Suppression, available through Napco Quickloader software, suppress reporting within programmed "windows". Conversely, Exception Reporting can transmit a "fail to close" if the panel is not armed within programmed intervals and, similarly, a "fail to open" if the panel is not disarmed within programmed intervals. Furthermore, the panel can be programmed to automatically arm either area at any time. A log containing up to 800 events (accessible through Quickloader™ software) monitors control-panel activity referenced to a precision real-time clock. A detailed event history may be displayed at the computer, using NAPCO's PCD-Windows Quickloader Software.

Keypads feature a liquid-crystal display for messages. In normal use, the LCD shows zone identification and status messages. Conventional LEDs and a sounder are also provided for annunciation.

Data may be quickly and easily downloaded to the control panel using a PC-compatible computer with NAPCO's PCD-Windows Quickloader software and PCI2000 computer interface. Or, the panel may be programmed using the keypad in its secondary mode of operation. In the keypad programming modes (there are two: Dealer and User), the LCD shows memory address, data values, programming prompts, and the alphanumeric characters required for entering up to 96 user codes and custom zone descriptions.

## GEM-P9600M

The standard GEM-P9600 may be converted to the Mercantile "GEM-P9600M" version with the optional accessory, H1217. The H1217 kit includes the model H217 heavy-duty UL commercial enclosure, the required (2) tamper switches and required tamper screws. **Note:** Do not use Fire Zones in a Mercantile installation.

**NOTE:** Failure to install and program as described in this manual for UL-listed systems voids the listing mark of Underwriters Laboratories, Inc.

## FEATURES

- ✓ Eight end-of-line-resistor burglary zones programmable for Area, Exit/Entry Delay, Interior, Follower, Day Zone, Chime, Fire options, Sensor Watch, Swinger Shutdown, Zone Anding and a variety of other features.
- ✓ Supports up to 96 zones with optional zone-expansion modules and 4-zone keypads.
- ✓ Supports up to 96 individually coded users, each with a programmable authority level.
- ✓ Supports three on-board relay outputs and up to 96 external relay outputs.
- ✓ Supports three keypad panics: Fire, Police & Auxiliary
- ✓ Supports up to 8 independent area partitions.
- ✓ Supports up to 8 separate access stations by up to 96 users.
- ✓ Supports up to 64 separately-addressable X-10 devices with the GEM-X10KIT and PC04 interfaces.
- ✓ English-language prompts & system status messages.
- ✓ User-customized zone descriptions, re-programmable as required.
- ✓ Supports 2-wire and 4-wire smoke detectors.
- ✓ Reports alarms, restores and troubles by zone.
- ✓ 255 Event Schedule



- ✓ 800 Event Log.
- ✓ Overview Mode permits monitoring and control of total system from one keypad.
- ✓ Guard-Tour programmable for start time, tour length, and check points (tour stations).
- ✓ Two programmable Entry Delay times.
- ✓ Two Interior-Zone groups.
- ✓ Dynamic battery test interrupts charging and places battery under load every four hours.
- ✓ Chime by zone; programmable duration.
- ✓ Non-volatile RAM retains memory during power losses.
- ✓ Quickloader programmable.
- ✓ Auto-Download Log.
- ✓ Exclusive *V.A.L.I.D.* feature (Verifying Automatic Line-Integrity Diagnostic) reduces false alarms due to changes in line resistance.

### **Communicator Features**

- ✓ Compatible with all major receiver formats, including BFSK, 4/2, Modem 2, SIA, 4/3/1, 4+2 Express and Point ID.
- ✓ Rotary dial and TouchTone™ with Rotary backup.
- ✓ Three 20-digit telephone numbers.
- ✓ Backup Reporting; Double Reporting; Split Reporting.
- ✓ 96 User Codes with Opening/Closing Reporting by user.
- ✓ AC Failure Reporting with programmable report delay.
- ✓ Supervised telephone line with programmable delay.
- ✓ Pager capability.

### **Keypad Features**

- ✓ English-language LCD display; LED and sounder annunciators.
- ✓ Supports up to fifteen 4-wire keypads.
- ✓ Access only capability.
- ✓ Provisions for fire, police and auxiliary panic alarms.
- ✓ Integral 4-zone EZM included in each keypad (GEM-RP1CAe2/GEM-K1CA only).
- ✓ Communicator Test to Central facilitates testing; Locate, Fault-Find and EZM-Locate diagnostics simplify troubleshooting.
- ✓ PGM output.

## SPECIFICATIONS

### GEM-P9600

Panel Dimensions: 12.375" x 13.875" x 3.55" (H x W x D)

Operating Temperature: 0-49°C (32-120°F)

Input Power: 16.5VAC via CLASS 2 Plug-In 40VA or 50VA Transformer

Loop Voltage: 10-13VDC

Loop Current: 2.4mA with 2.2K Ohm end-of-line resistor (Model EOL2.2K); 5mA for 2-wire smoke-detector zones; 1.4 mA using a 3.9K Ohm resistor (Model EOL 3.9K) with Zone Doubling

Loop Resistance: 300 Ohm max.; 50 Ohm for 2-wire smoke-detector zones

Relay Outputs (Burglary; Reset; Aux): Wet, 12Vdc, 1.2A max.; Dry (cut related jumper for dry contacts; see Wiring Diagram), SPDT contacts 24Vdc, 2A, 0.6 PF

Auxiliary Power Output: 12Vdc regulated

Remote Power Output: 12Vdc regulated (for keypads)

Combined Standby Current (Remote Power + Aux. Power + Reset Relay Power): See following charts.

RESIDENTIAL BURGLARY & COMMERCIAL BURGLARY						
TRANSFORMER	RECHARGEABLE BATTERY	POWER SUPPLY	GEM-P9600 COMBINED STANDBY CURRENT	GEM-P9600 ALARM CURRENT	POWER SUPPLY STANDBY CURRENT	STANDBY TIME
TRF11 (16.5 VAC, 40 VA)	RBAT4 (12 VDC, 4 AH)	N/A	750 mA	2.0 A	N/A	4 Hours
TRF11 (16.5 VAC, 40 VA)	RBAT6 (12 VDC, 6 AH)	N/A	750 mA	2.0 A	N/A	6 Hours
TRF11 (16.5 VAC, 40 VA) <sup>(3)</sup>	RBAT6 (12 VDC, 6 AH)	PS3002 (13.2 VDC, 1.9 A)	750 mA <sup>(1)</sup>	1.9 A <sup>(2)</sup>	1.2 A <sup>(1,2)</sup>	4 Hours
TRF11 (16.5 VAC, 40 VA) <sup>(3)</sup>	2 RBAT6 (12 VDC, 6 AH)	PS3002 (13.2 VDC, 1.9 A)	750 mA	1.9 A	1.4 A	4 Hours

RESIDENTIAL FIRE, COMBINATION RESIDENTIAL FIRE & BURGLARY				
TRANSFORMER	RECHARGEABLE BATTERY	GEM-P9600 COMBINED STANDBY CURRENT	GEM-P9600 ALARM CURRENT	STANDBY TIME
TRF11 (16.5 VAC, 40 VA)	RBAT7 (12 VDC, 7 AH)	150 mA	650 mA	24 Hours

Note: <sup>(1)</sup> With 1 RBAT6 battery, GEM-P9600 combined standby current + PS3002 standby current may not exceed 1.2A.

<sup>(2)</sup> W(2) With 2 RBAT6 batteries, GEM-P9600 combined standby current + alarm current may not exceed 1.9A.

Standby Time: Residential Fire/Burglary & Commercial Burglary, 24 hours minimum

EZM Module: GEM-EZM8: Input, 50mA (not including PGM output)

PGM Output: 5mA, 12V Special Application

Keypad Current:

GEM-RP1CAe2/GEM-K1CA: 100mA; 35mA if backlighting is disabled (cut W1, W2 & W3)

GEM-RP2ASe2/GEM-K2AS: 50 mA

GEM-RP3DGTL/GEM-K3DGTL: 50 mA

GEM-RP4RFC/GEM-K4RF: 75mA Standby

GEM-RP4C/GEM-K4: 45mA Standby

PGM Output: 5mA, 12V Special Application

Maximum Number of Keypads: 15

Maximum Wiring Length for each run (#22AWG): 1000' divided by total number of keypads and EZMs on run

Keypad Dimensions: 4" x 5" x 1" (H x W x D); 11.1cm

## ORDERING INFORMATION

### System Components

GEM-P9600: Residential UL-Listed Burg Control Panel.

GEM-RP1CAe2/GEM-K1CA: 32-Character LCD Burg & Residential Fire Keypad with 4 EOL Zones.

GEM-RP2ASe2/GEM-K2AS: LCD Burg & Residential Fire Keypad with remote panic.

GEM-RP3DGTL/GEM-K3DGTL: Digital Burg and Residential Fire Keypad with remote panic.

GEM-RP4RFC/GEM-K4RF: Digital Icon Burg and Residential Fire Keypad with Integral RF Receiver.

GEM-RP4C/GEM-K4: Digital Icon Burg and Residential Fire Keypad.



## OPTIONAL ACCESSORIES AND PERIPHERALS

**EOL130:** 2-Wire Fire Zone Resistor, 130W, 3W  
**EOL2.2K:** End-of-Line Resistor Assy., 2.2K for Fire Circuit  
**FT2200:** End-of-Line Relay/Resistor Supervisory Module  
**GEM-DT:** Wireless Dual-Technology Sensor \*\*  
**GEM-EVA 1:** Electronic Voice Annunciator \*  
**GEM-EZM4:** 4-Zone Expansion Zone Module  
**GEM-EZM8:** 8-Zone Expansion Zone Module \*\*  
**GEM-GB:** Wireless Glass-Break Detector \*\*  
**GEM-KEYF:** Key Fob Transmitter \*\*  
**GEM-HEAT:** Wireless Heat Detector \*\*  
**GEM-PIR:** Wireless PIR \*\*  
**GEM-PIRPET:** Wireless Pet Immune Transmitter \*  
**GEM-PRINT:** Parallel Printer Interface \*  
**GEM-RECV8:** Wireless Receiver, 8 Zones \*\*  
**GEM-RECV16:** Wireless Receiver, 16 Zones \*\*  
**GEM-RECV96:** Wireless Receiver, 96 Zones \*\*  
**GEM-RS232KIT:** Home Automation Interface \*  
**GEM-SMK:** Wireless Smoke Detector \*\*  
**GEM-TRANS2:** Window/Door Transmitter, 2-Point \*\*  
**GEM-RTRANS:** Recessed Window/Door Transmitter  
**GEM-WP:** Waterproof Panic Transmitter \*\*  
**GEM-X10KIT:** X-10 Interface \*  
**GEM-OUT8:** 8 output active low output module  
**H1217:** Mercantile Conversion Kit  
**M278:** Line-Reversal Module \*  
**PCD3000:** Downloading Software (for DOS) for IBM PC-Compatible\*  
**PCD-Windows:** Downloading Software (for Windows) for IBM PC-Compatible\*  
**PCI2000/3000:** Software with Interface for IBM PC-Compatible Computer  
**PCI-MINI:** Notebook Computer Interface \*  
**PS3002:** Power-Supply Module, 13.2Vdc, 1.9A  
**RB1000:** Relay Board, single output \*  
**RBAT4:** Rechargeable Battery, 12VDC, 4AH  
**RBAT6:** Rechargeable Battery, 12VDC, 6AH  
**RBAT7:** Rechargeable Battery, 12 VDC, 7AH  
**RBATH1:** Dual Battery Harness \*  
**RM3008:** Relay Module (in enclosure)  
**RPB-3:** Universal Keypad Mounting Box  
**TRF11:** Transformer, 16Vac/40VA, Class 2  
**TRF14:** Transformer, 16Vac/50VA, Class 2  
**WIZARD IIe:** Telephone Interface Module \*  
**WL1:** Wire Assembly with Lug Connector, 20"  
**VERI-PHONE:** Two-Way Voice/Listen-In Module \*  
**W834-1:** Keypad Cable, plug-in (20")  
**OI163:** Instruction Manual, GEM-P9600  
**OI193:** User Guide, GEM-RP1CAe2  
**OI192:** User Guide, GEM-RP2ASe2  
**OI249:** User Guide, GEM-RP3DGTL  
**OI278:** User Guide, GEM-RP4C & RP4RFC  
**WI1212:** Installation Manual, GEM-RP4C  
**WI1128:** Installation Manual, GEM-RP4RFC  
**OI279:** User Guide, GEM-K1CA  
**OI280:** User Guide, GEM-K2AS  
**OI281:** User Guide, GEM-K3DGTL  
**OI283:** User Guide, GEM-K4 & K4RF  
**WI1178:** Installation Manual, GEM-K4  
**WI1179:** Installation Manual, GEM-K4RF  
**WI777:** GEM-P9600 Programming Manual  
**WI1185:** GEM-P9600 Programming Manual

\* Not investigated by UL.

\*\* Not investigated by UL for commercial applications.

## UL LISTINGS

Household Burglar Alarm System Units: UL1023  
 Household Fire Warning System Units: UL985  
 Local Burglar Alarm Units and Systems: UL609  
 Central Station Burglar Alarm Units: UL1610  
 Police Station Alarm Units: UL365  
 Security Industry Association (SIA) False Alarm Reduction Standard CP-01

## COMPATIBLE UL-LISTED DEVICES

Refer to the following list of recommended devices.

### Bells:

Ademco AD8-12; AD10-12  
 Amseco MBL-8/12V; MBL-10/12V  
 Wheelock 46T-G4-12-R\*; 46T-G6-12-R; 46T-G10-12-R  
 Hochiki America AL-VB-1012\*; AL-MB-612\*  
 \*Not for Household Fire applications (<85dB at 10')

### Grade-A Bell:

Ademco AB-12 Bell in Box

### Horns:

Wheelock 34T-12-R; MT-12/24; MT4-12/24; MIZ-12  
 Faraday 6120-0-0-12-DC\*  
 Federal Signal 450E-24  
 Hochiki America AL-FH-12M\*  
 \*Not for Household Fire applications (<85dB at 10')

### Mini-Horn:

Federal Signal 460-024-R (red); -W (white); -BG (beige)

### Chimes:

Wheelock CH-CF1-12; CH-DF1-12 (both for private-mode signalling only)

### Strobes:

System Sensor SS1215ADA; SS1215ADAB  
 Wheelock LS12

### Strobe/Horns:

Wheelock 7002T-12-W-FR; 7001T-12-W-FR; V7001T-12-W-FR  
 Gentex SHG-12H  
 System Sensor MASS1215ADA; MASS1215ADAB

### Electronic Signals:

Wheelock ES-BH2-R; ES-DL2-R; ES-EL2-R

### Electronic Signal/Strobes:

Wheelock ES-BH2-WH-12DC-HF-R; ES-DL2-WS-12DC-VF-R;  
 ES-EL2-WS-12DC-HF-R

### Bell/Strobes:

Wheelock 46T-G6-12-WS-12-HF-R; 46T-G10-12-WS-12-HF-R  
 Transformers:  
 Basler Electric BE116240CAA 40VA; BE116250CAA 50 VA





**Compatible Smoke Detectors**

<b>UL Compatible Smoke Detectors (Providing UL Recognition or Listing)</b>					
<b>4 Wire Smoke Detectors</b>			<b>2 Wire Smoke Detectors</b>		
<b>Manufacturer</b>	<b>Model</b>	<b>Base</b>	<b>Manufacturer</b>	<b>Model</b>	<b>Base</b>
Gentex	812, 812T, 812P,	N/A	NAPCO	FW-2	N/A
	812PT, 812PH,	N/A	Sentrol/ESL	711U, 712U,	701U, 702U,
	8120, 8120T,	N/A		721U, 721UT,	702RE, 702RU
	8120P,	N/A		722U, 731U, 732U	
	8120PTY, 8120-PH	N/A	System Sensor	1100, 1151,	N/A
Hochiki	SLG-12 w/YBC-RL4-RA base	N/A		1400, 2100,	N/A
NAPCO	FW-4	N/A		2100T, 2100S,	N/A
Sentrol/ESL	445AT, 445C,	N/A		2100TS, 2151,	N/A
	445CT, 445CR,	N/A		2400, 2400TH	N/A
	445CRT	N/A	<b>Note:</b> Voltage Rating: 8.5-13.3 VDC Maximum Number of Detectors: 10		
System Sensor	1112, 2112,	N/A			
	21112T, 211TSRB	N/A			
	1412TH, 2412TH	N/A			
	2312/24T, 1412,	N/A			
<b>Note:</b> Subtract total smoke-detector alarm current from available standby current.					

**Note:** Any normally-open devices that do not require power from the control panel, such as pull stations, waterflow and thermostats may be used if acceptable to the authority having jurisdiction.

**SUMMARY OF UL REQUIREMENTS****Residential**

- ✓ Recognized Limited-Energy Cable for initiating, indicating and supplementary circuits.
- ✓ Initiating loops supervised if longer than 3 feet
- ✓ FT2200 End-of-Line Relay for Fire (if using 4-wire smoke detectors)
- ✓ Minimum alarm timeout of 5 minutes
- ✓ Maximum exit time: 60 seconds
- ✓ Maximum entry time: 45 seconds
- ✓ Do not program "Swinger Shutdown", "Force Arming", "Selective Bypass", "Group Bypass", or "50 ms Loop Response"
- ✓ "Abort Delay" may not exceed 45 seconds
- ✓ Program "Disable Callback Download"
- ✓ Automatic dialer may not dial a police station number that has not been dedicated for such service
- ✓ System must be tested at least weekly under AC/battery and Battery-Only conditions
- ✓ Replace the rechargeable battery at least every 5 years
- ✓ If the battery is heavily discharged, replace it or have it tested by a qualified technician
- ✓ For silent panic, connect only to UL-listed holdup devices
- ✓ All zones must be programmed for "Priority"
- ✓ Do not program any zones for "Keyswitch Arming"
- ✓ System must be serviced at least once every year
- ✓ Residential Fire and Combination Residential Fire & Burglary must program "Residential Fire"
- ✓ Keypad Expansion (EZM) Zones are not to be used as fire zones



# INSTALLATION

**CAUTION:** This equipment generates and uses radio-frequency energy. If not installed using conventional installation practices for RF devices, it may cause interference to radio and television reception. It has been tested and found to comply with the limits for a Class A computing device pursuant to Subpart B of Part 15 of FCC Rules, which are designed to provide reasonable protection against such interference. However, there is no guarantee that interference will not occur in a particular installation. If it has been found to cause interference to radio or television reception, which can be determined by removing and reapplying AC and battery power to the equipment, the installer should try to correct the interference by one or more of the following measures: reorient the receiving antenna; connect the power transformer to a different outlet so that the control panel and receiver are on different branch circuits; relocate the control panel with respect to the receiver.

## MOUNTING

### Control Panel

Choose a mounting location accessible to (a) a continuously-powered AC source, (b) system ground, a steel or copper ground rod, ideally no further away than 10 feet, and (c) telephone lines (keep telephone wiring away from keypad wires). Remove appropriate knockouts for cables. Place the control panel at a convenient viewing height and mark the mounting holes. Attach the enclosure using screws suitable for the mounting surface.

### Grounding

Connect the control-panel grounding screw through a No. 16 AWG. or larger wire to a long steel or copper ground rod driven deeply into the earth. Do not use a gas pipe, plastic pipe or ac ground connections. Make the run as short and direct as possible, without any sharp bends in the wire.

### Tamper Switches

Tamper switches may be installed to prevent opening of the control-panel door or removal of the cabinet from the wall. Ideally, tamper switches should be connected to a zone that is active at all times, thus it may be necessary to program that zone as a 24-Hour Zone or Day Zone. When used on a normally-open zone, normally-closed tamper switches (open when set) should be wired in parallel. On a normally-closed zone, install Napco TPS-2 normally-open tamper switches (closed when set) in series.

There are two places in the cabinet to mount tamper switches: (1) To prevent cabinet removal from the wall, there are three mounting holes on the left side of the cabinet, another hole on the back that allows the switch button to contact the wall. (2) To prevent opening the cabinet door, there are three mounting holes on the right side of the cabinet. When mounted, the switch button should contact the inside of the door. Be sure to alert the user that opening the enclosure door will cause a tamper alarm. **Note:** Each tamper switch is furnished with three machine screws for mounting, and one self-tapping screw. The sole purpose of the self-tapping screw is to tap the holes for the machine screws; it may be discarded after use.

### Keypad

A keypad should be located near each exit/entry door. The keypad features a handy pull-up reference label. Before mounting the keypad onto the wall, push the Sliding Label Plate (with label and felt backing affixed and handle facing forward) down the guides at the rear of the keypad until it snaps into place. Once installed, the Sliding Label Plate cannot be removed without first removing the keypad from the wall. **Note:** (1) The keypad fire and panic keys should not be considered a substitute for a listed manual initiating device, such as a pull box. (2) Each GEM-RP1CAe2/GEM-K1CA includes provisions for four additional zones. See ADDING EXPANSION ZONES.

If installing onto a double-gang box, insert mounting screws through the two vertical elongated holes on the left side of the case and into the box. If the box is visible when viewed from the front, adjust the keypad vertically and tighten the screws. Then, using hardware suitable for the mounting surface, add one or two screws at the right side of the keypad case directly into the wall to ensure a secure installation. **Note:** Do not overtighten the screws! Uneven walls may cause the keypad case to distort.



## Wiring

Wire keypad(s), zones, expansion zone modules and output devices as shown on the Wiring Diagram. Note that the Wiring Diagram contains important information not available elsewhere in this manual.

**CAUTION:** Do not run telephone wiring near speaker wires; do not run keypad wiring with loop wiring.

## Adding Expansion Zones

GEM-P9600 Series control panels will handle up to 8 zones as is, however this number may be increased to as many as 96 programmable zones using optional expansion zone modules (EZMs).

## Wireless Systems (NOT EVALUATED BY U.L. FOR COMMERCIAL APPLICATIONS)

With the addition of at least one GEM-RECV series receiver, the GEM-P9600 will support up to 96 wireless transmitters. The panel can accommodate one to four receivers within the premises, responding to the one with the stronger transmitter signal. If any transmitters are selected for the default program, a GEM-RECV receiver will automatically be programmed.

The keypad can display the status of any transmitter, indicating the condition of the zone (normal or open) and transmitter troubles (low battery, tamper or supervisory failure), and signal strength of the last transmission. A receiver failure will be indicated by "E06-NN" ("no response", with NN representing the receiver number).

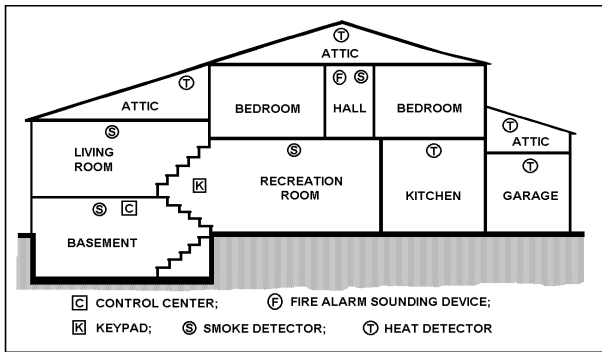

## TYPICAL RESIDENTIAL FIRE INSTALLATION (Where permitted by local codes)

At least one smoke detector should be installed directly outside each sleeping area. If there is more than one floor, additional smoke detectors should be installed on each level, including the basement. The living-area and basement smoke detectors should be installed near the stairway of the next upper level.

For increased protection, additional detectors should be installed in areas other than those required, such as the dining room, bedrooms, utility room, furnace room, and hallways. Heat detectors, rather than smoke detectors, are recommended in kitchens, attics, and garages due to conditions that may result in false

alarms and improper operation. Large areas and areas with partitions, ceiling beams, doorways, and open joists will require additional detectors.

Refer to NFPA Standard No. 74 (National Fire Protection Association, Batterymarch Park, Quincy, MA 02269) for additional information, including proper mounting of detectors.

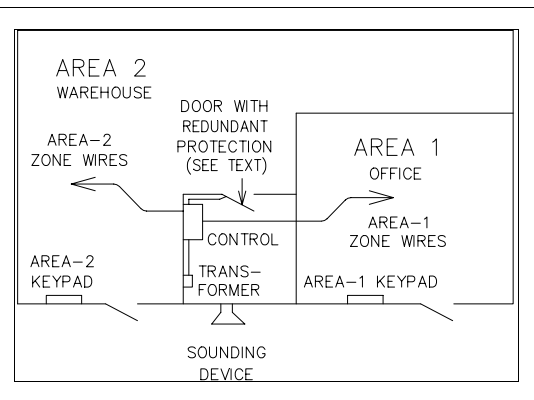

## TYPICAL PARTITIONED INSTALLATION

Described and illustrated here are an example of a partitioned system with common-area protection of the control-panel room. This system meets UL requirements for a partitioned installation.

- Both areas must be owned and managed by the same person(s).
- Both areas must be part of one building at one street address.
- The control panel and all wiring protecting each partitioned area must be confined to the respective area and may not encroach upon the other area. This requires that the control panel room have redundant protection; that is (a) multiple sets of door contacts, each wired to a separate zone and (b) one of those zones programmed for each area. In order to gain access to this protected area without causing an alarm, both partitions must be disarmed. In lieu of redundant protection, 24-Hour Zones may be used. Any zone protecting the control panel and transformer may not be programmed for bypass.

The sounding device must be placed such that the bell test can be heard by all partitions. Note: NFPA 74 (Household Fire Warning Equipment) requires that a fire alarm audible device be installed indoors. The User Program Code is not to be given to anyone except the authority responsible for all partitions.

INSTALLATION

## UL COMMERCIAL-BURGLARY INSTALLATIONS

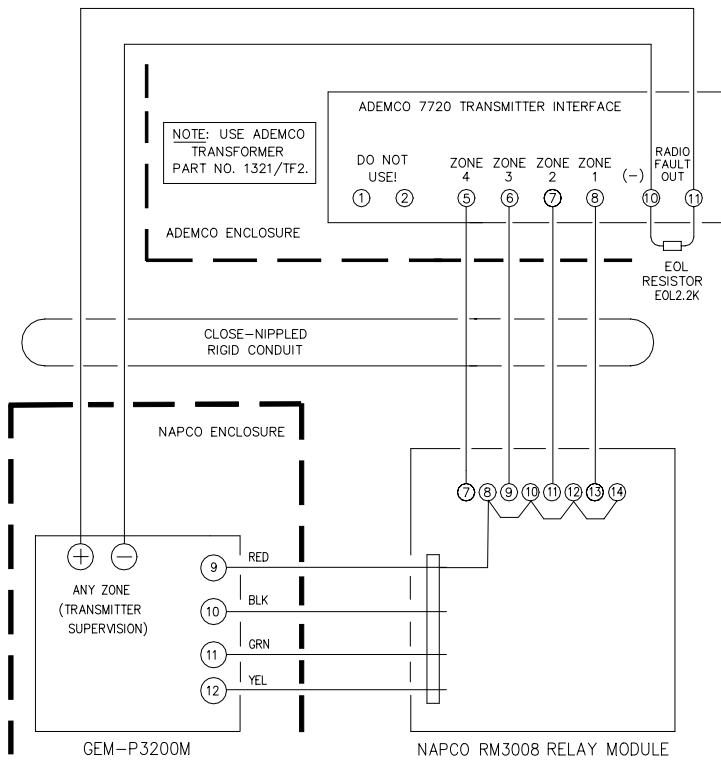

The GEM-P9600M can be used as part of a UL Central Station Grade C, B, or A installation. Normally, a digital communicator is classified as Grade C and may be classified Grade B if used with the specified Grade-A Local bell and bell housing. A UL Central Station Grade-A installation requires the use of a Napco RM3008 Relay Board and Ademco 7720 Radio System. Refer to the installation instructions furnished with each component for respective installation requirements.

For a UL Commercial Grade-A Police Station Connection, refer to GRADE-A LOCAL MERCANTILE INSTALLATIONS, which follows. Use the M278 Line-Reversal Monitor to provide basic line security; refer to the instructions accompanying the M278 for other installation requirements. For UL Commercial safe and vault applications, use a UL-listed shock sensor suitable for metal enclosures. Install tamper switches on front and rear of control-panel enclosure.

### Grade-A Local Mercantile Installations

A Grade-A Local Mercantile installation must use at least a 6.0AH standby battery. Programming must include Auto Bell Test on Arming. Trouble on Night Open may not be programmed for any zone. The minimum requirements for a listed Grade-A Local system include:

- Low-Battery Annunciation.
- An Ademco AB-12 Bell and Box (12-volt).
- Program Auto Bell Test on Arming.
- A maximum Entrance and Exit Delay of 60 seconds.

### Interfacing to the Ademco 7720 Long-Range Wireless System

The RM3008 may be used to interface the GEM-P9600M control panel to the Ademco 7720 transmitter in order to meet UL Central Station Grade-A or Grade-B requirements by using a digital communicator combined with one-way wireless. (Normally, a digital communicator is Grade C, and may be Grade B if the specified Grade-A local bell is used.) Refer to the wiring diagram which follows, and to the instructions furnished with the Napco and Ademco equipment for further information concerning the DACT, listed compatible receiver and formats, Grade-A local bell and bell housing. Enable Line Fault Test must be programmed.

### Central Station Grade-B Requirements





Wiring to the Ademco 7720 transmitter must be enclosed in rigid conduit when outside walls, or in flexible conduit when inside walls or above ceilings, for the entire length up to the transmitter room. The transmitter room must be protected by a UL listed intrusion detection unit that is connected to one of the input channels of the Ademco 7720. Relays must be programmed to trip the Ademco 7720 for alarms on all protective circuits, including tampers, telco phone failure, 24-hour test timer, transmitter low battery and ac loss. (See PCD3000 External Relay Control screen). One zone on the GEM-P9600M, programmed as a 24-Hour Zone, must supervise the radio.

### Central Station Grade-A Requirements

In addition to Grade-B Requirements (above), one relay on the RM3008 must be programmed to trip the Ademco 7720 when the telephone line fails. Daily openings and closings are required to be transmitted by the Napco panel along with the 24-hour DACT test signal and DACT trouble conditions.

## TESTING THE SYSTEM

After installation is completed, test the system as follows.

-  1. Call the central station to inform them of the test.
-  2. Initiate an alarm, preferably on a zone that activates a steady siren, and verify proper signaling.
-  3. Wait 5 minutes.
-  4. Call the central station to confirm their receipt of a good transmission.

**Note:** Be sure to test all enabled keypad panics.

### Signal Strength Testing/Wireless Systems

To test the operation of wireless transmitters, proceed as follows. (Note: Wireless systems have not been investigated by UL).

-  Fault a point of each transmitter to be tested by faulting the zone.

The transmitter signal strength can be displayed using the DISPLAY RF XMITTER STAT function. Enter a Level 3 User Code or enter the Dealer Code, press the **FUNCTION** button and answer NO until "DISPLAY RF XMITTER STAT" is displayed. Press YES (**INTERIOR** button) and the Wireless Signal Strength of the wireless zone will be displayed. The Wireless Signal Strength will be displayed from 1 to 10 with 10 being the strongest signal and any signal under 3 as unacceptable. Except in the Fault-Find Mode, signal strengths less than 3 will be entered into the system log. Press NEXT (**INTERIOR** button) to step the next zone.

The last received signal strength for each transmission is always stored in memory and can viewed at any time using this procedure. Signal strength can also be viewed through the PCD3000 Status Screen.

# WIRING CONNECTIONS

## BATTERY

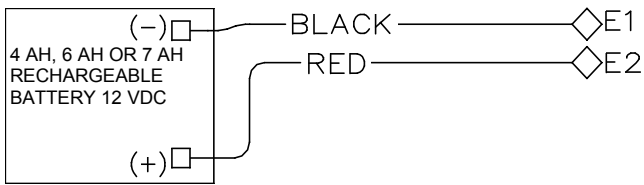

The RED (+) and BLACK (-) flying leads must be connected to a 12VDC 4, 6 or 7 AH Rechargeable Battery, to serve as backup power in the event of AC Power Failure. **NOTE:** To calculate the available standby time refer to the Standby-Battery Calculation Worksheet at the back of this manual.

## TRANSFORMER

AC IN, 16.5V/60HZ VIA TRF11 OR TRF14  
CLASS 2 TRANSFORMER  
DO NOT CONNECT TO SWITCHED OUTLET

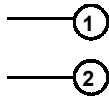

Connect a 16.5 VAC Transformer to Terminals 1 and 2, using a wire of #18 AWG. or less at a distance of 15 ft. or less from the control panel. **NOTE:** Do not connect to a switched outlet.

## SIREN/BELL BURG/FIRE ALARM OUTPUT

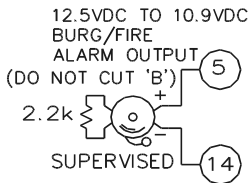

Connect the alarm sounding devices (self-contained sirens, speakers or a mechanical bells) to terminals 5 (+) and 14 (-). Any self-contained siren requiring a 12 VDC input can be connected. When connecting a mechanical bell, it must be supervised using a 2.2k Ohm resistor. To connect 8 Ohm Speakers use a Siren Driver with the proper polarity observed. **NOTE:** Refer to the Wiring Diagram for alarm current specification, bell supervision and burglary output relay. **Note:** In NFPA Household Fire Installations, only a single siren or bell can be used on this bell circuit.

## AUXILIARY ALARM OUTPUT

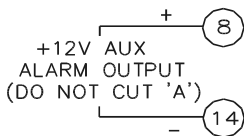

Auxiliary Output can be activated depending on the programming options selected (see GEM-P9600 Programming Instructions). Connect the device controlled by the programmable output between terminal 8 (+) and terminal 14 (-). A programming option "Aux. Output Chirp on Key-fob Arming" is available. If selected, an external siren driver can be connected to these terminals.

WIRING CONNECTIONS

# REMOTE BUS

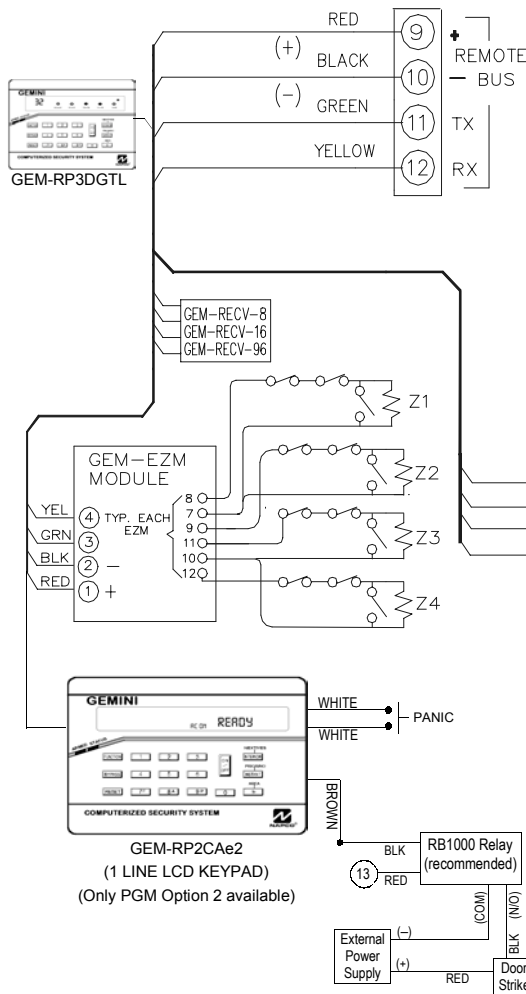

**NOTE:** Refer to the EZM Installation Instructions for specific wiring information.

- AVAILABLE DEVICES**
1. **KEYPADS:** GEM-RP1CAe2, GEM-RP2ASe2, GEM-RP3DGTL, GEM-K1CA, GEM-K2AS and GEM-K3DGTL.
  2. **X-10 INTERFACE:** GEM-X10
  3. **WIRED ZONE EXPANDER:** GEM-EZM4 & GEM-EZM8
  4. **WIRELESS RECEIVERS:** GEM-RECV8, GEM-RECV16 & GEM-RECV96
  5. **RELAY MODULE:** RM3008
  6. **VOICE INTERFACE:** GEM-EVA 1
  7. **TELEPHONE INTERFACE:** WIZARD IIe

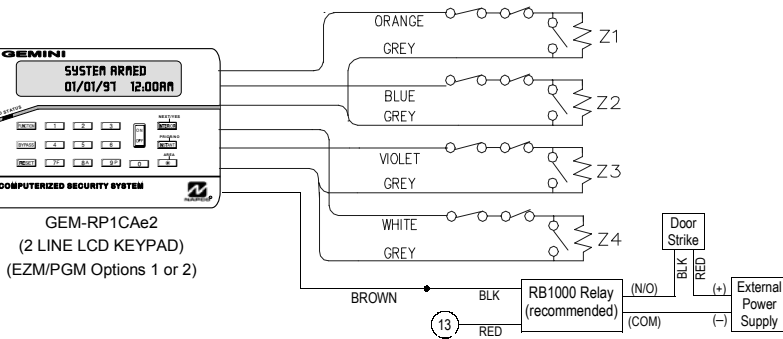

**Keypad Brown Wire: EZM/PGM Output Options**

Select either option with GEM-RP1CAe2/GEM-K1CA keypads. Option 2 for use with GEM-RP2ASe2/GEM-K2AS keypads only.

Option 1. Activates the PGM lug on the corresponding EZM module(s). Lug goes active (low) when any selected Area is armed.

Option 2. The Access Code will activate the keypad's PGM brown wire while armed or disarmed if the User Code is programmed for "Access Control on PGM Lug". The Access Code is programmed as any other User Code but without arm/disarm capability. **NOTE:** Options not investigated by UL.

Connect the available devices as shown above to the remote bus terminals (9, 10, 11 & 12). Observe the correct color wire connections. When connecting a keypad, first configure them accordingly (refer to the Keypad Configuration Mode at the back of this manual). Keypads should be located near every exit/entry door. Up to 15 keypads may be connected if the longest cable run from the panel, to the farthest keypad (daisy chained or home-run) is less than 1000 feet. The maximum distance for seven keypads is 300 feet using 22 AWG. wire. **NOTE:** When running keypad wire, avoid wiring parallel to other types of wiring that can cause electrical interference.

# EARTH GROUND



**NOTE:** Do not use a gas pipe, plastic pipe or AC ground connections.

Connect the control panel EARTH GROUND screw through a No. 16 AWG. or larger wire to a metal cold-water pipe. Do not use a gas pipe, plastic pipe or AC ground connections. Also, connect the circuit board to the metal enclosure. Connect a wire with a ground lug crimped or soldered onto one end of the EARTH GROUND screw to the cabinet. **NOTE:** Grounding connections should avoid bends in the grounding wire whenever possible.

# AUXILIARY POWER

- (+) — 13 Connect the auxiliary devices (motion detectors, glass breaks, etc.) to Terminals 13 and 14. Auxiliary Power provides a filtered 12 VDC nominal output which is used for powering auxiliary devices. **NOTE:** To calculate the available standby time refer to the Standby-Battery Calculation Worksheet at the back of this manual.
- (-) — 14

WIRING CONNECTIONS

## RESET OUTPUT

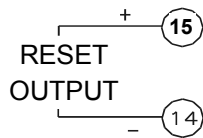

Reset Output can be activated depending on the programming options selected (see GEM-P9600 Programming Instructions). Connect the device controlled by the programmable output between terminal 15 (+) and terminal 14 (-).

## BASIC ZONE CONFIGURATION

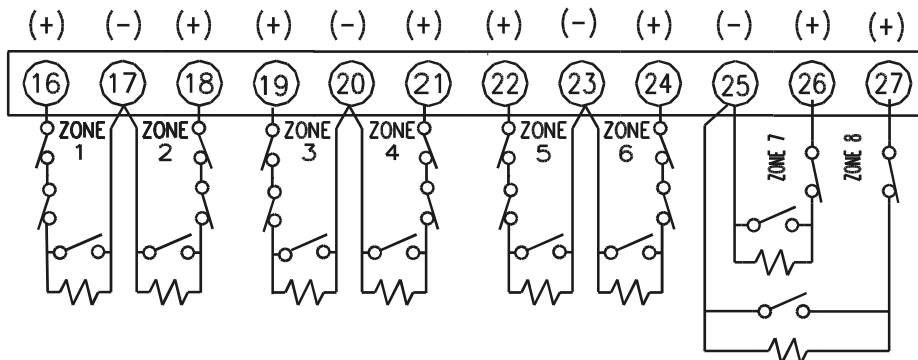

The basic zone configuration for the GEM-P9600 is 8 zones. Connect as shown above to terminals 16-27. Normally Closed (N.C.) devices may be wired in series or Normally Open (N.O.) devices may be wired in parallel. Use the 2.2K Ohm end-of-line (E.O.L.) resistor in each zone, if selected in programming (refer to the GEM-P9600 Programming Instructions). Zones 1-8 can be selected for a "Fast Loop Response (10ms or 50 ms)" or a "Normal Loop Response (750 ms)". Other zone options include Zone Type (Entry/Exit, Interior, 24 Hour Protection, Trouble and Fire), Instant, Chime, Area Selection and Relay Output selection.

## EXPANDED ZONE CONFIGURATION

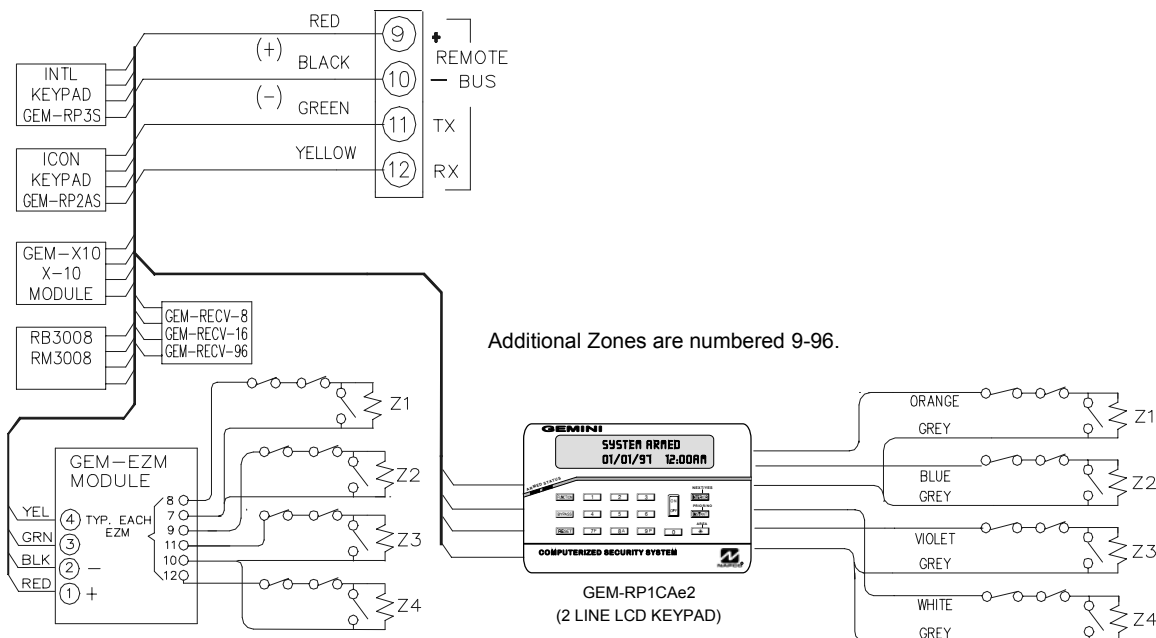

The GEM-P9600 Control Panel may be expanded up to 96 zones. This may be accomplished by adding 88 zones to the basic 8 zone configuration. Hardwired zone expanders include: GEM-EZM4 (4 additional zones per module), GEM-EZM8 (8 additional zones per module) and GEM-RP1CAe2 Keypad (4 additional zones per keypad). Wireless zone expanders include: GEM-RECV8 (8 additional zones per receiver), GEM-RECV16 (16 additional zones per receiver) and GEM-RECV96 (88 additional zones per receiver). Wireless transmitters include: GEM-TRANS2, GEM-KEYF, GEM-SMK, GEM-PIR, GEM-DT and GEM-GB.

WIRING CONNECTIONS



# 4-WIRE SMOKE DETECTORS

4-WIRE SMOKE DETECTOR WIRING

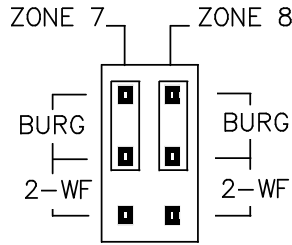
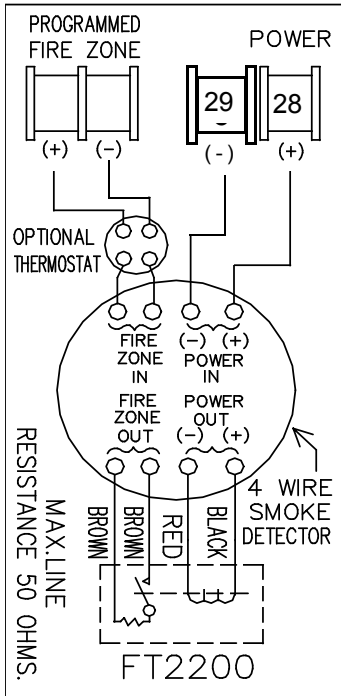

The GEM-P9600 can use conventional 12 VDC 4-wire smoke detectors. To use them, the select fire zone programming option and do not select 2-wire smoke detector programming option for the desired fire zone (refer to the GEM-P9600 Programming Instructions). Set JP7 to the BURG position as shown, if zones 7 or 8 are to be used.

Four wire smoke detectors may be connected to any programmed fire zone (1-8) as shown, within the panel. If external EZMs are used for zones 9-96, then 4-wire smoke detectors may be connected to any programmed fire zones (9-96).

Power must be obtained from terminal 28 (+) and 29 (-). If Fire Alarm Verification is desired to reset the smoke detectors, select this option for the desired fire zone.

NOTE: Do not program Fire Alarm Verification in California

# 2-WIRE SMOKE DETECTORS

2-WIRE SMOKE DETECTOR WIRING

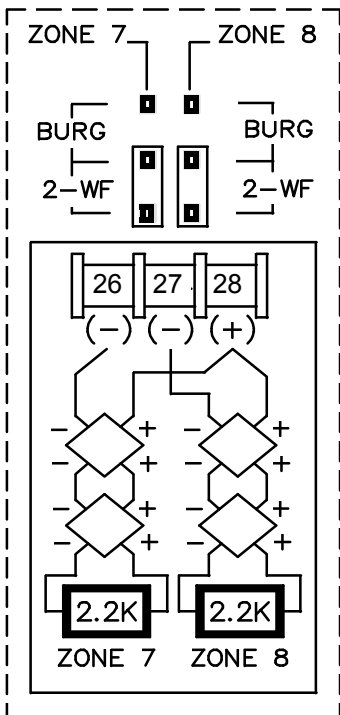

Two-wire smoke detectors may be connected to control panel zones 1-8. Zones 7 and 8 may be configured for 2 wire fire through the JP7 jumper settings, while zones 1-6 may be configured for 2 wire fire with the use of an EOL130 resistor and the cut of a control panel resistor. To enable, program the zone(s) as Fire Zones, enable 2-Wire Fire (refer to the GEM-P9600 Programming Instructions) and set JP7 to the position as shown. Connect the 2-wire smoke detectors as shown.

If Fire Alarm Verification is desired to reset the smoke detectors, select this option for the desired fire zone (zone 7 or 8).0

NOTE: Do not program Fire Alarm Verification in California

WIRING CONNECTIONS

## 2-WIRE SMOKE DETECTORS

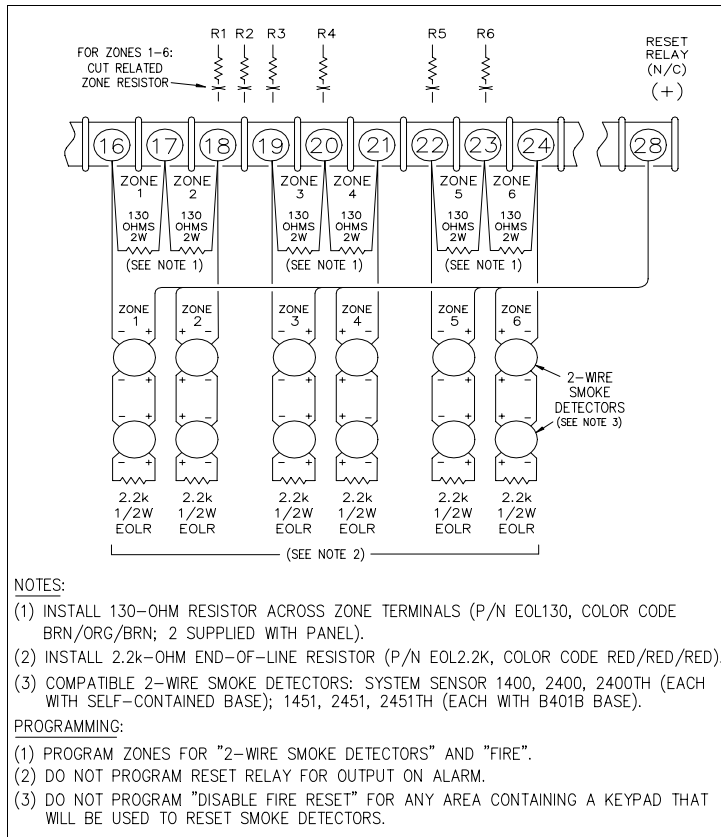

Connecting 2-wire smoke detectors to zones 1-6

Where more than two 2-wire smoke detector zones are required, select any of Zones 1-6 for 2-wire fire as follows:

1. Program the selected zone(s) (1-6) for 2-Wire Smoke Detectors and Fire.
2. Cut the lead of the 2700W resistor (color code: red/violet/red) associated with the selected zone (s). See following table.

ZONE	RESISTOR	LOCATION ON BOARD
1	R1	ABOVE TERMINAL 18
2	R2	ABOVE TERMINAL 18/19
3	R3	ABOVE TERMINAL 19
4	R4	ABOVE TERMINAL 20
5	R5	ABOVE TERMINAL 22
6	R6	ABOVE TERMINAL 23

3. Install a 130W resistor (Napco Part No. EOL130; color code: brown/orange/ brown), 3 watts, across the two terminals of each selected zone.
4. Wire the positive (+) terminal of the smoke detector to Terminal 28. Wire the negative (-) terminal of the smoke detector to the positive terminal (+) of the zone.

WIRING CONNECTIONS

## TELEPHONE LINES

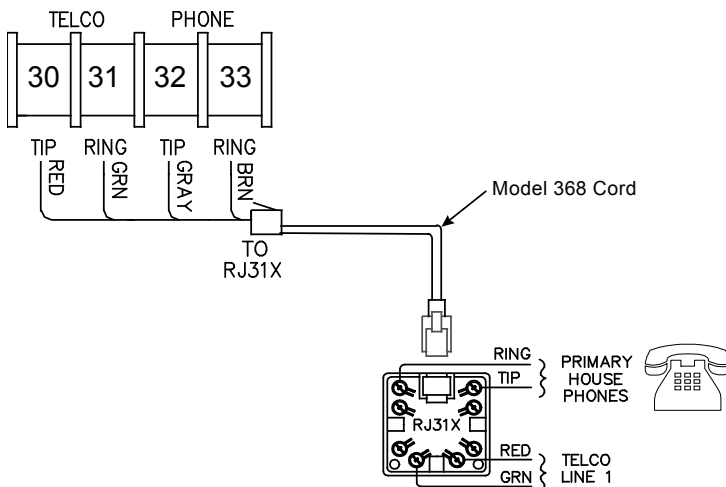

Connect the Model 368 Cord as follows: 30 (RED = Telco Tip), 31 (GREEN = Telco Ring), 32 (GRAY = Home Tip) and 33 (BROWN = Home Ring). Insert the modular plug into an approved USOCRJ31X jack (or a CA31A jack for Canadian installations). The Telco Line is used by the control panel to dial the central station and for downloading. This line should not be connected to party lines or coin operated telephones. If connected to a line with call waiting, then call waiting interrupt numbers must be programmed into the CS Telephone Numbers (refer to the GEM-P9600 Programming Instructions).

# KEYPAD CONFIGURATION MODE

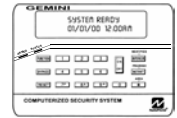

This section will focus on configuring the GEM-RP1CAe2/GEM-K1CA and GEM-RP2ASe2/GEM-K2AS Keypads. If there is more than one keypad in the system, *only Keypad No. 1 may be used for programming.*

## KEYPAD INSTALLATION

Each keypad must be assigned an address number (1–15) and each requires its own configuration procedure (see CONFIGURING THE KEYPADS, which follows, and DIRECT ADDRESS KEYPAD AREA OPTIONS). At least 1 keypad must be used; only 1 is required for a single-area Commercial Burglary installation.

- **GEM-RP1CAe2/GEM-K1CA** - is a 2-line combination fire/burglary/access keypad capable of supporting 4 EZM zones. A GEM-RP1CAe2 or GEM-K1CA is recommended for use as Keypad #1.
- **GEM-RP2ASe2/GEM-K2AS** - is a utility LCD keypad combining several preset LCD words with a limited message line. **NOTE:** Due to space constraints, available messages are abbreviated and will scroll automatically.







## CONFIGURING THE KEYPADS

A total of up to 7 keypads may be connected to the panel. GEM-RP1CAe2/GEM-K1CA and GEM-RP2ASe2/GEM-K2AS keypads may be intermixed but require different configuration procedures, as described in the following paragraphs. If you have a GEM-K1CA keypad, please see the "Important Note" on page 3 regarding the differences between the GEM-RP1CAe2 and the GEM-K1CA keypad buttons. The buttons displayed below will be for the GEM-K1CA keypad.

### Configuring the GEM-RP1CAe2/GEM-K1CA Keypad

Each GEM-RP1CAe2/GEM-K1CA keypad must be configured for (a) keypad tactile beep; (b) entry sounder; (c) keypad address; (d) EZM address; and (e) zone response.

**To enter the GEM-RP1CAe2/GEM-K1CA Configuration Mode:**

1. Move jumper JP1 (located at the upper center of the control panel board) from Pins 1-2 (top two) to Pins 2-3 (bottom two). **NOTE:** See the Wiring Diagram.
2. After about 15 seconds, the display will read "XX OUT OF SYSTEM", where XX indicates the keypad address.
3. Press       and proceed as follows. (Repeat the following procedure for all keypads.)



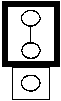

NORMAL  
KEYPAD  
CONFIGURE



Keypad Beep

ON





### Keypad Tactile Beep

Upon entering the Keypad Configuration Mode, "KEYPAD BEEP ON" will be displayed, indicating that the tactile beep, which sounds when any button is pressed, is on. To turn off the tactile beep, press the  button (the  button will toggle the tactile beep on and off). Press the  button to continue or press the  button to exit.

Entry Sounder

ON

### Entry Sounder

To turn off the keypad sounder during entry time, press the  button (the  button will toggle the entry sounder on and off). Press the  button to continue or press the  button to exit.

Keypad Address

01



### Keypad Address

If more than one keypad is installed, each must be assigned a unique keypad address (that is, no two keypads may be numbered alike):

 keypads must be numbered consecutively (missing numbers are not permitted)

 only Keypad No. 1 may be used for programming.

*To assign the keypad number, proceed as follows:*

1. Enter the assigned keypad number 01–15, then press the  button to save. A valid number will be acknowledged by a short beep; an invalid number will be rejected by a long beep.
2. Press the  button to continue or press the  button to exit.





### Compatibility Number

The compatibility number is a 4-digit security code that, if programmed into both the control panel and each GEM-RP1CAe2/GEM-K1CA keypad, dedicates the keypad to only that panel. That is, (a) similar keypads not having the correct compatibility number will not operate in the system and (b) a

keypad may not be removed for use on a system with a different compatibility number. **Note:** (1) If assigning compatibility numbers, record and store them in a safe place. (2) The GEM-RP2ASe2/GEM-K2AS and GEM-RP3DGTL/GEM-K3DGTL Keypads will function with or without a Compatibility Number.

While the compatibility number may be changed, the old number must be known in order to program the new number. **Note:** If neither the control panel nor the keypad is given a compatibility number, both default to "0000" (thereby maintaining compatibility).

To program the compatibility number, press the **FUNCTION** button until "NEW COMPAT# 0000" is displayed. Enter the 4-digit compatibility number that is programmed into the panel. **Note:** If the keypad had been previously programmed for a compatibility number other than "0000", the display would read "OLD COMPAT# XXXX". Enter the existing number before attempting to change it. Press the **FUNCTION** button to continue or press the **RESET** button to exit.



### EZM Address

The keypad's internal EZM (Expansion Zone Module) may be utilized to provide four additional wired zones. Whether used alone or in conjunction with optional GEM-EZM series modules or other keypad EZMs, it must be assigned a unique address (or Group number, see Keypad Programming

Workbook) similar to its keypad address. If no other EZMs are to be used, designate the keypad as Group "01" at the "EZM ADDRESS 00" display. In multiple-EZM systems, enter an assigned group number "01" through "22". (Each EZM must have a unique assigned group number, starting with "01" and proceeding consecutively). Press the **FUNCTION** button to continue or press the **RESET** button to exit.



### Zone Response

The normal loop response of each keypad expansion zone is 750mS, however the response time of any zone can be reduced to 50mS as follows.

1. Of the following, circle the number(s) in parentheses associated with the zone(s) to be changed: Zone 1=(1); Zone 2=(2); Zone 3=(4); Zone 4=(8)
2. Add up the circled numbers.
3. At the keypad, enter the sum as a two-digit number "01" through "15" on the display, then press the **ON/OFF** button.

**Example.** Change Zones 2, 3 and 4 to 50mS response.

1. Circle numbers for Zones 2, 3 and 4: (2), (4) and (8).
2. Add up the circled numbers: 2 + 4 + 8 = 14.
3. Enter "14" at the keypad, then press the **ON/OFF** button.

Press the **FUNCTION** button to continue or press the **RESET** button to exit.



### Program Control Message

The Access-Control message normally displays "\*\*ENTER NOW\*\*" however this display may be changed to any of the following messages as displayed in the table at right:

Press the **FUNCTION** button to continue (the display will loop back through selections,

for changes) or press the **RESET** button to exit the Keypad Configuration Mode (display will read "01 OUT OF SYSTEM"). Then replace Jumper JP5 across Pins 1-2 (top two).

Program Control Message	
0	(No Message)
1	**Enter Now**
2	Door Control
3	Gate Control
4	Light Control
5	Control #1
6	Control #2

### Configuring the GEM-RP2ASe2/GEM-K2AS and GEM-RP3DGTL/GEM-K3DGTL Keypads

Up to 7 GEM-RP2ASe2/GEM-K2AS and/or GEM-RP3DGTL/GEM-K3DGTL keypads may be connected to the panel (Keypads 1–7). Each must be configured for a keypad address. In addition, the keypad may be configured to disable (a) touchpad backlight; (b) LCD backlight; and (c) entry sounder. Keypads are configured by the proper selection of jumpers. Refer to the label on the circuit board insulation paper for jumper locations and a summary of settings. For the GEM-RP4RFC/RP4C and GEM-K4RF/GEM-K4 keypads, see their respective installation instructions (listed on page 8).

#### GEM-RP2ASe2 KEYPAD

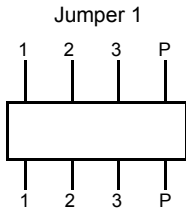



KEYPAD NUMBER	ADDRESS JUMPER			
	1	2	3	PARK
1	OFF OR ON	OFF	OFF	MAY BE USED TO HOLD SPARE JUMPER
2	OFF	ON	OFF	
3	ON	ON	OFF	
4	OFF	OFF	ON	
5	ON	OFF	ON	
6	OFF	ON	ON	
7	ON	ON	ON	

#### KEYPAD ADDRESS

If more than one keypad is installed:

 Each must be assigned a unique address (that is, no two keypads may be numbered alike).

 Keypads must be addressed consecutively (that is, missing numbers are not permitted).

 Only Keypad No. 1 may be used for programming. (However, for ease of programming, it is recommended that a GEM-RP1CAe2/ GEM-K1CA be selected as Keypad #1.)

Assign the keypad address number by selecting Jumpers J1–3 in accordance with the table at left.

**\*Note:** (1) Keypads are factory supplied with no jumpers installed and as such are automatically configured as Keypad No. 1. (2) Only one keypad in the system may be configured as Keypad No. 1, otherwise none will function.

#### GEM-RP3DGTL KEYPAD

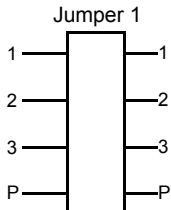

ADDRESS NUMBER	KEYPAD NUMBER						
	1	2	3	4	5	6	7
1	OFF OR ON	OFF	ON	OFF	ON	OFF	ON
2	OFF	ON	ON	OFF	OFF	ON	ON
3	OFF	OFF	OFF	ON	ON	ON	ON
P	MAY BE USED TO HOLD SPARE JUMPER						

#### TOUCHPAD BACK LIGHT

Cut Jumper A to disable touch pad backlighting to conserve 11mA standby current.

#### LCD BACKLIGHT

Cut Jumper B to disable LCD backlighting.

#### DISABLE SOUNDER

Cut Jumper C to disable the sounder. (Do not disable in UL applications.)



**NAPCO Security Systems, Inc.**  
 333 Bayview Avenue, Amityville, New York 11701  
 For Sales and Repairs, call toll free: (800) 645-9445  
 For direct line to Technical Service, call toll free: (800) 645-9440  
 Internet: <http://www.napcosecurity.com>

## BASIC OPERATION

This section provides a brief overview of system operation. For detailed operation, refer to the User's Guide furnished with the keypad (see page 8 for a complete listing) and to the Keypad Programming Modes at the end of this manual. **NOTE:** Keypad displays shown in this text are for the GEM-RP1CAe2/GEM-K1CA keypads. GEM-RP2ASe2/GEM-K2AS displays will be similar, although abbreviated, and will scroll automatically.

### USER CODES & ZONE DESCRIPTIONS

(Refer to the GEM-P9600 Programming Instructions (WI777 and WI1185) for a detailed explanation of programming). Up to 96 personal user codes may be programmed at the keypad. **NOTE:** The Area Options associated with each User Code may only be programmed in the Dealer Program Mode.

#### Default User Code.

The first code programmed should replace the default (User 01) code, "U01 123 - - ", (1,2,3), which should not be selected as a user code.

Each user should be assigned his own dissimilar code and should be cautioned against divulging his code to anyone else. Thus should it become necessary to remove a user from the system, that one code may be cancelled without affecting other codes, and that user would then be prevented from entry. **Note:** Duplicate User Codes are not allowed by the panel; therefore a duplicate Code entered in the LCD Window will erase when  is pressed.

#### Changing or Canceling a User Code

To change any user code, merely program over the existing user code as described in the Programming Instructions. Similarly, to cancel a user code, blank out each number of the user code.

#### Arm/Disarm Code (Programmable in Dealer Program Mode only)

An Arm/Disarm Code may be used to arm/disarm the area in which it is programmed. Up to 6 digits may be programmed or it may be programmed as a two-digit code for the purposes of arming quickly.

#### Arm-Only Code (Programmable in Dealer Program Mode only)

An Arm-Only Code may only be used to arm the area in which it is programmed; it never has any disarm capability. Up to 6 digits may be programmed or it may be programmed as a two-digit code for the purposes of arming quickly.

#### Service Code (Programmable in Dealer Program Mode only)

A Service Code is an Arm/Disarm Code that is easily activated when needed, and dormant at other times. Intended for the occasional or temporary user (repairman, etc.) who would otherwise be denied access to the premises. It may then be used to arm and disarm just as any other User Code. A Service Code can be armed/disarmed from a disarmed state, but it cannot be armed/disarmed from an armed state, after another user code has been entered. Up to 6 digits may be programmed or it may be programmed as a two-digit code for the purposes of quicker arming.







#### Keypad Access Code (Programmable in Dealer Program Mode only)



Any User Code may have Keypad Access through a door with a striker by programming the keypad's Access Byte (the last two digits of the code). Program the Keypad Access Byte for the applicable keypads 1 through 8. If the Access Byte is programmed, that User Code will function *only* a Remote Access Code and not as an Arm/Disarm Code. Entering the code will cause a 5-second active-low output on the PGM line with a pulsing sounder at the keypad and "\*\*ENTER NOW\*\*" (or other customized message) displayed. **Note:** (1) Keypads may be programmed for access only, eliminating their arm/disarm function (keypad will then normally display "\*\*ENTER CODE\*\*"). (2) Keypad access may be logged into the event log by keypad. The Access Code will trip the panel's Aux. Relay while armed or disarmed if the "Access Control on Auxiliary Output" and "Aux. Output Access Control Time" is programmed. The Access Code is programmed as any other user code but without arm/disarm capability. **Note:** These systems have not been investigated by UL for compliance with UL294 (Access Control Systems).





#### Ambush Code

The Ambush Code is special user code entered by the user typically to cause a silent report to be sent to the central station. Thus, should the user be forced to disarm by an assailant, he can silently signal an emergency while appearing to be merely disarming the panel. (Check the glossary for programming required to enable this feature).



#### Zone Descriptions. (GEM-RP1CAe2/GEM-K1CA only)

Zone descriptions follow the Program Code in the normal programming sequence ("01-" will appear in the display). Program the description, up to two lines, letter by letter. Buttons  and  control the position of the cursor. Buttons   will clear the entry at the cursor. When programming zone descriptions, buttons  and  will scroll

not only through numbers 0-9, but through the alphabet and a series of punctuation marks and symbols as well. (Roughly note the order in which the letters, numbers and symbols are displayed so that you will be able to determine the proper direction to scroll, up or down, for fastest access. As familiarity improves, so will programming speed). When the description has been entered and is satisfactory as displayed (e.g. "GARAGE"), you **MUST** press the  or  button to save it in memory.

To advance to the next zone (or to any other zone, for that matter), position the cursor over the displayed Zone Number, i. e., "01" using buttons  and . Change the Zone Number using buttons  and . Repeat the zone-description programming procedure for the new zone. Advance to the next zone and repeat until all zones (up to 96 zones) have been programmed.

## ARMING AND DISARMING THE SYSTEM

In the normal disarmed state, only the green STATUS LED will be on and the display will read "SYSTEM READY". To silence an alarm, enter any User Code, then press the  or  button. Any valid User Code may be used to arm or disarm; an Arm-Only Code may only be used to arm.

### Arming

 To arm, enter a valid User Code, then press the  button. (For all "Classic GEM-RP keypads)

 To arm, enter a valid User Code, then press the  button. (For all "K Series" keypads)

(If a wrong code is entered, the keypad will display "INVALID ENTRY / TRY AGAIN"). The green STATUS LED will go off, the red ARMED LED will go on, and the display will read "PLEASE EXIT IN / XXX SECONDS" ("XXX" representing the programmed exit-delay time, in seconds). The exit delay will immediately start counting down toward "000", in 10-second decrements, indicating the available time remaining to exit through an exit/entry door.

1. If Exit Delay Restart is enabled, after the panel is armed and the exit door is opened and then closed, exit delay will restart at 60 seconds. If re-entry occurs within this 60-second interval, the alarm device will sound a 2-second warning "chirp", if programmed, as an entry reminder to the user to return to the keypad and disarm.
2. (GEM-RP1CAe2/GEM-K1CA keypads only). An "S" in the display (e.g. "EXIT TIME XXX S") will appear as a reminder that the system is being armed with the Service Code active. (To turn off the Service Code, disarm, then rearm using a regular Arm/Disarm Code).
3. If a System Trouble is displayed, there should be an attempt to correct the system trouble (for example by calling an alarm maintenance or an alarm repairman). If this cannot be done, then press the  button to allow 5 minutes to access the keypad without the system trouble display. Immediate attention should be provided, when system troubles are encountered.
4. In commercial applications, if Start Exit Delay After Ringback is programmed, exit delay will not start until the central station acknowledges receipt by a ringback tone at the keypad. The display will read "PLEASE WAIT" while the control panel communicates to the central station. If the ringback tone does not sound within about 30 seconds, the START EXIT TIME function may be used to manually start exit delay.

### Disarming



When the exit time has elapsed, the display will read "SYSTEM ARMED". This indicates that upon entering the premises through an exit/entry door, there will be an entry delay to allow time to disarm the panel. The GEM-RP1CAe2 or GEM-K1CA display will read "DISARM NOW / XXX SECONDS" ("XXX" representing the programmed entry-delay time, in seconds). The sounder will come on and the entry delay will immediately start counting down toward "000" in intervals of 10 seconds, indicating the available time remaining to disarm the panel. (**Note:** The sounder will "pulse" with the GEM-P9600/3200 version 30 and above, and with the GEM-P1632/816 version 10 and above. The sounder will sound a "steady" tone with the GEM-P9600/3200 version 20 and lower, and with the GEM-P1632/816 version 9A and lower). The sounder will emit a rapid pulsing warning tone during the final 10 seconds.

To disarm the panel, enter a valid User Code, then press the  or  button.





### Arming in AWAY MODE

AWAY MODE provides for full protection of the perimeter and interior zones. Exit/Entry doors are provided with Exit/Entry delays. A "Classic" (non "K Series") keypad will display "SYSTEM ARMED", while a "K Series" keypad will display "ARMED AWAY." The RED LED will remain ON. With "K Series" keypads such as the GEM-K1CA and the GEM-K2AS, press  to begin the exit delay process (the exit delay will immediately start counting down toward "000", in 10-second decrements, indicating the available time remaining to exit through an exit/entry door).

## Arming in STAY MODE

STAY MODE provides partial protection by allowing free movement within the premises, while still protecting the perimeter zones. Exit/Entry doors are provided with Exit/Entry delays. A "Classic" series keypad will display "SYSTEM ARMED" with a Bypass Icon and a RED LED that remains ON, while a GREEN LED blinks. With "K Series" keypads such as the GEM-K1CA and the GEM-K2AS, pressing  bypasses all interior zones simultaneously, and arms the panel in "STAY MODE". The keypad will display "ARMED STAY". If  is pressed (hold for 2 seconds) when the panel is already armed in STAY MODE, the panel will enter "Instant Mode" and eliminate the entry time delay period.





### Instant Arming

INSTANT ARMING allows exit/entry zones to immediately go into alarm when violated, with no Exit/Entry time delay. This feature can be used to provide instant protection while you or someone else is on the premises. With the "Classic" keypads, to arm "Stay" and obtain Instant Arming, press  and , then enter your user code and press . With the "K Series" keypads, enter your user code and press . Then press and hold  until keypad beeps. Instant Arming will be automatically reset on disarming.

### Auto Arming (Not for UL Installations)



AUTO ARM allows the User to automatically arm the system at a specified time of the day and on specific days of the week. Schedule a specific closing time on any/all day(s) of the week. After a specific Fail-to-Close Window Start Time, if the user has not Armed the system during the Window Length, and the system has been instructed to "Fail-to-Close" and "Auto Arm if not closed at end of Window" then the system will arm, providing a 15 minute warning. **CAUTION:** If Automatic Interior Bypass is selected, *panel will Auto Arm in STAY Mode.*

### Delaying an Auto Arm (Not for UL Installations)

During the 15 minute pulsating sounder warning of an Auto Arm, a User can press the  or  button, until "TO DELAY AUTO ARM / PRESS 1-4 / N" is displayed. Enter the number of hours to delay arming, followed by the  or  button. If "DELAY AUTO ARM Y/N" is displayed, press the "NEXT/YES" button. The sounder can be silenced by pressing the  button during the 15 minute interval, but will come back on in the last 1 minute. This feature may be canceled by arming and disarming the keypad.

### EZ Arm (Easy Arm)

EASY ARM provides one button arming for non-security critical premises. Select Easy Arming for each Keypad, with optional reporting of Easy Arm Closings as User 35. Disarming still requires a valid user code.

 To arm, press the  button for "Classic" keypads;

 To arm, press and hold  or  for 3 seconds for "K Series" keypads.

### Keyswitch Arming

KEYSWITCH ARMING allows a zone input to be used to arm/disarm. The area will arm/disarm when the zone is momentarily shorted through a Momentary Switch. An end-of-line resistor must be used. Select Keyswitch Arm to optionally report as User 36.

### Remote Arming (Not for UL Installations)

REMOTE ARMING allows computer software control of arming/disarming of the system for non-security critical installations. Select Remote Arm to optionally report as User 34.





### Priority Arming

A 2-second tone and "CAN'T ARM SYSTEM/ZONE FAULTED" displayed when attempting to arm indicates a priority condition; that is, a problem exists on at least one zone that has been designated as a Priority Zone, or a system trouble exists. The trouble(s) must be corrected before the panel can be armed. The display will read "ZONE FAULTED", then automatically scroll through all unsecured zones. If a system trouble is indicated, it will display the system trouble.



### Area Arming/Manager's Mode

In a partitioned system, any of eight secured areas may be armed (or disarmed) from the Manager's Mode (if enabled). The Manager's Mode, is a low-security mode of operation. It provides quick access to other areas without having to go to another keypad of another area.











 To arm or disarm the alternate area (for "Classic" keypads):

1. Press a button between  and  representing the alternate area.
2. Press the  button, then the  or  button.



3. Arm or disarm the selected area using your user code (the user code must be valid for that area).
4. To return the keypad to its "home" area, press the  button, then the  or  button.

**Note:** If the "home" keypad has been changed to one of the alternate areas and remains unused for more than 5 minutes, it will revert back to the home area.





-  To arm all areas assigned to the user, press   [User Code]  or .
-  To disarm all areas assigned to the user, press   [User Code]  or .

## Overview Mode

To enable or disable Overview, see ACTIVATE OVERVIEW function later in this section. The Overview Mode is a high security mode of operation requiring a Level-3 User Code with Overview Option, wherein the status of both areas is displayed at the keypad. When arming, the "home" area remains disarmed. To arm the alternate area, see Keypad Area Change, which follows.

In the Overview Mode, "DASH" will be displayed, where each dash ("-") represents an area. In programmed areas, the dash will be replaced by one of the following:

- "A" = Area Armed
- "B" = Burglary Zone in Alarm
- "C" = Check Trouble; Area in Function-Display Mode
- "F" = Fire Zone in Alarm
- "R" = Area Ready (no faulted zones)
- "T" = Fire Trouble
- "Z" = Zone Fault

In the Overview Mode, the alternate ready area may be armed by pressing the   buttons. **Note:** The User Code must be valid in that area. Similarly, the alternate armed area ("A") may be disarmed by pressing the   buttons. If any zone is not secured, the system will not arm and the keypad will display "CAN'T ARM SYSTEM / AREA ## IN TROUBLE", where "#" represents the area number.



## BYPASSING ZONES

### Selective Bypass (Bypassing Specific Zones)

A Selective Bypass will bypass a specific zone that has Selective Bypass enabled, by pressing the  button followed by the zone number. The zone will be unbypassed the next time the system is disarmed.

### Security Bypass



Zones programmed for Selective Bypass may be removed from the system prior to arming as follows:



1. Enter a code valid for bypass (Authority Level 1 or higher and Bypass option enabled), then press the  button; "BYPASS ENABLED" will display.
2. Press the  button, then the zone number (or vice versa) to deactivate that zone.

**Note:** When the panel is subsequently disarmed, all bypassed zones revert to unbypassed zones (unless Disable Auto-Unbypass on Disarming is programmed or Interior Zones are programmed normally bypassed).



### Easy Bypass (Do not enable in UL applications.)

Enable this feature by programming Disable Code Required for Easy Bypass. Then, zones programmed for Selective Bypass may be bypassed quickly and easily as follows. **Note:** This is not a high-security feature.

1. At the "SYSTEM READY" or "ZONE FAULT" display, enter the zone number as a two-digit number (ex., "01", "15", etc.). Zones cannot be bypassed while the panel is armed.
2. Press the  button. To unbypass the zone, press the  button again. **Note:** Steps 1 and 2 may be reversed and this feature will still function.)

**Note:** If Bypass Faulted Zones is programmed, pressing the  and the  buttons simultaneously will bypass all zones in trouble (except Fire and PIR Zones) that are also programmed for Selective Bypass.

### Bypassing Interior Zones

Interior zones allow perimeter zones to be armed while part or all of the active interior remains disarmed. When the  button is pressed, the "BYPASSED" reminder will come on. Pressing the  button within 10 seconds will bypass the selected interior group without arming, otherwise Interior Bypass will time out and the system will revert to the regular disarmed state. All zones designated for the selected interior group(s) will be bypassed simultaneously when the system is armed. The alarm conditions will then be stored in the Alarm History Log and the Total Event Log (see HISTORY LOG).





## ALARM INDICATION

If programmed to silence an alarm, **enter a valid User Code and press the  button.**

The keypad must have permission to disarm the alarm (Alarm, Pulse Alarm, Fire Output, Reset Output or Auxiliary Outputs) from the specific area. This can be done through the PC Quickloader software, Area Features Screen or Area Bell Control.

Should a burglary alarm occur, the red ARMED LED will flash, and the display will alternately read "ALARM", then the zones violated. Disarm the panel; the display will read "ALARM" and will continue to indicate the violated zones until the  button is pressed or the panel is armed once again.

## FUNCTION MODE/DEALER PROGRAM MODE

The keypad can provide a wide assortment of utility functions as summarized in the Keypad Function Mode. The functions are displayed in a prompting "YES/NO" format. To skip a function, answer NO (press the PRIOR/NO button); to select and execute a function, answer YES (press the  button or the  button). The complete function list is provided here in its normal displayed sequence. However, since not all functions are designed for all systems (or intended for all users), only functions that are applicable and active are displayed. (For example, if no zones are bypassed, "DISPLAY ZN BYPASSED" will not appear). Furthermore, functions that are intended for use by the installer or servicer will not be displayed. **Note:** Functions may be manually scrolled forward or backward using the  and the  buttons, respectively.

To return to normal keypad operation, press the  button. (The keypad will automatically return to its normal operating mode if no activity is detected for longer than one minute). **Note:** Due to space constraints, GEM-RP2ASe2/GEM-K2AS message displays are abbreviated.

**Remember:** (1) Functions that are not active, not programmed and/or not applicable to the user's authority level will be suppressed and will not display. (2) Press the PRIOR/NO button to skip a function; press the NEXT/YES button to execute it. (3) The GEM-RP2ASe2/GEM-K2AS displays abbreviated messages that autoscroll.

### DISPLAY ZN FAULTS

Press the YES button to identify all unsecured zones (within the keypad's area) while disarmed. Press NEXT button to scroll through the zones. (Zones may be bypassed in this mode by pressing the  button). Manually bypassed zones will be indicated when displaying status.

### DISPLAY ZN BYPASSED

Press YES button to display zones that have been deactivated. Press NEXT button to scroll through the zones.

### DISPLAY ZN DIRECTORY

Press YES button to display a list of all programmed zone descriptions in the keypad area. Press NEXT button to scroll through the zones. To return to the system, press the  button at any time.

### ACTIVATE BELL TEST

Press YES button to activate the burg relay output (while disarmed) for about 2 seconds. If the device does not sound, it may be defective.

### DISPLAY PHONE #'S

The panel can function as an auto dialer to any of four programmed telephone numbers. (Telephone numbers must be programmed through Napco PCD-Windows Quickloader software). Select Telephone #1-4 using NEXT and PRIOR buttons, then press the  button. Pick up the phone to initiate dialing of the displayed number. (The phone will appear to be disconnected while dialing but will return to normal after a few seconds).

### DISPLAY SYS TRBL

Press YES button to check trouble (LOW BATTERY, AC POWER LOSS, etc.). Wait for the display to scroll through multiple system troubles, or use the NEXT and PRIOR buttons to manually scroll.

### DISPLAY FIRE ALARM

To display Fire Zone(s) in alarm, access DISPLAY FIRE ALARM and scroll through the zones using the NEXT button. Correct the problem, then press the  button to restore the "SYSTEM READY" condition.

### DISPLAY FIRE TRBL

To display Fire Zone(s) in trouble, access DISPLAY FIRE TRBL and scroll through the zones using the NEXT button. Correct the problem, then press the  button to restore the "SYSTEM READY" condition.

## DISPLAY OP/CL

- ✓ NAPCO's PCD-Windows Quickloader software offers a comprehensive array of programmable opening and closing suppression windows, by area, for all days of the week, for both normal and holiday schedules. A two-line display of the programmed schedule may be read at the keypad. The first line indicates:
  - ✓ the day of the week
  - ✓ opening or closing suppression window
  - ✓ "AUTO", if autoarming
  - ✓ normal (or delayed) schedule (see below)

To scroll through the days of the week, use the NEXT and PRIOR buttons.

The closing of any suppression window may be delayed up to four hours at the keypad, or the window may be totally disabled, up to one week in advance. Select the DAY/OP/CL schedule using the NEXT and PRIOR buttons. Select the delay (1-4 hours) or disable using the  button. **Note:** If the schedule includes autoarming, arming will be delayed accordingly. Also see Autoarm Function. (Autoarming can be disabled or delayed by area using PCD-Windows software).

## ACTIVATE OVERVIEW

This mode provides a system status display of all partitioned areas at a glance. **Note:** The keypad selected for the Overview Mode will remain in that mode. To convert the keypad back to its original use as an area keypad, enter the Function Mode and access DEACTIVATE OVERVIEW. The display will revert to "SYSTEM READY". Also see Overview Mode.

## ACTIVATE CHIME \*

Press YES button to sound a tone at the keypad when a Chime Zone is violated. The duration of the tone is programmable. To turn off the Chime Mode, press YES button at the DEACTIVATE CHIME function. **\*Note:** Chime and Watch modes display as "Monitor" on all GEM-RP2ASe2 and GEM-K2AS keypads.



## ACTIVATE WATCH\*

This option, if programmed, permits all zones designated as Day Zones to be turned on. When selected, a "W" will appear in the display (GEM-RP1CAe2 only) as long as the Watch Mode is active. To deactivate the Watch Mode, arm, then disarm. **\*Note:** Chime and Watch modes display as "Monitor" on all GEM-RP2ASe2 and GEM-K2AS keypads.

## GUARD TOUR (ON/OFF)

A Guard Tour schedule is programmable through Napco's PCD-Windows Quickloader software. *Guard Tour* is toggled on and off by pressing . When Guard Tour is toggled on, the programmed starting time of the tour will be signalled by all guard tour keypads pulsing and displaying "Do Guard Tour/ Enter Code". The tour must be started within 10 minutes of the signal. Entering the Guard-Tour Code at each keypad will silence its sounder and restore its "System Ready" display. Silencing the last keypad ends the tour. If the tour is not completed within the programmed duration, the panel may be programmed to report to the central station, trip the burg relay (or one of the 96 external relays), or both (or neither).

## RESET SYSTEM TRBL

- ✓ System troubles normally latch and display and sound at the keypad. Pressing the  button will silence the sounder; "SYSTEM READY" will be displayed. Correcting the trouble will clear most system trouble indications, however the following system troubles require a Level-2 or -3 code for manual reset (enter code; access RESET SYS TRBL then press the  button).
  - ✓ EZM Tamper
  - ✓ Keypad Tamper
  - ✓ Sensor Watch
  - ✓ Service Reminder

**Note:** (1) If a system trouble is not corrected, it will redisplay after 5 minutes. (2) If one or more of the foregoing system troubles appear during the first 5 minutes after power-up, they will be cleared automatically.

## RESET SENSOR MSG

Press YES button to reset a PIR Supervision system trouble.

## START EXIT TIME

If the central station ringback signal has not been received within about 30 seconds, a communication problem may exist. Press YES button to start exit delay manually.

## FAULT FIND

This troubleshooting aid will help the installer locate swingers. When accessed, two things occur:



- ✓ The loop response of each zone is set for the fastest response time.
- ✓ Causing or repairing a fault activates the sounder for about 7 seconds.

Tapping and poking at suspect points, the installer can easily locate swingers by listening for the beep. This eliminates the need of returning to the keypad to visually check after each attempt. Pressing the **RESET** button to restore normal operation. Arming the system automatically cancels the Fault find Mode. **Note:** When testing wireless systems, the keypad will not beep if the signal strength is less than 3, but the strength will still be displayed.

### ACTIVATE LOCATE

This feature will help the user find zone troubles and indicate when they are repaired. When accessed, the sounder will come on and the display will read "LOCATE", then scroll through the zones in trouble. As each zone is corrected, the sounder will stop momentarily, signaling its repair, and the display will indicate the remaining zones in trouble. The sounder and display will continue in this manner until all zones are repaired, or until the **RESET** button is pressed.

### EZM ZONE FIND

To find the physical location of an EZM, enter the number of any zone on that EZM, then press the **ENTER** button. This will cause the EZM sounder to pulse continuously until silenced. To silence the sounder, press the **RESET** button on any keypad.

### ACTIVATE DIALER TEST

Press YES to send a digital dialer test code to the central station using the system account number. (Be sure to notify the central station of the impending test). A successful test will clear a Failure to Communicate system trouble.

The History Log documents the 800 most recent events.

### DISPLAY ALARM LOG (Not available with GEM-RP2ASe2/GEM-K2AS or GEM-RP3DGTL/GEM-K3DGTL Keypads)

Displays most recent alarm events. Line 1 displays event and date. Line 2 displays time, area and zone. To check previous alarm events, scroll back using the PRIOR button.

### DISPLAY TOTAL LOG (Not available with GEM-RP2ASe2/GEM-K2AS or GEM-RP3DGTL/GEM-K3DGTL Keypads)

Displays most recent events of all types. Line 1 displays event and date. Line 2 displays time and, if applicable, area and zone or user. To check previous events, scroll back using the PRIOR button.

### DISPLAY FIRE LOG (Not available with GEM-RP2ASe2/GEM-K2AS or GEM-RP3DGTL/GEM-K3DGTL Keypads)

Displays most recent fire events. Line 1 displays event and date. Line 2 displays time, area and zone. To check previous fire events, scroll back using the PRIOR button.

### DISPLAY OP/CL LOG (Not available with GEM-RP2ASe2/GEM-K2AS or GEM-RP3DGTL/GEM-K3DGTL Keypads)

Displays most recent openings and closings. Line 1 displays event and date. Line 2 displays time, area and user. To check previous events, scroll back using the PRIOR button.

### DISPLAY SYSTEM LOG (Not available with GEM-RP2ASe2/GEM-K2AS or GEM-RP3DGTL/GEM-K3DGTL Keypads)

Displays most recent system events. Line 1 displays event and date. Line 2 displays time and other pertinent information, where necessary, depending upon event. To check previous system events, scroll back using the PRIOR button.

### TO ARM IN 1-4 HRS. (Not for UL Installations).

Use this function to (a) delay programmed autoarming up to 4 hours, 15 minutes or (b) initiate autoarming in 4 hours, 15 minutes as follows. **Note:** Autoarming may not be used in UL installations.

At the "AUTOARM IN 1-4HR" display:

For 1 hour, 15 minute delay: press the **1** button, then the **ENTER** button.

For 2 hour, 15 minute delay: press the **2** button, then the **ENTER** button.

For 3 hour, 15 minute delay: press the **3** button, then the **ENTER** button.



For 4 hour, 15 minute delay: press the **4** button, then the **ENTER** button.

Fifteen minutes prior to arming, the siren will sound a 2-second warning and the keypad will begin a 15-minute countdown with the sounder pulsing. (The sounder may be silenced by pressing the **RESET** button, but it will come back on one minute before arming). Within this countdown window, arming may be delayed an additional 1 to 4 hours, as above, or autoarming may be canceled by arming and disarming the panel.

**DISPLAY AUTO ARM SCHD** (Not for UL Installations)

Press the YES button to display the autoarm schedule programmed by the PCD-Windows software. Use NEXT and PRIOR button to scroll forward and back through the week. While the programmed schedule cannot be changed at the keypad, autoarming may be delayed up to four hours at the keypad, or it may be totally disabled, up to one week in advance. Select the day using the NEXT and PRIOR buttons. Then select the delay (1-4 hours) or disable using the  button. Fifteen minutes prior to autoarming, the siren will sound a 2-second warning and the keypad will begin a 15-minute countdown with the sounder pulsing. Within this countdown window, arming may be delayed an additional 1 to 4 hours (using TO ARM IN 1-4HRS function), or autoarming may be canceled by arming and disarming the panel.

**ACTIVATE PROGRAM**

At Keypad No. 1, press the YES button to activate the User Program (Program-1) Mode or Dealer Program (Program-2) Mode, depending upon the code entered. Scroll through the programmable functions using NEXT the button and PRIOR the button. To exit this mode at any time, press  . **Note:** Keypad No. 1 may be located in any area.

**ACTIVATE DOWNLOAD**

Used on-site for remote downloading of a control-panel program from the PCD-Windows. Press the YES button to initiate the data transfer.

**DISPLAY RF XMITTER STAT**

✓ Press the YES button to check the status of up to 96 transmitters. The keypad will display:

- ✓ zone number (Z01-Z96)
- ✓ transmitter ID code number (6 digits)
- ✓ point number (PT1-PT4; "9" for unsupervised)
- ✓ status of transmitter:

NODATA: transmission not yet received

NORMAL: transmitter's zone normal;

FAULT: transmitter's zone open;

LOBATT: transmitter battery low;

TAMPER: transmitter case open;

S.FAUL: supervisory failure (test transmission not received within programmed time);











✓ relative signal strength of the last transmission, on a scale of 1-10 (10 being the strongest). ("SS—" indicates transmission not yet received). **Note:** A signal strength of 3 or less is an indication that reception may be unreliable. In such cases, the use of an additional receiver located closer to the transmitter is recommended. If two receivers are connected to the GEM-P9600, only the higher signal strength of the two will be displayed.

**RELAY CONTROL**

Press the YES button to check the status (all on or all off) of up to 8 groups programmed with any combination of up to 96 available external relays. The group number will display with a related description. Scroll through the groups using the NEXT and PRIOR buttons; change the status of the displayed group by pressing the  button.

## KEYPAD MESSAGES

The GEM-RP1CAe2/GEM-K1CA Keypad can display the following messages. The GEM-RP2ASe2 and GEM-K2AS keypads will display similar abbreviated messages that may scroll through two screens.

- SYSTEM READY CW1** - All zones operating; system can be armed. GEM-RP1CAe2 only: C = Chime Mode on; W = Watch Mode on; 1-8 = Area.
- PLEASE WAIT** - Panel reporting to central station on arming. Wait for ringback signal to exit.
- EXIT TIME XXX S11** - Exit delay in progress. XXX = exit time remaining in 10-second decrements; GEM-RP1CAe2 only: S = Service Code active; I = arming with Instant protection; 1-8 = Area.
- ENTRY TIME XXX** - Entry delay in progress. XXX = entry time remaining in 10-second decrements.
- SYSTEM ARMED S11** - Panel armed. GEM-RP1CAe2 only: S = Service Code active; I = arming with Instant protection; 1-8 = Area.
- CHECK STATUS CAW** - One or more zones not secured. Display status for zone description(s). GEM-RP1CAe2 only: C = Chime Mode on; W = Sensor Watch Mode on
- CAN'T ARM/ZONES NOT NORMAL** - Arming attempted with Priority Zone in trouble. Secure zone to arm.
- DAY ZONE TRBL** - Trouble condition on Day Zone, followed by one or more zone descriptions.
- INVALID ENTRY/TRY AGAIN** - Wrong code/time/area number entered.
- CAN'T ARM SYSTEM** - Arming attempted with System Trouble present. Press the  button and then arm the system.
- ALARM** - Alarm condition, followed by one or more zone descriptions.
- \*\*\*\*FIRE\*\*\*\*** - Fire alarm condition, followed by one or more zone descriptions.
- FIRE TROUBLE** - Trouble condition on a Fire Zone. Press  button to silence the sounder. Correct the trouble, then press the  button again.
- FIRE ALARM** - Alarm condition on a Fire Zone. Press the  button to silence the sounder. Correct the cause of the alarm, then press the  button again.
- ZONES BYPASSED** - (When Zones Bypassed displayed) Indicates zones that have been deactivated.
- OV(R)-** Overview Mode (Status of up to 8 areas): R=Zone Ready; also, Z=Zone Fault; A=Armed; B=Burglary Output; F=Fire Alarm; T=Fire Trouble; C=Check Trouble; Display Mode.
- SYSTEM TROUBLE** - A System Trouble display will be followed by one or more of the following error codes:
- E01-00 - AC POWER FAIL.** Power failure. Check power transformer. Check for blown fuse or circuit breaker; general power outage.
- E02-00 - LOW BATTERY.** Battery below 11 volts. If not recharged within 24 hours, replace it.
- E03-00 - COMM FAIL.** Unsuccessful communication to central station. **Note:** Will also display if panel improperly programmed to report; i.e., Report Alarm, Report Codes, Subscriber ID Numbers, etc. must be programmed.
- E04-NN - WL TRBL.** Wireless transmitter supervisory failure. NN = transmitter number.
- E05-NN - WL LOBATT.** RF transmitter low battery. NN = transmitter number.
- E06-NN - RF REC TROUBLE.** RF receiver response trouble. NN = receiver number.
- E07-00 - DOWNLOAD FAIL.** Download failure.
- E08-00 - TELCO LINE1 FAIL.** Telephone line failure (system trouble displays after a programmed delay).
- E09-00 - NOT PROGRAMMED.** System cold start.
- E10-NN - BURG KEYPAD TRBL.** Keypad response failure. NN = keypad number.
- E11-NN - BURG KPD TAMPER.** Keypad cover removed. NN = keypad number.
- E12-NN - BURG EZM TRBL.** Expansion zone module failure. NN = module number.
- E13-NN - BURG EZM TAMPER.** EZM module cover removed. NN = module number.
- E14-NN - RELAY BOARD TRBL.** Relay board response failure. NN = relay board number.
- E15-NN - WL TAMPER.** Transmitter cover removed. NN = transmitter number.
- E16-NN - RF REC JAMMED.** Receiver jammed. NN = receiver number.
- E17-NN - RF REC TAMPER.** Receiver cover removed. NN = receiver number.
- E18-NN - LOBATT KEYFOB.** Key fob transmitter low battery. NN = key fob transmitter number.
- E19-00 - USER MEM ERROR.** Internal memory error. Select RESET SYSTEM TBL. Press the  button, then the  button.
- E20-00 - DEALER MEM ERROR.** Same as above.
- E22-NN - PIR SENSOR TRBL.** No trip detected on PIR Supervision Zone within programmed Sensor-Watch time. NN = Zone number. To reset, press YES () button at "RESET SENSOR MSG" function display.
- E23-00 - BURG BUS FAILED.** Failure of 4-wire bus. Check Terminals 11/12.
- E24-00 - TIME FOR SERVICE.** A service message can be programmed through the PCD3000 Quickloader (event-schedule screen) to remind the user to arrange for scheduled maintenance. At the programmed date and time, the keypad sounder will start to pulse and the display will read "TIME FOR SERVICE" (GEM-RP1CAe2) or "SERV" (GEM-RP2ASe2). This condition will behave as a system trouble and may be cleared as such, i.e., press  to silence sounder; access RESET SYSTEM TRBL, then press the  button.
- E27-00 - Printer Failure.** Call installing company for service.
- E39-00 - RF CAPACITY TRBL.** Receiver capacity error.
- E51-00 - Alarm Output Supervisory.**
- E99-00 - Keypad panic shorted too long.** GEM-RP2ASe2 / GEM-RP3DGTL only.
- NN OUT OF SYSTEM** - Keypad inoperative. NN = keypad number.
- ALARM** - (After panel is disarmed) displays zones violated.
- FAULT FIND** - Fault-find Mode activated.
- LOCATE** - Locate Mode activated.

# GLOSSARY

**Note:** Displayed messages shown are for the GEM-RP1CAe2 and GEM-K1CA keypads. GEM-RP2ASe2/GEM-K2AS and GEM-RP3DGTL/GEM-K3DGTL messages are similar but abbreviated. Refer to the appropriate GEM-P9600 Programming Manual (WI777 and/or WI1185) for address numbers.

## Abort Delay (Do not program for UL Applications.)

An Abort Delay is a delay period that allows cancellation of the central-station report by disarming the control panel before a report is sent. If Enable CP-01 Limits (Address 3905 bit 5) is enabled, the Abort Delay is 30 seconds, which can be removed, or increased. In addition, if an attempt is made to change the Abort Delay to less than 15 seconds or more than 45 seconds the time will be entered as 30 seconds. If enable CP-01 Limits is NOT enabled, the factory delay time will be set at 30 seconds, and can be deleted or increased to 255 seconds. Refer to "Enable CP-01 Limits" in this glossary. Enable program zones for *Abort Delay* (Address 1222, 1322, 1422, 1522, 1622, 1722, 1822, 1922, 2022, 2122) and select an *Abort Delay Time* (Address 2406). Also, a *Pre-Alarm Warning* may be selected for zones (Address 1208, 1308, 1408, 1508, 1608, 1708, 1808, 1908, 2008, 2108) allowing a keypad indication of alarm with no alarm outputs or central station reporting for the duration of abort delay time.

**Note:** If Abort Delay is selected for a 24-Hour Zone, the zone must be cleared before disarming the area.

## AC Failure

### AC-Fail Report Delay

If AC power is removed from the control panel, "E01-00 AC POWER FAIL" will display at the keypad with a flashing "SYS/TRBL" reminder and a pulsing sounder. Press the **RESET** button to silence the sounder; the "SYS/TRBL" as a reminder will remain on and "SYSTEM READY" will appear in the display. If a User Code is entered within 5 minutes, the panel may be armed successfully. After 5 minutes, the system trouble will again display.

AC Failure may be programmed to activate the burglary output or any external relay, and/or report to a central station (program Panel AC-Fail Report). An alarm and/or restore report to the central station will occur immediately unless an AC-Fail Report Delay is programmed (see Time Selection). AC Failure is logged immediately upon detection.

## Access Control; Access Control (Panel Access) on Aux Output; Aux Output Access Control Time; Panel Access

**NOTE:** The GEM-P9600 has not been evaluated by UL for compliance with UL294 (Access Control Systems).

The Aux Output can be programmed to activate for a programmable period of time (2 to 254 sec.). This allows it to be used for access functions such as opening and closing a garage door, or remotely activating an electric door strike through an RB1000 relay. This is achieved by programming a new KeyFob option, *Access on Aux Output*, into the Aux. 1 or Aux. 2 option locations on the Wireless KeyFobs screen. This feature also requires a valid time to be entered into the *Aux Output Access Control* in the Time Selection Screen.

If Access Control on Aux Output (Address 2418 bit 4) is selected, entering the Access Code (see User Code Programming in Easy Menu Driven Mode Programming) while disarmed will trip the panel's Aux Output. (This is commonly used to activate a door strike for the purposes of remotely unlocking a door). Each keypad is individually selected for Panel Access (Address 2440-2454). Also program Aux Output Access Control Timeout (Address 2402). **NOTE:** Do not program the Aux Output (Address 1086, 1098, 1110, 1124, 1134, 1144, 1154, 1164, 1174, 1184, 1194, 1215, 1315, 1415, 1515, 1615, 1715, 1815, 1915, 2015, 2115) as an output on alarm. Do not program *Aux Output Chirp on Keyfob Arm/Disarm* (Address 2421), unless *Enable Bell Output on Keyfob Arming* is selected also (Address 2422).

Panel Access is selectable for any keypad 1–7 by selecting the appropriate Area Option of any User Code (see User Code Programming in Easy Menu Driven Mode Programming); select the Panel Access option (Address 2440-2454) for those keypad numbers (1–15) that are to respond to the User Code. However, if the Access Option is programmed, the code will no longer function as an Arm/Disarm Code.

Entering a valid code at the keypad will cause the Aux output on panel to turn on for the programmed time. The RB1000 Relay may be used to activate a door strike, and power to the door strike should be supplied from an independent power source.

## Access, Garage Door Opener Control by KeyFob.

The Auxiliary Output can be programmed to activate by KeyFob, providing access functions such as opening and closing a garage door, or remotely activating an electric door strike. This is achieved by programming *Access on Aux. Output*, into the Aux. 1 or Aux. 2 option locations on the Wireless KeyFobs screen. This feature also requires a valid time to be entered into the *Auxiliary Relay Access Control time* in the Time Selection Screen.

## Access Number for Outside Line

Some subscribers will have a telephone system that requires one digit to access an outside line. The first dial tone encountered (prior to the access number) may have a frequency that is different from that of the accessed dial tone (440Hz). One or more 4-second Pre-Dial Delay "D"s may be entered before the access number instead of a dial tone with frequency "E". See Pre-Dial Delay; Telephone Numbers. (**Note:** The panel features automatic dial-tone detection and will normally not require any "E"s. To disable this feature, program an "8" in Address Location 4084.)

If the subscriber's system uses an access number, contact the telephone-equipment supplier to find out if a dial tone other than 440Hz is received prior to dialing the access number. If the communicator must delay before dialing the access number instead of attempting to recognize the dial tone, find out how many 4-second delays must be programmed.



**Alarm on Day Zone See Day Zone**

**Alarm Outputs** (See Wiring Diagram for UL requirements.)

The GEM-P9600 has three Form-C relay outputs: Burglary, Auxiliary and Reset. Each has a related jumper (B, A, and C, respectively) that may be cut for dry contacts.

The following table summarizes wiring for signaling an alarm in typical installations. See Time Selection for timeout duration.

OUTPUT	NORMAL OPERATING OUTPUT VOLTAGE TERMINALS	WET CONTACT TERMINALS <sup>(3)</sup>			JUMPER <sup>(4)</sup>
		COM	N/C	N/O	
Bell Output (Burg.) <sup>(1)</sup>	5(+) & 14(-) <sup>(2)</sup>	COM	N/C	N/O	
Bell Output (Pulsed)	5(+) & 14(-) <sup>(2)</sup>	3	4	5	B
Aux. Relay	8(+) & 14(-)	6	7	8	A
Reset Relay (Fire Verification)	28(+) & 14(-)	E22	28	15	C <sup>(5)</sup>

**U.L. INSTALLATIONS:**

- <sup>(1)</sup> For Residential Fire, cut jumper PS and install jumper JP6.
- <sup>(2)</sup> Combination Residential Burglary/Fire systems require distinctly different signals for burglary and fire; for Single Bell, program "Burg. Output" for burglary zones and "Pulsed Output" for fire zones.
- <sup>(3)</sup> Aux., Burg. and Reset Relays provide wet contacts (positive voltage on COM, N/C and N/O contacts); for negative (-) connection.
- <sup>(4)</sup> Cutting the Aux., Burg. or Reset Relay associated jumper will provide Dry Contacts (no voltage on COM, N/C and N/O contacts); for use with external power supplies and/or loads (see wiring diagram).
- <sup>(5)</sup> Removal of Reset Relay Jumper C will remove power to all smoke detectors, if any are installed.

See Time Selection for timeout requirements.

OUTPUT	WIRING	REMARKS
Fire Lug	E9(-)	See Fire Lug
Reset Output (Smoke Reset)	28(+) & 29(-)	To Smoke Power Relay

**Alarm; Alarm Restore Telco 1/Telco 3** See Report Telco 1/Telco 3

**Alarm; Alarm Restore Telco 2** See Backup Report on Telco 2

**Ambush (Keypad Ambush); Ambush Codes; Enable Global Ambush**

There are two types of Ambush Codes: (1) A 2-digit code (prefix) that is entered immediately prior to (and as part of) the regular User Code and (2) A separate and unique User Code. Disarming with an Ambush Code will cause a silent report to be sent to a central station. Thus, should a user be forced to disarm, he can silently signal an emergency while appearing to be merely disarming the system. The Ambush Zone will automatically report when programmed to report an alarm.

*Ambush Type 1:* (a 2-digit prefix code), this type must not be used in a SIA CP-01 compliant system. Enable as follows: (a) select "Ambush to Report Event Telco 1/Telco 3" (Address 1125, 1127, 1135, 1137); enter "Global Ambush Code" (Address 0495); and (c) enter an "Ambush CS Report Code" (0900). Each keypad is enabled for "Ambush" individually (Address 2440-2454).

*Ambush Type 2:* (a separate and unique user code), this type must be used in a SIA CP-01 compliant system. Enable as follows: In the Easy Menu Driven Program Mode (see WI777 or WI1185), the menu selection "Enter User Code" is used to program a user code with a "blank() 5" in the area for which the Ambush Code will be used. Enable all other locations and program as follows: (a) select "Ambush to Report Event Telco 1/Telco 3" (Address 1125, 1127, 1135, 1137); (b) enter an "Ambush CS Report Code" (0900). Each keypad is enabled for "Ambush" individually (Address 2440-2454); (c) select "Enable Ambush in User Assignment Code Type" (3905). Set User Code Type as Ambush.

Be sure to inform the user what their Ambush Code is, and that the Arm/Disarm Code must be entered less than 10 seconds after the



Ambush Code for an ambush report to be sent. When "ENABLE GLOBAL AMBUSH" is selected and no Ambush code has been entered and the keypads have been selected for AMBUSH, then the AMBUSH CODE will default to "99".

### Answering Machine Pickup Without Line Seizure See Callback-Method Download

### Anti-Jam Time

If the communicator does not detect a dial tone within 12 seconds, the Anti-Jam feature will be activated. That is, the communicator will go off line for a 16-second anti-jam interval in order to free the telephone circuit from an incoming call, then make another 12-second attempt at dial-tone detection. If still unsuccessful, the communicator will again go off line for 16 seconds, then proceed to dial anyway.

### Areas

#### Zone Area 1-Zone Area 8

#### Priority Area Arming

Although the default program will automatically set up Zones 1 through 8 for Zone Area 1, the panel may be partitioned into eight areas. Each zone must be assigned to at least one area. At least one zone must be assigned to Area 1. If a burglary zone is selected for both areas, that common zone will not arm until both areas are armed. If any zone disarms, the common zone will disarm.

In a multiple-area system, be sure to also program:

- Enable User Code by Area (see User Codes/Authority Levels);
- Keypad Area Assignments
- Bell Control (determines which bells an area may silence);
- Subscriber Opening/Closing ID Numbers and Event ID Numbers (if reporting);
- System Trouble Subscriber ID Number

If Priority Area Arming is selected, the Priority Area must be armed before the Arming Area can be armed.

### Arm Lug (Lug E4)

Lug E4 (ARM) will go to approximately 1Vdc when all areas in the system are armed. This lug may be used for auxiliary equipment. (For use, refer to the instructions furnished with the device.)

### Auto Bell Test on Arming (Required for UL Mercantile installations.)

This will activate the Burglary Output briefly 10 seconds after the area is armed. If the alarm does not sound, the device may be defective.

### Auto-Bypass (Do not program for UL installations.)

#### Auto-Bypass Re-entry

Zones programmed for Auto-Bypass will be bypassed (automatically removed) if in trouble when arming. A momentary beep will sound at the keypad to warn that the system has been armed without the protection of the auto-bypassed zone. (Note that the exit/entry door must be closed before arming, otherwise the Exit/Entry Zone will be auto-bypassed). **Note:** A zone in trouble that is not programmed for Auto-Bypass will cause an alarm on arming after a 10-second arming delay.

If Auto-Bypass Re-entry is selected, securing a zone that is programmed for Auto-Bypass, while armed, will cause that zone to re-enter the system in an armed state.

### Auto Disarm Rearm Delay

If the panel was auto-disarmed on schedule and a rearm delay is programmed (see Time Selection), the panel will automatically rearm after the delay if no activity has been detected.

### Automatic Interior Bypass (Address 2421, Bit 0)

Convert from Away to Stay based on no egress through exit door. Default is enabled. This feature will cause all Interior-1 Zones to automatically be bypassed if the Exit/Entry doors are not opened during the exit-delay period. If the  button is pressed while armed, exit delay will restart and the Exit/Entry doors may be opened to permit someone to exit (while others remain on the premises) without causing an alarm. This feature must be enabled in CP-01 installations. This feature is enabled in the factory program and it is also enabled when "Enable CP-01 Features" is selected in the Easy Program Menu.

### AUX. OUTPUT CHIRP ON KEYFOB ARM/DISARM

If enabled (Address 2421 Bit 3), when arming with a keyfob, the PGM2 output chirps. See also **Enable Bell Output Chirp on Keyfob Arming** (Address 2422, Bit 6). This feature will cause a 1-chirp indication on arming and 2-chirp indication on disarming. Connect steady input (burglary) of external siren driver to the panel's Auxiliary Alarm Output. **Note:** Do not use an external voice siren driver.

### Auto-Reset

#### Auto-Reset After Burglary Output Timeout

If a zone detects an alarm condition and is selected for Auto-Reset, it will automatically rearm itself as soon as the alarm condition is cleared. Auto-Reset may be delayed to occur after the Burglary Output timeout period by selecting Auto-Reset After Burglary Output Timeout and Auto-Reset. Zones that are not programmed for Auto-Reset will not be capable of signaling another alarm until (a) the cause of the alarm has been corrected and (b) the control panel is disarmed. Also see Swinger Shutdown.

### Auxiliary Relay See Alarm Outputs

### Backup Report on Telco 2



If Backup Reporting is selected and the communicator does not reach the first telephone number after two attempts, seven attempts will be made to reach the second telephone number. Enter Subscriber Identification Numbers for Telephone 2 and other information required for Telephone 2. Also program Backup Report on Telco 2. Any zone programmed to report to Telco 1 will backup report to Telco 2. **Note:** Subscriber Identification Numbers for both Telephones 1 and 2 must be entered, even if they are the same

### Battery

12Vdc standby power source in the control panel is used to provide backup protection in the event of a power loss. The battery is an integral part of the system and must be installed, even if ac power is present. Change the battery every 5 years or as required.

### Bell Control

In any system, the ability to silence any combination of alarm devices (outputs) initiated from any area. Bell Control must be programmed for all systems to be able to silence an alarm. For example, in a two-area system, each area could be programmed to silence only those alarms initiated within its own area; or both areas could be programmed to silence an alarm initiated from either area.

### Blocked View Option for User Codes

User codes can block another code from being viewed by another user. An unblocked code cannot view a blocked code, but a blocked code can view all codes. The master user code and the dealer program code can view all codes.

### Burglary Lug (Lug E10)



Lug E10 (BURG.) will go to about 1Vdc when the Burglary Output is tripped. This lug is intended for connection to UL-listed devices rated 5mA maximum and capable of operating over the voltage range of 8-13.0Vdc (12V, special application). Use Napco Part No. WL1 for connection.

**Burglary Output** See Alarm Outputs

### Bus Failure

Communication failure on the 4-wire bus will cause a system trouble and a report to the central station. Program System Trouble Reports and Report Codes for the 4-Wire Bus.

### Bypass Faulted Zones

If programmed, pressing the  and  buttons simultaneously will bypass all zones in trouble (except Fire and PIR Zones) that are also programmed for Selective Bypass. The message, "BYPASSED ALL ZONE FAULTS" will display.

**Call Waiting** See Disable Call Waiting

### Callback-Method Download

#### Answering Machine Pickup Without Line Seizure

**Disable Callback Download** (Required for UL installations)

**Disable Second Call Answering Machine Override** (Do Not program for UL Installations);

**Disable Answering Machine Download** (Required for UL installations)

#### Disable Function-Mode Download

#### Number of Rings Before Pickup

Data may be downloaded remotely to the panel after a programmed number of rings (3 to 15) and a control-panel confirmation callback. Program the number of rings; if not programmed, the panel will pick up after 15 rings.

The feature "2nd Call Answering Machine Override" allows downloading after (1) the panel detects 1 or 2 rings; (2) the panel does not detect another ring for 8 seconds; (3) the panel detects another ring within the next 22 seconds. At this point, the panel will connect and allow the panel to communicate with the downloading computer. In this way, the panel overrides the answering machine. The answering machine will pick up on its programmed number of rings, as usual. **Note:** The number of rings programmed into the panel must exceed that of the answering machine. (Disable Answering Machine Download must not be programmed). The panel will then listen for the signal from the PCD-Windows software and seize the line from the house phones as well as the answering machine and the connection will subsequently be established.

Program Disable Callback Download to prevent unauthorized downloading to an unattended panel. Program Disable Answering Machine Download to inhibit downloading to a telephone connected to an answering machine. Program Disable Function-Mode Download to prevent downloading at the keypad.

### Cancel Next Test Timer Report on Any Report See Test Timer

#### Cancel; Cancel Code; Cancel Report to Telco 3; Cancel Window Duration (Report Cancel Window)

CANCEL is the preventing of a report from being sent by entering a user disarm code. If the area is disarmed during Entry Delay or the "Pre-Alarm Warning", then no report will be sent and no messages will be displayed at the keypad. If the area is disarmed during the Abort-Delay, then an "Alarm Canceled" will be displayed at the keypad and no report will be sent. If the area is disarmed during or within the Cancel Window Duration, then an "Attempting to Cancel" will be followed by an "Alarm Canceled" for a successful cancellation. Otherwise, the report had been sent and will be responded appropriately to by the Central Station. Cancel must be provided with a Central Station Telephone Number, proper Subscriber O/C Report ID Numbers and a valid Cancel Code to Telco 3. A Cancel Window ("Report Cancel Window") is the duration that the system will attempt to cancel a report, after the report is sent.

#### Chime (Displays "MONITOR" on GEM-RP2ASe2 Keypads)

This annunciator feature may be used on any zone to sound a tone at the keypad while disarmed when the zone is faulted. Access the ACTIVATE CHIME function to enable or disable the Chime Mode from the keypad. This feature is programmable by zone and for duration of tone (see Time Selection). A time (in ¼ seconds) must be programmed for the chime to function.

**Chime 2** (Displays "MONITOR" on GEM-RP2ASe2 Keypads)

For a distinct pulsating "Chime Zone" tone, program the zone for Chime 2. This feature allows zones to have distinctive annunciator chime to identify the door(s) or zone(s). "Chime" must be activated on any keypad for all area keypads to chime.



**Chime on E4 Lug**

The E4 Lug can now serve as an output that follows the chime sounder. This can be used where a remote sounder is needed to follow the keypad sounder. This feature can be found on the Options page of the PCD software, or you can program a bit value of 2 in the right hand side of location 2420 [•] [2].

**"Clean Me™" Smoke Detector Support**

A new option "Enable Smoke Detector Dirty Trouble" will enable support of the Sentrol ESL 521 series Smoke Detector CleanMe™ self diagnostic feature. The Smoke Detector will signal the control panel when the detector needs to be cleaned, or when the sensitivity falls below an acceptable level; which will cause a report to central station as well as a trouble condition at the keypad.

**Clear Program**

**Caution:** Erases the dealer program. Use this feature to start a new customized default program. Access Location 4091, then press the  or  button.

**Closing Report****Closing Report Only on Conditional Closing****Conditional Closing****Include Selective/Group Bypass In Conditional Closing/Status****Status Report**

On arming, the communicator can transmit a unique Closing Code for each user and a status report that identifies the problem zone to the central station. Note that Subscriber Identification Numbers and a Closing Code must be entered for any closing report.

Select which users will report closings for each telephone number, even if Closing Report Only on Conditional Closing is selected. Normally, a closing report will consist of the Closing Code and the number of the user that armed. If the user armed with an auto-bypassed zone (or selective/group bypassed zone if Include Selective/Group Bypass In Conditional Closing/Status was programmed), the Conditional Closing Code will also be sent.

Select Closing Report Only on Conditional Closing to report only when arming with an auto-bypassed zone (and selective- / group-bypassed zone if Include Selective/Group Bypass in Conditional Closing/Status is programmed).

Select Status Report to send a closing followed by a status report that identifies the problem zone(s). A typical Status Report is represented by the following example.

Example (4/2 Format). A burglar breaks into a commercial establishment during the night, breaking the window foil on Zone 5. The Open/Close Subscriber Identification Number is "1234"; the Alarm Code for Zone 5 is "3,5" (Burglary Zone 5); the Subscriber Identification Number is "6789"; the Closing Code is "C". The communicator will send the following report to the central station.

When alarm occurs:



"6789 35" - Alarm, Zone 5

Closing Report:

"1234 C1" - Closing, User 1 (User 1 returned, inspected damage & rearmed; the same transmission would occur for User 11, 21, 31, etc.)

"1234 F5" - Trouble, Zone 5 (zone status at time of closing: Window foil still broken; Zone 5 auto-bypasses, repair required; the same transmission would occur for Zone 15, 25, 35, etc.)

**Cold Start**

**Caution:** Erases the entire program (codes, schedules, etc.), leaving the panel as it came right out of the box. Access Location 4093, then press the  or  button.

**Data Format**

Ask the central station which of these formats to use.

**Two-Digit or 4/2 Format.** Some central-station receivers require that a four-digit Account Code followed by a two-digit Alarm Code be sent in each report. Example. In a certain installation, the Alarm Subscriber Number is "1234"; a burglary alarm occurs on Zone 1. The Alarm Code for Zone 1 is "3". The communicator will send "1234 31" (Account No. 1234; Alarm, Zone 1).

**1400Hz Handshake/Kissoff.** 1400Hz Handshake overrides 2300Hz Handshake if both are selected.

**2300Hz Handshake/Kissoff.** Used with the following receiver formats: Radionics, DCI & Franklin Slow; Radionics Fast; Sescoa, Vertex, DCI & Franklin Fast; Radionics BFSK. 1400Hz Handshake overrides 2300Hz Handshake if both are selected.

**Zone Number on Pulse Alarm.** If selected, an Alarm Code need not be programmed (the zone number will replace the Alarm Code), however codes for restore, trouble, etc. are still required. Thus, in the foregoing example, if "E" is the designated Restore Code, and Zone 24 trips and is restored, the communicator will send "1234 24" (Account No. 1234; Alarm, Zone 24) followed by "1234 E6" (Account No. 1234; Zone 24 Restored).

**Single-Digit Event Code Format.** The single digit sent for a particular event can be either the Event Code or the units digit of the zone number.

**Sum-Check Format.** Sum Check is a sophisticated data format used to enhance the speed and check the accuracy of the received transmission. This format should be preferred whenever the central station is capable of receiving it. After transmitting the Subscriber Identification Number and the Alarm Code, the communicator sends a verifying digit that is the sum of both.



The receiver compares the verifying digit with the sum of the other numbers to check transmission accuracy.

**3/1 with Extended Restores.** Some receivers require a three-digit Account Code followed by a single-digit Alarm Code. Example. In another installation, the Alarm Subscriber Number is "123"; an alarm on Zone 1 is restored. The Restore Code for Zone 1 is "E,1". The communicator will send "123 E" (Account No. 123 Restored); followed by "EEE 1" (Restored, Zone 1).

**Modem Formats.** Modem formats (SIA, Point ID, Express, 4/3/1, Modem 2) are preset and automatic but require a Type for each zone. Program Zone Type as follows: Fire\* = "1" (Note: Not for Modem 2 Receivers); Panic = "2"; Burglary = "3"; Holdup = "4"; Gas Alarm = "7"; Heat Alarm = "8"; Auxiliary Alarm = "A" (Keypad displays "0"); 24-Hour Aux. Alarm = "B".

**Pager Formats.** The control panel has provisions for dialing a pager phone number. The panel will wait for ringing, wait for silence, then send its data. Caution: Because there is no handshake/kissoff, this feature should only be used for Double Reporting; it may not be used for Backup Reporting. Only one report is sent for any call. Pager digits are limited to "0" through "9". Digits represented by "A" through "F" will be converted to "0"s for transmission purposes. Pager formats are 10 digits, arranged as illustrated by the following examples.

Alarms, restores, etc. are transmitted in a 3-3-4 arrangement representing Report Code, Descriptor and Account Number.

Example 1. Burglary, Zone 22 (Report Code = "3".)

Transmits: 003 022 1234, where

003 = Report Code (always two zeros + programmable Report-Code digit, 0-9);

022 = Descriptor (always one zero + 2-digit descriptor, zone number: 01-96);

1234 = Account Number (4 digits, programmable).

Openings, closings, etc. are transmitted in a similar arrangement

Example 2. Closing, User 12 (Closing Code = "8")

Transmits 008 012 1234, where

008 = Report Code (always two zeros + programmable Opening/Closing digit, 0-9)

012 = Descriptor (always one zero + 2-digit descriptor (user number: 01-96);

1234 = Account Number (4 digits, programmable).

Keypad Report Codes and System Report Codes are transmitted in the same format.

✓ **Pager - Programmable Number of Resends of Report** Program the number of resends to allow the panel to send multiple reports of same signal to insure that signal is received by pager.

✓ **Pager - Maximum number of reports per session.** Program the maximum number of Pager reports to be sent per session.

✓ **Pager (Telco 3) Report Delay** Programmable delay of the Telco 3 report (typically used for Pager Reporting) intended to allow time for central station to allow to verify alarm report the alarm report.

**Compatible Receivers.** The following receivers are compatible with the GEM-P9600.

- **FBI CP220.** Formats: Ademco Slow; Silent Knight Slow; Silent Knight Fast; Sescoa; Vertex; DCI; Franklin Slow; Franklin Fast; SIA; Radionics Slow; Radionics Fast; Radionics BFSK; FBI 4/3/1; Universal High Speed.
- **Ademco 685.** Formats: Ademco Slow; Silent Knight Slow; Silent Knight Fast; Sescoa; Vertex; DCI; Franklin Slow; Franklin Fast; Radionics Slow; Radionics Fast; Radionics BFSK; Universal High Speed; Ademco Point ID; Ademco Express.
- **Radionics 6500.** Formats: Ademco Slow; Silent Knight Slow; Silent Knight Fast; Sescoa; Vertex; DCI; Franklin Slow; Franklin Fast; Radionics Slow; Radionics Fast; Radionics BFSK; Universal High Speed; Radionics Modem 2.
- **Osborne-Hoffman Quickalert.** Formats: Ademco Slow; Silent Knight Slow; Silent Knight Fast; Sescoa; Vertex; DCI; Franklin Slow; Franklin Fast; SIA; Radionics Slow; Radionics BFSK; Universal High Speed; Ademco Point ID; Ademco Express.
- **Silent Knight 9000.** Formats: Ademco Slow; Silent Knight Slow; Silent Knight Fast; Sescoa; Vertex; DCI; Franklin Slow; Franklin Fast; Radionics Slow; Radionics Fast; Radionics BFSK; Universal High Speed; SIA.

## Day Zone(Open; Short)

### Alarm on Day Zone

### Disable Auto-Reset on Day Zone

### Reset Day Zone with Arm/Disarm Only

### Enable Watch, Areas 1-8 (By Area)

A Day Zone will give an audible and visual indication at the keypad if there is a problem on the loop while disarmed. Open- and short-circuit conditions are programmed separately, by zone. This feature may be used to warn of a problem (a break in a window foil, for example) during the day, when the panel is not normally armed. When the Day Zone is tripped, "DAY ZONE TRBL" and the zone number(s) will alternately display at the keypad and the sounder will pulse. Press the **RESET** button to silence the sounder and reset the keypad. "ZONE FAULT" will be displayed until the condition is corrected. If Reset Day Zone With Arm/Disarm Only is programmed, arm and disarm the panel to reset the Day-Zone indication at the keypad.

If Alarm on Day Zone is programmed for a zone, a Day Zone condition will cause the alarm outputs programmed for that zone (sirens, relays) to activate.

**Note:** (1) If a zone is programmed for both Day Zone Open and Day Zone Short, either condition must be reset before the other can activate. (2) Day Zone Short will not function if No EOL Resistor is also programmed.

Report Trouble or Trouble Restore is programmed in conjunction with Day Zone Open/Day Zone Short and Trouble on Open/Trouble on Short (the trouble reported will be that programmed under Day Zone Open and/or Day Zone Short).

**Note:** Do not program a Day Zone for 24-hour protection. The keypad will annunciate as a Day Zone but the panel will transmit an Alarm Code and a Trouble Code when tripped.

Program Disable Auto-Reset on Day Zone to prevent repeated Day-Zone trips. This will cause the keypad display and sounder to activate only once in any arm/disarm period.

If Enable Watch is selected (by area), zones programmed for Day Zone can only be activated when ACTIVATE WATCH is accessed. Arming and disarming will turn off the Watch Mode. If Report Trouble is selected, a trouble on a Day Zone will be reported only when the Watch Mode is on.

**Dealer Security Code** See Master Security Code

### Dial-Tone Detection

#### Disable Auto Dial-Tone Detection

The panel features automatic dial-tone detection to ensure that a dial tone is present before the communicator dials. To disable this feature, program an "8" in Location 4084.

When an "E" is programmed before the first digit of an outside telephone number, the communicator dial-tone detection circuit is set to detect the standard 440Hz dial tone. The "E" is generally entered in the location immediately preceding the telephone number.

It may be necessary to program at least one 4-second pre-dial delay before a dial-tone detection "E". With certain nonstandard exchanges, pre-dial delay "D"s may be used without a dial-tone detection "E". (See Access Number for Outside Line; Pre-Dial Delay; Telephone Numbers.)

#### Digital Dialer Report Enter/Exit Test Mode (SIA CP-01 Requirement: 4.6.4.2)

**Initiation Report.** At the initiation of a test, the control panel sends a message to the central station that a test is in progress. The "Fault Find" function (a Function Menu selection) is enabled, and normally causes all zones to give a 7-second beep at the keypad(s) when any zone is faulted or restored. As required by SIA CP-01, Fault Find is expanded with the following features when **Digital Dialer Report Enter/Exit Test Mode** is programmed. This option is programmed when "Enable CP-01 Feature" is selected in the Easy Program Menu:

- When Fault Find is entered, it reports to Central Station that "Test Mode" is in progress. On completion of the report, a Ring-Back will be given.
- Fault Find can not be initiated from an armed panel, and all digital dialer reporting is inhibited while in Fault Find.
- Fault Find Central Station Reporting Code is located at **address 0907**.
- Keypad will display the following warning that the system is in Fault Find: "FAULT FIND RF SIG POWER - -"
- If 24-hour zone is open at end of test, no report is sent (GEM-P9600). If a 24-hour zone is tripped and not restored during Fault Find, when the mode is exited the zone will display as "Faulted" on the keypad display.
- When Fault Find is exited by pressing , a Fault Find Restore Report will be sent, and upon completion of the report a Ring-Back will be given.

### Digital Dialer Test

Activating the digital dialer test from the Function Menu (ACTIVATE DIALER TEST) will send the programmed report code to the central station. Program DD TEST for SYSTEM-TROUBLE REPORTS and enter a DD TEST Report Code. Note that in this case the report code received is not indicative of a system trouble, but is an indication of a successful transmission. Should the transmission fail, the keypad will display "E03-00 COMM FAIL". This system trouble may be reset by pressing the  button. Any successful subsequent report will also clear the system trouble.

**Disable Answering Machine Download** See Callback-Method Download

**Disable Auto-Reset on Day Zone** See Day Zone

#### Disable Auto Status

Non 24-Hour Zones that are open (or shorted) normally display "ZONE FAULTS" (while disarmed) followed by the zone number(s) and description(s). In high-security applications, program Disable Auto Status. Unsecured zones will then be indicated by a "CHECK STATUS" display. Status may be displayed manually using the DISPLAY STATUS function, however a valid user code will be required.

#### Disable Auto-Unbypass on Disarming

Normally, manually bypassed zones revert to active (disarmed) zones on disarming. Select this feature to maintain bypassed zones on disarming until manually unbypassed.

#### Disable Call Waiting (TouchTone® Dialing Only)

A digital communicator connected to a telephone line with Call Waiting may be disrupted by this feature. However, most lines with Call Waiting also have Selective Call Waiting, which permits the feature to be turned off by dialing a "\*\*70" just before the telephone number. A "\*" will be dialed by programming a "B".

If the installation has the Call Waiting feature, be sure that it also has Selective Call Waiting, and confirm the disable code with the telephone company. Then program this code ("B70") directly before the phone numbers (after dial-tone detection or pre-dial delay) in the telephone-number locations. See Telephone Numbers.

**Caution:** Should the user cancel his Call Waiting service, the communicator will dial a wrong number unless the phone number is corrected.

#### Disable Call Waiting on 1<sup>st</sup> Attempt (Address 3905, Bit 6)

Cancel "\*"70" after the 1<sup>st</sup> dial attempt. Default is disabled. When enabled, this option will dial the Central Station telephone number as it is programmed in the panel. If the first communication is unsuccessful, the next and remaining dial attempts will remove the \*



star button (entered as a "B" from the keypad) and the 2 subsequent digits from the Central Station telephone number.



**Disable Callback Download** See Callback-Method Download

**Disable Code Required for Easy Bypass** See Selective Bypass (Do not program in UL Installations)

**Disable Code Required for Function Mode Level 1**

Intended primarily for residential applications, this feature eliminates the user code requirement to access the Function Mode (for Level-1 Users only), rendering the system more user friendly.

**Disable Fire Reset (by Area)**

Normally, pressing the  button will momentarily remove power to the smoke detectors. If Disable Fire Reset is selected for any area, the  button will no longer activate the Reset Output so that the integrity of the smoke detector's Alarm Memory feature (LED indication) will be maintained. Also see Alarm Outputs; Smoke Detectors.

**Disable Function-Mode Download** See Callback-Method Download

**Disable Openings/Closings**

Provides the flexibility of disabling openings and/or closings from any area(s).

**Disable Wait-for-Handshake/Kissoff**

Causes data transmission to start immediately after the telephone number.

**Disable Wait-for-Silence (Pager Format)**

Causes data transmission to start immediately after the pager telephone number.

**Double Reporting** See Report Telco 3

**Download Security Code** See Master Security Code

**Download To an Armed Panel**

This allows the panel to accept a download even if Armed. However if the programming to be altered effects the arming profile of the control, such as zone features, it is recommended that the panel be disarmed and then rearmed to allow these changes to be processed properly. Any program changes such as adding/changing user codes, adding users to an area, or changing Entry/Exit Delays will be processed properly with the panel armed.

**Don't Clear Aux. Relay with Arm/Disarm**

Used in conjunction with Key-Fob Option "C" above to prevent a disarm from resetting the Aux. Relay.

**"E" Lugs (E3, E5, E7, E9, E10, E11, E14, E18, E19, E22)**

E9 - See Fire Lug

E10 - See Burglary Lug



E19 - See Veri-Phone: Silence All Outputs During Audio Session

E22 - Common terminal for Reset Relay. Use Napco Part No. WL1 for field wiring.



**Easy Arming**

Permits quick arming by simply pressing the  or  button for 2 seconds. Each keypad may be individually programmed for Easy Arming (see Keypad Features). Disarming still requires entry of a valid user code. Do not program Easy Arming in UL installations. If closings are reported, Easy Arming will report as User 99.

**Easy Exit (Not Evaluated by UL)**

While armed in the Interior Bypass/Stay Mode, Easy Exit can be initiated by pressing  or . Easy Exit restarts the Exit delay, allowing a User to exit an armed premises without disarming and rearming the system.

**Easy Setup for RF Only**

Removes all EZMs automatically programmed in the menu-driven Keypad Program Mode. This must be the last step in the programming menu. Access Location 4090, then press the  or  button.

**Enable Bell Output on Keyfob Arming (Address 2422, Bit 6)**

This feature is associated with **AUX. OUTPUT CHIRP ON KEYFOB ARM/DISARM (Address 2421-Bit 3)**. Normally the chirp on a keyfob arm/disarm is transmitted to the PGM2 output. Selecting "ENABLE BELL OUTPUT CHIRP ON KEYFOB ARMING" causes the "Bell" to chirp instead of the PGM2 upon remote arming.

**Enable Burg Output Warning On Entry**

Causes the Burglary Output to "chirp" if the entry door is opened within 60 seconds after exit time has elapsed. This feature may be useful in cases where a keypad is not within audible range to remind a user to disarm if inadvertently exiting after exit delay has expired.

**Enable CP-01 Limits (SIA CP-01 Requirement: 4.2.5.1)**

When address 3905 bit 5 is enabled, three time limits are enabled as per the SIA CP-01 standards: (1) Exit Delay Time: If an attempt is made to change the Exit Delay time to less than 45 seconds the time will be entered as 60 seconds. The maximum pro-



programmable time is 255 seconds; (2) Entry Delay: If an attempt is made to change the Entry Delay time to less than 30 seconds the time will be entered as 30 seconds. The maximum programmable time is 255 seconds; and (3) Abort Delay: If an attempt is made to change the Abort Delay to less than 15 seconds or more than 45 seconds the time will be entered as 30 seconds.

**NOTE:** In accordance with UL standards, the aggregate of the Entry Delay time and Abort Delay time "window" will not be programmed to exceed one minute. **Note:** When Address 3905 bit 5 "Enable CP-01 Limits" is enabled, the Exit Delay keypad sounder (including the Exit Urgency sound during the final 10 seconds of the Exit Delay) is enabled. **Note:** If "Enable CP-01 Limits" is enabled in EZ Programming, any Zone in a Group *will only activate an alarm and send a report ONCE*. After the Zone has reported, it will remain in the Group and may still initiate the Zone ANDing sequence.

**Enable Exit Delay Restart** See Entry/Exit Delay

### Enable Line Fault Test

#### Telco Line Test Delay

Enable Line Fault Test will cause the panel to monitor the phone line. A failure will display as "E08-00 TELCO LINE1 FAIL". Program this system trouble to activate the Burglary Output.

If a time is entered in Telco Line Test Delay, the line will be tested for the programmed time before a system trouble is activated. A minimum of 30 seconds is recommended.

**Enable Local Alarm on First Zone "AND" Trip** See Zone ANDing (Do not program in UL installations.)

### Enable Reporting to PC Preset

This feature allows a PC computer with Quickloader Software to function as a receiver. If programmed, all alarms sent to Telephone No. 1 will be sent to PC PRESET as well (regardless of whether or not transmissions to Telephone No. 1 were successful). PC PRESET must be in its Standby mode for this feature to operate.

**Enable User Code by Area** See User Codes/Authority Levels/Access Bytes

### Entry/Exit Delay

#### Entry/Exit 1; Entry/Exit 2

#### Entry Relay

#### Enable Exit-Delay Restart

Delays permit exit and entry through the Entry/Exit Zone(s) after the system is armed without setting off an immediate alarm. Entry delay allows the user time to enter and disarm the panel. Exit delay allows the user to leave the premises after the panel has been armed. Unless the keypad has been configured otherwise, the sounder will come on and will pulse during the last 10 seconds of entry delay to remind the user to disarm.

Two individually-programmable entry-delay times are provided to accommodate different entry zones. If two or more Exit/Entry Zones are entered in succession, the delay programmed for the last Exit/Entry Zone entered will take precedence over all others. Exit-Delay time and Entry-Delay time may each be programmed for up to 255 seconds (4 minutes). See Time Selection.

An external relay may be programmed to trip upon entry (see Programming Manual: Relay Event ID Codes, Area Entry Relays), and remain on for a programmed duration.

If the system has been armed with Exit-Delay Restart enabled, when the exit door is opened and then closed, the programmed exit delay will restart at 60 seconds. Thus, if a long exit delay is programmed, it will be reduced to 60 seconds after exiting, yet still allow reentry before entry time starts. If re-entry occurs within that 60 seconds, exit delay will restart once again (and only once again) at 60 seconds.

If re-entry occurs within 60 seconds after exit delay has expired, the alarm will sound a 2-second warning (with the entry sounder) to remind the user to disarm. (Exit-Delay Restart may be useful in reducing false alarms caused by a user who re-enters the premises shortly after exiting.)

**Note:** In UL installations, maximum exit delay is 60 seconds; maximum entry delay is 45 seconds. In UL Mercantile installations, maximum entry delay is 60 seconds.

Entry delay may be canceled by pressing and holding the  button prior to arming, however it will be restored automatically upon disarming. (When armed with Instant protection, an "I" will appear at the right side of the display.)

### Exit/Entry Follower

A zone programmed as an Exit/Entry Follower will ignore detection during the exit delay, and only during entry delay if the Exit/Entry Zone is entered first. Thus, detection devices (passive infrared detectors, for example) along the path between the keypad and the exit/entry door will not signal an alarm during exit/entry delay under normal conditions. However, if a device in the Exit/Entry Follower Zone detects a violation when the exit/entry door has not first been entered, there will be no entry delay and the Exit/Entry Follower Zone will go into an instant alarm.

If the panel is armed with the entry delays canceled (Instant protection), any violation on the Exit/Entry Zone or the Exit/Entry Follower Zone will cause an immediate alarm.

### Exit Time Restart

This option allows for the following scenario prior to the end of the Exit Time: a violation of an entry/exit zone, a restore, and a second violation of an entry/exit zone *restarts the Exit Time*. The panel does not allow the Exit Time to be restarted more than once. The default setting for this option is *enabled*. Restart events are logged. (SIA CP-01: 4.2.2.3).

### Exit Urgency Annunciation

When armed Away, exit is audible, and time is 60 seconds (default). Enabled with "Enable CP-01 Limits" in the EZ Program Menu.



(SIA CP-01: 4.2.2.2).

## Expansion Zones

### EZM Type

### EZM PGM Armed Terminal Control

### EZM Tamper See Tamper

Zones 9–96 are expansion zones added to the basic system using expansion zone modules (EZMs). Any combination of GEM-EZM4 (4 zones), GEM-EZM8 (8 zones) and/or the 4-zone modules integral to each GEM-RP1CAe2 and GEM-K1CA keypads may be used. Refer to Section 2: ADDING EXPANSION ZONES and the Wiring Diagram. Also see the instructions accompanying each module for wiring information.

Regardless of how the modules are arranged, the expansion zones are divided into consecutively-numbered groups of four. Each 4-zone module comprises one group of zones; each 8-zone module comprises two groups. Each group is assigned a number.

For each EZM group, program EZM Type (two nibbles, left and right), as follows: EZM Not Used: leave both nibbles blank (); Burglary EZM: enter "1" in the right nibble (1).

If EZM PGM Armed Terminal Control is programmed for the EZM module, Terminal 6 on the module will go low when the areas programmed for that module are armed. This may be used to display area-armed status (for example) on an external LED. **Note:** (1) This terminal is intended for connection to UL-listed devices rated 5mA maximum and capable of operating from 8.0–13.0Vdc (12V, special application). (2) In two-group modules (GEM-EZM8), only the lower of the two groups may be programmed.

### Extended Format See Data Format

## Fire

### Keypad Fire

Any zone may be programmed for Fire. Connect normally-open devices across a Fire Zone. The EOL2.2K end-of-line resistor must be installed (4-wire smoke detectors require an FT2200 relay instead of a resistor to supervise the power to the detector). A short across the zone will cause a fire alarm, which will be indicated at the keypad by a "FIRE" LCD display and pulsing sounder. An open circuit on the Fire Zone will identify a trouble and cause flashing "FIRE" LCD display and pulsing sounder after a 10-second delay. The sounder may be silenced using the **RESET** button. The LED will go off within 30 seconds after reset if the alarm or trouble is cleared. For Smoke-Detector Reset, see Alarm Outputs.

A fire condition that has not been restored will cause the zone number and description to scroll. To reset (acknowledge) the condition, enter a valid code, then press the **RESET** button.

If Keypad Fire is programmed, pressing both the **7F** and the **\*** keypad buttons at the same time will sound a fire panic alarm and display "\*\*\*FIRE ALARM\*\*\*" at the keypad. The Keypad Fire function is supplementary to the hardwired zones. **Note:** This feature shall not be considered a substitute for listed manual initiating devices.

### Fire Alarm Verification (Not for use in California.)

Fire Zone programmed for "Fire Alarm Verification" will cause all zones to power down for 12 seconds. (All devices must be wired with + power on Terminal 28). After this time, power is restored and a 4-second power-up time is started. Thereafter, the zone will be active again. This represents a total processing delay of 16 seconds from the time the alarm is first detected. If an alarm condition still exists at this time or reoccurs within 2 minutes, an alarm will be initiated, otherwise the zone will return to its original state. **NOTE:** A zone programmed for "Fire Alarm Verification" must be programmed as a "Fire Zone" as well.

### Fire Output (Lug E9)

Lug E9 (FIRE) will go to about 1Vdc when a Fire Zone programmed for Fire Output is tripped. This lug may be used for auxiliary equipment. (For use, refer to the instructions furnished with the device). Use Napco Part No. WL1 for connection.

### Fire Output Cadence

The bell output will sound in a Temporal Cadence fashion in the event of a fire alarm. Program all Fire Zones or events to activate the PulseBurg Output, and program the Option PulseBurg output Cadenced.

### Global System Troubles by Output

System troubles (Low Battery, AC Failure, etc.) can trip any output (Pulsed Burg, Auxiliary, etc.). **Note:** RF TROUBLE will report for RF Low Battery, RF Supervisory Failure or GEM-DT Self-Test Failure.

### Interior Stay Zones; Interior Normally Bypassed (Stay Mode); Auto Interior Bypass (Stay)/Easy Exit

(Applies to "GEM-RP" keypads only). Removal of a programmed group of interior (Stay) zones from the system will permit freedom of movement throughout the premises but still allow protection from intrusion through armed perimeter zones. Pressing **INTERIOR** prior to arming will select the Interior Zones, then arm to bypass. The next time the control panel is disarmed, all bypassed zones will automatically revert to non-bypassed (disarmed) zones. When **INTERIOR** is pressed, the "BYPASS" reminder will come on.

The bypassed zones may be displayed on the keypad (see GEM-RP1CAe2/GEM-K1CA FUNCTION MODE).



If Interior Normally Bypassed is selected, all Interior (STAY) Zones will always be inactive. The "BYPASS" reminder will always display, indicating that only partial protection will be provided upon arming. To temporarily restore interior protection, press **INTERIOR**; the "BYPASS" reminder will go out upon arming, denoting full protection, however Interior (Stay) Zones will once again be bypassed the next time the panel is disarmed.

If "Auto Interior Bypass" is programmed, all Interior Zones will automatically be bypassed if the Exit/Entry doors are not opened during



exit delay. If  is pressed while armed Stay, exit delay will restart and Exit/Entry doors may be opened to permit someone to exit (while others remain on premises) without causing an alarm.

### Interior (STAY) Bypass

(Applies to "GEM-RP" keypads only). "Interior (Stay) bypass" zones allows freedom of movement inside the premises, while still providing perimeter partial protection, in ARMED STAY mode by pressing  before arming. All zones (including Interior Bypass Zones) are all protected with full protection, in ARMED AWAY mode, by arming without the perimeter button. The next time the zone is disarmed, the zone will become a full protected zone. Interior zones can be made to be normally bypassed by enabling "Interior Normally Bypassed" and to be unbypassed by pressing . The next time the zone is armed, the zone will become a partially protected zone.

**Jumpers** (Refer to Wiring Diagram for UL configuration.)

**A:** Cut for dry contacts on the Auxiliary Relay.

**B:** Cut for dry contacts on the Burglary Relay.

**C:** Cut for dry contacts on the Reset Relay.

**D:** Cut if using a PS3002 Power-Supply Module.

**JP5:** Keypad Configuration Jumper (top-right corner, above micro shield) is installed across top and center pins for normal operation. When configuring the GEM-RP1CAe2 and GEM-K1CA keypads, move jumper across center and lower pins.

**JP6 & PS:** For Residential Fire. See Alarm Outputs.

**JP7:** 2-Wire Fire jumpers. Select Zones 7 and/or 8 for use as either 2-Wire Fire Zones or Burglary Zones. Note: If customizing a single-area default program, Zone 8 is configured as a 2-Wire Fire Zone. In a two-area default program, Zones 7 and 8 are configured as 2-Wire Fire Zones common to both areas; be sure to move JP7 Zone-7 jumper to the 2-WF position (see Wiring Diagram).

### Keypad Digital Dialer Test

A Digital Dialer Test (Central Station Comm. Test) can be initiated from the function menu. Press  until "DIGITAL DIALER TEST Y/N" is displayed and then press [NEXT/YES] to initiate the transmission of a Test Timer signal. Note: Test Timer reporting codes and *Report Test Timer on Telco1 or Telco 3* must be programmed.

**Keypad Jumpers: GEM-RP1CAe2 (and GEM-K1CA)** (Refer to label LA1374 on the circuit board fishpaper for jumper locations and a summary of settings)

**JP1:** Cut to enable Keypad Tamper.

**W1 & W3:** Cut both to disable touchpad backlighting.

**W2:** Cut to disable LCD backlighting.

**Keypad Jumpers: GEM-RP2ASe2/RP3DGTL** (Refer to label LA1390 on the circuit board fishpaper for jumper locations and a summary of settings)

See Section 3: Configuring the GEM-RP2ASe2/GEM-RP3DGTL Keypad for jumper selection.

### Key Fob Transmitters

#### Aux. Output Chirp on Key-Fob Arming

#### Burg Output Chirp on Key-Fob Arming

#### Don't Clear Aux. Relay with Arm/Disarm

Aux. Output Chirp on Key-Fob Arming will cause one 50 mS chirp to sound on arming and two 50mS chirps on disarming. Use the steady output of a siren driver. Do not use a voice siren driver.

Burg Output Chirp on Key-Fob Arming will cause one 50 mS chirp to sound on arming and two 50mS chirps on disarming. Use the steady output of a siren driver. Do not use a voice siren driver.

Programming a "C as the Key-Fob Aux-1 or Aux-2 option will provide the ability to toggle the Aux. Relay on or off. If there is an Aux. Relay timeout programmed, it will follow this timeout unless toggled off by the key fob. To provide key-fob-only control, program no timeout. Program Don't Clear Aux. Relay with Arm/Disarm to prevent a disarm from resetting the Aux. Relay.

Key-fob users can report openings and closings. Key fobs 1–8 report as Users 81–96, respectively.

### Keyfob Zone Assignment

Keyfobs can be assigned to zones to allow individual reporting. Each of the 4 keyfob buttons can be assigned to a zone. For example, On button = point 1; Off button = point 2; A1 = point 3; A2 = point 4. Up to 96 keyfobs can be assigned to the GEM-P9600, providing multiple wireless panic buttons on a system, each reporting to the Central Station or a pager and/or annunciating on a keypad the keyfob zone number with description/location. To assign a keyfob to a zone, program the keyfob as you would a transmitter, entering the keyfob's ID code, check sum and point number at the appropriate zone.

### KeyFob or Keypad Garage Door opener control

The Auxiliary Relay can be programmed to activate for a programmable period of time. This allows it to be used for access functions such as opening and closing a garage door. This is achieved through a new KeyFob option, Access control, by programming ( *Access on Aux. Output* ) into the Aux. 1 or Aux. 2 option locations. Also program the option Access Control on Auxiliary Output , and a time into the Auxiliary Output Access Control duration. If an Access Control from the keypad is desired, also program a Panel Access Code.

### KeyFob Disarm Activates Entry Lighting



Disarming with a KeyFob can activate Remote Relays or X-10 Devices by programming the event EntryRelay Area1, or EntryRelay Area2 on the External Relay Control screen. This event will cause the programmed outputs to activate on either a KeyFob Disarm OR the opening of the Exit Entry zone while the system is armed.

**Keypad Access** see Access Control

### Keypad Area Assignments

In multiple-area systems, assign an Area Number ("1"– "8") to each keypad.

### Keypad Features

The following programmed system features will activate only if they have also been enabled at the keypad.

- Ambush
- Easy Arming
- Access Control
- Keypad (Police) Panic
- Keypad Auxiliary Panic
- Keypad Fire Panic
- Keypad Panic See Panic Zone

**Keypad Panic** See Panic Zone

### Keypad Sounder on Alarm

If a programmed zone goes into alarm, the keypad sounder will activate and will remain activated until the **RESET** button is pressed or the system is disarmed.

**Keypad Tamper** See Tamper

### Keyswitch Arming

The area will arm/disarm when the programmed zone is momentarily shorted (momentary keyswitch). To supervise the keyswitch, program the zone for Day Zone on Open.

### Leading Digits for Pager Format

In Pager Format reporting, the message typically begins with 00. With some pager services, this will cause the Pager's Voice Mail feature to activate. Program these digits to any number desired. Typical Pager report - 003 022 1234, where 3 is the Event, 22 is the zone, and 1234 is the Subscriber ID number.

If the Leading Digits are programmed as 98 (1<sup>st</sup> digit = Address Location 0520 [•] [9], 2<sup>nd</sup> digit = Address Location 0521 [•] [8]), the Pager report will now appear as 983 022 1234.

### Line-Reversal Module, M278

The Line-Reversal Module allows the panel to be monitored by a central station through leased lines. On alarm, the module reverses normal line-voltage polarity. For details, refer to the instructions furnished with the module.

### Logging of Security Bypassed Zones

The panel will log by User, Date, Time, and Zone any zones which are bypassed with the Security Bypass Mode. This is useful in a system where openings are on 24 hour protection zones and access is only allowed if the zone is Bypassed by an authorized User, and then Unbypassed when done. A typical application would be a warehouse or shipping terminal where the overhead doors are programmed for 24 hour protection and must be Bypassed to allow access, and then Unbypassed again.

To activate this feature, DO NOT program *Disable Code Required for EZ Bypass* is Program BE (Bypass Enable) for each user who is to have this ability.

To Security Bypass a zone:

1. Enter Arm/ Disarm code \* *Code must be Bypass Enabled*
2. Press the **BYPASS** button. The display will read, "BYPASS ENABLED".
3. Press the **BYPASS** button, again.
4. Enter the zone #. The display will read, "BYPASSED ZONE #"
5. To bypass another zone, repeat steps 3 and 4.

To Security Unbypass a zone, follow the same procedure. When the zone # is entered (step 4), the display will read "UNBYPASSED ZONE #".

To Arm/Disarm the system without altering the state of Bypassed zones, program the option *Disable Auto-Unbypass on Disarming*. (Address Location 2417 = [4][•])

- ✓ It is not possible to Bypass/Unbypass Zones using the Directory Mode procedure.
- ✓ Typically, any zone, other than a fire zone, will automatically be unbypassed when the panel is disarmed. In order to unbypass a fire zone, follow procedures 1 through 4. After executing step 4 the display will read - Unbypassed, Zone #.
- ✓ When a fire zone is bypassed the panel will go into a fire trouble condition. It will also transmit the fire trouble to the CS, if programmed to do so.
- ✓ Zones 1-9 are entered as 01 - 09.

**Loop Response** (750mS required for UL installations)

Loop response is the amount of time in milliseconds (mS) that a normally-closed circuit must remain open, or a normally-open circuit must remain closed, to trigger an alarm. The slower the loop response, the more immune the system will be to intermittents (“swingers”). Loop response times for Zones 1 through 8 are programmed into the control panel; those for Zones 9 through 96 loop responses are selected at the respective keypad configuration mode or expansion module jumper. (Refer to keypad instructions and EZM Installation Instructions.)

Selectable loop-response times for Zones 1–8 are:

750mS (.75 sec.): The slowest loop-response time, recommended for use with magnetic contacts, window foil, etc. Unless programmed otherwise, loop-response time will be 750mS for all zones.

50mS (.05 sec.): Used for momentary Panic Buttons and area-protection devices, such as photoelectric eyes, passive infrared sensors, floor mats, etc.

10mS (.01 sec.): An extremely fast loop response used primarily for window bugs.

#### **Low Battery** (Required for UL Mercantile installations)

A low-battery system trouble will announce at the keypad when the battery terminal voltage drops below normal. This condition may signal a local sounding device, report to a central station (program Panel Low Bat Report Code), or both. If a battery is installed and low terminal voltage is detected, a restore will not occur until the battery is recharged to its specified level and passes a dynamic test. The dynamic test may be initiated manually by pressing the **RESET** button, or it will be initiated automatically, every four hours, by the panel.

In wireless installations, when displaying RF transmitter status, a “LoBatt” indication denotes a low-battery condition at the transmitter.

#### **Master Security Code**

#### **Dealer Security Code**

#### **Download Security Code**

The factory-programmed Master Security Code (printed on the label affixed to the micro can) is unique and cannot be changed. Use this code to enter the Dealer Program Mode to program (or change) the Dealer Security Code. If a Dealer Security Code is programmed, both the Dealer Security Code and the Master Security Code will work. However, should system RAM fail, only the Master Security Code will work.

The Dealer Security Code is needed to enter the Dealer Program Mode, thus allowing the dealer to program codes, zone features, reporting features and zone descriptions (see Programming Manuals WI777/WI1185). This code may be changed as required.

**Important!** The label containing the Master Security Code should be removed. Record the code in a secure place for reference as programming changes cannot be made without it (or the Dealer Security Code).

To change the Dealer Security Code, access the Direct Address Program Mode. Advance to the “PROG” screen, then change the 6-digit code as required.

The Download Security Code is the six-digit code required to establish connection to the PCD-Windows Software.

#### **Memory Failure**

A User or Dealer Memory error will cause the sounder to pulse, the “SYS/TRBL” reminder to flash, and the display to read “E19-00 USER MEM ERROR” or “E20-00 DEALER MEM ERROR”. Press the **RESET** button to silence the sounder (“SYSTEM READY” will display, along with the “SYS/TRBL” reminder). Activate RESET SYSTEM TROUBLE to manually reset the system trouble. A Memory Failure can be programmed to activate an alarm output and/or report using its associated system Report Code.

#### **Modem Ite CS Format**

The GEM-P9600 control supports Radionics Modem Ite central station reporting format.

#### **Never Arm** (Do not use for primary Burglary protection)

A zone programmed as Never Arm cannot go into alarm. If tripped, it will display at the keypad when the DISPLAY STATUS function is selected. A chime will sound at the keypad while armed or disarmed, if Chime is also programmed for that zone and enabled. This feature is suggested for use as a garage-door or driveway monitor, or similar application.

#### **No EOL Resistor**

Program for any zone not wired with a 2200 Ohm end-of-line resistor (Napco Part No. EOL2.2K). This will disable any zone-short indication (if programmed, Day Zone Short is disabled). If not programmed, an end-of-line resistor must be installed. Note: This selection is automatically disabled for zones selected as Fire. Do not program for UL installations.

#### **Number of Rings Before Pickup** See Callback-Method Download

#### **One-Button Arming** See Easy Arming

#### **Opening Report**

#### **Opening Report Only After Alarm Report** (Do not program for UL installations)

Opening and closing reports are generally used in commercial installations. On disarming, the communicator can send an Opening Code for Users 1–96 (Opening Report), or it may transmit only when the control panel is disarmed after an alarm has been reported (Opening Report Only After Alarm Report). (Note: Key Fobs 1–8 report as Users 81–96). Subscriber Identification Numbers and Opening Codes must be entered for either opening report.

Program Opening Report Only After Alarm Report to report only when disarming after an alarm report. This feature may be used by the central station to verify that the subscriber has responded and disarmed the panel. If Opening Report Only After Alarm Report is selected, also select Opening Report for each user.



### Opening/Closing Reporting for Key-fob Users

Key-Fob users can now report openings and closings.

- GEM-P9600: Key Fobs 1-16 report as Users 81-96.







### Panics

#### Keypad Aux Panic

#### Keypad (Police) Panic

#### Keypad Fire Panic See Fire

#### Remote Panic

The Panic Zone is always a 24-Hour Zone. Each keypad is individually selectable for keypad panics (see Keypad Features). If Keypad Panic is programmed for a keypad, police panic is activated by simultaneously pressing the  and  buttons. If Keypad Aux. is programmed, pressing  and  buttons simultaneously will trip an auxiliary emergency alarm. If Keypad Fire is programmed, pressing  and  buttons at the same time will activate fire panic.

A remote panic button may be connected to a GEM-RP2ASe2 Keypad. Splice the two white wires from the keypad to a normally-open momentary-contact pushbutton. Additional panic buttons may be wired in parallel with the first. If remote panic will not be used, insulate both white wires, as a short across them will cause a panic alarm. (In UL installations, remote-panic buttons must be located within 3 feet of the keypad, with no intervening walls or barriers. Tamper must be enabled on the keypad.

#### Power-Up Delay

If programmed, power-up will be delayed for 5 minutes to allow devices such as PIRs time to stabilize (warm up). This will prevent false alarms when ac power is restored after a long power outage and the backup battery is discharged. SIA CP-01 requires you must program this feature on all zones with sensors.

#### Pre-Alarm Warning (Not for UL applications)

Programmable by zone, this feature will cause an alarm to sound only at the keypad for the duration of the programmed abort delay (see Abort Delay; Time Selection). After the delay has elapsed, the alarm output will activate and a report will be sent. **Note:** If no Abort Delay time is programmed, Pre-Alarm Warning time will be 10 seconds.

#### Pre-Dial Delay

A Pre-Dial Delay may be used whenever a delay is required before dialing. It may be required when programming Dial-Tone Detection, which causes the communicator to wait before it attempts to detect a dial tone (see Dial-Tone Detection). Certain telephone exchanges send a nonstandard dial tone that the communicator may not be able to detect. With these nonstandard exchanges, it is possible to program Pre-Dial Delay rather than Dial-Tone Detection. This will cause the communicator to wait for a predetermined period of time before dialing rather than look for a nonstandard dial tone.



Contact the telephone-equipment supplier to find out how long a delay is required before dialing. Select Pre-Dial Delay by programming one "D" for each 4-second delay required immediately before the telephone number. **Note:** In UL installations, do not program more than one "D" before the telephone number.

See Backup Report on Telco 2; Report Telco 3 (Double or Split Reporting). Also see Access Number for Outside Line; Telephone Numbers.

#### Priority Area Arming



Prevents area arming if the alternate Priority Area has not yet been armed.

#### Priority Zone (Required for all zones in UL installations.)

A zone that will prevent arming if in trouble. If an attempt is made to arm, the sounder will come on and "ZONES NOT NORMAL/CAN'T ARM" will be displayed for 4 seconds. The keypad may be reset by simply pressing the  or  button. The problem on a Priority Zone must be corrected before the panel can be armed. Any zone may be selected as a Priority Zone. A zone in trouble that is neither a Priority Zone nor an Auto-Bypass Zone will cause an alarm on arming.

#### Priority Zone with Bypass

A Priority Zone that will permit arming if the priority condition is bypassed. If the system is so programmed, the zone will auto-bypass and (optional) the condition will be reported to a central station.

As above, if an attempt is made to arm, the sounder will come on and "ZONES NOT NORMAL/CAN'T ARM" will be displayed. To reset the keypad, press the  or  button; the display will read "ZONE FAULTS". To arm the panel, press the  button, then enter the User Code.

Any zone not selected as a Priority Zone may be programmed as a Priority Zone with Bypass.

#### Pulse Burglary Output See Alarm Outputs

#### Receiver Format

The communicator can be programmed to transmit to any standard central-station receiver. A receiver format must be entered for each telephone number used, but a different format may be assigned to each.

Refer to Backup Report on Telco 2 and Report Telco 3 to determine whether or not Telephones 2 and/or 3 will be programmed. Call the central station for each telephone number used to confirm the type of receiver in use. Select the receiver format entry for each telephone number from the following table.

ENTRY	RECEIVER FORMAT	DATA FREQ. (Hz)	DUTY CYCLE (ON/OFF)	INTERDIGIT TIME
(blank)	Ademco, Silent Knight Slow	1900	60/40mS	600mS
1	Sescoa, Vertex, DCI, Franklin Fast	1800	30/20	800
2	Radionics Fast	1850	13/12	400
3	Silent Knight Fast	1900	40/30	560
4	Radionics, DCI, Franklin Slow	1800	60/40	600
5	Universal Hi-Speed	1850	30/20	350
8	Radionics BFSK	Modem Formats		
9	4/3/1*			
A	Radionics Modem 2*			
B	SIA*			
C	Point ID*			
D	Express (Touch-tone 4/2 Format)			
0	Radionics Modem IIe			

\*These formats do not use programmable codes, but Event ID Codes to identify the type of zone as follows:

- 1 – Fire
- 2 – Panic
- 3 – Burglary
- 4 – Holdup
- 7 – Gas Alarm
- 8 – Heat Alarm
- A – Auxiliary Alarm (keypad displays “0”)
- B – 24-Hour Auxiliary Alarm

#### Relay Control (External Relays)

In addition to the three relays provided on the motherboard, up to 24 external relays (8 per RB3008 Relay Module) or X-10 devices (24 per GEM-X10 module) may be controlled from the keypad, by event or by schedule through the use of PCD-Windows downloading software. Program these outputs to activate by event on PCD-Windows External Relay Control screen, or by schedule on the Event Scheduler screen.

#### Relay Follows Zone

External Relays can be programmed to follow an open or shorted zone. On the PCD-Windows External Relay Control screen, program the External Relay to “follow” an open zone, or to “follow” a shorted zone.

**Relay Outputs** See Alarm Outputs

#### Relay / X-10 Mapping

It is possible to have a relay or X-10 device activate for multiple events, with a maximum of 24 events. This allows the relay or X-10 device to be activated by multiple events or conditions. This is programmed by assigning or mapping events to relay numbers. PCD Windows must be used to program Relay/X-10 mapping. Referring to the PCD-Windows External Relay Control screen, the “Relay / Entry#” column typically indicates the number of the relay which will accept the commands on that line. However, the “Map” column, which is used to transfer the function defined on that line to a device on another line.

**Remote Panic** See Panic Zone

#### Report Digital Dialer Exit Error/Recent Closing (SIA CP-01 Requirement: 4.2.2.6)

A Recent Closing transmission is sent if an alarm occurs within two (2) minutes after the expiration of the Exit Time. If the user number is available, it is included in the Recent Closing transmission. **Note:** Recent Closing transmissions are not sent for fire alarms.

#### Report Telco 1

#### Report Telco 3 (Double or Split Reporting)

Alarms, alarm restores, troubles and trouble restores may be selected individually for each zone. Violation of a zone selected to report will communicate the code(s) selected for that zone to the central station.

Normally, Report Telco 1 is used to report to the central station. Report Telco 3 is used when certain zones will report to a different receiver (split reporting); Report Telco 1 and Report Telco 3 are both used on the same zone to report to two receivers successively (Double Reporting). (Double Reporting requires a successful report to Telco 1 before reporting to Telco 3). Also see Backup Report on Telco 2.

**Reset Day Zone with Arm/Disarm Only** See Day Zone

**Reset Relay** See Alarm Outputs

#### Resound on Wireless Smoke Low Battery

If a wireless smoke detector low battery is detected, it will re-sound the trouble at the keypad every 4 hours when disarmed and every 12 hours when armed, until the condition is corrected.



**RF Jam Reporting**

RF Receiver Jam will report as RF Receiver Trouble.

**Second Call Answering Machine Override**

If using the PCD-Windows PC downloader Software, the Telco Answering Service can now be disabled. Call the panel, hang up after one ring by pressing the F10 key. The PCD-Windows will automatically call the panel back and the panel will answer in one ring. See Callback-Method Download for more information.

**Selective Bypass**

**Disable Code Required for Easy Bypass (Not for UL installations.)**

Any or all zones (1–96) programmed for Selective Bypass may be removed from the system, but each must be removed separately. Refer to BYPASSING ZONES in Section 3 for operation. Security Bypass: Recommended for commercial applications, requires entry of a valid user code. Easy Bypass: Recommended for residential applications, is selected by programming Disable Code Entry for Easy Bypass; this will permit bypassing/unbypassing zones without the need of entering a code (see Easy Bypass in Section 3). Do not program this feature in high-security applications. When one or more zones is bypassed, the “BYPASSED” reminder on the GEM-RP1CAe2 and GEM-K1CA keypads will display.

**Sensor Watch**

Program for any zone containing a PIR or dual-technology sensor, floor mats, door contacts, or other device where some activity is expected. This feature supervises the sensor by verifying that the zone activates before the PIR timer runs out. If no trip is detected within the programmed Sensor-Watch time, a system trouble will result and “E22-NN PIR SENSOR TRBL” will be displayed at the keypad, where NN are the zone number(s). Select the RESET SENSOR MSG function to reset this system trouble.

Program the Sensor-Watch PIR timer in Location 4088. Select a value in accordance with the anticipated activity within the coverage area while disarmed. In calculating the Sensor-Watch time, note that only the disarmed hours (the time between armed periods) are added. In moderate traffic areas, a Sensor-Watch time of perhaps 1 hour may be appropriate, whereas in remote areas, a time of 8 hours or more may be in order. Supervision time should be calculated for the supervised zone with the least amount of traffic. Up to 255 hours may be programmed (see Time Selection).

**Silence All Outputs During Audio Session See Veri-Phone**

**Silence All Outputs During Audio Session with Lug E19**

Whenever an active low is applied to control-panel Lug E19 (Listen-In), all output relays will turn off. Connect Veri-Phone Terminal 16 (INHO) to Lug E19.

**Single-Digit Format See Data Format**

**Smoke Detectors**

Connect smoke detectors as shown in the following diagrams. The normally-closed contacts of the Reset Relay are used to reset the smoke detectors.

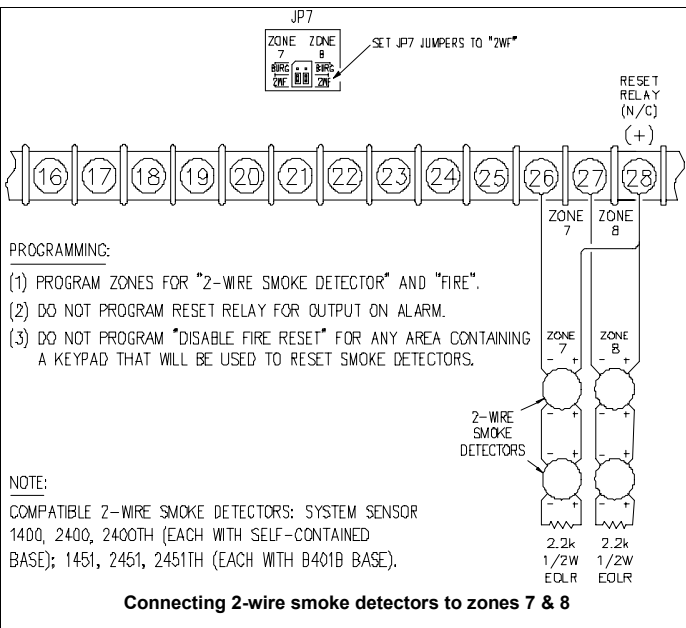

**Two-Wire Smoke Detectors: Use Zones 7 and 8.**

Zones 7 and 8 have been designed so they can be easily configured as 2-wire smoke detector zones by means of jumpers (JP7) located above Terminal 21.

1. If Zone 7 is selected as a 2-Wire Fire Zone, move the left jumper on JP7 from the top two pins (BURG) to the bottom two pins (2WF).
2. Similarly, if Zone 8 is selected as a 2-Wire Fire Zone, move the right jumper on JP7 from the top two pins (BURG) to the bottom two pins (2WF).
3. Connect 2-wire smoke detectors to Zones 7 and/or 8 as shown.

**Two-Wire Smoke Detectors: Use Zones 1-6.**

Additionally, where more than two 2-wire smoke detector zones are required, select any of Zones 1–6 for 2-wire fire as follows:

1. Program the selected zone(s) (1–6) for 2-Wire Smoke Detectors and Fire.
2. Cut out the 2700Ω resistor (color code: red/violet/red) associated with the selected zone(s). See table below.
3. Install a 130Ω resistor across the 2 terminals of each zone used (color code: brown/orange/brown).
4. Wire positive (+) terminal of smoke detector to terminal 28. Wire negative (-) terminal of smoke detector to positive (+) terminal of the zone.

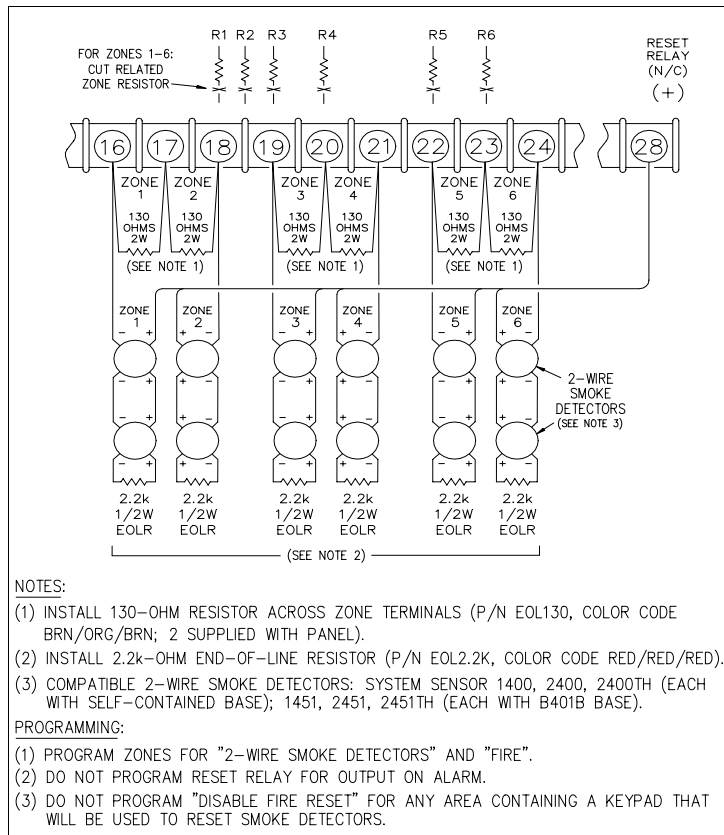

Connecting 2-wire smoke detectors to zones 1-6

ZONE	RESISTOR	LOCATION ON BOARD
1	R1	ABOVE TERMINAL 18
2	R2	ABOVE TERMINAL 18/19
3	R3	ABOVE TERMINAL 19
4	R4	ABOVE TERMINAL 20
5	R5	ABOVE TERMINAL 22
6	R6	ABOVE TERMINAL 23

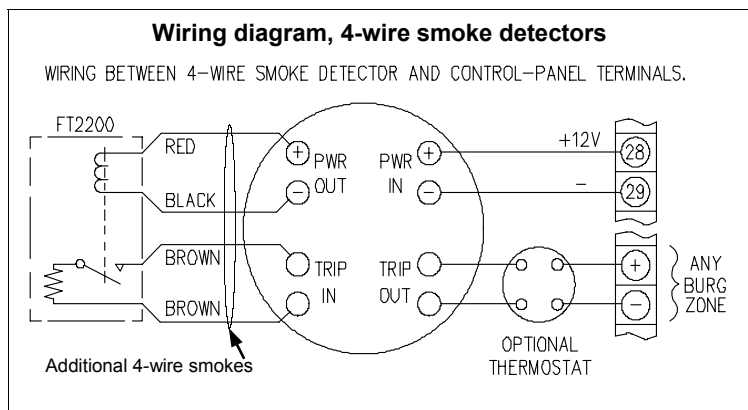

**Four-Wire Smoke Detectors.** If installing 4-wire smokes, subtract smoke-detector alarm current from available standby current. See COMPATIBLE UL-LISTED DEVICES.

Wire 4-wire smokes as shown in the following wiring diagram. Program each zone for Fire. Also program zones for Pulse Burglary Output, and Disable Fire Reset in the applicable area(s) (System Options). If they are of the self-resetting type, 4-wire smokes may be powered from Terminals 13 and 14 (AUX. PWR.) instead of Terminal 28 and 29, thus freeing the Reset Relay for other uses.

**Sound Alarm On Exit Error (SIA CP-01 Requirement: 4.2.2.4)**

An Exit Error sequence is initiated if an entry/exit zone is violated at the expiration of the Exit Time. An Exit Error is processed as follows:



1. The local alarm shall immediately sound.
2. The keypad annunciator sounds an Entry Delay.
3. An Entry Delay is initiated.
4. If the alarm system is not Disarmed at the end of the Entry Delay, the Alarm Transmission Sequence is initiated.
5. The Alarm Transmission includes the alarm and an Exit Error.

**Split Reporting** See Report Telco 3

**Start Exit Delay After Ringback**

When a closing report is successfully received, the central station will acknowledge by returning a kiss-off signal. When the kiss-off is received by the communicator, a 2-second ringback tone will sound at the keypad. Start Exit Delay After Ringback will cause the exit delay to start after the ringback sounds.



If this option is chosen and no ringback sounds shortly after the control panel is armed, exit delay will not start and opening the exit/entry door will cause an instant alarm. To manually start the exit delay, select the START EXIT TIME function, then press the  or  button to execute.

**Note:** (1) If this feature is selected, Exit/Entry Follower Zones will not arm until either a ringback sounds or the START EXIT TIME function is used. (2) If communicator, telephone lines or central-station receiver is out of service, the system will be armed without communication capability.

**Status Report** See Closing Report

### Subscriber Identification Numbers

If reporting openings and/or closings, program Subscriber Opening/Closing Identification Numbers for each area for each telephone number used. If reporting events, program Subscriber ID Numbers for each area for each telephone number used. Subscriber ID numbers must be programmed for each area and telephone number, even if all are the same. Start with the left-most location.

**Sum Check** See Data Format

### Supervised Bell Output

When the option Supervised Bell Output is enabled, a 2.2K ohm resistor must be installed across the bell or sounding device terminals. In the event that the Burg Output is cut, or the circuit is opened, an E51-00 FIRE BELL TRBL trouble condition will occur. Note: Due to the fact that there is a constant loop current flowing through the Burg Output circuit for supervision, some sirens or siren drivers may emit a low volume hum or buzz if the 2.2K EOL resistor is not installed. If Supervised Bell Output is not required, this can be eliminated by cutting resistor R207 which is located just to the right of the Burg Output relay adjacent to the Burg Output terminal.

### Suppress "BYPASSED" Reminder When Armed

Program to inhibit the LCD "BYPASSED" display while armed.

### Swinger Shutdown

Swinger Shutdown is a common term used in the burglary alarm industry. It is a feature of an alarm panel that prevents multiple false alarms from being generated from faulty detectors (or wiring) by limiting the number of alarms a zone may report during a single arming period. NAPCO has this programmable-by-zone feature named *Swinger Shutdown*, and has been available on its panels for years. The SIA False Alarm Reduction standard CP-01 (to which the panel now complies) requires the SIA definition of "swinger shutdown" on all non-fire zones. Our programmable feature allows three trips per arming period which is unacceptable in CP-01 installations. Therefore, to reduce confusion, the following defines both definitions of "Swinger Shutdown", namely (1) the **NAPCO Programming Feature** and (2) the **CP-01 Requirement**:

**Swinger Shutdown (NAPCO Programming Feature):** Program a zone with this feature to allow only three alarms per arming period. *Auto-Reset* must also be programmed for the zone for this feature to work.

**Swinger Shutdown (CP-01 Requirement):** *To meet CP-01, all non-fire zones must not be programmed for Auto-Reset. A zone not programmed for Auto-Reset will trip only one alarm per arming period. The panel leaves the factory with no zones programmed for Auto-Reset. If "Enable CP-01 Features" is selected in the Easy Programming menu, all non-fire zones will not be programmed for Auto-Reset.*

### System Trouble Audible Automatic Timeout Inhibit System Trouble Audible

In the event of a System Trouble while the system is disarmed, the keypad will scroll the trouble description in the display and activate the sounder until [RESET] is pressed. If [RESET] has not been pressed within 10 minutes of the trouble, the sounder will automatically turn off in 10 minutes.

To disable System Trouble Audible Automatic Timeout, enable *Disable System Trouble Audible Timeout* in the PCD-WINDOWS Keypad Features screen. NOTE: If the system were Armed when the trouble occurred, the keypad would display the SYS TBL icon, but NOT activate the sounder.

For installations where an audible on system trouble is not desired at all, the option, *Inhibit System Trouble Audible* can be enabled. Regardless of the system status, Armed or Disarmed, there will be no keypad sounder at all in the event of a system trouble. However, the trouble will still scroll in the keypad display until [RESET] is pressed and the SYS TBL icon will display until the trouble is restored. (Do Not program in UL Installations)

- To disable System Trouble Audible, enable the option *disable System Trouble Audible* in the PCD-Windows Keypad Features screen.

### Tamper

#### EZM Tamper

#### Keypad Tamper

#### RF Tamper

Removing the cover of an expansion zone module will cause the sounder to pulse and the "SYS/TRBL" reminder to flash. The keypad will display "E13-NN BURG EZM TAMPER", where "NN" denotes the module number. Press the  button to silence the sounder ("SYSTEM READY" will display). Correct the problem, then select RESET SYSTEM TBL to manually reset the system trouble display.

Removing a keypad from the wall causes a similar system trouble indication. The keypad will display "E11-NN BURG KPD TAMPER", where "NN" denotes the keypad number. Press the  button to silence the sounder ("SYSTEM READY" will display). To manually





reset the system trouble, correct the problem then select RESET SYSTEM TBL.

**Note:** If either of the tamper conditions is not corrected within 5 minutes, the system trouble will again display at the keypad. A Tamper condition can be programmed to activate the burglary output and/or report using its associated system Report Code. In wireless installations, when displaying RF transmitter status, a "Tamper" indication denotes that the transmitter case is open.

#### Telco Fail See Enable Line-Fault Test

#### TELCO FAIL ONLY WHEN ARMED

The Telco Line Cut Monitor will only be active when the system is armed.

#### Telco Line Test Delay See Enable Line-Fault Test; Time Selection

#### Telemetry Trouble

If any device connected to the on-board Serial Port (such as a Home Automation system or AES Radio) fails to respond to a poll by the control panel, a Telemetry Trouble system trouble will result. On the PCD-Windows System Features screen, enable Telemetry Trouble: = XT to report on alarm or activate and output. On the PCD-Windows System Reporting Codes screen, program a reporting code for Telemetry Trouble.

*Keypad readout will be:* E58-00 SERVICE  
TELEMETRY TRBL

*The event Log will read:* TROUBLE: TELEMETRY  
TROUBLE RESTORE: TELEMETRY

*Keypad programming* Address Location 1099 = [●][ ] 4 - Telemetry Trouble  
*Telemetry Trouble:* 8 - Telemetry Fail

#### Telemetry Failure

If the device connected to the on-board Serial Port (such as a Home Automation system or AES Radio) is not able to carry out its intended function, it can send a signal to the control panel, and a Telemetry Trouble system trouble will result. On the PCD-Windows System Features screen, enable Telemetry Failure: = XF to report on alarm or activate and output. On the PCD-Windows System Reporting Codes screen, program a reporting code for Telemetry Failure.

*Keypad readout will be:* E59-00 SERVICE  
TELEMETRY COMM

*The event Log will read:* TROUBLE: TELEMETRY FAIL  
*Trouble Restore:* TELEMETRY FAIL

*Keypad programming* Address Location 1100 = [●][ ] 4 - Telemetry Trouble  
*Telemetry Failure* 8 - Telemetry Fail

#### Telephone Numbers

##### Dialing Prefix

To report to a central station, Telephone Number 1 must be programmed. Telephone Number 2 is programmed for Backup Reporting; Telephone Number 3 is programmed for Double or Split Reporting.

Private telephone systems may require a Dial-Tone Detection "E" or Pre-Dial Delay "D", followed by an access number to obtain an outside line. (See Access Number for Outside Line.)

It should be noted here that the telephone number need not actually start in the first location shown, and may not end in the last. Extra locations have been provided to allow for one or more prefix digits: a Pre-Dial Delay "D" or a Dial-Tone Detection "E". What is important is that the telephone number, with its associated Pre-Dial Delay, Access Number, and Dial-Tone Detection, be wholly contained within that group of locations, and that they be in their proper sequence.

If needed, a Dialing Prefix of up to 20 digits may be programmed. This prefix will be dialed immediately before the programmed Central Station telephone numbers.

##### Test Timer

##### Cancel Next Test Timer Report on Any Report

The test timer schedule is programmed using NAPCO's PCD-Windows Quickloader Software. If Test Timer is programmed, an automatic test report will be transmitted to the central station on the scheduled day(s) at the scheduled time. (UL installations require a report at least every 24 hours). To report test timer, select Report Test Timer and program a report code. Program the Test Timer event schedule and reporting time.

If Cancel Next Test Timer Report on Any Report is programmed, any report will cause the next test-timer transmission to be aborted, however subsequent test-timer transmissions will report as scheduled. Do not program this feature in UL installations.

##### Timeout

Specifies the length of time that an alarm, alert, or delay will remain active. Auxiliary Output Access Control Time, Abort-Delay Time, and Chime Time must be programmed, or the feature will not activate. See Time Selection.

##### Time and Date Message Option

In the event of a memory corruption, the loss of the system clock will occur and a message 'SET TIME / DATE' will be displayed on the GEM-RP1CAe2 keypad. The message will remain until the Time and Date have been re-programmed.



TIME <sup>(1)</sup>	UNITS	MAX. PROG. TIME
RESET OUTPUT	MIN.	UNTIMED <sup>(2)</sup>
AUXILIARY OUTPUT	MIN.	UNTIMED <sup>(2)</sup>
AUXILIARY OUTPUT ACCESS CONTROL TIME	SEC.	4 MIN, 15 SEC (255 SEC)
BURGLARY OUTPUT	MIN.	UNTIMED <sup>(1)(2)</sup>
PULSE-BURG OUTPUT	MIN.	UNTIMED <sup>(1)(2)</sup>
FIRE OUTPUT	MIN.	UNTIMED <sup>(2)</sup>
ABORT DELAY	SEC.	4 MIN, 15 SEC (255 SEC) <sup>(3)</sup>
CHIME TIME	¼ SEC.	63.25 SEC (255 QTR-SEC) <sup>(3)</sup>
AC-FAIL REPORT DELAY	10 MIN.	42 HR, 30 MIN (2550 MIN)
EXIT DELAY	SEC.	4 MIN, 15 SEC (255 SEC) <sup>(4)</sup>
ENTRY DELAY 1	SEC.	4 MIN, 15 SEC (255 SEC) <sup>(4)</sup>
ENTRY DELAY 2	SEC.	4 MIN, 15 SEC (255 SEC) <sup>(4)</sup>
TELCO LINE-TEST DLY	SEC.	4 MIN, 15 SEC (255 SEC) <sup>(5)</sup>
AUTO ARM REARM DLY	MIN.	4 HR, 15 MIN (255 MIN)
SENSOR-WATCH TIME	DISARMED HOURS	255 HOURS <sup>(6)</sup>

**NOTES:** <sup>(1)</sup> The output used for Burglary must be at least 4 minutes in Residential UL installations, 15 minutes in Commercial UL installations. <sup>(2)</sup> If both locations are left blank, this feature will remain active until the system is disarmed. When both locations are programmed "F", maximum time will be 4 hours, 15 minutes (255 minutes). <sup>(3)</sup> If both locations are left blank, this feature will not activate (timeout = 0). <sup>(4)</sup> In UL installations: Maximum Exit Delay = 60 sec; Maximum Entry Delay = 45 sec. <sup>(5)</sup> If programming locations are left blank, delay will default to 10 sec. <sup>(6)</sup> Time in units of disarmed hours (accumulated between armed periods).

**Time Selection**

The following times are programmable: Any timeout up to those shown in the foregoing table may be programmed. Note that each of the above times is programmed in two locations. The first location has an assigned time factor of 16, the second a time factor of 1.

1st BOX	2nd BOX
tx16	tx1

Time t:	0	1	2	3	4	5	6	7	8	9	10	11	12	13	14	15
Entry:	*	1	2	3	4	5	6	7	8	9	0	B	C	D	E	F

\*Blank.

**Note:** If both programming locations are left blank, refer to the notes in the Time Selection table for feature timeout. To select a time up to 15 seconds, 15 minutes, 15 hours, or 15 days, program the respective entry into the second box only; do not program the first box. To select a time greater than 15 seconds, 15 minutes, 15 hours or 15 days, program both boxes as follows:

1. For the feature selected, choose an appropriate time in units shown (all seconds, minutes, hours, or days — not minutes and seconds, etc.).
2. Divide the time chosen by 16. Enter the quotient in the 1st BOX and the remainder in the 2nd BOX.
3. Check entries by adding the contents of the 2nd BOX to 16 times the contents of the 1st BOX. (Remember that a "zero" entry represents 10.)

Example. Program Entry Delay 1 for 1 minutes.

1. Entry Delay 1 is in units of seconds, thus delay time is 90 seconds.
2. Divide by 16: 90/16 = 5 (quotient) + 10 (remainder).
3. Enter the quotient in the 1st BOX and the remainder in the 2nd BOX
4. Check entries (remember, a "0" entry = 10): (16x5) + 10 = 90

**TouchTone Dialing Only**

**TouchTone Dialing with Rotary Backup**

Select TouchTone Dialing Only if the subscriber has TouchTone service. TouchTone dialing is faster than rotary dialing, but not always as reliable.

For the communicator to use TouchTone on all dial attempts, program TouchTone Dialing Only. To use TouchTone on the first attempt with subsequent Rotary dial, program TouchTone Dialing with Rotary Backup. TouchTone Dialing Only will override TouchTone Dialing with Rotary Backup if both are selected. Note that if Backup Reporting is also selected, the communicator will alternate between TouchTone and rotary dial to reach Telephone 1, then Telephone 2. See Backup Report on Telco 2.

**Transmit "402" Closing Code**

Program to send a "402" closing code (for Ademco Point ID modem format) in place of a "401" code.

**Trouble**

An abnormal zone condition (a break in a normally-closed loop; a short on a normally-open loop; or either on an end-of-line-resistor supervised loop) when disarmed.

Trouble on a Burglary Zone is automatically displayed at the keypad unless Disable Auto Status is programmed. If a Burglary Zone is in trouble, it will go into alarm about 10 seconds after arming. However, if Auto Bypass is programmed, the keypad will beep upon arming (does not apply to selective- or group-bypassed zones).

Trouble (open and/or short circuit) on a Day Zone is indicated by a pulsing sounder; display the Day Zone(s) in trouble on the LCD. Keypad indications are reset by the **RESET** button unless Reset Day Zone With Arm/Disarm is selected.

Trouble on a Fire Zone will be indicated by the "FIRE/TRBL" reminder and the sounder. An open circuit (trouble) will cause a flashing "FIRE" display and a pulsing sounder after a 15-second delay. (A short circuit will cause an alarm condition: steady-on "FIRE" display and pulsing sounder). The **RESET** button will silence the sounder. Clear the trouble, then press the **RESET** button once again. The keypad will reset after a brief delay.

#### **Trouble on Open**

#### **Trouble on Short**

#### **Trouble on Night Open** (Not for UL installations)

Trouble on Open will identify an open circuit on a loop as a trouble. Trouble on Short will identify a short circuit as a trouble. Trouble on Night Open, which will identify an open circuit on a normally-closed zone while armed as a trouble condition (not an alarm), is intended for use with a Napco Monitor-Series dual-technology sensor. While there will be no indication at the keypad, any of these trouble conditions can be reported if Report Trouble is programmed as well. See Sensor Watch.

**Trouble/Trouble Restore Telco 1/Telco 3** See Report Telco 1/Telco 3

**Trouble/Trouble Restore Telco 2** See Backup Report on Telco 2

**Two-Digit Format** See Data Format

**Two-Wire Smoke Detectors** See Smoke Detectors

**Unvacated Premises:** Convert from Away to Stay based on no egress through exit door. Default is enabled. (GEM-P9600 panel-- This feature is AUTOMATIC INTERIOR BYPASS). The panel uses the existing programmable feature "Auto Interior Bypass". This feature must be enabled in CP-01 installations. This feature is enabled in the factory program and it is also enabled when "Enable CP-01 Features" is selected in the Easy Program Menu. (Address 2421, Bit 0).

#### **User Codes/Authority Levels/Access Bytes**

#### **User Closing and Opening Reports by Telephone Numbers**

#### **Enable User Code by Area**

Up to 96 six-digit User Codes are programmable, each with its dedicated Authority Level and Access Byte. (The Authority Level comprises an Option Code). Refer to Programming Manuals WI777/WI1185 for descriptions of levels and options.

If reporting to a central station, program User Closing and Opening Reports by Telephone Numbers. In multiple-area systems, program Enable User Code by Area.

#### **Unsupervised Transmitters**

(Programmable with PCD-3000 Software Only) Transmitters can now be unsupervised by programming a "9" in place of point number "1". **NOTE:** All points of that transmitter will be unsupervised.

#### **Veri-Phone™**

#### **Silence All Outputs During Audio Session**

#### **Veri-Phone Zones Priority Over Alarms**

#### **Veri-Phone Zones Trip Auxiliary Relay**

If Silence All Outputs During Audio Session is selected, all output relays will turn off whenever an active low is applied to control-panel Lug E19 (Listen In). Connect Veri-Phone Terminal 16 (INHO) to Lug E19. **Note:** Do not program Keypad Sounder on Alarm for Listen-In Zones.

If Veri-Phone Zones Priority Over Alarms is programmed and an active low is applied to the panel's Listen-In Lug (E19), any subsequent alarm reports (except fire alarms) generated during an audio session will be delayed until the end of the session. (Whenever a listen-in session is in progress, the Veri-Phone will output an active low at its INHO Terminal (16) and Lug E1.)

Program Veri-Phone Zones Trip Auxiliary Relay to have selectable Listen-In Zones. Connect Veri-Phone Terminal 14 (TRIGH) to control-panel Terminal 8 (AUX. N/O). Program the zone or event for Auxiliary Relay. Do not use the Auxiliary Relay for any other purpose.

#### **Veri-phone Trips Fire Output**

To have selectable Listen-In Zones, use the Fire Output to trigger the Veri-Phone. Connect Veri-Phone Terminal 13 (TRIGL) to control panel Lug E9 (Fire Output). Program the zone or event for Fire Output; do not use the Fire Output for any other purpose. **NOTE:** Veri-phone trips Auxiliary Relay and Veri-phone trips Fire Output cannot be enabled together. The Auxiliary Relay can be used for Keyfob Chirp on arming and disarming.

**Watch Mode** (by Area) See Day Zone

**Wireless Trouble Reporting by Zone** All reports of Wireless trouble (Transmitter Low Battery, Transmitter Tamper, Transmitter Su-



pervisory Failure) to central station will identify identifying the zone of the transmitter.

**Zone ANDing, Groups 1–8 (Not for UL installations); Enable Local Alarm on First Zone “AND” Trip (Not for UL installations)**

Up to 8 groups of at least two zones each can be “AND”ed, wherein the system will go into alarm only if any two zones of the group are tripped within 2 minutes. This feature is designed to afford redundant protection for devices, such as glass break detectors, PIRs, etc., that may show a tendency to false under certain conditions. Program each Group for any number of Zones available. All Zones in any Group must be within the same Area. Do not mix 24-Hour Zones and non-24-Hour Zones within the same Group. Do not include a Panic Zone as part of any Group. Auto-Reset must be programmed for each Zone ANDing Zone. **Note:** Any zone that is bypassed or goes into Swinger Shutdown will automatically disable Zone Anding for the entire Group. If “Enable Local Alarm on First ZoneAND Trip” (Address 2419) is programmed, a trip on any Zone of the Group will cause an alarm output and alarm display at the keypad; there will be no communication to the central station. **Note:** If “Enable CP-01 Limits” is enabled in EZ Programming, any Zone in a Group *will only activate an alarm and send a report ONCE*. After the Zone has reported, it will remain in the Group and may still initiate the Zone ANDing sequence.

**Zone Area 1–Zone Area 8** See Areas

**Zone Number on Pulse Alarm** See Data Formats: Two-Digit Format

**Zone Type** See Data Formats: Modem Formats

**2-Wire, 4-Wire Smoke Detectors** See Smoke Detectors

**4-Wire Bus Failure** See Bus Failure

**24-Hour Zone**

A zone that provides protection at all times, whether or not the system is armed. If programmed for silent alarm (no Burg Output, Aux. Output, Fire Output or Keypad Sounder on Alarm programmed) there will not be any indication on the keypad. If an Audible output is programmed, the keypad will flash the red Armed LED and display “ALARM” followed by the zone description.

**Note:** Do not program a Day Zone as a 24-Hour Zone.



# STANDBY-BATTERY CALCULATION WORKSHEET

Use the procedure given below to determine the required standby battery capacity in Ampere-Hours (AH). NOTE: It is not totally accurate to merely multiply the combined standby current (in amperes) by the standby time (in hours) to obtain the battery capacity (in ampere-hours), since other factors (control-panel charging capabilities, temperature, battery condition, etc.) affect battery operation. The following calculations will yield the theoretical minimum required capacity.

## 1. STANDBY CURRENT

DEVICE	QTY		STANDBY CURRENT (Amps)		
			EACH	=	TOTAL
GEM-P9600	1	X	0.120	=	
GEM-EZM4/8		X	0.050	=	
GEM-EZM8		X	0.050	=	
GEM-RP1CAe2/ GEM-K1CA		X	0.100	=	
GEM-RP1CAe2/ GEM-K1CA <sup>(1)</sup>		X	0.035	=	
GEM-RP2ASe2/ GEM-K2AS		X	0.065	=	
GEM-RP2ASe2/ GEM-K2AS <sup>(2)</sup>		X	0.020	=	
GEM-RP3DGTL/ GEM-K3DGTL		X	0.050	=	
RM3008 <sup>(3)</sup>		X	0.040	=	
		X		=	
		X		=	
<b>TOTAL STANDBY CURRENT</b> →					Amps

- <sup>(1)</sup> Backlighting disabled (cut Jumpers W1, W2 & W3).
  - <sup>(2)</sup> Backlighting disabled (cut Jumpers A, B & C).
  - <sup>(4)</sup> Standby Time in Hours.
- (Box 1)

$$X \left[ \text{Amps} \right] = \left[ \text{AH.} \right]$$

(Standby Time)<sup>(4)</sup> (Box 2)

## 2. ALARM CURRENT

DEVICE	QTY		ALARM CURRENT (Amps)		
			EACH	=	TOTAL
<b>TOTAL STANDBY CURRENT</b> (from Box 1, above) →					
GEM-P9600 <sup>(1)</sup>		X	0.100	=	0.100
BELLS		X		=	
STROBES		X		=	
HORNS / STROBES		X		=	
		X		=	
		X		=	
<b>TOTAL ALARM CURRENT</b> →					Amps

- <sup>(1)</sup> Alarm current drawn in alarm.
- <sup>(2)</sup> Alarm Time in Hours. Example: For a 15 minute alarm timeout, Alarm Time = 15/60 = 0.25.

$$X \left[ \text{Amps} \right] = \left[ \text{AH.} \right]$$

(Alarm Time)<sup>(2)</sup> (Box 3)

**MINIMUM REQUIRED BATTERY CAPACITY = BOX 2 + BOX** → AH.

STANDBY-BATTERY CALCULATION WORKSHEET

# WIRING LEGEND

Should removal of the circuit board be necessary, use this wiring legend to relocate wire leads to their proper terminals. Enter wire identification number or color code in WIRE NUMBER column and enter wire function in DESCRIPTION column (optional).

TERMINAL	WIRE NO.	DESCRIPTION
1		
2		
3		
4		
5		
6		
7		
8		
9		
10		
11		
12		
13		
14		
15		
16		
17		
18		
19		
20		
21		
22		
23		
24		
25		
26		
27		
28		
29		
30		
31		
32		
33		

WIRING LEGEND

# KEYPAD PROGRAMMING MODES

- Note:**
1. Functions that are not active, not programmed and/or not applicable to user's authority level will be suppressed and will not display.
  2. Due to space constraints, GEM-RP2ASe2/GEM-K2AS messages are abbreviated.
  3. The function mode uses a real time, filtered display. Many functions may not be displayed until it's condition is satisfied. For example, "DISPLAY ZN FAULTS" will not display unless there is a faulted zone to display.

## FUNCTION MODE

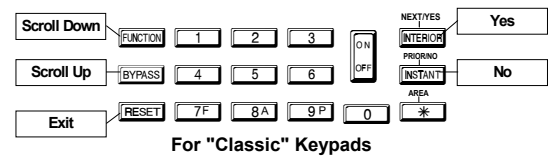
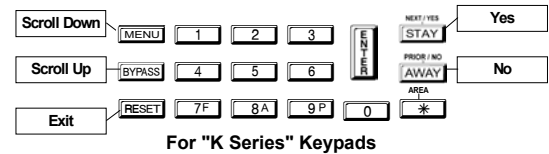
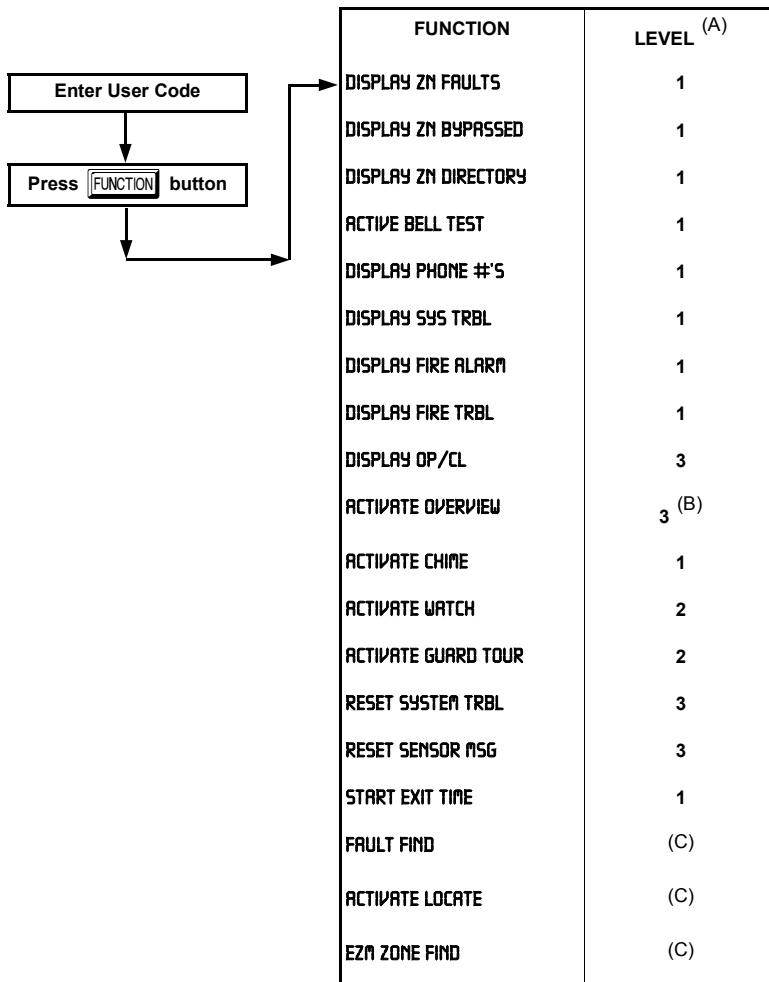

EASY MENU PROGRAM MODE

FUNCTION	LEVEL (A)
ACTIVATE DIALER TEST	3
DISPLAY ALARM LOG (D)	3
DISPLAY TOTAL LOG (D)	3
DISPLAY FIRE LOG (D)	3
DISPLAY OP/CL LOG (D)	3
DISPLAY SYSTEM LOG (D)	3
TO ARM IN 1-4HRS	2
DISPLAY AUTO ARM SCHD	3
ACTIVATE PROGRAM	3 (B)
ACTIVATE DOWNLOAD	3
DISPLAY RF XMITTER STAT	3
RELAY CONTROL	1

- (A) Minimum level required to access function
- (B) Level 3 code with appropriate option
- (C) Requires dealer code
- (D) Not available in GEM-RP2ASe2/GEM-K2AS keypads
- (E) Initial Configuration only; suppressed thereafter

**Note:**

1. Functions that are not active, not programmed and/or not applicable to user's authority level will be suppressed and will not display.
2. Due to space constraints, GEM-RP2ASe2/GEM-K2AS messages are abbreviated.
3. The function mode uses a real time, filtered display. Many functions may not be displayed until it's condition is satisfied. For example, "DISPLAY ZN FAULTS" will not display unless there is a faulted zone to display.

**DEALER MODE**

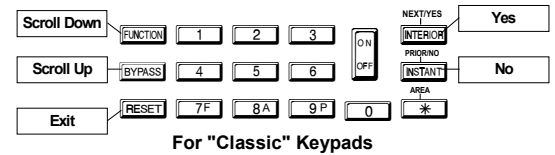
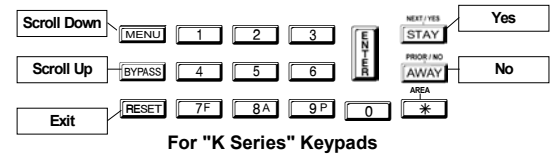
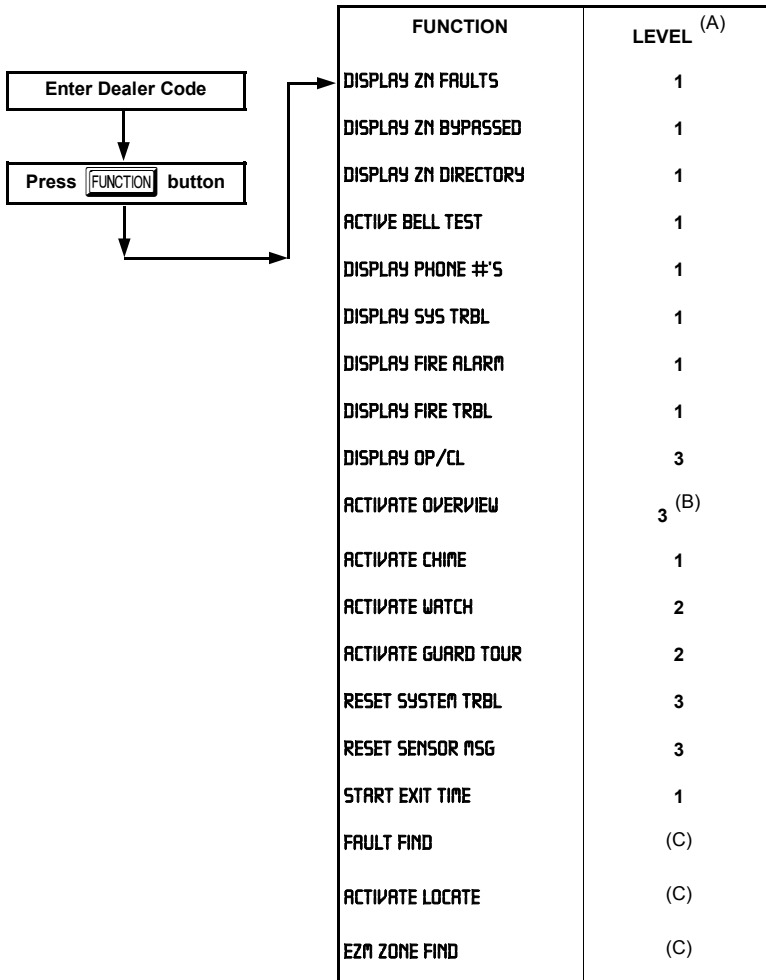

EASY MENU PROGRAM MODE

FUNCTION	LEVEL (A)
ACTIVATE DIALER TEST	3
DISPLAY ALARM LOG (D)	3
DISPLAY TOTAL LOG (D)	3
DISPLAY FIRE LOG (D)	3
DISPLAY OP/CL LOG (D)	3
DISPLAY SYSTEM LOG (D)	3
TO ARM IN 1-4HRS	2
DISPLAY AUTO ARM SCHD	3
ACTIVATE PROGRAM	3 (B)
ACTIVATE DOWNLOAD	3
DISPLAY RF XMITTER STAT	3
RELAY CONTROL	1

- (A) Minimum level required to access function
- (B) Level 3 code with appropriate option
- (C) Requires dealer code
- (D) Not available in GEM-RP2ASe2/GEM-K2AS keypads
- (E) Initial Configuration only; suppressed thereafter



**EASY MENU PROGRAM MODE**

FUNCTION <sup>(F)</sup>
# OF ZNS IN AREA1 ENTER # ZONES XX <sup>(E)</sup>
# OF ZNS IN AREA2 ENTER # ZONES XX <sup>(E)</sup>
FIRE ZONES ENTER ZONE # XX <sup>(E)</sup>
2-WIRE FIRE ZNS ENTER ZONE # XX <sup>(E)</sup>
REPORT ALL ZONES TO CENTRAL? Y/N <sup>(E)</sup>
EXIT/ENTRY ZONES ENTER ZONE # XX <sup>(E)</sup>
INTERIOR ZONES ENTER ZONE # XX <sup>(E)</sup>
24 HOUR ZONES ENTER ZONE # XX <sup>(E)</sup>
CHIME ZONES ENTER ZONE # XX <sup>(E)</sup>
CHIME 2 ZONES ENTER ZONE # XX <sup>(E)</sup>
EXIT/ENTRY 2 ZNS ENTER ZONE # XX <sup>(E)</sup>
SQMS LOOP ZONES ENTER ZONE # XX <sup>(E)</sup>
RUX OUTPUT ZONES ENTER ZONE # XX <sup>(E)</sup>
SENSOR WATCH ZNS ENTER ZONE # XX <sup>(E)</sup>
KP SNDR ALRM ZNS ENTER ZONE # XX <sup>(E)</sup>
AUTO BYP RENT ZN ENTER ZONE # XX <sup>(E)</sup>
ENABLE NO EDLR ZONES Y/N <sup>(E)</sup>
ENABLE TELCO LINE TEST? Y/N <sup>(E)</sup>
ENABLE BURG OUT CHIRPP? Y/N <sup>(E)</sup>
ENABLE SIA CP-01 Y/N <sup>(E)</sup>
# AREA 1 KEYPADS ENTER # KPS 00
# AREA 2 KEYPADS ENTER # KPS 00
CENTRAL PHONE #
CENTRAL STATION ACCOUNT # ( _ )
SEE WI FOR INFO RCVR FORMAT (B)
ENTER USER CODE U01 123 - 9-
ZN# XMIT#+CS P ZNO:- 000000:0-0
KF R XMIT#+CS OP 01-0 000000:0 00
01- <sup>(D)</sup>
ENTER DATE { _ / / } <sup>(D)</sup>
ENTER TIME { _ : } <sup>(D)</sup>
DEALER CODE 456789

FUNCTION <sup>(G)</sup>
ENTER USER CODE U01 123 - 9-
01-
ENTER DATE { _ / / }
ENTER TIME { _ : }

- (A) Minimum level required to access function
- (B) Level 3 code with appropriate option
- (C) Requires dealer code
- (D) Not available in GEM-RP2ASe2/GEM-K2AS keypads
- (E) Initial Configuration only; suppressed thereafter
- (F) These selections appear if you enter Dealer Mode
- (G) These selections appear if you enter Function Mode

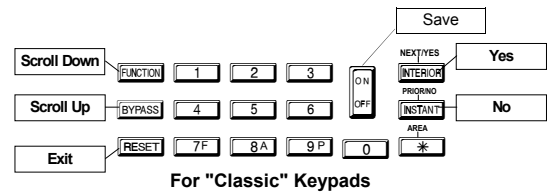
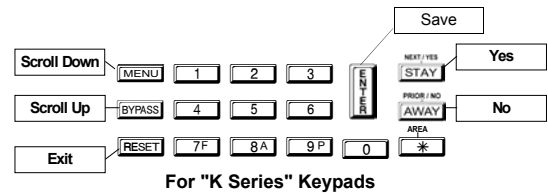
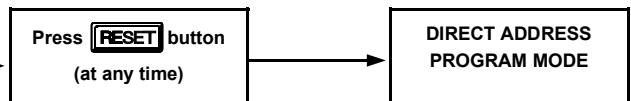

# NOTES

### KEYPAD CONFIGURATION MODE

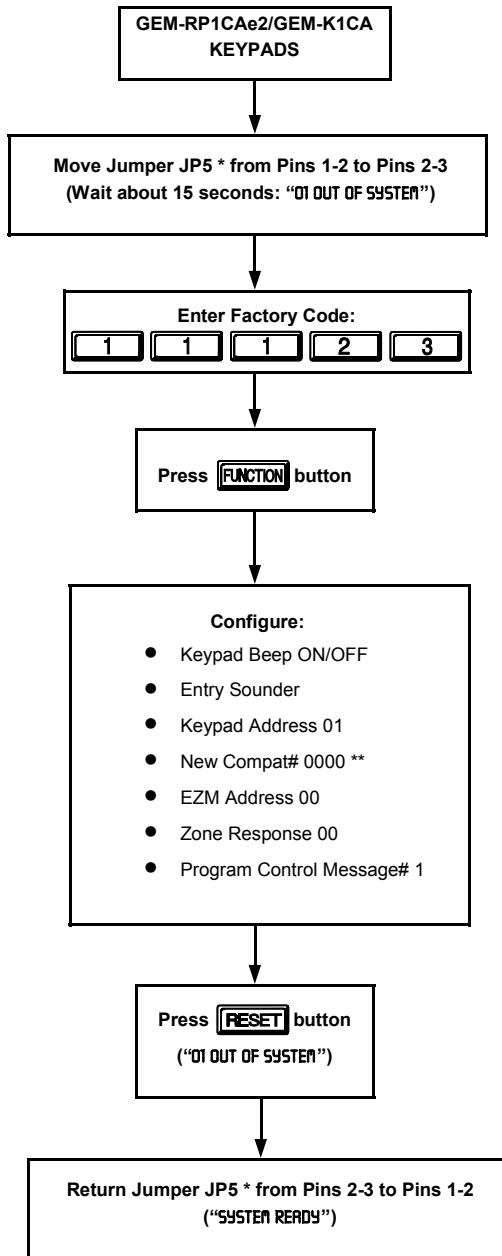

### GEM-RP2ASe2 KEYPADS

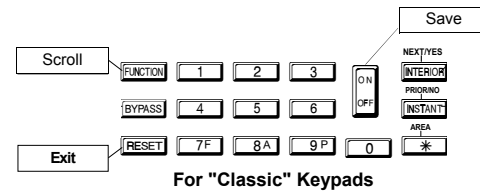
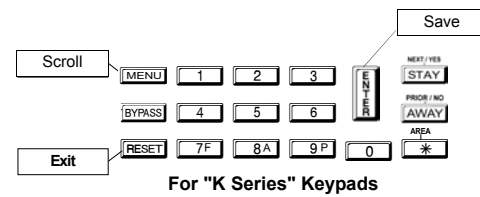
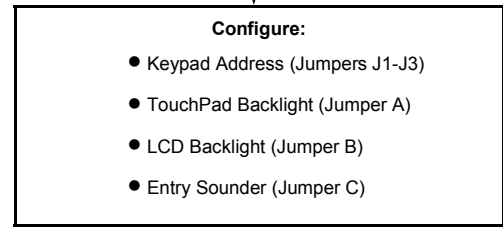

\* JP5 is located at the top-right corner of the circuit board.

\*\* If a Compatibility Number other than "0000" is programmed, "OLD COMPAT# XXXX" is displayed.



<b>CP-01 Quick Reference Chart--SIA False Alarm Reduction</b>	
<b>Feature Description</b>	<b>Programming Address Location</b>
CP-01 FEATURES are enabled with one global selection in the panel.	Enabled in EZ Programming
<b>Exit Delay.</b> Minimum allowed programmable Exit Delay time is 45 seconds. Default is 60 seconds. If an attempt is made to change the Exit Delay time to less than 45 seconds the time will be entered as 60 seconds. The maximum programmable time is 255 seconds. The panel uses the existing programmable by zone feature "Entry/ Exit 1" to comply with CP-01. At least one Entry/Exit zone must be programmed for each area. The factory program enables Zone 1 as Entry/Exit and the option to program any zone as Entry/Exit is given in the Easy Program Menu. The existing programmable Entry and Exit delay times are also used. The factory program sets the Exit Time Delay as 60 seconds and Entry Time Delay as 30 seconds. These same times are entered when "Enable CP-01 Features" is selected in the Easy Program Menu.	0000 (Pre-existing)
When " <b>Enable CP-01 Limits</b> " (Address 3905, Bit 5) is enabled, the panel will sound an <b>audible egress</b> sequence when it is armed Away (with interior zones not bypassed). The keypad mini-sounder will beep once every second during the beginning exit delay and beep rapidly the last 10 seconds of exit delay to indicate exit urgency. If the panel is armed Stay (with interior zones bypassed) the keypad mini-sounder is silent and the exit time is double the programmed time. If "Enable CP-01 Limits" (Address 3905, Bit 5) is NOT enabled, the panel will NOT sound an audible egress sequence. <b>Note:</b> This feature affects the operation of "Zone ANDing" as follows: If "Enable CP-01 Limits" is enabled, any Zone in a Group will only activate an alarm and send a report ONCE. After the Zone has reported, it will remain in the Group and may still initiate the Zone ANDing sequence.	3905, Bit 5 (see Note 1) (3905 . . . . . 6 . . .)* (3905 2 .)**
<b>Exit Time Restart.</b> This option allows for the following scenario before the end of the Exit Time: a violation of an entry/exit zone, a restore, and a second violation of an entry/exit zone restarts the Exit Time. The panel does not allow the Exit Time to be restarted more than once. The default setting for this option is enabled. Restart is event logged.	3905, Bit 1 (see Note 1) (3905 . 2 . . . . .)* (3905 . 2)**
<b>Sound Alarm on Exit Error.</b> An Exit Error sequence is initiated if an entry/exit zone is violated at the expiration of the Exit Time. "Exit Error" Central Station Reporting Code is located at address 0348.	3905, Bit 2 (see Note 1) (3905 . . 3 . . . . .)* (3905 . 4)**
<b>Unvacated Premises.</b> Convert from Away to Stay based on no egress through exit door ...default is enabled. (GEM-P9600 panel--This feature is AUTOMATIC INTERIOR BYPASS). The panel uses the existing programmable feature "Auto Interior Bypass". This feature must be enabled in CP-01 installations. This feature is enabled in the factory program and it is also enabled when "Enable CP-01 Features" is selected in the Easy Program Menu.	2421, Bit 0 (2421 1 . . . . .)* (2421 . 1)**
<b>Report Exit Error/Recent Closing.</b> A Recent Closing transmission is sent if an alarm occurs within two (2) minutes after the expiration of the Exit Time. If the user number is available, it is included in the Recent Closing transmission. "Recent Close" Central Station Reporting Code is located at address 0886. <b>Note:</b> Address 3905, bit 2 (Sound Alarm on Exit Error) must also be set to enable this feature.	3905, Bit 3 (see Note 4) (3905 . . . 4 . . . . .)* (3905 . 8)**
<b>Entry Delay.</b> Entry Delay time is 30 second minimum, default is 30 seconds. If an attempt is made to change the Entry Delay time to less than 30 seconds the time will be entered as 30 seconds. The maximum programmable time is 255 seconds. The panel uses the existing programmable by zone feature "Entry/ Exit 1" to comply with CP-01. At least one Entry/Exit zone must be programmed for each area. The factory program enables Zone 1 as Entry/Exit and the option to program any zone as Entry/Exit is given in the Easy Program Menu. The existing programmable Entry and Exit delay times are also used. The factory program sets the Exit Time Delay as 60 seconds and Entry Time Delay as 30 seconds. These same times are entered when "Enable CP-01 Features" is selected in the Easy Program Menu.	0001, 0002 (Pre-existing feature)
<b>Progress Annunciation.</b> Entry urgency annunciation must be different than the alarm mini-sounder. Requires <i>Keypad Sounder on Alarm</i> on all non-fire zones. Locations 1264, 1364, 1464, 1564, 1664, 1764, 1864, 1964, 2064, 2164.	Feature in EZ Programming
<b>Disarm.</b> The panel will silence the keypad entry delay tones and alarm annunciation on the first press of a keypad digit for 2.5 seconds.	New Panel Operation
<b>Enable Bell Output on Keyfob Arming.</b> Normally the chirp on a keyfob arm/disarm is transmitted to the Aux. Output. Selecting "Enable Bell Output on Keyfob Arming" causes the "Bell" to chirp instead of the Aux. on remote Arming. The panel uses the existing programmable feature "Aux. Output Chirp on Keyfob Arm/Disarm" (Address 2421 Bit 3). This feature must be programmed in a CP-01 installation if a GEM-KEYF is used in the system. The feature is selected in the factory program and is enabled if "Enable CP-01--Enabled" is selected in the Easy Programming Menu.	2422, Bit 6 (see Note 3) (2422 . . . . . 7 . . .)* (2422 4 .)**
<b>Enable CP-01 Limits.</b> When address 3905 bit 5 is enabled, three time limits are enabled as per the SIA CP-01 standards: (1) If the Exit Delay time is programmed for less than 45 seconds, the enabled Exit Delay time will be set to 60 seconds; (2) If the Entry Delay time is programmed for less than 30 seconds, the enabled Entry Delay time will be set to 30 seconds; and (3) If an attempt is made to change the Abort Delay to less than 15 seconds or more than 45 seconds the time will be entered as 30 seconds. (4) Enables Exit Delay sounder. (5) Doubles Exit Delay time when arming Stay due to Silent Exit.	3905, Bit 5 (see Note 1) (3905 . . . . . 6 . . .)* (3905 2 .)**
<b>Abort Window Disarm.</b> The panel will silence the keypad entry delay tones and alarm annunciation on the first press of a keypad digit for 2.5 seconds. Disarming of the area within the Abort Delay period will cause a cancellation of the Central Station alarm report.	New Panel/Keypad Feature
<b>Abort Annunciation after Disarming.</b> Default is enabled. If the panel is disarmed during Abort Delay, the keypad will enunciate abort. "Alarm Cancelled" is displayed on keypad LCD for RP1/K1 and RP2/K2, and "C" in the 7-segment display for the RP3/K3.	New Panel/Keypad Feature
<b>Report Cancel Window.</b> When the system is in alarm and the user disarms in an attempt to Cancel within a maximum of 5 minutes after abort timeout, a Cancel Report will be sent. If Cancel Report is enabled by entering a cancel time, Cancel will enunciate on the keypad if the system is disarmed during the Cancel Window. The existing programmable option <i>Report Cancel Window</i> must be programmed for at least 5 minutes in a CP-01 installation. When "Enable CP-01" Features is selected in the easy program menu, this time is set to 7 minutes.	Address 4082
<b>Duress Feature.</b> The existing programmable option " <b>Enable Global Ambush</b> " must not be enabled in CP-01 installations. It is not enabled in the factory program and is not enabled when Enable CP-01 Feature is selected in the Easy Program Menu.	Pre-existing feature

<p><b>Duress Code.</b> The panel will not allow duplicate User Codes to be programmed. Every user program code may now be selected as an Ambush Code for Area 1 or Area 2 by entering a _5 in the Area 1 Options or Area 2 Options respectively. <b>Note:</b> Keypad(s) must be enabled for Ambush.</p>	<p>New Operation of the Panel</p>
<p><b>Cross Zoning.</b> Required Option for cross zoning with either programmable time period or specified by manufacturer. Default is disabled. The existing programmable by zone feature "Zone ANDing Groups" are available for the cross zoning option required by CP-01. This feature is not enabled in the factory program and not enabled when Enable CP-01 Features are enable in the Easy Program Menu. Cross Zone set time = one (1) minute.</p>	<p>Pre-existing feature</p>
<p><b>Swinger Shutdown.</b> Zone will only trip once and will not restore automatically. "Auto-Reset" (Addresses 1219, 1319, 1419, 1519, 1619, 1719, 1819, 1919, 2019, 2119) and "Swinger Shutdown" (Addresses 1220, 1320, 1420, 1520, 1620, 1720, 1820, 1920, 2020, 2120) are disabled in order to meet the CP-01 requirement of only one alarm activation per zone during an arming period. These features are not selected on zones 1-8 in the factory program and are removed from all zones when "Enable CP-01 Features" is selected in the Easy Program Menu. In a SIA CP-01 installation, these options must not be selected. Auto-Reset must be programmed for all burglary zones in a UL Installation. See the glossary entry, "Swinger Shutdown" in this manual.</p>	<p>Pre-existing features</p>
<p><b>Fire Alarms.</b> Fire Alarm Verification available option on Fire Zones. Default is disabled. The existing programmable option "Fire Alarm Verification" is available as required by CP-01. This feature is not enabled in the factory program and not enabled when "Enable CP-01 Features" is selected in the Easy Program Menu.</p>	<p>Pre-existing feature</p>
<p><b>Call Waiting.</b> Disable Call Waiting on 1st Attempt. Default is disabled. When enabled, the telephone number must be programmed with *70 in front of the telephone number. The first attempt will dial with *70 (disabling call waiting). Subsequent attempts (if first attempt is unsuccessful) will dial without *70. <b>Note:</b> The digits used to disable Call Waiting may vary with location. Be sure to confirm with local telephone company. <b>Note:</b> Disabling Call Waiting on a non Call-Waiting line can result in a delay in the connection to Central Station.</p>	<p>3905, Bit 6 (see Note 2) (3905 . . . . . 7 .)* (3905 4 .)**</p>
<p><b>Enable Ambush Code Type in User Assignment.</b> There are two types of Ambush Codes: (1) A 2-digit code (prefix) that is entered immediately prior to (and as part of) the regular User Code and (2) A separate and unique User Code. Disarming with an Ambush Code will cause a silent report to be sent to a central station. Thus, should a user be forced to disarm, he can silently signal an emergency while appearing to be merely disarming the system. The Ambush Zone will automatically report when programmed to report an alarm.</p>	<p>3905, Bit 7 (see Note 2) (3905 . . . . . 8 .)* (3905 8 .)**</p>
<p><b>System Test.</b> Test Mode for all zones, the sounders, and communicator. The "Fault Find" function (a Function Menu selection) is enabled, and normally causes all hardwired zones to give a two second beep at the keypad(s) when any zone is faulted or restored. As required by SIA CP-01, Fault Find is expanded with the following features when <b>Digital Dialer Report Enter/Exit Test Mode</b> is programmed. This option is programmed when "Enable CP-01 Feature" is selected in the Easy Program Menu:</p> <ul style="list-style-type: none"> <li>• When Fault Find is entered, it reports to Central Station that "Test Mode" is in progress.</li> <li>• Fault Find can not be initiated from an armed panel, and all digital dialer reporting in same area is inhibited while in Fault Find.</li> <li>• Fault Find Central Station Reporting Code is located at address 0887.</li> <li>• Keypad will display the following warning that the system is in Fault Find: "FAULT FIND RF SIG POWER --"</li> <li>• If a 24-hour zone is tripped and not restored during Fault Find, when the mode is exited the zone will display as "Faulted" on the keypad display.</li> <li>• When Fault Find is exited by pressing <b>RESET</b>, a Fault Find Restore Report will be sent.</li> </ul>	<p>3905, Bit 4 (see Note 4) (3905 . . . . 5 . . .)* (3905 1 .)**</p>
<p><b>Notes:</b></p> <p><b>Note 1:</b> This feature is enabled in the factory program and is enabled when "Enable CP-01 Features" is selected in the Easy Program Menu. This feature must be enabled in CP-01-compliant installations.</p> <p><b>Note 2:</b> This feature is not enabled in the factory program and is not enabled when "Enable CP-01 Features" is selected in the Easy Program Menu.</p> <p><b>Note 3:</b> This feature is enabled in the factory program and is enabled when "Enable CP-01 Features" is selected in the Easy Programming Menu. This feature must be programmed in CP-01-compliant installations if a GEM-KEYF is used in the system.</p> <p><b>Note 4:</b> This feature is programmed when "Enable CP-01 Features" is selected in the Easy Programming Menu.</p> <ul style="list-style-type: none"> <li>• At least one Exit/Entry zone must be programmed for each area. (SIA CP-01 Specification 4.2.1)</li> <li>• The GEM-P9600 control panel and at least one GEM-RP1CAe2/GEM-K1CA, GEM-RP2ASe2/GEM-K2AS or a GEM-RP3DGTL/GEM-K3DGTL must be installed.</li> <li>• The following optional accessories support the SIA False Alarm Reduction (FAR) classification, and may be used if desired: GEM-EZOUT8, GEM-RB3008, GEM-RM3008, GEM-EZM8, GEM-EZM4/8, GEM-RECV8/16/32, GEM-TRANS2, GEM-PIR, GEM-SMOKE, GEM-HEAT, GEM-KFOB.</li> <li>• Programming at Installation may be subordinate to other UL requirements for the intended application.</li> <li>• Un-vacated premises: When the system/partition is armed with AWAY button, the system will arm STAY if no exit. There must be a minimum of one Stay/Away or Delay Stay/Away zone enrolled on the partition.</li> <li>• Cross zoning is not recommended for Line security Installations nor is it to be implemented on exit / entry zones.</li> <li>• There is a Communication Delay of 30 seconds in this control panel. It can be removed, or it can be increased up to 45 seconds at the option of the end user by consulting with the Installer.</li> <li>• Do not duplicate any reporting codes. This applies for all communication formats other than SIA sending automatic programmed reporting codes.</li> <li>• In UL installations, Entry Delay time plus Abort Delay time (total combined times) cannot exceed 60 seconds.</li> <li>• Exit Time Restart must be disabled for UL Line Security/Encryption applications.</li> </ul>	

\*Illustrates the LCD display for the GEM-RP1CAe2 and GEM-K1CA keypads.

\*\*Illustrates the LCD display for the GEM-RP2ASe2/GEM-K2AS, and GEM-RP3DGTL/GEM-K3DGTL keypads. Although the data is the same, the GEM-RP3DGTL/GEM-K3DGTL keypads will *display* the data differently—the address location number scrolls, then disappears briefly; the keypad will then display the data entry locations.

# GEM-P9600 FACTORY DEFAULT DESCRIPTION

The Factory Program of the GEM-P9600 will change with the release of the new version that complies with Security Industry Association False Alarm Reduction Control Panel-01 Standard (SIA FAR CP-01).

## Out of Box Panel Operation (After CP-01 Changes)

The following describes the new panel factory defaults:

With this new SIA CP-01 compliant panels, the Easy Program Menu has been increased to allow several additional features to be programmed in the Menu, rather than requiring that these features be programmed through the Direct Address programming method. If you enter Dealer Program Mode, you will be required to first enter Easy Program Mode and answer Easy Program Mode questions before making any needed changes to the factory program via Direct Address Programming Mode.

Once the panel is removed from its box, you have two choices: (1) Enter Dealer Program Mode in order to allow the EZ Program Menu to appear, then answer the questions; (2) Upload the Factory Default Program to PCD-Windows, make desired changes, and re-download this modified PCD-Windows program back to the panel.

A critical addition to the Easy Program Menu is the question "**Enable CP-01 Features? Y/N**". If the answer to this question is "**No**" then the following changes to the program occur:

1. All zones (96 in the GEM-P9600, 32 in GEM-P3200) are programmed for Priority, Selective Bypass, Alarm Output, Auto Reset and Swinger Shutdown. Only the zones selected by the first EPM question "How many Zones" are programmed for Area 1.
2. Default User 1 Code = "123" and it is set up to arm Area 1 and be a user program code.
3. Keypad Time/Date Display enabled.
4. All zones are programmed with report codes and as burg/fire alarm types depending on whether they were selected as fire zones. Zones not selected as fire are burg type.
5. The reporting format is selectable in the Easy Program Mode.
6. Touch Tone with Rotary Back-up is enabled.
7. Exit Delay = 60 seconds.
8. Entry Delay 1 and 2 are both 30 seconds.
9. AC Fail Report Delay is 60 minutes.
10. Alarm and Pulse Alarm time-outs are 15 minutes.
11. Chime is set to 2 seconds.
12. Change Pulse Alarm to Cadence Alarm is enabled.
13. Auto Reset after Alarm Time-Out is enabled.

If the answer to the question "**Enable CP-01 Features? Y/N**" is "**Yes**", then the following changes to the above program occur:

1. Auto Reset and Swinger Shutdown are removed from burg zones.
2. 2421-Bit 3 "Aux. Output Chirp on Keyfob Arm/Disarm" is enabled.
3. 2421-Bit 0 "Automatic Interior Bypass" is enabled.
4. 2422-Bit 6 "Enable Bell Output on Keyfob Arming" is enabled.
5. 3905-Bit 1 "Exit Time Restart" is enabled.
6. 3905-Bit 2 "Sound Alarm on Exit Error" is enabled.
7. 3905-Bit 3 "Report Exit Error/Recent Closing" is enabled.
8. 3905-Bit 4 "Digital Dialer Report Enter/Exit Test Mode" is enabled.
9. 3905-Bit 5 "Enable CP-01 Limits" is enabled.
10. 2406 "Abort Delay" is changed to 30 seconds.
11. 4082 "Report Cancel Window" is set to 7 minutes .
12. 3905-Bit 7 "Enable Ambush Code Type in User Assignment" enabled.

Subsequent entering of the Dealer Program allows only a subset of the Easy Program Menu which does not include the question "Enable CP-01 Features" and prevents the existing program from being deleted, but allows the system to be expanded. The CP-01 Quick Reference Chart (see pages 61-62 of this manual) and the explanation of the Easy Program Question "Enable CP-01" (above) should be reviewed before installing the panel.

**Note:** When 3905-5 "Enable CP-01 Limits" is enabled, the Exit Delay keypad sounder (including the Exit Urgency sound during the final 10 seconds of the Exit Delay) is enabled.

## STATEMENT FOR CANADIAN MODELS

NOTICE: The Canadian Department of Communications label identifies certified equipment. This certification means that the equipment meets certain telecommunications network protective, operational and safety requirements. The Department does not guarantee the equipment will operate to the user's satisfaction.

Before installing this equipment, users should ensure that it is permissible to be connected to the facilities of the local telecommunications company. The equipment must also be installed using an acceptable method of connection. In some cases, the company's inside wiring associated with a single line individual service may be extended by means of a certified connector assembly (telephone extension cord). The customer should be aware that compliance with the above conditions may not prevent degradation of service in some situations.

Repairs to certified equipment should be made by an authorized Canadian maintenance facility designated by the supplier. Any repairs or alterations made by the user to this equipment, or equipment malfunctions, may give the telecommunications company cause to request the user to disconnect the equipment.

Users should ensure for their own protection that the electrical ground connections of the power utility, telephone lines and internal metallic water pipe system, if present, are connected together. This precaution may be particularly important in rural areas.

Caution: Users should not attempt to make such connections themselves, but should contact the appropriate electric inspection authority, or electrician, as appropriate.

NOTICE: The ringer Equivalence Number (REN) assigned to each terminal device provides an indication of the maximum number of terminals allowed to be connected to telephone interface. The termination of an interface may consist of any combination of devices subject only to the requirement that the sum of the Ringer Equivalence Numbers of all the devices does not exceed 5.

## CSA-LISTED TRANSFORMERS

The following power transformers are CSA-Listed.  
Magnetic Consultants: MG1620, MG1630, *MG1640*, PG1620  
Frost: FTC2016, FTC3016, FTC4016  
Hammond: BD2F

This digital apparatus does not exceed Class A limits for radio noise emissions from digital apparatus set out in the Radio Interference Regulations of the Canadian Department of Communications.

Le present appareil numerique n'emet pas de bruits radioelectriques les depassant les limites applicables aux appareils numeriques de la classe A prescrites dans le Reglement sur le brouillage radioelectrique edicte par le Ministere des Communications du Canada.



## FCC STATEMENT

This equipment generates and uses radio-frequency energy and, if not installed and used properly, that is, in strict accordance with the manufacturer's instructions, may cause interference to radio and television reception. It has been type tested and found to comply with the limits for a Class-B computing device in accordance with the specifications in Subpart J of Part 15 of FCC Rules, which are designed to provide reasonable protection against such interference in a residential installation.

However, there is no guarantee that interference will not occur in a particular installation. If this equipment does cause interference to radio or television reception, which can be determined by turning the equipment off and on, the user is encouraged to try to correct the interference by one or more of the following measures: reorient the receiving antenna; relocate the computer with respect to the receiver; move the computer away from the receiver; plug the computer into a different outlet so that computer and receiver are on different branch circuits.

If necessary, the user should consult the dealer or an experienced radio/television technician for additional suggestions. The user may find the following booklet prepared by the Federal Communications Commission helpful: "How to Identify and Resolve Radio-TV Interference Problems". This booklet is available from the U.S. Government Printing Office, Washington, DC 20402; Stock No. 004-000-00345-4.

**CAUTION:** This equipment generates and uses radio-frequency energy. If not installed using conventional installation practices for RF devices, it may cause interference to radio and television reception. It has been tested and found to comply with the limits for a Class A computing device pursuant to Subpart B of Part 15 of FCC Rules, which are designed to provide reasonable protection against such interference. However, there is no guarantee that interference will not occur in a particular installation. If it has been found to cause interference to radio or television reception, which can be determined by removing and reapplying AC and battery power to the equipment, the installer should try to correct the interference by one or more of the following measures: reorient the receiving antenna; connect the power transformer to a different outlet so that the control panel and receiver are on different branch circuits; relocate the control panel with respect to the receiver.



# Notes:

# Notes:



## NAPCO LIMITED WARRANTY

NAPCO SECURITY SYSTEMS, INC. (NAPCO) warrants its products to be free from manufacturing defects in materials and workmanship for *thirty-six months* following the date of manufacture. NAPCO will, within said period, at its option, repair or replace any product failing to operate correctly without charge to the original purchaser or user.

This warranty shall not apply to any equipment, or any part thereof, which has been repaired by others, improperly installed, improperly used, abused, altered, damaged, subjected to acts of God, or on which any serial numbers have been altered, defaced or removed. Seller will not be responsible for any dismantling or reinstallation charges.

THERE ARE NO WARRANTIES, EXPRESS OR IMPLIED, WHICH EXTEND BEYOND THE DESCRIPTION ON THE FACE HEREOF. THERE IS NO EXPRESS OR IMPLIED WARRANTY OF MERCHANTABILITY OR A WARRANTY OF FITNESS FOR A PARTICULAR PURPOSE. ADDITIONALLY, THIS WARRANTY IS IN LIEU OF ALL OTHER OBLIGATIONS OR LIABILITIES ON THE PART OF NAPCO.

Any action for breach of warranty, including but not limited to any implied warranty of merchantability, must be brought within the six months following the end of the warranty period.

IN NO CASE SHALL NAPCO BE LIABLE TO ANYONE FOR ANY CONSEQUENTIAL OR INCIDENTAL DAMAGES FOR BREACH OF THIS OR ANY OTHER WARRANTY, EXPRESS OR IMPLIED, EVEN IF THE LOSS OR DAMAGE IS CAUSED BY THE SELLER'S OWN NEGLIGENCE OR FAULT.

In case of defect, contact the security professional who installed and maintains your security system. In order to exercise the warranty, the product must be returned by the security professional, shipping costs prepaid and insured to NAPCO. After repair or replacement, NAPCO assumes the cost of returning products under warranty. NAPCO shall have no obligation under this warranty, or otherwise, if the product has been repaired by others, improperly installed, improperly used, abused, altered, damaged, subjected to accident, nuisance, flood, fire or acts of God, or on which any serial numbers have been altered, defaced or removed. NAPCO will not be responsible for any dismantling, reassembly or reinstallation charges.

This warranty contains the entire warranty. It is the sole warranty and any prior agreements or representations, whether oral or written, are either merged herein or are expressly cancelled. NAPCO neither assumes, nor au-

thorizes any other person purporting to act on its behalf to modify, to change, or to assume for it, any other warranty or liability concerning its products.

In no event shall NAPCO be liable for an amount in excess of NAPCO's original selling price of the product, for any loss or damage, whether direct, indirect, incidental, consequential, or otherwise arising out of any failure of the product. Seller's warranty, as hereinabove set forth, shall not be enlarged, diminished or affected by and no obligation or liability shall arise or grow out of Seller's rendering of technical advice or service in connection with Buyer's order of the goods furnished hereunder.

NAPCO RECOMMENDS THAT THE ENTIRE SYSTEM BE COMPLETELY TESTED WEEKLY.

**Warning:** Despite frequent testing, and due to, but not limited to, any or all of the following; criminal tampering, electrical or communications disruption, it is possible for the system to fail to perform as expected. NAPCO does not represent that the product/system may not be compromised or circumvented; or that the product or system will prevent any personal injury or property loss by burglary, robbery, fire or otherwise; nor that the product or system will in all cases provide adequate warning or protection. A properly installed and maintained alarm may only reduce risk of burglary, robbery, fire or otherwise but it is not insurance or a guarantee that these events will not occur. CONSEQUENTLY, SELLER SHALL HAVE NO LIABILITY FOR ANY PERSONAL INJURY, PROPERTY DAMAGE, OR OTHER LOSS BASED ON A CLAIM THE PRODUCT FAILED TO GIVE WARNING. Therefore, the installer should in turn advise the consumer to take any and all precautions for his or her safety including, but not limited to, fleeing the premises and calling police or fire department, in order to mitigate the possibilities of harm and/or damage.

NAPCO is not an insurer of either the property or safety of the user's family or employees, and limits its liability for any loss or damage including incidental or consequential damages to NAPCO's original selling price of the product regardless of the cause of such loss or damage.

Some states do not allow limitations on how long an implied warranty lasts or do not allow the exclusion or limitation of incidental or consequential damages, or differentiate in their treatment of limitations of liability for ordinary or gross negligence, so the above limitations or exclusions may not apply to you. This Warranty gives you specific legal rights and you may also have other rights which vary from state to state.

