



GenRad

GR1417
Four-Terminal
Capacitance
Standard

Form 1417-0100-B

Instruction Manual

Contents

Specifications

Introduction – Section 1

Operation – Section 2

Use With GR Bridges – Section 3

Theory – Section 4

Service and Maintenance – Section 5

CAUTION
Do not apply dc.

GR1417 Four-Terminal Capacitance Standard

Form 1417-0100-B

WARRANTY

We warrant that this product is free from defects in material and workmanship and, when properly used, will perform in accordance with GenRad's applicable published specifications. If within one (1) year after original shipment it is found not to meet this standard, it will be repaired or at the option of GenRad, replaced at no charge when returned to a GenRad service facility.

CHANGES IN THE PRODUCT NOT APPROVED BY GENRAD SHALL VOID THIS WARRANTY.

GENRAD SHALL NOT BE LIABLE FOR ANY INDIRECT, SPECIAL, OR CONSEQUENTIAL DAMAGES, EVEN IF NOTICE HAS BEEN GIVEN OF THE POSSIBILITY OF SUCH DAMAGES.

THIS WARRANTY IS IN LIEU OF ALL OTHER WARRANTIES, EXPRESS OR IMPLIED, INCLUDING, BUT NOT LIMITED TO, ANY IMPLIED WARRANTY OF MERCHANTABILITY OR FITNESS FOR A PARTICULAR PURPOSE.

SERVICE POLICY

Your local GenRad office or representative will assist you in all matters relating to product maintenance, such as calibration, repair, replacement parts and service contracts.

GenRad policy is to maintain product repair capability for a period of five (5) years after original shipment and to make this capability available at the then prevailing schedule of charges.

Specifications

Capacitance Value (Internal Standard)	Ratio Accuracy		D Accuracy		Approximate Terminal Impedance		E Max (V)
	100 & 120 Hz	1 kHz	100 & 120 Hz	1 kHz	Z _A (Ω)	Z _B (Ω)	
1 μF	---	---	±.001	±.001	0.03	0.03	20
10 μF	0.02%	0.04%	±.001	±.001	7.0	15.5	6
100 μF	0.02%	0.04%	±.001	±.001	3.1	6.4	2
1 mF	0.02%	0.06%	±.001	±.002	1.1	2.2	0.8
10 mF	0.03%	0.2%	±.001	±.005	0.37	0.72	0.5
100 mF	0.1%	*	±.003	*	0.13	0.23	0.25
1 F	0.25%	*	±.01	*	0.04	0.05	0.06

*Not Specified

Capacitance: Internal Standard: \pm μF to 1 F in 7 switch-selected decade values. External Standard: Indicated capacitance, multiplied by C ext/1 μF.

Capacitance Accuracy, direct-reading: 0.25% plus ratio accuracy (see table) at 100 Hz, 120 Hz, and 1 kHz, 20 to 25°C, with low applied voltage (<1/4 E max) using internal standard and a proper four-terminal measurement. (May also be used as a two-terminal standard, with a D < 1 and a capacitance change from the four-terminal value of < 1/2% up to 1 mF at 120 Hz or less.)

Capacitance Ratio Accuracy: See table.

Dissipation Factor: 0.01 at 100 Hz, 120 Hz and 1 kHz. For D accuracy, see table.

Terminal Impedances: See figure and table (approx values given).

Temperature Coefficient: Approximately -140 ppm/°C.

Voltage Characteristic: Approximately +0.3% change from 0_v to E max (see table) at 100 Hz. Less at higher frequencies.

Mechanical: DIMENSIONS: (wxhxd): 8.5x5.9x5.25 in. (21.5x14.7x13.2 cm). WEIGHT: 6 lb (2.7 kg) net, 11 lb (5 kg) shipping.

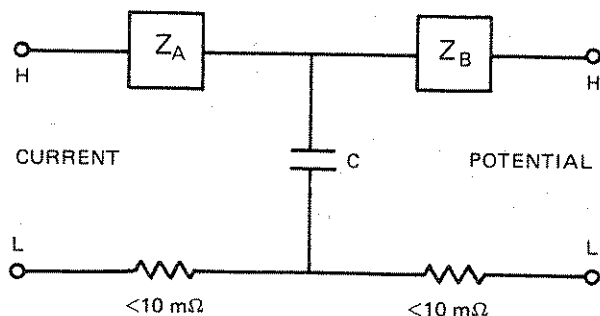

Description

1417 Four-Terminal Capacitance Standard

Catalog Number

1417-9700

Introduction—Section 1

1.1 PURPOSE.

The 1417 Four-Terminal Capacitance Standard is a standard used to calibrate bridges and meters that measure high values of capacitance with a 4-terminal connection. It also has some use in the calibration of instruments that make a 2-terminal connection. Most instruments that measure high capacitance do so at 100 Hz, 120 Hz or 1 kHz; the 1417 is compensated to have good direct-reading accuracy at these frequencies. It can be calibrated to be highly precise, making use of its precise capacitance-scaling ability.

1.2 DESCRIPTION.

The 1417 uses 2 precision transformers to multiply the value of a capacitance standard by factors of 10 up to 10^6 . It has an internal standard of $1 \mu\text{F}$ so that 7 decade values of $1 \mu\text{F}$ to 1 F are switch selected. Other values may be obtained by use of an external standard.

This standard does not act as a capacitor at dc and the application of dc can alter the capacitance values.

CAUTION
Do not apply dc.

1.3 CONTROLS AND CONNECTIONS.

There are 2 panel knobs driving rotary switches. The CAPACITANCE switch selects the capacitance value as

indicated when the internal standard is used. When an external standard is used, the value is that indicated by the C dial, multiplied by $C_{\text{ext}}/1 \mu\text{F}$ (see para 2.6).

The TEST FREQUENCY switch selects proper padding capacitors and resistors to give good direct-reading capacitance accuracy and a D of .01 at 100 Hz, 120 Hz and 1 kHz. (see para 2.7 for use at other frequencies). It also has a fourth position that removes the internal $1\text{-}\mu\text{F}$ standard and connects instead the EXTERNAL STANDARD terminals (see para 2.6).

There are 4 pairs of binding posts on standard 19-mm (3/4-in.) spacing plus 2 ground (case) binding posts. All pairs have terminals marked H and L, and L terminals are all common.

The pairs of terminals on the left are those that should be connected to the measuring instrument. They are labeled POTENTIAL AND CURRENT, common nomenclature for a 4-terminal standard. Generally, these are connected to bridge terminals with similar markings.

The VOLTMETER terminals on the right are directly across the standard capacitor used, whether it is the internal standard or an external standard. Their primary use is to monitor the voltage across the standard so that corrections can be made when precise measurements are required (see para 2.4). These terminals may also be used to add capacitance to the internal standard (see para 2.6).

The EXTERNAL STANDARD terminals are used to connect an external capacitor to obtain other than decade values (see para 2.6). These terminals are switched in the circuit by the TEST FREQUENCY switch.

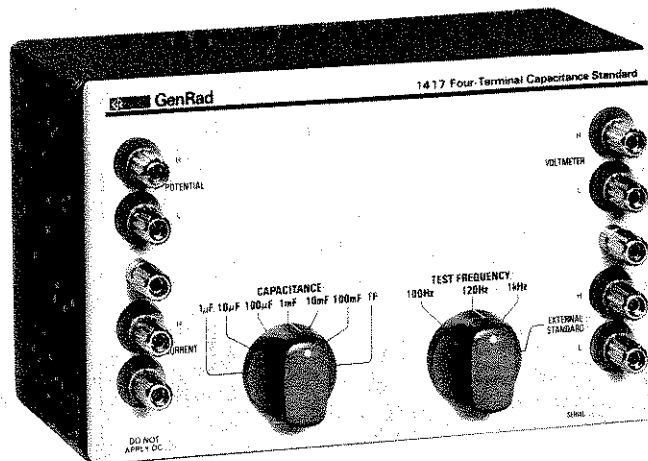

Figure 1-1. GR 1417 Standard.

Operation—Section 2

2.1 GENERAL.

The manner in which the 1417 should be used depends on many factors: the accuracy required, the test frequency, the applied voltage, the capacitance values required, and the instrument with which it is used. The operation is very simple in many applications, but can become more complex, particularly when the highest accuracy is required. It is strongly suggested that the theory and calibration techniques used be thoroughly understood to avoid possible errors.

Because different instruments measure under different conditions and have different accuracy specifications, specific instructions are given in Section 3 for each GR instrument that measures high-valued capacitance. These refer to the following paragraphs which describe procedures and precautions that should be used to obtain accurate calibrations for the 1417, so that it may be used to make accurate calibrations of measuring instruments.

2.2 CONNECTIONS TO INSTRUMENTS.

2.2.1 Four-Terminal Connections.

The connections to 4-terminal measuring instruments are made to the H and L CURRENT terminals and H and L POTENTIAL terminals. Usually the terminals of the measuring instrument use a similar notation (although + may be used instead of H and — instead of L) and, in general, these terminals are connected to the corresponding terminals of the 1417, but not always. Section 3, which describes the calibration of specific GR instruments, gives the proper connections for each instrument.

The 1417 also has terminals that tie directly to its case. It is not usually necessary to make any connection to this terminal. However, if strong fields are present, grounding the case may give better results. There is no direct connection between the case and the internal circuitry.

2.2.2 Terminal Impedances.

The 1417 has impedance in series with each of its terminals as shown in Figure 4-4 and Table 4-2. These have no effect on a perfect 4-terminal measurement. However, no instrument makes such a perfect measurement, so that connections should be made in such a way that the larger terminal impedances are connected to the bridge or meter terminals that are most immune to such errors. This is why the various instruments described in Section 3 have different connections. There is a best way to connect to each unit.

2.2.3 Connecting Leads.

The connecting leads used should be short and use reasonably heavy wire to avoid increasing these terminal impedances. However, in many cases test lead sets are supplied for particular instruments. If these lead sets are used also in

the application of the instrument, it is desirable to use them for the calibration as well, so that the calibration is made on the instrument as it will be used. If special lead sets are used it must be remembered that they can affect the calibration.

2.2.4 Mutual Inductance In Leads

While a good four-terminal measurement can be immune to self-inductance in the leads, mutual inductance between the current leads and the potential leads can still cause an error, an error which is very important at very high capacitance. The equivalent circuit of figure 4-3 gives the formula

$$C_{\text{meas}} = \frac{C}{1 \pm \omega^2 CM}$$

The mutual inductance can be positive or negative. This error is critical at very high capacitance, even at 100 Hz, and much more critical at 1 kHz. For example 2.5 nH gives 0.1% error when measuring 1F at 100 Hz or when measuring 10 mF at 1 kHz. The inductance of 2 coaxial, circular, single-turn coils both of 1-cm radius, 1 cm apart, is about 5 nH; it is obvious that great care must be taken when $\omega^2 C$ is large.

Mutual inductance between the current circuit and the potential circuit occurs in the 1417, the connecting leads, and inside the measuring instrument. The mutual inductance inside the 1417 is usually negligible compared to that of the leads. At the highest capacitance values (100 mF and 1 F) it is approx 1 nH. At lower values it causes negligible error at 120 Hz and less than .02% at 1 kHz.

The sections following, on the calibration of specific instruments, note the effect, if any, of the mutual inductances of these instruments and their lead sets.

2.3 ACCURACY.

2.3.1 Accuracy of the 1417.

With no calibration, the accuracy of the 1417 depends on many factors: the accuracy of the initial adjustment, drift in the standard capacitor, its temperature coefficient, the signal level applied, and mutual inductance in its connections. Under reasonable conditions (see para 2.3.3), its uncalibrated or direct-reading accuracy is 0.25%.

The ultimate corrected accuracy is much better. Measurements have been made to $\pm 0.01\%$. This corrected accuracy is possible because the inductive voltage dividers used to scale the capacitance values (see Section 4) are extremely precise.

This scaling accuracy is the RATIO ACCURACY given in the specifications. This is the accuracy of the ratio between the capacitance value at any setting to the value at 1 μF , assuming that the signal level on the internal standard remains constant, or that the change caused by a changing

signal level is negligible, or can be precisely determined. To utilize the good ratio accuracy, it is necessary to know the 1- μ F value precisely:

A changing signal level causes a change in the effective value of the standard because of the non-linearity of the input impedance of the voltage dividers (not a non-linearity in their ratios). The effect is largest at low frequencies and negligible at 1 kHz. Typical changes with level are shown in figure 2-2. Methods of determining this level change and making a suitable correction are discussed in para 2.4.2 and 2.4.3.

At 1 kHz, the level effect is negligible (less than .004%), but (see para 2.2.4) mutual inductance effects become noticeable. The RATIO ACCURACY given in the specifications for 1 kHz include the errors caused by mutual inductance inside the 1417, which are generally negligible compared to that of the leads or the measuring device.

2.3.2 Required Accuracy.

In calibration, it is always desirable to have the calibration accuracy of the standard far better than that of the instrument being calibrated. This is not always possible and is never possible at the highest accuracy level for any type

of measurement. As a result, the accuracy of the measuring instrument may depend on the accuracy of the standard used to check it.

Suppose, for example, one has a standard whose calibrated value is known (or can be assumed to be) within $\pm A\%$ and a measuring instrument whose accuracy specification is $\pm B\%$. Now we can say:

1. The instrument *is* within calibration if it reads the calibrated value of the standard to $\pm(B-A)\%$, if $B > A$, and
2. The instrument *may* be within calibration if it reads the calibrated value of the standard to $\pm(A+B)\%$.

There is an area of uncertainty of $\pm A\%$ at both + and - tolerance limits of the instrument. If $A > B$, it is impossible to say whether the instrument is within tolerance or not.

Fortunately, most manufacturers give conservative tolerances to allow for their calibration uncertainties and for aging and environmental effects, so that measurements made in a good environment generally will be within the $B-A$ tolerance, if the instrument is working properly, but only so long as A is not too large. If the instrument is not within the tolerance, but is within the $A+B$ tolerance, it can be readjusted, or if this is not practical, it should be assigned a new specification of $\pm(A+B)\%$.

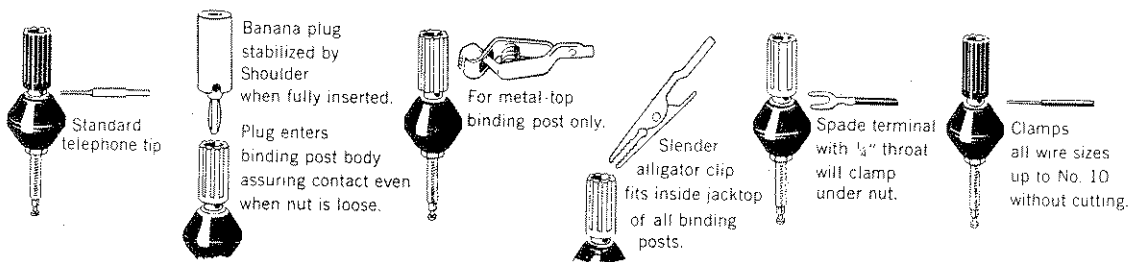

Figure 2-1. Methods of connection to binding-post terminals.

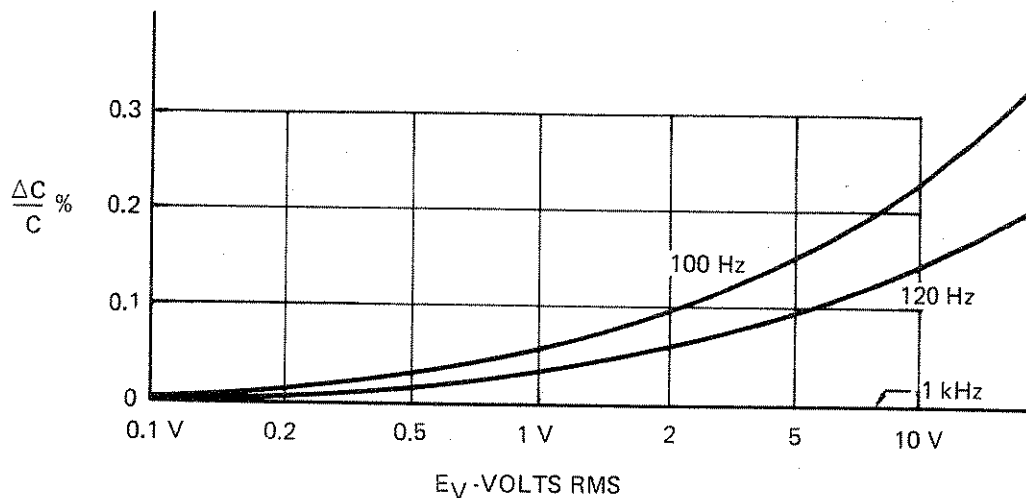

Figure 2-2. Changes in capacitance vs voltage at VOLTMETER terminals.

AVAILABLE INTERCONNECTION ACCESSORIES

TYPE NO.	DESCRIPTION	CATALOG NO.
274-NQ	Double-plug patch cord, in-line 920-mm (36-in.) long	0274-9860
274-NP	Double-plug patch cord, right-angle 920-mm (36-in.) long	0274-9880
274-NL	Shielded double-plug patch cord, 920-mm (36-in.) long	0274-9883
274-LLB 274-LLR	Single-plug patch cord, black, 920-mm (36-in.) long Single-plug patch cord, red, 920-mm (36-in.) long	0274-9468 0274-9492

In many cases, the accuracy of the instrument is far better than required by a specific application, in which case this broader A+B tolerance is of no consequence. For example, if a 0.1% instrument is used to measure $\pm 10\%$ capacitors, errors of a few hundredths percent in the calibration of the 1417 standard are of no importance. It may even make sense to use the simpler calibration procedures that give reduced accuracy.

2.3.3 Direct-Reading Measurements.

The 1417 should be accurate to $\pm 0.25\%$ without corrections if:

1. Proper 4-terminal connections are made (see 2.2.1 and 2.2.2).
2. The TEST FREQUENCY switch is set to a setting (100 Hz, 120 Hz or 1 kHz) corresponding to the frequency of the test signal,
3. The ambient temperature is within the range $23^{\circ}\text{C} \pm 5^{\circ}\text{C}$ and
4. At 100 Hz or 120 Hz, the level at the VOLTMETER terminals is less than 5 V (or the voltage at the CURRENT terminals is less than 0.25% of the value of E_{max} given in the specifications) and the dividers used in the 1417 have not been left magnetized (see para 5.3) or
5. A 1-kHz test frequency is used and the voltage on the VOLTMETER terminal is 20 V or less (or the voltage at the CURRENT input terminals is less than E_{max}).

If these conditions are not all met, the appropriate calibration procedures given below should be used to ensure better accuracy. It is good practice to at least make the $1\text{-}\mu\text{F}$ calibration checks to avoid errors due to long-term drift.

2.4 CALIBRATION CORRECTIONS FOR BETTER ACCURACY.

2.4.1 The $1\text{-}\mu\text{F}$ Calibration.

If accuracy better than 0.25% is required, or if the conditions of para 2.3.3 are not met, a calibration measure-

ment at $1\text{-}\mu\text{F}$ is necessary. Such a calibration will give accuracy within 0.1% for all capacitance values, if the voltage level on the 1417 is kept within the range of items 4 or 5 of para 2.3.3. If at 100 Hz or 120 Hz, the level on the voltmeter terminals, E_V , is held constant for all measurements, the percent correction obtained from the $1\text{-}\mu\text{F}$ calibrating measurement can be used for all values and should give a measurement accuracy equal to the specified RATIO ACCURACY. The level of E_V will not affect the 1-kHz values of the 1417 so long as it is below 20 V.

If at 100 or 120 Hz this level (E_V) is not constant, and high accuracy is required, see para 2.4.2 and 2.4.3.

The $1\text{-}\mu\text{F}$ value of the 1417 may be calibrated with either a precision 2-terminal (or 3-terminal) bridge, or a less-precise bridge with good resolution and a precision $1\text{-}\mu\text{F}$ standard.

A recommended precision bridge is the GR 1615 (or 1620 system). A 2-terminal measurement should be made across the VOLTMETER terminals with the TEST FREQUENCY switch set to the frequency used. This bridge will apply a very low voltage (E_V) to the 1417. Less precise bridges may also be used, such as the GR 1656 or GR 1608, if they are calibrated by measuring a precise $1\text{-}\mu\text{F}$ standard, such as the GR 1409-Y. Both these bridges have .01% (or better) resolution at even decade values. The standard and the 1417 should be measured and the difference between the measurements is the difference between the calibrated value of the standard and the actual value of the 1417. These bridges normally apply a low voltage to the unknown.

This calibrating measurement may also be made with an instrument that one intends to calibrate with the 1417. As above, both a $1\text{-}\mu\text{F}$ standard and the 1417 are measured and the difference between them (plus the calibration correction of the standard) is used as a correction for the 1417. However, to be meaningful, the measurement device used

must have a resolution substantially better than the accuracy to which it is to be calibrated.

2.4.2 Approximate Level Corrections.

If at low frequencies (100 Hz or 120 Hz) the voltage level at the VOLTMETER terminal, E_V , is not very low or is not constant at various 1417 capacitance settings, a level correction should be made for best accuracy. The method for making these corrections is given in para 2.4.3. However, for those GR instruments discussed in Section 3, an approximate correction, accurate to 0.1%, can be made without making additional calibrating measurements on the 1417.

The procedure is as follows:

a. Measure the low-level 1- μ F value of the 1417 at the desired test frequency as in para 2.4.1 and note the percent deviation from the nominal value.

b. From the tables of Section 3, note the value of E_V for each specific range of the instrument used and 1417 setting. Then, from the typical calibration curve of Figure 2-2, determine the approximate percent capacitance change.

c. Apply the corrections of a and b above to the measurements made on the higher 1417 settings.

Better accuracy can be obtained if a capacitance vs level curve is made for the specific unit used.

2.4.3 The Capacitance vs Level Corrections.

To obtain the best accuracy at low frequencies, it is necessary to make a precise capacitance-vs-level correction chart for the specific 1417 used, to measure the voltage at the VOLTMETER terminals at each setting of the 1417 during use, and to apply the previously determined correction. The curves should be similar to the typical correction curves of Figure 2-2. (This is not necessary at 1 kHz). It is preferable to demagnetize the dividers of the 1417 before these capacitance-vs-level corrections are determined (see para 5.3).

A precision bridge is not necessary to make this correction curve, but the bridge should have good resolution and must be able to apply 20 V to the 1- μ F value or at least as much voltage as will be required in use. The bridge may be 2-terminal because the connection of the 1417 is to the VOLTMETER terminals.

The GR 1615 Precision Capacitance Bridge is not suitable for these calibration measurements at low frequencies because in its normal connection it applies very little voltage to a

1- μ F capacitor and in its reverse connection the detector mismatch results in poor sensitivity.

The GR 1656 Impedance Bridge may be used, and, with a GR 1311 oscillator, allows measurements to 20 V at 100 and 120 Hz. To obtain precision at low-levels, the recommended connection of Figure 2-3 should be used, the operator, bench, and all nearby equipment should be grounded, and the operator should not touch the metallic surfaces of the 1656 during balance. While this connection leaves the case of the 1656 ungrounded, the 1656 is battery powered, so that hum from external sources only can affect the measurement. This connection grounds the 1656 HIGH UNKNOWN terminal and the L VOLTMETER terminal of the 1417, so that a voltmeter with a grounded low terminal can be used. The voltmeter should be disconnected from the circuit for the final balance, but the voltage should be measured when the 1656 is fairly well balanced, because the voltage on the 1417 depends on bridge adjustments. With this method, resolution to .01% down to 0.2 V, is possible if care is used.

The 1656 should be set to the 100 nF MULTIPLIER setting, so that readings will be made at full scale to obtain .01% readout resolution. All readings should be made using a 9 as the first (left most) digit of the readout. This allows balance up to 9XXX = 10110, which is more than adequate and minimizes the effect of errors in the main bridge adjustment.

Since the 1656 is only 0.1% accurate and because the connection may introduce a small, but constant error, the resulting calibration curve is only precise for relative values. The precise value should be obtained at a specific level (preferably a low level) by calibrating the 1656 in this connection with a precision standard or by a measurement on a precision bridge, as described in para 2.4.1.

2.5 PRECAUTIONS.

2.5.1 Magnetization of the Divider Core.

CAUTION

Do not apply dc to the 1417.

Dc applied to the 1417 can make a severe permanent change in the inductance of the transformer dividers, which can affect the low-frequency calibrated value. A

CAUTION

A 500- μ F capacitor must always be connected between the H terminal of the 1417 and the current terminal of any bridge connected to it. This protects the 1417 from possible damage.

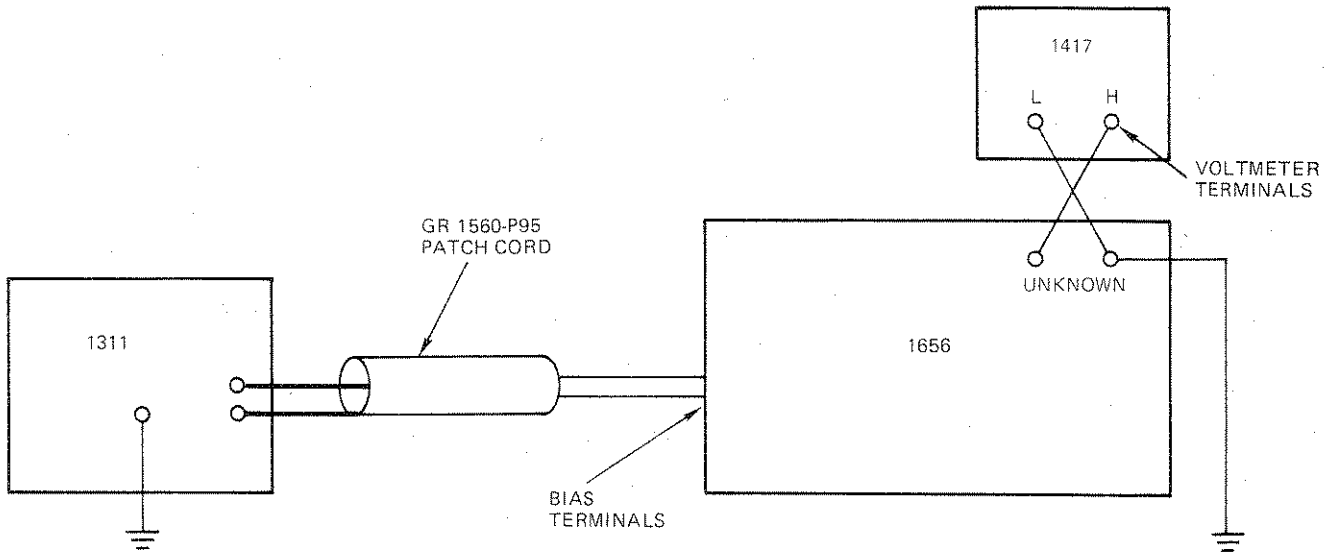

Figure 2-3. Connection diagram for 1417 calibration checks.

noticeable change can be made by as little as 0.1 ampere-turn and, since there are 4000 turns on one divider, it could be affected by as little as $25 \mu\text{A}$. The result is a reduction in the inductance of the cores and a reduction in the effective value of the 1417. This effect is a result of residual magnetization of the cores. It can be removed by cyclic demagnetization, see para 5.3.

A residual magnetization can also result from switching large ac signals on and off. If the signal level, E_V , is above 10 V at 100 or 120 Hz, it is preferable to reduce the drive signal slowly before connecting or disconnecting the 1417.

2.5.2 Maximum Input Voltage.

The maximum input voltage is given in the specifications. This limit is based on a maximum power of 2 W, a current of 2 A and a voltage of 20 V, whichever is limiting, at 100 Hz. These limits are adequate for testing all GR instruments.

Aside from possible overheating, the reason for these limits is the two 1.5-W Zener diodes (in series opposing) that shunt the VOLTMETER terminals. These clamp the output to a safe value to protect the operator and the instrument. If the voltage at these terminals exceeds about 27 V rms, these diodes will clip and cause measurement errors. A maximum of 20 V rms is recommended. If the 27-V limit is exceeded and the source can deliver high power, the protecting Zener diodes may be destroyed, either shorting, making the 1417 unusable, or opening, and removing the protection feature. Usually they will short unless extreme power is applied.

2.6 USE OF AN EXTERNAL STANDARD.

An external standard may be used to get referenced values between those decade values provided or to extend the range.

This can be accomplished in two ways: by using the external standard by itself or by adding it to the internal $1\text{-}\mu\text{F}$ standard.

When an external standard is connected across the EXTERNAL STANDARD terminals and the TEST FREQUENCY switch is set to that position, the 4-terminal capacitance is ideally that indicated on the CAPACITANCE switch multiplied by $C_{\text{ext}}/1\mu\text{F}$. This value is subject to the errors discussed in para 4.3.

The low frequency error of the effective value of the EXT CAP is

$$C'_{\text{ext}} = C_{\text{ext}} \left(1 - \frac{1}{\omega^2 L C_{\text{ext}}} \right)$$

The larger the external capacitance, the less (percent) error will occur. This error can be quite large at low frequencies if C_{ext} is substantially less than $1 \mu\text{F}$. This error can be corrected for by use of the procedures of para 2.4. If C_{ext} is low, these corrections will be critical.

When using an external capacitor connected this way, the D value will be the D of the external capacitor plus a small quantity. The D should be determined by a measurement at the $1\text{-}\mu\text{F}$ position and it may be set to a desired value by adding resistance in series with the external standard.

When an external standard is connected to the VOLTMETER terminals, it is added (in parallel) with the internal standard and thus increases all values. Ideally, the measured capacitance is the value indicated by the CAPACITANCE switch multiplied by $(1 + C_{\text{ext}}/1 \mu\text{F})$. This connection has one advantage in that the internal padding capacitors used to compensate for the low-frequency inductance error (para 4.3) are still effective (if the proper TEST FREQUENCY position is used). The effective value is

$$C' = 1 \mu\text{F} + C_{\text{ext}} + C_p - 1/\omega^2 L$$

where C_p is the padding capacitor that cancels the inductance term. Moreover, the larger C_{ext} is, the less the (percent) error caused by this term. However, for precise measurements this error should be determined as before para 2.4.

The D values will be approximately

$$.01) 1\mu F / (1\mu F + C_{ext}).$$

For precise D calibrations, this value should also be determined by a measurement at the 1- μF setting.

2.7 APPLICATION OF OTHER FREQUENCIES.

The value of the GR1417 depends somewhat on frequency (see Figure 2-4). It is padded to give good direct-reading accuracy at 100 Hz, 120 Hz and 1 kHz, but may be used at other frequencies. For frequencies between 100 Hz and 1 kHz, the full accuracy of the 1417 may be realized by measuring the 1- μF value of the 1417 at the desired frequency in the 1-kHz position of the TEST FREQUENCY switch and either noting the error for future use or increasing the value to 1 μF , by adding padding capacitors at the VOLT-METER terminals.

Below 100 Hz, the low-frequency error (see para 4.3) increases and, while corrections or padding should be used, level effects will be increased so that full corrected accuracy becomes more difficult to maintain.

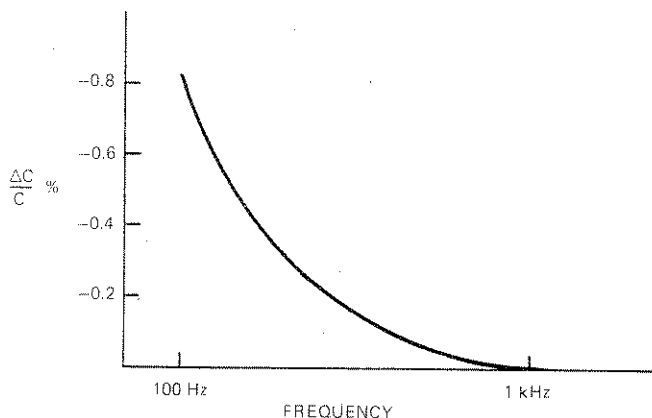

Figure 2-4. Typical capacitance change with frequency. Note corrections are made at 100 Hz and 120 Hz.

Above 1 kHz, the low-frequency error is negligible but the effect of mutual inductance (para 4.3) is increased and eventually the divider ratios deteriorate. The increased error (both ratio and direct reading) should be less than $\pm(.02\%) (f_kHz)^2$, if the mutual inductance external to the 1417 is negligible. The 1-kHz TEST FREQUENCY position should be used.

At frequencies other than 100, 120 and 1000 Hz the D readings will not be .01. They will be approximately $(.01) f/f_s$, where f is the test frequency and f_s the setting of the TEST FREQUENCY switch. For accurate D values, an external series capacitor and resistor should be used which, on the 1 μF position, give a calibrated value of 1 μF and a D of .01.

2.8 TWO-TERMINAL MEASUREMENTS.

The lower values of the 1417 may be used as a 2-terminal standard at low frequencies. The D is increased because of the terminal resistances, and the C value is changed slightly because of terminal inductance and the variation in the α and β ratios (effective terminal capacitance see para 4.4). All those effects are reduced if the CURRENT and POTENTIAL terminals are connected in parallel. Table 2-1 shows approximate D values and the change in capacitance from its 4-terminal value for both this parallel connection and for connections to the current terminals only at 120 Hz.

Table 2-1
TWO-TERMINAL MEASUREMENTS*

1417 Setting	Current Terminals $\Delta C(\%)$	D	Current & Potent. Term. In Parallel $\Delta C(\%)$	D
1 μF	0	.01	0	.01
10 μF	+0.3	.063	+0.2	.045
100 μF	+0.8	0.24	+0.4	0.17
1 mF	-1.4	0.85	-0.15	0.56
10 mF	+2.5	2.85	+1.5	1.92

*Typical C and D values.

Use with GR Bridges – Section 3

3.1 USE WITH 1617 BRIDGE.

The 1617 Capacitance Bridge is a 1% manual unit whose accuracy depends on its dial calibration (an internal adjustment), its standard capacitor, and its range resistors. The dial calibration and standard can be checked with a precision capacitance decade box (see 1617 Instruction Manual), but a standard of high capacitance, such as the 1417, is required to check the higher range resistors. The 1617 dial is logarithmic and equally accurate at readings of 1 or 10. Therefore, the ranges can be checked at either point, or both.

Because the 1617 accuracy is only 1%, and the applied power is low (if the recommended test voltages are used), the 0.25% direct-reading accuracy of the 1417 is usually adequate, but a single calibration of the 1417 at 1- μ F (see para 2.4.1) is nevertheless suggested as a precaution. The voltage, E_V , reaches 3 V on two measurements, which would mean a capacitance change of +0.1%, but this should be negligible compared to the ability to read the 1617 dial.

The 1617 makes a 4-terminal measurement, but errors occur if the lead impedances or terminal impedances of the 1417 are sufficiently high. To keep these errors at a minimum, different connections are used on different ranges (see Tables 3-1 and 3-2). The remaining lead errors affect D on some ranges, giving a repeatable error on two lower ranges and a less precise error in three higher ranges. To check the D accuracy on the higher ranges, measurements should be made at 10 on the dial.

Table 3-1 also lists the recommended 1617 test voltages (GEN LEVEL switch). When measuring high capacitance,

the 1617 is subject to error caused by hum pickup. This error can and should be removed by making two measurements with the METER switch set to GEN NORM and GEN REV and taking the average readings.

The 4-terminal lead set (P/N 1617-2210) should be used (with the shorting links on the 1617 unknown terminals disconnected.) At very high values, the mutual inductance between the leads is important. The potential leads (the two inner leads) should be tightly twisted to reduce this error (see para 2.2). If this precaution is not taken, the error can be more than 10% at 1 F.

Table 3-2
TEST CONNECTIONS

1617 Terminal	1417 Connections	
	"A"	"B"
- UNKNOWN (outside)	H POTENTIAL	L CURRENT
-UNKNOWN (inside)	H CURRENT	L POTENTIAL
+ UNKNOWN (inside)	L CURRENT	H POTENTIAL
+ UNKNOWN (outside)	L POTENTIAL	H CURRENT

3.2 USE WITH 1657 Digibridge.

The accuracy of the 1657 depends mainly on three precision resistors and a crystal oscillator. These can most easily be checked by resistance measurements of 10 Ω , 1 k Ω and 100 k Ω , and one precise capacitance measurement. However, if one wants assurance that it measures high capacitance values accurately also, one may use the 1417.

Table 3-1
CALIBRATION WITH 1417

1417 Setting	1617 Multiplier	Connection	Gen Level(V)	Nom C Read.	C Tol.	D Nominal	D Tol.	E_V (120 Hz)
1 μ F	100 nF	A or B	2.0	10	$\pm 1\%$.01	$\pm .001$	0.24
1 μ F	1 μ F	A or B	2.0	1	$\pm 1\%$.01	$\pm .001$	1.45
10 μ F	1 μ F	A	2.0	10	$\pm 1\%$.008	$\pm .001$	0.77
10 μ F	10 μ F	A	0.5	1	$\pm 1\%$.008	$\pm .001$	1.2
100 μ F	10 μ F	A	0.5	10	$\pm 1\%$.009	$\pm .001$	0.64
100 μ F	100 μ F	A	0.2	1	$\pm 1\%$.009	$\pm .001$	1.4
1 mF	100 μ F	B	0.2	10	$\pm 1\%$.01	$\pm .001$	0.75
1 mF	.1 mF	B	0.2	1	$\pm 1\%$	---		3.0
10 mF	1 mF	B	0.2	10	$\pm 1\%$.01	$\pm .0011$	1.55
10 mF	10 mF	B	0.2	1	$\pm 1\%$	---		3.1
100 mF	10 mF	B	0.2	10	$\pm 1\%$.01	$\pm .002$	1.50
100 mF	100 mF	B	0.2	1	$\pm 2\%$	---		1.55
1 F	100 mF	B	0.5	10	$\pm 2\%$.01	$\pm .011$	1.0

- NOTES (1) Use 1417 frequency setting corresponding to test frequency.
 (2) Make two measurements with 1617 input direct and reversed and take average.
 (3) Twist leads at C values > 1 mF.

The 1657 is 0.2% accurate at the lower values, so that the 1417 should be calibrated before it is used. However, because the 1657 applies low power (see Table 3-3) a single, low-level calibration (see para 2.4.1) for each frequency is all that is required.

Connections between the 1657 and the 1417 should be made as given in Table 3-4. The 1657 I+ connection may have a slight dc offset voltage. A large capacitor (500 μ F) should be put in series with the connection.

A test lead set should be used. The mutual inductance of the 1657 gives negligible error compared to its specifications, but care should be used in the lead configuration when measuring 1 mF at 1 kHz.

Note that the maximum reading is 999.99 mF at 1 kHz and 99.999 mF at 120 Hz. It would be preferable to use an external standard with the 1417, of say 0.9 μ F to check these range extremes.

Table 3-3
1657 ACCURACY

1417 Setting	120 Hz		1 kHz		Range	E _v (120-Hz)	
	Δ C(%)	D	Δ C(%)	D			
1 μ F	0.2	.001	2	0.2	.001	2	0.15
10 μ F	0.2	.001	2	0.2	.001	1	.07
100 μ F	0.2	.001	1	0.2	.001	1	1.25
1 mF	0.2	.001	1	1*	.01	1	0.64
10 mF	1	.005	1	---	---	1	Low
100 mF	10	**	.05	---	---	1	Low

*Goes to 999.99 μ F. **Goes to 99.999 mF

Table 3-4
INTERCONNECTION

1657	1417
P- (rear left)	L POTENTIAL
P+ (rear right)	H POTENTIAL
I- (front left)	L CURRENT
I+ (front right)	H CURRENT

3.3 USE WITH 1683 BRIDGE

The GR 1683 Automatic RLC Bridge measures at both 120 Hz and 1 kHz to a base accuracy of 0.1% (see Table 3-5) so that calibration to full accuracy requires careful calibration and use of the 1417.

CAUTION

GR 1683 applies 2.2 V at 1 A; danger of residual magnetization (see para 2.5.1.)

At 120 Hz, a voltage-vs-level curve should be used to obtain full accuracy (see para 2.4.2). At 1 mF full output of the 1683 can give 25.5 V on the 1417 VOLTMETER terminals, which is close to the Zener-diode clipping point. It is suggested that the GR 1683 OSC LEVEL be set to 1 V for this measurement. Because of the high level supplied by this bridge, it is recommended that the 1417 be connected and disconnected and all range changes made with the 1683 OSC LEVEL set to 0.

At 1 kHz there is negligible level error but the above precaution is recommended to avoid changes in the 1417 calibration due to transients.

The measurement connections between the 1683 and 1417 are given in Table 3-7. The mutual inductance error

caused by the 1683 is negligible compared to its specifications, if the current leads are twisted together and the potential leads are twisted together.

Table 3-5
1683 ACCURACY*

1417 Setting	120 Hz		1 kHz	
	Δ C(%)	D	Δ C(%)	D
1 μ F	0.11	.0011	0.11	.0011
10 μ F	0.11	.0011	0.11	.0011
100 μ F	0.11	.0011	0.11	.0011
1 mF	0.11	.0011	1.1	.01
10 mF	1.1	.01	6	0.1
100 mF	6	0.1	---	---

*1683 C reading of 10000 and D = .01

Table 3-6

TYPICAL VOLTAGES AT VOLTMETER TERMINALS
1683 OSCILLATOR SETTING (120 Hz)

1417 Setting	Full	1 V
1 μ F	2.1	1
10 μ F	5.3	2.5
100 μ F	14.7	6.9
1 mF	25.5	12
10 mF	17.8	8.4
100 mF	7.6	3.6

The connections between the 1683 and the 1417 are given in Table 3-7.

Table 3-7

BRIDGE-STANDARD CONNECTIONS

1683	1417
+CURRENT	CURRENT H
-CURRENT	CURRENT L
+POTENTIAL	POTENTIAL H
-POTENTIAL	POTENTIAL L

3.4 WITH 1685/1686 INSTRUMENTS.

The 1685 Digital Impedance Meter and the 1686-A and 1686-9000 Digital Capacitance Meters are very similar in operation and specifications. The 1685 measures resistance and inductance as well as capacitance and its ratio and accuracy can be most easily checked by measurements of precision resistors. However, a 1417 is useful for checking its operation for high-capacitance measurements. The 1686 only measures capacitance, so a standard such as the 1417 is necessary to check its high-capacitance ratio errors.

The 1685 and 1686 have the same specifications for capacitance, but the 1686 applies slightly more power on some ranges (see Tables 3-8 and 3-9). The 1686-A has slightly improved specifications compared to the 1686-9000 and has an additional range up to 200 mF. Each has rear-panel level control that should be set full on (cw). All these instruments will make a measurement at 120 Hz up to 5 times the full-scale value on the highest range. The error "E" will appear in the readouts but the measurement is valid, if not too accurate (see Tables 3-8 and 3-9).

The connections are the same for all three instruments and are given in Table 3-10. The test lead sets P/N 1685-9600 for 1685, P/N 1686-9602 for 1686 should be used. These instruments with their lead sets have approx. 0.2 μ H mutual inductance between the current and potential pairs which

causes an error on the highest ranges (see Table 3-11 and para 4.3). This error increases the measured value and should be subtracted from all measurements to obtain the best accuracy.

Table 3-8
1685/1686-9000 ACCURACY*

1417 Setting	120 Hz		1 kHz		120 Hz	
	$\Delta C(\%)$	D	$\Delta C(\%)$	D	1686 EV Approx	1685 EV Approx
1 μF	± 0.35	± 0.0019	± 0.12	± 0.0019	1	0.95
10 μF	± 0.35	± 0.0019	± 0.12	± 0.0019	3.5	3.3
100 μF	± 0.35	± 0.0019	± 0.36	± 0.0057	7.7	7.7
1 mF	± 0.7	± 0.0038	$\pm 1.2^{**}$	± 0.019	1.7	1.7
10 mF	± 1.4	± 0.0176	---	---	0.9	0.9
100 mF	6†	---	---	---	0.4	0.4

†Overrange.

*At half full scale and D = .01.

**Range not recommended.

Table 3-9
1686-A ACCURACY†

1417 Setting	120 Hz		1 kHz		E _v (120-Hz)
	$\Delta C(\%)$	D	$\Delta C(\%)$	D	
1 μF	± 0.35	± 0.0019	± 0.12	± 0.0019	1
10 μF	± 0.35	± 0.0019	± 0.12	± 0.0019	3.5
100 μF	± 0.35	± 0.0019	± 0.36	± 0.0057	7.7
1 mF	± 0.7	± 0.0038	± 1.2	± 0.019	1.7
10 mF	± 1.05	± 0.0176	---	---	0.9
100 mF	± 3.4	± 0.11	---	---	0.4
1 F	28*	---	---	---	0.1

*Overrange

†At half full scale and D = .01.

Table 3-10
CONNECTIONS

1685-1686 Cable		1417
I+	RED	H CURRENT
P+	RED, WHITE SLEEVE	H POTENTIAL
P-	BLACK, WHITE SLEEVE	L POTENTIAL
I-	BLACK	L CURRENT

Table 3-11
MUTUAL INDUCTANCE ERROR-(APPROX.)

1417 Setting	120 H	1 kHz
1 μF	0	0
10 μF	0	+0.01%
100 μF	0	+0.08%
1 mF	+0.01%	+0.8%
10 mF	+0.11%	+0.8%
100 mF	+1.1%	---
1 F	+11%	---

3.5 WITH 2230 SYSTEMS.

The bridge of the 2230 Component Network System actually measures C parallel and G parallel, but the computer in the system converts the measurement data to give a display of C series and D. It measures capacitors at 120 Hz and 1 kHz to good accuracy (see Table 3-12) so that the correction procedures of para 2.4.2 or 2.4.3 should be used. The mutual inductance of the leads of this bridge does not affect the accuracy because of its limited capacitance range. The connections are given in Table 3-13.

One precaution should be considered. The I+ connection is not decoupled from the signal source. This source should have a very low offset voltage, but if not adjusted properly it can supply direct current to the 1417. If the measurements are in error, a large capacitor should be placed in series with this connection to determine if this is cause of the inaccuracy.

Table 3-12
2230 AUTOMATIC TEST SYSTEM, CGRL BRIDGE

Cap. Value	120 Hz Accuracy				1 kHz Accuracy		
	Range	C	D	E _v	Range	C	D
1 μF	5	$\pm 0.125\%$	± 0.001	1	6	$\pm 0.12\%$	± 0.001
10 μF	6	$\pm 0.12\%$	± 0.001	3.1	7	$\pm 0.12\%$	± 0.001
100 μF	7	$\pm 0.12\%$	± 0.001	8.4	8	$\pm 0.14\%$	± 0.002
1 mF	8	$\pm 0.14\%$	± 0.002	1.6	---	---	---

TABLE 3-13
INTERCONNECTIONS

2230	1417
I+	H CURRENT
P+	H POTENTIAL
P-	L POTENTIAL
I-	L CURRENT

Theory – Section 4

4.1 GENERAL.

Capacitors that are stable enough for use as standards would be extremely expensive at high capacitance values. Electrolytic types have poor stability. The 1417 is a network that simulates higher values, effectively multiplying the capacitance of its 1- μF standard, a stabilized polystyrene capacitor, to higher values by means of two inductive voltage dividers (IVD's). It should not be used as a circuit component, for it cannot be used at dc and, generally, it must be used as a 4-terminal device (see para 2.8).

4.2 BASIC CIRCUIT.

The basic circuit of the GR 1417 is shown in Figure 4-1. C is the internal 1 μF and the two autotransformers are IVD's with selectable ratios α and β . The open-circuit transfer impedance of this network $Z_T = E_o/I_{in}$. This transfer impedance is decreased by attenuating the input current by a factor α and the output voltage by β . If the dividers are ideal, that is they have exact and equal ratios, infinite open-circuit impedance and zero short circuit (winding) impedance, the equivalent for this network becomes a 2-terminal capacitor of value $C/\alpha\beta$, where α and β are the nominal ratios.

Needless to say, the IVD's are not ideal, and each imperfection causes specific additions to such an ideal equivalent circuit.

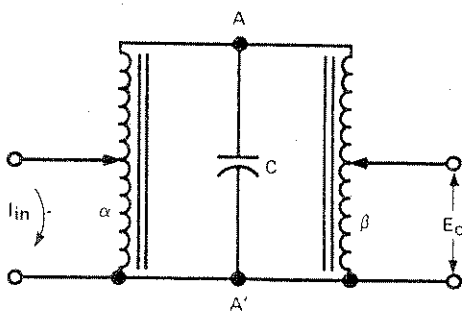

Figure 4-1. Basic circuit diagram.

4.3 ERRORS IN EFFECTIVE 4-TERMINAL CAPACITANCE.

The transformers of Figure 4-1 are passive 3-terminal networks and can be replaced by equivalent, 3-impedance T networks, as shown in Figure 4-2. It should be noted that these impedances are slightly non-linear.

For this network the transfer admittance is

$$Y_T = \frac{1}{Z_T} = \frac{I_{in}}{E_o} = \left(\frac{Z_2+Z_3}{Z_2} \right) \left(\frac{Z_5+Z_6}{Z_6} \right) \times \left(j\omega C + \frac{1}{Z_2+Z_3} + \frac{1}{Z_5+Z_6} \right) \quad (1)$$

The first two factors are the reciprocals of the open-circuit divider ratios α and β in the 1417. It is relatively easy to get very precise ratios with high permeability toroidal cores. The dividers of the GR 1417 have ratio errors that are negligible compared to any of its specifications. The feature of the GR 1417 is that, if the last factor can be held constant, the ratio between capacitance settings depends only on these precise divider ratios. This is reflected in the specified ratio accuracy, which is the ratio between the capacitance at any setting and that at 1 μF , if conditions are such that the last factor is constant.

The last factor is the admittance of capacitor C in parallel with the open-circuit input impedances of the dividers. These divider impedances are independent of the ratio settings α and β . If we assume that these divider impedances are purely inductive and (in parallel) have an inductance L, the last factor becomes:

$$j\omega C \left(1 - \frac{1}{\omega^2 LC} \right) = j\omega C' \quad (2)$$

so that the transfer capacitance

$$C_T = \frac{Y_T}{j\omega} = \frac{C}{\alpha\beta} \left(1 - \frac{1}{\omega^2 LC} \right) = \frac{C'}{\alpha\beta} \quad (3)$$

Where C' is the effective value of the standard C. This value has an error that depends on frequency squared, as shown. It also depends on signal level because of the non-linearity of inductance L. To keep this error small, the LC product should be kept as large as possible.

It was considered important to have the minimum value of capacitance (C') be 1 μF , so that this value could be measured on precision bridges or compared against a precision standard (see para 2.4.). Available bridges and standards are substantially less accurate at higher values. This capacitance can be measured by a two-terminal bridge (A to A' in Figure 4-2).

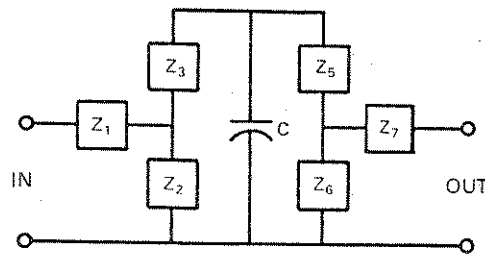

Figure 4-2. General equivalent circuit.

Therefore, to keep the LC product high, the value of L is quite high, ≈ 400 H. With a $1\text{-}\mu\text{F}$ capacitor, this causes error of about 0.50% at 120 Hz. However, because L is reasonably constant, this error is compensated by additional padding capacitance at 100 Hz and 120 Hz, to give a direct-reading accuracy of 0.25% over a reasonable range of voltage levels. Correcting for this error can give much better accuracy (para 2.4). This error is negligible at 1 kHz.

There is an additional source of error which is important at higher frequencies. If there is mutual inductance between the input (CURRENT) circuit and the output (POTENTIAL) circuit, as shown in Figure 4-3a, it appears effectively as an inductance in series with the standard C_T (Figure 4-3b). This mutual inductance can be + or - and gives an error

$$C'_T = \frac{C_T}{1 \pm \omega^2 M C_T}$$

where C_T is the 4-terminal transfer capacitance. Usually the coupling internal to the 1417 is substantially less than the coupling in the external connections (para 2.2) but there is some. The effect of the internal coupling is included in the RATIO ACCURACY specification.

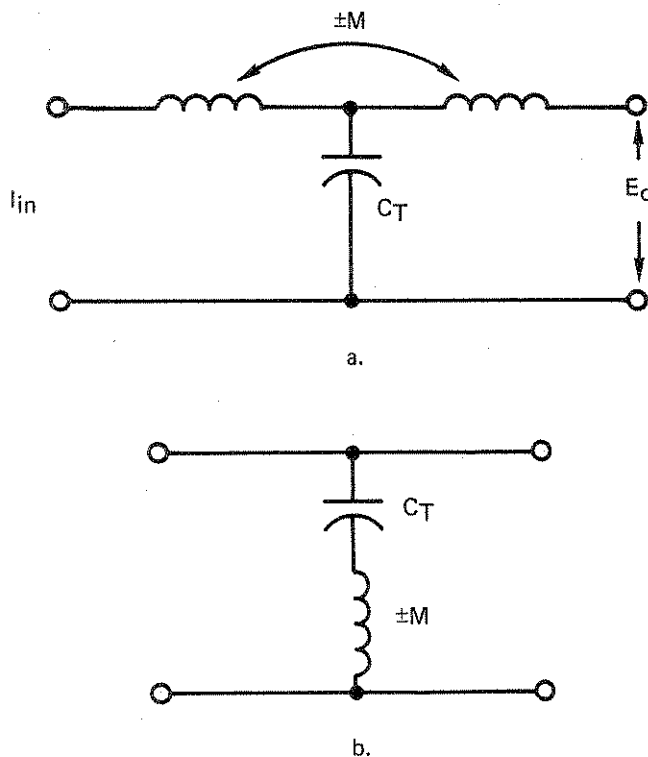

Figure 4-3. Equivalent circuits for mutual inductance errors.

4.4 TERMINAL IMPEDANCES.

Although a true 4-terminal measurement would be completely immune to impedance in series with any of the terminals, no instrument makes such an ideal measurement, so these impedances should be kept small to avoid measurement errors. The terminal impedances of the 1417 are shown in Figure 4-4.

The lower two branch, or terminal, impedances of Figure 4-4 are small, for they are simply the impedance of the

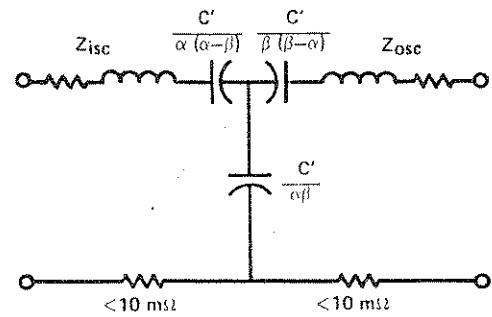

Figure 4-4. Actual equivalent circuit.

wired common connection of Figure 4-1. The upper two terminal impedances are much more critical. From the equivalent circuit of Figure 4-2, the (open-circuit) input impedance can be shown to be:

$$Z_{in} = Z_1 + \frac{Z_2 Z_3}{Z_2 + Z_3} + \left(\frac{Z_2}{Z_2 + Z_3} \right)^2 \frac{1}{\left(j\omega C + \frac{1}{Z_2 + Z_3} + \frac{1}{Z_5 + Z_6} \right)} \quad (4)$$

which can be written as:

$$Z_{in} = Z_{isc} + \frac{a^2}{j\omega C'} \quad (5)$$

where Z_{isc} is the input impedance with a short across the capacitor. Subtracting the transfer impedance, we get the upper input terminal impedance

$$Z_{in} - Z_T = Z_{isc} + \frac{a^2}{j\omega C'} - \frac{\alpha \beta}{j\omega C'} = Z_{isc} + \frac{\alpha(\alpha - \beta)}{j\omega C'} \quad (6)$$

(The other terminal impedance is easily found by symmetry.)

The first term is mostly resistive and a function of the winding resistance of the input divider. For a given core and winding area, this resistance is proportional to N^2 , where N is the number of turns. Because the open-circuit inductance is also proportional to N^2 , there is a tradeoff between keeping this resistance low and keeping the error of equation 2 small. The compromise reached was based on the characteristics of several instruments. These windings also have some leakage inductance, but the impedance of this inductance is small compared to the resistance, even at 1 kHz. These impedances are given in Table 4-2.

The second term in this terminal impedance is capacitive (+ or -) and is the result of inequality between the divider ratios α and β . These ratios can be exactly equal (nominally) when their product is 10^{-2} , 10^{-4} , or 10^{-6} , but, when it is 10^{-1} , 10^{-3} , or 10^{-5} , they can be equal only if they are irrational numbers. If these dividers are autotransformers and possible ratios are limited to ratios of integral numbers of turns, either these $\alpha\beta$ ratios must be slightly inaccurate or

α and β must differ. A resistive divider across one turn of one divider can, however, give greatly increased resolution. Such a divider is used on the 10- μ F setting because this capacitive terminal impedance must be small to avoid an error on a specific bridge. Table 4-1 shows the winding scheme used and the resulting capacitive term of equation 6. Capacitance is always much less than the winding resistance, even at 50 Hz.

Table 4-1
DIVIDER WINDING DATA

RATIO $1/\alpha\beta$	"CURRENT" TURNS α		"POTENTIAL" TURNS β		$\alpha\beta$ ERROR	$\frac{C^*}{\alpha(\alpha-\beta)}$
1	3000	1	4000	1	0	∞
10	949	.316333	1264 $\frac{1}{2}$ *	.316125	+9 ppm	15 mF
10 ²	300	0.1	400	0.1	0	∞
10 ³	96	.0320	125	.03125	0	42 mF
10 ⁴	30	.01	40	.01	0	∞
10 ⁵	10	.003333	12	.003	0	.9 F
10 ⁶	3	.001	4	.001	0	∞

*Resistive divider across one turn
 $\sqrt{10} = 3.16227766 \dots$

4.5 DISSIPATION FACTOR.

The dissipation factor of the 1417 is intentionally set to be .01 at 100 Hz, 120 Hz and 1 kHz (at the appropriate switch setting). This insures that, in spite of instrument errors, the D indication will be positive, allowing a valid D reading and proper operation. This is done by adding resistors in series with the standard capacitor, as shown in Figure 5-3.

The D value is affected by loss in the IVD's and changes with level slightly, but should remain within ± 0.001 . The D also includes loss in the standard capacitor and phase-shift errors in the IVD's but the effects are small.

Table 4-2
TYPICAL TERMINAL IMPEDANCES

Setting	Current			Potential		
	R	L	C*	R	L	C*
1 μ F	.019 Ω	.3 μ H	∞	.024 Ω	.54 μ H	∞
10 μ F	7.1 Ω	567 μ H	15 mF	15.2 Ω	736 μ H	-15 mF
100 μ F	3.06 Ω	123 μ H	∞	6.3 Ω	152	∞
1 mF	1.1 Ω	19.5 μ H	42 mF	2.15 Ω	20.2	-43 mF
10 mF	.36 Ω	3.5 μ H	∞	.70 Ω	4.3	∞
100 mF	.125 Ω	1.0 μ H	.9F	.205 Ω	1.2	-1 F
1 F	.035 Ω	.3 μ H	∞	.055 Ω	.4 μ H	∞

*Calculated from ratios of Table 4-1.

Service and Maintenance—Section 5

5.1 GR FIELD SERVICE.

Our warranty attests the quality of materials and workmanship in our products. When difficulties do occur, our service engineers will assist in any way possible. If the difficulty cannot be eliminated by use of the following service instructions, please write or phone the nearest GR service facility, giving full information of the trouble and of steps taken to remedy it. Describe the instrument by type, serial, and ID numbers (Refer to front and rear panels.)

5.2 INSTRUMENT RETURN.

Before returning an instrument to GenRad for service, please ask our nearest office for a "Returned Material" number. Use of this number in correspondence and on a tag tied to the instrument will ensure proper handling and identification. After the initial warranty period, please avoid unnecessary delay by indicating how payment will be made, i.e., send a purchase-order number or (for transportation charges) request "C.O.D."

For return shipment, please use packaging that is adequate to protect the instrument from damage, i.e., equivalent to the original packaging. Advice may be obtained from any GR office.

5.3 CALIBRATION PROCEDURE.

If the low-level value of the $1\ \mu\text{F}$ CAPACITANCE setting for any TEST FREQUENCY position is found to be outside limits at $23^\circ \pm 5^\circ\text{C}$, (see section 2) its padding capacitors may be added or removed to bring it in tolerance. However, before repadding, cyclically demagnetize the divider cores as described in para 5.5, to ensure that the error is not caused by residual magnetization.

The padding capacitors for the 1-kHz position are on the capacitance standard C. This adjustment affects all TEST FREQUENCY switch positions and should be adjusted first. The 100-Hz and 120-Hz positions have separate padding capacitors and these padding capacitors are located on the TEST FREQUENCY switch, see Figure 5-1.

If the $1\text{-}\mu\text{F}$ capacitance measurement indicates a short circuit, or if the waveform at the VOLTMETER terminals is non-sinusoidal (when a low-level sinusoidal signal is applied), the Zener diodes CR1 and CR2 may be shorted and should be replaced.

The other values of capacitance for the other CAPACITANCE settings are related to this $1\text{-}\mu\text{F}$ value by the process ratios of the inductive dividers T_1 and T_2 . Except for gross damage or burn out, these ratios should not change with time.

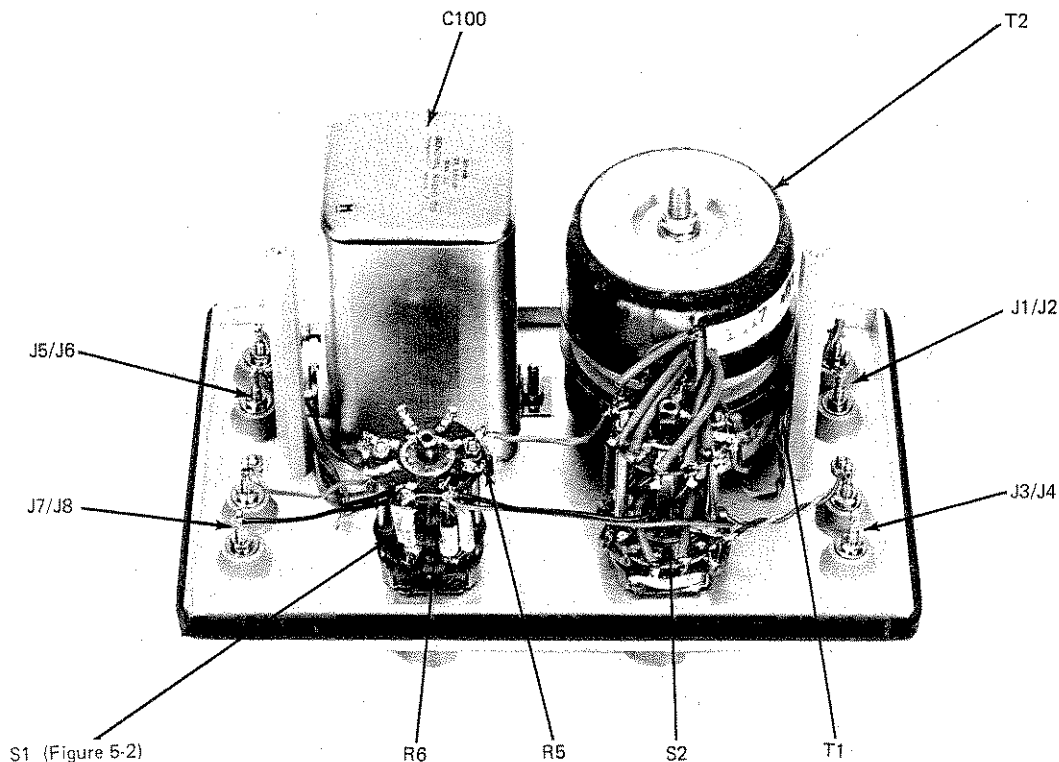

Figure 5-1. Internal view (transformer shields removed).

5.4 DETERMINATION OF OTHER PARAMETERS.

5.4.1 Divider Ratios.

The divider ratios for both T_1 and T_2 can be checked by comparing them with a precision inductive voltage divider, using standard ratio measuring techniques. The input voltage (<20 V) should be applied at the VOLTMETER terminals and the outputs checked at both the CURRENT terminals and POTENTIAL terminals. The TEST FREQUENCY switch should be set to the EXTERNAL STANDARD position.

The ratios should be those values given in Table 4-1 to within $\pm 0.005\%$, from 50 Hz to 2 kHz. A high-resolution divider is required to measure the 1000 to 1 ratio to this precision. One should note that the 1417 could have applications as a precision divider.

5.4.2 Terminal Impedances.

The resistive and inductive parts of the terminal impedances can be measured with a suitable bridge. The GR 1608 is recommended because it can measure R and Q ($L = RQ/\omega$). The measurements are made at the CURRENT terminals to measure Z_A (see specs) and at the POTENTIAL terminals to measure Z_B . The VOLTMETER terminals should be shorted. The parameters L and R vary only slightly with frequency.

The capacitive part of the terminal impedances is a function of the α and β ratios and can be determined by calculation. (See Section 4).

5.4.3 Divider Inductance.

The open-circuit inductance for the two dividers in parallel (L in equations of section 4) can be determined by measuring inductance across the VOLTMETER terminals with the TEST FREQUENCY switch in the EXTERNAL STANDARD position. A low-frequency signal should be used because the dividers are resonant at 1 kHz (appear capacitive). The inductance should be approximately 400 H at 100 Hz, at low-levels.

5.5 SERVICE.

5.5.1 Demagnetization of Divider Cores.

Residual magnetization in the divider cores, resulting from the application of dc or a large ac transient, can be removed by cyclic demagnetization. In this procedure, the cores are cycled around their internal loops with a large signal, which is then slowly reduced in level to zero, leaving the cores unmagnetized. The amplitude of the signal should be less than 27 V or 2W, to avoid damage to the 39 V, 1.5-W Zener diodes that shunt the cores. Therefore, to get a high flux level, a very low frequency signal should be used; 20 V at 20 Hz is adequate and at lower frequencies the level may be proportionally lower. A GR 1310 set for full output at 5 Hz, can provide a satisfactory signal.

Procedure:

- Set the 1417 TEST FREQUENCY switch to EXTERNAL STANDARD.
- With the oscillator at low level, connect it to the 1417 VOLTMETER terminals.
- Increase the oscillator level (not more than 25 V, see above).
- Slowly decrease the oscillator level to zero.

5.5.2 Knob Removal.

If it should be necessary to remove the knob on a front-panel control, either to replace one that has been damaged or to replace the associated control, proceed as follows:

- Grasp the knob firmly with the fingers and pull the knob straight away from the panel.
- Observe the position of the set screw in the bushing, with respect to any panel marking (or at the full ccw position of a continuous control).
- Release the set screw and pull the bushing off the shaft.
- Remove and retain the black Nylon thrust washer, behind the dial/knob assembly, as appropriate.

NOTE

To separate the bushing from the knob, if for any reason they should be combined off the instrument, drive a machine tap a turn or two into the bushing for a sufficient grip for easy separation.

5.5.3 Knob Installation.

To install a knob assembly on the control shaft:

- Place the black Nylon thrust washer over the control shaft, if appropriate.
- Mount the bushing on the shaft, using a small slotted piece of wrapping paper as a shim for adequate panel clearance.
- Orient the set screw on the bushing with respect to the panel-marking index and lock the set screw.

NOTE

Make sure that the end of the shaft does not protrude through the bushing or the knob won't set properly.

- Place the knob on the bushing with the retention spring opposite the set screw.
- Push the knob in until it bottoms and pull it slightly to check that the retention spring is seated in the groove in the bushing.

NOTE

If the retention spring in the knob comes loose, re-install it in the interior notch with the small slit in the outer wall.

MECHANICAL PARTS LIST

FIG	QNT	DESCRIPTION	GR PART NO	FMC NO	MFGR PART NO
1	1	BINDING POST,CURRENT L,J4	0938-3000	24655	0938-3000
2	1	BINDING POST,CURRENT H,J3	0938-3000	24655	0938-3000
3	1	BINDING POST	0938-3022	24655	0938-3022
4	1	BINDING POST,POTENTIAL L,J2	0938-3000	24655	0938-3000
5	1	BINDING POST,POTENTIAL H,J1	0938-3000	24655	0938-3000
6	1	GASKET	5331-3100	24655	5331-3100
7	1	CABINET ASM	1417-1100	24655	1417-1100
8	4	FEET	5260-2060	24655	5260-2060
9	1	BINDING POST,VOLTMETER H,J5	0938-3000	24655	0938-3000
10	1	BINDING POST,VOLTMETER L,J6	0938-3000	24655	0938-3000
11	1	BINDING PCST	0938-3022	24655	0938-3022
12	1	BINDING POST,EXTERNAL STANDARD H,J7	0938-3000	24655	0938-3000
13	1	BINDING POST,EXTERNAL STANDARD L,J8	0938-3000	24655	0938-3000
14	1	KNOB ASM, TEST FREQUENCY, S1	5500-5421	24655	5500-5421
		INCLUDES			
	1	RETAINER	5220-5401	24655	5220-5401
15	1	KNOB ASM, CAPACITANCE, S2	5500-5421	24655	5500-5421
		INCLUDES			
	1	RETAINER	5220-5401	24655	5220-5401

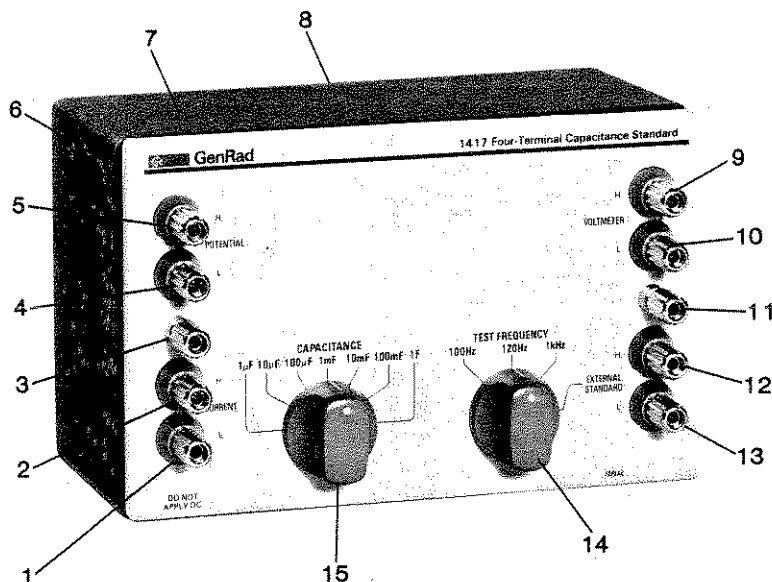

REFERENCE DESIGNATOR ABBREVIATIONS

B = Motor	P = Plug
BT = Battery	Q = Transistor
C = Capacitor	R = Resistor
CR = Diode	S = Switch
DS = Lamp	T = Transformer
F = Fuse	U = Integrated Circuit
J = Jack	VR = Diode, Zener
K = Relay	X = Socket for Plug-In
KL = Relay Coil	Y = Crystal
KS = Relay Switch	Z = Network
L = Inductor	
M = Meter	
MK = Microphone	

References
ASA Y32.16 and MIL-STD-16C

ELECTRICAL PARTS LIST
CHASSIS MOUNTED PARTS

REFDES	DESCRIPTION	PART NO.	FMC	MFGR	PART NUMBER
C 100	CAPACITOR ASM 1UF .01PCT 160V	0236-4000	24655	0236-4000	
C 102	CAP MYLAR .001UF 10 PCT 200V	4860-7309	56289	410P .001 UF 10PCT	
C 103	CAP CER TUB 600PF 10PCT 500V NM	4400-4900	00656	BC-CI-1-NM 600PF	
C 200	CAP MYLAR .0047 UF 5PCT 100V S	4860-7398	24655	4860-7398	
C 201	CAP MYLAR .001UF 10 PCT 200V	4860-7309	56289	410P .001 UF 10PCT	
C 202	CAP MYLAR .001UF 10 PCT 200V	4860-7309	56289	410P .001 UF 10PCT	
C 203	CAP CER TUB 600PF 10PCT 500V NM	4400-4900	00656	BC-CI-1-NM 600PF	
C 300	CAP MYLAR .0036 UF 5PCT 200V S	4860-7374	56289	410P .0036 UF 5PCT	
C 301	CAP MYLAR .001UF 10 PCT 200V	4860-7309	56289	410P .001 UF 10PCT	
C 302	CAP MYLAR .001UF 10 PCT 200V	4860-7309	56289	410P .001 UF 10PCT	
C 303	CAP CER TUB 600PF 10PCT 500V NM	4400-4900	00656	BC-CI-1-NM 600PF	
CR 1	ZENER LMZ-39A 39V 5PCT 1.5W	6083-1059	24444	LMZ-39A 1.5R398	
CR 2	ZENER LMZ-39A 39V 5PCT 1.5W	6083-1059	24444	LMZ-39A 1.5R398	
J 1	BINDING POST ASM	0938-3000	24655	0938-3000	
J 2	BINDING POST ASM	0938-3000	24655	0938-3000	
J 3	BINDING POST ASM	0938-3000	24655	0938-3000	
J 4	BINDING POST ASM	0938-3000	24655	0938-3000	
J 5	BINDING POST ASM	0938-3000	24655	0938-3000	
J 6	BINDING POST ASM	0938-3000	24655	0938-3000	
J 7	BINDING POST ASM	0938-3000	24655	0938-3000	
J 8	BINDING POST ASM	0938-3000	24655	0938-3000	
R 1	RES FLM 200HM 1/10PCT 50PPM 1/8W	6190-0004	75042	CEA 200 OHM 0.1PCT	
R 2	RES FLM 12.7 OHM 1 PCT 1/8W	6250-9127	81349	RN55D12R7F	
R 3	RES FLM 2 OHM 1PCT 300PPM 1/2W	6619-2805	24655	6619-2805	
R 4	RES COMP 6.8 OHM 5PCT 1/4W	6099-9685	81349	RCR07G6R8J	
R 5	RES FLM 2 OHM 1PCT 300PPM 1/2W	6619-2805	24655	6619-2805	
R 6	RES FLM 2 OHM 1PCT 300PPM 1/2W	6619-2805	24655	6619-2805	
R 7	RES COMP 62 OHM 5PCT 1/4W D	6099-0625	81349	RCR07G620J	
S 1	SWITCH ROTARY ASM	7890-5608	24655	7890-5608	
S 2	SWITCH ROTARY ASM	7890-5607	24655	7890-5607	
T 1	TRANSFORMER, CURRENT DIVIDER	1417-4000	24655	1417-4000	
T 2	TRANSFORMER, POTENTIAL DIVIDER	1417-4010	24655	1417-4010	

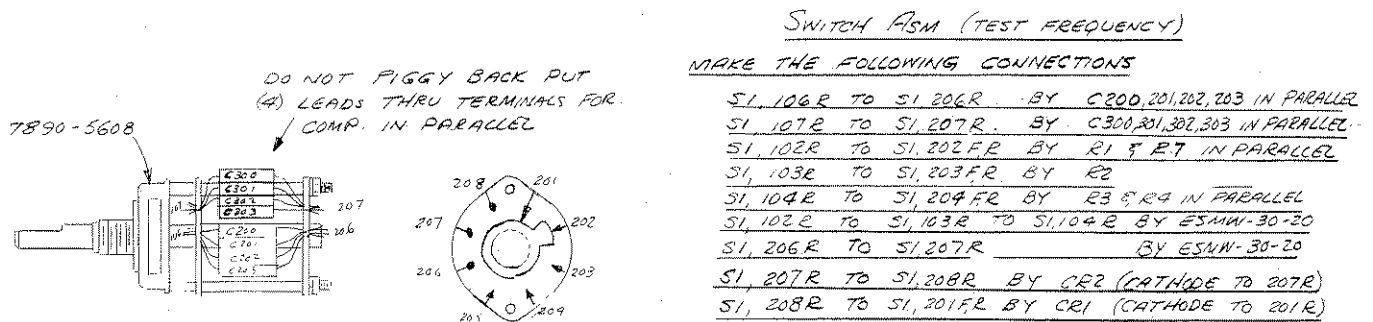

Figure 5-2. TEST FREQUENCY Switch (S2) details showing padding capacitors.



GenRad

Component Test Division
Route 117
Bolton, Massachusetts 01740

Corporate Headquarters
300 Baker Ave.
Concord, MA 01742

Sales & Service Offices

USA

Boston (Sales)	TEL: (617) 890-4900	TWX: 710-324-0893
(Service)	TEL: (617) 369-4400	TWX: 710-347-1051
Chicago	TEL: (312) 577-1881	TWX: 910-291-1209
Cincinnati	TEL: (513) 831-9210	TWX: 810-460-8323
Colorado Springs	TEL: (303) 593-8238	
Dallas	TEL: (214) 234-3357	TWX: 910-867-4771
Los Angeles	TEL: (714) 540-9830	TWX: 910-595-1762
New York (NY)	TEL: (212) 964-2722	TWX: 710-988-2205
(NJ)	TEL: (201) 797-8001	
Orlando	TEL: (305) 894-4303	TWX: 810-850-0270
San Francisco	TEL: (408) 727-0127	TWX: 910-338-0291
Washington, D.C.	TEL: (301) 964-1314	TWX: 710-828-9783
Toronto	TEL: (416) 252-3395	TLX: 06-967624
Ottawa	TEL: (613) 729-4610	
Maidenhead	TEL: (0628) 39181	TLX: 851-848321
Paris	TEL: (01) 7970739	TLX: 842-220991
Rennes	TEL: (099) 535154	

Canada

United Kingdom France

Germany

Furtwangen
Munich
Nuremberg
Wiesbaden
Milan
Rome

TEL: (07723) 1515	TLX: 792-908
TEL: (089) 41690	TLX: 841-529917
TEL: (0911) 508041	
TEL: (6121) 370057	TLX: 841-04186489
TEL: (02) 8466541	TLX: 843-320373
TEL: (06) 455839	
TEL: (4998) 74240	TLX: 844-59535
TEL: (01) 552420	TLX: 845-53638
TEL: 343-4411	TLX: 232-2240 Label J

Italy

Netherlands Best
Switzerland Zurich
Japan Tokyo

Asia, Pacific, and Latin America, contact:
International Department
Waltham, MA 02254 USA
TEL: (617) 890-4900
TWX: 710-324-0893
CABLE: GENRAD Waltham MA

The information presented herein is subject to change and intended for general information only.

Printed in USA