



Shaft Hedge Clipper

Operator's Manual

MODEL

HCA-260

WARNING  **DANGER**



The muffler or catalytic muffler and surrounding cover may become extremely hot.

 Always keep clear of exhaust and muffler area, otherwise serious personal injury may occur.



WARNING



The engine exhaust from this product contains chemicals known to the State of California to cause cancer, birth defects or other reproductive harm.



WARNING  **DANGER**

Read rules for safe operation and instructions carefully. ECHO provides an Operator's Manual and a Safety Manual. Both must be read and understood for proper and safe operation. Failure to do so could result in serious injury.

INTRODUCTION

Welcome to the ECHO family. This ECHO product was designed and manufactured to provide long life and on-the-job dependability. Read and understand this manual and the SAFETY MANUAL you found in the same package. You will find both easy to use and full of helpful operating tips and SAFETY messages.

THE OPERATOR'S MANUAL

Read and understand this manual before operation. Keep it in a safe place for future reference. It contains specifications and information for operation, starting, stopping, maintenance, storage and assembly specific to this product.

THE SAFETY MANUAL

Read and understand this manual before operation. Keep it in a safe place for future reference. It explains possible hazards involved with the use of Hedge Clippers and what measures you should take to make their use safer.

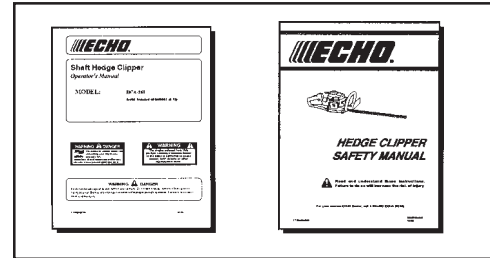

TABLE OF CONTENTS

Introduction	2	Maintenance	17
- The Operator's Manual	2	- SkillLevel	17
- The Safety manual	2	- Maintenance Intervals	17
Safety	3	- Air Filter	18
- Manual Safety Symbols and Important Information ..	3	- Fuel Filter	18
- International Symbols	3	- Spark Plug	19
- Personal Conditions and Safety Equipment	4	- Cooling System	19
- Equipment	6	- Exhaust System	20
Emissions Control	6	- Carburetor Adjustment	21
Description	7	- Lubrication	22
Contents	9	- Sharpening Blades	24
Assembly	10	- Blade Adjustment	24
- Drive Shaft Assembly / Power Head	10	Troubleshooting	25
- Front (Loop) Handle Installation	11	Storage	26
- Throttle Linkage and Ignition Leads	11	Specifications	27
Operation	12	Servicing Information	28
- Fuel	12	- Parts/Serial Number	28
- Adjusting Cutting Angle	13	- Service	28
- Rotate Cutter Assembly	14	- ECHO Consumer Product Support	28
- Starting Cold Engine	14	- Warranty Card	28
- Starting Warm Engine	15	- Additional or Replacement Manuals	28
- Stopping Engine	16		
- Hedge Trimming	16		

Specifications, descriptions and illustrative material in this literature are as accurate as known at the time of publication, but are subject to change without notice. Illustrations may include optional equipment and accessories, and may not include all standard equipment.

SAFETY

MANUAL SAFETY SYMBOLS AND IMPORTANT INFORMATION

Throughout this manual and on the product itself, you will find safety alerts and helpful, informational messages preceded by symbols or key words. The following is an explanation of those symbols and key words and what they mean to you.



THIS SYMBOL ACCOMPANIED BY THE WORDS WARNING AND DANGER CALLS ATTENTION TO AN ACT OR CONDITION THAT CAN LEAD TO SERIOUS PERSONAL INJURY TO OPERATOR AND BYSTANDERS.



THE CIRCLE WITH THE SLASH SYMBOL MEANS WHATEVER IS SHOWN WITHIN THE CIRCLE IS PROHIBITED.













IMPORTANT **NOTE**

IMPORTANT
The enclosed message provides information necessary for the protection of the unit.

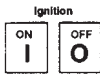
NOTE
This enclosed message provides tips for use, care and maintenance of the unit.

INTERNATIONAL SYMBOLS

Symbol form/shape	Symbol description/application	Symbol form/shape	Symbol description/application
	Read and understand Operator's Manual.		Fuel and oil mixture
	Wear eyes, ears and head protection		Finger Severing
	Hot Surface		Wear hand protection. Use two handed.
	Safety/Alert		DO NOT smoke near fuel.
	Avoid all power lines. This unit is not insulated against electrical current.		DONOT allow flames or sparks near fuel.
	Do not operate closer than 15 M (50 ft.) from electrical hazards.		Keep bystanders at least 15 meters (50 feet) away.

Symbol form/shape	Symbol description/application	Symbol form/shape	Symbol description/application
	Emergency stop		Plan retreat path from falling objects.
	Primer bulb		Wear slip resistant foot wear.
	Carburetor adjustment - High speed mixture		Ignition ON/OFF
	Carburetor adjustment - Low speed mixture		Carburetor adjustment - Idle speed
	Choke Control "Cold Start" Position (Choke Closed)		Choke Control "Run" Position (Choke Open)

PERSONAL CONDITION AND SAFETY EQUIPMENT

WARNING  **DANGER**

Hedge Clipper users risk injury to themselves and others if the hedge clipper is used improperly and or safety precautions are not followed. Proper clothing and safety gear must be worn when operating a hedge clipper.

Physical Condition

Your judgment and physical dexterity may not be good:

- if you are tired or sick,
- if you are taking medication,
- if you have taken alcohol or drugs.

Operate unit only if you are physically and mentally well.

Eye Protection

Eye protection that meets ANSI Z87.1 or CE requirements must be worn whenever you operate the unit.

Hand Protection

Wear no-slip, heavy duty work gloves to improve your grip on the handles. Gloves also reduce the transmission of machine vibration to your hands.

Hearing Protection

Wear hearing protection. ECHO recommends wearing hearing protection whenever unit is used.

Proper Clothing

Wear snug fitting, durable clothing;

- Pants should have long legs, shirts with long sleeves.
- DONOT WEAR SHORTS,
- DONOT WEAR TIES, SCARFS, JEWELRY.

Wear protective hair covering to contain long hair.

Wear sturdy work shoes with nonskid soles;

- DONOT WEAR OPENTOED SHOES,
- DONOT OPERATE UNIT BAREFOOTED.

Wear no-slip, heavy duty work gloves.

Hot Humid Weather

Heavy protective clothing can increase operator fatigue which may lead to heat stroke. Schedule heavy work for early morning or late afternoon hours when temperatures are cooler.

Vibration and Cold

It is believed that a condition called Raynaud's Phenomenon, which affects the fingers of certain individuals, may be brought about by exposure to vibration and cold. Exposure to vibration and cold may cause tingling and burning sensations, followed by loss of color and numbness in the fingers. The following precautions are strongly recommended, because the minimum exposure which might trigger the ailment is unknown.

- Keep your body warm, especially the head, neck, feet, ankles, hands, and wrists.
- Maintain good blood circulation by performing vigorous arm exercises during frequent work breaks, and also by not smoking.
- Limit the hours of operation. Try to fill each day with jobs where operating the unit or other hand-held power equipment is not required.
- If you experience discomfort, redness, and swelling of the fingers followed by whitening and loss of feeling, consult your physician before further exposing yourself to cold and vibration.



Repetitive Stress Injuries

It is believed that overusing the muscles and tendons of the fingers, hands, arms, and shoulders may cause soreness, swelling, numbness, weakness, and extreme pain in those areas. Certain repetitive hand activities may put you at a high risk for developing a Repetitive Stress Injury (RSI). An extreme RSI condition is Carpal Tunnel Syndrome (CTS), which could occur when your wrist swells and squeezes a vital nerve that runs through the area. Some believe that prolonged exposure to vibration may contribute to CTS. CTS can cause severe pain for months or even years.

To reduce the risk of RSI/CTS, do the following:

- Avoid using your wrist in a bent, extended, or twisted position. Instead try to maintain a straight wrist position. Also, when grasping, use your whole hand, not just the thumb and index finger.
- Take periodic breaks to minimize repetition and rest your hands.
- Reduce the speed and force with which you do the repetitive movement.
- Do exercises to strengthen the hand and arm muscles.
- Immediately stop using all power equipment and consult a doctor if you feel tingling, numbness, or pain in the fingers, hands, wrists, or arms. The sooner RSI/CTS is diagnosed, the more likely permanent nerve and muscle damage can be prevented.

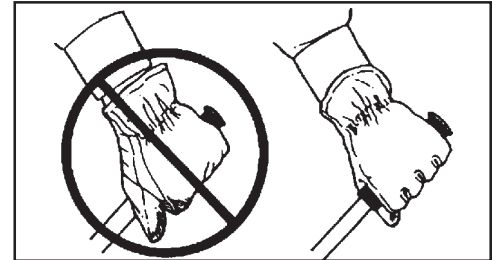

WARNING DANGER

Do not operate this product indoors or in inadequately ventilated areas. Engine exhaust contains poisonous emissions and can cause serious injury or death.

Read the Manuals

- Provide all users of this equipment with the Operator's Manual and Safety Manual for instructions on Safe Operation.

Clear the Work Area

- Spectators and fellow workers must be warned, and children and animals prevented from coming nearer than 15 m (50 ft.) while the unit is in use.

Keep a Firm Grip

- Hold the front and rear handles with both hands, with thumbs and fingers tightly encircling the handles.

Keep a Solid Stance

- Maintain footing and balance at all times. Do not stand on slippery, uneven or unstable surfaces. Do not work in odd positions or on ladders. Do not over reach.

Cutting Angle Adjustments

- Only adjust cutting blade angle with unit flat on the ground, with the engine stop switch in the "STOP" position. Never adjust cutting angle with unit standing upright.

Avoid Contact With Gear Box Assembly During Use

- Gear box assembly becomes hot during use. Avoid contact with gear box assembly when using unit or making cutting angle adjustments.

Avoid Hot Surfaces

- Keep exhaust area clear of flammable debris. Avoid contact during and immediately after operation.

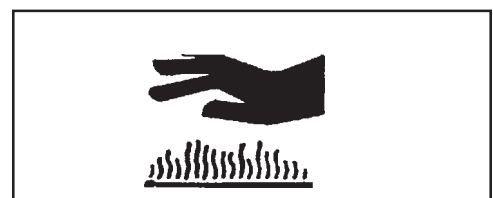
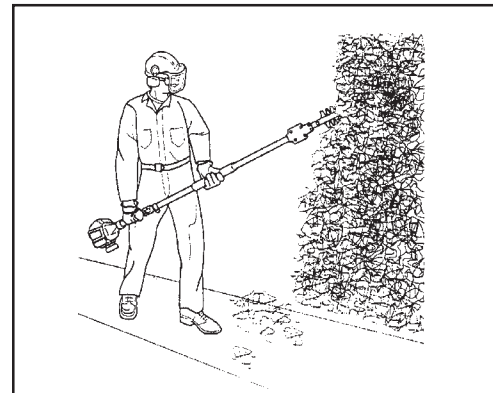

EQUIPMENT

WARNING DANGER

Use only ECHO approved attachments. Serious injury may result from the use of a non-approved attachment combination. ECHO, INC. will not be responsible for the failure of cutting devices, attachments, or accessories which have not been tested and approved by ECHO. Read and comply with all safety instructions listed in this manual and safety manual.

- Check unit for loose/missing nuts, bolts, and screws. Tighten and/or replace as needed.
- Inspect fuel lines, tank and area around carburetor for fuel leaks. DO NOT operate unit if leaks are found.
- Never adjust blades when the engine is operating.
- Inspect hand guard for damage. Replace if damaged or missing.
- Check that the blade assembly is firmly attached and in safe operating condition. Dull, loose or damaged blades should not be used.

EMISSION CONTROL

EPA Phase 2 / C.A.R.B. TIER III

The emission control system for the engine is EM/TWC (Engine Modification and 3-way Catalyst) and for the fuel tank the Control System is EVAP (Evaporative Emissions). Evaporative emission may be applicable to California models only.

IMPORTANT ENGINE INFORMATION

ENGINE FAMILY: 7EHXS.0254KA DISPLACEMENT: 25.4 cc
EMISSION COMPLIANCE PERIOD : 300 HRS.
THIS ENGINE MEETS U.S. EPA PHASE 2 EMISSION REGULATIONS FOR SMALL NONROAD ENGINES. REFER TO OWNER'S MANUAL FOR MAINTENANCE SPECIFICATIONS AND ADJUSTMENTS.



IMPORTANT ENGINE INFORMATION

ENGINE FAMILY: 7EHXS.0254KA DISPLACEMENT: 25.4 cc
EMISSION COMPLIANCE PERIOD : 300 HRS.
THIS ENGINE MEETS U.S. EPA PH2 EXH AND 2007 AND LATER CALIFORNIA EXH AND EVAP EMISSION REGULATIONS FOR S.O.R.E. REFER TO OWNER'S MANUAL FOR MAINTENANCE SPECIFICATIONS AND ADJUSTMENTS.



Emission Control Label (located on Engine) (EXAMPLE ONLY, information on label varies by FAMILY).

PRODUCT EMISSION DURABILITY

The 300 hour emission durability compliance period is the time span selected by the manufacturer certifying the engine emissions output meets applicable emissions regulations, provided that approved maintenance procedures are followed as listed in the Maintenance Section of this manual.

DESCRIPTION

Locate these safety decals on your unit. Make sure the decals are legible and that you understand and follow the instructions on them. If a decal cannot be read, a new one can be ordered from your ECHO dealer. See PARTS ORDERING instructions for specific information.

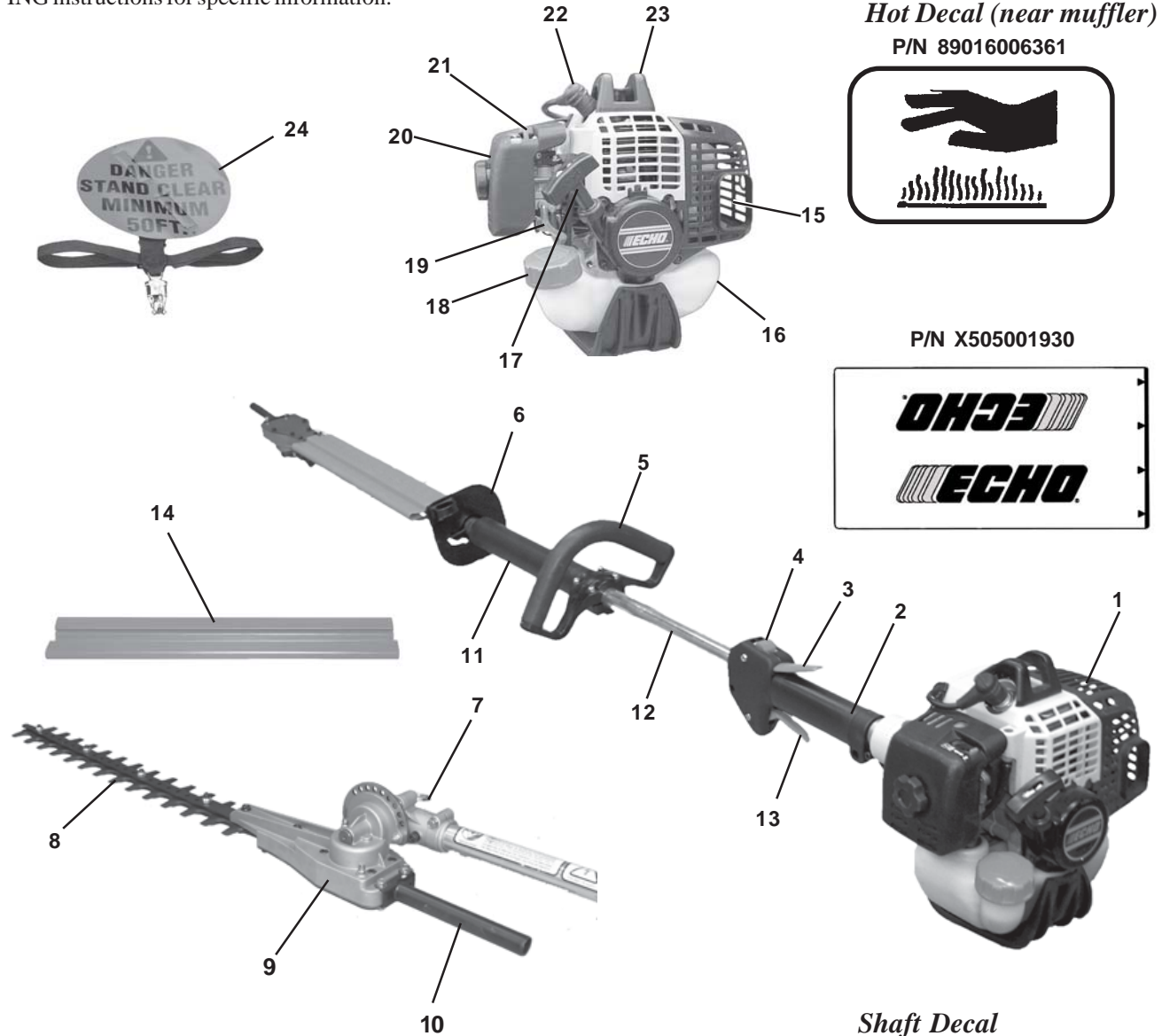

Hot Decal (near muffler)

P/N 89016006361

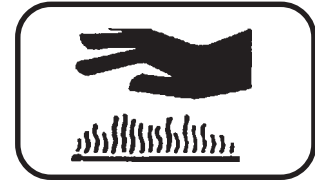

P/N X505001930



P/N 89017854331



P/N 89016012360



Shaft Decal

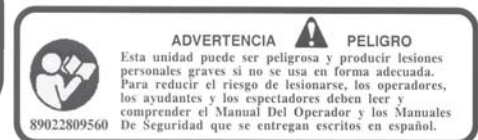

Spanish Decal

P/N 89022809560

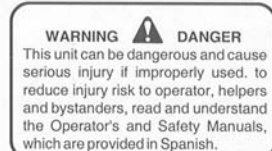

English Translation



1. **POWER HEAD** - Factory Assembled. Includes the Engine, Clutch, Fuel System, Ignition System and Recoil Starter.
2. **GRIP, RIGHT HAND, REAR** - Cushioned grip for Right Hand.
3. **THROTTLE TRIGGER LOCKOUT** - This lever must be held during starting. Operation of the throttle trigger is prevented unless throttle trigger lockout lever is engaged.
4. **STOP SWITCH** - Controls engine ignition. Move switch forward to start and run engine, back to "STOP" position to stop engine.
5. **FRONT LEFT HAND LOOP HANDLE** - Adjustable, rubber grip loop handle for proper cutting attitude and operator comfort.
6. **HAND GUARD / BLADE LOCK** - Locks blade in place for travel / storage. Always assure blade cover is installed when locking blade.
7. **BLADE INDEXING RING** - Pull ring out and turn 1/4 turn to lockout position when adjusting blade angle.
8. **BLADES** - Double reciprocating blades mounted to a blade support bar. Double-sided blades are capable of cutting on either side of the blade.
9. **GEAR HOUSING ASSEMBLY** - Gear housing contains drive gears for transmitting power to cutting blades. Pivoting design permits blades to articulate 180 degrees in 15-degree increments.
10. **BLADE ADJUSTMENT HANDLE** - Provides secure hand grip for adjusting cutting blade angle.
11. **FRONT DRIVE SHAFT GRIP** - Cushioned hand grip for gripping drive shaft assembly.
12. **DRIVE SHAFT ASSEMBLY** - Includes the flex drive shaft, rear handle assembly, harness ring, cushioned front shaft grip, and safety decals.
13. **THROTTLE TRIGGER** - Controls engine speed. Spring loaded to return to idle when released. During acceleration, depress gradually for best operating technique.
14. **BLADE COVER** - Used to cover blade during transport and storage. Remove blade cover before using unit.
15. **SPARK ARRESTOR - CATALYTIC MUFFLER / MUFFLER** - The muffler or catalytic muffler controls exhaust noise and emission. The spark arrestor screen prevents hot, glowing particles of carbon from leaving the muffler. Keep exhaust area clear of flammable debris.
16. **FUEL TANK** - Contains fuel and fuel filter.
17. **RECOIL STARTER HANDLE** - Pull handle slowly until starter engages, then quickly and firmly. **DO NOT** pull rope all the way out or allow the handle to snap back, damage to the starter will occur.
18. **FUEL TANK CAP** - Covers and seals fuel tank opening.
19. **PURGE BULB** - Pumping purge bulb before starting engine draws fresh fuel from the fuel tank, purging air from the carburetor. Pump purge bulb until fuel is visible and flows freely in the clear fuel tank return line. Pump purge bulb an additional 4 or 5 times.
20. **AIR CLEANER** - Contains replaceable filter element.
21. **CHOKE CONTROL** - Located on the top of the air cleaner housing. Move the lever to "COLD START" () to close the choke for Cold Starting. Move lever to "RUN" () position after engine fires.
22. **SPARK PLUG** - Provides spark to ignite fuel mixture.
23. **TOP GUARD** - Protects arm from the hot engine.
24. **SHOULDER HARNESS** - An adjustable strap that suspends the unit from the operator.

CONTENTS

Due to packaging restrictions, some assembly is required.

After opening the carton, check for damage. Immediately notify your retailer or ECHO Dealer of damaged or missing parts. Use the contents list to check for missing parts.

- ___ 1 - Power Head
- ___ 1 - Drive Shaft /Gear Case Assembly
- ___ 1 - Operators Manual
- ___ 1 - Hedge Clipper Safety Manual
- ___ 1 - Warranty Statement
- ___ 1 - Warranty Registration Card
- ___ 1 - Front Handle
- ___ 1 - Front Handle Bracket
- ___ 4 - 5 mm x 35 mm screws
- ___ 4 - 5 mm hex nuts
- ___ 1 - Safety Glasses
- ___ 1 - Shoulder Harness
- ___ 1 - Blade Cover
- ___ 1 - Echo Power Blend™ 2-stroke oil sample
- ___ 1 - T-Wrench
- ___ 1 - 4 mm Hex Wrench
- ___ 1 - 8 mm/10 mm Wrench

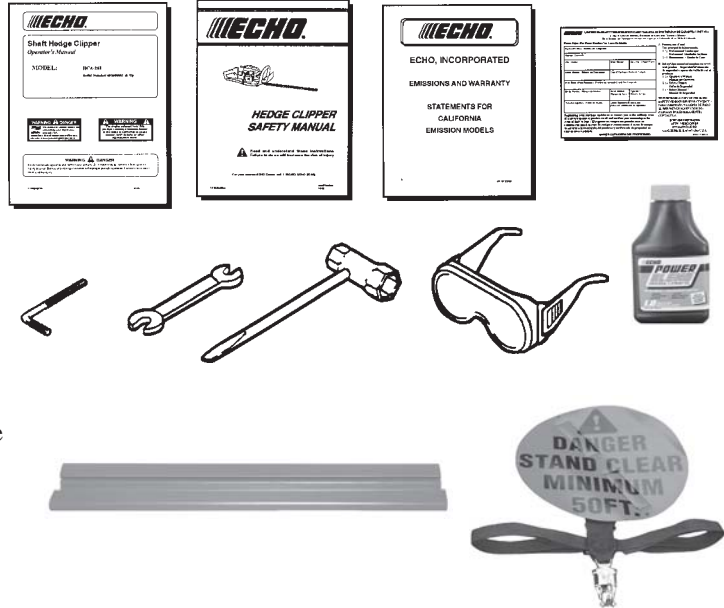

ASSEMBLY

Tools Required: 4 mm hex wrench, 8mm x 10mm Open End Wrench, Screwdriver

Parts Required: Power Head, Drive Shaft/Gear Case Assembly, Front (Loop) Handle Assembly: Loop Handle, Handle Mounting Bracket
5 x 35 mm screws (4), 5 mm hex nuts (4)

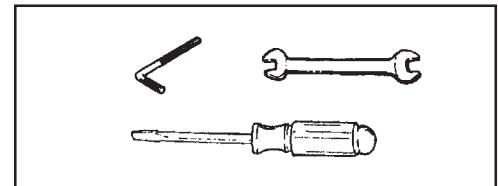

DRIVE SHAFT/GEAR CASE ASSEMBLY/POWER HEAD

1. Loosen bolt (A) at engine drive shaft clamp.
2. Remove vinyl cap from drive shaft.
3. Carefully fit drive shaft assembly to engine, making sure that inner drive shaft engages clutch mount.

NOTE

Lower gear housing cutter head assembly must be in line with the engine.

4. Turn drive shaft assembly so that center line of housing is midway between the two arrows on drive shaft.
5. Tighten bolt (A).

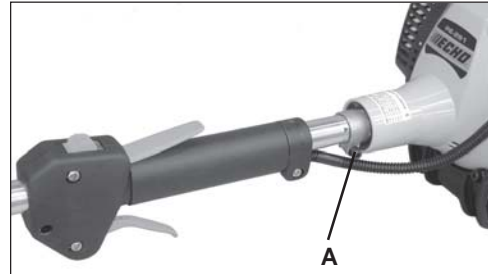

THROTTLE LINKAGE AND IGNITION LEADS

1. Close choke and remove air filter cover.
2. Place inner cable wire end into large carburetor throttle swivel hole (A).
3. Loosen nut (B) and place threaded end of throttle linkage in bracket slot. Finger tighten nut (B).
4. Check throttle for freedom of movement and that wide open throttle / low idle extremes are adjusted properly (see Carburetor Adjustment page 21). If proper adjustment cannot be achieved with adjusting nut (B), consult with your Echo Dealer for correct adjustment procedure.
5. Tighten nut (B). Connect 2 ignition leads (C, D) from throttle cable tubing to 2 ignition leads (C, D) on engine.
6. Bundle and secure ignition leads against engine housing with clip (E).
7. Install air filter and cover.

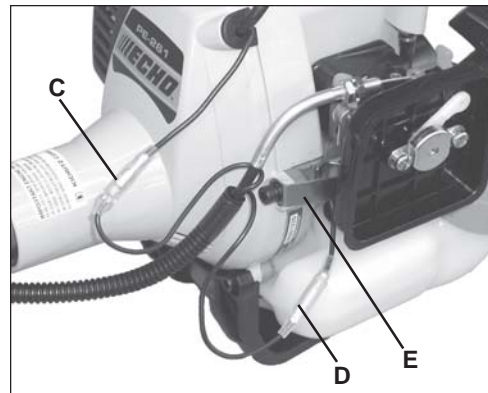
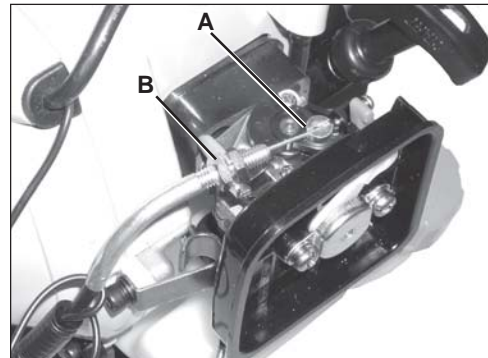

FRONT (LOOP) HANDLE INSTALLATION

NOTE

Label shows minimum spacing for front handle location.

1. Install front handle on drive shaft. DO NOT tighten screws yet.
2. Loosen harness clamp screw.
3. Put on harness and attach unit to harness.
4. Slide harness clamp up or down for comfortable operation
5. Tighten harness clamp screw.
6. Position front handle for comfortable operation, and tighten screws.

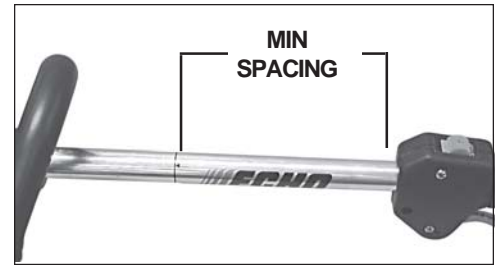

OPERATION

NOTICE: Use of unmixed, improperly mixed, or fuel older than 90 days, (stale fuel), may cause hard starting, poor performance, or severe engine damage and void the product warranty. Read and follow instructions in the Storage section of this manual.

FUEL

WARNING

Alternative fuels, such as E-20 (20% ethanol), E-85 (85% ethanol) or any fuels not meeting ECHO requirements are **NOT** approved for use in ECHO 2-stroke gasoline engines. Use of alternative fuels may cause performance problems, loss of power, overheating, fuel vapor lock, and unintended machine operation, including, but not limited to, improper clutch engagement. Alternative fuels may also cause premature deterioration of fuel lines, gaskets, carburetors and other engine components.

Fuel Requirements

Gasoline - Use 89 Octane [R+M/2] (mid grade or higher) gasoline known to be good quality. Gasoline may contain up to 10% Ethanol (grain alcohol) or 15% MTBE (methyl tertiary-butyl ether). Gasoline containing methanol (wood alcohol) is **NOT** approved.

Two Stroke Oil - A two-stroke engine oil meeting ISO-L-EGD (ISO/CD 13738) and J.A.S.O. FC Standards must be used. Echo brand premium Power Blend™ Universal 2-Stroke Oil meets these standards. Engine problems due to inadequate lubrication caused by failure to use an ISO-L-EGD and J.A.S.O. FC certified oil, such as Echo premium Power Blend™, will void the two-stroke engine warranty. (Emission related parts only are covered for two years, regardless of two-stroke oil used, per the statement listed in the Emission Defect Warranty Explanation.)

IMPORTANT

Echo premium Power Blend™ Universal 2-Stroke Oil may be mixed at 50:1 ratio for application in all Echo engines sold in the past regardless of ratio specified in those manuals.

Handling Fuel

WARNING DANGER

Fuel is VERY flammable. Use extreme care when mixing, storing or handling or serious personal injury may result.

- Use an approved fuel container.
- DO NOT smoke near fuel.
- DO NOT allow flames or sparks near fuel.
- Fuel tanks/cans may be under pressure. Always loosen fuel caps slowly allowing pressure to equalize.
- NEVER refuel a unit when the engine is HOT or RUNNING!
- DO NOT fill fuel tanks indoors. ALWAYS fill fuel tanks outdoors over bare ground.
- DO NOT overfill fuel tank. Wipe up spills immediately.
- Securely tighten fuel tank cap and close fuel container after refueling.
- Inspect for fuel leakage. If fuel leakage is found, do not start or operate unit until leakage is repaired.
- Move at least 3m (10 ft.) from refueling location before starting the engine.

Mixing Instructions

1. Fill an approved fuel container with half of the required amount of gasoline.
2. Add the proper amount of 2-stroke oil to gasoline.
3. Close container and shake to mix oil with gasoline.
4. Add remaining gasoline, close fuel container, and remix.

IMPORTANT

Spilled fuel is a leading cause of hydrocarbon emissions. Some states may require the use of automatic fuel shut-off containers to reduce fuel spillage.

After use

- DO NOT store a unit with fuel in its tank.
Leaks can occur. Return unused fuel to an approved fuel storage container.

Storage - Fuel storage laws vary by locality. Contact your local government for the laws affecting your area. As a precaution, store fuel in an approved, airtight container. Store in a well-ventilated, unoccupied building, away from sparks and flames.

IMPORTANT

Stored fuel ages. Do not mix more fuel than you expect to use in thirty (30) days, ninety (90) days when a fuel stabilizer is added.

IMPORTANT

Stored two-stroke fuel may separate. ALWAYS shake fuel container thoroughly before each use.

Fuel to Oil Mix - 50:1 Ratio

U.S.		METRIC	
GAS	OIL	GAS	OIL
Gallons	Fl. oz.	Liter	cc.
1	2.6	4	80
2	5.2	8	160
5	13	20	400

ADJUSTING CUTTING ANGLE

WARNING  **DANGER**

Never adjust cutting assembly with engine running.

WARNING  **DANGER**

Hedge clipper blades are sharp. Always wear gloves when adjusting cutting assembly.

WARNING  **DANGER**

DO NOT stand hedge clipper on end when adjusting cutting angle, otherwise serious injury may result

1. Place unit on a flat clear area. Assure stop switch is in the "STOP" position.
2. Pull out indexing ring (A), and turn ¼ turn to lockout position.
3. Turn hedge clipper ¼ turn so that indexing ring faces downward.
4. Release hand-guard blade lock (B) with right hand, while holding blade-adjustment handle (C) with left hand.
5. Rotate blades to desired cutting position.
6. Turn indexing ring ¼ turn to lock blade in place.

WARNING  **DANGER**

Gear case assembly becomes HOT during use. Always grip assembly at blade-adjustment handle when making cutting angle adjustments, otherwise serious injury may result.

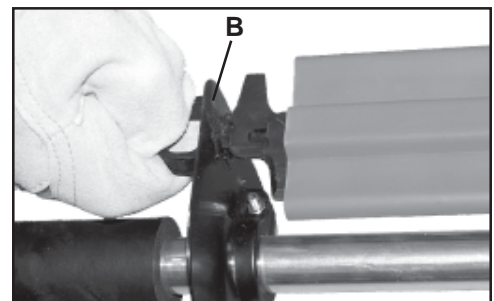
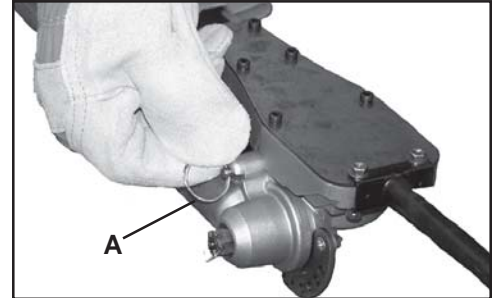

ROTATE CUTTER ASSEMBLY

Always use the unit from the right-hand side of your body – NEVER from the left side. Rotate cutter assembly 180 degrees on driveshaft in order to avoid cutting directly above your head, and to avoid contact with hot muffler.

1. Loosen gearcase clamping screw (A), hand guard clamping screw (B), and remove gearcase locating screw (C).
2. Rotate cutter assembly 180-degrees on driveshaft until locating hole in driveshaft is visible through locating hole in gearcase.
3. Install gearcase locating screw (C), and securely tighten all hardware.

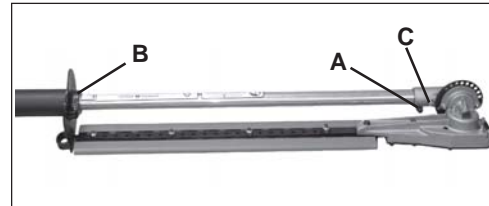

WARNING DANGER

Hedge Clipper blades are very sharp. Wear gloves to protect hands when rotating cutter assembly or serious personal injury may result.

WARNING DANGER

During operation, the complete unit, especially the drive shaft housing and gearcase may become too hot to touch. Avoid contact when rotating cutter assembly.

STARTING COLD ENGINE

NOTE

The blade cover is used for transportation and storage. Remove blade cover before using the unit.

WARNING DANGER

The attachment will operate immediately when the engine starts and could result in loss of control and possible serious injury. Keep movable parts of the attachment off the ground and away from objects that could become entangled or thrown.

1. *Stop Switch*
Move stop switch button (A) forward away from the STOP position.
2. *Close Choke*
Move choke lever (B) to Cold Start ( Position.

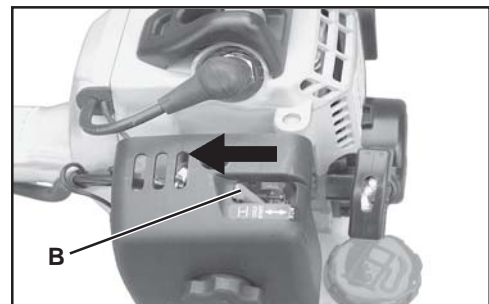
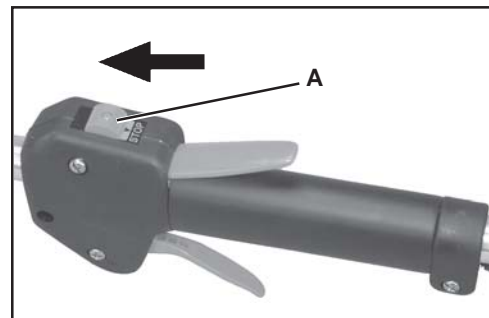

3. *Purge Bulb*
Pump purge bulb (C) until fuel is visible and flows freely in the clear fuel tank return line. Pump bulb an additional 4 or 5 times.
4. *Recoil Starter*
Lay the unit on a flat area and keep movable attachment parts clear of all obstacles. Firmly grasp right hand grip and throttle trigger lockout with left hand and fully depress throttle trigger to wide open position. Rapidly pull recoil starter handle/rope (D) until engine fires (or maximum five [5] pulls).
5. *Choke*
After engine fires (or five [5] pulls), move choke lever back to "Run" (⏏) position. Hold throttle trigger and throttle trigger lockout fully depressed and pull recoil starter handle/rope until engine starts and runs. Release throttle trigger and allow unit to warm up at idle for several minutes.

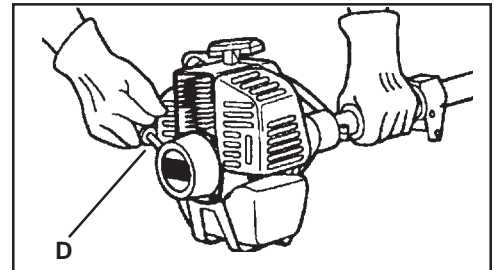
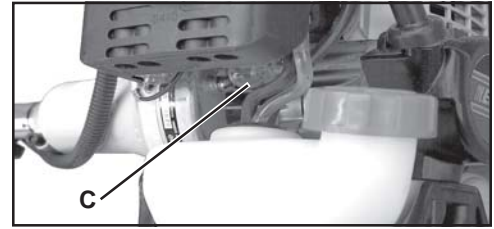

NOTE

If engine does not start with choke in Run position after 5 pulls, repeat instructions 2 - 5.

6. *Throttle Trigger*
After engine warm up, gradually depress throttle trigger to increase engine RPM to operating speed.

STARTING WARM ENGINE

The starting procedure is the same as Cold Start except DO NOT close the choke, and do not depress throttle trigger to wide open position.

WARNING  **DANGER**

The attachment should not move at idle, otherwise serious personal injury may result.

NOTE

If attachment moves, readjust carburetor according to "Carburetor Adjustment" instructions in this manual or see your ECHO Dealer.

1. *Stop Switch*
Move stop switch button (A) away from the STOP position.
2. *Purge Bulb*
Pump purge bulb (C) until fuel is visible and flows freely in the "Clear" fuel return line. Pump bulb an addition 4 or 5 times.
3. *Recoil Starter*
Lay the unit on a flat area and keep movable attachment parts clear of all obstacles. Rapidly pull recoil starter handle/rope until engine fires.

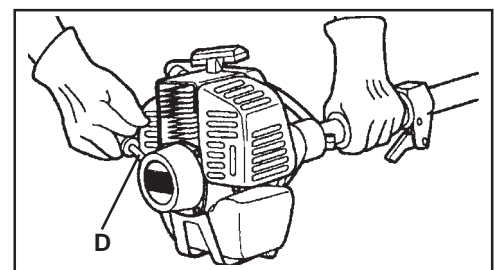
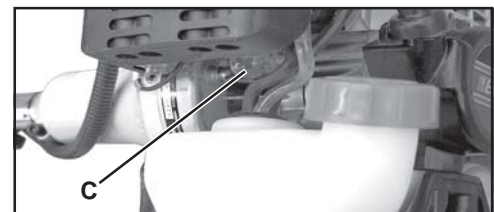
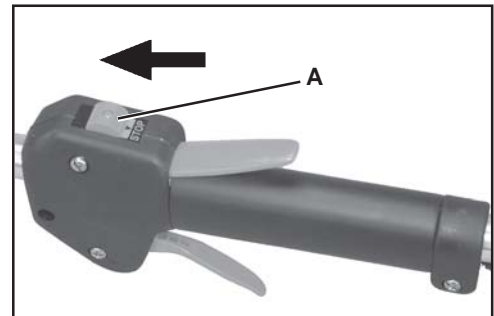

NOTE

If engine does not start after 5 pulls, use Cold Start Procedure.

STOPPING ENGINE

1. *Throttle*
Release throttle and allow engine to return to idle before shutting off engine.
2. *Stop Switch*
Move stop switch button (A) to STOP position.

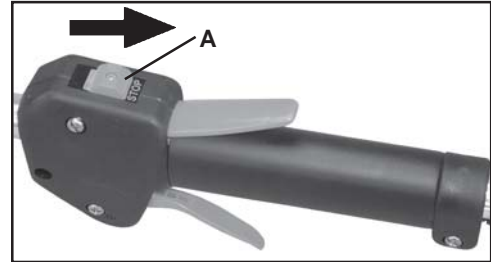

WARNING DANGER

If engine does not stop when stop switch is moved to STOP position, close choke - COLD START position - to stall engine. Have your ECHO dealer repair stop switch before using shaft hedge clipper again.

IMPORTANT

Always install blade cover, and return cutting assembly to folded/locked position for travel/storage.

HEDGE TRIMMING

1. Hold trimmer firmly and squeeze throttle trigger to accelerate engine.
2. Tilt trimmer so cutting teeth are angled slightly toward the hedge or shrub and proceed to cut.

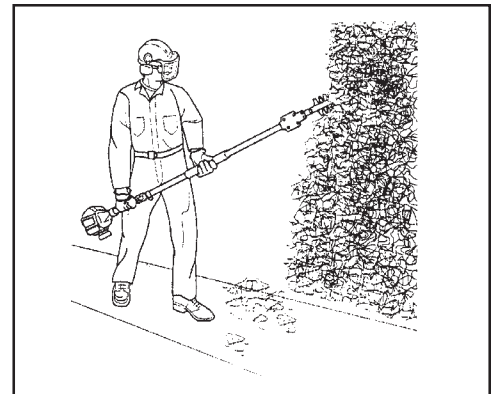

WARNING DANGER

Never remove hands from unit when blades are moving.

WARNING DANGER

The engine continues running even when the blades have stopped due to an obstruction. If this occurs, stop the engine, disconnect ignition cable and remove the obstruction.

MAINTENANCE

Your ECHO product is designed to provide many hours of trouble free service. Regular scheduled maintenance will help achieve that goal. If you are unsure or are not equipped with the necessary tools, you may want to take your unit to an ECHO Service Dealer for maintenance. To help you decide whether you want to DO-IT-YOURSELF or have the ECHO Dealer do it, each maintenance task has been graded. If the task is not listed, see your ECHO Dealer for repairs.

SKILL LEVEL

- Level 1**= Easy to do. Most required tools come with unit.
- Level 2**= Moderate difficulty. Some specialized tools may be required.
- Level 3**= Experience required. Specialized tools are required. ECHO recommends that the unit be returned to your ECHO dealer for service

ECHO offers **REPOWER™** Maintenance Kits and Parts to make your maintenance job easier. Just below each task heading are listed the various part numbers required for that task. See your ECHO dealer for these parts.

MAINTENANCE INTERVALS

COMPONENT/ SYSTEM	MAINTENANCE PROCEDURE	REQ'D SKILL LEVEL	DAILY OR BEFORE USE	EVERY REFUEL	3 MONTHS OR 90 HOURS	6 MONTHS OR 270 HOURS	YEARLY 600 HOURS
Recommended Echo Dealer Maintenance Procedures							
Cylinder Exhaust Port	Inspect/Clean/Decarbon	3			I / C		
Sharpen Blades	Inspect/Clean	3	I (3)				
Do-it-Yourself Maintenance Procedures							
Air Filter	Inspect/Clean/Replace	1	I / C		R*		
Choke	Inspect/Clean	2	I / C				
Fuel Filter	Inspect/Replace	1			I		R *
Fuel System, leaks	Inspect/Replace	1	I (4) *	I (4)			
Cooling System	Inspect/Clean	2	I / C				
Muffler Spark Arrestor	Inspect/Replace	2			I *		
Drive Shaft (Flex Cable Models)	Grease	2			I (1)		
Gear Housing	Grease	2	I (2)				
Blades	Inspect/Clean	1	I / C (3)				
Recoil Starter Rope	Inspect/Clean	1	I / C *				
Spark Plug	Inspect/Clean	2			I / C	R *	
Screws/Nuts/Bolts	Inspect/Tighten/Replace	1	I / R *				

MAINTENANCE PROCEDURE LETTER CODES: I = INSPECT, R = REPLACE, C = CLEAN

IMPORTANT NOTE - Time intervals shown are maximum. Actual use and your experience will determine the frequency of required maintenance.

MAINTENANCE PROCEDURE NOTES:

- (1) Apply ECHO® LUBE™ every 25 hours.
- (2) Apply ECHO® LUBE™ every 15 - 25 hours
- (3) Inspect blade and clean and sharpen as needed. Lubricate blades periodically during use.
- (4) Low evaporative fuel tanks DO NOT require regular maintenance to maintain emission integrity.
- * All recommendations to replace are based on the finding of damage or wear during inspection..

AIR FILTER

Level 1.

Tools required: 25 or 50 mm (1 or 2 in.) cleaning brush

Parts required: 90030REPOWER™ Air & Fuel Filter Kit

1. Close choke (Cold Start Position []). This prevents dirt from entering the carburetor throat when the air filter is removed. Brush accumulated dirt from air cleaner area.
2. Remove air filter cover. Brush dirt from inside cover.
3. Remove air filter and lightly brush debris from filter. Replace filter if it is damaged, fuel soaked, very dirty, or the rubber sealing edges are deformed.
4. If filter can be reused, be certain it:
 - Fits tightly in the air filter cavity.
 - Is installed with the original side out.
5. Install air filter cover.

NOTE

Carburetor adjustment may be needed after air filter cleaning or replacement. See Carburetor Adjustment Section.

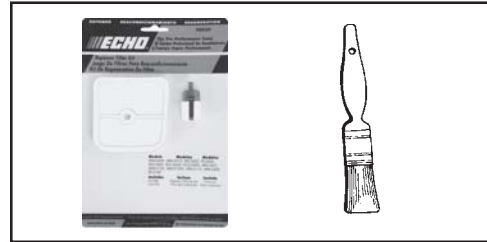

FUEL FILTER

Level 1.

Tools required: 200-250 mm (8 - 10 in.) length of wire with one end bent into a hook, clean rag, funnel, and an approved fuel container

Parts required: 90030REPOWER™ Air & Fuel Filter Kit

WARNING DANGER

Fuel is **VERY** flammable. Use extreme care when mixing, storing or handling.

1. Use a clean rag to remove loose dirt from around fuel cap and empty fuel tank.
2. Use the “fuel line hook” to pull the fuel line and filter from the tank.
3. Remove the filter from the line and install the new filter.



SPARK PLUG

Level 2.

Tools Required: T-Wrench, feeler gauge, soft metal brush

Parts Required: REPOWER™ Tune-Up Kit P/N 90075

IMPORTANT

Use only NGK BPM-8Y spark plug (BPMR-8Y in Canada) otherwise severe engine damage may occur.

1. Remove spark plug and check for fouling, worn and rounded center electrode.
2. Clean the plug or replace with a new one. DO NOT sand blast to clean. Remaining sand will damage engine.
3. Adjust spark plug gap by bending outer electrode.
4. Tighten spark plug to 150-170 kg/cm (130-150 in. lb.).

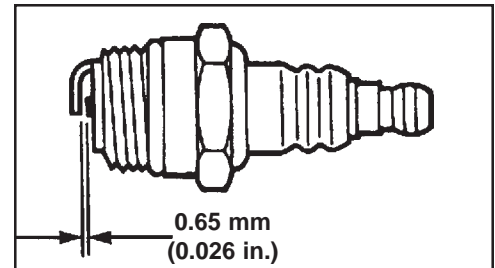
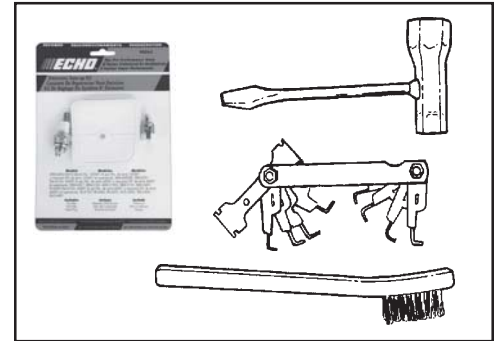

COOLING SYSTEM

Level 2.

Tools required: Cross head screwdriver, 4 mm hex wrench, cleaning brush 25 or 50 mm (1 or 2 in.)

Parts Required: None if you are careful.

IMPORTANT

To maintain proper engine operating temperatures, cooling air must pass freely through the cylinder fin area. This flow of air carries combustion heat away from the engine.

Overheating and engine seizure can occur when:

- Air intakes are blocked, preventing cooling air from reaching the cylinder.
- Dust and grass build up on the outside of the cylinder. This build up insulates the engine and prevents the heat from leaving.

Removal of cooling passage blockages or cleaning of cooling fins is considered "Normal Maintenance". Any failure attributed to lack of maintenance is not warranted.

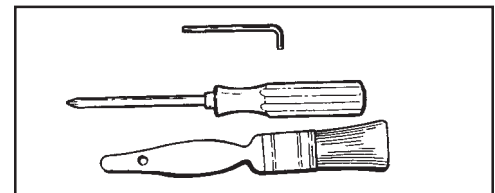

1. Remove spark plug lead.
2. Remove two (2) muffler cover screws and muffler cover (A).
3. Remove screw and top guard (B).
4. Remove cylinder cover (C).

IMPORTANT

DO NOT use a metal scraper to remove dirt from the cylinder fins.

5. Use brush to remove dirt from the cylinder fins.
6. Remove grass and leaves from the grid between the recoil starter and fuel tank.
7. Assemble components in reverse order.

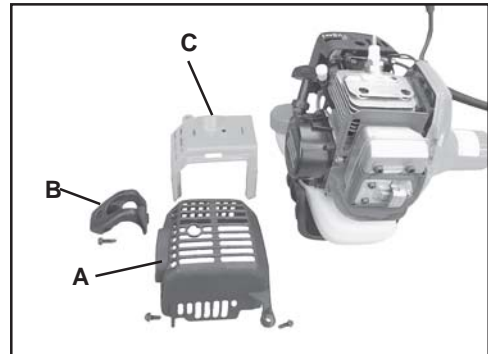

EXHAUST SYSTEM

Spark Arrestor Screen

Level 2.

Tools Required: Cross head screwdriver, 4mm hex wrench, soft metal brush

Parts Required: Spark Arrestor Screen, Gasket

1. Remove two (2) muffler cover screws and muffler cover (A).
2. Place piston at Top Dead Center (TDC) to prevent carbon/dirt from entering cylinder.
3. Remove spark arrestor screen cover (B), gasket (C), and screen (D) from muffler body.
4. Clean carbon deposits from muffler components.

NOTE

When cleaning carbon deposits, be careful not to damage the catalytic element inside muffler.

5. Replace screen if it is cracked, plugged or has holes burned through.
6. Assemble components in reverse order.

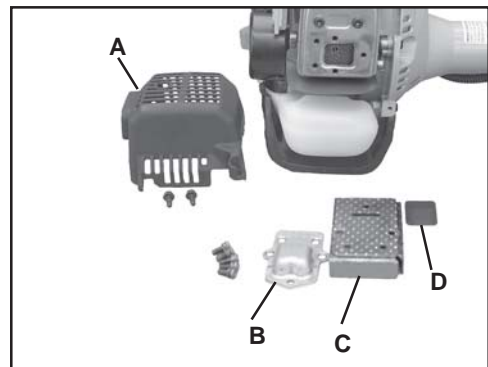
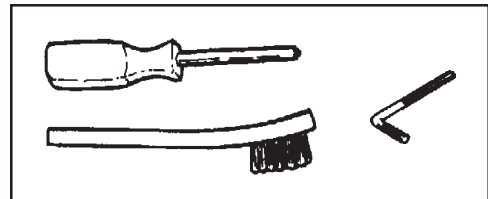

Cylinder Exhaust Port

Level 3.

IMPORTANT

The cylinder exhaust port must be inspected and cleaned of excess carbon every 3 months or 90 hours of operation in order to maintain this engine within the emissions durability period. ECHO strongly recommends that you return your unit to your ECHO dealer for this important maintenance service.

CARBURETOR ADJUSTMENT

Engine Break-In

New engines must be operated a minimum duration of two tanks of fuel break-in before carburetor adjustments can be made. During the break-in period your engine performance will increase and exhaust emissions will stabilize. Idle speed can be adjusted as required.

High Altitude Adjustment

High altitude adjustment is not required for proper operation of this engine.

Level 2.

Tools required: Screwdriver, tachometer (ECHOP/N99051130017).

Parts required: None.

NOTE

Every unit is run at the factory and the carburetor is set in compliance with emission regulations. This carburetor does not have acceleration and high speed adjustment needles.

1. Check idle speed and reset if necessary. If a tachometer is available, idle speed screw (A) should be set to the specifications found on page 27 "Specifications" of this manual. Turn idle screw (A) clockwise to increase idle speed; counter clockwise to decrease idle speed.

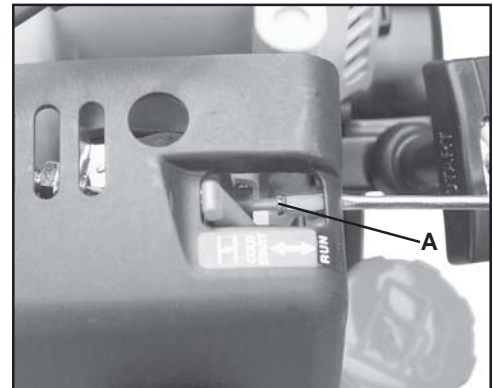
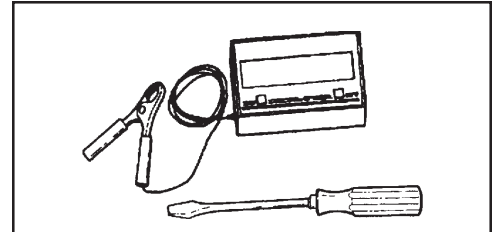

WARNING  **DANGER**

When carburetor adjustment is completed, the blades should not move at idle, otherwise serious personal injury may result.

LUBRICATION

Blades

Level 1.

Tools Required: Clean rag, brush, oil can

Parts Required: 20W Engine Oil (lubrication), 50-50 mixture of kerosene and 20W oil (cleaning)

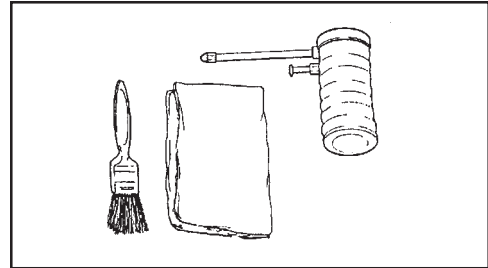

WARNING DANGER

Always disconnect spark plug wire before servicing cutting attachment. Blades are very sharp. Wear gloves to protect hands, otherwise serious personal injury may result.

1. Brush loose debris from blade and coat both sides of blade with the 50-50 cleaning mixture.
2. Allow cleaning mixture to soften the remaining gummy residue then wipe it from the blade.
3. Apply clean oil to the entire length of the blade. Be certain the blade bolts are lubricated.
4. Wipe excess oil from the blade before putting the unit back in service.

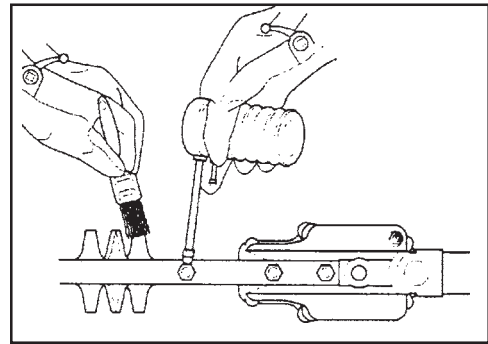

Gear Housing Assembly

Level 2

Tools required: Grease gun, rag

Parts required: ECHO® LUBE™ 14 oz. cartridge P/N91015 or Lithium Based Grease

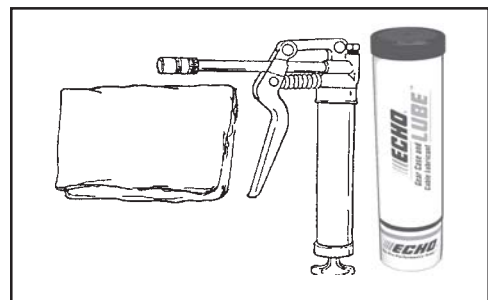

1. Clean dirt from grease fittings (A).
2. Carefully pump grease in each fitting (A). **DO NOT** force grease. Too much pressure will force grease past seals and cause damage. Apply 1-2 pumps of grease every 15-25 hours of operation.

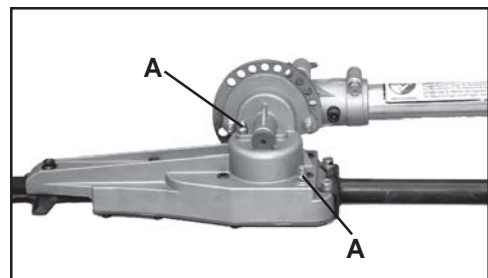

Drive Shaft Assembly

Level 1

NOTE

Hedge Clipper drive shaft should be greased every 25 hours of operation.

Tools required: 4 mm hex wrench, 8mm open end wrench, clean rag, small brush.

Parts required: ECHO[®] LUBE™ 14 oz. cartridge P/N91015 or Lithium-based Grease.

WARNING DANGER

Blades are very sharp. Wear gloves to protect hands, otherwise serious personal injury may result.

1. Carefully remove locating screw (A) and loosen clamping screw (B). Remove the flex drive shaft assembly from the gear housing.
2. Pull the drive shaft (C) from the drive shaft assembly, and wipe clean. Re-coat with a thin coating [1/2 oz. (15 ml)] of grease.
3. Slide the flex shaft back into the drive shaft assembly, being careful not to get dirt on the flex shaft.
4. Align the locating screw hole in gear case with the locating hole in drive shaft assembly, install and tighten locating screw (A), and tighten clamping screw (B).

IMPORTANT

Flat edge of washer (D) must be against drive shaft.

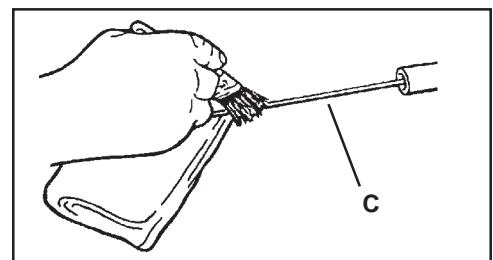
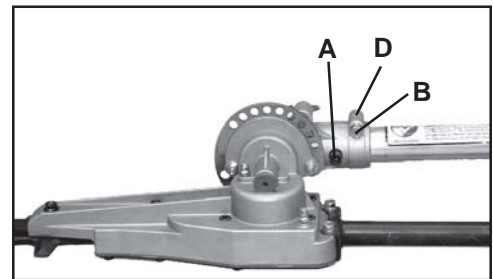
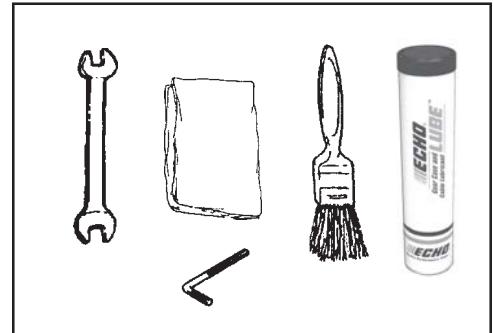

SHARPENING BLADES

Level 3.

Tools required: Flat file, screwdriver

Parts required: None

WARNING DANGER

Hedge Clipper Blades are very sharp. Wear gloves to protect hands.

1. Disconnect spark plug wire from spark plug.
2. Slide blades to allow file clearance using slots (A) on bottom of blades. Do not pry against cutting edges.
3. Follow the original shape, and file each cutting edge carefully to avoid damage to adjacent teeth. Maintain 6 mm (.25 in.) radius at base of each tooth.

IMPORTANT

If a power grinder is used, **DO NOT** allow blade to over heat.

4. Lubricate blades. See "Lubrication" on page 22.
5. Connect spark plug wire.

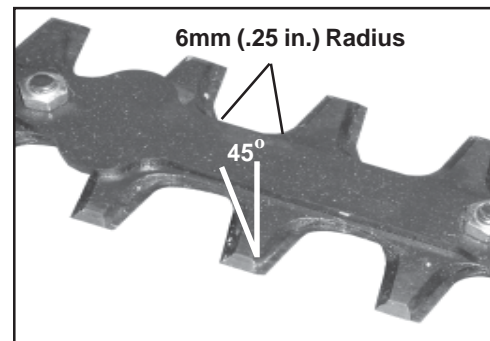
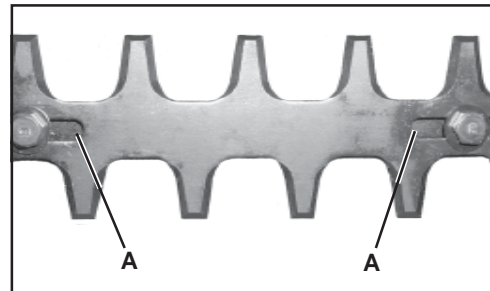
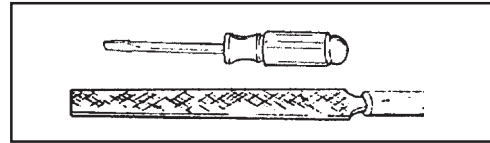

BLADE ADJUSTMENT

Level 2.

Tools required: (2) 10 mm wrenches

Parts required: None

IMPORTANT

Blades should only be removed and reinstalled by an Authorized ECHO Servicing Dealer, otherwise premature wear or internal damage may occur.

1. Tighten blade bolts until snug, then loosen blade bolts 1/2 turn.
2. Hold blade bolts from turning using 10 mm wrench, and tighten blade lock nuts with other 10 mm wrench.

NOTE

Locking ability of Hedge Clipper blade lock nuts will diminish each time they are removed. Replace if turning resistance is not felt when installing locknuts.

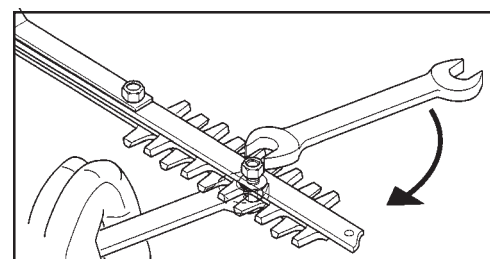
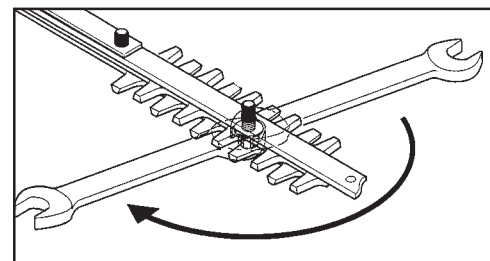
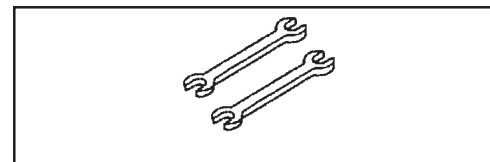

TROUBLESHOOTING

ENGINE PROBLEM TROUBLESHOOTING CHART				
Problem	Check	Status	Cause	Remedy
Engine cranks - starts hard/ doesn't start	Fuel at carburetor	No fuel at carburetor	Fuel strainer clogged Fuel line clogged Carburetor	Clean or replace Clean or replace See your Echo dealer
	Fuel at cylinder	No fuel at cylinder	Carburetor	See your Echo dealer
		Muffler wet with fuel	Fuel Mixture too rich	Open choke Clean/replace air filter Adjust carburetor See your Echo dealer
	Spark at end of plug wire	No spark	Stop switch off Electrical problem Interlock switch	Turn switch to ON See your Echo dealer See your Echo dealer
	Spark at plug	No spark	Spark gap incorrect Covered with carbon Fouled with fuel Plug defective	Adjust to .65mm (0.026 in.) Clean or replace Clean or replace Replace plug
Engine runs, but dies or does not accelerate properly	Air filter	Air filter dirty	Normal wear	Clean or replace
	Fuel filter	Fuel filter dirty	Contaminants/residues in fuel	Replace
	Fuel vent	Fuel vent plugged	Contaminants/residues in fuel	Clean or replace
	Spark Plug	Plug dirty/worn	Normal wear	Clean and adjust or replace
	Carburetor	Improper adjustment	Vibration	Adjust
	Cooling System	Cooling system dirty/plugged	Extended operation in dirty/dusty locations	Clean
	Spark Arrestor Screen	Spark arrestor screen plugged	Normal wear	Replace
Engine does not crank	N/A	N/A	Internal engine problem	See your Echo dealer

WARNING  **DANGER**

Fuel vapors are **extremely** flammable and may cause fire and/or explosion. **Never** test for ignition spark by grounding spark plug near cylinder plug hole, otherwise serious personal injury may result.

STORAGE

WARNING DANGER

During operation the muffler or catalytic muffler and surrounding cover become hot. Always keep exhaust area clear of flammable debris during transportation or when storing, otherwise serious property damage or personal injury may result.

IMPORTANT

Always store and transport shaft hedge clippers in a stable, horizontal position. Always install blade cover, and return cutting assembly to folded/locked position for travel/storage.

Long Term Storage (over 30 days)

Do not store your unit for a prolonged period of time (30 days or longer) without performing protective storage maintenance which includes the following:

1. Store unit in a dry, dust free place, out of the reach of children.

WARNING DANGER

Do not store in enclosure where fuel fumes may accumulate or reach an open flame or spark or serious personal injury may result.

2. Place the stop switch in the "OFF" position.
3. Remove accumulation of grease, oil, dirt and debris from exterior of unit.
4. Perform all periodic lubrication and services that are required.
5. Apply a light coating of clean 20W engine oil along entire length of blades and on blade bolts.
6. Install blade cover.
7. Tighten all the screws and nuts.
8. **Drain** the fuel tank **completely** and pull the recoil starter handle several times to remove fuel from the carburetor.
9. Remove the spark plug and pour 7 cc (1/4 oz.) of fresh, clean, two-stroke engine oil into the cylinder through the spark plug hole.
 - A. Place a clean cloth over the spark plug hole.
 - B. Pull the recoil starter handle 2-3 times to distribute the oil inside the engine.
 - C. Observe the piston location through the spark plug hole. Pull the recoil handle slowly until the piston reaches the top of its travel and leave it there.
10. Install the spark plug (do not connect ignition cable).

SPECIFICATIONS

MODEL	HCA-260
Length	2235 mm (88.0 in.)
Width	250 mm (9.84 in.)
Height	250 mm (9.84 in.)
Weight (dry) *	6.35 kg (14.0 lb.)
Engine Type	Air cooled, two-stroke, single cylinder gasoline engine
Bore	34.0 mm (1.34 in.)
Stroke	28.0 mm (1.10 in.)
Displacement	25.4 cc (1.55 cu. in.)
Exhaust System	Spark Arrestor Muffler w/Catalyst
Carburetor	Walbro Model w/purge
Ignition System	Flywheel Magneto, CDI (capacitor discharge ignition)
Spark Plug	BPM-8Y (Gap 0.65 mm (0.026 in.))
Fuel	Mixed (Gasoline and Two-stroke Oil)
Fuel/Oil Ratio	50:1 two-stroke air cooled engine oil
Gasoline	89 Octane unleaded. DO NOT use fuel containing methyl alcohol, more than 10% ethyl alcohol or 15% MTBE.
Oil	Power Blend™ Premium Universal 2-Stroke Oil
Fuel Tank Capacity	0.58 lit. (19.6 US fl. oz.)
Starter System	Automatic Rewind Starter
Clutch	Centrifugal Type
Gear Case Ratio	4.072:1
Cutter	Double Reciprocating Blade - Double Edge
Effective Length	464 mm (18.5 in.)
Pitch	35 mm (1.38 in.)
Maximum Diameter Cut	
Soft Material	25.4 mm (1 in.)
Woody Material	13 mm (1/2 in.)
Cutting Angle Adjustment	-30 ~ 180 Degrees in 15 degree increments
Idle Speed	2,750 - 3,250 RPM
Clutch Engagement Speed	3,700 - 4,300 RPM
Wide Open Throttle Speed	10,000 - 11,000 RPM

SERVICING INFORMATION

PARTS/SERIAL NUMBER

Genuine ECHO Parts and ECHO REPOWER™ Parts and Assemblies for your ECHO products are available only from an Authorized ECHO Dealer. When you do need to buy parts **always** have the Model Number and Serial Number of the unit with you. You can find these numbers on the engine housing. For future reference, write them in the space provided below.

Model Number _____ Serial Number _____

SERVICE

An Authorized ECHO Service Dealer must perform Service of this product during the warranty period. For the name and address of the Authorized ECHO Service Dealer nearest you, ask your retailer or call: 1-800-432-ECHO (3246). Dealer information is also available on our Web Site. When presenting your unit for Warranty service/repairs, proof of purchase is required.

ECHO CONSUMER PRODUCT SUPPORT

If you require assistance or have questions concerning the application, operation or maintenance of this product you may call the ECHO Consumer Product Support Department at 1-800-673-1558 from 8:30 am to 4:30 pm (Central Standard Time) Monday through Friday. Before calling, please know the model and serial number of your unit to help your Consumer Product Support Representative.

WARRANTY REGISTRATION

To ensure trouble free warranty coverage it is important that you register your ECHO equipment on-line at www.echo-usa.com. Other registration options are by automated phone at 1-800-432-3246 or by filling out the warranty registration card supplied with your unit. Registering your product confirms your warranty coverage and provides a direct link between you and ECHO if we find it necessary to contact you.

ADDITIONAL OR REPLACEMENT MANUALS

Safety Manuals in English/Spanish or English/French are available free of charge, from your ECHO dealer or at www.echo-usa.com.

Operator's and Parts Manuals are available by:

- Downloading free from www.echo-usa.com
- Purchasing from your Echo Dealer.
- Manuals are available by sending a written request stating the model number and serial number of your Echo unit, part number of the manual, your name and address, and mail to the address below.

Safety Videos are available from your Echo dealer. A \$5.00 shipping charge will be required for each video.

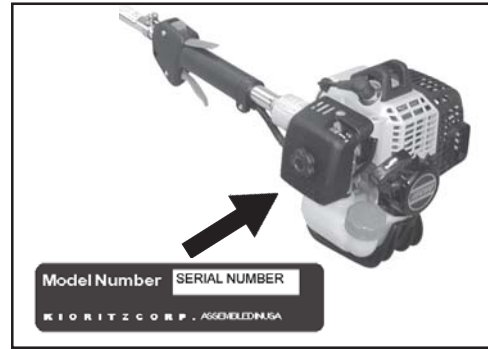

DEALER?

CALL

1-800-432-ECHO

1-800-432-3246

OR

WWW.ECHO-USA.COM

CONSUMER PRODUCT SUPPORT

1-800-673-1558

8:30 - 4:30 Mon - Fri C.S.T.

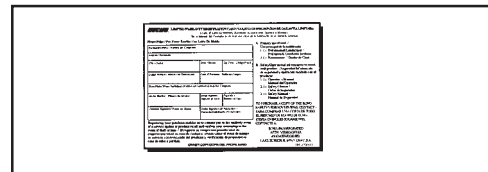

ECHO®

ECHO, INCORPORATED

400 OAKWOOD ROAD
LAKE ZURICH, IL 60047

www.echo-usa.com

11001001/11999999

12001001/12999999