

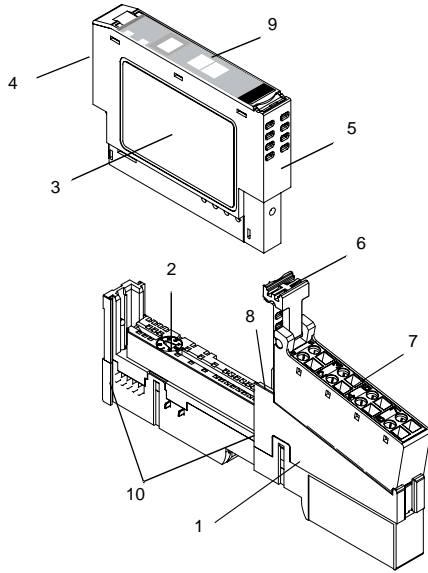

Helm Instrument Company, Inc.
 361 West Dussel Drive
 Maumee, Ohio 43537 USA
 419/ 893-4356
 Fax: 419/ 893-1371
 www.helminstrument.com

Installation Instructions HM1734-WM-2HR POINT I/O Strain Gage Input Module



	Description		Description
1	Mounting Base ¹	6	RTB Removal Handle
2	Mechanical Keying (orange)	7	Removable Terminal Block (RTB) ¹
3	Module Wiring Diagram	8	DIN Rail Locking Screw (orange)
4	Module Locking Mechanism	9	Slide-in Writable Label
5	Insertable I/O Module	10	Interlocking Side Pieces

¹ Wiring Base Assembly consists of item 1) mounting base, 1734-MB and item 7) removable terminal block, 1734-RT or -RTS.

POINT I/O is a trademark of Rockwell Automation
 DeviceNet is a trademark of ODVA, Inc.

This Series C product can be used with DeviceNet and PROFIBUS adapters. It can be used with Ethernet/IP and Ethernet adapters using RSLogix 5000, version 11 (or higher) software.

Important User Information

Because of the variety of uses for the products described in this publication, those responsible for the application and use of these products must satisfy themselves that all necessary steps have been taken to assure that each application and use meets all performance and safety requirements, including any applicable laws, regulations, codes and standards. In no event will Allen-Bradley be responsible or liable for indirect or consequential damage resulting from the use or application of these products.

Any illustrations, charts, sample programs, and layout examples shown in this publication are intended solely for purposes of example. Since there are many variables and requirements associated with any particular installation, Allen-Bradley does not assume responsibility or liability (to include intellectual property liability) for actual use based upon the examples shown in this publication.

Allen-Bradley publication SGI-1.1, *Safety Guidelines for the Application, Installation and Maintenance of Solid-State Control* (available from your local Allen-Bradley office), describes some important differences between solid-state equipment and electromechanical devices that should be taken into consideration when applying products such as those described in this publication.

Reproduction of the contents of this copyrighted publication, in whole or part, without written permission of Rockwell Automation, is prohibited.

Throughout this publication, notes may be used to make you aware of safety considerations. The following annotations and their accompanying statements help you to identify a potential hazard, avoid a potential hazard, and recognize the consequences of a potential hazard.

WARNING

Identifies information about practices or circumstances that can cause an explosion in a hazardous environment, which may lead to personal injury or death, property damage, or economic loss.

ATTENTION



Identifies information about practices or circumstances that can lead to personal injury or death, property damage, or economic loss.

IMPORTANT

Identifies information that is critical for successful application and understanding of the product.

ATTENTION

Environment and Enclosure



This equipment is intended for use in a Pollution Degree 2 industrial environment, in overvoltage Category II applications (as defined in IEC publication 60664-1), at altitudes up to 2000 meters without derating.

This equipment is considered Group 1, Class A industrial equipment according to IEC/CISPR Publication 11. Without appropriate precautions, there may be potential difficulties ensuring electromagnetic compatibility in other environments due to conducted as well as radiated disturbance.

This equipment is supplied as "open type" equipment. It must be mounted within an enclosure that is suitably designed for those specific environmental conditions that will be present and appropriately designed to prevent personal injury resulting from accessibility to live parts. The interior of the enclosure must be accessible only by the use of a tool. Subsequent sections of this publication may contain additional information regarding specific enclosure type ratings that are required to comply with certain product safety certifications.

See NEMA Standards publication 250 and IEC publication 60529, as applicable, for explanations of the degrees of protection provided by different types of enclosure. Also, see the appropriate sections in this publication, as well as the Allen-Bradley publication 1770-4.1 ("Industrial Automation Wiring and Grounding Guidelines"), for additional installation requirements pertaining to this equipment.

ATTENTION



POINT I/O is grounded through the DIN rail to chassis ground. Use zinc plated, yellow chromated steel DIN rail to assure proper grounding. Using other DIN rail materials (e.g. aluminum, plastic, etc.) which can corrode, oxidize or are poor conductors can result in improper or intermittent platform grounding.

WARNING**EXPLOSION HAZARD**

- Do not disconnect equipment unless power has been removed or the area is known to be nonhazardous.
 - Do not disconnect connections to this equipment unless power has been removed or the area is known to be nonhazardous. Secure any external connections that mate to this equipment by using screws, sliding latches, threaded connectors, or other means provided with this product.
 - Substitution of components may impair suitability for Class I, Division 2.
 - If this product contains batteries, they must only be changed in an area known to be nonhazardous.
-

ATTENTION**Preventing Electrostatic Discharge**

This equipment is sensitive to electrostatic discharge, which can cause internal damage and affect normal operation. Follow these guidelines when you handle this equipment:

- Touch a grounded object to discharge potential static.
 - Wear an approved grounding wriststrap.
 - Do not touch connectors or pins on component boards.
 - Do not touch circuit components inside the equipment.
 - If available, use a static-safe workstation.
 - When not in use, store the equipment in appropriate static-safe packaging.
-

Installing the Mounting Base

To install the mounting base on the DIN rail, proceed as follows.

1. Position the mounting base vertically above the installed units (adapter, power supply or existing module).
2. Slide the mounting base down allowing the interlocking side pieces to engage the adjacent module or adapter.
3. Press firmly to seat the mounting base on the DIN rail. The mounting base will snap into place.
4. To remove the mounting base from the DIN rail, remove the module, and use a small bladed screwdriver to rotate the base locking screw to a vertical position. This releases the locking mechanism. Then lift straight up to remove.

Installing the I/O Module

The module can be installed before, or after base installation. Make sure that the mounting base is correctly keyed before installing the module into the mounting base. In addition, make sure the mounting base locking screw is positioned horizontal referenced to the base.

WARNING

When you insert or remove the module while backplane power is on, an electrical arc can occur. This could cause an explosion in hazardous location installations. Be sure that power is removed or the area is nonhazardous before proceeding.

-
1. Using a bladed screwdriver, rotate the keyswitch (2) on the mounting base clockwise until the number required for the type of module being installed aligns with the notch in the base.
 2. Make certain the DIN rail locking screw is in the horizontal position. (You cannot insert the module if the locking mechanism is unlocked.)

3. Insert the module straight down into the mounting base and press to secure. The module will lock into place.

Installing the Removable Terminal Block (RTB)

A removable terminal block is supplied with your wiring base assembly. To remove, pull up on the RTB handle. This allows the mounting base to be removed and replaced as necessary without removing any of the wiring. To reinsert the removable terminal block, proceed as follows.

1. Insert the end opposite the handle into the base unit. This end has a curved section that engages with the wiring base.
2. Rotate the terminal block into the wiring base until it locks itself in place.
3. If an I/O module is installed, snap the RTB handle into place on the module.

WARNING

When you connect or disconnect the Removable Terminal Block (RTB) with field side power applied, an electrical arc can occur. This could cause an explosion in hazardous location installations.

Be sure that power is removed or the area is nonhazardous before proceeding.

Removing a Mounting Base

To remove a mounting base, you must remove any installed module, and the module installed in the base to the right. Remove the removable terminal block (if wired).

1. Unlatch the RTB handle on the I/O module.
2. Pull on the RTB handle to remove the removable terminal block.

WARNING

When you connect or disconnect the Removable Terminal Block (RTB) with field side power applied, an electrical arc can occur. This could cause an explosion in hazardous location installations.

Be sure that power is removed or the area is nonhazardous before proceeding.

-
3. Press on the module lock on the top of the module.
 4. Pull on the I/O module to remove from the base.

WARNING

When you insert or remove the module while backplane power is on, an electrical arc can occur. This could cause an explosion in hazardous location installations. Be sure that power is removed or the area is nonhazardous before proceeding.

-
5. Repeat steps 1, 2, 3 and 4 for the module to the right.
 6. Use a small bladed screwdriver to rotate the orange base locking screw to a vertical position. This releases the locking mechanism.
 7. Then lift straight up to remove.

COMMUNICATION WITH THE MODULE

I/O messages are sent to (consumed) and received from (produced) the POINT I/O modules. These messages are mapped into the processor's memory. This POINT I/O input module produces 2 bytes of input data (scanner Rx) and 2 bytes of output data (scanner Tx).

Data Map for HM1734-WM on DeviceNet

INPUT DATA TAGS

Data Tags Local:x.I	Data Type	Bit	Description
.Data[n]	DINT	-	Weigh Value
	Bit	31	Sign Bit Indicator in Run Mode

n: Beginning input index of the HM-1734WM in DeviceNet mapping.

OUTPUT TAGS

Data Tags Local:x.O	Data Type	Bit	Description
.Data[m]	Bit	0	Set Cal Mode Bit
	Bit	1	Set Run Mode Bit
	Bit	2	CH1 Clear Tare Bit (momentary)
	Bit	3	CH1 SetTare Bit (momentary)
	Bit	4	CH1 Set AD Trim Bit (Factory use only)
	Bit	5	Read AD rim Bit (Factory use only)
	Bit	6	CH2 Clear Tare Bit (momentary)
	Bit	7	CH2 SetTare Bit (momentary)
	Bit	8	CH2 Set AD Trim Bit (Factory use only)
	Bit	9	Set CH1Only Bit
	Bit	10	Set_To_4msec (Frequency)
	Bit	11	Set_To_8msec (Frequency)
	Bit	12	Set_To_16msec (Frequency)
	Bit	13	Set_To_32msec (Frequency)
	Bit	14	Set_To_40msec (Frequency)
	Bit	15	Set_To_48msec (Frequency)
	Bit	16	Vibration Filter Bit
	Bit	17	Set Motion Stabilization Filter (MSF) range from -0.002% to +0.001% of full scale
	Bit	18	Set Motion Stabilization Filter (MSF) range from -0.004% to +0.002% of full scale
	Bit	19	Set Motion Stabilization Filter (MSF) range from -0.008% to +0.004% of full scale
	Bit	20	Set Motion Stabilization Filter (MSF) range from -0.010% to +0.005% of full scale
	Bit	21	Set Zero Dead Band to 0.025% of full scale
	Bit	22	Set Zero Dead Band to 0.05% of full scale
	Bit	23	Set Zero Dead Band to 0.075% of full scale
	Bit	24	Set Average Sample_bit0
	Bit	25	Set Average Sample_bit1
	Bit	26	Set Average Sample_bit2
	Bit	27	Set Average Sample_bit3
	Bit	28	Set Average Sample_bit4
	Bit	29	Set Average Sample_bit5
	Bit	30	Set Average Sample_bit6
	Bit	31	Set Average Sample_bit7

m: Beginning Output index of the HM-1734WM in DeviceNet mapping.

Data Map for HM1734-WM on DeviceNet

Required Controller Tags

Data Tags Name	Data Type	
HM1734WM1_a	DINT[9]	
HM1734WM1_a[0]	DINT	CH1 Set Scale Value
HM1734WM1_a[1]	DINT	CH1 Set AutoCal Reference Weigh Actual Value
HM1734WM1_a[2]	DINT	CH1 Get Weigh Value
HM1734WM1_a[3]	DINT	CH2 Set Scale Value
HM1734WM1_a[4]	DINT	CH2 Set AutoCal Reference Weigh Actual Value
HM1734WM1_a[5]	DINT	CH2 Get Weigh Value
HM1734WM1_a[6]	DINT	CH1 Set AutoCal Enable Bit
HM1734WM1_a[7]	DINT	CH2 Set AutoCal Enable Bit
HM1734WM1_a[8]	DINT	Set Average Sample Count
HM1734WM1_b	REAL[2]	
HM1734WM1_b[0]	REAL	CH1 Set MV_V
HM1734WM1_b[1]	REAL	CH2 Set MV_V

SETTING UP HM1734WM MODULE USING 1734-AENT/A on Ethernet/IP

HM1734WM MODULE PROPERTIES

General Tab Settings

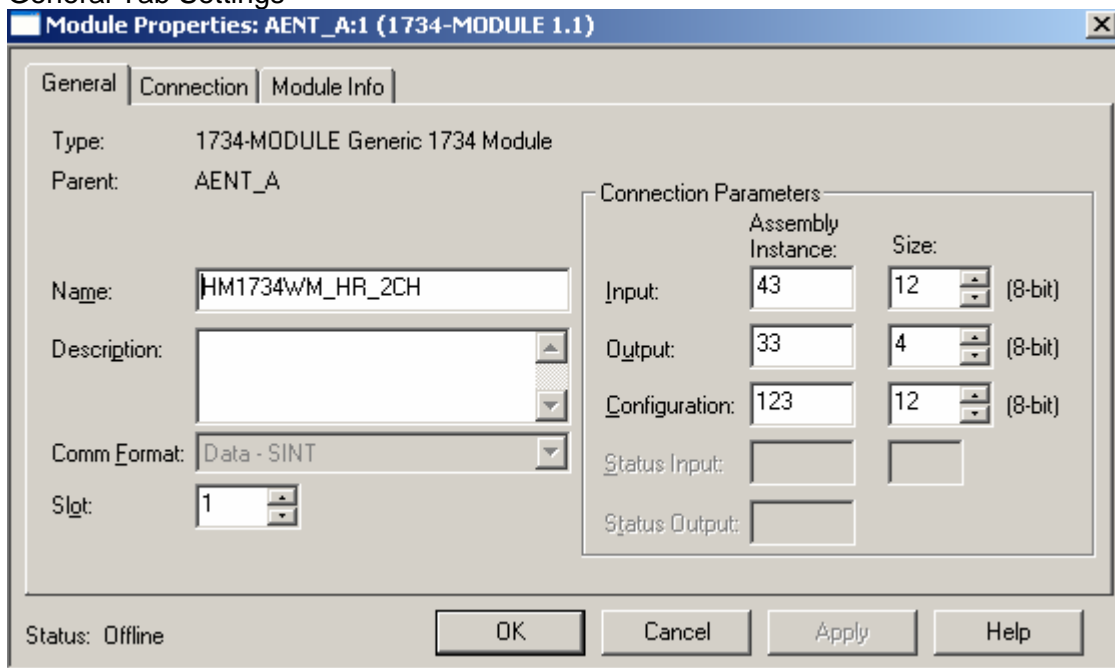

Connection Tab Settings

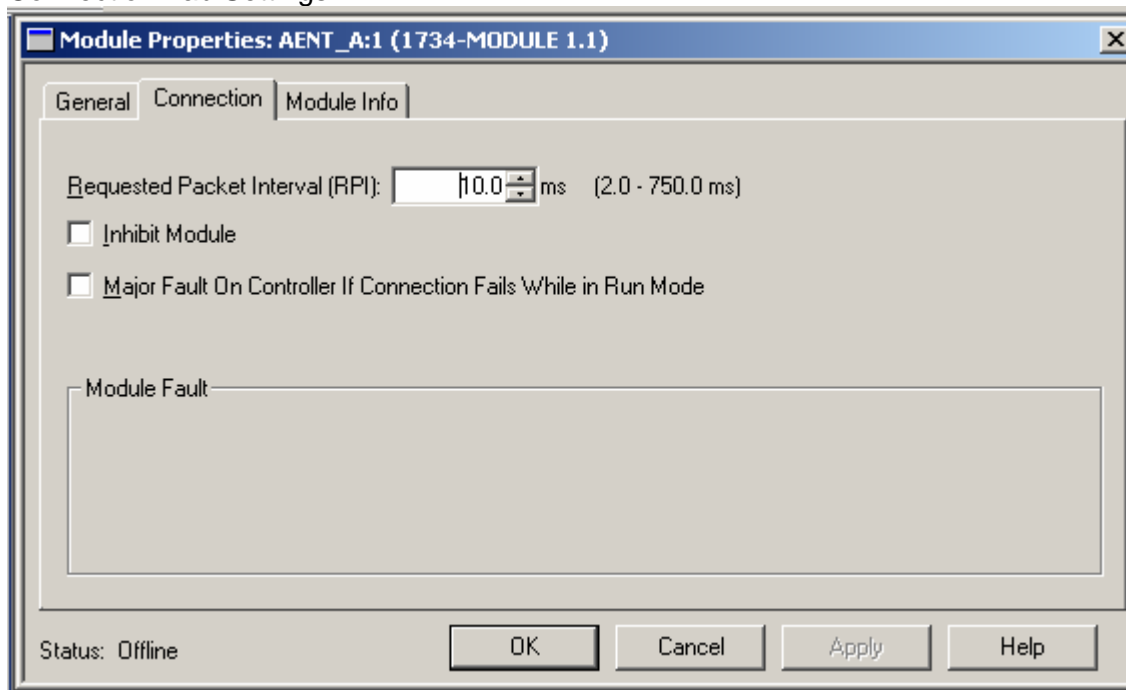

Data Map for HM1734-WM on Ethernet/IP

INPUT DATA TAGS

Data Tags name:x.I	Data Type	Bit	Description
.Data[4]	SINT	-	CH1 Raw Weigh Value LSByte
.Data[5]	SINT	-	CH1 Raw Weigh Value Middle Byte
.Data[6]	SINT	-	CH1 Raw Weigh Value Middle Byte
.Data[7]	SINT	-	CH1 Raw Weigh Value MSByte
.Data[8]	SINT	-	CH2 Raw Weigh Value LSByte
.Data[9]	SINT	-	CH2 Raw Weigh Value Middle Byte
.Data[10]	SINT	-	CH2 Raw Weigh Value Middle Byte
.Data[11]	SINT	-	CH2 Raw Weigh Value MSByte
	Bit	7	Sign Bit Indicator in Run Mode – Bit 7 of MSByte

x: Point I/O slot position of HM-1734WM.

OUTPUT TAGS

[n] = slot number for module		
AENT_A:[n]:O.Data	SINT[4]	Description
AENT_A:1:O.Data[0]	SINT	
AENT_A:1:O.Data[0].0	bit	Set Cal Mode Bit
AENT_A:1:O.Data[0].1	bit	Set Run Mode Bit
AENT_A:1:O.Data[0].2	bit	Ch1 Clear Tare Bit (momentary)
AENT_A:1:O.Data[0].3	bit	Ch1 Tare Bit (momentary)
AENT_A:1:O.Data[0].4	bit	Ch1 Set AD Trim Bit (Factory Use Only)
AENT_A:1:O.Data[0].5	bit	Read AD Trim Bit (Factory Use Only)
AENT_A:1:O.Data[0].6	bit	Ch2 Clear Tare Bit (momentary)
AENT_A:1:O.Data[0].7	bit	Ch2 Tare Bit (momentary)
AENT_A:1:O.Data[1]	SINT	
AENT_A:1:O.Data[1].0	bit	Ch2 Set AD Trim Bit (Factory Use Only)
AENT_A:1:O.Data[1].1	bit	Set ch1_only
AENT_A:1:O.Data[1].2	bit	Set_to_4ms (Frequency)
AENT_A:1:O.Data[1].3	bit	Set_to_8ms (Frequency)
AENT_A:1:O.Data[1].4	bit	Set_to_16ms (Frequency)
AENT_A:1:O.Data[1].5	bit	Set_to_32ms (Frequency)
AENT_A:1:O.Data[1].6	bit	Set_to_40ms (Frequency)
AENT_A:1:O.Data[1].7	bit	Set_to_48ms (Frequency)
AENT_A:1:O.Data[2]	SINT	
AENT_A:1:O.Data[2].0	bit	Vibration Filter Bit
AENT_A:1:O.Data[2].1	bit	Set Motion Stabilization Filter (MSF) range from -0.002% to +0.001% of full scale
AENT_A:1:O.Data[2].2	bit	Set Motion Stabilization Filter (MSF) range from -0.004% to +0.002% of full scale
AENT_A:1:O.Data[2].3	bit	Set Motion Stabilization Filter (MSF) range from -0.008% to +0.004% of full scale
AENT_A:1:O.Data[2].4	bit	Set Motion Stabilization Filter (MSF) range from -0.010% to +0.005% of full scale
AENT_A:1:O.Data[2].5	bit	Set Zero Dead Band to 0.025% of full scale
AENT_A:1:O.Data[2].6	bit	Set Zero Dead Band to 0.05% of full scale
AENT_A:1:O.Data[2].7	bit	Set Zero Dead Band to 0.075% of full scale
AENT_A:1:O.Data[3]	SINT	
AENT_A:1:O.Data[3].0	bit	Average Sample_bit0
AENT_A:1:O.Data[3].1	bit	Average Sample_bit1
AENT_A:1:O.Data[3].2	bit	Average Sample_bit2
AENT_A:1:O.Data[3].3	bit	Average Sample_bit3
AENT_A:1:O.Data[3].4	bit	Average Sample_bit4
AENT_A:1:O.Data[3].5	bit	Average Sample_bit5
AENT_A:1:O.Data[3].6	bit	Average Sample_bit6
AENT_A:1:O.Data[3].7	bit	Average Sample_bit7

Data Map for HM1734-WM on Ethernet/IP

Required Controller Tags

Data Tags Name	Data Type	
HM1734WM1a	DINT[9]	
HM1734WM1_a[0]	DINT	CH1 Set Scale Value
HM1734WM1_a[1]	DINT	CH1 Set AutoCal Reference Weigh Actual Value
HM1734WM1_a[2]	DINT	CH1 Get Weigh Value
HM1734WM1_a[3]	DINT	CH2 Set Scale Value
HM1734WM1_a[4]	DINT	CH2 Set AutoCal Reference Weigh Actual Value
HM1734WM1_a[5]	DINT	CH2 Get Weigh Value
HM1734WM1_a[6]	DINT	CH1 Set AutoCal Enable Bit
HM1734WM1_a[7]	DINT	CH2 Set AutoCal Enable Bit
HM1734WM1_a[8]	DINT	Set Average Sample Count
HM1734WM1b	REAL[2]	
HM1734WM1_b[0]	REAL	CH1 Set MV_V
HM1734WM1_b[1]	REAL	CH2 Set MV_V

OUTPUT TAG DESCRIPTIONS

CALMODE

DeviceNet Bit 0

Ethernet/IP (Data[0]): Bit 0

Used for initial installation. All math is disabled, weigh value is not scaled, leaving raw A/D value.
Value = 2,090,000 to 2,100,000 at normal zero (at rest state).

RUNMODE

DeviceNet Bit 1

Ethernet/IP (Data[0]): Bit 1

A/D values scaled with math in ladder logic
Factory cal setting 100,000 counts = 2MV/V

CLEAR TARE CH1/CH2 Bit

DeviceNet Bit 2 (Channel 1)

DeviceNet Bit 6 (Channel 2)

Ethernet/IP (Data[0]): Bit 2 (Channel 1)

Ethernet/IP (Data[0]): Bit 6 (Channel 2)

Clears internal tare value for "zero state".

Useful when troubleshooting load cell wiring or other failures.

TARE CH1/CH2

DeviceNet Bit 3 (Channel 1)

DeviceNet Bit 7 (Channel 2)

Ethernet/IP (Data[0]): Bit 3 (Channel 1)

Ethernet/IP (Data[0]): Bit 7 (Channel 2)

Sets A/D value to zero.

SET ADTRIM CH1/CH2 Bit

DeviceNet Bit 4 (Channel 1)

DeviceNet Bit 8 (Channel 2)

Ethernet/IP (Data[0]): Bit 4 (Channel 1)

Ethernet/IP (Data[1]): Bit 0 (Channel 2)

(HELM Factory setting only).

READ ADTRIM BIT

DeviceNet Bit 5

Ethernet/IP (Data[0]): Bit 5

(HELM Factory setting only).

SET-TO-CH1 Bit

DeviceNet Bit 9

Ethernet/IP (Data[1]): Bit 1

Used for one channel operation where a faster sample speed is required.

1 = 2msec (max speed)

0 = 4msec (max speed-default)

FREQUENCY BITS

DeviceNet Bits 10 through 15

Ethernet/IP (Data[1]): Bits 2 through 7

Used to set sample rate and filter options.

With no bits set: Sample = 100msec.

Set one bit only.

Note: For one channel operation, sample rate is at bit selected.

For two channel operation, sample rate is 2 times bit time selected.

OUTPUT TAG DESCRIPTIONS

VIBRATION FILTER

DeviceNet Bit 16

Ethernet/IP (Data[2]): Bit 0

Filter ON/OFF Bit

0 = Normal Average

1 = Rolling Average

MSF BITS – (Motion Stabilization Filter)

DeviceNet Bits 17,18,19,20

Ethernet/IP (Data[2]): Bits 1,2,3,4

Used for applications with constant or static type loads to keep display value stable.

MSF1_2 (1 count up – 2 counts down).

MSF2_4

MSF4_8

MSF5_10

Set one bit only.

ZERO-DEAD-BAND Bits

DeviceNet Bits 21,22,23

Ethernet/IP (Data[2]): Bits 5,6,7

Useful for Auto-Tare functions with production runs.

Set only one bit.

ZEROBAND_025 = .025% full scale

ZEROBAND_05 = .05% full scale

ZEROBAND_075 = .075% full scale

Auto tare occurs when load cell weight is at bit level or lower.

SET AVERAGE SAMPLE Bits

DeviceNet Bits 24 through 31

Ethernet/IP (Data[3]): Bits 0 through 7

See Required Controller Tags:

HM1734WM1_a[8]

REQUIRED CONTROLLER TAGS

CH1/CH2 SCALE SET

HM1734WM1_a[0]**HM1734WM1_a[3]**

Full scale setting for CH1, CH2

Value is determined by capacity of load cell and by resolution required.

Example: 10KG = 10,000

SET AUTOCAL REFERENCE WEIGH VALUE CH1, CH2

HM1734WM1_a[1]**HM1734WM1_a[4]**

Enter desired value to read based on known weight from calibrate procedure.

GET WEIGH VALUE CH1, CH2

HM1734WM1_a[2]**HM1734WM1_a[5]**

Reports measured weigh value in RUN mode.

Reports raw A/D count value in CAL mode.

SET AUTOCAL CH1, CH2 Enable Bit

HM1734WM1_a[6]**HM1734WM1_a[7]**

With ladder logic provided, an auto-cal method for calibrating is available.

Set to (1) to initiate Auto-Cal for the channel.

Ladder logic will clear the bit.

SET AVERAGE SAMPLE COUNT

HM1734WM1_a[8]

Set number of samples to take for average type filter.

Two Channel operation; Max value (50).

One Channel operation; Max value (100).

SET mV/V CH1, CH2

HM1734WM1_b[0]**HM1734WM1_b[1]**

CH1/CH2 MV_V Settings

Enter 2.0MV/V for nominal load cell.

Actual value is from load cell specification.

Troubleshooting with the Indicators

Module Status:

Off	No power applied to device.
Green	Device operating normally.
Flashing Green	Device needs commissioning due to configuration missing, incomplete or incorrect.
Flashing Red	Recoverable fault.
Red	Unrecoverable fault. May require device replacement.
Flashing Red/Green	Device is in self-test.

Network Status:

Off	Device is not on-line. Device has not completed dup_MAC_id test. Device not powered. Check module status indicator.
Green	Device on-line and has connections to the established state.
Flashing Green	Device is on-line but has no connections in the established state.
Flashing Red	One or more I/O connections is in timed-out state.
Red	Critical link failure – failed communications device.
Flashing Red/Green	Network access error and is in communication faulted state. Device has received and accepted an Identity Communication Faulted Request – long protocol message.

Setup Procedure

A complete listing of a sample ladder logic program is included at the back of this manual.

Examples shown here are for reference.



All values are 0 (default) on initial start-up.
This means that all alarms are disabled.
You must make the following adjustments for proper operation:

- Balance sensor input(s)
- Set Calibration numbers

Follow Steps 1 and 2 for each channel.

Step 1. Balance Sensor Input

1. Set to CAL mode.
2. Set Clear Tare bit momentarily.
3. Check Raw A/D value. (Range 2,090,000 to 2,100,000)
CH1 = Controller Tag HM1734WM1-a[2]
CH2 = Controller Tag HM1734WM1-a[5]
4. Set Zero Tare bit momentarily.

Step 2. Set Calibration Numbers

1. Set Scale to capacity of load cell.
2. Set mV/V to load cell specification.
Example:
100 ton load cell, 2.025 mV/V
For scale set, enter 100
For mV/V set, enter 2.025
3. Set to RUN mode.

Specifications - HM1734-WM Strain Gage Input Module

Module Location	1734-TOP (screw terminal) or 1734-TOPS (spring loaded terminal)
Type of input	Strain Gage (350 ohm, 700 ohm)
Gage Excitation Voltage	3.3V
Input Impedance	5.11 meg. ohm
Display Resolution	Up to .0025% of full scale
Module Accuracy	Dependent on Load Cell Specification
Module Update Time	Software selectable from 2ms to 100ms
Number of Channels	2 (isolated)
A/D Conversion Method	Successive Approximation - 24 bit
Normal Mode Rejection: (between +/- input)	116DB CMRR
Amplifier Bandwidth	200 kHz
Calibration	Software Selectable
Isolation:	500 VDC continuous between inputs and chassis ground, and between input and backplane
LED indicators	2 LED's for Power and Alarm
Recommended Cable	Strain Gage Cable (Helm part number 6117)
Operating Temperatures	0°C to 60°C (32°F to 140°F)
Hazardous Environment Classification	Class 1 Division 2 Hazardous Environment
Pointbus Current	5V @ 72ma
External Power	24V @ 19.5ma
Voltage Range	10-28.8V dc
Dimensions	2.21H x 0.47W x 2.97L (Millimeters 56H x 12W x 75.5L)

Register Module in RSNetWorx

In RSNetworx, double click module icon. Not Registered, select NO
Vendor, Device and Product fields should now be correct.

In RSNetWorx, double click module icon. Not Registered, select YES.

EDS Wizard, next, register and EDS file, next, register a single file, browse, select file, open, next.

EDS File Install Results, examine results, next.

Check icon graphic image and color.

Vendor, Device and Product fields should now be correct.

Next Select device to register, next, complete, finish.

HM1734 WM-HR 2CH SUPPORT LADDER FOR DEVICENET

Move raw value to temp for Ch1

0

MOV

Move	
Source	Local:1:I.Data[1] 2101418
Dest	advalue 2101416

Move raw value to temp for Ch2

1

MOV

Move	
Source	Local:1:I.Data[2] 1212987
Dest	advalue2 1212945

In Cal Mode, Report raw AD Value

2

Set Cal Mode Bit
Local:1:O.Data[0].16

Set Run Mode Bit
Local:1:O.Data[0].17

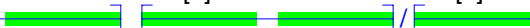

Get Weigh Value Ch1

MOV

Move	
Source	advalue 2101416
Dest	HM1734WM1_A[2] 2101419

Get Weigh Value
Report Ch2

MOV

Move	
Source	advalue2 1212945
Dest	HM1734WM1_A[5] 1212831

3

In Run mode, Calculate Scaled Weigh Value with mV/V and Scale value for Ch1

Set Run Mode Bit Local:1:O.Data[0].17
Set Cal Mode Bit Local:1:O.Data[0].16

MVM
Masked Move
Source advalue 2101416
Mask 2147483647
Dest temp_DINT1 3

DIV
Divide
Source A 2.0
Source B HM1734WM1_B[0] 1.9998899
Dest temp_FLOAT1 1.0000551

MUL
Multiply
Source A temp_FLOAT1 1.0000551
Source B temp_DINT1 3
Dest temp_FLOAT2 3.0001652

DIV
Divide
Source A HM1734WM1_A[0] 100000
Source B 100000
Dest temp_FLOAT3 1.0

MUL
Multiply
Source A temp_FLOAT3 1.0
Source B temp_FLOAT2 3.0001652
Dest temp_DINT2 3

4

Set Scale Value to Negative if Sign bit is 1 for Ch1

Set Run Mode Bit
Local:1:O.Data[0].17

Get Sign Bit in Run
Mode for Ch1

Local:1:I.Data[1].31

Get Weigh Value Ch1

MUL

Source A	temp_DINT2
	3
Source B	-1
Dest	HM1734WM1_A[2]
	2101419

Get Sign Bit in Run
Mode for Ch1

Local:1:I.Data[1].31

Get Weigh Value Ch1

MOV

Source	temp_DINT2
	3
Dest	HM1734WM1_A[2]
	2101419

5

In Run mode, Calculate Scaled Weigh Value with mV/V and Scale value Ch2

Set Run Mode Bit
Local:1:O.Data[0].17

Set Cal Mode Bit
Local:1:O.Data[0].16

MVM
Masked Move
Source advalue2
1212945
Mask 2147483647
Dest temp_dint3
914037

DIV
Divide
Source A 2.0
Source B HM1734WM1_B[1]
1.99999
Dest temp_FLOAT1a
1.000005

MUL
Multiply
Source A temp_FLOAT1a
1.000005
Source B temp_dint3
914037
Dest temp_FLOAT2a
914041.56

DIV
Divide
Source A HM1734WM1_A[3]
100000
Source B 100000
Dest temp_FLOAT3a
1.0

MUL
Multiply
Source A temp_FLOAT3a
1.0
Source B temp_FLOAT2a
914041.56
Dest temp_dint4
914042

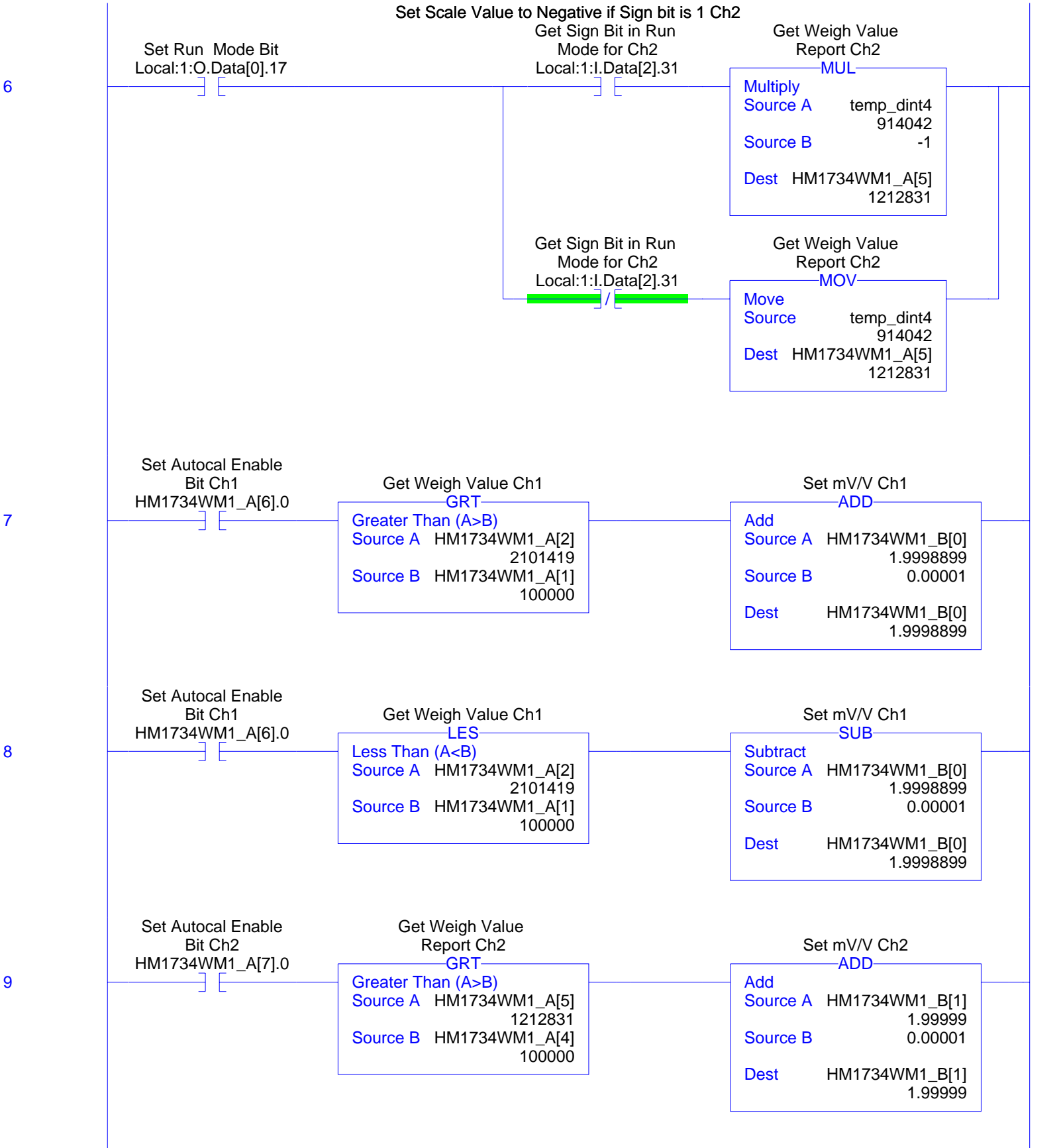

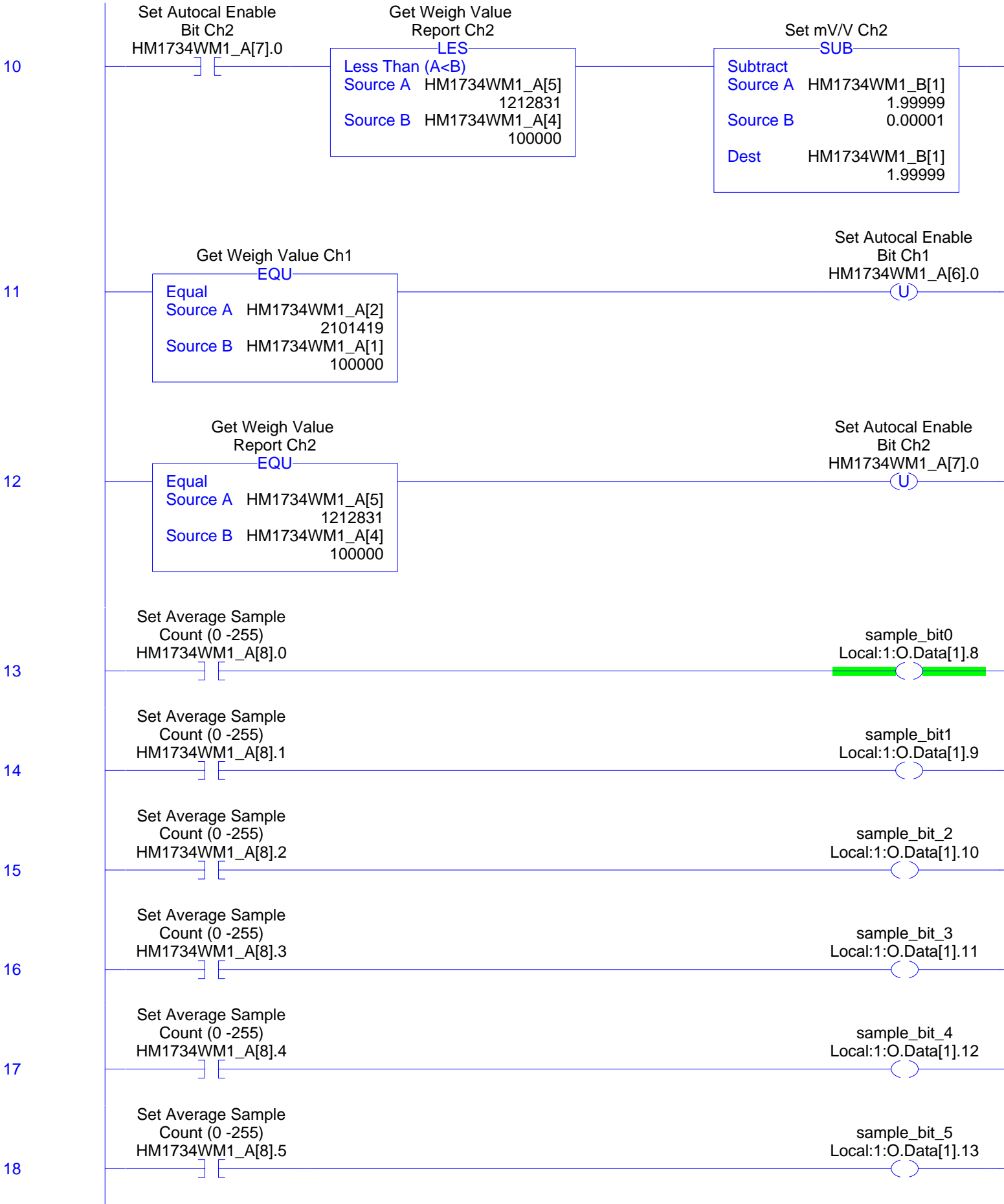

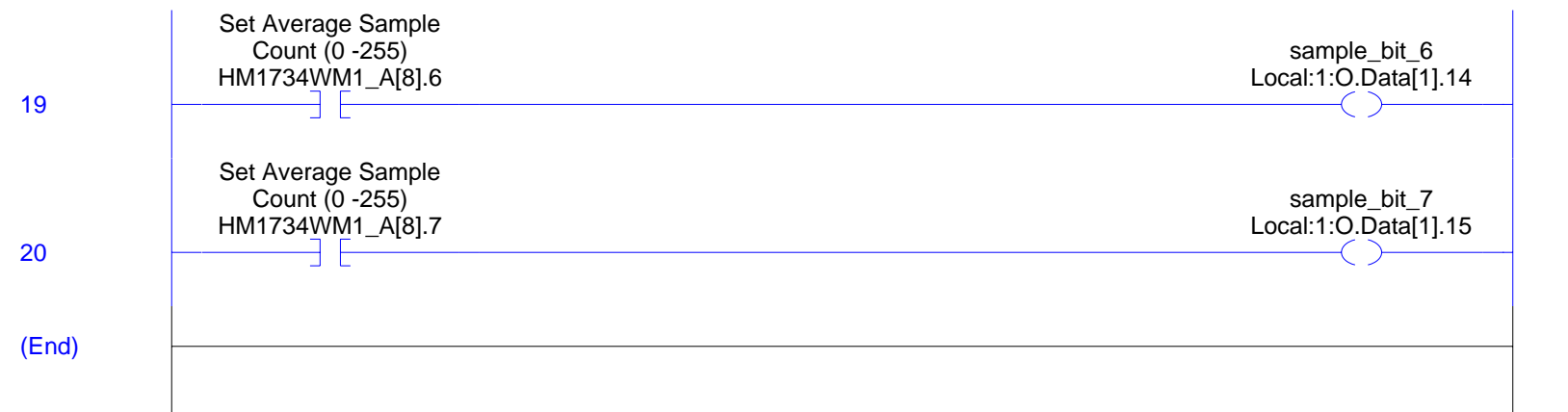

HM1734WM-HR 2CH MODULE SUPPORT LADDER FOR ETHERNET_IP

Make 32bit data from four 8bit data tags for CH1

0

BTD

Bit Field Distribute

Source	AENT_A:1:I.Data[4]
	20
Source Bit	0
Dest	advalue
	20
Dest Bit	0
Length	8

BTD

Bit Field Distribute

Source	AENT_A:1:I.Data[5]
	0
Source Bit	0
Dest	advalue
	20
Dest Bit	8
Length	8

BTD

Bit Field Distribute

Source	AENT_A:1:I.Data[6]
	0
Source Bit	0
Dest	advalue
	20
Dest Bit	16
Length	8

BTD

Bit Field Distribute

Source	AENT_A:1:I.Data[7]
	0
Source Bit	0
Dest	advalue
	20
Dest Bit	24
Length	8

1

In Cal Mode, Report raw AD Value for CH1

Set Cal Mode Bit
AENT_A:1:O.Data[0].0

Set Run Mode Bit
AENT_A:1:O.Data[0].1

Get Weigh Value Ch1

MOV

Move

Source	advalue
	20
Dest	HM1734WM1_A[2]
	2

2

In Run mode, Calculate Scaled Weigh Value with mV/V and Scale value for CH1

Set Run Mode Bit Set Cal Mode Bit
AENT_A:1:O.Data[0].1 AENT_A:1:O.Data[0].0

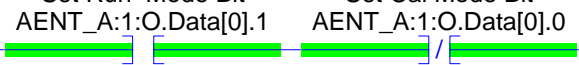

MVM

Masked Move

Source	advalue
	20
Mask	16#7FFFFFFF
Dest	temp_DINT1
	20

DIV

Divide

Source A	2.0
Source B	HM1734WM1_B[0]
	0.0
Dest	temp_Float1
	1.0

MUL

Multiply

Source A	temp_Float1
	1.0
Source B	temp_DINT1
	20
Dest	temp_Float2
	20.0

DIV

Divide

Source A	HM1734WM1_A[0]
	10000
Source B	100000
Dest	temp_Float3
	0.1

MUL

Multiply

Source A	temp_Float3
	0.1
Source B	temp_Float2
	20.0
Dest	temp_DINT2
	1

3

Set Scale Value to Negative if Sign bit is 1 for CH1

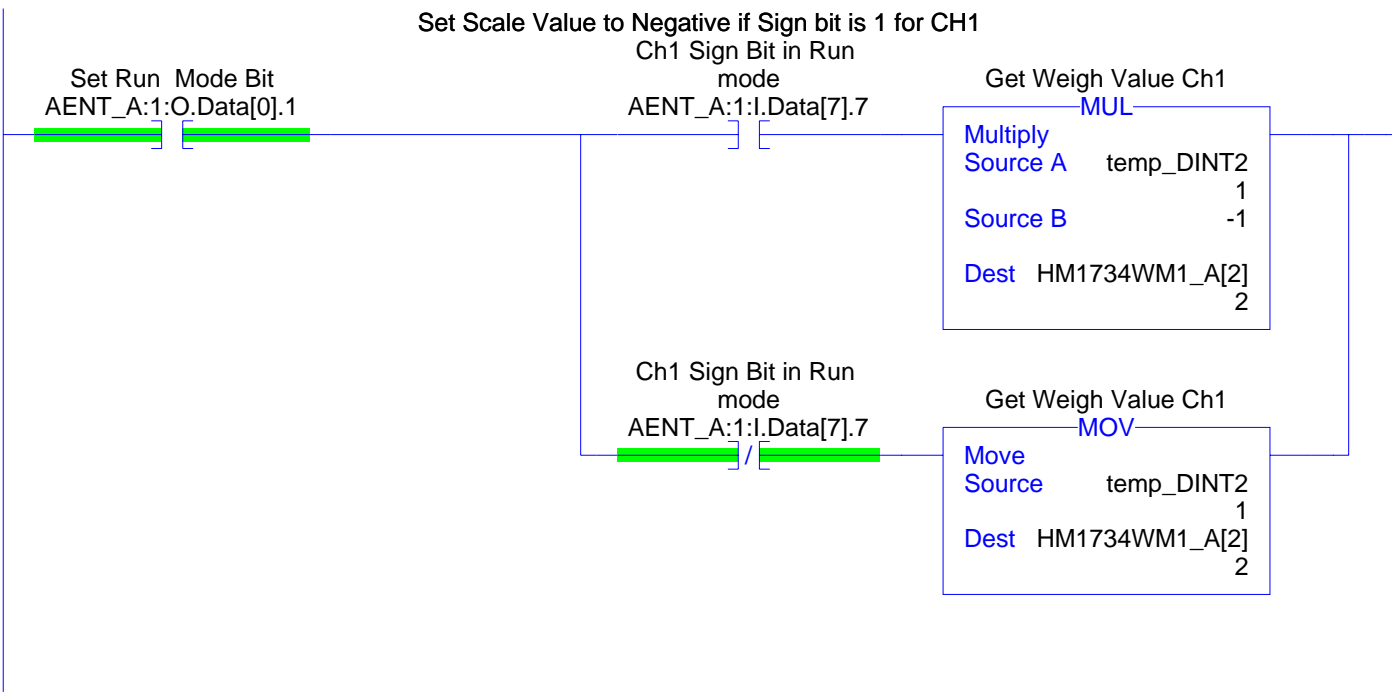

Make 32bit data from four 8bit data tags for CH2

4

BTD
 Bit Field Distribute
 Source AENT_A:1:I.Data[8]
 19
 Source Bit 0
 Dest advalue2
 -2147483640
 Dest Bit 0
 Length 8

BTD
 Bit Field Distribute
 Source AENT_A:1:I.Data[9]
 0
 Source Bit 0
 Dest advalue2
 -2147483640
 Dest Bit 8
 Length 8

BTD
 Bit Field Distribute
 Source AENT_A:1:I.Data[10]
 0
 Source Bit 0
 Dest advalue2
 -2147483640
 Dest Bit 16
 Length 8

BTD
 Bit Field Distribute
 Source AENT_A:1:I.Data[11]
 -128
 Source Bit 0
 Dest advalue2
 -2147483640
 Dest Bit 24
 Length 8

5

In Cal Mode, Report raw AD Value

Set Cal Mode Bit AENT_A:1:O.Data[0].0

Set Run Mode Bit AENT_A:1:O.Data[0].1

Get Weigh Value Ch2

MOV
 Move
 Source advalue2
 -2147483640
 Dest HM1734WM1_A[5]
 0

6

In Run mode, Calculate Scaled Weigh Value with mV/V and Scale value

Set Run Mode Bit Set Cal Mode Bit
 AENT_A:1:O.Data[0].1 AENT_A:1:O.Data[0].0

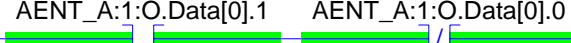

MVM
 Masked Move
 Source advalue2
 -2147483640
 Mask 16#7FFFFFFF
 Dest temp_dint3
 29

DIV
 Divide
 Source A 2.0
 Source B HM1734WM1_B[1]
 0.0
 Dest temp_Float1a
 1.0

MUL
 Multiply
 Source A temp_Float1a
 1.0
 Source B temp_dint3
 29
 Dest temp_Float2a
 29.0

DIV
 Divide
 Source A HM1734WM1_A[3]
 10000
 Source B 100000
 Dest temp_Float3a
 0.1

MUL
 Multiply
 Source A temp_Float3a
 0.1
 Source B temp_Float2a
 29.0
 Dest temp_dint4
 3

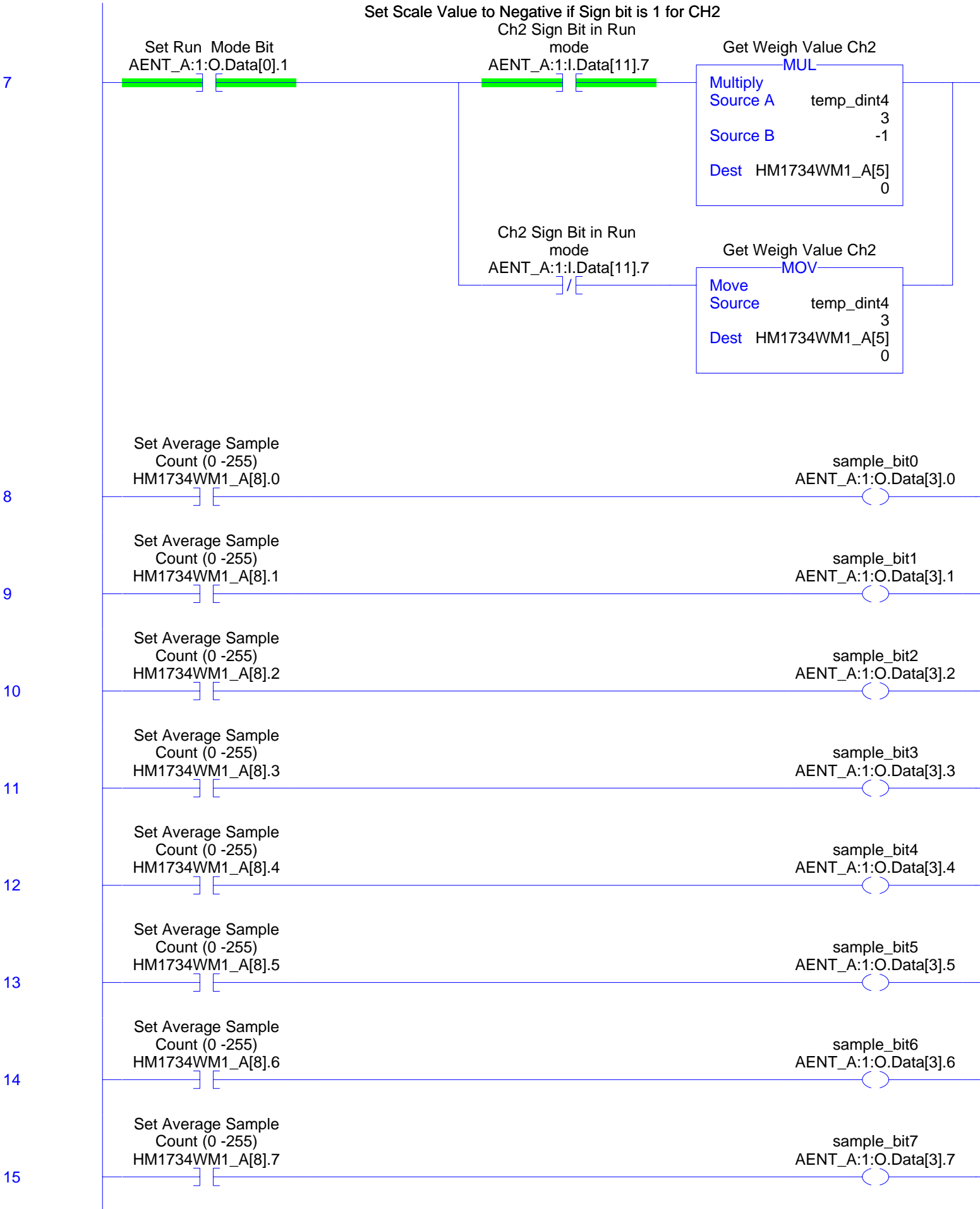

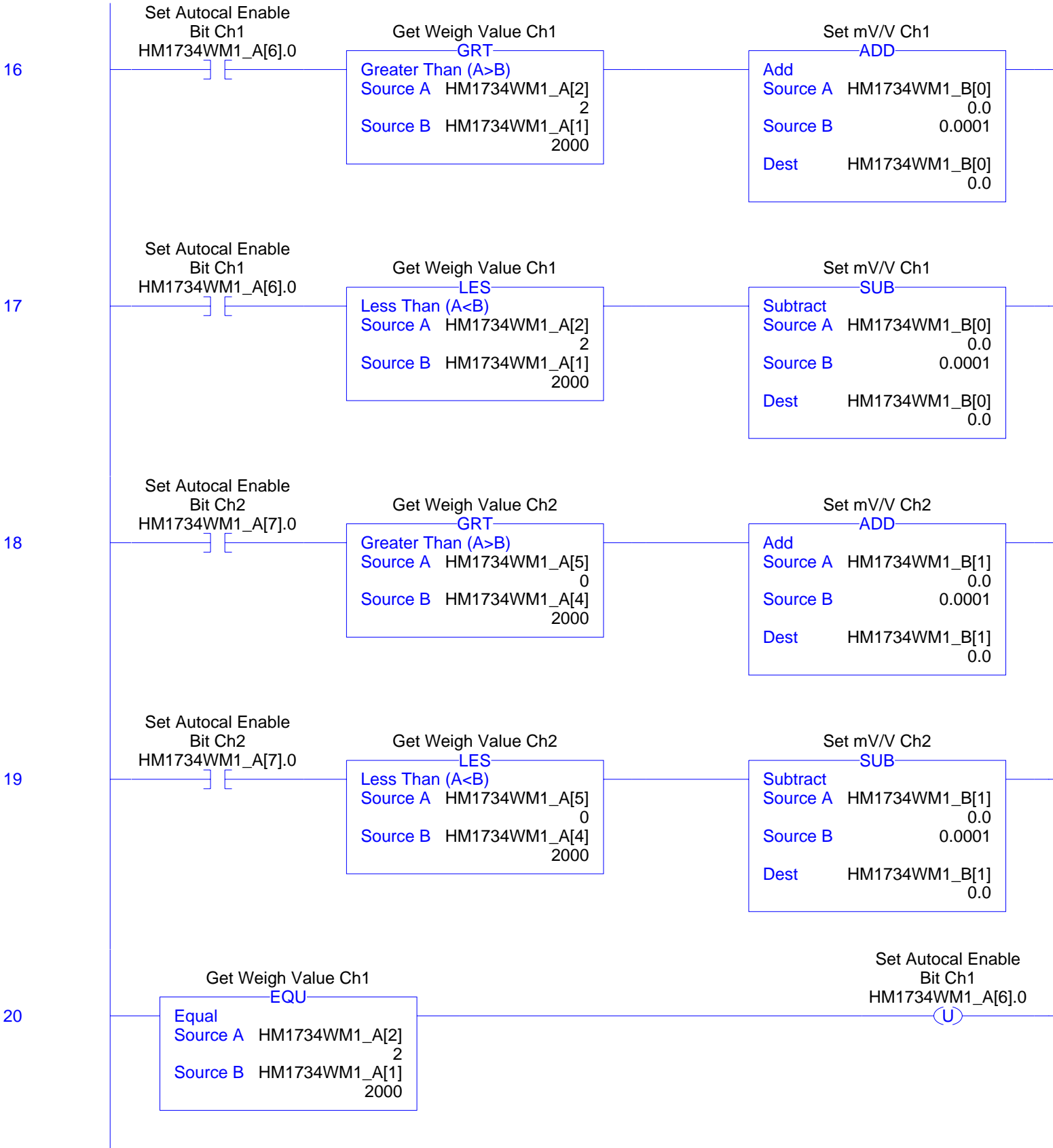

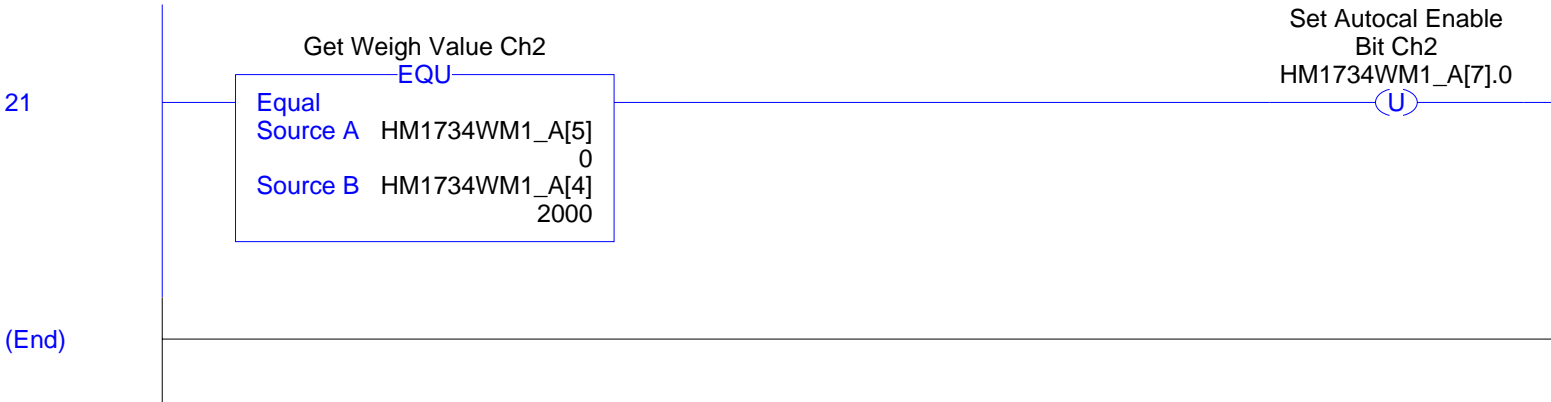

HM-1734-WM Point I/O Sensor Connections

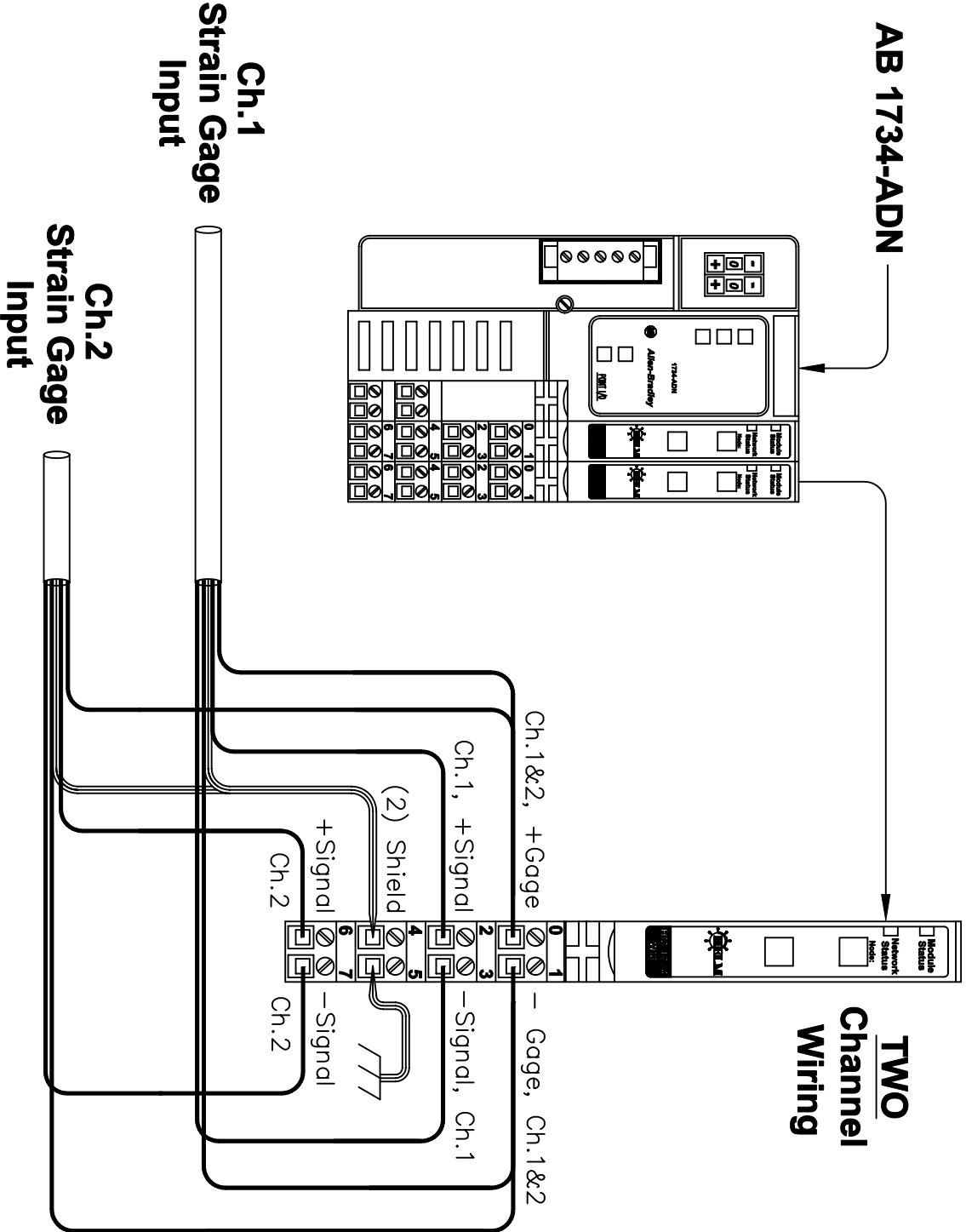

TWO
Channel
Wiring

ONE
Channel
Wiring

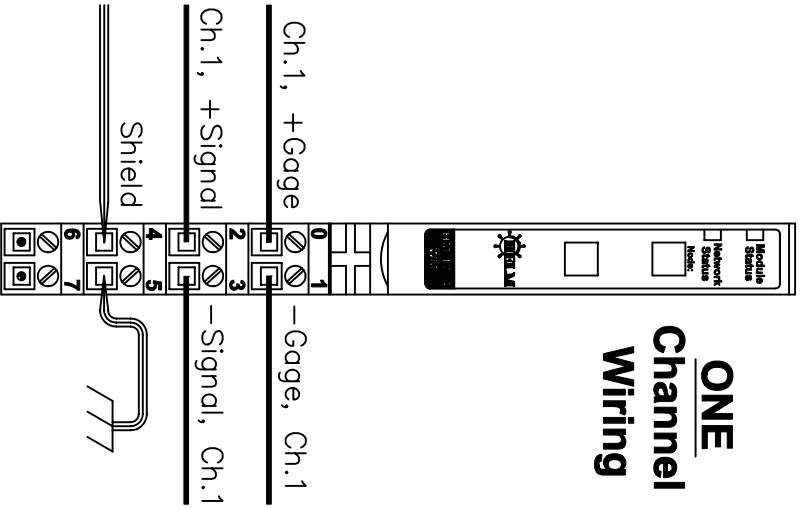

- NOTES:**
- 1.) MINIMUM INPUT OHMS:
 - a. 350 ON EACH CHANNEL, WHEN USING TWO CHANNELS.
 - b. 175 ON ONE CHANNEL, WHEN USING ONLY ONE CHANNEL.

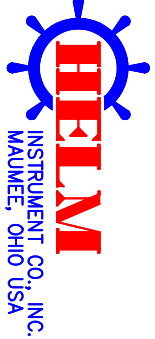

THIS DRAWING AS WELL AS THE SUBJECT MATTER THEREON IS EXCLUSIVE PROPERTY OF HELM INSTRUMENT CO., INC. IT IS TO BE TREATED BY YOU AS CONFIDENTIAL, PROPRIETARY INFORMATION. THE DRAWING OR SUBJECT MATTER THEREOF SHALL NO BE DUPLICATED OR DISCLOSED WITHOUT THE EXPRESS WRITTEN CONSENT OF HELM INSTRUMENT CO., INC.

SCALE:	FULL	DESIGNED BY:	N.F.N.	DRAWN BY:	M.H.L.
DATE:	05/30/09	CHECKED BY:	N.F.N.	APPROVED BY:	R.J.G.
TITLE:	SENSOR CONNECTIONS, HM-1734-WM (HELM)				
DRAWER:	REV.11.23.09.NFN	DRAWING NUMBER:	E1133W03B		