



OFFICEJET PRO X476 AND X576 MFP SERIES

Repair Manual





HP OfficeJet Pro X476 and X576 MFP Series

Repair Manual

Copyright and License

© 2013 Copyright Hewlett-Packard Development Company, L.P.

Reproduction, adaptation, or translation without prior written permission is prohibited, except as allowed under the copyright laws.

The information contained herein is subject to change without notice.

The only warranties for HP products and services are set forth in the express warranty statements accompanying such products and services. Nothing herein should be construed as constituting an additional warranty. HP shall not be liable for technical or editorial errors or omissions contained herein.

CN598-90007

Edition 2, 12/2013

Trademark Credits

Adobe®, Acrobat®, and PostScript® are trademarks of Adobe Systems Incorporated.

Intel® Core™ is a trademark of Intel Corporation in the U.S. and other countries.

Java™ is a US trademark of Sun Microsystems, Inc.

Microsoft®, Windows®, Windows® XP, and Windows Vista® are U.S. registered trademarks of Microsoft Corporation.

UNIX® is a registered trademark of The Open Group.

ENERGY STAR and the ENERGY STAR mark are registered U.S. marks.

Conventions used in this guide

 **TIP:** Tips provide helpful hints or shortcuts.

 **NOTE:** Notes provide important information to explain a concept or to complete a task.

 **CAUTION:** Cautions indicate procedures that you should follow to avoid losing data or damaging the product.

 **WARNING!** Warnings alert you to specific procedures that you should follow to avoid personal injury, catastrophic loss of data, or extensive damage to the product.

Table of contents

1 Removal and replacement	1
Removal and replacement strategy	2
Electrostatic discharge	2
Required tools	3
OfficeJet Pro X special tools kit	3
Advanced Cleaning Kit	4
Service approach	5
Before performing service	5
After performing service	5
Post-service test	6
Print-quality test	6
Removal and replacement procedures	7
Customer replaceable parts	7
Tray 2	7
Ink cartridges	8
Duplex module	12
Output bin	13
Output bin flap	13
Menu access	14
Access the Engineering menu	14
Access the Support Menu	14
Place the product into MFG (manufacturing) mode	14
Place the product into Audit mode	15
Perform tap tests and interpret results	16
10 tap test results (OOBE states)	16
12 tap test results (REDI sensor values)	18
61 tap results (Align & color calibrations)	20
909 tap test results (BDD status)	21
Covers	22
Rear cover	22
Left door	23
Left rear cover	26

Left front cover	27
Top cover and control panel	29
Top cap assembly	33
Front cover	35
Right cover	36
Main assemblies	37
Aerosol fan assembly	37
Separator/pick assembly	43
Document feeder assembly	49
Duplex drive module	52
Scanner assembly and scanner support bracket	53
Power supply	59
Backscatter drop detect (BDD) assembly	61
Service sled assembly	63
Right cross brace	69
Printbar	71
Printbar calibration procedure	79
Printbar FFC replacement	81
Platen	82
Drying path gear assembly	86
Printbar lift mechanism assembly	87
Tray lift transmission assembly	89
Output drive kit	91
Output drive gears	94
Output drive shaft 6	94
Output drive shaft 5	96
Output drive shaft 4	98
Drive shaft 3	99
Inner top frame	102
Top paper guide	105
Top left paper guide assembly	108
Center left paper guide assembly	110
Paper REDI sensors in the center left paper guide assembly	113
Service sled transmission	114
Printed circuit-board assemblies (PCAs)	115
Fax PCA	115
PCA safety shield	116
Sensor carriage PCA and encoder strip	117
Power button PCA	121
Duplex module sensor PCA	122
Temperature sensor	123

REDI distribution PCA	124
Feed motor encoder sensor PCA	125
Eject flap opto PCA	128
Printzone distribution PCA	129
Media presence sensor PCA/flag	131
Main PCA	132
Main PCA calibration procedure	137
Tray 3 interconnect PCA	140
Pick encoder distribution PCA	141
Wireless PCA	142
2 Parts and diagrams	143
Order parts by authorized service providers	144
Order replacement parts	144
Related documentation and software	144
Supplies part numbers	144
Customer self-repair parts	145
Cables and power cords	146
Service part number and retail SKU cross-references	146
How to use the parts lists and diagrams	148
Assembly locations	149
Front view	149
Back view	150
Covers, panels, and doors	152
Scanner assembly	154
Internal assemblies	156
Alphabetical parts list	166
Numerical parts list	171
Index	177

List of figures

Figure 1-1	OfficeJet Pro X special tools–ink supply door switch	3
Figure 1-2	OfficeJet Pro X special tools–printbar lift knob	4
Figure 1-3	OfficeJet Pro X special tools–service sled advance tool	4
Figure 1-4	OfficeJet Pro X special tools–printbar dolly	4
Figure 1-5	Remove Tray 2 (1 of 2)	7
Figure 1-6	Remove Tray 2 (2 of 2)	7
Figure 1-7	Replace the ink cartridges (1 of 7)	8
Figure 1-8	Replace the ink cartridges (2 of 7)	8
Figure 1-9	Replace the ink cartridges (3 of 7)	9
Figure 1-10	Replace the ink cartridges (4 of 7)	10
Figure 1-11	Replace the ink cartridges (5 of 7)	10
Figure 1-12	Replace the ink cartridges (6 of 7)	11
Figure 1-13	Replace the ink cartridges (7 of 7)	11
Figure 1-14	Remove the duplex module (1 of 2)	12
Figure 1-15	Remove the duplex module (2 of 2)	12
Figure 1-16	Remove the output bin	13
Figure 1-17	Remove the output bin flap	13
Figure 1-18	X476/X576 control panel button locations	14
Figure 1-19	10 tap test results	17
Figure 1-20	12 tap test report	19
Figure 1-21	61 tap test results	20
Figure 1-22	909 tap test results	21
Figure 1-23	Remove the rear cover (1 of 2)	22
Figure 1-24	Remove the rear cover (2 of 2)	22
Figure 1-25	Remove left door (1 of 6)	23
Figure 1-26	Remove the left door (2 of 6)	23
Figure 1-27	Remove the left door (3 of 6)	24
Figure 1-28	Remove the left door (4 of 6)	25
Figure 1-29	Remove the left door (5 of 6)	25
Figure 1-30	Remove the left door (6 of 6)	26
Figure 1-31	Remove the left rear cover (1 of 2)	26
Figure 1-32	Remove the left rear cover (2 of 2)	27

Figure 1-33	Remove the left front cover (1 of 2)	27
Figure 1-34	Remove the left front cover (2 of 2)	28
Figure 1-35	Remove the top cover and control panel (1 of 7)	29
Figure 1-36	Remove the top cover and control panel (2 of 7)	30
Figure 1-37	Remove the top cover and control panel (3 of 7)	30
Figure 1-38	Remove the top cover and control panel (4 of 7)	31
Figure 1-39	Remove the top cover and control panel (5 of 7)	31
Figure 1-40	Remove the top cover and control panel (6 of 7)	32
Figure 1-41	Remove the top cover and control panel (7 of 7)	32
Figure 1-42	Remove the top cap assembly (1 of 3)	33
Figure 1-43	Remove the top cap (2 of 3)	33
Figure 1-44	Remove the top cap (3 of 3)	34
Figure 1-45	Remove the front cover (1 of 2)	35
Figure 1-46	Remove the front cover (2 of 2)	35
Figure 1-47	Remove the right cover (1 of 2)	36
Figure 1-48	Remove the right cover (2 of 2)	36
Figure 1-49	Remove the aerosol fan (1 of 12)	37
Figure 1-50	Remove the aerosol fan (2 of 12)	37
Figure 1-51	Remove the aerosol fan (3 of 12)	38
Figure 1-52	Remove the aerosol fan (4 of 12)	38
Figure 1-53	Remove the aerosol fan (5 of 12)	39
Figure 1-54	Remove the aerosol fan (6 of 12)	39
Figure 1-55	Remove the aerosol fan (7 of 12)	40
Figure 1-56	Remove the aerosol fan (8 of 12)	40
Figure 1-57	Remove the aerosol fan (9 of 12)	41
Figure 1-58	Remove the aerosol fan (10 of 12)	41
Figure 1-59	Remove the aerosol fan (11 of 12)	42
Figure 1-60	Remove the aerosol fan (12 of 12)	42
Figure 1-61	Remove the separator/pick assembly (1 of 4)	43
Figure 1-62	Remove the separator/pick assembly (2 of 4)	44
Figure 1-63	Remove the separator/pick assembly (3 of 4)	45
Figure 1-64	Remove the separator/pick assembly (4 of 4)	45
Figure 1-65	Reinstall the separator/pick assembly (1 of 5)	46
Figure 1-66	Reinstall the separator/pick assembly (2 of 5)	46
Figure 1-67	Reinstall the separator/pick assembly (3 of 5)	47
Figure 1-68	Reinstall the separator/pick assembly (4 of 5)	47
Figure 1-69	Reinstall the separator/pick assembly (5 of 5)	48
Figure 1-70	Remove the document feeder (1 of 5)	49
Figure 1-71	Remove the document feeder (2 of 5)	49
Figure 1-72	Remove the document feeder (3 of 5)	50
Figure 1-73	Remove the document feeder (4 of 5)	50

Figure 1-74	Remove the document feeder (5 of 5)	51
Figure 1-75	Remove the duplex drive module (1 of 2)	52
Figure 1-76	Remove the duplex drive module (2 of 2)	52
Figure 1-77	Remove the scanner and scanner support bracket (1 of 9)	53
Figure 1-78	Remove the scanner and scanner support bracket (2 of 9)	54
Figure 1-79	Remove the scanner and scanner support bracket (3 of 9)	54
Figure 1-80	Remove the scanner and scanner support bracket (4 of 9)	55
Figure 1-81	Remove the scanner and scanner support bracket (5 of 9)	55
Figure 1-82	Remove the scanner and scanner support bracket (6 of 9)	56
Figure 1-83	Remove the scanner and scanner support bracket (7 of 9)	56
Figure 1-84	Remove the scanner and scanner support bracket (8 of 9)	57
Figure 1-85	Remove the scanner and scanner support bracket (9 of 9)	57
Figure 1-86	Calibrate the scanner (scanner barcode location)	58
Figure 1-87	Remove the power supply (1 of 3)	59
Figure 1-88	Remove the power supply (2 of 3)	60
Figure 1-89	Remove the power supply (3 of 3)	60
Figure 1-90	Remove the backscatter drop detect assembly (1 of 2)	61
Figure 1-91	Remove the backscatter drop detect assembly (2 of 2)	62
Figure 1-92	Remove the service sled assembly (1 of 6)	63
Figure 1-93	Remove the service sled assembly (2 of 6)	64
Figure 1-94	Remove the service sled assembly (3 of 6)	65
Figure 1-95	Remove the service sled assembly (4 of 6)	65
Figure 1-96	Remove the service sled assembly (5 of 6)	66
Figure 1-97	Remove the service sled assembly (6 of 6)	66
Figure 1-98	Remove the web advance rack assembly (1 of 2)	67
Figure 1-99	Remove the web advance rack assembly (2 of 2)	68
Figure 1-100	Remove the right cross brace (1 of 4)	69
Figure 1-101	Remove the right cross brace (2 of 4)	70
Figure 1-102	Remove the right cross brace (3 of 4)	70
Figure 1-103	Remove the right cross brace (4 of 4)	71
Figure 1-104	Remove the printbar (1 of 12)	72
Figure 1-105	Remove the printbar (2 of 12)	72
Figure 1-106	Remove the printbar (3 of 12)	73
Figure 1-107	Remove the printbar (4 of 12)	73
Figure 1-108	Remove the printbar (5 of 12)	74
Figure 1-109	Remove the printbar (6 of 12)	75
Figure 1-110	Remove the printbar (7 of 12)	75
Figure 1-111	Remove the printbar (8 of 12)	76
Figure 1-112	Remove the printbar (9 of 12)	76
Figure 1-113	Remove the printbar (10 of 12)	77
Figure 1-114	Remove the printbar (11 of 12)	77

Figure 1-115	Remove the printbar (12 of 12)	78
Figure 1-116	Replace the printbar control FFCs (1 of 2)	81
Figure 1-117	Replace the printbar control FFCs (2 of 2)	81
Figure 1-118	Remove the platen (1 of 7)	82
Figure 1-119	Remove the platen (2 of 7)	83
Figure 1-120	Remove the platen (3 of 7)	83
Figure 1-121	Remove the platen (4 of 7)	84
Figure 1-122	Remove the platen (5 of 7)	84
Figure 1-123	Remove the platen (6 of 7)	85
Figure 1-124	Remove the platen (7 of 7)	86
Figure 1-125	Remove the drying path gear assembly	86
Figure 1-126	Remove the printbar lift motor (1 of 3)	87
Figure 1-127	Remove the printbar lift motor (2 of 3)	87
Figure 1-128	Remove the printbar lift motor (3 of 3)	88
Figure 1-129	Remove the tray lift transmission assembly (1 of 2)	89
Figure 1-130	Remove the tray lift transmission assembly (2 of 2)	90
Figure 1-131	Remove the flap actuator solenoid	91
Figure 1-132	Remove the rack-eject lifter flap (1 of 3)	92
Figure 1-133	Remove the rack-eject lifter flap (2 of 3)	92
Figure 1-134	Remove the rack-eject lifter flap (3 of 3)	93
Figure 1-135	Remove the eject drive gear module	93
Figure 1-136	Remove the output drive gears	94
Figure 1-137	Remove the output drive shaft 6 (1 of 3)	95
Figure 1-138	Remove the output drive shaft 6 (2 of 3)	95
Figure 1-139	Remove the output drive shaft 6 (3 of 3)	96
Figure 1-140	Remove the output drive shaft 5 (1 of 2)	97
Figure 1-141	Remove the output drive shaft 5 (2 of 2)	97
Figure 1-142	Remove the output drive shaft 4 (1 of 2)	98
Figure 1-143	Remove the output drive shaft 4 (2 of 2)	99
Figure 1-144	Remove drive shaft 3 (1 of 4)	100
Figure 1-145	Remove drive shaft 3 (2 of 4)	100
Figure 1-146	Remove drive shaft 3 (3 of 4)	101
Figure 1-147	Remove drive shaft 3 (4 of 4)	101
Figure 1-148	Remove the inner top frame (1 of 5)	102
Figure 1-149	Remove the inner top frame (2 of 5)	102
Figure 1-150	Remove the inner top frame (3 of 5)	103
Figure 1-151	Remove the inner top frame (4 of 5)	103
Figure 1-152	Remove the inner top frame (5 of 5)	104
Figure 1-153	Remove the top paper guide (1 of 6)	105
Figure 1-154	Remove the top paper guide (2 of 6)	105
Figure 1-155	Remove the top paper guide (3 of 6)	106

Figure 1-156	Remove the top paper guide (4 of 6)	106
Figure 1-157	Remove the top paper guide (5 of 6)	107
Figure 1-158	Remove the top paper guide (6 of 6)	107
Figure 1-159	Remove the top left paper guide (1 of 3)	108
Figure 1-160	Remove the top left paper guide (2 of 3)	109
Figure 1-161	Remove the top left paper guide (3 of 3)	109
Figure 1-162	Reinstall the top left paper guide	110
Figure 1-163	Remove the center left paper guide (1 of 4)	110
Figure 1-164	Remove the center left paper guide (2 of 4)	111
Figure 1-165	Remove the center left paper guide (3 of 4)	111
Figure 1-166	Remove the center left paper guide (4 of 4)	112
Figure 1-167	Remove the paper REDI sensors	113
Figure 1-168	Correctly positioned service sled transmission	114
Figure 1-169	Incorrectly positioned service sled transmission	114
Figure 1-170	Remove the fax PCA (1 of 2)	115
Figure 1-171	Remove the fax PCA (2 of 2)	115
Figure 1-172	Remove the PCA safety shield (1 of 2)	116
Figure 1-173	Remove the PCA safety shield (2 of 2)	116
Figure 1-174	Remove the sensor carriage PCA and encoder strip (1 of 8)	117
Figure 1-175	Remove the sensor carriage PCA and encoder strip (2 of 8)	117
Figure 1-176	Remove the sensor carriage PCA and encoder strip (3 of 8)	118
Figure 1-177	Remove the sensor carriage PCA and encoder strip (4 of 8)	118
Figure 1-178	Remove the sensor carriage PCA and encoder strip (5 of 8)	119
Figure 1-179	Remove the sensor carriage PCA and encoder strip (6 of 8)	119
Figure 1-180	Remove the sensor carriage PCA and encoder strip (7 of 8)	120
Figure 1-181	Remove the sensor carriage PCA and encoder strip (8 of 8)	120
Figure 1-182	Remove the power button PCA (1 of 2)	121
Figure 1-183	Remove the power button PCA (2 of 2)	121
Figure 1-184	Remove the duplex module sensor PCA (1 of 2)	122
Figure 1-185	Remove the duplex module sensor PCA (2 of 2)	122
Figure 1-186	Remove the temperature sensor (1 of 2)	123
Figure 1-187	Remove the temperature sensor (2 of 2)	123
Figure 1-188	Remove the REDI distribution PCA PCA (1 of 3)	124
Figure 1-189	Remove the REDI distribution PCA PCA (2 of 3)	124
Figure 1-190	Remove the REDI distribution PCA PCA (3 of 3)	125
Figure 1-191	Remove the feed motor encoder sensor PCA (1 of 4)	125
Figure 1-192	Remove the feed motor encoder sensor PCA (2 of 4)	126
Figure 1-193	Remove the feed motor encoder sensor PCA (3 of 4)	126
Figure 1-194	Remove the feed motor encoder sensor PCA (4 of 4)	127
Figure 1-195	Remove the eject flap opto PCA	128
Figure 1-196	Remove the printzone distribution PCA (1 of 3)	129

Figure 1-197	Remove the printzone distribution PCA (2 of 3)	129
Figure 1-198	Remove the printzone distribution PCA (3 of 3)	130
Figure 1-199	Remove the media presence sensor PCA/flag (1 of 2)	131
Figure 1-200	Remove the media presence sensor PCA/flag (2 of 2)	131
Figure 1-201	Remove the main PCA (1 of 8)	133
Figure 1-202	Remove the main PCA (2 of 8)	133
Figure 1-203	Remove the main PCA (3 of 8)	134
Figure 1-204	Remove the main PCA (4 of 8)	134
Figure 1-205	Remove the main PCA (5 of 8)	135
Figure 1-206	Remove the main PCA (6 of 8)	135
Figure 1-207	Remove the main PCA (7 of 8)	136
Figure 1-208	Remove the main PCA (8 of 8)	136
Figure 1-209	Remove the Tray 3 interconnect PCA (1 of 2)	140
Figure 1-210	Remove the Tray 3 interconnect PCA (2 of 2)	140
Figure 1-211	Remove the pick encoder distribution PCA (1 of 2)	141
Figure 1-212	Remove the pick encoder distribution PCA (2 of 2)	141
Figure 1-213	Remove the wireless PCA.	142
Figure 2-1	Front view	149
Figure 2-2	Back view	150
Figure 2-3	Covers, panels, and doors	152
Figure 2-4	Scanner assembly	154
Figure 2-5	Internal assemblies (1 of 3)	156
Figure 2-6	Internal assemblies (2 of 3)	158
Figure 2-7	Internal assemblies (3 of 3)	160
Figure 2-8	PCA locations (1 of 2)	162
Figure 2-9	PCA locations (2 of 2)	164

1 Removal and replacement

- [Removal and replacement strategy](#)
- [Service approach](#)
- [Removal and replacement procedures](#)

Removal and replacement strategy

 **WARNING!** Turn the product off, wait 5 seconds, and then remove the power cord before attempting to service the product. If this warning is not followed, severe injury can result, in addition to damage to the product. The power must be on for certain functional checks during problem solving. However, the power supply should be disconnected during parts removal.



The sheet-metal parts can have sharp edges. Be careful when handling sheet-metal parts.

 **CAUTION:** Many repair operations will require you to flatten or straighten flex cables. However, where possible, try to avoid doing so. You *must* make sure that all FFCs are fully seated in their connectors. Failure to fully seat an FFC into a connector can cause a short circuit in a PCA.

 **NOTE:** To install a self-tapping screw, first turn it counterclockwise to align it with the existing thread pattern, and then carefully turn it clockwise to tighten. Do not overtighten. If a self-tapping screw-hole becomes stripped, repair the screw-hole or replace the affected assembly.

Throughout this chapter, the reinstallation process should follow the reverse order of the removal process documented. Where necessary, the tasks include reinstallation tips to aid in the installation of replacement parts.

Electrostatic discharge

 **CAUTION:**  Some parts are sensitive to electrostatic discharge (ESD). Look for the ESD reminder when removing product parts. Always perform service work at an ESD-protected workstation or mat. If an ESD workstation or mat is not available, ground yourself by touching the sheet-metal chassis *before* touching an ESD-sensitive part.

Protect the ESD-sensitive parts by placing them in ESD pouches when they are out of the product.

Required tools

- #T10 TORX driver with a magnetic tip and a 152 mm (6 in) shaft length
- #T10 TORX driver with a magnetic tip and a 25 mm (1 in) shaft length
- Small flat-blade screwdriver
- Needle-nose pliers
- Tweezers
- ESD mat (if one is available) or ESD strap
- Penlight
- 1/4" (6.4mm) nut driver (for use with the OfficeJet Pro X special tools kit)

⚠ CAUTION: While the use of a motorized screwdriver is recommended, the screwdriver must have a torque limiter, and it must be set to a low torque.

OfficeJet Pro X special tools kit

The OfficeJet Pro X special tools kit (part number CN598-67056) is required for replacing the service sled and printbar assemblies.

The OfficeJet Pro X special tools kit contains the following parts:

- Ink supply door switch—used to tell the printer that the supply door is closed when the front cover is removed.

Figure 1-1 OfficeJet Pro X special tools—ink supply door switch

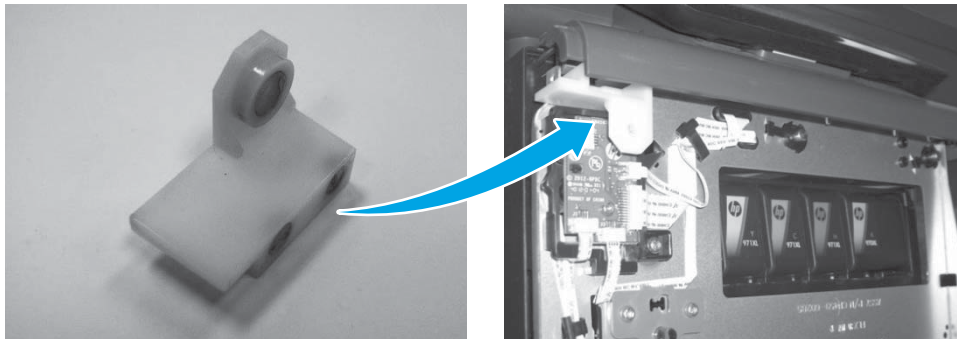

- Printbar lift knob—used for lifting and holding the printbar.

 **NOTE:** Use a one-quarter inch nut driver to raise the printbar.

Figure 1-2 OfficeJet Pro X special tools—printbar lift knob



- Service sled advance tool—used to remove and reinstall the service sled.

 **NOTE:** Use a one-quarter inch nut driver to remove or install the service sled

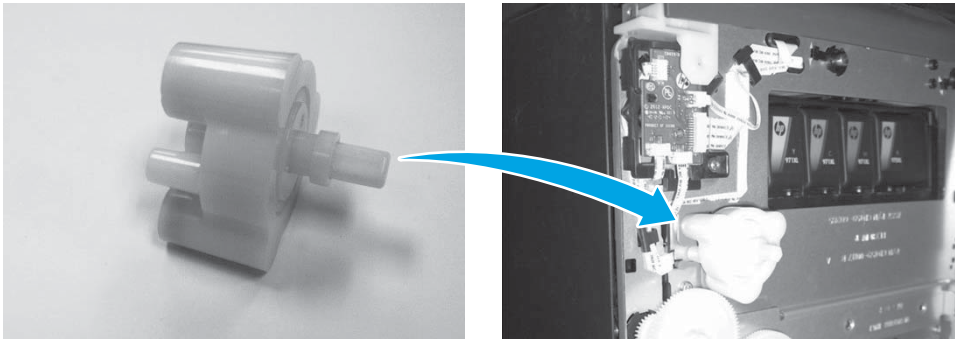
Figure 1-3 OfficeJet Pro X special tools—service sled advance tool



- Printbar dolly—used to support the printbar during removal and installation.

Figure 1-4 OfficeJet Pro X special tools—printbar dolly

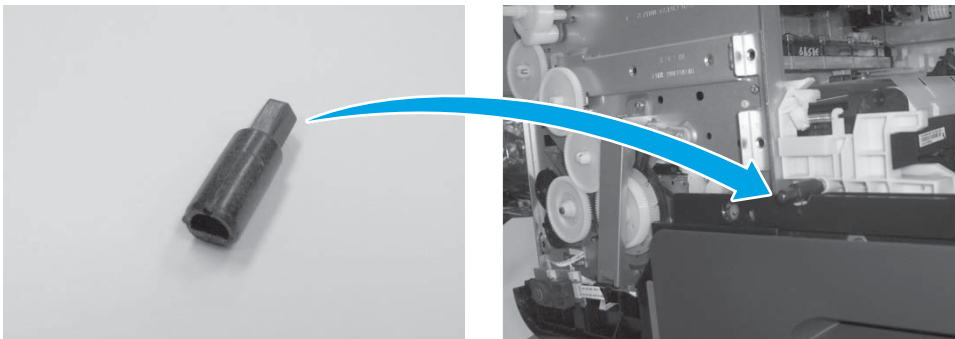
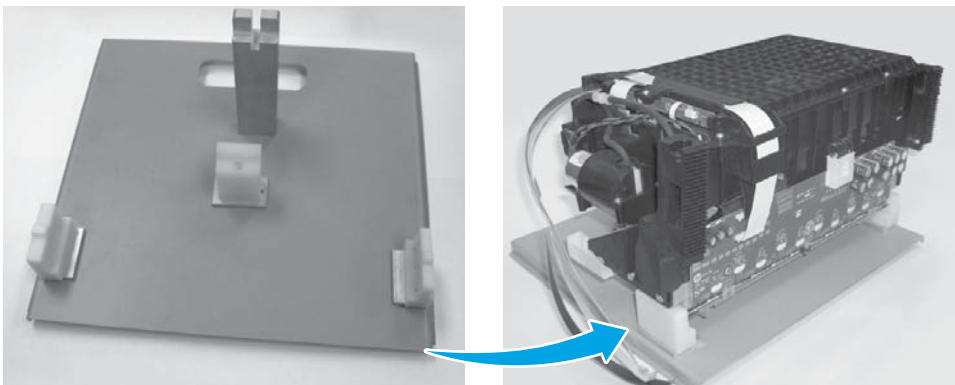

Advanced Cleaning Kit

The Advanced Cleaning Kit (part number CN459-67006) is used for resolving shim whiskers print quality issues.

The Advanced Cleaning Kit contains the following items:

- Sheet cleaner - full mid
- Shim whisker kit Instructions
- Corrugated box
- Corrugated insert

Service approach

 **IMPORTANT:** Ensure the product has the latest firmware installed for the initial installation of the product. Certain repairs to this product also require updated firmware, as noted in this document. Download firmware for this product at www.hp.com.

 **CAUTION:** When working on the product, do not pick up the unit by the scanner assembly or output tray. If you need to move the product while performing any service procedures, remove the scanner assembly/output tray to reduce the weight of the product and decrease the chances of damaging the product.

Before performing service

- Remove all paper from the product.
- Turn off the power using the power button.
- Unplug the power cable and interface cable or cables.
- Remove the output bin.
- Place the product on an ESD workstation or mat, or use an ESD strap (if one is available). If an ESD workstation, mat, or strap is not available, ground yourself by touching the sheet-metal chassis *before* touching an ESD-sensitive part.
- Remove the Tray 2 cassette.
- Remove the duplex module, which is located inside the left door.

 **NOTE:** When removing the duplex module, avoid making direct contact with the black cylinder to prevent ink smear on skin or clothes. Keep the duplex module level to avoid spilling any maintenance ink.

After performing service

- Plug in the power cable.
- Reinstall the output bin.
- Reinstall the ink cartridges (if they were removed prior to performing service).
- Reinstall the Tray 2 cassette.

- Reinstall the duplex module.
- Load paper in the product.

Post-service test

Perform the following test to verify that the repair or replacement was successful.

Print-quality test

1. Verify that the necessary reassembly steps have been completed.
2. Make sure that the tray contains clean, unmarked paper.
3. Attach the power cord and interface cable or interface cables, and then turn on the product.
4. Verify that the expected startup sounds occur.
5. Print a configuration page, and verify that the expected printing sounds occur.
6. Print a print-quality page, and then verify that there are no lines, streaks, banding, or other print quality defects.
7. Send a print job from the host computer, and then verify that the output meets expectations.
8. Clean the outside of the product with a damp cloth.

Removal and replacement procedures

Customer replaceable parts

Tray 2

1. Pull out the tray.

Figure 1-5 Remove Tray 2 (1 of 2)

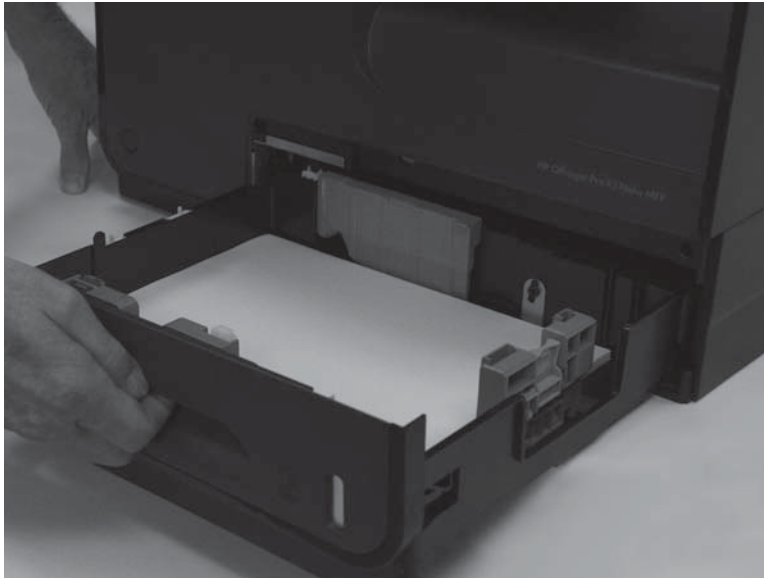

2. Press the latch in left-rear corner of the tray.

Figure 1-6 Remove Tray 2 (2 of 2)

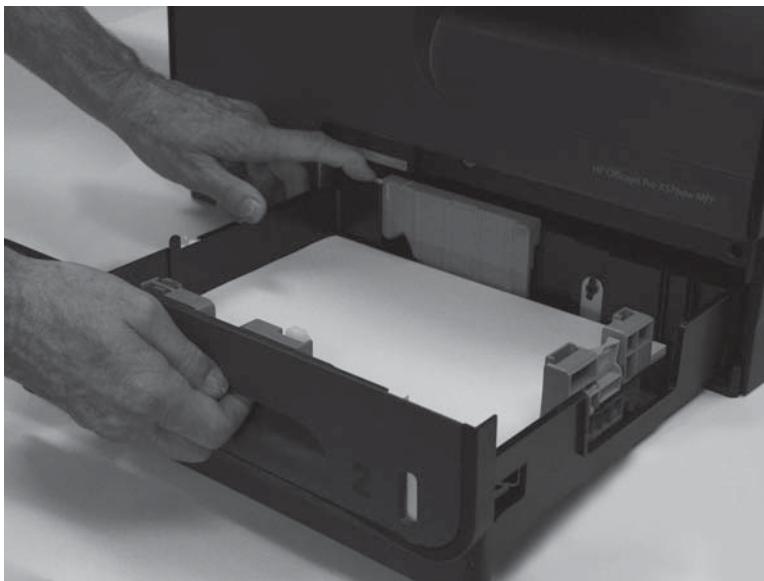

3. Remove the tray from the product.

Ink cartridges

The product uses four colors and has a different ink cartridge for each color: yellow (Y), cyan (C), magenta (M), and black (K).

1. Open the ink cartridge access door.

Figure 1-7 Replace the ink cartridges (1 of 7)



2. Push the old ink cartridge inward to unlock it.

Figure 1-8 Replace the ink cartridges (2 of 7)

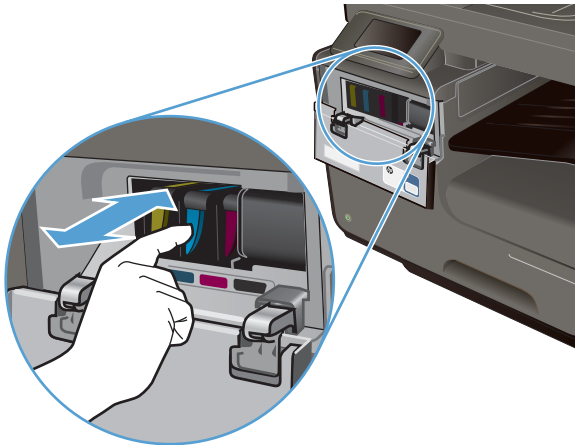

3. Grasp the edge of the old ink cartridge, and then pull the cartridge straight out to remove it.

Figure 1-9 Replace the ink cartridges (3 of 7)

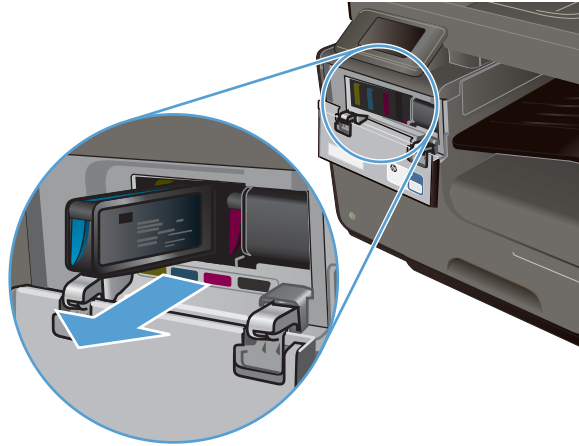

4. Remove the new ink cartridge from the packaging.

Figure 1-10 Replace the ink cartridges (4 of 7)

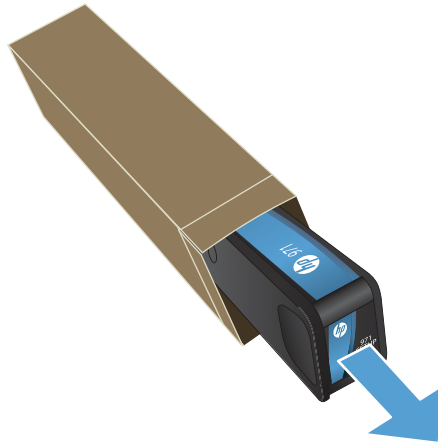

 **NOTE:** Do not touch the metal connector of the ink cartridge. Fingerprints on the connector can cause product operation problems.

Figure 1-11 Replace the ink cartridges (5 of 7)



5. Insert the new ink cartridge into the product.

Figure 1-12 Replace the ink cartridges (6 of 7)

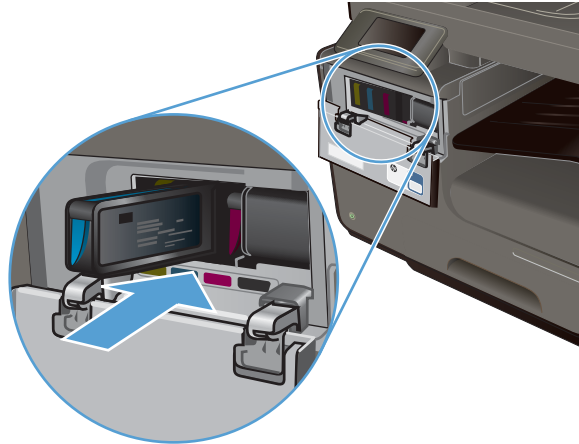

6. Close the ink cartridge door.

Figure 1-13 Replace the ink cartridges (7 of 7)



7. Place the old ink cartridge in the box, and refer to the HP recycling instructions at www.hp.com/recycle.

Duplex module

1. Open the left door.

Figure 1-14 Remove the duplex module (1 of 2)



2. Pull the duplex module out of the product.

Figure 1-15 Remove the duplex module (2 of 2)

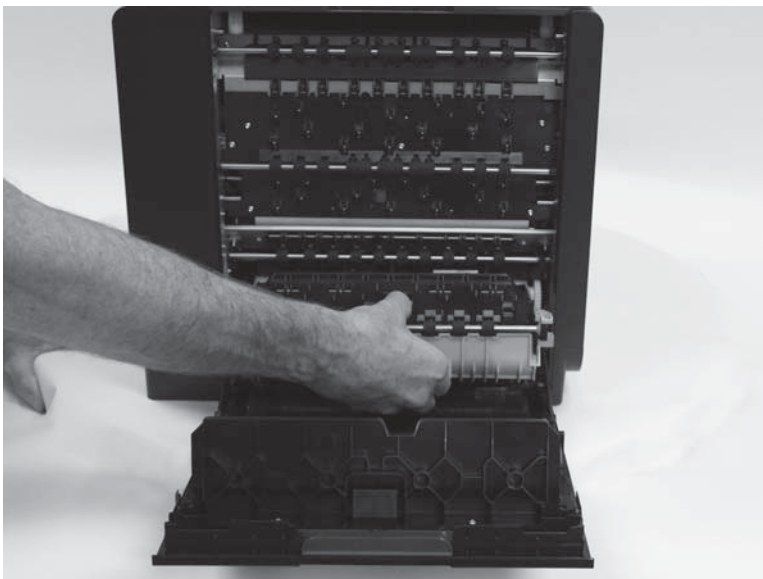

 **NOTE:** When removing the duplex module, avoid making direct contact with the black cylinder to prevent ink smear on skin or clothes. Keep the duplex module level to avoid spilling any maintenance ink.

When removing the duplex module, do not let the bottom of the duplex module touch or rest on the ribs on the left door, which will damage them and might lead to paper damage and jams.

Output bin

- ▲ Lift and remove the output bin.

Figure 1-16 Remove the output bin



Output bin flap

1. Remove the output bin. See [Output bin on page 13](#).
2. Flex the middle of the output bin flap, and then remove the flap by pulling the rear pin (callout 1) away from the product first.

Figure 1-17 Remove the output bin flap



 **Reinstallation tip** With the flap in the open position, insert the front pin into the product first, and then flex or bend the flap to install the rear pin.

Menu access

These hidden engineering menus are used for testing and calibration. Some or all of them are referenced in remove and replace sections as required.



WARNING! Misuse of these menus could damage the product or make it unusable.

NOTE: These buttons are not illuminated until they are touched with sufficient pressure. Locate these buttons by sweeping your finger over the general areas indicated in [Figure 1-18 X476/X576 control panel button locations on page 14](#).

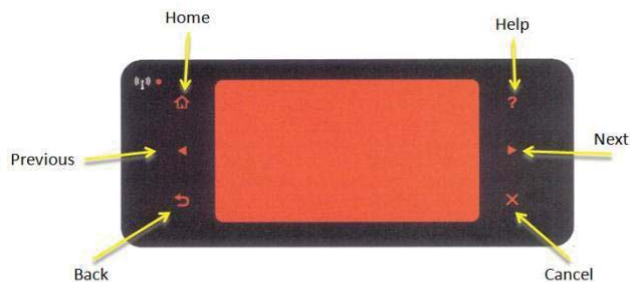
Figure 1-18 X476/X576 control panel button locations



Access the Engineering menu

1. Touch the Home  button.
2. Touch the Back  button.
3. Touch the Home  button twice to enter the [Engineering menu](#).

NOTE: The [Service menu](#) is accessed from the [Engineering menu](#).



Access the Support Menu



Touch the Back  button four times consecutively to open the [Support Menu](#).

NOTE: The [Support Menu](#) is usually used by HP call center agents for assisting customers.

Place the product into MFG (manufacturing) mode

NOTE: These two modes are ONLY to be used by authorized service providers. They should NEVER be accessed by the end user.





1. Press and hold the power button while plugging in the product. The HP logo appears on the product control panel, and then disappears. Continue to hold the power button for five seconds after the logo disappears.
2. Release the power button.
3. Touch the Home  button.
4. Touch the Back  button.



5. Touch the Home  button twice.
6. After a new screen appears, touch the Home  button again to enter MFG (off) mode.
7. Press the power button to enter MFG (on) mode.

Place the product into Audit mode

 **NOTE:** These two modes are ONLY to be used by authorized service providers. They should NEVER be accessed by the end user.

 **WARNING!** Audit mode is used only when the main PCA is replaced.

1. Press and hold the power button while plugging in the product. The HP logo appears on the control panel, and then disappears. Continue to hold the power button for five seconds after the logo disappears.
2. Release the power button.
3. Touch the Home  button.
4. Touch the Back  button
5. Touch the Home  button twice.
6. Touch the  button.
7. Press the power button.

 **NOTE:** The product touchscreen is not active in this menu access mode. Use the  and  buttons on the control panel frame.

Perform tap tests and interpret results

Perform a tap test

1. Open the Engineering Menu. See [Access the Engineering menu on page 14](#).
2. Touch [Manufacturing Menu](#).
3. Use the arrow key to find the [Reports Menu](#), and then touch the [OK](#) button.
4. Use the arrow key to find the [Print-mech tap tests](#), and then touch the [OK](#) button.
5. Use the arrow key to find the tap test to run.

10 tap test results (OOBE states)

The printed tap test results contain a sequence of numbers at line number 68, "Startup Complete," of the printed report.

Use the following table to interpret these numbers.

Table 1-1 10 tap test results, row 68

Column	Code	Acceptable values
Column 1	DSID_PEN_PRINTER_STARTUP_BITS	A value of 1 indicates that the printbar has been started up. This means that shipping fluid has been removed from the printbar and replaced with ink. This is the expected state for a printer after initialization.
Column 2	DSID_OOBE_STATE	255—OOBE messaging complete.
Column 3	DSID_INK_SUPPLY_OOBE_COMPELTE	1—SHF purge is complete and service wipes have been enabled.
Column 4	DSID_CAL_OOBE_STATE	A value of 2 means that the OOBE printed calibrations are complete. A value of 1 means the OOBE printed calibrations are in progress A value of 0 means the OOBE printed calibration does not exist so no printing/calibration for OOBE is attempted.
Column 5	DSID_IQ_LIST_INDEX	A value of 3 means that pen height and beam center have been completed, and that BDD is scheduled (or pending) to perform normally. NOTE: For 1315FR firmware and above.
Column 6	DSID_BDD_FAIL_MASK	0—internal use only.

Table 1-1 10 tap test results, row 68 (continued)

Column	Code	Acceptable values
Column 7	DSID_IDS_FIRST_CHARGE_REQUIRED	0—internal use only.
Column 8	DSID_PRINTHEAD_CAL_NEEDED	A value of 0 indicates that OOBE calibrations (not IQ calibrations) are complete. This is so the messaging is complete for the calibrations. For example, if this value is 0, but the CAL_OOBE_STATE=1, you will get the printed OOBE calibrations, but the control panel may display Preparing instead of Calibrating .

Figure 1-19 10 tap test results

Printer Hardware Information

Extended Self Test Diagnostic Page - 1 of 2





Product Information

11. Product Name: HP Officejet Pro 8540 MFP series
 12. Product Number: CNE598A
 13. Serial Number: CN2AM9J0DS
 14. Service ID: 22334
 15. Date/Time: 11/5/2013 13:46:58
 16. Printer ID: 0
 17. Default Symbol Set: 341
 18. Total Page Count: 611
 19. Duplex Page Count: 42

Revision Information

24. Main PCA Revision: ID: 20516 MFG: 5 PAM: 4 NUM: 8
 25. Digital ASIC: SHEMP Rev A.3 Mfg: Marvell
 26. Analog ASIC: 1- REV: 0 MFG: 0, 2- REV: 0 MFG: 0
 27. Firmware Version: L2PICN133MR
 28. Flows Revision: OFFICIAL
 29. Patch Revision: 0
 33. Duplexer Installed: Yes

Ink Delivery System Information

43. Ink Supply:	Yellow	Cyan	Magenta	Black
44. Ink Level:	E  F	E  F	E  F	E  F
45. Ink Status:	Ready	Ready	Ready	Ready
47. Ink Status Slider:	200	200	200	200
48. Selectability Number:	971XL	971XL	971XL	970XL
49. SHAID Status:	0	0	0	0
50. SHAID Function:	0	0	0	0
51. Host/Trade Acumen Bit:	0	0	0	0
52. Start Up Complete:	0	0	0	0
53. Supply Serial Number:	178009178	182981570	178533525	183277097
54. Mfg. Date:	10/14/2012	11/18/2012	10/21/2012	11/18/2012
55. Ink Install:	01/01/2013	01/01/2013	01/01/2013	01/01/2013
56. Warranty Ends:	10/15/2014	11/19/2014	10/22/2014	11/19/2014
57. Warranty Status:	OK	OK	OK	OK
58. NERO: 0				
59. IRO: 00				

Print Head Assembly Information

60. TVAL: 190
 61. Total Dot Count (Kilo dots):
 a. Magenta: 1979745
 b. Cyan: 1668988
 c. Yellow: 1868496
 d. Black: 183277097
 75. TTOE done: 1

68. Startup complete: 1 255 1 2 0 0 0 0

DD-SYS:	1200			
DD-HIS:	0	200	100	1200
DD-CURR:	0	200	100	1200

A. Last successful calibration at page count: 81
 65. Last failed calibration at page count: 0
 66. Last calibration at page count: 81
 67. Dots printed since last power on: 507

69. NUMBER OF CALIBRATIONS:	PRN_ALIGN_0	PRN_ALIGN_1	PRN_ALIGN_2	COLOR_CAL_0	COLOR_CAL_1	COLOR_CAL_2
Success:	1	1	1	1	1	1
Failed :	0	0	0	0	0	0

12 tap test results (REDI sensor values)

Table 1-2 12 tap test report

Callout	Report area	Item	Acceptable values
1	Print Humidity Sensor Data	Stable Relative Humidity	0–100 RH
2	Pen TSR Ambient Temperature Estimate	Pen TSR Ambient Temperature x10 °C	± 10 °C of current ambient temperature
3	Digital Temperature Sensor Ambient Temperature	Digital Temperature Sensor Ambient Temperature x10 °C	± 10 °C of current ambient temperature
4	Print REDI Sensor Calibration Data	TOF sensor, p value ¹	Between 10 and 100
5	Print REDI Sensor Calibration Data	TOF sensor, m value ¹	Between 25 and 380

¹ "M" is mirror result, "P" is blocked with paper.

Figure 1-20 12 tap test report

```

HP Officejet Pro 8730s MFP series
Serial Number: CM2C19J063
Service ID: 23074
Test Service ID: 2E33B-PD0M-QYSD-TRVM
FW Revision: LE11CM1333R
Total Engine Page Count: 559

```

1 Stable Relative Humidity: 43

-----Print TSR Ambient Temperature Estimate-----

2 Pen TSR Ambient Temperature x10C: 200

-----Digital Temperature Sensor Ambient Temperature-----

3 Digital Temperature Sensor Ambient Temperature x10 C: 266

-----Print REDI Sensor Calibration Data-----

4 TOF sensor, p value: 26

5 TOF sensor m value: 356

```

AMD Home: 0 Rear Home: 0
Cap: 291 Uncap: 280
Uncap: 0 Cap: 0
Wire: 98 Dev Wire: 8
Scraps: 0 Fluid Disp: 0
Pump Cycles: 14 Pump Durations: 32200

```

1 ----- Print Humidity Sensor Data -----

Factory Clock Count: 594

Factory Humidity: 45

Correction Factor 1: 5749

Correction Factor 2: 5821

Raw Clock Count: 586

Corrected Clock Count: 566

Stable Relative Humidity: 43

2 ----- Pen TSR Ambient Temperature Estimate -----

Pen TSR Ambient Temperature x10 C: 200

3 ----- Digital Temperature Sensor Ambient Temperature -----

Digital Temperature Sensor Ambient Temperature x10 C: 266

----- Print REDI Sensor Calibration Data -----

4 TOF sensor, p value: 26

TOF sensor, m value: 356

PE sensor, p value: 24

PE sensor, m value: 287

LFP sensor, p value: 20

LFP sensor, m value: 349

UPF sensor, p value: 33

UPF sensor, m value: 316

RETR sensor, m value: 31

RETR sensor, m value: 188

MP tray media sensor, p value: 27

MP tray media sensor, m value: 353

P calibration valid: 1

M Calibration valid: 1

```

-----Timers and counters-----
Pages Since Last Wipe : 7
Web Advance Counter : 37
Engine Page Count : 559

-----Data_X_1000-----
PRINT_DOT_COUNT_K : 0
PRINT_DOT_COUNT_C : 0
PRINT_DOT_COUNT_M : 0
PRINT_DOT_COUNT_Y : 0
SPIT_DOT_COUNT_R : 7229583
SPIT_DOT_COUNT_C : 8678028
SPIT_DOT_COUNT_M : 8178028
SPIT_DOT_COUNT_Y : 7659576
TOTAL_DOT_COUNT_R : 8468583
TOTAL_DOT_COUNT_C : 9136529
TOTAL_DOT_COUNT_M : 8598946
TOTAL_DOT_COUNT_Y : 8264604

```

61 tap results (Align & color calibrations)

 **NOTE:** If you hold the up or down arrows down, the tap count will start incrementing by 10, or 100

An acceptable 61 tap test has identical values for the parameters in the “Color scale (factory)” (callout 1) and “Color scale (current)” (callout 2) on the printed report areas. “Color scale (factory)” (callout 1) and “Color scale (current)” will be identical after a main PCA replacement, but may not be the same under other conditions. The values should also be identical after a printbar replacement.

Figure 1-21 61 tap test results

```

*****
WRITING SYSTEM CALIBRATION REPORT
*****

= ledb : 14
= ledb no saturation : 14

= pen_to_slm_X(zero column) #7200: -45
= pen_to_slm_Y(tof) #7200: 0
= Measured zero column and tof #7200:
= Tray: Main MP Accessory
= side: Front Back Front Back Front Back
= Z-Col: 0 0 0 0 0 0
= TOF: 0 0 0 0 0 0

error type: sensor_s_target centroid lphase ledb vernier 3_sigma analysis
= Last pen align 0 status = 0x0 : 0 0 0 0 0 0 0 0 0 0
= Last pen align 1 status = 0x0 : 0 0 0 0 0 0 0 0 0 0
= Last pen align 2 status = 0x0 : 0 0 0 0 0 0 0 0 0 0

= Last pen align analysis die status(hex) for page 0: 0 0 0 0 0 0 0 0 0 0
= Last pen align analysis die status(hex) for page 1: 0 0 0 0 0 0 0 0 0 0
= Last pen align analysis die status(hex) for page 2: 0 0 0 0 0 0 0 0 0 0

= Last successful pen alignment values in NVM:

= Pen die X alignment(factory) #7200:
= die: 0 1 2 3 4 5 6 7 8 9
= K: -24 -6 -6 0 6 6 6 18 18 24
= C: -24 -6 -6 0 6 6 6 18 18 24

= Color scale (factory) :
= dia: 0 1 2 3 4 5 6 7 8 9
1 = K: 0x7eec 0x7f3c 0x8265 0x8280 0x8215 0x8070 0x7fcf 0x804b 0x7cea 0x7d65
= C: 0x7d51 0x7fbo 0x8063 0x81b5 0x80c5 0x81a1 0x7fc5 0x80ed 0x7dea 0x7fe6
= M: 0x7d51 0x7fbo 0x8063 0x81b5 0x80c5 0x81a1 0x7fc5 0x80ed 0x7dea 0x7fe6
= Y: 0x7d51 0x7fbo 0x8063 0x81b5 0x80c5 0x81a1 0x7fc5 0x80ed 0x7dea 0x7fe6

= Color scale (factory) :
= dia: 0 1 2 3 4 5 6 7 8 9
2 = K: 0x7eec 0x7f3c 0x8265 0x8280 0x8215 0x8070 0x7fcf 0x804b 0x7cea 0x7d65
= C: 0x7d51 0x7fbo 0x8063 0x81b5 0x80c5 0x81a1 0x7fc5 0x80ed 0x7dea 0x7fe6
= M: 0x7d51 0x7fbo 0x8063 0x81b5 0x80c5 0x81a1 0x7fc5 0x80ed 0x7dea 0x7fe6
= Y: 0x7d51 0x7fbo 0x8063 0x81b5 0x80c5 0x81a1 0x7fc5 0x80ed 0x7dea 0x7fe6

= Last density cal analysis die status(hex) for page 1: 0 0 0 0 0 0 0 0 0 0
= Last density cal analysis die status(hex) for page 2: 0 0 0 0 0 0 0 0 0 0

= Last successful density cal values in NVM:

1 = Color scale (factory):
= dia: 0 1 2 3 4 5 6 7 8 9
= K: 0x7eec 0x7f3c 0x8265 0x8280 0x8215 0x8070 0x7fcf 0x804b 0x7cea 0x7d65
= C: 0x7d51 0x7fbo 0x8063 0x81b5 0x80c5 0x81a1 0x7fc5 0x80ed 0x7dea 0x7fe6
= M: 0x7d51 0x7fbo 0x8063 0x81b5 0x80c5 0x81a1 0x7fc5 0x80ed 0x7dea 0x7fe6
= Y: 0x7d51 0x7fbo 0x8063 0x81b5 0x80c5 0x81a1 0x7fc5 0x80ed 0x7dea 0x7fe6

2 = Color scale (factory):
= dia: 0 1 2 3 4 5 6 7 8 9
= K: 0x7eec 0x7f3c 0x8265 0x8280 0x8215 0x8070 0x7fcf 0x804b 0x7cea 0x7d65
= C: 0x7d51 0x7fbo 0x8063 0x81b5 0x80c5 0x81a1 0x7fc5 0x80ed 0x7dea 0x7fe6
= M: 0x7d51 0x7fbo 0x8063 0x81b5 0x80c5 0x81a1 0x7fc5 0x80ed 0x7dea 0x7fe6
= Y: 0x7d51 0x7fbo 0x8063 0x81b5 0x80c5 0x81a1 0x7fc5 0x80ed 0x7dea 0x7fe6

= Last successful calibration at page count: 552
= Last failed calibration at page count: 0
= Last Calibration at page count: 552

Number of Calibrations: PEN_ALIGN_0 PEN_ALIGN_1 PEN_ALIGN_2 COLOR_CAL_0 COLOR_CAL_1 COLOR_CAL_2
Success: 3 3 3 2 2 2
Failed : 0 0 0 0 0 0
    
```

Covers

Rear cover

1. Remove the left rear cover. See [Left rear cover on page 26](#).
2. Remove one screw (callout 1).

Figure 1-23 Remove the rear cover (1 of 2)

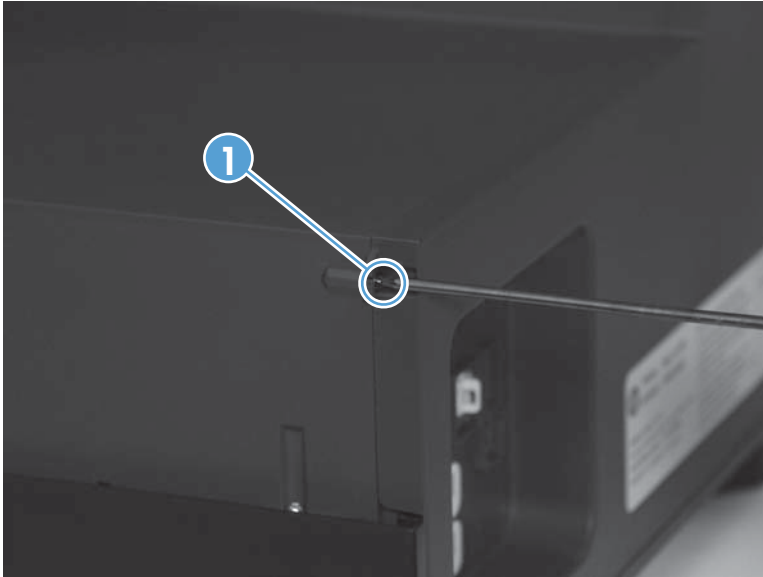

3. Pull the cover to the right, and then remove it.

Figure 1-24 Remove the rear cover (2 of 2)



Left door

1. Open the left door.

Figure 1-25 Remove left door (1 of 6)

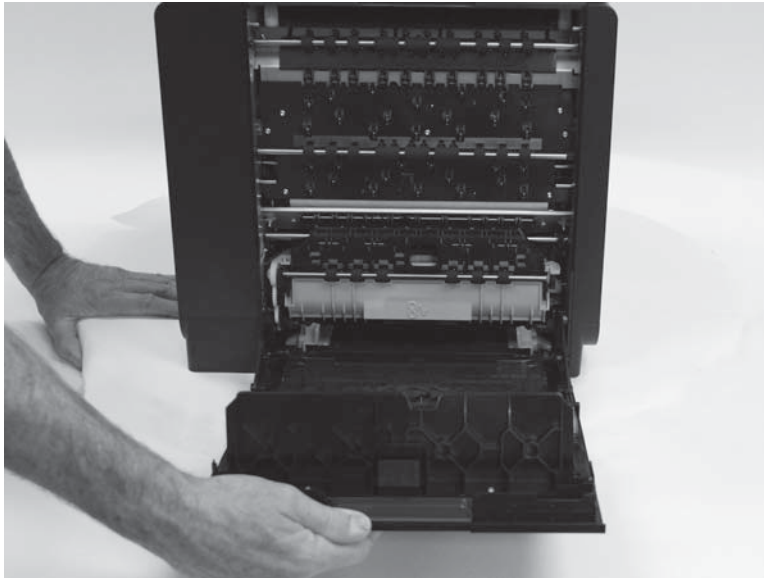

2. Remove the duplex module.

Figure 1-26 Remove the left door (2 of 6)



3. Unhook each restraining strap by twisting the bottom end of the strap away from the door.

Figure 1-27 Remove the left door (3 of 6)



4. Underneath the rear door hinge, locate the catch lever.

Figure 1-28 Remove the left door (4 of 6)



The following figure shows the tab on the underside of the product.

Figure 1-29 Remove the left door (5 of 6)

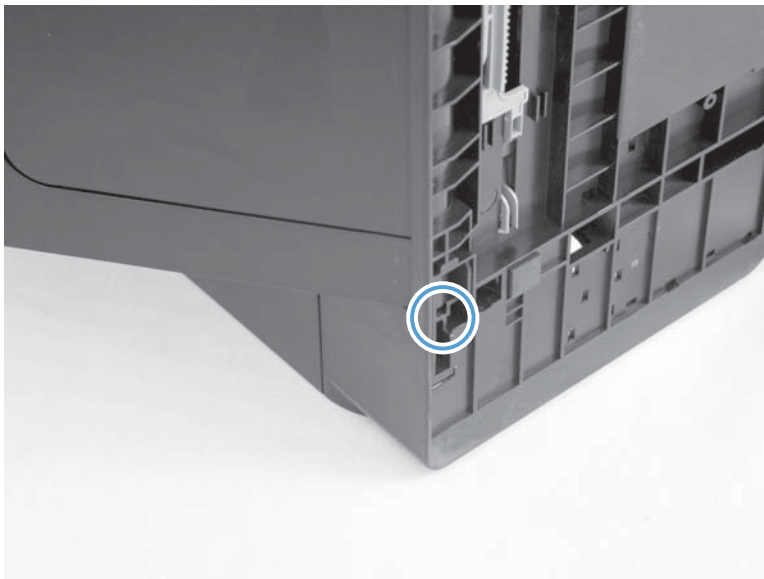

5. While pushing the catch lever to the rear of the product, rotate the door to the right, and then remove the door.

Figure 1-30 Remove the left door (6 of 6)



Left rear cover

1. Remove the left door. See [Left door on page 23](#).
2. Remove two screws (callout 1).

Figure 1-31 Remove the left rear cover (1 of 2)

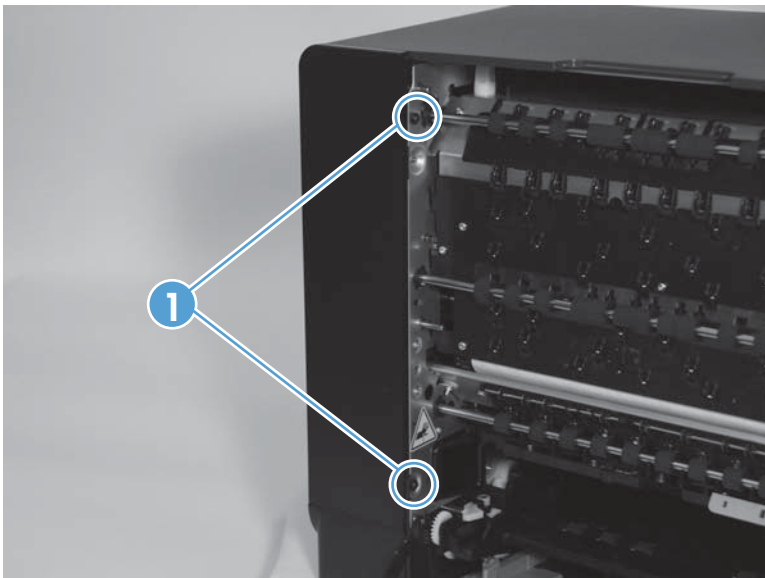

3. Remove the cover by sliding the cover up 10 mm (0.4 in), and then rotating the cover away from the product.

Figure 1-32 Remove the left rear cover (2 of 2)



Left front cover

1. Remove the left door. See [Left door on page 23](#).
2. Remove one screw (callout 1).

Figure 1-33 Remove the left front cover (1 of 2)

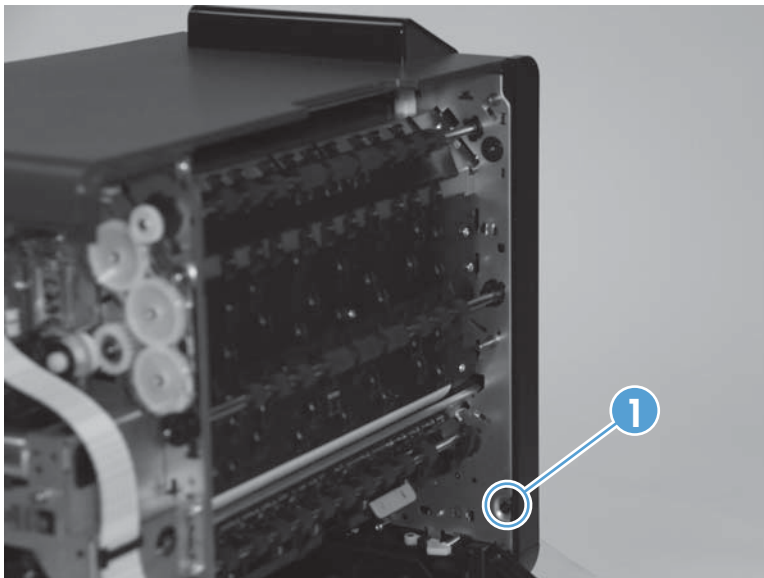

3. Use a screwdriver to depress the tab (callout 1), and then remove the cover (callout 2) by sliding the cover up 10 mm (0.4 in), and then rotating the cover away from the product.

Figure 1-34 Remove the left front cover (2 of 2)

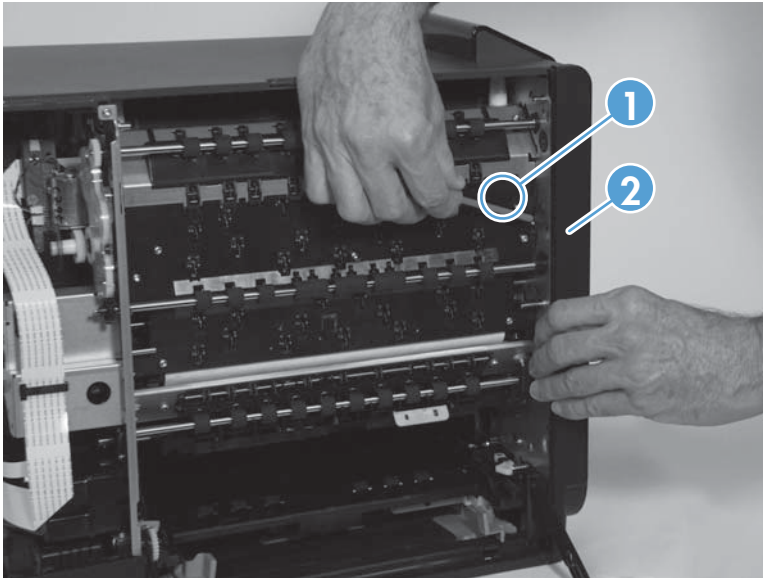

Top cover and control panel

1. Remove the following components.
 - Rear cover. See [Rear cover on page 22](#).
 - Scanner assembly. See [Scanner assembly and scanner support bracket on page 53](#).
 - Scanner support bracket. See [Scanner assembly and scanner support bracket on page 53](#).
 - Left door. See [Left door on page 23](#).
 - Left rear cover. See [Left rear cover on page 26](#).
 - Left front cover. See [Left front cover on page 27](#).
2. Rotate the ZIF (zero-insertion force) latch, and then disconnect the control panel flex cable (callout 1) from the main PCA.

Figure 1-35 Remove the top cover and control panel (1 of 7)

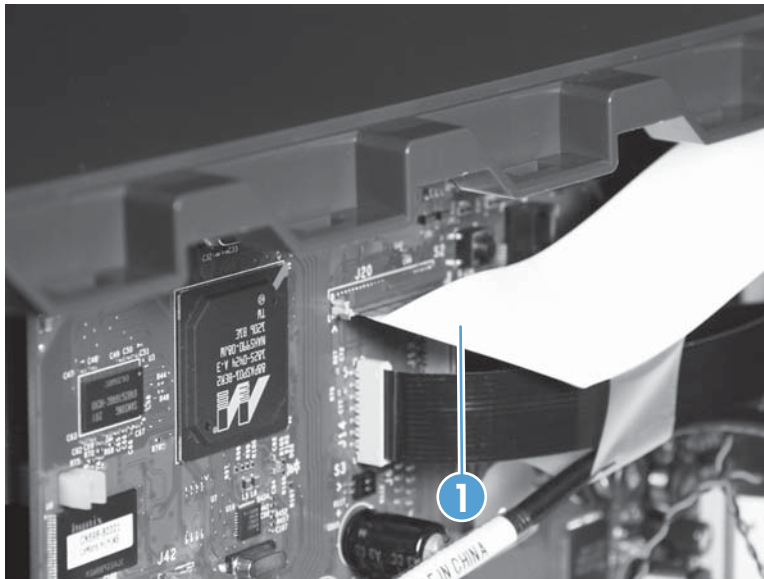

3. Disconnect the USB cable (callout 1) and the speaker cable (callout 2).

Figure 1-36 Remove the top cover and control panel (2 of 7)

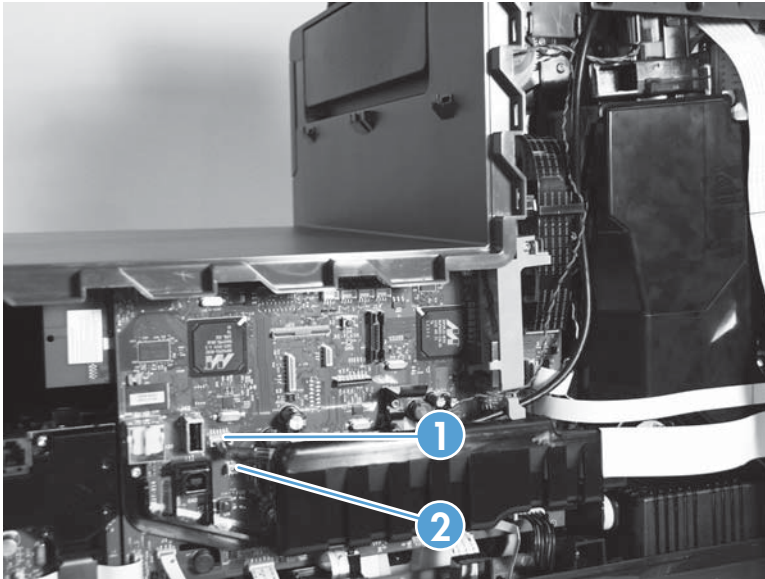

4. Unthread the cables (callout 1) through the back of the product.

Figure 1-37 Remove the top cover and control panel (3 of 7)

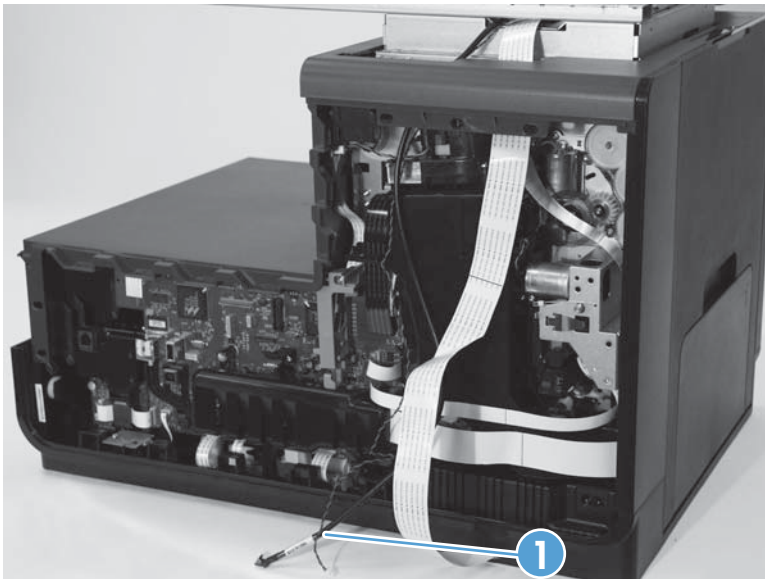

5. On the top cover, remove three screws (callout 1) from behind the control panel, and then remove the control panel.

Figure 1-38 Remove the top cover and control panel (4 of 7)

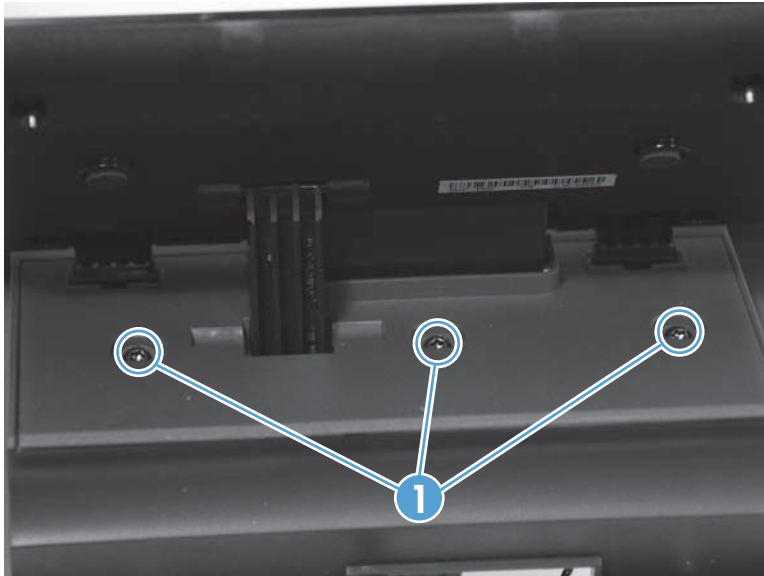

6. Reattach the control panel.
7. In the control panel cavity, remove one screw (callout 1).

Figure 1-39 Remove the top cover and control panel (5 of 7)

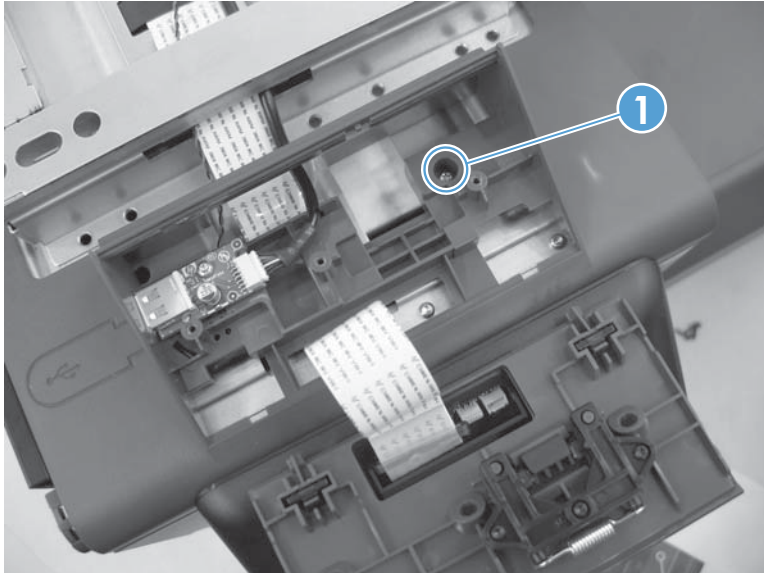

8. Remove four screws (callout 1) from the top cover.

Figure 1-40 Remove the top cover and control panel (6 of 7)

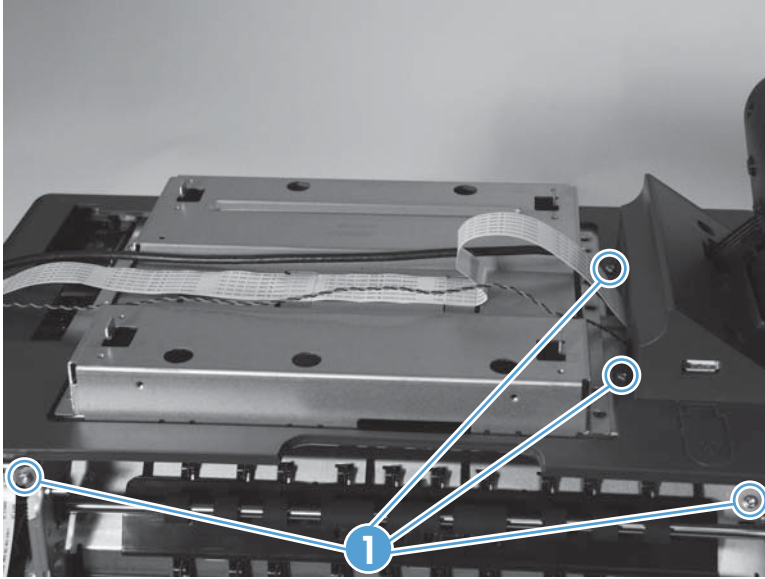

9. Remove the top cover from the product by sliding it to the right, and then lifting it away.

Figure 1-41 Remove the top cover and control panel (7 of 7)



Top cap assembly

1. Remove the following components:
 - Scanner assembly. See [Scanner assembly and scanner support bracket on page 53](#).
 - Top cover. See [Top cover and control panel on page 29](#).
 - Front cover. See [Front cover on page 35](#).
2. Disconnect the eject flap opto PCA flex cable connection (callout 1), and then unthread the cable (callout 2) from the product frame.

Figure 1-42 Remove the top cap assembly (1 of 3)

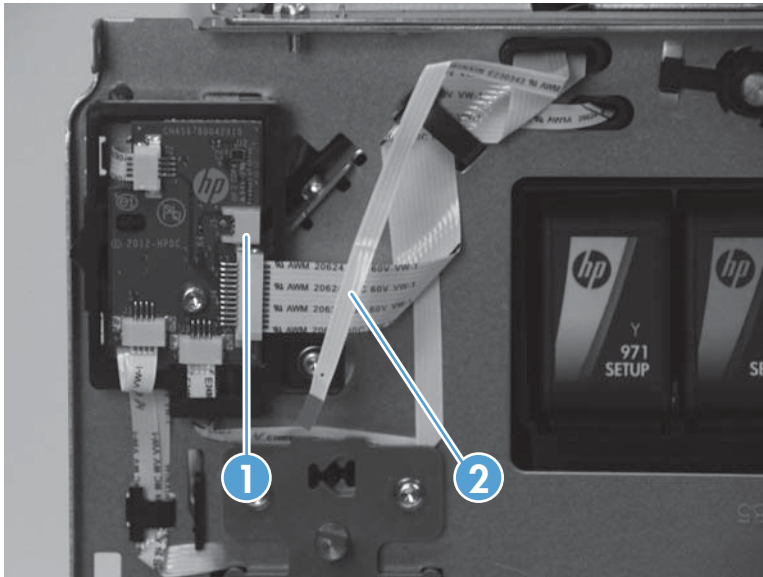

3. Remove nine screws (callout 1).

Figure 1-43 Remove the top cap (2 of 3)

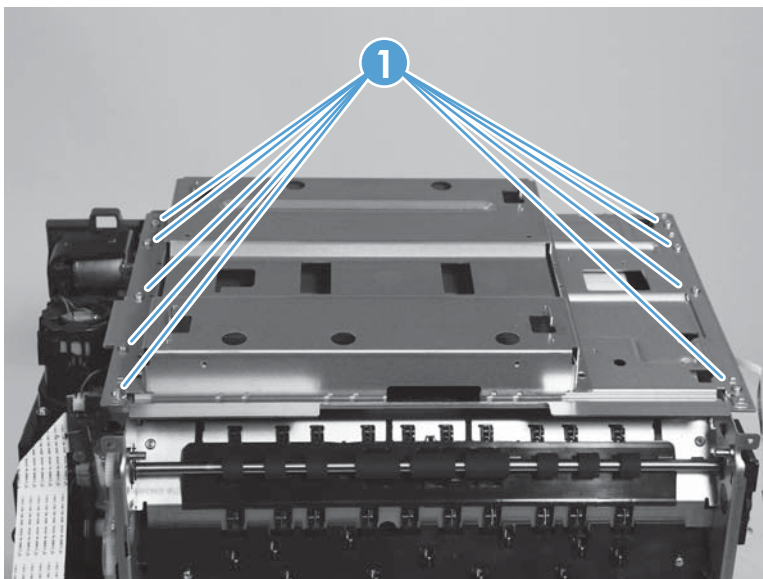

4. Lift the assembly up to remove it from the product.

Figure 1-44 Remove the top cap (3 of 3)

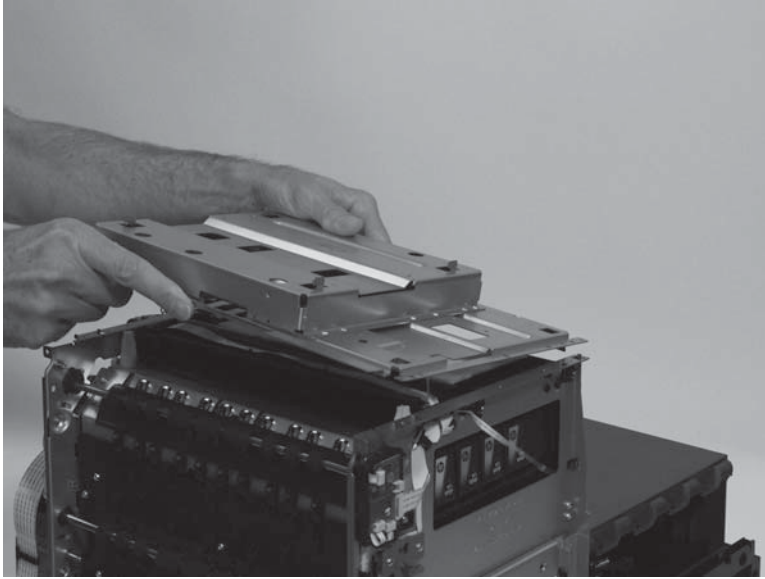

Front cover

1. Remove the following components:
 - Scanner assembly. See [Scanner assembly and scanner support bracket on page 53](#).
 - Top cover and control panel. See [Top cover and control panel on page 29](#).
2. Remove one screw (callout 1).

Figure 1-45 Remove the front cover (1 of 2)

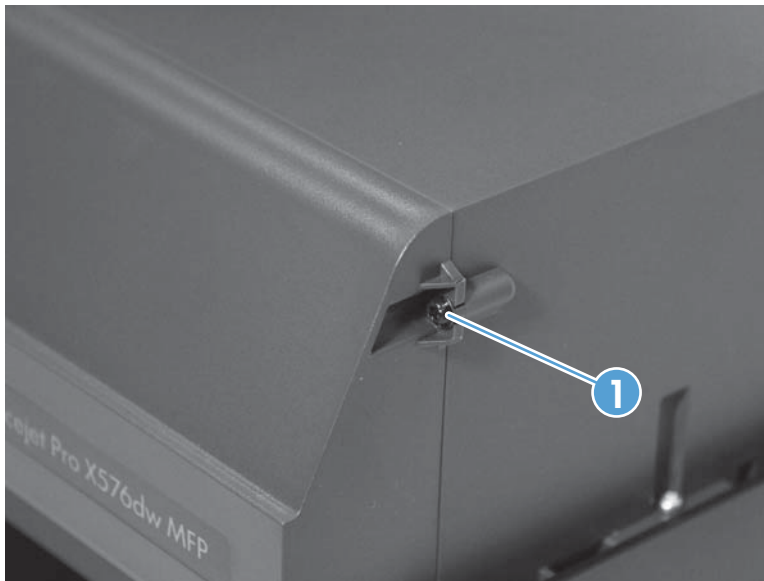

3. Remove the front cover.

Figure 1-46 Remove the front cover (2 of 2)

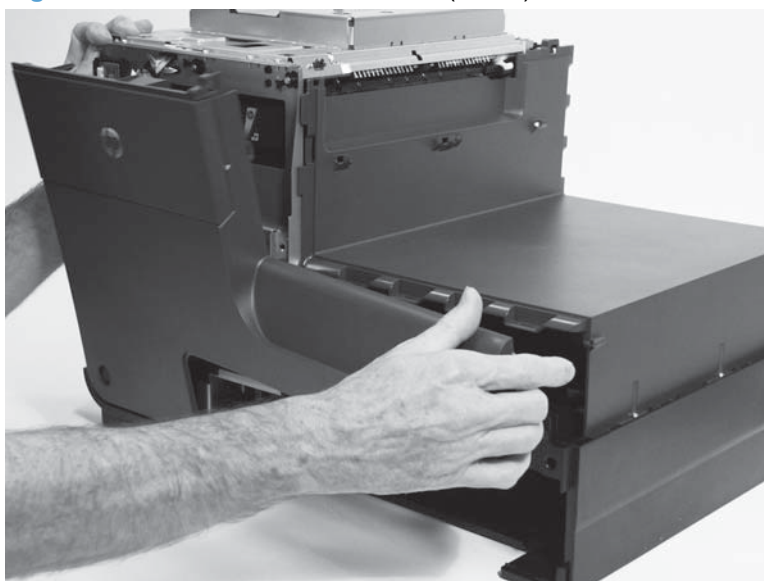

Right cover

1. Remove the following components:
 - Scanner assembly. See [Scanner assembly and scanner support bracket on page 53](#).
 - Top cover and control panel. See [Top cover and control panel on page 29](#).
 - Front cover. See [Front cover on page 35](#).
2. Remove three screws (callout 1).

Figure 1-47 Remove the right cover (1 of 2)

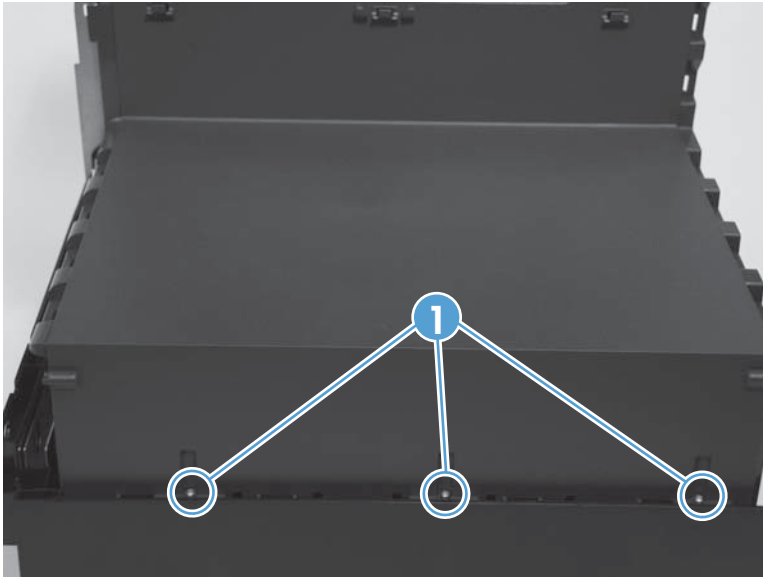

3. Remove the right cover from the product.

Figure 1-48 Remove the right cover (2 of 2)



Main assemblies

Aerosol fan assembly

1. Remove the following components:
 - Rear cover. See [Rear cover on page 22](#).
 - PCA safety shield. See [PCA safety shield on page 116](#).
2. Disconnect the control panel flex cable (callout 1). Rotate the ZIF connector to unclasp the connector first, and then disconnect the cable.

Figure 1-49 Remove the aerosol fan (1 of 12)

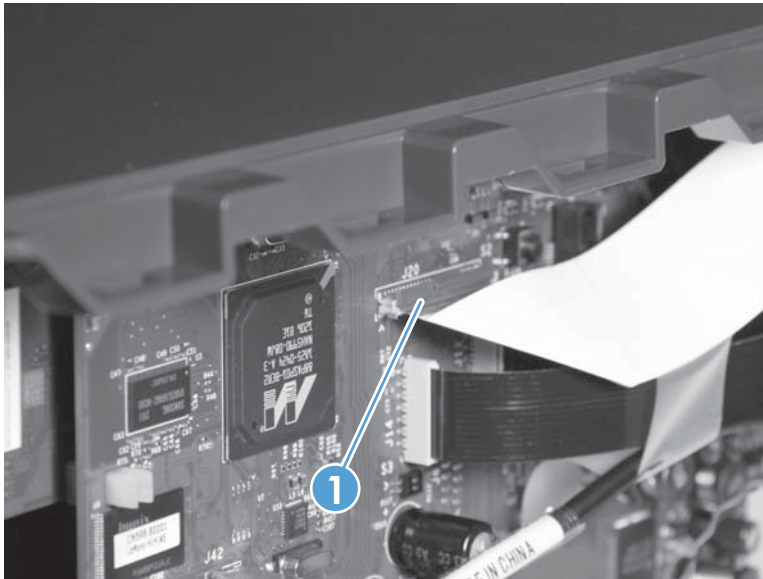

3. Disconnect the printbar lift distribution cable (callout 1) and the sensor carriage cable (callout 2).

Figure 1-50 Remove the aerosol fan (2 of 12)

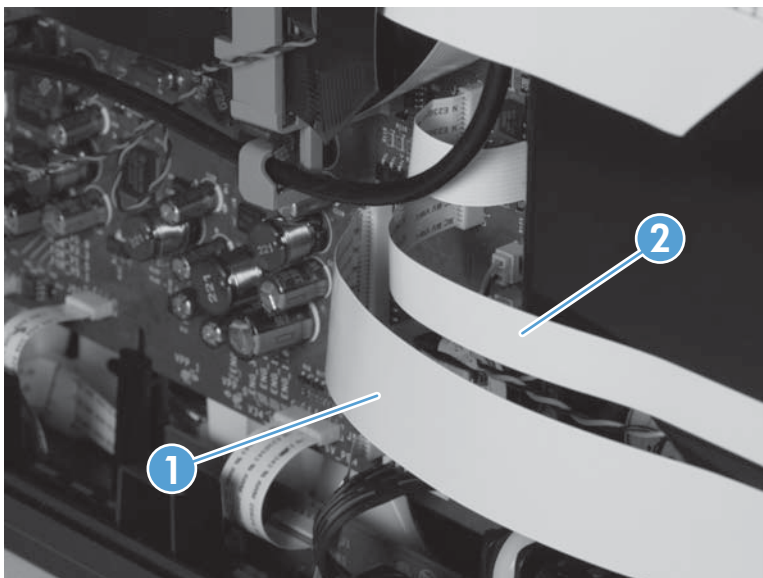

4. Unthread the printbar lift distribution cable (callout 1).

Figure 1-51 Remove the aerosol fan (3 of 12)

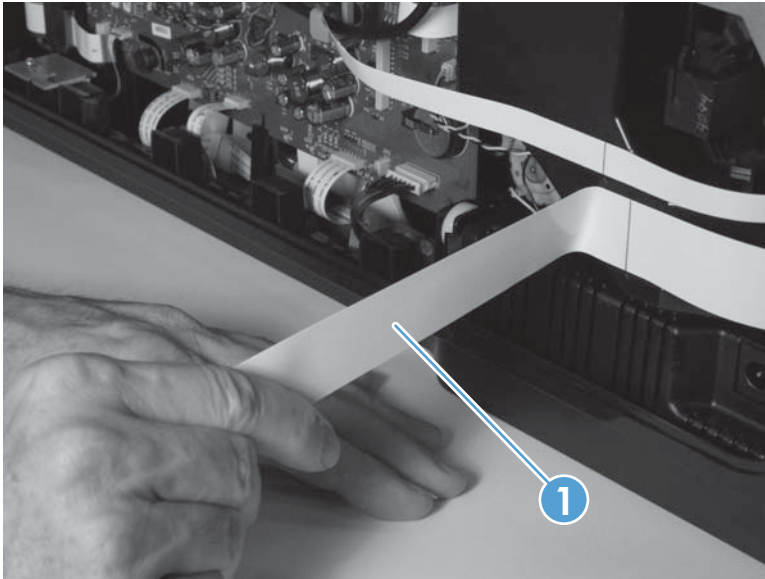

5. Unthread the sensor carriage cable (callout 1).

Figure 1-52 Remove the aerosol fan (4 of 12)

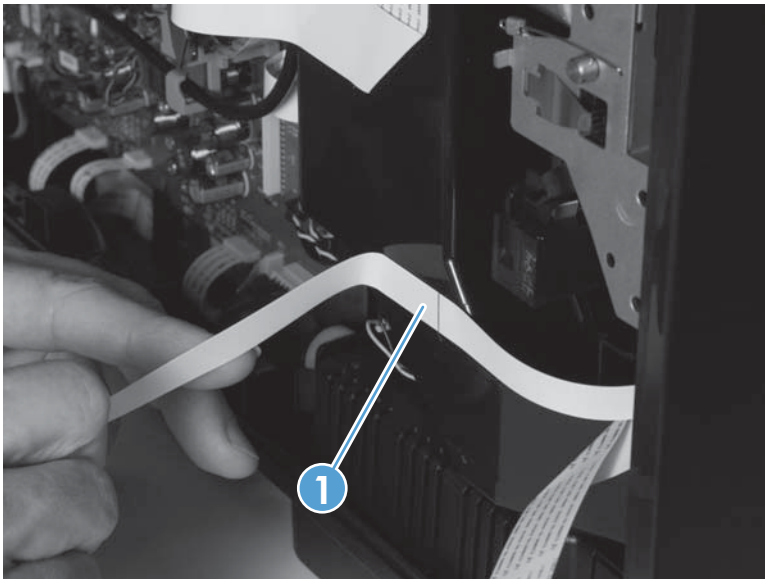

6. Unthread the control panel cable (callout 1) through the ferrite.

Figure 1-53 Remove the aerosol fan (5 of 12)

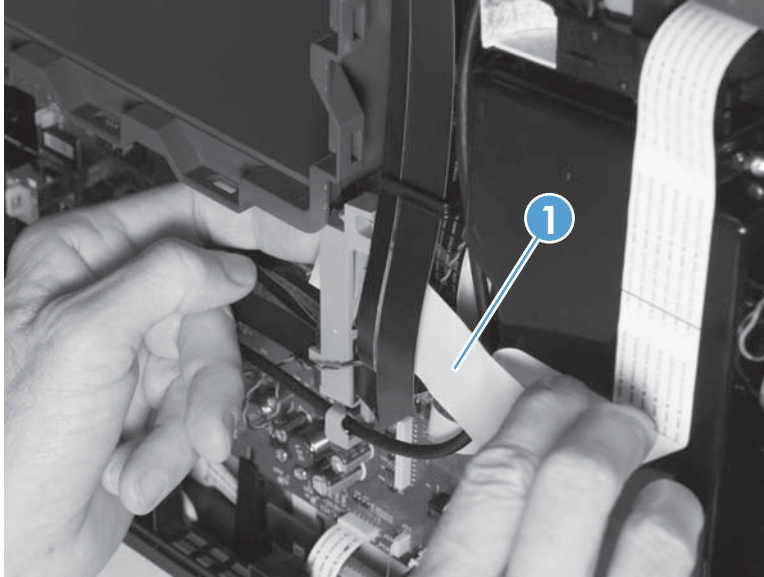

7. Use needle-nose pliers to disconnect the fan motor power cable (callout 1).

Figure 1-54 Remove the aerosol fan (6 of 12)

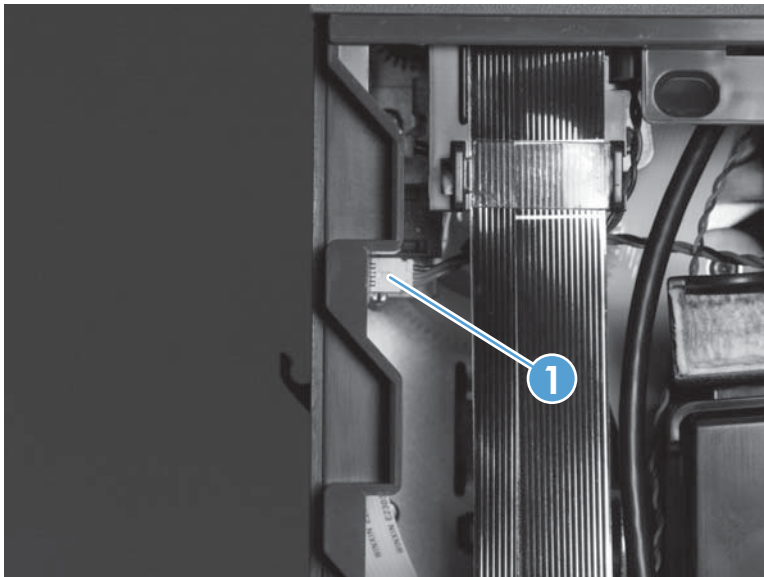

8. Disconnect the feed drive motor cable (callout 1).

Figure 1-55 Remove the aerosol fan (7 of 12)

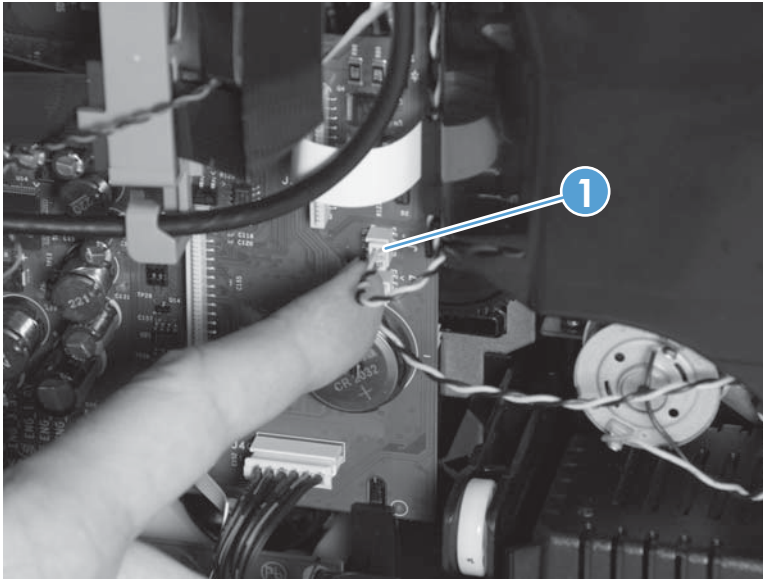

9. Unthread the feed drive motor cable from the fan assembly housing.

Figure 1-56 Remove the aerosol fan (8 of 12)

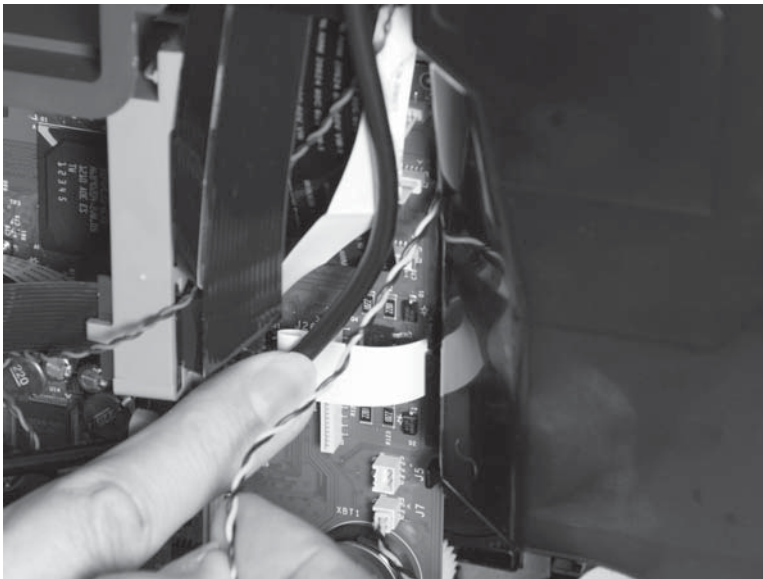

10. Push the sensor carriage ferrite (callout 1) out through the side of the snap using a small screwdriver. Leave the sensor carriage motor plugged in. During re-assembly, the sensor carriage ferrite can be pushed to the left back through the snaps as shown in [Figure 1-57 Remove the aerosol fan \(9 of 12\) on page 41](#).

Figure 1-57 Remove the aerosol fan (9 of 12)

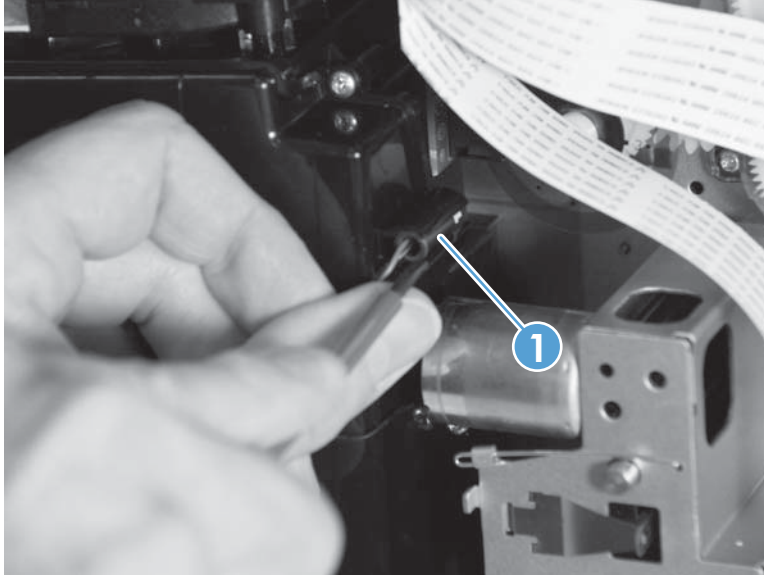

11. Remove three screws (callout 1) mounting the housing to the sheet metal.

Figure 1-58 Remove the aerosol fan (10 of 12)

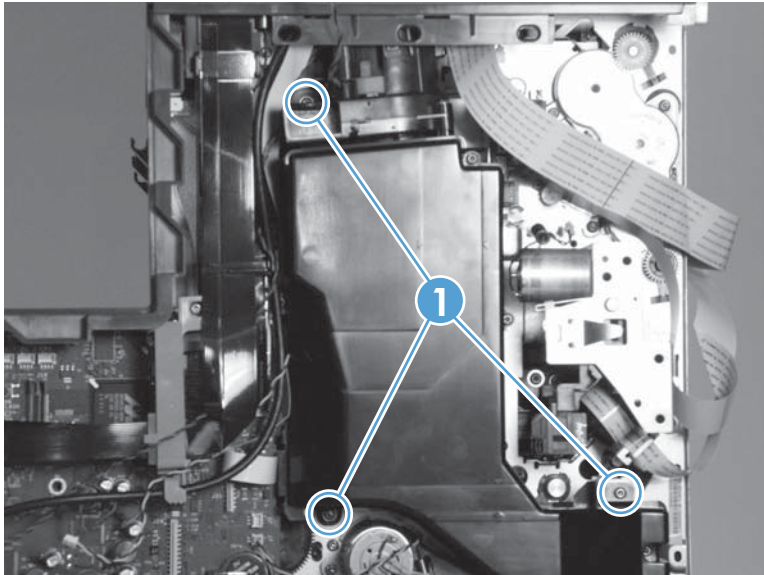

12. Pull out the fan assembly.

Figure 1-59 Remove the aerosol fan (11 of 12)

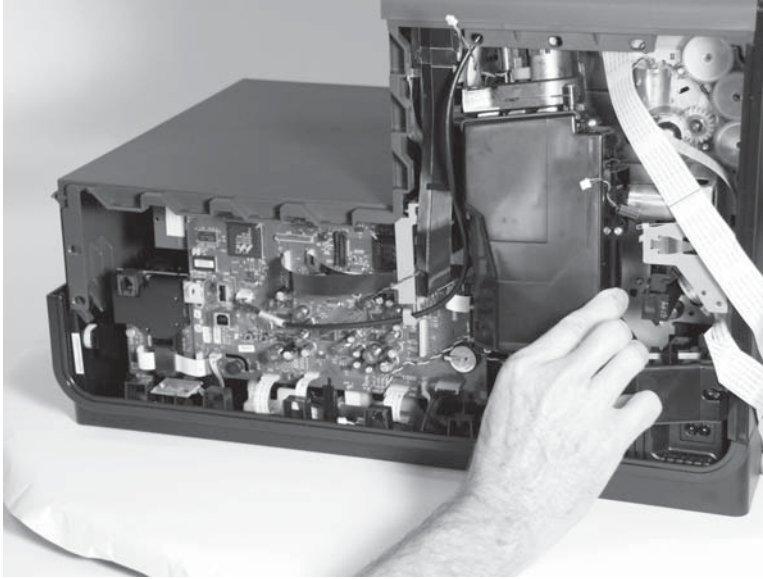

CAUTION: Avoid placing the assembly on any surface with the duct opening and gasket ring in contact with the surface. Doing so will leave an ink ring on the surface. Additionally, avoid touching the duct opening and gasket ring.

Reinstallation tip Align the black lines (callout 1) on the flex cables with the indicators on the fan assembly housing.

Figure 1-60 Remove the aerosol fan (12 of 12)

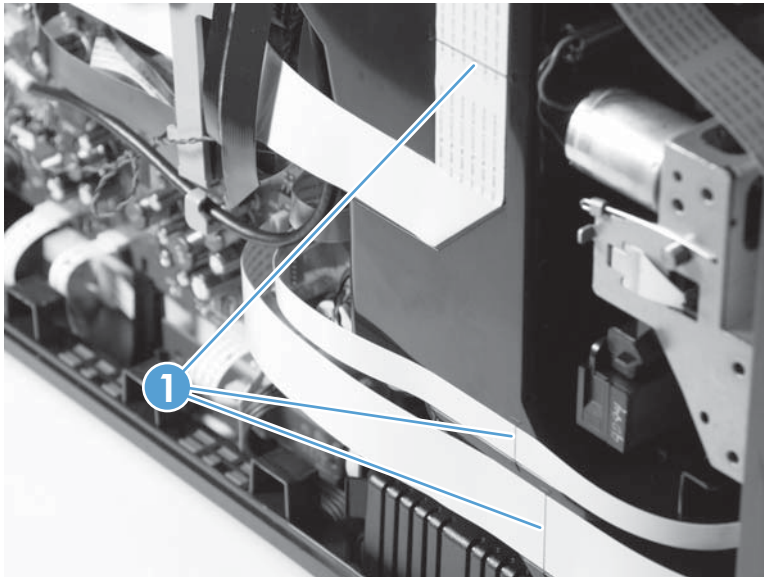

Separator/pick assembly

1. Remove the service sled assembly. See [Service sled assembly on page 63](#).
2. Remove one screw, and then remove the separator assembly.

Figure 1-61 Remove the separator/pick assembly (1 of 4)

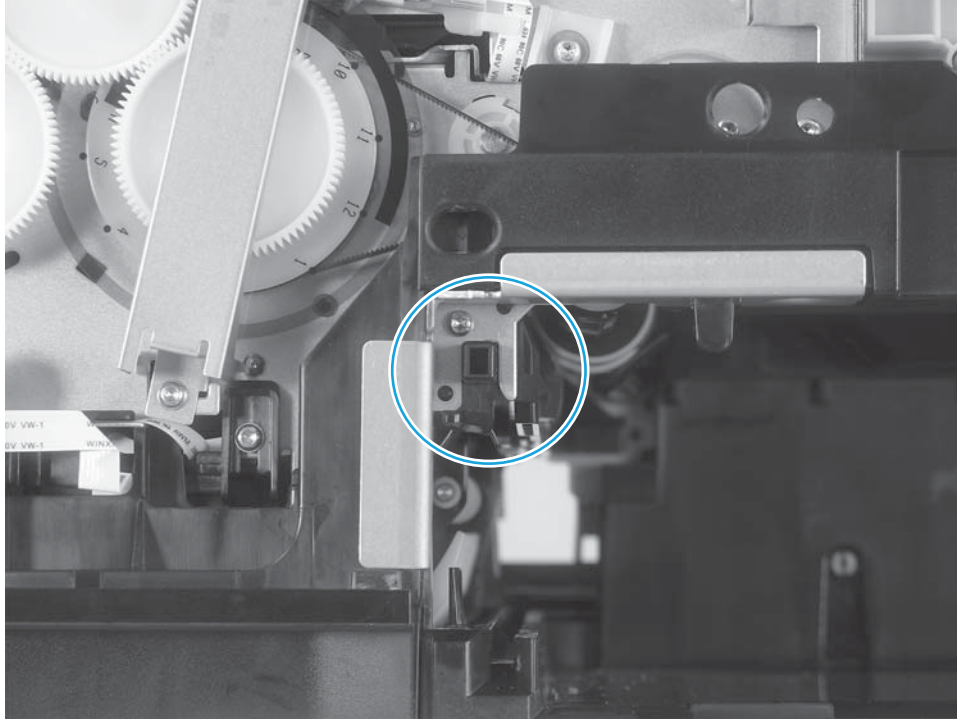

3. Rotate the pick assembly to position the white tabs (callout 1) as shown below.

 **NOTE:** If you have a new pick assembly removal tool, use that tool and follow the instructions provided with the tool to remove the assembly.

Figure 1-62 Remove the separator/pick assembly (2 of 4)



4. Use a small flat blade screwdriver (or hook screwdriver) to depress the black locking tab on the left side of the pick assembly, and then push down on the pick assembly to partially release it. Repeat for the locking tab on the right.

Figure 1-63 Remove the separator/pick assembly (3 of 4)

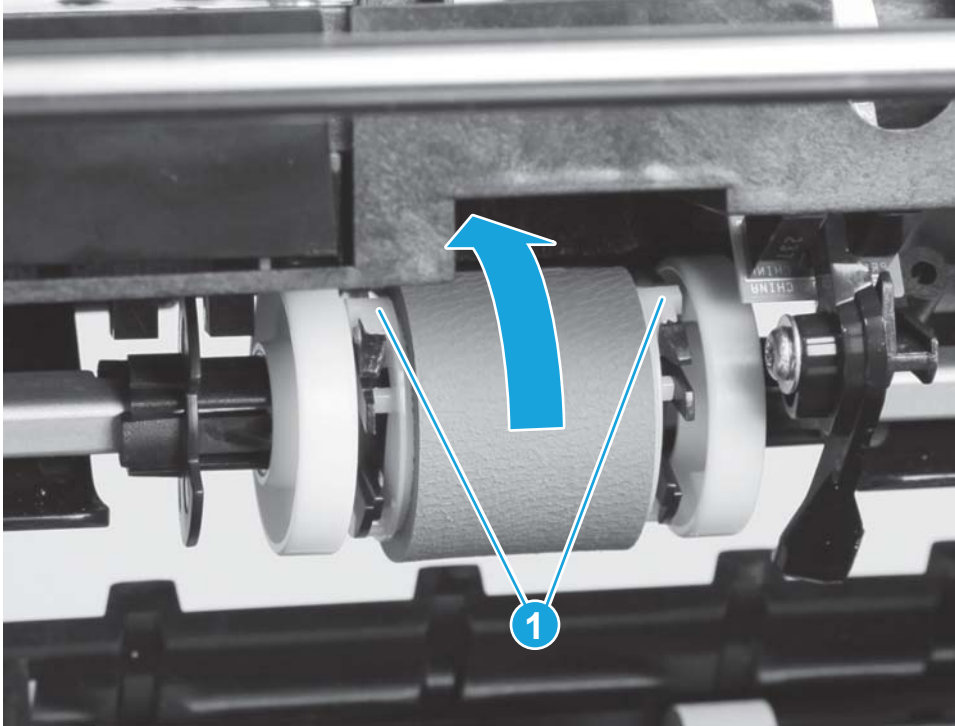
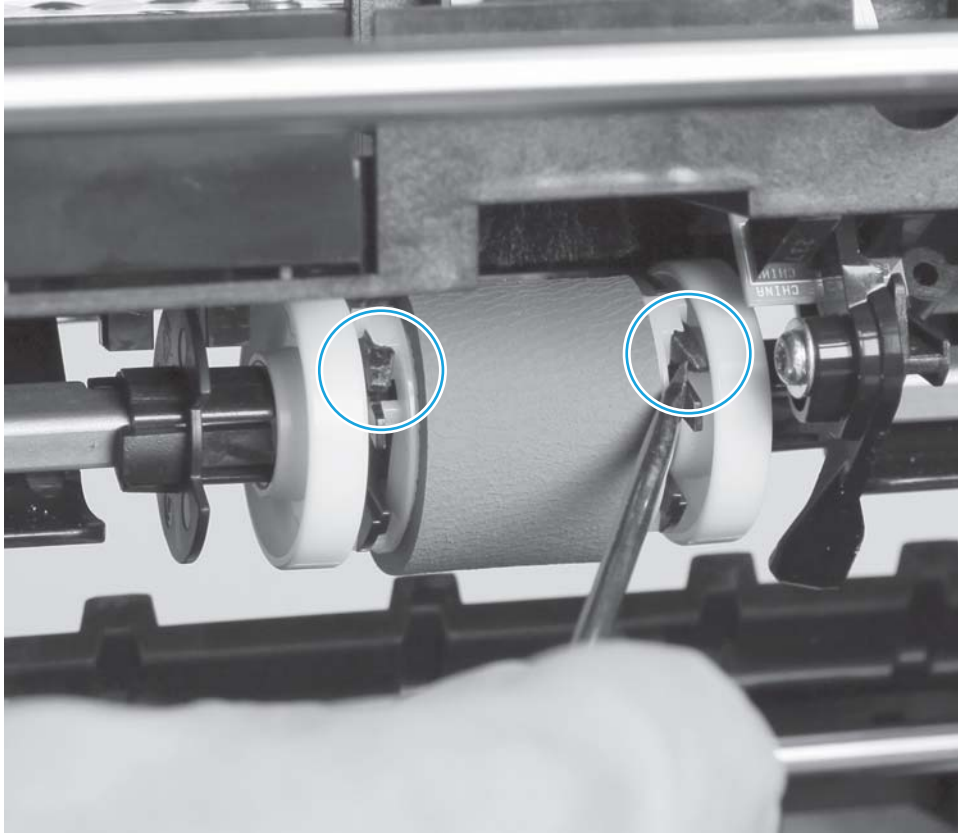

5. Push down on the pick assembly to remove it.

Figure 1-64 Remove the separator/pick assembly (4 of 4)

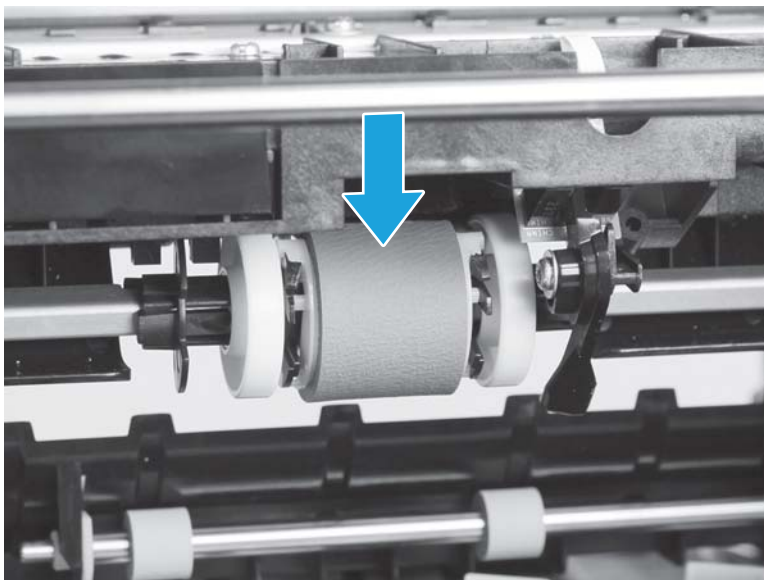

Reinstall the pick assembly/separator

Wear a vinyl glove while handling the new pick assembly to prevent skin oils from contaminating the roller.

1. Rotate the pick assembly shaft and mounting bracket so that the narrow tabs (callout 1) on the bracket are positioned near the bottom of the bracket, and the wide tabs (callout 2) are near the top of the bracket as shown below.

Figure 1-65 Reinstall the separator/pick assembly (1 of 5)

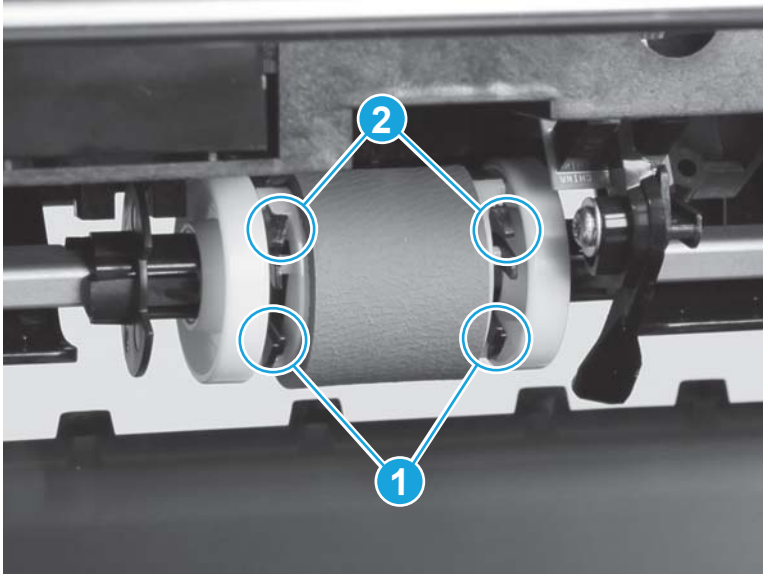

2. Position the flat side of the pick assembly against the flat side of the pick assembly shaft as shown below.

Figure 1-66 Reinstall the separator/pick assembly (2 of 5)



3. Attach the narrower pick assembly tabs.

Figure 1-67 Reinstall the separator/pick assembly (3 of 5)

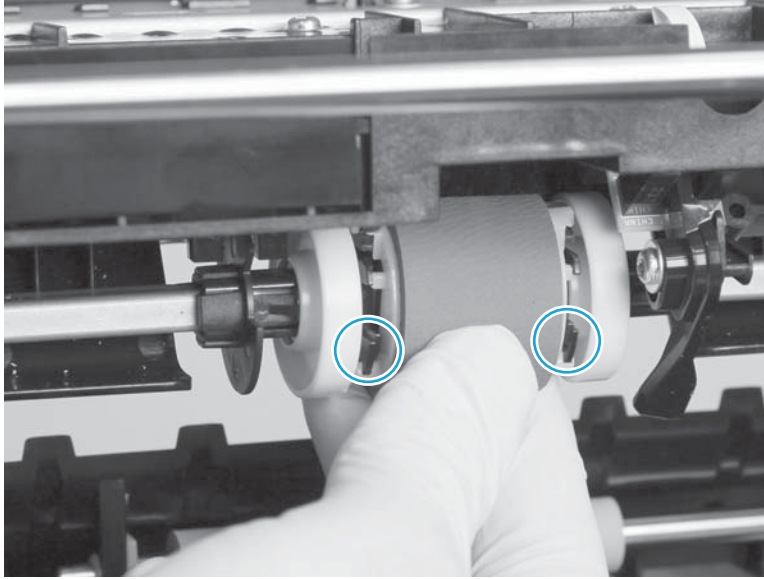

4. Press down on the top of the pick assembly until the wide tabs snap into place.

 **NOTE:** Reposition the roller shaft if it rotates while snapping the wider tabs into place.

Figure 1-68 Reinstall the separator/pick assembly (4 of 5)



5. Verify that the tabs are correctly snapped into place and the pick assembly is seated squarely in the mounting bracket.

Figure 1-69 Reinstall the separator/pick assembly (5 of 5)

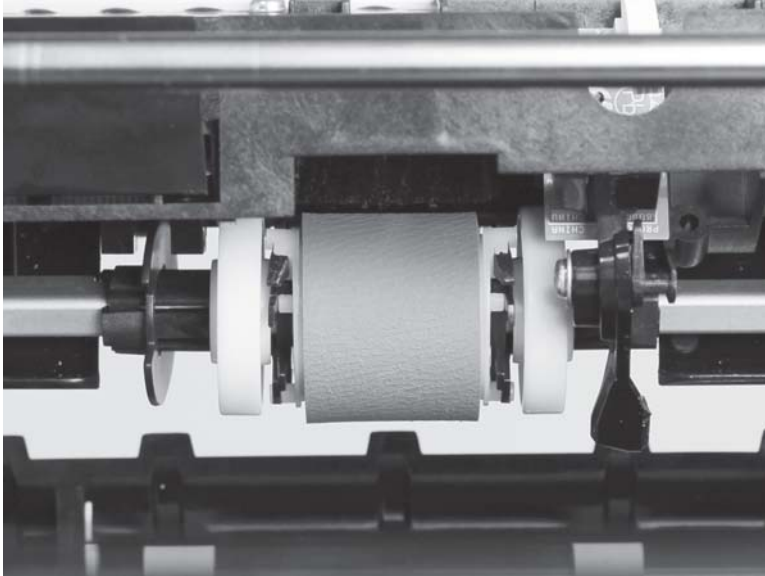

6. Reinstall the separator assembly.

Document feeder assembly

1. Lift the document feeder assembly (which also functions as the flatbed scanner lid).

Figure 1-70 Remove the document feeder (1 of 5)

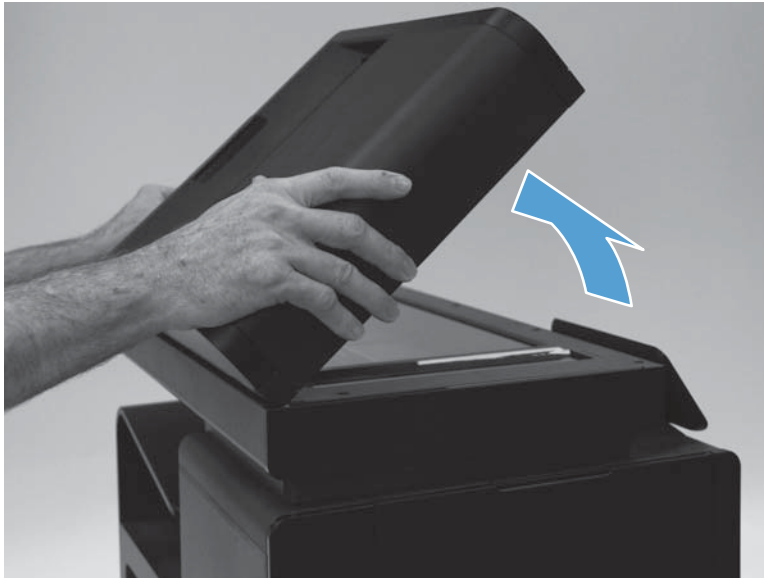

2. Lift the left hinge.

Figure 1-71 Remove the document feeder (2 of 5)

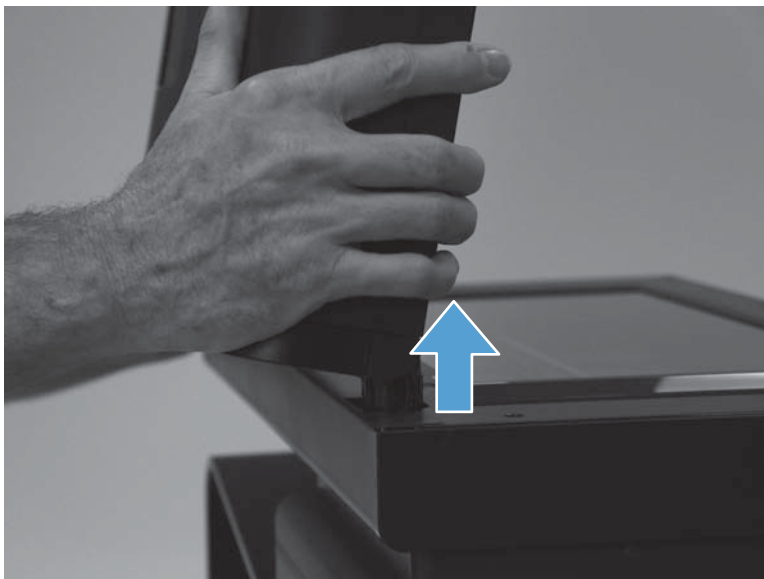

3. While holding the document feeder, use a screwdriver to remove the document feeder connector cover (callout 1).

Figure 1-72 Remove the document feeder (3 of 5)



4. Use a screwdriver to disconnect the cable connector (callout 1).

Figure 1-73 Remove the document feeder (4 of 5)

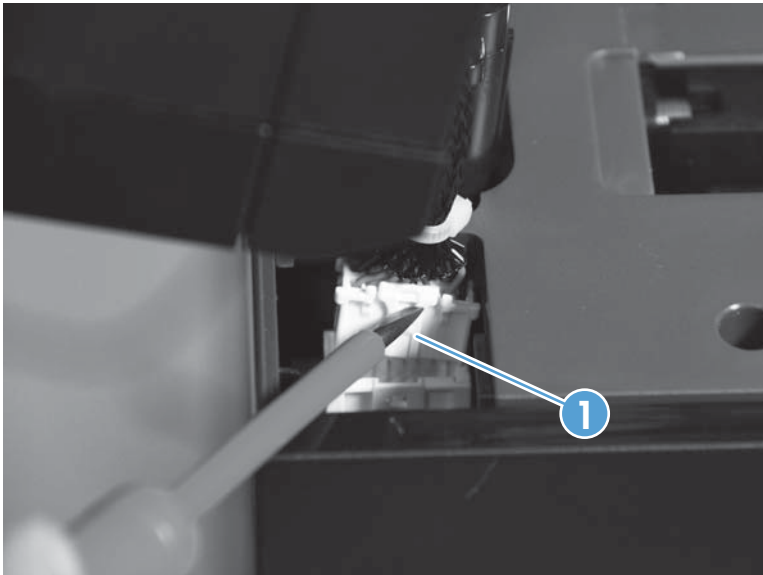

5. Tilt the assembly toward the front of the product, and then lift the document feeder up to remove it.

Figure 1-74 Remove the document feeder (5 of 5)

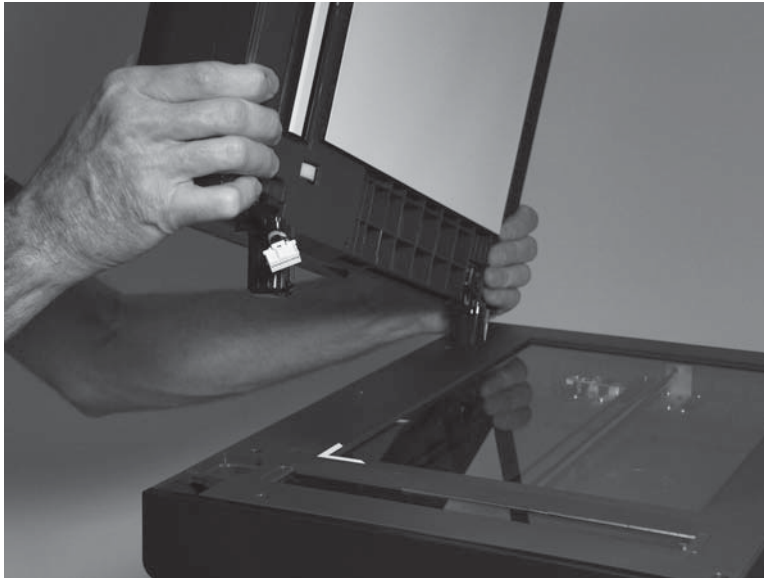

 **NOTE:** The posts on the document feeder are stiff and require some effort to remove from the product.

Duplex drive module

1. Remove the following components:
 - Rear cover. See [Rear cover on page 22](#).
 - Aerosol fan assembly. See [Aerosol fan assembly on page 37](#).
 - Power supply. See [Power supply on page 59](#).
2. Disconnect one wire connector (callout 1).

Figure 1-75 Remove the duplex drive module (1 of 2)

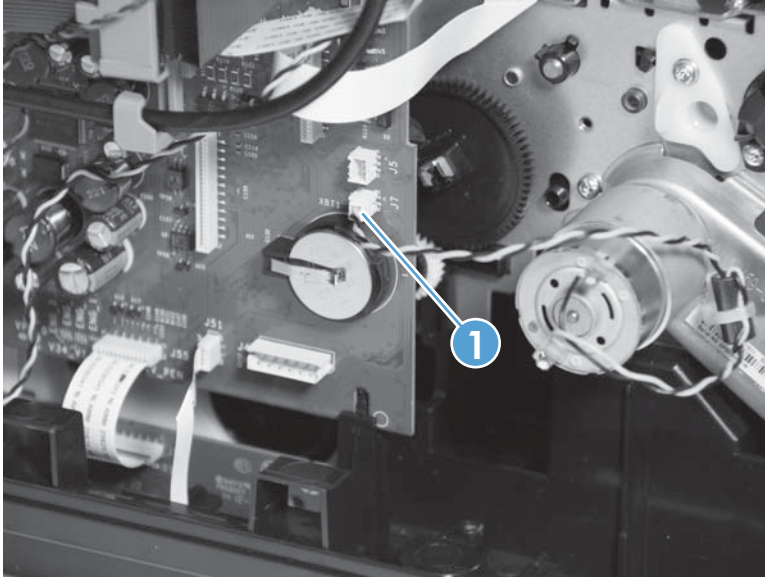

3. Remove two screws (callout 1), and then remove the module.

Figure 1-76 Remove the duplex drive module (2 of 2)

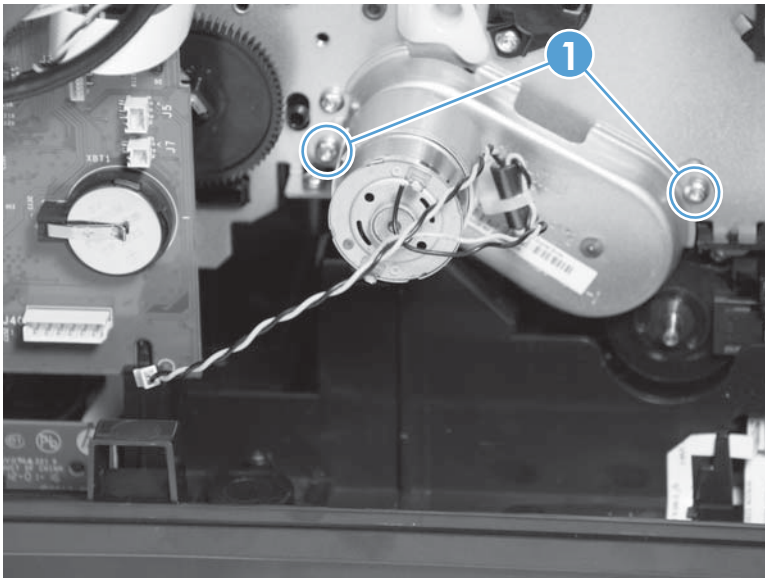

Scanner assembly and scanner support bracket

 **IMPORTANT:** Ensure the product firmware is upgraded to at least version 1336MR before performing this repair procedure. If the firmware upgrade cannot be completed, contact HP support.

The scanner assembly includes the document feeder assembly. The scanner can be removed with or without the document feeder attached

1. Remove the rear cover. See [Rear cover on page 22](#).
2. Remove the scanner base cover (callout 1).

Figure 1-77 Remove the scanner and scanner support bracket (1 of 9)

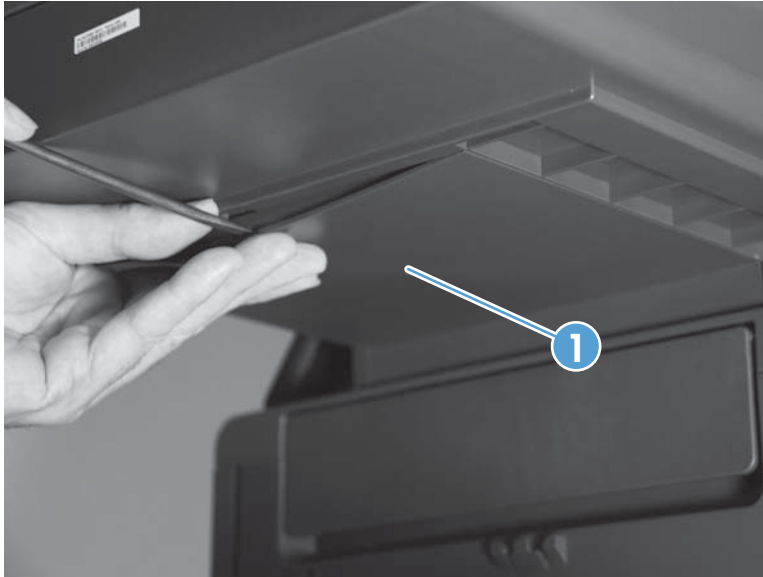

3. On the main PCA, disconnect two flex cables (callout 1). The black cable has two connections.

 **TIP:** Unscrew the gray FFC retainer to make unthreading the FFCs easier. This will also make it easier to remove the control panel FFC.

Figure 1-78 Remove the scanner and scanner support bracket (2 of 9)



4. Unthread the scanner flex cables.

Figure 1-79 Remove the scanner and scanner support bracket (3 of 9)

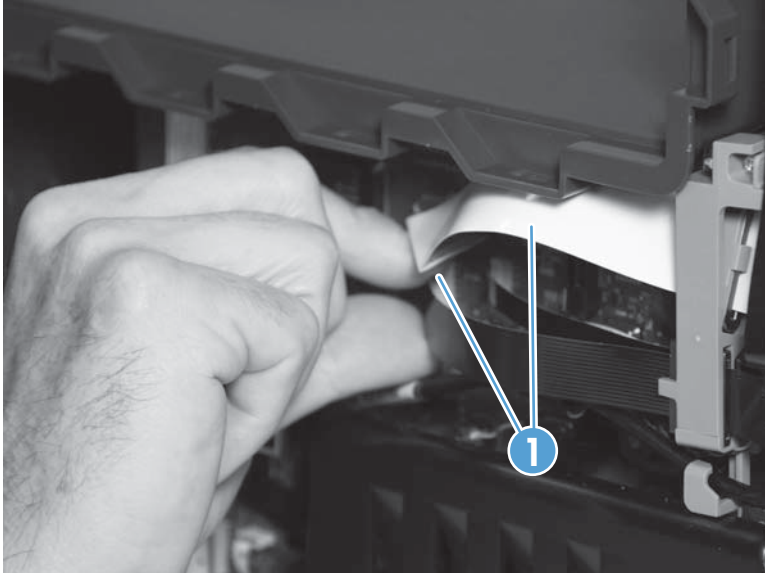

5. Unthread the document feeder flex cable.

Figure 1-80 Remove the scanner and scanner support bracket (4 of 9)



6. Remove two plugs (callout 1) from the left side of the scanner assembly.

Figure 1-81 Remove the scanner and scanner support bracket (5 of 9)

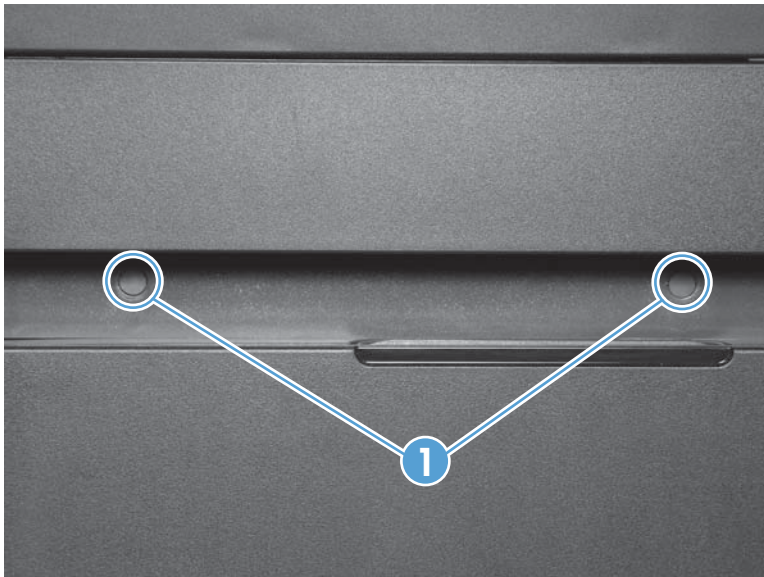

7. Remove two screws (callout 1).

Figure 1-82 Remove the scanner and scanner support bracket (6 of 9)

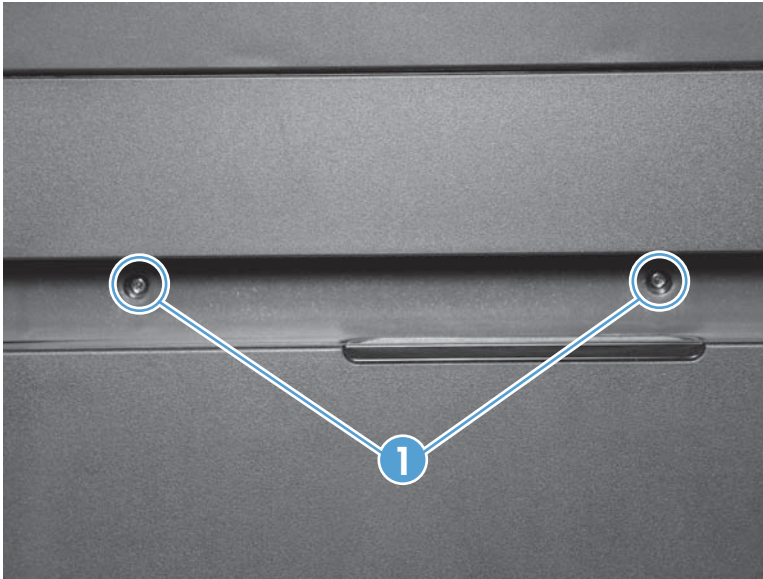

8. Move the scanner assembly toward the left side of the product.

Figure 1-83 Remove the scanner and scanner support bracket (7 of 9)

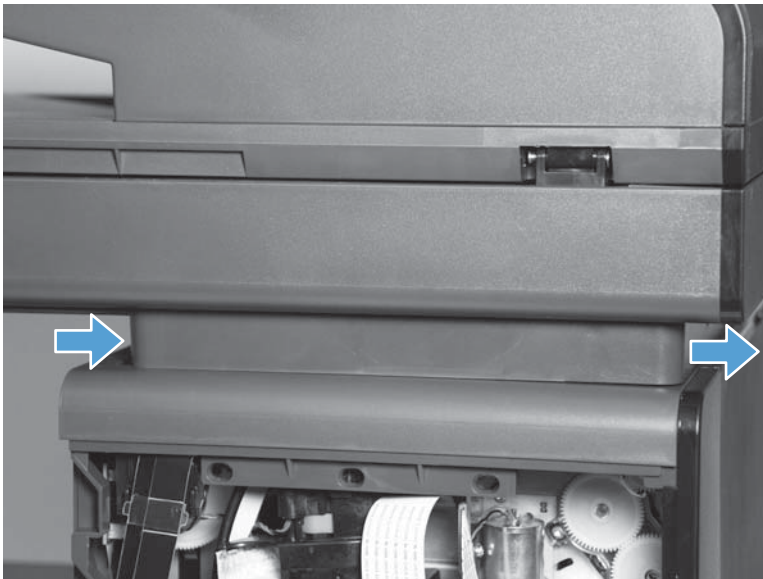

9. Lift the assembly to remove it.

Figure 1-84 Remove the scanner and scanner support bracket (8 of 9)



10. Remove eight screws, and then remove the scanner support bracket.

 **NOTE:** Removing the scanner support bracket is not necessary if only the scanner is being replaced.

Figure 1-85 Remove the scanner and scanner support bracket (9 of 9)



Calibrate the scanner

1. Open the [Engineering](#) menu. See [Access the Engineering menu on page 14](#) for information on accessing the [Engineering](#) menu.
2. Select [Service](#), select [System Configuration](#), and then touch the [OK](#) button.
3. Scroll to [Enter scanner barcode](#), and then touch the [OK](#) button.
4. Enter the scanner calibration bar code, and then touch the [OK](#) button.

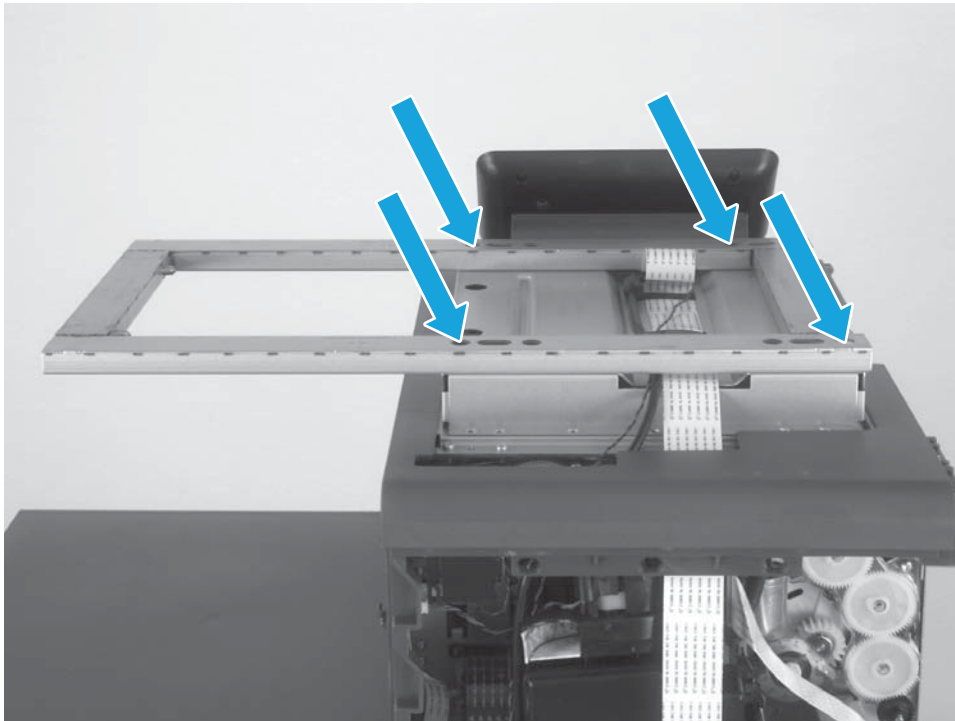

NOTE: The scanner calibration bar code is located underneath the main scan glass on the left side of the glass. See [Figure 1-86 Calibrate the scanner \(scanner barcode location\) on page 58](#).

5. Touch the [Cancel](#)  button to return to the [Engineering menu](#) when the calibration is complete.

Figure 1-86 Calibrate the scanner (scanner barcode location)



Power supply

⚠ CAUTION: Make sure that the power cable is disconnected from the product.

1. Remove the following components:
 - Rear cover. See [Rear cover on page 22](#).
 - Left door. See [Left door on page 23](#).
 - Left rear cover. See [Left rear cover on page 26](#).
 - Aerosol fan assembly. See [Aerosol fan assembly on page 37](#).
2. Disconnect the cable that connects the power supply to the main PCA.

Figure 1-87 Remove the power supply (1 of 3)

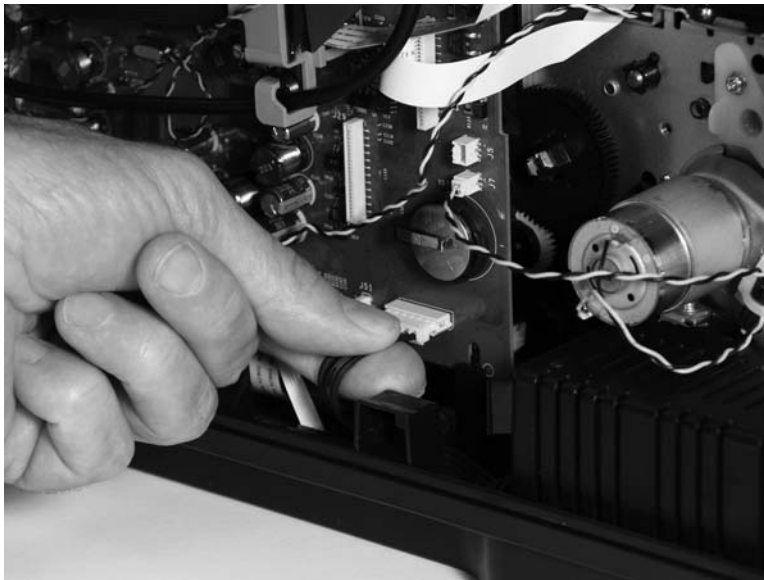

3. Remove two screws (callout 1) from the base of the power supply.

Figure 1-88 Remove the power supply (2 of 3)

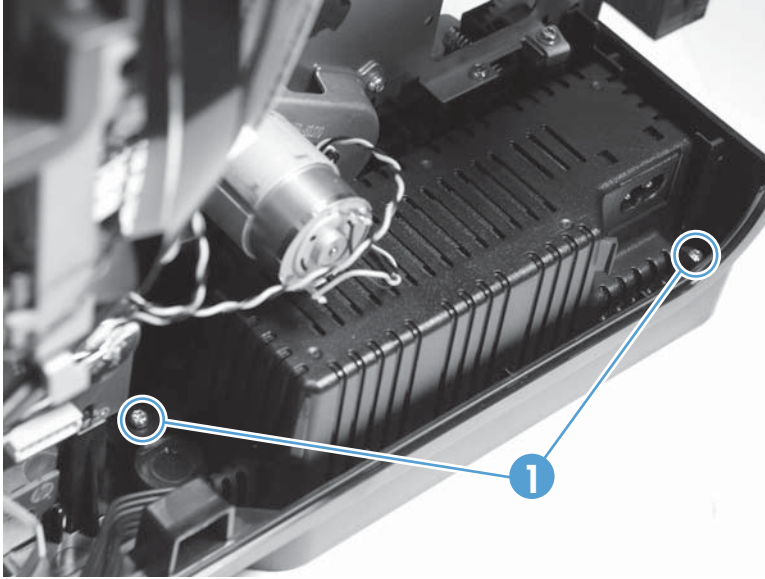

4. Remove the power supply.

Figure 1-89 Remove the power supply (3 of 3)

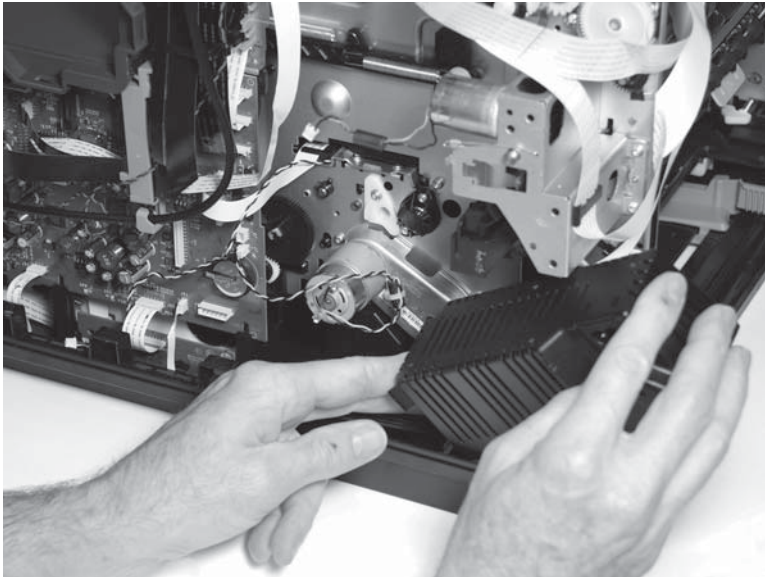

 **NOTE:** It might be necessary to loosen the fasteners on the duplex drive module in order to remove the power supply. If that is the case, see [Duplex drive module on page 52](#).

Backscatter drop detect (BDD) assembly

 **IMPORTANT:** Ensure the product firmware is upgraded to at least version 1336MR before performing this repair procedure. If the firmware upgrade cannot be completed, contact HP support.

1. Remove the following components:
 - Rear cover. See [Rear cover on page 22](#).
 - Aerosol fan assembly. See [Aerosol fan assembly on page 37](#).
2. Verify that the sensor carriage is in the home position.
3. Remove one screw (callout 1).

Figure 1-90 Remove the backscatter drop detect assembly (1 of 2)

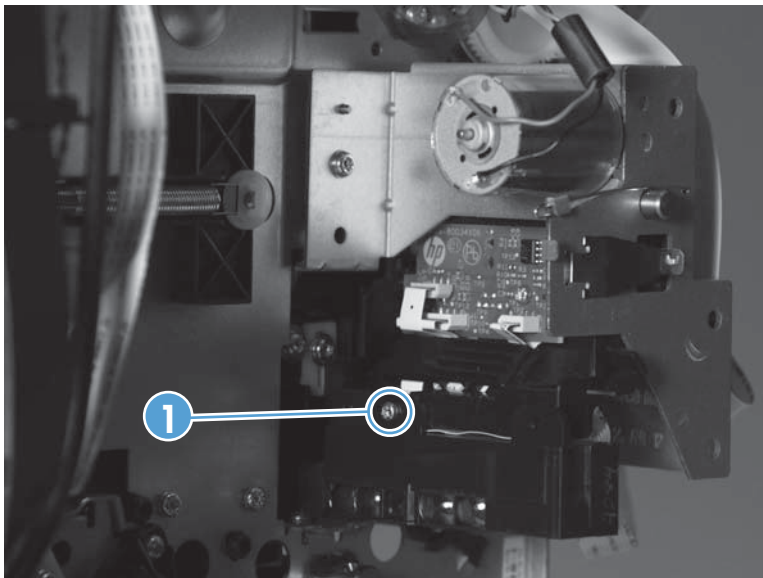

4. Detach the BDD assembly, and then disconnect the flex cable (callout 1).

Figure 1-91 Remove the backscatter drop detect assembly (2 of 2)

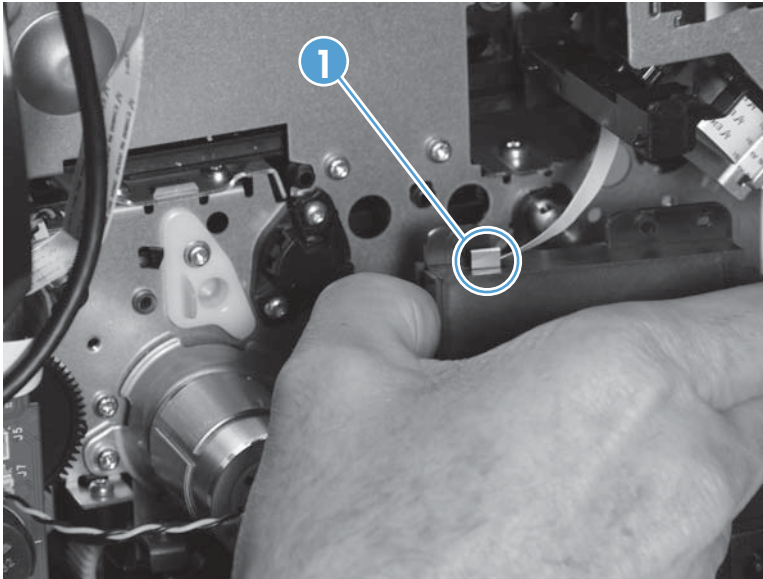

5. After installing a new BDD assembly, perform the following calibrations:
 - a. From the control panel, open the [Service](#) menu. See [Access the Engineering menu on page 14](#) for information on how to access the [Service](#) menu.
 - b. Select [System Configuration](#), and then select [Enable Drop Detect Calibration](#).
 - c. Touch the [OK](#) button.
 - d. After resetting the drop detect calibrations, run Clean Printhead, level 1. This will take approximately 17 minutes.

Service sled assembly

Remove the following components:

- Scanner assembly. See [Scanner assembly and scanner support bracket on page 53](#).
- Scanner support bracket. See [Scanner assembly and scanner support bracket on page 53](#).
- Left door. See [Left door on page 23](#).
- Left rear cover. See [Left rear cover on page 26](#).
- Left front cover. See [Left front cover on page 27](#).
- Top cover. See [Top cover and control panel on page 29](#).
- Front cover. See [Front cover on page 35](#).
- Right cover. See [Right cover on page 36](#).
- Right cross brace. See [Right cross brace on page 69](#).

Service sled assembly

 **IMPORTANT:** The OfficeJet Pro X special tools kit (part CN598-67056) is required when replacing the service sled assembly.

1. On the front of the product, locate the printbar lock mount.

Figure 1-92 Remove the service sled assembly (1 of 6)

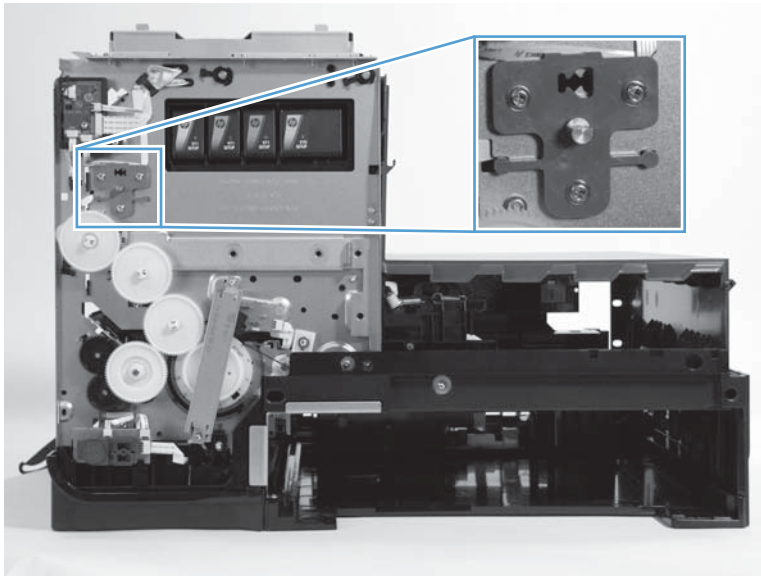

2. Insert the printbar lift lock tool into the printbar lock mount. When mounted correctly and with the printbar already in the up position, the printbar lift lock tool needs only to be held in place while the service sled is removed. It locks the printbar in the up position. If you need to raise the printbar, use a one-quarter inch nut driver to turn the printbar lift lock tool counter-clockwise. **Use extreme caution when driving the printbar lift lock tool to raise the printbar. Over-driving might break the lock tool.**

 **NOTE:** The printbar lock tool may look different than what is shown here.

 **NOTE:** Do not use excessive force when installing the printbar lift lock tool.

 **CAUTION:** The printbar lift lock tool must remain in place until either the printbar is removed, or the service sled assembly is reinstalled in the product. If the printbar drops to the bottom of the product, the printbar might be damaged, and likely will need to be replaced.

Figure 1-93 Remove the service sled assembly (2 of 6)



3. Locate the service sled cartridge drive shaft (callout 1).

Figure 1-94 Remove the service sled assembly (3 of 6)

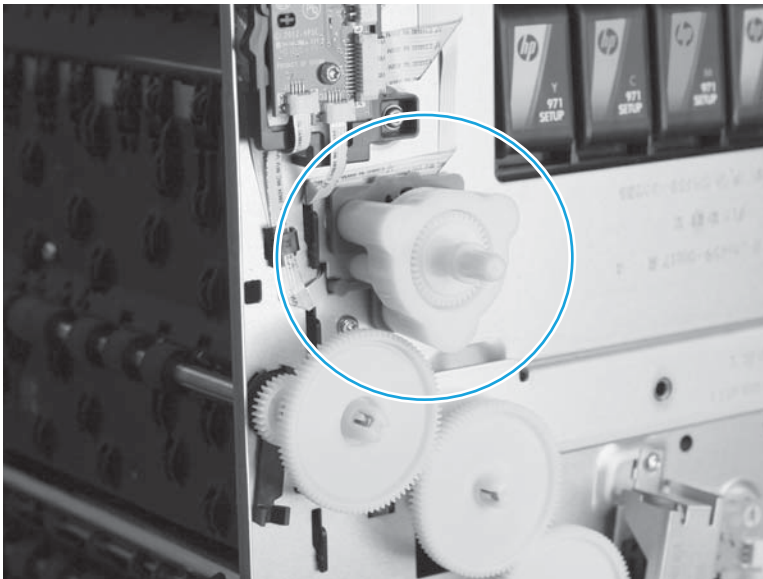
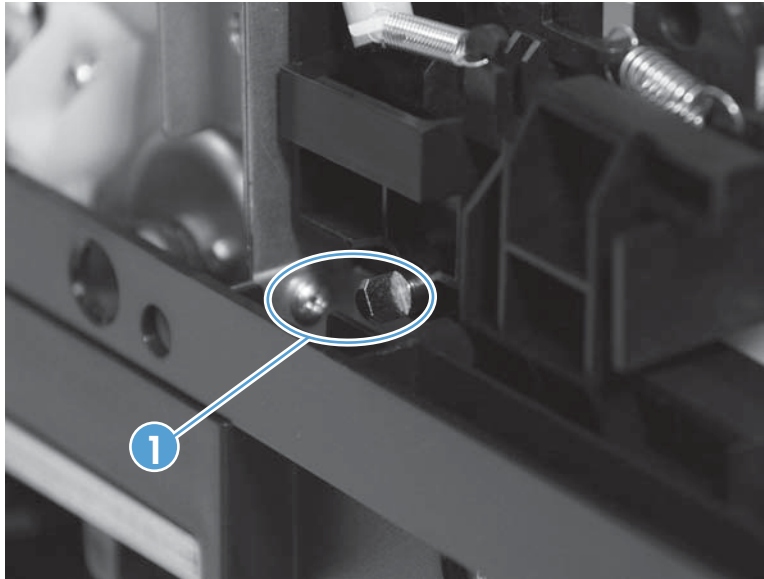

4. Mount the service sled advance tool on the drive shaft.

 **NOTE:** On older products, part of the base material may need to be removed to mount the service sled advance tool on the drive shaft.

Figure 1-95 Remove the service sled assembly (4 of 6)



5. Turn the tool clockwise to fully advance the service sled forward.

Figure 1-96 Remove the service sled assembly (5 of 6)

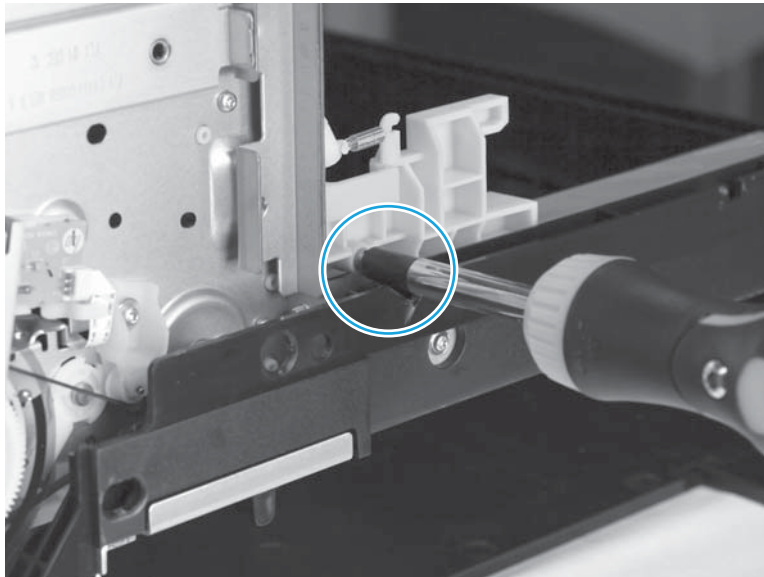
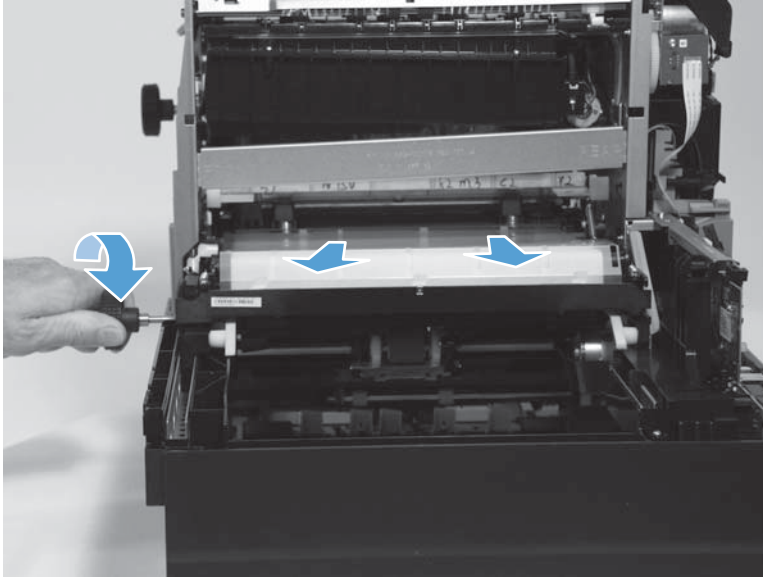

6. Lift the service sled cartridge from the product.

Figure 1-97 Remove the service sled assembly (6 of 6)

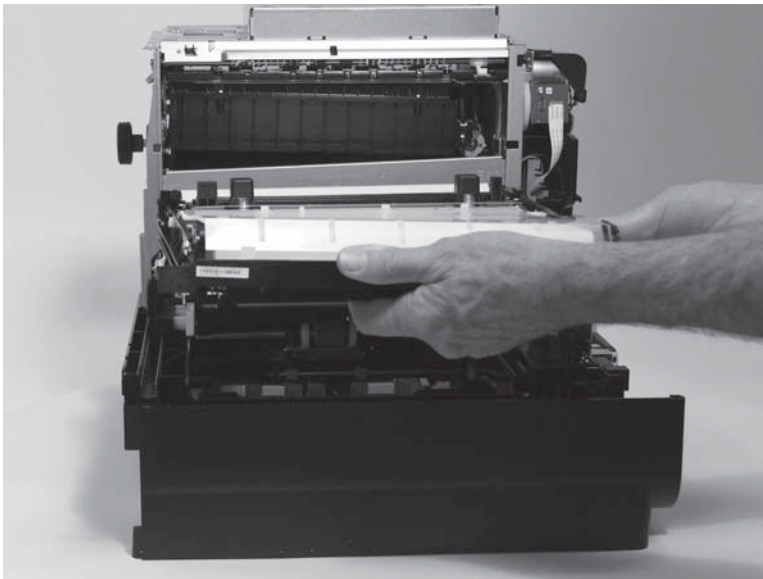

 **NOTE:** Do not touch the web contact roller during the removal process. The roller is saturated with ink. Also, any contaminants from your hands that transfer to the roller could affect print quality.

7. After reinstalling the service sled assembly, test for correct operation using the following steps:
 - a. Open the [Engineering menu](#). See [Access the Engineering menu on page 14](#) for information on accessing the [Engineering menu](#).
 - b. Select [Service](#), select [Service Tests](#), select [Test Service Station](#), and then touch the [OK](#) button.

- c. Select two service cycles, and then touch the **OK** button.
- d. The service sled module should move out of, and back into cap smoothly. If the operation isn't smooth, check for correct installation, including whether the service sled is aligned correctly. Also check that the service sled transmission is in the correct position. See [Service sled transmission on page 114](#).

 **Reinstallation tip** During the reinstallation process, ensure that the service sled is aligned with the case part.

 **NOTE:** If you are working on the product at a repair center, use the special alignment tool (PN T-285463) to make sure the sled is aligned correctly. In the field, you will have to align it by sight. See [Service sled transmission on page 114](#).

Web advance rack assembly

1. Remove one screw (callout 1) from behind the flag.

Figure 1-98 Remove the web advance rack assembly (1 of 2)

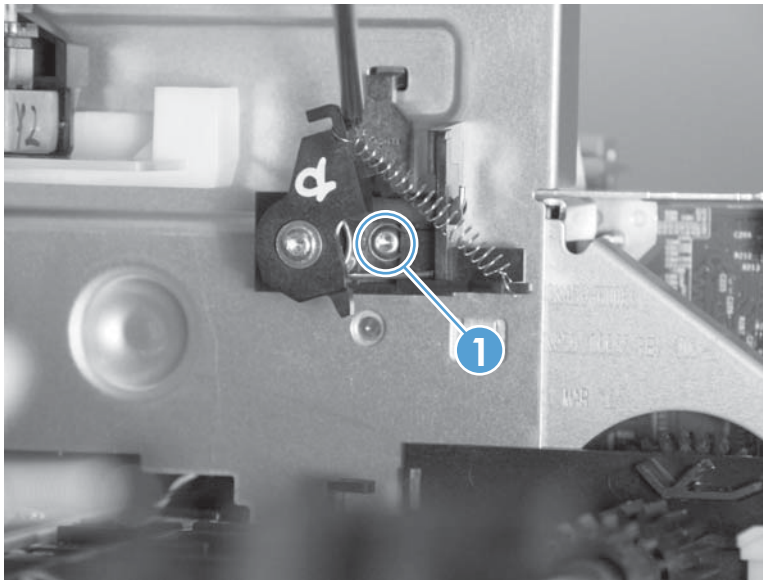

2. Rotate the assembly upward to clear the tab from the right wall, and then remove the assembly.

Figure 1-99 Remove the web advance rack assembly (2 of 2)

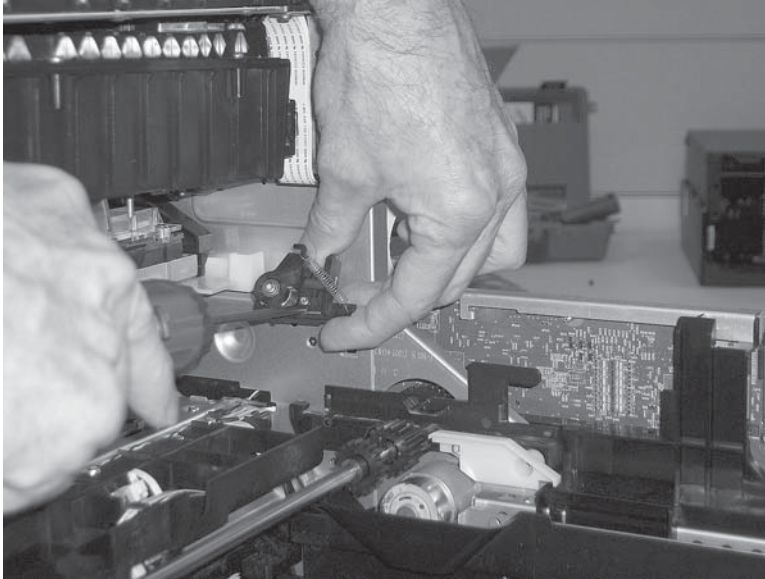

Right cross brace

1. Remove the following components:
 - Rear cover. See [Rear cover on page 22](#).
 - Left door. See [Left door on page 23](#).
 - Left rear cover. See [Left rear cover on page 26](#).
 - Left front cover. See [Left front cover on page 27](#).
 - Top cover. See [Top cover and control panel on page 29](#).
 - Front cover. See [Front cover on page 35](#).
 - Right cover. See [Right cover on page 36](#).
2. Remove two screws (callout 1) from the front of the product.

Figure 1-100 Remove the right cross brace (1 of 4)

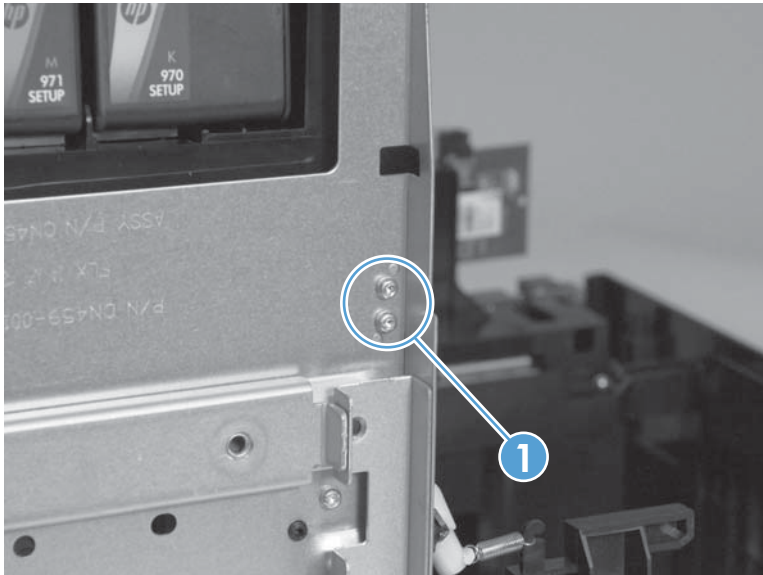

3. Remove two screws (callout 1) from the rear of the product.

Figure 1-101 Remove the right cross brace (2 of 4)

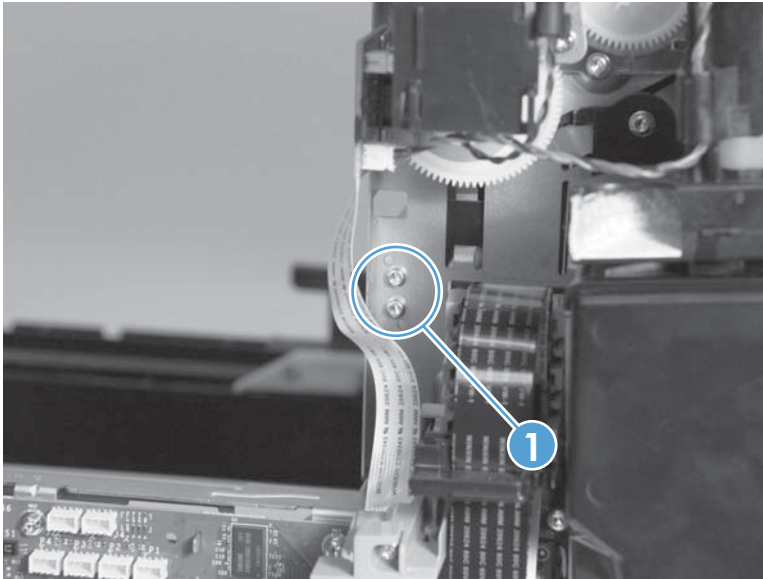

4. Remove the brace.

Figure 1-102 Remove the right cross brace (3 of 4)

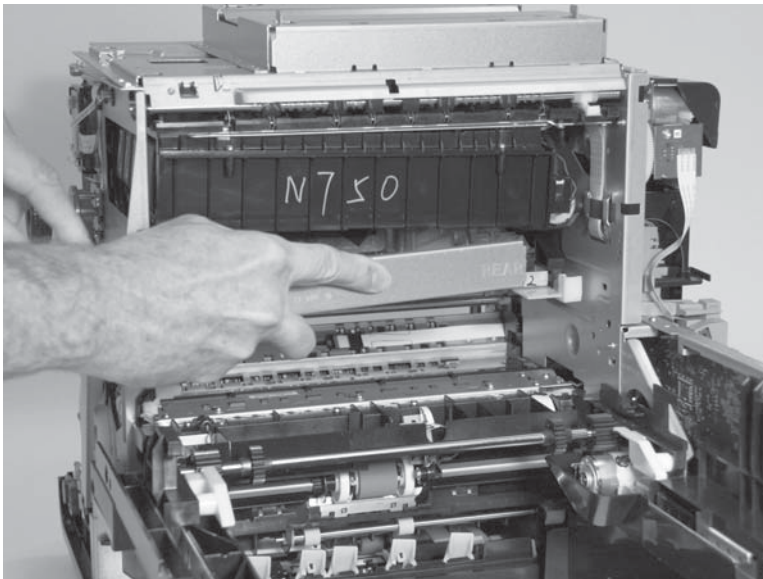



 **Reinstallation tip** The front and rear ends are labeled. Set the locator bumps on the bar in the locator holes on the product.

Figure 1-103 Remove the right cross brace (4 of 4)



Printbar

 **IMPORTANT:** Ensure the product firmware is upgraded to at least version 1336MR before performing this repair procedure. If the firmware upgrade cannot be completed, contact HP support.

 **NOTE:** Refer to document number CN598-67045.

 **NOTE:** If the product has printed more than 30,000 pages, replacing the service sled assembly is recommended.

 **WARNING!** The printbar testing and calibration instructions must be followed exactly. Failure to follow these instructions exactly may result in a printer problem that is not recoverable in the field.

1. Before replacing the printbar:
 - Replace the duplex module. The duplex module must be replaced any time the printbar is replaced.
 - A set of trade supplies will be required to test that the printbar has been installed correctly. The existing customer supplies will be sufficient as long as they have ink left.
2. Remove the following components:
 - Service sled cartridge. See [Service sled assembly on page 63](#).
 - Aerosol duct, remove for easier access (optional).
 - Right cross brace. See [Right cross brace on page 69](#).
 - Web advance rack assembly. See [Web advance rack assembly on page 67](#).

IMPORTANT: The OfficeJet Pro X special tools kit (part CN598-67056) is required when replacing a printbar. If you are working on the product at a repair center, use the special alignment tool (PN T-285463) to make sure the sled is aligned correctly. In the field, you will have to align it by sight. See [Service sled transmission on page 114](#).

CAUTION: The printbar lift lock tool must remain in place until the printbar is lowered onto the dolly. If the printbar drops to the bottom of the product, the printbar might be damaged.

3. Install the nozzle “helmet” on the printbar to protect the ink nozzles. Install the two front rubber bumpers (callout 1) into the matching notches in the printbar, then rotate the printbar safety cap back and up to engage the catches on the back of the printbar (callout 2).

Figure 1-104 Remove the printbar (1 of 12)

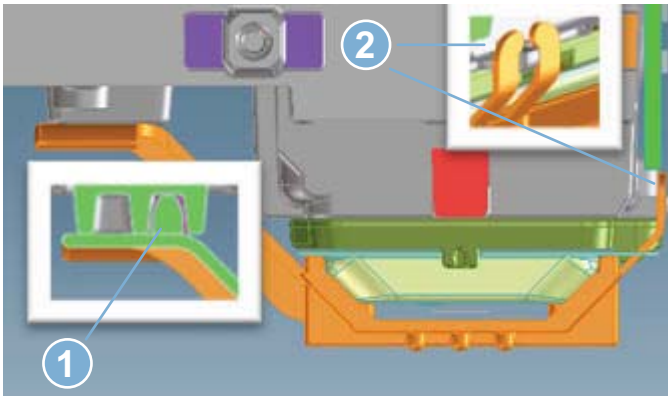

4. Install the printbar dolly.
 - a. Locate the service sled guides (callout 1).

Figure 1-105 Remove the printbar (2 of 12)

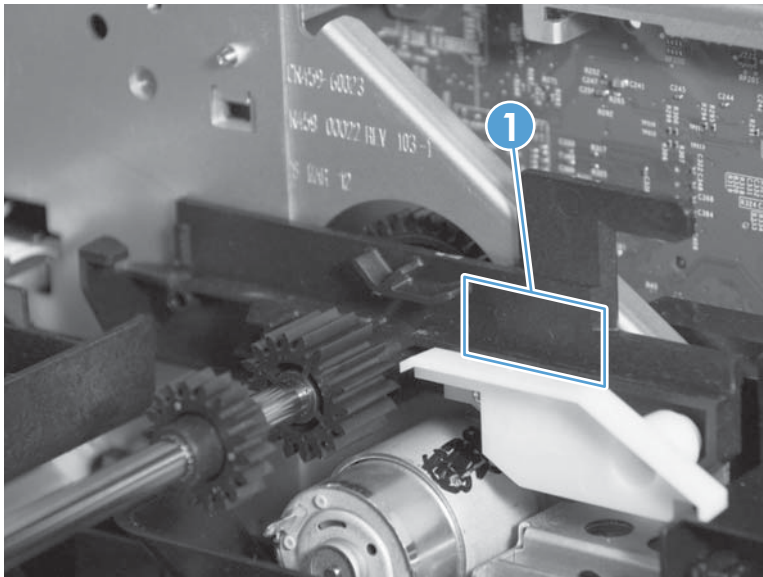

- b. Place the dolly (callout 1) on the guides.

Figure 1-106 Remove the printbar (3 of 12)

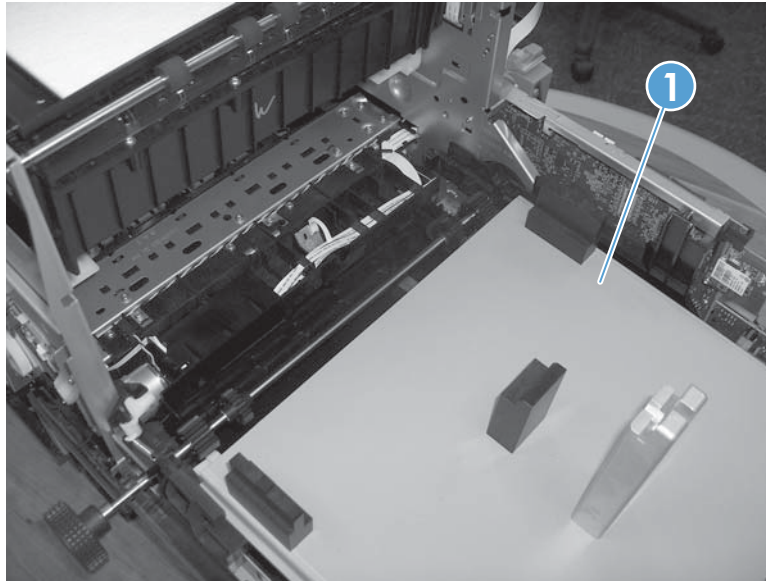

- c. Push the dolly into the product until it reaches the left side, and then lower the printbar by hand onto to the seated dolly. This will prevent the printbar from inadvertently dropping onto the dolly.

Figure 1-107 Remove the printbar (4 of 12)

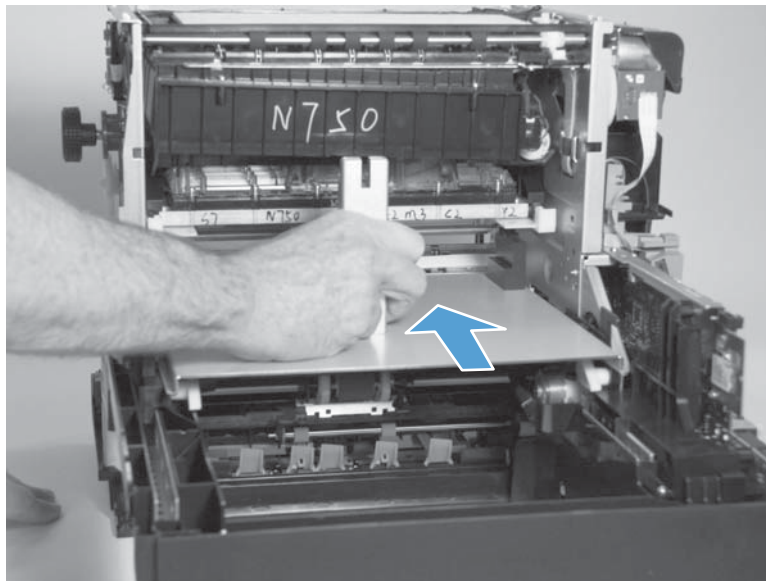

- 5. Remove the top cap assembly. See [Top cap assembly on page 33](#).

6. Disconnect three printbar flex cables (callout 1).

⚠ CAUTION: Two of these cables are installed in zero insertion force (ZIF) sockets that have a black holder on top. The black holder must be pulled up *carefully* to release the cables. It is very easy to break these connectors.

Figure 1-108 Remove the printbar (5 of 12)

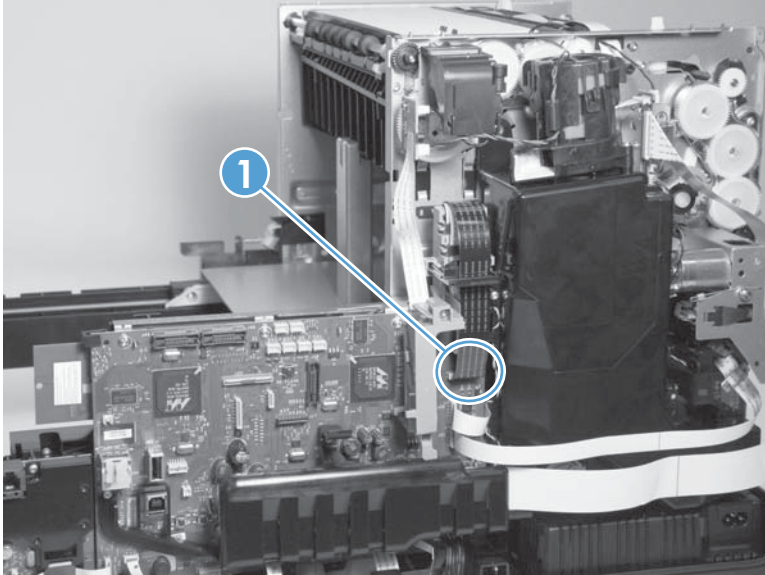

7. Unthread the three flex cables through the ferrite holder (callout 1).

Figure 1-109 Remove the printbar (6 of 12)

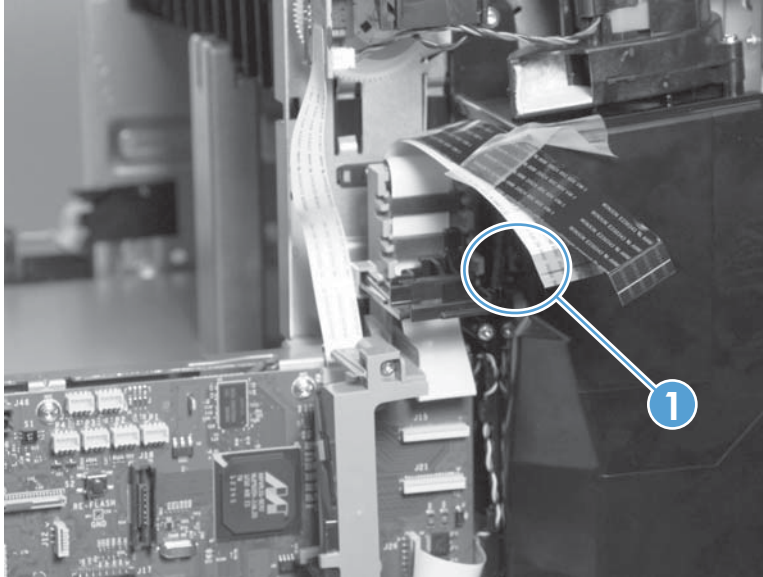

Reinstallation tip When reinstalling, remember to thread the two white flex cables through the ferrites correctly. (The black flex cable goes through a slot in the plastic holder.) Doing so ensures that the product meets regulatory standards.

Reinstallation tip When reinstalling, inspect the printbar flex cables for damage. If any damage exists, replace the damaged cable.

Reinstallation tip Manually clasp the cables to make sure that the ZIF sockets are closed on the cables correctly.

8. Carefully use a screwdriver to remove the flex cable retainer (callout 1) from the product. Take care to avoid damaging the cable.

Figure 1-110 Remove the printbar (7 of 12)

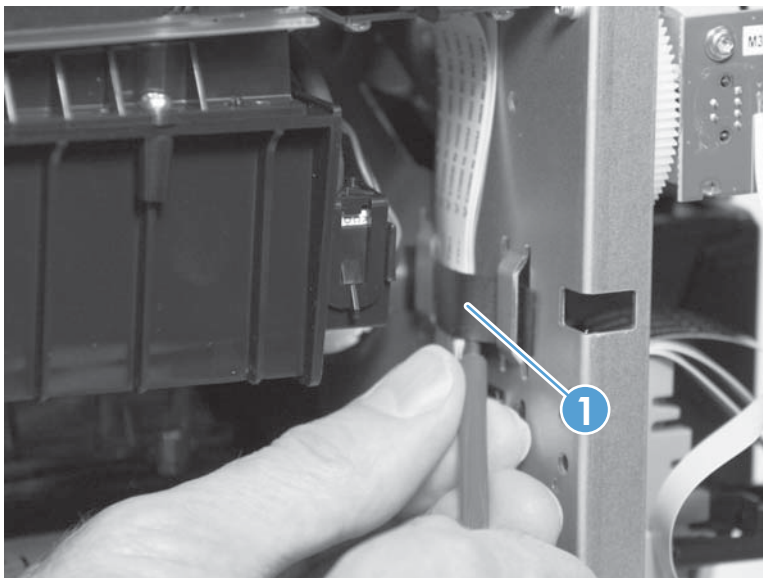

9. Unthread all three of the printbar cables through the front frame of the product.

Figure 1-111 Remove the printbar (8 of 12)

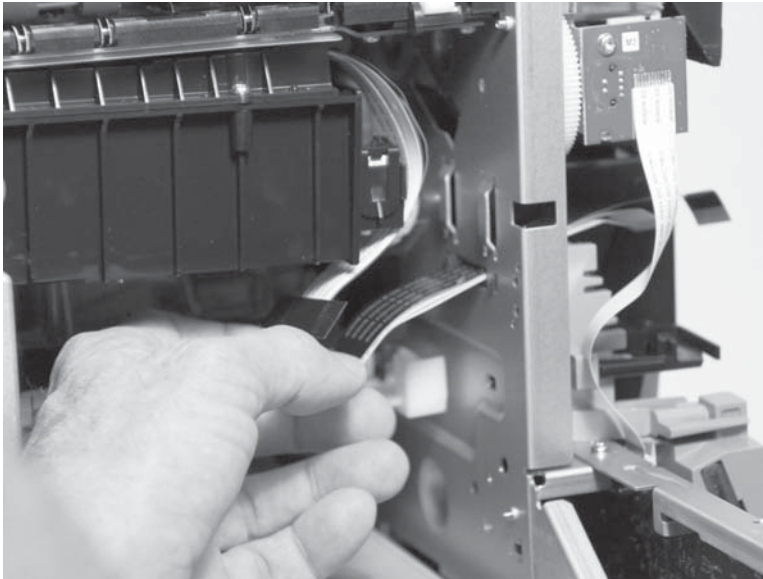

10. Gently remove the printbar lift lock tool to lower the printbar onto the dolly.
11. Locate both lift guides (callout 1) on the top left of the product.

Figure 1-112 Remove the printbar (9 of 12)

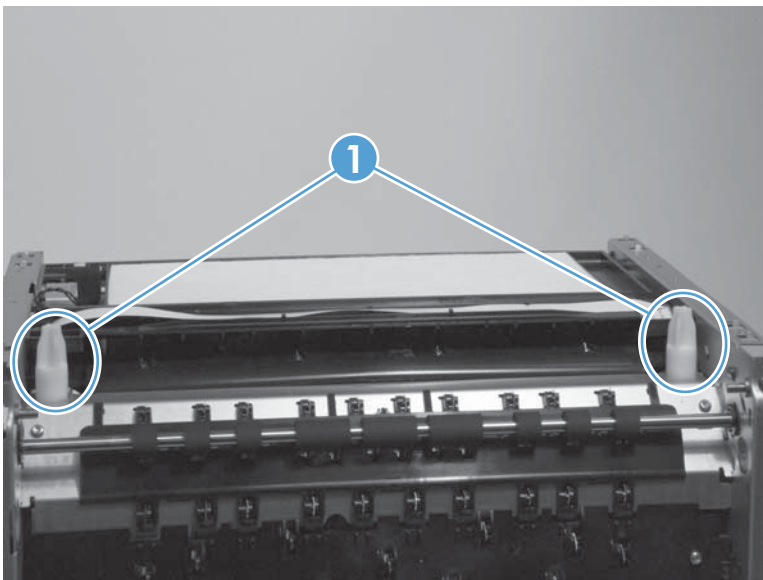

12. Pull each lift guide up to remove.

⚠ CAUTION: The lift guides are greasy.

Figure 1-113 Remove the printbar (10 of 12)

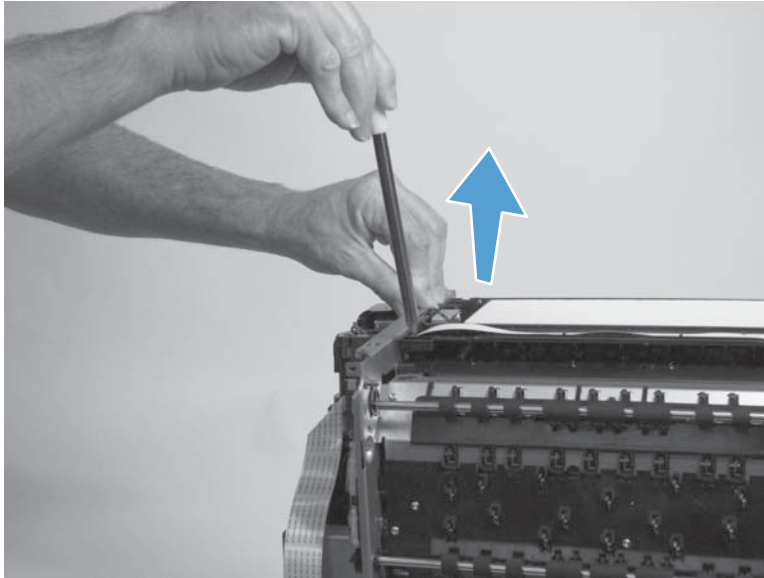

13. Slide the dolly (callout 1) forward, away from the product, to remove the printbar assembly (callout 2).

Figure 1-114 Remove the printbar (11 of 12)

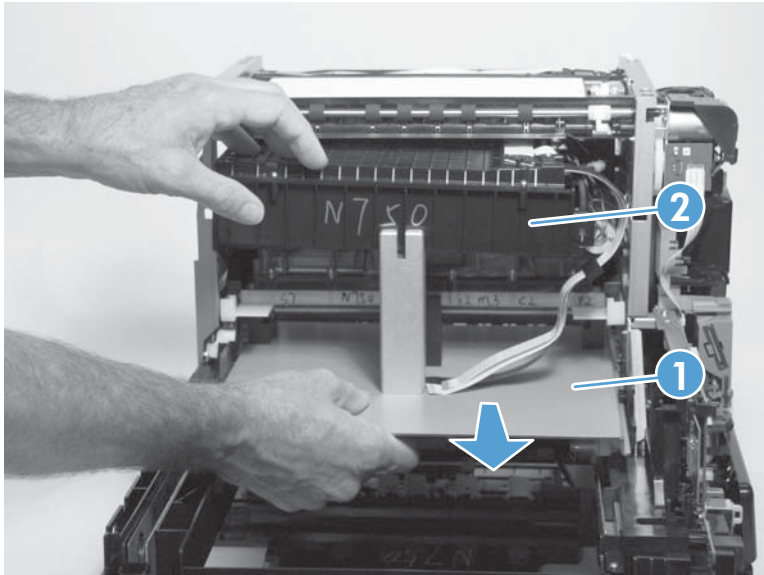

⚠ CAUTION: Use extreme care when handling the printbar while it is out of the product. It can be easily damaged.

14. Before reinstalling the printbar, check the shims for a significant buildup of ink/duct. If there is a significant build up, the shims can be cleaned very carefully with a **lint free** wipe.

Figure 1-115 Remove the printbar (12 of 12)

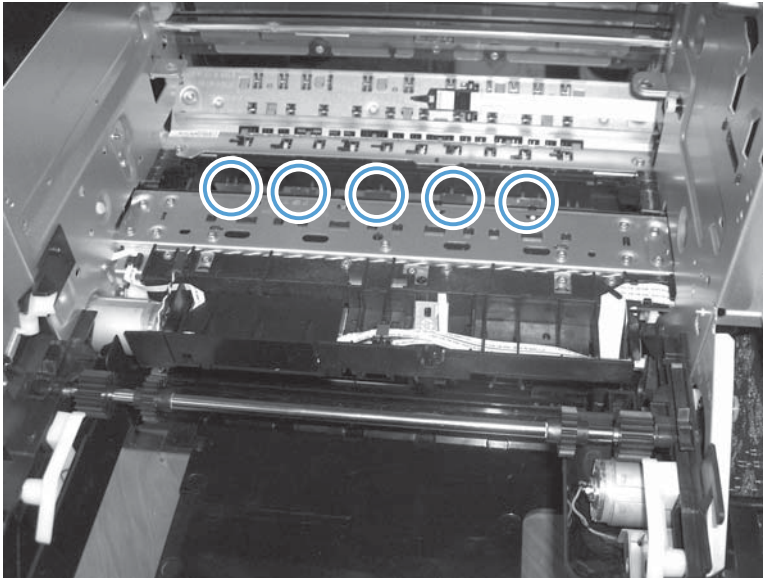

Reinstall the printbar

1. Slide the printbar dolly with new printbar gently into position and ensure it is fully seated. Insert the front and rear lift guide rods and ensure they are fully seated in their pockets.

 **Reinstallation tip** Ensure that the lift guide pockets have adequate grease in them during reinstallation. Failure to apply enough lubricant to the lift pocket guides can cause a noticeable increase in product operation noise.

Reinstallation tip Lift guide rods must be replaced in the same position. For example, front guide back into the front of the product.

If the printbar lift rod Z stop is broken, it must be replaced (part CN598-67048). If you are installing a new Z-stop, the top of the lift guide rods will stand proud of the top of the case. Installing the top cap assembly will cause the Z stop to crush down to the correct height.

2. Reinstall the top cap.
3. Reinstall the printbar lock. Turn the lock to lift the printbar to its top-most position. There should not be more than a 1.5 mm gap between where the printbar guide meets the lift rod Z stop on the front and rear guide rods. If a larger gap is evident, the printbar guide may be misaligned by a tooth. Lower the printbar back onto the dolly and see step 10 of Remove the printbar to remove and reinstall the lift guide rods.
4. Remove the printbar dolly and verify that the service sled drive is *not* easy to turn. If the service sled is not easy to turn, this indicates that the service sled transmission is in the correct position. See [Service sled transmission on page 114](#) for details.

 **Reinstallation tip** Remove the printbar safety cap before reinstalling the service sled.

Printbar calibration procedure

Test the printbar installation

Test the printbar installation after installing a printbar.

1. Temporarily connect the front panel into the main PCA. Temporarily install the right case part.
2. Place the printer into MFG (on) mode. See [Place the product into MFG \(manufacturing\) mode on page 14](#) for information on putting the product into MFG mode.

 **WARNING!** Follow the instructions for placing the product into MFG (manufacturing) mode **exactly** as listed in [Place the product into MFG \(manufacturing\) mode on page 14](#). Failure to follow these instructions while placing the product into MFG (manufacturing) mode can render the product inoperable.

- Temporarily install a set of trade supplies or use the existing customer supplies. Host supplies will be rejected in MFG (on) mode.
3. Verify that the new printbar is functional:
 - a. Temporarily install the left door.
 - b. Cover the ink supply door sensor with a magnet.
 - c. Print a Printer Status Report page.
 - d. Ensure that the service sled is aligned with the arrows. Perform a 21 tap test. Observe that the service sled moves smoothly, and that once it caps the printbar, that the cap is level and aligned correctly.
 - e. Turn the product off using the power button, and then unplug the product.
 4. Reinstall the product covers.

 **IMPORTANT:** All the product covers must be installed before calibrating the printbar.

A new duplex module must be installed before calibration/initialization.

Calibrate the printbar

1. Place the product into MFG (off) mode, and then place the product into MFG (on) mode. See [Place the product into MFG \(manufacturing\) mode on page 14](#) for information on placing the product into these MFG modes.

 **NOTE:** Use trade ink supplies while in MFG (on) mode. Host supplies will be rejected in MFG (on) mode.

2. Open the [Engineering menu](#). See [Access the Engineering menu on page 14](#) for information accessing the [Engineering menu](#).

 **WARNING!** Follow the instructions for accessing the [Engineering menu](#) **exactly** as listed in [Access the Engineering menu on page 14](#). Failure to follow these instructions when accessing the [Engineering menu](#) can render the product inoperable.

3. Select the [Service Menu](#), scroll to [System Configuration](#), select [Service ink container Or Duplex module](#), select [Replace Duplex Module](#), and then touch the [OK](#) button.

 **WARNING!** Replacement of the duplex module is critical. Failure to replace the duplex module and to inform the firmware that the duplex module has been replaced will likely force the system into an unrecoverable error.

4. From the [Service Menu](#), scroll to [System Configuration](#), select [Replace Printbar](#) and follow the onscreen prompts, and then touch the [OK](#) button.
5. After the product restarts, remove the trade supplies, and then install the HP Setup supplies that came with the printbar replacement kit.

 **NOTE:** An initialization screen will be displayed on the product control panel while the printbar purges the shipping fluid.

 **NOTE:** After the printbar purges the shipping fluid, the product begins calibrating. The calibrations will take approximately 20 to 25 minutes and a total of nine pages will print. When the calibrations are complete, the control panel will return to the [Home](#) screen.

6. Turn off the product, and then turn the product on. The product will boot in user (standard) mode.

 **NOTE:** Use the power button to turn the product off and on. If the power button does not work, see the Troubleshooting guide.

7. Print a Print Quality Report. If there are problems, then follow the Print Quality Checklist in the Troubleshooting Guide.
8. Open the [Engineering](#) menu. See [Access the Engineering menu on page 14](#) for information accessing the [Engineering menu](#).
9. Run the following tap tests:

- 10 tap
- 12 tap
- 61 tap
- 909 tap

For more information on running and verifying tap test results, see [Perform tap tests and interpret results on page 16](#).

10. Return to the [Ready](#) screen, and then complete the customer configurations, including network settings, preferred paper size and trays, and so forth.

Printbar FFC replacement

 **IMPORTANT:** The printbar safety cap must remain securely fastened to the printbar during this procedure. If the printbar safety cap is unfastened, then the printbar might be damaged and require replacement.

1. Remove the printbar. See [Printbar on page 71](#)
2. Remove two screws, and then remove the two FFC retainers.

Figure 1-116 Replace the printbar control FFCs (1 of 2)

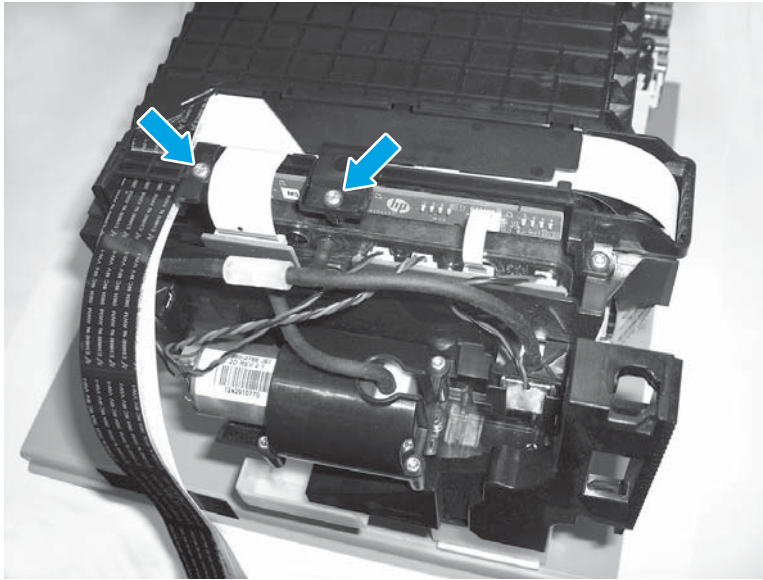

3. Remove two printbar FFCs installed in ZIF sockets, and then remove the prime pump FFC.

Figure 1-117 Replace the printbar control FFCs (2 of 2)

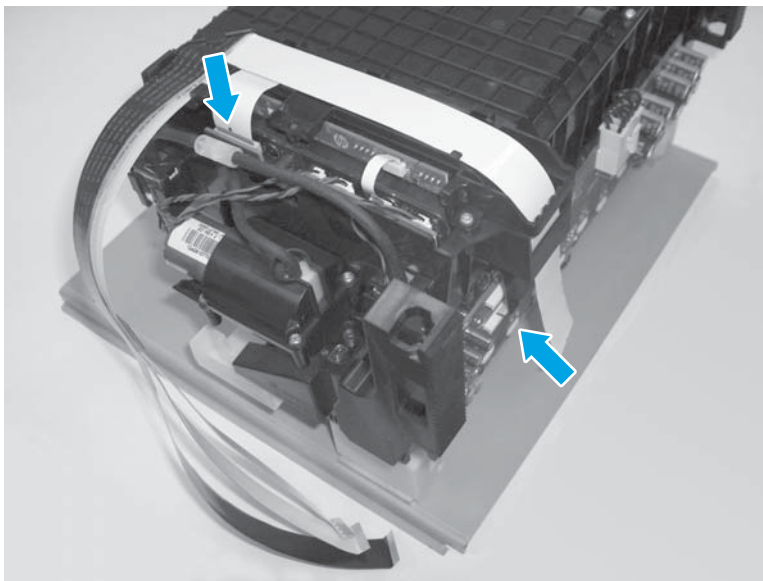

4. Install the new FFCs.

Platen

 **IMPORTANT:** Ensure the product firmware is upgraded to at least version 1336MR before performing this repair procedure. If the firmware upgrade cannot be completed, contact HP support.

1. Remove the following components:
 - Aerosol fan assembly. See [Aerosol fan assembly on page 37](#).
 - Right cross brace. See [Right cross brace on page 69](#).
 - Service sled assembly. See [Service sled assembly on page 63](#).
2. Remove the printzone distribution PCA cover (callout 1).

Figure 1-118 Remove the platen (1 of 7)

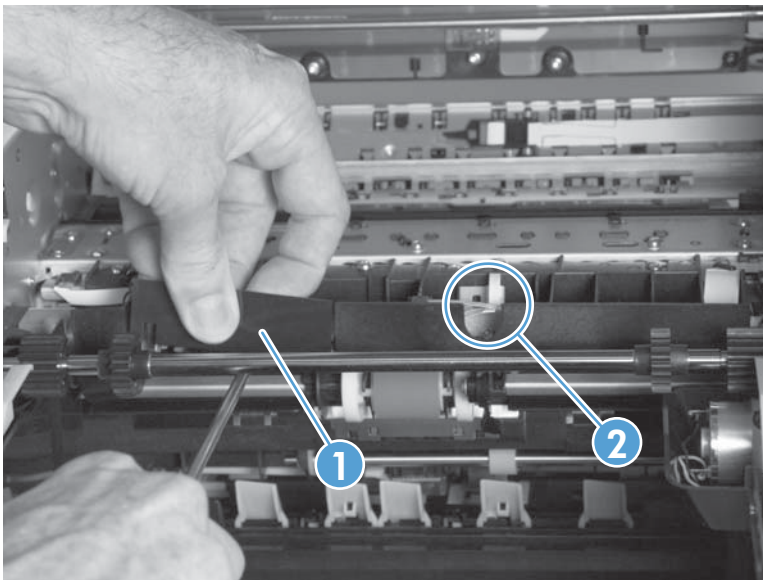

 **NOTE:** The printzone distribution PCA is indicated by callout 2.

3. Disconnect two flat flexible cables (callout 1). Note that the white cable is on the left and the black cable is on the right, and then unthread the cables through the chassis wall.

Figure 1-119 Remove the platen (2 of 7)

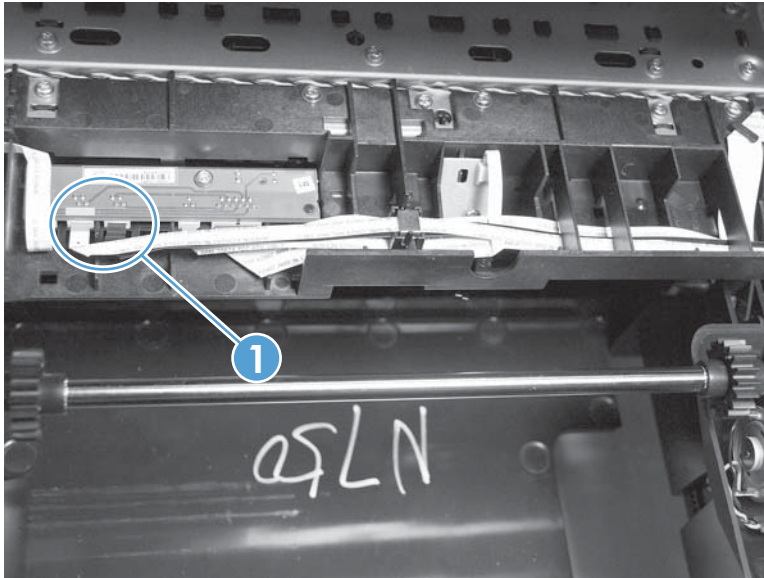

 **Reinstallation tip** Remember the cable orientation and order. Take care to avoid crimping the flex cables when removing or reinstalling them.

4. Lower the platen (callout 1).

Figure 1-120 Remove the platen (3 of 7)

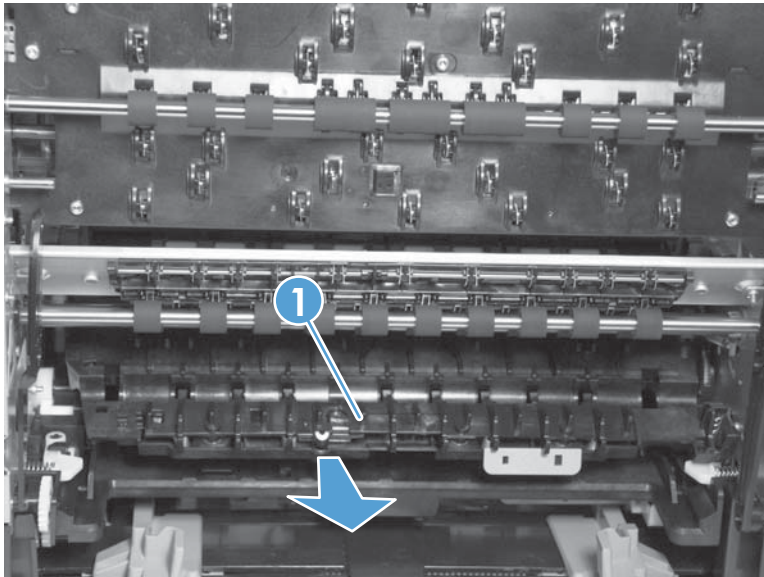

5. Remove one screw (callout 1) from the rear wall.

Figure 1-121 Remove the platen (4 of 7)

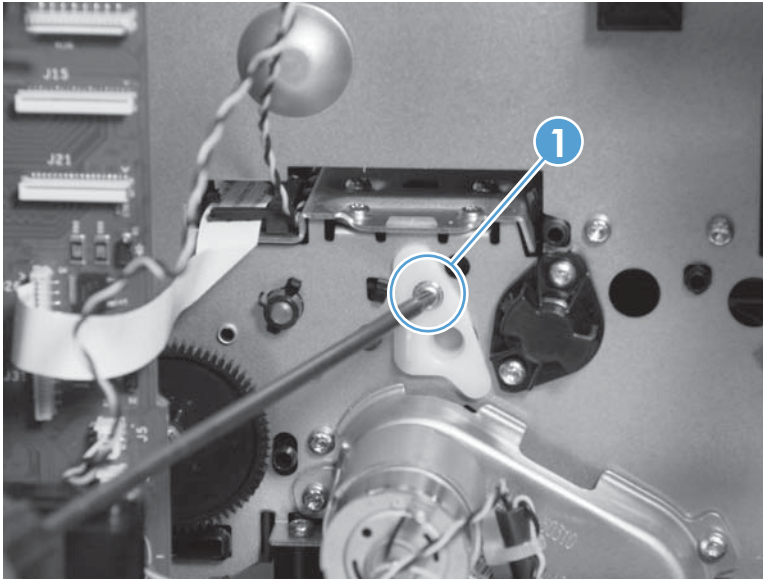

6. Remove the bracket (callout 1).

Figure 1-122 Remove the platen (5 of 7)

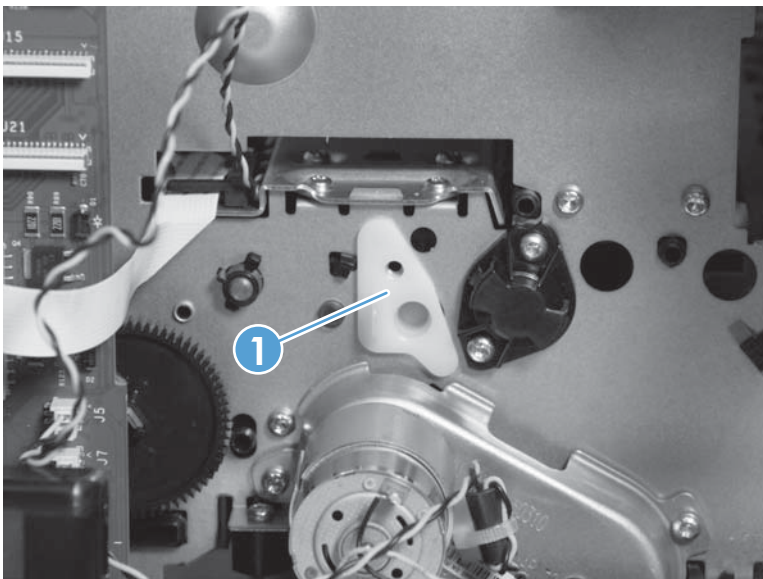

7. Push the platen towards the rear of the product to clear the retention spring on the front pivot, and then remove the platen.

Figure 1-123 Remove the platen (6 of 7)

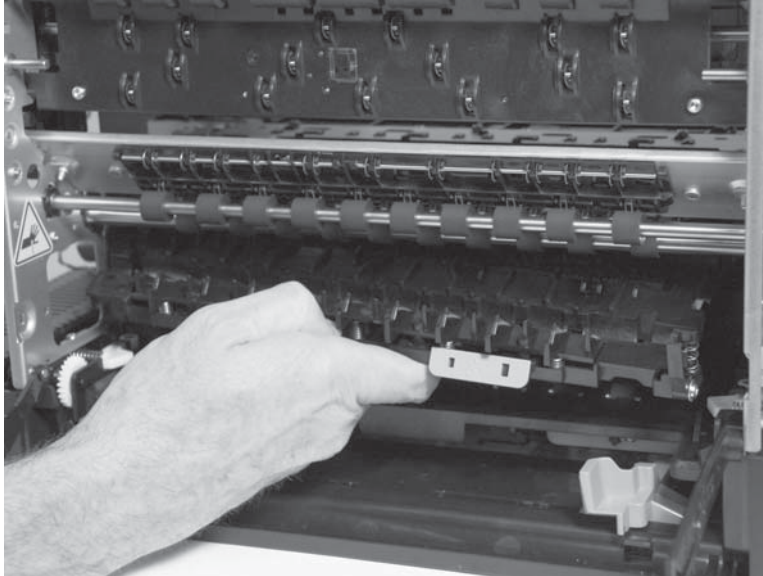

 **TIP:** Temporarily tape the two REDI FFCs together to make them easier to thread through the wall. Remove the tape after the FFCs are threaded through the wall.

8. New REDI sensors were installed with the new platen and require calibration. Use the following steps to calibrate the REDI sensors.

Calibrate the REDI sensors

- a. Open the [Engineering menu](#).
- b. From the [Engineering Menu](#), select the [Service Menu](#), and then select [System Configuration](#).
- c. Select [Paper Sensor Calibration](#).



NOTE: The paper sensor calibrations require one sheet of blank HP Colorlok paper. HP Colorlok paper **must** be used for the Paper Sensor Calibration. The same sheet of paper can be reused if it is undamaged.

- d. Select [Calibrate Main tray](#). The tray will eject one blank page.
- e. Select [Calibrate MP tray](#). The product will eject one blank page into the tray.



Reinstallation tip Place the black cable (callout 1) under the white cable and thread the cables through the hole in the product interior.

Reinstallation tip While reinstalling the right end of the platen, depress the spring in the front of the unit.

Figure 1-124 Remove the platen (7 of 7)

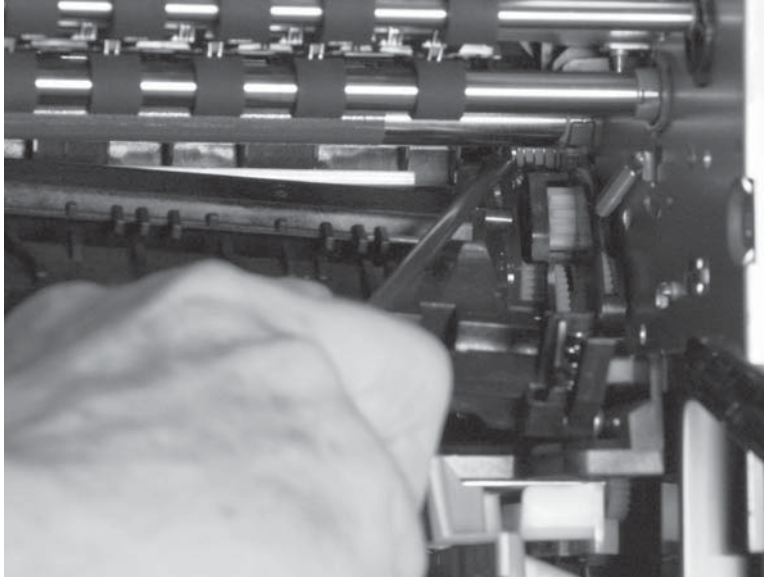

Drying path gear assembly

1. Remove the following components:
 - Rear cover. See [Rear cover on page 22](#).
 - Left rear cover. See [Left rear cover on page 26](#).
 - PCA safety shield. See [PCA safety shield on page 116](#).
2. Remove three screws (callout 1), and then remove the assembly (callout 2).

Figure 1-125 Remove the drying path gear assembly

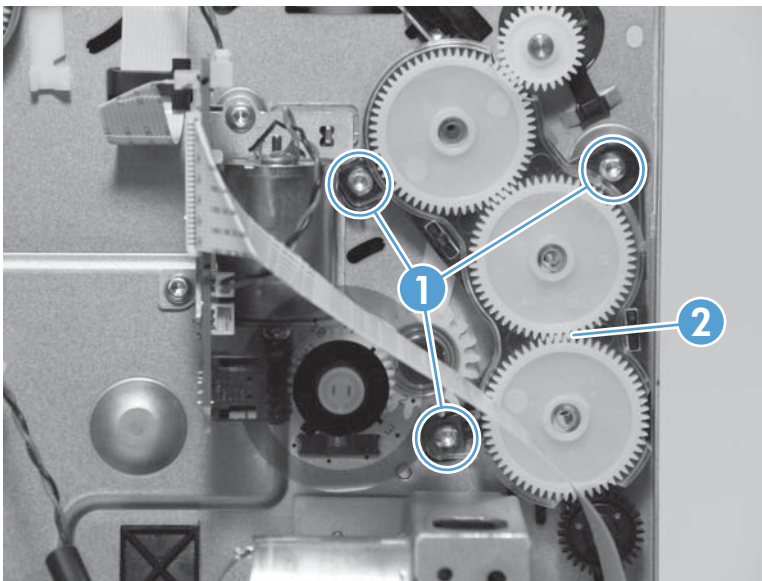

Printbar lift mechanism assembly

Remove the following components:

- Aerosol fan assembly. See [Aerosol fan assembly on page 37](#).
- Drying path gear assembly. See [Drying path gear assembly on page 86](#).

Printbar lift bracket worm drive

1. Disconnect three wire connectors (callout 1).

Figure 1-126 Remove the printbar lift motor (1 of 3)

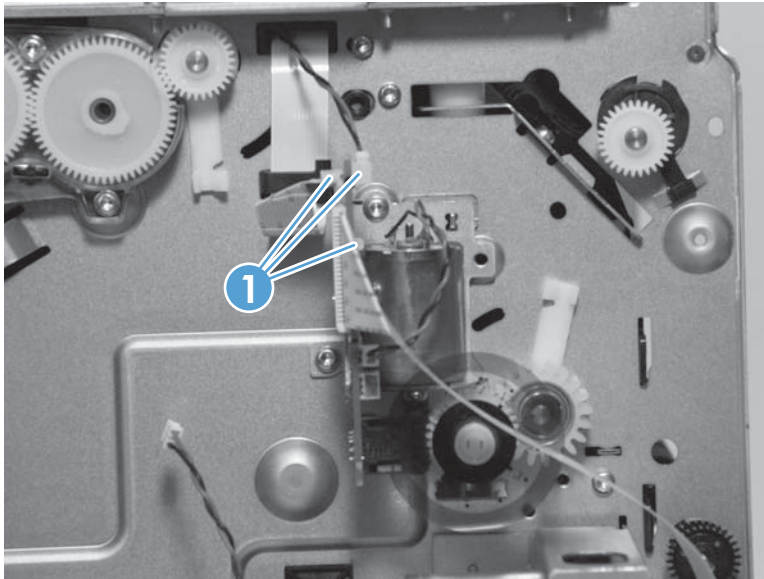

2. Remove two screws (callout 1), and then remove the assembly.

Figure 1-127 Remove the printbar lift motor (2 of 3)

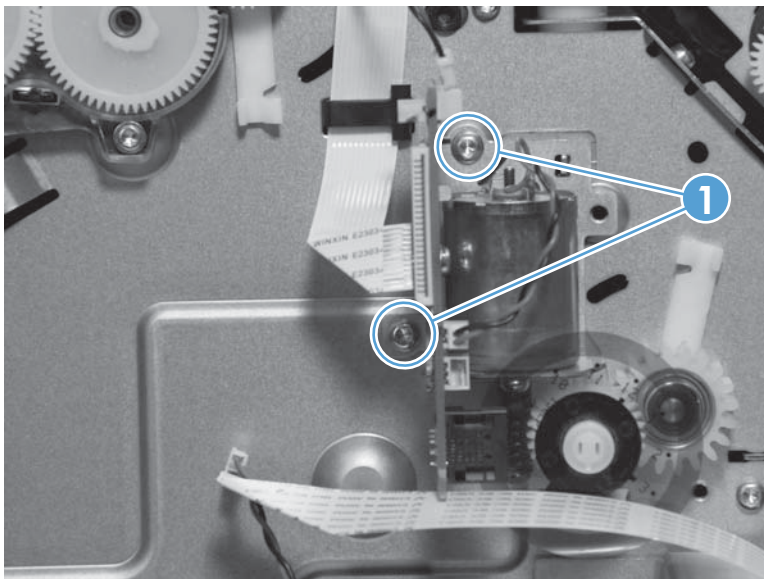

3. Remove the plastic clip (callout 1) from the printbar lift encoder shaft. Remove the lift encoder/gear assembly.

Figure 1-128 Remove the printbar lift motor (3 of 3)

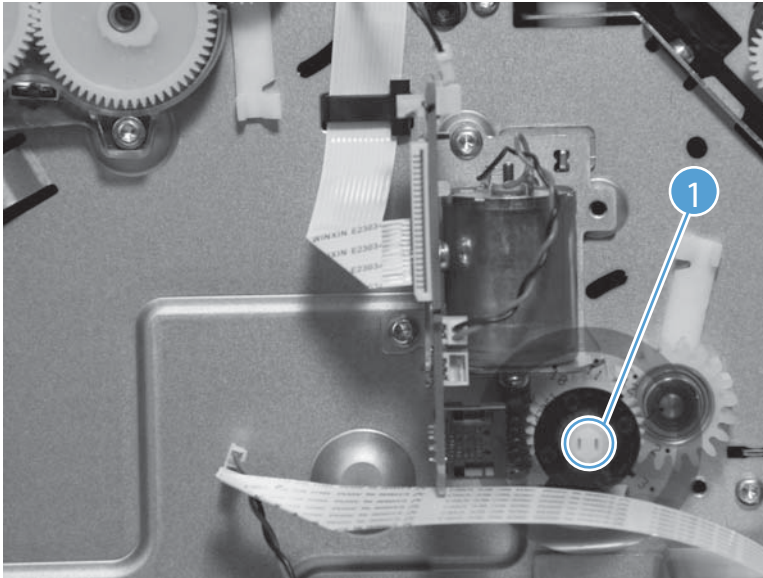

 **Reinstallation tip** Fit the encoder wheel through the sensor on the back of the PCA assembly.

Reinstallation tip Use the clip supplied with the printbar lift mechanism kit. Do **not** reuse the existing clip.

Tray lift transmission assembly

1. Remove the following components:
 - Main PCA. See [Main PCA on page 132](#).
 - Pick encoder distribution PCA. See [Pick encoder distribution PCA on page 141](#).
 - Tray 3 interconnect PCA. See [Tray 3 interconnect PCA on page 140](#).
2. Remove two screws (callout 1).

Figure 1-129 Remove the tray lift transmission assembly (1 of 2)

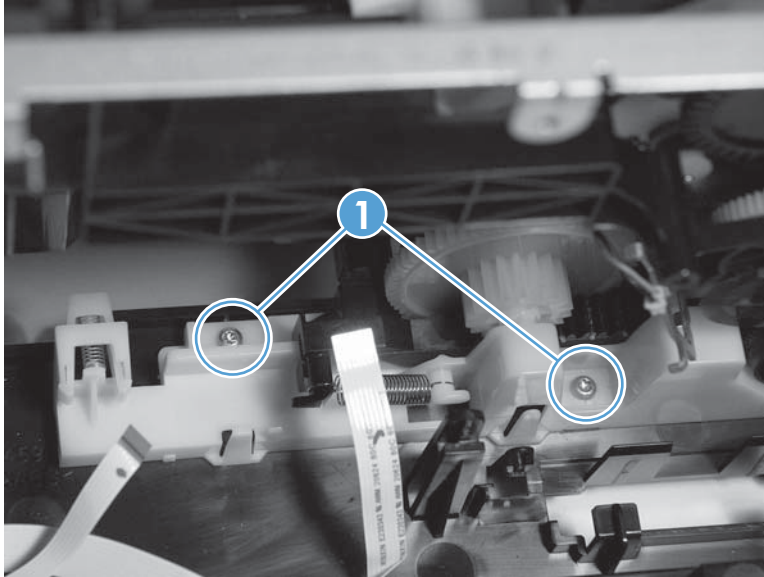

3. Carefully remove the assembly (callout 1). The main gear drive axle must clear a post on the product chassis before the assembly can be removed.

Figure 1-130 Remove the tray lift transmission assembly (2 of 2)

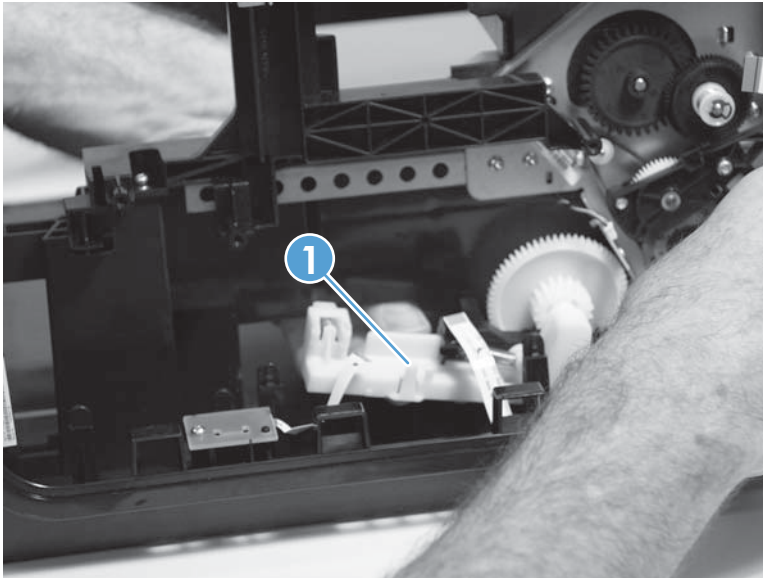

 **Reinstallation tip** When reinstalling the tray lift transmission assembly, ensure the service sled is installed correctly. See [Service sled transmission on page 114](#).

Output drive kit

Remove the following components:

- Rear cover. See [Rear cover on page 22](#).
- Left door. See [Left door on page 23](#).
- Left rear cover. See [Left rear cover on page 26](#).
- Left front cover. See [Left front cover on page 27](#).
- Top cover. See [Top cover and control panel on page 29](#).
- Top cap assembly. See [Top cap assembly on page 33](#).

Flap actuator solenoid

1. Remove two screws (callout 1).

Figure 1-131 Remove the flap actuator solenoid

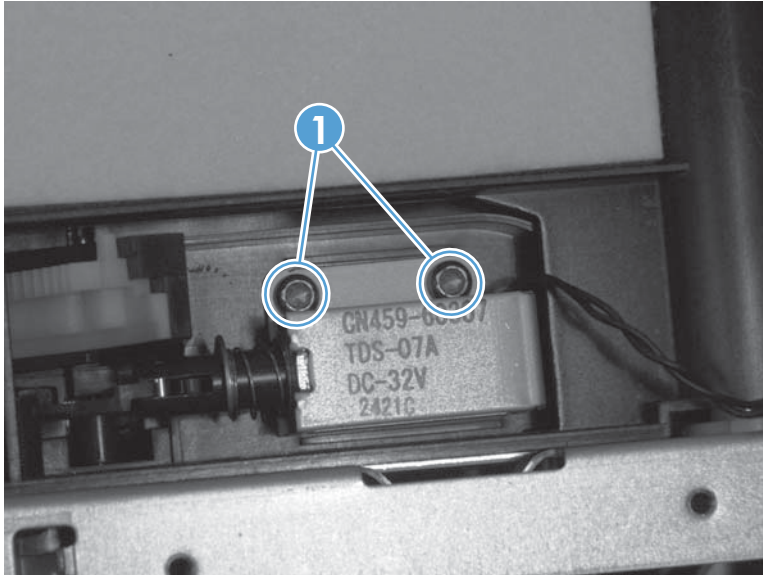

2. Remove the solenoid and disconnect the solenoid activation cable.

Rack-eject lifter flap

1. Pull the actuator forward.

Figure 1-132 Remove the rack-eject lifter flap (1 of 3)

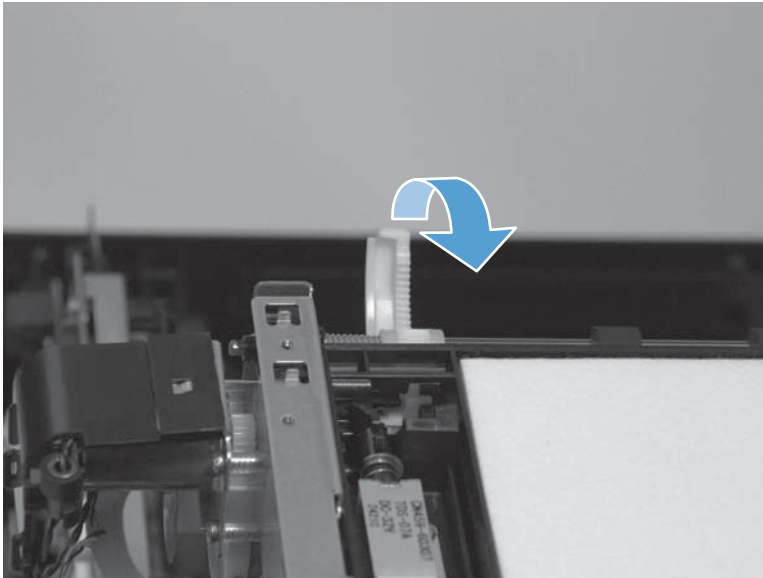

2. Locate the tab (callout 1) on the right of the actuator.

Figure 1-133 Remove the rack-eject lifter flap (2 of 3)

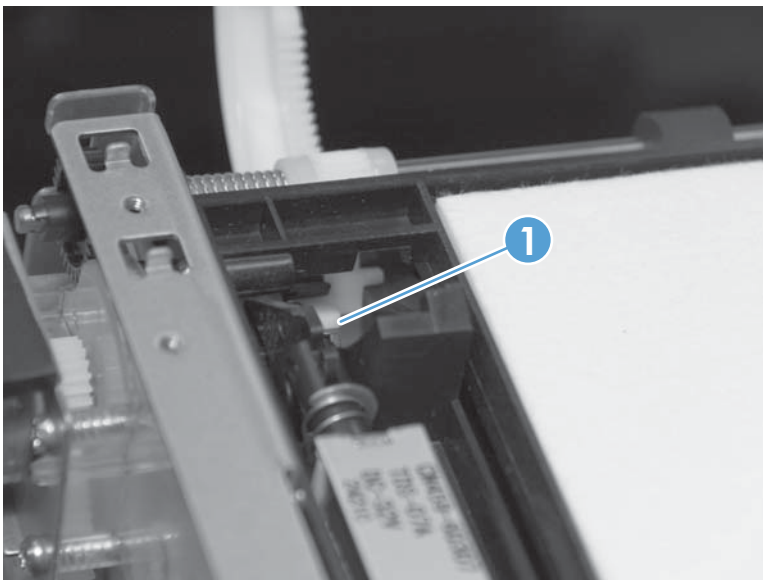

3. Use a screwdriver to lift the tab, and then rotate the actuator to remove it.

Figure 1-134 Remove the rack-eject lifter flap (3 of 3)

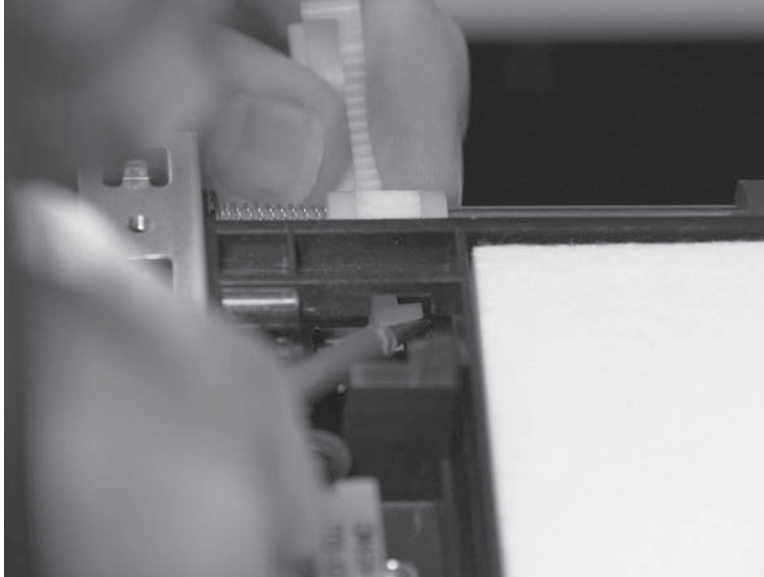

 **Reinstallation tip** Ensure that the actuator is correctly aligned during reinstallation. If the actuator is aligned incorrectly, the actuator flap will not open. The actuator must pass through the guide anchored on both sides of the guide.

Eject drive gear module

- ▲ Remove four screws (callout 1), and then remove the assembly.

Figure 1-135 Remove the eject drive gear module

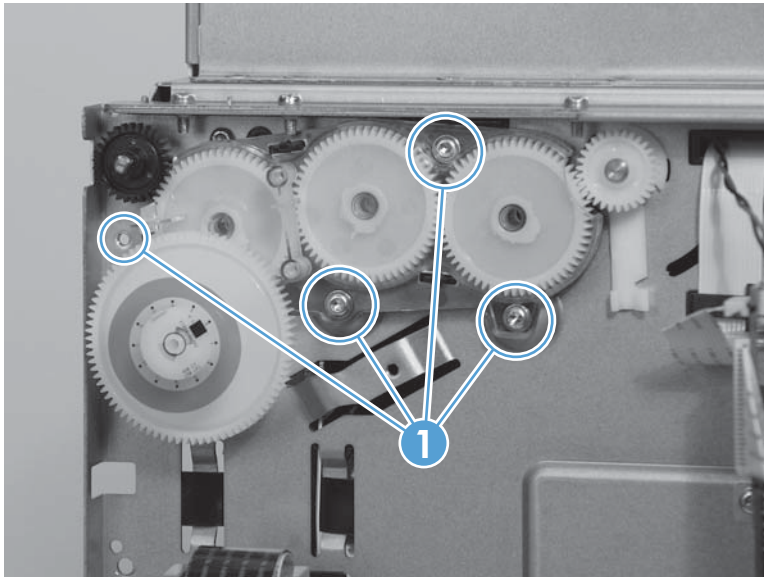

Output drive gears

1. Spread the retainers (using a pair of tweezers) holding the gear onto the shaft, and then slide the gear off the shaft. Repeat this step for each gear.

Figure 1-136 Remove the output drive gears

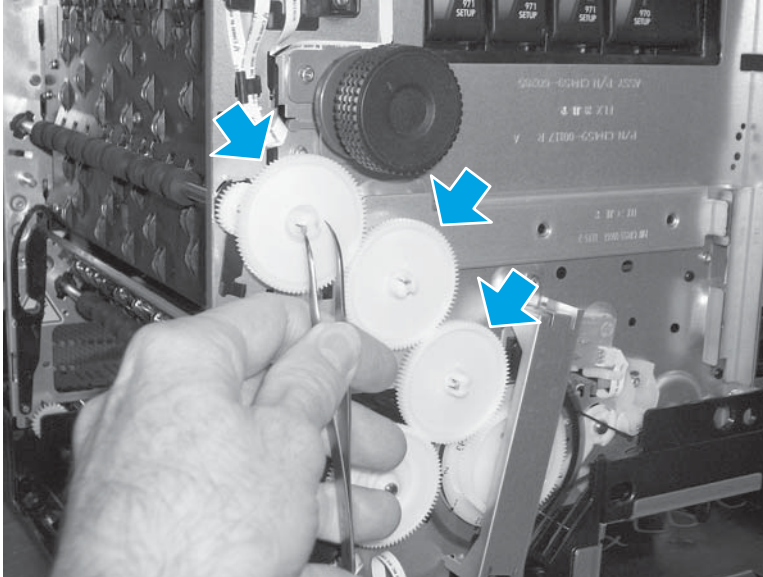

2. Snap the new output drive gears onto the shafts.

Output drive shaft 6

1. Remove the following components:
 - Rear cover. See [Rear cover on page 22](#).
 - Left door. See [Left door on page 23](#).
 - Left rear cover. See [Left rear cover on page 26](#).
 - Left front cover. See [Left front cover on page 27](#).
 - Top cover. See [Top cover and control panel on page 29](#).
 - Top cap assembly. See [Top cap assembly on page 33](#).
 - Front cover. See [Front cover on page 35](#).
 - Right cover. See [Right cover on page 36](#).
 - Output flap actuator. See [Rack-eject lifter flap on page 92](#).

2. Pry apart the clip (callout 1) from the pulley on the rear of the shaft.

Figure 1-137 Remove the output drive shaft 6 (1 of 3)

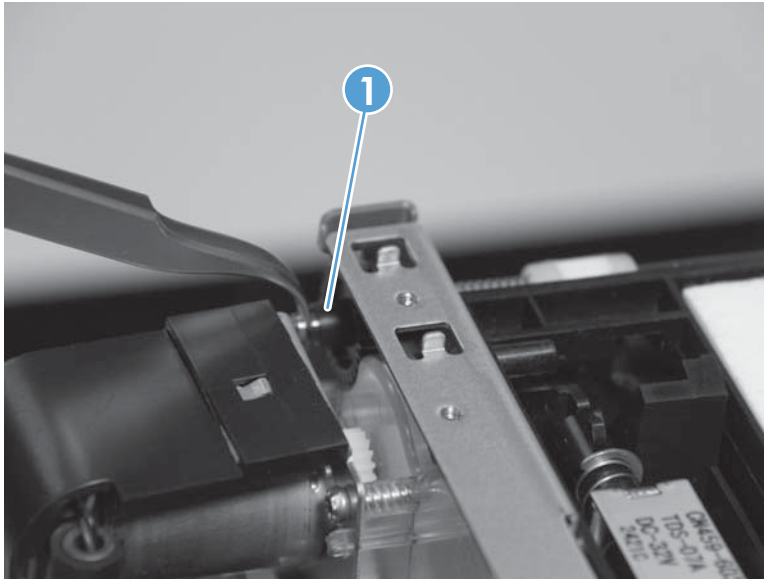

3. Rotate the front output drive shaft bearing counterclockwise.

Figure 1-138 Remove the output drive shaft 6 (2 of 3)



4. Grip the rear pulley, pull the shaft (callout 1) to the front of the product, and then remove the shaft.

Figure 1-139 Remove the output drive shaft 6 (3 of 3)

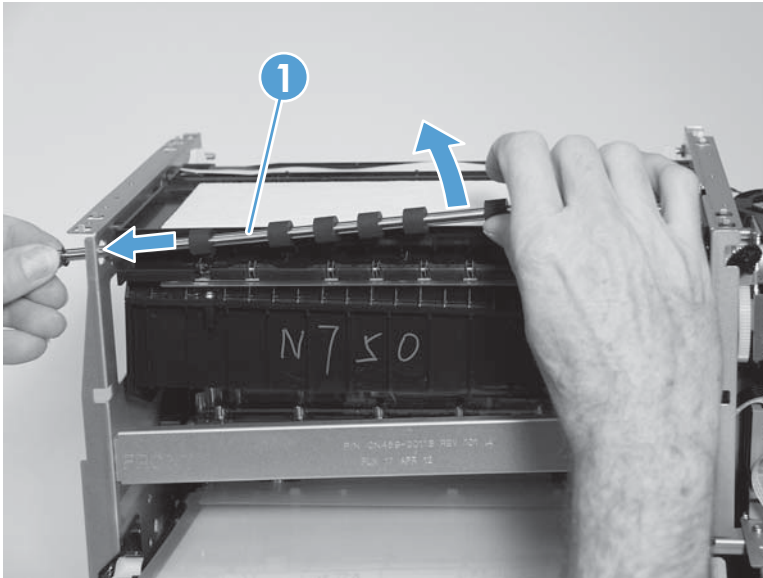

Output drive shaft 5

1. Remove the following components:
 - Rear cover. See [Rear cover on page 22](#).
 - Left door. See [Left door on page 23](#).
 - Left rear cover. See [Left rear cover on page 26](#).
 - Left front cover. See [Left front cover on page 27](#).
 - Top cover. See [Top cover and control panel on page 29](#).
 - Top cap assembly. See [Top cap assembly on page 33](#).
 - Front cover. See [Front cover on page 35](#).
 - Right cover. See [Right cover on page 36](#).
 - Inner top frame. See [Inner top frame on page 102](#).

2. Rotate the rear output drive shaft bearing counterclockwise.

Figure 1-140 Remove the output drive shaft 5 (1 of 2)

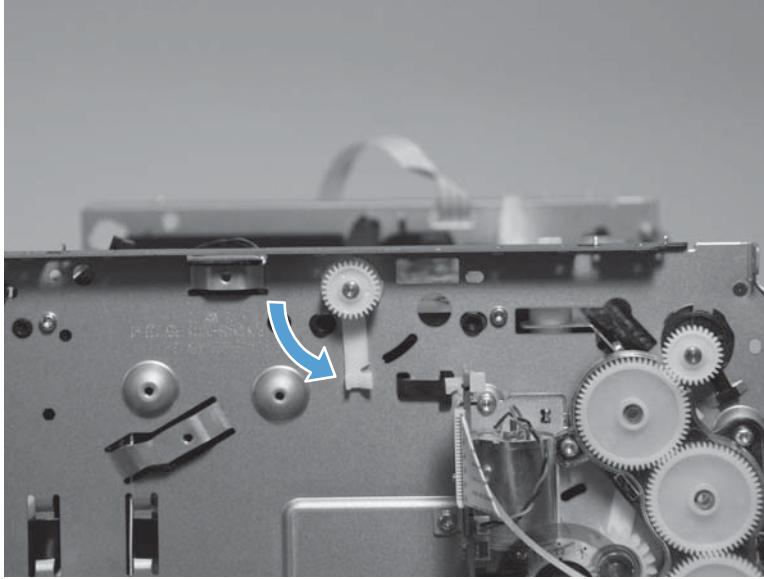

3. Pull the shaft (callout 1) to the rear of the product, and then remove the shaft.

Figure 1-141 Remove the output drive shaft 5 (2 of 2)

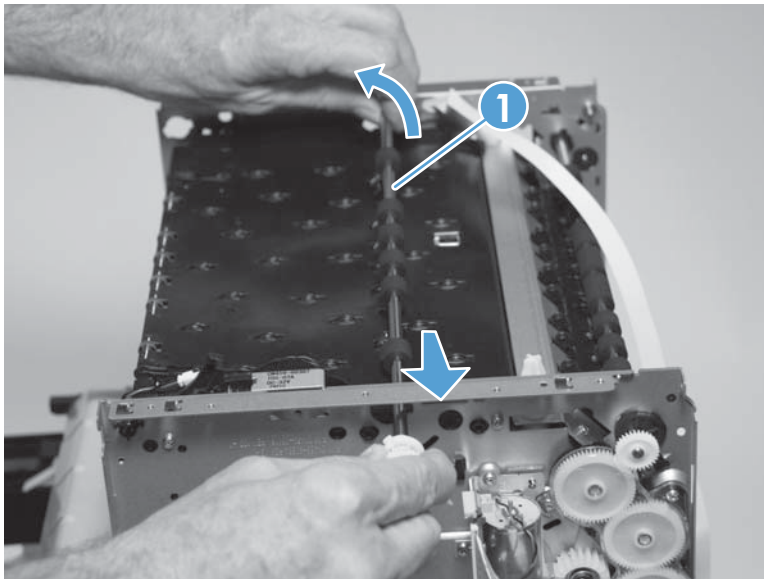

Output drive shaft 4

1. Remove the following components:
 - Rear cover. See [Rear cover on page 22](#).
 - Left door. See [Left door on page 23](#).
 - Left rear cover. See [Left rear cover on page 26](#).
 - Left front cover. See [Left front cover on page 27](#).
 - Drying path gear assembly. See [Drying path gear assembly on page 86](#).
2. Rotate the rear output drive shaft bearing counterclockwise.

Figure 1-142 Remove the output drive shaft 4 (1 of 2)

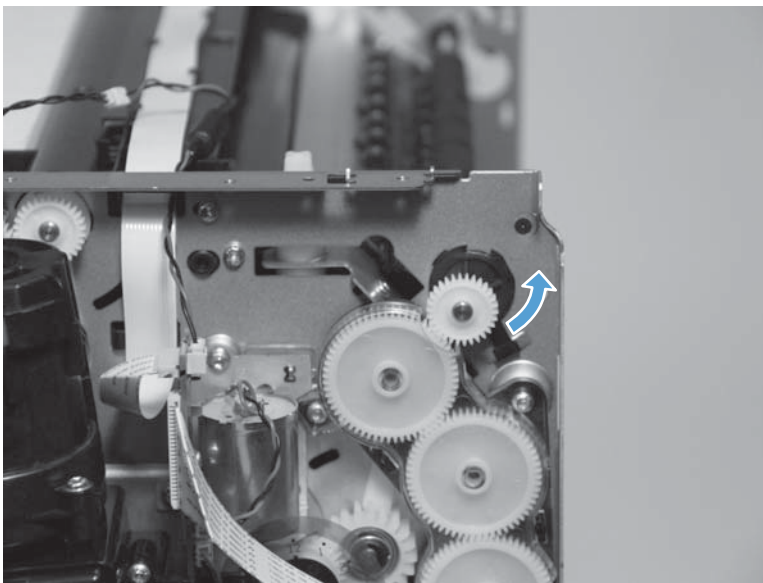

3. Remove the shaft (callout 1).

Figure 1-143 Remove the output drive shaft 4 (2 of 2)

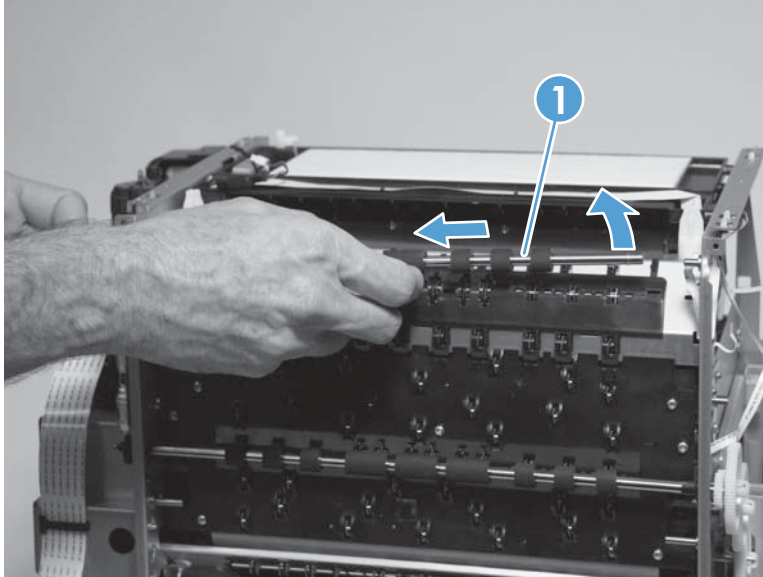

Drive shaft 3

1. Remove the following components:
 - Rear cover. See [Rear cover on page 22](#).
 - Left door. See [Left door on page 23](#).
 - Left rear cover. See [Left rear cover on page 26](#).
 - Left front cover. See [Left front cover on page 27](#).
 - Top cover. See [Top cover and control panel on page 29](#).
 - Front cover. See [Front cover on page 35](#).

2. Remove one gear (callout 1).

Figure 1-144 Remove drive shaft 3 (1 of 4)

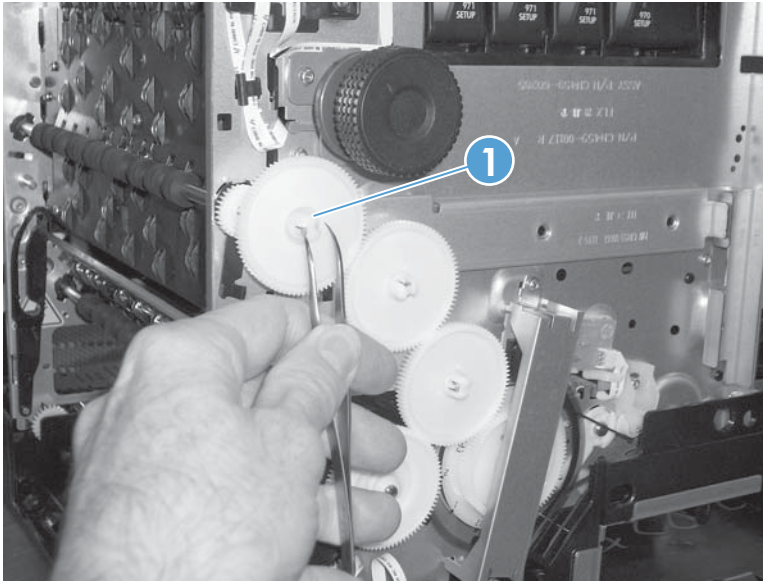

3. Use tweezers to release the hooks on the rear gear so it can slide off the shaft.

Figure 1-145 Remove drive shaft 3 (2 of 4)

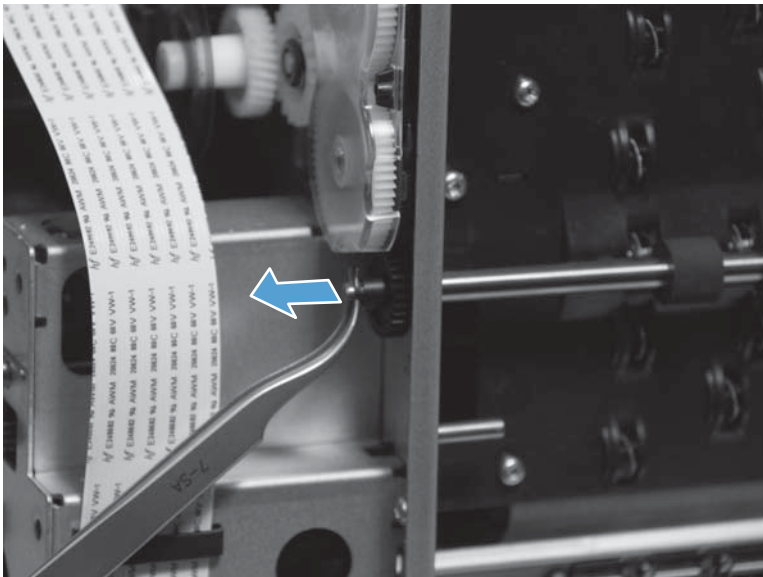

4. Rotate the front output drive shaft bearing counterclockwise.

Figure 1-146 Remove drive shaft 3 (3 of 4)

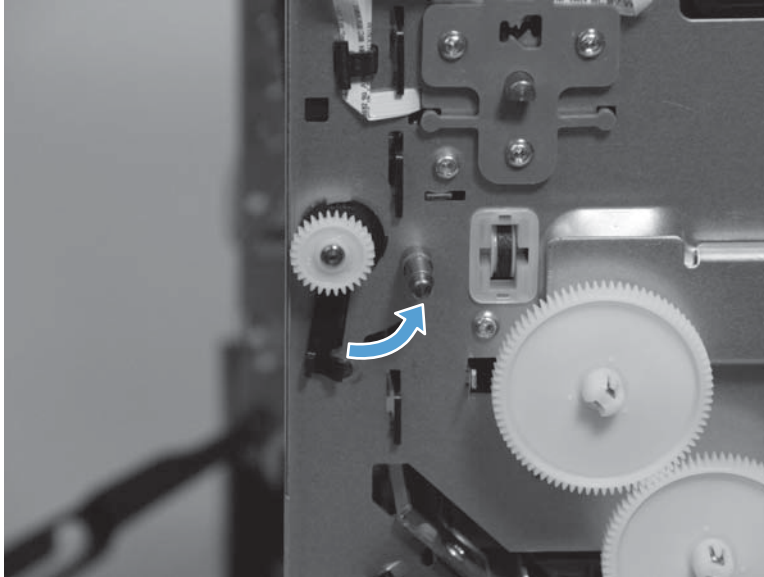

5. Remove the shaft (callout 1).

Figure 1-147 Remove drive shaft 3 (4 of 4)

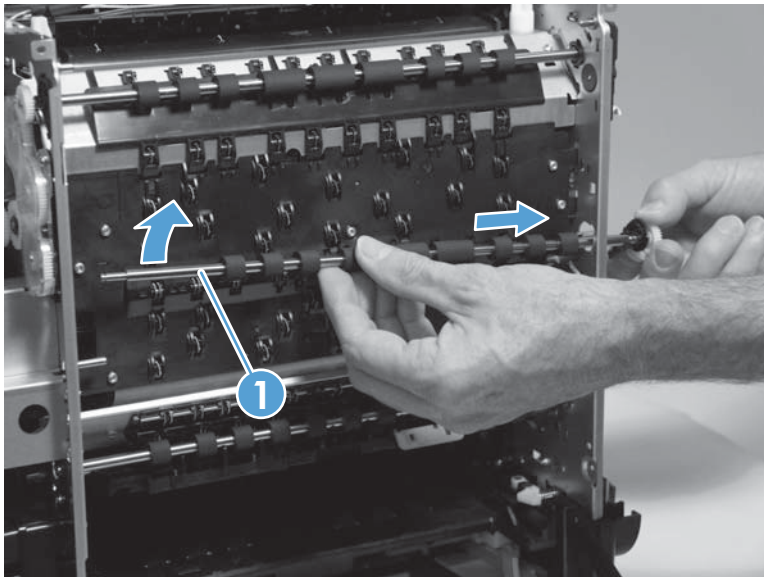

Inner top frame

1. Remove the following components:
 - Top cover. See [Top cover and control panel on page 29](#).
 - Top cap assembly. See [Top cap assembly on page 33](#).
 - Aerosol fan assembly. See [Aerosol fan assembly on page 37](#).
 - Eject drive gear module. See [Eject drive gear module on page 93](#).
2. Disconnect the printzone distribution PCA flex cable (callout 1).

Figure 1-148 Remove the inner top frame (1 of 5)

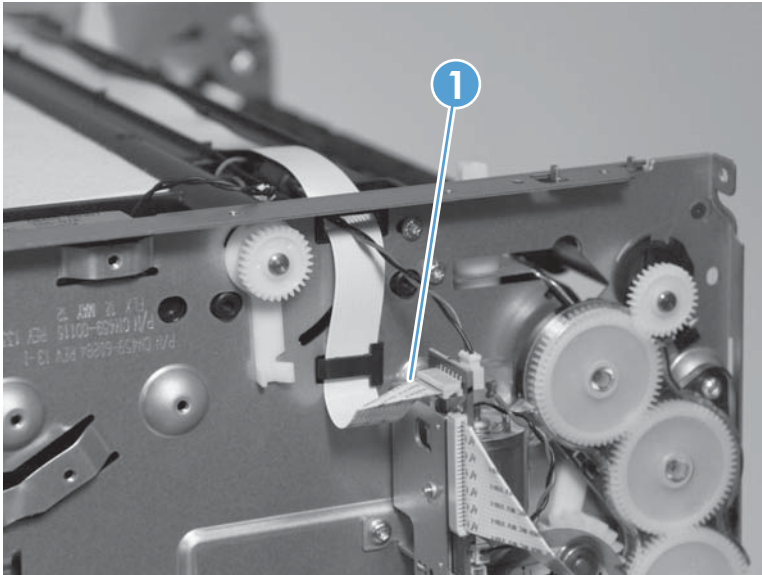

3. Unthread the flex cable (callout 1).

Figure 1-149 Remove the inner top frame (2 of 5)

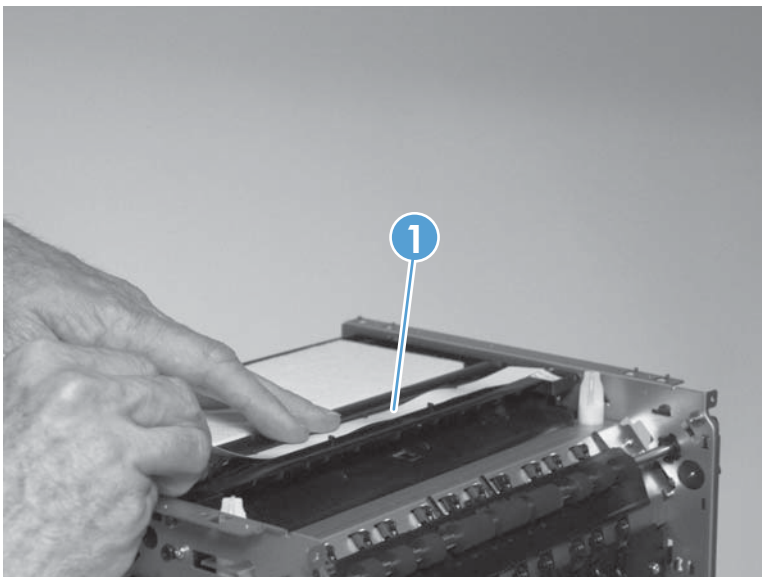

4. Disconnect the flap actuator solenoid cable (callout 1) from the printzone distribution PCA.

Figure 1-150 Remove the inner top frame (3 of 5)

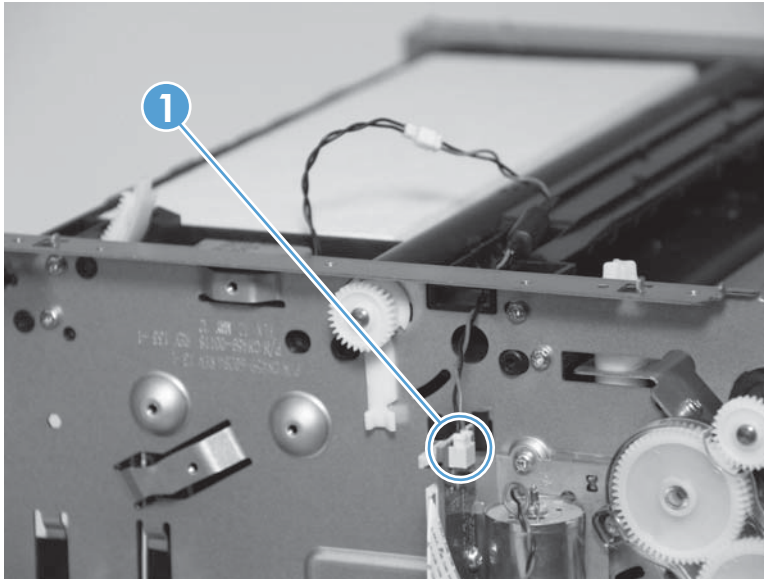

5. Remove two screws (callout 1) from the rear of the product.

Figure 1-151 Remove the inner top frame (4 of 5)

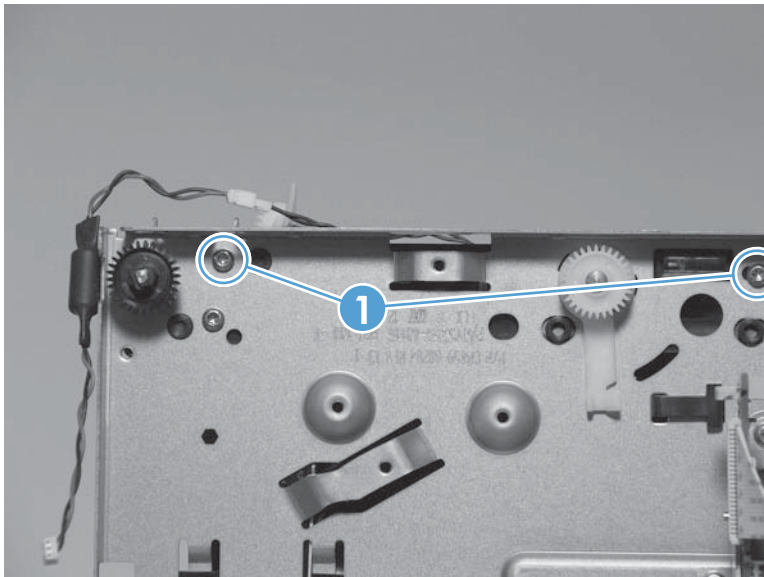

6. Remove the inner top frame.

Figure 1-152 Remove the inner top frame (5 of 5)

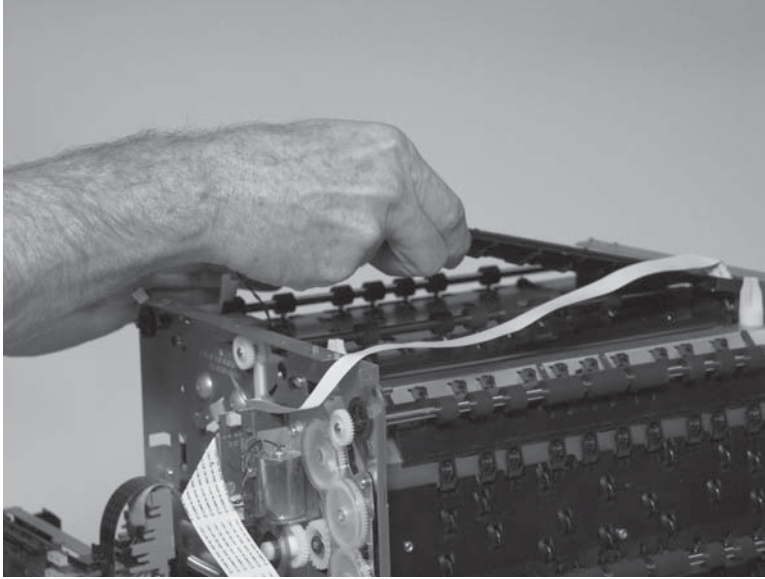

 **NOTE:** It can be quite difficult getting the inner top frame out from the slots in the metal cube. Bias the assembly toward the front, and it should lift out from the rear.

Top paper guide

1. Remove the following components:
 - Printbar. See [Printbar on page 71](#).
 - Output drive shaft 6. See [Output drive shaft 6 on page 94](#).
 - Output drive shaft 5. See [Output drive shaft 5 on page 96](#).
2. Disconnect two cables (callout 1) from the printzone distribution PCA.

Figure 1-153 Remove the top paper guide (1 of 6)

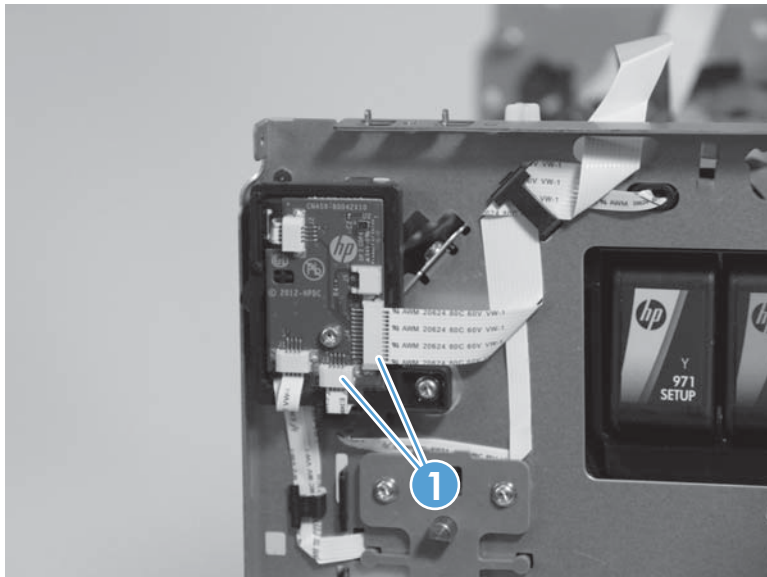

3. Remove the flex cable (callout 1) and the wire retainer (callout 2).

Figure 1-154 Remove the top paper guide (2 of 6)

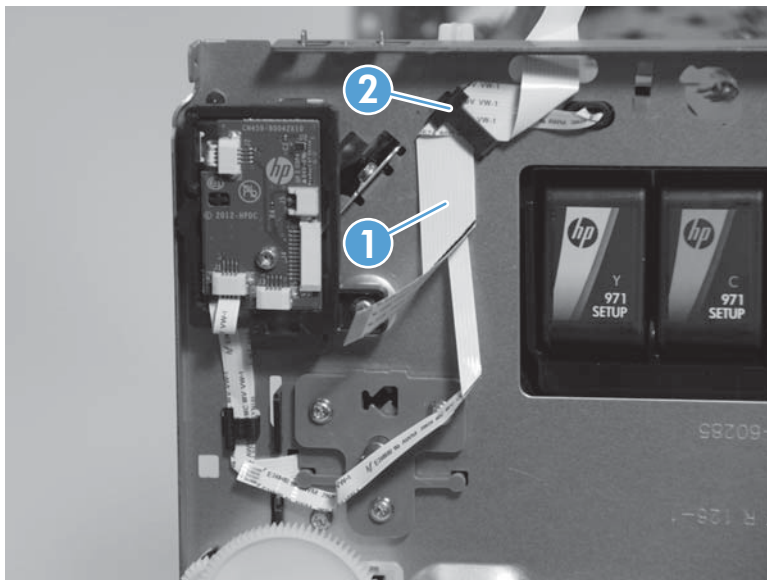

4. Remove two screws (callout 1) from the rear of the product.

Figure 1-155 Remove the top paper guide (3 of 6)

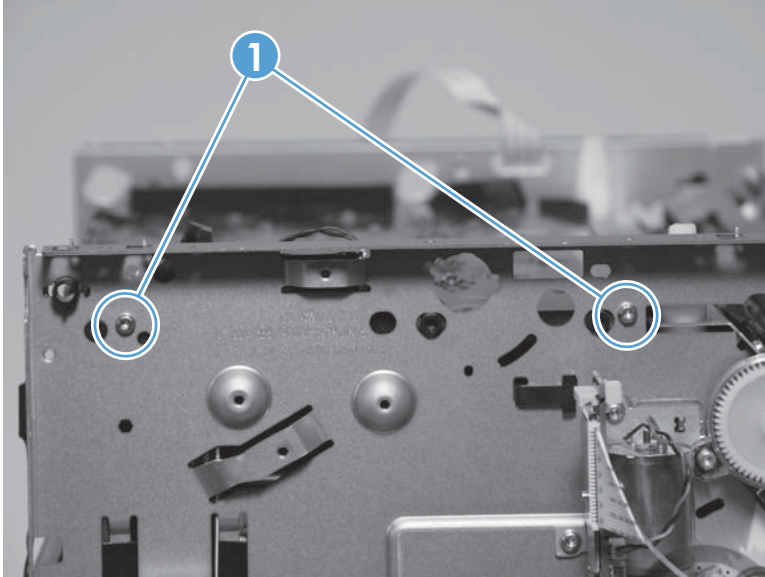

5. Raise the top paper guide (callout 1).

Figure 1-156 Remove the top paper guide (4 of 6)

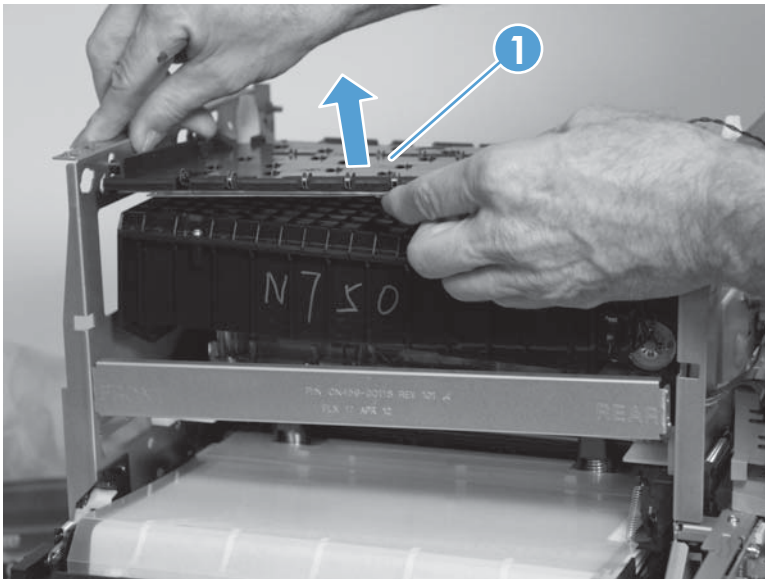

6. Use a screwdriver to unclip the plastic shield (callout 1) from underneath the top paper guide.

 **NOTE:** Use caution to avoid breaking the plastic tabs on the shield. Take care to correctly plug the shield back into the top paper guide.

Figure 1-157 Remove the top paper guide (5 of 6)



7. Remove the guide.

Figure 1-158 Remove the top paper guide (6 of 6)

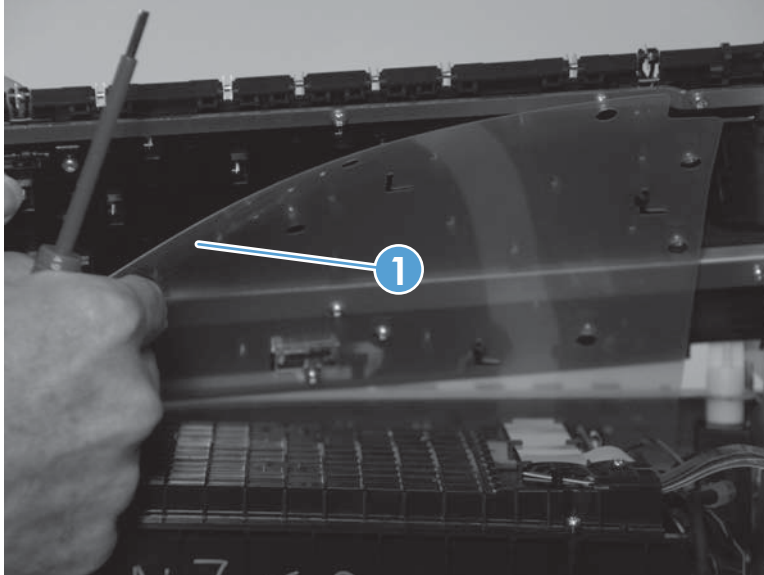
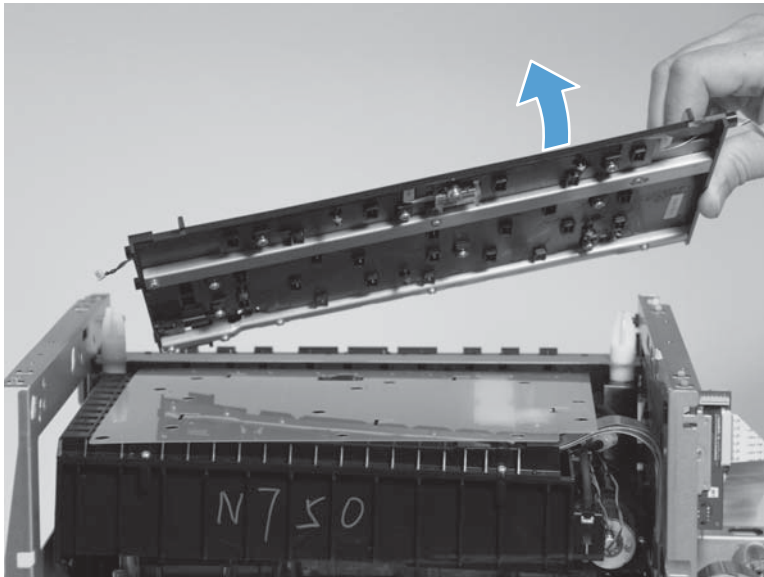

Top left paper guide assembly

1. Remove the following components:
 - Rear cover. See [Rear cover on page 22](#).
 - Left door. See [Left door on page 23](#).
 - Left rear cover. See [Left rear cover on page 26](#).
 - Left front cover. See [Left front cover on page 27](#).
 - Top cover. See [Top cover and control panel on page 29](#).
 - Top cap assembly. See [Top cap assembly on page 33](#).
 - Front cover. See [Front cover on page 35](#).
 - Right cover. See [Right cover on page 36](#).
 - Printbar. See [Printbar on page 71](#).
 - Output drive shaft 4. See [Output drive shaft 4 on page 98](#).
 - Drying path gear assembly. See [Drying path gear assembly on page 86](#).
2. Remove the paper path shaft 4 front bearing (callout 1).

Figure 1-159 Remove the top left paper guide (1 of 3)

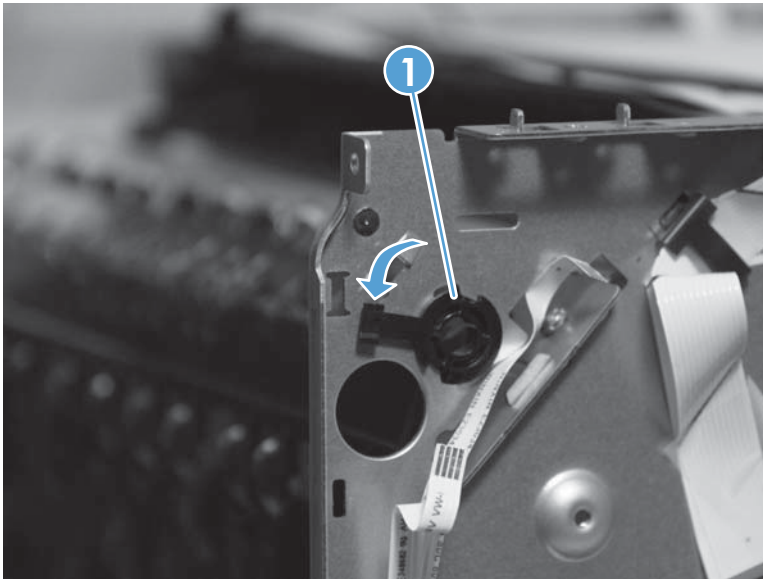

3. Remove two screws (callout 1).

Figure 1-160 Remove the top left paper guide (2 of 3)

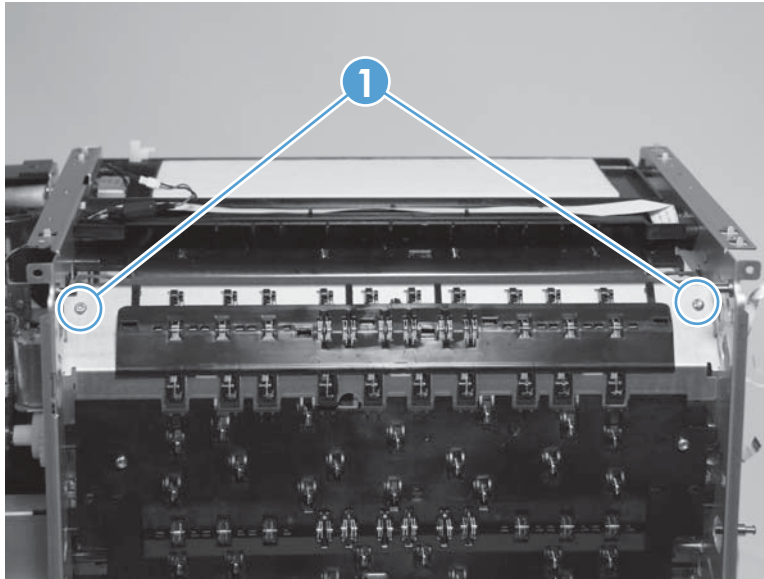

4. Remove the paper guide assembly (callout 1).

Figure 1-161 Remove the top left paper guide (3 of 3)

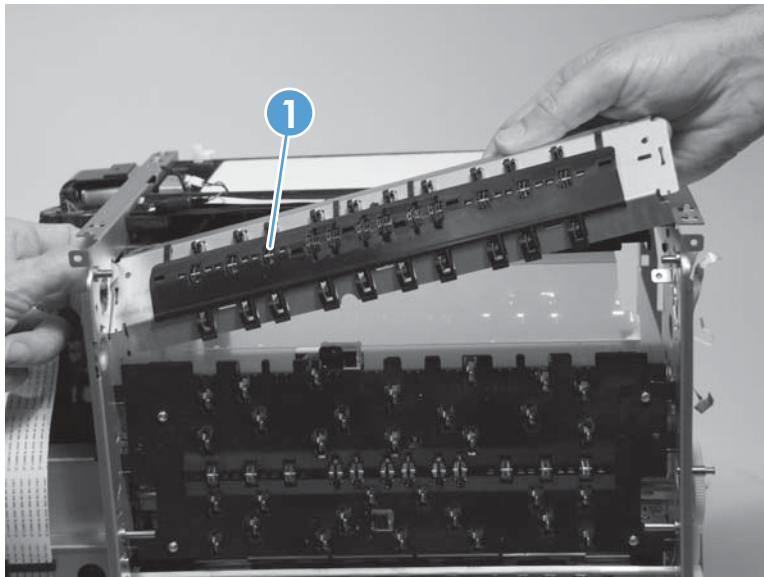

 **Reinstallation tip** During the reinstallation process, the bottom metal edge of the assembly inserts into the grooves in the plastic center left paper guide.

Figure 1-162 Reinstall the top left paper guide



Center left paper guide assembly

1. Remove the following components:
 - Top left paper guide assembly. See [Top left paper guide assembly on page 108](#).
 - Drive shaft 3. See [Drive shaft 3 on page 99](#).
2. Remove three screws (callout 1).

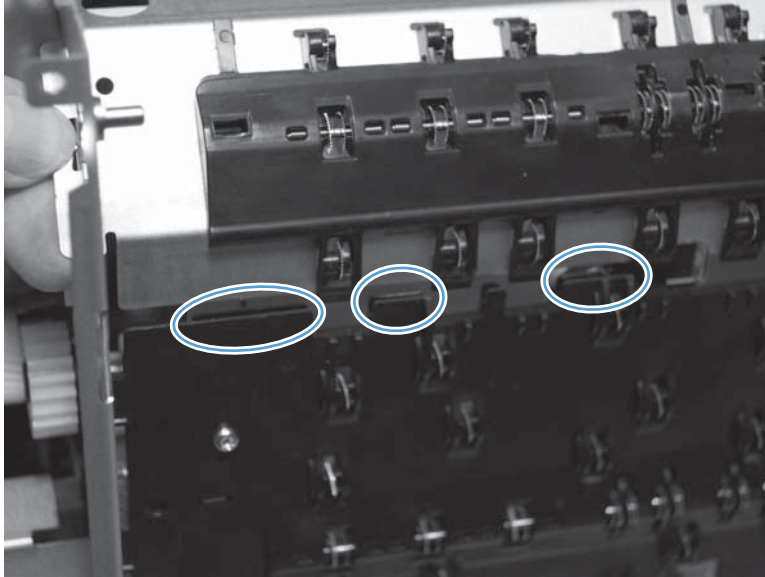
Figure 1-163 Remove the center left paper guide (1 of 4)

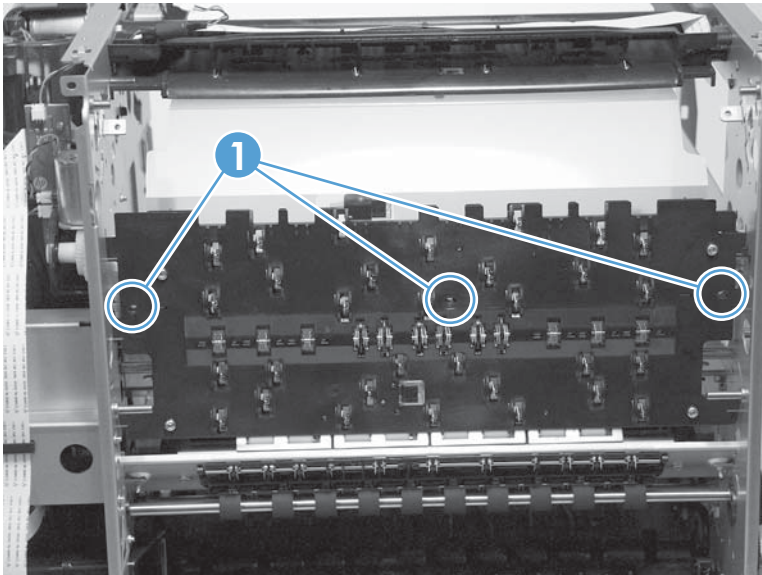

3. Locate two dust shield tabs (callout 1) inside the product.

Figure 1-164 Remove the center left paper guide (2 of 4)

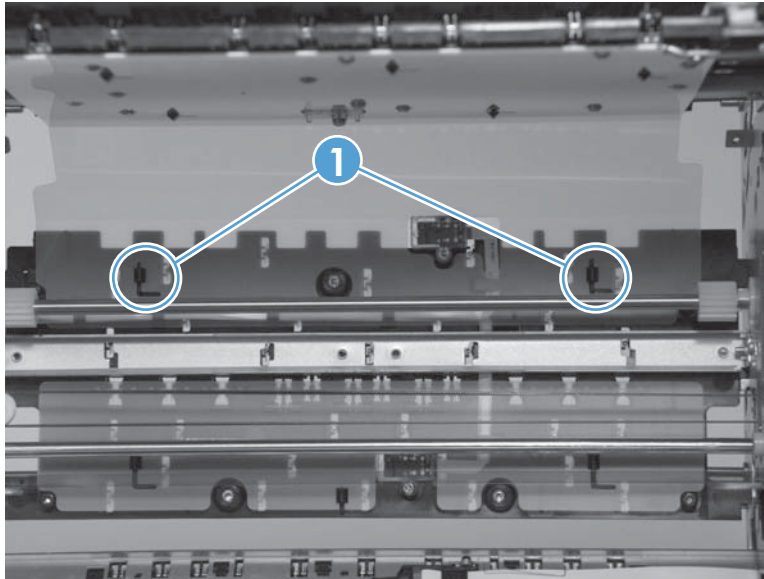

4. Lift and flex the assembly to remove it.

Figure 1-165 Remove the center left paper guide (3 of 4)

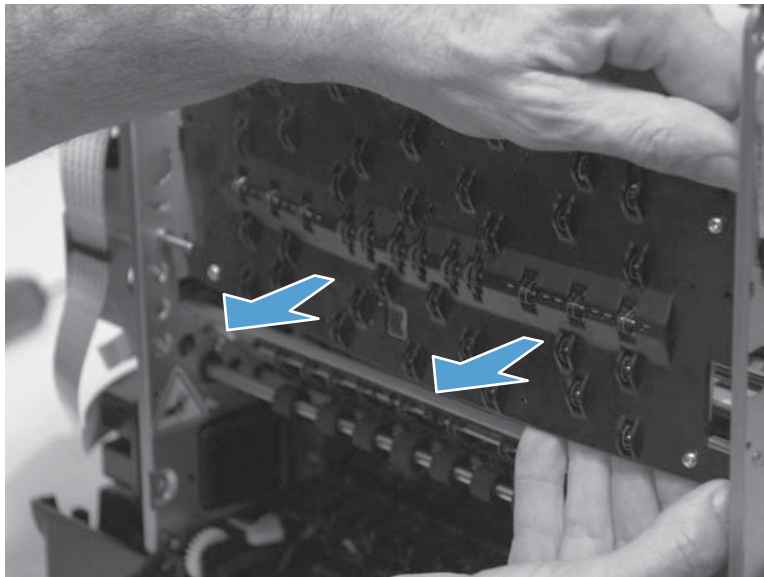

5. Remove one cable retainer (callout 1).

Figure 1-166 Remove the center left paper guide (4 of 4)

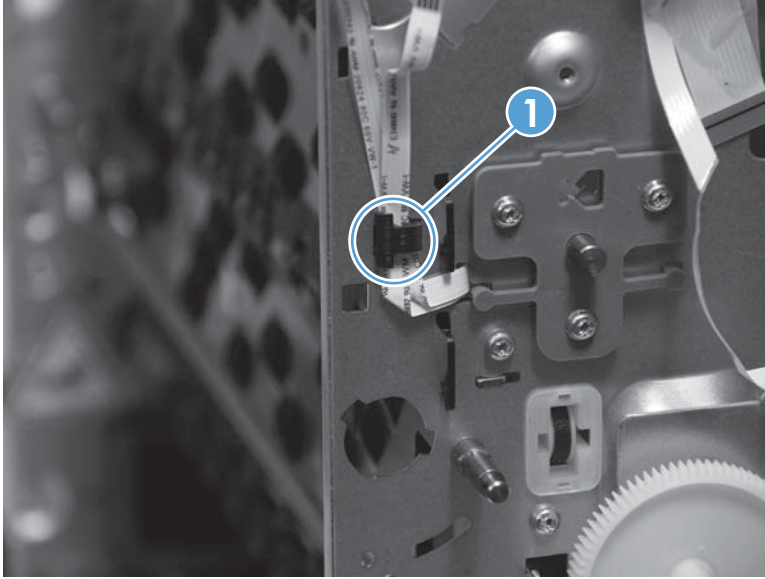

Paper REDI sensors in the center left paper guide assembly

 **IMPORTANT:** Ensure the product firmware is upgraded to at least version 1336MR before performing this repair procedure. If the firmware upgrade cannot be completed, contact HP support.

There are two paper REDI sensors; the lower paper path REDI sensor and the upper paper path REDI sensor. This procedure works for both.

1. Remove the printbar. See [Printbar on page 71](#).
2. Remove two screws (callout 1) and disconnect two flex cables (callout 2), and then remove the sensors (callout 3).

Figure 1-167 Remove the paper REDI sensors

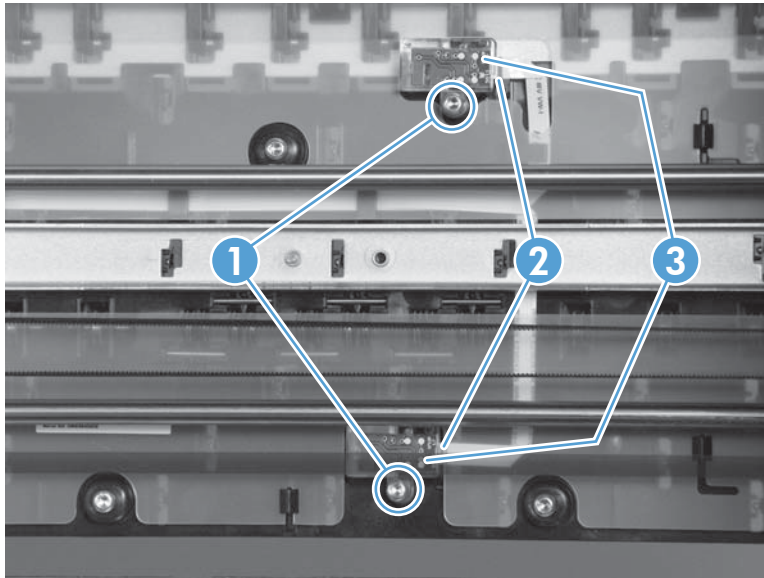

3. After replacing the sensors, use the following steps to calibrate the REDI sensors.

Calibrate the REDI sensors

- a. Open the [Engineering menu](#). See [Access the Engineering menu on page 14](#) for information accessing the [Engineering menu](#).
- b. From the [Engineering menu](#), select the [Service Menu](#), and then select [System Configuration](#).
- c. Select [Paper Sensor Calibration](#).

 **NOTE:** The paper sensor calibrations require one sheet of blank HP Colorlok paper. HP Colorlok paper **must** be used for the Paper Sensor Calibration. The same sheet of paper can be reused if it is undamaged.

- d. Select [Calibrate Main tray](#). The tray will eject one blank page.
- e. Select [Calibrate MP tray](#). The product will eject one blank page into the tray.

Service sled transmission

Before reassembling the product, ensure that the service sled transmission is installed in the correct position. If the service sled transmission is not installed correctly, the product will not operate correctly.

The service sled transmission is located behind the main PCA. Remove the aerosol fan assembly to check or adjust the positioning of the service sled transmission.

- Service sled transmission in the correct position.

Figure 1-168 Correctly positioned service sled transmission

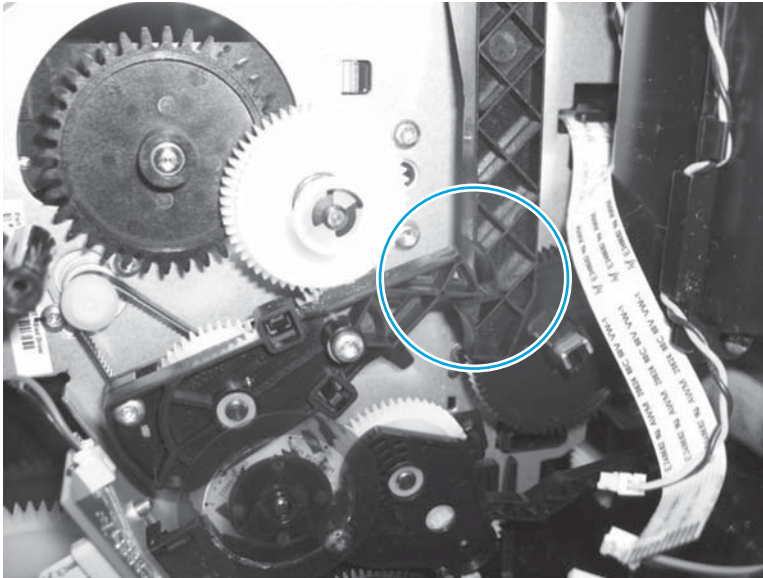

- Service sled transmission in the incorrect position.

Figure 1-169 Incorrectly positioned service sled transmission

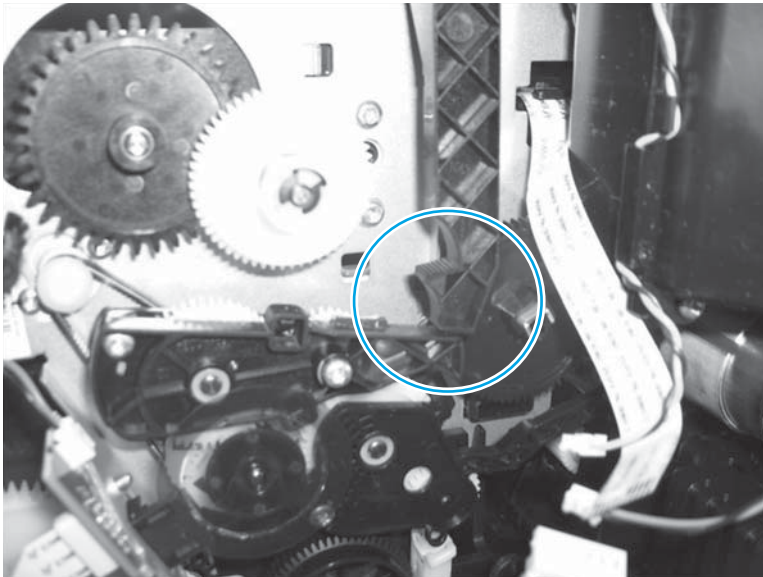

Printed circuit-board assemblies (PCAs)

Fax PCA

 **NOTE:** If the fax PCA is removed permanently, cover the fax line port opening in the rear cover with a piece of electrical tape.

1. Remove the rear cover. See [Rear cover on page 22](#).
2. Disconnect one cable connector (callout 1).

Figure 1-170 Remove the fax PCA (1 of 2)

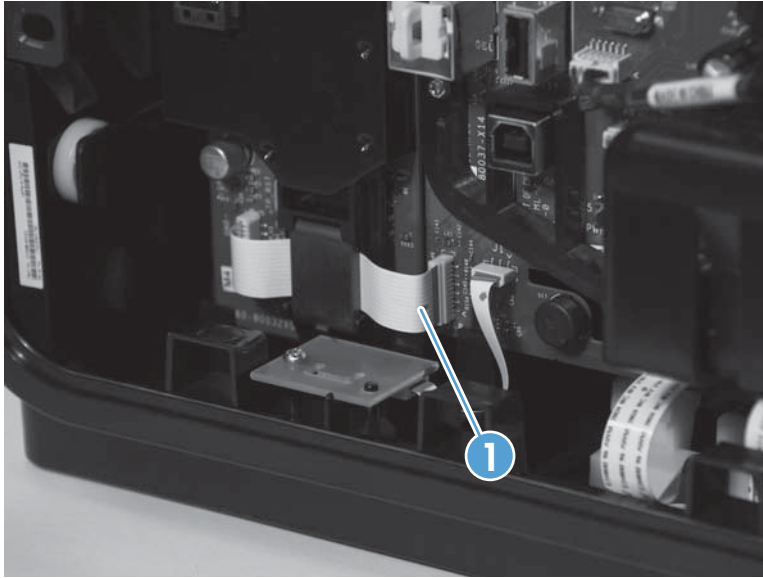

3. Remove one screw (callout 1).

Figure 1-171 Remove the fax PCA (2 of 2)

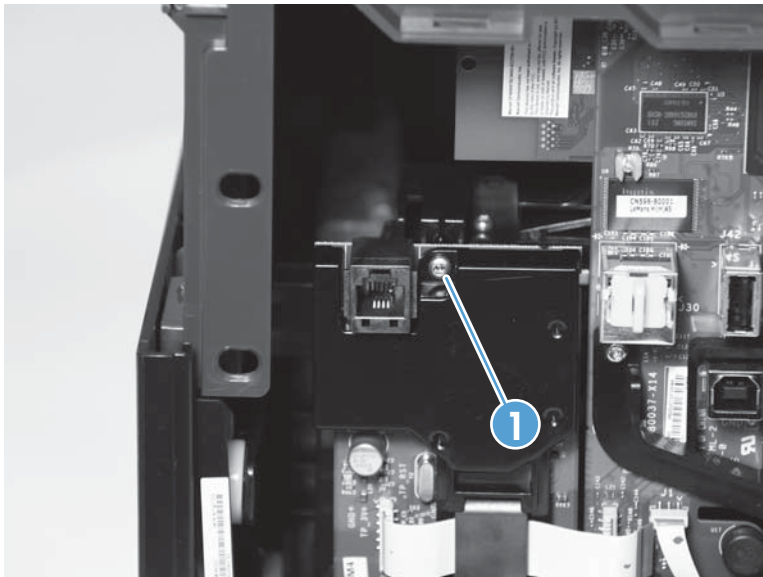

4. Remove the PCA.

PCA safety shield

1. Remove the rear cover. See [Rear cover on page 22](#).
2. Remove two screws (callout 1).

Figure 1-172 Remove the PCA safety shield (1 of 2)

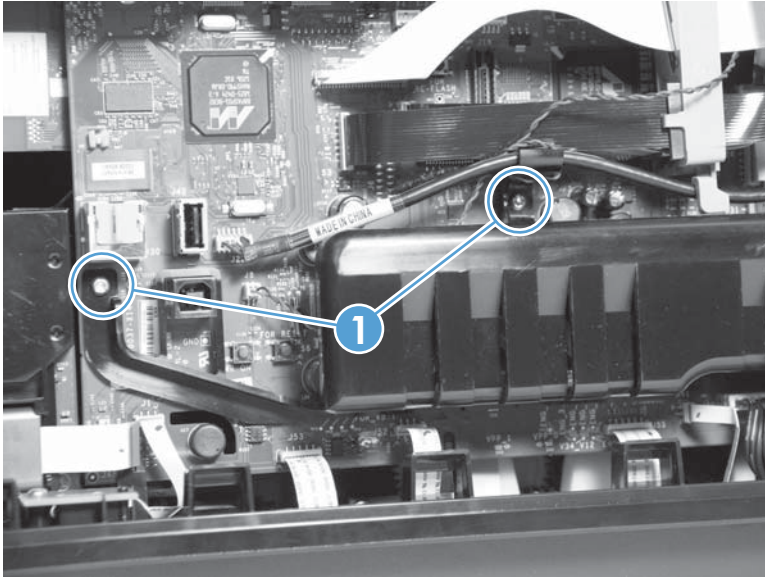

3. Remove the shield (callout 1) by pushing the shield toward the aerosol fan assembly.

Figure 1-173 Remove the PCA safety shield (2 of 2)

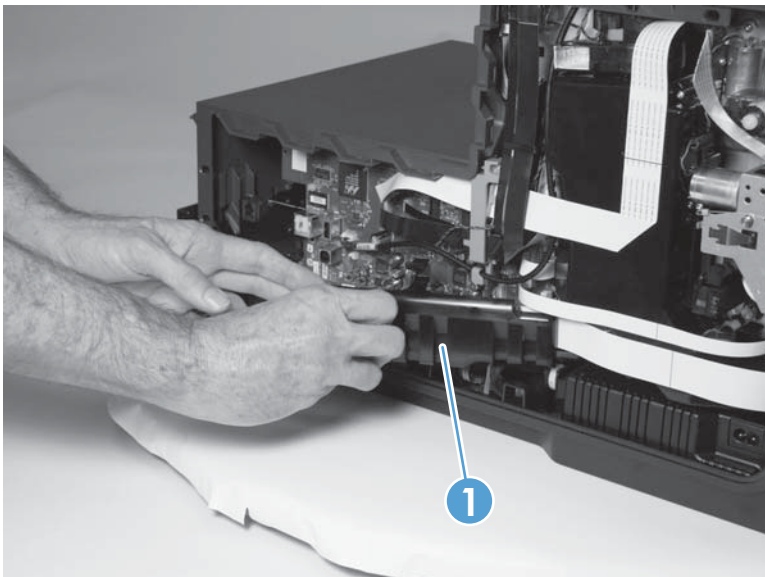

Sensor carriage PCA and encoder strip

1. Remove the following components:
 - Rear cover. See [Rear cover on page 22](#).
 - Aerosol fan assembly. See [Aerosol fan assembly on page 37](#).
2. Disconnect three wire connectors (callout 1).

Figure 1-174 Remove the sensor carriage PCA and encoder strip (1 of 8)

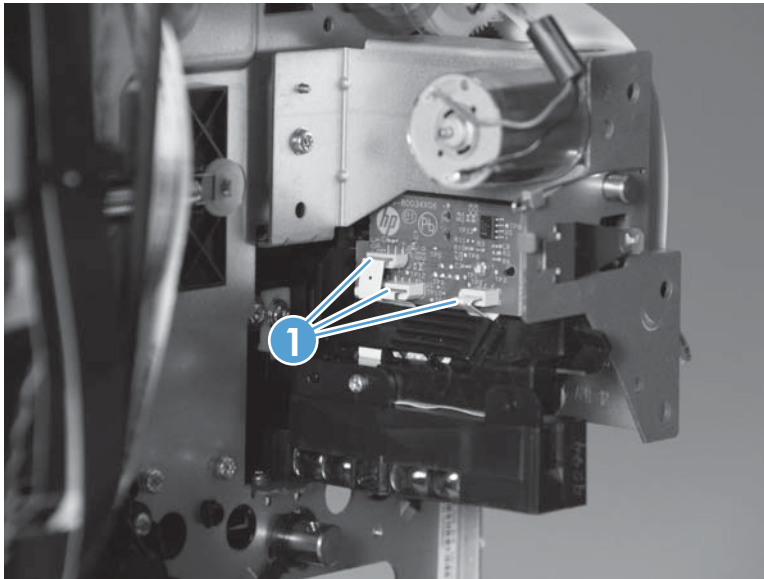

3. Remove one screw (callout 1).

Figure 1-175 Remove the sensor carriage PCA and encoder strip (2 of 8)

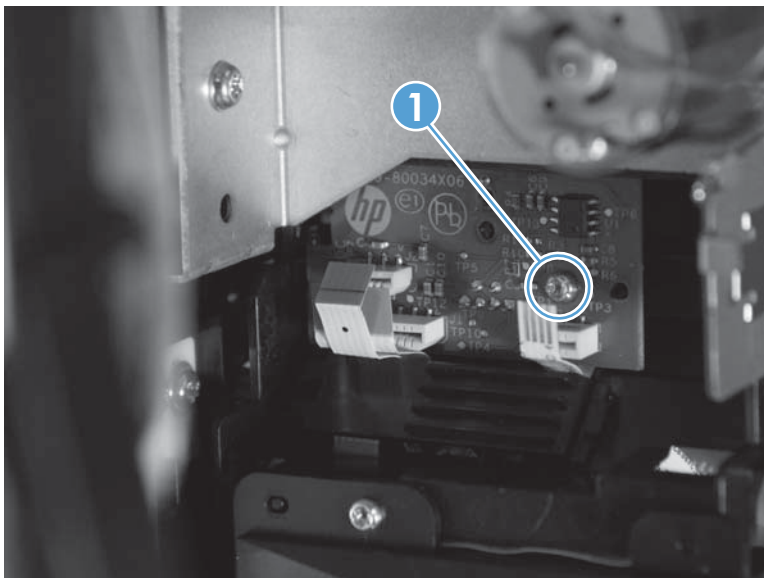

4. Remove the PCA (callout 1).

Figure 1-176 Remove the sensor carriage PCA and encoder strip (3 of 8)

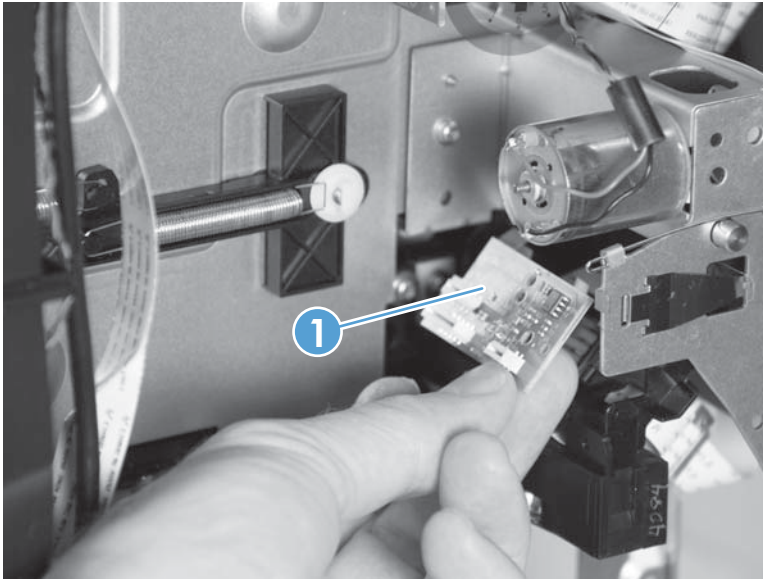

5. Locate the sensor carriage encoder strip (callout 1). The sensor carriage encoder strip feeds through the product, passes through the encoder strip sensor on the back of the sensor carriage PCA (callout 2), and then attaches to the bracket (callout 3) at the back of the product.

Figure 1-177 Remove the sensor carriage PCA and encoder strip (4 of 8)

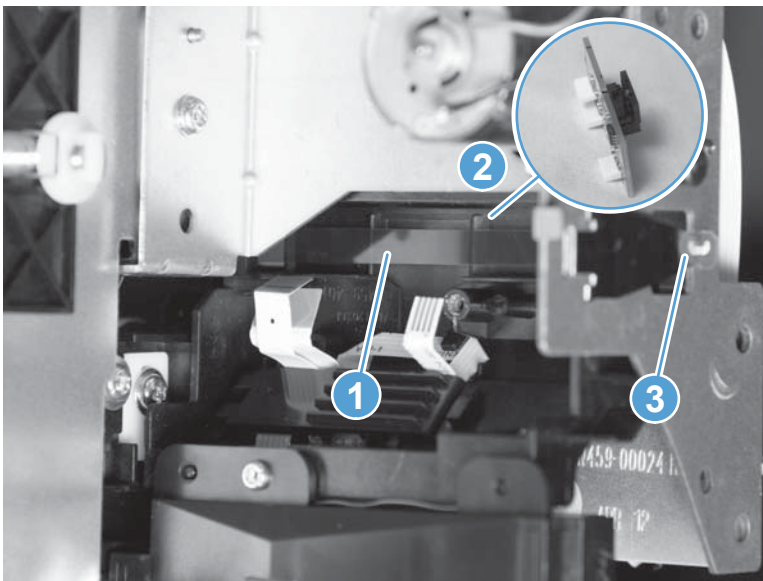

6. Thread a piece of floss or thread through the opening on the end of the sensor carriage encoder strip (callout 1), and then depress the bracket (callout 2) while lifting up on the sensor carriage encoder strip to remove the encoder strip from the bracket.

Figure 1-178 Remove the sensor carriage PCA and encoder strip (5 of 8)

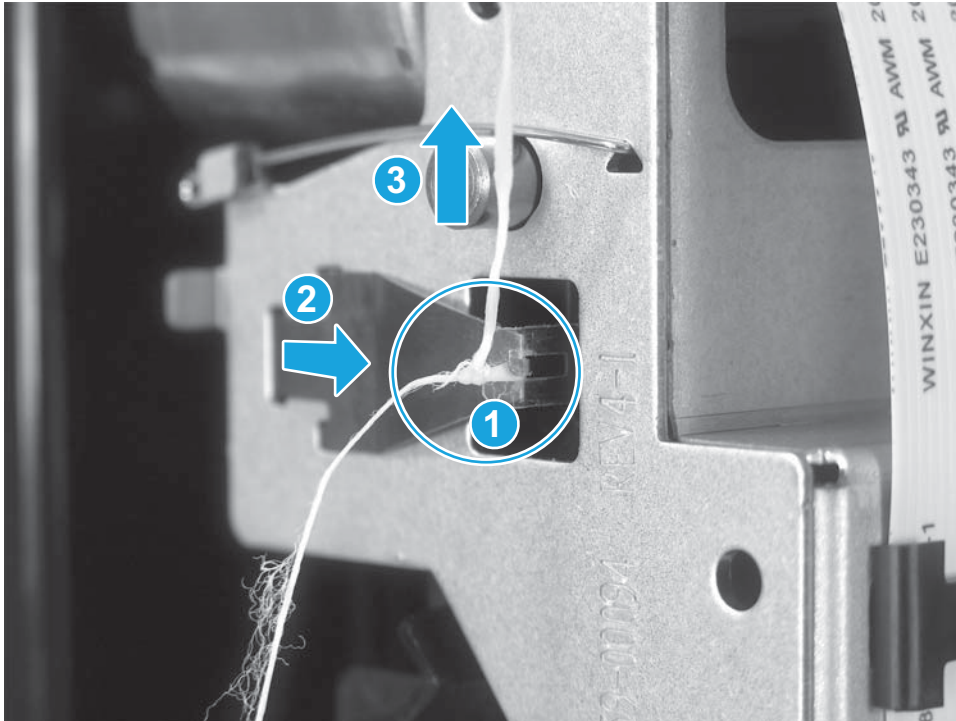

7. At the front of product, use a pair of needle nose pliers to grasp the encoder strip, and then lift it off the bracket.

Figure 1-179 Remove the sensor carriage PCA and encoder strip (6 of 8)

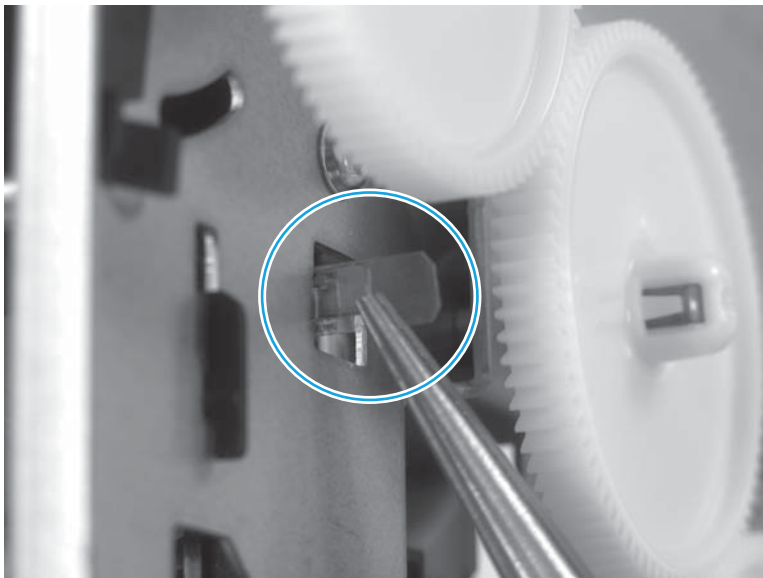

8. At the front of the product, carefully pull the encoder strip through the product and remove it. Ensure that you can still grasp the thread at the back of the product.

9. At the front of the product, tie the thread or floss passed through the product to the new encoder strip. The encoder strip must be positioned with the smiley face as shown in [Figure 1-180](#) [Remove the sensor carriage PCA and encoder strip \(7 of 8\)](#) on page 120.

Figure 1-180 Remove the sensor carriage PCA and encoder strip (7 of 8)

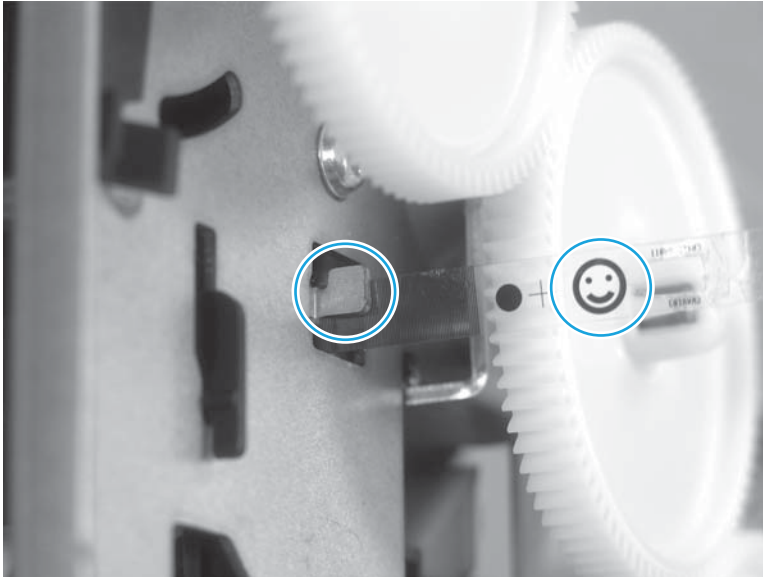

10. Carefully pull the encoder strip through the product, and then reattach the encoder strip on the bracket at the rear of the product.
11. Install the new sensor carriage PCA. Ensure that the encoder strip threads through encoder strip sensor on the back of the sensor carriage PCA.

Figure 1-181 Remove the sensor carriage PCA and encoder strip (8 of 8)

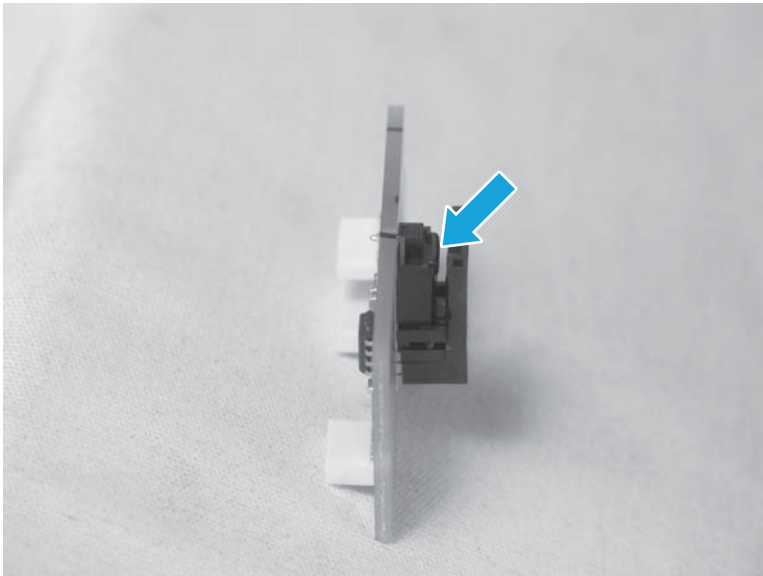

IMPORTANT: Threading the sensor carriage encoder strip through the product and through the encoder strip sensor on the back of the sensor carriage PCA can be a difficult procedure. If the sensor carriage encoder strip is not correctly positioned, then the front panel will display a 61000012 error when the product is turned on.

Power button PCA

The power button PCA is located in the product front cover.

1. Remove the front cover. See [Front cover on page 35](#).
2. Disconnect three wire connectors (callout 1).

Figure 1-182 Remove the power button PCA (1 of 2)

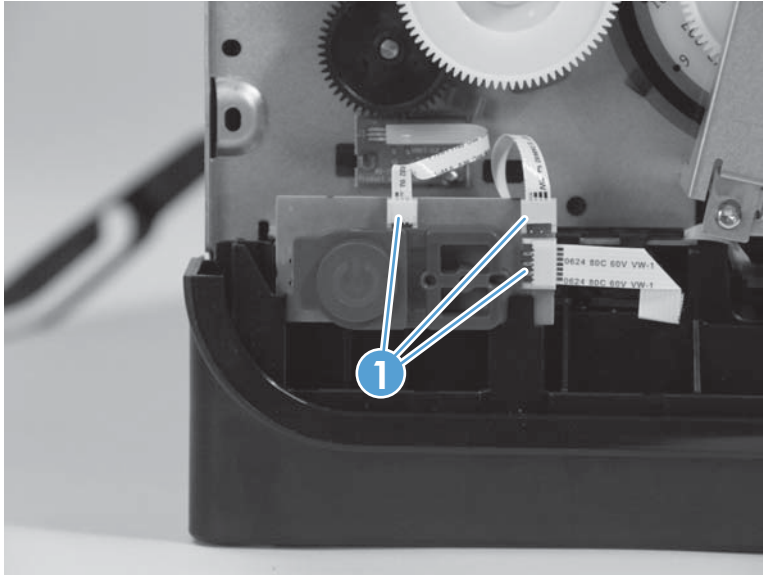

3. Remove the assembly (callout 1).

Figure 1-183 Remove the power button PCA (2 of 2)

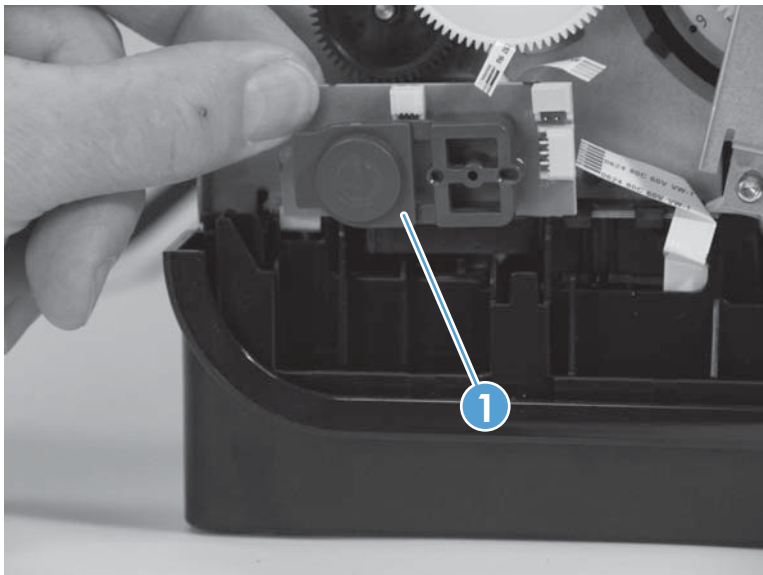

Duplex module sensor PCA

1. Remove the front cover. See [Front cover on page 35](#).
2. Remove one screw (callout 1).

Figure 1-184 Remove the duplex module sensor PCA (1 of 2)

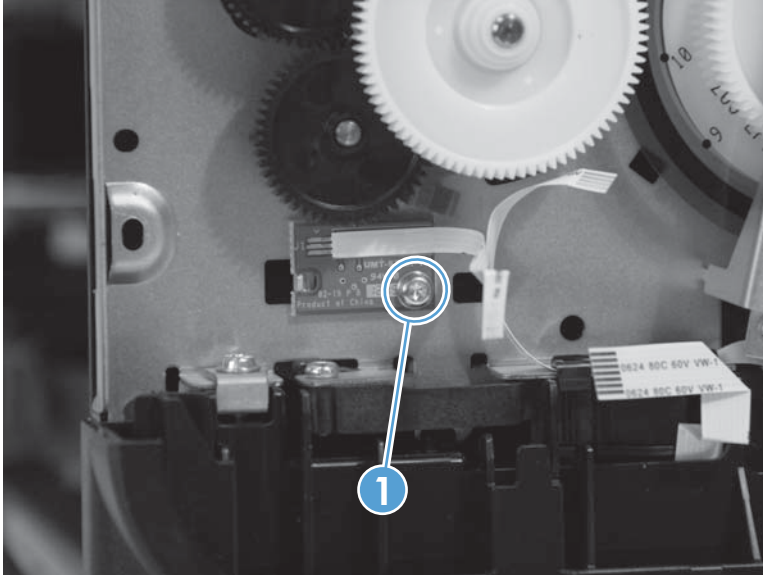

3. Remove the sensor PCA (callout 1).

Figure 1-185 Remove the duplex module sensor PCA (2 of 2)

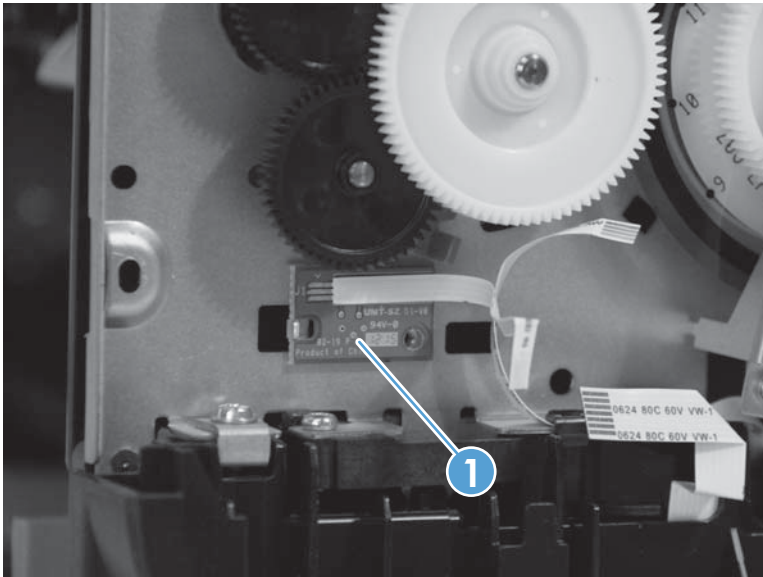

Temperature sensor

1. Remove the rear cover. See [Rear cover on page 22](#).
2. Disconnect one cable (callout 1).

Figure 1-186 Remove the temperature sensor (1 of 2)

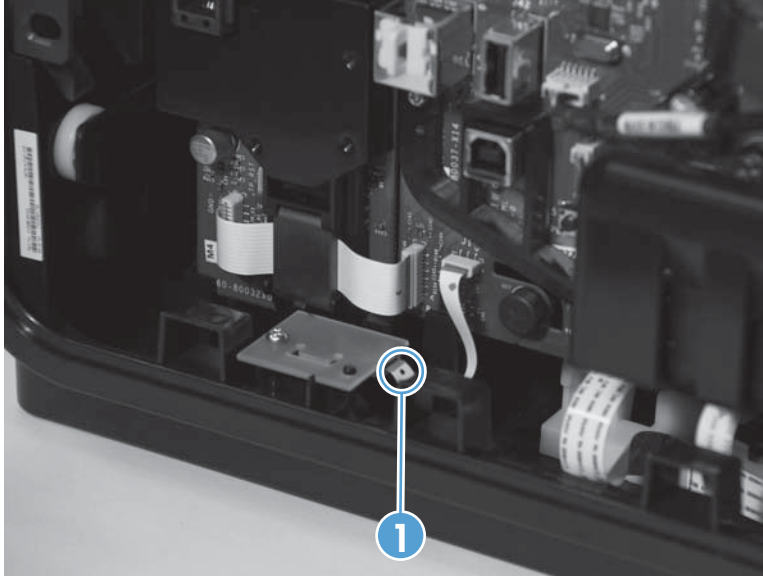

3. Remove one screw (callout 1), and then remove the sensor.

Figure 1-187 Remove the temperature sensor (2 of 2)

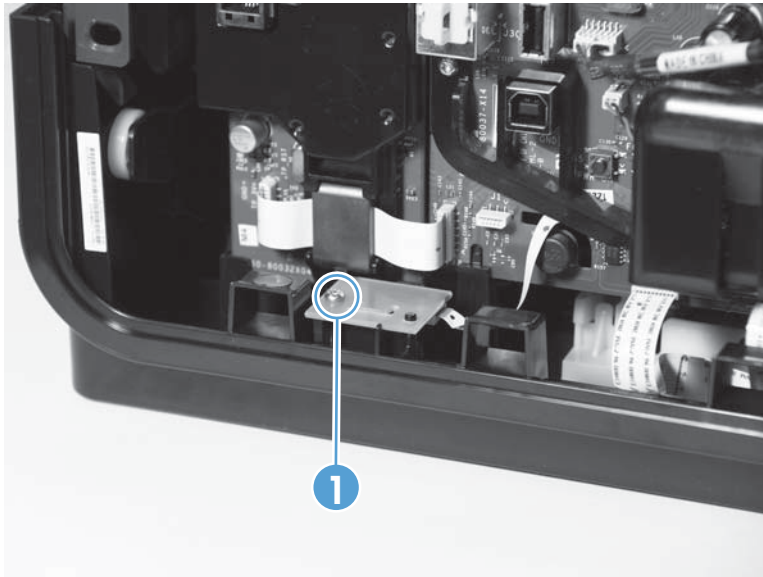

4. After reinstalling the temperature sensor, test for the correct operation: A correctly operating temperature sensor is indicated by the results of a 12 tap test. Print a 12 tap test, and check for the correct temperature. See [12 tap test results \(REDI sensor values\) on page 18](#).

REDI distribution PCA

1. Remove the front cover. See [Front cover on page 35](#).
2. Disconnect five wire connectors (callout 1).

Figure 1-188 Remove the REDI distribution PCA PCA (1 of 3)

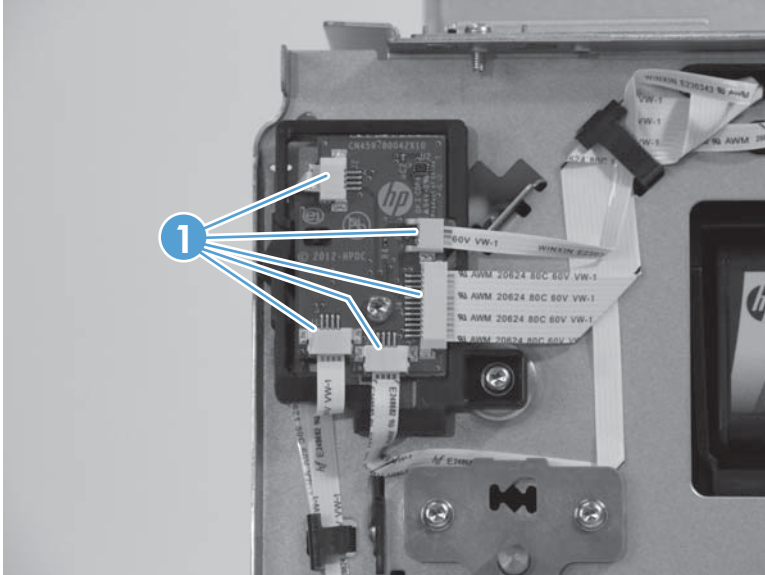

3. Remove one screw (callout 1).

Figure 1-189 Remove the REDI distribution PCA PCA (2 of 3)

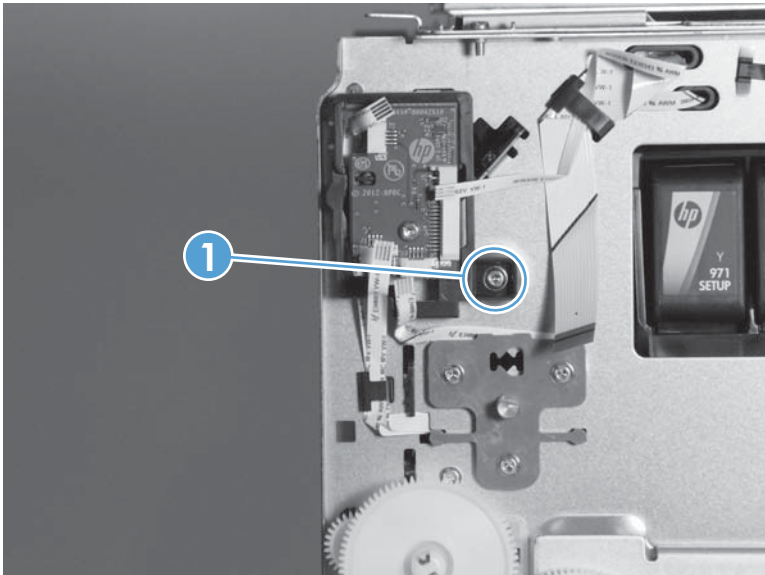

4. Remove the sensor PCA.

Figure 1-190 Remove the REDI distribution PCA PCA (3 of 3)

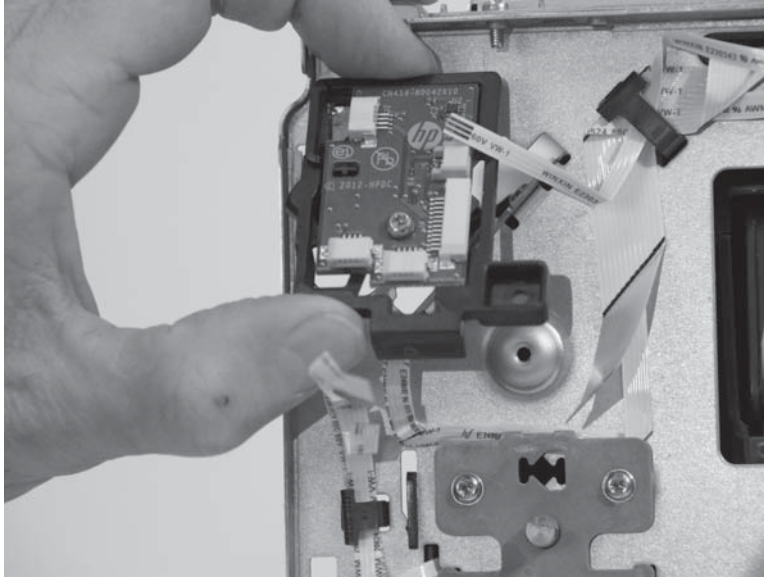

 **Reinstallation tip** Ensure that the upper left flex cable does not poke through the front wall. It should not be visible when looking at the wall from the left door.

Feed motor encoder sensor PCA

1. Remove the front cover. See [Front cover on page 35](#).
2. Remove two screws (callout 1) from the guard bracket, and then remove the bracket.

Figure 1-191 Remove the feed motor encoder sensor PCA (1 of 4)

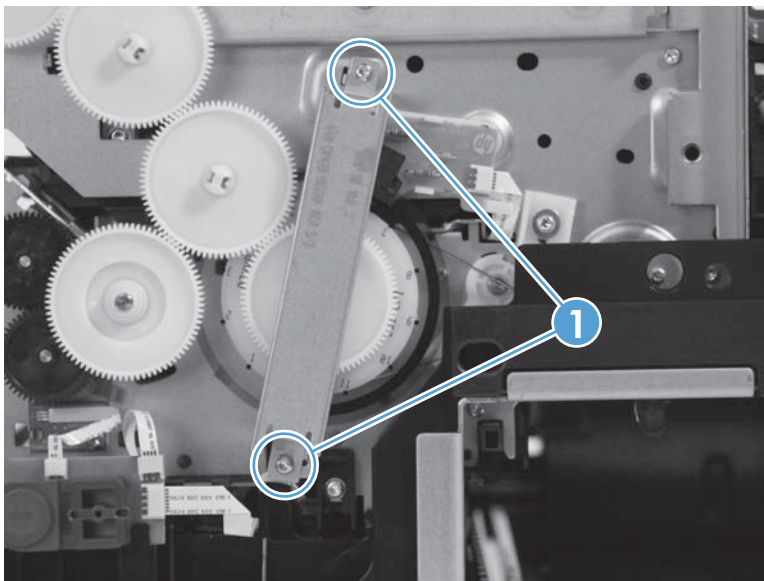

3. Disconnect the flex cable (callout 1).

Figure 1-192 Remove the feed motor encoder sensor PCA (2 of 4)

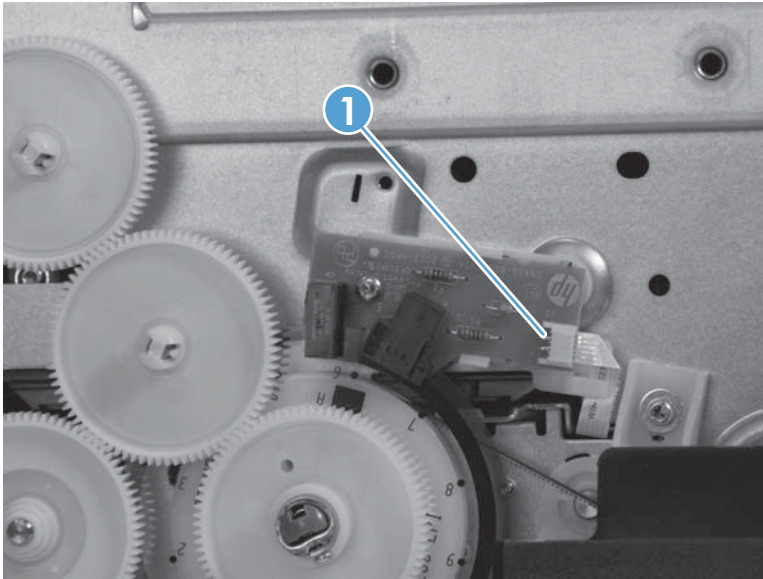

4. Remove one screw (callout 1).

Figure 1-193 Remove the feed motor encoder sensor PCA (3 of 4)

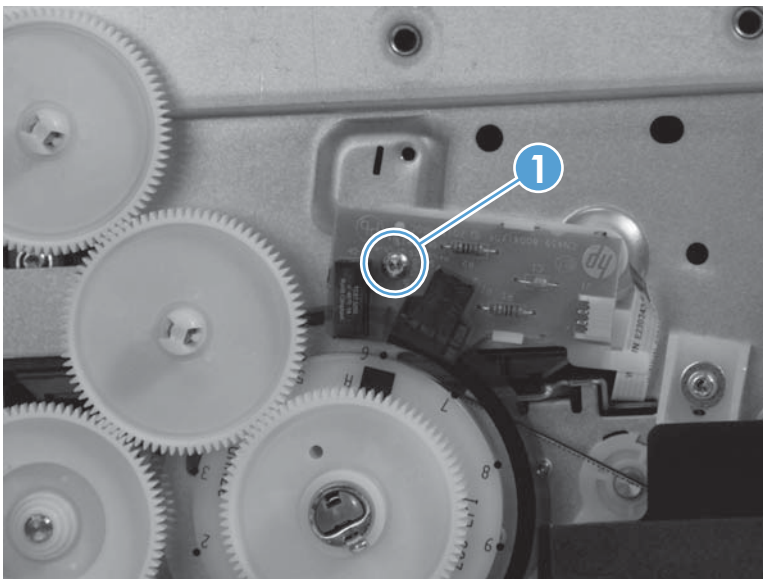

5. Unclip and remove the sensor PCA (callout 1).

Figure 1-194 Remove the feed motor encoder sensor PCA (4 of 4)

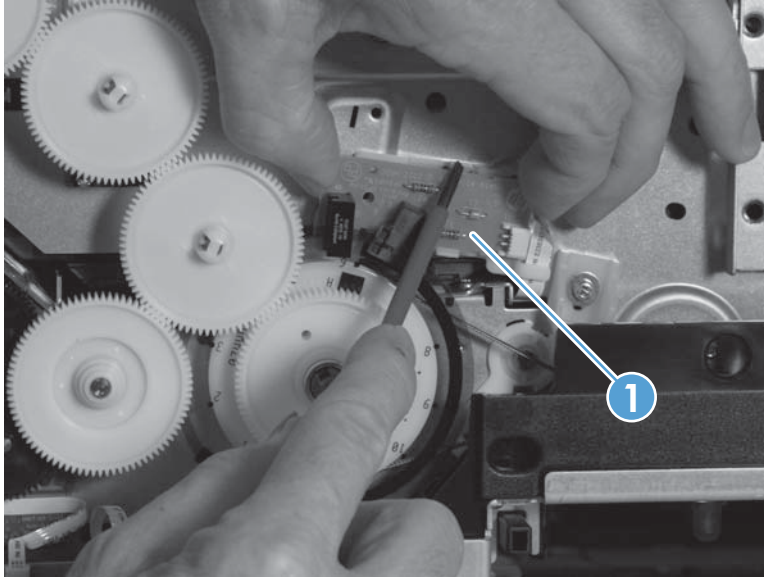

 **Reinstallation tip** Make sure that the encoder disk is inserted into both sensors on the sensor PCA.

Eject flap opto PCA

1. Remove the following components:
 - Rear cover. See [Rear cover on page 22](#).
 - Left door. See [Left door on page 23](#).
 - Left rear cover. See [Left rear cover on page 26](#).
 - Left front cover. See [Left front cover on page 27](#).
 - Top cover. See [Top cover and control panel on page 29](#).
 - Front cover. See [Front cover on page 35](#).
 - Top cap assembly. See [Top cap assembly on page 33](#).
2. Remove one screw (callout 1) from the underneath of the top cap assembly, and then remove the sensor PCA (callout 2).

Figure 1-195 Remove the eject flap opto PCA

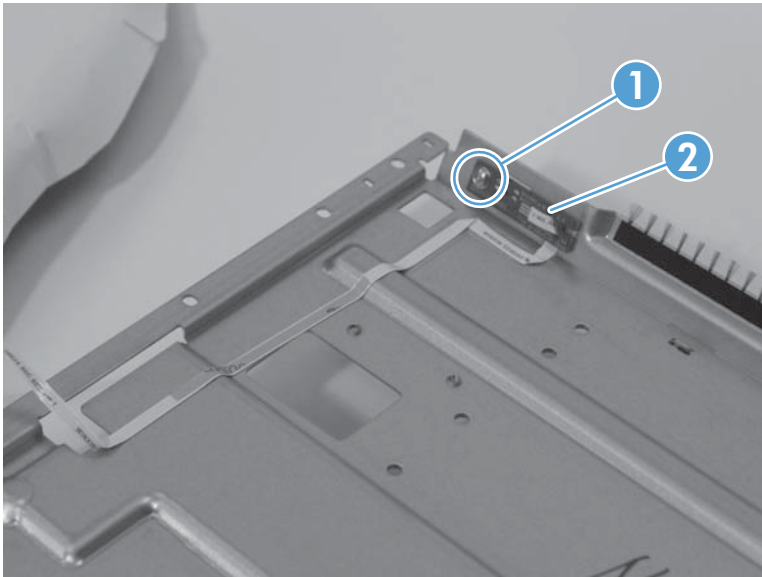

Printzone distribution PCA

1. Remove the service sled assembly. See [Service sled assembly on page 63](#).
2. Use a screwdriver to remove the PCA cover (callout 1).

Figure 1-196 Remove the printzone distribution PCA (1 of 3)

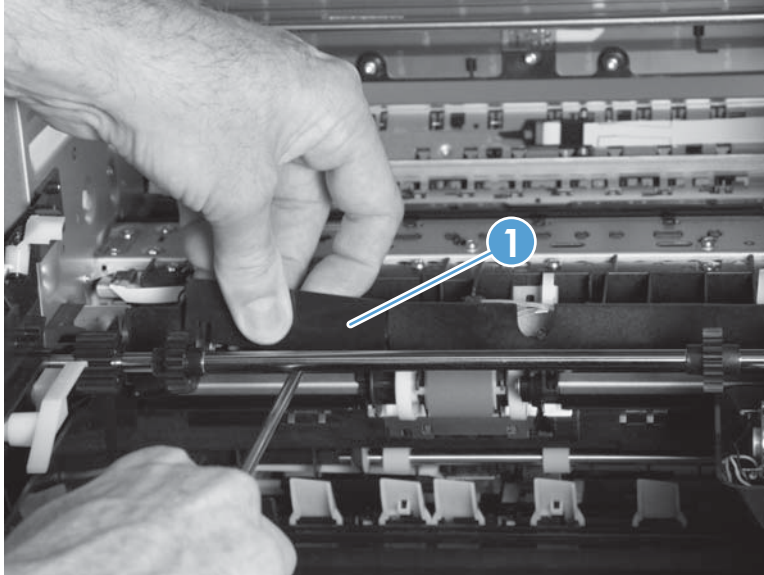

3. Remove one screw (callout 1).

Figure 1-197 Remove the printzone distribution PCA (2 of 3)

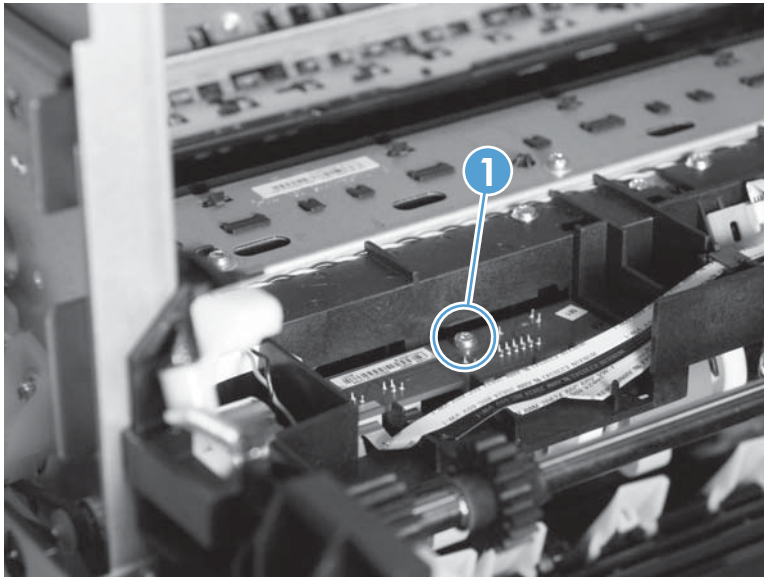

4. Disconnect five flex cables (callout 1), and then remove the PCA (callout 2).

Figure 1-198 Remove the printzone distribution PCA (3 of 3)

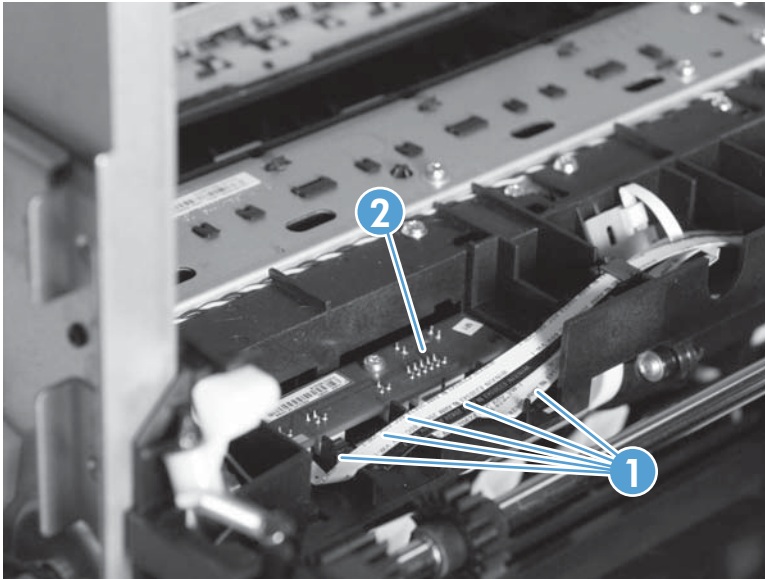

Media presence sensor PCA/flag

1. Remove the service sled assembly. See [Service sled assembly on page 63](#).
2. Remove one screw (callout 1) from the sensor flag (callout 2), and then remove the flag.

Figure 1-199 Remove the media presence sensor PCA/flag (1 of 2)

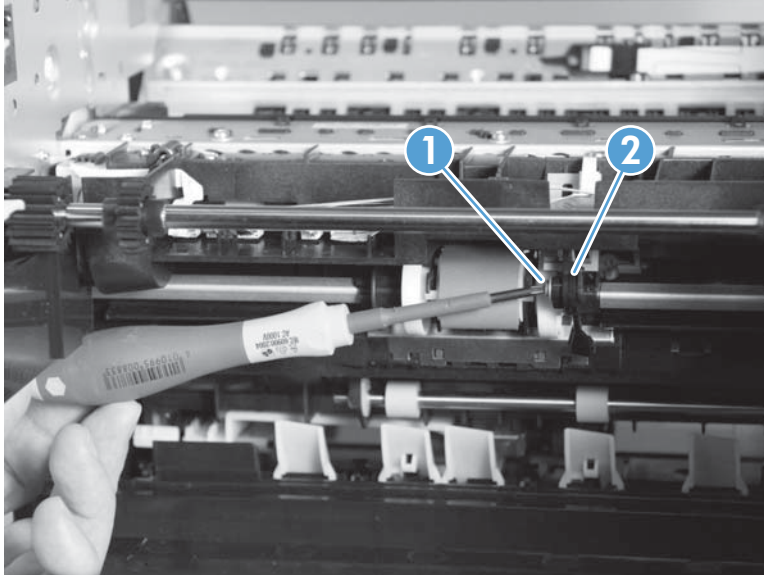

3. Disconnect the flex cable connector (callout 1), remove one screw (callout 2), and then remove the sensor PCA.

Figure 1-200 Remove the media presence sensor PCA/flag (2 of 2)

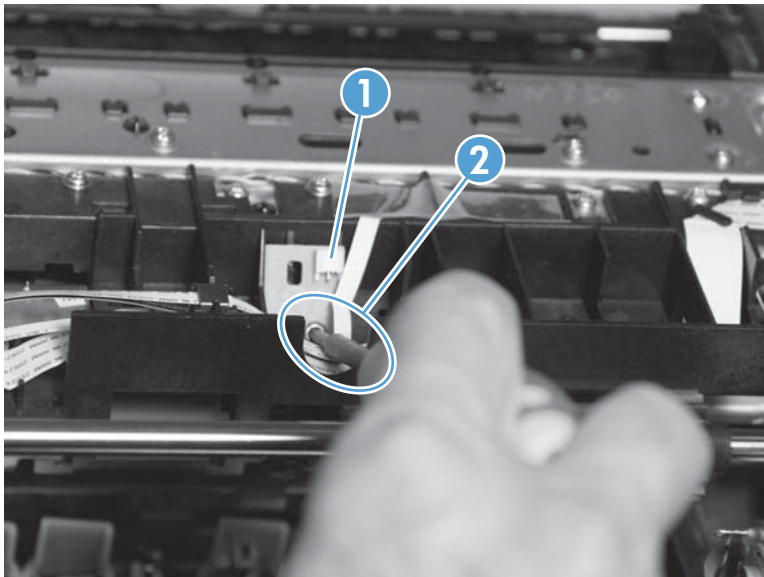

Main PCA

 **NOTE:** If the product has printed more than 5,000 pages, replacement of the duplex module assembly is recommended.

If the product has printed more than 30,000 pages, replacement of the service sled assembly is recommended. This only applies if the main PCA is being replaced.

 **NOTE:** The replacement main PCA should already have the required revision of firmware – 1336MR or later. Earlier versions of firmware do not support the required calibrations. If the replacement main PCA has older firmware, contact HP support.

1. Remove the following components:
 - Rear cover. See [Rear cover on page 22](#).
 - PCA safety shield. See [PCA safety shield on page 116](#).

2. Disconnect all cables from the PCA.

Figure 1-201 Remove the main PCA (1 of 8)

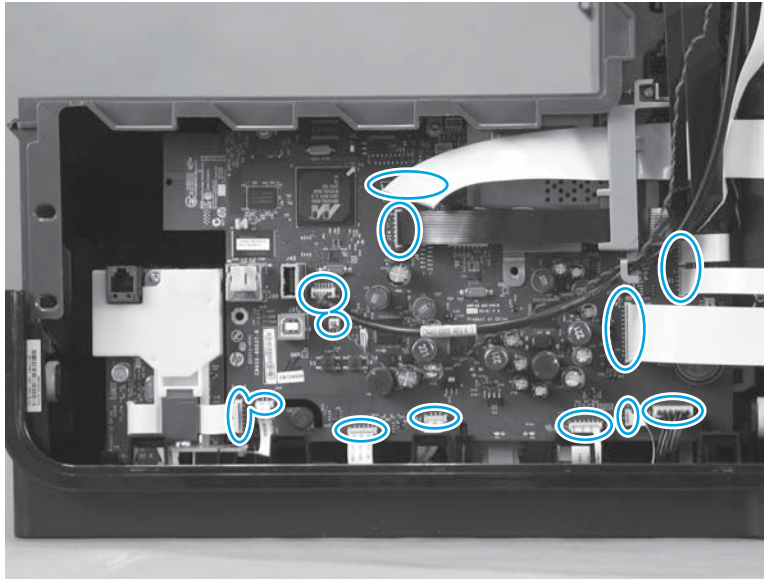

 **NOTE:** Additional clearance can be obtained by removing the aerosol fan assembly.

 **IMPORTANT:** The main PCA sockets highlighted in [Figure 1-202 Remove the main PCA \(2 of 8\) on page 133](#) are ZIF sockets. Take care to not break the latches on these ZIF sockets when removing or installing the FFCs in these sockets.

Figure 1-202 Remove the main PCA (2 of 8)



3. Remove one screw (callout 1) from behind the three print bar cables.

Figure 1-203 Remove the main PCA (3 of 8)

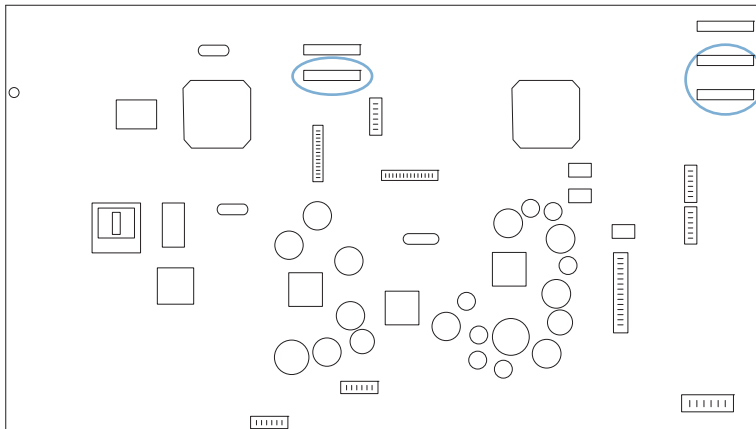
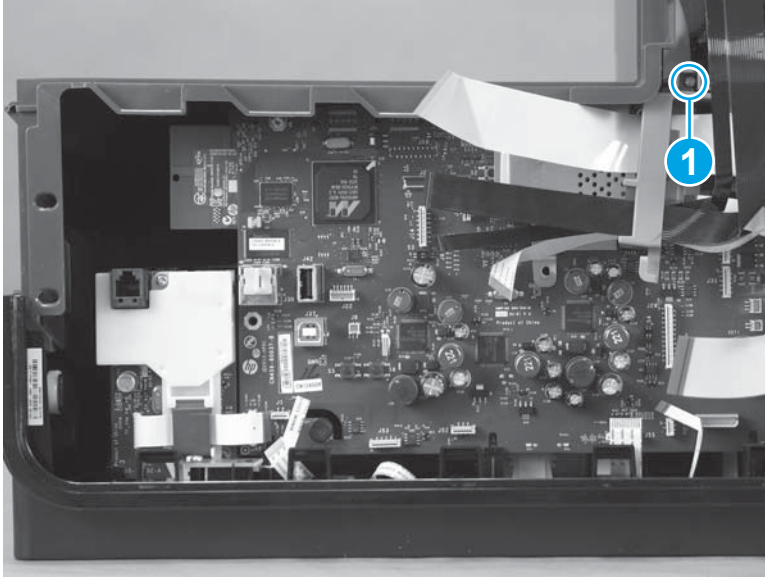

4. Lift the wire harness (callout 1) away from the PCA. The printbar flex cables can remain in the wire harness.

Figure 1-204 Remove the main PCA (4 of 8)

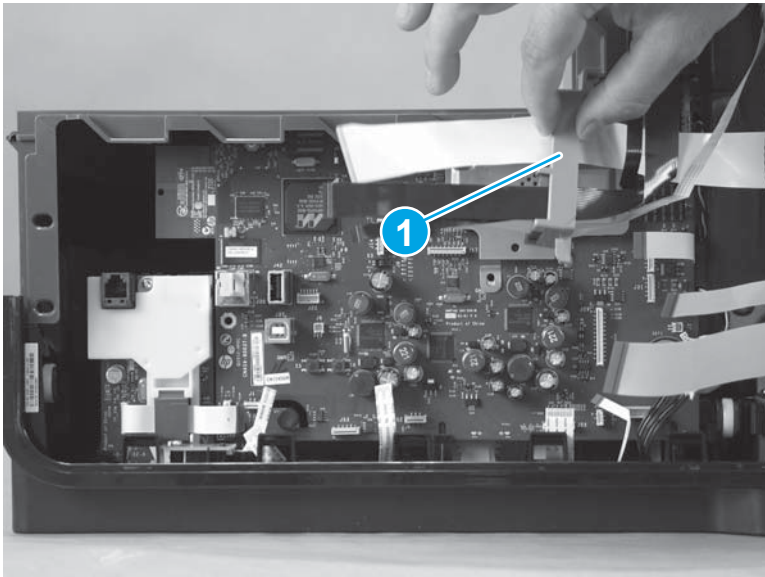

5. Remove three screws (callout 1) from the PCA.

Figure 1-205 Remove the main PCA (5 of 8)

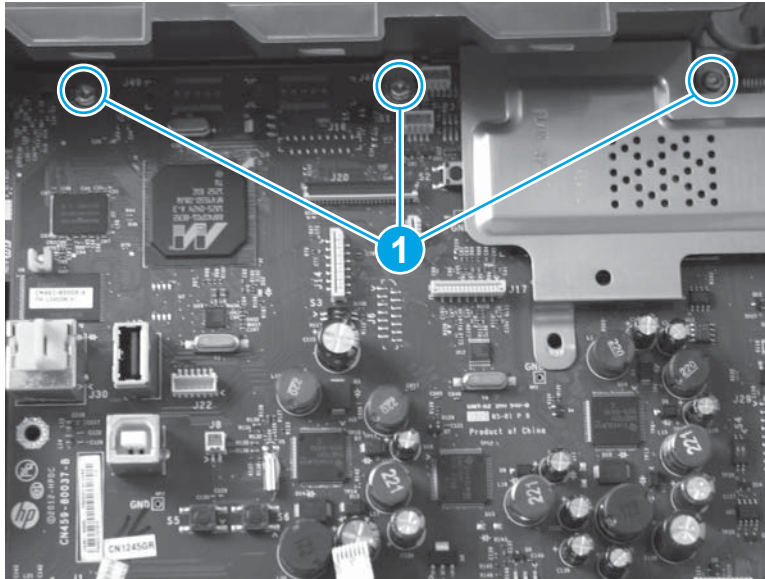

6. Remove the EMI shield.

Figure 1-206 Remove the main PCA (6 of 8)



7. Lift the PCA up slightly to remove it from the mounting posts, and then lower it into the product.

Figure 1-207 Remove the main PCA (7 of 8)

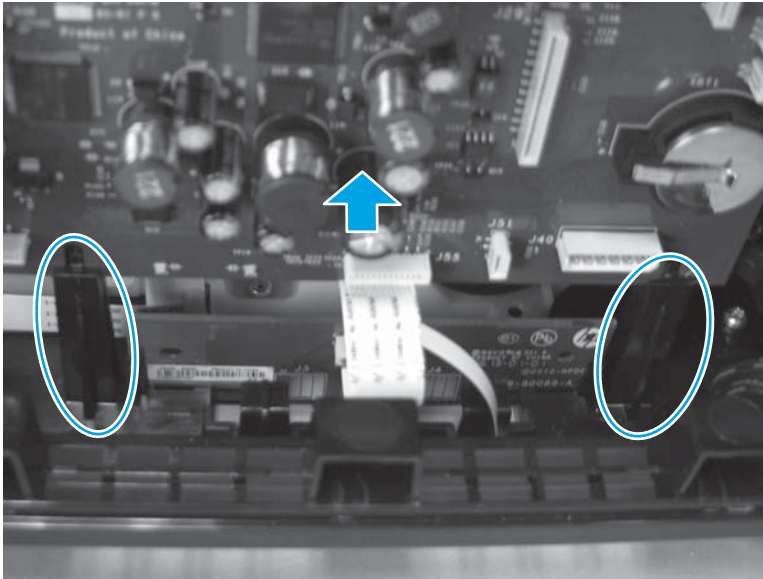

8. Rotate the top of the PCA (callout 1) outward, and then lift the PCA up (callout 2) to remove.

Figure 1-208 Remove the main PCA (8 of 8)

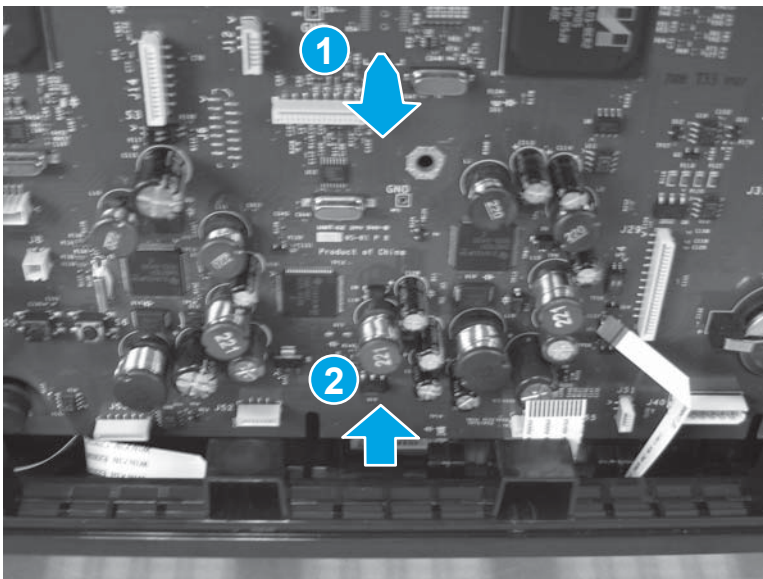

 **Reinstallation tip** Fit the bottom of the PCA onto the mounting posts in the product frame.

When reinstalling the main PCA, ensure the service sled is installed correctly. See [Service sled transmission on page 114](#).

 **NOTE:** After replacing the main PCA, perform the calibration procedure.

Main PCA calibration procedure

Test the main PCA installation

1. Place the product into Audit mode. See [Place the product into Audit mode on page 15](#) for information on placing the product into Audit mode.
2. Press the power button to enter Audit (on) mode.
 - Temporarily install a set of trade supplies or use the existing customer supplies. Host supplies will be rejected in MFG (on) mode.
3. Select the [Country](#) and the [Language](#), and then enter the localization information.
4. Verify the main PCA functionality:
 - a. Cover the IDS door sensor with a magnet.
 - b. Print a verification page.
 - c. Press the power button to turn the product off.

Calibrate the main PCA

1. Turn the product on and enter the [Engineering](#) menu. See [Access the Engineering menu on page 14](#) for information on accessing the [Engineering](#) menu.
2. Select [Service](#), select [System Configuration](#), and then touch the [OK](#) button.
3. Scroll to [Enter Serial Number](#). Use the up and down arrows on the control panel to enter the serial number

 **NOTE:** The serial number only contains 10 digits. Any digits entered after the tenth are ignored.

4. Scroll to [Enter Ethernet MAC](#) address, and then touch the [OK](#) button. Enter the Ethernet MAC address using the up and down arrows on the control panel, and then touch the [OK](#) button.

 **NOTE:** The Ethernet MAC address is located on the back panel.

5. For DW models only: Scroll to [Enter wireless MAC](#) address and then touch the [OK](#) button.
6. Enter the wireless MAC address using the up and down arrows on the control panel, and then touch the [OK](#) button.

 **NOTE:** The wireless MAC address is located on the back panel.

7. Scroll to [Paper Sensor Calibration](#), and then touch the [OK](#) button.

 **NOTE:** HP Colorlok paper must be used for the Paper Sensor Calibration.

The paper sensor calibrations require one sheet of blank paper for each calibration. The same sheet of paper can be reused if it is undamaged.

8. Select [Calibrate Main tray](#). The tray will eject one blank page.

9. Select **Calibrate MP tray**. The tray will eject one blank page.
10. MFP models only: Scroll to **Enter scanner barcode** and then touch the **OK** button.
11. Enter the scanner calibration bar code, and then touch the **OK** button.

 **NOTE:** The scanner calibration bar code is located underneath the main scan glass on the left side of the glass.

12. Touch the **Cancel** button to return to the **Engineering menu**.
13. Select the **Manufacturing menu**.
14. Scroll to the **Special Tests** menu, and then touch the **OK** button.
15. Scroll to **TouchScreen Calibration**, and then touch the **OK** button.
16. Calibrate the touch screen.

 **IMPORTANT:** Use a stylus or other rounded object to complete the interactive screen calibration in order to prevent scratching or damaging the screen.

17. Touch the **Cancel** button to return to the **Engineering menu**.
18. Select the **Underware** menu.
19. Scroll to the **System** menu, and then touch the **OK** button.
20. Scroll to **Set Derivative**, and then touch the **OK** button.
21. Set the derivative for the country/region. Select from the following choices:

Table 1-3 Country/region derivatives

Code name	Product Number	Country/region
LEMANS_AMERICAS	X476dn, X476dw, X576dw	North America
LEMANS_AP	X476dn, X476dw, X576dw	Asia Pacific
LEMANS_AP_TAIWAN	X476dn, X476dw, X576dw	Taiwan
LEMANS_EMEA	X476dn, X476dw, X576dw	Europe
LEMANS_LA	X476dn, X476dw, X576dw	Latin America
LEMANS_JAPAN	X476dn, X476dw, X576dw	Japan

22. Enter the language and country/region information.

 **NOTE:** The localization information is similar to the information entered after turning the product on in Audit Mode. However, the derivative has additional country/region specific settings. This will be the last time you will be prompted to enter language and countryregion information in this process.

23. Turn the product off, and then unplug it.
24. Finish assembling the case parts.

25. Turn the product on to User Mode.
26. Open the [Engineering](#) menu. See [Access the Engineering menu on page 14](#) for information on accessing the [Engineering](#) menu.
27. Select the [Service](#) menu. See [Access the Support Menu on page 14](#) for information on accessing the [Service](#) menu.
28. Scroll to [System Configuration](#), and then touch the [OK](#) button.
29. Scroll to [Trigger All Calibrations](#), and then touch the [OK](#) button.



NOTE: The product automatically restarts and begins the calibrations. The calibrations will take approximately 20 to 25 minutes and a total of 9 pages will print. When the calibrations are complete, the control panel will return to the [Home](#) screen.

30. From the [Ready](#) screen, touch the left arrow, and then select [Setup](#).
31. Scroll to and touch [Print Reports](#), and then select [Print Quality Report](#).



NOTE: If there are any discrepancies in the Print Quality Report, consult the *Troubleshooting Manual* for recovery methods.

32. Touch the [Back](#) button  twice to return to the [Ready](#) screen.
33. Open the [Engineering](#) menu. See [Menu access on page 14](#) for information on accessing the [Engineering](#) menu.
34. Select the [Manufacturing](#) menu.
35. Scroll to the [Reports](#) menu, and then touch the [OK](#) button.
36. Run the following tap tests:
 - 10 tap
 - 12 tap
 - 61 tap
 - 909 tap

For more information on running and verifying tap test results, see [Perform tap tests and interpret results on page 16](#).

37. Return to the [Ready](#) screen, and then complete the customer configurations, including network settings, preferred paper size and trays, and so forth.

Tray 3 interconnect PCA

1. Remove the rear cover. See [Rear cover on page 22](#).
2. Remove the FFC (callout 1) from the tray 3 interconnect PCA.

Figure 1-209 Remove the Tray 3 interconnect PCA (1 of 2)

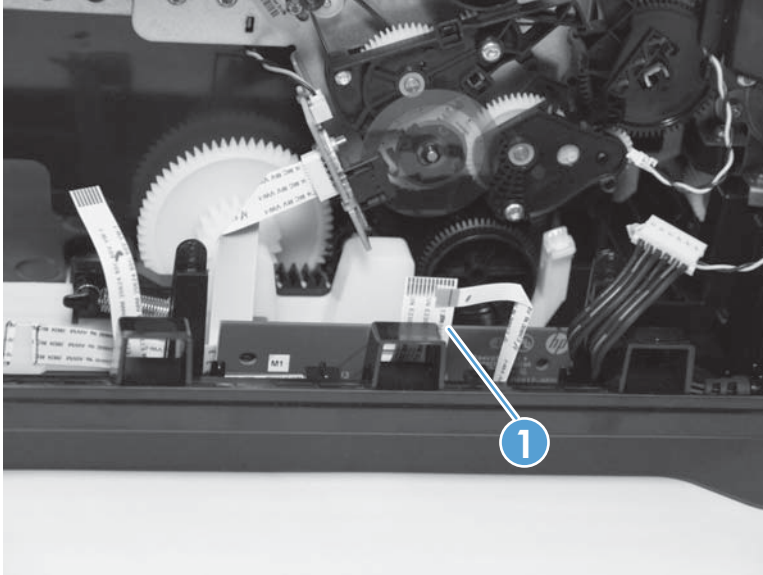

3. Use a small screwdriver to release the tab on the right side of the PCA (callout 1), and lift the PCA slightly. Release the tab on the left side of the PCA (callout 2), and then remove the PCA.

Figure 1-210 Remove the Tray 3 interconnect PCA (2 of 2)

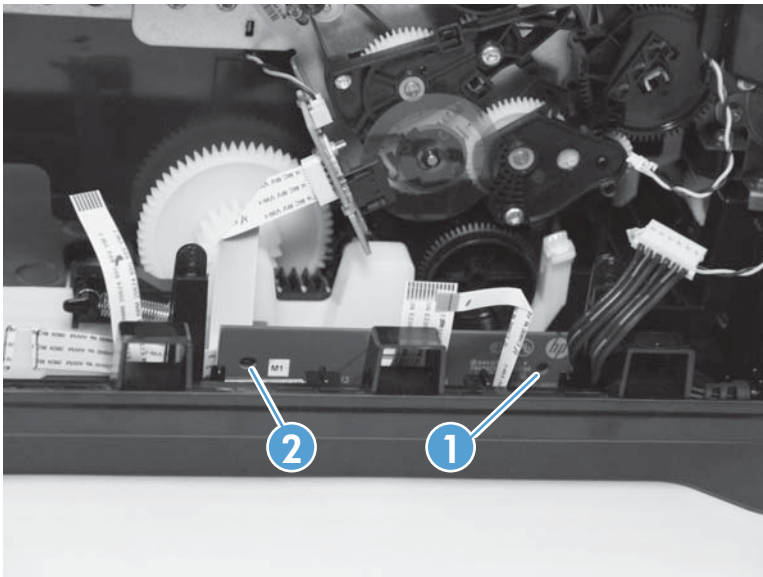

Pick encoder distribution PCA

1. Remove the main PCA. See [Main PCA on page 132](#).
2. Disconnect two cables (callout 1).

Figure 1-211 Remove the pick encoder distribution PCA (1 of 2)

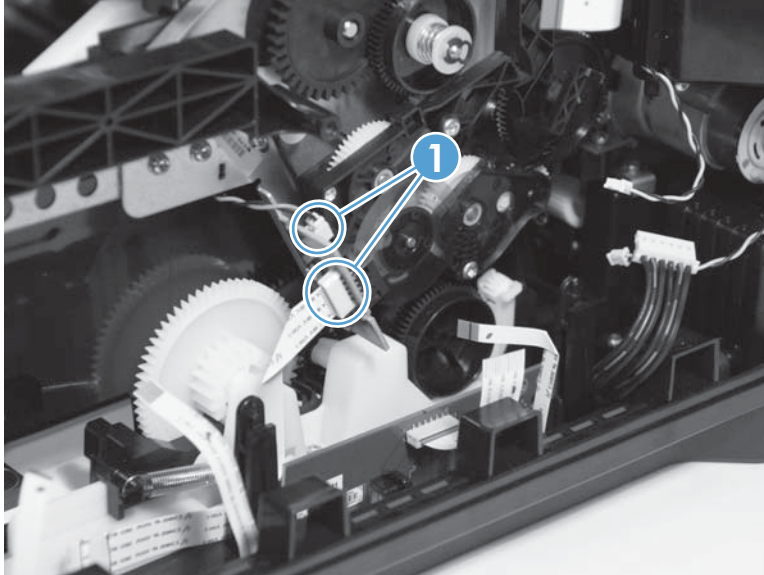

3. Remove one screw (callout 1), which requires the T10 Torx driver with the 25 mm (1 in) shaft.

Figure 1-212 Remove the pick encoder distribution PCA (2 of 2)

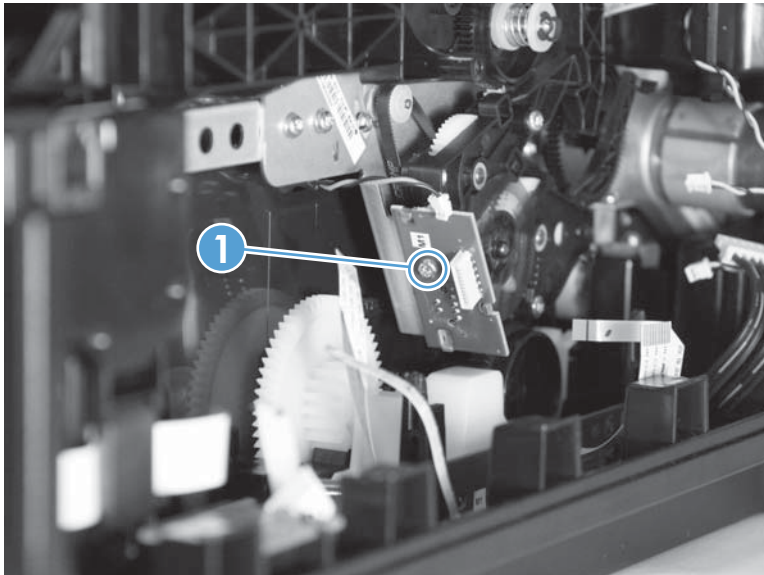

4. Remove the PCA.

 **Reinstallation tip** Make sure that the encoder disk is seated correctly in the sensor when reinstalling the PCA.

Wireless PCA

1. Remove the main PCA. See [Main PCA on page 132](#).
2. Remove the screw and retention holder that fastens the wireless PCA to the main PCA
3. Remove the wireless PCA connector by lifting the wireless PCA vertically from the main PCA.

Figure 1-213 Remove the wireless PCA.

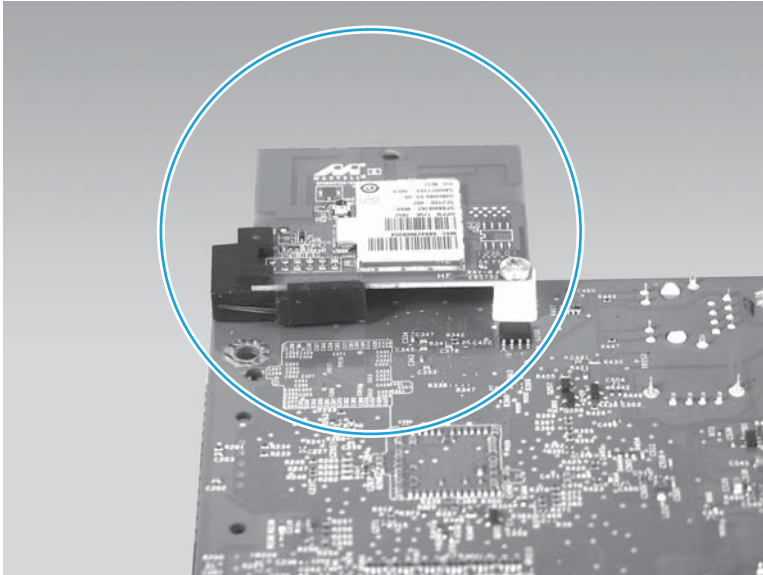

2 Parts and diagrams



NOTE: In this chapter, part numbers are listed only for available replaceable parts.

- [Order parts by authorized service providers](#)
- [How to use the parts lists and diagrams](#)
- [Assembly locations](#)
- [Covers, panels, and doors](#)
- [Scanner assembly](#)
- [Internal assemblies](#)
- [Alphabetical parts list](#)
- [Numerical parts list](#)

Order parts by authorized service providers

Order replacement parts

Table 2-1 Order parts, accessories, and supplies

Order supplies and paper	www.hp.com/go/suresupply .
Order genuine HP parts or accessories	www.hp.com/buy/parts
Order through service or support providers	Contact an HP-authorized service or support provider.

Related documentation and software

Table 2-2 Related documentation and software

Item	Description	Part number
HP Officejet Pro X476 and X576 Series Printers User Guide	Product user guide	CE863-90907
HP Officejet Pro X476 and X576 Series Printers Repair Manual	English repair manual (this manual)	CN598-90007
HP Officejet Pro X476 and X576 Series Printers Troubleshooting Manual	English troubleshooting manual	CN598-90006

Supplies part numbers

Table 2-3 Ink cartridge supplies

Selectability	Size	Color	Type	Part Number
970	32 mm	Black	Host	D8J18-30001
971	A	Cyan	Host	CN622-30002
971	A	Magenta	Host	CN623-30002
971	A	Yellow	Host	CN624-30002
970	A	Black	Trade	CN621-30001
971	A	Cyan	Trade	CN622-30001
971	A	Magenta	Trade	CN623-30001
971	A	Yellow	Trade	CN624-30001
970XL	XL	Black	Trade	CN625-30001
971XL	XL	Cyan	Trade	CN626-30001
971XL	XL	Magenta	Trade	CN627-30001
971XL	XL	Yellow	Trade	CN628-30001



NOTE: For information about the yield for the cartridges, see www.hp.com/go/pageyield. Actual yield depends on specific use.

Some ink cartridges may not be available in all countries/regions.

Customer self-repair parts

The following customer self-repair parts are available for the product.

Each kit includes parts and installation instructions. The customer self repair (CSR) level indicates the expected difficulty the customer will experience when replacing this part:

- A: Easy
- B: Difficult

Table 2-4 Customer self-repair parts

Item	Description	CSR level	Part number
Document feeder assembly	<ul style="list-style-type: none">• Document feeder assembly• Document feeder foam pad• Document feeder replacement instructions	B	CN598-67008
Duplex assembly	Duplex module	A	CN598-67004
Output bin assembly	Output bin	A	CN598-67007
Main tray assembly	Main tray	A	CN598-67005
Accessory paper tray (Tray 3)	500-sheet paper feeder (optional Tray 3)	A	CN595-65001
Left door assembly	Left door	B	CN598-67001
Left door strap	Left door strap	B	CN598-67002
Left door rear strap	Left door rear strap	B	CN598-67003
Eject flap assembly	Eject flap	B	CN598-67006

Cables and power cords

The following cables and power cords are available for the product.

Table 2-5 Cables and power cords

Part number	Description
8121-0868	USB cable, A-to-B, 1.8 m (6.0 ft) long
8121-1186	USB cable, 1.8m (6.0 ft) long, unbagged
8120-8905	Ethernet cable assembly (black), Cat-5e, 3 m (9.8 ft) long
8120-6313	Power cord (black), 2-wire, 1.8 m (6.0 ft) long—US, Canada, Mexico
8121-0514	Power cord (black), 2-wire, 1.8 m (6.0 ft) long—Chile
8120-8373	Power cord (black), 2-wire, 1.8 m (6.0 ft) long—China
8121-0870	Power cord (black), 2-wire, 1.8 m (6.0 ft) long—Australia, NZ
8120-8699	Power cord (black), 2-wire, 1.8 m (6.0 ft) long—UK, HK, Singapore, Middle East
8121-0664	Power cord (black), 2-wire, 1.8 m (6.0 ft) long—Thailand
8120-6314	Power cord (black), 2-wire, 1.8 m (6.0 ft) long—Europe, Indonesia, Vietnam, Middle East
8120-8441	Power cord (black), 2-wire, 1.8 m (6.0 ft) long—Korea
8120-8367	Power cord (black), 2-wire, 1.8 m (6.0 ft) long—Argentina
8121-0963	Power cord (black), 2-wire, 1.8 m (6.0 ft) long—Taiwan
8121-1081	Power cord (black), 2-wire, 1.8 m (6.0 ft) long—Brazil
8121-1168	Power cord (black), 2-wire, 1.8 m (6.0 ft) long— India (6A-2wire)

Service part number and retail SKU cross-references

The following table lists the service part numbers and corresponding retail SKU numbers for X476 and X576 series products.

Table 2-6 Service part number and retail SKU cross-references

Product	Service part number	Retail SKU number	Country/region
X476dn	CN460-69001	CN460A#B1H	North America only
	CN460-69003	CN460A#201	U.S. government only

Table 2-6 Service part number and retail SKU cross-references (continued)

Product	Service part number	Retail SKU number	Country/region	
X476dw	CN461-69003	CN461A#A80	Europe, the Middle East, and Africa	
		CN461A#ACQ		
		CN461A#BHG		
	CN461-69009	CN461A#ABT	Israel	
	CN461-69010	CN461A#A80	Turkey	
	CN461-69001	CN461A#B1H	North America only	
	CN461-69004	CN461A#AB0	Taiwan only	
	CN461-69005	CN461A#AB2	India and China	
				CN461A#ACJ
		CN461-69006	CN461A#AB1	Rest of Asia Pacific
	CN461A#BBU			
	CN461A#BGM			
	CN461-69002	CN461A#AC4	Latin America	
				CN461A#AC8
				CN461A#AKH
CN461A#AKY				
X576dw	CN598-69002	CN598A#A80	Europe, the Middle East, and Africa	
		CN598A#ACQ		
		CN598A#BHG		
	CN598-69008	CN598A#ABT	Israel	
	CN598-69009	CN598A#A80	Turkey	
	CN598-69001	CN598A#B1H	North America only	
	CN598-69003	CN598A#AB0	Taiwan only	
	CN598-69004	CN598A#AB2	India and China	
				CN598A#ACJ
	CN598-69005	CN598A#AB1	Rest of Asia Pacific	
				CN598A#BBU
				CN598A#BGM

How to use the parts lists and diagrams

The figures in this chapter show the major subassemblies in the product and their component parts. A parts list table follows each exploded view assembly diagram. Each table lists the item number, the associated part number, and the description of each part. If a part is not listed in the table, then it is not a field replacement unit (FRU).

 **CAUTION:** Be sure to order the correct part. When looking for part numbers for electrical components, pay careful attention to the voltage that is listed in the description column. Doing so will ensure that the part number selected is for the correct product model.

 **NOTE:** In this manual, the abbreviation “PCA” stands for “printed circuit-board assembly.” Components described as a PCA might consist of a single circuit board or a circuit board plus other parts, such as cables and sensors.

Assembly locations

Front view

Figure 2-1 Front view

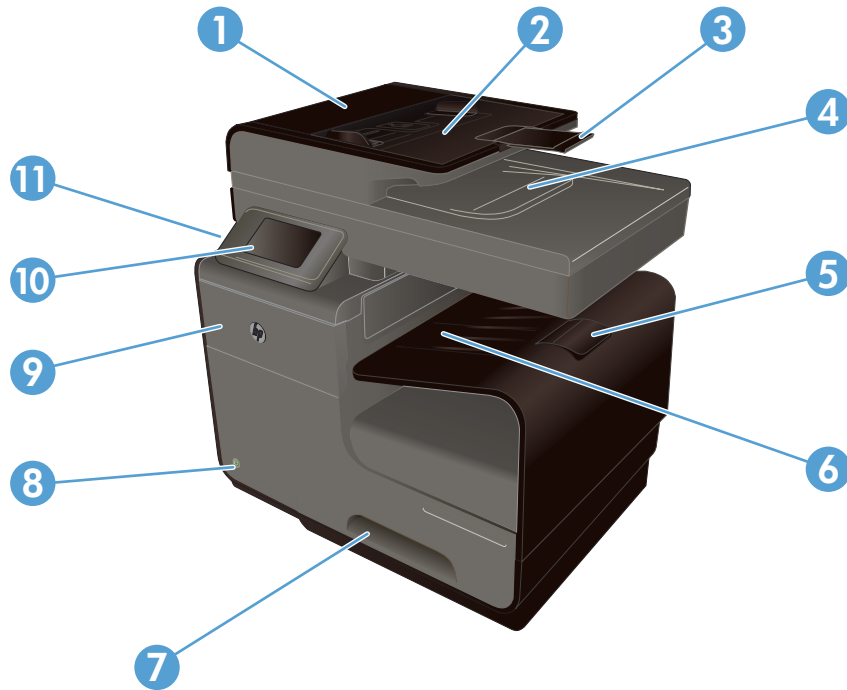

1	Document feeder cover (provides access for clearing jams)
2	Document feeder input tray
3	Document feeder input tray extension
4	Document feeder output bin
5	Output bin extension
6	Output bin
7	Tray 2 (Main paper tray)
8	On/Off button
9	Ink cartridge door
10	Color touchscreen control panel
11	USB 2.0 port

Back view

Figure 2-2 Back view

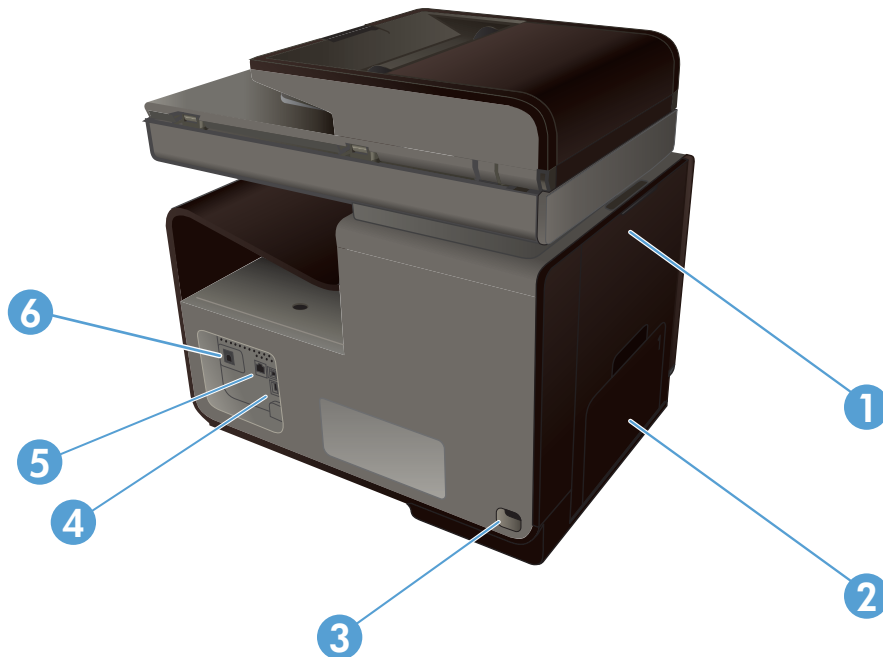

1	Left door (access for clearing jams)
2	Tray 1 (Multi-purpose tray)
3	Power connection
4	Hi-Speed USB 2.0 ports
5	Ethernet port
6	Fax line port

Covers, panels, and doors

Figure 2-3 Covers, panels, and doors

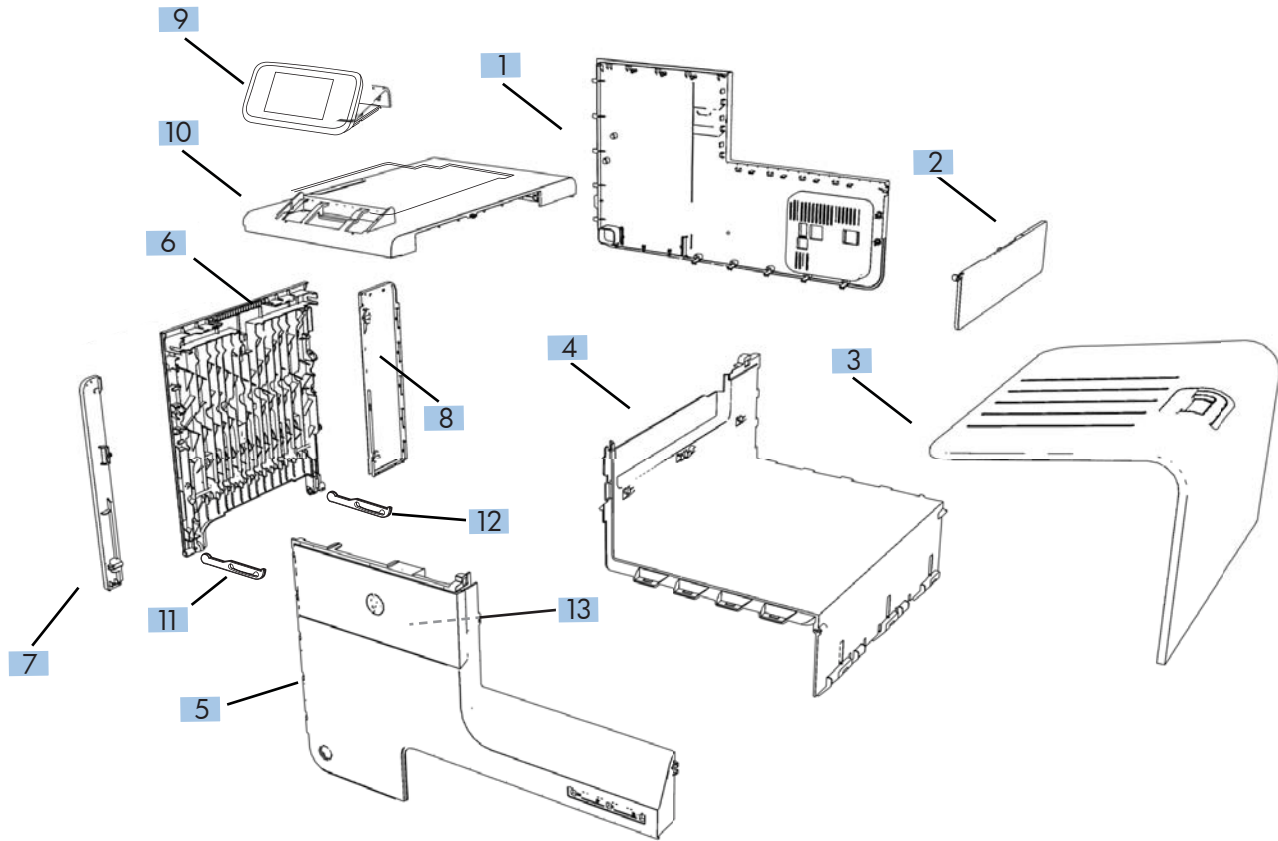

Table 2-7 Covers, panels, and doors

Ref	Description	Part number	Qty
1	Rear cover	CN598-67047	1
2	Eject flap assembly	CN598-67023	1
3	Output bin	CN598-67007	1
4	Right cover	CN598-67051	1
5	Front cover	CN598-67052	1
6	Left door	CN598-67001	1
7	Left front cover	CN598-67050	1
8	Left rear cover	CN598-67049	1
9	Control-panel assembly — non-wireless models	CN460-67005	1
9	Control-panel assembly — wireless models	CN461-67003	1
10	Top cover	CN460-67010	1
11	Strap, left door	CN598-67002	1
12	Strap, left door, rear	CN598-67003	1
13	Hinge, ISS door	CN598-67053	2

Scanner assembly

Figure 2-4 Scanner assembly

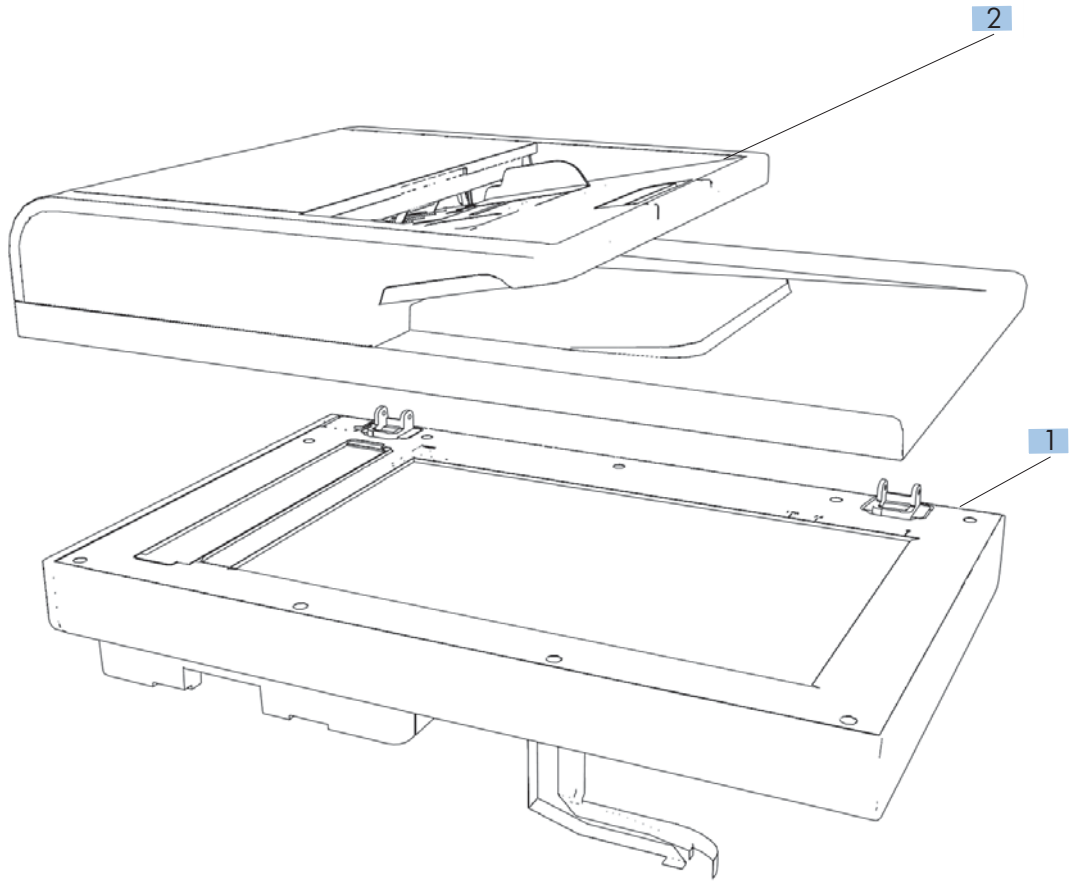

Table 2-8 Scanner assembly

Ref	Description	Part number	Qty
1	Scanner assembly	CN460-67009	1
2	Document feeder assembly	CN598-67008	1

Internal assemblies

Figure 2-5 Internal assemblies (1 of 3)

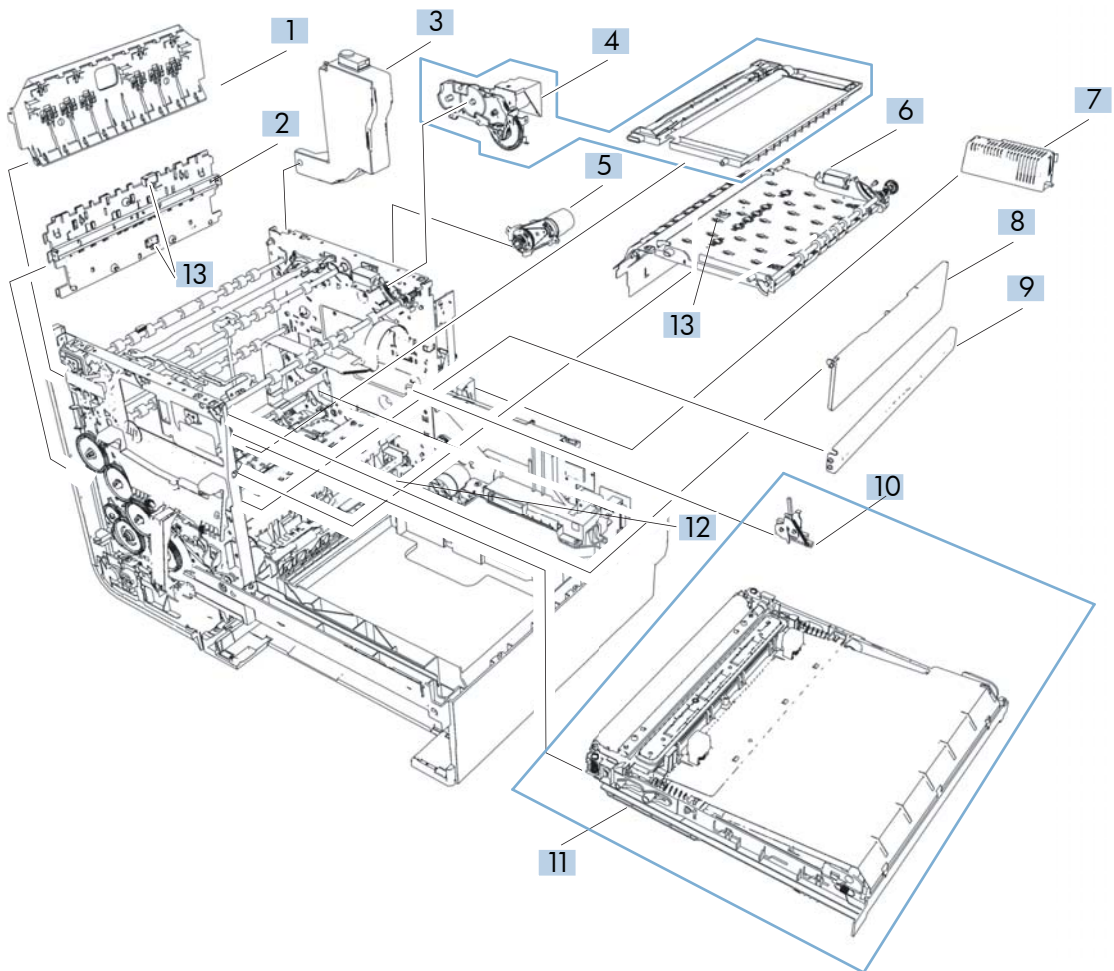

Table 2-9 Internal assemblies (1 of 3)

Ref	Description	Part number	Qty
1	Upper hanger assembly	Not supported	1
2	Vertical star wheel wall	Not supported	1
3	Aerosol fan assembly	CN598-67046	1
4	Output Drive Kit	CN598-67022	1
Not shown	Eject drive gear module (part of output drive kit)	CN459-60292	1
Not shown	Flap actuator solenoid (part of output drive kit)	CN459-60307	1
Not shown	Rack-eject lifter flap (part of output drive kit)	CN459-40410	1
5	Duplex drive module	CN598-67036	1
6	Floor eject assembly	Not supported	1
7	Power supply	CN598-67016	1
7	Power supply—India and China only	CN598-67017	1
8	Eject flap assembly	CN598-67023	1
9	Cross brace, right	Not supported	1
10	Web advance rack assembly	CN598-67021	1
11	Service sled assembly	CN598-67021	1
12	Media presence sensor PCA/flag	CN598-67034	1
13	REDI sensors	CN598-67038	3
Not shown	BDD sensor	CN598-67035	1
Not shown	FFC, 11 pin printzone	CN598-67039	1
Not shown	FFC, 24 pin printbar lift	CN598-67040	1
Not shown	FFC, 10 pin pick drive enc	CN598-67041	1
Not shown	FFC, 12 pin REDI distribution	CN598-67042	1
Not shown	FFC, 5 pin sensor carriage BDD	CN598-67043	1
Not shown	FFC, 3xFFC, printbar bundle kit	CN598-67044	1

Figure 2-6 Internal assemblies (2 of 3)

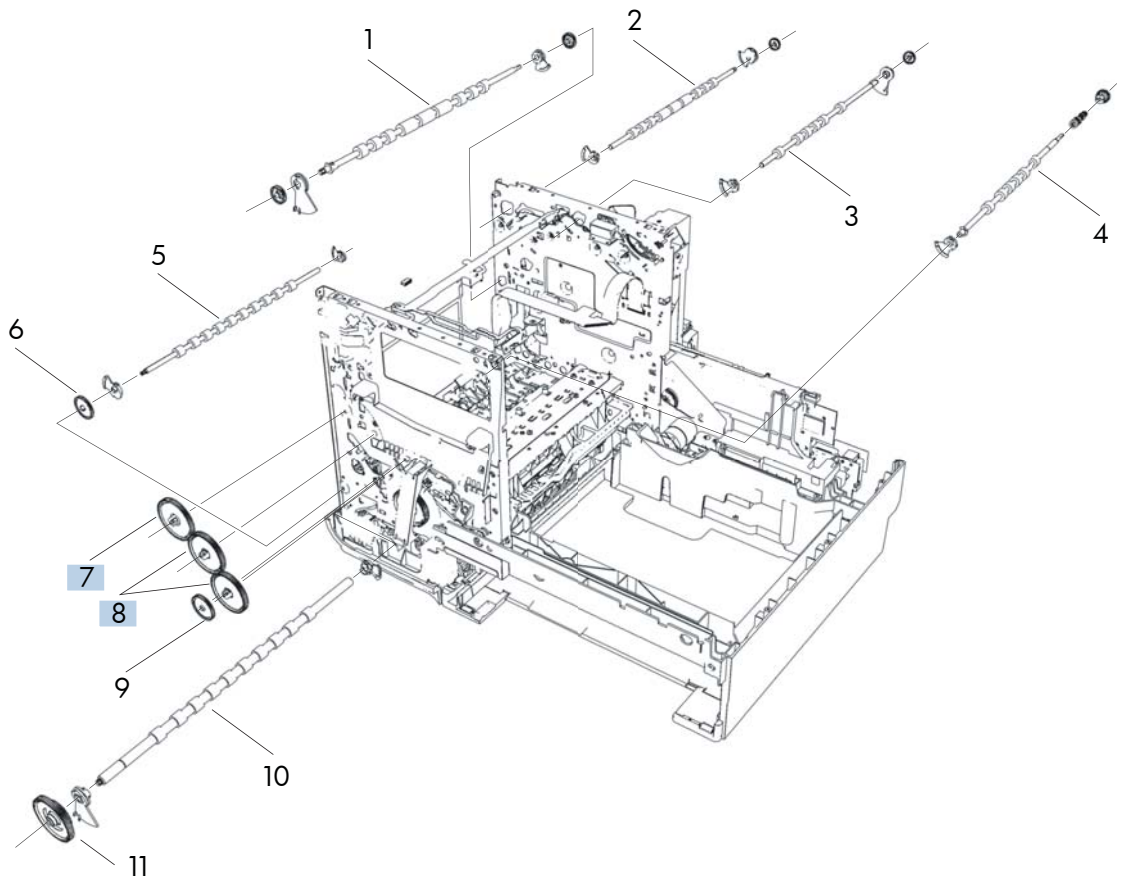

Table 2-10 Internal assemblies (2 of 3)

Ref	Description	Part number	Qty
1	Transfer 3 shaft	Not supported	1
2	Output upper 4 shaft	Not supported	1
3	Output eject 5 shaft	Not supported	1
4	Output eject 6 shaft	Not supported	1
5	Output lower 2 shaft	Not supported	1
6	Gear, shaft output lower	Not supported	1
7	Gear, output idler gear, 83t/30t	CN598-67031	1
8	Gear, idler gear train, 78t/48t	CN598-67031	2
9	Spurgear, idler gear train, 52t	Not supported	1
10	Platen output 1 shaft	Not supported	1
11	Gear, shaft output platen 1	Not supported	1

Figure 2-7 Internal assemblies (3 of 3)

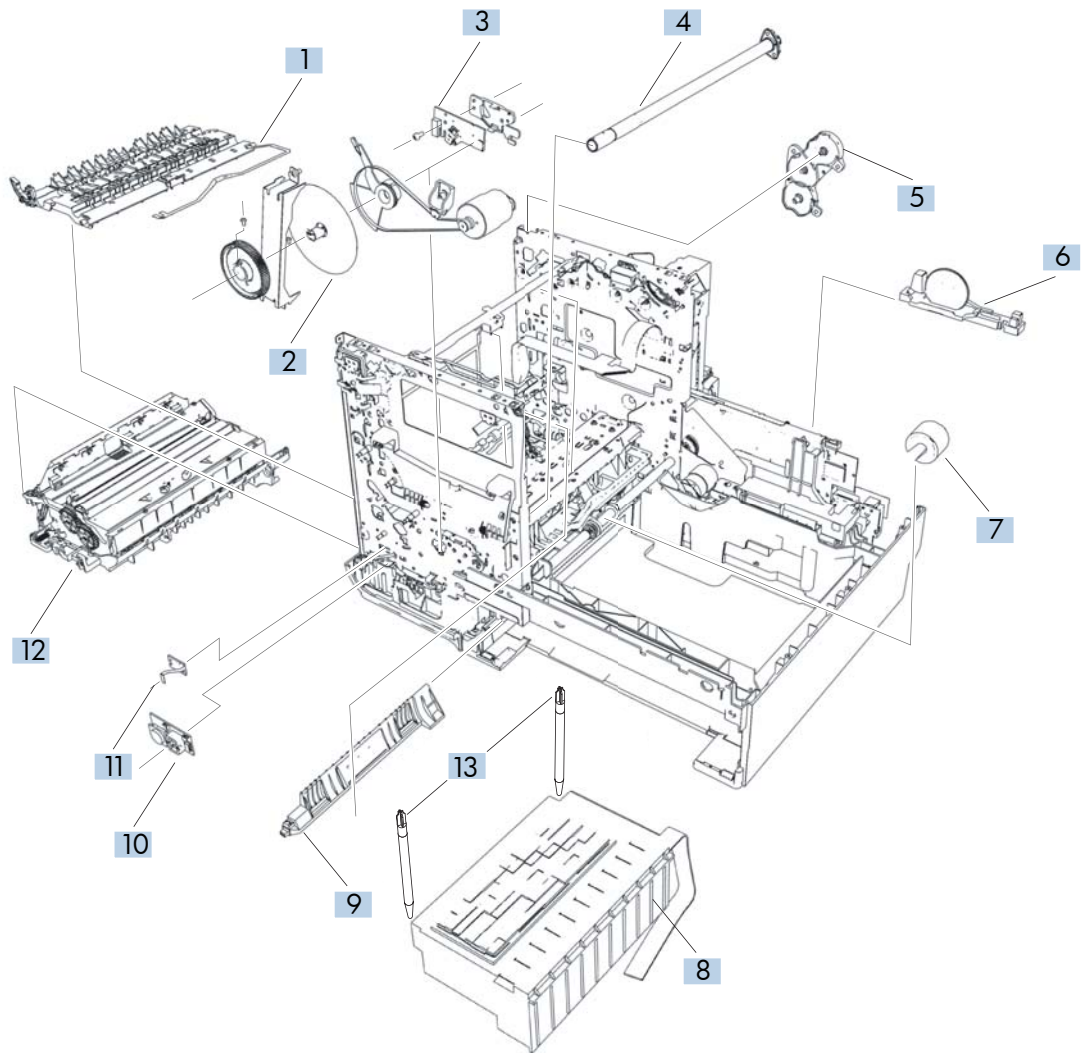

Table 2-11 Internal assemblies (3 of 3)

Ref	Description	Part number	Qty
1	Platen NOTE: The platen kit contains a TOF REDI sensor and a print zone REDI sensor.	CN598-67025	1
2	Encoder disk	(Not supported)	1
3	Feedshaft Encoder PCA	CN598-67030	1
4	Feedshaft	(Not supported)	1
5	Drying path gear assembly	CN598-67060	1
6	Tray lift transmission assembly	CN598-67020	1
7	Separator/pick assembly kit	CN598-67018	1
8	Printbar	CN598-67045	1
Not shown	Printbar lift mechanism assembly	CN598-67027	1
9	Separation assembly	CN598-67018	1
10	Power button assembly	CN598-67019	1
11	Duplex presence sensor PCA	CN598-67057	1
12	Duplex module	CN598-67004	1
13	Z stop, printbar lift rod	CN598-67048	2
Not shown	Shaft, printbar lift, clutched	CN598-67028	1

Figure 2-8 PCA locations (1 of 2)

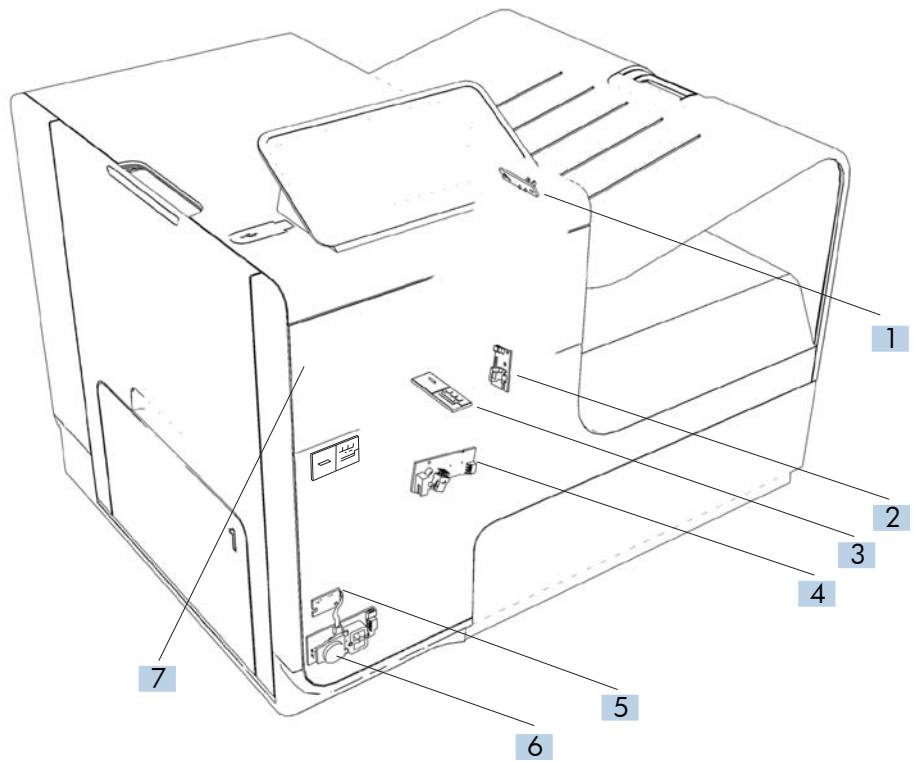

Table 2-12 PCA locations (1 of 2)

Ref	Description	Part number	Qty
1	Eject flap opto PCA	CN598-67023	1
2	Pick encoder distribution PCA	CN598-67029	1
3	Print zone distribution PCA	CN598-67033	1
4	Feedshaft encoder PCA	CN598-67030	1
5	Duplex presence sensor PCA	CN598-67057	1
6	Power button assembly	CN598-67019	1
7	REDI distribution PCA	CN598-67037	1

Figure 2-9 PCA locations (2 of 2)

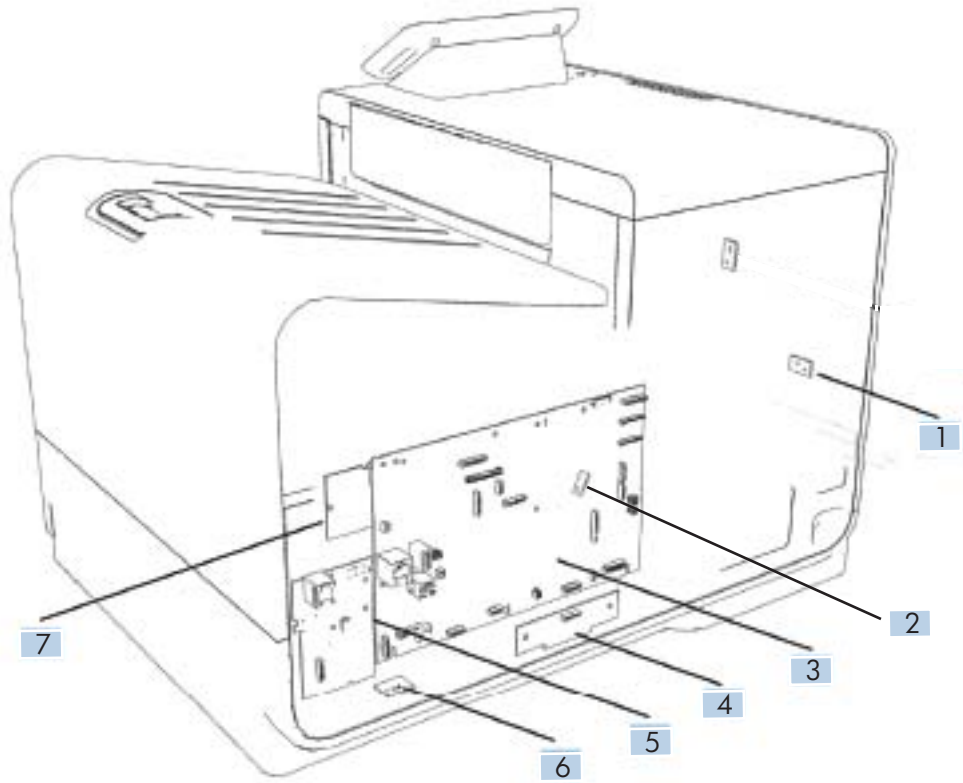

Table 2-13 PCA locations (2 of 2)

Ref	Description	Part number	Qty
1	Sensor carriage PCA/encoder strip	CN598-67061	1
2	Media presence flag/opto PCA kit	CN598-67034	1
3	Main PCA (X476dn models)	CN460-67006	1
3	Main PCA (X476dw models)	CN461-67002	1
3	Main PCA (X576 models)	CN598-67054	1
4	Tray 3 interconnect PCA	CN598-67059	1
5	Fax PCA	CN460-67007	1
6	Temperature sensor	CN598-67024	1
7	Wireless PCA	CN598-67055	1
Not shown	Control panel FFC	CN460-67008	1

Alphabetical parts list

Table 2-14 Alphabetical parts list

Description	Part number	Table and page
Aerosol fan assembly	CN598-67046	Internal assemblies (1 of 3) on page 157
BDD sensor	CN598-67035	Internal assemblies (1 of 3) on page 157
Control panel FFC	CN460-67008	PCA locations (2 of 2) on page 165
Control-panel assembly — non-wireless models	CN460-67005	Covers, panels, and doors on page 153
Control-panel assembly — wireless models	CN461-67003	Covers, panels, and doors on page 153
Cross brace, right	Not supported	Internal assemblies (1 of 3) on page 157
Document feeder assembly	CN598-67008	Scanner assembly on page 155
Drying path gear assembly	CN598-67060	Internal assemblies (3 of 3) on page 161
Duplex drive module	CN598-67036	Internal assemblies (1 of 3) on page 157
Duplex module	CN598-67004	Internal assemblies (3 of 3) on page 161
Duplex presence sensor PCA	CN598-67057	Internal assemblies (3 of 3) on page 161
Duplex presence sensor PCA	CN598-67057	PCA locations (1 of 2) on page 163
Eject drive gear module (part of output drive kit)	CN459-60292	Internal assemblies (1 of 3) on page 157
Eject flap assembly	CN598-67023	Covers, panels, and doors on page 153
Eject flap assembly	CN598-67023	Internal assemblies (1 of 3) on page 157
Eject flap opto PCA	CN598-67023	PCA locations (1 of 2) on page 163
Encoder disk	(Not supported)	Internal assemblies (3 of 3) on page 161
Fax PCA	CN460-67007	PCA locations (2 of 2) on page 165
Feedshaft	(Not supported)	Internal assemblies (3 of 3) on page 161

Table 2-14 Alphabetical parts list (continued)

Description	Part number	Table and page
Feedshaft Encoder PCA	CN598-67030	Internal assemblies (3 of 3) on page 161
Feedshaft encoder PCA	CN598-67030	PCA locations (1 of 2) on page 163
FFC, 10 pin pick drive enc	CN598-67041	Internal assemblies (1 of 3) on page 157
FFC, 11 pin printzone	CN598-67039	Internal assemblies (1 of 3) on page 157
FFC, 12 pin REDI distribution	CN598-67042	Internal assemblies (1 of 3) on page 157
FFC, 24 pin printbar lift	CN598-67040	Internal assemblies (1 of 3) on page 157
FFC, 3xFFC, printbar bundle kit	CN598-67044	Internal assemblies (1 of 3) on page 157
FFC, 5 pin sensor carriage BDD	CN598-67043	Internal assemblies (1 of 3) on page 157
Flap actuator solenoid (part of output drive kit)	CN459-60307	Internal assemblies (1 of 3) on page 157
Floor eject assembly	Not supported	Internal assemblies (1 of 3) on page 157
Front cover	CN598-67052	Covers, panels, and doors on page 153
Gear, idler gear train, 78t/48t	CN598-67031	Internal assemblies (2 of 3) on page 159
Gear, output idler gear, 83t/30t	CN598-67031	Internal assemblies (2 of 3) on page 159
Gear, shaft output lower	Not supported	Internal assemblies (2 of 3) on page 159
Gear, shaft output platen 1	Not supported	Internal assemblies (2 of 3) on page 159
Hinge, ISS door	CN598-67053	Covers, panels, and doors on page 153
Left door	CN598-67001	Covers, panels, and doors on page 153
Left front cover	CN598-67050	Covers, panels, and doors on page 153
Left rear cover	CN598-67049	Covers, panels, and doors on page 153
Main PCA (X476dn models)	CN460-67006	PCA locations (2 of 2) on page 165

Table 2-14 Alphabetical parts list (continued)

Description	Part number	Table and page
Main PCA (X476dw models)	CN461-67002	PCA locations (2 of 2) on page 165
Main PCA (X576 models)	CN598-67054	PCA locations (2 of 2) on page 165
Media presence flag/opto PCA kit	CN598-67034	PCA locations (2 of 2) on page 165
Media presence sensor PCA/flag	CN598-67034	Internal assemblies (1 of 3) on page 157
Output bin	CN598-67007	Covers, panels, and doors on page 153
Output Drive Kit	CN598-67022	Internal assemblies (1 of 3) on page 157
Output eject 5 shaft	Not supported	Internal assemblies (2 of 3) on page 159
Output eject 6 shaft	Not supported	Internal assemblies (2 of 3) on page 159
Output lower 2 shaft	Not supported	Internal assemblies (2 of 3) on page 159
Output upper 4 shaft	Not supported	Internal assemblies (2 of 3) on page 159
Pick encoder distribution PCA	CN598-67029	PCA locations (1 of 2) on page 163
Platen output 1 shaft	Not supported	Internal assemblies (2 of 3) on page 159
Platen	CN598-67025	Internal assemblies (3 of 3) on page 161
NOTE: The platen kit contains a TOF REDI sensor and a print zone REDI sensor.		
Power button assembly	CN598-67019	Internal assemblies (3 of 3) on page 161
Power button assembly	CN598-67019	PCA locations (1 of 2) on page 163
Power supply	CN598-67016	Internal assemblies (1 of 3) on page 157
Power supply—India and China only	CN598-67017	Internal assemblies (1 of 3) on page 157
Print zone distribution PCA	CN598-67033	PCA locations (1 of 2) on page 163
Printbar	CN598-67045	Internal assemblies (3 of 3) on page 161

Table 2-14 Alphabetical parts list (continued)

Description	Part number	Table and page
Printbar lift mechanism assembly	CN598-67027	Internal assemblies (3 of 3) on page 161
Rack-eject lifter flap (part of output drive kit)	CN459-40410	Internal assemblies (1 of 3) on page 157
Rear cover	CN598-67047	Covers, panels, and doors on page 153
REDI distribution PCA	CN598-67037	PCA locations (1 of 2) on page 163
REDI sensors	CN598-67038	Internal assemblies (1 of 3) on page 157
Right cover	CN598-67051	Covers, panels, and doors on page 153
Scanner assembly	CN460-67009	Scanner assembly on page 155
Sensor carriage PCA/encoder strip	CN598-67061	PCA locations (2 of 2) on page 165
Separation assembly	CN598-67018	Internal assemblies (3 of 3) on page 161
Separator/pick assembly kit	CN598-67018	Internal assemblies (3 of 3) on page 161
Service sled assembly	CN598-67021	Internal assemblies (1 of 3) on page 157
Shaft, printbar lift, clutched	CN598-67028	Internal assemblies (3 of 3) on page 161
Spurgear, idler gear train, 52t	Not supported	Internal assemblies (2 of 3) on page 159
Strap, left door	CN598-67002	Covers, panels, and doors on page 153
Strap, left door, rear	CN598-67003	Covers, panels, and doors on page 153
Temperature sensor	CN598-67024	PCA locations (2 of 2) on page 165
Top cover	CN460-67010	Covers, panels, and doors on page 153
Transfer 3 shaft	Not supported	Internal assemblies (2 of 3) on page 159
Tray 3 interconnect PCA	CN598-67059	PCA locations (2 of 2) on page 165
Tray lift transmission assembly	CN598-67020	Internal assemblies (3 of 3) on page 161

Table 2-14 Alphabetical parts list (continued)

Description	Part number	Table and page
Upper hanger assembly	Not supported	Internal assemblies (1 of 3) on page 157
Vertical star wheel wall	Not supported	Internal assemblies (1 of 3) on page 157
Web advance rack assembly	CN598-67021	Internal assemblies (1 of 3) on page 157
Wireless PCA	CN598-67055	PCA locations (2 of 2) on page 165
Z stop, printbar lift rod	CN598-67048	Internal assemblies (3 of 3) on page 161

Numerical parts list

Table 2-15 Numerical parts list

Part number	Description	Table and page
(Not supported)	Encoder disk	Internal assemblies (3 of 3) on page 161
(Not supported)	Feedshaft	Internal assemblies (3 of 3) on page 161
CN459-40410	Rack-eject lifter flap (part of output drive kit)	Internal assemblies (1 of 3) on page 157
CN459-60292	Eject drive gear module (part of output drive kit)	Internal assemblies (1 of 3) on page 157
CN459-60307	Flap actuator solenoid (part of output drive kit)	Internal assemblies (1 of 3) on page 157
CN460-67005	Control-panel assembly — non-wireless models	Covers, panels, and doors on page 153
CN460-67006	Main PCA (X476dn models)	PCA locations (2 of 2) on page 165
CN460-67007	Fax PCA	PCA locations (2 of 2) on page 165
CN460-67008	Control panel FFC	PCA locations (2 of 2) on page 165
CN460-67009	Scanner assembly	Scanner assembly on page 155
CN460-67010	Top cover	Covers, panels, and doors on page 153
CN461-67002	Main PCA (X476dw models)	PCA locations (2 of 2) on page 165
CN461-67003	Control-panel assembly — wireless models	Covers, panels, and doors on page 153
CN598-67001	Left door	Covers, panels, and doors on page 153
CN598-67002	Strap, left door	Covers, panels, and doors on page 153
CN598-67003	Strap, left door, rear	Covers, panels, and doors on page 153
CN598-67004	Duplex module	Internal assemblies (3 of 3) on page 161
CN598-67007	Output bin	Covers, panels, and doors on page 153
CN598-67008	Document feeder assembly	Scanner assembly on page 155

Table 2-15 Numerical parts list (continued)

Part number	Description	Table and page
CN598-67016	Power supply	Internal assemblies (1 of 3) on page 157
CN598-67017	Power supply—India and China only	Internal assemblies (1 of 3) on page 157
CN598-67018	Separator/pick assembly kit	Internal assemblies (3 of 3) on page 161
CN598-67018	Separation assembly	Internal assemblies (3 of 3) on page 161
CN598-67019	Power button assembly	Internal assemblies (3 of 3) on page 161
CN598-67019	Power button assembly	PCA locations (1 of 2) on page 163
CN598-67020	Tray lift transmission assembly	Internal assemblies (3 of 3) on page 161
CN598-67021	Web advance rack assembly	Internal assemblies (1 of 3) on page 157
CN598-67021	Service sled assembly	Internal assemblies (1 of 3) on page 157
CN598-67022	Output Drive Kit	Internal assemblies (1 of 3) on page 157
CN598-67023	Eject flap assembly	Covers, panels, and doors on page 153
CN598-67023	Eject flap assembly	Internal assemblies (1 of 3) on page 157
CN598-67023	Eject flap opto PCA	PCA locations (1 of 2) on page 163
CN598-67024	Temperature sensor	PCA locations (2 of 2) on page 165
CN598-67025	Platen NOTE: The platen kit contains a TOF REDI sensor and a print zone REDI sensor.	Internal assemblies (3 of 3) on page 161
CN598-67027	Printbar lift mechanism assembly	Internal assemblies (3 of 3) on page 161
CN598-67028	Shaft, printbar lift, clutched	Internal assemblies (3 of 3) on page 161
CN598-67029	Pick encoder distribution PCA	PCA locations (1 of 2) on page 163
CN598-67030	Feedshaft Encoder PCA	Internal assemblies (3 of 3) on page 161

Table 2-15 Numerical parts list (continued)

Part number	Description	Table and page
CN598-67030	Feedshaft encoder PCA	PCA locations (1 of 2) on page 163
CN598-67031	Gear, output idler gear, 83t/30t	Internal assemblies (2 of 3) on page 159
CN598-67031	Gear, idler gear train, 78t/48t	Internal assemblies (2 of 3) on page 159
CN598-67033	Print zone distribution PCA	PCA locations (1 of 2) on page 163
CN598-67034	Media presence sensor PCA/flag	Internal assemblies (1 of 3) on page 157
CN598-67034	Media presence flag/opto PCA kit	PCA locations (2 of 2) on page 165
CN598-67035	BDD sensor	Internal assemblies (1 of 3) on page 157
CN598-67036	Duplex drive module	Internal assemblies (1 of 3) on page 157
CN598-67037	REDI distribution PCA	PCA locations (1 of 2) on page 163
CN598-67038	REDI sensors	Internal assemblies (1 of 3) on page 157
CN598-67039	FFC, 11 pin printzone	Internal assemblies (1 of 3) on page 157
CN598-67040	FFC, 24 pin printbar lift	Internal assemblies (1 of 3) on page 157
CN598-67041	FFC, 10 pin pick drive enc	Internal assemblies (1 of 3) on page 157
CN598-67042	FFC, 12 pin REDI distribution	Internal assemblies (1 of 3) on page 157
CN598-67043	FFC, 5 pin sensor carriage BDD	Internal assemblies (1 of 3) on page 157
CN598-67044	FFC, 3xFFC, printbar bundle kit	Internal assemblies (1 of 3) on page 157
CN598-67045	Printbar	Internal assemblies (3 of 3) on page 161
CN598-67046	Aerosol fan assembly	Internal assemblies (1 of 3) on page 157
CN598-67047	Rear cover	Covers, panels, and doors on page 153
CN598-67048	Z stop, printbar lift rod	Internal assemblies (3 of 3) on page 161

Table 2-15 Numerical parts list (continued)

Part number	Description	Table and page
CN598-67049	Left rear cover	Covers, panels, and doors on page 153
CN598-67050	Left front cover	Covers, panels, and doors on page 153
CN598-67051	Right cover	Covers, panels, and doors on page 153
CN598-67052	Front cover	Covers, panels, and doors on page 153
CN598-67053	Hinge, ISS door	Covers, panels, and doors on page 153
CN598-67054	Main PCA (X576 models)	PCA locations (2 of 2) on page 165
CN598-67055	Wireless PCA	PCA locations (2 of 2) on page 165
CN598-67057	Duplex presence sensor PCA	Internal assemblies (3 of 3) on page 161
CN598-67057	Duplex presence sensor PCA	PCA locations (1 of 2) on page 163
CN598-67059	Tray 3 interconnect PCA	PCA locations (2 of 2) on page 165
CN598-67060	Drying path gear assembly	Internal assemblies (3 of 3) on page 161
CN598-67061	Sensor carriage PCA/encoder strip	PCA locations (2 of 2) on page 165
Not supported	Upper hanger assembly	Internal assemblies (1 of 3) on page 157
Not supported	Vertical star wheel wall	Internal assemblies (1 of 3) on page 157
Not supported	Floor eject assembly	Internal assemblies (1 of 3) on page 157
Not supported	Cross brace, right	Internal assemblies (1 of 3) on page 157
Not supported	Transfer 3 shaft	Internal assemblies (2 of 3) on page 159
Not supported	Output upper 4 shaft	Internal assemblies (2 of 3) on page 159
Not supported	Output eject 5 shaft	Internal assemblies (2 of 3) on page 159
Not supported	Output eject 6 shaft	Internal assemblies (2 of 3) on page 159

Table 2-15 Numerical parts list (continued)

Part number	Description	Table and page
Not supported	Output lower 2 shaft	Internal assemblies (2 of 3) on page 159
Not supported	Gear, shaft output lower	Internal assemblies (2 of 3) on page 159
Not supported	Spurgear, idler gear train, 52t	Internal assemblies (2 of 3) on page 159
Not supported	Platen output 1 shaft	Internal assemblies (2 of 3) on page 159
Not supported	Gear, shaft output platen 1	Internal assemblies (2 of 3) on page 159

Index

A

- accessories
 - ordering 144
- after-service checklist 5

B

- bin, output
 - locating 149

C

- cautions iii
- checklists
 - after-service 5
 - preservice 5
- conventions, document iii
- covers
 - front, removing 35
 - left door, removing 23
 - left front, removing 27
 - left rear, removing 26
 - locations 152
 - parts list 152
 - right, removing 36
 - top cap, removing 33
- covers, removing
 - rear 22

D

- diagrams 143
 - covers, panels, and doors 152
 - internal assemblies 156
- document conventions iii
- document feeder
 - locating 149
 - replacing 49
- door release, locating 149
- doors
 - parts list 152

E

- eject flap sensor PCA, removing 128
- electrostatic discharge (ESD) 2
- ESD (electrostatic discharge)
 - precaution during parts removal 2
- ethernet port
 - locating 150

F

- front cover, removing 35

I

- ink cartridges
 - door release, locating 149
- input tray
 - locating 149
- interface ports
 - locating 150
- internal assembly
 - locations 156
 - parts list 156

L

- left door, removing 23
- left front cover, removing 27
- left rear cover, removing 26

M

- main PCA, removing 132

N

- notes iii

O

- ordering
 - product documents 144
 - supplies and accessories 144

- output bin
 - locating 149

P

- panels
 - parts list 152
- parts 143
 - cover locations 152
 - door locations 152
 - internal assembly locations 156
 - panel locations 152
- pliers, required 3
- ports
 - locating 150
- post-service tests 6
- preservice checklist 5
- print quality
 - test 6

R

- rear cover, removing 22
- removing parts
 - cautions for 2
 - checklists 5
 - Eject flap opto PCA 128
 - front cover 35
 - left door 23
 - left front cover 27
 - left rear cover 26
 - main PCA 132
 - rear cover 22
 - right cover 36
 - tools, required 3
 - top cap 33
- replacing
 - document feeder 49
 - parts 2
 - scanner assembly 53

right cover, removing 36

S

scanner assembly

replacing 53

screwdrivers, required 3

screws

replacing 2

service

tools, required 3

static precautions 2

supplies

ordering 144

T

tests

post-service 6

print-quality 6

tips iii

tools, required 3

top cap, removing 33

trays

locating 149

U

USB port

locating 150

W

warnings iii



CN598-90007

