



HP Z440, Z640, and Z840 Workstation Series

Maintenance and Service Guide

Copyright Information

© Copyright 2014, 2015 HP Development Company, L.P.

Third Edition: September 2015

First Edition: October 2014

Part Number: 748721-003

Warranty

The information contained herein is subject to change without notice. The only warranties for HP products and services are set forth in the express warranty statements accompanying such products and services. Nothing herein should be construed as constituting an additional warranty. HP shall not be liable for technical or editorial errors or omissions contained herein.

Not all features are available in all editions of Windows. This workstation may require upgraded and/or separately purchased hardware, drivers, and/or software to take full advantage of Windows functionality. Go to <http://www.microsoft.com> for details.

Trademark Credits

Microsoft and Windows are U.S. registered trademarks of the Microsoft group of companies.

Intel, Intel Xeon, and Thunderbolt are trademarks of Intel Corporation in the U.S. and other countries.

Bluetooth is a trademark owned by its proprietor and used by HP under license.

ENERGY STAR is a registered trademark owned by the U.S. Environmental Protection Agency (EPA).

Red Hat is a registered trademark of Red Hat, Inc. in the United States and other countries.

NVIDIA and the NVIDIA logo are trademarks and/or registered trademarks of NVIDIA Corporation in the U.S. and other countries.

About this guide

This guide provides service and maintenance information, technical details and configuration guidance for the HP Z440, Z640, and Z840 Workstations.



IMPORTANT: Removal and replacement procedures are now available in videos on the HP website.

Go to the HP Customer Self-Repair Services Media Library at <http://www.hp.com/go/sml>.

Guide topics

[Hardware overview on page 1](#)

[System management on page 23](#)

[Component replacement information and guidelines on page 45](#)

[Diagnostics and troubleshooting on page 76](#)

[Configuring password security and resetting CMOS on page 98](#)

[Linux technical notes on page 102](#)

[Configuring RAID devices on page 105](#)

[System board designators on page 115](#)



NOTE: View the *HP Z440, Z640, and Z840 Workstation Series User Guide* at http://www.hp.com/support/workstation_manuals.

Table of contents

1 Hardware overview	1
HP Z440 Workstation components	1
HP Z440 Workstation front panel components	2
HP Z440 Workstation rear panel components	3
HP Z440 Workstation chassis components	4
HP Z440 Workstation system board components	5
HP Z440 Workstation system board architecture	6
HP Z440 Workstation specifications	6
HP Z640 Workstation components	8
HP Z640 Workstation front panel components	8
HP Z640 Workstation rear panel components	9
HP Z640 Workstation chassis components	10
HP Z640 Workstation system board components	11
HP Z640 Workstation system board architecture	12
HP Z640 Workstation system board riser architecture	13
HP Z640 Workstation specifications	13
HP Z840 Workstation components	15
HP Z840 Workstation front panel components	15
HP Z840 Workstation rear panel components	16
HP Z840 Workstation chassis components	17
HP Z840 Workstation system board components	18
HP Z840 Workstation system board architecture	19
HP Z840 Workstation specifications	20
Environmental specifications	21
Ensuring proper ventilation	22
2 System management	23
Power management features	23
ERP compliance mode	23
Hyper-Threading Technology (HTT)	24
SATA Power Management	24
Intel Turbo Boost Technology	24
BIOS ROM	24
Computer Setup (F10) Utility	25
Computer Setup (F10) Utility functions	25
Accessing Computer Setup (F10) Utility	26

Computer Setup (F10) Utility menu	27
Desktop management	32
Initial computer configuration and deployment	33
Installing a remote system	33
Copying a setup configuration to another computer	33
Updating and managing software	34
LANDesk Software	34
HP Driver Pack	34
HP SoftPaq Download Manager	34
HP System Software Manager	35
ROM Flash	35
Remote ROM Flash	35
HPQFlash	35
FailSafe Boot Block	35
Recovering the computer from Boot Block Recovery mode	36
Workstation security	36
Asset tracking	36
SATA hard drive security	37
DriveLock applications	37
Using DriveLock	38
Password security	39
Establishing a setup password using Computer Setup (F10) Utility	39
Establishing a power-on password using computer setup	39
Entering a power-on password	40
Entering a setup password	40
Changing a power-on or setup password	40
Deleting a power-on or setup password	41
National keyboard delimiter characters	42
Clearing passwords	42
Chassis security	42
Smart Cover Sensor	42
Cable lock (optional)	43
Fault notification and recovery	43
ECC fault prediction	43
Thermal sensors	43
Dual-state power button	43
Changing the power button configuration (Windows only)	44
3 Component replacement information and guidelines	45
Warnings and cautions	45
Service considerations	46

Tools and software requirements	46
Electrostatic discharge (ESD) information	46
Product recycling	48
Component replacement guidelines	48
Battery	48
Cable management	49
Processor and processor heatsink	50
Expansion slots	51
Card configuration restrictions for power supplies	51
Choosing an expansion card slot	51
HP Z440 Workstation slot identification and description	52
HP Z440 Workstation installation sequence recommendations	53
HP Z640 Workstation slot identification and description	54
HP Z640 Workstation installation sequence recommendations	55
HP Z840 Workstation slot identification and description	56
HP Z840 Workstation installation sequence recommendations	57
Hard drives and optical drives	59
Handling hard drives	59
Removal and replacement tips	59
Drive installation and cabling scenarios	59
HP Z440 Workstations — Intel AHCI SATA controller guidelines	60
HP Z440 Workstations — LSI 9217-4i4e RAID controller guidelines	61
HP Z640 Workstations — Intel AHCI SATA controller guidelines	62
HP Z640 Workstations — LSI 9217-4i4e RAID controller guidelines	63
HP Z840 Workstation cabling guidelines	64
Memory	65
Supported DIMM configurations	65
BIOS errors and warnings	65
DIMM installation guidelines	65
HP Z440 Workstation DIMM installation order	66
HP Z640 Workstation DIMM installation order	67
HP Z840 Workstation DIMM installation order	68
Power supply	69
Power supply specifications	69
HP Z440 power supply specifications	69
HP Z640 power supply specifications	70
HP Z840 power supply specifications	71
Power consumption and heat dissipation	72
Resetting the power supply	72
System board	72
System cabling	73

HP Z440 Workstation system cabling	73
HP Z640 Workstation system cabling	74
HP Z840 Workstation system cabling	75

4 Diagnostics and troubleshooting 76

Calling support	76
Locating ID labels	77
Locating warranty information	77
Diagnosis guidelines	78
Diagnosis at startup	78
Diagnosis during operation	78
Troubleshooting checklist	79
HP troubleshooting resources and tools	79
Online support	79
Troubleshooting a problem	79
Instant Support and Active Chat	80
Customer Advisories, Customer and Security Bulletins, and Customer Notices	80
Product Change Notifications	80
Helpful hints	80
At startup	80
During operation	81
Customer Self-Repair program	81
Troubleshooting scenarios and solutions	82
Solving minor problems	82
Solving hard drive problems	84
Solving display problems	85
Solving audio problems	87
Solving printer problems	88
Solving power supply problems	88
Testing power supply	88
Using HP PC Hardware Diagnostics (UEFI)	90
Downloading HP PC Hardware Diagnostics (UEFI) to a USB device	90
Diagnostic codes and errors	91
Diagnostic LED and audible (beep) codes	91
LED color definitions	93
POST error messages	94

5 Configuring password security and resetting CMOS 98

Preparing to configure passwords	98
Resetting the password jumper	99
Clearing and resetting the CMOS	100

Using the CMOS button to reset CMOS	100
Using Computer Setup (F10) Utility to reset CMOS	101
Appendix A Linux technical notes	102
System RAM	102
Audio	102
Network cards	103
Hyper-Threading Technology	103
NVIDIA Graphics Workstations	103
AMD Graphics Workstations	104
Appendix B Configuring RAID devices	105
RAID hard drive maximum and associated storage controller options	105
Supported RAID configurations	106
Configuring Intel SATA RAID	107
Configuring system BIOS	107
Configuring RAID with the Intel utility	108
Configuring RAID on an LSI 2308 or LSI 9217-4i4e controller	109
RAID 0 configuration	109
RAID 1 configuration	110
RAID 1E/10 configuration	111
Configuring RAID on an LSI 9270-8i MegaRAID controller	112
RAID 0	112
Software RAID solution	113
Software RAID considerations	113
Performance considerations	113
Configuring software RAID	114
Appendix C System board designators	115
HP Z440 and Z640 Workstation system board designators	115
HP Z840 Workstations	117
Appendix D Statement of Volatility	120
Z440 Workstation	120
Z640 Workstation	120
Z840 Workstation	121
Index	122

1 Hardware overview

This chapter presents an overview of workstation hardware components.

- [HP Z440 Workstation components](#)
- [HP Z640 Workstation components](#)
- [HP Z840 Workstation components](#)
- [Environmental specifications](#)
- [Ensuring proper ventilation](#)

HP Z440 Workstation components

For complete and current information on supported accessories and components for the computer, see <http://partsurfer.hp.com>.

- [HP Z440 Workstation front panel components](#)
- [HP Z440 Workstation rear panel components](#)
- [HP Z440 Workstation chassis components](#)
- [HP Z440 Workstation system board components](#)
- [HP Z440 Workstation system board architecture](#)
- [HP Z440 Workstation specifications](#)



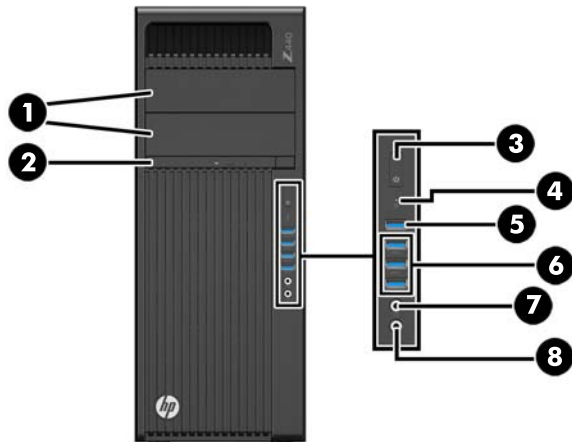



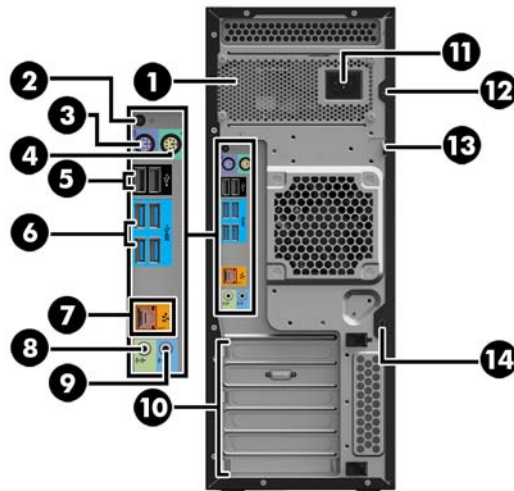

HP Z440 Workstation front panel components



1	External drive bays	5	 USB 3.0 charging port
2	Optical drive	6	 USB 3.0 ports (3)
3	 Power button and LED	7	 Audio-out (headphone)/Audio-in (microphone) combo jack
4	 Hard drive activity light	8	 Audio-in (microphone) jack

HP Z440 Workstation rear panel components



1		Power supply Built-In Self-Test (BIST) LED	8		Audio line-out jack (light green)
2		Rear power button and LED	9		Audio line-in jack (blue)
3		PS/2 keyboard connector (purple)	10		PCI/PCIe card slots
4		PS/2 mouse connector (green)	11		Power cord connector
5		USB 2.0 ports (2, black)	12		Universal chassis clamp opening
6		USB 3.0 ports (4, blue)	13		Padlock loop
7		AMT-enabled RJ-45 (network) jack (orange)	14		Security slot

HP Z440 Workstation chassis components

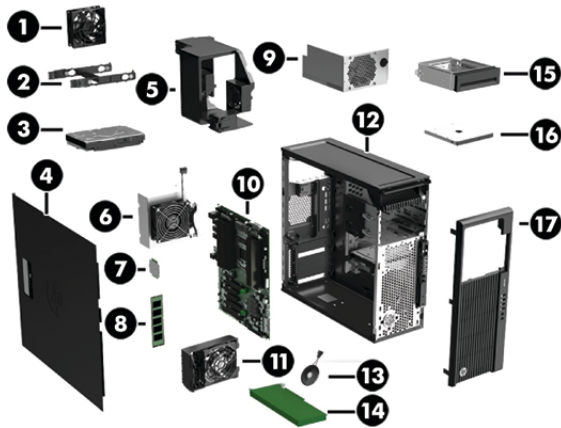

1	Fan	10	System board
2	Hard drive carrier	11	Rear system fan and holder
3	Hard drive, 3.5-inch	12	Chassis
4	Side access panel	13	Speaker
5	Memory fans	14	PCIe card
6	Heat sink	15	Front bay filler (optional)
7	Processor	16	Optical drive, slim
8	Memory module (DIMM)	17	Front bezel
9	Power supply		

HP Z440 Workstation system board components

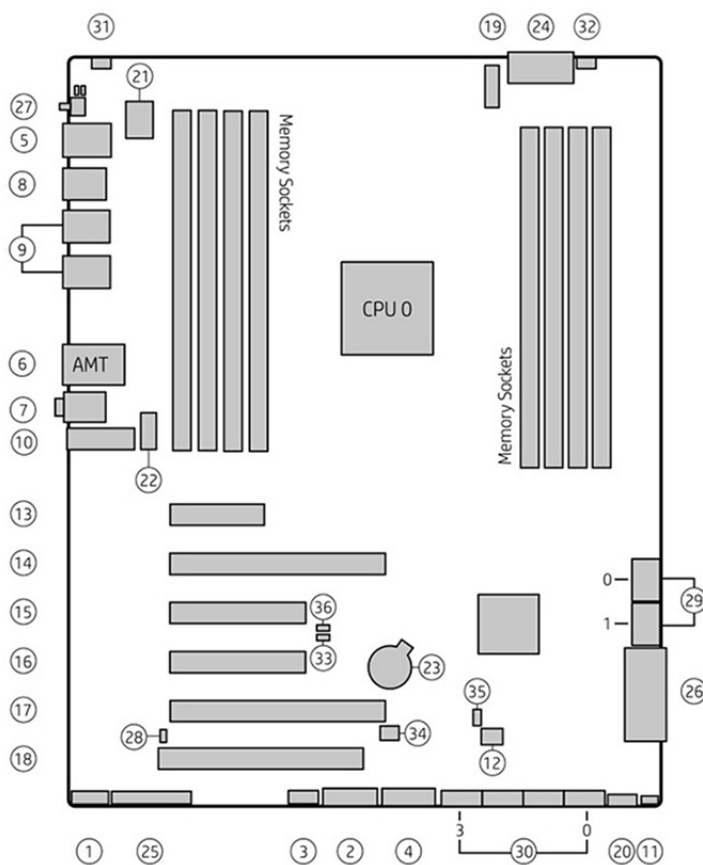

I/O		PCI/PCIe		Power		Security	
1	Front audio	13	PCIe2 x1	23	Battery	31	Chassis intrusion sensor
2	Front USB 3.0	14	PCIe3 x16	24	Processor and memory power	32	Chassis solenoid lock
3	Internal USB 2.0	15	PCIe2 x4	25	Front UI/power button/LED	Service	
4	Internal USB 3.0	16	PCIe3 x8	26	Main power	33	Boot Block Recovery (BBR) jumper
5	Keyboard/mouse	17	PCIe3 x16	27	Rear power button/LED	34	Clear CMOS button
6	Network	18	PCI 32/33	SATA (SAS Optional)		35	ME/AMT flash override
7	Rear audio	Cooling		28	Hard drive LED	36	Password jumper
8	Rear USB 2.0	19	CPU0 fan	29	SATA 6 Gb/s		
9	Rear USB 3.0	20	Front fan	30	sSATA 6 Gb/s		
10	Serial (optional)	21	Memory fans				
11	Speaker	22	Rear fan				
12	Thunderbolt™ GPIO						

NOTE: For related expansion card slot information, see [Expansion slots on page 51](#)

HP Z440 Workstation system board architecture

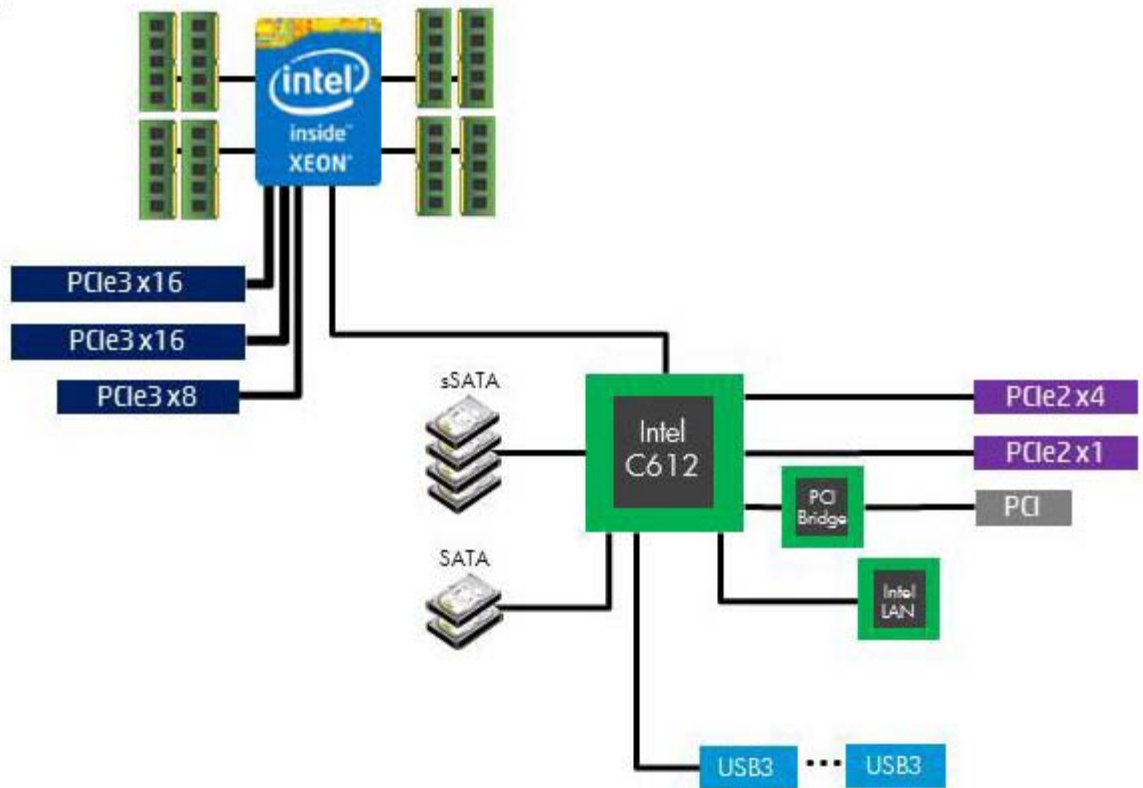

- Dark blue slots are attached to CPU0 and available with CPU0.
- Purple and gray slots are attached to PCH.
- White slots are attached to CPU1 and available when CPU1 is installed.



NOTE: The PCIe designators indicate the mechanical connector size and number of electrical PCIe lanes routed to an expansion slot. For example, x16(8) means that the expansion slot is mechanically an x16 length connector, with 8 PCIe lanes supported.

HP Z440 Workstation specifications

	Intel Series C612 chipset:
Processor technology	<ul style="list-style-type: none"> • Support for the Intel Xeon Processor E5-1600 Series and E5-2600 Series • Integrated 4-channel memory controller • Microarchitecture improvements • Large L3 cache for superior performance • Intel QuickPath Interconnect (QPI) connects processors and I/O controller with speeds up to 9.6 GT/s
Power supply	<ul style="list-style-type: none"> • 700 W Gold, 90% efficient, wide-ranging, active Power Factor Correction, two auxiliary dongles on two 12V rails, ERP 0.5W, Built-in-Self Test (BIST) • 525 W Bronze, 85% efficient, wide-ranging, active Power Factor Correction, ERP 0.5W, Built-in-Self Test (BIST)
Memory technology	<ul style="list-style-type: none"> • Dual in-line memory modules (DIMMs) based on DDR4 2133 MHz technology

	<ul style="list-style-type: none"> • Error checking and correcting (ECC)-protected • Four direct-attach memory channels enable low-latency access and fast data transfer for improved performance • Up to 128 GB system memory (16 GB DIMMs) • 2133 MHz 4, 8, 16 GB ECC Registered DIMMs <p>NOTE: Only ECC DIMMs are supported.</p> <p>NOTE: Distribute DIMMs across all memory channels for optimal performance.</p>								
Graphics cards	<p>Supports:</p> <ul style="list-style-type: none"> • PCIe Gen3 (PCIe3) bus speeds; can support two PCIe Gen3 graphics cards in PCIe3 x16 slots • Up to 225 W graphics or compute card in the primary graphics slot (700 W PSU) • Up to 75 W graphics in primary slot (525 W PSU) • A second graphics card in the second PCIe3 x16 slot • Third and fourth 2D graphics cards in additional PCIe2 slots • Combined power consumption of all cards not to exceed 335 W (subject to overall system power limitations and configuration restrictions) (700 W PSU) • Combined power consumption of all cards not to exceed 140 W (subject to overall system power limitations and configuration restrictions) (525 W PSU) 								
I/O technology	<ul style="list-style-type: none"> • SATA RAID 0/1/5/10 on sSATA • Six SATA/AHCI ports (2 SATA 6 Gb/s, 4 sSATA 6Gb/s) • Two ports capable of optional eSATA. eSATA capable with optional dual eSATA bulkhead kit. • Eight external USB 3.0 ports (4 front, 4 rear) • Two external USB 2.0 ports (2 rear) • Two internal USB 2.0 ports • One internal USB 3.0 port • Serial Attached SCSI (SAS) drives supported with 9217-4i4e plug-in card 								
Weight	<ul style="list-style-type: none"> • Standard configuration: 13.7 kg (30.2 lb) • Minimum configuration: 11.0 kg (24.3 lb) • Maximum configuration: 17.7 kg (39.4 lb) 								
Chassis dimensions	<table> <thead> <tr> <th>Tower configuration:</th> <th>Desktop configuration:</th> </tr> </thead> <tbody> <tr> <td>• Height: 43.18 cm (17.00 in)</td> <td>• Height: 16.89 cm (6.65 in)</td> </tr> <tr> <td>• Width: 16.89 cm (6.65 in)</td> <td>• Width: 43.18 cm (17.00 in)</td> </tr> <tr> <td>• Depth: 44.45 cm (17.50 in)</td> <td>• Depth: 44.45 cm (17.50 in)</td> </tr> </tbody> </table>	Tower configuration:	Desktop configuration:	• Height: 43.18 cm (17.00 in)	• Height: 16.89 cm (6.65 in)	• Width: 16.89 cm (6.65 in)	• Width: 43.18 cm (17.00 in)	• Depth: 44.45 cm (17.50 in)	• Depth: 44.45 cm (17.50 in)
Tower configuration:	Desktop configuration:								
• Height: 43.18 cm (17.00 in)	• Height: 16.89 cm (6.65 in)								
• Width: 16.89 cm (6.65 in)	• Width: 43.18 cm (17.00 in)								
• Depth: 44.45 cm (17.50 in)	• Depth: 44.45 cm (17.50 in)								

HP Z640 Workstation components

For complete and current information on supported accessories and components for the computer, see <http://partsurfer.hp.com>.

- [HP Z640 Workstation front panel components](#)
- [HP Z640 Workstation rear panel components](#)
- [HP Z640 Workstation chassis components](#)
- [HP Z640 Workstation system board components](#)
- [HP Z640 Workstation system board architecture](#)
- [HP Z640 Workstation system board riser architecture](#)
- [HP Z640 Workstation specifications](#)



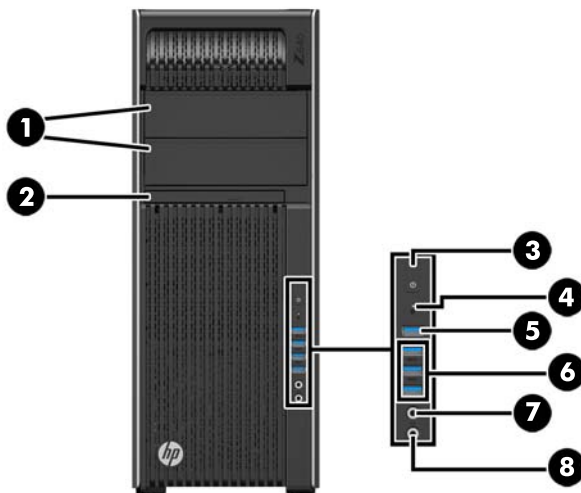



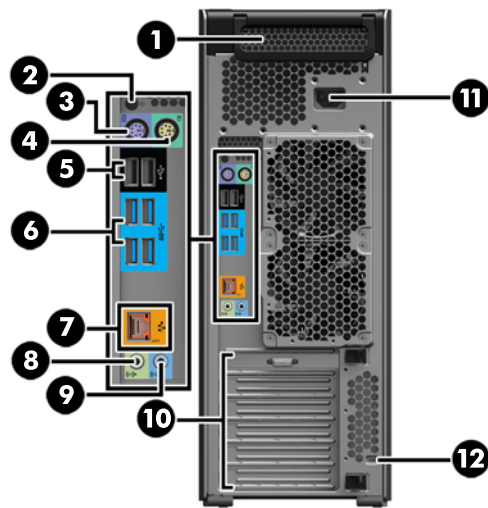

HP Z640 Workstation front panel components



1	External drive bays	5	 USB 3.0 charging port
2	Optical drive	6	 USB 3.0 ports (3)
3	 Power button and LED	7	 Audio-out (headphone)/Audio-in (microphone) combo jack
4	 Hard drive activity light	8	 Microphone jack

HP Z640 Workstation rear panel components



1		Power supply Built-In Self-Test (BIST) LED	7		AMT-enabled network jack (orange)
2		Rear power button and LED	8		Audio line-out jack (green)
3		PS/2 keyboard connector (purple)	9		Audio line-in jack (blue)
4		PS/2 mouse connector (light green)	10		PCI/PCIe card slots
5		USB 2.0 ports (2, black)	11		Power cord connector
6		USB 3.0 ports (4, blue)	12		Security slot

HP Z640 Workstation chassis components

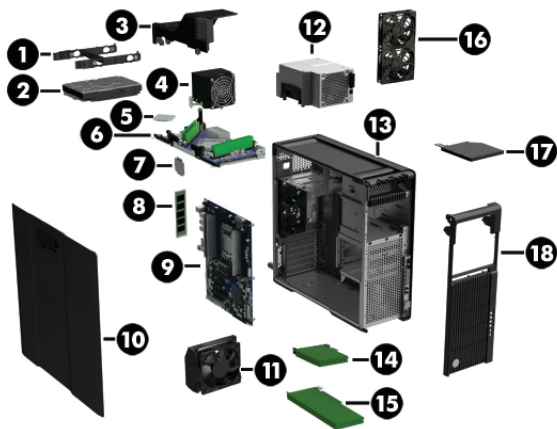

1	Hard drive carrier	10	Side access panel
2	Hard drive, 3.5-inch	11	Card guide and front fan
3	Fan baffle	12	Power supply
4	Processor Heatsink	13	Chassis
5	Processor	14	PCI card
6	Second processor module (optional)	15	PCIe card
7	Second processor (optional)	16	Rear system fan
8	Memory module (DIMM)	17	Optical drive, slim
9	System board	18	Front bezel

HP Z640 Workstation system board components

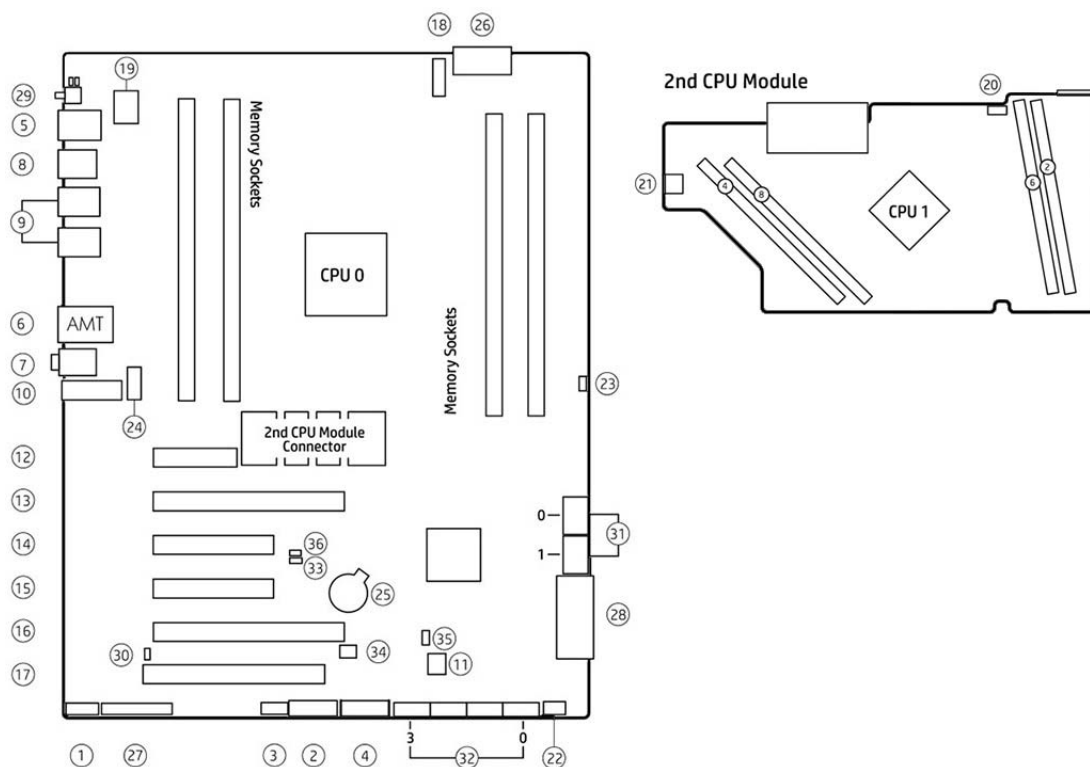

I/O		PCI/PCIe		Power	
1	Front audio	12	PCIe2 x1	25	Battery
2	Front USB 3.0	13	PCIe3 x16	26	Processor and memory power
3	Internal USB 2.0	14	PCIe2 x4	27	Front UI, power button, LED
4	Internal USB 3.0	15	PCIe3 x8	28	Main power
5	Keyboard/mouse	16	PCIe3 x16	29	Rear power button/LED
6	Network	17	PCI 32/33	SATA (SAS optional)	
7	Rear audio	Cooling		30	Hard drive LED
8	Rear USB 2.0	18	CPU0 fan	31	SATA 6 Gb/s
9	Rear USB 3.0	19	CPU0 memory fans	32	sSATA 6 Gb/s
10	Serial (option)	20	CPU1 fan (option)	Service	
11	Thunderbolt GPIO	21	CPU1 memory fan (option)	33	Boot Block Recovery (BBR) jumper
		22	Front fan	34	Clear CMOS button
		23	HDSJ	35	ME/AMT flash override
		24	Rear fans	36	Password jumper

For related expansion card slot information, see [Expansion slots on page 51](#)

HP Z640 Workstation system board architecture

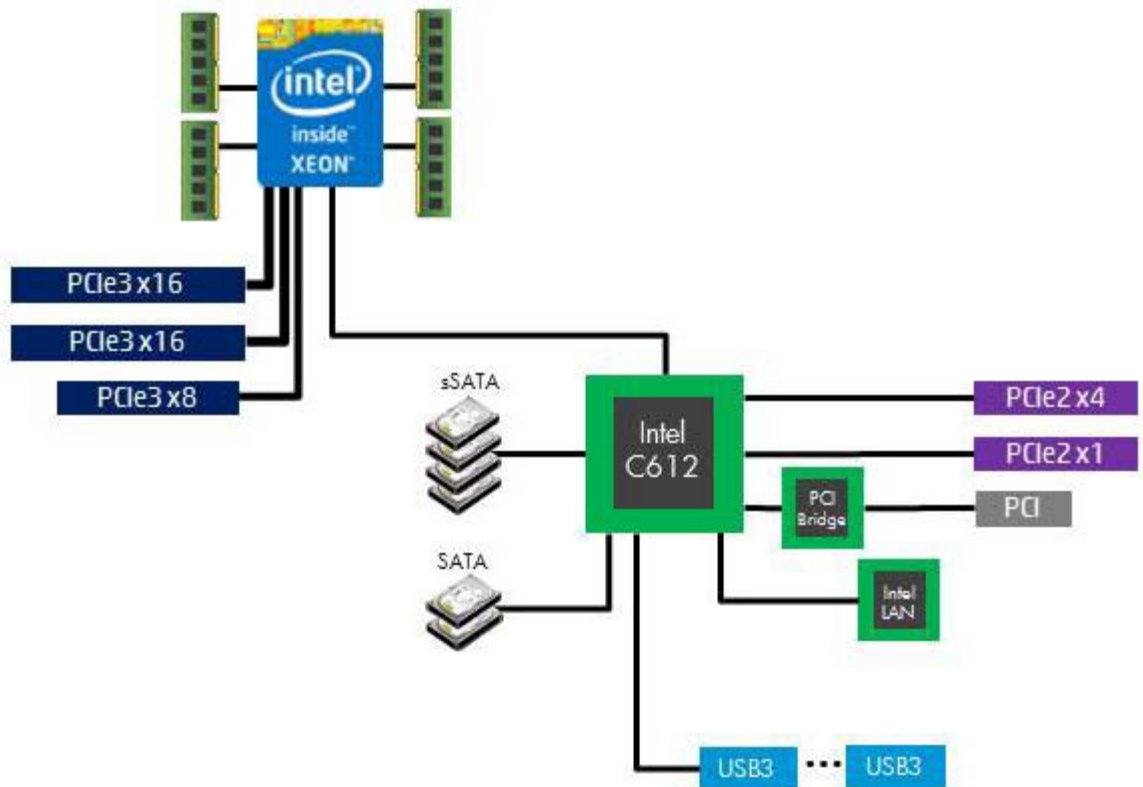

- Dark blue slots are attached to CPU0 and available with CPU0.
- Purple and gray slots are attached to PCH.
- White slots are attached to CPU1 and available when CPU1 is installed.

NOTE: The PCIe designators indicate the mechanical connector size and number of electrical PCIe lanes routed to an expansion slot. For example, x16 (8) means that the expansion slot is mechanically an x16 length connector, with 8 PCIe lanes supported.

HP Z640 Workstation system board riser architecture

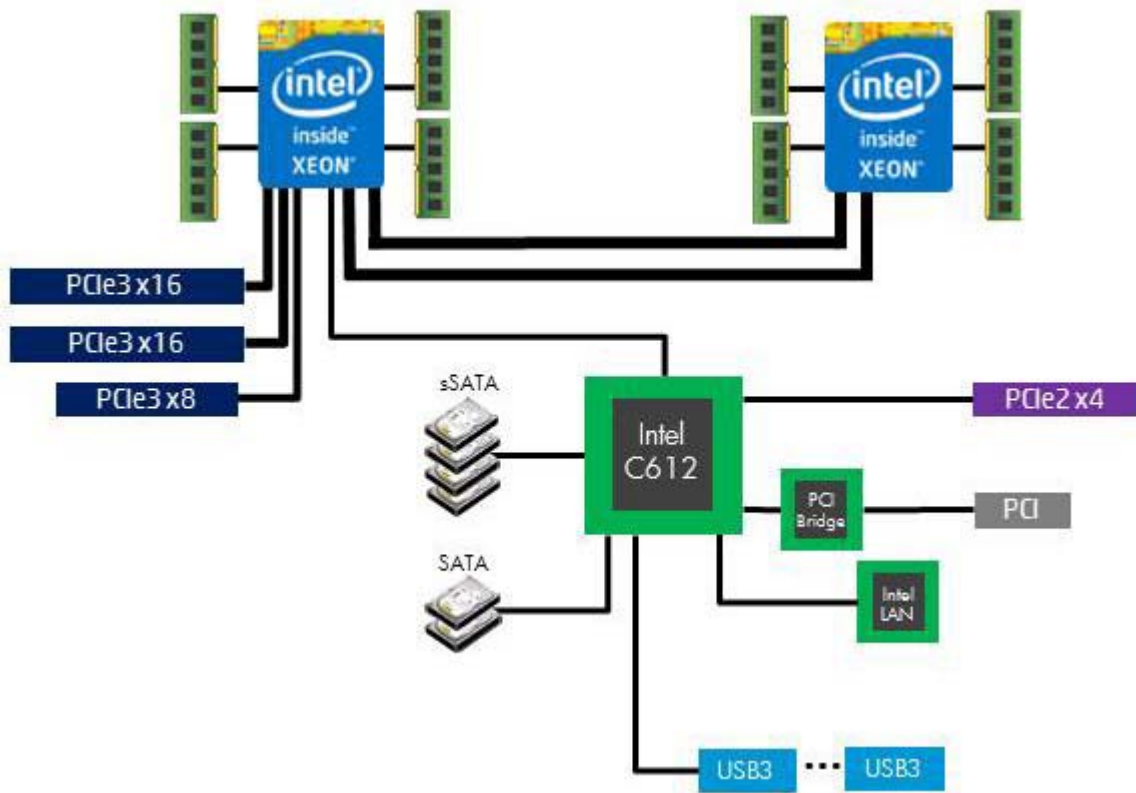

- Dark blue slots are attached to CPU0 and available with CPU0.
- Purple and gray slots are attached to PCH.
- White slots are attached to CPU1 and available when CPU1 is installed.

HP Z640 Workstation specifications

	Intel Series C612 chipset:
Processor technology	<ul style="list-style-type: none"> • Support for the Intel Xeon Processor E5-1600 Series and E5-2600 Series • Integrated 4-channel memory controller • Microarchitecture improvements • Large L3 cache for superior performance • Intel QuickPath Interconnect (QPI) connects processors and I/O controller with speeds up to 9.6 GT/s
Power supply	<ul style="list-style-type: none"> • 925 W Gold, 90% efficient, wide-ranging, active Power Factor Correction, two auxiliary dongles on two separate 12V rails, ERP 0.5W, Built-in-Self Test (BIST)
Memory technology	<ul style="list-style-type: none"> • Dual in-line memory modules (DIMMs) based on DDR4 2133 MHz technology • Error checking and correcting (ECC)-protected • Eight direct-attach memory channels (four per processor) enable low-latency access and fast data transfer for improved performance • Configurations with one processor have four DIMM slots; a second processor adds four more DIMM slots • With one processor, up to 128 GB system memory (32 GB DIMMs)

Memory	<ul style="list-style-type: none"> • With second processor, up to 256 GB system memory (32 GB DIMMs) • 2133 MHz 4, 8, 16 ECC Registered DIMMs • 2133 MHz 32 GB ECC Load Reducing DIMM <p>NOTE: Do not install memory modules into memory slots if corresponding processor is not installed.</p> <p>Only Registered and LR ECC DIMMs are supported.</p> <p>Do not mix any of the different types (RDIMM [Registered] and LR DIMM [Load Reduction]) of memory. The system will not boot and will produce a memory error.</p> <p>For maximum performance, on workstations with two processors, install the same number of DIMMs per processor and install them in pairs of the same size.</p> <p>Distribute DIMMs across all memory channels for optimal performance.</p> <p>Do not install memory modules into memory slots if corresponding processor is not installed.</p>
Graphics cards	<ul style="list-style-type: none"> • PCIe Gen3 (PCIe3) bus speeds; can support two PCIe Gen3 graphics cards in PCIe3 x16 slots • Up to 225 W graphics or compute card in the primary graphics slot • A second graphics card in the second PCIe3 x16 slot • Third and fourth 2D graphics cards in additional PCIe2 slots • Combined power consumption of all cards cannot exceed 375 W (subject to overall system power limitations and configuration restrictions)
I/O technology	<ul style="list-style-type: none"> • SATA RAID 0/1/5/10 on sSATA • Six SATA/AHCI ports (2 SATA 6 Gb/s, 4 sSATA 6Gb/s) • Two ports available for optional eSATA. eSATA capable with optional dual eSATA bulkhead kit. • Eight external USB 3.0 ports (4 front, 4 rear) • Two external USB 2.0 ports (2 rear) • Two internal USB 2.0 ports • One internal USB 3.0 port • Serial Attached SCSI (SAS) drives supported with 9217-4i4e plug-in card
Weight	<ul style="list-style-type: none"> • Standard configuration: 17.0 kg (37.5 lb) • Minimum configuration: 15.0 kg (33.1 lb) • Maximum configuration: 21.8 kg (48.1 lb)
Chassis dimensions	<ul style="list-style-type: none"> • Height: 44.45 cm (17.50 in) • Width: 17.15 cm (6.75 in) • Depth: 46.48 cm (18.30 in)



HP Z840 Workstation components

For information on supported accessories and components, see <http://partsurfer.hp.com>.

- [HP Z840 Workstation front panel components](#)
- [HP Z840 Workstation rear panel components](#)
- [HP Z840 Workstation chassis components](#)
- [HP Z840 Workstation system board components](#)
- [HP Z840 Workstation system board architecture](#)
- [HP Z840 Workstation specifications](#)

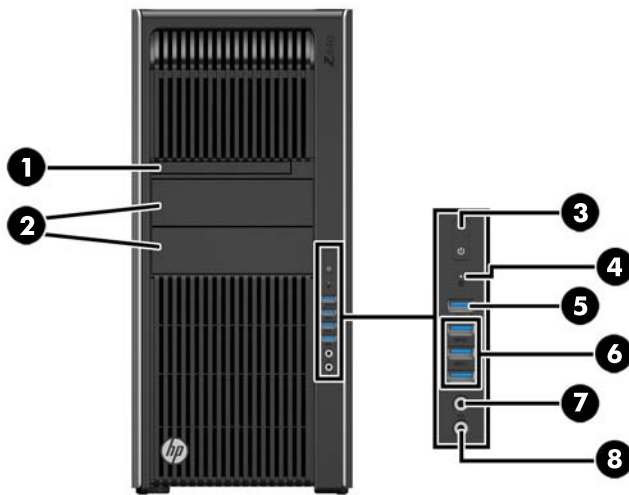





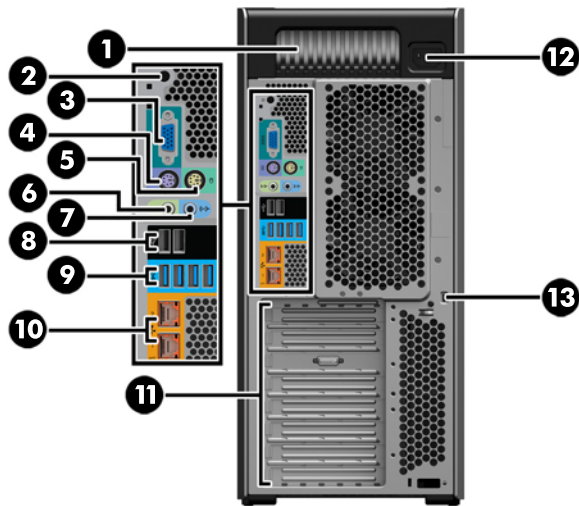

HP Z840 Workstation front panel components



1	Optical drive	5	 USB 3.0 charging port
2	External drive bays	6	 USB 3.0 ports (3)
3	 Power button	7	 Audio-out (headphone)/Audio-in (microphone) combo jack
4	 Hard drive activity light	8	 Microphone jack

HP Z840 Workstation rear panel components



1	Power supply Built-In Self-Test (BIST) LED	8	 USB 2.0 ports (2, black)
2	 Rear power button	9	 USB 3.0 ports (4, blue)
3	 Serial connector (teal blue)	10	 Network jacks (2, orange) <i>Bottom connector is AMT enabled</i>
4	 PS/2 keyboard connector (purple)	11	PCIe card slots
5	 PS/2 mouse connector (light green)	12	Power cord connector
6	 Audio line-out jack (green)	13	Security slot
7	 Audio line-in jack (blue)		

HP Z840 Workstation chassis components

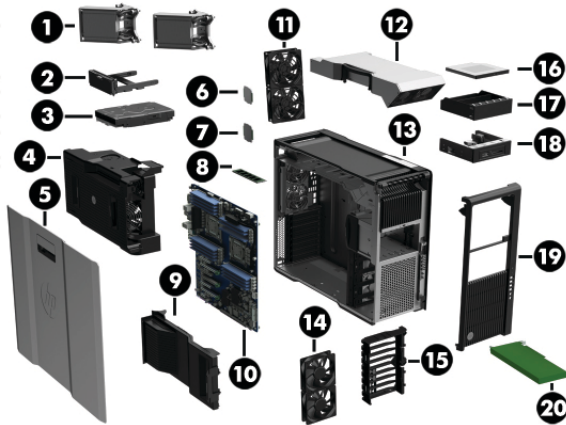

1	Processor heatsinks (primary and secondary)	11	Rear system fans
2	Hard drive carrier	12	Power supply
3	Hard drive	13	Chassis
4	Processor/memory fans	14	Front system fans (two fans with 1125 W power supply)
5	Side access panel	15	PCI card guide
6	Processor	16	Optical drive, slim
7	Second processor (optional)	17	Front bay filler
8	Memory module (DIMM)	18	Media card reader
9	PCI Retainer	19	Front bezel
10	System board	20	PCIe card

HP Z840 Workstation system board components

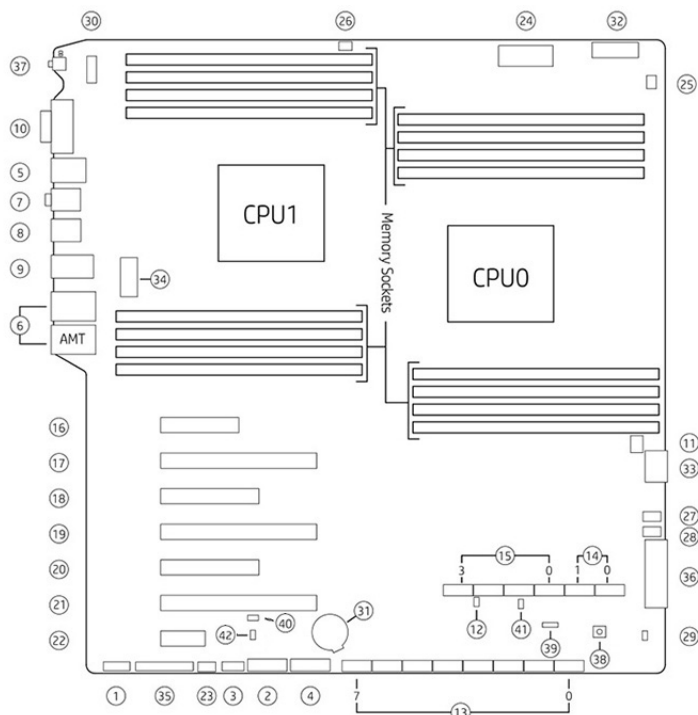

I/O		PCI/PCIe		Power	
1	Front audio	16	PCIe3 x4 – CPU0	31	Battery
2	Front USB 3.0	17	PCIe3 x16 – CPU0	32	PCU/memory power
3	Internal USB 2.0	18	PCIe3 x8 – CPU1	33	CPU0/memory power
4	Internal USB 3.0	19	PCIe3 x16 – CPU1	34	CPU1/memory power
5	Keyboard/mouse	20	PCIe2 x8 (4) PCH (single proc) PCIe3 x8 CPU1 (dual proc)	35	Front power button/LED/speaker
6	Network	21	PCIe3 x16 – CPU0	36	Main power
7	Rear audio	22	PCIe2 x1 – PCH	37	Rear power button/LED
8	Rear USB 2.0	Cooling		Service	
9	Rear USB 3.0	23	Auxiliary fan	38	Clear CMOS button
10	Serial	24	CPU/memory fans	39	Boot Block Recovery (BBR) jumper
11	Thunderbolt GPIO	25	CPU0 auxiliary cooler	40	ME/AMT Flash override
SAS/SATA		26	CPU1 auxiliary cooler	41	Password jumper
12	Hard drive LED	27	Front fan 1 (top)	42	Override Option for Slot 5
13	SAS/SATA 6Gb/s	28	Front fan 2 (bottom)		
14	SATA 6 Gb/s	29	Hard drive thermal jumper		
15	sSATA 6 Gb/s	30	Rear chassis fans		

NOTE: For related expansion card slot information, see [Expansion slots on page 51](#).

HP Z840 Workstation system board architecture

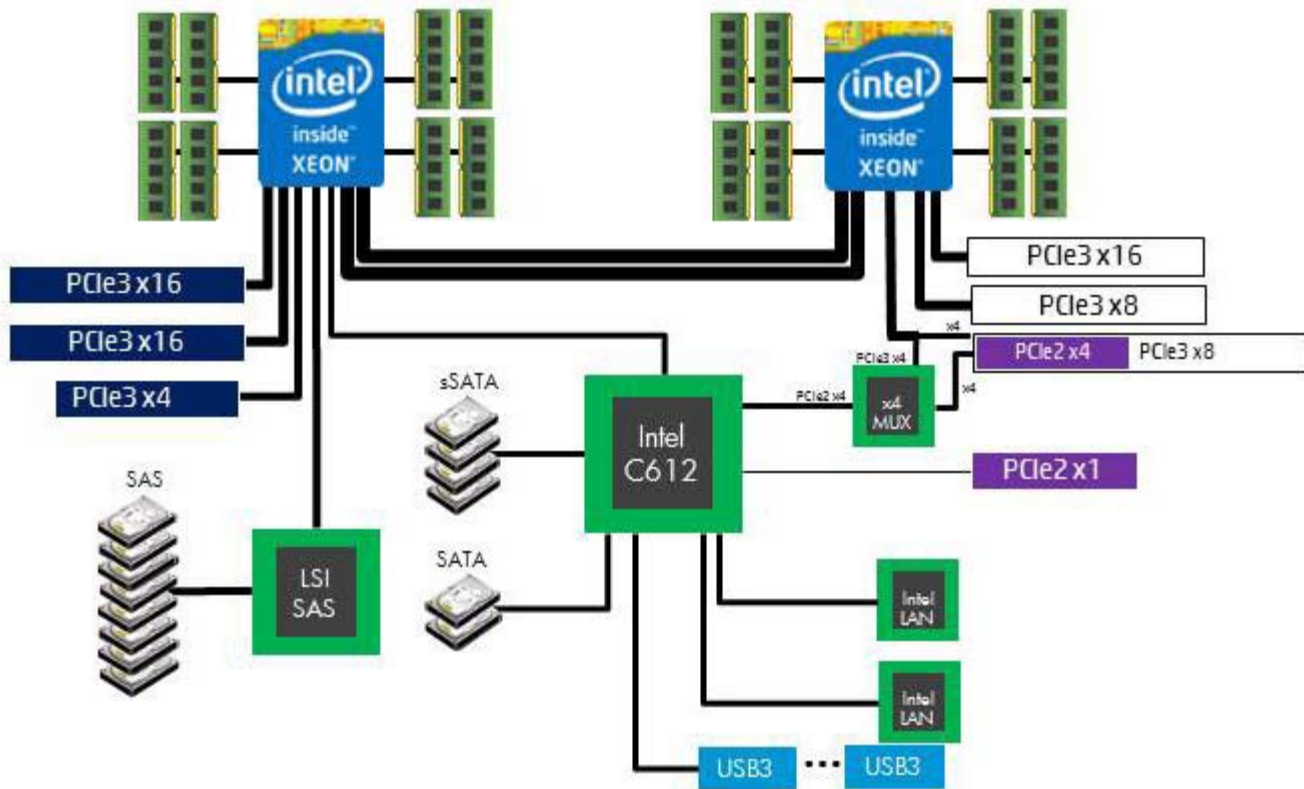

- Dark blue slots are attached to CPU0 and available with CPU0.
- Purple and gray slots are attached to PCH.
- White slots are attached to CPU1 and available when CPU1 is installed.
- Purple/white slots connect to PCH in UP config and connect to CPU1 in DP config.

NOTE: The PCIe designators indicate the mechanical connector size and number of electrical PCIe lanes routed to an expansion slot. For example, x16(8) means that the expansion slot is mechanically a x16 length connector, with 8 PCIe lanes supported.

HP Z840 Workstation specifications

Processor technology	<p>Intel Series C612 chipset:</p> <ul style="list-style-type: none">• Support for the Intel Xeon Processor E5-2600 Series, including processors up to 150 W• Integrated 4-channel memory controller• Microarchitecture improvements• Large L3 cache for superior performance• Intel QuickPath Interconnect (QPI) connects processors and I/O controller with speeds up to 9.6 GT/s
Power supply	<ul style="list-style-type: none">• 850 W Silver, 88% efficient, wide-ranging, active Power Factor Correction, single auxiliary dongle on a 12V rail, ERP 0.5W, Built-in-Self Test (BIST)• 1125 W Gold, 90% efficient, wide-ranging, active Power Factor Correction, three auxiliary dongles on three separate 12V rails, ERP 0.5W, Built-in-Self Test (BIST)• China's Energy Conservation Program (CECP) configurations• European Union ErP LOT6 2013 power limit of 0.5 W in off mode
Memory technology	<ul style="list-style-type: none">• Dual in-line memory modules (DIMMs) based on DDR4 2133MHz technology• Error checking and correcting (ECC)-protected• Eight direct-attach memory channels (four per processor) enable low-latency access and fast data transfer for improved performance• Configurations with one processor have eight DIMM slots; a second processor adds eight more DIMM slots• With one processor, up to 1 TB system memory (128 GB DIMMs)• With second processor, up to 2 TB system memory (128 GB DIMMs)• 2133 MHz 4, 8, 16 GB ECC Registered DIMM• 2133 MHz 32, 64, 128 GB ECC Load Reducing DIMM <p>NOTE: Do not install memory modules into memory slots if corresponding processor is not installed.</p> <p>Only Registered and LR ECC DIMMs are supported.</p> <p>Do not mix any of the different types RDIMM [Registered] and LR DIMM [Load Reduction]) of memory. The system will not boot and will produce a memory error.</p> <p>For maximum performance, on workstations with two processors, install the same number of DIMMs per processor and install them in pairs of the same size.</p> <p>Distribute DIMMs across all memory channels for optimal performance.</p> <p>Do not install memory modules into memory slots if corresponding processor is not installed.</p>
Graphics cards	<ul style="list-style-type: none">• PCIe Gen3 (PCIe3) bus speeds; can support three PCIe Gen3 graphics cards in PCIe3 x16 slots• Up to one 150 W or two 75 W graphics cards with 850 W power supply• Up to two 300 W or three 225 W graphics cards with optional 1125 W power supply (other configuration restrictions may be required)
I/O technology	<ul style="list-style-type: none">• SAS RAID 0/1/1E/10 on LSI SAS 2308 controller• SATA RAID 0/1/5/10 on sSATA• Six SATA/AHCI ports (2 SATA 6 Gb/s, 4 sSATA 6Gb/s)• Eight SAS ports (6 GB/s)• Two ports (6.0 GB/s) available for optional eSATA. eSATA capable with optional dual eSATA bulkhead kit.• Eight external and one internal USB 3.0 port

	<ul style="list-style-type: none"> • Two external and two internal USB 2.0 ports
Weight	<ul style="list-style-type: none"> • Standard configuration: 23.5 kg (51.8 lb) • Minimum configuration: 19.8 kg (43.7 lb) • Maximum configuration: 28.9 kg (63.7 lb)
Chassis dimensions	<ul style="list-style-type: none"> • Height: 44.4 cm (17.5 in) • Width: 20.3 cm (8.0 in) • Depth: 52.5 cm (20.7 in)

Environmental specifications

The following table lists the environmental specifications of HP Workstations.

Temperature	<p>Operating: 5 to 35°C (40 to 95°F)</p> <p>Non-operating: -40 to 60°C (-40 to 140°F)</p> <p>NOTE: Derate by one degree C (1.8 degrees F) for every 305 m (1,000 ft) altitude over 1,524 m (5,000 ft).</p>
Humidity	<p>Operating: 8 to 85% Relative Humidity (RH), non-condensing</p> <p>Non-operating: 8 to 90% Relative Humidity (RH), non-condensing</p>
Altitude	<p>Operating: 0 to 3,048 m (10,000 ft)</p> <p>Non-operating: 0 to 9,144 m (30,000 ft)</p>
Shock	<p>Operating: ½-sine: 40g, 2-3 ms (~62 cm/sec)</p> <p>Non-operating:</p> <ul style="list-style-type: none"> • ½-sine: 160 cm/s, 2-3 ms (~105 g) • square: 422 cm/s, 20 g <p>NOTE: Values represent individual shock events and do not indicate repetitive shock events.</p>
Vibration	<p>Operating Random: 0.5 g (rms), 5-300 Hz, up to 0.0025 g²/Hz</p> <p>Non-Operating: random: 2.0 g (rms), 10-500 Hz, up to 0.0150 g²/Hz</p> <p>NOTE: Values do not indicate continuous vibration.</p>

Ensuring proper ventilation

Proper ventilation for the system is important for workstation operation. Follow these guidelines:

- Operate the workstation on a sturdy, level surface.
- Provide at least 15.24 cm (6 inches) of clearance at the front and back of the workstation. (Workstation models vary.)

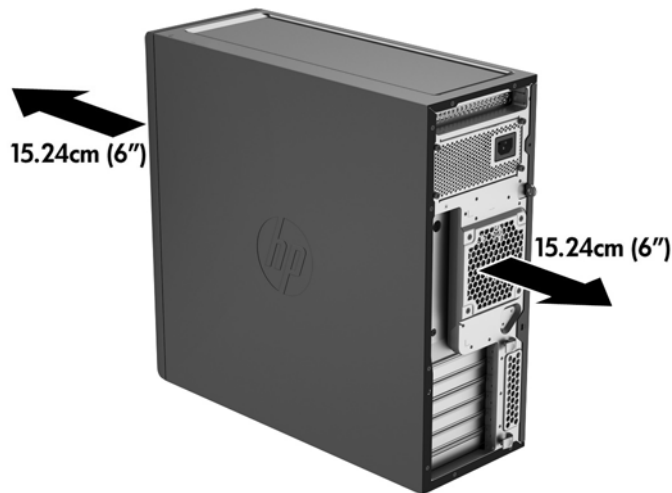

- Ensure that the ambient air temperature falls within the environmental specifications listed in this document.

 **NOTE:** The ambient upper limit of 35°C (95°F) is only good up to 1524 m (5000 ft) elevation. There is a 1°C (33.8°F) per 304.8 m (1000 ft) derating above 1524 m (5000 ft). So, at 3,048 m (10,000 ft), the upper ambient air temperature limit is 30°C (86°F).

- For cabinet installation, ensure adequate cabinet ventilation and ensure that the ambient temperature within the cabinet does not exceed specified limits.
- Never restrict the incoming or outgoing airflow of the workstation by blocking any vents or air intakes, as shown in the following figure.

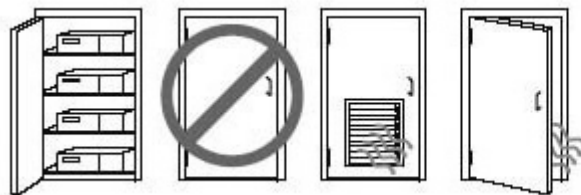

2 System management

This section describes the tools and utilities that provide system management for the workstation.

Topics

[Power management features on page 23](#)

[BIOS ROM on page 24](#)

[Computer Setup \(F10\) Utility on page 25](#)

[Desktop management on page 32](#)

Power management features

ERP compliance mode

This computer provides ERP compliance mode capability.

When this feature is enabled, the computer shuts down to the lowest possible power state. The computer must then be turned on with the power button. One of the effects is that "wake on LAN" is disabled.

When this feature is disabled, the computer shuts down conventionally.

Enabling ERP compliance mode	1.	Power on or restart the workstation and press F10 during startup to launch the Computer Setup (F10) utility.
	2.	Using the arrow keys, select Advanced , then select Power Options , and then S4/S5 Maximum Power Savings .
	3.	Select Enable , and then press Enter to accept the change.
	4.	Select Main , and then select Save Change and Exit . Press Enter to accept the change.
	5.	If using Windows 8 or Windows 8.1, boot to Windows and search in the Start Menu for the setting Change what the power buttons do . Uncheck Turn on fast startup (recommended) . If the checkbox is not available, select Change settings that are currently unavailable at the top of the window. If using Windows 10, use the taskbar search field to search for Power Options. Select Choose what the power button does , then select Turn on fast startup (recommended) .
Disabling ERP compliance mode	1.	Power on or restart the workstation and press F10 during startup to launch the Computer Setup (F10) utility.
	2.	Using the arrow keys, select Advanced , then select Power Options , and then S4/S5 Maximum Power Savings .
	3.	Select Disable , and then press Enter to accept the change.
	4.	Select Main , and then select Save Change and Exit . Press Enter to accept the change.
	5.	If using Windows 8 or Windows 8.1, boot to Windows and search in the Start Menu for the setting Change what the power buttons do . Check Turn on fast startup (recommended) . If the check box is not available, select Change settings that are currently unavailable at the top of the window. If using Windows 10, use the taskbar search field to search for Power Options. Select Choose what the power button does , then select Turn on fast startup (recommended) .

Hyper-Threading Technology (HTT)

This computer supports HTT, an Intel-proprietary technology that improves processor performance through parallelization of computations (doing multiple tasks at once).

The operating system treats an HTT-enabled processor as two virtual processors and shares the workload between them when possible. This feature requires that the operating system support multiple processors and be specifically optimized for HTT.

Use the Computer Setup (F10) Utility to enable HTT.

Go to <http://www.hp.com/go/quickspecs> to determine if your processor supports HTT.

SATA Power Management

SATA Power Management enables or disables SATA bus and/or device power management.

Intel Turbo Boost Technology

The HP Z Workstation series supports Intel® Turbo Boost Technology.

This feature enables the processor to run at frequencies above the normal frequency. When all processor cores are not necessary for the workload, inactive cores are turned off and power is diverted to the active cores to increase their performance.

Turbo Boost is enabled and disabled with the Computer Setup (F10) Utility.

Go to <http://www.hp.com/go/quickspecs> to determine if your processor supports Turbo Boost.

BIOS ROM

The BIOS ROM is a collection of machine language applications stored as firmware in ROM. It includes functions such as Power-On Self-Test (POST), PCI device initialization, Plug and Play support, power management, and Computer Setup (F10) Utility.

Go to <http://www.hp.com/go/quickspecs> to review the latest BIOS ROM specifications.

Computer Setup (F10) Utility

Topics

[Computer Setup \(F10\) Utility functions on page 25](#)

[Accessing Computer Setup \(F10\) Utility on page 26](#)

[Computer Setup \(F10\) Utility menu on page 27](#)

Computer Setup (F10) Utility functions

This section presents the Computer Setup (F10) Utility functions. In most cases, OS-specific information is described for a Windows-based computer, however much of this information applies to all operating systems. Occasional notes about non-Windows operating systems are included.

Computer Setup (F10) Utility enables you to perform the following tasks:

- Update BIOS using a USB device.
- Change factory default settings and set or change the workstation configuration, which might be necessary when you add or remove hardware.
- Determine whether all devices installed on the workstation are recognized by the system and are functioning.
- Determine information about the operating environment of the workstation.
- Solve system configuration errors that are detected but not resolved during the Power-On Self-Test (POST).
- Establish and manage passwords and other security features.
- Establish and manage energy-saving time-outs.
- Set the workstation date and time, and modify or restore factory default settings.
- Set, view, change, or verify the workstation configuration, including settings for processor, graphics, memory, audio, storage, communications, and input devices.
- Modify the boot order of installed mass storage devices such as SATA drives, optical drives, and network drives.
- Enable or disable Network Server Mode. This mode enables the workstation to start the operating system when the power-on password is enabled, with or without a keyboard or mouse attached. When the keyboard and mouse are attached to the workstation, they remain locked until the power-on password is entered.
- Select Post Messages Enabled or Disabled to change the display status of Power-On Self-Test (POST) messages. Post Messages Disabled suppresses most POST messages, such as memory count, product name, and other non-error text messages. If a POST error occurs, the error is displayed regardless of the mode selected. To manually switch to Post Messages Enabled during POST, press any key (except **F1** through **F12**).
- Specify an Ownership Tag, which is displayed on the screen when the workstation is started or restarted.
- Specify the Asset Tag or property identification number assigned to this workstation.
- Enable power-on password prompts during system restarts (warm-starts) and when the computer is started.

- Hide or show the integrated I/O functionality, including serial, USB, or parallel ports, audio, or embedded NIC. Hidden devices are inaccessible, which increases system security.
- Enable or disable removable media boot ability.
- Enable or disable removable media write ability (if supported by hardware).
- Replicate the workstation setup by saving system configuration information to removable storage or restoring it.

Accessing Computer Setup (F10) Utility

Accessing Computer Setup (F10) Utility requires a keyboard. To access Computer Setup (F10) Utility:

1. Turn on or restart the workstation.
2. When the display is active and **Press the Esc key for Startup Menu** appears at the bottom of the screen, press **F10** or **Esc**.

If you do not press **F10** or **Esc** at the appropriate time, try again. Turn the workstation off, then on, and press **F10** again to access the utility. You can also press **Ctrl+Alt+Del** before starting if you do not press **F10** before the message disappears.

3. Select a language from the list, and press the **Enter** key.

In the Computer Setup (F10) Utility menu, the following headings are displayed: Main, Security, Advanced, and UEFI Drivers.



NOTE: The option for selecting the language is available on first boot only. To reset the selection, press **Esc** during POST and from the Startup menu, select **Change Language** to switch between languages.

4. Use the left and right arrow keys to select the appropriate heading, use the up and down arrow keys to select an option, and then press **Enter**.
5. Choose from the following:
 - To apply and save changes, select **Main** and then select **Save Changes and Exit**. Press **Enter** to accept the changes.
 - To remove changes you have made, select **Ignore Changes and Exit**, and then press **Enter** to acknowledge the cancellation.
 - To restore factory settings, select **Main**, and then select **Apply Defaults and Exit**.

CAUTION: Do not turn off the workstation while saving Computer Setup (F10) Utility changes, because the Complementary Metal-Oxide Semiconductor (CMOS) nonvolatile storage could become corrupted. Turn off after you exit the F10 Setup screen.

Computer Setup (F10) Utility menu

The following table describes the functions available in the Computer Setup (F10) Utility menu.



NOTE: With new BIOS releases, the following content is subject to change, so the menu might be different than shown.

Heading	Option	Description
Main	System Information	Displays the following information: <ul style="list-style-type: none">• Product Name• Manufacturer• SKU Number• Processor Type• Processor Speed• Processor Stepping• Memory Size<ul style="list-style-type: none">◦ Channel A◦ Channel B• Integrated MAC• Chassis serial number• Asset Tracking Number• System Board ID• BIOS Version & Date• ME Firmware Version
	Update System BIOS	Enables you to upgrade the BIOS from a ROM image on a CD, USB flash drive, or hard drive or network.
	Set Machine Unique Data	Provides these options: <ul style="list-style-type: none">• Enter Asset Tag—A 16-byte string identifying the workstation.• Enter Ownership Tag—An 80-byte string identifying ownership of the workstation. This tag appears on the screen during POST.• Enter UUID (Universal Unique Identifier)—Can only be updated if the current chassis serial number is invalid. (These ID numbers are normally set in the factory and are used to uniquely identify the workstation.)• Keyboard Layout—Enables you to set the keyboard locale for System ID entry.
	Replicated Setup	Provides these options: <ul style="list-style-type: none">• Save to Removable Storage Device—Saves the workstation configuration, including CMOS, in the cpqsetup.txt file. This file can be saved to a USB removable storage device.• Restore from Removable Storage Device—Restores the workstation configuration from a USB removable storage device.
	Save Custom Defaults	Saves the current settings as default settings for the next operation.
	Apply Factory Defaults and Exit	Restores the factory settings as the default settings for the next operation.

Heading	Option	Description
	Apply Custom Defaults and Exit	Restores the default settings defined in Default Setup.
	Ignore Changes and Exit	Exits workstation setup without applying or saving changes.
	Save Changes and Exit	Saves changes to system configuration and exits the workstation setup.
Security	Set up BIOS Administrator Password	Enables you to set and enable a setup password for the administrator. If you create a setup password, you must use it to change workstation setup options, to flash the ROM, and to make changes to certain Plug and Play settings under Windows.
	Set up BIOS Power-On Password	Enables you to set and enable the power-on password.
	Change BIOS Power-On Password	Allows you to change an existing BIOS Power-On Password.
	DriveLock Security	Lets you assign or modify a master password or user password for hard drives. When enabled, this feature prompts the user to provide one of the DriveLock passwords during POST. If the user does not successfully enter one of the passwords, the hard drive remains inaccessible until one of the passwords is successfully entered during a subsequent cold-boot sequence. NOTE: This selection appears only when the system includes at least one drive that supports the DriveLock feature.
	Password Policy	Allows you to control the characteristics of a valid password.
	TPM Embedded Security	Allows you to control TPM once a BIOS Administrator password is set. <ul style="list-style-type: none"> • TPM Device - Makes the TPM device hidden or available. • TPM State - Makes the TPM device disabled or enabled. • TPM Clear - Lets you clear the TPM device. • Embedded Security Device—This option becomes available if Embedded Device is set to Available under Device Security. <p>NOTE: Embedded Security Device must be set to Device Available in the Device Security menu, and you must create a Setup Password, in order to configure the Embedded Security Device.</p> <p>Embedded Security Device—(Hidden or Available) turns the Trusted Platform Mechanism (TPM) on and off. Device Hidden is the default. If this option is made available, the following options become available:</p> <ul style="list-style-type: none"> ◦ Reset to factory settings ◦ Measure boot variables/devices to PCR1 <p>For more information on TPM go to http://technet.microsoft.com/en-us/library/cc749022(v=ws.10).aspx.</p> <p>To enable the Embedded Security Device and to access any security features associated with the device, you must enter a setup password.</p> <p>Setting a device to Available enables the operating system to access the device. Hidden makes the device unavailable. It is disabled by the BIOS and cannot be enabled by the operating system.</p> <p>CAUTION: Choosing Reset to Factory Settings may result in significant data loss. The embedded security device is a critical component of many security schemes. Erasing the security keys prevents access to data protected by the Embedded Security Device.</p>

Heading	Option	Description
	USB Device Control	<p>Set workstation USB ports to Enabled/Disabled:</p> <ul style="list-style-type: none"> • Front USB Ports • Rear USB Ports <ul style="list-style-type: none"> ◦ USB Port 1 ◦ USB Port 2 ◦ USB Port 3 ◦ USB Port 4 ◦ USB Port 5 ◦ USB Port 6 • Internal USB Ports <ul style="list-style-type: none"> ◦ USB Port 1 ◦ USB Port 2 ◦ USB Port 3
	Slot Settings	Lets you enable or disable any PCIe slot.
	System Security	<p>Provides these options:</p> <ul style="list-style-type: none"> • Virtualization Technology (VTx)—Enables or disables Intel Virtualization Technology to increase workstation performance. (Only visible on supported processors) • Virtualization Technology Directed I/O (VTd)—(Enabled or Disabled) Controls the underlying processor and chipset features needed to support a virtual appliance. • Trusted Execution Technology—(Disabled/Enabled) Turns Intel TXT feature on or off. • OS Management of Embedded Security Device—Enables or disables the ability of the operating system to control the TPM device, including turning it on and off, initializing it, and resetting it. <ul style="list-style-type: none"> ◦ Reset of Embedded Security Device through OS—Enables or disables the ability of the operating system to reset the TPM. Available only when OS Management of Embedded Security Device is enabled. ◦ No PPI provisioning ◦ Allow PPI policy to be changed by OS
Advanced	Boot Options	<p>Enables you to configure the boot order by physically reordering the menu entries. The following is the default boot order presented in the menu:</p> <ul style="list-style-type: none"> • UEFI Boot Sources <ul style="list-style-type: none"> ◦ OS-specific Boot Manager ◦ ATAPI CD/DVD Drive ◦ USB Floppy/CD ◦ USB Hard Drive ◦ Hard Drive (may only appear if the device has an EFI boot file on it) • Legacy Boot Sources <ul style="list-style-type: none"> ◦ ATAPI CD/DVD Drive ◦ USB Floppy/CD

Heading	Option	Description
		<ul style="list-style-type: none"> ◦ Hard Drive <ul style="list-style-type: none"> — USB Hard Drive — <i>Hard Drive Name</i> ◦ Network Controller (This option is available only if the workstation is connected to a network.) <p>Use the arrow keys to move the cursor to a listed device, and then perform one of the following actions:</p> <ul style="list-style-type: none"> • Press Enter to select or deselect the device. • Use the arrow keys to move a selected device up or down in the boot order. Press F10 to accept the new boot order. • For a selected device, press F5 to enable or disable it as a bootable device. <p>MS-DOS drive lettering assignments might not apply after an operating system other than MS-DOS has started.</p> <p>Boot devices can be disabled in the boot order process. These order changes are stored in the physical ROM when the F10 Setup changes are confirmed. Select Main, select Save Changes, and then select Exit.</p> <p>You can temporarily override the boot order. To start one time from a device other than the default device specified in Boot Order, restart the workstation and press F9 when the F9=Boot Menu message appears on the screen. After POST completes, a list of bootable devices is displayed. Use the arrow keys to select the preferred bootable device, and then press Enter. The workstation then starts from the selected non-default device for this one time.</p>
	Device Configurations	<p>Lists installed storage devices and provides options for obtaining specific information about each device:</p> <p>To see additional information about a device, use the Up and Down arrow keys to see a device and press Enter to show additional details about the device if available.</p> <p>Hard Disk</p> <ul style="list-style-type: none"> • SATA0 <DRIVE CAPACITY>, <DRIVE MFG and/or MODEL> (If installed) • SATA1 <DRIVE CAPACITY>, <DRIVE MFG and/or MODEL> (If installed) • SATA5 <DRIVE CAPACITY>, <mSATA DRIVE MFG and/or MODEL> (If mSATA installed in SLOT2) <p>CD-ROM</p> <ul style="list-style-type: none"> • SATA2 <MFG MODEL> (If installed)
	Secure Boot Configuration	<ul style="list-style-type: none"> • Legacy Support—(Enable/Disable) • Secure Boot—(Enable/Disable) • Key Management <ul style="list-style-type: none"> ◦ Clear Secure Boot Keys—(Clear/Don't Clear) ◦ Key Ownership—(HP Keys/Custom Keys) • Fast Boot—(Enable/Disable) <p>For more information on secure boot management go to http://h10025.www1.hp.com/ewfrf/wc/document?docname=c03653226&cc=us&dlc=en&lc=en.</p>
	Power Options	<p>Enables you to set the following:</p> <ul style="list-style-type: none"> • Operating System Power Options

Heading	Option	Description
		<ul style="list-style-type: none"> ◦ Runtime Power Management—(Enable or Disable) ◦ Idle Power Savings—Extended (default) or Normal; extended mode reduces processor power consumption when the processor is idle. ◦ Unique Blink States—(Enable or Disable) • Thermal Options—Lets you set the rate of the system fan when the processor is in idle. • Hardware Power Options <ul style="list-style-type: none"> ◦ After Power Loss (On, Off, Previous State)—“On” means the system will power on again after power is restored. “Off” means it will remain shut down after power is restored. “Previous State” directs the previous state to be the default after power is restored. ◦ S4/S5 Max Power Savings (Disables/Enabled)
	Management Operations	<p>Lets you set the following AMT (Intel Active Management Technology) configuration options:</p> <ul style="list-style-type: none"> • AMT—(Enabled/Disabled) Allows for remote discovery, repair and protection of networked workstations. Enabling the AMT function also enables the Network Controller (required for AMT to function correctly). • Unconfigure AMT/ME—(Disabled/Enabled) Restores AMT/ME defaults. When you save and exit after enabling this option, you will be prompted to complete the process upon restart. A Setup Password (even if one is set) does not need to be entered to complete the process. <p>NOTE: Information about Intel AMT can be found at www.intel.com.</p> <ul style="list-style-type: none"> • Hide Un-Configure ME Confirmation Prompt—(Disabled/Enabled) • WatchDog Timer—(Enabled/Disabled) OS and BIOS WatchDog Timers can be set independently (in minutes): <ul style="list-style-type: none"> ◦ OS WatchDog Timer—Sets the OS WatchDog Timer ◦ BIOS WatchDog Timer—Sets the BIOS WatchDog Timer
	Option ROM Launch Policy	<ul style="list-style-type: none"> • PXE Option ROMS—(Legacy, UEFI Only, Do Not Launch) • Storage Option ROMS—(Legacy, UEFI Only, Do Not Launch) • Video Option ROMS—(Legacy, UEFI Only)
	Network BIOS Update	<ul style="list-style-type: none"> • Configurations • Check for Updates Now
	Update BIOS via Network	<ul style="list-style-type: none"> • Update BIOS via Network—(Enable/Disable) • Update Source—(HP, Custom) • Update Address (Only appears if Custom is selected in Update Source) • Automatic BIOS Update Setting—(Enable/Disable) <p>For more information about Update BIOS via Network, go to http://h20565.www2.hp.com/portal/site/hpsc/template.PAGE/action.process/public/psi/mostViewedDisplay/?sp4ts.oid=5403903&javax.portlet.action=true&spf_p.tpst=psiContentDisplay&javax.portlet.begCacheTok=com.vignette.cachetoken&spf_p.prp_psiContentDisplay=wsrp-interactionState%3DdocId%253Demr_na-c04119260%257CdocLocale%253Den_US&javax.portlet.endCacheTok=com.vignette.cachetoken.</p>

Desktop management

This section summarizes capabilities, features, and key components of computer management.

Topics

[Initial computer configuration and deployment on page 33](#)

[Installing a remote system on page 33](#)

[Copying a setup configuration to another computer on page 33](#)

[Updating and managing software on page 34](#)

[LANDesk Software on page 34](#)

[HP Driver Pack on page 34](#)

[HP SoftPaq Download Manager on page 34](#)

[HP System Software Manager on page 35](#)

[ROM Flash on page 35](#)

[FailSafe Boot Block on page 35](#)

[Workstation security on page 36](#)

[Fault notification and recovery on page 43](#)

[Dual-state power button on page 43](#)



NOTE: Support for specific features described in this guide can vary by model and software version.

Initial computer configuration and deployment

The computer includes a preinstalled system software image. After a brief software unbundling process, the computer is ready to use.

If you prefer to replace the preinstalled software image with a customized set of system and application software, you can deploy a customized software image using either of the following methods:

- Installing additional software applications after unbundling the preinstalled software image
- Using a disk-cloning process to copy the contents from one hard drive to another

The ROM-based setup and Advanced Configuration and Power Interface (ACPI) hardware provide further assistance with recovery of system software, configuration management and troubleshooting, and power management.

Support for specific features described in this guide can vary by model and software version.

The best deployment method depends on the information technology environment and processes.

Installing a remote system

When the computer has been configured as a remote system, you can start it and set it up by using software and configuration information on a network server. This feature is usually used for system setup and configuration and can be used to perform the following functions:

- Deploy a software image on new PCs
- Format a hard drive
- Install application software or drivers
- Update the operating system, application software, or drivers

To initiate a remote system installation, press **F12** when **F12=Network Service Boot** appears in the lower right corner of the HP logo screen. Follow the onscreen instructions to continue the installation process. The default boot order can be changed in the BIOS so that the system always attempts to boot from the network.

Copying a setup configuration to another computer

This section provides information about replicating the computer setup.

 **CAUTION:** Setup configuration is model specific. File system corruption can result if source and target computers are not the same model.

To copy a setup configuration:

1. Select a computer to use as the source of the setup configuration.
2. Connect a removable storage device to the computer, and then restart the computer.
3. As soon as the computer turns on, press and hold **F10** until you enter Computer Setup (F10) Utility. If necessary, press **Enter** to bypass the title screen.

 **NOTE:** If you do not press **F10** at the appropriate time, you must restart the computer, and then press and hold **F10** to access the utility.

4. Select **Main**, select **Replicated Setup**, and then select **Back up current settings to USB device**. Follow the instructions on the screen to create the configuration file `cpqsetup.txt` and write it to a USB storage device.

5. Turn off the computer you want to configure (the target computer), and connect the removable storage device that contains the configuration.
6. Turn on the target computer.
7. Press and hold the **F10** key until you enter Computer Setup (F10) Utility. If necessary, press **Enter** to bypass the title screen.
8. Select **Main**, select **Replicated Setup**, and then select **Restore current settings from USB Device**. Follow the instructions on the screen.
9. Restart the computer when the configuration is complete.

Updating and managing software

HP provides several tools for managing and updating software on desktops and computers:

- LANDesk Software
- HP Driver Pack
- HP SoftPaq Download Manager
- System Software Manager

LANDesk Software

LANDesk and HP have partnered to help HP customers increase control over IT resources, reduce risks associated with owning them, and boost productivity within the IT environment.

Centrally leverage and manage the power of HP Professional Innovation tools with these features:

- Deployment and migration
- Remote assistance
- Mobile user and device management
- Energy conservation and power management
- HP hardware management

Go to <http://www.landesk.com/partners/hp/client-management/> for more information about LANDesk Client Management Solutions for HP.

HP Driver Pack

The HP Driver Pack contains the Microsoft® Windows drivers in an .INF-based installation format. This .INF installation method can be used alone or with bare-metal operating system deployment tools that require .INF based drivers. Select 32bit or 64bit to see a list of platforms (notebooks and tablets, workstations, and desktops) and the respective driver packs under the operating system. For more information, go to <http://www8.hp.com/us/en/ads/clientmanagement/drivers-pack.html>.

HP SoftPaq Download Manager

HP SoftPaq Download Manager is a free, easy-to-use interface for locating and downloading software updates for the HP client PC models in your environment. By specifying your models, operating system, and language, you can quickly locate, sort, and select the SoftPaqs you need. For more information, go to <http://www8.hp.com/us/en/ads/clientmanagement/drivers-bios.html#softpaq-download-mng>.

HP System Software Manager

HP System Software Manager (SSM) is a utility that is available on Windows computers. It enables you to update system-level software on multiple systems simultaneously. When executed on a PC client system, SSM detects hardware and software versions and then updates the software from a central repository, known as a *file store*. Driver versions supported by SSM are noted with a special icon in the software, on the driver download website, and on the Support Software CD.

To download the utility or to obtain more information about SSM, go to <http://www8.hp.com/us/en/ads/clientmanagement/drivers-bios.html#system-sw-mng>.

ROM Flash

BIOS settings are stored on a programmable flash ROM. By establishing a setup password in Computer Setup (F10) Utility, you can protect unauthorized users from modifying the BIOS settings. This function is important to be sure that the operating integrity of the computer.

To upgrade the BIOS, download the latest SoftPaq images from http://www.hp.com/support/workstation_swdrivers.

Remote ROM Flash

Remote ROM Flash allows system administrators to safely upgrade the ROM on remote HP computers from a centralized network management console, resulting in a consistent deployment of, and greater control over, HP PC ROM images over the network.

To use Remote ROM Flash, the computer must be turned on, or turned on using Remote Wakeup.

For more information about Remote ROM Flash and HPQFlash, see the HP Client Manager Software or System Software Manager sections at <http://www.hp.com/go/ssm>.

HPQFlash

The HPQFlash utility is used to locally update or restore the system ROM on PCs using a Windows operating system. For more information about HPQFlash, go to <http://www.hp.com/go/ssm>, and enter the name of the computer.

FailSafe Boot Block

FailSafe Boot Block enables BIOS recovery in the unlikely event of a ROM flash failure.

For example, if a power failure occurs during a ROM upgrade, Boot Block uses a flash-protected section of the ROM to verify a valid system ROM flash when power is restored to the computer.

If the system ROM is valid, the computer starts normally. If the system ROM fails the validation check, FailSafe Boot Block provides enough support to start the computer from a BIOS image CD that has been created from a SoftPaq. The BIOS image CD programs the system ROM with a valid image.

When Boot Block detects an invalid system ROM, the computer power LED blinks red eight times and the computer beeps eight times; then the computer pauses for two seconds. On some models, a Boot Block recovery mode message appears.

In preparation for system recovery, use the BIOS CD media file in the SoftPaq to create a BIOS image CD or USB flash drive.

Recovering the computer from Boot Block Recovery mode

To recover the computer after it enters Boot Block recovery mode:

1. Remove any media such as USB flash drives or discs in the optical drives.
2. Insert a BIOS image CD into the DVD drive. You can also use USB media such as an HP DriveKey.
3. Turn the computer off, and then turn it on.

If no BIOS image CD or USB media is found, you are prompted to insert one and restart the computer.

If a setup password has been established, the Caps Lock light turns on and you are prompted for the password.

4. Enter the setup password.

If the computer starts from the boot media and successfully reprograms the ROM, three keyboard lights turn on and a rising-tone series of beeps signals successful recovery.

5. Remove the boot media and turn off the computer.
6. Restart the computer.

Workstation security

This section provides information about providing system security through asset tracking, password security, hard drive locking, and chassis locks.

Asset tracking

Asset tracking features provide data that can be managed using HP Systems Insight Manager (HP SIM), HP Console Management Controller (CMC), or other systems-management applications.

Seamless, automatic integration between asset tracking features and these products enables you to choose the management tool that is best suited to the environment and to leverage investments in existing tools.

HP also offers several solutions for controlling access to valuable components and information:

- Security features such as the Smart Cover Sensor (side access panel sensor) help prevent unauthorized access to the data and to the internal components of the computer
- Capability for protecting valuable data assets by disabling parallel, serial, or USB ports, or by disabling removable-media boot capability
- Memory Change and Side access panel sensor (Smart Cover Sensor) alerts, which can be forwarded to system management applications to deliver proactive notification of tampering with a computer's internal components

The Smart Cover Sensor and cable lock are available as options on select systems.

You can manage security settings as follows:

- Locally, with Computer Setup (F10) Utility
- Remotely, with HP CMS or HP System Software Manager (SSM), which enable the secure, consistent deployment and control of security settings from a simple command line utility

For more information about Computer Setup (F10) Utility, see [Computer Setup \(F10\) Utility menu on page 27](#).

The following Computer Setup (F10) Utility features let you manage computer security.

Feature	Purpose
Removable Media Boot Control	Prevents booting from removable media drives
USB Interface Control	Prevents transfer of data through the integrated USB interface
Power-On Password	Prevents use of the computer until the password is entered (applies to initial system startup and restarts)
Setup Password	Prevents reconfiguration of the computer (through Computer Setup (F10) Utility) until the password is entered

SATA hard drive security

HP computers include the HP DriveLock facility for SATA hard drives to prevent unauthorized access to data.

⚠ WARNING! Enabling DriveLock can render a SATA hard drive permanently inaccessible if the master password is lost or forgotten. No method exists to recover the password or access the data.

DriveLock has been implemented as an extension to Computer Setup (F10) Utility functions. It is only available when hard drives that support the ATA security command set are detected. On HP computers, it is not available when the SATA emulation mode is RAID.

DriveLock is for HP customers for whom data security is the paramount concern. For such customers, the cost of a hard drive and the loss of the data stored on it is inconsequential when compared to the damage that could result from unauthorized access to its contents.

To balance this level of security with the need to address the issue of a forgotten password, the HP implementation of DriveLock employs a two-password security scheme. One password is intended to be set and used by a system administrator, while the other is typically set and used by the user.

No "back door" can be used to unlock the drive if both passwords are lost. Therefore, DriveLock is most safely used when the data contained on the hard drive is replicated on a corporate information system or is regularly backed up.

If both DriveLock passwords are lost, the hard drive is inaccessible. For users who do not fit the previously defined customer profile, this outcome might not be acceptable. For users who fit this profile, the outcome might be a tolerable risk, given the nature of the data stored on the hard drive.

DriveLock applications

The most practical use of DriveLock is in a corporate environment. The system administrator would be responsible for configuring the hard drive, which involves setting the DriveLock master password and a temporary user password. If the system administrator forgets the user password or if the equipment is passed on to another employee, the master password can be used to reset the user password and restore access to the hard drive.

HP recommends that corporate system administrators who enable DriveLock also establish a corporate policy for setting and maintaining master passwords. This precaution will prevent loss of information if an employee sets both DriveLock passwords before leaving the company. In such a scenario, the hard drive is inaccessible and must be replaced. Likewise, by not setting a master password, system administrators might find themselves locked out of a hard drive and unable to perform routine checks for unauthorized software, other asset control functions, and support.

For users with less stringent security requirements, HP does not recommend enabling DriveLock. Users in this category include personal users, or users who do not maintain sensitive data on their hard drives as a common practice. For these users, the potential loss of a hard drive resulting from forgetting both passwords is much greater than the value of the data DriveLock protects.

Access to Computer Setup (F10) Utility and DriveLock can be restricted through the setup password. By specifying a setup password and not giving it to users, system administrators can restrict users from enabling DriveLock.

Using DriveLock

When hard drives that support the ATA security command set are detected, DriveLock appears under the Security menu in the Computer Setup (F10) Utility menu. You are presented with options to set the master password and to enable DriveLock. You must provide a user password to enable DriveLock. Because the initial configuration of DriveLock is typically performed by a system administrator, a master password should be set first.

HP encourages system administrators to set a master password whether they plan to enable DriveLock or not. This gives the administrator the ability to modify DriveLock settings if the drive is locked in the future. After the master password is set, the system administrator can enable DriveLock or leave it disabled.

If a locked hard drive is present, POST requires a password to unlock the device. If a power-on password is set and it matches the device's user password, POST does not prompt the user to re-enter the password. Otherwise, the user is prompted to enter a DriveLock password.

For a cold start, use the master or user password. For a warm start, enter the same password used to unlock the drive during the preceding cold start.

Users have two attempts to enter a correct password. During cold start, if neither attempt succeeds, POST continues but the drive remains inaccessible. During a warm-start or restart from Windows, if neither attempt succeeds, POST halts and the user is instructed to cycle power.

Enabling DriveLock

To enable and set the DriveLock user password:

1. Turn on or restart the computer.
2. As soon as the computer is turned on, repeatedly press the **F10** key until Computer Setup (F10) Utility starts.

If you do not press **F10** at the appropriate time, you must restart the computer, and then repeatedly press **F10** to access the utility.
3. Select **Security** and then select **DriveLock Security**.
4. For each DriveLock-capable drive, select the drive by pressing **Enter**.
5. Under Enable/Disable DriveLock options, select **Enable**, and then press **Enter** to enable DriveLock for that drive.

 **NOTE:** To set the DriveLock master password, select **Master**.

 **CAUTION:** If you forget the DriveLock password, the drive is inaccessible.

6. Enter a new user password (1 to 32 characters long), and then press **Enter** to accept.
7. Enter the password again in the **Enter New Password Again** field. If you forget this password, the drive is permanently disabled.
8. Select **Main** and then select **Save Changes and Exit**. Press **Enter** to accept the changes. After you press **Enter**, the computer performs a cold start before invoking the DriveLock function.

When the computer starts, you are prompted to enter the DriveLock password for each DriveLock-capable drive for which you have set a password. You have two attempts to enter the password correctly. If the password is not entered correctly, the computer attempts to start anyway. However, the boot process most likely fails because data from a locked drive cannot be accessed.

In a single-drive computer, when DriveLock is enabled, the computer might not be able to boot to the operating system, and might try to boot from the network or from another storage device (depending on the boot ordering options). Regardless of the outcome of the start attempts, the locked drive remains inaccessible without the DriveLock password.

In a two-drive computer that has a boot drive and a data drive, you can apply the DriveLock feature to the data drive only. In this case, the computer can always start, but the data drive is accessible only when the DriveLock password is entered.

Cold starts require that you enter DriveLock passwords. However, DriveLock passwords are also required for warm starts. For example, if you boot to DOS and press **Ctrl+Alt+Del**, you must enter the DriveLock password before the computer completes the next start cycle. This warm-start behavior is consistent with the DriveLock feature.

Password security

The power-on password prevents unauthorized access to applications or data when the computer is turned on or restarted. The setup password specifically prevents unauthorized access to the Computer Setup (F10) Utility and can also be used as an override to the power-on password. An administrator can enter the setup password at the prompt for the power-on password and gain access to the computer.

You can establish a network-wide setup password to enable the system administrator to log in to all network systems to perform maintenance without needing to know the power-on password.

Establishing a setup password using Computer Setup (F10) Utility

Establishing a setup password through the Computer Setup (F10) Utility prevents reconfiguration of the computer (through the use of Computer Setup (F10) Utility) until the password is entered.

To establish a setup password using the Computer Setup (F10) Utility menu:

1. Turn on or restart the computer.
2. As soon as the computer is turned on, repeatedly press the **F10** key until you enter Computer Setup (F10) Utility.

If you do not press **F10** at the appropriate time, you must restart the computer, and then repeatedly press **F10** to access the utility.
3. Select **Security** and then select **Set up BIOS Administrator Password**. Follow the onscreen instructions.
4. Before exiting, select **Main** and then select **Save Changes and Exit**.

Establishing a power-on password using computer setup

Establishing a power-on password through Computer Setup (F10) Utility prevents access to the computer when power is connected, unless you specify the password. When a power-on password is set, Computer Setup (F10) Utility presents Password Options in the Security menu. The password options include Network Server Mode and Password Prompt on Warm Boot.

When Network Server Mode is disabled, you must enter the password when the computer is turned on and the key icon appears on the monitor. When Password Prompt on Warm Boot is enabled, you must enter the password. The password must also be entered each time the computer is restarted. When Network Server Mode is enabled, the password prompt is not presented during POST.

To enable Network Server Mode, you must set a power-on password under **Advanced > Password Options**. This option enables the computer to start without requiring the power-on password, but the keyboard and mouse are locked until you enter the password.

To establish a power-on password through the Computer (F10) menu:

1. Turn on or restart the computer.
2. As soon as the computer is turned on, repeatedly press the **F10** key until you enter Computer Setup (F10) Utility.

If you do not press **F10** at the appropriate time, you must restart the computer, and then repeatedly press **F10** to access the utility.
3. Select **Security > Set up BIOS Power-On Password**, and then follow the onscreen instructions.
4. Before exiting, select **Main > Save Changes and Exit**.

Entering a power-on password

To enter a power-on password:

1. Restart the computer.
2. When the key icon appears on the monitor, enter the current password, and then press **Enter**.

Type carefully. For security reasons, the characters you enter do not appear on the screen.

If you enter the password incorrectly, a broken key icon appears. Try again. After three unsuccessful tries, you will enter the F10 setup screen with read-only permission. (See the Setup Browse Mode option under the Power-On options.)

Entering a setup password

If a setup password has been established on the computer, you will be prompted to enter it each time you run Computer Setup (F10) Utility.

To enter a setup password:

1. Restart the computer.
2. As soon as the computer is turned on, repeatedly press the **F10** key until you enter Computer Setup (F10) Utility.

If you do not press **F10** at the appropriate time, you must restart the computer, and then repeatedly press **F10** to access the utility.
3. When the key icon appears on the monitor, enter the setup password, and press **Enter**.

Type carefully. For security reasons, the characters you enter do not appear on the screen.

If you enter the password incorrectly, a broken key icon appears. Try again. After three unsuccessful tries, you must restart the computer before you can continue.

Changing a power-on or setup password

To change a power-on or setup password:

1. Restart the computer.
2. To change the power-on password, go to step 4.
3. To change the setup password, as soon as the computer is turned on, repeatedly press the **F10** key until you enter Computer Setup (F10) Utility.

If you do not press **F10** at the appropriate time, you must restart the computer, and then repeatedly press **F10** to access the utility.

4. When the key icon appears, enter the current password, a slash (/) or alternative delimiter character, the new password, another slash (/) or alternative delimiter character, and the new password again as shown:

current password/new password/new password

For information about the alternative delimiter characters, see [National keyboard delimiter characters on page 42](#).

Type carefully. For security reasons, the characters you enter do not appear on the screen.

5. Press **Enter**.

The new password takes effect the next time you turn on the computer.

The power-on and setup passwords can also be changed using the Security options in Computer Setup (F10) Utility.

Deleting a power-on or setup password

To delete a power-on or setup password:

1. Turn on or restart the computer.
2. Choose from the following:
 - To delete the power-on password, go to step 4.
 - To delete the setup password, as soon as the computer is turned on, press and hold **F10** until you enter Computer Setup (F10) Utility. Press **Enter** to bypass the title screen, if necessary.

If you do not press F10 at the appropriate time, you must restart the computer and then press and hold F10 again to access the utility.

Use the appropriate operating system shutdown process.
3. When the key icon appears, enter the current password followed by a slash (/) or alternative delimiter character: *current password/*

For information about the alternative delimiter characters see the following section.
4. Press **Enter**.

National keyboard delimiter characters

Each keyboard meets country-specific requirements. The syntax and keys you use for changing or deleting passwords depend on the keyboard included with the computer.

Language	Delimiter	Language	Delimiter	Language	Delimiter
Arabic	/	Greek	-	Russian	/
Belgian	=	Hebrew	.	Slovakian	-
BHCSY*	-	Hungarian	-	Spanish	-
Brazilian	/	Italian	-	Swedish/Finnish	/
Chinese	/	Japanese	/	Swiss	-
Czech	-	Korean	/	Taiwanese	/
Danish	-	Latin American	-	Thai	/
French	!	Norwegian	-	Turkish	.
French Canadian	é	Polish	-	U.K. English	/
German	-	Portuguese	-	U.S. English	/

* Bosnia-Herzegovina, Croatia, Slovenia, and Yugoslavia

Clearing passwords

If you forget the password, you cannot access the computer.

For instructions about clearing passwords, see [Resetting the password jumper on page 99](#).

Chassis security

Smart Cover Sensor

The Smart Cover Sensor, an optional feature, is a combination of hardware and software technology that alerts you if the interior or the computer is accessed (provided the sensor has been configured in Computer Setup (F10) Utility). The sensor alerts you when the side panel is removed (desktop and tower models) or when the computer is opened (all-in-one models). When the Smart Cover Sensor is installed, Smart Cover appears under the Security menu in the Computer Setup (F10) Utility menu.

Three levels of protection are available:

Level	Setting	Description
Level 0	Disabled	Sensor* is disabled (default).
Level 1	Notify User	When the computer restarts, a message indicates that the computer has been opened or the access panel has been removed.
Level 2	Setup Password	When the computer restarts, a message indicates that the computer has been opened or the access panel has been removed. You must enter the setup password to continue.

* Smart Cover Sensor settings can be changed using Computer Setup (F10) Utility.

Setting the protection level

To set the Smart Cover Sensor protection level:

1. Turn on or restart the computer.
2. During startup, press and hold the **F10** key until you enter Computer Setup (F10) Utility. Press **Enter** to bypass the title screen, if necessary.



NOTE: If you do not press the **F10** key at the appropriate time, you must restart the computer, and then press and hold the **F10** key again to access Computer Setup (F10) Utility.

If you are using a PS/2 keyboard, you might see a keyboard error message. Disregard it.

3. Select **Security > Smart Cover > Cover Removal Sensor**, and follow the onscreen instructions.
4. Before exiting, select **Main > Save Changes and Exit**.

Cable lock (optional)

To prevent theft, you can attach a keyed cable lock to the bottom-left corner of the chassis. This cable lock attaches to the chassis and secures it to the work area.

Fault notification and recovery

Fault notification and recovery features combine innovative hardware and software technology to prevent the loss of critical data and minimize unplanned downtime.

If the computer is connected to a network that is managed by HP CMS, the computer sends a fault notice to the network management application. With HP CMS, you can also remotely schedule diagnostics to run on managed PCs and create a summary report of failed tests.

ECC fault prediction

When the computer encounters an excessive number of error checking and correcting (ECC) memory errors, it displays a local alert message. This message contains information about the errant DIMM, enabling you to take action before you experience noncorrectable memory errors. ECC DIMMs are standard on this computer.

Thermal sensors

Several thermal sensors in the HP Workstation regulate computer fans to maintain an acceptable, efficient chassis temperature.

Dual-state power button

With ACPI enabled, the power button can function as an on/off switch or as a button. This feature does not completely turn off power, but instead causes the computer to enter a low-power standby state. This enables you to go to standby without closing applications, and to return to the same operational state without any data loss.

Changing the power button configuration (Windows only)

 **CAUTION:** To reduce the risk of data loss, do not use the power button to turn off the computer unless the system is unresponsive.

 **NOTE:** If the computer is unresponsive, press and hold the power button for four seconds to completely turn off power to the computer.

Windows 7 or Windows 10

1. Select **Start**, and then select **Control Panel > System and Security > Power Options**.
2. In the left pane, click **Choose what the power buttons do**.
3. Select the desired options.

If you choose Sleep or Hibernate, you can press the power button to initiate standby, and then press it again to exit standby and return to your work. To completely turn off the workstation, select **Start > Shut Down**.

Windows 8

1. Point to the upper-right or lower-right corner of the Start screen to display the charms.
2. Select **Search**.
3. In the **Search** field, type `control`.
4. Select **Control Panel**, and then select **System and Security > Power Options**.
5. Select **Choose What the Power Button Does**.
6. Select the desired options.

3 Component replacement information and guidelines

This chapter provides warnings, cautions, information, and guidelines for removal and replacement procedures. It does not document the step-by-step procedures.

 **IMPORTANT:** Removal and replacement procedures are now available in videos on the HP website.

Go to the HP Customer Self Repair Services Media Library at <http://www.hp.com/go/sml>.

This chapter includes these topics:

- [Warnings and cautions](#)
- [Service considerations](#)
- [Product recycling](#)
- [Component replacement guidelines](#)

Warnings and cautions

 **WARNING!** These symbols on any surface or area of the equipment indicate the following:

 Presence of a hot surface or hot component. If this surface is contacted, the potential for injury exists. To reduce the risk of injury from a hot component, let the surface cool before touching.

 Presence of an electrical shock hazard. To reduce the risk of injury from electrical shock, do not open any enclosed area marked with this symbol.

 Product must always be lifted by two persons to avoid personal injury due to product weight.

 **WARNING!** To reduce the risk of electric shock or damage to your equipment:

- Do not disable the power cord grounding plug. The grounding plug is an important safety feature.
- Plug the power cord in a grounded (earthed) outlet that is easily accessible at all times.
- Disconnect power from the equipment by unplugging the power cord from the electrical outlet.

 **WARNING!** To reduce the risk of serious injury, read the *Safety & Comfort Guide*. It describes proper computer setup, posture, health, and work habits for computer users, and provides important electrical and mechanical safety information. This guide is located at <http://www.hp.com/ergo>.

 **WARNING!** Do not use the front bezel as a handle or lifting point when lifting or moving the computer. Lifting the computer from the front bezel, or lifting it incorrectly, could cause the computer to fall, causing possible injury to you and damage to the computer. To properly and safely lift the computer, lift from the bottom of the computer.

CAUTION: Static electricity can damage the electronic components of the computer. To prevent damage to the computer, observe the following Electrostatic Discharge (ESD) precautions while servicing the computer:

- Discharge static electricity by briefly touching a grounded metal object before you begin.
- Work on a static-free mat.
- Wear a static strap to ensure that any accumulated electrostatic charge is discharged from your body to the ground.
- Create a common ground for the equipment you are working on by connecting the static-free mat, static strap, and peripheral units to that piece of equipment.

NOTE: HP accessories are for use in HP products. They have been extensively tested for reliability and are manufactured to high quality standards.

Service considerations

Tools and software requirements

The tools necessary for computer component removal and installation are:

- Torx T-15 driver
- Flat blade and cross-tip screwdrivers
- Diagnostics software

Electrostatic discharge (ESD) information

Generating static

Different activities generate different amounts of static electricity through electrostatic discharge (ESD). Static electricity increases as humidity decreases.

CAUTION: Static electricity in the amount of 700 volts might degrade a product.

Event	Relative humidity		
	55%	40%	10%
Walking across carpet	7,500V	15,000V	35,000V
Walking across vinyl floor	3,000V	5,000V	12,000V
Motions of bench worker	400V	800V	6,000V
Removing bubble pack from PCB	7,000V	20,000V	26,500V
Packing PCBs in foam-lined box	5,000V	11,000V	21,000V

Preventing ESD equipment damage

Many electronic components are sensitive to ESD. Circuitry design and structure determine the degree of sensitivity. The following packaging and grounding precautions are necessary to prevent damage to electric components and accessories:

- Transport products in static-safe containers such as tubes, bags, or boxes, to avoid hand contact.
- Protect electrostatic parts and assemblies with nonconductive or approved containers or packaging.
- Keep electrostatic-sensitive parts in their containers until they arrive at static-free stations.
- Place items on a grounded surface before removing them from containers.
- When handling or touching a sensitive component or assembly, ground yourself by touching the chassis.

	<ul style="list-style-type: none"> • Avoid contact with pins, leads, or circuitry. • Place reusable electrostatic-sensitive parts from assemblies in protective packaging or nonconductive foam. 								
Personal grounding methods and equipment	<p>Use the following items to help prevent ESD damage:</p> <ul style="list-style-type: none"> • Wrist straps — These are flexible straps with a maximum of one megohm \pm 10% resistance in the ground cords. To provide a proper ground, wear the strap against bare skin. The ground cord must be connected and fit snugly into the banana plug connector on the grounding mat or computer. • Heel straps, toe straps, and boot straps — These can be used at standing computers and are compatible with most types of shoes or boots. On conductive floors or dissipative floor mats, use them on both feet with a maximum of one megohm \pm 10% resistance between the operator and ground. 								
Static shielding materials	<p>Static shielding materials provide the following levels of protection.</p> <table border="1"> <thead> <tr> <th>Method</th> <th>Voltage</th> </tr> </thead> <tbody> <tr> <td>Antistatic plastic</td> <td>1,500V</td> </tr> <tr> <td>Carbon-loaded plastic</td> <td>7,500V</td> </tr> <tr> <td>Metalized laminate</td> <td>15,000V</td> </tr> </tbody> </table>	Method	Voltage	Antistatic plastic	1,500V	Carbon-loaded plastic	7,500V	Metalized laminate	15,000V
Method	Voltage								
Antistatic plastic	1,500V								
Carbon-loaded plastic	7,500V								
Metalized laminate	15,000V								
Grounding the work area to prevent static damage	<ul style="list-style-type: none"> • Cover the work surface with approved static-dissipative material. Use a wrist strap connected to the work surface, and properly grounded tools and equipment. • Use static-dissipative mats, foot straps, or air ionizers to give added protection. • Handle electrostatic-sensitive components, parts, and assemblies by the case or PCB laminate. Handle them only in static-free work areas. • Disconnect power and input signals before inserting and removing connectors or test equipment. • Use fixtures made of static-safe materials when fixtures must directly contact dissipative surfaces. • Keep work area free of nonconductive materials, such as plastic assembly aids and Styrofoam. • Use field service tools (such as cutters, screwdrivers, and vacuums) that are conductive. 								
Recommended ESD prevention materials and equipment	<ul style="list-style-type: none"> • Antistatic tape • Antistatic smocks, aprons, and sleeve protectors • Conductive bins and other assembly or soldering aids • Conductive foam • Conductive tabletop computers with a ground cord of one megohm \pm 10% resistance • Static-dissipative table or floor mats with a hard-tie to ground • Field service kits • Static awareness labels • Wrist straps and footwear straps providing one megohm \pm 10% resistance • Material-handling packages • Conductive plastic bags • Conductive plastic tubes • Conductive tote boxes • Opaque shielding bags • Transparent metallized shielding bags • Transparent shielding tubes 								

Product recycling

HP encourages customers to recycle used electronic hardware, HP original print cartridges, and rechargeable batteries.

For information about recycling HP components or products, see <http://www.hp.com/go/recycle>.

Component replacement guidelines

This section provides information and guidelines for removal and replacement procedures. It does not document the step-by-step procedures.



IMPORTANT: Removal and replacement procedures are now available in videos on the HP website.

Go to the HP Customer Self Repair Services Media Library at <http://www.hp.com/go/sml>. In Media Selection, choose the **Desktops & Workstations** product category and the **Personal Workstations** product family, then choose your platform

This chapter provides guidelines for removal and replacement procedures.

[Battery on page 48](#)

[Cable management on page 49](#)

[Processor and processor heatsink on page 50](#)

[Expansion slots on page 51](#)

[Hard drives and optical drives on page 59](#)

[Memory on page 65](#)

[Power supply specifications on page 69](#)

[System board on page 72](#)

Battery

The battery that comes with the computer provides power to the real-time clock and has a minimum lifetime of about three years. Observe the following warning and caution when replacing the battery.



WARNING! HP Z Series Workstations use lithium batteries. There is a risk of fire and chemical burn if the battery is handled improperly. Do not disassemble, crush, puncture, short external contacts, dispose of in water or fire, or expose battery to temperatures higher than 60°C (140°F).



CAUTION: Before removing the battery, back up the CMOS settings in case they are lost when the battery is removed. Use Computer Setup (F10) Utility to back up the settings.



NOTE: Do not dispose of batteries, battery packs, and accumulators with general household waste.

Cable management

Proper routing of the internal cables is critical to the operation of the workstation. Follow good cable management practices when removing and installing components.

- Handle cables with care to avoid damage.
- Apply only the tension required to seat or unseat cables during insertion or removal from the connector.
- When possible, handle cables by the connector or pull-strap.
- Route cables in such a way that they cannot be caught or snagged by parts being removed or replaced.
- Keep cables away from direct contact with major heat sources, such as the heatsink. (Some air flow guides have a cable guide that lets you route cables safely around the heatsink.)
- Do not jam cables on top of expansion cards or DIMMs. Circuit cards and DIMMs are not designed to take excessive pressure.
- Keep cables clear of movable or rotating parts (such as the power supply and drive cage) to prevent them from being cut or crimped when the component is lowered into its normal position.
- In all cases, avoid bending or twisting the cables. Do not bend any cable sharply. A sharp bend can break the internal wires.
- Never bend a SATA data cable tighter than a 30 mm (1.18 in) radius.
- Never crease a SATA data cable.
- Do not rely on components like the drive cage, power supply, or computer cover to push cables down into the chassis. Always position the cables to lay properly by themselves or in the cable guides and chassis areas designed for cable routing.

When removing the power supply power cable from the connector on the system board, always follow these steps:

1. Squeeze on the top of the retaining latch attached to the cable end of the connector.
2. Grasp the cable end of the connector and pull it straight out.

 **CAUTION:** Always pull the connector — NEVER pull on the cable. Pulling on the cable could damage the cable and result in a failed power supply.

Processor and processor heatsink

 **CAUTION:** Observe the following cautions when removing or replacing the heatsink.

- When removing the heatsink, loosen all screws a little at a time to ensure the processor remains level. Do *not* fully loosen one screw, and then move on to the next.
- After you remove the processor heatsink from the chassis, use alcohol and a soft cloth to clean the thermal compound residue from the processor and the heatsink, allowing the alcohol on the processor and processor heatsink to dry completely.
- If you are reusing the original heatsink, apply thermal compound to the center of the processor top surface.
- If you are using a new processor heatsink, do not apply thermal compound to the processor because the new heatsink already has thermal compound applied to the heatsink surface. Instead, remove the thermal compound protective liner from the bottom of the new heatsink.
- Do not overtighten the heatsink screws. Overtightening can strip the threads in the chassis.
- Do not fully tighten one screw and then move on to the next. Instead, tighten all screws a little at a time, ensuring that the processor remains level.

CAUTION: Observe the following cautions when removing or replacing the processor.

- If you are installing a second processor, it must be of the same type as the first processor.
 - Internal components might be powered even when the computer is off. To prevent damage, disconnect the computer power cord before you remove or install a component.
 - The processor socket contacts and pads are extremely fragile. Do not touch the processor socket contacts or the gold pads underneath the processor. Use extreme care and handle the processor only by the edges.
 - The processor socket contacts are delicate and bend easily. To avoid bending the contacts, use extreme care when installing the processor in the socket.
 - Installing a processor incorrectly can damage the system board. Contact an HP authorized reseller or service provider to install the processor. If you plan to install the processor yourself, view the entire remove and replace video before you begin.
 - Failure to follow the computer preparation instructions can result in an improperly installed processor, causing extensive computer damage.
-

Expansion slots

This section identifies and describes computer expansion card slots, and presents card configuration information.

Go to <http://www.hp.com/go/quickspecs> to learn which graphics cards are supported in the workstation, how much memory each graphics card includes, and graphics card power requirements.

Card configuration restrictions for power supplies

 **CAUTION:** To prevent damage, the overall power consumption of the computer (including I/O cards, processor, and memory) must not exceed the maximum rating of the computer power supply. For power supply information, see [Power supply specifications on page 69](#).

Choosing an expansion card slot

Whenever possible, use the following tips to help you select the proper slot for an expansion card:

- Use the PCIe x16 slot for the primary graphics card. If you do not use this slot for the graphics card, only cards certified as After Market Options are supported.
- Install a second graphics card in the other PCIe x16 slot.
- Install a card in a slot that most closely matches its interface technology:
 - Install a PCIe Gen1 x16 or a PCIe Gen1 x8 card in the PCIe Gen2 x16 slot.
 - Install a PCIe Gen1 x4 card in the PCIe Gen1 x4 slot.
 - Install a PCIe Gen1 x1 card in the PCIe Gen1 x1 slot.
 - Install a PCI card in the PCI slot.
 - Whenever possible, install a PCIe x1 card in an x1 slot.
- Leave as much space as possible between cards (especially graphics cards) to allow heat to dissipate more efficiently.
- For best operational efficiency, select a slot that:
 - Electrically matches the number of PCIe card lanes (for example, x1 in an x1 slot).
 - Has more lanes electrically.
 - Has fewer lanes, but is closer to your needs. For example, place an x16 card in an x4 slot, and an x4 card in an x1 slot.
- An x1 connector supports an x1 card only. While an x1 card can be inserted into a larger slot, this may limit potential future card placement.

HP Z440 Workstation slot identification and description

Maximum power used by all slots must not exceed total system power and is subject to configuration limitations.

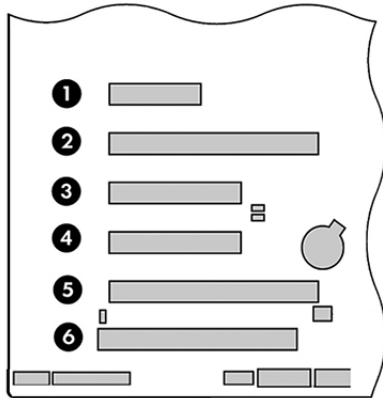

Slot	Type	Mechanical compatibility	Electrical compatibility
1	PCIe2 x4 (1)	x4	x1
2	PCIe3 x16	x16	x16
3	PCIe2 x8 (4)	x8	x4
4	PCIe3 x8	x8	x8
5	PCIe3 x16	x16	x16
6	PCI 32/33	PCI	PCI



NOTE: The PCIe designators indicate the mechanical connector size and number of electrical PCIe lanes routed to an expansion slot. For example, x16 (8) means that the expansion slot is mechanically a x16 length connector, with 8 PCIe lanes supported.

Slot two is the primary graphics slot; slot five is the secondary graphics slot.

Slots one, three, and four use open-ended PCIe connectors, so a PCIe x16 card can be inserted. Graphics cards greater than 75 watts require the use of an auxiliary power cable adapter.

HP Z440 Workstation installation sequence recommendations

Load order	Card description	Slot 1	Slot 2	Slot 3	Slot 4	Slot 5	Slot 6
1	First PCIe graphic card		Only				
2	Second PCIe graphic card or Tesla C2075					Only	
3	Third PCIe graphic card				Only		
4	Fourth PCIe graphic card			Only			
5	SAS card			2nd	1st	3rd	
6	Z Turbo Drive 1st			3rd	1st	2nd	
7	Z Turbo Drive 2nd			2nd		1st	
8	PCIe 1394b card	1st		2nd			
9	PCIe audio card	1st		2nd	3rd	4th	
10	PCIe NIC card (LAN)	1st		2nd	3rd	4th	
11	e-SATA bulkhead kit			2nd	3rd		1st
12	Second serial port kit			2nd	3rd		1st

NOTE: Slot sequenced from the rear I/O aperture to the board edge.

HP Z640 Workstation slot identification and description

Maximum power used by all slots must not exceed total system power and is subject to configuration limitations.

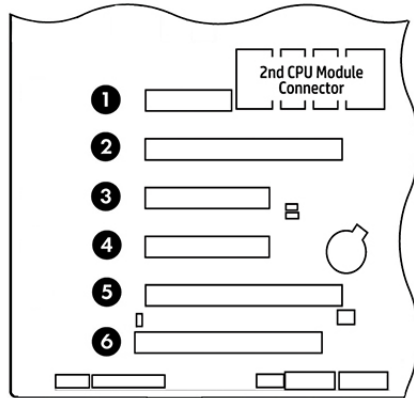

 **NOTE:** Slot 1 is not available in dual processor configurations.

Slot	Type	Mechanical compatibility	Electrical compatibility
1	PCIe2 x4 (1)	x4	x1
2	PCIe3 x16	x16	x16
3	PCIe2 x8 (4)	x8	x4
4	PCIe3 x8	x8	x8
5	PCIe3 x16	x16	x16
6	PCI 32/33	PCI	PCI

 **NOTE:** The PCIe designators indicate the mechanical connector size and number of electrical PCIe lanes routed to an expansion slot. For example, x16 (8) means that the expansion slot is mechanically an x16 length connector, with 8 PCIe lanes supported.

 **NOTE:** Slots two, four, and five are PCIe GEN3 slots. Slot two is the primary graphics slot; slot five is the secondary graphics slot.

Slots three and four use open-ended PCIe connectors, so a PCIe x16 card can be inserted. This allows the workstation to support more PCIe x16 expansion cards. A x16 card typically trains and runs at the maximum lane width available by the expansion slot. The card runs at the reduced lane width, with a corresponding performance decrease. Graphics cards greater than 75 watts require the use of an auxiliary power cable adapter.

HP Z640 Workstation installation sequence recommendations

Load order	Card description	Slot 1	Slot 2	Slot 3	Slot 4	Slot 5	Slot 6
1	Second System Board (Riser)	Only					
2	First PCIe graphic card		Only				
3	Second PCIe graphic card or High Performance GPU Compute card					Only	
4	PCIe 1394b card			Only			
5	Third PCIe graphics card			Only			
6	Fourth PCIe graphics card				Only		
7	SAS card			1st	2nd	3rd	
8	Z Turbo Drive 1st			3rd	1st	2nd	
9	Z Turbo Drive 2nd			2nd		1st	
10	PCIe audio card	4th		1st	2nd	3rd	
11	PCIe Network (LAN) card	4th		1st	2nd	3rd	
12	eSATA bulkhead kit			4th	1st	2nd	3rd
13	Serial port bulkhead				3rd	2nd	1st

NOTE: Slot sequenced from the rear I/O aperture to the board edge.

HP Z840 Workstation slot identification and description

Maximum power used by all slots must not exceed total system power and is subject to configuration limitations.

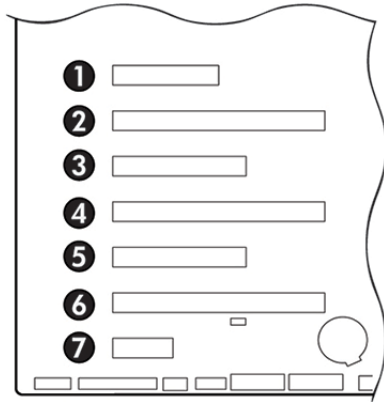

Slot	Type	Mechanical compatibility	Electrical compatibility
1	PCIe3 x4	x4	x4
2	PCIe3 x16	x16	x16
3	PCIe3 x8	x8	x8
4	PCIe3 x16	x16	x16
5	PCIe2 x8	x8	x4
5	PCIe3 x8 (CPU1)	x8	x8
6	PCIe3 x16	x16	x16
7	PCIe2 x1	x1	x1

NOTE: The PCIe designators indicate the mechanical connector size and number of electrical PCIe lanes routed to an expansion slot. For example, x16(8) means that the expansion slot is mechanically an x16 length connector, with 8 PCIe lanes supported.

NOTE: Slots one and five use open-ended PCIe connectors, so a PCIe x16 card can be inserted. This allows the workstation to support more PCIe x16 expansion cards. An x16 card typically trains and runs at the maximum lane width available by the expansion slot. The card runs at the reduced lane width, with a corresponding performance decrease.

NOTE: A eighth slot opening in the chassis has no corresponding expansion connector on the system board. This slot opening is provided for devices that do not require system board plug-in capability.

NOTE: It is normal for the expansion card retention clamp to have a slight (5-10 degree) angle when closed. If the angle is greater than this, open the clamp and ensure that all cards are properly seated and all the brackets are mated to the chassis, and then re-close the clamp.

HP Z840 Workstation installation sequence recommendations

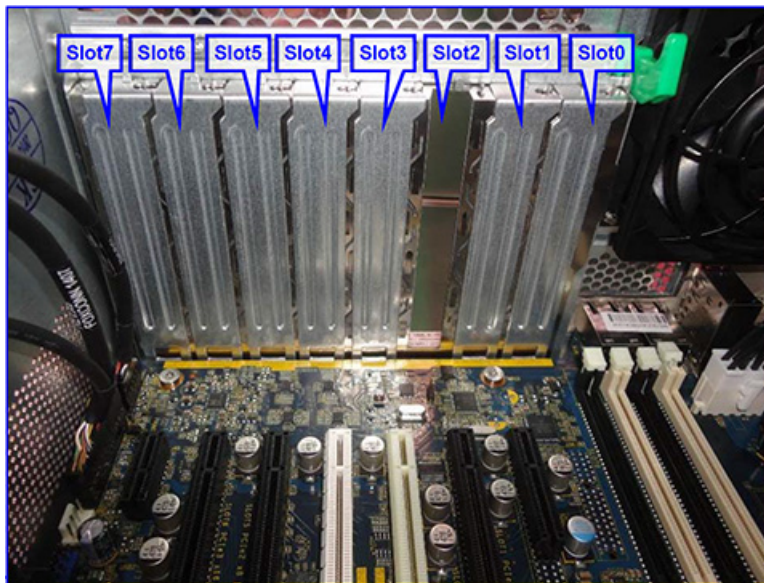

Requires 2nd processor

Load order	Card description	Type	Slot 0(Mech only)	Slot 1(PCI e3 x8)	Slot 2(PCI e3 x16)	Slot 3(PCIe 3 x8)	Slot 4(PCIe 3 x16)	Slot 5(PCIe2 x8) (PCIe3 x8 [2nd CPU])	Slot 6 (PCIe3 x16)	Slot 7 (PCIe 2 x1)
1	1st high performance GPU Compute card	PCIe-x16							Only	
2	2nd high performance GPU Compute card (requires 2nd CPU and 1125w PSU)	PCIe-x16			Only					
3	1st PCIe graphics card	PCIe-x16			1st ¹		3rd			2nd
4	2nd PCIe graphics card	PCIe-x16					2nd			1st ²
5	3rd PCIe graphics (requires 2nd processor)	PCIe-x16					2nd	1st		
6	4th PCIe graphics (requires 2nd processor and 1125w PSU)	PCIe-x16					Only			
7	Thunderbolt	PCIe-x4						Only ⁵		
8	8 port RAID LSI 9270-8i SAS 6Gb/s	PCIe-x8			2nd		5th	4th	3rd	1st ³
9	Z Turbo Drive 1st card (M.2)	PCIe-x4			1st				3rd	2nd

Requires 2nd processor										
Load order	Card description	Type	Slot 0 (Mech only)	Slot 1 (PCI e3 x8)	Slot 2 (PCI e3 x16)	Slot 3 (PCIe 3 x8)	Slot 4 (PCIe 3 x16)	Slot 5 (PCIe2 x8) (PCIe3 x8 [2nd CPU])	Slot 6 (PCIe3 x16)	Slot 7 (PCIe 2 x1)
10	Z Turbo Drive 2nd card (M.2)	PCIe-x4						2nd	1st	
11	PCIe 1394b card	PCIe-x1								Only ⁶
12	PCIe Network (LAN)	PCIe-x1; x4;x8		1st		4th	5th	2nd	3rd	
13	eSATA bulkhead kit	N/A	1st							2nd
14	MiniSAS-4x Cable (PCI Bulkhead)	N/A	Only							
15	MiniSAS- 4x Cable (Chassis Panel Opening)	N/A								See note 4

* Slots 3 and 4 require second processor.

1: If two Tesla cards are installed, place the first Tesla card in Slot #6 and the second Tesla card in Slot #2 so both are on CPU0. Place the first graphics card in Slot #4.

2: If a second graphics card is used with a Tesla card, place the Tesla card in Slot #6 and the second graphics in the alternate slot(s).

3: If an LSI RAID card is being used with a Tesla card or second graphics card, place the Tesla/graphics card in Slot #6 and the RAID card in Slot 1.

4: Install this panel cable kit in the back panel opening found above slot 7.

5: If 2nd CPU configuration with Thunderbolt card, move E3 jumper to rear pins.

6: 1394 card is not supported in Slot 7 if double wide card loaded in Slot 6.

NOTE: Slot sequenced from the rear I/O aperture to the board edge.

Hard drives and optical drives

Handling hard drives

 **CAUTION:** Take proper precautions when handling hard drives to prevent loss of work and damage to the computer or drive.

- Do not remove hard drives from the shipping package for storage. Keep hard drives in their protective packaging until they are mounted in the computer.
- Always shut down the operating system, turn off the power, and unplug the power cord. Never remove a drive while the computer is on or in standby mode.
- Before handling a drive, make sure you discharge static electricity. While handling a drive, avoid touching the connector.
- Handle a drive carefully. Do not drop it from any height.
- To prevent possible ESD damage when the drive is installed, connect the drive power cable before connecting the data cable. This discharges accumulated static electricity through the drive power cable to the computer chassis.
- Do not use excessive force when inserting a drive.
- Avoid exposing a hard drive to liquids, temperature extremes, or products that have magnetic fields such as monitors or speakers.
- If you must mail a drive, use a bubble-pack mailer or other protective packaging and label the package “Fragile: Handle With Care.”

Removal and replacement tips

- To verify the type, size, and capacity of the storage devices installed in the computer, run **Computer Setup (F10) Utility**.
- Adding a new drive may require that you make new connections from the drive to the system board. Please note the following:
 - The primary Serial ATA (SATA) hard drive must be connected to the dark blue primary SATA connector on the system board labeled SATA0.
 - Connect a secondary hard drive to SATA.
 - Connect SATA optical drives to the black SATA2 connector.
 - Connect an optional eSATA adapter cable to the black ESATA connector on the system board.
 - Connect a media card reader USB cable to the USB connector on the system board labeled MEDIA. If the media card reader has a 1394 port, connect the 1394 cable to the 1394 PCI card.

Drive installation and cabling scenarios

This section presents cabling guidelines for the most common maximum storage configurations. If you add or remove drives, HP recommends you follow these guidelines for highest drive performance and efficient cable routing.

HP Z440 Workstations — Intel AHCI SATA controller guidelines

See [HP Z440 Workstation system board components on page 5](#) to determine the location of system board connectors.



NOTE: Port 0 is the default port for the boot drive (the default port can be changed manually in the BIOS).

RAID card (RC) or system board (SB) connector	Drive installation scenarios		
	1	2	3
RC J8	SAS HDD 1	SAS HDD 1-B	SATA HDD 1-B
RC J7	SAS HDD 2	SATA HDD 2-D	SAS HDD 2-D
RC J6	SAS HDD 3	SATA HDD 3-D	SAS HDD 3-D
RC J5	SAS HDD 4	SATA HDD 4-D	SAS HDD 4-D
SB SATA 0	—	—	—
SB SATA 1	—	—	—
SB SATA 2	ODD 1	ODD 1	ODD 1
SB SATA 3	ODD 2	ODD 2	ODD 2
SB SATA 4	eSATA (top)	eSATA (top)	eSATA (top)
SB SATA 5	eSATA (bottom)	eSATA (bottom)	eSATA (bottom)

eSATA = external SATA (2 ports per cable assembly)

HDD = hard drive

ODD = optical drive

NOTE: Only the most common configurations are shown here.

HP Z440 Workstations — LSI 9217-4i4e RAID controller guidelines

See [HP Z440 Workstation system board components on page 5](#) to determine the location of system board connectors.



NOTE: Hard drives attached to RC J8 are designated by the 9217-4i4e BIOS to be boot devices. If the hard drive connected to RC J8 is a member of a RAID array, the RAID array is the boot device.

System board connector	Drive installation scenarios		
	1	2	3
RC – Port 0	SAS HDD1	SAS HDD1–B	SAS HDD1–B
RC – Port 1	SAS HDD2	SAS HDD2–D	SAS HDD2–D
RC – Port 2	SAS HDD3	SAS HDD3–D	SAS HDD3–D
RC – Port 3	SAS HDD4	SAS HDD4–D	SAS HDD4–D
SATA 0	ODD 1	ODD 1	ODD 1
SATA 1	ODD 2	ODD 2	ODD 2
sSATA 0	—	—	—
sSATA 1	—	—	—
sSATA 2	eSATA (top)	SATA (top)	SATA (top)
sSATA 3	SATA (bottom)	SATA (bottom)	SATA (bottom)

eSATA = external SATA (2 ports per cable assembly)

If eSATA is installed, the ODD is attached to sSATA 3.

If 4 SATA HDDs are installed on sSATA and eSATA is installed, there will be no ODD.

HDD = hard drive

ODD = optical drive

NOTE: Only the most common configurations are shown here.

HP Z640 Workstations — Intel AHCI SATA controller guidelines

See [HP Z640 Workstation system board components on page 11](#) to determine the location of system board connectors.



NOTE: sSATA port 0 is the default port for the boot drive (the default port can be changed manually in the BIOS).

RAID card (RC) or system board (SB) connector	Drive installation scenarios		
	1	2	3
RC J8	SAS HDD 1	SAS HDD 1-B	SATA HDD 1-B
RC J7	SAS HDD 2	SATA HDD 2-D	SAS HDD 2-D
RC J6	SAS HDD 3	SATA HDD 3-D	SAS HDD 3-D
RC J5	SAS HDD 4	SATA HDD 4-D	SAS HDD 4-D
SB SATA 0	—	—	—
SB SATA 1	—	—	—
SB SATA 2	ODD 1	ODD 1	ODD 1
SB SATA 3	ODD 2	ODD 2	ODD 2
SB SATA 4	eSATA (top)	eSATA (top)	eSATA (top)
SB SATA 5	eSATA (bottom)	eSATA (bottom)	eSATA (bottom)

eSATA = external SATA (2 ports per cable assembly)

HDD = hard drive

ODD = optical drive

NOTE: Only the most common configurations are shown here.

HP Z640 Workstations — LSI 9217-4i4e RAID controller guidelines

See [HP Z640 Workstation system board components on page 11](#) to determine the location of system board connectors.



NOTE: Hard drives attached to RC J8 are designated by the 9217-4i4e BIOS to be boot devices. If the hard drive connected to RC J8 is a member of a RAID array, the RAID array is the boot device.

System board connector	Drive installation scenarios		
	1	2	3
RC – Port 0	SAS HDD 1	SAS HDD 1-B	SATA HDD 1-B
RC – Port 1	SAS HDD 2	SATA HDD 2-D	SAS HDD 2-D
RC – Port 2	SAS HDD 3	SATA HDD 3-D	SAS HDD 3-D
RC – Port 3	SAS HDD 4	SATA HDD 4-D	SAS HDD 4-D
SATA 0	ODD 1	ODD 1	ODD 1
SATA 1	ODD 2	ODD 2	ODD 2
sSATA 0	—	—	—
sSATA 1	—	—	—
sSATA 02	eSATA (top)	eSATA (top)	eSATA (top)
sSATA 3	eSATA (bottom)	eSATA (bottom)	eSATA (bottom)

eSATA = external SATA (2 ports per cable assembly)

HDD = hard drive

ODD = optical drive

NOTE: If there are fewer than three hard drives in the configuration, the cables from HDD bays 1 and 2 are pre-plugged to the RAID card adapter ports.

NOTE: Only the most common configurations are shown here.

HP Z840 Workstation cabling guidelines

See [HP Z840 Workstation system board components on page 18](#) to determine the location of system board connectors.



NOTE: Port 0 is the default port for the boot drive (the default port can be changed manually in the BIOS).

System board connector	Drive configuration scenarios					
	1	2	3	4	5 SATA RAID 5 Only	6 SATA RAID 5 Only
SAS 0	HDD 1	HDD 1	eSAS 2	HDD 1	—	—
SAS 1	HDD 2	HDD 2	eSAS 2	HDD 2	—	—
SAS 2	HDD 3	HDD 3	eSAS 2	HDD 3	—	—
SAS 3	HDD 4	HDD 4	eSAS 2	HDD 4	—	—
SAS 4	HDD 5	eSAS 1	eSAS 1	HDD 5	—	—
SAS 5	HDD 6	eSAS 1	eSAS 1	HDD 6	—	—
SAS 6	—	eSAS 1	eSAS 1	ODD 1	ODD 1	—
SAS 7	—	eSAS 1	eSAS 1	ODD 2	ODD 2	—
SATA 0	ODD 1	ODD 1	ODD 1	eSATA	eSATA	ODD 1
SATA 1	ODD 2	ODD 2	ODD 2	eSATA	eSATA	ODD 2
sSATA 0	—	—	HDD 1	—	HDD 1	HDD 1
sSATA 1	—	—	HDD 2	—	HDD 2	HDD 2
sSATA 2	—	—	HDD 3	—	HDD 3	HDD 3
sSATA 3	—	—	HDD 4	—	HDD 4	HDD 4

eSATA = external SATA (2 ports per cable assembly)

HDD = SATA or SSD hard drive

ODD = optical drive

NOTE: Only the most common configurations are shown here.

Memory

Supported DIMM configurations

 **NOTE:** Mirroring and DIMM sparing are not supported.

Platform	Configuration
HP Z440	<ul style="list-style-type: none">• Eight DIMM slots• Registered ECC DIMMS only• Maximum capacity: 128 GB
HP Z640	<ul style="list-style-type: none">• Four DIMM slots (single processor) or eight DIMM slots (dual processor)• Registered ECC DIMMS and ECC Load Reducing DIMMS• Maximum capacity:<ul style="list-style-type: none">◦ RDIMMs: 64 GB for single processor and 128 GB for dual processor◦ LRDIMMs: 128 GB for single processor and 256 GB for dual processor.• The workstation can be configured for NUMA
HP Z840	<ul style="list-style-type: none">• 16 DIMM slots (8 per processor)• ECC Registered DIMMs and ECC Load Reducing DIMMS• Maximum capacity:<ul style="list-style-type: none">◦ RDIMMs: 128 GB for single processor and 256 GB for dual processor◦ LRDIMMs: 1024 GB for single processor and 2048 GB for dual processor• The workstation can be configured for NUMA

BIOS errors and warnings

The BIOS generates warnings/errors on invalid memory configurations:

- If the BIOS can find a valid memory configuration by disabling plugged-in memory, it does so and reports a warning during POST. the workstation can still be started. The warning will indicate the location of the failed DIMM on the system board.
- If there is no way for the BIOS to obtain a valid memory configuration by disabling plugged-in memory, the BIOS halts with a diagnostics 2006 code for memory error (five beeps and blinks).

DIMM installation guidelines

- Install only HP-approved DDR4 DIMMs

 **CAUTION:** HP ships only DIMMs that are electrically and thermally compatible with this workstation. Because third-party DIMMs might not be electrically or thermally compatible, they are not supported by HP.

- Install only HP-approved DDR4 DIMMs. See <http://www.hp.com/go/quickspecs> to find DIMMs that are compatible with the workstation.
- UDIMM (Unbuffered), RDIMM (Registered) and LR DIMM (Load Reduction) memory cannot be mixed. All memory installed in the system must be either UDIMM or RDIMM or LR DIMMs. [Supported DIMM configurations on page 65](#) specifies which technologies are supported on each platform.

CAUTION: DIMMs and their sockets are keyed for proper installation. To prevent socket or DIMM damage, align these guides properly when installing DIMMs.

HP Z440 Workstation DIMM installation order

Install DIMMs in this order.

NOTE: If you install DIMMs of different sizes, load them in order of size, starting with largest and finishing with the smallest (largest in DIMM 1, smallest in last loaded DIMM slot).

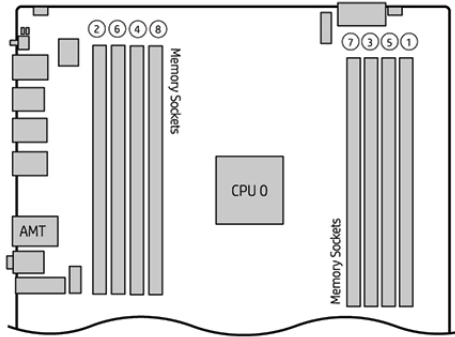

HP Z640 Workstation DIMM installation order

Install DIMMs in this order.

 **NOTE:** If you install DIMMs of different sizes, load them in order of size, starting with largest and finishing with the smallest (largest in DIMM 1, smallest in last loaded DIMM slot).

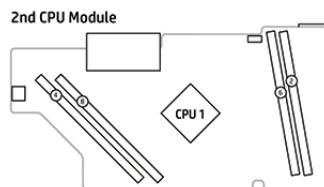
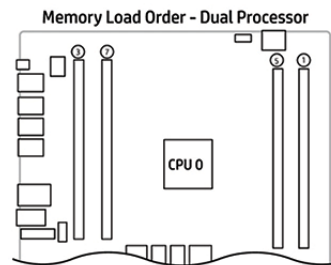
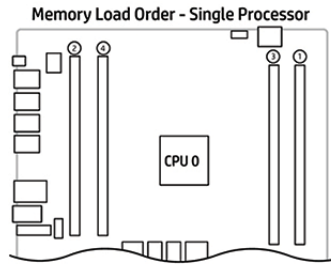

HP Z840 Workstation DIMM installation order

Install DIMMs in this order.

 **NOTE:** If you install DIMMs of different sizes, load them in order of size, starting with largest and finishing with the smallest (largest in DIMM 1, smallest in last loaded DIMM slot).

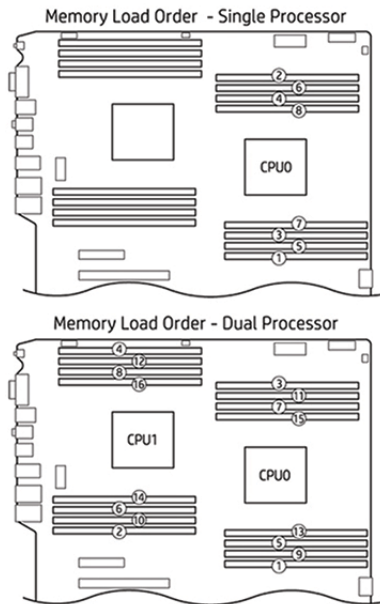

Power supply

Power supply specifications

All power supplies have these specifications:

- Wide-ranging, active Power Factor Correction (PFC)
- ENERGY STAR® qualified (configuration dependent)
- FEMP Standby Power compliant @115V (<1 W in S5 – Power Off)
- ErP Compliant @ 230 (<0.5 W in S5 – Power Off)
- CECP Compliant @ 220V (<4W in S3 – Suspend to RAM)
- Surge tolerant (withstands power surges up to 2000V)

HP Z440 power supply specifications

	700W 90% Efficient, Custom PSU (Wide-Ranging, Active PFC)		525W 85% Efficient, Custom PSU (Wide-Ranging, Active PFC)	
Operating voltage range	90–269 VAC		90–269 VAC	
Rated voltage range	100–240 VAC	118 VAC	100–240 VAC	118 VAC
Rated line frequency	50–60 Hz	400 Hz	50–60 Hz	400 Hz
Operating line frequency range	47–66 Hz	393–407 Hz	47–66 Hz	393–407 Hz
Rated input current	100–240V @ 9.5A	118V @ 9.5A	100–240V @ 9.5A	118V @ 9.5A
Heat dissipation (configuration and software dependent)	Typical: 1648 btu/hr (415 kg cal/hr) Max: 2746 btu/hr (692 kg cal/hr)		Typical: 1311 btu/hr (330 kg cal/hr) Max: 2185 btu/hr (551 kg cal/hr)	
Power supply fan (All fans are variable speed)	92x25mm		92x25mm	
ENERGY STAR Qualified (Configuration dependent)	Yes		Yes	
Power supply efficiency	90% efficient		85% efficient	
FEMP Standby Power Compliant @115V (<1W in S5 – Power Off)	Yes		Yes	
ErP Compliant @ 230V (<0.5 W in S5 – Power Off)	Yes		Yes	
CECP Compliant @ 220V (<4W in S3 – Suspend to RAM)	Yes; Configuration dependent		Yes; Configuration dependent	
Power consumption in sleep mode (as defined by ENERGY STAR)	<15 W		<15 W	
Built-in Self Test LED	Yes		Yes	
Surge Tolerant Full Ranging Power Supply (withstands power surges up to 2000V)	Yes		Yes	

HP Z640 power supply specifications

	925w 90% Efficient, Custom PSU (Wide-Ranging, Active PFC)	
Operating voltage range	90–269 VAC	
Rated voltage range	100–127 V 200–240 V	118 V
Rated line frequency	50–60 Hz	400 Hz
Operating line frequency range	47–66 Hz	393–407 Hz
Rated input current	11.3A @ 100–127 VAC 5.5A @ 200–240 VAC	11.3A @ 400 V
Heat dissipation (configuration and software dependent)	Typical: 2105 btu/hr (530 kg cal/hr) Max: 3629 btu/hr (914 kg cal/hr)	
Power supply fan (All fans are variable speed)	92x25mm	
ENERGY STAR Qualified (Configuration dependent)	Yes	
Power supply efficiency	90% efficient	
FEMP Standby Power Compliant @115V (<1W in S5 – Power Off)	Yes	
ErP Compliant @ 230V (<0.5 W in S5 – Power Off)	Yes	
CECP Compliant @ 220V (<4W in S3 – Suspend to RAM)	Yes; Configuration dependent	
Power consumption in sleep mode (as defined by ENERGY STAR)	<20 W	
Built-in Self Test LED	Yes	
Surge Tolerant Full Ranging Power Supply (withstands power surges up to 2000V)	Yes	

HP Z840 power supply specifications

	850W 88% Efficient, Custom PSU (Wide-Ranging, Active PFC)		1125W/1275W*/1450W* 90% Efficient, Custom PSU (Wide-Ranging, Active PFC)	
Operating voltage range	90–269 VAC		90–269 VAC	
Rated voltage range	100–127 VAC 200–240 VAC	118 VAC	100 VAC 115–127 VAC 200–240 VAC	118 VAC
Rated line frequency	50–60 Hz	400 Hz	50–60 Hz	400 Hz
Operating line frequency range	47–66 Hz	393–407 Hz	47–66 Hz	393–407 Hz
Rated input current	11.5 @ 100–127V 5.5a @ 200–240V	11A @ 118 VAC	12A @ 100 VAC 12A @ 115–127 VAC 10A @ 200–240 VAC	12A @ 118 VAC
Heat dissipation (configuration and software dependent)	Typical: 2142 btu/hr (540 kg cal/hr) Max: 3335 btu/hr (840 kg cal/hr)		Typical: 2773 btu/hr (699 kg cal/hr) Max 1: 3878 btu/hr (977 kg cal/hr) Max 2: 5002 btu/hr (1260 kg cal/hr) Max 3: 5624 btu/hr (1417 kg cal/hr)	
Power supply fan (All fans are variable speed)	(2) 80x25mm		(2) 80x25mm	
ENERGY STAR Qualified (Configuration dependent)	Yes		Yes	
Power supply efficiency	88% efficient		90% efficient	
FEMP Standby Power Compliant @115V (<1W in S5 – Power Off)	Yes		Yes	
ErP Compliant @ 230V (<0.5 W in S5 – Power Off)	Yes		Yes	
CECP Compliant @ 220V (<4W in S3 – Suspend to RAM)	Yes; Configuration dependent		Yes; Configuration dependent	
Power consumption in sleep mode (as defined by ENERGY STAR)	<23 W		<30 W	
Built-in Self Test LED	Yes		Yes	
Surge Tolerant Full Ranging Power Supply (withstands power surges up to 2000V)	Yes		Yes	

*The 1125 W power supply can also supply 1275W of output power when the input voltage is greater than 105V. If the input voltage is less than 105V, the maximum power that can be drawn is 900W. An uninterruptible power supply (UPS) is highly recommended if 1275W output power is desired. The 1125W Power Supply can also supply 1450W of output power when the input voltage is greater than 180V under all conditions.

Power consumption and heat dissipation

Power consumption and heat dissipation specifications are available for multiple configurations. To review available specifications, see <http://www.hp.com/go/quickspecs>.

To reach zero power consumption, unplug the workstation from the power outlet or use a power strip with an on/off switch. For additional information about power-saving features, see the operating system installation instructions.

This product is in compliance with U.S. Executive Order 13221.

Resetting the power supply

If an overload triggers the power supply overload protection, power is immediately disconnected.

To reset the power supply:

1. Disconnect the power cord from the workstation.
2. Determine what caused the overload and fix the problem. For troubleshooting information, see [Diagnostics and troubleshooting on page 76](#).
3. Reconnect the power cord and restart the workstation.

When you power off the workstation through the operating system, power consumption falls below what is considered low power consumption but does not reach zero. This low power consumption feature extends the life of the power supply.

System board

If you replace the system board:

- Make a note of the cable connections before disconnecting them from the system board.
- Follow good cable management practices. See [Cable management on page 49](#).

The following tables show system cabling for the workstations.

System cabling

HP Z440 Workstation system cabling

See [HP Z440 Workstation system board components on page 5](#) to determine the location of system board connectors.

Cable	To	Cable designator on system board
PSU cable	PCA (Main PWR)	P1
PSU cable	PCA (PWR MEM)	P2
PSU cable	First hard drive (Bay 6)	D1
PSU cable	Second hard drive (Bay 5)	D2
PSU cable	Third hard drive (Bay 4)	D3
PSU cable	First optical drive (Bay 1)	D4
PSU cable	Second optical drive (Bay 2)	D5
PSU cable	Other drive (Bay 3)	D6
PSU cable	First graphics card	G1 (600 W PSU only)
Speaker	PCA	P6 (SPKR) white
Cooler fan cable	PCA	P8 (CPU0 FAN) white
System fan cable	PCA	P95 (REAR FAN) white
Memory fan cable	PCAx	P92 (MEM FAN) white
Front audio cable *	PCA	P28 (FRONT AUD) black
Front 1394 cable	PCA	J12 1394,White
LED/Power button cable	PCA	P5 (PB/LED) black
Front USB 3.0 cable	PCA	P29 (USB 3.0) blue
Front USB 2.0 cable	PCA	P27 (FRONT USB 2.0) yellow
Media card reader	PCA	P24 (USB2) blue
Front fan cable	PCA	P9 (FRNTFAN) white
Second serial port	PCA	P52 (COM) black
Chassis solenoid lock	PCA	P124 (SOL_LOCK) black
Chassis Intrusion Sender	PCA	P125 (I_SENSE) white

* If an audio card is installed, connect the front audio cable to the audio card connector.

HP Z640 Workstation system cabling

See [HP Z640 Workstation system board components on page 11](#) to determine the location of system board connectors.

Cable	To	Cable/system board designator
PSU cable	PCA P1(PWR)	P1
PSU cable	PCA P2(PWRMEM)	P2
PSU cable	First hard drive	HDD BAY 0
PSU cable	Second hard drive	HDD BAY 1
PSU cable	Third hard drive	HDD BAY 2
PSU cable	First optical drive	D1
PSU cable	Second optical drive	D2
PSU cable	First graphic card	G1
PSU cable	Second graphic card	G2
Speaker	PCA	Pre-connected to FUI cable
CPU 0 HS fan cable	PCA	P8 (CPU 0 FAN) white
Rear fans cable	PCA	P11 (REAR FANS) white
MB memory fan cable	PCA	P91 (MEM FAN) black blind-mate
Front fan cable	PCA	P9 (FRNTFAN) white
Front audio cable *	PCA	P28 (FRONT AUDIO) black
Front USB3.0 cable	PCA	P29 (FRNT USB3) blue
Front USB2.0 cable	PCA	P27 (FRNT USB2) yellow
Front UI cable	PCA	P5(PB/LED) black
Front 1394 cable	PCA	J12 (1394) white
Media card reader	PCA	P24 (I-USB2.0) blue
SAS card LED cable	PCA	P127 black
eSATA external connection	PCA	P64 (SATA4) black, P65 (SATA5) black
Hood lock cable	PCA	P124 (HOOD_LOCK) black
Hood sensor cable	PCA	P2 on FUI Cable, white
Serial option cable	PCA	P52 (COM) black
Second processor memory fan cable	Riser PCA	P9 (MEM_FAN) black blind-mate

* If an audio card is installed, connect the front audio cable to the audio card connector.

HP Z840 Workstation system cabling

See [HP Z840 Workstation system board components on page 18](#) to determine the location of system board connectors.

Cable	To	Cable/system board designator
PSU cable (C1)	PCA (P1)	P1
PSU cable (C3)	PCA (P2)	P2
PSU cable (C3)	PCA (P3)	P3
PSU cable (C3)	PCA (P4)	P4
PSU cable (C2)	Graphics card	G1
PSU cable (C2)	Graphics card	G2
PSU cable (C2)	Graphics card	G3
PSU cable (C1)	Hard drive cable	H1
PSU cable (C1)	Slimline optical drive / hard drive	D1 (Slim SATA power)
PSU cable (C1)	Optical drive / hard drive	D2 (SATA power)
PSU cable (C1)	Optical drive / hard drive	D3 (SATA power)
PSU cable (C1)	Optical drive	D4 (IDE power)
PSU cable (C1)	Optical drive	D5 (IDE power)
Front fan cable (top)	PCA	P157 (FRONT FAN 1) white
Front fan cable (bottom)	PCA	P158 (FRONT FAN 2) white
Rear fan cable	PCA	P159 (REAR FAN) white
Front audio cable *	PCA	P23 (FRONT AUD) black
Front UI cable cable	PCA	P5 (FRONT PANEL) black
Front USB 3.0 cable	PCA	P26 (FRONT USB 3.0) blue

* If an audio card is installed, connect the front audio cable to audio card connector.

4 Diagnostics and troubleshooting

This chapter describes the tools available for diagnosing and troubleshooting system issues.

- [Calling support](#)
- [Locating ID labels](#)
- [Locating warranty information](#)
- [Diagnosis guidelines](#)
- [Troubleshooting checklist](#)
- [HP troubleshooting resources and tools](#)
- [Troubleshooting scenarios and solutions](#)
- [Using HP PC Hardware Diagnostics \(UEFI\)](#)
- [Diagnostic codes and errors](#)

Calling support

At times you might encounter an issue that requires support. When you call support:

- Have the computer readily accessible.
- Write down the computer serial numbers, product numbers, model names, and model numbers and have them in front of you.
- Note any applicable error messages.
- Note any add-on options.
- Note the operating system.
- Note any third-party hardware or software.
- Note the details of any blinking LEDs on the front of the computer (tower and desktop configurations) or on the side of the computer (all-in-one configurations).
- Note the applications you were using when you encountered the problem.

 **NOTE:** When calling in for service or support, you might be asked for the product number (example: PS988AV) of the computer. If the computer has a product number, it is generally located next to the 10- or 12-digit serial number of the computer.

 **NOTE:** On most models, the serial number and product number labels can be found on the top or side panel and at the rear of the computer (tower and desktop configurations) or on a pull-out card on the side of the display (all-in-one configurations).

For a listing of all worldwide support phone numbers, go to <http://www.hp.com/support>, select your region, and click **Connect with HP** in the upper-right corner.

Locating ID labels

To assist in troubleshooting, product, serial, and authentication numbers are available on each computer.

- All workstations have a serial number (unique for each workstation) and product number. Have these numbers available when you contact support.
- The Certificate of Authentication (COA) is used for systems with native Windows 7 preinstalled.



NOTE: Systems with Windows 8.1 downgraded to Windows 7 do not have a COA.

- The Genuine Microsoft Label (GML) is used for systems with Windows 8 preinstalled.
- A service label shows the build ID and Feature Byte strings, which are needed for system board replacement.

In general, these labels can be found on the top, rear, or bottom of the chassis (tower and desktop configuration). Your computer might look different from the illustration.



Locating warranty information

To locate base warranty information, see <http://www.hp.com/support/warranty-lookuptool>.

To locate an existing Care Pack, see <http://www.hp.com/go/lookuptool>.

To extend a standard product warranty, visit <http://www.hp.com/hps/carepack>. HP Care Pack Services offer upgraded service levels to extend and expand a standard product warranty.

Diagnosis guidelines

If you encounter a problem with the computer, monitor, or software, the following sections provide a list of general suggestions that help you isolate and focus on the problem before taking further action.

Diagnosis at startup

- Verify that the computer and monitor are plugged into a working electrical outlet.
- Remove all CDs, or USB drive keys from your system before turning it on.
- Verify that the computer is turned on and the blue power light is blue (normal operation) and not red (error state).
- If you have installed an operating system other than the factory-installed operating system, check to be sure that it is supported on your system by visiting <http://www.hp.com/go/quickspecs>.
- Verify that the monitor is turned on and the green monitor light is on. Note that not all monitors are equipped with LED lights to indicate their functionality.
- Turn up the brightness and contrast controls of the monitor if the monitor is dim.

Diagnosis during operation

- Look for blinking LEDs on the side of the computer. The blinking lights are error codes that will help you diagnose the problem. Refer to the [Diagnostic LED and audible \(beep\) codes on page 91](#) section of this document for information on interpreting diagnostic lights and audible codes.
- Check all cables for loose or incorrect connections.
- Wake the computer by pressing any key on the keyboard or the power button. If the system remains in suspend mode, shut down the system by pressing and holding the power button for at least four seconds, then press the power button again to restart the system. If the system does not shut down, unplug the power cord, wait a few seconds, then plug it in again. If it does not restart, press the power button to start the computer.
- Reconfigure the computer after installing a non–plug and play expansion board or other option.
- Be sure that all required device drivers have been installed. For example, if you have connected a printer, you must install a printer driver.
- If you are working on a network, plug another computer with a different cable into the network connection. There might be a problem with the network plug or cable.
- If you recently added new hardware, remove the hardware and verify if the computer functions properly.
- If you recently installed new software, uninstall the software and verify if the computer functions properly.
- If the screen is blank, plug the monitor into a different video port on the computer if one is available. Alternatively, replace the monitor with a monitor that you know is working properly.
- Upgrade the BIOS. A new release of the BIOS might have been released that supports new features or fixes your problem.
- Press the **Caps Lock** key. If the **Caps Lock** LED toggles on or off, the keyboard is operating correctly.

Troubleshooting checklist

Before running diagnostic utilities, make sure that.

- The computer is connected to a working electrical outlet and powered on, and the power light is illuminated.
- The monitor (for tower or desktop configurations) is connected to a working electrical outlet and powered on, and the power light is illuminated.
- The monitor brightness and contrast are properly adjusted.
- The keyboard is operating correctly (press and hold any key and listen for a beep).
- All cables are properly connected.
- All necessary device drivers are installed
- All external media (such as optical disks or USB drive keys) are removed before startup.
- The latest version of BIOS, drivers, and software are installed.

HP troubleshooting resources and tools

This section provides information on the HP Help and Support Center, Online support, and Helpful Hints for troubleshooting.

Online support

Online access and support resources include web-based troubleshooting tools, technical knowledge databases, driver and patch downloads, online communities, and product change notification services.

The following websites are also available to you:

- <http://www.hp.com>—Provides useful product information.
- http://www.hp.com/support/workstation_manuals—Provides the latest online documentation.
- <http://www.hp.com/go/workstationsupport>—Provides technical support information for workstations.
- <http://www.hp.com/support>—Provides a listing of the worldwide technical support phone numbers. Access the telephone numbers by visiting the website, then select your region, and click **Contact HP** in the upper-left corner.
- http://www.hp.com/support/workstation_swdrivers—Provides access to software and drivers for workstations.

Troubleshooting a problem

To help you troubleshoot problems with your system, HP provides the Business Support Center (BSC). The BSC is a portal to an extensive selection of online tools. To access BSC and troubleshoot a problem with the workstation, complete the following:

1. Visit <http://www.hp.com/go/workstationsupport>.
2. Under the **Business Support Center** menu on the left, select **Troubleshoot a problem**.
3. Under **Select your product** (center window), select **Workstations** (under **personal computing**).
4. Under **Select your product**, continue with selections as appropriate to the workstation series and model, and to the problem you are troubleshooting.

Instant Support and Active Chat

HP Instant Support is a set of web-based support tools that automate and speed up the resolution of desktop computing, tape storage, and printing problems.

Active Chat enables you to electronically submit a support ticket to HP over the web. When you submit a support ticket, Active Chat collects information about the computer and pass it to an online support specialist. The collection of information might take up to 30 seconds depending on the computer configuration. When you submit a support ticket, you receive a confirmation message containing your case ID, the support hours for your location, and the estimated time of response.

For more information about HP Instant Support and Active Chat and how to use them, go to <http://instantsupport.hp.com/>.



NOTE: This feature is not available on Linux.

Customer Advisories, Customer and Security Bulletins, and Customer Notices

To find advisories, bulletins, and notices:

1. Visit <http://www.hp.com/go/workstationsupport>.
2. Select the desired product.
3. Under **Resources for <your selected product>**, select **See more....**
4. Under **Self-Help resources:** in the center of the window, choose the desired action and appropriate information in the scroll list to view the index.

Product Change Notifications

Product Change Notifications (PCNs) are proactive notifications for product changes occurring within a 30-60 day window of the effective date of the change in the manufacturing process. PCNs give customers advanced notice of changes to their product, such as an updated BIOS version that they may need to qualify prior to the change taking place. The latest PCNs are located at: <http://www.hp.com/go/workstationsupport>.

Helpful hints

If you encounter a problem with the workstation, monitor, or software, the following general suggestions might help you isolate and focus on the problem before taking further action.

At startup

- Verify that the workstation and monitor are plugged into a working electrical outlet.
- Remove all optical discs and USB drive keys from the drives before powering on the workstation.
- Verify that the workstation is turned on and the power light is on.
- If you have installed an operating system other than the factory-installed operating system, check to be sure that it is supported on your system by visiting <http://www.hp.com/go/quickspecs>.
- Verify that the monitor is turned on and the green monitor light is on.
- Turn up the brightness and contrast controls of the monitor if the monitor is dim.
- If the workstation has multiple video sources and only a single monitor, the monitor must be connected to the source selected as the primary VGA adapter. During startup, the other monitor connectors are disabled; if the monitor is connected to one of these ports, it will not function after Power-on Self Test (POST). You can select the default VGA source in Computer Setup (F10).

During operation

- Look for blinking LEDs on the workstation. The blinking lights are error codes that will help you diagnose the problem. Refer to the *Diagnostic lights and audible (beep) codes* section of this document for information on interpreting diagnostic lights and audible codes.
- Press and hold any key. If the system beeps, then your keyboard is operating correctly.
- Check all cables for loose or incorrect connections.
- Wake the workstation by pressing any key on the keyboard or the power button. If the system remains in suspend mode, shut down the system by pressing and holding the power button for at least four seconds, then press the power button again to restart the system. If the system does not shut down, unplug the power cord, wait a few seconds, then plug it in again. If it does not restart, press the power button to start the workstation.
- Reconfigure the workstation after installing a non–plug and play expansion board or other option. Refer to the *Hardware installation problems* section of this document for instructions.
- Be sure that all required device drivers have been installed. For example, if you have connected a printer, you must install a printer driver.
- If you are working on a network, plug another workstation with a different cable into the network connection. There might be a problem with the network plug or cable.
- If you recently added new hardware, remove the hardware and verify if the workstation functions properly.
- If you recently installed new software, uninstall the software and verify if the workstation functions properly.
- If the monitor connected to a tower, desktop or all-in-one computer is blank:
 - Plug the monitor into a different video port on the computer if one is available. Alternatively, replace the monitor with a monitor that you know is working properly.
 - Verify that the computer *and monitor* are plugged into a working electrical outlet.
 - Verify that the monitor is turned on and the green monitor light is on.
 - Turn up the brightness and contrast controls of the monitor if the monitor is dim.
- If the internal display on an all-in-one computer is blank, open the computer and make sure the graphics card is properly installed.
- Upgrade the BIOS. A new release of the BIOS might have been released that supports new features or fixes your problem.

Customer Self-Repair program

Under the Customer Self-Repair program, you can order a replacement part and install the part without onsite HP technical assistance. Customer self-repair may be required for some components. See <http://www.hp.com/go/selfrepair> for information on the program.



NOTE: Some components are not eligible for customer self-repair and must be returned to HP for service. Call HP Support for further instructions before attempting to remove or repair these components.

Troubleshooting scenarios and solutions

This section presents troubleshooting scenarios and possible solutions for a Windows-based system.

Solving minor problems

Problem	Cause	Possible Solution
Workstation appears frozen and does not shut down when the power button is pressed.	Software control of the power switch is not functional.	<ol style="list-style-type: none">1. Press and hold the power button for at least four seconds until the computer shuts down.2. Disconnect the electrical plug from the outlet.3. Restart the computer.
Workstation seems to be frozen.	Program in use has stopped responding to commands.	<ol style="list-style-type: none">1. If possible, use the Windows Task Manager to isolate and terminate the offending process.2. Attempt the normal Windows shutdown procedure.3. Restart the computer using the power button.
Workstation date and time display is incorrect.	Real-time clock (RTC) battery might need replacement.	<ol style="list-style-type: none">1. Reset the date and time in the Control Panel.2. Replace the RTC battery.
Workstation appears to pause periodically.	Network driver is loaded and no network connection is established.	Establish a network connection, or use Computer Setup (F10) Utility or the Microsoft Windows Device Manager to disable the network controller.
Cursor does not move using the arrow keys on the keypad.	The Num Lock key might be on.	Press Num Lock. The Num Lock key can be disabled or enabled in Computer Setup (F10) Utility.
Poor performance is experienced.	Processor is hot.	<ol style="list-style-type: none">1. Verify that airflow to the computer is not blocked.2. Verify that chassis fans are connected and working properly. Some fans operate only when needed.3. Verify that the processor heatsink is installed properly.
	Hard drive is full.	Transfer data from the hard drive to create more space on the hard drive.
Workstation powered off automatically and the Power LED flashes red 2 times (once every second), followed by a 2-second pause, and then two simultaneous beeps sounded.	Processor thermal protection is activated. A fan might be blocked or not turning. OR The processor heatsink is not properly attached to the processor.	<ol style="list-style-type: none">1. Verify that the computer air vents are not blocked.2. Open the access panel and press the computer power button.3. Verify that the system fan is running.4. Verify that the processor heatsink fan spins. If the fan is not spinning, verify that the heatsink fan cable is plugged into the system board connector and that the heatsink is properly seated.5. Replace the processor heatsink.
System does not power on, and the LEDs on the front of the computer are not flashing.	System cannot power on.	Press and hold the power button for less than four seconds. If the hard drive LED turns white: <ol style="list-style-type: none">1. To find a faulty device, remove all devices one at a time:<ol style="list-style-type: none">a. Disconnect AC power to the computer.b. Remove a device.c. Reconnect AC power and power on the computer.

Problem	Cause	Possible Solution
		<ol style="list-style-type: none"> 2. Repeat this process until the faulty device is identified. Remove the graphics card last. Replace the faulty device. 3. If no faulty device is found, replace the system board.
		OR
		<ol style="list-style-type: none"> 1. Press and hold the power button for <i>less than</i> four seconds. If the hard drive LED does not illuminate: <ol style="list-style-type: none"> a. Verify that the computer is plugged into a working AC outlet. b. Verify that the power button harness is connected to the inline front panel I/O device assembly connector. 2. Verify that the power supply unit (PSU) cables are connected to the system board. 3. Verify power supply unit PSU functionality: <ol style="list-style-type: none"> a. Disconnect the AC power. b. HP Z840 Workstation only—Remove PSU. All other workstations, unplug cables connected to the system board. c. Reconnect AC power <ul style="list-style-type: none"> • If the PSU fan spins and the BIST LED illuminates, the PSU is good; replace the system board. • If the PSU fan does not spin or the LED does not illuminate, replace the PSU.

Solving hard drive problems

Problem	Cause	Solution
Hard drive error	Hard disk has bad sectors or has failed.	Locate and block the usage of bad sectors. If necessary, reformat the hard disk. If the drive is detected by the BIOS, run DPS Self-test.
Disk transaction problem	The directory structure is bad, or there is a problem with a file.	<ol style="list-style-type: none"> 1. Right-click Start, select Explore, and select a drive. 2. Select File > Properties > Tools. 3. Under Error-checking, select Check Now.
Drive not found (identified)	Improper cable connection	On computers with discrete data and power cables, ensure that the data and power cables are securely connected to the hard drive. (See the <i>Hard drive</i> section of this guide for connection details.)
	Improperly seated hard drive	On systems with blind-mate drive connections, check for connector damage on the drive and in the chassis. Reseat the hard drive and its carrier in the chassis to ensure a proper connection. (See the <i>Hard drive</i> section of this guide for connection details.)
	The system might not have automatically recognized a newly installed device.	<ol style="list-style-type: none"> 1. Run Computer Setup (F10) Utility. 2. If the system does not recognize the new device, verify that the device is listed in Computer Setup (F10) Utility. If it is listed, the probable cause is a driver problem. If it is not listed, the probable cause is a hardware problem. 3. If this drive is newly installed, enter Setup and try adding a POST delay under Advanced > Power-On.
Non-system disk or NTLDR missing message	Drive responds slowly immediately after power-up.	Run Computer Setup (F10) utility and increase the POST Delay in Advanced > Power-On Options .
	System is trying to start from nonbootable media.	Remove the optical disc or USB drive.
	System is trying to start from a damaged hard drive.	Insert a bootable system optical disc or USB drive and restart the computer.
	System files missing or not properly installed.	<ol style="list-style-type: none"> 1. Insert a bootable system optical disc or USB drive and restart. 2. Verify that the hard drive is partitioned and formatted. 3. Install the files for the appropriate operating system, if necessary.
Workstation will not start.	Hard drive boot disabled in Computer Setup.	Run Computer Setup (F10) Utility and enable the hard drive entry in the Advanced > Boot Order list.
	Hard drive is damaged.	Replace the hard drive.

Solving display problems

These suggestions apply to monitors connected to desktop and tower configurations, and to external monitors connected to all-in-one configurations.

Problem	Cause	Solution
Blank screen (no video).	The cable connections are not correct.	Verify the cable connections from the monitor to the computer and to a working electrical outlet.
	The monitor is off.	Turn the monitor on (LED is on). You might need to refer to the monitor manual for an explanation of LED signals.
	Screen blanking utility installed or energy saver features enabled.	Press a key or the mouse button and, if set, enter your password.
	System ROM is bad; system is running in FailSafe Boot Block mode (indicated by 8 beeps).	Reflash the ROM using a SoftPaq.
	Fixed-sync monitor does not sync at the resolution specified.	Verify that the monitor can accept the same horizontal scan rate as the resolution specified.
	Computer is in Hibernate mode.	Press the power button to resume from Hibernate mode.
	Workstation monitor settings are not compatible with the monitor.	<ol style="list-style-type: none"> 1. When you see Press F8 in the bottom-right corner of the screen, restart the computer and press F8 during startup. 2. Using the keyboard arrow keys, select Enable VGA Mode and then press Enter. 3. For Windows, double-click the Display icon in the Control Panel and then select the Settings tab. 4. Use the sliding control to reset the resolution.
The display works properly during the POST but goes blank when the operating system starts.	The display settings in the operating system are incompatible with your graphics card and monitor.	<ol style="list-style-type: none"> 1. For Windows, restart your computer in VGA mode. 2. After the operating system starts, change the display settings to match those supported by your graphics card and monitor. 3. Refer to your operating system and graphics card documentation for information about changing display settings.
Power LED flashes red 6 times (once every second), followed by a two-second pause, and then the computer beeps 6 times.	Pre-video graphics error.	<p>For systems with a graphics card:</p> <ol style="list-style-type: none"> 1. Reseat the graphics card. 2. If the card requires external power, make sure the power cable is properly connected. 3. Replace the graphics card. 4. Replace the system board. <p>For systems with no graphics card installed, the processor may have no integrated graphics capability.</p>
Monitor does not function when used with Energy Saver features.	Monitor without Energy Saver capabilities is being used with Energy Saver features enabled.	Disable the monitor Energy Saver feature.
Dim characters	The brightness and contrast controls are not set properly.	Adjust the monitor brightness and contrast controls.

Problem	Cause	Solution
	Cables are not properly connected.	Verify that the graphics cable is connected to the graphics card and the monitor.
Blurry video or requested resolution cannot be set.	If the graphics controller was upgraded, the correct video drivers might not be loaded.	Install the video drivers included in the upgrade kit, or download and install the latest drivers for your graphics card from http://welcome.hp.com/country/us/en/support.html .
	Monitor cannot display requested resolution.	Change the requested resolution.
The picture is broken up, rolls, jitters, or flashes.	The monitor connections might be faulty, or the monitor might be incorrectly adjusted.	<ol style="list-style-type: none"> 1. Be sure the monitor cable is securely connected to the computer. 2. In a multiple CRT monitor system, ensure that the monitors' electromagnetic fields are not interfering with each other. Move them apart if necessary. 3. Move fluorescent lights or fans that are too close to the CRT monitor.
	Monitor must be degaussed.	Degauss the monitor.
Vibrating or rattling noise coming from inside a CRT monitor when powered on.	Monitor degaussing coil has been activated.	None. It is normal for the degaussing coil to be activated when the monitor is powered on.
Clicking noise coming from inside a CRT monitor.	Electronic relays have been activated inside the monitor.	None. It is normal for some monitors to make a clicking noise when turned on and off, when going in and out of Standby mode, and when changing resolutions.
High pitched noise coming from inside a flat-panel monitor.	Brightness and contrast settings are too high.	Lower brightness and contrast settings.
Fuzzy focus; streaking, ghosting, or shadowing effects; horizontal scrolling lines; faint vertical bars; or unable to center the picture on the screen (flat-panel monitors using an analog VGA input connection only.)	Flat-panel monitor's internal digital conversion circuits might be unable to correctly interpret the output synchronization of the graphics card.	<ol style="list-style-type: none"> 1. Select the monitor's Auto-Adjustment option in the monitor's onscreen display menu. 2. Manually synchronize the Clock and Clock Phase onscreen display functions. 3. Download SoftPak SP22333 to assist with the synchronization).
Some typed symbols do not appear correctly.	The font you are using does not support that symbol.	<p>Use the Character Map to locate and select the appropriate symbol.</p> <p>Select Start>All Programs> Accessories>System Tools>Character Map. You can copy the symbol from the Character Map into a document.</p>

Solving audio problems

Problem	Cause	Solution
Sound does not come out of the speaker or headphones.	Software volume control is turned down.	Double-click the Speaker icon on the taskbar and use the volume slider to adjust the volume.
	The external speakers are not turned on.	Turn on the external speakers.
	External speakers plugged into the wrong audio jack.	See your sound card documentation for proper speaker connection.
	Digital CD audio is not enabled.	Enable digital CD audio: <ol style="list-style-type: none"> 1. From the Control Panel, select System. 2. On the Hardware tab, select the Device Manager button. 3. Right-click the CD/DVD device and select Properties. 4. On the Properties tab, select Enable digital CD audio for this CD-ROM device.
	Headphones or devices connected to the line-out connector have muted the internal speaker.	Turn on and use headphones or external speakers, if connected, or disconnect headphones or external speakers.
	Volume is muted.	<ol style="list-style-type: none"> 1. From the Control Panel, select Sound, Speech and Audio Devices, and then select Sounds and Audio Devices. 2. Deselect the Mute checkbox.
Noise or no sound comes out of the speakers or headphones.	Computer is in Standby mode.	Press the power button to resume from Standby mode.
		<ol style="list-style-type: none"> 1. If you are using digital speakers that have a stereo jack and you want the system to autoswitch to digital, use a stereo-to-mono adapter to engage the auto sense feature, or use multimedia device properties to switch the audio signal from analog to digital. 2. If the headphones have a mono jack, use the multimedia device properties to switch the system to analog out. <p>NOTE: If you set digital as the Output Mode, the internal speaker and external analog speakers no longer output audio until you switch back to an auto sense or analog mode.</p> <p>If you set analog as the Output Mode, external digital speakers do not function until you change the output mode back to an auto-sense or digital mode.</p>
Sound occurs intermittently.	Processor resources are being used by other open applications.	Shut down all open processor-intensive applications.
Workstation appears to be locked up while recording audio.	The hard disk might be full.	1. Before recording, be sure there is enough free space on the hard disk.
		2. Try recording the audio file in a compressed format.

Solving printer problems

Problem	Cause	Solution
Printer does not print.	Printer is not turned on and online.	Turn the printer on and be sure it is online.
	The correct printer driver for the application is not installed.	<ol style="list-style-type: none">1. Install the correct printer driver for the application.2. Try printing using the MS-DOS command: DIR C:\> [printer port] Replace <i>printer port</i> with the address of the printer used. If the printer works, reload the printer driver.
	If you are on a network, you might not have made a connection to the printer.	Make the proper network connection to the printer.
Printer does not turn on.	Printer might have failed.	Run printer self-test.
	The cables might not be connected properly.	

Solving power supply problems

This section presents power supply troubleshooting scenarios.

Testing power supply

Before replacing the power supply unit (PSU), use the Built-In Self-Test (BIST) feature to learn if the power supply still works.

 **NOTE:** Not all PSUs have the BIST functionality. Refer to the *Rear panel components* section of this document to determine BIST availability for your workstation.

To test the power supply:

1. Unplug the AC power.

 **NOTE:** For the HP Z840 Workstation, you **must** remove the power supply from the chassis.

2. Unplug all power cables to the system boards.
3. Plug in AC power and verify the following:
 - If the green BIST LED on the rear of the workstation is illuminated **and** the fan is spinning, the PSU is functional.
 - If the green BIST LED is not illuminated **or** the fan is not spinning, replace the PSU.

See the *Rear panel components* section of this document to locate the BIST LED on your workstation.

Problem	Cause	Solution
PSU shuts down intermittently.	Power supply fault.	Replace the PSU.
Workstation powers off and the Power LED flashes red 2 times (once	Processor thermal protection is activated.	<ol style="list-style-type: none">1. Ensure that the workstation air vents are not blocked.

Problem	Cause	Solution
every second), followed by a two-second pause.	<p>A fan might be blocked or not turning.</p> <p>OR</p> <p>The processor heatsink fan assembly is not properly attached to the processor.</p>	<ol style="list-style-type: none"> 2. Open the access panel and press the workstation power button. 3. Verify that the system fan is running. 4. Verify that the processor heatsink fan spins. If the heatsink fan is not spinning, verify that the fan cable is plugged into the system board connector. Verify that the fan is properly seated. 5. Replace the processor heatsink.
Power LED flashes red (once every 2 seconds).	Power failure (power supply is overloaded).	<ol style="list-style-type: none"> 1. Determine whether a device is causing the problem by performing the following: <ol style="list-style-type: none"> a. Disconnect AC power. b. Remove all attached devices. c. Power on the workstation. <p>If the system enters the POST, perform the following:</p> <ol style="list-style-type: none"> a. Power off the workstation. b. Replace one device at a time and repeat this procedure until a failure occurs. c. Replace the device causing the failure d. Continue adding devices one at a time to verify that all devices are functioning. 2. Verify power supply functionality. <ol style="list-style-type: none"> a. Disconnect AC power. b. Remove the Z840 PSU from the chassis. c. Unplug all system board power cables for the Z440 and Z640. d. Plug in AC power. <ul style="list-style-type: none"> • If the PSU fan spins and the LED illuminates (see Testing power supply on page 88), the power supply is good. Replace the system board. • If the PSU fan does not spin or the LED does not illuminate (see Testing power supply on page 88), replace the power supply.

Using HP PC Hardware Diagnostics (UEFI)

HP PC Hardware Diagnostics is a Unified Extensible Firmware Interface (UEFI) that allows you to run diagnostic tests to determine whether the computer hardware is functioning properly. The tool runs outside the operating system so that it can isolate hardware failures from issues that are caused by the operating system or other software components.

To start HP PC Hardware Diagnostics UEFI:

1. Turn on or restart the computer, quickly press the Windows button on the computer, and then press **F2**. The BIOS searches three places for the diagnostic tools, in the following order:
 - a. Connected USB drive
[Downloading HP PC Hardware Diagnostics \(UEFI\) to a USB device on page 90](#)
 - b. Hard drive
 - c. BIOS
2. When the diagnostic tool opens, use the keyboard arrow keys to select the type of diagnostic test you want to run, and then follow the on-screen instructions.

Downloading HP PC Hardware Diagnostics (UEFI) to a USB device



NOTE: Instructions for downloading HP PC Hardware Diagnostics (UEFI) are provided in English only.

There are two options to download HP PC Hardware Diagnostics to USB device.

Option 1: HP PC Diagnostics homepage—Provides access to the latest UEFI version

1. Go to <http://www.hp.com/go/techcenter/pcdiags>.
2. Click the **Download** link, and then select **Run**.

Option 2: Support and Drivers pages—Provides downloads for a specific product for earlier and later versions.

1. Go to <http://www.hp.com>.
2. Point to **Support**, located at the top of the page, and then click **Download Drivers**.
3. In the text box, enter the product name, and then click **Go**.

– or –

Click **Find Now** to let HP automatically detect your product.

4. Select your computer model, and then select your operating system.
5. In the **Diagnostic** section, click **HP UEFI Support Environment**.

– or –

Click **Download**, and then select **Run**.

Diagnostic codes and errors

This section presents information about diagnostic LED codes, LED color definitions, and POST error messages to help you troubleshoot problems.

Diagnostic LED and audible (beep) codes

This section describes the front panel LED error and operation codes as well as the audible codes that might occur before or during the POST.

Activity	Possible cause	Recommended action
White Power LED [†] on. No beeps.	Computer on.	
White Power LED [†] blinks every two seconds.* No beeps.	Computer in Sleep mode (S3-Suspend to RAM). Select models only.	
White Power LED [†] is off.* No beeps.	Computer in Hibernate mode (S4-Suspend to disk) or system is off (S5).	N/A
White Power LED [†] blinks three times*, once per second.* No beeps.	Computer in Sleep mode (S3-Suspend to RAM). Select models only.	
White Power LED [†] blinks four times*, once per second.* No beeps.	Computer in Hibernate mode (S4-Suspend to disk).	
For the following LED activity and beeps, the beeps are heard through the chassis speaker. Blinks and beeps repeat for five cycles, after which, only the blinks continue to repeat.		
Red Power LED blinks two times, once every second, followed by a two-second pause. Two beeps.	Processor thermal protection activated by either of the following methods:	<p>CAUTION: Internal components might be powered even when the computer is off. To prevent damage, disconnect the computer power cord before you remove a component.</p> <ol style="list-style-type: none"> 1. Ensure that the computer air vents are not blocked and the cooling fan is running. 2. Open the access panel, press power button, and verify that the processor fan is spinning. If the processor fan is not spinning, make sure the fan cable is plugged into the computer board header. Ensure the fan is fully and properly seated or installed. 3. If fan is plugged in and seated properly, but is not spinning, the problem might be in the processor fan. Contact HP for assistance. 4. Verify that the fan assembly is properly attached. If problems persist, there might be a problem with the processor heatsink. Contact HP for assistance.
Red Power LED blinks three times, once every second, followed by a two-second pause. Three beeps.	Processor not installed (not an indicator of bad processor).	<ol style="list-style-type: none"> 1. Verify that the processor is present. 2. Reseat the processor.
Red Power LED blinks four times, once every second, followed by a two-second pause. Four beeps.	Power failure (power supply is overloaded).	<p>CAUTION: Internal components might be powered even when the computer is off. To prevent damage, disconnect the computer power cord before you remove a component.</p> <ol style="list-style-type: none"> 1. Open the access panel and ensure that all power connections are secure on the system board.

Activity	Possible cause	Recommended action
		<ol style="list-style-type: none"> 2. Check if a device is causing the problem by removing all attached devices (such as hard, diskette, or optical drives, and expansion cards.) Power on the computer. If the system enters the POST, power off and replace one device at a time; repeat this procedure until failure occurs. Replace the device that is causing the failure. Continue adding devices one at a time to ensure all devices are functioning properly. 3. Check power supply functionality: <ol style="list-style-type: none"> a. Disconnect AC power b. Remove all internal power supply cables from the system board. c. Plug in AC power. <ul style="list-style-type: none"> • If the power supply fan spins and the LED lights, then the power supply is good. Replace the system board. • If the power supply fan does not spin or the LED does not light, replace the power supply.
<p>Red Power LED blinks five times, once every second, followed by a two-second pause. Five beeps.</p>	<p>Pre-video memory error.</p>	<p>CAUTION: Internal components might be powered even when the computer is off. To prevent damage, disconnect the computer power cord before you remove a component.</p> <ol style="list-style-type: none"> 1. Reseat DIMMs. 2. Replace DIMMs one at a time to isolate faulty module. 3. Replace third-party memory with HP memory. 4. The problem might be on the system board. Contact HP for assistance.
<p>Red Power LED blinks six times, once every second, followed by a two-second pause. Six beeps.</p>	<p>Pre-video graphics error.</p>	<p>CAUTION: Internal components might be powered even when the computer is off. To prevent damage, disconnect the computer power cord before you remove a component.</p> <p>(BIOS did not detect a VGA-compatible device)</p> <p>For systems with integrated graphics, the problem might be the system board. Contact HP for assistance.</p> <p>For systems with graphic cards:</p> <ol style="list-style-type: none"> 1. Reseat the graphics card. 2. The problem might be the graphics card. 3. The problem might be the system board. Contact HP for assistance.
<p>Red Power LED blinks eight times, once every second, then stops blinking.</p>	<p>Entering FailSafe (BootBlock) Recovery Mode</p>	<p>Either FailSafe detected a corrupted ROM, or the user pressed Esc before powering on. The BIOS does not halt at this point, but attempts to boot to a ROMPaq floppy or CD-ROM (USB devices are not supported).</p> <ol style="list-style-type: none"> 1. Reflash ROM with a ROMPaq floppy or CD-ROM. 2. The problem might be in the system board. Contact HP for assistance.
<p>System does not power-on and LEDs are not blinking. No beeps.</p>	<p>System unable to power on.</p>	<p>CAUTION: Internal components might be powered even when the computer is off. To prevent damage, disconnect the computer power cord before you remove a component.</p> <p>To resolve the problem, choose one of the following options:</p>

Activity	Possible cause	Recommended action
		<p>Press and hold the power button for less than four seconds. If the hard drive LED turns white, then:</p> <ol style="list-style-type: none"> 1. Remove the expansion cards one at a time and try holding the power button again for less than four seconds. 2. The problem might be on the system board. Contact HP for assistance. <p>Press and hold the power button for less than four seconds. If the hard drive LED does not turn on white then:</p> <ol style="list-style-type: none"> 1. Check that unit is plugged into a working AC outlet. 2. Open the access panel and check that the power button harness is properly connected to the system board. 3. Check that all power supply cables are properly connected to the system board. 4. Check the power supply functionality. <ol style="list-style-type: none"> a. Disconnect the AC power. b. HP Z840 Workstation only—Remove the power supply from the chassis. All other workstations, unplug cables connected to system board. c. Plug in AC power. <ul style="list-style-type: none"> • If the power supply fan spins and the BIST LED illuminates, the power supply is good; replace the system board. • If the power supply fan does not spin or the LED does not illuminate, replace the power supply.

* The BIOS option you select controls the blue LED function during these suspend modes.

LED color definitions

The following table describes what each LED light on the computer front panel signifies.

LED state	LED color	System status
Solid	White	System is on.
Flashing	White	System is in Standby.
Solid or flashing	Red	System has experienced an error. (See POST error messages on page 94.)
None	No light	System is in Hibernate, or is off.

POST error messages

The Power-On Self Text (POST) is a series of diagnostic tests that runs automatically when the computer is powered on.

Audible and visual messages occur before the operating system starts if the POST encounters a problem. POST checks the following items to ensure that the computer system is functioning properly:

- Keyboard
- DIMMs
- Diskette drives
- All mass storage devices
- Processors
- Controllers
- Fans
- Temperature sensors
- Cables (front/rear panels, audio, and USB ports)

The table shown next describes the POST error messages.

Screen message	Probable cause	Recommended action
102—System Board Failure		Potential system board problem; contact HP Support.
110—Out of memory space for option ROMs	Option ROM for a device could not run because of memory constraints.	Run Computer Setup (F10) Utility to disable unneeded option ROMs, and to enable ACPI/USB Buffers at Top of Memory.
161—Real-Time Clock Power Loss		<ol style="list-style-type: none">1. Run Computer Setup (F10) utility and set default settings.2. Replace the CMOS battery.3. Replace the system board.
162—Systems Options Error		<ol style="list-style-type: none">1. Run Computer Setup (F10) utility and set default settings.2. Replace the CMOS battery.3. Replace the system board.
163—Time and Date Not Set	<ul style="list-style-type: none">• Invalid time or date in configuration memory.• RTC battery might need replacement.• CMOS jumper might not be properly installed.	<ol style="list-style-type: none">1. Set the date and time from the Control Panel or in Computer Setup (F10) Utility (depending on the operating system).2. If the problem persists, replace the RTC battery.
164—Memory Size Error	Memory configuration is incorrect.	Confirm that the correct memory is installed in the system.
201—Memory Error	RAM failure.	<ol style="list-style-type: none">1. Run Computer Setup (F10) utility or the Windows utilities.2. Be sure that memory modules are installed correctly.3. Verify the memory module type.

Screen message	Probable cause	Recommended action
		<ol style="list-style-type: none"> Remove and replace memory modules one at a time to isolate faulty modules. Replace faulty memory modules. If the error persists after replacing memory modules, replace the system board.
214—DIMM Configuration Warning	DIMMs are not installed correctly (not paired correctly).	See the service label on the computer access panel for the correct memory configurations, and reseal the DIMMs accordingly.
301—Keyboard Error	Keyboard failure.	<ol style="list-style-type: none"> Reconnect the keyboard with the computer powered off. Connect a keyboard directly to the computer (instead of through a switch box). Be sure that none of the keys are pressed. Replace the keyboard.
303—Keyboard Controller Error	I/O board keyboard controller is defective or is not set properly.	<ol style="list-style-type: none"> Reconnect the keyboard with the computer powered off. Connect a keyboard directly to the computer (instead of through a switch box). Replace the system board.
304—Keyboard or System Unit Error	Keyboard failure.	<ol style="list-style-type: none"> Reconnect the keyboard with the computer powered off. Connect a keyboard directly to the computer (instead of through a switch box). Be sure that none of the keys are pressed. Replace keyboard. Replace system board.
510—Splash Screen image corrupted	Splash Screen image has errors.	Update system BIOS/UEFI.
511—CPU Fan not detected	Fan is not connected or is defective.	<ol style="list-style-type: none"> Reseat the fan cable. Reseat the fan. Replace the fan.
512—Rear chassis fan not detected	Fan missing, disconnected, or defective.	<ol style="list-style-type: none"> Reseat the fan cable. Reseat the fan. Replace the fan.
513—Front Chassis fan not detected	Front fan missing, disconnected, or defective.	<ol style="list-style-type: none"> Reseat the fan cable. Reseat the fan. Replace the fan.
514—Power supply wattage insufficient for hardware configuration	Computer configuration requires more power than the power supply can provide	Reduce the computer power consumption.
515—Power supply fan not detected	Power supply fan is disconnected or defective.	<ol style="list-style-type: none"> Reseat the power supply cables. Replace the power supply.

Screen message	Probable cause	Recommended action
517—Memory fan not detected	Memory fan missing, disconnected, or defective.	<ol style="list-style-type: none"> 1. Reseat the fan cable. 2. Reseat the fan. 3. Replace the fan.
518—PCI fan not detected	PCI fan missing, disconnected, or defective.	<ol style="list-style-type: none"> 1. Reseat the fan cable. 2. Reseat the fan. 3. Replace the fan.
519—Hard drive fan not detected	Hard drive fan missing, disconnected, or defective.	<ol style="list-style-type: none"> 1. Reseat the fan cable. 2. Reseat the fan. 3. Replace the fan.
520—Memory fan (2) not detected	Memory fan (2) missing, disconnected, or defective.	<ol style="list-style-type: none"> 1. Reseat the fan cable. 2. Reseat the fan. 3. Replace the fan.
521—Memory fan (3) not detected	Memory fan(3) missing, disconnected, or defective.	<ol style="list-style-type: none"> 1. Reseat the fan cable. 2. Reseat the fan. 3. Replace the fan.
522—Memory fan (4) not detected	Memory fan(4) missing, disconnected, or defective.	<ol style="list-style-type: none"> 1. Reseat the fan cable. 2. Reseat the fan. 3. Replace the fan.
523—CPU fan (2) not detected	Processor fan(2) missing, disconnected, or defective.	<ol style="list-style-type: none"> 1. Reseat the fan cable. 2. Reseat the fan. 3. Replace the fan.
524—Rear chassis fan(2) not detected	Rear chassis fan(2) missing, disconnected, or defective.	<ol style="list-style-type: none"> 1. Reseat the fan cable. 2. Reseat the fan. 3. Replace the fan.
525—Front chassis fan(2) not detected	Front chassis fan(2) missing, disconnected, or defective.	<ol style="list-style-type: none"> 1. Reseat the fan cable. 2. Reseat the fan. 3. Replace the fan.
526—CPU Liquid Cooling pump not detected	Liquid cooling pump on CPU1 is not detected.	<ol style="list-style-type: none"> 1. Reseat the pump cable. 2. Replace the pump.
527—CPU Liquid Cooling pump (2) not detected	Liquid cooling pump on CPU2 is not detected.	<ol style="list-style-type: none"> 1. Reseat the pump cable. 2. Replace the pump.
529—Unsupported WiFi Device(s) Detected	An unsupported WiFi device has been installed into an internal slot.	Remove the unsupported device.
917—Front Audio Not Connected	Front Audio mechanism is missing or is not connected.	<ol style="list-style-type: none"> 1. Replace or reconnect the missing front audio mechanism to the system board. 2. Reseat or replace the missing mechanism cable.

Screen message	Probable cause	Recommended action
918—Front USB Not Connected	Front USB mechanism is missing or is not connected.	<ol style="list-style-type: none"> 1. Replace or reconnect the missing Front USB mechanism to the system board. 2. Reseat or replace the missing mechanism cable.
921—Front USB Not Connected	Front USB mechanism is missing or is not connected.	<ol style="list-style-type: none"> 1. Replace or reconnect the missing Front USB mechanism to the system board. 2. Reseat or replace the missing mechanism cable.
922—Front USB 2 Not Connected	Front USB 2 mechanism is missing or is not connected.	<ol style="list-style-type: none"> 1. Replace or reconnect the missing Front USB 2 mechanism to the system board. 2. Reseat or replace the missing mechanism cable.
923—Fatal IRPP error.		Potential system problem; contact HP Support.
924—Fatal IIO error		Potential system problem; contact HP Support.
925—Fatal Misc. Error	A fatal miscellaneous chipset error is selected.	
927—Fatal error on DIMM in slot CPU X DIMM Y	Fatal multibit ECC error detected on the DIMM in the slot labeled DIMM Y (where Y is a number), as labeled on the system board.	Replace the DIMM in the identified slot.
928—Fatal error occurred in the designated slot.	Fatal error occurred in the designated slot.	Move the card to a different slot. If the problem persists, replace the card.
929—Fatal MCA Errorr	An MCA condition is detected on the system.	
939—Front USB 3.0 Not Connected	Front USB 3.0 mechanism is missing or is not connected.	<ol style="list-style-type: none"> 1. Replace or reconnect the missing Front USB 3.0 mechanism to the system board. 2. Reseat or replace the missing mechanism cable.
940—Front 1394 Not Connected	Front 1394 mechanism is missing or is not connected.	<ol style="list-style-type: none"> 1. Replace or reconnect the missing Front 1394 mechanism to the system board. 2. Reseat or replace the missing mechanism cable.
941—PCIe Device(s) installed in slots 3 or 4 with a single CPU	Invalid system configuration.	<ol style="list-style-type: none"> 1. Move the PCIe device from PCIe slots 3 and/or 4 to other PCIe slots. 2. Add a second processor using appropriate HP accessory kit.
942—Memory Train Error	A DIMM or DIMMs did not train correctly.	
1801—Microcode Update Error	Unknown or unsupported processor stepping.	The microcode update failed. If the processor stepping is supported, contact HP Support.
1802—Processor Not Supported	The system board does not support the processor.	Replace the processor with a compatible one.

5 Configuring password security and resetting CMOS

This chapter describes how to configure password security and to reset CMOS.

- [Preparing to configure passwords on page 98](#)
- [Resetting the password jumper on page 99](#)
- [Clearing and resetting the CMOS on page 100](#)

Preparing to configure passwords

Computer Setup (F10) Utility enables you to create setup and power-on passwords.

There are three possibilities for setting passwords:

- Define a setup password only. You will need the password to enter Computer Setup (F10) Utility, but you will not need a password to start the workstation.
- Define a power-on password only. This password lets you start the workstation or enter the setup utility.
- Define both. In this case, the setup password lets you start the workstation and enter the setup utility. The power-on password starts the workstation but does not let you enter the setup utility,

After you create both passwords, you can use the setup password in place of the power-on password as an override to log into the computer (a useful feature for a network administrator).



NOTE: You can only clear the passwords with the password jumper. Clearing CMOS does not clear the passwords.



CAUTION: Before pressing the Clear CMOS button, back up your computer CMOS settings.

Pressing the Clear CMOS button resets CMOS values to factory defaults and erases customized information, including asset numbers and special settings.

To back up the CMOS settings, run Computer Setup (F10) Utility and select **Save to Diskette** from the **Main//** menu.

Resetting the password jumper

Use the following procedure to disable the power-on or setup password features and clear the power-on and setup passwords.

⚠ WARNING! To reduce the risk of personal injury from electrical shock and hot surfaces, be sure to disconnect the power cord from the wall outlet and allow the internal system components to cool before touching.

⚠ CAUTION: When the computer is plugged in, the power supply has voltage applied to the system board, even when the computer is turned off. Failure to disconnect the power cord can result in damage to the system.

⚠ CAUTION: Static electricity can damage the electronic components of the computer or optional equipment. Before beginning these procedures, be sure that you are discharged of static electricity by briefly touching a grounded metal object.

1. Access the jumper:
 - a. Shut down the operating system, turn off the computer and external devices, and then disconnect the computer power cord and external devices from power outlets.
 - b. Disconnect any external devices.
 - c. Verify that the AC power cord is disconnected from the power outlet.
 - d. Open the workstation.
 - e. Locate the password header and jumper.

The password header is E49. The password jumper is blue so it can be easily identified.
2. Remove the jumper from pins 1 and 2. Do not lose the jumper.
3. Restart the computer:
 - a. Close the workstation.
 - b. Reconnect the AC power cord to the power outlet.
 - c. Turn on the computer and wait for the workstation to display the HP splash screen.
4. Repeat step 1.
5. Replace the jumper on pins 1 and 2.
6. Repeat step 3, except press the **F10** key during startup to access Computer Setup (F10) Utility.
7. Use the setup utility to create new passwords.

Clearing and resetting the CMOS

This section describes the steps necessary to successfully clear and reset the CMOS. The CMOS of the computer stores password information and information about the computer configuration.

Using the CMOS button to reset CMOS

To clear CMOS using the Clear CMOS button, use the following procedure:

 **WARNING!** To reduce the risk of personal injury from electrical shock and hot surfaces, disconnect the power cord from the wall outlet and allow the internal system components to cool before touching.

 **CAUTION:** When the computer is plugged in, the power supply has voltage applied to the system board, even when the computer is powered off. Failure to disconnect the power cord can result in damage to the system.

Static electricity can damage the electronic components of the computer or optional equipment. Before beginning these procedures, be sure that you are discharged of static electricity by briefly touching a grounded metal object.

1. Back up your computer CMOS settings run Computer Setup (F10) Utility, and select **Main > Replicated Setup > Back up current settings to USB device.**

 **CAUTION:** Pressing the Clear CMOS button resets CMOS values to factory defaults and erases customized information, including asset numbers and special settings.

2. Shut down the operating system, power off the computer and external devices, and disconnect peripheral devices.
3. Disconnect the AC power cord from the power outlet.

 **NOTE:** The CMOS button does not clear CMOS if the power cord is connected.

4. Open the workstation.
5. Locate, press, and hold the CMOS button for five seconds.

For assistance locating the CMOS button and other system board components, see the system board layout in [HP Z840 Workstation system board components on page 18](#).

6. Close the workstation, reconnect external devices, connect the power cord and power on the workstation.
7. The system boots to an F1 prompt and displays a message that the date/time has changed and that system options have changed.
8. Press **F1**. The system shuts down for three seconds and then powers on again.
9. Use the F10 (Setup) Utility to reset the date and time.

Using Computer Setup (F10) Utility to reset CMOS

1. Access Computer Setup (F10) Utility menu.
2. When Computer Setup message appears in the lower-right corner of the screen, press **F10**, and then press **Enter** to bypass the title screen, if necessary.

If you do not press **F10** while the message is displayed, the computer must be rebooted to access this utility.

3. From Computer Setup (F10) Utility menu, select **Main > Replicated Setup > Restore current settings from USB device**.

This restores the settings that include boot sequence order and other factory settings. However, it does not force hardware rediscovery.

4. Choose **Restore Factory Settings as Default**, and then press **F10** to accept.
5. Select **Main > Apply Defaults and Exit**, and then press **F10** to accept.
6. Reset the computer passwords and configuration information, such as the system date and time.



NOTE: This step does not clear the passwords.

A Linux technical notes

HP offers a variety of Linux solutions for HP workstation customers:

- HP offers an Ubuntu preload on some new Z Series Workstations.
- HP certifies and supports Ubuntu on HP workstations.
- HP certifies and supports Red Hat Enterprise Linux (RHEL) on HP workstations.
- HP certifies SUSE Linux Enterprise Desktop (SLED) on HP workstations.
- HP offers a SLED 11 preload on some older Z Series Workstations.

For Linux setup and restore procedures, see the user guide for your workstation at http://www.hp.com/support/workstation_manuals.

- [System RAM](#)
- [Audio](#)
- [Network cards](#)
- [Hyper-Threading Technology](#)
- [NVIDIA Graphics Workstations](#)
- [AMD Graphics Workstations](#)

 **NOTE:** After you set up the operating system, make sure that the latest BIOS, drivers, and software updates are installed.

 **CAUTION:** Do not add optional hardware or third-party devices to the workstation until the operating system is successfully installed. Adding hardware might cause errors and prevent the operating system from installing correctly.

System RAM

HP supports different amounts of total RAM in various HP workstations, based on the number of hardware DIMM slots and the capabilities of the system. The total memory supported for each configuration is listed in the *Hardware Support Matrix for HP Linux Workstations* at http://www.hp.com/support/linux_hardware_matrix.

Audio

All HP workstations come with built-in audio hardware. The audio hardware is supported by the *Advanced Linux Sound Architecture* (ALSA) drivers included with all modern Linux distributions.

The audio hardware provides basic playback and recording features. The ability to simultaneously play audio from multiple sources, such as applications and CDs, is provided in the ALSA driver that provides audio mixing. The performance of software audio mixing and playback is greatly improved in ALSA version 1.0.13 and later.

After the driver is installed, the optional NVIDIA and AMD graphics cards that are supported in HP workstations also provide audio functionality over HDMI. The signal can be passed through the DisplayPort connector to a monitor with audio capabilities. The vendor driver must be installed. Such a configuration might present two audio hardware choices. If you do not hear sound through the speakers, one possible

reason is that the graphics card (default) is selected for audio output instead of the DisplayPort. Check the audio settings (for example, **Sound** in gnome-control-center).

In some systems, embedded Intel HD graphics may also present a similar HDMI audio device that can be used through the DisplayPort interface. No proprietary driver is needed for this device, just a sufficiently recent kernel.

Network cards

All HP workstations include one or two integrated network interface controllers. Some support optional NICs. Most Linux distributions have drivers for these interfaces.

Hyper-Threading Technology

The Z Series Workstations support Hyper-Threading Technology (HTT), an Intel technology that improves processor performance by enabling the processor to simultaneously perform multiple tasks. The operating system treats an HTT-enabled processor as two virtual processors and shares the workload between them when possible. This feature can be used only if the operating system support multiple processors and is specifically optimized for HTT.

To enable HTT:

1. During startup, press **F10** to enter Computer Setup (F10) Utility.
2. Select **Advanced > Performance Options**.
3. Set **Intel Hyper-Threading Technology** to **Enable**, and then press **F10** to exit the menu.
4. Select **Main > Save Changes and Exit**.
5. Restart the system to enable HTT.



NOTE: On most recent Linux distributions (including RHEL 6, SLED 11, and updates to those streams), the kernel automatically detects that HTT is enabled and works correctly.

NVIDIA Graphics Workstations

Some workstation configurations come with NVIDIA Quadro graphics hardware. HP recommends the use of NVIDIA drivers for best results on Linux systems.

HP provides recommended versions of the drivers with RPM-compatible installers for RHEL and SLED distributions. These are available from the HP Installer Kit for Linux and from workstation driver repositories on hp.com. When HP installers are used, their contents and documentation links are located in the `/opt/hp/nvidia` folder.

When installing Linux on a workstation that contains an NVIDIA card, administrators should select a VESA-compatible driver to avoid the instability that is experienced with some open-source versions of the Nouveau and DRM drivers.

Open-source versions of Nouveau drivers and NVIDIA drivers cannot coexist in the same runtime environment because they use the same hardware resources. If administrators create their own Linux environments using NVIDIA drivers but choose not to use HP-packaged versions, HP recommends that they manually append the following boot loader parameters to properly suppress the Nouveau driver at runtime (grub example below):

```
kernel /vmlinuz ... rdblacklist=nouveau nouveau.modeset=0
```

This action is applied by HP installers but must be applied/restored under other circumstances.

To customize display characteristics and resolutions when the computer is using an NVIDIA driver, execute the following command:

```
/usr/bin/nvidia-settings
```

To create and manipulate the `/etc/X11/xorg.conf` file, execute:

```
/usr/bin/nvidia-xconfig
```

AMD Graphics Workstations

Some workstation configurations include AMD graphics hardware. HP recommends use of AMD graphics drivers for best results on Linux systems.

HP also provides recommended versions of AMD graphics drivers with RPM-compatible installers for RHEL and SLED distributions. These are available from the HP Installer Kit for Linux and workstation driver support packages on hp.com.

The open source RADEON and RADEONHD drivers can conflict with the AMD graphics drivers by claiming the hardware early in the boot process. The AMD driver installation process usually blacklists conflicting drivers and turns off kernel mode-setting in the initial RAM image.

Administrator customization of the display characteristics and many other aspects of an AMD graphics driver environment is available through the following command, which starts the Catalyst Control Center:

```
/usr/bin/amdcccle
```

Some settings for AMD graphics, including reconfiguration of the `/etc/X11/xorg.conf` file, can be accomplished through the many options provided by the following command:

```
/usr/bin/aticonfig
```

Information can be found in these directories after the driver is installed:

```
/opt/hp/ati
```

```
/usr/share/ati
```

```
/usr/share/doc/fglrx
```

If the automatic init script attempts to rebuild the kernel module, the name of the log file is `/var/log/fglrx-build.log`.

B Configuring RAID devices

This appendix explains how to configure RAID arrays on your workstation.

- [RAID hard drive maximum and associated storage controller options](#)
- [Supported RAID configurations](#)
- [Configuring Intel SATA RAID](#)
- [Configuring RAID on an LSI 2308 or LSI 9217-4i4e controller](#)
- [Configuring RAID on an LSI 9270-8i MegaRAID controller](#)
- [Software RAID solution](#)

For additional information about RAID configuration, go to http://www.hp.com/support/RAID_FAQs.

RAID hard drive maximum and associated storage controller options

This section lists the maximum number of hard drives supported on HP workstations according to RAID configuration and storage controller options.



NOTE: This section applies to internal workstation configurations that do not use add-in cards and external enclosures.

	Hard Drives							
	SATA		SAS		Optional			
	8.5 mm (3.5 in)	6.3 mm (2.5 in)	8.5 mm (3.5 in)	6.3 mm (2.5 in)	RSTe	LSI 2308	LSI 9217-4i4e	LSI 9270-8i
Z440	4	4	4	4	Yes	—	Yes	Yes
Z640	4	4	4	4	Yes	—	Yes	Yes
Z840	6	8	6	8	Yes	Yes	—	Yes

Supported RAID configurations

All workstation platforms have the following controllers:

- LSI 2308 controllers — HP Z840 Workstations
- LSI 9217-4i4e controllers — HP Z440 and Z640 Workstations (optional)
- LSI 9270-8i controllers — HP Z440, Z640, and Z840 Workstations (optional)

The following RAID configurations are supported:

Configuration	Description	Controllers
RAID 0 Integrated striped disk array	<ul style="list-style-type: none"> • Requires a minimum of two drives. • Provides improved I/O performance. • Provides no fault tolerance. • Loses all data if any disk in the array fails. • Increases disk performance. 	<ul style="list-style-type: none"> • Intel with RSTe • LSI 2308 • LSI 9217-4i4e • LSI 9270-8i
RAID 1 Mirrored disk array	<ul style="list-style-type: none"> • Supports a maximum of two drives. • Provides 100% redundancy: all data from one drive is duplicated on a second drive. • Recovers from a single-drive failure. • Serves as a good entry-level redundant system. 	<ul style="list-style-type: none"> • Intel with RSTe • LSI 2308 • LSI 9217-4i4e • LSI 9270-8i
RAID 5 Striped disk array with distributed parity	<ul style="list-style-type: none"> • Supports three or more drives. • Provides fault tolerance and I/O performance improvement, especially for write-biased applications. • Retains all data if a single drive fails, but performance is compromised and data loss is possible if a second drive fails until the failed drive is replaced and the array rebuilt. 	<ul style="list-style-type: none"> • Intel with RSTe • LSI 9270-8i
RAID 10 Striped and mirrored disk array	<ul style="list-style-type: none"> • Supports four or more drives. • Requires an even number of drives. • Provides excellent performance. • Uses several drives to stripe data, then copies the striped drives to provide redundancy. • Offers high data transfer of striped arrays and provides increased data accessibility (reads). 	<ul style="list-style-type: none"> • Intel with RSTe • LSI 2308 • LSI 9217-4i4e • LSI 9270-8i
RAID 1E Two-way mirroring	<ul style="list-style-type: none"> • Provides benefits comparable to RAID 10. • Requires an odd number of drives. • Requires a minimum of three drives. • Delivers improved read performance. 	<ul style="list-style-type: none"> • LSI 2308 • LSI 9217-4i4e

Configuring Intel SATA RAID

This section describes how to use Intel® Rapid Storage Technology enterprise (Intel® RSTe) to set up and manage SATA RAID volumes.



NOTE: These instructions apply to Windows-based systems. They also apply to Linux distributions that include the iscsi kernel driver support for the RSTe technology. This driver is included on recent releases of most upstream and enterprise distributions, and may be available for addition to some previous releases. If this driver is not available in the distribution, or is not applicable to the platform (e.g., the RST controller), the Software RAID solution is recommended.

You can create a SATA RAID array that contains up to the maximum number of internal SATA hard drives and eSATA drives (if you use an optional eSATA bulkhead cable) supported on your workstation.

Two or more hard drives must be attached to a controller (sSATA) for that controller's option ROM to run. If two or more drives are on each controller, a unique option ROM executes for each controller.

The Intel SATA AHCI option ROM configuration utilities run when you select **RAID+AHCI** for the SATA emulation mode.

Configuring system BIOS

To set up a RAID configuration, the emulation mode must be set to RAID+AHCI in Computer Setup (F10) Utility. This is the default setting. If the mode has been changed, follow these steps to reinstate it.

1. During startup, press **F10** to enter Computer Setup (F10) Utility. Use the arrow keys to navigate and select options.
2. Select a language from the list, and then press **Enter**.
3. Select **Advanced > Device Configurations**, then press **Enter**.
4. Select **SATA Controller Mode > RAID**, then press **F10** to accept the new settings.

Configuring RAID with the Intel utility

Follow these steps to create RAID volumes.



NOTE: The option ROM displays once for each controller. To expand the mini option ROM screen to full screen, press the **Space Bar** as soon as the mini option ROM screen displays. As soon as the desired option ROM first displays, immediately press **Ctrl+I** to enter the option ROM configuration.

1. Press **Ctrl+I** as soon as the desired option ROM appears to enter the Intel Rapid Storage Technology enterprise utility (RSTe). Use the arrow keys and the space bar to navigate and select options.



NOTE: If only one hard drive is attached, the utility does not open.

2. Select **Create RAID Volume**, then press **Enter**.
3. Type a name for the RAID volume in the **Name** field, then press **Tab**.
4. Use the up and down arrow keys to select the RAID Level, and then press **Tab**.
5. If three or more hard drives are installed, complete the following steps:
 - a. Press **Enter** to display the **Select** dialog box.
 - b. Select individual physical members of the volume using the up and down arrow keys to navigate available drives, and then use the spacebar to make your selection.
 - c. Press **Enter** to exit the Select dialog box and to return to the Create Volume Menu dialog box.
6. If appropriate, use the up and down arrow keys to select a size in the **Stripe Size** field, and then press **Tab**.
7. Enter the desired volume size in the **Capacity** field, and then press **Tab**.



NOTE: The default Capacity is about 95% of the maximum capacity to allow for replacement of failed drives with a drive of the same capacity.

8. Press **Enter** to initiate volume creation.
9. When the warning message appears, press **Y** to create the volume.
10. Use the up and down arrow keys to select **Exit**, then press **Enter** or press **ESC** twice to exit.
11. Press **Y** to confirm the exit.

Configuring RAID on an LSI 2308 or LSI 9217-4i4e controller

This section explains how to use the LSI Logic Configuration Utility to set up a SATA or SAS RAID array on the LSI 2308 or LSI 9217-4i4e controllers.



NOTE: These instructions apply to both Windows-based systems and Linux-based systems.

RAID 0 configuration

Follow these steps to configure an Integrated Striped (IS) volume with the BIOS-based configuration utility. The procedure assumes that the system has the required disk and disk controllers.

1. During startup, press **Ctrl+C** when prompted to start the LSI Logic Configuration Utility. Use the arrow keys and the space bar to navigate and select options.
2. Select an appropriate adapter, then press **Enter**.
3. Select **RAID Properties**, and then press **Enter**.
4. Select **Create IS Volume**, and then press **Enter**.
5. On the Create New Array screen, select the first disk for the IS volume. In the RAID Disk column for this disk, and then select **Yes**.



WARNING! If partitions have been defined on the selected disk, data on the disk will be lost when the striped volume is created.

6. To select additional drives for the striped volume (up to the maximum number allowed for the workstation), repeat step 5.
7. When all drives are selected, press **C** to create the array. Select **Save changes then exit this menu**, and then press **Enter**.
8. When the new array is created, the Adapter Properties screen appears. Press **Esc** twice, and then select **Exit**.

RAID 1 configuration

Follow these steps to configure an Integrated Mirroring (IM) volume with the BIOS-based configuration utility. The procedure assumes that the system has the required drives and drive controllers.

1. During BIOS startup, press **Ctrl+C** when prompted to start the LSI Logic Configuration Utility. Use the arrow keys and the space bar to navigate and select options.
2. Select an appropriate adapter, then press **Enter**.
3. Select **RAID Properties**, and then press **Enter**.
4. Select **Create IM Volume**, and then press **Enter**.
5. To configure a two-disk mirrored volume with an optional hot-spare disk:
 - a. On the Create New Array screen, select the primary disk for the IM volume (the disk with the data you want to mirror.)
 - b. On the RAID Disk column for this disk, and then select **Yes**. The value in the Array Disk column changes to Primary.

 **WARNING!** If partitions have been defined on the selected disk, data on the disk will be lost when the mirrored volume is created.

 - c. Select the secondary (mirrored) disk for the IM volume and set the Array Disk column value to **Yes**.
 - d. Press **Delete** to allow the data on the disk to be erased, or press any other key to deselect the disk.
6. When all drives are selected, press **C** to create the array.
7. Select **Save changes then exit this menu**, and then press **Enter**.
8. When the new array is created, the Adapter Properties screen appears. Press **Esc** twice, and then select **Exit**.

RAID 1E/10 configuration

Follow these steps to configure an Integrated Mirroring Extended (IME) volume. The procedure assumes the system has the required disk and disk controllers.



NOTE: If an odd number of drives is used, a RAID 1E array is created. If an even number of drives is used, a RAID 10 array is created.

1. During BIOS startup, press **Ctrl+C** when prompted to start the LSI Logic Configuration Utility. Use the arrow keys and the space bar to navigate and select options.
2. Select an appropriate adapter, and then press **Enter**.
3. Select **RAID Properties**, and then press **Enter**.
4. Select **Create IME Volume**, and then press **Enter**.
5. To configure a mirrored volume or an optional hot spare drive with up to the maximum number of drives allowed for the workstation, complete the following steps:
 - a. On the Create New Array screen, select the primary disk for the IME volume (the disk with the data you want to mirror.)
 - b. In the **RAID Disk** column for this disk, select **Yes**. The value in the Array Disk column changes to Primary.

WARNING! If partitions have been defined on the selected disk, data on the disk will be lost when the mirrored volume is created.

 - c. Select the next disk for the IME volume (mirrored) disk for the IM volume and set the Array Disk column value to **Yes**.
 - d. Press **Delete** to allow the data on the disk to be erased, or press any other key to deselect the disk.
6. Repeat step 5 to select up to the workstation-specific maximum number of drives for the IME volume, including of a hot spare.
7. After all drives are selected, press **C** to create the array.
8. Select **Save changes then exit this menu**, and then press **Enter**.
9. When the new array is created, the Adapter Properties screen appears. Press **Esc** twice, and then select **Exit**.

Configuring RAID on an LSI 9270-8i MegaRAID controller

This section explains how to use the LSI Logic Configuration Utility to set up SATA or SAS RAID arrays on the LSI 9270-8i MegaRAID controller.



NOTE: These instructions apply to both Windows-based systems and Linux-based systems.

RAID 0

Follow these steps to configure a RAID 0 volume with the BIOS-based configuration utility. The procedure assumes that the system has the required disk and disk controllers.



NOTE: For more information about the 9270-8i RAID controller, see the *MegaRAID SAS Software User Guide* at http://www.lsi.com/downloads/Public/RAID%20Controllers/RAID%20Controllers%20Common%20Files/51530-00_Rev0.zip, particularly the “Introduction to RAID” and “WebBIOS Configuration Utility” sections.

1. Be sure the drives you want to configure are connected to the LSI 9270-8i MegaRAID controller.
2. During startup, press **Ctrl+H** to enter the LSI 9270-8i WebBios utility. Use the arrow keys and the space bar to navigate and select options.
3. Configure the array:
 - a. In the left pane, select **Configuration Wizard**.
 - b. Select **Add Configuration**, and then select **Next**.
 - c. Select **Manual Configuration**, and then select **Next**.
 - d. Select the drives to include in the RAID array, and then select **Add To Array**.
 - e. Select **Accept DG**, and then select **Next**.
 - f. Select **Add to SPAN**, and then select **Next**.
4. Select the desired options for your RAID array. Available options:
 - RAID Level (available options depend on the number of disks in your RAID volume): RAID 0, RAID 1, RAID 5, RAID 6
 - Strip Size: 8KB, 16KB, 32KB, 64KB, 128KB, 256KB, 512KB, 1MB
 - Access Policy: RW (Read/Write), Read Only, Blocked
 - Read Policy: Normal, Ahead
 - Write Policy: Write Through, Always Write Back, Write Back with BBU
 - IO Policy: Direct, Cached
 - Drive Cache: No Change, Enable, Disable
 - Disable BGI: No, Yes
 - Select Size: Specify the size of the RAID array
5. Select **Next**.
6. A message warns you of the effect of your particular Write Policy setting:

- **Write Through:**The configuration might result in slower performance.
 - **Always Write Back:** The configuration results in optimal performance, but there is a risk of data loss in the event of power failure.
 - **Write Back with BBU:** If you have installed a BBU, write back is enabled only when the battery has a sufficient charge. During a learning cycle, the caching policy reverts to write-through until the learning cycle is complete.
7. Select **Yes** to accept the warning, and then select **Next**.
 8. Select **Accept**, and then select **Yes** to save the configuration.
 9. Select **Yes** to initialize the virtual drive you created.

Software RAID solution

This section summarizes software RAID considerations that are specific to the Linux environment, and provides links to additional configuration resources.

Software RAID considerations

The Linux kernel software RAID driver (called *md*, for *multiple device*) offers integrated software RAID without the need for additional hardware disk controllers or kernel patches. Unlike most hardware RAID solutions, software RAID can be used with all types of disk technologies, including SATA, SAS, SCSI, and solid-state drives. This software solution requires only minimal setup of the disks themselves.

However, when compared to hardware-based RAID, software RAID has disadvantages in managing the disks, breaking up data as necessary, and managing parity data. The processor must assume some extra loading: disk-intensive workloads result in roughly double the processor overhead (for example, from 15% to 30%). For most applications, this overhead is easily handled by excess headroom in the processors. But for some applications where disk and processor performance are very well balanced and already near bottleneck levels, this additional processor overhead can become troublesome.

Hardware RAID offers advantages because of its large hardware cache and the capability for better scheduling of operations in parallel. However, software RAID offers more flexibility for disk and disk controller setup. Additionally, hardware RAID requires that a failed RAID controller must be replaced with an identical model to avoid data loss, whereas software RAID imposes no such requirements.

Some software RAID schemes offer data protection through mirroring (copying the data to multiple disks in case one disk fails) or parity data (checksums that allow error detection and limited rebuilding of data in case of a failure). For all software RAID solutions on HP workstations, redundancy can be restored only after the system is shut down so that the failed drive can be replaced. This replacement requires only a minimum amount of work.

Performance considerations

Disk I/O bandwidth is typically limited by the system bus speeds, the disk controller, and the disks themselves. The balance of these hardware limitations, as affected by the software configuration, determines the location of the any bottleneck is in the system.

Several RAID levels offer improved performance relative to stand-alone disk performance. If disk throughput is restricted because of a single disk controller, RAID can probably do little to improve performance until another controller is added. Conversely, if raw disk performance is the bottleneck, a tuned software RAID solution can dramatically improve the throughput. The slower disk performance is, relative to the rest of the system, the better RAID performance will scale, because the slowest piece of the performance pipeline is being directly addressed by moving to RAID.

Configuring software RAID

See the following sites for additional information about configuring software RAID on Red Hat Enterprise Linux (RHEL) or SUSE Linux Enterprise Desktop (SLED):

- Red Hat Enterprise Linux 6—See the *Storage Administration Guide* at http://docs.redhat.com/docs/en-US/Red_Hat_Enterprise_Linux/6/html/Storage_Administration_Guide/index.html
- SLED 11—See the *Deployment Guide* at http://www.suse.com/documentation/sled11/book_sle_deployment/?page=documentation/sled11/book_sle_deployment/data/book_sle_deployment.html.

For more information about Open Source and Linux at HP, go to <http://h10018.www1.hp.com/wwsolutions/linux/index.html>.

C System board designators

HP Z440 and Z640 Workstation system board designators

Designator	Name on board	Component
E1	ME/AMT Flash Override	BIOS ME/AMT Flash Override Header
E14	BB ROM	Bootblock header
E15	BBR	Boot block recovery
E49	PSWD	Password clear jumper
J9	RJ-45	RJ-45
J20	J20 SLOT6 PCI	PCI slot
J31	J31 SLOT1-PCIe2x x 1	PCI Express Gen 2x1 Slot, Open Ended (Not available when Riser is plugged in)
J33	J33 SLOT4-PCIe3 x8	PCI Express Gen 3 x8 Slot, Open Ended
J41	J41 SLOT2-PCIe3 x 16	PCI Express Gen 3x16 Slot, Graphics Slot
J42	J42 SLOT3-PCIe2 x 4	PCI Express Gen 2x4, Open Ended
J43	J43 SLOT5-PCIe3 x16	PCI Express Gen 3 x16 Graphics Slot
J68	PS2	Stack keyboard/mouse connector
J78	AUDIO	Stacked Dual Audio
P1	MAIN POWER	Main power connector
P2	CPU0 +MEM PWR	CPU0 and memory power connector
P5	FRONT UI	Front power button/LED/speaker header
P8	CPUFAN	Processor fan header
P23	FRONT AUDIO	Header for front panel audio
P26	FRONT USB3	Front USB 3.0 header
P27	INT USB3	Internal USB 3.0 header
P54	SERIAL	Serial port
P60	sSATA0	sSATA connector
P61	sSATA1	sSATA connector
P626	sSATA2	sSATA connector
P63	sSATA3	sSATA connector
P91	MEM FAN	Memory fan
P95	REARFANS	Rear fan header
P150	INT USB2	Internal USB 2.0 header

Designator	Name on board	Component
SW3	Rear Power Switch	Rear power button/LED
SW50	CMOS	Clear CMOS button
XBT1	BAT	Battery
XMM1	CPU0-DIMM8	CPU0 Memory DIMM8
XMM2	CPU0-DIMM7	CPU0 Memory DIMM7 (not loaded on Z640)
XMM3	CPU0-DIMM6	CPU0 Memory DIMM6
XMM4	CPU0-DIMM5	CPU0 Memory DIMM5 (not loaded on Z640)
XMM5	CPU0-DIMM1	CPU0 Memory DIMM1
XMM6	CPU0-DIMM2	CPU0 Memory DIMM2 (not loaded on Z640)
XMM7	CPU0-DIMM3	CPU0 Memory DIMM3
XMM8	CPU0-DIMM4	CPU0 Memory DIMM4 (not loaded on Z640)

HP Z840 Workstations

Designator	Name on board	Component
E1/JP1	ME/AMT Flash Override	BIOS ME/AMT Flash Override Header
E3/JP3	[no label]	Override Option for Slot 5
E14	BB ROM	ROM Bootblock Header
E15/JP15	BBR	Boot Block Recovery
E49/JP49	PSWD	Password Clear Jumper
E72	TBT1	Thunderbolt Header
E73	[no label]	Thunderbolt Header
J9	RJ-45	RJ-45
J11	RJ-45	RJ-45
J31	J31 SLOT1-PCIe3 x4	PCI Express Gen 3 x4 Slot, Open Ended
J41	J41 SLOT2-PCIe3 x16	PCI Express Gen 3 x16 Graphics Slot
J42	J42 SLOT3-PCIe3 x8	PCI Express Gen 3 x8 Slot, Open Ended
J43	J43 SLOT4-PCIe3 x16	PCI Express Gen 3 x16 Graphics Slot
J44	J44 SLOT6-PCIe3 x16	PCI Express Gen 3 x16 Graphics Slot
J45	J45 SLOT7-PCIe2 x1	PCI Express Gen 2 x1 Slot, Open Ended
J66	PS2	Stacked Keyboard/Mouse
J78	AUDIO	Stacked Dual Audio
J81	Rear USB2	Stacked Dual USB 2.0
P1	MAIN POWER	Main Power Connector
P2	CPU0 +MEM PWR	CPU0 and Memory Power Connector
P3	CPU0 +MEM PWR	CPU0 and Memory Power Connector
P4	CPU1 +MEM PWR	CPU1 and Memory Power Connector
P5	FRONT UI	Front Power Button/LED/Speaker Header
P23	FRONT AUDIO	Front Audio
P26	FRONT USB3	Front USB 3.0 Header
P27	INT USB3	Internal USB 3.0 Header
P54	SERIAL	Serial Port
P60	SATA0	AHCI SATA0 Connector
P61	SATA1	AHCI SATA1 Connector
P62	sSATA0	sSATA Connector
P63	sSATA1	sSATA Connector
P64	sSATA2	sSATA Connector
P65	sSATA3	sSATA Connector

Designator	Name on board	Component
P70	CPU+MEM FANS	Processor and Memory Fans
P80	SAS0	SAS/SATA Port 0
P81	SAS1	SAS/SATA Port 1
P82	SAS2	SAS/SATA Port 2
P83	SAS3	SAS/SATA Port 3
P84	SAS4	SAS/SATA Port 4
P85	SAS5	SAS/SATA Port 5
P86	SAS6	SAS/SATA Port 6
P87	SAS7	SAS/SATA Port 7
P150	INT USB2	Internal USB 2.0 Header
P154	AUX FAN	Auxiliary Fan Header
P155	CPU0 AUX COOLER	CPU0 Auxiliary Cooler/Fan Header
P156	CPU1 AUX COOLER	CPU1 Auxiliary Cooler/Fan Header
P157	FRONT FAN1	Front Fan 1 Header
P158	FRONT FAN2	Front Fan 2Header
P159	REAR FAN	Rear Fan Header
SW3	Rear Power Switch	Rear Power Button/LED
SW50	CMOS	Clear CMOS Button
XBT1	BAT	Battery
XMM1	CPU0-DIMM8	CPU0 Memory DIMM8
XMM2	CPU0-DIMM7	CPU0 Memory DIMM7
XMM3	CPU0-DIMM6	CPU0 Memory DIMM6
XMM4	CPU0-DIMM5	CPU0 Memory DIMM5
XMM5	CPU0-DIMM1	CPU0 Memory DIMM1
XMM6	CPU0-DIMM2	CPU0 Memory DIMM2
XMM7	CPU0-DIMM3	CPU0 Memory DIMM3
XMM8	CPU0-DIMM4	CPU0 Memory DIMM4
XMM9	CPU1-DIMM1	CPU1 Memory DIMM1
XMM10	CPU1-DIMM2	CPU1 Memory DIMM2
XMM11	CPU1-DIMM3	CPU1 Memory DIMM3
XMM12	CPU1-DIMM4	CPU1 Memory DIMM4
XMM13	CPU1-DIMM8	CPU1 Memory DIMM8
XMM14	CPU1-DIMM7	CPU1 Memory DIMM7

Designator	Name on board	Component
XMM15	CPU1-DIMM6	CPU1 Memory DIMM6
XMM16	CPU1-DIMM5	CPU1 Memory DIMM5

D Statement of Volatility

Z440 Workstation

HP confirms that Intel-based Z440 personal workstation contains DDR RAM volatile memory (memory amount depends on the customer configuration). In addition, the motherboard in the condition originally shipped without subsequent modification or the addition or installation of any applications, features, or functionality, contain the following nonvolatile memory: PCH Real Time Clock (RTC) battery backed-up configuration memory (256 Bytes), Super I/O battery backed-up configuration memory (16 Bytes), masked keyboard ROM (2K Bytes), DIMM Serial Presence Detect (SPD) configuration data (256 Bytes per module, 128 Bytes programmable), TPM module (2.35 kB), and Serial Flash IC for System BIOS (128M Bits).

The volatile memory is cleared by removing power from the system for greater than 30 seconds. The nonvolatile memory on the motherboard is restored by following the steps below:

1. If TPM Ownership has been taken enter F10 setup.
2. Navigate to the **Security** tab.
3. Select **TPM Embedded Security > TPM Clear > Clear**.
4. Save and exit BIOS.
5. Press **F1** when prompted to accept the clearing of the TPM nonvolatile memory.
6. Download the latest BIOS for this system and operating system off of the HP website.
7. Follow the instructions on the website to flash the BIOS. This will clear all settings and passwords related to the BIOS.
8. Power down the system and remove the AC power cord. The RTC and Super I/O battery backed-up memory is cleared by removing the battery found on the motherboard, allowing the board to sit for greater than 60 seconds, and then replacing the battery.

The DIMM SPD EEPROM is not readily available to the user, however there appear to be tools publicly available to read and write this part. To eliminate the possibility that it could contain sensitive information, remove the DIMMs or use one of these tools.

Z640 Workstation

HP confirms that Intel-based Z640 personal workstation contains DDR RAM volatile memory (memory amount depends on the customer configuration). In addition, the motherboard in the condition originally shipped without subsequent modification or the addition or installation of any applications, features, or functionality, contain the following nonvolatile memory: PCH Real Time Clock (RTC) battery backed-up configuration memory (256 Bytes), Super I/O battery backed-up configuration memory (16 Bytes), masked keyboard ROM (2K Bytes), DIMM Serial Presence Detect (SPD) configuration data (256 Bytes per module, 128 Bytes programmable), TPM module (2.35 kB), and Serial Flash IC for System BIOS (128M Bits).

The volatile memory is cleared by removing power from the system for greater than 30 seconds. The nonvolatile memory on the motherboard is restored by following the steps below:

1. If TPM Ownership has been taken enter F10 setup.
2. Navigate to the **Security** tab.
3. Select **TPM Embedded Security > TPM Clear > Clear**.

4. Save and exit BIOS.
5. Press **F1** when prompted to accept the clearing of the TPM nonvolatile memory.
6. Download the latest BIOS for this system and operating system off of the HP website.
7. Follow the instructions on the website to flash the BIOS. This will clear all settings and passwords related to the BIOS.
8. Power down the system and remove the AC power cord. The RTC and Super I/O battery backed-up memory is cleared by removing the battery found on the motherboard, allowing the board to sit for greater than 60 seconds, and then replacing the battery.

The DIMM SPD EEPROM is not readily available to the user, however there appear to be tools publicly available to read and write this part. To eliminate the possibility that it could contain sensitive information, remove the DIMMs or use one of these tools.

Z840 Workstation

HP confirms that Intel-based Z840 personal workstation contains DDR RAM volatile memory (memory amount depends on the customer configuration). In addition, the motherboard in the condition originally shipped without subsequent modification or the addition or installation of any applications, features, or functionality, contain the following nonvolatile memory: PCH Real Time Clock (RTC) battery backed-up configuration memory (256 Bytes), Super I/O battery backed-up configuration memory (16 Bytes), SAS FLASH memory (32Mbits) and an EEPROM (64K Bits), masked keyboard ROM (2K Bytes), secondary LOM Flash (4 Mbits), DIMM Serial Presence Detect (SPD) configuration data (256 Bytes per module, 128 Bytes programmable), TPM module (2.35 kB), and Serial Flash IC for System BIOS (128M Bits).

The volatile memory is cleared by removing power from the system for greater than 30 seconds. The nonvolatile memory on the motherboard is restored by following the steps below:

1. If TPM Ownership has been taken enter F10 setup.
2. Navigate to the **Security** tab.
3. Select **TPM Embedded Security > TPM Clear > Clear**.
4. Save and exit BIOS.
5. Press **F1** when prompted to accept the clearing of the TPM nonvolatile memory.
6. Download the latest BIOS for this system and operating system off of the HP website.
7. Follow the instructions on the website to flash the BIOS. This will clear all settings and passwords related to the BIOS.
8. Power down the system and remove the AC power cord. The RTC, Super I/O battery backed-up memory and LSI 2308 SAS controller battery backed memory is cleared by removing the battery found on the motherboard, allowing the board to sit for greater than 60 seconds, and then replacing the battery.

The secondary LOM Flash is inaccessible to the user via any publicly available tools. There are programs used by HP in manufacturing and R&D that allow access, but these are not available outside of HP. The embedded LSI 2308 SAS controller flash ROM can be read, written, and erased via a firmware and BIOS utility SASFLASH.exe available in the latest soft pack release on the HP website. The embedded LSI 2308 SAS controller battery backed memory can be erased following the instructions stated above in step 8. The DIMM SPD EEPROM is not readily available to the user, however there appear to be tools publicly available to read and write this part. To eliminate the possibility that it could contain sensitive information, remove the DIMMs or use one of these tools.

Index

- C**
 - Cable management 49
 - CMOS 98
 - clearing and resetting 100
 - Computer Setup (F10) Utility 25
 - menu 27
 - Configuring RAID devices 105
 - maximum hard drives allowed 105
 - SAS RAID on LSI 2308 or LSI 9217-4i controllers 109
 - SAS RAID on LSI 9270-8i MegaRAID controller 112
 - SATA RAID 107
- D**
 - Desktop management 32
 - Dual-state power button 43
 - FailSafe Boot Block ROM 35
 - Fault notification and recovery 43
 - HP SoftPak Download Manager 34
 - HP System Software Manager 35
 - HPQFlash 35
 - Initial configuration 33
 - Remote ROM Flash 35
 - Remote system install 33
 - ROM Flash 35
 - Updating software 34
 - Workstation security 36
 - Diagnostic codes and errors 91
 - LED and beep codes 91
 - LED colors 93
 - POST errors 94
 - Diagnostics 76
 - Diagnostics and troubleshooting
 - Diagnosis guidelines 78
 - HP PC Hardware Diagnostics 90
 - Locating ID labels 77
 - Locating warranty info 77
 - DIMM configurations, supported 65
 - DIMM installation order
 - HP Z440 Workstation 66
 - HP Z640 Workstation 67
 - HP Z840 Workstation 68
- E**
 - Expansion card slot identification
 - HP Z440 Workstation 52
 - HP Z640 Workstation 54
 - HP Z840 Workstation 56
- H**
 - HP PC Hardware Diagnostics (UEFI) downloading 90
- M**
 - Memory
 - DIMM installation guidelines 65
- O**
 - Operating system setup 102
- P**
 - password
 - security 39
 - Password configuration 98
 - Password jumper
 - resetting 99
 - Power supply
 - Expansion card configuration restrictions 51
 - power consumption 72
 - resetting 72
 - specifications 69
 - Product features
 - ERP compliance mode 23
 - Hyper-threading 24
 - Physical characteristics 6, 13, 20
 - SATA Power Management 24
 - System board architecture 6, 12
 - Turbo Boost 24
- R**
 - Replacing components
 - Battery 48
- S**
 - cable management 49
 - Component locations 5, 11, 18
 - expansion slots 51
 - guidelines 48
 - hard drive 59
 - information and guidelines 45
 - Memory 65
 - power supply 69
 - processor and processor heatsink 50
 - Service considerations 46
 - warnings and cautions 45
- S**
 - System board designators 115
 - System management 23
- T**
 - Troubleshooting 76
- W**
 - Workstation components
 - HP Z440 Workstation 1
 - HP Z440 Workstation front panel 2
 - HP Z440 Workstation rear panel 3
 - HP Z640 Workstation 8
 - HP Z640 Workstation chassis 10
 - HP Z640 Workstation front panel 8
 - HP Z640 Workstation rear panel 9
 - HP Z840 Workstation 15
 - HP Z840 Workstation chassis 17
 - HP Z840 Workstation front panel 15
 - HP Z840 Workstation rear panel 16
 - Workstation setup
 - Ensuring proper ventilation 22