

LAW ENFORCEMENT • FIRE & EMS • UTILITY • PUBLIC WORKS

PRODUCT CATALOG SUPPLEMENT

CONSOLES & COMPUTER MOUNTS

PRISONER & K9 TRANSPORTS

EMERGENCY SCENE LIGHTING



Havis-Shields
EQUIPMENT CORPORATION

CONSOLIDATOR® • KWIK-KIT™ • KWIK-RAZE® • COLLINS DYNAMICS®

LAST UPDATED: FEBRUARY 4, 2009



How to use the Havis-Shields Catalog Supplement

As corrections and additions are made to our product catalog (HS-CATALOG-F-8-06), they will all be noted here in the HS-Supplement. The supplement is updated on a monthly basis and will be available the first Wednesday of every month via **www.havis.com** as a PDF. The date that the supplement was last updated is on the cover.

For any of the latest product updates, please see www.havis.com for the latest information.

Please note, any changes or additions to the Vehicle Application Chart will be in the Excel file available on www.havis.com which will be updated monthly with the supplement.

The changes/additions will be listed by page number in order of the catalog. Changes or additions can be found by looking at any **bold/italic** text in the description.

If it is a new product all together, it will be noted by the product.

When only a vehicle year is updated for a certain part, you will find these updates listed on the last page of the supplement.

PART NUMBER

C-VS-1600-EXPL

Italic text is the new info

Page number part is found

PAGE C16

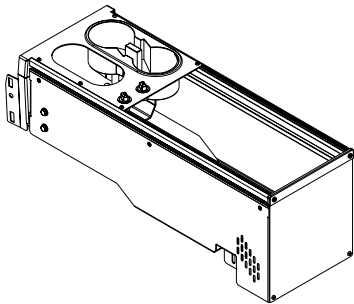

16" Console for 2006-2008 Ford Explorer and 2008 Ford Sport Trac

- Replaces top of factory OEM console without permanent modification
- Includes gear shift cover plate with (2) lighter plug outlets & cup holder
- 10" maximum depth near the front of console 5" minimum (see side view)
- No vehicle mounting kit required
- Includes filler plates (FP) and/or equipment brackets (EB) to completely enclose mounting area less internal mount options
- C-TCB-7 Telescoping computer base recommended, C-TCB-26 also fits
- See console appendix (page C82) for mounting depth allowed for control heads and/or options

Maximum Equipment Mounting Area	Weight
16"	16 lbs.



Contact us at:

Ph: 800.524.9900 or 215.957.0720

E-mail: sales@havis.com

Fax: 215.957.0729

Web: www.havis.com



PART NUMBER

CONSOLIDATOR®

C-VS-1600-EXPL

VEHICLE SPECIFIC CONSOLES

PAGE C16

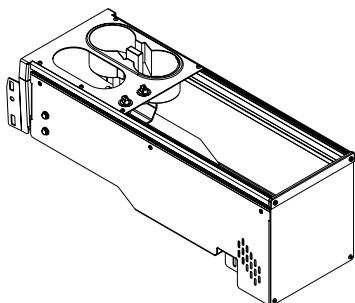

16" Console for 2006-2008 Ford Explorer and 2008 Ford Sport Trac

- Replaces top of factory OEM console without permanent modification
- Includes gear shift cover plate with (2) lighter plug outlets & cup holder
- 10" maximum depth near the front of console 5" minimum (see side view)
- No vehicle mounting kit required
- Includes filler plates (FP) and/or equipment brackets (EB) to completely enclose mounting area less internal mount options
- C-TCB-7 Telescoping computer base recommended, C-TCB-26 also fits
- See console appendix (page C82) for mounting depth allowed for control heads and/or options

Maximum Equipment Mounting Area	Weight
16"	16 lbs.



C-SS, C-SS-2

LAPTOP SCREEN SUPPORTS

PAGE C62, C70

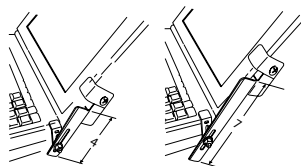

- Laptop screen support
 - Adjustable 4" or 7" support arm
 - Fits most laptop computers
- C-SS / 7" laptop screen support**
C-SS-2 / 4" laptop screen support

1 lb.

C-VS-1800-ESC-1

NEW! PAGE C18

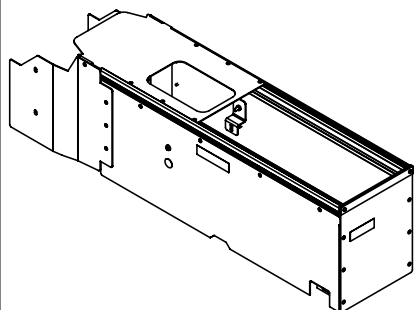

18" Console for Ford Escape

- Replaces factory OEM console without permanent modification
- Includes gear shift cover plate
- Uses OEM mounting points and hardware
- 11" maximum depth at forward 14"; 9.75" deep at rear 4"
- Includes filler plates (FP) and/or equipment brackets (EB) to completely enclose mounting area less internal mount options
- Cup holder, 12 volt outlets and other options sold separately
- C-TCB-7 telescoping computer base recommended
- No vehicle mounting kit required
- See console appendix (page C82) for mounting depth allowed for control heads and/or options

C-TM-CHGR-1

NEW! PAGE C40

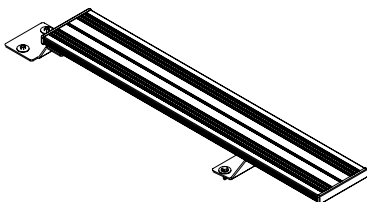

Trak Mount for 2008 Dodge Charger

- Includes hump-mount brackets C-B44 front & rear
- Includes 32" Trak extrusion & mount hardware
- Attaches to OEM seat bolts.
- Track is supplied by OEM for '06-07 Charger
- Track is optional for 2008 Charger

MOTOROLA PRODUCTS

- The following products fit the MW-800 or MW-810 model

C-3330-800	C-3549-800	C-3522-800
C-3329-800-1	C-3052-800	C-KBM-M80
C-3333-800	S-DMM-MOT-M80	

Contact us at:

Ph: 800.524.9900 or 215.957.0720
 E-mail: sales@havis.com

Fax: 215.957.0729
 Web: www.havis.com



C-3610

PAGE C64

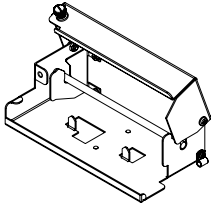

Pentax Printer Mount Assembly

- Can be used with all Pentax 2" roll feed PocketJet II *and III series mobile printers*
- For use with TM Series and Adjustable Tilt & Swivel Mounts
- 10.375" W X 3.25" H X 5.5" D
- Mounting hardware included

C-3610-ARM

PAGE C64

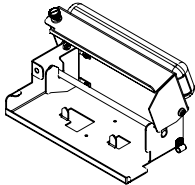

Pentax Printer Mount with Armrest

- Can be used with all Pentax 2" roll feed PocketJet II *and III series mobile printers*
- **Mounts to C-CB-1 and C-CB-2 (see page C9); drilling required**
- 10.375" W X 4.5" H X 5.5" D
- Mounting hardware included

C-3610-CV

PAGE C64 AND C69

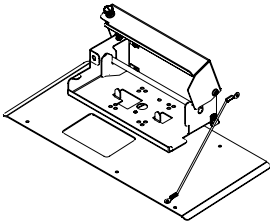

- Printer housing for 96-09 Crown Victoria
- Glove box mount for all Pentax 2" roll-feed Pocketjet II *and III series mobile printers*
- Slides out when glove box door opens for easy access to paper roll
- Kit includes door replacement plate & door strap lanyard for extra strength
- May not be combined with C-3549-800

C-VS-1200-EXPD-1

NEW! PAGE C17

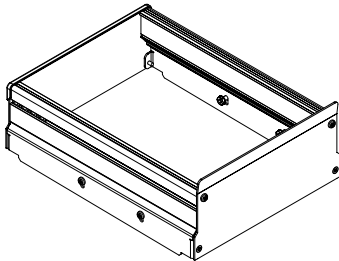

12" Console for 2007-2008 Ford Expedition or Expedition EL with Center Shift Console

- Includes filler plates (FP) and/or equipment brackets (EB) to completely enclose mounting area less internal mount options
- Removal of OEM arm rest pad and inner storage pocket required
- No permanent modification required.
- No vehicle mounting kit required.
- 12.5" maximum depth
- Includes one extruded aluminum nut track on each side
- C-ARM-2 optional side mount arm rest recommended
- Utilizes four existing drink holders
- See console appendix (page C82) for mounting depth allowed for control heads and/or options

C-VS-0309-F250

NEW! PAGE C17

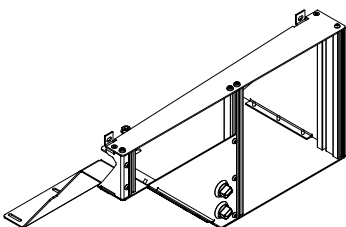

12" Console for 1999-2007 Ford F-250, F-350, F-450 and F-550

- Double wide console (3" control head space driver side / 9" passenger side)
- Lower center dash removal required
- Mounts safely away from driver's leg and does not interfere with 4 wheel drive shifter
- No vehicle mounting kit required.
- Includes filler plates (FP) and/or equipment brackets (EB) to completely enclose mounting area less internal mount options
- Includes two 12 volt sockets
- Includes one extruded aluminum nut track on passenger side for console accessory mounting.
- C-EB30-F50-1P optional face plate available for OEM optional Dash switch's and trailer brake control.
- Some permanent modifications required if deep control heads are used (cutting plastic dash behind console)
- See console appendix for mounting depth allowed for control heads and/or options.

Contact us at:

Ph: 800.524.9900 or 215.957.0720

Fax: 215.957.0729

E-mail: sales@havis.com

Web: www.havis.com



C-CB-1-3610-ARM

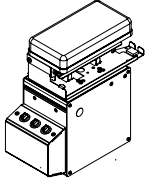

Combination Box with Removable Hinged Arm Rest, Printer Mount, and (3) Three Lighter Plug Outlets

- (new iso)

C-VS-800-CV

NEW! PAGE C15

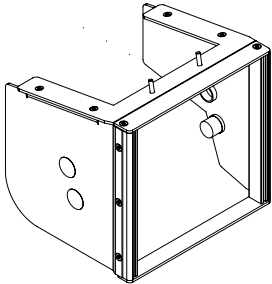

8" Under Dash Console For 1995-2009 Ford Crown Victoria

- Uses existing side tray brackets from ashtray
- Includes filler plates (FP) and/or equipment brackets (EB) to completely enclose mounting area less internal mount options
- Used to mount remote type control heads (limited depth)
- Must be ordered separately: HVAC control relocation bracket (P/N C-EB40-ACV-1P), AM/FM relocation bracket (P/N C-EB40-RCV-1P)
- Relocates lighter plug and trunk release to the side
- No vehicle mounting kit required
- See console appendix (page C82) for mounting depth allowed for control heads and/or options.
- Does not work on 2008 Police Package Crown Victoria with a CD player

Maximum Equipment Mounting Area	Weight
8"	3 lbs.

C-3329-UNV

PAGE C68

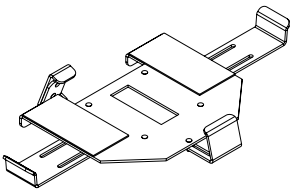

- Fits Motorola MW-520, Data 911, **Staco M779** & Litton (L3) Keyboard all of which use either the (TIPP) Texas Industrial Peripheral or TG3 keyboard
- **Adjustable to accommodate keyboards that fall within the following measurements:**
 - **Minimum Size Keyboard: 10" wide x 6.25" front to back x 1" high**
 - **Maximum Size Keyboard: 14.5" wide x 8.5" front to back x 1.5" high**
- Mounts to end of most manufacturers consoles w/ plate or adjustable TCB telescoping computer base
- Spring loaded release designed for one-handed removal
- Use with swivel adapter bracket C-3085-UN-1 (page C69) or tilt swivel C-3075-3 (page C60)

3 lbs.

C-VS-1300-TBZ

NEW! PAGE C17 (AFTER C-VS-GM)

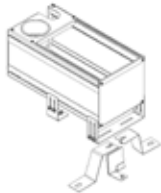

13" Console for 2002-2008 Chevrolet Trailblazer

- Permanent modification of OEM console required. Rear armrest storage section must be cut off and removed.
- New console replaces the removed OEM section
- Includes a single cup holder
- 13" of control head mounting area and 8" depth (overall console length is 18")
- Includes filler plates (FP) and/or equipment brackets (EB) to completely enclose mounting area less internal mount options

C-3311-EG

NEW! PAGE C73



Equipment Guard for Trunk Tray Bearing Slide for '00-07 Impala and '06-07 Charger

- Equipment guard for full size trunk mounted radio tray
- 31" W x 10" H
- Bolts to C-3311, C-3311-2, and C-TTB-CHGR radio trays
- Allows access to OEM spare tire (Full size or temp. spare)
- Guards equipment on tray from other objects
- Black powder coated perforated 14 gauge steel

Contact us at:

Ph: 800.524.9900 or 215.957.0720

E-mail: sales@havis.com

Fax: 215.957.0729

Web: www.havis.com



C-3583

PAGE C74

Storage Lock Box

- Storage box manufactured from black powder coated steel, features a hinged lid with a cam-style lock and a foam lined insert **to protect your inexpensive weapons**
- Interior...

KO-DCF-29

PAGE C67

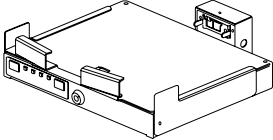

Intelligent docking station for Panasonic CF-28 or CF-29 or CF-30

- Kodiak docking station CF-28, CF-29 or **CF-30**
- Intelligent docking station for Panasonic CF-28, CF-29 or **CF-30**
- Voltage monitor ...

TRUNK TRAY DESCRIPTION UPDATES

PAGE C72-75

Part Number	Max Weight Carrying rating
C-3311 SERIES	100 LBS
C-TTB-CV	100 LBS
C-TTB-CHGR	100 LBS
C-TTB-CV-F	200 LBS
C-3190	75 LBS
C-3190-P	75 LBS
C-3190-F	100 LBS

C-TSM-CV-P

PAGE C75

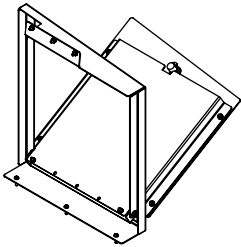

Trunk Side Mount 1997-2009 Crown Victoria- Passenger Side

- C-TSM-CV-P Passenger side mount
- Hinged platform for mounting electronic equipment
- Equipment protected in closed position
- Mounts on passenger side fender area. Mounting surface 12/5" wide x 14.5" high
- Locking latch
- Removable inner panel for bench top pre-assembly
- See console appendix (page C82) for product dimensions.

AIR BAG CONTROL SWITCHES

PAGE C71

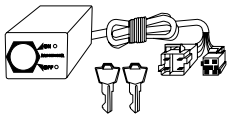

Air bag control (on/off) switch is used to protect your equipment from damage in air bag deployment.

Vehicle Make	Model	Years	Airbag Control Switch Part Number	Special Notes
Chevy	Suburban	2003-2008	AOI-US2GM	
	Impala	2001-2008	AOI-US2GM	
	Tahoe	2003-2008	AOI-US2GM	
	Trailblazer	2003-2008	AOI-US2GM	
	Trailblazer	2007-2008	AOI-US2GMTRLSC	Side airbag cut-off switch
	G Series Cargo Van	2003-2008	AOI-US2GM	
Ford	C&K Pickups	2003-2007	AOI-US2GM	
	Explorer	2004-2008	AOI-US2GFADPSC	For both driver & passenger curtain air bags
	Expedition	2006-2008	AOI-US2FLMSC	For both driver & passenger curtain air bags
	E-Series Van	2008	AOI-US2GMTSC	
Dodge	Durango	2006-2008	AOI-US2CDSCDUR	Side airbag cutoff switch

Contact us at:

Ph: 800.524.9900 or 215.957.0720

Fax: 215.957.0729

E-mail: sales@havis.com

Web: www.havis.com



C-VS-1200-DUR

PAGE C15

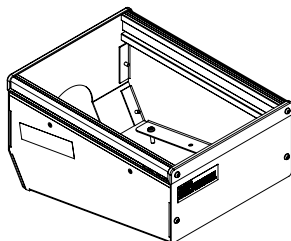

12" console for 2004-2008 Dodge Durango

- Replaces top of factory OEM console without permanent modification
- 7" maximum depth near the front of the console and maximum 5" depth near the rear with varying equipment restrictions on the sides
- No vehicle mounting kit required
- 12" maximum equipment mounting area
- Includes filler plates (FP) and/or equipment brackets (EB) to completely enclose mounting area less internal mount options
- **Includes a C-EB15-DUR-1P face plate for the OEM switch and 12 volt socket**
- See pgs C20-28 for control head equipment brackets

REPLACEMENT PARTS & ACCESSORIES

PAGE C76

CM216560

Lighter Plug Socket and Cap (replaces CM216510 Lighter Socket and CM216550 Cap only)

ACCESSORY POCKETS

NEW! PAGE C36

- Internal mounting - five sides allow mounting in any position
- Black powder coated steel finish
- Removable Carpeted Liner (in base only)
- Provides storage space for your equipment

	Part Number	Description
	Console Lo-Profile Internal Mount Accessory Pocket	<ul style="list-style-type: none"> • Fits all consoles, ideal for low profile console series • 3" or 6" high x 8 5/8" wide x 2 1/2" deep
	C-AP-0325 (shown)	Accessory Pocket 3" high, 2.5" deep internal mount
	C-AP-0625	Accessory Pocket 6" high, 2.5" deep internal mount
	Console Internal Mount Accessory Pocket	<ul style="list-style-type: none"> • Fits all consoles • 6", 9", or 12" high x 8-5/8" wide x 4-1/2" • 6", 9", or 13" high x 8-5/8" wide x 9-1/2" deep for truck mounted 10" high consoles
	C-AP	Accessory Pocket 3" high, 5" deep internal mount (front or rear mounting)
	C-AP-0645 (shown)	Accessory Pocket 6" high, 4.5" deep internal mount
	C-AP-0945	Accessory Pocket 9" high, 4.5" deep internal mount
	C-AP-1245	Accessory Pocket 12" high, 4.5" deep internal mount
	C-AP-0695	Accessory Pocket 6" high, 9.5" deep internal mount
	C-AP-0995	Accessory Pocket 9" high, 9.5" deep internal mount
C-AP-1395	Accessory Pocket 13" high, 9.5" deep internal mount	
	Console Internal Mount Accessory Pocket with Lid and Lock	<ul style="list-style-type: none"> • Includes lid with a push button slam locking latch (not available without the lock) • Fits all consoles • 6", 9", or 12" high x 8-5/8" wide x 4-1/2" deep • 6", 9" or 13" high x 8-5/8" wide x 9-1/2" deep for truck mounted 10" high consoles (C-2410 & C-3010)
	C-AP-0645-L (shown)	Accessory Pocket 6" high, 4.5" deep internal mount with lid and lock
	C-AP-0945-L	Accessory Pocket 9" high, 4.5" deep internal mount with lid and lock
	C-AP-1245-L	Accessory Pocket 12" high, 4.5" deep internal mount with lid and lock
	C-AP-0695-L	Accessory Pocket 6" high, 9.5" deep internal mount with lid and lock
	C-AP-0995-L	Accessory Pocket 9" high, 9.5" deep internal mount with lid and lock
C-AP-1395-L	Accessory Pocket 13" high, 9.5" deep internal mount with lid and lock	

C-AP-HFB

NEW! PAGE C36

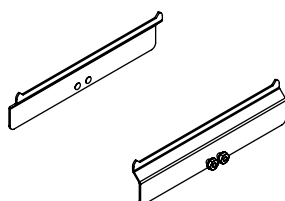

Hanging File Adapter Brackets for C-AP-1395 Accessory Pocket

- Holds Pendaflex® file folders securely for mobile organization
- Includes a pair of black powder coated steel brackets that mounts inside the front and rear end panels of the C-AP-1395 accessory pocket internally mounted accessory pocket (sold separately)
- Cannot use with C-AP with locking lid

Contact us at:

Ph: 800.524.9900 or 215.957.0720

E-mail: sales@havis.com

Fax: 215.957.0729

Web: www.havis.com



C-3334-1

PAGE C67

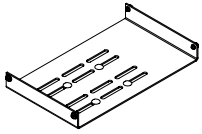

Adapter Mounting Plate Assembly For Panasonic Docking Station

- Mounts CF-WEB273, CF-WEB273-2 and **CF-WEB301M** to C-3075 or C-3085 Series Tilt Swivels (sold separately)

3 lbs.

C-D SERIES CONSOLES

PAGE C19

- Specify Vehicle: (example: C-D1510-FL1)
 - FL1 = 2004-2006 Freightliner Model M-2
 - ST1 = 2004-2006 Sterling Model new Advanced Acterra
 - IN1 = 2004-2006 International **DuraStar models 4100, 4300 & 4400 and WorkStar models 7300, 7400, 7500, 7600 & 7700**

C-VS-1200-F250-1

NEW! PAGE C17

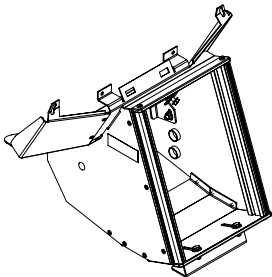

12" Under Dash Console for 2008 Ford F-Series Pick-Up F-250, 350, 450 & 550

- Includes filler plates (FP) and/or equipment brackets (EB) to completely enclose mounting area less internal mount options
- Under dash console
- 12" maximum depth near the center of the console
- Works with OEM center console and OEM 4 x 4 floor shifter
- Does not work with OEM manual floor shifter
- No vehicle mounting kit required

C-TM-EXPD-1

NEW! PAGE C40

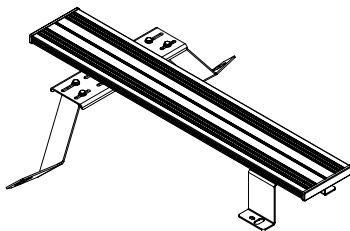

32" Trak Mount Base Assembly with Front and Rear Mounting Brackets for 2007-2008 Ford Expedition

- Heavy duty trak mount platform
- Fits 2007-2008 Ford Expedition
- Includes Hump-Mount Bracket C-B48 front and C-B49 rear
- Requires removal of OEM console. Mounts to existing front seat bolts and utilizes rear mount holes.

MOUNTING BRACKETS

C-B48

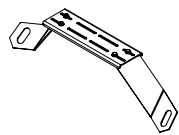

Front
(3 piece)

C-B49

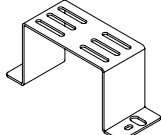

Expedition
2007-2008

Rear
(1 piece)

C-M-32

Kit Includes:

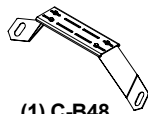

(1) C-B48
Ford



(1) C-B1
Expedition



(1) C-B22
2007-2008

C-B47

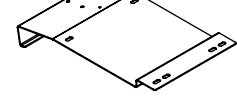

Front (1 pc) base mount bracket assembly
for 2005-2008 Dodge Ram 2500, 3500, &
4500 Pick-Up

- Mounts to OEM Center seat bolts
- Designed to support either the C-TCB-8 or the C-PED Silver Billet Telescoping Computer Mounts

C-M-28

Kit Includes:

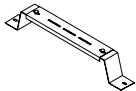

(2) C-B26



(2) C-B1

General Motors

G-Series Van

2000-2008

TM-Series Consoles

6 lbs.

Contact us at:

Ph: 800.524.9900 or 215.957.0720

E-mail: sales@havis.com

Fax: 215.957.0729

Web: www.havis.com



NEW! C-MAP-TL



- 18" gooseneck halogen map light
- Top Mount
- Clean and red lenses included

NEW! C-MAP-SL



- 18" gooseneck halogen map light
- Side Mount
- Clear and red lenses included

C-PED0812

PAGE C58

8" Silver Billet Telescoping Computer Pedestal

- 8" closed outer pole height, 10.25" height fully extended
- 12" top platform
- 2.312" square mounting hole pattern
- Must use option C-PED-PLT support plate for Trak-Mount applications
- Ideal for SUV or flat mount surfaces

C-PED-PLT

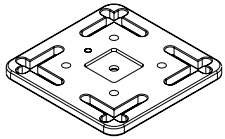

Optional Support Plate for Silver Billet Telescoping Computer Pedestal Mount

- 5.5" square base plate for Trak-Mount application
- **Includes 1/4-20 mounting hardware.**



1 lb

C-TM-F250-1

NEW! PAGE C40

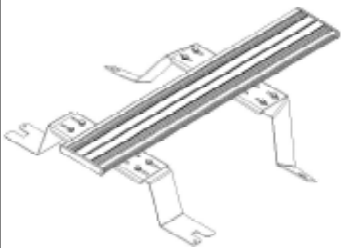

Trak-Mount Base Assembly fits 2008 Ford F-250, 350, 450, and 550 Pickups

- Includes hump-mount brackets C-B50 front and C-B51 rear
- Includes 32" Trak extrusion and mount hardware
- Attaches to OEM seat bolts
- Requires removal of OEM console and mounts through existing holes in floor pan where OEM console was

C-WH-RCV

Radio relocation wire harness (Crown Victoria)

- Intended for 1996-2009 Ford Crown Victoria
- Only needed when radio is relocated 12" from original location
- 4' Antenna Extension Cable Included
- **Does not work on 2008 Police Package Crown Victoria with a CD player**

AOI-US2GMTSC

Side Curtain Airbag Switch for 2008 Chevrolet Express/GMC Savannah 3500 Passenger Van

Contact us at:

Ph: 800.524.9900 or 215.957.0720

E-mail: sales@havis.com

Fax: 215.957.0729

Web: www.havis.com



DASH MONITOR MOUNTS

How To Order Monitor Mounts:

All monitor mount part numbers begin with "S-DMM-" followed by a configuration based on your manufacturer/model/vehicle/type:

S-DMM- [] + [] + []

Manufacturer & Model Code	Description	Vehicle Code	Description	Type Code	Description
AMR-MTX-	Amrel Matrix DP860	CHGR-	'06 - 07 Charger	F	Fixed
CBN-CT1	Coban Technologies CT-ONE-12	CHGR-1-	2008 Charger	SO	Swing Out**
CBN-VM2-	Coban Technologies VMDT II	CV-	'96 - 09 Crown Victoria*	T	Tilt
DATA-911-	Data911 D9-02-2009, M5 & M6 Computer Systems	IMP-	'00 - 05 Impala	TS	Tilt/Swivel***
DATA-911-84-	Data911 M2C-8.4TR	IMP-1-	'06 - 08 Impala		
DLX-TX2-	Datalux TX200	UNV-	Universal Flat Dash		
DRT-M3	AED (Advanced Electronic Design) Rugged tablet				
FSE-CAM-	Fleet Safety Equipment Cam				
L3-MV2-	L3 Mobile Vu II				
LDC-CF19-	Ledco CF-19 Docking Station				
MOT-M80-	Motorola MW800 or MW810				
PAN-CF2-	Panasonic CF-VDL01 or CF-VDL02				
PLA-LX1-	Planar LX1200-TI				
POL-TRP-	Polaris Trooper II				
ROBO-1205-	RoboVu-1205-PS or 1205-DLT				
ROBO-VU3	RoboVu, 3				
VESA	VESA (Video Electronics Standards Association) standard 100/75 hole pattern: 75mm x 75mm or 100mm x 100mm				
XPT-104-	Xplore Tech iX104				

* Does not work on 2008 Police Package Crown Victoria with a CD player
 ** Swing out available with Crown Victoria application ONLY
 *** TS is not available for Impala models prior to 2006

Examples:

S-DMM- DATA-911 + CV + SO

S-DMM- MOT-M80 + IMP-1 + F

Contact us at:

Ph: 800.524.9900 or 215.957.0720

Fax: 215.957.0729

E-mail: sales@havis.com

Web: www.havis.com



TECHNICAL BULLETIN

New **S-UMM Series Universal Monitor Mounts** replace the C-3522 Series Monitor Mounts. See the chart below for new part numbers.

How To Order Monitor Mounts:

All monitor mount part numbers begin with "**S-UMM-**" followed by a configuration based on your manufacturer/model:

S-UMM-

Manufacturer & Model Code	Description
AMR-MTX	Amrel Matrix DP860
CBN-CT1	Coban Technologies CT-ONE-12
CBN-VM2	Coban Technologies VMDT II
DATA-911	Data911 D9-02-2009
DATA-911-84	Data911 M2C-8.4TR
DLX-TX2	Datalux TX200
DRT-M3	AED (Advanced Electronic Design) Rugged tablet
FSE-CAM	Fleet Safety Equipment Cam
L3-MV2	L3 Mobile Vu II
LDC-CF19	Ledco CF-19 Docking Station
MOT-M80	Motorola MW800 or MW810
PAN-CF2	Panasonic CF-VDL01 or CF-VDL02
PLA-LX1	Planar LX1200-TI
POL-TRP	Polaris Trooper II
ROBO-1205	RoboVu-1205-PS or 1205-DLT
VESA	VESA (Video Electronics Standards Association) standard 100/75 hole pattern: 75mm x 75mm or 100mm x 100mm
XPT-104	Xplore Tech iX104

Examples:

S-UMM-

MOT-M80

(Replaces p/n: C-3522-800)

C-3334-184

NEW! PAGE C67

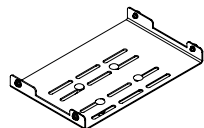

Adapter Mounting Plate Assembly for Panasonic Docking Station Model CFWEB184A

- Adapter mounting plate assembly w/ hardware for Panasonic docking station
- This unit allows for clearance of wires and cables
- Mounts CFWEB184A to C-3075 & C-3065 series tilt swivels (sold sep.)

C-TSM-CV-D

NEW! PAGE C75

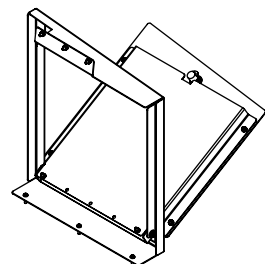

Trunk Side Mount 1997-2009 Crown Victoria- Driver Side

- Hinged platform for mounting electronic equipment
- Equipment protected in closed position
- Mounts on driver side fender area. Mounting surface 12.5" wide x 13.75" high
- Locking latch
- Removable inner panel for bench top pre-assembly
- Fuel shutoff switch accessible
- See console appendix (page C82) for product dimensions.

Contact us at:

Ph: 800.524.9900 or 215.957.0720

E-mail: sales@havis.com

Fax: 215.957.0729

Web: www.havis.com



C-TM-RAM-1

NEW! PAGE C40

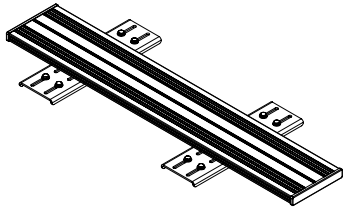

32" Trak Mount Base Assembly for 2003-2008 Dodge Ram 1500, 2500 and 3500

- Heavy duty trak mount platform
- Fits 2003-2007 Dodge Ram
- Includes center seat mount brackets front & rear
- Requires removal of OEM center seat. Mounts to existing center seat brackets with hardware supplied.

C-M-34

NEW! PAGE C40

Vehicle Specific Mounting Bracket for 2008 Ford F-250, 350, 450, 550 Pickup Bucket Seats

- Vehicle specific mounting bracket kit
- For 2008 Ford F-250,350,450,550, pickup with bucket seats
- Basic mount for C-Series, LP-Series and C-TM-series consoles
- Kit includes: (1) C-B50 (1) C-B1(1) C-B6 Vehicle specific Front hump mount bracket and universal bail mount brackets
- Provides quick and easy installation of a wide range of consoles
- Requires drilling mount holes for rear bracket. Front bracket attaches to existing seat mounting bolts

C-AB-825-H

ADAPTER HOUSINGS

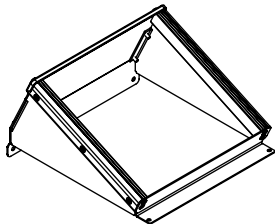

C-Series Accessory 8" High 25" Angled Internal Mounting Adapter For C-Series Consoles

- Offers two different mounting planes when mounted on Consolidator Consoles (25° angled and 0° horizontal)
- Attaches to top end of horizontal C-Series console and uses 9.5" of Mounting Space, 8" Total 25° Angled Mounting Space.
- 4.675" High x 9" Wide x 9.5" Length
- Filler plates (FP) and/or equipment brackets (EB) sold separately
- See console appendix (page C82) for mounting depth allowed for control heads and/or options



Shown mounted on Console. Example: If mounted on a C-2410 console, there will be a total of 22.5" inches of face plate and options mounting space available. (8" angled and 14.5" horizontal)

C-TCB-37

Telescoping Computer Base Universal Side Mount

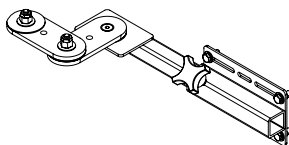

- Telescoping computer base For C-AS & C-VS Van Series Consoles
- Recommended for Keyboard mounts C-3329-XXX or C-KBM-XXX Series with C-3065-3 Tilt Swivel.
- Ideal solution for limited space and any angled console.
- Adjustable with locking knob to set telescoping length
- Length closed 7", Telescoping length 5" inches
- Articulating swivel arms make it easy to position a keyboard where you want it.

LIN4 MOUNTING BRACKETS

- C-LIN4-1 Mounting Bracket (1 light max) 2.5" height**
- C-LIN4-2 Mounting Bracket (2 lights max) 3.75" height**
- C-LIN4-4 Mounting Bracket (4 light max) 5.5" height**

- Mounting brackets for Whelen LIN4 Series LED
- Made from .125" aluminum with black powder coat finish which is durable and rust free.
- Simplifies front and rear deck, grille and license plate mounting
- Stainless mounting bracket hardware included
- Whelen LIN4 LED sold separately
- Hardware for mounting lights supplied with light purchase.
- **C-TIR3-3 & C-TIR3-UNV also accept LIN4 series lights**

Contact us at:

Ph: 800.524.9900 or 215.957.0720

Fax: 215.957.0729

E-mail: sales@havis.com

Web: www.havis.com



QUICK RELEASE MOUNTING SOLUTIONS

PAGE C66

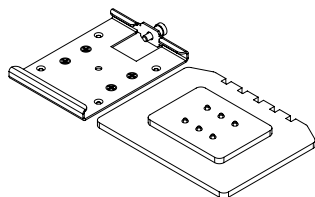

C-QRS-PAN Quick Release Slide for Panasonic Keyboard

(Panasonic PDRC keyboard mounts directly to C-QRS-PAN, no interface plate needed)

Note: C-KBM-PAN is now obsolete.

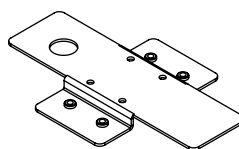

New!
C-KBM-STA
Keyboard mounting plate for Staco M779

C-3222

PAGE C67

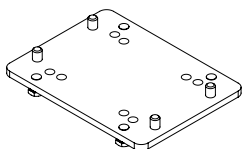

Adapter Mounting Plate for docking and mounting stations

- For **CF-27, CF-28, CF-29 -Kodiak, Gamber Johnson**, PC Mobil and other docking and mounting stations
- Using 4.25" x 2" and 4" x 2" hole patterns
- Aligns holes to fit C-3075 or C-3085 Series Tilt Swivels

1 lb.

C-3190

PAGE C72

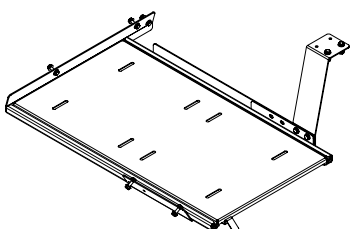

For 1995-2009 Ford Crown Victoria (Driver Side)

- Welded one-piece frame
- Mounts per Ford 2003 CVPI.com guidelines
- Spare tire stays in OEM Mount
- **9" clearance deck to shelf**
- Equipment mounting surface 15" wide x 27.5" deep
- Black powder coated 14 gauge steel
- Easy to use slide and latch
- Ships motor freight when ordering 6 or more

29 lbs.

C-3190-P

PAGE C72

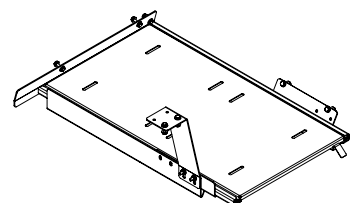

For 1995-2009 Ford Crown Victoria (Passenger Side)

- Welded one-piece frame
- Mounts per Ford 2003 CVPI .com guidelines
- Spare tire must be removed from OEM Mount
- **9" clearance deck to shelf**
- Equipment mounting surface 15" wide x 27.5" deep
- Black powder coated 14 gauge steel
- Easy to use slide and latch

29 lbs.

C-TTB-EG

NEW! PAGE C74

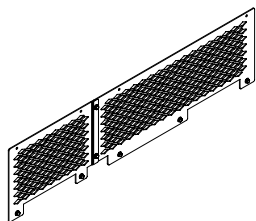

Equipment Guard for Full Width Trunk Tray

- 42" wide x 10.875" high
- Bolts to C-TTB-F-CV trunk tray
- 2 piece design allows for driver side access to tray mounted electronics
- Perforated for air flow
- Guards equipment on tray from other objects
- 12 gauge steel
- Black powder coat finish

C-AB-7535-CHGR-1

RADIO RELOCATION BRACKETS & WIRE HARNESS



- AM/FM Radio Relocation Bracket for use with C-VS-2400-CHGR-1 Consolidator Console for 2008 Dodge Charger
- Attaches to top end of horizontal C-VS console and uses 7.5" of mounting space (35° angled)
- Includes radio relocation 24" wire extension harness



Contact us at:

Ph: 800.524.9900 or 215.957.0720

E-mail: sales@havis.com

Fax: 215.957.0729

Web: www.havis.com



C-3371-HP460 G-3371-HP450

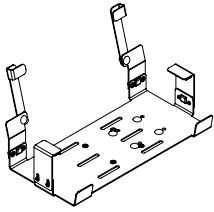

Printer Mount for Hewlett Packard HP450 and HP460

- Printer mount assembly for HP450 laser jet printer and HP460C printer
- Slotted design allow universal mount
- Includes paper support arms



2 lbs.

C-B39

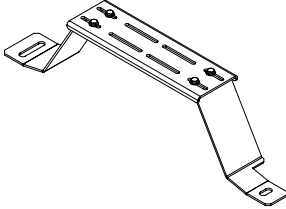

3 Piece Rear Hump bracket assembly for Tahoe, Suburban, Yukon, Yukon XL, Silverado, and Sierra Pick-ups 2000-2008

C-M-33

Kit Includes:

(1) C-B33

(1) C-B1

(1) C-B3

Ford

Crown Victoria

1995-2009

C-Series Consoles

TM-Series Consoles

7 lbs.

- Include vehicle specific hump mount brackets and universal bail mount brackets
- Provide quick and easy installation of a wide range of consoles and accessories
- In most dcases require no drilling and attach to existing seat mounting holes

C-2226-PAN-CF30



Universal Locking Laptop Mounting Plate

- For Panasonic Toughbook model CF-30
- Economical mount solution (no electrical plugs or connectors)
- Recommended for C-3065 Series tilt/swivel mounts (sold separately)
- Ideal solution for limited space
- Locking latch includes 2 keys keyed alike

C-VS-WP-SILV-1



Optional wire/extension cover panel

- For 2007-2008 Chevrolet Silverado LT1 & LT2 with optional OEM full length OEM center console
- For use with C-VS-1000-TAH console only. order separately
- One piece wrap around panel contour to dashboard for custom appearance
- Includes a C-FP-3 filler plate to cover a 3" equipment space
- Optional equipment bracket for 3" space must be ordered separately if desired.
- Easily removed for wiring access and service

C-WH-CHGR-1

24" Radio Relocation Wire Harness for 2008 Dodge Charger

- Includes power, audio, and antenna wiring

Contact us at:

Ph: 800.524.9900 or 215.957.0720

E-mail: sales@havis.com

Fax: 215.957.0729

Web: www.havis.com



CONSOLIDATOR®

TELESCOPING COMPUTER BASES (TCB SERIES)

PAGES C52-C57

VEHICLE INFORMATION

TCB HEIGHT DIMENSIONS

C-TCB-2	Vehicle Make	Model	Year	Closed	Extended	Weight
	Universal Side Mount	Telescoping Computer Base for Enclosed console models C-2410, C-2411, C-3010, C-3011, C-VS-3011-DUR	N/A	13"	20"	4 lbs.
C-TCB-8						
	Universal Top Mount	Universal Telescoping Computer Base for vans and trucks with sturdy welded flat base for floor mounting	N/A	11"	18"	7 lbs.
C-TCB-12						
	Ford	Bronco	1992-1996	16"	21"	9 lbs.
C-TCB-14						
	Universal Telescoping Base	Telescoping Computer Base with 60° Angle for Trak-Mount	N/A	6.5"	9.5"	8 lbs.
C-TCB-17						
	Ford	F-150 Pick-Up F-150 Heritage	1997-2003 2004	15.5"	21.5"	10 lbs.
C-TCB-24						
	Ford	Excursion F-250 Pick-up F-350 Pick-up F-450 Pick-up F-550 Pick-up	1999-2006 1999-2007 1999-2007 1999-2007 1999-2007	16"	22"	9 lbs.
C-TCB-26						
	Ford	Explorer Sport Trac	2002-2007 2007	10"	16"	9 lbs.
C-TCB-27						
	Dodge	1500 Ram Pick-Up	2002-2008	16"	22"	9 lbs.
C-TCB-31						
	Ford	F-150 Pick-Up (Except 2004 F-150 Heritage)	2004-2007	14"	20"	6 lbs.
C-TCB-33						
	Chevrolet	Malibu	2004- 2008	10"	16"	10 lbs.
C-TCB-34						
	Chevrolet/ GMC	Colorado/Canyon	2004-2008	10"	16"	9 lbs.

Crown Vic Vehicle Hump Bracket C-B53, replaces C-B16 bracket, changed from a two-piece to three-piece design. Updated in the C-TM-CV trak mount assembly allowing for an easier installation and trak adjustment after installation.

Contact us at:

Ph: 800.524.9900 or 215.957.0720

E-mail: sales@havis.com

Fax: 215.957.0729

Web: www.havis.com



CONSOLIDATOR®

EQUIPMENT BRACKETS & FILLER PLATES

PAGES C20-C28

For the latest equipment bracket list and updates, please refer to www.havis.com

S-CM-112-IMP-1 Console Accessory Box External Mount 2006-2008 Chevrolet Impala

- AM/FM Radio Relocation Bracket for use with S-DMM-xxx-IMP-1-x Dash monitor mounts for 2006-2008 Chevrolet Impala
- Mounts under center of dash - (there is no OEM ash tray)
- Extension wire harness not needed

C-LS-18 18" HEAVY DUTY SLIDE RAIL SYSTEM

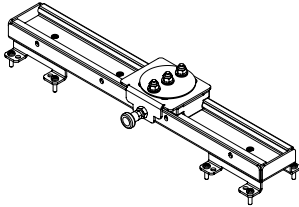

- Ideal for any cab over "dog house" mounting, such as custom fire apparatus
- Unique roller bearing carriage insures smooth, friction free operation
- Holds S-UMM, C-3090, C-3075 or C-3065 Series device mounts and motion adapters
- Spring pin lock allows the mount to be locked in four locations along rail
- 2.46" high



C-MAP-T-LED

12" high durable, flexible, top mounted gooseneck map light

- Two high-output Lumileds® 3W LED's - one for red light and one for white light
- On/Off/On. Red/Off/White rocker switch for selecting white or red light
- Electronically regulated light output for maximum efficiency and guaranteed life >30,000 hours
- Uniform wide area light output with near-zero glare and no wasted light
- Clear lens to protect the LED's
- 12" wire lead (18 gauge) with stripped ends
- More than three times light output compared to halogen models with a 40% reduction in current draw
- Extra large 1 1/8" diameter by 2 1/2" long finned aluminum heatsink to provide effective cooling of the LED's
- Interchangeable with the same hole pattern as Havis-Shields C-MAP-T halogen maplights

C-3371-HP-460

PRINTER MOUNT FOR HEWLETT PACKARD HP450 AND HP460

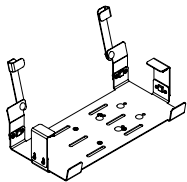

- Printer mount assembly for HP450 laser jet printer and HP460C printer
- Slotted design allow universal mount
- Includes paper support arms
- Shipping weight: 2 lbs.



CM93051

REPLACEMENT ARM REST PAD

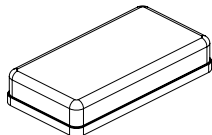

- For C-3610-ARM, C-ARM-10-TM, C-ARM-3, C-ARM-3-TM, C-ARM-8-TM, C-CB-1 & C-CB-2
- Armrest pad option for printer mount C-3371-HP460



CM002564

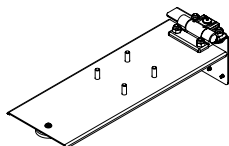

- Hinged flip up armrest plate option for C-3371-HP460 printer mount
- Parts purchased separately
- Some assembly required
- Order armrest pad separately p/n CM93051



Contact us at:

Ph: 800.524.9900 or 215.957.0720

Fax: 215.957.0729

E-mail: sales@havis.com

Web: www.havis.com



Old Part # New Part #

One (1) Compartment

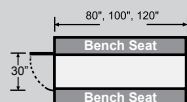

KK-x-80-01	KK-80-01	Kwik-Kit 80" - Single Rear Entry Door
KK-x-96-01	KK-100-01	Kwik-Kit 100" - Single Rear Entry Door
KK-x-114-01	KK-120-01	Kwik-Kit 120" - Single Rear Entry Door

Two (2) Compartment

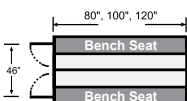

KK-x-80-02	KK-80-02	Kwik-Kit 80" - Dual Rear Entry Doors
KK-x-96-02	KK-100-02	Kwik-Kit 100" - Dual Rear Entry Doors
KK-x-114-02	KK-120-02	Kwik-Kit 120" - Dual Rear Entry Doors

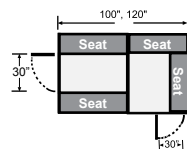

KK-x-100-03	KK-100-03	Kwik-Kit 100" - Single Rear Entry Door - Single Side Entry Door
KK-x-120-03	KK-120-03	Kwik-Kit 120" - Single Rear Entry Door - Single Side Entry Door

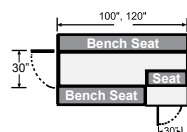

KK-x-96-05	KK-100-05	Kwik-Kit 100" - Single Rear Entry Door - Single Side Entry Door
KK-x-114-05	KK-120-05	Kwik-Kit 120" - Single Rear Entry Door - Single Side Entry Door

Three (3) Compartment

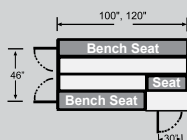

KK-x-96-06	KK-100-06	Kwik-Kit 100" - Dual Rear Entry Doors - Single Side Entry Door
KK-x-114-06	KK-120-06	Kwik-Kit 120" - Dual Rear Entry Doors - Single Side Entry Door

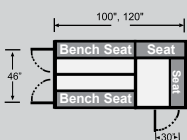

KK-x-100-04	KK-100-04	Kwik-Kit 100" - Dual Rear Entry Doors - Single Side Entry Door
KK-x-120-04	KK-120-04	Kwik-Kit 120" - Dual Rear Entry Doors - Single Side Entry Door

Four (4) Compartment

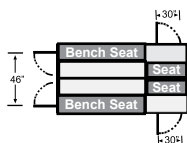

New!	KK-100-07*	Kwik-Kit 100" - Dual Rear Entry Doors - Dual Side Entry Doors *Only available for 135" Wheel Base Chevrolet Express Van with Optional Driver Swing-out Side Entry Doors
-------------	------------	---

Sprinter Kwik-Kit™ Prisoner Transport Inserts

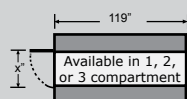

Available in 1, 2, or 3 compartment	KK-S-120-01	KK-S-119-01	Kwik-Kit 119" Single Rear Entry Door
	KK-S-120-02	KK-S-119-02	Kwik-Kit 119" Dual Rear Entry Doors
	KK-S-120-06	KK-S-119-06	Kwik-Kit 119" Dual Rear Entry Doors - Single Side Entry Door

Contact us at:

Ph: 800.524.9900 or 215.957.0720

Fax: 215.957.0729

E-mail: sales@havis.com

Web: www.havis.com



TRANSPORT PRODUCTS

Kwik-Kit Accessories and Options

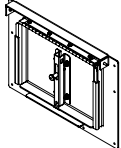
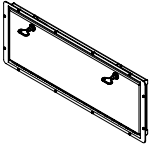
Part Number	Description	Est. Install Time
KK-MPT 	Kwik-Kit Meal Pass Through Option <ul style="list-style-type: none"> • For any Kwik-Kit compartment door • Designed to mount in lower half of compartment door viewing area (window) • Requires cutting out lower perforated aluminum viewing area • Pass through hatch door hinges up providing 8" high x 11" wide opening • Heavy duty slide bolt latch has provision for customer supplied padlock • Can be installed anytime (field upgradable) • White powder coat finish 	0.75 hour
KK-STORAGE 	Kwik-Kit Locking Under-Bench Storage Option <ul style="list-style-type: none"> • Designed to be used in 3 or 4 compartment Kwik-Kits (side entry compartment) • Replaces existing vertical bench cover panel located in the side compartment bench only • Storage Door hinges down providing 10" high x 28" wide opening • Enclosed under bench storage space = 12" high x 39.5" wide x 11.5" deep • Uses existing panel mount holes for accurate location • Two tamper proof locks with two keys • Gasket seal to minimize water penetration • White powder coat finish 	0.5 hour
KK-F-HVAC-1	Heat/AC Standard Kit for Kwik-Kit Ford	5 hours
KK-FD-HVAC-1	Heat/AC Standard Kit for Kwik-Kit Ford Diesel	5 hours
KK-C-HVAC-1	Heat/AC Standard Kit for Kwik-Kit Chevy	5 hours
KK-S-HVAC	Sprinter* Van Diesel Engine Heat/air conditioning system (23,000 BTU air, 32,000 BTU heat) *Sprinter kits include underbody condenser	7 hours
PT-THERM 1	Thermometer (Dual Display)	.5 hour
HS-DL	Single Exterior Door Lock: Exterior locking bar assembly with a drop forged latch handle and hasp, keyed alike	
PT-VIDEO-MDVR	Prisoner Transport Mobile Digital Video Recorder Option <ul style="list-style-type: none"> • 12-volt event based digital recorder provides the ability to capture a video record from all cameras in the PT-VIDEO system • Designed specifically for mobile applications • Recording to Compact Flash Card media for unmatched reliability. • 12V (positive or negative) five channel configurable multi-event triggered inputs. RE: Ignition, Manual switch, Door switch, Emergency Lights etc... • True low cost VCR replacement with no moving parts, no internal fan, no audible noise. • Optional integrated GPS position and speed tracking and recording. • Back End Software included • Includes C-EB25-MMT-1P equipment bracket 	
PT-VIDEO-GPS	Prisoner Transport Global Positioning System Option <ul style="list-style-type: none"> • Integrated GPS position and speed tracking and recording • Used only with PT-VIDEO-MDVR 	
KK-SDI	Optional Sound Deadening Insulation <ul style="list-style-type: none"> • Applying sound deadening material to the interior walls reduces sound and insulates, improving climate controls • Easy to install self-adhesive polyester foam • (1) 20 foot roll of 1" thick x 54" wide material 	

Contact us at:

Ph: 800.524.9900 or 215.957.0720

Fax: 215.957.0729

E-mail: sales@havis.com

Web: www.havis.com



TRANSPORT PRODUCTS

DOOR PANELS

PAGE T7

- Makes doors safer for handling **dogs, recommended for K9 transportation systems**

K-9 TRANSPORTATION SYSTEMS

PAGE T8

Vehicle Make & Model	Year	K-9 Kit Part Number	32" Deep K-9 Kit Part Number	PT/K-9 Kit Part Number
Chevrolet/GMC				
NEW! Impala	2006-2008	KK-K9-C19-K		
NEW! Crown Victoria Sedan with Fire Suppression Option	1998-2009	KK-K9-F7-K-FS		
Yukon/Tahoe 4 Door	2000- 2006	KK-K9-C14-K	KK-K9-C14-K-32	KK-K9-C14-K-PT
NEW! Yukon/Tahoe 4 Door	2007-2008	KK-K9-C20-K	KK-K9-C20-K-32	KK-K9-C20-K-PT

AceK9.com Door Pop System	KK-K9-HA-FKT-I	12" Fan, 350 CFM activation module, manual switch and materials (must order KK-K9-HP-5010 to activate this fan)
AceK9.com Door Pop System	KK-K9-HA-2510	K9 Heat Alarm Pro includes: S.O.S. horn alert module, dual window drop module, lightbar activation module, siren activation module, remote pager/beeper module
AceK9.com Door Pop System	KK-K9-HP-5010-H <i>(old part number: KK-K9-HA-5000)</i>	Remote door Hot-N-Pop system including S.O.S. horn alert module, dual window drop module, lightbar activation module, and siren activation module (Heavy duty solenoid for SUV, truck, special applications)
AceK9.com Door Pop System	KK-K9-HP-5010-S (NEW!)	Remote door Hot-N-Pop system including S.O.S. horn alert module, dual window drop module, lightbar activation module, siren activation module, Remote Pager/Beeper Module (Standard Duty solenoid for Sedans)

WINDOW GUARDS

PAGE T5

- Van window guards (WGI-C1 – C4 & WGI-F1 – F4) come standard with tamper proof hardware and (2) T-25 TORX 1/4" Hex Insert screw driver tips.

Tahoe Yukon 4 door Double rear door	2000- 2006	WGI-C14	2	1/2 hour	15 lbs.
NEW! Tahoe/Yukon	2007-2008	WGI-C20	2	1/2 hour	15 lbs.
Chevrolet Impala	2006-2008	WGI-C19-H	2	1/2 hour	15 lbs

PARTITIONS

PAGE T4

Vehicle Make & Model	Year	Front Partition Part Numbers		Middle Partition Part Numbers		Rear Partition Part Numbers	
		Front*	Filler Panel Mtg. Kit*	Middle	Filler Panel Mtg. Kit*	Rear	Filler Panel Mtg. Kit*
Chevrolet/GMC Express/Savana G Van 12 or 15 pass/dual side doors	2003-2007	P-FRONT-1	P-MFK-1	P-MID-1	P-MFK-5	P-REAR-1	P-MFK-9
	2008	P-FRONT-1	P-MFK-4	P-MID-1	P-MFK-7		
Express/Savana G Van 12 or 15 pass/sliding side doors	2003-2007	P-FRONT-2	P-MFK-3	P-MID-1	P-MFK-5	P-REAR-1	P-MFK-9
	2008	P-FRONT-2	P-MFK-8	P-MID-1	P-MFK-7		

** P-REAR-2 is not applicable for the 2008 Ford E-Series 15 passenger window van; this partition will work for the 2008 Ford E-Series 12 passenger window van

Contact us at:

Ph: 800.524.9900 or 215.957.0720

E-mail: sales@havis.com

Fax: 215.957.0729

Web: www.havis.com



LIGHTING PRODUCTS

New! Magnafire 5000™ Series! Havis-Shields introduces the new Magnafire 5000™ Space Saver Series Light fixture. Virtually identical to the current Magnafire 3000, specifically designed to save space. The new design allows for all the same mounting applications as the 3000 series. Part numbers and price will be the same as the current configured light assemblies as their corresponding bulb watt selection:

3000 Series	5000 Series	Description
KR-31	KR-51	70 Watt, 12VDC, HID
KR-31-24	KR-51-24	70 Watt, 24VDC, HID
KR-32	N/A	150 Watt, 12VDC, HID
KR-32-24	N/A	150 Watt, 24VDC, HID
KR-33	KR-53	350 Watt, 120VAC, HAL
N/A	KR-55	500 Watt, 120VAC, HAL
KR-36	KR-56	750 Watt, 120VAC, HAL
KR-37	KR-57	750 Watt, 220VAC, HAL
KR-39	N/A	900 Watt, 240VAC, HAL



MAGNAFIRE 5000 SERIES

Part Number	Watts	Volts	Amps	Bulb Type	Bulb Lumen Rating*	Bulb Life
KR-51	70	12	6	Metal Halide HID	6,000	10,000 hrs
KR-51-24	70	24	3	Metal Halide HID	6,000	10,000 hrs
KR-53	350	120	3	Quartz Halogen	13,250	400 hrs
KR-55	500	120	4.5	Quartz Halogen	10,500	2,000 hrs
KR-56	750	120	6.25	Quartz Halogen	25,200	400 hrs
KR-57	750	220	3.5	Quartz Halogen	19,200	1500 hrs

Brow Mount and Recessed Mount Part Numbers

3000 Series	5000 Series	Description
KR-1500	KR-2500	Brow Mount E-One
KR-1500-SP-KOV	KR-2500-SP-KOV	Brow Mount Spartan/Kovatch
KR-1800	KR-2600	2.5" Recessed Mount
KR-1900	KR-2700	2.5" Recessed Mount
KR-2100	KR-2800	2" Recessed Mount
KR-2200	KR-2900	5.5" Flush Recessed Mount
KR-2300	KR-3100	5.5" Flush Recessed Mount

KR-GG-5000 New Grille Guard for Magnafire 5000 Light Fixture

KR-SB-600-W4 Series Non-Telescoping Side Mount

- One 2-piece locking collar
- One Silver Billet 4" offset mounting bracket with 4 hole mount plate
- 180° horizontal rotation and 90° vertical tilt (with Magnafire 5000 light fixture)
- 100° horizontal rotation and 90° vertical tilt (with Magnafire 3000 light fixture)
- Non-concealed wire standard
- On/Off switch optional.

Contact us at:

LIGHTING PRODUCTS

New Kwik Eject Power Line Disconnect System- available in Yellow, White, or Red

Kwik-Raze® Kwik Eject™ Series Power Line Disconnect System

- KE-15-120-X** Kwik-Eject 15 Amp 120 Volt includes Safety Cover
 - KE-20-120-X** Kwik-Eject 20 Amp 120 Volt includes Safety Cover
 - KE-15-220-X** Kwik-Eject 15 Amp 220 Volt includes Safety Cover
 - KE-CP-X** Kwik-Eject Replacement Weatherproof Safety Cover Plate
- *-”X” specify “-1” for yellow, “-2” for white, “-3” for red**

Optional Plugs

- KR-5269C** Connector NEMA 5-15R Female
- KR-5369C** Connector NEMA 5-20R Female
- KR-5669C** Connector NEMA 6-15R Female

KR-SB-GR-12, 18, 24 Silver Billet 12” Grab Rail Bracket Assemblies

New Kwik-Raze Brow Mounts

KR-35XX
E-One Quest Chassis Cab Brow Mount

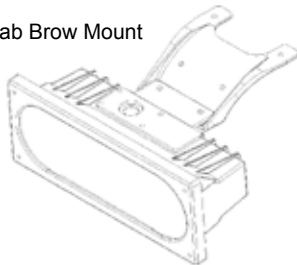

KR-36XX
E-One Quest Chassis Cab Side Mount

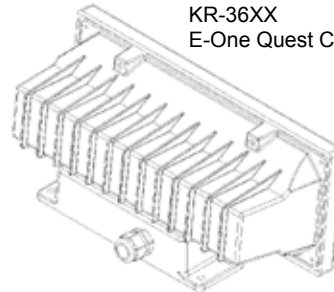

3500 Series E-One Quest Chassis Cab Brow Mount for Magnafire 3000 & 5000
3600 Series E-One Quest Chassis Cab Brow Mount for Magnafire 3000 & 5000

- Brow mounts are E-One Quest Chassis specific
- Available with Magnafire 3000 or 5000 series fixture
- Casting designed to match roof radius
- Relamps from the front of the fixture

Brow Mounts for Magnafire 3000®	Lighthoods Available
KR-15XX-ALF-X	KR-31 (70 Watt, 12 Volt)
KR-15XX-FM2-X	KR-31-24 (70 Watt, 24 Volt)
KR-15XX	KR-32 (150 Watt, 12 Volt)
KR-15XX-SP-KOV	KR-32-24 (150 Watt, 24 Volt)
KR-35XX	KR-33 (350 Watt, 120 Volt)
KR-36XX	KR-36 (750 Watt, 120 Volt)
	KR-37 (750 Watt, 220 Volt)
	KR-39 (900 Watt, 240 Volt)

Brow Mounts for Magnafire 5000®	Lighthoods Available
KR-25XX-ALF-X	KR-51 (70 Watt, 12 Volt)
KR-25XX-FM2-X	KR-51-24 (70 Watt, 24 Volt)
KR-25XX	KR-53 (350 Watt, 120 Volt)
KR-25XX-SP-KOV	KR-55 (500 Watt, 120 Volt)
KR-35XX	KR-56 (750 Watt, 120 Volt)
KR-36XX	KR-57 (750 Watt, 220 Volt)

XX = Lighthouse (specify 31, 31-24, 32, 32-24, 33, 36, 37, or 39)
 X = Center, Driver, or Passenger Mount (specify -C, -D, or -P)

XX = Lighthouse (specify 51, 51-24, 53, 55, 56, or 57)
 X = Center, Driver, or Passenger Mount (specify -C, -D, or -P)

Contact us at:

Ph: 800.524.9900 or 215.957.0720
 E-mail: sales@havis.com

Fax: 215.957.0729
 Web: www.havis.com



LIGHTING PRODUCTS

Bottom Raising Poles

KR-SB-400 Series Thru Body Mount

- 48" inner telescoping pole, 12" outer pole standard
- One Silver Billet thru-body mounting bracket

KR-SB-500 Series Side Mount

- Specify 2", 4" or 7" offset
- 67.5" inner telescoping pole, 24" outer pole standard
- Two Silver Billet offset mounting brackets

All bottom raise poles come standard with the following:

- Silver Billet mounting brackets
- **Concealed wire optional with Stonco fixtures and standard on all others**

700 Series Portable

- Cast aluminum black portable base
- 30" straight power cord standard (with Halogen & Magnafire lights KR-33, 36, 37, and 39)
- **9 ft. 16/2 coil cord with cigarette plug standard when ordering with Magnafire H.I.D KR-31, KR-32, or FX Series Fixture**
- On/ off switch standard
- Optional kwik-release hold down assembly (specify "HD")
- Optional plugs available (see page L12)

SB-800 and SB-800-SL Top Raise Tripod Specs

- Optional truck mount assembly (specify "TM" or "TM-7") - see below
- On/ off switch standard
- Optional plugs available
- Concealed coil cord
- Special lengths are available
- **9 ft. 16/2 coil cord with cigarette plug standard when ordering with Magnafire H.I.D. KR-31, KR-32, or FX Series Fixture**
- Anodized aluminum top-raising pole with a 320 grit spiral bright dipped finish
- Silver Billet Locking Collar with a knurled handle adjustment
- 1.38" OD inner pole / 1.88" OD outer pole
- 3/4" bushing and swivel for mounting light fixtures

16/2 TPR 9 ft. coil cord with #20 Lighter Plug

For use on H.I.D. 70 watt, 12 VDC light fixtures
- **Standard with KR-731 and KR-SB-831 Series**
(Part # RM265119)

16/2 TPR 9 ft. coil cord with #20 Valox® Lighter Plug (NEW)

For use on H.I.D. 70 watt, 12 VDC light fixtures
- Standard with KR-731 and KR-SB-831 Series
(Part # RM265120)

Standard and Special Pole Length Chart

N6 800 series- 1.5" has already been added to top raise pole lengths which is then reflected in the overall length because the tripod legs hang 1.5" below outer pole in closed position (**applies to old style tripod KR-800 Series only**)

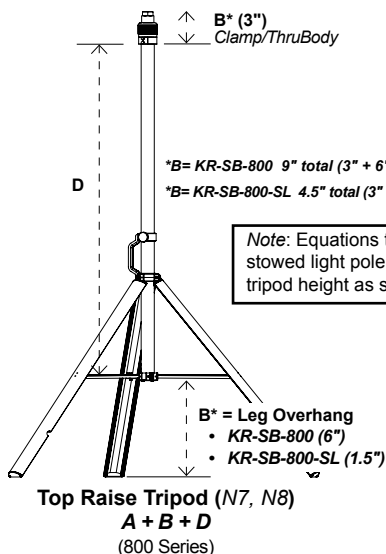

Contact us at:

Ph: 800.524.9900 or 215.957.0720

E-mail: sales@havis.com

Fax: 215.957.0729

Web: www.havis.com



LIGHTING PRODUCTS

Questar Application Guide

PAGE L29

Vehicle Make & Model	Years	Dist. A	Dist. B	Application Notes
DaimlerChrysler				
<i>NEW</i> Charger	2006-2008	16"	22"	
<i>NEW</i> Magnum	2005-2008	16"	22"	
Ford				
<i>NEW</i> Sport Trac	2008	12"	18"	

INTERIOR LIGHTING

PAGE L29



Cold Cathode Compartment Surface Mount Light with Dual Wire Leads and Connectors (KR-CCL-2) (New Picture)

KR-DL

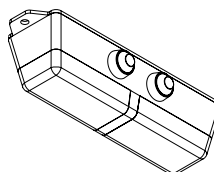

- Vehicle cab compact size dome light
- Easy to retrofit
- Includes two clear & two red lenses
- Uses two individually switched 7 Watt, 12 VDC Xelogen® replacement lamps
- 5.75" L x 2.25" W x 1.38" H
- Also available in packages of twelve (12). Order part number: **KR-DL-12**

LIGHTING ACCESSORIES

PAGE L12

KRM89086 Switch DPST for 220 Vac Light Fixtures

Plugs:

KR-5266C (Male)	KR-5269C (Female)	KR-4720C (Male)	KR-4729C (Female)	KR-2311 (Male)	KR-2313 (Female)	KR-2321 (Male)	KR-2323C (Female)
3 prong straight NEMA 5-15P 15A/125V	NEMA 5-15 15A/125V connector	3 prong twist lock NEMA L5-15P plug 15A/125V	NEMA L5-15R 15A/125V connector	3 prong twist NEMA L5-L20P lock plug 20A/125V	NEMA L5-20R 20A-125V connector	3 prong twist NEMA L6-20P lock plug 20A/250V	NEMA L6-20R 20A-250V connector

KWIK-STRIKE 4000

PAGE L21

ADAPTER PLATES & BRACKETS

PAGE L17

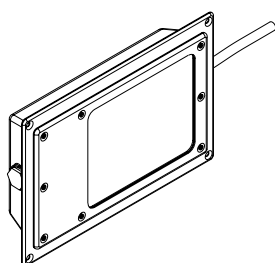

Lamp:

- 4250H = Halogen 250 Watt, 120 Volt
- 4150H = Halogen 150 Watt, 120 Volt
- 4100H = Halogen 100 Watt, 120 Volt
- See page L13 for replacement bulbs

KRM001704

- 4000™ Series Kwik Strike Gasket Retrofit

Adapter Plates with Brackets

- Includes (2) KRM25024 plates mounted to KR-SB offset brackets
- Change prefix "KR-SB" to "KR-SBP" when ordering complete configured pole
- Offset shafts are shortened to keep original offset distance
- Shipped with pole configured as complete assembly

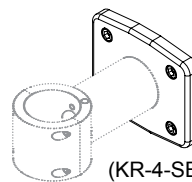

(KR-4-SB-P shown)

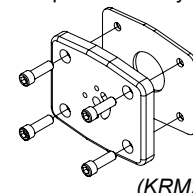

w/ gasket & hardware

(KRM25024 shown)

KR-4000-SMC 4000 Series Kwik-Strike Side Mount Casting

KR-SB-__31DM*

PAGE L8

KR-1500 SERIES BROW MOUNTS

PAGE L19

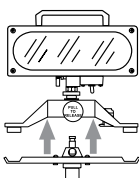

Wattage	Bulb Lumen Rating	Amps Drawn	Bulb Life
70 watts	6000	6 amps @ 12VDC	10,000 hrs

- Available for Spartan, KME, E-ONE, American LaFrance, 2003-2007 Freightliner M2 cabs, and other manufacturers

Contact us at:

Ph: 800.524.9900 or 215.957.0720

E-mail: sales@havis.com

Fax: 215.957.0729

Web: www.havis.com



FX SERIES DECK LIGHTS



- Single and dual stage reflectors provide halogen spot, flood and enhanced flood beam patterns
- Black anodized aluminum with chrome plated reflector housing
- On/ off switch standard
- **All models are standard 12 volt and, if specified available with 24 volts. Add "-24" after configured model number for this option.**
- Order mounting bases separately; see below

CD-FX-6-24 Enhanced flood light (24 Volt)

- Candlepower: 205,000 Spot / 85,000 Flood
- Lumens: 1,900
- 2.94 @ 24 Amps
- Bulb: (1) CD-H170W24H1 base, 70 watt/24 volt
- Bulb life: 150 hours

CD-FX-9-24 Selectable spot/flood light

- Candlepower: 430,000 Spot
- Lumens: 2,150
- Amp Draw: 2.94 @ 24 Amps
- Bulb: (2) CD-H270W24 H2 base, 70 watt, 24 volt
- Bulb life: 100 hours

CD-FX-12-24 Selectable spot/flood light

- Candlepower: 530,000 spot
- Lumens: 2,150
- Amp Draw: 2.94 @ 24 Amps
- Bulb: (2) CD-H270W24H2 base, 70 watt, 24 volt
- Bulb life: 100 hours

HID FX SERIES LIGHTS

CD-FX-HID-1 lights allow for all the same mounting applications as the CD-FX Series with less amp draw!

INTERIOR LIGHTING

NEW! PAGE L29

Waterproof Cold Cathode Compartment Surface Mount Light with 12" Lead and Switch KR-CCL-1-WP

Waterproof Cold Cathode Compartment Surface Mount Light with Dual Wire Leads and Connectors KR-CCL-2-WP

Waterproof Cold Cathode Compartment Surface Mount Light with No Switch (KR-CCL-3-WP)



Optional Bracket for Cold Cathode Lights

- 1/2" offset depth from surface, 1-1/4" mounting height to top of light fixture
- KR-CCL series lights sold separately
- Works with waterproof lights
- KR-CCL-BKT-1 shown with KR-CCCL-1-WP Cold Cathode mounted to extursion

Contact us at:

Ph: 800.524.9900 or 215.957.0720

Fax: 215.957.0729

E-mail: sales@havis.com

Web: www.havis.com



Vehicle Year Updates

When only a vehicle year is updated for a certain part, you will find these updates listed here.

Vehicle Application Chart Chevrolet/GMC

1997-2009	G-Series Van (Dual swing out doors)
1997-2009	G-Series Van (Side sliding door)
2006-2009	Impala
2007-2009	Silverado / Sierra Pickup
2007-2009	Suburban/Yukon XL
2007-2009	Tahoe/Yukon
2002-2009	Trailblazer / Envoy (Standard Length ONLY)
1997-2009	Dodge Dakota Pickup
2004-2009	Dodge Durango
2003-2009	Dodge Ram Full-Size 1500, 2500 & 3500
2008-2009	Dodge Charger (police package)
1995-2009	Crown Victoria
2007-2009	Expedition (retail, center OEM console)
2007-2009	Expedition EL (retail, center OEM console)
2007-2009	Expedition SSV (Column gear shifter)
2007-2009	Expedition SSV EL (Column gear shifter)
2006-2009	Explorer
2007-2009	Sport Trac
2008-2009	Escape
1997-2009	E-Series Van (Dual swing out doors)
1997-2009	E-Series Van (Side sliding door)
2004-2009	F-150 Pickup (Column Gear Shifter)
2004-2009	F-150 Pickup (Console Gear Shifter)
2008-2009	F-250, 350, 450, 550 Pickup
1999-2009	Ranger

Page	Part Number	Description
C15	C-VS-700-DUR	7" Console for 2004- 2008 Dodge Durango
	C-VS-1200-DUR	12" Console for 2004- 2008 Dodge Durango
	C-VS-3011-DUR	For 2004- 2008 Dodge Durango
	C-VS-WP-DUR	Wiring Cover Panel for Durango C-VS-3011-DUR and C-TM-DUR fits 2004- 2008
C17	C-VS-1000-TAH	2007 - 2008
	C-VS-1100-F150	Fits 2004- 2008 Ford F-150 Pick-Up with optional bucket seats and OEM console only
	C-VS-2400-CHGR	24" Vehicle Specific Console for 2006- 2007 Dodge Charger and 2005-2008 Magnum
	C-VS-1200-GM	12" Console for 2003- 2006 Sierra/Silverado Classic Body Style P/U's, 2003-2006 Yukon/Tahoe, and Yukon XL/Suburban SUV's with bucket seats and OEM floor console
C18	C-VS-0812-CHGR	20" Vehicle Specific Console for 2006- 2007 Dodge Charger and 2005-2008 Magnum
C39	C-TM-EXC	32" Trak Mount base assembly with front and rear mounting brackets for 1999-2006 Ford Excursion and 1999-2007 Ford F-250, 350, 450, and 550 Pickups
	C-TM-DUR	Trak Mount assembly for 2004- 2007 Dodge Durango
C40	C-TM-F150	32" trak-Mount for 2004- 2007 Ford F-150 Pick-Up (Fits 2004-2007 Ford F-150 Pickup (column shift only) and 2007 Ford Expedition (SSV w/ column shift only)
	C-M-15	1999-2008
C48	C-M-17-IMP	2000-2008
	C-M-25	2000-2008
	C-M-24	Vehicle Mounting Bracket kit for 1999-2007 Ford F-250, 350, 450, and 550 Pickups
	C-M-32	2007-2008
	C-M-28	2000-2008
	C-M-21	1998-2003 and 1997-2007 Dakota

Contact us at:

continued...

Ph: 800.524.9900 or 215.957.0720

Fax: 215.957.0729

E-mail: sales@havis.com

Web: www.havis.com



By: Havis-Shields

HAVIS-SHIELDS CATALOG SUPPLEMENT

Vehicle Year Updates Continued...

C49/50	C-B44	2006- 2007
	C-B48	2007- 2008
	C-B49	2007- 2008
	C-B26	1997- 2008
	C-B17	2000- 2008
	C-B42	2000- 2008
	C-B43	2006- 2008
	C-B24	2000- 2008
	C-B39	2000- 2008
C51-57	C-TCB-32	Telescoping Computer Base for 2002- 2007 Trailblazer/Envoy
	C-TCB-22	2000- 2008
	C-TCB-34	2004- 2008
	C-TCB-36	2006- 2008
	C-TCB-1	1995- 2008
	C-TCB-5	1997- 2008
	C-TCB-26	2002- 2008 & 2007- 2008 Sport Trac
	C-TCB-6	Telescoping Computer Base for 1999- 2007 Ford Ranger
	C-TCB-24	Telescoping Computer Base for 1999-2007 Ford F-250, 350, 450, and 550 Pickups
	C-TCB-28	1997-2007
	C-TCB-27	Telescoping Computer Base for 2002- 2007 Dodge 1500 Ram Pick Up
C63	C-WH-CHGR	4' Wire Harness for Aftermarket AM/FM Radio Relocation for 2006- 2007 Dodge Charger or Magnum
C71	AOI-US2CD	Airbag Control Switch for both Driver and Passenger Air bags for 2004- 2008 Durango, 2005- 2008 Magnum, and 2006 Charger
	AOI-US2CDSC	Airbag control switch for both Driver and Passenger Air Bags for 2006- 2008 Dodge Charger and Magnum
	AOI-US2GM	Airbag control switch for 2001-2007 Chevrolet Impala sedans and 2003- 2008 Suburban, Tahoe, Trailblazer, G Series Cargo Van, and C & K Series Pickups
C75	C-TTB-CHGR	Trunk Tray for 2006- 2008 Dodge Charger (full width)
	C-STB-CHGR	Spare Tire Bracket for 2006- 2008 Dodge Charger
	C-TSM-CHGR-D	Trunk Side Mount 2006- 2008 Dodge Charger-Driver side
	C-TSM-CHGR-P	Trunk Side Mount 2006- 2008 Dodge Charger-Passenger side
C80	Appendix	2006- 2008 Dodge Charger 2 Piece Computer Mount
		2006- 2008 Dodge Charger Modular Computer Mount
		2006- 2008 Dodge Charger Dash Monitor Mount
		2006- 2008 Dodge Charger Laptop Computer Mount
		2006- 2008 Dodge Charger 2 Piece Computer Mount with Stout Mount Console
C81	Appendix	2006- 2008 Dodge Charger 2 Piece Computer Mount with Stout Mount Console
T6	WGI-C16	Interior Window Guards for 2002- 2008 Trailblazer
	WGI-D21	Interior Window Guards for 2004- 2008 Dodge Durango
	WGI-D22	Interior Window Guards for 2005- 2008 Magnum
	WGI-D23	Interior Window Guard for 2006- 2008 Dodge Charger
	WGI-F14	Interior Window Guards for 1997- 2008 Expedition
	WGI-F15	Interior Window Guard for 1999-2007 Ford F-250, 350, 450, and 550 Pickups
T7	DP-C16-A	Door Panels for 2002- 2008 Trailblazer
	DP-D21-A	Door Panels for 2004- 2008 Dodge Durango
	DP-D22-A	Door Panels for 2005-2008 Magnum
	DP-D23-A	Door Panels for 2006- 2008 Dodge Charger
	DP-F5-A	Door Panels for 2006- 2008 Expedition
	DP-F15-A	Door Panels for 1999-2007 Ford F-250, 350, 450, and 550 Pickups
T8	KK-K9-C16-K	K9 Transportation system for 2002- 2008 Trailblazer (5 passenger/short only)
	KK-K9-D22-K	K9 Transportation system for 2005- 2008 Magnum
	KK-K9-D23-K	K9 Transportation system for 2006- 2008 Dodge Charger (24.5" Deep)
	KK-K9-F14-K	K9 Transportation system for 2005- 2008 Expedition
	KK-K9-F7-K	K9 Transportation system for 1998- 2009 Crown Victoria
L29	Questar	Questar for 2006- 2008 Dodge Charger

Questar for 2005-**2008** Magnum.

Contact us at:

Ph: 800.524.9900 or 215.957.0720

Fax: 215.957.0729

E-mail: sales@havis.com

Web: www.havis.com



ISOVIEW AND PICTURE UPDATES

C-ARM-2

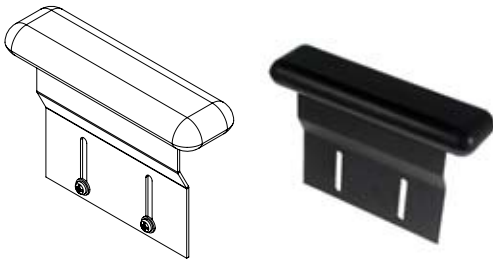

C-TM-GMC

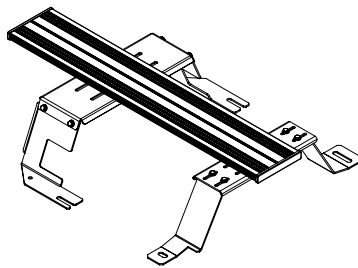

Contact us at:

Ph: 800.524.9900 or 215.957.0720
E-mail: sales@havis.com

Fax: 215.957.0729
Web: www.havis.com



By: Havis-Shields

HAVIS-SHIELDS CATALOG SUPPLEMENT

Console Appendix

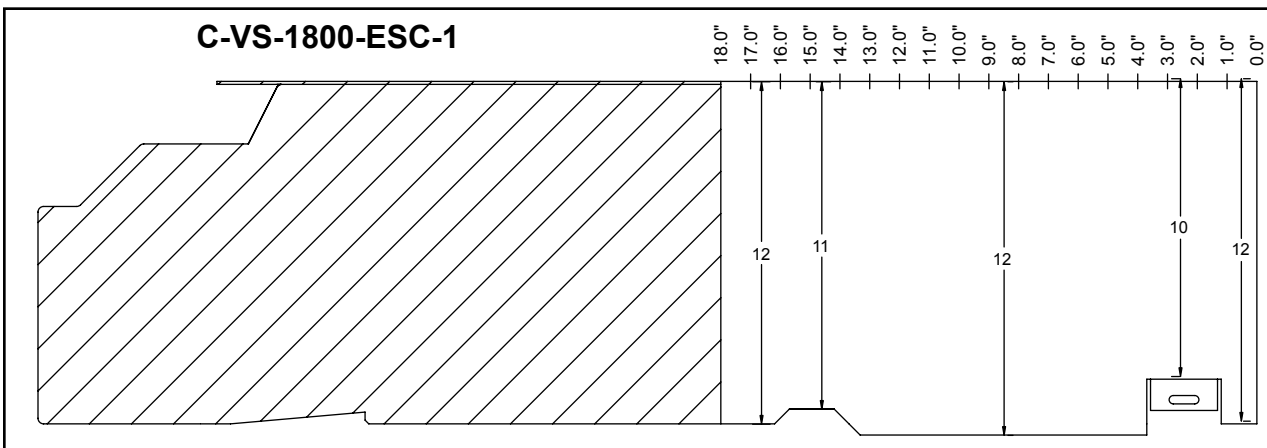
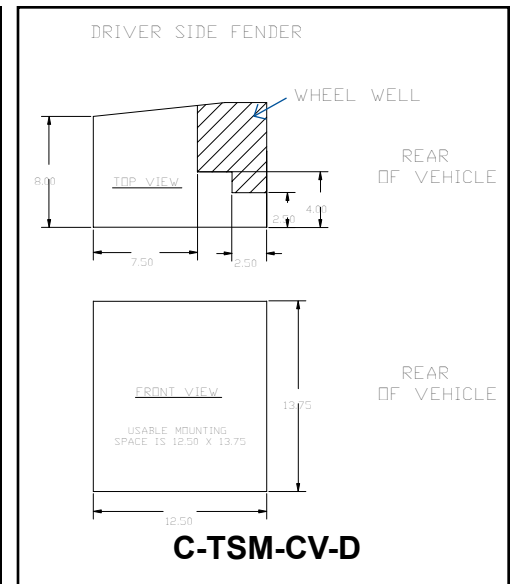
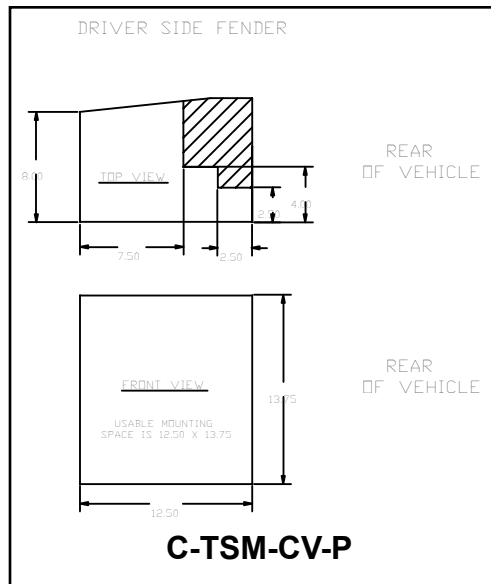
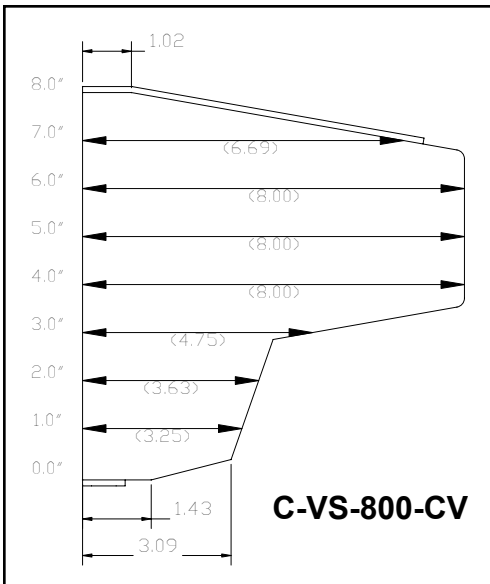
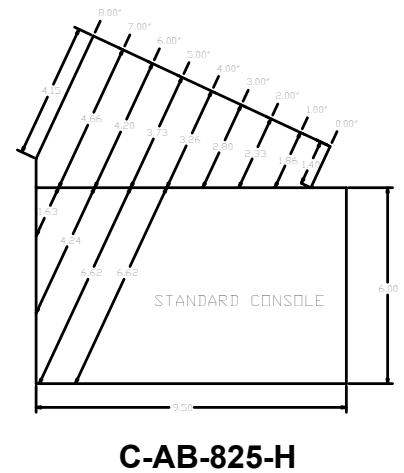
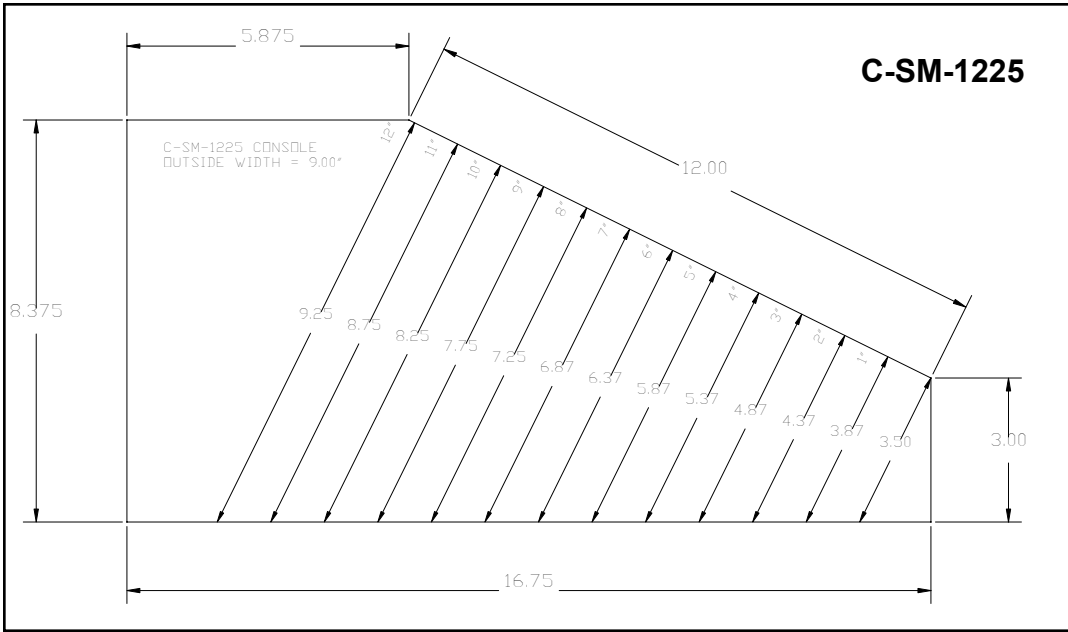

Contact us at:

Ph: 800.524.9900 or 215.957.0720

E-mail: sales@havis.com

Fax: 215.957.0729

Web: www.havis.com



2006-2007 Dodge Charger 2 Piece Computer Mount

****This is a sample configuration. These parts can be substituted depending on vehicle or application.****

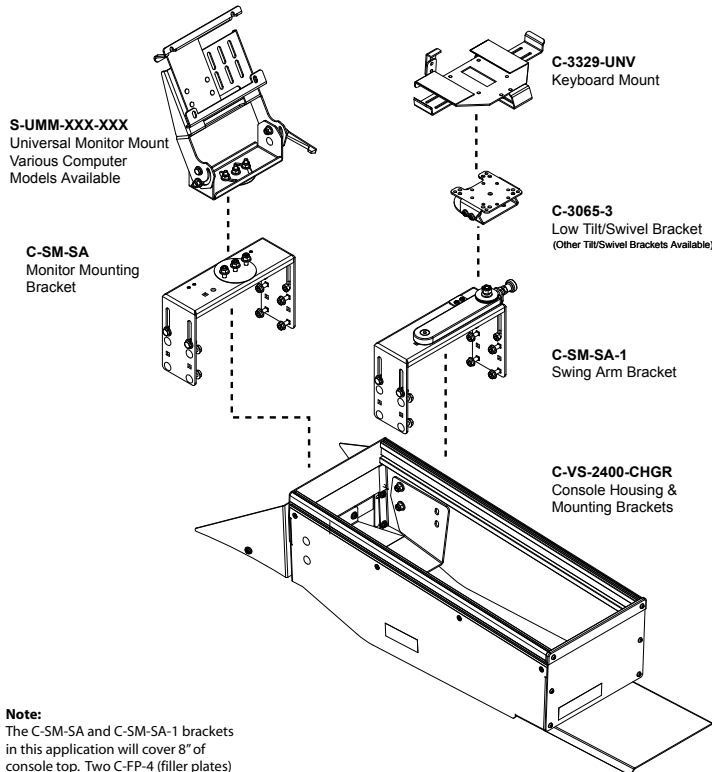

2006-2007 Dodge Charger Modular Computer Mount

****This is a sample configuration. These parts can be substituted depending on vehicle or application.****

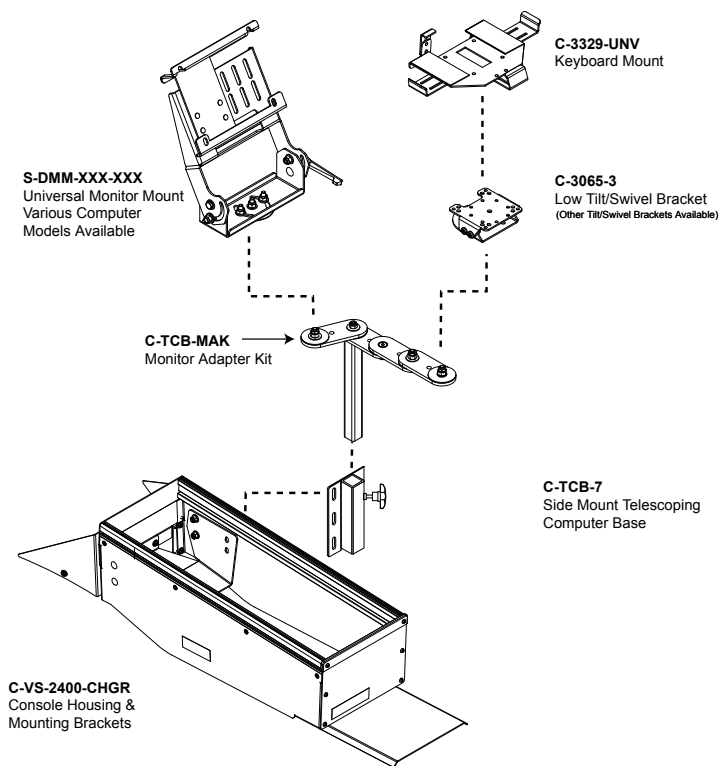

Stout Mount™ 2 Piece Computer Mount

****This is a sample configuration. These parts can be substituted depending on vehicle or application.****

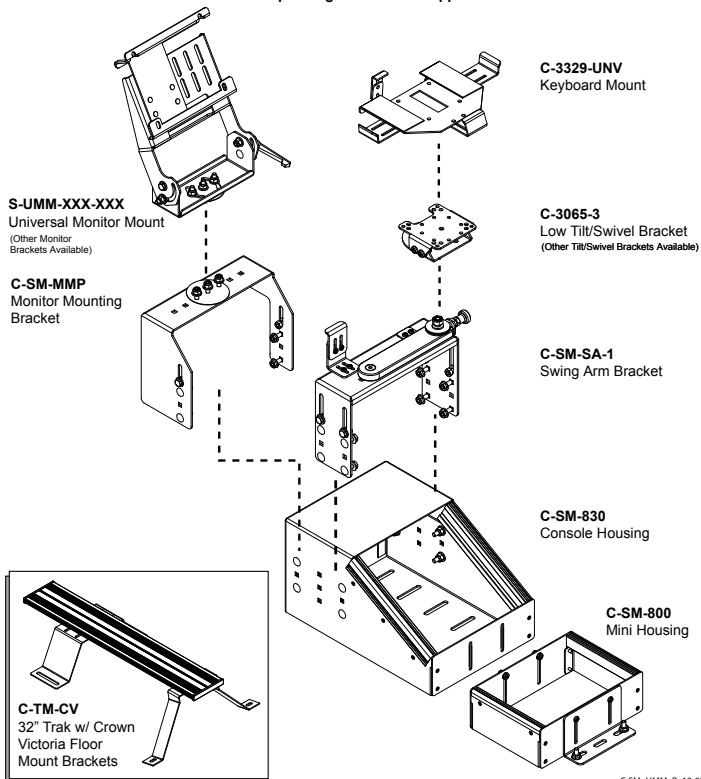

Stout Mount™ 2006-2008 Impala 2 Piece Computer Mount

****This is a sample configuration. These parts can be substituted depending on vehicle or application.****

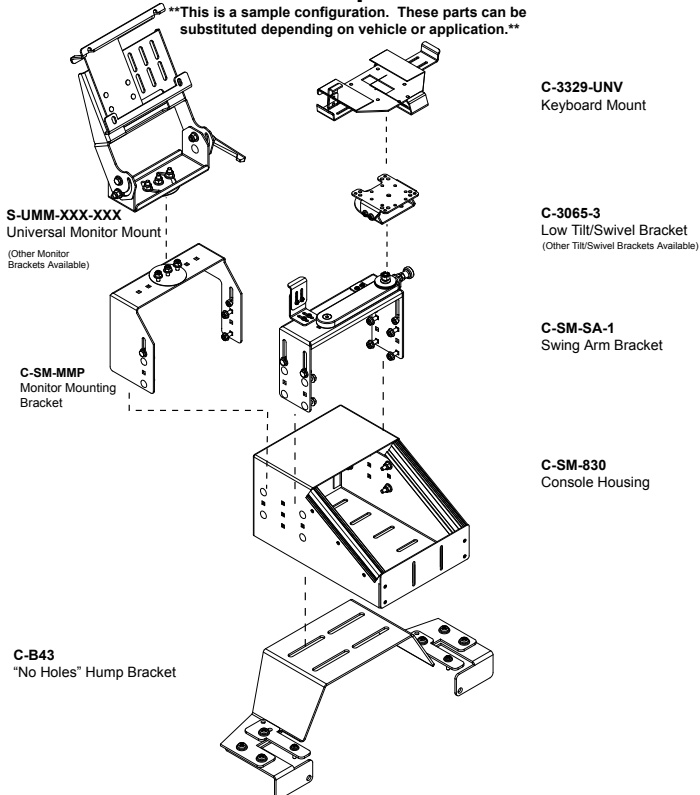



2006-2008 Dodge Charger 2 Piece Computer Mount with Stout Mount™ Console

This is a sample configuration. These parts can be substituted depending on vehicle or application.

S-UMM-DATA-911
Data 911
Monitor Mount
(Other Monitor Brackets Available)

C-SM-MMP
Monitor Mounting
Bracket

C-3329-UNV
Keyboard Mount

C-3065-3
Low Tilt/Swivel Bracket
(Other Tilt/Swivel Brackets Available)

C-SM-SA-1
Swing Arm Bracket

C-SM-830
Console Housing

C-SM-800
Mini Housing

OEM Track
25" Track comes
standard with 2006
Dodge Charger Police Package

2006-2008 Ford Explorer Modular Computer Mount

This is a sample configuration. These parts can be substituted depending on vehicle or application.

S-UMM-XXX-XXX
Universal Monitor Mount
Various Computer
Models Available

C-TCB-MAK
Monitor Adapter Kit

C-VS-1600-EXPL
Console Housing &
Mounting Brackets

C-3329-UNV
Keyboard Mount

C-3065-3
Low Tilt/Swivel Bracket
(Other Tilt/Swivel Brackets Available)

C-TCB-7
Side Mount Telescoping
Computer Base

Angled Series Console with 2 Piece Computer Mount

This is a sample configuration. These parts can be substituted depending on vehicle or application.

S-UMM-XXX-XXX
Universal Monitor Mount
Various Computer
Models Available

C-AS-MMP
Monitor Mounting
Platform

C-AS-1525
Console

C-TM-32-XX
Track Mount Kit

C-3329-800
Keyboard Mount

C-3082-3
Universal
Mounting Bracket
(Other Tilt/Swivel Brackets Available)

C-TCB-7
Telescoping
Computer Base

CPU mounting available but not shown

Enclosed Series Console (C-TM Series) with 2 Piece Computer Mount

This is a sample configuration. These parts can be substituted depending on vehicle or application.

S-UMM-XXX-XXX
Universal Monitor Mount
Various Computer
Models Available

C-3078
Side Rail Mount

C-3068-4
Riser Brackets

C-1800TM
Trak Mount Console

C-3329-UNV
Keyboard Mount

C-3082-3
Universal Mounting Bracket
(Other Tilt/Swivel Brackets Available)

C-TCB-1
Telescoping
Computer Base



Havis-Shields is committed to quality workmanship and Customer Service; therefore, please contact us if you feel a product is not performing, as it should. To return products under Havis-Shields Warranty, contact our Customer Service team at 1.800.524.9900 or call the distributor from whom you purchased the product.

Warranty: Havis-Shields will warrant all furnished equipment against parts failure or malfunction due to design, construction, assembly errors, and/or defective workmanship for a period of time specified below by product line.

This warranty will exclude optional accessory equipment not manufactured by Havis-Shields as well as any malfunction caused by unapproved alteration to original parts, improper installation, overload, damage from accident, abuse, or neglect, or failure to properly service equipment. In addition, this warranty does not cover labor costs. All defects in accessory equipment will be warranted according to the manufacturer's warranty policy (switches, bulbs, etc).

Claims for missing or incorrect parts must be requested within ten (10) business days of receipt of equipment. Warranty claims must be submitted in writing to Havis-Shields. Havis-Shields will issue appropriate credit or replacement part only after receipt and inspection of defective goods. Customer must request factory Return Authorization Form and receive authorization prior to submitting goods. Special orders are not returnable. This warrant is in lieu of all other warranties expressed or implied.

Consolidator®

Havis-Shields warrants its Consolidator products for a life time period. This warranty includes structural components such as mounting brackets and extruded parts.

Lighting

All telescoping pole mounting brackets and clamps are guaranteed for life against breakage under normal use.

All Havis-Shields lighting fixtures are warranted against manufacturing defects for two years with the following exceptions:

- ***All halogen lamps/bulbs are not warranted***
- ***All electronic ballasts 5 years warranty***
- ***All HID lamps/bulbs 3 years warranty***

Transport

Havis-Shields warrants its Transport products (K-9 & Prisoner Transports, and Window Guards) for a period of two years.

Pricing: Prices and specifications are subject to change without notice. Possession of a price list does not constitute the right to purchase directly from Havis-Shields.

Shipping: All prices are F.O.B. factory. Freight is prepaid and charged to the customer and will be shipped "best way" unless otherwise requested. An approximate shipping cost can be quoted when an order is placed. All air and motor freight shipment requests will be made on a freight collect basis only. Customer's freight company name, phone number and account number is required when applicable. Minimum order: \$25.00 net. Terms: net 30 days on pre-approved credit accounts.

Packaging: Partial shipments will be made unless otherwise specified by the customer. In addition, products can be bulk packaged or assembled as complete units. Primarily orders are bulk packaged unless custom packaging is requested when placing an order. Custom packaging may incur some additional cost.

Return Authorization: Customer must request factory Return Authorization form and receive authorization number prior to submitting goods. Havis-Shields must be notified and give its consent for the return of the item (s). RA# must be clearly marked on outside of package. Products being returned due to customer purchasing or shipping error must be returned within 30 days. Shipping cost is the responsibility of the customer and returns are subject to a 20% restocking fee. No items under \$50 net will be authorized for return. Items found upon inspection to be defective in material or workmanship by Havis-Shields will be replaced. Unauthorized returns will be refused. Special orders are not returnable.

Contact us at:

Ph: 800.524.9900 or 215.957.0720

E-mail: sales@havis.com

Fax: 215.957.0729

Web: www.havis.com