

WATER
HEATING
VENTILATION
AIR CON
GAS

FUTURE VALVE TECHNOLOGY

Technical Product Guide

Balancing Valves



New
Now includes
Hook-Up II

Traditional Valves



Public Health Range



About Hattersley



The origins of Hattersley date to 1897, when 20 year-old Richard Hattersley started a small tool-making business in Halifax. In the early 1900s he relocated to Ormskirk, and in 1910 he joined with three other engineering companies, including Newman Hender & Co. of Woodchester, to form United Brassfounders & Engineers.

By 1937 Hattersley & Newman Hender both enjoyed worldwide sales, with Hattersley exporting to some 73 countries. During the second world war, both companies entered war production, making fuses for armaments, brass rods for munitions factories and, of course, special valves for military purposes.

In 2004, Crane Limited purchased the Hattersley valve brand and business from Hattersley Newman Hender Limited, a subsidiary of Tomkins plc.

Quality Assurance

Rigid quality control and inspection at all stages of manufacture ensure that Hattersley products are suitable for their intended application and will give reliable service. Every valve is individually tested in accordance with the relevant product standard.

Hattersley is an approved manufacturer under various quality schemes, including the British Standard Institution (BSI) Kitemark, and is ISO9001:2008 accredited. In addition, the company has been approved and/or listed by third party organisations including the United Kingdom Water Regulations Advisory Scheme.

Future

Today, the Hattersley brand is synonymous with quality, reliability and service to the very highest standards, and has industry experience in many market sectors including heating and ventilation, chemicals, textiles, drugs, waste treatment and power generation. Hattersley can supply a skilfully engineered solution for every application. Flagship products include a full range of commissioning valves suitable for constant and variable flow systems.



Contents

Introduction

About Hattersley	2
Introduction to Sister Brands	4-5
Valve Selection Guide	8-10

Balancing Valves

Balancing – Automatic	11
Balancing – Static	21
Differential Pressure Control Valves	51
Hook-Up II	57
MultiComm	69
Pressure Independent Control Valves	71
ProComm	73

Traditional Valves

Air Vents/De-Aerators	75
Ball Valves	77
Butterfly Valves	91
Check Valves	109
Gate Valves	123
Gland Cocks/Drain Taps	143
Globe Valves	147
Lubricated Plug Valves	155
Radiator Valves	165
Strainers	175

Public Health Range

Introduction	183
Thermal Balancing Valves	184
Thermostatic Mixing Valves	185
Pressure Reducing Valves	187
Check Valves	189
Non-Return Valves	190
Ball Valves	191

NABIC

NABIC Safety & Control Valves	195
-------------------------------	-----

Brownall

Brownall Plant Room Valves	207
----------------------------	-----

Miscellaneous

Flange Tables	213
Typical Kv Values	223
Quality Assurance	226

Figure Number Index

Fig. No. Index	227
----------------	-----

Sister Brands

Today, Hattersley is a leading brand of Crane Building Services & Utilities, and is joined by an array of complementary building services brands which include NABIC, Brownall, Wade, Rhodes and IAT.



www.baa.com/photolibary

Heathrow Terminal 5 is equipped with a range of Hattersley products.

NABIC™

One of the UK's leading suppliers of gunmetal safety valves, NABIC has long been recognised as the industry standard for commercial and industrial hot water applications. With the introduction of new products, this leadership has been extended to cover other building service fluids such as steam and air.

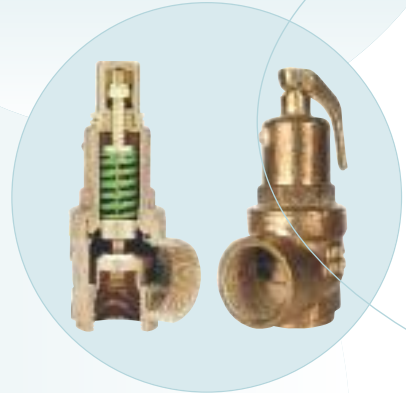

brownall™

The Brownall range of automatic air eliminators cover low, medium and high pressure applications and are suitable for use with water, aviation fuel, diesel and light oils. The range is completed by three-way vent valves, offering efficient performance and reliable service combined with potential savings in time and cost by simplifying the venting system for single/multiboiler or calorifier installations.



Wade™

An extensive range of low and medium pressure brass compression fittings, valves and accessories. The range also covers SISTEM-P and compact push in fittings, nickel plated BSP fittings, quick release couplings, air guns, recoil hoses and tubing.



RHODES™

Rhodes is a market leader in the design and manufacture of sight flow indicator equipment, having produced indicators since 1951. Rhodes sight flow indicators can be found in process, petrochemical and pharmaceutical plants all over the world.



The importance of safe and reliable potable water systems has never been greater, and a range of I.A.T. products complements the existing Hattersley range.







Project: Henrietta House, London

Client: CB Richard Ellis of London

Contractor: Silverline Engineering

Distributor: T G Lynes

Specification: Range of Hattersley isolation valves

A range of isolating valves has been specified for installation within the fancoils of Henrietta House, a prestigious office development in London's West End. The building is undergoing refurbishment before CB Richard Ellis of London relocates its headquarters to the office in May 2011.

The building is 7 floors tall and will provide 9000m² of luxurious office space. The Hattersley valves, including the newly designed Fig. 100 ball valve range, will control the heating and cooling of each floor. Hattersley was selected because its valves are light, compact and easy to install and operate. For Silverline Engineering, the fact that design features include improved leak protection, and resistance to damage onsite, will ensure a long and maintenance-free life expectancy.

Valve Selection Guide

Application	Size Range	LTHW - Max 100°C	MTHW - Max 110°C	CHW	HTHW - Above 120°C ⁽¹⁾
Isolation	15mm - 50mm	100	100	100EXT	
	65mm - 300mm	950 or 4970	950 or 4970	950 or 4970	4990-PN25 ⁽⁶⁾
Check	15mm - 50mm	47	47	47	4872
	65mm - 300mm	850	850	850	M650-PN25
Double Check	15mm - 50mm				
	65mm - 300mm				
Regulating ⁽³⁾	15mm - 50mm	1432/1432L	1432/1432L	1432/1432L	1200DR-PN40
	65mm - 300mm	973G	973G	973G	4993-PN25 ⁽⁶⁾
		M733DR	M733DR	M733DR	M733DR
Flow Measurement ⁽³⁾	15mm - 50mm	1000 ⁽³⁾	1000 ⁽³⁾	1000 ⁽³⁾	M4000-PN40
	65mm - 300mm	M2000-PN16	M2000-PN16	M2000-PN16	M3000-PN40
Commissioning ⁽³⁾	15mm - 50mm	1732 ⁽³⁾	1732 ⁽³⁾	1732 ⁽³⁾	5200-PN40
	65mm - 300mm	5973G	5973G	5973G	M3000/4993 ⁽⁶⁾
	65mm - 300mm	M737	M737	M737	
Motorflow (Control) ⁽³⁾	15mm - 20mm	1832 ⁽³⁾	1832 ⁽³⁾	1832 ⁽³⁾	
Automatic Flow Balancing	15mm - 50mm	1051	1051	1051	
	65mm - 300mm	2050	2050	2050	
Strainers	15mm - 50mm	817	817	817	808-PN25
	65mm - 300mm	810-PN16	810-PN16	810-PN16	810-PN16
Fan Coils ⁽³⁾	15mm	Conventional		Conventional	
	20mm				
	25mm	266 ⁽²⁾		266 ⁽²⁾	
Drains	Plant	81HU	81HU	81HU	
	General	371	371	371	
Thermostatic Mixing Valves	15mm - 20mm				
Combined Vent & Drain	25mm - 50mm	110	110		
	65mm - 150mm	201T-PN16	201T		
Radiator Valves	Wheel	Angle Pattern	3150	Straight Pattern	3250
	Lockshield		3300LS		3400LS
Thermostatic Radiator Valves	Standard	Angle Pattern	3180	Straight Pattern	3280
	Remote		3075/2RS		3275/RS

(1) HTHW - Pressure/temp refer to catalogue on individual products

(2) See page 8

(3) Low/Med/Standard flows available (see catalogue)

(4) Fig 249C 15mm - 28mm size range

(4A) Fig 249 32mm - 50mm size range

(5) 549-PN6 available

(6) For temp up to 125°C - 65mm+ (Isol 976) (Reg 979) (CS 5979)

(7) Available with isolating valves - Fig. 78. De-Aerators - Fig. 770 (20mm-50mm) Fig. 771 (50-150mm)

Application	Size Range	Mains Cold Water	Hot & Cold Water Services	Steam (Sat) to 10 bar	Condensate	Air	Gas (Isolation)
Isolation	15mm - 50mm			13	30	113	Main incoming gas to building 65 - 300mm 971YL (FL Butterfly)
	65mm - 300mm	950W	950W	17-PN16 (to 80mm)	M541-PN16	951W	
Check	15mm - 50mm	47	47	1013	47		Main incoming gas to building 65 - 300mm 971YL (FL Butterfly)
	65mm - 300mm	5870	5870		M651-PN16		
Double Check	15mm - 28mm	249 ^(4A)	249C ⁽⁴⁾				Inside building 15-50mm 100YL (Ball)
	65mm - 300mm	2761-PN16					
Regulating ⁽³⁾	15mm - 50mm		1432/1432L				Inside building 15-50mm 100YL (Ball)
	65mm - 300mm		953W				
Flow Measurement ⁽³⁾	15mm - 50mm		1000 ⁽³⁾				65-200mm 201M-PN16 (Plug)
	65mm - 300mm		M2000				
Commissioning ⁽³⁾	15mm - 50mm		1732 ⁽³⁾				65-200mm 201M-PN16 (Plug)
	65mm - 300mm		5953W				
Motorflow (Control) ⁽³⁾	15mm - 20mm						
Automatic Flow Balancing	15mm - 50mm		1051				
	65mm - 300mm						
Strainers	15mm - 50mm		807				
	65mm - 300mm		810	810			
Fan Coils ⁽³⁾	15mm						
	20mm						
	25mm						
Drains	Plant/Rm		81HU			113	
	General		371				
Thermostatic Mixing Valves	15mm - 20mm		77 ⁽⁷⁾				
Combined Vent & Drain	25mm - 50mm		110				
	65mm - 150mm						
Radiator Valves	Wheel						
	Lockshield						
Thermostatic Radiator Valves	Standard						
	Remote						

(1) HTHW - Pressure/temp refer to catalogue on individual products

(2) See page 8

(3) Low/Med/Standard flows available (see catalogue)

(4) Fig 249C 15mm - 28mm size range

(4A) Fig 249 32mm - 50mm size range

(5) 549-PN6 available

(6) For temp up to 125°C - 65mm+ (Isol 976) (Reg 979) (CS 5979)

(7) Available with isolating valves - Fig. 78. De-Aerators - Fig. 770 (20mm-50mm) Fig. 771 (50-150mm)

Valve Selection Guide

Application	Size Range	LTHW	MTHW	CHW
Isolation	15mm - 50mm	30	30	30
	65mm - 300mm	M541-PN16 ⁽⁵⁾	M541-PN16 ⁽⁵⁾	M541-PN16 ⁽⁵⁾
Check	15mm - 50mm	47	47	47
	65mm - 300mm	651-PN16	651-PN16	651-PN16
Regulating	15mm - 50mm	1432/1432L	1432/1432L	1432/1432L
	65mm - 300mm	M733DR-PN16	M733DR-PN16	M733DR-PN16
Flow Measurement	15mm - 50mm	1000	1000	1000
	65mm - 300mm	M2000-PN16	M2000-PN16	M2000-PN16
Commissioning	15mm - 50mm	1732 ⁽³⁾	1732 ⁽³⁾	1732 ⁽³⁾
	65mm - 300mm	M2733-PN16	M2733-PN16	M2733-PN16

COMMISSIONING VALVE SIZING CHART

Type	Size	at 1.0 kPa Signal	at 4.7 kPa Signal
1000L	1/2"	0.014 l/s	0.03 l/s
1000M	1/2"	0.028 l/s	0.06 l/s
1000	1/2"	0.054 l/s	0.117 l/s
1000	3/4"	0.116 l/s	0.251 l/s
1000	1"	0.207 l/s	0.449 l/s
1000	1 1/4"	0.425 l/s	0.923 l/s
1000	1 1/2"	0.640 l/s	1.388 l/s
1000	2"	1.325 l/s	2.875 l/s
M2000	65mm	2.75 l/s	5.93 l/s
M2000	80mm	3.82 l/s	8.27 l/s
M2000	100mm	6.25 l/s	13.54 l/s
M2000	125mm	9.48 l/s	20.52 l/s
M2000	150mm	13.7 l/s	29.5 l/s
M2000	200mm	23.2 l/s	50.3 l/s
M2000	250mm	34.8 l/s	75.3 l/s
M2000	300mm	50.5 l/s	109.4 l/s

Based on medium grade pipe and water with an SG of 1.

COMPACT HOOK-UP

Fig. No.	Description
266H	Hook-Up with 1732 DRV, strainer and blow down valve for LTHW and MTHW applications.
266C	Hook-Up with 1732 DRV, strainer, blow down valve and extension stem on lever operated ball valve for chilled water applications.
267H	Hook-Up with 1832 motorised FODRV, strainer and blow down valve for LTHW and MTHW applications.
267C	Hook-Up with 1832 motorised FODRV strainer, blow down valve and extension stem on lever operated ball valve for chilled water applications.
268H	Hook-Up with 1732 DRV for LTHW and MTHW applications.
268C	Hook-Up with 1732 DRV for chilled water applications and extension stem on lever operated ball valve.
262H	Hook-Up with 1050 Autoflow for LTHW and MTHW applications.
262C	Hook-Up with 1050 Autoflow for chilled water applications and extension stem on lever operated ball valve.

Balancing Valves - Automatic

Hattersley Autoflow (automatic balancing) valves give users and specifiers a major alternative to traditional commissioning products.

Autoflow offers a radical, cost-effective method of regulating hot and chilled water systems. It is available in DZR copper alloy in sizes 1/2" to 2" with threaded ends and ductile iron in sizes from 2 1/2" to 14" (65 to 350mm).

FEATURES

- Automatically maintains flow at the specified rate regardless of fluctuations in pressure
- Factory selection of the appropriate cartridge provides desired flow rate
- Tamperproof
- Self adjusting universal DZR assembly with multi-purpose functions
- Compact size
- Energy efficient, preventing overflows or excess flow rates

BENEFITS

- Ensures constant volume irrespective of pressure fluctuations caused by pump speed or overflows from operation of remote control valve
- Design changes can be easily made by selection of the appropriate cartridge, eliminating the need for recommissioning
- Easy to insulate
- Can be installed in any pipework configuration - does not require straight lengths of pipe
- Dynamic flow-limiting characteristics permit variable volume systems to function correctly
- DZR Y-Pattern and universal pattern can optionally be used as strainers (Figures 1052 and 1053)



Fig. 1050, 1051, 1052 and 1053 DZR Autoflow

PORT IDENTIFICATION, THREADS AND SPECIFYING INFORMATION

Port Identification and Connection Size - Figs. 1050, 1051, 1052 and 1053

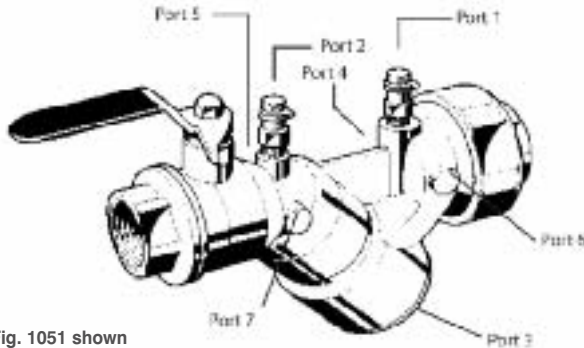

Fig. 1051 shown

How to Specify Hattersley Autoflow Valves

Automatic balancing valves have replaceable cartridges with flow rates determined at the factory. The flow cartridges are stainless steel or nickel finish. Deep drawn metal cartridges are not acceptable. Each cartridge is coded to indicate specific flow rate duty. The flow cartridge is 17 to 200 kPa rated as standard. Rating 34 to 400 kPa available as option.

$\frac{1}{2}$ to 2" sizes are available with two body types, standard Y-Pattern and universal Y-Pattern with integral isolating ball valve and union connection. Bodies are DZR copper alloy with pressure tapping ports and are fitted with colour coded test points. Optional extended stems are available with universal type to allow for insulation. End connections are threaded as standard. $\frac{1}{2}$ to 2" sizes have optional strainer facility in lieu of flow cartridge.

Maximum pressure: 25 bar
Maximum temperature: 120°C

Hattersley Autoflow Ref:

$\frac{1}{2}$ to 2" DZR Y-Pattern: Fig.1050
 $\frac{1}{2}$ to 2" DZR Universal Pattern: Fig. 1051
65 to 350mm Ductile Iron: Fig. 2050

NES Ref: Y11.2230

- Ports 1 and 2 are threaded $\frac{1}{4}$ " BSP (PI) and fitted with figure 631 test points
- Port 1 can be supplied optionally threaded $\frac{1}{2}$ " BSP (PI)
- Port 3 is threaded $\frac{1}{4}$ " BSP (PI) in sizes $\frac{1}{2}$ to $\frac{3}{4}$ " and $\frac{1}{2}$ " BSP (PI) in sizes 1 to 2" and fitted with blank plug
- All other ports can be supplied threaded $\frac{1}{4}$ " BSP (PI) to order
- For all figure numbers, ports are identified with 'Y' part of body in same orientation
- Ports 4, 5, 6 and 7 apply only to figures 1051/1053
- Figures 1050/1052 have ports 1, 2 and 3 only

For Commissioning Valve Coefficients please refer to pages 47-49.

Every effort has been made to ensure that the information contained in this publication is accurate at the time of publishing. Hattersley Ltd assumes no responsibility or liability for typographical errors or omissions or for any misinterpretation of the information within the publication and reserves the right to change without notice.

Fig. 1050, 1051 DZR Autoflow Fig. 2050 Ductile Iron Autoflow

FLOW RATES

Flow Rates for Valves 6" (150mm) and above

Valve Size	Recommended Minimum Flow (l/s)	Velocity (m/s)	Maximum Flow (l/s)	Velocity
6	4.7	0.25	34	1.79
8	8.5	0.25	60	1.79
10	12.6	0.24	94	1.76
12	17.7	0.23	128	1.70
14	22.7	0.25	162	1.82

1/2" Body

Flow (l/s)	Cartridge			Pipe Velocity (m/s)
	Code	Size (inch)	Adaptor (inch to inch)	
0.021	T	0.50	No Adaptor	0.10
0.032	Y	0.50	No Adaptor	0.16
0.042	U	0.50	No Adaptor	0.21
0.047	Z	0.50	No Adaptor	0.23
0.056	V	0.50	No Adaptor	0.28
0.063	A	0.50	No Adaptor	0.31
0.079	AX	0.50	No Adaptor	0.39
0.095	AY	0.50	No Adaptor	0.47
0.110	AZ	0.50	No Adaptor	0.54
0.126	B	0.50	No Adaptor	0.62
0.142	BX	0.50	No Adaptor	0.70
0.158	BY	0.50	No Adaptor	0.78
0.166	BU	0.50	No Adaptor	0.82
0.174	BZ	0.50	No Adaptor	0.85
0.189	C	0.50	No Adaptor	0.93
0.221	CY	0.50	No Adaptor	1.09
0.253	D	0.50	No Adaptor	1.24
0.284	DY	0.50	No Adaptor	1.40
0.316	E	0.75	No Adaptor	1.55
0.379	F	0.75	No Adaptor	1.86
0.442	G	0.75	No Adaptor	2.17

3/4" Body

Flow (l/s)	Cartridge			Pipe Velocity (m/s)
	Code	Size (inch)	Adaptor (inch to inch)	
0.021	T	0.50	No Adaptor	0.06
0.032	Y	0.50	No Adaptor	0.09
0.042	U	0.50	No Adaptor	0.12
0.047	Z	0.50	No Adaptor	0.13
0.056	V	0.50	No Adaptor	0.15
0.063	A	0.50	No Adaptor	0.17
0.079	AX	0.50	No Adaptor	0.22
0.095	AY	0.50	No Adaptor	0.26
0.110	AZ	0.50	No Adaptor	0.30
0.126	B	0.50	No Adaptor	0.34
0.142	BX	0.50	No Adaptor	0.39
0.158	BY	0.50	No Adaptor	0.43
0.166	BU	0.50	No Adaptor	0.45
0.174	BZ	0.50	No Adaptor	0.47
0.189	C	0.50	No Adaptor	0.52
0.221	CY	0.50	No Adaptor	0.60
0.253	D	0.50	No Adaptor	0.69
0.284	DY	0.50	No Adaptor	0.78
0.316	E	0.75	No adaptor	0.86
0.379	F	0.75	No adaptor	1.03
0.442	G	0.75	No adaptor	1.21
0.505	H	0.75	No adaptor	1.38

The following tables list the flow rates attainable using the standard range of cartridges and adaptors for valves up to 100mm (4") size.

Above this size a multi-cartridge permutation is used to obtain the desired flow rate.

These tables indicate the minimum and maximum flow rates for each size from 150 to 350mm (6 to 14"). Flow rates increase in increments of approximately 0.32l/s.

For Commissioning Valve Coefficients please refer to pages 47-49.

Every effort has been made to ensure that the information contained in this publication is accurate at the time of publishing. Hattersley Ltd assumes no responsibility or liability for typographical errors or omissions or for any misinterpretation of the information within the publication and reserves the right to change without notice.

Fig. 1050, 1051 DZR Autoflow
Fig. 2050 Ductile Iron Autoflow

FLOW RATES

1" Body

Flow (l/s)	Cartridge			Pipe Velocity (m/s)
	Code	Size (inch)	Adaptor (inch to inch)	
0.042	U	0.50	1.25 to 0.75	0.07
0.047	Z	0.50	1.25 to 0.75	0.08
0.064	A	0.50	1.25 to 0.75	0.11
0.079	AX	0.50	1.25 to 0.75	0.13
0.095	AY	0.50	1.25 to 0.75	0.16
0.110	AZ	0.50	1.25 to 0.75	0.19
0.126	B	0.50	1.25 to 0.75	0.22
0.158	BY	0.50	1.25 to 0.75	0.27
0.169	BU	0.50	1.25 to 0.75	0.29
0.189	C	0.50	1.25 to 0.75	0.32
0.221	CY	0.50	1.25 to 0.75	0.38
0.253	D	0.50	1.25 to 0.75	0.43
0.284	DY	0.50	1.25 to 0.75	0.49
0.316	E	0.75	1.25 to 0.75	0.54
0.379	F	0.75	1.25 to 0.75	0.65
0.442	G	0.75	1.25 to 0.75	0.75
0.505	H	0.75	1.25 to 0.75	0.86
0.568	I	1.25	No adaptor	0.97
0.631	AO	1.25	No adaptor	1.08
0.694	AA	1.25	No adaptor	1.19
0.758	AB	1.25	No adaptor	1.29
0.821	AC	1.25	No adaptor	1.40
0.884	AD	1.25	No adaptor	1.51
0.947	AE	1.25	No adaptor	1.62
1.010	AF	1.25	No adaptor	1.73
1.073	AG	1.25	No adaptor	1.83
1.136	AH	1.25	No adaptor	1.94

1 1/4" Body

Flow (l/s)	Cartridge			Pipe Velocity (m/s)
	Code	Size (inch)	Adaptor (inch to inch)	
0.189	C	0.50	1.25 to 0.75	0.19
0.221	CY	0.50	1.25 to 0.75	0.22
0.253	D	0.50	1.25 to 0.75	0.25
0.284	DY	0.50	1.25 to 0.75	0.28
0.316	E	0.75	1.25 to 0.75	0.31
0.375	F	0.75	1.25 to 0.75	0.37
0.442	G	0.75	1.25 to 0.75	0.43
0.505	H	0.75	1.25 to 0.75	0.50
0.568	I	1.25	No adaptor	0.56
0.631	AO	1.25	No adaptor	0.62
0.694	AA	1.25	No adaptor	0.68
0.758	AB	1.25	No adaptor	0.74
0.821	AC	1.25	No adaptor	0.81
0.884	AD	1.25	No adaptor	0.87
0.947	AE	1.25	No adaptor	0.93
1.010	AF	1.25	No adaptor	0.99
1.073	AG	1.25	No adaptor	1.05
1.136	AH	1.25	No adaptor	1.12
1.199	AI	1.25	No adaptor	1.18

For Commissioning Valve Coefficients please refer to pages 47-49.

Every effort has been made to ensure that the information contained in this publication is accurate at the time of publishing. Hattersley Ltd assumes no responsibility or liability for typographical errors or omissions or for any misinterpretation of the information within the publication and reserves the right to change without notice.

Fig. 1050, 1051 DZR Autoflow
Fig. 2050 Ductile Iron Autoflow

FLOW RATES

1½" Body

Flow (l/s)	Cartridge			Pipe Velocity (m/s)
	Code	Size (inch)	Adaptor (inch to inch)	
0.442	G	0.75	2 to 0.75	0.32
0.505	H	0.75	2 to 0.75	0.37
0.568	I	1.25	2 to 1.25	0.41
0.631	AO	1.25	2 to 1.25	0.46
0.694	AA	1.25	2 to 1.25	0.50
0.758	AB	1.25	2 to 1.25	0.55
0.821	AC	1.25	2 to 1.25	0.60
0.884	AD	1.25	2 to 1.25	0.64
0.947	AE	1.25	2 to 1.25	0.69
1.010	AF	1.25	2 to 1.25	0.73
1.073	AG	1.25	2 to 1.25	0.78
1.136	AH	1.25	2 to 1.25	0.82
1.199	AI	1.25	2 to 1.25	0.87
1.263	BO	2	No adaptor	0.92
1.389	BB	2	No adaptor	1.01
1.515	BD	2	No adaptor	1.10
1.641	BF	2	No adaptor	1.19
1.768	BH	2	No adaptor	1.28
1.894	CO	2	No adaptor	1.37
2.020	CB	2	No adaptor	1.46
2.146	CD	2	No adaptor	1.56
2.273	CF	2	No adaptor	1.65
2.399	CH	2	No adaptor	1.74
2.525	DO	2	No adaptor	1.83
2.651	DB	2	No adaptor	1.92
2.778	DD	2	No adaptor	2.01

2" Body

Flow (l/s)	Cartridge			Pipe Velocity (m/s)
	Code	Size (inch)	Adaptor (inch to inch)	
0.821	AC	1.25	2 to 1.25	0.37
0.884	AD	1.25	2 to 1.25	0.40
0.947	AE	1.25	2 to 1.25	0.43
1.263	BO	2	No adaptor	0.57
1.389	BB	2	No adaptor	0.63
1.515	BD	2	No adaptor	0.69
1.641	BF	2	No adaptor	0.74
1.768	BH	2	No adaptor	0.80
1.894	CO	2	No adaptor	0.86
2.020	CB	2	No adaptor	0.92
2.146	CD	2	No adaptor	0.97
2.273	CF	2	No adaptor	1.03
2.399	CH	2	No adaptor	1.09
2.525	DO	2	No adaptor	1.14
2.651	DB	2	No adaptor	1.20
2.778	DD	2	No adaptor	1.26
2.904	DF	2	No adaptor	1.32
3.030	DH	2	No adaptor	1.37
3.157	EO	2	No adaptor	1.43

For Commissioning Valve Coefficients please refer to pages 47-49.

Every effort has been made to ensure that the information contained in this publication is accurate at the time of publishing. Hattersley Ltd assumes no responsibility or liability for typographical errors or omissions or for any misinterpretation of the information within the publication and reserves the right to change without notice.

Fig. 1050, 1051 DZR Autoflow
Fig. 2050 Ductile Iron Autoflow

FLOW RATES

2¹/₂" Body

Flow (l/s)	Cartridge			Pipe Velocity (m/s)
	Code	Size (inch)	Adaptor (inch to inch)	
1.199	AI	1.25	2.5 to 1.25	0.32
1.263	BO	2	2.5 to 2	0.34
1.389	BB	2	2.5 to 2	0.37
1.515	BD	2	2.5 to 2	0.41
1.641	BF	2	2.5 to 2	0.44
1.768	BH	2	2.5 to 2	0.48
1.894	CO	2	2.5 to 2	0.51
2.020	CB	2	2.5 to 2	0.54
2.146	CD	2	2.5 to 2	0.58
2.273	CF	2	2.5 to 2	0.61
2.399	CH	2	2.5 to 2	0.65
2.525	DO	2	2.5 to 2	0.68
2.651	DB	2	2.5 to 2	0.72
2.778	DD	2	2.5 to 2	0.75
2.904	DF	2	2.5 to 2	0.78
3.030	DH	2	2.5 to 2	0.82
3.157	EO	2	2.5 to 2	0.85
3.283	EB	2.5	No adaptor	0.89
3.535	EF	2.5	No adaptor	0.95
3.788	FO	2.5	No adaptor	1.02
4.040	FD	2.5	No adaptor	1.09
4.293	FH	2.5	No adaptor	1.16
4.545	GB	2.5	No adaptor	1.23

3" Body ANSI

Flow (l/s)	Cartridge			Pipe Velocity (m/s)
	Code	Size (inch)	Adaptor (inch to inch)	
2.146	CD	2	3 to 2	0.42
2.273	CF	2	3 to 2	0.44
2.399	CH	2	3 to 2	0.47
2.525	DO	2	3 to 2	0.49
2.651	DB	2	3 to 2	0.52
2.778	DD	2	3 to 2	0.54
2.904	DF	2	3 to 2	0.57
3.030	DH	2	3 to 2	0.59
3.157	EO	2	3 to 2	0.62
3.283	EB	3	No adaptor	0.64
3.535	EF	3	No adaptor	0.69
3.788	FO	3	No adaptor	0.74
4.040	FD	3	No adaptor	0.79
4.293	FH	3	No adaptor	0.84
4.545	GB	3	No adaptor	0.89
4.735	GE	3	No adaptor	0.93
5.050	HO	3	No adaptor	0.99
5.366	HE	3	No adaptor	1.05
5.682	IO	3	No adaptor	1.11
5.997	IE	3	No adaptor	1.17
6.313	AOO	3	No adaptor	1.23
6.629	AOE	3	No adaptor	1.30
6.944	AAO	3	No adaptor	1.36
7.260	AAE	3	No adaptor	1.42
7.576	ABO	3	No adaptor	1.48
7.891	ABE	3	No adaptor	1.54
8.207	ACO	3	No adaptor	1.60
8.523	ACE	3	No adaptor	1.67

For Commissioning Valve
Coefficients please refer to
pages 47-49.

Every effort has been made to ensure that the information contained in this publication is accurate at the time of publishing. Hattersley Ltd assumes no responsibility or liability for typographical errors or omissions or for any misinterpretation of the information within the publication and reserves the right to change without notice.

Fig. 1050, 1051 DZR Autoflow Fig. 2050 Ductile Iron Autoflow

FLOW RATES

4" Body ANSI (fittings provided for installation in PN16 rated systems)

Flow (l/s)	Cartridge			Pipe Velocity (m/s)
	Code	Size (inch)	Adaptor (inch to inch)	
5.366	HE	3/B	No adaptor	0.62
5.682	IO	3/B	No adaptor	0.65
5.997	IE	3/B	No adaptor	0.69
6.313	AOO	3/B	No adaptor	0.73
6.629	AOE	3/B	No adaptor	0.77
6.944	AAO	3/B	No adaptor	0.81
7.260	AAE	3/B	No adaptor	0.84
7.576	ABO	3/B	No adaptor	0.87
7.891	ABE	3/B	No adaptor	0.91
8.207	ACO	3/B	No adaptor	0.95
8.523	ACE	3/B	No adaptor	0.98
8.838	ADO	3/2	No adaptor/3 to 2	1.02
9.154	ADE	3/2	No adaptor/3 to 2	1.06
9.470	AEO	3/3	No adaptor	1.09
9.785	AEE	3/3	No adaptor	1.13
10.101	AFO	3/3	No adaptor	1.16
10.416	AFE	3/3	No adaptor	1.20
10.732	AGO	3/3	No adaptor	1.24
11.048	AGE	3/3	No adaptor	1.27
11.363	AHO	3/3	No adaptor	1.31
11.679	AHE	3/3	No adaptor	1.35
11.995	AIO	3/3	No adaptor	1.38
12.310	AIE	3/3	No adaptor	1.42
12.626	BOO	3/3	No adaptor	1.46
12.942	BOE	3/3	No adaptor	1.49
13.257	BAO	3/3	No adaptor	1.53
13.573	BAE	3/3	No adaptor	1.56
13.889	BBO	3/3	No adaptor	1.60
14.204	BBE	3/3	No adaptor	1.64
14.520	BCO	3/3	No adaptor	1.67
14.836	BCE	3/3	No adaptor	1.71
15.151	BDO	3/3	No adaptor	1.75
15.467	BDE	3/3	No adaptor	1.78
15.783	BEO	3/3	No adaptor	1.82
16.098	BEE	3/3	No adaptor	1.86
16.414	BFO	3/3	No adaptor	1.89
16.729	BFE	3/3	No adaptor	1.93
17.045	GO	3/3	No adaptor	1.96

For Commissioning Valve Coefficients please refer to pages 47-49.

Every effort has been made to ensure that the information contained in this publication is accurate at the time of publishing. Hattersley Ltd assumes no responsibility or liability for typographical errors or omissions or for any misinterpretation of the information within the publication and reserves the right to change without notice.

Fig. 1050 (Flow Control) Fig. 1052 (Strainer)
DZR Y-Pattern Autoflow

FEATURES AND BENEFITS

- Ensures constant volume irrespective of changing conditions
- Energy efficient, preventing overflows or excess flow rates
- Tamperproof



MATERIAL SPECIFICATION

Component	Material	Specification	
		BS EN	ASTM
Body	DZR Copper Alloy	12164 CW602N	
Cover	DZR Copper Alloy	12164 CW602N	
Seals	EPDM		
Drain Plug	Brass	12164 CW614N	
Test Point	Fig. 631		
Flow Cartridge	Stainless Steel	10270 X10CrNr18-8	A276-304
Flow Cartridge Adaptor	Brass	12164 CW619N	
Strainer Element	Stainless Steel	10270 X10CrNr18-8	A276-304

DIMENSIONAL DRAWINGS

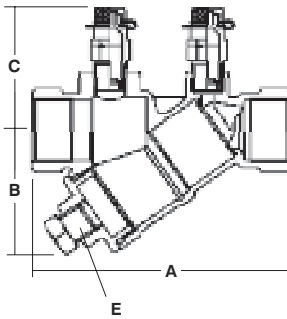

DIMENSIONS AND WEIGHTS

Nom Size	in	1/2	3/4	1	1 1/4	1 1/2	2
A	mm	101	106	141	148	177	179
B	mm	51	51	68	68	104	104
C (Approx)	mm	56	56	60	60	65	65
E	(BS21 Pl)	1/4	1/4	1/2	1/2	1/2	1/2
Weight	kg	0.52	0.55	0.98	1.1	2.2	2.4

PRESSURE/TEMPERATURE RATING

21 bar at 120°C
25 bar up to 100°C

TEST PRESSURES (HYDRAULIC)

Shell: 37.5 bar

SPECIFICATION

Taper threaded BS EN 10266 (ISO 7-1) formerly BS 21.

Autoflow regulator is factory set for correct flow.

Cartridge removable from body to provide access for change, inspection and cleaning without removing body from pipeline.

Supplied with two figure 631 test points in port positions 1 and 2 - see page 10.

Other ports can be supplied threaded, see page 10 for details.

Drain valve optional.

Test points can be supplied with extension pieces to clear insulation.

Tagged with flow rate.

Figure 1052 fitted with 20 mesh stainless steel filter in lieu of flow cartridge.

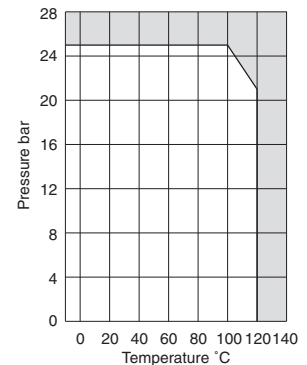

For Commissioning Valve Coefficients please refer to pages 47-49.

Every effort has been made to ensure that the information contained in this publication is accurate at the time of publishing. Hattersley Ltd assumes no responsibility or liability for typographical errors or omissions or for any misinterpretation of the information within the publication and reserves the right to change without notice.

Fig. 1051 (Flow Control) Fig. 1053 (Strainer) DZR Universal Autoflow

FEATURES AND BENEFITS

- Ensures constant volume irrespective of changing conditions
- Energy efficient, preventing overflows or excess flow rates
- Tamperproof



MATERIAL SPECIFICATION

Component	Material	Specification	
		BS EN	ASTM
Body	DZR Copper Alloy	12164 CW602N	
Tail Pipe	DZR Copper Alloy	12164 CW602N	
Union Nut	Brass	12164 CW614N	
Ball (hard chrome plated)	Brass	12164 CW614N	
Stem	Brass	12164 CW614N	
Stem Seals	PTFE or PTFE/Neoprene		
Seats	PTFE or PTFE/Neoprene		
Cover	DZR Copper Alloy	12164 CW602N	
Drain Plug	Brass	12164 CW614N	
Test Point	Fig. 631		
Flow Cartridge	Stainless Steel	10270 X10CrNi18-8	A276-304
Flow Cartridge Adaptor	Brass	12164 CW614N	
Seals	EPDM		
Strainer Element	Stainless Steel	10270 X10CrNi18-8	A276-304

DIMENSIONAL DRAWINGS

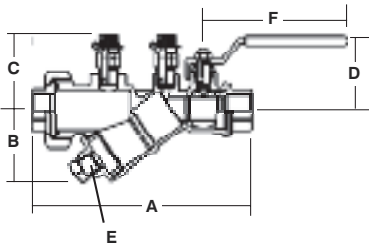

DIMENSIONS AND WEIGHTS

Nom Size	in	1/2	3/4	1	1 1/4	1 1/2	2
A	mm	157	160	219	221	253	253
B	mm	51	51	68	68	103	103
C (Approx)	mm	56	56	60	60	65	65
D	mm	51	51	66	66	87	87
E	(BS21 Pl)	1/4	1/4	1/2	1/2	1/2	1/2
F	mm	100	100	120	120	140	140
Weight	kg	1.1	1.1	2.3	2.3	4.6	4.6

For Commissioning Valve Coefficients please refer to pages 47-49.

Every effort has been made to ensure that the information contained in this publication is accurate at the time of publishing. Hattersley Ltd assumes no responsibility or liability for typographical errors or omissions or for any misinterpretation of the information within the publication and reserves the right to change without notice.

PRESSURE/TEMPERATURE RATING

See pressure/temperature chart

TEST PRESSURES (HYDRAULIC)

Shell: 37.5 bar

SPECIFICATION

Taper threaded BS EN 10266 (ISO 7-1) formerly BS 21.

Autoflow regulator factory set to automatically ensure correct flow.

Cartridge removable from body to provide access for change, inspection and cleaning without removing body from pipeline.

Supplied with two figure 631 test points in port positions 1 and 2 - see page 10. Other ports can be supplied drilled and tapped, see page 10 for details.

Drain valve optional.

Extension stem for ball valve available.

Test points can be supplied with extension pieces to clear insulation.

Tagged with flow rate.

Figure 1053 fitted with 20 mesh stainless steel filter in lieu of flow cartridge.

Alternative end connections available on request.

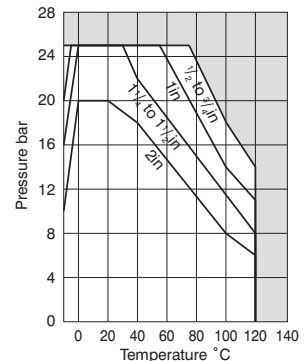

Fig. 2050 Ductile Iron Autoflow

FEATURES AND BENEFITS

- Ensures constant volume irrespective of changing conditions
- Energy efficient, preventing overflows or excess flow rates
- Tamperproof



MATERIAL SPECIFICATION

Component	Material	Specification	
		BS EN	ASTM
Body	Ductile Iron	1563 EN GJS 500/7	A536 60-40-18
Flow Cartridge Adaptor	Brass	12164 CW614N	
Test Points	Fig. 631		
Flow Cartridge	Nickel Plated Brass		
Seals	EPDM		
Drain Plug	Brass	12164 CW614N	
Eye Bolt	Steel		

DIMENSIONAL DRAWINGS

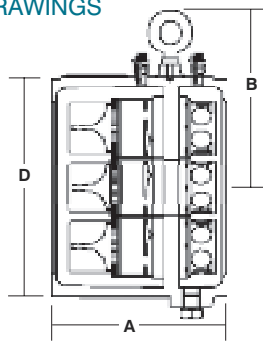

PRESSURE/TEMPERATURE RATING
16 bar from -10 to 120°C

TEST PRESSURES (HYDRAULIC)

Shell: 24 bar

SPECIFICATION

Ductile iron body designed to fit between ANSI 150 flanges. A pair of ANSI 150 slip-on flanges will be supplied with the assembly where required for installation into BS1387 tube

Supplied with lifting eye bolt to assist with installation.

Autoflow regulator factory set to automatically ensure correct flow.

Changes to flow specification can be accommodated by changing the relevant flow regulators.

Supplied complete with two figure 631 test points and drain plug.

Optional bolts and gaskets available.

Suitable for PN40 pressure rating.

DIMENSIONS AND WEIGHTS

Nom Size	mm in	65 2 1/2	80 3	100 4	150 6	200 8	250 10	300 12	350 14
A	mm	148	223	244	258	279	279	279	279
	in	5.82	8.78	8.78	8.78	8.78	8.78	8.78	8.78
B (Approx)	mm	-	-	155	175	205	235	250	300
	in	-	-	6	7	8	9	10	12
D	mm	108	127	173	216	280	340	406	450
	in	4.25	5.00	6.82	8.50	11.00	13.35	16.00	17.72
*Weight (max)	kg	6.1	10	12	19	30	35	53	69

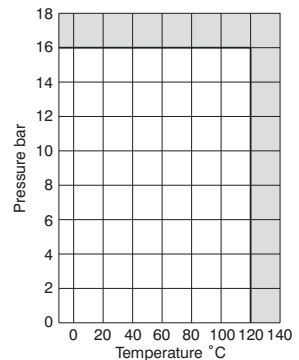

For Commissioning Valve Coefficients please refer to pages 47-49.

Every effort has been made to ensure that the information contained in this publication is accurate at the time of publishing. Hattersley Ltd assumes no responsibility or liability for typographical errors or omissions or for any misinterpretation of the information within the publication and reserves the right to change without notice.

Balancing Valves - Static

Hattersley's range of static balancing valves includes Double Regulating Valves and Fixed Orifice Double Regulating Valves. The integral fixed orifice design offers greater accuracy, makes set-up easier and involves fewer

connections resulting in lower installation costs. Available in medium and low flow versions, Hattersley's static balancing valves offer positive flow control at all handwheel settings.



ONE VALVE SYSTEM (MEASUREMENT AND REGULATION AT ONE POINT)

Commissioning Set Components



Service	Commissioning Set (CS) Fig. No.	Metering Station (MS) Fig. No.	Double Regulating Valve (DRV) Fig. No.	End Connections	Size Range	Body Material
Chilled Water	2432	1000	1432	Screwed	1/2 - 2"	Bronze/DZR
LTHW, MTHW	2432C	1000	1432C	Compression	15mm	Bronze/DZR
-	1732 + 1832	-	-	-	-	-
-	1732C + 1832C	-	-	-	-	-
-	1732L + 1832L	-	-	Screwed	1/2"	Bronze/DZR
-	1732LC + 1832LC	-	-	Compression	15mm	Bronze/DZR
-	1732M + 1832M	-	-	Screwed	1/2"	Bronze/DZR
-	1732MC + 1832MC	-	-	Compression	15mm	Bronze/DZR
HTHW	5200	[-]	1200DR]	Flanged	15-50mm	Bronze
-	-	[4000]	-]	-	-	Stainless Steel

VARIABLE ORIFICE DOUBLE REGULATING VALVES (VODRV'S)

Service	FODRV/ VODRV Fig. No.	Isolating Valve Fig. No.	End Connections	Size Range	Body Material
Chilled Water	1732	30	Screwed	1/2 - 2"	DZR
-	1832	-	-	-	-
LTHW MTHW	M737	M541	Flanged	50-300mm	Cast Iron
HTHW	1200DRZ	1200	Flanged	15-50mm	Bronze

1732 FODRV replaces Bronze VODRV

Preferred Arrangement

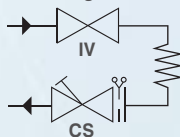

Fig. 631 for Pressure and Temperature Measurement Hattersley Test Points

BS 7350

When fitted to measuring devices and strainers, test points are supplied with cap retainers in red and blue for upstream and downstream port identification. This meets the requirements of BS 7350.

Test points are fitted with green cap retainers.

Figure 631 - 10 test points per pack
Figure 633 - 5 test points per pack

Hattersley figure 631 test points are WRAS Approved products and are listed in the water fittings and materials directory.



Strategically placed test points allow access to live fluid systems for pressure and temperature measurements. Maximum temperature is 120°C and maximum pressure is 3450kPa. Suitable for Chilled Water, LTHW and MTHW.

Test Probes

The application of a silicone lubricant to the probe shaft prior to insertion is recommended.

Test points are available in either standard length, figure 631, or extended length, figure 633, both threaded 1/4" BSP (Tr). The extended length test point requires special test probe available from Hattersley.

The single piece DZR copper alloy body houses a uniquely designed elastomeric core, providing excellent sealing performance and wear resistance.

Double sealing on the cap is provided by precision metal to metal jointing backed up by a resilient O-Ring, allowing convenient, positive finger tightening.

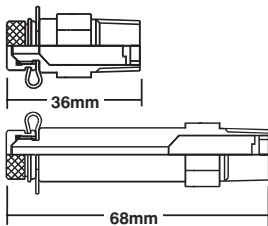

For Commissioning Valve Coefficients please refer to pages 47-49.

Every effort has been made to ensure that the information contained in this publication is accurate at the time of publishing. Hattersley Ltd assumes no responsibility or liability for typographical errors or omissions or for any misinterpretation of the information within the publication and reserves the right to change without notice.

Fig. 750 Hattersley Valve Controlled Test Points

Suitable for 40 bar pressure up to 180°C including HTHW service.

FEATURES AND BENEFITS

- Double isolating
- Uses standard air vent key
- Fitted with cap retainers in red and blue for upstream and downstream port identification.
When used in pairs on measuring devices this meets the requirements of BS 7350
- Recommended by Hattersley and fitted as standard to Hattersley M3000 and 4000 metering stations
- Copper alloy construction
- Accepts commercially available probes
- Threaded $\frac{1}{4}$ ISO 7 (Tr)

DIMENSIONAL DRAWINGS

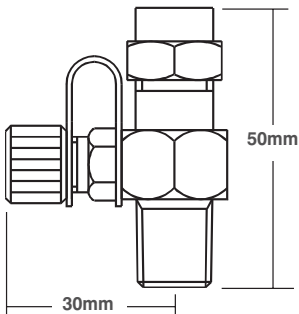

For Commissioning Valve Coefficients please refer to pages 47-49.

Every effort has been made to ensure that the information contained in this publication is accurate at the time of publishing. Hattersley Ltd assumes no responsibility or liability for typographical errors or omissions or for any misinterpretation of the information within the publication and reserves the right to change without notice.

Fig. 1000 DZR Brass Metering Stations



FEATURES AND BENEFITS

- Precise and accurate measurement, conforming to BS 7350:1990
- Dezincification resistant material preventing corrosion cracking and fungal growth
- WRAS approved for use with potable water
- Supplied with red and blue test points for upstream and downstream port identification

MATERIAL SPECIFICATION

Component	Material	Specification BS EN
Metering Station	DZR Brass	12165 CW602N
Test Point	Fig. 631	



DIMENSIONAL DRAWINGS

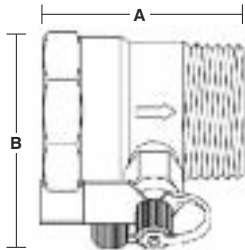

DIMENSIONS AND WEIGHTS

Nom Size	mm in	15 1/2	22 3/4	28 1	32 1 1/4	40 1 1/2	50 2
A (threaded)	mm	57	58	66	72	72	82
B	mm	55	61	65	71	73	79
Weight	kg	0.29	0.30	0.40	0.50	0.54	0.77

PRESSURE/ TEMPERATURE RATING

Threaded Ends
PN20 Series B
15 bar at 120°C
20 bar from -10 to 100°C

TEST PRESSURES (HYDRAULIC)

Shell: 30 bar

SPECIFICATION

Kitemarked to BS 7350:1990.
WRAS Approved Product.
Supplied fitted with two figure 631 test points
Figure 1000 end connections threaded to
BS EN 10266 (ISO 7-1) formerly BS 21.
Taper female with the exception of the 1/2" inlet
which is parallel.

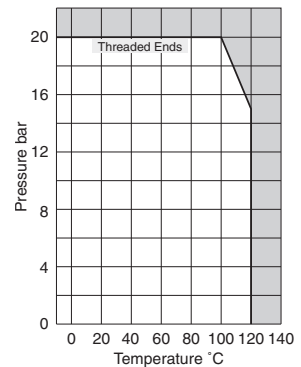

For Commissioning Valve Coefficients please refer to pages 47-49.

Every effort has been made to ensure that the information contained in this publication is accurate at the time of publishing. Hattersley Ltd assumes no responsibility or liability for typographical errors or omissions or for any misinterpretation of the information within the publication and reserves the right to change without notice.

Fig. 1000L, 1000M DZR Brass Low & Medium Flow Metering Stations



FEATURES AND BENEFITS

- Precise and accurate measurement, conforming to BS 7350:1990
- Dezincification resistant material preventing corrosion cracking and fungal growth
- WRAS approved for use with potable water
- Supplied with red and blue test points for upstream and downstream port identification

MATERIAL SPECIFICATION

Component	Material	Specification BS EN
Metering Station	DZR Brass	12165 CW602N
Test Point	Fig. 631	



DIMENSIONAL DRAWINGS

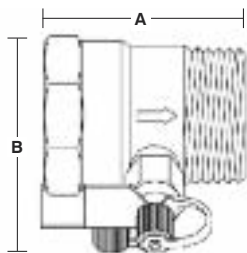

DIMENSIONS AND WEIGHTS

Nom Size	mm	15
	in	1/2
A (threaded)	mm	57
B	mm	55
Weight	kg	0.29

PRESSURE/ TEMPERATURE RATING

Threaded Ends
PN20 Series B
15 bar at 120°C
20 bar from -10 to 100°C

TEST PRESSURES (HYDRAULIC)

Shell: 30 bar

SPECIFICATION

Generally in accordance with BS 7350:1990.
WRAS Approved Product.
Supplied fitted with two figure 631 test points.
Outlet connection taper threaded BS EN 10266 (ISO 7-1) formerly BS 21.
Inlet connection screwed BS 2779 (ISO 228) parallel.
Suitable for use with flow rates down to 0.01l/s.

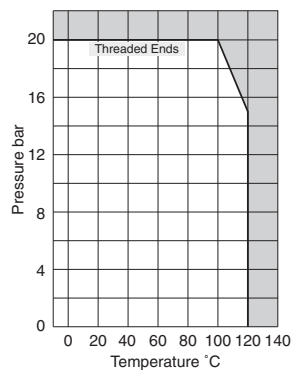

For Commissioning Valve Coefficients please refer to pages 47-49.

Every effort has been made to ensure that the information contained in this publication is accurate at the time of publishing. Hattersley Ltd assumes no responsibility or liability for typographical errors or omissions or for any misinterpretation of the information within the publication and reserves the right to change without notice.

Fig. 1432, 1432L, 1432C, 1432LC Bronze Double Regulating Valve



FEATURES AND BENEFITS

- Provides precise and accurate flow regulation
- Easy to operate with handwheel and numerical indicator
- Robust bronze body for long service life
- WRAS approved for use with potable water
- Positive flow control at all handwheel settings



MATERIAL SPECIFICATION

Component	Material	Specification BS EN
Handwheel	Plastic	-
Stem	DZR copper alloy	12165 CW602N
Stem Seals	EPDM	-
Disc	DZR copper alloy	12165 CW602N
Disc Seal (1-2")	PTFE	-
Bonnet	DZR copper alloy	12165 CW602N
Body	Bronze	1982 CC491K

PRESSURE/TEMPERATURE RATING

Threaded Ends
BS 7350 PN20
17.2 bar at 120°C
20 bar at -10 to 100°C

Compressions Ends
5 bar at 120°C
6 bar at 110°C
10 bar at 65°C
16 bar from -10 to 30°C

TEST PRESSURES (HYDRAULIC)

Body: 30 bar
Seat: 22 bar

SPECIFICATION

Kitemarked to BS 7350:1990.
Handwheel operated.
Numerical indicator.
Inside screw non-rising handwheel.
Characterised regulating disc.
Flow charts available.
End connections threaded.
Sizes 1 to 2" taper threaded BS EN 10266 (ISO 7-1) formerly BS 21.
Sizes 1/2 & 3/4" to ISO 228 parallel.
Sizes DN15 & DN20 when used with compression adaptors suitable for copper pipe to BS EN 1057 R250 (half hard).
WRAS Approved Product.

APPLICATION

Figure 1432 can be used with Hattersley metering stations for commissioning.

DIMENSIONAL DRAWINGS

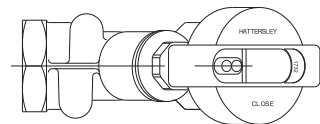
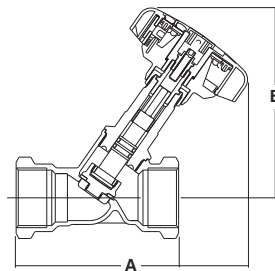

DIMENSIONS AND WEIGHTS

Nom Size	in	1/2L	1/2	3/4	1	1 1/4	1 1/2	2
A	mm	87	87	96	100	114	125	146
A (compression)	mm	105	105	118	-	-	-	-
B	mm	110	110	111	132	133	148	149
Weight	kg	0.54	0.54	0.58	0.88	1.05	1.43	1.88

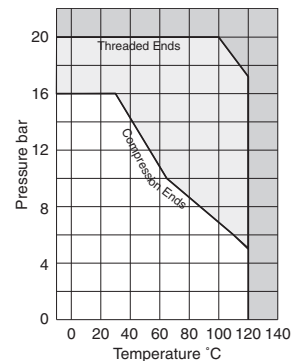

For Commissioning Valve Coefficients please refer to pages 47-49.

Every effort has been made to ensure that the information contained in this publication is accurate at the time of publishing. Hattersley Ltd assumes no responsibility or liability for typographical errors or omissions or for any misinterpretation of the information within the publication and reserves the right to change without notice.

Fig. 1732, 1732M, 1732L, 1732C, 1732MC, 1732LC Bronze Fixed Orifice Double Regulating Valve (FODRV)



FEATURES AND BENEFITS

- Provides precise and accurate flow regulation
- Easy to operate with handwheel and numerical indicator
- Integral orifice and test points – no need for separate DRV and metering station
- WRAS approved for use with potable water
- Positive flow control at all handwheel settings



MATERIAL SPECIFICATION

Component	Material	Specification BS EN
Handwheel	Plastic	
Stem	DZR copper alloy	12165 CW602N
Stem Seals	EPDM	
Disc	DZR copper alloy	12165 CW602N
Disc Seal (1-2")	PTFE	
Bonnet	DZR copper alloy	12165 CW602N
Body	Bronze	1982 CC491K
Orifice Insert	DZR copper alloy	12165 CW602N
Fig. 631 Test Valve	DZR copper alloy	12165 CW602N

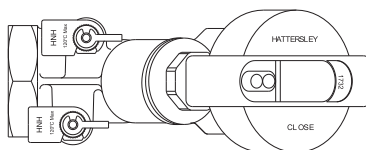

DIMENSIONAL DRAWINGS

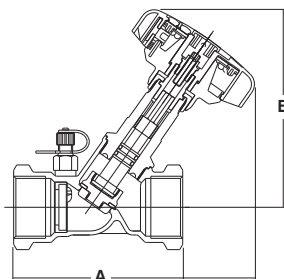

PRESSURE/TEMPERATURE RATING

Threaded Ends
BS 7350 PN20
17.2 bar at 120°C
20 bar at -10 to 100°C

Compressions Ends
5 bar at 120°C
6 bar at 110°C
10 bar at 65°C
16 bar from -10 to 30°C

TEST PRESSURES (HYDRAULIC)

Body: 30 bar
Seat: 22 bar

SPECIFICATION

Kitemarked to BS 7350:1990.
Handwheel operated.
Numerical indicator.
Inside screw non-rising handwheel.
Characterised regulating disc.
Integral fixed orifice.
Supplied with two figure 631 test points.
Flow charts available.
End connections threaded.

Sizes 1 to 2" taper threaded
BS EN 10266 (ISO 7-1) formerly BS 21.
Sizes 1/2" & 3/4" to ISO 228 parallel.
Sizes DN15 & DN20 when used with compression adaptors suitable for copper pipe to BS EN 1057 R250 (half hard).
WRAS Approved Product.

DIMENSIONS AND WEIGHTS

Nom Size	in	1/2L	1/2M	1/2	3/4	1	1 1/4	1 1/2	2
A	mm	87	87	87	96	100	114	125	146
A (compression)	mm	105	105	105	118	-	-	-	-
B	mm	110	110	110	111	132	133	148	149
Weight	kg	0.61	0.61	0.61	0.65	0.95	1.13	1.52	1.98

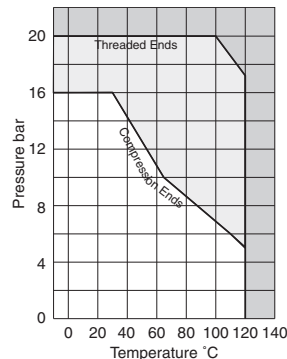

For Commissioning Valve Coefficients please refer to pages 47-49.

Every effort has been made to ensure that the information contained in this publication is accurate at the time of publishing. Hattersley Ltd assumes no responsibility or liability for typographical errors or omissions or for any misinterpretation of the information within the publication and reserves the right to change without notice.

Fig. 1832, 1832M, 1832L Bronze Motorised Fixed Orifice Double Regulating Valve

(Motorised FODRV)

FEATURES AND BENEFITS

- Provides precise and accurate flow regulation
- Designed for circuits where combined functions of actuated regulation and flow measurement are required
- Operated by motorised actuator
- Integral fixed orifice commissioning valve and two port control panel – faster commissioning



MATERIAL SPECIFICATION

Component	Material	Specification BS EN
Stem	DZR copper alloy	12165 CW602N
Stem Seals	EPDM	
Disc	EPDM	
Bonnet	DZR copper alloy	12165 CW602N
Body	Bronze	1982 CC491K
Orifice Insert	DZR copper alloy	12165 CW602N
Fig. 631 Test Valve	DZR copper alloy	12165 CW602N

DIMENSIONAL DRAWINGS

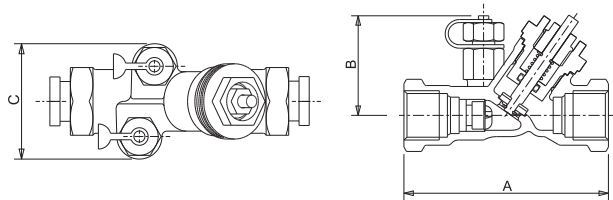

PRESSURE/ TEMPERATURE RATING

Threaded Ends
BS 7350 PN20
16 bar at 120°C
25 bar at -10 to 100°C

TEST PRESSURES (HYDRAULIC)

Body: 30 bar
Seat: 1.4 bar DP
Note: Max DP = 1.2 bar

SPECIFICATION

Actuator operated for on/off or modulating control.
Double regulating device allows flow to be balanced.
Integral fixed orifice.
Supplied with 2 Figure 631 test points.
Flow charts available.
End connections threaded
Sizes 1/2" & 3/4" to ISO 228 parallel.
The 1832 Motorised FODRV is designed for installations in circuits where combined functions of actuated regulation and flow measurement are required.
Accuracy of flow measurement is +5% across all driving settings.

- 1832:** 1/2" has a flow range of 0.061 to 0.132l/s
3/4" has a flow range of 0.131 to 0.289l/s
- 1832M:** 1/2" medium flow version is suitable for flow applications in the range of 0.03 to 0.07l/s
- 1832L:** 1/2" low flow version is suitable for flow applications in the range of 0.01 to 0.03l/s

DIMENSIONS AND WEIGHTS

Nom Size	in	1/2L	1/2M	1/2	3/4
A	mm	87	87	87	96
B	mm	50	50	50	51
Weight	kg	0.41	0.41	0.41	0.45

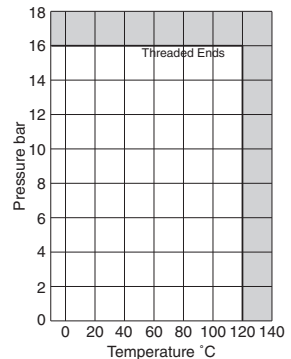

For Commissioning Valve Coefficients please refer to pages 47-49.

Every effort has been made to ensure that the information contained in this publication is accurate at the time of publishing. Hattersley Ltd assumes no responsibility or liability for typographical errors or omissions or for any misinterpretation of the information within the publication and reserves the right to change without notice.

Fig. 1200DR Bronze Double Regulating Valves

FEATURES AND BENEFITS

- Provides precise and accurate flow regulation
- Easy to operate with handwheel
- Robust bronze body for long service life
- Suitable for high pressure applications



MATERIAL SPECIFICATION

Component	Material	Specification	
		BS EN	ASTM
Stem	Manganese Bronze	12164 CW721R	
Gland Packing	Asbestos Free		
Bonnet	Bronze	1982 CC491K	B62
Swivel Nut	Manganese Bronze	12164 CW721R	
Disc	Stainless Steel		
Seat	Stainless Steel		
Body	Bronze	1982 CC491K	B62

DIMENSIONAL DRAWINGS

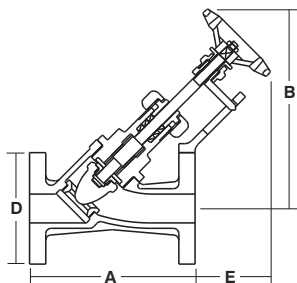

DIMENSIONS AND WEIGHTS

Nom Size	mm	15	20	25	32	40	50
A	mm	133	146	162	184	200	238
B (open)	mm	168	187	213	238	267	306
D	mm	95	105	115	140	150	165
E (open)	mm	64	79	92	98	117	121
Weight	kg	2.5	3.5	4.9	7.5	10	14

PRESSURE/ TEMPERATURE RATING

BS 5154 PN40 Series A
34 bar at 180°C
40 bar from -10 to 120°C

TEST PRESSURES (HYDRAULIC)

Shell: 60 bar
Seat: 44 bar

SPECIFICATION

Conforms to BS 7350:1990.
Rising stem.
Screwed bonnet.
Flanged to BS EN 1092-3 PN40.
Fitted with parabolic regulating disc in Stainless Steel, double regulating device and indicator.
Flow charts available.

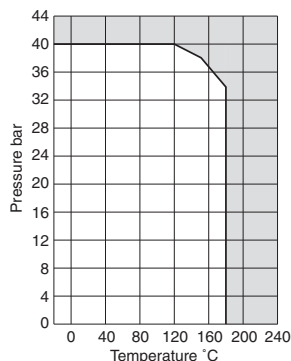

For Commissioning Valve Coefficients please refer to pages 47-49.

Every effort has been made to ensure that the information contained in this publication is accurate at the time of publishing. Hattersley Ltd assumes no responsibility or liability for typographical errors or omissions or for any misinterpretation of the information within the publication and reserves the right to change without notice.

Fig. M2000

Stainless Steel Metering Stations

FEATURES AND BENEFITS

- Compact, wafer design for fitting in tight spaces
- Accurate flow measurement
- Supplied with red and blue test points for upstream and downstream port identification

MATERIAL SPECIFICATION

Component	Material	Specification	
		BS EN	ASTM
Body	Stainless Steel	10088-1 X2 CrNiNo17-12-2	A276-316L
Extension Sleeve	Stainless Steel		
Test Points	Fig. 631		



DIMENSIONAL DRAWINGS

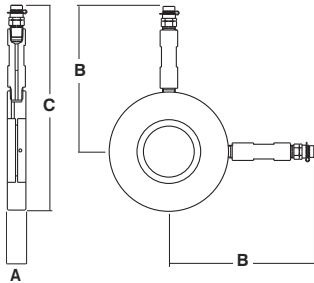

DIMENSIONS AND WEIGHTS

Nom Size	mm	50	65	80	100	125	150	200	250	300
A	mm	20	20	20	20	20	20	20	20	20
B	mm	150	160	170	180	195	205	235	260	260
C	mm	205	225	240	260	290	315	370	426	481
Weight	kg	1.3	1.6	1.9	2.1	2.8	3.3	5.0	6.0	7.0

Note: Weight shown above includes extensions, test points, gaskets and box.

For Commissioning Valve Coefficients please refer to pages 47-49.

Every effort has been made to ensure that the information contained in this publication is accurate at the time of publishing. Hattersley Ltd assumes no responsibility or liability for typographical errors or omissions or for any misinterpretation of the information within the publication and reserves the right to change without notice.

PRESSURE/TEMPERATURE RATING

16 bar from -10 to 120°C
 Note: The Test Point figure 631 has a maximum working temperature of 120°C.
 For higher temperature requirements contact Hattersley Sales Office.

SPECIFICATION

Kitemarked to BS 7350:1990.
 Outside diameter locates metering station centrally on the relevant BS EN 1092-2 PN16 flange bolting.
 Compatibility with other flanges available.
 Supplied complete with extensions and figure 631 test points.
 Flow charts available.



Use with figure M733DR to make Commissioning Set M2733.

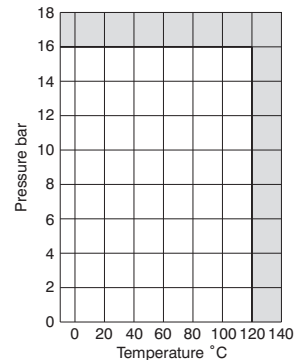

Fig. M2000 Cast Iron Metering Stations

FEATURES AND BENEFITS

- Compact, wafer design for fitting in tight spaces
- Accurate flow measurement
- Supplied with red and blue test points for upstream and downstream port identification



MATERIAL SPECIFICATION

Component	Material	Specification	
		BS EN	ASTM
Body (350 to 450mm) (500 to 700mm)	Cast Iron	1561 EN-JL1030	A126 CIB
	Carbon Steel		
Orifice Plate	Stainless Steel	10088-1 X2 CrNiNo17-12-2 AISI 316	
Retaining Ring	18/8 Stainless Steel		
Extension Sleeve	Stainless Steel		
Test Points	Fig. 631		

DIMENSIONAL DRAWINGS

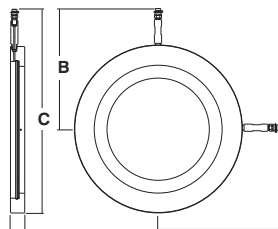

DIMENSIONS AND WEIGHTS

Nom Size	mm	350	400	450	500	600
A	mm	38	38	38	38	38
B	mm	320	345	375	397	456
C	mm	545	595	655	707	825
Weight	kg	32	39	50	30	40

Note: Weight shown above includes extensions, test points, gaskets lifting hook and box. Larger sizes available on request.

For Commissioning Valve Coefficients please refer to pages 47-49.

Every effort has been made to ensure that the information contained in this publication is accurate at the time of publishing. Hattersley Ltd assumes no responsibility or liability for typographical errors or omissions or for any misinterpretation of the information within the publication and reserves the right to change without notice.

PRESSURE/ TEMPERATURE RATING

PN16

16 bar from -10 to 120°C

Note: The Test Point figure 631 has a maximum working temperature of 120°C
If other test points are fitted the maximum operating temperature should be obtained from the test point manufacturer.

TEST PRESSURES (HYDRAULIC)

Shell: 24 bar

SPECIFICATION

Outside diameter locates metering station centrally on BS EN 1092-2 PN16 flange bolting.

Adaptations to suit other flanges available.

Supplied complete with extensions and figure 631 test points.

Flow charts available.

Note: When used with a butterfly valve a minimum of 5 diameters of straight length of same diameter pipe as the valve must be fitted on both sides of the metering station.

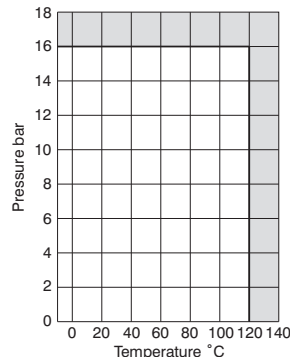

Fig. M3000 Stainless Steel Metering Stations

FEATURES AND BENEFITS

- Compact, wafer design for fitting in tight spaces
- Accurate flow measurement
- Supplied with red and blue test points for upstream and downstream port identification

MATERIAL SPECIFICATION

Component	Material	Specification	
		BS EN	ASTM
Body	Stainless Steel	10088-1 X2CrNiMo 17-12-2	AISI 316
Extension Sleeve	Stainless Steel		
Valve Controlled Test Points	Fig. 750		



DIMENSIONAL DRAWINGS

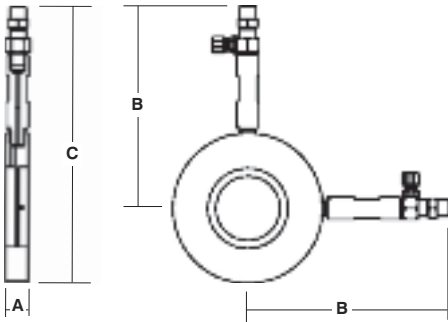

PRESSURE/TEMPERATURE RATING

24.2 bar at 180°C
25 bar from -10 to 120°C
Note: The Valve Controlled Test Point figure 750 has a maximum working temperature of 180°C. If other test points are fitted the maximum operating temperature should be obtained from the test point manufacturer.

SPECIFICATION

Outside diameter locates metering station centrally on the relevant BS EN 1092-2 flange bolting.
Compatibility with other flanges available.
Supplied complete with extensions and figure 750 test points.
Flow charts available.



Use with double regulating valve to make Commissioning Set

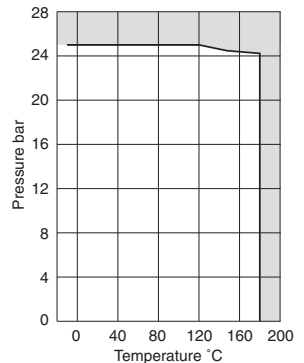

DIMENSIONS AND WEIGHTS

Nom Size	mm	50	65	80	100	125	150	200	250	300
A	mm	20	20	20	20	20	20	20	20	20
B	mm	165	175	185	195	208	223	253	282	312
C	mm	220	240	255	280	306	336	396	453	513
Weight	kg	1.3	1.6	1.9	2.1	2.8	3.3	5.0	6.0	7.0

Note: Weight shown above includes extensions, test points, gaskets and box.

For Commissioning Valve Coefficients please refer to pages 47-49.

Every effort has been made to ensure that the information contained in this publication is accurate at the time of publishing. Hattersley Ltd assumes no responsibility or liability for typographical errors or omissions or for any misinterpretation of the information within the publication and reserves the right to change without notice.

Fig. M4000 Stainless Steel Metering Stations

FEATURES AND BENEFITS

- Suitable for high pressure applications
- Compact, flanged design for fitting in tight spaces
- Accurate flow measurement
- Supplied with red and blue test points for upstream and downstream port identification

MATERIAL SPECIFICATION

Component	Material	Specification	
		BS EN	ASTM
Metering Station	Stainless Steel	10088-1 X2CrNiMo 17-12-2	AISI 316 17
Valve Controlled Test Point	Fig. 750		

DIMENSIONAL DRAWINGS

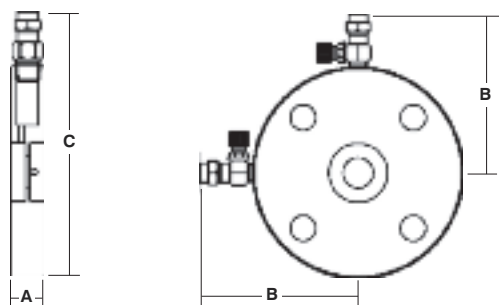

PRESSURE/ TEMPERATURE RATING

PN40 Series A

34 bar at 180°C

40 bar from -10 to 120°C

Note: The Valve Controlled Test Point figure 750 has a maximum working temperature of 180°C. If other test points are fitted the maximum operating temperature should be obtained from the test point manufacturer.

SPECIFICATION

Conforms to BS 7350.

One piece full flange diameter.

Integral orifice plate.

Flange dimensions to BS EN 1092-2 PN40.

Supplied complete with flange bolts, nuts and figure 750 test points.

Flow charts available.

Can also be used with figure 1200 PN40 isolating valve to form an orifice valve (PTV).



Use with figure 1200DR to make Commissioning Set 5200

TEST PRESSURES (HYDRAULIC)

Shell: 60 bar

DIMENSIONS AND WEIGHTS

Nom Size	mm	15	20	25	32	40	50
A	mm	18	18	18	18	18	18
B	mm	95	100	105	115	120	130
C	mm	140	150	160	185	195	210
Weight	kg	1.4	1.6	1.8	2.5	2.9	3.5

Weights shown above include test points and gaskets.

For Commissioning Valve Coefficients please refer to pages 47-49.

Every effort has been made to ensure that the information contained in this publication is accurate at the time of publishing. Hattersley Ltd assumes no responsibility or liability for typographical errors or omissions or for any misinterpretation of the information within the publication and reserves the right to change without notice.

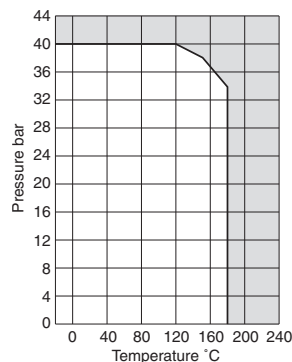

Fig. M733DR Cast Iron Globe Valves with Double Regulating Feature



FEATURES AND BENEFITS

- Robust iron body materials for long service life
- Precise flow regulation
- Flanged with handwheel – easy to install and operate
- Positive flow control at all handwheel settings



MATERIAL SPECIFICATION

Component	Material	Specification	
		BS EN	ASTM
Indicator Ring	Polymer		
Indicator	Polymer		
Gland	H T Brass	12164 CW721R	B138 C67500
Gland Packing	Graphite		
Stuffing Box	H T Brass	12164 CW721R	B138 C67500
Stem (50 to 100mm)	H T Brass	12164 CW721R	B138 C67500
Stem (125 to 200mm)	Stainless Steel	10088-1 X2 CrNiNo	17-12-2 A276-316L
Indicator Sleeve	Polymer		
Bonnet	Ductile Iron	1563 EN JS 1050	A536 80 55 06
Bonnet Gasket	Asbestos Free		
Disc Stem Nut	H T Brass	12164 CW721R	B138 C67500
Disc	Cast Iron	1561 EN JLI030	A126 CI B
Disc Coating	EPDM		
Body	Cast Iron	1561 EN JLI030	A126 CI B
Seat Ring	Bronze	1982 CC491K	

DIMENSIONAL DRAWINGS

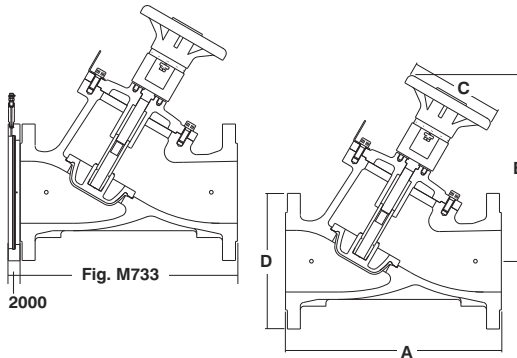

PRESSURE/TEMPERATURE RATING

16 bar from -10 to 120°C
Note: The maximum temperature is determined by the EPDM elastomer coated disc.

TEST PRESSURES (HYDRAULIC)

Shell: 24 bar
Seat: 17.6 bar

SPECIFICATION

Kitemarked to BS 7350:1990.
Inside screw, non-rising stem.
EPDM coated disc.
Flanged to BS EN 1092-2 PN16.
Fitted with regulating disc, double regulating device and indicator.



Use with M2000 PN16 to make Commissioning Set M2733

DIMENSIONS AND WEIGHTS

Nom Size	mm	50	65	80	100	125	150	200
A	mm	230	290	310	350	400	480	600
B	mm	250	278	292	310	350	385	450
C	mm	166	166	166	166	250	250	250
D	mm	165	185	200	220	250	285	340
Weight	kg	15	21	26	37	65	82	139

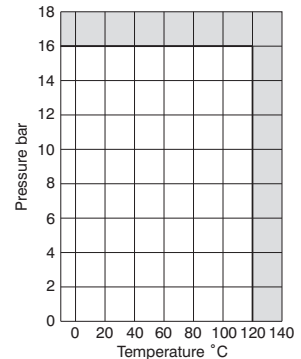

For Commissioning Valve Coefficients please refer to pages 47-49.

Every effort has been made to ensure that the information contained in this publication is accurate at the time of publishing. Hattersley Ltd assumes no responsibility or liability for typographical errors or omissions or for any misinterpretation of the information within the publication and reserves the right to change without notice.

Fig. M733DR Ductile Iron Globe Valves with Double Regulating Feature

FEATURES AND BENEFITS

- Robust iron body materials for long service life
- Precise flow regulation
- Flanged with handwheel – easy to install and operate
- Positive flow control at all handwheel settings



MATERIAL SPECIFICATION

Component	Material	Specification	
		BS EN	ASTM
Stem	316 SS	10088 X5CrNiMo17-12-2	A276 316
Gland (200 to 300mm)	Cast Iron	1561 GRADE 250	
Gland Nut	Mild Steel		
Bonnet	Ductile Iron		536 65-45-12
Bonnet Gasket	Asbestos Free		
Disc	Cast Iron	1561 GRADE 250	
Disc Insert	PTFE		
Disc Coating	EPDM		
Seat Ring	Bronze	1982 CC491K	
Body	Ductile Iron		536 65-45-12
Packing	Asbestos Free		

DIMENSIONAL DRAWINGS

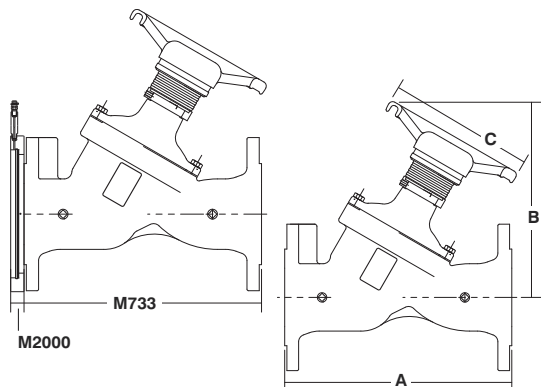

DIMENSIONS AND WEIGHTS

Nom Size	mm	250	300
A	mm	730	850
B	mm	575	645
C	mm	420	420
Weight	kg	192	251

For Commissioning Valve Coefficients please refer to pages 47-49.

Every effort has been made to ensure that the information contained in this publication is accurate at the time of publishing. Hattersley Ltd assumes no responsibility or liability for typographical errors or omissions or for any misinterpretation of the information within the publication and reserves the right to change without notice.

PRESSURE/ TEMPERATURE RATING

16 bar from -10 to 120°C

TEST PRESSURES (HYDRAULIC)

Shell: 24 bar

Seat: 17.6 bar

SPECIFICATION

Conforms to BS 7350: 1990.

Inside screw, non-rising stem.

Copper alloy trim.

Flanged to BS EN 1092-2 PN16.

Fitted with regulating disc, double regulating device and indicator.



Use with figure M2000 to make Commissioning Set M2733

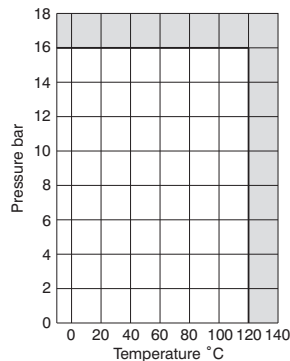

Fig. M737 Cast Iron Variable Orifice Double Regulating Valves



FEATURES AND BENEFITS

- Robust iron body materials for long service life
- Precise flow regulation
- Flanged with handwheel – easy to install and operate
- Positive flow control at all handwheel settings



MATERIAL SPECIFICATION

Component	Material	Specification	
		BS EN	ASTM
Indicator Ring	Polymer		
Indicator	Polymer		
Gland	H T Brass	1561 EN JSI040	
Gland Flange	Graphite		
Stuffing Box	H T Brass	1561 EN JSI040	
Stem (50 to 100mm)	H T Brass	1561 EN JSI040	
Stem (125 to 200mm)	Stainless Steel	10270 X10CrNr18-8	A276-304
Indicator Sleeve	Polymer		
Bonnet	Ductile Iron	1561 EN JSI050	
Bonnet Gasket	Asbestos Free		
Disc Stem Nut	H T Brass	1561 EN JSI040	
Disc	Cast Iron	1541 EN JLI040	A126 Cl B
Disc Coating	EPDM		
Body	Cast Iron	1561 EN-JLI030	A126 Cl B
Extension Sleeve	Bronze	1982 CC491K	B505 C83600

DIMENSIONAL DRAWINGS

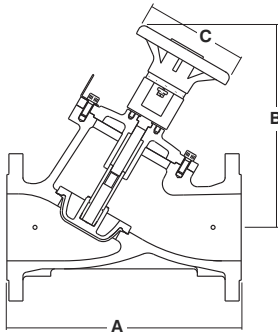

DIMENSIONS AND WEIGHTS

Nom Size	mm	50	65	80	100	125	150	200
A	mm	230	290	310	350	400	480	600
B	mm	250	278	292	310	350	385	450
C	mm	166	166	166	166	250	250	250
D	mm	165	185	200	220	250	285	340
Weight	kg	15	21	26	37	65	82	139

PRESSURE/TEMPERATURE RATING

16 bar from -10 to 120°C

Note: The maximum temperature is determined by the EPDM elastomer coated disc.

TEST PRESSURES (HYDRAULIC)

Shell: 24 bar
Seat: 17.6 bar

SPECIFICATION

Kitemarked to BS 7350:1990.

Inside screw, non-rising stem.

EPDM coated disc.

Flanged to BS EN 1092-2 PN16

Fitted with regulating disc, double regulating device and indicator, figure 631 test points and extensions.

Valves can be supplied with vapour seal.

Optional insulation boxes.

Flow charts available.

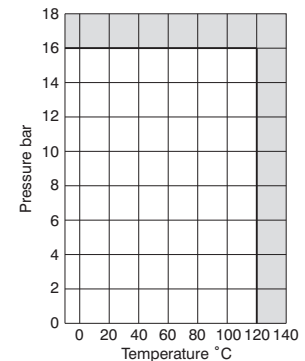

For Commissioning Valve Coefficients please refer to pages 47-49.

Every effort has been made to ensure that the information contained in this publication is accurate at the time of publishing. Hattersley Ltd assumes no responsibility or liability for typographical errors or omissions or for any misinterpretation of the information within the publication and reserves the right to change without notice.

Fig. M737

Ductile Iron Variable Orifice Double Regulating Valves

FEATURES AND BENEFITS

- Robust iron body materials for long service life
- Precise flow regulation
- Flanged with handwheel – easy to install and operate
- Positive flow control at all handwheel settings



MATERIAL SPECIFICATION

Component	Material	Specification	
		BS EN	ASTM
Handwheel	Ductile Iron	1563 EN-JSI030	A536-65-45-12
Gland	Cast Iron	1561 EN-JLI030	A126 Cl B
Gland Packing	Asbestos Free		
Stem	Stainless Steel	10088-1 X2 CrNiNo17-12-2	A276-316L
Seat Retainer	Bronze		
Disc	Cast Iron	1561 EN-JLI030	A126 Cl B
Disc Insert	PTFE or PTFE/Neoprene		
Disc Coating	EPDM		
Regulating Cone	Bronze		
Bonnet	Ductile Iron	1563 EN-JSI030	A536-65-45-12
Bonnet Gasket	Asbestos Free		
Body Seat Ring	Bronze	1982 CC491K	
Body	Ductile Iron	1563 EN-JSI030	A536-65-45-12m

DIMENSIONAL DRAWINGS

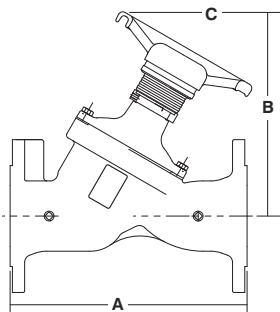

DIMENSIONS AND WEIGHTS

Nom Size	mm	250	300
A	mm	730	850
B (open)	mm	575	645
C	mm	420	420
Weight	kg	192	251

PRESSURE/ TEMPERATURE RATING

BS EN 1092-2 PN16
16 bar from -10 to 120°C

TEST PRESSURES (HYDRAULIC)

Shell: 24 bar
Seat: 17.6 bar

SPECIFICATION

BS 7350:1990.
Face to face dimensions to BS EN 558-1 basic series 1.
Ductile iron body.
Inside screw.
Non-rising stem.
Bronze body seat.
Flanged to BS EN 1092-2 PN16.
Flow charts available.

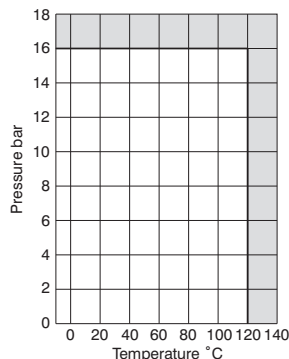

For Commissioning Valve Coefficients please refer to pages 47-49.

Every effort has been made to ensure that the information contained in this publication is accurate at the time of publishing. Hattersley Ltd assumes no responsibility or liability for typographical errors or omissions or for any misinterpretation of the information within the publication and reserves the right to change without notice.

Fig. 953, 953G Cast Iron with Double Regulating Feature

FEATURES AND BENEFITS

- Robust iron body materials for long service life
- Precise flow regulation
- Flanged with handwheel – easy to install and operate
- Positive flow control at all handwheel settings

MATERIAL SPECIFICATION

Component	Material	Specification	
		BS EN	ASTM
Body	Ductile Iron		
Shaft	Stainless Steel	10088-1 X17CrNi16-2	AISI 431
Disc	Aluminium Bronze	1982 CC333G	B148 C95800
Disc	Stainless Steel	10270 X10CrNi18-8	A276 304
Liner	EPDM		
Bearings	PTFE Coated Steel		



PRESSURE/TEMPERATURE RATING

EPDM Seat
16 bar from -10 up to 120°C

SERVICE RATING

Suitable for Chilled Water, LTHW and MTHW

TEST PRESSURES

Shell: 24 bar
Seat: 17.6 bar

SPECIFICATION

Valves up to and including 200mm can be supplied lever operated or fully enclosed gear operated.

All operators fitted with double regulating feature.

Flow charts available.

Note: Butterfly valves should not be less than 30° open when used for regulation duties.

DIMENSIONAL DRAWINGS

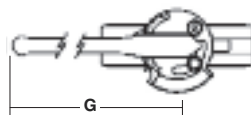
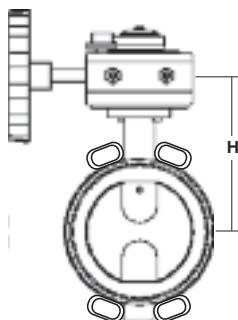
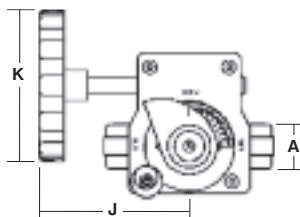

DIMENSIONS AND WEIGHTS

Nom Size	mm	50	65	80	100	125	150	200	250	300
A	mm	43	46	46	52	56	56	60	68	78
F*	mm	264	272	279	301	314	345	369	-	-
G	mm	250	250	250	250	250	315	315	-	-
H	mm	182	190	197	219	232	254	278	281	306
J	mm	123	123	123	123	123	123	123	228	228
K dia	mm	125	125	125	125	125	125	125	300	300
Weight (953W)	kg	4.1	4.9	5.2	6.5	8.5	11.4	16	-	-
Weight (953WG)	kg	4.9	5.7	6.0	7.3	9.3	12	16	29	41

*F dimension is centre of valve to maximum lift of lever

For Commissioning Valve Coefficients please refer to pages 47-49.

Every effort has been made to ensure that the information contained in this publication is accurate at the time of publishing. Hattersley Ltd assumes no responsibility or liability for typographical errors or omissions or for any misinterpretation of the information within the publication and reserves the right to change without notice.

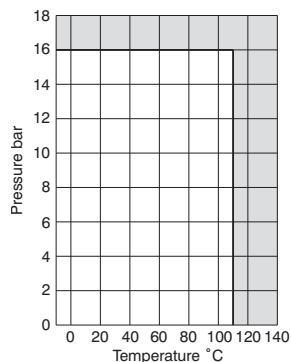

Fig. 973, 973G Ductile Iron with Double Regulating Feature

FEATURES AND BENEFITS

- Robust iron body materials for long service life
- Precise flow regulation
- Flanged with handwheel – easy to install and operate
- Positive flow control at all handwheel settings

MATERIAL SPECIFICATION

Component	Material	Specification	
		BS EN	ASTM
Body	Ductile Iron	1561 EN-JL1030	A126 CI B
Shaft	Stainless Steel	10088-1 X17CrNi16-2	AISI 431
Disc	Aluminium Bronze	1982 CC333G	B148 C95800
Disc	Stainless Steel	10270 X10CrNi18-8	A276 304
Liner	EPDM		
Bearings	PTFE Coated Steel		



PRESSURE/ TEMPERATURE RATING

EPDM Seat
16 bar from -10 up to 120°C

SERVICE RATING

Suitable for Chilled Water, LTHW and MTHW

TEST PRESSURES

Shell: 24 bar
Seat: 17.6 bar

SPECIFICATION

Generally conforms to BS EN 593: 2009.
Valves up to and including 200mm can be supplied lever operated or fully enclosed gear operated.

All operators fitted with double regulating feature.

Flow charts available.

Note: Butterfly valves should not be less than 30° open when used for regulation duties.

Stainless Steel disc option 4973 - 4973G.

DIMENSIONAL DRAWINGS

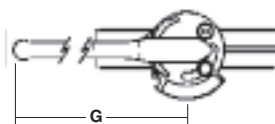
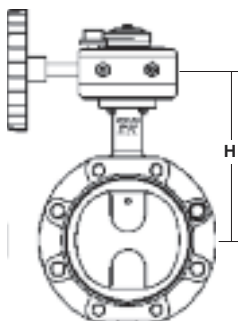
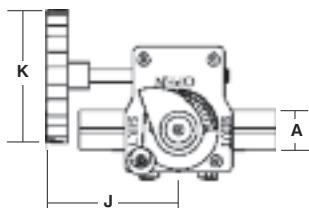

DIMENSIONS AND WEIGHTS

Nom Size	mm	50	65	80	100	125	150	200	250	300
A	mm	43	46	46	52	56	56	60	68	78
D	mm	165	185	200	220	250	285	340	405	460
F*	mm	264	272	279	301	314	345	369	-	-
G	mm	250	250	250	250	250	315	315	-	-
H	mm	182	190	197	219	232	254	278	281	306
J	mm	123	123	123	123	123	123	123	228	228
K dia	mm	125	125	125	125	125	125	125	300	300
Weight (973W)	kg	4.6	5.4	7.2	8.8	12	14	20	-	-
Weight (973WG)	kg	5.4	6.2	8.0	9.6	12	15	21	33	45

*F dimension is centre of valve to maximum lift of lever

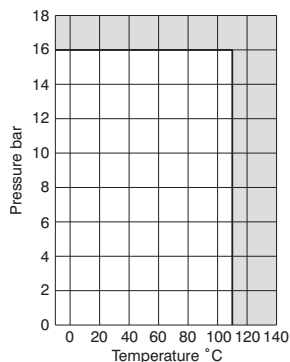

For Commissioning Valve Coefficients please refer to pages 47-49.

Every effort has been made to ensure that the information contained in this publication is accurate at the time of publishing. Hattersley Ltd assumes no responsibility or liability for typographical errors or omissions or for any misinterpretation of the information within the publication and reserves the right to change without notice.

Fig. 4983G Ductile Iron Fully-lugged Double Regulating Valve

FEATURES AND BENEFITS

- Robust iron body materials for long service life
- Precise flow regulation
- Flanged with handwheel – easy to install and operate
- Positive flow control at all handwheel settings



MATERIAL SPECIFICATION

Component	Material	Specification BS EN
Body	Ductile Iron	1563 EN GJS 56017
Plug	Carbon Steel	
Liner	EPDM	
Shaft (lower)	Steel	AISI 431
Disc	Stainless Steel	SS304
Shaft (upper)	Steel	AISI 431
O-Ring	EPDM	
Lock Plate	Brass	ASTM B16 C36000
Snap Ring	Carbon Steel	
Gearbox	-	

DIMENSIONAL DRAWINGS

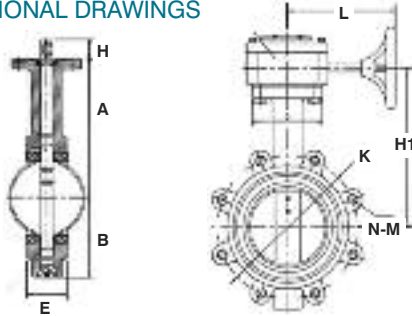

PRESSURE/TEMPERATURE RATING

25 bar from -10 to 120°C

TEST PRESSURES (HYDRAULIC)

Shell: 37.5 bar
Seat: 27.5 bar

SPECIFICATION

A fully lugged butterfly valve for use with PN25 flanges.

High temperature EPDM liner for applications up to 120°C.

A double regulating gearbox as standard. Can be used in conjunction with a flow measurement device, figure M3000 to regulate and measure flow.

DIMENSIONS AND WEIGHTS

Nom Size	mm	50	65	80	100	125	150	200	250	300
A	mm	140	152	160	180	191	202	241	274	315
B	mm	68	76	85	100	120	132	160	200	230
H	mm	35	35	35	35	35	35	45	45	45
D	mm	90	90	90	90	90	90	125	125	125
E	mm	43	45	46	51.5	56	56.5	60	68.5	79.5
L	mm	160	160	160	160	160	160	238	238	238
K	mm	125	145	160	190	220	250	310	370	430
N-M	mm	4-M16	8-M16	8-M20	8-M20	8-M24	8-M24	12-M27	16-M27	
H-I	mm	172.5	184.5	192.5	212.5	223.5	234.5	278.0	311.0	366.0
Weight	kg	10.0	10.8	11.0	13.0	16.0	18.5	29.8	40.0	53.0

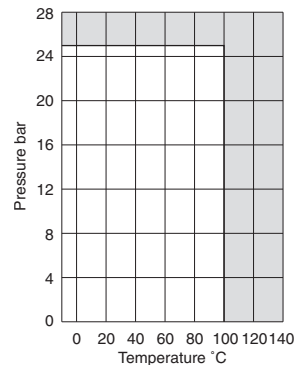

For Commissioning Valve Coefficients please refer to pages 47-49.

Every effort has been made to ensure that the information contained in this publication is accurate at the time of publishing. Hattersley Ltd assumes no responsibility or liability for typographical errors or omissions or for any misinterpretation of the information within the publication and reserves the right to change without notice.

Fig. 5953, 5953G Cast Iron Metrex Commissioning Sets

FEATURES AND BENEFITS

- Robust iron body materials for long service life
- Precise flow regulation and accurate measurement
- Flanged with handwheel – easy to install and operate
- Positive flow control at all handwheel settings



MATERIAL SPECIFICATION

Component	Material	Specification		
		BS EN	ASTM	DIN
Valve	Fig. 953G			
Test Points	Fig. 631			
Extension Sleeve	Gunmetal	1400LG2	B62	1705 G-CuSn5ZnPb
Housing	Cast Iron (Nickel Plated)	1452 Gr220	A126 Cl B	1691 GG22
Orifice Plate	Stainless Steel	970 316S31	AISI 316	17440 X5CrNiMo1812

DIMENSIONAL DRAWINGS

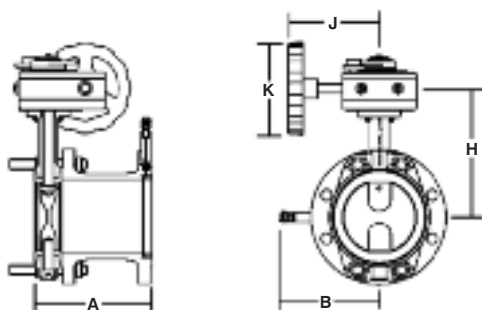

PRESSURE/ TEMPERATURE RATING

EPDM Seat
16 bar from -10°C to 120°C

TEST PRESSURES

Shell: 24 bar
Seat: 17.6 bar

SPECIFICATION

Gear operation provides infinitely variable settings between fully open and closed positions.

Comprehensive flow charts available.
Metering station kitemarked to BS 7350.
Lever operated version available in sizes 50 to 200mm.

NOTES

The valve should not be less than 30° open for regulation duties.

DIMENSIONS AND WEIGHTS

Nom Size	mm	50	65	80	100	125	150	200	250	300
A	mm	133	151	166	192	221	246	300	358	418
B	mm	135	145	160	165	180	190	225	255	275
H	mm	182	190	197	219	232	254	278	281	306
J	mm	123	123	123	123	123	123	123	228	228
K	dia	125	125	125	125	125	125	300	300	
Weight	kg	10.0	10.8	11.0	13.0	16.0	18.5	29.8	40.0	53.0

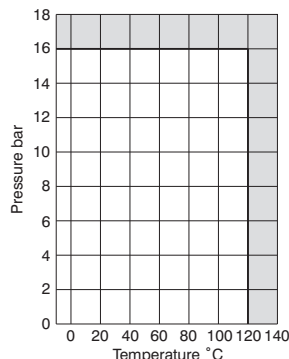

For Commissioning Valve Coefficients please refer to pages 47-49.

Every effort has been made to ensure that the information contained in this publication is accurate at the time of publishing. Hattersley Ltd assumes no responsibility or liability for typographical errors or omissions or for any misinterpretation of the information within the publication and reserves the right to change without notice.

Fig. 5973, 5973G Cast Iron Metrex Commissioning Sets Chilled Water, LTHW & MTHW

FEATURES AND BENEFITS

- Robust iron body materials for long service life
- Precise flow regulation and accurate measurement
- Flanged with handwheel – easy to install and operate
- Positive flow control at all handwheel settings



MATERIAL SPECIFICATION

Component	Material	Specification	
		BS EN	ASTM
Valve	Fig. 973 (see page 41 for materials)		
Test Points	Fig. 631		
Extension Sleeve	Bronze	1982 CC491K	B62
Housing	Cast Iron	1561 EN-JL1040	A126 Cl B
Orifice Plate	Stainless Steel	10088-1 XCrNiMo	17-12-2 AISI 316

PRESSURE/TEMPERATURE RATING

EPDM Seat
16 bar from -10 to 120°C

SERVICE RATING

Suitable for Chilled Water, LTHW and MTHW

TEST PRESSURES (HYDRAULIC)

Shell: 24 bar
Seat: 17.6 bar

SPECIFICATION

A close coupled commissioning set comprising a lugged butterfly valve and metering station to offer all the advantages of the close coupled concept together with an accuracy of $\pm 5\%$ of flow rate. Gear operation provides infinitely variable settings between fully open and closed positions. The commissioning set is supplied as a single unit.

Supplied complete with figure 631 test points and necessary bolting for connection of the valve end to the system. Comprehensive flow charts available. Note: The valve should be not less than 30° open for regulation duties. Wrench operated version available in sizes 50 to 200mm. Figure 9973G available, stainless steel disc.

DIMENSIONAL DRAWINGS

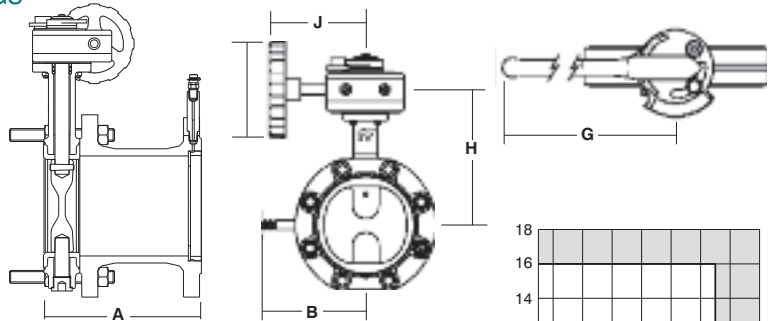

DIMENSIONS AND WEIGHTS

Nom Size	mm	50	65	80	100	125	150	200	250	300
A	mm	133	151	166	192	221	246	300	358	418
B	mm	135	145	160	165	180	190	225	255	275
H	mm	182	190	197	219	232	254	278	281	306
J	mm	123	123	123	123	123	123	123	228	228
K dia	mm	125	125	125	125	125	125	125	300	300
Weight (geared) kg		13	15	21	26	33	45	69	94	131

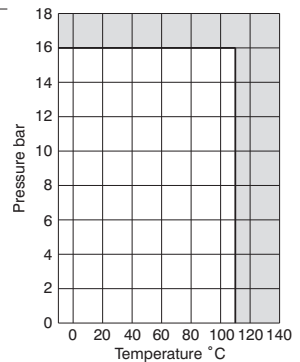

For Commissioning Valve Coefficients please refer to pages 47-49.

Every effort has been made to ensure that the information contained in this publication is accurate at the time of publishing. Hattersley Ltd assumes no responsibility or liability for typographical errors or omissions or for any misinterpretation of the information within the publication and reserves the right to change without notice.

Fig. 4993G Steel Fully-lugged Double Regulating Valve

FEATURES AND BENEFITS

- Precise flow regulation
- Flanged with handwheel – easy to install and operate
- Positive flow control at all handwheel settings
- Bi-directional isolation
- Double eccentric disc



MATERIAL SPECIFICATION

Component	Material	Specification	
		BS EN	ASTM
Body	Steel	10213-2 GP240GH	A216 WCB
Body Seat	Stainless Steel	10270 X10CrNr18-8	A276-304
Disc	Stainless Steel	10270 X10CrNr18-8	A276-304
Disc Seal Ring	PTFE or PTFE/Neoprene		
Retaining Ring	Stainless Steel	10270 X10CrNr18-8	A276-304
Stem	Stainless Steel	10270 X10CrNr18-8	A276-304
Disc Pin	Stainless Steel	10270 X10CrNr18-8	A276-304
Bottom Cap	Steel	10213-2 GP240GH	A216 WCB
Gland Packing	PTFE or PTFE/Neoprene		
Bearings	Bronze-PTFE		
Gearbox	Cast Iron	1561 EN-JL1030	A126 Cl B
Handwheel	Stainless Steel	10270 X10CrNr18-8	A276-304

DIMENSIONAL DRAWINGS

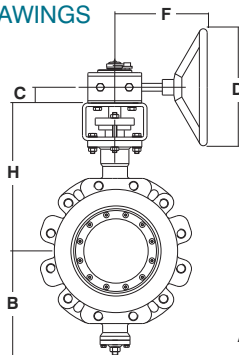

PRESSURE/ TEMPERATURE RATING

25 bar from -10 to 135°C
20.7 bar at 149°C
3.4 bar at 204°C

TEST PRESSURES (HYDRAULIC)

Body: 37.5 bar
Seat: 27.5 bar

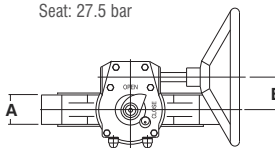

SPECIFICATION

Designed to BS EN 593: 2009.
Face to face dimensions to BS EN 558-1 basic series 16.
Reinforced PTFE disc seal.
Stainless steel body seat.
Double eccentric disc.
Bi-directional isolation.
Valves fitted with double regulating feature.
Actuator flange ISO 5211/1.
To suit flange connections BS EN 1092-2 PN25, alternative flanges available.

DIMENSIONS AND WEIGHTS

Nom Size	mm	50	65	80	100	125	150
A	mm	43	46	64	64	70	76
B	mm	123	131	150	175	187	218
H	mm	215	215	220	281	294	317
C	mm	27	27	27	35	35	42
D dia	mm	125	200	200	250	300	300
E	mm	39	39	39	52	52	67
F	mm	152	159	159	184	197	223
Weight	kg	10	12	17	24	33	47

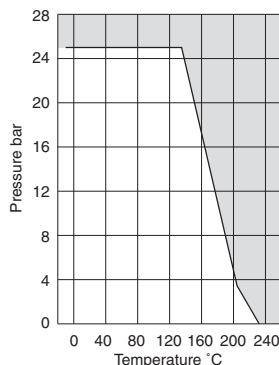

For Commissioning Valve Coefficients please refer to pages 47-49.

Every effort has been made to ensure that the information contained in this publication is accurate at the time of publishing. Hattersley Ltd assumes no responsibility or liability for typographical errors or omissions or for any misinterpretation of the information within the publication and reserves the right to change without notice.

Fig. 4993G Steel Fully-lugged Double Regulating Valve

FEATURES AND BENEFITS

- Precise flow regulation
- Flanged with handwheel – easy to install and operate
- Positive flow control at all handwheel settings
- Bi-directional isolation
- Double eccentric disc



MATERIAL SPECIFICATION

Component	Material	Specification	
		BS EN	ASTM
Body	Steel	10213-2 GP240GH	A216 WCB
Body Seat	Stainless Steel	10270 X10CrNi18-8	A276-304
Disc	Stainless Steel	10270 X10CrNi18-8	A276-304
Disc Seal Ring	PTFE or PTFE/Neoprene		
Retaining Ring	Stainless Steel	10270 X10CrNi18-8	A276-304
Stem	Stainless Steel	10270 X10CrNi18-8	A276-304
Disc Pin	Stainless Steel	10270 X10CrNi18-8	A276-304
Bottom Cap	Steel		
Gland Packing	PTFE Graphite		
Bearings	Bronze-PTFE		
Gearbox	Cast Iron	1561 EN-JL1030	A126 Cl B
Handwheel	Stainless Steel		

DIMENSIONAL DRAWINGS

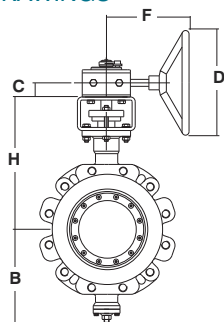

PRESSURE/TEMPERATURE RATING

25 bar from -10 to 135°C
20.7 bar at 149°C
3.4 bar at 204°C

TEST PRESSURES (HYDRAULIC)

Body: 37.5 bar
Seat: 27.5 bar

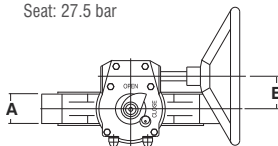

DIMENSIONS AND WEIGHTS

Nom Size	mm	200	250	300	350	400	450	500
A	mm	89	114	114	127	140	152	152
B	mm	294	333	382	398	448	473	555
H	mm	369	396	461	477	557	583	643
C	mm	42	50	50	50	66	66	66
D dia	mm	300	457	457	457	610	610	610
E	mm	67	90	123	154	138	138	138
F	mm	223	279	331	356	477	477	477
Weight	kg	73	126	167	243	340	454	493

SPECIFICATION

Designed to BS EN 593:2009.
Face to face dimensions to BS EN 558-1 basic series 16.
Reinforced PTFE disc seal.
Stainless steel body seat.
Double eccentric disc.
Bi-directional isolation.
Valves fitted with double regulating feature
Actuator flange ISO 5211/1.
To suit flange connections BS EN 1092-2 PN25, alternative flanges available.

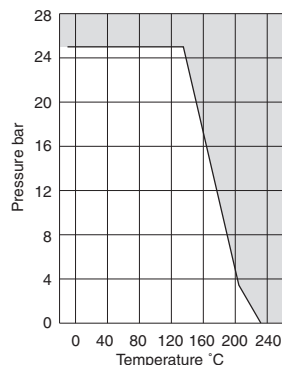

For Commissioning Valve Coefficients please refer to pages 47-49.

Every effort has been made to ensure that the information contained in this publication is accurate at the time of publishing. Hattersley Ltd assumes no responsibility or liability for typographical errors or omissions or for any misinterpretation of the information within the publication and reserves the right to change without notice.

Fig. 4993G Steel Fully-lugged Double Regulating Valve

FEATURES AND BENEFITS

- Precise flow regulation
- Flanged with handwheel – easy to install and operate
- Positive flow control at all handwheel settings
- Bi-directional isolation
- Double eccentric disc



MATERIAL SPECIFICATION

Component	Material	Specification	
		BS EN	ASTM
Disc Seal Ring	PTFE or PTFE/Neoprene		
Retaining Ring	Stainless Steel	10270 X10CrNr18-8	A276-304
Stem	Stainless Steel	10270 X10CrNr18-8	A276-304
Disc Pin	Stainless Steel	10270 X10CrNr18-8	A276-304
Bottom Cap	Steel		
Gland Packing	PTFE Graphite		
Bearings	Bronze-PTFE		
Gearbox	Cast Iron	1561 EN-JL1030	A126 Cl B
Handwheel	Steel		
Body	Steel	10213-2 GP240GH	A216 WCB
Body Seat	Stainless Steel	10270 X10CrNr18-8	A276-304
Disc	Stainless Steel	10270 X10CrNr18-8	A276-304

DIMENSIONAL DRAWINGS

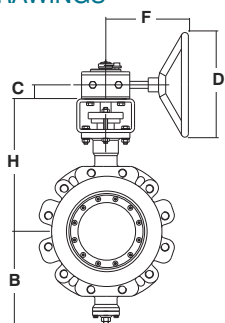

PRESSURE/ TEMPERATURE RATING

40 bar from -10 to 90°C
20.7 bar at 149°C
3.4 bar at 204°C

TEST PRESSURES (HYDRAULIC)

Body: 60 bar
Seat: 44 bar

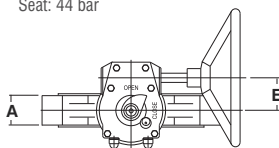

SPECIFICATION

Designed to BS EN 593:2009.
Face to face dimensions to BS EN 558-1 basic series 16.
Reinforced PTFE disc seal.
Stainless steel body seat.
Double eccentric disc.
Bi-directional isolation.
Valves fitted with double regulating feature.
Actuator flange ISO 5211/1.
To suit flange connections BS EN 1092-2 PN40, alternative flanges available.

DIMENSIONS AND WEIGHTS

Nom Size	mm	50	65	80	100	125	150
A	mm	43	46	64	64	70	76
B	mm	123	131	150	175	187	218
H	mm	215	215	220	281	294	317
C	mm	27	27	27	35	35	42
D dia	mm	125	200	200	250	300	300
E	mm	39	39	39	52	52	67
F	mm	152	159	159	184	197	223
Weight	kg	10	12	17	24	33	47

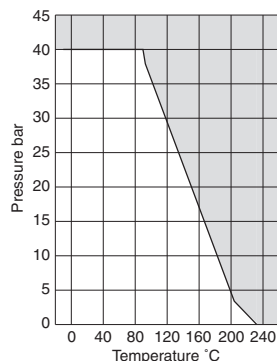

For Commissioning Valve Coefficients please refer to pages 47-49.

Every effort has been made to ensure that the information contained in this publication is accurate at the time of publishing. Hattersley Ltd assumes no responsibility or liability for typographical errors or omissions or for any misinterpretation of the information within the publication and reserves the right to change without notice.

Fig. 4993G Steel Fully-lugged Double Regulating Valve

FEATURES AND BENEFITS

- Precise flow regulation
- Flanged with handwheel – easy to install and operate
- Positive flow control at all handwheel settings
- Bi-directional isolation
- Double eccentric disc



MATERIAL SPECIFICATION

Component	Material	Specification	
		BS EN	ASTM
Body	Steel	10213-2 GP240GH	A216 WCB
Body Seat	Stainless Steel	10270 X10CrNr18-8	A276-304
Disc	Stainless Steel	10270 X10CrNr18-8	A276-304
Disc Seal Ring	PTFE or PTFE/Neoprene		
Retaining Ring	Stainless Steel	10270 X10CrNr18-8	A276-304
Stem	Stainless Steel	10270 X10CrNr18-8	A276-304
Disc Pin	Stainless Steel	10270 X10CrNr18-8	A276-304
Gland Packing	PTFE Graphite		
Bearings	Bronze-PTFE		
Gearbox	Cast Iron	1561 EN-JL1030	A126 Cl B
Handwheel	Steel		

DIMENSIONAL DRAWINGS

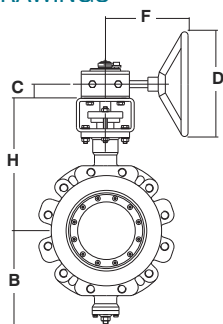

PRESSURE/TEMPERATURE RATING

40 bar from -10 to 90°C
20.7 bar at 149°C
3.4 bar at 204°C

TEST PRESSURES (HYDRAULIC)

Body: 60 bar
Seat: 44 bar

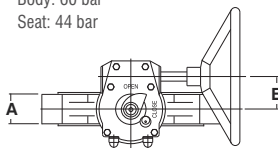

SPECIFICATION

Designed to BS EN 593:2009.
Face to face dimensions to BS EN 558-1 basic series 16.
Reinforced PTFE disc seal.
Stainless steel body seat.
Double eccentric disc.
Bi-directional isolation.
Valves fitted with double regulating feature.
Actuator flange ISO 5211/1.
To suit flange connections BS EN 1092-2 PN40, alternative flanges available.

DIMENSIONS AND WEIGHTS

Nom Size	mm	200	250	300	350	400	450	500
A	mm	89	114	114	127	140	152	152
B	mm	294	333	382	398	448	473	555
H	mm	369	396	461	477	557	583	643
C	mm	42	50	50	50	66	66	66
D dia	mm	300	457	457	457	610	610	610
E	mm	67	90	123	154	138	138	138
F	mm	223	279	331	356	477	477	477
Weight	kg	79	143	203	288	415	469	589

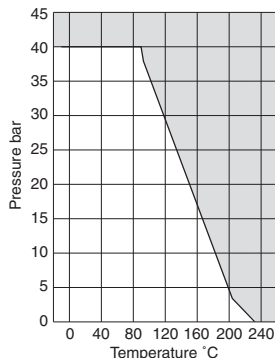

For Commissioning Valve Coefficients please refer to pages 47-49.

Every effort has been made to ensure that the information contained in this publication is accurate at the time of publishing. Hattersley Ltd assumes no responsibility or liability for typographical errors or omissions or for any misinterpretation of the information within the publication and reserves the right to change without notice.

Cast Iron and Steel Commissioning Valves Coefficients

Fig. M2000

Nom Size	mm	50	65	80	100	125	150	200
Flow Kv		71.91	155.9	217.3	380.2	576.6	830.8	1412
Headloss Factor		0.45	0.4	0.4	0.35	0.35	0.35	0.35
Kvs		48.24	98.58	137.4	224.9	341.1	491.5	835.4

Nom Size	mm	250	300	350	400	450	500	600
Flow Kv		2116	3073	3810	4968	6087	7958	11621
Headloss Factor		0.35	0.35	0.35	0.35	0.35	0.35	0.35
Kvs		1252	1818	2254	2939	3601	4708	6875

Fig. M3000

Nom Size	mm	50	65	80	100	125	150	200	250	300
Flow Kv		-	155.9	217.3	380.2	576.6	830.8	1412	2116	3073
Headloss Factor		-	0.4	0.4	0.35	0.35	0.35	0.35	0.35	0.35
Kvs		-	98.58	137.4	224.9	341.1	491.5	835.4	1252	1818

Fig. M733DR

Nom Size	mm	50	65	80	100	125	150	200	250	300
Flow Kv (fully open)		48.39	78.16	114.1	198.3	312.8	438.2	833.3	1185	1450

Fig. M737

Nom Size	mm	50	65	80	100	125	150	200	250	300
Flow Kv (fully open)		48.39	78.16	114.1	198.3	312.8	438.2	833.3	1185	1450
Kvs		49.47	81.79	128.1	223.9	349.4	445.9	889.5	1185	1450

Fig. 5953G

Nom Size	mm	50	65	80	100	125	150	200	250	300
Headloss Factor		0.45	0.4	0.4	0.35	0.35	0.35	0.35	0.35	0.35
Kvs		48.24	98.58	137.4	224.9	341.1	491.5	835.4	1252	1818

Fig. 5973G

Nom Size	mm	50	65	80	100	125	150	200	250	300
Headloss Factor		0.45	0.4	0.4	0.35	0.35	0.35	0.35	0.35	0.35
Kvs		48.24	98.58	137.4	224.9	341.1	491.5	835.4	1252	1818

Fig. 4983G PN25

Nom Size	mm	50	65	80	100	125	150	200	250	300
Headloss Factor		1.86	0.95	0.50	0.29	0.37	0.43	0.31	0.56	0.33
Kvs		85	204	370	820	982	1353	2923	3374	6350

Every effort has been made to ensure that the information contained in this publication is accurate at the time of publishing. Hattersley Ltd assumes no responsibility or liability for typographical errors or omissions or for any misinterpretation of the information within the publication and reserves the right to change without notice.

Bronze Commissioning Valves Coefficients

Headloss Factor %

The headloss across a metering station is less than the differential pressure (ϵP) signal indicated at the pressure tappings as shown on the metering station flow charts.

The value of headloss for the metering station is shown as a percentage of the signal in the tables below.

The headloss of the DRV is obtained from the graph at the fully open position at the particular design flow rate. The total headloss of the metering station and DRV (commissioning set), when directly coupled or independently located, is the summation of the two separate values.

Fig. 1000

Nom Size	mm	15	22	28	32	40	50
Flow Kv		2.244	5.4	9.63	21.68	34.38	71.1
Headloss Factor		0.75	0.6	0.6	0.5	0.45	0.45
Kvs		1.943	4.181	7.46	15.33	23.06	47.7

Fig. 1000C

Nom Size	mm	15
Flow Kv		2.354
Headloss Factor		0.75
Kvs		2.039

Fig. 1000M

Nom Size	mm	15
Flow Kv		1.101
Headloss Factor		0.83
Kvs		1.003

Fig. 1000L

Nom Size	mm	15
Flow Kv		0.533
Headloss Factor		0.9
Kvs		0.506

Fig. 1000MC

Nom Size	mm	15
Flow Kv		1.129
Headloss Factor		0.83
Kvs		1.029

Fig. 1000LC

Nom Size	mm	15
Flow Kv		0.539
Headloss Factor		0.9
Kvs		0.511

Fig. 1432, 1432L, 1432C, 1432LC

Nom Size	in	1/2L	1/2	3/4	1	1 1/4	1 1/2	2
1432 Flow Kv (fully open)		2.26	2.14	3.6	6.37	12.3	21.3	31.3
1432L Flow Kv		-	2.26	-	-	-	-	-
1432C Flow Kv		-	2.14	3.6	-	-	-	-
1432LC Flow Kv		-	2.26	-	-	-	-	-

Fig. 2432, 2432LM, 2432LL

Nom Size	in	1/2	3/4	1	1 1/4	1 1/2	2
2432 Flow Kv		1.549	2.995	5.31	10.7	18.11	28.65
2432LM Flow Kv		0.99	-	-	-	-	-
2432LL Flow Kv		0.519	-	-	-	-	-

Every effort has been made to ensure that the information contained in this publication is accurate at the time of publishing. Hattersley Ltd assumes no responsibility or liability for typographical errors or omissions or for any misinterpretation of the information within the publication and reserves the right to change without notice.

Bronze Commissioning Valves Coefficients

Fig. 1732, 1732M, 1732L, 1732C, 1732MC, 1732LC

Nom Size	in	1/2L	1/2M	1/2	3/4	1	1 1/4	1 1/2	2
1732 Flow Kv		-	-	1.87	3.14	5.59	10.8	18.1	29.1
1732 Kvs		-	-	1.943	4.181	7.46	15.33	23.06	47.7
1732M Flow Kv		-	-	1.06	-	-	-	-	-
1732M Kvs		-	-	1.003	-	-	-	-	-
1732L Flow Kv		-	-	0.57	-	-	-	-	-
1732L Kvs		-	-	0.506	-	-	-	-	-
1732C Flow Kv		-	-	1.87	3.14	-	-	-	-
1732C Kvs		-	-	2.037	4.457	-	-	-	-
1732MC Flow Kv		-	-	1.06	-	-	-	-	-
1732MC Kvs		-	-	1.029	-	-	-	-	-
1732LC Flow Kv		-	-	0.57	-	-	-	-	-
1732LC Kvs		-	-	0.511	-	-	-	-	-

Fig. 1832, 1832M, 1832L

Nom Size	in	1/2	3/4
1832 Flow Kv		1.703	2.973
1832 Kvs		1.943	4.181
1832M Flow Kv		1.056	-
1832M Kvs		1.003	-
1832L Flow Kv		0.532	-
1832L Kvs		0.506	-

Fig. 1200DR

Nom Size	mm	15	20	25	35	40	50
Flow Kv		4.74	9.96	18.46	26.71	42.15	70.95

Fig. 4000

Nom Size	mm	15	20	25	35	40	50
Flow Kv		2.293	5.331	9.506	22.15	36.36	70.91
Headloss Factor		0.75	0.6	0.6	0.5	0.45	0.45
Kvs		1.986	4.129	7.363	15.66	24.39	47.57

Every effort has been made to ensure that the information contained in this publication is accurate at the time of publishing. Hattersley Ltd assumes no responsibility or liability for typographical errors or omissions or for any misinterpretation of the information within the publication and reserves the right to change without notice.



The Baltic Arts Centre, Gateshead, Tyne & Wear
Specification: Range of Hattersley Commissioning and Traditional Valves

Differential Pressure Control Valves

Extremely efficient, the DPCV is set to a maximum differential pressure limit, under dynamic balancing conditions, which ensures flow cannot exceed a desired rate. It therefore helps reduce energy consumption and the risk of noise, and simplifies the commissioning process.

The EPM diaphragm, which separates the upper and lower chamber of the valve, in combination with the balanced piston, is key to stabilising differential pressure within the system. The rubber-seated piston, controlled by the diaphragm, closes the valve on rising differential pressure and opens it on falling differential pressure. The valve will continue to move in this way until equilibrium of pressure is achieved. This ensures the maximum desired flow rates or differential pressures are not exceeded.

Installing a DPCV in a system to control differential pressure can also help to minimise the risk of noise.

Installing a DPCV in a circuit ensures the system remains balanced, independent from any changes in other areas of the circuit, which greatly simplifies the balancing and commissioning procedure. It also maintains the control authority of the 2 port control valve.

Available in sizes from DN15 to DN50, in flow and return configurations, the DPCV operates at a temperature range of -10°C to 100°C and is PN16 rated. The pressure differential is set on installation, across a 20 to 80 kPa range, and can be easily adjusted on commissioning as required by the changing conditions.

Hattersley offers other accessories which are highly recommended in order to achieve an optimum performance. See page 57 for details.



Differential Pressure Control Valves Features and Benefits

Diaphragm

Separates and balances the upper and lower chambers and therefore the differential pressure. The Diaphragm reacts quickly to fluctuation in pressure.

Lower Chamber*

The lower pressure, after the load, is transmitted to the lower chamber.

Body

PN16 rated. Compact design allows for installation in limited spaces.

Male Threaded Ends

Male and female adapters are available so that the DPCV can be placed in any standard pipework. See page 55 for details. The valve is easily replaceable without disturbing the surrounding pipework.

Upper Chamber*

The higher pressure, before the load, is transmitted to the upper chamber.

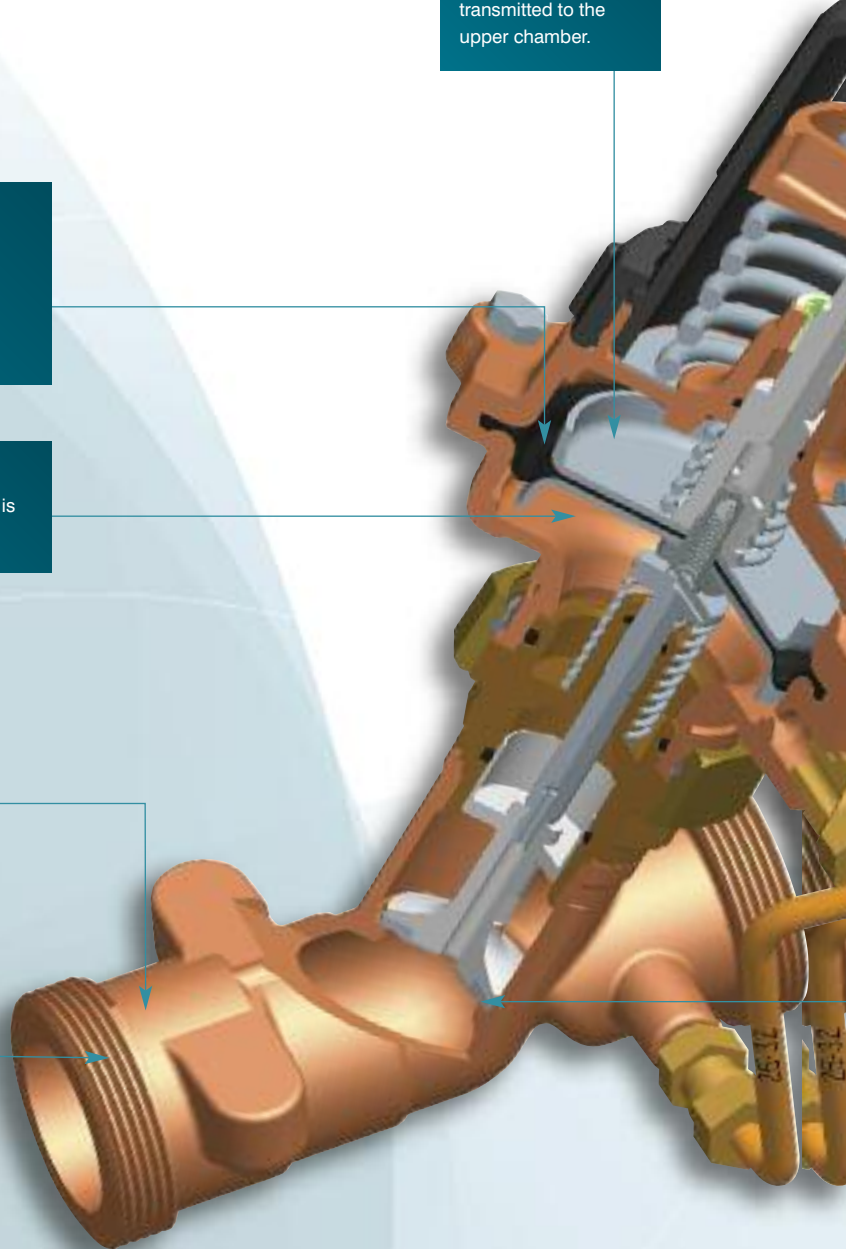

*Please see page 55 for typical installation layouts.



Impulse Tube

Alongside the DPCV, an impulse tube is supplied as standard. It is essential to the valve's performance as it taps pressure from the other side of the circuit and links it to the valve's chambers.



Adjuster

Easily sets differential pressure across a 20-80 kPa range, and can be adjusted to maintain desired flow rates or differential pressure, matching circuit conditions.

Integral Impulse Tube*

Pressure from before the load is linked to the upper chamber (flow mounted configuration only).

Rubber Seated Piston

Closes on rising differential pressure and opens on falling differential pressure. Maintains the desired system flow rate.

Fig. F300 Flow
Fig. R300 Return

FEATURES AND BENEFITS

- Maintains a consistent performance
- Use with variable speed pumps within HVAC systems
- Enhances efficiency
- Reduces energy consumption
- Simplifies the commissioning process
- Easily adjusted to meet future conditions



MATERIAL SPECIFICATION

Component	Material
Body	Bronze BS EN 1982 (CC491K)
Bonnet	Bronze BS EN 1982 (CC491K)
Chamber	Bronze BS EN 1982 (CC491K)
Adjuster	Nylon Grade PA6
Stem / Piston	Stainless Steel BS EN 10088 - 1:2005
Diaphragm	Rubber EPM
O-Ring Seals	Rubber EPDM

DIMENSIONS AND WEIGHTS

Size		DN15	DN20	DN25	DN32	DN40	DN50
A	mm	90	96	114	132.5	150.5	184
B	mm	175	175	185	190	195	205
End Connection	in	3/4"	1"	1 1/4"	1 1/2"	1 3/4"	2 3/8"
		BSP Parallel Male					
Weight	kg	2.34	2.39	2.62	2.76	3.07	3.57

DIMENSIONAL DRAWINGS

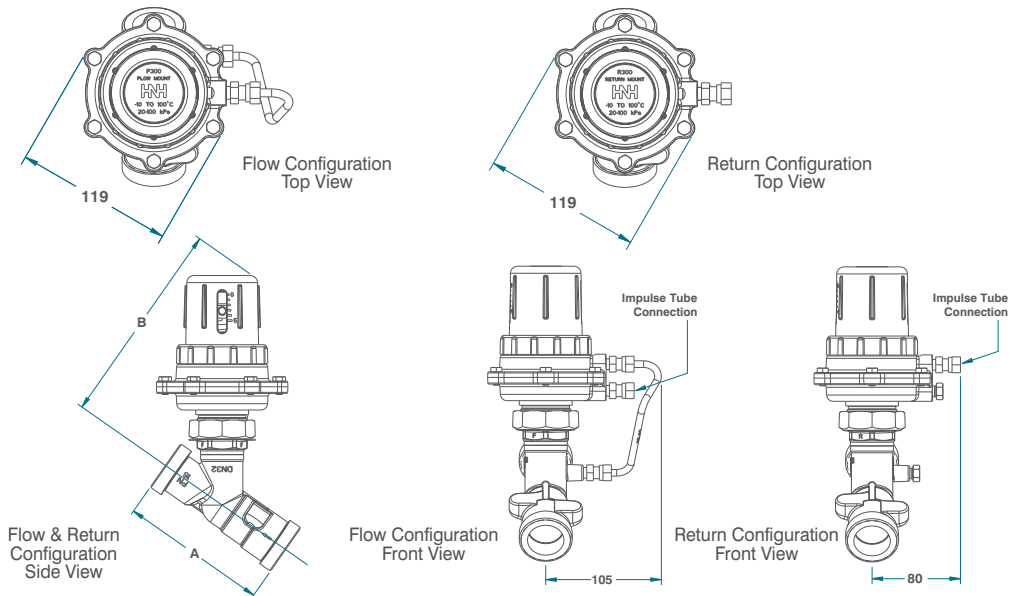

Every effort has been made to ensure that the information contained in this publication is accurate at the time of publishing. Hattersley Ltd assumes no responsibility or liability for typographical errors or omissions or for any misinterpretation of the information within the publication and reserves the right to change without notice.

DPCV Accessories



COMPANION VALVE

Hattersley highly recommends the use of a companion valve as a part of the circuit. As well as providing standard flow measuring and regulating features, the companion valve has an integral tapping point for an impulse tube to link the valve and the DPCV.

Additional impulse tubes are available on request.



ISOLATING BALL VALVE

Installing a ball valve in the impulse tube allows isolation of the tube during flushing. This helps to ensure that the tube is kept free from debris.



MALE AND FEMALE TAILPIECES

Hattersley offers additional male and female BSP taper threaded couplings, giving the contractors a variety of options on installation and enabling a fast and easy connection to the pipework.

TYPICAL INSTALLATION LAYOUTS

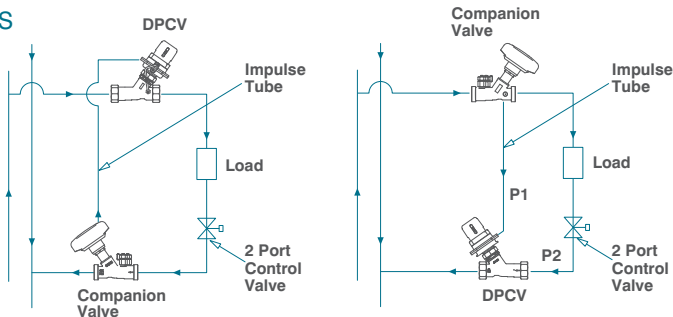

Example Flow Configuration (F300)

Example RETURN Configuration (R300)

Every effort has been made to ensure that the information contained in this publication is accurate at the time of publishing. Hattersley Ltd assumes no responsibility or liability for typographical errors or omissions or for any misinterpretation of the information within the publication and reserves the right to change without notice.

Companion Valve – DP1732 - Standard Flow, DP1732M - Medium Flow, DP1732L - Low Flow

FEATURES AND BENEFITS

- Has an integral tapping point for the impulse tube to link with the Hattersley DPCV
- Integral orifice and test points provide precise and accurate flow measurement
- Easy to operate with Double Regulating handwheel and numerical position indicator
- Positive flow control at all handwheel settings
- Manufactured using WRAS Approved materials
- Can be used plugged, as supplied, for PN25 applications or with an impulse tube for PN16 applications
- Characterised regulating disc tends towards equal percentage performance
- Male threaded ends for easy connection to all pipework systems



MATERIAL SPECIFICATION

Component	Material
Body	Bronze - BS EN 1982: CC491K
Bonnet DN15 to DN32	DZR Brass - BS EN 12164: CW602N
Bonnet DN40 & DN50	Bronze - BS EN 1982: CC491K
Stem/Disc	DZR Brass - BS EN 12164: CW602N
'O' Ring Seal	EPDM Rubber WRAS Approved
Plug R1/8 Inch	DZR Brass - BS EN 12164: CW602N
Fig. 631 Test Points	DZR Brass - BS EN 12164: CW602N

DIMENSIONAL DRAWINGS

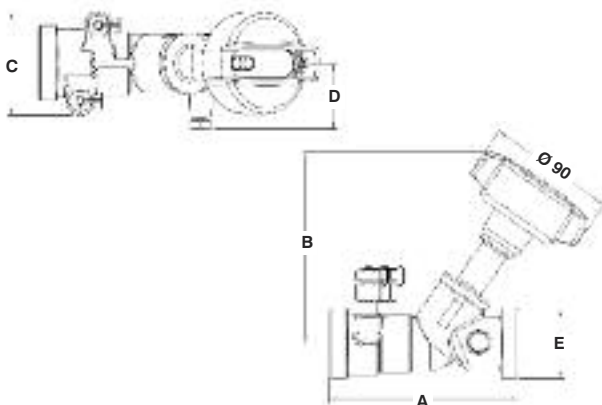

PRESSURE/TEMPERATURE RATING WHEN IMPULSE TUBE IS INSERTED

Temperature °C	-10 - 30	40	50	65	80	90	100	110	120
Pressure bar	16	14.3	12.6	10	8.7	7.8	6.9	6	5

WHEN PLUGGED

Temperature °C	-10 - 30	110	120
Pressure bar	25	23.4	21.8

DIMENSIONS AND WEIGHTS

Flg No.	DP 1732	DP 1732M	DP 1732L	DP 1732	DP 1732	DP 1732	DP 1732	DP 1732	
A	mm	90	90	90	96	114	132.5	150.5	184
B	mm	105	105	105	106	127	128	143	144
C	mm	50	50	50	54	62	66	70	78
D	mm	34	34	34	36	39	43	46	48
E	mm	G ³ / ₄ "	G ³ / ₄ "	G ³ / ₄ "	G1"	G1 ¹ / ₄ "	G1 ¹ / ₂ "	G1 ³ / ₄ "	G2 ³ / ₈ "
Kv		1.87	1.06	0.57	3.14	5.59	10.80	18.10	29.10
Kvs		1.943	1.003	0.506	4.181	7.46	15.33	23.06	47.7
Weight	kg	0.60	0.60	0.60	0.65	0.99	1.12	1.48	2.13

END CONNECTIONS

Male parallel threads to ISO 228

SPECIFICATION

Inside screw non-rising stem.

Characterised regulating disc.

Integral fixed orifice.

Supplied with 2 Fig. 631 test points fitted.

Every effort has been made to ensure that the information contained in this publication is accurate at the time of publishing. Hattersley Ltd assumes no responsibility or liability for typographical errors or omissions or for any misinterpretation of the information within the publication and reserves the right to change without notice.

Hook-Up II

Hook-Up II provides flow control, measurement, flushing and isolation, using bronze and DZR brass components. It is PN16 rated with versions suitable for chilled, low and medium temperature hot water, ranging from -10°C to a maximum of 120°C. Available in 1/2", 3/4" and 1" sizes.

The Hook-Up II is pre-fabricated using proven, stringently tested Hattersley products. The fully assembled unit is tested to BS EN 12266-1:2003 prior to delivery. For a complete list of components see the specification for each figure number on the following pages.

The newly designed Hook-Up II features a number of design improvements. A single cast H-Body reduces the number of joints, the weight and the size of the module. A combination of components can be selected to attach to the H-Body, depending on the site specifications.

BENEFITS

For the design engineer there are many advantages. With all the components supplied as one pre-tested unit, minimal design involvement is needed and the performance of the entire unit is known in advance.

For the contractor the need for only four connections offers significant reductions in costs. The fully tested, guaranteed and standardised components are pressure tested before leaving Hattersley. Apart from the cleaning of the strainer, the Hook-Up II is designed to be maintenance free.

This brochure outlines our standard range but other configurations can be made by special arrangement. Our technical team will assist with valve sizing etc.



Flow and Return Connections:

- A** Flow Connection from Pipework
- B** Flow Connection to the Terminal Unit
- C** Return Connection from the Terminal Unit
- D** Return Connection to Pipework

Commissioning Set

Adjusts and sets the flow rate with proven high accuracy. Customers can opt for manually set FODRV valve or a motorised FODRV valve (left).



2

Centralised Isolation Valve

Allows easy back flushing, forward flushing and isolation. An extension stem is added for chilled water services

1



Figure 266 for heated water is shown here.

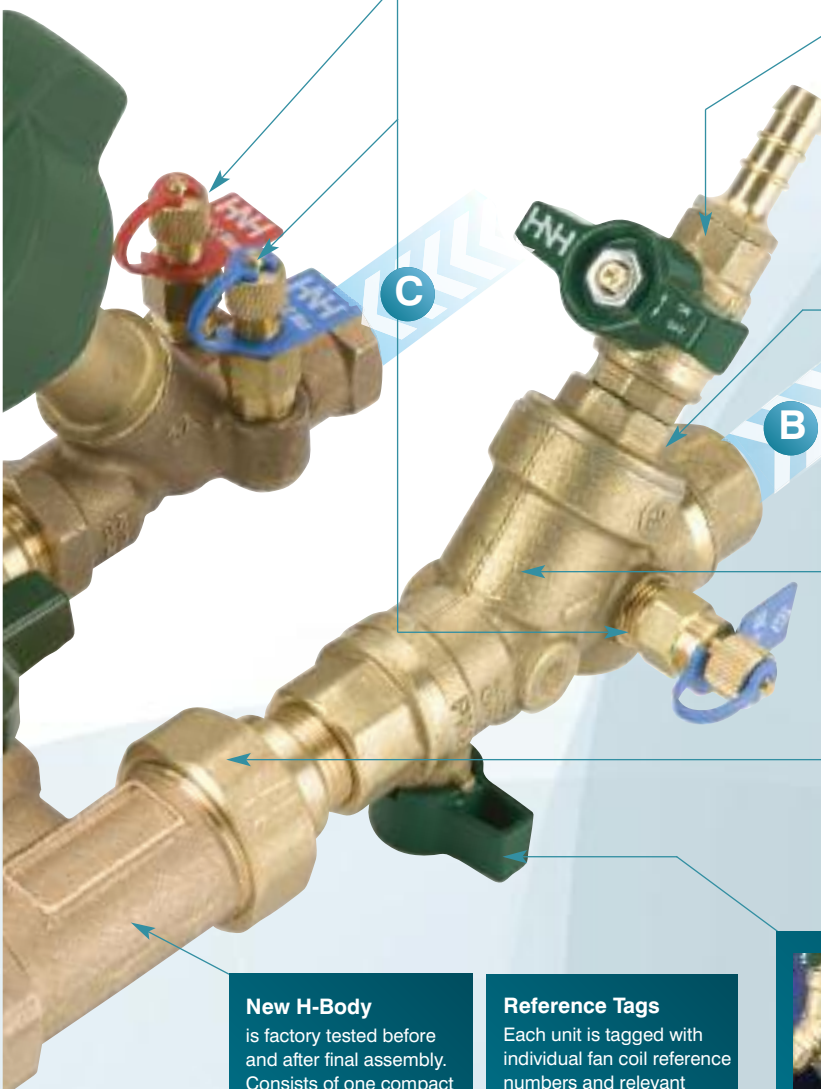

Pressure Test Points
 On commissioning valves for flow measurement.
 On strainer to check pressure drop across load.

3

Draincock
 For routine maintenance, allows flushing of strainer without need to remove basket.

4

End Connectors
 Simple connection to system. BSP female threads allow connections to any possible pipes using adaptors. Installed directly on flow and return connections of heating and cooling terminal units ie. fan coils and chilled beams.

5

Strainer (optional)
 Keeps system clean. Filters flow before it reaches terminal unit.

6

Union Connector
 Allows custom alignment and features an integral O-Ring to ensure joints are pressure tight.

7

New H-Body
 is factory tested before and after final assembly. Consists of one compact casting; reducing weight and size.

10

Reference Tags
 Each unit is tagged with individual fan coil reference numbers and relevant customer information as requested.

9

Extension Stems
 For chilled water services, extension stems are fitted as standard to the isolation ball valve to enable lagging.

8

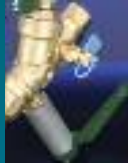





Project: Wembley WO5 development, London

Client: Quintain

Architect: PRP/The Manser Practice

Project Manager: Stace LLP

Mechanical Contractor: FCS Services

Specification: Hattersley Hook-Up II

Hattersley Hook-Up II flow management modules have been specified for the HVAC system of Quintain's new mixed-use development in the Wembley WO5 district, which surrounds the Wembley Arena. The project will have 3 phases; the student accommodation will be constructed first, followed by apartments and then a 4* Hilton Hotel. Hattersley valves will be installed in all stages of the development to provide heating, ventilation and air conditioning.

The Hook-Up II is ideal for this project as it provides easy flow control and accurate flow measurement, along with flushing and isolating capabilities from a single, pre-fabricated unit. Only four connections need to be made on-site, speeding up installation time and reducing costs. All modules are tested in advance so design engineers know the exact performance of the entire unit prior to installation.

The construction of student halls of residence has just started and will comprise 656 bedrooms, communal kitchens and car parking over 11 floors.

Fig. C266, H266 Manual (with Drain and Strainer)

FEATURES AND BENEFITS

- Ultra compact, prefabricated unit
- Provides flow control, measurement, flushing and isolation
- Can be tailored to customer's specifications
- For use with Chilled Water, LTHW and MTHW
- Reduces time, costs and specification risks



Fig. C266 for chilled water



Fig. H266 for heated water

MATERIAL SPECIFICATION

Component	Material	Specification BS EN
1. H-Body	Bronze	1982 CC491K
2. Fig. 1732/M/L FODRV	Bronze	1982 CC491K
3. Fig. 1807 Strainer Ball	DZR Brass	12165 CW602N
4. Union Connector	DZR Brass	12164 CW602N
5. Fig. 103 Blow Down Valve	DZR Brass	12165 CW602N
6. Fig. 631 Test Point	DZR Brass	12164 CW602N
7. Adaptors for 1" only*	DZR Brass	12164 CW602N
8. Union Nut	Brass	12164 CW614N

*For 1" system pipework, adaptors can be fitted to our standard units.

PRESSURE/TEMPERATURE RATING

PN16 -10 to 120°C

TEST PRESSURES

Tested to BS EN 12266-1:2003

SPECIFICATION

Both modules can adopt a left or right-handed configuration.

SERVICE RATING

Figure C266 is suitable for chilled water applications.

Figure H266 is suitable for LTHW and MTHW applications.

DIMENSIONAL DRAWINGS

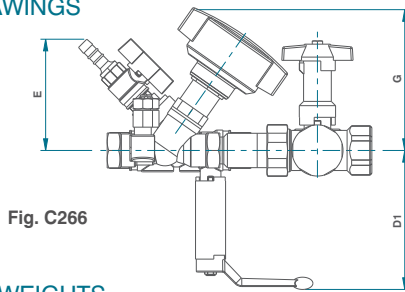

Fig. C266

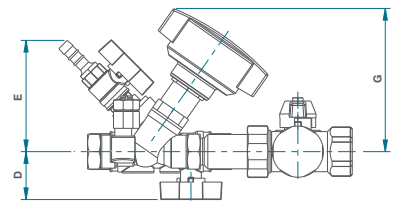
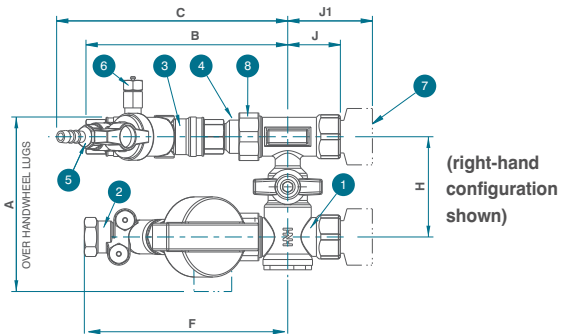

Fig. H266

DIMENSIONS AND WEIGHTS

Nom Size	mm	1/2 female	3/4 female	1 female
A	mm	143	143	150
B	mm	170	185	221
C	mm	205	215	251
D	mm	38	47	50
D1	mm	105	119	123
E	mm	110	120	120
F	mm	168	175	190
H	mm	80	80	80
J	mm	42	42	42
J1	mm	-	-	70
Weight	kg	2.35	2.70	3.40



Every effort has been made to ensure that the information contained in this publication is accurate at the time of publishing. Hattersley Ltd assumes no responsibility or liability for typographical errors or omissions or for any misinterpretation of the information within the publication and reserves the right to change without notice.

Fig. C268, H268 Manual (with Drain and Strainer)

FEATURES AND BENEFITS

- Ultra compact, prefabricated unit
- Provides flow control, measurement, flushing and isolation
- Can be tailored to customer's specifications
- For use with Chilled Water, LTHW and MTHW
- Reduces time, costs and specification risks



Fig. C268 for chilled water



Fig. H268 for heated water

MATERIAL SPECIFICATION

Component	Material	Specification BS EN
1. H-Body (DN15 - DN20)	Bronze	1982 CC491K
2. Fig. 1732/M/L DRV	Bronze	1982 CC491K
3. Fig. 100 Ball Valve	DZR Brass	12165 CW602N
4. Union Connector	DZR Brass	12165 CW602N
5. Adaptors for 1" only*	DZR Brass	12165 CW602N
6. Union Nut	Brass	12164 CW614N

*For 1" system pipework, adaptors can be fitted to our standard units.

PRESSURE/ TEMPERATURE RATING

PN16 -10 to 120°C

TEST PRESSURES

Tested to BS EN 12266-1:2003

SPECIFICATION

Both modules can adopt a left or right-handed configuration.

SERVICE RATING

Figure C268 is suitable for chilled water applications.

Figure H268 is suitable for LTHW and MTHW applications.

DIMENSIONAL DRAWINGS

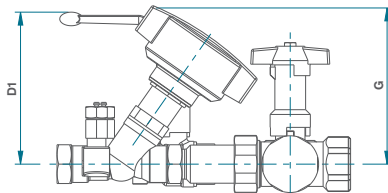

Fig. C268

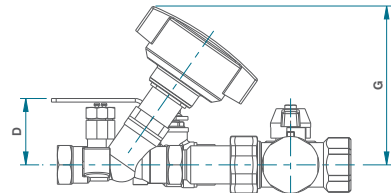
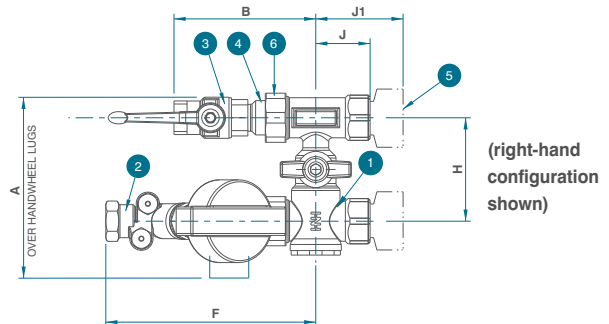

Fig. H268

DIMENSIONS AND WEIGHTS

Nom Size	mm	1/2 female	3/4 female	1 female
A	mm	143	143	150
B	mm	120	125	149
D	mm	45	54	57
D1	mm	110	119	123
F	mm	168	175	190
G	mm	110	111	132
H	mm	80	80	80
J	mm	42	42	42
J1	mm	-	-	70
Weight	kg	1.90	2.20	2.75



Every effort has been made to ensure that the information contained in this publication is accurate at the time of publishing. Hattersley Ltd assumes no responsibility or liability for typographical errors or omissions or for any misinterpretation of the information within the publication and reserves the right to change without notice.

Fig. C267 H267 MotoBalance (with Drain and Strainer)

FEATURES AND BENEFITS

- Ultra compact, prefabricated unit
- Provides flow control, measurement, flushing and isolation
- Can be tailored to customer's specifications
- For use with Chilled Water, LTHW and MTHW
- Reduces time, costs and specification risks



Fig. C267 for chilled water



Fig. H267 for heated water

MATERIAL SPECIFICATION

Component	Material	Specification BS EN
1. H-Body	Bronze	1982 CC491K
2. Fig. 1832/M/L FODRV	Bronze	1982 CC491K
3. Fig. 1807 Strainer Ball	DZR Brass	12165 CW602N
4. Union Connector	DZR Brass	12164 CW602N
5. Fig. 103 Blow Down Valve	DZR Brass	12165 CW602N
6. Fig. 631 Test Point	DZR Brass	12164 CW602N
7. Union Nut	Brass	12164 CW614N

PRESSURE/TEMPERATURE RATING

PN16 -10 to 120°C

TEST PRESSURES

Tested to BS EN 12266-1: 2003

SPECIFICATION

Both modules can adopt a left or right-handed configuration.

SERVICE RATING

Figure C267 is suitable for chilled water applications.

Figure H267 is suitable for LTHW and MTHW applications.

DIMENSIONAL DRAWINGS

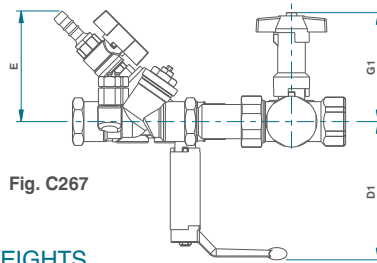

Fig. C267

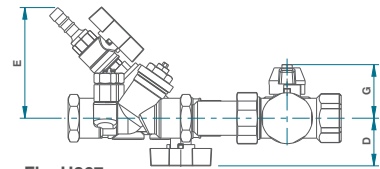
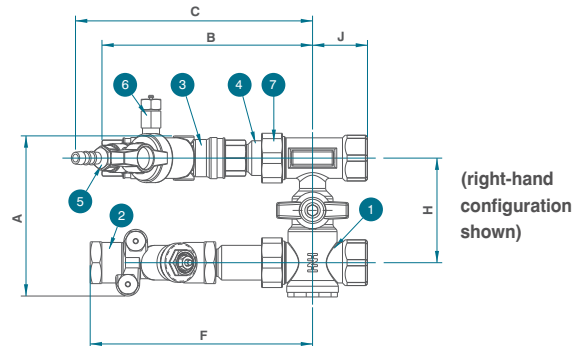

Fig. H267

DIMENSIONS AND WEIGHTS

Nom Size	mm	1/2 female	3/4 female
A	mm	125	125
B	mm	170	185
C	mm	205	215
D	mm	38	47
D1	mm	105	119
E	mm	110	120
F	mm	168	175
G	mm	43	43
G1	mm	85	85
H	mm	80	80
J	mm	42	42
Weight	kg	2.20	2.54



Every effort has been made to ensure that the information contained in this publication is accurate at the time of publishing. Hattersley Ltd assumes no responsibility or liability for typographical errors or omissions or for any misinterpretation of the information within the publication and reserves the right to change without notice.

Fig. C269, H269 MotoBalance (with Drain and Strainer)

FEATURES AND BENEFITS

- Ultra compact, prefabricated unit
- Provides flow control, measurement, flushing and isolation
- Can be tailored to customer's specifications
- For use with Chilled Water, LTHW and MTHW
- Reduces time, costs and specification risks

MATERIAL SPECIFICATION

Component	Material	Specification BS EN
1. H-Body (DN15 - DN20)	Bronze	1982 CC491K
2. Fig. 1832/M/L DRV	Bronze	1982 CC491K
3. Fig. 100 Ball Valve	DZR Brass	12165 CW602N
4. Union Connector	DZR Brass	12165 CW602N
5. Union Nut	Brass	12164 CW614N



Fig. C269 for chilled water



Fig. H269 for heated water

PRESSURE/ TEMPERATURE RATING

PN16 -10 to 120°C

TEST PRESSURES (HYDRAULIC)

Tested to BS EN 12266-1

SPECIFICATION

Both modules can adopt a left or right-handed configuration.

SERVICE RATING

Figure C269 is suitable for chilled water applications.

Figure H269 is suitable for LTHW and MTHW applications.

DIMENSIONAL DRAWINGS

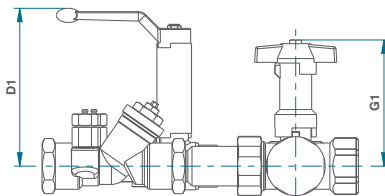

Fig. C269

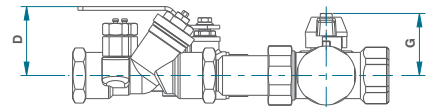
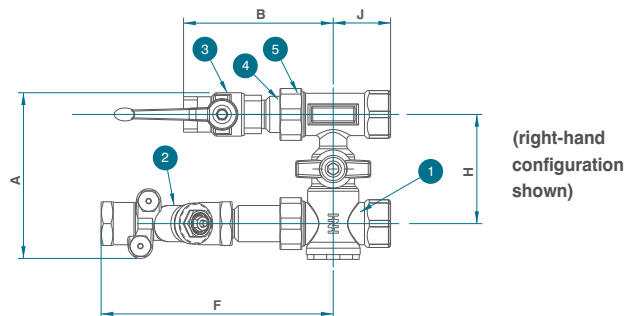

Fig. H269

DIMENSIONS AND WEIGHTS

Nom Size	mm	1/2 female	3/4 female
A	mm	125	125
B	mm	120	125
D	mm	45	54
D1	mm	110	119
F	mm	168	175
G	mm	43	43
G1	mm	85	85
H	mm	80	80
J	mm	42	42
Weight	kg	1.75	2.04



Every effort has been made to ensure that the information contained in this publication is accurate at the time of publishing. Hattersley Ltd assumes no responsibility or liability for typographical errors or omissions or for any misinterpretation of the information within the publication and reserves the right to change without notice.

Fig. C262, H262 Autoflow (with Drain and Strainer)

FEATURES AND BENEFITS

- Ultra compact, prefabricated unit
- Provides flow control, measurement, flushing and isolation
- Can be tailored to customer's specifications
- For use with Chilled Water, LTHW and MTHW
- Reduces time, costs and specification risks



Fig. C262 for chilled water



Fig. H262 for heated water

MATERIAL SPECIFICATION

Component	Material	Specification BS EN
1. H-Body	Bronze	1982 CC491K
2. Fig. 1051 Autoflow	DZR Brass	12165 CW602N
3. Fig. 1807 Strainer Ball	DZR Brass	12165 CW602N
4. Union Connector	DZR Brass	12164 CW602N
5. Fig. 103 Blow Down Valve	DZR Brass	12165 CW602N
6. Fig. 631 Test Point	DZR Brass	12164 CW602N
7. Adaptors for 1" only*	DZR Brass	12164 CW602N
8. Union Nut	Brass	12164 CW614N

*For 1" system pipework, adaptors can be fitted to our standard units.

**PRESSURE/
TEMPERATURE RATING**
PN16 -10 to 120°C

TEST PRESSURES
Tested to BS EN 12266-1:2003

SPECIFICATION

Both modules can adopt a left or right-handed configuration.

SERVICE RATING

Figure C262 is suitable for chilled water applications.

Figure H262 is suitable for LTHW and MTHW applications.

DIMENSIONAL DRAWINGS

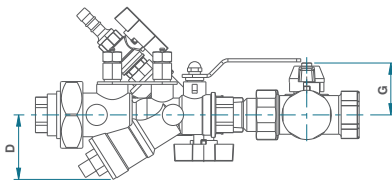

Fig. H262

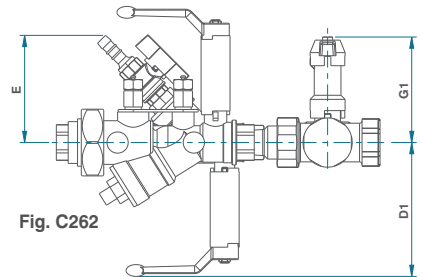
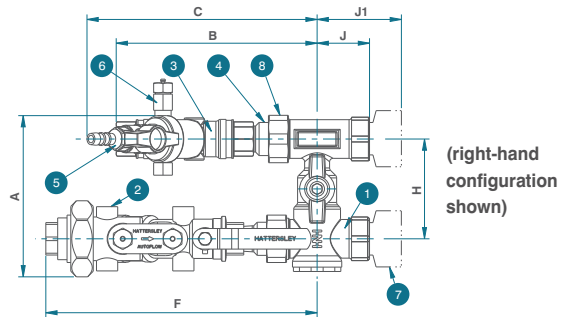

Fig. C262

DIMENSIONS AND WEIGHTS

Nom Size	mm	1/2 female	3/4 female	1 female
A	mm	130	135	140
B	mm	170	185	221
C	mm	205	215	251
D	mm	51	51	68
D1	mm	105	119	123
E	mm	110	120	120
F	mm	220	225	295
G	mm	43	43	43
G1	mm	85	85	85
H	mm	80	80	80
J	mm	42	42	42
J1	mm	-	-	70
Weight	kg	2.78	3.09	4.67



Every effort has been made to ensure that the information contained in this publication is accurate at the time of publishing. Hattersley Ltd assumes no responsibility or liability for typographical errors or omissions or for any misinterpretation of the information within the publication and reserves the right to change without notice.

Fig. C264, H264 Autoflow (with Drain and Strainer)

FEATURES AND BENEFITS

- Ultra compact, prefabricated unit
- Provides flow control, measurement, flushing and isolation
- Can be tailored to customer's specifications
- For use with Chilled Water, LTHW and MTHW
- Reduces time, costs and specification risks



Fig. C264 for chilled water



Fig. H264 for heated water

MATERIAL SPECIFICATION

Component	Material	Specification BS EN
1. H-Body (DN15 - DN20)	Bronze	1982 CC491K
2. Fig. 1051 Autoflow	DZR Brass	12165 CW602N
3. Fig. 100 Ball Valve	DZR Brass	12165 CW602N
4. Union Connector	DZR Brass	12165 CW602N
5. Adaptors for 1" only*	DZR Brass	12164 CW602N
6. Union Nut	Brass	12164 CW614N

*For 1" system pipework, adaptors can be fitted to our standard units.

PRESSURE/ TEMPERATURE RATING

PN16 -10 to 120°C

TEST PRESSURES

Tested to BS EN 12266-1: 2003

SPECIFICATION

Both modules can adopt a left or right-handed configuration.

SERVICE RATING

Figure C264 is suitable for chilled water applications.

Figure H264 is suitable for LTHW and MTHW applications.

DIMENSIONAL DRAWINGS

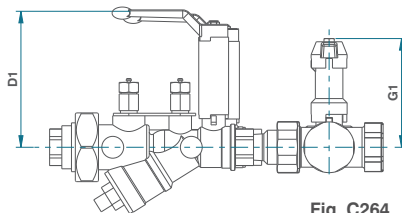

Fig. C264

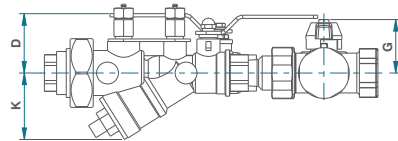
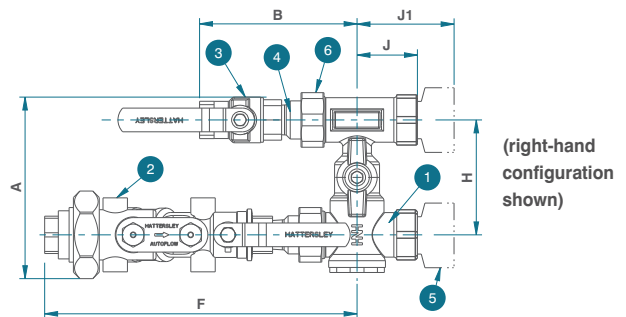

Fig. H264

DIMENSIONS AND WEIGHTS

Nom Size	mm	1/2 female	3/4 female	1 female
A	mm	130	135	140
B	mm	120	125	149
D	mm	45	54	57
D1	mm	110	119	123
F	mm	220	225	295
G	mm	43	43	43
G1	mm	85	85	85
H	mm	80	80	80
J	mm	42	42	42
J1	mm	-	-	70
K	mm	51	51	68
Weight	kg	2.33	2.59	4.07



(right-hand configuration shown)

Every effort has been made to ensure that the information contained in this publication is accurate at the time of publishing. Hattersley Ltd assumes no responsibility or liability for typographical errors or omissions or for any misinterpretation of the information within the publication and reserves the right to change without notice.



Gulf Hotel, Bahrain
Specification: Hattersley Globe and Butterfly Valves

MultiComm

On large projects, significant time and cost can be eliminated by enabling commissioning at convenient locations. Ends of corridors, or accessible cupboards can be used, which would also eliminate disruption to occupiers during maintenance works.

The MultiComm is an exceptionally efficient, practical and versatile system:

- Depending on flow rates, up to six terminals can be served from a single MultiComm unit.
- All units are custom built to suit site specification.
- All site connections can be made without the need to access the internal components.
- MultiComm is suitable for variable flow or constant flow systems.
- All connections are BSPT Female, enabling standard pipe or specialist adaptors to be used.
- Fan coil units can be flushed, vented and balanced without the time-consuming 'looping out' procedure. This can be carried out by one commissioning engineer instead of a team.
- A single strainer serves all circuits, eliminating the need for individual strainers.
- All systems can be flushed through the unique Hook-Up H-Body.
- The single DPCV maintains constant differential pressure between manifolds.

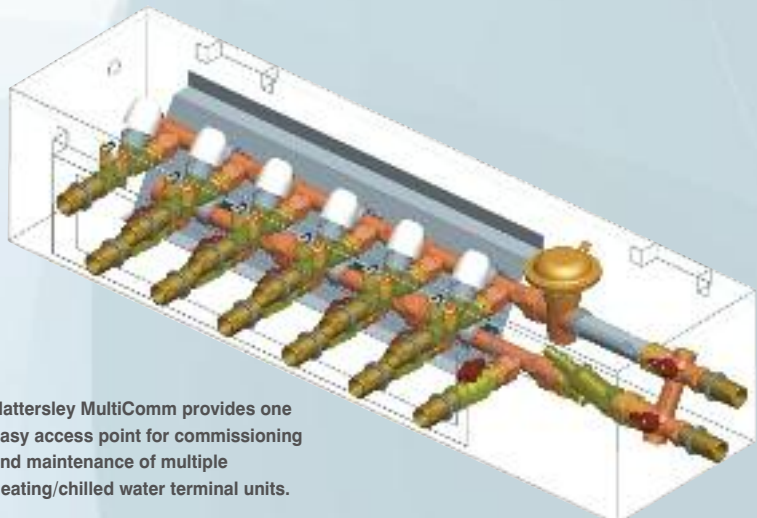

Hattersley MultiComm provides one easy access point for commissioning and maintenance of multiple heating/chilled water terminal units.

MultiComm

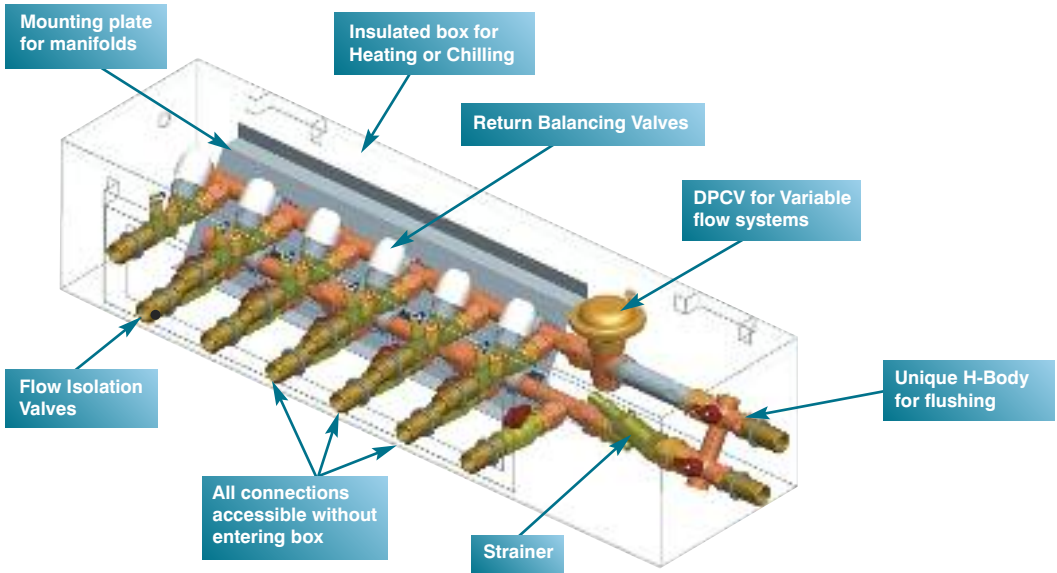

PRESSURE/TEMPERATURE RATING

Maximum pressure: 16 bar
Temperature rating: -10 to 100°C

MATERIAL SPECIFICATION

Component	Material
H-Body	Bronze
Strainer	Bronze (Fig. 817)
Manifolds	Bronze
Isolation Valves	DZR Brass (Fig. 100)
Regulation Valves	Bronze (1732 or 1832)

DIMENSIONS AND WEIGHTS

Units with outlets and inlets on same side

Outlets & Inlets		6x6	5x5	4x4	3x3	2x2
Length	mm	1120	1120	880	880	640
Height	mm	250	250	250	250	250
Width	mm	290	290	290	290	290
Weight	kg	40	38	36	34	30

Units with outlets and inlets on opposite side

Outlets & Inlets		6x6	5x5	4x4	3x3	2x2
Length	mm	1120	1120	880	880	640
Height	mm	200	200	200	200	200
Width	mm	400	400	400	400	400
Weight	kg	40	38	36	34	30

TYPICAL SCHEMATIC

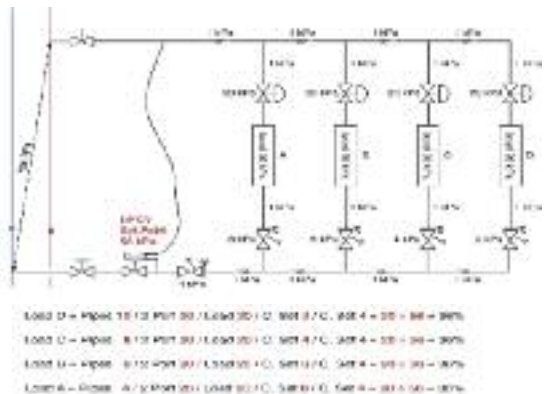

Every effort has been made to ensure that the information contained in this publication is accurate at the time of publishing. Hattersley Ltd assumes no responsibility or liability for typographical errors or omissions or for any misinterpretation of the information within the publication and reserves the right to change without notice.

Pressure Independent Control Valves

FEATURES AND BENEFITS

- Unique flow measurement for accurate commissioning and troubleshooting
- Pre-set flow rates
- Reacts to system changes to maintain stable flow rates
- Equal percentage control characteristic ensures improved system control
- Removable cartridge for flushing, complies with CIBSE and BSRIA recommendation
- Also available as part of Hook-Up II flow management system



Figure 305*

Details
available on
request



Figure C270 series - Hook-Up with PICV*

* Please note PICV and actuator are sold separately.

Call us on
0845 604 1790

or visit us online
www.hattersley.com

 **Hattersley**™



One Reading Central, Reading, Berkshire
Specification: Hattersley Fixed Orifice Double Regulating Valves

ProComm

State of the-art electronics, microprocessor and hydraulics in one compact unit.

The ProComm makes the on-site measurement of differential pressure and flow rates of water in HVAC systems an extremely simple operation.

With a range of sophisticated features providing extremely accurate measurement, coupled with a database of over 1300 valves from 34 manufacturers worldwide, the ProComm is the ultimate instrument for commissioning engineers.

Ease of use

The nine button keypad allows simple navigation through the menu system that provides the option to select the most appropriate screen for the work being carried out. This can show the full parameter of data available or simply a screen showing just the differential pressure - useful for those wishing to use the ProComm as a simple manometer.

Unlike any other commissioning unit, the most commonly used functions – Flow and Pressure – are shown as the default screen from the Display menu. This means that for most general commissioning purposes the most valuable data is shown at the touch of a button – in large text.

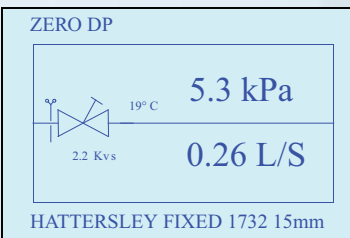
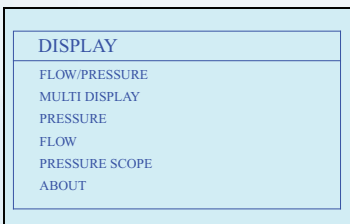

Sophistication

Accuracy of measurement is one of the most important elements of the function of commissioning units. The ProComm gives differential pressure readings with accuracy better than 1% or 100 Pascals, plus, an integral damping system further improves reading confidence on unstable systems.

This level of accuracy is achieved with the use of the latest wet/wet sensor technology. ProComm incorporates a unique crossover valve arrangement designed to protect the sensor, if exposed to high differential pressures.

More sophistication is available as Bluetooth can be fitted as an option to enable direct communication with a laptop, PDA or another ProComm (peer to peer).

Convenience

Designed to be as portable as possible, the compact and lightweight unit is easily operated in the hand or may be clipped to a lanyard.

The complete ProComm unit includes:

- 1 x Carry case
- 1 x Handheld transducer and display unit
- 2 x Connector tubes with isolating valves (2 metres)
- 2 x Straight Mechseal style adaptors
- 2 x Angled binder style adaptors
- 1 x PP3 battery
- 1 x Lanyard
- 1 x Set of operating instructions
- 1 x Calibration certificate
- 1 x Quick start guide



ProComm

TECHNICAL SPECIFICATION

Calibrated Range: 0.3 kPa to 250 kPa
Accuracy: +/- 0.03 kPa 0.3 to 1kPa
 +/- 0.05 kPa 1.0 to 10 kPa
 +/- 5% 10kPa to 250kPa

Maximum Static Pressure: 10 bar

Resolution: 0.01 kPa < 100kPa
 0.1 kPa > 100kPa

ENVIRONMENT

Media Temperature: Max 95°C
Storage Temperature: Ambient (Avoid low temperature to protect unit/sensor)

Power Supply: PP3 9v battery.

Effective Operating Time: 20 hours with standard alkaline PP3 battery
 (Dependent on use of backlight).

Calibration: Annual calibration is recommended.

Valve Database: 1300 valves stored including all major European manufacturers.

Pre-set Defaults

	Set Default	Menu Option	The following settings can be changed by the user	
Language	English	French	Design Flow	0 l/sec
		Italian	Target Flow	0%
Pressure	kPa	Spanish	Flow Alerts	ON
		Pa	Light Timer	10 minutes
		psi	Auto off Timer	10 minutes
		bar	DP Cut Off	30 kPa
		feet H ₂ O	Update time	1 second
		Inches H ₂ O	Sample time	3 seconds
Flow	l/sec	metres H ₂ O	Specific Gravity	01:00
		mm H ₂ O		
		cm H ₂ O		
		l/min		
Temperature	Celsius	l/hr		
		galls/m (imp)		
		galls/m (US)		
		m ³ /hr		
		Fahrenheit		

Every effort has been made to ensure that the information contained in this publication is accurate at the time of publishing. Hattersley Ltd assumes no responsibility or liability for typographical errors or omissions or for any misinterpretation of the information within the publication and reserves the right to change without notice.

Air Vents/De-Aerators

Offering an efficient performance, the Hattersley Air Vents remove inevitable and potentially dangerous air trapped in the system. Designed to simplify the venting process, for single or multi-boiler and calorifier installations, the range offers savings in time and costs.



**Fig. 775
Automatic**



FEATURES AND BENEFITS

- Removes inevitable potentially dangerous air trapped in system
- Simplifies the venting process
- Saves time and costs

MATERIAL SPECIFICATION

Component	Material	Specification	
		BS EN	ASTM
Body	Brass	12165 CW617N	B455 C38000
Cover	Brass	12165 CW617N	B455 C38000
Float	Polypropylene		
Seals	EPDM		
Anti Vacuum Cap	Brass	12165 CW617N	B455 C38000
Non Return Valve	Brass	12165 CW617N	B455 C38000

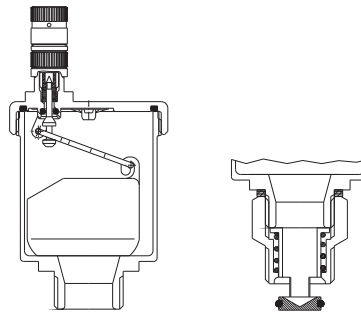

DIMENSIONAL DRAWINGS

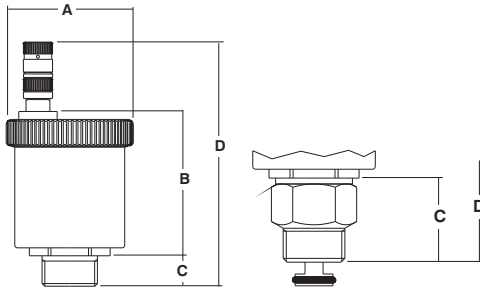

DIMENSIONS AND WEIGHTS

Nom Size	in	3/8	1/2	3/4	1
A	mm	48	48	48	48
B	mm	54.5	54.5	56	56
C	mm	11.5	11.5	12.5	12.5
D	mm	89.5	89.5	92	92
Weight	kg	0.18	0.18	0.25	0.25
With Non Return Valve					
C	mm	28	28	-	-
D	mm	106	106	-	-
Weight	kg	0.23	0.23	-	-

**PRESSURE/
TEMPERATURE RATING**
10 bar at 120°C

**MAXIMUM DISCHARGE
PRESSURE**
2.5 bar

SPECIFICATION
Brass body and cover.
Polypropylene float.
EPDM seals.
WRAS approved product.
Anti vacuum cap.

BSP parallel thread.
Non return valve option available in sizes 3/8" and 1/2".
Isolation valve option available in sizes 3/4" and 1".

NOTE

The non-return valve base allows the automatic air vent to be removed without draining the system.

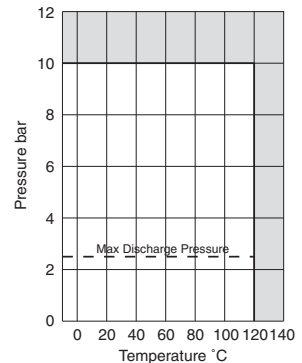

Every effort has been made to ensure that the information contained in this publication is accurate at the time of publishing. Hattersley Ltd assumes no responsibility or liability for typographical errors or omissions or for any misinterpretation of the information within the publication and reserves the right to change without notice.

Ball Valves

The Hattersley Series of ball valves consists of compact, lightweight units which are easy to install and operate, yet their ability to withstand robust construction ensures long, trouble-free service life. They offer full flow with minimum turbulence in the open position and bubble tight closure in the closed position. Only a quarter-turn is required to fully open or close the valve.

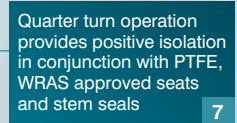
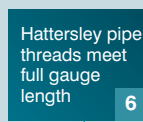
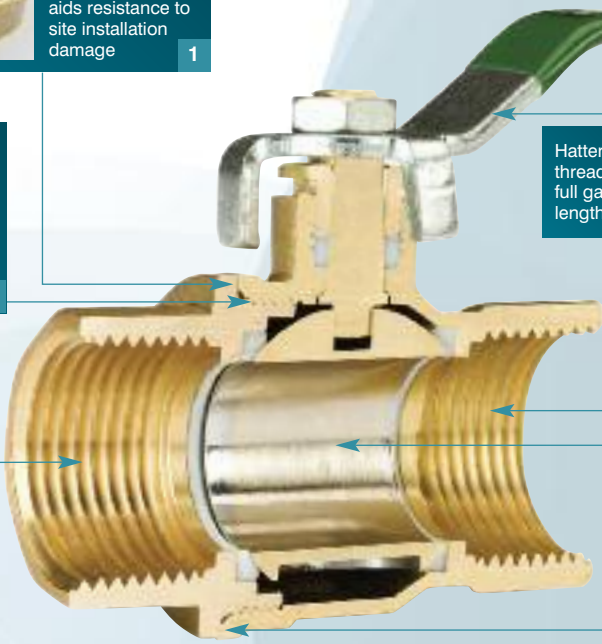
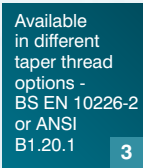
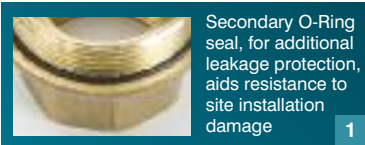

Ball is DZR brass chrome plated, designed for a long life. Temperature range is -10° to 120°C. Ball is full bore

5

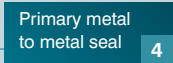

The New Figure 100 Series. See website for Next Generation DZR Ball Valves video.

Fig. 100, 100EXT Threaded DZR - Lever Operated



FEATURES AND BENEFITS

- Dezincification resistant
- Light, compact and easy to install and operate
- Improved leak protection
- More resistant to damage during installation
- Sizes from 1/4" to 2"
- WRAS Approved



Fig. 100

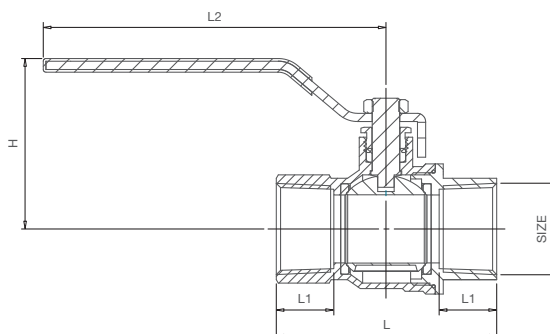

Fig. 100EXT

MATERIAL SPECIFICATION

Component	Material
Hex-Nut	Steel Plated
Lever	Steel Dacromet Plated
Sleeve	Green PVC
Packing Nut	Brass CW617N
Packing Gland	PTFE WRAS Approved
Body	DZR Brass CW602N
Seats	PTFE WRAS Approved
Ball	DZR Brass CW602N Chrome Plated
O-Ring	Rubber EPDM WRAS Approved
Bonnet	DZR Brass CW602N
Stem	DZR Brass CW602N
Extension Stem Outer	Aluminium
Extension Stem Inner	Brass Nickel Plated

DIMENSIONAL DRAWINGS



PRESSURE/TEMPERATURE RATINGS THREADED

Temperature °C	-10 to 100	120
Pressure bar	25	21.8

Intermediate pressure ratings shall be determined by interpolation.

SPECIFICATION

UK End Connection: BS EN 10226-2:2005 formerly BS21 Taper.

US End Connection: ANSI B1.20.1:1983.

Operator: Lever.

Quarter turn.

PTFE seats and stem seal.

WRAS listed.

DIMENSIONS AND WEIGHTS

Nom Size	Fig	in	1/4	3/8	1/2	3/4	1	1 1/4	1 1/2	2
L	100	mm	46	46	58.5	67	80.5	94	102	124
L1		mm	12	12	15.5	17	21	23	23	26.5
L2	100	mm	89	89	98.5	98.5	125	140	140	165
H	100	mm	41	41	48	51	62	77.5	83	95.5
H	100EXT	mm	-	-	103	107	116	129	135	150
Weight	100	g	152	136	205	302	511	890	1292	2238
Weight	100EXT	g	-	-	270	366	589	1009	1410	2283

Every effort has been made to ensure that the information contained in this publication is accurate at the time of publishing. Hattersley Ltd assumes no responsibility or liability for typographical errors or omissions or for any misinterpretation of the information within the publication and reserves the right to change without notice.

Fig. 100TH, 100LS Threaded DZR - T-Handle or Lockshield



FEATURES AND BENEFITS

- Dezincification resistant
- Light, compact and easy to install and operate
- Improved leak protection
- More resistant to damage during installation
- Sizes from 1/4" to 2"
- WRAS Approved



Fig. 100TH

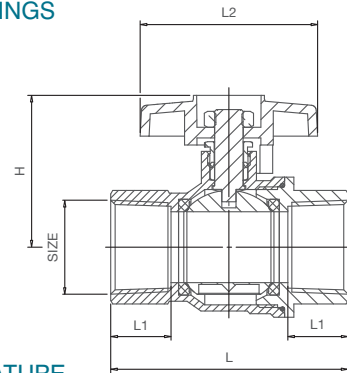

Fig. 100LS

MATERIAL SPECIFICATION

Component	Material
Hex-Nut	Steel Plated
T-Handle	Aluminium AL-46100 Green
Packing Nut	Brass CW617N
Packing Gland	PTFE WRAS Approved
Body	DZR Brass CW602N
Seats	PTFE WRAS Approved
Ball	DZR Brass CW602N Chrome Plated
O-Ring	Rubber EPDM WRAS Approved
Bonnet	DZR Brass CW602N
Stem	DZR Brass CW602N
Lockshield	Brass CW617N
Lockshield Cover	Polypropylene Green

DIMENSIONAL DRAWINGS



PRESSURE/TEMPERATURE RATINGS THREADED

Temperature °C	-10 to 100	120
Pressure bar	25	21.8

Intermediate pressure ratings shall be determined by interpolation.

SPECIFICATION

UK End Connection: BS EN 10226-2:2005 formerly BS21 Taper.

US End Connection: ANSI B1.20.1:1983.

Operator: T-Handle/Spanner/Socket.

Quarter turn.

PTFE seats and stem seal.

WRAS listed.

DIMENSIONS AND WEIGHTS

Nom Size	Fig	in	1/2	3/4	1	1 1/4	1 1/2	2
L		mm	59	67	80.5	94	102	124
L1		mm	15.5	17	21	23	23	26.5
L2	100TH	mm	50	50	55	82	82	110
H	100TH	mm	40	43	54	61	67	80.5
H	100LS	mm	42	45	58	67	73.5	86.5
Weight	100TH	g	183	277	470	809	1210	2106
Weight	100LS	g	207	302	506	867	1269	2166

Every effort has been made to ensure that the information contained in this publication is accurate at the time of publishing. Hattersley Ltd assumes no responsibility or liability for typographical errors or omissions or for any misinterpretation of the information within the publication and reserves the right to change without notice.

Fig. 100C, 100CEXT Compression Ended DZR - Lever Operated



FEATURES AND BENEFITS

- Dezincification resistant
- Light, compact and easy to install and operate
- Improved leak protection
- More resistant to damage during installation
- Sizes from 15 to 54mm
- WRAS Approved



Fig. 100C

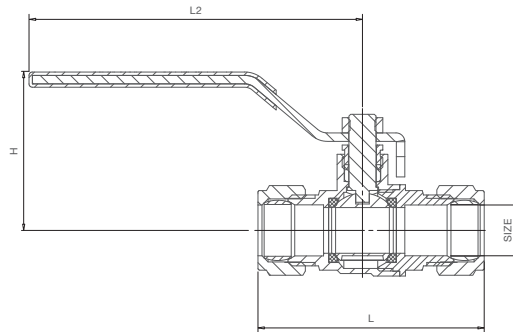

Fig. 100CEXT

MATERIAL SPECIFICATION

Component	Material
Hex-Nut	Steel Plated
Lever	Steel Dacromet Plated
Handle Sleeve	Green PVC
Packing Nut	Brass CW617N
Packing Gland	PTFE WRAS Approved
Body	DZR Brass CW602N
Seats	PTFE WRAS Approved
Ball	DZR Brass CW602N Chrome Plated
Bonnet	DZR Brass CW602N
Compression Olive	Brass CW507L
Compression Nut	DZR Brass CW602N
Stem	DZR Brass CW602N
Extension Stem Outer	Aluminium
Extension Stem Inner	Brass Nickel Plated

DIMENSIONAL DRAWINGS



PRESSURE/TEMPERATURE RATINGS COMPRESSION

Temperature °C	-10 to 30	40	50	65	80	90	100	110	120
Pressure bar	16	14.3	12.6	10	8.7	7.8	6.9	6	5

Intermediate pressure ratings shall be determined by interpolation

DIMENSIONS AND WEIGHTS

Nom Size	Fig	mm	15	22	28	35	42	54
L	C	mm	66.5	80	92.5	104.5	122	141
L2	C	mm	98.5	98.5	125	140	140	165
H	C	mm	47	51	62	77.5	83	97.5
H	CEXT	mm	103	107	116	129	135	150
Weight	C	g	212	368	608	1007	1549	2538
Weight	CEXT	g	275	429	682	1125	1667	2683

SPECIFICATION

UK End Connection: Compression Ends to BS EN 1254-2:1998.
Operator: Lever.
Quarter turn.
PTFE seats and stem seal.
WRAS listed.

Every effort has been made to ensure that the information contained in this publication is accurate at the time of publishing. Hattersley Ltd assumes no responsibility or liability for typographical errors or omissions or for any misinterpretation of the information within the publication and reserves the right to change without notice.

Fig. 100CTH, 100CLS Compression Ended DZR - T-Handle or Lockshield



FEATURES AND BENEFITS

- Dezincification resistant
- Light, compact and easy to install and operate
- Improved leak protection
- More resistant to damage during installation
- Sizes from 15 to 54mm
- WRAS Approved



Fig. 100CTH

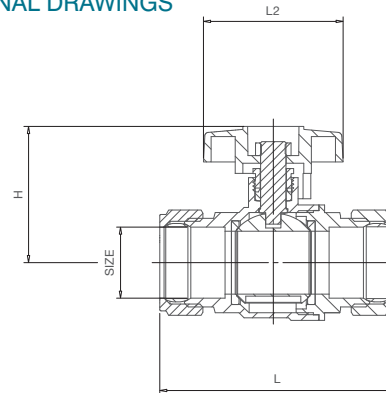

Fig. 100CLS

MATERIAL SPECIFICATION

Component	Material
Hex-Nut	Steel Plated
T-Handle	Aluminium AL-46100 Green
Packing Nut	Brass CW617N
Packing Gland	PTFE WRAS Approved
Body	DZR Brass CW602N
Seats	PTFE WRAS Approved
Ball	DZR Brass CW602N Chrome Plated
Bonnet	DZR Brass CW602N
Compression Olive	Brass CW507L
Compression Nut	DZR Brass CW602N
Stem	DZR Brass CW602N
Lockshield	Brass CW617N
Lockshield Cover	Polypropylene Green

DIMENSIONAL DRAWINGS



PRESSURE/TEMPERATURE RATINGS COMPRESSION

Temperature °C	-10 to 30	40	50	65	80	90	100	110	120
Pressure bar	16	14.3	12.6	10	8.7	7.8	6.9	6	5

Intermediate pressure ratings shall be determined by interpolation

DIMENSIONS AND WEIGHTS

Nom Size	Fig	mm	15	22	28	35	42	54
L		mm	66.5	80	92.5	104.5	122	141
L2		mm	50	50	55	82	82	110
H	CTH	mm	40	43	54	61	67	80.5
H	CLS	mm	42	45	59.5	67	73.5	86.5
Weight	CTH	kg	187	343	567	977	1487	2634
Weight	CLS	kg	220	376	614	1039	1549	2437

SPECIFICATION

UK End Connection: Compression ends to BS EN 1254-2:1998.

Operator: T-Handle/Spanner/Socket.

Quarter turn.

PTFE seats and stem seal.

WRAS listed.

Every effort has been made to ensure that the information contained in this publication is accurate at the time of publishing. Hattersley Ltd assumes no responsibility or liability for typographical errors or omissions or for any misinterpretation of the information within the publication and reserves the right to change without notice.

Fig. 100YL Gas Threaded DZR - Lever Operated

FEATURES AND BENEFITS

- Dezincification resistant
- Light, compact and easy to install and operate
- More resistant to damage during installation
- Sizes from 1/4" to 2"
- Tested to BS EN 331:1998



SPECIFICATION

UK End Connection: BS EN 10226-2:2005 formerly BS21 Taper.

US End Connection ANSI B1.20.1:1983.

Operator: Lever.

Specification: Quarter turn.

PTFE seats and stem seal.

Tested by GL Industrial Services and complies with the essential requirements of BS EN 331:1998.

MATERIAL SPECIFICATION

Component	Material
Hex-Nut	Dacromet Plated Steel
Handle Sleeve	PVC Yellow
Handle	Dacromet Plated Steel
Packing Nut	Brass CW617N
Packing Gland	PTFE
Body	DZR Brass CW602N
Ball	DZR Brass CW602N
Seats	PTFE
O-Ring	NBR BS EN549 approval
Bonnet	DZR Brass CW602N
Stem	DZR Brass CW602N

DIMENSIONAL DRAWINGS

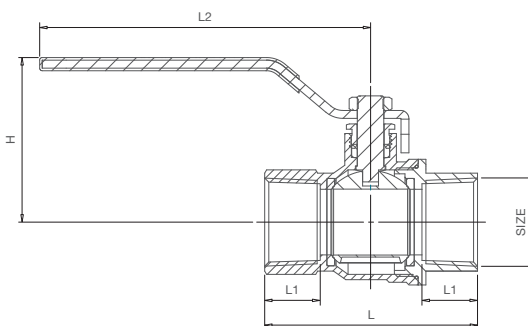

PRESSURE/TEMPERATURE RATINGS COMPRESSION

NON-GAS APPLICATION

Temperature °C	-10 to 100	110
Pressure bar	25	23.5

GAS APPLICATION

Temperature °C	-20 to 60
Pressure bar	5

Intermediate pressure ratings shall be determined by interpolation

DIMENSIONS AND WEIGHTS

Nom Size	in	1/4	3/8	1/2	3/4	1	1 1/4	1 1/2	2
L	mm	46	46	59	67	80.5	94	102	124
L1	in	12	12	15.5	17	21	23	23	26.5
L2	in	89	89	98.5	98.5	125	140	140	165
H	mm	41	41	48	51	63	78	83.5	97.5
Weight	kg	152	136	205	302	511	890	1292	2238

Every effort has been made to ensure that the information contained in this publication is accurate at the time of publishing. Hattersley Ltd assumes no responsibility or liability for typographical errors or omissions or for any misinterpretation of the information within the publication and reserves the right to change without notice.

Fig. 100CYL Gas Compression DZR - Lever Operated

FEATURES AND BENEFITS

- Dezincification resistant
- Light, compact and easy to install and operate
- More resistant to damage during installation
- Sizes from 15 to 54mm
- Tested to BS EN 331:1998



MATERIAL SPECIFICATION

Component	Material
Handle Sleeve	PVC Yellow
Hex-Nut	Dacromet Plated Steel
Handle	Dacromet Plated Steel
Packing Nut	Brass CW617N
Packing Gland	PTFE
Body	DZR Brass CW602N
Seats	PTFE
Ball	CW602N
O-Ring	NBR BS EN549 approval
Bonnet	DZR Bras CW602N
Sleeve	CW507L
Sleeve Nut	CW602N
Stem	DZR Brass CW602N

DIMENSIONAL DRAWINGS

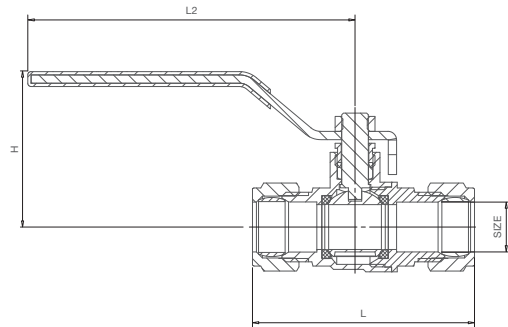

SPECIFICATION

UK End Connection: Compression ends to BS EN 1254-2:1998.

Operator: Lever.

Specification: Quarter turn.

PTFE seats and stem seal.

Tested by GL Industrial Services and complies with the essential requirements of BS EN 331:1998.

PRESSURE/TEMPERATURE RATINGS COMPRESSION

NON-GAS APPLICATION

Temperature °C	-10 to 30	110
Pressure bar	16	5

GAS APPLICATION

Temperature °C	-10 to 60
Pressure bar	5

Intermediate pressure ratings shall be determined by interpolation

DIMENSIONS AND WEIGHTS

Nom Size	mm	15	22	28	35	42	54
L	mm	66.5	80	92.5	104.5	122	141
L2	mm	98.5	98.5	125	140	140	165
H	mm	47	51	63	78	83.5	97.5
Weight	g	212	368	608	1007	1545	2538

Every effort has been made to ensure that the information contained in this publication is accurate at the time of publishing. Hattersley Ltd assumes no responsibility or liability for typographical errors or omissions or for any misinterpretation of the information within the publication and reserves the right to change without notice.

Fig. 108C Service Ball Valve



FEATURES AND BENEFITS

- Light, compact and easy to install and operate
- WRAS Approved for use on wholesome (potable) water
- Compression ends to BS EN 1254-2 for use with BS EN 1057 R250 (half-hard) copper tube
- Part of Hattersley's extensive public health range
- Chrome plated finish
- Handle can be removed to allow for screwdriver operation



MATERIAL SPECIFICATION

Component	Material
Screw	Steel Dacromet Plated
Handle	Nylon (Ral 9017)
Stem	DZR Brass Chromium Plated
O-Ring	EPDM WRAS Approved
Nut	DZR Brass CW602N Chromium Plated
Olive	Brass CW507L
Body	DZR Brass CW602N Chromium Plated
PTFE Seat	PTFE WRAS Approved
Ball	DZR Brass CW602N Chromium Plated
Seat Retainer	DZR Brass CW602N Chromium Plated

Temperature °C	-10 to 30	65	110	120
Pressure bar	16	10	6	5

DIMENSIONAL DRAWINGS

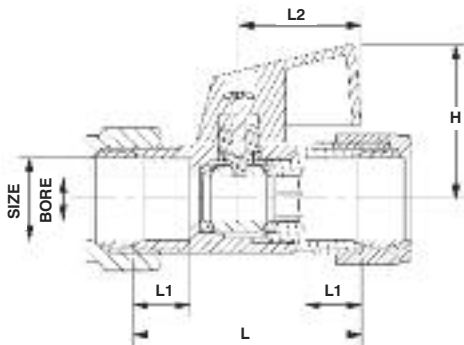

DIMENSIONS AND WEIGHTS

Nom Size	mm	DN15	DN22
Bore	mm	Ø8	Ø14
L	mm	42	53
L1	mm	11	13
L2	mm	23	23
H	mm	29	34
Weight	g	123	260

PRESSURE/ TEMPERATURE RATING

PN16

OPERATOR

Handle (The handle can be removed to allow for screwdriver operation).

SPECIFICATION

Compression ends to BS EN 1254-2 for use with BS EN 1057 R250 (half-hard) copper tube. WRAS Approved product.

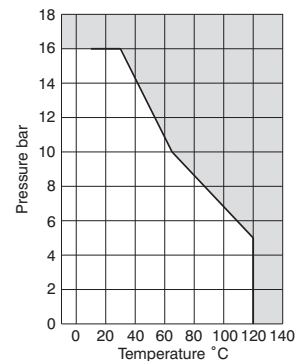

Every effort has been made to ensure that the information contained in this publication is accurate at the time of publishing. Hattersley Ltd assumes no responsibility or liability for typographical errors or omissions or for any misinterpretation of the information within the publication and reserves the right to change without notice.

Fig. 110
DZR - 3-way (T-Port) Vent Valve

FEATURES AND BENEFITS

- Dezincification resistant copper alloy 3-way (T-port) vent valve
- PTFE seats and seals. Blow-out proof stem
- Ends threaded to BS EN 10266 (ISO 7)
- Wrench operated. Ports permanently marked
- Sizes 1" to 2"

MATERIAL SPECIFICATION

Component	Material	Specification BS EN
Lever	Aluminium	
Stem	DZR Copper Alloy	12164 CW602N
Stem Seal	PTFE	
Body Seal	EPDM	
Ball (hard chrome plated)	DZR Copper Alloy	12164 CW602N
Seat Rings	PTFE	
Body Ends	DZR Copper Alloy	12165 CW602N
Body	DZR Copper Alloy	12165 CW602N



DIMENSIONAL DRAWINGS

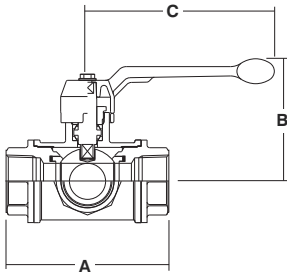

PRESSURE/TEMPERATURE RATING

As shown in pressure/ temperature graph.

TEST PRESSURES (HYDRAULIC)

25 bar pneumatic

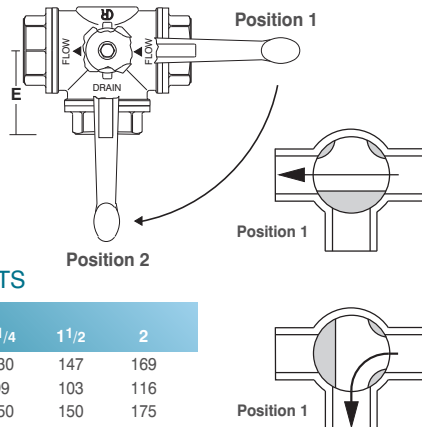

DIMENSIONS AND WEIGHTS

Nom Size	in	1	1 1/4	1 1/2	2
A	mm	113	130	147	169
B	mm	82	99	103	116
C	mm	120	150	150	175
E (=A/2)	mm	57	65	74	85
Weight (approx)	kg	1.7	2.5	3.6	5.7

SPECIFICATION

- 90° operation.
- Hard chrome plated DZR ball.
- Valve ports permanently marked.
- Fixed lever.
- Internally threaded ends to BS EN 10266 (ISO 7).
- Blow-out proof stem.
- PTFE seats and stem seals.

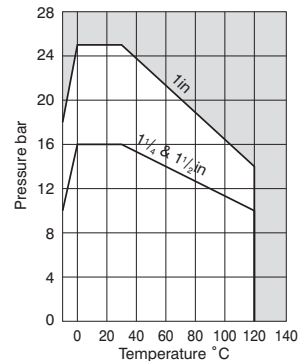

Every effort has been made to ensure that the information contained in this publication is accurate at the time of publishing. Hattersley Ltd assumes no responsibility or liability for typographical errors or omissions or for any misinterpretation of the information within the publication and reserves the right to change without notice.

Fig. 113
Full Bore Bronze

FEATURES AND BENEFITS

- Light, compact and easy to install and operate
- Robust construction for long life



MATERIAL SPECIFICATION

Component	Material	Specification ASTM
Lever	Steel	
Stem	Copper Alloy	B16-C36000
Stem Seals	PTFE or PTFE/Neoprene	
Ball (hard chrome plated)	Copper Alloy	B16-C36000
Seat Rings	PTFE or PTFE/Neoprene	
Seat Retainer	Bronze	BS84-C84400
Body	Bronze	BS84-C84400

DIMENSIONAL DRAWINGS

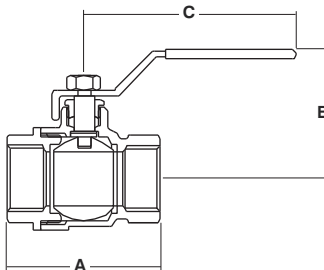

DIMENSIONS AND WEIGHTS

Nom Size	in	1/2	3/4	1	1 1/4	1 1/2	2	2 1/2
A	mm	55	62	73	83	92	107	144
B	mm	46	55	62	70	75	82	82
C	mm	82	103	106	106	150	160	162
Weight	kg	0.25	0.45	0.70	1.15	1.70	2.95	-

PRESSURE/TEMPERATURE RATING

- 1/2" to 2" sizes**
 40 bar from -10 to 100°C
 18 bar at 140°C
 25 bar from -10 to 100°C
- 2 1/2" and 3" sizes**
 18 bar at 140°C

SPECIFICATION

- Blow-out proof stem.
- Full bore hard chrome plated ball.
- Virgin PTFE seats and stem seals.
- Taper threaded BS EN 10 (ISO 7-1) formerly BS 21.

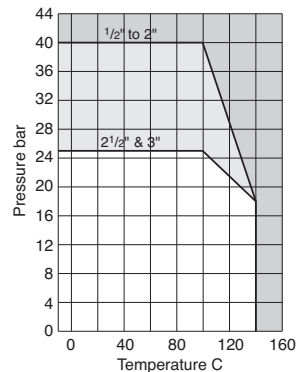

Every effort has been made to ensure that the information contained in this publication is accurate at the time of publishing. Hattersley Ltd assumes no responsibility or liability for typographical errors or omissions or for any misinterpretation of the information within the publication and reserves the right to change without notice.

Fig. 100MHU Male Hose Union



FEATURES AND BENEFITS

- Worldwide availability
- High quality range
- Long and trouble-free service life
- Full bore



MATERIAL SPECIFICATION

Component	Material
Shield Cover	Green PP (RAL6002)
Hex-Nut	Q235 Dacromet Plated
Lockshield	CW617N
Packing Nut	CW617N
Packing Gland	PTFE(701-N) WRAS approval
Body	CW602N
Ball	CW602N
PTFE	PTFE(701-N) WRAS approval
O-Ring	EPDM WRAS approval
Bonnet	CW602N
Washer	PTFE(701-N) WRAS approval
Tailpiece	CW602N
Union Ring	CW602N
Stem	CW602N

PRESSURE/ TEMPERATURE RATING

-10°C to 100°C

TEST PRESSURES (HYDRAULIC)

25 bar

SPECIFICATION

Quarter turn.
PTFE seats and stem seal.
WRAS listed.

DIMENSIONAL DRAWINGS

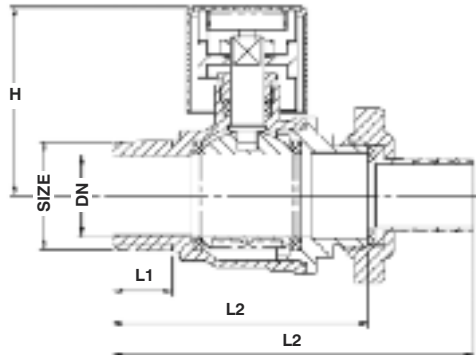

DIMENSIONS AND WEIGHTS

Nom Size	in	G 1/2	G 3/4	G 1
DN	mm	15	20	25
L	mm	84	98	109
L1	mm	14	15.5	18
L2	mm	58	66	77
H	mm	41.8	45.3	57.7

Every effort has been made to ensure that the information contained in this publication is accurate at the time of publishing. Hattersley Ltd assumes no responsibility or liability for typographical errors or omissions or for any misinterpretation of the information within the publication and reserves the right to change without notice.

Fig. 107MHU Brass with Male Union

FEATURES AND BENEFITS

- Dezincification resistant copper alloy ball valve
- PTFE seats and seals
- Blow-out proof stem
- Fitted with hose union and captive cap
- Lockshield operation
- Ends threaded to BS EN 10266 (ISO 7)
- Sizes 1/2" - 1"



MATERIAL SPECIFICATION

Component	Material	Specification	
		BS EN	ASTM
T-Handle	Aluminium		
Stem	Brass	12164 CW617N	B124 Alloy 2
Stem Seals	PTFE		
Ball (hard chrome plated)	Brass	12164 CW617N	B124 Alloy 2
Seat Rings	Virgin PTFE		
Tail	Brass	12165 CW617N	B124 Alloy 2
Tail O-Ring	Nitrile		
Union Nut	Brass	12165 CW617N	B124 Alloy 2
Body End	Brass	12165 CW617N	B124 Alloy 2
Body	Brass	12165 CW617N	B124 Alloy 2

DIMENSIONAL DRAWINGS

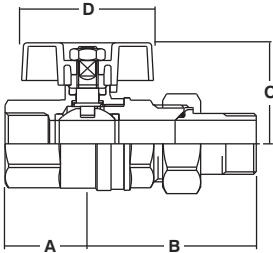

DIMENSIONS AND WEIGHTS

Nom Size	in	1/2	3/4
A	mm	25	29
B	mm	59	68
C	mm	33	43
D	mm	47	56
Weight	kg	0.28	0.48

PRESSURE/ TEMPERATURE RATING

32 bar from -10 to 120°C

TEST PRESSURES (HYDRAULIC)

25 bar pneumatic

SPECIFICATION

Nickel plated body.
Blow-out proof stem.
Full bore hard chrome plated ball.
Virgin PTFE seats and stem seal T-Handle.
Union nut with male tail threaded BS EN 10266 (ISO 7).
Internal threaded end to BS EN 2779 (ISO 228/1).

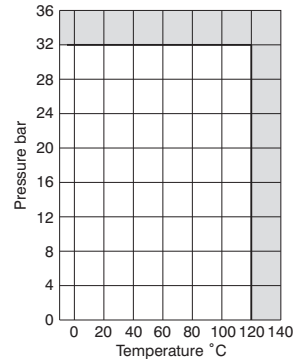

Every effort has been made to ensure that the information contained in this publication is accurate at the time of publishing. Hattersley Ltd assumes no responsibility or liability for typographical errors or omissions or for any misinterpretation of the information within the publication and reserves the right to change without notice.

Fig. 1807 DZR Strainer Ball Valve

FEATURES AND BENEFITS

- Light, compact and easy to install and operate
- Robust construction for long life



MATERIAL SPECIFICATION

Component	Material	Specification	
		BS EN	ASTM
Handle	Aluminium		
Stem	DZR Copper Alloy	12164 CW602N	
Stem Seal	EPDM		
Gland Seals	Virgin PTFE		
Ball	DZR Copper Alloy Hard chrome plated	12164 CW602N	
Seat Rings	Virgin PTFE		
Body	DZR Copper Alloy	12165 CW602N	
Screen	Stainless Steel		AISI 304
Cap Gasket	Asbestos Free		
Cap	DZR Copper Alloy	12165 CW602N	

DIMENSIONAL DRAWINGS

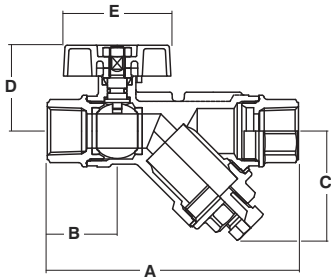

DIMENSIONS AND WEIGHTS

Nom Size	in	1/2	3/4	1
A	mm	110	129	151
B	mm	31	35	42
C	mm	48	60	59
D	mm	38	46	50
E	mm	47	56	56
Drain plug	BSP	1/4	1/4	1/4
Weight	kg	0.54	0.80	1.23

PRESSURE/TEMPERATURE RATING

PN25 - 1/2 to 1 1/2" sizes
25 bar 0° to 20°C
7 bar at 120°C

PN20 - 2" size
20 bar 0° to 20°C
6 bar at 120°C

TEST PRESSURES

25 bar pneumatic

SPECIFICATION

DZR body.
Blow-out proof stem.
Hard chrome plated ball.
Virgin PTFE seats.
T-Handle operated.
0.8mm diameter perforated 304 stainless steel screen.
Drain plug.
Taper threaded BS EN 10 (ISO 7-1) formerly BS 21.

OPTIONAL FEATURES

Lever.
Extension stem.
Figure 103 hose outlet blowdown valve.

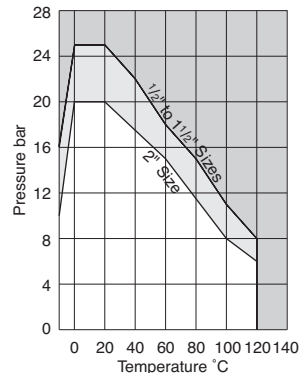

Every effort has been made to ensure that the information contained in this publication is accurate at the time of publishing. Hattersley Ltd assumes no responsibility or liability for typographical errors or omissions or for any misinterpretation of the information within the publication and reserves the right to change without notice.

Fig. 1807C DZR Strainer Ball Valve

FEATURES AND BENEFITS

- Light, compact and easy to install and operate
- Robust construction for long life



MATERIAL SPECIFICATION

Component	Material	Specification	
		BS EN	ASTM
Cap Gasket	Asbestos Free		
Screen	Stainless Steel	10270 X10CrNr18-8	A276-304
Compression Ring	Brass	B16	C36000
Cap	DZR Copper Alloy	12164 CW602N	
Compression Nut	Brass	12164 CW614N	B16-C36000 / B124-C37700
Handle	Aluminium		
Stem	DZR Copper Alloy	12164 CW602N	
Stem Seals	EPDM		
Gland Seals	Virgin PTFE		
Ball (hard chrome plated)	DZR Copper Alloy	12164 CW602N	
Seat Rings	Virgin PTFE		
Body	DZR Copper Alloy	12164 CW602N	

DIMENSIONAL DRAWINGS

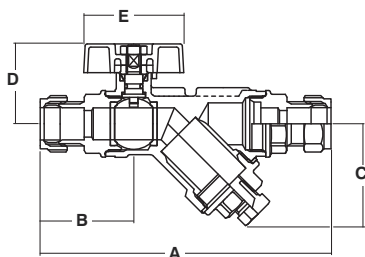

DIMENSIONS AND WEIGHTS

Nom Size	mm	15	22	28
A	mm	137	159	175
B	mm	45	50	53
C	mm	48	60	59
D	mm	38	46	50
E	mm	47	56	56
Drain plug	BSP	1/4	1/4	1/4
Weight	kg	0.6	0.9	1.3

PRESSURE/ TEMPERATURE RATING

PN16
5 bar at 120°C
6 bar at 110°C
10 bar at 65°C
16 bar at -10 to 30°C

TEST PRESSURES

25 bar pneumatic

SPECIFICATION

DZR body.
Blow-out proof stem.
Hard chrome plated ball.
Virgin PTFE seats.
T-Handle operated.
0.8mm diameter perforated 304 stainless steel screen.
Drain plug.
Compression ends to BS EN 1254-2.
Use with R250 (half hard) copper tube.

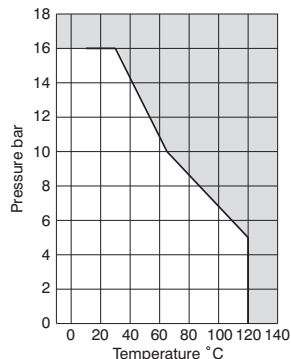

Every effort has been made to ensure that the information contained in this publication is accurate at the time of publishing. Hattersley Ltd assumes no responsibility or liability for typographical errors or omissions or for any misinterpretation of the information within the publication and reserves the right to change without notice.

Butterfly Valves

Hattersley butterfly valves are compact quarter turn valves.

The body is elastomer lined providing a resilient bubble tight shut off. The valves are supplied in wafer or lugged variants and may be lever or gearbox operated. Linings are EPDM or Nitrile rubber depending on the intended service conditions. Primarily recommended for on off service, they may also be used for non-critical throttling applications. Only a quarter turn is needed to fully open or close the valve.

Hattersley also offer a range of high performance butterfly valves, developed for high integrity shut-off and regulation duties. This range is ideal where increased pressure and elevated temperature specifications are outside the normal operating parameters of concentric disc valves. The Hattersley high performance valves have enhanced features to provide impeccable performance and reliability.

Valve Figure Number Guide

Fig. No.	Body		Liner		Disc/Pins		Shaft
	CI	DI	E	N	A	SS	SS
950		•	•		•		•
951	•			•	•		•
970		•	•		•		•
971		•		•	•		•
4941	•			•		•	•
4950		•	•		•	•	•
4951	•			•		•	•
4970		•	•		•	•	•
4971		•		•		•	•



Fig. 950 Semi-lugged Wafer Pattern

950, 950G

FEATURES AND BENEFITS

- Rubber liner bonded to backing ring
- Two high strength, low friction bearings for upper and lower shafts, restrain shaft deflection, ensuring effective stem sealing
- Long neck for insulation
- Maintenance free
- Good control characteristics



MATERIAL SPECIFICATION

Component	Material	Specification	
		BS EN	ASTM
Body	Ductile Iron	1563 EN-JS1030	A536-65-45-12
Shaft	Stainless Steel	10088-1 X12Cr13	A276 410
Disc	Al Bronze	1982 CC333G	B148 C95300
Bushes	PTFE		
O-Ring	Buna N		
Liner	EPDM		

PRESSURE/ TEMPERATURE RATING

16 bar from -10 to 120°C
15.7 bar at 130°C

TEST PRESSURES

Hydrostatic
Body: 24 bar
Seat: 17.6 bar

SPECIFICATION

Generally conforms to BS EN 593:2009.
Ductile Iron body epoxy coated.
Centring holes.
Aluminium bronze disc.
EPDM liner.
Trigger lever.
Valves DN250 and larger supplied as standard with fully enclosed gear operator.
To suit flange connections BS EN 1092-2 PN16.
Valves may be used for flow regulation.

DIMENSIONAL DRAWINGS

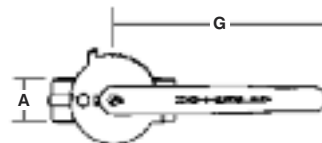
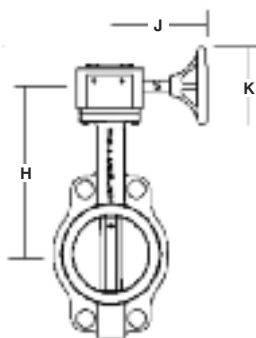
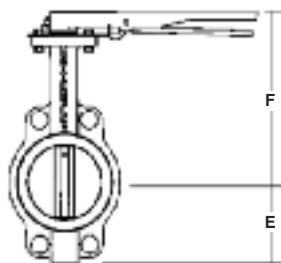

DIMENSIONS AND WEIGHTS

Nom Size	mm	50	65	80	100	125	150	200	250	300	350	400	450	500	600
A	mm	44	48	48	54	57	57	63	70	79	79	89	108	133	156
B	mm	83	95	102	124	136	150	197	210	248	280	305	381	381	458
C	mm	195	207	213	232	245	257	305	-	-	369	400	422	480	562
D	mm	162	175	181	200	213	255	260	292	337	442	492	553	480	562
E	mm	260	260	260	260	260	260	356	-	-	38	54	105	105	110
F	mm	204	217	223	242	255	267	300	332	377	300	450	450	450	450
G	mm	150	150	150	150	300	300	300	300	300	230	230	340	230	360
H	mm	240	240	240	240	240	230	230	230	230	80	120	185	120	185
J	mm	60	60	60	60	60	60	80	80	80	-	-	-	-	-
Weight lever	kg	3	4	5	7	8	9	15	80	80	-	-	-	-	-
Weight geared	kg	8	9	10	11	13	14	19	32	47	60	100	145	190	290

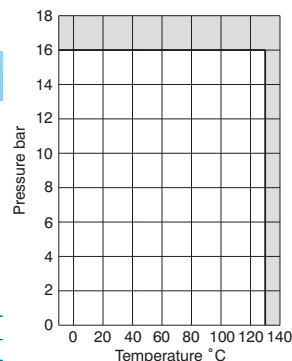

Every effort has been made to ensure that the information contained in this publication is accurate at the time of publishing. Hattersley Ltd assumes no responsibility or liability for typographical errors or omissions or for any misinterpretation of the information within the publication and reserves the right to change without notice.

Fig. C950
Wafer Type Butterfly Valve



FEATURES AND BENEFITS

- Rubber liner bonded to backing ring
- Two high strength, low friction bearings for upper and lower shafts, restrain shaft deflection, ensuring effective stem sealing
- Long neck for insulation
- Maintenance free
- Good control characteristics



MATERIAL SPECIFICATION

Component	Material	Specification	
		BS EN	ASTM
Body	Ductile Iron	1563 EN-JS1030	A536 65-45-12
Operating Shaft	Stainless Steel	10088-1 X12Cr13	A276 410 Shaft
Disc	Al Bronze	1982 CC333G	B148 C95300
Taper Pins	Stainless Steel	10088-1 X5CrNiMo17-12-2	A276 316
Bushes	PTFE		
O-Ring	Buna N		
Liner	EPDM		

PRESSURE/TEMPERATURE RATING

16 bar from -10 to 120°C
15.7 bar at 130°C

TEST PRESSURES (HYDRAULIC)

Body: 24 bar
Seat: 17.6 bar

SPECIFICATION

Generally conforms to BS EN 593:2009.
Ductile Iron body epoxy coated.
Centring holes.
Aluminium bronze disc.
EPDM liner.
Trigger lever.
Valves DN250 and larger supplied as standard with fully enclosed gear operator.
To suit flange connections BS EN 1092-2 PN16.
Valves may be used for flow regulation.

DIMENSIONAL DRAWINGS

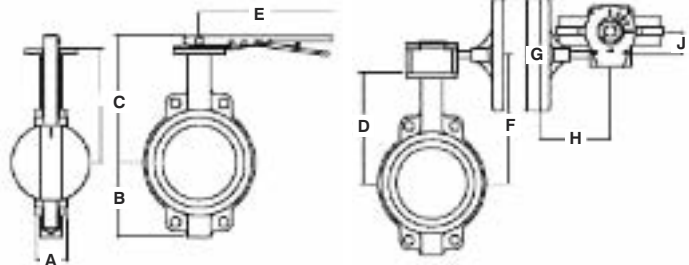

DIMENSIONS AND WEIGHTS

Nom Size	mm	50	65	80	100	125	150	200	250	300
A	mm	44	48	48	54	57	57	63	70	79
B	mm	83	95	102	124	136	150	197	210	248
C	mm	195	207	213	232	245	257	305		
D	mm	162	175	181	200	213	225	260	292	337
E	mm	260	260	260	260	260	260	356		
F	mm	204	217	223	242	255	267	300	332	377
G	mm	150	150	150	150	300	300	300	300	300
H	mm	240	240	240	240	240	230	230	230	230
J	mm	60	60	60	60	60	60	80	80	80
Weight	kg	3	4	5	7	8	9	15	31	40
PED Categorisation										
Valve size		50	65	80	100	125	150	200	250	300
Group 2 Liquids Cat.		SEP	SEP	SEP	SEP	SEP	SEP	SEP	SEP	SEP

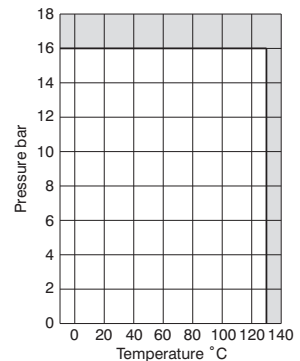

Every effort has been made to ensure that the information contained in this publication is accurate at the time of publishing. Hattersley Ltd assumes no responsibility or liability for typographical errors or omissions or for any misinterpretation of the information within the publication and reserves the right to change without notice.

Fig. 970 Fully-lugged Wafer Pattern

970, 970G

FEATURES AND BENEFITS

- Available up to DN600
- Valve body fully-lugged
- Long neck for insulation
- Maintenance free
- Good control characteristics



MATERIAL SPECIFICATION

Component	Material	Specification	
		BS EN	ASTM
Body	Ductile Iron	1563 EN-JS 1030	A536 65-45-12
Shaft	Stainless Steel	10088-1 X5CrNiMo17-12-2	A532 Gr316
Disc	Bronze	1982 CC333G	B148-C95300
Bushes (up to 100mm)	PTFE		
125mm and above	Bronze (lubricated)		
O-Ring	Buna N		
Liner	EPDM		

PRESSURE/TEMPERATURE RATING

PN16 from -10 up to 130°C

TEST PRESSURES

Hydrostatic
Body: 24 bar
Seat: 17.6 bar

SPECIFICATION

Conforms to BS EN 593:2009.

Fully-lugged.

Lever or gearbox.

Valves DN250 and larger supplied as standard with fully enclosed gear operator.

Valves may be used for flow regulation.

DIMENSIONAL DRAWINGS

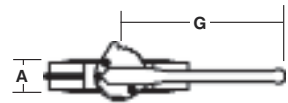
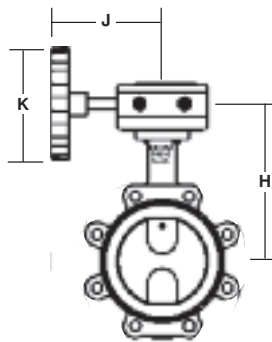
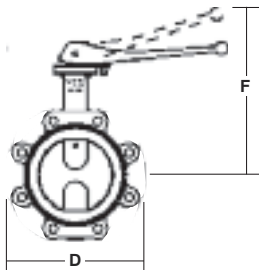

DIMENSIONS AND WEIGHTS

Nom Size	mm	50	65	80	100	125	150	200	250	300	350	400	450	500	600
A	mm	43	46	46	52	56	56	60	68	78	78	102	114	127	154
D	mm	165	185	200	220	250	285	340	405	460	520	580	640	715	840
F	mm	264	272	279	301	314	345	369	-	-	-	-	-	-	-
G	mm	250	250	250	250	250	315	315	-	-	-	-	-	-	-
H	mm	182	190	197	219	232	254	278	281	306	354	408	433	458	557
J	mm	123	123	123	123	123	123	123	228	228	228	305	305	305	305
K	mm	125	125	125	125	125	125	125	300	300	300	400	400	400	400
Shaft size A/F	mm	10	10	10	12	12	16	16	24	24	24	30	30	30	30
Weight lever	kg	4.6	5.4	7.2	8.8	12	14	20	-	-	-	-	-	-	-
Weight geared	kg	5.4	6.2	8.0	9.6	12	15	21	33	45	55	91	111	136	225

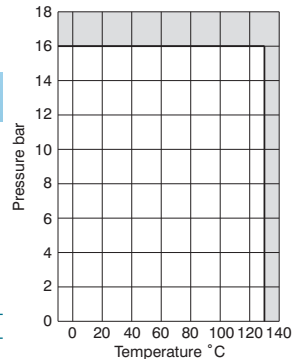

Every effort has been made to ensure that the information contained in this publication is accurate at the time of publishing. Hattersley Ltd assumes no responsibility or liability for typographical errors or omissions or for any misinterpretation of the information within the publication and reserves the right to change without notice.

Fig. 950W Semi-lugged Wafer Pattern

950W, 950WG



FEATURES AND BENEFITS

- Rubber liner bonded to steel backing ring
- Two high strength, low friction bearings for upper and lower shafts, restrain shaft deflection, ensuring effective stem sealing
- Long neck for insulation
- Maintenance free
- Good control characteristics



MATERIAL SPECIFICATION

Component	Material	Specification	
		BS EN	ASTM
Body	Ductile Iron	1563 EN-JS 1030	A536 65-45-12
Shaft	Stainless Steel	10088-1 X5CrNiMo17-12-2	A532 Gr316
Disc	Bronze	1982 CC333G	B148-C95300
Bushes (up to 100mm)	PTFE		
125mm and above	Bronze (lubricated)		
O-Ring	Buna N		
Liner	EPDM		

PRESSURE/ TEMPERATURE RATING

PN16 from -10 up to 110°C

TEST PRESSURES

Each valve is individually hydrostatically tested to BS EN 12266-1 at the following test pressures.

Shell: 24 bar
Seat: 17.6 bar

SPECIFICATION

Conforms to BS EN 593:2009.

Semi-lugged.

Aluminium bronze or stainless steel disc.
WRAS approved.

Lever or gearbox.

Valves DN250 and larger supplied as standard with fully enclosed gear operator.
Valves may be used for flow regulation.

DIMENSIONAL DRAWINGS

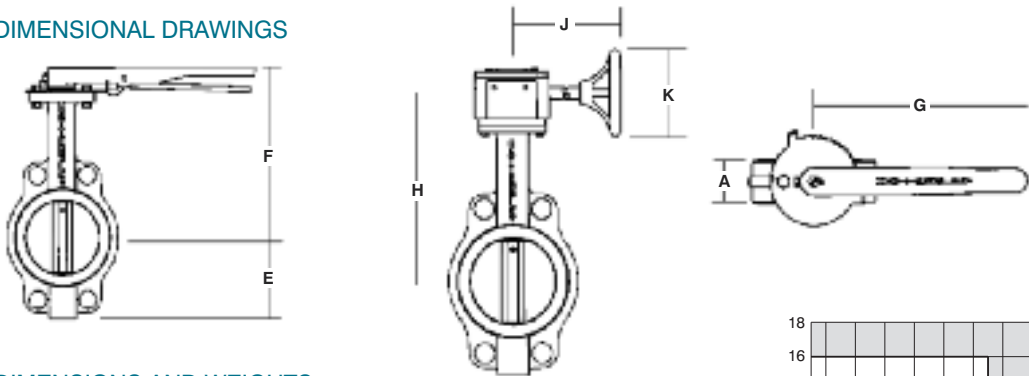

DIMENSIONS AND WEIGHTS

Nom Size	mm	50	65	80	100	125	150	200	250	300	350	400	450	500	600
A	mm	42	45	45	52	54	56	61	66	77	77	87	106	132	152
E	mm	80	89	95	114	127	139	175	203	242	267	301	327	361	459
F	mm	183	197	203	222	235	248	282	-	-	-	-	-	-	-
G	mm	270	270	270	270	270	270	270	-	-	-	-	-	-	-
H	mm	279	302	314	352	378	403	478	537	622	678	764	812	918	1098
J	mm	154	154	154	154	154	154	238	238	222	222	300	300	350	350
K	mm	152	152	152	152	152	152	300	300	300	300	300	300	300	300
Weight lever	kg	4	5	5	6	9	10	15	-	-	-	-	-	-	-
Weight geared	kg	8	9	10	11	13	14	19	32	47	59	93	117	-	-

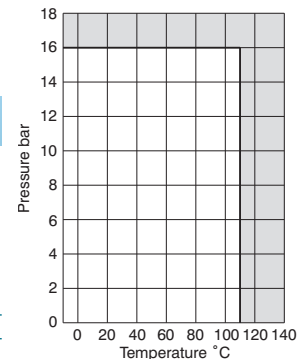

Every effort has been made to ensure that the information contained in this publication is accurate at the time of publishing. Hattersley Ltd assumes no responsibility or liability for typographical errors or omissions or for any misinterpretation of the information within the publication and reserves the right to change without notice.

Fig. 970W Fully-lugged Wafer Pattern



FEATURES AND BENEFITS

- Available up to DN600
- Valve body fully lugged
- Suitable for end of line duty up to 10 bar
- Long neck for insulation
- Maintenance free
- Good control characteristics



MATERIAL SPECIFICATION

Component	Material	Specification	
		BS EN	ASTM
Body	Ductile Iron	1563 EN-JS 1030	A536 65-45-12
Shaft	Stainless Steel	10088-1 X5CrNiMo17-12-2	A532 Gr316
Disc	Bronze	1982 CC333G	B148-C95300
Bushes (up to 100mm)	PTFE		
125mm and above	Bronze (lubricated)		
O-Ring	Buna N		
Liner	EPDM		

PRESSURE/TEMPERATURE RATING

PN16 from -10 up to 120°C

TEST PRESSURES

Each valve is individually hydrostatically tested to BS EN 12266-1 at the following test pressures.
Shell: 24 bar
Seat: 17.6 bar

SPECIFICATION

Conforms to BS EN 593:2009.
Fully-lugged.
Aluminium bronze disc.
WRAS approved.
Lever or gearbox.
Valves DN250 and larger supplied as standard with fully enclosed gear operator.
Valves may be used for flow regulation.

DIMENSIONAL DRAWINGS

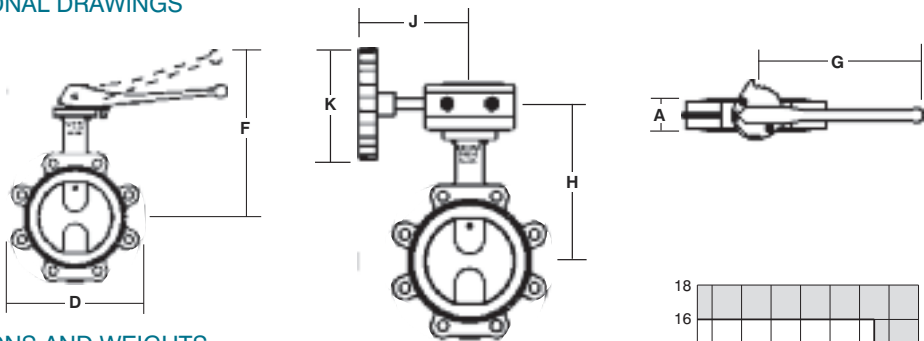

DIMENSIONS AND WEIGHTS

Nom Size	mm	50	65	80	100	125	150	200	250	300	350	400	450	500	600
A	mm	42	45	45	52	54	56	61	66	77	77	87	106	132	152
E	mm	80	89	95	114	127	139	175	203	242	267	301	327	361	459
F	mm	183	197	203	222	235	248	282	-	-	-	-	-	-	-
G	mm	270	270	270	270	270	270	270	-	-	-	-	-	-	-
H	mm	279	302	314	352	378	403	478	537	622	678	764	812	918	1098
J	mm	154	154	154	154	154	154	238	238	222	222	300	300	350	350
K	mm	152	152	152	152	152	152	300	300	300	300	300	300	300	300
Weight lever	kg	4	5	5	6	9	10	15	-	-	-	-	-	-	-
Weight geared	kg	8	9	10	11	13	14	19	32	47	59	93	117	-	-

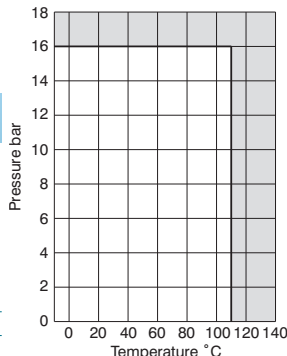

Every effort has been made to ensure that the information contained in this publication is accurate at the time of publishing. Hattersley Ltd assumes no responsibility or liability for typographical errors or omissions or for any misinterpretation of the information within the publication and reserves the right to change without notice.

Fig. 951 and 951G Semi-lugged, Lever/Gearbox Operated Wafer Pattern to BS EN 593:2009

FEATURES AND BENEFITS

- Aluminium Bronze disc
- Stainless Steel shaft
- 951 - Trigger lever, 951G - Gearbox operated
- Sizes 350 to 600mm PN16 only
- Valves are suitable for use with flanges conforming to BS EN 1092-2 PN10 or PN16 and ANSI B16.1 Class 125 (sizes 2" to 12")



MATERIAL SPECIFICATION

Component	Material
Body	Ductile Iron ASTM A536 (Epoxy Paint)
Disc	Aluminium Bronze
Liner	Nitrile Temp. -10 to 90°C
Shaft	Stainless Steel Type 410
Taper Pin	Stainless Steel Type 316
Key	Carbon Steel
O-Ring	Buna-N
Bushing	PTFE
Lever & Screw	Carbon Steel (Epoxy Paint)
Stop Plate	Carbon Steel (Zn Plated)

PRESSURE/ TEMPERATURE RATING

PN16 from -10 up to 90 °C

TEST PRESSURES

Each valve is individually hydrostatically tested to BS EN 12266-1:2003 at the following test pressures:

Shell: 24 bar
Seat: 17.6 bar

SPECIFICATION

Semi-lugged.
Lever or gearbox.
Valves DN250 and larger supplied as standard with a fully enclosed gear operator.
Valves may be used for flow regulation.
Suitable for gas applications.
Figures 951 and 951G are suitable for Group 1 and 2 gases and Group 1 and 2 liquids as defined by the Pressure Equipment Directive 97/23/EC.

DIMENSIONS AND WEIGHTS

Fig 951

Nom Size	mm	50	65	80	100	125	150	200
A	mm	195	207	213	232	245	257	305
B	mm	83	95	102	124	136	150	197
C	mm	44	48	48	54	57	57	63
D	mm	32	32	32	32	32	32	44
E	mm	102	121	130	171	197	219	268
F	mm	260	260	260	260	260	260	356
G	mm	32	46	64	90	111	145	193
Weight	kg	3.5	4	5.4	6.7	9	9.9	16.4

Fig 951G

Nom Size	mm	50	65	80	100	125	150	200	250	300	350	400	450	500	600
A	mm	162	175	181	200	213	225	260	292	337	368	400	422	479	562
B	mm	83	95	102	124	136	150	197	210	248	279	305	381	381	457
C	mm	44	48	48	54	57	57	63	70	79	79	89	108	133	156
D	mm	42	42	42	42	42	42	40	40	40	40	-	-	-	-
E	mm	102	121	130	171	197	219	268	332	410	435	508	543	592	708
F	mm	150	150	150	150	300	300	300	300	300	450	450	450	450	450
G	mm	32	46	64	90	111	145	193	241	290	325	380	427	474	574
K	mm	240	240	240	240	240	240	230	230	230	230	277	277	321	335
Weight	kg	15	15.5	16.9	18.2	20.5	21.4	29	33.5	45.8	56.2	88.4	110.2	160.5	260

DIMENSIONAL DRAWINGS

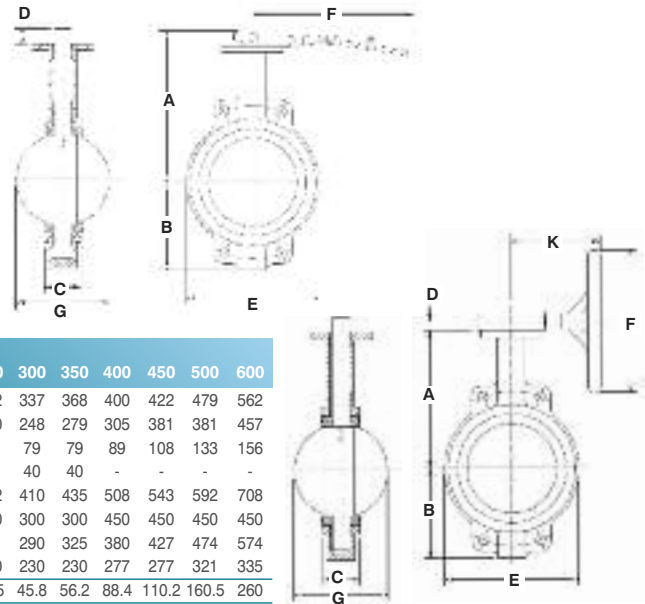

Every effort has been made to ensure that the information contained in this publication is accurate at the time of publishing. Hattersley Ltd assumes no responsibility or liability for typographical errors or omissions or for any misinterpretation of the information within the publication and reserves the right to change without notice.

Fig. 971 and 971G Fully-lugged, Lever/Gearbox Operated Wafer Pattern to BS EN 593: 2009

FEATURES AND BENEFITS

- Aluminium Bronze disc
- Stainless Steel shaft
- 971 - Trigger lever, 971G - Gearbox operated
- Valves are suitable for use with flanges conforming to BS EN 1092-2 PN10 or PN16 - Sizes 65-150mm
- Sizes 200-600mm PN16 only



MATERIAL SPECIFICATION

Component	Material
Body	Ductile Iron ASTM A536 (Epoxy Paint)
Disc	Aluminium Bronze
Liner	Nitrile Temp. -10 to 90 °C
Shaft	Stainless Steel Type 410
Taper Pin	Stainless Steel Type 316
Key	Carbon Steel
O-Ring	Buna-N
Bushing	PTFE
Lever & Screw	Carbon Steel (Epoxy Paint)
Stop Plate	Carbon Steel (Zn Plated)

PRESSURE/ TEMPERATURE RATING

PN16 from -10 up to 90 °C

TEST PRESSURES

Each valve is individually hydrostatically tested to BS EN 12266-1:2003 at the following test pressures:

Shell: 24 bar
Seat: 17.6 bar

SPECIFICATION

Fully-lugged.

Lever or gearbox.

Valves DN250 and larger supplied as standard with a fully enclosed gear operator.

Valves may be used for flow regulation.

Suitable for gas applications.

Fig. 971 and 971G are suitable for Group 1 and 2 gases and Group 1 and 2 liquids as defined by the Pressure Equipment Directive 97/23/EC.

DIMENSIONS AND WEIGHTS

Fig. 971

Nom Size	mm	50	65	80	100	125	150	200
A	mm	195	207	213	232	245	257	305
B	mm	83	95	102	124	136	150	197
C	mm	44	48	48	54	57	57	63
D	mm	32	32	32	32	32	32	44
E	mm	102	121	130	171	197	219	268
F	mm	260	260	260	260	260	260	356
G	mm	32	46	64	90	111	145	193
Weight	kg	4	4.5	7.2	12.6	13.5	14.9	24.1

Fig. 971G

Nom Size	mm	50	65	80	100	125	150	200	250	300	350	400	450	500	600
A	mm	162	175	181	200	213	225	260	292	337	368	400	422	479	562
B	mm	83	95	102	124	136	150	197	210	248	279	305	381	381	457
C	mm	44	48	48	54	57	57	63	70	79	79	89	108	133	156
D	mm	42	42	42	42	42	42	40	40	40	40	-	-	-	-
E	mm	102	121	130	171	197	219	268	332	410	435	508	543	592	708
F	mm	150	150	150	300	300	300	300	300	300	300	450	450	450	450
G	mm	32	46	64	90	111	145	193	241	290	325	380	427	474	574
K	mm	240	240	240	240	240	240	230	230	230	230	277	277	321	335
Weight	kg	15.5	16	18.7	24.1	25	26.4	36.7	47.1	62.1	84.9	123.8	139.7	215.5	337.3

DIMENSIONAL DRAWINGS

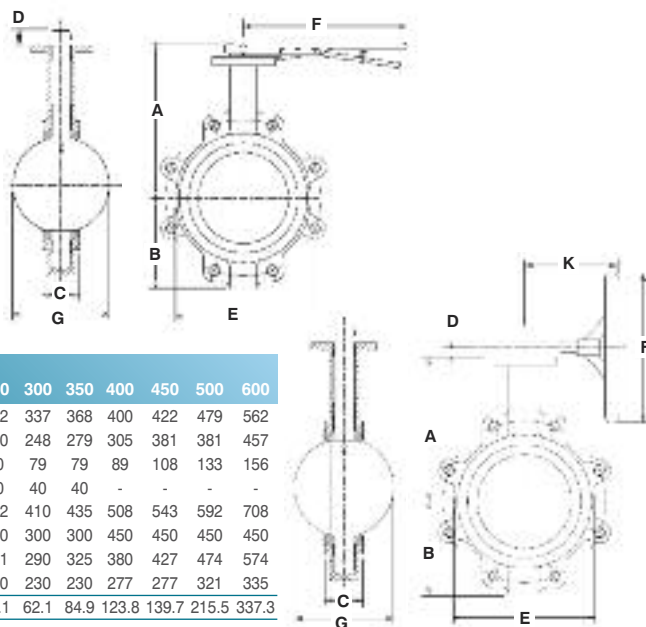

Every effort has been made to ensure that the information contained in this publication is accurate at the time of publishing. Hattersley Ltd assumes no responsibility or liability for typographical errors or omissions or for any misinterpretation of the information within the publication and reserves the right to change without notice.

Fig. 980ANSI
Ductile Iron Fully Lugged Butterfly Valve Class 150



MATERIAL SPECIFICATION

Component	Material	Specification	
		BS EN	ASTM
Body	Ductile Iron	1563 EN-JS1030	A536 65-45-12
Operating Shaft	Stainless Steel	10088-1 X12Cr13	A276 410
Disc	Al Bronze	12165 CW307G	B150 C63000
Taper pins	Stainless Steel	10088-1 X5CrNiMo17-12-2	A276 316
Bushes	EDPM		
O-Ring	Buna N		
Liner	EPDM		

DIMENSIONAL DRAWINGS

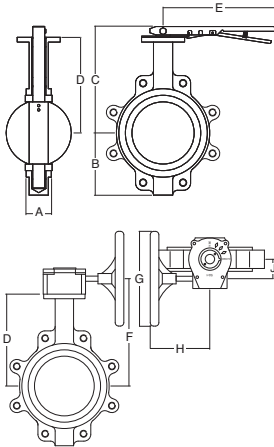

DIMENSIONS AND WEIGHTS

Nom Size	mm	50	65	80	100	125	150	200	250	300
A	mm	44	48	48	54	57	57	63	70	79
B	mm	83	95	102	124	136	150	197	210	248
C	mm	195	207	213	232	245	257	-	-	-
D	mm	162	175	181	200	213	225	260	292	337
E	mm	260	260	260	260	260	260	-	-	-
F	mm	204	217	223	242	255	267	300	332	377
G	mm	150	150	150	150	300	300	300	300	300
H	mm	240	240	240	240	240	230	230	230	230
J	mm	60	60	60	60	60	60	80	80	80
Weight	kg	10	11	12	13	16	19	30	40	53

PRESSURE/TEMPERATURE RATING

19.65 bar from -10 to 37.8°C
16.93 bar at 120°C

TEST PRESSURES (HYDRAULIC)

Body: 29.5 bar
Seat: 21.6 bar

SPECIFICATION

Generally conforms to BS EN 593.
Ductile iron body epoxy coated.
Fully lugged.
Aluminium bronze disk.
EPDM liner phenolic backed.
Trigger Lever.
Valves DN200 and larger supplied as standard with fully enclosed gear operator.
Suitable for fitting between flanges to ANSI B16.1 Class 125 and 150.
Valves may be used for flow regulation.

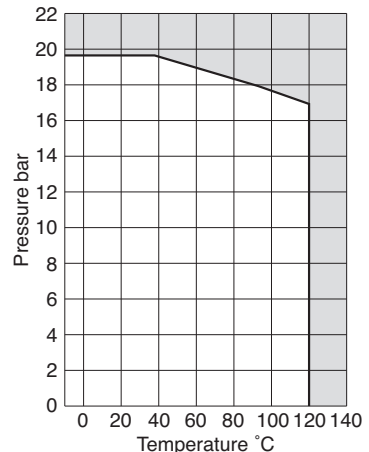

Every effort has been made to ensure that the information contained in this publication is accurate at the time of publishing. Hattersley Ltd assumes no responsibility or liability for typographical errors or omissions or for any misinterpretation of the information within the publication and reserves the right to change without notice.

Fig. 4970/4970G Ductile Iron Fully-lugged

FEATURES AND BENEFITS

- Available up to DN600
- Valve body fully-lugged
- Long neck for insulation
- Maintenance free
- Good control characteristics



MATERIAL SPECIFICATION

Component	Material	Specification	
		BS EN	ASTM
Body	Ductile Iron	1563 EN-JS1030	A536-65-45-12
Operating Shaft	Stainless Steel	10088-1 X12Cr13	A276 410
Disc	Stainless Steel	110213-4 GX5CrNiMo19-11-2	A351 CF8M
Taper Pins	Stainless Steel	10088-1X5CrNiMo17-12-2	A276 316
Bushes	PTFE		
O-Ring	Buna N		
Liner	EPDM		

DIMENSIONAL DRAWINGS

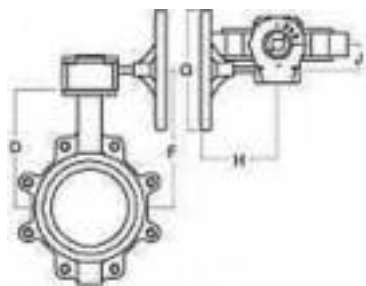

PRESSURE/ TEMPERATURE RATING

16 bar from -10 to 120°C
15.7 bar at 130°C

TEST PRESSURES

Body: 24 bar
Seat: 17.6 bar

SPECIFICATION

Generally conforms to BS EN 593:2009.
Ductile Iron body epoxy coated.
Fully-lugged.
Stainless steel disc.
EPDM liner.

To suit flange connections BS EN 1092-2 PN16.
Valves may be used for flow regulation.
Valves DN250 and larger supplied as standard with fully enclosed gear operator.
Valves DN450 and larger supplied with spur gear unit as part of gear operator.

DIMENSIONS AND WEIGHTS

Nom Size	mm	50	65	80	100	125	150	200	250	300	350	400	450	500	600
A	mm	44	48	48	54	57	57	63	70	79	79	89	108	133	156
B	mm	83	95	102	124	136	150	197	210	248	280	305	381	381	458
C	mm	195	207	213	232	245	257	305	-	-	369	400	422	480	562
D	mm	162	175	181	200	213	225	260	292	337	520	580	640	715	840
E	mm	260	260	260	260	260	260	356	-	-	38	54	105	105	110
F	mm	204	217	223	242	255	267	300	332	377	300	450	450	450	450
G	mm	150	150	150	150	300	300	300	300	300	230	230	340	340	360
H	mm	240	240	240	240	240	230	230	230	230	80	120	185	185	185
J	mm	60	60	60	60	60	60	80	80	80	-	-	-	-	-
Weight	kg	3	4	6	12	13	14	22	43	57	65	104	150	198	300

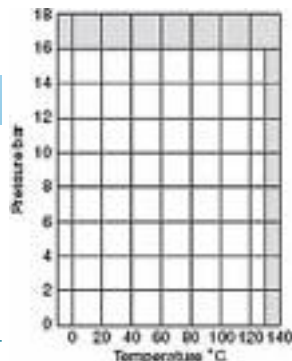

Every effort has been made to ensure that the information contained in this publication is accurate at the time of publishing. Hattersley Ltd assumes no responsibility or liability for typographical errors or omissions or for any misinterpretation of the information within the publication and reserves the right to change without notice.

Fig. 4990
Steel Fully-lugged

FEATURES AND BENEFITS

- Carbon steel body with stainless steel seat
- Stainless steel stem and double offset disc
- Reinforced PTFE seat
- End of line servicing up to full rating
- High Kv values



MATERIAL SPECIFICATION

Component	Material	Specification	
		BS EN	ASTM
Body	Steel	10213-2 GP240GH	A216 WCB
Body Seat	Stainless Steel	12073 XCrNiMn23-12-2	
Disc	Stainless Steel	10088-1 X17CrNi16-2	AISI 431
Disc Seal Ring	PTFE or PTFE/Neoprene		
Retaining Ring	Stainless Steel	10088-1 X17CrNi16-2	AISI 431
Stem	Stainless Steel	10088-1 X17CrNi16-2	AISI 431
Disc Pin	Stainless Steel	10088-1 X17CrNi16-2	AISI 431
Bottom Cap	Steel		
Gland Packing	PTFE Graphite		
Bearings	Bronze-PTFE		
Lever			

DIMENSIONAL DRAWINGS

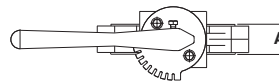
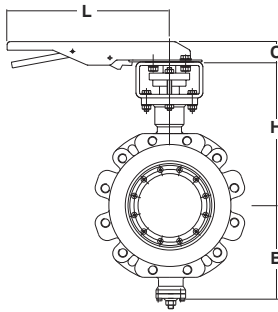

DIMENSIONS AND WEIGHTS

Nom Size	mm	50	65	80	100	125	150
A	mm	43	46	46	52	56	56
B	mm	123	131	150	175	187	218
H	mm	215	215	225	244	260	270
C	mm	27	27	27	35	35	42
L	mm	265	265	265	265	265	265
Weight	kg	-	-	-	-	-	-

PRESSURE/TEMPERATURE RATING

16 bar from -10 to 163°C
3.4 bar at 204°C

TEST PRESSURES (HYDRAULIC)

Body: 24 bar
Seat: 17.6 bar

SPECIFICATION

Designed to BS EN 593:2009.
Face to face dimensions to BS EN 558-1 basic series 20.
Reinforced PTFE disc seal.
Stainless steel body seat.
Double eccentric disc.
Bi-directional isolation.
Valves are supplied lever operated.
Actuator flange ISO 5211/1.
To suit flange connections BS EN 1092-2 PN16, alternative flanges available.
Wafer pattern available figure 4985 PN16.

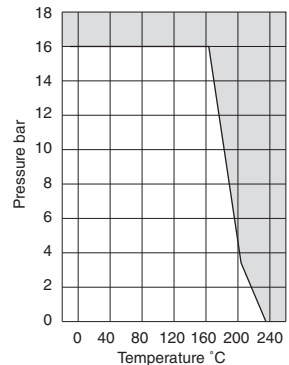

Every effort has been made to ensure that the information contained in this publication is accurate at the time of publishing. Hattersley Ltd assumes no responsibility or liability for typographical errors or omissions or for any misinterpretation of the information within the publication and reserves the right to change without notice.

Fig. 4990G Steel Fully-lugged

FEATURES AND BENEFITS

- Carbon steel body with stainless steel seat
- Stainless steel stem and double offset disc
- Reinforced PTFE seat
- End of line servicing up to full rating
- High Kv values



MATERIAL SPECIFICATION

Component	Material	Specification	
		BS EN	ASTM
Body	Steel	10213-2 GP240GH	A216 WCB
Body Seat	Stainless Steel	12073 XCrNiMn23-12-2	
Disc	Stainless Steel	10088-1 X17CrNi16-2	AISI 431
Disc Seal Ring	PTFE or PTFE Neoprene		
Retaining Ring	Stainless Steel	10088-1 X17CrNi16-2	AISI 431
Stem	Stainless Steel	10088-1 X17CrNi16-2	AISI 431
Disc Pin	Stainless Steel	10088-1 X17CrNi16-2	AISI 431
Bottom Cap	Steel		
Gland Packing	PTFE Graphite		
Gearbox	Cast Iron	1561 EN-JL1030	A126 Cl B
Handwheel	Steel		

DIMENSIONAL DRAWINGS

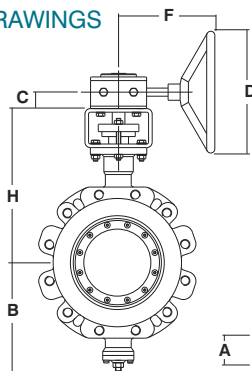

PRESSURE/ TEMPERATURE RATING

16bar from -10 to 163°C
3.4bar at 204°C

TEST PRESSURES (HYDRAULIC)

Body: 24 bar
Seat: 17.6 bar

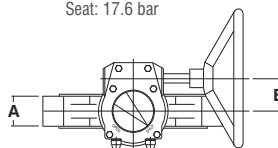

SPECIFICATION

Designed to BS EN 593:2009.
Face to face dimensions to BS EN 558-1 basic series 20.
Reinforced PTFE disc seal.
Stainless steel body seat.
Double eccentric disc.
Bi-directional isolation.
Valves are supplied gear operated.
Actuator flange ISO 5211/1.
To suit flange connections BS EN 1092-2 PN16,
alternative flanges available.
Wafer pattern available figure 4985G PN16.

DIMENSIONS AND WEIGHTS

Nom Size	mm	50	65	80	100	125	150
A	mm	43	46	46	52	56	56
B	mm	123	131	150	175	187	218
H	mm	215	215	225	244	260	270
C	mm	27	27	27	27	27	27
D dia	mm	125	200	200	200	200	200
E	mm	39	39	39	39	39	39
F	mm	152	159	159	159	159	159
Weight	kg	-	-	-	-	-	-

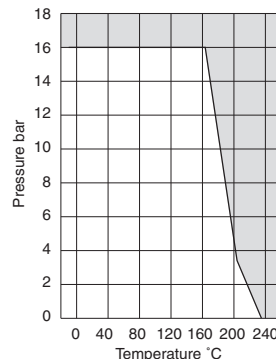

Every effort has been made to ensure that the information contained in this publication is accurate at the time of publishing. Hattersley Ltd assumes no responsibility or liability for typographical errors or omissions or for any misinterpretation of the information within the publication and reserves the right to change without notice.

Fig. 4990G
Steel Fully-lugged

FEATURES AND BENEFITS

- Carbon steel body with stainless steel seat
- Stainless steel stem and double offset disc
- Reinforced PTFE seat
- End of line servicing up to full rating
- High Kv values



MATERIAL SPECIFICATION

Component	Material	Specification	
		BS EN	ASTM
Body	Steel	10213-2 GP240GH	A216 WCB
Body Seat	Stainless Steel	12073 XCrNiMn23-12-2	
Disc	Stainless Steel	10088-1 X17CrNi16-2	AISI 431
Disc Seal Ring	PTFE or PTFE/Neoprene		
Retaining Ring	Stainless Steel	10088-1 X17CrNi16-2	AISI 431
Stem	Stainless Steel	10088-1 X2 CrNiNo17-12-2	A276-316L
Disc Pin	Stainless Steel	10088-1 X17CrNi16-2	AISI 431
Bottom Cap	Steel		
Gland Packing	PTFE Graphite		
Bearings	Bronze-PTFE		
Gearbox	Cast Iron	1561 EN-JL030	A126 Cl B
Handwheel	Steel		

DIMENSIONAL DRAWINGS

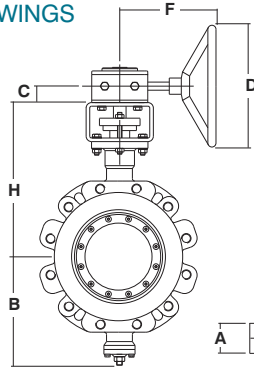

PRESSURE/TEMPERATURE RATING

16 bar from -10 to 163°C
3.4 bar at 204°C

TEST PRESSURES (HYDRAULIC)

Body: 24 bar
Seat: 17.6 bar

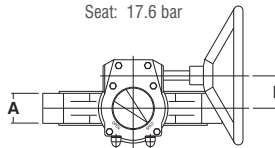

SPECIFICATION

Designed to BS EN 593:2009.
Face to face dimensions to BS EN 558-1 basic series 20.
Reinforced PTFE disc seal.
Stainless steel body seat.
Double eccentric disc.
Bi-directional isolation.
Valves are supplied gear operated.
Actuator flange ISO 5211/1.
To suit flange connections BS EN 1092-2 PN16, alternative flanges available.
Wafer pattern available figure 4985G PN16.

DIMENSIONS AND WEIGHTS

Nom Size	mm	200	250	300	350	400	450	500
A	mm	60	68	78	78	102	-	127
B	mm	294	333	382	398	448	-	555
H	mm	320	366	390	425	440	-	510
C	mm	35	42	42	50	50	-	50
D dia	mm	300	300	300	457	457	-	457
E	mm	52	67	67	90	90	-	123
F	mm	197	223	223	279	279	-	331
Weight	kg	-	-	-	-	-	-	-

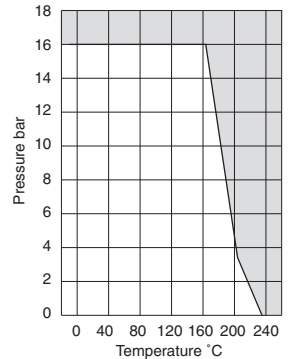

Every effort has been made to ensure that the information contained in this publication is accurate at the time of publishing. Hattersley Ltd assumes no responsibility or liability for typographical errors or omissions or for any misinterpretation of the information within the publication and reserves the right to change without notice.

Fig. 4990G Steel Fully-lugged

FEATURES AND BENEFITS

- Carbon steel body with stainless steel seat
- Stainless steel stem and double offset disc
- Reinforced PTFE seat
- End of line servicing up to full rating
- High Kv values



MATERIAL SPECIFICATION

Component	Material	Specification	
		BS EN	ASTM
Body	Steel	10213-2 GP240GH	A216 WCB
Body Seat	Stainless Steel	12073 XCrNiMn23-12-2	
Disc	Stainless Steel	10088-1 X17CrNi16-2	AISI 431
Disc Seal Ring	PTFE or PTFE/Neoprene		
Retaining Ring	Stainless Steel	10088-1 X17CrNi16-2	AISI 431
Stem	Stainless Steel	10088-1 X17CrNi16-2	AISI 431
Disc Pin	Stainless Steel	10088-1 X17CrNi16-2	AISI 431
Bottom Cap	Steel		
Gland Packing	PTFE Graphite		
Bearings	Bronze-PTFE		
Gearbox	Cast Iron	1561 EN-JLI030	A126 Cl B
Handwheel	Steel		

DIMENSIONAL DRAWINGS

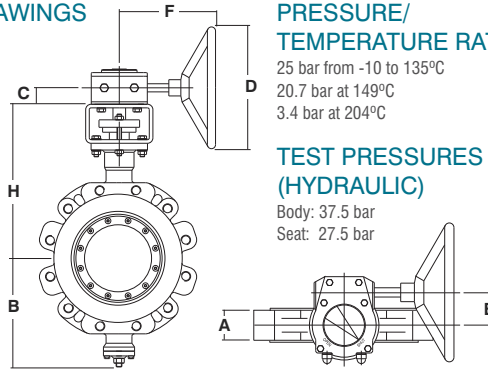

PRESSURE/ TEMPERATURE RATING

25 bar from -10 to 135°C
20.7 bar at 149°C
3.4 bar at 204°C

TEST PRESSURES (HYDRAULIC)

Body: 37.5 bar
Seat: 27.5 bar

SPECIFICATION

Designed to BS EN 593:2009.
Face to face dimensions to BS EN 558-1 basic series 16.
Reinforced PTFE disc seal.
Stainless steel body seat.
Double eccentric disc.
Bi-directional isolation.
Valves are supplied gear operated.
Actuator flange ISO 5211/1.
To suit flange connections BS EN 1092-2 PN25, alternative flanges available.

DIMENSIONS AND WEIGHTS

Nom Size	mm	50	65	80	100	125	150
A	mm	43	46	65	65	70	76
B	mm	123	131	150	175	187	218
H	mm	215	215	220	281	294	317
C	mm	27	27	27	35	35	42
D dia	mm	125	200	200	250	300	300
E	mm	39	39	39	52	52	67
F	mm	152	159	159	184	197	223
Weight	kg	10	12	17	24	32	47

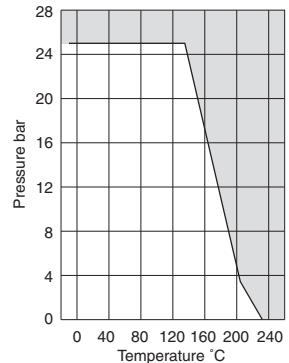

Every effort has been made to ensure that the information contained in this publication is accurate at the time of publishing. Hattersley Ltd assumes no responsibility or liability for typographical errors or omissions or for any misinterpretation of the information within the publication and reserves the right to change without notice.

Fig. 4990G
Steel Fully-lugged

FEATURES AND BENEFITS

- Carbon steel body with stainless steel seat
- Stainless steel stem and double offset disc
- Reinforced PTFE seat
- End of line servicing up to full rating
- High Kv values



MATERIAL SPECIFICATION

Component	Material	Specification	
		BS EN	ASTM
Body	Steel	10213-2 GP240GH	A216 WCB
Body Seat	Stainless Steel	12073 XCrNiMn23-12-2	
Disc	Stainless Steel	10088-1 X17CrNi16-2	AISI 431
Disc Seal Ring	PTFE or PTFE/Neoprene		
Retaining ring	Stainless Steel	10088-1 X17CrNi16-2	AISI 431
Stem	Stainless Steel	10088-1 X17CrNi16-2	AISI 431
Disc Pin	Stainless Steel	10088-1 X17CrNi16-2	AISI 431
Bottom Cap	Steel		
Gland Packing	PTFE Graphite		
Bearings	Bronze-PTFE		
Gearbox	Cast Iron	1561 EN-JL1030	A126 Cl B
Handwheel	Steel		

DIMENSIONAL DRAWINGS

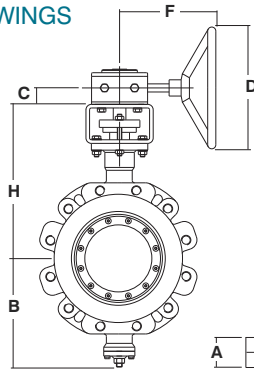

PRESSURE/TEMPERATURE RATING

25 bar from -10 to 135°C
20.7 bar at 149°C
3.4 bar at 204°C

TEST PRESSURES (HYDRAULIC)

Body: 37.5 bar
Seat: 27.5 bar

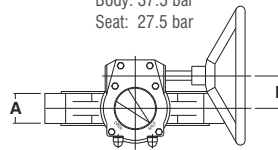

SPECIFICATION

Designed to BS EN 593:2009.
Face to face dimensions to BS EN 558-1 basic series 16.
Reinforced PTFE disc seal.
Stainless steel body seat.
Double eccentric disc.
Bi-directional isolation.
Valves are supplied gear operated.
Actuator flange ISO 5211/1.
To suit flange connections BS EN 1092-2 PN25, alternative flanges available.

DIMENSIONS AND WEIGHTS

Nom Size	mm	200	250	300	350	400	450	500
A	mm	89	114	114	127	140	152	152
B	mm	294	333	382	398	448	473	555
H	mm	369	396	461	477	557	583	643
C	mm	42	50	50	50	66	66	66
D dia	mm	300	457	457	457	610	610	610
E	mm	67	90	123	154	138	138	138
F	mm	223	229	331	356	477	477	477
Weight	kg	73	126	167	243	340	454	493

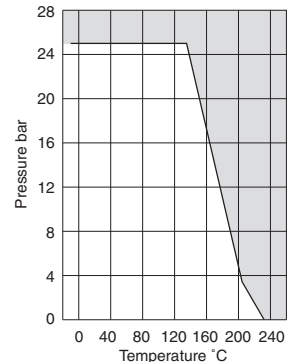

Every effort has been made to ensure that the information contained in this publication is accurate at the time of publishing. Hattersley Ltd assumes no responsibility or liability for typographical errors or omissions or for any misinterpretation of the information within the publication and reserves the right to change without notice.

Fig. 4990G
Steel Fully-lugged

FEATURES AND BENEFITS

- Carbon steel body with stainless steel seat
- Stainless steel stem and double offset disc
- Reinforced PTFE seat
- End of line servicing up to full rating
- High Kv values



MATERIAL SPECIFICATION

Component	Material	Specification	
		BS EN	ASTM
Body	Steel	10213-2 GP240GH	A216 WCB
Body Seat	Stainless Steel	12073 XCrNiMn23-12-2	
Disc	Stainless Steel	10088-1 X17CrNi16-2	AISI 431
Disc Seal Ring	PTFE or PTFE/ Neoprene		
Retaining Ring	Stainless Steel	10088-1 X2 CrNiNo17-12-2 A276-316L	
Stem	Stainless Steel	10088-1 X17CrNi16-2	AISI 431
Disc Pin	Stainless Steel	10088-1 X17CrNi16-2	AISI 431
Bottom Cap	Steel		
Gland Packing	PTFE Graphite		
Gearbox	Cast Iron	1561 EN-JL1030	A126 Cl B
Handwheel	Steel		

DIMENSIONAL DRAWINGS

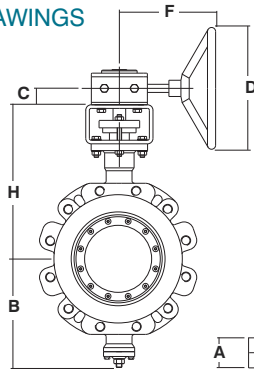

**PRESSURE/
TEMPERATURE
RATING**

40 bar from -10 to 90°C
20.7 bar at 149°C
3.4 bar at 204°C

**TEST PRESSURES
(HYDRAULIC)**

Body: 60 bar
Seat: 44 bar

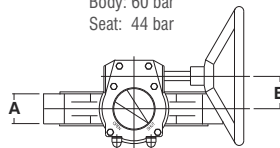

SPECIFICATION

Designed to BS EN 593:2009.
Face to face dimensions to BS EN 558-1 basic series 16.
Reinforced PTFE disc seal.
Stainless steel body seat.
Double eccentric disc.
Bi-directional isolation.
Valves are supplied gear operated.
Actuator flange ISO 5211/1.
To suit flange connections BS EN 1092-2 PN40, alternative flanges available.

DIMENSIONS AND WEIGHTS

Nom Size	mm	50	65	80	100	125	150
A	mm	43	46	64	64	70	76
B	mm	123	131	150	175	187	218
H	mm	215	215	220	281	294	317
C	mm	27	27	27	35	35	42
D dia	mm	125	200	200	250	300	300
E	mm	39	39	39	52	52	67
F	mm	152	159	159	184	197	223
Weight	kg	10	12	17	24	32	47

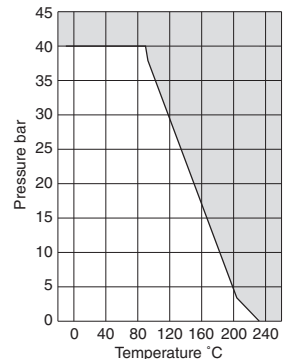

Every effort has been made to ensure that the information contained in this publication is accurate at the time of publishing. Hattersley Ltd assumes no responsibility or liability for typographical errors or omissions or for any misinterpretation of the information within the publication and reserves the right to change without notice.

Fig. 4990G Steel Fully-lugged

FEATURES AND BENEFITS

- Carbon steel body with stainless steel seat
- Stainless steel stem and double offset disc
- Reinforced PTFE seat
- End of line servicing up to full rating
- High Kv values



MATERIAL SPECIFICATION

Component	Material	Specification	
		BS EN	ASTM
Body	Steel	10213-2 GP240GH	A216 WCB
Body Seat	Stainless Steel	12073 XCrNiMn23-12-2	
Disc	Stainless Steel	10088-33 X8CrNiS 18-9	AISI 420
Disc Seal Ring	PTFE or PTFE/ Neoprene		
Retaining Ring	Stainless Steel	10088-1 X17CrNi16-2	AISI 431
Stem	Stainless Steel	10088-1 X17CrNi16-2	AISI 431
Disc Pin	Stainless Steel	10088-1 X17CrNi16-2	AISI 431
Bottom Cap	Steel		
Gland Packing	PTFE Graphite		
Bearings	Bronze-PTFE		
Gearbox	Cast Iron	1561 EN-JLI030	A126 Cl B
Handwheel	Steel		

DIMENSIONAL DRAWINGS

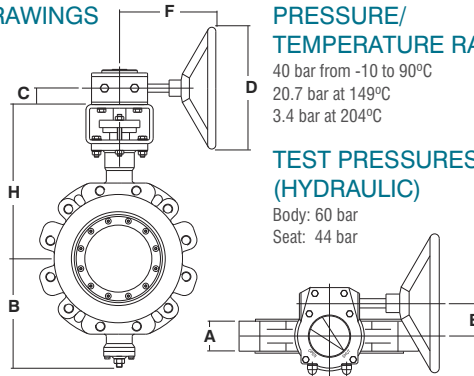

PRESSURE/ TEMPERATURE RATING

40 bar from -10 to 90°C
20.7 bar at 149°C
3.4 bar at 204°C

TEST PRESSURES (HYDRAULIC)

Body: 60 bar
Seat: 44 bar

SPECIFICATION

Designed to BS EN 593:2009.
Face to face dimensions to BS EN 558-1 basic series 16.
Reinforced PTFE disc seal.
Stainless steel body seat.
Double eccentric disc.
Bi-directional isolation.
Valves are supplied gear operated
Actuator flange ISO 5211/1.
To suit flange connections BS EN 1092-2 PN40, alternative flanges available.

DIMENSIONS AND WEIGHTS

Nom Size	mm	200	250	300	350	400	450	500
A	mm	89	114	114	127	140	152	152
B	mm	294	333	382	398	448	473	555
H	mm	369	396	461	477	557	583	643
C	mm	42	50	50	50	66	66	66
D dia	mm	300	457	457	457	610	610	610
E	mm	67	90	123	154	138	138	138
F	mm	223	279	331	356	477	477	477
Weight	kg	79	143	203	288	415	469	589

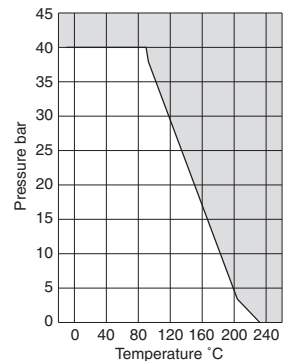

Every effort has been made to ensure that the information contained in this publication is accurate at the time of publishing. Hattersley Ltd assumes no responsibility or liability for typographical errors or omissions or for any misinterpretation of the information within the publication and reserves the right to change without notice.



The Cube, Birmingham
Specification: Hattersley Hook-Ups

Check Valves

Check valves permit flow in one direction only, and close automatically if flow reverses. They are entirely automatic in action, depending upon pressure and velocity of flow within the line to perform their functions of opening and closing. Most Hattersley swing check valves can be installed in horizontal or vertical upward flow piping. Lift check valves must be used in horizontal lines only.

Hattersley offers four basic types of bronze check valves, namely:

- Horizontal lift check
- Vertical lift check
- Swing check
- Double check

Swing check valves, having 6 diameters of straight lengths of pipe upstream and 3 diameters downstream, are suitable for velocities up to 3 metres/second. If the valve is situated such that turbulent flow enters the valve, the velocity should not exceed 2 metres/second.

Horizontal lift check valves are primarily used for air, gas and steam services whilst swing check valves are most suitable for water and other liquids.

For air, gas and low pressure applications, especially where bubble tight closure is required, a valve with rubber faced disc is necessary.

Compressed air service requires a horizontal lift check valve with a nitrile rubber facing on the disc and fitted with a recoil spring. The valve should always be installed as far away from the compressor as possible.

When selecting valves, reference to codes of practice and other mandatory specifications should be made which may preclude certain types for specific applications.

Double check valves are designed to prevent contamination of water caused by back syphonage, back flow and cross connection in supplies such as those to hose taps, cisterns, stand pipes, showers and basins.

Valves, where designated, are WRAS Approved Products and listed in the Water Fittings and Materials Directory.



Fig. 42
Bronze - Horizontal Lift

FEATURES AND BENEFITS

- Robust and high quality bronze body
- Horizontal lift pattern
- Metal to metal seat for enhance sealing
- Taper threaded to BS EN 10226 ISO 7-1 (BS 21)

MATERIAL SPECIFICATION

Component	Material	Specification	
		BS EN	ASTM
Body	Bronze	1982 CC491K	B62 C83600
Cap	Bronze	1982 CC491K	B62 C83600
Disc (1/4" - 1")	Bronze	1982 CC491K	B62 C83600



DIMENSIONAL DRAWINGS

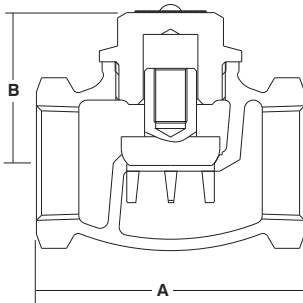

DIMENSIONS AND WEIGHTS

Nom Size	in	1/2	3/4	1	1 1/4	1 1/2	2
A	mm	60	74	86	99	109	130
B	mm	39	43	51	58	64	70
Weight	kg	0.5	0.7	1.6	1.7	2.5	3.5

PRESSURE/ TEMPERATURE RATING

BS 5154 PN32 Series B
14 bar at 198°C
32 bar from -10 to 100°C

TEST PRESSURES

Shell: 6 bar (pneumatic)
Seat: 35.2 bar (hydraulic)

SPECIFICATION

BS 5154:1991.
Bronze body.
Horizontal lift pattern.
Metal to metal seat.
Guided disc.
Threaded cap.
Taper threaded to BS EN 10226 ISO 7-1 (BS 21).
Available taper threaded NPT to ASTM B1.20.1 (42AT).

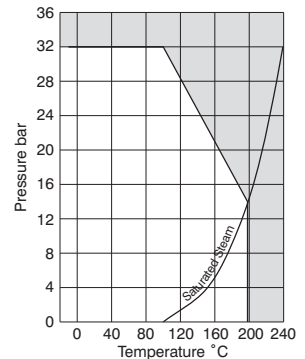

Every effort has been made to ensure that the information contained in this publication is accurate at the time of publishing. Hattersley Ltd assumes no responsibility or liability for typographical errors or omissions or for any misinterpretation of the information within the publication and reserves the right to change without notice.

Fig. 47
Bronze - Swing Pattern

FEATURES AND BENEFITS

- Horizontal swing pattern
- Robust and high quality bronze body
- Metal to metal seat for enhance sealing
- Taper threaded to BS EN 10226 ISO 7-1 (BS 21)



MATERIAL SPECIFICATION

Component	Material	Specification	
		BS EN	ASTM
Cap	Bronze	1982 CC491K	B62 C83600
Hinge Pin	Stainless Steel	10088-1 X2 CrNiNo17-12-2	A276-316L
Hinge	Stainless Steel	970 GR316S11	
Disc Nut	Brass	12164 CW614N	B455 C38500
Body	Bronze	1982 CC491K	B62 C83600
Hinge	Bronze	1982 CC491K	B62 C83600
Disc	Brass	12164 CW614N	B455 C38500
Disc (1 1/4" - 3")	Bronze	1982 CC491K	B62 C83600

DIMENSIONAL DRAWINGS

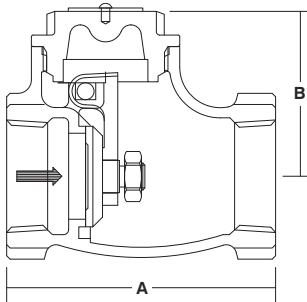

DIMENSIONS AND WEIGHTS

Nom Size	in	1/4	3/8	1/2	3/4	1	1 1/4	1 1/2	2	2 1/2	3
A	mm	48	48	58	66	80	89	95	108	155	190
B	mm	33	33	38	42	49	56	65	76	98	99
Weight	kg	0.20	0.19	0.32	0.43	0.61	1.01	1.34	2.12	4.08	5.76

**PRESSURE/
TEMPERATURE RATING**

BS 5154
25 bar -10 to 100°C
10.5 bar at 186°C

TEST PRESSURES

Shell: 6 bar (pneumatic)
Seat: 27.5 bar (hydraulic)

SPECIFICATION

BS 5154:1991.
Bronze body.
Horizontal swing pattern.
Threaded cover.
Taper threaded to BS EN 10226 ISO 7-1 (BS 21).

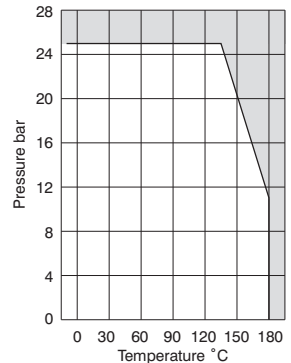

Every effort has been made to ensure that the information contained in this publication is accurate at the time of publishing. Hattersley Ltd assumes no responsibility or liability for typographical errors or omissions or for any misinterpretation of the information within the publication and reserves the right to change without notice.

Fig. 48
Bronze - Oblique Swing Pattern

FEATURES AND BENEFITS

- Oblique swing pattern
- Robust and high quality bronze body
- Metal to metal seat for enhance sealing



MATERIAL SPECIFICATION

Component	Material	Specification BS EN	
Cap	Bronze	1982 CC491K	B62 C83600
Hinge Pin	Brass	12164 CW603N	B16-C36000
Hinge	Bronze	1982 CC491K	B62 C83600
Hinge Pin Plug	Brass	12164 CW617N	B124 Alloy 2
Disc	Bronze	1982 CC491K	B62 C83600
Disc Nut	Brass	12164 CW603N	B16-C36000
Body	Bronze	1982 CC491K	B62 C83600

DIMENSIONAL DRAWINGS

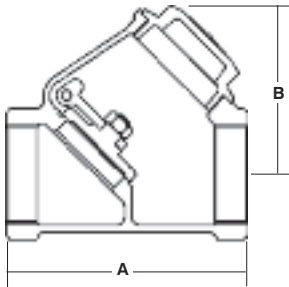

DIMENSIONS AND WEIGHTS

Nom Size	in	1/2	3/4	1	1 1/4	1 1/2	2
A	mm	60	70	86.4	96	116	136
B	mm	45	50	58	68	75	94
Weight	kg	0.28	0.42	0.62	1.0	1.4	2.1

**PRESSURE/
TEMPERATURE RATING**

BS5154 PN32 Series A
14 bar at 260°C
32 bar from -10 to 120°C

**TEST PRESSURES
(HYDRAULIC)**

Shell: 48 bar
Seat: 35.2 bar

SPECIFICATION

Oblique swing pattern.
Threaded cover.
Metal to metal seat.
Ends threaded internal
BS EN 10266 (ISO 7).
Suitable for mounting in horizontal
and vertical pipe (with vertical
flow upwards).

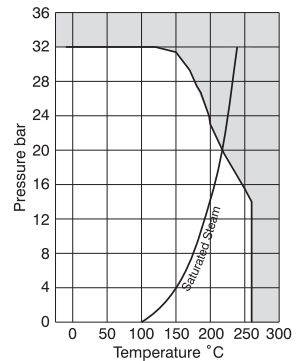

Every effort has been made to ensure that the information contained in this publication is accurate at the time of publishing. Hattersley Ltd assumes no responsibility or liability for typographical errors or omissions or for any misinterpretation of the information within the publication and reserves the right to change without notice.

Fig. 49
Bronze - Vertical Lift Pattern

FEATURES AND BENEFITS

- Robust and high quality bronze body
- Suitable for mounting horizontally or vertically
- Resilient seat

MATERIAL SPECIFICATION

Component	Material	Specification BS EN	
Body	Bronze	1982 CC491K	B62 C83600
Disc	Bronze	1982 CC491K	B62 C83600
Spring	Stainless Steel	10270 X10CrNr18-8	A276-304
End Cap	Bronze	1982 CC491K	B62 C83600
Seat	EPDM		



DIMENSIONAL DRAWINGS

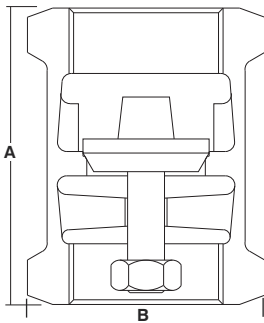

DIMENSIONS AND WEIGHTS

Nom Size	in	1/2	3/4	1	1 1/4	1 1/2	2
A	mm	53	59	67	79	84	96
B	mm	33	40	50	60	66	80
Weight	kg	0.18	0.27	0.44	0.63	0.93	1.4

**PRESSURE/
TEMPERATURE RATING**

BS 5154 PN32 Series B
32 bar from -10 to 120°C

**TEST PRESSURES
(PNEUMATIC)**

Body: 6 bar
Seat: 6 bar

SPECIFICATION

Bronze body.
Stainless steel spring.
Taper threaded BS EN 10266
(ISO 7-1) formerly BS 21.
Available with NPT threads to ASTM
B1.20.1.
Suitable for mounting horizontally or
vertically (flow upwards).
Resilient seat.

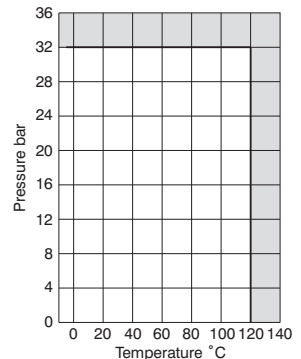

Every effort has been made to ensure that the information contained in this publication is accurate at the time of publishing. Hattersley Ltd assumes no responsibility or liability for typographical errors or omissions or for any misinterpretation of the information within the publication and reserves the right to change without notice.

Fig. 249 & 249C Brass - Single & Double Check (Fig. 249C Chromium Plated) Check Valves



FEATURES AND BENEFITS

- WRAS approved for use with potable water
- Compression ends for use with half hard R250 copper pipe
- Single, double and chromium plated options available

MATERIAL SPECIFICATION

Component	Material	Specification BS EN
Body	DZR Brass	12165 CW602N



DIMENSIONAL DRAWINGS

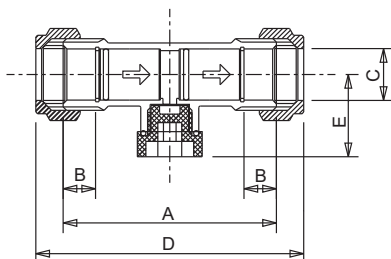

Fig. 249 & 249C

PRESSURE/ TEMPERATURE RATING

16 bar from -10 to 85°C

TEST PRESSURES (HYDRAULIC)

Body: 24 bar
Seat: 17.6 bar

SPECIFICATION

Fig. No. 249

Double Check - 15mm, 22mm, 28mm

Fig. No. 249C

Double Check chromium plated - 15mm

Manufactured to BS 6282.

WRAS approved PN16 85°C.

Application: Water.

End Connection: Compression.

Back Flow Prevention Device category:

Single check - Class 2 as per Water Supply.

Contamination Risks (water fittings)

Regulations 1999.

Double check - Class 3 as per Water Supply.

Contamination Risks (water fittings)

Regulations 1999.

DIMENSIONS AND WEIGHTS

Nom Size	mm	15 Fig. 249	22 Fig. 249	28 Fig. 249	15 Fig. 249C
A	mm	61.4	74.6	88.6	61.4
B	mm	9.5	10.5	12.5	9.5
C	mm	15.2	22.2	28.25	15.2
D	mm	78.5	91.4	106.3	78.5
E	mm	24.5	27.5	30.5	24.5
Weight (approx)	kg	0.116	0.212	0.360	0.116

Every effort has been made to ensure that the information contained in this publication is accurate at the time of publishing. Hattersley Ltd assumes no responsibility or liability for typographical errors or omissions or for any misinterpretation of the information within the publication and reserves the right to change without notice.

Fig. 761 and 2761 Aquacheck® Non Return Valve



FEATURES AND BENEFITS

- Spring loaded axially guided disc
- Positive non-slam shut-off
- Flanged to BS EN 1092-2
- Resilient seat located in body

MATERIAL SPECIFICATION

Component	Material	Specification	
		BS EN	ASTM
Body	Ductile Iron	1563 EN-JS1030	A536-65-45-12
Plunger DN50-150	Bronze		
Plunger DN200-400	Cast Iron	1561 EN-JLI030	A126 Cl B
Seat Retaining Ring	Steel - Xylan Coated		
Seat	Nitrile		
Guide	Bronze		
Spring	Stainless Steel	10270 X10CrNi18-8	A276-304



DIMENSIONAL DRAWINGS

Single Check Valve
Fig. 761

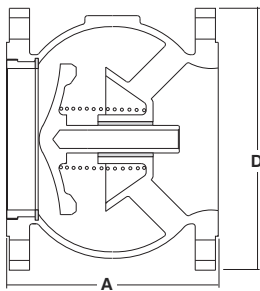

Double Check Valve
configuration Fig. 2761

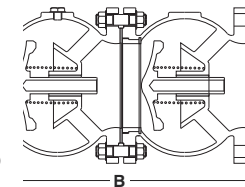

DIMENSIONS AND WEIGHTS

Nom Size	mm	50	65	80	100	125	150	200	250	300
A	mm	120	119	130	155	200	230	280	344	385
B	mm	240	241	260	310	403	460	560	688	770
D	mm	165	185	200	220	250	285	340	405	460
Weight 761	kg	5	7	9	13	21	28	47	83	123
Weight 2761	kg	11	15	20	27	44	58	97	168	249

Note: These valves are not intended to be used as backflow prevention devices conforming to Schedule 2 Section 6 of the WRAS Water Regulations Guide.

Every effort has been made to ensure that the information contained in this publication is accurate at the time of publishing. Hattersley Ltd assumes no responsibility or liability for typographical errors or omissions or for any misinterpretation of the information within the publication and reserves the right to change without notice.

PRESSURE/ TEMPERATURE RATING

16 bar from -10 to 85°C

TEST PRESSURES (HYDRAULIC)

Body: 24 bar
Seat: 17.6 bar

SPECIFICATION

Spring Loaded axially guided disc.
Resilient Seat located in body.
Flanged to BS EN 1092-2 PN16.
Alternative pressure ratings to PN25.
Alternative flange details including BS EN 1092-2 PN25 and PN40 and ANSI B16.1 Class 125.

NOTES

Sizes:
50mm to 250mm WRAS Approved.
300mm is not WRAS Approved.

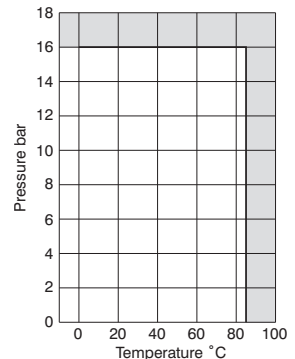

Fig. 1013 Bronze - Horizontal Lift Pattern

FEATURES AND BENEFITS

- Robust and high quality bronze body
- Horizontal lift pattern
- Replaceable PTFE, glass filled disc
- Taper threaded to BS EN 10226 ISO 7-1 (BS 21)

MATERIAL SPECIFICATION

Component	Material	Specification BS EN	
Cap (1 ¹ / ₄ " to 2")	Bronze	1982 CC491K	B62 C83600
Cap (1 ¹ / ₂ " to 1")	Brass	12164 CW603N	B16 C36000
Disc Holder	Bronze	1982 CC491K	B62 C83600
Disc	PTFE - Glass Filled		
Body	Bronze	1982 CC491K	B62 C83600



DIMENSIONAL DRAWINGS

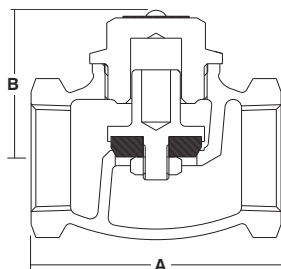

DIMENSIONS AND WEIGHTS

Nom Size	in	1/2	3/4	1	1 ¹ / ₄	1 ¹ / ₂	2
A	mm	60	74	86	99	109	130
B	mm	39	43	51	58	64	70
Weight	kg	0.4	0.6	1.1	1.3	2.1	3.4

PRESSURE/ TEMPERATURE RATING

BS 5154 PN32 Series B
14 bar at 198°C
32 bar from -10 to 100°C

TEST PRESSURES

Body: 6 bar - pneumatic
Seat: 35.2 bar - hydraulic

SPECIFICATION

BS 5154:1991.
Bronze body.
Horizontal lift pattern.
Replaceable PTFE - glass filled disc.
Guided disc.
Threaded cap.
Taper threaded BS EN 10266 (ISO 7-1) formerly BS 21.

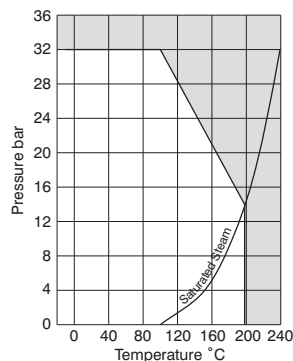

Every effort has been made to ensure that the information contained in this publication is accurate at the time of publishing. Hattersley Ltd assumes no responsibility or liability for typographical errors or omissions or for any misinterpretation of the information within the publication and reserves the right to change without notice.

Fig. 3047 Bronze - Swing Pattern

FEATURES AND BENEFITS

- Horizontal swing pattern
- Robust and high quality bronze body
- Various disc materials available
- Taper threaded to BS EN 10226 ISO 7-1 (BS 21)



MATERIAL SPECIFICATION

Component	Material	Specification BS EN
Body	Bronze	1982 CC491K
Cap	Bronze	1982 CC491K
Disc Holder (1/2" to 1")	Brass	12164 CW614N
Disc Holder (1 1/4" to 2")	Bronze	1982 CC491K
Disc	Nitrile	2751 BA80
Disc Nut	Brass	12164 CW614N
Disc Retaining Washer	Brass	12164 CW614N
Hinge	Bronze	1982 CC491K
Hinge Pin	Stainless Steel	970 GR316S11
Hinge Nut	Brass	12164 CW614N
Identification Plate	Aluminium	
Drive Screw	Steel Electro Brassed	

DIMENSIONAL DRAWINGS

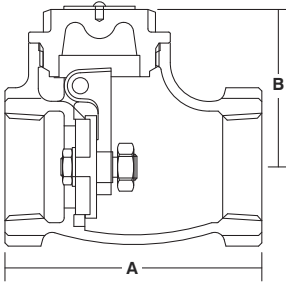

DIMENSIONS AND WEIGHTS

Nom Size	in	1/2	3/4	1	1 1/4	1 1/2	2
A	mm	58	66	80	89	95	108
B	mm	38	42	49	56	65	76
Weight	kg	0.33	0.43	0.63	1.01	1.34	2.12

PRESSURE/ TEMPERATURE RATING

BS 5154:1991 PN25
25 bar from -10 to restricted 90°C

TEST PRESSURES

Body: 6 bar - pneumatic
Seat: 27.5 bar - hydraulic

SPECIFICATION

Horizontal swing pattern.
Threaded cover.
Alternative disc materials available.
Ends threaded internal BS EN 10226 (ISO 7).
Suitable for mounting in horizontal and vertical pipe (with vertical flow upwards).

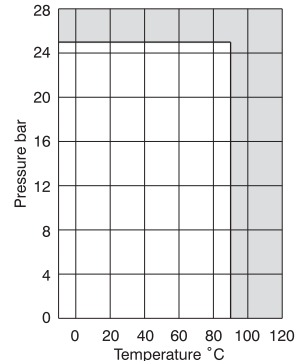

Every effort has been made to ensure that the information contained in this publication is accurate at the time of publishing. Hattersley Ltd assumes no responsibility or liability for typographical errors or omissions or for any misinterpretation of the information within the publication and reserves the right to change without notice.

Fig. M650

Ductile Iron - Swing Pattern

FEATURES AND BENEFITS

- Suitable for velocities of up to 3 metres/second
- Ideal for water or other liquids
- Bolted cover
- Suitable for mounting in horizontal and vertical pipelines



MATERIAL SPECIFICATION

Component	Material	Specification BS EN
Cover	Ductile Iron	1563 EN-JS 1050
Cover Gasket	Asbestos Free	
Hinge Pin	Stainless Steel	970 420537
Hinge	Ductile Iron	1563 EN-JS 1050
Disc	Ductile Iron	1563 EN-JS 1050
Disc Face Ring	Bronze	1982 CC491K
Body Ring	Bronze	1982 CC491K
Body	Ductile Iron	1563 EN-JS 1050

DIMENSIONAL DRAWINGS

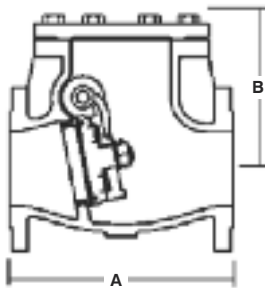

DIMENSIONS AND WEIGHTS

Nom Size	mm	50	65	80	100	125	150	200	250	300
A	mm	203	216	241	292	330	356	495	622	699
B	mm	121	135	141	168	182	215	267	305	343
Weight	kg	16	22	28	40	62	82	144	232	310

PRESSURE/TEMPERATURE RATING

BS EN 12334 PN25
25 bar from -10 to 120°C
21.5 bar at 220°C

TEST PRESSURES (HYDRAULIC)

PN25
Shell: 37.5 bar
Seat: 27.5 bar

SPECIFICATION

BS EN 12334:2001 PN25.
Horizontal swing pattern.
Bolted cover.
Flanged to BS EN 1092-2 PN25.
Copper alloy trim.
Suitable for mounting in horizontal and vertical pipelines (with vertical flow upwards).

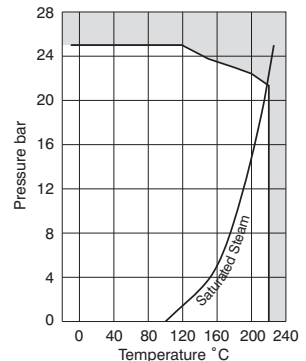

Every effort has been made to ensure that the information contained in this publication is accurate at the time of publishing. Hattersley Ltd assumes no responsibility or liability for typographical errors or omissions or for any misinterpretation of the information within the publication and reserves the right to change without notice.

Fig. M651 Cast Iron - Swing Pattern

FEATURES AND BENEFITS

- Suitable for velocities of up to 3 metres/second
- Ideal for water or other liquids
- Bolted cover
- Suitable for mounting in horizontal and vertical pipelines



MATERIAL SPECIFICATION

Component	Material	Specification	
		BS EN	ASTM
Cover	Cast Iron	1561 EN JLI040	A126 CI B
Cover Gasket	Reinforced Compressed Graphite		
Hinge Pin	Brass	12164 CW603N	B16-C36000
Hinge Pin Plug	Brass	12164 CW603N	B16-C36000
Hinge	Ductile Iron	1563 EN-JS1040	A536 70-50-05
Disc	Cast Iron	1561 EN JLI040	A126 CI B
Disc Face Ring	Bronze	1982 CC491K	B62-C83600
Body Seat Ring	Bronze	1982 CC491K	B62-C83600
Body	Cast Iron	1561 EN JLI040	A126 CI B

DIMENSIONAL DRAWINGS

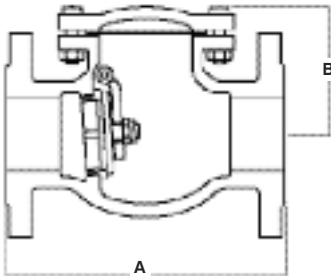

DIMENSIONS AND WEIGHTS

Nom Size	mm	50	65	80	100	125	150	200	250	300
A	mm	203	216	241	292	330	356	495	622	699
B	mm	113	133	143	163	197	212	257	298	330
Weight	kg	13	18	21	35	48	68	113	218	282

PRESSURE/ TEMPERATURE RATING

BS EN 1092-2 PN16
16 bar from -10 to 120°C
11.8 bar at 230°C

TEST PRESSURES

Seat: 17.6 bar (hydraulic)
Body: 24 bar (hydraulic)

SPECIFICATION

BS EN 12334:2001.
Face to Face dimensions to BS EN 558-1 basic series 10.
Cast iron body.
Bolted cover.
Bronze trim.
Suitable for mounting in horizontal and vertical pipes (with the flow upwards).
Flanged to BS EN 1092-2 PN16.
Flanges drilled to BS 10 available.

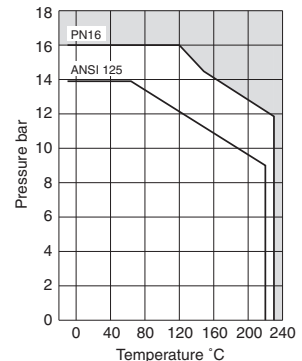

Every effort has been made to ensure that the information contained in this publication is accurate at the time of publishing. Hattersley Ltd assumes no responsibility or liability for typographical errors or omissions or for any misinterpretation of the information within the publication and reserves the right to change without notice.

Fig. M653 Cast Iron with Lever and Weight

FEATURES AND BENEFITS

- Lever and weight offers the ability to alter the flow resistance
- Bolted cover
- Suitable for mounting in horizontal and vertical pipelines
- Flanged to BS EN 1092-2



MATERIAL SPECIFICATION

Component	Material	Specification	
		BS EN	ASTM
Cover	Cast Iron	1561 EN-JLI030	A126 CI B
Cover Gasket	Asbestos Free		
Hinge Pin Plug	Stainless Steel	10270 X10CrNr18-8	A276-304
Hinge	Ductile Iron	1561 EN JS1050	
Gland Packing	Asbestos Free		
Disc	Cast Iron	1561 EN-JLI030	A126 CI B
Disc Face Ring	Bronze		
Body Ring	Bronze		
Body	Cast Iron	1561 EN-JLI030	A126 CI B
Counter Weight	Cast Iron	1561 EN-JLI030	A126 CI B
Operating Shaft	Stainless Steel	10088-1 X2 CrNiNo17-12-2	A276-316L
Operating Lever	Stainless Steel	10270 X10CrNr18-8	A276-304
Spring	Stainless Steel	10270 X10CrNr18-8	A276-304

DIMENSIONAL DRAWINGS

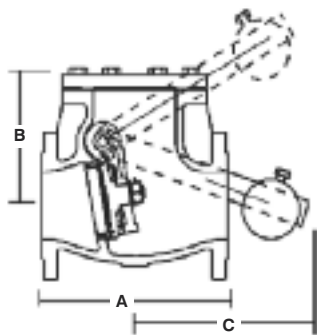

DIMENSIONS AND WEIGHTS

Nom Size	mm	50	65	80	100	125	150	200	250	300
A	mm	203	216	241	292	330	356	495	622	699
B	mm	121	135	141	168	182	215	267	305	343
C	mm	200	200	215	250	300	290	580	730	720
Weight	kg	21	27	33	45	66	86	152	244	320

PRESSURE/ TEMPERATURE RATING

BS EN 12334:2001 PN16

16 bar from -10 to 120°C

BS 5153 ANSI

11.8 bar at 230°C

9 bar at 218°C

13.8 bar from -10 to 66°C

TEST PRESSURES

PN16

Shell: 24 bar

Seat: 17.6 bar

Class 125

Shell: 24.1 bar

Seat: 13.8 bar

SPECIFICATION

Flanged to BS EN 1092-2 PN16 and bolted cover
Outside lever and adjustable weight.

If valve fig number M653 is to be used in a vertical pipeline this must meet ANSI B16.1 Class 125.

Copper alloy trim.

Suitable for mounting in horizontal and vertical pipelines (with vertical flow upwards).

BS EN 12334:2001 PN16.

be stated on order so that the lever and weight assembly can be positioned accordingly.

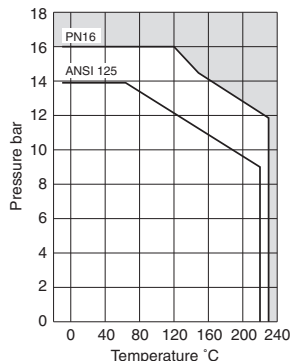

Every effort has been made to ensure that the information contained in this publication is accurate at the time of publishing. Hattersley Ltd assumes no responsibility or liability for typographical errors or omissions or for any misinterpretation of the information within the publication and reserves the right to change without notice.

Fig. 850
Cast Iron - Wafer Pattern

FEATURES AND BENEFITS

- Double door wafer pattern with spring assisted closure
- Elastomer seat vulcanised to the body casting to ensure extended seal life
- Suitable for mounting in horizontal and vertical pipelines
- Ideal for fitting between flanges to BS EN 1092-2



MATERIAL SPECIFICATION

Component	Material	Specification BS EN
Body	Cast Iron	BS1452 GR220
Seat	EPDM	
Disc	Gunmetal	BS1400 LG2
Shaft	Stainless Steel	BS970 BS970 304 S12
Spring	Stainless Steel	BS970 BS970 304 S12
Washer	Stainless Steel	
Seal	EPDM	
Setscrew	Stainless Steel	
Stop Pin	Stainless Steel	BS970 304 S12
Bushing	Teflon	

DIMENSIONAL DRAWINGS

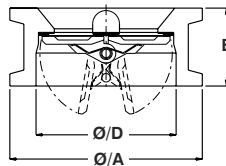
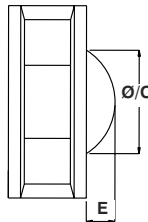
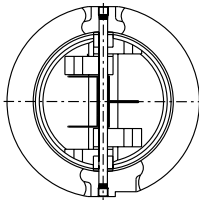

**PRESSURE/
TEMPERATURE
RATING**

16 bar up to 120°C

**TEST PRESSURES
(HYDRAULIC)**

Shell: 24 bar

Seat: 17.6 bar

SPECIFICATION

Face-to-face in accordance with BS 5155 (long pattern) ISO 5752 (long pattern).

Suitable for fitting between flanges to BS 4504 PN10/16, ANSI B16.1 Class 125 and BS 10 Table D/E.

Sizes 250mm and above are fitted with an eyebolt.

DIMENSIONS AND WEIGHTS

Nom Size	mm	65	80	100	125	150	200	250	300	350	400	450	500	600
A	mm	118	140	158	188	212	268	325	375	430	475	528	580	690
B	mm	45	64	64	70	76	89	114	114	127	140	150	152	178
C	mm	59	69	90	110	136	185	225	278	331	381	430	475	575
D	mm	84	100	115	135	160	210	256	306	356	406	460	510	610
E	mm	13.7	15.7	25.2	33.7	43.2	61.2	71.7	96.7	121.7	146.7	155	175	195
Weight	kg	3	4	5	6	9	13	23	31	48	62	86	104	181

Every effort has been made to ensure that the information contained in this publication is accurate at the time of publishing. Hattersley Ltd assumes no responsibility or liability for typographical errors or omissions or for any misinterpretation of the information within the publication and reserves the right to change without notice.

Fig. 850
Cast Iron - Wafer Pattern

FEATURES AND BENEFITS

- Double door wafer pattern with spring assisted closure
- Elastomer seat vulcanised to the body casting to ensure extended seal life
- Suitable for mounting in horizontal and vertical pipelines
- Ideal for fitting between flanges to BS EN 1092-2



MATERIAL SPECIFICATION

Component	Specification BS EN
Body	A536 65-45-12
Plate	B584 C83600
Spring	SUS 316
Hinge Pin	SUS 304
Stop Pin	SUS 304
Retainer	A105
Body Bearing	SUS 304
Plate Bearing	SUS 304
Eye Bolt	A105
Seat	EPDM

DIMENSIONAL DRAWINGS

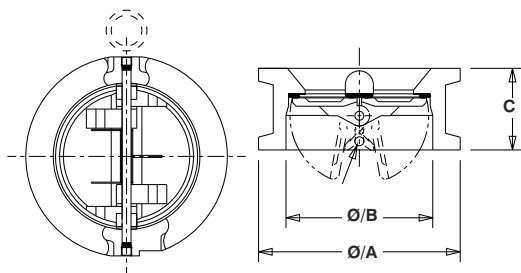

**PRESSURE/
TEMPERATURE
RATING**

25 bar up to 120°C

**TEST PRESSURES
(HYDRAULIC)**

Shell: 37.5 bar
Seat: 27.5 bar

SPECIFICATION

Face-to-face in accordance with BS 5155 (long pattern) ISO 5752 (long pattern).

Suitable for fitting between flanges to BS 4504 PN10/16. ANSI B16.1 Class 125 and BS 10 Table D/E.

Sizes 150mm and above are fitted with an eyebolt.

DIMENSIONS AND WEIGHTS

Nom Size	DN	40	50	65	80	100	125	150	200	250	300	350	400	450	500	600
A	mm	86	105	124	137	168	194	222	276	340	400	457	507	565	625	731
B	mm	60	60	73	89	114	141	168	219	273	324	356	406	457	508	610
C	mm	43	54	54	57	64	70	76	95	108	143	184	191	203	213	222
Weight	kg	1.8	2.5	3.5	4.5	8	10	13	28	45	68	95	132	147	202	265

Every effort has been made to ensure that the information contained in this publication is accurate at the time of publishing. Hattersley Ltd assumes no responsibility or liability for typographical errors or omissions or for any misinterpretation of the information within the publication and reserves the right to change without notice.

Gate Valves

Hattersley gate valves offer the ultimate in dependable service wherever minimum pressure drop is important.

They serve as efficient stop valves with fluid flow in either direction. The straight through design offers little resistance to flow and reduces pressure drop to a minimum. A gate-like disc - actuated by a

stem screw and handwheel - moves up and down at right angles to the path of flow, and seats against two seat faces to shut off the flow. Gate valves are not recommended for throttling since the control characteristic is not appropriate and subsequent damage, due to erosion, may prevent the valve providing an effective shut off.

Fig. No.	PN Rating	Series	End Connections	Size Range	Bonnet Pattern	Wedge Material
35 PN16†	16	B	Flanged	15 - 100mm	Threaded	Bronze
30C†	16	B	Compression	15 - 54mm	Threaded	Bronze
30CLS†	16	B	Compression	15 - 54mm	Threaded	Bronze
30*†	20	B	Threaded	1/4 - 3"	Threaded	DZR Alloy
30LS*†	20	B	Threaded	1/4 - 3"	Threaded	DZR Alloy
33X*†	20	B	Threaded	1/4 - 4"	Threaded	Bronze
33XLS*†	20	B	Threaded	1/4 - 4"	Threaded	Bronze
33*	32	B	Threaded	1/4 - 3"	Threaded	Bronze
669	32	B	Threaded	1/4 - 2"	Union	Bronze
28	-	-	Threaded	1/2 - 3"	Threaded	Bronze
609	32	A	Threaded	1/4 - 3"	Threaded	Bronze

† WRAS Approved Product

* Kitemarked to the relevant British Standard

Fig. No.	PN Rating	Class Rating	End Connections	Size Range	Pattern
M549 PN6	6	-	Flanged	50 - 300mm	Inside Screw
M549E	-	100	Flanged	2 - 12"	Inside Screw
M552 PN6	6	-	Flanged	50 - 300mm	Outside Screw
M552E	-	100	Flanged	2 - 12"	Inside Screw
1552 PN6	6	-	Flanged	50 - 300mm	Outside Screw
M511 PN10	10	-	Flanged	50 - 150mm	Inside Screw
M541 PN16	16	-	Flanged	50 - 400mm	Inside Screw
1541 PN16	16	-	Flanged	50 - 400mm	Inside Screw
M544 PN16	16	-	Flanged	50 - 300mm	Outside Screw
M540 PN25	25	-	Flanged	50 - 150mm	Outside Screw
501 ANSI	-	125	Flanged	2 - 12"	Inside Screw
504 ANSI	-	125	Flanged	2 - 12"	Outside Screw

Alternative Trim Materials

Prefix 1: All Iron

Prefix 4: Stainless Steel

Prefix 5: Aluminium Bronze



Fig. 33X - 33XLS
Bronze



FEATURES AND BENEFITS

- Robust and high quality bronze body with integral seating surfaces
- Kitemarked to BS EN 12288
- WRAS approved for use with potable water
- Inside screw pattern with non-rising stem



MATERIAL SPECIFICATION

Component	Material	Specification	
		BS EN	ASTM
Body	Bronze	1982 CC491K	B505 C83600
Bonnet	Bronze	1982 CC491K	B62 C83600
Stem (1/4" to 2")	DZR Brass	12164 CW602N	
Stem (2 1/2" & 3")	Brass	12164 CW614N	
Stem (4")	Al Bronze	12163 CW301G	B150 C64200
Disc	Bronze	1982 CC491K	B505 C83600
Stuffing Box (1/4" to 2")	DZR Brass	12164 CW602N	
Stuffing Box (2 1/2" & 3")	Brass	12165 CW617N	B124 C37700
Stuffing Box 4"	Bronze	1982 CC491K	B505 C83600
Packing Ring	Asbestos Free		
Gland (1/2" to 3")	Brass	12164 CW614N	
Gland (4")	Bronze	1982 CC491K	B62 C83600
Lockshield Cap	Brass	12164 CW614N	
Packing Nut (1/2" to 3")	Brass	12164 CW614N	
Packing Nut (4")	Bronze	1982 CC491K	B62-C83600
Handwheel	Aluminium		
Identification Plate	Aluminium		
Gasket	Fibre		
Handwheel Nut	Brass	12164 CW614N	

DIMENSIONAL DRAWINGS

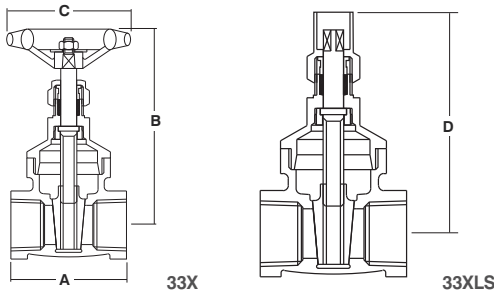

PRESSURE/TEMPERATURE RATING

BS EN 12288 PN20 Series B
9 bar at 180°C
20 bar from -10 to 100°C

TEST PRESSURES (HYDRAULIC)

Air Seat: 6 bar
Shell: 6 bar

SPECIFICATION

Kitemarked to BS EN 12288:2010.
WRAS Approved Product.
Non-rising stem.
Threaded bonnet.
One piece wedge.
Taper threaded BS EN 10266 (ISO 7-1) formerly BS 21.
Available with NPT thread (33XAT) 1/2 to 4".
Available with lockshield (33XLS) up to 2".

DIMENSIONS AND WEIGHTS

Nom Size	in	1/4	3/8	1/2	3/4	1	1 1/4	1 1/2	2	2 1/2	3	4
A	mm	46	46	51	55	63	71	73	83	96	105	162
B	mm	75	75	82	95	118	144	166	190	219	259	366
C	mm	57	57	5	69	69	76	81	94	140	150	232
D	mm	87	87	86	112	124	149	175	196	-	-	-
Weight	kg	0.27	0.26	0.35	0.55	0.84	1.18	1.66	2.55	4.30	6.4	18.37

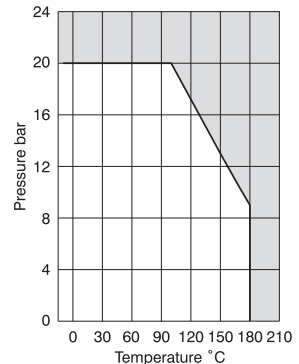

Every effort has been made to ensure that the information contained in this publication is accurate at the time of publishing. Hattersley Ltd assumes no responsibility or liability for typographical errors or omissions or for any misinterpretation of the information within the publication and reserves the right to change without notice.

Fig. 30 - 30LS
DZR



FEATURES AND BENEFITS

- Dezincification Resistant Brass prevents corrosion and fungal growth
- Kitemarked to BS EN 12288
- WRAS approved for use with potable water
- Inside screw pattern with non-rising stem



MATERIAL SPECIFICATION

Component	Material	Specification BS EN
Handwheel Nut	Brass	12164 CW614N
Identification Plate	Aluminium	
Handwheel	Aluminium	
Stem	DZR Brass	12164 CW602N
Packing Nut	Brass	12164 CW614N
Gland	Brass	12164 CW614N
Packing Ring	Asbestos Free	
Body	DZR Brass	12164 CW602N
Disc	DZR Brass	12164 CW602N
Stuffing Box	DZR Brass	12164 CW602N
Bonnet	DZR Brass	12164 CW602N

DIMENSIONAL DRAWINGS

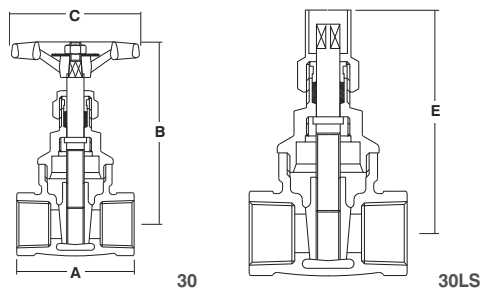

PRESSURE/TEMPERATURE RATING

BS EN 12288 PN20 Series B
9 bar at 180°C
20 bar from -10 to 100°C

TEST PRESSURES (HYDRAULIC)

Air Seat: 6 bar
Shell: 6 bar

SPECIFICATION

Kitemarked to BS EN 12288:2010.
WRAS Approved Product.
Non-rising stem.
Threaded bonnet.
One piece wedge.
Taper threaded BS EN 10266 (ISO 7-1) formerly BS 21.
Available with lockshield (30LS).
Available with NPT thread (30AT).

DIMENSIONS AND WEIGHTS

Nom Size	in	1/2	3/4	1	1 1/4	1 1/2	2
A	mm	51.6	56	64	72	75	91
B	mm	90	100	120	125	145	170
C	mm	56.8	56.8	69.2	69.2	75.5	81.5
D	mm	80	85	105	110	130	155
Lockshield key	Fig.	391	391	391	391	391	391
	Ref	A	A	2	2	2A	3
Weight	kg	0.32	0.45	0.7	1.22	1.55	2.45

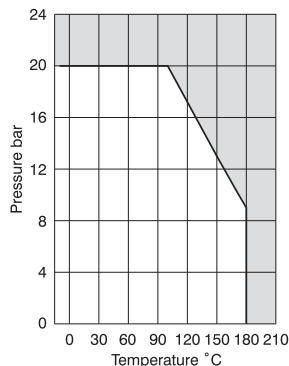

Every effort has been made to ensure that the information contained in this publication is accurate at the time of publishing. Hattersley Ltd assumes no responsibility or liability for typographical errors or omissions or for any misinterpretation of the information within the publication and reserves the right to change without notice.

Fig. 30C
Bronze



FEATURES AND BENEFITS

- Robust and high quality bronze body with integral seating surfaces
- Offers the ultimate in dependable service wherever minimum pressure drop is important
- WRAS Approved for use with potable water
- Inside screw pattern with non-rising stem



MATERIAL SPECIFICATION

Component	Material	Specification BS EN
Body	Bronze	BS EN 1982 (CC491K)
Bonnet	Bronze	BS EN 1982 (CC491K)
Stem	DZR Brass	BS EN 12164 CW602N
Disc	Bronze	BS EN 1982 (CC491K)
Stem Retainer	DZR Brass	BS EN 12164 CW602N
Packing Ring	Asbestos Free	
Gland (28-54 only)	Brass	BS EN 12164 CW614N
Packing Nut	Brass	BS EN 12164 CW614N
Handwheel	Aluminium	
Identification Plate	Aluminium	
Handwheel Nut	Brass	BS EN 12164 CW614N
Compression Olive	Brass	BS EN 12449:1999 CW505L OR CW507L
Compression Nut	Brass	BS EN 12165 CW617N

PRESSURE/TEMPERATURE RATINGS COMPRESSION

Temperature °C	-10 to 30	40	50	65	80	90	100	110	120
Pressure bar	16	14.3	12.6	10	8.7	7.8	6.9	6	5

Intermediate pressure ratings shall be determined by interpolation.

DIMENSIONAL DRAWINGS

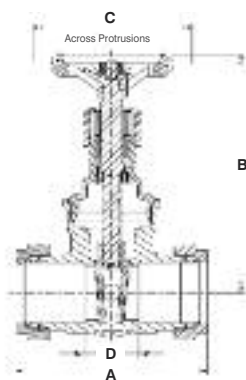

PRESSURE/TEMPERATURE RATING
PN16

TEST PRESSURES (PNEUMATIC)

Seat: 6 bar
Shell: 6 bar

SPECIFICATION

UK End Connection: Compression ends to BS EN 1057:2006: Half hard R250.
Operator: Handwheel.

Gate valves are best for services that require infrequent valve operation and where the disc is kept either fully open or closed. They are not practical for throttling.

Valves are manufactured in accordance with BS EN 12288: 2010 (formerly BS 5154) PN20 for Series B ratings, but are limited to the pressure/temperature ratings detailed in BS EN 1057:2006 for compression end fittings.

This valve is to be used on Group 2 liquids only, as defined by the Pressure Equipment Directive 97/23/EC.

DIMENSIONS AND WEIGHTS

Nom Size	mm	15	22	28	35	42	54
A	mm	69	75	86	100	111	133
B	mm	74	86	105	110	130	152
C	mm	48	69	76	81	94	100
D	mm	26.5	23.5	25.5	30.5	34.5	37
Weight	kg	0.34	0.50	0.70	0.95	1.45	2.50

Every effort has been made to ensure that the information contained in this publication is accurate at the time of publishing. Hattersley Ltd assumes no responsibility or liability for typographical errors or omissions or for any misinterpretation of the information within the publication and reserves the right to change without notice.

Fig. 30CLS
Bronze



FEATURES AND BENEFITS

- Robust and high quality bronze body with integral seating surfaces
- Offers the ultimate in dependable service wherever minimum pressure drop is important
- WRAS Approved for use with potable water
- Inside screw pattern with non-rising stem



MATERIAL SPECIFICATION

Component	Material	Specification BS EN
Body	Bronze	BS EN 1982 (CC491K)
Bonnet	Bronze	BS EN 1982 (CC491K)
Stem	DZR Brass	BS EN 12164 CW602N
Disc	Bronze	BS EN 1982 (CC491K)
Stem Retainer	DZR Brass	BS EN 12164 CW602N
Packing Ring	Asbestos Free	
Gland (28-54 only)	Brass	BS EN 12164 CW614N
Lockshield	Brass	BS EN 12164 CW614N
Compression Olive	Brass	BS EN 12449:1999 CW505L OR CW507L
Compression Nut	Brass	BS EN 12165 CW617N

PRESSURE/TEMPERATURE RATINGS COMPRESSION

Temperature °C	-10 to 30	40	50	65	80	90	100	110	120
Pressure bar	16	14.3	12.6	10	8.7	7.8	6.9	6	5

Intermediate pressure ratings shall be determined by interpolation.

DIMENSIONAL DRAWINGS

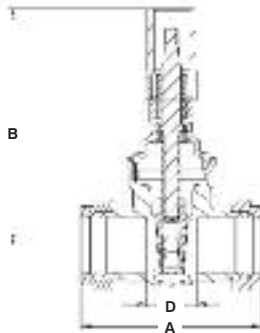

**PRESSURE/
TEMPERATURE RATING**
PN16

**TEST PRESSURES
(HYDRAULIC)**

Seat: 6 bar
Shell: 6 bar

SPECIFICATION

UK End Connection: Compression ends to BS EN 1057: 2006: Half hard R250.
Operator: Handwheel.

Gate valves are best for services that require infrequent valve operation and where the disc is kept either fully open or closed. They are not practical for throttling.

Valves are manufactured in accordance with BS EN 12288:2010 (formerly BS 5154) PN20 for Series B ratings, but are limited to the pressure/temperature ratings detailed in BS EN 1057:2006 for compression end fittings.

This valve is to be used on Group 2 liquids only, as defined by the Pressure Equipment Directive 97/23/EC.

DIMENSIONS AND WEIGHTS

Nom Size	mm	15	22	28	35	42	54
A	mm	69	75	86	100	111	133
B	mm	78	90	110	115	136	160
D	mm	26.5	23.5	25.5	30.5	34.5	37
Weight	kg	0.34	0.50	0.70	0.95	1.45	2.50

Every effort has been made to ensure that the information contained in this publication is accurate at the time of publishing. Hattersley Ltd assumes no responsibility or liability for typographical errors or omissions or for any misinterpretation of the information within the publication and reserves the right to change without notice.

Fig. C31
Bronze



FEATURES AND BENEFITS

- Robust and high quality bronze body with integral seating surfaces
- Inside screw pattern with rising stem
- Suitable for high pressures up to 16 bar



MATERIAL SPECIFICATION

Component	Material	Specification	
		BS EN	ASTM
Handwheel	Cast Iron	1561 EN-JL1030	A126 Cl B
Stem	Brass	12164 CW603N	B16 C36000
Gland Packing	PTFE		
Stem Ring	Brass	12164 CW603N	B16 C36000
Bonnet	Bronze	1982 CC490K	B584 C84400
Wedge	Bronze	1982 CC490K	B584 C84400
Body	Bronze	1982 CC490K	B584 C84400

DIMENSIONAL DRAWINGS

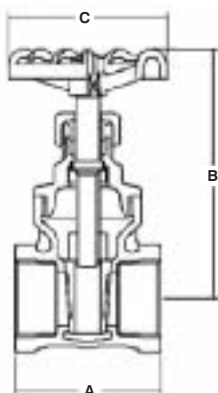

DIMENSIONS AND WEIGHTS

Nom Size	in	1/2	3/4	1	1 1/4	1 1/2	2
A	mm	53	57	64	70	74	85
B	mm	75	84	95	116	127	151
C	mm	54	58	64	70	74	85
Weight	kg	0.3	0.4	0.6	0.8	0.9	1.5

PRESSURE/TEMPERATURE RATING

7 bar at 170°C
16 bar from -10 to 100°C

TEST PRESSURES (HYDRAULIC)

Each valve is individually hydrostatically tested to BS EN 12266 at the following test.
Shell: 24 bar
Seat: 17.6 bar

SPECIFICATION

Bronze body and bonnet.
Non-rising stem.
Threaded bonnet.
One piece wedge.
Taper threaded BS EN 10226 (ISO 7-1) formerly BS 21.
Available with NPT thread (C31AT) subject to minimum quantities.
Generally in accordance with BS EN 12266.

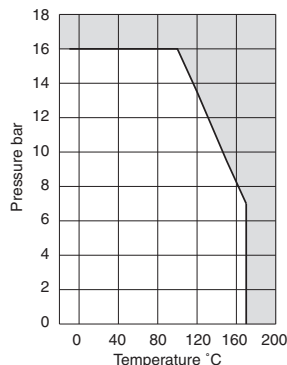

Every effort has been made to ensure that the information contained in this publication is accurate at the time of publishing. Hattersley Ltd assumes no responsibility or liability for typographical errors or omissions or for any misinterpretation of the information within the publication and reserves the right to change without notice.

Fig. 33
Bronze



FEATURES AND BENEFITS

- Robust and high quality bronze body with integral seating surfaces
- Kitemarked to BS EN 12288
- Inside screw pattern with non-rising stem
- Suitable for high pressures up to 32 bar



MATERIAL SPECIFICATION

Component	Material	Specification	
		BS EN	ASTM
Disc	Bronze	1982 CC491K	B62 C83600
Packing Ring	Asbestos Free		
Handwheel	Aluminium		
Gland	Brass	12164 CW614N	B455 C38500
Stuffing Box	DZR Brass	12164 CW602N	
Stem	DZR Brass	12164 CW602N	
Stem (2 1/2" & 3")	Al Bronze	12163 CW301G	B150 C64200
Bonnet	Bronze	1982 CC491K	B62 C83600
Body	Bronze	1982 CC491K	B62 C83600
Packing Nut	Brass	12164 CW614N	
Identification Plate	Aluminium		
Handwheel Nut	Brass	12164 CW614N	

DIMENSIONAL DRAWINGS

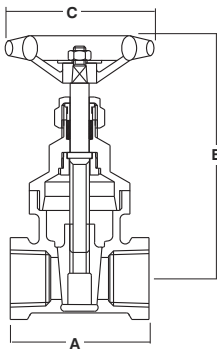

DIMENSIONS AND WEIGHTS

Nom Size	in	1/4	3/8	1/2	3/4	1	1 1/4	1 1/2	2	2 1/2	3
A	mm	46	46	51	55	63	71	73	83	108	117
B	mm	78	78	86	98	120	148	172	196	241	256
C	mm	60	60	70	80	85	95	102	120	140	150
Weight	kg	0.36	0.35	0.47	0.6	0.92	1.41	1.92	2.72	5.62	7.89

PRESSURE/TEMPERATURE RATING

BS EN 12288 PN32 Series B
14 bar at 198°C
32 bar from -10 to 100°C

TEST PRESSURES (HYDRAULIC)

Shell: 48 bar
Seat: 35.2 bar

SPECIFICATION

Kitemarked to BS EN 12288:2010.
Non-rising stem.
Threaded bonnet.
One piece wedge.
Taper threaded BS EN 10226 (ISO 7-1) formerly BS 21.
Available with NPT thread (33AT) 1/2 to 3".

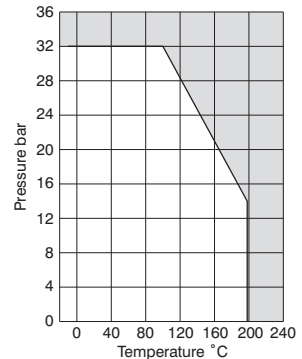

Every effort has been made to ensure that the information contained in this publication is accurate at the time of publishing. Hattersley Ltd assumes no responsibility or liability for typographical errors or omissions or for any misinterpretation of the information within the publication and reserves the right to change without notice.

Fig. 669
Bronze

FEATURES AND BENEFITS

- Robust and high quality bronze body with integral seating surfaces
- Inside screw pattern with rising stem
- Suitable for high pressures up to 32 bar



MATERIAL SPECIFICATION

Component	Material	Specification	
		BS EN	ASTM
Body	Bronze	1982 CC491K	B62 C83600
Packing Ring	Asbestos Free		
Bonnet	Bronze	1982 CC491K	B62 C83600
Stem	Bronze	1982 CC491K	B62 C83600
Disc	Bronze	1982 CC491K	B62 C83600
Gland	Brass	12164 CW614N	
Packing Nut	Brass	12164 CW614N	
Handwheel	Aluminium		
Handwheel Nut	Brass	12164 CW614N	
Union Ring	Bronze	1982 CC491K	B62 C83600
Identification Plate	Aluminium		

DIMENSIONAL DRAWINGS

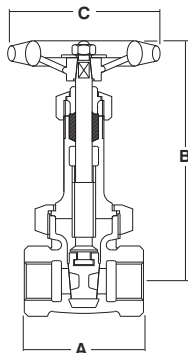

DIMENSIONS AND WEIGHTS

Nom Size	in	1/4	3/8	1/2	3/4	1	1 1/4	1 1/2	2
A	mm	46	46	51	55	63	71	73	83
B	mm	134	134	137	169	194	232	266	321
C	mm	69	69	76	81	94	100	120	140
Weight	kg	0.32	0.31	0.46	0.72	1.10	1.50	2.25	3.20

PRESSURE/TEMPERATURE RATING

BS EN 12288 PN32 Series A
14 bar at 260°C
32 bar from -10 to 120°C

TEST PRESSURES (HYDRAULIC)

Shell: 48 bar
Seat: 35.2 bar

SPECIFICATION

BS EN 12288:2010.
Rising stem.
Union bonnet.
One piece wedge.
Taper threaded BS EN 10226 (ISO 7-1) formerly BS 21.
Available with NPT thread (669AT).

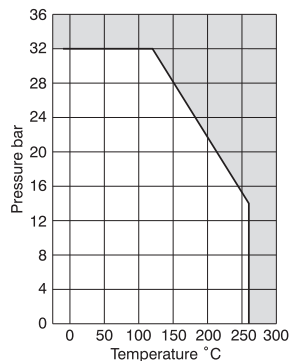

Every effort has been made to ensure that the information contained in this publication is accurate at the time of publishing. Hattersley Ltd assumes no responsibility or liability for typographical errors or omissions or for any misinterpretation of the information within the publication and reserves the right to change without notice.

Fig. 28
Bronze - Lever operated

FEATURES AND BENEFITS

- Robust and high quality bronze body with integral seating surfaces
- Lever operated for ease of use
- Fitted with asbestos-free gland packing as standard



MATERIAL SPECIFICATION

Component	Material
Body	Bronze / Brass
Wedge	Brass
Lever	Brass
Washer	Brass
Plug	Brass
O-Ring	NBR
Gasket	Fibre

DIMENSIONAL DRAWINGS

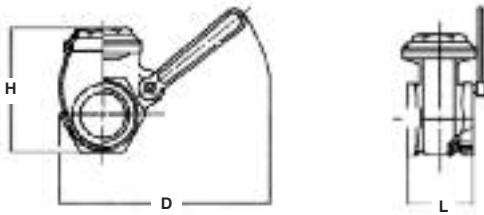

**PRESSURE/
TEMPERATURE RATING**

16 bar
-20°C to +90°C

SPECIFICATION

Screwed BSP
Lever Operated.
Bronze Body up to 1 1/2".
Brass Body 2" to 4".

DIMENSIONS AND WEIGHTS

Nom Size	DN in	15 1/2	20 3/4	25 1	32 1 1/4	40 1 1/2	50 2	65 2 1/2	80 3	100 4
L	mm	46	51	57	61	67	75	80	86	92
H	mm	57	66	76	88	96	115	150	170	210
D	mm	130	147	155	184	215	230	355	370	400
Weight	kg	0.39	0.56	0.78	1.10	1.42	1.62	2.85	3.80	5.80

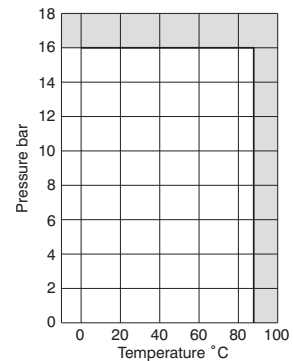

Every effort has been made to ensure that the information contained in this publication is accurate at the time of publishing. Hattersley Ltd assumes no responsibility or liability for typographical errors or omissions or for any misinterpretation of the information within the publication and reserves the right to change without notice.

Fig. 35
Bronze



FEATURES AND BENEFITS

- Robust and high quality bronze body with integral seating surfaces
- Flanges ends require no pipe threading
- Inside screw pattern with non-rising stem



MATERIAL SPECIFICATION

Component	Material	Specification	
		BS EN	ASTM
Gland	Brass	12164 CW614N	
Body	Bronze	1982 CC491K	B62 C83600
Bonnet	Bronze	1982 CC491K	B62 C83600
Stem	Brass	12164 CW614N	
Disc	Bronze	1982 CC491K	B62 C83600
Stuffing Box	Brass	12165 CW617N	B124 C37700
Packing Ring	Graphite		
Packing Nut	Brass	12164 CW614N	
Handwheel	Aluminium		
Identification Plate	Aluminium		
Handwheel Nut	Brass	12164 CW614N	

DIMENSIONAL DRAWINGS

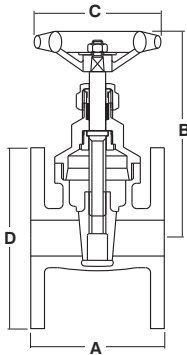

DIMENSIONS AND WEIGHTS

Nom Size	mm	20	25	32	40	50	65	80	100
A	mm	90	100	110	120	135	165	185	190
B	mm	110	130	145	165	200	240	280	365
C	mm	80	85	95	120	120	155	180	230
D	mm	105	115	140	150	165	185	200	220
Weight	kg	2.1	2.7	4.0	4.4	6.3	9.1	15.4	22.2

**PRESSURE/
TEMPERATURE RATING**

BS 5154 PN16 Series
7 bar at 170°C
16 bar from -10 to 100°C

**TEST PRESSURES
(HYDRAULIC)**

Shell: 24 bar
Seat: 17.6 bar

SPECIFICATION

Non-rising stem.
Threaded bonnet.
One piece wedge.
Flanged to BS EN 1092-3 PN16.

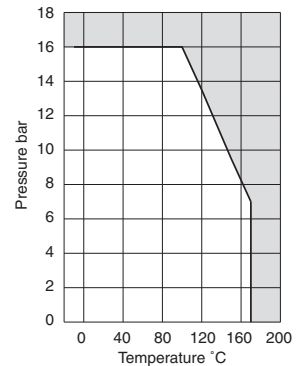

Every effort has been made to ensure that the information contained in this publication is accurate at the time of publishing. Hattersley Ltd assumes no responsibility or liability for typographical errors or omissions or for any misinterpretation of the information within the publication and reserves the right to change without notice.

**Fig. 609
Bronze**

FEATURES AND BENEFITS

- Robust and high quality bronze body with integral seating surfaces
- Inside screw pattern with rising stem
- Suitable for high pressures up to 32 bar



MATERIAL SPECIFICATION

Component	Material	Specification	
		BS EN	ASTM
Body	Bronze	1982 CC491K	B62 C83600
Bonnet	Bronze	1982 CC491K	B62 C83600
Stem (1/4" to 2")	Bronze	1982 CC491K	B62 C83600
Stem (2 1/2")	AL. Brass (CA 12)	12163 CW301G	
Stem (3")	Bronze	1982 CC491K	B62 C83600
Disc	Bronze	1982 CC491K	B62 C83600
Packing Ring	Asbestos Free		
Gland	Brass	12164 CW614N	
Packing Nut (2 1/2" & 3")	Brass	12164 CW721R	
Packing Nut (1/4" to 2")	Brass	12164 CW614N	
Handwheel	Aluminium		
Identification Plate	Aluminium		
Handwheel Nut	Brass	12164 CW614N	

DIMENSIONAL DRAWINGS

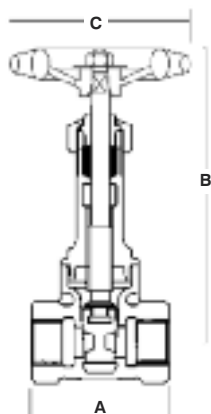

DIMENSIONS AND WEIGHTS

Nom Size	in	1/4	3/8	1/2	3/4	1	1 1/4	1 1/2	2	2 1/2	3
A	mm	46	46	51	55	63	71	73	83	108	117
B (open)	mm	129	129	133	162	191	223	253	307	374	436
C	mm	60	70	70	80	85	95	105	120	140	180
Weight	kg	0.35	0.40	0.50	0.75	1.30	1.70	2.60	3.50	6.00	8.80

**PRESSURE/
TEMPERATURE RATING**

14 bar at 198°C
32 bar from -10 to 100°C

**TEST PRESSURES
(HYDRAULIC)**

Each valve is individually hydrostatically tested to BS EN 12266 at the following test pressures.

Shell: 48 bar
Seat: 35.2 bar

SPECIFICATION

Rising stem.
Threaded bonnet.
One piece wedge.
Bronze trim.
Taper threaded BS EN 10226 (ISO 7-1) formerly BS 21.
Complies with BS EN 12288:2010.

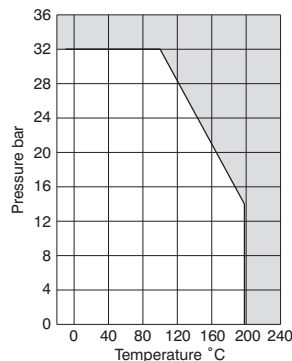

Every effort has been made to ensure that the information contained in this publication is accurate at the time of publishing. Hattersley Ltd assumes no responsibility or liability for typographical errors or omissions or for any misinterpretation of the information within the publication and reserves the right to change without notice.

Fig. C618
Bronze



FEATURES AND BENEFITS

- Robust and high quality bronze body with integral seating surfaces
- Inside screw pattern with rising stem
- Suitable for high pressures up to 20 bar



MATERIAL SPECIFICATION

Component	Material	Specification	
		BS EN	ASTM
Handwheel	Cast Iron	1561 EN-JL1030	A126 Cl B
Stem	Copper Alloy	12164 CW714R	B21-C48200
Gland Nut	Copper Alloy	12164 CW603N	B16-C36000
Gland	Copper Alloy	12164 CW603N	B16-C36000
Gland Packing	PTFE		
Bonnet	Bronze	1982 CC491K	B62-C83600
Body	Bronze	1982 CC491K	B62-C83600
Wedge	Bronze	1982 CC491K	B62-C83600

DIMENSIONAL DRAWINGS

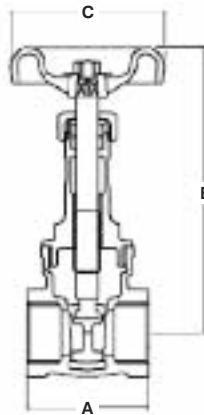

PRESSURE/TEMPERATURE RATING

9 bar at 180°C
20 bar from -10 to 100°C

TEST PRESSURES (HYDRAULIC)

Each valve is individually hydrostatically tested to BS EN 12266 at the following test pressures.
Shell: 30 bar
Seat: 22 bar

SPECIFICATION

Rising stem.
Threaded bonnet.
One piece wedge.
Bronze trim.
Taper threaded BS EN 10226 (ISO 7-1) formerly BS 21.
Complies with BS EN 12288:2010.
Available with NPT thread (C618AT).
Complies with MSS SP-80 Class 150.

DIMENSIONS AND WEIGHTS

Nom Size	in	1/2	3/4	1	1 1/4	1 1/2	2
A	mm	48	52	59	64	68	75
B	mm	117	140	167	195	222	264
C	mm	53	64	73	80	90	102
Weight	kg	0.35	0.53	0.75	1.05	1.41	2.03

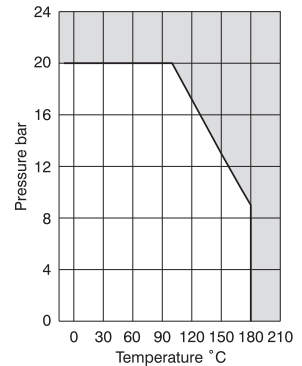

Every effort has been made to ensure that the information contained in this publication is accurate at the time of publishing. Hattersley Ltd assumes no responsibility or liability for typographical errors or omissions or for any misinterpretation of the information within the publication and reserves the right to change without notice.

Fig. M549 Cast Iron

FEATURES AND BENEFITS

- Cast Iron with integral flanges
- Inside screw pattern with non-rising stem
- Ideal for use for non-corrosive and reasonably clean services
- Seat rings are threaded and securely fixed into the body



MATERIAL SPECIFICATION

Component	Material	Specification	
		BS EN	ASTM
Handwheel	Cast Iron	1561 EN-JL1030	A126 CI B
Gland	Cast Iron	1561 EN-JL1030	A126 CI B
Gland Packing	Expanded Graphite		
Stuffing Box	Cast Iron	1561 EN-JL1030	A126 CI B
Stuffing Box Gasket	Asbestos Free		
Stem	Brass	12164 CW614N	
Bonnet	Cast Iron	1561 EN-JL1040	
Bonnet Gasket	Asbestos Free		
Wedge Nut	Brass	12164 CW614N	
Wedge	Brass	12164 CW614N	
Wedge Facing Ring	Bronze	1982 CC491K	
Body Seat Ring	Bronze	1982 CC491K	
Body	Cast Iron	1561 EN-JL1040	

DIMENSIONAL DRAWINGS

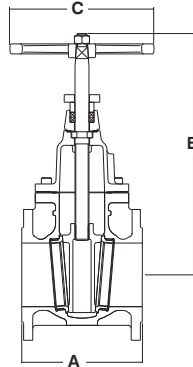

DIMENSIONS AND WEIGHTS

Nom Size	mm	50	65	80	100	125	150	200	250	300
	in	2	2 1/2	3	4	5	6	8	10	12
A PN6	mm	150	170	180	190	200	210	230	250	270
A Table E	in	5 3/4	6 1/4	6 1/2	6 3/4	7 1/2	8 1/4	9 1/2	10 3/4	12
B	mm	202	222	250	303	351	411	498	579	680
C	mm	130	130	150	185	185	195	225	245	185
D PN6	mm	140	160	190	210	240	265	320	375	440
D Table E	in	6	6 1/2	7 1/4	8 1/2	10	11	13 1/4	16	18
Weight	kg	13	16	22	29	40	51	88	150	205

PRESSURE/ TEMPERATURE RATING

BS EN 1171 PN6
6 bar at -10 to 120°C
5.4 bar at 150°C

TEST PRESSURES (HYDRAULIC)

Shell: 9 bar
Seat: 6.6 bar

SPECIFICATION

Inside screw.
Non-rising stem.
Bronze trim.
Flanged to BS EN 1092-2 PN6.
Also available flanged to BS10 Table E Fig. 549E.

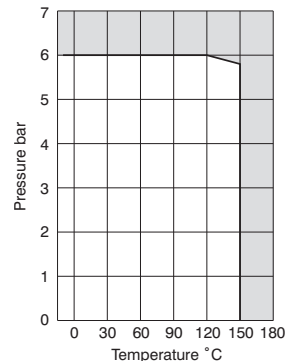

Every effort has been made to ensure that the information contained in this publication is accurate at the time of publishing. Hattersley Ltd assumes no responsibility or liability for typographical errors or omissions or for any misinterpretation of the information within the publication and reserves the right to change without notice.

Fig. M552, M552E, M1552 Cast Iron

FEATURES AND BENEFITS

- Cast Iron with integral flanges
- Outside screw pattern with rising stem
- Ideal for use on more active media where fluid might have an adverse affect on thread
- Flanges ends require no pipe threading



MATERIAL SPECIFICATION

Component	Material	Specification	
		BS EN	ASTM
Body	Cast Iron	1561 EN-JLI040	A126 CI B
Wedge	Cast Iron	1561 EN-JLI040	A126 CI B
Bonnet	Cast Iron	1561 EN-JLI040	A126 CI B
Yoke Joint	Cast Iron	1561 EN-JLI040	A126 CI B
Yoke Sleeve	Cast Bronze	1982 CC491K	B62 C83600
Bonnet Gasket	Asbestos Free		
Wedge Nut	Brass	12164 CW614N	
Stem	Steel	10087 11sMn30	A105
Stuffing Box	Cast Iron	1561 EN-JLI030	A126 CI B
Stuffing Box Gasket	Asbestos Free		
Gland Follower	Ductile Iron	1563 EN-JSI040	
Packing Gland	Brass		
Handwheel	Cast Iron	1561 EN-JLI030	A126 CI B

DIMENSIONAL DRAWINGS

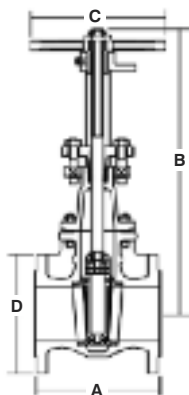

DIMENSIONS AND WEIGHTS

Nom Size	mm	50	65	80	100	125	150	200	250	300
	in	2	2 1/2	3	4	5	6	8	10	12
A PN6	mm	146	159	165	171	191	210	241	273	305
A Table E	in	5 3/4	6 1/4	6 1/2	6 3/4	7 1/2	8 1/4	9 1/2	10 3/4	12
B (open)	mm	405	415	486	632	710	842	1100	1228	1373
C	mm	190	190	190	305	305	305	305	405	405
Weight	kg	14	18	25	34	48	59	91	157	210

PRESSURE/ TEMPERATURE RATING

BS EN 1171: 2002 PN6
6 bar at -10 to 120°C
5.4 bar at 150°C

TEST PRESSURES (HYDRAULIC)

Shell: 9 bar
Seat: 6.6 bar

SPECIFICATION

Outside screw.
Rising stem.
Bronze trim.
Flanged to BS EN1092-2 PN6.
Also available flanged to BS10 Table E figure 552E.
Available with all iron trim figure 1552 PN6.

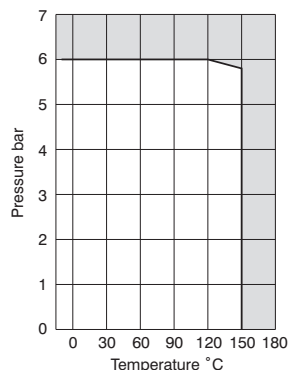

Every effort has been made to ensure that the information contained in this publication is accurate at the time of publishing. Hattersley Ltd assumes no responsibility or liability for typographical errors or omissions or for any misinterpretation of the information within the publication and reserves the right to change without notice.

Fig. M511

Cast Iron

FEATURES AND BENEFITS

- Cast Iron with integral flanges
- Inside screw pattern with non-rising stem
- Ideal for use for non-corrosive and reasonably clean services
- Seat rings are threaded and securely fixed into the body



MATERIAL SPECIFICATION

Component	Material	Specification	
		BS EN	ASTM
Handwheel	Cast Iron	1561 EN-JL1040	A126 CI B
Gland	Cast Iron	1561 EN-JL1040	A126 CI B
Gland Packing	Graphite		
Stuffing Box	Cast Iron	1561 EN-JL1040	A126 CI B
Stuffing Box Gasket	Graphite		
Stem	Copper Alloy	12164 CW603N	B16-C36000
Bonnet	Cast Iron	1561 EN-JL1040	A126 CI B
Bonnet Gasket	Graphite		
Wedge Nut	Bronze		
Wedge	Cast Iron	1561 EN-JL1040	A126 CI B
Wedge Facing Ring	Bronze		
Body Seat Ring	Bronze		
Body	Cast Iron	1561 EN-JL1040	A126 CI B

DIMENSIONAL DRAWINGS

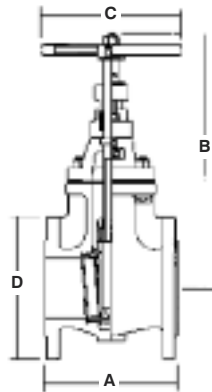

DIMENSIONS AND WEIGHTS

Nom Size	mm	50	65	80	100	125	150
A	mm	150	170	180	190	200	210
B	mm	292	324	360	380	454	490
C	mm	160	160	200	200	250	250
D	mm	160	185	200	220	250	285
Weight	kg	17	20	28	34	51	62

PRESSURE/TEMPERATURE RATING

BS EN 1171:2002 PN10
10 bar at -10 to 120°C
7.4 bar at 230°C

TEST PRESSURES

Each valve is individually hydrostatically tested to BS EN 12266:Part 1 at the following test pressures;
Shell: 15 bar
Seat: 11 bar

SPECIFICATION

Complies with BS EN 1171: 2002.
Face to face dimension to BS EN 558-1 series 14.
Inside screw.
Non-rising stem.
Bronze trim.
Flanged to BS EN 1092-2 PN10.

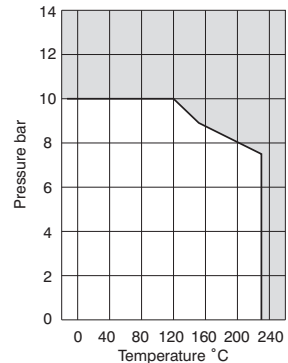

Every effort has been made to ensure that the information contained in this publication is accurate at the time of publishing. Hattersley Ltd assumes no responsibility or liability for typographical errors or omissions or for any misinterpretation of the information within the publication and reserves the right to change without notice.

Fig. M541, M1541 Cast Iron

FEATURES AND BENEFITS

- Cast Iron with integral flanges
- Flanged ends require no pipe threading



MATERIAL SPECIFICATION

Component	Material	Specification BS EN
Body	Grey Iron	1561 EN-JL1040
Bonnet	Grey Iron	1561 EN-JL1040
Disc	Grey Iron	1561 EN-JL1040
Body Seat Ring	Bronze	1982 (CC491K)
Disc Seat Ring	Bronze	1982 (CC491K)
Stem	Stainless Steel	970: 410S21
Gasket	Graphite	Graphite (Asbestos Free)
Gland Packing Nut	Stainless Steel	970: 304S31
Handwheel	Grey Iron	1561 EN-JL1040
Stem Retaining Ring	Stainless Steel	970: 304S31
Disc Stem Nut	Bronze	1982 (CC491K)
Packing Ring	Graphite	Graphite (Asbestos Free)
Handwheel Retaining Nut	Steel	4190 GR4
Handwheel Washer	Steel	4320
Body ID Plate (Not Shown)	Aluminium	

DIMENSIONAL DRAWINGS

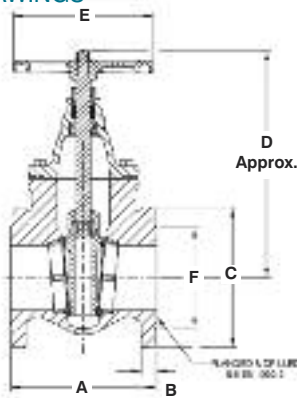

DIMENSIONS AND WEIGHTS

Nom Size	mm	65	80	100	125	150	200
A	mm	190	203	229	254	267	292
B	mm	20	22	24	26	28	30
C	mm	185	200	220	250	285	340
D	mm	262	286	356	426	463	578
E	mm	190	190	220	300	300	350
F	mm	118	132	156	184	211	266
Weight	kg	18.7	23.9	37.6	50.7	63.8	104.3

PRESSURE/ TEMPERATURE RATING

-10 to 120° C at 16 bar
200°C at 12.8 bar

TEST PRESSURES (HYDRAULIC)

Shell: 24 bar
Seat: 17.6 bar

SPECIFICATION

Wedge disc.
Non-rising stem.
Inside screw.
Handwheel operated.

OPTIONAL FEATURES

Flanges undrilled.

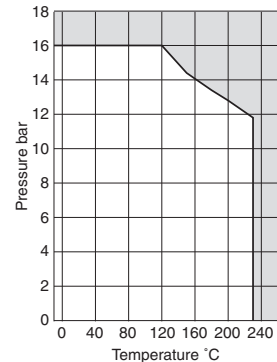

All dimensions are nominal.
Please note sizes 50, 250 and
300mm are also available,
please refer to the website.

Every effort has been made to ensure that the information contained in this publication is accurate at the time of publishing. Hattersley Ltd assumes no responsibility or liability for typographical errors or omissions or for any misinterpretation of the information within the publication and reserves the right to change without notice.

Fig. M544 - M544E Cast Iron

FEATURES AND BENEFITS

- Cast Iron with integral flanges
- Outside screw pattern with rising stem
- Ideal for use on more active media where fluid might have an adverse effect on thread
- Flanges ends require no pipe threading



MATERIAL SPECIFICATION

Component	Material	Specification	
		BS EN	ASTM
Handwheel	Cast Iron	1561 EN-JLI030	A126 CI B
Yoke Sleeve	Bronze		
Yoke (100 to 300mm)	Cast Iron	1561 EN-JLI030	A126 CI B
Gland	Cast Iron	1561 EN-JLI030	A126 CI B
Gland Packing	Expanded Graphite		
Yoke Joint (100 & 300mm)	Asbestos Free		
Stem	Steel	EN10087	11sMn30
Bonnet	Cast Iron	1561 EN-JLI040	A126 CI B
Bonnet Gasket	Asbestos Free		
Stem Cone Bush	Brass	12164 CW614N	B16-C36000 / B124-C37700
Wedge Nut	Bronze		
Wedge	Cast Iron	1561 EN-JLI040	A126 CI B
Wedge Facing Ring	Bronze		
Body Seat Ring	Cast Iron	1561 EN-JLI040	A126 CI B
Body	Cast Iron	1561 EN-JLI040	A126 CI B

DIMENSIONAL DRAWINGS

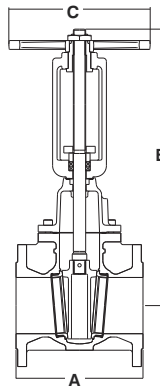

DIMENSIONS AND WEIGHTS

Nom Size	mm in	50	65	80	100	125	150	200	250	300
		2	2 1/2	3	4	5	6	8	10	12
A PN6	mm	178	190	203	229	254	267	292	330	356
B (open)	mm	343	345	443	520	572	668	884	955	1054
C	mm	190	190	190	305	305	305	305	405	405
D PN16	mm	165	185	200	220	250	285	340	405	460
D Table E	in	6	6 1/2	7 1/4	8 1/2	10	11	13 1/4	16	18
D Table F	in	6 1/2	7 1/4	8	9	11	12	14 1/2	17	19 1/4
Weight	kg	17	20	28	40	56	69	125	227	265

PRESSURE/ TEMPERATURE RATING

BS EN 1171 PN16
16 bar at -10 to 120°C
11.8 bar at 230°C

TEST PRESSURES (HYDRAULIC)

Shell: 24 bar
Seat: 17.6 bar

SPECIFICATION

BS 5150 and BS EN 1171.
Outside screw.
Rising stem.
Flanged to BS EN 1092-2 PN16.
Bronze trim.
Flanges drilled to BS10 available figure 544E.
Face to face dimensions at BS EN 558-1 basic series 3.

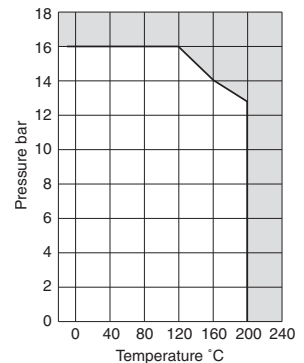

Every effort has been made to ensure that the information contained in this publication is accurate at the time of publishing. Hattersley Ltd assumes no responsibility or liability for typographical errors or omissions or for any misinterpretation of the information within the publication and reserves the right to change without notice.

Fig. M540 Ductile Iron

FEATURES AND BENEFITS

- Ductile Iron with integral flanges
- Inside screw pattern with non-rising stem
- Ideal for use for non-corrosive and reasonably clean services
- Seat rings are threaded and securely fixed into the body



MATERIAL SPECIFICATION

Component	Material	Specification	
		BS EN	ASTM
Handwheel	Cast Iron	1561 EN JL1030	
Gland Flange	Ductile Iron	1561 EN JS1050	
Gland	H T Brass	1561 EN JS1040	
Gland Packing	Expanded Graphite		
Stuffing Box	Ductile Iron	1561 EN JS1050	
Stuffing Box Gasket	Asbestos Free		
Stem	Al Bronze	12163 CW301G	B150 C64200
Bonnet	Ductile Iron	1563 EN JS1050	
Bonnet Gasket	Asbestos Free		
Wedge Nut	Al Bronze	12163 CW301G	B150 C64200
Wedge	Ductile Iron	1563 EN JS1050	
Wedge Facing Ring	Bronze		
Body Seat Ring	Bronze		
Body	Ductile Iron	1563 EN JS1050	

DIMENSIONAL DRAWINGS

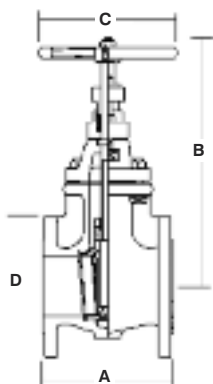

DIMENSIONS AND WEIGHTS

Nom Size	mm	50	65	80	100	125	150
A	mm	178	190	203	229	254	267
B	mm	322	322	340	420	477	542
C	mm	190	190	190	305	305	305
D	mm	165	185	200	235	270	300
Weight	kg	16	19	24	35	45	62

PRESSURE/ TEMPERATURE RATING

BS EN 1171:2002 PN25
25 bar at -10 to 120°C
21.5 bar at 220°C

TEST PRESSURES (HYDRAULIC)

PN25
Shell: 37.5 bar
Seat: 27.5 bar

SPECIFICATION

Inside screw.
Non-rising stem.
Flanged to BS EN 1092-2 PN25.
Bronze trim.

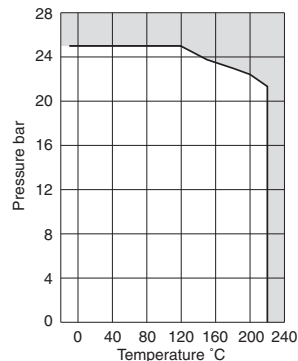

Every effort has been made to ensure that the information contained in this publication is accurate at the time of publishing. Hattersley Ltd assumes no responsibility or liability for typographical errors or omissions or for any misinterpretation of the information within the publication and reserves the right to change without notice.

Fig. 501
Cast Iron

FEATURES AND BENEFITS

- Cast Iron with integral flanges
- Inside screw pattern with non-rising stem
- Ideal for use for non-corrosive and reasonably clean services
- Seat rings are threaded and securely fixed into the body



MATERIAL SPECIFICATION

Component	Material	Specification	
		BS EN	ASTM
Handwheel	Cast Iron	1561 EN-JLI030	A126 CI B
Gland	Cast Iron	1561 EN-JLI030	A126 CI B
Gland Packing	Graphite		
Stuffing Box	Cast Iron	1561 EN-JLI030	A126 CI B
Stuffing Box Gasket	Graphite		
Stem	Copper Alloy	12164 CW603N	B16 C36000
Bonnet	Cast Iron	1561 EN-JLI040	A126 CI B
Bonnet Gasket	Graphite		
Wedge Nut	Bronze	1982 CC491K	B62 C83600
Wedge	Cast Iron	1561 EN-JLI040	A126 CI B
Wedge Facing Ring	Bronze	1982 CC491K	B62 C83600
Body Seat Ring	Bronze	1982 CC491K	B62 C83600
Body	Cast Iron	1561 EN-JLI040	A126 CI B

DIMENSIONAL DRAWINGS

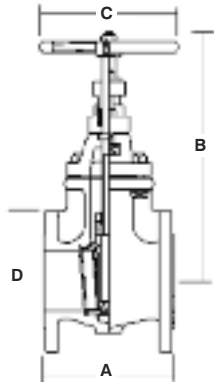

DIMENSIONS AND WEIGHTS

Nom Size	in										
		2	2 1/2	3	4	5	6	8	10	12	
A	in	7	7 1/2	8	9	10	10 1/2	11 1/2	13	14	
B	in	11	12 1/2	13 1/2	15 1/4	18	20	25	29	35	
C	in	7	7	8	10	12	12	14	16	18	
D	in	6	7	7 1/2	9	10	11	13 1/2	16	19	
Weight	kg	20	25	29	48	65	80	126	179	205	

PRESSURE/TEMPERATURE RATING

13.8 bar at -10 to 65°C
8.6 bar at 232°C

TEST PRESSURES

Each valve is individually hydrostatically tested to MSS SP-70 at the following test pressures.
Shell: 24.1 bar
Seat: 15.2 bar

SPECIFICATION

Face to face dimensions.
ANSI B16.10 & basic BS EN 558-2 Series 3.
Inside screw.
Flanged to ANSI B16.1 Class 125 and BS 1560 3.2.
Bronze trim.
Complies with MSS SP-70 Class 125 and BS5150 ANSI 125.

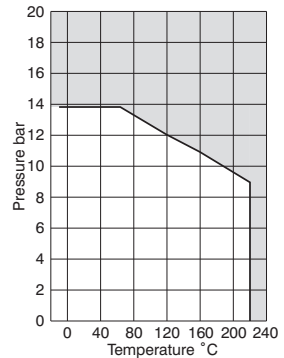

Every effort has been made to ensure that the information contained in this publication is accurate at the time of publishing. Hattersley Ltd assumes no responsibility or liability for typographical errors or omissions or for any misinterpretation of the information within the publication and reserves the right to change without notice.

Fig. 504
Cast Iron

FEATURES AND BENEFITS

- Cast Iron with integral flanges
- Outside screw pattern with rising stem
- Ideal for use on more active media where fluid might have an adverse affect on thread
- Flanges ends require no pipe threading



MATERIAL SPECIFICATION

Component	Material	Specification	
		BS EN	ASTM
Handwheel	Cast Iron	1561 EN-JLI030	A126 CI B
Gland	Cast Iron	1561 EN-JLI030	A126 CI B
Gland Packing	Graphite		
Stuffing Box	Cast Iron	1561 EN-JLI030	A126 CI B
Stuffing Box Gasket	Graphite		
Stem	Copper Alloy	12164 CW603N	B16 C36000
Bonnet	Cast Iron	1561 EN-JLI030	A126 CI B
Bonnet Gasket	Graphite		
Wedge Nut	Bronze	1982 CC491K	B62 C83600
Wedge	Cast Iron	1561 EN-JLI030	A126 CI B
Wedge Facing Ring	Bronze	1982 CC491K	B62 C83600
Body Seat Ring	Bronze	1982 CC491K	B62 C83600
Body	Cast Iron	1561 EN-JLI030	A126 CI B

DIMENSIONAL DRAWINGS

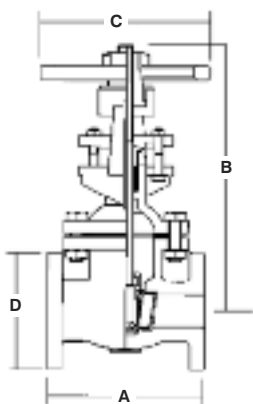

DIMENSIONS AND WEIGHTS

Nom Size	in	2	2 1/2	3	4	5	6	8	10	12
A	in	7	7 1/2	8	9	10	10 1/2	11 1/2	13	14
B	in	13 3/4	15 1/2	18	22 1/4	26	31	37	47	55
C	in	7	7	8	10	12	12	14	16	18
D	in	6	7	7 1/2	9	10	11	13 1/2	16	19
Weight	kg	24	26	29	50	71	88	136	198	268

PRESSURE/TEMPERATURE RATING

BS EN 1092-2 Class 125
13.8 bar from -10 to 65°C
8.6 bar at 232°C

TEST PRESSURES

Each valve is individually hydrostatically tested to MSS SP-70 at the following test pressures.
Shell: 24.1 bar
Seat: 15.2 bar

SPECIFICATION

BS 5150:1990 ANSI 125.
Face to face dimensions ANSI B16.10.
Outside screw.
Rising stem.
Bronze trim.
Flanged to ANSI B16.1 Class 125.
Complies with MSS SP-70 Class 125.

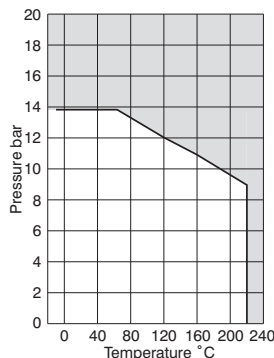

Every effort has been made to ensure that the information contained in this publication is accurate at the time of publishing. Hattersley Ltd assumes no responsibility or liability for typographical errors or omissions or for any misinterpretation of the information within the publication and reserves the right to change without notice.

Gland Cocks/Drain Taps

Fitting Hattersley's Drain Taps and Gland Cocks enable systems to be drained without removing pipework. They prevent the build up of sediment that flows through the pipework thus extending its life expectancy.

Malleable Iron Levers

MI Lever No.	Y1	Y2	Y3	Y4	Y5	Y6	Y7	Y8	Y9	
Square Size	mm	8.7	9.5	10.3	12.7	14.3	15.9	19.1	22.2	25.4

MI Lever No.	D1	D2	D3	D3 ^{1/2}	D4 ^{1/2}	D5	D6	D7	D7 ^{1/2}	D8
Square Size	mm	7.9	10.3	11.1	13.5	15.9	17.5	19.1	23.8	31.8



Fig. 370-371 Bronze



FEATURES AND BENEFITS

- Enables system to be drained without removing pipework
- Prevents build-up of sediment
- Extends life expectancy of pipework

MATERIAL SPECIFICATION

Component	Material	Specification BS EN
Body	Bronze	1982 CC491K
Stem	Brass	12164 CW603N
Bonnet	Brass	12164 CW603N
Disc Holder	Brass	12164 CW603N



DIMENSIONAL DRAWINGS

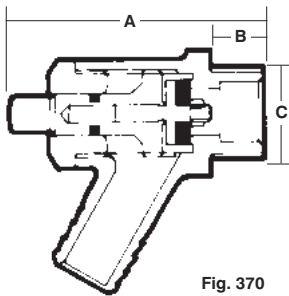

Fig. 370

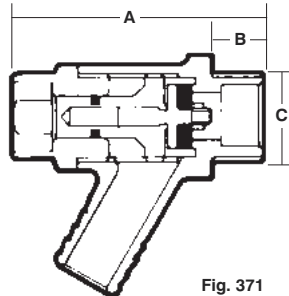

Fig. 371

PRESSURE/ TEMPERATURE RATING

Suitable for pressures of 13 bar up to a maximum temperature of 120°C.

DIMENSIONS AND WEIGHTS

Nom Size	in	in		
		1/2	3/4	1
A (370)	mm	57	73	79
A (371)	mm	59	75	83
B	mm	13	16	19
C	mm	10	10	11
Lockshield key	Fig.	391	391	393
	Ref	2	3	6
Weight	kg	0.22	0.36	0.68

Every effort has been made to ensure that the information contained in this publication is accurate at the time of publishing. Hattersley Ltd assumes no responsibility or liability for typographical errors or omissions or for any misinterpretation of the information within the publication and reserves the right to change without notice.

Fig. 81HU
Bronze Hose Union

FEATURES AND BENEFITS

- Enables system to be drained without removing pipework
- Prevents build-up of sediment
- Extends life expectancy of pipework



MATERIAL SPECIFICATION

Component	Material	Specification	
		BS EN	ASTM
Gland (1/2" to 1")	Brass	12165 CW617N	B124 Alloy 2
Gland (1 1/4" to 2")	Bronze	1982 CC491K	B62
Gland Packing	Asbestos Free		
Plug	Bronze	1982 CC491K	B62
Cap and Tail	Brass	12164 CW614N	B455-385
Body	Bronze	1982 CC491K	B62

DIMENSIONAL DRAWINGS

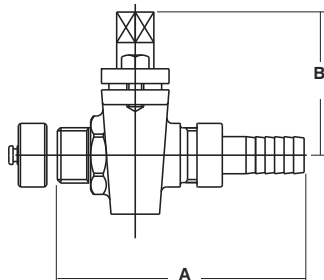

DIMENSIONS AND WEIGHTS

Nom Size	in	1/4	3/8	1/2	3/4	1	1 1/4	1 1/2
A	mm	95	102	93	117	145	184	203
B	mm	47	54	54	64	79	90	100
MI Lever No.		Y1	Y2	D2	D3 1/2	D4 1/2	Y6	Y7
Weight	kg	0.32	0.35	0.38	0.67	1.2	1.5	2.5

MALLEABLE IRON LEVERS

MI Lever No.	Y1	Y2	D2	D3 1/2	D4 1/2	Y6	Y7
Square size	mm	8.7	9.5	10.3	13.5	15.9	19.1

PRESSURE/ TEMPERATURE RATING

10 bar 0 to 120°C

TEST PRESSURES (HYDRAULIC)

Body: 20 bar

SPECIFICATION

90° operation.

Sizes 1/2" to 1" supplied complete with cap and strap.
Other sizes available with cap and chain on request.

Plugs have square heads with a slot to indicate plug position.

Malleable iron levers available on request.

Malleable iron lever can be pinned to the plug head at extra charge.

Taper threaded BS EN 10226 (ISO 7-1) formerly BS 21.

Figure 81HU Gland Cocks are not suitable for gas service.

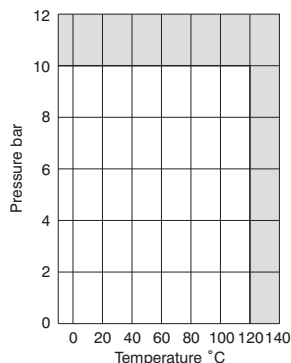

Every effort has been made to ensure that the information contained in this publication is accurate at the time of publishing. Hattersley Ltd assumes no responsibility or liability for typographical errors or omissions or for any misinterpretation of the information within the publication and reserves the right to change without notice.



Terminal 5, Heathrow Airport, London
Specification: Hattersley Automatic and Static Balancing Valves

Globe Valves

Hattersley globe valves are highly efficient for throttling service because seat and disc designs provide flow characteristics with proportionate relationships between valve lift and flow rate. This assures accurate flow control/regulation. Globe valve bodies are normally of spherical shape, ensuring maximum strength against line pressures and pipeline strains. Wide faced hexagon ends on threaded valves provide a firm wrench grip which prevents damage to the valve.

The majority of Hattersley globe valves are inside screw pattern, having either a screwed bonnet or union bonnet configuration. A wide choice of disc and seat materials is offered in this range to enable the user to select a valve most suited for the intended service.

There are five basic seat and disc arrangements available:

1. Metal to metal: the seat being integral with the body.
2. Renewable alloy or stainless steel disc and seat.
3. Renewable composition or elastomeric disc.
4. Renewable composition elastomeric disc alloy seat.
5. Vee-Reg pattern stainless steel disc and seat giving protection against wire drawing on steam service.



Fig. C4
Bronze



FEATURES AND BENEFITS

- High quality bronze body with robust spherical shape
- Rising stem and screwed bonnet
- Assures accurate flow regulation/control
- Suitable for high pressures up to 16 bar



MATERIAL SPECIFICATION

Component	Material	Specification ASTM
Handwheel	Cast Iron	A126 CI B
Stem	Brass	B16 C36000
Gland Nut	Brass	B16 C36000
Gland Follower	Brass	B16 C36000
Gland Packing	PTFE	
Bonnet	Bronze	B584 C84400
Disc 1/2" to 1"	Bronze	B16 C36000
Disc 1 1/4" to 2"	Bronze	B584 C84400
Body	Bronze	B584 C84400

DIMENSIONAL DRAWINGS

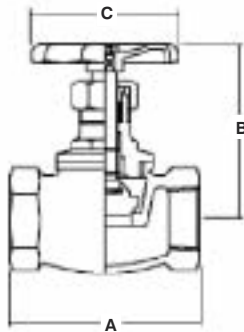

DIMENSIONS AND WEIGHTS

Nom Size	in	1/2	3/4	1	1 1/4	1 1/2	2
A	mm	49	56	65	75	84	99
B	mm	70	70	87	94	104	124
C	mm	53	58	64	74	74	87
Weight	kg	0.26	0.35	0.55	0.72	1.01	1.54

PRESSURE/TEMPERATURE RATING

7 bar at 170°C
16 bar from -10 to 100°C

TEST PRESSURES (PNEUMATIC)

Each valve is individually hydrostatically tested to BS 5154 at the following test pressures.
Shell: 24 bar
Seat: 17.6 bar

SPECIFICATION

Rising stem.
Threaded bonnet.
Metal disc.
Taper thread BS EN 12288 (BS 21-ISO 7).
Available with NPT thread (C4AT) subject to minimum quantities.

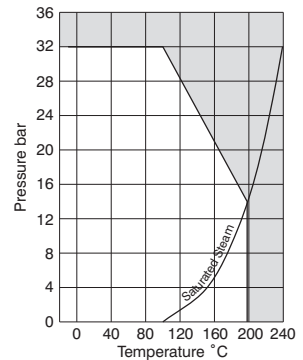

Every effort has been made to ensure that the information contained in this publication is accurate at the time of publishing. Hattersley Ltd assumes no responsibility or liability for typographical errors or omissions or for any misinterpretation of the information within the publication and reserves the right to change without notice.

Fig. 5
Bronze

FEATURES AND BENEFITS

- High quality bronze body with robust spherical shape
- Rising stem and screwed bonnet
- Assures accurate flow regulation/control
- Suitable for high pressures up to 32 bar



MATERIAL SPECIFICATION

Component	Material	Specification	
		BS EN	ASTM
Body	Cast Bronze	1982 CC491K	B62 C83600
Disc (1/2" to 1")	Brass	12165 CW617N	B124 C37700
Disc (1 1/4" to 2")	Bronze	1982 CC491K	B62 C83600
Stem	Brass	12164 CW617N	B455 C38000
Bonnet	Bronze	1982 CC491K	B62 C83600
Stem Packing	Teflon	PTFE	
Packing	PTFE		
Handwheel	Aluminium		
Gland Nut	Brass	12164 CW614N	B455 C38500
Lock Nut	Brass	12164 CW614N	B455 C38500

DIMENSIONAL DRAWINGS

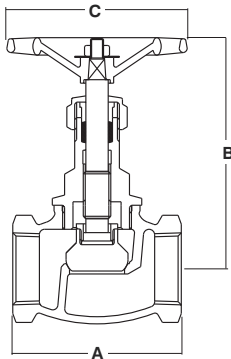

DIMENSIONS AND WEIGHTS

Nom Size	in	1/2	3/4	1	1 1/4	1 1/2	2
A	mm	60	74	86	99	109	130
B (open)	mm	92	108	118	137	162	166
C	mm	70	76	82	94	101	119
Weight	kg	0.4	0.5	0.9	1.4	1.7	2.7

PRESSURE/TEMPERATURE RATING

BS 5154 PN32 Series B
14 bar at 198°C
32 bar from -10 to 100°C

TEST PRESSURES (PNEUMATIC)

Body: 6 bar
Seat: 6 bar

SPECIFICATION

Rising stem.
Screwed bonnet.
Available with NPT threads to ASTM B1.20.1.
Taper threaded BS EN 10226 (ISO 7-1) formerly BS 21.
BS 5154.
Bronze Body.

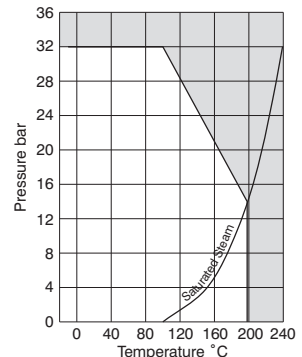

Every effort has been made to ensure that the information contained in this publication is accurate at the time of publishing. Hattersley Ltd assumes no responsibility or liability for typographical errors or omissions or for any misinterpretation of the information within the publication and reserves the right to change without notice.

Fig. 5N - 5NLS
Bronze Needle

FEATURES AND BENEFITS

- High quality bronze body with robust spherical shape
- Rising stem and screwed bonnet
- Assures accurate flow regulation/control
- Suitable for high pressures up to 32 bar



MATERIAL SPECIFICATION

Component	Material	Specification	
		BS EN	ASTM
Body	Cast Bronze	1982 CC491K	B62 C83600
Stem	Brass	12164 CW617N	B124 Alloy 2
Stem Packing	Teflon	PTFE	
Bonnet	Cast Bronze	1982 CC491K	B62 C83600
Packing Nut	Brass	12164 CW614N	B455 C38500
Handwheel	Aluminium		
Identification Plate	Aluminium		
Handwheel Nut	Brass	12164 CW614N	B455 C38500

DIMENSIONAL DRAWINGS

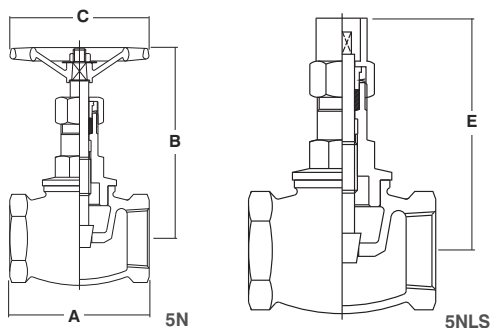

DIMENSIONS AND WEIGHTS

Nom Size	in	1/4	3/8	1/2	3/4	1
A	mm	51	51	60	74	86
B (open)	mm	72	72	92	108	118
C	mm	57	57	68	75	82
E	mm	75	75	95	111	121
Lockshield key	Fig.	391	391	391	391	391
	Ref	IP	IP	IP	IP	IP
Weight	kg	0.2	0.2	0.4	0.6	0.9

PRESSURE/TEMPERATURE RATING

BS 5154: 1991 PN32 Series B
14 bar at 198°C
32 bar from -10 to 100°C

TEST PRESSURES (PNEUMATIC)

Body: 6 bar
Seat: 6 bar

SPECIFICATION

Rising stem.
Screwed bonnet.
Taper threaded BS EN 10226 (ISO 7-1) formerly BS 21.

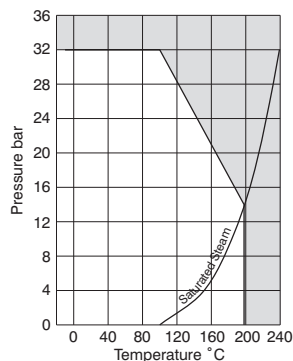

Every effort has been made to ensure that the information contained in this publication is accurate at the time of publishing. Hattersley Ltd assumes no responsibility or liability for typographical errors or omissions or for any misinterpretation of the information within the publication and reserves the right to change without notice.

Fig. 13
Bronze

FEATURES AND BENEFITS

- High quality bronze body with robust spherical shape
- Rising stem and screwed bonnet
- Assures accurate flow regulation/control
- Suitable for high pressures up to 32 bar



MATERIAL SPECIFICATION

Component	Material	Specification	
		BS EN	ASTM
Handwheel Nut	Aluminium		
Gland Nut	Brass	12164 CW614N	B16 C36000 B124 C37700
Packing	PTFE		
Bonnet	Bronze	1982 CC491K	B62 C83600
Stem	Brass	12165 CW617N	B455 C38000
Disc Stem Nut	Brass	12164 CW603N	B16 C36000
Disc Holder	Brass	12164 CW614N	B16 C36000 B124 C37700
Disc Retaining Washer	Brass	12164 CW614N	B16 C36000 B124 C37700
Body	Bronze	1982 CC491K	B62 C83600

DIMENSIONAL DRAWINGS

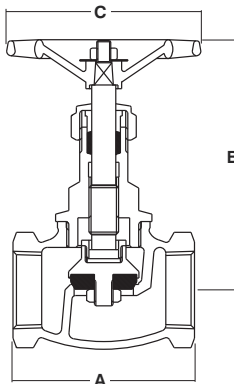

DIMENSIONS AND WEIGHTS

Nom Size	in	1/4	3/8	1/2	3/4	1	1 1/4	1 1/2	2
A	mm	51	51	60	74	86	99	109	130
B (open)	mm	72	72	92	108	118	137	162	166
C	mm	56.5	56.5	68.3	75.1	82	94	100	119
Weight	kg	0.3	0.3	0.5	0.6	1.1	1.6	2.2	3.7

PRESSURE/TEMPERATURE RATING

BS 5154:1991 PN32 Series B
14 bar at 198°C
32 bar from -10 to 100°C

TEST PRESSURES (PNEUMATIC)

Shell: 6 bar
Seat: 6 bar

SPECIFICATION

BS 5154:1991.
Bronze body.
PTFE replacement disc.
Rising stem.
Screwed bonnet.
Taper threaded BS EN 10226 (ISO 7-1) formerly BS 21.
Available with NPT threads to ASTM B1.20.1

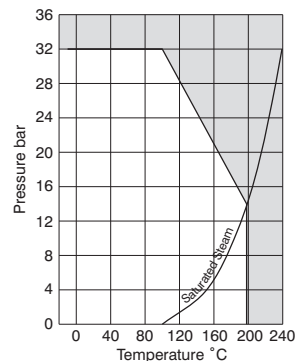

Every effort has been made to ensure that the information contained in this publication is accurate at the time of publishing. Hattersley Ltd assumes no responsibility or liability for typographical errors or omissions or for any misinterpretation of the information within the publication and reserves the right to change without notice.

Fig. 23
Bronze

FEATURES AND BENEFITS

- High quality bronze body with robust spherical shape
- Rising stem and union bonnet
- Assures accurate flow regulation/control
- Suitable for high pressures up to 40 bar



MATERIAL SPECIFICATION

Component	Material	Specification	
		BS EN	ASTM
Handwheel	Aluminium		
Gland	Brass	12164 CW614N	
Packing	Non Asbestos		
Bonnet	Bronze	1982 CC491K	B62 C83600
Union Ring	Bronze	1982 CC491K	B62 C83600
Disc	316 St. Steel		
Stem	Man Bronze	12164 CW721R	B138C67500
Disc Stem Ring	Man Bronze	12164 CW721R	B138C67500
Body Seat Ring	13% Cr St	10088 X12Cr13	A276 410
Body	Bronze	1982 CC491K	B62 C83600
Lock Washer	Brass	2870	CZ 123
Packing Nut (1/4" to 1 1/2")	Brass	12164	CW721R
Packing Nut 2"	Bronze	1982 CC491K	
Handwheel Nut	Brass	12164 CW614N	
Identification Plate	Aluminium		

DIMENSIONAL DRAWINGS

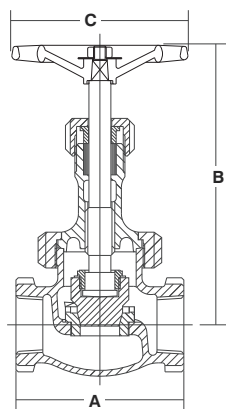

DIMENSIONS AND WEIGHTS

Nom Size	in	1/4	3/8	1/2	3/4	1	1 1/4	1 1/2	2
A	mm	59	59	68	81	95	108	121	146
B	mm	126	126	142	154	173	201	225	255
C	mm	76	76	81	94	100	119	139	150
Weight	kg	0.56	0.55	0.8	1.24	1.82	2.73	3.78	6.03

**PRESSURE/
TEMPERATURE RATING**

PN40
17.5 bar at 260°F
40 bar from -10 to 120°C

**TEST PRESSURES
(HYDRAULIC)**

Shell: 60 bar
Seat: 44 bar

SPECIFICATION

BS 5154:1991.
Bronze body.
316 stainless steel disc.
Rising stem.
Union bonnet.
Taper threaded BS EN 10226
(ISO 7-1) formerly BS 21.
Available with NPT threads to
ASTM B1.20.1.

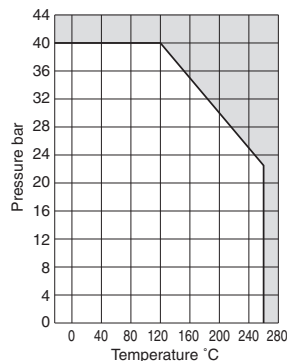

Every effort has been made to ensure that the information contained in this publication is accurate at the time of publishing. Hattersley Ltd assumes no responsibility or liability for typographical errors or omissions or for any misinterpretation of the information within the publication and reserves the right to change without notice.

Fig.17
Bronze

FEATURES AND BENEFITS

- High quality bronze body with robust spherical shape
- Rising stem and screwed bonnet
- Assures accurate flow regulation/control
- Integral flanges require no pipe threading



MATERIAL SPECIFICATION

Component	Material	Specification	
		BS EN	ASTM
Body	Bronze	1982 CC491K	B62 C83600
Disc Stem Ring	Man Bronze	12164 CW721R	B138 C67500
Packing	Asbestos Free		
Gland	Brass	12164 CW614N	
Packing Nut	Brass	12164 CW614N	
Washer	Brass	12164 CW614N	
Disc Retaining Nut	Brass	12164 CW614N	
Handwheel	Aluminium		
Handwheel Nut	Brass	12164 CW614N	
Identification Plate	Aluminium		
Bonnet	Bronze	1982 CC491K	B62 C83600
Stem	Brass	12164	CW721R
Disc	PTFE		
Disc Holder	Bronze	1982 CC491K	B62 C83600

DIMENSIONAL DRAWINGS

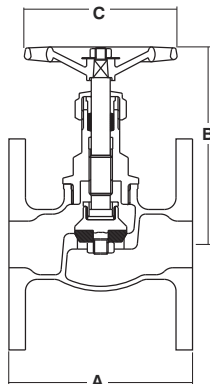

DIMENSIONS AND WEIGHTS

Nom Size	mm	15	20	25	32	40	50
A	mm	80	90	100	110	120	135
B	mm	101	119	130	155	172	196
C	mm	70	80	95	95	105	120
D	mm	95	105	115	140	150	165
E	mm	6.0	6.0	8.0	8.0	9.0	11.0
Weight	kg	1.24	1.76	2.30	2.82	5.22	5.71

PRESSURE/TEMPERATURE RATING

BS 5154: 1991 PN16 Series B
7 bar at 170°C
16 bar from -10 to 100°C

TEST PRESSURES (HYDRAULIC)

Shell: 24 bar
Seat: 17.6 bar

SPECIFICATION

Rising stem.
Screwed bonnet.
Renewable glass filled PTFE disc.
Conical seat disc (15 to 50mm).
Flanged to BS EN 1092-3.
Also available with flanges drilled to BS10 Table E and F and ANSI from PN16 flanges.
Face to face dimensions of all valves are to PN16 detail.

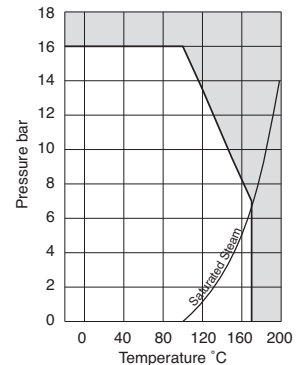

Every effort has been made to ensure that the information contained in this publication is accurate at the time of publishing. Hattersley Ltd assumes no responsibility or liability for typographical errors or omissions or for any misinterpretation of the information within the publication and reserves the right to change without notice.

Fig. 731
Cast Iron

FEATURES AND BENEFITS

- Valve body is made of high grade cast iron and has integral flanges
- Supplied with asbestos free gland packing and gaskets
- Outside screw pattern with rising stem
- Ideal for use on more active media where fluid might have an adverse effect on thread



MATERIAL SPECIFICATION

Component	Material	Specification	
		BS EN	ASTM
Handwheel	Cast Iron	1561 EN-JL1030	A126 C1B
Yoke Bush	Bronze	1982 CC491K	B62 C83600
Stem	Brass	12164 CW603R	B16 C36000
Gland Flange	Ductile Iron	1563 EN-JS1030	A536 65-45-12
Gland Follower	Bronze	1982 CC491K	B62 C83600
Gland Packing	Graphite		
Bonnet	Cast Iron	1561 EN-JL1040	A126 C1B
Bonnet Gasket	Graphite		
Disc Stem Nut	Bronze	1982 CC491K	B62 C83600
Disc	Bronze	1982 CC491K	B584 C83600
Body Seat Ring	Bronze	1982 CC491K	B584 C83600
Body	Cast Iron	1561 EN-JL1040	A126 C1B

DIMENSIONAL DRAWINGS

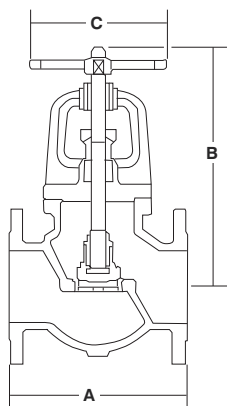

DIMENSIONS AND WEIGHTS

Nom Size	mm	50	65	80	100	125	150	200	250	300
A	mm	203	216	241	292	330	356	495	622	698
B (open)	mm	259	300	318	402	419	479	537	640	733
C	mm	178	178	200	254	300	300	348	400	457
Weight	kg	16	21	26	44	62	83	141	221	295

PRESSURE/TEMPERATURE RATING

16 bar from -10 to 120°C
11.8 bar at 230°C

TEST PRESSURES (HYDRAULIC)

Body: 24 bar
Seat: 17.6 bar

SPECIFICATION

BS EN 13789:2010.
Face to face dimensions BS EN 588-1 basic series 10.
Cast iron body and bonnet.
Outside screw, rising stem.
Bronze trim.
Sizes DN125 to DN300 have a centre guided disc.
Handwheel operated.
Flanged to BS EN 1092-2 PN16.
Also available flanged BS 5152 ANSI 125 figure 731 ANSI.

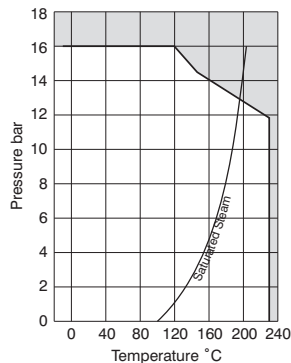

Every effort has been made to ensure that the information contained in this publication is accurate at the time of publishing. Hattersley Ltd assumes no responsibility or liability for typographical errors or omissions or for any misinterpretation of the information within the publication and reserves the right to change without notice.

Lubricated Plug Valves

The principle of the HNH-Milliken plug valve is as simple as its design. The plug, which is the only moving part of the valve, when open, presents a straight through passage in line with the pipeline, and when turned through 90° to the closed position stops the flow.

A special sealing compound is used to effect a completely leak tight seal. When line pressure is applied to the valve in the closed position, the parallel plug is forced to the downstream side of the valve. The plug is then in contact with the body in the area surrounding the outlet port. The sealing compound, which surrounds the outlet port by means of special grooves in the plug, forms a barrier to line pressure. It is also spread over the sealing surfaces of the plug and body so that a very thin film of compound is established between the plug and body surfaces on the downstream side.

The metal to metal contact of plug and body together with the barrier of sealing compound ensures a completely leak tight valve. The sealing compound to some extent preserves the body and plug surfaces from corrosion, and provides lubrication for ease of operation. Providing the valve is correctly maintained, which in general simply means injecting a small amount of sealing compound from time to time and moving the plug, a valve giving positive shut-off will result in and provide many years of satisfactory service.

Steam Jacketing

Steam jacketed bottom covers can be fitted to the HNH-Milliken valves shown in the table. Steam jacketing is used on viscous services where heat is required to keep the media in a liquid state.

Steam Jacket Availability

Nom Size	mm	25	32	40	50	65	80	100	125	150	200	250
	in	1	1 1/4	1 1/2	2	2 1/2	3	4	5	6	8	10
200S		-	-	-	•	•	•	•	•	-	-	

Specification

Screwed end valve are supplied screwed internal to BS EN 10266 (ISO 7) or API Line Pipe Thread as required.

PN16 flanged end valves are drilled to BS EN 1092 2PN16 and class 125 conform to ANSI B16.1 Class 125.

PN25 flanged end valves are drilled to BS EN 1092 2PN25 and Class 250 conform to ANSI B16.1 Class 250.

Health and Safety

HNH-Milliken plug valves contain sealing compound and grease which, for their intended use, do not present a significant hazard to health.

If skin contact occurs when recharging the valve with compound wash hands thoroughly with soap and water and maintain good standards of hygiene.

Health and safety data sheets are available for each compound and give guidance on safe handling and remedial action if misused.

Flanges

This catalogue provides information for screwed end valves and valves fitted with flanges to BS EN 1092-2 and ANSI B16.1. Valves with BS10 flanges can be supplied, details on application.

Gearing

In this catalogue the dimensional tables indicate where, in our opinion, valves should be fitted with gearing.

Cast Iron HNH-Milliken Plug Valves Operating and Test Pressures

Flanged	Sizes	Pressure/Temperature Rating	
		Hot	Cold
BS EN 1092-2 PN16	All	11.2 bar at 250°C	16 bar from -10 to 120°C
ANSI B16.1 Class 125	1/2 to 12"	125lb/in ² at 450°F	200lb/in ² from -20 to 150°F
ANSI B16.1 Class 125	14 to 24"	100lb/in ² at 353°F	150lb/in ² from -20 to 150°F
BS1560 Class 125	15 to 300mm	8.6 bar at 230°C	13.8 bar from -10 to 65°C
BS1560 Class 125	350 to 600mm	6.9 bar at 180°C	10.3 bar from -10 to 65°C
ANSI B16.1 Class 250	1/2 to 12"	250lb/in ² at 450°F	500lb/in ² from -20 to 150°F
ANSI B16.1 Class 250	14 to 24"	200lb/in ² at 406°F	300lb/in ² from -20 to 150°F
BS1560 Class 250	15 to 300mm	17.2 bar at 230°C	34.5 bar from -10 to 65°C
BS1560 Class 250	350 to 600mm	14.1 bar at 200°C	20.7 bar from -10 to 65°C

Screwed	Sizes	Pressure/Temperature Rating	
		Hot	Cold
PN16	All	10.8 bar at 260°C (157lb/in ² at 500°F)	16 bar from -10 to 120°C (232lb/in ² from -23 to 248°F)
Class 250All	17.5 bar at 260°C	34.5 bar from -10 to 120°C (253lb/in ² at 500°F)	500lb/in ² from -23 to 248°F

Hydrostatic Test Pressures

Fig. No	End Connection	Pressure Rating	Nominal Size	Body Test bar	Body Test lbf/in ²	Seat Test bar	Seat Test lbf/in ²
200M	Screwed	PN16	DN15 (1/2") to DN80 (3")	24.0	348	17.6	255
200R			DN25 (1") to DN50 (2")				
200L/T			DN15 (1/2") to DN50 (2")				
171MG	Flanged	PN16	DN150 (6") to DN600 (24")	24.0	348	17.6	255
201M			DN25 (1") to DN200 (8")				
201R	Flanged	ANSI 125	DN32 (1 1/4") to DN100 (4")	24.1	350	13.8	200
201T			DN50 (2") to DN150 (6")				
221T			DN80 (3")				
205M	Flanged	ANSI 250	DN50 (2") to DN150 (6")	51.7	750	34.5	500
401M							

Note 1: All valves 1/2" to 1 1/2" inclusive are pneumatically tested to:
Body: 6 to 7 bar
Seat: 6 to 7 bar

VALVE PRESSURE/TEMPERATURE RATING

The pressure/temperature ratings given apply to the valve only.

The maximum temperature at which a valve may operate depends upon the sealing compound with which the valve is filled.

However, should the sealing compound have an operating temperature different to that of the valve the lower temperature must apply.

Every effort has been made to ensure that the information contained in this publication is accurate at the time of publishing. Hattersley Ltd assumes no responsibility or liability for typographical errors or omissions or for any misinterpretation of the information within the publication and reserves the right to change without notice.

Fig. 170M (Screwed), 171M (Flanged) Cast Iron HNH-Milliken - Short Pattern, Reduced Bore

FEATURES AND BENEFITS

- Sealing compound effects a completely leak tight seal.
- When open - presents a straight through passage in line with pipeline
- Stops flow after 90° turn

DIMENSIONAL DRAWINGS

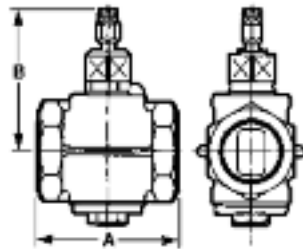

170M - Sizes 1" to 4"

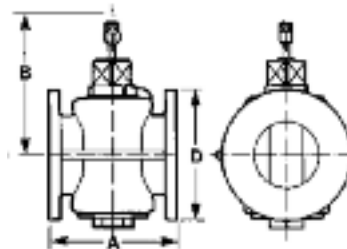
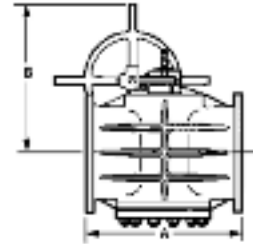

171M - Sizes 1" to 8"

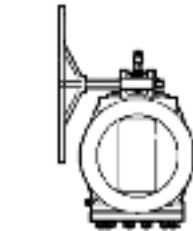

171MG* - Sizes 6" to 24"
supplied with fully enclosed gearing

DIMENSIONS AND WEIGHTS

Dimensions 170M and 171M

Nom Size	mm	25	32	40	50	65	80	100	125	150	200
	in	1	1 1/4	1 1/2	2	2 1/2	3	4	5	6	8
A (170M)	mm	92	102	111	152	165	187	225	-	-	-
A (171M)	mm	102	111	118	178	190	203	225	254	267	292
	in	4	4 3/8	4 5/8	7	7 1/2	8	9	10	10 1/2	11 1/2
B	mm	103	108	119	127	197	206	254	270	298	327
D Flanged ANSI 125	in	4 1/4	4 5/8	5	6	7	7 1/2	9	10	11	13 1/2
Wrench (screwed)		G	G	J	J	L	L	O	-	-	-
Wrench (flanged)		G/C	G/C	J/C	J	L	L	O	P	P	Q
Weight (screwed)	kg	1.7	1.9	2.4	4.3	6.6	10	21	-	-	-
Weight (flanged)	kg	2.9	4.2	5.0	8.2	11	17	24	44	57	77

DETAILS OF TAPPED HOLES

The close proximity of the flange to the body does not allow room for all bolt holes to be drilled through. These holes are drilled and tapped as follows:

Valve size	Tapped
125mm	M16
150 to 200mm	M20
250 to 300mm	M24

Dimensions 171MG (with gear unit)

Nom Size	mm	150	200	250	300	400	450	500	600
	in	6	8	10	12	16	18	20	24
A	mm	267	292	330	356	762	864	914	1067
B	mm	380	473	532	576	738	802	843	914
D Flanged ANSI 125	in	11	13 1/2	16	19	23 1/2	25	27 1/2	32
Weight	kg	71	95	163	224	558	625	1190	1610

Every effort has been made to ensure that the information contained in this publication is accurate at the time of publishing. Hattersley Ltd assumes no responsibility or liability for typographical errors or omissions or for any misinterpretation of the information within the publication and reserves the right to change without notice.

Fig. 200M (Screwed), 201M (Flanged) Cast Iron HNH-Milliken - Short Pattern, Full Bore

FEATURES AND BENEFITS

- Sealing compound effects a completely leak tight seal.
- When open - presents a straight through passage in line with pipeline
- Stops flow after 90° turn

DIMENSIONAL DRAWINGS

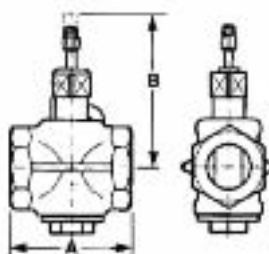

200M - Sizes 1/2" to 3"

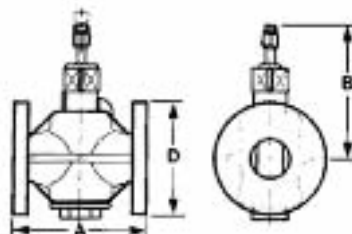
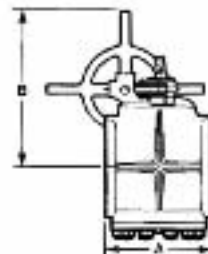

201M - Sizes 1" to 8"
Sizes 5", 6" and 8" have bolted bottom cover

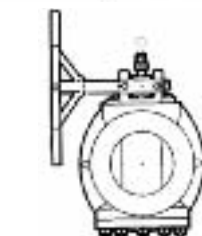

201M - Sizes 5" to 8"

DIMENSIONS AND WEIGHTS

Dimensions 200M and 201M

Nom Size	mm in	15 1/2	20 3/4	25 1	32 1 1/4	40 1 1/2	50 2	65 2 1/2	80 3	100 4	125 5	150 6
A (200M)	mm	81	88	106	111	117	152	165	187	-	-	-
A (201M)	mm	-	-	121	111	117	178	190	203	229	254	267
	in	-	-	4 3/4	4 3/8	4 5/8	7	7 1/2	8	9	10	10 1/2
B	mm	-	-	108	124	127	197	206	254	270	299	327
D Flanged PN16	mm	-	-	115	140	150	165	185	200	220	250	285
D Flanged ANSI 125	in	-	-	4 1/4	4 5/8	5	6	7	7 1/2	9	10	11
Wrench		G	G	G	J	J	L	L	O	P	P	Q
Weight (200M)	kg	0.8	1.2	2.1	2.6	3.1	6.0	8.8	14	31	-	-
Weight (201M)	kg	2.7	2.7	3.9	4.6	5.7	10	13	19	39	58	77

Dimensions 201MG (with gear unit)

Nom Size	mm in	125 5	150 6	200 8
A	mm	254	267	292
	in	10	10 1/2	11 1/2
B	mm	381	473	533
D Flanged PN16	mm	250	285	340
D Flanged ANSI 125	in	10	11	13 1/4
Weight	kg	72	95	167

DETAILS OF TAPPED HOLES

The close proximity of the flange to the body does not allow room for all bolt holes to be drilled through. These holes are drilled and tapped as follows:

Valve size	Tapped
100 and 125mm	M16
150 to 200mm	M20

Every effort has been made to ensure that the information contained in this publication is accurate at the time of publishing. Hattersley Ltd assumes no responsibility or liability for typographical errors or omissions or for any misinterpretation of the information within the publication and reserves the right to change without notice.

Fig. 200R (Screwed), 201R (Flanged) Cast Iron HNH-Milliken Plug Valves - Round Port, Full Bore

FEATURES AND BENEFITS

- Sealing compound effects a completely leak tight seal.
- When open - presents a straight through passage in line with pipeline
- Stops flow after 90° turn



DIMENSIONAL DRAWINGS

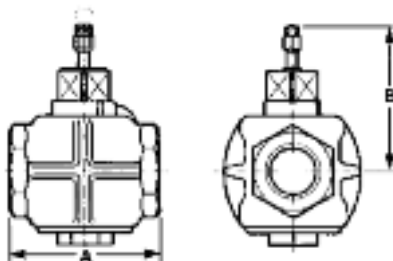

200R - Sizes 1", 1 1/2" and 2" only

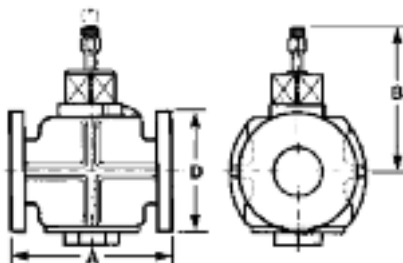

201R - Sizes 1 1/4" to 4"
4" size has bolted bottom cover

DIMENSIONS AND WEIGHTS

Dimensions 200R and 201R

Nom Size	mm in	25	32	40	50	65	80	100
		1	1 1/4	1 1/2	2	2 1/2	3	4
A (200R)	mm	106	-	140	190	-	-	-
A (201R)	mm	-	127	133	190	222	244	324
	in	5	5 1/4	7 1/2	8 3/4	9 5/8	12 3/4	-
B	mm	114	124	140	206	216	245	286
D Flanged ANSI 125	in	4 1/4	4 5/8	5	6	7	7 1/2	9
Wrench		J	J	L	O	O	P	Q
Weight (200R)	kg	1.9	3.6	4.9	12	19	25	60
Weight (201R)	kg	3.8	5.8	7.5	17	23	30	61

Every effort has been made to ensure that the information contained in this publication is accurate at the time of publishing. Hattersley Ltd assumes no responsibility or liability for typographical errors or omissions or for any misinterpretation of the information within the publication and reserves the right to change without notice.

Fig. 200L/T, 201T, 201TG Fig. 221T Cast Iron HNH-Milliken Plug Valves - 3 Way Pattern L-Port & T-Port

FEATURES AND BENEFITS

- Sealing compound effects a completely leak tight seal.
- When open - presents a straight through passage in line with pipeline
- Stops flow after 90° turn



DIMENSIONAL DRAWINGS

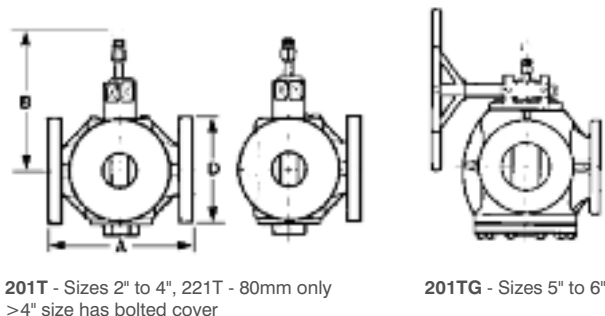
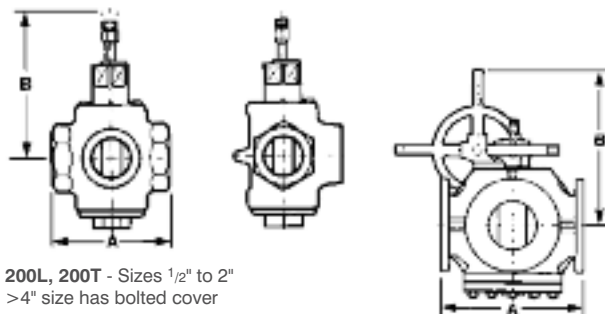

201TG - Sizes 5" to 6"

DIMENSIONS AND WEIGHTS

Dimensions (wrench operated)

Nom Size	mm in	15	20	25	32	40	50	65	80	100
		1/2	3/4	1	1 1/4	1 1/2	2	2 1/2	3	4
A (200L/T)	mm	99	99	108	127	140	162	-	-	-
A (201T/221T)	mm	-	-	-	-	-	216	248	267	324
	in	-	-	-	-	-	8 1/2	9 3/4	10 1/2	12 3/4
B	mm	108	108	118	133	133	206	222	257	302
Flanged PN16	mm	-	-	-	-	-	165	185	200	220
D Flanged ANSI 125	in	-	-	-	-	-	6	7	7 1/2	9
Wrench		G	G	J	J	L	L	O	P	Q
Weight (screwed)	kg	1.7	1.6	2.5	3.8	5.2	8.4	15	29	51
Weight (flanged)	kg	-	-	-	-	-	13	24	39	82

Dimensions (with gear unit)

Nom Size	mm in	125	150
		5	6
A	mm	387	406
	in	15 1/4	16
B	mm	476	521
D Flanged PN16	mm	250	285
D Flanged ANSI 125	in	10	11
Weight	kg	125	151

VALVE IDENTIFICATION

Ends	Operation	Fig No
Non-transflow		
Screwed	Wrench	200L
Screwed	Wrench	200T
Flanged	Wrench	201T
Flanged	Geared	201TG
Transflow		
Flanged	Wrench	221T

Transflow pattern valves allow reduced flow through the ports during rotation of the plug from one position to another.

Every effort has been made to ensure that the information contained in this publication is accurate at the time of publishing. Hattersley Ltd assumes no responsibility or liability for typographical errors or omissions or for any misinterpretation of the information within the publication and reserves the right to change without notice.

Fig. 401M (Flanged) Cast Iron HNH-Milliken Plug Valves - Regular Pattern, Full Bore

FEATURES AND BENEFITS

- Sealing compound effects a completely leak tight seal.
- When open - presents a straight through passage in line with pipeline
- Stops flow after 90° turn

DIMENSIONAL DRAWINGS

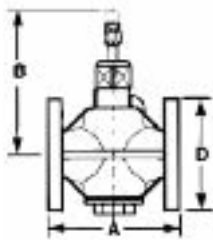

401M - Sizes 2" to 4"

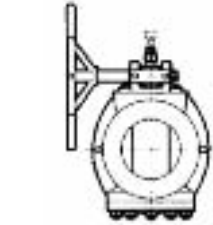

401MG - Sizes 5" to 6"

DIMENSIONS AND WEIGHTS

Dimensions 401M

Nom Size	mm in	15	20	25	32	40	50	65	80	100
		1/2	3/4	1	1 1/4	1 1/2	2	2 1/2	3	4
A (401M)	mm	-	-	-	-	-	216	241	283	305
	in	-	-	-	-	-	8 1/2	9 1/2	11 1/8	12
B	mm	102	105	108	124	127	187	206	254	270
D Flanged ANSI 250	in	-	-	4 7/8	5 1/4	6 1/8	6 1/2	7 1/2	8 1/4	10
Wrench		G	G	G	J	J	L	L	O	P
Weight (401M)	kg	3.0	3.7	5.0	5.6	7.0	15	17	28	51

Dimensions 401MG (with gear unit)

Nom Size	mm in	125	150
		5	6
A	mm	381	403
	in	15	15 7/8
B	mm	381	473
D Flanged ANSI 250	in	11	12 1/2
Weight	kg	92	120

Every effort has been made to ensure that the information contained in this publication is accurate at the time of publishing. Hattersley Ltd assumes no responsibility or liability for typographical errors or omissions or for any misinterpretation of the information within the publication and reserves the right to change without notice.

Servicing Instructions

HNH-Milliken Parallel Plug Valves

Positive isolation with minimum maintenance

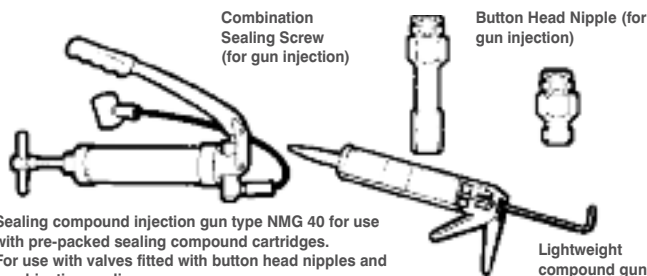

Sealing compound injection gun type NMG 40 for use with pre-packed sealing compound cartridges. For use with valves fitted with button head nipples and combination sealing screws.

Injection of Compound

When the combination screw has reached its limit (screwed fully down) this indicates that the valve needs recharging with sealing compound.

When using the lightweight compound gun, remove the combination screw, partially fill the compound reservoir in the plug, replace the combination screw, and screw down.

This operation may need repeating several times. When using the NMG 40 high pressure gun, attach the nozzle to the injection nipple and give several steady strokes of the lever.

VALVES MUST EITHER BE FULLY OPEN OR FULLY CLOSED WHILST THEY ARE BEING CHARGED.

Indication of Full Charging

The first indication of the valve becoming fully charged is an increase in the effort required to rotate the combination screw, or with the high pressure gun injection an increase in the effort required on the lever.

The effort required to operate the valve should have increased from the initial operation prior to injection of sealing compound.

Method of injection

Where the number of valves to be charged is small, ie. 12-15 valves, especially if they are in the smaller sizes, lightweight gun injection can be successfully used. For larger quantities use of the NMG40 high pressure gun is recommended.

Valve Leakage

Leakage through the valve indicates that the valve requires injection of sealing compound or that it needs opening and closing a minimum of three times to distribute the compound evenly.

Operating Torque

Should a valve become jammed or unusually stiff to operate, this can generally be cured by the injection of sealing compound. If this is ineffective, it will be necessary to dismantle the valve, clean the components and recharge with sealing compound.

Servicing

Advice is available from the Hattersley Service Department in connection with all aspects of operation, lubrication and maintenance.

SEALING

In service sealing compound should be used for each individual medium to affect good isolation. Our recommendations for sealing compounds are the result of considerable research. If there is any doubt as to the suitability of a particular compound for a given service, test should be carried out in a new clean valve. This is the only way to conduct such tests. Laboratory tests using a beaker of line fluid and immersing a stick of compound have proved misleading. Where samples of fluid can be supplied, together with details of temperature and pressure, and if known frequency of operation, we will carry out specific tests and give our recommendations based upon the results.

CONSTRUCTION

Only five major parts are involved when dismantling ie. body, parallel plug, PTFE thrust ring, bottom cover and plug support spring.

OPERATION

Care must be taken particularly with geared valves that the plug is eased off the body stop after operation to ensure the plug is free to float.

ROUTINE MAINTENANCE

Valves are despatched by Hattersley charged with sealing compound. A compound identification tag states clearly that the valve has been assembled and tested with a universal compound. The user is advised to follow the chart overleaf for specific applications. When injecting additional sealing compound, care should be taken to ensure that it is of the correct type. Where the service permits, the valve should be partially or fully operated once to ensure free operation and to determine the effort required.

For infrequently operated valves maintenance merely consists of two or three turns of the combination screw or, if gun injection, several strokes of the lever, and opening and closing the valve a minimum of three times to distribute the compound evenly around the plug at three monthly intervals. It is difficult to be specific how often the valve should be recharged with sealing compound, since this is determined by the frequency of operation, type of service, pressure and temperature.

No.	Temperature Range	Colour of Compound	Colour of Box Label	Availability	Do NOT use for	Cleaning Solvent
18*	32° to 450°F 0° to 230°C	Black	Buff	Bulk	Water or Strong Chemicals	Water Trichloroethane
44	-40° to 284°F -40° to 140°C	Black	Green Prepacked Cartridges	Tubes, Bulk and Strong Chemicals	Strong Chemicals Trichloroethane	Trichloroethane
74	-31° to 500°F -34° to 260°C	Grey	Apple Green	Bulk and Prepacked Cartridges	Nitrating Acids Steam, HTHW	Paraffin Hot Water
90**	-20° to 375°F -30° to 190°C	White	White	Bulk and Prepacked Cartridges	Solvents	Acetone

* Not suitable for gun injection ** UK WFBS Listed

Sealing Compound Recommendations

* Refer to Technical Department

Service	Sealing Compound	Service	Sealing Compound	Service	Sealing Compound
Acetone/Acetate	74	Chloride of Lime	90,74	Ferrous Chloride (Pure)	90,74
Acetone	74	Chocolate	No	Fish Oil	44
Air	90,74		compound	Fuel JP4	44
Alcohols	74	Chrome Alum	90,74	Fuel Oil	44
Alkaline Solutions	74	Chrome Tanning Liquor	90,74	Furlural	44
Ammonia Anhydrous	74	Coal Gas	44		
Ammonia (Gas)	74	Coal Gas Condensate	90,44	Gases	*
Ammonia (Liquid)	74	Coal/Petroleum Mixed Gas		Gas (Manufactured)	90,44
Ammoniacal Copper Hydroxide	74	Condensate	90,44	Gas (Natural)	90,44
Ammonium Hydroxide	74	Coal Tar	18	Gas Oil	44
Amyl Alcohol (Pure)	74	Coal Tar Oils	74	Gasoline	44
Aniline Dyes	74	Coal Tar Solvents	44	Glucose	90
Anthraccine Oil	74	Coal Washers	90,74	Glycerine (Glycerol)	90,74
Aromatic Hydrocarbons	44	Coconut Oil	90,74	Grain Alcohols (Ethyl Alcohol)	74
Aromatic Solvents	44	Coke Oven Gas	90,74	Grease	44,74
Asphalt	18,74	Condensate	90	Gypsum (Calcium Sulphate)	90
Asphalt Emulsions	18,74	Corn Oil	90,74		
		Corn Syrup (Glucose)	90	Helium Gas	90,44
Barium Hydroxide	74	Cotton Seed Oil	90,74	Heptane	44
Beet Sugar Liquors	90	Creosote	44,18	Heavy Oil (Coke Plant)	44
Benzene	44	Cumene	44	Hexane	44
Benzyl Alcohol	74	Cutting Oil	44	Hydraulic Fluid (Haughtosafe 271)	44
Bocarbonate of Soda	74	Cyanide Solutions	90,74	Hydraulic Oil	44
Bitumen	18,74			Hydrocarbons (Aromatic)	44
Blast Furnace Gas	90,74	Denatured Alcohol	74	Hydrogen Gas	90,44
Boiler Blow Down	90	Dextrine	90		
Borax	90	Diesel Fuel	44	Kerosene	44
Brake Fluid	74	Distillate Petroleum	44	Ketones (Not Acetone)	44,74
Bunker Fuel	161	Disinfectant Solution	90		
Butadiene	44			Lard	90
Butane (Gas or Liquid)	44	Enamel (see Paint)		Latex	*
Butanol	74	Epsom Salts	90	Light Naphthas	44
Butyl Alcohol	74	Ethane Gas	44	Light Oil	44,74
		Ethanalamine	74,44	Linseed Oil	90,74
Calcium Chloride Solution	90,74	Ether, Petroleum	44	Liquid Petroleum Gas (LPG)	44
Calcium Hydroxide (Lime Water)	90,74	Ethers	44	Lubricating Oil	44
Calcium Sulphate	90,74	Ethyl Acetate	44	Lye Solutions (Alkalies)	74
Cane Sugar Liquors	90	Ethyl Alcohol (Ethanol)	74		
Carbolic Acid (Phenol Sol.)	74	Ethyl Benzine	44	Magnesium Hydroxide	90
Carbonate of Soda	74	Ethyl Chloride Gas or Liquid	44	Maltose (Malt Syrup)	90
Carbon Bisulphide	44	Ethylene	44,18	Manufactured Gas	90,44
Carbon Dioxide	90,74	Ethylene Dichloride (Dry)	44,74	Methane Gas	90,44
Carbon Monoxide Gas	90,74	Ethylene Gas	44,18	Methyl Alcohol (Methanol)	74
Carburetted Water Gas	44,74	Ethylene Glyco/Water Sol. (50% Antifreeze)	90,74	Methyl Bromide	74
Caster Oil	74	Ethylene Glycol	74	Methyl Chloride, Gas or Liquid	44
Caustic Potash	74			Methylated Spirits	74
Caustic Soda	74			Milk of Lime	90,74
Cellulose Acetate Solutions	74			Mineral Oil	44
Cellulose Nitrate	74			Mineral Spirits	44
Cement (Dry)	90,74			Molasses	90
Cement Slurries	90,74			Monoethanolomine	74,44

Sealing Compound Recommendations

* Refer to Technical Department

Service	Sealing Compound	Service	Sealing Compound	Service	Sealing Compound
Naptha	44	Sewage	90,44	Water (Cold)	90
Naptha Vapours	44	Sewage Gas	90,44	Water (Cold, Domestic)	90
Naphthalene	44,74	Shell Cornea	44	Water (Hot, Heating)	90
Natural Gas	90,44	Shell Garia "A"	44	Water/Gas	90,74
Nitrobenzene	44	Shell Turbine Oil	44	Water Softener Salts	90,74
Nitrogen Gas	90,44	Shellac in Alcohol	74	Wax Emulsions	90,74
		Shock Absorber Oil (Mineral)	*	Waxes	44,74
Oil Gas Mixture	44	Sludge and Sewage	90,44	White Spirit	44
Oil (Petroleum)	44	Soap Solutions	90,74	Wood Alcohol (Methyl Alcohol)	74
Oil Tar	18,74	Soda Liquor (Paper Industry)	74	Wort, Beer	90
Oil Water Mixtures	90,44	Sodium Carbonate (Soda Ash)	74	Xylol (Xylene)	44
		Sodium Cyanide Solution	90,74		
Paints		Sodium Hydroxide			
- Alcohol Solvent Base	74	(up to 50% Conc.)	74		
- Hydrocarbon Solvent Base	44	Sodium Metasilicate	74		
- Varnish	44	Sodium Nitrate	90		
- Water Based	90	Sodium Phosphate (Tri-basic)	90,74		
- White Spirit Based	44	Sodium Silicate	74		
Paraffin	44	Sodium Sulphate	90,74		
Paraffin Wax	90,44	Soluble Oil	90,74		
Pentane	44	Solvent Naptha	17,44		
Petrolatum (Petroleum Jelly)	44,74	Starch Solutions	90		
Petroleum Gas	90,44	Sugar Solutions	90		
Petroleum Ether	44	Sulphur (Liquid)	44,18,74		
Phthalic Anhydride	74	Sulphur Dioxide	74		
Pine Resin	90,74	Sulphur Trioxide	74		
Pitch	18,74	Synthetic Resins	*		
Polyester Resin Solvent	*	Synthetic Tannins	*		
Polyisobutylene	44				
Polyvinyl Acetate Emulsion	*	Tanning Liquors	90,74		
Potash (Potassium Carbonate)	90,74	Tar	18,74		
Potassium Cyanide Liquor	90,74	Tar Oil (Creosote)	44,18		
Potassium Sulphate	90	Teepol	90		
Producer Gas	90,44	Tempering Oil	44,18		
Propane (Gas or Liquid)	90,44	Tetraethyl Lead	44		
Propylene	44	Toluene (Toluol)	44		
Pyridine	*	Triethanolamine	74		
		Trimethylamine	44,74		
Quenching Oil	44,18	Trisodium Phosphate	90,74		
		Turpentine	44		
Rapeseed Oil	90,44,74	Tallow	90		
Road Tars	18,74				
Rosin (Fine Resin)	*	Vacuum Service	90,44		
Rubber Latex	*	Varnish (See Paints)			
Rubber Solvent	*	Vegetable Oils	90,74		
		Vegetable Oils and Water	90,74		
		Vegetable Tannins	90,74		
		Vinyl Chloride Monomer	74		

Radiator Valves

Series 3000 radiator valves from Hattersley are recognised as the industry standard for high quality and dependable performance. The range incorporates Thermostatic, Wheelhead and Lockshield valves; and also a Universal valve body to accommodate TRV and Wheel heads. All valves are available in 1/2" and 3/4" BSP sizes, each supplied complete with complementary compression end adaptors.

The chrome plated brass valves are complemented by a range of accessories including Remote Sensors and Transmitters, and Tamperproof TRV locks.

The Hattersley Series 3000 radiator valves enable isolation, regulation and give thermostatic control.

Universal Valve Body for TRV and Wheel Head

The range offers interchangeability of the TRV head and the Wheelhead. The revolutionary body design enables both the TRV head and the Wheelhead to be connected directly to a common valve body without the need for adaptors. This design breakthrough therefore reduces the cost of stock holding and increases the versatility of the range.

Function

Thermostatic valves are typically used for regulating the fluid flow to the radiators of central heating systems. They are provided with a regulating element which automatically controls the opening of the valve to keep the ambient temperature of the room, where they are installed, constant at the set value. This prevents unwanted temperature rises and achieves considerable energy savings.

The Series 3000 Radiator valve range is eminently suitable for building services installations where durability and rugged construction are predominant, while satisfying the aesthetic requirements demanded for modern commercial and domestic interiors.

Maximum working pressure: 10 bar operating between 5 to 100°C.

The Hattersley range of valves and TRV controls are approved to standards UNI EN 215.

Additional information available on request.



Series 3000 Hydraulic Characteristics



Valve with Angle Connections

Fig.	Description	Size	Kv (m ³ /h) Proportional Band (K)				Kvs
			1	1.5	2	3	
3100	Universal TRV/Wheel Valve Body	1/2"	0.34	0.52	0.64	0.90	2.39
3100	Universal TRV/Wheel Valve Body	3/4"	0.40	0.63	0.81	1.09	3.19
3300	Lockshield Valve	1/2"	0.34	0.52	0.64	0.90	2.39
3300	Lockshield Valve	3/4"	0.40	0.63	0.81	1.09	3.19

Fig.	Description	Size	Nominal Flow (l/h)	Max. Diff Pres. (bar)
3100	Universal TRV/Wheel Valve Body	1/2"	180	1
3100	Universal TRV/Wheel Valve Body	3/4"	240	1
3300	Lockshield Valve	1/2"	180	1
3300	Lockshield Valve	3/4"	240	1

Valve with Straight Connections

Fig.	Description	Size	Kv (m ³ /h) Proportional Band (K)				Kvs
			1	1.5	2	3	
3200	Universal TRV/Wheel Valve Body	1/2"	0.32	0.50	0.67	0.86	1.52
3200	Universal TRV/Wheel Valve Body	3/4"	0.43	0.63	0.82	1.05	2.20
3400	Lockshield Valve	1/2"	0.32	0.50	0.67	0.86	1.52
3400	Lockshield Valve	3/4"	0.43	0.63	0.82	1.05	2.20

Fig.	Description	Size	Nominal Flow (l/h)	Max. Diff Pres. (bar)
3200	Universal TRV/Wheel Valve Body	1/2"	180	1
3200	Universal TRV/Wheel Valve Body	3/4"	240	1
3400	Lockshield Valve	1/2"	180	1
3400	Lockshield Valve	3/4"	240	1

Kv = is flow rate in m³/h at 1 bar Dp at 20°C
Kvs = Kv with valve fully open

Flow and Headloss Calculation Formulae

$$Q = \frac{K_v \sqrt{\Delta p}}{36}$$

$$\Delta p = \left(\frac{Q \times 36}{K_v} \right)^2$$

where Q is in l/s and Δp is in kPa

Every effort has been made to ensure that the information contained in this publication is accurate at the time of publishing. Hattersley Ltd assumes no responsibility or liability for typographical errors or omissions or for any misinterpretation of the information within the publication and reserves the right to change without notice.

Fig. 3150
Angle Wheel Head

FEATURES AND BENEFITS

- Regulates the fluid flow to radiators of the central heating system
- Prevents unwanted temperature rises and achieves considerable energy savings
- Suitable for installations where durability and rugged construction are predominant



MATERIAL SPECIFICATION

Component	Material	Specification BS EN
Body	Brass (Chrome Plated)	BS EN 12164 CW617N
Valve Insert Assembly	EPDM Valve Disc	
T80 Std Wheel Head	Thermoplastic	ABS
Tailpiece Ring	Brass	BS EN 12164 CW617N
Tailpiece	Brass	BS EN 12164 CW617N
Compression Olive	Brass	BS EN 12164 CW602N
Compression Adaptor	Brass	BS EN 12164 CW614N
Hydraulic Seals	Rubber	EPDM

DIMENSIONAL DRAWINGS

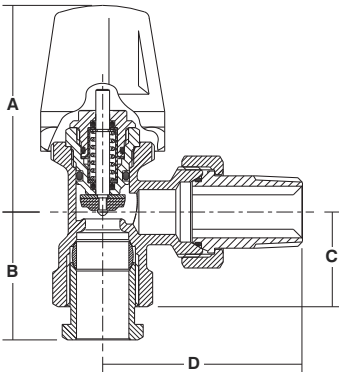

DIMENSIONS AND WEIGHTS

Nom Size	mm	15	22
A	mm	60	61
B	mm	37	42
C	mm	27.5	30.5
D	mm	58	66
Body Weight	kg	0.350	0.519

Every effort has been made to ensure that the information contained in this publication is accurate at the time of publishing. Hattersley Ltd assumes no responsibility or liability for typographical errors or omissions or for any misinterpretation of the information within the publication and reserves the right to change without notice.

Fig. 3250
Straight Wheel Head

FEATURES AND BENEFITS

- Regulates the fluid flow to radiators of the central heating system
- Prevents unwanted temperature rises and achieves considerable energy savings
- Suitable for installations where durability and rugged construction are predominant



MATERIAL SPECIFICATION

Component	Material	Specification BS EN
Body	Brass (Chrome Plated)	BS EN 12164 CW617N
Valve Insert Assembly	EPDM Valve Disc	
T80 Std Wheel Head	Thermoplastic	ABS
Tailpiece Ring	Brass	BS EN 12164 CW617N
Tailpiece	Brass	BS EN 12164 CW617N
Compression Olive	Brass	BS EN 12164 CW602N
Compression Adaptor	Brass	BS EN 12164 CW614N
Hydraulic Seals	Rubber	EPDM

DIMENSIONAL DRAWINGS

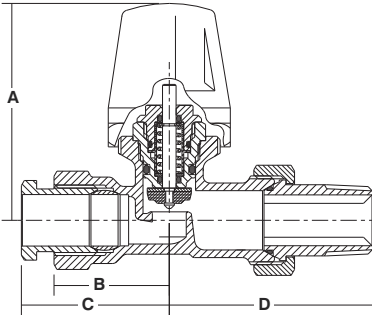

DIMENSIONS AND WEIGHTS

Nom Size	mm	15	22
A	mm	64	64
B	mm	34	40
C	mm	44	51
D	mm	60	65
Body Weight	kg	0.391	0.580

Every effort has been made to ensure that the information contained in this publication is accurate at the time of publishing. Hattersley Ltd assumes no responsibility or liability for typographical errors or omissions or for any misinterpretation of the information within the publication and reserves the right to change without notice.

Fig. 3300LS Angle Lockshield

FEATURES AND BENEFITS

- Regulates the fluid flow to radiators of the central heating system
- Prevents unwanted temperature rises and achieves considerable energy savings
- Suitable for installations where durability and rugged construction are predominant



MATERIAL SPECIFICATION

Component	Material	Specification BS EN
Body	Brass (Chrome Plated)	BS EN 12164 CW617N
Lockshield Assembly	Brass	BS EN 12164 CW614N
Lockshield Cap	Thermoplastic	ABS
Tailpiece Ring	Brass	BS EN 12164 CW617N
Tailpiece	Brass	BS EN 12164 CW617N
Compression Olive	Brass	BS EN 12164 CW602N
Compression Adaptor	Brass	BS EN 12164 CW614N
Hydraulic Seals	Rubber	EPDM

DIMENSIONAL DRAWINGS

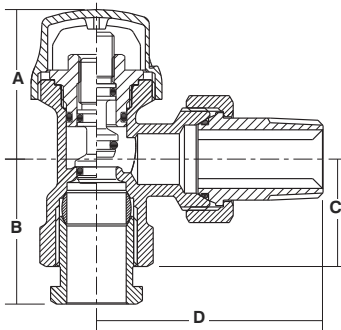

DIMENSIONS AND WEIGHTS

Nom Size	mm	15	22
A	mm	36.5	40.5
B	mm	38.5	39.5
C	mm	27.5	30.5
D	mm	58	66
Body Weight	kg	0.232	0.387

Every effort has been made to ensure that the information contained in this publication is accurate at the time of publishing. Hattersley Ltd assumes no responsibility or liability for typographical errors or omissions or for any misinterpretation of the information within the publication and reserves the right to change without notice.

Fig. 3400LS Straight Lockshield

FEATURES AND BENEFITS

- Regulates the fluid flow to radiators of the central heating system
- Prevents unwanted temperature rises and achieves considerable energy savings
- Suitable for installations where durability and rugged construction are predominant



MATERIAL SPECIFICATION

Component	Material	Specification BS EN
Body	Brass (Chrome Plated)	BS EN 12164 CW617N
Lockshield Assembly	Brass	BS EN 12164 CW614N
Lockshield Cap	Thermoplastic	ABS
Tailpiece Ring	Brass	BS EN 12164 CW617N
Tailpiece	Brass	BS EN 12164 CW617N
Compression Olive	Brass	BS EN 12164 CW602N
Compression Adaptor	Brass	BS EN 12164 CW614N
Hydraulic Seals	Rubber	EPDM

DIMENSIONAL DRAWINGS

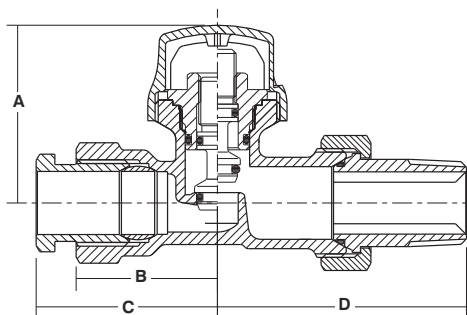

DIMENSIONS AND WEIGHTS

Nom Size	mm	15	22
A	mm	43	44
B	mm	34	40
C	mm	44	51
D	mm	60	65
Body Weight	kg	0.232	0.387

Every effort has been made to ensure that the information contained in this publication is accurate at the time of publishing. Hattersley Ltd assumes no responsibility or liability for typographical errors or omissions or for any misinterpretation of the information within the publication and reserves the right to change without notice.

Fig. 3180
Angle TRV

FEATURES AND BENEFITS

- Regulates the fluid flow to radiators of the central heating system
- Prevents unwanted temperature rises and achieves considerable energy savings
- Suitable for installations where durability and rugged construction are predominant



MATERIAL SPECIFICATION

Component	Material	Specification BS EN
Body	Brass (Chrome Plated)	BS EN12164 CW617N
Valve Insert Assembly	EPDM Valve Disc	
T80 Std Wheel Head	Thermoplastic	ABS
Tailpiece Ring	Brass	BS EN12164 CW617N
Tailpiece	Brass	BS EN12164 CW617N
Compression Olive	Brass	BS EN12164 CW602N
Compression Adaptor	Brass	BS EN12164 CW614N
Hydraulic Seals	Rubber	EPDM

DIMENSIONAL DRAWINGS

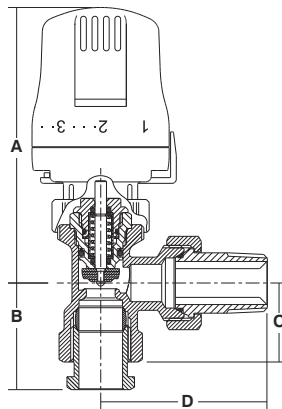

DIMENSIONS AND WEIGHTS

Nom Size	mm	15	22
A	mm	37	42
B	mm	96	98
C	mm	27.5	30.5
D	mm	58	66
Body Weight	kg	0.350	0.519

Every effort has been made to ensure that the information contained in this publication is accurate at the time of publishing. Hattersley Ltd assumes no responsibility or liability for typographical errors or omissions or for any misinterpretation of the information within the publication and reserves the right to change without notice.

Fig. 3280
Straight TRV

FEATURES AND BENEFITS

- Regulates the fluid flow to radiators of the central heating system
- Prevents unwanted temperature rises and achieves considerable energy savings
- Suitable for installations where durability and rugged construction are predominant



MATERIAL SPECIFICATION

Component	Material	Specification BS EN
Body	Brass (Chrome Plated)	BS EN 12164 CW617N
Valve Insert Assembly	EPDM Valve Disc	
T80 Std Wheel Head	Thermoplastic	ABS
Tailpiece Ring	Brass	BS EN 12164 CW617N
Tailpiece	Brass	BS EN 12164 CW617N
Compression Olive	Brass	BS EN 12164 CW602N
Compression Adaptor	Brass	BS EN 12164 CW614N
Hydraulic Seals	Rubber	EPDM

DIMENSIONAL DRAWINGS

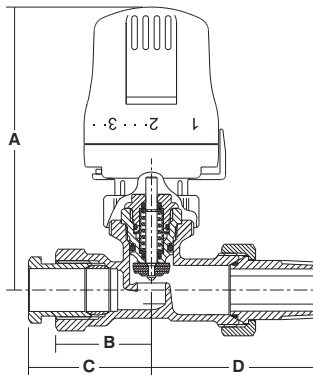

DIMENSIONS AND WEIGHTS

Nom Size	mm	15	22
A	mm	100	100
B	mm	34	40
C	mm	44	51
D	mm	60	65
Body Weight	kg	0.391	0.580

Every effort has been made to ensure that the information contained in this publication is accurate at the time of publishing. Hattersley Ltd assumes no responsibility or liability for typographical errors or omissions or for any misinterpretation of the information within the publication and reserves the right to change without notice.

Fig. 75/RS and 70/RT Accessories



Fig. 75/RS

TRV HEAD WITH REMOTE SENSOR FIG. 75/RS

Max isolating differential pressure 1 bar
 Temperature adjustment range 0° to 28°C
 Frost protection cut in 7° C
 Max ambient temperature 50°C

0	*	1	2	3	4	5
0°C	7°C	12°C	16°C	20°C	24°C	28°C



Fig. 70/RT

TRV TRANSMITTER FIG. 70/RT

Max isolating differential pressure 1 bar
 Temperature adjustment range 6° to 28°C
 Frost protection cut in 6°C
 Max ambient temperature 50°C

0	*	1	2	3	4	5
0°C	6°C	12°C	16°C	20°C	24°C	28°C

Every effort has been made to ensure that the information contained in this publication is accurate at the time of publishing. Hattersley Ltd assumes no responsibility or liability for typographical errors or omissions or for any misinterpretation of the information within the publication and reserves the right to change without notice.



Wheelock Square Tower, Shanghai
Specification: Range of Hattersley Traditional Valves

Strainers

Scale and dirt in piping systems can cause endless trouble and serious damage to pipeline equipment. Installation of Hattersley strainers will help eliminate the problems caused by foreign matter within piping systems. Generous proportions of Hattersley strainers allow the units to collect significant quantities of foreign matter before pressure losses necessitate cleaning of the basket.



Fig. 817
Bronze Y-Type



FEATURES AND BENEFITS

- Robust and high quality bronze body
- Streamlined flow contours minimise pressure drop
- Compact design with short face to face
- Perforated stainless steel screen
- Captive asbestos-free non-stick gasket
- Comprehensive flow characteristics available

MATERIAL SPECIFICATION

Component	Material	Specification BS EN
Cap	Bronze	
Screen	Stainless Steel	304
Body	Bronze	1982 CC491K



**PRESSURE/
TEMPERATURE RATING**

PN16
16 bar -10° to 100°C
7 bar at 170°C

SPECIFICATION

Bronze body.
304 stainless steel.
End connections threaded to BS EN 10266
(BS21 Taper ISO R7) & B1.20.1 ANSI.

**TEST PRESSURES
(HYDRAULIC)**

6 bar air

DIMENSIONAL DRAWINGS

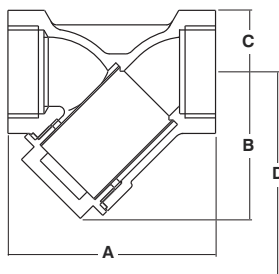

D=withdrawal distance for the screen

DIMENSIONS AND WEIGHTS

Nom Size	in	1/2	3/4	1	1 1/4	1 1/2	2
A	mm	58	70	88	96	107	126
B	mm	33	42	48	55	61	79
C	mm	15	18	20	26	31	36
D	mm	62	80	93	108	118	153
kv		4.8	8.8	16.1	25.5	36	38
Weight	kg	0.2	0.3	0.4	0.7	1.0	1.5

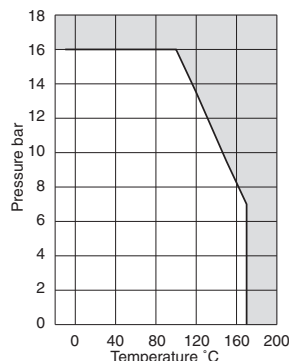

Every effort has been made to ensure that the information contained in this publication is accurate at the time of publishing. Hattersley Ltd assumes no responsibility or liability for typographical errors or omissions or for any misinterpretation of the information within the publication and reserves the right to change without notice.

Fig. 807/907 Bronze Y-Type



FEATURES AND BENEFITS

- Robust and high quality bronze body
- Streamlined flow contours minimise pressure drop
- Compact design with short face to face
- Perforated stainless steel screen
- Captive asbestos-free non-stick gasket
- Comprehensive flow characteristics available

MATERIAL SPECIFICATION

Component	Material	Specification	
		BS EN	ASTM
Body	Bronze	1982 CC491K	B62
Screen	Stainless Steel	10088-1 X10CrNi18-10	AISI 304
Gasket	Asbestos Free (non-stick)		
Cap	Bronze	1982 CC491K	B62



PRESSURE/TEMPERATURE RATING

PN32
14 bar at 198°C
32 bar from -10 to 100°C
Note: Fig. 907 restricted to 135°C

TEST PRESSURES (HYDRAULIC)

Shell: 6 bar air

SPECIFICATION

Standard screen has 0.75mm diameter holes.
Screwed cap.
Ends threaded to BS EN 10266 (BS21 ISO R7).
Figure 907 supplied complete with two Figure 631 test points and plugs.

DIMENSIONAL DRAWINGS

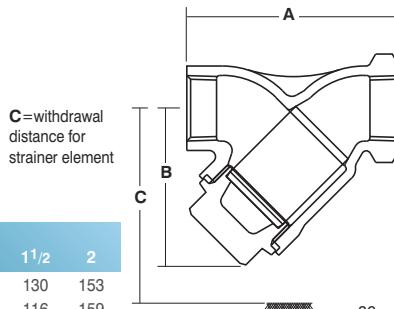

DIMENSIONS AND WEIGHTS

Nom Size	in	1/2	3/4	1	1 1/4	1 1/2	2
A	mm	68	80	95	115	130	153
B	mm	49	64	89	97	116	159
C	mm	65	90	115	135	165	235
k Factor		3.3	4.2	3.6	3.2	3.3	3.5
Weight	kg	0.4	0.5	0.9	1.5	1.8	3.3

SCREEN DATA

Nom Size	in	1/2	3/4	1	1 1/4	1 1/2	2
Holes Dia	mm	0.75	0.75	0.75	0.75	0.75	0.75
Holes cm ²		50	50	50	50	50	50
Free Flow Area	cm ²	22.6	22.6	22.6	22.6	22.6	22.6
Element Area	cm ²	24.6	36	68.5	107.1	143.1	255
Free Flow Area	cm ²	5.5	8.1	15.5	24.2	32.3	57.6
% Nominal Bore		434	284	305	305	283	284

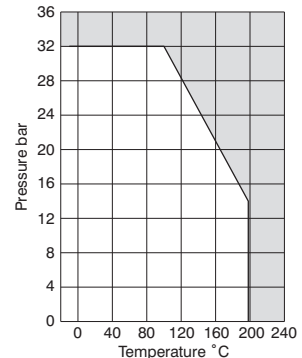

Every effort has been made to ensure that the information contained in this publication is accurate at the time of publishing. Hattersley Ltd assumes no responsibility or liability for typographical errors or omissions or for any misinterpretation of the information within the publication and reserves the right to change without notice.

Fig. 1807 DZR Strainer Ball Valve



FEATURES AND BENEFITS

- Integral ball valve for quick and easy isolation
- Dezincification resistant body material prevents corrosion and fungal growth
- Streamlined flow contours minimise pressure drop
- Perforated stainless steel screen



MATERIAL SPECIFICATION

Component	Material	Specification	
		BS EN	ASTM
Handle	Aluminium		
Stem	DZR Copper Alloy	12164 CW602N	
Stem Seal	EPDM		
Gland Seals	Virgin PTFE		
Ball	DZR Copper Alloy Hard chrome plated	12164 CW602N	
Seat Rings	Virgin PTFE		
Body	DZR Copper Alloy	12165 CW602N	
Screen	Stainless Steel		AISI 304
Cap Gasket	Asbestos Free		
Cap	DZR Copper Alloy	12165 CW602N	

DIMENSIONAL DRAWINGS

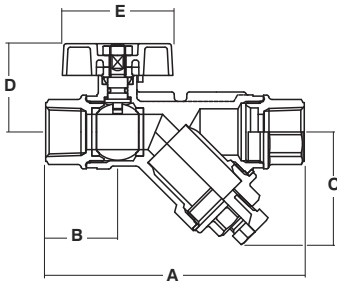

DIMENSIONS AND WEIGHTS

Nom Size	in	1/2	3/4	1
A	mm	110	129	151
B	mm	31	35	42
C	mm	48	60	59
D	mm	38	46	50
E	mm	47	56	56
Drain Plug	BSP	1/4	1/4	1/4
Weight	kg	0.54	0.80	1.23

PRESSURE/ TEMPERATURE RATING

PN25 - 1/2 to 1 1/2" sizes
25 bar 0°C to 20°C, 7 bar at 120°C
PN20 - 2" size
20 bar 0 to 20°C, 6 bar at 120°C

TEST PRESSURES (PNEUMATIC)

6 bar

OPTIONAL FEATURES

Lever
Extension stem
Figure 103 hose outlet blowdown valve

SPECIFICATION

DZR body.
Blow-out proof stem.
Hard chrome plated ball.
Virgin PTFE seats.
T-Handle operated.
0.8mm diameter perforated 304 stainless steel screen.
Drain plug.
BS EN 10266 Taper threaded (ISO R7).
WRAS Approved Product.

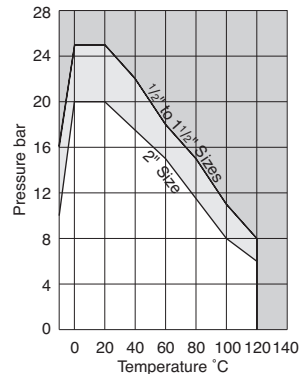

Every effort has been made to ensure that the information contained in this publication is accurate at the time of publishing. Hattersley Ltd assumes no responsibility or liability for typographical errors or omissions or for any misinterpretation of the information within the publication and reserves the right to change without notice.

Fig. 1807C
DZR Strainer Ball Valve



FEATURES AND BENEFITS

- Integral ball valve for quick and easy isolation
- Dezincification resistant body material prevents corrosion and fungal growth
- Streamlined flow contours minimise pressure drop
- Perforated stainless steel screen

MATERIAL SPECIFICATION

Component	Material	Specification	
		BS EN	ASTM
Handle	Aluminium		
Stem	DZR Copper Alloy	12164 CW602N	
Stem Seal	EPDM		
Gland Seals	Virgin PTFE		
Ball	DZR Copper Alloy Hard chrome plated	12164 CW602N	
Seat Rings	Virgin PTFE		
Body	DZR Copper Alloy	12165 CW602N	
Screen	Stainless Steel		AISI 304
Cap Gasket	Asbestos Free		
Cap	DZR Copper Alloy	12165 CW602N	
Compression Ring	Brass		
Compression Nut	Brass	12165 CW617N	B124 C37700



DIMENSIONAL DRAWINGS

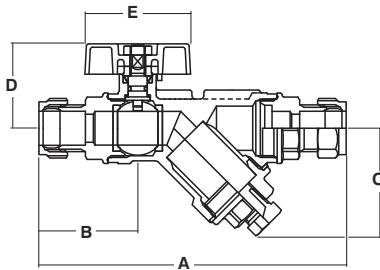

DIMENSIONS AND WEIGHTS

Nom Size	mm	15	22	28
A	mm	137	159	175
B	mm	45	50	53
C	mm	48	60	59
D	mm	38	46	50
E	mm	47	56	56
Drain Plug	BSP	1/4	1/4	1/4
Weight	kg	0.6	0.9	1.3

**PRESSURE/
TEMPERATURE RATING**

PN16
5 bar at 120°C
6 bar at 110°C
10 bar at 65°C
16 bar at -10 to 30°C

**TEST PRESSURES
(PNEUMATIC)**

25 bar

OPTIONAL FEATURES

- Lever
- Extension stem
- Figure 103 hose outlet blowdown valve

SPECIFICATION

DZR body.
Blow-out proof stem.
Hard chrome plated ball.
Virgin PTFE seats.
T-Handle operated.
0.8mm diameter perforated 304 stainless steel screen.
Drain plug.
Compression ends to BS EN 1254-2.
Use with R250 (half hard) copper tube.
WRAS Approved Product.

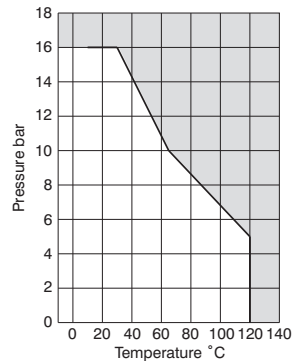

Every effort has been made to ensure that the information contained in this publication is accurate at the time of publishing. Hattersley Ltd assumes no responsibility or liability for typographical errors or omissions or for any misinterpretation of the information within the publication and reserves the right to change without notice.

Fig. 810/910 Cast Iron Y-Type

FEATURES AND BENEFITS

- High strength cast iron construction
- Streamlined flow contours minimise pressure drop
- Asbestos-free non-stick gasket
- Suitable for saturated steam service
- Comprehensive flow characteristics available



MATERIAL SPECIFICATION

Component	Material	Specification	
		BS EN	ASTM
Body sizes	DN50 to 400	Cast Iron	1561 EN-JL1040 A126 Class B
	DN450 to 600	Ductile Iron	1563 EN-JS1050 A536 80-55-06
Cover sizes	DN50 to 400	Cast Iron	1561 EN-JL1040 A126 Class B
	DN450 to 600	Ductile Iron	1563 EN-JS1050 A536 80-55-06
Screen	Stainless Steel	1449 304S315	AISI 304
Gasket	Teflon/Graphite		
Plug	Cast Iron	EN-JL1040	A126 Class B

PRESSURE/ TEMPERATURE RATING

13 bar at 220°C
16 bar from -10 to 120°C
Note: 910 restricted to 135°C

TEST PRESSURES (HYDRAULIC)

Shell: 24 bar

SPECIFICATION

Bolted cover.
Figure 910 supplied complete with two figure 631 test points and plugs.
Flanges to BS EN 1092-2 PN16.

DIMENSIONAL DRAWINGS

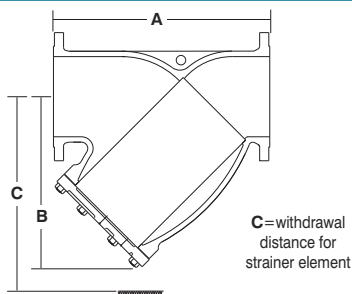

DIMENSIONS AND WEIGHTS

Nom Size	mm	50	65	80	100	125	150	200	250	300	350	400	450	500	600
A	mm	230	273	295	352	416	470	573	660	770	960	1079	1168	1275	1450
B	mm	146	174	198	232	285	305	401	473	554	740	840	910	968	1160
C	mm	178	216	248	300	373	450	621	703	834	740	840	910	968	1160
Cover Plug	mm	1/2	1	1	1	1 1/4	1 1/2	1 1/2	2	2	-	-	-	-	-
Weight	kg	10.5	14.9	19.2	32.4	48	64.5	106	175	251	458	556	628	780	1080
Flow	kv	59	93	136	229	363	499	817	1361	1928	-	-	-	-	-

SCREEN DATA

Nom Size	mm	50	65	80	100	125	150	200	250	300	350	400	450	500	600
Hole Dia	mm	1.6	1.6	1.6	1.6	1.6	1.6	1.6	1.6	1.6	3	3	3	3	3
Free Flow Area/cm ²	%	33	33	33	40	40	40	40	40	40	40	40	40	40	40

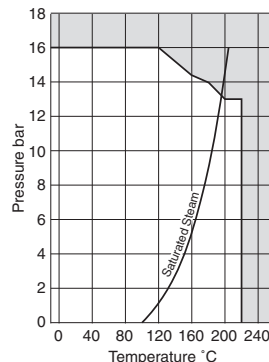

Every effort has been made to ensure that the information contained in this publication is accurate at the time of publishing. Hattersley Ltd assumes no responsibility or liability for typographical errors or omissions or for any misinterpretation of the information within the publication and reserves the right to change without notice.

Fig. 811/911 Ductile Iron Y-Type

FEATURES AND BENEFITS

- High strength ductile iron construction
- Streamlined flow contours minimise pressure drop
- Asbestos-free non-stick gasket
- Suitable for saturated steam service
- Comprehensive flow characteristics available



MATERIAL SPECIFICATION

Component	Material	Specification	
		BS EN	ASTM
Body	Ductile Iron	1561 EN JS1050	
Cover	Ductile Iron	1561 EN JS1050	
Screen	Stainless Steel	SS 304	AISI 304
Gasket	Teflon/Graphite		
Plug	Ductile Iron	1561 EN JS1050	

PRESSURE/TEMPERATURE RATING

PN25
21.5 bar at 220°C
25 bar from -10 to 120°C
Note: 911 restricted to 180°C

TEST PRESSURES (HYDRAULIC)

Shell: 37.5 bar

SPECIFICATION

Bolted cover.
Figure 911 supplied complete with two figure 631 valve controlled test points.
All other sizes flanged to BS EN 1092-2 PN25.

DIMENSIONAL DRAWINGS

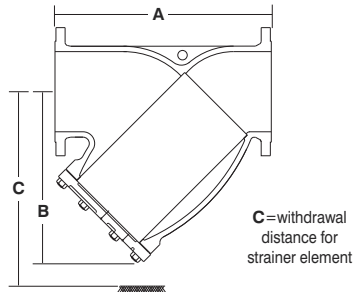

DIMENSIONS AND WEIGHTS

Nom Size	mm	50	65	80	100	125	150	200	250	300
A	mm	230	273	295	352	416	470	573	660	770
B	mm	146	174	198	232	285	305	401	473	554
C	mm	178	216	248	300	373	450	621	703	834
Cover Plug	mm	1/2	1	1	1	1 1/4	1 1/2	1 1/2	2	2
Weight	kg	10.5	14.9	19.2	32.4	48	64.5	106	175	251
Flow	kv	59	93	136	229	363	499	817	1361	1928

SCREEN DATA

Nom Size	mm	50	65	80	100	125	150	200	250	300
Hole Dia	mm	1.6	1.6	1.6	1.6	1.6	1.6	1.6	1.6	1.6
Free Flow Area/cm ²	%	33	33	33	40	40	40	40	40	40

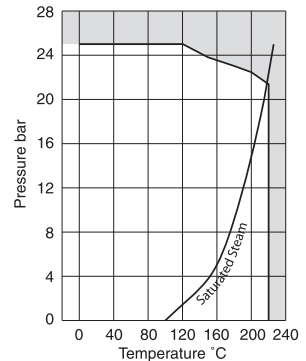

Every effort has been made to ensure that the information contained in this publication is accurate at the time of publishing. Hattersley Ltd assumes no responsibility or liability for typographical errors or omissions or for any misinterpretation of the information within the publication and reserves the right to change without notice.



Queen Elizabeth Hospital, Birmingham
Specification: Hattersley Thermal Balancing Valves

Public Health Range

The Hattersley Public Health range consists of a number of WRAS approved valves specifically designed for the control of hot water systems.

Thermal disinfection raises water temperatures to a level at which Legionella will not survive. This can be carried out by raising the temperature of the whole contents of the calorifier to 70°C then circulating the water throughout the system for at least an hour.

To be effective, the temperature at the calorifier should be high enough to ensure that the temperature at the taps and appliances does not fall below 60°C.

The range consists of valves which offer self-balancing, thermostatically controlled regulation of flow and thermal disinfection assisting with protection against Legionella. These systems are complemented by Thermostatic Mixing Valves which blend hot water (stored at temperatures high enough to kill bacteria) with cold, to ensure constant and safe outlet temperatures to prevent scalding.

These systems are ideal for a range of projects including healthcare, schools, workplace and domestic environments.



Fig. 1900 Thermal Balancing Valves



FEATURES AND BENEFITS

- Ideal for domestic hot water systems to assist with protection against Legionella
- Provides self-balancing, thermostatically controlled regulation of flow and disinfection
- Suitable for circuits greater than 10 metres in length
- Thermostatically controlled regulation of the volume flow – self-balancing
- Assists with disinfection at temperatures above 70°C by increasing the flow automatically
- Has an accuracy of +/- 1°C

MATERIAL SPECIFICATION

Component	Material	Specification BS EN
Body	Bronze	BS EN 1982 CC491K
Upper part	Bronze	BS EN 1982 CC491K
Valve stem	Bronze	BS EN 1982 CC491K
Valve cone	Bronze	BS EN 1982 CC491K
Upper part seal, valve stem seal	EPDM	70 EPDM
Closing upper part valve cone seal	PTFE	Teflon
Drain plug	Bronze	BS EN 1982 CC491K
Closing handle	Plastic	Polyacetal (PA)
Plate / clamping band	Plastic	Polyacetal (PA)



DIMENSIONAL DRAWINGS

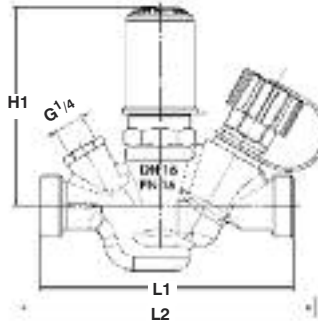

PRESSURE/ TEMPERATURE RATING

Max Temperature 90°C
Nominal Pressure PN16

OPERATION

When the set point is preset to 57°C, the valve remains completely open up to a valve temperature of 52°C.

Between 52°C and the preset set point of 57°C, the valve starts to close. When the set point temperature has been reached, a minimum volume flow is continuously flowing through the circulation system.

If the storage temperature is further increased to temperatures greater than 70°C to effect disinfection, the valve increases the flow.

DIMENSIONS AND WEIGHTS

Nom Inside Dia	mm	15	20	25
Height (H1)	mm	85	85	95
Length (L1)	mm	110	123	133
Length (L2) Copper Tails	mm	176	186	200
Length (L2) Mapress Copper	mm	172	174	182
Length (L2) Mepla	mm	174	178	186
Weight	kg	0.7	0.9	1.2
Flow Kv	cmb/h	0.92	1.70	2.71
Drain Valve (G)	BSP	1/4	1/4	1/4

Every effort has been made to ensure that the information contained in this publication is accurate at the time of publishing. Hattersley Ltd assumes no responsibility or liability for typographical errors or omissions or for any misinterpretation of the information within the publication and reserves the right to change without notice.

Fig. 77
Thermostatic Mixing Valves



FEATURES AND BENEFITS

- Blends hot and cold water to ensure constant, controlled safe outlet temperature
- Fulfils the 'duty of care' requirements against scalding
- Ideal for healthcare, schools, workplace and domestic environments
- Flat face union ensures easy removal for maintenance
- Integral strainers and check valves
- Tamper proof adjustment

MATERIAL SPECIFICATION

Component	Material
O-Ring	EPDM Rubber
1.5 Strainer	Stainless Steel 304
Reduction Union	DZR Brass CW602N
Element	Vernet 0304
Spring	Stainless Steel 304
Top	DZR Brass CW602N
Valve Body	DZR Brass CW602N



DIMENSIONAL DRAWINGS

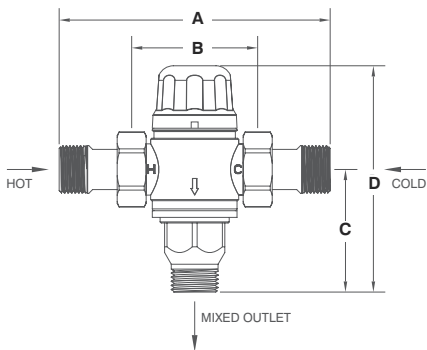

DIMENSIONS AND WEIGHTS

Nom Size	mm	15	22
A	mm	122	145
B	mm	58	58
C	mm	55	70
D	mm	102	117
Weight	kg	0.6	0.8

FACTORY SETTING

38°C

TEMPERATURE SETTING RANGE

35-46°C

MINIMUM HOT TO MIX TEMPERATURE

10°C

TEMPERATURE STABILITY

±2°C

MAXIMUM WORKING PRESSURE

10 bar

Kv

1.26

MINIMUM FLOW PRESSURE

0.2 bar

SPECIFICATION

Pressure Rating: PN10.
Operator: Lockshield.

Figure 77 has been independently tested and certified as meeting the requirements of the D08 specification under the TMV 3 scheme.

Hattersley products are designed for installation and use within suitably designed systems reflecting CIBSE, BSRIA and HVAC guidelines.

Every effort has been made to ensure that the information contained in this publication is accurate at the time of publishing. Hattersley Ltd assumes no responsibility or liability for typographical errors or omissions or for any misinterpretation of the information within the publication and reserves the right to change without notice.

Fig. 78
Thermostatic Mixing Valves



FEATURES AND BENEFITS

- Blends hot and cold water to ensure constant, controlled safe outlet temperature
- Fulfils the 'duty of care' requirements against scalding
- Ideal for healthcare, schools, workplace and domestic environments
- Flat face union ensures easy removal for maintenance
- Integral strainers and check valves
- Tamper proof adjustment
- Includes ball valves for isolation



MATERIAL SPECIFICATION

Component	Material
O-Ring	EPDM Rubber
1.5 Strainer	Stainless Steel 304
Reduction Union	DZR Brass CW602N
Element	Vernet 0304
Spring	Stainless Steel 304
Top	DZR Brass CW602N
Valve Body	DZR Brass CW602N
Ball	DZR Brass CW602N
T-Handle	Al Alloy
Ball Seal	PTFE

DIMENSIONAL DRAWINGS

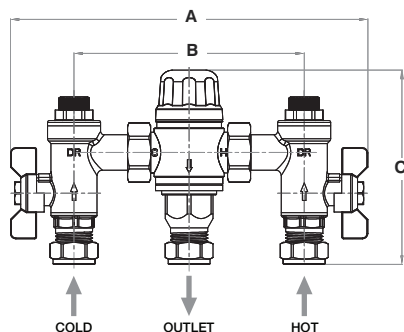

DIMENSIONS AND WEIGHTS

Nom Size	mm	15	22
A	mm	200	200
B	mm	128	128
C	mm	110	110
Weight	kg	1.1	1.3

FACTORY SETTING

38°C

TEMPERATURE SETTING RANGE

35-46°C

MINIMUM HOT TO MIX TEMPERATURE

10°C

TEMPERATURE STABILITY

±2°C

MAXIMUM WORKING PRESSURE

10 bar

Kv

1.26

MINIMUM FLOW PRESSURE

0.2 bar

SPECIFICATION

Pressure Rating: PN10.

Operator: Lockshield.

Figure 78 has been independently tested and certified as meeting the requirements of the D08 specification under the TMV 3 scheme.

Hattersley products are designed for installation and use within suitably designed systems reflecting CIBSE, BSRIA and HVAC guidelines.

Every effort has been made to ensure that the information contained in this publication is accurate at the time of publishing. Hattersley Ltd assumes no responsibility or liability for typographical errors or omissions or for any misinterpretation of the information within the publication and reserves the right to change without notice.

Fig. 430
Pressure Reducing Valves



FEATURES AND BENEFITS

- PRVs enable control of pressure from boosted cold water supplies to match site requirements
- Simple to install
- Recommend that isolation valves are fitted upstream and downstream of the valve to enable isolation for cleaning of filter
- WRAS approved
- Manufactured in accordance with BS EN 1567
- Figure 430 must be fitted with adjustable cartridge element pointing downwards

MATERIAL SPECIFICATION

Component	Material
Body	Bronze
Disc	Bronze
Cartridge	Stainless Steel
	Bronze
	Nitrile
Filter	Stainless Steel
Gaskets	Nitrile



*Pressure gauge is required for each installed valve and is ordered separately.

DIMENSIONAL DRAWINGS

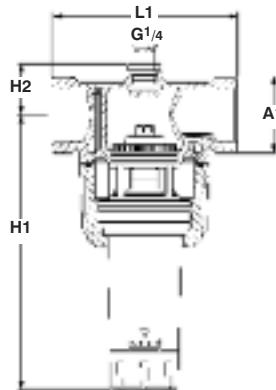

PRESSURE/TEMPERATURE RATING

Pressure Rating: 16 bar
Maximum Fluid Temperature: 60°C
Maximum Inlet Pressure: 16 bar
Outlet Pressure: 1.5 bar - 6.0 bar

SPECIFICATION

- Suitable for:
- Water
 - Compressed Air

DIMENSIONS AND WEIGHTS

Nom Size	mm Fig	15 430	20 430	25 430	32 430	40 430	50 430	Gauge 435
L1	mm	90	90	100	105	130	140	
H1	mm	150	150	150	225	225	225	Fits all sizes
H2	mm	25	25	25	38	38	38	
A1	mm	G ^{3/4}	G1	G1 ^{1/4}	G1 ^{1/2}	G1 ^{3/4}	G2 ^{3/8}	
Weight	kg	0.90	0.93	1.00	2.20	2.30	2.50	0.25

Every effort has been made to ensure that the information contained in this publication is accurate at the time of publishing. Hattersley Ltd assumes no responsibility or liability for typographical errors or omissions or for any misinterpretation of the information within the publication and reserves the right to change without notice.

Fig. 440 Pressure Reducing Valves



FEATURES AND BENEFITS

- PRVs enable control of pressure from boosted cold water supplies to match site requirements
- Simple to install
- Recommend that isolation valves are fitted upstream and downstream of the valve to enable isolation for cleaning of filter
- WRAS approved
- Manufactured in accordance with BS EN 1567
- Figure 440 can be installed horizontally or vertically

MATERIAL SPECIFICATION

Component	Material
Body	Bronze
Cover	Bronze
Insert	Stainless Steel
	Bronze
Filter	Stainless Steel
Spring	Stainless Steel
Disc	Brass



1. Pressure Gauge
2. Valve Body
3. Blanking Plug
4. Insert
5. Spring
6. Spring Plate
7. Spring Cover
8. Adjustment Spindle

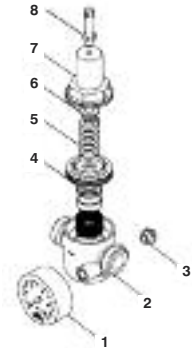

*Pressure gauge is required for each installed valve and is ordered separately.

DIMENSIONAL DRAWINGS

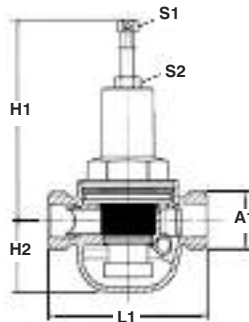

PRESSURE/TEMPERATURE RATING

Pressure Rating: 25 bar
Maximum Fluid Temperature: 90°C
Maximum Inlet Pressure: 25 bar
Outlet Pressure: 1.0 bar - 7.0 bar

SPECIFICATION

- Suitable for:
- Water
 - Compressed Air

DIMENSIONS AND WEIGHTS

Nom Size	mm Fig	15 440	20 440	25 440	32 440	40 440	50 440	Gauge 445
L1	mm	75	92	98	98	128	148	
H1	mm	110	110	150	160	190	265	
H2	mm	30	42	46	46	52	75	Fits all sizes
S1	mm	10	10	12	12	12	13	
S2	mm	13	13	17	17	17	19	
A1	mm	G ³ / ₄	G1	G1 ¹ / ₄	G1 ¹ / ₂	G1 ³ / ₄	G2 ³ / ₈	
Weight	kg	0.80	1.30	1.70	1.90	3.60	6.70	0.25

Every effort has been made to ensure that the information contained in this publication is accurate at the time of publishing. Hattersley Ltd assumes no responsibility or liability for typographical errors or omissions or for any misinterpretation of the information within the publication and reserves the right to change without notice.

Fig. 249 & 249C Brass - Single & Double Check (Fig. 249C Chromium Plated) Check Valves



FEATURES AND BENEFITS

- WRAS approved for use with potable water
- Compression ends for use with half hard R250 copper pipe
- Single, double and chromium plated options available

MATERIAL SPECIFICATION

Component	Material	Specification BS EN
Body	DZR Brass	12165 CW602N



DIMENSIONAL DRAWINGS

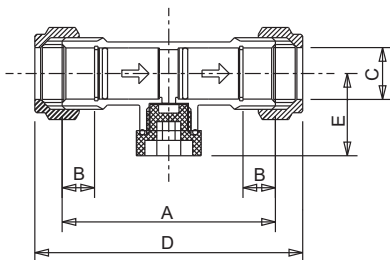

Fig. 249 & 249C

PRESSURE/ TEMPERATURE RATING

16 bar from -10 to 85°C

TEST PRESSURES (HYDRAULIC)

Body: 24 bar
Seat: 17.6 bar

SPECIFICATION

Fig. No. 249

Double Check - 15mm, 22mm, 28mm

Fig. No. 249C

Double Check chromium plated - 15mm

Manufactured to BS 6282.

WRAS approved PN16 85°C.

Application: Water.

End Connection: Compression.

Back Flow Prevention Device category:

Single check - Class 2 as per Water Supply.

Contamination Risks (water fittings)

Regulations 1999.

Double check - Class 3 as per Water Supply.

Contamination Risks (water fittings)

Regulations 1999.

DIMENSIONS AND WEIGHTS

Nom Size	mm	15 Fig. 249	22 Fig. 249	28 Fig. 249	15 Fig. 249C
A	mm	61.4	74.6	88.6	61.4
B	mm	9.5	10.5	12.5	9.5
C	mm	15.2	22.2	28.25	15.2
D	mm	78.5	91.4	106.3	78.5
E	mm	24.5	27.5	30.5	24.5
Weight (approx)	kg	0.116	0.212	0.360	0.116

Every effort has been made to ensure that the information contained in this publication is accurate at the time of publishing. Hattersley Ltd assumes no responsibility or liability for typographical errors or omissions or for any misinterpretation of the information within the publication and reserves the right to change without notice.

Fig. 761 and 2761 Aquacheck® Non-Return Valve



FEATURES AND BENEFITS

- Spring loaded axially guided disc
- Positive non-slam shut-off
- Flanged to BS EN 1092-2
- Resilient seat located in body



MATERIAL SPECIFICATION

Component	Material	Specification	
		BS EN	ASTM
Body	Ductile Iron	1563 EN-JS1030	A536-65-45-12
Plunger DN50-150	Bronze		
Plunger DN200-400	Cast Iron	1561 EN-JLI030	A126 Cl B
Seat Retaining Ring	Steel - Xylan Coated		
Seat	Nitrile		
Guide	Bronze		
Spring	Stainless Steel	10270 X10CrNi18-8	A276-304

DIMENSIONAL DRAWINGS

Single Check Valve
Fig. 761

Double Check Valve
configuration Fig. 2761

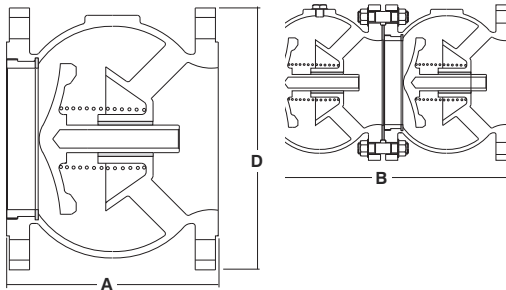

DIMENSIONS AND WEIGHTS

Nom Size	mm	50	65	80	100	125	150	200	250	300
A	mm	120	119	130	155	200	230	280	344	385
B	mm	240	241	260	310	403	460	560	688	770
D	mm	165	185	200	220	250	285	340	405	460
Weight 761	kg	5	7	9	13	21	28	47	83	123
Weight 2761	kg	11	15	20	27	44	58	97	168	249

Note: These valves are not intended to be used as backflow prevention devices conforming to Schedule 2 Section 6 of the WRAS Water Regulations Guide.

Every effort has been made to ensure that the information contained in this publication is accurate at the time of publishing. Hattersley Ltd assumes no responsibility or liability for typographical errors or omissions or for any misinterpretation of the information within the publication and reserves the right to change without notice.

PRESSURE/TEMPERATURE RATING

16 bar from -10 to 85°C

TEST PRESSURES (HYDRAULIC)

Body: 24 bar
Seat: 17.6 bar

SPECIFICATION

Spring Loaded axially guided disc.
Resilient Seat located in body.
Flanged to BS EN 1092-2 PN16.
Alternative pressure ratings to PN25.
Alternative flange details including BS EN 1092-2 PN25 and PN40 and ANSI B16.1 Class 125.

NOTES

Sizes:
50mm to 250mm WRAS Approved.
300mm is not WRAS Approved.

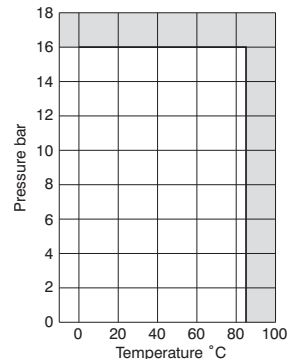

Fig. 108C Service Ball Valve



FEATURES AND BENEFITS

- Light, compact and easy to install and operate
- WRAS Approved for use on wholesome (potable) water
- Compression ends to BS EN 1254-2 for use with BS EN 1057 R250 (half-hard) copper tube
- Part of Hattersley's extensive public health range
- Chrome plated finish
- Handle can be removed to allow for screwdriver operation



MATERIAL SPECIFICATION

Component	Material
Screw	Steel Dacromet Plated
Handle	Nylon (Ral 9017)
Stem	DZR Brass Chromium Plated
O-Ring	EPDM WRAS Approved
Nut	DZR Brass CW602N Chromium Plated
Olive	Brass CW507L
Body	DZR Brass CW602N Chromium Plated
PTFE Seat	PTFE WRAS Approved
Ball	DZR Brass CW602N Chromium Plated
Seat Retainer	DZR Brass CW602N Chromium Plated

Temperature °C	-10 to 30	65	110	120
Pressure bar	16	10	6	5

DIMENSIONAL DRAWINGS

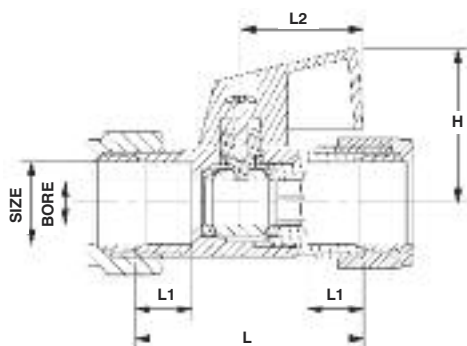

DIMENSIONS AND WEIGHTS

Nom Size	mm	DN15	DN22
Bore	mm	Ø8	Ø14
L	mm	42	53
L1	mm	11	13
L2	mm	23	23
H	mm	29	34
Weight	g	123	260

PRESSURE/ TEMPERATURE RATING

PN16

OPERATOR

Handle (The handle can be removed to allow for screwdriver operation).

SPECIFICATION

Compression ends to BS EN 1254-2 for use with BS EN 1057 R250 (half-hard) copper tube. WRAS Approved product.

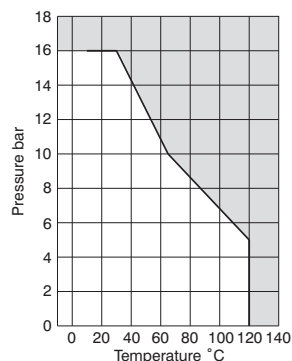

Every effort has been made to ensure that the information contained in this publication is accurate at the time of publishing. Hattersley Ltd assumes no responsibility or liability for typographical errors or omissions or for any misinterpretation of the information within the publication and reserves the right to change without notice.





Project: Ricoh Arena

Client: Coventry Football Club

Contractor: Haden Young

Specification: Hattersley Hook-Up and commissioning valves

For the past six years, Hattersley Hook-Up units and commissioning valves have been heating and cooling the 32,000 seat Ricoh Arena that is home to Coventry City FC. The site also comprises an exhibition hall, a hotel, a leisure club, a casino, and one of the UK's largest Tesco Extra supermarkets.

Throughout the stadium Hook-Up flow management modules, part of Hattersley's extensive range of commissioning valves, are providing heating and air-conditioning.

The units provide precise flow control, flow measurement, system and coil flushing and isolation capabilities from a single compact and lightweight unit. Built from bronze and DZR brass they can be used for chilled and heating water systems from -10 °C to 120°C.

Safety & Control Valves

For Air, Steam and Water

One of the UK's leading suppliers of gunmetal safety valves, NABIC has long been recognised as the industry standard for commercial and industrial hot water applications. In fact, our valves are ideal for hot water supply, heating, pump relief, bypass relief, outside installation and for use with difficult gases and liquids.

Designed and tested to the latest British Standards with third party certified discharge capacities, NABIC valves are manufactured under an ISO 9001 quality assurance system. Every valve is tested after assembly and again before despatch to ensure high product quality is maintained.

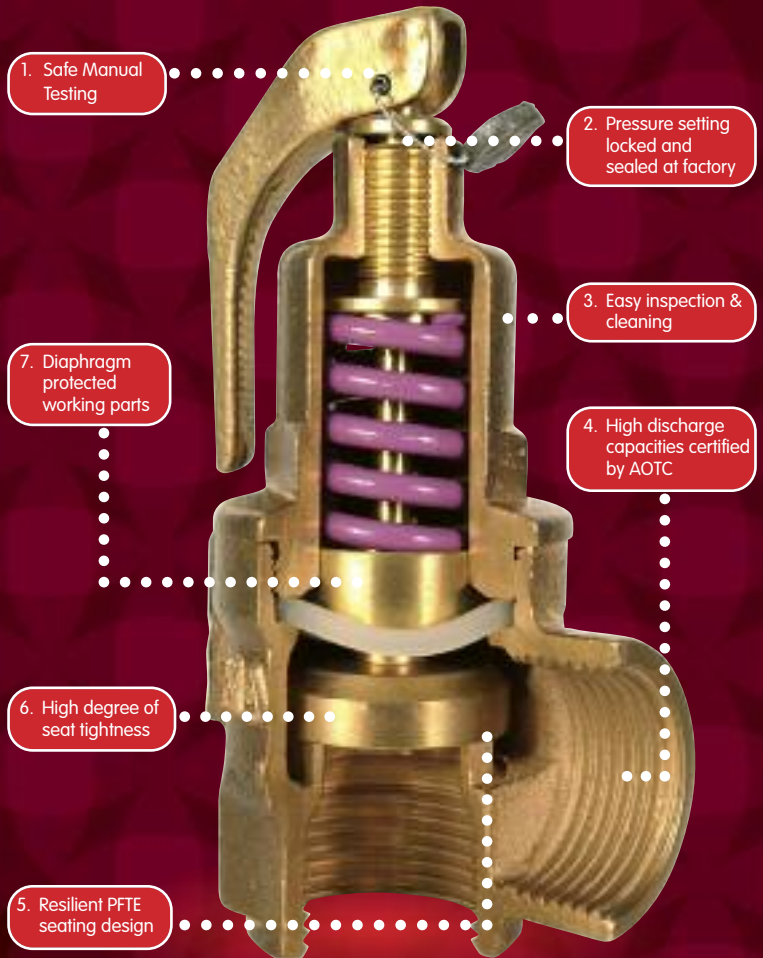

Fig. 542
Safety Relief Valve



Figure 542 Safety Valve is an extremely versatile valve, suitable for use on hot water, steam or air. Although designed primarily for the protection of hot water boilers, its wide range of applications make it an ideal valve for stocking as a general purpose safety valve.

Body Material | Gunmetal
Maximum Pressure | 10.5 bar
Maximum Temperature | 195°C

Fig. 500
High Lift Safety Valve

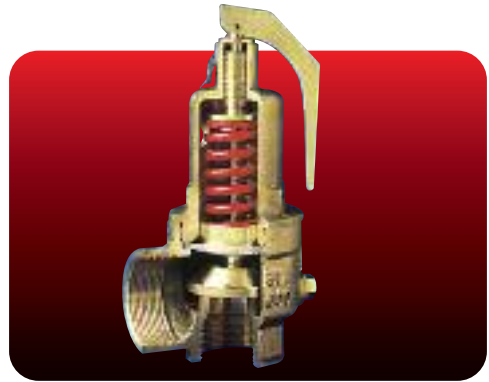

Figure 500 High Lift Safety Valve has been designed primarily for use on unvented hot water heating systems, where a high-capacity emergency steam relief capability is required. High capacity and resilient PTFE seating, also make it ideal for steam, air and inert gas applications. A PTFE to Viton seating design is also available where greater seal tightness is required.

Body Material | Gunmetal
Maximum Pressure | 12.5 bar
Maximum Temperature | 195°C

Fig. 542L
Pressure Relief Valve



NABIC Pressure Relief Valves are intended for use where pressure tightness is required on the discharge side of the valve. They are ideal for pump relief, bypass relief, outside installations, and on cold water mains to protect from PRV failure.

Body Material | Gunmetal
Maximum Pressure | 10.5 bar
Maximum Temperature | 195°C

Fig. 500L
Pressure Relief Valve



Body Material | Gunmetal
Maximum Pressure | 12.5 bar
Maximum Temperature | 195°C

Fig. 500T
Combined Pressure and
Temperature Relief Valve



Figure 500T Combined Pressure & Temperature Relief Valve has been designed for use on unvented hot water supply systems, where protection against excess temperature is required in addition to pressure protection. Pressure and temperature elements of the valve operate independently, thereby providing dual safety protection in the one valve.

Body Material | Gunmetal
Maximum Working Temperature | 75°C
Maximum Pressure | 12.5 bar
Maximum Temperature | 95°C

Fig. 500SS
Pressure Relief Valve

with Stainless Steel Wetted Parts



This version of the Figure 500 has been produced for applications where the properties of stainless steel are required for the service fluid being used but the working environment does not necessitate a full stainless steel valve. It can be supplied with a test lever or as a sealed dome version to suit customer requirements.

Wetted Parts | Stainless Steel
Body Material | Gunmetal
Maximum Set Pressure | 12.5 bar
Maximum Temperature | 195°C

Fig. 520
Double Spring Safety Valve

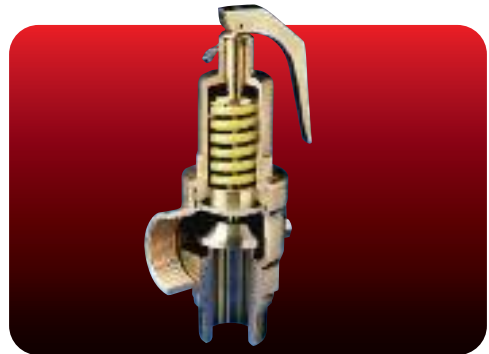

Figure 520 High Lift Safety Valve has been designed and tested to BS 6759. Based on the proven design of the figure 500 Safety Valve, the high capacity and resilient PTFE seating make figure 520 ideal for steam, hot water, air and inert gas applications.

Body Material | Gunmetal
Maximum Pressure | 12.5 bar
Maximum Temperature | 195°C

Fig. 500ST
High Lift Safety Valve

with Stainless Steel Wetted Parts



Wetted Parts | Stainless Steel
Body Material | Gunmetal
Maximum Set Pressure | 12.5 bar
Maximum Temperature | 195°C



The Stainless Steel version of the figure 500 High Lift Safety Valve has been specifically developed for use where difficult fluids or gases are encountered. Its anti-corrosion properties, high discharge capacities and excellent seat tightness make it an ideal valve for these applications. For other specific technical requirements please consult the NABIC technical department.

Fig. 500FN High Lift Safety Valve

Body Material | Stainless Steel
Maximum Pressure | 11 bar
Maximum Temperature | 195°C

Fig. 500FS High Lift Safety Valve

Body Material | Stainless Steel
Maximum Pressure | 11 bar
Maximum Temperature | 195°C

Fig. 500FF High Lift Safety Valve

Body Material | Stainless Steel
Maximum Pressure | 11 bar
Maximum Temperature | 195°C

Connection options are:
FN-Screwed x Screwed
FS-Flanged x Screwed
FF-Flanged x Flanged

Designed for hygienic applications, these full stainless steel constructed valves have connections to BS 4285. Figure 500AA has clamp type couplings which conform to part 3 and the figure 500DF has threaded (IDF type) couplings to part 4. Both ranges of valves are highly polished, with inlet bore finish of 0.4 µm. For other specific requirements please consult the NABIC technical department.

Fig. 500AA High Lift Safety Valve

Body Material | Stainless steel
Maximum Set Pressure | 11 bar
Maximum Temperature | 195°C

Fig. 500AS High Lift Safety Valve

Body Material | Stainless steel
Maximum Set Pressure | 11 bar
Maximum Temperature | 195°C

Fig. 500DF High Lift Safety Valve

Body Material | Stainless steel
Maximum Set Pressure | 11 bar
Maximum Temperature | 195°C



Connection options are:
AA-Hygenic Clamp x Hygenic Clamp
AS-Hygenic Clamp x Screwed
DF-IDF Thread x IDF Thread

Figure 568 Anti-Vacuum Valves are used to protect drying cylinders, calorifiers and tankers from collapse due to internal vacuum. They are also used on steam systems, to assist condensate drainage and to prevent suction of contents from vats. Vacuum valves are normally fitted vertically, at the top of the vessel or pipeline being protected. Horizontal revolving cylinders however, should have a figure 568 fitted at each end, diametrically opposite one another.

Fig. 568SS Stainless Steel Anti-Vacuum Valve

Body Material | Stainless Steel
Maximum Set Pressure | 13.5 bar
Maximum Temperature | 195°C



Fig. 568 Anti-Vacuum Valve

Body Material | Gunmetal
Maximum Set Pressure | 13.5 bar
Maximum Temperature | 195°C

Figure 100 Automatic Air Vent is an extremely efficient valve designed for use on central heating installations where the removal of large air bubbles trapped in the system helps to reduce noise levels, maintain circulation and improve heat output. They can also be fitted to other fluid systems where air inclusion causes problems.

Fig. 100 Automatic Air-Vent

Body Material | Gunmetal
Float | Stainless Steel
Maximum Pressure | 10 bar
Minimum Pressure | 0.15 bar
Maximum Temperature | 93°C



Figure 503 Three Way Valve has been designed for use on vented hot water systems, to ensure there is a permanent connection from the boiler or calorifier to atmosphere. Fitting a figure 503 allows the use of a single common vent pipe, and permits continued operation of the system whilst maintenance is carried out on an individual unit.

Fig. 503 Three Way Vent Valve

Body Material | Gunmetal
Maximum Working Pressure | 7 bar
Maximum Working Temperature | 93°C



Figure 175 Three Way Vent Cock has been designed for use on vented hot water systems, to ensure there is a permanent connection from the boiler or calorifier to atmosphere. Fitting a figure 175 allows the use of a single common vent pipe, and permits continued operation of the system whilst maintenance is carried out on an individual unit.

Fig. 175 Three Way Vent Cock

Body Material | Gunmetal
Maximum Working Pressure | 7 bar
Maximum Working Temperature | 100°C



The RPZ Anti-Pollution valve is a type BA safety device used to prevent contamination of drinking water through syphoning or backflow up to class 4 fluid category. They are particularly suitable for industrial and commercial applications and can also be used for supplies to buildings within the scope of the water regulations.

Fig. 255 Reduced Pressure Zone Anti-Pollution Valve

Body Material | Gunmetal
 Check Valves | Plastic
 Seals | EPDM
 Maximum Working Pressure | 10 bar
 Maximum Working Temperature | 60°C



Fig. 256A Pipe Interrupter



Figure 256A is classified as a DC type suitable for protecting up to fluid category 5. Incorporating ventilation ports that are totally unrestricted and permanent, water is guided past these air vents using a venturi type nozzle. Since they are constantly open to atmosphere, this stops syphonage and allows the escape of water in the event of backflow.

Body Material | Brass
 Internals | Plastic
 O-Rings | EPDM
 Maximum Set Pressure | 10 bar
 Maximum Temperature | 60°C

Fig. 256B Pipe Interrupter



Figure 256B is classified as a DB type suitable for protecting up to fluid category 4. This device has a moving element which seals the ventilation gaps during normal flow conditions. When negative pressures occur on the inlet side which could cause syphonage, the membrane retracts seals the flow ports and simultaneously vents the outlet side of the pipe interrupter.

Body Material | Brass
 Internals | Plastic
 O-Rings | EPDM
 Maximum Set Pressure | 10 bar
 Maximum Temperature | 60°C

Figure 5 and figure 8 Fusible Plugs are used to protect internally fired steam boilers. If overheating occurs due to low water conditions, the plugs are designed to operate and allow pressure to reduce, thereby preventing collapse of the boiler.

Fig. 8 Fusible Plugs For Steam

Body Material | Gunmetal
Maximum Pressure | 24 bar

Fig. 5 Fusible Plugs For Steam

Body Material | Gunmetal
Maximum Pressure | 24 bar



Figure 17H Fusible plugs are used to protect compressed air systems from the risk of an explosion occurring due to ignition of oil vapour. Figure 22 Fusible Plugs are used to protect air receivers from the risk of an explosion occurring due to external fire. Both plugs are designed to operate when high temperatures occur, thereby reducing pressure and providing audible warning of dangerous conditions.

Fig. 17H Fusible Plugs For Air

Body Material | Brass
Maximum Pressure | 20 bar

Fig. 22 Fusible Plugs For Air

Body Material | Brass
Maximum Pressure | 20 bar

Higher Pressure versions available upon request.

Fig. 300
Test Pump



Figure 300 is a portable, stirrup type, hydraulic test pump of brass construction. Its dual pressure range facility provides increased capacity per stroke at low pressures, with quick and easy changeover to the high pressure range.

Body Material | Brass
Low Pressure Range | 0-16 bar
High Pressure Range | 0-70 bar

Fig. 362
Pressure Gauge Tester



Figure 362 Pressure Gauge Tester is a compact portable unit, used for checking pressure gauges on site. The tester is comprised of a small hand-operated air pump with fine adjustment facility. Suitable fittings are supplied to enable most gauges in common use to be tested throughout their range.

Fig. 122
Test Pump



Figure 122 is a hydraulic test pump of robust construction. A precision built pump in high pressure bronze, with steel lever, supplied with a screw base which can be fitted to the lid of the carrying case. Alternately, the pump can be fitted with a tripod kit at extra cost.

Body Material | Gunmetal
Maximum Pressure | 700 bar



Figure 55N is a robust gunmetal stop valve, with a stainless steel needle type valve and seat. A dust cap protects the test gauge connection, which is tapped $\frac{3}{8}$ " BSP. The boiler connector is threaded $\frac{1}{2}$ " BSP male. Figure 174 is a flanged version of figure 55N. The Test Valves are used on steam boilers, to provide a means for attaching a test pressure gauge. This enables the calibration of the boiler gauge to be checked under working conditions. It also serves a useful purpose as an air vent, to facilitate draining and filling of the boiler.

Fig. 55N Test Valve

Body Material | Gunmetal
Maximum Pressure | 17.5 bar
Maximum Temperature | 260°C

Fig. 174 Text Valve

Body Material | Gunmetal
Maximum Pressure | 17.5 bar
Maximum Temperature | 260°C

Figure 850 Pressure Reducing Valve is designed for general and commercial use, and is used where there is a requirement to lower the pressure of a fluid from one level to another. It also maintains the reduced pressure at a constant value, irrespective of fluctuations in the inlet pressure or changes in the flow demand.

Fig. 850 Pressure Reducing Valve

- Body Material | Brass Nickel Plated
- Maximum Inlet Pressure | 25 bar
- Maximum Outlet Pressure | 7 bar
- Minimum Outlet Pressure | 0.5 bar
- Minimum Working Temperature | 85°C



Figure 345 complies with BS 5235 and has a range of 20°C to 120°C. It has a 100mm diameter dial and an immersion depth of 100mm. Supplied complete with pocket, which is screwed 1/2" BSP. We are happy to provide other temperature gauges and connections on request.

Figure 210 is manufactured to BS 1780 and has a 100mm diameter dial, 3/8" BSP bottom connection and full size Bourdon tube.

Also available straight from stock are figure 219 DN10 Scroll Syphon Kit and figure 215 DN10 Pressure Gauge Cock.

Fig. 210 Altitude Gauge

Fig. 345 Vapour Pressure Thermometer

	Valve Size DN									
	10	15	20	25	32	40	50	65	80	100
Fig. 500	•	•	•	•	•	•	•	•		
Fig. 500L	•	•	•	•	•	•	•	•		
Fig. 500 FLG			•	•	•	•	•	•		
Fig. 500SS		•	•	•	•	•	•	•		
Fig. 500FN		•	•	•						
Fig. 500FF		•	•	•						
Fig. 500AA		•	•	•						
Fig. 500AS		•	•	•						
Fig. 500DF		•	•	•						
Fig. 500T*		•	•	•	•	•	•			
Fig. 520								•	•	•
Fig. 542		•	•	•	•	•	•	•	•	
Fig. 542 FLG					•	•	•	•	•	
Fig. 542L		•	•	•	•	•	•	•	•	
Fig. 542L FLG					•	•	•	•	•	
Fig. 800		•	•	•						
Fig. 175			•	•	•	•	•	•		
Fig. 503			•	•	•	•	•	•		
Fig. 568		•	•	•	•	•	•			
Fig. 850		•	•	•	•	•	•	•	•	•
Fig. 100		•								
Fig. 55N		•								
Fig. 255		•	•	•	•	•	•	•		
Fig. 256A	•	•	•	•						
Fig. 256B	•	•	•							

Quality Guarantee

Constructed from high performance materials, NABIC products are produced using the latest technology and manufacturing techniques within a quality system to ISO 9001. Inspection of components throughout all stages of manufacture and individual testing of completed products prior to despatch ensures quality and reliability is maintained.

Designed to relevant standards the majority of NABIC products are third party certified and UK WFBS listed.



Plant Room Valves

Automatic Air Eliminators and Boiler Vent Valves

With a proven track record for high quality, Brownall offers an exclusive range of Automatic Air Eliminators (AAE) covering low, medium and high pressure applications, complemented by the Three-way Vent Valves and Vent Cocks for boilers.

Offering efficient performance, the Brownall range removes inevitable and potentially dangerous air trapped in the system. Air Eliminators are suitable for use with water, glycol, aviation fuel, diesel and light oils.

Installed at the highest point of the fluid carrying system, the trapped air will enter the float chamber of the air eliminator. This reduces the float buoyancy and allows air to escape through the outlet orifice.

To complement the AAE, the Univent and Vent Cocks are installed to provide a direct connection from the boiler to the atmosphere. Designed to simplify the venting process, for single or multi point boiler and calorifier installations, the range offers savings in time and costs. Bronze body parts enable the range to operate in high-turbulence aerated hot water, which can be a very corrosive environment.

All the above make Brownall the number one choice with professional building services, consulting engineers and specifying authorities.

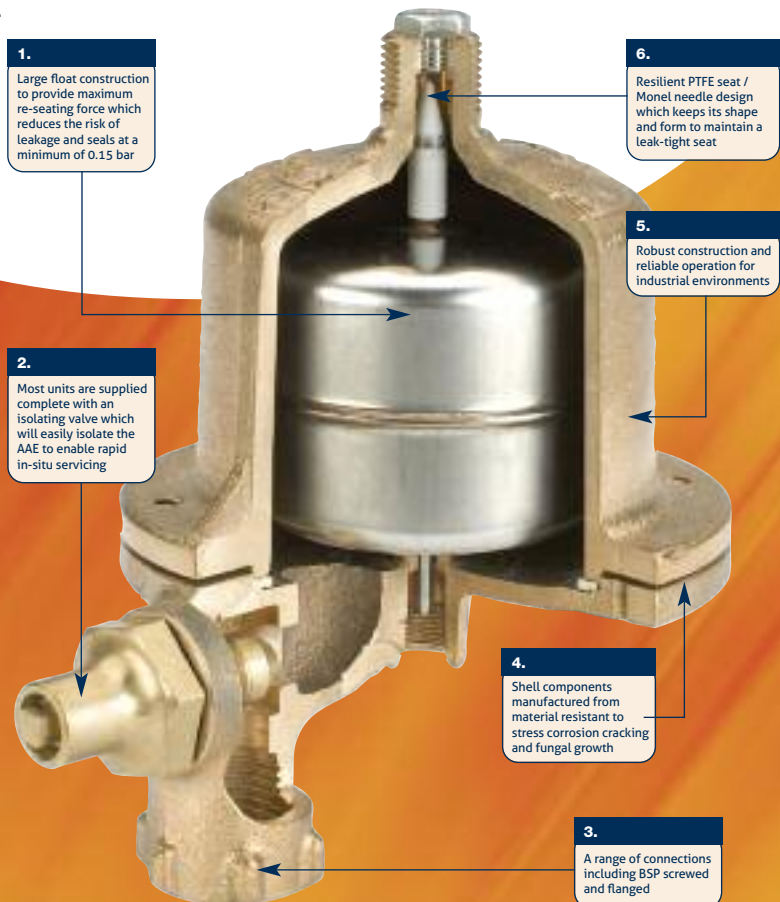

Automatic Air Eliminators

TYPE	PART NO.	DETAILS
Type A	AE-A	Vertical Inlet. Available Special Order
Type B	AE-B	Vertical Inlet with Integral Lockshield Isolating Valve
Type C	AE-C	Vertical Inlet with Integral Lockshield Isolating Valve & Check Valve
Type D	AE-D	Side Inlet Available Special Order
Type MPH	AE-MPHW-015	Vertical Inlet with Integral Lockshield Isolating Valve
Type HPHW	AE-HPHW-F	BST'F' Vertical Inlet with Integral Lockshield Isolating Valve
Type HPHW	AE-HPHW-H	BST'H' Vertical Inlet with Integral Lockshield Isolating Valve
Type HPHW	AE-HPHW-16	PN16 Vertical Inlet with Integral Lockshield Isolating Valve
Type HPHW	AE-HPHW-150	Class 150 vertical inlet with Integral Lockshield Isolating Valve

Standard Pressure Applications - Type A, B, C and D

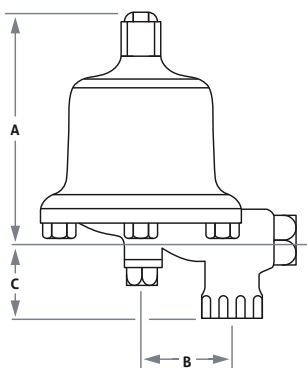

Type	A	B	C	Weight kg
A	102	43	35	1.25
B	102	43	35	1.28
C	108	43	35	1.28

Technical Data

Connections	Inlet: BS EN 10226-1:2004 – Rp 1/2 (Female) Outlet: BS EN ISO 228-1:2003 – G 3/8 (Male)
Pressure Rating	Up to 10 bar (150 lbf/in ²) Non-Shock
Temp Rating	Up to 93°C (200°F)
Recommended Min. Working Pressure	0.15bar (5ft effective head)

Materials of Construction

Body and Dome	Bronze (Gunmetal)
Spindle and Seating	Stainless Steel
Valve	PTFE Needle
Float	Stainless Steel



Medium Pressure Hot Water Applications - MPHW

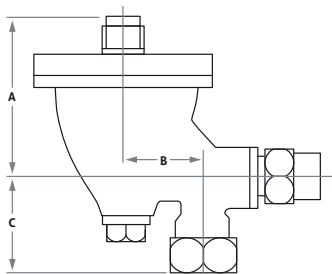

Type	A	B	C	Weight kg
MPHW	108	43	41	2.4

Technical Data

Connections	Inlet: BS EN 10226-1:2004 – Rp 1/2 (Female) Outlet: BS EN ISO 228-1:2003 – G 3/8 (Male)
Pressure Rating	Up to 7 bar (100 lbf/in ²)
Temp Rating	Up to 149°C (300°F)
Recommended Min. Working Pressure	0.15bar (5ft effective head)

Materials of Construction

Body and Dome	Bronze (Gunmetal)
Spindle and Seating	Stainless Steel
Valve	Monel
Float	Nickel Alloy, Silver Brazed

High Pressure Hot Water Applications - HPHW

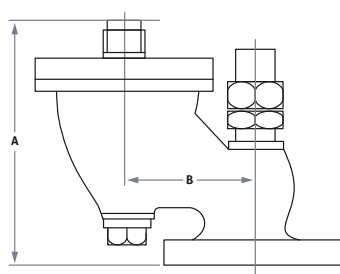

Type	A	B	Weight kg
BST 'F'	152	83	3.85
BST 'H'	152	83	3.85
PN16	152	83	3.85
Class 150	152	83	3.85

Technical Data

Connections:	Inlet: BS 10:2009 Table F or H 1/2 (Flanged) Can be supplied drilled to PN16 or Ansi Class 150 Outlet: BS EN ISO 228-1:2003 – G 3/8 (Male)
Pressure Rating	HPHW/F 10.5 bar (150 lbf/in ²) HPHW/H 17 bar (250 lbf/in ²)
Temp Rating	HPHW/F 182°C (360°F) HPHW/H 204°C (400°F)
Recommended Min. Working Pressure	0.15bar (5ft effective head)

Materials of Construction

Body and Dome	Bronze (Gunmetal)
Spindle and Seating	Stainless Steel
Valve	Monel
Float	Nickel Alloy, Silver Brazed

Service Kits (Float Assembly) Types A, B (AE-SP-ABD) & C (AE-SP-C)

Types B and C Automatic Air Eliminators are manufactured with in-built isolating valves which, when closed, allow the dome to be removed and the float assembly replaced, allowing rapid in-situ servicing.

Type A and D require an additional isolating valve on the inlet, to isolate it from the system prior to removing the float assembly.

AE-SP-BC isolator kit available for types B & C air eliminators. AE-SP-MPHW Service kit is available for types MPHW and HPHW air eliminators.

Service kits comprise of a float assembly (inc. needle and spindle), seat, washer and retaining screws.

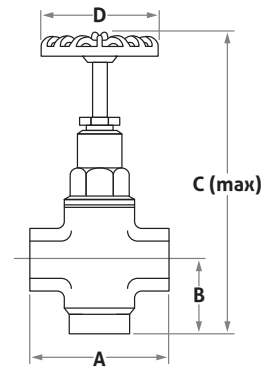

Fig. 1688 Three-way Univent

Figure 1688, Three-way Univent is designed for use on vented hot water systems to ensure that there is always a direct connection from the boiler/ calorifier to the atmosphere. Made from body materials resistant to stress corrosion cracking, it can be used for single or multi-boiler installations.

In-line servicing, using Univent replacement cartridges, allows valve maintenance to be carried out without disturbing the pipework.

The Univent can be opened and closed using the integral hand wheel. To close the drain port and open the vent, turn the handwheel clockwise to its full travel. Turn the handwheel anti-clockwise to open the drain and close the vent.



Technical Data

Max pressure: 7 bar

Max temperature: 93 °C

Connections: BS EN 10226-1:2004 – Rp (Female)

Materials:

Body: Bronze (Gunmetal)

Head: Bronze (Gunmetal)

Trim: Brass

Spindle: Brass bar

Renewable Seat: EPDM

Nominal Size	Product code	A	B	C (max)	D	Weight kg
25mm (1")	UV-1688-025D	96	47	200	89	1.83
32mm (1 1/4")	UV-1688-032D	118	63	237	102	2.93
40mm (1 1/2")	UV-1688-040D	144	74	269	127	4.39
50mm (2")	UV-1688-050D	160	79	283	152	6.10
65mm (2 1/2")	UV-1688-065D	190	115	395	200	14.25

Univent Replacement Cartridge (Fig. 1688 only)



Replacement cartridges for the Three-way Univent valve allow rapid in-situ servicing.

Size	Product code
25mm (1")	UV-SP-1688-025
32mm (1 1/4")	UV-SP-1688-032
40mm (1 1/2")	UV-SP-1688-040
50mm (2")	UV-SP-1688-050
65mm (2 1/2")	UV-SP-1688-065

Fig. 1988 Three-way Vent Cocks

Figure 1988 is resistant to stress corrosion cracking and used on single, multi-boiler or calorifier installations. Fitting a Three-way Vent Cock ensures a constant connection from the boiler or calorifier to the atmosphere.

Levers are available as an optional extra.

Technical Data

Max pressure: 7 bar

Max temperature: 93 °C

Connections: BS EN 10226-1:2004 – Rp (Female)

Materials

Body: Bronze (Gunmetal)

Plug: Bronze (Gunmetal)

Gland: Bronze (Gunmetal)

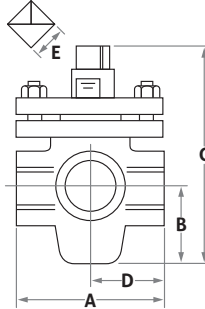

Normal size	Product code	A	B	C	D	E
25mm (1")	VCN-LA-025	90	43	132	45	18
32mm (1 1/4")	VCN-LA-032	122	48	155	56	20
40mm (1 1/2")	VCN-LC-040	143	57	177	68	25
50mm (2")	VCN-LC-050	165	66	204	80	36

Valve Levers

Size	Product code
25mm (1")	VC-LA-025
32mm (1 1/4")	VC-LA-032
40mm (1 1/2")	VC-LC-040
50mm (2")	VC-LC-050

Typical Multi-Boiler System incorporating Brownall Univents/Vent Cocks Fig. 1688/1988

The use of screw-down valves for multi-boiler hot water installations can allow the use of a single vent pipe to serve any number of boilers. No boiler in the system can be left in an unvented condition irrespective of the selected settings of the valves. At all times the vent valve ensures a full bore exit from the boiler to atmosphere.

In operation, clockwise turning of the handwheel closes the drain and opens the vent. Anti-clockwise

rotation of the handwheel opens the drain and closes the vent.

Note: The diagram shown is schematic and is not intended as a guide to the installation of the vent valves. It is essential that vent valves are fitted in accordance with the manufacturer's recommendations and comply with Health and Safety regulations etc.

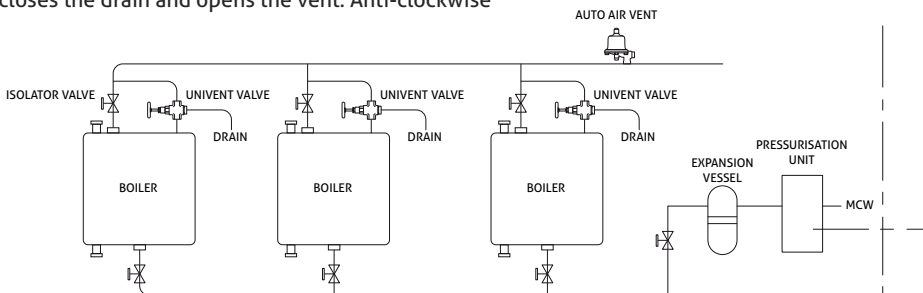

Please note: Three-way Univents and Three-way Vent Cocks are interchangeable.



The Sage, Gateshead, Tyne & Wear
Specification: Hattersley Commissioning Valves

Flange Tables

This information is extracted from the following European, British and American standards:

- BS EN 1092 Circular flanges for pipes, valves, fittings and accessories, PN designated Part 1 Steel flanges.
- Part 2 Cast iron flanges.
- BS 4504 Flanges and bolting for pipes, valves, and fittings metric series (for copper alloy flanges only).
- ANSI B16.1 Cast Iron pipe flanges and flanged fittings.
- ANSI B16.5 Steel pipe flanges and flanged fittings.
- ANSI B16.24 Bronze flanges and flanged fittings BS10 Flanges and bolting for pipes, valves and fittings.

Notes:

1. Raised joint faces are applicable to BS EN 1092-1, BS EN 1092-2, BS10 ANSI table H steel, and classes 150 to 1500 inclusive.
2. ANSI Class 125 refers to cast iron only.
3. ANSI 600, 900, 1500 flange thickness does not include raised face.
4. Dimensions for flanges to BS EN 1092 are given in millimetres only. Dimensions for ANSI and BS 10 flanges are shown in inches with the metric equivalent (to nearest whole millimetre) in brackets.

Nominal Size 15mm (1/2")

BS EN 1092	Dia. of flange	Bolt circle diameter	No. of bolts	Dia. of bolts	Dia. of holes	Dia. of raised face(3) Iron	Dia. of raised face(3) Steel	Height of raised face(3)	Thickness of flange			
									Grey Cast Iron	Copper Alloy	Cast and Forged Steel	Ductile Cast Iron
PN6	80	55	4	M10	11	38	40	2	12 (1)	-	12	-
PN10	95	65	4	M12	14	46	45	2	14 (1)	-	16	14
PN16	95	65	4	M12	14	46	45	2	14 (1)	6 (2)	16	14
PN25	95	65	4	M12	14	46	45	2	16 (1)	8 (2)	16	14
PN40	95	65	4	M12	14	46	45	2	-	9 (2)	16	16
PN64	105	75	4	M12	14	-	45	2	-	-	20	-
ANSI												
Class 125/150	3 ¹ / ₂ (89)	2 ³ / ₈ (60)	4	1 ¹ / ₂ (13)	5 ¹ / ₈ (16)	-	1 ³ / ₈ (35)	1 ¹ / ₁₆ (2)	-	5 ¹ / ₁₆ (8)	7 ¹ / ₁₆ (11)	-
Class 300	3 ³ / ₄ (95)	2 ⁵ / ₈ (67)	4	1 ¹ / ₂ (13)	5 ¹ / ₈ (16)	-	1 ³ / ₈ (35)	1 ¹ / ₁₆ (2)	-	1 ¹ / ₂ (13)	1 ¹ / ₂ (13)	-
Class 600	3 ³ / ₄ (95)	2 ⁵ / ₈ (67)	4	1 ¹ / ₂ (13)	5 ¹ / ₈ (16)	-	1 ³ / ₈ (35)	1 ¹ / ₄ (6)	-	-	9 ¹ / ₁₆ (14)	-
Class 900	4 ³ / ₄ (121)	3 ¹ / ₄ (83)	4	3 ¹ / ₄ (19)	7 ¹ / ₈ (22)	-	1 ³ / ₈ (35)	1 ¹ / ₄ (6)	-	-	7 ¹ / ₈ (22)	-
Class 1500	4 ³ / ₄ (121)	3 ¹ / ₄ (83)	4	3 ¹ / ₄ (19)	7 ¹ / ₈ (22)	-	1 ³ / ₈ (35)	1 ¹ / ₄ (6)	-	-	7 ¹ / ₈ (22)	-
BS 10												
Table A	3 ³ / ₄ (95)	2 ⁵ / ₈ (67)	4	1 ¹ / ₂ (13)	9 ¹ / ₁₆ (14)	-	-	-	1 ¹ / ₂ (13)	1 ¹ / ₄ (6)	-	-
Table D	3 ³ / ₄ (95)	2 ⁵ / ₈ (67)	4	1 ¹ / ₂ (13)	9 ¹ / ₁₆ (14)	-	-	-	1 ¹ / ₂ (13)	1 ¹ / ₄ (6)	3 ¹ / ₈ (10)	-
Table E	3 ³ / ₄ (95)	2 ⁵ / ₈ (67)	4	1 ¹ / ₂ (13)	9 ¹ / ₁₆ (14)	-	-	-	1 ¹ / ₂ (13)	1 ¹ / ₄ (6)	3 ¹ / ₈ (10)	-
Table F	3 ³ / ₄ (95)	2 ⁵ / ₈ (67)	4	1 ¹ / ₂ (13)	9 ¹ / ₁₆ (14)	-	-	-	1 ¹ / ₂ (13)	5 ¹ / ₁₆ (8)	3 ¹ / ₈ (10)	-
Table H	4 ¹ / ₂ (114)	3 ¹ / ₄ (83)	4	5 ¹ / ₈ (16)	1 ¹ / ₁₆ (17)	-	2 ¹ / ₄ (57)	1 ¹ / ₁₆ (2)	5 ¹ / ₈ (16)	3 ¹ / ₈ (10)	1 ¹ / ₂ (13)	-

(1) These flange thicknesses are also valid for ductile iron flanges type 21-2 (2) Flange thicknesses for copper alloy are from BS 4504

(3) Copper alloy flanges are always flat-faced

Nominal Size 20mm (3/4")

BS EN 1092	Dia. of flange	Bolt circle diameter	No. of bolts	Dia. of bolts	Dia. of holes	Dia. of raised face(3) Iron	Dia. of raised face(3) Steel	Height of raised face(3)	Thickness of flange			
									Grey Cast Iron	Copper Alloy	Cast and Forged Steel	Ductile Cast Iron
PN6	90	65	4	M10	11	48	50	2	14 (1)	-	14	-
PN10	105	75	4	M12	14	56	58	2	16 (1)	-	18	16
PN16	105	75	4	M12	14	56	58	2	16 (1)	6 (2)	18	16
PN25	105	75	4	M12	14	56	58	2	18 (1)	8 (2)	18	16
PN40	105	75	4	M12	14	56	58	2	-	9 (2)	18	18
PN64	130	90	4	M16	18	-	58	2	-	-	22	-
PN100	130	90	4	M16	18	-	58	2	-	-	22	-
ANSI												
Class 125/150	37/8 (98)	23/4 (70)	4	1/2 (13)	5/8 (16)	-	111/16 (43)	1/16 (2)	-	11/32 (9)	9/16 (14)	-
Class 300	45/8 (117)	31/4 (83)	4	5/8 (16)	3/4 (19)	-	111/16 (43)	1/16 (2)	-	17/32 (13)	5/8 (16)	-
Class 600	45/8 (117)	31/4 (83)	4	5/8 (16)	3/4 (19)	-	111/16 (43)	1/4 (6)	-	-	5/8 (16)	-
Class 900	51/8 (130)	31/2 (89)	4	3/4 (19)	7/8 (22)	-	111/16 (43)	1/4 (6)	-	-	1 (25)	-
Class 1500	51/8 (130)	31/2 (89)	4	3/4 (19)	7/8 (22)	-	111/16 (43)	1/4 (6)	-	-	1 (25)	-
BS 10												
Table A	4 (102)	27/8 (73)	4	1/2 (13)	9/16 (14)	-	-	-	1/2 (13)	1/4 (6)	-	-
Table D	4 (102)	27/8 (73)	4	1/2 (13)	9/16 (14)	-	-	-	1/2 (13)	1/4 (6)	3/8 (10)	-
Table E	4 (102)	27/8 (73)	4	1/2 (13)	9/16 (14)	-	-	-	1/2 (13)	1/4 (6)	3/8 (10)	-
Table F	4 (102)	27/8 (73)	4	1/2 (13)	9/16 (14)	-	-	-	1/2 (13)	5/16 (8)	3/8 (10)	-
Table H	41/2 (114)	31/4 (83)	4	5/8 (16)	11/16 (17)	-	21/4 (57)	1/16 (2)	5/8 (16)	3/8 (10)	1/2 (13)	-

- (1) These flange thicknesses are also valid for ductile iron flanges type 21-2 (2) Flange thicknesses for copper alloy are from BS 4504
 (3) Copper alloy flanges are always flat-faced

Nominal Size 25mm (1")

BS EN 1092	Dia. of flange	Bolt circle diameter	No. of bolts	Dia. of bolts	Dia. of holes	Dia. of raised face(3) Iron	Dia. of raised face(3) Steel	Height of raised face(3) Iron	Height of raised face(3) Steel	Thickness of flange			
										Grey Cast Iron	Copper Alloy	Cast and Forged Steel	Ductile Cast Iron
PN 6	100	75	4	M10	11	58	60	3	2	14 (1)	-	14	-
PN10	115	85	4	M12	14	65	68	3	2	16 (1)	-	18	16
PN16	115	85	4	M12	14	65	68	3	2	16 (1)	8 (2)	18	16
PN25	115	85	4	M12	14	65	68	3	2	18 (1)	9 (2)	18	16
PN40	115	85	4	M12	14	65	68	3	2	-	11 (2)	18	18
PN64	140	100	4	M16	18	-	68	-	2	-	-	24	-
PN100	140	100	4	M16	18	-	68	-	2	-	-	24	-
ANSI													
Class 125/150	41/4 (114)	31/8 (79)	4	1/2 (13)	5/8 (16)	-	2 (51)	-	1/16 (2)	7/16 (11)	3/8 (10)	7/16 (11)	9/16 (14)
Class 300	47/8 (124)	31/2 (89)	4	5/8 (16)	3/4 (19)	-	2 (51)	-	1/16 (2)	-	19/32 (15)	11/16 (17)	-
Class 600	47/8 (124)	31/2 (89)	4	5/8 (16)	3/4 (19)	-	2 (51)	-	1/4 (6)	-	-	11/16 (17)	-
Class 900	57/8 (149)	4 (102)	4	7/8 (22)	1 (25)	-	2 (51)	-	1/4 (6)	-	-	11/8 (29)	-
Class 1500	57/8 (149)	4 (102)	4	7/8 (22)	1 (25)	-	2 (51)	-	1/4 (6)	-	-	11/8 (29)	-
BS 10													
Table A	41/2 (114)	31/4 (83)	4	1/2 (13)	9/16 (14)	-	-	-	-	1/2 (13)	5/16 (8)	-	-
Table D	41/2 (114)	31/4 (83)	4	1/2 (13)	9/16 (14)	-	-	-	-	1/2 (13)	5/16 (8)	3/8 (10)	-
Table E	41/2 (114)	31/4 (83)	4	1/2 (13)	9/16 (14)	-	-	-	-	1/2 (13)	5/16 (8)	3/8 (10)	-
Table F	43/4 (121)	37/16 (87)	4	5/8 (16)	11/16 (17)	-	-	-	-	1/2 (13)	3/8 (10)	3/8 (10)	-
Table H	43/4 (121)	37/16 (87)	4	5/8 (16)	11/16 (17)	-	21/2 (64)	-	1/16 (2)	3/4 (19)	7/16 (11)	9/16 (14)	-

- (1) These flange thicknesses are also valid for ductile iron flanges type 21-2 (2) Flange thicknesses for copper alloy are from BS 4504
 (3) Copper alloy flanges are always flat-faced

Nominal Size 32mm (1 1/4")

BS EN 1092	Dia. of flange	Bolt circle diameter	No. of bolts	Dia. of bolts	Dia. of holes Iron	Dia. of holes Steel	Dia. of raised face(3) Iron	Dia. of raised face(3) Steel	Height of raised face(3) Iron	Height of raised face(3) Steel	Thickness of flange			
											Grey Cast Iron	Copper Alloy	Cast and Forged Steel	Ductile Cast Iron
PN 6	120	90	4	M12	14	14	69	70	3	2	16 (1)	-	14	-
PN10	140	100	4	M16	19	18	76	78	3	2	18 (1)	-	18	18
PN16	140	100	4	M16	19	18	76	78	3	2	18 (1)	8 (2)	18	18
PN25	140	100	4	M16	19	18	76	78	3	2	20 (1)	9 (2)	18	18
PN40	140	100	4	M16	19	18	76	78	3	2	-	11 (2)	18	20
PN64	155	110	4	M20	-	22	-	78	-	2	-	-	26	-
PN100	155	110	4	M20	-	22	-	78	-	2	-	-	26	-
ANSI														
Class 125/150	4 5/8 (117)	3 1/2 (89)	4	1/2 (13)	5/8 (16)	5/8 (16)	-	2 1/2 (64)	-	1/16 (2)	1/2 (13)	13/32 (10)	1/2 (13)	5/8 (16)
Class 300	5 1/4 (133)	3 7/8 (98)	4	5/8 (16)	-	3/4 (19)	-	2 1/2 (64)	-	1/16 (2)	-	5/8 (16)	3/4 (19)	-
Class 600	5 1/4 (133)	3 7/8 (98)	4	5/8 (16)	-	3/4 (19)	-	2 1/2 (64)	-	1/4 (6)	-	-	13/16 (21)	-
Class 900	6 1/4 (159)	4 3/8 (111)	4	7/8 (22)	-	1 (25)	-	2 1/2 (64)	-	1/4 (6)	-	-	1 1/8 (29)	-
Class 1500	6 1/4 (159)	4 3/8 (111)	4	7/8 (22)	-	1 (25)	-	2 1/2 (64)	-	1/4 (6)	-	-	1 1/8 (29)	-
BS 10														
Table A	4 3/4 (121)	3 7/16 (87)	4	1/2 (13)	9/16 (14)	9/16 (14)	-	-	-	-	5/8 (16)	5/16 (8)	-	-
Table D	4 3/4 (121)	3 7/16 (87)	4	1/2 (13)	9/16 (14)	9/16 (14)	-	-	-	-	5/8 (16)	5/16 (8)	1/2 (13)	-
Table E	4 3/4 (121)	3 7/16 (87)	4	1/2 (13)	9/16 (14)	9/16 (14)	-	-	-	-	5/8 (16)	5/16 (8)	1/2 (13)	-
Table F	5 1/4 (133)	3 7/8 (98)	4	5/8 (16)	1 1/16 (17)	1 1/16 (17)	-	-	-	-	5/8 (16)	3/8 (10)	1/2 (13)	-
Table H	5 1/4 (133)	3 7/8 (98)	4	5/8 (16)	1 1/16 (17)	1 1/16 (17)	-	3 (76)	-	1/16 (2)	7/8 (22)	7/16 (11)	1 1/16 (17)	-

(1) These flange thicknesses are also valid for ductile iron flanges type 21-2 (2) Flange thicknesses for copper alloy are from BS 4504 (3) Copper alloy flanges are always flat-faced

Nominal Size 40mm (1 1/2")

BS EN 1092	Dia. of flange	Bolt circle diameter	No. of bolts	Dia. of bolts	Dia. of holes Iron	Dia. of holes Steel	Dia. of raised face(3) Iron	Dia. of raised face(3) Steel	Height of raised face(3) Iron	Height of raised face(3) Steel	Thickness of flange			
											Grey Cast Iron	Copper Alloy	Cast and Forged Steel	Ductile Cast Iron
PN6	130	100	4	M12	14	14	78	80	3	2	16 (1)	-	14	-
PN10	150	110	4	M16	19	18	84	88	3	2	18 (1)	-	18	19
PN16	150	110	4	M16	19	18	84	88	3	2	18 (1)	9 (2)	18	19
PN25	150	110	4	M16	19	18	84	88	3	2	20 (1)	11 (2)	18	19
PN40	150	110	4	M16	19	18	84	88	3	2	-	13 (2)	18	19
PN64	170	125	4	M20	-	22	-	88	-	2	-	-	28	-
PN100	170	125	4	M20	-	22	-	88	-	2	-	-	28	-
ANSI														
Class 125/150	5 (127)	3 7/8 (98)	4	1/2 (13)	5/8 (16)	5/8 (16)	-	2 7/8 (73)	-	1/16 (2)	9/16 (14)	7/16 (11)	9/16 (14)	1 1/16 (17)
Class 300	6 1/8 (156)	4 1/2 (114)	4	3/4 (19)	-	7/8 (22)	-	2 7/8 (73)	-	1/16 (2)	-	1 1/16 (17)	13/16 (21)	-
Class 600	6 1/8 (156)	4 1/2 (114)	4	3/4 (19)	-	7/8 (22)	-	2 7/8 (73)	-	1/4 (6)	-	-	7/8 (22)	-
Class 900	7 (178)	4 7/8 (124)	4	1 (25)	-	1 1/8 (29)	-	2 7/8 (73)	-	1/4 (6)	-	-	1 1/4 (32)	-
Class 1500	7 (178)	4 7/8 (124)	4	1 (25)	-	1 1/8 (29)	-	2 7/8 (73)	-	1/4 (6)	-	-	1 1/4 (32)	-
BS 10														
Table A	5 1/4 (133)	3 7/8 (98)	4	1/2 (13)	9/16 (14)	9/16 (14)	-	-	-	-	5/8 (16)	3/8 (10)	-	-
Table D	5 1/4 (133)	3 7/8 (98)	4	1/2 (13)	9/16 (14)	9/16 (14)	-	-	-	-	5/8 (16)	3/8 (10)	1/2 (13)	-
Table E	5 1/4 (133)	3 7/8 (98)	4	1/2 (13)	9/16 (14)	9/16 (14)	-	-	-	-	5/8 (16)	3/8 (10)	1/2 (13)	-
Table F	5 1/2 (140)	4 1/8 (105)	4	5/8 (16)	1 1/16 (17)	1 1/16 (17)	-	-	-	-	5/8 (16)	7/16 (11)	1/2 (13)	-
Table H	5 1/2 (140)	4 1/8 (105)	4	5/8 (16)	1 1/16 (17)	1 1/16 (17)	-	3 1/4 (83)	-	1/16 (2)	7/8 (22)	1/2 (13)	1 1/16 (17)	-

(1) These flange thicknesses are also valid for ductile iron flanges type 21-2 (2) Flange thicknesses for copper alloy are from BS 4504 (3) Copper alloy flanges are always flat-faced

Nominal Size 50mm (2")

BS EN 1092	Dia. of flange	Bolt circle diameter	No. of bolts	Dia. of bolts	Dia. of holes Iron	Dia. of holes Steel	Dia. of raised face(3) Iron	Dia. of raised face(3) Steel	Height of raised face(3) Iron	Height of raised face(3) Steel	Thickness of flange			
											Grey Cast Iron	Copper Alloy	Cast and Forged Steel	Ductile Cast Iron
PN 6	140	110	4	M12	14	14	88	90	3	2	16 (1)	-	14	-
PN10	165	125	4	M16	19	18	99	102	3	2	20 (1)	-	18	19
PN16	165	125	4	M16	19	18	99	102	3	2	20 (1)	11 (2)	18	19
PN25	165	125	4	M16	19	18	99	102	3	2	22 (1)	11 (2)	20	19
PN40	165	125	4	M16	19	18	99	102	3	2	-	13 (2)	20	19
PN64	180	135	4	M20	-	22	-	102	-	2	-	-	26	-
PN100	195	145	4	M24	-	26	-	102	-	2	-	-	30	-
ANSI														
Class 125/150	6 (152)	4 ³ / ₄ (121)	4	5/8 (16)	3/4 (19)	3/4 (19)	-	3 ⁵ / ₈ (92)	-	1/16 (2)	5/8 (16)	1/2 (13)	5/8 (16)	-
Class 300	6 ¹ / ₂ (165)	5 (127)	8	5/8 (16)	-	3/4 (19)	-	3 ⁵ / ₈ (92)	-	1/16 (2)	-	3/4 (19)	7/8 (22)	-
Class 600	6 ¹ / ₂ (165)	5 (127)	8	5/8 (16)	-	3/4 (19)	-	3 ⁵ / ₈ (92)	-	1/4 (6)	-	- 1	(25)	-
Class 900	8 ¹ / ₂ (216)	6 ¹ / ₂ (165)	8	7/8 (22)	-	1 (25)	-	3 ⁵ / ₈ (92)	-	1/4 (6)	-	- 1	1/2 (38)	-
Class 1500	8 ¹ / ₂ (216)	6 ¹ / ₂ (165)	8	7/8 (22)	-	1 (25)	-	3 ⁵ / ₈ (92)	-	1/4 (6)	-	- 1	1/2 (38)	-
BS 10														
Table A	6 (152)	4 ¹ / ₂ (114)	4	5/8 (16)	1 ¹ / ₁₆ (17)	1 ¹ / ₁₆ (17)	-	-	-	-	5/8 (16)	3/8 (10)	-	-
Table D	6 (152)	4 ¹ / ₂ (114)	4	5/8 (16)	1 ¹ / ₁₆ (17)	1 ¹ / ₁₆ (17)	-	-	-	-	1 ¹ / ₁₆ (17)	3/8 (10)	9/16 (14)	-
Table E	6 (152)	4 ¹ / ₂ (114)	4	5/8 (16)	1 ¹ / ₁₆ (17)	1 ¹ / ₁₆ (17)	-	-	-	-	3/4 (19)	3/8 (10)	9/16 (14)	-
Table F	6 ¹ / ₂ (165)	5 (127)	4	5/8 (16)	1 ¹ / ₁₆ (17)	1 ¹ / ₁₆ (17)	-	-	-	-	3/4 (19)	7/16 (11)	5/8 (16)	-
Table H	6 ¹ / ₂ (165)	5 (127)	4	5/8 (16)	1 ¹ / ₁₆ (17)	1 ¹ / ₁₆ (17)	-	4 (102)	-	1/16 (2)	1 (25)	1/2 (13)	3/4 (19)	-

(1) These flange thicknesses are also valid for ductile iron flanges type 21-2 (2) Flange thicknesses for copper alloy are from BS 4504 (3) Copper alloy flanges are always flat-faced

Nominal Size 65mm (2¹/₂")

BS EN 1092	Dia. of flange	Bolt circle diameter	No. of bolts	Dia. of bolts	Dia. of holes Iron	Dia. of holes Steel	Dia. of raised face(3) Iron	Dia. of raised face(3) Steel	Height of raised face(3) Iron	Height of raised face(3) Steel	Thickness of flange			
											Grey Cast Iron	Copper Alloy	Cast and Forged Steel	Ductile Cast Iron
PN 6	160	130	4	M12	14	14	108	110	2	3	16 (1)	-	14	-
PN 10	185	145	4 (2)	M16	19	18	118	122	2	3	20 (1)	-	18	19
PN 16	185	145	4 (2)	M16	19	18	118	122	2	3	20 (1)	13	18	19
PN 25	185	145	8	M16	19	18	118	122	2	3	24 (1)	13	22	19
PN 40	185	145	8	M16	19	18	118	122	2	3	-	14	22	19
PN 64	205	160	8	M20	-	22	-	122	2	-	-	-	26	-
PN 100	220	170	8	M24	-	26	-	122	2	-	-	-	34	-
ANSI														
Class 125/150	7 (178)	5 ¹ / ₂ (140)	4	5/8 (16)	3/4 (19)	3/4 (19)	-	4 ¹ / ₈ (105)	-	1/16 (2)	1 ¹ / ₁₆ (17)	9/16 (14)	1 ¹ / ₁₆ (17)	-
Class 300	7 ¹ / ₂ (191)	5 ⁷ / ₈ (149)	8	3/4 (19)	-	7/8 (22)	-	4 ¹ / ₈ (105)	-	1/16 (2)	-	1 ³ / ₁₆ (21)	1 (25)	-
Class 600	7 ¹ / ₂ (191)	5 ⁷ / ₈ (149)	8	3/4 (19)	-	7/8 (22)	-	4 ¹ / ₈ (105)	-	1/4 (6)	-	-	1 ¹ / ₈ (29)	-
Class 900	9 ⁵ / ₈ (244)	7 ¹ / ₂ (191)	8	1 (25)	-	1 ¹ / ₈ (29)	-	4 ¹ / ₈ (105)	-	1/4 (6)	-	-	1 ⁵ / ₈ (41)	-
Class 1500	9 ⁵ / ₈ (244)	7 ¹ / ₂ (191)	8	1 (25)	-	1 ¹ / ₈ (29)	-	4 ¹ / ₈ (105)	-	1/4 (6)	-	-	1 ⁵ / ₈ (41)	-
BS 10														
Table A	6 ¹ / ₂ (165)	5 (127)	4	5/8 (16)	1 ¹ / ₁₆ (17)	1 ¹ / ₁₆ (17)	-	-	-	-	1 ¹ / ₁₆ (17)	7/16 (11)	-	-
Table D	6 ¹ / ₂ (165)	5 (127)	4	5/8 (16)	1 ¹ / ₁₆ (17)	1 ¹ / ₁₆ (17)	-	-	-	-	1 ¹ / ₁₆ (17)	7/16 (11)	9/16 (14)	-
Table E	6 ¹ / ₂ (165)	5 (127)	4	5/8 (16)	1 ¹ / ₁₆ (17)	1 ¹ / ₁₆ (17)	-	-	-	-	3/4 (19)	7/16 (11)	9/16 (14)	-
Table F	7 ¹ / ₄ (184)	5 ³ / ₄ (146)	8	5/8 (16)	1 ¹ / ₁₆ (17)	1 ¹ / ₁₆ (17)	-	-	-	-	3/4 (19)	1/2 (13)	5/8 (16)	-
Table H	7 ¹ / ₄ (184)	5 ³ / ₄ (146)	8	5/8 (16)	1 ¹ / ₁₆ (17)	1 ¹ / ₁₆ (17)	-	4 ¹ / ₂ (114)	-	1/16 (2)	1 (25)	9/16 (14)	3/4 (19)	-

(1) These flange thicknesses are also valid for ductile iron flanges type 21-2 (2) Steel flanges in this DN and PN may be supplied with 8 holes. For compliance with these, equivalent cast iron flanges may be supplied with 8 holes as special order and after agreement between manufacturer and customer (3) Flange thicknesses for copper alloy are from BS 4504 (4) Copper alloy flanges are always flat-faced

Nominal Size 80mm (3")

BS EN 1092	Dia. of flange	Bolt circle diameter	No. of bolts	Dia. of bolts	Dia. of holes Iron	Dia. of holes Steel	Dia. of raised face(3) Iron	Dia. of raised face(3) Steel	Height of raised face(3) Iron	Height of raised face(3) Steel	Thickness of flange			
											Grey Cast Iron	Copper Alloy	Cast and Forged Steel	Ductile Cast Iron
PN 6	190	150	4	M16	19	18	124	128	3	2	18 (1)	-	16	-
PN10	200	160	8	M16	19	18	132	138	3	2	22 (1)	-	20	19
PN16	200	160	8	M16	19	18	132	138	3	2	22 (1)	13 (2)	20	19
PN25	200	160	8	M16	19	18	132	138	3	2	26 (1)	14 (2)	24	19
PN40	200	160	8	M16	19	18	132	138	3	2	-	16 (2)	24	19
PN64	215	170	8	M20	-	22	-	138	-	2	-	-	28	-
PN100	230	180	8	M24	-	26	-	138	-	2	-	-	36	-
ANSI														
Class 125/150	7 ¹ / ₂ (191)	6 (152)	4	5/8 (16)	3/4 (19)	3/4 (19)	-	5 (127)	-	1/16 (2)	3/4 (19)	5/8 (16)	3/4 (19)	-
Class 300	8 ¹ / ₄ (210)	6 ⁵ / ₈ (168)	8	3/4 (19)	-	7/8 (22)	-	5 (127)	-	1/16 (2)	-	29/32 (23)	1 ¹ / ₈ (29)	-
Class 600	8 ¹ / ₄ (210)	6 ⁵ / ₈ (168)	8	3/4 (19)	-	7/8 (22)	-	5 (127)	-	1/4 (6)	-	-	1 ¹ / ₄ (32)	-
Class 900	9 ¹ / ₂ (241)	7 ¹ / ₂ (192)	8	7/8 (22)	-	1 (25)	-	5 (127)	-	1/4 (6)	-	-	1 ¹ / ₂ (38)	-
Class 1500	10 ¹ / ₂ (267)	8 (203)	8	1 ¹ / ₈ (29)	-	1 ¹ / ₄ (32)	-	5 (127)	-	1/4 (6)	-	-	1 ⁷ / ₈ (46)	-
BS 10														
Table A	7 ¹ / ₄ (184)	5 ³ / ₄ (146)	4	5/8 (16)	1 ¹ / ₁₆ (17)	1 ¹ / ₁₆ (17)	-	-	-	-	1 ¹ / ₁₆ (17)	1/2 (13)	-	-
Table D	7 ¹ / ₄ (184)	5 ³ / ₄ (146)	4	5/8 (16)	1 ¹ / ₁₆ (17)	1 ¹ / ₁₆ (17)	-	-	-	-	3/4 (19)	1/2 (13)	9/16 (14)	-
Table E	7 ¹ / ₄ (184)	5 ³ / ₄ (146)	4	5/8 (16)	1 ¹ / ₁₆ (17)	1 ¹ / ₁₆ (17)	-	-	-	-	3/4 (19)	1/2 (13)	9/16 (14)	-
Table F	8 (203)	6 ¹ / ₂ (165)	8	5/8 (16)	1 ¹ / ₁₆ (17)	1 ¹ / ₁₆ (17)	-	-	-	-	3/4 (19)	9/16 (14)	5/8 (16)	-
Table H	8 (203)	6 ¹ / ₂ (165)	8	5/8 (16)	1 ¹ / ₁₆ (17)	1 ¹ / ₁₆ (17)	-	5 (127)	-	1/16 (2)	1 ¹ / ₈ (29)	5/8 (16)	7/8 (22)	-

(1) These flange thicknesses are also valid for ductile iron flanges type 21-2 (2) Flange thicknesses for copper alloy are from BS 4504 (3) Copper alloy flanges are always flat-faced

Nominal Size 100mm (4")

BS EN 1092	Dia. of flange	Bolt circle diameter	No. of bolts	Dia. of bolts	Dia. of holes Iron	Dia. of holes Steel	Dia. of raised face(3) Iron	Dia. of raised face(3) Steel	Height of raised face(3) Iron	Height of raised face(3) Steel	Thickness of flange			
											Grey Cast Iron	Copper Alloy	Cast and Forged Steel	Ductile Cast Iron
PN 6	210	170	4	M16	19	18	144	148	3	2	18 (1)	-	16	-
PN10	220	180	8	M16	19	18	156	158	3	2	24 (1)	-	20	19
PN16	220	180	8	M16	19	18	156	158	3	2	24 (1)	16 (2)	20	19
PN25	235	190	8	M20	23	22	156	162	3	2	28 (1)	17 (2)	24	19
PN40	235	190	8	M20	23	22	156	162	3	2	-	19 (2)	24	19
PN64	250	200	8	M24	-	26	-	162	-	2	-	-	30	-
PN100	265	210	8	M27	-	30	-	162	-	2	-	-	40	-
ANSI														
Class 125/150	9 (229)	7 ¹ / ₂ (191)	8	5/8 (16)	3/4 (19)	3/4 (19)	-	6 ³ / ₁₆ (157)	-	1/16 (2)	1 ⁵ / ₁₆ (24)	1 ¹ / ₁₆ (17)	1 ⁵ / ₁₆ (24)	-
Class 300	10 (254)	7 ⁷ / ₈ (200)	8	3/4 (19)	-	7/8 (22)	-	6 ³ / ₁₆ (157)	-	1/16 (2)	-	1 ¹ / ₁₆ (27)	1 ¹ / ₄ (32)	-
Class 600	10 ³ / ₄ (273)	8 ¹ / ₂ (216)	8	7/8 (22)	-	1 (25)	-	6 ³ / ₁₆ (157)	-	1/4 (6)	-	-	1 ¹ / ₂ (38)	-
Class 900	11 ¹ / ₂ (292)	9 ¹ / ₄ (235)	8	1 ¹ / ₈ (29)	-	1 ¹ / ₄ (32)	-	6 ³ / ₁₆ (157)	-	1/4 (6)	-	-	1 ³ / ₄ (44)	-
Class 1500	12 ¹ / ₄ (311)	9 ¹ / ₂ (241)	8	1 ¹ / ₄ (32)	-	1 ³ / ₈ (35)	-	6 ³ / ₁₆ (157)	-	1/4 (6)	-	-	2 ¹ / ₈ (54)	-
BS 10														
Table A	8 ¹ / ₂ (216)	7 (178)	4	5/8 (16)	1 ¹ / ₁₆ (17)	1 ¹ / ₁₆ (17)	-	-	-	-	3/4 (19)	5/8 (16)	-	-
Table D	8 ¹ / ₂ (216)	7 (178)	4	5/8 (16)	1 ¹ / ₁₆ (17)	1 ¹ / ₁₆ (17)	-	-	-	-	3/4 (19)	5/8 (16)	1 ¹ / ₁₆ (17)	-
Table E	8 ¹ / ₂ (216)	7 (178)	8	5/8 (16)	1 ¹ / ₁₆ (17)	1 ¹ / ₁₆ (17)	-	-	-	-	7/8 (22)	5/8 (16)	1 ¹ / ₁₆ (17)	-
Table F	9 (229)	7 ¹ / ₂ (191)	8	5/8 (16)	1 ¹ / ₁₆ (17)	1 ¹ / ₁₆ (17)	-	-	-	-	7/8 (22)	1 ¹ / ₁₆ (17)	3/4 (19)	-
Table H	9 (229)	7 ¹ / ₂ (191)	8	5/8 (16)	1 ¹ / ₁₆ (17)	1 ¹ / ₁₆ (17)	-	6 (152)	-	1/16 (2)	1 ¹ / ₄ (32)	3/4 (19)	1 (25)	-

(1) These flange thicknesses are also valid for ductile iron flanges type 21-2 (2) Flange thicknesses for copper alloy are from BS 4504 (3) Copper alloy flanges are always flat-faced

Nominal Size 125mm (5")

BS EN 1092	Dia. of flange	Bolt circle diameter	No. of bolts	Dia. of bolts	Dia. of holes Iron	Dia. of holes Steel	Dia. of raised face(3) Iron	Dia. of raised face(3) Steel	Height of raised face(3) Iron	Height of raised face(3) Steel	Thickness of flange			
											Grey Cast Iron	Copper Alloy	Cast and Forged Steel	Ductile Cast Iron
PN 6	240	200	8	M16	19	18	174	178	3	2	20 (1)	-	18	-
PN10	250	210	8	M16	19	18	184	188	3	2	26 (1)	-	22	19
PN16	250	210	8	M16	19	18	184	188	3	2	26 (1)	-	22	19
PN25	270	220	8	M24	28	26	184	188	3	2	30 (1)	-	26	19
PN40	270	220	8	M24	28	26	184	188	3	2	-	-	26	23.5
PN64	295	240	8	M27	-	30	-	188	-	2	-	-	34	-
PN100	315	250	8	M30	-	33	-	188	-	2	-	-	40	-
ANSI														
Class 125/150	10 (254)	8 ¹ / ₂ (216)	8	3/4 (19)	7/8 (22)	7/8 (22)	-	7 ⁵ / ₁₆ (186)	-	1/16 (2)	5/16 (24)	3/4 (19)	5/16 (24)	-
Class 300	11 (279)	9 ¹ / ₄ (235)	8	3/4 (19)	-	7/8 (22)	-	7 ⁵ / ₁₆ (186)	-	1/16 (2)	-	1 ¹ / ₈ (29)	1 ³ / ₈ (35)	-
Class 600	13 (330)	10 ¹ / ₂ (267)	8	1 (25)	-	1 ¹ / ₈ (29)	-	7 ⁵ / ₁₆ (186)	-	1/4 (6)	-	-	1 ³ / ₄ (44)	-
Class 900	13 ³ / ₄ (349)	11 (279)	8	1 ¹ / ₄ (32)	-	1 ³ / ₈ (35)	-	7 ⁵ / ₁₆ (186)	-	1/4 (6)	-	-	2 (51)	-
Class 1500	14 ³ / ₄ (375)	11 ¹ / ₂ (292)	8	1 ¹ / ₂ (38)	-	1 ⁵ / ₈ (41)	-	7 ⁵ / ₁₆ (186)	-	1/4 (6)	-	-	2 ⁷ / ₈ (73)	-
BS 10														
Table A	10 (254)	8 ¹ / ₄ (210)	4	5/8 (16)	1 ¹ / ₁₆ (17)	1 ¹ / ₁₆ (17)	-	-	-	-	3/4 (19)	1 ¹ / ₁₆ (17)	-	-
Table D	10 (254)	8 ¹ / ₄ (210)	8	5/8 (16)	1 ¹ / ₁₆ (17)	1 ¹ / ₁₆ (17)	-	-	-	-	1 ³ / ₁₆ (21)	1 ¹ / ₁₆ (17)	1 ¹ / ₁₆ (17)	-
Table E	10 (254)	8 ¹ / ₄ (210)	8	5/8 (16)	1 ¹ / ₁₆ (17)	1 ¹ / ₁₆ (17)	-	-	-	-	7/8 (22)	1 ¹ / ₁₆ (17)	1 ¹ / ₁₆ (17)	-
Table F	11 (279)	9 ¹ / ₄ (235)	8	3/4 (19)	7/8 (22)	7/8 (22)	-	-	-	-	1 (25)	3/4 (19)	7/8 (22)	-
Table H	11 (279)	9 ¹ / ₄ (235)	8	3/4 (19)	7/8 (22)	7/8 (22)	-	7 (178)	-	1/16 (2)	1 ³ / ₈ (35)	7/8 (22)	1 ¹ / ₈ (29)	-

- (1) These flange thicknesses are also valid for ductile iron flanges type 21-2
- (2) Copper alloy flanges are always flat-faced

Nominal Size 150mm (6")

BS EN 1092	Dia. of flange	Bolt circle diameter	No. of bolts	Dia. of bolts	Dia. of holes Iron	Dia. of holes Steel	Dia. of raised face(3) Iron	Dia. of raised face(3) Steel	Height of raised face(3) Iron	Height of raised face(3) Steel	Thickness of flange			
											Grey Cast Iron	Copper Alloy	Cast and Forged Steel	Ductile Cast Iron
PN6	265	225	8	M16	19	18	199	202	3	2	20 (1)	-	18	-
PN10	285	240	8	M20	23	22	211	212	3	2	26 (1)	-	22	19
PN16	285	240	8	M20	23	22	211	212	3	2	26 (1)	-	22	19
PN25	300	250	8	M24	28	26	211	218	3	2	34 (1)	-	28	20
PN40	300	250	8	M24	28	26	211	218	3	2	-	-	28	26
PN64	345	280	8	M30	-	33	-	218	-	2	-	-	36	-
PN100	355	290	12	M30	-	33	-	218	-	2	-	-	44	-
ANSI														
Class 125/150	11 (279)	9 ¹ / ₂ (241)	8	3/4 (19)	7/8 (22)	7/8 (22)	-	8 ¹ / ₂ (216)	-	1/16 (2)	1 (25)	1 ³ / ₁₆ (21)	1 (25)	-
Class 300	12 ¹ / ₂ (318)	10 ⁵ / ₈ (270)	12	3/4 (19)	-	7/8 (22)	-	8 ¹ / ₂ (216)	-	1/16 (2)	-	1 ³ / ₁₆ (30)	1 ⁷ / ₈ (37)	-
Class 600	14 (356)	11 ¹ / ₂ (292)	12	1 (25)	-	1 ¹ / ₈ (29)	-	8 ¹ / ₂ (216)	-	1/4 (6)	-	-	1 ⁷ / ₈ (48)	-
Class 900	15 (381)	12 ¹ / ₂ (318)	12	1 ¹ / ₈ (29)	-	1 ¹ / ₄ (32)	-	8 ¹ / ₂ (216)	-	1/4 (6)	-	-	2 ³ / ₁₆ (56)	-
Class 1500	15 ¹ / ₂ (394)	12 ¹ / ₂ (318)	12	1 ³ / ₈ (35)	-	1 ¹ / ₂ (38)	-	8 ¹ / ₂ (216)	-	1/4 (6)	-	-	3 ¹ / ₄ (83)	-
BS 10														
Table A	11 (279)	9 ¹ / ₄ (235)	4	5/8 (16)	1 ¹ / ₁₆ (17)	1 ¹ / ₁₆ (17)	-	-	-	-	1 ³ / ₁₆ (21)	1 ¹ / ₁₆ (17)	-	-
Table D	11 (279)	9 ¹ / ₄ (235)	8	5/8 (16)	1 ¹ / ₁₆ (17)	1 ¹ / ₁₆ (17)	-	-	-	-	1 ³ / ₁₆ (21)	1 ¹ / ₁₆ (17)	1 ¹ / ₁₆ (17)	-
Table E	11 (279)	9 ¹ / ₄ (235)	8	3/4 (19)	7/8 (22)	7/8 (22)	-	-	-	-	7/8 (22)	1 ¹ / ₁₆ (17)	1 ¹ / ₁₆ (17)	-
Table F	12 (305)	10 ¹ / ₄ (260)	12	3/4 (19)	7/8 (22)	7/8 (22)	-	-	-	-	1 (25)	7/8 (22)	7/8 (22)	-
Table H	12 (305)	10 ¹ / ₄ (260)	12	3/4 (19)	7/8 (22)	7/8 (22)	-	8 ¹ / ₄ (210)	-	1/16 (2)	1 ³ / ₈ (35)	1 (25)	1 ¹ / ₈ (29)	-

- (1) These flange thicknesses are also valid for ductile iron flanges type 21-2
- (2) Copper alloy flanges are always flat-faced

Nominal Size 200mm (8")

BS EN 1092	Dia. of flange	Bolt circle diameter	No. of bolts	Dia. of bolts	Dia. of holes Iron	Dia. of holes Steel	Dia. of raised face(3) Iron	Dia. of raised face(3) Steel	Height of raised face(3) Iron	Height of raised face(3) Steel	Thickness of flange			
											Grey Cast Iron	Copper Alloy	Cast and Forged Steel	Ductile Cast Iron
PN 6	320	280	8	M16	19	18	254	258	3	2	22 (1)	-	20	-
PN10	340	295	8	M20	23	22	266	268	3	2	26 (1)	-	24	20
PN16	340	295	12	M20	23	22	266	268	3	2	30 (1)	-	24	20
PN25	360	310	12	M24	28	26	274	278	3	2	34 (1)	-	30	22
PN40	375	320	12	M27	31	30	284	285	3	2	-	-	34	30
PN64	415	345	12	M33	-	36	-	285	-	2	-	-	42	-
PN100	430	360	12	M33	-	36	-	285	-	2	-	-	52	-
ANSI														
Class 125/150	13 ¹ / ₂ (343)	11 ³ / ₄ (298)	8	3/4 (19)	7/8 (22)	7/8 (22)	-	10 ⁵ / ₈ (270)	-	1/16 (2)	1 1/8 (29)	1 5/16 (24)	1 1/8 (29)	-
Class 300	15 (381)	13 (330)	12	7/8 (22)	-	1 (25)	-	10 ⁵ / ₈ (270)	-	1/16 (2)	-	1 3/8 (35)	1 5/8 (41)	-
Class 600	16 ¹ / ₂ (419)	13 ³ / ₄ (349)	12	1 1/8 (29)	-	1 1/4 (32)	-	10 ⁵ / ₈ (270)	-	1/4 (6)	-	-	2 3/16 (56)	-
Class 900	18 ¹ / ₂ (470)	15 ¹ / ₂ (394)	12	1 3/8 (35)	-	1 1/2 (38)	-	10 ⁵ / ₈ (270)	-	1/4 (6)	-	-	2 1/2 (64)	-
Class 1500	19 (438)	15 ¹ / ₂ (394)	12	1 5/8 (41)	-	1 3/4 (44)	-	10 ⁵ / ₈ (270)	-	1/4 (6)	-	-	3 5/8 (92)	-
BS 10														
Table A	13 ¹ / ₄ (337)	11 ¹ / ₂ (292)	8	5/8 (16)	11/16 (17)	11/16 (17)	-	-	-	-	7/8 (22)	3/4 (19)	1/2 (13)	-
Table D	13 ¹ / ₄ (337)	11 ¹ / ₂ (292)	8	5/8 (16)	11/16 (17)	11/16 (17)	-	-	-	-	7/8 (22)	3/4 (19)	3/4 (19)	-
Table E	13 ¹ / ₄ (337)	11 ¹ / ₂ (292)	8	3/4 (19)	7/8 (22)	7/8 (22)	-	-	-	-	1 (25)	3/4 (19)	3/4 (19)	-
Table F	14 ¹ / ₂ (368)	12 ³ / ₄ (324)	12	3/4 (19)	7/8 (22)	7/8 (22)	-	-	-	-	1 1/8 (29)	1 (25)	1 (25)	-
Table H	14 ¹ / ₂ (368)	12 ³ / ₄ (324)	12	3/4 (19)	7/8 (22)	7/8 (22)	-	10 ¹ / ₄ (260)	-	1/16 (2)	1 1/2 (38)	1 1/4 (32)	1 1/4 (32)	-

(1) These flange thicknesses are also valid for ductile iron flanges type 21-2

(2) Copper alloy flanges are always flat-faced

Nominal Size 250mm (10")

BS EN 1092	Dia. of flange	Bolt circle diameter	No. of bolts	Dia. of bolts	Dia. of holes Iron	Dia. of holes Steel	Dia. of raised face(3) Iron	Dia. of raised face(3) Steel	Height of raised face(3) Iron	Height of raised face(3) Steel	Thickness of flange			
											Grey Cast Iron	Copper Alloy	Cast and Forged Steel	Ductile Cast Iron
PN6	375	335	12	M16	19	18	309	312	3	2	24 (1)	-	22	-
PN10	395 (2)	350	12	M20	23	22	319	320	3	2	28 (1)	-	26	22
PN16	405 (2)	355	12	M24	28	26	319	320	3	2	32 (1)	-	26	22
PN25	425	370	12	M27	31	30	330	335	3	2	-	-	32	24.5
PN40	450	385	12	M30	34	33	345	345	3	2	-	-	38	34.5
PN64	470	400	12	M33	-	36	-	345	-	2	-	-	46	-
PN100	505	430	12	M36	-	39	-	345	-	2	-	-	60	-
ANSI														
Class 125/150	16 (406)	14 ¹ / ₄ (362)	12	7/8 (22)	1 (25)	1 (25)	-	12 ³ / ₄ (324)	-	1/16 (2)	1 3/16 (30)	1 (25)	1 3/16 (30)	-
Class 300	17 ¹ / ₂ (445)	15 ¹ / ₄ (387)	16	1 (25)	-	1 1/8 (29)	-	12 ³ / ₄ (324)	-	1/16 (2)	-	-	1 7/8 (41)	-
Class 600	20 (508)	17 (432)	16	1 1/4 (32)	-	1 3/8 (35)	-	12 ³ / ₄ (324)	-	1/4 (6)	-	-	2 1/2 (64)	-
Class 900	21 ¹ / ₂ (546)	18 ¹ / ₂ (470)	16	1 3/8 (35)	-	1 1/2 (38)	-	12 ³ / ₄ (324)	-	1/4 (6)	-	-	2 3/4 (70)	-
Class 1500	23 (584)	19 (483)	12	1 7/8 (41)	-	2 (51)	-	12 ³ / ₄ (324)	-	1/4 (6)	-	-	4 1/4 (108)	-
BS 10														
Table A	16 (406)	14 (356)	8	3/4 (19)	7/8 (22)	7/8 (22)	-	-	-	-	1 5/16 (24)	3/4 (19)	-	-
Table D	16 (406)	14 (356)	8	3/4 (19)	7/8 (22)	7/8 (22)	-	-	-	-	1 (25)	3/4 (19)	3/4 (19)	-
Table E	16 (406)	14 (356)	12	3/4 (19)	7/8 (22)	7/8 (22)	-	-	-	-	1 (25)	7/8 (22)	7/8 (22)	-
Table F	17 (432)	15 (381)	12	7/8 (22)	1 (25)	1 (25)	-	-	-	-	1 1/8 (29)	1 (25)	1 (25)	-
Table H	17 (432)	15 (381)	12	7/8 (22)	1 (25)	1 (25)	-	12 ¹ / ₄ (311)	-	1/16 (2)	1 5/8 (41)	1 3/8 (35)	1 3/8 (35)	-

(1) These flange thicknesses are also valid for ductile iron flanges type 21-2

(2) For ductile iron pipes and fittings the outside diameters shall be: for PN10, D = 400mm, for PN16, D = 400mm

(3) Copper alloy flanges are always flat-faced

Nominal Size 300mm (12")

BS EN 1092	Dia. of flange	Bolt circle diameter	No. of bolts	Dia. of bolts	Dia. of holes Iron	Dia. of holes Steel	Dia. of raised face(3) Iron	Dia. of raised face(3) Steel	Height of raised face(3) Iron	Height of raised face(3) Steel	Thickness of flange			
											Grey Cast Iron	Copper Alloy	Cast and Forged Steel	Ductile Cast Iron
PN6	440	395	12	M20	23	22	363	365	4	2	24 (1)	-	22	-
PN10	445 (2)	400	12	M20	23	22	370	370	4	2	28 (1)	-	26	24.5
PN16	460 (2)	410	12	M24	28	26	370	378	4	2	32 (1)	-	28	24.5
PN25	485	430	16	M27	31	30	389	395	4	2	40 (1)	-	34	27.5
PN40	515	450	16	M30	34	33	409	410	4	2	-	-	42	39.5
PN64	530	460	16	M33	-	36	-	410	-	2	-	-	52	-
PN100	585	500	16	M39	-	42	-	410	-	2	-	-	68	-
ANSI														
Class 125/150	19 (483)	17 (432)	12	7/8 (22)	1 (25)	1 (25)	-	15 (381)	-	1/16 (2)	1 1/4 (32)	1 1/16 (27)	1 1/4 (32)	-
Class 300	20 1/2 (521)	17 3/4 (451)	16	1 1/8 (29)	-	1 1/4 (32)	-	15 (381)	-	1/16 (2)	-	-	2 (51)	-
Class 600	22 (559)	19 1/4 (489)	20	1 1/4 (32)	-	1 3/8 (35)	-	15 (381)	-	1/4 (6)	-	-	2 5/8 (67)	-
Class 900	24 (610)	21 (533)	20	1 3/8 (35)	-	1 1/2 (38)	-	15 (381)	-	1/4 (6)	-	-	3 1/8 (80)	-
Class 1500	26 1/2 (673)	22 1/2 (571)	16	2 (51)	-	2 1/8 (54)	-	15 (381)	-	1/4 (6)	-	-	4 7/8 (124)	-
BS 10														
Table A	18 (457)	16 (406)	8	3/4 (19)	7/8 (22)	7/8 (22)	-	-	-	-	1 5/16 (24)	7/8 (22)	-	-
Table D	18 (457)	16 (406)	12	3/4 (19)	7/8 (22)	7/8 (22)	-	-	-	-	1 (25)	7/8 (22)	7/8 (22)	-
Table E	18 (457)	16 (406)	12	7/8 (22)	1 (25)	1 (25)	-	-	-	-	1 1/8 (29)	1 (25)	1 (25)	-
Table F	19 1/4 (489)	17 1/4 (438)	16	7/8 (22)	1 (25)	1 (25)	-	-	-	-	1 1/4 (32)	1 1/8 (29)	1 1/8 (29)	-
Table H	19 1/4 (489)	17 1/4 (438)	16	7/8 (22)	1 (25)	1 (25)	-	14 1/4 (362)	-	1/16 (2)	1 3/4 (44)	1 1/2 (38)	1 1/2 (38)	-

(1) These flange thicknesses are also valid for ductile iron flanges type 21-2

(2) For ductile iron pipes and fittings the outside diameter shall be: for PN10, D = 455mm; for PN16, D = 455 mm

(3) Copper alloy flanges are always flat-faced

Nominal Size 350mm (14")

BS EN 1092	Dia. of flange	Bolt circle diameter	No. of bolts	Dia. of bolts	Dia. of holes Iron	Dia. of holes Steel	Dia. of raised face(3) Iron	Dia. of raised face(3) Steel	Height of raised face(3) Iron	Height of raised face(3) Steel	Thickness of flange			
											Grey Cast Iron	Copper Alloy	Cast and Forged Steel	Ductile Cast Iron
PN6	490	445	12	M20	23	22	413	415	4	2	26 (1)	-	22	-
PN10	505	460	16	M20	23	22	429	430	4	2	30 (1)	-	26	24.5
PN16	520	470	16	M24	28	26	429	438	4	2	36 (1)	-	30	26.5
PN25	555	490	16	M30	34	33	448	450	4	2	44 (1)	-	38	30
PN40	580	510	16	M33	37	36	465	465	4	2	-	-	46	44
PN64	600	525	16	M36	-	39	-	465	-	2	-	-	56	-
PN100	655	560	16	M45	-	48	-	465	-	2	-	-	74	-
ANSI														
Class 125/150	21 (533)	18 3/4 (476)	12	1 (25)	1 1/8 (29)	1 1/8 (29)	-	16 1/4 (413)	-	1/16 (2)	1 3/8 (35)	-	1 3/8 (35)	-
Class 300	23 (584)	20 1/4 (514)	20	1 1/8 (29)	-	1 1/4 (32)	-	16 1/4 (413)	-	1/16 (2)	-	-	2 1/8 (54)	-
Class 600	23 3/4 (603)	20 3/4 (527)	20	1 3/8 (35)	-	1 1/2 (38)	-	16 1/4 (413)	-	1/4 (6)	-	-	2 3/4 (70)	-
Class 900	25 1/4 (641)	22 (559)	20	1 1/2 (38)	-	1 5/8 (41)	-	16 1/4 (413)	-	1/4 (6)	-	-	3 (86)	-
Class 1500	29 1/2 (749)	25 (635)	16	2 1/4 (57)	-	2 3/8 (60)	-	16 1/4 (413)	-	1/4 (6)	-	-	5 1/4 (133)	-
BS 10														
Table A	20 3/4 (527)	18 1/2 (470)	8	7/8 (22)	1 (25)	1 (25)	-	-	-	-	1 (25)	1 (25)	-	-
Table D	20 3/4 (527)	18 1/2 (470)	12	7/8 (22)	1 (25)	1 (25)	-	-	-	-	1 1/8 (29)	1 (25)	1 (25)	-
Table E	20 3/4 (527)	18 1/2 (470)	12	7/8 (22)	1 (25)	1 (25)	-	-	-	-	1 1/4 (32)	1 (25)	1 (25)	-
Table F	21 3/4 (552)	19 1/2 (495)	16	1 (25)	1 1/8 (29)	1 1/8 (29)	-	-	-	-	1 3/8 (35)	1 1/4 (32)	1 1/4 (32)	-
Table H	21 3/4 (552)	19 1/2 (495)	16	1 (25)	1 1/8 (29)	1 1/8 (29)	-	16 1/2 (419)	-	1/16 (2)	1 7/8 (48)	1 5/8 (41)	1 5/8 (41)	-

(1) These flange thicknesses are also valid for ductile iron flanges type 21-2

(2) Copper alloy flanges are always flat-faced

Nominal Size 400mm (16")

BS EN 1092	Dia. of flange	Bolt circle diameter	No. of bolts	Dia. of bolts	Dia. of holes Iron	Dia. of holes Steel	Dia. of raised face(3) Iron	Dia. of raised face(3) Steel	Height of raised face(3) Iron	Height of raised face(3) Steel	Thickness of flange			
											Grey Cast Iron	Copper Alloy	Cast and Forged Steel	Ductile Cast Iron
PN6	540	495	16	M20	23	22	463	465	4	2	28 (1)	-	22	-
PN10	565	515	16	M24	28	26	480	482	4	2	32 (1)	-	26	24.5
PN16	580	525	16	M27	31	30	480	490	4	2	38 (1)	-	32	28
PN25	620	550	16	M33	37	36	503	505	4	2	48 (1)	-	40	32
PN40	660	585	16	M36	41	39	535	535	4	2	-	-	50	48
PN64	670	585	16	M39	-	42	-	535	-	2	-	-	60	-
PN100	715	620	16	M45	-	48	-	535	-	2	-	-	78	-
ANSI														
Class 125/150	23 ¹ / ₂ (597)	21 ¹ / ₄ (540)	16	1 (25)	1 ¹ / ₈ (29)	1 ¹ / ₈ (29)	-	18 ¹ / ₂ (470)	-	1 ¹ / ₈ (2)	1 ⁷ / ₁₆ (37)	-	17 ¹ / ₁₆ (37)	-
Class 300	25 ¹ / ₂ (648)	22 ¹ / ₂ (572)	20	1 ¹ / ₄ (32)	-	1 ³ / ₈ (35)	-	18 ¹ / ₂ (470)	-	1 ¹ / ₈ (2)	-	-	2 ¹ / ₄ (57)	-
Class 600	27 (686)	23 ³ / ₄ (603)	20	1 ¹ / ₂ (38)	-	1 ⁵ / ₈ (41)	-	18 ¹ / ₂ (470)	-	1 ¹ / ₄ (6)	-	-	3 (76)	-
Class 900	27 ³ / ₄ (705)	24 ¹ / ₄ (616)	20	1 ⁵ / ₈ (41)	-	1 ³ / ₄ (44)	-	18 ¹ / ₂ (470)	-	1 ¹ / ₄ (6)	-	-	3 ¹ / ₂ (89)	-
Class 1500	32 ¹ / ₂ (826)	27 ³ / ₄ (705)	16	2 ¹ / ₂ (64)	-	2 ⁵ / ₈ (67)	-	18 ¹ / ₂ (470)	-	1 ¹ / ₄ (6)	-	-	5 ³ / ₄ (146)	-
BS 10														
Table A	22 ³ / ₄ (578)	20 ¹ / ₂ (521)	12	7 ⁸ / ₁₆ (22)	1 (25)	1 (25)	-	-	-	-	1 ¹ / ₁₆ (27)	1 (25)	-	-
Table D	22 ³ / ₄ (578)	20 ¹ / ₂ (521)	12	7 ⁸ / ₁₆ (22)	1 (25)	1 (25)	-	-	-	-	1 ¹ / ₈ (29)	1 (25)	1 (25)	-
Table E	22 ³ / ₄ (578)	20 ¹ / ₂ (521)	12	7 ⁸ / ₁₆ (22)	1 (25)	1 (25)	-	-	-	-	1 ¹ / ₄ (32)	1 (25)	1 (25)	-
Table F	24 (610)	21 ³ / ₄ (552)	20	1 (25)	1 ¹ / ₈ (29)	1 ¹ / ₈ (29)	-	-	-	-	1 ³ / ₈ (35)	1 ¹ / ₄ (32)	1 ¹ / ₄ (32)	-
Table H	24 (610)	21 ³ / ₄ (552)	20	1 (25)	1 ¹ / ₈ (29)	1 ¹ / ₈ (29)	-	19 (483)	-	1 ¹ / ₁₆ (2)	2 (51)	1 ³ / ₄ (44)	1 ³ / ₄ (44)	-

- (1) These flange thicknesses are also valid for ductile iron flanges type 21-2
- (2) Copper alloy flanges are always flat-faced

Nominal Size 450mm (18")

BS EN 1092	Dia. of flange	Bolt circle diameter	No. of bolts	Dia. of bolts	Dia. of holes Iron	Dia. of holes Steel	Dia. of raised face(3) Iron	Dia. of raised face(3) Steel	Height of raised face(3) Iron	Height of raised face(3) Steel	Thickness of flange			
											Grey Cast Iron	Copper Alloy	Cast and Forged Steel	Ductile Cast Iron
PN6	595	550	16	M20	23	22	518	520	4	2	28 (1)	-	22	-
PN10	615	565	20	M24	28	26	530	532	4	2	32 (1)	-	28	25.5
PN16	640	585	20	M27	31	30	548	550	4	2	40 (1)	-	40	30
PN25	670	600	20	M33	37	36	548	555	4	2	50 (1)	-	46	34.5
PN40	685	610	20	M36	41	39	560	560	4	2	-	-	57	49
PN64	-	-	-	-	-	-	-	-	-	-	-	-	-	-
PN100	-	-	-	-	-	-	-	-	-	-	-	-	-	-
ANSI														
Class 125/150	25 (635)	22 ³ / ₄ (578)	16	1 ¹ / ₈ (29)	1 ¹ / ₄ (32)	1 ¹ / ₄ (32)	-	21 (533)	-	1 ¹ / ₁₆ (2)	1 ⁹ / ₁₆ (40)	-	1 ⁹ / ₁₆ (40)	-
Class 300	28 (711)	24 ³ / ₄ (629)	24	1 ¹ / ₄ (32)	-	1 ³ / ₈ (35)	-	21 (533)	-	1 ¹ / ₁₆ (2)	-	-	2 ³ / ₈ (60)	-
Class 600	29 ¹ / ₄ (743)	25 ³ / ₄ (654)	20	1 ⁵ / ₈ (41)	-	1 ³ / ₄ (44)	-	21 (533)	-	1 ¹ / ₄ (6)	-	-	3 ¹ / ₄ (83)	-
Class 900	31 (787)	27 (686)	20	1 ⁷ / ₈ (48)	-	2 (51)	-	21 (533)	-	1 ¹ / ₄ (6)	-	-	4 (102)	-
Class 1500	36 (914)	30 ¹ / ₂ (775)	16	2 ³ / ₄ (70)	-	2 ⁷ / ₈ (73)	-	21 (533)	-	1 ¹ / ₄ (6)	-	-	6 ³ / ₈ (162)	-
BS 10														
Table A	25 ¹ / ₄ (641)	23 (584)	12	7 ⁸ / ₁₆ (22)	-	1 (25)	-	-	-	-	1 ¹ / ₁₆ (27)	1 ¹ / ₁₆ (27)	-	-
Table D	25 ¹ / ₄ (641)	23 (584)	12	7 ⁸ / ₁₆ (22)	-	1 (25)	-	-	-	-	1 ¹ / ₄ (32)	1 ¹ / ₈ (29)	1 ¹ / ₈ (29)	-
Table E	25 ¹ / ₄ (641)	23 (584)	16	7 ⁸ / ₁₆ (22)	-	1 (25)	-	-	-	-	1 ³ / ₈ (35)	1 ¹ / ₈ (29)	1 ¹ / ₈ (29)	-
Table F	26 ¹ / ₂ (673)	24 (610)	20	1 ¹ / ₈ (29)	-	1 ¹ / ₄ (32)	-	-	-	-	1 ¹ / ₂ (38)	1 ³ / ₈ (35)	1 ³ / ₈ (35)	-
Table H	26 ¹ / ₂ (673)	24 (610)	20	1 ¹ / ₈ (29)	-	1 ¹ / ₄ (32)	-	21 (533)	-	1 ¹ / ₁₆ (2)	2 ¹ / ₈ (54)	1 ⁷ / ₈ (48)	1 ⁷ / ₈ (48)	-

- (1) These flange thicknesses are also valid for ductile iron flanges type 21-2
- (2) Copper alloy flanges are always flat-faced

Nominal Size 500mm (20")

BS EN 1092	Dia. of flange	Bolt circle diameter	No. of bolts	Dia. of bolts	Dia. of holes Iron	Dia. of holes Steel	Dia. of raised face(3) Iron	Dia. of raised face(3) Steel	Height of raised face(3) Iron	Height of raised face(3) Steel	Thickness of flange			
											Grey Cast Iron	Copper Alloy	Cast and Forged Steel	Ductile Cast Iron
PN6	645	600	20	M20	23	22	568	570	4	2	30 (1)	-	24 (2)	-
PN10	670	620	20	M24	28	26	582	585	4	2	34 (1)	-	28 (2)	26.5
PN16	715	650	20	M30	34	33	609	610	4	2	42 (1)	-	44 (2)	31.5
PN25	730	660	20	M33	37	36	609	615	4	2	52 (1)	-	48 (2)	36.5
PN40	755	670	20	M39	44	42	615	615	4	2	-	-	57 (2)	52
PN64	800	705	20	M45	-	48	-	615	-	2	-	-	68 (2)	-
PN100	870	760	20	M52	-	56	-	615	-	2	-	-	94 (2)	-
ANSI														
Class 125/150	27 ¹ / ₂ (699)	25 (635)	20	1 ¹ / ₈ (29)	1 ¹ / ₄ (32)	1 ¹ / ₄ (32)	-	23 (584)	-	1 ¹ / ₈ (2)	1 ¹ / ₁₆ (43)	-	1 ¹ / ₁₆ (43)	-
Class 300	30 ¹ / ₂ (775)	27 (686)	24	1 ¹ / ₄ (32)	-	1 ³ / ₈ (35)	-	23 (584)	-	1 ¹ / ₈ (2)	-	-	2 ¹ / ₂ (64)	-
Class 600	32 (813)	28 ¹ / ₂ (724)	24	1 ⁵ / ₈ (41)	-	1 ³ / ₄ (44)	-	23 (584)	-	1 ¹ / ₄ (6)	-	-	3 ¹ / ₂ (89)	-
Class 900	33 ³ / ₄ (857)	29 ¹ / ₂ (749)	20	2 (51)	-	2 ¹ / ₈ (54)	-	23 (584)	-	1 ¹ / ₄ (6)	-	-	4 ¹ / ₄ (108)	-
Class 1500	38 ³ / ₄ (984)	32 ³ / ₄ (832)	16	3 (76)	-	3 ¹ / ₈ (79)	-	23 (584)	-	1 ¹ / ₄ (6)	-	-	7 (178)	-
BS 10														
Table A	27 ³ / ₄ (705)	25 ¹ / ₄ (641)	12	7 ⁸ / ₁₆ (22)	1 (25)	1 (25)	-	-	-	-	1 ¹ / ₈ (29)	1 ¹ / ₈ (29)	-	-
Table D	27 ³ / ₄ (705)	25 ¹ / ₄ (641)	16	7 ⁸ / ₁₆ (22)	1 (25)	1 (25)	-	-	-	-	1 ¹ / ₄ (32)	1 ¹ / ₄ (32)	-	-
Table E	27 ³ / ₄ (705)	25 ¹ / ₄ (641)	16	7 ⁸ / ₁₆ (22)	1 (25)	1 (25)	-	-	-	-	1 ¹ / ₂ (38)	1 ¹ / ₄ (32)	1 ¹ / ₄ (32)	-
Table F	29 (737)	26 ¹ / ₂ (673)	24	1 ¹ / ₈ (29)	1 ¹ / ₄ (32)	1 ¹ / ₄ (32)	-	-	-	-	1 ⁵ / ₈ (41)	1 ¹ / ₂ (38)	1 ¹ / ₂ (38)	-
Table H	29 (737)	26 ¹ / ₂ (673)	24	1 ¹ / ₈ (29)	1 ¹ / ₄ (32)	1 ¹ / ₄ (32)	-	23 ¹ / ₂ (597)	-	1 ¹ / ₈ (2)	2 ¹ / ₄ (57)	2 (51)	2 (51)	-

(1) These flange thicknesses are also valid for ductile iron flanges type 21-2

(2) These flange thicknesses are changed substantially as a result of the flange calculation method used in BS EN 1092-1

(3) Copper alloy flanges are always flat-faced

Nominal Size 600mm (24")

BS EN 1092	Dia. of flange	Bolt circle diameter	No. of bolts	Dia. of bolts	Dia. of holes Iron	Dia. of holes Steel	Dia. of raised face(3) Iron	Dia. of raised face(3) Steel	Height of raised face(3) Iron	Height of raised face(3) Steel	Thickness of flange			
											Grey Cast Iron	Copper Alloy	Cast and Forged Steel	Ductile Cast Iron
PN6	755	705	20	M24	28	26	667	670	5	2	30 (1)	-	30	-
PN10	780	725	20	M27	31	30	682	685	5	2	36 (1)	-	34	30
PN16	840	770	20	M33	37	36	720	725	5	2	48 (1)	-	54	36
PN25	845	770	20	M36	41	39	720	720	5	2	-	-	58	42
PN40	890	795	20	M45	50	48	735	735	5	2	-	-	72	58
PN64	930	820	20	M52	-	56	-	735	-	2	-	-	76	-
ANSI														
Class 125/150	32 (813)	29 ¹ / ₂ (749)	20	1 ¹ / ₄ (32)	1 ³ / ₈ (35)	1 ³ / ₈ (35)	-	27 ¹ / ₄ (692)	-	1 ¹ / ₈ (2)	1 ⁷ / ₈ (48)	-	1 ⁷ / ₈ (48)	-
Class 300	36 (914)	32 (813)	24	1 ¹ / ₂ (38)	-	1 ⁵ / ₈ (41)	-	27 ¹ / ₄ (692)	-	1 ¹ / ₈ (2)	-	-	2 ³ / ₄ (70)	-
Class 600	37 (940)	33 (838)	24	1 ⁷ / ₈ (48)	-	2 (51)	-	27 ¹ / ₄ (692)	-	1 ¹ / ₄ (6)	-	-	4 (102)	-
Class 900	41 (1041)	35 ¹ / ₂ (902)	20	2 ¹ / ₂ (64)	-	2 ⁵ / ₈ (67)	-	27 ¹ / ₄ (692)	-	1 ¹ / ₄ (6)	-	-	5 ¹ / ₂ (140)	-
Class 1500	46 (1168)	39 (991)	16	3 ¹ / ₂ (89)	-	3 ⁵ / ₈ (92)	-	27 ¹ / ₄ (692)	-	1 ¹ / ₄ (6)	-	-	8 (203)	-
BS 10														
Table A	32 ¹ / ₂ (826)	29 ³ / ₄ (756)	12	1 (25)	1 ¹ / ₈ (29)	1 ¹ / ₈ (29)	-	-	-	-	1 ³ / ₁₆ (30)	1 ³ / ₁₆ (30)	-	-
Table D	32 ¹ / ₂ (826)	29 ³ / ₄ (756)	16	1 (25)	1 ¹ / ₈ (29)	1 ¹ / ₈ (29)	-	-	-	-	1 ³ / ₈ (35)	1 ³ / ₈ (35)	1 ³ / ₈ (35)	-
Table E	32 ¹ / ₂ (826)	29 ³ / ₄ (756)	16	1 ¹ / ₈ (29)	1 ¹ / ₄ (32)	1 ¹ / ₄ (32)	-	-	-	-	1 ⁵ / ₈ (41)	1 ¹ / ₂ (38)	1 ¹ / ₂ (38)	-
Table F	33 ¹ / ₂ (851)	30 ³ / ₄ (781)	24	1 ¹ / ₄ (32)	1 ¹ / ₄ (32)	1 ³ / ₈ (35)	-	-	-	-	1 ³ / ₄ (44)	1 ⁵ / ₈ (41)	1 ⁵ / ₈ (41)	-
Table H	33 ¹ / ₂ (851)	30 ³ / ₄ (781)	24	1 ¹ / ₄ (32)	1 ³ / ₈ (35)	1 ³ / ₈ (35)	-	27 ¹ / ₂ (699)	-	1 ¹ / ₈ (2)	2 ¹ / ₂ (64)	2 ¹ / ₄ (57)	2 ¹ / ₄ (57)	-

(1) These flange thicknesses are also valid for ductile iron flanges type 21-2

(2) These flange thicknesses are changed substantially as a result of the flange calculation method used in BS EN 1092-1

(3) Copper alloy flanges are always flat-faced

Typical Kv Values

BALL VALVE

ie. Fig. 100

Size	Kv
15	31
20	45
25	63
32	102
40	375
50	420

BUTTERFLY VALVE

ie. Fig. 970

Size	Kv
65	227
80	350
100	696
125	1186
150	1832
200	3638
250	6194
300	9570
350	8163
400	12083
450	14169
500	18512
600	24208

GATE VALVE

ie. Fig. 30

Size	Kv
15	14
20	32
25	57
32	90
40	129
50	230

GATE VALVE

ie. Fig. M541

Size	Kv
65	360
80	519
100	923
125	1443
150	2077
200	3693
250	5771
300	8310

CHECK VALVE

ie. Fig. 47

Size	Kv
15	6.61
20	17.75
25	29.35
32	37.82
40	62.1
50	114

CHECK VALVE

ie. Fig. M651

Size	Kv
65	187
80	496
100	599
125	799
150	1428
200	2129
250	2725
300	3850

GLOBE VALVE

ie. Fig. 5

Size	Kv
15	3.05
20	5.71
25	10
32	14.22
40	18.79
50	34.23

GLOBE VALVE

ie. Fig. 731

Size	Kv
65	71
80	109
100	168
125	264
150	380
200	676
250	1065
300	1515

STRAINER

ie. Fig. 807

Size	Kv
15	5.6
20	8.5
25	15.1
32	26.4
40	31.9
50	52.5

STRAINER

ie. Fig. 810

Size	Kv
65	94
80	135
100	225
125	327
150	481
200	793
250	1353
300	1897

COMMISSIONING VALVE

ie. Fig. 1732

Size	Kv
15	1.87
20	3.14
25	5.59
32	10.8
40	18.1
50	29.1

COMMISSIONING VALVE

ie. Fig. M733

Size	Kv
65	69.4
80	101
100	175.8
125	274.9
150	387.6
200	717.7
250	1108
300	1593



Project: Sir Charles Parsons School, Newcastle

Client: Newcastle City Council

Civil Engineer: Sir Robert McAlpine

HVAC Contractor: Integral

Distributor: BSS (Newcastle) Ltd.

Specification: A range of Hattersley isolating and commissioning valves

A wide range of Hattersley valves, including Fig. 1732 commissioning valves, have been installed in Charles Parsons School, Walker. The secondary school was regenerated as part of the Government's *Building Schools for the Future (BSF)* programme and was one of 16 schools being redeveloped in the Newcastle-Upon-Tyne area. Valves were installed in the new purpose-built accommodation to provide heating, ventilation and air conditioning throughout the building. Sir Charles Parsons School is a large school for students with special educational needs and so along with classrooms, the building also houses sensory rooms and state-of-the-art swimming and therapy pools. The Hattersley valves are preferred because of their weight and space saving. The Hattersley technical team and regional manager liaised closely with contractors and specifiers to ensure this project ran smoothly.



Quality Assurance



WRc Evaluation and Testing Centre

The WRc Evaluation and Testing Centre is responsible for the Water Regulations Advisory Scheme, with testing and approval of water fittings meeting the requirements of the United Kingdom Water Regulations/Bylaws (Scotland).

Valves for use in public water supply systems and domestic situations must not contravene the United Kingdom Water Regulations. Valves which are designated WRAS Approved Product and listed in the Water Fittings and Materials Directory will not contravene those bylaws.

Many Hattersley valves have been tested and certified as being WRAS Approved Products and are listed in the Water Fittings and Materials Directory.



The Kitemark

The Kitemark is a registered trademark owned by British Standards Institution and may only be used by manufacturers who are approved licensees and whose products fully comply with the individual product standards.

Annual product audits and regular surveillance visits by BSI ensure continuing compliance with specification requirements and confirm acceptable Quality Systems to BS EN ISO 9000.



Firm of Assessed Capability

BS EN/ISO 9000 is the reference Standard for Quality Systems.



CE Mark

The symbol shown is the European mark for product certification.

Fig. No. Index

Fig. Number	Page	Fig. Number	Page	Fig. Number	Page	Fig. Number	Page
C4	148	200R	159	M653	120	1432LC	26
5	149	200T	160	669	130	M1541	138
5N	150	201M	158	731	154	M1552	136
5NLS	150	201R	159	M733DR	34-35	DP1732	56
13	151	201T	160	M737	36-37	DP1732L	56
17	153	201TG	160	750	23	DP1732M	56
23	152	221T	160	775	76	1732	27
28	131	249	114/189	761	115/190	1732C	27
30	125	249C	114/189	807	177	1732L	27
30C	126	C262	66	810	180	1732LC	27
30CLS	127	H262	66	811	181	1732M	27
30LS	125	C264	67	817	176	1732MC	27
C31	128	H264	67	850	121-122	1807	89/178
33	129	C266	62	907	177	1807C	90/179
33X	124	H266	62	910	180	1832	28
33XLS	124	C267	64	911	181	1832L	28
35	132	H267	64	950	92	1832M	28
42	110	C268	63	C950	93	1900	184
47	111	H268	63	950W	95	M2000	30-31
48	112	C269	65	950G	92	2050	20
49	113	H269	65	950WG	95	2761	115/190
70/RT	173	C270	71	951	97	M3000	32
75/RS	173	F300	54	951G	97	3047	117
77	185	R300	54	953	38	3150	167
78	186	305	71	953G	38	3180	171
81HU	145	370	144	970	94	3250	168
100	78	371	144	970G	94	3280	172
100TH	79	401M	161	970W	96	3300LS	169
100C	80	430	187	971	98	3400LS	170
100CEXT	80	440	188	971G	98	M4000	33
100CLS	81	501	141	973	39	4970	100
100CTH	81	504	142	973G	39	4970G	100
100CYL	83	M511	137	980	99	4983G	40
100EXT	78	M540	140	1000	24	4990	101
100LS	79	M541	138	1000L	25	4990G	102-107
100MHU	87	M544	139	1000M	25	4993G	43-46
100YL	82	M544E	139	1013	116	5953	41
107MHU	88	M549	135	1050	18	5953G	41
108C	84/191	M552	136	1051	19	5973	42
110	85	M552E	136	1052	18	5973G	42
113	86	609	133	1053	19	MultiComm	69-70
170M	157	C618	134	1200DR	29	ProComm	73-74
171M	157	631	22	1432	26		
200L	160	M650	118	1432C	26		
200M	158	M651	119	1432L	26		



Distributor details



PO BOX 719, IPSWICH IP1 9DU
 HOME SALES: +44 (0)1744 458670
 EXPORT SALES: +44 (0)1744 458671
 TECHNICAL HELPLINE: 0845 604 1790
 FAX: +44 (0)1744 26912
 EMAIL: uksales@hattersley.com
 EMAIL: export@hattersley.com
 EMAIL: tech-enquiries@hattersley.com

www.hattersley.com



FM311
ISO 9001



www.flowoffluids.com

Visit www.flowoffluids.com to order your copy of the New Technical Paper 410.

- Designed and manufactured under quality management systems in accordance with BS EN 9001:2008.
- For full terms and conditions, please visit our website.
- We hope our communications have an impact on you - but not the environment - we have taken steps to ensure this brochure is printed on Forestry Stewardship Council material and the paper is made by an elemental chlorine free process.

Every effort has been made to ensure that the information contained in this publication is accurate at the time of publishing. Hattersley Ltd assumes no responsibility or liability for typographical errors or omissions or for any misinterpretation of the information within the publication and reserves the right to change without notice.

1/11/11

CRANE

BUILDING SERVICES & UTILITIES

www.cranesbu.com