

Heathkit DX-100 "Official" Modifications and Other Info

The following information is compiled from documents published by the Heath Company for the DX-100 transmitter. Some of the information was widely distributed but some was not. The information is provided for reference purposes only.

Glenn Zook, K9STH/AA9STH

HEATHKIT TRANSMITTER MODEL DX-100



SPECIFICATIONS

RF Power Output.....	100-125 watts phone, 120-140 watts CW
Output Impedance.....	50-600 Ω (non-reactive)
Output Coupling.....	Pi network (coaxial)
Operation.....	Crystal-VFO, CW-Phone, Local-Remote
Band Coverage.....	160, 80, 40, 20, 15, 11, 10
Audio Output.....	85 watts at 300-3000 cycles
Tube Complement:	
Power Section.....	6AL5 bias rectifier 5V4 low voltage rectifier 2 - 5R4GY high voltage rectifier OA2 regulator
Audio Section.....	12AX7 speech amplifier 12BY7 audio driver 2 - 1625 modulator
RF Section.....	6AU6 VFO 12BY7 crystal oscillator-buffer 5763 driver 2 - 6146 parallel power amplifier 6AQ5 clamp
Power Requirements.....	115 volts AC, 50 to 60 cycles
Standby.....	150 watts
CW.....	400 watts (intermittent)
Phone.....	450-600 watts
Cabinet Size.....	20 7/8" wide x 13 3/4" high x 16" deep
Net Weight.....	100 lbs.
Shipping Weight.....	107 lbs.

Change to 200pf

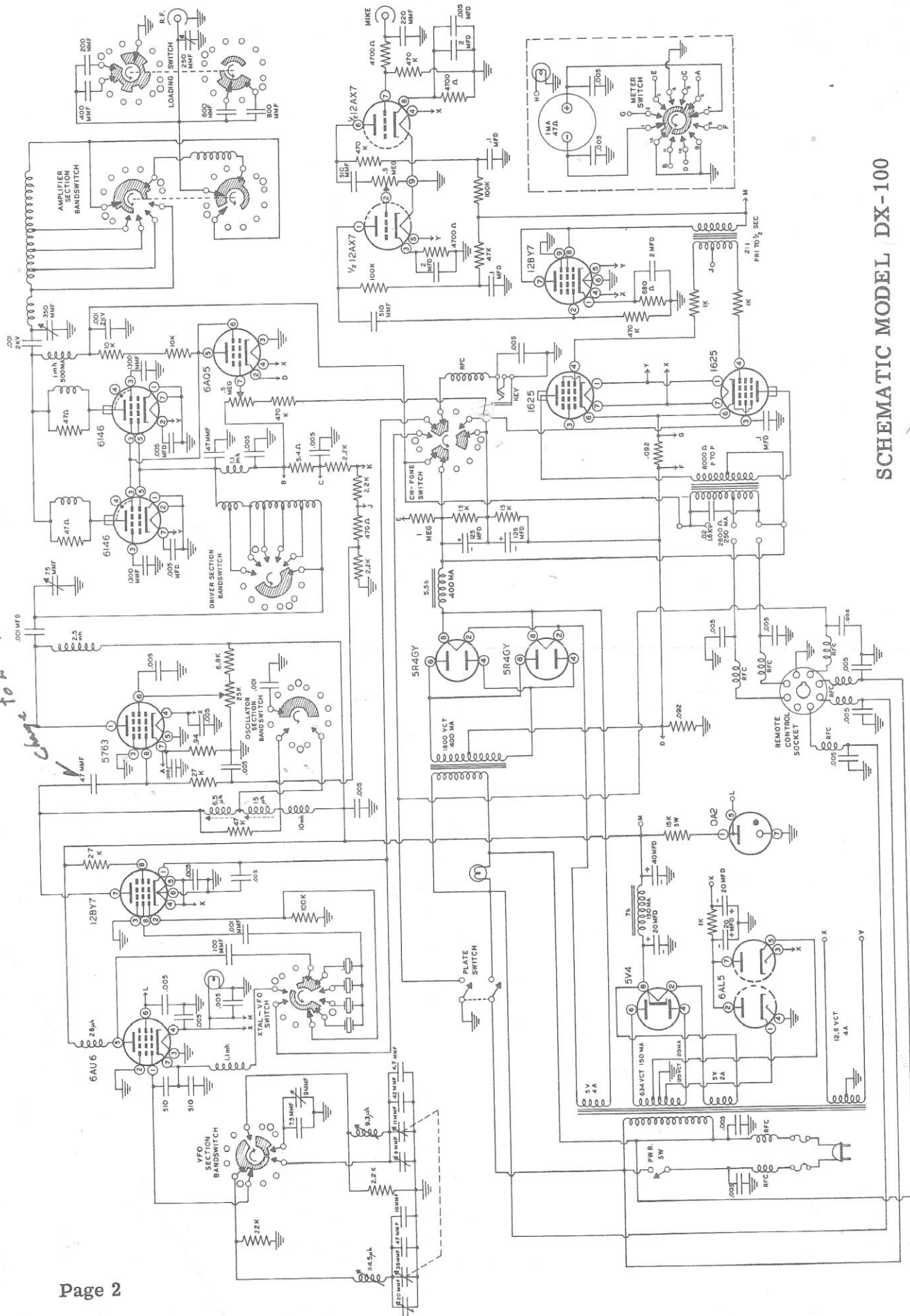

SCHEMATIC MODEL DX-100

PHYSICAL DESCRIPTION

ASSEMBLY: Top chassis view showing "potted" transformers, shielded and illuminated meter, completely enclosed VFO and final shield. Note use of ceramic plate caps on modulator tubes for safety and heat dissipating plate caps on final amplifiers for long tube life. Chassis is constructed of 16 gauge (approximately 1/16" thick) steel, copper plated, making an extremely strong unit.

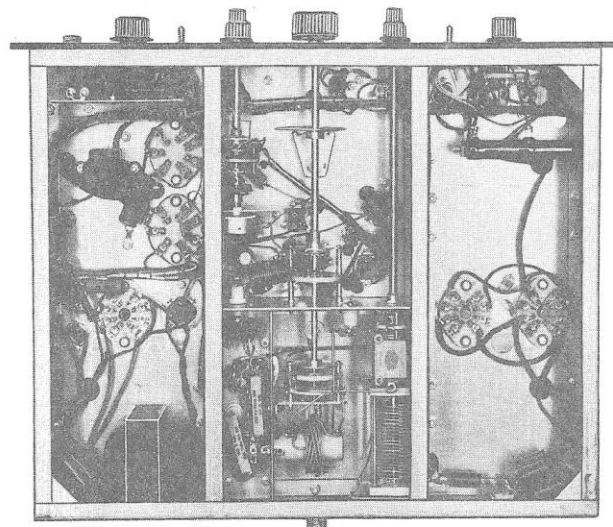
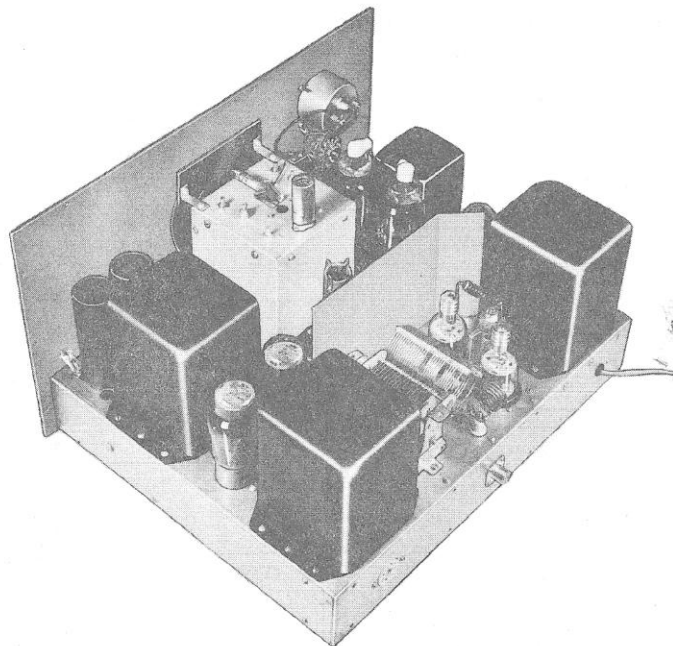

Sectional framing of chassis (shown in bottom view) isolates power, audio and RF circuits and contributes to chassis rigidity. This view shows low voltage power supply and audio on the left, low power RF stages at center front and the output pi network circuit at center rear. The high voltage supply is on the right. Note the use of ceramic tube sockets and switches.

CABINET: The DX-100 cabinet represents a novel innovation in cabinetry, in that a cabinet of this size and type is supplied completely disassembled. This feature permits a considerable saving in cabinet cost. Upon assembling, the cabinet joints interlock, thus making a very rigid and well shielded assembly. The cabinet has a two-tone crackle finish and adequate ventilation.

ELECTRICAL CHARACTERISTICS

VFO: The VFO consists of a 6AU6 tube operating as an electron coupled Clapp oscillator in the frequency ranges of 1750-2000 kc, 7000-7425 kc and 6740-6807.5 kc. The coils are wound on heavy ceramic forms for stability and have temperature compensating capacitors associated with them. The main tuning and trimmer capacitors feature ceramic insulation. A double bearing differential tuning capacitor provides a large degree of band spread on all frequencies as follows:

1750-2000 kc = 4"
3500-4000 kc = 5"
7000-7300 kc = 4 1/2"
14.000-14.350 mc = 2 1/4"

21.000-21.450 mc = 1 3/4"
26.960-27.230 mc = 1 1/8"
28.000-29.700 mc = 4"

The VFO may be zero beat with an incoming signal without placing the transmitter on the air. The screen of the VFO tube is regulated at 150 volts by an OA2 tube and all of the tuned circuits are completely shielded.

OSCILLATOR: A 12BY7 tube operates as the crystal oscillator in a Colpitts circuit when using crystal control. Four crystal positions or VFO excitation are available by means of a front panel control switch (crystals not supplied). When in VFO position the 12BY7 operates as a buffer-doubler, either untuned or broad banded. It is capacity coupled to the 5763 driver stage.

DRIVER: A 5763 tube with variable screen voltage and fixed bias furnishes the grid drive to the final amplifier. The fixed bias keeps the tube cut off during standby or key-up conditions and the adjustable screen voltage controls the amount of drive to the final amplifier. Pi interstage coupling between the driver and the final helps to suppress harmonics of the first three stages which might otherwise appear at the final output.

FINAL AMPLIFIER: Two parallel 6146 tubes operating at approximately 740 volts constitute the final amplifier. The tubes operate with combination fixed and automatic bias and also have "clamp tube" protection of the screen circuit. A pi output circuit further suppresses harmonic output and allows matching to a variety of antenna impedances.

AUDIO: The speech amplifier consists of a 12AX7 two stage resistance coupled amplifier and a 12BY7 triode connected driver. This drives two push-pull 1625 tubes in class AB2. The modulator and speech amplifier components are chosen to limit the audio to approximately 300-3000 cps.

POWER SUPPLIES: A 5V4 rectifier in the low voltage supply delivers 360 volts at 150 ma for operation of the low level audio and RF circuits. A 6AL5 bias rectifier supplies negative voltages to the driver, modulator and final grids. Two 5R4GY rectifiers working into a choke input filter with 60 microfarads of output capacity, deliver approximately 740 volts at 400 ma to the modulator and final amplifier tubes.

CONTROLS: Front panel controls include VFO, driver and final tuning, meter switching, gain control, drive level control, crystal-VFO switching, band switch, fine and coarse loading, CW-phone switch and power and plate switches. In addition, a control socket on the rear apron of the chassis allows remote operation of the plate switch, furnishes 110 volts AC for operation of antenna and/or receiver muting relays and makes audio output available to drive higher power modulators. Also, there is a screwdriver adjustment of the clamp tube threshold behind the panel.

The DX-100 is priced complete and includes all tubes, cabinet and power supplies (crystals, mike and key are not included).

HEATHKIT DX-100 TRANSMITTER

AVERAGE VOLTAGES AT VARIOUS CHECK POINTS

The following voltages have been measured with a Heathkit V-7A VTVM meter. These voltages were taken from DX-100 Transmitters and then, in the case of each individual reading, they were averaged and the resultant of this figures was included in this chart for the average voltage at this point. For this reason, there may be a discrepancy between the voltage in your transmitter and the voltage shown on the chart. If the voltage you measure is within a reasonable amount, it can be accepted as proper operation. It is normal, for example, for the plate voltage in the DX-100 Transmitter to vary between 725 volts DC and 825 volts DC. This can be explained by the varying of line voltages in different locations and by the difference in component tolerance.

WARNING: At numerous places in the DX-100 lethal voltages are present, in some cases exceeding 1000 volts. The Heath Company cannot accept any responsibility for injuries incurred while servicing or testin the transmitter.

TRANSMITTER SETTING:

AUDIO GAIN	XTAL-VFO	BAND		FREQUENCY		METER		CW-PHONE	
0	VFO	10 M.		29.3 MC		Grid 4	Plate 250 MA	PHONE	
						Volts 700			
Pin Number	1	2	3	4	5	6	7	8	9
VFO									
6AU6	-2.5	0	0	5.8AC	365	145	.5	-	-
Crystal Oscillator									
12BY7	0	-9	0	5.8AC	5.8AC	0	360	220	0
Driver									
5763	360	0	0	5.8	0	250	0	-70	-70
Clamp									
6AQ5	-30	0	0	5.8AC	180	180	-30	-	-
Final Amplifier									
6146-2	0	0	190	0	-70	0	5.8AC	0	-
Audio Section									
12AX7	270	0	2.5	6AC	6AC	155	0	1.5	0
12BY7	9.5	0	0	6AC	6AC	0	350	350	0
1625-2	6AC	0	330	-40	-40	0	6AC	0	0
Power Supply									
5V4	0	370	680	300AC	350	300AC	0	370	-
6AL5	54AC	-75	6AC	0	53AC	0	-75	-	-
5R4-2	0	740	0	880	0	-75	0	740	-
OA2	146	0	0	0	146	0	0	-	-

IMPROVED KEYING FOR THE DX-100

The original keying circuit of the DX-100 involved simultaneous keying of the VFO and buffer stages in the cathode circuit. The two remaining stages were biased to cutoff and remained idle until excited by the buffer. This method of keying is simple, fool-proof, and allows break-in operation. However as the VFO is started and stopped very suddenly there is a tendency toward chirps or frequency shift, particularly on the higher frequencies. Also, there may be key clicks as there is no provision for wave shaping.

The sudden starting of an oscillator produces a sharp wave front with a possibility of over-shoot and the following stages running class C further sharpen the wave front. This transient response results in harmonics which splatter over adjacent frequencies causing key clicks. See Figure 1.

From the above discussion you will see that there are two problems which must be solved before good keying is possible. One is to eliminate the chirp caused by a small, but instantaneous frequency shift of the VFO when power is applied suddenly. Two is to eliminate the extremely sharp wave front which produces harmonics causing clicks

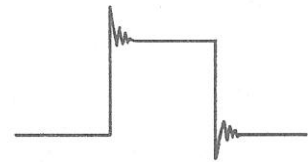

Figure 1

A good solution to the chirp problem is to allow the VFO to run continuously and key a following stage. This might preclude the possibility of operating break-in on one's own frequency; however, the VFO in the DX-100 is well shielded in its own case and again shielded by the transmitter cabinet. Tests performed with a good receiver using coax antenna feed gave a reading of only S1 for the VFO signal. This would readily allow break-in on any frequency.



Figure 2

The solution to the click problem is to round off the corners of the transmitted wave and thus prevent the higher order harmonics. See Figure 2. This may be done by using a keying system that allows the introduction of a time constant in the circuit. The time constant slows the starting and stopping time and eliminates the sharp wave front and over-shoot.

Grid block keying is one method in which it is quite simple to introduce a time constant. In grid block keying a relatively high negative potential is applied to the grid of the keyed stage, cutting off the tube's conduction. When the key is depressed this negative voltage is shunted to ground and the tube allowed to operate.

OPERATION

In the following modification the key lead is removed from the phone-CW switch and connected to a separate tie point. Then pin 9 of the phone-CW switch is tied to pin 7. This results in the plate switch turning on the VFO and buffer stages whenever the high voltage is on, in the CW as well as the Phone position. However, the buffer stage is rendered inoperative by a negative bias and only the VFO operates.

As it would not be practical to tune up the low power stages with high voltage on the final, a push-button switch is installed which duplicates the effect of both the plate switch and the key without applying high voltage.

Approximately -60 volts is obtained from the bias supply and passed through two 27 K and one 100 K Ω resistors to the grid of the 12BY7 buffer cutting the tube off. See Figure 3. When the key is depressed the point between the two 27 K resistors is grounded. The first 27 K Ω resistor isolates the bias supply so that it is not shorted, the second 27 K resistor in conjunction

with the .15 μ fd capacitor provides the time constant for the "make" side of the wave. The .15 μ fd capacitor has to discharge through the 27 K resistor to ground by way of the key contacts. Thus, the negative voltage on the grid of the 12BY7 does not instantaneously fall to zero and a slope is introduced on the wave front. With the key down, the 12BY7 is self-biased through the 27 K and 100 K resistors. When the key is released the .15 μ fd capacitor has to charge through both 27 K resistors, and the tube grid voltage rises at a relatively slow rate to cut off. This produces a slope on the "break" and again eliminates the click.

INSTALLATION

The installation is extremely simple with the possible exception of boring the hole for the push-button switch. Using Figure 4, lay out the hole on the panel, then mark the spot with a center punch. Drill the hole first with a small drill to insure accuracy; it would be well to hold a plate or block behind the panel to protect the filter capacitors. Now drill the hole with progressively larger drills and if necessary use a reamer until a 3/8" hole is obtained.

Wire the push-button switch in the following manner before it is mounted: With a blade-type push-button switch such as the Switchcraft (1004), connect the two moving blades together and connect a wire approximately 7 inches long to this point. This wire should carry some means of identification such as a different color from others used. Connect two wires about the same length to the two stationary contacts of the switch. These wires need not be distinguished from each other. Mount the push-button switch on the panel and feed the three wires through the chassis hole between the filter capacitors. See Figure 5 for the following wiring. The identified wire is connected to terminal 1 of the key jack (ground); the other two wires are connected as shown.

Mount a one-lug terminal strip near the key jack using the corner screw holding the filter capacitor. Mount a three-lug terminal strip behind the 12BY7 stage using the screw which holds the octagonal loading capacitor.

The key jack line choke is removed from terminal 9 of the phone-CW switch and connected to the one-lug terminal strip. Terminal 9 is then connected to terminal 7 with a jumper. The 100 K Ω resistor from pin 2 of the 12BY7 oscillator socket to ground is removed. The rest of the wiring is easily accomplished by following Figure 5.

ADJUSTMENT

After the modification has been completed, turn on the transmitter and readjust the clamp circuit. With plate power applied to the final and no excitation (VFO-xtal switch in an unused xtal position), set the clamp (screw driver adjustment) until the final plate current just returns to zero. Do not pass this setting.

Turn off the high voltage, set switch for VFO operation and while holding the push-button switch tune VFO and buffer for desired operating frequency. Now release push-button, turn on HV and tune final and loading for normal operation.

The push-button switch is used for frequency spotting or tune-up and the final tuned as before.

This modification is strictly optional on the part of the builder. It will work equally well for crystal or VFO operation and produces a far superior signal on both.

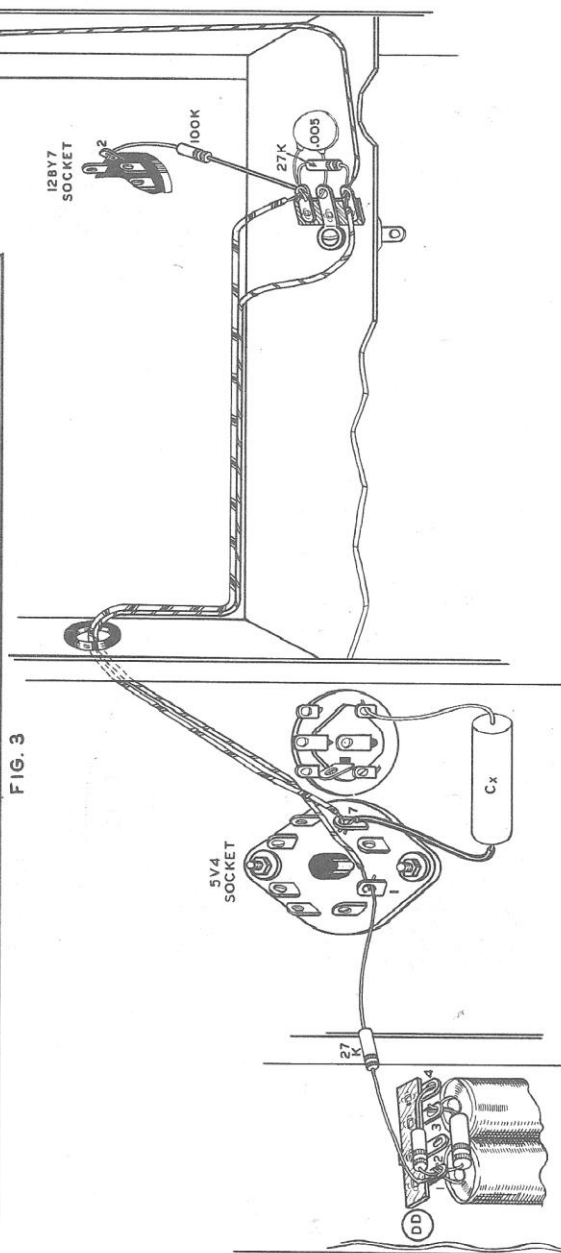
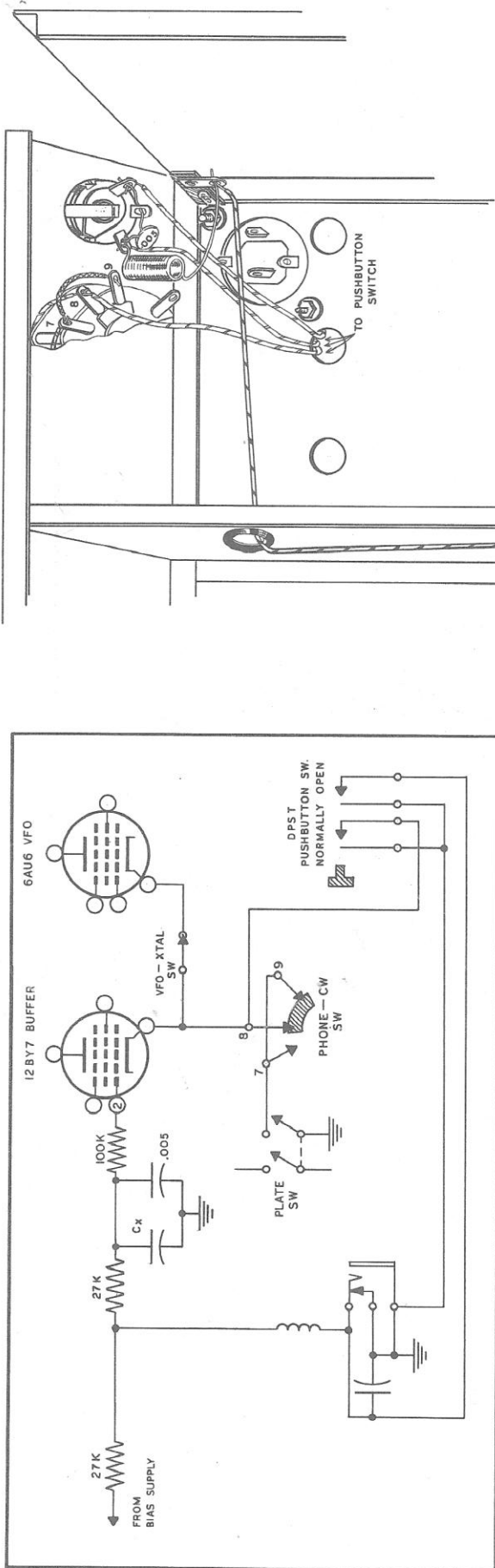

FIG. 3

FIG. 5

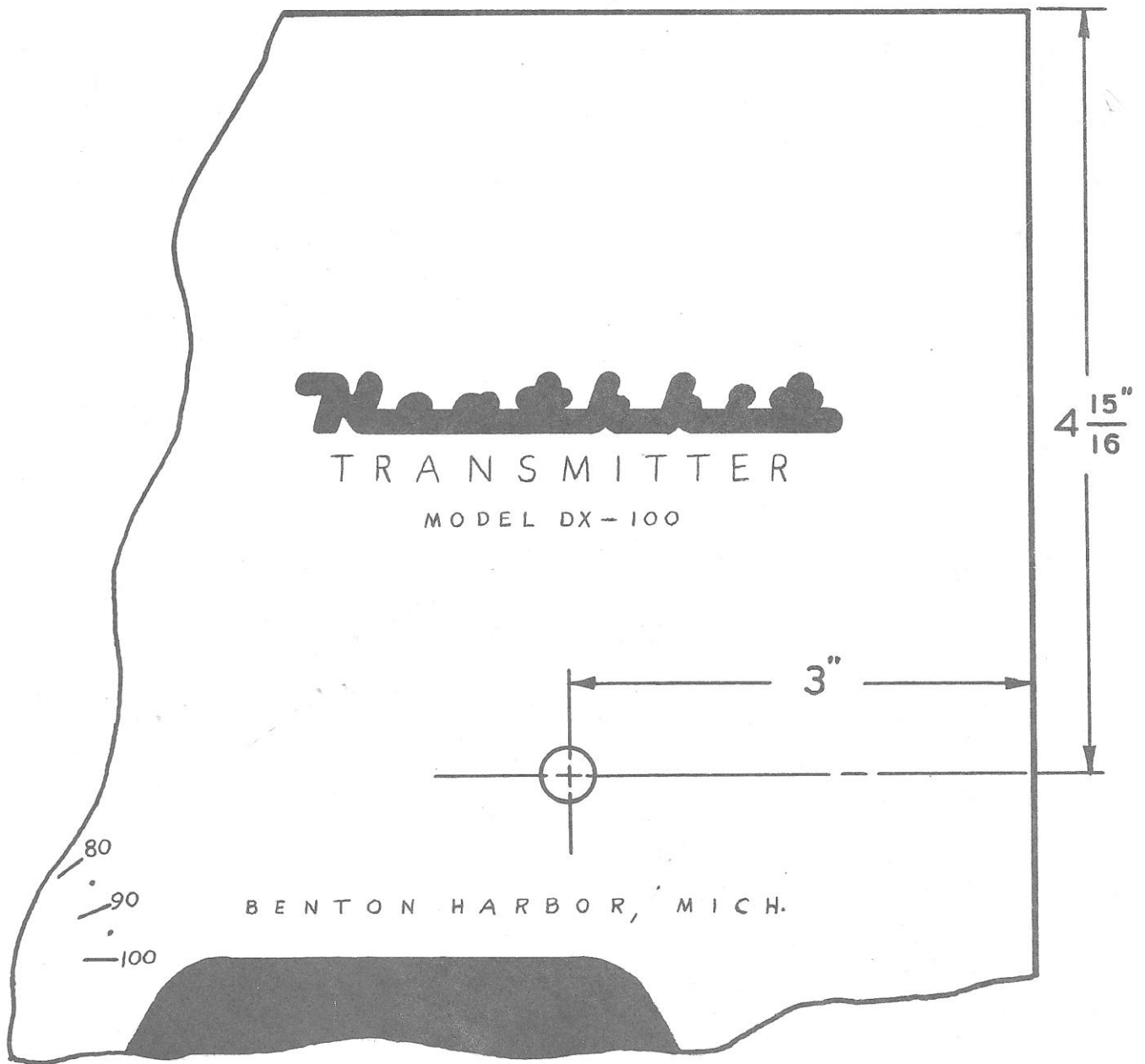

FIG. 4

Loading Control Modification

DX-100 LOADING CONTROL MODIFICATION

Model MK-3

INTRODUCTION

The MK-3 Modification Kit replaces the combination fixed and variable pi network output loading capacitor arrangement in the DX-100 with a single variable capacitor in order to provide smooth, continuous loading on all bands.

STEP-BY-STEP

Refer to your DX-100 manual for notes on wiring and soldering. Reference to the DX-100 manual will also be made regarding some of the steps in this modification.

- () Remove the Transmitter from the cabinet and place on end.
- () Referring to Pictorial 8 on Page 38 of the DX-100 manual, remove the lead from band switch lug C2.
- () Remove the lead from the output coaxial connector.
- () Remove the wires grounding the fine loading variable capacitor.
- () Referring to Figure 17, Page 43, remove all of the loading components shown (switch, variable capacitor, fixed capacitor, and standoff insulator) except the front panel bushing. Save the flexible coupling for use later in this modification.
- () Referring to Figure 1 in this manual, drill three 5/32" diameter holes in the rear apron of the Transmitter chassis at the exact locations shown. Figure 1 on Page 3 is drawn to size and may be used as a template for hole layout.
- () Place a #6 lockwasher over the short threaded end of each of the mounting studs supplied and mount a stud, by means of the short thread, in each of the three threaded holes in the rear of the 3-gang variable capacitor.
- () Place a #6 x 1/8" spacer over the long thread of each of the mounting studs and mount the variable capacitor on the inside of the chassis in the three holes drilled in the rear apron. Position with the bottom side of the capacitor toward the bottom of the chassis and secure with #6 nuts and lockwashers on the outside of the rear apron.
- () Cut off the projecting portion of the mounting studs flush with the face of the #6 nuts.
- () Mount two #6 solder lugs on the bottom of the capacitor, securing in the two tapped holes nearest the band switch with #6-32 x 3/16" RHMS. Refer to Figure 2 of this manual.

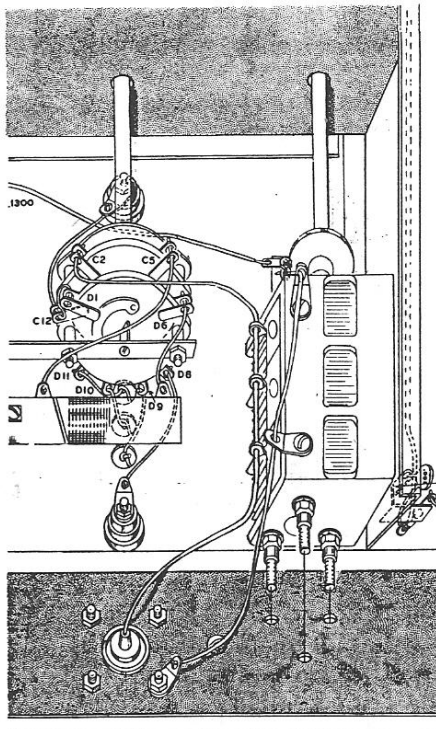

- () Pass the end of a length of #14 bare wire through the three stator lugs of the variable capacitor, bending the lugs to allow passage of the wire. Now solder one end to lug C2 on the band switch and the other end to the output coaxial connector. Solder each of the three stator lugs.
- () Solder one end of a second length of #14 bare wire to the ground lug holding the final amplifier ground strap to the chassis top plate. Pass the other end through the two ground lugs on the bottom of the variable capacitor and solder to the ground lug near the output coaxial connector. Now solder the capacitor ground lugs.
- () Place the flexible coupling on the variable capacitor shaft and secure with the setscrew.
- () Insert the shaft extension supplied through the bushing at the loading location on the front panel, through the 3/8" hole left in the partition, and insert into the other side of the flexible coupling, allowing 3/8" of the shaft to extend from the front panel bushing. Secure the shaft in the coupling with the setscrew.
- () Rotate the variable capacitor full meshed and install the knob supplied on the loading control shaft with the index mark at zero.

This completes the loading control modification of your DX-100 Transmitter.

TESTING AND OPERATION

- () Connect a 100 watt light bulb dummy load to the RF output connector of the Transmitter.
- () Place the band switch in the 80-meter position and turn the power on.
- () With the loading control full CCW, turn the plate switch to "ON" and quickly dip the final.
- () Maintaining a dip with the final tuning, slowly rotate the loading control in a CW direction until the plate current reading at the resonant dip is at the operating value of 250 ma.
- () If normal loading as described above is obtained, reinstall the Transmitter in the cabinet.

Your modified DX-100 is now ready for operation. Loading into an antenna is accomplished in the same manner as above.

IN CASE OF DIFFICULTY

If improper or erratic loading is noted, recheck your work and check for wrong or poorly soldered connections.

Make sure no portion of the bare lead which is connected from band switch lug C2, through the capacitor lugs to the output connector, is touching any other component, wire or ground.

Check to make sure none of the capacitor plates are bent so as to touch one another. Also check for the presence of foreign particles lodged between the capacitor plates.

The Service, Warranty Replacement of Parts and Shipping Instructions which appear in the Model DX-100 Transmitter manual will also apply to a transmitter including this modification. Due to the simplicity of the MK-3 Modification Kit, no minimum service fee has been fixed; the charges will be determined by the amount of time required to service the Modification Kit and the price of any additional material that may be required.

Modification to use SB-10 SSB
Adapter

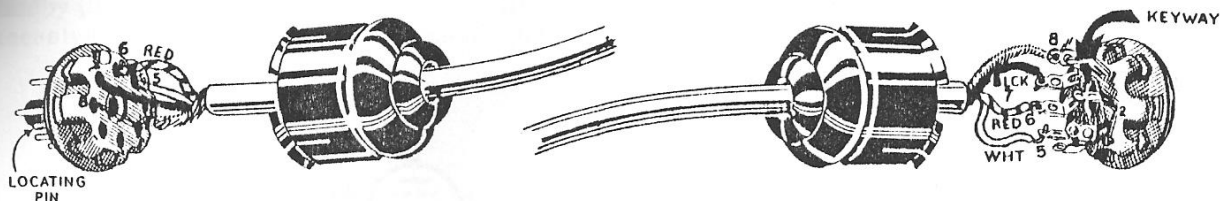

Figure 19

- () Locate the length of 3 conductor shielded cable. Referring to Figure 19, strip the outer jacket for a distance of 1" from each end of the cable. Then unbraid and twist the shield into a pigtail. On one end, strip and tin each wire for a distance of 3/8". Slide an octal socket cap over this end and connect the white lead to pin 5, the red to pin 6, the black to pin 7, and the shield to pin 8 of a female octal socket. Now snap the cover into place. At the other end, strip and tin each lead for a distance of 1/2". Slide an octal plug cover over the cable. Connect the white lead to pin 5, the red to pin 6, and the black to pin 7 of a male octal plug. Using a short length of #20 bare wire, connect the shield to pin 8. Trim off any excess shield. Now snap the cover into place.

To connect the adapter to the Heathkit "Apache" Model TX-1 Transmitter, connect one coaxial cable between the connector on the back of the transmitter marked "RF Excitation to SSB Adapter" and the "RF Excitation Input" connector on the adapter. Connect the other coaxial cable between the connector on the back of the transmitter marked "SSB Input to Final" and the "SSB Output" connector on the adapter. Plug the female end of the shielded power cable into the adapter and the male end into the transmitter accessory socket. Now connect the center conductor spade terminal on the single conductor shielded wire to terminal strip lug #4 on the back of the adapter and connect the shield to terminal #2. Plug the phone jack on the other end of the wire into the key jack on the front of the transmitter. After connecting a dummy load to the RF output connector of the transmitter and making sure the proper AB1 operating conditions have been set up in the "Apache" (see the Model TX-1 Manual), the SB-10 is ready for testing and adjustment.

If the SB-10 is intended for use with Heathkit Model DX-100 or DX-100B Transmitter, a modification of these units is necessary. A single modification kit applicable to either the DX-100 or DX-100B can be purchased from the Heath Company. This kit contains all necessary components and hardware and is supplied with complete and detailed instructions. However, the modification is not complex and since most "junk boxes" will furnish the necessary parts, the information on the modification is included here.

Three basic changes are made in the DX-100 and DX-100B when modifying these transmitters for SSB operation. First, the RF path is broken between the output circuit of the driver (5763) stage and the grids of the final amplifier (2-6146). The drive is brought out to a coaxial connector on the rear of the chassis. The final amplifier grid lead is also brought out to a second coaxial connector on the rear of the chassis. Second, the final amplifier is placed in Class AB1 for

TRANSMITTER SERVICE AND MAINTENANCE HINTS

In the interest of assisting our customers to maintain optimum performance from their Heath-kit Transmitters, this additional information is submitted to afford a better understanding of general operation. These conditions do not represent average operating characteristics for Heathkits but are data compiled through the handling of requests from many customers whose technical skills vary greatly.

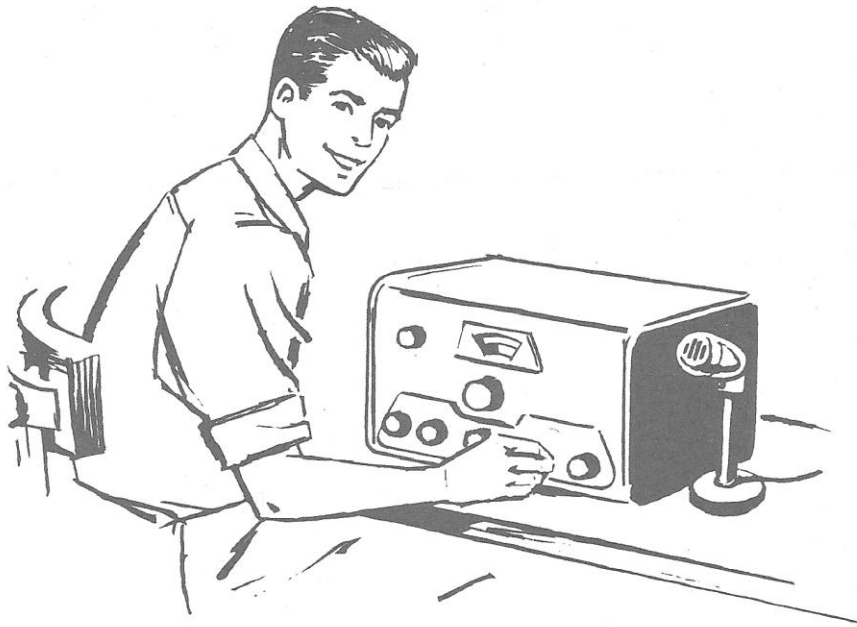

INDEX

SUBJECT	SECTION	CROSS REFERENCE
Antenna Considerations	5-B	9-A, B, C
Creeping Plate Current	13	4-A, B, C, D, E, F, G,
Downward Modulation	3-B, C	1-A, B
Driver Plate Current	8-A, B	
Excessive Plate Current	5-A, B	4-A, C
Excitation (Grid Drive)	4-A, B, C, D, E, F, G	
Meters	15	
Modulator Idling Current	12-A, B	1-A, B
Noise in Transformers	2	
Operation at Reduced RF Output	7	
Parasitic or Self-Oscillation	6	5-B
Repeated Tube Burnout	14-A, B	10
RF on Panel	11	
Short Circuit in Power Supply	1-A, B	3-B, C
Splatter	3-A	
T. V. I.	9-A, B, C	5-B
Voltages	10	

(1) Arcing within the power supply:

- (A) In the field, little or no trouble has been experienced through defective electrolytic condensers. However, they may be damaged if they are incorrectly installed or if the bleeder resistor should be open or otherwise defective. If arcing occurs in the condensers, inspect first the bleeder resistor. Look for a loose or broken connection and check the high voltage potential.
- (B) An open bleeder resistor or a defective high voltage filter capacitor may show up by other indications than an audible sound. Distorted audio, downward or inadequate modulation, or hum on the carrier may result as well as extremely low plate voltage.

(2) Noise in the transformers:

When operating a transmitter under full load, there will be some sound in the high voltage power transformer and choke. This of course is normal provided the sound remains at a low level and cannot be heard at distances greater than eight or ten feet from the transmitter. When operating phone, the modulation transformer will "talk back" at a low level. This should not be sufficiently high to cause feed-back if the microphone is located near the transmitter.

(3) Downward modulation and splatter:

- (A) Splatter may be detected by extreme distortion in the audio. It is generally caused by over-modulation, that is, greater than 100%.
- (B) An indication of downward modulation may be detected through use of a dummy antenna such as a light bulb or "on the air" checks. This condition can also be traced to defective components or possibly a gassy modulator tube as well as a defective bleeder resistor or a leaky electrolytic condenser. A shorted winding within the modulation transformer is another source of downward modulation.
- (C) The possibility of weak rectifiers must be taken into consideration if quality of modulation or CW signal is not up to standard. For good audio quality, the importance of a satisfactory microphone cannot be stressed too strongly. Modern transmitters will operate satisfactorily with most high output, high impedance microphones. These include ribbon, dynamic, crystal or cardioid.

(4) Excitation:

- (A) Insufficient excitation, gradual drop-off of available grid drive during prolonged phone or CW operation, superfluous oscillation and minor key chirp may be classed among the most difficult problems to solve. Should any of the above symptoms be experienced, the following service procedure is suggested.
- (B) The oscillator, buffer, and VFO tubes should be checked if possible by direct substitution. Should you be using crystal excitation, eliminate the VFO as a source of trouble. "Cold", loose, or unsoldered connections, can and do cause lack of excitation, spurious oscillation, and TVI. Should your transmitter use cathode bypass condensers in the oscillator and buffer stage, they should be checked for a possible short circuit. A condition of this type would result in little or absolutely no excitation. If crystals are used, be sure they are in satisfactory operating condition. The contacts of the crystal selector switch, and/or VFO selector switch, must at all times be clean and secure.

After making a general inspection of the VFO, oscillator and buffer circuits, it may be well to determine whether or not the VFO or crystals as the case may be, are oscillating. This can be checked simply by measuring the negative voltage between the grid and ground of the oscillator tube. The negative potential will vary but should fall somewhere between -8 and

-14 volts. No voltage at this point of course indicates no oscillation which then can be traced to one of the above mentioned symptoms as well as an open or possibly shorted coupling condenser between the crystal circuit or VFO circuit and the grid of the oscillator tube.

Incorrect adjustment of the oscillator peaking coils is often the cause of inadequate excitation especially on the higher bands, that is, 10, 11, or possibly 15 meters. You may find it necessary to broaden out the peak adjustment of these coils in order to reach a "happy medium" so that adequate excitation may be obtained on all bands.

- (C) Lead dress and parts placement throughout the VFO, oscillator, and buffer circuits cannot be emphasized too strongly.
- (D) Should difficulty be encountered in making correct alignment adjustments to the VFO, whether it be a built-in VFO or an external unit, refer to the Construction Manual and reverse the alignment procedure as directed. This is in reference to adjustments of the slugs within the VFO coils and the trimmer capacitors. In other words, should correct tracking be difficult to obtain, following the directions in the Construction Manual, then go through the alignment procedure once again. However, when adjustment of the slug is called for, use the trimmer condenser and in a like manner, when it is time to adjust the trimmer, use the slug. Often this reversal of alignment procedure will prove entirely satisfactory. Should tracking be considerably out of tolerance, you might then suspect the coil that is in the circuit for those particular frequencies, also, the frequency determining condensers. If alignment or tracking is off on all bands, then the defect would lie within a component common to all frequencies. This then would indicate a tube or possibly the tuning condenser of the VFO bandswitch.
- (E) Severe keying chirp or frequency shift may be traced once again to a defective VFO tuning capacitor, VFO tube, or oscillator tube as well as inadequate voltage regulation or extremely high voltage. Should chirp or frequency shift take place when operating the transmitter crystal controlled, once again change the oscillator and possibly the buffer tubes, but above all, make certain the crystals are not dirty or otherwise defective. Here again, poor voltage regulation could cause a frequency shift. Dirty key contacts are also a high offender of chirp.
- (F) It may be noted on some transmitters especially on the fundamental frequency of crystal or VFO operation, that the excitation current (grid drive) cannot be reduced to a satisfactory value, even with the grid drive control at minimum. As an example, let us assume that the available excitation cannot be reduced to the prescribed value on 80 meters. Check then the oscillator coil for 80 meters looking for a resistor directly in parallel with the coil. If such is found (it may be approximately 15 K Ω in value) reduce the value of this resistor as much as is necessary to bring the grid drive within the specified limits for that particular transmitter. The same procedure would hold true on any band if excitation should be excessive. Remember that in multiband transmitters, the excitation will normally drop off on the higher frequencies, in the vicinity of 10 meters, or possibly even in the 15 meter band. This may be considered normal and the final amplifier may be operated with approximately two-thirds the excitation recommended in the Manual without adverse effects. Therefore do not be concerned if excitation is noticeably lower on the high frequencies.
- (G) During prolonged operation should a noticeable drop-off of excitation occur requiring constant adjustment of the grid drive control, one may usually suspect a defective tube within the oscillator, buffer, or VFO circuit. A resistor that is heating due to excessive current will thus rise in value and result in loss of excitation. Once again the standard troubleshooting procedure will apply resulting in replacement of any components such as tubes, condensers, controls or resistors that look doubtful or definitely show a discrepancy. It is not uncommon to notice a slight drop-off in excitation shortly after the plate switch has been turned on and the transmitter is in operation. A minor adjustment of the grid drive control should rectify this condition. Do not exceed the specified excitation limits with the plate switch in the "ON" position.

(5) Excessive plate current:

- (A) Occasionally it may be noted that the final amplifier will tend to draw excessive current and no adjustment of the final amplifier tuning condenser will bring the dip indication down to a reasonable level. Should this condition be experienced, it can generally be traced namely to unsatisfactory antenna requirements, thereby constituting a high standing wave ratio (SWR). If such should be the case and there is an intolerable SWR, the pi-network output circuit cannot effectively match the impedance of the transmitter to the impedance of the antenna. Bear in mind that a pi-network is not an all purpose loading circuit but is a device used to match impedance! If your antenna is not satisfactory for certain frequencies, then the impedance mismatch might rise to several thousand ohms. Should this happen, a high voltage will develop across one or several of the components in the pi-network. Subsequent failure of the capacitor may result, reflecting back to the final amplifier and plate tank coil. This condition also promotes excessive heating of the tank coil due to the higher than normal circulating current that would develop. Therefore, should the final plate coil become sufficiently hot to melt the coil form and distort the physical appearance of the coil, it is then necessary to replace not only the coil but possibly the loading capacitor as well (this would be true if fixed mica capacitors are used in the pi-network). In general, poor loading characteristics may be attributed to (1) inadequate antenna facilities; (2) the possibility that a defective loading capacitor was included with the kit or that it has been damaged while in operation and, (3) parasitic oscillation within the final amplifier.
- (B) Although a pi-network tank circuit can and will abolish the necessities of a separate antenna coupler, and even aid in the suppression of harmonics, it is not a "cure all" for antenna matching and never will be. It has definite limitations regarding both the impedance and the reactance that it can handle. In general, the pi-network used in our transmitters will match antenna impedances from a low of 50 Ω to a high of 600 Ω provided there is no capacitive or inductive reactance to tune out.

Inasmuch as there is no way of anticipating the type of antenna match which will be required in conjunction with a transmitter in the field, or even the individual characteristics of each type, the following few paragraphs will be strictly a general description of the "do's" and "don'ts" as is applicable to antennas in general.

Any transmitter regardless of power, is of course no better than its radiator. Thus it is far more practical to increase antenna efficiency than to increase power output from 100 to 1000 watts, not to mention the cost of a ten to one power increase.

One major step towards effective radiation is to present a load to the transmitter that is within its matching range. This means an antenna tuned to resonance and exhibiting neither high capacitance nor inductive reactance. As a rule, high reactance results in high SWR and may cause extreme voltages (as high as 4000), to appear at the transmitter antenna terminal. This as you can see will immediately damage the loading capacitors, loading switch, or plate tank coil, due to high circulating currents. These currents are sufficiently heavy (possibly 30 amperes in some cases) to heat the tank coil to destruction.

In a transmitter rated at approximately 100 watts, the tank coil could normally carry 300 watts, but on many occasions has been completely destroyed by heavy currents resulting purely from improper matching. In a transmitter of this type, the loading capacitors will normally operate at approximately 250 volts, that is, at an impedance of 600 Ω . The capacitors used in many pi-networks carry an AC test of 1200 volts, but have been shorted by the high voltages developed through mismatch.

There are no set rules for determining what type or size of antennas that should be used. The physical and geographical location of the transmitter is an important factor in antenna design.

Most any single wire antenna that is end-fed will result in a high impedance and indeter-

minate reactance at the transmitter. This as you can see often results in very high voltages. If a long wire antenna is used, a separate external coupler must be incorporated to bring the impedance down to a range the pi-network in the transmitter will accept. If a balanced antenna such as a dipole is used, once again a coupler completely external from the transmitter must be employed to change the 50-600 Ω output of your transmitter to a balanced output and of the correct impedance for the type of antenna employed. Simply because a transmitter seems to load in accordance with the information given in the instruction manual, does not necessarily indicate you are getting full power out to the antenna unless a coupler or other matching device is placed between the antenna lead-in and the transmitter output.

There are a few occasions when no additional coupler is needed. If you are using a half-wave dipole fed with coaxial cable on a specific frequency, no additional coupling is needed. By the same token, a rotary beam cut for a specific frequency fed with coaxial cable (RG8U) needs only the matching facilities afforded by the pi-network. The Windom type of antenna seems to be quite popular, however, from past experience in the field, we find that this type of antenna definitely should not be used. Of course Balun coils are generally incorporated between the Windom antenna and the transmitter. Normally, one would then assume this is a balanced antenna, however a simple test made with a neon bulb will prove a condition of unbalance due to the fact that when in operation with a Windom antenna through Balun coils, the neon bulb will light at one end and the top of one coil but at the same end and same side of the other coil, it will not light. This is a condition of unbalance. However it may be possible to load a Windom antenna with a tuned type of antenna coupler which will compensate for the inherent unbalance.

The design center of any antenna should be based on a minimum SWR. Of course the optimum would represent a ratio of 1 to 1. This means that all of the energy reaching the antenna is being radiated with no energy reflected back to the transmitter.

Whatever the antenna type or design, a little research on the results to be expected from it and some experimentation at low power levels may prevent serious damage to your new transmitter. There is also the increased enjoyment and pride gained from good coverage and good reports.

We fully realize that the owner of a new transmitter will be anxious to get on the air and therefore possibly not too careful in his choice of antennas. However, it is hardly worth risking serious damage to your transmitter to get on the air a few hours sooner. Use of any transmitter with an improperly selected antenna, may result in serious damage which could show up immediately or create a severe weakening of components which will cause continuous trouble and breakdown of other components before the original source of difficulty has been located. Many fine articles have been written on antenna design and the various amateur handbooks and magazines contain much information that would be useful in the design and installation of a suitable RF radiator for your locality. Stay off the air until a good antenna has been installed. This will save considerable grief and expense in the future.

(6) Parasitic or self-oscillation:

Assuming that all requirements so far discussed have been met but the final amplifier will not dip as it should, it will then be necessary to look for parasitic oscillation within the vicinity of the final amplifier. This condition might result if the screen bypass condensers in the final amplifier were defective or incorrectly installed, i. e., loose connections, a gassy or "soft" tube or tubes in the final amplifier circuit, incorrect adjustment of the clamp circuit, a defective clamp tube, if such is used, as well as a defective R. F. choke are other possibilities. Parasitic or self-oscillation will show up in one of two common characteristics, either inability to obtain a satisfactory final amplifier dip indication or strong harmonic output as well as a poor CW note. Generally however harmonic output within modern transmitters (which is the exception rather than the rule) is through incorrect loading of the final amplifier, unsatisfactory adjustment of the oscillator stage, incorrect choice of crys-

tals, or improper calibration of the VFO. If the final tank circuit were tuned to a harmonic or should the antenna favor a harmonic frequency, the above conditions may show up. Once again, lead dress and parts placement throughout the entire circuitry of any transmitter, is of the utmost importance. In the case of self-oscillation, a careful scrutiny of all wiring and soldered connections is extremely important.

(7) Operation of medium-power transmitters at reduced R. F. output:

Many customers have asked us how they might reduce the R. F. output of medium power rigs for novice operation as well as for using the transmitter as an exciter for a high power R. F. final. Power reduction can be accomplished by loading technique, that is, placing the pi-network in such a position that the transmitter loads somewhere below 100 mils. The R. F. output can also be controlled to some degree by varying the amount of available grid drive or in other words, excitation. One other very satisfactory method of reducing power output in a more or less permanent manner, is through use of the clamp control adjustment in transmitters that have this type of circuit. Follow the Manual instructions for initial set-up and test of the transmitter, then load to a satisfactory antenna as would be the case for normal operation. Let us say, for example, load the final amplifier to 250 mils, then turn the clamp control counterclockwise (this is done with the plate switch on) until the plate current indication falls to the desired level, that is 100 ma or below. Through this method then it will be impossible to exceed FCC power input regulations for novice operation or in the case that the transmitter is used as an exciter for a high power final amplifier, the driven final cannot be damaged through over-excitation. The output of the transmitter cannot be increased then until the clamp control is reset.

(8) Driver plate current:

(A) Many transmitters offer a metering range for the driver plate current. The driver plate current may not necessarily remain at a constant or specified level in direct proportion to frequency of transmission. The driver plate current will vary from frequency to frequency and from transmitter to transmitter. It is not at all critical and therefore we do not state in the operating manuals any specific driver current reading. When operating the higher frequencies such as 10, 11, or 15 meters, you will notice a slight drop-off in available grid drive. This, as was mentioned in a previous paragraph, is normal.

(B) At this point it should be mentioned that the grid drive may not necessarily be reduced to zero when operating a particular band in which the VFO or crystal oscillator operates on a fundamental. An example of this would be the 40, 80, or possibly the 160 meter band. Note that the VFO operates on a fundamental of 160 meters and doubles to 80. On 40 meters once again, it becomes fundamental then doubles to 20 and triples to 15 meters. The oscillator circuit becomes "straight through" at a frequency of 40 meters and once again at 160 meters. At this point available excitation is extremely high. There may be some residual indication on the meter with the grid drive control at minimum. We mention this as it does not in any way indicate abnormal operation of the transmitter or an error in wiring. It will not prove detrimental to the function of your transmitter.

(9) T. V. I. :

(A) TVI has been a subject of considerable comment and of course manufacturers of any amateur transmitting equipment are apt to receive information from the field concerning television interference. Generally however, TVI is not caused by the transmitter itself, except in some extreme circumstances. Should you now or at any future time be troubled with TVI, either in your own set or neighbor's, a few simple tests should be made in order to determine the origin of TVI. One very satisfactory method (possibly not always sure fire) of determining TVI origin, is to first disconnect the transmitter from its antenna. In place of the antenna, use a dummy load such as a light bulb. Load the transmitter into this dummy antenna on the specific frequency that seems to cause TVI. Check your own TV receiver and have your immediate neighbors check. If no TVI is present when operating the

transmitter under these conditions but was previously when actually "on the air" you may be reasonably sure that the source of TVI is radiation from external nonlinear systems. This will be discussed in detail shortly. On the other hand should TVI be noticed on your own or immediate neighbor's TV receivers when operating the transmitter into a dummy load, one more consideration must be given before blaming the transmitter itself; that is simply what is the make, type, and year of the TV receiver that is causing trouble. Many of the lesser expensive and older TV receivers will show the tell-tale TVI yet this may not necessarily be "genuine television interference" but due to the circuitry of some of the older and present lesser expensive TV receivers, the detector will block due to an excessive presence of R. F. energy. A condition of this type with many of the simpler TV receivers is not uncommon and such over-loading conditions can be readily detected by the experienced radio amateurs.

Operating your transmitter into a dummy load and assuming that there is TVI after making certain it is not simple R. F. blocking or overload, then the transmitter itself may be at fault. The usual procedure should then be taken in locating parasitics not only in the VFO, the buffer, but the final amplifier as well. Loose or improperly soldered connections are a high offender of TVI. Refer to any one of the many radio amateur manuals such as ARRL or the Radio Handbook for further information covering localization and elimination of TVI that is known to be brought forth from the transmitter itself through the possibility of parasitics or self-oscillation.

- (B) A moment ago we mentioned harmonic radiation from external non-linear systems. This is by far the greatest offender of TVI and can be caused by such simple things as corroded or rusted TV antennas and masts as well as guy wires, corroded heat ducts within yours or your neighbor's home, rusty or corroded rain pipes, plumbing fixtures within yours or your neighbor's home, dirty fuses in the fuse box, BX cable, BX boxes and switches, ceiling and wall fixtures as well as chandeliers, conduits, hot water installations such as the heater and associated plumbing, the power line itself, the telephone line, lightning arrestors, and lightning rods, metal fences, metal roofs, or metal lathe found in the newer houses as a base for plaster and stucco, metal TV towers, reinforcement rods in concrete, your own or your neighbor's thermostat - in other words, any combination of two pieces of metal that may be touching one another and may be corroded or rusted sufficiently so as to form a rectifier. Even the common AC-DC table model radio receiver has been traced as a cause of TVI due to the fact that the selenium rectifier within the receiver is detecting and rere-diating a harmonic.
- (C) There is not sufficient room in this publication to discuss the literally hundreds of points that must be checked in the event that TVI should be present. However, there is a booklet available at \$.25 entitled, "Television Interference" third edition, published by Remington-Rand Laboratory of Advanced Research, South Norwalk, Connecticut, and reference to Page 25 of this booklet does offer an excellent description for localization and elimination of the previously discussed TVI offenders. The entire book, some 107 pages, deals with various types of TVI. Therefore, should you now or at any future date encounter such interference, it is our feeling that this booklet will prove invaluable.

(10) Voltages:

In some of the larger transmitters, no voltage chart is published in the operation manual. Due to the fact that most voltages within the circuitry of medium to high power transmitters are lethal, we feel it advisable not to include any check points other than the resistance measurements as specified. Of course the plate voltage may be checked through use of the meter located on the panel as is the case with medium power transmitters, or in the smaller rigs by use of a VOM or VTVM before the transmitter has been placed in its cabinet. The low voltage power supply in most medium power transmitters will fall somewhere between 350 and 420 volts. The actual voltage will vary depending upon the power line supply voltage and individual power transformer characteristics.

(11) R. F. on panel:

If at any operating frequency the chassis, cabinet, or panel of the transmitter should become "hot" with R. F., this is an indication that grounding facilities are not adequate. In some locations, that is if the transmitter is located on the second story or quite some distance from a good earth ground, it will be found necessary to run two or possibly three separate ground wires from the transmitter itself to earth ground. Each ground wire should be sufficiently heavy as is recommended in the Manual and of a different length to prevent the possibility of any one or all of the leads becoming resonant at any specified frequency. Do not rely entirely upon a water-pipe for satisfactory ground connections. Copper ground stakes at least six feet long should be used. If the ground is damp, most of the time, generally one is sufficient. If in doubt, use two or three ground stakes placed about three feet apart and each one tied together by heavy copper wire. To be doubly safe throughout the summer months, keep the ground around the stakes wet.

(12) Modulator idling current:

(A) When operating phone with transmitters employing high level plate modulation, it occasionally may be noted that the resting current of the modulator stage is appreciably higher or in some cases lower than the specified idling current stated in the operation manual. A variance of $\pm 50\%$ from the average resting current is not unusual nor does it mean that corrective measures should be taken. The grid characteristics in individual tubes of the same type will vary slightly causing a variation from the manual. On the other hand, if the idling current is upwards of, say 100 ma., then one or both of the modulator tubes should be replaced. If no change is noted after replacement then check the bias voltage and all components within the circuitry of the modulator tubes.

(B) Parts placement and lead dress throughout any transmitter is of the utmost importance. We strongly urge the kit builder to follow exactly the step-by-step instructions and the pictorial diagrams included with the Construction Manual when assembling R. F. equipment. Above all, if difficulty is experienced, a visual check should be made. As mentioned before, incorrectly soldered or "cold" connections are serious offenders causing parasitic oscillation, low excitation, and generally unsatisfactory operation of the entire transmitter.

(13) Creeping plate current:

Should the final plate current creep upwards continually during operation regardless of whether you are using phone or CW emission, the most common explanation for this characteristic is weak or "soft" output tubes in the final. The remedy for this condition may be caused by a defect in the tube at time of shipment if the characteristic is noted immediately after the kit has been placed on the air for the first time. Abuse of the transmitter is a common cause for output tube damage, that is operation of the transmitter under severe mismatch conditions, or loading the final amplifier far beyond its normal rating. For trouble-free results, the tubes in the final amplifier portion of any transmitter should be replaced after approximately five hundred air-time hours. It is true in most cases that tubes will last considerably longer than this time but due to slow deterioration of the tubes from use, they may cause other undesirable circumstances. Rather than allow the tubes to remain in your transmitter until they fail from fatigue, you will be money and time ahead to replace immediately upon noticing signs of weakness or at least every five hundred hours. This is merely a suggestion and the final decision is up to the operator.

(14) Tube burnout:

(A) As repeated above, for best results tubes should be replaced frequently or as soon as deterioration is noted. However, frequent burnout of one specific tube or tubes is not a normal condition. Should you in any transmitter experience a shorting condition or other defect resulting quite often in a specific tube, it will be well to check the surrounding circuitry

of that particular tube before making additional replacements. Often a shorted coupling condenser between the plate of one tube to the grid of another, will cause the full plate voltage to be applied to that grid. The tube will then internally break down causing a grid-cathode (or similar) short. A reoccurring failure of this type almost invariably can be traced to a shorted coupling capacitor.

- (B) A blue glow outlining the plates of many tubes may be noted. This does not indicate a gaseous condition within the tube. In most tubes that operate at a high plate potential, there will be stray electrons not collected by the plate. These stray electrons then bombard the glass envelope causing a fluorescence (blue glow) due to impurities in the glass. Generally a condition of this type is favorable as it does indicate the tube is in good operating condition as the bombardment and subsequent fluorescing is a sign of a "hard" vacuum. A tube that is gaseous may be readily detected by the overall purple glow. This is noted mostly in rectifier tubes.

(15) Meters:

Most of the lesser expensive transmitters on the market employ a moving vane type meter. This meter is capable of extremely high inertia. The meters are not damped and therefore if the meter selector switch should be in the plate position while the transmitter is being keyed, the meter indicator needle may peg in itself at the extreme right side. However, the mechanical construction of the moving vane, bearings and the meter needle indicator itself is such that this pegging condition will in no way harm the meter. To lessen this characteristic when operating CW, be sure the selector switch is placed in the grid position, thus the indicator extrusions will not be quite as severe. The more expensive meter movements of the moving coil type are electrically damped thus reducing the ballistics and virtually eliminating severe pegging.

DO'S

DONT'S

- | | |
|---|--|
| 1. Allow transmitter to warm up before turning plate switch on. | 1. Change band with plate switch on. |
| 2. Be sure your antenna and/or external match meets requirements of pi-network. | 2. Change frequency of VFO more than ± 20 kc without retuning. |
| 3. Be sure of a good ground. | 3. Exceed 5 ma. grid drive. |
| 4. Check the various metering positions frequently while operating. | 4. Exceed plate current limitations. |
| 5. Make final tuning adjustments as quickly as possible. | 5. Operate transmitter out of resonance or without load. |
| 6. Replace tubes at first sign of fatigue. | 6. Operate transmitter outside of cabinet. |
| 7. Keep transmitter free of dust. | 7. Operate into highly reactive antennas. |
| 8. Ground antenna during electrical storms and atmospheric disturbances. | |

IMPORTANT

A brief discussion of antenna considerations has been given in this publication. It represents the maximum assistance that can be offered by the Heath Company, as far as antenna problems are concerned. The selection and installation of transmitting antennas will be governed by individual preference and seriously influenced by local geographical conditions. Therefore, it becomes a subject almost completely divorced from the design and maintenance of most modern transmitters. The most important requirement is that the operator be able to tune the entire antenna system to the desired operating frequency, without presenting to the transmitter an impedance falling outside the specified value or range of output impedances. Otherwise, transmitter components such as loading coils and capacitors may be permanently damaged.

If such problems or uncertainties arise, it is suggested that you consult a specialist on the subject or perhaps the answer can be found through the cooperation of your "HAM" acquaintances. Also you might refer to any one of the many texts on transmitting antennas, some of which are listed here.

HEATH COMPANY
Benton Harbor, Michigan

BIBLIOGRAPHY

- | | |
|--------------------------------|---|
| "Radio Handbook" | Editors and Engineers, Ltd.
1300 Kenwood Road
Santa Barbara, California |
| "The Radio Amateurs' Handbook" | American Radio Realy League
West Hartford, Connecticut |
| "The Antenna Handbook" | American Radio Realy League
West Hartford, Connecticut |
| "The Antenna Manual" | Editors and Engineers, Ltd.
1300 Kenwood Road
Santa Barbara, California |
| "The Beam Antenna Handbook" | Radio Publications
Wilton, Connecticut |

NOTES