

HITACHI

PA

No. 0067

SERVICE MANUAL

NTSC

A3LXU4 CHASSIS

32CX12B/CY62

35CX45B/CZ67

R/C:

CLU-417UI

CAUTION: Before servicing this chassis, it is important that the service technician read the "Safety Precautions" and "Product Safety Notices" in this Service Manual.

This television receiver will display television Closed Captioning (or) in accordance with paragraph 15.119 of the FCC rules.

TABLE OF CONTENTS

SAFETY PRECAUTIONS	2	WIRING DRAWING OF 35CX45B/CZ67 FINAL ASSEMBLY	54
PRODUCT SAFETY NOTICE.....	3	PRINTED WIRING BOARD FOIL PATTERN	55
POWER SOURCE	3	CIRCUIT SCHEMATIC DIAGRAM.....	57
TECHNICAL SPECIFICATIONS.....	4	CIRCUIT SCHEMATIC DIAGRAM OF P in P.....	58
TECHNICAL CAUTIONS	5	CIRCUIT SCHEMATIC DIAGRAM OF 32CX12B/CY62 and 35CX45B/CZ67	59
ADJUSTMENT SPECIFICATIONS.....	6		
WAVEFORMS AT EACH SECTION.....	26		
TROUBLESHOOTING FLOWCHARTS.....	30		
REPLACEMENT PARTS LIST.....	33		
NOTES	50		
WIRING DRAWING OF 32CX12B/CY62 FINAL ASSEMBLY	53		

SPECIFICATIONS AND PARTS ARE SUBJECT TO CHANGE FOR IMPROVEMENT

SOLID STATE COLOR TELEVISION

DECEMBER 1996

HHEA - MANUFACTURING DIVISION

SAFETY PRECAUTIONS

NOTICE: Comply with all cautions and safety related notes located on or inside the cabinet and on the chassis or picture tube.

WARNING: Since the chassis of this receiver is connected to one side of the AC power supply during operation, whenever the receiver is plugged in, service should not be attempted by anyone unfamiliar with the precautions necessary when working on this type of receiver.

The following precautions should be observed:

1. Do not install, remove, or handle the picture tube in any manner unless shatterproof goggles are worn. People not so equipped should be kept away from the picture tube while handling.
2. When service is required, an isolation transformer should be inserted between power line and the receiver before any service is performed on a "HOT" chassis receiver.
3. When replacing a chassis in the receiver, all the protective devices must be put back in place, such as barriers, nonmetallic knobs, adjustment and compartment covershields, isolation resistors, capacitors, etc.
4. When service is required, observe the original lead dress in the high voltage circuitry area.
5. Always use the manufacturer's replacement components. Critical components as indicated on the circuit diagram should not be replaced by another manufacturer's. Furthermore, where a short circuit has occurred, replace those components that indicate evidence of overheating.
6. Before returning a serviced receiver to the customer, the service technician must thoroughly test the unit to be certain that it is completely safe to operate without danger of electrical shock, and be sure that no protective device built into the receiver by the manufacturer has become defective, or inadvertently defeated during servicing.

Therefore, the following checks should be performed for the continued protection of the customer and service technician.

Leakage Current Cold Check

With the AC plug removed from the 120VAC 60Hz source, place a jumper across the two plug prongs. Turn the AC power switch ON using an insulation tester (DC500V), connect one lead to the jumpered AC plug and touch the other lead to each exposed metal part (antennas, screwheads, metal overlays, control shafts, etc.), particularly any exposed metal part having a return path to the chassis should have a minimum resistor reading of $0.24M\Omega$ and a maximum resistor reading of $5.2M\Omega$. Any resistance value below or above this range indicates an abnormality which requires corrective action. Exposed metal part not having a return path to the chassis will indicate an open circuit.

Leakage Current Hot Check

Plug the AC line cord directly into an AC 120V 60Hz outlet (do not use an isolation transformer for this check). Turn the AC power ON. Using a "Leakage Current Tester (Simpson's Model 229 or equivalent)", measure for current from all exposed metal parts of the cabinet (antennas, screwheads, overlays, control shafts, etc.) particularly any exposed metal part having a return path to the chassis or to a known earth ground (water pipe, conduit, etc.). Any current measured must not exceed 0.5mA.

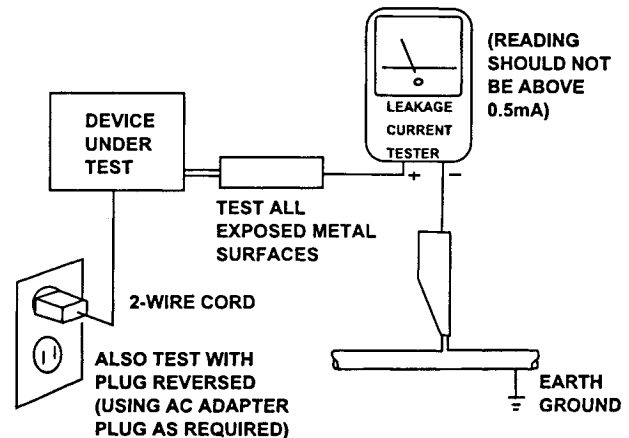

AC LEAKAGE TEST

ANY MEASUREMENTS NOT WITHIN THE LIMITS OUT LINED ABOVE ARE INDICATIVE OF A POTENTIAL SHOCK HAZARD AND MUST BE CORRECTED BEFORE RETURNING THE RECEIVER TO THE CUSTOMER.

High Voltage

This receiver is provided with a hold down circuit for clearly indicating that voltage has increased in excess of a predetermined value. Comply with all notes described in this Service Manual regarding this hold down circuit when servicing, so that this hold down circuit is operated correctly.

Serviceman Warning

With minimum BRIGHTNESS and CONTRAST, the operating high voltage in this receiver is lower than 37.0KV. In case any component having influence on the high voltage is replaced, confirm that high voltage with minimum BRIGHTNESS and CONTRAST is lower than 37.0KV. To measure high voltage use a high impedance High Voltage Meter. Connect (-) to chassis earth and (+) to the CPT Anode button (See the following connection diagram).

NOTE: Turn the power switch OFF without fail before the connection to the Anode button is made.

PRODUCT SAFETY NOTICE

Many electrical and mechanical parts in HITACHI television receivers have special safety related characteristics. These are often not evident from visual inspection nor can the protection afforded by them necessarily be obtained by using replacement components rated for higher voltage, wattage, etc. Replacements parts which have these special safety characteristics are identified in this Model Service Manual.

Electrical components having such features are identified with an \triangle mark in the schematics and parts list in this Model Service Manual.

The use of a substitute replacement component which does not have the same safety characteristics as the HITACHI recommended replacement one, shown in the parts list in this Model Service Manual, may create shock, fire, X-Radiation, or other hazards.

Production Safety is continuously under review and new instructions are issued from time to time. For the latest information, always consult the current HITACHI Service Manual. A subscription to, or additional copies of HITACHI Service Manual may be obtained at a nominal charge from HITACHI SALES CORPORATION.

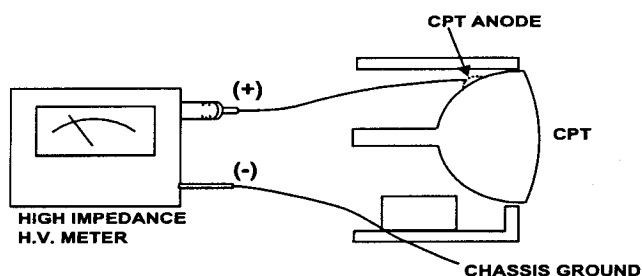

X-Radiation

TUBE: The primary source of X-Radiation in this receiver is the picture tube. The tube utilized in this chassis is specially constructed to limit X-Radiation emission. For continued X-Radiation protection, the replacement tube must be the same type as the original HITACHI approved type.

When troubleshooting and making test measurements in a receiver with an excessive high voltage problem, avoid coming unnecessarily close to the picture tube and the high voltage component.

Do not operate the chassis longer than is necessary to locate the cause of the excessive voltage.

This Service Manual is intended for qualified service technicians; it is not meant for the casual do-it-yourselfer. Qualified technicians have the necessary test equipment and tools, and have been trained to properly and safely repair complex products such as those covered by this manual. Improperly performed repairs can adversely affect the product and its safety. Consumers should not risk trying to do the necessary repairs and should instead refer to a qualified service technician.

WARNING

Lead in solder used in this product is listed by the California Health and Welfare agency as a known reproductive toxicant which may cause birth defects or other reproductive harm

(California Health and Safety Code, Section 25249.5).

When servicing or handling circuit boards and other components with lead in solder, avoid unprotected skin contact with the solder. Also, when soldering do not inhale any smoke or fumes produced.

SAFETY NOTICE USE ISOLATION TRANSFORMER WHEN SERVICING

Components having special safety characteristics are identified by \triangle on the parts list in this Model Service Manual and its supplements and bulletins. Before servicing this, it is important that the service technician read and follow the "Safety Precautions" and the "Product Safety Notices" in this Service Manual.

For continued X-Radiation protection, replace picture tube with original type or Hitachi equivalent type.

POWER SOURCE

This television receiver is designed to operate on 120Volts/60Hz, AC house current. Insert the power cord into a 120 Volts/60Hz outlet.

NEVER CONNECT THE TV TO OTHER THAN THE SPECIFIED VOLTAGE OR TO DIRECT CURRENT.

Use of this TV set in 50 Hz areas will not harm the TV set, However, it will cause the clock display to run slower. Consult service personnel if you move to an area where the power supply frequency is 50 Hz.

TECHNICAL SPECIFICATIONS**POWER RATINGS**

32CX12B/CY62	190 watts
35CX45B/CZ67	205 watts

COLOR PICTURE TUBE

32CX12B/CY62	A80LJF30X
35CX45B/CZ67	A89AEJ15X02

CAUTION

The following symbol near the fuse indicates fast operating fuse (to be replaced). Fuse ratings appear within the symbol.

Example:

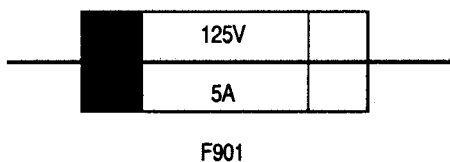

The rating of fuse F901 is 5.0A-125V.

Replace with the same type fuse for continued protection against fire.

TECHNICAL CAUTIONS

High Voltage Limiter Circuit Operation Check and Overvoltage Protection Circuit Operation Check

Adjustment Preparation

1. Connect a High Voltage Voltmeter between CPT Anode terminal (Anode capside) and Ground. (TP701)
2. Set the AC input voltage to 120 +/- 3V.
3. Receive Circle Pattern or Broadcast Signal and set "BRIGHTNESS" and "CONTRAST" to maximum. Adjust the SCREEN VR and SUB-BRIGHTNESS VR (R340) so that Beam Current is $I_B \pm 0.1$ mA. (The voltage at ABL terminal (C747) should be 12V or less.)

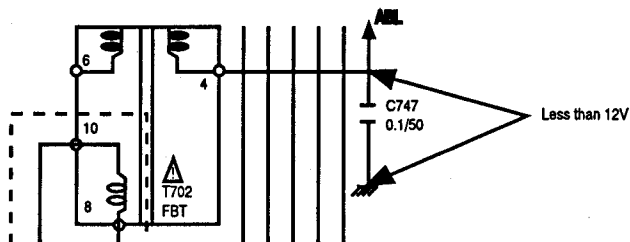
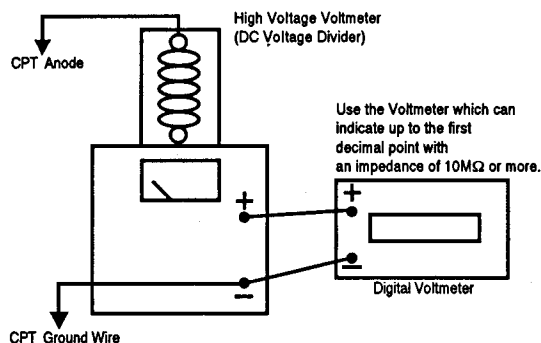

Adjustment Preparation

1. Check that the normal High Voltage is $E_{HT} \pm 1KV$.

CHASSIS	EHT±1KV	IB ± 0.1mA	E1±1.3KV
CZ67	30.0KV	1.70mA	36.0KV
CY62	30.0KV	1.50mA	36.0KV

Adjustment Preparation

4. Set AC input voltage to $100 \pm 5V$. Short circuit both ends of R903.

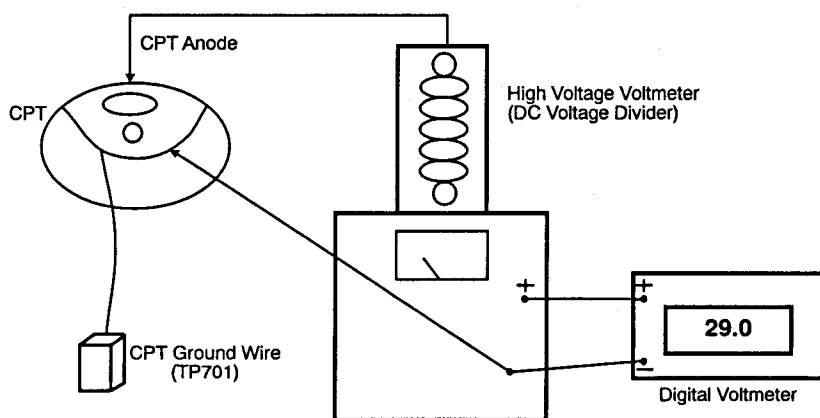

Short Circuit

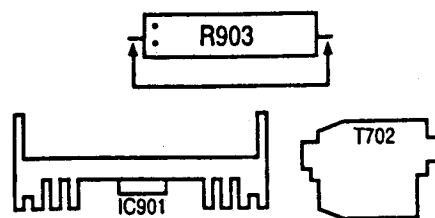

Adjustment Procedure

Use the voltmeter impedance 10MΩ or more with indication to the first decimal place.

2. Keep CONTRAST, BRIGHTNESS, and SCREEN VR as in item (3). Increase AC input voltage gradually and check that the picture disappears when high voltage is E1. Immediately after checking that it disappears, turn OFF the set switch. Remove adjustment Jig and High Voltage Voltmeter. When connecting or removing High Voltage Voltmeter to or from Anode cap, be sure to turn OFF the switch of the set. Also, be sure to perform it after the chassis discharge of residual high voltage, because the high voltage of CPT Anode may be left.

ADJUSTMENT SPECIFICATIONS

A3LXU4 CHASSIS

PAGE #

I. MAIN CHASSIS ADJUSTMENT	8
1. I ² C Bus System	8
2. Adjustment Procedure - Start-Up	8
2-1 How to Get to Adjustment Code	8
2-2 Changing Data and Adjustment Code	8
3. Adjustment Mode	8
4. Adjustment Procedure	9
4-1 VCO for OSD Adjustment	9
4-2 Deflection Circuit Picture Adjustment Check	9
4-2-1 Verticle Size Adjustment (R62A)	9
4-2-2 Side Pin Distortion Coarse Adjustment (R752)	9
4-2-3 Horizontal Side Adjustment (R755)	10
4-2-4 High Voltage Limiter Circuit Operation Check and Overvoltage Protection Circuit Operation Check	10
4-2-5 FBT Protection Circuit Operation Check	10
4-2-6 +16V Short Protection Circuit Check	10
4-2-7 Load Reduction Circuit Operation Check	10
4-2-8 MFC Circuit Operation Check (35CX45B/CZ67 Only)	11
4-3 MTS Adjustment	11
4-3-1 Input Level Adjustment	11
4-3-2 Stereo VCO Adjustment	11
4-3-3 Filter Adjustment	11
4-3-4 Separation Adjustment	12
4-3-5 SAP VCO Adjustment	12
II. MEMORY INITIALIZE	12
4-4 Timer Sound Operation Check	12
III. OPERATION CHECK	12
4-5 AFC Operation Check	12
5. Channel Selection Circuit Operation Check	12
5-1 Channel Up/Down Selection	12
5-2 Channel Up/Down Selection (Sub-Picture)	13
5-3 Volume Up/Down	13
5-4 Power On/Off	13
5-4-1 Input	13
5-5 Menu	13
5-6 Menu Mode (Using Remo-Con)	14
5-6-1 Set-Up Mode	14
5-6-2 Customize Mode	14
5-6-3 Video Mode	15
5-6-4 Audio Mode	15
IV. P IN P OPERATION CHECK	16
6. P in P	16
6-1 Move	16
6-2 Swap	16
6-3 Freeze	16
6-4 Freeze (at P in P off)	17
6-5 Weak Electric Field Check	17
V. YNR OPERATION CHECK	17

VI. FINAL ADJUSTMENT/COMMON SERVICE ADJUSTMENT	18
7-1. Purity Convergence Adjustment	18
7-1-1. Purity Adjustment (Using Microscope)	18
7-1-2. Purity Adjustment (Hand Operated)	19
7-1-3. Static Convergence Adjustment	21
7-1-4. Dynamic Convergence Adjustment	21
7-2. Focus Adjustment	22
7-3. Deflection Circuit Picture Adjustment	22
7-3-1. Horizontal Center Adjustment	22
7-3-2. Vertical Size Adjustment	22
7-3-3. Side Pin Distortion Adjustment	22
7-3-4. Horizontal Size Adjustment	22
7-4. White Balance Adjustment	23
7-5. Sub-black Level Adjustment	23
7-6. Channel Selector Operation Check	23
7-6-1. C.C.D. Display Position Adjustment	23
7-7. Matching Check with Other Equipments	23
7-7-1. VIDEO 1 Input Terminal Matching Check	23
7-7-2. VIDEO 2 Input Terminal Matching Check	23
7-7-3. VIDEO 3 Input Terminal Matching Check	23
7-7-4. S-INPUT Terminal Matching Check	24
7-7-5. AUDIO Output Level Check	24
7-8. Safety Check	24
7-8-1. Polarity Check	24
7-9. MTS Operation Check	24
7-9-1. STEREO/SAP Broadcast Receiving Check	24
7-9-2. MTS Mode Check	24
7-9-3. STEREO Separation Check	24
7-10. Setting for Delivery	24
7-11. Magnetic Field Correction Circuit Operation Check (35V ONLY)	24
VII. ADJUSTMENT POSITION LIST	25

Refer to CHASSIS SERVICE MANUAL PA NO. 0074 for additional technical information.

Note:

1. MAIN CHASSIS ADJUSTMENT is done with precision equipment. Readjustment is only recommended if the service technician replaced a defective component related to the circuit.
2. COMMON SERVICE ADJUSTMENT is recommended for the service technician after final troubleshooting and repair is done. Quick check and fine tuning is advisable to verify that the problem is eliminated.

I. MAIN CHASSIS ADJUSTMENT

1. PC BUS SYSTEM

A3LXU4 Chassis uses PC Bus control System. Fig. 1 shows this control system.

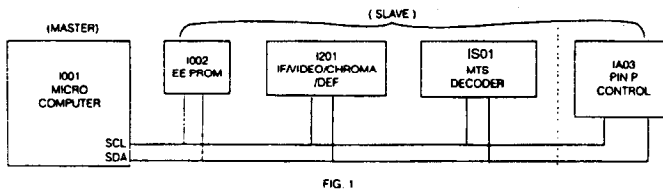

I001 (Master) controls other ICs (slave). Adjustment data is memorized in I002 (EEPROM). I001 reads this data and controls other ICs.

Adjustment items applied in this chassis are shown in Table 1.

2. ADJUSTMENT PROCEDURE—START UP

2-1 How to Get to Adjustment Mode

Chassis adjustment can be done by using the front control panel buttons with CTV set turned off. Press "POWER" and "MENU" or "INPUT" keys at the same time, and hold more than 3 seconds. The CTV set turns on in adjustment mode with OSD as follows.

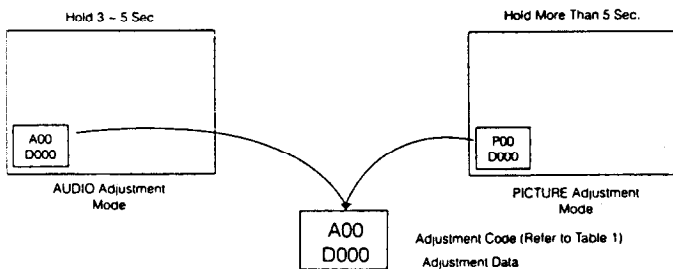

"To Escape from Adjustment Mode"

Press "POWER" key or "POWER" button of remote control once at anytime. Then set returns to normal state.

TABLE 1 ADJUSTMENT CODE

CODE NAME	ADJUSTMENT MODE	(ITEM) REMARK	SERVICE* MODE DATA
A 00	Audio Adj. Key Code	—	—
A 01	Stereo VCO Adj.	—	032
A 02	SAP VCO Adj.	—	038
A 03	Filter Adj.	—	028
A 04	Input Level Adj.	—	023
A 05	Stereo VCO Adj.	—	011
A 06	Stereo VCO Adj.	—	024
P 00	Picture Adj. Key Code	—	—
P 01	PIP Color Adj.	—	027
P 02	PIP Tint Adj.	—	036

*This data is an approximate service mode data. Fine adjustment must be done using the specified test procedure and adjustment tools.

2-2 Changing Data and Adjustment Code

When set is in adjustment mode, the cursor "◀▶, ▲, ▼" and "ENTER" keys of the customer's remote control will be the adjustment keys.

- Use any Hitachi remote control with "ENTER" button as shown when making an adjustment.

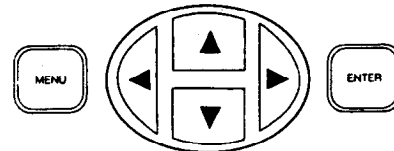

"▲, ▼" keys are used for changing adjustment code.

"◀▶," keys are used for changing data.

"ENTER" key is used for changing "Cut Off Mode" Normal mode". (Refer to cut off adjustment)

3. ADJUSTMENT MODE

If below display appears

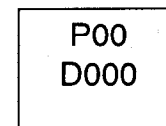
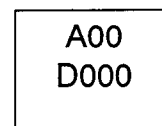

Adjustment code can not be changed by cursor "▲, ▼" keys.

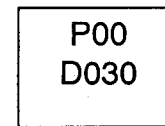
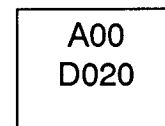

Set data "D020" at "A00" or "D030" at "P00" by "◀▶," keys. Then adjustment code can be changed by "▲, ▼" keys.

B. By Front Control Panel — Another Method

- Before turning ON the set, press INPUT. Then press POWER and keep pressing INPUT for about 3 seconds.
- After 3 seconds, a small square will appear on the left lower corner and there are two different displays. One

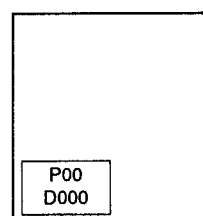

shows A and D, and the other P and D for the picture adjustment.

D = Data value
P = Picture
A = Audio

P00
D000

3. Since this adjustment is by control panel, the P and D has a value of zero. For the adjustment mode, first you have to input a data value of 30 and then you can select the other P options.

A00
D000

The same for the other adjustment of A and D for this adjustment you need an input value of 20 so you can select other options for A.

3. To make selection you have to use the arrow keys on front control panel.

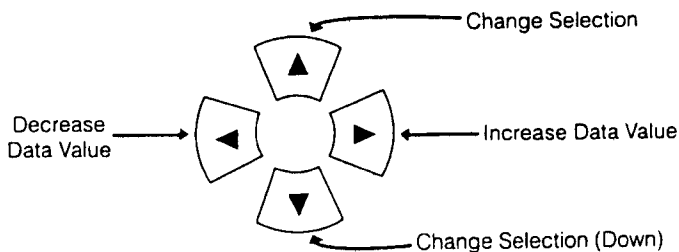
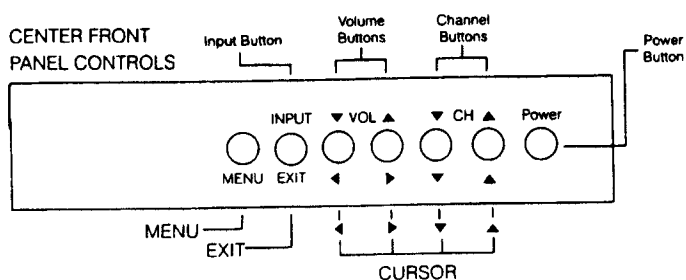

Match front panel control cursor to remote control cursor.

4. ADJUSTMENT PROCEDURE

4-1 VCO For OSD Adjustment.

This chassis starts in initial turn ON and AUTO demonstration mode before memory initialize. So memory initialize should be done according to next procedure before adjustment start.

Initial Turn ON Procedure

- (1) Supply AC power. TV Set is turned ON.
- (2) Turn OFF the set using power switch (S001).
Remo-Con not used.
- (3) Turn ON the set again.
- (4) Memory initialize (see item 4-4. Memory Initialize) should be done.

Adjustment Preparation

- (1) Receive Color Bar or Circle Pattern Signal.
- (2) Connect a DC Voltmeter to point (A).

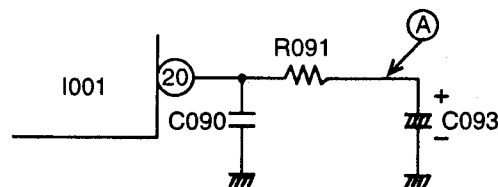

Adjustment Procedure

- (1) Adjust L010 so that the Voltmeter is $2.5 \pm 0.2V$

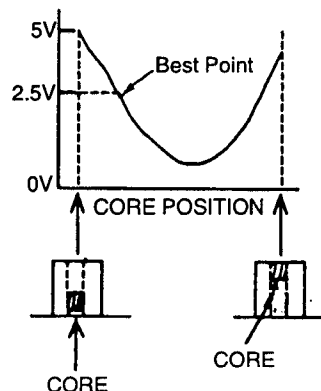

4-2. DEFLECTION CIRCUIT PICTURE ADJUSTMENT OPERATION CHECK

4-2-1. Vertical Size Adjustment (R62A)

Adjustment Preparation

- (1) Receive Circle Pattern Signal.
- (2) Set "CONTRAST" to maximum and "BRIGHTNESS" to the center.

Adjustment Procedure

- (1) Adjust Vertical Size Adjustment VR (R62A) so that the inner circle of Circle Pattern comes in contact with the top and bottom of the screen.

4-2-2. Side Pin Distortion Coarse Adjustment (R752)

Adjustment Preparation

- (1) Receive Circle Pattern Signal.
- (2) Set "CONTRAST" to maximum and "BRIGHTNESS" to the center.

Adjustment Procedure

- (1) Vary R752 so that the right and left vertical lines are straight.

4-2-3. Horizontal Size Adjustment (R755), Horizontal Center Adjustment (R704) and Horizontal Size Correction Adjustment (R775)

Adjustment Preparation

- (1) Receive Circle Pattern Signal.
- (2) Set "CONTRAST" to maximum and "BRIGHTNESS" to the center.

Adjustment Procedure

- (1) Set the R775 at the counterclockwise end.
- (2) Vary R755 so that the horizontal size markers at the right and left end are 1.0 - 1.0 on the average.
- (3) Vary R775 so that the horizontal size markers at right and left are 1.5 -1.5 on the average.
- (4) Vary R704 so that the difference of the horizontal size markers at the right and left end are within 1.5.

4-2-4. High Voltage Limiter Circuit Operation Check and Overvoltage Protection Circuit Operation Check

Adjustment Preparation

- (1) Connect a High Voltage Voltmeter between CPT Anode terminal (Anode cap side) and the Ground (TP701).
- (2) Set AC input voltage to $120 \pm 3V$.
- (3) Receive Circle Pattern and set "BRIGHTNESS" and "CONTRAST" to maximum. Adjust SCREEN VR and SUB-BRIGHTNESS VR(R340) so that Beam Current is $I_b \pm 0.1mA$.
(The voltage of ABL terminal - C747 both ends should be 12V or less)

Adjustment Procedure

- (1) Check that the normal High Voltage is $EHT \pm 1KV$.

CHASSIS	EHT	$I_b \pm 0.1 mA$	E1 (KV)
CZ67	30.0KV	1.70mA	36.0KV
CY62	30.0KV	1.50mA	36.0KV

Adjustment Preparation

- 4) Set AC input voltage to $100 \pm 5V$. Then short-circuit both ends of R903.

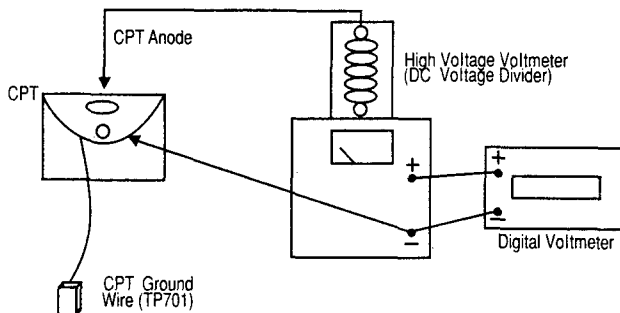

Use a Voltmeter with input impedance 10M ohm or more with indication to the 1st decimal place.

Adjustment Procedure

- (2) Keep CONTRAST, BRIGHTNESS, and SCREEN VR as in item (3). Increase AC input voltage gradually, and check that the picture disappears when high voltage is E1. Immediately after checking that it disappears, turn OFF the set. Remove adjustment jig and High Voltage Voltmeter.

When connecting or removing High Voltage Voltmeter to or from Anode cap, be sure to turn OFF the switch of the set. Also, be sure to perform it after the chassis discharge residual High Voltage, because the high voltage of CPT Anode may be left.

4-2-5. FBT Protection Circuit Operation Check

Adjustment Procedure

- (1) Set "CONTRAST" to maximum, "BRIGHTNESS" to center.
- (2) After turning ON the switch of the set, turn ON the switch (S) of the jig as shown below.
(Operating current limiter circuit.).
Check that the picture disappears.
- (3) Immediately after checking, turn OFF the switch of the set.

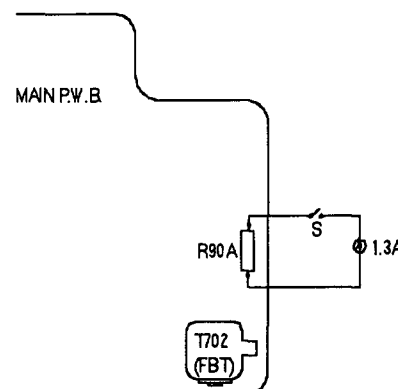

4-2-6. +16V Short Protection Circuit Check.

Adjustment Preparation

- (1) Adjust "CONTRAST" to maximum, "BRIGHTNESS" to center.

Adjustment Procedure

- (1) Connect 100KΩ resistor between Q703 Base and GND and check that the picture disappears.
- (2) Disconnect resistor immediately.

4-2-7. Load Reduction Circuit Operation Check.

Adjustment Preparation

- (1) Receive Circle Pattern Signal.
- (2) Set "VIDEO" mode "CONTRAST" to maximum, "BRIGHTNESS" to center.
- (3) Connect a DC Voltmeter to both sides of R912.
- (4) Check to make sure the potential difference is more than 10V.
- (5) Receive Crosshatch Signal.
- (6) Set "VIDEO" mode "CONTRAST" to minimum, "BRIGHTNESS" to center.
- (7) Check the potential difference is less than 3V.

4-2-8 MFC Circuit Operation Check (35CX45B/CZ67 Only)

Adjustment Preparation

- Receive Circle Pattern.
- Connect the Jig (Shown below) to the PG3 Pin in MFC. P.W.B.

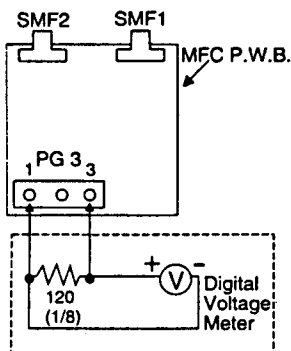

Adjustment Procedure

- Then turn SMF1 to "STRONG", turn SMF2 to "NOR TH", check that the voltage is $V = +2.0 \pm 0.5V$.
- Then turn SMF1 to "WEAK", check that the voltage is $V = +1.5 \pm 0.5V$.
- Then turn SMF2 to "SOUTH", check that voltage is $V = -2.9 \pm 0.5V$.
- Then turn SMF1 to "WEAK", check that the voltage is $V = 1.5 \pm 0.5V$.
- Then turn SMF2 to "E/W", check that the voltage is $V = 0V$.

4-3. MTS ADJUSTMENT

4-3-1. Input Level Adjustment

Adjustment Preparation

- Apply the signal to TUNER (UF01) IF output terminals of TUNER PWB using the jig shown below.

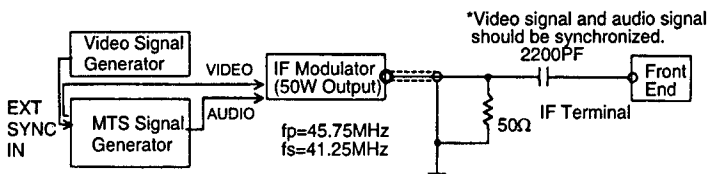

IF Modulator output signal waveforms
(Color Bar or All White)

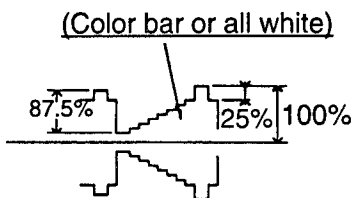

Sound Modulation Condition

- Noise Reduction Encoder: ON
- Stereo Signal:
 - R = 0(L only), 300Hz, 30% modulation (Note 2)*
 - R = 0(L only), 3KHz, 30% modulation (Note 2)*
- Monaural Signal:
 - Monaural, 400Hz 100% modulation (PRE-EN OFF)
- SAP Signal:
 - SAP, 300Hz 30% modulation (Note 2)*

- Connect AC Voltmeter V_o to IS01 pin ②.
(Use the AC voltmeter of Matsushita made, model VP-950C equivalent.)
- Select adjustment code "A04".

Adjustment Procedure

- Adjust the data "A04" to $V_o = \text{Sig } 450\text{mVrms} \pm 10\text{mVrms}$ at IS01 pin ②.

4-3-2. Stereo VCO adjustment

Adjustment Preparation

- Connect a frequency counter to IS01 pin ②. Use the probe of 1:1. (Probe standard $R_i \geq 1M \text{ ohm}$ $C_i \leq 15\text{pF}$)
- Input of IS01 pin ⑦ is no signal.
- Connect capacitor ($100\mu\text{F}/16\text{V}$) as follows.
- Select adjustment code "A01".

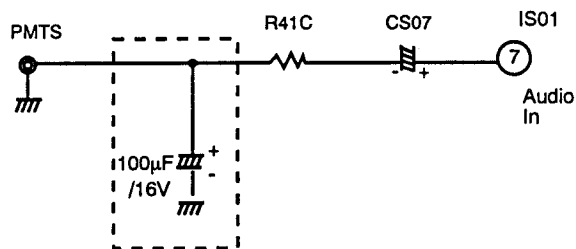

Adjustment Procedure

- Adjust the data to set to $15.73 \pm 0.1\text{KHz}$. by "◀ ▶" keys.
- Delete capacitor ($100\mu\text{F}/16\text{V}$).

4-3-3. FILTER ADJUSTMENT

Adjustment Preparation

- Set capacitor $100\mu\text{F}/16\text{V}$ as shown as follows.
- Apply the signal to IS01 pin ⑦ with the jig shown as follows.

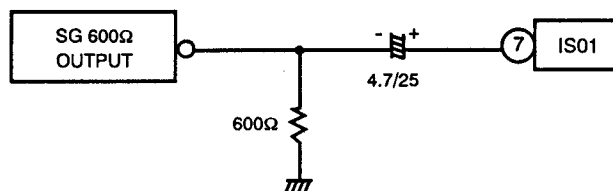
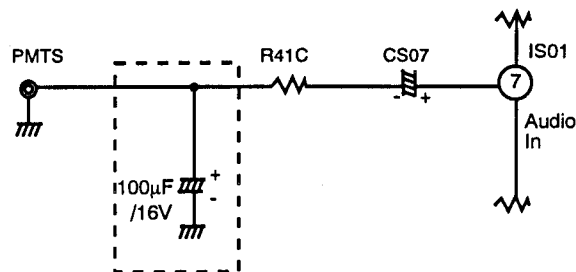

- (a) SG output signal spec.

- FREQUENCY
 $f = 15.73\text{KHz}$ (sin wave)
- Signal level
 $V = 100\text{mVrms}$

- (3) Connect an AC voltmeter or oscilloscope to IS01 pin ⑳
- (4) Select adjustment code "A03"

Adjustment Procedure

- (1) Adjust the data so that the voltage of IS01 ⑳ pin is minimum by "◀ ▶" keys.

4-3-4. Separation Adjustment

(The adjustment of items 4-3-1 to 4-3-3 should have been finished.)

Adjustment Procedure

- (1) Use the same jig as input level adjustment.
- (2) Connect an AC voltage meter through AUDIO AMP. to IS01 ⑳ or connect an oscilloscope.
- (3) Select adjustment code "A06" and set data "D032".

Adjustment Procedure

- (1) Select sound output signal ① and select adjustment code "A05" and adjust by "◀ ▶" keys, so that 300HZ level is min. (L separation adjustment)
- (2) Select sound input signal ② and select adjustment code "A05" and adjust by "◀ ▶" so that 3KHz level is min. (separation adjustment)
- (3) Repeat (1) and (2).
adjustment precision: within +1dB from min. point.

4-3-5. SAP VCO adjustment

Adjustment Preparation

- (1) Connect a frequency counter to IS01 ⑳.
- (2) Select adjustment Code "A02"

Adjustment Procedure

- (1) Adjustment the data by "◀ ▶" keys so that frequency is $78.67 \pm 0.5\text{KHz}$.

II. MEMORY INITIALIZE

4-4. Timer Sound Operation Check

Adjustment Procedure

- (1) Press the memory initialize key with the Remo-Con jig. Check that the below OSD appears.
- (2) Press RECALL (EXIT) key with remo-con jig.
- (3) After 5 sec. operation, check that the set has selected CH 03 and a "beeping" sound comes out from the left side (L-CH).

Note: Do not draw out the outlet within 5 seconds. Do not perform any key operation, either. After this operation, each setting should become to delivery setting automatically.

SPLITER	0	1
POWER ON 1	0	1
POWER ON 2	0	1
PinP 1	0	1
PinP 2	0	1
AUX 1	0	1
AUX 2	0	1
TUNER	0	1

4-5. AFC OPERATION CHECK

Adjustment Preparation

- (1) Connect the jig shown below to the ANT Terminal.

Adjustment Procedure

- (1) Receive a Standard Carrier Signal (not offset) with the channel up/down or direct selection buttons. Check that it is pulled into the standard tuning point.
- (2) Receive an Offset Signal of $\pm 1.5\text{MHz}$. Check that it is pulled into the standard tuning point. (Perform the Channel Selection Operation again.)
- (3) Receive an Offset Signal of -1.5MHz . Check that it is pulled into the standard tuning point. (Perform the Channel Selection Operation again.)

Note 1: Modulation signal should be used at the Circle Pattern and the Color Bar Signal.

Checking jig (All channel converter can be used)

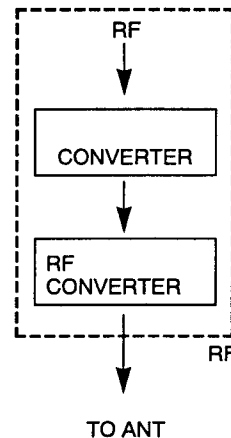

5. CHANNEL SELECTION CIRCUIT OPERATION CHECK

5-1 Channel up/down selection

Adjustment Preparation

- (1) Set the TV set so that VHF (11, 13CH), UHF (14, 46, 63CH) and CATV (A, E, P, W, CH) can be received.
- (2) Set SIGNAL SOURCE mode to ANTENNA. (Press the MENU key, and select the SETUP and SIGNAL SOURCE mode using (▶) button.

Adjustment Procedure

- (1) Check that VHF are received correctly by pressing CH UP (▲) or DOWN (▼) button.

Adjustment Preparation

- (3) Set SIGNAL SOURCE mode to CATV 1.

Adjustment Procedure

- (2) Perform the same operation as in item (1), and check that VHF and CATV are received correctly.

Adjustment Preparation

- (4) Set SIGNAL SOURCE mode to CATV 2.

Adjustment Procedure

- (3) Perform the same operation as in item (1), and check that VHF and CATV are received correctly.

Adjustment Preparation

- (1) Set the TV set so that VHF (11, 13CH), UHF (14, 46, 63CH) and CATV (A, E, P, W, A-2, GG, OO, WW, CH) can be received.

Adjustment Procedure

- (1) Set SIGNAL SOURCE to ANTENNA.
- (2) Select AUTO CHANNEL SET and press (▶) button. After AUTO CHANNEL SET operation is completed, by pressing the channel UP (▲) or DOWN (▼) button, check that the channels having broadcast signal(s) can be received.
- (3) Set SIGNAL SOURCE mode to CATV 1.
- (4) Perform the same operation as in item (2) check that CATV can be received correctly.

Note: Display while AUTO CHANNEL SET is operating.

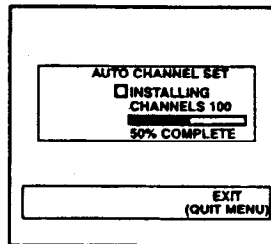

5-2 Channel up/down Selection (sub picture)

Adjustment Preparation

- (1) Press PiP button of remote control, and PiP is selected on TV screen.
- (2) Press PiP CH button, and select sub picture selection mode. (Indicator ▶" OSD should be at PiP as right drawing.)

Adjustment Procedure

- (1) Channel up/down selection 5-1 should be done to sub-picture also.

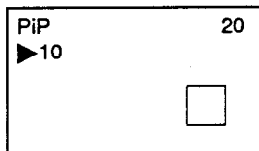

Adjustment Preparation

- (2) Set to CHANNEL LIST mode. (Menu under SET-UP mode)

Adjustment Procedure

- (5) Check that the above items is scanned and the channels is listed "ON" on the CHANNEL LIST.

Note: CATV channels, actual input channels numbers and indicated channel numbers.

A	14
E	18
P	29
W	36
A-2	98
GG (W+7)	43
OO (W+15)	51
WW (W+23)	59

Note: CATV channels, actual input channels numbers and indicated channel numbers shown in Table 3 below.

5-3 VOL UP/DOWN

Adjustment Procedure

- (1) Check that the sound volume level and volume indication is going up or down continuously by pressing sound volume UP (▲) or DOWN (▼) button.



5-4 POWER ON/OFF

Adjustment Procedure

- (1) Check that the power alternates between ON and OFF by pressing the POWER button.

5-4-1 INPUT

Adjustment Procedure

- (1) Check that the OSD displays by pressing the INPUT button, such as below.
Receiving CH → VIDEO
→ VIDEO (S-IN)
→ Receiving CH

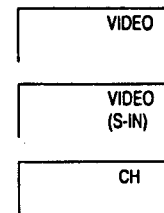

5-5 MENU

Adjustment Procedure

- (1) Check that the MENU OSD displays by pressing MENU button.

TABLE 3

A	B	C	D	E	F	G	H	I	J	K	L	M	N	O	P	Q	R	S	T	U	V	W
14	15	16	17	18	19	20	21	22	23	24	25	26	27	28	29	37	31	32	33	34	35	36
MID BAND											SUPER BAND											
W+1	W+2	W+3	W+4	W+5	W+6	W+7	W+8	W+9	W+10	W+11	W+12	W+13	W+14	W+15	W+16	W+17	W+18	W+19	W+20	W+21	W+22	W+23
37	38	39	40	41	42	43	44	45	46	47	48	49	50	51	52	53	54	55	56	57	58	59
HYPER BAND																						
W+24	W+25	W+26	W+27	W+28	W+29	W+30	W+31	W+32	W+33	W+34	W+35	W+36	W+37	W+38	W+39	W+40	W+41	W+42	W+43	W+44	W+45	W+46
60	61	62	63	64	65	66	67	68	69	70	71	72	73	74	75	76	77	78	79	80	81	82
HYPER BAND											ULTRA BAND											
W+47	W+48	W+49	W+50	W+51	W+52	W+53	W+54	W+55	W+56	W+57	W+58	A-5	A-4	A-3	A-2	A-1	W+59	W+60	W+61	W+62	W+63	W+64
83	84	85	86	87	88	89	90	91	92	93	94	95	96	97	98	99	100	101	102	103	104	105
ULTRA BAND											MID BAND					ULTRA BAND						
W+65	W+66	W+67	W+68	W+69	W+70	W+71	W+72	W+73	W+74	W+75	W+76	W+77	W+78	W+79	W+80	W+81	W+82	W+83	W+84			
106	107	108	109	110	111	112	113	114	115	116	117	118	119	120	121	122	123	124	125			
ULTRA BAND																						

Note: MENU OSD is displayed as below.

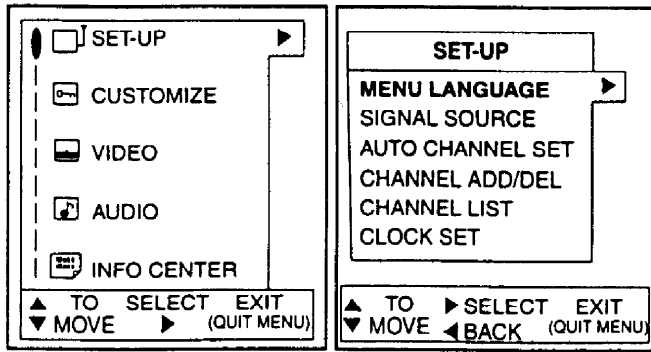

1st page

2nd page of SET-UP mode

- (2) After MENU OSD is displayed. Check that the keys function change as below.
- MENU → MENU
 - CH UP → ▲ Key
 - CH DOWN → ▼ Key
 - VOLUME → ► Key
 - VOLUME DOWN → ◀ Key
 - INPUT → INPUT

5-6 MENU Mode (using Remo-con)

5-6-1 SET UP mode

Adjustment Preparation

- (1) Set to MENU LANGUAGE mode.

Adjustment Procedure

- (1) Check that language (ENGLISH, FRENCH, SPANISH) is selected by pressing the ▲, ▼ button.

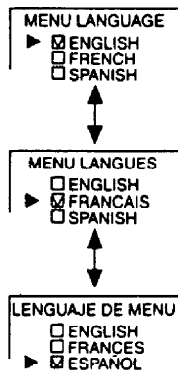

Adjustment Preparation

- (1) Set to CHANNEL ADD/DEL mode.

Adjustment Procedure

- (1) Check that ADD or DELETE is selected by pressing the ► button.

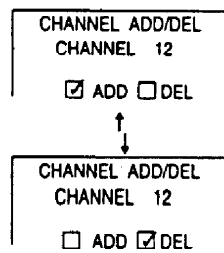

Adjustment Preparation

- (1) Connect diode (1S2076, 1S270TA or equivalent) between ① and ②.

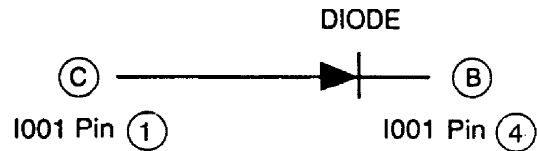

Remarks: The addition of the above diode intends to check the operation with clock counting operation as 60 times mode.

- (2) Set to CLOCK SET mode.

Adjustment Procedure

- (1) After clock setting is done and the indication disappears, perform CH indication. Check that clock indication is displayed in addition to the CH indication, and that the clock indication is going to 1 second per minute.

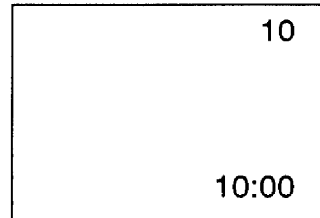

5-6-2 CUSTOMIZE mode

Adjustment Preparation

- (1) Set to CHANNEL ID mode.

Adjustment Procedure

- (1) Select the letter "A" by pressing the ▲, ▼ button, and select the input position by pressing the ► button.
- (2) After pressing the ◀ button, check that it indicates "AAAA" same as CH no. indication.
- (3) Select CHANNEL ID Mode again. Select the "Cancel" by pressing the ► button and press the ◀ button.
- (4) Check that "AAAA" is selected when the CH No. is indicated after pressing the "MENU" button.

Adjustment Preparation

- (2) Set to FAMILY FAVORITES mode.

Adjustment Procedure

- (1) Select FAMILY FAVORITES option by pressing ► button.
- (2) Select the four categories and the registration position by using the cursor buttons.
- (3) Change to your favorite channel.
- (4) Press MENU button to set your favorite channel to be registered.
- (5) To delete your favorite channel, enter 00 as your channel, then press MENU button.

Adjustment Preparation

- (3) Set to CHILD LOCK OPTIONS mode.

Adjustment Procedure

- (1) Select CHILD LOCK OPTIONS, then press ► button to enter.
- (2) Press "0" button three times ("000"), then press ► button to enter to set child lock options ON/OFF.
- (3) Check that the picture becomes pitch-dark, and no sound comes out when CHANNEL is set to ON.
- (4) Check that the picture and sound return to the previous condition when CHANNEL is set to ON.

Note: The following is the CHILD LOCK OPTION

Mode	Options
CHANNEL LOCK	To lock/unlock tv signal from viewing.
VIDEO LOCK	To lock/unlock of video (S-IN includes, too.)
QUICK LOCK	To lock/unlock tv and video at the same time.
TV TIME OUT	To lock tv signal for a specific time period.
SECRET CODE CHANGE	To change secret code.

Adjustment Preparation

- (1) Set the mode to CLOSED CAPTION.
- (2) Receive a signal having a CLOSED CAPTION signal.

Adjustment Procedure

- (1) Set DISPLAY setting to "ON" with ►, ◀ button. At this time, set the other settings as follows.
 1. DISPLAY: ON
 2. MODE: C.C.
 3. CHANNEL: 1
- (2) Check that the CAPTION corresponding to the above setting is displayed on the screen.
- (3) Set CHANNEL to 2.
- (4) Check that the CAPTION of CHANNEL 2 is displayed on the screen.
- (5) Set CHANNEL to 1.
- (6) Check that the CAPTION of CHANNEL 1 (FIELD 2) is displayed on the screen.
- (7) Set the mode to TEXT.
- (8) Check that a black window appears and TEXT letters are displayed at the center of the screen.
- (9) Repeat adjustment procedure from (3) to (6), and check that TEXT letters are displayed corresponding to each mode.
- (10) Set the mode to CAPTION.
- (11) The black window should disappear returning to the state of (2).
- (12) Set ON/OFF to OFF.
- (13) Check that the CAPTION letters disappear.

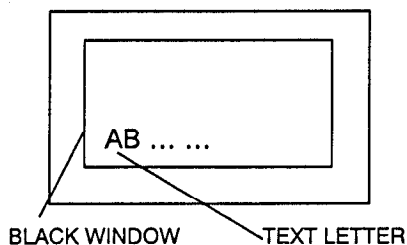

5-6-3 VIDEO mode

Adjustment Preparation

- (1) Receive the color bar signal.
- (2) Set to CONTRAST mode.

► ; BRIGHTER
◀ ; DARKER

Adjustment Procedure

- (1) Check that CONTRAST is changed by pressing control ◀ / ► buttons.

Adjustment Preparation

- (2) Set to TINT mode.

► ; MORE GREEN
◀ ; MORE RED

Adjustment Procedure

- (3) Check that TINT is changed by pressing control ◀ / ► buttons.

Adjustment Preparation

- (4) Set to COLOR mode.

► ; DEEPER
◀ ; LIGHTER

Adjustment Procedure

- (3) Check that COLOR is changed by pressing control ◀ / ► buttons.

Adjustment Preparation

- (5) Set to BRIGHTNESS mode.

► ; BRIGHTER
◀ ; DARKER

Adjustment Procedure

- (4) Check that BRIGHTNESS is changed by pressing control ◀ / ► buttons.

Adjustment Preparation

- (6) Set to SHARPNESS mode.

► ; CLEARER
◀ ; SOFTER

Adjustment Procedure

- (5) Check that SHARPNESS is changed by pressing control ◀ / ► buttons.

Adjustment Preparation

- (7) Set to COLOR TEMP mode.

► ; WARM
◀ ; COOL

Adjustment Procedure

- (6) Check that COLOR TEMP is changed by pressing control ◀ / ► buttons.

Adjustment Preparation

- (8) Set to RESET mode.

Adjustment Procedure

- (7) Check that all picture setting modes return to delivery settings by pressing ► button.

5-6-4 AUDIO mode

Adjustment Preparation

- (1) Set to BALANCE mode.

► ; RIGHT
◀ ; LEFT

Adjustment Procedure

- (1) Check that BALANCE is changed by pressing control ◀ / ► buttons.

Adjustment Preparation

- (2) Set to BASS mode.

► ; STRONG
◀ ; WEAK

Adjustment Procedure

- (2) Check that BASS is changed by pressing control ◀ / ► buttons.

Adjustment Preparation

- (3) Set to TREBLE mode.

Adjustment Procedure

- (3) Check that TREBLE is changed by pressing ◀ / ► buttons.

Adjustment Preparation

- (1) Set to VOLUME CORRECTION mode.

Adjustment Preparation

- (1) Select the registration point using the cursor button and received Channel No. is memorized by pressing the MENU button.
Note: 4CH can be memorized.
- (2) Check that volume level changes and sets 100%-50% (5% step) using ▼, ▲, button.

Adjustment Preparation

- (4) Set to RESET mode.

Adjustment Procedure

- (4) Check that all sound setting modes return to delivery settings by pressing ► button.

Adjustment Preparation

- (5)
 - (a) Set to "Volume" step at *10. Set to "BASS" and "TREBLE" at center when "LOUDNESS" is turned OFF. Set to "LOUDNESS" Mode.
 - (b) Set "LOUDNESS" to OFF, and "BASS/TREBLE" to center.
 - (c) Set it to LOUDNESS Mode.

Adjustment Procedure

- (5) Check that "BASS" and "TREBLE" are changed as below table when set to "LOUDNESS" is turned ON by pressing ► control button "LOUDNESS" turn OFF after checked.

LOUDNESS	BASS	TREBLE
OFF	CENTER	
ON	+21 STEP	

(when volume is 10)

***Note:** According to Volume Setting Level, this function works as shown in below figure.

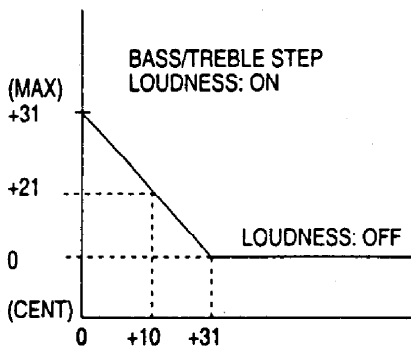

Adjustment Procedure

- (1) Check that by pressing "P in P" button of remo-con, sub-picture alternates between ON and OFF. When sub-picture is ON, check that the channel number and "V" are displayed.

6-1 MOVE

Adjustment Preparation

- (1) Press "P in P" button to set to P in P mode.
- (2) Press "INPUT" button to change sub-picture between VIDEO input and MAIN picture.

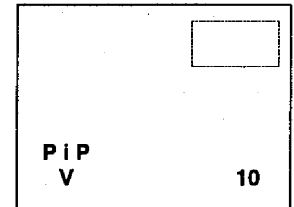
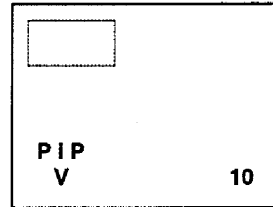

Adjustment Procedure

- (1) Check that by pressing MOVE button of remo-con twice quickly, sub-picture moves counterclockwise. At this time, check that sub-picture Channel also moves as well.
- (2) Check that by pressing MOVE button once and quickly pressing the cursor buttons, the sub-picture move to the direction of the cursors.

Note: When sub-picture is in the upper side of the screen, the channel number of main picture comes to the lower right, as shown in the figure on the preceding page.

6-2 SWAP

Adjustment Preparation

- (1) Press "P in P" button to set to P in P mode.

Adjustment Procedure

- (1) Check that by pressing "SWAP" button, the contents of main picture and sub-picture are exchanged.

6-3 FREEZE

Adjustment Preparation

- (1) Press "P in P" button to set to P in P mode.
- (2) Sub-picture should be moving picture by pressing "SWAP" button.

Adjustment Procedure

- (1) Check that, by pressing "FREEZE" button, sub-picture alternates between moving picture and frozen picture.

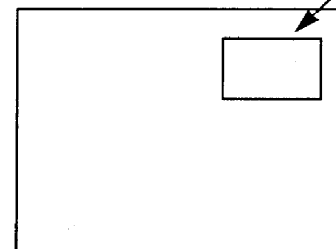
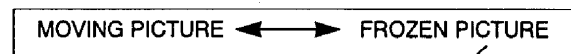

- (2) Press "P in P" button to make sub-picture disappear.

IV. P IN P OPERATION CHECK

6. P IN P

Adjustment Preparation

- (1) Connect a signal to ANT input and receive it.
- (2) Connect a signal to VIDEO input.

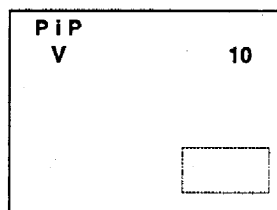

6-4 FREEZE (AT P IN P OFF)

Adjustment Preparation

- (1) Connect a signal to ANTENNA input and VIDEO input. Both signals should be moving picture.
- (2) Set P in P to OFF.

Adjustment Procedure

- (1) Check that frozen picture of main screen appears by pressing FREEZE button of the remo-con.
- (2) Check it also in the TV and VIDEO modes.
- (3) Check that sub-picture disappears by pressing FREEZE button at picture frozen.
- (4) Check that it turns to normal P in P sub-picture by pressing P in P button at picture frozen.

MOVING PICTURE

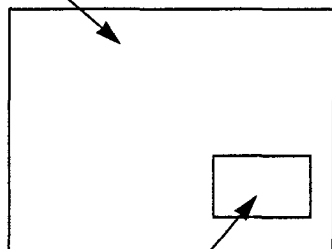

SUB PICTURE

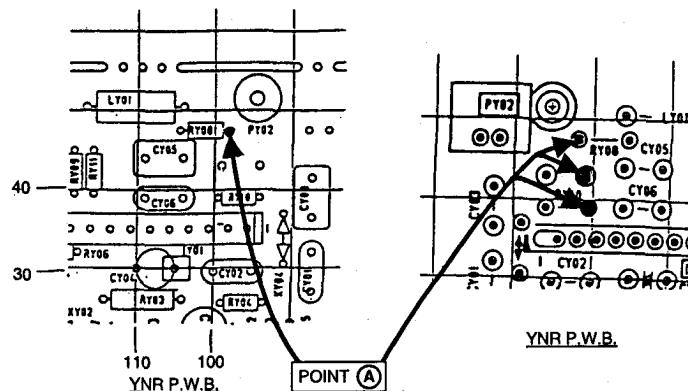

- (2) Connect the DC Voltmeter to point (B) of MAIN P.W.B. and check that the DC Voltmeter is $1.15V \pm 0.3V$.

6-5 WEAK ELECTRIC FIELD CHECK

Adjustment Preparation

- (1) Connect one side of the 300 ohm feeder to 75 ohm-300 ohm antenna adaptor. Connect the antenna adaptor to the VHF antenna terminal board as shown below.
- (2) Turn to no signal condition.

Adjustment Procedure

- (1) Check that the phenomena such as oscillation and abnormal beat etc. do not occur in all the channel.

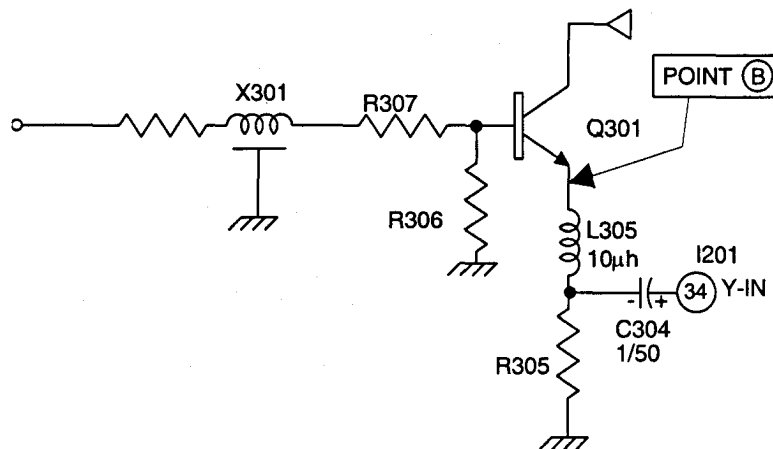
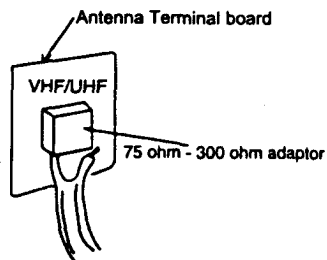

Y. YNR Operation Check (35V ONLY)

Adjustment Preparation

- (1) Receive Circle Pattern

Adjustment Procedure

- (1) Connect the DC Voltmeter to point (A) of YNR P.W.B. and check that the DC Voltmeter is $9.3V \pm 0.3V$.

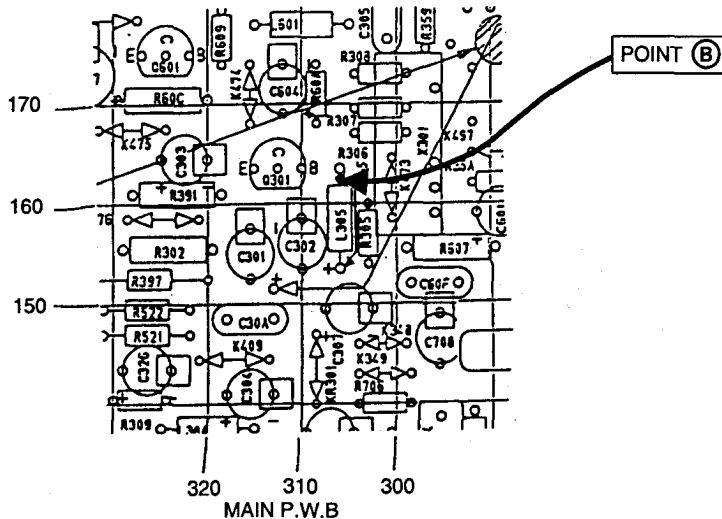
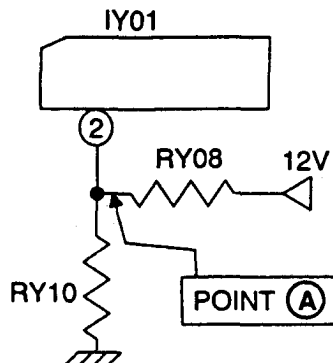

7. FINAL ADJUSTMENT/Common Service Adjustment

7-1. Purity Convergence Adjustment

Note: For ITC TYPE A89AEJ15X02 (35V Dark Tint) only applies to item 7-1-1 (8) (PURITY Check).

Preparation of Adjustment

- (1) Keep DY attached to CPT funnel.
- (2) Turn ON the set and receive Crosshatch Signal (or Circle Pattern Signal). Adjust the Static Convergence coarsely according to item 7-1-3.
- (3) Receive Circle Pattern Signal and adjust the White Balance according to item 7-4.
- (4) Set BRIGHTNESS control and CONTRAST control to maximum, and heat-run the set with Circle Pattern Signal received for 40 minutes or more.

7-1-1. Purity Adjustment

THIS ADJUSTMENT METHOD APPLIES TO THE PURITY ADJUSTMENT BY USING MICROSCOPE

- (1) Adjust coarsely White Balance, Static Convergence (center) and Focus.
- (2) Receive Circle Pattern and heat-run more than T minutes with CONTRAST and BRIGHTNESS maximum. Do not delete the raster nor vary the current before fixing the position of DY. Heat-run should be done with perfect raster. (DY and Tilt should have been coarsely adjusted)

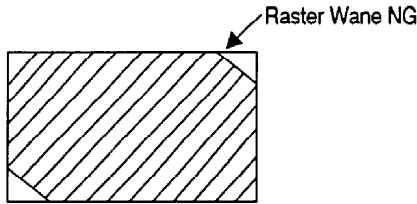

TABLE 1.

CPT	T
A80LJF30X	45 Min

- (3) The magnetic field in the artificial magnetic field should follow the table below and the set should face as table 2. Degauss it from the outside.

DESTINATION	VERTICAL FIELD	HORIZONTAL FIELD
USA	0.45 G	0.3 G
CANADA	0.54 G	0.15 G
UNIVERSAL	0.35 G	0.3 G
PANAMA, HAWAII	0.2 G	0.3 G
TAIWAN	0.22 G	0.37 G

TABLE 2. Directions for adjustment

A80LJF30X	North
-----------	-------

- (4) Adjust the position of Purity Magnet and DY, keep the landing balance of (3) and (9), and adjust so that the landing of (3) and (9) is as follows while observing with a microscope. A80LJF30X

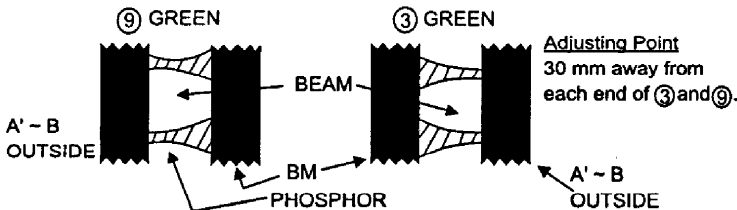

- (A) Open the Purity Magnet as follows in order to move the raster only in the right-left direction.

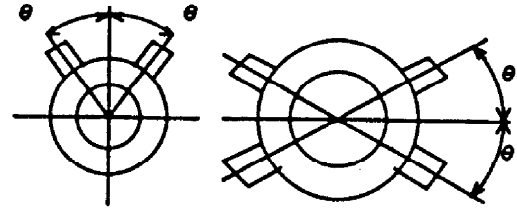

Keep the balance of (3) / (9) DY landing

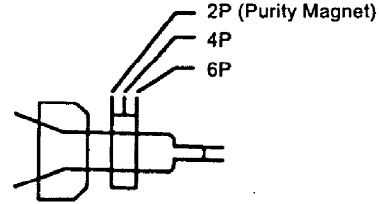

- (B) YPB (Yoke Pull-Back) should be as follows. (Distance between the bumped position of DY toward the funnel and the just-landing position of (3) and (9).)

CPT	YPB (DESIGN CENTER)
A80LJF30X	2.2mm

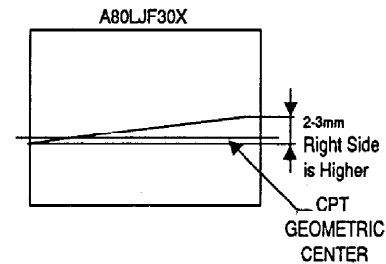
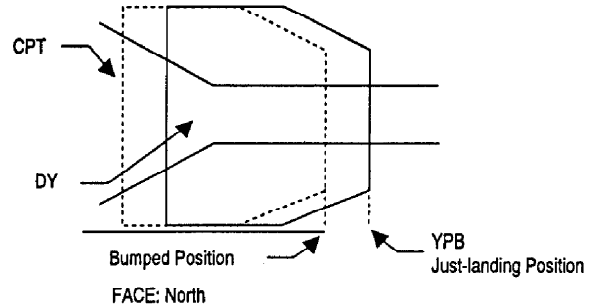

- (C) DY Tilt should be as follows:

- (5) Fix DY with fixing torque of 14kg.cm Control the torque by an electrical driver.
- (6) If any mislanding occurs, correct with magnets. At this time, if the white unevenness is all right, no magnet is needed.
- (7) After peripheral convergence is adjusted, check the position of DY and tighten the DY again. (14kg.cm)

Reference

THE JIG

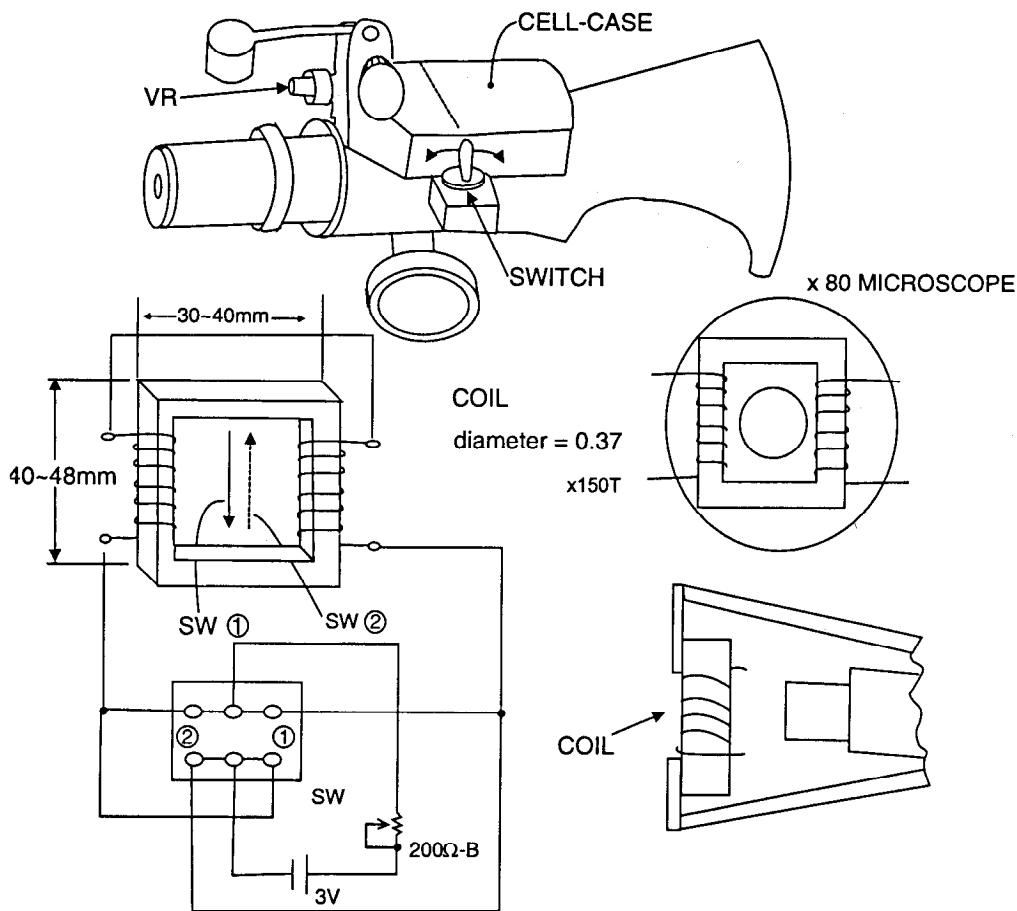

Fix coil to CRT side of microscope. Set it up side down and measure it. Check that beam moves to the right and left equally in quantity .

(8) Purity Check

The magnetic field in the artificial magnetic field should follow the magnetic field according to the destination, and the set should face as follows. After degaussing in each direction, check these items visually and with a microscope.

- (A) No problem in white unevenness.
- (B) Each single color must not hit any other colors.
- (C) If white or each single color is defective, apply a magnet (S) on CPT for correction. If any magnet is applied, check it after degaussing.

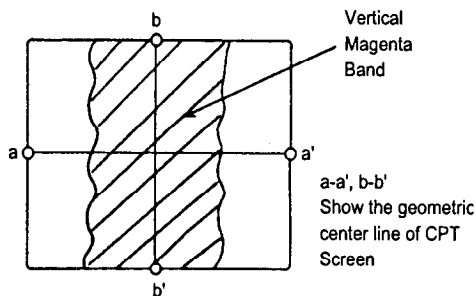

Fig. 7-1-2-1

CPT	CHECK FACE
A80LJF30X	SOUTH, NORTH
A89AEJ15X02	SOUTH, NORTH

7-1-2. Purity Adjustment

(THIS ADJUSTMENT METHOD APPLIES TO THE HAND-OPERATED PURITY ADJUSTMENT.)

- (1) Use the Earth's magnetic field (Location of the set).
- (2) Adjust Focus coarsely according to item 7-2.
- (3) Adjust Convergence coarsely according to item 7-1-4.
- (4) Receive Circle Pattern Signal and check that CONTRAST and BRIGHTNESS are maximum.
- (5) Receive Magenta Signal. When the Magenta Signal is not available, short-circuit between the Base and Emitter of Q855 to set to Magenta.
- (6) Press DY fully against CPT funnel and turn the Purity Magnet so that the Vertical Magenta Band comes to the center of the picture. (Fig. 7-1-2-1) Check that color unevenness of both sides are approximately equal at this time. The openings of the Purity magnet should be symmetric. (Fig. 7-1-2-2)

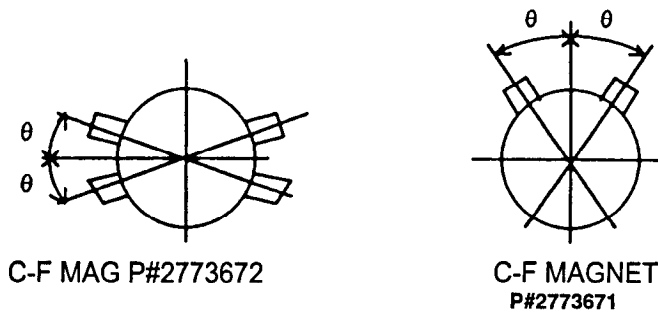
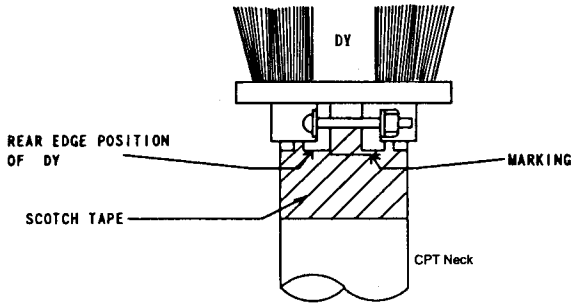

Fig. 7-1-2-2

The openings of purity magnet should be symmetric on the right and left sides (P#2773672) and on the upper and lower side (P#2773671).

- (7) Receive the Single Red Signal.
When the Single Red Signal is not available, short-circuit between the Base and Emitter of Q854, and between the Base and Emitter of Q857 to set to Single Red Signal.
- (8) Pull back DY gradually and when the color unevenness of both sides of the picture disappear, mark the rear edge position of DY on the tape wound around CPT neck as shown in Fig. 7-1-2-3. Pull back DY further and just before the color unevenness starts to appear on both sides of the picture, mark the rear edge position of DY on the tape by the same way.
At this time, pull back DY so that the center axis of DY and CPT axis match.

Fig. 7-1-2-3



- (9) Move DY so that the rear edge position of DY comes to the center of the two marked lines and fasten DY as $d = d'$. (Fig 7-1-2-4).
Further insert the rubber wedge between DY and CPT funnel from the top and raise DY backwards.

Fig. 7-1-2-4

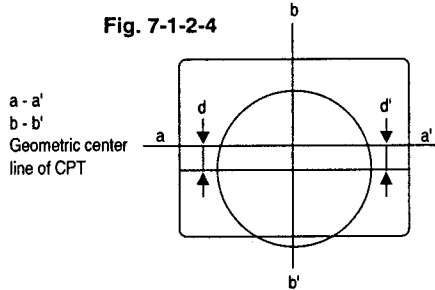

- (10) Set CPT axis direction magnetic field according to the Earth's magnetic field setting.
(The direction of the magnetic field should be from the CPT screen side to the neck side.)
- (11) After degaussing it from outside, check the Purity in each color of R,G and B visually. Then, turn the screen to White and check the landing at the screen position shown in Fig. 7-1-2-5 with a microscope.

Criteria with microscope

There should be no mislanding at positions 2-4-8 and 10. (Refer to the mislanding criteria)
Green beam should be at the center of the green phosphor at position C.

- (12) Turn over the direction of CPT axis direction magnetic field of the Earth's magnetic field and check it by the same way as item (11). The positions of mislanding criteria with microscope should be 2, 4, 8 and 10. (Fig. 7-1-2-5)

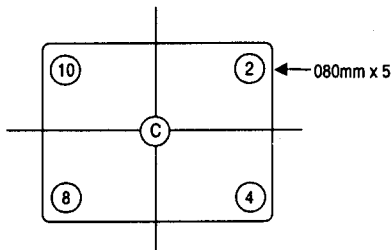

Fig. 7-1-2-5

Mis-Landing Criteria

The following conditions are defined as mislanding. Each color beam shines on the phosphor of the applied color and there are phosphor parts which are not luminous (shaded parts in the Fig. 7-1-2-6) between the luminous part and black matrix or each color beam shines on the phosphor of not applied color.

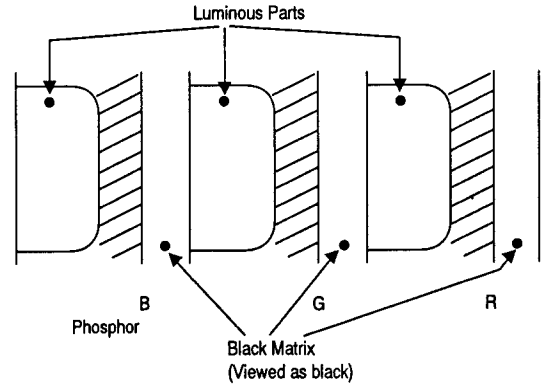

Fig. 7-1-2-6 Enlarged view of screen with microscope

- (13) To improve the mislanding mentioned above, it's acceptable to stick the permanent magnet to CPT funnel. (Fig. 7-1-2-7 and Fig. 7-1-2-8)

Usage

Apply a silicone rubber KE-40 WRTV to the permanent magnet shown in the Figure 7-1-2-8., adhere it to CPT funnel and then fix it with permaseal tape.

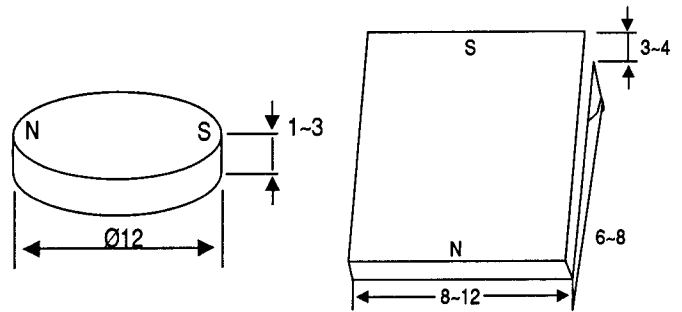

Fig. 7-1-2-7

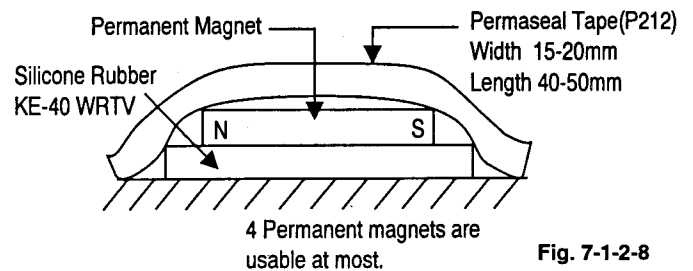
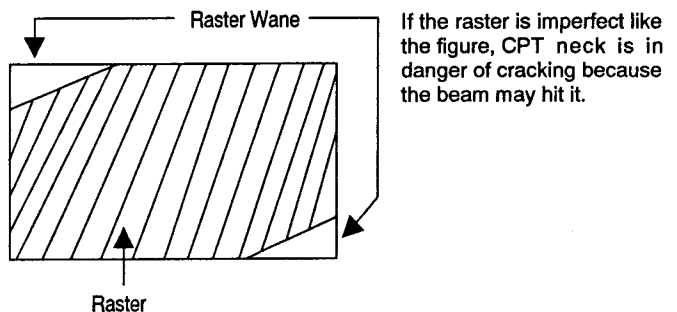

Fig. 7-1-2-8

Notes for pre-heat

Before pre-heating, stick DY to CPT funnel and fix it so that the raster is perfect.



7-1-3. Static Convergence Adjustment (Screen Center Part) (Except ITC CPT)

- (1) Receive the Crosshatch Signal and set BRIGHTNESS to center, CONTRAST to minimum.

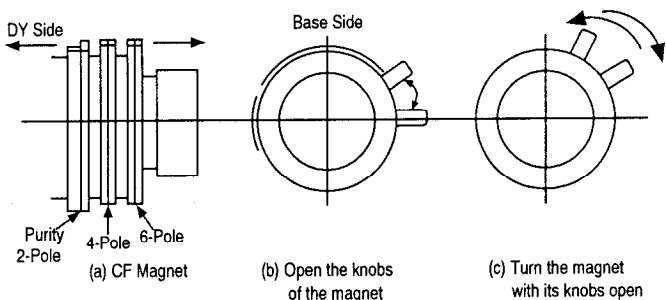

Fig. 7-1-3-1

Open the knobs of 4-pole magnet (2 sheets) (Fig. 7-1-3-1(b)) and match the blue/red vertical lines at the center of the screen as shown in fig. 7-1-3-2(a).

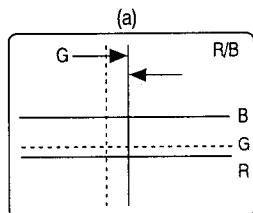

Fig. 7-1-3-2

- (3) Turn the 4-pole magnet with its knobs open (Fig. 7-1-3-1(c)) and match the blue/red horizontal lines as shown in Fig. 7-1-3-2(b).

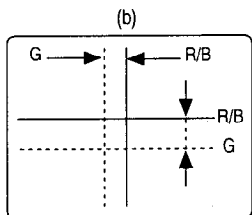

Fig. 7-1-3-2

- (4) Open the knobs of 6-pole magnet (2 sheets) and match the green vertical line at the center of the screen to the blue/red vertical lines shown in Fig. 7-1-3-2(c).

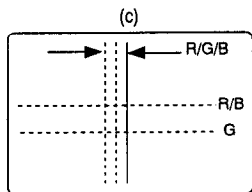

Fig. 7-1-3-2

- (5) Turn the 6-pole magnet with its knobs open and match the green horizontal line at the center of the screen to the blue/red horizontal lines as shown in Fig. 7-1-3-2(d).

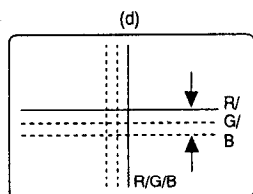

Fig. 7-1-3-2

- (6) After the adjustment of items (1) - (5), if red/blue/green (3 colors) do not match, repeat the adjustment of (1) - (5).
- (7) After checking that Purity and Static Convergence are adjusted to the best condition, fix C-F Magnet with white paint.

7-1-4. Dynamic Convergence Adjustment (Except ITC CPT Type)

- (1) Insert an adjustment wedge (temporary) between the top of DY opening and CPT funnel as shown in Fig. 7-1-4-1. By inserting the wedge gradually, match the red and blue vertical lines at the top and bottom of the screen and also match the red and blue horizontal lines of both sides of the screen as shown in Fig. 7-1-4-2 (a).
 - (2) Adjust the swinging in the right/left directions of DY while observing 6 and 12 horizontal lines of the screen and match the red and blue horizontal lines.
- As shown in Fig. 7-1-4-2 (b), when the blue is outside from the red on CPT screen, insert the DY fixing wedge between the right-side DY viewed from the rear of CPT and CPT funnel.
- (3) AS shown in Fig. 7-1-4-2 (c), when the blue is inside from the red on CPT screen, insert the wedge between the left-side DY and CPT funnel.
 - (4) Insert two DY fixing wedges with approx. 120 to the DY fixing wedge inserted in the Items (2) or (3) and remove the adjustment wedge (temporary). Use the DY fixing wedge after peeling off the tape. After the location, press and adhere it to the funnel.

HITACHI CPT A80LJF30X

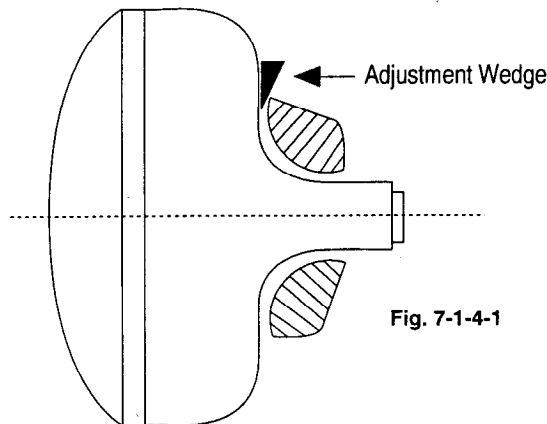

Fig. 7-1-4-1

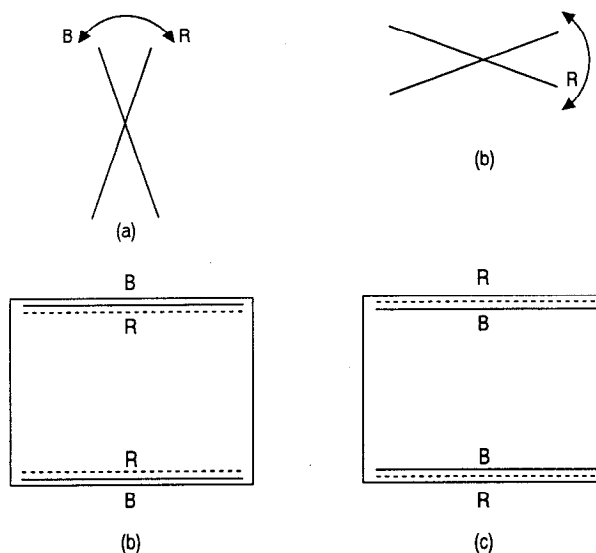

Fig. 7-1-4-2

7-2 Focus Adjustment

NO.	MODEL	CPT	CONDITION	FOCUS VR SETTING POSITION
1	35CX45B CZ67	A89AEJ15X02	<ul style="list-style-type: none"> • Receive the Crosshatch Signal • Picture Control: Maximum • Sharpness Control: Center • Brightness Control: Where the background is set. 	Turn the Focus VR gradually clockwise from the full counterclockwise. Then set it to the point where the focus of the 5th vertical line from the screen center becomes best.
2	32CX12B CY62	A80LJF30X (HED-US)	Same as above	Turn the Focus VR gradually clockwise from the full counterclockwise. Then set it to the point where the focus of center vertical line from the screen center becomes best.

7-3. Deflection Circuit Picture Adjustment

7-3-1. Horizontal Center Adjustment VR(R704)

Adjustment Preparation

- (1) Receive Circle Pattern Signal. Set CONTRAST to maximum and BRIGHTNESS to center.

Adjustment Procedure

- (1) Adjust H. size marker, turn VR(R704) to adjust difference of right and left horizontal size marker until it is within 0.5.

7-3-2. Vertical Size Adjustment VR(R62A)

Adjustment Preparation

- (1) The set should face the North or South.
- (2) Receive Circle Pattern Signal, and set CONTRAST to maximum and BRIGHTNESS to center.

Adjustment Procedure

- (1) Adjust V. size VR(R62A) so that the outer circle of the Circle Pattern is like the figure below.

Note: Wait 5 minutes or more after turning the power ON to perform this adjustment.

- (i) When the picture center is below CPT center
Adjust so that 1/2 of the width of the outer circle comes to the top of the screen.

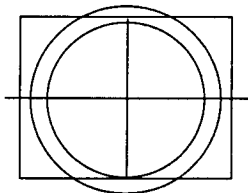

- (ii) Standard Condition
Adjust so that the inner circle comes in contact with the top and bottom of the screen.

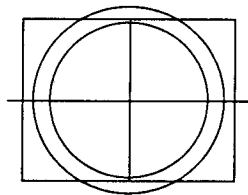

- (iii) When the picture center is above CPT center.
 - (1) When the picture center is 0-2 mm above CPT center, adjust so that the bottom of the inner circle comes in contact with the bottom of the screen.

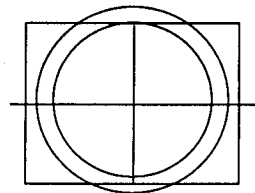

- (2) Except for the above, adjust so that 1/2 of the width of the outer circle comes to the bottom of the screen.

7-3-3. Side Pin Distortion Adjustment VR(R752)

Adjustment Preparation

- (1) Receive Crosshatch Signal and set CONTRAST to maximum and BRIGHTNESS to the point where the background is set.

Adjustment Procedure

- (1) Adjust VR(R752) so that the line of the right and left is straight.

7-3-4. Horizontal Size Adjustment VR(R755, R775)

Adjustment Preparation

- (1) Receive Circle Pattern Signal.
- (2) Set CONTRAST to maximum and BRIGHTNESS to center.

Adjustment Procedure

- (1) Set the VR(R775) at the counterclockwise end.
- (2) Vary VR(R755) so that the horizontal size markers at the right and left end are A - A on the average.*
- (3) Vary VR(R775) so that the horizontal size markers at right and left are B - B on the average.*
- (4) Vary VR(R704) so that the difference of the horizontal size markers at the right and left end are within 1.5.

* CPT SIZE	A	B
35V	0.5	1.0
32V	1.0	1.5

7.4. White Balance Adjustment

Adjustment Preparation

- (1) Apply heat-run 10 minutes or more after the power is turned ON.
- (2) Check that the Purity Adjustment has been completed.
- (3) Set the vertical incident illumination on the CPT surface to 20 lux or less.
- (4) Receive White Raster Signal.
- (5) Set Drive Adjusting VRs (R860, R864) to the mechanical center.
- (6) Turn Low Brightness White Balance adjusting VRs (R866, R870, R868) fully counterclockwise.
- (7) Set the Color Temperature Control (White Control) to OFF (warm).
- (8) Turn the SCREEN Adjusting VR fully counterclockwise.
- (9) Turn S851 switch to ON position.

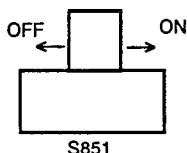

Adjustment Procedure

- (1) Turn the SCREEN Adjusting VR clockwise and set it to the position where the bright colored line starts appearing on CPT screen. Do not turn thereafter, the Low Brightness White Balance VR (This is called VR-A) corresponding to the color first appearing. When a bright colored line does not appear, set the SCREEN VR fully clockwise.
- (2) Turn clockwise the Low Brightness White Balance VRs except VR-A and adjust so that the red, green and blue bright colored lines appear on the screen equally.
- (3) Turn S851 switchback to OFF position.
- (4) Set CONTRAST and BRIGHTNESS control to minimum and turn SUB-BLACK LEVEL VR (R340) to set at the position where the white raster is just slightly seen.
- (5) Set the White Balance Meter at the center of the screen.
- (6) Adjust CONTRAST control so that the indication of the Brightness Meter is 80% of the full scale. Then, turn the Drive adjusting VRs (R860, R864) and adjust the High-Brightness White Balance.
- (7) Adjust CONTRAST control to minimum and check that the Low-Brightness White Balance is obtained by directly observing the CPT surface, without using a mirror.
- (8) When the Low Brightness White Balance is not obtained, adjust other Low-Brightness White Balance VRs except VR-A and return to item (6). **White Balance Color Temperature Setting 7,200°K.**
- (9) Set White Control (Color Temperature Control) to COOL, and check that Color Temperature is approximately 9,300°K.

7-5. Sub-Black Level Adjustment VR(R340) Adjustment Preparation

- (1) Apply heat-run for 10 minutes or more after the power is turned ON.
- (2) Receive Color Bar Signal.
- (3) Set CONTRAST and COLOR Controls to minimum.
- (4) Set the vertical incident illumination on the CPT surface to 20 lux or less.
- (5) Set BRIGHTNESS control to the center position.
- (6) Set White Control to WARM.

Adjustment Procedure

- (1) Turn SUB-BLACK LEVEL adjustment VR (R340) as follows. SUB-BLACK LEVEL adjustment the background of A1,A2, are set to black and A3 is set lighter black.

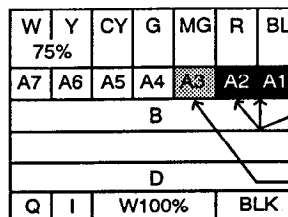

The background is set to black. Perform the adjustment without observing the boundary parts.

The background is set to lighter black.

- (2) Check by directly observing the CPT surface, without using a mirror.

7-6. Channel Selector Operation Check

7-6-1. CCD Display Position Adjustment.

Adjustment Preparation

- (1) Receive an Encoded Signal of Closed Caption Signal.
- (2) Press and hold down the INPUT key and press POWER key of MAIN P.W.B. front keys, turn ON the set.

Adjustment Procedure

- (1) When the TEXT from the CAPTION appears On Screen. Adjust the size of TEXT and from area satisfies the following specification by using (◀), (▶) control buttons.

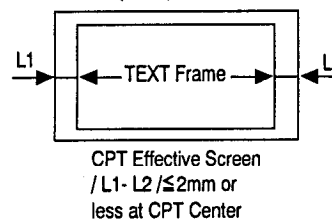

- (2) When the adjustment item(1) is finished, turn OFF the set by pressing the POWER key.

7-7. Matching Check With Other Equipments

7-7-1. VIDEO 1 Input Terminal Matching Check

Adjustment Preparation

- (1) Input a Video Signal to the VIDEO 1 terminal. The Video Signal Level should be within 1 ± 0.2 Vp-p (75 Ohm terminal) with 100% White Signal.
- (2) Input an Audio Signal to the AUDIO 1 terminal. The Audio Signal Level should be 400m Vrms \pm 2m Vrms at this time. (Connect VCR or TV TUNER)
- (3) Connect an Audio AMP to the AUDIO OUT terminals. (Or connect VIDEO and AUDIO terminals of a standard monitor.

Adjustment Procedure

- (1) Check that the set receives signal when the INPUT1 Mode is selected, by pressing the INPUT (FUNCTION) button on the front side of the set.
- (2) When an External Input is performed, the Video and Audio should not be abnormal.
The 100% White Signal that RF input receives should be as bright as the Video Signal 1Vp-p (75 Ohm terminal). As for the sound, when the 100% modulation that RF input receives is 25KHZ, DIV., the Sound Level should be as much as the External Audio Signal (400 Vrms) level.

7-7-2. VIDEO 2 Input Terminal Matching Check.

Adjustment Preparation

- (1) Same as 7-7-1.

Adjustment Procedure

- (1) Check that the set receives signal at INPUT2 Mode.

7-7-3. VIDEO 3 Input Terminal Matching Check

Same as 7-7-2.

7-7-4. S-IN Input terminal Matching check.

Adjustment Preparation

- (1) Connect the Video/Chroma Signal to S-IN terminal.
- (2) Connect the Sound Signal to AUDIO 1 input terminals.

Adjustment Procedure

- (1) Check that the set receives signal at S-IN Mode.

7-7-5. AUDIO Output Level Check

Adjustment Preparation

- (1) Input the same Audio Signal as Item 7-7-1 (2) to AUDIO IN terminal(L). At this time, connect nothing to R terminal.
- (2) Input the same Audio Signal as Item 7-7-1 (2) to AUDIO IN terminal (R). At this time, connect nothing to L terminal.
- (3) Check that the Normal Sound is output from both sides of the speakers when signal in item (1) is input.
- (4) Check that the Normal Sound is output from only the right ((R) speaker when signal in Item (2) is input.

Adjustment Procedure

- (1) Check that the Audio Output of AUDIO AMP connected to AUDIO Hi-Fi OUT terminals or monitor changes according to the "VOLUME" of the set.
- (2) Confirm that the Output Level of item(1) should be 1V rms (2.8 Vp-p) \pm 20%. (Above level is equivalent to maximum VOL-UME, 100% Modulated Signal Input.)

7-8. Safety Check

7-8-1. Polarity Check

There should be electricity between AC Power Cord and Chassis Earth.

7-9. MTS Operation Check

7-9-1. STEREO/SAP Broadcast Receiving Check

Adjustment Preparation

- (1) Set the set so that a MTS Broadcast (STEREO/SAP) can be received.
- (2) Set MTS Mode to STEREO or SAP Mode.
Note: To select between "STEREO/SAP", display sound setting of MTS Mode and select SOUND MENU.
- (3) Set BALANCE to the center.

Adjustment Procedure

- (1) When one of the MTS Broadcast Stereo or SAP is received, check that "ST" or "SA" is displayed on the screen.

STEREO	11
or SAP	ST
	or SA

- (2) STEREO Broadcast Receiving Check
 - (I) Select MTS Mode and press Cursor (▶) button to display "STEREO" on the screen.
 - (II) When only Lch signal is received, Lch sound comes out from the left speaker.
 - (III) When only Rch signal is received, Rch sound comes out from the right speaker.
 - (IV) When Monaural Signal is received, Monaural Sound comes out from both of the right and left speakers.
- (3) SAP Broadcast Receiving Check
 - (I) Select MTS Mode and press Cursor (▶) button to display "SAP" on the screen.
 - (II) SAP signal comes out from both of the right and left speakers.
 - (III) When no SAP signal, the sound on "MAIN" side comes out.

Note: When the Channel selection is performed or RECALL button is operated "ST" or "SA" is shown below the Channel No. (For approximately 5 seconds)

7-9-2. MTS Mode Check

Adjustment Preparation

- (1) Set the set so that a MTS Broadcast (STEREO/SAP) can be received.
- (2) Set BALANCE to the center.

Adjustment Procedure

- (1) When "MTS MODE" Mode is set to "MONO" side, check that STEREO and MONO indication lamps which have been ON are turned OFF and that Monaural Sound comes out from the right and left speakers.
- (2) When "MTS MODE" Mode is set to "STEREO" side, check that STEREO and MONO indication lamps which have been OFF are turned ON and that STEREO and SAP sound can be received.

7-9-3. STEREO Separation Check

Adjustment Preparation

- (1) Set the set so that a MTS Broadcast (STEREO/SAP) can be received.
- (2) Set Surround to "OFF".
- (3) Set MTS MODE to "STEREO".
- (4) Connect AUDIO OUT terminals L and R to an Oscilloscope.

Adjustment Procedure

- (1) When STEREO L only signal (or R only signal) is received, check that the Output Level Ratio of L CH and R CH is 15 dB or more. (Example)

CH	Output Level
L	1.2 Vpp
R	0.21 Vpp or less

When only L is received (100% modulation)

7-10. Setting For Delivery

Setting is possible by Remo-Con jig.

SPECIFICATION BY MODELS

NAME	SPECIFICATIONS BY MODEL
SIGNAL SOURCE	ANTENNA
RECEPTION CHANNEL	CH 03
SOUND (VOLUME)	"10" On-Screen Display
INPUT SELECT (AVX)	TV Mode
CONTRAST	Maximum
COLOR	Center
TINT	Center
BRIGHTNESS	Center
SHARPNESS	Center
WHITE CONTROL	Cool
BALANCE	Center
BASS	Center
TREBLE	Center
MTS MODE	STEREO
SURROUND	OFF
LOUDNESS	OFF
INTERNAL SPEAKERS	ON
P IN P	OFF
CLOSED CAPTION	OFF
CLOSED CAPTION MODE	C.C.
CLOSED CAPTION CHANNEL	1

7-11. Magnetic Field Correction Circuit Operation Check. (35CX45B Only)

Adjustment Preparation

- (1) Receive Circle Pattern Signal.
- (2) Set "Weak/Strong SW" to "Strong".
- (3) Set "Direction SW" to "N".
- (4) Check that the raster rotates to counterclockwise when "Direction SW" set from "N" to "S".
- (5) Set "Weak/Strong SW" set to "Weak".
- (6) Set "Direction SW" to "N".
- (7) Check that the raster rotates to counterclockwise when "Direction SW" set from "N" to "S".
(Check the rotation angle is less than "Strong" position.)
- (8) Set "Weak/Strong SW" to "Strong" and "Direction SW" to "EW".

35CX45B/CZ67 REAR PANEL

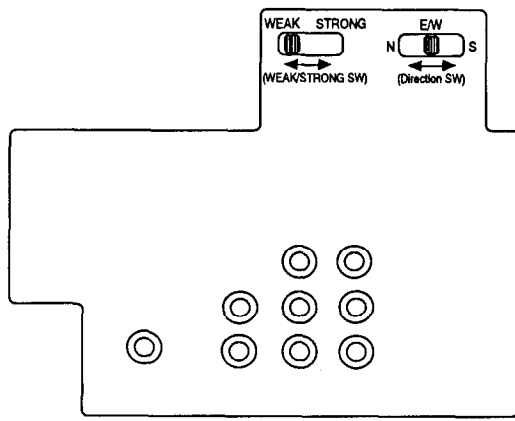

Direction of Raster Rotation

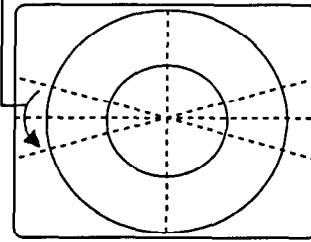

CPT SCREEN

3. ADJUSTMENT POSITION LIST

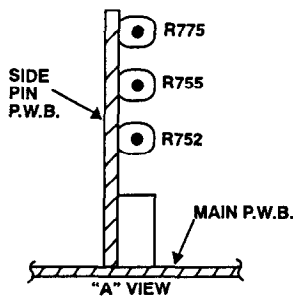
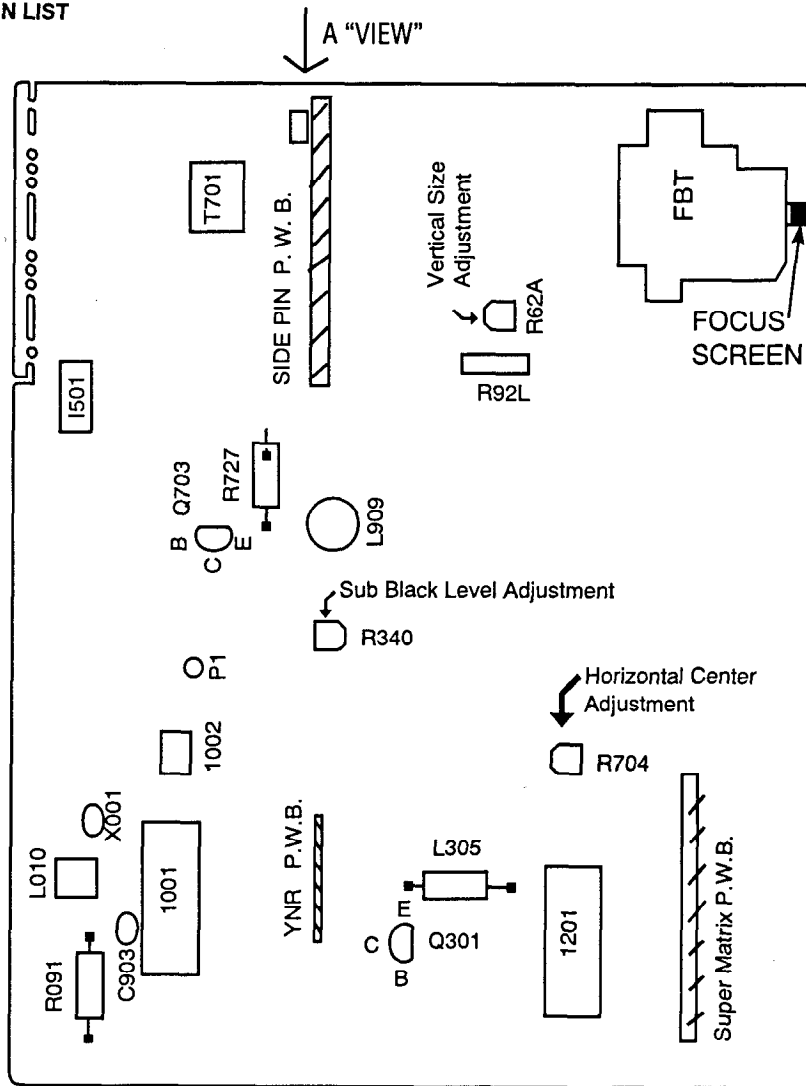

WAVEFORMS AT EACH SECTION

Number inside circle correspond to locations shown in the circuit diagram.

① PA1M Pin 6 Video (V1)

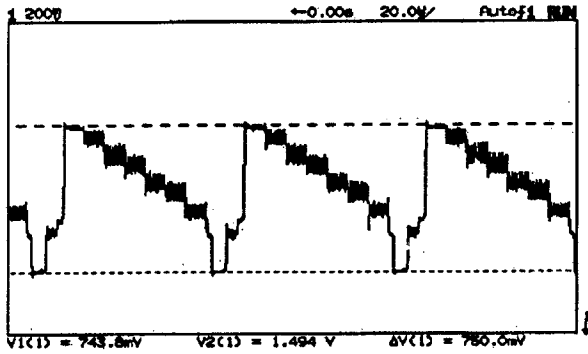

⑤ PinP E3P1 Pin 8 (Luminance Out - Y out)

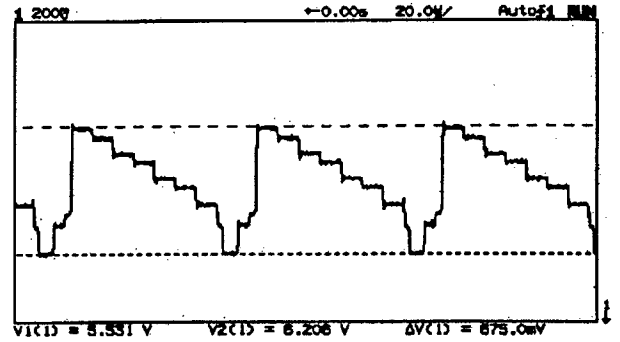

② Comb Filter U301 Pin 3 (Chroma Out - C out)

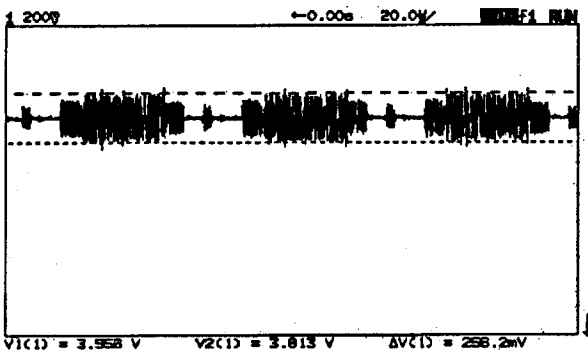

⑥ PinP E3P1 Pin 6 (Chrominance Out - C out)

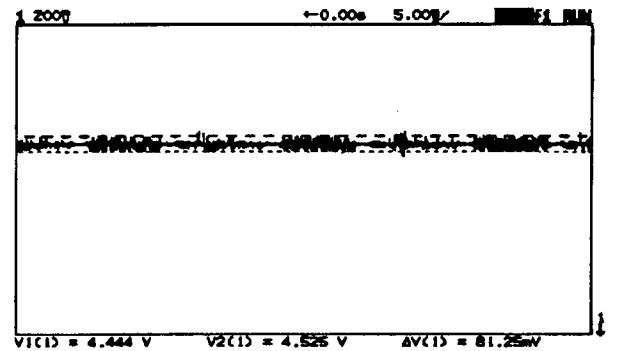

③ Comb Filter U301 Pin 1 (Luminance Out - Y out)

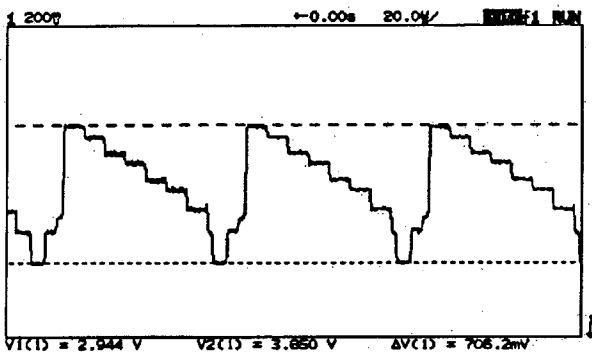

⑦ YNR EY01 Pin 3 (Luminance In - Y In) CZ67 Only

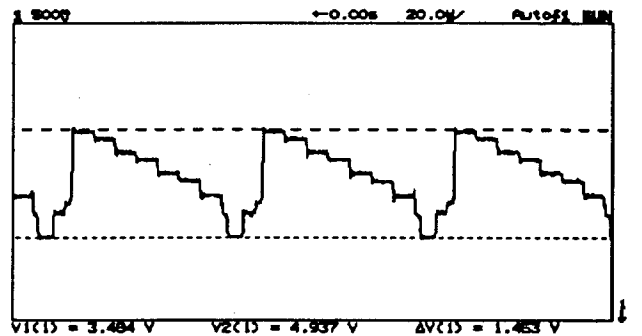

④ PinP E3P1 Pin 10 (Chroma In - C In)

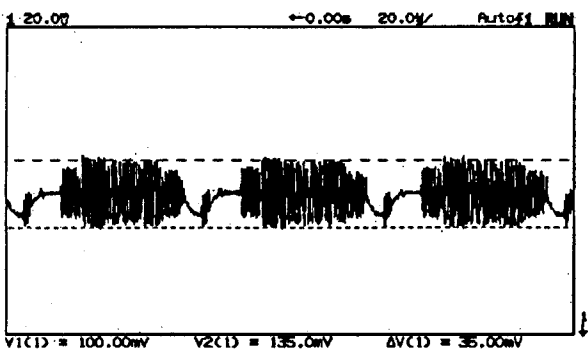

⑧ YNR EY01 Pin 2 (Luminance Out - Y out) CZ67 Only

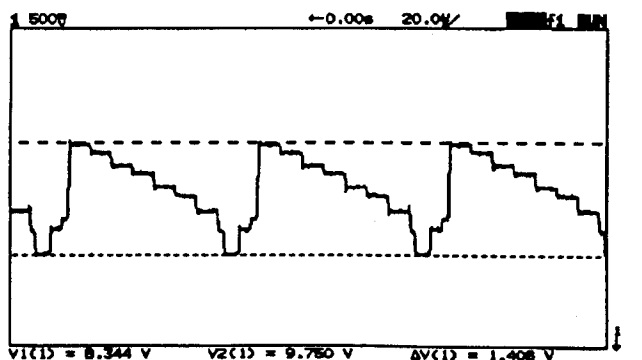

WAVEFORMS AT EACH SECTION

Number inside circle correspond to locations shown in the circuit diagram.

⑨ I201 Pin 21 (-Y)

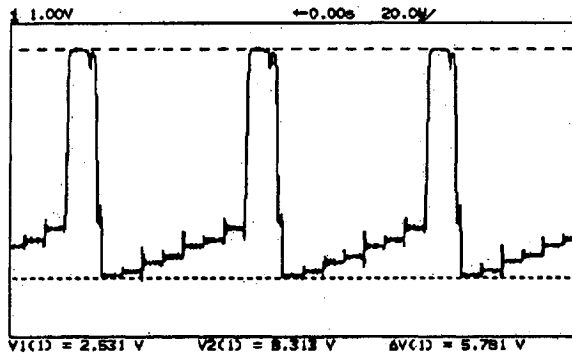

⑬ I001 Pin 23 (CVIN)

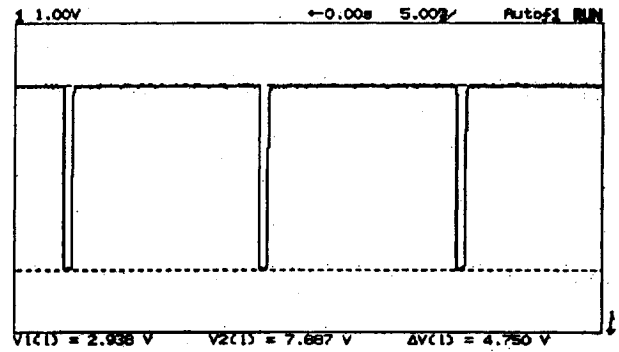

⑩ I201 Pin 20 (B-Y)

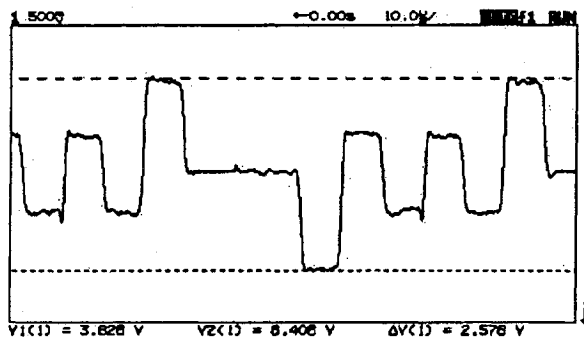

⑭ Super Matrix PY1S Pin 2 (-Y)

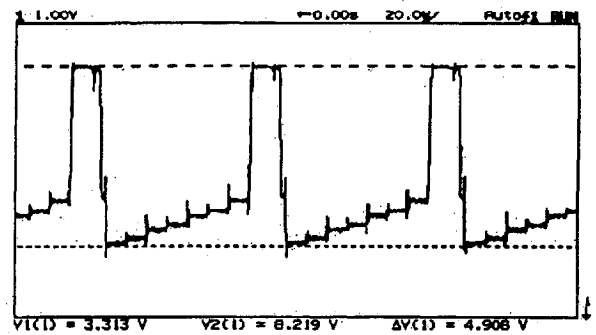

⑪ I201 Pin 19 (G-Y)

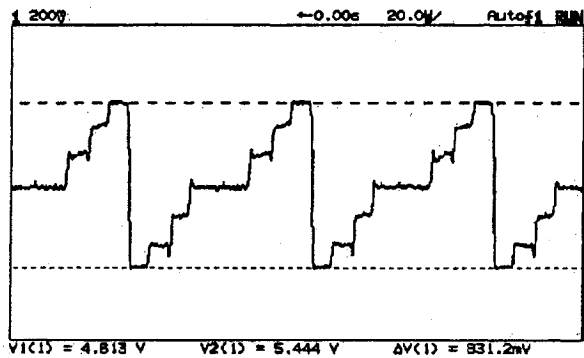

⑮ Super Matrix QM04 Emitter (R-Y)

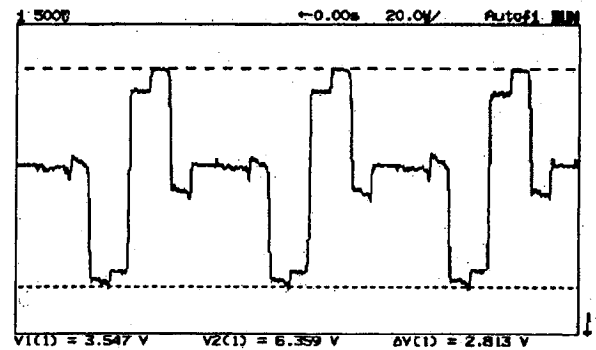

⑫ I201 Pin 18 (R-Y)

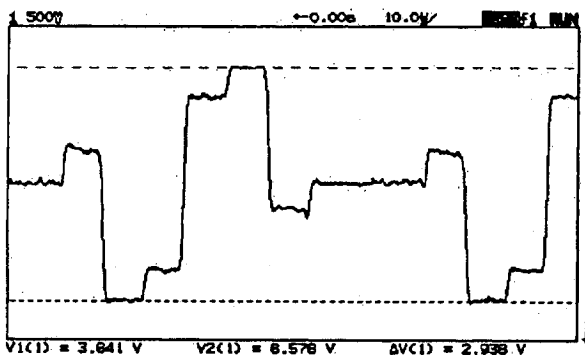

⑯ Super Matrix QM05 Emitter (G-Y)

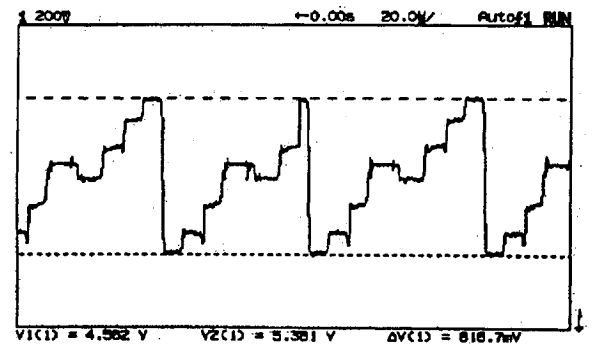

WAVEFORMS AT EACH SECTION

Number inside circle correspond to locations shown in the circuit diagram.

⑰ Super Matrix QM06 Emitter (B-Y)

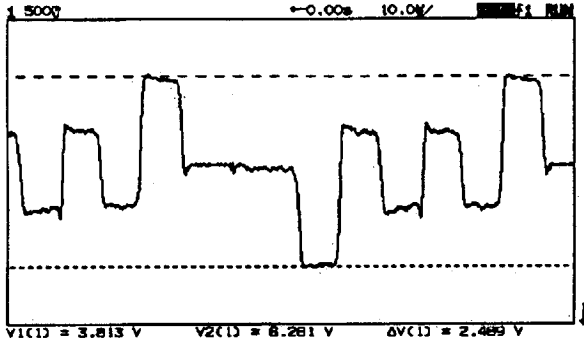

⑳ P65B Pin (Side Pin Input 1)

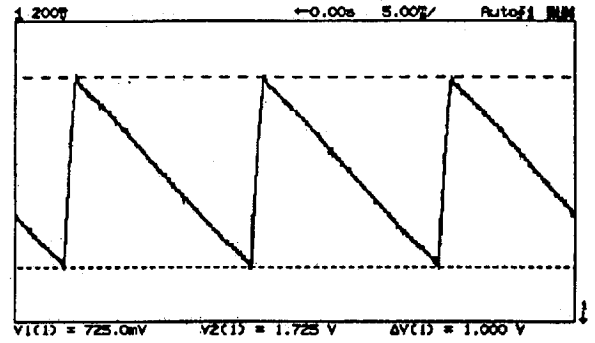

⑱ CPT Q851 Collector (Red Drive)

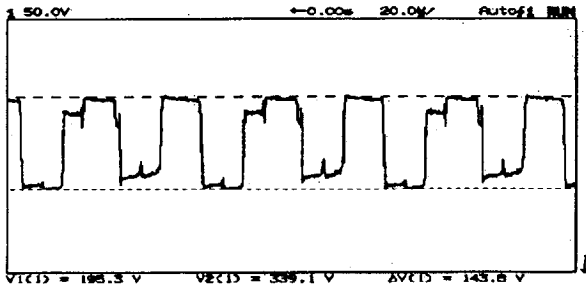

㉑ P65B Pin 2 (Side Pin Input 2)

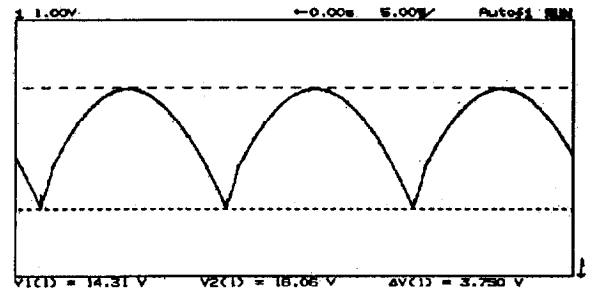

㉒ CPT Q857 Collector (Blue Drive)

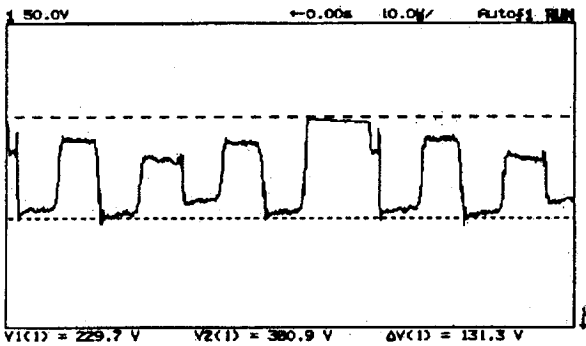

㉓ Q650 Emitter (Side Pin Drive)

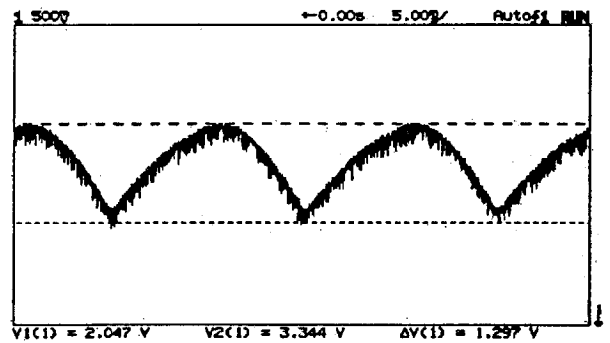

㉔ CPT Q854 Collector (Green Drive)

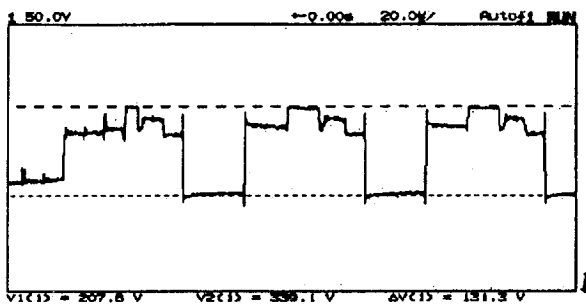

㉕ Q750 Base (Side Pin Adjustment)

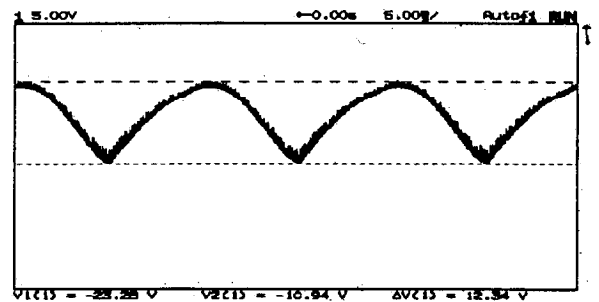

WAVEFORMS AT EACH SECTION

Number inside circle correspond to locations shown in the circuit diagram.

②⑤ Q751 Collector (Side Pin Drive)

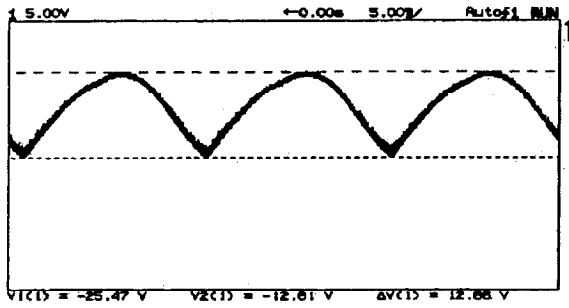

②⑧ I620 Pin 12 (V Out)

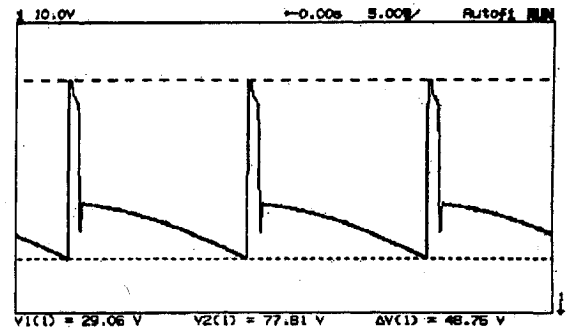

②⑥ P65B Pin 5 (Side Pin Drive)

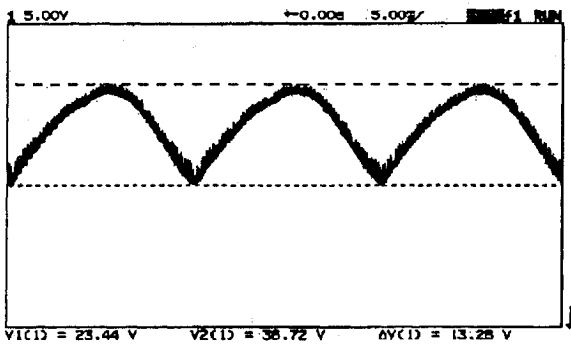

②⑨ Q701 Collector (H Drive)

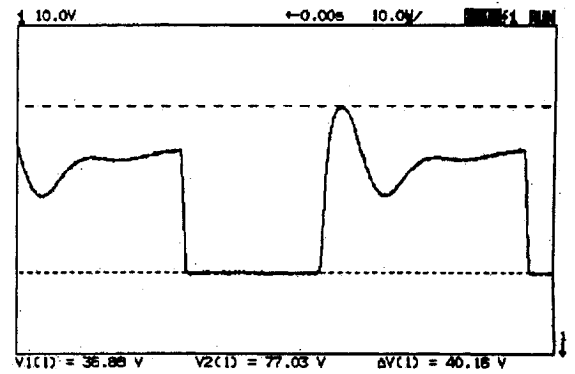

②⑦ Q752 Collector (Side Pin Out)

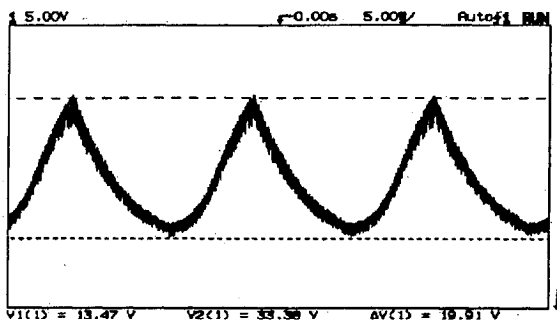

③⑩ EM Pin 4 (H.O.T.)

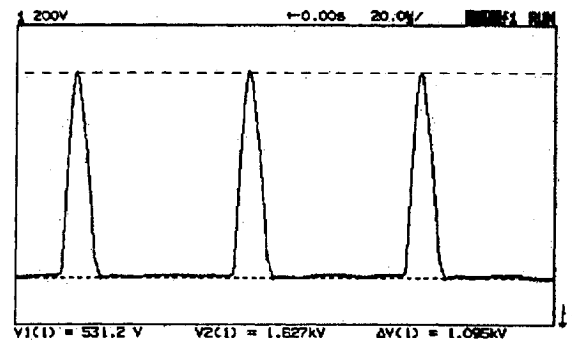

TROUBLESHOOTING

PRODUCT SAFETY NOTE

The shaded and \triangle marked components have special characteristics important to safety. Read carefully the Product Safety Notice of each service manual. Don't degrade the safety of the receiver though improper servicing when replacing any of this components.

HOW TO USE THE FLOW CHART

- (1) The flow chart shows the following:

This shows the name of the faulty circuit and main parts to be checked.
This shows the point to be checked.

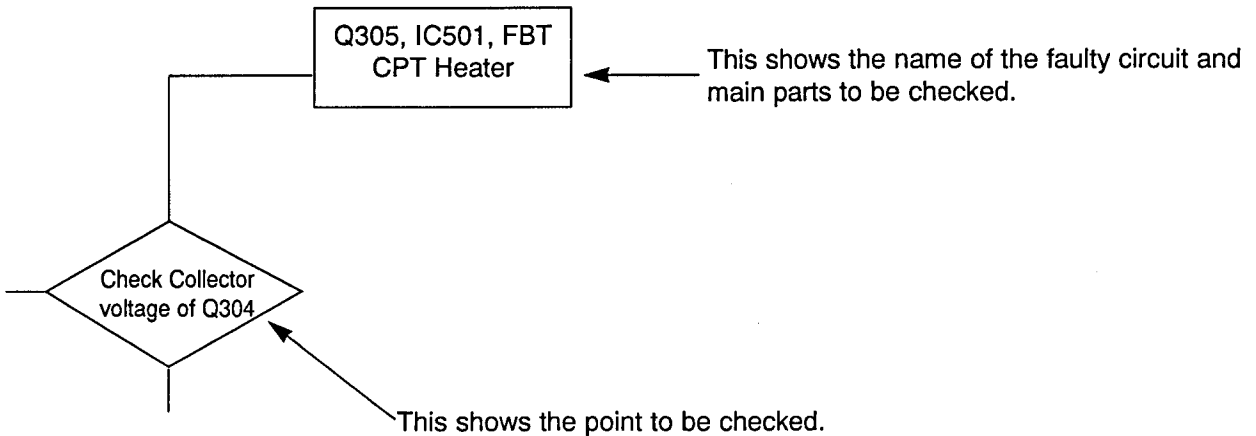

- (2) The voltage shown in the chart may differ to some extent depending on the condition of the set and tester.

PRECAUTION ON MAKING MEASUREMENTS AND ON HANDLING.

1. When any parts become abnormally hot or there is a small burning, cut OFF the power immediately.
2. Do not make shorts between circuits or across terminals except for those specified.
3. When applying a signal for checking purposes, make connection in the alternate current system for any not specified.
4. When measuring the voltages of ICs and TRs, be careful to see that the lead bar of the tester does not touch any other terminal.
5. Measure the voltage correctly.
6. Measure the resistance over a small range.
7. Be sure to switch OFF the power when replacing parts.
8. Do not apply a soldering iron for a long time when replacing parts. (Use a solder-wick.)
9. Use an isolation transformer when troubleshooting.

1. NO RASTER AND SOUND

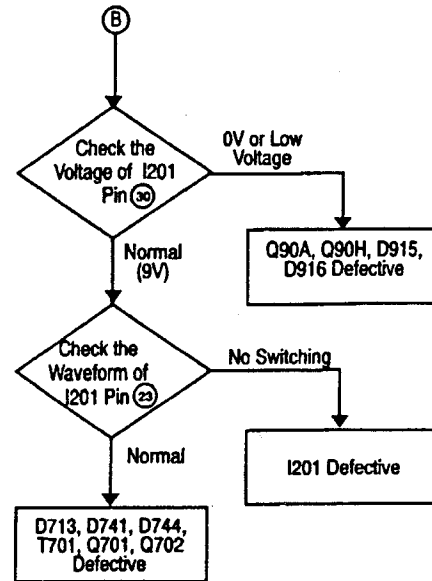
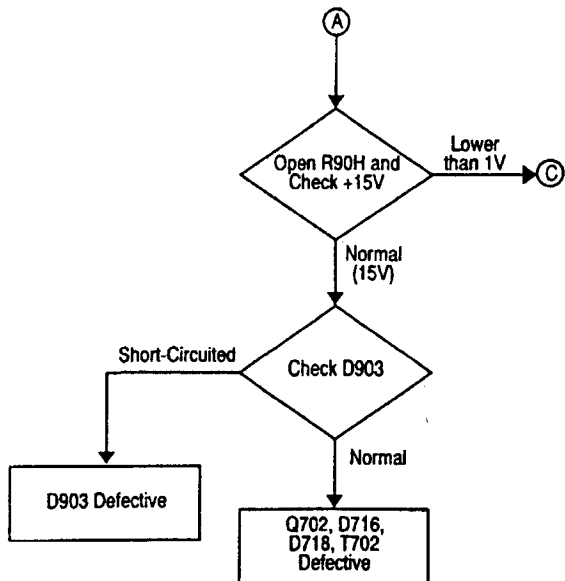
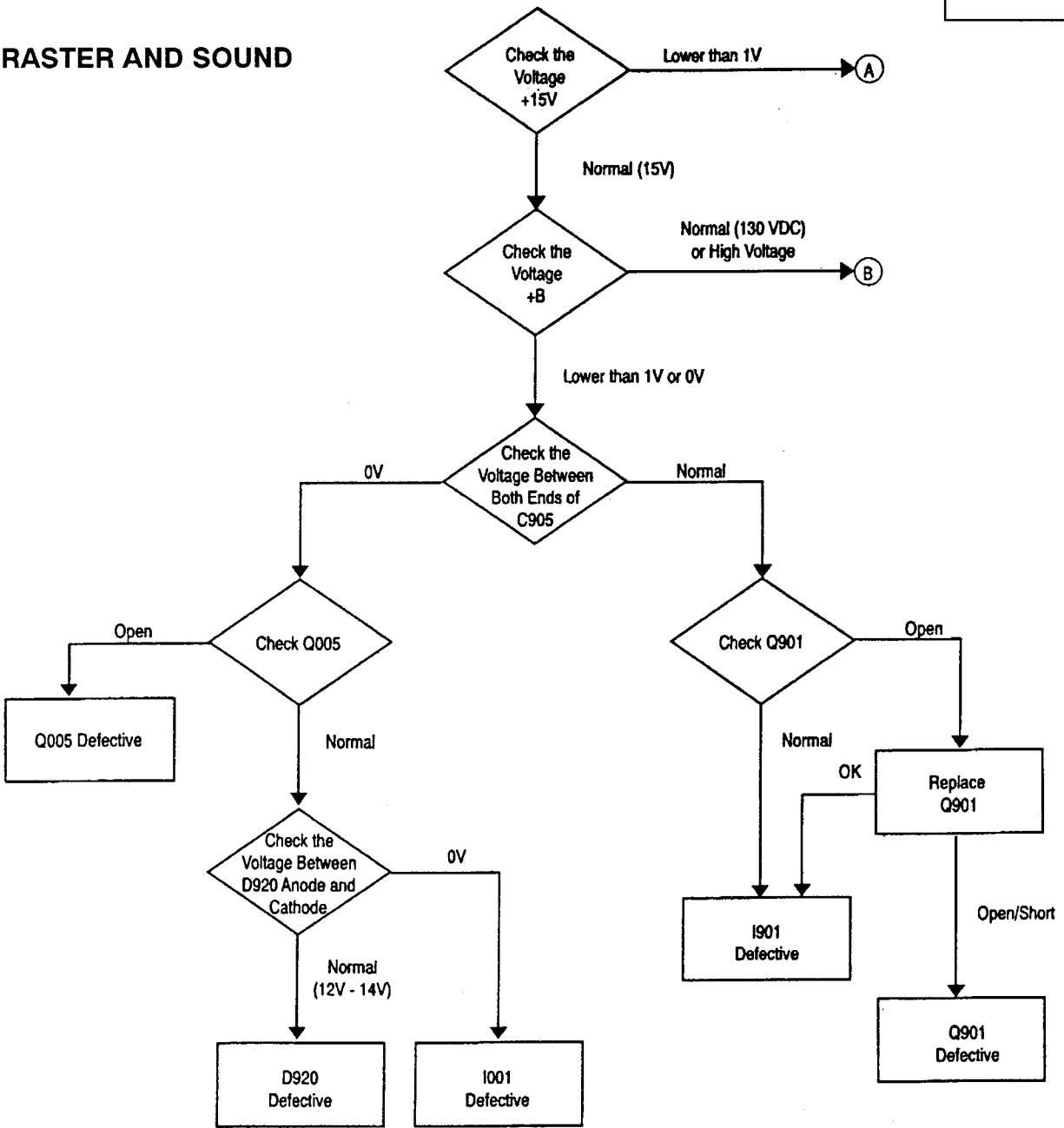

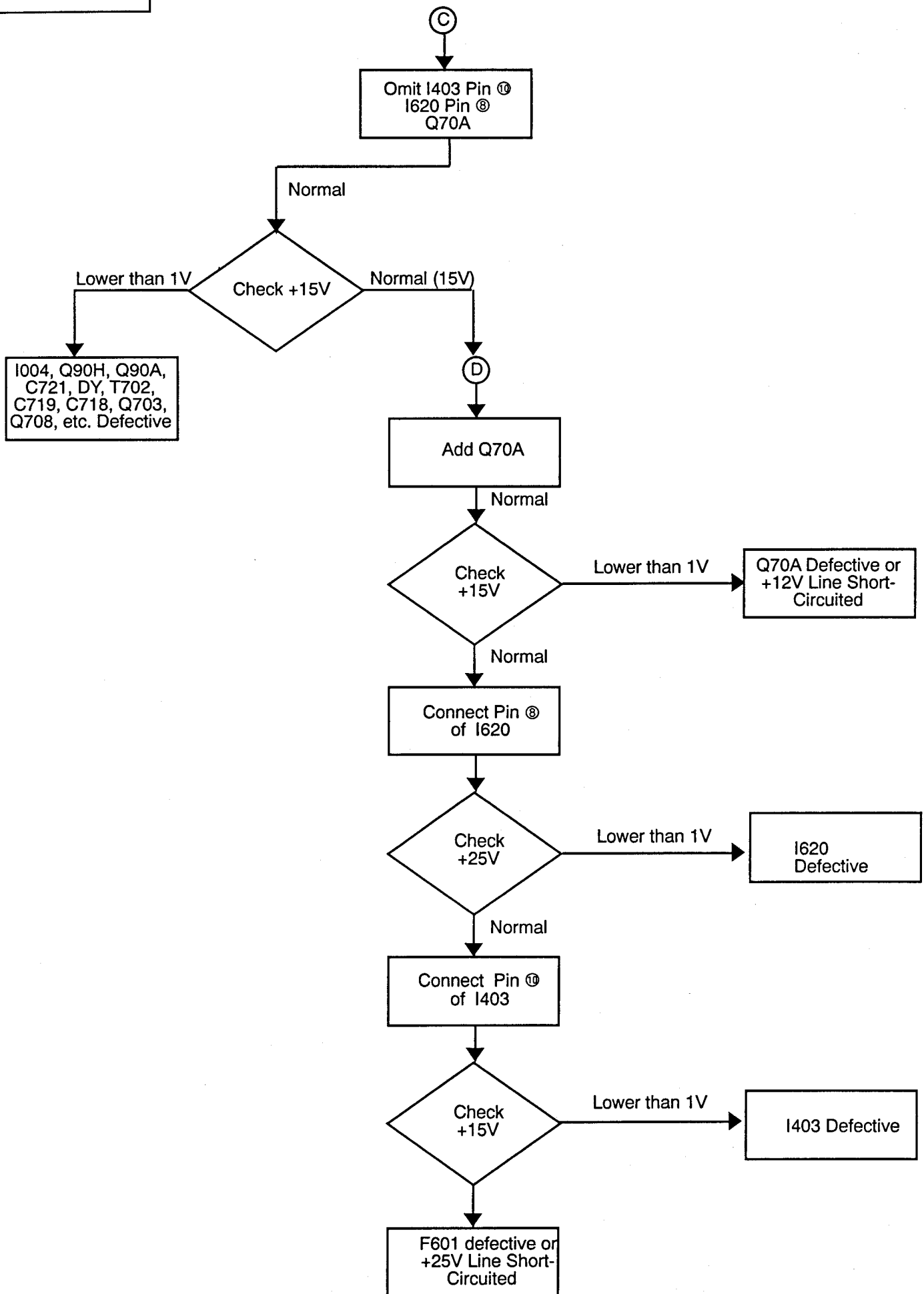

PRODUCT SAFETY NOTE: Components marked with a Δ have special characters important to safety. Before replacing any of these components, read carefully, the PRODUCT SAFETY NOTICE of this Service Manual. Don't degrade the safety of the receiver through improper servicing.

ABBREVIATIONS

Capacitors: CD: Ceramic Disc
 PF: Polyester Film
 EL: Electrolytic
 PP: Polypropylene
 PR: Paper
 TA: Tantalum
 TM: Trimmer

Resistors: CF: Carbon Film
 CC: Carbon Composition
 MF: Metal Oxide Film
 VR: Variable Resistor
 WW: Wire Wound
 FR: Fuse Resistor
 MG: Metal Glaze

Semiconductors: TR: Transistor
 DI: Diode
 ZD: Zener Diode
 VA: Varistor
 TH: Thermistor
 IC: Integrated Circuit

SYMBOL NO.	PART NO.	PART DESCRIPTION	SYMBOL NO.	PART NO.	PART DESCRIPTION
		MAIN PWB CAPACITORS	C30A	0890071R	CD 56PF-J 50V
			C30C	0890061R	CD 10PF- 50V
C001	0890087R	CD 1000PF-K 50V	C30K	0800015R	EL 10UF-M 16V
C002	0800047R	EL 100UF-M 6.3V	C314	0880044R	PF 0.01UF-KEB 50V
C003	0800072R	EL 470UF-M 6.3V	C316	0800009R	EL 4.7UF-M 25V
C004	0244141R	CD 0.01UF-KB B 50V	C317	0800049R	EL 100UF-M 16V
C005	0890114R	CD 10PF-D CH 50 V	C318	0800015R	EL 10UF-M 16V
C006	0890121R	CD 33PF-J CH 50V	C319	0880044R	PF 0.01UF-KEB 50V
C007	0800003R	EL 1.0UF-M 50V	C31A	0800015R	EL 10UF-M 16V
C008	0276717R	PP 0.1UF-J 50V (TF TYP E)	C31C	0880044R	PF 0.01UF-KEB 50V
C00T	0283127	TM (RED)	C31E	0244141R	CD 0.01UF-KB B 50V
C00W	0800003R	EL 1.0UF-M 50V	C31H	0800015R	EL 10UF-M 16V
C010	0800009R	EL 4.7UF-M 25V	C31K	0880044R	PF 0.01UF-KEB 50V
C011	0800049R	EL 100UF-M 16V	C322	0800049R	EL 100UF-M 16V
C012	0800009R	EL 4.7UF-M 25V	C323	0800015R	EL 10UF-M 16V
C013	0800015R	EL 10UF-M 16V	C325	0800015R	EL 10UF-M 16V
C014	0800015R	EL 10UF-M 16V	C326	0800009R	EL 4.7UF-M 25V
C018	0880051R	PP 0.033UF-KEB 50V	C327	0800049R	EL 100UF-M 16V
C019	0890086R	CD 820PF-K 50V	C330	0800042R	EL 47UF-M 25V
C01A	0880048R	PP 0.022UF-KEB 50V	C332	0244141R	CD 0.01UF-KB B 50V
C01E	0800074N	EL 470UF-M 16V	C341	0890079R	CD 270PF-K 50V
C022	0880048R	PF 0.022UF-KEB 50V	C342	0244171R	CD 0.01UF-Z F 50V TAPE
C023	0880044R	PF 0.01UF-KEB 50V	C390	0890063R	CD 15PF-J 50V
C024	0890085R	CD 680PF-K 50V	C391	0880044R	PF 0.01UF-KEB 50V
C025	0800009R	EL 4.7UF-M 25V	C392	0890078R	CD 220PF-K 50V
C02H	0800015R	EL 10UF-M 16V	C402	0800015R	EL 10UF-M 16V
C031	0276717R	PP 0.1UF-J 50V (TF TYP E)	C403	0800015R	EL 10UF-M 16V
C032	0890078R	CD 220PF-K 50V	C404	0800049R	EL 100UF-M 16V
C040	0880057R	PF 0.1UF-KEB 50V	C430	0800001R	EL 0.47UF-M 50V (SME)
C090	0890087R	CD 1000PF-K 50V	C431	0800001R	EL 0.47UF-M 50V (SME)
C091	0800003R	EL 1.0UF-M 50V	C432	0800016R	EL 10UF-M 25V
C093	0800005R	EL 2.2UF-M 50V	C433	0800047R	EL 100UF-M 6.3V
C094	0800047R	EL 100UF-M 6.3V	C434	0244105R	CD 2200PF-K 50V TAPE
C095	0890121R	CD 33PF-J CH 50V	C435	0800059R	EL 220UF-M 25V
C096	0890121R	CD 33PF-J CH 50V	C436	0244105R	CD 2200PF-K 50V TAPE
C0A1	0800001R	EL 0.47UF-M 50V (SME)	C437	0800059R	EL 220UF-M 25V
C0A2	0890078R	CD 220PF-K 50V	C438	0800047R	EL 100UF-M 6.3V
C0A3	0244107R	CD 3300PF-K 50V TAPE	C439	0276717R	PP 0.1UF-J 50V (TF TYP E)
C0A4	0880044R	PF 0.01UF-KEB 50V (CY62)	C43A	0800083F	EL 1000UF-M 25V
C0A6	0880053R	PF 0.047UF-KEB 50V	C43C	0800082F	EL 1000UF-M 16V
C0A7	0800003R	EL 1.0UF-M 50V	C43E	0800041R	EL 47UF-M 16V
C0A8	0800015R	EL 10UF-M 16V	C43H	0276717R	PP 0.1UF-J 50V (TF TYP E)
C0A9	0880044R	PF 0.01UF-KEB 50V	C43K	0800082F	EL 1000UF-M 16V
C0C1	0800003R	EL 1.0UF-M 50V	C440	0800059R	EL 220UF-M 25V
C0C2	0890084R	CD 560PF-K 50V	C441	0800015R	EL 10UF-M 16V
C111	0890072R	CD 68PF-J 50V	C444	0800042R	EL 47UF-M 25V
C301	0800003R	EL 1.0UF-M 50V	C445	0800042R	EL 47UF-M 25V
C302	0800005R	EL 2.2UF-M 50V	C450	0800009R	EL 4.7UF-M 25V
C303	0800015R	EL 10UF-M 16V	C451	0800009R	EL 4.7UF-M 25V
C304	0800003R	EL 1.0UF-M 50V	C453	0800009R	EL 4.7UF-M 25V
C305	0244141R	CD 0.01UF-KB B 50V	C454	0800009R	EL 4.7UF-M 25V
C307	0800005R	EL 2.2UF-M 50V	C455	0800009R	EL 4.7UF-M 25V
C309	0800009R	EL 4.7UF-M 25V	C456	0800009R	EL 4.7UF-M 25V

PRODUCT SAFETY NOTE: Components marked with a Δ have special characters important to safety. Before replacing any of these components, read carefully, the PRODUCT SAFETY NOTICE of this Service Manual. Don't degrade the safety of the receiver through improper servicing.

SYMBOL NO.	PART NO.	PART DESCRIPTION	SYMBOL NO.	PART NO.	PART DESCRIPTION
C457	0800009R	EL 4.7UF-M 25V	C72A	0244501R	CD 1000PF-K 500V
C458	0800009R	EL 4.7UF-M 25V	C72C	0800073R	EL 470UF-M 10V
C501	0246445R	CD 16PF-J CH 50V	C72H	0800048R	EL 100UF-M 10V
C502	0244141R	CD 0.01UF-KB B 50V	C730	0800084F	EL 1000UF-M 35V
C503	0800001R	EL 0.47UF-M 50V (SME)	C732	0800083F	EL 1000UF-M 25V
C504	0800082F	EL 1000UF-M 16V	C733	0800056R	EL 220UF-M 6.3V
C507	0800074N	EL 470UF-M 16V	C736	0244501R	CD 1000PF-K 500V
C510	0880044R	PF 0.01UF-KEB 50V	Δ C737	0800019R	EL 10UF-M 63V
C535	0800049R	EL 100UF-M 16V	C738	0255524F	EL 4.7MF-M 250V(KME) (CY62)
C550	0800015R	EL 10UF-M 16V	C738	0253974F	EL 33UF 250V CE04W2E33 (CZ67)
C551	0880044R	PF 0.01UF-KEB 50V	C73A	0800041R	EL 47UF-M 16V
C601	0800003R	EL 1.0UF-M 50V	C73C	0890086R	CD 820PF-K 50V
C602	0890089R	CD 1500PF-K 50V	C73H	0890087R	CD 1000PF-K 50V
C603	0880046R	PF 0.015UF-K 50V	C742	0254823G	EL 100UF-M 160V
C604	0800048R	EL 100UF-M 10V	C747	0276717R	PP 0.1UF-J 50V (TF TYP E)
C605	0800003R	EL 1.0UF-M 50V	C74A	0258130F	EL 330MF-M 100V(KME) (CZ67)
C606	0890087R	CD 1000PF-K 50V	C74H	0243508R	CD 390PF-K 500V (CZ67)
C607	0244107R	CD 3300PF-K 50V TAPE	C755	0880035R	PP 2200PF-50V
C608	0800003R	EL 1.0UF-M 50V	C756	0800015R	EL 10UF-M 16V
C609	0800015R	EL 10UF-M 16V	C757	0800015R	EL 10UF-M 16V
C60F	0890082R	CD 390PF-K 50V	C901	0279697	PF 0.1MF-M 250V
C620	0800057R	EL 220UF-M 10V	Δ C902	0248593F	CD 4700PF-Z 250V
C621	0880042R	PF 0.0068UF-KEB50V	Δ C903	0248593F	CD 4700PF-Z 250V
C622	0292716R	TA 1.0UF-K 20V	Δ C904	0244505F	CD 0.0022MF-K 500V
C623	0248696R	CD 330PF-J SL 50V TAPE	Δ C905	0253891	EL 470UF 200V HR
C624	0800061N	EL 220UF-M 35V	C906	0253957F	EL 22UF-M 160V
C625	0800007R	EL 3.3UF-M 50V	C907	0800064R	EL 330UF-M 6.3V
C626	0276717R	PP 0.1UF-J 50V (TF TYP E)	C908	0800003R	EL 1.0UF-M 50V
C627	0800007R	EL 3.3UF-M 50V	C909	0800001R	EL 0.47UF-M 50V (SME)
C628	0800003R	EL 1.0UF-M 50V	C90A	0248593F	CD 4700PF-Z 250V
C629	0800083F	EL 1000UF-M 25V (CY62)	C90C	0880044R	PF 0.01UF-KEB 50V
C629	0800084F	EL 1000UF-M 35V (CZ67)	C90E	0880031R	PP1000PP-K 50V
C62A	0800056R	EL 220UF-M 6.3V	C90F	0880044R	PF 0.01UF-KEB 50V
C62H	0276717R	PP 0.1UF-J 50V (TF TYP E)	C90H	0284891F	EL 150UF 200V
C630	0890087R	CD 1000PF-K 50V	C90K	0880066F	PF 0.47 50V
C701	0890087R	CD 1000PF-K 50V	C910	0880044R	PF 0.01UF-KEB 50V
C702	0800003R	EL 1.0UF-M 50V	C911	0890081R	CD 330PF 50V
C703	0800003R	EL 1.0UF-M 50V	C912	0258192F	EL 2200UF 25V
C704	0880051R	PF 0.033UF-KEB 50V	C913	0890087R	CD 1000PF-K 50V
C705	0890087R	CD 1000PF-K 50V	C914	0800024R	EL 22UF-M 25V
C706	0244141R	CD 0.01UF-KB B 50V	C915	0800015R	EL 10UF-M 16V
C707	0800049R	EL 100UF-M 16V	C917	0245612F	CD 4700PF-KF B 1KV
C708	0800001R	EL 0.47UF-M 50V (SME)	C919	0245608F	CD 1000PF-K B 1000V
C714	0880044R	PF 0.01UF-KEB 50V	C91C	0890082R	CD 390PF-K 50V
C715	0247842R	CD 33PF-SL 500V	C91H	0800061N	EL 220UF-M 35V
C716	0880019R	PF 0.33UF-KB 50V	Δ C920	0279697	PF 0.1MF-M 250V
C718	0244729	CD 2200PF 2KV	Δ C969	0248593	CD 4700PF-Z 250V
C719	0244728	CD 1800PF 2KV	CA01	0800049R	EL 100UF-M 16V (CZ67)
C71A	0244211	CD 1000PF-K 2KV (CY62)	CAN1	0800049R	EL 100UF-M 16V
C71A	0244212	CD 1200PF-K 2KV (CZ67)	CAZ1	0890081R	CD 330PF 50V
C71C	0244105R	CD 2200PF-K 50V TAPE	CAZ2	0800015R	EL 10UF-M 16V
C71E	0255524F	EL 4.7MF-M 250V(KME)	CS01	0800049R	EL 100UF-M 16V
C71F	0243506R	CD 270PF-K 500V	CS02	0800023R	EL 22UF-M 16V
Δ C71H	0244725	CD 1000PF-K 2.0KV B (CZ67)	CS03	0800003R	EL 1.0UF-M 50V
C71K	0255524F	EL 4.7MF-M 250V(KME)	CS04	0800009R	EL 4.7UF-M 25V
Δ C720	0244501R	CD 1000PF-K 500V	CS05	0800003R	EL 1.0UF-M 50V
Δ C721	0262429F	PP 12000PF-J 1800V	CS06	0800015R	EL 10UF-M 16V
C722	0299707F	PF 0.015UF-K 630V	CS07	0880057R	PF 0.1UF-KEB 50V
C723	0263001	EL 3.3UF-M 100V	CS08	0880053R	PF 0.047UF-KEB 50V
Δ C724	0299931F	PP 0.27UF-K 200V	CS09	0800001R	EL 0.47UF-M 50V (SME)
Δ C725	0800003R	EL 1.0UF-M 50V	CS10	0880057R	PF 0.1UF-KEB 50V
Δ C726	0299931F	PP 0.27UF-K 200V (CY62)	CS11	0800003R	EL 1.0UF-M 50V
Δ C726	0299932F	PP 0.33UF-K 200V (CZ67)	CS12	0800003R	EL 1.0UF-M 50V

PRODUCT SAFETY NOTE: Components marked with a Δ have special characters important to safety. Before replacing any of these components, read carefully, the PRODUCT SAFETY NOTICE of this Service Manual. Don't degrade the safety of the receiver through improper servicing.

SYMBOL NO.	PART NO.	PART DESCRIPTION	SYMBOL NO.	PART NO.	PART DESCRIPTION
CS13	0800003R	EL 1.0UF-M 50V	C879	0890074R	CD 100PF-J 50V
CS14	0292712F	TA 3.3UF-K 16V	C880	0890081R	CD 330PF 50V (CY62)
CS15	0292714F	TA 10UF-K 16V	C880	0890086R	CD 820PF-K 50V (CZ67)
CS16	0800003R	EL 1.0UF-M 50V	C881	0890081R	CD 330PF 50V (CY62)
CS17	0800003R	EL 1.0UF-M 50V	C881	0890086R	CD 820PF-K 50V (CZ67)
CS21	0880052R	PF 0.039UF-KEB 50V	C882	0890081R	CD 330PF 50V (CY62)
CS22	0880044R	PF 0.01UF-KEB 50V	C882	0890086R	CD 820PF-K 50V (CZ67)
CS23	0880052R	PF 0.039UF-KEB 50V	CF01	0800049R	EL 100UF-M 16V
CS24	0880052R	PF 0.039UF-KEB 50V	CF02	0880057R	PF 0.1UF-KEB 50V
CS25	0800003R	EL 1.0UF-M 50V	CF03	0800079N	CEL-102M6R3WHLT-SME
CS26	0800003R	EL 1.0UF-M 50V	CF04	0800082N	EL 1000UF-MB16V(SME)
CS27	0800015R	EL 10UF-M 16V	CF05	0800015R	EL 10UF-M 16V
CS28	0800015R	EL 10UF-M 16V	CF07	0880057R	PF 0.1UF-KEB 50V
CS29	0800015R	EL 10UF-M 16V	CF08	0800079N	CEL-102M6R3WHLT-SME
CS30	0800049R	EL 100UF-M 16V	CF14	0880057R	PF 0.1UF-KEB 50V
CS31	0800058R	EL 220UF-M 16V	CF15	0880057R	PF 0.1UF-KEB 50V
CS32	0800015R	EL 10UF-M 16V	CF16	0800079N	CEL-102M6R3WHLT-SME
CS33	0880041R	PF 0.0056UF-KEB50V	CM01	0800049R	EL 100UF-M 16V
CS34	0800015R	EL 10UF-M 16V	CM02	0890087R	CD 1000PF-K 50V
CS35	0800007R	EL 3.3UF-M 50V	CV01	0284621R	EL 0.47UF 50V (BP)
CS36	0800009R	EL 4.7UF-M 25V	CV04	0890081R	CD 330PF 50V
CS37	0800009R	EL 4.7UF-M 25V	CV05	0800049R	EL 100UF-M 16V
CS38	0284623R	EL 1UF-SME(BP) 50V	CV06	0880044R	PF 0.01UF-KEB 50V
CS39	0284623R	EL 1UF-SME(BP) 50V	CV09	0890074R	CD 100PF-J 50V
CS40	0800023R	EL 22UF-M 16V	CV10	0244541F	CD 0.01MF-K B 500V
		TUNER/CPT/VM/SIDE PIN/SM PWB CAPACITORS	CV11	0890074R	CD 100PF-J 50V
			CV12	0244509R	CD 4700PF-KB B 500V
			CV13	0253959F	EL 47UF-M 160V
			CV14	0253959F	EL 47UF-M 160V
C320	0800015R	EL 10UF-M 16V	CV15	0253957F	EL 22UF-M 160V
C321	0244141R	CD 0.01UF-KB B 50V	CV16	0247848R	CD 56PF-J SL 500V
C630	0880053R	PF 0.047UF-KEB 50V	CV17	0800075F	EL 470UF-M 25V
C631	0800041R	EL 47UF-M 16V	CV18	0800042R	EL 47UF-M 25V
C632	0880039R	PF 0.0047UF-KEB50V (CY62)	CV19	0253959F	EL 47UF-M 160V
C632	0880042R	PF 0.0068UF-KEB50V (CZ67)	CV20	0244541F	CD 0.01MF-K B 500V
C633	0800005R	EL 2.2UF-M 50V	CV21	0244171R	CD 0.01UF-Z F 50V TAPE
C634	0800003R	EL 1.0UF-M 50V	CV22	0880057R	PF 0.1UF-KEB 50V
C636	0800005R	EL 2.2UF-M 50V	CV23	0800049R	EL 100UF-M 16V
C637	0800018R	EL 10UF-M 50V	CV24	0800041R	EL 47UF-M 16V
C735	0800005R	EL 2.2UF-M 50V (CY62)	CV28	0890077R	CD 180PF-K 50V
C735	0800007R	EL 3.3UF-M 50V (CZ67)			PINP PWB CAPACITORS
C750	0800005R	EL 2.2UF-M 50V			
C751	0800044R	EL 47UF-M 50V	CA01	0890086R	CD 820PF-K 50V
C752	0284623R	EL 1UF-SME(BP) 50V	CA02	0880044R	PF 0.01UF-KEB 50V
C851	0800049R	EL 100UF-M 16V	CA03	0880044R	PF 0.01UF-KEB 50V
C854	0890077R	CD 180PF-K 50V (CY62)	CA04	0800049R	EL 100UF-M 16V
C854	0890079R	CD 270PF-K 50V (CZ67)	CA05	0880044R	PF 0.01UF-KEB 50V
C856	0890077R	CD 180PF-K 50V (CY62)	CA07	0880044R	PF 0.01UF-KEB 50V
C856	0890081R	CD 330PF 50V (CZ67)	CA08	0800049R	EL 100UF-M 16V
C857	0890077R	CD 180PF-K 50V (CY62)	CA09	0880044R	PF 0.01UF-KEB 50V
C857	0890078R	CD 220PF-K 50V (CZ67)	CA10	0880044R	PF 0.01UF-KEB 50V
C859	0255524F	EL 4.7MF-M 250V(KME)	CA11	0800041R	EL 47UF-M 16V
C860	0244889	CD 2200PF-K B 2KV	CA12	0800049R	EL 100UF-M 16V
C866	0244171R	CD 0.01UF-Z F 50V TAPE	CA13	0880044R	PF 0.01UF-KEB 50V
C874	0880057R	PF 0.1UF-KEB 50V (CY62)	CA14	0890078R	CD 220PF-K 50V
C874	0890087R	CD 1000PF-K 50V (CZ67)	CA15	0880044R	PF 0.01UF-KEB 50V
C875	0880057R	PF 0.1UF-KEB 50V (CY62)	CA16	0800015R	EL 10UF-M 16V
C875	0890087R	CD 1000PF-K 50V (CZ67)	CA17	0800001R	EL 0.47UF-M 50V (SME)
C876	0880057R	PF 0.1UF-KEB 50V (CY62)	CA18	0246445R	CD 16PF-J CH 50V
C876	0890087R	CD 1000PF-K 50V (CZ67)	CA19	0890085R	CD 680PF-K 50V
C877	0890074R	CD 100PF-J 50V	CA20	0800001R	EL 0.47UF-M 50V (SME)
C878	0890074R	CD 100PF-J 50V			

PRODUCT SAFETY NOTE: Components marked with a Δ have special characters important to safety. Before replacing any of these components, read carefully, the PRODUCT SAFETY NOTICE of this Service Manual. Don't degrade the safety of the receiver through improper servicing.

SYMBOL NO.	PART NO.	PART DESCRIPTION	SYMBOL NO.	PART NO.	PART DESCRIPTION
CA21	0880044R	PF 0.01UF-KEB 50V	D009	2398611M	DI 1SS254 TAPE (35V) SI 4NSEC
CA22	0890078R	CD 220PF-K 50V	D00H	2398611M	DI 1SS254 TAPE (35V) SI 4NSEC
CA25	0800003R	EL 1.0UF-M 50V	D010	2398611M	DI 1SS254 TAPE (35V) SI 4NSEC
CA26	0880044R	PF 0.01UF-KEB 50V	D011	2398611M	DI 1SS254 TAPE (35V) SI 4NSEC
CA27	0800005R	EL 2.2UF-M 50V	D012	2339889M	ZD HZS12 (C3) 0.005A
CA28	0880044R	PF 0.01UF-KEB 50V	D013	2339889M	ZD HZS12 (C3) 0.005A
CA29	0880044R	PF 0.01UF-KEB 50V	D014	2339889M	ZD HZS12 (C3) 0.005A
CA32	0800015R	EL 10UF-M 16V	D023	2339862M	ZD HZS-9A2 TA
CA35	0800058R	EL 220UF-M 16V	D024	2398611M	DI 1SS254 TAPE (35V) SI 4NSEC
CA37	0880057R	PF 0.1UF-KEB 50V	D301	2398611M	DI 1SS254 TAPE (35V) SI 4NSEC
CA38	0880044R	PF 0.01UF-KEB 50V	D302	2398611M	DI 1SS254 TAPE (35V) SI 4NSEC
CA40	0800049R	EL 100UF-M 16V	D303	2398611M	DI 1SS254 TAPE (35V) SI 4NSEC
CA41	0880044R	PF 0.01UF-KEB 50V	D304	2339868M	ZD HZS9C2 TAPE
CA42	0800049R	EL 100UF-M 16V	D305	2339862M	ZD HZS-9A2 TA
CA43	0880044R	PF 0.01UF-KEB 50V	D306	2339862M	ZD HZS-9A2 TA
CA44	0800041R	EL 47UF-M 16V	D307	2398611M	DI 1SS254 TAPE (35V) SI 4NSEC
CA48	0880044R	PF 0.01UF-KEB 50V	D308	2398611M	DI 1SS254 TAPE (35V) SI 4NSEC
CA49	0880044R	PF 0.01UF-KEB 50V	D311	2398611M	DI 1SS254 TAPE (35V) SI 4NSEC
CA54	0880044R	PF 0.01UF-KEB 50V	D312	2398611M	DI 1SS254 TAPE (35V) SI 4NSEC
CA55	0800049R	EL 100UF-M 16V	D382	2339867M	ZD HZS-9-C1 TAPE (SI.200MA)
CA60	0800015R	EL 10UF-M 16V	D383	2398611M	DI 1SS254 TAPE (35V) SI 4NSEC
CA61	0800007R	EL 3.3UF-M 50V	D390	2398611M	DI 1SS254 TAPE (35V) SI 4NSEC
CA62	0890085R	CD 680PF-K 50V	D391	2398611M	DI 1SS254 TAPE (35V) SI 4NSEC
CA63	0890089R	CD 1500PF-K 50V	D393	2339889M	ZD HZS12 (C3) 0.005A
CA66	0890066R	CD 27PF-J 50V	D401	2339812M	ZD HZS3A2 TA (SI.200MA)
CA67	0800015R	EL 10UF-M 16V	D402	2339812M	ZD HZS3A2 TA (SI.200MA)
CA68	0880044R	PF 0.01UF-KEB 50V	D403	2398611M	DI 1SS254 TAPE (35V) SI 4NSEC
CA69	0800003R	EL 1.0UF-M 50V	D404	2398611M	DI 1SS254 TAPE (35V) SI 4NSEC
CA70	0880057R	PF 0.1UF-KEB 50V	D405	2398611M	DI 1SS254 TAPE (35V) SI 4NSEC
CA71	0880057R	PF 0.1UF-KEB 50V	D406	2398611M	DI 1SS254 TAPE (35V) SI 4NSEC
CA72	0890087R	CD 1000PF-K 50V	D407	2398611M	DI 1SS254 TAPE (35V) SI 4NSEC
CE20	0800015R	EL 10UF-M 16V	D601	2398611M	DI 1SS254 TAPE (35V) SI 4NSEC
CE21	0880044R	PF 0.01UF-KEB 50V	D602	2398611M	DI 1SS254 TAPE (35V) SI 4NSEC
CE22	0800015R	EL 10UF-M 16V	D605	2398611M	DI 1SS254 TAPE (35V) SI 4NSEC
CE25	0244105R	CD 2200PF-K 50V TAPE	D620	2339862M	ZD HZS-9A2 TA
35V CONTROL PWB CAPACITORS			D621	2339491M	DI AM01Z (200 TAPE) 1A
C0516	0880016R	PF FILM 0.1UF 50V	D622	2339491M	DI AM01Z (200 TAPE) 1A
C3801	0800015R	EL 10UF-M 16V	D623	2398611M	DI 1SS254 TAPE (35V) SI 4NSEC
C3802	0800015R	EL 10UF-M 16V	D701	2398611M	DI 1SS254 TAPE (35V) SI 4NSEC
C3803	0800041R	EL 47UF-M 16V	D703	2398611M	DI 1SS254 TAPE (35V) SI 4NSEC
C3804	0800015R	EL 10UF-M 16V	D704	2398611M	DI 1SS254 TAPE (35V) SI 4NSEC
C3805	0244171R	CD 0.01UF-Z F 50V TAPE	D705	CH00031M	DI AU02V1(280V)
35V MAGNETIC FIELD PWB CAPACITORS			Δ D707	2339242M	ZD HZS33L2 TAPE
CMF1	0800015R	EL 10UF-M 16V	Δ D708	2339223M	ZD HZS27 (3L)
CMF2	0800049R	EL 100UF-M 16V	D712	2339251M	ZD HZS36-1L TAPE
CMF3	0284623R	EL 1UF-SME(BP) 50V	D713	2339491M	DI AM01Z (200 TAPE) 1A
CY01	0890083R	CD 470PF-K 50V	D714	2398611M	DI 1SS254 TAPE (35V) SI 4NSEC
CY02	0890083R	CD 470PF-K 50V	D715	2338944	DI FML-G12S (F) (200V) SI 0.04US (CZ67)
CY03	0880044R	PF 0.01UF-KEB 50V	Δ D716	2348511	DI RS3FS
CY04	0800015R	EL 10UF-M 16V	Δ D717	2348511	DI RS3FS (CZ67)
CY05	0276717R	PP 0.1UF-J 50V (TF TYP E)	Δ D718	2336612M	DI RU3AM TA
CY06	0890076R	CD 150PF-K 50V	D71A	2339481M	DI AS01Z (200 TAPE) SI 0.6A
CY07	0800049R	EL 100UF-M 16V	D72A	2331809M	ZD DI HZ-6 TAPE (C3) SI 500MW
CY08	0880044R	PF 0.01UF-KEB 50V	D72H	2331812M	ZD DI HZ-7 TAPE (A2) SI 500MW
MAIN PWB DIODES			Δ D73A	2339851M	ZD HZS7A1 TAPE (SI.200MA)
D003	2398611M	DI 1SS254 TAPE (35V) SI 4NSEC	Δ D73C	2339481M	DI AS01Z (200 TAPE) SI 0.6A
			D73E	CH00031M	DI AU02V1(280V)
			D73F	2398611M	DI 1SS254 TAPE (35V) SI 4NSEC
			D73H	CH00031M	DI AU02V1(280V)
			D73K	CH00031M	DI AU02V1(280V)
			D740	2398611M	DI 1SS254 TAPE (35V) SI 4NSEC
			D741	2339491M	DI AM01Z (200 TAPE) 1A

PRODUCT SAFETY NOTE: Components marked with a Δ have special characters important to safety. Before replacing any of these components, read carefully, the PRODUCT SAFETY NOTICE of this Service Manual. Don't degrade the safety of the receiver through improper servicing.

SYMBOL NO.	PART NO.	PART DESCRIPTION	SYMBOL NO.	PART NO.	PART DESCRIPTION
D742	2339851M	ZD HZS7A1 TAPE (SI.200MA)	DV06	2398611M	DI 1SS254 TAPE (35V) SI 4NSEC
D743	2339834M	ZD HZS5(B1) TAPE	DV07	2398611M	DI 1SS254 TAPE (35V) SI 4NSEC
D744	2339882M	ZD DI HZS-12(A2) TAPE			
D745	2339491M	DI AM01Z (200 TAPE) 1A (CZ67)			PINP PWB DIODES
D750	2398611M	DI 1SS254 TAPE (35V) SI 4NSEC			
D781	2339822M	ZD HZS4A2 TA	DA01	2398611M	DI 1SS254 TAPE (35V) SI 4NSEC
Δ D901	2342062	DI D3SBA60-4103	DA02	2339867M	ZD HZS-9-C1 TAPE (SI.200MA)
D902	2339491M	DI AM01Z (200 TAPE) 1A	DA03	2339867M	ZD HZS-9-C1 TAPE (SI.200MA)
D903	2339491M	DI AM01Z (200 TAPE) 1A	DA04	2339867M	ZD HZS-9-C1 TAPE (SI.200MA)
D904	2331991M	DI R02A (V) SI 1.2A 6	DA05	2398611M	DI 1SS254 TAPE (35V) SI 4NSEC
D905	2339481M	DI AS01Z (200 TAPE) SI 0.6A	DA06	2339867M	ZD HZS-9-C1 TAPE (SI.200MA)
D906	2339876M	ZD HZS11B3 TA	DA07	2398611M	DI 1SS254 TAPE (35V) SI 4NSEC
D907	2339481M	DI AS01Z (200 TAPE) SI 0.6A	DA08	2398611M	DI 1SS254 TAPE (35V) SI 4NSEC
D908	2339481M	DI AS01Z (200 TAPE) SI 0.6A	DA09	2398611M	DI 1SS254 TAPE (35V) SI 4NSEC
D909	2339812M	ZD HZS3A2 TA (SI.200MA)	DA10	2398611M	DI 1SS254 TAPE (35V) SI 4NSEC
D90A	2398611M	DI 1SS254 TAPE (35V) SI 4NSEC	DA11	2398611M	DI 1SS254 TAPE (35V) SI 4NSEC
D90C	2398611M	DI 1SS254 TAPE (35V) SI 4NSEC	DE20	2398611M	DI 1SS254 TAPE (35V) SI 4NSEC
D90E	2339835M	ZD HZS5B2 TAPE			
D90F	2398611M	DI 1SS254 TAPE (35V) SI 4NSEC			35V CONTROL PWB DIODES
D90H	2339835M	ZD HZS5B2 TAPE			
D90K	2339833M	ZD HZS5A3 TA SI 200MA	ZD0501	2339885M	ZD HZS12B2 TA
D910	2338944	DI FML-G12S (F) (200V) SI 0.04US	ZD0502	2339885M	ZD HZS12B2 TA
D912	2339481M	DI AS01Z (200 TAPE) SI 0.6A	ZD3801	2331154M	ZD HZ-12 (A1-3 B1-3.TA) SI 200MA
D913	2339835M	ZD HZS5B2 TAPE	ZD3802	2331154M	ZD HZ-12 (A1-3 B1-3.TA) SI 200MA
D914	2339491M	DI AM01Z (200 TAPE) 1A			
D915	2339848M	ZD HZS-6-C2 TAPE			MAIN PWB FUSES
D916	2339848M	ZD HZS-6-C2 TAPE			
D920	2398611M	DI 1SS254 TAPE (35V) SI 4NSEC	Δ F601	2722382	FUSE-DC0.75A-J/UL(L)
D921	2339191M	ZD HZS20-1L TAPE	Δ F901	2722358	FUSE AC05A
DS01	2339868M	ZD HZS9C2 TAPE	Δ F902	2722353	FUSE AC1.6A
		TUNER/CPT/VM/SIDE PIN/SM PWB DIODES			MAIN PWB SURGE PROTECTOR
D626	2398611M	DI 1SS254 TAPE (35V) SI 4NSEC	Δ G901	2340741	SURGE PROTECTOR DSP-301N-S00B
D627	2398611M	DI 1SS254 TAPE (35V) SI 4NSEC			
D628	2398611M	DI 1SS254 TAPE (35V) SI 4NSEC			CPT PWB SPARK GAP
D719	2398611M	DI 1SS254 TAPE (35V) SI 4NSEC			
D720	2398611M	DI 1SS254 TAPE (35V) SI 4NSEC	G801	2340037	SPARK GAP
D721	2335991M	ZD HZ-T33 (02 TP)			
D722	2398611M	DI 1SS254 TAPE (35V) SI 4NSEC			MAIN PWB FILTER
D801	2339821M	ZD HZS4A1 TA			
D804	2398611M	DI 1SS254 TAPE (35V) SI 4NSEC	Δ H901	2793313	CP-EXN-G131P365L
D805	2398611M	DI 1SS254 TAPE (35V) SI 4NSEC			
D806	2398611M	DI 1SS254 TAPE (35V) SI 4NSEC			PINP PWB FILTERS
D820	2339601M	ZD HZS-2 TAPE (ALL) SI 400MW	HA02	2791754	FX-DSS306B101M
D821	2339601M	ZD HZS-2 TAPE (ALL) SI 400MW	HA03	2791754	FX-DSS306B101M
D822	2339601M	ZD HZS-2 TAPE (ALL) SI 400MW	HA07	2791759	FX-DSS306B102M
D823	2339868M	ZD HZS9C2 TAPE	HA08	2791759	FX-DSS306B102M
D825	2339868M	ZD HZS9C2 TAPE	HA09	2791762	FX-DSS306FZ103M
D826	2339868M	ZD HZS9C2 TAPE	HA10	2791762	FX-DSS306FZ103M
D855	2398611M	DI 1SS254 TAPE (35V) SI 4NSEC			
D856	2398611M	DI 1SS254 TAPE (35V) SI 4NSEC			
D857	2398611M	DI 1SS254 TAPE (35V) SI 4NSEC			MAIN PWB INTEGRATED CIRCUITS
D858	2398611M	DI 1SS254 TAPE (35V) SI 4NSEC			
DF01	2339971M	ZD HZS33-1 TA	I001	CP03581	IC LC864164B-5B67 DIGITAL MONOLITHIC
DF02	2339971M	ZD HZS33-1 TA	I002	CP01991U	IC ST24C02CB6
DM01	2339868M	ZD HZS9C2 TAPE	I003	2003522R	IC PST572D-2 (ANALOG IC)
DV01	2339491M	DI AM01Z (200 TAPE) 1A	I004	2020461	IC AN78L05
DV02	2339491M	DI AM01Z (200 TAPE) 1A	I005	CP03621	IC MM1069XS ANALOG MONOLITHIC
DV03	2339491M	DI AM01Z (200 TAPE) 1A	Δ I201	2004133	IC LA7674
DV04	2339491M	DI AM01Z (200 TAPE) 1A	I301	2003981	IC BA7604N
DV05	2398611M	DI 1SS254 TAPE (35V) SI 4NSEC	I302	CZ00081	IC LA7952 ANALOG MONOLITHIC

PRODUCT SAFETY NOTE: Components marked with a \triangle have special characters important to safety. Before replacing any of these components, read carefully, the PRODUCT SAFETY NOTICE of this Service Manual. Don't degrade the safety of the receiver through improper servicing.

SYMBOL NO.	PART NO.	PART DESCRIPTION	SYMBOL NO.	PART NO.	PART DESCRIPTION
\triangle I403	2004341	IC AN7178	L905	2122652M	FERRITE CORE
I404	2366301	IC UPD4052BC	L906	2122652M	FERRITE CORE
I620	2003541	IC LA7838	L907	2122652M	FERRITE CORE
I701	2003423	IC UPC7893AHF ICL	L908	2122652M	FERRITE CORE
I901	2912177	IC STR30130	L909	BH00204R	FILTER COIL 18UH
\triangle I902	2000521	IC PC713F6	L90A	2122263M	LA AXIAL COIL 561
\triangle I904	2000465	IC PS2501-1 (KC/LC)	L920	2122653M	FERRITE CORE 1.65UH TAPE
IS01	CP00812	IC UPC1852BCT ANALOG MONOLITHIC	L922	BH00209R	FILTER COIL 47UH
IS02	2004901	IC TA8776N	LA01	2122253M	COIL-AXIAL 100UH-K (CZ67)
		SIDE PIN PWB INTEGRATED CIRCUIT	LAN1	2122253M	COIL-AXIAL 100UH-K
			LS01	2122253M	COIL-AXIAL 100UH-K
I621	2362601	IC HA17458PS			TUNER/CPT/VM/SM PWB INDUCTORS/COILS
\triangle I720	2000521	IC PC713F6			
		PINP PWB INTEGRATED CIRCUITS	L851	2122245M	COIL-AXIAL 27UH-K
			L852	2122245M	COIL-AXIAL 27UH-K
			L853	2122245M	COIL-AXIAL 27UH-K
IA01	2020341	IC MM1111XS	L854	2122253M	COIL-AXIAL 100UH-K
IA02	CP00841	IC M52694P ANALOG MONOLITHIC	L855	2122253M	COIL-AXIAL 100UH-K
IA03	CP00831	IC M65607SP DIGITAL MONOLITHIC	L856	2122253M	COIL-AXIAL 100UH-K
IA04	CP00851	IC HM53461-10 DIGITAL MONOLITHIC	L857	2123468M	FERRITE BEADS CORE LEAD 0.8MH
IA05	2366361	IC AN7805	L858	2123468M	FERRITE BEADS CORE LEAD 0.8MH
I05	CP01771	IC M52684AP ANALOG MONOLITHIC	L859	2123468M	FERRITE BEADS CORE LEAD 0.8MH
		35V YNR PWB INTEGRATED CIRCUITS	L860	2123468M	FERRITE BEADS CORE LEAD 0.8MH
			L861	2123468M	FERRITE BEADS CORE LEAD 0.8MH
			L862	2123468M	FERRITE BEADS CORE LEAD 0.8MH
IY01	2381211	IC M51494L	L863	2123468M	FERRITE BEADS CORE LEAD 0.8MH
		MAIN PWB INDUCTORS/COILS	LF01	2122253M	COIL-AXIAL 100UH-K
			LF02	2122253M	COIL-AXIAL 100UH-K
L001	2122253M	COIL-AXIAL 100UH-K	LF04	2122253M	COIL-AXIAL 100UH-K
L003	2122942M	COIL-AXIAL 8.2UHKM BELTING	LF05	2122253M	COIL-AXIAL 100UH-K
L004	2122942M	COIL-AXIAL 8.2UHKM BELTING	LF06	2122253M	COIL-AXIAL 100UH-K
L005	2122942M	COIL-AXIAL 8.2UHKM BELTING	LM01	2122253M	COIL-AXIAL 100UH-K
L006	2122942M	COIL-AXIAL 8.2UHKM BELTING	LV01	2122943M	COIL-AXIAL 10UHKM BELTING
L008	2120482	FILTER COIL 100 UHK	LV02	2123468M	FERRITE BEADS CORE LEAD 0.8MH
L010	BH00101	OSCILLATOR COIL	LV03	2123468M	FERRITE BEADS CORE LEAD 0.8MH
L011	2122253M	COIL-AXIAL 100UH-K	LV04	2123468M	FERRITE BEADS CORE LEAD 0.8MH
L201	2122253M	COIL-AXIAL 100UH-K			PINP PWB INDUCTORS/COILS
L301	2122253M	COIL-AXIAL 100UH-K	LA01	2123781R	FILTER COIL 101K
L304	2122954M	COIL-AXIAL 68UHKM BELTING	LA02	2123781R	FILTER COIL 101K
L305	2122951M	COIL-AXIAL 39UHKM BELTING	LA03	2122253M	COIL-AXIAL 100UH-K
L308	2122951M	COIL-AXIAL 39UHKM BELTING	LA04	2123781R	FILTER COIL 101K
L309	2122956M	COIL-AXIAL 100UHKM BELTING	LA07	2122934M	COIL-AXIAL 2.2UH-M
L311	2122253M	COIL-AXIAL 100UH-K	LA09	2122934M	COIL-AXIAL 2.2UH-M
L502	2122253M	COIL-AXIAL 100UH-K			35V YNR PWB INDUCTOR/COIL
L601	2122956M	COIL-AXIAL 100UHKM BELTING			
L700	2122938M	COIL-AXIAL 4.7UHKM BELTING			
\triangle L701	2122652M	FERRITE CORE	LY01	2122253M	COIL-AXIAL 100UH-K
L702	2124513	COIL-H.LINEARITY A3LXU4			MAIN PWB TRANSISTORS
L703	2771893	FERRITE BEADS CORE (005)			
\triangle L704	2275381	COIL-CHOKING 1000UH			
L705	2122248M	COIL-AXIAL 47UH-K (CY62)	Q002	2320596M	TRS. 2SC458 (C TZ/D TZ) SI 230MHZ
L705	2122253M	COIL-AXIAL 100UH-K (CZ67)	Q003	2320596M	TRS. 2SC458 (C TZ/D TZ) SI 230MHZ
L709	BH00205R	FILTER COIL 22UH (CY62)	Q005	2320663M	TRS. 2SC1213A (C)
L709	BH00206R	FILTER COIL 27UH (CZ67)	Q009	2320596M	TRS. 2SC458 (C TZ/D TZ) SI 230MHZ
L710	2122244M	COIL-AXIAL 22UH-K	Q101	2320144M	TRS. 2SC1906 (TAPE) SI 750MHZ
L711	2122652M	FERRITE CORE	Q203	2320596M	TRS. 2SC458 (C TZ/D TZ) SI 230MHZ
L712	BH00222R	FILTER COIL 390UH	Q301	2320596M	TRS. 2SC458 (C TZ/D TZ) SI 230MHZ
L71A	2122652M	FERRITE CORE	Q302	2320596M	TRS. 2SC458 (C TZ/D TZ) SI 230MHZ
\triangle L901	2272293	LINE FILTER-LL	Q305	2320596M	TRS. 2SC458 (C TZ/D TZ) SI 230MHZ
\triangle L902	2121676	LINE FILTER			

PRODUCT SAFETY NOTE: Components marked with a Δ have special characters important to safety. Before replacing any of these components, read carefully, the PRODUCT SAFETY NOTICE of this Service Manual. Don't degrade the safety of the receiver through improper servicing.

SYMBOL NO.	PART NO.	PART DESCRIPTION	SYMBOL NO.	PART NO.	PART DESCRIPTION
Q306	2320637M	TRS. 2SA673 (C 26TZ/D 26TZ) SI 80MHZ	QM02	2320637M	TRS. 2SA673 (C 26TZ/D 26TZ) SI 80MHZ
Q30E	2320596M	TRS. 2SC458 (C TZ/D TZ) SI 230MHZ	QM03	2320637M	TRS. 2SA673 (C 26TZ/D 26TZ) SI 80MHZ
Q30K	2320637M	TRS. 2SA673 (C 26TZ/D 26TZ) SI 80MHZ	QM04	2320596M	TRS. 2SC458 (C TZ/D TZ) SI 230MHZ
Q310	2320596M	TRS. 2SC458 (C TZ/D TZ) SI 230MHZ	QM05	2320596M	TRS. 2SC458 (C TZ/D TZ) SI 230MHZ
Q312	2320596M	TRS. 2SC458 (C TZ/D TZ) SI 230MHZ	QM06	2320596M	TRS. 2SC458 (C TZ/D TZ) SI 230MHZ
Q314	2320637M	TRS. 2SA673 (C 26TZ/D 26TZ) SI 80MHZ	QM07	2320637M	TRS. 2SA673 (C 26TZ/D 26TZ) SI 80MHZ
Q315	2320596M	TRS. 2SC458 (C TZ/D TZ) SI 230MHZ	QM08	2320596M	TRS. 2SC458 (C TZ/D TZ) SI 230MHZ
Q381	2320596M	TRS. 2SC458 (C TZ/D TZ) SI 230MHZ	QM09	2320637M	TRS. 2SA673 (C 26TZ/D 26TZ) SI 80MHZ
Q401	2320637M	TRS. 2SA673 (C 26TZ/D 26TZ) SI 80MHZ	QM10	2320596M	TRS. 2SC458 (C TZ/D TZ) SI 230MHZ
Q402	2320596M	TRS. 2SC458 (C TZ/D TZ) SI 230MHZ	QM11	2320596M	TRS. 2SC458 (C TZ/D TZ) SI 230MHZ
Q403	2320637M	TRS. 2SA673 (C 26TZ/D 26TZ) SI 80MHZ	QV01	2320596M	TRS. 2SC458 (C TZ/D TZ) SI 230MHZ
Q404	2320596M	TRS. 2SC458 (C TZ/D TZ) SI 230MHZ	QV02	2320596M	TRS. 2SC458 (C TZ/D TZ) SI 230MHZ
Q405	2320596M	TRS. 2SC458 (C TZ/D TZ) SI 230MHZ	QV03	2320596M	TRS. 2SC458 (C TZ/D TZ) SI 230MHZ
Q406	2320596M	TRS. 2SC458 (C TZ/D TZ) SI 230MHZ	QV04	2320596M	TRS. 2SC458 (C TZ/D TZ) SI 230MHZ
Q407	2320647M	TRS. 2SC1213 (C 21TZ/D21TZ) SI 80MHZ4	QV05	2320596M	TRS. 2SC458 (C TZ/D TZ) SI 230MHZ
Q601	2320596M	TRS. 2SC458 (C TZ/D TZ) SI 230MHZ	QV06	2320596M	TRS. 2SC458 (C TZ/D TZ) SI 230MHZ
Q602	2320596M	TRS. 2SC458 (C TZ/D TZ) SI 230MHZ	QV07	2320647M	TRS. 2SC1213 (C21TZ/D21TZ) SI 80MHZ4
Q603	2320637M	TRS. 2SA673 (C 26TZ/D 26TZ) SI 80MHZ	QV08	2321351M	TRS. 2SA836/844D/E 100MA 200MW 200MHZSI
Q701	2323523M	TRS. 2SD789 D TAPE	QV09	2315381	TRS. 2SA1837
Δ Q702	2315275F	TRS. 2SC4589-06 (1500V)	QV10	2315391	TRS. 2SC4793
Δ Q703	2320637M	TRS. 2SA673 (C 26TZ/D 26TZ) SI 80MHZ	QV11	2320596M	TRS. 2SC458 (C TZ/D TZ) SI 230MHZ
Δ Q708	2320596M	TRS. 2SC458 (C TZ/D TZ) SI 230MHZ	QV12	2320596M	TRS. 2SC458 (C TZ/D TZ) SI 230MHZ
Q709	2320637M	TRS. 2SA673 (C 26TZ/D 26TZ) SI 80MHZ			
Q70A	2323431	TRS. 2SC1983			PINP PWB TRANSISTORS
Q70H	2315411	TRS. 2SD2012			
Q710	2320637M	TRS. 2SA673 (C 26TZ/D 26TZ) SI 80MHZ	QA01	2320596M	TRS. 2SC458 (C TZ/D TZ) SI 230MHZ
Q752	2323434	TRS. 2SC1983 (O/Y)	QA02	2320596M	TRS. 2SC458 (C TZ/D TZ) SI 230MHZ
Q761	2320596M	TRS. 2SC458 (C TZ/D TZ) SI 230MHZ	QA03	2320637M	TRS. 2SA673 (C 26TZ/D 26TZ) SI 80MHZ
Q901	2327883M	TRS. 2SA1207 (S/T) SI 150MHZ	QA04	2320596M	TRS. 2SC458 (C TZ/D TZ) SI 230MHZ
Q904	2326216	TRS. 2SC3116 (S/T)	QA05	2320596M	TRS. 2SC458 (C TZ/D TZ) SI 230MHZ
Q905	2328451	TRS. FN651	QA08	2320596M	TRS. 2SC458 (C TZ/D TZ) SI 230MHZ
Q906	2320631M	TRS. 2SA673 (B 26TZ/C 26TZ) SI 80MHZ	QA09	2320596M	TRS. 2SC458 (C TZ/D TZ) SI 230MHZ
Q907	2323526M	TRS. 2SD789 D/E TAPE	QA10	2320596M	TRS. 2SC458 (C TZ/D TZ) SI 230MHZ
Q908	2320591M	TRS. 2SC458 (B TZ/C TZ) SI 230MHZ	QA11	2320596M	TRS. 2SC458 (C TZ/D TZ) SI 230MHZ
Q909	2320596M	TRS. 2SC458 (C TZ/D TZ) SI 230MHZ	QA16	2320596M	TRS. 2SC458 (C TZ/D TZ) SI 230MHZ
Q90A	2320681M	TRS. 2SA673A (BC) TAPE	QA17	2320596M	TRS. 2SC458 (C TZ/D TZ) SI 230MHZ
Q90C	2326631	THYRISTOR CR5AS-8(B-A1)	QA18	2320637M	TRS. 2SA673 (C 26TZ/D 26TZ) SI 80MHZ
Q90H	2320663M	TRS. 2SC1213A (C)	QA19	2320596M	TRS. 2SC458 (C TZ/D TZ) SI 230MHZ
QS01	2320596M	TRS. 2SC458 (C TZ/D TZ) SI 230MHZ	QA20	2320596M	TRS. 2SC458 (C TZ/D TZ) SI 230MHZ
QS02	2320596M	TRS. 2SC458 (C TZ/D TZ) SI 230MHZ			35V CONTROL PWB TRANSISTORS
		TUNER/CPT/VM/SIDE PIN/SM PWB TRANSISTORS	Q3801	2320598M	TRS. 2SC458 (B TZ/C TZ/D TZ)
Q650	2320598M	TRS. 2SC458 (B TZ/C TZ/D TZ)	Q3802	2320598M	TRS. 2SC458 (B TZ/C TZ/D TZ)
Q750	2320596M	TRS. 2SC458 (C TZ/D TZ) SI 230MHZ			35V MAG. FIELD/YNR PWB TRANSISTORS
Q751	2320637M	TRS. 2SA673 (C 26TZ/D 26TZ) SI 80MHZ			
Q752	2320663M	TRS. 2SC1213A (C)	QMF1	2320647M	TRS. 2SC1213 (C21TZ/D21TZ) SI 80MHZ4
Q753	2321321M	TRS. 2SA844 (D TZ/E TZ) SI 200MHZ	QY01	2320596M	TRS. 2SC458 (C TZ/D TZ) SI 230MHZ
Q811	2320596M	TRS. 2SC458 (C TZ/D TZ) SI 230MHZ	QY02	2320596M	TRS. 2SC458 (C TZ/D TZ) SI 230MHZ
Q812	2320596M	TRS. 2SC458 (C TZ/D TZ) SI 230MHZ			MAIN PWB RESISTORS
Q851	2315491	TRS. 2SC4544			
Q852	2320591M	TRS. 2SC458 (B TZ/C TZ) SI 230MHZ	R001	0700032M	CF 1/16W 220-JB
Q853	2320637M	TRS. 2SA673 (C 26TZ/D 26TZ) SI 80MHZ	R002	0700032M	CF 1/16W 220-JB
Q854	2315491	TRS. 2SC4544	R003	0700041M	CF 1/16W 1.0K-JB
Q855	2320591M	TRS. 2SC458 (B TZ/C TZ) SI 230MHZ	R005	0700041M	CF 1/16W 1.0K-JB
Q856	2320637M	TRS. 2SA673 (C 26TZ/D 26TZ) SI 80MHZ	R007	0700041M	CF 1/16W 1.0K-JB
Q857	2315491	TRS. 2SC4544	R008	0700049M	CF 1/16W 4.7K-JB
Q858	2320591M	TRS. 2SC458 (B TZ/C TZ) SI 230MHZ	R009	0700041M	CF 1/16W 1.0K-JB
Q859	2320637M	TRS. 2SA673 (C 26TZ/D 26TZ) SI 80MHZ	R00A	0700041M	CF 1/16W 1.0K-JB (CY62)
QF01	2320596M	TRS. 2SC458 (C TZ/D TZ) SI 230MHZ	R00C	0700054M	CF 1/16W 10K-JB
QM01	2320637M	TRS. 2SA673 (C 26TZ/D 26TZ) SI 80MHZ			

PRODUCT SAFETY NOTE: Components marked with a Δ have special characters important to safety. Before replacing any of these components, read carefully, the PRODUCT SAFETY NOTICE of this Service Manual. Don't degrade the safety of the receiver through improper servicing.

SYMBOL NO.	PART NO.	PART DESCRIPTION	SYMBOL NO.	PART NO.	PART DESCRIPTION
R00K	0700064M	CF 1/16W 56K-JB	R059	0700052M	CF 1/16W 6.8K-JB
R012	0700042M	CF 1/16W 1.2K-JB (CY62)	R05A	0700054M	CF 1/16W 10K-JB
R013	0700041M	CF 1/16W 1.0K-JB (CY62)	R05C	0700041M	CF 1/16W 1.0K-JB
R014	0700043M	CF 1/16W 1.5K-JB (CY62)	R05E	0700054M	CF 1/16W 10K-JB
R015	0700046M	CF 1/16W 2.7K-JB (CY62)	R05H	0700054M	CF 1/16W 10K-JB
R016	0700049M	CF 1/16W 4.7K-JB (CY62)	R05K	0700058M	CF 1/16W 22K-JB
R017	0700032M	CF 1/16W 220-JB	R060	0700058M	CF 1/16W 22K-JB
R019	0700047M	CF 1/16W 3.3K-JB	R061	0700061M	CF 1/16W 33K-JB
R01A	0700041M	CF 1/16W 1.0K-JB	R062	0100065M	CF 1/8W 1K-JB
R01C	0700054M	CF 1/16W 10K-JB	R063	0100065M	CF 1/8W 1K-JB
R01E	0700041M	CF 1/16W 1.0K-JB	R064	0100065M	CF 1/8W 1K-JB
R01H	0700041M	CF 1/16W 1.0K-JB	R067	0700036M	CF 1/16W 470-JB
R01K	0700041M	CF 1/16W 1.0K-JB	R069	0700041M	CF 1/16W 1.0K-JB
R01M	0700058M	CF 1/16W 22K-JB	R06A	0100065M	CF 1/8W 1K-JB
R01P	0700037M	CF 1/16W 560-JB	R06C	0700051M	CF 1/16W 5.6K-JB
R01R	0700041M	CF 1/16W 1.0K-JB	R06E	0700045M	CF 1/16W 2.2K-JB
R01S	0700058M	CF 1/16W 22K-JB	R06F	0700049M	CF 1/16W 4.7K-JB
R01T	0700041M	CF 1/16W 1.0K-JB	R06H	0700041M	CF 1/16W 1.0K-JB
R020	0700041M	CF 1/16W 1.0K-JB	R06K	0700067M	CF 1/16W 100K-JB
R021	0700036M	CF 1/16W 470-JB (CY62)	R071	0700054M	CF 1/16W 10K-JB (CY62)
R021	0700038M	CF 1/16W 680-JB (CZ67)	R072	0700047M	CF 1/16W 3.3K-JB (CY62)
R023	0700048M	CF 1/16W 3.9K-JB	R072	0700049M	CF 1/16W 4.7K-JB (CZ67)
R024	0700041M	CF 1/16W 1.0K-JB	R073	0700047M	CF 1/16W 3.3K-JB (CY62)
R025	0700041M	CF 1/16W 1.0K-JB	R073	0700049M	CF 1/16W 4.7K-JB (CZ67)
R026	0700052M	CF 1/16W 6.8K-JB	R074	0700047M	CF 1/16W 3.3K-JB (CY62)
R027	0700047M	CF 1/16W 3.3K-JB (CY62)	R074	0700049M	CF 1/16W 4.7K-JB (CZ67)
R027	0700046M	CF 1/16W 2.7K-JB (CZ67)	R08C	0700056M	CF 1/16W 15K-JB
R028	0700043M	CF 1/16W 1.5K-JB	R091	0700058M	CF 1/16W 22K-JB
R029	0700052M	CF 1/16W 6.8K-JB	R09C	0700041M	CF 1/16W 1.0K-JB
R02A	0700056M	CF 1/16W 15K-JB	R09K	0700041M	CF 1/16W 1.0K-JB
R02E	0700056M	CF 1/16W 15K-JB	ROA1	0700067M	CF 1/16W 100K-JB
R030	0700056M	CF 1/16W 15K-JB	ROA2	0700058M	CF 1/16W 22K-JB
R031	0700054M	CF 1/16W 10K-JB	ROA3	0100125M	CF 1/8W 330K-JB
R032	0700049M	CF 1/16W 4.7K-JB (CY62)	ROA4	0700035M	CF 1/16W 390-JB
R032	0700046M	CF 1/16W 2.7K-JB (CZ67)	ROA5	0100066M	CF 1/8W 1.1K-JB (CZ67)
R033	0700052M	CF 1/16W 6.8K-JB	ROA6	0100065M	CF 1/8W 1K-JB (CZ67)
R034	0700054M	CF 1/16W 10K-JB (CY62)	ROA7	0100065M	CF 1/8W 1K-JB (CZ67)
R034	0700053M	CF 1/16W 8.2K-JB (CZ67)	ROA8	0700045M	CF 1/16W 2.2K-JB
R035	0700055M	CF 1/16W 12K-JB (CY62)	ROA9	0700046M	CF 1/16W 2.7K-JB
R035	0700052M	CF 1/16W 6.8K-JB (CZ67)	ROC1	0700035M	CF 1/16W 390-JB
R036	0700055M	CF 1/16W 12K-JB	R101	0100041M	CF 1/8W 100-JB
R037	0700061M	CF 1/16W 33K-JB	R102	0100041M	CF 1/8W 100-JB
R038	0100065M	CF 1/8W 1K-JB	R103	0100041M	CF 1/8W 100-JB
R039	0700041M	CF 1/16W 1.0K-JB	R107	0100041M	CF 1/8W 100-JB
R03A	0700041M	CF 1/16W 1.0K-JB	R2Z1	0700036M	CF 1/16W 470-JB
R03C	0700041M	CF 1/16W 1.0K-JB	R2Z2	0700037M	CF 1/16W 560-JB
R03E	0700041M	CF 1/16W 1.0K-JB	R302	0100133M	CF 1/8W 680K-JB
R03H	0700041M	CF 1/16W 1.0K-JB	R303	0700056M	CF 1/16W 15K-JB
R040	0700041M	CF 1/16W 1.0K-JB	R305	0700036M	CF 1/16W 470-JB
R041	0700041M	CF 1/16W 1.0K-JB	R306	0700033M	CF 1/16W 270-JB (CY62)
R042	0700041M	CF 1/16W 1.0K-JB	R306	0700034M	CF 1/16W 330-JB (CZ67)
R043	0700041M	CF 1/16W 1.0K-JB	R307	0700035M	CF 1/16W 390-JB (CY62)
R044	0700055M	CF 1/16W 12K-JB	R307	0700034M	CF 1/16W 330-JB (CZ67)
R045	0700058M	CF 1/16W 22K-JB	R308	0700038M	CF 1/16W 680-JB
R046	0700067M	CF 1/16W 100K-JB	R309	0700037M	CF 1/16W 560-JB
R047	0700045M	CF 1/16W 2.2K-JB	R30E	0700058M	CF 1/16W 22K-JB
R048	0700047M	CF 1/16W 3.3K-JB	R30H	0700038M	CF 1/16W 680-JB
R049	0700027M	CF 1/16W 100-JB	R30K	0700038M	CF 1/16W 680-JB
R04A	0700045M	CF 1/16W 2.2K-JB (CY62)	R310	0700038M	CF 1/16W 680-JB
R04A	0700046M	CF 1/16W 2.7K-JB (CZ67)	R312	0700023M	CF 1/16W 47-J
R057	0700041M	CF 1/16W 1.0K-JB	R316	0700037M	CF 1/16W 560-JB
R058	0700041M	CF 1/16W 1.0K-JB	R317	0700029M	CF 1/16W 150-JB

PRODUCT SAFETY NOTE: Components marked with a Δ have special characters important to safety. Before replacing any of these components, read carefully, the PRODUCT SAFETY NOTICE of this Service Manual. Don't degrade the safety of the receiver through improper servicing.

SYMBOL NO.	PART NO.	PART DESCRIPTION	SYMBOL NO.	PART NO.	PART DESCRIPTION
R318	0700034M	CF 1/16W 330-JB	R40H	0700062M	CF 1/16W 39K-JB
R335	0700032M	CF 1/16W 220-JB	R40K	0700063M	CF 1/16W 47K-JB
R336	0700054M	CF 1/16W 10K-JB	R410	0700063M	CF 1/16W 47K-JB
R337	0700058M	CF 1/16W 22K-JB	R411	0700063M	CF 1/16W 47K-JB
R338	0700036M	CF 1/16W 470-JB	R412	0700063M	CF 1/16W 47K-JB
R339	0187060M	CF 1/16W 620-JB	R413	0700063M	CF 1/16W 47K-JB
R33A	0700035M	CF 1/16W 390-JB	R419	0700036M	CF 1/16W 470-JB
R33C	0700037M	CF 1/16W 560-JB	R41A	0700036M	CF 1/16W 470-JB
R33E	0700057M	CF 1/16W 18K-JB	R41C	0700041M	CF 1/16W 1.0K-JB
R33H	0700032M	CF 1/16W 220-JB	R430	0700041M	CF 1/16W 1.0K-JB
R340	0150287	VR RV06 10K-B	R431	0700041M	CF 1/16W 1.0K-JB
R341	0700052M	CF 1/16W 6.8K-JB	R439	0700041M	CF 1/16W 1.0K-JB
R342	0700049M	CF 1/16W 4.7K-JB	R43A	0700041M	CF 1/16W 1.0K-JB
R343	0700046M	CF 1/16W 2.7K-JB	R43E	0700049M	CF 1/16W 4.7K-JB
R344	0700051M	CF 1/16W 5.6K-JB	R43K	0700054M	CF 1/16W 10K-JB
R345	0700031M	CF 1/16W 180-JB	R440	0700045M	CF 1/16W 2.2K-JB
R346	0700061M	CF 1/16W 33K-JB	R441	0700045M	CF 1/16W 2.2K-JB
R348	0100041M	CF 1/8W 100-JB	R442	0700041M	CF 1/16W 1.0K-JB
R349	0100041M	CF 1/8W 100-JB	R443	0700041M	CF 1/16W 1.0K-JB
R34A	0100038M	CF 1/8W 75-JB	R444	0700048M	CF 1/16W 3.9K-JB
R34C	0100041M	CF 1/8W 100-JB	R445	0700048M	CF 1/16W 3.9K-JB
R34H	0100038M	CF 1/8W 75-JB	R446	0700034M	CF 1/16W 330-JB
R34K	0100038M	CF 1/8W 75-JB (CY62)	R447	0100113M	CF 1/8W 100K-JB
R350	0100041M	CF 1/8W 100-JB	R448	0700034M	CF 1/16W 330-JB
R351	0100041M	CF 1/8W 100-JB	Δ R449	0119505G	MF FLM 2.2-J
R352	0700041M	CF 1/16W 1.0K-JB	R44A	0700063M	CF 1/16W 47K-JB
R354	0700027M	CF 1/16W 100-JB	R44C	0700063M	CF 1/16W 47K-JB
R355	0700049M	CF 1/16W 4.7K-JB	R44E	0100077M	CF 1/8W 3.3K-JB
R356	0700054M	CF 1/16W 10K-JB	Δ R44H	0119505G	MF FLM 2.2-J
R358	0700056M	CF 1/16W 15K-JB	R450	0100077M	CF 1/8W 3.3K-JB
R359	0700054M	CF 1/16W 10K-JB	R451	0100133M	CF 1/8W 680K-JB (CZ67)
R35A	0700057M	CF 1/16W 18K-JB	R452	0700063M	CF 1/16W 47K-JB
R35E	0700041M	CF 1/16W 1.0K-JB	R453	0700045M	CF 1/16W 2.2K-JB
R360	0700041M	CF 1/16W 1.0K-JB	R454	0700063M	CF 1/16W 47K-JB
R364	0700054M	CF 1/16W 10K-JB	R458	0700063M	CF 1/16W 47K-JB
R365	0700034M	CF 1/16W 330-JB	R45A	0700049M	CF 1/16W 4.7K-JB
R366	0700054M	CF 1/16W 10K-JB	R45H	0700049M	CF 1/16W 4.7K-JB
R367	0700052M	CF 1/16W 6.8K-JB	R470	0100065M	CF 1/8W 1K-JB
R368	0100041M	CF 1/8W 100-JB	R471	0100113M	CF 1/8W 100K-JB
R369	0700037M	CF 1/16W 560-JB	R472	0700063M	CF 1/16W 47K-JB
R370	0700037M	CF 1/16W 560-JB	R473	0100113M	CF 1/8W 100K-JB
R382	0700047M	CF 1/16W 3.3K-JB	R474	0100065M	CF 1/8W 1K-JB
R383	0700049M	CF 1/16W 4.7K-JB	R475	0700063M	CF 1/16W 47K-JB
R384	0700065M	CF 1/16W 68K-JB	R476	0100113M	CF 1/8W 100K-JB
R390	0700035M	CF 1/16W 390-JB	R477	0100065M	CF 1/8W 1K-JB
R393	0114139M	CF SRD 1/4 P 220-J	R478	0700063M	CF 1/16W 47K-JB
R395	0700052M	CF 1/16W 6.8K-JB	R479	0100113M	CF 1/8W 100K-JB
R396	0700042M	CF 1/16W 1.2K-JB	R47A	0100065M	CF 1/8W 1K-JB
R397	0700051M	CF 1/16W 5.6K-JB	R47C	0100065M	CF 1/8W 1K-JB
R39A	0700054M	CF 1/16W 10K-JB	R47E	0100113M	CF 1/8W 100K-JB
R401	0700041M	CF 1/16W 1.0K-JB	R47F	0100065M	CF 1/8W 1K-JB
R402	0700034M	CF 1/16W 330-JB	R47H	0700063M	CF 1/16W 47K-JB
R403	0700041M	CF 1/16W 1.0K-JB	R47K	0100113M	CF 1/8W 100K-JB
R404	0700062M	CF 1/16W 39K-JB	R480	0100065M	CF 1/8W 1K-JB
R405	0700041M	CF 1/16W 1.0K-JB	R481	0100113M	CF 1/8W 100K-JB (CY62)
R406	0700054M	CF 1/16W 10K-JB	R482	0700063M	CF 1/16W 47K-JB
R407	0700041M	CF 1/16W 1.0K-JB	R483	0100065M	CF 1/8W 1K-JB
R408	0700041M	CF 1/16W 1.0K-JB	R484	0100113M	CF 1/8W 100K-JB (CY62)
R409	0700034M	CF 1/16W 330-JB	R485	0700063M	CF 1/16W 47K-JB
R40A	0700041M	CF 1/16W 1.0K-JB	R501	0700057M	CF 1/16W 18K-JB
R40C	0700054M	CF 1/16W 10K-JB	R502	0700058M	CF 1/16W 22K-JB
R40E	0700063M	CF 1/16W 47K-JB	R521	0700061M	CF 1/16W 33K-JB

PRODUCT SAFETY NOTE: Components marked with a \triangle have special characters important to safety. Before replacing any of these components, read carefully, the PRODUCT SAFETY NOTICE of this Service Manual. Don't degrade the safety of the receiver through improper servicing.

SYMBOL NO.	PART NO.	PART DESCRIPTION	SYMBOL NO.	PART NO.	PART DESCRIPTION
R522	0700031M	CF 1/16W 180-JB	\triangle R725	0119505G	MF FLM 2.2-J
R570	0700062M	CF 1/16W 39K-JB	\triangle R726	0119505G	MF FLM 2.2-J
R571	0700037M	CF 1/16W 560-JB	R727	0119688M	MF 1W 0.22-JB
R572	0700037M	CF 1/16W 560-JB	R728	0700044M	CF 1/16W 1.8K-JB
R601	0700058M	CF 1/16W 22K-JB	R729	0700048M	CF 1/16W 3.9K-JB
R602	0700027M	CF 1/16W 100-JB	R732	0100077M	CF 1/8W 3.3K-JB
R603	0700059M	CF 1/16W 27K-JB	R734	0113748M	CF 1/2 P-B 820-JB
R604	0700054M	CF 1/16W 10K-JB	R735	0113748M	CF 1/2 P-B 820-JB
R607	0100119M	CF 1/8W 180K-JB	\triangle R736	0700032M	CF 1/16W 220-JB
R608	0700038M	CF 1/16W 680-JB	R738	0700045M	CF 1/16W 2.2K-JB
R609	0700042M	CF 1/16W 1.2K-JB	R739	0700041M	CF 1/16W 1.0K-JB
R60A	0700041M	CF 1/16W 1.0K-JB	R73A	0114049M	CF 1/4W 22-JB
R60C	0100055M	CF 1/8W 390-JB	R73C	0700023M	CF 1/16W 47-J
R60E	0700041M	CF 1/16W 1.0K-JB	\triangle R73E	0119838S	MF 1/4-S 0.5-J
R60H	0700032M	CF 1/16W 220-JB	R73H	0114161M	CF 1/4W 1K-JB
R610	0700048M	CF 1/16W 3.9K-JB	R73K	0700036M	CF 1/16W 470-JB
R613	0700055M	CF 1/16W 12K-JB	R740	0110125S	MF 150-JS (CY62)
R614	0700048M	CF 1/16W 3.9K-JB	\triangle R745	0700054M	CF 1/16W 10K-JB
R621	0700035M	CF 1/16W 390-JB	\triangle R746	0700053M	CF 1/16W 8.2K-JB
R622	0700065M	CF 1/16W 68K-JB	R74A	0100061M	CF 1/8W 680-JB
R623	0700058M	CF 1/16W 22K-JB	R74C	0100107M	CF 1/8W 56K-JB (CY62)
R624	0100131M	CF 1/8W 560K-JB	R74C	0100103M	CF 1/8W 39K-JB (CZ67)
R625	0114135M	CF 1/4W 150-JB	R74H	0100107M	CF 1/8W 56K-JB (CY62)
R626	0700059M	CF 1/16W 27K-JB	R74H	0100109M	CF 1/8W 68K-JB (CZ67)
R627	0100129M	CF 1/8W 470K-JB	R750A	0114131M	CF 1/4W 100-JB
R628	0187106M	CF 1/16W 51K-JB	R763	0110259S	MF 3.9K-JS
R629	0700064M	CF 1/16W 56K-JB (CY62)	R765	0100071M	CF 1/8W 1.8K-JB
R629	0187104M	CF 1/16W 43K-JB (CZ67)	R781	0100073M	CF 1/8W 2.2K-JB
R62A	0150160	VR RV06 100K-B 0.1W	R782	0700054M	CF 1/16W 10K-JB
R62C	0119841M	MF FLM 1W 0.82-JB (CY62)	R783	0700046M	CF 1/16W 2.7K-JB
R62C	0119731M	MF 1W R68-K TAPE (CZ67)	R785	0700054M	CF 1/16W 10K-JB
R62H	0700044M	CF 1/16W 1.8K-JB (CY62)	R786	0110241S	MF 680-JS
R62H	0700043M	CF 1/16W 1.5K-JB (CZ67)	R787	0110219	MF 82-J 2W
R62K	0700037M	CF 1/16W 560-JB	R788	0700063M	CF 1/16W 47K-JB
R630	0700032M	CF 1/16W 220-JB	R789	0700061M	CF 1/16W 33K-JB
R631	0700065M	CF 1/16W 68K-JB (CY62)	R790	0700046M	CF 1/16W 2.7K-JB
R631	0700067M	CF 1/16W 100K-JB (CZ67)	R791	0700049M	CF 1/16W 4.7K-JB
R632	0114163M	CF 1/4W 1.2K-JB (CY62)	R792	0100091M	CF 1/8W 12K-JB
R632	0114161M	CF 1/4W 1K-JB (CZ67)	R793	0110177S	MF 22K-JS
R634	0114161M	CF 1/4W 1K-JB (CZ67)	R794	0110257S	MF 3.3K-JS
R636	0113746M	CF 1/2W 680-JB	R798	0113760M	CF 1/2W 2.7K-JB
R637	0110115S	MF FLM 56-JS	\triangle R901	2341281	TH 3R0Q
R64C	0700049M	CF 1/16W 4.7K-JB	R902	0147811	WW 15W 1.5-KM
R650	0700067M	CF 1/16W 100K-JB	R903	0141161	WW 15W 220-JF
R651	0100125M	CF 1/8W 330K-JB	R904	0110221S	MF FLM 100-JS
R652	0700057M	CF 1/16W 18K-JB	R905	0110197S	MF FLM 2W 10-JS
R701	0700036M	CF 1/16W 470-JB	R906	0110197S	MF FLM 2W 10-JS
R702	0700045M	CF 1/16W 2.2K-JB	R907	0110173S	MF FLM 15K-JS
R703	0700041M	CF 1/16W 1.0K-JB	R908	0100113M	CF 1/8W 100K-JB
R704	0150287	VR RV06 10K-B	R909	0100129M	CF 1/8W 470K-JB
R705	0700054M	CF 1/16W 10K-JB	R90A	0119722M	MF 1.0-JB/W
R706	0700045M	CF 1/16W 2.2K-JB	R90C	0700053M	CF 1/16W 8.2K-JB
R707	0700029M	CF 1/16W 150-JB	R90F	0110125S	MF FLM 150-JS
R708	0100125M	CF 1/8W 330K-JB	R90H	0114059M	CF SRD 1/4 PF 56-J
R709	0114141M	CF 1/4W 270-JB	R90K	0110125S	MF FLM 150-JS
R70A	0114141M	CF 1/4W 270-JB	R910	0100133M	CF 1/8W 680K-JB
R710	0700033M	CF 1/16W 270-JB	R912	0141159	WW 15W 180-JF (CY62)
R716	0113729M	CF 1/2W 150-JB	R912	0141161	WW 15W 220-JF (CZ67)
R717	0700067M	CF 1/16W 100K-JB	R914	0110155S	MF 2.7K-JS 1W
R718	0100037M	CF 1/8W 68-JB	R915	0110261S	MF FLM 4.7K-JS
R720	0114141M	CF 1/4W 270-JB	R916	0114221M	CF 1/4 PB 68K-J
\triangle R721	0119838S	MF 1/4-S 0.5-J	R917	0114209M	CF SRD 1/4 PF 22K-J

PRODUCT SAFETY NOTE: Components marked with a Δ have special characters important to safety. Before replacing any of these components, read carefully, the PRODUCT SAFETY NOTICE of this Service Manual. Don't degrade the safety of the receiver through improper servicing.

SYMBOL NO.	PART NO.	PART DESCRIPTION	SYMBOL NO.	PART NO.	PART DESCRIPTION
R918	0100010M	CF 1/8W 5.1-JB	RS25	0700027M	CF 1/16W 100-JB
R919	0700027M	CF 1/16W 100-JB	RS26	0700054M	CF 1/16W 10K-JB
R91A	0700032M	CF 1/16W 220-JB	RS27	0700027M	CF 1/16W 100-JB
R91C	0100101M	CF 1/8W 33K-JB	RS28	0700063M	CF 1/16W 47K-JB
R91E	0110129S	MF FLM 220-JS			
R91F	0114171M	CF 1/4W 2.7K-JB			TUNER/CPT/VM/SIDE PIN/SM
R91H	0114053M	CF SRD 1/4 PB 33-J			PWB RESISTORS
R91K	0110141S	MF 680-JS			
R920	0700027M	CF 1/16W 100-JB	R361	0100038M	CF 1/8W 75-JB
R921	0700067M	CF 1/16W 100K-JB	R362	0100038M	CF 1/8W 75-JB
R922	0114179M	CF SRD 1/4 PF 5.6K-J	R647	0700044M	CF 1/16W 1.8K-JB
R923	0114149M	CF SRD 1/4 PF 560-J	R648	0114143M	CF 1/4W 330-JB
R924	0147620	WW 2.7-KF	R649	0100056M	CF 1/8W 430-JB
R925	0100073M	CF 1/8W 2.2K-JB	R651	0700066M	CF 1/16W 82K-JB (CY62)
R926	0700049M	CF 1/16W 4.7K-JB	R651	0700067M	CF 1/16W 100K-JB (CZ67)
R927	0700064M	CF 1/16W 56K-JB	R652	0700066M	CF 1/16W 82K-JB (CY62)
R928	0700051M	CF 1/16W 5.6K-JB	R652	0700064M	CF 1/16W 56K-JB (CZ67)
R929	0700061M	CF 1/16W 33K-JB	R653	0700064M	CF 1/16W 56K-JB
R92A	0113750M	CF 1/2W 1K-JB	R654	0700057M	CF 1/16W 18K-JB
R92C	0700046M	CF 1/16W 2.7K-JB	R655	0700063M	CF 1/16W 47K-JB (CY62)
R92E	0113725M	CF SRD1/2P-B 100-J	R655	0700059M	CF 1/16W 27K-JB (CZ67)
R92F	0113746M	CF 1/2W 680-JB	R656	0700049M	CF 1/16W 4.7K-JB
R92H	0700032M	CF 1/16W 220-JB	R657	0100119M	CF 1/8W 180K-JB (CY62)
R92K	0700064M	CF 1/16W 56K-JB	R657	0100117M	CF 1/8W 150K-JB (CZ67)
R930	0700051M	CF 1/16W 5.6K-JB	R658	0700058M	CF 1/16W 22K-JB (CY62)
R931	0700051M	CF 1/16W 5.6K-JB	R658	0700055M	CF 1/16W 12K-JB (CZ67)
R932	0700051M	CF 1/16W 5.6K-JB	R659	0100117M	CF 1/8W 150K-JB
R933	0119508S	MF 1/4W 56-JF	R663	0700059M	CF 1/16W 27K-JB
R934	0100029M	CF 1/8W 33-JB	R664	0700063M	CF 1/16W 47K-JB (CY62)
R936	0110197S	MF FLM 2W 10-JS	R664	0700066M	CF 1/16W 82K-JB (CZ67)
R939	0119505G	MF FLM 2.2-J	R665	0700064M	CF 1/16W 56K-JB
R93A	0100111M	CF 1/8W 82K-JB	R666	0700061M	CF 1/16W 33K-JB
R93H	0113746M	CF 1/2W 680-JB	R667	0100133M	CF 1/8W 680K-JB
R942	0110217S	MF FLM 68-JS	R668	2340371	TH 112301-9
R944	0110223S	MF FLM 120-JS	R669	0700067M	CF 1/16W 100K-JB
R969	0147060	WW 2W 33-K	R670	0700045M	CF 1/16W 2.2K-JB
R970	0141195	WW 10W 330-J	R671	0700065M	CF 1/16W 68K-JB (CZ67)
RA0N	0700041M	CF 1/16W 1.0K-JB (CY62)	R750	0100073M	CF 1/8W 2.2K-JB
RAZ1	0700036M	CF 1/16W 470-JB	R751	0700065M	CF 1/16W 68K-JB
RAZ2	0700037M	CF 1/16W 560-JB	R752	0150279	VR RV06 100K-B(V)
RS01	0179552M	MG 220K-J TAPE	R753	0700056M	CF 1/16W 15K-JB
RS02	0700041M	CF 1/16W 1.0K-JB	R754	0700038M	CF 1/16W 680-JB
RS03	0100133M	CF 1/8W 680K-JB	R755	0150276	VR RV06 20K-B(V)
RS04	0700065M	CF 1/16W 68K-JB	R756	0700057M	CF 1/16W 18K-JB
RS05	0700027M	CF 1/16W 100-JB	R757	0700064M	CF 1/16W 56K-JB
RS06	0700027M	CF 1/16W 100-JB	R758	0700051M	CF 1/16W 5.6K-JB
RS07	0187076M	CF 1/16W 3.0K-JB	R759	0700064M	CF 1/16W 56K-JB
RS08	0187082M	CF 1/16W 5.1K-JB	R760	0700066M	CF 1/16W 82K-JB
RS09	0119636M	MF 1/8W 16K-FB	R762	0700058M	CF 1/16W 22K-JB
RS10	0119601M	MF 1/8W 560-FB	R764	0100075M	CF 1/8W 2.7K-JB
RS11	0100127M	CF 1/8W 390K-JB	R766	0700027M	CF 1/16W 100-JB
RS12	0110211S	MF FLM 39-JS	R767	0700044M	CF 1/16W 1.8K-JB
RS13	0700054M	CF 1/16W 10K-JB	R768	0700056M	CF 1/16W 15K-JB
RS14	0700054M	CF 1/16W 10K-JB	R769	0700054M	CF 1/16W 10K-JB
RS17	0700027M	CF 1/16W 100-JB	R770	0100115M	CF 1/8W 120K-JB
RS18	0700027M	CF 1/16W 100-JB	R771	0700055M	CF 1/16W 12K-JB
RS19	0700032M	CF 1/16W 220-JB	R772	0700046M	CF 1/16W 2.7K-JB
RS20	0700032M	CF 1/16W 220-JB	R773	0700049M	CF 1/16W 4.7K-JB
RS21	0700048M	CF 1/16W 3.9K-JB	R774	0700055M	CF 1/16W 12K-JB
RS22	0700046M	CF 1/16W 2.7K-JB	R775	0150275	VR RV06 10K-B(V)
RS23	0700063M	CF 1/16W 47K-JB	R776	0700051M	CF 1/16W 5.6K-JB
RS24	0700054M	CF 1/16W 10K-JB	R801	0100053M	CF 1/8W 330-JB

PRODUCT SAFETY NOTE: Components marked with a Δ have special characters important to safety. Before replacing any of these components, read carefully, the PRODUCT SAFETY NOTICE of this Service Manual. Don't degrade the safety of the receiver through improper servicing.

SYMBOL NO.	PART NO.	PART DESCRIPTION	SYMBOL NO.	PART NO.	PART DESCRIPTION
R802	0110257S	MF 3.3K-JS (CY62)	RF09	0100065M	CF 1/8W 1K-JB
R802	0110255S	MF 2.7K-JS (CZ67)	RF10	0100065M	CF 1/8W 1K-JB
R803	0110257S	MF 3.3K-JS (CY62)	RF11	0100057M	CF 1/8W 470-JB
R803	0110255S	MF 2.7K-JS (CZ67)	RF12	0100099M	CF 1/8W 27K-JB
R804	0110257S	MF 3.3K-JS (CY62)	RF13	0100103M	CF 1/8W 39K-JB
R804	0110255S	MF 2.7K-JS (CZ67)	RF14	0100057M	CF 1/8W 470-JB
R811	0100035M	CF 1/8W 56-JB (CY62)	RF15	0100049M	CF 1/8W 220-JB
R811	0100033M	CF 1/8W 47-JB (CZ67)	RF16	0100065M	CF 1/8W 1K-JB
R812	0100035M	CF 1/8W 56-JB (CY62)	RF17	0100065M	CF 1/8W 1K-JB
R812	0100033M	CF 1/8W 47-JB (CZ67)	RF18	0100065M	CF 1/8W 1K-JB
R813	0100035M	CF 1/8W 56-JB (CY62)	RF19	0100065M	CF 1/8W 1K-JB
R813	0100033M	CF 1/8W 47-JB (CZ67)	RM01	0700032M	CF 1/16W 220-JB
R814	0700038M	CF 1/16W 680-JB	RM02	0700032M	CF 1/16W 220-JB
R816	0700049M	CF 1/16W 4.7K-JB	RM03	0700032M	CF 1/16W 220-JB
R817	0700045M	CF 1/16W 2.2K-JB	RM04	0100057M	CF 1/8W 470-JB
R818	0700049M	CF 1/16W 4.7K-JB	RM05	0100057M	CF 1/8W 470-JB
R851	0110257S	MF 3.3K-JS (CY62)	RM06	0100057M	CF 1/8W 470-JB
R851	0110255S	MF 2.7K-JS (CZ67)	RM07	0700035M	CF 1/16W 390-JB
R852	0110257S	MF 3.3K-JS (CY62)	RM08	0700041M	CF 1/16W 1.0K-JB
R852	0110255S	MF 2.7K-JS (CZ67)	RM09	0700041M	CF 1/16W 1.0K-JB
R853	0110257S	MF 3.3K-JS (CY62)	RM10	0700051M	CF 1/16W 5.6K-JB
R853	0110255S	MF 2.7K-JS (CZ67)	RM11	0700055M	CF 1/16W 12K-JB
R854	0113750M	CF 1/2W 1K-JB	RM12	0700043M	CF 1/16W 1.5K-JB
R855	0113750M	CF 1/2W 1K-JB	RM13	0700043M	CF 1/16W 1.5K-JB
R856	0113750M	CF 1/2W 1K-JB	RM14	0700043M	CF 1/16W 1.5K-JB
R857	0100053M	CF 1/8W 330-JB	RM15	0100049M	CF 1/8W 220-JB
R858	0100053M	CF 1/8W 330-JB	RM16	0100049M	CF 1/8W 220-JB
R860	0150108	VR RV6 100-B	RM17	0100049M	CF 1/8W 220-JB
R861	0700023M	CF 1/16W 47-J (CY62)	RM18	0187074M	CF 1/16W 2.4K-JB
R861	0700018M	CF 1/16W 22-J (CZ67)	RM19	0700044M	CF 1/16W 1.8K-JB
R863	0700023M	CF 1/16W 47-J (CY62)	RM20	0700038M	CF 1/16W 680-JB
R863	0700021M	CF 1/16W 33-J (CZ67)	RM21	0700035M	CF 1/16W 390-JB
R864	0150108	VR RV6 100-B	RM22	0700051M	CF 1/16W 5.6K-JB
R865	0700023M	CF 1/16W 47-J (CY62)	RM23	0700043M	CF 1/16W 1.5K-JB
R865	0700018M	CF 1/16W 22-J (CZ67)	RM24	0700052M	CF 1/16W 6.8K-JB
R866	0150302	VR RV6 2K-B (V)	RM25	0700064M	CF 1/16W 56K-JB
R867	0700038M	CF 1/16W 680-JB	RM26	0700041M	CF 1/16W 1.0K-JB
R868	0150302	VR RV6 2K-B (V)	RM27	0700046M	CF 1/16W 2.7K-JB
R869	0700038M	CF 1/16W 680-JB	RM28	0700041M	CF 1/16W 1.0K-JB
R870	0150302	VR RV6 2K-B (V)	RV01	0700067M	CF 1/16W 100K-JB
R871	0700038M	CF 1/16W 680-JB	RV02	0700059M	CF 1/16W 27K-JB
R874	0700041M	CF 1/16W 1.0K-JB	RV04	0700035M	CF 1/16W 390-JB
R875	0100049M	CF 1/8W 220-JB	RV06	0700034M	CF 1/16W 330-JB
R876	0100049M	CF 1/8W 220-JB	RV07	0700057M	CF 1/16W 18K-JB
R877	0100049M	CF 1/8W 220-JB	RV08	0700067M	CF 1/16W 100K-JB
R878	0100055M	CF 1/8W 390-JB	RV09	0700033M	CF 1/16W 270-JB
R879	0100055M	CF 1/8W 390-JB	RV10	0700033M	CF 1/16W 270-JB
R880	0100055M	CF 1/8W 390-JB	RV11	0700042M	CF 1/16W 1.2K-JB
R886	0700038M	CF 1/16W 680-JB	RV12	0700045M	CF 1/16W 2.2K-JB
R889	0114131M	CF 1/4W 100-JB	RV13	0700058M	CF 1/16W 22K-JB
R890	0114131M	CF 1/4W 100-JB	RV16	0113742M	CF 1/2W 470-JB
R891	0114131M	CF 1/4W 100-JB	RV17	0700046M	CF 1/16W 2.7K-JB
R892	0700024M	CF 1/16W 56-J (CY62)	RV19	0700028M	CF 1/16W 120-JB (CY62)
R892	0700022M	CF 1/16W 39-J (CZ67)	RV19	0700021M	CF 1/16W 33-J (CZ67)
RF01	0700031M	CF 1/16W 180-JB	RV20	0700041M	CF 1/16W 1.0K-JB
RF02	0700033M	CF 1/16W 270-JB	RV21	0113701M	CF SRD1/2P-B 10-J
RF03	0100053M	CF 1/8W 330-JB	RV22	0100039M	CF 1/8W 82-JB
RF04	0100041M	CF 1/8W 100-JB	RV23	0100039M	CF 1/8W 82-JB
RF05	0100089M	CF 1/8W 10K-JB	RV24	0114165M	CF SRD 1/4 PF 1.5K-J
RF06	0100083M	CF 1/8W 5.6K-JB	RV25	0100069M	CF 1/8W 1.5K-JB
RF07	0100065M	CF 1/8W 1K-JB	RV26	0114143M	CF 1/4W 330-JB
RF08	0100065M	CF 1/8W 1K-JB	RV27	0114221M	CF 1/4 PB 68K-J

PRODUCT SAFETY NOTE: Components marked with a Δ have special characters important to safety. Before replacing any of these components, read carefully, the PRODUCT SAFETY NOTICE of this Service Manual. Don't degrade the safety of the receiver through improper servicing.

SYMBOL NO.	PART NO.	PART DESCRIPTION	SYMBOL NO.	PART NO.	PART DESCRIPTION
RV28	0114221M	CF 1/4 PB 68K-J	RA58	0700027M	CF 1/16W 100-JB
RV29	0100053M	CF 1/8W 330-JB	RA59	0700037M	CF 1/16W 560-JB
RV30	0113776M	CF SRD1/2P-B 12K-J	RA60	0700066M	CF 1/16W 82K-JB
RV31	0113716M	CF SRD1/2P-B 43-J	RA61	0700036M	CF 1/16W 470-JB
RV32	0113716M	CF SRD1/2P-B 43-J	RA62	0700028M	CF 1/16W 120-JB
RV33	0113686M	CF 1/2W 2.7-J	RA63	0179536M	MG 1M J TAPE
RV34	0113686M	CF 1/2W 2.7-J	RA64	0700043M	CF 1/16W 1.5K-JB
RV35	0110229S	MF 220-JS	RA65	0187034M	CF 1/16W 51-J
RV36	0110135S	MF 390-JS (CY62)	RA66	0700034M	CF 1/16W 330-JB
RV36	0110131S	MF 270-JS (CZ67)	RA69	0700027M	CF 1/16W 100-JB
RV37	0110132S	MF 300-JS	RA73	0700032M	CF 1/16W 220-JB
RV38	0700049M	CF 1/16W 4.7K-JB	RA74	0700032M	CF 1/16W 220-JB
RV39	0700051M	CF 1/16W 5.6K-JB	RA78	0100059M	CF 1/8W 560-JB
RV40	0700061M	CF 1/16W 33K-JB	RA80	0700041M	CF 1/16W 1.0K-JB
RV41	0700036M	CF 1/16W 470-JB	RA81	0700052M	CF 1/16W 6.8K-JB
RV42	0700043M	CF 1/16W 1.5K-JB	RA82	0700041M	CF 1/16W 1.0K-JB
RV43	0700035M	CF 1/16W 390-JB	RA83	0100059M	CF 1/8W 560-JB
RV44	0700043M	CF 1/16W 1.5K-JB	RA84	0700054M	CF 1/16W 10K-JB
RV45	0700067M	CF 1/16W 100K-JB	RA85	0700063M	CF 1/16W 47K-JB
RV46	0700067M	CF 1/16W 100K-JB (CY62)	RA86	0700054M	CF 1/16W 10K-JB
RV46	0700066M	CF 1/16W 82K-JB (CZ67)	RA87	0100065M	CF 1/8W 1K-JB
RV47	0700046M	CF 1/16W 2.7K-JB	RA89	0700058M	CF 1/16W 22K-JB
RV48	0700041M	CF 1/16W 1.0K-JB	RA90	0700054M	CF 1/16W 10K-JB
RV49	0700041M	CF 1/16W 1.0K-JB	RA91	0700054M	CF 1/16W 10K-JB
RV50	0700035M	CF 1/16W 390-JB	RA92	0700054M	CF 1/16W 10K-JB
RV51	0700056M	CF 1/16W 15K-JB (CY62)	RA93	0700054M	CF 1/16W 10K-JB
RV51	0700053M	CF 1/16W 8.2K-JB (CZ67)	RA94	0700041M	CF 1/16W 1.0K-JB
		PINP PWB RESISTORS	RA95	0700053M	CF 1/16W 8.2K-JB
			RA96	0700056M	CF 1/16W 15K-JB
RA02	0700027M	CF 1/16W 100-JB	RA97	0700033M	CF 1/16W 270-JB
RA03	0700027M	CF 1/16W 100-JB	RA98	0700043M	CF 1/16W 1.5K-JB
RA04	0700036M	CF 1/16W 470-JB	RE01	0700054M	CF 1/16W 10K-JB
RA05	0100117M	CF 1/8W 150K-JB	RE02	0700037M	CF 1/16W 560-JB
RA06	0700037M	CF 1/16W 560-JB	RE04	0100041M	CF 1/8W 100-JB
RA07	0700041M	CF 1/16W 1.0K-JB	RE05	0100041M	CF 1/8W 100-JB
RA08	0700054M	CF 1/16W 10K-JB	RE10	0700055M	CF 1/16W 12K-JB
RA09	0700054M	CF 1/16W 10K-JB	RE11	0700041M	CF 1/16W 1.0K-JB
RA10	0700027M	CF 1/16W 100-JB	RE12	0700058M	CF 1/16W 22K-JB
RA11	0700027M	CF 1/16W 100-JB	RE13	0700058M	CF 1/16W 22K-JB
RA32	0700047M	CF 1/16W 3.3K-JB	RE20	0700059M	CF 1/16W 27K-JB
RA33	0700052M	CF 1/16W 6.8K-JB	RE21	0700059M	CF 1/16W 27K-JB
RA34	0700063M	CF 1/16W 47K-JB	RE22	0700063M	CF 1/16W 47K-JB
RA35	0700058M	CF 1/16W 22K-JB	RE23	0700059M	CF 1/16W 27K-JB
RA36	0700054M	CF 1/16W 10K-JB	RE24	0700059M	CF 1/16W 27K-JB
RA37	0700058M	CF 1/16W 22K-JB	RE25	0700045M	CF 1/16W 2.2K-JB
RA38	0700054M	CF 1/16W 10K-JB	RE26	0700042M	CF 1/16W 1.2K-JB
RA39	0700035M	CF 1/16W 390-JB			35V CONTROL PWB RESISTORS
RA40	0700054M	CF 1/16W 10K-JB			
RA43	0700067M	CF 1/16W 100K-JB	R0504	0100065M	CF 1/8W 1K-JB
RA44	0700063M	CF 1/16W 47K-JB	R0516	0700041M	CF 1/16W 1.0K-JB
RA45	0700039M	CF 1/16W 820-JB	R0517	0700043M	CF 1/16W 1.5K-JB
RA46	0110209S	MF FLM 33-JS	R0518	0700046M	CF 1/16W 2.7K-JB
RA47	0110209S	MF FLM 33-JS	R0519	0700049M	CF 1/16W 4.7K-JB
RA48	0187038M	CF 1/16W 75-J	R0520	0100065M	CF 1/8W 1K-JB
RA49	0187038M	CF 1/16W 75-J	R3801	0187038M	CF 1/16W 75-J
RA50	0700028M	CF 1/16W 120-JB	R3802	0100041M	CF 1/8W 100-JB
RA51	0700032M	CF 1/16W 220-JB	R3803	0700041M	CF 1/16W 1.0K-JB
RA53	0100041M	CF 1/8W 100-JB	R3804	0700041M	CF 1/16W 1.0K-JB
RA55	0700027M	CF 1/16W 100-JB	R3805	0100123M	CF 1/8W 270K-JB
RA56	0100097M	CF 1/8W 22K-JB	R3806	0700064M	CF 1/16W 56K-JB
RA57	0700027M	CF 1/16W 100-JB	R3807	0700047M	CF 1/16W 3.3K-JB

PRODUCT SAFETY NOTE: Components marked with a Δ have special characters important to safety. Before replacing any of these components, read carefully, the PRODUCT SAFETY NOTICE of this Service Manual. Don't degrade the safety of the receiver through improper servicing.

SYMBOL NO.	PART NO.	PART DESCRIPTION	SYMBOL NO.	PART NO.	PART DESCRIPTION
N901D	2787531	MICA SHETT	EA02	2974201S	CONN. W/WIRE SEH 8J L60 (C-B)
N901E	8815126	WASHER-4LOCKING	NA01	MD01161	M3 PIP SHIELD CASE A
N910	4107502	PWB METAL R (A1) TC-30	NA02	MD01171	M3 PIP SHIELD CASE B
N912	4107512	A3LXU4 PWB METAL L TC-30	PA01	2902248	PLUG PIN SUB MINI9P
NE901	3772201	AC CORD HOLDER NYLON	PA02	2902247	PLUG PIN SUB MINI 8P
P65A	2675583	PLUG.JL-BT-E-5P	P001	2675287	PLUG PIN (PH 8P)
P66A	2675583	PLUG.JL-BT-E-5P	P301	2902252	12P PLUG PIN
P901	2782611	CENTER PIN	ZA01	3787482	PCB HOLDER (16L)
P902	2782611	CENTER PIN			
PA1M	2902267	PLUG PIN SUB MINI 8P			35V CONTROL PWB MISC. PARTS
PAIM	2902264	PLUG PIN SUB MINI 5P			
PFJ	2902266	PLUG PIN SUB MINI 7P (CZ67)	J01	2983116	3P PIN JACK S.TERMINAL
PFVA	2902265	PLUG PIN SUB MINI 6P (CZ67)	PFJ	2902246	PLUG PIN SUB MINI 7P
PG	2902261	PLUGPIN SUB MINI 2P (CZ67)	PFV	2902251	11P PLUG PIN
PM	2665272	4P PLUG PIN WITH BASE			
PMTS	2953681	PIN JACK			35V MAG. FIELD/YNR MISCELLANEOUS PARTS
PS	2902264	PLUG PIN SUB MINI 5P			
PSL	2902262	PLUG PIN SUB MINI 3P			
PSMA	ED00565	CP-TAC-L09X-A1	EY02	2956485	CONNECTOR CO-01C-A—471
PSR	2902263	PLUG PIN SUB MINI 4P	PG2	2902241	PLUG PIN SUB MINI 2P
PTU	2902266	PLUG PIN SUB MINI 7P	PG3	2661942	3P PLUG PIN WITH L TYPE
PVM1	2902265	PLUG PIN SUB MINI 6P	PY01	2675565	PLUG PIN JL-F-E 7P
PVM2	2661756	1P PLUG PIN WITH BASE	PY02	2661756	1P PLUG PIN WITH BASE
PW	2661753	4P PLUG PIN WITH BASE			
PYNR	2675585	PLUG PIN JL-BT-E 7P (CZ67)			CHASSIS MISCELLANEOUS PARTS
Z001	9451104	VARNISH CLOTH TUBE 0.8X1.8 YELLOW			
Z002	9414017	SILICONE COMPOUND(G-746)	#001	NT00791	TUNER HOLDER A3LXU4
Z003	9413926	SILICON RUBBER	#021	3701202	PWB HOLDER G7-A (CY62)
Z004	9485158	HOT MELT (AX-1503C)	#106	NT00123	TERMINAL BOARD A3-4
Z005	9451115	UL CSA TUBE NO.08	#160	3739671	BS CORD HOLDER NYLON6
		TUNER/CPT/VM PWB MISCELLANEOUS PARTS	#906	PH00973	TERMINAL LABEL A3-4 (CY62)
			#907	PH00974	TERMINAL LABEL A3-4 (CZ67)
			EANT	HP00351	RF SPLIT
			EFE1	2979172	MINI PLUG WITH COAXIAL CABLE
E851	EY00302	CPT-SOCKET(S)	EFE2	2979173	PLUG WITH COAXIAL CABLE
ES	2976691	CONN. W/WIRE SEH 5J (L300)	EFJ	EF01501	CONN.W/WIRE EH C-C 7J L430
EVM2	2956485	CONNECTOR CO-01C-A—471	EFV	EF01511	CONN.W/WIRE EH C-C 11J-6J L430
EY1S	EF01321	CONNECTOR CO-08C-B2R5-561	EG	2973682S	CONN.W/WIRE SEH 2J(L620) UL1007
JSIN	2983122	S-SOCKET	ENTS	2979175	PIN PULG
NQ851	4348493	CPT HEAT SINK A3LXU4 AL	EVM1	EF02922	CO-06C-C2R5-560
NQ854	4348493	CPT HEAT SINK A3LXU4 AL			
NQ857	4348493	CPT HEAT SINK A3LXU4 AL			COMPLETE CTV ASSEMBLY PARTS
NQV09	3446473	HEATSINK H30 P10			INSTRUCTION BOOK
NQV09A	4520883	3*12 SCREW WITH WASHER			
NQV10	3446473	HEATSINK H30 P10	N201	QR07151	A3LXU4 INSTRUCTION BOOK (E)
NQV10A	4520883	3*12 SCREW WITH WASHER	N201	QR07171	A3LXU4 INSTRUCTION BOOK (F)
P31	2661751	2P PLUG PIN WITH BASE			
P65B	2675563	PLUG JL-F-E-5P			OWNERS ASSEMBLY PARTS
P66B	2675563	PLUG JL-F-E-5P			
P801	2902263	PLUG PIN SUB MINI 4P	E203	2784243	DRY BATTERY SUM-3 (G)
PA1	2902267	PLUG PIN SUB MINI 8P	N202	H461705	WARRANTY CARD (E) 20-35V
PMTS	2953681	PIN JACK	N205	3611877	POLYETHLENE COVER
PSMB	ED00505	CP-TAC-L09P-A1	N209	H461901	HITACHI EXT. SVC CARD
PTU2	2902266	PLUG PIN SUB MINI 7P	N302	4712247	CUSTOMER REGISTRATION CARD (PTV &
PVM1	2902265	PLUG PIN SUB MINI 6P	CTV)		
Δ PVMC	2902261	PLUGPIN SUB MINI 2P (CY62)	Z201	9542102	STAPLE(MAX NO.10)
PVMC2	2902261	PLUGPIN SUB MINI 2P (CZ67)			
PY1	2902267	PLUG PIN SUB MINI 8P			ACESSORY ASSEMBLY PARTS
		PINP PWB MISCELLANEOUS PARTS			REMOTE CONTROL
			E301	HL00227	R/C-CLU-417UI
EA01	2974231S	CONN. W/WIRE SEH 9J L60 (C-B)			

PRODUCT SAFETY NOTE: Components marked with a Δ have special characters important to safety. Before replacing any of these components, read carefully, the PRODUCT SAFETY NOTICE of this Service Manual. Don't degrade the safety of the receiver through improper servicing.

SYMBOL NO.	PART NO.	PART DESCRIPTION	SYMBOL NO.	PART NO.	PART DESCRIPTION
		SPEAKER PARTS	#225	3875771	LATCH 4T02 NYLON
Δ SP451	GK00202	SPEAKER 4 OHM 5W	#250	3487425	HITACHI BADGE 32CX12B
Δ SP452	GK00202	SPEAKER 4 OHM 5W	#281	4286581	PVC WASHER 2.0T
		SPEAKER WIRING ASSEMBLY PARTS	#301	H310885	R/C LENS
JSL	2976753	CONN. W/WIRE EH 3J (L620) (CY62)	#310	8781642	SCREW 4*12 TAPPING
JSL	2976752	CONN. W/WIRE EH 3J (L820) (CZ67)	#400	PH00911	INDOOR PLATE 32CX12B
JSR	2976763	CONN. W/WIRE EH 4J (L680) (CY62)	#521	3164048	BACKCOVER 32CX12B
JSR	2976762	CONN. W/WIRE EH 4J (L780) (CZ67)	#530	8440444	SP HIMERON C29-BV20
N101	0544510	TERMINAL PIECE (CZ67)	#601	3727972	POWER CORD HANGER
Z101	9449603	NITTOH TAPE #747	#680	H461171	PATENT AND TELESONICS LABEL
Z501	9316403	RESIN FLUX CORED WIRE SOLDER (RH50-2.3-A)	#805	4518378	6X35 TAPPING SCREW WITH WASHER .STEEL
		CPT PARTS	#860	4520771	HEXAGON HEAD TAPPING SCREW 4*18
Δ V1	DE00961	CPT A80LJF30X (CY62)	#895	8781646	SCREW 4 X 16 TAPPING
Δ V1	2471594	CPT A89AEJ15X02 (CZ67)	#900	PC00345	BUTTONS
		DEFLECTION YOKE PARTS	#901	H390047	HIMERON SHEET
Δ E601	BY00511	DEFLECTION YOKE 31V MURATA (CY62)	#920	8441429	HIMERON SHEET(I) HIMERON
		CPT SUB ASSEMBLY PARTS	#921	8441428	HIMERON SHEET(H) HIMERON
E602	2994511	CRT EARTH WIRE (CY62)	N401	QN01007	SERVICEMAN WARNING LABEL A
E602	2908402	CRT EARTH WIRE (35V) (CZ67)			35CX45B FINAL/CABINET ASSEMBLY PARTS
E603	2771461	EDGE MAGNET (CY62)	#013	3123694	35CX45B CABINET ASSEMBLY
E603	GX00131	MAGNET-CHEVRON FUNNEL (CZ67)	#080	3164774	BACKCOVER 35CX45B
E604	2775082	MAGNET VM (CY62)	#086	H920131	THREE BOND TB1521 1KG CAN
EVM	2976645	CONNECTOR CO-02C-N2R5-241 (CY62)	#100	4521713H	SCREW HEXAGON HEAD
EVM3	EF03704	CONNECTOR,2J CONN-CONN L=300 SVM (CZ67)	#103	H420631	FRAME SUPPORT BRACKET
JM	2665293	6P MINI CONN LEAD (CZ67)	#105	4516581	SCREW 4*16 SPECIAL WASHER SWRM
Δ L905	2229022	DEGAUSSING COIL (CY62)	#111	4107241	SUPPORT METAL AV JACK SECC 20/
Δ L970	2229023	DEGAUSSING COIL (35V) (CZ67)	#112	8781642	SCREW 4*12 TAPPING
LMFC	BZ00411	COIL M.F.COIL (CZ67)	#119	4520771	HEXAGON HEAD TAPPING SCREW 4*18
N601	4615641	WEDGE (CY62)	#145	3768982	BC STOPPER N
N606	3330941	EARTH SPRING (CY62)	#151	H830071	WASHER 1/4 FLAT
N606	3333922	EARTH SPRING (CZ67) SUS.	#152	4517801	6 FLANGE-NUT
N607	3763751	SK BINDER	#153	H830071	WASHER 1/4 FLAT
N608	3763752	SK BINDER 200 NYLON 66	#170	H311141	CABINET WIRE CLAMP
N610	2772981	FERRITE SHEET ASS'Y	#180	NT00804	CHASSIS RAIL B A3LXU4
N611	2772211	MAG. PIECE (CY62)	#200	8781646	SCREW 4 X 16 TAPPING
N612	2956801	EARTH RING (CY62)	#220	4520771	HEXAGON HEAD TAPPING SCREW 4*18
N612	H420831	HOOK (CZ67)	#250	3727972	POWER CORD HANGER
N613	4621186	CUSHION 2908 CR	#260	4778201	LABEL BASE 35CX45B PVC
Z601	9449506	SCOTCH TAPE NO.29 19MM	#269	3756631	PLASTIC RIVET
Z603	9473101	WHITE PAINT	#282	QD03062	FRAME ASSEMBLY A3LXU4-35CX45B
Z604	9553945	ADHESIVE TAPE PERMACEL P212 (FIBER GLASS)	#283	3273872	BUTTON 35CX45B
Z606	9436111	TAPE-ADHESIVE W50 NITTO#223S	#284	3487425	HITACHI BADGE 35CX45B
Z608	H920251	PERMACEL TAPE P-201 W19	#285	NT00803	CHASSIS RAIL A A3LXU4
Z609	9449503	ADHESIVE TAPE (SCOTCH NO.3 W=9)	#285	3204184	R/C LENS 35CX45B
Z610	9449553	TAPE-ADHESIVE W19 NITTO#223S(B PVC)	#286	3483712	SP NET (R) 35CX45B
		FINAL/CABINET ASSEMBLY PARTS	#287	3483722	SP NET (L) 35CX45B
#010	H920182	VELCRO	#288B	3828163	INDOOR PLATE 35CX45B PC
#151	QD00265	FRAME 32CX12B	#289	8781642	SCREW 4*12 TAPPING
#200	PH03841	DOOR 32CX12B	#290	9485101	ADHESIVE DIA-BOND DY-470
		32CX12B FINAL ASSEMBLY PARTS	#292	8815126	WASHER-4LOCKING
			#293A	H390041	HIMERON SHEET 85X10
			#293B	H390051	BUTTON CUSHION
			#294	4733887H	HIMERON 3170
			#294A	8441616	HIMERON SHEET
			#295A	QD03071	FRAME SUBASSEMBLY-A3LXU4 - 35CX45B
			#296A	3106402	FRAME 35CX45B PS6075
			#297	3821953	DOOR 35CX45B PS
			#298	3875771	LATCH 4T02 NYLON
			#299	H390043	HIMERON SHEET 740X10
			#90	3707943	INSULATOR FOOT

PRODUCT SAFETY NOTE: Components marked with a  have special characters important to safety. Before replacing any of these components, read carefully, the PRODUCT SAFETY NOTICE of this Service Manual. Don't degrade the safety of the receiver through improper servicing.

SYMBOL NO.	PART NO.	PART DESCRIPTION	SYMBOL NO.	PART NO.	PART DESCRIPTION
#91	4137976	4X20 TAPPING SCREW WITH WASHER			
#92	4326625	CT3170 EVER TIGHT BOLT (L) SWCH18A			
#93	3874421	BRACKET 35CX45B PS			
#94	4516582	SCREW 4X26 TAPPING WITH BOLT			
N101	3785502	V LOCK 11.5			
N102	3785511	V LOCK 16			
N103	3785522	V LOCK 20			
N108	3705232	ANODE CLAMPER 94V0 (101			
N109	3763751	SK BINDER			
N120	4690171	CAUTION LABEL C (F)			
N401	QN01661	SERVICEMAN WARNING LABEL (E)			
Z101	9413945	SILICONE KE-1300 (WHITE)			
PACKING ASSEMBLY PARTS					
#11	H361003	CARTON BOX 32CX12B			
#15A	9542103	STAPLE(A-18)			
#20	H360985	CARTON BOX 35CX45B			
#21	3621552	UPPER CUSHION 35CX45B			
#22	3621562	BOTTOM CUSHION 35CX45B			
#24	H360762	LAMINATED POLY FOAM BAG			
#25	H361021	TOP CUSHION 32CX12B			
#26	H361031	BOTTOM CUSHION 32CX12B			
#30	H461791	TAG & BAR CODE			
#44	9449901	CELLOPHANE TAPE			
#50	H461719	MODEL NAME LABEL 35CX45B-511			
#54	H462004	MODEL NAME LABEL 32CX12B-511			

NOTES

NOTES

NOTES

32CX12B

WIRING DRAWING OF 35CX12B FINAL ASSEMBLY

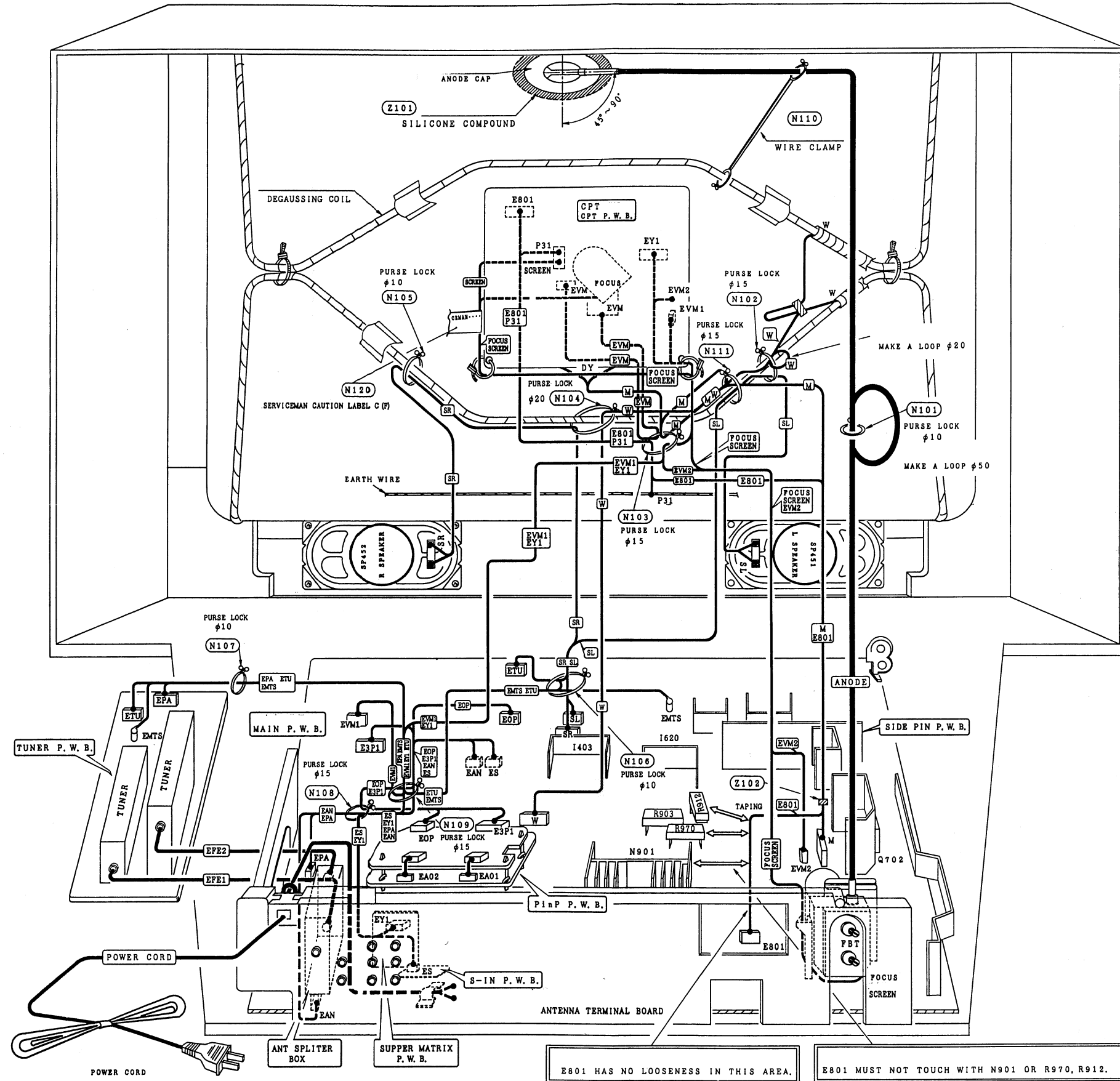

E801 MUST NOT TOUCH WITH N901 OR R970, R912.

35XC45B

WIRING DRAWING OF 35CX45B FINAL ASSEMBLY

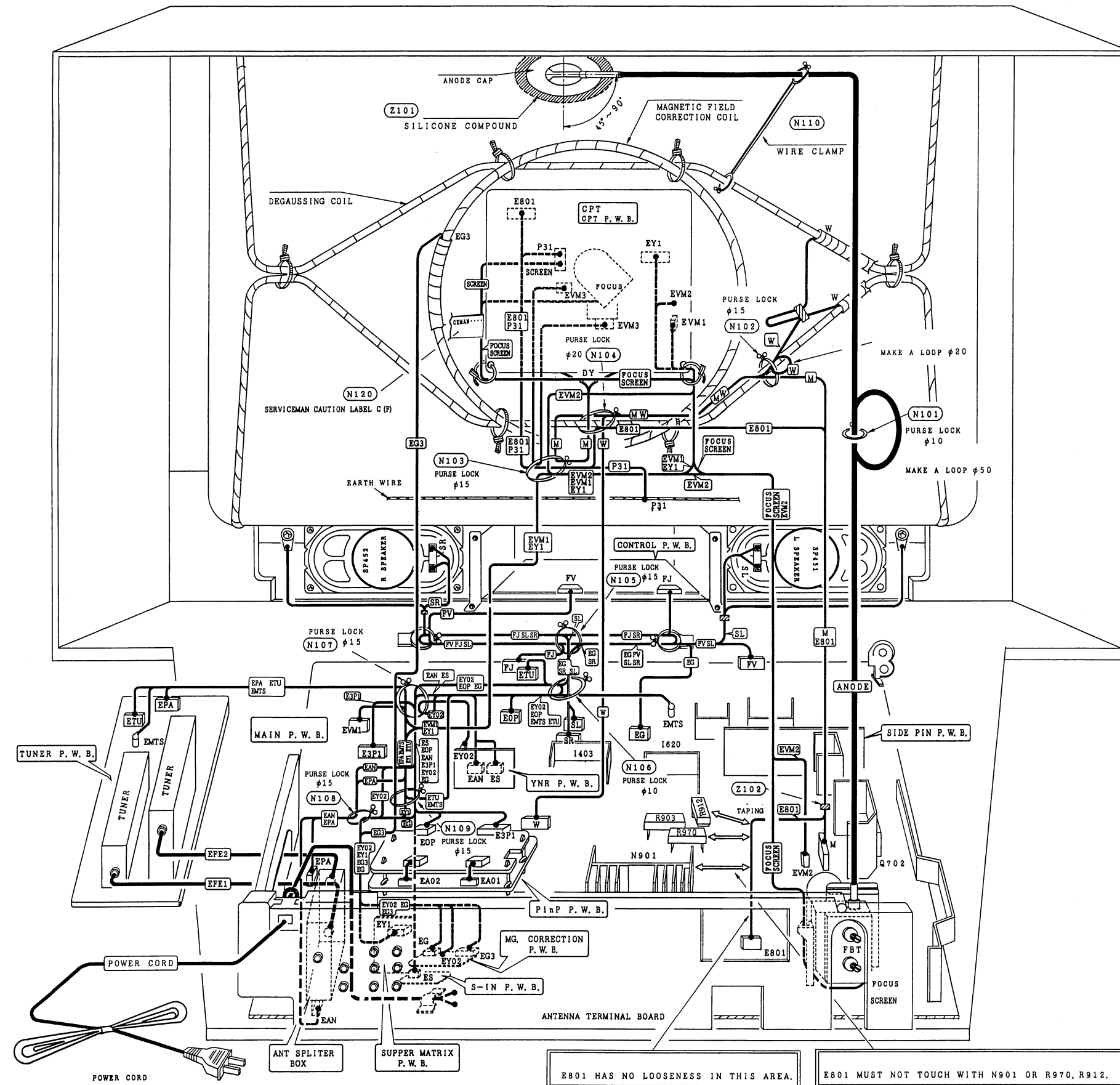

CIRCUIT SCHEMATIC DIAGRAM OF 32CX12B/CY62 and 35CX45B/CZ67
ANALOG/DIGITAL PinP PART

PRODUCT SAFETY NOTE: Components marked with a  and shaded have special characteristics important to safety. Before replacing any of these components, read carefully the PRODUCT SAFETY NOTICE of this Service Manual. Don't degrade the safety of the receiver through improper servicing.

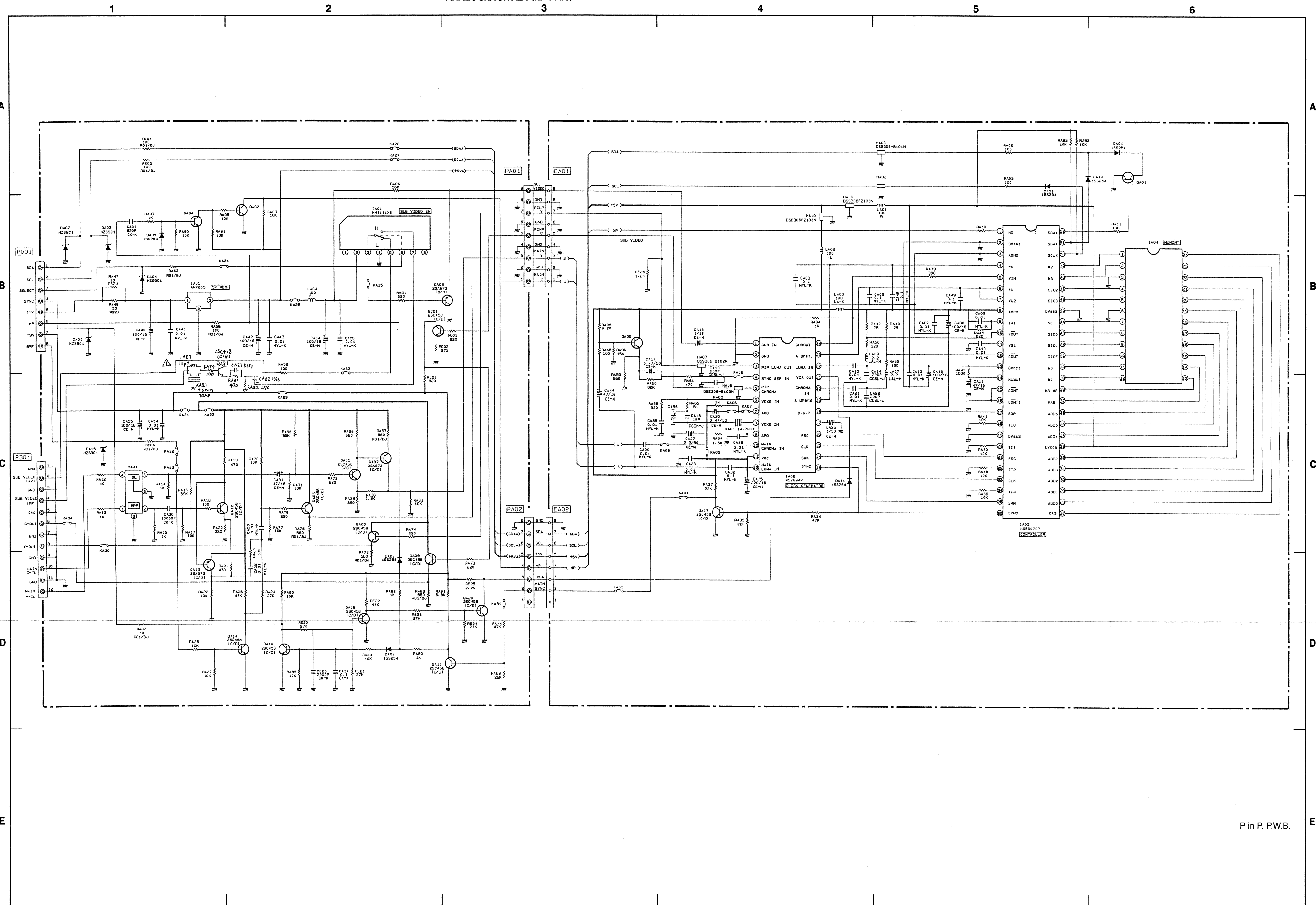

P in P. P.W.B.

Circuit No	Pin No	DC Voltage Vdc
IA04	1	1.4
	2	0.8
	3	0
	4	1
	5	0.6
	6	0
	7	0.3
	8	1.3
	9	3
	10	4.8
	11	2.5
	12	2.2
	13	3.8
	14	3.7
	15	2.3
16	2.8	
17	2.8	
18	4.9	
19	0.5	
20	2.8	
21	2.6	
22	2.3	
23	1.9	
24	4	

Circuit No	Pin No	DC Voltage Vdc
IA05	1	9.6
	2	0
	3	4.9

Circuit No	Pin No	DC Voltage Vdc
I05	1	1
	2	0
	3	1
	4	1
	5	0.6
	6	0.3
	7	4.1
	8	3.8
	9	3
	10	4.9
	11	2
	12	2
	13	2.8
	14	3

Circuit No	Pin No	DC Voltage Vdc
QA01	B	0
	C	4.9
	E	0
QA02	B	0.7
	C	0
	E	0
QA03	B	0
	C	0
	E	2.6
QA04	B	0
	C	2.3
	E	0

Circuit No	Pin No	DC Voltage Vdc
QA05	B	3
	C	4.8
	E	2.3
QA08	B	1.8
	C	9
	E	1.1
QA09	B	1.2
	C	9
	E	0.6
QA10	B	0.3
	C	0.3
	E	0
QA11	B	0.6
	C	0.7
	E	0
QA16	B	2
	C	4.9
	E	1.3
QA17	B	0.3
	C	3
	E	0
QA18	B	4.5
	C	1
	E	5
QA19	B	0.1
	C	3.7
	E	0
QA20	B	0.6
	C	0.6
	E	0

Circuit No	Pin No	DC Voltage Vdc
IA01	1	0
	2	4.9
	3	2
	4	0
	5	0.9
	6	4.8
	7	2.7
	8	0

Circuit No	Pin No	DC Voltage Vdc
IA02	1	2.9
	2	0
	3	1.8
	4	3
	5	1.3
	6	3.3
	7	4.1
	8	12.3
	9	2.4
	10	2.8
	11	4.4
	12	3.3
	13	1
	14	0

Circuit No	Pin No	DC Voltage Vdc
IA02	15	1.7
	16	1.8
	17	1.8
	18	0.2
	19	2.4
	20	2.4
	21	3.2
	22	3.1
	23	3.6
	24	2.9

Circuit No	Pin No	DC Voltage Vdc
IA03	1	0.6
	2	0
	3	0
	4	2.4
	5	2.8
	6	3.6
	7	3.6
	8	4.8
	9	3.6
	10	4.2
	11	2
	12	4.4
	13	4.9
	14	4.9
	15	0
16	0	
17	0.2	
18	1	
19	0	
20	4.9	

Circuit No	Pin No	DC Voltage Vdc
IA03	21	1.8
	22	0
	23	1.7
	24	0
	25	0
	26	1
	27	4
	28	1.9
	29	2.3
	30	2.7
	31	2.8
	32	0.5
	33	4.9
	34	2.8
	35	2.8
36	2.3	
37	3.7	
38	3.8	
39	2.1	
40	2.8	
41	4.8	
42	2.4	
43	1.5	
44	0.3	
45	0	
46	0.6	
47	1	
48	0.9	
49	1.4	
50	4.8	
51	4.8	
52	0	

• Since this is a basic circuit diagram, the value of the parts is subject to be altered for improvement.
 • All DC voltage to be measured with a tester (100kΩ/M). Voltage taken on a complex color bar signal including a standard color bar signal.

CIRCUIT SCHEMATIC DIAGRAM OF 32CX12B/CY62 and 35CX45B/CZ67
MAIN PWB - SIGNAL PART

PRODUCT SAFETY NOTE: Components marked with a  and shaded have special characteristics important to safety. Before replacing any of these components, read carefully the PRODUCT SAFETY NOTICE of this Service Manual. Don't degrade the safety of the receiver through improper servicing.

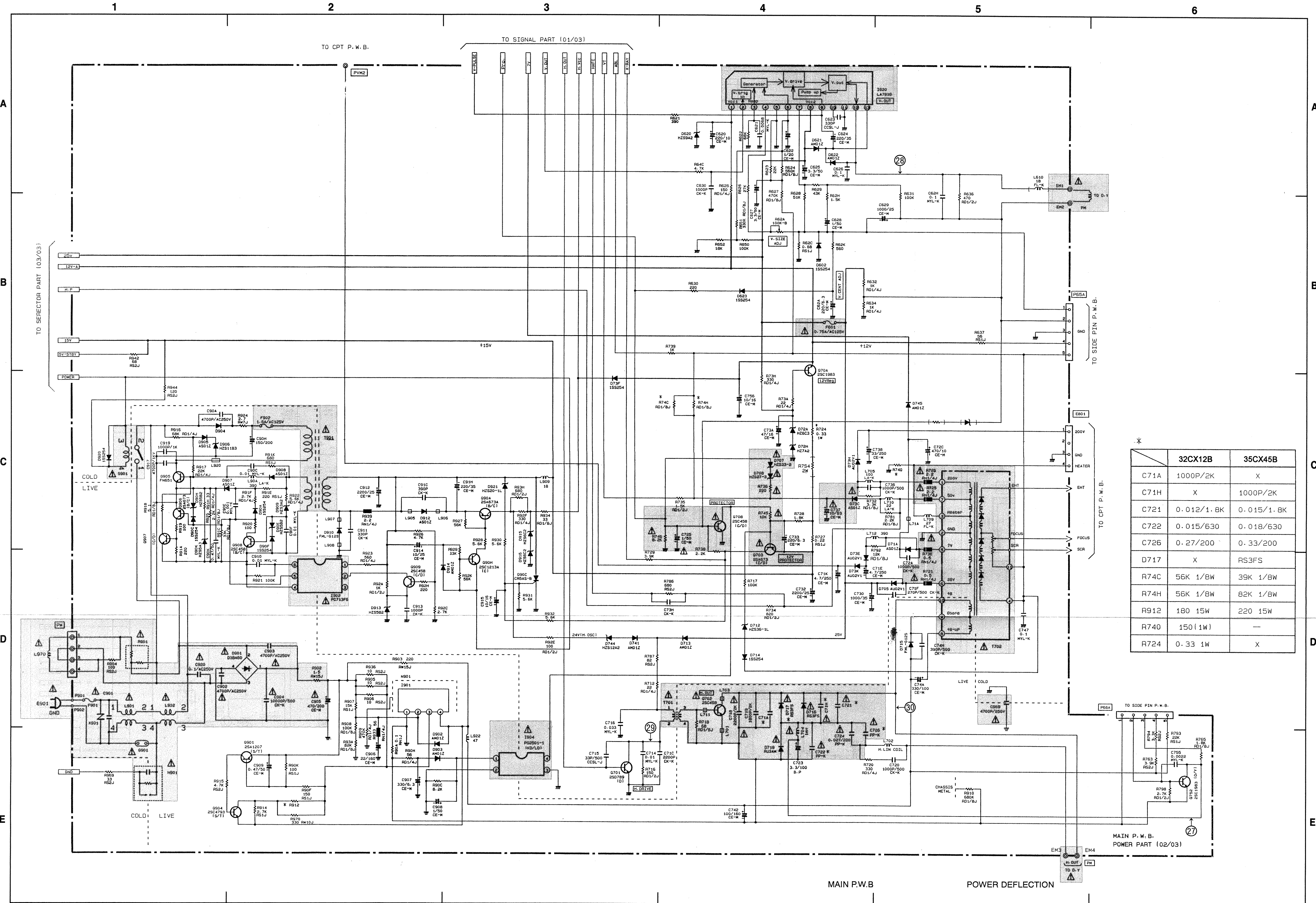

	32CX12B	35CX45B
C71A	1000P/2K	X
C71H	X	1000P/2K
C721	0.012/1.8K	0.015/1.8K
C722	0.015/630	0.018/630
C726	0.27/200	0.33/200
D717	X	RS3FS
R74C	56K 1/8W	39K 1/8W
R74H	56K 1/8W	82K 1/8W
R912	180 15W	220 15W
R740	150 (1W)	—
R724	0.33 1W	X

Circuit No.	Pin No.	DC Voltage Vdc
1820	1	8.4
	2	4.5
	3	4.4
	4	4.3
	5	0
	6	3.9
	7	4.1
	8	2.7
	9	2.6
	10	1.4
	11	0
	12	15.6
	13	27.9

Circuit No.	Pin No.	DC Voltage Vdc
1901	1	0
	2	130.1
	3	150.8
	4	128.1
	5	0

Circuit No.	Pin No.	DC Voltage Vdc
1902	1	14
	2	13
	3	0
	4	74.8
	5	77.5
	6	75.2

Circuit No.	Pin No.	DC Voltage Vdc
1904	1	0.4
	2	0
	3	0
	4	15

Circuit No.	Pin No.	DC Voltage Vdc
Q701	B	0.3
	C	17.2
	E	0
Q702	B	-0.5
	C	128
	E	-0.3
Q705	B	15
	C	0
	E	15.4
Q708	B	0
	C	15
	E	0
Q70A	B	13
	C	15
	E	12.4
Q752	B	0.2
	C	20.6
	E	0
Q901	B	150
	C	151.5
	E	151.3
Q904	B	121
	C	120
	E	120
Q905	B	70
	C	210
	E	71

Circuit No.	Pin No.	DC Voltage Vdc
Q906	B	71
	C	70
	E	70
Q907	B	69
	C	128
	E	68
Q908	B	68
	C	70
	E	68
Q909	B	76
	C	83.5
	E	76
Q90A	B	38.9
	C	11.7
	E	38.9
Q90C	K	0
	A	15.4
	B	0
Q90H	C	38.7
	B	0
	E	0

* Since this is a basic circuit diagram, the value of the parts is subject to be altered for improvement.
 • All DC voltage to be measured with a tester (100kΩ/V). Voltage taken on a complex color bar signal including a standard color bar signal.

CIRCUIT SCHEMATIC DIAGRAM OF 32CX12B/CY62 and 35CX45B/CZ67

PRODUCT SAFETY NOTE: Components marked with a triangle and shaded have special characteristics important to safety. Before replacing any of these components, read carefully the PRODUCT SAFETY NOTICE of this Service Manual. Don't degrade the safety of the receiver through improper servicing.

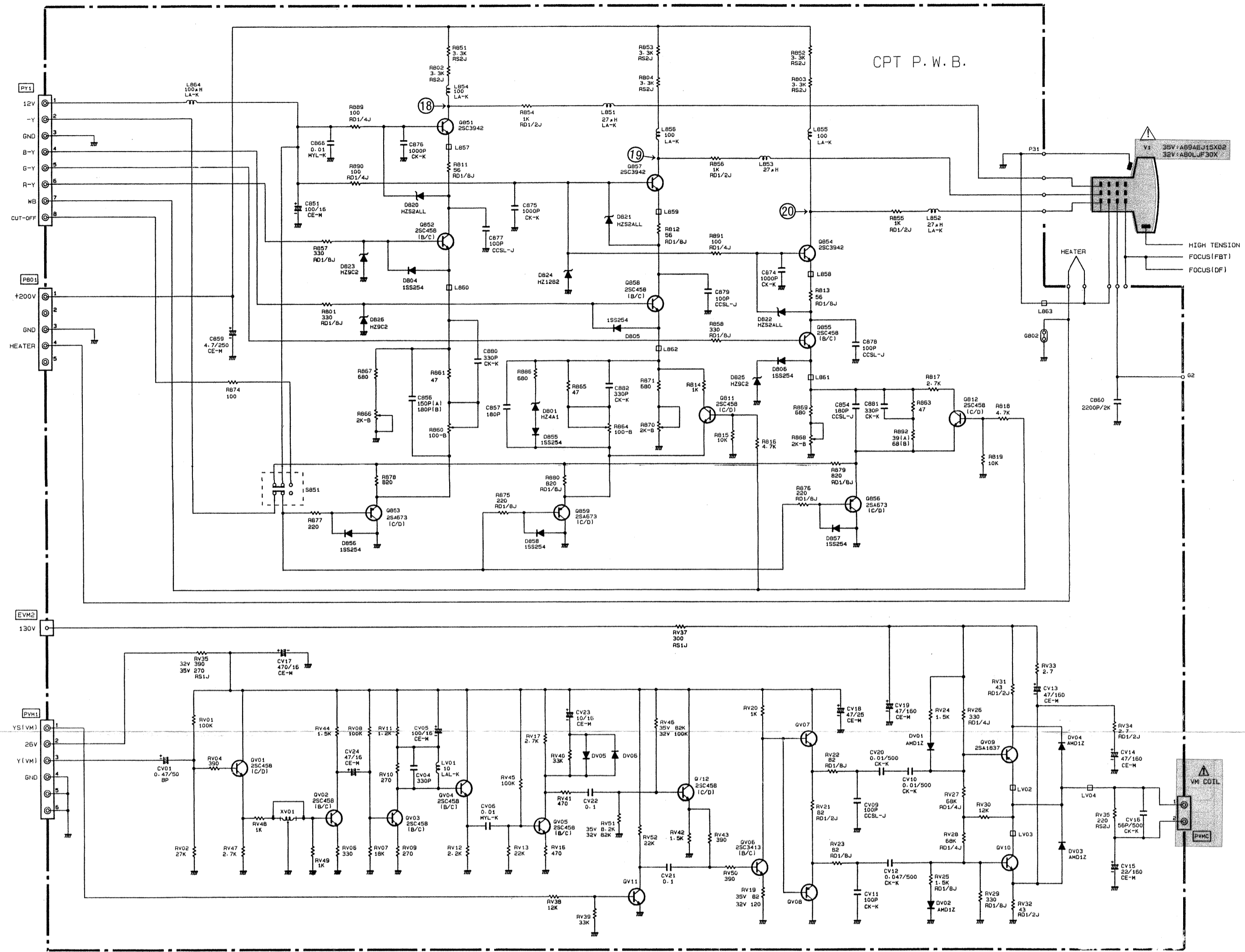

CPT P.W.B.

- Since this is a basic circuit diagram, the value of the parts is subject to be altered for improvement.
- All DC voltage to be measured with a tester (100kΩ/V). Voltage taken on a complex color bar signal including a standard color bar signal.

Circuit No.	Pin No.	DC Voltage Vdc
QV01	B	3.8
	C	23.2
	E	3.2
QV02	B	1.6
	C	15
	E	0.8
QV03	B	2.6
	C	10.7
	E	1.9
QV04	B	10.6
	C	19.2
	E	10
QV05	B	3
	C	5.6
	E	2.4
QV06	B	1
	C	19.1
	E	0.4
QV07	B	14.1
	C	19.2
	E	14
QV08	B	14.1
	C	0
	E	14
QV09	B	14.7
	C	67.7
	E	147.5

Circuit No.	Pin No.	DC Voltage Vdc
QV10	B	0.3
	C	89
	E	0.1
QV11	B	0
	C	0
	E	0
QV12	B	19.1
	C	11.1
	E	1.1
Q811	B	4.8
	C	4.3
	E	4.4
Q812	B	4.8
	C	4.2
	E	4.4
Q851	B	12.1
	C	143
	E	11.6
Q852	B	5.3
	C	11.1
	E	14
Q853	B	4.8
	C	3.7
	E	4.4
Q854	B	14.7
	C	140.2
	E	11.6

Circuit No.	Pin No.	DC Voltage Vdc
Q855	B	5.5
	C	11.1
	E	5.1
Q856	B	3.7
	C	0
	E	0
Q857	B	4.4
	C	136.5
	E	11.6
Q858	B	5.6
	C	11
	E	5.25
Q859	B	42
	C	40.2
	E	30.6

CIRCUIT SCHEMATIC DIAGRAM OF 32CX12B/CY62 and 35CX45B/CZ62
TUNER/CONTROL PART

PRODUCT SAFETY NOTE: Components marked with a triangle and shaded have special characteristics important to safety. Before replacing any of these components, read carefully the PRODUCT SAFETY NOTICE of this Service Manual. Don't degrade the safety of the receiver through improper servicing.

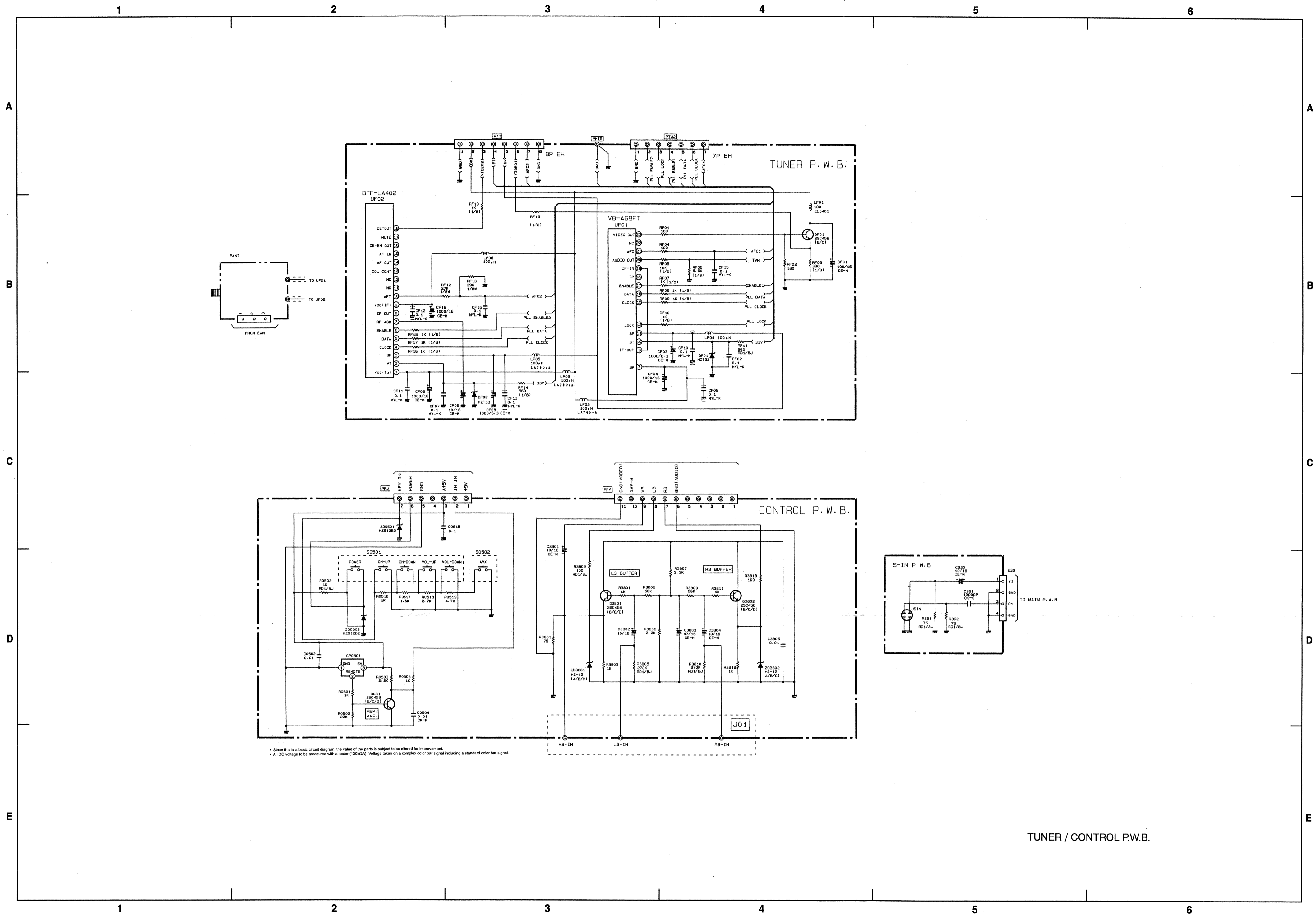

• Since this is a basic circuit diagram, the value of the parts is subject to be altered for improvement.
• All DC voltage to be measured with a tester (100kΩ). Voltage taken on a complex color bar signal including a standard color bar signal.

• Since this is a basic circuit diagram, the value of the parts is subject to be altered for improvement.
• All DC voltage to be measured with a tester (100kΩ). Voltage taken on a complex color bar signal including a standard color bar signal.

Circuit No.	Pin No.	DC Voltage Vdc
QF01	B	1.7
	C	9.2
	E	1
Q3801	B	4
	C	12.4
	E	3.4
Q3802	B	4
	C	12.4
	E	3.4

CIRCUIT SCHEMATIC DIAGRAM OF 32CX12B/CY62 and 35CX45B/CZ67
SIDE PIN/SUPER MATRIX/YNR/MAG. FIELD CORRECTION PART

PRODUCT SAFETY NOTE: Components marked with a triangle and shaded have special characteristics important to safety. Before replacing any of these components, read carefully the PRODUCT SAFETY NOTICE of this Service Manual. Don't degrade the safety of the receiver through improper servicing.

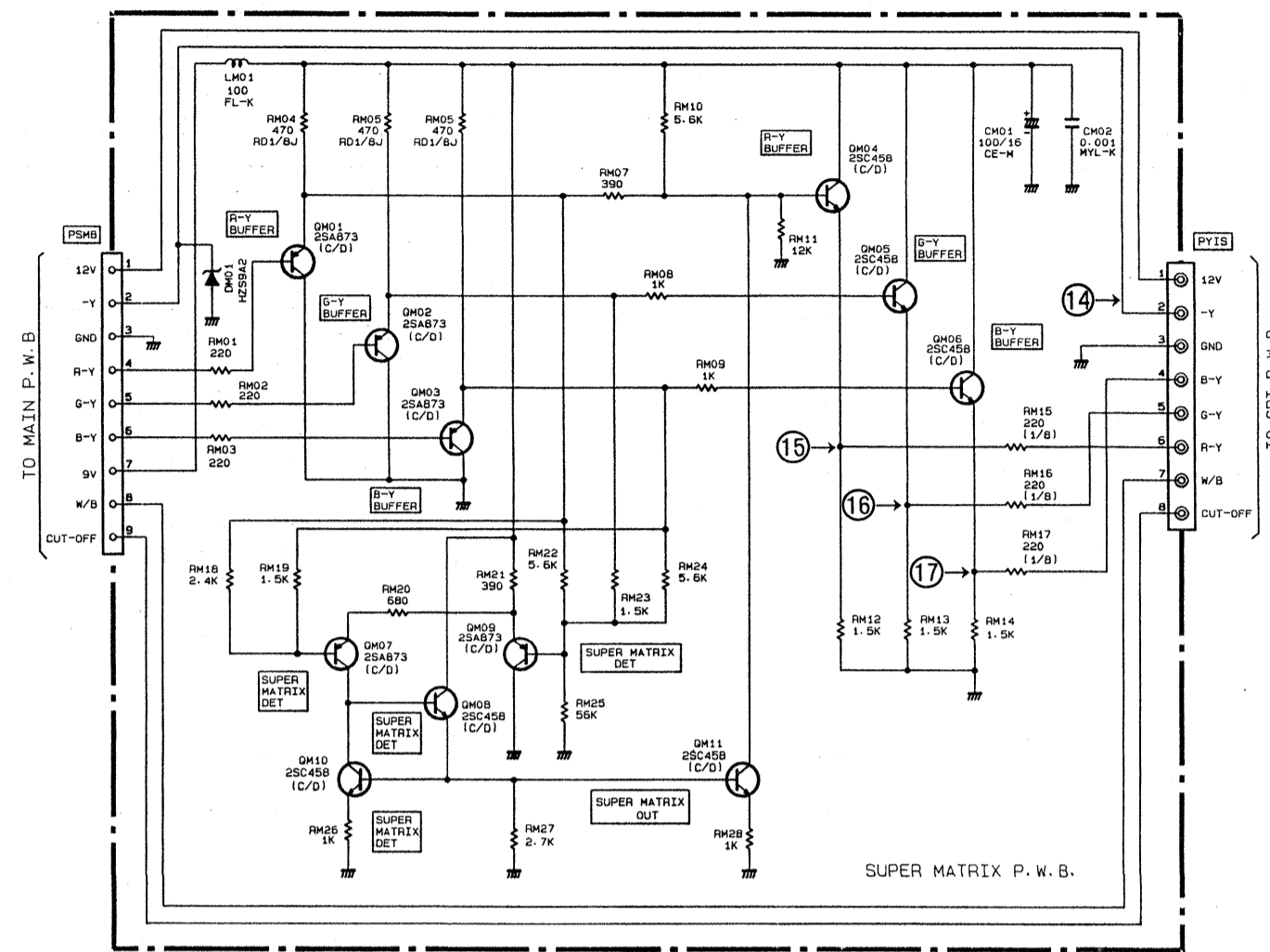
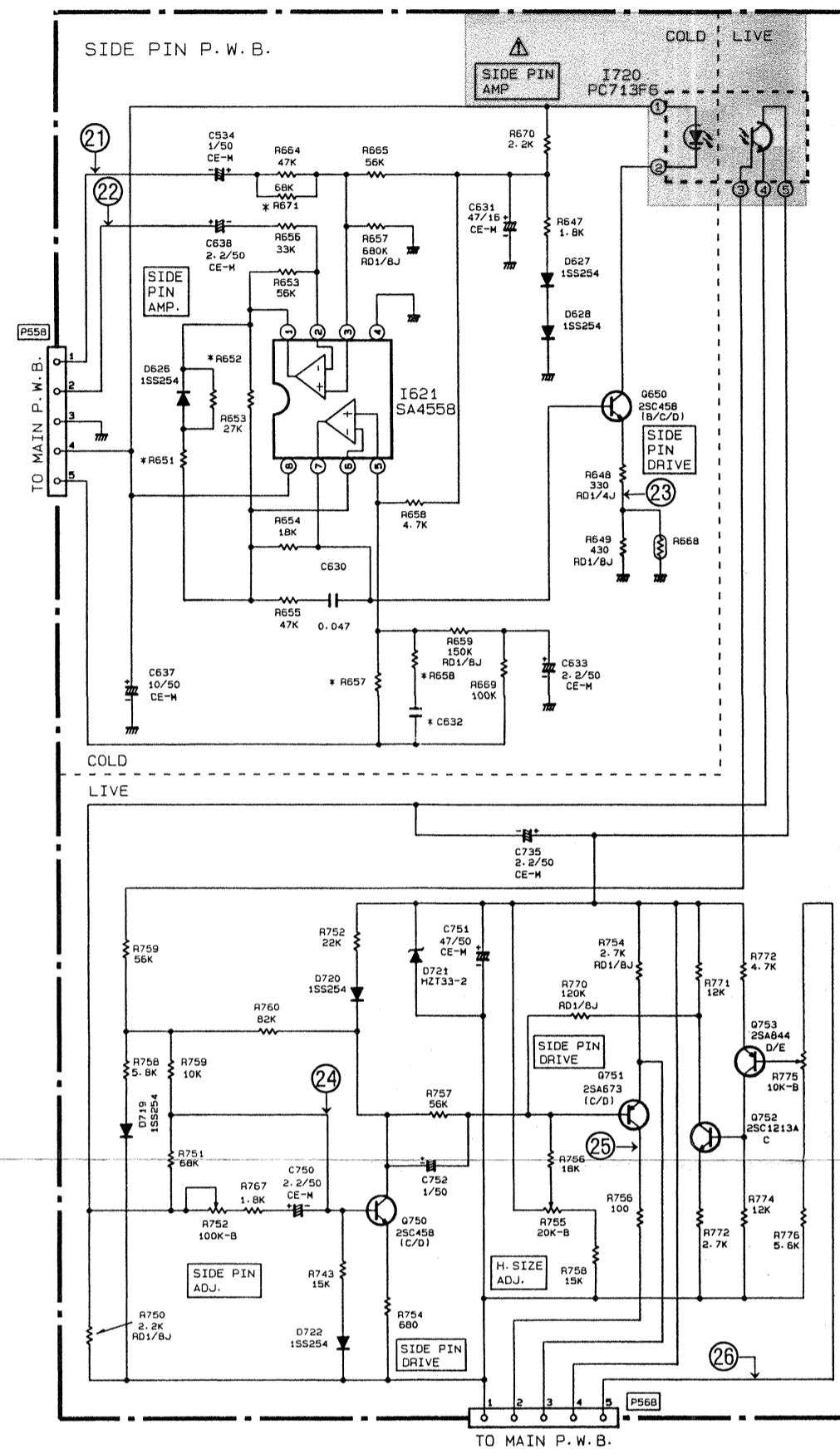

	32CX12B	35CX45B
C632	0.0047	0.0068
R651	82K	100K
R652	82K	56K
R657	180K	150K
R658	22K	12K
R664	47K	82K
R671	-	68K

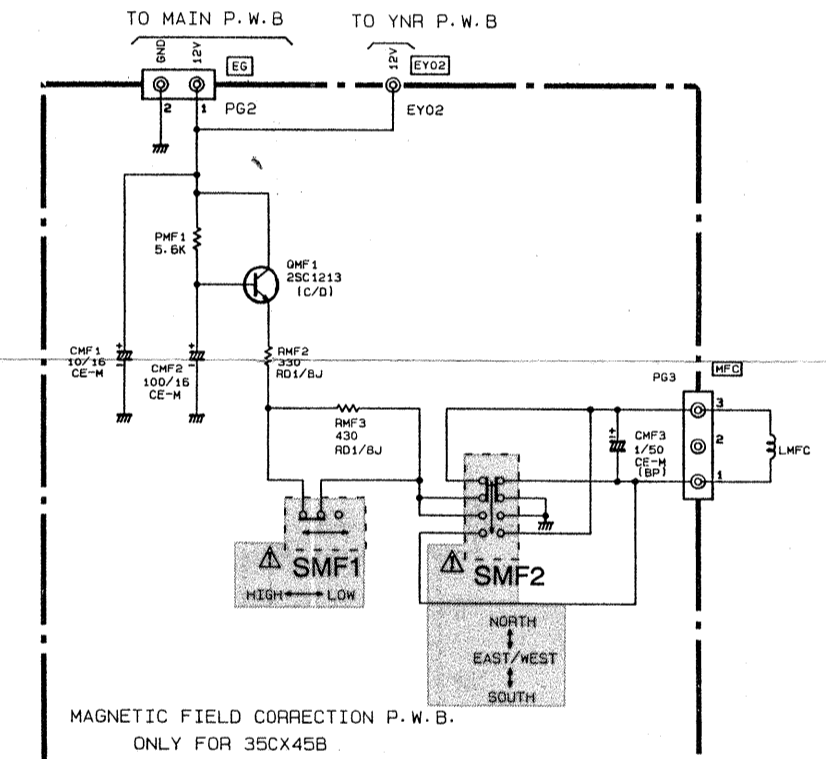
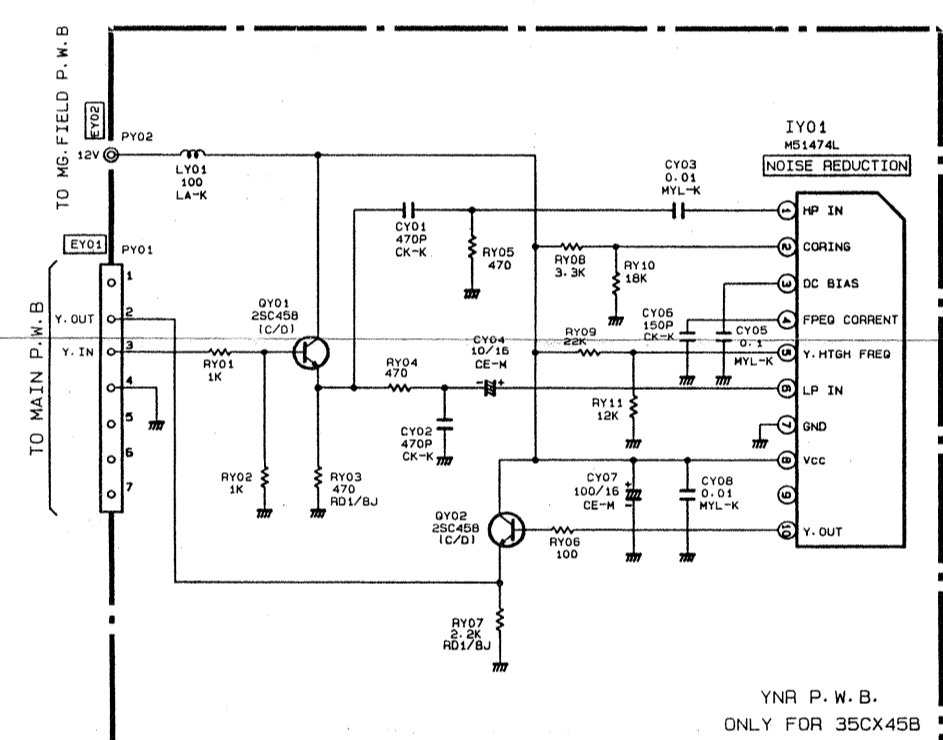

SIDE PIN / SUPER MATRIX / YNR /
MAGNETIC FIELD CORRECTION PART

Circuit No	Pin No	DC Voltage Vdc
I621	1	5.3
	2	5.2
	3	5.2
	4	0
	5	5.9
	6	5.9
	7	6.5
	8	11.3
I720	1	11.3
	2	10.2
	3	0
	4	3.4
	5	30.9
IY01	1	5.4
	2	10.3
	3	6.5
	4	0
	5	4.4
	6	5.5
	7	0
	8	12.3
	9	4.4
	10	9.5

Circuit No	Pin No	DC Voltage Vdc
Q650	B	6.6
	C	10.2
	E	5.9
Q750	B	0.9
	C	12.2
	E	0.2
Q751	B	23.5
	C	0
	E	23.7
Q752	B	-0.3
	C	30.1
	E	-0.3
Q753	B	42.2
	C	-1.3
	E	30.8
QM01	B	5.1
	C	0
	E	5.7
QM02	B	5.2
	C	0
	E	5.9
QM03	B	5.4
	C	0
	E	5.8
QM04	B	5.7
	C	12.8
	E	5
QM05	B	5.8
	C	8.8
	E	5.2

Circuit No	Pin No	DC Voltage Vdc
QM06	B	6
	C	8.8
	E	5.3
QM07	B	5.9
	C	1.3
	E	6.3
QM08	B	1.3
	C	8.8
	E	0.7
QM09	B	5.8
	C	0
	E	6.4
QM10	B	0.7
	C	-1.3
	E	0.2
QM11	B	0.7
	C	5.7
	E	5.7
QMF1	B	12.3
	C	11.8
	E	2.1
QY01	B	12.3
	C	0
	E	1.4
QY02	B	9.5
	C	12.8
	E	8.7

*NOTE: YNR PWB and MAGNETIC FIELD PWB only for 35CX45B

• Since this is a basic circuit diagram, the value of the parts is subject to be altered for improvement.
• All DC voltage to be measured with a tester (100kΩ). Voltage taken on a complex color bar signal including a standard color bar signal.