

Hooded Roof Propeller Fans

Belt and Direct Drive

Exhaust, Supply and Reversible

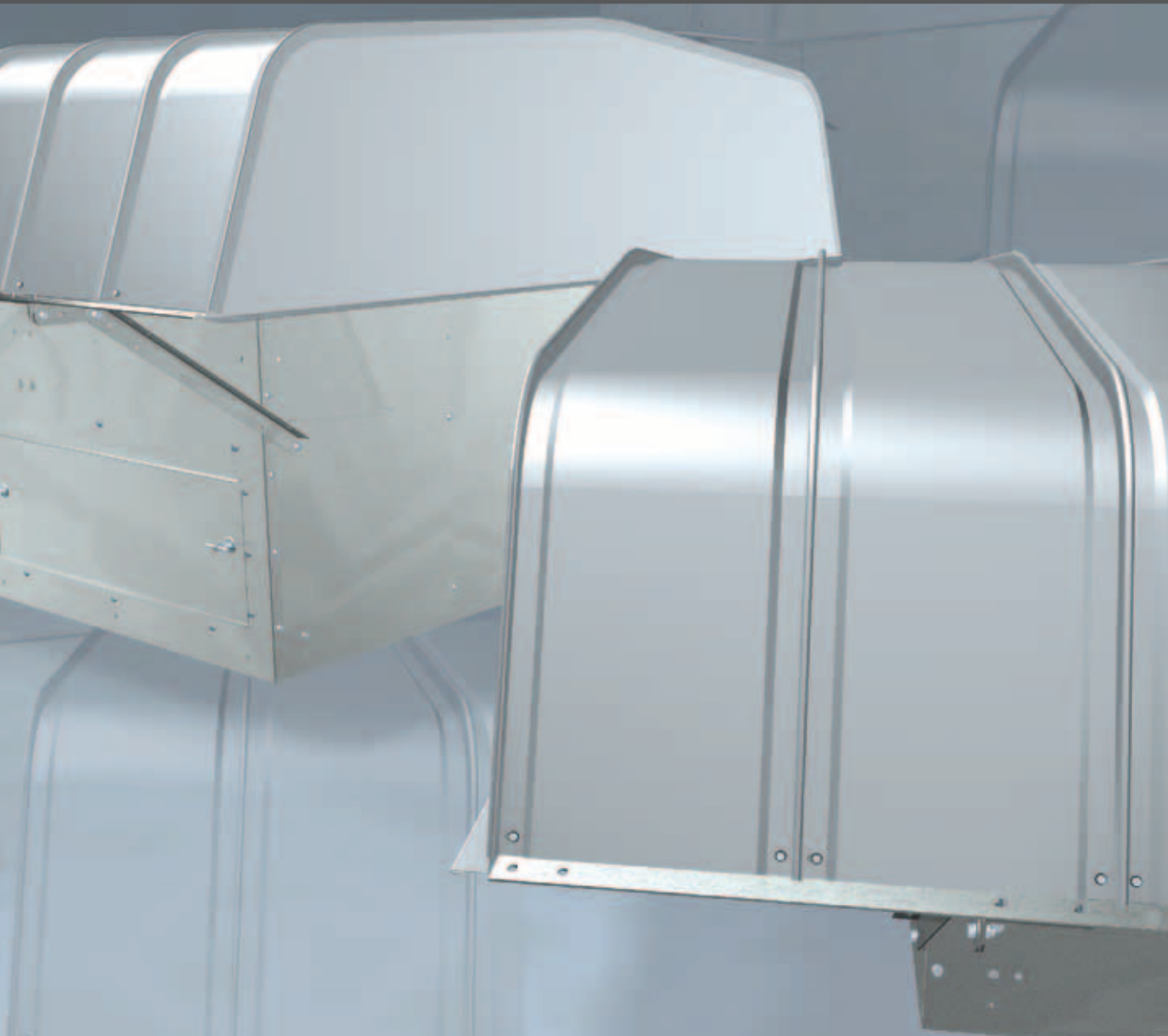

BUILDING VALUE IN AIR.



March
2012

Hooded Roof Propeller Fans

Exhaust Supply/Reversible Belt and Direct Drive

Table of Contents

Model Comparison..... 3
 Standard Construction Features.....4-5
 Options and Accessories.....6-7
 Seismic..... 7
 High Wind & Hurricane 7
 Basics of Fan Selection..... 8

Reversible Models 9
 Dimensional Data 10
 Material Data 11
 Model Number Code 16
 Performance Pages12-49
 Typical Specifications50-51
 Warranty 52

From general ventilation of factories and warehouses to industrial duty, the range of construction and performance capabilities offered in this catalog represent the most comprehensive hooded propeller roof fan line available.

Regardless of fan size, performance or duty level, all Greenheck hooded propeller roof fans are built to perform with the same high standards of reliability and durability.

Exhaust, supply and reversible models are available in belt or direct drive. Filtered supply is also available. Propellers are available in fabricated steel, fabricated aluminum or cast aluminum. Drive frames and panels are constructed to match the level of duty and the motor size.

Greenheck offers a complete line of accessories, which include protective guards, tall bases, dampers, disconnect switches and special coatings.



Greenheck Fan Corporation certifies that the RE2, RCE3, RS2, RCS3, RBE, RBCE, RBS, RBCS, RBF and RBCF models shown herein are licensed to bear the AMCA Seal. The ratings shown are based on tests and procedures performed in accordance with AMCA Publication 211 and AMCA Publication 311 and comply with the requirements of the AMCA Certified Ratings Program.



Hooded Propeller Roof Fan models are listed for electrical (UL/cUL 705) File no. E40001

*UL is optional and must be specified

Performance as cataloged is assured.



Enjoy Greenheck's extraordinary service, before, during and after the sale.

Greenheck offers added value to our wide selection of top performing, energy-efficient products by providing several unique Greenheck service programs.

- Our Quick Delivery Program ensures shipment of our in-stock products within 24 hours of placing your order. Our Quick Build made-to-order products can be produced in 1-3-5-10- or 15-day production cycles, depending upon their complexity.
- Greenheck's free Computer Aided Product Selection program (CAPS), rated by many as the best in the industry, helps you conveniently and efficiently select the right products for the challenge at hand.
- Greenheck has been Green for a long time! Our energy-saving products and ongoing corporate commitment to sustainability can help you qualify for LEED credits.
- Our 3D service allows you to download at no charge lightweight, easy-to-use AutoDesk™ Revit™ 3D drawings for many of our ventilation products.

Find out more about these special Greenheck services at greenheck.com



Model Comparison

Exhaust Supply/Reversible Belt and Direct Drive

Direct Drive Fan Selection

Two propeller and drive frame combinations are available. These models are designed and constructed for applications with static pressure ranges up to 1 in. wg. Models RE2 and RS2 are available with welded and die formed steel blades,

while models RCE3 and RCS3 offer a cast aluminum propeller. For low sound applications, it is best to select the largest fan with the lowest RPM to meet the performance requirements. This ensures the tip speeds will be as low as possible.





Construction Levels		Models - Performance Pages				Size Range Wheel Diameter	Performance	Propellers	
		Exhaust	Supply	Filtered	Reversible				
Level 2	Fully welded steel or die formed steel blades	RE2 pg 12	RS2 pg 14	—	—	18 to 54 in. (457 to 1372 mm)	Up to 44,000 cfm (74,756 m ³ /hr) and up to 1 in. wg (249 Pa)	Level 2	
Level 3	Cast aluminum airfoil blades	RCE3 pg 13	RCS3 pg 15	*RPDRF	*RPDR pg 16-17	20 to 54 in. (508 to 1372 mm)	Up to 46,000 cfm (78,155 m ³ /hr) and up to 1 in. wg (249 Pa)	Level 3	

*Reversible performance is equivalent in the exhaust and supply mode.

Belt Drive Fan Selection

Application requirements for sound and static pressure determine propeller type. Propellers are

available in fabricated steel, fabricated aluminum or cast aluminum.

Construction Levels		Models - Performance Pages				Size Range Wheel Diameter	Performance	Propellers	
		Exhaust	Supply	Filtered	Reversible				
Level 1	Galvanized steel blades riveted to the hub	RBE pg 19-25	RBS pg 28-34	RBF pg 37-43	—	20 to 54 in. (508 to 1372 mm)	Up to 30,000 cfm (50,970 m ³ /hr) and up to 5/8 in. wg (156 Pa)	Level 1	
Level 2	Dual thickness galvanized steel blades riveted to the hub	RBE pg 19-25	RBS pg 28-34	RBF pg 37-43	—	20 to 60 in. (508 to 1524 mm)	Up to 53,000 cfm (90,048 m ³ /hr) and up to 3/4 in. wg (19 Pa)	Level 2	
Level 3	Fabricated, fully welded and gusseted steel blades	RBE pg 19-25	RBS pg 28-34	RBF pg 37-43	—	24 to 72 in. (610 to 1829 mm)	Up to 87,000 cfm (149,513 m ³ /hr) and up to 1 in. wg (249 Pa)	Level 3	
Level 3	Cast aluminum airfoil blades	RBCE pg 26-27	RBCS pg 35-36	RBCF pg 44-45 *RPBRF	*RPBR pg 46-49	24 to 72 in. (610 to 1829 mm)	Up to 87,000 cfm (149,513 m ³ /hr) and up to 1 in. wg (249 Pa)	Level 3 - Cast	

Belt Drive Blade Designs



L Propeller: Swept, steeply pitched blade design. These propellers typically run at lower RPMs and generate low sound levels making them the best selection for sound critical applications or applications requiring the best combination of

both air and sound performance. Typically used when the static pressure is 0.5 in. wg (13 mm) or less.



H Propeller: Straight, moderately pitched blade. It is designed for applications where static pressures are above 0.5 in. wg (13 mm). These propellers typically run at higher RPMs and generate slightly higher sound levels than the “L” propellers.

Superior Hood Design

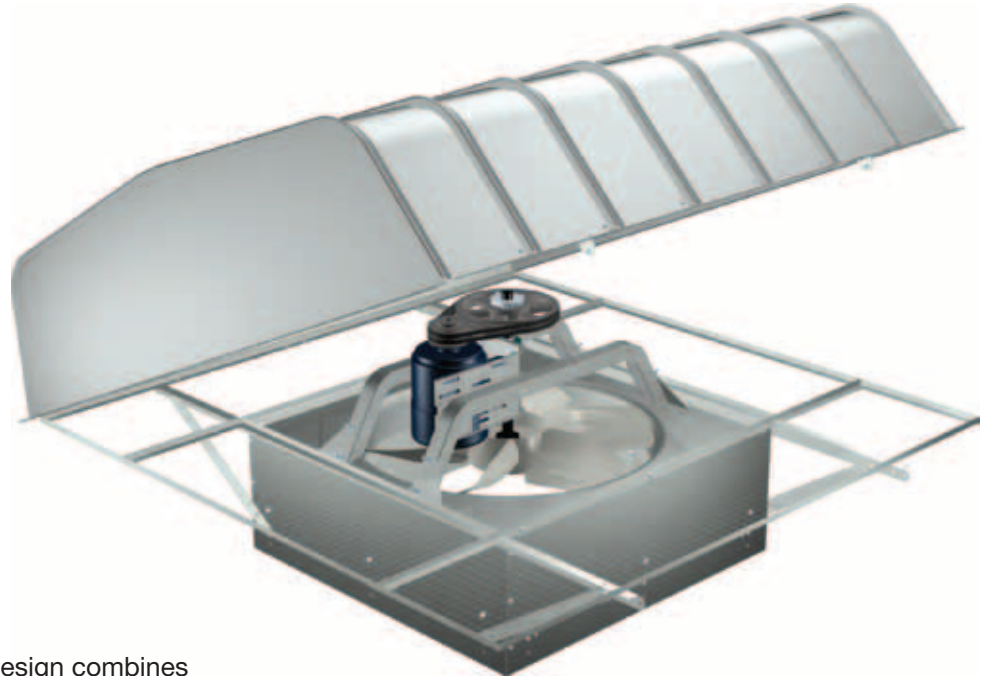
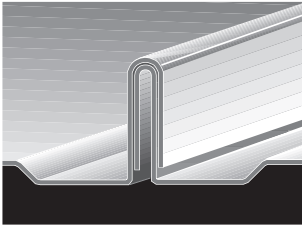

Greenheck's interlocking rib design combines four material thicknesses with I-beam design principles producing a hood far superior in strength to conventional designs (an important feature in high snow or wind load regions).

Formed channels adjacent to the ribs provide water drainage to ensure weather tightness.

Hoods are available in galvanized steel, painted steel or aluminum construction. Hood support angles are heavy-gauge galvanized steel.

Construction Features

- **Fan hoods** and **bases** are constructed of galvanized, aluminum, steel or painted steel as specified. Hood panels are arched and precision roll formed for strength and weather tightness. Hoods are bolted to heavy-gauge support angles. Bases include prepunched mounting holes.
- **Propellers** are constructed with either fabricated steel, fabricated aluminum or cast aluminum blades and hubs. All propellers are statically and dynamically balanced. Reversing fan propellers are designed to produce a high level of efficiency over a broad selection range. Tapered airfoil blades are cast of aluminum alloy. The reversible propeller is designed to move air in both the exhaust or supply modes.
- Permanently lubricated, sealed ball bearing pillow block **bearings** are 100% factory tested and are designed specifically for air handling applications with a minimum (L_{10}) life in excess of 100,000 hours (L_{50} average life of 500,000 hours) at maximum cataloged operating speeds.
- **Fan shafts** are precisely ground and polished steel sized so the first critical speed is at least 25% over the maximum operating speed. Close tolerances where the shaft makes contact with the bearing result in longer bearing life.
- Heavy-duty ball bearing **motors** are carefully matched to the fan load.
- **Drives** shall be sized for a minimum of 150% of driven horsepower. **Pulleys** shall be fully machined cast iron, keyed and securely attached to propeller and motor shafts. **Motor sheaves** shall be adjustable for final system balancing. **Belts** are static free and oil resistant.
- **Drive frames** (belt drive fans) or **motor support frames** (direct drive fans) and panel assemblies are constructed of heavy-gauge steel.
- **Fan panels** are constructed of heavy-gauge steel with a deep formed inlet venturi. Reversible fans are constructed of heavy-gauge steel with a double venturi for efficient airflow.

Standard Construction Features

Access and Service

Periodic maintenance requires accessibility to fan components such as motors, belts, pulleys and propellers located under the hood. Greenheck's hooded roof propeller fan design incorporates many service friendly features which reduce maintenance time and promotes proper servicing.

These features include:

- **Hinged Hood** - Sizes 36 and smaller are able to be hinged by removing two of the four hood fasteners. The hood may then be laid over on the roof deck while servicing.
- **Removable Hood** - Sizes 36 and larger allow for complete removal of the hood by removing the four hood fasteners.
- **Removable Birdscreens** - Fan components can be quickly and easily inspected by simply removing the quick release birdscreen sections on either end of the unit while leaving the hood in place. Birdscreens are constructed of 1/2 inch galvanized steel mesh. Filters are optional. Sizes 42 and larger should be accessed from underneath the hood by removing the birdscreen or filters.



Filtered Supply

Filtered supply fans (models RBF, RBCF, RPDRF and RPBRF) with 2-inch aluminum mesh washable filters are available for applications where contaminants must be removed from supply air. Basic hood and fan construction is similar to the non-filtered models.



Filter removal for cleaning or replacement can be easily done by opening the hood and sliding the filters out of the open end racks. In fan sizes 36 and larger, access panels on either end of the hood are provided to allow filter removal without raising the hood.

Reversible Fans

Ventilation requirements are often subject to daily or seasonal changes in temperature. Greenheck's reversible fans (models RPDR, RPBR, RPDRF and RPBRF) are designed for non-ducted systems or those with short duct runs and offers the ability to either exhaust or supply air on demand to maintain comfortable working conditions. By exhausting excess heat or supplying fresh outside air, the reversing fan saves cooling costs. Fewer fans required on the job means lower initial costs and lower installation costs with fewer roof penetrations.

One Fan – Two Functions

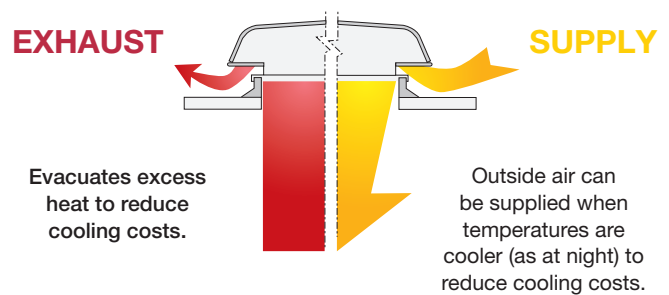

Most Units Ship Fully Assembled

To minimize installation time, most fans are shipped to the jobsite completely assembled. Due to shipping size limitations, hoods for larger fans will be shipped knocked down in sections, including any fan larger than size 42. Hood assembly requires no special tools or training. Complete illustrated assembly and installation instructions are packed with each fan. See the chart below for models that can ship assembled.

Model	Sizes					
	18	20	24	30	36	42
RE2	A	A	A	A	A	A
RS2	A	A	A	A	A	A
RCE3	—	A	A	A	A	A
RCS3	—	A	A	A	A	A
RBE	—	A	A	A	A	A
RBS	—	A	A	A	A	A
RBCE	—	—	A	A	A	A
RBCS	—	—	A	A	A	A
RBF	—	A	A	A	A	S
RBCF	—	—	A	A	A	S
RPDR	—	—	A	A	A	S
RPBR	—	—	A	A	A	S
RPDRF	—	—	A	S	S	S
RPBRF	—	—	A	S	S	S

A = ships assembled S = ships in sections
 — = sizes not available

Tall Base –

Tall bases are recommended for installations including a gravity damper or a motorized damper and greatly simplifies installation and servicing. The damper components are factory assembled as part of the tall base and shipped as a single unit reducing field assembly time and costs. Inspection, service and cleaning of the damper, actuator and linkages are made easy with an access door including two cam latches with plated steel handles and a slide-out rack. Tall bases are designed to provide the necessary minimum spacing between the propeller and the damper. The tall base increases the standard height to provide additional weather tightness from rain and snow intake due to the elevated hood. There is ample space within the tall base for ease of initial electrical wiring.



Tie Down Feature – In locations where strong winds may occur, cable tie-downs are recommended to secure fans to roof structure to prevent damage to the hood. Cables are by others.

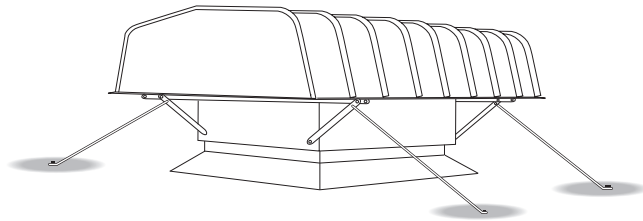

Four galvanized steel brackets are provided as standard on all hooded propeller roof fans as cable attachment tie-down points at the ends of each hood support rail.

Safety Guards – Safety guards mounted to the fan inlet are recommended to protect the fan and nearby personnel in non-ducted applications. When a safety guard is not ordered with the fan, it should be provided by the installer.

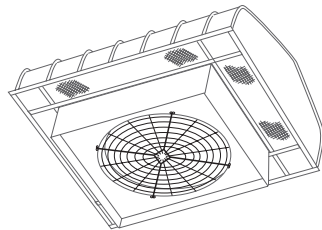

Aluminum Housings – Aluminum exterior construction is available for the hood sections and bases of all models. Aluminum housings can also be coated with decorative or protective finishes.

Roof Curbs – Prefabricated roof curbs are available to reduce installation time and costs by ensuring compatibility between the fan, the curb and the roof opening. All curbs are available in steel or aluminum construction and are lined with fiberglass insulation to prevent condensation and reduce sound levels. See Greenheck's roof curb catalog for complete details.

Curb Cap Stripping – Rubber curb cap stripping attached to the underside of the fan curb cap is available to provide a seal between the fan and the roof curb.

Insect Screen Base – Insect screen bases are available for applications where the building must be kept free of insects, as in food processing operations.

Construction is steel or aluminum with a fine mesh aluminum screen. The base includes an access door to allow the screen section to be easily removed for cleaning and periodic inspection.

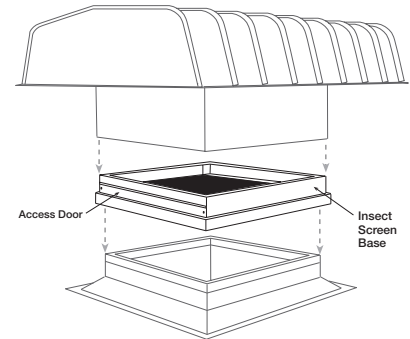

Hood Insulation – Fiberglass insulation attached to the underside of the hood is available to minimize condensation and reduce sound (available in either 1/2 in. or 1 in. thicknesses).

Special Coatings – Special coatings are available for decorative or protective purposes. Decorative coatings are applied to exterior surfaces of the hood and base. Protective coatings are applied to the entire unit. Coatings include baked polyesters, enamels, epoxies, phenolics, vinyl and others. Protection from corrosive atmospheres requires individual consideration.

Extended Lubrication Lines – Extended lubrication lines allow for fan shaft bearing lubrication without disassembling the unit or removing the hood. Lubrication lines with grease fittings are extended from the fan shaft bearings to the exterior of the fan base.

Lifting Lugs – Four heavy-gauge steel brackets are available to provide lifting points when raising the fan to the roof.

Disconnect Switches – Toggle type and heavy-duty disconnect switches are available for positive electrical shut-off and safety in servicing fans. The following switches are available to meet individual electrical requirements and can be factory mounted or shipped loose for field mounting. Wiring from the motor to the disconnect box is provided with factory mounted disconnect switches.

- NEMA-1 for general purpose
- NEMA-3R for rain resistant
- NEMA-4 for watertight
- NEMA-3R and NEMA-4 for heavy-duty
- NEMA-7 and NEMA-9 for Class 1 and Class 2 hazardous locations and explosion resistant applications.



UL/cUL 705 – All belt and selected direct drive fans with totally enclosed, TE standard efficiency, single speed motors are available with the UL/cUL 705 listing for electrical.

1-Point Wiring – Available when the following items are selected: a tall base, common voltages on the motor and the actuator and disconnect mounted and wired. The wires are pulled from the motor and the actuator on the damper to the disconnect box. (Hard wiring of the components to the disconnect switch is by others.)

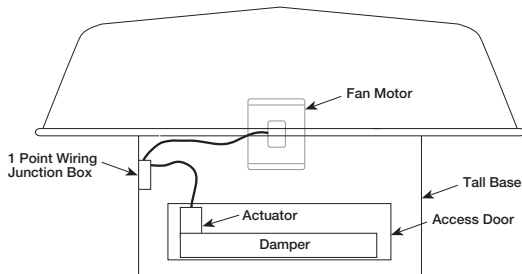

Exception: When a specific voltage is not available on the actuator, Greenheck will provide a hard wired transformer to the actuator. Greenheck will then pull the wires from the transformer to the disconnect box.

Wiring Pigtail – Available only in conjunction with factory mounted disconnect switches. Liquid-Tite wiring extends beyond the fan and allows direct hook-up to the power supply. This eliminates field wiring within the fan. Internal or external power supply can be specified.

End Switches – Factory mounted end switches allow the damper to open completely before the fan is energized. This will reduce the back pressure and brake horsepower load on the fan motor at start-up.

Dampers

Backdraft Dampers Exhaust and Supply Gravity or Motorized

Backdraft dampers are constructed with a galvanized steel frame and aluminum blades with vinyl blade seals. Gravity dampers open by pressure differential and close by an adjustable spring.

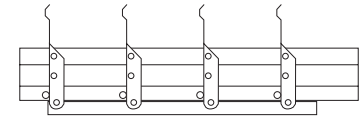

Backdraft Damper Gravity

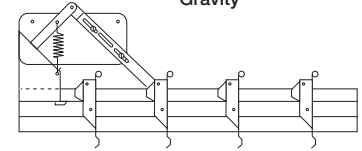

Backdraft Damper Motorized

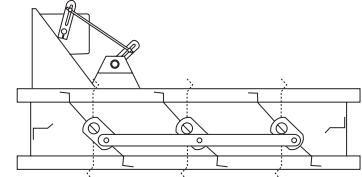

Heavy Duty Backdraft Damper - Motorized

Heavy-duty Backdraft Dampers Exhaust and Supply Motorized

Constructed with heavy galvanized steel frames and blades, these dampers are available in standard leakage, low leakage and insulated low leakage configurations. These dampers are designed to handle higher volumes of air than the standard backdraft damper. Ultra low leakage dampers with extruded aluminum blades are available with galvanized steel or extruded aluminum frames. All low leakage dampers include vinyl blade and jamb seals.

High Wind and Hurricane Ratings – All certified rooftop prop models are tested to both Miami-Dade County and the state of Florida high wind standards for use in hurricane zones. Sizes up to a 42 inch prop on unfiltered models and up to a 36 inch prop on filtered models are available with the high wind ratings. For more information see Miami-Dade County NOA-09-0511.03 and Florida Product Approval FL12917.1

Seismic Rated Fans – All certified rooftop prop fans have been tested and certified to the worst case scenario seismic conditions for use anywhere in the United States. All fans have been shaker table tested and are certified to California OSHPD seismic standards as well as IBC 2006 and 2009 standards. For more information see California OSHPD certification - OSP-0113-10

The first consideration in any fan selection is the amount of air to be moved and the resistance to this air movement. With specific performance and application criteria in mind, propeller fan selections typically require decisions based on the following criteria:

Belt Drive vs. Direct Drive

Belt drive fans offer the ability to adjust fan speed for system balancing if necessary. They also offer more flexibility in speeds and motor selections. In a cost comparison, belt drive fans are typically less costly than comparable size direct drive fans with low speed motors.

Direct drive fans are often preferred for jobs where maintenance access is difficult. Maintenance costs are generally lower with direct drive fans since there are no belts or bearings to replace and no pulleys to adjust.

Larger Fans vs. Smaller Fans

In most applications, several fans may meet the specified airflow and pressure requirements. Just as larger fans tend to turn slower and generate less sound, they also tend to have higher initial costs but lower operating costs. Smaller fans have more stable performance curves, lower initial costs, higher sound levels and higher operating costs because of their higher speeds.

Low Sound vs. High Static Pressure

Fans selected for high static pressures run at higher speeds and produce higher tip speeds resulting in higher sound levels. Conversely, in low pressure applications fans generally run at lower speeds producing lower sound levels and are recommended for sound sensitive applications.

How Accessories Affect Static Pressure

All accessory losses must be accounted for when calculating the static pressure load for a fan. In reality, dampers and damper guards actually add very little to the total system pressure when properly installed. This means propeller roof fans can be specified with low pressure capabilities (below 3/8 in. wg) when used in conjunction with properly applied accessories (as within our installation recommendations).

When fans are over-specified to compensate for losses that do not actually exist, both cost and sound levels can be higher than necessary. This results primarily from larger motors and higher tip speeds.

Motor Service Factor

Hooded roof fan motors are cooled by the airstream. With an uninterrupted flow of cooling air, motors may be operated in their service factor range (up to 20% above the motor nameplate horsepower) without damage due to overheating. Lesser overloads are recommended for applications using totally enclosed or explosion resistant motors.

Belt drive performance tables in this catalog show two RPM selections for each propeller type (L or H) at a given motor horsepower. The first selection is a 1.0 brake horsepower (Bhp) service factor. The second speed selection is at 1.2 Bhp service factor. Direct drive performance tables show Bhp levels with service factors ranging up to 1.2 Bhp. When a selection at 1.2 Bhp service factor is not desirable for the application, specify the next higher motor horsepower.

Propeller Fan Rotation Guide

The propeller blade should cup and throw the air when rotating in the correct rotation as shown below.

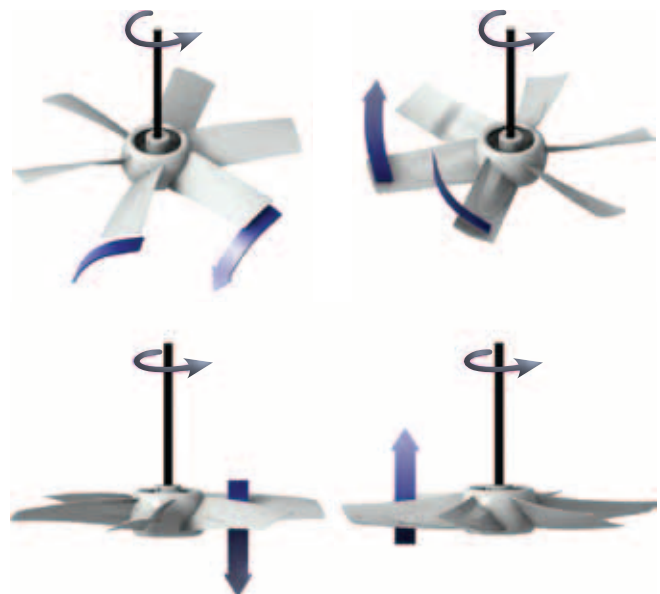

Reversible Models Only

Filter Performance and Control Center

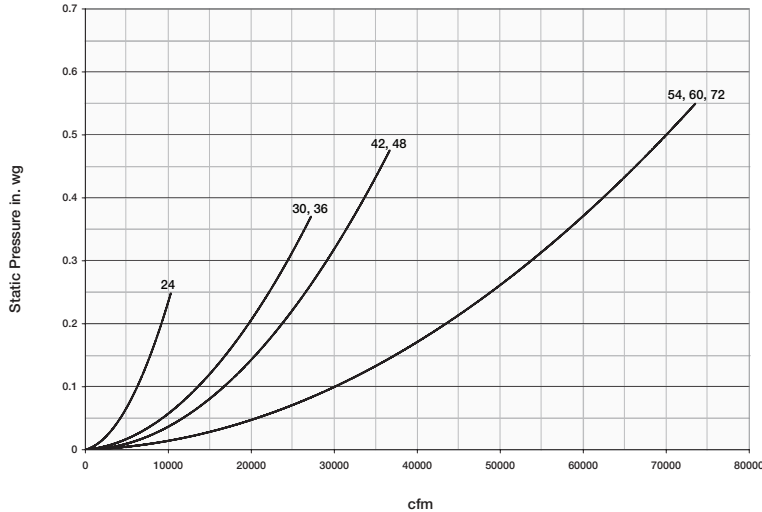

Filter Performance

For reversible models RPDRF and RPBRF, with 2-inch washable aluminum filters, use the filter performance graph above to determine the static pressure drop added by the filters. The filter loss is included in the performance data and no calculation will need to be determined for the RBF and RBCF models.

The airflow (cfm) and the desired fan size must be known to determine the pressure drop added by the filters.

Example: Size 42-inch RPDRF for 20,000 cfm at 0.125 in. wg.

- On the graph above, locate the 20,000 cfm line and read upward to its intersection with the 42-inch curve. Read left to the static pressure (in. wg), in this case 0.14 in. wg.
- Add 0.14 in. wg from the filter chart to the original 0.125 in. wg for a total of 0.265 in. wg.
- Using the RPDR-42 performance table on page 17, 20,000 cfm at 0.265 in. wg falls into the 5 hp range at 1025 frpm. In a supply mode you do not want to exceed 600 frpm to prevent intake of moisture.

Reversible Fan Control Center

Model ES-CC

The model ES-CC control center is designed specifically for Greenheck's reversible fan models. Its function is the selection and control of the exhaust/supply operation from a convenient remote location.

The ease of installation and operation of the control center makes it more economical than the design and construction of a custom control system in the field. (Wiring between fan and control center is by others).

Controls are housed in a NEMA-1 cabinet constructed of heavy-gauge steel and coated with Greenheck's Permatecor™ finish. A door interlocking disconnect switch is provided to help prevent electrical shock when the door is opened. Magnetic starters are included as part of the control center as standard.

Controls

Mode Selector - The mode selector switch is used to engage the desired fan function. A time delay is provided to allow the fan to come to a complete stop before reversing.

Options - An indicator light mounted on the control panel door is available to indicate power to the fan.

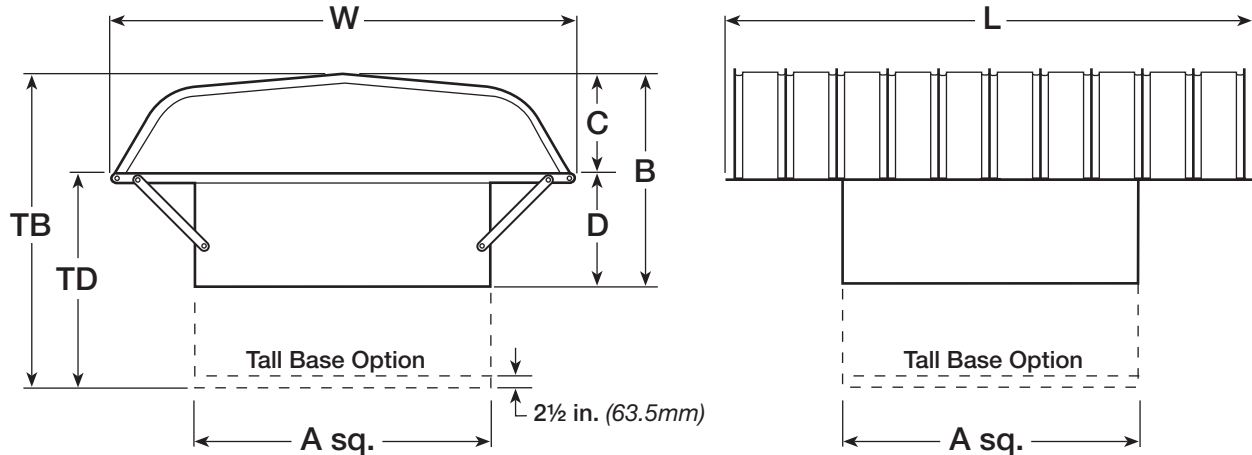

Exhaust / Supply RE2, RS2, RCE3, RCS3, RBE, RBS, RBF, RBCE, RBCS, RBCF

(Belt Drive Sizes 20-72 Direct Drive Sizes 18-54)

Fan Size	A*	C	Standard Base		Tall Base		Standard Hood	Filtered Hood	Damper Size*	Roof Opening*
			B	D	TB	TD	W x L	W x L		
18	28 1/4 (718)	13 (330)	23 (584)	10 (254)	40 1/4 (1022)	27 1/4 (692)	48 x 51 (1219 x 1295)	—	18 (457)	20 1/2 (521)
20	30 1/4 (768)	16 (406)	27 (686)	11 (279)	44 1/4 (1124)	28 1/4 (718)	54 x 51 (1372 x 1295)	54 x 51 (1372 x 1295)	20 (508)	22 1/2 (572)
24	34 1/4 (870)	18 (457)	29 (737)	11 (279)	46 1/4 (1175)	28 1/4 (718)	66 x 63 (1676 x 1600)	66 x 63 (1676 x 1600)	24 (610)	26 1/2 (673)
30	40 1/4 (1022)	20 (508)	34 (864)	14 (356)	51 1/4 (1302)	31 1/4 (794)	75 x 75 (1905 x 1905)	78 x 87 (1981 x 2210)	30 (762)	32 1/2 (826)
36	46 1/4 (1175)	22 (559)	39 1/2 (1003)	17 1/2 (445)	56 1/4 (1441)	34 3/4 (883)	88 x 87 (2235 x 2210)	94 x 87 (2388 x 2210)	36 (914)	38 1/2 (978)
42	52 1/4 (1327)	24 (610)	42 1/2 (1080)	18 1/2 (470)	59 3/4 (1518)	35 3/4 (908)	86 x 99 (2184 x 2515)	93 x 99 (2362 x 2515)	42 (1067)	44 1/2 (1130)
48	58 1/4 (1480)	24 (610)	43 1/2 (1105)	19 1/2 (495)	60 3/4 (1543)	36 3/4 (933)	93 x 111 (2362 x 2819)	112 x 111 (2845 x 2819)	48 (1219)	50 1/2 (1283)
54	64 1/4 (1632)	26 1/2 (673)	49 (1245)	22 1/2 (572)	66 1/4 (1683)	39 3/4 (1010)	112 x 111 (2845 x 2819)	124 x 123 (3150 x 3124)	54 (1372)	56 1/2 (1435)
60	70 1/4 (1784)	26 1/2 (673)	50 (1270)	23 1/2 (597)	67 1/4 (1708)	40 3/4 (1035)	124 x 123 (3150 x 3124)	136 x 135 (3454 x 3429)	60 (1524)	62 1/2 (1588)
72	82 1/2 (2096)	29 (737)	53 (1346)	24 (610)	70 1/4 (1784)	41 1/4 (1048)	136 x 135 (3454 x 3429)	136 x 147 (3454 x 3734)	72 (1829)	74 1/2 (1892)

Reversible RPDR, RPBR, RPDRF and RPBRF

24	34 1/4 (870)	18 (457)	32 (813)	14 (356)	46 1/4 (1175)	28 1/4 (718)	66 x 63 (1676 x 1600)	66 x 63 (1676 x 1600)	24 (610)	26 1/2 (521)
30	40 1/4 (1022)	20 (508)	34 (864)	14 (356)	51 1/4 (1302)	31 1/4 (794)	74 x 75 (1880 x 1905)	78 x 87 (1981 x 2210)	30 (762)	32 1/2 (826)
36	46 1/4 (1175)	21 (533)	38 1/2 (978)	17 1/2 (445)	55 1/4 (1416)	34 3/4 (883)	76 x 87 (1930 x 2210)	94 x 87 (2388 x 2210)	36 (914)	38 1/2 (978)
42	52 1/4 (1327)	24 1/2 (622)	43 (1092)	18 1/2 (470)	60 1/4 (1530)	35 3/4 (908)	86 x 99 (2184 x 2515)	100 x 99 (2540 x 2515)	42 (1067)	44 1/2 (1130)
48	58 1/4 (1480)	24 1/2 (622)	44 (1118)	19 1/2 (495)	61 1/4 (1556)	36 3/4 (933)	100 x 111 (2540 x 2819)	112 x 111 (2845 x 2819)	48 (1219)	50 1/2 (1283)
54	64 1/4 (1632)	27 (686)	49 1/2 (1257)	22 1/2 (572)	66 1/4 (1695)	39 3/4 (1010)	112 x 111 (2845 x 2819)	124 x 123 (3150 x 3124)	54 (1372)	56 1/2 (1435)
60	70 1/4 (1784)	27 (686)	50 1/2 (1283)	23 1/2 (597)	67 1/4 (1721)	40 3/4 (1035)	124 x 123 (3150 x 3124)	136 x 135 (3454 x 3429)	60 (1524)	62 1/2 (1588)
72	80 1/4 (2038)	29 (737)	53 (1346)	24 (610)	70 1/4 (1784)	41 1/4 (1048)	136 x 135 (3454 x 3429)	136 x 147 (3454 x 3734)	72 (1829)	74 1/2 (1892)

All dimensions shown in inches (millimeters); *square dimensions

Fan Size	Minimum Material Gauges				Fan Panel	Drive Frame Channel	Belt Drive Shaft Size	Max Motor Frame Size		Approximate Weight (lbs)	
	Base		Hood					Belt	Direct	Galv.	Alum.
	Galv.	Alum.	Galv.	Alum.							
Level 1, Models: RBE, RBS and RBF											
20	20	0.080	22	0.40	18	11	3/4	145T	-	195	165
24	20	0.080	22	0.40	18	11	3/4	145T	-	235	200
30	20	0.080	22	0.051	18	11	3/4	184T	-	280	240
36	20	0.080	22	0.051	16	11	3/4	184T	-	320	275
Level 2, Models: RBE, RBS, RBF, RE2 and RS2											
18	20	0.080	22	0.040	18	14	-	-	56	185	160
20	20	0.080	22	0.040	18	11	3/4	145T	145T	210	180
24	20	0.080	22	0.040	18	11	3/4	145T	184T	245	210
30	20	0.080	22	0.051	18	11	1	184T	184T	285	245
36	20	0.080	22	0.051	16	11	1	184T	215T	330	280
42	20	0.080	22	0.051	16	10	1 1/4	184T	256T	450	385
48	20	0.080	22	0.051	16	10	1 1/4	184T	256T	645	550
54	18	0.100	22	0.051	16	10	1 1/4	184T	256T	805	685
60	18	0.100	22	0.051	14	10	1 1/2	215T	-	935	795
Level 3, Models: RBE, RBCE, RBS, RBCE, RBF, RBCF, RCE3 and RCS3											
20	20	0.080	22	0.040	18	11	3/4	-	145T	220	190
24	20	0.080	22	0.040	18	11	3/4	145T	184T	260	225
30	20	0.080	22	0.051	18	11	1	184T	184T	295	250
36	20	0.080	22	0.051	16	11	1	184T	215T	340	290
42	20	0.080	22	0.051	16	10	1 1/2	215T	256T	465	395
48	20	0.080	22	0.051	16	10	1 1/2	215T	256T	670	570
54	18	0.100	22	0.051	16	10	1 1/2	256T	256T	825	705
60	18	0.100	22	0.051	14	10	1 3/4	256T	-	970	825
72	18	0.100	22	0.051	12	10	2	256T	-	1145	970
Reversible, Models: RPDR, RPBR, RPDRF and RPBRF											
24	18	0.064	24	0.040	-	-	-	-	-	260	225
30	18	0.064	24	0.040	-	-	-	-	-	295	250
36	18	0.064	24	0.040	-	-	-	-	-	340	290
42	18	0.080	22	0.051	-	-	-	-	-	465	395
48	18	0.080	22	0.051	-	-	-	-	-	670	570
54	16	0.100	22	0.051	-	-	-	-	-	825	705
60	16	0.100	20	0.051	-	-	-	-	-	970	825
72	16	0.100	20	0.051	-	-	-	-	-	1145	975

Direct Drive Model Number Code

The model number system is designed to completely identify the fan. The correct code letters must be specified to designate direct drive with

exhaust or supply air configuration. The remainder of the model number is determined by the size and performance selected from the following pages.

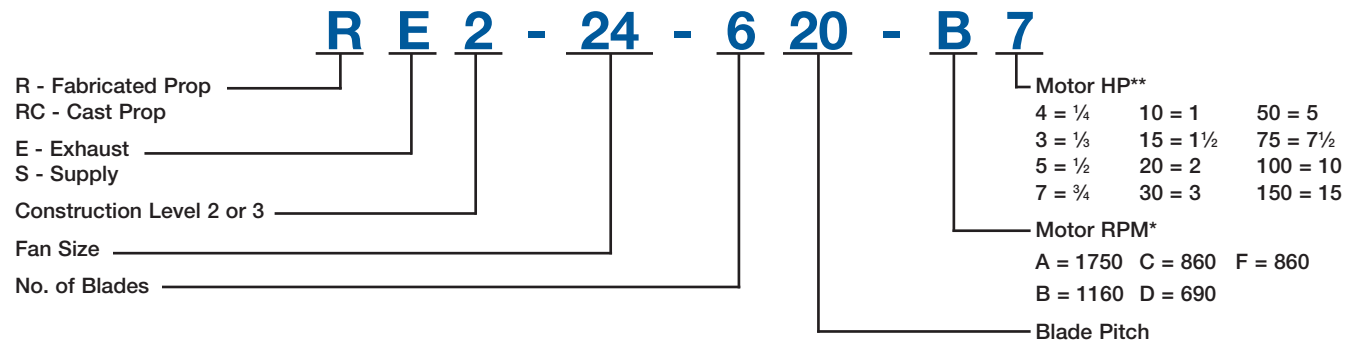

Reversible Model Number Code

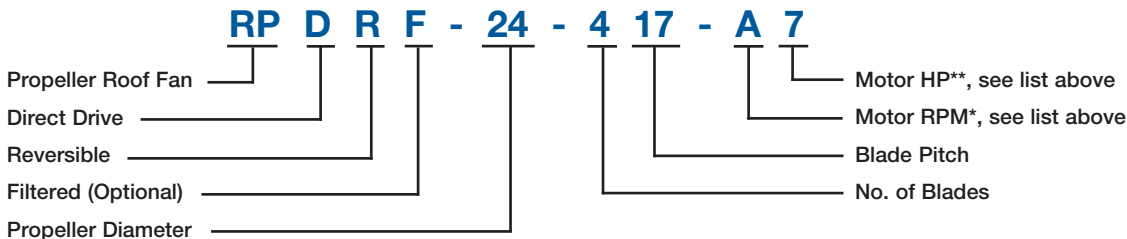

Direct Drive Exhaust

RE2-18-54



Model Number	Motor HP	Fan RPM	Max BHP	*Sones	CFM / Static Pressure in Inches WG											
					0.00	0.10	0.125	0.15	0.20	0.25	0.30	0.375	0.50	0.625	0.75	1.00
RE2 Performance Limits																
RE2-18-423-B6	1/6	1160	0.19	12.9	2742	2414	2323	2232	2041	1822	1597	1177				
RE2-18-432-B4	1/4	1160	0.29	15.0	3116	2825	2739	2632	2416	2203	1983	1549	656			
RE2-18-440-B3	1/3	1160	0.39	16.9	3386	2996	2886	2774	2557	2378	2163	1720				
RE2-18-411-A4	1/4	1750	0.30	22	2901	2688	2628	2567	2450	2333	2216	2027	1707			
RE2-18-415-A3	1/3	1750	0.38	23	3367	3144	3087	3030	2915	2797	2674	2473	2057	1625		
RE2-18-421-A5	1/2	1750	0.58	24	3981	3765	3711	3659	3553	3444	3328	3146	2787	2390	1857	1373
RE2-20-414-B6	1/6	1160	0.20	15.7	3080	2725	2626	2525	2294	1999	1680	1303	781			
RE2-20-421-B4	1/4	1160	0.29	17.9	3645	3244	3140	3034	2785	2500	2253					
RE2-20-427-B3	1/3	1160	0.39	18.9	3970	3574	3474	3359	3089	2809	2558	2126				
RE2-20-404-A4	1/4	1750	0.30	28	3089	2848	2789	2730	2603	2474	2335	2129	1783	1392	1107	
RE2-20-408-A3	1/3	1750	0.40	29	3674	3451	3395	3339	3192	3064	2930	2709	2317	1883	1546	903
RE2-20-412-A5	1/2	1750	0.58	30	4373	4155	4101	4037	3900	3766	3633	3425	3006	2531	1986	1477
RE2-20-418-A7	3/4	1750	0.91	32	5145	4913	4855	4795	4671	4547	4417	4218	3764	3287	2784	1922
RE2-20-424-A10	1	1750	1.17	34	5780	5507	5439	5370	5232	5093	4946	4725	4324	3807	3463	
RE2-20-435-A15	1½	1750	1.87	36	6483	6222	6157	6092	5936	5774	5606	5338	4911	4495	3955	2613
RE2-24-617-C4	1/4	860	0.28	16.7	4535	3976	3811	3631	3192	2684	2144					
RE2-24-621-C3	1/3	860	0.37	19.6	4958	4380	4209	4033	3657	3154	2589					
RE2-24-631-C5	1/2	860	0.57	20	5761	5091	4880	4675	4303	3832	3361	2238				
RE2-24-620-B7	3/4	1160	0.83	24	6551	6095	5977	5859	5605	5326	5062	4604	3805			
RE2-24-627-B10	1	1160	1.15	26	7340	6909	6772	6634	6370	6116	5850	5412	4579			
RE2-24-601-A7	3/4	1750	0.80	37	4919	4716	4664	4608	4497	4386	4252	4039	3641	3300	3011	2403
RE2-24-606-A10	1	1750	1.18	40	6559	6338	6283	6228	6107	5974	5841	5631	5227	4799	4350	3497
RE2-24-612-A15	1½	1750	1.72	41	7990	7710	7640	7570	7432	7298	7164	6931	6463	6036	5515	4532
RE2-24-616-A20	2	1750	2.22	42	8958	8723	8665	8606	8489	8355	8210	7991	7598	7157	6658	5501
RE2-30-618-C7	3/4	860	0.86	24	9151	8466	8278	8090	7698	7283	6828	6026	4525	3297		
RE2-30-625-C10	1	860	1.15	29	10117	9405	9223	9041	8591	8088	7590	6776	4600	3708	2714	
RE2-30-635-C15	1½	860	1.80	33	11552	10704	10497	10289	9821	9289	8615	7635	5280	4396		
RE2-30-605-B7	3/4	1160	0.88	31	7628	7235	7135	7028	6815	6565	6304	5900	5162	4381	3619	2214
RE2-30-609-B10	1	1160	1.19	31	9129	8716	8612	8503	8286	8069	7803	7378	6637	5731	4753	3241
RE2-30-615-B15	1½	1160	1.80	33	11481	10986	10863	10739	10502	10266	10025	9609	8808	7956	6936	4815
RE2-30-620-B20	2	1160	2.31	34	12763	12327	12219	12110	11885	11552	11219	10706	9843	8931	7789	5540
RE2-36-608-C7	3/4	860	0.83	28	9860	9164	8969	8775	8357	7916	7431	6714	5296	3823	2471	
RE2-36-612-C10	1	860	1.18	30	12054	11324	11115	10906	10447	9960	9470	8710	7230	5332	3779	
RE2-36-618-C15	1½	860	1.70	32	14330	13477	13241	13005	12532	12053	11543	10674	9238	7414	5518	2870
RE2-36-600-B10	1	1160	1.18	35	8001	7528	7397	7244	6942	6663	6380	5949	5216	4615	3929	2501
RE2-36-606-B15	1½	1160	1.79	37	12216	11724	11597	11450	11155	10860	10559	10106	9374	8466	7496	5502
RE2-36-609-B20	2	1160	2.23	39	13970	13475	13352	13228	12959	12677	12395	11915	11057	10069	9136	6883
RE2-36-615-B30	3	1160	3.51	41	17695	17217	17098	16978	16739	16434	16097	15589	14632	13650	12637	10360
RE2-42-602-C10	1	860	1.10	31	8248	7498	7326	7146	6774	6440	6113	5624	4774	3819	2896	
RE2-42-608-C15	1½	860	1.63	33	13322	12666	12501	12333	11997	11616	11210	10604	9558	8326	7157	4615
RE2-42-612-C20	2	860	2.30	34	16659	15900	15709	15508	15105	14703	14245	13550	12384	11184	9794	7321
RE2-42-618-C30	3	860	3.53	38	20833	19931	19704	19458	18964	18471	17975	17215	15982	14526	13096	10298
RE2-42-627-C50	5	860	5.75	42	24809	24003	23801	23600	23188	22562	21916	20827	19325	17993	16421	12586
RE2-48-405-C15	1½	860	1.69	44	16467	15471	15228	14984	14497	13940	13377	12489	10775	8986	7113	3487
RE2-48-409-C20	2	860	2.35	46	20499	19443	19185	18930	18422	17854	17274	16341	14660	12904	10993	6665
RE2-48-413-C30	3	860	3.40	49	24743	23533	23242	22969	22421	21857	21148	20084	18501	16720	14919	10781
RE2-48-421-C50	5	860	5.89	54	30865	29709	29420	29131	28491	27794	27098	26120	24429	22624	20654	16320
RE2-54-419-F50	5	690	5.77	53	36939	34858	34325	33781	32693	31655	30638	28940	26112	23257	20185	14004
RE2-54-409-C50	5	860	5.54	54	33516	32232	31911	31590	30975	30361	29747	28562	26470	24499	22503	17879
RE2-54-415-C75	7½	860	8.67	55	41470	40161	39834	39507	38758	37868	36978	35722	33672	31561	29317	24635

Performance certified is for model RE2 exhaust for installation type A: free inlet, free outlet. Power rating (Bhp) does not include transmission losses. Performance ratings include the effects of appurtenances (Birdscreen).
 The sound ratings shown are loudness values in fan sones at 5 feet (1.5 m) in a hemispherical free field calculated per AMCA Standard 301. Values shown are for installation type A: free outlet hemispherical sone levels. The AMCA Certified Ratings Sound Seal applies to some ratings only.
 *Sones shown apply to the highest cataloged cfm at each fan rpm. For selections at other cfm and static pressure points, refer to the CAPS computerized selection program.
 Numbers in blue have a larger Bhp and require the next size larger motor.

Direct Drive Cast Aluminum Exhaust

RCE3-20—54



Model Number	Motor HP	Fan RPM	Max BHP	*Sones	CFM / Static Pressure in Inches WG											
					0.00	0.10	0.125	0.15	0.20	0.25	0.30	0.375	0.50	0.625	0.75	1.00
RCE3 Performance Limits																
RCE3-20-620-B4	1/4	1160	0.30	15.3	3419	3134	3056	2976	2810	2606	2290	1789	1444	886		
RCE3-20-626-B3	1/3	1160	0.40	15.3	3911	3587	3495	3401	3210	3014	2782	2197	1679	1303	667	
RCE3-20-634-B5	1/2	1160	0.58	16.8	4289	3954	3857	3732	3520	3319	3031	2393	2037	1369	722	
RCE3-20-306-A4	1/4	1750	0.30	18.5	2845	2551	2483	2400	2231	2031	1830	1530	1178			
RCE3-20-313-A5	1/2	1750	0.45	19.7	3818	3516	3436	3364	3223	3084	2912	2641	2011	1400	817	
RCE3-20-318-A5	1/2	1750	0.60	21	4225	3967	3895	3820	3657	3502	3346	3113	2584	1801	1233	
RCE3-20-618-A7	3/4	1750	0.90	24	4867	4667	4618	4568	4477	4387	4296	4134	3803	3355	2828	2215
RCE3-20-623-A10	1	1750	1.21	29	5547	5343	5292	5239	5125	5011	4898	4730	4430	4085	3408	2690
RCE3-24-427-C4	1/4	860	0.28	15.2	4978	4121	3897	3688	3147	2115	1561	792				
RCE3-24-626-C3	1/3	860	0.37	14.0	5278	4692	4531	4372	4020	3515	2616	1734	790			
RCE3-24-610-B4	1/4	1160	0.30	17.6	4391	3975	3881	3786	3577	3354	3110	2686	1775	1175		
RCE3-24-416-B3	1/3	1160	0.40	17.1	5301	4729	4566	4413	4113	3815	3510	2905	1474			
RCE3-24-424-B5	1/2	1160	0.59	19.2	6342	5818	5660	5488	5211	4905	4522	3911	2218	1273		
RCE3-24-625-B7	3/4	1160	0.88	20	7040	6580	6485	6366	6124	5901	5655	5207	4302	2549	1860	
RCE3-24-633-B10	1	1160	1.20	23	8028	7553	7419	7283	6982	6683	6385	5916	4996	3091	2248	
RCE3-24-403-A5	1/2	1750	0.52	31	4858	4487	4398	4304	4112	3930	3739	3422	2855	2184	1835	
RCE3-24-606-A7	3/4	1750	0.90	32	5784	5530	5460	5391	5252	5115	4983	4797	4448	4058	3524	2549
RCE3-24-414-A10	1	1750	1.18	33	7388	7003	6904	6804	6615	6429	6227	5945	5479	5000	4483	2593
RCE3-24-617-A15	1½	1750	1.78	34	8432	8107	8026	7957	7819	7681	7548	7347	7002	6602	6203	5361
RCE3-24-621-A20	2	1750	2.41	39	9652	9360	9287	9214	9061	8901	8740	8523	8192	7795	7372	6379
RCE3-30-605-C4	1/4	860	0.29	18.2	5609	4739	4534	4352	3931	3462	2740	1740				
RCE3-30-607-C3	1/3	860	0.37	17.4	6417	5533	5332	5125	4706	4244	3639	2391				
RCE3-30-615-C5	1/2	860	0.56	16.4	7798	6911	6691	6470	6001	5499	5008	3847	1592			
RCE3-30-623-C7	3/4	860	0.87	18.3	9114	8217	7980	7737	7244	6742	6146	4948	2561			
RCE3-30-630-C10	1	860	1.15	20	9883	8802	8568	8333	7840	7302	6710	4215				
RCE3-30-603-B5	1/2	1160	0.60	27	6885	6299	6148	5994	5682	5361	5063	4560	3464	2494	1417	
RCE3-30-607-B7	3/4	1160	0.90	25	8656	7970	7800	7651	7357	7053	6746	6278	5408	3923	2591	
RCE3-30-612-B10	1	1160	1.20	24	9941	9328	9164	8991	8648	8326	8005	7499	6650	5591	3717	
RCE3-30-620-B15	1½	1160	1.76	26	11548	10940	10789	10639	10326	9989	9642	9068	8099	6950	4614	
RCE3-30-626-B20	2	1160	2.41	28	12868	12202	12037	11871	11541	11136	10684	10061	9091	7917	5544	2654
RCE3-36-601-C5	1/2	860	0.57	25	9219	8273	8003	7713	7017	6249	5362	4038				
RCE3-36-606-C7	3/4	860	0.83	25	11147	10114	9843	9555	8900	8157	7372	5893	3385			
RCE3-36-612-C10	1	860	1.14	24	13058	12051	11764	11377	10655	9980	9178	7772	4443			
RCE3-36-616-C15	1½	860	1.44	25	14425	13194	12854	12487	11751	10951	10050	8606	5062			
RCE3-36-630-C20	2	860	2.35	29	16244	14958	14614	14167	13167	11879	10545	7823	5353	3370		
RCE3-36-300-B7	3/4	1160	0.68	26	10426	9166	8849	8481	7719	7073	6168	4452				
RCE3-36-404-B10	1	1160	1.18	32	12812	11893	11534	11319	10902	10302	9618	8617	6496	3715		
RCE3-36-605-B15	1½	1160	1.81	34	14623	13994	13837	13660	13270	12874	12391	11653	10293	8503	6653	
RCE3-36-608-B20	2	1160	2.34	35	16205	15288	15091	14893	14490	14076	13654	13010	11536	9754	7733	3312
RCE3-36-616-B30	3	1160	3.54	39	19458	18590	18361	18114	17618	17092	16548	15729	14193	12433	10488	5629
RCE3-36-630-B50	5	1160	5.76	44	21911	20994	20756	20501	19993	19413	18750	17563	15139	11778	9457	6158
RCE3-42-611-F7	3/4	690	0.87	19.2	13930	12209	11801	11374	10451	9310	8185	6097				
RCE3-42-616-F10	1	690	1.20	19.8	15931	14330	13961	13460	12479	11546	10289	8038				
RCE3-42-624-F15	1½	690	1.80	23	18324	16430	15881	15299	14228	13122	11927	9962	5122			
RCE3-42-630-F20	2	690	2.33	24	19575	17650	17067	16491	15425	14385	13137	10580	5867			
RCE3-42-607-C10	1	860	1.17	28	14459	13168	12815	12450	11716	11004	10251	8983	6713	4324		
RCE3-42-611-C15	1½	860	1.68	28	17362	16063	15678	15292	14632	13930	13207	11843	9446	6622	3460	
RCE3-42-616-C20	2	860	2.32	29	19856	18528	18219	17923	17311	16501	15714	14590	12052	8855	5165	
RCE3-42-623-C30	3	860	3.31	32	22468	21128	20720	20295	19447	18603	17730	16393	14043	10986	7237	
RCE3-48-408-F7	3/4	690	0.86	21	17457	14601	13762	12833	11140	9125	6274					
RCE3-48-607-F10	1	690	1.17	22	18591	16525	15914	15334	14091	12686	11171	8443				
RCE3-48-612-F15	1½	690	1.81	23	22289	20196	19595	18955	17695	16301	14743	12309	6140			
RCE3-48-617-F20	2	690	2.38	26	24348	21852	21301	20754	19489	18044	16522	13937	7982			
RCE3-48-627-F30	3	690	3.45	28	26494	24087	23315	22578	21222	19772	17676	13442	8960			
RCE3-48-603-C15	1½	860	1.71	36	19773	18118	17700	17283	16350	15401	14385	12810	9608	5852		
RCE3-48-607-C20	2	860	2.27	33	23171	21549	21180	20701	19726	18796	17800	16116	13033	9075		
RCE3-48-611-C30	3	860	3.33	33	27514	25664	25232	24791	23872	22864	21742	20236	17002	13351	8463	
RCE3-48-620-C50	5	860	5.32	36	31410	29616	29034	28451	27430	26468	25460	23843	20623	16468	10796	
RCE3-48-631-C75	7½	860	7.80	42	34013	31658	31127	30585	29379	28063	26606	24292	18161	15030	11775	
RCE3-54-330-F50	5	690	5.59	46	36212	33116	32365	31613	30348	29048	27620	25306	21143	14888		
RCE3-54-315-C50	5	860	5.60	50	38118	36174	35687	35122	33984	32974	31978	30404	27499	24217	20575	9493
RCE3-54-323-C75	7½	860	8.37	55	42298	40107	39559	39066	38113	37160	36163	34639	31463	28305	25033	16045

Performance certified is for model RE2 exhaust for installation type A: free inlet, free outlet. Power rating (Bhp) does not include transmission losses. Performance ratings include the effects of appurtenances (Birdscreen).
 The sound ratings shown are loudness values in fan sones at 5 feet (1.5 m) in a hemispherical free field calculated per AMCA Standard 301. Values shown are for installation type A: free outlet hemispherical sone levels. The AMCA Certified Ratings Sound Seal applies to sone ratings only.
 *Sones shown apply to the highest cataloged cfm at each fan rpm. For selections at other cfm and static pressure points, refer to the CAPS computerized selection program.

Numbers in blue have a larger Bhp and require the next size larger motor.

Model Number	Motor HP	Fan RPM	Max BHP	*Sones	CFM / Static Pressure in Inches WG											
					0.00	0.10	0.125	0.15	0.20	0.25	0.30	0.375	0.50	0.625	0.75	1.00
RS2 Performance Limits																
RS2-18-424-B6	1/6	1160	0.19	19.3	2891	2638	2569	2479	2248	1987						
RS2-18-433-B4	1/4	1160	0.28	22	3401	3131	3050	2949	2705	2389	1970					
RS2-18-440-B3	1/3	1160	0.37	23	3779	3515	3345	3184	2870	2514	2139					
RS2-18-412-A4	1/4	1750	0.28	31	3065	2908	2869	2828	2744	2646	2534	2299	1867	1453	1120	
RS2-18-415-A3	1/3	1750	0.38	32	3575	3414	3372	3322	3222	3121	3011	2825	2365	1705	1367	
RS2-18-422-A5	1/2	1750	0.60	33	4191	4010	3965	3921	3838	3755	3672	3476	3060	2486	1933	
RS2-20-416-B6	1/6	1160	0.19	22	3242	2926	2843	2747	2499	2093	1686	1182				
RS2-20-422-B4	1/4	1160	0.29	25	3916	3590	3503	3408	3154	2819	2324					
RS2-20-428-B3	1/3	1160	0.38	26	4426	4065	3956	3845	3553	3217	2721					
RS2-20-405-A4	1/4	1750	0.30	37	3240	3013	2954	2895	2781	2669	2503	2247	1856	1402	1017	
RS2-20-407-A3	1/3	1750	0.38	38	3610	3401	3339	3276	3151	3025	2898	2698	2182	1717	1309	
RS2-20-413-A5	1/2	1750	0.60	40	4572	4384	4337	4289	4168	4047	3929	3759	3267	2666	2041	
RS2-20-419-A7	3/4	1750	0.84	41	5501	5288	5235	5181	5068	4955	4838	4636	4204	3493	2521	
RS2-20-425-A10	1	1750	1.13	43	6322	6081	6021	5961	5844	5727	5603	5360	4882	4223	2858	
RS2-20-436-A15	1½	1750	1.74	45	7281	7060	7005	6950	6797	6590	6384	6078	5478	4613	3190	
RS2-24-618-C4	1/4	860	0.30	19.7	5012	4529	4410	4225	3766	3006	2303	1395				
RS2-24-622-C3	1/3	860	0.38	23	5548	5060	4930	4747	4237	3498	2597	1486				
RS2-24-633-C5	1/2	860	0.56	24	6685	6088	5898	5631	4939	4282						
RS2-24-622-B7	3/4	1160	0.90	30	7484	7130	7042	6947	6755	6564	6188	5634	4132	2725		
RS2-24-628-B10	1	1160	1.19	31	8420	8059	7969	7875	7635	7377	6936	6215	4722			
RS2-24-603-A7	3/4	1750	0.88	45	5590	5393	5344	5295	5183	5054	4925	4691	4252	3785	3268	2414
RS2-24-606-A10	1	1750	1.11	48	6756	6483	6414	6346	6209	6098	6001	5788	5413	4985	4300	3312
RS2-24-612-A15	1½	1750	1.79	49	8444	8220	8164	8108	7995	7863	7726	7520	7168	6712	6066	4691
RS2-24-617-A20	2	1750	2.28	50	9766	9571	9522	9473	9375	9278	9180	8988	8573	8124	7622	5925
RS2-30-619-C7	3/4	860	0.87	29	9970	9435	9295	9143	8840	8429	7901	6696	4374	2697		
RS2-30-625-C10	1	860	1.18	33	11577	10998	10827	10653	10305	9897	9394	8224	5457	3057		
RS2-30-635-C15	1½	860	1.79	37	13519	12942	12793	12586	12173	11650	10817	9403	5733			
RS2-30-605-B7	3/4	1160	0.87	36	8004	7540	7435	7332	7126	6902	6673	6233	5354	4407	3352	1580
RS2-30-609-B10	1	1160	1.14	37	9179	8819	8729	8639	8428	8195	7961	7599	6750	5625	4593	2558
RS2-30-616-B15	1½	1160	1.77	38	12118	11712	11610	11509	11290	11054	10818	10434	9776	8376	6930	4186
RS2-30-621-B20	2	1160	2.37	40	14207	13783	13676	13570	13357	13134	12912	12578	11654	10472	8760	5010
RS2-36-608-C7	3/4	860	0.87	31	10368	9770	9600	9429	9075	8655	8115	7149	5418	3563	2147	
RS2-36-613-C10	1	860	1.20	35	12782	12206	12062	11918	11564	11197	10688	9697	7557	5309	3431	
RS2-36-619-C15	1½	860	1.77	35	15784	15145	14985	14825	14447	14067	13552	12421	10134			
RS2-36-605-B15	1½	1160	1.75	41	12229	11775	11661	11547	11259	10962	10667	10228	9282	8226	7132	4819
RS2-36-609-B20	2	1160	2.29	45	14617	14216	14116	14016	13791	13527	13264	12865	12081	10911	9590	6806
RS2-36-615-B30	3	1160	3.39	47	18477	18083	17984	17885	17688	17491	17273	16871	16101	15051	13502	10029
RS2-42-604-C10	1	860	1.16	34	10410	9823	9634	9429	9028	8661	8297	7759	6722	5524	4352	1892
RS2-42-609-C15	1½	860	1.73	37	14918	14214	14034	13846	13472	13068	12633	11992	10917	9514	8123	4949
RS2-42-613-C20	2	860	2.37	38	18043	17419	17263	17107	16759	16391	16008	15173	13993	12440	10921	7062
RS2-42-619-C30	3	860	3.54	40	22564	21911	21747	21584	21224	20822	20419	19797	18338	16086	14475	10641
RS2-42-628-C50	5	860	5.58	44	28326	27511	27307	27104	26702	26309	25916	25326	22814	20699	18517	13889
RS2-48-406-C15	1½	860	1.70	48	17653	16860	16662	16434	15581	15003	14426	13452	11664	9604	7461	3219
RS2-48-409-C20	2	860	2.26	50	21078	20184	19961	19671	19079	18489	17903	16873	14822	12789	10588	6065
RS2-48-413-C30	3	860	3.34	54	26137	25150	24903	24644	24095	23547	22998	21787	19847	17768	15750	9811
RS2-48-421-C50	5	860	5.87	57	34260	33175	32904	32633	32087	31474	30860	29847	27391	25101	22890	16888
RS2-54-420-F50	5	690	5.90	56	40612	39282	38949	38602	37788	36975	36162	34413	30917	26631	22598	13995
RS2-54-410-C50	5	860	5.90	58	36501	35366	35082	34798	34221	33593	32965	32024	30461	28032	25102	19450
RS2-54-415-C75	7½	860	8.48	59	44221	43095	42813	42532	41969	41406	40758	39766	37897	35653	32852	27125

Performance certified is for model RE2 exhaust for installation type A: free inlet, free outlet. Power rating (Bhp) does not include transmission losses. Performance ratings include the effects of appurtenances (Birdscreen).
 The sound ratings shown are loudness values in fan sones at 5 feet (1.5 m) in a hemispherical free field calculated per AMCA Standard 301. Values shown are for installation type A: free outlet hemispherical sone levels. The AMCA Certified Ratings Sound Seal applies to sone ratings only.
 *Sones shown apply to the highest cataloged cfm at each fan rpm. For selections at other cfm and static pressure points, refer to the CAPS computerized selection program.

Numbers in blue have a larger Bhp and require the next size larger motor.

Direct Drive Cast Aluminum Supply

RCS3-20—54



Model Number	Motor HP	Fan RPM	Max BHP	*Sones	CFM / Static Pressure in Inches WG											
					0.00	0.10	0.125	0.15	0.20	0.25	0.30	0.375	0.50	0.625	0.75	1.00
RCS3 Performance Limits																
RCS3-20-427-B4	1/4	1160	0.30	24	3971	3646	3566	3481	3288	2974	2472	1403	676			
RCS3-20-434-B3	1/3	1160	0.41	26	4350	4020	3934	3831	3626	3263	2765	1601	693			
RCS3-20-628-B5	1/2	1160	0.42	24	4365	4121	4060	4000	3815	3574	3219	2749	1319			
RCS3-20-604-A4	1/4	1750	0.27	29	2392	2195	2144	2093	1993	1894	1797	1637	1330	1026	747	
RCS3-20-608-A3	1/3	1750	0.36	28	3170	2983	2938	2894	2805	2715	2599	2414	2091	1741	1383	
RCS3-20-614-A5	1/2	1750	0.59	31	4364	4209	4171	4132	4033	3940	3847	3707	3329	2880	2458	1545
RCS3-20-620-A7	3/4	1750	0.90	42	5439	5277	5236	5196	5114	5033	4951	4825	4596	4009	3502	2057
RCS3-20-624-A10	1	1750	1.15	38	5955	5791	5750	5709	5627	5544	5461	5326	5074	4601	3978	2213
RCS3-24-621-C4	1/4	860	0.28	17.7	4696	4247	4113	3929	3203	2060	1559					
RCS3-24-630-C3	1/3	860	0.40	18.7	5643	5140	4969	4771	4034	2378						
RCS3-24-638-C5	1/2	860	0.54	19.3	6250	5580	5345	5037	3366	2359						
RCS3-24-607-B4	1/4	1160	0.28	21	3907	3510	3399	3262	2901	2500	2189	1829	1181			
RCS3-24-613-B3	1/3	1160	0.38	24	4731	4361	4261	4149	3874	3555	3060	2327	1564	802		
RCS3-24-617-B5	1/2	1160	0.53	24	5556	5220	5131	5043	4843	4576	4070	3234	2140	1271		
RCS3-24-627-B7	3/4	1160	0.88	29	7131	6806	6725	6628	6433	6224	5913	5211	2839	1719		
RCS3-24-634-B10	1	1160	1.13	33	8025	7616	7498	7380	7118	6768	6442	5498	3015	1710		
RCS3-24-310-A5	1/2	1750	0.59	33	5900	5444	5342	5247	5058	4874	4680	4328	3332	2403	1773	
RCS3-24-315-A7	3/4	1750	0.91	35	7042	6625	6517	6409	6235	6067	5876	5578	4882	3433	2456	
RCS3-24-320-A10	1	1750	1.21	38	8010	7639	7548	7460	7284	7086	6857	6607	6072	4932	2841	
RCS3-24-617-A15	1½	1750	1.80	47	8381	8161	8106	8051	7940	7822	7705	7529	7179	6472	5686	3751
RCS3-24-621-A20	2	1750	2.40	49	9555	9337	9283	9229	9120	9012	8904	8742	8415	7980	7357	4341
RCS3-30-607-C4	1/4	860	0.28	21	6197	5384	5151	4904	4337	3595	1925					
RCS3-30-610-C3	1/3	860	0.37	22	7035	6285	6079	5855	5304	4454	3669	2549				
RCS3-30-616-C5	1/2	860	0.56	25	8580	7874	7674	7443	6984	6353	5060	3583				
RCS3-30-624-C7	3/4	860	0.85	24	10292	9537	9318	9044	8544	7454	6623	4448				
RCS3-30-630-C10	1	860	1.09	28	11435	10613	10364	10123	9658	8667	7313	3894				
RCS3-30-605-B5	1/2	1160	0.59	32	7566	6954	6803	6634	6287	5916	5476	4787	3569	2141		
RCS3-30-610-B7	3/4	1160	0.91	35	9489	8918	8787	8656	8367	8062	7698	7044	5509	4005	2287	
RCS3-30-614-B10	1	1160	1.20	37	10898	10327	10194	10060	9793	9459	9106	8534	6795	5169	3226	
RCS3-30-621-B15	1½	1160	1.79	41	12998	12446	12295	12144	11841	11555	11274	10698	8924	6952	4576	
RCS3-30-627-B20	2	1160	2.39	43	14636	14117	13987	13858	13537	13186	12829	12200	10188	8239	4621	
RCS3-36-604-C5	1/2	860	0.60	29	9756	8708	8434	8118	7479	6809	5763	4230				
RCS3-36-609-C7	3/4	860	0.86	31	11505	10507	10227	9957	9340	8594	7575	5892				
RCS3-36-615-C10	1	860	1.20	34	13325	12446	12136	11800	11092	10330	9304	7266				
RCS3-36-622-C15	1½	860	1.72	35	15294	14240	13980	13679	12913	11905	10567	8033				
RCS3-36-630-C20	2	860	2.31	41	16511	15442	15136	14829	14055	12262	10302					
RCS3-36-307-B7	3/4	1160	0.88	37	11414	10101	9781	9469	8840	8090	7337	5985				
RCS3-36-602-B10	1	1160	1.20	43	11775	10991	10770	10551	10156	9730	9272	8575	6908	5415	3853	
RCS3-36-607-B15	1½	1160	1.81	49	14733	13937	13731	13525	13118	12712	12290	11563	10139	8143		
RCS3-36-611-B20	2	1160	2.41	51	16777	15980	15764	15548	15099	14634	14176	13475	11940	9961	7326	
RCS3-36-618-B30	3	1160	3.54	57	19215	18606	18454	18302	17882	17426	16973	16300	14178	11984	8312	
RCS3-36-630-B50	5	1160	5.64	65	22271	21506	21315	21120	20665	20210	19692	18773	15269			
RCS3-42-613-F7	3/4	690	0.91	26	14268	12744	12334	11821	10797	9648	8303	5985				
RCS3-42-617-F10	1	690	1.18	30	15985	14624	14297	13825	12765	11500	9980	7437				
RCS3-42-625-F15	1½	690	1.75	31	18793	17337	16949	16513	15432	13803	12402	9628				
RCS3-42-632-F20	2	690	2.35	35	20595	19019	18625	18230	17192	15588	13573	9429				
RCS3-42-607-C10	1	860	1.10	38	14105	12834	12537	12249	11645	10913	9940	8487	6225	4105		
RCS3-42-613-C15	1½	860	1.76	41	17783	16553	16250	15948	15277	14454	13633	12305	9534	6419		
RCS3-42-617-C20	2	860	2.28	45	19923	18809	18546	18284	17735	16972	16127	14605	11679	7984		
RCS3-42-625-C30	3	860	3.38	48	23424	22285	21986	21674	21052	20304	19488	17490	14592	10384		
RCS3-48-606-F7	3/4	690	0.90	29	16536	14348	13728	13248	12143	10689	9177	6709				
RCS3-48-609-F10	1	690	1.15	31	18428	16390	15841	15291	14152	12798	11279	8320				
RCS3-48-614-F15	1½	690	1.74	34	22297	19887	19319	18729	17474	16065	14294	10955	4328			
RCS3-48-620-F20	2	690	2.41	35	25138	22886	22299	21660	20345	18806	17144	13065				
RCS3-48-629-F30	3	690	3.49	37	28131	25634	24975	24186	22778	21231	18753	12425				
RCS3-48-606-C15	1½	860	1.77	45	20610	19000	18598	18010	17020	16221	15326	13627	10542			
RCS3-48-609-C20	2	860	2.24	46	22968	21539	21079	20539	19641	18759	17837	16250	12939	9130		
RCS3-48-614-C30	3	860	3.36	49	27791	25756	25318	24881	23969	23021	22007	20375	16674	11984	6696	
RCS3-48-623-C50	5	860	5.31	52	32415	30833	30320	29806	28783	27768	26607	24584	20762	15038		
RCS3-48-633-C75	7½	860	7.74	53	36140	33689	33277	32865	32000	30758	29457	26963	17880			
RCS3-54-330-F50	5	690	5.78	51	40402	38373	37755	37034	35587	34018	32387	29537	22164			
RCS3-54-315-C50	5	860	5.50	57	40124	38440	38019	37586	36629	35672	34623	32996	30223	26780	21872	
RCS3-54-323-C75	7½	860	8.40	60	46870	45132	44698	44263	43222	42045	40899	39431	36607	32994	28133	

Performance certified is for model RE2 exhaust for installation type A: free inlet, free outlet. Power rating (Bhp) does not include transmission losses. Performance ratings include the effects of appurtenances (Birdscreen).

The sound ratings shown are loudness values in fan sones at 5 feet (1.5 m) in a hemispherical free field calculated per AMCA Standard 301. Values shown are for installation type A: free outlet hemispherical sone levels. The AMCA Certified Ratings Sound Seal applies to sone ratings only.

*Sones shown apply to the highest cataloged cfm at each fan rpm. For selections at other cfm and static pressure points, refer to the CAPS computerized selection program.

Numbers in blue have a larger Bhp and require the next size larger motor.

Direct Drive Reversible (Exhaust and Supply) RPDR-24—36



Model Number	Motor HP	Fan RPM	Max BHP	*Sones	CFM / Static Pressure in Inches WG													
					0.00	0.10	0.125	0.15	0.20	0.25	0.30	0.375	0.50	0.625	0.75	1.00		
RPDR Performance Limits																		
RPDR-24-625-C4	1/4	870	0.25	18.4	4562	3760												
RPDR-24-632-C3	1/3		0.35	13.1	5200	4035	3655	3216	2503									
RPDR-24-421-B3	1/3	1160	0.35	27	5069	4492	4324	4153	3575	2962								
RPDR-24-429-B5	1/2		0.56	28	6062	5389	5164	4921	4092	3372								
RPDR-24-623-B5			0.56	26	5765	5300	5173	5020	4555	4097								
RPDR-24-632-B7	3/4		0.83	24	6933	6334	6165	5996	5149	4513	3700	3227						
RPDR-24-417-A7	3/4	1750	0.87	48	6476	6150	6068	5978	5799	5619	5363	4978	4104					
RPDR-24-421-A10	1		1.16	53	7647	7298	7206	7101	6892	6680	6453	6051	4994					
RPDR-24-428-A15	1½		1.79	55	8981	8566	8462	8347	8108	7859	7553	6998	5650					
RPDR-24-622-A15			1.80	52	8459	8169	8096	8024	7869	7709	7548	7177	6426					
RPDR-24-432-A20	2		2.08	57	9462	8965	8853	8742	8512	8236	7943	7270	5732					
RPDR-24-625-A20			2.10	55	9177	8864	8786	8708	8538	8354	8170	7752	6927					
RPDR-30-618-C5	1/2	870			7801	6997	6741	6426	5603	4578	3485	2076						
RPDR-30-625-C7	3/4		0.75	28	9293	8298	7998	7692	6562	5237	4267							
RPDR-30-410-B5	1/2	1160	0.55	30	7219	6498	6308	6096	5621	5004	4139	2889						
RPDR-30-416-B7	3/4		0.83	36	9029	8257	8052	7836	7352	6751	5772	4080						
RPDR-30-617-B10	1		1.18	53	10105	9540	9381	9217	8891	8450	7888	6985	4932					
RPDR-30-625-B15	1½		1.79	44	12391	11716	11522	11305	10868	10409	9843	8328	6174	4161				
RPDR-30-630-B20	2	2.19	48	13345	12620	12411	12172	11691	11135	10352	8202	5895						
RPDR-30-405-A10	1	1750	1.08	57	8271	7738	7621	7503	7255	6969	6684	6308						
RPDR-30-410-A15	1½		1.80	64	10890	10424	10308	10188	9940	9692	9429	9008	8175	6901	5197			
RPDR-30-414-A20	2		2.29	69	12763	12291	12173	12049	11782	11515	11249	10808						
RPDR-30-420-A30	3		3.40	81	15185	14639	14503	14367	14091	13813	13535	13043						
RPDR-30-623-A50	5	5.53	97	17853	17431	17326	17220	17009	16796	16537	16147	15447	14670	13473	10345			
RPDR-36-617-F5	1/2	680	0.56	11.3	9774	8319	7835	6904	4892									
RPDR-36-625-F7	3/4		0.81	13.3	11387	9487	8557	7122	5449									
RPDR-36-410-C5	1/2	870	0.56	26	9299	7900	7569	7144	5751									
RPDR-36-611-C7	3/4		0.78	30	10555	9479	9216	8945	8315									
RPDR-36-617-C10	1		1.18	36	12506	11442	11138	10824	10129	8613	6952	5276						
RPDR-36-625-C15	1½		1.77	45	14569	13180	12821	12391	11104	8909	7581	5713						
RPDR-36-409-B10	1	1160	1.22	42	11904	10843	10577	10319	9810	9210	8464	6474						
RPDR-36-605-B10			1.17	47	10869	10079	9866	9654	9235	8811	8339	7260	5274					
RPDR-36-610-B15	1½	1.72	51	13614	12775	12584	12393	12011	11614	11218	10457							
RPDR-36-614-B20	2	2.32	56	15450	14659	14459	14258	13858	13444	13005	12171	9283						
RPDR-36-620-B30	3	3.17	69	17821	17120	16945	16740	16202	15664	15088	13982	10505						

Performance shown is for Model RPDR without ducts or filters. *Sones shown apply to the highest cataloged cfm at each fan rpm. For selections at other cfm and static pressure points, refer to the CAPS computerized selection program.

Numbers in blue have a larger Bhp and require the next size larger motor.

Direct Drive Reversible (Exhaust and Supply)

RPDR-42—54



Model Number	Motor HP	Fan RPM	Max BHP	*Sones	CFM / Static Pressure in Inches WG										
					0.00	0.10	0.125	0.15	0.20	0.25	0.30	0.375	0.50	0.625	0.75
RPDR Performance Limits															
RPDR-42-615-F7	3/4	680	0.84	31	14402	12474	11925	11345	9057	7245					
RPDR-42-620-F10	1		1.11	34	16168	13857	13084	12421	10201	8697					
RPDR-42-625-F15	1½		1.57	36	16848	14450	13687	12460	10688	9444	7991				
RPDR-42-630-F20	2		2.00	40	17652	15010	13917	12774	11322	10204	8751				
RPDR-42-609-C10	1	870	1.21	43	14217	12909	12562	12204	11435	10354	8889	6836			
RPDR-42-613-C15	1½		1.76	43	17100	15685	15307	14927	14120	13055	11451	9248	5983		
RPDR-42-618-C20	2		2.06	48	19782	18231	17820	17409	16323	15126	13430	11066			
RPDR-42-625-C30	3		3.30	55	21556	19467	19083	18698	17665	15743	14280	12748	10019		
RPDR-42-402-B10	1	1160	1.15	67	9651	8301	7827	7494	6750	5485	4541				
RPDR-42-405-B15	1½		1.44	60	13631	12360	12040	11687	10941	10140	8970	7206			
RPDR-42-608-B20	2		2.42	71	17765	16812	16569	16311	15796	15260	14718	13724	11285		
RPDR-42-613-B30	3		3.66	73	22800	21739	21473	21208	20663	20093	19514	18586	16122	13175	10783
RPDR-42-620-B50	5		5.42	87	27581	26356	26050	25738	25112	24419	23467	22144	19658	16427	
RPDR-42-627-F75	7½		7.90	106	29289	27799	27398	26996	26241	25583	24925	23206			
RPDR-48-407-F5	1/2	680	0.56	33	12084	9534	8578	7015	4659						
RPDR-48-412-F7	3/4		0.78	28	15447	12868									
RPDR-48-612-F10	1		1.17	47	16887	15058	14524	13904	12172	9604					
RPDR-48-618-F15	1½		1.75	40	20376	18372	17861	17217	15722	13146					
RPDR-48-623-F20	2	2.29	42	22604	20397	19821	19144	17523	14886						
RPDR-48-630-F30	3	3.26	44	24574	22176	21556	20805	18446	15110	12990					
RPDR-48-404-C7	3/4	870	0.86	37	12326	10408	9882	9227	7081	5552					
RPDR-48-407-C10	1		1.16	44	15460	13608	13081	12554	11153	8810	7026				
RPDR-48-411-C15	1½		1.6	44	19017	17100	16617	16087	14886	13357	10947				
RPDR-48-611-C20	2		2.35	48	20781	19392	19033	18675	17863	16899	15599	12798	9166		
RPDR-48-616-C30	3		3.3	52	24740	23208	22835	22463	21716	20716	19576	17210	12510		
RPDR-48-625-C50	5		5.44	63	29935	28122	27670	27219	26306	25209	23983	21365	16034		
RPDR-48-630-C75	7½	6.84	68	31440	29556	29089	28626	27687	26513	24967	20339	16291			
RPDR-48-402-B15	1½	1160	1.7	58	13075	11690	11330	10937	10015	8892	7495	5720			
RPDR-48-405-B20	2		2.24	72	18115	16674	16335	15996	15231	14412	13419	10766	7692		
RPDR-48-409-B30	3		3.22	71	23111	21700	21357	21013	20315	19537	18755	17254	13165		
RPDR-48-612-B50	5		5.81	84	28807	27732	27464	27195	26661	26126	25591	24613	22560	19581	
RPDR-48-618-B75	7½		8.49	99	34759	33596	33305	33014	32426	31829	31233	30299	28412	25974	
RPDR-48-624-B100	10		11.4	90	39237	37922	37594	37265	36602	35930	35258	34192	32145		
RPDR-54-408-F15	1½	680	1.56	37	18757	16256	15817	15252	13528	11803	9988				
RPDR-54-605-F15			1.47	37	15372	13528	12937	12310	11024	9833	8717	6725			
RPDR-54-412-F20	2		2.19	44	23448	21036	20478	19975	18724	17040	15419	12366			
RPDR-54-609-F20			2.28	39	20828	19100	18586	17998	16760	15658	14372	12226	8830		
RPDR-54-614-F30	3	3.29	45	27131	25358	24904	24450	23195	22042	20882	18836				
RPDR-54-622-F50	5	5.61	61	35052	33002	32458	31915	30683	29336	27626	25674	21873			
RPDR-54-630-F75	7½	7.83	58	39868	37356	36782	36208	34918	33249	31118	28695				
RPDR-54-408-C30	3	870	3.27	58	23998	21915	21371	20987	20300	19383	17956	16148	12532		
RPDR-54-415-C50	5		5.23	70	32838	31114	30648	30182	29249	28189	27059	25422	22179		
RPDR-54-422-C75	7½		8.47	75	40692	38668	38211	37755	36841	35888	34745	32728	28582		
RPDR-54-617-C75			8.18	81	38959	37368	36977	36605	35860	35115	34153	32712	30409		
RPDR-54-622-C100	10	11.36	100	44846	43262	42867	42456	41606	40756	39817	38281	35163	32619	29704	

Performance shown is for Model RPDR without ducts or filters. *Sones shown apply to the highest cataloged cfm at each fan rpm. For selections at other cfm and static pressure points, refer to the CAPS computerized selection program.

Numbers in blue have a larger Bhp and require the next size larger motor.

Belt Drive Model Number Code

The model number system is designed to completely identify the fan. The correct code letters must be specified to designate belt drive with exhaust, supply or filtered supply air configuration. The remainder

of the model number is determined by the size and performance selected from the following pages.

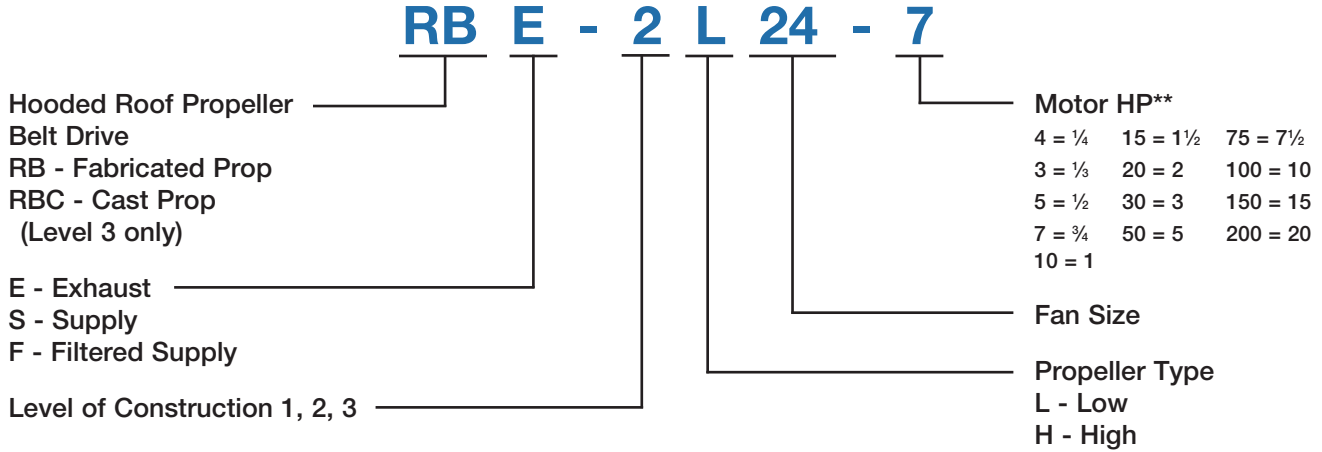

Reversible Model Number Code

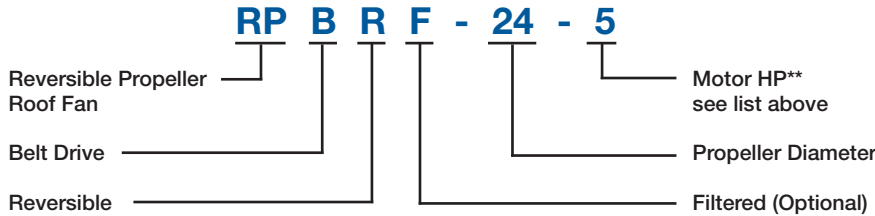

Using The Performance Table

Shown below is a portion of a typical performance table used in this catalog. Performance data shown offers the best selections for each propeller type ("L" or "H") relative to sound, RPM and static pressure.

Consider "L" type propellers first for most applications.

When using the performance tables, look first at the "L" selections, because they offer the lowest speed and sound levels. Many applications can be met with the "L" type propeller.

Model Number	Motor HP	Fan RPM	Max BHP	*Sones	CFM / Static Pressure in Inches WG												
					0.00	0.10	0.125	0.15	0.20	0.25	0.30	0.375	0.50	0.625	0.75	1.00	
Level 1 Performance					Max RPM			L - 696		H - 895		Max Motor Frame Size - 56				TS = RPM x 7.854	
RBE-L30-4	1/4	382	0.15	9.9	5454												
		449	0.25	11.4	6411	4506	3791										
		476	0.30	12.1	6797	5144	4417	3784									
RBE-H30-4	1/4	493	0.15	11.4	302	3487	3001	2317									
		579	0.25	14.1	4638	4576	4285	3917	2793	2366							
		617	0.30	16.0	6010	5022	4754	4455	3686	2783							

"L" type low pressure propeller

"H" type high pressure propeller

Shows level of construction based on fan RPM and motor frame size. See performance pages.

Note that each max. Bhp is cataloged at a 1.0 and 1.2 service factor. See Basics of Fan Selection.

Optimum selection range for the "L" type propeller.

Optimum selection range for the "H" type propeller.

CFM values shown in black are the most efficient selections. Values shown in gray are not recommended.

Belt Drive Exhaust

RBE-20

Model Number	Motor HP	Fan RPM	Max BHP	*Sones	CFM / Static Pressure in Inches WG													
					0.00	0.10	0.125	0.15	0.20	0.25	0.30	0.375	0.50	0.625	0.75	1.00		
Level 1 Performance		Max RPM	L - 1025	H - 1348	Max Motor Frame Size - 145T						TS = RPM x 5.235							
RBE-1L20-4	1/4	653	0.16	11.2	2883	2284	2043											
		768	0.25	12.7	3390	2932	2796	2589										
		817	0.31	13.4	3607	3177	3059	2908	2523									
RBE-1H20-4	1/4	856	0.15	16.9	2550	2176	2077	1976	1744	1341								
		1007	0.25	18.1	2999	2687	2606	2521	2351	2168	1844	1442						
		1075	0.30	18.7	3202	2908	2836	2758	2599	2439	2253	1767						
RBE-1L20-3	1/3	845	0.34	13.8	3730	3314	3206	3085	2712									
		894	0.40	14.6	3947	3553	3456	3346	3037	2687								
RBE-1H20-3	1/3	1117	0.33	19.3	3327	3044	2975	2902	2749	2595	2434	1992						
		1175	0.40	20	3500	3230	3164	3098	2954	2808	2661	2400	1725					
RBE-1L20-5	1/2	963	0.50	15.7	4251	3885	3795	3704	3483	3154								
		1025	0.60	16.9	4525	4180	4095	4010	3825	3562	3255							
RBE-1H20-5	1/2	1284	0.50	22	3824	3577	3516	3456	3331	3198	3065	2863	2253					
		1348	0.60	24	4015	3778	3721	3664	3549	3422	3296	3104	2733	2094				
Level 2 Performance		Max RPM	L - 1171	H - 1550	Max Motor Frame Size - 145T						TS = RPM x 5.235							
RBE-2L20-5	1/2	963	0.50	15.7	4251	3885	3795	3704	3483	3154	2830	2244	1498					
		1025	0.60	16.9	4525	4180	4095	4010	3825	3562	3255	2794	1941					
RBE-2H20-5	1/2	1284	0.50	22	3824	3577	3516	3456	3331	3198	3065	2863	2253					
		1348	0.60	24	4015	3778	3721	3664	3549	3422	3296	3104	2733	2094				
RBE-2L20-7	3/4	1102	0.75	18.7	4865	4543	4464	4385	4228	4042	3767	3340	2482	1863				
		1171	0.90	21	5169	4866	4791	4717	4569	4409	4212	3807	3135	2341	1759			
RBE-2H20-7	3/4	1451	0.75	27	4322	4101	4048	3994	3888	3777	3660	3482	3181	2643	2170			
		1550	0.90	31	4617	4410	4359	4309	4209	4109	4002	3837	3560	3244	2638			

CFM values shown in black are the most efficient selections. Values shown in gray are not recommended.

Performance certified is for model RBE exhaust for installation type A: free inlet, free outlet. Power rating (Bhp) does not include transmission losses. Performance ratings include the effects of appurtenances (Birdscreen).

The sound ratings shown are loudness values in fan sones at 5 feet (1.5 m) in a hemispherical free field calculated per AMCA Standard 301. Values shown are for installation type A: free inlet hemispherical sone levels. The AMCA Certified Ratings Sound Seal applies to sone ratings only.

*Sones shown apply to the highest cataloged cfm in black type at each fan RPM. For selections at other cfm and static pressure points, refer to the CAPS computerized selection program.

Belt Drive Exhaust

RBE-24



Model Number	Motor HP	Fan RPM	Max BHP	*Sones	CFM / Static Pressure in Inches WG														
					0.00	0.10	0.125	0.15	0.20	0.25	0.30	0.375	0.50	0.625	0.75	1.00			
Level 1 Performance		Max RPM	L - 809	H - 1152	Max Motor Frame Size - 145T						TS = RPM x 6.283								
RBE-1L24-4	1/4	493	0.15	11.1	3911	2832	2512												
		579	0.25	12.1	4594	3740	3480	3181											
		616	0.30	12.6	4887	4116	3864	3608	3095										
RBE-1H24-4	1/4	728	0.15	12.1	3417	2825	2661	2491											
		856	0.25	15.4	4018	3552	3403	3254	2976	2643									
		909	0.30	16.7	4266	3836	3705	3562	3296	3014	2611								
RBE-1L24-3	1/3	635	0.33	12.9	5038	4308	4057	3820	3302										
		678	0.40	13.6	5379	4736	4492	4265	3783	3342									
RBE-1H24-3	1/3	939	0.33	17.2	4407	3995	3873	3735	3472	3210	2908								
		1001	0.40	19.2	4698	4321	4207	4088	3830	3594	3336	2766							
RBE-1L24-5	1/2	730	0.50	14.6	5792	5214	5017	4791	4377	3907	3519								
		775	0.60	15.7	6149	5604	5461	5249	4844	4426	4015								
RBE-1H24-5	1/2	1080	0.50	22	5069	4732	4626	4520	4288	4057	3839	3469							
		1152	0.60	29	5407	5101	5003	4904	4698	4473	4264	3945							
RBE-1L24-7	3/4	809	0.68	16.6	6418	5895	5767	5588	5191	4813	4383								
Level 2 Performance		Max RPM	L - 888	H - 1311	Max Motor Frame Size - 145T						TS = RPM x 6.283								
RBE-2L24-5	1/2	730	0.50	14.6	5792	5214	5017	4791	4377	3907	3519	2606							
		775	0.60	15.7	6149	5604	5461	5249	4844	4426	4015	3266	2073						
RBE-2H24-5	1/2	1080	0.60	22	5069	4732	4626	4520	4288	4057	3839	3469	2633	1963					
		1152	0.60	29	5407	5101	5003	4904	4698	4473	4264	3945	3155	2556	1872				
RBE-2L24-7	3/4	835	0.75	17.2	6625	6117	5993	5845	5452	5091	4687	4144	2914						
		888	0.90	19.2	7045	6567	6450	6333	5991	5636	5293	4721	3650	2683					
RBE-2H24-7	3/4	1235	0.84	31	5796	5511	5432	5340	5155	4952	4742	4456	3925	3132	2603				
		1311	0.90	34	6153	5884	5817	5734	5560	5383	5184	4901	4430	3759	3144	1986			
Level 3 Performance		Max RPM	L - 1278	H - 1461	Max Motor Frame Size - 145T						TS = RPM x 6.283								
RBE-3L24-7	3/4	952	0.50	18.6	5460	5020	4907	4793	4577	4279	3934								
		1094	0.75	23	6274	5895	5797	5698	5501	5313	5075	4661							
		1161	0.90	24	6658	6303	6210	6117	5931	5750	5571	5202	4385						
RBE-3H24-7	3/4	1087	0.53	19.4	5222	4787	4670	4554	4326	4083	3830	3329	2272	1768					
		1249	0.78	23	6001	5631	5529	5427	5225	5027	4819	4501	3779	2734	2295				
		1327	0.90	25	6375	6031	5936	5840	5648	5461	5274	4975	4432	3493	2758				
RBE-3L24-10	1	1203	1.00	25	6899	6558	6468	6378	6199	6020	5850	5522	4830						
		1278	1.20	26	7329	7010	6926	6841	6672	6503	6338	6082	5502	4640					
RBE-3H24-10	1	1375	1.07	26	6606	6273	6185	6093	5907	5725	5545	5261	4756	3995	3034	2236			
		1461	1.20	29	7019	6706	6628	6541	6367	6193	6023	5766	5313	4800	3901	2764			

CFM values shown in black are the most efficient selections. Values shown in gray are not recommended.

Performance certified is for model RBE exhaust for installation type A: free inlet, free outlet. Power rating (Bhp) does not include transmission losses. Performance ratings include the effects of appurtenances (Birdscreen).

The sound ratings shown are loudness values in fan sones at 5 feet (1.5 m) in a hemispherical free field calculated per AMCA Standard 301. Values shown are for installation type A: free inlet hemispherical sone levels. The AMCA Certified Ratings Sound Seal applies to sone ratings only.

*Sones shown apply to the highest cataloged cfm in black type at each fan RPM. For selections at other cfm and static pressure points, refer to the CAPS computerized selection program.

Numbers in blue have a larger Bhp and require the next size larger motor.

Belt Drive Exhaust

RBE-30



Model Number	Motor HP	Fan RPM	Max BHP	*Sones	CFM / Static Pressure in Inches WG													
					0.00	0.10	0.125	0.15	0.20	0.25	0.30	0.375	0.50	0.625	0.75	1.00		
Level 1 Performance		Max RPM	L - 696	H - 895	Max Motor Frame Size - 184T						TS = RPM x 7.854							
RBE-1L30-4	1/4	382	0.15	9.9	5454													
		449	0.25	11.4	6411	4506	3791											
		476	0.30	12.1	6797	5144	4417	3784										
RBE-1H30-4	1/4	493	0.15	11.4	4802	3487	3001	2317										
		579	0.25	14.1	5639	4576	4285	3917	2793	2366								
		617	0.30	16.0	6010	5022	4754	4455	3686	2783								
RBE-1L30-3	1/3	491	0.33	12.5	7011	5487	4778	4133										
		523	0.40	13.5	7468	6053	5536	4877										
RBE-1H30-3	1/3	634	0.33	16.3	6175	5218	4958	4691	3968	2965	2589							
		682	0.40	19.2	6643	5762	5524	5281	4716	3947	3115							
RBE-1L30-5	1/2	563	0.50	14.8	8039	6744	6385	5830	4681									
		599	0.60	15.9	8553	7350	7016	6672	5512									
RBE-1H30-5	1/2	733	0.50	20	7139	6329	6109	5886	5429	4829	3992	3163						
		780	0.60	22	7597	6844	6638	6431	6008	5520	4917	3669						
RBE-1L30-7	3/4	646	0.75	17.8	9224	8125	7820	7509	6634	5613								
		686	0.90	19.4	9795	8773	8488	8199	7573	6556	5651							
RBE-1H30-7	3/4	836	0.75	24	8143	7445	7258	7065	6675	6279	5786	4851	3537					
		895	0.90	23	8717	8072	7899	7722	7361	6992	6611	5871	4176					
RBE-1L30-10	1	696	0.95	19.8	9938	8931	8653	8370	7789	6795	5882							
Level 2 Performance		Max RPM	L - 864	H - 1125	Max Motor Frame Size - 184T						TS = RPM x 7.854							
RBE-2L30-7	3/4	646	0.75	17.8	9224	8125	7820	7509	6634	5613	4748	3597						
		686	0.90	19.4	9795	8773	8488	8199	7573	6556	5651	4512						
RBE-2H30-7	3/4	836	0.83	24	8143	7445	7258	7065	6675	6279	5786	4851	3537	2808	1877			
		895	0.90	23	8717	8072	7899	7722	7361	6992	6611	5871	4176	3510	2772			
RBE-2L30-10	1	710	1.00	20	10138	9152	8884	8606	8038	7127	6203	5042	3158					
		754	1.20	22	10766	9841	9601	9340	8810	8166	7243	6015	4342					
RBE-2H30-10	1	915	1.09	22	8912	8283	8114	7942	7589	7230	6869	6187	4404	3736	3065			
		980	1.16	25	9545	8965	8807	8648	8322	7992	7655	7106	5902	4449	3840	2395		
RBE-2L30-15	1½	813	1.51	25	11608	10755	10534	10307	9822	9326	8642	7371	5672	4110				
		864	1.81	28	12337	11537	11329	11121	10675	10214	9746	8597	6789	5337	3697			
RBE-2H30-15	1½	1063	1.69	29	10354	9827	9681	9535	9242	8938	8633	8166	7237	5881	4760	3632		
		1125	1.80	34	10958	10462	10329	10191	9915	9632	9345	8907	8114	7084	5500	4359		
Level 3 Performance		Max RPM	L - 996	H - 1239	Max Motor Frame Size - 184T						TS = RPM x 7.854							
RBE-3L30-15	1½	817	1.00	23	9566	8908	8744	8548	8144	7739	7294	6182	4166	3210				
		938	1.50	28	10982	10410	10267	10123	9798	9446	9094	8537	7045	4976	4222			
		996	1.80	30	11661	11122	10987	10852	10573	10241	9910	9412	8026	6430	5042	3449		
RBE-3H30-15	1½	923	1.01	24	9638	8982	8816	8650	8279	7892	7481	6880	5837	4622	3377			
		1060	1.52	29	11069	10500	10356	10211	9921	9600	9264	8739	7864	6963	5956	3785		
		1125	1.80	31	11748	11213	11077	10940	10668	10388	10072	9595	8755	7947	7063	5049		
RBE-3H30-20	2	1168	2.00	33	12197	11681	11551	11420	11157	10895	10599	10143	9339	8554	7733	5855		
		1239	2.41	36	12938	12452	12331	12207	11960	11712	11459	11029	10290	9534	8799	7147		

CFM values shown in black are the most efficient selections. Values shown in gray are not recommended.

Performance certified is for model RBE exhaust for installation type A: free inlet, free outlet. Power rating (Bhp) does not include transmission losses. Performance ratings include the effects of appurtenances (Birdscreen).

The sound ratings shown are loudness values in fan sones at 5 feet (1.5 m) in a hemispherical free field calculated per AMCA Standard 301. Values shown are for installation type A: free inlet hemispherical sone levels. The AMCA Certified Ratings Sound Seal applies to sone ratings only.

*Sones shown apply to the highest cataloged cfm in black type at each fan RPM. For selections at other cfm and static pressure points, refer to the CAPS computerized selection program.

Numbers in blue have a larger Bhp and require the next size larger motor.

Belt Drive Exhaust

RBE-36



Model Number	Motor HP	Fan RPM	Max BHP	*Sones	CFM / Static Pressure in Inches WG														
					0.00	0.10	0.125	0.15	0.20	0.25	0.30	0.375	0.50	0.625	0.75	1.00			
Level 1 Performance		Max RPM	L - 551	H - 679	Max Motor Frame Size - 184T						TS = RPM x 9.424								
RBE-1L36-3	1/3	326	0.25	11.1	8055	5191													
		358	0.33	11.0	8846	6334	5591												
		382	0.40	11.4	9439	7135	6430	5787											
RBE-1H36-3	1/3	403	0.25	8.3	7760	5632	4935	4069											
		442	0.33	9.6	8511	6597	6072	5422	3682										
		472	0.40	10.6	9089	7300	6832	6303	4991	3516									
RBE-1L36-5	1/2	411	0.50	12.5	10155	8027	7458	6773											
		437	0.60	13.5	10798	8807	8285	7706	6544										
RBE-1H36-5	1/2	508	0.50	11.6	9782	8078	7710	7260	6190	4514	3600								
		540	0.60	12.6	10399	8757	8429	8047	7133	6003	4474								
RBE-1L36-7	3/4	471	0.75	14.4	11638	9806	9321	8836	7690	6720									
		500	0.90	15.3	12354	10641	10185	9728	8735	7698									
RBE-1H36-7	3/4	582	0.75	14.8	11207	9636	9331	9026	8268	7339	6248	4413							
		617	0.90	15.9	11881	10364	10070	9783	9133	8357	7426	5354							
RBE-1L36-10	1	518	1.00	16.1	12799	11153	10713	10272	9368	8290	7431								
		551	1.21	17.7	13614	12080	11667	11254	10425	9480	8542								
RBE-1H36-10	1	640	1.00	17.1	12324	10842	10551	10274	9691	8975	8112	6600							
		679	1.20	19.2	13075	11644	11361	11096	10574	9946	9244	7949	5287						
Level 2 Performance		Max RPM	L - 693	H - 856	Max Motor Frame Size - 184T						TS = RPM x 9.424								
RBE-2L36-10	1	518	1.00	16.1	12799	11153	10713	10272	9368	8290	7431	5096							
		550	1.20	17.6	13590	12053	11638	11224	10394	9445	8509	6827	3401						
RBE-2H36-10	1	640	1.00	17.1	12324	10842	10551	10274	9691	8975	8112	6600							
		679	1.20	19.2	13075	11644	11361	11096	10574	9946	9244	7949	5287						
RBE-2L36-15	1½	593	1.51	20	14652	13225	12860	12476	11707	10937	10005	8780	5624						
		630	1.81	22	15566	14216	13894	13534	12811	12086	11319	10009	7555	4590					
RBE-2H36-15	1½	732	1.50	22	14096	12724	12461	12199	11714	11229	10604	9552	7203	5161					
		778	1.81	26	14982	13651	13404	13157	12686	12230	11728	10845	8976	6420					
RBE-2L36-20	2	652	2.00	24	16110	14801	14490	14155	13457	12757	12056	10788	8961	5723					
		693	2.40	27	17123	15884	15591	15298	14644	13986	13327	12256	10416	7791	5177				
RBE-2H36-20	2	806	2.01	28	15521	14213	13974	13736	13272	12832	12392	11548	9871	7307	5769				
		856	2.40	34	16484	15209	14985	14760	14311	13893	13479	12777	11342	9566	7133				
Level 3 Performance		Max RPM	L - 922	H - 1357	Max Motor Frame Size - 184T						TS = RPM x 9.424								
RBE-3L36-20	2	689	1.57	23	14330	13423	13184	12942	12445	11898	11193	9948	7624	5080	3792				
		757	2.00	26	15744	14919	14712	14492	14053	13588	13090	12113	10014	8009	5630				
		805	2.40	29	16743	15966	15772	15574	15160	14747	14288	13542	11835	9788	6994	4634			
RBE-3H36-20	2	857	1.51	27	13552	12869	12698	12532	12187	11600	11140	10354	8812	6740	4949				
		941	2.00	32	14880	14258	14102	13947	13644	13287	12752	12134	10784	9369	7449				
		1000	2.40	34	15813	15228	15081	14935	14647	14361	13942	13231	12213	10883	9382	5957			
RBE-3L36-30	3	866	3.00	33	18011	17290	17109	16929	16551	16167	15781	15128	13741	11945	10171	6265			
		922	3.61	37	19176	18498	18329	18159	17814	17453	17092	16516	15416	13927	12092	7865			
RBE-3H36-30	3	1077	3.00	38	17031	16487	16351	16215	15944	15679	15414	14763	13832	12634	11499	8313			
		1144	3.60	41	18090	17578	17450	17322	17066	16815	16565	16105	15080	14291	13018	10499			
RBE-3H36-50	5	1277	5.00	49	20194	19735	19620	19506	19276	19047	18821	18485	17719	16823	16146	14042			
		1357	6.01	55	21459	21027	20919	20811	20595	20380	20164	19848	19309	18381	17651	15848			

Performance certified is for model RBE exhaust for installation type A: free inlet, free outlet. Power rating (Bhp) does not include transmission losses. Performance ratings include the effects of appurtenances (Birdscreen).

The sound ratings shown are loudness values in fan sones at 5 feet (1.5 m) in a hemispherical free field calculated per AMCA Standard 301. Values shown are for installation type A: free inlet hemispherical sone levels. The AMCA Certified Ratings Sound Seal applies to sone ratings only.

*Sones shown apply to the highest cataloged cfm in black type at each fan RPM. For selections at other cfm and static pressure points, refer to the CAPS computerized selection program.

Numbers in blue have a larger Bhp and require the next size larger motor.

Belt Drive Exhaust

RBE-42

Model Number	Motor HP	Fan RPM	Max BHP	*Sones	CFM / Static Pressure in Inches WG													
					0.00	0.10	0.125	0.20	0.25	0.375	0.50	0.625	0.75	1.00	1.25	1.50		
Level 2 Performance					Max RPM			H - 888			Max Motor Frame Size - 184T			TS = RPM x 10.995				
RBE-2H42-5	1/2	338	0.35	10.0	10491	7567	6870	3292										
		388	0.52	12.2	12043	9565	8865	6384	4240									
		413	0.60	13.3	12819	10452	9881	7890	5765									
RBE-2H42-7	3/4	445	0.82	14.8	13812	11567	11094	9415	7879	3494								
		473	0.90	16.1	14681	12532	12081	10509	9442	5072								
RBE-2H42-10	1	490	1.04	16.9	15209	13151	12672	11181	10228	6062								
		519	1.20	18.5	16109	14193	13669	12362	11369	7910	4331							
RBE-2H42-15	1½	560	1.55	20	17381	15645	15142	13930	13000	10496	6627							
		594	1.81	23	18437	16832	16358	15130	14371	12281	8772	5623						
RBE-2H42-20	2	616	2.09	24	19119	17593	17136	15897	15214	13155	10263	6842						
		655	2.40	27	20330	18932	18502	17239	16597	14671	12586	9239	6401					
RBE-2H42-30	3	706	3.07	33	21913	20664	20265	19069	18371	16739	14982	12594	9400					
		749	3.60	39	23247	22085	21735	20608	19856	18439	16659	14991	12204	6980				
RBE-2H42-50	5	836	5.34	56	25948	24906	24646	23663	22990	21508	20163	18571	17206	12150	7724			
		888	5.98	71	27562	26581	26336	25461	24827	23301	22117	20659	19266	15631	10644	6871		
Level 3 Performance					Max RPM		L - 868		H - 898		Max Motor Frame Size - 215T			TS = RPM x 10.995				
RBE-3L42-30	3	601	2.18	21	19413	18211	17825	16666	15751	12990	9256	7507	5607					
		689	3.30	25	22256	21256	20964	19954	19280	17106	14750	11100	9392	6222				
		733	3.61	28	23677	22737	22502	21562	20928	19150	16915	14449	11200	8409	4992			
RBE-3H42-30	3	621	2.02	21	18031	16701	16370	15355	14771	12938	11049	8668	5826					
		713	3.53	25	20703	19490	19242	18331	17758	16406	14769	13170	11268	6536	4320			
		764	3.61	28	22184	21021	20790	20007	19392	18212	16763	15119	13691	8876	5796			
RBE-3L42-50	5	816	5.69	34	26358	25514	25303	24548	23979	22557	20709	18749	16590	11605	9230	6165		
		868	6.01	39	28038	27244	27046	26394	25859	24522	23097	21119	19272	13887	11311	8837		
RBE-3H42-50	5	851	5.33	33	24710	23618	23407	22785	22264	21046	19930	18622	17149	14348	9781	6945		
		898	6.01	37	26074	25040	24812	24222	23791	22526	21581	20362	19109	16508	13339	9159		

CFM values shown in black are the most efficient selections. Values shown in gray are not recommended.

Belt Drive Exhaust

RBE-48

Model Number	Motor HP	Fan RPM	Max BHP	*Sones	CFM / Static Pressure in Inches WG													
					0.00	0.10	0.125	0.20	0.25	0.375	0.50	0.625	0.75	1.00	1.25	1.50		
Level 2 Performance					Max RPM			H - 734			Max Motor Frame Size - 184T			TS = RPM x 12.566				
RBE-2H48-5	1/2	277	0.33	8.6	12379	8262	7088											
		318	0.50	10.8	14211	10766	9784	6372										
		338	0.60	11.8	15105	11907	11003	8166	5287									
RBE-2H48-7	3/4	364	0.75	13.4	16267	13349	12526	9827	8053									
		387	0.90	14.7	17295	14544	13822	11369	9720									
RBE-2H48-10	1	399	1.00	15.5	17831	15143	14487	12163	10486	5191								
		426	1.21	17.7	19038	16477	15925	13826	12263	7670								
RBE-2H48-15	1½	457	1.52	18.9	20423	17987	17472	15648	14296	10799	5668							
		487	1.80	20	21764	19430	18946	17343	16095	12737	8301							
RBE-2H48-20	2	505	2.01	21	22568	20306	19822	18341	17150	13880	10318							
		536	2.41	23	23954	21883	21317	20000	18915	15972	13014	8492						
RBE-2H48-30	3	578	3.01	26	25831	23992	23387	22097	21241	18614	15691	13000	8525					
		614	3.62	30	27440	25779	25209	23867	23101	20742	18116	15504	12139					
RBE-2H48-50	5	683	4.98	39	30523	29088	28650	27204	26515	24645	22422	20022	17649	11162				
		726	6.05	47	32445	31095	30758	29321	28605	26984	24938	22812	20437	15888	9261			
		734	6.05	49	32802	31467	31134	29729	28991	27388	25394	23296	20980	16755	9957			
Level 3 Performance					Max RPM		L - 690		H - 842		Max Motor Frame Size - 215T			TS = RPM x 12.566				
RBE-3L48-30	3	476	2.04	17.7	22859	20984	20370	18513	17254	12637	9907	7097						
		547	3.03	25	26268	24645	24240	22661	21583	18730	14418	11985	9718					
		584	3.63	28	28045	26525	26145	24755	23753	21196	17918	14271	12197	7369				
RBE-3H48-30	3	509	2.32	18.8	21653	19775	19280	17840	16878	14449	11185	6812	4901					
		585	3.55	23	24886	23279	22849	21566	20738	18641	16528	14175	10017	5511				
		624	3.61	28	26545	25050	24650	23440	22655	20702	18721	16740	13767	7564				
RBE-3L48-50	5	650	5.36	30	31214	29849	29507	28412	27512	25242	22879	19766	16328	12478	7952			
		690	6.02	32	33135	31849	31527	30562	29743	27622	25451	23022	19395	15045	11406	6525		
RBE-3H48-50	5	693	5.40	29	29480	28135	27798	26710	25984	24230	22456	20673	18889	13150	8218			
		742	6.00	32	31565	30308	29994	28996	28318	26659	25020	23354	21688	18066	11715	8110		
RBE-3H48-75	7½	795	7.71	40	33819	32646	32353	31442	30809	29239	27717	26173	24617	21508	16584	11165		
		842	9.01	45	35819	34711	34434	33592	32994	31499	30055	28614	27145	24209	21031	15499		

CFM values shown in black are the most efficient selections. Values shown in gray are not recommended.

Performance certified is for model RBE exhaust for installation type A: free inlet, free outlet. Power rating (Bhp) does not include transmission losses. Performance ratings include the effects of appurtenances (Birdscreen).

The sound ratings shown are loudness values in fan sones at 5 feet (1.5 m) in a hemispherical free field calculated per AMCA Standard 301. Values shown are for installation type A: free inlet hemispherical sone levels. The AMCA Certified Ratings Sound Seal applies to sone ratings only.

*Sones shown apply to the highest cataloged cfm in black type at each fan RPM. For selections at other cfm and static pressure points, refer to the CAPS computerized selection program.

Numbers in blue have a larger Bhp and require the next size larger motor.

Belt Drive Exhaust RBE-54



Model Number	Motor HP	Fan RPM	Max BHP	*Sones	CFM / Static Pressure in Inches WG													
					0.00	0.10	0.125	0.20	0.25	0.375	0.50	0.625	0.75	1.00	1.25	1.50		
Level 2 Performance					Max RPM H - 557			Max Motor Frame Size - 184T					TS = RPM x 14.135					
RBE-2H54-10	1	280	0.78	11.9	18851	14568	13407	9247	6336									
		307	1.00	13.8	20669	16883	15757	12618	9576									
		326	1.20	15.1	21948	18426	17409	14410	12038	5978								
RBE-2H54-15	1½	352	1.51	17.3	23698	20482	19598	16766	14942	8686								
		374	1.81	19.3	25180	22191	21359	18693	16989	11473								
RBE-2H54-20	2	387	2.11	21	26055	23188	22386	19814	18162	13122	8026							
		411	2.41	23	27671	24993	24258	21904	20279	16261	10535							
RBE-2H54-30	3	443	3.08	27	29825	27370	26704	24608	23058	19416	14657	10047						
		471	3.62	33	31710	29427	28800	26852	25473	21977	18316	13288	9516					
RBE-2H54-50	5	524	4.99	50	35278	33273	32710	31003	29816	26618	23574	20144	15596					
		557	5.99	68	37500	35637	35114	33525	32419	29494	26549	23666	19845	12361				
Level 3 Performance					Max RPM L - 650 H - 795		Max Motor Frame Size - 256T					TS = RPM x 14.135						
RBE-3L54-30	3	394	2.10	22	26909	23779	22959	20206	18192	13008	8641							
		452	3.36	26	30871	28180	27468	25219	23621	18470	14785	10925	6745					
		480	3.61	30	32783	30269	29598	27540	26055	21999	16979	14088	10300					
RBE-3H54-30	3	436	2.00	23	24948	22898	22432	20612	19611	16053	11664	7233						
		501	3.01	28	28667	26830	26425	24988	23931	21363	18312	14607	10306					
		532	3.60	31	30441	28684	28303	27089	26002	23863	20887	17846	14051					
RBE-3L54-50	5	535	5.41	33	36539	34316	33718	31913	30655	27261	23247	18856	16478	9554				
		568	6.02	34	38793	36699	36159	34458	33324	30206	26872	22013	19249	13411				
RBE-3H54-50	5	594	5.01	36	33989	32368	32023	30999	30233	28027	25927	23289	20608	13798				
		631	6.01	40	36106	34580	34224	33260	32617	30439	28709	26282	23906	18164	11501			
RBE-3L54-75	7½	612	7.92	36	41798	39855	39369	37805	36752	33952	30956	27549	23119	18373	12437			
		650	9.27	39	44393	42564	42106	40659	39669	37113	34363	31450	27707	21765	16615	10999		
RBE-3H54-75	7½	679	7.51	45	38852	37435	37080	36167	35570	33736	31909	30184	27776	23148	17215	11522		
		722	9.00	50	41313	39980	39646	38751	38190	36657	34719	33208	31310	27059	22191	16231		
RBE-3H54-100	10	748	10.01	54	42801	41514	41192	40306	39764	38402	36470	34938	33399	29186	24824	19356		
		795	12.00	61	45490	44279	43977	43103	42593	41317	39704	38024	36651	32982	29215	24770		

CFM values shown in black are the most efficient selections. Values shown in gray are not recommended.

Belt Drive Exhaust RBE-60

Level 2 Performance					Max RPM H - 559			Max Motor Frame Size - 215T					TS = RPM x 15.691					
RBE-2H60-15	1½	296	1.03	14.9	23150	18962	17812	14223	11132									
		340	1.51	18.6	26591	22990	22044	19035	16979									
		360	1.80	21	28156	24770	23882	21078	19201	13270								
RBE-2H60-20	2	373	2.01	22	29172	25909	25061	22389	20551	15125								
		392	2.40	24	30658	27561	26767	24274	22493	17755								
RBE-2H60-30	3	427	3.00	27	33396	30557	29837	27598	26026	22035	16942							
		450	3.63	29	35195	32502	31826	29718	28287	24464	20142	14973						
RBE-2H60-50	5	502	5.03	33	39261	36843	36244	34402	33124	29778	26406	22367	17733					
		536	6.03	36	41921	39655	39093	37383	36208	33163	29935	26659	22581					
RBE-2H60-75	7½	559	7.00	39	43719	41547	41005	39377	38264	35387	32285	29285	25738	14495				
Level 3 Performance					Max RPM L - 582 H - 677		Max Motor Frame Size - 256T					TS = RPM x 15.691						
RBE-3L60-50	5	369	3.37	20	35914	32231	31102	27861	25816	18779	14586	9917						
		434	5.12	23	42240	39241	38413	35554	33678	29245	23078	19060	15268					
		462	6.03	28	44966	42187	41409	38794	37025	32914	27914	22136	19290	11822				
RBE-3H60-50	5	427	3.00	24	33396	30557	29837	27598	26026	22035	16942							
		502	5.03	30	39261	36843	36244	34402	33124	29778	26406	22367	17733					
		536	6.03	33	41921	39655	39093	37383	36208	33163	29935	26659	22581					
RBE-3L60-75	7½	497	7.71	37	48372	45838	45115	42788	41118	37163	33215	27852	23262	17019				
		528	9.02	37	51389	49048	48367	46269	44691	40833	37313	33026	27644	21503	14952			
RBE-3H60-75	7½	575	7.51	37	44971	42858	42330	40753	39673	36888	33914	30964	27758	19794				
		614	9.02	41	48021	46043	45548	44073	43075	40493	37809	34967	32254	25387				
RBE-3L60-100	10	547	10.42	38	53238	51003	50348	48376	46857	43106	39664	35968	30958	23888	17760			
		582	12.10	43	56645	54544	53978	52124	50801	47250	43881	40629	36745	27742	22857	16919		
RBE-3H60-100	10	632	10.00	43	49429	47507	47026	45594	44630	42134	39575	36813	34140	27883	19549			
		677	12.00	49	52948	51154	50706	49366	48472	46186	43809	41335	38757	33604	27050			

CFM values shown in black are the most efficient selections. Values shown in gray are not recommended.

Performance certified is for model RBE exhaust for installation type A: free inlet, free outlet. Power rating (Bhp) does not include transmission losses. Performance ratings include the effects of appurtenances (Birdscreen).

The sound ratings shown are loudness values in fan sones at 5 feet (1.5 m) in a hemispherical free field calculated per AMCA Standard 301. Values shown are for installation type A: free inlet hemispherical sone levels. The AMCA Certified Ratings Sound Seal applies to sone ratings only.

*Sones shown apply to the highest cataloged cfm in black type at each fan RPM. For selections at other cfm and static pressure points, refer to the CAPS computerized selection program.

Numbers in blue have a larger Bhp and require the next size larger motor.

Belt Drive Exhaust

RBE-72



Model Number	Motor HP	Fan RPM	Max BHP	*Sones	CFM / Static Pressure in Inches WG													
					0.00	0.10	0.125	0.20	0.25	0.375	0.50	0.625	0.75	1.00	1.25	1.50		
Level 3 Performance		Max RPM	L - 508	H - 530	Max Motor Frame Size - 256T							TS = RPM x 18.802						
RBE-3L72-20	2	223	1.6	16.4	36120	28338	25951	18327	13349									
		245	2.01	18.6	39684	32769	30791	23682	19643	8142								
		261	2.41	20	42275	35821	34064	27764	22914	12416								
RBE-3H72-20	2	266	1.53	16.6	32832	27962	26612	21777	17274									
		292	2.02	19	36042	31687	30478	26666	23225									
		310	2.41	21	38263	34232	33080	29545	26840	16096								
RBE-3L72-30	3	280	3.11	23	45353	39381	37804	32337	28109	18519								
		297	3.61	25	48107	42515	41029	36254	32309	23453	12879							
RBE-3H72-30	3	334	3.02	23	41226	37577	36497	33283	31028	23252								
		355	3.63	25	43818	40468	39451	36447	34355	27879	17579							
RBE-3L72-50	5	332	5.48	29	53776	48853	47523	43463	40522	31480	24068	14381						
		353	6	31	57177	52563	51345	47594	44890	36937	29057	21236	13105					
RBE-3H72-50	5	396	5.03	30	48878	46017	45121	42399	40616	35891	29151	19316						
		420	6.01	32	51841	49143	48392	45814	44127	39746	34315	27129						
RBE-3L72-75	7½	380	7.98	33	61550	57281	56182	52710	50365	43472	35429	29582	21117					
		403	9.01	35	65276	61264	60229	56993	54803	48851	41508	34102	28368	14011				
RBE-3H72-75	7½	453	7.54	36	55914	53413	52787	50454	48867	44905	40749	34841	27475					
		481	9.02	40	59370	57014	56425	54338	52837	49153	45263	40639	34817					
RBE-3L72-100	10	418	11.01	37	67706	63847	62849	59755	57643	52013	45200	37717	32765	17620				
		445	12.1	41	72079	68466	67534	64673	62689	57568	51667	45017	38036	26379	14297			
RBE-3H72-100	10	498	10.02	43	61468	59193	58624	56676	55226	51655	47951	43965	38550	23339				
		530	12.1	49	65418	63280	62746	61040	59678	56300	52917	49364	45127	33918				
RBE-3L72-150	15	479	16.2	46	77586	74230	73385	70771	68941	64334	59295	53357	47095	36917	23487			
		508	18	52	82283	79119	78328	75876	74199	69854	65283	60221	54396	42796	32808	20643		
RBE-3H72-150	15	570	15	54	70355	68367	67870	66379	65174	62008	58907	55677	52373	43416	30699			
		606	18	59	74799	72929	72461	71059	70066	67088	64146	61218	58111	50925	41596	27100		

CFM values shown in black are the most efficient selections. Values shown in gray are not recommended.

Performance certified is for model RBE exhaust for installation type A: free inlet, free outlet. Power rating (Bhp) does not include transmission losses. Performance ratings include the effects of appurtenances (Birdscreen).

The sound ratings shown are loudness values in fan Sones at 5 feet (1.5 m) in a hemispherical free field calculated per AMCA Standard 301. Values shown are for installation type A: free inlet hemispherical sone levels. The AMCA Certified Ratings Sound Seal applies to sone ratings only.

*Sones shown apply to the highest cataloged cfm in black type at each fan RPM. For selections at other cfm and static pressure points, refer to the CAPS computerized selection program.

Numbers in blue have a larger Bhp and require the next size larger motor.

Belt Drive Cast Aluminum Exhaust

RBCE-24—36



Model Number	Motor HP	Fan RPM	Max BHP	*Sones	CFM / Static Pressure in Inches WG												
					0.00	0.10	0.125	0.15	0.20	0.25	0.30	0.375	0.50	0.625	0.75	1.00	
24 Performance		Max RPM H - 1605			Max Motor Frame Size - 145T						TS = RPM x 6.283						
RBCE-3H24-3	1/3	830	0.25	12.4	4483	3870	3719	3546	3133	2625	1585	1038					
		912	0.33	14.4	4926	4366	4230	4093	3757	3377	2905	1657	827				
		972	0.40	15.8	5250	4729	4593	4469	4186	3844	3472	2335	1305				
RBCE-3H24-5	1/2	1048	0.50	16.8	5661	5183	5053	4930	4692	4408	4083	3527	1876	1154			
		1113	0.60	17.7	6012	5560	5445	5323	5103	4857	4572	4104	2494	1661	980		
RBCE-3H24-7	3/4	1199	0.75	19.6	6476	6052	5955	5843	5626	5425	5185	4773	3970	2296	1664		
		1274	0.90	22	6882	6478	6386	6291	6078	5887	5684	5329	4650	3733	2228	1040	
RBCE-3H24-10	1	1320	1.00	23	7130	6738	6650	6561	6358	6166	5984	5658	5014	4233	2562	1415	
		1402	1.20	26	7573	7199	7116	7033	6852	6659	6487	6207	5642	5003	4159	2056	
RBCE-3H24-15	1½	1511	1.50	31	8162	7809	7732	7654	7500	7321	7146	6908	6444	5880	5255	2863	
		1605	1.80	37	8669	8332	8259	8187	8041	7885	7716	7481	7075	6588	6049	4420	
30 Performance		Max RPM H - 1476			Max Motor Frame Size - 184T						TS = RPM x 7.854						
RBCE-3H30-5	1/2	665	0.33	12	6533	5397	5067	4701	3942	2621	1861						
		764	0.50	14.1	7506	6535	6281	5993	5375	4754	3587	2441					
		812	0.60	15.4	7978	7067	6832	6580	6024	5431	4786	3173					
RBCE-3H30-7	3/4	875	0.75	17.4	8597	7756	7538	7320	6831	6294	5747	4777	2707				
		930	0.90	19.3	9137	8350	8144	7940	7506	7029	6505	5730	3550	2041			
RBCE-3H30-10	1	963	1.00	21	9461	8704	8505	8307	7904	7448	6955	6210	4039	2753			
		1023	1.20	22	10051	9342	9155	8968	8596	8188	7756	7044	5739	3716	2328		
RBCE-3H30-15	1½	1102	1.50	24	10827	10175	10002	9828	9481	9136	8741	8117	7030	5146	3786		
		1171	1.80	25	11505	10897	10733	10570	10243	9918	9579	9016	7993	6890	4823	2464	
RBCE-3H30-20	2	1213	2.00	27	11917	11334	11176	11018	10702	10388	10075	9538	8568	7588	5887	3373	
		1289	2.40	30	12664	12116	11972	11824	11526	11230	10935	10466	9594	8658	7655	4625	
RBCE-3H30-30	3	1389	3.00	36	13647	13138	13011	12874	12598	12323	12048	11637	10869	10026	9164	6298	
		1476	3.61	41	14501	14023	13903	13781	13522	13262	13003	12616	11935	11188	10361	8625	
36 Performance		Max RPM H - 1591			Max Motor Frame Size - 184T						TS = RPM x 9.424						
RBCE-3H36-7	3/4	693	0.50	17.1	9832	8385	7982	7550	6708	5725	4048						
		796	0.75	20	11293	10056	9727	9381	8642	7914	7112	5487					
		845	0.90	22	11988	10829	10526	10207	9532	8837	8142	6925					
RBCE-3H36-10	1	876	1.00	23	12428	11313	11021	10722	10086	9408	8747	7636					
		930	1.20	25	13194	12148	11876	11600	11017	10391	9761	8811	6671				
RBCE-3H36-15	1½	1002	1.50	27	14216	13249	12999	12745	12223	11674	11079	10209	8601	5925			
		1065	1.80	30	15110	14204	13969	13733	13252	12743	12213	11378	9998	8226			
RBCE-3H36-20	2	1103	2.00	31	15649	14777	14550	14322	13860	13379	12880	12071	10749	9220	6745		
		1172	2.40	33	16628	15812	15598	15384	14953	14516	14049	13320	12069	10781	9173		
RBCE-3H36-30	3	1263	3.01	37	17919	17168	16969	16771	16374	15970	15562	14908	13743	12598	11344	7283	
		1342	3.61	40	19040	18338	18151	17964	17591	17215	16833	16238	15178	14083	12990	10251	
RBCE-3H36-50	5	1497	5.01	45	21239	20612	20452	20285	19950	19615	19280	18766	17868	16909	15923	13956	
		1591	6.01	50	22572	21982	21835	21681	21366	21050	20735	20257	19438	18573	17639	15808	

Performance certified is for model RBCE exhaust for installation type A: free inlet, free outlet. Power rating (Bhp) does not include transmission losses. Performance ratings include the effects of appurtenances (Birdscreen).

The sound ratings shown are loudness values in fan sones at 5 feet (1.5 m) in a hemispherical free field calculated per AMCA Standard 301. Values shown are for installation type A: free inlet hemispherical sone levels. The AMCA Certified Ratings Sound Seal applies to sone ratings only.

*Sones shown apply to the highest cataloged cfm at each fan rpm. For selections at other cfm and static pressure points, refer to the CAPS computerized selection program.

Belt Drive Cast Aluminum Exhaust

RBCE-42-72



Model Number	Motor HP	Fan RPM	Max BHP	*Sones	CFM / Static Pressure in Inches WG											
					0.00	0.10	0.125	0.20	0.25	0.375	0.50	0.625	0.75	1.00	1.25	1.50
42 Performance					Max RPM H - 1238			Max Motor Frame Size - 215T					TS = RPM x 10.995			
RBCE-3H42-10	1	620	0.75	17.3	13701	11858	11361	9776	8517	4001						
		681	1.00	19.7	15049	13395	12945	11579	10554	7347						
		724	1.20	22	15999	14447	14040	12760	11868	9118	5073					
RBCE-3H42-15	1½	780	1.50	24	17237	15800	15434	14258	13461	11155	8145	4001				
		830	1.80	27	18342	16995	16651	15565	14821	12800	10286	6815				
RBCE-3H42-20	2	859	2.00	28	18982	17683	17351	16313	15596	13694	11413	8405	4645			
		911	2.40	30	20132	18910	18597	17638	16962	15256	13238	10809	7565			
RBCE-3H42-30	3	983	3.00	33	21723	20594	20305	19433	18817	17244	15540	13562	11224	4851		
		1043	3.60	36	23049	21985	21717	20895	20337	18860	17357	15631	13653	8237		
RBCE-3H42-50	5	1164	5.01	42	25722	24770	24531	23801	23310	22023	20696	19343	17796	14149	9092	
		1238	6.01	47	27358	26462	26238	25557	25095	23913	22668	21413	20072	16964	13130	7889
48 Performance					Max RPM H - 1299			Max Motor Frame Size - 215T					TS = RPM x 12.566			
RBCE-3H48-20	2	716	1.50	26	20726	18695	18077	16305	15035	11320	6243					
		787	2	30	22781	20988	20454	18833	17730	14693	10874	6074				
		836	2.4	33	24199	22498	22068	20506	19528	16806	13526	9417	4866			
RBCE-3H48-30	3	901	3.01	36	26081	24484	24118	22707	21781	19345	16622	13352	9283			
		957	3.6	38	27702	26183	25838	24592	23680	21459	19070	16209	12924			
RBCE-3H48-50	5	1068	5.01	45	30915	29524	29215	28258	27429	25456	23390	21237	18700	12639		
		1135	6.01	50	32854	31527	31236	30362	29655	27749	25888	23886	21748	16626	10065	
RBCE-3H48-75	7½	1222	7.5	58	35373	34128	33845	33034	32493	30694	29005	27200	25334	21056	15907	9598
		1299	9.01	67	37602	36431	36143	35380	34871	33292	31648	30046	28305	24604	20260	14857
54 Performance					Max RPM H - 968			Max Motor Frame Size - 256T					TS = RPM x 14.135			
RBCE-3H54-30	3	532	1.99	22	24860	22718	22185	20702	19470	15727	11392					
		611	3.01	26	28552	26683	26219	24873	24014	21307	17904	14094	10436			
		648	3.60	28	30281	28517	28080	26784	25974	23630	20733	17182	13651			
RBCE-3H54-50	5	724	5.02	32	33833	32252	31859	30685	29920	28107	25806	23143	19990	13677		
		769	6.02	36	35935	34447	34075	32970	32233	30511	28535	26204	23524	17507	11235	
RBCE-3H54-75	7½	828	7.51	40	38692	37310	36965	35936	35252	33609	32021	29987	27747	22424	16893	
		880	9.02	45	41122	39822	39497	38526	37882	36299	34808	33110	31170	26552	21244	16164
RBCE-3H54-100	10	911	10.00	48	42571	41315	41001	40062	39440	37888	36447	34939	33090	28913	23848	18844
		968	12.00	56	45235	44052	43757	42870	42285	40822	39428	38072	36508	32833	28458	23599
60 Performance					Max RPM H - 814			Max Motor Frame Size - 256T					TS = RPM x 15.691			
RBCE-3H60-50	5	517	3.08	25	32940	30485	29879	28146	26950	23106	18254	13380				
		608	5.01	32	38738	36639	36124	34579	33612	30975	27690	23760	19477			
		646	6.01	34	41159	39183	38695	37240	36296	34028	31105	27739	23811	15973		
RBCE-3H60-75	7½	696	7.52	38	44345	42510	42052	40701	39801	37681	35274	32431	29182	21805	14227	
		740	9.03	42	47148	45423	44991	43716	42870	40836	38820	36297	33489	26823	19970	
RBCE-3H60-100	10	766	10.02	44	48805	47138	46721	45486	44668	42680	40772	38444	35848	29727	22992	16147
		814	12	49	51863	50294	49902	48734	47965	46050	44255	42335	40041	34764	28467	22272
72 Performance					Max RPM H - 714			Max Motor Frame Size - 256T					TS = RPM x 18.802			
RBCE-3H72-75	7½	464	4.95	29	50660	46744	45715	42627	40365	33143	26752	10599				
		533	7.51	34	58193	54819	53945	51256	49464	44440	37857	32422	20045			
		567	9.04	38	61905	58734	57940	55413	53728	49262	43510	37958	32427			
RBCE-3H72-100	10	587	10.03	40	64089	61026	60260	57835	56208	51980	46771	40991	36055	13429		
		624	12.04	44	68128	65247	64526	62277	60746	56919	52645	46994	42022	27563		
RBCE-3H72-150	15	672	15	50	73369	70693	70024	67976	66554	63000	59236	54816	49539	40631	19366	
		714	18	56	77955	75436	74807	72914	71576	68231	64867	61125	56486	47522	37081	

Performance certified is for model RBCE exhaust for installation type A: free inlet, free outlet. Power rating (Bhp) does not include transmission losses. Performance ratings include the effects of appurtenances (Birdscreen).

The sound ratings shown are loudness values in fan sones at 5 feet (1.5 m) in a hemispherical free field calculated per AMCA Standard 301. Values shown are for installation type A: free inlet hemispherical sone levels. The AMCA Certified Ratings Sound Seal applies to sone ratings only.

*Sones shown apply to the highest cataloged cfm at each fan rpm. For selections at other cfm and static pressure points, refer to the CAPS computerized selection program.

Belt Drive Supply

RBS-20



Model Number	Motor HP	Fan RPM	Max BHP	Sones	CFM / Static Pressure in Inches WG														
					0.00	0.10	0.125	0.15	0.20	0.25	0.30	0.375	0.50	0.625	0.75	1.00			
Level 1 Performance		Max RPM	L - 1052	H - 1366	Max Motor Frame Size - 145T						TS = RPM x 5.235								
RBS-1L20-4	1/4	669	0.15	14.3	3389	2474	2123												
		786	0.25	16.3	3981	3294	3049	2770											
		835	0.30	17.2	4230	3586	3399	3151	2587										
RBS-1H20-4	1/4	870	0.16	17.8	2755	2352	2244	2103	1795										
		1023	0.25	19.5	3239	2907	2814	2723	2508	2270									
		1084	0.30	20	3432	3127	3035	2949	2769	2543	2319								
RBS-1L20-3	1/3	862	0.33	17.7	4366	3746	3581	3347	2822										
		919	0.40	18.8	4655	4078	3923	3753	3289	2764									
RBS-1H20-3	1/3	1122	0.33	21	3552	3263	3172	3088	2921	2710	2493								
		1193	0.40	22	3777	3515	3429	3345	3188	3015	2810	2470							
RBS-1L20-5	1/2	990	0.50	20	5015	4486	4341	4198	3826	3380									
		1052	0.60	22	5329	4838	4701	4566	4269	3868	3424								
RBS-1H20-5	1/2	1291	0.50	24	4088	3855	3779	3699	3549	3404	3236	2952							
		1366	0.60	26	4325	4106	4043	3968	3821	3684	3546	3283	2772						
Level 2 Performance		Max RPM	L - 1205	H - 1564	Max Motor Frame Size - 145T						TS = RPM x 5.235								
RBS-2L20-5	1/2	990	0.50	20	5015	4486	4341	4198	3826	3380									
		1052	0.60	22	5329	4838	4701	4566	4269	3868	3424								
RBS-2H20-5	1/2	1291	0.50	24	4088	3855	3779	3699	3549	3404	3236	2952							
		1366	0.60	26	4325	4106	4043	3968	3821	3684	3546	3283	2772						
RBS-2L20-7	3/4	1134	0.75	24	5744	5297	5170	5043	4793	4474	4094	3460							
		1205	0.90	27	6104	5690	5571	5451	5214	4976	4632	4076							
RBS-2H20-7	3/4	1477	0.75	31	4676	4474	4423	4361	4221	4090	3963	3760	3347						
		1564	0.88	34	4952	4760	4712	4665	4534	4404	4284	4104	3732	3345					

CFM values shown in black are the most efficient selections. Values shown in gray are not recommended.

Performance certified is for model RBS supply for installation type A: free inlet, free outlet. Power rating (Bhp) does not include transmission losses. Performance ratings include the effects of appurtenances (Birdscreen).
 The sound ratings shown are loudness values in fan sones at 5 feet (1.5 m) in a hemispherical free field calculated per AMCA Standard 301. Values shown are for installation type A: free outlet hemispherical sone levels. The AMCA Certified Ratings Sound Seal applies to sone ratings only.
 *Sones shown apply to the highest cataloged cfm in black type at each fan RPM. For selections at other cfm and static pressure points, refer to the CAPS computerized selection program.

Belt Drive Supply

RBS-24

Model Number	Motor HP	Fan RPM	Max BHP	Sones	CFM / Static Pressure in Inches WG														
					0.00	0.10	0.125	0.15	0.20	0.25	0.30	0.375	0.50	0.625	0.75	1.00			
Level 1 Performance		Max RPM	L - 809	H - 1157	Max Motor Frame Size - 145T							TS = RPM x 6.283							
RBS-1L24-4	1/4	495	0.15	11.6	4501	3083	2469												
		582	0.25	12.9	5292	4271	3873	3387											
		619	0.30	13.6	5628	4677	4371	3968	3008										
RBS-1H24-4	1/4	726	0.15	11.8	3626	3093	2862	2563	1776										
		853	0.25	15.8	4261	3825	3703	3571	3077	2524	1955								
		914	0.30	19.1	4565	4156	4059	3936	3583	3122	2460								
RBS-1L24-3	1/3	638	0.33	13.9	5801	4881	4615	4249	3313										
		680	0.40	14.7	6183	5326	5098	4813	4049	3167									
RBS-1H24-3	1/3	943	0.33	19.8	4710	4312	4218	4107	3825	3355	2852								
		1006	0.40	22	5025	4649	4561	4473	4250	3872	3458	2503							
RBS-1L24-5	1/2	733	0.50	16.3	6665	5878	5667	5455	4852	4050	3273								
		779	0.60	17.9	7083	6364	6151	5952	5477	4819	4019								
RBS-1H24-5	1/2	1083	0.50	24	5410	5057	4975	4893	4708	4500	4079	3474							
		1157	0.60	25	5779	5445	5369	5292	5140	4945	4702	4125	2862						
RBS-1L24-7	3/4	809	0.67	18.9	7356	6677	6463	6271	5862	5269									
Level 2 Performance		Max RPM	L - 891	H - 1322	Max Motor Frame Size - 145T							TS = RPM x 6.283							
RBS-2L24-5	1/2	733	0.50	16.3	6665	5878	5667	5455	4852	4050	3273	1835							
		779	0.60	17.9	7083	6364	6151	5952	5477	4819	4019	2672							
RBS-2H24-5	1/2	1083	0.58	24	5410	5057	4975	4893	4708	4500	4079	3474	2411	1870					
		1157	0.60	25	5779	5445	5369	5292	5140	4945	4702	4125	2862	2355	1849				
RBS-2L24-7	3/4	839	0.75	20	7629	6988	6778	6588	6219	5707	5061	3980	1991						
		891	0.90	23	8102	7522	7325	7129	6782	6382	5843	4841	2866						
RBS-2H24-7	3/4	1230	0.75	29	6144	5828	5754	5683	5539	5377	5193	4725	3808	2814	2338				
		1322	0.90	37	6603	6309	6237	6170	6036	5902	5740	5484	4652	3599	2926	2025			
Level 3 Performance		Max RPM	L - 1278	H - 1420	Max Motor Frame Size - 145T							TS = RPM x 6.283							
RBS-3L24-7	3/4	951	0.50	22	6030	5614	5481	5348	5049	4591	3955								
		1093	0.75	27	6930	6577	6485	6369	6138	5899	5542	4739							
		1161	0.90	28	7361	7029	6946	6849	6631	6413	6152	5565	4383						
RBS-3H24-7	3/4	1063	0.49	22	5575	5215	5120	5024	4827	4572	4212	3446	2285						
		1221	0.77	25	6403	6090	6012	5931	5764	5597	5384	4992	3921	2925	1911				
		1299	0.90	28	6813	6518	6444	6371	6215	6058	5893	5580	4685	3787	2768				
RBS-3L24-10	1	1205	1.00	30	7640	7320	7240	7157	6947	6738	6527	6036	4861						
		1278	1.20	31	8103	7801	7726	7650	7467	7269	7071	6706	5641	4663					
RBS-3H24-10	1	1346	1.00	29	7059	6775	6704	6632	6484	6333	6182	5893	5205	4213	3302				
		1420	1.20	31	7447	7178	7110	7043	6906	6762	6619	6379	5852	4866	4121	2320			

CFM values shown in black are the most efficient selections. Values shown in gray are not recommended.

Performance certified is for model RBS supply for installation type A: free inlet, free outlet. Power rating (Bhp) does not include transmission losses. Performance ratings include the effects of appurtenances (Birdscreen).

The sound ratings shown are loudness values in fan sones at 5 feet (1.5 m) in a hemispherical free field calculated per AMCA Standard 301. Values shown are for installation type A: free outlet hemispherical sone levels. The AMCA Certified Ratings Sound Seal applies to sone ratings only.

*Sones shown apply to the highest cataloged cfm in black type at each fan RPM. For selections at other cfm and static pressure points, refer to the CAPS computerized selection program.

Numbers in blue have a larger Bhp and require the next size larger motor.

Model Number	Motor HP	Fan RPM	Max BHP	Sones	CFM / Static Pressure in Inches WG														
					0.00	0.10	0.125	0.15	0.20	0.25	0.30	0.375	0.50	0.625	0.75	1.00			
Level 1 Performance		Max RPM	L - 696	H - 906	Max Motor Frame Size - 184T						TS = RPM x 7.854								
RBS-1L30-4	1/4	382	0.15	10.9	5857	3056	1565												
		449	0.25	12.6	6885	5115	4215	2987											
		477	0.30	13.4	7314	5769	5045	4099											
RBS-1H30-4	1/4	505	0.17	13.1	5167	3875	3391	2484	1629										
		593	0.29	16.3	6068	5183	4863	4337	3094	2274	1591								
		624	0.30	17.8	6385	5558	5316	4850	3985	2773	2081								
RBS-1L30-3	1/3	493	0.33	13.9	7559	6135	5486	4654	2381										
		525	0.40	15.0	8050	6795	6258	5595	3716										
RBS-1H30-3	1/3	646	0.35	19.0	6610	5815	5587	5260	4419	3116	2431								
		686	0.40	22	7019	6273	6074	5854	5027	4212	3076	2145							
RBS-1L30-5	1/2	466	0.28	13.1	7145	5515	4736	3670											
		601	0.60	17.7	9215	8259	7879	7450	6315	4714	2796								
RBS-1H30-5	1/2	740	0.51	24	7572	6884	6706	6515	5964	5213	4309	3008							
		788	0.60	26	8063	7420	7253	7085	6708	5932	5363	3767	2412						
RBS-1L30-7	3/4	647	0.75	19.7	9921	9101	8772	8403	7518	6343	4714								
		689	0.90	22	10565	9858	9548	9239	8489	7533	6318	3852							
		696	0.90	22	10672	9983	9677	9370	8648	7725	6543	4146							
RBS-1H30-7	3/4	846	0.87	27	8657	8061	7905	7750	7420	7012	6243	5281	3336	2136					
		906	0.90	29	9271	8718	8573	8427	8136	7808	7299	6380	4289	3086					
Level 2 Performance		Max RPM	L - 869	H - 1136	Max Motor Frame Size - 184T						TS = RPM x 7.854								
RBS-2L30-7	3/4	647	0.75	19.7	9921	9101	8772	8403	7518	6343									
		689	0.90	22	10565	9858	9548	9239	8489	7533	6318								
RBS-2H30-7	3/4	846	0.75	27	8657	8061	7905	7750	7420	7012	6243	5281							
		906	0.90	29	9271	8718	8573	8427	8136	7808	7299	6380	4289						
RBS-2L30-10	1	712	1.00	23	10917	10268	9969	9669	8990	8137	7050								
		758	1.20	25	11623	11013	10800	10519	9922	9209	8341								
RBS-2H30-10	1	940	1.00	30	9619	9087	8948	8808	8527	8224	7903	6893	4983						
		991	1.20	31	10140	9637	9508	9375	9109	8840	8536	7751	6391	4453					
RBS-2L30-15	1½	815	1.50	28	12497	11929	11788	11555	11032	10438	9734	8425							
		869	1.81	31	13325	12793	12660	12522	12031	11523	10949	9894							
RBS-2H30-15	1½	1064	1.50	34	10887	10418	10301	10179	9931	9683	9424	8999	7637	6066	4535				
		1136	1.80	38	11624	11185	11075	10965	10733	10501	10269	9887	8793	7720	5659				
Level 3 Performance		Max RPM	L - 995	H - 1243	Max Motor Frame Size - 184T						TS = RPM x 7.854								
RBS-3L30-15	1½	813	0.99	24	10284	9748	9614	9458	9002	8286	7513	6204	3921						
		934	1.50	30	11815	11349	11232	11115	10851	10496	9892	8937	7045	4752	3864				
		995	1.80	33	12587	12149	12039	11930	11711	11406	11012	10134	8432	6625	4791				
RBS-3H30-15	1½	925	0.99	31	9858	9399	9284	9132	8829	8480	8083	7156	5525	4085					
		1063	1.50	39	11329	10930	10830	10730	10484	10220	9954	9435	8157	6701	5497				
RBS-3H30-20	2	1129	1.80	43	12033	11656	11562	11468	11263	11014	10765	10334	9359	7874	6697	4273			
		1170	2.00	46	12470	12106	12016	11925	11743	11503	11263	10883	10054	8734	7441	5166			
		1243	2.40	52	13248	12906	12820	12735	12564	12366	12140	11801	11109	10133	8746	6635			

CFM values shown in black are the most efficient selections. Values shown in gray are not recommended.

Performance certified is for model RBS supply for installation type A: free inlet, free outlet. Power rating (Bhp) does not include transmission losses. Performance ratings include the effects of appurtenances (Birdscreen).

The sound ratings shown are loudness values in fan sones at 5 feet (1.5 m) in a hemispherical free field calculated per AMCA Standard 301. Values shown are for installation type A: free outlet hemispherical sone levels. The AMCA Certified Ratings Sound Seal applies to sone ratings only.

*Sones shown apply to the highest cataloged cfm in black type at each fan RPM. For selections at other cfm and static pressure points, refer to the CAPS computerized selection program.

Numbers in blue have a larger Bhp and require the next size larger motor.

Model Number	Motor HP	Fan RPM	Max BHP	Sones	CFM / Static Pressure in Inches WG														
					0.00	0.10	0.125	0.15	0.20	0.25	0.30	0.375	0.50	0.625	0.75	1.00			
Level 1 Performance		Max RPM	L - 551	H - 621	Max Motor Frame Size - 184T						TS = RPM x 9.424								
RBS-1L36-3	1/3	324	0.25	11.9	8911	5112													
		356	0.33	12.4	9792	6728	5349												
		380	0.40	12.9	10452	7802	6634	5250											
RBS-1H36-3	1/3	368	0.25	9.7	8146	5071	3751	2929											
		404	0.33	10.5	8942	6145	5438	4138											
		431	0.40	11.1	9540	6902	6270	5591	3593										
RBS-1L36-5	1/2	410	0.50	13.6	11277	9182	8064	6946											
		435	0.60	14.4	11964	10237	9193	8194	5827										
RBS-1H36-5	1/2	464	0.50	12.1	10270	7877	7219	6621	4696	3393									
		493	0.60	13.5	10912	8747	8023	7475	6307	4396									
RBS-1L36-7	3/4	469	0.75	15.8	12899	11566	10734	9720	7793										
		497	0.90	17.0	13670	12501	11877	11012	9214	7172									
RBS-1H36-7	3/4	531	0.75	14.8	11753	10433	9176	8540	7499	5909	4507								
		564	0.90	17.0	12484	11262	10368	9517	8480	7459	5612								
RBS-1L36-10	1	516	1.00	18.1	14192	13129	12638	11851	10082	8278									
		548	1.21	20.0	15072	14174	13722	13155	11525	9918	8074								
		551	1.21	20	15155	14271	13822	13275	11664	10069	8256								
RBS-1H36-10	1	585	1.00	18.4	12949	11784	11445	10152	9077	8116	6693	4741							
		621	1.20	21	13746	12671	12352	11584	10077	9206	8271	5959							
Level 2 Performance		Max RPM	L - 690	H - 783	Max Motor Frame Size - 184T						TS = RPM x 9.424								
RBS-2L36-10	1	516	1.00	18.1	14192	13129	12638	11851	10082	8278									
		548	1.21	20	15072	14174	13722	13155	11525	9918	8074								
RBS-2H36-10	1	585	1.00	18.4	12949	11784	11445	10152	9077	8116	6693	4741							
		621	1.20	21	13746	12671	12352	11584	10077	9206	8271	5959							
RBS-2L36-15	1½	590	1.50	23	16228	15490	15108	14688	13443	11857	10344								
		628	1.81	26	17273	16580	16343	15949	14997	13594	12170	9930							
RBS-2H36-15	1½	669	1.50	24	14808	13840	13544	13248	11527	10567	9753	8441	5249						
		711	1.80	28	15738	14846	14575	14296	12942	11761	10962	9770	6679						
RBS-2L36-20	2	650	2.00	28	17878	17208	17041	16670	15879	14597	13153	11072							
		690	2.41	33	18978	18347	18190	17970	17252	16276	14986	13056	9351						
RBS-2H36-20	2	737	2.01	30	16313	15453	15208	14939	14402	12556	11691	10571	7535	5483					
		783	2.41	35	17331	16521	16319	16067	15561	13933	13011	11918	10084	7068					
Level 3 Performance		Max RPM	L - 919	H - 1417	Max Motor Frame Size - 184T						TS = RPM x 9.424								
RBS-3L36-20	2	688	1.51	27	15058	14240	14004	13768	12994	12063	11040	9728	7209						
		756	2.00	32	16546	15814	15611	15396	14967	14135	13290	11933	9885	7388					
		804	2.40	35	17596	16908	16734	16533	16129	15553	14758	13499	11564	9594	6192				
RBS-3H36-20	2	895	1.53	35	13789	13213	13032	12850	12486	12097	11635	10657	8923	6978	5274				
		983	2.01	42	15144	14620	14484	14318	13987	13653	13298	12623	11126	9498	7713				
		1044	2.40	46	16084	15591	15467	15327	15015	14703	14380	13878	12546	11118	9475	6392			
RBS-3L36-30	3	865	3.00	40	18932	18291	18131	17964	17589	17214	16576	15468	13531	11749	9940				
		919	3.60	45	20113	19511	19360	19210	18869	18516	18148	17105	15274	13604	11865	6846			
RBS-3H36-30	3	1125	3.01	51	17332	16874	16760	16645	16366	16077	15787	15330	14355	13051	11699	8636			
		1195	3.60	57	18410	17979	17872	17764	17525	17252	16980	16566	15835	14654	13415	10636			
RBS-3H36-50	5	1333	5.00	71	20536	20150	20053	19957	19764	19543	19298	18932	18304	17648	16589	14365			
		1417	6.00	82	21831	21467	21376	21285	21103	20922	20694	20349	19775	19161	18438	16367			

CFM values shown in black are the most efficient selections. Values shown in gray are not recommended.

Performance certified is for model RBS supply for installation type A: free inlet, free outlet. Power rating (Bhp) does not include transmission losses. Performance ratings include the effects of appurtenances (Birdscreen).

The sound ratings shown are loudness values in fan sones at 5 feet (1.5 m) in a hemispherical free field calculated per AMCA Standard 301. Values shown are for installation type A: free outlet hemispherical sone levels. The AMCA Certified Ratings Sound Seal applies to sone ratings only.

*Sones shown apply to the highest cataloged cfm in black type at each fan RPM. For selections at other cfm and static pressure points, refer to the CAPS computerized selection program.

Numbers in blue have a larger Bhp and require the next size larger motor.

Belt Drive Supply

RBS-42



Model Number	Motor HP	Fan RPM	Max BHP	Sones	CFM / Static Pressure in Inches WG													
					0.00	0.10	0.125	0.20	0.25	0.375	0.50	0.625	0.75	1.00	1.25	1.50		
Level 2 Performance					Max RPM H - 907			Max Motor Frame Size - 184T					TS = RPM x 10.995					
RBS-2H42-5	1/2	335	0.33	11.5	11521	7684	6129											
		385	0.50	14.5	13240	10042	9046	4472										
		410	0.60	16.6	14100	11662	10215	6707										
RBS-2H42-7	3/4	440	0.75	21	15132	13116	11748	8582	5771									
		467	0.90	22	16060	14161	13686	10570	8318									
RBS-2H42-10	1	484	1.00	22	16645	14813	14354	11312	9193									
		515	1.21	24	17711	16111	15559	12739	11503									
RBS-2H42-15	1½	556	1.50	26	19121	17839	17167	14830	13288	8553								
		589	1.81	28	20256	19188	18573	17244	14904	11066								
RBS-2H42-20	2	610	2.01	29	20978	19947	19458	18070	15940	12128	7173							
		649	2.41	33	22319	21350	21081	19587	18521	14892	10690							
RBS-2H42-30	3	698	3.01	38	24004	23103	22878	21487	20828	17081	13685	9309						
		742	3.61	44	25517	24670	24458	23365	22530	19272	16872	13339						
RBS-2H42-50	5	826	4.99	57	28406	27645	27455	26876	25971	24380	20730	18705	15293					
		878	5.99	68	30194	29478	29299	28762	28159	26407	23387	20962	18669	11382				
		907	5.99	75	31192	30498	30325	29805	29365	27526	24974	22349	20586	13856				
Level 3 Performance					Max RPM L - 870 H - 899		Max Motor Frame Size - 215T					TS = RPM x 10.995						
RBS-3L42-30	3	606	2.23	27	20689	19559	19242	18092	17174	13296	10722	5971						
		696	3.11	32	23762	22778	22532	21631	20963	18766	15059	12789	10368					
		735	3.62	35	25094	24161	23928	23134	22502	20684	17936	14566	12816					
RBS-3H42-30	3	622	2.00	30	19600	18510	18291	17325	16491	13247	10535							
		714	3.00	37	22499	21478	21297	20612	20066	17868	15068	12644						
		757	3.60	39	23854	22856	22685	22108	21593	19953	17582	14685	12681					
RBS-3L42-50	5	820	5.03	45	27995	27160	26951	26324	25798	24381	22479	19949	16747	13011				
		870	6.01	53	29703	28915	28718	28127	27706	26371	24914	22796	19835	15729	9555			
RBS-3H42-50	5	842	5.00	49	26532	25567	25414	24955	24567	23351	21390	19395	16679	13140				
		899	6.00	57	28328	27378	27235	26805	26518	25450	24117	22080	19830	15793				

CFM values shown in black are the most efficient selections. Values shown in gray are not recommended.

Belt Drive Supply

RBS-48

Level 2 Performance					Max RPM H - 734			Max Motor Frame Size - 184T					TS = RPM x 12.566					
RBS-2H48-5	1/2	280	0.33	11.4	13918	8846	6160											
		321	0.50	14.1	15956	12566	10607											
		342	0.60	15.7	16999	14136	12585	5910										
RBS-2H48-7	3/4	369	0.76	17.8	18342	15797	14812	9896										
		391	0.87	19.5	19435	17094	16371	12056	7865									
RBS-2H48-10	1	404	1.00	21	20081	17852	17152	13234	10056									
		430	1.20	23	21374	19284	18693	15673	12812									
RBS-2H48-15	1½	463	1.51	25	23014	21039	20607	18454	15820	7340								
		494	1.81	26	24555	22673	22267	20673	18769	12184								
RBS-2H48-20	2	511	2.01	27	25400	23563	23171	21694	20131	14131								
		541	2.40	28	26891	25125	24755	23473	22369	17019	9380							
RBS-2H48-30	3	584	3.01	31	29028	27349	27006	25977	25011	21005	15704							
		620	3.61	33	30818	29199	28876	27906	27133	24212	19224	12739						
RBS-2H48-50	5	690	4.94	39	34297	32833	32482	31611	31031	29124	25736	21202	15788					
		734	6.01	43	36484	35108	34764	33914	33369	31742	29323	25201	21121					
Level 3 Performance					Max RPM L - 689 H - 851		Max Motor Frame Size - 2154T					TS = RPM x 12.566						
RBS-3L48-30	3	476	2.07	27	24129	22316	21760	19065	17416	12829	7428							
		546	3.07	33	27677	26141	25711	23728	22117	18468	14467	9575						
		581	3.60	37	29452	28030	27626	26283	24124	21168	17725	13118	8913					
RBS-3H48-30	3	515	1.98	30	23423	22013	21618	20415	18592	15222	10518							
		591	3.20	36	26880	25651	25344	24313	23615	20028	17309	13483	8407					
		629	3.61	40	28608	27454	27165	26225	25569	22652	19683	16949	12682					
RBS-3L48-50	5	647	5.00	44	32797	31555	31200	30112	29232	25826	22540	19601	15513					
		689	6.02	49	34926	33760	33453	32432	31699	28256	25920	22705	19639	11962				
RBS-3H48-50	5	703	5.20	48	31974	30941	30682	29896	29309	27840	24559	21992	19633	12041				
		744	6.01	53	33839	32862	32618	31886	31351	29964	27366	24516	22497	16655				
RBS-3H48-75	7½	804	7.56	64	36568	35664	35438	34761	34309	33026	31689	28696	26122	22080	15462			
		851	9.03	74	38705	37852	37638	36998	36572	35395	34182	31996	29385	25478	20761	13622		

CFM values shown in black are the most efficient selections. Values shown in gray are not recommended.

Performance certified is for model RBS supply for installation type A: free inlet, free outlet. Power rating (Bhp) does not include transmission losses. Performance ratings include the effects of appurtenances (Birdscreen).

The sound ratings shown are loudness values in fan sones at 5 feet (1.5 m) in a hemispherical free field calculated per AMCA Standard 301. Values shown are for installation type A: free outlet hemispherical sone levels. The AMCA Certified Ratings Sound Seal applies to sone ratings only.

*Sones shown apply to the highest cataloged cfm in black type at each fan RPM. For selections at other cfm and static pressure points, refer to the CAPS computerized selection program.

Numbers in blue have a larger Bhp and require the next size larger motor.

54 Belt Drive Supply

RBS-54

Model Number	Motor HP	Fan RPM	Max BHP	Sones	CFM / Static Pressure in Inches WG													
					0.00	0.10	0.125	0.20	0.25	0.375	0.50	0.625	0.75	1.00	1.25	1.50		
Level 2 Performance					Max RPM H - 562				Max Motor Frame Size - 184T				TS = RPM x 14.135					
RBS-2H54-10	1	280	0.76	14.7	21226	16396	13638	7155										
		307	1.00	17.4	23273	19128	17616	10230	7289									
		326	1.20	19.0	24713	20903	19662	13216	9486									
RBS-2H54-15	1½	352	1.51	22	26684	23213	22245	16788	12833									
		374	1.81	24	28352	25134	24223	20565	16167	8690								
RBS-2H54-20	2	387	2.01	25	29338	26297	25376	22125	17876	10215								
		411	2.41	27	31157	28477	27480	24733	22123	12931								
RBS-2H54-30	3	443	3.02	32	33583	31339	30343	27923	25957	17574	11346							
		470	3.60	37	35630	33720	32782	30365	28709	21375	14422							
RBS-2H54-50	5	524	4.98	49	39723	38020	37571	35118	33817	29590	22202	15960						
		557	6.00	59	42225	40623	40222	38076	36742	33281	26638	20360	15561					
		562	5.96	61	42604	41016	40619	38531	37181	33788	27699	21146	16131					
Level 3 Performance					Max RPM L - 646 H - 779				Max Motor Frame Size - 256T				TS = RPM x 14.135					
RBS-3L54-30	3	391	2.00	24	28170	25018	24058	19981	17151	11221								
		449	3.32	29	32349	29604	28917	26257	23687	17730	12493	6550						
		478	3.61	32	34438	31860	31215	28928	26908	20907	16419	9868						
RBS-3H54-30	3	420	1.88	27	27032	24788	23812	20683	18637	13048								
		482	3.02	34	31023	29327	28634	26119	24241	19836	14716	9660						
		523	3.62	40	33662	32275	31636	29457	27844	23618	19544	14551						
RBS-3L54-50	5	531	5.13	39	38257	35936	35355	33614	32031	26861	21757	17976	11636					
		565	6.00	45	40706	38525	37979	36343	35104	30702	25600	21496	17813	7961				
RBS-3H54-50	5	583	5.02	46	37523	36367	35961	34205	32795	29033	25356	21652	17152					
		610	5.75	48	39261	38156	37880	36242	34952	31436	27832	24450	20368	12255				
RBS-3L54-75	7½	608	7.76	49	43805	41777	41270	39750	38736	35317	30435	25963	22495	12861				
		646	9.03	52	46542	44634	44157	42726	41772	38833	34737	30198	26145	19711	10512			
RBS-3H54-75	7½	667	7.52	57	42930	41919	41667	40413	39410	36342	32966	29733	26667	19063				
		708	9.02	65	45569	44617	44379	43376	42431	39680	36619	33480	30502	23950	16683			
RBS-3H54-100	10	734	10.01	70	47242	46324	46094	45241	44330	41765	38889	35802	32880	26991	19894			
		779	12.00	81	50138	49273	49057	48408	47590	45327	42687	39832	36984	31629	25280	18704		

CFM values shown in black are the most efficient selections. Values shown in gray are not recommended.

Belt Drive Supply

RBS-60

Level 2 Performance					Max RPM H - 559				Max Motor Frame Size - 215T				TS = RPM x 15.691					
RBS-2H60-15	1½	303	1.00	15.3	24579	19882	18165	13512	9183									
		348	1.59	19.5	28230	24246	23177	18964	16389	6961								
		371	1.81	22	30096	26396	25393	21535	19197	11232								
RBS-2H60-20	2	383	2.01	23	31069	27505	26534	22946	20534	13231								
		406	2.41	26	32935	29610	28694	25592	23038	17245	9219							
RBS-2H60-30	3	438	3.01	28	35531	32452	31651	29103	26790	21653	14495							
		464	3.61	31	37640	34734	34007	31615	29751	24587	19189	12201						
RBS-2H60-50	5	518	5.03	36	42020	39417	38766	36709	35273	30666	26397	21318	14867					
		551	6.01	40	44697	42250	41638	39758	38408	34481	30069	26018	20414					
		559	5.95	41	45346	42934	42331	40491	39160	35390	30942	27113	21853					
Level 3 Performance					Max RPM L - 582 H - 695				Max Motor Frame Size - 256T				TS = RPM x 15.691					
RBS-3L60-50	5	370	3.09	27	37981	34515	33198	28782	25731	19197								
		435	5.03	37	44654	41728	40996	37809	35356	28866	23400							
		462	6.02	40	47425	44670	43982	41236	39126	32784	27487	22237						
RBS-3H60-50	5	440	3.05	27	35693	32628	31834	29298	27021	21882	14864							
		517	5.01	34	41939	39331	38679	36616	35177	30548	26284	21141	14713					
		551	6.01	36	44697	42250	41638	39758	38408	34481	30069	26018	20414					
RBS-3L60-75	7½	497	7.50	45	51018	48457	47817	45594	43633	37950	32548	27834	22817					
		529	9.04	50	54303	51897	51295	49491	47667	42746	37215	32540	28063					
RBS-3H60-75	7½	591	7.52	42	47942	45660	45090	43379	42143	38972	34570	30847	26758	16067				
		631	9.01	50	51187	49050	48516	46913	45820	42873	39217	35247	31942	22622				
RBS-3L60-100	10	548	10.06	54	56253	53931	53350	51608	50029	45531	39917	35250	31035					
		582	12.00	54	59743	57557	57010	55370	54205	50017	45052	40248	36007	27724				
RBS-3H60-100	10	649	10.04	54	52647	50569	50050	48492	47453	44593	41264	37255	33969	25862	16130			
		695	12.00	64	56378	54438	53953	52498	51528	48932	46256	42643	39019	32640	23373			

CFM values shown in black are the most efficient selections. Values shown in gray are not recommended.

Performance certified is for model RBS supply for installation type A: free inlet, free outlet. Power rating (Bhp) does not include transmission losses. Performance ratings include the effects of appurtenances (Birdscreen).

The sound ratings shown are loudness values in fan sones at 5 feet (1.5 m) in a hemispherical free field calculated per AMCA Standard 301. Values shown are for installation type A: free outlet hemispherical sone levels. The AMCA Certified Ratings Sound Seal applies to sone ratings only.

*Sones shown apply to the highest cataloged cfm in black type at each fan RPM. For selections at other cfm and static pressure points, refer to the CAPS computerized selection program.

Numbers in blue have a larger Bhp and require the next size larger motor.

Belt Drive Cast Aluminum Supply

RBCS-24—36



Model Number	Motor HP	Fan RPM	Max BHP	Sones @ F.A.	CFM / Static Pressure in Inches WG													
					0.00	0.10	0.125	0.15	0.20	0.25	0.30	0.375	0.50	0.625	0.75	1.00		
24 Performance				Max RPM	H - 1535	Max Motor Frame Size - 145T						TS = RPM x 6.283						
RBCS-3H24-3	1/3	795	0.25	14.6	4722	4231	4110	3984	3299	1781	1086							
		873	0.33	16.1	5186	4736	4626	4516	4224	3360	1978	1025						
		930	0.40	17.3	5524	5101	4998	4895	4688	4267	2957	1693						
RBCS-3H24-5	1/2	1001	0.50	18.8	5946	5551	5456	5360	5168	4932	4448	2566	1098					
		1066	0.60	20	6332	5960	5870	5780	5600	5420	5146	4048	1864					
RBCS-3H24-7	3/4	1147	0.75	23	6813	6466	6382	6299	6131	5964	5796	5327	2838	1562				
		1220	0.90	25	7247	6919	6840	6761	6604	6447	6289	5991	4444	2405	1272			
RBCS-3H24-10	1	1261	1.00	26	7490	7173	7096	7020	6868	6715	6563	6333	5298	2869	1764			
		1342	1.20	29	7971	7673	7599	7527	7385	7242	7099	6884	6351	4247	2697			
RBCS-3H24-15	1½	1444	1.50	33	8577	8300	8231	8162	8030	7897	7764	7564	7213	6409	4025	1894		
		1535	1.80	37	9118	8857	8792	8727	8601	8476	8351	8163	7850	7396	6295	2949		
30 Performance				Max RPM	H - 1445	Max Motor Frame Size - 184T						TS = RPM x 7.854						
RBCS-3H30-5	1/2	652	0.33	15.2	7278	6272	5844	5149	3910	1970								
		749	0.50	19.2	8361	7522	7279	7012	5869	4844	2972							
		796	0.60	22	8886	8098	7896	7647	6786	5799	4729	2337						
RBCS-3H30-7	3/4	857	0.75	23	9567	8838	8651	8456	7989	6948	6076	3769						
		911	0.90	25	10169	9487	9311	9134	8721	8027	7062	5785	2402					
RBCS-3H30-10	1	943	1.00	26	10527	9869	9699	9528	9149	8710	7694	6511	3282					
		1002	1.20	28	11185	10568	10409	10248	9927	9528	8880	7597	4766	2076				
RBCS-3H30-15	1½	1080	1.50	31	12056	11484	11340	11191	10893	10569	10199	9101	7332	4265				
		1147	1.80	34	12804	12265	12130	11993	11712	11432	11099	10500	8590	6780	3833			
RBCS-3H30-20	2	1188	2.00	36	13262	12741	12611	12480	12210	11939	11643	11138	9354	7746	4785			
		1264	2.41	40	14110	13621	13499	13376	13125	12871	12616	12164	10834	9269	7606	2498		
RBCS-3H30-30	3	1360	3.00	47	15182	14727	14613	14500	14271	14035	13798	13435	12700	11084	9700	5255		
		1445	3.60	53	16131	15703	15596	15489	15275	15055	14833	14499	13851	12790	11257	8297		
36 Performance				Max RPM	H - 1488	Max Motor Frame Size - 184T						TS = RPM x 9.424						
RBCS-3H36-7	3/4	648	0.50	22	10280	8914	8516	8065	6680	4767								
		744	0.75	24	11803	10656	10326	9989	9212	8104	6588	3403						
		791	0.90	25	12548	11458	11185	10869	10211	9311	8095	5726						
RBCS-3H36-10	1	819	1.00	26	12992	11933	11690	11385	10759	9991	8982	6904						
		871	1.20	29	13817	12808	12583	12334	11760	11152	10310	8608	4541					
RBCS-3H36-15	1½	938	1.50	33	14880	13926	13718	13509	13005	12462	11896	10622	7651					
		996	1.80	36	15800	14888	14691	14495	14065	13563	13040	12067	9620	6199				
RBCS-3H36-20	2	1032	2.00	38	16371	15490	15292	15103	14716	14232	13738	12929	10805	7852				
		1097	2.41	41	17403	16573	16371	16193	15836	15424	14969	14255	12623	10239	7087			
RBCS-3H36-30	3	1181	3.00	47	18735	17965	17772	17591	17260	16928	16518	15883	14675	12935	10564			
		1255	3.60	53	19909	19184	19003	18821	18502	18190	17862	17265	16230	14828	12941	7598		
RBCS-3H36-50	5	1400	5.00	67	22209	21559	21397	21234	20913	20634	20354	19914	19022	18084	16858	13339		
		1488	6.00	78	23605	22994	22841	22688	22382	22101	21838	21444	20653	19799	18907	16207		

Performance certified is for model RBCS supply for installation type A: free inlet, free outlet. Power rating (Bhp) does not include transmission losses. Performance ratings include the effects of appurtenances (Birdscreen).

The sound ratings shown are loudness values in fan sones at 5 feet (1.5 m) in a hemispherical free field calculated per AMCA Standard 301. Values shown are for installation type A: free outlet hemispherical sone levels. The AMCA Certified Ratings Sound Seal applies to sone ratings only.

*Sones shown apply to the highest cataloged cfm at each fan rpm. For selections at other cfm and static pressure points, refer to the CAPS computerized selection program.

Belt Drive Cast Aluminum Supply

RBCS-42-72



Model Number	Motor HP	Fan RPM	Max BHP	Sones @ F.A.	CFM / Static Pressure in Inches WG													
					0.00	0.10	0.125	0.20	0.25	0.375	0.50	0.625	0.75	1.00	1.25	1.50		
42 Performance					Max RPM H - 1210			Max Motor Frame Size - 215T					TS = RPM x 10.995					
RBCS-3H42-10	1	607	0.76	21	14494	12645	12189	10381	8657									
		667	1.00	25	15927	14239	13825	12300	11186	6444								
		708	1.20	27	16906	15312	14922	13581	12561	9024								
RBCS-3H42-15	1½	762	1.50	29	18195	16693	16347	15242	14257	11548	6870							
		811	1.81	32	19365	17932	17621	16602	15788	13486	10123							
RBCS-3H42-20	2	839	2.00	33	20034	18635	18335	17361	16648	14479	11384	6908						
		893	2.41	37	21323	19985	19703	18807	18188	16204	13971	10641						
RBCS-3H42-30	3	961	3.00	42	22947	21672	21410	20603	20028	18333	16458	13742	10413					
		1021	3.61	46	24380	23156	22906	22165	21627	20188	18391	16458	13650					
RBCS-3H42-50	5	1139	5.00	53	27197	26100	25826	25160	24717	23506	22082	20482	18783	13953				
		1210	6.01	58	28893	27860	27602	26942	26526	25412	24257	22704	21234	17138	11188			
48 Performance					Max RPM H - 1315			Max Motor Frame Size - 215T					TS = RPM x 12.566					
RBCS-3H48-20	2	726	1.51	33	20514	18732	18206	16357	14968	11087	5981							
		797	2.00	37	22521	20912	20488	18936	17724	14581	10549							
		847	2.41	41	23933	22431	22031	20688	19598	16687	13260	9148						
RBCS-3H48-30	3	912	3.00	45	25770	24389	24018	22823	21908	19208	16460	12950	9004					
		970	3.61	49	27409	26123	25774	24697	23893	21471	18950	16027	12577					
RBCS-3H48-50	5	1081	5.00	59	30545	29395	29102	28163	27500	25562	23270	21049	18504	12182				
		1149	6.00	65	32467	31384	31114	30241	29651	27952	25905	23709	21605	16128	9542			
RBCS-3H48-75	7½	1238	7.51	75	34982	33977	33726	32935	32388	30900	29153	27166	25172	20842	15435			
		1315	9.00	86	37158	36212	35975	35247	34733	33393	31867	30112	28148	24420	19684	14353		
54 Performance					Max RPM H - 912			Max Motor Frame Size - 256T					TS = RPM x 14.135					
RBCS-3H54-30	3	501	1.99	27	25648	23380	22606	20561	19091	14486	8587							
		575	3.01	35	29437	27649	27015	25102	23926	20645	16357	11166						
		611	3.61	39	31280	29597	29116	27245	26139	23206	19698	14854	10239					
RBCS-3H54-50	5	681	5.00	44	34863	33354	32976	31433	30336	27830	25065	21834	17547	7482				
		724	6.01	48	37064	35645	35290	33976	32904	30525	28038	25318	21936	13777				
RBCS-3H54-75	7½	780	7.52	55	39931	38614	38284	37244	36249	33930	31724	29347	26769	19571	11876			
		829	9.02	60	42440	41200	40890	39960	39133	36855	34816	32647	30336	24690	17428			
RBCS-3H54-100	10	858	10.01	62	43924	42726	42427	41529	40823	38565	36595	34553	32399	27314	20364	13670		
		912	12.00	67	46689	45562	45280	44435	43871	41818	39860	38007	36019	31746	26163	19488		
60 Performance					Max RPM H - 733			Max Motor Frame Size - 256T					TS = RPM x 15.691					
RBCS-3H60-50	5	465	3.08	30	35105	32774	32192	29702	28334	22686	12143							
		547	5.01	39	41296	39314	38819	37088	35590	32390	27608	18953						
		582	6.02	45	43938	42076	41610	40204	38797	35827	32009	26676	17562					
RBCS-3H60-75	7½	626	7.50	50	47260	45529	45096	43797	42756	39731	36800	32866	27547					
		665	9.00	54	50204	48574	48167	46945	46130	43132	40737	37364	33123	18949				
RBCS-3H60-100	10	690	10.04	57	52092	50521	50128	48950	48165	45436	42975	40082	36587	23624				
		733	12.05	62	55338	53859	53490	52381	51641	49344	46767	44599	41427	33284	18588			
72 Performance					Max RPM H - 720			Max Motor Frame Size - 256T					TS = RPM x 18.802					
RBCS-3H72-75	7½	469	4.98	39	51921	49645	49076	46588	44683	38706	28381							
		538	7.52	47	59560	57576	57080	55540	53880	49446	44122	34897	18789					
		572	9.04	51	63324	61458	60991	59592	58303	54398	49522	43190	34195					
RBCS-3H72-100	10	592	10.02	54	65538	63735	63284	61932	60878	57106	52631	47792	38837					
		629	12.01	58	69634	67937	67513	66240	65392	62048	58269	53714	47878	25521				
RBCS-3H72-150	15	678	15.00	63	75058	73484	73091	71910	71123	68481	65187	61319	57093	43561				
		720	18.00	68	79708	78226	77855	76743	76002	73912	70810	67658	63679	53801	36647			

Performance certified is for model RBCS supply for installation type A: free inlet, free outlet. Power rating (Bhp) does not include transmission losses. Performance ratings include the effects of appurtenances (Birdscreen).

The sound ratings shown are loudness values in fan sones at 5 feet (1.5 m) in a hemispherical free field calculated per AMCA Standard 301. Values shown are for installation type A: free outlet hemispherical sone levels. The AMCA Certified Ratings Sound Seal applies to sone ratings only.

*Sones shown apply to the highest cataloged cfm at each fan rpm. For selections at other cfm and static pressure points, refer to the CAPS computerized selection program.

Belt Drive Filtered Supply

RBF-24



Model Number	Motor HP	Fan RPM	Max BHP	Sones	CFM / Static Pressure in Inches WG														
					0.00	0.10	0.125	0.15	0.20	0.25	0.30	0.375	0.50	0.625	0.75	1.00			
Level 1 Performance		Max RPM	L - 809	H - 1154	Max Motor Frame Size - 145T						TS = RPM x 6.283								
RBF-1L24-4	1/4	497	0.15	12.1	4157	2604													
		584	0.25	13.1	4884	3766	3238	2898											
		620	0.30	13.6	5186	4168	3805	3321											
RBF-1H24-4	1/4	727	0.15	11.6	3469	2867	2639	2409	1651										
		855	0.25	15.9	4079	3648	3492	3275	2892	2341	1817								
		913	0.30	19.1	4356	3955	3849	3666	3294	2924	2290								
RBF-1L24-3	1/3	641	0.33	14.0	5361	4396	4074	3561											
		683	0.40	14.6	5712	4823	4547	4229	3449										
RBF-1H24-3	1/3	941	0.33	19.8	4490	4101	3999	3855	3480	3127	2614								
		1006	0.40	22	4800	4440	4344	4248	3902	3584	3246	2386							
RBF-1L24-5	1/2	736	0.50	15.7	6156	5350	5113	4846	4065										
		781	0.60	17.2	6532	5791	5566	5342	4760	4061									
RBF-1H24-5	1/2	1081	0.50	24	5158	4826	4736	4647	4414	4080	3781	3246							
		1154	0.60	25	5506	5196	5115	5031	4864	4564	4272	3841	2665						
RBF-1L24-7	3/4	809	0.67	18.1	6766	6062	5845	5629	5133	4386									
Level 2 Performance		Max RPM	L - 895	H - 1319	Max Motor Frame Size - 145T						TS = RPM x 6.283								
RBF-2L24-5	1/2	736	0.50	15.7	6156	5350	5113	4846	4065	3454	2687								
		781	0.60	17.2	6532	5791	5566	5342	4760	4061	3335	2467							
RBF-2H24-5	1/2	1081	0.59	24	5158	4826	4736	4647	4414	4080	3781	3246	2215	1707					
		1154	0.60	25	5506	5196	5115	5031	4864	4564	4272	3841	2665	2154	1678				
RBF-2L24-7	3/4	842	0.75	19.1	7042	6379	6170	5962	5507	4813	4290	3241							
		895	0.90	22	7486	6883	6686	6489	6095	5630	4905	4117	2720						
RBF-2H24-7	3/4	1235	0.83	30	5892	5603	5531	5452	5296	5112	4798	4409	3601	2628	2184				
		1319	0.90	37	6293	6022	5955	5885	5739	5592	5372	4965	4337	3320	2684	1833			
Level 3 Performance		Max RPM	L - 1285	H - 1364	Max Motor Frame Size - 145T						TS = RPM x 6.283								
RBF-3L24-7	3/4	956	0.50	22	5613	5146	5002	4851	4329	3951	3552	2736	1693						
		1098	0.75	27	6447	6087	5948	5820	5559	5105	4738	4227	3090	2141					
		1167	0.90	27	6852	6537	6407	6276	6042	5767	5273	4807	3888	2726	2040				
RBF-3H24-7	3/4	1008	0.46	20	5065	4689	4591	4474	4246	4028	3618	2858	1618						
		1158	0.76	23	5818	5495	5410	5326	5131	4930	4741	4321	3251	2200	1046				
		1264	0.90	26	6351	6058	5980	5902	5745	5557	5374	5114	4267	3376	2352				
RBF-3L24-10	1	1209	1.00	29	7099	6807	6683	6557	6326	6078	5660	5148	4361	3234	2398				
		1285	1.20	31	7545	7271	7180	7062	6834	6621	6367	5743	5029	4121	3067	1805			
RBF-3H24-10	1	1310	1.00	27	6582	6300	6225	6150	6000	5827	5645	5393	4764	3762	2939				
		1364	1.20	29	6853	6583	6512	6440	6296	6140	5966	5717	5210	4227	3522	1542			

CFM values shown in black are the most efficient selections. Values shown in gray are not recommended.

Performance certified is for model RBF filtered supply for installation type A: free inlet, free outlet. Power rating (Bhp) does not include transmission losses. Performance ratings include the effects of appurtenances (2 inch (51 mm) filters). The sound ratings shown are loudness values in fan sones at 5 feet (1.5 m) in a hemispherical free field calculated per AMCA Standard 301. Values shown are for installation type A: free outlet hemispherical sone levels. The AMCA Certified Ratings Sound Seal applies to sone ratings only. *Sones shown apply to the highest cataloged cfm in black type at each fan RPM. For selections at other cfm and static pressure points, refer to the CAPS computerized selection program. Numbers in blue have a larger Bhp and require the next size larger motor.

Belt Drive Filtered Supply

RBF-42



Model Number	Motor HP	Fan RPM	Max BHP	Sones	CFM / Static Pressure in Inches WG													
					0.00	0.10	0.125	0.20	0.25	0.375	0.50	0.625	0.75	1.00	1.25	1.50		
Level 2 Performance					Max RPM H - 885			Max Motor Frame Size - 184T					TS = RPM x 10.995					
RBF-2H42-5	1/2	337	0.33	11.6	10546	7071	4718											
		387	0.50	14.3	12111	9685	8377	4205										
		412	0.60	15.8	12893	10576	9475	5137	3732									
RBF-2H42-7	3/4	444	0.75	17.9	13895	11695	11234	8189	5129									
		471	0.90	19.8	14739	12667	12189	9710	6119									
RBF-2H42-10	1	488	1.09	21	15271	13350	12784	10528	8184	3604								
		518	1.20	24	16210	14536	13821	11849	10406	5299								
RBF-2H42-15	1½	559	1.51	27	17493	16062	15458	14116	12366	6846								
		595	1.81	29	18620	17320	16872	15391	14208	9711	5981							
RBF-2H42-20	2	614	2.00	30	19215	17979	17571	16056	15388	11658	6728							
		653	2.41	33	20435	19323	18939	17406	16777	13714	8180	5991						
RBF-2H42-30	3	704	3.17	39	22031	21063	20707	19431	18561	15994	13175	8183	5909					
		747	3.60	44	23377	22517	22183	21122	20121	18667	15472	9758	8050					
RBF-2H42-50	5	833	5.07	52	26068	25297	25104	24200	23531	21715	19413	17185	12624	7979				
		885	5.99	58	27695	26970	26788	26003	25436	23519	22360	19603	17378	10145				
Level 3 Performance					Max RPM L - 870 H - 897		Max Motor Frame Size - 215T					TS = RPM x 10.995						
RBF-3L42-30	3	601	2.02	26	18741	17418	16970	15128	13662	10901	8459							
		690	3.23	32	21516	20364	20076	18729	17660	14751	12416	10308	7671					
		733	3.60	35	22857	21772	21501	20414	19407	16588	14296	12188	10196					
RBF-3H42-30	3	620	2.03	28	18044	17074	16822	15482	14263	11914	9524	5502						
		712	3.01	34	20722	19888	19668	18929	18040	15682	13606	11567	7397					
		756	3.60	36	22003	21219	21015	20395	19700	17344	15284	13641	11447					
RBF-3L42-50	5	818	5.26	42	25508	24536	24293	23564	22765	20498	17922	15916	14020	10230				
		870	6.02	48	27129	26215	25987	25301	24768	22648	20262	18165	16279	12914	8275			
RBF-3H42-50	5	846	5.00	46	24622	23922	23746	23196	22826	21083	19015	17116	15649	10706				
		897	6.01	52	26106	25446	25281	24767	24419	23057	20920	19317	17624	14456	8631			

CFM values shown in black are the most efficient selections. Values shown in gray are not recommended.

Belt Drive Filtered Supply

RBF-48

Level 2 Performance					Max RPM H - 734			Max Motor Frame Size - 184T					TS = RPM x 12.566					
RBF-2H48-5	1/2	279	0.33	11.1	12224	7648	5556											
		320	0.50	13.7	14020	10046	9042											
		340	0.60	15.1	14897	11141	10234	5629										
RBF-2H48-7	3/4	367	0.75	17.1	16080	12665	11741	8467	4935									
		390	0.90	19.0	17087	13937	13012	10534	7368									
RBF-2H48-10	1	404	1.01	20	17701	14702	13806	11391	8838									
		429	1.21	22	18796	16054	15197	12884	11285									
RBF-2H48-15	1½	462	1.51	24	20242	17804	16998	14729	13358	7314								
		491	1.81	26	21513	19322	18556	16327	15048	10442								
RBF-2H48-20	2	508	2.00	26	22258	20208	19456	17293	15997	12133								
		540	2.40	28	23660	21856	21134	19077	17747	14792	9165							
RBF-2H48-30	3	582	3.02	30	25500	23989	23319	21372	20122	17322	13558	7956						
		618	3.60	33	27077	25748	25164	23308	22111	19361	16739	11795						
RBF-2H48-50	5	688	4.98	39	30144	28950	28652	26992	25902	23249	20922	18533	14098					
		731	5.97	43	32028	30904	30624	29229	28177	25656	23317	21151	18386	9605				
		734	6.04	43	32159	31041	30761	29384	28334	25822	23482	21330	18676	9871				
Level 3 Performance					Max RPM L - 689 H - 822		Max Motor Frame Size - 215T					TS = RPM x 12.566						
RBF-3L48-30	3	476	1.99	25	22170	19589	18856	16177	14597	10394								
		547	3.12	32	25477	23244	22672	20669	19069	15640	11774	8540						
		582	3.61	35	27107	25015	24478	22711	21337	17818	14718	11011						
RBF-3H48-30	3	505	2.25	28	20890	19195	18710	16804	15680	12852	7931	4948						
		580	2.90	34	23992	22523	22149	20663	19595	17160	14645	9826	7230					
		623	3.61	38	25771	24406	24059	22868	21811	19443	17270	14684	9996					
RBF-3L48-50	5	648	5.06	41	30181	28313	27832	26383	25238	21898	19097	16248	12786					
		689	6.01	47	32091	30334	29890	28527	27557	24601	21601	19054	16052	10594				
RBF-3H48-50	5	681	5.01	44	28170	26926	26608	25654	24777	22455	20417	18383	15983	9089				
		742	6.02	52	30694	29552	29265	28389	27805	25638	23638	21790	19894	13477	8883			
RBF-3H48-75	7½	795	8.57	60	32886	31820	31554	30739	30194	28336	26387	24608	22906	19057	12321	8532		
		822	9.01	65	34003	32972	32714	31929	31402	29728	27803	26031	24362	20821	14005	10340		

CFM values shown in black are the most efficient selections. Values shown in gray are not recommended.

Performance certified is for model RBF filtered supply for installation type A: free inlet, free outlet. Power rating (Bhp) does not include transmission losses. Performance ratings include the effects of appurtenances (2 inch (51 mm) filters). The sound ratings shown are loudness values in fan sones at 5 feet (1.5 m) in a hemispherical free field calculated per AMCA Standard 301. Values shown are for installation type A: free outlet hemispherical sone levels. The AMCA Certified Ratings Sound Seal applies to sone ratings only. *Sones shown apply to the highest cataloged cfm in black type at each fan rpm. For selections at other cfm and static pressure points, refer to the CAPS computerized selection program.

Numbers in blue have a larger Bhp and require the next size larger motor.

Belt Drive Filtered Supply RBF-54



Model Number	Motor HP	Fan RPM	Max BHP	Sones	CFM / Static Pressure in Inches WG													
					0.00	0.10	0.125	0.20	0.25	0.375	0.50	0.625	0.75	1.00	1.25	1.50		
Level 2 Performance		Max RPM			H - 555			Max Motor Frame Size - 184T					TS = RPM x 14.135					
RBF-2H54-1	1	279	0.76	14.1	19215	14019	12208	7060										
		306	1.00	17.0	21075	16399	15101	9349	7370									
		326	1.21	18.7	22452	18037	16988	11332	9106									
RBF-2H54-15	1½	351	1.51	21	24174	20041	19066	15210	11177									
		373	1.81	23	25689	21844	20854	17724	14182									
RBF-2H54-20	2	386	2.01	25	26585	22895	21895	18998	16216	10013								
		410	2.41	27	28238	24812	23850	21289	19118	12055								
RBF-2H54-30	3	442	3.02	32	30442	27260	26435	23954	22249	14726	11238							
		469	3.61	36	32301	29257	28579	26152	24694	19396	13550							
RBF-2H54-50	5	523	5.00	48	36020	33200	32610	30526	29129	25473	19262	15035						
		555	5.98	57	38224	35513	34956	33110	31690	28553	24051	17674	14947					
Level 3 Performance		Max RPM		L - 646		H - 768		Max Motor Frame Size - 256T					TS = RPM x 14.135					
RBF-3L54-30	3	390	2.01	23	25724	21676	20292	16586	13976	8853								
		448	3.06	28	29550	26282	25230	21680	19648	15002	9899							
		476	3.61	31	31397	28407	27472	24106	22129	17001	13470	8819						
RBF-3H54-30	3	422	2.00	27	25672	22830	22183	19341	17607	12802								
		484	3.01	33	29444	26917	26332	24445	22626	18722	14418							
		514	3.61	36	31269	28877	28307	26709	25123	21328	17462	13047						
RBF-3L54-50	5	531	5.19	38	35024	32510	31671	28925	26844	22430	18310	14940	10421					
		566	6.03	45	37333	35004	34294	31857	29974	25635	20788	18406	14450					
RBF-3H54-50	5	574	5.02	43	34919	32752	32242	30768	29816	26181	22944	19457	15547					
		610	6.02	48	37109	35055	34575	33161	32266	29154	25988	22850	19447					
RBF-3L54-75	7½	608	7.83	48	40103	37935	37393	35205	33548	29229	25419	21489	18990	11626				
		646	9.03	52	42610	40569	40059	38117	36708	32482	28919	24737	22114	15715	10264			
RBF-3H54-75	7½	657	7.53	55	39969	38044	37595	36258	35417	33009	29773	26971	24021	17290				
		698	9.02	62	42463	40652	40211	38953	38131	36174	33133	30359	27665	21814	15042			
RBF-3H54-100	10	723	10.04	67	43984	42235	41799	40584	39774	37883	35208	32369	29828	24310	18000			
		768	12.00	77	46721	45075	44664	43502	42739	40926	38870	36004	33530	28581	23100	16892		

CFM values shown in black are the most efficient selections. Values shown in gray are not recommended.

Belt Drive Filtered Supply RBF-60

Model Number	Motor HP	Fan RPM	Max BHP	Sones	CFM / Static Pressure in Inches WG												
					0.00	0.10	0.125	0.20	0.25	0.375	0.50	0.625	0.75	1.00	1.25	1.50	
Level 2 Performance		Max RPM			H - 559			Max Motor Frame Size - 215T					TS = RPM x 15.691				
RBF-2H60-15	1½	307	1.00	15.4	22637	18147	16725	12243	8168								
		352	1.51	19.5	25955	22077	21068	17425	14831								
		373	1.80	22	27504	23862	22910	19592	17302	9537							
RBF-2H60-20	2	387	2.01	23	28536	25039	24121	21021	18794	11740							
		411	2.40	25	30306	27034	26169	23416	21287	15522	7748						
RBF-2H60-30	3	443	3.02	28	32665	29653	28855	26450	24540	19688	12921						
		471	3.62	30	34730	31896	31171	28908	27305	22703	17420	10648					
RBF-2H60-50	5	525	5.03	36	38712	36169	35534	33535	32182	28285	24199	19226	13095				
		559	6.04	40	41219	38831	38234	36387	35116	31690	27807	23765	18500				
Level 3 Performance		Max RPM		L - 582		H - 703		Max Motor Frame Size - 256T					TS = RPM x 15.691				
RBF-3L60-50	5	370	3.09	26	34863	30428	29156	23864	22393								
		435	5.02	34	40987	37740	36453	33238	31328	25590							
		463	6.03	38	43626	40755	39603	36332	34537	28408	23689						
RBF-3H60-50	5	447	3.10	27	32960	29974	29188	26804	24940	20125	13577						
		525	5.03	34	38712	36169	35534	33535	32182	28285	24199	19226	13095				
		558	6.03	36	41145	38753	38155	36303	35030	31591	27702	23636	18339				
RBF-3L60-75	7½	498	7.52	43	46924	44255	43478	40125	38457	31842	29110	23815					
		529	9.03	48	49844	47332	46704	43690	41859	37629	32243	28255					
RBF-3H60-75	7½	601	7.59	42	44316	42095	41540	39858	38676	35720	32130	28560	24561	14299			
		638	9.01	48	47044	44952	44429	42860	41763	38979	35852	32440	29097	20154	10145		
RBF-3L60-100	10	548	10.02	52	51635	49209	48603	45857	43917	40125	34127	31495	26428				
		582	12.00	56	54838	52555	51984	49686	47763	43985	37441	35103	31384				
RBF-3H60-100	10	661	10.25	53	48740	46721	46216	44702	43663	40976	38118	34802	31567	23834	14202		
		703	12.00	61	51837	49938	49464	48040	47091	44574	42047	39057	35960	29533	20850	11848	

CFM values shown in black are the most efficient selections. Values shown in gray are not recommended.

Performance certified is for model RBF filtered supply for installation type A: free inlet, free outlet. Power rating (Bhp) does not include transmission losses. Performance ratings include the effects of appurtenances (2 inch (51 mm) filters). The sound ratings shown are loudness values in fan sones at 5 feet (1.5 m) in a hemispherical free field calculated per AMCA Standard 301. Values shown are for installation type A: free outlet hemispherical sone levels. The AMCA Certified Ratings Sound Seal applies to sone ratings only. *Sones shown apply to the highest cataloged cfm in black type at each fan rpm. For selections at other cfm and static pressure points, refer to the CAPS computerized selection program.

Numbers in blue have a larger Bhp and require the next size larger motor.

Belt Drive Filtered Supply

RBF-72



Model Number	Motor HP	Fan RPM	Max BHP	Sones	CFM / Static Pressure in Inches WG													
					0.00	0.10	0.125	0.20	0.25	0.375	0.50	0.625	0.75	1.00	1.25	1.50		
Level 3 Performance		Max RPM	L - 505	H - 620	Max Motor Frame Size - 256T							TS = RPM x 18.802						
RBF-3L72-20	2	222	1.58	15.6	34977	24323	21410	13899										
		243	2.01	18.0	38286	28728	26069	19092	13018									
		258	2.41	19.9	40649	31772	29276	21989	18366									
RBF-3H72-20	2	272	1.59	15.0	27269	21917	20312	13744	9221									
		298	2.01	18.3	29876	25178	23721	19364	14280									
		317	2.41	21	31781	27455	26135	22013	18312									
RBF-3L72-30	3	278	3.01	23	43800	35852	33411	26467	22487									
		295	3.60	25	46479	39324	36830	30255	26074	14660								
RBF-3H72-30	3	341	3.06	23	34187	30240	29113	25283	22751	12928								
		363	3.61	25	36392	32753	31697	28196	25790	17135								
RBF-3L72-50	5	330	5.04	31	51993	45967	44002	37797	33867	25643								
		350	6.01	32	55144	49572	47932	41927	38240	29356	21490							
RBF-3H72-50	5	404	5.01	29	40503	37156	36410	33438	31283	25939	17013							
		430	6.02	32	43109	39911	39226	36662	34644	29582	21718	14566						
RBF-3L72-75	7½	377	7.52	34	59398	54372	52850	47351	43934	35436	28868							
		401	9.05	36	63180	58586	57154	52317	48841	40773	33203	27344						
RBF-3H72-75	7½	463	7.54	36	46418	43379	42743	40541	38796	34091	29452	21104						
		492	9.05	41	49325	46405	45807	43885	42327	37947	33534	26627	20272					
RBF-3L72-100	10	415	10.03	38	65385	61024	59641	55169	51649	43867	36378	30746						
		441	12.10	42	69482	65388	64218	60314	56984	49469	42165	35814	30378					
RBF-3H72-100	10	510	10.03	44	51130	48275	47698	45939	44436	40292	36010	31138	23627					
		542	12.10	49	54338	51585	51042	49413	48139	44378	40356	36369	29939	18023				
RBF-3L72-150	15	475	15.00	48	74839	71038	70088	66512	63902	56541	49731	43151	37776					
		505	18.10	54	79565	75991	75097	71898	69624	62605	56227	49789	43811	34038				
RBF-3H72-150	15	583	15.00	54	58448	55873	55299	53785	52775	49488	45761	42015	38335	26213				
		620	18.00	58	62158	59736	59131	57696	56746	53883	50505	46988	43467	33086	23071			

CFM values shown in black are the most efficient selections. Values shown in gray are not recommended.

Performance certified is for model RBF filtered supply for installation type A: free inlet, free outlet. Power rating (Bhp) does not include transmission losses. Performance ratings include the effects of appurtenances (2 inch (51 mm) filters). The sound ratings shown are loudness values in fan sones at 5 feet (1.5 m) in a hemispherical free field calculated per AMCA Standard 301. Values shown are for installation type A: free outlet hemispherical sone levels. The AMCA Certified Ratings Sound Seal applies to sone ratings only. *Sones shown apply to the highest cataloged cfm in black type at each fan rpm. For selections at other cfm and static pressure points, refer to the CAPS computerized selection program. *Numbers in blue have a larger Bhp and require the next size larger motor.*

Belt Drive Cast Aluminum Filtered Supply

RBCF-24—36



Model Number	Motor HP	Fan RPM	Max BHP	Sones @ F.A.	CFM / Static Pressure in Inches WG											
					0.00	0.10	0.125	0.15	0.20	0.25	0.30	0.375	0.50	0.625	0.75	1.00
24 Performance			Max RPM	H - 1445	Max Motor Frame Size - 145T						TS = RPM x 6.283					
RBCF-3H24-3	1/3	748	0.25	13.7	4380	3846	3597	3100	1857	1424	948					
		821	0.33	15.1	4807	4363	4182	3954	3091	1973	1573	923				
		876	0.40	16.2	5129	4730	4595	4399	3752	2340	2000	1407				
RBCF-3H24-5	1/2	943	0.50	17.5	5522	5172	5046	4916	4523	3757	2454	1964	1020			
		1002	0.60	18.8	5867	5556	5438	5320	5005	4601	3716	2392	1542			
RBCF-3H24-7	3/4	1080	0.75	21	6324	6039	5950	5841	5608	5277	4737	2912	2196	1372		
		1147	0.90	23	6716	6448	6381	6282	6076	5805	5471	4516	2693	1953	1177	
RBCF-3H24-10	1	1188	1.00	24	6956	6697	6633	6550	6351	6121	5821	4958	2972	2295	1546	
		1263	1.20	26	7395	7152	7091	7030	6849	6662	6409	5949	4191	2877	2194	
RBCF-3H24-15	1½	1360	1.50	30	7963	7737	7681	7624	7486	7313	7139	6759	5599	3535	2988	1680
		1445	1.80	33	8461	8248	8195	8142	8035	7875	7712	7420	6752	5339	3573	2421
30 Performance			Max RPM	H - 1457	Max Motor Frame Size - 184T						TS = RPM x 7.854					
RBCF-3H30-5	1/2	657	0.33	15.4	6630	5996	5060	4501	3146	1807						
		755	0.50	19.5	7619	6740	6498	6090	5133	3933	2818					
		802	0.60	22	8093	7282	7047	6822	5950	4944	3798	2098				
RBCF-3H30-7	3/4	864	0.75	23	8719	7987	7766	7551	6902	6088	5131	3564				
		918	0.90	25	9264	8594	8385	8177	7782	6984	6166	4682	2072			
RBCF-3H30-10	1	951	1.00	26	9597	8954	8761	8559	8173	7490	6749	5399	3135			
		1010	1.20	29	10192	9587	9425	9236	8863	8482	7718	6586	4375	1597		
RBCF-3H30-15	1½	1088	1.50	31	10979	10417	10277	10118	9766	9428	8970	7973	6004	4031		
		1157	1.80	35	11675	11147	11015	10883	10559	10230	9918	9056	7429	5470	3673	
RBCF-3H30-20	2	1198	2.00	37	12089	11579	11451	11324	11025	10706	10400	9704	8191	6304	4545	
		1273	2.40	41	12846	12366	12246	12126	11871	11570	11271	10846	9485	7912	6106	1818
RBCF-3H30-30	3	1371	3.00	47	13835	13389	13277	13166	12943	12684	12405	11996	10987	9712	8213	4988
		1457	3.60	54	14703	14283	14178	14073	13864	13650	13387	12993	12370	11128	9851	6784
36 Performance			Max RPM	H - 1476	Max Motor Frame Size - 184T						TS = RPM x 9.424					
RBCF-3H36-7	3/4	643	0.49	22	9070	7804	7350	6751	5587	3653						
		739	0.75	24	10425	9292	9040	8742	7720	6728	5371	2552				
		784	0.90	25	11059	9975	9740	9503	8691	7740	6758	4338				
RBCF-3H36-10	1	812	1.00	26	11454	10391	10171	9942	9270	8331	7428	5436				
		863	1.20	28	12174	11143	10949	10734	10285	9428	8567	7191	3337			
RBCF-3H36-15	1½	930	1.50	32	13119	12123	11945	11760	11361	10809	9997	8826	5969			
		988	1.80	36	13937	12966	12798	12630	12263	11886	11222	10067	8042	4655		
RBCF-3H36-20	2	1023	2.00	37	14431	13472	13310	13147	12802	12439	11925	10813	8986	6019		
		1087	2.40	41	15333	14393	14241	14088	13780	13437	13095	12187	10480	8447	5285	
RBCF-3H36-30	3	1171	3.00	46	16518	15597	15455	15313	15030	14731	14413	13873	12261	10697	8593	
		1245	3.61	52	17562	16658	16518	16385	16119	15852	15558	15110	13857	12352	10815	5701
RBCF-3H36-50	5	1389	5.01	66	19594	18783	18581	18456	18217	17978	17739	17349	16679	15429	14064	11120
		1476	6.01	77	20821	20058	19867	19699	19474	19249	19024	18679	18049	17200	15926	13408

Performance certified is for model RBCF filtered supply for installation type A: free inlet, free outlet. Power rating (Bhp) does not include transmission losses. Performance ratings include the effects of appurtenances (2 inch (51 mm) filters).

The sound ratings shown are loudness values in fan sones at 5 feet (1.5 m) in a hemispherical free field calculated per AMCA Standard 301. Values shown are for installation type A: free outlet hemispherical sone levels. The AMCA Certified Ratings Sound Seal applies to sone ratings only.

*Sones shown apply to the highest cataloged cfm at each fan rpm. For selections at other cfm and static pressure points, refer to the CAPS computerized selection program.

Belt Drive Cast Aluminum Filtered Supply

RBCF-42-72



Model Number	Motor HP	Fan RPM	Max BHP	Sones @ F.A.	CFM / Static Pressure in Inches WG													
					0.00	0.10	0.125	0.20	0.25	0.375	0.50	0.625	0.75	1.00	1.25	1.50		
42 Performance					Max RPM H - 1214			Max Motor Frame Size - 215T					TS = RPM x 10.995					
RBCF-3H42-10	1	608	0.75	21	12456	10544	10012	8186	6821	2587								
		668	1.00	25	13685	11981	11502	9962	8796	5400								
		710	1.20	27	14546	12967	12519	11116	10057	7091	3456							
RBCF-3H42-15	1½	765	1.50	29	15672	14237	13823	12562	11648	9077	5957							
		813	1.81	32	16656	15328	14944	13762	12941	10616	7934	4757						
RBCF-3H42-20	2	842	2.01	34	17250	15982	15613	14476	13708	11494	9002	6071						
		894	2.40	37	18315	17146	16798	15737	15015	13039	10854	8309	5367					
RBCF-3H42-30	3	963	3.00	43	19729	18677	18354	17376	16712	14973	12994	10845	8432					
		1024	3.61	46	20978	20014	19715	18801	18180	16599	14812	12917	10761	5815				
RBCF-3H42-50	5	1142	5.01	53	23396	22531	22315	21502	20954	19554	18095	16476	14776	10931	6369			
		1214	6.01	58	24871	24057	23854	23124	22611	21305	19974	18537	16950	13570	9614	5033		
48 Performance					Max RPM H - 1303			Max Motor Frame Size - 215T					TS = RPM x 12.566					
RBCF-3H48-20	2	718	1.51	32	17780	16003	15497	13944	12690	9025	4360							
		789	2.00	37	19538	17984	17504	16141	15153	12099	8590							
		839	2.41	41	20776	19359	18908	17609	16728	14016	10871	7344						
RBCF-3H48-30	3	904	3.01	45	22386	21128	20710	19483	18692	16461	13694	10612	7030					
		960	3.60	49	23773	22627	22244	21070	20325	18357	15852	13141	10225					
RBCF-3H48-50	5	1071	5.00	58	26522	25495	25238	24189	23492	21824	19991	17635	15253	9938				
		1138	6.00	64	28181	27215	26973	26045	25381	23796	22134	20168	17972	13173	7084			
RBCF-3H48-75	7½	1226	7.51	74	30360	29463	29239	28455	27839	26339	24878	23272	21316	17141	12573			
		1303	9.01	84	32267	31423	31212	30543	29963	28526	27155	25712	24183	20324	16123	11593		
54 Performance					Max RPM H - 844			Max Motor Frame Size - 256T					TS = RPM x 14.135					
RBCF-3H54-30	3	463	1.98	24	22867	20549	19882	17810	16389	10651								
		532	3.01	30	26274	24428	23790	22033	20810	17374	12054	6316						
		565	3.60	33	27904	26251	25650	23959	22843	19936	15601	10639						
RBCF-3H54-50	5	631	5.02	40	31164	29695	29312	27727	26747	24199	21463	17378	12819					
		670	6.01	43	33090	31707	31361	29926	28988	26629	24178	20960	16742					
RBCF-3H54-75	7½	722	7.52	48	35658	34375	34054	32855	31928	29789	27524	25245	21879	14166				
		767	9.01	53	37881	36672	36370	35358	34472	32422	30338	28197	25801	18570	11878			
RBCF-3H54-100	10	795	10.03	57	39263	38098	37807	36903	36049	34039	32058	29996	27926	21685	14652			
		844	12.00	61	41683	40586	40311	39488	38782	36834	35004	33080	31134	26198	19324	13393		
60 Performance					Max RPM H - 763			Max Motor Frame Size - 256T					TS = RPM x 15.691					
RBCF-3H60-50	5	485	3.09	32	38444	34309	33282	30117	27973	21185	14144							
		570	5.01	42	45182	41663	40783	38159	36353	31700	25886	19562						
		606	6.02	48	48036	44726	43898	41426	39767	35477	30611	24426	18963					
RBCF-3H60-75	7½	652	7.51	52	51682	48605	47836	45534	44006	40055	35913	31013	25030					
		693	9.02	57	54932	52037	51314	49143	47706	44033	40282	36069	30977	20978				
RBCF-3H60-100	10	718	10.03	60	56913	54120	53421	51326	49936	46420	42799	38919	34499	24346				
		763	12.04	67	60480	57852	57194	55223	53910	50646	47243	43837	39955	30376	21833			
72 Performance					Max RPM H - 766			Max Motor Frame Size - 256T					TS = RPM x 18.802					
RBCF-3H72-75	7½	498	4.95	42	37357	34733	34076	31876	30066	24771	18795	10042						
		572	7.50	51	42908	40623	40052	38337	37049	33193	28196	22988	16911					
		608	9.01	56	45608	43459	42922	41308	40232	36637	31497	27381	22717					
RBCF-3H72-100	10	630	10.02	58	47258	45184	44666	43109	42070	38753	33340	30244	25605	12726				
		670	12.05	62	50259	48309	47821	46358	45381	42536	39227	34389	30469	21090				
RBCF-3H72-150	15	721	15.00	68	54084	52272	51819	50460	49553	47255	44130	41191	36569	28762	18919			
		766	18.00	74	57460	55754	55328	54048	53195	51060	48399	45457	40367	34267	26318	13797		

Performance certified is for model RBCF filtered supply for installation type A: free inlet, free outlet. Power rating (Bhp) does not include transmission losses.

Performance ratings include the effects of appurtenances (2 inch (51 mm) filters).

The sound ratings shown are loudness values in fan sones at 5 feet (1.5 m) in a hemispherical free field calculated per AMCA Standard 301. Values shown are for installation type A: free outlet hemispherical sone levels. The AMCA Certified Ratings Sound Seal applies to sone ratings only.

*Sones shown apply to the highest cataloged cfm at each fan rpm. For selections at other cfm and static pressure points, refer to the CAPS computerized selection program.

Belt Drive Reversible (Exhaust and Supply)

RPBR-24—30



Model Number	Motor HP	Fan RPM	Max BHP	*Sones	CFM / Static Pressure in Inches WG												
					0.00	0.10	0.125	0.15	0.20	0.25	0.30	0.375	0.50	0.625	0.75	1.00	
24 Performance					Max RPM = 1635				Max Motor Frame Size - 145T				TS = RPM x 6.307				
RPBR-24-4	1/4	850	0.24	24	4457	3612	3269	2929	2140								
		905	0.29	24	4746	4013	3695	3375	2720								
RPBR-24-3	1/3	940	0.33	24	4929	4262	3961	3650	3034								
		995	0.39	25	5218	4626	4365	4075	3494	2866							
RPBR-24-5	1/2	1025	0.43	25	5375	4804	4581	4303	3737	3169							
		1070	0.48	26	5611	5069	4899	4637	4094	3553	2930						
		1100	0.53	27	5768	5244	5098	4854	4328	3804	3244						
		1135	0.58	28	5952	5448	5306	5105	4599	4090	3576						
RPBR-24-7	3/4	1195	0.68	30	6267	5794	5659	5524	5055	4567	4084	3262					
		1240	0.76	32	6503	6052	5922	5792	5387	4918	4453	3732					
		1295	0.86	34	6791	6366	6241	6117	5783	5341	4892	4221					
RPBR-24-10	1	1330	0.93	36	6974	6563	6443	6322	6032	5606	5167	4515					
		1370	1.02	37	7184	6785	6673	6555	6313	5904	5478	4846	3662				
		1425	1.15	39	7473	7089	6987	6874	6648	6302	5900	5289	4239				
RPBR-24-15	1 1/2	1460	1.23	40	7656	7282	7186	7076	6855	6552	6164	5565	4572				
		1505	1.34	42	7892	7529	7438	7334	7120	6871	6498	5917	4956	3809			
		1550	1.47	44	8128	7775	7687	7591	7383	7175	6824	6265	5333	4288			
		1590	1.60	46	8338	7994	7908	7819	7616	7414	7111	6572	5661	4706			
		1635	1.73	48	8574	8239	8156	8072	7877	7680	7431	6912	6024	5134			
30 Performance					Max RPM = 1450				Max Motor Frame Size - 184T				TS = RPM x 7.919				
RPBR-30-3	1/3	650	0.31	19.5	6943	5328											
		690	0.38	21	7371	6013	5233										
RPBR-30-5	1/2	745	0.47	23	7958	6730	6286	5506									
		805	0.59	26	8599	7493	7163	6686									
RPBR-30-7	3/4	835	0.66	28	8919	7869	7550	7222	5833								
		875	0.76	30	9347	8359	8061	7757	6666								
		920	0.88	33	9827	8904	8628	8339	7548								
RPBR-30-10	1	960	1.01	35	10255	9384	9122	8850	8265	7071							
		1000	1.10	38	10682	9861	9609	9354	8822	7900							
RPBR-30-15	1 1/2	1050	1.32	42	11216	10452	10213	9973	9471	8825	7711						
		1095	1.47	46	11697	10981	10751	10521	10047	9561	8645						
		1145	1.71	51	12231	11547	11344	11125	10679	10215	9574	8021					
RPBR-30-20	2	1180	1.88	52	12605	11941	11757	11544	11118	10667	10198	8749					
		1230	2.12	53	13139	12502	12343	12139	11730	11306	10873	9783					
		1265	2.29	54	13513	12894	12739	12554	12156	11749	11328	10431					
RPBR-30-30	3	1315	2.58	56	14047	13451	13302	13143	12760	12377	11972	11326	9115				
		1360	2.88	57	14528	13952	13808	13664	13299	12929	12545	11958	10049				
		1405	3.16	60	15008	14451	14311	14172	13836	13478	13113	12545	10984				
		1450	3.46	63	15489	14949	14814	14679	14369	14022	13675	13126	11851				

Performance shown is for Model RPBR without ducts or filters. *Sones shown apply to the highest cataloged cfm at each fan rpm. For selections at other cfm and static pressure points, refer to the CAPS computerized selection program. Bhp does not include transmission losses.

Belt Drive Reversible (Exhaust and Supply)

RPBR-36—42



Model Number	Motor HP	Fan RPM	Max BHP	*Sones	CFM / Static Pressure in Inches WG													
					0.00	0.10	0.125	0.15	0.20	0.25	0.30	0.375	0.50	0.625	0.75	1.00		
36 Performance		Max RPM = 1415			Max Motor Frame Size - 184T						TS = RPM x 9.490							
RPBR-36-5	1/2	625	0.50	21	9602	7847	6731											
		655	0.57	23	10063	8429	7707											
RPBR-36-7	3/4	710	0.73	26	10908	9473	8993	8255										
		750	0.85	29	11522	10203	9763	9244										
RPBR-36-10	1	800	1.05	33	12290	11098	10707	10281	8903									
		830	1.17	35	12751	11629	11253	10855	9786									
RPBR-36-15	1½	875	1.39	38	13443	12418	12062	11704	10892	9151								
		910	1.55	39	13980	13027	12684	12341	11606	10490								
		945	1.74	41	14518	13631	13301	12971	12279	11363	9537							
RPBR-36-20	2	1010	2.11	45	15517	14712	14436	14127	13508	12832	11822							
		1040	2.29	48	15977	15196	14955	14655	14055	13411	12566							
RPBR-36-30	3	1110	2.81	54	17053	16321	16138	15876	15314	14741	14127	12734						
		1150	3.10	58	17667	16961	16784	16568	16025	15482	14897	13734						
		1195	3.45	63	18359	17679	17508	17338	16819	16297	15753	14838						
RPBR-36-50	5	1240	3.94	67	19050	18395	18231	18067	17607	17103	16600	15774	13048					
		1280	4.31	70	19665	19030	18871	18712	18302	17815	17327	16545	14661					
		1325	4.74	74	20356	19742	19589	19436	19081	18610	18139	17403	15787					
		1370	5.33	78	21047	20454	20306	20157	19854	19399	18944	18252	16893	13943				
		1415	5.83	83	21739	21164	21021	20877	20590	20183	19742	19081	17888	15771				
42 Performance		Max RPM = 1180			Max Motor Frame Size - 184T						TS = RPM x 11.061							
RPBR-42-5	1/2	500	0.43	20	11888	7929	6714											
		555	0.59	23	13196	10135	8716	7566										
RPBR-42-7	3/4	585	0.69	25	13909	11025	10066	8687										
		630	0.87	29	14979	12342	11615	10512	8421									
RPBR-42-10	1	665	1.02	32	15812	13406	12647	11969	9631									
		690	1.15	35	16406	14155	13373	12719	10577	8993								
RPBR-42-15	1½	725	1.33	37	17238	15190	14429	13753	12020	10055								
		765	1.56	38	18189	16314	15634	14913	13734	11584	10121							
		795	1.75	40	18903	17100	16525	15831	14635	12700	11045							
RPBR-42-20	2	840	2.09	43	19972	18269	17836	17186	15963	14832	12764	10865						
		875	2.34	47	20805	19171	18756	18224	16979	15949	14099	11889						
RPBR-42-30	3	910	2.62	49	21637	20068	19669	19250	18036	16991	15770	13166						
		950	2.98	52	22588	21088	20706	20323	19247	18164	17215	14677						
		995	3.44	56	23658	22229	21863	21498	20589	19479	18558	16567	13282					
RPBR-42-50	5	1025	3.74	58	24371	22985	22631	22277	21473	20396	19440	17988	14207					
		1065	4.21	62	25322	23988	23650	23309	22627	21605	20603	19333	15745					
		1100	4.65	66	26154	24862	24538	24207	23547	22650	21646	20379	17061	14485				
		1140	5.14	70	27106	25859	25547	25229	24592	23832	22864	21560	18702	15651				
		1180	5.72	75	28057	26852	26551	26246	25631	25002	24067	22725	20603	17195				

Performance shown is for Model RPBR without ducts or filters. *Sones shown apply to the highest cataloged cfm at each fan rpm. For selections at other cfm and static pressure points, refer to the CAPS computerized selection program. Bhp does not include transmission losses.

Belt Drive Reversible (Exhaust and Supply)

RPBR-48—54



Model Number	Motor HP	Fan RPM	Max BHP	*Sones	CFM / Static Pressure in Inches WG													
					0.00	0.10	0.125	0.15	0.20	0.25	0.30	0.375	0.50	0.625	0.75	1.00		
48 Performance					Max RPM = 1130				Max Motor Frame Size - 215T				TS = RPM x 12.664					
RPBR-48-7	3/4	480	0.70	22	15117	11759	9863	8160										
		520	0.88	24	16377	13482	12394	10401	7791									
RPBR-48-10	1	545	1.03	26	17164	14448	13520	12121	8988									
		560	1.11	27	17636	15022	14185	13130	9689									
RPBR-48-15	1½	615	1.48	32	19368	17071	16371	15607	13017	10316								
		650	1.77	35	20471	18313	17700	17022	15323	11928	10176							
RPBR-48-20	2	680	1.99	38	21415	19368	18815	18175	16682	14030	11595							
		705	2.28	40	22203	20239	19706	19124	17795	15743	12747	10309						
RPBR-48-30	3	755	2.73	44	23777	21967	21469	20971	19827	18415	16065	12718						
		805	3.26	48	25352	23678	23211	22744	21739	20633	19174	15240						
RPBR-48-50	5	830	3.69	50	26139	24527	24074	23621	22682	21620	20305	16988	12697					
		870	4.19	54	27399	25862	25448	25016	24151	23162	22083	19725	14601					
		905	4.84	57	28501	27024	26642	26227	25396	24494	23520	21664	16221	12956				
		940	5.34	61	29604	28181	27825	27430	26630	25811	24873	23240	18335	14775				
		975	5.89	65	30706	29334	28992	28627	27856	27085	26211	24791	20761	16432				
RPBR-48-75	7½	1015	6.76	70	31966	30648	30319	29987	29247	28506	27722	26420	23476	18280	15476			
		1050	7.39	74	33068	31794	31476	31158	30456	29740	29024	27772	25242	20432	17151			
		1090	8.17	80	34328	33101	32794	32487	31831	31141	30451	29301	27040	23206	19021			
		1130	8.82	86	35587	34404	34108	33812	33198	32532	31867	30814	28809	25924	20955			
54 Performance					Max RPM = 830				Max Motor Frame Size - 254T				TS = RPM x 14.380					
RPBR-54-15	1½	400	1.36	22	21919	17308	16286	14889	12572									
		430	1.70	24	23563	19934	18247	17296	15056	12438								
RPBR-54-20	2	455	2.04	26	24933	21732	19940	18947	16737	14760	11949							
		480	2.35	28	26303	23425	22219	20565	18661	16782	14492							
RPBR-54-30	3	505	2.80	31	27673	25051	24045	22449	20536	18466	16757	12966						
		525	3.10	33	28769	26278	25404	24266	21853	19923	18328	15064						
		545	3.43	35	29865	27496	26749	25778	23151	21531	19681	16967						
RPBR-54-50	5	570	4.07	38	31235	29008	28339	27483	24752	23317	21409	19214	13506					
		595	4.54	41	32605	30510	29869	29167	27006	24956	23425	21038	16226					
		620	5.07	44	33974	32003	31388	30773	29124	26570	25251	22717	18739					
		645	5.85	47	35344	33488	32897	32306	30839	28342	26895	24564	21011	15996				
RPBR-54-75	7½	670	6.47	51	36714	34966	34397	33828	32534	30626	28517	26570	23130	18640				
		695	7.43	53	38084	36438	35889	35340	34211	32687	30117	28352	24830	21118	16083			
		725	8.23	57	39728	38152	37670	37144	36092	34742	32737	30322	26834	23838	19482			
		750	8.81	60	41098	39574	39147	38639	37622	36436	34994	31942	28786	25923	22080			
RPBR-54-100	10	770	9.68	63	42194	40710	40325	39830	38840	37779	36404	33224	30390	27286	23927			
		790	10.39	66	43290	41843	41481	41017	40052	39086	37773	34715	31907	28632	25737			
		810	11.62	69	44386	42975	42622	42200	41259	40317	39131	36548	33232	29963	27518	19602		
		830	11.90	73	45482	44105	43760	43380	42461	41542	40480	38359	34546	31493	28973	21740		

Performance shown is for Model RPBR without ducts or filters. *Sones shown apply to the highest cataloged cfm at each fan rpm. For selections at other cfm and static pressure points, refer to the CAPS computerized selection program. Bhp does not include transmission losses. Numbers in blue have a larger Bhp and require the next size larger motor.

Belt Drive Reversible (Exhaust and Supply)

RPBR-60-72



Model Number	Motor HP	Fan RPM	Max BHP	*Sones	CFM / Static Pressure in Inches WG											
					0.00	0.10	0.125	0.15	0.20	0.25	0.30	0.375	0.50	0.625	0.75	1.00
60 Performance					Max RPM = 805			Max Motor Frame Size - 254T				TS = RPM x 15.708				
RPBR-60-20	2	440	1.97	30	26801	22934	20935	19685	16982	14113						
		465	2.28	31	28324	24749	23472	21633	19147	16546						
RPBR-60-30	3	480	2.56	32	29238	25826	24765	22781	20422	17930	15228					
		495	2.78	33	30151	26859	25865	24173	21678	19255	16750					
		515	3.09	35	31370	28198	27318	26307	23275	20987	18655					
		530	3.46	36	32283	29197	28398	27437	24444	22269	20014	16247				
RPBR-60-50	5	555	3.91	39	33806	30851	30135	29262	26362	24367	22202	18879				
		580	4.41	42	35329	32493	31808	31066	28817	26352	24345	21252				
		605	4.98	45	36852	34125	33468	32811	31166	28288	26446	23473				
		630	5.76	49	38375	35754	35117	34486	33000	30229	28448	25640	20748			
RPBR-60-75	7½	650	6.26	52	39593	37074	36429	35818	34451	32383	30006	27349	22676			
		670	6.79	55	40811	38388	37735	37142	35891	34371	31545	29033	24566			
		685	7.46	58	41725	39370	38711	38131	36964	35477	32687	30278	25906	21066		
		705	8.06	60	42943	40675	40017	39445	38318	36941	34720	31856	27664	23259		
		725	8.69	64	44161	41977	41336	40753	39657	38393	36852	33414	29396	25188		
RPBR-60-100	10	745	9.36	67	45379	43274	42651	42056	40990	39835	38468	34955	31108	27082		
		765	10.33	71	46598	44568	43961	43355	42316	41266	39935	36480	32800	28888	24768	
		785	11.07	75	47816	45858	45267	44676	43637	42625	41391	38473	34469	30649	26710	
		805	11.85	79	49034	47146	46569	45992	44952	43965	42838	40611	36072	32386	28619	
72 Performance					Max RPM = 705			Max Motor Frame Size - 256T				TS = RPM x 18.848				
RPBR-72-20	2	340	1.90	24	34031	26236	20400									
		360	2.29	26	36033	29279	24290	19836								
RPBR-72-30	3	380	2.66	29	38035	32645	29312	23838								
		395	3.12	30	39537	34778	31605	26730	19246							
		415	3.51	33	41538	36988	34846	31914	22763							
RPBR-72-50	5	430	3.86	36	43040	38632	37354	34212	25790							
		450	4.55	38	45042	40808	39812	37392	29697	22927						
		470	5.07	41	47043	42968	42014	40746	35422	26674						
		490	5.90	44	49045	45114	44200	43285	38511	30662	24621					
RPBR-72-75	7½	510	6.50	47	51047	47249	46370	45491	41539	34519	28232					
		535	7.41	52	53549	49901	49064	48226	45766	41083	33242					
		555	8.50	56	55551	52013	51205	50398	48783	44148	37112	28724				
RPBR-72-100	10	580	9.50	60	58054	54662	53868	53095	51550	48112	44064	33551				
		600	10.50	63	60056	56777	55987	55240	53746	51477	47147	37528				
		620	11.60	67	62057	58885	58098	57376	55930	54484	50181	41395				
RPBR-72-150	15	640	13.00	71	64059	60986	60217	59502	58101	56701	53490	47044	33024			
		660	14.10	75	66061	63081	62336	61620	60262	58904	56846	51051	36772			
		685	15.60	81	68563	65692	64974	64257	62948	61640	60331	54869	41793			
		705	17.60	86	70565	67775	67078	66380	65088	63816	62545	58014	45701	35158		

Performance shown is for Model RPBR without ducts or filters. *Sones shown apply to the highest cataloged cfm at each fan rpm. For selections at other cfm and static pressure points, refer to the CAPS computerized selection program. Bhp does not include transmission losses.

Belt Drive - Models RBE, RBS, RBF, RBCE, RBCS and RBCF

Belt driven, axial type hooded propeller roof fans shall be provided as follows:

Propellers shall be constructed with fabricated steel, fabricated aluminum or cast aluminum blades and hubs. A standard square key and set screw or tapered bushing shall lock the propeller to the motor shaft. All propellers shall be statically and dynamically balanced.

Fan hood and base construction shall be galvanized steel, painted steel or aluminum. Hood panels shall be arched with interlocking ribs. Fan bases shall be low profile except where tall bases are specified. (Where access doors are required for inspection and service of damper and actuator, tall bases should be specified.) Hood support angles shall be heavy-gauge galvanized steel. Birdscreens constructed of 1/2 in. galvanized mesh shall be horizontally mounted in the discharge/intake perimeter of the hood.

Motors shall be permanently lubricated, heavy-duty type, matched to the fan load and furnished at the specified voltage, phase and enclosure.

Drive frame and panel assemblies shall be galvanized steel or painted steel. Drive frames shall be formed channels and fan panels shall have a deep formed inlet venturi.

Ground and polished steel fan shafts shall be mounted in sealed ball bearing pillow blocks with grease zerks. Bearings shall be selected for a minimum (L_{10}) life in excess of 100,000 hours (L_{50} average life of 500,000 hours) at maximum cataloged operating speeds. Drives shall be sized for a minimum of 150 percent of driven horsepower. Pulleys shall be fully machined cast iron, keyed and securely attached to propeller and motor shafts. Motor sheaves shall be adjustable for final system balancing.

The axial exhaust, supply and filtered supply fans shall bear the AMCA Certified Ratings seal for Sound and Air Performance.

Fans shall be models RBE, RBS, RBF, RBCE, RBCS and RBCF as manufactured by Greenheck Fan Corporation, Schofield, Wisconsin, USA.

Reversible - Models RPBR and RPBRF

All hooded reversible roof ventilators shall be belt drive axial type. Propeller construction shall be cast aluminum, airfoil, reversible design. A standard square key and set screw or taper lock bushing shall lock the propeller to the motor shaft. Propellers shall be statically and dynamically balanced.

Fan hood and base construction shall be aluminum, galvanized steel or painted steel as specified. Hood panels shall be arched with interlocking seams for weather protection. Fan bases shall be low profile except where tall bases are specified. (Where access doors are required to service dampers and actuators, tall bases should be specified).

Birdscreens constructed of 1/2 in. galvanized mesh shall be horizontally mounted in the discharge/intake perimeter of the hood. Hood support members shall be heavy-gauge galvanized steel angles.

Motors shall be heavy-duty ball bearing type carefully matched to the fan load and furnished at the specified voltage, phase and enclosure.

Drive frame assemblies shall be constructed of heavy-gauge steel angles. Fan panels shall be heavy-gauge steel with formed flanges and a double venturi.

Safety guards of heavy welded wire construction shall be attached to the underside of the fan panel.

Ground and polished steel fan shafts shall be mounted in sealed ball bearing pillow blocks with grease zerks. Bearings shall be selected for a minimum (L_{10}) life in excess of 100,000 hours (L_{50} average life of 500,000 hours) at maximum cataloged operating speed. A standard square key and set screws or tapered lock bushing shall attach the propeller securely to the fan shaft. Retaining rings shall be provided at each end of the fan shaft. Pulleys shall be of the fully machined cast iron type, keyed and securely attached to the wheel and motor shafts. The motor sheaves shall be adjustable for final system balancing. Drives shall be sized for a minimum 150 percent of driven horsepower.

Each unit shall bear a permanently affixed nametag with a fan model number, a serial number and a mark. Optional control centers shall bear a nametag with identical information.

Hooded reversible axial roof ventilators shall be belt drive models RPBR and RPBRF (filtered) as manufactured by Greenheck Fan Corporation, Schofield, Wisconsin, USA.

Direct Drive - Models RE2, RS2, RCE3 and RCS3

Direct driven, axial type hooded propeller roof fans shall be provided as follows:

Propellers shall be constructed with fabricated steel, fabricated aluminum or cast aluminum blades and hubs. A standard square key and set screw or tapered bushing shall lock the propeller to the motor shaft. All propellers shall be statically and dynamically balanced.

Fan hood and base construction shall be galvanized steel, painted steel or aluminum. Hood panels shall be arched with interlocking ribs.

Fan bases shall be low profile except where tall bases are specified. (Where access doors are required for inspection and service of damper and actuator, tall bases should be specified.) Hood support angles shall be heavy-gauge galvanized steel. Birdscreens constructed of 1/2 in. galvanized mesh shall be horizontally mounted in the discharge/intake perimeter of the hood.

Motors shall be permanently lubricated, heavy-duty type, matched to the fan load and furnished at the specified voltage, phase and enclosure.

Motor drive frame and panel assemblies shall be galvanized steel or painted steel. Drive frames shall be formed channels and fan panels shall have a deep formed inlet venturi.

The axial exhaust and supply fans shall bear the AMCA Certified Ratings seal for Sound and Air Performance.

Fans shall be models RE2, RS2, RCE3 and RCS3 as manufactured by Greenheck Fan Corporation, Schofield, Wisconsin, USA.

Reversible - Models RPDR and RPDRF

All hooded reversible roof ventilators shall be direct drive axial type. Propeller construction shall be cast aluminum, airfoil, reversible design. A standard square key and set screw or taper lock bushing shall lock the propeller to the motor shaft. Propellers shall be statically and dynamically balanced.

Fan hood and base construction shall be aluminum, galvanized steel or painted steel as specified. Hood panels shall be arched with interlocking seams for weather protection. Fan bases shall be low profile except where tall bases are specified. (Where access doors are required to service dampers and actuators, tall bases should be specified.)

Birdscreens constructed of 1/2 in. galvanized mesh shall be horizontally mounted in the discharge/intake perimeter of the hood. Hood support members shall be heavy-gauge galvanized steel angles.

Motors shall be heavy-duty ball bearing type carefully matched to the fan load and furnished at the specified voltage, phase and enclosure.

Motor support frame assemblies shall be constructed of heavy-gauge steel angles. Fan panels shall be heavy-gauge steel with formed flanges and a double venturi.

Safety guards of heavy welded wire construction shall be attached to the underside of the fan panel.

Each unit shall bear a permanently affixed nametag with a fan model number, a serial number and a mark. Optional control centers shall bear a nametag with identical information.

Hooded reversible axial roof ventilators shall be direct drive models RPDR and RPDRF (filtered) as manufactured by Greenheck Fan Corporation, Schofield, Wisconsin, USA.

Other Propeller Fan Products



Greenheck's sidewall propeller fan line is the ideal choice for factory and warehouse applications where high volumes of air and low pressures are required. Performance spans the range between 300 to 87,000 cfm (510 to 147,814 m³/hr) with static pressures up to 1.0 in. wg (249 Pa). Fan sizes range from 8 to 54 inches (203 to 1372 mm) for direct drive and 20 to 72 inches (508 to 1829 mm) for belt drive. Regardless of fan size, performance or duty level, all Greenheck sidewall propeller fans are built to perform with the same high standards of reliability and durability.

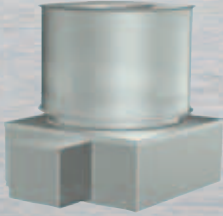

Greenheck upblast propeller fan models RBU, RBUMO, RDU and RGU are designed to discharge contaminants up and away from the building for most commercial jobs and many industrial applications. These roof exhaust fans include both belt and direct drive fans with steel or aluminum blades. Drive frames and panels are constructed to match the level of duty and motor size. Regardless of fan size, performance or duty level, all Greenheck upblast propeller roof fans are built to perform with the same high standards of reliability and durability.



Greenheck's four-way recirculating roof propeller fan model ESRMD is designed to offer the flexibility to meet changing temperature needs to maintain comfortable temperatures in factories, warehouses and other facilities with high ceilings. When temperatures change with production processes or seasonal shifts, the four-way fan can exhaust, supply, recirculate or mix air as required. The ESRMD is available in six direct drive sizes. Performance capabilities range from 4,000 to 40,000 cfm (6,800 to 67,900 m³/hr) with static pressures up to 0.375 in. wg (93 Pa).



Building Value in Air

Greenheck delivers value to mechanical engineers by helping them solve virtually any air quality challenges their clients face with a comprehensive selection of

top quality, innovative air-related equipment. We offer extra value to contractors by providing easy-to-install, competitively priced, reliable products that arrive on time.

And building owners and occupants value the energy efficiency, low maintenance and quiet, dependable operation they experience long after the construction project ends.

Our Warranty

Greenheck warrants this equipment to be free from defects in material and workmanship for a period of one year from the shipment date. Any units or parts which prove defective during the warranty period will be replaced at our option when returned to our factory, transportation prepaid. Motors are warranted by the motor manufacturer for a period of one year. Should motors furnished by Greenheck prove defective during this period, they should be returned to the nearest authorized motor service station. Greenheck will not be responsible for any removal or installation costs.

As a result of our commitment to continuous improvement, Greenheck reserves the right to change specifications without notice.



Prepared to Support Green Building Efforts

