

# Brass Cylinders Security Hardware Cam and Specialty Lock Locksmith Supplies

## Suggested List Price

January 17, 2011



### BRASS CYLINDERS

Mortise Cylinder Deadbolts . . . . .	2-5
How to Order . . . . .	6-7
Mortise Cylinders . . . . .	8
Mortise Dummy . . . . .	8
Turnknob Cylinders . . . . .	9
Mortise Parts . . . . .	10
Mortise Accessories . . . . .	10-11
Mortise/Rim Bump Halt Kit . . . . .	11
Rim Cylinders . . . . .	12
Rim Dummy . . . . .	12
Rim Parts and Accessories . . . . .	12
1599 Key-In-Knob/Deadbolt . . . . .	13
1539 Key-In-Knob Repl. Cylinders . . . . .	14
Specialty Key-In-Knob/Deadbolt . . . . .	15-16
Key-in-Knob/Deadbolt Bump Halt Kit . . . . .	16
Profile Cylinders . . . . .	17
Interchangeable Cores . . . . .	17
Interchangeable Core Housings . . . . .	18
Specialty . . . . .	19
Cylinder Kits . . . . .	19
Keyway Availability . . . . .	20-21
Cylinder Availability . . . . .	22-23
Replacement Keys for Cylinders . . . . .	48
Stock Cylinder List . . . . .	24

### SECURITY HARDWARE

Product Numbering System . . . . .	25
Auxiliary Locks . . . . .	25
Replacement Rim Cylinders . . . . .	25
Replacement Door Knobs & Accessories . . . . .	26
Window and Patio Door Locks . . . . .	26
Door Viewers and Door Locks . . . . .	26
Specialty Locks . . . . .	26-27
Key Accessories & Assortments . . . . .	27
KeyCaps . . . . .	27

### CAM AND SPECIALTY LOCKS

Stocking Program . . . . .	28
Ordering Information . . . . .	28
How to Order Custom Cam Locks . . . . .	29
Cam Rotation Chart . . . . .	30
Standard Cams . . . . .	31
Special Cams . . . . .	32
Cam Locks Custom Built . . . . .	33
Cam Lock Kits . . . . .	33
Thumbturn and Latching Cam Locks . . . . .	34
Tubular Cam Locks Custom Built . . . . .	34
Tubular Cam Lock Kits . . . . .	34
Desk and Drawer Locks . . . . .	35
Removable Core Locks . . . . .	35
Sliding Door Locks . . . . .	36
Filing Cabinet Locks . . . . .	36
Switch Locks . . . . .	36
Show Case Locks . . . . .	37
Special Purpose Locks . . . . .	37
Cams . . . . .	37
Disc Tumbler Kit . . . . .	37
Mobile Kit 781-00-8X . . . . .	38
Cam Lock Kit 782-00-8X . . . . .	39
Accessories . . . . .	40
Components . . . . .	40-41

### LOCKSMITH SUPPLIES

Picks . . . . .	42
Electric Lockpick and Pick Gun . . . . .	43
Pick Kits . . . . .	43
Locksmith Tools . . . . .	43-44
Key Stamps . . . . .	44
Pins and Pinning Kits . . . . .	44
Spindles . . . . .	45
Strikes . . . . .	45
Key Cabinets . . . . .	45
Depth Key Set . . . . .	46
Software . . . . .	47
Padlock . . . . .	47
Limited Warranty . . . . .	47



# Mortise Cylinder Deadbolts

Lead Time 4 weeks

• Solid Brass • 1" Bolt Throw • Fits Doors 1 3/8" to 1 3/4" Thick



4520 Series Double Cylinder  
Standard Profile Roses

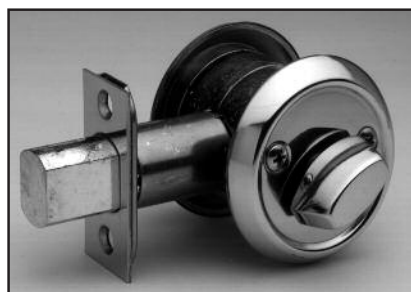

4510 Series Single Cylinder  
Standard Profile Roses



Dummy  
Cylinder Option 2



ADA Turnknob  
Cylinder Option 3



Thumbturn  
Cylinder Option 4



Captive Thumbturn  
Cylinder Option 6  
US3 & US26D Only  
5 Pin Only



Keyed  
Cylinder Option 5



I.C. Core Housing  
Cylinder Option 8

## How To Order Mortise Deadbolts

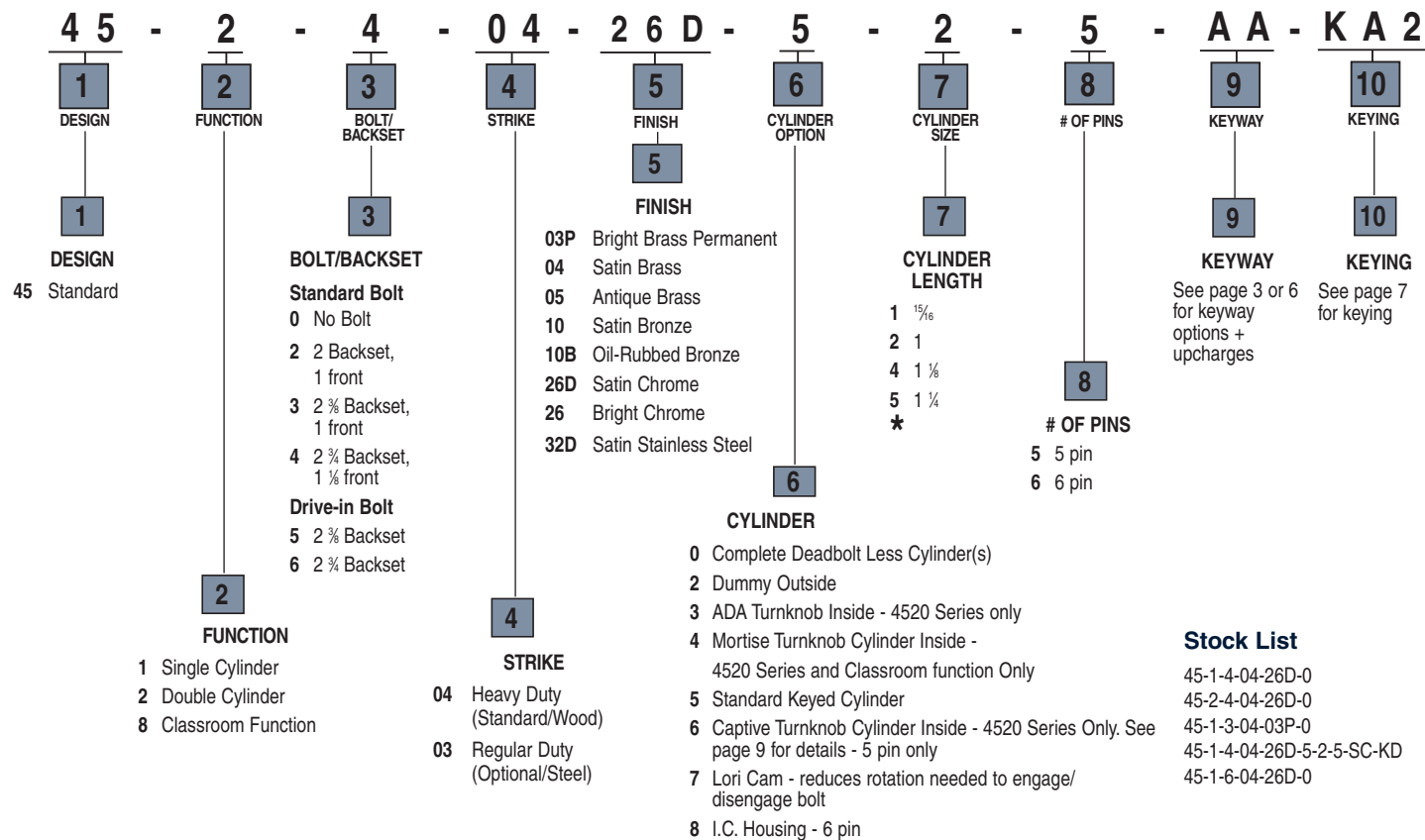

\* 1 3/8" - 2" mortise cylinders can be ordered separately. See pages 6 & 7, 8 & 9 or 22 & 23.

Complete Stock list available on page 24.

# Mortise Cylinder Deadbolts

## Application Guide

Fits existing hole size 1<sup>5</sup>/<sub>8</sub>" - 2<sup>1</sup>/<sub>8</sub>"  
Operates with Adams Rite cam

DOOR THICKNESS	OUTSIDE CYL. LENGTH	INSIDE CYLINDER LENGTH
1 <sup>3</sup> / <sub>4</sub> ", 1 <sup>3</sup> / <sub>8</sub> "	1 <sup>5</sup> / <sub>16</sub> " cylinder	1 <sup>5</sup> / <sub>16</sub> " keyed or thumbturn cylinder
1 <sup>3</sup> / <sub>4</sub> ", 1 <sup>7</sup> / <sub>8</sub> "	1" cylinder	1" keyed or thumbturn cylinder
1 <sup>7</sup> / <sub>8</sub> ", 2 <sup>1</sup> / <sub>8</sub> "	1 <sup>1</sup> / <sub>8</sub> " cylinder	1 <sup>1</sup> / <sub>8</sub> " keyed or thumbturn cylinder
2 <sup>1</sup> / <sub>8</sub> ", 2 <sup>3</sup> / <sub>8</sub> "	1 <sup>1</sup> / <sub>4</sub> " cylinder	1 <sup>1</sup> / <sub>4</sub> " keyed or thumbturn cylinder, or special 4500-xx-5050 thumbturn assembly

## Deadbolt Pricing

DESIGN	FUNCTION	BOLT/ BACKSET	STRIKE OPTION	FINISH	CYLINDER OPTION	SIZE	# OF PINS	KEYWAYS	KEYING	LIST
45 Standard	1 Single Cylinder	0 No Bolt Deduct 6.00 2 2 3 2- <sup>3</sup> / <sub>8</sub> 4 2- <sup>3</sup> / <sub>8</sub> 5 2- <sup>3</sup> / <sub>8</sub> (drive-in) 6 2- <sup>3</sup> / <sub>8</sub> (drive-in)	04 heavy duty strike (standard)  03 regular duty strike (optional)	04 US4	0 less cylinder; Deduct \$6.00 2 dummy cyl. out. 5 standard 7 Lori cam 8 I.C. core housing (Model 4500 only) (Core sold separately) (6-pin only); Add \$6.06	1 1 <sup>5</sup> / <sub>16</sub> 2 1 4 1- <sup>1</sup> / <sub>8</sub> 5 1- <sup>1</sup> / <sub>4</sub>	5 = 5 pin 6 = 6 pin  Add 2.43 for 6 pin.	AA Arrow 1179	See page 7 for keying codes.	49.10
								NA Composite R1064E		
								NB Composite HR1		
								CA Corbin 60 1001EH		
								CB Corbin 67 1001EN		
								*CC Corbin 77 R1001EN		
								*CD Corbin 59A1-A2		
								CE Corbin/Russwin L4		
								XE Dexter 67 D1054K		
								DA Dominion 1054F S54F		
								DB Dominion 1054F D05/D06		
								45 Standard		
UB Lori L100, Eagle 11929, Harloc 700										
*UD Lori 90										
*UE Lori 80										
KS Kwikset										
LA Lockwood 1004										
*RA Russwin 5981R, N1011P										
RB Russwin D1										
*RC Russwin 981-852										
GA Sargent LA										
GB Sargent LA-LC										
45 Standard	8 Classroom	0 No Bolt Deduct 6.00 2 2 3 2- <sup>3</sup> / <sub>8</sub> 4 2- <sup>3</sup> / <sub>8</sub> 5 2- <sup>3</sup> / <sub>8</sub> (drive-in) 6 2- <sup>3</sup> / <sub>8</sub> (drive-in)	04 heavy duty strike (standard)  03 regular duty strike (optional)	04 US4	0 less cylinder; Deduct \$6.00 2 dummy cyl. out. 3 ADA turnknob inside 4520 Series and Classroom function Add \$6.00 5 standard 7 Lori cam 8 I.C. core housing (Model 4500 only) (Core sold separately) (6-pin only); Add \$6.06	1 1 <sup>5</sup> / <sub>16</sub> 2 1 4 1- <sup>1</sup> / <sub>8</sub> 5 1- <sup>1</sup> / <sub>4</sub>	5 = 5 pin 6 = 6 pin  Add 2.43 for 6 pin		GC Sargent RA-RC	See page 7 for keying codes.
								SC Schlage C		
								SX Schlage		
								SE Schlage E		
								*SF Schlage F		
								FA Segal 9		
								WA Weiser E, Falcon 1054WB-WC		
								WE 1555 Weiser		
								YA Yale 8 (999)		
								YG Yale GA		

1<sup>1</sup>/<sub>8</sub>" cylinders can be used on 1<sup>3</sup>/<sub>4</sub>" and 1<sup>1</sup>/<sub>2</sub>" doors, for 6 pin applications, using an 861D solid collar - page 11.  
See page 7 for additional master keying prices

\* Upcharge for these keyways  
\$2.20 + list per cylinder

Stock list available on page 24.

## Component Pricing

Order Ilco 4500 Series Deadbolts by components in four easy steps. Reduce inventory while increasing turns, fill rates and profitability. Order each component separately. The order should contain the same amount of components from each group to qualify for our special pricing. Order deadbolts by:

1. Function; single or double cylinder.
2. Bolt; drive-in or standard, 2, 2 $\frac{3}{4}$  or 2  $\frac{3}{4}$  backset.
3. Front; 1 or 1 $\frac{1}{2}$ .
4. Cylinder. Remember to order 2 cylinders for the 4520 Series double cylinder deadbolt. The 4510 already has an inside thumbturn furnished. Also remember to order the correct finish and length depending upon the door thickness. See application guide on pg. 3.



## Step 1: Deadbolt Function

DESCRIPTION	ITEM NUMBER	LIST
Single cylinder deadbolt (less cylinder bolt & front)	<b>4510-xx-1-00-900</b> substitute 2 digit finish code for xx	
	04=US4	27.40
	05=US5      10=US10      26D=US26D      03P=US3PVD	30.40
	10B=US10B      26=US26      32D=US32D	40.70
Double cylinder deadbolt (less cylinder bolt & front)	<b>4520-xx-1-00-900</b> substitute 2 digit finish code for xx	
	04=US4	26.60
	05=US5      10=US10      26D=US26D      03P=US3PVD	30.05
	10B=US10B      26=US26      32D=US32D	36.40

## Step 2: Bolts (Less Front/Face Plate) Available in 26D and 03 finish only

DESCRIPTION	ITEM NUMBER	LIST
Drive-In 2 $\frac{3}{4}$ backset	4540-xx-5014	15.65
Bolt 2 $\frac{3}{4}$ backset	4550-xx-5001	15.65
Standard 2 $\frac{3}{4}$ backset	4500-xx-5000	12.55
	4510-xx-5001	12.55
Special 2 backset, bolt & housing 2 backset, bolt only 2 backset, housing only	4900-xx-5008	25.05
	4900-xx-5004	12.55
	4900-84-5005	12.55

## Step 3: Front/Face Plate

DESCRIPTION	ITEM NUMBER	LIST
1 Inch for 2 & 2 $\frac{3}{4}$ bolts	4500-xx-5012	3.15
1 $\frac{1}{2}$ Inch for 2 $\frac{3}{4}$ bolts	4510-xx-5012	3.15

# 4500 & 4900 Series Parts

## Exploded View

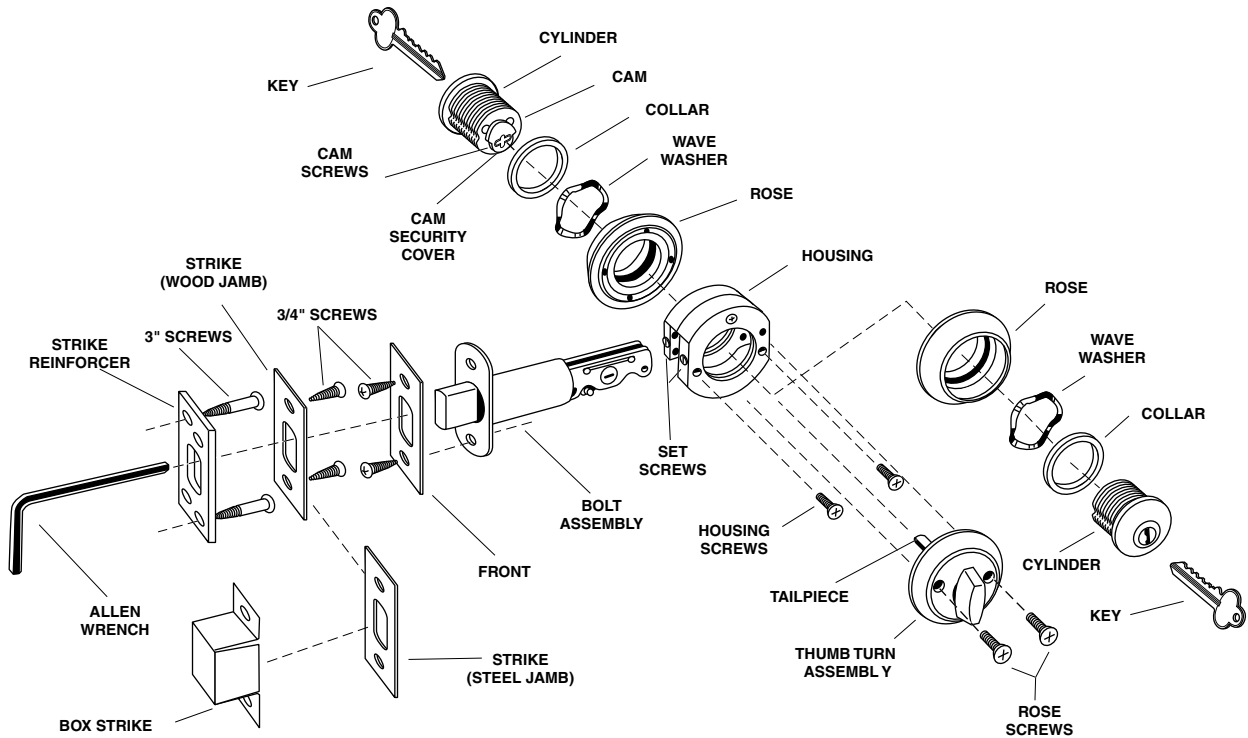

## Deadbolt Parts

Lead Time 3 days

Product No.	Description	Sugg. List
<b>STRIKES (WITH SCREWS)</b>		
4500-xx-5011	for wood jamb, w/reinforcer (heavy duty)	6.85
4500-xx-5013	for steel jamb, w/dust box (regular duty)	4.60
4500-83-2000	dust box only	1.30
<b>Housing for Bolts</b>		
4500-84-5003	for 2 $\frac{3}{4}$ " and 2 $\frac{1}{2}$ " backsets	13.30
4900-84-5005	for 2" backset	13.30
<b>Thumbturn / Rose Assembly</b>		
4500-xx-5016	thumbturn assembly for both 4500&4900	15.35
4500-82-2007	thumbturn tailpiece only	.50
4500-82-2008	long thumbturn tailpiece only	1.05
<b>Screws</b>		
4200-98-4011	cam screw	.35
4500-82-4014	housing screw $\frac{5}{16}$ " x 1"	.35
4500-xx-4018	thumbturn assembly / rose screws	.35

Product No.	Description	Sugg. List
4500-99-4015	set screw	.35
4500-80-1017	3 screw for heavy duty strike	1.00
4500-xx-1036	$\frac{3}{8}$ " screw for regular strike / front	.35
<b>Collars &amp; Roses</b>		
4500-xx-5017	standard rose for 4500	11.00
4000-xx-1004	collar $\frac{5}{16}$ "	1.45
4500-81-4020	wave washer	1.00
4900-xx-5017	low profile rose for 4900	11.00
<b>Miscellaneous</b>		
4500-80-4016	$\frac{5}{16}$ " Allen wrench	.85
863R	cylinder cam for LORI deadbolts	1.20
4500-80-2013	security cover for cam	.40
4500-82-1012	steel strike reinforcer less screws	1.00
4500-xx-5050	2 $\frac{1}{4}$ " thick door kit for 4510: Use with 1 $\frac{1}{4}$ " cylinder outside	13.30

Pricing is for standard keyways and keying. See page 6 & 7 for additional pricing details that may apply.

# How to Order Cylinders

**(BH)<sup>†</sup> 7 1 6 5 A A 2 - 2 6 D - K A 2**

Example: Standard 1 inch, 5 pin mortise cylinder, Arrow keyway with Adams Rite cam, satin chrome finish, keyed alike in pairs.



†Add 'BH' prefix to description for Bump Halt Bump Resistance Technology.



## 1 Model Number

MODEL	DESCRIPTION	MODEL	DESCRIPTION	MODEL	DESCRIPTION
<b>MORTISE CYLINDERS</b>		<b>TURN KNOB MORTISE CYLINDERS</b>		<b>RIM CYLINDERS</b>	
7124	3/4 (19 mm) 4 Pin	7151	1 5/16 (23.8 mm) Turn Knob	7015	5 Pin Cylinder
7155	1 5/16 (23.8 mm) 5 Pin	7161	1 (25.4 mm) Turn Knob	7016	6 Pin Cylinder
7165	1 (25.4 mm) 5 Pin	7181	1 1/8 (28.6 mm) Turn Knob	7075	5 Pin Cylinder with screw cap
7185	1 1/8 (28.6 mm) 5 Pin (Drilled 6 Pin)	7201	1 1/4 (31.7 mm) Turn Knob	7076	6 Pin Cylinder with screw cap
7186	1 1/8 (28.6 mm) 6 Pin	7221	1 3/8 (34.9 mm) Turn Knob	<b>TURN KNOB RIM CYLINDERS</b>	
7205	1 1/4 (31.7 mm) 5 Pin (Drilled 7 Pin)	7241	1 1/2 (38.1 mm) Turn Knob	7011	Turnknob Rim Cylinder
7206	1 1/4 (31.7 mm) 6 Pin (Drilled 7 Pin)	7261	1 5/8 (41.2 mm) Turn Knob	<b>DUMMY RIM CYLINDERS</b>	
7207	1 1/4 (31.7 mm) 7 Pin	7281	1 3/4 (44.4 mm) Turn Knob	7010	1 1/8 (28.6 mm) Dummy
7225	1 3/8 (34.9 mm) 5 Pin (Drilled 7 Pin)	7301	1 7/8 (47.6 mm) Turn Knob	<b>KEY-IN-KNOB</b>	
7226	1 3/8 (34.9 mm) 6 Pin (Drilled 7 Pin)	7321	2 (50.8 mm) Turn Knob	15235	5 Pin Yale 5300
7227	1 3/8 (34.9 mm) 7 Pin	ADA7151	1 5/16 (23.8 mm) ADA Turn Knob	15236	6 Pin Yale 5300
7245	1 1/2 (38.1 mm) 5 Pin (Drilled 7 Pin)	ADA7161	1 (25.4 mm) ADA Turn Knob	15245	5 Pin Yale 5400
7246	1 1/2 (38.1 mm) 6 Pin (Drilled 7 Pin)	ADA7181	1 1/8 (28.6 mm) ADA Turn Knob	15246	6 Pin Yale 5400
7247	1 1/2 (38.1 mm) 7 Pin	ADA7201	1 1/4 (31.7 mm) ADA Turn Knob	15255	5 Pin Yale Knob
7265	1 5/8 (41.2 mm) 5 pin	ADA7221	1 3/8 (34.9 mm) ADA Turn Knob	15256	6 Pin Yale Knob
7266	1 5/8 (41.2 mm) 6 pin	ADA7241	1 1/2 (38.1 mm) ADA Turn Knob	15355	5 Pin Corbin Russwin
7285	1 3/4 (44.4 mm) 5 pin	ADA7261	1 5/8 (41.2 mm) ADA Turn Knob	15356	6 Pin Corbin Russwin
7286	1 3/4 (44.4 mm) 6 pin	ADA7281	1 3/4 (44.4 mm) ADA Turn Knob	15395	5 Pin Universal Lockset/Leverset/Padlock
7305	1 7/8 (47.6 mm) 5 pin	ADA7301	1 7/8 (47.6 mm) ADA Turn Knob	15396	6 Pin Universal Lockset/Leverset/Padlock
7306	1 7/8 (47.6 mm) 6 pin	ADA7321	2 (50.8 mm) ADA Turn Knob	15495	5 Pin Cylindrical Deadbolt
7325	2 (50.8 mm) 5 pin	41651	1 5/16 (23.8 mm) Captive Turn Knob	15496	6 Pin Cylindrical Deadbolt
7326	2 (50.8 mm) 6 pin	41671	1 1/8 (28.6 mm) Captive Turn Knob	15695	5 Pin Emtek Cylindrical Deadbolts
		<b>DUMMY MORTISE CYLINDERS</b>		15696	6 Pin Emtek Cylindrical Deadbolts
		7150	1 5/16 (23.8 mm) Dummy	15795	5 Pin Sargent 6 Line, 10 Line, T Zone
		7160	1 (25.4 mm) Dummy	15796	6 Pin Sargent 6 Line, 10 Line, T Zone
		7180	1 1/8 (28.6 mm) Dummy	15985	5 Pin Combination Knob/Deadbolt
		7200	1 1/4 (31.7 mm) Dummy	15995	5 Pin Combination Knob/Deadbolt
				15996	6 Pin Combination Knob/Deadbolt

## 2 Keyways

Arrow <b>AA</b> 1179	Corbin 60 <b>CA</b> 1001EH	Corbin * <b>CD</b> 59A1-A2	Dominion 1054F <b>DA</b> S54F	<b>UB</b> Lori L100 Eagle 11929 Harloc 700	Kwikset <b>KS</b> 1176	Weiser <b>WE</b> P1555
Russwin * <b>RC</b> 981 852	Sargent RA-RC <b>GC</b> RA-RC	Schlage E <b>SE</b> 1145E	Yale 8 <b>YA</b> 999	Composite <b>NA</b> R1064E	Corbin 67 <b>CB</b> 1001EN	Corbin/ Russwin <b>CE</b> L4
Dominion 1054F <b>DB</b> D05/D06	Lori 90 * <b>UD</b> Centric 90	Lockwood <b>LA</b> 1004	Russwin * <b>RA</b> 5981R N1011P	Sargent LA <b>GA</b> 1007LA	Schlage C <b>SC</b> 1145	Schlage F * <b>SF</b> 1145F
Yale <b>YG</b> Yale GA	Composite <b>NB</b> HR1	Corbin 77 * <b>CC</b> R1001EN	Dexter 67 <b>XE</b> D1054K	ILCO® <b>UA</b> X1054K	Lori 80 * <b>UE</b> Lori 80	Weiser E <b>WA</b> Falcon 1054WB 1054WC
Russwin D1 <b>RB</b> 1011D1	Sargent LA-LC <b>GB</b> LA-LC	Schlage <b>SX</b> C-K, 1145	Segal 9 <b>FA</b> (1022)			

\* Add \$2.20 to Sugg. List for these keyways





















Comments: 1 1/8 mortise drilled 6 pin. • 1 1/4 - 1 1/2 mortise drilled 7 pin except Yale and Kwikset. • Key-In-Knob drilled 6 pin except 15985.



Ordering Ilco cylinders is easy. Follow the five step process to order the correct Ilco cylinder everytime.

- 1** Specify model number for cylinder type and length.
- 2** Specify double letter code for manufacturer's keyway.
- 3** Specify code number for cam or tailpiece.  
Not required for KIK or Dummy cylinders
- 4** Specify code number for finish.
- 5** Specify code letters for keying.

### 3 Cams and Tailpieces

<b>1</b> Standard (863G) 	<b>2</b> Adams Rite (863A) 	<b>3</b> Clover (863D) 
<b>4</b> Narrow (863E) 	<b>5</b> Marks Cam (863F) 	<b>6</b> Yale (863) 
<b>7</b> Sargent Offset (863U) 	<b>11</b> 14PR-RM (863H) 	<b>12</b> 22PR-A-RM (863J) 
<b>13</b> 22PR-E-RM (863K) 	<b>15</b> Schlage L (863M) 	<b>16</b> Sargent/Yale (863N) 
<b>17</b> Segal/Emhardt (863P) 	<b>18</b> Lori Deadbolt (863R) 	<b>19</b> Clover Corbin/ Russwin Best (863S) 
<b>20</b> Adams Rite 4070 (863T) 	<b>8</b> Standard 1 3/4 (44.5 mm) 862 	<b>9</b> Long 2 3/8 (60.3mm) 862A 
<b>10</b> Long Standard 2 3/8 (60.3 mm) 862B for 7075 	<b>14</b> Long Lazy Action 2 3/8 (60.3mm) 862L for 7075 	

Cams and Tailpieces are also sold separately.

### 4 Finish Codes

CODE	DESCRIPTION	US #	BHMA
03	Bright Brass	032	605
03P †	Bright Brass Permanent	03	605
04	Satin Brass	04	606
05	Antique Brass	05	609
10	Satin Bronze	10	612
10B	Oil Rubbed Bronze	10B	613
26	Bright Chrome	26	625
26D	Satin Chrome	26D	626
28	Clear Aluminum Anodized	28	628
29	Black Aluminum	19	622
32 †	Bright Stainless Steel	32	629
32D †	Satin Stainless Steel	32D	630
46	Duracolor Brown Aluminum	46	624

†Add \$.100 to suggested list.

All finish codes are ANSI/BHMA E (equivalent in appearance to category A) codes and do not reflect the product's base material.

### 5 Keying Codes

CODE	DESCRIPTION
KA	All keyed alike
KD	Keyed different
KA2	Keyed alike in pairs
KA4	Keyed alike in fours
0B	O bitted - Blade Height
MK ★	Master keyed
GMK ★	Grand master keyed

\*When requesting MK or GMK, an additional Keying Code is required (KA, KD, KA2, etc.)

Example: 7165AA2-26D-MK/KA2

Chart at right indicates stock KA bitting combinations. Any other combination add \$2.20 to suggested list.

### Factory Keyed Alike Key Combinations (no up-charge)

YA .019 (OEM)	SC.015 (OEM)
13335	13531
14251	15513
14455	24642
24158	26264
34532	31315
34562	31515
41224	33563
41242	34032
41255	34562
41256	35315
41263	42642
41321	44634
42131	46246
42145	51315
43244	54645
43263	55313
44254	62646
45324	64254
43356	66464
14544	78348

**NOTE: Minimum order 10 each per item.**

## Master Keyed Cylinders

All Keyways Available

Description	Sugg. List
Master Keying add per cylinder (one level)	4.70
Great and Grandmaster Keying add per cylinder (two levels and above)	5.25
Extra Keys	3.60
Construction Keying (per cylinder)	4.95

**Note:** Included are (1) one each of the Master and or Grandmaster Keys for the system. Package will be sent separately from the cylinders via certified mail, return receipt requested. Name and address for this package must be supplied with the cylinder order.

The charts shown on these two pages are based on the product number structure. Refer to Availability Chart on page 22 & 23.

# Mortise Cylinders

Lead time 4 weeks unless listed below.

ILCO® Mortise Cylinders are machined from solid bar brass. This line offers a broad selection of models, providing the flexibility required for numerous applications. Threadsize is 1.150 x 32 UNS. Cylinder face diameter 1.360. A mortise cylinder kit and accessories are also available. Refer to pages 10, 11, and 24.

- 32 keyways (See page 6)
- 11 lengths (See below)
- 16 cams (See page 7)
- 13 finishes (See page 7)
- Furnished with Ilco® Look Alike® keys.
- Rekeyable to original manufacturers' systems.



Available for a \$2.20 upcharge per cylinder and add 'BH' prefix when ordering.



BHMA/ANSI  
A156.5  
Grade 1

Model	Length	Pinning	Sugg. List	
7124	3/4"	(19 mm)	4 pin	11.25
7155	5/16"	(23.8 mm)	5 pin	11.25
7165	1"	(25.4 mm)	5 pin	11.25
7185	1 1/8"	(28.6 mm)	5 pin (6 pin drilled)	11.35
7186	1 1/8"	(28.6 mm)	6 pin	12.35
7205	1 1/4"	(31.7 mm)	5 pin (7 pin drilled)	11.45
7206	1 1/4"	(31.7 mm)	6 pin (7 pin drilled)	12.45
7207	1 1/4"	(31.7 mm)	7 pin	13.45
7225	1 3/8"	(34.9 mm)	5 pin (7 pin drilled)	21.70
7226	1 3/8"	(34.9 mm)	6 pin (7 pin drilled)	22.70
7227	1 3/8"	(34.9 mm)	7 pin	23.70
7245	1 1/2"	(38.1 mm)	5 pin (7 pin drilled)	21.90
7246	1 1/2"	(38.1 mm)	6 pin (7 pin drilled)	22.90
7247	1 1/2"	(38.1 mm)	7 pin	23.90
7265	1 5/8"	(41.2 mm)	5 pin (6 pin drilled) Schlage C only	41.55
7266	1 5/8"	(41.2 mm)	6 pin Schlage C only	44.05
7285	1 3/4"	(44.4 mm)	5 pin (6 pin drilled) Schlage C only	42.60
7286	1 3/4"	(44.4 mm)	6 pin Schlage C only	45.10
7305	1 7/8"	(47.6 mm)	5 pin (6 pin drilled) Schlage C only	43.95
7306	1 7/8"	(47.6 mm)	6 pin Schlage C only	46.45
7325	2"	(50.8 mm)	5 pin (6 pin drilled) Schlage C only	46.45
7326	2"	(50.8 mm)	6 pin Schlage C only	47.35

## Stock List

\$1.00 list upcharge per cylinder for these finishes: 03P, 32 & 32D. 2.20 list upcharge per cylinder for these keyways: CC, CD, UD, UE, RA & RC

7165AA2-03-KA2	7165FA2-26D-KA2	7165KS2-03-KA2	7185RB1-03-KA2	7185SC1-26D-KA2	7185SX1-26D-KA2	7185WE1-26D-KD
7165AA2-26D-KA2	7165FA2-46-KA2	7165KS2-26D-KA2	7185RB1-26D-KA2	7185SC1-46-KA2	7185SX1-46-KA2	7185WE1-26D-KA2
7165AA2-46-KA2	7185FA1-03-KD	7165KS2-46-KA2	7205RB1-03-KD	7185SC2-26D-KA2	7205SX1-03-KD	7165YA2-03-KA2
7185AA1-03-KD	7185FA1-26D-KD	7185KS1-03-KD	7205RB1-26D-KD	7205SC1-03-KD	7205SX1-26D-KD	7165YA2-26D-KA2
7185AA1-26D-KD	7185FA1-03-KA2	7185KS1-26D-KD	7205RB1-03-KA2	7205SC1-26D-KD	7205SX1-03-KA2	7165YA2-46-KA2
7185AA1-03-KA2	7185FA1-26D-KA2	7185KS1-03-KA2	7205RB1-26D-KA2	7205SC1-03-KA2	7205SX1-26D-KA2	7185YA1-03-KD
7185AA1-26D-KA2	7185FA1-03-TE6060	7185KS1-26D-KA2	7155SC2-26D-KA2	7205SC1-26D-KA2	7205UA1-03-KD	7185YA1-26D-KD
7205AA1-03-KD	7205FA1-03-KD	7205KS1-03-KD	7165SC2-10B-KA2	7185SE1-26D-KA2	7165WA2-03-KA2	7185YA1-03-KA2
7205AA1-26D-KD	7205FA1-26D-KD	7205KS1-03-KA2	7205RB2-03-KA2	7165SX2-26D-KD	7165WA2-26D-KD	7185YA1-26D-KA2
7205AA1-03-KA2	7205FA1-03-KA2	7185LA1-03-KD	7165SC2-26D-KA2	7165SX2-03-KA2	7165WA2-46-KA2	7205YA1-03-KD
7205AA1-26D-KA2	7205FA1-26D-KA2	7205LA1-03-KD	7165SC2-46-KA2	7165SX2-26D-KA2	7185WA1-03-KD	7205YA1-26D-KD
7185CA1-03-KD	7205FA1-03-TE6060	7165RB2-03-KA2	7185SC1-03-KD	7165SX2-46-KA2	7185WA1-26D-KD	7205YA1-03-KA2
7185CA1-26D-KD	7185GA1-03-KD	7165RB2-26D-KA2	7185SC1-26D-KD	7165SX2-46-KD	7185WA1-03-KA2	7205YA1-26D-KA2
7185CA1-03-KA2	7185GA1-26D-KD	7165RB2-46-KA2	7185SC2-26D-KD	7185SX1-03-KD	7185WA1-26D-KA2	
7185CA1-26D-KA2	7185GA1-03-KA2	7185RB1-03-KD	7185SC1-10B-KA2	7185SX1-26D-KD	7165WE2-26D-KA2	
7165FA2-03-KA2	7185GA1-26D-KA2	7185RB1-26D-KD	7185SC1-03-KA2	7185SX1-03-KA2	7165WE2-26D-KD	

# Mortise Dummy

Lead time 4 weeks unless listed below.



Cam code not required when ordering.

- 4 lengths
- 13 finishes (See page 7)

Model	Length	Type	Sugg. List	
7150	1 5/16"	(23.8 mm)	mortise	6.85
7160	1"	(25.4 mm)	mortise	6.85
7180	1 1/8"	(28.6 mm)	mortise	6.85
7200	1 1/4"	(31.7 mm)	mortise	6.85

## Stock List

7150DC-26D	7160DC-26D	7180DC-03	7180DC-46	7200DC-26D
7160DC-03	7160DC-46	7180DC-26D	7200DC-03	7200DC-46



# Turnknob Cylinders

Lead time 4 weeks unless listed below.



### Standard Turnknob

- 10 lengths
- 16 cams (See page 7)

Model	Length	Available Finishes	Sugg. List
7151	$\frac{15}{16}$ " (23.8 mm)	03, 04, 05, 10, 10B, 26, 26D, 28, 29, 46	11.20
7161	1" (25.4 mm)	03, 04, 05, 10, 10B, 26, 26D, 28, 29, 46	11.20
7181	$1\frac{1}{8}$ " (28.6 mm)	03, 04, 05, 10, 10B, 26, 26D, 28, 29, 46	11.20
7201	$1\frac{1}{4}$ " (31.7 mm)	03, 04, 05, 10, 10B, 26, 26D, 28, 29, 46	11.20
7221	$1\frac{3}{8}$ " (34.9 mm)	03, 04, 05, 10, 10B, 26, 26D, 28, 29, 46	25.00
7241	$1\frac{1}{2}$ " (38.1 mm)	03, 04, 05, 10, 10B, 26, 26D, 28, 29, 46	25.50
7261	$1\frac{5}{8}$ " (41.2 mm)	03, 04, 05, 10, 10B, 26, 26D, 28, 29, 46	26.00
7281	$1\frac{3}{4}$ " (44.4 mm)	03, 04, 05, 10, 10B, 26, 26D, 28, 29, 46	26.50
7301	$1\frac{7}{8}$ " (47.6 mm)	03, 04, 05, 10, 10B, 26, 26D, 28, 29, 46	27.00
7321	2" (50.8 mm)	03, 04, 05, 10, 10B, 26, 26D, 28, 29, 46	27.50

### Stock List

7151TK2-26D	7181TK1-03
7161TK1-03	7181TK1-26D
7161TK2-03	7181TK2-26D
7161TK2-26D	7181TK1-46
7161TK2-46	7201TK1-26D

### Classroom Function

Model	Length	Available Finishes	Sugg. List
4135	$\frac{15}{16}$ " (23.8 mm)	03, 13, 26D, 29	12.90
4136	1" (25.4 mm)	03, 13, 26D, 29	13.55
4137	$1\frac{1}{8}$ " (28.6 mm)	03, 13, 26D, 29	14.20
4138	$1\frac{1}{4}$ " (31.7 mm)	03, 13, 26D, 29	14.80

### Captive Turnknob

- 3 keyways (Schlage C, Schlage C-K, Weiser)
- 2 finishes (03, 26D)

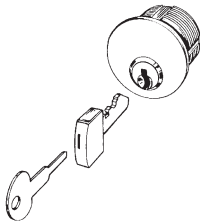

Model	Length	Description	Sugg. List
41651	$\frac{15}{16}$ " (23.8 mm)	(for use with 4900)	23.70
41671	$1\frac{1}{8}$ " (28.6 mm)	(for use with 4500)	23.70

### Replacement Keys for Captive Turnknob

Model	Description	Sugg. List
4165-XX-5001	Captive thumbturn key blank	15.95
4165-XX-5002	Captive thumbturn cut key	19.50
4165-82-2001	Flat steel thumbturn key	1.35

"XX" indicates finish. Specify 03 or 26D

### ADA Turnknob

- 10 lengths
- 16 cams (See page 7)



Model	Length	Available Finishes	Sugg. List
ADA7151	$\frac{15}{16}$ " (23.8 mm)	03, 26D, 10B	15.10
ADA7161	1" (25.4 mm)	03, 26D, 10B	15.10
ADA7181	$1\frac{1}{8}$ " (28.6 mm)	03, 26D, 10B	15.10
ADA7201	$1\frac{1}{4}$ " (31.7 mm)	03, 26D, 10B	15.10
ADA7221	$1\frac{3}{8}$ " (34.9 mm)	03, 26D, 10B	25.00
ADA7241	$1\frac{1}{2}$ " (38.1 mm)	03, 26D, 10B	25.50
ADA7261	$1\frac{5}{8}$ " (41.2 mm)	03, 26D, 10B	26.00
ADA7281	$1\frac{3}{4}$ " (44.4 mm)	03, 26D, 10B	26.50
ADA7301	$1\frac{7}{8}$ " (47.6 mm)	03, 26D, 10B	27.00
ADA7321	2" (50.8 mm)	03, 26D, 10B	27.50

See Availability Chart (pg. 22 & 23) for additional details.

Pricing is for standard keying. See pages 6 & 7 for additional ordering and pricing details that may apply.

# Mortise Parts

## Keyed & Turn Knob Exploded View

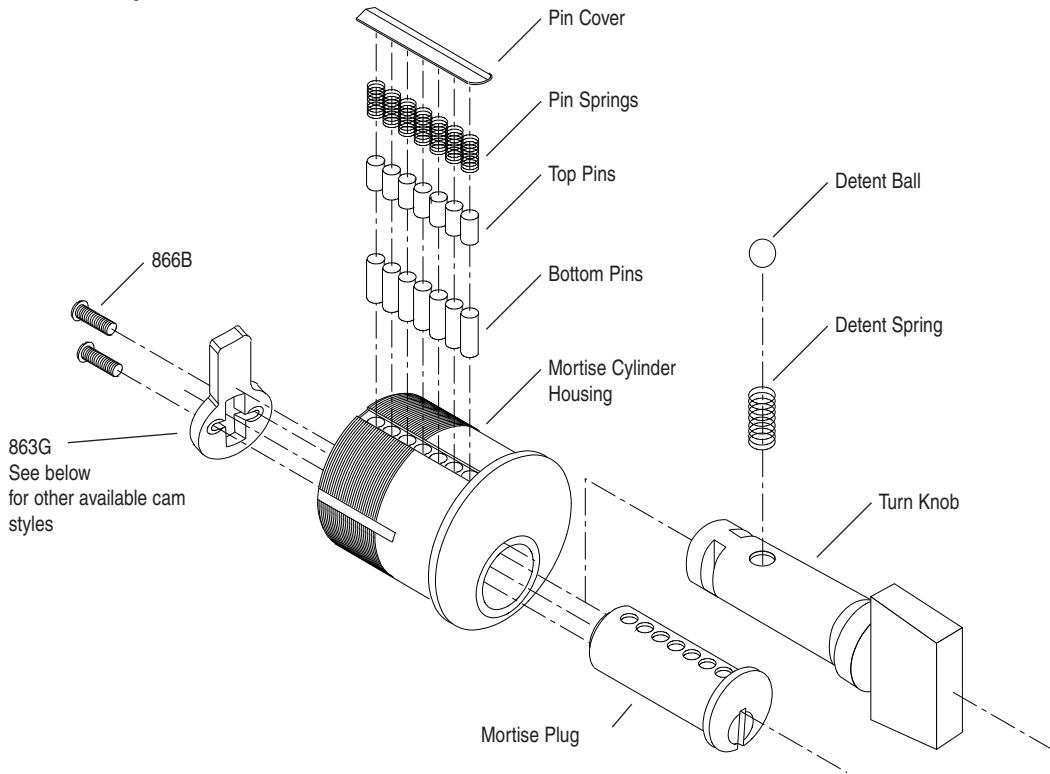

## Mortise Accessories

Lead Time 3 days

### Stock Cams

Product No.	Cam No.	Description	Sugg. List
6 (863)	6	Yale Cam	1.20
2 (863A)	2	Adams Rite Cam	1.20
3 (863D)	3	Standard/Lockwood/Marks Cloverleaf	1.20
4 (863E)	4	Narrow Cam	1.20
5 (863F)	5	Marks Cam	1.20
1 (863G)	1	Standard Cam	1.20
11 (863H)	11	Dominion 14PR-RM Cam	1.80
12 (863J)	12	Dominion 22PR-A-RM Cam	1.80
13 (863K)	13	Dominion 22PR-E-RM Cam	1.80
15 (863M)	15	Schlage L Cam	1.20
16 (863N)	16	Sargent/Yale Cam	1.20
17 (863P)	17	Segal/Emhart Cam DL4000 Corbin Russwin Pocket Mortise Deadbolt	1.20
18 (863R)	18	Lori Deadbolt	1.20
19 (863S)	19	Corbin/Russwin/Best Cloverleaf	1.20
20 (863T)	20	Adams Rite 4070 Cam	1.20
7 (863U)	7	Sargent Offset Cam	1.20

**Stock Adjustable Spring Collars**



861A

Product No.	Description	Adjustment	Sugg. List
861A-03-10	Bright Brass, Solid Brass	$\frac{3}{16}'' - \frac{13}{32}''$ (7.9 mm-20.6 mm)	5.55
861A-26D-10	Satin Chrome, Solid Brass	$\frac{3}{16}'' - \frac{13}{32}''$ (7.9 mm-20.6 mm)	5.55
861A-26-10	Bright Chrome, Solid Brass	$\frac{3}{16}'' - \frac{13}{32}''$ (7.9 mm-20.6 mm)	3.85
861V-XX-10	Steel	$\frac{7}{64}'' - \frac{1}{4}''$ (2.8 mm-6.35)	3.00

(Replace "XX" with finish 03, 10B, 26D, 26.)

**Stock Tapered Collars**



861B

Product No.	Description	Projection	Head Recess	Sugg. List
861B-03-10	Bright Brass Hardened Steel Collar	$\frac{7}{16}''$	$\frac{1}{4}''$	5.90
861B-26D-10	Satin Chrome Hardened Steel Collar	$\frac{7}{16}''$	$\frac{1}{4}''$	5.90
861B-46-10	Duracolor Hardened Steel Collar	$\frac{7}{16}''$	$\frac{1}{4}''$	5.90

**Stock Solid Collars**

(Replace "XX" with finish 03, 04, 10, 10B, 26, 26D, 28, 29 or 46.)



861  
 $\frac{3}{32}'' - \frac{5}{8}''$

Product No.	Description	Thickness	Sugg. List
861C-XX-10	Aluminum Collar	$\frac{3}{32}''$ (2.4 mm)	1.90
861D-XX-10	Aluminum Collar	$\frac{1}{8}''$ (3.2 mm)	1.90
861E-XX-10	Aluminum Collar	$\frac{5}{32}''$ (4.0 mm)	1.90
861K-XX-10	Aluminum Collar	$\frac{3}{16}''$ (4.8 mm)	1.90
861L-XX-10	Aluminum Collar	$\frac{7}{32}''$ (5.6 mm)	1.90
861F-XX-10	Aluminum Collar	$\frac{1}{4}''$ (6.4 mm)	1.90
861M-XX-10	Aluminum Collar	$\frac{9}{32}''$ (7.1 mm)	2.00
861N-XX-10	Aluminum Collar	$\frac{5}{16}''$ (7.9 mm)	2.00
861P-XX-10	Aluminum Collar	$\frac{11}{32}''$ (8.7 mm)	2.00
861Q-XX-10	Aluminum Collar	$\frac{3}{8}''$ (9.5 mm)	2.25
861R-XX-10	Aluminum Collar	$\frac{1}{2}''$ (12.7 mm)	2.25
861T-XX-10	Aluminum Collar	$\frac{5}{8}''$ (15.9 mm)	2.25
861K-00-10	Grey Vinyl Collar	$\frac{3}{16}''$ (4.8 mm)	2.25

**Stock Miscellaneous Parts**



869



866B-00-10



704-04-11



705-04-11

Product No.	Description	Sugg. List
869-00-10	Cash Box Nut - Fits thread on Standard Mortise Cylinder	3.15
866B-00-10	Mortise Cam Screws, (Bag of 100) 3 x 48 self tapping	6.75
704-04-11	Standard Throw Turn Knob Disc, $\frac{3}{16}''$ (4.8 mm) Sq. Hub	17.15
705-04-11	Long Throw Turn Knob Disc, $\frac{3}{16}''$ (4.8 mm) Sq. Hub	17.15



**Bump Halt Kit**

Product No.	Description	Sugg. List
7000BH-00-10	Bump resistance Kit includes 10 pins and 10 springs for Mortise and Rim Cylinders	11.00

## Rim Cylinders

These solid bar brass rim cylinders are ideal for use on 1 3/8" (35 mm) to 2 1/4" (57 mm) thick doors. Each cylinder is furnished with trim ring, mounting plate and break-off screws. A service kit and accessories are also available. Refer to pages 19 and below.

**Lead time 4 weeks unless listed below.**



- 32 keyways (See page 6)
- 13 finishes (See page 7)
- 5, 6 and 7 pin
- Furnished with Ilco® Look Alike® keys.
- Horizontal or vertical tailpiece installation.
- Rekeyable to original manufacturers' systems.



Available for a \$2.20 upcharge per cylinder and add 'BH' prefix when ordering.

Model	Pinning	Sugg. List
7015	5 pin (6 pin drilled)	12.10
7016	6 pin	13.10
7017	7 pin	quote
7075	5 pin with screwcap	13.00
7076	6 pin with screwcap	14.00

\$1.00 list upcharge per cylinder for these finishes: 03P, 32 & 32D. 2.20 list upcharge per cylinder for these keyways: CC, CD, UD, UE, RA & RC.

### Stock List

7015AA8-03-KD	7015FA8-26D-KD	7015KS8-03-KA2	7015SC8-03-KA2	7015SX8-03-KA2	7015WA8-26D-KD	7015YA8-26D-KD
7015AA8-26D-KD	7015FA8-03-KA2	7015KS8-26D-KA2	7015SC8-26D-KA2	7015SX8-26D-KA2	7015WA8-03-KA2	7015YA8-03-KA2
7015AA8-03-KA2	7015FA8-26D-KA2	7015SC8-03-KD	7015SC8-46-KA2	7015UA8-03-KD	7015WA8-26D-KA2	7015YA8-26D-KA2
7015AA8-26D-KA2	7015KS8-03-KD	7015SC8-26D-KD	7015SX8-03-KD	7015UB8-03-KD	7015WE8-26D-KD	
7015FA8-03-KD	7015KS8-26D-KD	7015SC8-46-KD	7015SX8-26D-KD	7015WA8-03-KD	7015YA8-03-KD	

Chart on page 7 indicates stock KA bitting combinations. Any other combination add \$2.20 to suggested list.

See Availability Chart (pg. 22 & 23) for additional details.

Pricing is for standard keyways and keying. See pages 6 & 7 for additional ordering and pricing details that may apply.

## Rim Dummy

**Lead time 4 weeks unless listed below**



**Stock List**  
7010DC-26D

- 13 finishes (See page 7)

Model	Length	Type	Sugg. List
7010	1 1/8" (28.6 mm)	rim	9.15

Cam code not required when ordering.

## Rim Turnknob

**Lead time 4 weeks unless listed below**



Model	Length	Finishes	Sugg. List
7011	1 1/8" (28.6 mm)	03, 04, 05, 10, 10B, 26, 26D, 28, 29, 46	23.25
ADA-7011	1 1/8" (28.6 mm)	03, 10B, 26D	23.25

## Rim Parts & Accessories

**Lead Time 3 days**

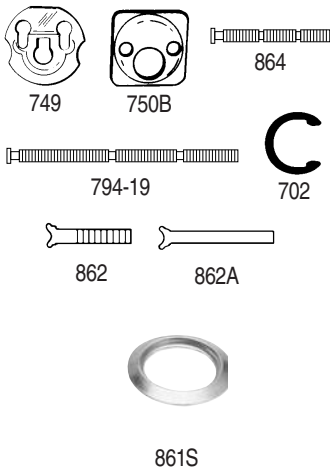

### Stock Accessories & Trim Rings

Product No.	Description	Sugg. List
749-22-10	Universal Mounting Plate	1.65
750B-00-10	Standard Mounting Plate	1.65
864-03-10	Standard Break-off Connecting Screw 12-24 x 1 1/4" (44.5 mm)	1.20
794-19	Extra Long Break-off Screw 12-24 x 2 3/8" (60.3 mm)	1.35
862-00-10	Standard Break-off Tailpiece 1 3/4" (44.45 mm)	1.20
862A-00-10	Extra Long Tailpiece 2 3/8" (60.33 mm)	1.35
862B-00-10	Long Standard Tailpiece - Screwcap	1.35
862L-00-10	Long Lazy Action Tailpiece - Screwcap	1.35
702-00-10	7015 Rim Plug Retaining Ring	1.20
861S-03-10	Bright Brass 1.360" (34.5 mm) diameter recess	1.65
861S-10-10	Satin Bronze 1.360" (34.5 mm) diameter recess	1.65
861S-10B-10	Oil Rubbed Bronze 1.360" (34.5 mm) diameter recess	1.65
861S-13-10	Dark Duracolor 1.360" (34.5 mm) diameter recess	1.65
861S-26D-10	Satin Chrome 1.360" (34.5 mm) diameter recess	1.65
861S-29-10	Black 1.360" (34.5 mm) diameter recess	1.65
861S-46-10	Duracolor 1.360" (34.5 mm) diameter recess	1.65
1599SW-00-10	Split Washer	1.05

# 1599 Key-In-Knob/Deadbolt Combination Replacement Cylinders

Lead time 4 weeks unless listed below.

## Universal Knob/Lever Locksets Plus Arrow & Schlage Deadbolts (Arrow Knob Designs TA, BD, DD use 1539 knob cylinder)



- 32 Keyways (See page 6)
- Arrow D, E, F, K, Schlage B100, B200, B400, H Series deadlock
- Operates most Grade 1 & 2 knob cylinder locksets and leversets
- CL3900 Corbin Lever and Falcon T Series with tailpieces below
- 560 and 660, ND Series Schlage Deadbolts
- Screw Cap Retainer
- 04 and 26D finish
- Solid Brass



Available for a \$2.20 upcharge per cylinder and add 'BH' prefix when ordering.

Model	Keyways	Pinning	Application	Sugg. List
15985	See Application Chart	5 pin only	Arrow, Schlage	13.90
15995	SC, KW, YA Stock cylinders ONLY	5 pin (6 pin drilled)	Arrow, Schlage	10.60
15995	All others	5 pin (6 pin drilled)	Arrow, Schlage	13.90
15996	All	6 pin	Arrow, Schlage	14.90

\$2.20 list upcharge per cylinder for these keyways: CC, CD, UD, UE, RA & RC.

### Stock List

15995AA-04-0B	15995CE-26D-KD	15995GC-26D-0B	15995RB-04-KD	15995SE-04-0B	15995SX-26D-KD	15995YA-04-0B
15995AA-04-KD	15995GA-04-0B	15995GC-26D-KD	15995RB-26D-0B	15995SE-04-KD	15995WA-04-0B	15995YA-04-KD
15995AA-26D-0B	15995GA-04-KD	15995KS-04-0B	15995RB-26D-KD	15995SE-26D-0B	15995WA-04-KD	15995YA-26D-0B
15995AA-26D-KD	15995GA-26D-0B	15995KS-04-KD	15995SC-04-0B	15995SE-26D-KD	15995WA-26D-0B	15995YA-26D-KD
15995CA-26D-KD	15995GA-26D-KD	15995KS-26D-0B	15995SC-04-KD	15995SX-04-0B	15995WA-26D-KD	15995YG-26D-KD
15995CA-26D-0B	15995GB-26D-0B	15995KS-26D-KD	15995SC-26D-0B	15995SX-04-KD	15995WE-26D-0B	15995YG-26D-0B
15995CE-26D-0B	15995GB-26D-KD	15995RB-04-0B	15995SC-26D-KD	15995SX-26D-0B	15995WE-26D-KD	

### Exploded View

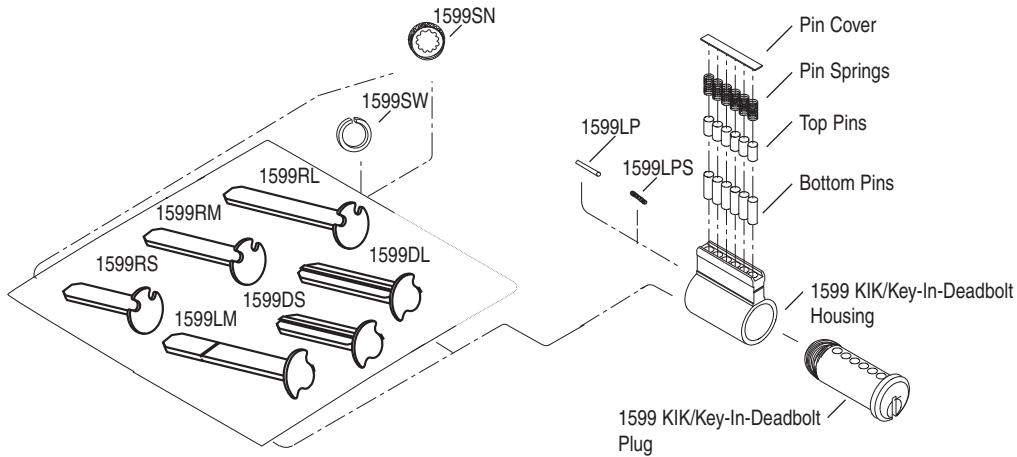

### Replacement Parts

Lead Time 3 days

Product No.	Description	Sugg. List
1599DL-00-10	Tailpiece	1.45
1599DS-00-10	Tailpiece	1.45
1599LM-00-10	Tailpiece	1.45
1599RL-00-10	Tailpiece	1.45
1599RM-00-10	Tailpiece	1.45
1599RS-00-10	Tailpiece	1.45
1599FT-00-10	Tailpiece for Falcon T Series	1.45
1599CL-00-10	Tailpiece for Corbin/Russwin CL3900 Lever	1.45
1599LP-00-10	Lock pin	.50
1599LPS-00-10	Lock pin spring	.50
1599SN-00-10	Screw Nut	1.65
1599SW-00-10	Split washer	1.05

Pricing is for standard keyways and keying.

See pages 6 & 7 for additional ordering and pricing details that may apply

Refer to pages 20 & 21 for Application Chart

January 17, 2011

# Key-In-Knob Replacement Cylinders

Lead time 4 weeks unless listed below.

## 1539 Universal Knob/Lever Locksets

- 32 Keyways (See pages 6)
- 04 and 26D finish
- Operates most Grade 1 & 2 knob cylinder locksets and leversets
- Solid Brass
- Arrow style snap on tailpiece



Available for a \$2.20 upcharge per cylinder and add 'BH' prefix when ordering.



Model	Keyways	Pinning	Application	Sugg. List
15395	SC, KS, YA Stock Cylinders ONLY*	5 pin (6 pin drilled)	Universal	10.25
15395	All others	5 pin (6 pin drilled)	Universal	12.60
15396	All	6 pin	Universal	13.60
1539		Dummy	Universal	9.30

\$2.20 list upcharge per cylinder for these keyways: CC, CD, UD, UE, RA & RC.

### Stock List

15995AA-04-0B	15995CE-26D-KD	15995GC-26D-0B	15995RB-04-KD	15995SE-04-0B	15995SX-26D-KD	15995YA-04-0B
15995AA-04-KD	15995GA-04-0B	15995GC-26D-KD	15995RB-26D-0B	15995SE-04-KD	15995WA-04-0B	15995YA-04-KD
15995AA-26D-0B	15995GA-04-KD	15995KS-04-0B	15995RB-26D-KD	15995SE-26D-0B	15995WA-04-KD	15995YA-26D-0B
15995AA-26D-KD	15995GA-26D-0B	15995KS-04-KD	15995SC-04-0B	15995SE-26D-KD	15995WA-26D-0B	15995YA-26D-KD
15995CA-26D-KD	15995GA-26D-KD	15995KS-26D-0B	15995SC-04-KD	15995SX-04-0B	15995WA-26D-KD	15995YG-26D-KD
15995CA-26D-0B	15995GB-26D-0B	15995KS-26D-KD	15995SC-26D-0B	15995SX-04-KD	15995WE-26D-0B	15995YG-26D-0B
15995CE-26D-0B	15995GB-26D-KD	15995RB-04-0B	15995SC-26D-KD	15995SX-26D-0B	15995WE-26D-KD	

### Exploded View

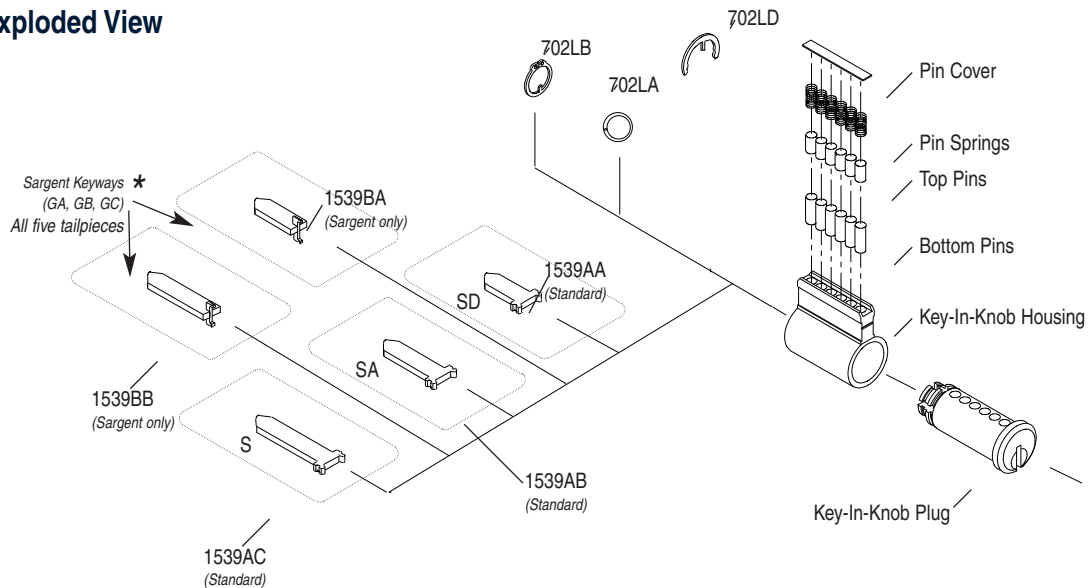

### Replacement Parts

Product Number	Description	Sugg. List
<b>1539 PARTS</b>		
702LA-00-10	Tailpiece retainer "o" ring	1.05
702LB-00-10	Tailpiece retainer snap ring	1.05
702LD-00-10	Plug/Cylinder E-Ring retainer	1.05
<b>STANDARD TAILPIECES*</b>		
1539AA-00-10	short	1.85
1539AB-00-10	medium	1.85
1539AC-00-10	long	1.85
1539BA-00-10	short* Sargent keyways	1.95
1539BB-00-10	long* Sargent keyways	1.95
1539CA-00-10	American padlock driver	1.95
1539DA-00-10	Andersen Window French and sliding door tailpiece	1.70
1539FA-00-10	Falcon B series lever tailpiece	2.10

### In Stock

Product Number	Description	Sugg. List
<b>FALCON S SERIES KNOB TAILPIECES</b>		
1539FB-00-10	short	1.52
1539FC-00-10	medium	1.52
1539FD-00-10	long	1.52
<b>MARKS USA TAILPIECES</b>		
1539GA-00-10	Knob locks (1903-L9)	1.52
1539GB-00-10	Lever Locks (1903-SL9)	1.52
<b>MONARCH 19 SERIES KNOB AND LEVER TRIM TAILPIECES</b>		
- Same as Standard		
<b>PDQ SW, PAT &amp; SPIRIT SERIES LEVER TAILPIECES</b>		
1539LA-00-10	short	1.52
1539LB-00-10	medium	1.52
1539LC-00-10	long	1.52

Brazed tailpieces required for cylinders when used in vertical position in Sargent keyways when repinned with 6 pin key. (packed standard with cylinders ordered with these keyways in addition to three standard tailpieces shown above).

Pricing is for standard keyways and keying. See pages 6 & 7 for additional ordering and pricing details that may apply. Refer to pages 20 & 21 for Application Chart

## Key-In-Deadbolt Replacement Cylinders

### 1549 Corbin Russwin/Yale Cylindrical Deadbolts

Lead time 4 weeks

- 32 Keyways (See pages 6 & 7)
- Fits Yale and Corbin Russwin, single and double, grade one and two, cylindrical deadbolts
- 04 and 26D finish
- Solid Brass Plug and Housing
- Screwcap Tailpiece/Plug Retainer



Available for a \$2.20 upcharge per cylinder and add 'BH' prefix when ordering.

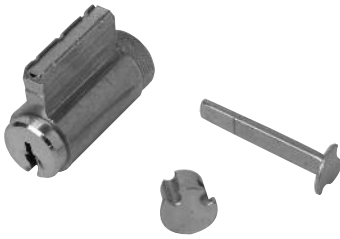

Model	Pinning	Sugg. List
15495	5 pin (6 pin drilled)	13.90
15496	6 pin	14.90

\$2.20 list upcharge per cylinder for these keyways: CC, CD, UD, UE, RA & RC.

### 1569 Emtek Cylindrical Deadbolts

Lead time 4 weeks

- 32 Keyways (See pages 6 & 7)
- Fits EMTEK Single and Double Deadbolts plus knobs & levers
- 04 and 26D finish
- Solid Brass Plug and Housing
- Screwcap Tailpiece/Plug Retainer



Available for a \$2.20 upcharge per cylinder and add 'BH' prefix when ordering.



Model	Pinning	Sugg. List
15695	5 pin (6 pin drilled)	13.90
15696	6 pin - not available in YA & YG (Yale keyways)	14.90

\$2.20 list upcharge per cylinder for these keyways: CC, CD, UD, UE, RA & RC.

#### Replacement Parts

Product No.	Description	Sugg. List
1569EKDH-00-10	Double Horizontal tailpiece -black	1.45
1569EKDV-00-10	Double Vertical tailpiece - chromate	1.45
1569EKS-00-10	Single tailpiece	1.45
1569FA-00-10	Knob and Lever metal adapter	1.45

### 1579 Sargent Key-In-Knob/Lever — Weiser Single Deadbolts plus Power Bolt

Lead time 4 weeks

- 32 Keyways (See pages 6 & 7)
- Fits Sargent® 6 Line Knob, 10 Line Lever, 11 Line (T-Zone) Lever
- 04 and 26D finish
- Solid Brass Plug and Housing
- Screwcap Tailpiece/Plug Retainer
- Fits Weiser single deadbolt and Power Bolt with adding 1579WDTPK below



Available for a \$2.20 upcharge per cylinder and add 'BH' prefix when ordering.



Model	Pinning	Sugg. List
15795	5 pin (6 pin drilled)	13.90
15796	6 pin	14.90

\$2.20 list upcharge per cylinder for these keyways: CC, CD, UD, UE, RA & RC.

#### Replacement Parts

Product No.	Description	Sugg. List
1579WDTPK-00-10	Weiser single Cylindrical deadbolt plus Power Bolt tailpiece kit	1.45
1579SGT6-00-10	Sargent 6 Line Knob tailpiece	1.45
1579TZ-00-10	Sargent T-Zone Lever tailpiece	1.45
1599RS-00-10	Sargent 10 Line Lever tailpiece	1.45

## Yale Knob/Lever Locksets

Lead time 4 weeks

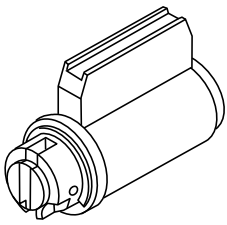

- 21 keyways (See pages 22 & 23)
- 04 and 26D finish only

**Yale 5300 Series**  
Augusta lever short tailpiece

**Yale 5400 Series**  
Augusta lever long tailpiece

**Yale Knob Series**  
5300, 5400, 5500, 6200



Available for a \$2.20 upcharge per cylinder and add 'BH' prefix when ordering.

Model	Pinning	Application	Keyways	Sugg. List
15235	5 pin (6 pin drilled)	Old Yale 5300 Series (Short tailpiece)	(See application chart)	19.70
15236	6 pin	Old Yale 5300 Series (Short tailpiece)	(See application chart)	20.70
15245	5 pin (6 pin drilled)	Yale 5400, 5300LN Series (Long tailpiece)	(See application chart)	19.70
15246	6 pin	Yale 5400, 5300LN Series (Long tailpiece)	(See application chart)	20.70
15255	5 pin (6 pin drilled)	Yale Knob Series (No tailpiece)	(See application chart)	19.70
15256	6 pin	Yale Knob Series (No tailpiece)	(See application chart)	20.70

\$2.20 list upcharge per cylinder for these keyways: CC, CD, UD, UE, RA, RC & RC.

### Parts

Product No.	Description	Sugg. List
1525AA-00-10	Spacer ring	1.65
1525BA-00-10	Cylinder retainer	1.05
1525BC-00-10	Tailpiece retainer for 1523 & 1524	1.05
1523AA-00-10	Tailpiece for 1523	1.45
1524AA-00-10	Tailpiece for 1524	1.45

## 1535 Key-In-Knob Replacement Cylinders - Corbin/Ruswin Knob/unit Locksets

Lead time 4 weeks

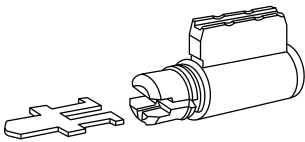

- 20 keyways (See pages 22 & 23)
- 04 and 26D finish only
- 400, 1400, 3300, 4200, 4300, 5600 Series knob
- 300, 500 & 5200 Unit Locks



Available for a \$2.20 upcharge per cylinder and add 'BH' prefix when ordering.

Model	Pinning	Application	Keyways	Sugg. List
15355	5 pin (6 pin drilled)	Corbin/Ruswin	(See application chart)	19.70
15356	6 pin	Corbin/Ruswin	(See application chart)	20.70

\$2.20 list upcharge per cylinder for these keyways: CC, CD, UD, UE, RA, RC & RC

### Parts

Product No.	Description	Sugg. List
702LD-00-10	Plug & tailpiece retainer	1.05
1535BA-00-10	tailpiece	1.45

Pricing is for standard keyways and keying. See page 6 & 7 for additional ordering and pricing details that may apply. Refer to page 20 & 21 for Applications Chart.

### Bump Halt Kit

Product No.	Description	Sugg. List
1500BH-00-10	Bump resistance Kit includes 10 pin and 10 springs for KIK/KIL/KID Cylinders	11.00



## Schlage Replacement Plugs

Lead time 2 weeks

- Solid brass • Exact tolerances • 04 and 26D finishes

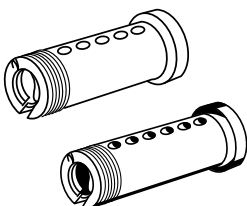

- 15316 – for all Schlage products except mortise, cabinet and F Series
- 15215 – for Schlage B100, B200, B400 and H Series deadlocks
- 16 keyways available (See pages 22 & 23)
- Only available in 04 and 26D finishes

Model	Length	Type	Sugg. List
15215	5 pin	Schlage 33-005	6.20
15316	6 pin	Schlage 33-006	6.20

No cam or keying code required to order.



# Profile Cylinders

Lead time 6 weeks

- Available in 03, 04 and 26D finishes. (Other finishes and lengths available by quote.)
- Repinnable (chamber caps are M4-0.70 X 6mm long set screws)

## Turnknob Cylinder

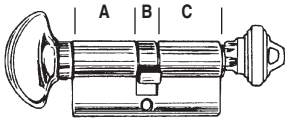

Model	Length	Keyway	Dimensions	Sugg. List
51221	TK	Double Turnknob	28mm (A) x 10mm (B) x 28mm (C)	54.10
5222E	TK	Privacy/Emergency-Slot Outside	28mm (A) x 10mm (B) x 28mm (C)	54.10
52225	5 pin	SC, SE, SF, SX, CD, KS (composite), WA (Composite)	28mm (A) x 10mm (B) x 28mm (C)	51.55
52885	5 pin	SC, SE, SF, SX, CD, KS (composite), WA (Composite)	25mm (A) x 10mm (B) x 25mm (C)	62.40
52336	6 pin	SC, SE, SF, SX	30mm (A) x 10mm (B) x 30mm (C)	56.15
523A6	6 pin	GA	30mm (A) x 10mm (B) x 30mm (C)	62.40

## Double Cylinder

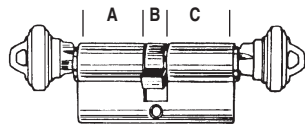

Model	Length	Keyway	Dimensions	Sugg. List
53225	5 pin	SC, SE, SF, SX, CD, KS (composite), WA (Composite)	28mm (A) x 10mm (B) x 28mm (C)	51.55
53226	6 pin	SC, SE, SF, SX	28mm (A) x 10mm (B) x 28mm (C)	56.15
53885	5 pin	SC, SE, SF, SX, CD, KS (composite), WA (Composite)	25mm (A) x 10mm (B) x 25mm (C)	62.40

## Half Cylinder

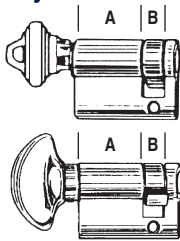

Model	Length	Keyway	Dimensions	Sugg. List
53025	5 pin	SC, SE, SF, SX, CD, KS (composite), WA (Composite)	28mm (A) x 10mm (B)	24.20
53026	6 pin	SC, SE, SF, SX	28mm (A) x 10mm (B)	29.80
52021	TK	Turnknob	28mm (A) x 10mm (B)	25.30

### Custom profile cylinders - 4 3/8" length overall maximum

1 to 50 pieces	260.90
51 to 100 pieces	196.50
101 to 250 pieces	130.45

\$2.20 list upcharge per cylinder for specified KA

## How to Order Profile Cylinders

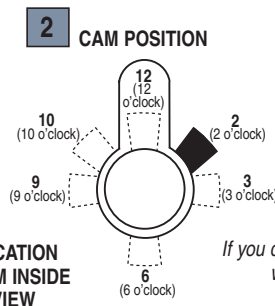
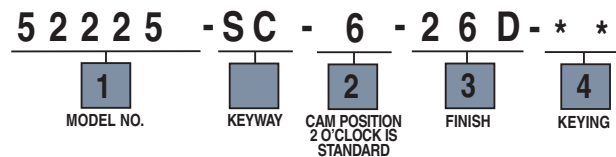

- 4 FINISH  
04 = Satin Brass  
26D = Satin Chrome
- 5 KEYING  
Page 7

## Interchangeable Cores

Lead time 4 weeks

### Solid Brass I.C. Cores



- Solid brass plug and housing
- 6 or 7 pin cores replace Arrow, Best, Falcon, KSP
- 04 or 26D finish
- One control key per order standard

COMING SOON!  
WA, WB, WC, & TB  
Keyways

Product No.	Description	Sugg. List
28016	6 pin uncombined	12.30
28017	7 pin uncombined	12.70
28026	6 pin combined - A2 system only	25.30
28027	7 pin combined - A2 system only	26.55
C28026-BA-26D	Combined Construction Core Extra Master or Control Keys	19.50 3.60

## How to Order I.C. Core

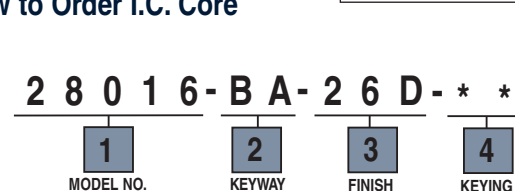

- 2 KEYWAY
- BA - Best A      BH - Best H  
BB - Best B      BJ - Best J  
BC - Best C      BK - Best K  
BD - Best D      BL - Best L  
BE - Best E      BM - Best M  
BF - Best F      BQ - Best Q  
BG - Best G      BU - Lori 62\*

- 3 FINISH  
04 = Satin Brass  
26D = Satin Chrome
- 4 KEYING  
Page 7

# Interchangeable Core Housings

Lead time 3 days

## Stock Thin Head Mortise/Rim with removable cam/tailpiece



- All housing variations (other than stock list shown below) are stocked without cam or tailpiece.
- Interchange any of 5 cams or tailpiece to any finish, or length of housing
- Cam or R2800 Rim Cylinder Kit can be ordered separately.
- Thin Head Mortise can be converted to a rim cylinder in the field
- "R" prefix indicates removable cam style
- Comes standard with 1/4" ring
- Accepts Best, Arrow and Falcon Cores

Model	Pinning	Length	Sugg. List
R28106	Thin Head Mortise - 6 pin	1 1/4"	13.55
R28107	Thin Head Mortise - 7 pin	1 3/8"	13.55
R28206	Thin Head Rim - 6 pin	1 1/4"	14.20
R28207	Thin Head Rim - 7 pin	1 3/8"	14.20
R28406	Tapered Head - 6 pin	15/16"	13.80
R28407	Tapered Head - 7 pin	1"	13.80

### Parts and Accessories

Product No.	Description	Sugg. List
R2800 Conversion Kit	Rim Cylinder Conversion Kit	2.65
R2800-00-8X	SFIC Housing Accessory Kit	99.00
2800SP-00-10	Spacer (10/Pack)	1.20
R2800CS-00-10	Cam Screw (100/Pack)	6.75
R2800G#1-00-10	Std. Yale Cam (10/Pack)	1.20
R2800A#2-00-10	Adams Rite Cam (10/Pack)	1.20
R2800S#3-00-10	Cloverleaf Cam (10/Pack)	1.20
R2800M#4-00-10	Schlage L Cam (10/Pack)	1.20
R2800N#5-00-10	Sargent/Yale Cam (10/Pk)	1.20
R2800RR-00-10	Retaining Ring for Rim Adapter	.75
R2800TR-00-10	Rim Tailpiece Retainer	.75
2800F-03-10	Collar (US3) (10/Pack)	5.90
2800F-04-10	Collar (US4) (10/Pack)	5.90
2800F-10B-10	Collar (US10B) (10/Pack)	5.90
2800F-26-10	Collar (US26) (10/Pack)	5.90
2800F-26D-10	Collar (US26D) (10/Pack)	5.90

### Stock Complete List

Mortise	Rim
R28106-1-26D	R28206-9-26D
R28106-2-26D	R28207-9-26D
R28106-3-26D	
R28106-5-26D	
R28107-1-26D	
R28107-2-26D	
R28107-3-26D	
R28107-4-26D	
R28107-5-26D	

**NOTE: All housing variations, cams and tailpiece are in stock for 3 day shipment, when ordered separately.**

## How to Order I.C. Housings (removable cam)

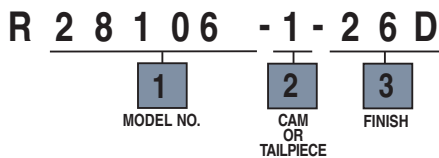

- 2 CAM OR TAILPIECE**
- 0 = No Cam
  - 1 = Standard (Yale)
  - 2 = Adams Rite
  - 3 = Cloverleaf (Corbin/Ruswin/Best)
  - 4 = Schlage L
  - 5 = Sargent Yale
  - 9 = Rim Only

- 3 FINISH**
- 03 = Bright Brass
  - 04 = Satin Brass
  - 10 = Satiin Bronze
  - 10B = Oil Rubbed Bronze
  - 26 = Bright Chrome
  - 26D = Satin Chrome



## Specialty

Lead time 6 weeks

### Post Office Box

Lead time 6 weeks

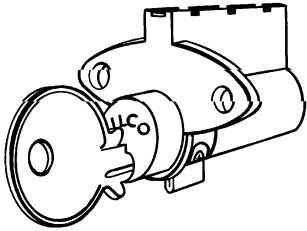

This cylinder operates both the old and new style U.S.P.S. "post office" boxes. Designed for durability, these cylinders are assembled with a bottom cam (for older style boxes), a rear cam and mounting screws are included for newer style boxes.

**Applications:** U.S.P.S. 1500 series P.O. box doors - bottom cam • U.S.P.S .2900 series P.O. Box doors - rear cam  
• Salisbury Industries model 2200 boxes - bottom cam

- Solid Brass
- Yale (8) 999 keyway
- Additional keyways available by quotation.
- 5 pin with 6 pin key (999A)

Model	Pinning	Sugg. List
7835YA-04-KD	U.S.P.S. Post Office Box	28.35

## Cylinder Kits

Lead Time 3 days

### Mortise and Rim Parts Kit



An assortment of the most popular accessories including extra long screws and tailpieces. **Includes:**

- 10 each of the following mortise cams: Standard, Adams Rite, Clover, Narrow, Yale, Marks, Corbin/Ruswin and Dominion
- 20 mortise cam screws
- 10 each standard & extra long tailpieces
- 10 each standard & extra long break-off screws
- 10 rim mounting plates
- 10 "C" clips
- 1 #1 point Phillips hex drive

Model	Pinning	Sugg. List
876-00-8X	Cylinder Cam Kit	81.55

### Collar Kit



An assortment of the most popular styles and sizes. Includes:

- 4 each bright brass & satin chrome tapered hardened collars (861B)
- 4 each bright brass & satin chrome adjustable spring collars (861A)
- 5 each of 3/32" (2.4 mm), 1/8" (3.2 mm), 5/32" (4.0 mm) & 1/4" (6.4 mm) clear aluminum collars & duracolor finishes
- 5 3/16" (4.8 mm) grey vinyl rings
- 5 cash box nuts

Model	Pinning	Sugg. List
870-00-8X	Cylinder Collar Kit	168.80



# Keyway Availability

✓ Available

N/A Not Available

√\* Composite only

^ Available 5 pin only

## MANUFACTURER'S LOCKSET

## MANUFACTURER'S KEYWAY

	MODEL	ARROW	COMPOSITE (1ST PIN .246")	COMPOSITE (1ST PIN .216")	CORBIN 60	CORBIN 67	CORBIN 77	CORBIN 59A1+2	CORBIN/RUSSWIN L4
		AA	NA	NB	CA	CB	CC	CD	CE
Advanced Technology LK-10 lever	1539/1599	✓	✓	✓	✓	✓	✓	✓	✓
Alarm Lock Trilogy DL2700,DL2500LE lever & DL2750, DL2500KO knob	1539/1599	✓	✓	✓	✓	✓	✓	✓	✓
American 3600, 3700, 3800 Series	1539†	✓	✓	✓	✓	✓	✓	✓	✓
Andersen Window, French Wood Hinge & Gliding Doors	1539†	✓	✓	✓	✓	✓	✓	✓	✓
Arrow H, W, S, M & L series knobs & levers; J & K series double lock	1539	✓	✓	✓	✓	✓	✓	✓	✓
Arrow 5 Pin D, E, & (K & M-old) series deadbolts (5 pin only)	1598	✓	N/A	✓	✓	N/A	N/A	N/A	✓
Arrow 6 Pin D, E, & (K-old) series deadbolts	1599	✓	✓	✓	✓	✓	✓	✓	✓
Corbin 400, 1400, 5600 knob 300 unit lock (Yale 5 pin only)	1535	✓	N/A	✓	✓	N/A	N/A	✓	✓
Corbin CL 3300, 3600 levers	1539/1599	✓	✓	✓	✓	✓	✓	✓	✓
Corbin/Russwin 4200 knob, 5200 unit lock (Yale 5 pin only)	1535	✓	N/A	✓	✓	N/A	N/A	✓	✓
Corbin/Russwin CL3900 Lever	1599†	✓	✓	✓	✓	✓	✓	✓	✓
Corbin/Russwin Cylindrical Deadbolts	1549	✓	✓	✓	✓	✓	✓	✓	✓
Dominion 300 series knob	1539/1599	✓	✓	✓	✓	✓	✓	✓	✓
Emtek Cylindrical Deadbolts	1569	✓	✓	✓	✓	✓	✓	✓	✓
Falcon F series key in lever	1539/1599	✓	✓	✓	✓	✓	✓	✓	✓
Falcon B series lever	1539/1599	✓	✓	✓	✓	✓	✓	✓	✓
Falcon S series knob	1539†	✓	✓	✓	✓	✓	✓	✓	✓
Falcon T series lever	1599†	✓	✓	✓	✓	✓	✓	✓	✓
Harloc 6900 series knob, 3500 series lever	1539/1599	✓	✓	✓	✓	✓	✓	✓	✓
Locknetics CM5000 series	1539/1599	✓	✓	✓	✓	✓	✓	✓	✓
Lori 1400 series padlock	1539/1599	✓	✓	✓	✓	✓	✓	✓	✓
LSDA – 100 & LH100 knob, L100 & LX100 lever	1539/1599	✓	✓	✓	✓	✓	✓	✓	✓
Marks 110, 180 knob & 190 lever & CL 2700	1539†	✓	✓	✓	✓	✓	✓	✓	✓
Master 29, 6600 & 6700 Pro series padlocks	1539	✓	✓	✓	✓	✓	✓	✓	✓
Monarch 19 series lever & knob trim	1539†	✓	✓	✓	✓	✓	✓	✓	✓
Omni key-by-pass knob & lever	1539/1599	✓	✓	✓	✓	✓	✓	✓	✓
PDQ SW PAT & Spirit series lever	1539†	✓	✓	✓	✓	✓	✓	✓	✓
Russwin 400, 3300, 4300 knob 500 unit lock (Yale 5 pin only)	1535	✓	N/A	✓	✓	N/A	N/A	✓	✓
Sargent 6 Line Knob, 10 Line Lever, 11 Line (T-Zone) Lever	1579	✓	✓	✓	✓	✓	✓	✓	✓
Schlage 5 Pin, B & H series deadbolt (5 pin only)	1598	✓	N/A	✓	✓	N/A	N/A	N/A	✓
Schlage 6 Pin, B & H series ND Series deadbolt	1599	✓	✓	✓	✓	✓	✓	✓	✓
Schlage A & D knob & lever H series lockset	1539/1599	✓	✓	✓	✓	✓	✓	✓	✓
Schlage 560 & 660 Series Deadbolts	1599	✓	✓	✓	✓	✓	✓	✓	✓
S. Parker – B2635, B9160 & ULB9160 knob & L7160, 8161, XL7160 & XL8160 lever	1539/1599	✓	✓	✓	✓	✓	✓	✓	✓
Uscan – K100 & US53-80 knob, L100, L200 levers	1539/1599	✓	✓	✓	✓	✓	✓	✓	✓
US Lock – 2010, 2012, 2020, ZB0 knobs, 2010L & 2002L levers	1539/1599	✓	✓	✓	✓	✓	✓	✓	✓
Von Duprin 22 series 210K & 210L series	1539/1599	✓	✓	✓	✓	✓	✓	✓	✓
Weiser SC1 Deadbolt & Power Bolt	1579†	✓	✓	✓	✓	✓	✓	✓	✓
Yale 5300 series Augusta lever (short tailpiece)	1523	✓	N/A	✓	✓	N/A	N/A	✓	✓
Yale 5400 series Augusta lever (long tailpiece) & LN 5300	1524	✓	N/A	✓	✓	N/A	N/A	✓	✓
Yale 5300, 5400, 5500, 6200 knob series	1525	✓	N/A	✓	✓	N/A	N/A	✓	✓

### PROFILE CYLINDERS

Single cylinder • Thumb-turn x Key • 5 pin only	5222	N/A	N/A	✓	N/A	N/A	N/A	N/A	N/A
Double cylinder • Key x key • 5 pin (6 pin available)	5322	N/A	N/A	✓	N/A	N/A	N/A	N/A	N/A
Half cylinder • Keyed • 5 pin (6 pin available)	5302	N/A	N/A	✓	N/A	N/A	N/A	N/A	N/A

### PLUGS

Replaces Schlage 5 pin plug #33-005	1521	✓	N/A	✓	✓	N/A	N/A	N/A	N/A
Replaces Schlage 6 pin plug #33-006	1531	✓	N/A	✓	✓	N/A	N/A	✓	✓
Olympus Cabinet Locks	1531	✓	N/A	✓	✓	N/A	N/A	✓	✓

†Order tailpieces or kits for these applications separately. See pages 13-15.





# Cylinder Availability by Style, Length and Keyway

To use the chart to the right and below, select the cylinder type, length cam, and number of pins. Then read down to the desired keyway. Use the legend below to determine the availability.

**Stock** - Available for shipment in 3 days - 5 pin only - Most popular finishes and keying only. See page 24 for specific **Stock Cylinder List**. Any other cylinder combination not listed in **Stock Cylinder List** is considered Non-Stock and has a 4 week delivery. NOTE: All stock 1½" cylinders have a standard (#1) cam installed and are packed with an Adams Rite (#2) cam. All 1" cylinders have an Adams Rite (#2) cam installed and are packed with a standard (#1) cam.

Available

Composite Keyway Only

Not Available

Quotation Only - Minimum order of 500 and special pricing established by quotation only.

LENGTH	MORTISE																					
	¾"	1½"	1"	1½"	1½"	1½"	1½"	1½"	1½"	1½"	1½"	1½"	1½"	1½"	1½"	1½"	1½"	1½"	1½"	2"		
NUMBER OF PINS	4	5	5	5	6	5	6	7	5	6	7	5	6	7	5	6	5	6	5	6	5	6
STANDARD MODEL	7124	7155	7165	7185	7186	7205	7206	7207	7225	7226	7227	7245	7246	7247	7265	7266	7285	7286	7305	7306	7325	7326
STANDARD CAM/TAIPIECE	2	2	2	1	1	1	1	1	1	1	1	1	1	1	1	1	1	1	1	1	1	1
KEYWAY CODE																						
ARROW-1179 AA	N/A	√	√	√	√	√	√	N/A			N/A			N/A	N/A	N/A	N/A	N/A	N/A	N/A	N/A	N/A
COMPOSITE NA	N/A		√	√	N/A	√	N/A	N/A		N/A	N/A		N/A	N/A	N/A	N/A	N/A	N/A	N/A	N/A	N/A	N/A
COMPOSITE NB	N/A	√	√	√	N/A	√	N/A	N/A		N/A	N/A		N/A	N/A	N/A	N/A	N/A	N/A	N/A	N/A	N/A	N/A
CORBIN 60 CA	N/A	√	√	√	√	√	√								N/A	N/A	N/A	N/A	N/A	N/A	N/A	N/A
CORBIN 67 CB	N/A		√	√	√	√	√								N/A	N/A	N/A	N/A	N/A	N/A	N/A	N/A
CORBIN 77 CC	N/A		√	√	√	√	√								N/A	N/A	N/A	N/A	N/A	N/A	N/A	N/A
CORBIN 59 A1-A2 CD	N/A			√	√	√	√	N/A	N/A	N/A	N/A	N/A	N/A	N/A	N/A	N/A	N/A	N/A	N/A	N/A	N/A	N/A
CORBIN/RUSSWIN L4 CE	N/A	√	√	√	√	√	√	N/A	N/A	N/A	N/A	N/A	N/A	N/A	N/A	N/A	N/A	N/A	N/A	N/A	N/A	N/A
DEXTER 67 XE	N/A	N/A	√	√	√	√	√	N/A			N/A			N/A	N/A	N/A	N/A	N/A	N/A	N/A	N/A	N/A
DOMINION 1054F DA	N/A		√	√	N/A	√	N/A	N/A		N/A	N/A		N/A	N/A	N/A	N/A	N/A	N/A	N/A	N/A	N/A	N/A
DOMINION 1054F DB	N/A		√	√	√	√	√	N/A			N/A			N/A	N/A	N/A	N/A	N/A	N/A	N/A	N/A	N/A
ILCO X1054K UA	N/A		√	√	√	√	√	√	√	√	√	√	√	√	N/A	N/A	N/A	N/A	N/A	N/A	N/A	N/A
KWIKSET 1176 KS	N/A	√	√	√	N/A	√	N/A	N/A		N/A	N/A		N/A	N/A	N/A	N/A	N/A	N/A	N/A	N/A	N/A	N/A
LOCKWOOD 1004 LA	√	√	√	√	√	√	√	√	√	√	√	√	√	√	N/A	N/A	N/A	N/A	N/A	N/A	N/A	N/A
LORI L100/EAGLE 11929 HARLOC 700 UB	N/A	√	√	√		√	N/A	N/A	N/A	N/A	N/A	N/A	N/A	N/A	N/A	N/A	N/A	N/A	N/A	N/A	N/A	N/A
LORI 80 UE	N/A	√	√	√	N/A	√	N/A	N/A	N/A	N/A	N/A	N/A	N/A	N/A	N/A	N/A	N/A	N/A	N/A	N/A	N/A	N/A
LORICENTRIC 90 UD	N/A	N/A	N/A	N/A	√	N/A	√	N/A	N/A	N/A	N/A	N/A	N/A	N/A	N/A	N/A	N/A	N/A	N/A	N/A	N/A	N/A
RUSSWIN 981R RA	N/A	√	√	√	√	√	√	N/A			N/A			N/A	N/A	N/A	N/A	N/A	N/A	N/A	N/A	N/A
RUSSWIN D1 RB	N/A	√	√	√	√	√	√	N/A			N/A			N/A	N/A	N/A	N/A	N/A	N/A	N/A	N/A	N/A
RUSSWIN 981-852 RC	N/A	N/A	√	√	√	√	√	N/A			N/A			N/A	N/A	N/A	N/A	N/A	N/A	N/A	N/A	N/A
SARGENT LA GA	N/A	N/A	√	√	√	√	√	√			N/A			N/A	N/A	N/A	N/A	N/A	N/A	N/A	N/A	N/A
SARGENT LA-LC GB	N/A	N/A	N/A	√	√	√	√	N/A	N/A	N/A	N/A	N/A	N/A	N/A	N/A	N/A	N/A	N/A	N/A	N/A	N/A	N/A
SARGENT RA-RC GC	N/A	N/A		√	√	√	√	N/A	N/A	N/A	N/A	N/A	N/A	N/A	N/A	N/A	N/A	N/A	N/A	N/A	N/A	N/A
SCHLAGE C SC	N/A	√	√	√	√	√	√	N/A	√	√	N/A	√	√	N/A	√	√	√	√	√	√	√	√
SCHLAGE CK SX	N/A	√	√	√	√	√	√	N/A	N/A	N/A	N/A			N/A	N/A	N/A	N/A	N/A	N/A	N/A	N/A	N/A
SCHLAGE E SE	N/A	√	√	√	√	√	√	N/A			N/A			N/A	N/A	N/A	N/A	N/A	N/A	N/A	N/A	N/A
SCHLAGE F SF	N/A		√	√	√	√	√	N/A			N/A			N/A	N/A	N/A	N/A	N/A	N/A	N/A	N/A	N/A
SEGAL 9 FA	N/A	√	√	√	√	√	√	√	√	√	√	√	√	√	N/A	N/A	N/A	N/A	N/A	N/A	N/A	N/A
WEISER/FALCON E WA	N/A	√	√	√	√	√	√	N/A			N/A			N/A	N/A	N/A	N/A	N/A	N/A	N/A	N/A	N/A
WEISER 1555 WE	N/A	√	√	√	N/A	√	N/A	N/A	N/A	N/A	N/A	N/A	N/A	N/A	N/A	N/A	N/A	N/A	N/A	N/A	N/A	N/A
YALE 8 (999) YA	N/A	√	√	√	√	√	√	N/A			N/A			N/A	N/A	N/A	N/A	N/A	N/A	N/A	N/A	N/A
YALE GA YG	N/A			√	√	√	√	N/A	N/A	N/A	N/A	N/A	N/A	N/A	N/A	N/A	N/A	N/A	N/A	N/A	N/A	N/A



LENGTH	TURNKNOB											DUMMY				
	MORTISE										RIM	MORTISE				RIM
	1 1/8"	1"	1 1/2"	1 3/4"	1 1/2"	1 1/2"	1 5/8"	1 3/4"	1 7/8"	2"		1 1/8"	1"	1 1/2"	1 3/4"	
STANDARD CAM/TAIPIECE	2	2	1	1	1	1	1	1	1	1						
STANDARD MODEL	7151	7161	7181	7201	7221	7241	7261	7281	7301	7321	7011	7150	7160	7180	7200	7010

Check page 9 for Turnknob finish availability

NUMBER OF PINS	RIM						KEY-IN-KNOB						PROFILE							
				SCREWCAP			UNIVERSAL KNOB/LEVER		SARGENT/WEISER		KNOB/LEVER DEADBOLT		DEADBOLT 5 PIN	CORBIN RUSSWIN		CYLINDER TURN KNOB	DOUBLE CYLINDER		HALF CYLINDER	
	5	6	7	5	6	5	6	5	6	5	6	5	5	6	5	5	6	5	6	
STANDARD MODEL	7015	7016	7017	7075	7076	15395	15396	15795	15796	15995	15996	15985	15355	15356	52225	53225	53226	53025	53026	
KEYWAY CODE																				
ARROW-1179 AA	√	√	N/A	√	√	√	√	√	√	√	√	√			N/A	N/A	N/A	N/A	N/A	
COMPOSITE NA	√	N/A	N/A	√	N/A	√	N/A	√	N/A	√	N/A	N/A	N/A	N/A	N/A	N/A	N/A	N/A	N/A	
COMPOSITE NB	√	N/A	N/A	√	N/A	√	N/A	√	N/A	√	N/A	√	√	N/A	√*	√*	N/A	√*	N/A	
CORBIN 60 CA	√	√		√	√	√	√	√	√	√	√	√	√	N/A	N/A	N/A	N/A	N/A	N/A	
CORBIN 67 CB	√	√	N/A	√	√	√	√	√	√	√	√	N/A	N/A	N/A	N/A	N/A	N/A	N/A	N/A	
CORBIN 77 CC	√	√	N/A	√	√	√	√	√	√	√	√	N/A	N/A	N/A	N/A	N/A	N/A	N/A	N/A	
CORBIN 59 A1-A2 CD	√	√	N/A	√	√	√	√	√	√	√	√	N/A	√	√	N/A	N/A	N/A	N/A	N/A	
CORBIN/RUSSWIN L4 CE	√	√	N/A	√	√	√	√	√	√	√	√	√	√	√	N/A	N/A	N/A	N/A	N/A	
DEXTER 67 XE	√	√	N/A	√	√	√	√	√	√	√	√	N/A	N/A	N/A	√*	√*	N/A	√*	N/A	
DOMINION 1054F DA	√		N/A	√		√	N/A	√	N/A	√	N/A	N/A	N/A	N/A	N/A	N/A	N/A	N/A	N/A	
DOMINION 1054F DB	√	√	N/A	√	√	√	√	√	√	√	√	N/A	N/A	N/A	N/A	N/A	N/A	N/A	N/A	
ILCO X1054K UA	√	√		√	√	√	√	√	√	√	√	N/A	N/A	N/A	N/A	N/A	N/A	N/A	N/A	
KWIKSET 1176 KS	√	N/A	N/A	√	N/A	√	N/A	√	N/A	√	N/A	√	N/A	N/A	√*	√*	N/A	√*	N/A	
LOCKWOOD 1004 LA	√	√		√	√	√	√	√	√	√	√				N/A	N/A	N/A	N/A	N/A	
LORI L100/EAGLE 11929 HARLOC 700 UB	√	N/A	N/A	√	N/A	√	N/A	√	N/A	√	N/A	N/A	N/A	N/A	N/A	N/A	N/A	N/A	N/A	
LORI 80 UE	√	N/A	N/A	√	N/A	√	N/A	√	N/A	√	N/A	N/A	N/A	N/A	N/A	N/A	N/A	N/A	N/A	
LORICENTRIC 90 UD	N/A	√	N/A	N/A	√	N/A	√	N/A	√	N/A	√		N/A		N/A	N/A	N/A	N/A	N/A	
RUSSWIN 981R RA	√	√	N/A	√	√	√	√	√	√	√	√	√	√	√	N/A	N/A	N/A	N/A	N/A	
RUSSWIN 981-852 RB	√	√		√	√	√	√	√	√	√	√	√	√	√	N/A	N/A	N/A	N/A	N/A	
RUSSWIN D1 RC	√	√	N/A	√	√	√	√	√	√	√	√	N/A	N/A	N/A	N/A	N/A	N/A	N/A	N/A	
SARGENT LA GA	√	√	N/A	√	√	√	√	√	√	√	√	N/A			N/A	N/A	N/A	N/A	N/A	
SARGENT LA-LC GB	√	√	N/A	√	√	√	√	√	√	√	√	N/A	√	√	N/A	N/A	N/A	N/A	N/A	
SARGENT RA-RC GC	√	√	N/A	√	√	√	√	√	√	√	√	N/A	√	√	N/A	N/A	N/A	N/A	N/A	
SCHLAGE C SC	√	√	N/A	√	√	√	√	√	√	√	√	√	√	√	√	√	√	√	√	
SCHLAGE CK SX	√	√	√	√	√	N/A	√	√	√	√	√	√	√	√	√	√	√	√	√	
SCHLAGE E SE	√	√	N/A	√	√	√	√	√	√	√	√	√	√	√	√	√	√	√	√	
SCHLAGE F SF	√	√	N/A	√	√	√	√	√	√	√	√	N/A	N/A	N/A	N/A	N/A	N/A	N/A	N/A	
SEGAL 9 FA	√	√		√	√	√	√	√	√	√	√	√	√	√	N/A	N/A	N/A	N/A	N/A	
WEISER/FALCON E WA	√	√	N/A	√	√	√	√	√	√	√	√	√	√	√	N/A	N/A	N/A	N/A	N/A	
WEISER 1555 WE	√	N/A	N/A	√	N/A	√	N/A	√	N/A	√	N/A	N/A	N/A	N/A	N/A	N/A	N/A	N/A	N/A	
YALE 8 (999) YA	√	√	N/A	√	√	√	√	√	√	√	√	√	√	√	N/A	N/A	N/A	N/A	N/A	
YALE GA YG	√	√	N/A	√	√	√	√	√	√	√	√	N/A	N/A	N/A	N/A	N/A	N/A	N/A	N/A	



## Stock Brass Cylinder List

Available for shipment in 3 days - 5 pin only - Most popular finishes and keying only

All 1 1/2" cylinders are packed with Adams Rite cam and drilled 6 pin.

All 1" cylinders are packed with standard cams

### By Keyway

#### Arrow 1179 (AA)

7165AA2-03-KA2  
7165AA2-26D-KA2  
7165AA2-46-KA2  
7185AA1-03-KD  
7185AA1-26D-KD  
7185AA1-03-KA2  
7185AA1-26D-KA2  
7205AA1-03-KD  
7205AA1-26D-KD  
7205AA1-03-KA2  
7205AA1-26D-KA2  
7015AA8-03-KD  
7015AA8-26D-KD  
7015AA8-03-KA2  
7015AA8-26D-KA2  
15395AA-04-OB  
15395AA-04-KD  
15395AA-26D-OB  
15395AA-26D-KD  
15995AA-04-OB  
15995AA-04-KD  
15995AA-26D-OB  
15995AA-26D-KD

#### Corbin 60 (CA)

7185CA1-03-KD  
7185CA1-26D-KD  
7185CA1-03-KA2  
7185CA1-26D-KA2  
15395CA-26D-OB  
15395CA-26D-KD  
15995CA-26D-KD  
15995CA-26D-OB

#### Corbin/Russwin L4 (CE)

15395CE-26D-OB  
15395CE-26D-KD  
15995CE-26D-OB  
15995CE-26D-KD

#### Dummys

7160DC-03  
7160DC-26D  
7160DC-46  
7180DC-03  
7180DC-26D  
7180DC-46  
7200DC-03  
7200DC-26D  
7200DC-46  
7150DC-26D  
7010DC-26D

#### Segal 9 (FA)

7165FA2-03-KA2  
7165FA2-26D-KA2  
7165FA2-46-KA2  
7185FA1-03-KD  
7185FA1-26D-KD  
7185FA1-03-KA2  
7185FA1-26D-KA2  
7185FA1-03-TE6060  
7205FA1-03-KD

7205FA1-26D-KD  
7205FA1-03-KA2  
7205FA1-26D-KA2  
7205FA1-03-TE6060  
7015FA8-03-KD  
7015FA8-26D-KD  
7015FA8-03-KA2  
7015FA8-26D-KA2

#### Sargent LA (GA)

7185GA1-03-KD  
7185GA1-26D-KD  
7185GA1-03-KA2  
7185GA1-26D-KA2  
15395GA-04-OB  
15395GA-04-KD  
15395GA-26D-OB  
15395GA-26D-KD  
15995GA-04-OB  
15995GA-04-KD  
15995GA-26D-OB  
15995GA-26D-KD

#### Sargent LA-LC (GB)

15395GB-26D-OB  
15395GB-26D-KD  
15995GB-26D-OB  
15995GB-26D-KD

#### Sargent RA-RC (GC)

15395GC-26D-OB  
15395GC-26D-KD  
15995GC-26D-OB  
15995GC-26D-KD

#### Kwikset 1176 (KS)

7165KS2-03-KA2  
7165KS2-26D-KA2  
7165KS2-46-KA2  
7185KS1-03-KD  
7185KS1-26D-KD  
7185KS1-03-KA2  
7185KS1-26D-KA2  
7205KS1-03-KD  
7205KS1-03-KA2  
7015KS8-03-KD  
7015KS8-26D-KD  
7015KS8-03-KA2  
7015KS8-26D-KA2  
15395KS-04-OB  
15395KS-04-KD  
15395KS-26D-OB  
15395KS-26D-KD  
15995KS-04-OB  
15995KS-04-KD  
15995KS-26D-OB  
15995KS-26D-KD

#### 1004 Lockwood (LA)

7185LA1-03-KD  
7205LA1-03-KD

#### Mortise Deadbolts

45-1-4-04-26D-0  
45-2-4-04-26D-0  
45-1-3-04-03P-0  
45-1-4-04-26D-5-2-5-SC-KD  
45-1-6-04-26D-0

#### Russwin D1 (RB)

7165RB2-03-KA2  
7165RB2-26D-KA2  
7165RB2-46-KA2  
7185RB1-03-KD  
7185RB1-26D-KD  
7185RB1-03-KA2  
7185RB1-26D-KA2  
7205RB1-03-KD  
7205RB1-26D-KD  
7205RB1-03-KA2  
7205RB1-26D-KA2  
15395RB-04-OB  
15395RB-04-KD  
15395RB-26D-OB  
15395RB-26D-KD  
15995RB-04-OB  
15995RB-04-KD  
15995RB-26D-OB  
15995RB-26D-KD

#### Schlage C (SC)

7155SC2-26D-KA2  
7165SC2-10B-KA2  
7165SC2-03-KA2  
7165SC2-26D-KA2  
7165SC2-46-KA2  
7185SC1-03-KD  
7185SC1-26D-KD  
7185SC2-26D-KD  
7185SC1-10B-KA2  
7185SC1-03-KA2  
7185SC1-26D-KA2  
7185SC1-46-KA2  
7185SC2-26D-KA2  
7205SC1-03-KD  
7205SC1-26D-KD  
7205SC1-03-KA2  
7205SC1-26D-KA2  
7015SC8-03-KD  
7015SC8-26D-KD  
7015SC8-03-KA2  
7015SC8-26D-KA2  
7015SC8-46-KD  
7015SC8-03-KA2  
7015SC8-26D-KA2  
7015SC8-46-KA2  
15395SC-04-OB  
15395SC-04-KD  
15395SC-26D-OB  
15395SC-26D-KD  
15995SC-04-OB  
15995SC-04-KD  
15995SC-26D-OB  
15995SC-26D-KD

#### Schlage E (SE)

7185SE1-26D-KA2  
15395SE-04-OB  
15395SE-04-KD  
15395SE-26D-OB  
15395SE-26D-KD  
15995SE-04-OB  
15995SE-04-KD  
15995SE-26D-OB  
15995SE-26D-KD

#### Turnknobs

7151TK2-26D  
7161TK1-03  
7161TK2-03  
7161TK2-10B  
7161TK2-26D  
7161TK2-46  
7181TK1-03  
7181TK1-26D  
7181TK1-46  
7181TK2-26D  
7201TK1-26D

#### Schlage C-K (SX)

7165SX2-26D-KD  
7165SX2-03-KA2  
7165SX2-26D-KA2  
7165SX2-46-KA2  
7165SX2-46-KD  
7185SX1-03-KD  
7185SX1-26D-KD  
7185SX1-03-KA2  
7185SX1-26D-KA2  
7185SX1-46-KA2  
7205SX1-03-KD  
7205SX1-26D-KD  
7205SX1-03-KA2  
7205SX1-26D-KA2  
7015SX8-03-KD  
7015SX8-26D-KD  
7015SX8-03-KA2  
7015SX8-26D-KA2  
15395SX-04-OB  
15395SX-04-KD  
15395SX-26D-OB  
15395SX-26D-KD  
15995SX-04-OB  
15995SX-04-KD  
15995SX-26D-OB  
15995SX-26D-KD

#### Ilco X1054K (UA)

7205UA1-03-KD  
7015UA8-03-KD

#### Lori L100 (UB)

7015UB8-03-KD

#### Weiser/Falcon E (WA)

7165WA2-03-KA2  
7165WA2-26D-KA2  
7165WA2-46-KA2  
7185WA1-03-KD  
7185WA1-26D-KD  
7185WA1-03-KA2  
7185WA1-26D-KA2  
7015WA8-03-KD  
7015WA8-26D-KD  
7015WA8-03-KA2  
7015WA8-26D-KA2  
15395WA-04-OB  
15395WA-04-KD  
15395WA-26D-OB  
15395WA-26D-KD  
15995WA-04-OB  
15995WA-04-KD  
15995WA-26D-OB  
15995WA-26D-KD

#### Weiser 1555 (WE)

7165WE2-26D-KA2  
7165WE2-26D-KD  
7185WE1-26D-KD  
7185WE1-26D-KA2  
7015WE8-26D-KD  
15995WE-26D-OB  
15995WE-26D-KD

#### Yale 8 (YA)

7165YA2-03-KA2  
7165YA2-26D-KA2  
7165YA2-46-KA2  
7185YA1-03-KD  
7185YA1-26D-KD  
7185YA1-03-KA2  
7185YA1-26D-KA2  
7205YA1-03-KD  
7205YA1-26D-KD  
7205YA1-03-KA2  
7205YA1-26D-KA2  
7015YA8-03-KD  
7015YA8-26D-KD  
7015YA8-03-KA2  
7015YA8-26D-KA2  
15395YA-04-OB  
15395YA-04-KD  
15395YA-26D-OB  
15395YA-26D-KD  
15995YA-04-OB  
15995YA-04-KD  
15995YA-26D-OB  
15995YA-26D-KD

#### Yale GA (YG)

15395YG-26D-KD  
15395YG-26D-OB  
15995YG-26D-KD  
15995YG-26D-OB





## Replacement Door Knobs & Accessories

Lead Time 3 days

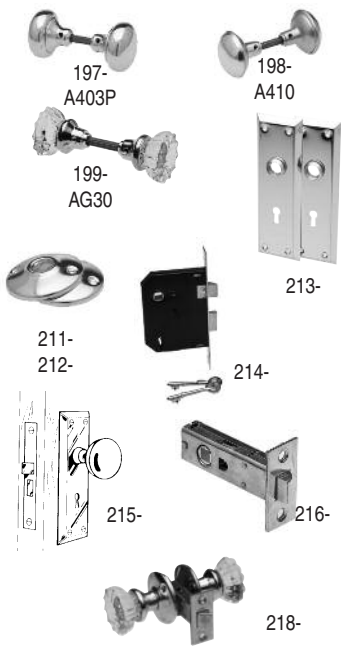

Product Number	Description	Std. Pak	Master Carton	Sugg. List
197-03-51	Replacement Knobs Solid Brass, Blister Carded	5	20	10.60
198-04-51	Replacement Knobs Brass Plated, Blister Carded	5	20	5.10
199A-03-51	Replacement Knobs Clear - Bright Brass Hardware	5	20	9.60
AG30A	Replacement Knobs Clear, Blister Carded, Bright Brass Hardware	5	20	9.60
A403P	Replacement Knobs Solid Brass, Box Pack	5	20	11.05
A410	Replacement Knobs Brass Plated, Box Pack	5	20	5.60
211-03-15	Roses for 198, 199, A410, AG30, Knobs, Bright Brass	5	20	2.65
212-03-51	Roses for 197 and A403P Knobs, Bright Brass	5	20	4.15
213-04-51	Trim Plates, Satin Brass	5	20	5.30
214-04-51	Bit Key Lock, Satin Brass	5	20	8.55
215-04-51	Bit Key Mortise Lockset	5	20	19.75
216-03-51	Replacement Latch for Tubular Locks,	5	20	8.85
218A-03-51	Clear Design Tubular Latchset, Bright Brass - 2 3/8 backset	5	20	13.75
221-25-15	Replacement Latch for Schlage Heavy Duty, Weiser-Falcon and Unican® Series Pushbutton Locks, Satin Chrome - 2 3/4 backset	5	20	55.00
766-00-51	Replacement Spindle - 3 5/8	5	20	4.45
767-00-51	Replacement Spindle - 4 1/2	5	20	4.70

## Window and Patio Door Locks

Lead Time 3 days



Product Number	Description	Keyway	Std. Pak	Master Carton	Sugg. List
203-03-51*	Keyed Sash Lock, Bright Brass	IN29	5	20	8.05
300-59-51*	Heavy Duty Keyed Patio Door Lock, Satin Silver	IN29	5	20	11.05

\* Available in KA (Special Order - Requires 4 week lead time)

## Door Viewers & Door Locks

Lead Time 3 days



Product Number	Description	Keyway	Std. Pak	Master Carton	Sugg. List
183-03-51	160° Door Viewer, Bright Brass	-	5	20	3.30
201-03-51	Chain Door Guard, Bright Brass	-	5	20	7.15

## Specialty Locks

Lead Time 3 days

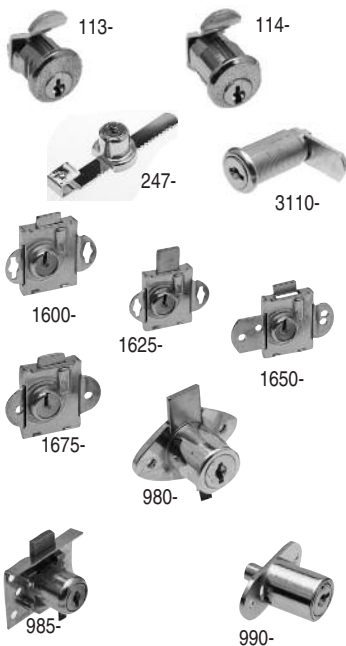

Product Number	Description	Keyway	Std. Pak	Master Carton	Sugg. List
113-14-51	Mail Box Lock with Spring Clip	CO106	5	20	6.85
114-14-51	Mail Box Lock with Threaded Barrel	CO106	5	20	6.85
247-14-51*	Showcase Lock	N54G	5	20	9.45
3120-14-51*	Cam Lock Kit-Fits metal doors up to 3/32 thick	N54G	5	20	6.55
3580-14-51*	Cam Lock Kit-Fits door up to 1/4 thick	N54G	5	20	6.35
3780-14-51*	Cam Lock Kit-Fits doors up to 1/2 thick	N54G	5	20	6.65
3110-14-51*	Cam Lock Kit-Fits doors up to 3/4 thick	N54G	5	20	7.15
3130-14-51*	Cam Lock Kit-Fits doors up to 1 thick	N54G	5	20	7.45
1600-04-11	Letter box lock for Auth., United Florence Boxes	1271L	10	100	6.70
1625-04-11	Letter box lock with 1/2 bolt for Cole, Columbia, Amalgamated	1271L	10	100	7.40
1650-04-11	Letter box lock with Long ear for Cole, Columbia, Amalgamated	1271L	10	100	7.40
1675-04-11	Letter box lock for Couch Boxes	1271L	10	100	17.15
980-03-51*	Cabinet/Drawer Lock	N54G	5	20	6.30
984-03-51*	Cabinet/Drawer Lock Mortise Mount, Spring Latch	N54G	5	20	8.65
985-03-51*	Cabinet/Drawer Lock Mortise Mount,	N54G	5	20	8.80
990-14-51*	Sliding Door Lock	N54G	5	20	8.80
1701-04-11*	Drawer lock with 3/4 horizontal mount	O1014S	10	40	8.45
1701-14-11*	Drawer lock with 3/4 horizontal mount	O1014S	10	40	8.45
1702-04-11*	Drawer lock with 7/8 horizontal mount	O1014S	10	40	8.45
1702-14-11*	Drawer lock with 7/8 horizontal mount	O1014S	10	40	8.45
1703-04-11*	Drawer lock with 1 1/8 horizontal mount	O1014S	10	40	8.45

\* Available in KA (Special Order - Requires 4 week lead time)

## Specialty Locks (continued)

Lead Time 3 days

NOTE: Master Keying available for 1700 Series - Add \$2.22 per lock



1700 Series

Product Number	Description	Keyway	Std. Pak	Master Carton	Sugg. List
1703-14-11*	Drawer lock with 1 1/8 horizontal mount	O1014S	10	40	8.45
1751-04-11*	Drawer lock with 3/4 vertical mount	O1014S	10	40	8.45
1751-14-11*	Drawer lock with 3/4 vertical mount	O1014S	10	40	8.45
1752-04-11*	Drawer lock with 7/8 vertical mount	O1014S	10	40	8.45
1752-14-11*	Drawer lock with 7/8 vertical mount	O1014S	10	40	8.45
1753-04-11*	Drawer lock with 1 1/8 vertical mount	O1014S	10	40	8.45
1753-14-11*	Drawer lock with 1 1/8 vertical mount	O1014S	10	40	8.45

\* Available in KA (Requires 4 week lead time)

## Key Accessories & Assortments

Lead Time 3 days



Split Key Ring



1KRA



226-

Product Number	Description	Std. Pak	Master Carton	Sugg. List
1KRA	Key Identification Assortment/200 rings in 8 colors	1	-	41.50
PT1A	Colored Key Tag Assortment	1	-	55.00
226-14-51	Snap Apart Key Ring	5	40	2.05
232-00-51	Magnetic Key Case - Large	5	40	2.95
234-00-51	Magnetic Key Case - Regular	5	40	2.20
261-00-8X	5/8 (16 mm) Key Rings, 100/box	1	-	6.35
262-00-8X	3/4 (20 mm) Key Rings, 100/box	1	-	7.75
264-00-8X	1 (25 mm) Key Rings, 100/box	1	-	10.10
265-00-8X	1 3/16 (30 mm) Key Rings, 100/box	1	-	14.00
266-00-8X	1 1/4 (32 mm) Key Rings, 50/box	1	-	8.45
267-00-8X	1 1/2 (40 mm) Key Rings, 50/box	1	-	11.80
268-00-8X	2 (50 mm) Key Rings, 50/box	1	-	22.40
765G-00-8X	19/32 Dia. Split Key Rings	1000	-	15.25

## KeyCaps

Lead Time 3 days



Product Number	Description	Std. Pak	Master Carton	Sugg. List
	New Ilco KeyCaps-A slip over key head cover for most house keys that includes a bright, long lasting LED light, for locating lock key holes in low or no light. KeyCaps are carded.			
KeyCap - Leopard		10	40	2.80
KeyCap - Burberry		10	40	2.80
KeyCap - Smiley		10	40	2.80
KeyCap - US Flag		10	40	2.80
KeyCap-1	KeyCap Assortment includes clear display, insert for display and 40 KeyCaps (10 each of 4 different patterns)	1		111.95



# How to Order Custom Cam Locks

Lead Time 4-6 weeks

## 1. Choose Cam Lock Model

- a) By referring to the price list (see pages 30 and 31), determine the Cam Lock model you require  
Example: **35800** = 5/8 cam.

## 2. Determine the Cam Position and Rotation

- a) By using the Cam Rotation chart on page 30, determine cam position, rotation and key removal position. The 2 digit code number replaces the 00 at the end of the model number.  
Example: **35801** = Cam in 12 o'clock position when locked; key turn is to the right with a 90° rotation; key removed in one position

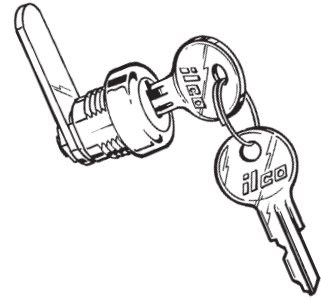

## 3. Choose Cam

- a) By using the Standard Cams chart on page 31, determine which cam is required.  
b) Special cams can be determined by using the Special Cams chart on page 32 or by submitting a drawing  
Example: **35801-J** = 1 1/4 straight cam

## 4. Determine Finish

- a) Standard Finish - Nickel (14)  
b) Other finishes available upon request (minimum order and extra lead time required).  
Example: **35801-J-14** = nickel finish

## 5. Determine Packaging

- 01 Bulk  
11 Polybag  
51 Blister Pack  
Example: **35801-J-14-11** = polybag

## 6. Determine Variations/Options

- All variations/options are to be written manually under special instructions.  
Example: **35801-J-14-KA2** = locks are keyed alike in pairs

- 1 key per lock (A)
- Master keying (B)
- Clip (C)
- Fixed Stop Washer (D)
- No Keys (E)
- Fixed/Riveted Cam (33800 Series only) (F)
- Numbered (N)
- Unassembled (U)
- Special Keying is also available
  - KD (keyed different)
  - KA (keyed alike)
  - KA560 (keyed alike to special combination)
  - KA2 (keyed alike in twos)
  - MK (master keyed)

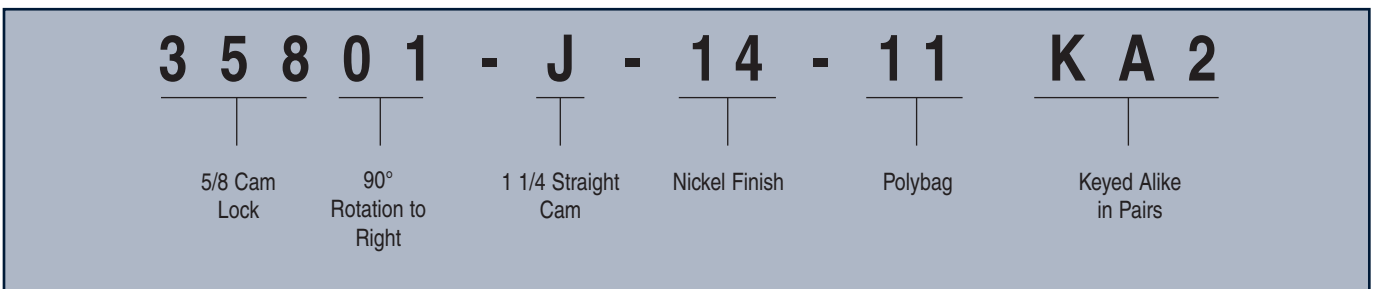



## Cam Rotation Chart

After determining the Cam Lock model, it is important to establish the cam position, rotation, degrees and key removal position by using the chart below. NOTE: Designs are shown with key in upright position.

CAM POSITION & ROTATION	CAM POSITION WHEN LOCKED	ROTATION	DEGREES	KEY REMOVAL POSITIONS	CODE NUMBER
	12 O'CLOCK	RIGHT	90	1 (12 o'clock)	01
		LEFT	90	1 (12 o'clock)	02
		RIGHT	90	2 (12 and 3 o'clock)	03
		LEFT	90	2 (12 and 9 o'clock)	04
		RIGHT	180	2 (12 and 6 o'clock)	05
		LEFT	180	2 (12 and 6 o'clock)	06
		RIGHT	180	3**	* 07
LEFT	180	3**	* 08		
	3 O'CLOCK	RIGHT	90	1 (3 o'clock)	31
		LEFT	90	1 (3 o'clock)	32
		RIGHT	90	2 (3 and 6 o'clock)	33
		LEFT	90	2 (3 and 12 o'clock)	34
		RIGHT	180	2 (3 and 9 o'clock)	35
		LEFT	180	2 (3 and 9 o'clock)	36
		RIGHT	180	3 **	* 37
LEFT	180	3**	* 38		
	6 O'CLOCK	RIGHT	90	1 (6 o'clock)	61
		LEFT	90	1 (6 o'clock)	62
		RIGHT	90	2 (6 and 9 o'clock)	63
		LEFT	90	2 (6 and 3 o'clock)	64
		RIGHT	180	2 (6 and 12 o'clock)	65
		LEFT	180	2 (6 and 12 o'clock)	66
		RIGHT	180	3**	* 67
LEFT	180	3**	* 68		
	9 O'CLOCK	RIGHT	90	1 (9 o'clock)	91
		LEFT	90	1 (9 o'clock)	92
		RIGHT	90	2 (9 and 12 o'clock)	93
		LEFT	90	2 (9 and 6 o'clock)	94
		RIGHT	180	2 (9 and 3 o'clock)	95
		LEFT	180	2 (9 and 3 o'clock)	96
		RIGHT	180	3**	* 97
LEFT	180	3**	* 98		

\* Tubular Cam Locks only.

\*\* Removal positions are to be written manually for tubular cam locks.

Flats on shell are parallel to keyways in locked position. Example:

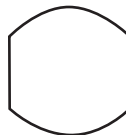

# Standard Cams

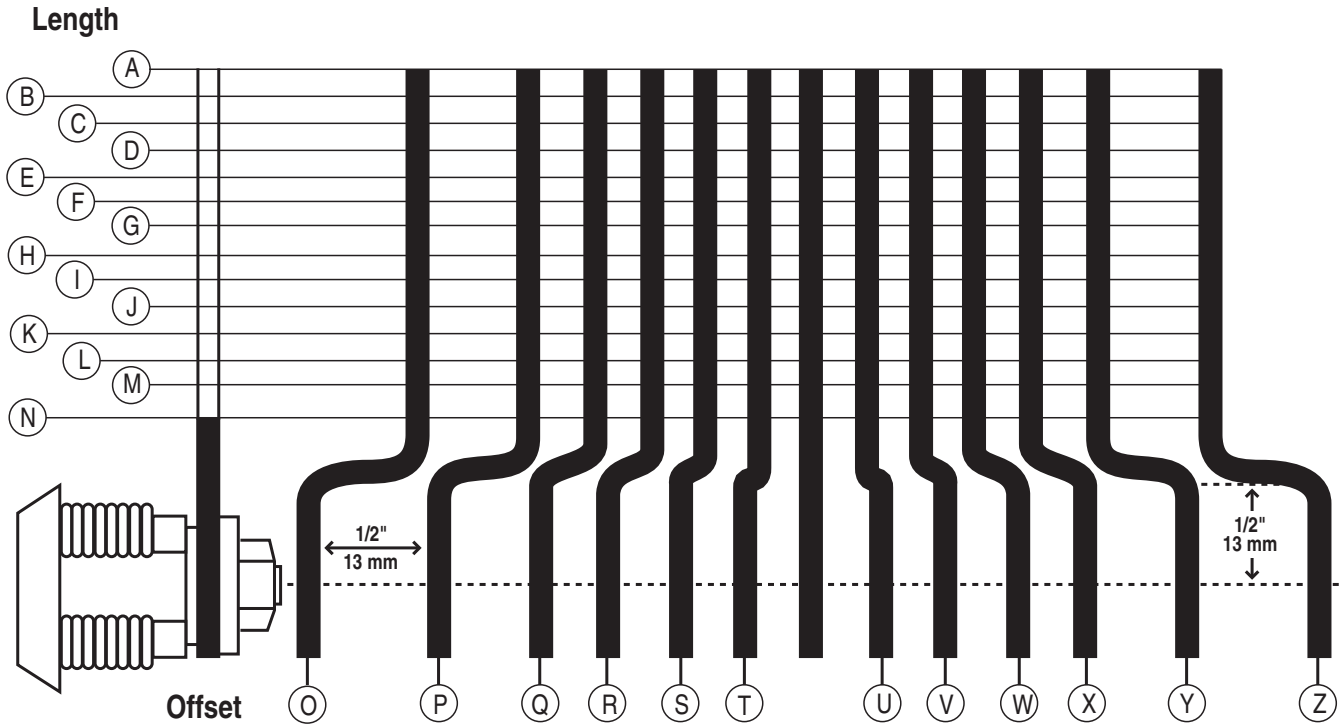

### How to order cams:

1. When ordering a cam, determine the length, ie. 2-3/8 = A cam
2. If the cam is offset (bent) determine the length as in step 1. Then determine the offset (bend) desired.
  - A. By specifying the letters that represent both outside and inside offsets, the cam will be shipped unassembled. The lock can be assembled and installed as either an outside or inside offset cam.
    - ie. 2 3/8 (60mm) long with 1/4 (6mm) offset = AQX cam
  - B. By specifying only th letter that represents the outside or inside offset, the lock will be shipped preassembled with the offset specified.
    - ie. 2 3/8 (60 mm) long with 1/4 (6mm) inside offset = AX cam
    - 2 3/8 (60 mm) long with 1/4 (6mm) outside offset = AQ cam
3. When ordering a cam for tubular cam locks add 137 in front of the number.
  - ie. 2 3/8 (60mm) long with 1/4 (6mm) offset = 137=AQX-Cam

STANDARD LENGTHS		CODE
2 3/8	60 mm	A
2 1/4	57 mm	B
2 1/8	54 mm	C
2	51 mm	D
1 7/8	48 mm	E
1 3/4	44 mm	F
1 5/8	41 mm	G
1 1/2	38 mm	H
1 3/8	35 mm	I
1 1/4	32 mm	J
1 1/8	29 mm	K
1	25 mm	L
7/8	22 mm	M
3/4	19 mm	* N

STANDARD OFFSETS		POSITION	CODE
1/2	13 mm	Outside	O
3/8	10 mm		P
1/4	6 mm		Q
3/16	5 mm		R
1/8	3 mm		S
1/16	1.6 mm		T
1/16	1.6 mm	Inside	U
1/8	3 mm		V
3/16	5 mm		W
1/4	6 mm		X
3/8	10 mm		Y
1/2	13 mm		Z

\* Cannot be made with 1/4, 3/8, or 1/2 offset



## Special Cams

A special cam may be required. Determine the one needed by referring to the chart below, or submit a drawing when ordering.

<p><b>STRAIGHT</b></p>	
<p><b>OFFSET BEND</b></p>	
<p><b>90° SINGLE BEND</b></p>	
<p><b>DOUBLE END</b></p>	
<p><b>HOOK</b></p>	

NOTE: Specify A, B, C, and D, dimensions.

Material is  $\frac{3}{4}$  (16 mm) wide x .110 thick



# Cam Locks Custom Built

Lead Time 4-6 weeks

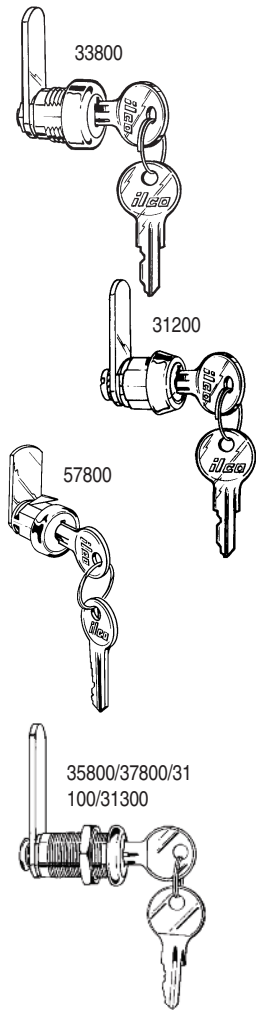

Series	Description	Standard Pack Qty	Sugg. List
33800	Cam Lock 3/8 (10 mm)	10	5.00 ea.
F33800	Cam Lock 3/8 (10 mm) – Spin Riveted	10	5.00 ea.
31200	Cam Lock 1/2 (13 mm) – Shell Clip	10	5.00 ea.
F31200	Cam Lock 1/2 (13 mm) – Spin Riveted	10	5.00 ea.
51200	Cam Lock 1/2 (13 mm) – Metal /Panel Boxes – Cam Retaining Clip – Shell Clip	10	5.00 ea.
35800	Cam Lock 5/8 (16 mm)	10	5.00 ea.
F35800	Cam Lock 5/8 (16 mm) – Spin Riveted	10	5.00 ea.
45800	Cam Lock 5/8 (16 mm) – Squared Head	10	5.00 ea.
F45800	Cam Lock 5/8 (16 mm) – Squared Head – Spin Riveted	10	5.00 ea.
37800	Cam Lock 7/8 (22 mm)	10	5.00 ea.
47800	Cam Lock 7/8 (22 mm) – Squared Head	10	5.00 ea.
57800	Cam Lock 7/8 (22 mm) – 3/4 dia. (19 mm) – Metal/Panel Box – 15 to 24 Gauge	10	5.00 ea.
31100	Cam Lock 1 1/8 (29 mm)	10	5.65 ea.
41100	Cam Lock 1 1/8 (29 mm)– Squared Head	10	5.65 ea.
31300	Cam Lock 1 3/8 (35 mm)	10	5.40 ea.
41300	Cam Lock 1 3/8 (35 mm)– Squared Head	10	5.40 ea.

Follow the How to Order Cam Locks Instructions on page 31.

- N54G Single Bitted Keyway
- Offset cams available. Add \$.50 to list price.
- Master keying available (100 combinations). Add \$1.12 to list price.
- Finishes: – Nickel (14)  
– Other finishes available upon request.
- Bulk Packaged (01)
- Specify cam rotation and key removal when ordering.

# Cam Lock Kits

In stock

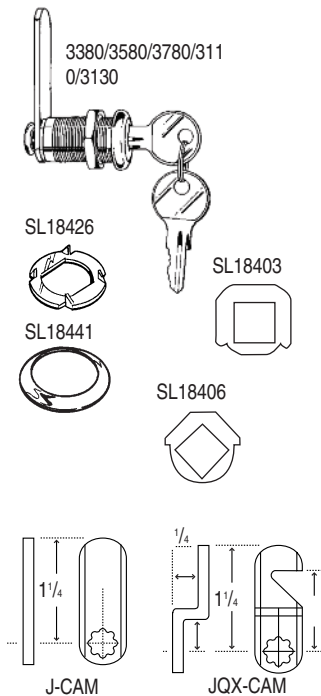

Series	Description	Standard Pack Qty	Sugg. List
3380-14-11	Cam Lock Kit 3/8 (10 mm)	10	5.75 ea.
3120-14-11	Cam Lock Kit 1/2 (13 mm)	10	5.75 ea.
3580-14-11	Cam Lock Kit 5/8 (16 mm)	10	5.75 ea.
3780-14-11	Cam Lock Kit 7/8 (22 mm)	10	5.75 ea.
3110-14-11	Cam Lock Kit 1 1/8 (29 mm)	10	6.10 ea.
3130-14-11	Cam Lock Kit 1 3/8 (35 mm)	10	6.10 ea.

Kit includes:

- N54G Single Bitted Keyway
- Cam Lock with 2 keys / Hex Nut / Cam Attachment
- 90° Stop Washer (SL18403)
- 180° Stop Washer (SL18406)
- Ring (SL18441)
- Wood Washer (SL18426)
- 1/4 Straight Cam (J)
- 1/4 Cam with 1/4 Offset (JQX)

## Thumbturn and Latching Cam Locks

Lead Time 4-6 weeks

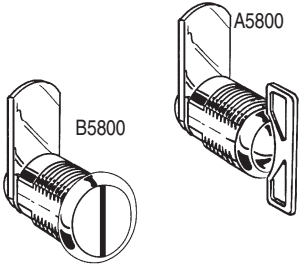

Series	Description	Standard Pack Qty	Sugg. List
A5800	Thumbturn Cam Lock 5/8 (16 mm)	10	3.45 ea.
A7800	Thumbturn Cam Lock 7/8 (22 mm)	10	3.45 ea.
A1100	Thumbturn Cam Lock 1 1/8 (29 mm)	10	3.45 ea.
B5800	Latching Cam Lock 5/8 (16 mm)	10	3.45 ea.

Follow the How to Order Cam Locks Instructions on page 29.

- Offset cams available. Add \$.50 to list price.

## Tubular Cam Locks "Custom Built"

Lead Time 4-6 weeks

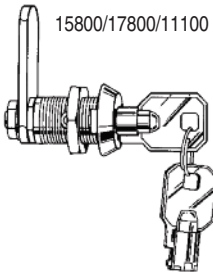

Series	Description	Standard Pack Qty	Sugg. List
25800	Tubular Cam Lock 1/2 (13 mm) – Metal / Panel Boxes – Shell Clip	—	13.00 ea.
15800	Tubular Cam Lock 5/8 (16 mm)	—	13.00 ea.
17800	Tubular Cam Lock 7/8 (22 mm)	—	13.00 ea.
11100	Tubular Cam Lock 1 1/8 (29 mm)	—	13.40 ea.

Follow the How to Order Cam Locks Instructions on page 29.

- 1137 Tubular Keyway
- Offset cams available. Add \$.50 to list price.
- Master keying not available.
- Finish: – Chrome (26)

## Tubular Cam Lock Kits

Lead Time 4-6 weeks

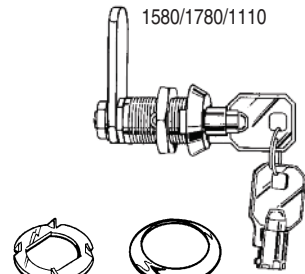

SL18426

SL18441



SD1011



SD1012

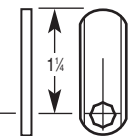

137-J-CAM

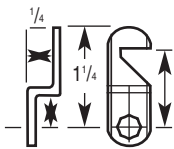

137-JQX-CAM

Series	Description	Standard Pack Qty	Sugg. List
1580-26-11	Tubular Cam Lock Kit 5/8 (16 mm)	10	14.05 ea.
1780-26-11	Tubular Cam Lock Kit 7/8 (22 mm)	10	14.25 ea.
1110-26-11	Tubular Cam Lock Kit 1 1/8 (29 mm)	10	14.70 ea.

Kit includes:

- Cam Lock with 2 keys / Hex Nut / Cam Attachment
- 90° Stop Washer (SD1011)
- 180° Stop Washer (SD1012)
- Ring (SL18441)
- Wood Washer (SL18426)
- 1 1/4 Straight Cam (137-J)
- 1 1/4 Cam with 1/4 Offset (137-JQX)

- 1137 Tubular Keyway
- Finish: – Chrome (26)
- Poly Bagged (11)

## Desk and Drawer Locks

Lead Time 4-6 weeks

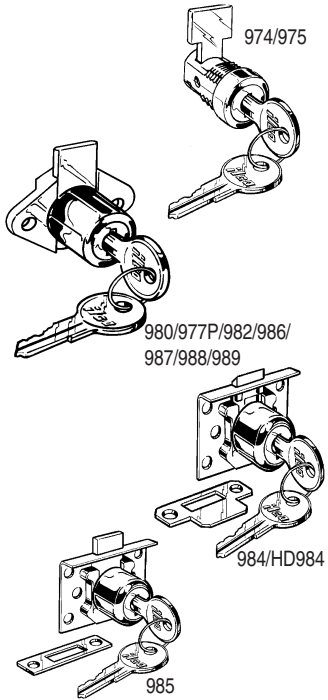

Product No.	Description	Standard Pack Qty	Sugg. List
974-14-11	Desk Lock	10	5.80 ea.
975-14-11	Desk Lock – Removable Core	10	5.80 ea.
984-03-11	Half Mortise Lock 7/8 (22 mm)	10	8.05 ea.
HD984-03-11	Half Mortise Lock 7/8 (22 mm)	10	13.15 ea.
985-03-11	Half Mortise Lock 7/8 (22 mm)	10	8.20 ea.
977P-353-11	Drawer Lock 7/8 (22 mm)	10	3.65 ea.
980-03-11	Drawer Lock 7/8 (22 mm)	10	5.65 ea.
980-14-11	Drawer Lock 7/8 (22 mm)	10	5.65 ea.
982-03-11	Drawer Lock 7/8 (22 mm)	10	5.65 ea.
982-14-11	Drawer Lock 7/8 (22 mm)	10	5.65 ea.
986-03-11	Drawer Lock 1 1/8 (29 mm)	10	5.65 ea.
986-14-11	Drawer Lock 1 1/8 (29 mm)	10	5.65 ea.
987-03-11	Drawer Lock 1 1/8 (29 mm)	10	5.65 ea.
987-14-11	Drawer Lock 1 1/8 (29 mm)	10	5.65 ea.
988-03-11	Drawer Lock 1 1/4 (32 mm)	10	5.85 ea.
988-14-11	Drawer Lock 1 1/4 (32 mm)	10	5.85 ea.
989-03-11	Drawer Lock 1 1/4 (32 mm)	10	5.85 ea.
989-14-11	Drawer Lock 1 1/4 (32 mm)	10	5.85 ea.

- N54G Single Bitted Keyway
- Drawer Locks:
  - supplied with standard cam 1 3/8 (35 mm)
  - other cams available (sample or drawing required).
- Master keying available (100 combinations). Add \$1.20 to list price.
- Finishes:
  - Brass (03)
  - Nickel (14)
  - Black (353)
  - Other finishes available upon request.
- Poly Bagged (11)

## Removable Core Locks

Lead Time 4-6 weeks

- Locking cylinder is removed from the front of the lock. No disassembly required.

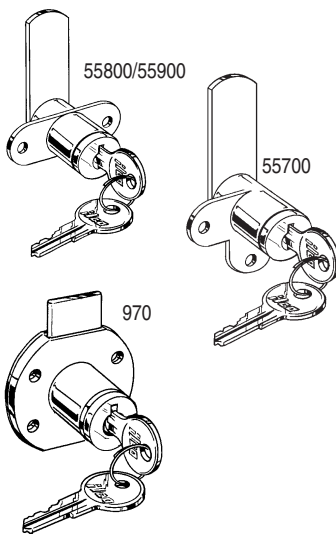

Product No.	Description	Standard Pack Qty	Sugg. List
970	Drawer Lock 13/16 (21 mm)	10	4.75 ea.
55700	Cam Lock 13/16 (21 mm)	10	5.30 ea.
55800	Cam Lock 13/16 (21 mm)	10	5.30 ea.
55900	Cam Lock 13/16 (21 mm)	10	5.30 ea.

- N54G Single Bitted Keyway
- Cam Locks:
  - supplied with standard 1 1/4 Straight Cam (J)
  - offset cams available. Add \$.50 to list price.
- Drawer Locks:
  - supplied with standard cam 1 3/8 (35 mm)
  - other cams available (sample or drawing required).
- Master keying available (100 combinations). Add \$1.20 to list price.
- EKY127 Core Removal Key \$1.80
- Finishes:
  - 11/16 Diameter Locks
    - Black (353)
    - Other finishes available upon request.
  - 3/4 Diameter Locks
    - Nickel (14)
    - Other finishes available upon request.
- Bulk Packaged (01)
- Specify cam rotation and key removal when ordering cam locks.

## Sliding Door Locks

Lead Time 4-6 weeks

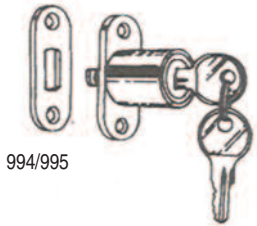
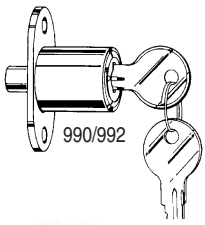

Product No.	Description	Standard Pack Qty	Sugg. List
990-14-11	Sliding Door Lock – Plunger bolt – 15/32 bolt projection – Key removes in locked and unlocked positions	10	8.20 ea.
992-14-11	Sliding Door Lock – Plunger bolt – 15/32 bolt projection – Key removes in locked pos.	10	8.20 ea.
994-14-11	Sliding Door Lock – T-bolt – 5/32 bolt projection – Key removes in locked and unlocked positions	10	8.20 ea.
995-14-11	Sliding Door Lock – T-bolt – 9/32 bolt projection – Key removes in locked and unlocked positions	10	8.20 ea.

- N54G Single Bitted Keyway
- Master keying available (100 combinations). Add \$1.20 to list price.
- Finish: Nickel (14)
- Poly Bagged (11)

## Filing Cabinet Locks

Lead Time 4-6 weeks

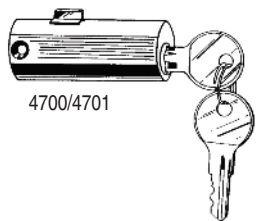

Product No.	Description	Standard Pack Qty	Sugg. List
4700-14-11	Filing Cabinet Lock – 1 1/2 (44 mm) – Round bolt	10	8.50 ea.
4701-14-11	Filing Cabinet Lock – 2 (51 mm) – Rectangular bolt	10	8.50 ea.

- N54G Single Bitted Keyway
- Finish: Nickel (14)
- Master keying not available.

*NOTE: Filing cabinet locks can be keyed alike to our disc tumbler locks.*

## Switch Locks

Lead Time 4-6 weeks

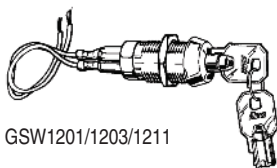

Product No.	Description	Standard Pack Qty	Sugg. List
GSW1201-26-11	Switch Lock – 1 position key removal	10	19.75 ea.
GSW1203-26-11	Switch Lock – 2 position key removal	10	19.75 ea.
GSW1211-26-11	Switch Lock – Spring back momentary contact	10	12.45 ea.

- Single Pole - Single Throw
- 1201 - Key removes in off position only
- 1203 - Key removes in off and on position
- 1211 - Key removes at 12 o'clock position
- Used on low voltage application like garage door openers and alarm systems.
- Length is 1 1/4

- 1137S Tubular Keyway
- Master keying not available.
- Finish: Chrome (26)
- Poly Bagged (11)

*NOTE: Switch locks supplied with wire leads (SEC1018).*

## Show Case Locks

Lead Time 4-6 weeks

247

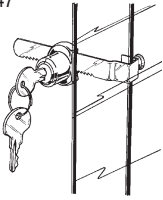

Product No.	Description	Standard Pack Qty	Sugg. List
247-14-11	Show Case Lock	10	10.15 ea.

- N54G Single Bitted Keyway
- Master keying available (100 combinations). Add \$1.20 to list price.
- Finish: Nickel (14)
- Poly Bagged (11)

## Special Purpose Locks

Lead Time 4-6 weeks

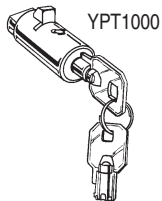

- 3/4 diameter. Length is 1 1/2
- Replacement lock for Pop Out handles used on vending machines

Product No.	Description	Standard Pack Qty	Sugg. List
YPT1000-26-11	Pop Out Handle – Lock only	10	20.25 ea.

- 1137S Tubular Keyway
- Master keying not available.
- Finish: Chrome (26)
- Poly Bagged (11)

## Cams

Lead Time 4-6 weeks

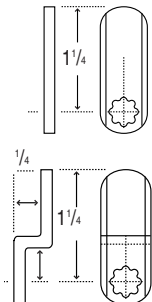

Product No.	Description	Standard Pack Qty	Sugg. List
A to N	Straight	10	5.00 pk.
AO to NZ	Offset	10	6.20 pk.

- Cams supplied poly bagged.
- Specify exact cam required – use cam chart (see pg 31).
- Special cams will be quoted upon request, sample or drawing is required (see pg 32).

## Disc Tumbler Kit

Lead Time 4-6 weeks



818A

Product No.	Description	Kit Contents	Std Pack Qty	Sugg. List
<b>REPLACEMENT PARTS FOR KIT</b>				
SL18602-01-65-8X	Disc Tumbler #1	50	100	6.00/C
SL18602-02-65-8X	Disc Tumbler #2	50	100	6.00/C
SL18602-03-65-8X	Disc Tumbler #3	50	100	6.00/C
SL18602-04-65-8X	Disc Tumbler #4	50	100	6.00/C
SL18602-05-65-8X	Disc Tumbler #5	50	100	6.00/C
PD1001-00-8X	Disc Tumbler Spring	150	100	3.65/C
SD1004-65-8X	Plug Retainer	50	100	7.20/C
818-09	Space and Depth Keys (set of 5)	1	1	12.00 ea
818-11	Plastic Case	1	1	6.00 ea
818A-00-8X	Wafer Keying Kit	1	1	45.60 ea
818AMK-00-8X	MK Wafer Keying Kit	1	1	17.00 ea

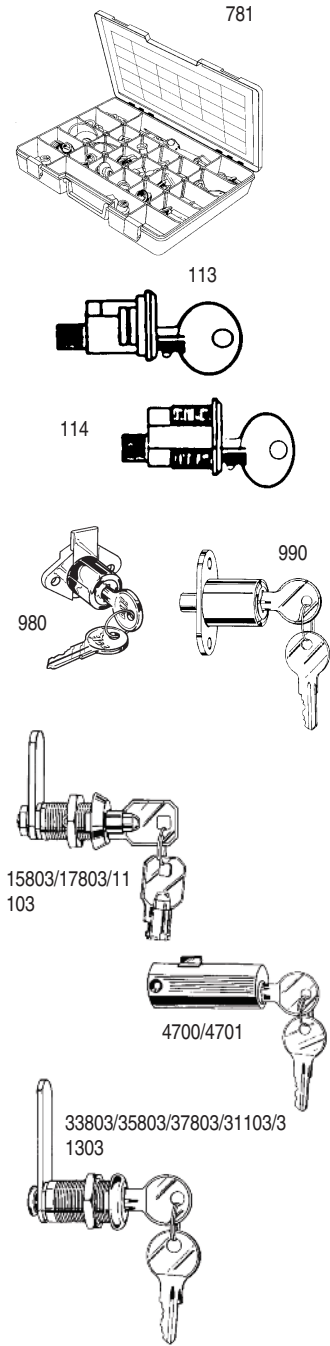

Product No.	Description	Kit Contents	Std Pack Qty	Sugg. List
781-00-8X	Mobile Kit includes: 24 of our most popular locks combined with 55 accessories and 20 cams in a 24 compartment durable travelling case.	—	1	272.70 ea.
<b>LOCKS</b>				
113-14-11	Mail Box Lock – Spring Clip	1	10	7.90 ea.
114-14-11	Mail Box Lock – Thread Barrel	1	10	7.90 ea.
980-03-11	Drawer Lock	1	10	5.45 ea.
980-14-11	Drawer Lock	1	10	5.45 ea.
984-03-11	Half Mortise Lock – Spring Latch	1	10	8.05 ea.
985-03-11	Half Mortise Lock – Deadbolt	1	10	8.05 ea.
990-04-11	Sliding Door Lock	1	10	7.55 ea.
15803-J-26-11	Tubular Cam Lock 5/8 (16 mm) – 2 Position Removal	1	10	13.00 ea.
17803-J-26-11	Tubular Cam Lock 7/8 (22 mm) – 2 Position Removal	1	10	13.00 ea.
11103-J-26-11	Tubular Cam Lock 1 1/8 (29 mm) – 2 Position Removal	1	10	13.40 ea.
33803-J-14-11	Cam Lock 3/8 (10 mm) – 2 Position Removal	1	10	5.00 ea.
35803-J-14-11	Cam Lock 5/8 (16 mm) – 2 Position Removal	1	10	5.00 ea.
37803-J-14-11	Cam Lock 7/8 (22 mm) – 2 Position Removal	1	10	5.00 ea.
31103-J-14-11	Cam Lock 1 1/8 (29 mm) – 2 Position Removal	1	10	5.35 ea.
31303-J-14-11	Cam Lock 1 3/8 (35 mm) – 2 Position Removal	1	10	5.35 ea.
<b>ACCESSORIES</b>				
PD1046-14-10	Protective Collar (Hardened)	5	10	33.65 pk
PD1047-14-10	Shell Ferrule	5	10	12.70 pk.
SL18419-22-10	Spacer 1/32 (1 mm)	5	10	4.70 pk.
SL18422-22-10	Spacer 1/16 (2 mm)	5	10	4.70 pk.
PD1058-22-10	Spacer 3/16 (5 mm)	5	10	4.70 pk.
PD1059-22-10	Spacer 1/4 (6 mm)	5	10	4.70 pk.
SEC1017-19-10	Dust Cap	5	10	12.55 pk.
SU16617-19-10	Clip	5	10	2.90 pk.
SL18426-22-10	Wood Washer	5	10	2.90 pk.
SL18441-14-10	Ring	5	10	7.21 pk.
SL18494-22-10	Attaching Plate	5	10	6.75 pk.
<b>CAMS</b>				
J-CAM-22-10	Straight Cam 1 1/4 (32 mm)	5	10	5.00 pk.
JQX-CAM-22-10	Offset Cam 1 1/4 (32 mm)long 1/4 (6 mm) Offset	5	10	6.20 pk.
307-CAM-22-10	Single Bend Cam 1 1/4 (32 mm) long 7/16 (11 mm) Bend	5	10	6.20 pk.
503-CAM-22-10	Hook Cam 1 1/2 (38 mm) long 1 1/8 (29 mm) to Hook]	5	10	6.20 pk.

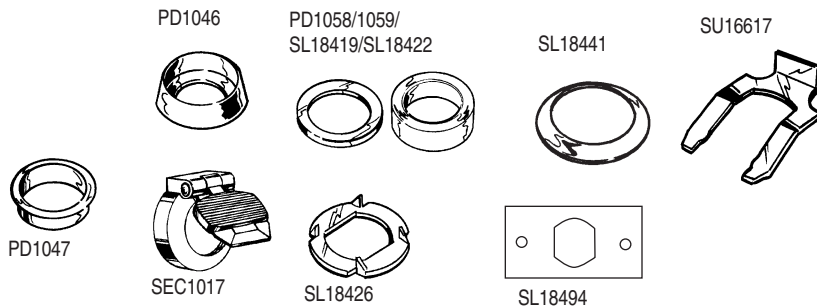

# Cam Lock Kit 782-00-8X

Lead Time 4-6 weeks

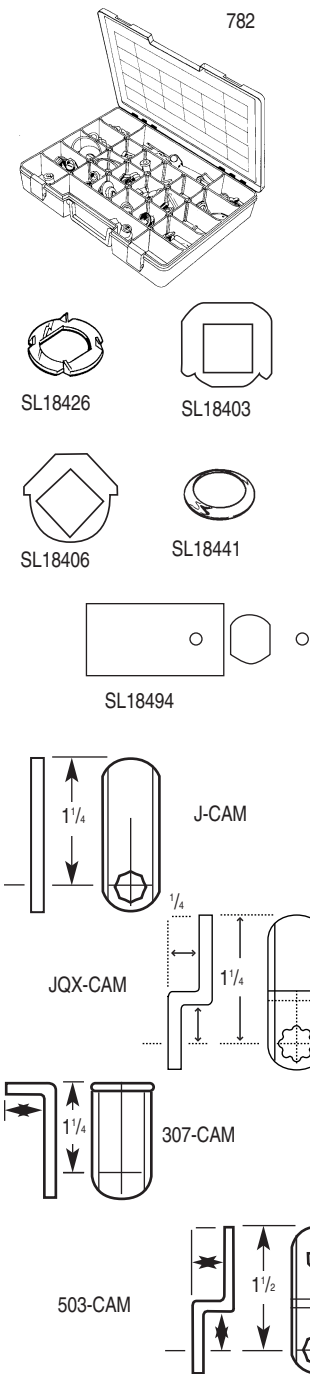

Product No.	Description	Kit Contents	Std Pack Qty	Sugg. List
782-00-8X	Cam Lock Kit (for N54G Single Bitted Keyway cam locks) Includes: 40 locks, 40 cams, 40 assorted spacers, 10 wood washers, 10 rings, 80 stop washers, 10 attaching plates, 40 screws and 40 nuts in a compartment durable traveling case.	—	1	236.90 ea.
<b>LOCKS</b>				
780-01D	Cam Lock-5/8 (16mm)— 4 spline shell/90° rotation	1	10	4.55 ea.
780-01E	Cam Lock-5/8 (16mm)— 2 spline shell/90° rotation	1	10	4.55 ea.
780-01F	Cam Lock-5/8 (16mm)— 2 spline shell/180° rotation	1	10	4.55 ea.
780-02D	Cam Lock-7/8 (22mm)— 4 spline shell/90° rotation	1	10	4.55 ea.
780-02E	Cam Lock-7/8(22mm)— 2 spline shell/90° rotation	1	10	4.55 ea.
780-02F	Cam Lock-7/8 (22mm)— 2 spline shell/180° rotation	1	10	4.55 ea.
780-03D	Cam Lock-1 1/8 (29mm)— 4 spline shell/90° rotation	1	10	4.85 ea.
780-03E	Cam Lock-1 1/8 (29mm)— 2 spline shell/90° rotation	1	10	4.85 ea.
780-03F	Cam Lock-1 1/8 (29mm)— 2 spline shell/180° rotation	1	10	4.85 ea.
780-04D	Cam Lock-1 3/8 (35mm)— 4 spline shell/90° rotation	1	10	4.85 ea.
780-04E	Cam Lock-1 3/8 (35mm)— 2 spline shell/90° rotation	1	10	4.85 ea.
780-04F	Cam Lock-1 3/8 (35mm)— 2 spline shell/180° rotation	1	10	4.85 ea.
<b>ACCESSORIES AND COMPONENTS</b>				
SL18403-22-8X	Stop Washer 90°	10	100	18.80/C
SL18406-22-8X	Stop Washer 180°	10	100	18.80/C
PD1005-00-8X	Hex Nut	10	100	26.45/C
PD1004-22-8X	SEMS Screw	10	100	39.70/C
<b>CAMS</b>				
J-CAM-22-10	Straight Cam 1 1/4 (32 mm)	10	10	5.00 pk.
JQX-CAM-22-10	Offset Cam 1 1/4 (32 mm) long [1 1/4 (6 mm) offset]	10	10	6.20 pk.
307-CAM-22-10	Single Bend Cam 1 1/4 (32 mm) long [7/16 (11 mm) bend]	10	10	6.20 pk.
503-CAM-22-10	Hook Cam 1 1/2 (38 mm) long [1 1/8 (29 mm) to hook]	10	10	6.15 pk.

N54G is single bitted keyway. 1137S is tubular keyway

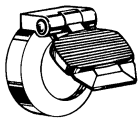

SEC1017



SL18441



PD1047

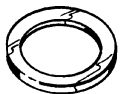

SL18419  
SL18422



PD1058  
PD1059



PD1046  
PU1095

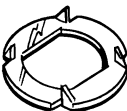

SL18426  
SL18427

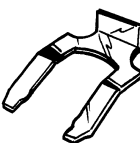

SU16617

Product No.	Description	Keyway		Standard Pack Qty	Sugg. List
		N54G	1137S		
PU2017	Adjustable Stop	√		10	17.50 pk.
SL18494	Attaching Plate	√	√	10	6.85 pk.
PU2018	Bar Guide	√		10	6.20 pk.
SU16617	Clip Shell Diameter (.640)	√	√	10	2.90 pk.
SU16647	Clip Shell Flats (.570)	√	√	10	2.90 pk.
SEC1017	Dust Cap		√	10	12.55 pk.
PU2019	Extension Pin 11/16	√		10	5.15 pk.
PU2020	Extension Pin 13/16	√		10	5.15 pk.
PU2021	Extension Pin 1	√		10	5.15 pk.
PU2008	Finger Pull	√	√	10	10.35 pk.
DO3	Key Blank Master	√		10	Reference Key Blank Price List
N54G	Key Blank Regular	√		10	
1579	Key Blank Reversible	√		10	
1054UN	Key Blank	√		10	
1137S	Key Blank Tubular – Steel		√	10	
1582	Key Blank Core Removal	√		10	
PD1088	Lock Washer – Internal Tooth	√		10	3.35 pk.
PU10092	O Ring	√		10	5.15 pk.
PD1046	Protective Collar 13/16 x .250	√	√	10	33.65 pk.
PU1095	Protective Collar 13/8 x .500	√	√	10	30.60 pk.
SL18441	Ring	√	√	10	7.20 pk.
PD1047	Shell Ferrule – Drawer Locks	√	√	10	10.30 pk.
SL18662	Shell Ferrule – Small Diameter Locks	√		10	6.30 pk.
PU1097	Spacer 7/8 x 0.060	√	√	10	4.70 pk.
PD1058	Spacer 7/8 x 0.187	√	√	10	4.70 pk.
PD1059	Spacer 7/8 x .250	√	√	10	4.70 pk.
SL18419	Spacer 1 1/16 x 0.31	√	√	10	4.70 pk.
SL18422	Spacer 1/16 x 0.62	√	√	10	4.70 pk.
SL18629	Spacer 13/4 x 0.030	√	√	10	4.70 pk.
PU2015	Washer (Nylon) .890 x 0.31	√	√	10	1.50 pk.
SEC1018	Wire Lead Set 10 Long		√	10	27.40 pk.
SL18426	Wood Washer – External Tooth (.635)	√		10	2.80 pk.
SL18427	Wood Washer – External Tooth (.670)	√	√	10	2.80 pk.
SL18727	Wood Washer – Internal Tooth (.635)	√	√	10	2.80 pk.

Components



SL18403



SL18406

Product No.	Description	Keyway		Standard Pack Qty	Sugg. List
		N54G	1137S		
SL18403	90° Stop Washer	√		100	13.25/C
SL18406	180° Stop Washer	√		100	13.25/C
S308	Backplate Drawer Lock	√		100	28.80/C
S308A	Backplate Spacer	√		100	28.80/C





PD1005



PD1004



SD1004



PD1013



PD1001



SL18602



SD1001



SD1006



SD1020  
SD1033

Product No.	Description	Keyway		Standard Pack Qty	Sugg. List
		N54G	1137S		
SD10002	Cam Retainer (990)	√		100	15.60 /C
SD10135	Cam Retainer Deadlocking (990)	√		100	15.60 /C
PD1010	Cam Retainer Spring (990)	√		100	6.00 /C
CD1047	Cylinder		√	100	42.20 /C
SL18602-01	Disc Tumbler No. 1 Regular	√		100	6.00 /C
SL18602-02	Disc Tumbler No. 2 Regular	√		100	6.00 /C
SL18602-03	Disc Tumbler No. 3 Regular	√		100	6.00 /C
SL18602-04	Disc Tumbler No. 4 Regular	√		100	6.00 /C
SL18602-05	Disc Tumbler No. 5 Regular	√		100	6.00 /C
SD1001-13	Disc Tumbler No. 13 Master	√		100	6.00 /C
SD1001-15	Disc Tumbler No. 15 Master	√		100	9.55 /C
SD1001-24	Disc Tumbler No. 24 Master	√		100	9.55 /C
SD1001-31	Disc Tumbler No. 31 Master	√		100	9.55 /C
SD1001-35	Disc Tumbler No. 35 Master	√		100	9.55 /C
SD1001-42	Disc Tumbler No. 42 Master	√		100	9.55 /C
SD1001-51	Disc Tumbler No. 51 Master	√		100	9.55 /C
SD1001-53	Disc Tumbler No. 53 Master	√		100	9.55 /C
PD1001	Disc Tumbler Spring	√		100	3.60 /C
PD1005	Hex Nut to secure shell	√	√	100	26.45 /C
PD1013	Hex Nut to secure cam		√	100	51.00 /C
PD1003	Lock Washer		√	100	5.45 /C
PD1006	Mounting Screw 6 x 5/8	√		100	6.00 /C
PU10076	Pal Nut to secure cam (33800)	√		100	8.95 /C
PD1014	Pin Tumbler Spring		√	100	3.60 /C
SD1004	Plug Retainer (974, 980, 990)	√		100	7.20 /C
PD1007	Plug Retainer Spring	√		100	3.60 /C
PU1078	Retainer Ring	√		100	10.30 /C
PD1008	Screw Retainer (990)	√		100	6.00 /C
PD1004	Screw SEMS 1/4 x 20 x 1/4	√		100	31.95 /C
SCR1042	Screw SEMS 1/4 x 20 x 3/8	√		100	31.95 /C
PD1012	Shell Pin		√	100	25.75 /C
PD1009	Shell Spring (990)	√		100	12.35 /C
CD1064	Spacer Washer		√	100	20.60 /C
PU1098	Strike (994, 995)	√		100	35.00 /C
SD1006	Top Pin (.202)		√	100	5.45 /C
SD1020	Top Pin (GSW only)		√	100	5.45 /C
SD1033	Top Pin (Special Anti Tip)		√	100	5.45 /C

901 Series UNIPIX Lock Picks  
(Interchangeable Handles)

Ico picks are designed to achieve the balance and feel that professional locksmiths need. Crafted from quality tempered spring steel and/or stainless steel.



P901 Handle Picks

Picks listed with an asterisk\* are available with a molded plastic handle. When ordering add the prefix P to the number listed.



	Product Number	Description	Standard Pack Contents	Sugg. List
	P901-	Pick with molded handle Add prefix P to numbers listed with an asterisk	5 ea.	3.85 ea.
	901-01*	Ball Pick	5 ea.	2.15 ea.
	901-02*	Ball Pick	5 ea.	2.15 ea.
	901-03*	Ball Pick	5 ea.	2.15 ea.
	901-04*	Ball Pick	5 ea.	2.15 ea.
	901-05*	Rake Pick	5 ea.	2.15 ea.
	901-06*	Rake Pick	5 ea.	2.15 ea.
	901-07*	Hook Pick	5 ea.	2.15 ea.
	901-08*	Hook Pick	5 ea.	2.15 ea.
	901-09*	Diamond Pick	5 ea.	2.15 ea.
	901-10*	Diamond Pick	5 ea.	2.15 ea.
	901-11*	Diamond Pick	5 ea.	2.15 ea.
	901-12*	Extractor Pick	5 ea.	2.15 ea.
	901-13*	Rake Pick	5 ea.	2.15 ea.
	901-14*	Rake Pick	5 ea.	2.15 ea.
	901-15*	Extractor Pick	5 ea.	2.15 ea.
	901-16	Combination Pick	5 ea.	2.15 ea.
	901-17	Combination Pick	5 ea.	2.15 ea.
	901-18*	Ball Pick	5 ea.	2.15 ea.
	901-19*	Diamond Pick	5 ea.	2.15 ea.
	901-20*	Ball Pick	5 ea.	2.15 ea.
	901-21*	Rake Pick	5 ea.	2.15 ea.
	901-22*	Hook Pick	5 ea.	2.15 ea.
	901-24	Extractor Pick w/wooden handle	5 ea.	2.15 ea.
	901-25*	Angled Diamond Pick	5 ea.	2.15 ea.
	901-23	Read Pick	5 ea.	2.15 ea.
<b>902 Series Tension Wrenches</b>				
Made from quality tempered spring steel, these tension wrenches are available in varying lengths, styles and degrees of tension to suit every picking style and technique.				
	902-01	Tension Wrench (Wishbone)	5 ea.	3.80 ea.
	902-02	Tension Wrench (double-sided)	5 ea.	2.15 ea.
	902-03	Medium Tension 5 3/8 x 1/8	5 ea.	2.15 ea.
	902-04	Light Tension 5 3/8 x 3/32	5 ea.	2.15 ea.
	902-05	Medium Tension 4 1/2 x 1/8	5 ea.	2.15 ea.
	902-06	Light Tension 4 1/2 x 3/32	5 ea.	2.15 ea.
	902-07	Medium Tension 3 1/4 x 1/8	5 ea.	2.15 ea.
	902-08	Light Tension 3 1/4 x 3/32	5 ea.	2.15 ea.
	902-09	Medium Tension 3 1/4 x 1/8	5 ea.	2.15 ea.
	902-10	Tension Wrench (letter box)	5 ea.	2.15 ea.
	902-11	Tension Wrench (letter box)	5 ea.	2.15 ea.
	902-12	Heavy Tension	5 ea.	2.15 ea.
	902-13	Heavy Tension	5 ea.	2.15 ea.

# Electric Lockpick and Pick Gun

Lead Time 3 days

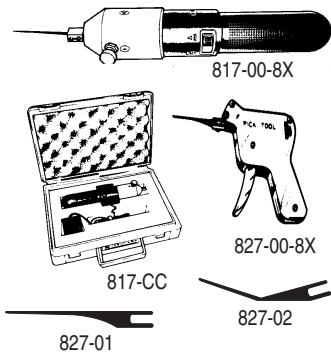

Product No.	Description	Standard Pack Qty	Sugg. List
817-00-8X	Electric Lock Pick. Includes 4 pick blades, 1 tension wrench, 1 allen wrench, battery charger	1 ea.	285.05 ea.
817-CC	Carrying Case	1 ea.	69.55 ea.
817-01	Replacement Pick Blades	1 ea.	3.95 ea.
827-00-8X	Pistol Pick. Includes 2 complete sets of extra springs, 3 straight picks, 3 angle picks, 2 tension wrench	1 ea.	52.15 ea.
<b>827 Replacement Parts</b>			
827-01	Straight Pick	5 ea.	1.85 ea.
827-02	Angle Pick	5 ea.	1.85 ea.

# Pick Kits

Lead Time 3 days

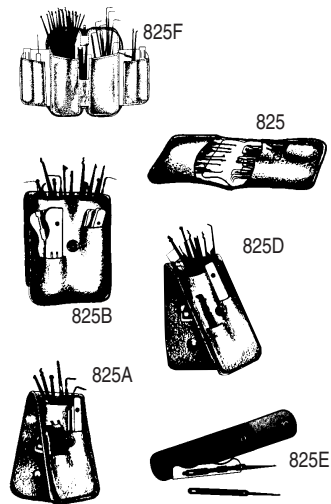

Product No.	Description	Standard Pack Qty	Sugg. List
825F	The Magnum. Contains all ILCO picks (24) and tension wrenches (13), two 903-01 and two 903-01 handles. Leather Case	1	83.15
825	The Expert. Contains 17 picks, 11 tension wrenches, two 903-01 handles and case.	1	94.90
825B	The Master. Contains 11 picks, 5 tension wrenches, one 903-01 handle and case.	1	47.35
825D	The Artisan. Contains 9 picks, 5 tension wrenches, one 903-01 handle and case	1	31.55
825A	The Journeyman. Contains 4 picks, 4 tension wrenches, one 903-01 handle and case	1	29.30
825E	Extractor Kit. Contains 2 extractor picks, one 903-01 handle and case	1	9.35

# Locksmith Tools

Lead Time 3 days

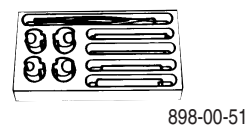

Product No.	Description	Standard Pack Qty	Sugg. List
898-00-51	Plug Holder/Follower Set A complete set, plus 6 tweezers and wooden case	1	134.00
891-00-51	Following Tool Set - includes the tools listed below	1	40.55
887-00-51	Following Tool (.500) Application: ILCO 4019 Rim Cyl.; Keil #30 Rim Cyl.; Lockwood 956 Rim Cyl.	1	12.25
888-00-51	Following Tool (.495) Application: Acro Lock, Arrow, Corbin, Dexter, Eagle, ILCO, Keil, Kwikset, Lockwood, National, Rockford National, Nesco, Russwin (.500 dia.), Sargent, Schlage, Taylor, Weiser (except Beverly style), Welch, Yale	1	12.25
889-00-51	Following Tool (.395) Application: Almont (peanut cylinder), Corbin (small pin), Eagle (small pin), ILCO (peanut cylinder), Yale (small pin)	1	12.25
890-00-51	Following Tool (.555)	1	22.05
897-00-11	Plug Holder Set - includes the following four holders	1	77.00
893-00-11	Plug Holder (.510)	1	20.55
894-00-11	Plug Holder (.500)	1	20.55
895-00-11	Plug Holder (.405)	1	20.55
896-00-11	Plug Holder (.550)	1	20.55

## Locksmith Tools (continued)

Lead Time 3 days

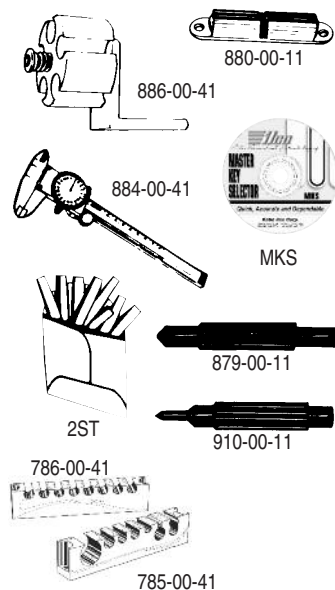

Product No.	Description	Standard Pack Qty	Sugg. List
899-00-11	Pin Tumbler Tweezers - 6" length with Pin Holder Tip	1	13.35
900-00-11	Short Pin Tumbler Tweezers - 4 length with Pin Holder Tip	1	9.50
843-01	Following Tool for ILCO 605 Die Cast Cylinder	1	10.85
885-00-41	Multi Plug Holder (Vise Mount)	1	55.45
886-00-41	Multi Plug Holder (Bench Mount)	1	55.45
830-00-11	Plug Holder, Aluminum (For Standard .510 plugs)	1	4.10
880-00-51	Key Deburrer	1	60.00
883-00-41	Micrometer Mounting Base	1	29.30
884-00-41	Micro-Dial Caliper	1	136.05
MKS-1	Master Key Selector CD - A convenient CD that allows quick set-up of 5 pin master key systems	1	33.60
2ST	Shim Stock - Curved stock 1/4 x 1 3/4 and only .0015 thick	12 pcs.	6.20
879-00-11	Pin & Plug Deburring Tool	1	21.35
910-00-11	Cylinder Plug Punch Marker	1	13.10
785-00-41	Cylinder Service Fixture	1	52.50
786-00-41	Multiple Plug Holder	1	52.50

## Key Stamps

Lead Time 3 days

Product No.	Description	Standard Pack Qty	Sugg. List
802	Hand Stamping Die. For stamping keys, tags, etc. for advertising and identification. Customer engraved on tool steel and tempered. 1st Line: Name (13 characters max) 2nd Line: Phone No. or address, etc. (13 characters max)	1	296.25
802M	"Master" Stamping Die (hand stamp)	1	121.20
802DND	"Do Not Duplicate" Stamp	1	145.10

## Pins and Pinning Kits

Lead Time 3 days

Color Coded Pins

Precision .003 diameter color coded pins use only top quality brass. Colors match industry standards. Pins are packed 150 per color coded envelope.

Indicate prefix T for Top Pins and B for Bottom Pins.

Example: A Top Pin .180 long would be T-.180. A Bottom Pin .285 long would be a B-.285.

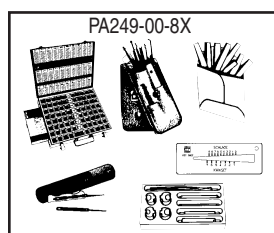

Product No.	Description	Standard Pack Qty	Sugg. List
PA249-00-8X	Starter Kit - Includes a 797 Color Pin Kit, Lock Picking Set, Key Extractors, Plug Holder and Follower Set, Shim Stock and Key Depth Gauge	1	399.25
746-00-8X	Mortise and Rim Tumbler Springs	150/bag	4.00
797-00-8X	.003 increment Color Pin Kit includes 40 top pins and 79 bottom pins	1	296.25
T.010 thru T.200	.005 increment Replacement Top Pins.	150/bag	2.75/bag
B.165 thru B360	.005 increment Replacement Bottom Pins.	150/bag	2.75/bag
T.024 thru T.141	.003 increment Replacement Top Pins.	150/bag	2.75/bag
B.126 thru B360	.003 increment Replacement Bottom Pins.	150/bag	2.75/bag

# Spindles

Lead Time 3 days



Straight Spindle



Swivel Spindle



Split Spindle



Swivel Spindle X caps



760-01

Spindle specifications listed in product descriptions are given in the following order: thickness, length and thread size.

Product No.	Description	Standard Pack Qty	Sugg. List
760-01	Spindle Cap	10 pr.	18.35
760-02	Headless Screws, Brass - 1/4 - 20 x 5/16 (8mm x 6mm-20)	100	22.85
760-03	Headless Screw, Brass Plated Steel - 1/4 -20 x 3/8 (10mm x 6mm-20)	100	22.85
760-04	Oval Head Screw, Brass Plated - Steel (10mm x 9-24)	100	16.50
760-20	Headless Screw, Brass Plated - Steel 1/4 -28 x 5/16	100	30.45
760-05*	Straight Spindle 9/32 x 3 1/2 x 20 - (7mm x 114mm)	10	2.90
760-06*	Straight Spindle 9/32 x 4 1/2 x 20 - (7mm x 114mm)	10	2.90
760-07*	Swivel Spindle 9/32 x 4 3/4 x 20 - (7mm x 120mm)	10	5.25
760-08*	Straight Spindle 9/32 x 4 1/2 x 20 - (7mm x 114mm)	10	5.25
760-09*	Swivel Spindle 9/32 x 4 3/4 x 20 - (7mm x 120mm)	10	5.25
760-10*	Swivel Spindle 9/32 x 6 x 20 - (7mm x 152mm)	10	5.25
760-11*	Split Spindle 9/32 x 2 5/8 x 20	10	5.25
760-12*	Swivel Spindle 9/32 x 4 3/4 x 20 with spindle caps for 3/8 center (7mm x 120mm)	10	8.40
760-13*	Straight Spindle 9/32 x 3 1/2 x 18 - (7mm x 89mm)	10	2.90
760-14*	Straight Spindle 9/32 x 4 1/2 x 18 - (7mm x 114mm)	10	2.90
760-15*	Swivel Spindle 9/32 x 4 3/4 x 18 - (7mm x 120mm)	10	5.25
760-16*	Swivel Spindle 9/32 x 4 3/4 x 18 - (7mm x 120mm)	10	5.25
760-17*	Swivel Spindle 9/32 x 6 x 18 - (7mm x 152mm)	10	5.25
760-18*	Split Spindle 9/32 x 2 5/8 x 18 - (7mm x 60mm)	10	5.25
760-19*	Swivel Spindle 9/32 x 4 3/4 x 18 with spindle caps for 3/8 center (7mm x 120mm)	10	8.40

• Spindles must be ordered in multiples of 10

# Strikes

Lead Time 3 days

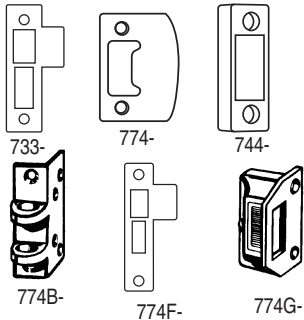

Product No.	Description	Standard Pack Qty	Sugg. List
733-03-11	Bit Key Lock Strike	1	2.05
744-03-11	Bit Key Lock Strike (ILCO 215)	10	3.25
774-03-11	Tubular and Cylindrical Strike	1	1.40
774B-53-11	Jimmyproof Deadlock Strike	1	4.60
774F-03-11	Mortise Lock Strike	10	6.20
774G-67-40	Night Latch Strike (220 Series)	10	3.90

# Key Cabinets

Lead Time 3 days

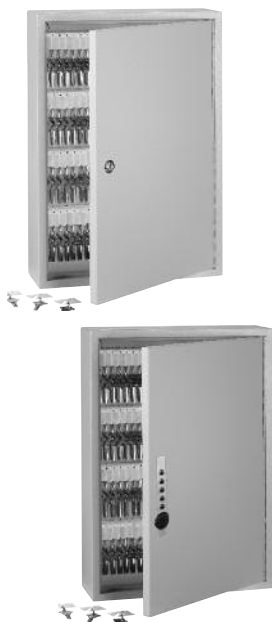

Product No.	Description	Standard Pack Qty	Sugg. List
Key Cabinet - 10	Key Cabinet with 10 key capacity	1	39.60
Key Cabinet - 30	Key Cabinet with 30 key capacity	1	51.90
Key Cabinet - 60	Key Cabinet with 60 key capacity	1	86.60
Key Cabinet - 120	Key Cabinet with 120 key capacity	1	123.65
Key Cabinet - 200	Key Cabinet with 200 key capacity	1	210.20
PBL Key Cabinet - 60	Key Cabinet with 60 key capacity with SIMPLEX® Push button lock	1	277.30
PBL Key Cabinet - 120	Key Cabinet with 120 key capacity with SIMPLEX® Push button lock	1	295.15
Key Tags 1 - 10	Key Tags numbered 1-10	10	6.45
Key Tags 11 - 30	Key Tags numbered 11-30	20	8.90
Key Tags 31 - 60	Key Tags numbered 31-60	30	13.35
Key Tags 61 - 120	Key Tags numbered 61-120	60	26.70
Key Tags 121 - 200	Key Tags numbered 121-200	80	35.60
	Red Tags are for use with standard tag to convert single key cabinets into double key cabinets		
Red Key Tags 1 - 10	Red Key Tags numbered 1-10	10	6.45
Red Key Tags 11 - 30	Red Key Tags numbered 11-30	20	8.90
Red Key Tags 31 - 60	Red Key Tags numbered 31-60	30	13.35
Red Key Tags 61 - 120	Red Key Tags numbered 61-120	60	26.70
Red Key Tags 121-200	Red KeyTags numbered 121-200	80	35.60
Key Tags - Blank	Blank Key Tags	30	9.65
Red Key Tags - Blank	Red Blank Key Tags	30	9.65
Key Snap Hooks	Key Snap Hooks	100	13.60

# Depth Key Set

Lead Time 3 days

Depth and space keys are used when cutting keys by code. They offer a method of making a new master system or adding keys to an existing system. A set of depth and space keys contains a cut key for each of the different depths used in a given series or a particular locking mechanism. All the cuts on a key are to the same depth, repeated as many times as the number of pins or disc tumblers used in the lock. These cuts are correctly spaced as required by the tumbler system in a specific lock.

*Example: A #2 depth key for a 5 pin plug has 5 correctly spaced cuts, each to the #2 depth.*

NOTE: The listed key blank numbers should be used for reference. These depth key sets may apply to other equivalent key blank numbers. For example, the DKA117 for Schlage will work for any Schlage letter key-way (C, CE, E, EF, F, FG, or G).

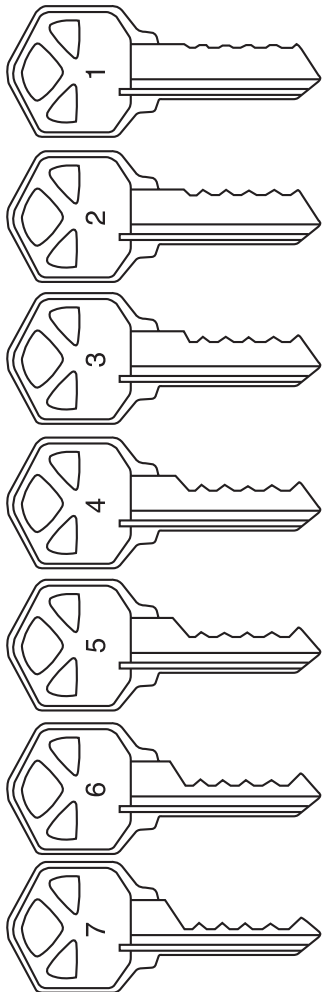

Product Number	Description	Spaces	Keys Per Set	Key Blank	Sugg. List
<b>A/LARGE PIN CYLINDER</b>					
DKA100	Arrow (New Standard & Sectional)	6	10	1179A	28.50
DKA101	Best and Falcon	7	10	A1114M	28.50
DKA103	Corbin - 60 Series	6	6	A1001EH	28.50
DKA104	Dexter Large Pin ('69 up)	6	10	F1054KA	28.50
DKA105	Dominion Standard Large Pin	5	8	1054F	28.50
DKA107	ILCO Standard Large Pin	6	10	X1054F	28.50
DKA108	ILCO 560-561 and 600 Series	5	7	1054MT	28.50
DKA109	Kwikset (New) also used on Corbin	5	7	1176	28.50
Russwin	pop out cylinder				
DKA110	Lockwood Standard Large Pin	7	10	1004L	28.50
DKA112	National Rockford Standard Pin	5	10	R1064E	28.50
DKA113	Russwin Standard Large Pin	6	10	A1011M	28.50
DKA114	Russwin Sectional Russwin 70 Series (Use Corbin 60 Series)	6	10	A11011-D1	28.50
DKA115	Sargent Standard Large Pin	6	10	L1010N	28.50
DKA116	Sargent Sectional	6	10	O1007LA	28.50
DKA117	Schlage Standard Large Pin	6	10	1145A	28.50
DKA119	Segal-Earle Standard Large Pin	5	7	1022	28.50
DKA120	Taylor Standard Large Pin	5	7	1141GE	28.50
DKA121	Weiser Standard Large Pin	7	10	L1054WB	28.50
DKA123	Weslock Standard Large Pin	5	8	1175N	28.50
DKA124	Yale Standard & Sectional	6	10	999A	28.50
<b>B/DISC TUMBLER</b>					
DKB200	Chicago 6 Disc	6	5	100AM	28.50
DKB201	Corbin All (Most) Dexter (Use B & S)	6	5	1000V	28.50
DKB202	Eagle Disc	5	5	1014S	28.50
DKB203	ILCO Disc	5	5	L1054B	28.50
DKB204	ILCO DF & U Series	5	5	1054UN	28.50
DKB205	Illinois Single Sided	5	4	1043F	28.50
DKB206	National (Rockford) (Most)	5	4	1069N	28.50
DKB207	Yale (Most)	5	5	O1122A	28.50
<b>C/SMALL PIN (INCLUDING LETTER BOX)</b>					
DKC300	Chicago, Pin	5	7	1014V	28.50
DKC301	Corbin (B4R, 4T)	6	10	1000F	28.50
DKC302	Eagle (long space)	4	10	1014DX	28.50
DKC303	Hudson Auth, Bommer & Others	5	6	1003M	28.50
DKC304	ILCO Pin	5	7	X1054JK	28.50
DKC305	American, Junkunc Pin Tumbler Padlock	6	8	1046	28.50
DKC306	ILCO Lockwood 3/4: dia. Cylinder	5	7	1004M	28.50
DKC307	Master Padlock Large 4 Pin	4	8	1092	28.50
DKC308	Master Padlock Small 4 Pin	4	6	1092B	28.50
DKC309	National (Rockford ) Not for letter box applications	5	10	1069LA	28.50
DKC310	National (Rockford) letter Amek Device, Auth, Bommer, etc.	5	10	1069LB	28.50
<b>D/AUTOMOTIVE</b>					
American Motors Pre '70 (Use B & S)					
DKD401	American Motors '70 up	5	5	1970AM	28.50
DKD402	Briggs & Stratton	5	5	H1098X	28.50
DKD403	Chrysler '56-'67 Pin Tumbler, Chrysler CV Side Bar Trunk Lock (Use GM)	5	5	1746P	28.50
DKD405	Chrysler '68 DP & DS Series	5	5	1768	28.50
DKD406	Chrysler '69 up EP & ES Series	5	5	P1770W	28.50
DKD407	Ford pre '52	5	5	1125H	28.50
DKD408	Ford '52-'64 (65 & 66 Mustang)	5	5	1127DU	28.50
DKD409	Ford '65 up Double Sided Ign.	5	5	1167FD	28.50
DKD410	Ford '65 up Double Sided Trunk	5	5	S1167FD	28.50
DKD411	General Motors All	6	5	P1098E	28.50
DKD412	84 1/2 Ford	10	5	1184FD	28.50



## Software

Lead Time 3 days

Product No.	Description	Standard Pack Qty	Sugg. List
Ilco Advantage	Complete key blank reference software	1	472.10

## Padlock

Lead Time 3 days



Product No.	Description	Standard Pack Qty	Sugg. List
1402-04	Frangible Shackle padlock - one key fits all	1	16.95

## Presentation Key

Lead Time 4-6 weeks

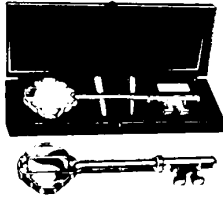

Product No.	Description	Standard Pack Qty	Sugg. List
703-03-41	A unique gift, an impressive award, and a real attention getter. Key comes with a luxurious jeweler's case. Key measures 8 1/4 long Polished Brass Presentation Key	1	41.20
703-27-41	Satin Chrome Presentation Key	1	41.20





















## Limited Warranty

Ilco warrants to the original purchaser for a period of one year that this product is free from defects in materials and workmanship. We will, at our discretion, repair or replace free of charge, including shipping charges back to you, any product found to be defective and subject to this warranty, provided it is delivered prepaid to Ilco. This warranty does not apply to any defects or malfunctions resulting from improper installation or use. Products and parts not manufactured by Ilco are guaranteed only in accordance with that manufacturer's warranty. Kaba Ilco shall not be liable for any consequential or incidental expenses resulting from breach of this warranty or any implied warranty. Some states do not allow the exclusion or limitation of consequential or incidental damages, so the above exclusion or limitation may not apply to you. This warranty gives you specific rights, and you have other rights, which vary from state to state.

### Broken Box Charge

Items ordered in less than full box quantities are subject to a \$10.00 surcharge per line item. Please see details on page 7 of this Price List

# Replacement Keys for Cylinders

KEYWAY	ORDER CODE	ILCO	5 PIN ILCO E-Z	LOOK-ALIKE	ILCO	6 PIN ILCO E-Z	LOOK-ALIKE
 Arrow	<b>AA</b>	1179	AR1	K2-A	1179A	AR4	K7
 Composite	<b>NA</b>	R1064E	NA25	4295	This keyway accepts and can be pinned to Kwikset & Weiser E/Falcon 1st pin @ .246"		
 Composite	<b>NB</b>	1014C	HR1	—	This keyway accepts and can be repinned to Dexter, Falcon G, Harloc SE-1, Lori L200, Sargent S & U, and Weslock 1st pin @ .216"		
 Corbin 60 Corbin 67 Corbin 77	<b>CA</b> <b>CB</b> <b>CC</b>	1001EH 1001EN R1001EN	CO87 CO7 SK1	Z1-60-5 — —	A1001EH 1001EG R1001EG	CO88 CO36 CO62	Z1-60-6 — —
 Corbin/Ruswin L4 Corbin 59	<b>CE</b> <b>CD</b>	1011-L4 1001AH	— —	— —	A1011-L4 A1001AH	RU101 CO91	— Z1-59A1-6
 Dexter 67	<b>XE</b>	D1054K	DE6	67-DEXTER	D1054KA	DE8	—
 Dominion 1054F Dominion 1054F	<b>DA</b> <b>DB</b>	(Round Head) (Large Head)		S54F DO5	— —	— —	— DO6
 Ilco X1054K	<b>UA</b>	X1054K	IN3	—	—	—	—
 Kwikset 1176	<b>KS</b>	1176	KW1	1063KW	A1176	KW5	—
 Lockwood 1004	<b>LA</b>	1004	L1	B308	1004A	—	B310
 Lori L100, Harloc 700 Eagle 11929	<b>UB</b>	X1014F	EA27	HARLOC	—	—	—
 Lori Locksmith 80 Loricentric 90	<b>UE</b> <b>UD</b>	5 pin only order <u>80 Loricentric</u> —		— —	— —	6 pin only order <u>90 Loricentric</u>	
 Ruswin D1 Ruswin 981R Ruswin 981-852	<b>RB</b> <b>RA</b> <b>RC</b>	1011D1 N1011P N1011P	RU45 RU52 RU52	5D1R 5981R 5981R	A1011D1 A1011P A1011P	RU46 RU16 RU16	6D1R — —
 Sargent LA-LC Sargent RA-RC	<b>GB</b> <b>GC</b>	1007LA 1007RA	S22½ —	275LA —	01007LA 01007RA	S22 —	6275LA —
 Sargent LA	<b>GA</b>	1007LA	S22½	275LA	01007LA	S22	6275LA
 Schlage C Schlage E Schlage F Schlage C-K	<b>SC</b> <b>SE</b> <b>SF</b> <b>SX</b>	1145 1145E 1145F	SC1 SC8 SC7	100-C 100-E —	1145A A1145E A1145F	SC4 SC9 SC10	101-C 101-E 101-F
 Segal 9	<b>FA</b>	1022	SE1	K9-Segal	1022AB	—	—
 Weiser E/Falcon Weiser 1555	<b>WA</b> <b>WE</b>	1054WB N1054WB	WR3 WR5	1555 P1555	A1054WB —	WR4 —	— —
 Yale 8 (999)	<b>YA</b>	999	Y1	8-Yale	999A	Y2	—
 Yale GA	<b>YG</b>	999GA	—	—	998GA	Y78	—

\* Supply keying information on combined cylinders. See page 7 for keying codes

**Kaba Ilco Corp.**  
**400 Jeffreys Road · Rocky Mount, NC 27804**  
 Phone **800.334.1381** · Fax **252.446.4702**  
[www.kaba-ilco.com](http://www.kaba-ilco.com)

Form No. 3038/0111